

THE  
NEW  
EGG  
FARM

# New Egg Farm

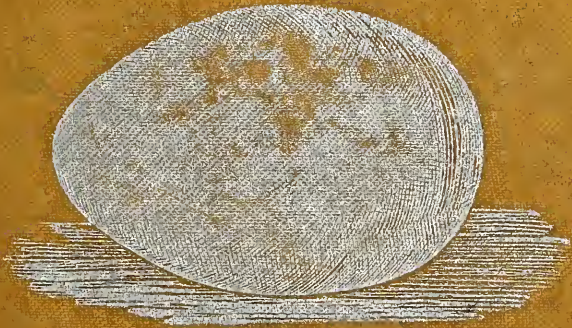

H. H. Stoddard

LIBRARY OF CONGRESS.

Chap. 54287 Copyright No. ....

Shelf S87

UNITED STATES OF AMERICA.











*Yours truly*  
*W. H. Stoddard*

# THE NEW EGG FARM

Or the  
management  
of poultry  
on a large  
scale for  
commercial  
purposes



A practical manual and reliable handbook upon producing eggs and poultry for market as a profitable business enterprise, either by itself or connected with other branches of agriculture.

By H. H. STODDARD

*For many years editor Poultry World and American Poultry Yard,  
Author of An Egg Farm, etc., etc.*

An entirely new work, embodying all that is most valuable from the author's first book, to which are added the results of a lifetime of work, invention, improvement and observation in the vast and growing commercial poultry industry in all sections of the country.

NEARLY 150 ILLUSTRATIONS

New York  
ORANGE JUDD COMPANY

1900

TWO COPIES RECEIVED.

Library of Congress,  
Office of the

DEC 2 - 1899

Register of Copyrights.

SF487  
.S87

57080

Copyright 1899

BY

ORANGE JUDD COMPANY

SECOND COPY.

53034  
Aug. 18. '99.

1. 8. 26/12.

## LIST OF ILLUSTRATIONS

FIG		PAGE
	<i>Portrait of Author—Frontispiece</i>	
1	Diagram for egg farm	18
2	Coop of growing chicks	24
3	Stone cutter's dray	27
4	Scraper for dry earth	29
5	Shovel for dry earth	30
6	Platform for drying earth	31
7	Loading dry earth	32
8	Bottom of dray	33
9	House for layers—winter arrangement	36
10	House for layers—summer arrangement	40
11	Winter quarters for laying stock	41
12	Pen for moving fowls	42
13	House for early hatched pullets	48
14	House for breeders	52
15	Yard and houses for breeders	53
16	Movable fence	54
17	Feed shelf	55
18	Hammer for feed shelf	56
19	Sash pulley	58
20	Office and watch house	59
21	House for sitters	63
22	House for sitters—interior	64
23	Plan of yards for sitters	66
24	Coop for sitters	76
25	Apparatus for sitters	77
26	Apparatus for sitters	78
27	Ground plan of hatching house	82
28	Section of covered yard	83
29	Interior of hatching house	84
30	Feed shelf and gate	86
31	Inside of house for sitters	94
32	Details of apparatus for sitters	97
33	Coop for hen and chicks	98
34	Boards and cleats	99
35	Diagram of coop	100
36	Feed box for chicks	100
37	Feed box with grating	103
38	Arrangement for opening feed boxes	105
39	Dubbed White Leghorns	107
40	Manner of numbering nests	126
41	Eggs laid by old hens	134
42	Eggs laid by pullets	135
43	Shelter for chickens	136
44	Shelter of rails and straw	137
45	Granary and cookhouse	139
46	East side view of granary showing driveway	140
47	Ground plan of granary and cookhouse	142
48	House for early chickens	143





# CONTENTS

CHAPTER	PAGE
I Introductory - - - - -	1
II Location - - - - -	8
III The Colony System - - - - -	17
IV Supplying Their Needs - - - - -	26
V Houses for Layers - - - - -	35
VI Houses for Breeders - - - - -	51
VII Houses for Sitters - - - - -	62
VIII Houses for Sitters in Mild Climate - - - - -	74
IX Management in Mild Climate - - - - -	92
X Coops for Chickens - - - - -	97
XI Fowls for Layers and Sitters - - - - -	102
XII The Kinds of Food - - - - -	112
XIII Breeding and Incubation - - - - -	118
XIV Management of Sitters - - - - -	125
XV Management of Young Chickens - - - - -	130
XVI Additional Buildings - - - - -	139
XVII The Intensive System - - - - -	146
XVIII The Exerciser - - - - -	152
XIX The Tilt Box - - - - -	158
XX Outdoor Exerciser - - - - -	178
XXI Success with Ducks - - - - -	186
XXII Perfecting the Details - - - - -	190
XXIII For Soft Feed - - - - -	206
XXIV Alternate and Parallel Systems - - - - -	212
XXV Healthy, Vigorous Birds - - - - -	235
XXVI Business Poultry Farming - - - - -	245
XXVII Artificial Incubation - - - - -	261
XXVIII Requisites of a Good Incubator - - - - -	266
XXIX Care of the Eggs - - - - -	281
XXX The Incubator Room - - - - -	298
XXXI Brooders - - - - -	304
XXXII Method of Heating and Ventilating Brooders	312
XXXIII The Brooder of the Future - - - - -	322



# AN EGG FARM.

---

## CHAPTER I.

### INTRODUCTORY.

During the last thirty years, farming has been divided into specialties. The history of modern industry shows that it is only through division of labor that the precision and skill can be attained that become necessary as competition constantly grows keener. Improvements in methods, and the invention of labor-saving machinery, are sure to follow the establishment of an industry as a specialty. Sheep farms, farms for milk, others for butter or cheese, small fruits, vegetable truck, etc., are not only common, but there is a further division—a gardener raising as a principal crop nothing but onions or celery, an orchardist nothing but peaches, and so on.

Eggs and poultry for the great cities are now produced in part by extensive establishments systematically conducted, instead of there being an entire dependence upon the old, haphazard way of a few on each farm. The production of eggs, rather than poultry meat, must always be the key to the poultry interest, because raising pullets for layers brings so many supernumerary cocks, that these, with the fowls past their prime, always keep the dressed poultry side of the market better supplied than the egg department, and therefore special establishments for raising table poultry, winter chickens and ducks in the northern states excepted, will not, in the long run, be demanded.

An account of "the state of the art," to date, of poultry raising as a separate branch of industry, should include, not merely the progress made, but a forecast of the future. It is only by comparing the present with twenty or thirty years ago, that the magnitude of the great revolutions in industrial affairs can be realized. In general, it may be said that the principal movements have not yet spent their force; but great as the changes have been, they will, in the next few years, be vastly intensified. A generation ago a little of almost every principal article of food was raised on every farm, and all consumed within a few miles, comparatively, of where it was produced; while now food production has not only been divided into separate branches, but the main divisions have been split into an almost endless number of subdivisions, and articles are common on every table that have been carried thousands of miles; this differentiation will go on further and with greater rapidity than has happened already.

The tendency of the times is to improve transportation, not only by the main railroads, but by the smaller lines and the common roads, a tendency which promotes the selection of the very best locality, as regards soil and climate, for carrying on any particular branch of food production. This choice of the best place, aided by the great modern development of cold storage, and the continually increasing facilities for transportation at reduced rates, will continue to augment the production of poultry in the South Central states, or what may be called the northern tier of the Southern states, and especially the region to the south, southeast and southwest of Kansas City, and enhance the importance of the extensive or colony plan of management best adapted to a mild climate, and which will be described in the following pages, and the intensive plan, pursued on a comparatively small plat of ground, will also receive due atten-

tion, since it has, by the late invention of labor-saving machinery, been made more feasible than previously, while the art of artificial incubation has also been perfected. Modifications of both the intensive and extensive systems will be fully described to suit the varying needs of localities as diverse as those in our country of magnificent distances, while the false and unnatural plans which have ended in ruin during the twenty years that have seen the principal progress in poultry affairs, will be treated but briefly and as a warning.

In managing animals of any kind, we must follow nature, for she will neither follow us nor be driven. The domestication of animals was only possible at the outset by proceeding on a natural groundwork. To illustrate: Man domesticated dogs that, when wild, followed one of their own number as a leader, by installing himself as leader instead—so naturalists state—and the cat will never be domesticated in such a way as to follow her master when he changes his abode, because originally a solitary animal. Just so the domestication of fowls was effected by building upon an original foundation. In understanding the nature and needs of poultry, it will assist if we investigate the condition and habits of the wild parent stock in India, for the nature of all animals remains essentially the same for long periods. The transfer of our domesticated birds from forest to farm has affected their life and most important habits surprisingly little. The tame fowls have the same cries of warning to each other, and other language, that observers have found them to use in their native jungles; they still hide their nests in some corner, just as if they were selecting a nook in a thicket; and they are attached to the premises where they live, as they and all other gallinaceous birds are to some small district, when wild. The wild jungle fowl is by no means foreign to our subject; and in attempting to manage poul-

try by thousands, only a proper regard for original nature will prevent failure. According to this nature, they live during the breeding season in distinct families under polygamy. Each family group has, by tacit agreement, a part of the forest for its beat, and the exclusion of strangers of the same species secures privacy and tranquillity. They have their freedom, and in that word are comprehended the needful exercise, sun, pure air, shade, and varied diet.

Some plans upon a large scale have comprised small separate flocks without freedom, and others have embraced large flocks in freedom without separation; a third plan, and better than either of the foregoing, being to keep small flocks separately, yet in full freedom. Small flocks at liberty on distinct farms have been kept successfully during centuries, because the owners were unconsciously imitating the natural groups of the wild jungle fowls. It has been found that when a flock of twenty, in free range on the farm, gave a handsome profit, and the number has been increased to hundreds, all in one flock, with the idea of correspondingly multiplying the gains, an unnatural mob has been formed, the hereditary instincts violated, and laying checked. The confusion has not, however, lessened the amount of feed consumed, and pecuniary results have been the wrong way. When it is attempted to divide the number, and place them in separate inclosures, the results are still far from satisfactory. Small flocks kept yarded may be multiplied on the same farm to any desired extent; but their wants can be all supplied only through an amount of labor that eats up the profits, unless the mechanical apparatus we shall describe in the following pages is used, the invention of which was the most important step ever taken in poultry culture since fowls were first domesticated. In this land of high wages, the expense of attendance determines, to a great extent,

the success of the whole project; hence the importance of the new system of poultry keeping by machinery.

Keeping fowls as a business should be regarded as a species of manufacturing, grain being the principal raw material, and eggs and poultry meat the finished products. The value of the products, of course, exceeds that of the raw material; but if the labor cost is not carefully watched, it may eat up the difference. The menace which will always hang over the keeper of poultry on a large scale, is the competition of the ordinary farmers, villagers and suburban residents, who enter the market incidentally merely to dispose of surplus. Every owner of a small flock of fowls pours his little rill of poultry products into the great market stream anyhow, irrespective of profit, and this makes it hard for the big establishment. It is, in this respect, like farming, in which so many are working for a living that it is next to impossible for anybody else to farm on a large scale for money. Or it is like the instance of the girls behind counters in the large stores, who usually receive very small wages, in some cases not enough to pay for decent board, the reason being that there are so many girls wanting places who have nothing to do and who can board with their parents. The increase of the number of small flocks of fowls, consequent upon the diffusion of population in the suburbs by means of the trolley lines, adds to the difficulties of the large scale operator. The big plant cannot stand this sort of competition unless labor-saving contrivances are used.

This is a "machine-ridden" age. Industrial inventions have revolutionized society, yet the transformation is far from being complete. One man now performs the work formerly done by fifty men, in making textile or metallic goods, or of thirty men in producing, milling and transporting breadstuffs; but the mission of invention, as concerns feeding mankind, is far from perfect

fulfillment. The raising of animal food is to be vastly improved. Crops have been cultivated cheaper, and yet cheaper, as year by year better agricultural implements and machinery have been devised, but in tending domestic animals, whether they are horses, cattle, sheep, swine or poultry, but little, comparatively, has been accomplished to diminish the amount of labor. Now it takes more time to tend the farm animals of the United States and care for their products—butter to be churned, wool to be sheared, steers to be fattened, colts to be broken and trained for sale, and so on—than it takes hours to raise the grain and forage these animals eat, harvest the same and haul it to mow or granary ready for consumption. Here is a great field for labor-saving inventions, a field white for the harvest. Machinery must be used in doing chores. Where horses or cows are kept in considerable numbers in the same stable, mechanical appliances have already been employed by the writer to supply them with water, hay and grain, lessening the labor very materially, and a way has been found to clean horse stables by machinery. Sheep for fattening are now fed in immense numbers with grain by specially constructed feed hoppers; milking machines are being perfected, and swine can be fed and tended, horses curried and brushed, and young horses have been broken and trained by the writer very satisfactorily indeed, no matter how incorrigible they were at the start, by the aid of machinery, at a great saving of time.

The first outlay for almost every modern machine is much greater than was the cost of the old-fashioned hand tools it superseded. But the sum total of the cost involved by the time the machine is worn out doing good, is less under the machine system than it was under the hand tool system sixty years ago. Otherwise, modern machinery would not be labor saving. The reaper and binder does the work of a file of men with cradles,



and another file to rake and bind. The price of the ponderous thing is greater than what cradles and rakes would cost. The farmer pays his harvesting bills for eight or ten years in advance when he buys a reaping machine that will last that length of time; that is, he hires fewer harvest hands for eight or ten years. His grain is cut, virtually, before it is sown. It is cut in a machine shop one thousand miles away; the reapers wear aprons and paper caps, and work cutting the farmer's grain in a factory he never sees; their wages are higher per diem than what cradlers would get, but his harvesting costs him less the new way, or there would be no labor saving about it. Just so in the new system of poultry keeping by machinery; there is the mechanic's bill at the outset. The machines will last many years; those which are indoors will last during the poultry man's lifetime. If the wages of the mechanics who construct them, including interest, amount to less than the wages of employes saved or superseded during the twenty or fifty years the apparatus lasts, interest on the wages included, then there is labor saving. Now, in any line of industry, no good machinery, well adapted to accomplish the work for which it was designed, ever yet failed to save labor, and the poultry machinery described in this book saves a greater per cent of labor than does the average farm machinery.

## CHAPTER II.

### LOCATION.

A location near a city secures certain important advantages. An article produced daily the year through, and which is prized for being fresh, should be raised as close to a market as possible. Thus the highest prices may be obtained, the special aim being to supply the demand for better eggs than any can be that are packed and sent great distances. Under the system which now supplies, to a great extent, northern cities, there is the time spent in collecting eggs from various sources, to which must be added the time for transportation, and the time they are in the dealer's hands after arrival. Then the jarring is more or less injurious, and after it, eggs will keep but a little while. They pass through so many hands that no one in particular is responsible for the character of the article. Under a better plan, eggs are delivered directly to consumers, families being visited regularly once a week. The egg route has this advantage over a milk route, that it need not be traversed so often, only a sixth of the whole being traveled daily; thus the expense of delivery is not great. As a team must be sent to town every day to collect stale bread from the bakeries, waste bits from the meat markets, etc., eggs can be sent, when only a day or two laid, with no extra trouble. If disposed of at stores, an arrangement should be made with the dealer whereby they may be kept in a separate lot, and sold under the name of the producer. Consumers readily appreciate eggs, butter or other produce that comes from a regular, responsible source.



When a lot is mixed with lots from other farms, its individuality is lost; if good, it may only be helping to sell the poor article of somebody else, and the producer does not reap the benefits of his pains in increased custom. No produce can be supplied to city dwellers to better mutual advantage to seller and buyer, than new laid eggs delivered direct, the dubious ones in the market causing much loss and vexation.

Poultry farms, at the west, have the benefits of cheap land and cheap grain; and at the south the season is earlier, and on the Atlantic coast, especially, cheap transportation by water is available. But the value of manure in some places at the north is so great, that it is more economical to bring grain here from the west than eggs, the latter being so troublesome to send by rail. Butchers' waste, procured fresh, being almost absolutely necessary, is an important consideration in favor of proximity to a city. When it is seen that high prices for eggs depend on the latter being produced near by and delivered fresh, and that the labor is no greater to raise them close by the market than at a distance at lower prices, with a deduction for transportation and breakage, it will be readily seen that there are certain special advantages in a location near a big northern city.

The site should not be far from a railroad freight depot or wharf. The amount of western grain needed is large. Hauling this many miles by team is too costly. Enriching wornout northern farms by feeding out grain from the prairies, is an indirect way of importing their rich mold. Therefore, we take care that this importation is judiciously contrived. A mill near by, for grinding, is desirable. A tract of arable land may be found (though rarely), surrounded on all sides by either woods, swamps or rocky pastures, so that there need be no danger that the fowls will stray into tilled fields of adjoining proprietors. In case such a farm could be procured,

the great expense of a fowl-proof fence all around it would be saved. If the tract is unfortunately bounded by cultivated lands, then it must be so large and of such cheap quality, that a border twenty or thirty rods wide may be afforded, to be kept in permanent pasture. The land should be upon a slope, for there must be a quick surface drainage after heavy rains; but the pitch should not be so steep as to prevent easy wagoning. A southern or southeastern inclination gives a proper sunny exposure; and if there is a belt of woods on the north to break the winds, so much the better. If near swamps, sea marshes or damp river valleys, the site should be so elevated as to be out of the reach of the worst raw, chilling fogs. We have enumerated all the above qualifications as necessary to a site for an egg farm, and it may be added that most of these apply whether the plant is in the northern or the southern states. Their combination with certain essentials of soil, which we shall state in another place, makes the matter of selection one of considerable difficulty. Many more important points are to be attended to than in choosing a place for ordinary farming or gardening.

#### A SOUTHERN LOCATION.

While proximity to a northern city has become more important year by year, in one sense, because a greater proportion of the whole population of our country, and of all other countries as well, is, as time rolls on, found in the large towns; yet there is, however, another aspect to the case; for transportation has received such an immense development that it is possible to utilize extremely favorable distant sites, formerly unavailable, for poultry raising. By going a tier or two of states further south from our northern farms, poultry plants may be established under more favorable auspices, in many respects, for supplying the large northern cities,

than can be afforded by sites near at hand. Just as early fruits and vegetables have, within a few years, comparatively, been raised in prodigious quantities at the south for shipment to New York, Boston, Chicago and other northern markets, under a regular organized system of gigantic proportions, we may look, in a short time, for something on a correspondingly large scale in the movements of poultry products. By seeking a milder climate, the construction of expensive winter shelters and the cost of fuel for warming them and carrying on artificial hatching and rearing, may be avoided.

The climate of the Gulf states, and of all the extreme south, will never be as favorable for poultry as the region of the latitude of North Carolina or southern Kansas. The high trans-Missouri plains, owing to the prevailing dryness and great purity of the air, afford the best sites for poultry farms in the whole country, the southern portion of this great area being the best. In all the region from the Dakotas to northern Texas, fowls of all kinds thrive amazingly. It is easier to raise a forty-five pound turkey in Nebraska than a thirty-five pound turkey in New England, from the same strain. Southern Kansas and vicinity, where winters are less severe than further north, lessening expense, as population increases in the cities of the northeast and of the extreme south, where the climate is unfavorable for poultry, and as railroad lines are multiplied, running north and south between British America and the Texas Gulf coast, will become the best locality in the United States and in the world for the raising of poultry products in prodigious quantities. Grain is cheaper in this region than in any other, and is likely to remain so for a long time.

Unless the proportion of freight rates should be materially altered, which is unlikely, it will continue to cost

less to transport eggs and fowls from this region of cheap corn to points where both corn and poultry products are comparatively dear, than to ship to the latter vicinity the grain from which these products are formed. Seventy years ago nearly every pound of provisions in the whole land was consumed within twenty miles of where it was raised; but now, since "many run to and fro, and knowledge is increased," there is a growing tendency toward shipments to great distances. It is common for the market to contain food supplies, the principal articles of which are from various localities a thousand or two thousand miles apart, while some are from even the most distant parts of the globe. A natural law of competition, as persistent as the attraction of gravitation, compels the production of commodities where the facilities are the best, unless the freight to the point of consumption is great enough to offset these facilities. But freight rates grow less and less as the machinery of transportation, like all other machinery, is constantly improved.

In treating of a location near a northern city, the advantages of delivering fresh eggs at an extra price direct to the consumers, without the intervention of a middleman, were set forth. A portion of the whole number of large scale poultry men will continue to avail themselves of these advantages, yet the tendency will be, in the future, for the production of a great and increasing proportion of eggs and poultry meat at points hundreds of miles distant from the consumers. The science of distribution—if it may be so called—has been constantly improving, the machinery of the produce commission business having been brought to a great pitch of perfection. Even the multiplication of department stores, which marks an important era in the distribution of commodities, has a bearing on our subject. As the retail food market division of one of these great

establishments is handy, the housewife can personally inspect her purchases, which she would probably not do if it was not made so very convenient for her in connection with her shopping in other lines, while facilities of electric cars and horseless omnibuses are constantly improving, so that communication is easy and quick between the department store and the home of the customer. The tendency of all inventions is to mass production at a few points remote from consumption, hence many poultry operators will, in the future, be diverted from a suburban region of high priced lands to a locality of cheaper acres and a more favorable climate.

Transportation is king and governs every department of industry. In the case we are considering, not only has improved transportation rendered distant sites feasible, but it has, through the means of trolley lines, checked, to some extent, the great increase of city homes, and by stimulating out-of-town residence, has added to the numbers of suburban people who raise eggs for their own families, with a surplus to take to the city. In other words, they leave the ranks of buyers of poultry products and become producers themselves, thus adding to the supply of near by raised strictly fresh eggs.

The production of eggs at a point remote from the large city market has also been made more feasible than formerly by the recent improvements in cold storage. It is true that nothing will ever quite equal a newly laid egg, but eggs absolutely newly laid when put into cold storage, will, the following winter, turn out to be very good indeed, even if not "fresh laid," and will meet a great demand at high prices. Eggs collected from ordinary farms by itinerant hucksters, or accumulated indiscriminately at grocery stores and then taken to cold storage, will always be more or less in bad repute. Hence the advantage possessed by the proprietor of a poultry farm on a large scale, where every nest is visited

daily, on system, and freshness of product guaranteed absolutely before put in cold storage.

The cold storage feature will, in the future, dominate in fixing the areas for the production of a large and increasing proportion of the enormous quantities of poultry products which our hundreds of millions of people yet to be will consume. The great packing houses for beef and pork at the principal cities of the middle west have grown with wonderful rapidity to a colossal size, pointing out the belt of country where animal food can be produced at the greatest advantage. Dressed poultry is already kept and transported from the trans-Mississippi region on an immense scale, by the same means as beef and pork, in the carcass, besides being canned, the principal operators being at Kansas City; but all that has been done, thus far, in this line is but as a drop in the bucket. The big eastern and northern cities will be supplied more and more in the future with poultry products from the southwest; particularly from southern Kansas, northern Texas, southern Missouri, Oklahoma, Indian Territory and Arkansas, although southeastern Nebraska, southwestern Iowa, and all of the area tributary to Kansas City will contribute to the immense volume of eggs and poultry which that great southwestern paradise of fowls will produce.

#### THE KIND OF SOIL.

The soil should be adapted to cultivation. Those who advocate a waste or sterile tract make a great mistake. Every rood should be capable of cultivation, and rocky or bushy land avoided. Shade may be artificially provided at a small cost in a manner to be hereafter described. It is necessary to raise crops, in order to get the full advantage of the manure. It exceeds in value that made by any other domestic animal, because it is from rich food more thoroughly digested than is the



case with quadrupeds. The scrapings from the roosts might be carried to another farm, it is true, but the nearer they are applied, the less labor; and the droppings where the fowls range, and at every coop of small chickens, etc., are too valuable to be lost, and cannot be gathered up save by the roots of plants on the spot. In order to distract attention from the main business as little as possible, crops of the simplest management should be mostly grown, and only those that can be consumed by the establishment—grass, clover, alfalfa, cabbages, lettuce, onions, potatoes, beets and other roots, large quantities of oat or rye straw, and the balance, grains of various sorts, corn especially being always in order. The principle of division of labor, carried out to full extent, would forbid our raising crops at all, were we able to gather all the manure and sell it for what it is really worth. But, as we have seen, much will be wasted unless there is tillage, and there is no price established for such manure; and if there were it is, under our system, all immediately mixed with earth, making it unfit for sale.

The quality of the soil may be poor, or worn-out at the start, thus securing cheapness; but it should be of a sort to which it would pay to apply valuable manure. For the sake of the health of the birds, choose a warm, dry soil. Land which dries quickly after rains is the kind; and another test is, whether it is ready for the plow early in spring. If it will produce peas or water-melons earlier than common, we are not far wrong. It should not be clayey or gravelly, but a sandy loam. Gravel for a subsoil, low enough down never to be reached by the plow, would be excellent, making a natural underdrainage; but gravel at the surface troubles the fowls in their rolling and dusting. A supply of hard gravel for the use of the birds should be screened to a proper size at some other place, and hauled to the

spot, and put in boxes for the use of the birds. The soil should answer for dry earth for the roosts and for dust baths, the loam being of a sort easily reduced to an impalpable powder. This is important, because we depend upon pulverized dry earth all through the business, to secure the cleanliness and health of the birds with the least possible labor. A great deal is said in poultry books and papers about the importance of cleaning the roosts frequently. We do not clean ours oftener than once in three or four months. The labor of going the rounds daily in a large establishment, thoroughly scraping floors, and removing manure, would be enormous. We set all our fowl houses on a ridge of earth, thrown up by plowing several times toward the center, and surround with a shallow ditch for surface drainage after heavy rains. Thus we secure dryness, wet being the foe that must be kept from the fowls at every stage. Then in winter a bed of dry earth, six inches deep, is put inside the houses instead of a floor, and a couple of inches added monthly if needed. The birds may be depended upon to cover their own droppings, not only daily, but hourly, when not at roost, a thick cloud of dust being raised every little while. The houses will always be freer from taint than if floors were used without dry earth, and scrubbed with soap and sand three times a day.



## CHAPTER III.

### THE COLONY PLAN.

A system of detached, widely separated poultry houses, movable or immovable, called the colony plan, is successful, because it secures natural conditions, especially exercise, cleanliness and pure air. Needing a large area of ground and making the attendant travel long distances, it is appropriately designated the extensive system, as contrasted with the intensive system, which concentrates the birds and buildings and employs the labor on a small space.

One of the best methods on the extensive principle and with movable houses, we will first describe, as it has been carried out during the last twenty years in nearly or quite every state in the Union, with various modifications to suit individual requirements or notions. The intensive plan has its own merits, which will be considered in the proper place.

Upon the colony poultry farm there are no yards, excepting for some special purposes, but we imitate a country town, where is stationed at every farmyard a flock at free range. This method we know has succeeded for hundreds of years, since men became partly civilized; so it is no new experiment, and it is based on a state of things still older, extending beyond the period of domestication. Across a tract of  $62\frac{1}{2}$  acres, 100 rods square, run parallel wagon roads, 10 rods apart, with fowl houses located quincunx style every 10 rods. In this way each house is surrounded by six others, and is 10 rods to 11 and a fraction, from each. Now, when

a flock is attached to each farmyard in a village, and runs at liberty, the premises may be as near each other as 8 or 6 rods even, without danger of the birds straying, ordinarily, when once fairly domiciled. This is because the neighbors' premises have a different look, and the buildings, garden, orchard, shrubbery, and fences serve as landmarks to enable them to find their way back. To make each flock upon our tract know its home, we have three styles of buildings, so unlike in color and other respects as to be distinguished by their occupants, and these alternate in such a way as to pre-

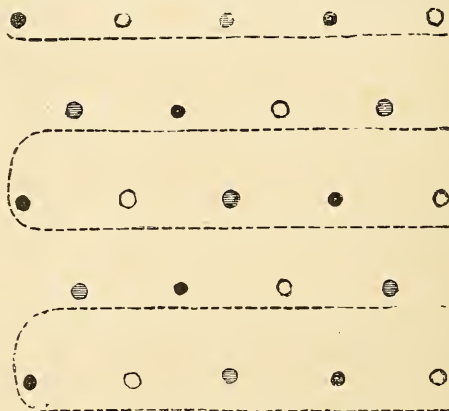

FIG. 1. DIAGRAM OF EGG FARM.

vent mistakes. Here the ancient instincts of the birds are our reliance, their powers of discrimination in regard to locality being very strong. It must be kept in mind that any faculty which was of use when the race was wild, may be definitely counted on, unless it has since been persistently bred out. The buildings are white, black, and uncolored, in succession, so that the six immediately adjoining any one are none of them like itself. The white and black coloring are of the cheapest sort—lime wash and coal tar.

In the diagram, Fig. 1, the quincunx order is shown, and the position of the wagon path is indicated by the dotted lines. The alternation of the colors of buildings will be understood from the white, black, and shaded dots, but the diagram represents only a small portion, a corner merely, of the main area of the farm occupied by the colony buildings, and the reader should imagine the roads extended a great distance at the right in the cut.

While pursuing the experiments which led to this system, we early perceived that while a flock thus situated would stay near home so long as no person approached, when feeding them we were followed by birds from neighboring flocks and there was confusion. Besides, so accustomed do fowls become to associating the sight of their keeper with a boon, that they will follow him from one station to another, when on his rounds collecting eggs, or attending to other matters. True, their ability to find their way back is wonderful, but fighting follows the meeting of birds that are strangers, and thus the quiet and order so essential to laying are impaired, and also frequent association of this kind will, after a while, break down all distinction between neighboring flocks. Such a trouble would be fatal to the whole plan. The solution of this difficulty is original with our system, and the key to its success. The feeding business is the cause of the trouble, and the only reason why fowls follow their keeper. The remedy is to bring about the feeding indirectly. From earliest chickenhood the birds, or the greater part of them, are brought up so as to never perceive that the keeper has anything to do with their feed. The small coops for young chickens, on a separate part of the farm, have boxes where the feed is placed, and a simple contrivance attached, that does not admit the chickens until some time afterward. This device will be explained when describing coops and other fixings for young birds. Adult fowls are given

soft feed early in the morning in a feed box in their house, so constructed that the keeper is not seen by them at all. All the hard grain for the day's allowance is deposited in or under a pile of straw outside, before they are let out of the building, and they scratch for it at intervals through the day. This employment is very salutary to their health and spirits, and assists in keeping the flock together. The bright eye and keen faculty for prying and searching are employed, instead of the birds moping or standing listless. They feel as if everything was right and natural, and their contentment influences laying to a surprising degree.

If straw is plenty and cheap, as it is in some parts of the country, scatter it liberally and sow grain upon it by any good broadcast seeding machine worked by a team, and follow with a hay tedder, alternating with a side delivery horserake whenever the straw becomes scattered too much. Or the driver of the hay tedder can drop a slender rill of grain with one hand, while managing his team with the other. If straw is too expensive, as it is apt to be if within fair shipping distance of a city, a plow can be used, every month or so, to loosen the soil, preferably, as we have seen, a loose, sandy loam, and a harrow employed to cover the grain. This harrow should have very short and slender teeth, a homemade affair constructed of one-inch or half-inch boards or two-inch planks, through which round nails or spikes are driven, answering better than the barrows in the market, as it will not do to cover the grain too deeply. The best thing of all is a wire drag, made by fastening numerous barbed wires to round poles of the size of a man's arm, or to scantling, or waste strips of board of various dimensions, if more convenient, by means of ordinary fence staples. This drag is cheap, simple, and effective; it will accommodate itself to uneven ground, and as it is of light draft, you can make it very broad

and take a wide sweep. Lay the poles or scantling on the ground about two feet apart and parallel. Staple the wires on, three inches apart, at right angles with the poles. If the ground to be harrowed is uneven, you should saw about two poles out of three into three-foot pieces, so that in operation it will undulate to fit the swells and hollows. Of course, there must be a sizable, long stick at front to which the team may be attached. Get plenty of help to turn the ugly thing over workwise, without tangling, when it is done, so that the poles will be on top and the wires on the ground. This wire harrow is also an excellent thing for every farmer who sows broadcast turnips, millet, clover, alfalfa, timothy, or any very small seed, and preparatory to nice gardening, it will make the soil fine as snuff, saving labor with the hand rake.

By broadcasting the seed before the fowls are let out in the morning, the sight of the keeper is associated with no gift or boon, whatever, and scrupulous care is taken during the fifteen or eighteen months that limit the lives of most of the main laying stock, never to throw them, directly, a morsel of food. This precaution of indirect feeding is not, however, carried out with the small classes of sitters and fowls with pedigree records, as will be explained hereafter. All motions near the indirectly fed fowls should be slow and gentle; they should never be frightened, and should regard their keeper with neither fear nor aversion, but with total indifference. The two points, of differently appearing premises at different stations, and indirect feeding, both being attended to, we are enabled to keep separate flocks in freedom upon one farm without yards. The method of overcoming, by use of a team, the loss of time in attendance caused by the scattering of the buildings, will be described in its proper place, as well as the ways of securing throughout the greatest economy in labor and lumber.

As it is impossible to raise any crop on vines, stalks, or trees above ground or below it, that hens will not damage, crops are put on one-half of the ground each year, and the fowls on the other half. Movable fowl houses are used to great advantage. By building small, light, and low, with strong sills made on purpose for runners, the houses may be moved every spring by an ordinary team, to the section tilled the previous summer. The distance traveled in transferring one hundred fowl houses, from one sixty-acre lot to another, is one-third of a mile for each building, and back with no load. The amount of labor is much less than would be involved in hauling the manure, mixed with dry earth, from the buildings. The moving is accomplished systematically; the fowls belonging to a building being all moved in one flock in a large box made on purpose, Fig. 12, in which they are quietly entrapped when attempting to leave their house in the morning, by placing it adjoining, after which the box is darkened and drawn upon runners, on which it stands, to the new station. On arriving, they are immediately allowed to escape into a spare house, shaped and colored like the one they left, placed beforehand, when they are ready to commence their day as usual, the whole operation of removal occupying only a few minutes. Besides this yearly moving, each building is moved every few days during spring, summer, and fall, its length only. Thus a fresh spot is secured, and to prevent all taint and uncleanness, as well as to keep the manure safe for next year's crops, an implement like a harrow, with teeth like those of a horse hoe or a cultivator, is drawn over the spot where it stood. The buildings are all moved in regular order, in the same direction, so as to keep the same distances apart; then back again over another strip of ground, so as to fertilize the whole lot in the course of the season. The frequent turning of



the soil not only keeps it sweet, but provides what fowls are so fond of—a place to scratch for insects, and roll and dust themselves in dry weather. The crop of weeds that will constantly appear in summer must be as constantly turned under; and whatever advantage there may be in green crops for manure will be secured; thus the enriching and pulverizing of the ground will fit it for large crops. It need not lie altogether fallow, either, for a few small spots may be sown thickly with lettuce, cabbages, or other plants that fowls will eat, protected until partly grown by movable fences or hurdles of wire netting, after which they may be allowed to help themselves. Oats may be sown in strips also; and whether the fowls scratch up and eat the seed, or forage upon the tender sprouts or the ripened grain, no matter. It is only necessary to compare the amount of labor spent in spading the ground in yards, to keep it fresh, with this way of using team and plow, to see the superiority of the latter method.

In poultry raising on a large scale, it is, ordinarily, next to impossible for the fowls to procure insect supplies to any important amount, in proportion to the numbers of the birds. Yet while in the colonization and no-fence plan, with the houses 10 to 11 rods apart and no crops, the insects procurable are so few as to be unimportant, the following modification of this method, where grasshoppers are very plenty, as they are in July and August in some parts of the United States, has been found to work well, to wit: Locate the buildings for laying stock 20 rods apart, instead of 10 rods, and in place of unlimited range, give each flock a long, low, covered run, the sides and top of which consist of wire netting, stretched over frames. This yard, or long runway, may be 2 or 3 ft. wide, 3 ft. high, and 6 or 8 rods long. It is important that it be built in movable sections, set end to end, each section being about 10 or

12 ft. long, and covered at top and sides, but open, of course, at the ends. The houses and runways being located on a fertile hayfield, an abundance of insects will breed in the tall grass or clover or alfalfa, and will be captured in the runway.

When the fowls have access to all parts of a hayfield or pasture, they devour the larvæ of the insects, or the young when so small that they do not amount to much as food. But under the runway plan, large numbers remain undisturbed till, full grown and fattened, they enter the trap. In some cases, tons of grasshoppers appear in hayfields where fowls cannot be allowed to run, because, in addition to other objections, the grass

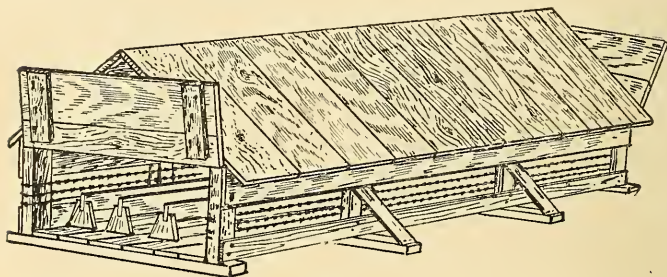

FIG. 2. COOP FOR GROWING CHICKS.

would be badly trampled by them and nests would be hidden. An occasional runway, as above described, penetrating the ranks of the grass like a tunnel, will receive, from time to time, traveling hoppers and jumpers in sufficient numbers to keep the birds on the alert, thus affording them exercise and lessening the feed bills very materially. The birds can pick what green food they need through the meshes. As remarked, the harvest of insects is specially valuable for only about two months in the year, and, as the houses are on runners, and the runways are constructed in sections, the whole outfit may be moved to any location desired, to stand dur-



ing the remaining ten months. The operation of the mower and other haying machinery will not be seriously interfered with in this plan, which is peculiarly adapted to the extensive alfalfa fields of the Great Plains region. If a location is preferred in a field of wheat, rye, barley, oats or millet, the birds may be turned loose after harvest and before the weeds have grown tall enough to encourage the fowls to steal their nests, while the scattered kernels gleaned in the stubble will be quite an item. Alfalfa, however, is destined to become one of the most important crops, which will occupy millions of acres of the great trans-Missouri region and feed countless numbers of horses, cattle, sheep and swine, and as grasshoppers breed in this crop in myriads, the tunnel plan is particularly suited to the alfalfa belt.

The sixty acres of grain, which, as previously stated, are raised every year on our colony poultry farm, may have some of these poultry-runway movable-grasshopper traps located thereon. If partly grown fowls, not yet of a laying age, or chicks just separated from their mother, are placed in such runways, among growing crops, a very good house to be attached to the runways is shown in Fig. 2. It may be built four feet high from floor to peak of roof and four by twelve feet on the floor. Movable perches rest in slots cut in the tops of blocks eight inches high. The ends of the building and the two doors are alike, the latter being fastened down nights by a padlock. Several barbed fence wires are stretched on both sides of the building, to admit air and keep out thieves. Moving is done by attaching a team to a chain fastened to one of the end crosspieces on which the floor rests.

## CHAPTER IV.

### SUPPLYING THEIR NEEDS.

The distance once around to each station amounts to several miles, and the rounds must be made a number of times every day. The distance would be too great for the attendant to walk over, even if empty handed, and transporting grain and water without a team would be out of the question. A supply of water through pipes, connecting with each station, would be too costly, especially as they would be idle when the land was cultivated. A running stream conducted in an open ditch to each building would freeze in winter, make the ground near its banks too damp, and be in the way of plowing, moving buildings, and other operations; besides, few lots suitable in other respects can be found where the slope of ground, with water supply at top, admits of the construction of such ditches. Each flock of fowls needs a pailful of water daily, taking account of the evaporation in hot weather, and the necessity of emptying the drinking vessels at night in winter, to prevent freezing. Such an amount of water could not well be carried by hand. By means of a cask blocked up in a comparatively high position on a wagon, a strong head is obtained, and when going the rounds, watering, the operator, by the use of hose and nozzle, and a cut-off to slacken or increase the flow at will, and by having the drinking vessels stand at a convenient place, can, without leaving his seat in the wagon, not only fill the receptacles, but clean and rinse them first.

The most convenient wagon for our use is that sometimes kept for moving stone at quarries, and called a stone cutter's dray, shown in Fig. 3. In Maine, such are used very commonly to carry timber about sawmills, and on short routes, where no stumps or stones are to be passed over, thus saving much lifting.

It is desirable that the driver should ride the 10-rod stages between the fowl houses to lighten his labor, and that the team should trot to save time. But to climb in and out of an ordinary wagon to ride 10 rods, would involve more exertion than walking. Besides, the labor of lifting grain in and out will be much less in a low

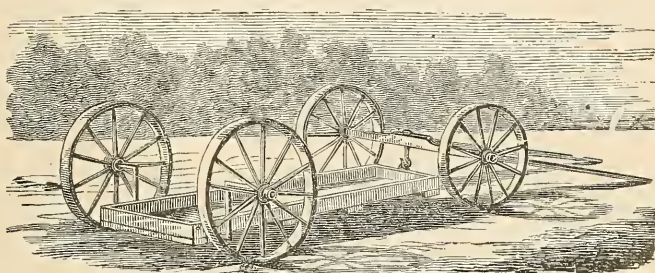

FIG. 3. STONE CUTTER'S DRAY.

wagon; the water cask may be filled and drawn from readily, and it is especially convenient in gathering dry earth. The vehicle should be built just heavy enough to support a barrel of water, five or six bushels of grain, and the driver; or, when rigged for earth, the amount desired to be carried is about equal to an ordinary horse cart load. It is not intended to be used off the premises at all, and as there are no stones, hummocks, or the like, and no deep ruts, the body is set so as to clear the ground by only 8 in. (10 in. are allowed in the Maine wagons). The body is 12 ft. long, and 4 ft. 2 in. wide behind, and 3 ft. wide in front, the tapering shape being necessary to give a chance to turn the

wagon without cramping; and the turning is also facilitated by making the axletrees so long that the wheels track 5 ft. 7 in., or about 4 in. wider than a common horse cart. The side boards are but 8 in. wide—the aim being to keep as near the ground as possible—and of 2-in. plank, serving as part of the body frame. Four crosspieces, underneath, fastened to the side boards by stout clamp bolts, complete the frame; and the whole is so constructed that no part of the body projects from under the side boards, the compactness of shape serving a useful purpose when we come to load dry earth. The rear axletree is made in one piece of wrought iron 2 in. square. The kingbolt should be made stout, and allowed to turn freely in the forward axletree. To carry eggs without breakage, a movable stand for the egg basket, furnished with springs, can be set on the wagon. A low sled may take the place of the wagon when the season requires it.

The road may be constructed quite narrow, as there will be no occasion to pass other teams; and an easy way to raise a path sufficiently to avoid wet, is to plow a strip of ground a number of times over, always throwing the furrow toward the center, or, better yet, use a road grader, and the rounded ridges thus made with ditches on each side are to remain in the field permanently, and may be cropped with the rest of the land, if desired. The wheels of the wagon are made with very wide tires, as shown in the cut, and these must not be driven in the same track twice in succession, but used as rollers to smooth down the whole ridge, for there must be no deep ruts to cause the wagon body to graze the ground, or to interfere with the use of the bicycle, which will be found very convenient for some purposes.

#### COLLECTING AND STORING DRY EARTH.

To gather and store dry earth, the following plan is submitted as available, not only for the poultry business,

and that invaluable invention, the earth closet, but for preparing absorbents and litter for stables and pigpens. The best farmers use dry earth for all their animals, not only for the cleanliness and health of the stock, but to lighten the labor of attendance, substitute a cheap litter for straw, and save every particle of manure.

The spot of ground set apart for the dry earth harvest should be kept free from weeds and turf, and harrowed as shallow as possible, using a harrow with numerous very short teeth, or, what is the very best for the purpose, the barbed wire drag, previously described. The ground should not have been plowed for a year, the object being to pulverize it only at the surface, for in

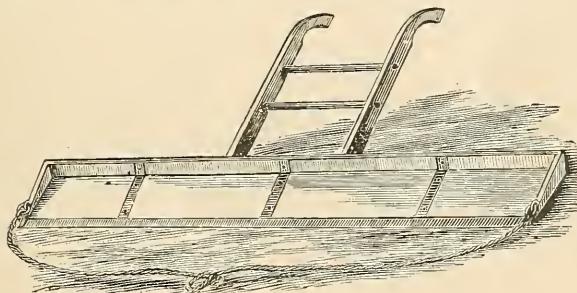

FIG. 4. SCRAPER FOR DRY EARTH.

this way the top soil can be better kept from absorbing moisture from below. There is seldom a summer without a spell of several weeks when the soil for a couple of inches at the top is almost dry. Select such a dry spell for the work.

The implements used are a light scraper, Fig. 4, 5 ft. long and 10 in. wide, and a shovel, Fig. 5, 2 ft. 3 in. long and 2 ft. wide. They are made lighter than similar ones designed to work among stones and gravel, and both are intended to be always used in a nearly perpendicular position, and, therefore, the backs need not be shod for wear, as is usual with team shovels and scrapers.

They are both built of wood, edged and bound with iron. The shovel is made somewhat concave, being designed to move a pretty full load for a short distance; the scraper, which only skims the surface, is made straight. A rope is used instead of an iron bail for draft attachment in the shovel to make it lighter, and for the same reason the iron edge and bands are thin. The mass moved being very dry, light, and mellow, admits of a rather slight construction of the implement; and, as this is to be used by backing the team at every shovelful, and pulling the shovel back by hand, as little weight as possible is desirable. The wooden rod con-

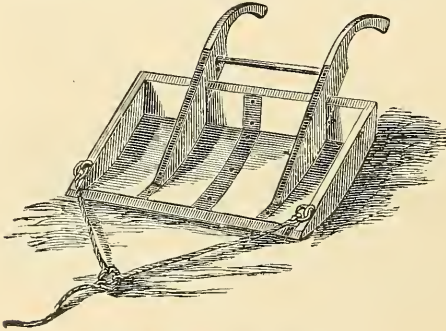

FIG. 5. SHOVEL FOR DRY EARTH.

necting the two crooked handles of the shovel is essential, serving as a convenient handle in backing. Now, during a time of dry weather, by harrowing your ground with the short-toothed harrow or the barbed wire drag, half a dozen times on a hot day, the soil will become sufficiently pulverized, and also advanced one stage in dryness. The next day—watching the weather as closely as a haymaker—hitch your horse to the scraper, and try to scrape 1 in. deep, no more, and gather the earth into small windrows, extending regularly across the field, the operation being like raking hay. Next, make the team follow the windrows, and cock the dirt into heaps of a



cart load each. Now, you have piles of earth nearly dry, but they will not grow any drier until placed so that moisture cannot be absorbed from below. To complete the drying, platforms of boards, Fig. 6, must be provided; these are 8 ft. square and built wedge-shaped, and 14 in. high at the highest part. These are now drawn thick end first by the team upon the planks which form the sides and serve as runners, and located one by each heap with the thin edge toward it.

Attach the team to the shovel by a rope about 12 ft. long, and transfer the earth to the platforms, heaping the first shovelful upon the edge next the pile to cover it, so that it may not obstruct the shovel. The platforms should be on the north side of the heaps at the commencement, so as to slope toward the south, and

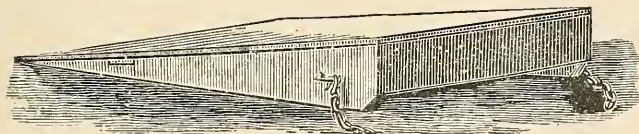

FIG. 6. PLATFORM FOR DRYING EARTH.

afford direct exposure to the sun. In two or three days of fine weather the piles will be nearly as free from moisture as if kiln-dried, if the earth has been well pulverized, for it is so loose and porous that the moisture from the bottom finds its way to the surface as fast as the latter dries. If the weather becomes threatening, house the earth without waiting for further drying, or cover with hay caps, according to circumstances. When ready for housing, draw the wagon close to the north side of the platform, and connect the two with a skid, 5 ft. by 14 in., with teeth projecting over the body to hold up the shovel, and let the earth drop through. The same length of rope between the horse and shovel will be

needed as when piling earth upon the platforms. Fig. 7 shows the manner of loading. Of course, the pile in the wagon must be leveled off occasionally, but this is easily and quickly done by using a big hoe, such as is sold for mixing mortar.

The flooring of the wagon, when used for carrying feed and water, consists of movable boards, which are taken out with the hind board when preparing to haul earth, and 1 1-2-inch planks, 5 in. wide, with planed edges, fitting accurately, are substituted. One end of each plank projects a few inches behind the body, and is so

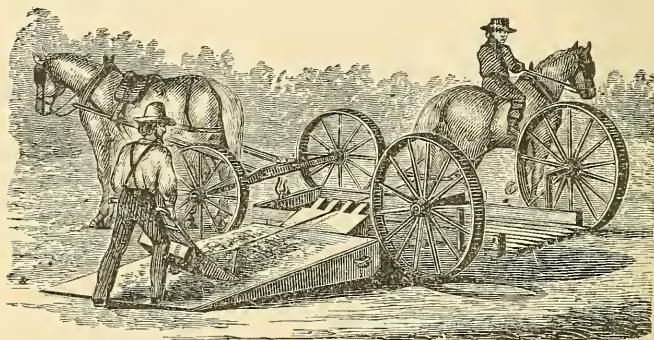

FIG. 7. LOADING DRY EARTH.

narrowed, Fig. 8, that a stout stick, 2 or 3 ft. long, may be inserted between the planks. By prying them up, one at a time, the wagon is readily unloaded. There will not be any appreciable leakage between the planks in hauling 20 or 30 rods, and, to save travel, the earth plat should not be more than that distance from the storeroom at farthest. An under-ground basement in the granary of the establishment is the proper storeroom, and, by driving in above, the load may be discharged through a trap door in the floor into a capacious, hopper-shaped bin. See Figs. 45 and 46. Underneath



the bin should be a space to drive in winter the wagon or sled, and, by pulling a slide, let the earth fall until a load is obtained to be carried to the stations. In this way, the earth is pulverized, heaped upon the drying platforms, loaded upon the wagon, transferred to the bin, and reloaded, without touching a hand shovel to it at all. The wagon may be loaded with the aid of the team shovel in less than three minutes.

The farmer may make an earth bin, of the kind described, in his barn cellar under a trap in the barn floor. The earth, upon a tract of such mellow loam as is suitable for poultry, will become, by pulverizing and drying, reduced completely to dust. The loading and unloading by team power not only saves labor, but overcomes the difficulties inseparable from shoveling such a light powder, that flies in the least wind. If the weather is such that the earth gets dry enough without the necessity of placing it on platforms, like that shown in Fig. 6, then the dry earth may be taken from the piles to the storeroom by using a wheel scraper instead of the



FIG. 8. BOTTOM OF DRAY.

dray. In the fall, when dry weather gives opportunity, labor may be still further saved by scraping heaps of dry earth directly upon the winter sites of the fowl houses, and drawing as many of the latter as are rendered tenantless by the sale of the old stock upon the heaps, where the earth can remain sheltered awaiting the new flock of pullets, and no wagon is needed at all for the earth in that case.

After the dry earth has been used in the houses through the winter, the final disposition of it must be made in the spring, as much with an eye to labor-saving as in collecting it. The fowl houses are to be pried up, to loosen their sills from the dust heap in which they

are embedded, and drawn off to summer quarters. Then the earth, mixed with the manure is to be first moved with the shovel, and scattered about the immediate vicinity, one shovelful in a place. The scraper is next used to spread the heaps, and the harrow comes last, reversing the order of gathering.

## CHAPTER V.

### HOUSES FOR LAYERS.

The form, proportions and fixtures of the fowl house, to secure a few eggs and chickens for home use, are of small consequence, so long as the proprietor has invented something a little different from what has ever been made before, and is satisfied. But business upon a large scale demands buildings that shall conduce in the highest degree to the thrift of their inmates, and to the convenience of the attendant, while the outlay, in both material and construction, should be the lowest possible. The buildings generally put up cost two or three dollars for each fowl provided for, while fanciers sometimes expend five dollars or more per head for the housing of their poultry. There are three classes of adult fowls necessary under our plan, which we designate as breeders, sitters and layers; and the latter, which are most numerous, are housed at a cost of materials not exceeding forty cents for each bird, estimates being based on hemlock lumber at twenty-three dollars per thousand. The accommodations for the breeding and sitting stock are necessarily more expensive, and there is, in addition, the cost of coops and appliances for raising chickens enough to replace two-thirds of the adults yearly.

The house used at the stations, for the layers, is represented by the larger of the two buildings shown in Fig. 9. It is not too large to be moved with convenience, and nothing smaller would accommodate a flock of fifty, the number to be kept at each station, with perches, nests, and sufficient ground room in stormy

weather, and at the same time afford high enough to give a circulation of air over the perches, and a proper

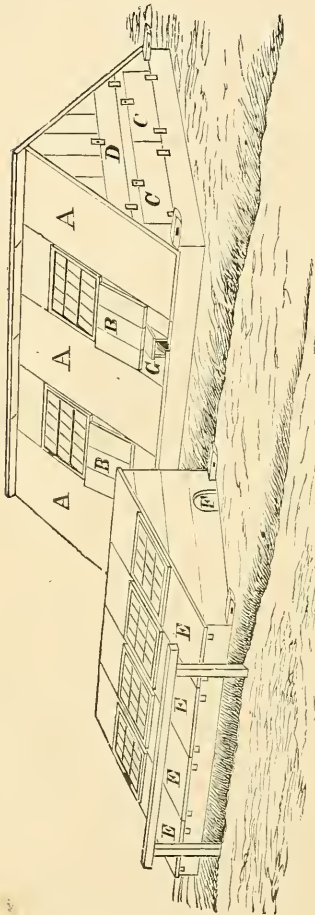

FIG. 9. HOUSE FOR LAVERS—WINTER ARRANGEMENT.

pitch of roof. It is fifteen feet long, eight and one-half feet wide, and four and one-half feet high at the peak. Let it be noted that any attempt to build so that the attendant may enter, either makes a stooping, slow job of every operation, from year's end to year's end, or if the house is carried high enough to allow standing upright, the weight interferes with moving, and the lumber costs too much. It is as easy to reach into a building designed for the keeper to stand outside, as to reach into a handy cupboard. To give sufficient air, the room is as lofty in proportion to the size of the birds or their breathing capacity, as a stable twenty feet high would be for cattle. It is just about as necessary for the poulterer to

have a roof over his head for protection in all weathers while at work, as it is for a farmer to make a shed over his land to defend his complexion from the sun while haying, or from the rain while transplanting cabbages.

The part of the roof on the south side at *A, A, A*, and nearly all on the north, consists of hinged doors opening to the right or left, and overlapping when closed, to shed rain. When it is desired to whitewash, throw open all the doors, thus turning the house inside out, take out the perches and nests, all built movable, and there will be no nook or cranny of the woodwork that the brush cannot be made to reach with ease, and no lack of elbow room. This arrangement of doors makes it convenient also to catch fowls upon the perches by night. The doors should shut as snugly as may be in coarse work, and the cracks unavoidably left around them will afford all the ventilation needed in winter, while in summer they may be opened more or less widely, according to the weather. When it is warm, yet wet, they may be partly opened and propped up, and boards put across their edges to shed rain. It is very desirable, under any plan for henneries, to build so that while moderately tight in winter, they may be thrown open on every side in hot weather; for fowls are warmly clad, and suffer much from the heat when in buildings made, as is too frequently the case, only with reference to the cold. The doors which form the north roof project six inches at the ridge, to keep out rain, as there is no ridge cap.

The two windows in the south roof are glazed, greenhouse fashion; that is, with overlapping panes, that snow may slide from them readily as soon as loosened by the warmth inside. They are two feet high and three feet wide, and set eighteen inches from the peak of the roof. A strip of tin is fastened over the upper part of the sash, and the sides and bottom of the sash overlap the roof, to be rain-proof. The shutters, *B, B*, used to darken the building on certain necessary occasions, elsewhere referred to, are hinged to the lower part of the sash, and when opened, as in the illustration,

rest upon the roof below the windows. The side sills project at both ends of the building; they are beveled, runner-fashion, and strengthened with iron, where holes are bored to attach chains; thus the house may be drawn by either end, for the purposes before described. The sills, which receive the principal strain during moving, should be so well braced as to keep the whole building in shape. The end sills, of two-inch plank, should be spiked upon the top of the others, flatwise, so as not to touch the ground while moving, and the side sills, four inches square, should be of chestnut or oak, to be as durable as possible, for they rest on the ground during a good part of the year. The spruce rafters, two by three inches, which answer for studs and rafters both, should be set at such distances apart as will correspond with the width of the doors and windows which are fastened to them.

A stout ridgepole, sawn of a triangular shape, runs the length of the building underneath the rafters, and two sticks are fastened to this ridgepole, one five feet from each end, and braced upon the center of the end sills to give firmness; for the covering, consisting chiefly of doors, does not strengthen the building, as in ordinary cases, where the covering is nailed to the frame. *C, C,* are doors, each three by one foot, opening outwards and downwards, to give the keeper access to the nests, which are one foot square, and the same in depth, and so contrived that the hens enter them at one side from a passage six inches wide and one foot high, boarded at side and top, running the length of the row of nests, and are thus indulged in their liking for privacy while laying. The nests are tight upon the top; the outside door should fit closely, and the opening admitting the fowls to the passage be made so small that the nests will be rather dark. It is found that when nests are open to view from the main apartment, hens will, in stormy

weather, for lack of other employment, sometimes enter them to scratch for food, and thus by chance break eggs and learn to eat them, and acquire the habit of pecking at and devouring eggs as fast as laid. But a darkened nest will deter them from entering, except to lay, for which purpose they prefer a dark, low corner. There is a row of six nests running across the building at each end, making twelve, which will be sufficient, as it will not happen that more than that number out of a flock will need them at once. The passages are made so that they may be taken out with the nests for whitewashing. The end sills, of plank 18 in. wide, serve as a tight floor for the nests and passage. The perches, two in number, are 18 in. apart, and each is 18 in. from the roof, and 2 ft. higher than the sills. Perches should be of 2 1-2x3 1-2 in. sawed stuff, the widest part up, with the upper corners rounded off a very little. From four to five average-sized fowls will occupy 2 ft. of perch. The perches, being each 12 ft. long, will accommodate a flock of fifty, and are to be placed so as not to extend over the part occupied by the nests.

The drinking vessel stands upon one of the platforms formed by the nests, and upon these platforms are also shallow boxes containing gravel, pounded charcoal, and a mixture of loam, sand and oyster-shell lime, made into an easily crumbled mortar. The boxes are ten inches wide, and being placed next the end wall, leave a space eight inches wide upon the platform, for the fowls to stand upon. The drinking pail and gravel boxes are protected, by their elevation, from the dirt that would otherwise be thrown into them by the fowls when scratching and dusting, and are fronted by slats with openings six by two and three-quarter inches between them. An opening is made in the end wall over the pail that is just large enough to admit the spout of a large watering pot, or the nozzle of a line of hose attached to the water cask



on the dray. The door, *D*, one foot wide, opening downwards, is for removing the pail and gravel boxes when desired, and when fastened ajar will be found more convenient for ventilation than the roof doors, when the weather is only moderately warm. Both ends of the building alike are furnished with doors.

In the summer this building may have its roof doors partly opened by day, as in Fig. 10, and its sills rest on the ground, ready for moving; but during the severest weather, generally about three or three and a half months of the year, this building does not stand with sills upon the ground, but it rests, as in Fig. 11, upon

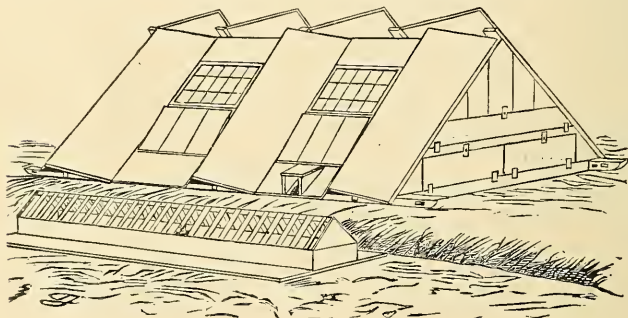

FIG. 10. HOUSE FOR LAYERS—SUMMER ARRANGEMENT.

the edges of a box or bin, *B*, of dimensions corresponding with the center of the sills of the building, made of planks nine inches wide and two inches thick, like a mortar bed with no bottom, filled with dry earth. This should be set upon ridges thrown up by the plow or road grader, as previously described, and it will be found that, by starting with the earth dry in the fall, it will not absorb moisture from the ground beneath during winter any faster than it dries away from the surface, where the fowls keep it stirred. There need be no cleaning of the house while thus arranged for winter,

but about once a month an inch or two of dry earth may be added. There will be no accumulations under the perches if the birds are not kept too profusely sup-

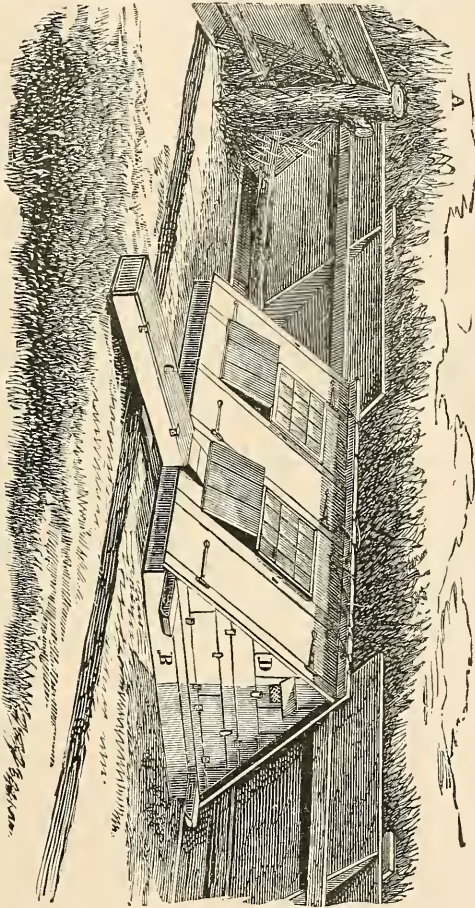

FIG. 11. WINTER QUARTERS FOR LAYING STOCK.

plied with gravel at that season, as they should be to induce them to pulverize every portion of the manure and mix it with the dry earth, in search of the gravel

which is very frequently voided. There can be no objection to saving labor by inducing the birds to perform the work of scavengers, which will give them salutary exercise, for it is not intended that they shall be deprived of as much gravel as they need, but only forced to use the same many times over. The bin, as it may be called, should be strengthened with braces across the corners, and kept from spreading by the pressure of its contents by strips nailed from side to side. After the building has been moved in spring to a new station, the bin is to be pried up until the earth drops through it, having no bottom, and when empty it may be readily

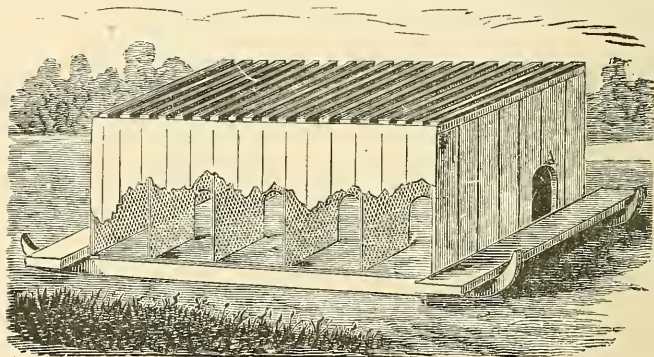

FIG. 12. PEN FOR MOVING FOWLS

hauled by team, like a sled, to the place where it is to be used, as will be explained, in connection with chicken raising. The building is hauled onto this bin in the fall and off in the spring, by taking the wedge-shaped platform for drying earth, previously figured, for a skid, and attaching the team to a rope twenty feet or more long, and using small rollers. It is a quick and not over troublesome operation, for it must be recollected that the house is not large or heavy.

Figure 12 represents a pen to move fowls in when their houses are to be moved a considerable distance, to sum-

mer quarters and to winter quarters. When this pen is put in the place occupied by the feed room at the end of the passage, Figs. 9 and 11, the fowls are baited into it, the door, *A*, corresponding to an opening in the side of the end of the passage, *C*. The partitions in the pen separate the flock into squads, to prevent too many fowls huddling together and trampling each other during moving, at which time a canvas covering should exclude the light. Chains may be passed around the ends of the crosspiece for draft. The artist has made the runners turn up too much, a bevel merely, like that on the sills of the movable houses, being all that is necessary.

During the winter, a low structure, 6 ft. wide, 12 ft. long, and 1 1-2 ft. high on one side and 3 1-2 ft. on the other, seen at the left in Fig. 9, serves the purpose of a feeding room, and the rest of the year is used as a shelter for chickens. Its winter location is about 4 ft. from the larger building. *E, E, E, E*, represent doors, which overlap each other to shed rain, and when closed rest upon the highest or north wall, and open upwards and to the south, resting upon a rail attached to posts set in the ground. In each door is a window 3 ft. square, glazed, as are all the windows in the various fowl houses, greenhouse style. This feed house is movable, being furnished with planks set edgewise, with runner-shaped ends for side sills. Inside, a feed box, slatted on both sides, rests on cleats attached to the end walls, 20 in. from the north wall, and near the top of the room, so that dirt cannot be scratched into it. It has a shelf 7 in. wide on both sides in front of the slats, on which the birds stand while feeding, and contains a trough made by nailing boards 3 in. wide to each edge of a board 5 in. wide. A door, *F*, in one end of the feed room, large enough to admit a fowl, communicates with a similar door, *G*, in the south side of the main building, by a movable covered passage 5 1-2 ft. long, 1 1-4

ft. high, and 1 ft. wide, it being like a box with a lid, and but one end, and with an opening on one side.

This passage is not shown in the cut, but appears at *C*, Fig. 11. Every night in winter, after the fowls are at roost, the door, Fig. 9, should be closed, and the window shutters of the main building likewise. In the morning a mixture of vegetables, boiled and mashed, scalded meal, and a little meat boiled and chopped fine, is placed in the feed trough, and the daily rations of hard grain buried underneath straw, which covers the ground of the feeding apartment to the depth of eight or ten inches. The fowls are prevented, by the shutters, from looking on. Next open the passage, and in a minute the fowls will all be at the feed box. After finishing the soft feed, the grain, consisting in part of buckwheat or cracked corn or wheat screenings, so as to make as much work as possible to find it, will be scratched for at intervals all day long. A little practice will enable the attendant to give just enough, and have none left over night. Placing grain for scratching indoors is only for inclement weather, however.

During a few of the coldest spells,—such as usually occur three or four times in the winter, and last three to seven days,—and during storms, fowls prefer to remain indoors all day; but they should never, except in the morning, before feeding, be prevented from going out if they choose. Altogether, there are not usually twenty days in a year during which fowls will voluntarily keep inside all day. Snow should be cleared from a plot of ground at each station, with the aid of the team, and the scraper and shovel previously described, or a road grader. If the winter is open and mild, have a pile of straw out of doors with grain buried under it, using the broadcast seeder and hay tedder before mentioned, and whenever there is no snow start the broadcast seeder and scatter a very little finely cracked corn with the



meal sifted out, or millet seed, far and wide on portions of the range not provided with straw, to encourage the habit of running around and searching. Keep your fowls always on the move. As soon as the buildings are moved to the new stations in spring, and the feeding rooms are also drawn off to be used in housing young chickens, the feed boxes are taken out, they merely resting on cleats without being fastened, and carried to the stations, where they stand on the ground out of doors during summer, for use each morning, chopped vegetables, meat or other soft feed being placed in them, out of sight of the birds, as before.

The winter quarters for the laying stock are further represented in Fig. 11. In this cut the same building is shown as in Fig. 9. The passage leading to the feed room is shown in one of these cuts, and the feed room is shown in the other. In Fig. 11, certain useful contrivances for windbreaks are illustrated, these being highly prized by fowls in cold weather. When the house is located for winter, the doors in the north roof are covered with building paper in overlapping sheets, tacked on slightly so that it may be removed in spring. Straw is laid over the paper to the depth of a foot. A temporary shed is made for a rod east, and the same distance west, of the building, connecting with the roof of the latter, the platforms for drying earth, Fig. 6, being used for this purpose and supported by stout rails. By turning a corner, as at the post, *A*, east, and also west of the building, this shed is made to inclose three sides of a court which is open to the south. The gaps in the roof of the shed at the corners, and the cracks between the platforms, are covered with straw and boards. There is nothing that fowls love better than convenient nooks where they can retreat from the crowd of their fellows, and select their own company. Confinement brings not only loss of health, but the vices of feather-

eating and egg-eating. No system of diet will remove the liability of fowls that are habitually kept indoors to learn to pluck each other. If the room is large and the flock small, there may be no risk of this, but the expense of such quarters would be fatal to success. When fowls are allowed freedom they never learn to eat feathers. If anybody wants to keep poultry in narrow quarters under some highly artificial plan, with no provisions made for securing exercise, and prevent outdoor range in winter in order to promote laying, he is welcome to do so. But nature, if thwarted, is sure to have her revenge, if not in one way, then in another. Whether indoors or out, the birds must be busily employed every day, and then they will be happy and contented, and not learn egg-eating, feather-plucking, or other abnormal practices. Without a chance to scratch in earth or straw, they will be as badly off as a rich man with nothing to do. Straw is scattered under the sheds, and on pleasant days a few handfuls of feed are buried under it, using a fork; but covering grain by hand in this way takes time and should be resorted to only in case of very bad weather. When the weather admits, a large pile is used for a scratching place, situated south of the feed room, where it can be moved by the aid of a team, as stated on a previous page. The arrangements for burying grain indoors have also been already described. The ground is raised a few inches by plowing in the fall, where the sheds are to be placed.

When the house is placed upon the dust bin, *B*, waste strips of cloth, called "headings," obtained at the woolen factories, are used to make the joints air-tight between the two. The passage leading to the feed room is represented at *C*, the feed room itself not being shown in the illustration, but given in Fig. 11, as was stated. A small opening, *D*, at each end of the house is for ventilation, and must never be closed. A projecting cap



over it keeps out rain, and wire cloth of one-eighth-inch mesh breaks the force of entering air in case of high winds, though ordinarily the current will be outward. Fresh air is admitted through the passage, *C*, and as it must enter the feed room through an outside door in the latter, and pass several angles before gaining admission to the roosting room, strong drafts are avoided. Care must be taken, during cold spells, to partially close this door at night, so as to raise the temperature at the roost about twenty degrees higher than it is outside, but further than this no effort should be made to retain heat at the risk of impure air. Fowls that have free range in the daytime the year round, and roost in buildings open on all sides in summer, and partially open in spring and fall, will not be injured by an attempt to strike a balance between warmth and ventilation during a few brief periods of extreme cold. An artificial summer in winter, obtained by means of a furnace and hot water pipes, for laying stock and for chicks artificially reared, has its uses in the intensive system, to be described further on, but is dispensed with in the extensive or colonization plan.

The house for layers, summer arrangement, is illustrated in Fig. 10. In this the feed box is seen in the foreground, and the doors in both roofs of the house are propped up a little, as in cases of extremely hot weather. It will be found that the birds will seek the protection of a building thus arranged, for shade, when the heat is severe, in preference to any other place. In summer the grain is buried under a profuse allowance of straw, by the use of a horserake and hay tedder, or under the soil, by means of the fine and short-toothed harrow or the barbed wire drag used in pulverizing earth for gathering, as before mentioned.

Figure 13 represents a house for the earliest hatched pullets that are expected to lay more in winter than the

others, and are, therefore, sheltered at greater expense. Winter laying depends more on breed, age, feeding and health, than upon warm rooms. Heat is necessary to productiveness, but a fowl kept in full vigor and good appetite by exercise will be warm, where a dull, mopish one would shiver. It will not pay to build expensive fowl houses when cheap ones can be used, and the arrangement we are about to describe involves as much outlay as is advisable, in order to secure warmth, excepting for some special purposes. A mound of earth,

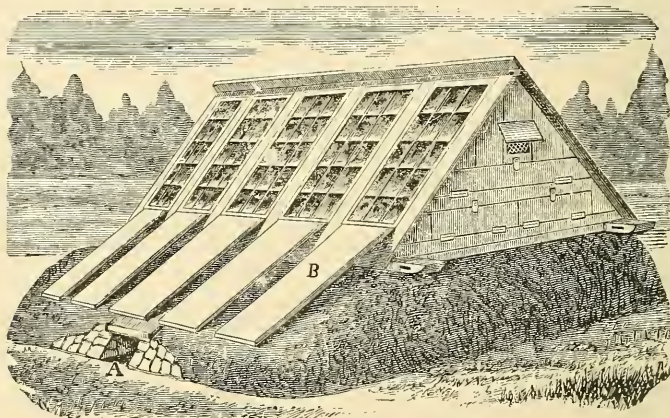

FIG. 13. HOUSE FOR EARLY HATCHED PULLETS.

nearly circular, and 25 ft. broad at the narrowest point, is raised by scraping with the team. It should be 3 1-2 ft. high at the center, and slope gradually to a level with the surface of the field. Upon this mound a cellar is dug 7 1-2 ft. by 14 1-2 ft., and 3 ft. deep, the bottom being 6 in. higher than the average of the surface beyond the mound. The cellar is walled substantially with stone, laid in cement, and floored with the latter material. Stations furnished with such cellars are upon a part of the farm where there is a gentle slope, and,

wherever necessary, a tile drain is put under the foundation of the walls.

The floor of an underground fowl house must always be a little higher than the adjoining field, not on account of drainage alone, but for ventilation. No room is fit to be occupied by stock that cannot be ventilated at the bottom. In this cellar the walled passage at *A* admits air within eight inches of the floor, which is covered with dry earth to that depth. The walls are topped with plank sills, upon the outer edges of which the runners of the itinerant building rest, calking being resorted to as in the previous case. It will not answer to house fowls in such a place unless there is plenty of glass above, and the south roof, therefore, contains five long windows, instead of two short ones, as in the other cases, each door being furnished with one. There is a shutter, *B*, to correspond with each window. Otherwise the house is of the usual pattern, and the winter sheds and feed room are attached to it, though omitted in the figure so as to show the embankment plainer. The house and mound have a bleak look in the illustration, but the sheds will make the whole sheltered and cosy. In the cut, the embankment is represented too steep. The slant should be such as to withstand heavy rains. The usual boarded passage, not shown in the cut, connects the feed room with the tunnel at *A*. There are sunny days enough in winter to keep the earth bed inside perfectly dry, and the air will be no damper than in an unglazed apartment entirely above ground. Straw mats of the greenhouse pattern are used at night upon the north roofs of all the buildings in winter. The amount of solar heat accumulated during a clear winter's day in a tight building roofed with glass is surprising, and this is to be retained as long as possible, always remembering, however, to give ventilation its due. Summer and winter the admission of air must

bē gauged by every change of wind and weather. It is one of the advantages of business upon a large scale, that operations which it would not pay to attend to with one flock, may be afforded where there are many. Unless the mats are put on before sundown, and sometimes on a mild day on a part of the windows at noon, so much glass will prove injurious because the fluctuations in temperature will be too violent.

The buildings are kept over the cellars only in winter, and are drawn on and off the sills above the walls by the use of small rollers, and a horse attached to tackle. The cellars must not lie idle after the houses are moved, but be roofed with the platforms for drying earth, and a few movable greenhouse sashes, and used as a shelter for chickens.

## CHAPTER VI.

### HOUSES FOR BREEDERS.

The quarters for the breeding stock combine houses very much like those for layers, only smaller, and yards made of movable fences. The houses for layers are movable, with no yards; the houses for sitters are stationary, with movable yards; and the houses and yards for breeders are both movable. The breeders are kept in fives and tens, no flock ever to exceed the latter number. The buildings are of two sizes, one 3 1-2 ft. wide, 4 ft. long, and 2 1-2 ft. high; and the other of the same width and height, and 7 1-2 ft. long. There are no runners, and the doors are few in number, though comprising the whole roof; each house, Fig. 14, is furnished with but one window, and but two or three nests are necessary, and one perch. Otherwise the houses are like those for layers on a reduced scale. They are designed to be moved by two persons, adjustable handles being attached at either end for this purpose. In this way, being without floors, they are shifted to different parts of the yards, and set on ridges of earth raised by the plow. In winter, each stands upon the edges of a dust bin of 2 in. by 8 in. plank.

The movable fences for the yards of both sitters and breeders are made as follows: Pickets, 2 in. wide, 1-2 in. thick and 6 ft. long, are nailed to two rails 3 in. square and 12 ft. long. At both ends of every rail, U-shaped pieces of stout hogshead hoop iron are fastened by screws so as to form staples through which round posts, 7 1-2 ft. long and 2 1-2 in. in diameter,

pointed at both ends, are thrust, and set in the ground. The rails in the alternate sections are at such distances apart that the tops of the pickets shall be in line, and the staples not interfere with those of the adjoining sections. Each post is supported, so as to resist the winds to which the fences expose so much surface, by a brace upon the outside of the yard, Fig. 15. This brace is made by sawing a rail stick in two, and furnishing each end with a staple like those upon the rails. The staples are fastened upon the braces in an obtuse angle, and the ends of the braces are beveled, the better to fit the posts. One of these staples passes around the post between the two staples of the upper rails, and through the lower one,

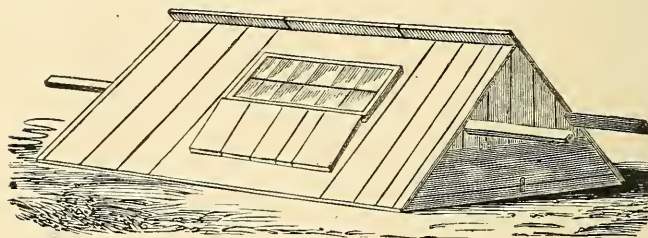

FIG. 14. HOUSE FOR BREEDERS.

which reaches to the ground, a short stake is driven into the earth, with its top inclining away from the fence, Fig. 16. The spaces between the pickets are 2 1-2 in. wide for breeders; for sitters, which are of a larger breed, 3 in. are allowed. The pickets are nailed on the yard side of the rails, to prevent fowls alighting on the rails. The fences which divide the breeding yards are boarded for 2 ft. at the bottom to keep neighboring cocks from fighting. This boarding is, however, not shown in the cut, neither is the runway shown, which, as will be described later, is attached to the end of each yard, which is at the rear in Fig. 15. Panels of wire netting attached to wooden frames may be used instead



of pickets, if desired, in which case the U-shaped pieces of stout hoop iron should be attached to the portions of the frames corresponding to the top and bottom rails of the picket fence. The wire netting fence stands better than the picket fence, because it does not take so much wind as the latter.

Before describing the runways for the purpose of exercise, which are attached to the yards, the latter being so very small, the absolute necessity of plenty of this exercise for the choice selected breeding stock will be enlarged upon. Dr. Holmes, when asked the age at which the education of a child should begin, answered: "A thousand years before it is born." All breeding animals must have exercise. Better breed strong stock

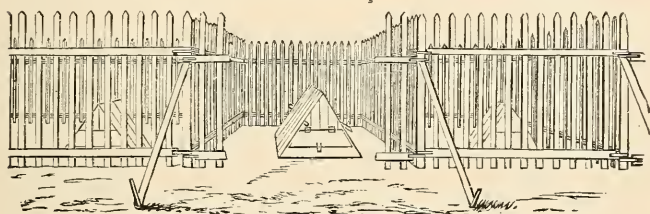

FIG. 15. YARDS AND HOUSES FOR BREEDERS.

in the first place than putter at doctoring sick fowls afterwards. When breeding ewes are confined in close quarters all winter, the lambs from them in the spring are born as limpsy as a wet rag. Said a Vermont raiser of high-class Merinos: "When I induce my ewes to go a half mile or so to a stack for their hay, and in order to get their grain make a journey back again, and repeat this round trip over and over, every day all winter, their lambs are born as solid and firm as a rock." Even the domesticated hares or rabbits, which stand close confinement better than any other animal, give much stronger progeny if allowed room to exercise during the breeding period and previously. Mr. Thomas Wright, the great



pigeon authority, says: "Nature designed the pigeon for exercise, and when it is deprived of it entirely it rarely lives many years and never breeds well for any considerable length of time," and adds: "In visiting lofts where the pigeons have flying privileges, we may expect to see young-looking old birds, but if we go where the aviary affords but little exercise we shall see old-looking young birds."

The exercise that fowls get on a free range is worth more than what they find there to eat. As for exercise,

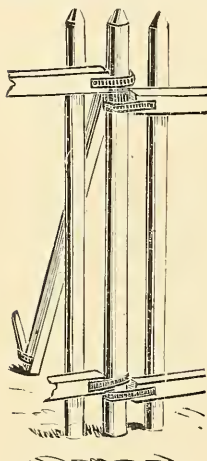

FIG. 16. MOVABLE FENCE.

in the ordinary poultry yard it is better than nothing, but it amounts to but little because the yard affords no vegetation and no insects for them to hunt. But poultry in confinement, even in a very small house and a very small yard, by means of the apparatus we are about to describe and which is attached to the yards for breeders, take more exercise year out and year in than they get on the best range in the world, and they are exceedingly contented and happy. Their feeding time is all the time. It is prolonged through the whole day.

Take two breeding flocks that are exactly alike as regards breed, age, size, thrift, vigor, and everything else. Give both flocks the same shelter, and food of the same sort and quantity exactly. Yard one flock in the usual manner, providing no incentives to exercise other than the yard affords, it being, as is usual, as bare as the middle of the street. Furnish the other flock with exercising apparatus and you will get eggs for hatching purposes entirely different in character from the eggs of the other flock. The vitality of eggs under different cir-

cumstances should be well understood by all who rear poultry. The matter is well illustrated by plant life. In the vegetable kingdom, there are all degrees of fertility. By this, we mean that a plant may bear some seeds that are plump, containing the germs of a future generation of plants, and which, if placed in the earth, will germinate and produce their kind, while there are other seeds on the same plant that are somewhat shriveled and shrunken and will not grow, although at first sight they do not, to any great extent, seem inferior to the plumpest and best specimens, aside from their dried-up appearance. At the further end of the series there are mere hulls without any vestige of meat or kernel to give promise of the reproduction of the species. Between the extremes of the empty hull and the plumpest grain there is a series embracing every gradation. It has been found by experiment that even if the same conditions of soil, warmth, and moisture are present, some grains give healthy plants which reach maturity, while others just start to grow a little and then die without making their way to the surface of the soil, where they might receive the genial rays of the sun.

There is something very much akin to this in the hatching of eggs. There are some that are perfectly and absolutely barren; there are others that are fertile and capable of producing vigorous chickens, and between these extremes there is every shade and



FIG. 17.

grade. Very often poultry men find chickens dead in the shell. Some die after the egg has been sat upon eighteen, nineteen, or twenty days, the chicks appearing full size and ready to burst the shell; some, however, die on the twelfth or fifteenth day, and others on the fifth or sixth day. In some cases, it appears as though the germinal speck just started in its growth and then was nipped in the bud. When a poultry man of an inquiring turn of mind breaks the eggs that have failed to hatch, he finds germs in every stage of growth, from the first trace of the development of organization up to the apparently perfectly formed chick, which looks as if all it had to

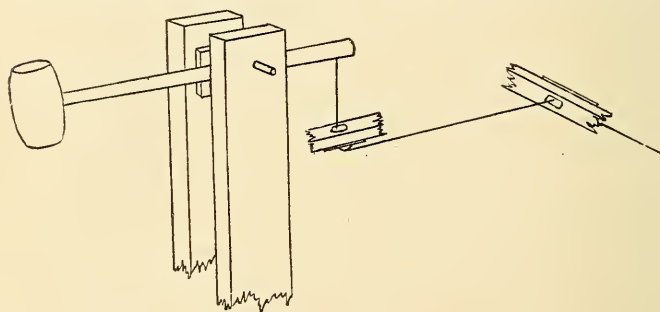

FIG. 18. STRIKER FOR FEED SHELF.

do was to break the shell and be warmed and dried, in order to run around and pick up its own living. There are very many cases of arrested development and death in the shell at different stages that cannot be attributed to any treatment the eggs have received after they were put under the sitting hen or into the incubator, for other eggs, subjected to exactly the same influences, hatched and produced vigorous chickens. Now, what is the reason for all this? Surely is it not the character which the egg itself received from the hen that laid it or the sire that fertilized it, or both? There is such a thing as inherited weakness, which may characterize an egg

before it is laid and give a tendency to the germ to die sooner or later, before it has become fully developed.

The necessity for securing a high degree of vitality in the eggs intended for hatching is the more imperative on account of the abnormal condition of our domestic fowls as regards the great numbers of eggs they lay. If the hen steals her nest, lays there twelve or fifteen eggs and stops to incubate, these are invariably of high vitality. By robbing nests daily, we force an unnatural number of eggs. To counteract the tendency to weakness of the germs, machinery is invoked, although it might seem at first thought that inanimate mechanical apparatus could have no intimate connection with vital processes.

To secure exercise in the yards for breeders, Fig. 15, runways, not shown in the cut, are attached to the rear of the yards. These runways are one hundred and fifty feet long and two and one-half feet high, built in movable sections. Extending across, over the tops of the fences in the breeders' yards, Fig. 15, is a continuous shelf, not shown in the cut, suspended over the yards by wires or cords, so that it may swing freely endwise. It is prevented by upright strips from swinging sidewise. A section of this long shelf is represented in Fig. 17, although it should be suspended by cords passing under the shelf in loops, instead of passing through the shelf, as in the cut. Grain is placed evenly the whole length of this long shelf and a hammer is kept handy at one end of the shelf. By tapping horizontally on the end, the whole shelf is slightly jarred, and a very little grain is dropped into each yard. At the end of the runways farthest from the houses, these runways communicate with another series of small yards over which is suspended another swinging shelf supplied with grain.

To obviate the necessity of the attendant going the length of the runways to operate this distant shelf, a ham-

mer is suspended on a pivot between two posts. This hammer is raised by pulling a wire, one end of which is within the reach of the operator, who stands at the shelf near the houses where the hand-hammer is. One end of a short cord is attached to the distant hammer, Fig. 18, passing around two sash pulleys, Fig. 19, so as to change the pull from perpendicular to horizontal, and the other end is attached to the wire above mentioned. One end of the shelf meets the blow of the hammer between the posts. After a little practice, a blow can be given each time with just sufficient force to jar off a little grain. If predatory pigeons or sparrows are feared, have wire netting attached to the shelf over the grain, a few inches above it. A small bell may be suspended near each shelf and rung after the hammer stroke, by means of a wire terminating at the same point that the hammer wire



FIG. 19.

does, as above described, so as to be within easy reach of the attendant. Spool wire, Fig. 102, is the best. Fowls quickly learn the meaning of sound signals, for, as everybody knows, they may be called by a whistle or by drumming on the feed pan or by any sort of noise customarily repeated at feed time. The bell is not absolutely necessary, for the birds hear the hammer stroke and soon learn its meaning.

The breeding fowls and breeding yards are few in number, and as these fowls are very choice and their perfect thrift is of the utmost importance, the feed shelves are to be jarred quite frequently during the day, and, therefore, the yards should be located near the feed storehouse, or the place where the eggs are put after gathering, or at whatever point the attendant will pass, or be at, the most frequently during the day. Or the hammers for both the shelves may be pivoted and have cords and wires attached, these last being extended to

the watchman's house, Fig. 20, or storeroom, or other permanent building, and operated by clockwork every twenty minutes. Of course, bell wires may also be pulled by the clockwork, but this will not be found worth while; for, as has been said, the sound of the hammer stroke will answer quite well as a call, although when a clock is not employed, calls are a pretty good thing, since they can be so readily put up and operated.

Under each shelf, a pile of straw should be kept to make work for the birds in addition to the running back and forth which the feed dropping induces. One

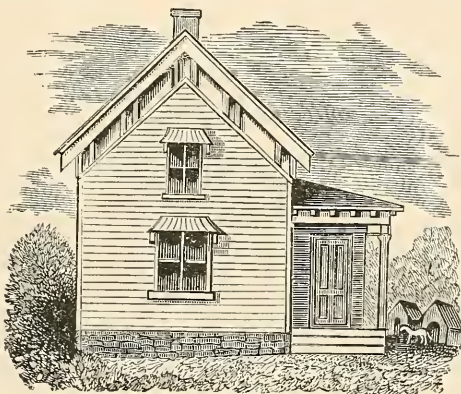

FIG. 20. OFFICE AND WATCH HOUSE.

great advantage of the long runs is that the birds will make frequent trips of their own accord to see what there is good to eat at the other end, the remembrance of a series of feasts being always vivid in their minds. Even if bells, hammers and shelves are operated but once every hour or two, or only three or four times daily, the fowls will keep running back and forth frequently. The difference between a given amount of ground space in a yard of a square form and in one long and narrow, as regards the exercise conferred respec-



tively, is simply enormous. In a square yard, or in one which is, say, twice or thrice as long as wide, the birds will not ramble much. They find that there is nothing to be gained and soon become discouraged and mope in complete listlessness. If it were not for the great expense of building material and the difficulty of moving so much fence, the yards could be made 10 or 12 ft. wide and 100 or 200 ft. long, instead of having runways. But the low, covered hurdles are so handy and can be shifted so quickly, to sweeten the ground by plow and harrow every month, in addition to the annual moving to another field entirely, that their invention was a great boon conferred on the poulterer. The importance of sweet, fresh earth in yards and runways cannot be too strongly insisted upon. The poultry man's nose and inhaling organs are 5 ft. or so from the ground, and he does not notice a taint in the soil, which would be very perceptible were he breathing as near the ground as the fowls are.

Were it not for the careful breeding, by selection and pedigree, we would not yard the breeding birds at all. The disadvantage of the yards and runways such as have been described, is that the straw on which the grain is dropped cannot be stirred by team and hay tedder and horserake. But, since the breeders' yards are few, the time taken in stirring the litter is unimportant. It will be found that the attendant's boots are handier than a fork, if the straw is comparatively new and unbroken, for he can easily kick it loose several times daily, when it becomes compacted under the feet of the fowls. The ideal way is to not only drop grain upon straw by mechanical apparatus, but to stir the straw also and mix straw and grain together by machinery. This can be done to great advantage under the intensive system, to be described further on, but as it is desired to have the houses and yards for the breeding birds movable, for

putting the land in crop every other year, the shelves and hammers, which are easily set up with or without bells, are all the apparatus with which we would burden the moving. In this connection, it may be observed that the advantage of the low down form of wagon for moving fences and hurdles to a distant spot annually is very apparent.

## CHAPTER VII.

### HOUSES FOR SITTERS.

The stock used for hatching purposes is managed differently from the layers, and needs different accommodations. The houses for sitters, Fig. 21, are near the center of the farm, where the granary and cook room are located. They accommodate 100 fowls each, are not movable, and are set upon a stone or brick underpinning, 10 in. high. They are 10 ft. 4 in. from the ground to the peak, and 20 ft. long by way of the ridge, and 16 ft. wide. The roofs are shingled, and the ends of the buildings covered with boards nailed upright and battened. About one-third of the roof towards the south is glazed, the windows being partially darkened as warm weather approaches. The form of these houses, like that of all in the establishment, with eaves near the ground, is adapted to afford as much ground room as possible in proportion to the lumber used. The roof of each house is crossed outside by a picket fence running at right angles with the ridge. This fence forms one side of the yard with which each house is furnished, and though it extends only 18 in. above the ridge of the building, the sitters, not being of a high-flying breed, will not get over it. By this arrangement, exit is afforded to the fowls and to their keeper at either end of the building, into a yard which is located at either end on alternate years. The two ends of the house, one fronting east and the other west, are both provided exactly alike with doors and windows. The large doors are 6 1-2x3 ft., opening outwards, and the smaller ones

attached to them are 7x9 in. The windows are 2x3 ft., and are hinged, opening upwards for ventilation. In hot weather the windows and doors in both ends of the building are opened wide, and to prevent the fowls escaping at the end where there is no yard, wire netting is fastened across the window casings inside, and there is an inside door of the same material hung to the stud, to which the outside door is hinged.

Figure 22 gives an interior view of the house. There are four perches, each 15 ft. long, and of the width and

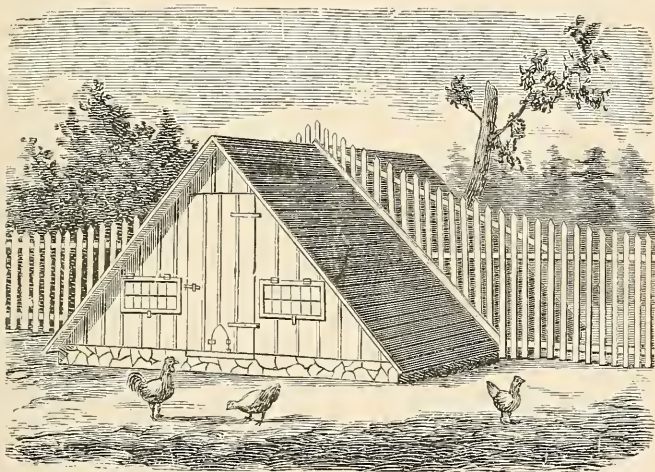

FIG. 21. HOUSE FOR SITTERS.

thickness of those for layers. They are placed 18 in. higher than the top of the underpinning, those nearest the nests being 3 1-2 ft., and those nearest the eaves 5 1-4 ft. from the center of the building. A space 2 1-2 ft. wide at each end of the room is left unoccupied by the perches. Three tiers of nests occupy the center of the room, each tier consisting of two rows placed back to back, and running in the same direction as the

perches. There are 12 nests in each row, or 72 in all, and as each nest is 1 ft. square and 1 ft. high, they occupy 12 ft. in length. This allows a space of 4 ft. at each end of the building between the nests and the doors, and as the latter are planned of a sufficient width to admit a wheelbarrow, and the perches are made so as to be easily moved, opportunity is afforded to wheel in or out the dry earth which fills the bottom of the room halfway up to the top of the underpinning. There are nests enough so that eighteen hens may be set at once, and leave room for fowls that are laying. The nests are

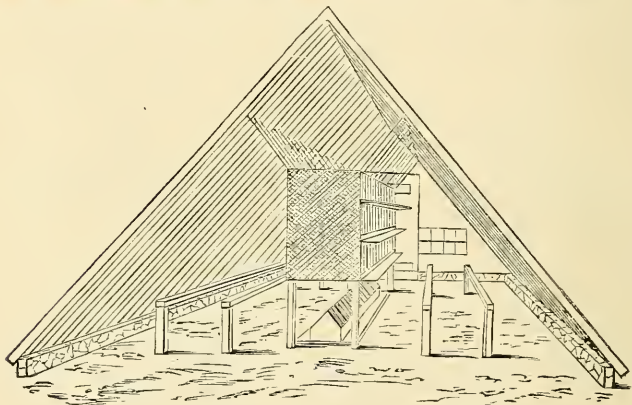

FIG. 22. HOUSE FOR SITTERS—INTERIOR.

placed so that the bottom of the lower ones are 6 in. higher than the perches, this height enabling attendant to avoid stooping, as there is much work to be done about the nests of sitting hens; while they are not so high as to prevent the fowls reaching them by flying upon the nearest perch, or as to render a ladder necessary. The nests are made so that the hens enter them at the front, where a 3 in. strip set edgewise prevents the eggs from tumbling out. An alighting board projects 2 1-2 in. in front of each row of nests.

The partitions at the backs of the nests are made of wire netting, one-inch mesh, to keep out rats, those at the sides of the same and of a two-inch wire netting, alternately, for purposes described in another place. In this way a circulation of air is allowed for the health of the sitters. Sufficient attention is not generally given to this point. Fowls in a state of nature being accustomed to scratch holes in the ground under bushes, to form their nests and incubate where there is plenty of air, pant and show distress in hot weather when forced to occupy close boxes. Large doors of wire netting, two-inch mesh, not shown in the illustration, prevent the fowls roosting at the entrance to the nests at night. These doors are closed after gathering the eggs towards evening, and opened again the first thing in the morning, and are made in two parts, folding together, so that there may be room for them overhead, when raised. A piece of rat-proof netting is placed in front of a nest occupied by a hen engaged in hatching, and fastened by buttons, to keep out laying fowls by day and rats by night. To keep the fowls from using the upper part of the room as a roosting place, wire netting or lathwork, a part of which is shown in the figure, extends from the top of the upper nests to the roof. Underneath the lower tier of nests is placed a feed box, made like those with which the houses for layers are furnished, and others of the same construction should be placed on the ground at the ends of the perches, and at right angles with the latter. Five houses for sitters, each with its yard, will be required for an establishment of the size we are describing. The arrangement of the yards is shown by Fig. 23. The fence, *A B*, is made like the buildings, *C*, non-movable. The fences on the remaining three sides of the yards are moved yearly. Suppose that last year the yards were located at *E*; then this year they are at *D*, and *E* is



devoted to crops. A strip of ground is left untilled near the doors of the buildings for a wagon path. To keep the yards free from taint and afford scratching ground, a part of each is plowed occasionally during the season when they are occupied by the fowls. All the fences running east and west, as *F B*, are composed of gates, so that by opening, for instance, at *F G*, through the whole range of yards, a strip of each may be plowed, and in a few days the operation may be repeated at another part of the yards.

To these yards, movable runways, made in sections, are annexed, not shown in the ground plan, Fig. 23,

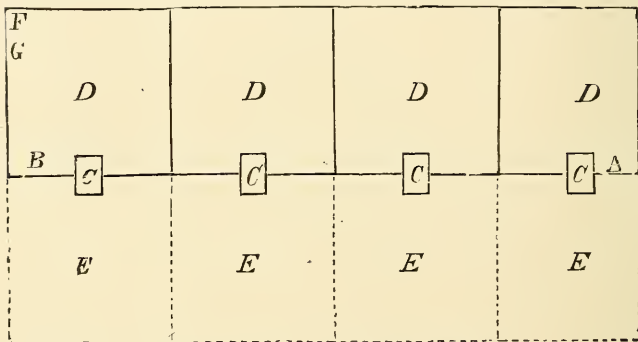

FIG. 23. PLAN OF YARDS FOR SITTERS.

and these runways extend to distant yards, where there are feed shelves, hammers, and so on, exactly like those in the yards for breeders, previously described. The paramount consideration is the welfare of the sitters when engaged in incubation. For the management of sitters in the buildings just described, see Chapter XIV.

#### HATCHING BY WHOLESALE.

There is a better plan than the one just described for houses and nests for sitting hens in the southwest, where the poultry business is destined, for reasons briefly stated

in the introduction, and which will be more fully given further on, to reach a greater development than in any other part of the United States or of the world.

Numerous unsatisfactory methods of managing sitters on a large scale have been tried. The plan of confining each in a small, separate pen, like that shown in Fig. 24, or some modification thereof, has been weighed in the balance and found wanting. It may be occasionally tried to advantage by the villager, who keeps only a dozen fowls or so and has only a very limited space for them, but on a large scale this separate confinement plan will not do at all, because the sitter does not sufficiently air her plumage, nest and eggs, and what is of still more importance, her bowels get out of order for lack of exercise, resulting in foul nests. This trouble does not always occur, it is true, but it will happen in a sufficiently large proportion of cases to be very objectionable indeed. No person can long endure the sight of a lot of sitting hens, some badly out of condition, and none just right, if he has a keen sense of what is thrift. We mean that instinctive demand that his charges shall be in the pink of condition, which distinguishes the best keepers in all departments of livestock raising, and without which nobody can make a good poultry man anyhow. Nature has provided that the sitter shall bustle around at a great rate, and race up and down the range as if determined to crowd in a half hour the exertion she spread over a whole day when a laying fowl. If denied this running exercise, sitters are liable to be afflicted with constipation, alternating with the other extreme, resulting in nests of unspeakable filthiness. Study nature, and you will find that a sitter allowed a free range never fouls her nest, and nobody has to bring a basin of warm water to wash her eggs. Any system of managing sitters in great numbers that calls for the washing of eggs and renovating filthy nests, cannot com-

pete with incubators. There is another thing about the sitting hen and her stolen nest. The delights of liberty keep her from returning to her nest prematurely. The eggs, and the nest itself, are thoroughly aired and purified from exhalations, and as the sitter keeps her feathers bristled nearly all the time, her plumage likewise undergoes as thorough a treatment as did your mother's feather bed when she used to give it a good sunning. The nest and the feathers upon the eggs are sweet in the case we have supposed, but they never are perfectly sweet and fresh when sitters are individually confined in small, separate pens in rows or tiers, an abomination in the sight of men and angels. Running and flying, rather than scratching, are demanded, although all are employed. There is an intimate relation between exercise of the legs and normal action of the bowels, this being true not only with fowls, but with all other species of animals which have locomotion and digestion, human kind included.

Another objection to separate rooms is, that if feed is placed so that the hen can leave her nest to eat at pleasure, rats are baited to the spot, or if each room is made rat-proof, it will be too expensive. To feed and water individual birds in separate apartments takes much time, and if several are placed in one room, they must be looked to, or two will take to the same nest. But if surveillance is attempted, it will be handier to carry it out by placing many in a large room.

Incubator manufacturers have fattened on the shortcomings of sitting hens under improper management, but a little ingenuity will achieve a success that will vindicate the methods of mother nature. Art is at its best not when supplanting nature's ways, but when assisting them to have free scope and be glorified. If a one-hundredth part of the mechanical ingenuity which has been lavished on incubators during the last thirty

years had been spent on contriving good methods of managing sitting hens, in place of the separate confinement plan, there are thousands of persons all over the United States, who have failed in attempts at artificial incubation, who might have followed nature's method with success. Incubators have their uses, but they are only for the winter or to supplement sitters. A given number of eggs can be attended to under Plymouth Rock sitting hens, and a larger per cent of strong, healthy chickens hatched out than by the use of incubators, and with less labor of the attendant, the grain for the birds costing less than the oil for the machines, and the whole equipment of buildings, nests, yards, runways and fixings, all told, costing decidedly less than incubators of the same egg capacity and the cellars to contain them. The incubator idea has been overworked, and the method of nature underrated. The patent office contains hundreds of inventions for regulating heat in incubators, over which persevering mechanics have racked their brains, but the animal economy in a state of health, either in case of man or the sitting fowl, regulates heat to a marvelous nicety that puts all mechanical devices to shame. Summer or winter, awake or asleep, whether we are sitting still or at violent exercise, though we may feel cold or hot at times, yet the thermometer shows that the temperature of our bodies is essentially invariable, cases of severe sickness excepted. Then look at the wonders of the plumage of a fowl. A feather is one of the masterpieces of nature. Combining strength, elasticity and lightness, it is at the same time a good non-conductor of heat, it affords the most perfect ventilation, and, like the fur of animals, it both sheds rain and repels dirt. A mole burrows in the dirt and remains as clean as a coin fresh from the mint. It is hard to tell which is the most marvelous production of nature, an egg or a feather.

In undertaking to compete with artificial incubation and rearing and to distance the artificial methods, any and every kind of sitters must not be employed. The Asiatic breeds give a gentle disposition and unrivalled persistence, but the feathers on their legs are in the way. The most gentle and Brahma-like Plymouth Rocks of large size, selected for motherliness and for freedom from the nervous activity and liability to scare and fret that some of the smaller breeds possess, are just the thing. To all intents and purposes, they are Light Brahmas, with their excessive size and the black of the plumage and the leg and toe feathering bred out, and length of wing and a certain lightness of movement, the reverse of the Brahma clumsiness and awkwardness, bred in. A hen of the improved breed of sitters can cover from sixteen to twenty eggs, according to the season.

Some persons have objected to the cost of the feed for sitting hens while they are incubating. It is not lost. They need a rest from laying, anyhow, and lay the better for it. If they do not lay at one time of the year, they will make up for it at another. While at a resting spell they would have to be fed, whether sitting or not, but the expense of heating incubators is a dead weight. Among other advantages of the natural system, an important one is that it does not demand so high priced a man as the artificial system does. The first is easy, the last is comparatively difficult and keeps the attendant on a rack and strain more or less, that must be paid for; or if he is a master of the art and so has little anxiety, then the time he spent in becoming a master of the art must be paid for. But, if you have the proper conveniences, calm as a May morning you can attend sitters, not by the hundreds, but by the thousands, with not a care in the world. Their temperature will always be correct.

It is essential to have complete control of the sitters and of their nests, and the attendance at every stage must be performed well, quickly and with ease. No operation must be awkward or at a disadvantage, if natural hatching on a large scale is to be made to beat hatching by machine. The maxim must be kept in mind, that whenever a thing is to be repeated hundreds of times and often, a saving of a second, and also avoiding a cramped or laborious position of the worker, is of the utmost importance in lessening expense.

Inconvenience costs money; not only is wear of muscles to be saved, but wear and tear of brain and patience. It takes too much mental steam to run incubators and brooders, as compared with sitters and brooding hens. Nature has, as we have said, regulated the heat of the latter perfectly, and made most exquisite provisions for ventilation and moisture—natural provisions not properly appreciated by poultry men during the incubator craze. Incubators are at their best in the winter broiler business, and as adjuncts to early spring hatching under hens in sections of country where winter is prone to linger in the lap of spring. But the millions of tons of poultry to be needed in the great future will be raised, dressed and shipped, both with and without cold storage, where the winters are so short and mild as to be reckoned with but slightly,—raised just a little to the south of where the bulk of the cattle, sheep and swine are now fattened. Just where the great district of the cheapest grain in the world touches another district where mild winters prevail, which are of much greater importance for poultry than for beef, pork and mutton production, and where natural incubation is at its best.

A man can work more hours each day, and have greater peace of mind and live longer on earth, if he attends to natural incubation and rearing when he has the very best conveniences for it, as compared with the



person running the very best incubators and brooders in the world under the mental tension and watchfulness their successful use implies. Tending sitters in great numbers, unless with conveniences, is, however, an abomination. Any plan of managing them that places the operator at the mercy of their whims and cranks, and the liability of their lice and uncleanness, makes his task irksome in the extreme, and costs in dollars and cents. They have certain traits and habits, however, which we can rely upon and turn to our advantage. Nature has placed within our reach vital machinery of such wonderful precision that nothing man can make will ever rival it.

Hatch chicks artificially and rear them in brooders, where location demands, and market them in ninety days from the shell, and besides, use the incubators, if you choose, to supplement sitters, but never rear a bird to keep to adult age for a sitter, or to exhibit, or for a breeder, except under a good, motherly hen. The egg must, in the first place, be laid by a fowl kept under sanitary conditions that were perfect, and during incubation be surrounded by air much better and purer than that in incubators averages; and then, while the chicks are getting their growth, they should never see a fence, but have the use of as much of the United States as they choose to travel over. Pullets thus hatched and reared, and from an ancestry thus hatched and reared for several generations, will have constitutions that will stand forcing (to get eggs for food purposes only), and can be put through the severest ordeal of rich and stimulating diet for a year after completing their growth, when they should be killed and their places given to new recruits. The colt reared in the green pastures and beside the still waters, and from a country-bred sire and dam, you can take at its maturity to toil in the city streets. You are trading on the vitality stored up by

the animal in its youth, and on that which was accumulated by dam and sire and great-great-grandsire. But, on the other hand, the city would be a poor place in which to raise colts.

The successful business men of our large towns were nearly all country reared and descended from country bred ancestry. They go to the city with a full head of vitality it has taken generations to accumulate. The artificial life dissipates vitality, it does not accumulate it, although it may sometimes accumulate money. No large city perpetuates its own number of inhabitants. It would become depopulated were it not for recruits from the country. The blooded fowls, or their eggs for hatching, bought and sold and disseminated by millions all over the world, would leave descendants more plenty than blackberries, were it not for the fact that not only are incubators and brooders used considerably, but both sellers and buyers are prone to stive the highly prized birds up in such close quarters, and subject them to so many other unnatural conditions, that they peter out after awhile. Trace the history of dozens of importations of choice poultry brought into your neighborhood, good reader, within your remembrance. Ask what has become of them. The answer will be, in a large proportion of cases, "they all ran out."

## CHAPTER VIII.

### FOR SITTERS IN MILD CLIMATES.

According to the best method of managing sitters in the region of mild winters, from which the bulk of poultry products is to come eventually, the house for sitters needs no glazing and no siding, or very little siding, but should have a good, tight, shingled roof to keep off rain. In the belt of country where the trainloads and shiploads of poultry, necessary to supply in the future not a hundred millions, but hundreds of millions, of our own people, and foreign lands as well, can be raised most profitably, the climate permits poultry to roost in trees the year round and do quite well, as has been demonstrated for a century.

In such a climate, with an enormous tract of prairie joining it on the north, affording a supply incalculable in quantity of the cheapest grain on earth, the cost of producing poultry products is at the very minimum, and even with cost of transportation added, it is still at the minimum. In the redistribution of industries, compelled by the laws of business competition—laws as irresistible as the attraction of gravitation—a commodity will always be produced, in the long run, at exactly the most advantageous point. Therefore, at Kansas City, or not more than a hundred or a few hundred miles away, will be shipped yearly thousands of tons of poultry, alive or dressed, refrigerated, frozen, or canned.

The buildings in Arkansas and Oklahoma will need next to no siding at all, but in southern Kansas there should be hinged or folding sides to be let down in win-

ter. To protect against heat in our model house for sitters at the southwest, a tight, level floor should extend from plate to plate, making an air chamber of all the space in the building above the posts. This floor may consist of matched stuff or of straight edged boards, reinforced by building paper. The roof gets hot and this air chamber protects the fowls, and their attendant also. A shutter of liberal dimensions, in each gable near the peak, governed by cords, must be kept open in summer, to permit the heated air to escape, but it must not be allowed to escape in winter, as it serves a useful purpose during the cool nights.

The length of the building is 155 ft., 144 ft. of which are in the hatching room. The width is 11 1-2 ft., width of central alley, 2 1-2 ft. Measurements in the direction across the alley are as follows: Nest, 1 1-3 ft.; treadle, 1 2-3 ft.; feeding space, 1 1-2 ft. The roof is double, that is, it slants down from the ridge in two directions. An alley for the attendant is dug in the ground, lengthwise of the building, in the center, 2 1-2 ft. deep and stoned or bricked at the sides. The building is double, there being nests, treadles, and a feed space each side of the alley. Immediately adjoining the alley on each side is a row of nests at the bottom of the fowl house proper, thus they will be 2 1-2 ft. above where the attendant stands. The place where work is to be done should be of this convenient height, for the same reason that a store counter or a work bench stands above the floor. It was a big mistake to locate nests, brooders, etc., on a level with the poultry keeper's feet, as has been done all over the United States.

A car runs the whole length of the building on a railroad in the alley, twenty inches above the bottom of the alley, the rails being held by supports fixed in the walls. As ease and dispatch in certain portions of the work depend on this transportation feature, the rails and the

car must be of the best, so that the latter may be moved at a touch. A wheelbarrow is sometimes used in a poultry house alley, but it is a nuisance, because, among other objections, two hands are used in propelling it, but a car can be pushed by one hand, or by the attendant's body, leaving both his hands free. The best way is as good as any other way. The car is provided with conveniences the most handy that can possibly be contrived for transporting the fresh, moist earth used in the nests of sitters, also eggs and, on occasion, mother hens with their broods of newly hatched chicks.

The laying hens, destined for sitting when they become broody, must occupy the same building as those

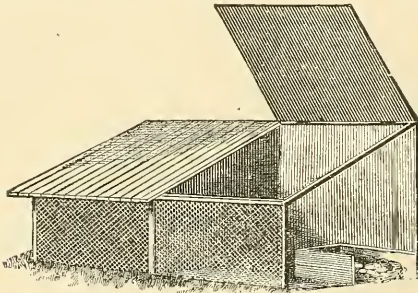

FIG. 24. COOP FOR SINGLE SITTER.

actually sitting, because it takes time to move sitters from place to place. A sitter incubates in the same nest she used while laying. To keep laying birds from access to nests of sitters a trap system is employed, each sitter shutting herself in. In other words, when the sitter is off her nest the trap is set, and when she goes on it is sprung and she is a prisoner. The construction of these traps will be described in detail, because they are the controlling feature of the system of management, with reference to which all the rest is contrived. By but little more than a simple turn of the wrist, the attendant can perform many of the most important

operations about the nests, from either end of a building one hundred and fifty feet long, without going down the alley.

Figure 25 shows the operation of a treadle, *T*, at the bottom of one of the separate passages, leading to a separate nest, this treadle being operated by the weight of the hen, which releases a figure 4 catch and closes the passage door, thus confining her and shutting laying fowls out. In this cut, the sides and top of the nest and of

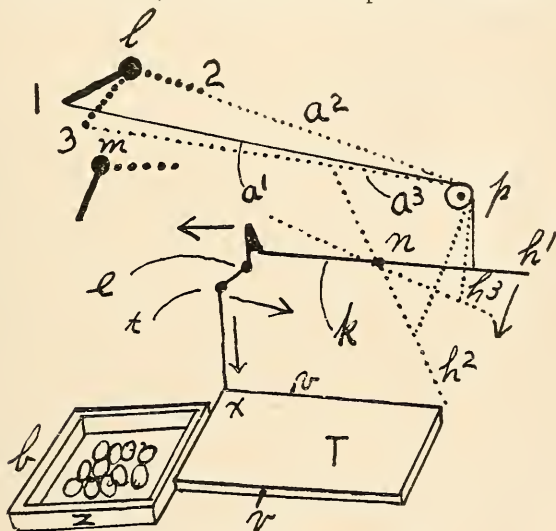

FIG. 25. APPARATUS FOR SITTERS.

the passage leading to the nest, and other things in the vicinity are omitted; the purpose being merely to show how the hen shuts herself in. The treadle, *T*, eleven inches wide, or just enough scant to play freely in an eleven-inch space, and twenty inches long, forms the bottom of the passage, which is large enough to admit a fowl and allow her access to the nest, *b*. In this cut, an edge view is given of the door, *h*<sup>1</sup>, pivoted at *n*, and raised by the cord, *a*<sup>1</sup>, which passes over the pulley, *p*.



Attached to the door is the door lever,  $k$ , this lever being held down by a figure 4 catch. This we call the first position of the door. The hen enters on the treadle at  $T$  and walks toward the nest at  $b$ . The treadle, being moved downward by her weight, turns on the pivot,  $v v$ , which has bearings on the side of the passage not shown in this cut. To the treadle is attached a rod, jointed at  $t$  and pivoted at  $e$  and at  $x$ . When  $x$  moves downward, as indicated by the arrow, the motions of the other parts

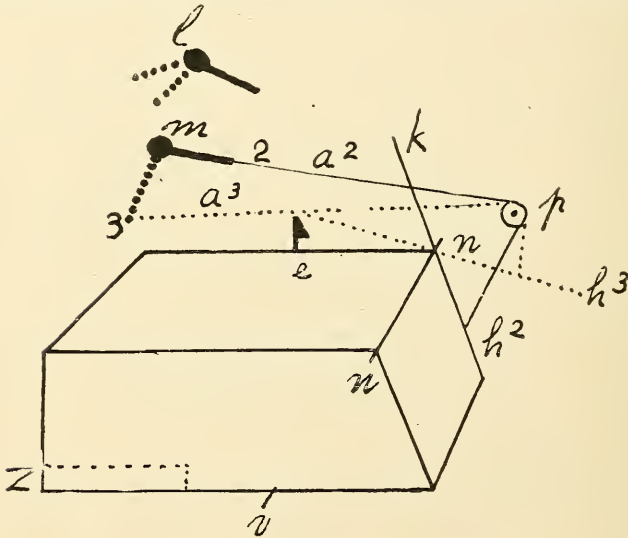

FIG. 26. APPARATUS FOR SITTERS.

are also in the directions of the arrows,  $t$  going downward and toward the right and the figure 4 toward the left, releasing the door lever, and causing the door,  $h^1$ , to fall by its own weight and close the passage. When the door is shut, it is in the second position, and it stands, not perpendicularly, but on a slant, as shown at  $h^2$ , Fig. 26. In this cut, the top and one side of the passage and nest are shown, which, of course, hide the

treadle rod, but Fig. 26, being designed only to show the working, is not an exact representation of the nest and the passage to the nest, there being in reality a liberal employment of wirework in top and sides of these for the sake of air.

Now, as there are 144 nests in a horizontal row or tier, each with its passage, door, treadle, and other parts; to set all these traps by hand, in other words, to go through the alley and depress each door-bar singly to make each engage with its catch, would take too much time. A trap-setter must be employed to set them all at once, or as many as are in use for hatching purposes. An iron shaft, *l*, in Fig. 25, and also *l* in Fig. 26, consisting of a common 3-4 in. water pipe, extends the whole length of the row of nests, a transverse section of this shaft being shown also at *l*, Fig. 29. The shaft has bearings made by driving staples into a 2x6 stick, attached immovably to the building. To the shaft, at intervals of 1 ft., corresponding to the width of the nests, are attached arms of large wire, each 11 in. long, with a loop or an eye in the end farthest from the shaft, as at 1 in Fig. 25, to which the cord, *a*<sup>1</sup>, is fastened, a small snap hook being tied permanently to the cord and snapped into the eye. This cord passes over the pulley, *p*, and is fastened to the door, *h*. It will be readily seen that when the shaft, *l*, has been turned, by means of a lever at either end of the building, operated by the attendant, so as to throw the arm to the point 1, as shown in Fig. 25, the door is raised to the first position (and, of course, all the doors in the tier, attached by cords in the same way, are brought to the first position) and all the sitters are able to enter the nests, their daily run out of doors being finished. Having set all the traps, the shaft is turned to bring the arm to the point 2, so that the cords may be slack, permitting each hen to drop her own door.

The doorway to the door is narrowed by tacking on strips of wood, according to the average size of the birds, so that two hens cannot enter abreast. One or two split shot, such as are sold to anglers for sinkers, are attached to the cord near the center, so as to take up the slack and keep the cord slightly taut over the pulley, *p*, while waiting for the hen to drop her door. Treadles should be made of three-eighths or one-half inch boards, so as to be quite light, and hung so that the end nearest the door will be merely heavy enough to overcome the friction of its pivots and of the joint and pivot of the rod, so as to keep the door end of the treadle down at all times, excepting when the trap is being either set or sprung.

When, the next day toward night, it is desired to open all the doors to liberate the sitters, the shaft, *l*, is turned so as to move the arms to the point 3 and the doors to the point *h*<sup>3</sup>, called the third position; they being lifted not quite as high as the first position, but high enough to let the birds pass out. When the sitters are all out, turn the shaft back to 2, to put the doors in the second position,—that is, they will be closed so that none of the birds can return to their nests prematurely; for overzealous sitters are prone to air the eggs too little, and to not spend sufficient time in dusting themselves, exercising, eating and drinking. After an interval of five or ten minutes or an hour or more, according to the weather, the trap-setter, *l*, is again employed as previously described, to bring the door bars into the keeping of the figure 4's, so that the doors will be in the first position.

Now there are one hundred and forty-four nests in one row and only one hundred or less of these are to be used at one time by sitters, leaving forty-four or more to be used by the laying fowls, which occupy the same building. When a nest is no longer needed for a sitter, and

is renovated and prepared for the use of the layers, the snap hook is detached from the eye and attached to a similar eye at the end of an arm belonging to a shaft, *m*, which is the duplicate of the shaft *l*, and which operates as the latter does, only it is never used to bring doors to the first position. The shaft, *m*, is to put the doors leading to layers' nests into the second position (closed) before liberating the sitters, this precaution being necessary to prevent sitters from blundering into the nests of layers. As before remarked, the sitters are let out toward night, the layers having finished business for the day.

The distances the shafts *m* and *l* are, respectively, from the point where the cord is attached to the door, *h*, must have careful attention; *m* can be the nearest to the alley and *l* the highest, and both must be so placed that the cord will exactly reach from arm 2, on both shafts, to the door, when these arms are at the second position. Then the first and third positions will take care of themselves, and the length of cord having been once fixed upon need never be changed. The cords are small and may be the best quality cotton shoe string, or other stout, non-stretchable material. Bore a three-sixteenth inch hole, slantingwise, through *h*, in which insert a homemade affair like a violin peg to attach the cord to, so that by turning the peg you can wind or unwind the cord and it may be readily brought to the exact length necessary to completely close the doors and also operate the figure 4's with precision.

When you arrive on the scene, the sitters' doors are supposed to be at the second position (closed) and the layers' doors at third position (nearly full open). The order then proceeds as follows: Layers' doors, you throw to second position (closed); sitters' doors, immediately to third position (nearly full open); after a short interval, sitters' second position (closed); after a longer

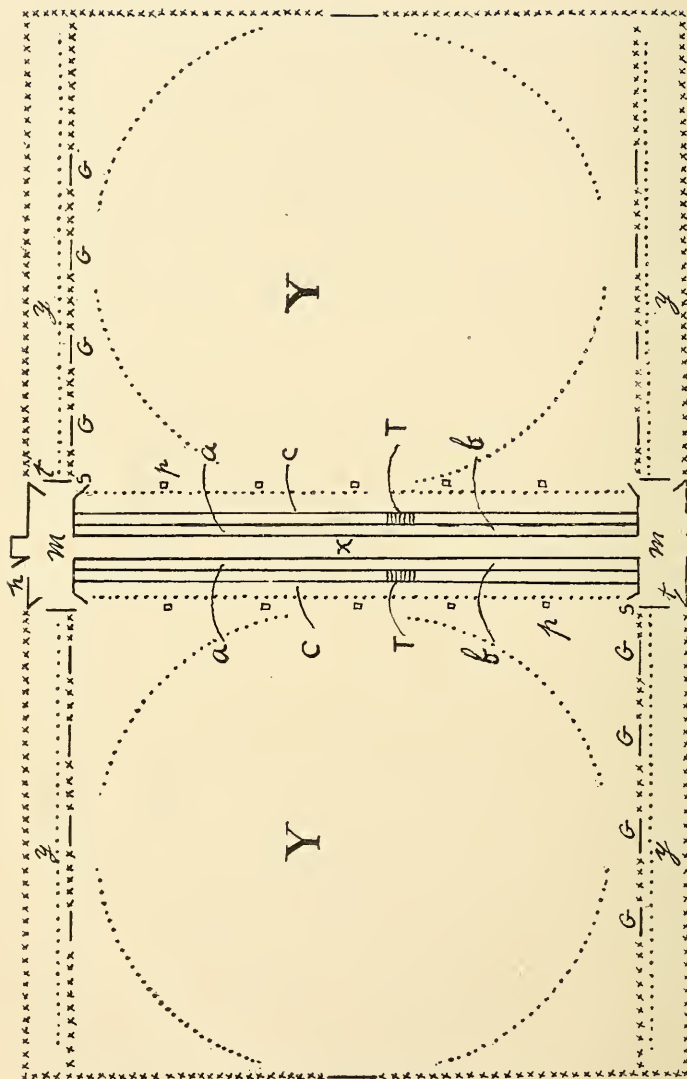

FIG. 27. GROUND PLAN OF HATCHING HOUSE.

interval, sitters' first position (wide open and traps set). Finally, after a still longer interval, the layers' nests to third position (nearly full open) and then everything to remain till the next afternoon. The whole program is elsewhere more fully described.

We now invite attention to Fig. 27, which is a ground plan of the hatching house with its yards attached; it being an equivalent of an incubator cellar and an equipment of 10 incubators of 300 egg capacity each, though

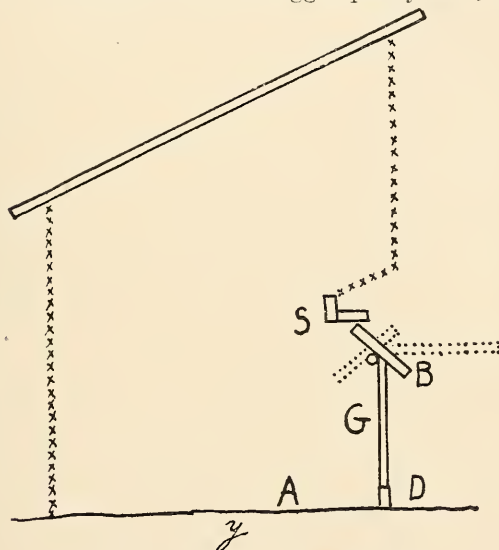

FIG. 28. SECTION OF COVERED YARD.

it costs much less and turns out more and better chicks, with more certainty and less work. *Y, Y* represent large yards and *y, y, y* small yards. The building is 11 1-2 ft. wide and 155 ft. long, or 144 ft. exclusive of the rooms, *m*, at the ends, but the length is very materially reduced in the cut to give space to show details plainly. The small yards, 5 1-2 ft. wide, are roofed over for protection against sun and rain, but there is no air chamber.



A transverse section of one of these covered yards is shown in Fig. 28. In both Fig. 27 and 28, the small

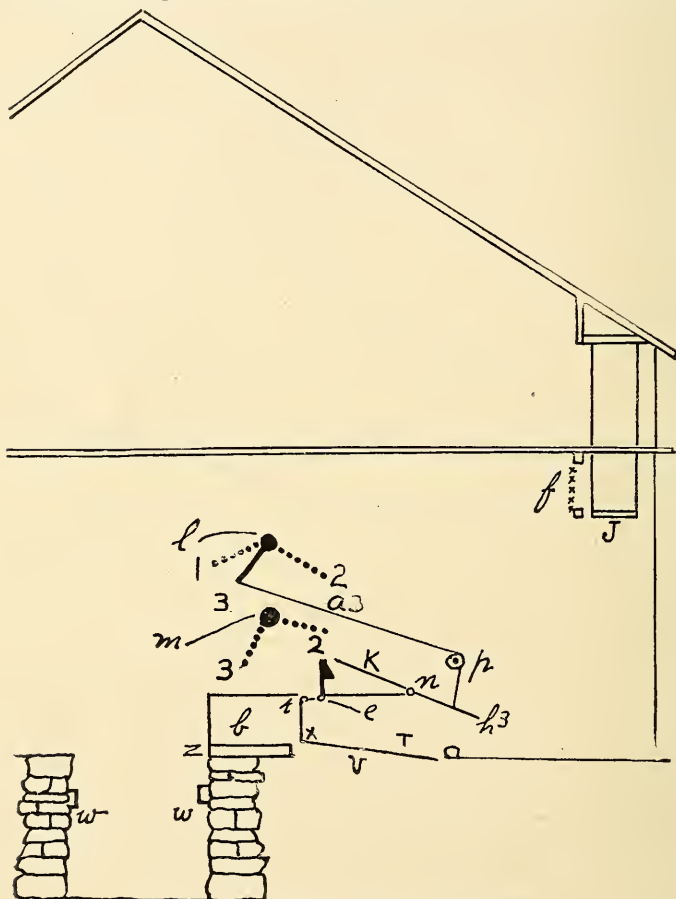

FIG. 29. INTERIOR OF HATCHING HOUSE.

crosses represent wire fences. In Fig. 27, the rooms, *m, m*, are where the operator stands to work the trap-setter and to control the layers' nests also, as mentioned

in the description of Fig. 25, and to operate the feed shelves, six in all, which are suspended in the main building and in the small yards over the dotted lines in the cut. The construction and working of these shelves is explained elsewhere. See Figs. 17 and 18. A transverse section of one of the shelves hung up in the main building is shown at *J*, Fig. 29. See description of various modifications of feed shelves, the simplest being the best. In Fig. 27, the long, narrow space, *a*, is occupied by nests and *c* by nest passages, both being of the kind previously described. A few of the nests are shown divided off in the cut at *b* and a few of the nest passages are divided off at *T*. Compare *T* in Fig. 27 with *T* in Fig. 25 and with *T* in Fig. 29, keeping in mind that the floor of each nest passage consists of a treadle. The alley, *x*, for the attendant, previously described, being sunk 2 1-2 ft. below the ground, the end rooms, *m*, *m*, are also excavated to the same depth for better convenience, and steps outside the building near the outside doors, *h*, *h*, lead from the ground level to the continuous pit or shallow cellar, *m x m*. At each end of the long alley and near the door, *h*, a small ell or projection will be seen, attached to the main building. The railroad extends into these ells, which are just large enough and high enough to hold the car, so that it will be out of the way when not in use. A section of the railroad track four feet long, situated between the ell and where the row of nests begins, is movable, that is, a piece of each rail is hinged at one end and can be turned up out of the way when railroad and car are not needed.

Gates, to permit fowls to pass from *Y* to *y*, are shown at *G*, *G*, *G*, *G*. Figure 30 illustrates one of these gates, *G*, made of wire netting, attached to a light wooden frame, and *G* in Fig. 28 shows a gate in a perpendicular position and also, by means of dotted lines, a horizontal position. The yard, *y*, in Fig. 28, is roofed over. As

there are four small yards, there are, of course, sixteen gates in all, each being two by two feet. The four gates of each group, *G*, *G*, *G*, *G*, are opened and closed as one gate, by means of a wire, starting from one operating room, *m*, and running the whole length of the main building to the opposite operating room. The farthest gate in a group is thirty-three feet from the main building. The gates are pivoted, transom fashion, and are perpendicular when closed, as at *G* in Fig. 30 and at *G* in Fig. 28, and horizontal while open. They have a common pivot, consisting of a shaft of iron pipe, to which they are fastened in such fashion that they turn

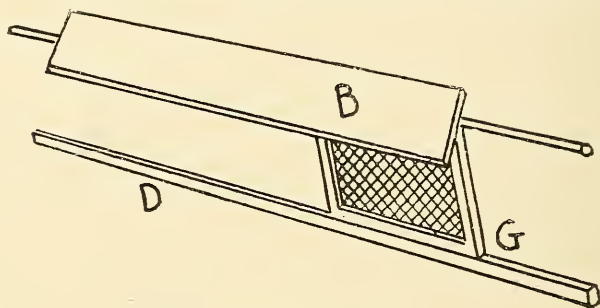

FIG. 30. GATE FOR COVERED YARDS.

with it, not on it. The shaft extends into the operating room a few inches, where is attached a strong spoke or arm, three feet long, and to this arm is fastened the wire above described. By taking hold of the arm itself, if you are at the nearest room, or by means of the wire if you are at the distant room, the shaft is caused to make one-quarter of a complete revolution, which is all that is required to open the gates. They are made so as to close by gravity when released, and when shut they come to rest over the bottom fence rail, *D*. A board, *B*, runs the whole length of yard, *y*, and rests on the gates. See *B* in Fig. 30, and compare with the trans-

verse section of *B*, Fig. 28. When the gate is open, this board is at the position shown by the dotted lines in Fig. 28, and the feed dropping from the shelf, *S*, will land at *A*, but when the gate is closed this board, being in another position under the feed shelf, intercepts the falling grain, causing it to reach the ground at *D*, in the big yard instead of in the small one.

Now, as heretofore mentioned, the layers of the sitting breed and the sitters actually sitting, occupy the same building. The layers are allowed the freedom of one large yard, *Y*, and two small yards, *y*, during the day, the four gates, *G*, being kept open all the time, excepting during the latter part of the afternoon. Wire netting is stretched so as to prevent the birds from getting at the feed shelf. The latter being only two and one-half feet from the ground, it is conveniently reached by the attendant, who passes the whole length of the covered yard each day to load the shelf. At intervals, during the day, whenever he is in either room, *m*, he operates the shelves at all four of the small yards for the exercise of the layers. The running they actually do while he is controlling their movements is only a small part of the scheme. The habit of expectation being formed, they will run back and forth hundreds of times every day and visit the small yards, whether the shelves are operated or not. The feed shelves in the main building are operated by hand hammers only and at either end indifferently, but those in the small yards are operated by pivoted hammers, cords, pulleys and wires (as described elsewhere) when you are at the end of the main building the farthest away, and by hand hammers when you are near. In the ground plan, Fig. 27, the straight dotted lines show the location of the six shelves. One of the shelves in the long building is shown suspended by wires or cords at *J*, Fig. 29. This shelf being, as we have said, operated by hand hammers at

either end, must be allowed to swing freely both ways and therefore it has no stopper, but the shelves in the covered yards, *y*, have stoppers to swing against, the same as shown at *i* in Fig. 111. At either operating room, no matter which, you can, by this very simple, extremely durable and exceedingly cheap apparatus, which, moreover, is not liable to get out of order, control every nest, either of sitting or laying bird, and operate any or all of the six feed shelves, and open or close all of the sixteen gates. You can separate the layers as a whole from the sitters in less than half a minute, and at will separate each individual sitter from all the layers and from all the other sitters.

The employment of sitting hens in large numbers has not hitherto been looked upon with favor, because poultry keepers have not availed themselves of suitable conveniences, having, in fact, not been aware of the certainty and precision with which the birds can be made to do what you want them to do. A flock of two hundred can be made to run two hundred feet in a minute, either towards you or away from you or to the right or the left, as you choose, and this without your having spent any time at all to speak of in their preliminary training. Just a few pulls of a wire or some other appliance, while you are at the premises working at other matters, and, lo and behold, they have a liberal education,—are highly accomplished, in fact, before you know it. You can then do just what you want with them by merely reaching for a lever or a cord. The bugbear of sitting hens has vanished into thin air. There is not a thing expensive, excepting the six hundred and sixty feet of shafts or pipe, and this, thanks to the cheapness of modern iron goods, costs less than the price of one of the ten incubators it displaces. The figure 4's and connections seem rather costly, but made in quantities are really quite inexpensive, and all the small wooden parts

of the nests and passages can be cheaply sawed by power. The pipes should be put in position and screwed together and the places for holes, of one-eighth inch diameter, marked, after which the drilling should be done by power and by means of these holes the arms can be readily attached in the main building and the gates fastened on at the covered yards. In comparison with this simple and cheap equipment, an equivalent in incubators and suitable incubator rooms or cellars is complicated and costly.

It is a matter of no consequence whether or no a sitter returns to the identical nest she left, but it is desirable that she should return to one not far away, and she will always do so. If her nest is near the center of the row, she will not go to either end of the row, and, if she belongs near the right-hand end of the row, she will not mistake the left-hand end for it. To facilitate matters, layers' nests are mixed with those of sitters the whole length of the row, and localities are designated by barrels, boxes, sheaves of straw, boughs, etc., placed just outside the building. See Chapter XIV.

Just before opening the nests of the sitters, a feed shelf in one of the small yards is operated, and, after waiting a short interval for the layers to get in—they make tracks at a rate not to hinder you long—they are shut in by operating the gates. The shelf and gates at the opposite small yard are next used to catch any layers not captured the first time, though probably ninety-eight per cent or more were caught. If one or two or three in a hundred are not entrapped at all there will be no particular harm. The principal object in separating the layers is to prevent them from devouring the feed designed for the sitters. Troughs, ample for a full day's supply of water for both layers and sitters, are in the large yard. Of course, labor saving requires that this be conducted by pipes and the flow governed by simply



turning a cock. Or, in the region of mild weather previously described, a float valve can be used during the greater part of the year to govern the supply and the attendant need not lift a finger. For the greatest convenience in feeding grain, bins are located in the operating rooms, *m*, Fig. 27, and access to the feed shelves is by doors at *t*, leading from the operating rooms into the small covered yards, and by the door, *s*, which leads to the shelves in the main building. The shelves are of course loaded by rule, an exact quantity of grain being placed on each daily, and all fed that day to the last kernel, so that rats will not be baited to the premises at night. The operation of charging the feed shelves is a very quick one, their height from the ground being convenient, four feet in the main building and three feet in the covered yards. With a shallow scoop of just the proper size and shape, the attendant distributes grain as fast as he can walk, about five hundred feet of shelves being tended in less than fifteen minutes, and one charge lasts all day.

The curved dotted lines in the big yards in the ground plan, Fig. 27, show the location of board fences, or rims, they may be called, since they are only one foot high. The yard is plentifully supplied with straw for scratching purposes and these rims are to keep it from getting into the corners of the yard. The wide gates in the center, at right and left in the cut, admit a team hitched to a hay tedder or to a side delivery rake. The area in which these implements are to be used is not circular, as the cut might appear to indicate, but elliptical, for as before stated, the cut was reduced to suit the limits of a page. The circuit then is as liberal as an ellipse occupying nearly all the space in a yard one hundred and forty-four feet by fifty feet. Plowing and harrowing, as well as raking, can be handily done in this ellipse on the occasions of the removal of the old straw

to be replaced with fresh, or when straw cannot be had. The stirring of straw with a hand fork, or digging soil with a spade, on any considerable scale, is a back number.

If it is desired to scatter grain broadcast, a seeder carried by the operator and worked by a small crank, as if he had a coffee mill slung over his shoulders, can be used, but the preferable plan is to first rake the straw into a continuous winding windrow with the side delivery rake, and then let the driver of the hay tedder rein his team with one hand and scatter grain with the other, while he goes lengthwise of the windrow. When the horseless carriage is perfected, substitute it for the team in seeding and raking at the hatching house yards and also for all operations where horses are used in the colony or itinerant plan. The motor-propelled bicycle is to be utilized, besides, to afford the attendant quick access to all parts of the plant. Use finely cracked corn always, on or under litter at the scratching places, and on feed shelves, in preference to whole grain, so as to make more work for the fowls. The board rims have an additional use and one which is quite important. Being in the track where the sitters race back and forth to find grain near the small yards, these diminutive fences are jumped upon at every trip, affording wing exercise. Nothing pleases a sitter better than to use her wings by flying up on something, as well as her feet. Not only does she secure, after her sedentary existence, grateful exercise of muscles, the largest in her body, which are attached to her wings; but by the thorough airing of her whole plumage her wing gymnastics give, and by the disinfecting properties of the earth in which she shuffles, her nest is kept sweet. Oh, nature understands her business, and the first air inhaled by the younglings should be altogether purer than the noisome exhalations of a reeking, perspiring incubator. The whole economy of incubation of any species of bird is one of the most perfect and admirable things in the universe.

## CHAPTER IX.

### MANAGING THE SITTERS.

We are now prepared to explain in full the management of the sitting hens. It is, say, 4 o'clock p. m. The sitters have been shut in their nests all day without food or water, the doors being in the second position, closed, but the hens have been exceedingly comfortable, owing to the special provision for guarding against the heat overhead and permitting the free circulation of air in every part of the building, the comfort of the attendant and of the birds both being secured. The layers have had access to all the yards and to their own nests all day, the doors leading to the latter remaining at the third position. Enter attendant at either operating room, it is immaterial which:

1. Operate feed shelf at one of the small yards.
2. Close the gates to that yard.
3. Operate feed shelf at opposite small yard at same side of main building.
4. Close the gates to that yard.
5. Put doors of layers' nests in second position (closed).
6. Put doors of sitters' nests in third position (not quite wide open).
7. Operate the long feed shelf same side of the building.
8. Put doors of sitters' nests in second position (closed).

Next go through the eight operations aforesaid on the other side of the building. Next go through the alley

and take from nests any sitters which failed to leave the nests at the proper time, the nests being "get-at-able" because each has a door fronting the alley, as will be described further on. The 7th operation in the program drops grain in full view of the sitters on a level with their nests and only about two feet away, and the sound of the bell or of the hammer being one to which they had been accustomed for months, if not for years, the cases will be few where taking them off by hand will be necessary. If there was very much of this removing sitters by "main strength and awkwardness," labor saving would bid a sad farewell to the whole scheme. But so strong is the confirmed habit of going with the crowd at the hammer stroke, and so exciting is the sight of their companions feasting so near, that few will fail to leave. Those proving tardy are marked by a dab of fresh red paint on the white groundwork of their feathers, and if you have plenty of other sitters, when the bird has received two or three marks you can not only relieve her from her task, but remove her from the building altogether. The nest boxes being of wirework mostly, the hens which did not leave their nests, if any, can be readily seen. Next, while the sitters are running all over the large yard, and from one small yard to the other, and visiting the water troughs and dusting places, the operator inspects all the nests to detect anything amiss. Whenever he reaches either end of the alley he operates all the shelves in the small yards, and perhaps in the main building also. The sitters will run around with persistent activity the most of the time, whether the feed shelves are worked or not. Finely cut dried clover rowen or nicely cured corn fodder early in the season, or some sort of green vegetable stuff later, and gravel, must be in the yards for all, both layers and sitters. When the birds have had time enough for eating, the doors of passages to sitters' nests are put in the

first position, held open by the figure 4's, the shaft and arms being left at the second position, with the cords slack so that the sitters can spring the traps, and the attendant's presence is now no longer necessary. The gates, *G, G, G, G*, should not be opened to let the layers out until about sundown, so as to give the sitters plenty of time to return to their nests, and so as to prevent

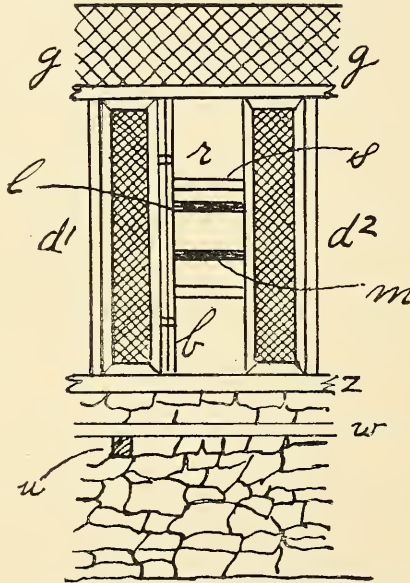

FIG. 31. ROW OF NESTS SEEN FROM BELOW.

birds among the layers having broody inclinations from taking possession of nests belonging to the sitters.

Figure 31 shows the convenience for the attendant's work at the nests, the view being taken from the sunken alley and giving the position of a row of nests on one side, the bottom of the nests being two and one-half feet higher than the ground at the bottom of the alley. One rail of the railroad track is shown at *w*, and one of

its supports as shown at *u*, it having been set in the stonework when the wall was built. The doors in front of the nests are of wirework, the mesh being one inch, to keep out rats, attached to a light wooden frame, *d*<sup>1</sup> showing a closed door, and *d*<sup>2</sup> one which is open; *b* is a nest with its front exposed as it would be for gathering eggs or for other purposes. One side of the wooden rim four inches wide, which surrounds the nest on four sides, is represented at *z*. Wirework, two-inch mesh, separating the roost from the alley, is seen at *g g*. Compare this cut with Figs. 25, 26, 27 and 29.

As was hinted before, when we were describing the regular daily program of the management of sitters, if there were many fowls to be lifted from their nests the task would be an onerous one. Not only do we propagate a sitting breed exemplary in all motherly conduct, and cull and reject obstinate laggards, but whenever we do have to catch a bird which overdoes the virtue of constancy, the conveniences must be such as to reduce the bother to the very minimum. Below the aperture, *r*, is seen the edge of the roost floor, *s*, upon which the delinquent bird is placed after she has been taken from the nest. When the nest, *b*, is opened, *r* is opened also. Take the fowl in both hands, with the thumbs confining her wings, and place her on the floor, *s*. Elsewhere an entirely different method of handling a sitter is described, one hand only being employed, and her wings being left free, which is the way to proceed when the bird is to be lowered and placed on the floor at your feet, but not the correct way when she is to be raised and put through a small door. The distance between *b* and *r* is small, which expedites the operation, and also both of these are within easy reach, *b* being 2 1-2 ft., and *s* 5 1-2 ft. above where the attendant stands. The trap-setter shaft is *l*, and *m* the layer nest shaft, correctly represented as being one but slightly higher than the other.



In all the other cuts these shafts were purposely placed wide apart, to give a plainer view of the cords, arms and other parts. In Fig. 29, for the same reason, the roost, *r*, was entirely omitted. It is 144 ft. long, and its floor, set on a slant downwards toward the outside of the building, is only 3 1-4 ft. wide, so that it will not intercept the grain which falls from the shelf. One perch only is needed, and this stands 18 in. above the roost floor and is 144 ft. long.

## CHAPTER X.

### COOPS FOR CHICKENS.

The construction of the coops for young chickens will now be described. A chicken coop must be adapted to warm weather and cold, and especially to rains, be easily cleaned, and made rat-proof at night. The old-fashioned triangular pattern, Fig. 33, secures all this, and also gives small chickens a chance to escape under the eaves from the feet of the hens. Two hens are put together with their broods, for reasons which will be given in another place. The size proper to accommodate a double brood is 2 1-2x3 1-2 ft. upon the ground, with roof 3 ft. from eaves to peak. A bit of scantling is fastened to each roof for a handle. The door, *a*, is hinged to open upwards. There is a small door at the rear that will allow chickens to pass, but not grown fowls.

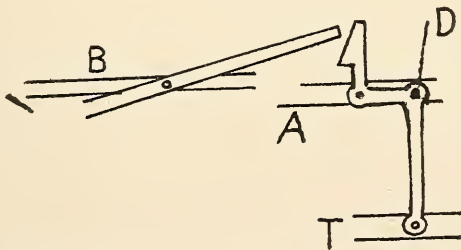

FIG. 32. THE FIGURE 4. SEE CUTS 25, 26 AND 29.

An opening for ventilation is made near the peak, and covered with wire cloth. Take inch boards, *b b*, Fig. 34, and nail strongly, planed side up, to the cleats, *c c*, and

clinch. Let both ends of each cleat project three inches, and the outside edge of each two inches. This is the movable floor, and must be of such size that the coop shall rest entirely upon the projecting ends and edges of the cleats, then when the doors are closed, all rain will be shed outside the floor. In Fig. 35, a section of the coop shows the floor in its place. When the doors are

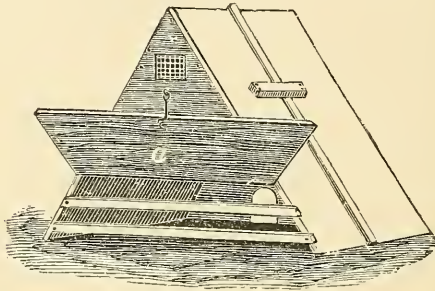

FIG. 33. COOP FOR CHICKS.

closed at night, leave the large one, *a*, Fig. 33, ajar one-half or one inch, according to the weather, for air, and fasten it with nails for pegs stuck in holes bored at various distances through the cleats, at *d d*, Fig. 34, which will make the coop perfectly rat-proof. Once a week, after opening the door, *a*, to enable the chickens to escape through the slats out of the way, slide the coop slowly length wise of the cleats away from the floor, which must be scraped thoroughly; then give it a shovelful of dry earth and replace. You will always have a dry, inodorous apartment, and will not shut up chickens in close, foul air. In every small coop or box for live animals there must be openings for the admission of air and escape of noxious emanations, not only at the top, but at the extreme bottom. This matter is often overlooked in shipping coops. to the great detriment of the occu-

pants, the openings at the top being erroneously deemed sufficient.

All the chickens destined for the itinerant stations must, as mentioned on Page 19, be fed indirectly. For two days only are they and the hens fed upon the floor of the coop. Then for a week they are fed in the box given in Fig. 36. It has no bottom, and the top, not shown in the figure, is temporary, and composed of loose boards. Place it so that its door shall meet the small door in the coop, having first dropped in the feed at the corner, and covered the box with the boards in such a manner as to admit a little light. After a week the

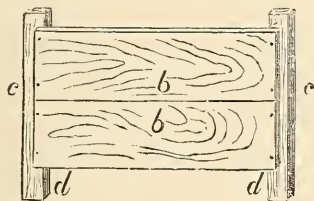

FIG. 34.

chickens, being strong enough to venture some distance, are fed from a box of galvanized iron 6x16 in., and 3-4 in. deep, Fig. 37. A wire grating, *F*, with meshes one inch square, protects the feed from the feet of the chickens, but admits their bills. The grating is covered at pleasure by a lid, *G*, these being hinged to opposite sides of the box. When such boxes are placed in a row, Fig. 38, each filled with feed, one for each coop, with the lids down, a snap-hook is attached to a ring which is fastened to each lid, and a wire connects with all the hooks, as in Fig. 38. One pull opens all the lids, and the chickens are at dinner.

These feed boxes are carried to the granary to be filled, using a wheelbarrow, in which many may be packed at a time. The coops are twenty feet apart, in a single row, and the wheelbarrow is rolled along the line, and the boxes, with lids closed, are put on the side of the coops near the small doors, which are shut, in order that the hens may not worry when the chickens are feed-

ing. If the distance is considerable, use the low-down wagon in place of the wheelbarrow. The hens are fed and watered in cups, fastened to the inside of the coops as high as they can reach. The cups are filled with whole corn once each twenty-four hours, after dark in

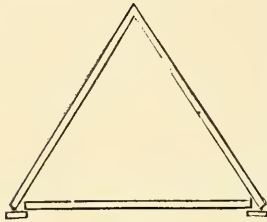

FIG. 35.

the evening, so as not to attract the attention of either hens or chickens. When the chickens are a month old, a part of their feed may be buried near the coop early in the morning, before they are let out, so that they may scratch during the day, although this is not essential, for when there

is unlimited range, young chicks will always take sufficient exercise. Whenever it is rainy, the box used the first week for feeding, Fig. 36, is again resorted to for that purpose.

The additional time required to feed chickens indirectly is slight, if operations are systematized. All the

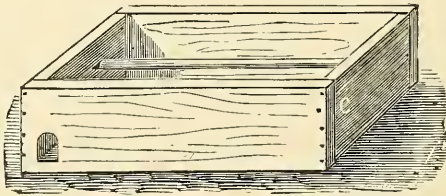

FIG. 36. FEED BOX FOR CHICKS.

chickens of the breeding or pedigree stock, and of the sitting class also, are reared at a separate part of the farm, and fed directly.

When the hens are removed from the chickens, the latter huddle together nights upon the floor for some

weeks, but when old enough to perch, the box, Fig. 36, is placed upon the movable coop floor, and the coop is placed upon the top of the whole, the box being of the size of the boards, *b b*, in Fig. 34, so that the eaves and sides of the coop overlap sufficiently to shed rain. The box has two perches permanently fastened to it, one of which is seen in Fig. 36. This roost is rat-proof, and half a bushel or so of dry earth keeps it clean.



## CHAPTER XI.

### FOWLS FOR LAYERS AND SITTERS.

The layers must be of a breed that affords chickens easily reared, for success in the nursery department is all important and they must be at the head of the list of prolific layers of fair sized eggs. None but a non-sitting race will answer, for, needing to be broken up frequently, sitters make fully double the labor during half of the year; and the feathers must be light, because dark ones show badly when chickens are dressed. There is at present no breed that fulfills all these conditions so well as the White Leghorn. It may degenerate in time, as other races of fowls have done, by being bred for fancy instead of utility, but it possessed at its first importation more vigor than any other non-sitting breed. In breeding poultry, show and utility do not get on well together in the long run. To fanciers unquestionably belongs the credit of originating improved breeds, but afterwards, in fixing conventional points for the show room, the stock is often ruined in their hands.

Many breeders of livestock,—not poultry alone, but in other departments,—do not fully understand the relation between fancy points and useful ones. The confusion in the minds of some writers on this matter is evident. “Why should not a fowl that scores high in shape of comb and tail and in color of legs and plumage, lay just as well as one that scores low in these things?” some one asks. The answer is that a fancy comb and a fancy plumage in that individual fowl have certainly no direct

power to prevent her from laying well, but this is only part of the story. That fowl has a history of descent. It is harder to breed to the point where good laying is a trait of the strain if you select your breeding stock each generation on the basis of fancy points as well as of laying qualities; for while choosing your breeders, you necessarily pass by on account of faulty plumage some of the most eminent layers that would have helped your strain mightily.

An illustration will not be amiss, there is so much ignorance prevailing on this point. Frederick the Great had a body guard of soldiers of gigantic stature. The question might be put, is there any reason in the world why a red haired or a brown haired man may not be as tall as black haired men? None in the world, surely; but if the monarch desired a guard of the very tallest

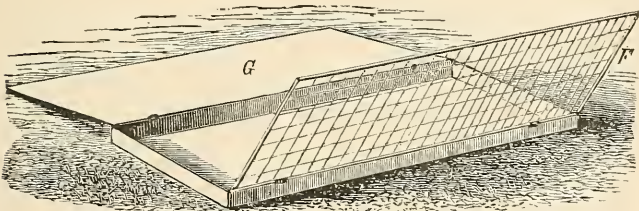

FIG. 37. FEED BOX WITH GRATING.

men his realm could possibly afford, then the average height of the battalion would be greater if there were no restrictions on color of eyes, hair, and so on, than if one specified shade only was admissible. Suppose the requirements were black hair together with blue eyes and great stature, the greater the better, how would the average height of the selected men turn out? As such eyes and hair do sometimes go together, the guard might thus be recruited if the realm contained popula-

tion enough, but the average height of its men would be less than if the selection had not been handicapped by the specifications we have supposed.

Apply the same reasoning to cattle. The Jerseys are now of every imaginable color—solid, broken, black, white, red, fawn, brown, roan, buff, spotted, brindled, ring-streaked, speckled and grizzled. Suppose it were desired to select breeders for a hundred years from all the pure Jerseys in the world to produce a strain of the largest sized, pure-bred animals possible. Two entirely separate herds are to be built up, neither of which shall draw from the other, but each to draw freely from the whole world beside. One herd must be produced of the greatest sized animals possible and all of a solid bay, and the other herd of the greatest sized animals possible, but entirely irrespective of color. Which herd, at the end of one hundred years, other things being equal, would contain the largest cattle?

A drawback to the Leghorn family is the great size of combs and wattles. Possibly this trait may be gradually bred out in time without impairing the useful traits of the breed, but it is doubtful. It has been noticed that the most vigorous birds and the best layers have these appendages the most fully developed, and it is probable that in the Mediterranean regions, where they originated and where they were bred at the monasteries for centuries, the monks of the middle ages being enthusiastic poultry fanciers, and the breed being extremely ancient, the conscious selection of the best layers for breeders resulted unwittingly in the selection of birds with the biggest combs.

Or, the mere fact of the keeping of the breed unmixed for hundreds of years, would, of itself, have resulted in a large combed breed, even if the keepers were not consciously selecting eggs for hatching from the best layers (if large combs and prolificness

naturally go together); for the best layers being the most fully represented by newly laid eggs in the nests, would, also, by obvious doctrine of chances, or, more properly, by mathematical law, be the most fully represented in eggs for hatching purposes and in number of chicks hatched and reared; unless, indeed, extreme prolificness was accompanied by deficient vitality of the germs. It would be inevitable that the numerical preponderance of eggs for hatching laid by large combed, prolific birds would operate to develop a strain of both large combs and prolificness, until a limit was reached beyond which the process could not go. This limit is discovered in the fact that the production of an unusually great number of eggs laid by a fowl is accompanied by

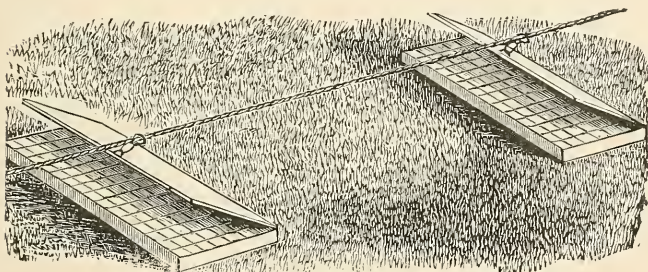

FIG. 38. ARRANGEMENT FOR OPENING FEED BOXES.

a lack of vitality in the eggs, excepting those at the beginning of the laying, which experience shows are comparatively exempt, though probably even these are somewhat affected.

There are two other ways in which the great size of combs of fowls from the Mediterranean may have been brought about. The combs were highly prized for food, and, at certain eras, the monks were more given to luxury than to austerity; or, in periods of rigid discipline, while living on bread and water they may have

sold the combs for the revenue of the house, and, therefore, may have kept up a careful selection of large combed birds for breeders. And there is, besides, the consideration of a warm climate. The wild parent stock of our domestic fowls live, in part at least, high up on the sides of mountains, and very likely the climate of Italy and vicinity may be warmer than that to which their progenitors were accustomed. As time progresses, the question of influence of a warm climate on size of comb will be determined by noting the appearance of the Leghorns now kept quite extensively in our southern states.

The drawbacks of large combs and wattles are, freezing in our northern states, and the discomforts and strain resulting from carrying so much weight on the head. It appears as though the circulation of blood in the head is somehow affected by these excessive appendages, for it has been observed that a Leghorn having frequent spells of giddiness and staggering can sometimes be quickly and permanently cured by trimming the comb, and we would always recommend the trimming of both comb and wattles for both sexes, Fig. 39, when two-thirds grown, especially in view of freezing, when zero weather occurs. Use shears or scissors instead of a knife so as to pinch the blood vessels and mitigate the flow of blood. The operation is not so painful as it might appear, we will state for the benefit of the Society for the Prevention of Cruelty to Animals. Nature evidently provided that the comb and wattles should be comparatively destitute of feeling. As, during the thousands on thousands of years the males fought for possession of the females and the comb and wattles were the parts seized upon in the struggle, a lack of sensitiveness in these appendages would be perpetuated and augmented on the principal of natural selection. So indifferent is a fowl that after being dubbed it will uncon-



FIG. 39. "DUBBED" WHITE LEGHORN.

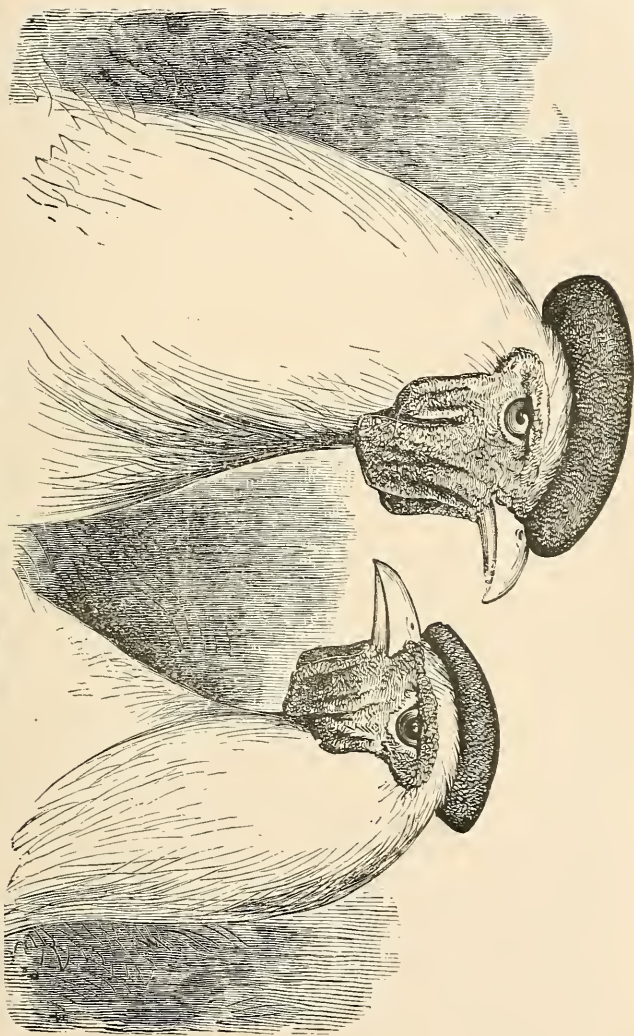



cernedly fall to eating its own comb and wattles, if allowed the privilege. This dullness or fewness of nerves of feeling in the combs, when understood, may alleviate the pangs felt by many persons at the mention of what has been wrongly called a cruel practice. It is easier for a fowl to stand dubbing than to endure a frozen comb.

The layers are relied upon to produce the principal part of the income, and as they are chief in point of numbers, the detached stations where they are kept form the main part of the establishment, to which the breeding and sitting departments are merely tributary. Most of the layers must be kept only until the age of from fifteen to twenty months, and then killed for sale, and their places supplied by young pullets. This course is necessary, because the yield of eggs is greatest during the first laying season if the hens are of an early maturing breed, and are fed high and stimulated to the utmost, as they must be to secure the highest profit. For, though hens are still vigorous at two years, it will be found that after a course of forcing to their greatest capacity through the first season, they cannot generally be made to lay profusely during the second. If we chose not to put on the full pressure of diet the first year, but to feed moderately high for two or three years, a fair yield of eggs would be afforded during each. But such a course would not pay as well as to keep pullets only, and maintain a forcing system constantly from the time they commence to lay until they stop, and then market them before they eat up the profits in the idleness of fall and winter.

Pullets grow fast during the early part of their lives, and give a return in flesh for what they eat then. After they commence laying, their eggs are prompt dividends, and, besides, their bodies increase in weight until the age of a year or more. Young hens may be killed a fortnight after ceasing to lay, and if they have been skillfully fed, their

flesh will prove excellent for the table as compared with fowls that are two or three years old. It is no wonder that there is little liking for the adult fowls the markets ordinarily afford, for they comprise many that are very old and comparatively unfit for food. But regular customers will soon approve fowls a year old, which have been supplied with the most suitable food, and brought to just the proper fatness, and delivered freshly killed and neatly dressed, and our experience proves that the families upon the egg route will order all that the establishment has to dispose of. The high pressure mode of feeding and turning off while yet young, is then the true policy.

The point is, there is a certain consumption of food to enable any animal to keep alive. The ordinary vital operations, aside from laying or increase of size, demand force, obtained through food—which is money—and we should aim to support only such fowls as are all the while giving returns in either growth or eggs. The long period of molting and recovering from its consequent exhaustion, costs, as does the maintenance of the vital fires during the cold of winter. It is a matter of quick balancing of profits and expenses with animals, which, like fowls, consume the value of their bodies in about ten months. If it is urged that the stimulating diet and unnatural prolificness will subject the stock to disease, the reply is that the regimen is not continued more than six or eight months, and in that time evil effects will not ordinarily follow, for the birds are allowed freedom, sun and air, and special provision is made for daily exercise. As none of the fowls to which this forcing system is applied, leave descendants, no evil effects are accumulated and entailed upon the stock. The layers are from the eggs of fowls that have not been subjected to any such pressure, and during the period of their principal growth they have been given a nutri-

tions but not especially stimulating food—like a colt at pasture. When they arrive at the laying age, they are then kept as is the horse, which is kept, broken to work, and put to constant and severe labor, and fed as high as he will bear.

#### FOWLS FOR SITTERS.

The sitters are of a breed chosen for persistence and regularity in incubation, fidelity to their chickens, and gentleness of disposition. The Plymouth Rocks are our choice, and cannot be excelled for hatching and rearing. The white variety is preferred, because when a fowl is dressed, white pin feathers show less than colored ones. Also, as stated elsewhere, there are occasions when we want to designate individuals by a dab of fresh red or blue paint, which shows well on white plumage.

The sitters are not kept at detached stations like the layers, for several reasons. One is, they should all be near together, because of the great amount of attendance necessary in connection with hatching. Then the buildings should be large enough for the keeper to enter, in order to take care of the nests and chickens, but the size of the structure and the risk of jarring eggs will prevent moving. Nor can the system of indirect feeding and no yards be pursued, for the sitters should be fed at the attendant's feet, and tamed so as to submit quietly to the handling they receive while hatching and rearing. Their yards are sufficiently large to admit of exercise, and for the same reason their dry grain is buried in the ground or under straw. In very cold weather, they are confined to their houses for warmth, and are given a stimulating diet to promote winter laying, not so much for the value of the eggs as to render it certain that there shall be a considerable number of birds ready to sit in February, and many more in March.

The fowls chiefly depended upon for this consist of the earliest pullets of the previous year, and also the old

hens that had been employed much of the time the preceding summer in hatching two or three broods. The prevention of laying, by hatching and rearing, causes birds thus occupied to lay earlier the next season. By a little management, there is no difficulty in procuring plenty of offers to sit from February to June. One-half the sitting stock is kept until two years old, and of the pullets of the sitting class raised yearly, some are hatched in February and March, and some in the first week in September, the better to secure sitting at various times in the year. Except in winter, the sitters should not be fed with a view to encourage laying, but the aim should be to keep them on as moderate an allowance as possible, and not have them become poor. Their specific purpose is incubation, and they should be made to do as much of this as possible. By uniting broods, when a hen has hatched one nestful of eggs she may be given another immediately, and, if managed rightly, she will not be injured by sitting a double term. Each hen must hatch two broods per year, at least, and some will hatch three. In this way, the stock of five hundred sitters will produce ten thousand chickens yearly, or an average of twenty apiece.

## CHAPTER XII

### THE KINDS OF FOOD.

When poultry are kept upon a large scale, they can obtain but few insects, for the latter are attracted and supported by vegetation, of which there is next to none near the adult fowls, though care is taken to rear a part of the chickens among growing crops. The ample grounds around each station house, and the areas inclosed by the yards for sitters and for breeders, give space to secure cleanliness and exercise, but that is about all. As far as affording insect foraging is concerned, a paved court in a city, or a continuous rock, would be almost as good. Ground room out of doors upon our farm, whether inclosed in yards or not, is principally for air, sun and exercise. These secured, it matters not whether there is more or less space, so long as there are so few insects to be procured. We hear much about the number of fowls proper to an acre—some say fifty, and others one hundred; but in order to give one hundred a good forage, they should have the range of no less than four or five acres, containing grass and a variety of other crops.

Now, if we give up as impracticable, as we must, pasturage of this sort, and afford nothing but a field entirely bald, save for a few patches of clover and such other green stuff as may be plucked when young and tender by the birds, under such circumstances one acre is as good as four. We go further, and say that fifteen or twenty square rods of ground, and the grain for the fowls buried to induce exercise, will answer the purpose

better than an acre without such an artificial provision of natural conditions. But the feed, which must be all brought to the fowls, costs, in money if purchased, or in labor if raised upon the cultivated part of the farm. In fowl keeping upon a small scale, where one flock has for a range as large a portion of a farm swarming with insects as they choose to travel over, food is obtained for nothing. The food for fowls is more expensive than that of any other livestock, in proportion to the value of the animals themselves, necessitating economy in its choice. There are many things "good" for fowls, but we must use principally those only which supply all the needful nutritive elements, and are, at the same time, the cheapest.

There are three classes of articles of which the natural and indispensable diet of fowls consists,—grains or seeds, green plants and insects. Corn and wheat screenings—corn especially—should be the main reliance to fill the first division; boiled potatoes and raw cabbage in winter, and newly mown grass, clover or alfalfa in summer, are the most suitable vegetables, and chandlers' scraps and butchers' waste, procured fresh, are the most economical animal food, excepting near the coast, where clams and various sorts of fish can be obtained at a trifling cost. While depending mostly upon the above, because they are the best and cheapest, a great many other things must be given occasionally for the sake of variety, such as oats, buckwheat, rye, barley, wheat and brewers' grains; dried corn fodder and clover rowen in winter; various vegetables, such as carrots, beets and yellow turnips, boiled and thickened with corn meal or wheat bran; raw onions chopped fine; and for animal food, sometimes near cities young calves may be obtained from milkmen at a low price, and the carcasses boiled and fed. This last remark applies chiefly to cities at the east and northeast.



In the cattle regions of the west, calves are too valuable to be thus sacrificed, while in the last named locality the by-products of the great packing houses form a ready and valuable substitute. It must be an invariable rule to give every bird, whether young chicken, layer, sitter, or fattening for the table, a portion in each of the three divisions,—grain, fresh vegetables and animal food,—every day in the year. It has been asserted by some that there is no substitute that can fill the place of insects for poultry. We say that beef and mutton, or lights and livers, or fresh butchers' waste of any kind, are as much better as oats are better than grass for horses of which much work is demanded. A partridge or wild jungle fowl can produce her normal number of eggs from forest fare, but not such great numbers as are laid by a Leghorn, Hamburg or Houdan.

A portion of the grain fed must be ground. The natural mill of a fowl's gizzard, containing hard gravel for millstones, is capable of grinding all sorts of grain perfectly, but at too great expense of muscular exertion which, though involuntary, is severe, and employs force that had better be used for growing eggs or flesh, and therefore meal and bran have their uses for the poulterer.

But the soft feed idea must not be overworked. The reasoning that a beginner naturally falls into is that it is a great pity that so much force should be applied at such a tremendous disadvantage in reducing hard grain in the gristmills of the birds when the miller can grind for thousands. But the wondrously powerful muscles of the gizzard are there to be used. Always go cautiously in any plan to tamper with nature in feeding, hatching, rearing, or anything else connected with poultry. Experiments have proved that the "balance of power," or equilibrium of functions in the fowl's economy makes the vigorous exercise of the gizzard very beneficial. The explanation is, in part, that the secre-

tion of the digestive fluids is promoted by the grinding process, just as the flow of saliva in a person's mouth is influenced by the act of chewing, even if nothing is chewed but a straw. A good illustration of the fallacy of unnatural expedients was afforded in feeding experiments with hogs. It having been noticed that numerous bits, large and small, of undigested corn were passed from these animals, when it had been fed raw and unground, it was supposed that a greater amount of nutriment would be afforded by a given weight of ground corn, as compared with an equal weight of the same grain unground. But by carefully weighing both the corn and the swine, the surprising result was reached that the whole grain gave the greatest gain in growth. The powerful muscles of the hog's jaws imply use, and the secretion of saliva certainly, and the flow of other digestive juices in the stomach probably, are by nature's methods, persistently fixed in the lapse of ages, connected with the workings of the aforesaid muscles.

The variety in feed for fowls previously hinted at is in accordance with nature. When on free range they glean a little of everything, and the particular article most feasible for the poulterer to feed is optional with him. Brewers' grains, the waste at fisheries where great numbers of fish are dressed, chandlers' greaves, and many other things are unavailable over large areas of our country. As for the "balanced ration" we hear so much about in connection with all species of domestic animals, we must feed what we can get and that which is the cheapest, which in our favored land is principally corn. The workings of the internal economy of a healthy animal, especially an omnivorous animal like the fowl, will "balance" the ration by selecting from our national grain the nutritive elements required by the varying needs of the system.

Feed millet and wheat for a change, but corn, being

the cheapest grain we have, is the proper food for chicks, and for laying fowls also, and you need pay no attention to the everlasting hue and cry about this noble grain being too oily. It isn't oily enough, and for either man or beast is improved by the addition of lard or some other form of fat. Ask one of these anti-corn cranks to explain the almost universal craving of humanity for butter to be eaten with bread. For a negro laborer at the south, corn meal, with fat bacon or pork, makes a perfect food, with the addition of a small quantity of fresh vegetables or wild fruit, the last as condiments merely, or to furnish acids to assist digestion, for they do not supply any strictly nutritive elements which the main diet lacks. The corn without the fat would be almost as incomplete as the fat without the corn. When the negroes or poor whites are without pork to accompany their universal diet of corn bread, they crave a shortening of lard in the latter, and failing to obtain this, sometimes use the oily kernels of black walnuts, or even the oil obtained from certain species of fish. "But fowls are not men," we hear some one exclaim. True, but both are omnivorous. Fish, flesh, cereals, vegetables and fruit are the appropriate food of both; the digestion of both is improved by the acid of fresh green stuff, and the perfect nourishment of both demands oily food.

Even in the tropics fat meats are sought by those who toil; bread and fruits will not suffice. Conversely in the Arctic regions, although much has been written about the fondness of the Esquimaux Indians for oils and fats, recent careful observers have stated that if these Indians can get lean meat they will eat it in connection with fat in very nearly the same proportion as is usual among their white brethren in temperate zones.

If it were not for the time and expense involved, corn boiled or fried in some form of animal or vegetable oil or fat would be the best possible staple for fowls, winter

and summer. But the edicts of labor saving are against this diet, as well as somewhat against the use of the fresh scraps from the butchers' shops, and chandlers' greaves, for the former must be chopped, and the latter are pressed in cakes so solid as to need considerable preparation before being used. The supplanting of the village butcher by the big packing house, moreover, makes it impossible to get chandlers' scrap cake in many localities, while the feasibility of feeding the packing house tankage, which takes its place, has not as yet been sufficiently demonstrated. For one thing, it is sold in a perfectly dry state and finely ground, so that it keeps well and can be fed with very little labor.

## CHAPTER XIII.

### BREEDING AND INCUBATION.

The proper management of the breeding stock is a very important part of the scheme, for there must annually be raised a large supply of pullets of the right quality. The profits of the establishment depend largely on the excellence of the fowls, and as they can be multiplied very fast from a chosen few, no pains should be spared to secure the very best as a source from which to stock the whole farm. There is but one way to do this, and that is to keep individual birds in experimental yards in order to test their merits, recording the degree of excellence and the pedigree of the best with as much care as would be given to breeding cows or horses.

We will suppose it is designed to produce a strain of Leghorns that shall excel in prolificness, laying at an early age, and in other requisites. Procure a pullet from A and a cockerel from B, and put them in yard No. 1; purchase of C and D one bird from each, for yard No. 2, and so on, always taking care that no specimens are obtained from any locality where disease has prevailed. If there is any doubt on this matter, quarantine your purchases on premises at a distance from your main establishment for two or three weeks. The smaller breeding yards are used as experimental yards, and to allow each cock a proper number of mates, two or more Plymouth Rock pullets, whose eggs can be distinguished by their color, are added. Give each Leghorn a name or number, and enter in a book all details necessary for testing progress in improving the breed, such as

weight, the age at which laying commenced, and the yield of eggs during the first year, at the expiration of which banish all but the best hens. The second year set the eggs of the reserved extra fowls, and keep the chickens produced by each pair separate from all others.

At the age of five or six months, cull out the most promising pullets and cockerels, and pair them for testing and recording pedigree and prolificness as before. By mating the produce of the original birds from A and B with the produce of those from C and D, finally the four stocks will become blended in one. Proceed in this manner a number of years, and when in the course of time a very extra prolific and vigorous hen has been found, which reached full size and commenced laying early, and whose ancestry have excelled in the same respects for several generations, as shown by the book, then from her eggs cocks are raised from which to breed to replenish the main stock of layers at the itinerant stations. These cocks are put in the larger breeding yards, each with a flock of ten hens, and no accounts are kept of the prolificness of individuals among their descendants.

After new stock is introduced to the experimental yards, as must be done yearly, care is taken for a series of years to avoid breeding akin, and as purchases will be made from fanciers who, to fix the conventional points, have most likely bred close and impaired strength, crossing will immediately give a decided increase of vigor. Towards the last, however, when sufficient stamina has been gained, and the stations are to be stocked, close breeding is resorted to, even the mating of brother with sisters, which is the closest kind of inbreeding. This is to increase the yield of eggs, the philosophy of the matter being as follows: Just as a fruit tree girdled or severely root pruned will give a profuse yield and then die, and as various domestic animals will for a short



time be more prolific after removal to unaccustomed climates, so the violent attack on vitality which occurs when there is in-and-in breeding is met by an energetic attempt of the organism to propagate in unusual numbers and thus maintain its kind. There has been much confusion on this point, for while scientific naturalists have insisted that no animal can thrive under continued close breeding, practical poultry keepers have pointed to the prolificness of in-and-in bred fowls as a proof that there was no deterioration. The fact is, individual perfection and rapid increase are, to a certain degree, incompatible. Under our plan of aiming chiefly to secure great quantities of eggs, we purposely give the constitution of the birds a shock in order to increase fecundity, having first, however, carefully built up, for some years, by careful selection and good sanitary conditions, sufficient strength to withstand the assault. This course may appear inconsistent, but experiments have shown us that it is correct.

The Plymouth Rocks are bred in the experimental yards with a different basis of selection. The best sitters, and those with the shortest legs and plenty of fluffy plumage and ample wings, are preferred. Note the behavior of the hens that are bringing up chicks, and cull out patterns of motherhood and set their eggs.

In the breeding and experimental yards, the fowls must be fed and managed in every respect with the greatest care. Over-fattening is to be deprecated above all other things, and may be avoided by burying all the grain, to make the birds exercise by scratching. The supply of grain should be moderate; meat should be given very often in very small quantities, and the allowance of fresh vegetables should be ample. Free range would be very desirable for all the breeders, but as it is impracticable, scrupulous care must be taken to furnish artificially natural conditions. Though the birds of the

laying class in the experimental yards are rated according to their prolificness, yet the test is merely a relative one, for they are not forced to profuse laying by stimulating feed.

#### SETTING THE EGGS.

Vigor and thrift in chickens depend, in the first place, upon the quality of the eggs set. Those obtained from breeding stock managed as described in the preceding section, will hatch strong and healthy chickens, observing one precaution. Care should be taken never to set eggs laid near the close of the season, when the hens have been very prolific, for such will produce chickens deficient in vigor. The production of eggs in great numbers is, in the best laying breeds, abnormal. The wild jungle fowl, in common with all birds in a state of nature, lays no more than she can cover, and this is true of domestic hens of sitting breeds, that steal their nests. It is the daily removal of the eggs by the keeper, and the supply of an abundance of nutritious food, that causes great prolificness. There are some species of wild birds that will produce from three to ten times their usual number of eggs, during a season when their food is abundant, if their nests are continually robbed. But when hens lay twenty or more per month, for several months, the eggs are impaired. This is one reason why chickens hatched in summer are sometimes so deficient in vigor, compared with those produced in early spring. For the sake of economy it is important to have as few non-impregnated eggs as possible. Over ninety per cent will be impregnated if the breeding cocks are strong and sprightly, and no more than ten hens are allowed in a flock. It is a good plan to keep two cocks for each group of breeding hens, and shut them up alternately, one day at a time, in a small but comfortable coop, entirely out of sight of the hens. The

eggs should not be kept more than three or four days, or ten at the most, before being set. Those laid the same day should be given to one hen, so that the whole brood may hatch simultaneously, for new-laid eggs hatch several hours sooner than those that have been laid a considerable time before being set.

Artificial hatching and rearing are not economical. Even if incubators hatch as great a proportion of eggs as hens, there is no way of rearing the chickens artificially, and securing ventilation, warmth, cleanliness and room for exercise, without greater outlay in labor and building materials than is necessary when hens are employed, provided the rigors of winter are over. The cost of fixtures for heating, and of fuel, and of suitable contrivances for providing exercise for the young broods, makes the plan entirely impracticable, except in case of high prices for broilers; and as for blooded fowls, no bird designed for a breeder should ever be reared in a brooder.

The nests of sitters should be made at bottom of damp earth, packed to a concave shape. Make the sides steep enough so that the eggs will lie close together and so that the hen can roll the outside ones towards the center easily, but do not pack the earth so dishing that eggs will lie two deep in the nest. It is not necessary to place them upon the ground, or to sprinkle the eggs with water, if this rule is followed. It is proper that the eggs should be in some way exposed to moderate dampness during incubation, as otherwise too much of the water in their composition evaporates. An elevated box furnished with nothing but dry litter is not suitable. Cover the earth with staw, bruised until pliable, and broken short. Long straw is apt to become entangled with the feet of the hen, causing breakage of eggs. It should not, however, be cut by a machine, because the sharp ends of the pieces will come in contact with the

skin of the hen, or that of the delicate chickens. In very cold weather line the nest with feathers. We have successfully hatched eggs by preparing a nest thus, in a room where during part of the time of incubation the temperature was below zero. Set hens in large numbers at a time, having kept some of them upon artificial eggs until all are ready. Of course, an entry must be made in a book of the family or strain, and other particulars of each clutch.

Examine the eggs after the hen has been upon them ten days, by the well-known method of placing them between the hands and attempting to look through them at a strong light; or a better way is to use an egg tester, such as is commonly sold by manufacturers of incubators and by poultry supply houses in all the large cities. Return to the hen only those eggs that appear opaque or clouded; those which show clear, orange-colored yolks, being unimpregnated, will not hatch, and may be used as feed for chickens.

When hatching is progressing, remove gently once or twice the empty shells, that might otherwise overcap the unhatched eggs, but further than this do not interfere, as a chicken worth hatching will contrive to get itself hatched. Sometimes the membrane surrounding the chick is so tough that the prisoner cannot get out, and in such a case the attendant can afford assistance, it is true, but apart from the objection of taking too much time to putter in this way, there is another trouble, namely: By saving chicks from tough membraned eggs you perpetuate a tough membraned breed. When dealing with the pedigreed chickens and selecting the choicest specimens to put in special broods by themselves, take those which not only get into the world without any trouble, but those which hatch out and become strong and lively the earliest. Let the chicks remain in the nest forty-eight hours without being fed,

allowing the hen, meanwhile, water, and a little corn, just a few kernels, placed in dishes by the nest. When removed to the coops, put in each double brood thirty chickens—less if it is cold weather, and forty sometimes in summer.

The large lice that often infest the bodies of sitting hens will leave for the young chicks and gather on their heads, unless care is taken. This trouble must be absolutely prevented. The liquid lice-killer, of late invention must be applied freely to the edges of the nest several times during the first fortnight of the sitting term, the wirework over the top and front of the nests being covered, meanwhile, with paper or cloth as closely as may be without stifling the sitters. Or powdered sulphur, if bought at wholesale rates, will prove cheap enough, and is not dangerous to the sitters. No covering of the nests is necessary when this is used, and it can be applied during the third week if desired, or at any other time. Two thorough applications will utterly destroy the enemy, an interval of four days being allowed between. Use two full handfuls each time. No matter how much lies at the bottom of the nest and on the straw and earth at its sides, it will not injure the hen or her newly hatched chicks. Apply it at night to the hen, and then keep her confined until the latter part of the next day, so that the fumes of the sulphur can take full effect. When you begin, disturb the hen slightly so that she will bristle her feathers, and then from a dredge box dust the sulphur down to every portion of her skin, from head to foot, not omitting a liberal dose upon all the eggs, so that the under parts of her body may get full benefit.

## CHAPTER XIV.

### MANAGEMENT OF SITTERS.

A special management of sitters in a mild climate, with mechanical contrivances for minimizing labor, has already been given, and we will now describe the management of the incubating hens kept in the buildings represented in Figs. 21 and 22, and adapted to cooler latitudes. This building, like the one for the southwest, secures plenty of room for the sitters to move about in when off their nests. It cannot be too strongly insisted upon, that it is natural for a sitting fowl to run about very actively when she has left her nest. She will always make the most vigorous use of her legs on such occasions, when allowed full range.

This extraordinary activity, in comparison with which the movements of a laying fowl appear moderate and sedate, keeps her in health and is particularly necessary in order that the bowels shall remain in good condition. Without a great deal of running hither and yon, your sitting birds will be afflicted with spells of constipation and looseness by turns, and will foul the nests, that is, a considerable per cent of them will, not all, and make so disgusting a mess that you will wish you had never seen a sitting hen in your life.

The management of sitters kept in quarters shown in Fig. 22, will be understood by reference to Fig. 40, which gives a nest rack viewed from the front, there being three tiers of nests with an alighting board under each tier. This rack may be seen in the center of Fig. 22. The nests are guarded against the depredations of rats



by the fine wire netting, as described. The use of the coarse netting that alternates with the fine, is as follows : Half the labor of managing chickens is saved by confining in the same coop two hens with their broods. They will agree perfectly, if well acquainted beforehand. We take a hint from nature here ; such wild birds as live chiefly on the ground sometimes incubate and lead their broods in company. Wild turkeys, and their tame descendants as well, are an instance in point. While sitting, adjoining hens form a particular acquaintance

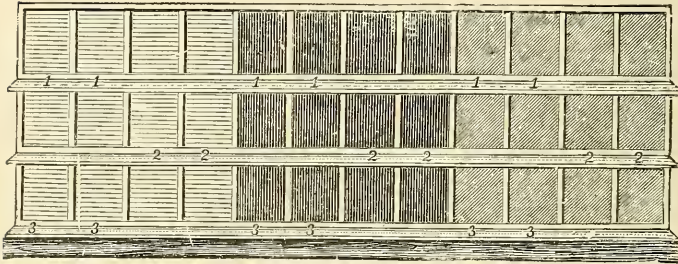

FIG. 40. MANNER OF NUMBERING NESTS FOR SITTERS.

through the coarse meshes of the netting, and, at the same time, they cannot interfere with each other, or roll the eggs from one nest to another.

Without a special system of management, a considerable number of sitting hens cannot incubate and feed in the same apartment without confusion, but by the following plan each is made to know her own nest and return to it after feeding. In the first place, the laying hens, before offering to sit, are induced to choose nests scattered evenly through the whole building, by properly distributing nest eggs and keeping half the nests closed. The nests on both sides of the house are divided vertically into three sections, one at each end of the room

and one at the center, by painting each division a special color—the center black, and the ends respectively red and blue. The contrast assists the fowls very much in determining their places.

No more than three pairs of sitters should be allowed to each division, or eighteen clutches on each side of the building. The six birds belonging in the middle division remember their places very readily, because they are so far from either end. To prevent those at the ends from making mistakes, as soon as the laying season commences, one end wall of the room is covered with straw, or evergreen boughs, and the other left bare. A few yards of cheap cotton cloth or some old newspapers will do to mark a distinction. All birds, wild or domesticated, possess a keen sense of locality, and a few neighboring objects enable them to recognize their nests. The nests that are used for hatching are numbered by affixing movable labels, and every sitter is distinguished by having a feather or two painted, the color showing her division, and the position of the mark, upon her head, body, or tail, signifying a number corresponding to that of her nest. This enables the attendant to correct mistakes of the birds (which will, however, be rare) before fastening them in daily. The colors show distinctly upon the white ground of the feathers. This plan appears somewhat whimsical, but it is simple and convenient. Figure 40 shows the numbers on the side of a room, arranged as if for eighteen clutches, the nests not numbered being for the use of laying fowls in the meantime. The shading represents the three different colors of the divisions. The sitters are assigned places two by two as above stated, and each of a pair of nests and each of the occupants receives the same number. Only three numerals are necessary to designate three dozen nests in all, in one house.

The incubating hens should be fed early in the morn-

ing, before any of the others are ready to lay. Those not sitting are shut into the yard; the large doors of coarse wirework, that prevent hens from roosting on the alighting boards at night, are raised at one side of the room only, and the pieces of wire cloth before the separate entrances to the nests of the sitting hens are removed and placed in front of the nests frequented by the layers. Next, grain is thrown upon the ground in view of all the sitters on that side of the room, when a call to which they are accustomed will cause nearly all to leave their nests. The laggards that refuse to leave are lifted from the nests and placed on the ground. The attendant must not take hold of the fowl. Push the hand gently under her and then spread out the fingers and lift her slowly off the eggs. There is a knack about it which is quickly learned, and, to beat artificial incubation all hollow, it must not be forgotten that our sitters are of a selected strain and very quiet. When they are off, the large doors are lowered and the hens are left from one-quarter to three-quarters of an hour, according to the weather, while the poulterer is repeating the operation at the other buildings. When the hens are off, inspect every nest to detect broken eggs, or anything else amiss. The sitters upon one side are all admitted to their nests at once, by raising the large wire doors, and then shut in safe from rats or the intrusions of laying hens, by the separate pieces of wire cloth. Repeat the operation at the nests on the opposite side of the house.

The houses for sitters should be located near the beginning and the finish of the route the wagon takes in attending to the main laying stock, thus making it convenient to work in the sitting department at intervals through the day and give the sitters a long spell off in warm weather. On very warm days, they should be off the nests from one to three hours on a stretch. In very

cold weather, from three to five minutes will do, and in medium weather, anywhere from ten minutes to thirty, forty-five or sixty minutes. Whenever the attendant is examining nests, or doing other work in the houses for sitters, he should operate the hammers and feed shelves as directed under the head of Houses for Sitters, Chapter VIII. The sitters will do much running besides, on their own account. The layers, which are in the same runways and buildings occupied by the sitters, feed at the same time as the latter, and the layers have numerous opportunities to feed, while each batch of sitters has one opportunity only. This is all right, for the sitters should be rather sparingly fed, in order to keep them keen and eager, so that they may leave their nests promptly at feeding time and not have to be removed by hand. Whenever the feed shelves are operated, there should be only the very smallest possible quantity of grain jarred down, consisting of millet or very fine cracked corn. The object is to confirm the habit, which all the birds will have, of running back and forth to see what is good at the other terminus of the yards between whiles, when the attendant is not present.

## CHAPTER XV.

### MANAGEMENT OF YOUNG CHICKENS.

In keeping poultry on a large scale, there is no one thing more important, or more difficult to manage, than the chicken department. A failure in the yearly supply of pullets, with which to recruit the stock of layers, would be fatal to the whole plan. It is quite an easy matter to raise nearly every chick of a hardy breed, when there are but a few upon an extensive range, but it is the reverse when we are desirous of rearing several hundreds upon an acre, and there is, practically, no insect forage at all. If there are persons who consider the occupation of a poulterer as "small potatoes," believing that it needs less thought and skill than to manage a cotton mill or a mercantile establishment, or horses and cattle, let them try once to raise chickens by the thousand, without losing money, and find the need of keeping their wits as sharp as in more pretentious kinds of business. Yet, all difficulties may be surmounted by thorough management.

To have strong chickens, it is necessary, while developing the desired strain, to avoid breeding akin, and to keep the breeding stock in a condition as near to normal as possible, securing for them sun, air and exercise, and avoiding a pampering diet. The greater the number of eggs produced by a fowl, the less vitality there will be in each, therefore the first only of a laying should be set. Early chickens are the most certain to live, and this is because force is stored up in the parent before laying commences, sufficient to endow the first eggs or chickens

with plenty of vigor, while later, the abnormal or artificial prolificness impairs the eggs. In spite of the uncongenial weather, March-hatched chickens are stronger than those produced in April, and the latter, in turn, are reared with greater ease than those hatched in May.

But, after attending to the above considerations, the chickens being hatched and assigned quarters, their thrift then depends chiefly on their diet. Of course, they must be kept clean, dry, free from vermin, and protected from other enemies, quadruped and biped, and be allowed space for exercise in the sun and open air; but all these things will not suffice, unless animal food is artificially provided as a substitute for the insects they would obtain if there were but few chickens on the premises. True enough, chickens can be reared on grain and vegetables alone, because they are like man, omnivorous. Children can be reared without eating any meat at all, but both men and fowls will do better with animal food than without it. Butchers' meat, such as calves' and sheep's plucks, are even better than insects for young chicks, provided they are fed plentifully, yet only a very little at a time, and care is taken to alternate with grain and green vegetable food. Chandlers' greaves may be used for chickens, if very nice and sweet—the article varies much in quality. They are very cheap feed, cheaper than the fresh bits from the butcher, but not as good for chickens as the latter. There must be constant vigilance in supplying animal food regularly and systematically. The young of birds in a wild state are given an animal diet, even in cases when, as they reach maturity, they live upon seeds.

The young of our domestic birds cannot do their very best upon grain and vegetables alone, because such things cannot be digested and assimilated fast enough by them to meet the great demands for nourishment caused by their rapid growth. Nature has provided



that the young of all birds shall mature and become fledged with wonderful rapidity, in order that the period of their helplessness, when they are likely to be preyed upon by their numerous enemies, shall be short. The formation of the coat of feathers, which succeeds the downy covering with which they emerge from the shell, demands a quick and certain supply of nutritive materials, and, in the case of domesticated species, the young are obliged at the same time to nourish the growth of bodies which, owing to the artificial treatment man has subjected their parents to for many generations, tend to an abnormal size. The fledging period is a critical one, and the feeding, from the time of incubation until the wing and tail feathers are fairly developed, should all be contrived with a view to assist the digestive organs in changing just as much easily assimilated material as possible into an abundance of good, rich blood. It will not do to wait until the time of the most rapid feathering, and then begin to allow a generous diet, but the systems of the young chicks must be prepared in advance, by being stored with nutriment in every cell and tissue.

For the first few days after incubation, feed the yolks of eggs slightly cooked by being dropped in hot water, not spoiled by being hard boiled. Mix these with an equal quantity of the crumbs of corn cake, made by baking a dough of Indian meal and milk. The clear eggs, that were put under sitters and tested out, will give you a supply of yolks for this purpose. As soon as the chicks are five or six days old, begin gradually to substitute boiled plucks and livers, run through a meat cutter, in place of the egg yolks, and the Indian meal may be cooked as a thick mush, and to stimulate appetite by variety, add sometimes wheat bran and ground oats. Also, cracked corn and wheat screenings, raw, may be introduced. All they will eat of tender grass, chopped fine, and boiled potatoes, nicely mashed, should be given. The grass

may, of course, be discontinued when the birds are strong enough to pluck it for themselves. Millet seed is excellent for young chicks, and for fowls of all ages for that matter, but it is more expensive than corn in proportion to the nutrition it contains; the latter, cracked, and the meal and also the coarser particles sifted out, is the main reliance for encouraging young chickens to range for the sake of exercise a considerable distance from the coops containing the mother hens.

Occasionally, the broadcast sower should make a trip parallel to the row of small chicken coops at a distance of three or four to eight or ten rods, according to the age of the chicks, and scatter a slight sprinkling of fine cracked corn. It is not necessary to do this every day, for the remembrance of what they have previously found will cause them to ramble freely, especially as there will be a few insects on the range, even if not many. It is very important that the chicken coops shall be set in a single row and at a distance from other fowls, so that all the insect forage possible may be secured for them, and, at the same time, they will be encouraged to ramble far and wide, exercise and employment of their natural hunting faculties being as beneficial as the forage itself. If you double up the rows, even if they are 50 or 100 ft. apart, the chicks will not do as well. Locate the row near your crops, for they will do no damage before weaning. Crops grow insects; insects grow chicks.

The chicks of the main laying stock should be kept at a place separate from the selected pedigree chicks and those of the breed of sitters, because, as the former grow toward maturity, they should gradually receive feed more forcing and stimulating than the latter. The adult fowls designed for breeders should be fed sparingly, and forced to literally scratch hard for a living; the sitters must be allowed a stimulating diet in winter, to induce them to lay so as to be ready to sit early in the season,

but during the summer and fall their feed should be such as to restrain rather than promote laying, while the fowls of the main stock should be crowded all their lives without any intermission, by plying them with a

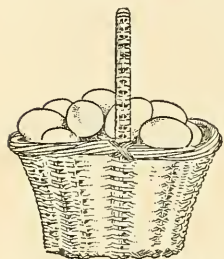

FIG. 41. LAID BY HENS.

diet growing richer and more stimulating, because containing a greater proportion of chandlers' scraps, or an equivalent in some other kind of animal food, the older they become. Cayenne pepper is the cheapest and best stimulant, with ground mustard and ginger for a change. Begin with a very little, and increase the quantity gradually, and be sure

to have these fiery condiments mixed evenly and uniformly through the mass of soft feed, by first scalding them in boiling water and mixing the infusion, dregs and all, with meal, mashed potatoes, or whatever the material of which the mess consists.

The chicks of the breed the main laying stock comprises are all that receive the indirect feeding previously described, which is another reason for locating them at a part of the ground distant from the pedigree chicks and sitting breed chicks, but all, irrespective of breed, may be housed at night in the "A coop," Fig. 33, a pattern which the writer's experience of over forty years of use has not enabled him to improve, cost being considered. To secure its full advantages, however, it must be used properly. The chief foes of young chicks are wet and rats. Unless the coop has a floor, the hen will scratch holes in the ground, which a hard rain will fill with water, and unless the floor is movable it cannot be readily cleaned. To arrange for the night, to avoid rats and at the same time give air, slide the coop toward the small rear door before pegging down the lid, *a*, as previously directed. This will give a crack at the edge

of the floor at the rear of the coop and also at the front, too small for rats to enter, and the animal heat will cause cold air to flow in at the very bottom of the coop, while comparatively warm air will escape near the top.

While the small A coops are good enough for ordinary use, yet some early chicks of the classes of breeders and sitters, which are to be reared under the most favorable auspices possible, are housed at scattered stations in the cellars vacated in early spring by the early-hatched pullets, and so have the advantage of a wide range. The house for pullets, a description of which has been given, is illustrated by Fig. 13. When this pullet house is moved off from the cellars, the latter are covered by some of the earth platforms, Fig. 6, a glazed sash being

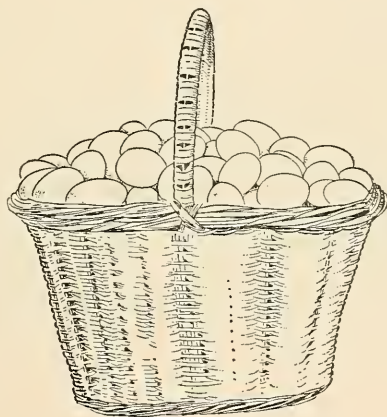

FIG. 42. EGGS LAID BY PULLETS.

temporarily hinged to one, after removing some boards, for a door. The platforms are laid two deep, as shown in Fig. 48. When the chicks are old enough to run in and out of the underground passage in the wall of earth in the foreground of this cut, they are restricted at first

to a small, lath covered pen, until they have learned the way, and afterward allowed to range where they choose, the mother hen being confined as before. No hen can ever be allowed to run at large with her brood, beneficial as the freedom is to her and her younglings, for, under

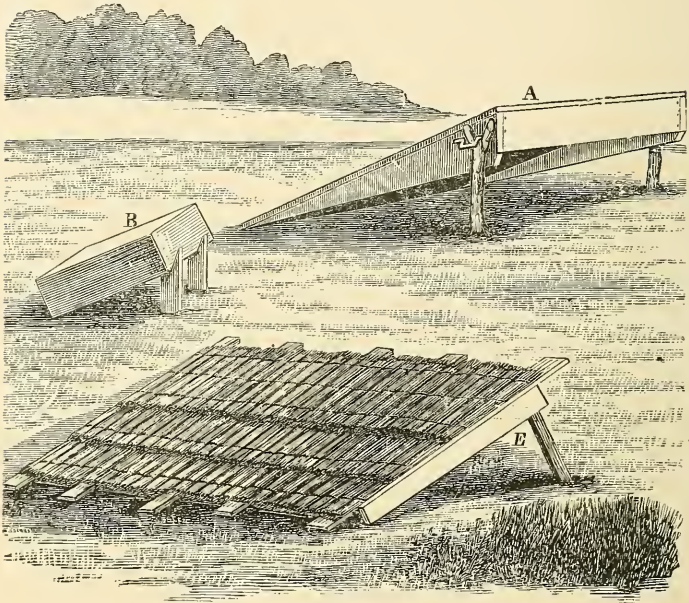

FIG. 43. SHELTER FOR CHICKENS.

this system, the practice and regularity cannot be secured at all times and in all changes of weather, which are essential in managing a large plant.

Shade is very essential in summer, for both fowls and chicks, especially for the latter, and is provided by propping on stakes some of the earth platforms, otherwise idle, as shown at A, Fig. 43. The basement parts of



the small coops, Fig. 36, not needed for weaned chicks till later in the summer, can also be propped up and covered with boards or straw, as at *B*, Fig. 43. In the foreground of this cut, *E* is a larger shelter from the sun, such as will answer for either chicks or layers, at the itinerant stations, made by propping a winter dust-bin, *B*, Fig. 11, in a slanting position, nailing lightly

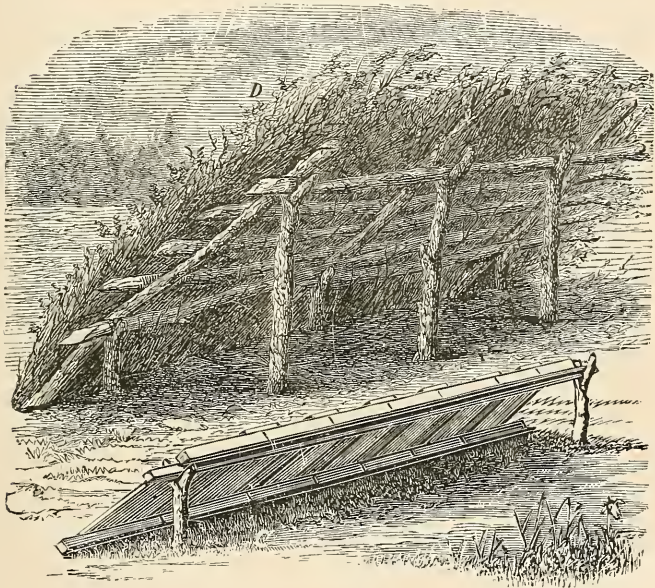

FIG. 44. TEMPORARY SHELTERS.

a few boards or poles across and thatching with the straw mats that were used on the roofs of winter houses. Spare floors to chicken coops, Fig. 34, may be arranged as at *C*, Fig. 44, and in the same cut *D* represents a shade made of rails and straw that were used in winter



quarters, Fig. 11, with brush or cornstalks added to keep the wind from blowing the straw away.

While speaking of shade for young chicks, it may be said here that for shade for layers at the colony stations, bins, *E*, Fig. 43, may be drawn upon the ground by the team, occasionally, so as to never be very far from the building when the latter is shifted, and some of the earth platforms are moved about for the same purpose, when not employed in the dry earth harvest. By using platforms at one station, straw mat screens at another, and movable booths of evergreen boughs at a third, neighboring premises are made to look unlike. In this way, all the various fixtures in the whole establishment are kept in use summer and winter, and chickens and grown fowls are sheltered from sun, wind and rain under structures that afford a great deal of ground room, which is what counts, but they are low like the houses, and, therefore, made with but little lumber.

## CHAPTER XVI.

### ADDITIONAL BUILDINGS.

The building which contains the cook room must also store the grain and vegetables, where they will be handy, and dry earth is kept at the same place, because, in connection with other apartments, a receptacle may be most economically constructed, which shall admit of labor-saving in unloading and reloading stuff which is so heavy.

The south elevation of the granary and cook house, Fig. 45, shows the manner of making a "side-hill barn" on nearly level ground, the object being to drive the wagon containing dry earth to as high a point in the building as possible. The driveway is made of masonry and earth, excepting near the building, where a wooden bridge is substituted, shown also in Fig. 46. A corresponding driveway at the north end, shown in Fig. 46,

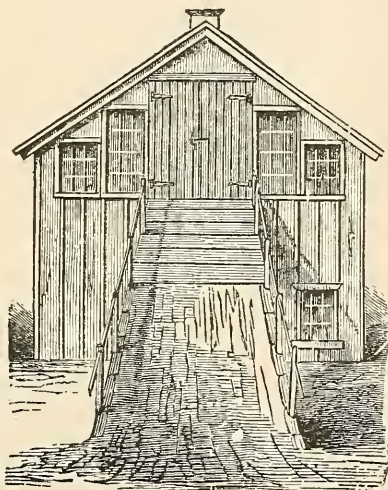

FIG. 45. SOUTH ELEVATION.

enables the team to pass out without backing. The dot-

ted lines in Fig. 46 indicate the floors, *A, A*, which follow the inclination of the driveways until the level space,

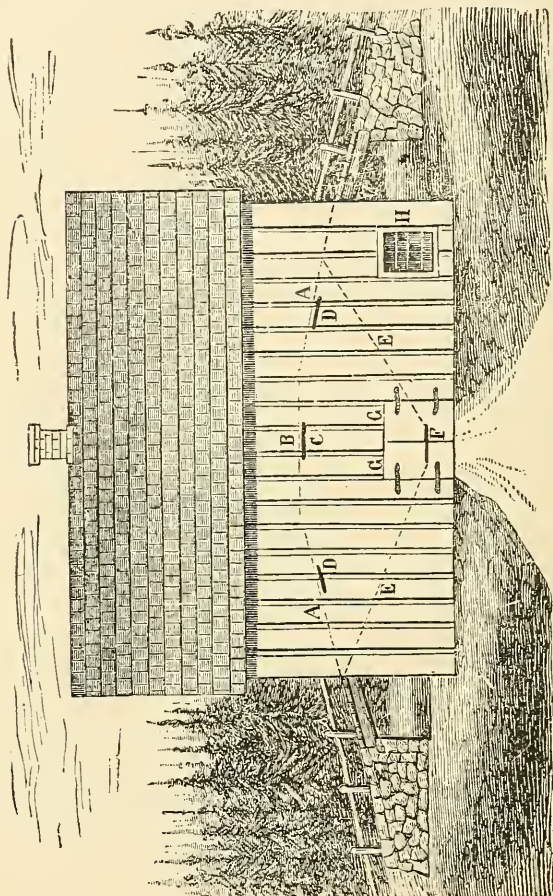

FIG. 46. EAST SIDE OF GRANARY AND COOKING HOUSE.

*B*, is gained at the center, where is a trap, *C*, through which the earth falls into a hopper-shaped chamber, as mentioned on Page 32. For filling the corners there are

additional trap-doors at *D, D*. This chamber or bin slopes at the bottom, the position of a part of which is shown by the dotted lines, *E, E*, which converge at the point, *F*, where is a slide-door, through which the contents are discharged to be carried to the stations, the wagon being backed for the latter purpose through the doors, *G, G*. West of the room where the dry earth is discharged into the wagon, is a bin for potatoes, etc., built of thick stone walls, to prevent freezing. This bin is filled from above by driving a load of roots to the floor, *B*, and allowing them to slide down an inclined plane. The cook room, with which the window, *H*, communicates, occupies the north part of the lower story, of which Fig. 47, Page 142, gives a ground plan. *I*, cook room, with its outside (north) door, *J*. *K*, grain bin, entered at the door, *L*. The root bin is at *M*, and entered at the door, *N*. The cook room is used in winter as a place in which to dress fowls, and contains also a work bench with tools. The cooking apparatus is at *O*. There is no chimney proper, but only a chimney top supported by strong timbers near the peak. A brick flue rises from *O* perpendicularly as far as the eaves, terminated by an ordinary stovepipe, which conducts the smoke to a large drum in the upper room, and from thence to the chimney top. In this way the garret is warmed for drying feathers, or for rearing a few winter chicks if desired. As shown in Fig. 45, the south wall of this nursery apartment is well glazed. The dimensions of the building are 36x30 ft., with 18 ft. posts.

Two buildings remain to be described. Figure 49 represents a hospital; that is, a building that can be used as such in an emergency. It is 14 ft. wide, 60 ft. long, and 8 ft. high at the peak. There is a passage 2 1-2 ft. wide, running its whole length the north side, which communicates with the twelve rooms into which the

building is divided by wire partitions. The glazed roof is upon the south side. There is an outside door (not shown in the figure) in the north wall, opposite the

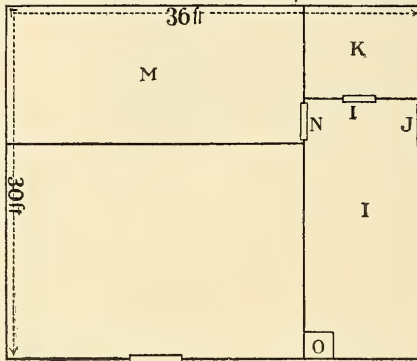

FIG. 47. GROUND PLAN.

chimney, for convenience in attending the fire. The building is warmed by coal, a fire-chamber of brick and a boiler and hot-water pipes being used.

It is injurious to animals to breathe the fumes that will escape when it is attempted to warm a room by passing a smoke-pipe through it, leading from a coal fire, unless the chimney is quite high, causing a strong draft, which is one reason for preferring hot water, and another is that the risk of overheating is not so great (for water cannot be heated above a certain temperature without turning to vapor or steam), and a third reason is that less fuel is needed with hot water than without. The original cost of hot-water fixtures is double, it is true, but they are kept in repair with hardly the expense of a cent, and cause a saving of fully half the fuel. The ventilator at the top of the building has immovable blinds at its sides, and horizontal doors at its bottom, opening upwards, and closing by their own weight,



moved by means of cords and pulleys, regulate the egress of air.

At the north side of the building are a number of small windows, covered with ordinary adjustable blinds, for the admission of fresh air, and in summer the doors at both ends of the structure may be opened, as in the illustration, and the windows in the roof should be partly curtained. This building is used for early chickens, and numerous other purposes, it not being expected to have much occasion to take care of sick fowls, for the true plan is to prevent disease by inducing constant exercise by scratching, by allowing sun, air, good food, and breeding from vigorous stock.

Never have any hospital at all on your premises for birds affected with roup, cholera or other serious epi-

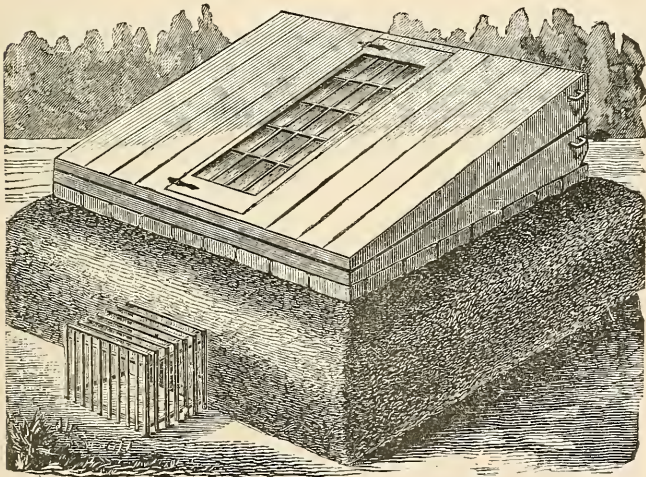

FIG. 48.—QUARTERS FOR EARLY CHICKENS.

demic or infectious disease. In time, it is confidently believed, some preventive, by inoculation or otherwise, will be provided by science to ward off the two dire



plagues, chicken cholera and roup; but till that happy era arrives the inflexible rule for treatment of diseased birds should be: Keep a sharp hatchet, and use when the disease first appears. The foundation principle must be to secure and maintain health and vigor. In introducing new blood, it had best be done by procuring eggs for hatching. But in the rare cases when it may be advisable to add live birds to the breeding stock, they

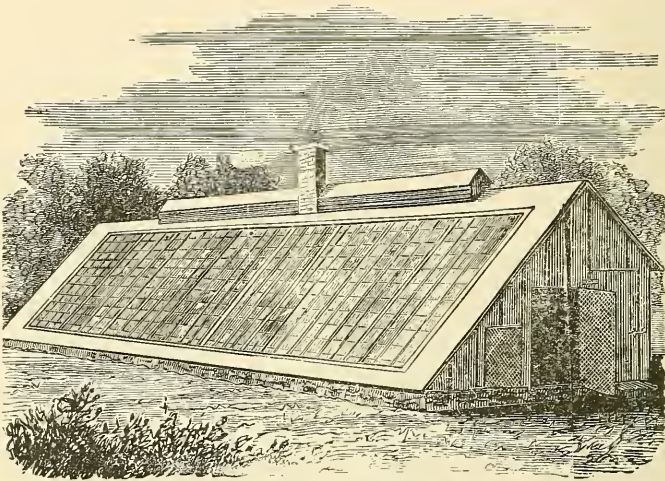

FIG. 49.—HOSPITAL FOR EGG FARM.

should first be quarantined at a distance from the main premises and frequently and carefully inspected, before being added to the flocks.

Of late, great advances have been made in the matter of destroying the parasitic vermin on fowls, and these pests will never again prove the terror to poultry men that they once were. The mites that infest the nests and perches, we have long known how to prevent. During sixteen consecutive years of fowl keeping in

Nebraska, not one of the minute vermin, the so-called "little red spider lice," has been found on the perches in the writer's fowl houses. Also the scaly leg parasite, while not yet entirely eradicated, has been readily controlled. But the large vermin, which cling to the bodies of the adult fowls, have, in years past, proved obstinate, unless, indeed, Persian insect powder was applied in quantity too expensive for ordinary use. But now, thanks to the discovery of the modern cheap liquid lice killers, the bodies of the birds need no longer be the hosts of these disgusting, creeping things. There is no such thing as spontaneous generation of lice, as every well informed person knows nowadays, and the goal we propose as attainable is to eradicate entirely parasitic vermin from a business stock of poultry, by thorough and persistent quarantine and treatment of the new purchased fowls before introduction to the breeding yards, thus keeping the aforesaid pest from restocking.

## CHAPTER XVII.

### THE INTENSIVE PLAN.

The condensed or intensive plan is to the itinerant colony or extensive system of poultry keeping what a greenhouse is to ordinary farming. In the former, as many fowls or chicks as practicable are yarded in a small space and also kept much of the time under a roof, while in the latter, comparatively few are allowed to the acre of ground and they are kept, for the most part, without yards, and never under a roof when it can be avoided.

During the last quarter of a century, the interest in pure bred fowls has been wonderful, and the money spent in disseminating breeds enormous in amount. Poultry associations and poultry exhibitions have multiplied and the hen fever has spread like wild fire. Millions of eggs of pure bred birds, for hatching purposes, have been sold and shipped to every corner of the land. But among the results have been disappointment, chagrin, and loss immeasurable. Thousands and tens of thousands of dollars have been squandered. Though the use of the scratching bin or shed has been well understood, and though it has been very generally provided of late years, it has proved impracticable for the ordinary fancier to mix the grain and straw often enough to induce the needful amount of exercise. He cannot stand around all day to secure the exercise of a few fowls, while if the large-scale man goes the rounds repeatedly to his hundreds of flocks, with rake or pitchfork in one hand and a basket of grain in the other, and

opens and shuts numbers of doors, the labor involved will intercept all or most of the profits.

The experience of the writer is corroborated by that of a great crowd of poultry men, to the effect that yarded fowls, as they have been, not as they might be, are failures as regards hatching and rearing purposes. Such a yard as is usually provided is a delusion and a snare. For a few generations, enough chickens can be hatched and reared to "keep the breed along," but if the young

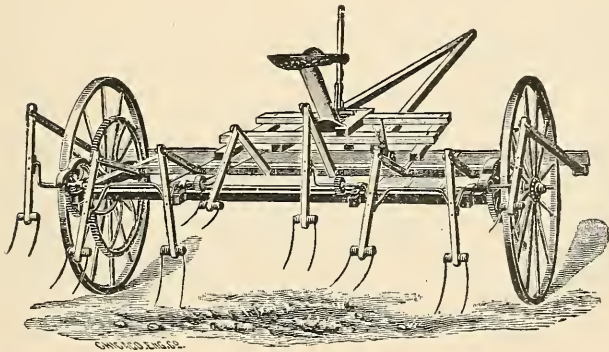

FIG. 51.—TEDDER FOR STIRRING LITTER.—(SEE PAGE 20.)

as well as the adult birds are confined, the end is extermination, unless, as is, happily, generally the case, the birds are allowed range a part of the year, or resort is had to a farm station for an intermediate generation or two, to restore wasted vitality.

Selling eggs at long prices for hatching from fowls yarded in the usual manner is an offense. For twenty years and longer, while yards have been common, the same old cry has been repeated: "The season has been bad for hatching." But every season always will be a bad one when the layers take insufficient exercise. It

does not need that the breeding stock should be actually sick, in order to impress a feeble and degenerate condition on the eggs. The fowls may be in apparently perfect health, yet their eggs may have become impaired.

The following, from a late issue of *The California Poultry Tribune*, would have been appropriate any and every season since the advent of pure bred fowls in the

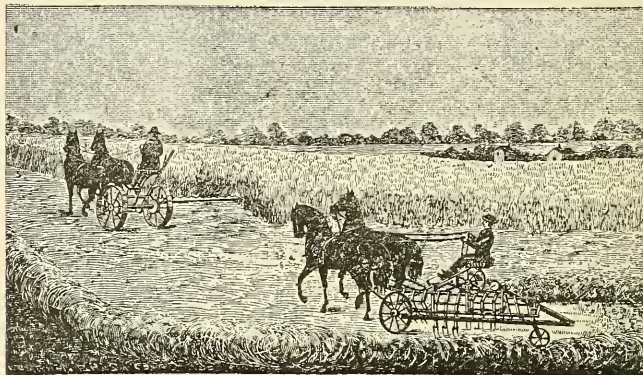

FIG. 52.—THE HARVEST.

United States caused the enclosed poultry yards to supersede the open range enjoyed by the birds of the former generations of poultry keepers :

“Eggs, as a rule, hatched but poorly this last season, and I think it a general complaint throughout the country. There seemed to be lack of fertility of eggs, and chicks that managed to get out of the shell appeared weak, lacked vitality ; in consequence, early show specimens are scarce and will bring good prices for the lucky owners.”

The non-hatching has been hastily attributed to the weather, but the weather never hinders the hen which runs at large and steals her nest and is actively engaged the greater part of the day in foraging for a living, from hatching twelve or thirteen chicks out of a nestful of thirteen eggs. The feed has been another scapegoat. Every combination of animal food, green stuff and cereals has



been tried, but no ration has been found that will neutralize the bad effects which the lack of exercise of the laying birds produces on their eggs.

In the first edition of "An Egg Farm," the importance of inducing exercise by scratching was inculcated for the first time in print. The reader is reminded that poultry literature is mostly of a very modern date. There have been, down to the present time, about two hundred books and pamphlets printed on poultry, in the English language, but when *An Egg Farm* was first published, a small but excellent poultry book by Wright, another by Geyelin, and a few other books, very meager ones, comprised all the works on fowl keeping which had then attained any considerable circulation, and nowhere had the importance of scratching, for the sake of exercise, been mentioned—though the experience of people with flower beds had, for long centuries previous, shown that the hen is, by nature, a scratching animal, as inveterate in parting the soil as is a duck in parting the water, and more so, in some cases, since the fondness for swimming has been bred out of some strains of Pekin ducks, by withholding bathing privileges from them for many consecutive generations. Since our first recommendation, in the original edition of *An Egg Farm*, as above stated, to furnish a scratching pile or scratching bin, the modern voluminous fowl literature of the country, including the poultry columns in the numerous agricultural periodicals, has reiterated the advice until fowl keepers have become well indoctrinated on this point.

But, while the use of horserake and hay tedder, for the free range colony system, was pointed out in the first edition, no better way was shown for mixing the grain and straw, in yards or buildings, than to do it by hand. We described the best way we then knew. The advent since, of simple mechanical apparatus, contrived by the author, to accomplish the mixing, constitutes a



revolution in intensive poultry keeping. By the use of this invention, the greatest objections to keeping poultry in confinement disappear, and by means of the new system yarded birds produce strongly vitalized eggs, that hatch well and make healthy, vigorous chicks. Now, even in quite narrow quarters, both the parent stock and the young chicks can be made to take as much exercise as they naturally do when running at large, and more, in fact. The apparatus is to birds in confinement what the wheel is to a squirrel in a cage.

As we have pointed out, it is utterly impracticable to mix straw and feed together by hand often enough to

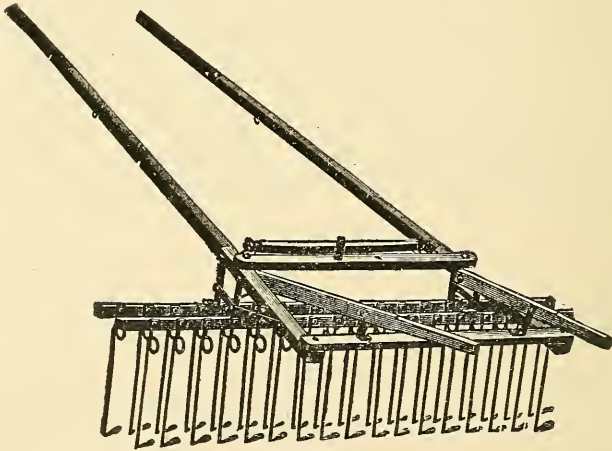

FIG. 53.—WEEDER AND SOIL STIRRING IMPLEMENT.

keep the flock of fowls well employed. It must be done often or it will not amount to much, and it must also be done right; that is, there must be a correct proportion between the quantity of grain and the quantity of straw. If too much straw is used, the fowls become discouraged

and will not work at all, and if too much grain is used, their appetite is soon satiated and they become listless and inactive thereafter for the remainder of the day. When a judicious scratching pile has been made, for young chicks or old birds, no matter which, it will be found that they will work it over in good thorough style in just about twenty minutes. A device for mixing the grain and straw automatically is evidently needed, so that it can be done often and labor saved.

## CHAPTER XVIII.

### THE EXERCISER.

We have already shown some simple contrivances for inducing fowls to run, in the few cases under the extensive system where it was necessary or convenient to employ yards or runways, but to induce them to scratch is another matter, which becomes very important under the intensive system, where yarding is the rule and open range the exception. While formerly one attendant could properly manage hundreds of yarded fowls, he can now tend thousands by means of the new machine, which is called the Exerciser.

In its invention, the problem was to devise a receptacle, suspended over the straw, to hold grain enough for a day, or for several days, if desired, inaccessible to rats and mice, and to discharge a little and often upon the straw beneath; for, as stated, if too much is distributed at a time, the birds will become cloyed and cease working, and if too little is dropped they will also cease, because they become discouraged.

The dropper or distributor, which is more accurate and precise than the feed shelf already described, and is, therefore, particularly adapted to feeding chicks in brooders, is constructed as follows: Let *e*, Fig. 58, represent a strip of tin, 3 ft. x 8 in.; *a* is a strip of wire cloth, 3 ft. x 3 5-8 in., with mesh 8 to the inch; *b*, *c*, and *d* are strips of wire cloth of the same length and width as *e*, and *b* has mesh 10 to the inch, *c* has 12 and *d* 14 to the inch. All these may be ordered at any hardware store. Figure 59 shows these strips, *a*, *b*, *c*, *d*,

and *e*, all soldered together in a regular gradation, according to sizes, the finest mesh being soldered to the tin. Let *e* lap over *d*, and *d* lap over *c*, and so on; no need of soldering continuously—a drop of solder every

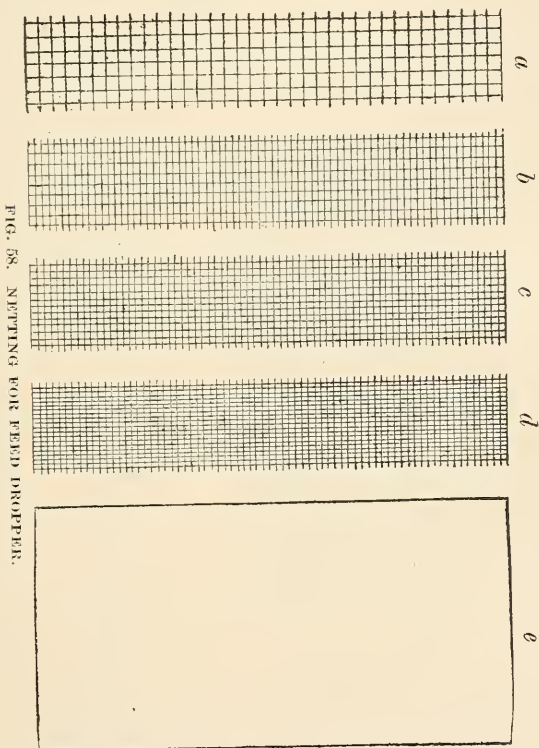

6 in. will do. There is a little knack in soldering such material. Press the strips flat on a floor or board, allowing each to lap at one edge 1-4 in. over its neighbor. You hold the wire cloth down firmly, by pressing end-

wise with a small stick, close by where the solder is put, so that the wire cannot spring, while another person does the soldering. In three seconds the solder will chill, and you move your stick 5 or 6 in. to the next point.

Figure 61 shows one of the end pieces to the dropper or feed cylinder. It may be either octagonal, square or

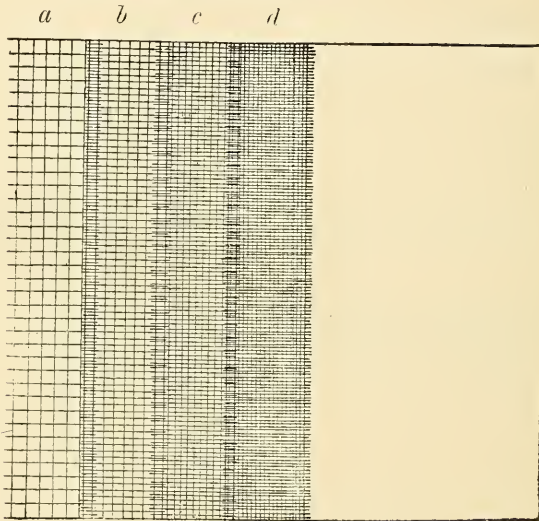

FIG. 59. STRIPS SOLDERED TOGETHER.

circular, and if of the latter shape, should be five and three-quarters inches in diameter, being cut from a seven-eighths inch board. It has a hole, *f*, in the center, to receive an iron shaft, consisting of a half-inch iron pipe. The shaft may be of any length desired, and to it may be attached as many cylinders as needed to feed a row of separate flocks in a long, narrow house. Figure 60 shows how the tin and wire of Fig. 59 are fastened to

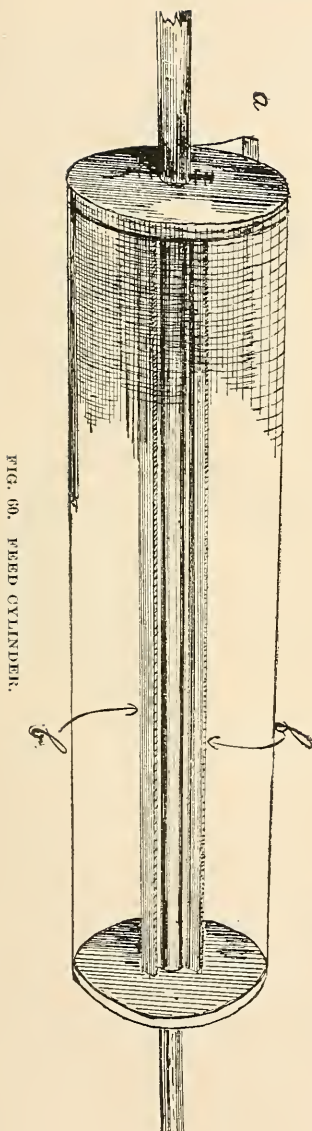

FIG. 60. FEED CYLINDER.

the end piece, Fig. 61. In Fig. 60, *a* represents the tin which is tacked closely at the bottom of the cylinder, but flares out into a flange at *a*. Above *a*, there is an open space, through which the cylinder is charged with grain. The flange assists in putting in the proper quantity quickly, the grain sliding down, of course, so as to rest on the tin at the underside of the cylinder. In Fig. 60, the cylinder is shown in correct position for filling. The cylinders are fastened to the shaft so as to move with it, not on it. The grain should be in the form of small particles of assorted sizes, from the dimensions of a pinhead to a kernel of wheat. Cracked corn with the meal sifted out is excellent.

The cylinder should be made to perform only about a hundredth of a revolution at a time, the motion, at first, after charging with grain, being in the direction to raise the tin upward, consequently the millet, wheat and cracked corn will come in contact first with the fine



mesh and afterward with a coarse and still coarser mesh successively, all the time losing grain of a coarser size, the coarsest particles of the whole falling through the open

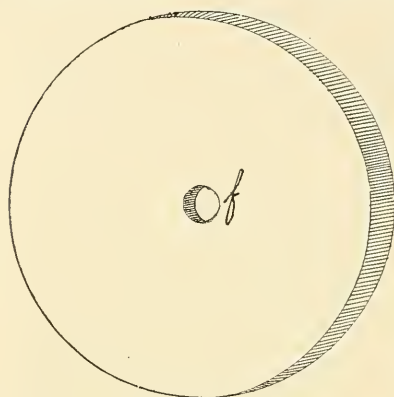

FIG. 61. END PIECE OF FEED CYLINDER  
IN POSITION.

space next to the flange, *a*, by the time the cylinder has made a complete revolution. The operation of revolving a cylinder and its successive positions are plainly shown in Figs. 92, 93, 94 and 95.

The sticks, *b, b*, Fig. 60, are to keep the cylinder in shape, while it is being slipped onto the shaft.

This shaft of half-inch iron pipe must have a hole drilled through it to receive a common wire nail, as shown in the left of Fig. 60; the nail being clamped against the wood by means of small staples.

At one end of the shaft or axle, attach a crank, which must be moved only the very slightest distance at a time, so as to spill the desired quantity at a dose into each pen of birds located under each cylinder, and supplied with straw, chaff, or litter, upon which the feed drops. Eight or ten hours or so must elapse before you make the axle accomplish a complete revolution. In a fraction of a second you can sift down a dose for a half dozen flocks or for a score of flocks, according to the length of the building and the axle. It takes no longer to feed several hundred birds than to feed twenty. A mere jar with the thick of the hand against the handle of the crank does the business. This jar should be given two or three times an hour.

In a large establishment, where an attendant must be on hand pretty much all the time, anyhow, this operation by a crank will be chosen, but the fancier or amateur, or ordinary keeper of one or a few flocks, will do well to attach clockwork to the dropper, and to the chaff box described further on, so that the feeding may be carried on regularly, while he is at his office or store or even out of town. The easiest way to make a crank and attach it to the axle of the dropper, is to use a half-inch iron pipe six inches long and another piece four inches long for a handle, and two elbows, one of which is to be screwed to one end of the axle, see Figs. 120 and

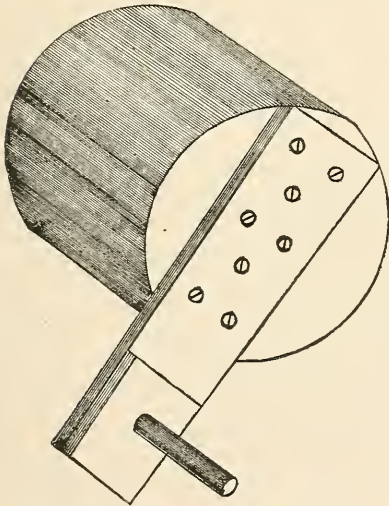

FIG. 62. CRANK FOR WOODEN SHAFT.

63. Or, if a blacksmith can be obtained more readily than a plumber, one end of the hollow axle may be plugged with iron and a wrought iron crank, Figure 67, may be attached with a nut and washer. Or a ready made crank with a wooden handle, Fig. 69, can generally be procured at a hardware store. Or, if you are near an agricultural implement factory or a railroad

shop and can get a handwheel, such as is represented in Fig. 68, it will be better than any sort of crank.

## CHAPTER XIX.

### THE TILT BOX.

A pile of straw, leaves, chaff, excelsior, hay, or almost any sort of litter must be located under the cylinder. If the litter would always remain loose and huffy so that the grain would rattle down in interstices, then no further machinery would be needed. But it will not remain loose. The scratching of the birds will soon reduce long straw to short bits, and their trampling will turn the pile into a compact mass, on top of which the grain will lie and be devoured at once, and therefore no exercise to speak of will be secured. An agitator or litter-stirring apparatus is therefore necessary, as well as a grain dropper, so that the litter and grain may be thoroughly mixed together.

There are a half dozen different methods of constructing simple machinery for mixing, but the simplest movement consists in using chaff, short cut straw or other stuff for litter that is short and heavy enough to roll and tumble readily, and placing it in a box or bin that is made to rock like a cradle. Let the floor be in a level position at the start, then rock the box till the floor stands at an almost perpendicular position, causing the litter to tumble, then rock the box back again to a level. The grain is dropped just before the litter begins to slide or tumble. By a simple device, to be presently described, the fowls are called out of the tilt box before it is rocked, and are not admitted till it is level again.

The operation of rocking or tilting will be understood by referring to Figs. 72 and 73. Suppose the box is at

rest, as shown at *A*, Fig. 73, the litter being represented by the dots being level. The first step is to tilt to the position, *B*, and then stop a second and drop feed from the cylinder, 10, before the litter tumbles, then pass to the full tilt, *C*, Fig. 72, which makes a windrow or ridge, then immediately go back to the level position, *D*, when

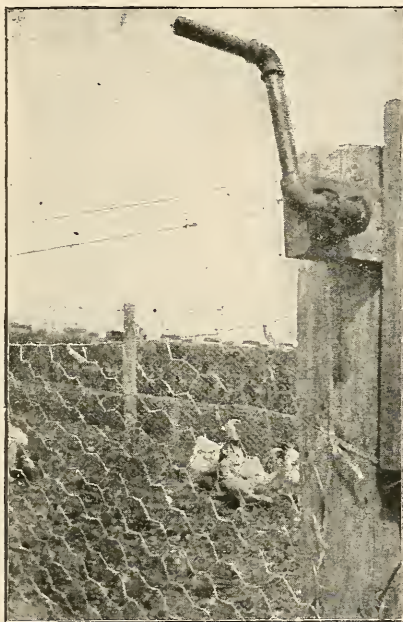

FIG. 53. END OF ROW OF FEED CYLINDERS.

the windrow will be found intact at *y*, with grain mixed through it ready for the fowls to enter and go to work. The shape of the windrow is not destroyed by the motion of the tilt box in returning to the original position. After the birds have worked about twenty minutes, scratching, the litter will be back to its original level,

or nearly level, position, as shown at *A*, Fig. 73. There is wire netting from *x* to *w* and from *w* to *v*, which gives light and air, and also permits the feed to drop through when the cylinder is jarred slightly while the box is at the half tilt. The portions of the box at *u*, *v*, *w*, *x* and *y* are boarded, and to put litter in the box or

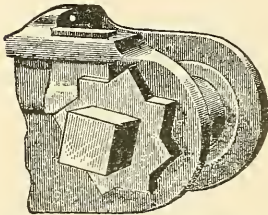

FIG. 64. FENCE RATCHET.

take it out, make *v* and the wire strip next it in the form of a door, to be hinged to the board, *w*. The tilt box is supported upon and rotated by an axle, 4, of iron pipe, which rests on joists, these being about two feet above the floor of the building, so as to give the box

room to tilt. A row of tilt boxes, each for a separate flock, may be attached to one continuous axle, and all tilted simultaneously, a row of feed cylinders being suspended above them to correspond.

If, for the sake of economy or convenience, a wooden axle is preferred, the tilt boxes may be nailed to a sawed stick 3x3 or 4x4, or larger, according to the number of tilt boxes it is to turn, the stick being rounded where it rests on the joists; or a straight pole from the forest may be substituted, Fig. 74, and clamped to the box by bolts, *b, b*, passing through pieces of hard wood, *a* and *c*. Clamps consisting of single blocks of wood and two bolts, Fig. 98, may be used to attach small (chick size) tilt boxes to iron axles. The feed cylinder and tilt box are useful for adult birds and for chicks reared artificially in brooders, the size being according to the size of the birds.

Various other mechanical movements designed for mixing grain and litter together have been tested, but none has been found as satisfactory as the tilt box. A

box is shown in Fig. 114, with a portion of its floor, 27, curved. There are revolving arms, 32, and spokes, 33, attached to the axle, 34. The box does not tilt or revolve, the motion of the arms and spokes sufficing to stir the litter. This apparatus works fairly well, and

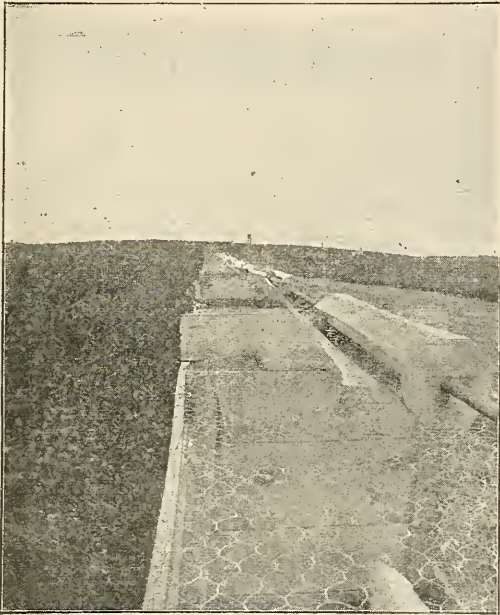

FIG. 65. ROW OF FEED CYLINDERS.

better than several other mixing machines tried at our establishment, but the tilt box excels all of them.

The method of calling out the occupants of the tilt box into an adjoining apartment remains to be described. The reader is referred to Figs. 71 and 76, which, however, are not literal representations, but are intended merely to show the principle. Figure 71 is in perspective,



and Fig. 76 is a transverse section of the same. Compare Fig. 72 with Fig. 76. Both cuts represent a tilt box turning on the axle 4, although the position is reversed in one cut, and both show the location of the octagonal feed cylinder overhead. Figures 71 and 76 show the essential features of the method of calling the



FIG. 66. CHICKS RESPONDING TO FOOD SIGNAL.

birds out of the way and keeping them away until the tilting operation is finished. The size and preparation of the various parts will be modified according to the dimensions of your fowl house, in case of laying stock, or the size and shape of your brooders, in case of winter chicks.

In Fig. 71 are given a tilting box and a stationary

box, both being set on legs and being a part of a series ranged along a passageway where the attendant goes. We will suppose we are describing apparatus of chick size. The tilt box, 1, underneath the cylinder, 10, is 2 or 2 1-2 ft. wide, 3 1-2 or 4 ft. long, according to the number of birds you prefer in a brood, and 1 ft. high. For the sake of light and air the top is made mostly of wire netting, one inch mesh. Bottom and ends are of boards, sides partly boards, partly wire. Each box should have three to five pecks of fine litter, the quan-

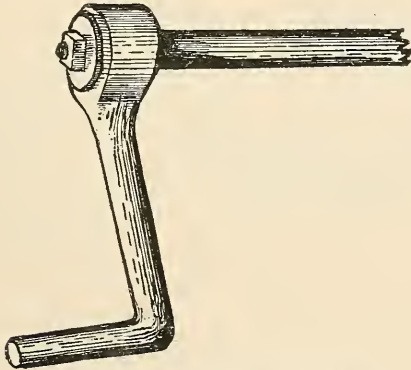

FIG. 67. WROUGHT IRON CRANK.

tity depending on the age of the chicks, number in a brood, and size of the box. The tilt boxes alternate with stationary boxes down the whole length of the passage, although but one tilt box, 1, and one stationary box, 7, are shown in Fig. 71.

You call the chicks out of the tilt box into the stationary box by means of a bell, 22, pulled by the handle at 24, and by setting in motion a small extra cylinder, 20, represented here as of a square form, which contains grain and is supported and moved by axle, 19, and crank, 21. The small cylinder is set directly over the

stationary box, 7, which adjoins the tilt box. These two boxes communicate by small exit apertures, 8 and 9, cut in the ends of each box. These apertures reciprocate when the tilt box is horizontal, but ingress and

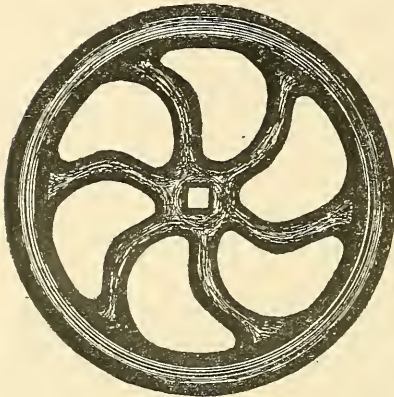

FIG. 68. CRANK WHEEL.

egress is cut off when the tilt box has tilted half its journey. In both Figs. 71 and 76, a board flap may be seen (the artist omitted giving it a numeral), with its lower edge curved, the flap being attached to the tilt box under the aperture, 9. It follows that when the tilt is partly accomplished, as shown by the dotted lines, com-

munication between the tilt box and the stationary box is cut off, so that the birds cannot return to the tilt box until the tilt is completed and the box is on its homeward passage and almost arrived at its original level position. A flap attached to a tilt box is shown more plainly in Fig. 141, which also represents the best shaped box that we have tried. The opening in the box through which the chicks pass in and out is made high enough above the floor to allow for a layer of litter. It will be noticed that the wirework at the top is in the form of a door, as previously explained, to facilitate removing litter and putting in fresh occasionally.



FIG. 69. CRANK.

Referring to Figs. 71 and 76, the order of movements

is as follows: You ring the bell at 22, at the same time causing the flag, 25, to flutter, although the flag is not absolutely necessary, and then you jar the crank, 21, slightly, causing a few particles to fall, and the chicks rush pell-mell through the exit apertures, 8 and 9, into the stationary box, 7. You then immediately begin to rotate the tilt box, pausing when the tilt is half accomplished, at which time the floor of the box stands at a slope of  $45^{\circ}$  and the litter has not begun to slump or slide at all. During this pause you tap the crank, 16, of the main cylinder, 10, causing a sprinkle of feed to

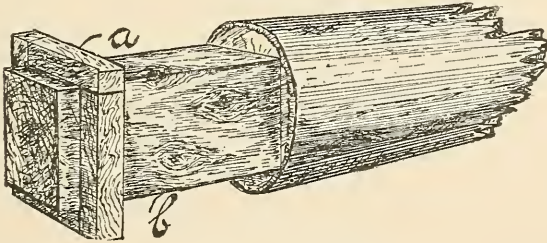

FIG. 70. END OF SHAFT.

drop upon the litter. Then you complete the tilt, and the feed will be found mixed all through the ridge or windrow of litter.

Next bring the tilt box to a level position, which affords ingress to the birds, and, no bell call being now necessary, in they will rush in two seconds, and proceed to tackle the windrow and level it, to a surprising degree uniformly, all over the bottom of the box, if the litter is not too coarse, and they will be just about twenty minutes doing it every time, if the quantities of both litter and grain are right. Three times an hour, or thirty or more times a day, you can repeat the operation as you choose.

The bell call, or a flag call, or some sort of a signal, is a necessity, at first, when the chicks are to be enticed

into the stationary box, preparatory to tilting. Later, no bell is needed, for the very slightest movement of the feed dropping appliances, unless absolutely noiseless, will serve the purpose of the bell. Referring to the hand bell shown in Figs. 71 and 76, a trip gong bell,

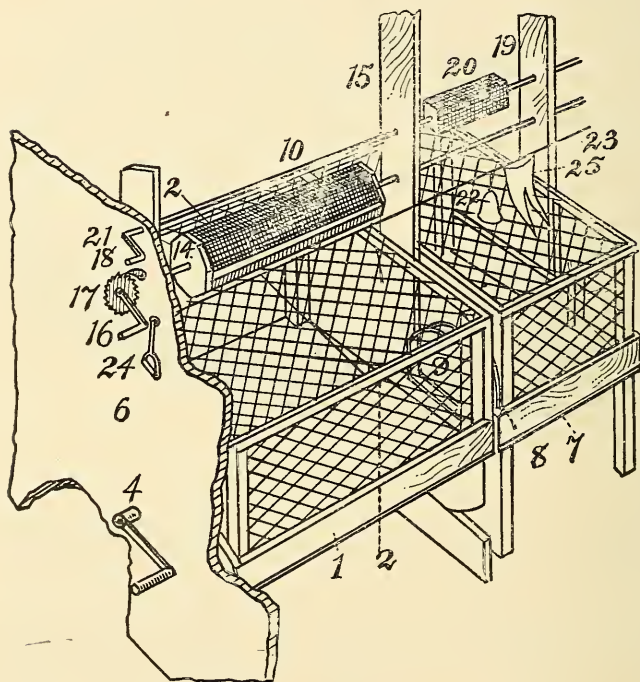

FIG. 71. DETAILS OF TILT BOX.

Fig. 126, is preferable, and you may use one for every fifty or seventy-five feet of your brooder house. Or suspend an ordinary sleigh bell by a cord over every brooder box. People ask how long it takes to teach chicks to understand the bell, and are surprised that only a few days are needed for this. Fowls, old and young, rely



much on their ears, and as nature has taught them, during thousands, or perhaps millions, of generations, to give heed to a language among themselves, they have a natural aptitude for learning the meaning of sound signals. After they have been taught, they will heed a bell hung at a great distance from their apartment, or,

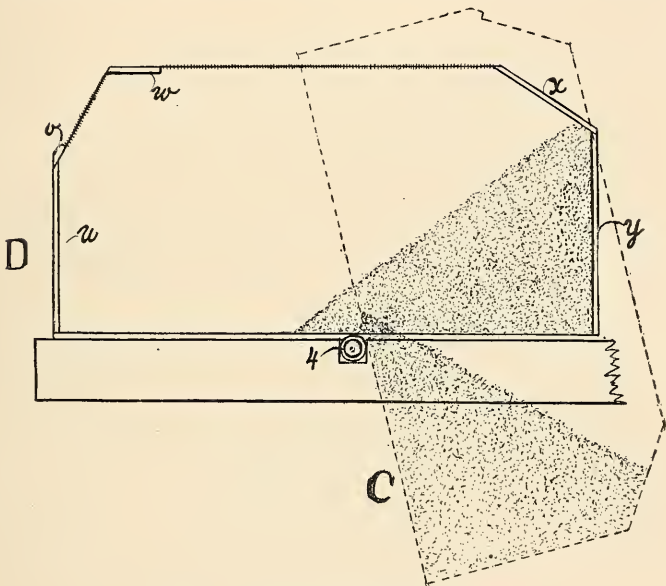

FIG. 72. TILT BOX—REVERSE OF FIG. 76.

as we have said, the slightest noise made by the friction or jarring of the feed-dropping apparatus, or its connecting parts, will render a bell unnecessary.

In Fig. 71, the axle, 14, is represented as fitted with a ratchet, 17, and pawl, 18; but these are unnecessary, the friction of 14 against its wooden supports being sufficient to hold it in the position it is left by the operator, unless the axle supports quite a long row of cylinders.



Or one or more brakes made of a stick of wood pivoted to an immovable stick at one end and having a weight attached to the other end, may be located so as to ride crosswise of the axle and impart the desired amount of friction. It is our aim to show homemade styles of

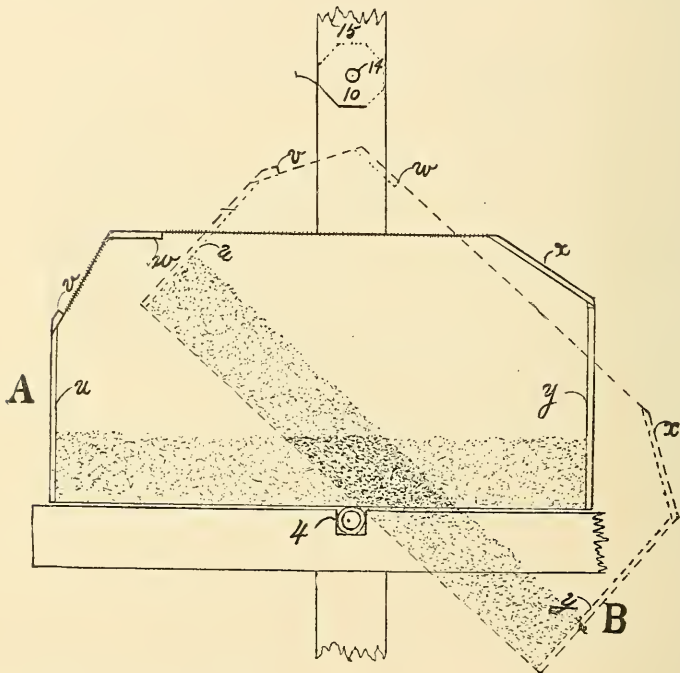

FIG. 73. USING THE TILT BOX.

construction for everything, as well as more elaborate patterns. Axles 4, 14 and 19 are represented in the cut as passing through a wall or partition in the foreground. Figure 76 represents the same as Fig. 71, it being a vertical section substantially through 2, 2. The numerals are the same in both cuts. The dotted lines in Fig. 76

represent the half tilt, which is the position at the time the dropping cylinder is moved to discharge feed upon the litter. The operation of tilting is further illustrated in Figs. 72 and 77.

Having shown the mode of operation, by means of Figs. 71 and 76, we beg to again remind the reader that

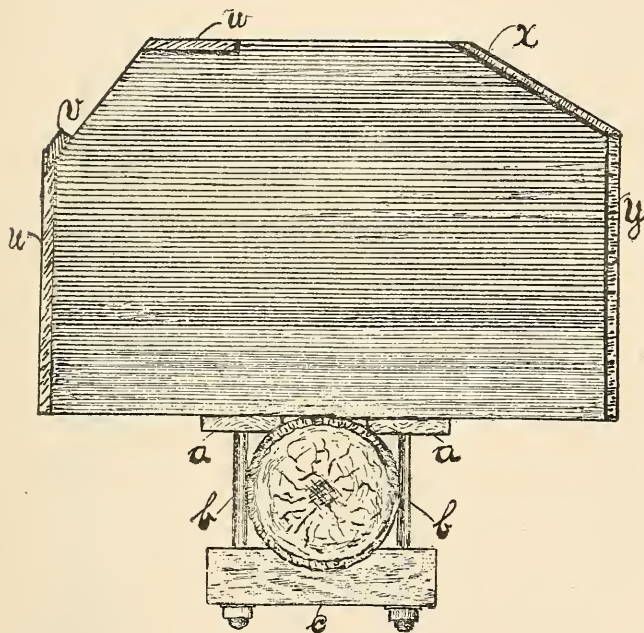

FIG. 74. TILT BOX ON POLE.

these two cuts are not literal representations of the exerciser, for in order to make plain "how the thing works," we have employed these in a general way to exhibit the principle merely. The shape and proportion of the two boxes or apartments, and of the other parts, must be modified to fit various cases. The essential

ideas are the dropping of grain and ringing a bell to call the birds out of the tilt box, a flap or revolving door to shut them out, the dropping of grain onto litter, the stirring or mixing of the litter and grain together, and, finally, allowing the birds admission to the tilt box ; all these stages being accomplished by an operator at one extreme end of the building.

To turn the shaft which supports the tilt boxes, a winch, Fig. 138, may be employed, such as is used for hoisting, provided the line of tilt boxes is a long one. Or, a long iron crank may be employed, as in Figs. 78, 79 and 80. It may be two and a half to three feet long, and one or one and a quarter inches in diameter. It will suffice for twenty or thirty chick tilt boxes, or five or six layer tilt boxes, and may be made by any blacksmith and attached by set screws. The figures last named show tilt boxes of the shape of Fig. 143, which is a very good style, these being built of wire wherever possible, for the sake of light and air, and the box being deepest at the rear to receive the windrow. The axle is not at the center, but nearest the rear, so as to allow revolving more easily on the return trip. In Figs. 78, 79 and 80, the call-cylinder axle and the axle of the regular feed dropping cylinders have the sort of handwheel attached that is shown in Fig. 68, a brake wheel procurable at car shops.

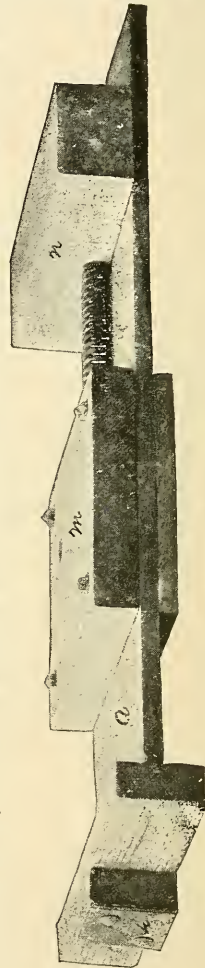

FIG. 75.

The levers or cranks attached to the tilt box axles are long, and the handwheels attached to the cylinder axles are of considerable size, because the axles represented in the cuts are each 145 ft. long. If the tilt box axle is of wood, a wooden lever, Fig. 88, strengthened by iron plates, may be fitted to one end of the axle, which is squared, Fig. 70, *b*, and after the lever is put on, a collar, *a*, keeps it in place.

## CHAPTER XX.

### OUTDOOR EXERCISER.

As exercise out of doors is very desirable during the whole year, except when the weather forbids, and as the tilt box is not very well adapted to out of doors, a style of apparatus different from that we have described is of great value for use in yards. While the form of exercise for indoors consists in scratching, the outdoor exercise is by running, jumping and flying. To begin with, two small yards of 50 to 100 square ft. of ground are constructed for each flock, 100, 150 or 200 ft. apart, according to the space at command, these being connected by low, narrow runways of wire netting stretched over frames of wood or iron, exactly as described for breeders and sitters on the extensive plan.

These runways are only 2 1-2 or 3 ft. high and the same in width and are preferably built in separate movable sections, say 12 ft. long. They are the same as those used for fowls kept yarded in connection with the extensive or itinerant plan. These sections or hurdles can be readily moved and the ground plowed to keep it sweet and clean, and being closed at top and sides by the wirework and open at both ends, they make a continuous passage or runway when placed in a line end to end. We have said that each runway terminates at either end in a small yard. Now, there is also an additional yard attached to each runway, midway between the two end yards. This center yard should be covered, 4 or 5 ft. wide, and considerably higher than the runways, say 4 ft. for Asiatics, 5 or 6 ft. for medium breeds and 7 or

8 ft., at least, for high fliers like the Leghorns. The length should be in proportion to the height, say 8 to 16 ft.

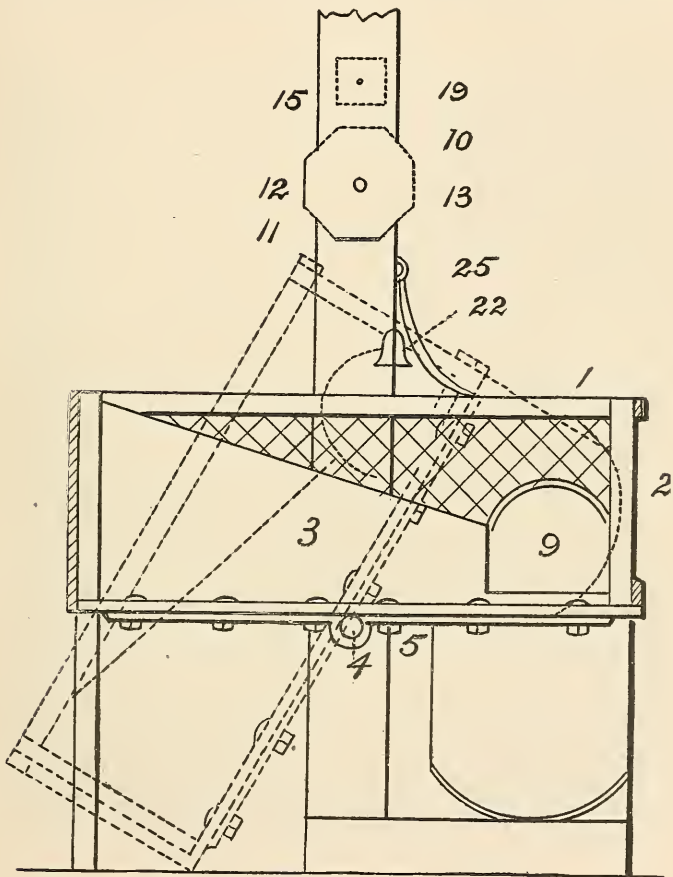

FIG. 76. TRANSVERSE SECTION OF TILT BOX.

These little yards with runway attached will afford fifty times the exercise in proportion to the building material employed and the space occupied, that the ordi-



nary yard will. The birds will take more exercise even than the farmer's flock, which runs at large. For the flock in a yard or on a free range will walk, while those in the runway will run, that's the difference. The surface of

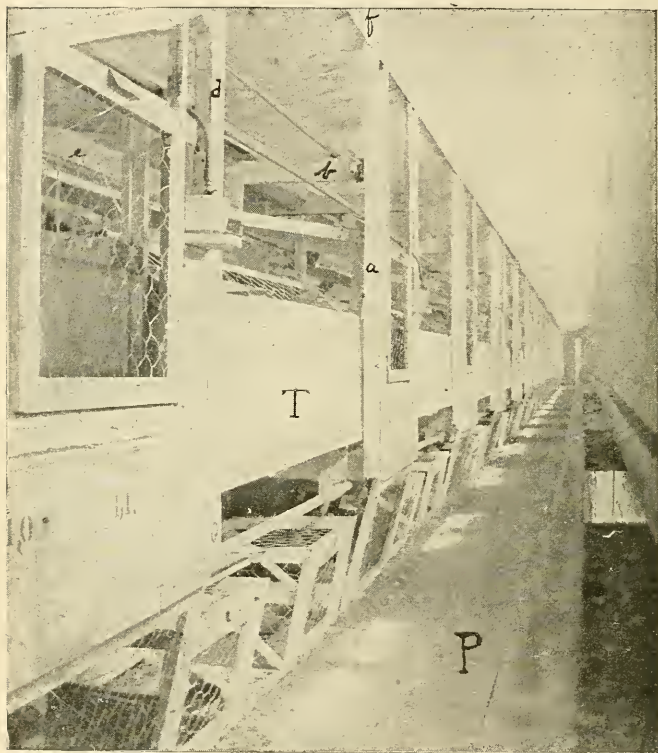

FIG. 77. INTERIOR ALTERNATE SYSTEM. SEE FIGS. 128 AND 130.

an ordinary yard becomes, in a short time, as bare as the desert of Sahara. It affords not the slightest incentive to exertion. There is no more vegetation growing on it than on the lid of a copper teakettle, and it is

seldom, indeed, that a stray grasshopper invades its sterile precincts. The nature of the fowls is to run, search, spy and hunt, yet they become discouraged and finally relapse into idleness and mope in a corner. But

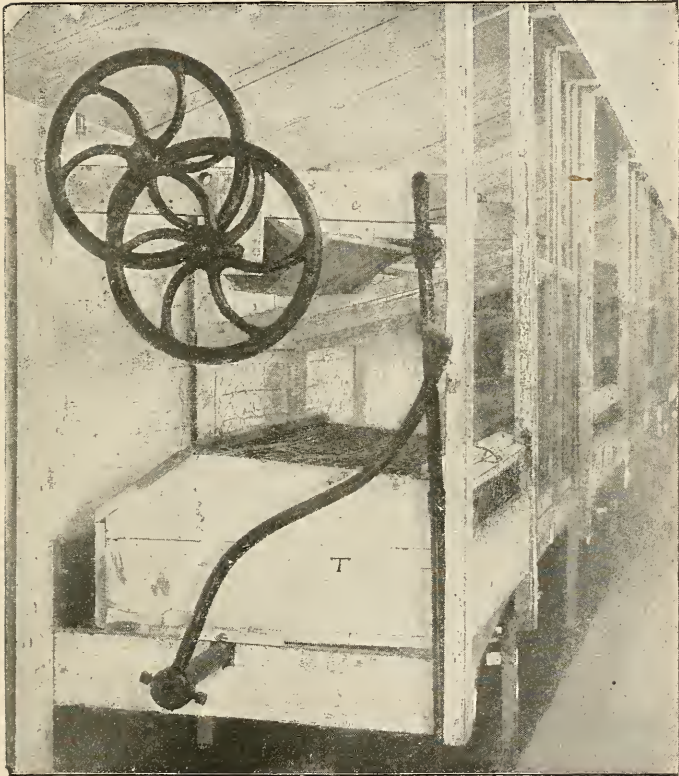

FIG. 78. ROW OF TILT BOXES, FROM END.

the runways we are describing cure all that, as the reader will see further on.

Figure 82 gives a partial view of a series of low, narrow runways, connecting with a row of end pens or small

yards. Figure 83 is a ground plan that will further assist the reader to understand the arrangement of the runways and pens. Let 1, 1, 1, 1 represent one row of

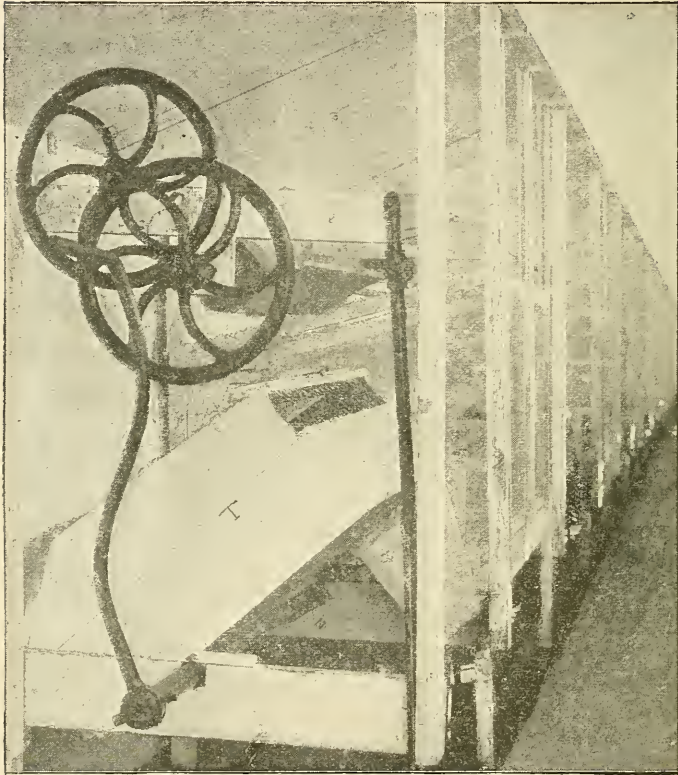

FIG. 79. TILT BOXES PARTLY TURNED.

end pens, which we will call the “nearby” pens, meaning those which are at the end the most convenient for access of the poultry keeper. These are for four flocks respectively, 2, 2, 2, 2 being the distant end yards for the

same flocks, and 3, 3, 3, 3 the midway yards, built high as was described, being intended for jumping and flying. The runways enable the birds to run from 1 to 2, passing through 3 on the way. Across the center of yard, 3, there is a board fence set at right angles with the runway. This fence is composed of a vertical frame, which supports horizontal movable boards, each six inches wide, more or less, as may be convenient. At first, leave all the boards out till the birds are used to the runways. Then slide in the bottom board, after a few days add another board, and build up in this way by easy stages. The dotted lines at 3 show the location of the fences.

Now, for the incentive to running back and forth the whole length of the runways and giving a good jump and fly at the halfway house. This incentive consists in locating a series of feed droppers over 1, 1, 1, 1, and another over 2, 2, 2, 2, at the respective centers as indicated by the dotted lines. These droppers or cylinders may be like those previously described, which are suspended over the tilt boxes of the indoor exerciser. Further on, we shall describe other feed droppers in the form of pouches or sieves instead of cylinders.

There is a bell at the nearby line of cylinders and another at the distant row. The operator stands at *A* to move the cylinders of the nearby pens and rings the bell, while, without leaving the spot, he can also ring the distant bell when desired by means of a bell wire, stretched from *A* to *B*, and he can also move the cylinders over 2, 2, 2, 2, without leaving his post at *A*, by means of a simple contrivance illustrated in Fig. 82. In this cut, the feeder is supposed to be looking directly down upon the cylinders and pens, it being a ground plan of three runways. The artist has broken off these runways, however, and the operating wires also, and omitted the halfway pens, the entire length being too



great to be shown in the diagram. The two cranks in the cut are supposed to be at the nearby pens, corre-

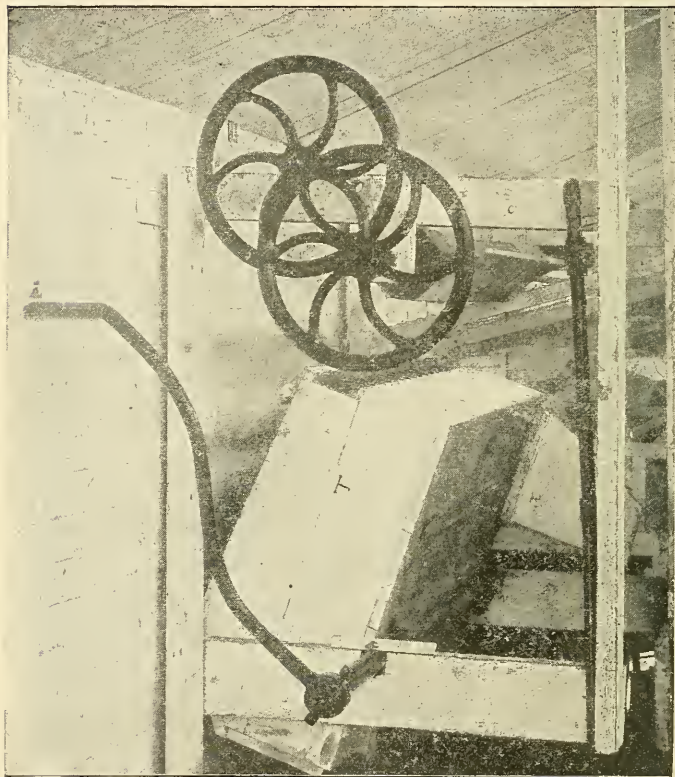

FIG. 80. TILT BOXES TURNED.

sponding to the point *A* in Fig. 83, so as to be within easy reach of the operator.

A row of cylinders over distant pens are seen in the background of Fig. 96. As previously stated, the cylinder axle of the nearby pens may be revolved by means

of the nearby crank. The cylinder axle belonging to the distant pens has, instead of a crank, a wooden spool, eight inches in diameter, attached to one end of the axle and a small flexible wire, No. 14, passes two or three times around this spool. To the short end of the wire is attached a weight, not shown in Fig. 82, while the long end extends the whole length of the runway, terminating at a point near the nearby pens, where it winds upon a small spool or axle, to which a crank and a ratchet and pawl are attached.

In Fig. 84, the two spools and their connecting wire are shown viewed from the end instead of from above as in Fig. 82—14*a* is the distant spool, 14*b* the wire and 14*c* the nearby spool in both figures. In Fig. 84, *W* is a weight which is hung in the pit, *P*, dug in the ground; *G, G*, four feet deep and walled or boarded at the sides, and furnished with a movable top or lid with a hole in it, through which the wire passes. The distance between the two spools may be fifty feet or so for young chicks, or several hundred feet for grown fowls, therefore the wire is represented as broken off the same as in Fig. 82. And we may say that in all the cuts the intention is merely to show the principles of construction, whether the illustrations are made to scale or not.

In Fig. 82, the spools are represented as somewhat elaborate, with rims, but these are not essential, and in Fig. 84 the spools are simple round sticks without rims, such as may be sawed from natural poles. The spool, which has a crank attached, instead of being of wood, may consist of an iron fence ratchet and pawl, Fig. 64, such as is used to tighten wires on fences. We have used it with great satisfaction, it being strong, durable and not liable to get out of order. These ratchets are in the market wherever barbed wire is sold, price five or six cents each. To operate the fence ratchet, get a



plumber to make a crank of a piece of half-inch iron pipe, six inches long, and for the handle another piece, four inches long, and two elbows, one of which he can attach to the shank of the ratchet by cutting four slits one-half inch long in one end of the elbow and hammering it to slip over the shank. Drill through both shank



FIG. 81. FOWLS AT EXERCISE.

and elbow and pin together with a common wire nail, Fig. 120.

In Fig. 63, this crank of half-inch iron pipe is shown attached to the ratchet. The latter, however, is obscure in the cut, being shown on a small scale. The whole is fastened to a post, about breast high, in a position for

use. The lower wire runs to the spool of the distant row of cylinders, the same as are numbered 14*a* in Figs. 82 and 84. In Figs. 66 and 96, the reader will perceive the same distant row of cylinders in the back ground. Figure 83 is an end view of the same. In

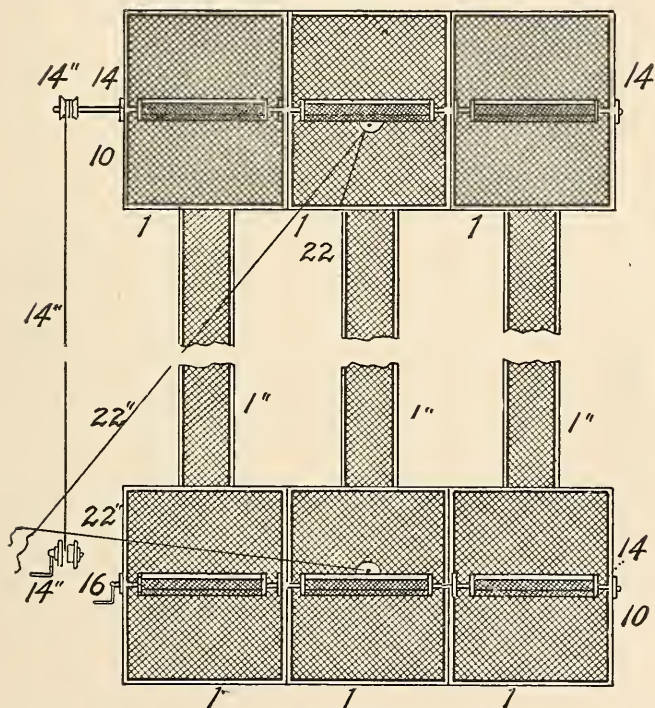

FIG. 82. PLAN OF PENS WITH CYLINDERS.

Fig. 63, the upper wire is for the bell and corresponds to 22 in Fig. 82.

If you want to make the nearby spool of wood, you can get your blacksmith to attach an iron handle and crank fitted with a set screw, Fig. 85, or, if you prefer

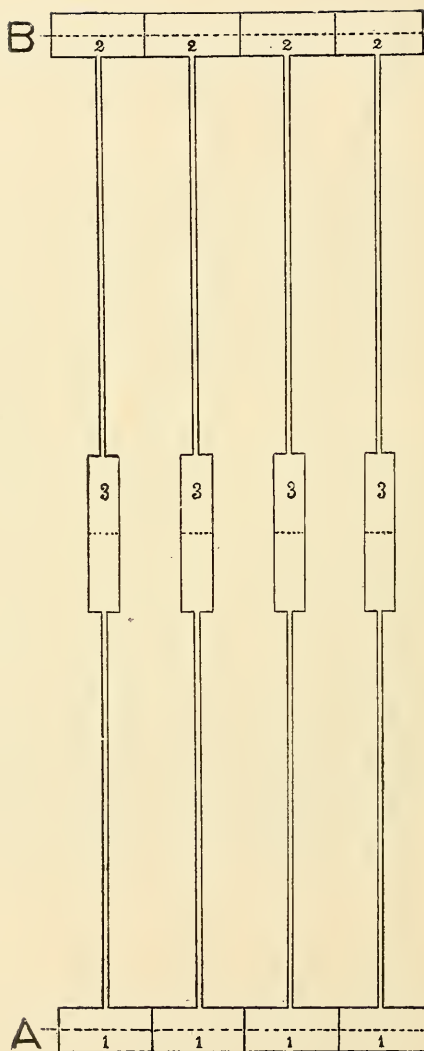

FIG. 83. GROUND PLAN OF RUNWAYS.

a homemade wooden crank, it may be fastened directly to your homemade wooden spool, Fig. 62. The nearby axle, 16, in Fig. 82, must be provided with a crank, which you can have made of pipe, the same as for the fence ratchet in Fig. 120, only you omit to split the elbow. Keep it intact, and it will just screw onto your axle of half-inch pipe.

The partitions of the nearby pens and also of the distant pens must be carried up nine inches higher than the tops of the pens, so as to serve as supports of the cylinder axles, and give the cylinders with their tin flanges room to turn. See Fig. 65.

The *modus operandi* can be easily discovered from the above description. The birds race like Jehu through the runway, whenever the bell is rung and grain dropped from the cylinder at either end. Moreover, when the keeper is not at hand and the cylinders have not been moved for some time, they make numerous trips back and forth on their own hook, because they have only one idea in their heads, which may be expressed thus: "Let's run and see what there is good at the other end." It will be found that it is very easy to teach fowls, old or young and of various species, to run at the sound of the bell. They are naturally great listeners and give close attention to every sort of sound within their hearing, which is very acute. A cock will respond to a crowing that is a mile or more away, if the wind is not unfavorable. Their own language they understand without learning. But they have an aptitude for learning aural signals other than the natural language of their species.

Witness the common hen with a brood of turkey chicks, peafowl chicks or ducklings. At first, her younglings do not know what she means when she calls them to partake of a choice morsel. It is not their mother tongue. But in a few days they learn its mean-

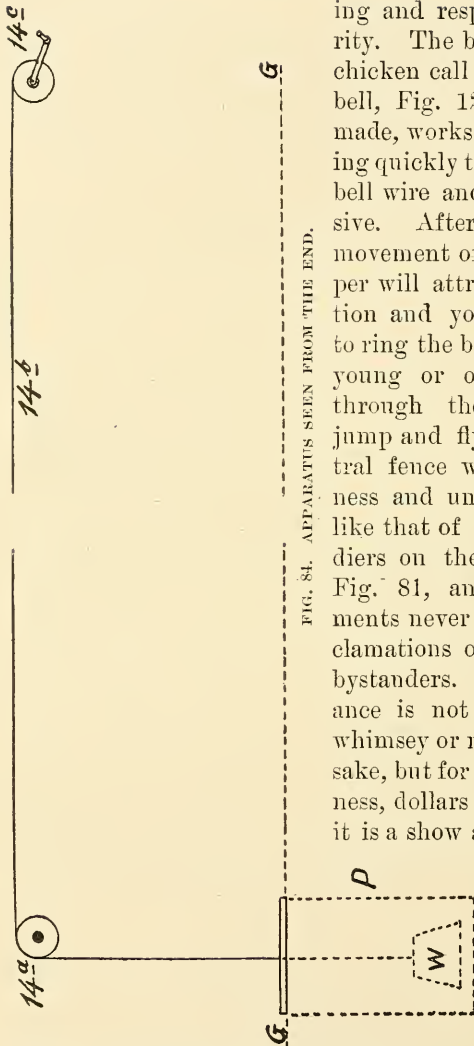

FIG. 84. APPARATUS SEEN FROM THE END.

ing and respond with alacrity. The best bell for our chicken call is the trip gong bell, Fig. 126. It is well-made, works easily, responding quickly to the pull of the bell wire and is not expensive. After a while, the movement of the feed dropper will attract their attention and you do not have to ring the bell. The birds, young or old, scamper through the runway and jump and fly over the central fence with a promptness and unanimity that is like that of well-drilled soldiers on the double quick, Fig. 81, and their movements never fail to elicit exclamations of delight from bystanders. The performance is not intended as a whimsey or novelty for fun's sake, but for downright business, dollars and cents. Yet it is a show all the same, as attractive as the performance of well-trained dogs or horses. Figure 145 represents a

group of spectators at a poultry show, witnessing, for

the first time, half-grown chicks in a runway at full speed, intent on the feed just dropped from the cylinders in the background. These chicks were, of course, taught on their native heath, before being trotted out for exhibition.



## CHAPTER XXI.

### SUCCESS WITH DUCKS.

The outdoor exerciser, in a modified form, is especially useful in commercial duck raising, an industry which has already assumed enormous proportions and which has come to stay; for the Chinese, who, for thousands of years, have made ducks a favorite source of food supply, knew what they were about, although Europeans had, meanwhile, hastily concluded that they would not pay as well as common fowls.

There is no other valuable animal food produced that is so cheaply raised as partly grown Pekin ducks by wholesale, by modern methods, which insure quick growth. On a small scale, without the benefits of care, skill and system, they are not profitable, since, when kept beyond a certain age, ducks of any breed will eat their heads off. The ducklings need no apparatus for exercise, being unlike chicks in this respect, for they will shuffle around, even if kept in a very small space, whether there is any incentive to move or not. They are naturally exceedingly active when very young. Neither do the laying ducks require special provision for exercise during the laying season, provided they have unlimited range and comparatively scanty feed during the remainder of the year, so that they may be induced to move about actively to forage on insects and vegetation.

In this off season, they must not be kept under the pressure of high feeding, which is advantageous to their owner when the laying season approaches and early eggs for hatching are desired. Now a good range, after the

laying season is over, with suitable forage, fresh water, security from marauders, and all other requisites, is commonly very difficult to obtain when the breeding birds number not hundreds but thousands; hence, the great advantages of the outdoor exerciser for the ducks reserved for breeding.

All that is requisite is a distant row of feed cylinders, as in Fig. 65, and in place of covered runways a row of

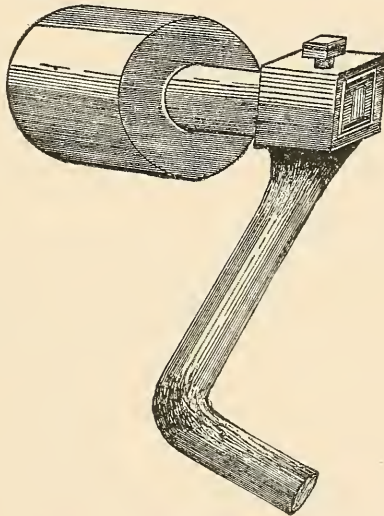

FIG. 85. CRANK, WITH SET SCREW.

long yards wide enough to admit a team for plowing, so as to keep the soil free of taint, and at the nearby end of the yards swimming tanks under the feed cylinders, as in Fig. 86. In this figure, a ditch is cut and boarded at sides and bottom; *c* showing the original surface of the ground, *e* an inclined plane of boards with lath tacked on to afford foothold, and *d*, a platform with a slight slant for drainage. The feed cylinder is at *A* and the

long yard begins at *Y*. If the "lay of the ground" admits of a shallow ditch, the approach, *e*, may be omitted.

The tank may be two, three or four feet wide, or more, according to the quantity of running water that can be supplied. As the idea is to have the tank several hundred feet long and divided by wirework into sections for the accommodation of numerous flocks, a brisk current is demanded for cleanliness's sake, therefore the tank

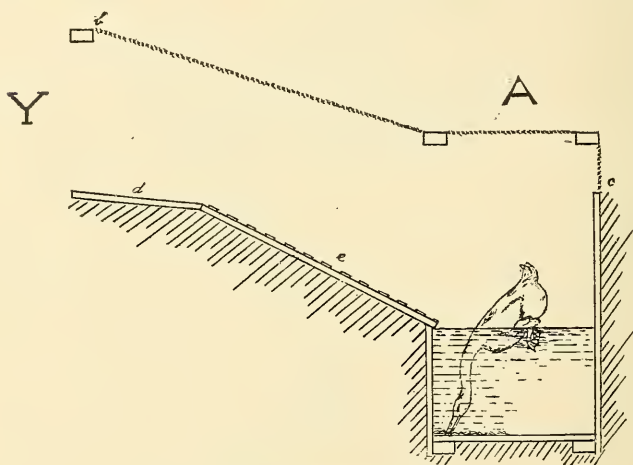

FIG. 86. EXERCISER FOR WATER FOWL.

should not be too wide. The depth of the water is very important. The ditch and the tank which lines it should be constructed so that the depth may be just sufficient to cause the ducks to assume the position shown in the cut, and grope and grovel for the feed which has been dropped from the cylinders above upon the bottom of the tank, thus giving play to all the principal sets of muscles. As they hurry through the yards, they will at times use their wings as well as their legs, and, while

reaching for their food at the bottom of the tank, their necks and bills will be actively employed. Nature will receive her just dues.

This is not like "hogging" feed out of a trough. Of course, there must be a bell near the distant feed cylinders and another at the tank. The cylinders need not be charged oftener than once a day, and by carrying a pail of soaked wheat, barley or cracked corn in one hand and a tin scoop in the other, the filling can be very quickly done. The establishment is supposed to have an attendant, employed at something near at hand, so that he may move the cylinders and ring the bells every hour or oftener, but the perfection of labor saving is to have this done by clockwork, similar to that which strikes the hours in a tower clock. Pekins, which are the duck for commercial raising, are indifferent to swimming, preferring dry land in fact; yet they can be induced to work in this way to their great benefit during the off season. In this way, the stamina of the strain of selected breeding birds can be maintained generation after generation and diseases kept at bay.

## CHAPTER XXII.

### PERFECTING THE DETAILS.

The axle for a row of feed cylinders may be made from iron pipe, half inch diameter, if the row is not over 150 ft. in length, and as the pressure of the weight of the grain in the cylinders tends to hold the lengths of pipe together, there is no danger of unscrewing. But, as in case of the tilt boxes, there is sometimes pressure, tending to unscrew the lengths of pipe, a collar, consisting of a short piece of larger pipe, should be slipped over the end of each length of pipe at the joint, this collar to be bolted to the pipe. Let *a, a*, in Fig. 87, represent each the end of a length of pipe, meeting at the joint, *e*. The collar, *e*, encloses the end of each pipe, being held in place by the bolts, *i, i*, which pass through holes drilled through both the collar and the pipes. For brooder chicks' tilt boxes, three-fourths inch pipe will answer for the axle, and no collars will be necessary unless the row of tilt boxes exceeds 150 ft. in length.

For axles to tilt boxes of grown fowls, the pipe should be two inches in diameter, and the collars may be omitted if the line of tilt boxes is less than 50 ft. in length. When operations are begun on a small scale, it will frequently happen that it is more convenient to use wooden axles for the tilt boxes, like Fig. 74, revolved by means of a long wooden lever, Fig. 88. To prevent a very disagreeable creaking, which frightens the birds, as well as annoys their owner, when such wooden axles are made to turn, fasten strips of tin under the axles at the

points where they bear on their supports, for wood against wood will creak in spite of oiling, while wood against metal will move silently, whether lubricated or not. A wooden axle should not be over 50 or 60 ft. long, for if too long it will "give" or twist too much.

To aid readers who prefer something simpler than the feed cylinder previously described for dropping grain, illustrations of a feed pouch are given. Figure 89 shows wire cloth of different

sizes of mesh, Fig. 58, nailed to end pieces of wood forming a sort of pouch, the whole being nailed to a square stick which serves as an axle, this axle being, of course, rounded at the bearing places, which are not shown in the cut. The narrow board in the foreground is at the side where the grain is put into the pouch, the attendant going the rounds with a pail of grain in one hand and a scoop in the other, this board answering the same purpose as the flange of tin, *a*, in the cylinder, Fig. 60, and the board, like the flange, is set flaring, to facilitate charging with grain. Such a pouch can be used indoors over a tilt box, or out of doors over a pen in the out-of-doors exerciser, and the shaft may be 3x3

FIG. 87. SHAFT AND COLLAR.

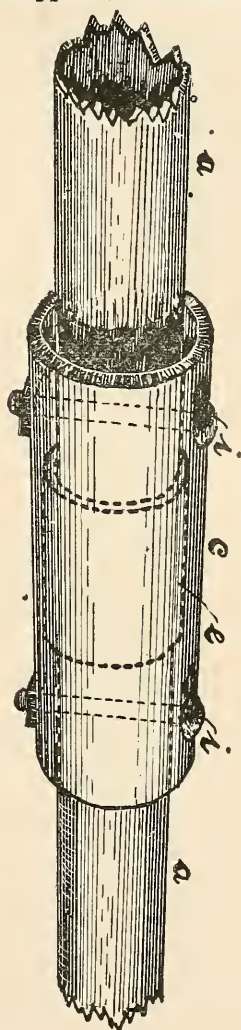



in. or 4x4 in., or any size demanded by its length and by the number of pouches fastened to it. The pouch may be two or three feet long, and the width of the end pieces must, of course, suit the size of the shaft.

A still simpler style, and easier to construct, shown in Fig. 110, goes well with the rough pole. The projecting bottom piece gives a sufficient surface to nail through. A flange board similar to that in Fig. 89 may be easily added, if desired. If the distant out-of-doors feed pens, such as are shown at *B*, in Fig. 83, are fitted with such a pole and pouches, no spool need be used, but a wire and weight can be employed, the same exactly as in Fig. 84, the big end of the pole serving for a spool.

FIG. 88. WOODEN LEVER FOR AXLE OF TILT BOXES.



If rounded bearings are to be made for a square shaft of a row of tilt boxes, or for a square shaft of a row of feed pouches or feed cylinders, then it will not be found a good plan to cut away the square corners of your wooden shaft, because it weakens it. Build onto it, instead, by simply nailing on rounded bearing pieces like that shown in Fig. 90. Figure 91 gives a transverse section of a shaft or axle, *c*, with four such pieces attached, *a*, on which the axle turns. The rounded bearing pieces may turn in a notch either square or rounded, cut in a horizontal stick and overlaid with tin, as previously mentioned.

A square wooden shaft for out-of-door feed boxes may be attached to the spool on

which the wire winds, by simply nailing on six half-moon pieces of inch board, *d*. Figs. 92, 93, 94 and 95. the square end of the shaft being simply toed with nails to the end of the roller before the half-moon pieces are nailed on. Figure 121 shows one of these half-moon pieces by itself. Figures 92 to 95 inclusive represent the same shaft and its belongings in different positions. In addition to a spool, these four cuts show both a pouch and a cylinder, and the reader can judge which is easiest to make. By studying these cuts, the different positions of both pouch and cylinder may be also noted, and it will be understood how the grain drops, little by little, through the meshes of various sizes, the cracked corn consisting of particles which are also of various sizes, whole wheat and broken wheat, or wheat screenings, oats, buckwheat or millet may also be employed to furnish different sizes. In these four cuts, *a* shows a bearing for shaft to rest on and turn on; *b* is a feed pouch; *c*, shaft; *d*, one of the six half-moon pieces, attached in pairs, and *e* is a feed cylinder. Figure 97 illustrates a still simpler home-made wooden shaft and cylinder, the roller or spool, and attachments, being made entirely of inch boards. Each end of the feed cylinder consists of two pieces of boards,

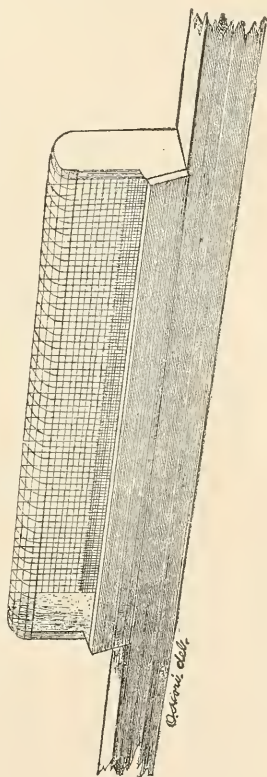

FIG. 89. FEED POUCH.

with a notch in each to receive the shaft. Three tools only are needed for making this style, a knife, a saw and a hammer. To cheapen construction, this homemade cylinder we are describing does not extend out into a flange as at *a*, Fig. 60. The flange is convenient for putting in grain, but not indispensable.

It being our aim to show how wood may be substituted for metal in the construction of nearly all the apparatus employed to induce poultry to take exercise, and how ordinary ingenuity may build a homemade equipment without the services of a trained mechanic,

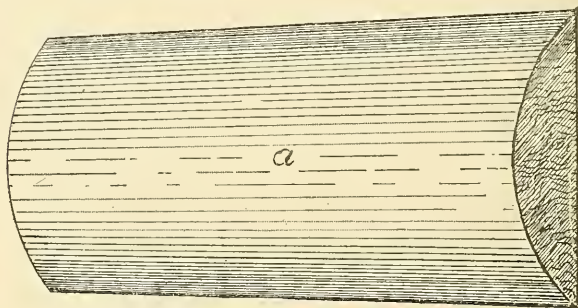

FIG. 90. ROUNDED BEARING FOR SQUARE SHAFT.

we illustrate by Fig. 99 a spool for the outdoor exerciser, with a strong wooden crank and handle, and posts and frame to support these. Figure 100 is a transverse section of the same, the letters in both cuts referring to the same parts. Figure 100 is drawn to a scale one-fourth inch to a foot. The same thing, only larger and stronger, may be attached to the axle of tilt boxes. All the parts are pieces of plank or scantling, excepting the stick marked *m* (cut off from a pole), the pin, *a*, which serves as a handle, and the smaller pins which keep the spool in position. Inch boards and 2x4 and 2x6 dimension stuff are the principal materials. The pins, *f*, *i*

and as also the handle, *a*, should be of hard wood. The pieces, *k* and *e*, have each a half-moon notch for the spool, *m*, to turn in. The crank, *b*, is reinforced by the pieces, *c*, *d* and *e*, to strengthen it where it encloses the square shank of the spool, *m*; also the pieces, *g* and *h*, serve to give a firm setting to the handle, *a*.

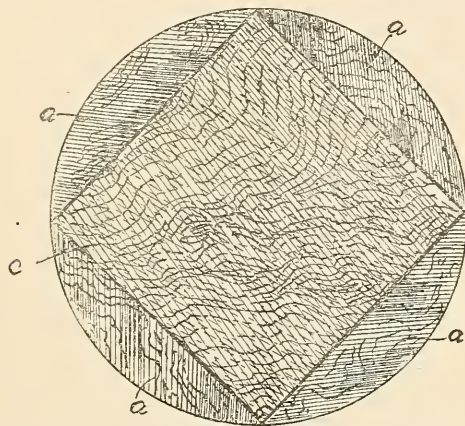

FIG. 91. TRANSVERSE SECTION OF AXLE SHAFT.

In the vertical section given in Fig. 100, the imaginary line of cleavage passes through the exact center of the windlass or spool stick, *m*, lengthwise, and also through the handle, *a*, lengthwise.

Instead of a pouch or cylinder, what may be called a sieve may be used for dropping feed. Figure 101 illustrates one of these turned bottom up, to show that the bottom is made with a double slant, and consists of wire mesh of different sizes, like that in a cylinder or pouch, and a strip of tin in the center, this last serving as a floor to hold the grain when the sieve is charged. A long row of these sieves may be fastened to an iron pipe by bolts passing through holes drilled in the latter.

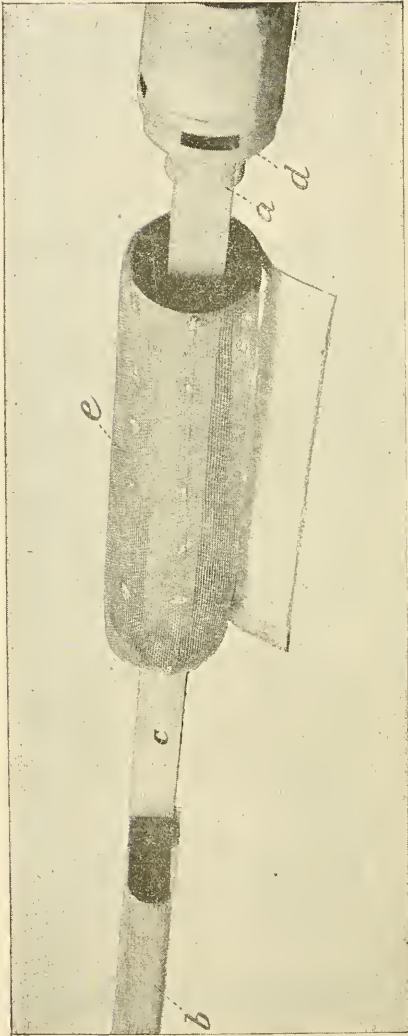

FIG. 92. SHAFT FOR OUTDOOR FEED BOXES.

Figure 104 shows the lid, Fig. 105 gives an end view of the sieve, and Fig. 106 a series of sieves in position, each over a separate pen, two stout wires being stretched under the sieves to hold them level. The hoppers of tin in the lid, Figs. 104 and 106, are to facilitate charging with grain, the lid being necessary to keep off sparrows and pigeons. Figure 108 gives a top view of a sieve when the lid is off. To drop the grain, strike with a hammer on the end of a pipe that is shown in the foreground in Fig. 106. This end should be plugged with iron to prevent battering. This pipe may be quite a long one if desired, and the feed will drop in nearly the same quantity at every sieve affixed throughout its entire length, the jar being practically of the same force at one end of the pipe as at the other, unless the pipe is of extreme length. A coiled spring or a bar spring, not shown in the cut, should be attached, to bring it back to the first position after each blow of the hammer.

This sieve will do very well in lieu of cylinders for both indoor and outdoor exercisers for grown fowls, but cylinders deliver grain in more accurate doses than sieves, and the former are therefore preferable for brooder chicks—for things must be done exactly thus and so with small chickens. For indoors, where cords or wires can be conveniently attached overhead, this whole line of sieves may be suspended, swing fashion, instead of resting on a framework. In this case no spring is needed, the whole series of sieves returning by force of gravity to the original position after being jarred by the blow of the hammer. This method of suspension and swinging is the same as described earlier in this book in connection with the use of feed shelves.

A hammer to be held in the hand for striking a row of sieves or a shelf nearby, should weigh one to three pounds, according as the shelf or the pipe connecting the sieves is 100 to 300 ft. long. For a row of distant



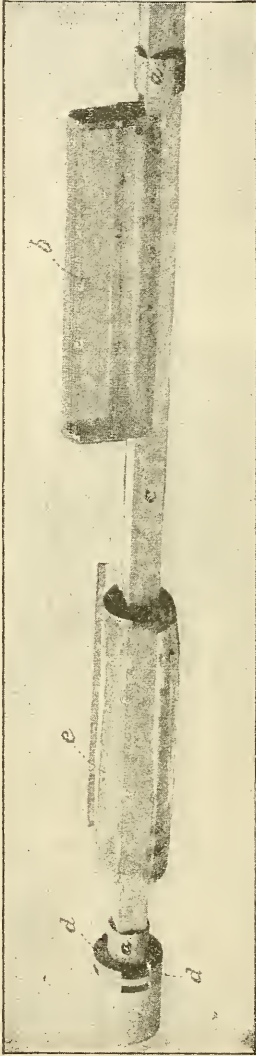

FIG. 93. SHAFT PARTLY REVOLVED.

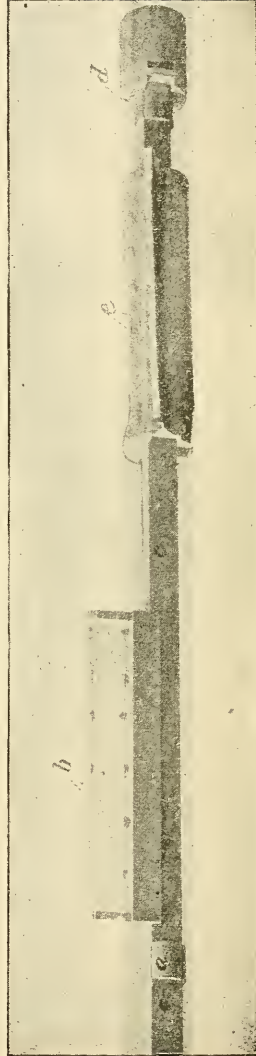

FIG. 94. SHAFT POUCH AND CYLINDER.

sieves have a pivoted hammer, Fig. 18, Page 56, and a cord which reaches from the hammer to *C*, passing over two sash pulleys, Fig. 19, Page 58, on the way. This cord can extend 100 or 500 ft., or more, for that matter, to where the operator is. It may extend inside your dwelling, say to the kitchen, where the cook can give it a pull from time to time, or it may run to an office, workshop or store, or be attached to strong clockwork that is wound up to run all day, and, just as clocks are made to strike the hours or half hours, so the pulls on the hammer-wire connected with your feed dropper may be timed with equal precision.

The tilt boxes for both brooder chicks and grown fowls will need larger and stronger clockwork, such as is attached to large orchestrions or music-producing machines, or apparatus used in gas works, in hotels, factories or private dwellings, where the motive power is very heavy weights. Better yet, the machinery governing the periodical pulls will be propelled by a steam engine, electricity or water power, as progress demands; for the idea of feeding and tending fowls, and larger species of domestic animals as well, by machinery, is destined to be expanded indefinitely.

To return to Fig. 18, of course the sticks to which the sash pulleys are attached, and also the uprights, must be immovable. Now, will the reader please turn to Page 170, and imagine that the whole of the apparatus of Fig. 75 is placed under the sash pulleys, close to the uprights in Fig. 18, Page 56, in such a position that when the hammer is dropped it will strike, kerchug, on the iron plate, *h*. To the board, *a*, attach the iron pipe which supports such a row of sieves as is shown in Fig. 106. The timber, *n*, is immovable, but *h*, *m* and *a*, with the 100 or 200 ft. or more of pipe attached, are all movable, and the coiled spring is compressible. Now, when the hammer strikes, everything in Fig. 75 moves

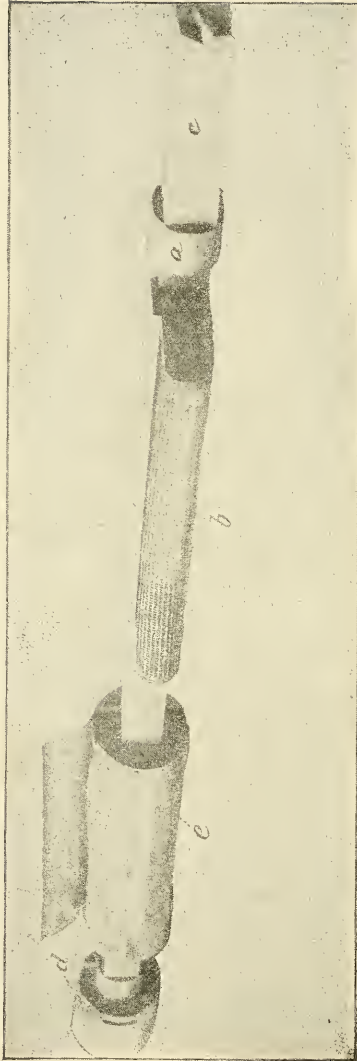

FIG. 95. SHAFT POUCH AND CYLINDER.

excepting *n*, and every one of the long line of sieves supposed to be attached is slightly jarred, and then the spring makes a move, forcing the whole line of sieves back again. You can drop grain one hundred times for each charging, and only a spoonful each time.

Pipe, sieves, operating wire, pulleys, cord, spring, concussion plate, *h*, hammer, etc., combine to effect the same purpose as is indicated by the wire, weight, spools and long pipe with cylinders in Figs. 82 and 84. The feed shelf serves the same purpose as the sieves and the cylinders heretofore described, except that it is not as accurate in distributing feed. The shelf has this advantage,—it is not necessary to use grain of different sizes, as is indispensable when the cylinder is employed.

When you strike at one end of a wooden shelf or beam several hundred feet long, the jar is felt in some degree throughout its entire length, but is weakest by considerable at the point most distant from the hammer. In order, therefore, to transmit the shock better, fasten an iron pipe, rod or bar to the boards. In Fig. 111, *e* represents such a bar fastened to the board, *a*. The concussion plate, *h*, receives the blow. The board, *a*, in Fig. 17, Page 55, is supposed to be a continuation of the board, *a*, in Fig. 111. After a blow and a swing forward, the whole long shelf swings back towards the hammer, and meeting the stopper, *i*, it remains at rest awaiting another whack. The simplicity of the employment of the force of gravity to effect the return to place, instead of the use of a spring, commends this style of feed dropper, and besides, tin and wire mesh are needed for feed cylinders and sieves, but not for feed shelves. One stroke with the hammer is enough for that time.

To keep the shelf in place, fasten two casters to the board, *f*, these boards, with the end pieces, being attached to some part of the building or to the frame

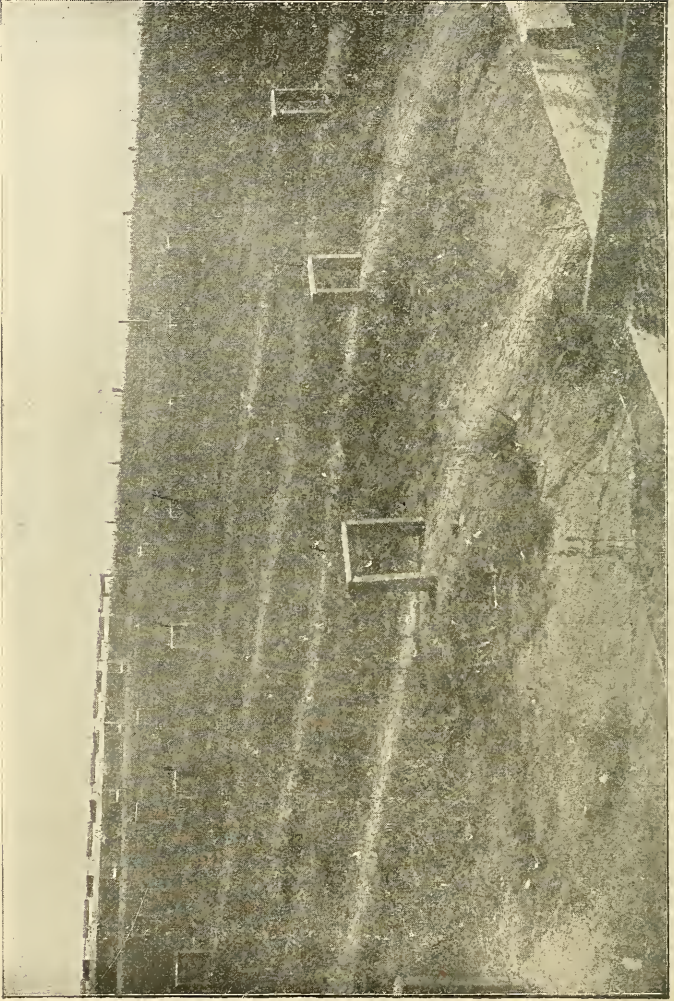

FIG. 96. PEN AND YARDS WITH ROW OF FEED CYLINDERS.



supporting the tilt box, so as to be stationary. As will be obvious, *e*, *a*, *c*, *h* and *d* are movable, but *f*, *g* and *i* are immovable. Two ordinary furniture caster wheels, Fig. 112, travel on the upper side of *a*, and another pair roll against the under surface of *a*, the shelf swinging and rolling back by its own weight after a stroke. If the shelf is one hundred and fifty feet long, or more, it should be widest nearest the hammer, and as you go towards the farthest end and the jar is less, each successive section board should be narrower. Begin with a board ten or twelve inches wide, and diminish to a width of five or six inches. In case of a shelf over a line of exercisers one hundred and fifty feet long or upwards, the boards must not only be narrow as you approach the end of the shelf furthest from the hammer, but they must be hung so as to be slanting. When they are fastened together put wedge-shaped cleats between, so that each board shall be slightly steeper than the preceding one. Figures 113 and 115 show these cleats and the varying slants of the boards, *e* being a slender iron bar firmly attached to the boards, the same as *e* in Fig. 111. This bar is not absolutely indispensable unless the shelf is extremely long. It is not to strengthen the shelf, but, as previously remarked, to transmit the jar of the hammer better than wood alone will do. In Figs. 105, 113 and 115, the boards, are foreshortened in the cuts so as to occupy moderate space and show the idea of the cleats and the slanting position, but the reader must imagine them to be, in practice, ten, twelve or fifteen feet long each.

If a feed shelf is indoors it is supposed to need no cover to protect the grain from pigeons, sparrows, stray fowls and rain. For outdoor use, however, fasten shallow boxes upon your shelf, with lids opening upwards, and a slot cut through both the shelf and the bottom of the box at one side, as in Fig. 109, only the cut gives a



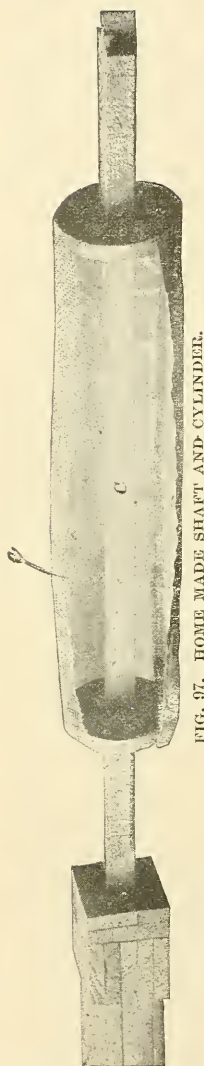

FIG. 97. HOME MADE SHAFT AND CYLINDER.

box not long enough and deeper than is necessary. If not convenient to hang this shelf up out of doors, you can put a caster or two under it every fifteen or twenty feet, and to send it back to first position after a shock, a spring, *b*, can be arranged to engage with the bar, *e*, or a spiral spring can be rigged at either end of the feed shelf on the plan shown in Fig. 75. See also Figs. 117 and 118.

Figure 119 shows how the hammer can be made to move *M* while *N* remains stationary. The stick, *N*, and the other scantling near *C*, as also the one above *N*, should be fastened to stout posts if outdoors, or if indoors to the frame of the building, so as to be firm. Two such pulleys, only one of which, however, could be shown in the cut, serve to steer the cord, *C*, in operating the hammer, and also to turn the cord or its wire continuation to a course at right angles to the hammer handle, so that it may be extended to where the operator stands, hundreds of feet away. Either a long feed shelf or a row of feed sieves may be attached to *M*, and these may be supported entirely by casters, or by swing cords, wires or jack chains. Notice a cord, *R*, in Fig. 119, this being one of a row of cords. The spiral spring, Fig. 107, is not visible in Fig. 119, but may

be seen in Fig. 110. When the suspension plan is adopted, side casters only just enough to steer the shelf are used; for nearly all the weight should be suspended by the cords or wires. Figure 122 shows a homemade style, a hard baked brick or a brick-shaped stone being used to add its weight to that of the hammer, which consists of a block of hard wood. This brick, *B*, is kept in place by pieces of inch board. *A* is the shelf, at the end of which is attached the concussion block, *M*. As will be readily understood, *M* and *A* move at a blow, compressing the spiral spring against the stick, *N*, which, with its attachments, is immovable.

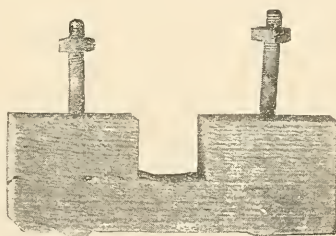

FIG. 98. BLOCK AND BOLTS TO FASTEN TILT BOX TO AXLES.

## CHAPTER XXIII.

### FOR SOFT FEED.

Now we have described thus far feed cylinders, feed sieves and feed shelves, whether with or without feed boxes attached, and these styles will all answer for dry feed, but not for meal dough, cooked vegetables, soaked grain, brewers' grains, fresh meat or any other form of moist feed. Ordinarily, it is true, dry feed is to be preferred for both young and old birds. They will soak their grain just right by drinking just the proper quantity of water.

Dry grain not only affords exercise, but is better anyhow as the main reliance, apart from the matter of exercise, except for fattening fowls just at the finish. For special purposes, however, as for feeding ducks, for instance, or other waterfowl, which demand a large proportion of soft feed, a feed trough controlled at a distance, like the cylinder sieve or shelf, is needed.

Figures 123 and 124 give side views of such a feed trough, and Fig. 125 shows a transverse section of the same, the letters in the several cuts referring to the same details. Regarding ducks, see Chapter XXI and Fig. 86. A good way is to have a water tank, Fig. 86, at one end of a long runway, *Y*, of low, movable, covered hurdles, which may be shifted so that the ground may be plowed to freshen it, and a trough, such as we are about to describe, at the other end. In both the side views of this feed trough, Figs. 123 and 124, will be seen a row of upright slats, through which the birds thrust their heads to feed. The fowls stand on the floor, *a*. The

feed is placed in the box or trough, *n v*, the lid, *n*, being raised for that purpose. The pieces of scantling, *r, s, u*, are the frame of the feed trough. The feed rests, of course, on the bottom board, *v*. When the doors, *d, d*, are

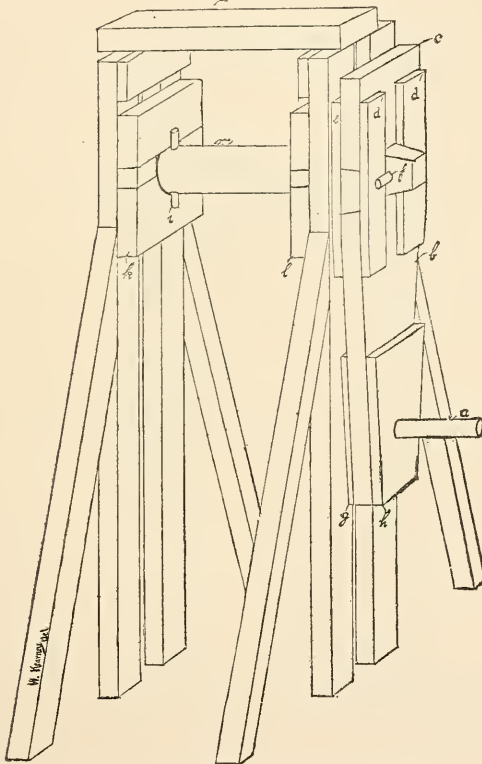

FIG. 99. WOODEN SPOOL, FRAME, ETC.

dropped, as in Fig. 123, the fowls can put their heads between the upright slats and reach the feed, but when these doors are being raised toward the position shown in

Fig. 124, the birds will naturally withdraw their heads, the doors being raised gently and gradually.

The construction of the doors is as follows: The board, *d*, Figs. 123 and 124, is of equal width at both ends and the tapering board, *c*, is nailed to it firmly.

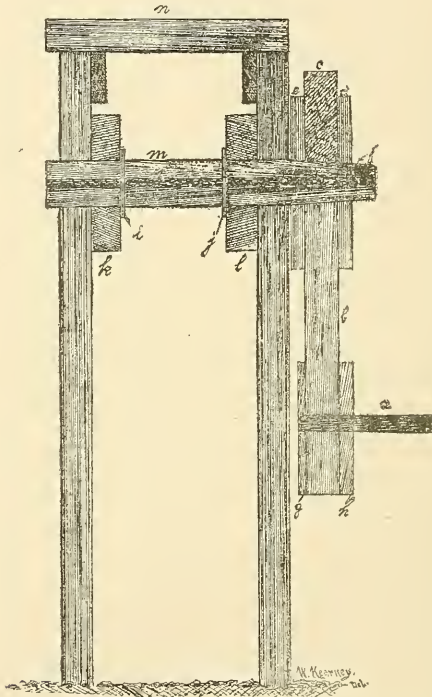

FIG. 100. TRANSVERSE SECTION OF FIGURE 99.

This board, *c*, is protected at *e* by a bolt or pin, so that *d* and *c* both rise together when the cord, *i*, is pulled. At *f, g*, there is a slot cut in the board, *d*, to enable it to be raised or lowered without being stopped by the pin, *e*. A flat, horseshoe-shaped piece of iron, *f, g*, is attached

to the board, *d*, next to and partly surrounding the slot, to give *d* strength when the cord *i* is pulled.

All the cords pass over side pulleys fastened to posts, and all these cords are attached to a wire, *h*, so that when this wire is pulled all the doors, *d*, *c*, are raised, as in Fig. 124. At the top of each post is another side pulley over which passes a cord, one end of which is attached to a weight and the other to the door, *d*, the latter being slightly the heavier. These weights render it easier, of course, to pull the wire, *h*. We call *h* a "wire," because, for outdoor use, a wire is better than a cord, the latter being affected by rains. In fact, it is well to substitute for the cord, *i*, a small chain such as are on the market, latterly made on purpose for pulley work.

In all three cuts, *w* represents a trip gong bell, Fig. 126, operated by the bell wire, *x*, which may be of annealed steel, No. 16, sold on spools, Fig. 127. This bell or some other style of bell, or an aural

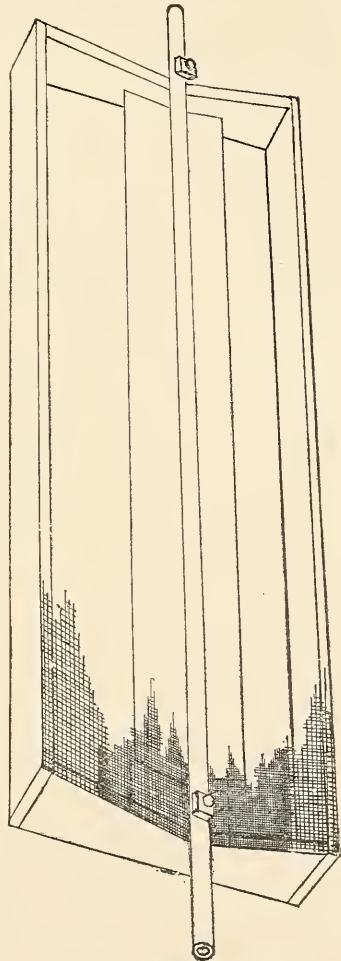

FIG. 101. A FEEDING SIEVE.



signal of some sort, is necessary, as heretofore explained, to call the birds to their meals.

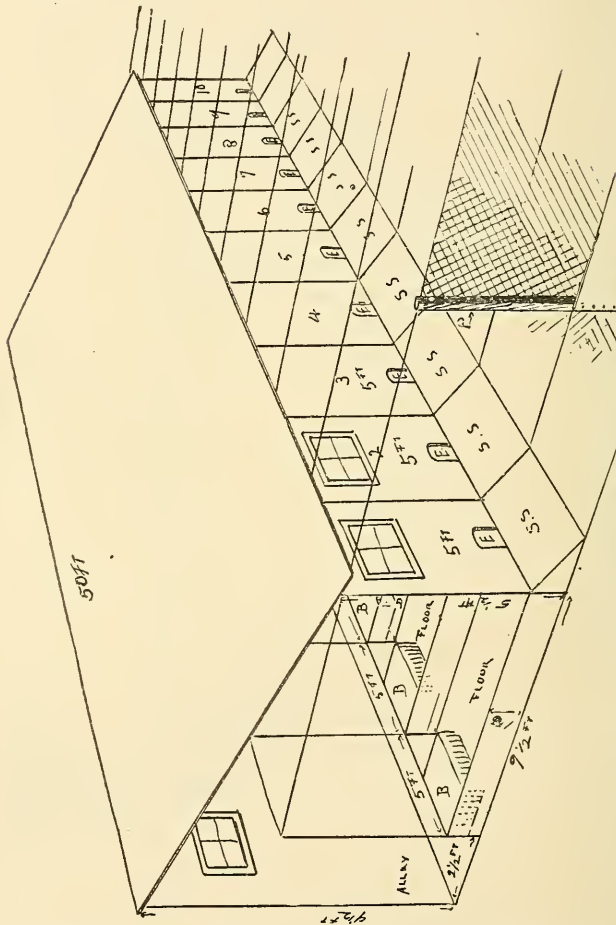

FIG. 102. BROODER HOUSE.—LAMP SYSTEM.

In Fig. 125 is seen one of the slats, *m*, nailed by toeing, as all the slats are, to the narrow side board or rim,

*b*, which runs the whole length of the feed trough, to hold the feed and to keep the birds from wasting it. The door is guided by passing between *b* and *c*. The floor, *a*, is nailed to the crosspiece, *o*, which is spiked to a short post. Of course, there are boards and wire netting to keep the birds from getting under the floor, *a*, and from flying above the slats; but as these do not directly concern the feeding apparatus they were omitted from the cut. The wire should be kept constantly taut by a weight of one to three pounds attached to each end, where the wire should pass over a pulley wheel about six inches in diameter. The weight furthest from the operator should meet a shelf and find rest at the same instant the doors, *d*, strike the ground, the weight remaining on this shelf until the operator pulls the wire again. The weight near the operator should be only just heavy enough to take up the slack of the wire.

## CHAPTER XXIV.

### THE ALTERNATE AND PARALLEL SYSTEMS.

The shape and arrangement of the tilt boxes should vary to meet the requirements of the poultry keeper. Instead of the openings on the tilt boxes for ingress and egress being at the end, as in Figs. 71, 76, 78 and 141. it will be necessary to have them on the side, in case of an extensive plant for winter chicks, when they are warmed by hot-water pipes in the usual way. But, whether the openings are at the side or the end, the ingress and egress is cut off at the half tilt.

When the exit openings are at the ends of the tilt boxes, a stationary box or apartment alternates with a tilt box in a row or series, hence, for the sake of convenience, we will call this the alternate method. Another method we call the parallel method, in which the tilt box, if for grown fowls, may be twenty, fifty, or one hundred feet, or more, long, divided by partitions into sections for the various flocks, the stationary boxes being in a row adjoining and parallel to the row of tilt boxes, and the exit openings of the tilt boxes being at the side. The parallel system will be fully explained further on.

The description of the indoor exerciser for grown fowls on the alternate system is as follows: In the interior views, Figs. 77 and 128, *P* is a passage for the attendant. This house is built with its sidewalks mostly underground, therefore the windows are set high and not shown in these two cuts, although the camera has revealed the light from them on the floor of the passage.

The small coops with slanting sides, Fig. 77, under the tilt box, *T*, are to shut birds in temporarily, for sale or other purposes, and have nothing to do with the exerciser, but are put there to utilize the vacant space under the front portion of the tilt boxes, the slant at the front of these coops being designed to keep them out of the way of the attendant's feet. As is obvious, Figs. 77 and 128 both represent the same interior. In each cut, a stationary box is in the foreground and stationary boxes alternate with tilt boxes all along the line through the whole length of the building. Under the stationary boxes are laying apartments, fifteen inches "between joints," in which are nests which are accessible to the attendant from the passage, *P*.

The exits for the fowls to gain access to their yards from the stationary boxes are not shown in Figs. 77 and 128, as they are on the side of the building opposite the passage. The side of the tilt box represented at *T* rises at the beginning of tilting. By reference to the ground plan, Fig. 130,

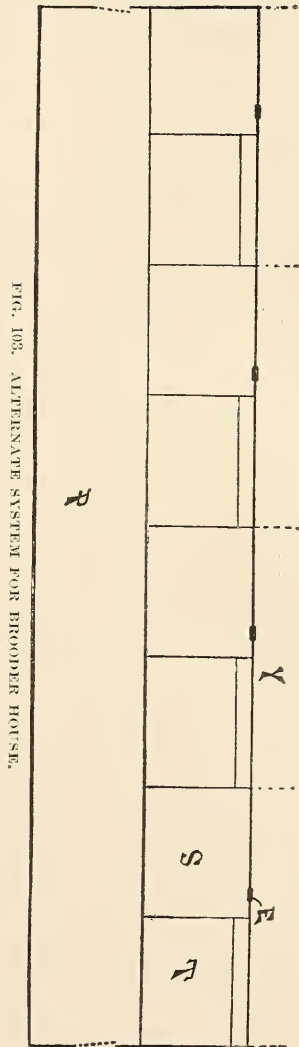

FIG. 103. ALTERNATE SYSTEM FOR BROODER HOUSE.

and the transverse section, Fig. 129, the positions of some of the most important parts of the frame of this building are shown, the letters referring to the same

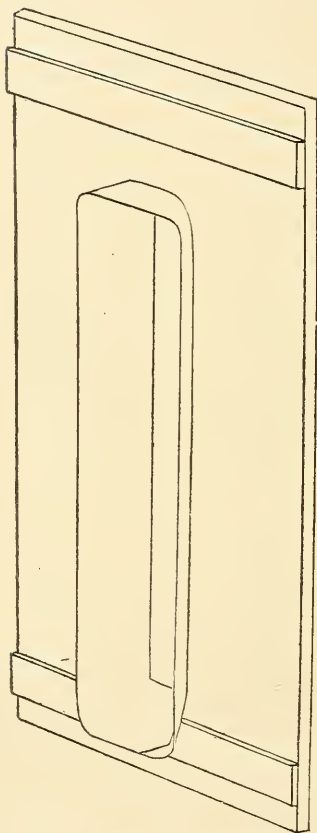

FIG. 104. LID OF FEED SIEVE.

sticks of 2x4 and 2x6 in all four cuts. Figs. 128 and 129 show the slant of the "shed roof." Throughout Figs. 77, 128, 129 and 130 the same letters indicate the same things.

In the ground plan, Fig. 130, the foundations of the brick walls at the sides are shown, the end walls not being included, as a portion only of a continuous building several hundred feet long is intended to be represented. The width of the building in Fig. 129 is 8 1-4 ft., the passage, *P*, being 8 ft. wide. There is a space of 1 ft. between the tilt boxes and the wall to give room for tilting. The posts, *a*, *d*, *c* and *o*, support the roof, the tilt boxes, stationary boxes and nesting rooms, *a* and *d* being 2x4 and *c* and *o* being 2x6.

Figure 129 is a transverse section substantially at an imaginary line passing through *a* in the ground plan, Fig. 130, the liberty usual in such cases, however, permits *c*, *b* and *g* to appear in the cut, although these

three sticks are slightly further toward the rear or background than the post, *a*. In Fig. 129, *E* represents an exit for the fowls, closed by a small door opening upward, as shown by the dotted lines. *W* is a window, likewise hinged at the top and opening in the same way as the exits. The exit doors, leading to the outside yards in a building hundreds of feet long, are all raised or lowered at one operation, and the same applies to the windows, although the device for accomplishing this important purpose, a great labor saver, could not well be shown in this cut. As the windows and exit doors fall and are held in place by their weight, augmented by a brick or a portion of one attached to each, or, as is the case in our own building, photographed for Figs. 77 and

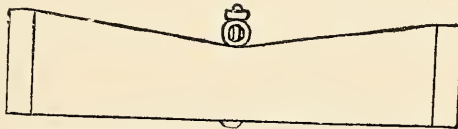

FIG. 105. END VIEW OF FEED SIEVE.

128, a box of sand nailed to each, the slanting position when closed is essential to the success of this plan. As is plain, *e* and *f* are purlines that extend the whole length of the building, being shown in three of the cuts. In Fig. 129, the slight notching at the edge of *c* shows where the iron axle of *T* rests. The building is underground as far as the tops of the brick walls in this cut and the roof is of inch boards covered with the best quality of felt paper and finished with two coats best cement applied hot, and on top of all is placed eight inches of straw, and on the straw cornstalks and brush to withstand the wind. This sort of roof and the underground feature secure warmth in winter and coolness in summer. When the temperature is 90 degrees outside it is but 80 degrees inside.



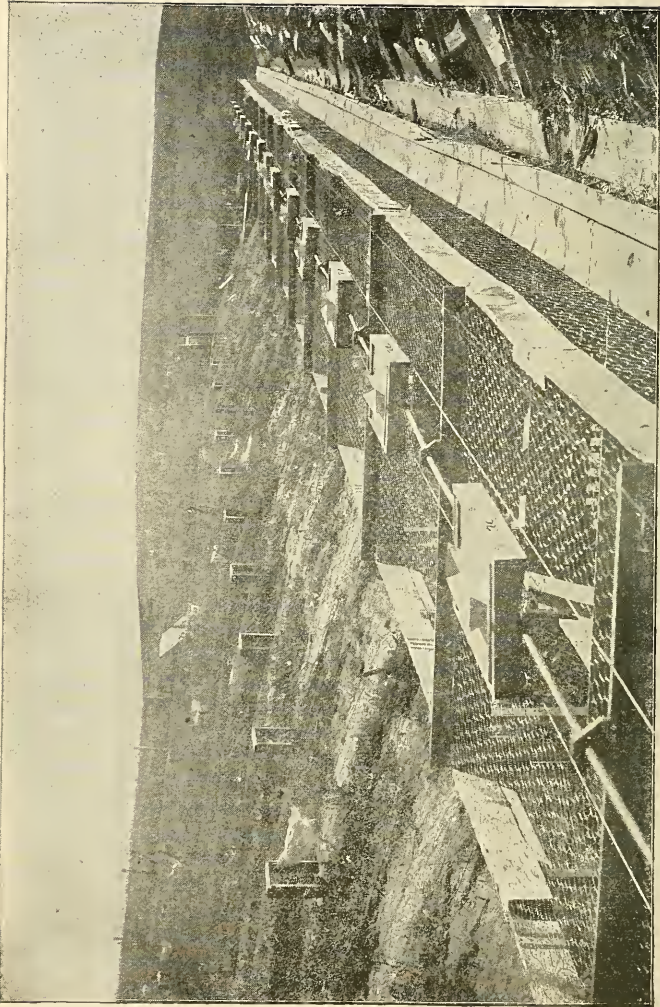

FIG. 106. PENS WITH FEED SIEVES.

The tilt boxes are placed with the under surfaces of their floors 2 1-2 ft. higher than the floor of the passage, and are 2 1-4 ft. high, with bottoms 3 1-2 ft. x 6 ft., the 6 ft. distance being parallel to the passage. The stationary box serves as a roost and is 5 ft. 3 in. x 3 ft., the 3 ft. distance being parallel to the passage. The floor of the stationary box is 8 in. higher than the floor of the



FIG. 107. SPIRAL SPRING.

tilt box, to allow for the depth of the litter in the latter. The posts which support the tilt boxes, stationary boxes and feed cylinders, see *a* and *d* in Figs. 77, 129 and 130, and *a* and *c* in Figs. 129 and 130, extend from the floor of the building to the roof.

Passing now to a consideration of the indoor exerciser on the parallel plan, the reader is asked to turn to Fig. 132, representing a perspective of a house for layers or a section of it, enough to show the idea, Fig. 117 being a transverse section of the same, Fig. 118 a longitudinal section, and Fig. 135 a ground plan, the same letters in each of these four referring to the same things. The parallel system is preferable in some important respects to the alternate system just described.

The elevation, Fig. 132, needs little description, and we call attention only to the windows, which, as will be observed,

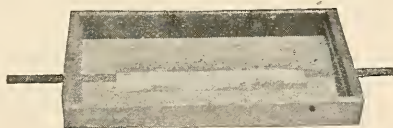

FIG. 108. TOP VIEW OF SIEVE.

are slanting when closed, as explained in the case of the building previously described. In ordinary windows, the sash are made smaller than the window frames, the latter enclosing the former. But when a large number of windows are to be raised or lowered simultaneously in a building, the sash should be larger than the window frames and the former should overlap the latter so that

no swelling of the sash by dampness will cause it to stick.

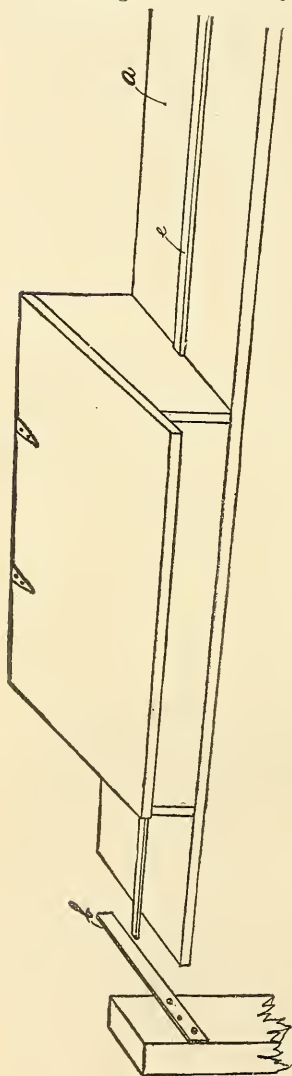

FIG. 109. PROTECTED FEED SHELF.

The sash must have weights, preferably flat bars of metal, fastened on to hold them down snugly in case of hard winds. If the casings were set perpendicularly, a hard wind would be apt to move the sash, in spite of the weight, at times when the admission of cold air would be very undesirable. To the bottom of each sash an ordinary sash cord is attached, each cord passing through a screw pulley, Fig. 134, fastened to the underside of the roof. The whole series of cords is attached to a half-inch iron pipe, located a few feet below the screw pulleys, and attached to convenient portions of the building where it is the most out of the way. This pipe is, of course, as long as the row of windows and is set loosely in staples or in holes bored in wood so as to be free to turn. For each cord, a small hole is drilled through the pipe to receive a nail, to which the cord is attached in

such a way that it will be wound up on the pipe when the latter is turned, by means of a large handwheel, Fig. 133, which is attached to one end of the pipe within reach of the operator.

The windows may all be opened a fraction of an inch, or several inches or wide open, with the greatest ease and dispatch in two or three seconds, and partly or wholly closed as quickly, and can be moved many times a day to suit varying wind and weather, a very important thing which would be impossible if each window were to be moved by hand. In a large establishment, like ours photographed for this book, there are several hundred windows, and it must be recollected that violent gales sometimes rise so suddenly that twenty men or fifty men could not close them all by hand quickly enough. The set of windows in Fig. 132 is on the same side as the tilt boxes, and a similar row of windows is supposed to be on the side not shown in this cut. The yards are also on the side not shown, but their position is indicated by  $y$  in Fig. 117.

Figure 117 gives a tranverse section substantially through  $m$  in the ground plan, Fig. 135. The yard fences,  $y$ , run in a direction parallel to the end walls of the building and enclose as many yards as there are tilt boxes. The posts,  $c^1$  and  $c^2$ , reach to the roof. The short post,  $k$ , forms one of the supports to the passage platform,  $g$ . This platform is the principal line of travel used by the attendant, who can, however, also go the whole length of the building between  $c^1$  and the wall, but in doing so must open a door at each room he passes through. Nearly all the work is done in passage,  $g$ . Labor saving forbids handling doors, except when unavoidable, and, be it repeated, commercial poultry keeping can be profitable only when the utmost care and ingenuity are employed in every operation, from a to izzard, to save

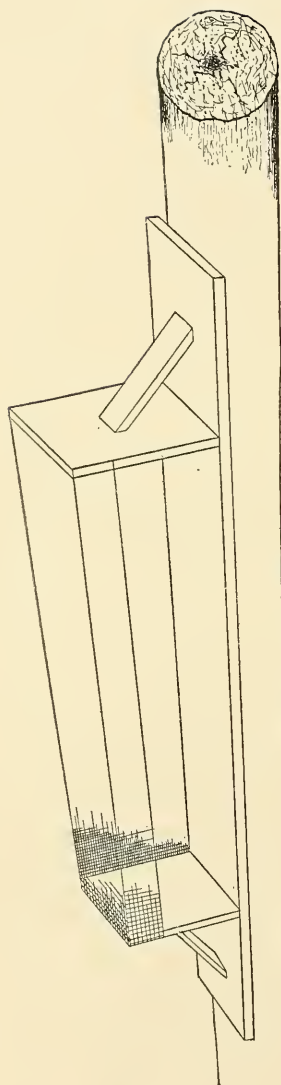

FIG. 119. FEED BOX ON WOODEN SHAFT.

labor. The fowls have the use of the floor, *f*, from the tilt box, *t*, to the wall at *y*.

The dots at *d* show the position of a feed cylinder over the tilt box, and the dots at *e* show the position of the call cylinder, which drops feed to keep the birds out of the tilt box while the latter is being tilted. The operation of this sort of tilt box with opening on side will be described in another place. The pit, *p*, is a foot deep, which is deeper than is needed for tilting, but as, in spite of all precautions, a fowl will sometimes escape and, roaming through the passage, *g*, blunder over behind the tilt box next the wall, space enough in the pit must be afforded to avoid crushing the vagrant. It will be plain enough that the tilt box tilts toward the wall and that the surface of the ground outside the building is not far from the top of the underpinning, hence *p* is described as a pit. The crosspiece, *n*, supports the floor, *r*. The tilt box aperture to admit the fowls is on the side next to



FIG. III. SHELF WITH CONCUSSION PAIR.

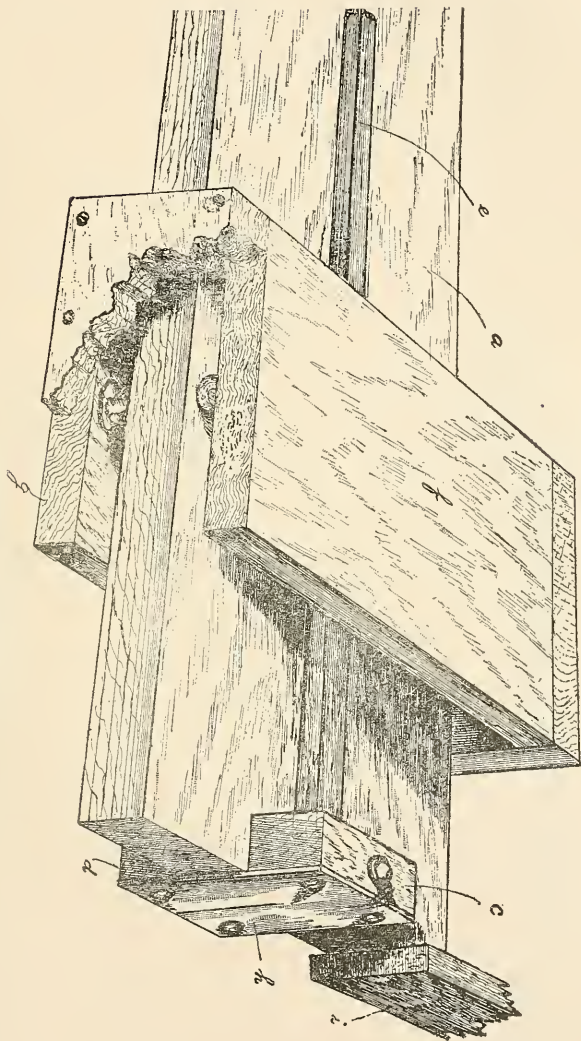



*k* and the wire netting, *i*, is to confine a fowl during tilting, should one chance to remain in the tilt box, a thing very unlikely to occur, however, unless the bird is a new acquisition, an untrained recruit.

The longitudinal section of the same building, Fig. 118, is substantially on a line through  $c^2$  in the transverse section, Fig. 117, and through the same upright post,  $c^2$ , in the ground plan, Fig. 135. In Fig. 118, the room between  $c^2$  and  $c^2$  is given to one flock, that is, the space is devoted to one apartment or stationary box, two call cylinders, *e*, *e*, being employed so as to drop grain over space enough to give all the birds a fair chance.

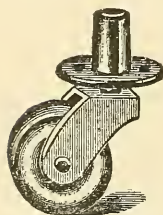

FIG. 112. CASTER  
WHEEL UNDER  
SHELF.

There is only a single perch for each flock and this is not shown, as it is not in line, but it is placed over the roost floor, *r*, and extends the whole length of the room from  $c^2$  to  $c^2$ . A scantling, *v*, reaching from *w* to *w*, supports the floor of the nesting apartment, *x*, the top of this apartment being indicated by *u*, just over which runs the cylinder axle. The movable nest boxes are made so that they can be easily reached by the attendant from the passage, *g*, in Fig. 117.

The ground plan, Fig. 135, calls for but slight description after it has been compared with the vertical sections. The space separated by the dotted lines in which the blocks, *m*, stand, is, of course, devoted to the continuous tilt box divided by partitions into smaller tilt boxes. This multiform or compound tilt box is as long as the whole building, minus a little at one end, where the stairs are which lead to the attendant's passage, these stairs being indicated by *s*, *s*, near which is the outside door. This multiform tilt box must have attached either the winch, Fig. 138, or the long lever, Fig. 88, and, in case the latter is employed, a short wing

or ell must be added to the main building, to give the lever room to describe an arc.

The rooms, or stationary boxes as we have named their equivalent in other cuts, for the separate flocks may be seen on this ground plan if the reader will imagine a line drawn from each block, *m*, through *k*, *c*<sup>2</sup>, *c*<sup>1</sup>, and thence to the wall. By referring to the transverse section, Fig. 117, it will be obvious that each flock will have a nesting apartment and a roost, a ladder being furnished for the convenience of the birds. The need of a piece of coarse wire netting under and at one side of the call cylinders will be evident, to keep the fowls away and, at the same time, allow feed to drop on the floor.

Among other merits of the parallel plan for arranging the tilt boxes, we enumerate: First, the birds have the benefit of the space under the passage, *g*; second, the nests, the perches and all the feed cylinders are very convenient of access by the attendant, and third, the tilt box is narrow in proportion to its length, thereby facilitating the tilting. Build all the boxes narrow and of thin, light lumber.

The tilt box is, as before stated, one continuous box supported by the axle, *l*, which rests on the blocks, *m*, in such a position that when the tilt box is level its underside is one inch higher than the upper surface of the floor, *f*. The continuous box, several hundred feet long, is divided into apartments by board parti-

FIG. 113.



tions, these apartments being in length the same as from the center of one block, *m*, to the center of the next block, *m*.

It is important to have the axle for tilt boxes for layers large and strong, if it is a long one. The strain

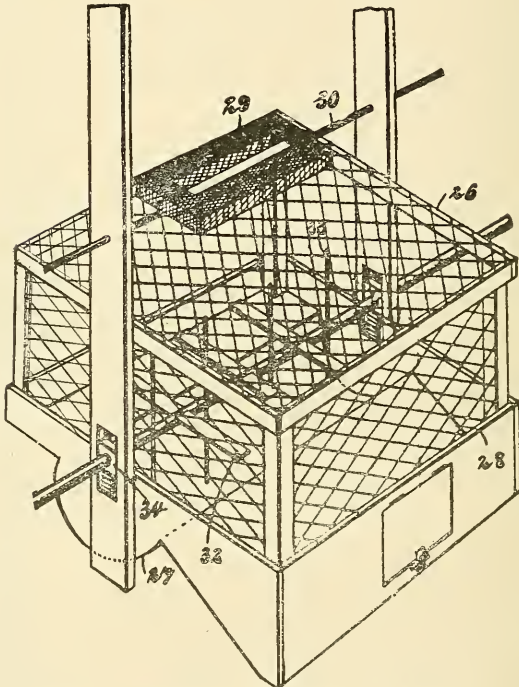

FIG. 114. A SUBSTITUTE FOR TILT BOX. SEE P. 161.

caused by the section used by one flock of fowls is not great, but, by extending the multiform box through a long building, the strain becomes greater than would be supposed. The axle can safely be of smaller calibre at the end farthest from the operator. For a building one hundred feet or more in length, a two-inch iron pipe,

reinforced by the collar at each joint, Fig. 35, is suitable for the first fifty feet at the end nearest the attendant. The lever, if one is used, should be six to twelve feet long, according to the length of the axle. A winch, Fig. 138, is preferable if the axle is long, and the handle of this winch should be strong and made to be grasped by both hands.

If there are ten or twelve tilt box apartments attached to the same axle, they should be 3 1-2x8 ft. and 2 1-4 ft. deep. If fifteen or twenty apartments, they should be 3x10 ft. or 3x12 ft., according to the size of the flocks; for it is readily understood that the narrower the tilt boxes, other things being equal, the easier it is to rotate them. After determining their width, you contrive the width of the building and the location of the posts, which last determines the size of the stationary boxes or apartments under the call cylinders. In Figs. 117 and 135 the tilt box is 3 ft. wide. Be sure to avoid making your tilt boxes too wide. Use thin, light-weight boards.

In Fig. 117, and in all other instances in the parallel system, the birds must enter at the side of the tilt boxes, of course, as in Figs. 131, 142 and 144. Also the tilt boxes for brooder chicks should be rounded a little on the front side. In Fig. 142, *S* represents the stationary box, *Y* the yard out of doors, *T* the tilt box, and *X* a curved flap to shut off ingress and egress at the opening between *T* and *S*. Compare this cut with Fig. 73 and observe the dotted line, which shows the half tilt and the full tilt. The feed cylin-

FIG. 115. SHELVES WITH CLEATS AND BAR.



der, or a feed shelf if preferred, is at 10 and the feed drops toward *T* through the curved partition of wire, one-inch mesh. In both cuts, this wire mesh is indicated in various places by small crosses. As is obvious,

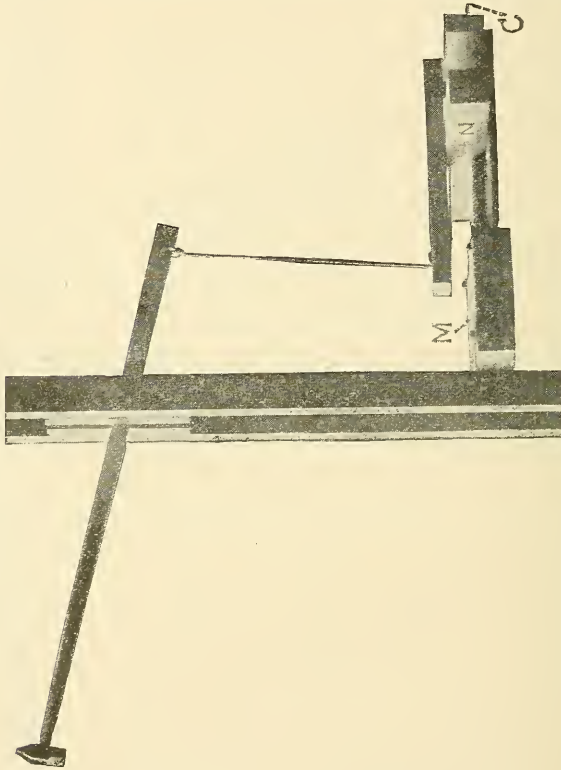

FIG. 116. APPARATUS FOR MOVING SHELF.

the chicks cannot enter the space over the tilt box between *S* and *Y*. The reader should study carefully the ground plan, Fig. 140. *P* is a passage or alley for the attendant, dug in the ground two feet, so as to bring the floor, *S*, to a height convenient for the attendant,

in which case, if *S* is on a level with the ground outside the brooder house, a pit must be dug to give the tilt box room to turn, as in the case of the tilt box for grown fowls, Fig. 117, where *t* is the tilt box and *p* the pit. The construction of the floor of the passage for the attendant on the same level with the stationary boxes, brooders or layers, as in Fig. 136, we utterly condemn.

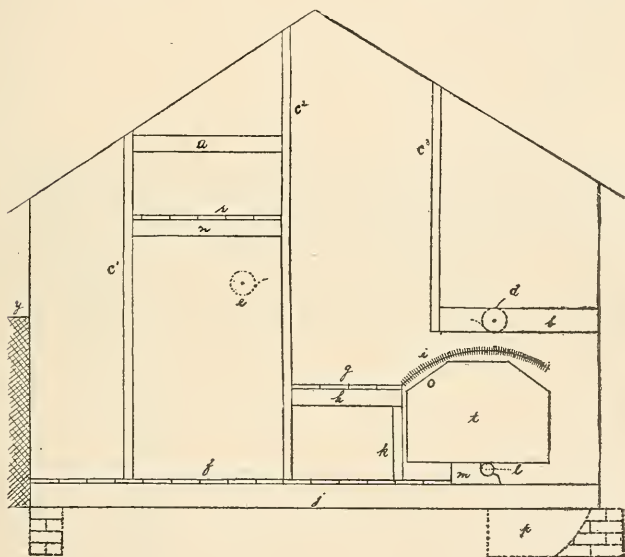

FIG. 117. TRANSVERSE SECTION OF HOUSE FOR LAYERS. (SEE FIG. 132.)

The rules of convenience and labor saving are against it, and why so many manufacturers of brooders perpetuate the nuisance is past our comprehension. As well might the counter of the salesman or the workbench of the mechanic be on a level with the floor. The brooder is the poulterer's workbench.

In the parallel plan for brooder house, the tilt boxes should be double, being built for two broods with a par-



tition of wire netting, one-inch mesh. See Fig. 131. For the younglings, this is better than the continuous or multiform tilt box used for layers, Fig. 117. In the ground plan, Fig. 140, the wire partition dividing the double tilt boxes is represented by small crosses. Each brood has an alley, *e*, six inches wide, communicating with *Y* and *S*, this alley being closed to suit occasions by small doors, one at each end. These doors, however, are not shown in the cut.

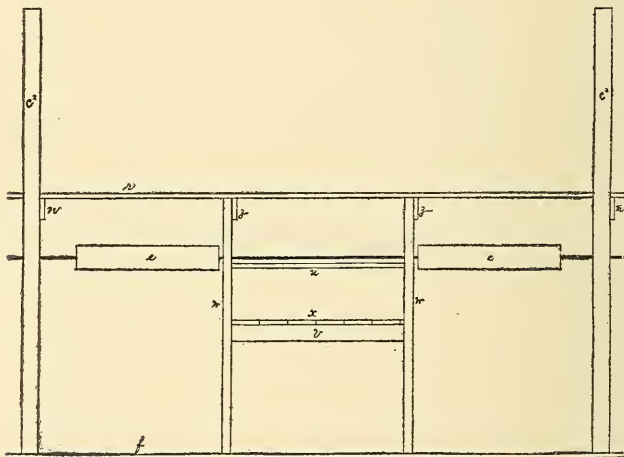
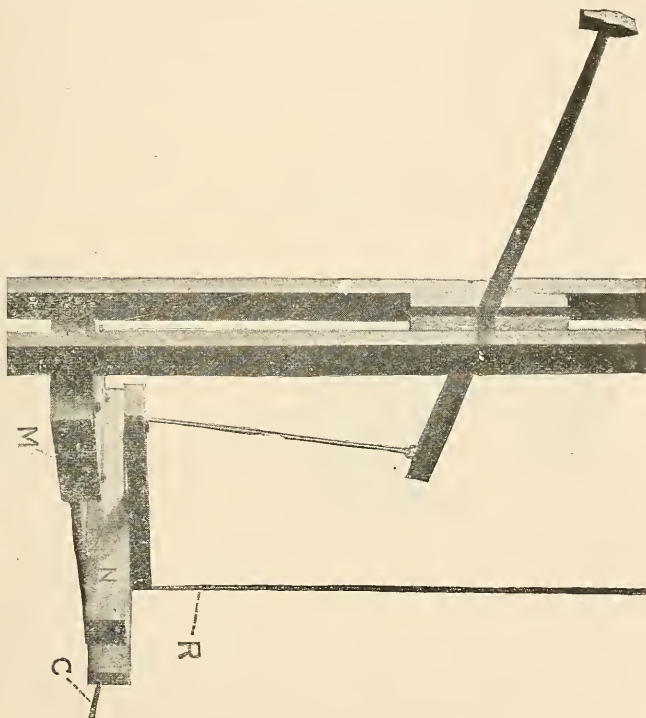

FIG. 118. LONGITUDINAL SECTION OF HOUSE FOR LAYERS. (SEE FIG. 132.)

If the brooder house is a long one, similar in external appearance to the one shown in Fig. 103, and heated by hot water, the parallel system should be followed, and by a little ingenuity room can be contrived to locate tilt boxes in any brooder house that is constructed substantially like Fig. 137, although not built with reference to their adoption. If, however, each brooder is heated by a separate lamp, the alternate system, Figs. 102, 103 and 141, should be followed. In any brooder house

already built, that is arranged essentially like Fig. 136, tilt boxes can be introduced. Whenever tilt boxes are put into a building of this sort or of the kind shown in Fig. 102, it will be necessary to dig a pit in which the

FIG. 119. APPARATUS FOR MOVING SHEEP.



winch or lever may turn and the attendant stand while operating the same.

If you hatch chickens artificially on a small scale, using only two, three or four brooders at a time, the best way will be to adopt the alternate plan and have no continuous axle with its lever or crank, and dispense also with feed cylinders or feed shelves. Rotate each tilt box

separately, by hand, just as you would rock a cradle, each having a separate axle made by nailing a stick, one and one-half or two inches square, across the bottom of the tilt box, at the under side, and letting it project a couple of inches beyond the ends of the box, these ends to be rounded, and each to rest in a notch of corresponding size cut in the edge of a horizontal bearing piece of inch board. A good shape for such a box is seen in Fig. 143.

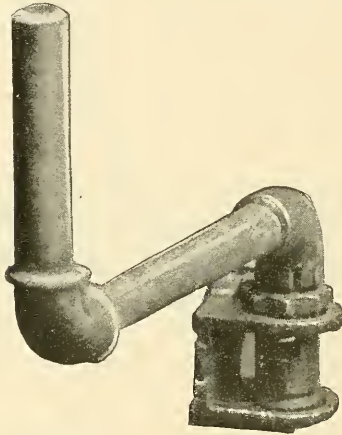

FIG. 120. CRANK MADE OF PIPING.

Of course, you walk to each tilt box in succession, and do without feed cylinders by sprinkling a pinch of millet or other fine feed by hand twice every time you tilt the box, one pinch to call them out of the tilt box to begin with. No signal will be needed to call them. Their quick eyes will watch your every motion. You can set a

tilt box, then a brooder or stationary box, for they are both the same thing; then a tilt box, then a brooder, right alongside of an alley three feet wide, which is sunk two feet in the ground for the attendant to walk in, or you can set the brooder and the frame which supports the tilt box on legs two feet long, as in Figs. 78, 79 and 80. The brooders should communicate with little yards or long narrow runways, with small outdoor exercisers attached, but for the first fifteen or twenty days of the younglings' existence there need be no going out doors at all, if you operate the tilt box often. The floor of the stationary box or brooder should be two inches higher

than the floor of the tilt box, to allow for the thickness of the two-inch layer of cut hay or chaff in the latter. You can use lamps and either hot water or hot air for your brooders, when you have but a small number.

Now, if you have eight, ten or more brooders occupied at the same time, use the alternate system and sunken alley above described, and attach all your tilt boxes to a continuous axle furnished with a crank and use feed cylinders, as in Fig. 79. The axle may be of three-quarter inch or inch iron pipe and must pass under the stationary boxes, or brooders or hovers, as they may be called, on its way from one tilt box to the next.



FIG. 121. PIECE FOR ATTACHING SHAFT TO SPOOL.

Under this plan, of course, you do not have to go from one box to the other, but stand at one end of the axle, where you tilt all at once. The quantity and kind of feed needed for each brood, according to the number of birds composing it and their age, is provided for when the feed cylinders are charged, which will ordinarily be but once a day, with the dry grain, which should be the main feed.

Green stuff and meat may be fed in the usual manner, it being not adapted to the feed cylinder. One of the merits of the system of poultry keeping by machinery is that the birds, both young and old, can digest plain, dry, uncooked grain and thrive upon it with very little else, excepting green stuff in slight allowance, gravel and water, if they are compelled to work hard for nearly all they get. Meat, vegetables, and the various prepared articles of food take too much time, besides costing ordinarily more than grain. Feeding milk is an uncleanly practice, daubing and soiling beaks and feathers more or less. A little green stuff is useful, not, as some persons

have claimed, on account of its nutritive constituents being better than those of grain, but because the acids of green stuff and fruit help all omnivorous or graminivorous animals, man included, to digest the grain food, which is the main reliance. No matter how nutritious

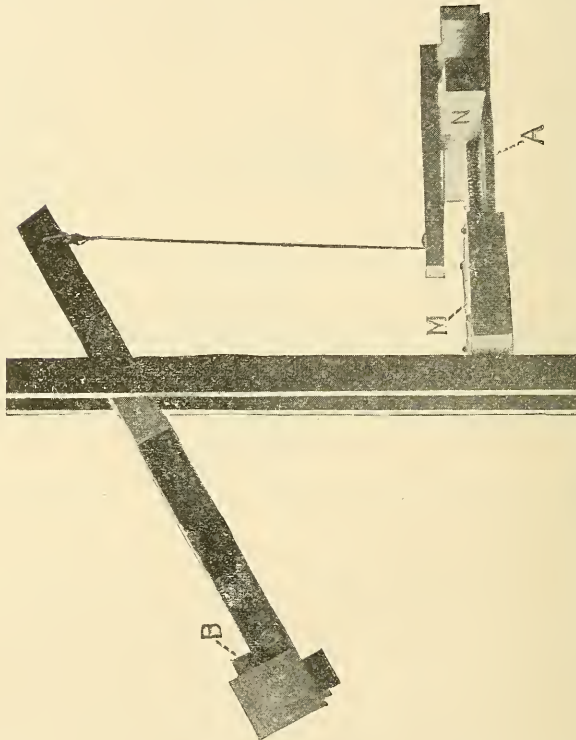

FIG. 122. SIMPLE APPARATUS FOR MOVING SHELF.

the diet on board ship, the sailors without fruit or vegetables will have scurvy after a while.

If your establishment contains fifteen or twenty brooders, or upwards, stick to the sunken alley, but change from the alternate to the parallel system, Figs. 140, 142

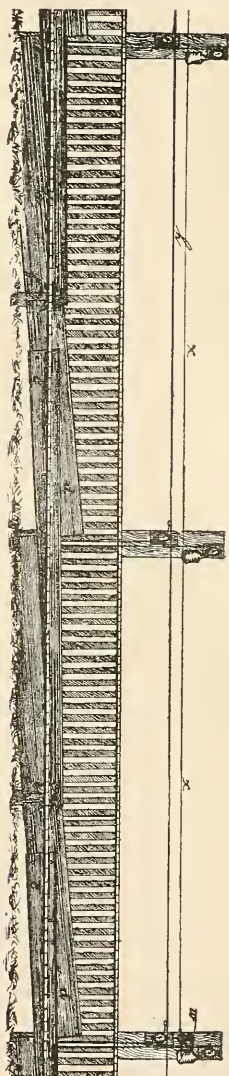

FIG. 123. FEED TROUGH—SIDE VIEW.

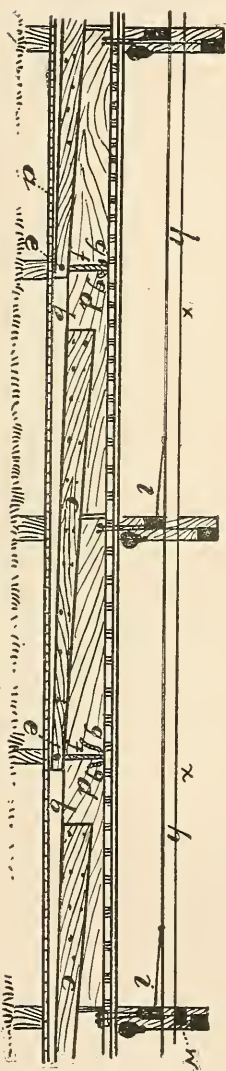

FIG. 124. FEED TROUGH—SIDE VIEW.



and 144, and use hot-water pipes of the usual style, Figs. 136 and 139.

What has been said, regarding three different methods of operation with chick tilt boxes, applies to layer tilt boxes with the exception that, when you have but two, three or four of these and walk to each, it will not be convenient to take hold of the tilt box directly, it being too heavy and swinging in too big an arc to be moved easily and followed conveniently on its trip, but a short wooden lever will be needed, which may be nailed to each box. If you have five or more layer tilt boxes on one axle, a call bell and a feed shelf, the latter operated by a hammer held in the hand will be cheaper than feed cylinders. A swinging feed shelf can be very readily suspended when it is indoors, the suspension cords or wires being attached to some part of the building.

The chaff or litter for layer tilt boxes should be fine, and for chick tilt boxes very fine. Coarse, stemmy hay cut short is very good. It must be somewhat heavy, for if too light and fluffy it does not tumble well in tilting. In Nebraska, Kansas, California and intermediate alfalfa regions, use the finely broken stems and leaves remaining after the alfalfa seed has been threshed out. There is nothing else so good for the purpose.

## CHAPTER XXV.

### HEALTHY, VIGOROUS BIRDS.

The introduction of mechanical contrivances in tending fowls marks a new era in poultry raising on a large scale. Hereafter the poulterer, working under the old system, can no more compete with those who have the new machinery than he can raise hay for cattle and use only scythes in competition with stockmen who have mowing machines. The ordinary scratching room, or "scratch pen," would be all right if the time could be afforded to mix grain with the litter often and a little at a time, but nobody ever did or ever will do this thoroughly by hand, daily, for any length of time. If done by hand it will be at a loss, and the more you do it without machinery the more you will lose. The country is full of abandoned incubators and brooders because the eggs used for hatching lacked, at the start, the vitality that nothing but exercise of the parent stock could bestow, and also such chicks as could be coaxed out of the shell died by inches for want of exercise in the brooders. Writers on poultry urge the sprinkling of millet on litter for the young broods, to induce scratching exercise; but doing this two or three times a day amounts to but little. It will slightly retard the mortality, the "leg weakness," the general debility and the "plastering up" at the rear of the body of the poor unfortunates, but will not wholly prevent these troubles.

Speaking of the disgusting and disheartening trouble last mentioned, complaint of which appears in the cor-

responsiveness of the poultry papers over and over again, it hardly occurs in case of chicks running at large in one instance in a thousand, we might say. It is wrongly attributed to looseness of the bowels, while its real cause is weakness of the muscles around the vent. These muscles are weak because all the other muscles of the body are weak. When the muscular system is toned up by the exercise on a free range while constantly hunting, literally, for "grub," one set of muscles concerned in evacuation throws back, or separates, the feathers around the vent with force, while with equal force another set of muscles expels the droppings. Much of the so-called diarrhoea is

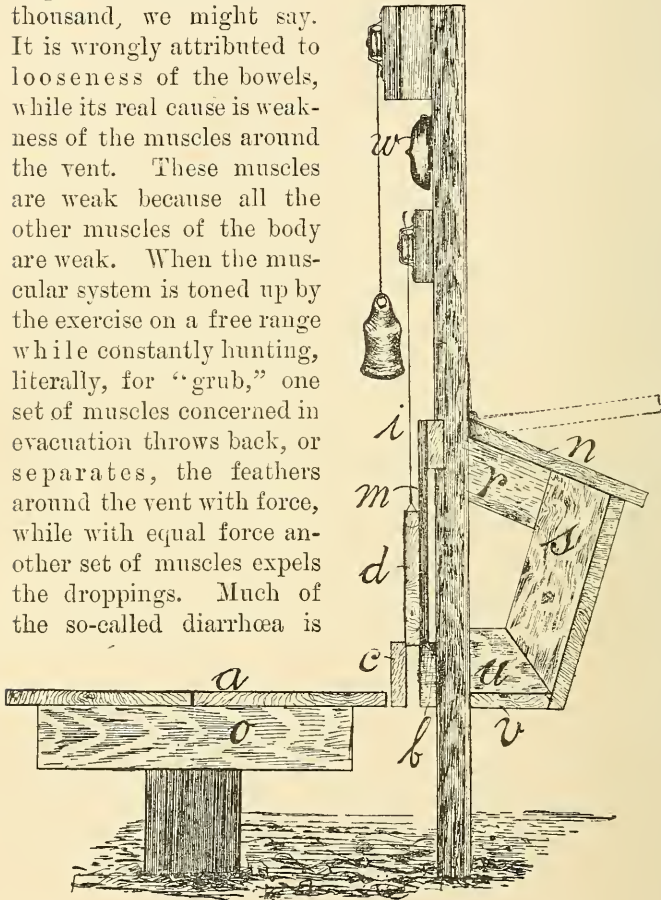

FIG. 125. FEED TROUGH APPARATUS.

not diarrhoea at all. The chicks are weak for lack of exercise, the whole system is enfeebled, but the bowels

are not suffering a whit more than all the other organs. The troublesome symptom of clogging near the vent is almost invariably caused by lack of exercise, but anything else that debilitates will cause it, and it is not necessarily an accompaniment of diarrhœa, dysentery, or any other specially diseased state of the bowels, or of abnormal or vitiated droppings.

These last may be in fully as normal a condition as any of the other waste products or various secretions of the animal economy. The feathers begin to be clogged, in the first place, by the thin matter that is voided last, the muscles concerned becoming tired toward the close of the orgasm. A powerful muscular action is necessary, to throw aside the numerous feathers surrounding the vent and to discharge the thin matter with sufficient force to prevent any dribbling or soiling of the surrounding parts. The chick, debilitated in every muscular tissue by unnatural confinement, has not the strength to prevent the leakage of a drop or two, which, adhering to the feathers, forms the nucleus of an unsightly deposit, which increases with every evacuation. The vent itself is not clogged. The deposit is outside the passage, not in it. The poultry keeper is apt to try a change of feed, thinking that the trouble consists in bad digestion, or he

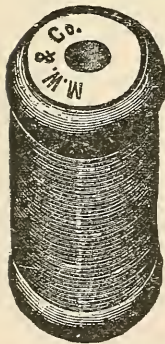

FIG. 127. WIRE FOR GONGS.

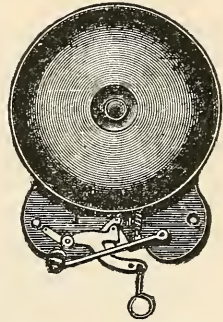

FIG. 126. TRIP GONG BELL.

finds fault with the brooder and changes from bottom heat to top heat, or vice versa. But the main cause is lack of exercise, and no style of brooder or

change of feed can possibly cure or prevent the symptoms in question.

Let us be understood. This is the first time, so far as the writer is aware, that the true nature of most of

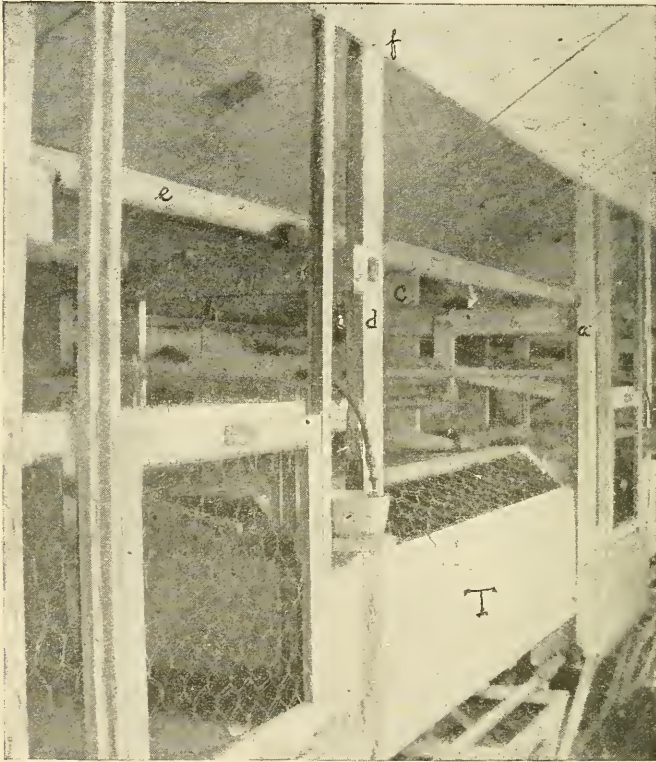
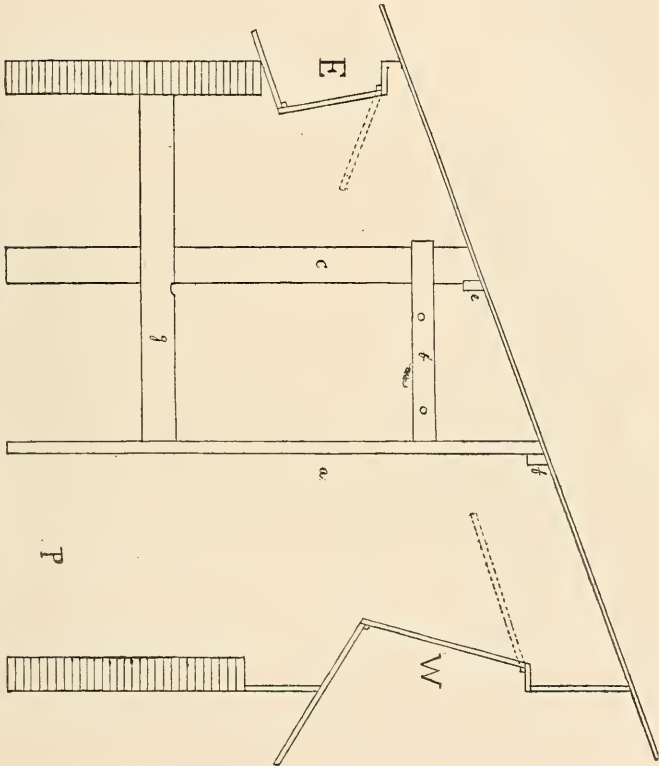

FIG. 128. INTERIOR ALTERNATE SYSTEM. SEE FIGS. 77 AND 130.

the so-called diarrhœa, looseness of the bowels and clogging of the vent has been published. It is not claimed here that the bowels and the evacuations are in a perfectly healthy state when the dribbling matter previously

described begins to adhere to the feathers. When there is deterioration of health and strength on account of dearth of exercise, or on account of jostling and crowding at night in an insufficiently warmed brooder, result-

FIG. 129. TRANSVERSE SECTION OF HOUSE WITH ALTERNATE SYSTEM.



ing in loss of sleep, every organ and function of the body is likely to be more or less impaired. What is asserted is that the bowels are not primarily or specially in fault. The whole digestive system may be as well off as any other part of the chick, and may be, in fact, the



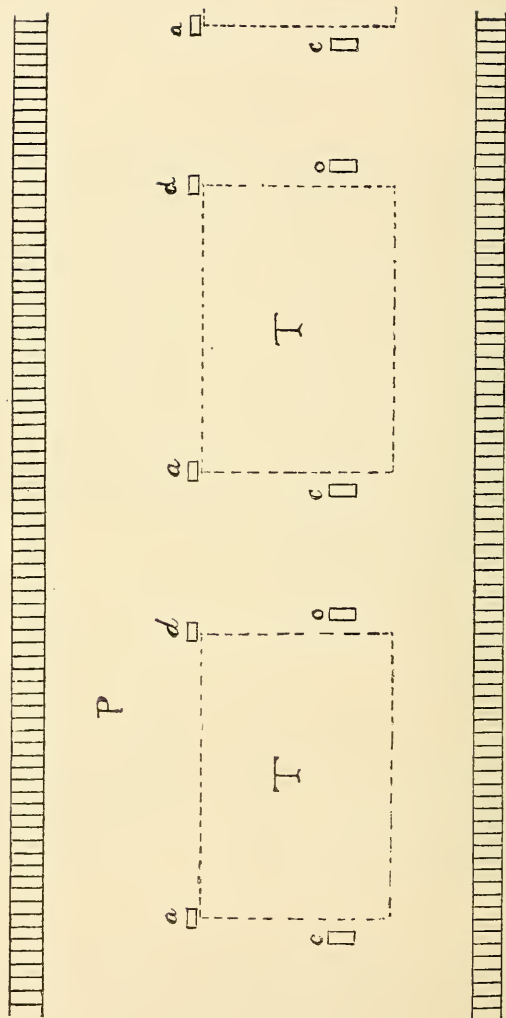

FIG. 130. GROUND PLAN OF HOUSE.

nearest to a healthy state of all the various organs; yet, since there is a great deal of muscular strength necessary to the proper performance of the act of evacuation, without such strength there will be soiling of the feathers, which will go on from bad to worse.

Reader, if you would test the correctness of the above, take a score,—or fifty or more if you have them,—of brooder chicks that have been confined in a manner to prevent exercise. Select only those that have the unsightly protuberance adhering to the feathers near the vent. Remove the deposit, and keep removing it carefully during the early stages of the experiment we are about to describe, using warm water and patience, and taking pains not to injure either the flesh or the feathers.

Separate your afflicted specimens into two broods, impartially, as regards size and health. Give each brood

FIG. 131. TILT BOX.

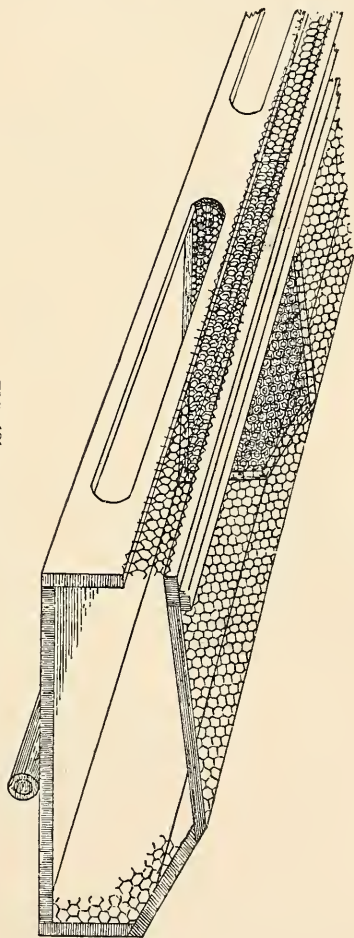

the same heat, sun, fresh air, water, and everything else down to the smallest detail. Only and excepting this, to wit: You contrive plenty of exercise for one of the squads, and for the other, not. Remove the filth from

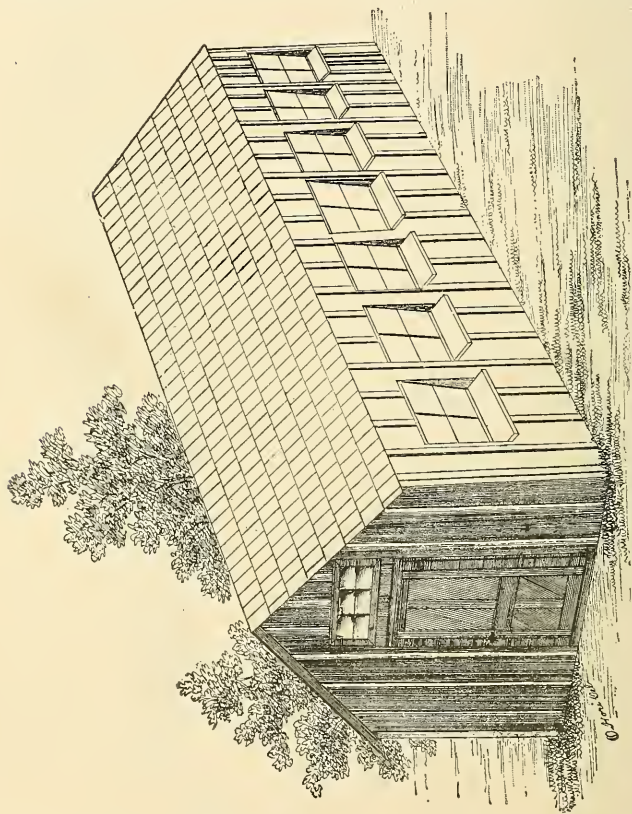

FIG. 132. HOUSE FOR LAYERS.

the posterior parts of all the birds in both squads if it reappears, for a week or so after separation. This is so as to be able to detect results after the exercise has been allowed time to take effect. The division into two

squads should be made before the specimens in either group become too debilitated to take exercise; because, you see, if exercise is to be tested, exercise must actually appear, in one squad, as a factor in the experiment. We will tell you beforehand, good reader, how it will turn out. You will not only find that exercise will prevent accumulations near the vent, but by careful watching you will discover that your squad which possesses strengthened muscles performs

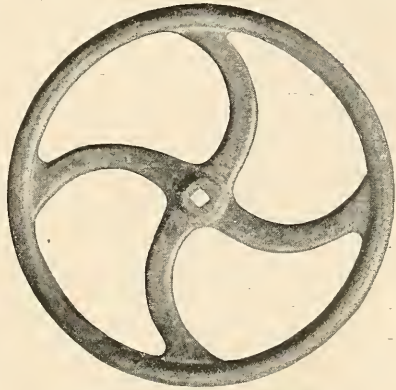

FIG. 133. LARGE HAND WHEEL.

FIG. 134.  
SCREW PUL-  
LEY.

the act of evacuation in a vigorous manner, throwing aside with force the feathers of the parts concerned and holding them rigidly till the last portion of the urine, as well as the more solid matter, has been vigorously ejected, while you will also perceive that the reverse is true of the other squad, which exhibits only feeble orgasms, dribbling and befouling.

When young chicks are under the care of the mother hen and are allowed freedom they are in motion nearly all the time in daylight hours. Plenty of exercise keeps up the proper balance between the muscular, the nervous, the circulatory and the digestive systems, and tones up every portion and function of the body. In such a case, there will be not more than one or two per cent of the young birds showing posterior parts befouled, and such birds were most certainly badly

hatched and so handicapped in the race of life, or they met with some injury or setback. Sometimes a whole season will not develop a single instance of the unsightly pest in flocks aggregating hundreds. Under natural conditions domestic birds, like their wild cousins, will have perfectly clean plumage. Folks say it is necessary for young chicks to "get at the ground." It is necessary for them to "get at" exercise.

In the instance of brooder chicks, throwing grain on top of a pile of litter does not amount to much. No matter how loose the litter may be when it is first put into the scratch box, the constant tramping of the chicks soon makes it a compact mass and the grain will not rattle down through it. Throwing them grain induces a momentary scramble but very little scratching. If the attendant stirs up the litter, using a rake or fork, it takes him over twenty minutes for sixty flocks, to do this properly and not stampede the birds, even when every door and other appliance at the brooders and scratching places is constructed so that it can be done as handily as possible, while unless the brooders and their belongings are made with special reference to this routine it will take forty minutes. With the indoor exerciser it can be done in one minute. That is, the machine saves the time of twenty men, at the very least. The best farm machinery saves the time of only eight to twelve men.

## CHAPTER XXVI.

### BUSINESS POULTRY FARMING.

Throughout the industrial realm everywhere the modern maxim is: "Use a machine instead of a man, wherever possible." In field, factory and mine, and on shipboard, progress demands the best of facilities for doing those things which are to be repeated over and over ten thousand times. On the other hand, when an operation is to be repeated but seldom, you must beware lest you lavish so much time on a machine to do it with that it costs more than the profits.

As we have seen, the surplus eggs and poultry from farms and rural places will be put on the market irrespective of profit, and the rapid extension of the trolley lines changes many urban residents to suburban; in other words, they become producers of poultry products instead of consumers merely. Therefore, the prices of eggs and dressed poultry are low and will continue low. To get around the difficulty, the artificial method of hatching and rearing has been resorted to by would-be broiler raisers on a large scale, so as to get high prices by securing chicks in cold weather when the ordinary farmer cannot, or does not, do it. But the first trouble is that winter eggs do not hatch well because the laying stock is in bad condition at that season from lack of exercise, and the second trouble is, that when you succeed in hatching, the chicks cannot exercise in yards in cold weather, sleet and snowdrifts. You cannot secure exercise for them indoors without the aid of machinery, unless you spend more time than they are worth. With-



out exercise so many will die that there will be no profits. In a nutshell, without exercise there cannot be thrift, and exercise in bad weather cannot be secured except at pecuniary loss, unless there are labor-saving contrivances. The large establishments will either raise chickens in moderate weather under an out-of-door system with plenty of range, and preferably in about the latitude of North Carolina and Arkansas, where the winters are short and mild, or adopt machinery, or allow large and, of course, expensive apartments for each flock, or shut up shop. The writer dislikes the

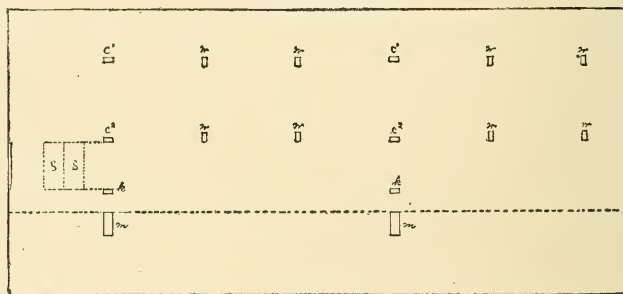

FIG. 132. GROUND PLAN OF HOUSE FOR LAYERS. (SEE PAGE 132).

role of dark prophet, and calls attention to the sombre truth only in order to show a way out of the difficulties. The trouble with large rooms for each flock is the great cost. Already cases are appearing where \$50,000, and even \$100,000, is spent on one set of poultry buildings.

Scores of large poultry farms have been abandoned because their owners did not, at the outset, correctly estimate the amount of labor needed to run them, which is, unless machinery is used, so enormous as to absorb the profits, or, more properly, to prevent all profits. There are ten thousand steps necessary on poultry farms as ordinarily conducted, possessing no labor-saving con-

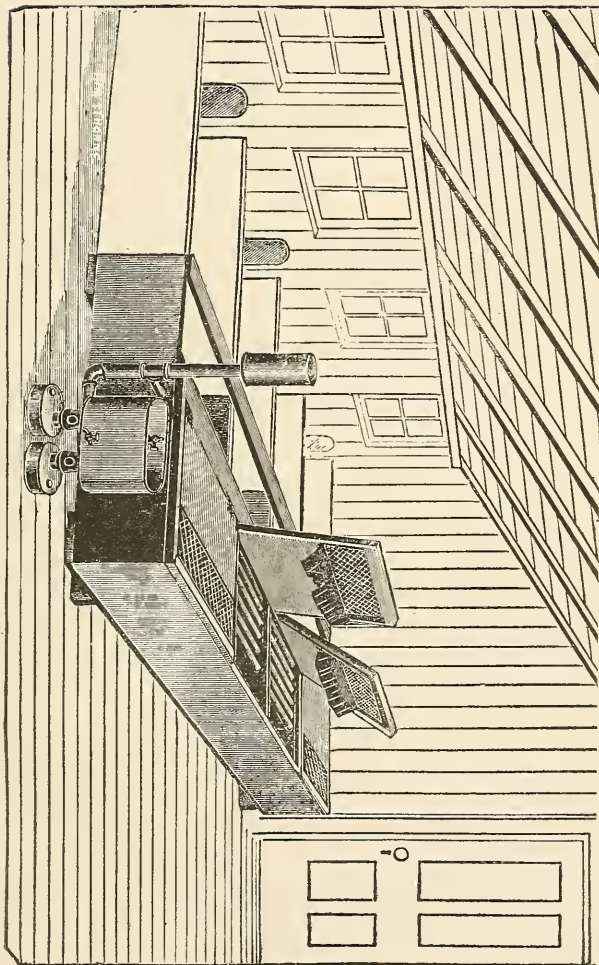

FIG. 136. HOT WATER HEATING SYSTEM.

trivances, and the day is never long enough, from earliest dawn till work by lantern light has been prolonged till bedtime, to attend to the hundreds of little details.

On poultry farming as a business there is no one better qualified to speak than that luminous and voluminous writer for the poultry press, intelligent and careful observer, and practical poultry keeper, W. H. Rudd, who, moreover, lives in Massachusetts, where poultry farms run on a more or less extensive scale are most numerous, and besides, his market and provision trade in Boston has, for thirty years past, given him an excellent opportunity to keep track of the progress in raising poultry products for the table as a business. He says:

“Where competent help is a necessity we are very doubtful whether it can be employed at a profit; at any rate, we have never known of an instance where it has been done.”

Since his utterance, quoted above, there have, however, been some very noticeable advances in poultry culture. With the aid of the new labor-saving machinery, skilled labor can be employed, in connection, of course, with a proper number of cheap hands, at a profit in poultry raising. There is much light work and routine work that can be done by low priced labor when machines are the central and governing feature. Without such machinery poultry will not be raised on a large scale in the future, any more than grain will be sown by hand, reaped with a sickle and threshed with a flail at a profit. It will be found cheaper to use comparatively small buildings with machinery, than large buildings without it. If help cannot be hired in a business, it is no business at all, and it is “not business” to be in such a business.

What would be thought of another industry where no employes could be hired at a profit? The truth is, that in cases where a poultry raising establishment depending on yards has been run on a moderate scale

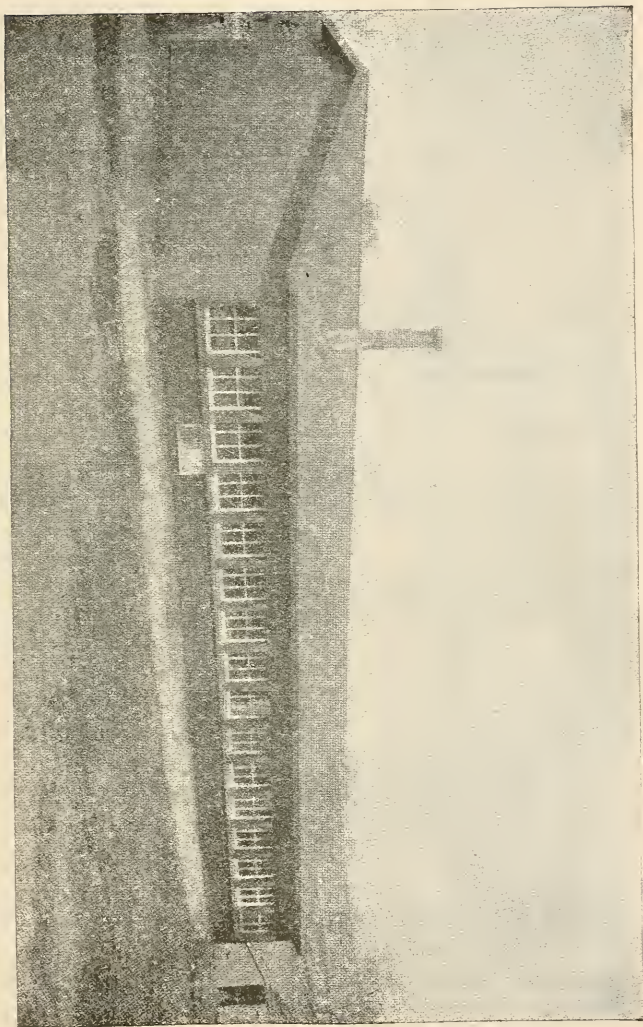

FIG. 137. BROODER HOUSE.

successfully without machinery, the owner working at nothing else the year round, either thoroughbred fowls and eggs have been sold at high prices and the business kept afloat in that way, or the proprietor has struggled and toiled with an amount of care, painstaking and unremitting industry, which, if employed in almost any

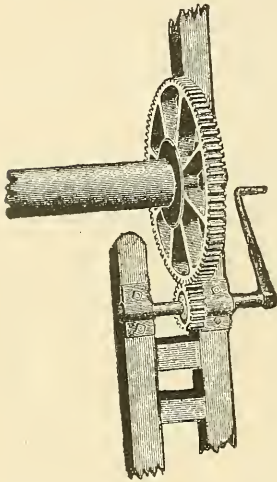

FIG. 138. SHAFT WITH WINCH.

other staple calling, in office, hotel, mine, factory or store, would have paid him better. In this last instance, talents and zeal have been virtually squandered, since they could have been employed to better advantage elsewhere. As regards the breeding and sale of fowls, or of livestock of any species, at fancy prices, it is an important branch of rural economy and brings about a vast amount of good in disseminating valuable breeds of animals all over the country, and finally at prices within the reach of the multitude.

But it is not a staple business. In the nature of things, but a few can work at it, and in the last analysis its foundation will be found to rest on the use which the breed serves in the hands of those who produce for sale at ordinary market rates. To illustrate, if the regular dairy business is not profitable, then the raiser of extra premium Jerseys or Holsteins will have no customers. The raisers of prize winners must be few in number; for if like produces like, then by natural increase their excellent breed will soon be common; while if, on the other hand, the superior qualities of their high priced specimens are not hereditary,



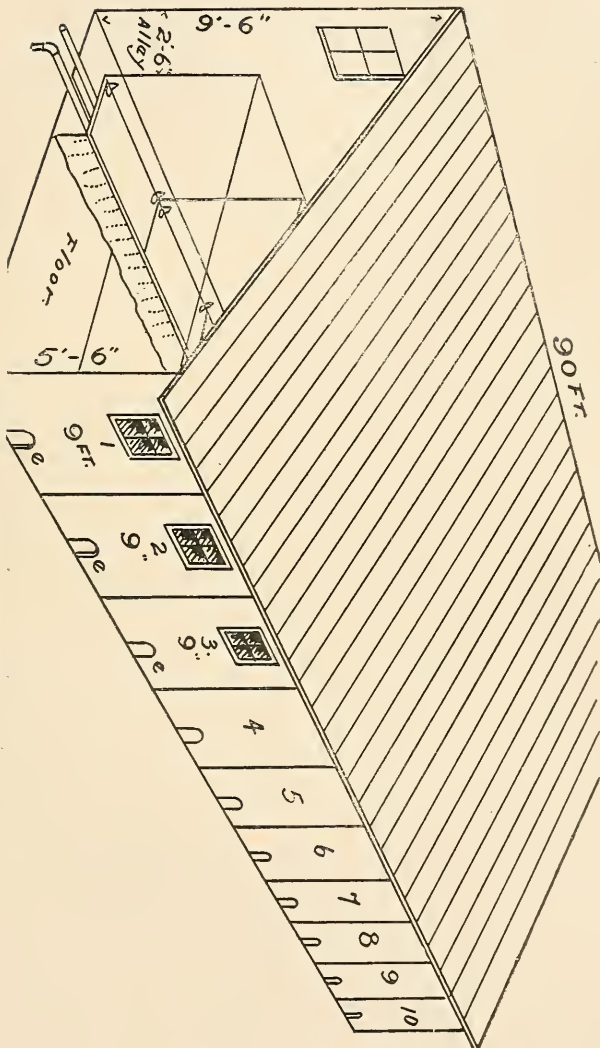

FIG. 139. PLAN OF BROODER HOUSE.



then the purchaser has been deluded, and the seller is laying snares instead of following a staple business.

To return to the matter of hiring help, machinery is a great promoter of efficient service in all branches of industry. The tender of the machine must feed it continually and faithfully, or the result is a "dead give away." The farm hand may lean on his hoe pretty often to see the pigeons fly, or the carpenter may dawdle over his jackplane occasionally to gossip, and not be noticed; but if the former is running a gang plow and the latter a planing machine, the stoppage of either attracts attention. The machine regulates the operative. In these latter days, the question whether there is, or should be, antagonism between employer and employe is often discussed. The fact is, the old saying, "there is no friendship in trade," is as true now as when it was first uttered. A seller tries to sell dear, and a buyer to buy cheap. The wage worker's commodity is his labor. Unless he is trying for promotion, or something of that sort, he is apt to try to see, not only how much money he can get for his work, but how little work he can do for his money.

To prevent shirking, piecework has been found a very successful device, and is followed almost invariably in great establishments where the nature of the product permits it, careful inspection of the articles produced being necessary in order to prevent slighting of the work. Working on shares, practiced in connection with farming to a great and increasing extent, is another way of enlisting the worker's self-interest. Where neither piecework nor work on shares is practicable, then two other things remain which will assist in securing faithful service of wage workers at a period when the false and pernicious doctrine is rife that anything that makes work is a benefit to the laborer and anything that uses up work is his enemy. The two

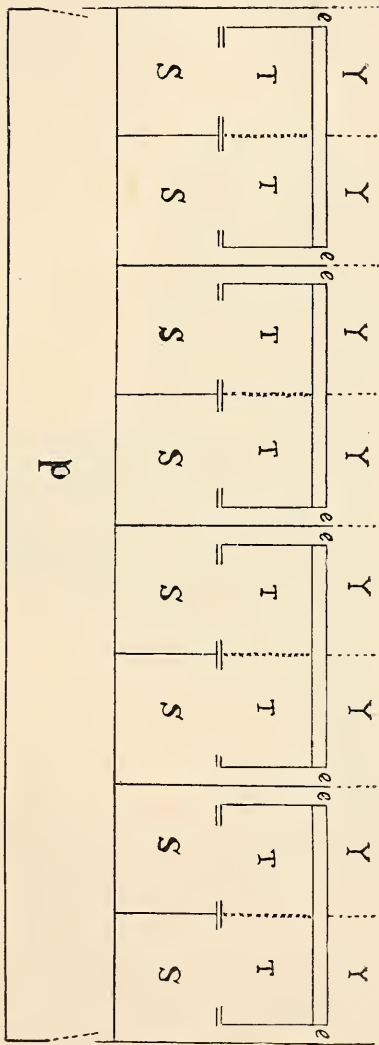

FIG. 140. GROUND PLAN OF BROODER HOUSE.

things meant are teams and machinery. Whenever a hand is driving a team, it must be kept going. Hence the great advantage in hiring help in prairie farming, where almost everything is done by teams, over hiring

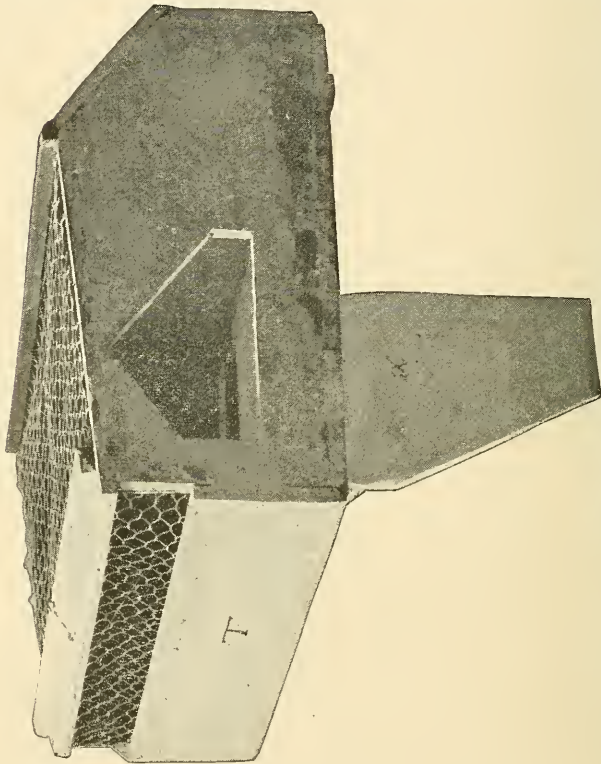

FIG. 141. TILT BOX WITH FLAP.

in garden work and horticulture, which are mostly handicrafts. In factories where the hired hand does nothing but tend a machine, he will be sufficiently regulated without working either on shares or by the piece.

In the large poultry establishments where the Exercis-

ers are used, the feed droppers, whether the latter are shelves or cylinders, will always speak for themselves and show whether they have been charged at the proper time and with the proper quantity, the orders being to do everything by rule, of course. The sound of the call bells, supposing that these are operated by employes and not by clockwork, will show what is going on at all times during the day, so that efficiency of the hired help is compelled. This is an advantage not to be despised, though an incidental one not considered when, for other purposes, poultry machinery was originally planned.

While the use of the Exerciser is as efficacious in giving vitality to eggs designed for hatching as in rearing chicks in brooders, its effects are more palpable and more quickly discovered in the latter case. Divide fifty chicks four days old impartially into two groups of twenty-five each. Put one group into a brooder without the Exerciser and the other group into a brooder exactly the same in all-respects, excepting that the latter has the Exerciser attached; treat both groups scrupulously alike as regards sun, air, feeding, watering and everything else down to the smallest details, and then compare the two groups every week till two, three, four weeks have elapsed. The contrast will be simply marvelous. A great deal of exercise, not merely a little, is just what artificially reared chickens need. It goes right to the spot. Hitherto the brooder chicks of the whole United States have not been allowed, one case in fifty, a full plenty of exercise, in winter especially. There is, to many persons, a fascination about artificial hatching and rearing, besides the expectations of pecuniary gains; so that thousands on thousands of dollars are invested in incubators, with an enormous amount of chagrin and disappointment as the almost invariable result. Lest the writer should appear to exaggerate on this point let an impartial and competent witness, Mr.

Lockwood Myrick, be called to the stand, who, in the *American Agriculturist*, says :

“There are few enterprises that present such an assurance of large and quick profits as that of raising broiler chickens artificially, that is, with incubators and brooders, instead of hens. With incubators a large number of chicks can be hatched at once and at seasons when hens do not sit. The market for broilers is never glutted. They are marketed at three months old, the dressed weight (undrawn) ranging from three to three and one-half pounds per pair. Eggs cost a trifle less than two cents each the year through. The feed consumed by a chick in three months costs but ten to twenty cents per pair.

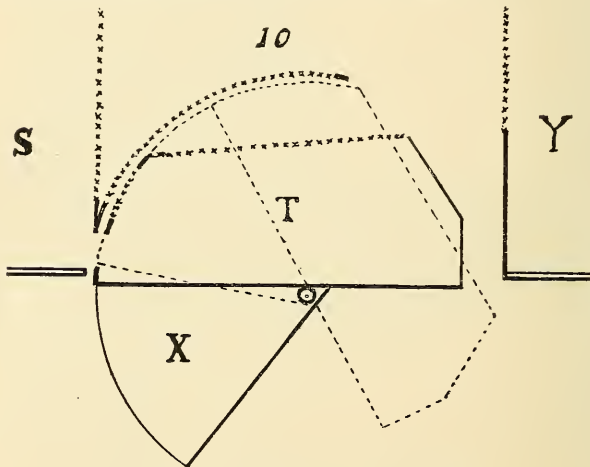

FIG. 142. TILT BOX—PARALLEL SYSTEM.

“The business has been tried in all parts of the country, but probably more extensively at Hammonton, South New Jersey. Within the last ten years it is said that more than fifty parties have undertaken the brooder business in this township. A better soil and climate for poultry cannot be found, and if success in the brooder business can be expected anywhere, certainly it should be found at Hammonton. And what is the result? Of all who have engaged in it only four remain, commercially, and of these but two run the whole year, and one of these expects to retire shortly. It is safe to say that there is not a single brooder man in Hammonton to-day who realizes \$500 per year net profit, and that is without making any charge for his time. One party mentioned above who says he cleared that sum two years ago, evidently has not since. Another, after four years' constant effort, says he has not received fifty cents a day for his labor. A third, who

runs but a few months annually, says he cannot make \$1.50 per day for the time he is in it.

"Evidently such a wide difference between the ideal and the real calls for an explanation and that can be given in two words, dead chicks. Incubators hatch from 50 to 60 per cent of the eggs. The trouble is not in the hatching, unless that means weakened vitality, but in keeping the chicks alive afterward. The death rate is awful, ranging from 60 to 80 per cent. When one-half a hatch reach to the broiler state, rarely done, the business is moderately profitable. If 60 per cent die, a prudent man can about pay his feed bills; when more than this die, as is usual, the business is unprofitable. This mortality is principally within three weeks from hatching. One of the first painful duties that awaits the novice is the burial of chicks; they are often buried by the bucketful daily.

"Practical men differ in placing blame for the mortality upon brooding or feeding. Many kinds of brooders have been tried, using top heat, bottom heat, heating with hot-water pipes and with single lamps, but the chicks die about the same with all. Feeding is a matter of great importance that has been most carefully studied, but no satisfactory ration has been found, or none that can entirely overcome the ill effects of imperfect brooding, and no brooder has been used that can overcome the ill effects of improper feeding if the trouble is in the ration. The "infant mortality" is the great cause of failure. After investing \$1,000 or more and losing a year's time, the average man sells at a sacrifice to a new enthusiast, who in turn sells again or dismantles the houses and devotes the land to more profitable uses. In the light of Hammonton's ten years' experience, it is plain that until some better system of artificial brooding is devised, the business is a very hazardous one; it cannot compete with the hen."

The above is very unwelcome to a host of people who have been hoping to find in broiler raising a sure path to fortune. Chicks of all gallinaceous species of fowls are so constituted in their essential physical nature that a tremendous amount of exertion is absolutely necessary, not only to thrive but to live itself. They are so constructed that without almost continual activity of their organs of locomotion the proper balance between their muscular system and their digestive and respiratory systems is lost. Their whole constitution becomes impaired because the equilibrium of vital forces ordained in nature has been broken up.

The Hammonton chicks died for the same reason that brooder chicks by the thousands have died all over the country. The heat and ventilation in the brooder and



the ration might both be right at Hammonton and yet the "infant mortality" be appalling. The riddle is solved. Canaries and young chickens are among the most active animals in the world. Nature is not a clumsy architect. Their hearts, lungs and digestive organs sustain an intimate relation to their muscles, and the harmony of parts in the make-up of an animal must be respected. When older the chicks could survive enforced idleness and inaction. But they are delicate little balls of down



FIG. 143. LIGHT TILT BOX.

at an early age unless gradually made robust by working for what they get. If you fight nature you will be whipped every time. Raisers of brooder chicks all over the coun-

try, who achieve a partial success, repeatedly testify that allowing the younglings the liberty of an outside yard always checks the mortality perceptibly.

But it will soon become generally known that a tilt box of a few square feet of floor will do more good than a yard of many square feet. The magical results of the little outdoor yards adopted by the most successful raisers of brooder chicks have been hastily attributed to the stimulating effects of the cold or to the influence of the fresh air or the direct rays of the sun. Wrong. No possible allowance, proportion or variety of heat, cold, fresh air, light or sun will save them without exercise. The curiosity and inquisitiveness of the little fellows led them to continually run indoors and out, like children, as children's mothers well know, and in this way a little exercise was gained by the use of the outdoor runs, but not enough by 99 per cent. You can afford pupils plenty of exercise in a city schoolyard of very limited dimen-

sions, by means of gymnastic apparatus; a caged squirrel allowed a wheel will thrive; and brooder chicks or layers provided with a gymnasium will take even more exercise than if on a free range.

You can secure plenty of hatchable eggs in winter by providing the Exerciser for your laying stock and in this way get two or three months the start of breeders who are dependent on the advent of spring, gentle spring. You need not mind the cold much, granted that your layers are through molting, if you keep their blood stirring, and, as regards the kind of feed, you may give them almost anything that comes handy. Attend to their muscles, and then their gizzards, which are bundles of powerful muscles, will work all right. There is much wasted talk about a "balanced ration," and much wasted time spent in weighing the constituents of hay, grain and other feed stuffs, and beef, fat, milk, eggs, and other animal products, expecting to be able to put certain raw materials into one part of the mill and take out finished goods at another part, as the manufacturer does. But the processes of nature are so subtle that you cannot always tell by what you put in exactly what you will take out. There is no way so good as actually trying. The test of sowing and reaping will instruct a farmer concerning the adaptation of his land to a crop better than elaborate analyses of the crop and the soil could ever do; and just so the only way to tell what a particular ration will do for fowls or other livestock is to try it.

The state agricultural experiment station of New York, at Geneva, reported in Bulletin 132 an interesting experiment with a milch cow:

"A cow fed during ninety-five days on a ration from which the fats had been nearly all extracted, continued to secrete milk similar to that produced when fed on the same kinds of hay and grain in their normal condition.

"The yield of milk fat during the ninety-five days was 62.9 lbs. The

food fat eaten during this time was 11.6 lbs., 5.7 lbs. only of which was digested, consequently at least 57.2 lbs. of the milk fat must have had some source other than fat in the food consumed.

"The milk fat could not have come from previously stored body fat. This assertion is supported by three considerations: (a) The cow's body could have contained scarcely more than 60 lbs. of fat at the beginning of the experiment; (b) she gained 47 lbs. in body weight during this period of time with no increase of body nitrogen, and was judged to be a much fatter cow at the end; (c) the formation of this quantity of milk fat from the body fat would have caused a marked condition of emaciation, which, because of an increase in the body weight, would have required the improbable increase in the body of 104 lbs. of water and intestinal contents."

Commenting on the above the editor of the *American Agriculturist* well says:

"To put in plain United States language that the average dairyman can understand, we state thus the case learnedly set forth by Dr. Jordan: This cow in three months gave in her milk 57 lbs. more fat than she consumed. Evidently the cow converted into fat part of the sugar, starch, fiber, protein, etc., that she consumed. That cows can really do this was not before known. This may explain why it is that rations deficient in fat or oil may produce milk rich in fat. The experiment also shows what wonderful and little understood processes go on in the animal system. Only a few weeks ago they removed a woman's stomach and she is now well and thriving, thus completely upsetting much of the 'physiology' we have been taught for years. Assuredly, how little is really known about the animal economy! Facts like these emphasize the marvel of life force."

Yet there are very many persons who reason that the constituents of wheat resemble the white of an egg and therefore they must feed that grain to laying hens even if it costs twice as much as corn—being afraid that the latter contains too much oily matter, forgetting that the yolk has much fat, and serves as the first food of a chick, as the first food of a calf is rich in cream, and that an omnivorous animal can digest and assimilate what it requires from a variety of foods, among which corn stands pre-eminent for cheapness in this country.

## CHAPTER XXVII.

### ARTIFICIAL INCUBATION.

The practice of this art reaches back to the dawn of history. The oldest written accounts are connected with Egypt. In "The Voiage and Travaile of Sir John Mandeville, Kt.," occurs the following, written in 1356 :

"Also at Cayre (Cairo), that I spake of before, sellen men, comounly men and women of other lawe, as we done here bestes in the market. And there is a common hows in that cytee that is all fulle of smale furneyns; and thidre bryngen wommen of the toun here eyren (eggs) of hennes, of gees, and of dokes, for to ben put in to the furneynses. And thei that kepen that hows covern hem with hete of hors dong, and outen henne, goos or doke or any other foul; and at the ende of three weeks or a monethe, thei comen agen and taken here chickens and norrische hem and bryngen hem forth, so that alle the countre is fulle of hem. And so men don there bothe wyntre and somer."

The fact of the successful prosecution of this art in Egypt having become disseminated throughout Europe, there were incubators of various patterns constructed in France, England and other countries, from the middle of the fifteenth to the close of the eighteenth century. In 1777, a method of heating egg ovens by pipes of hot water was tried in France, according to that excellent work, "Incubation and its Natural Laws," by Charles A. Cyphers, the best which has appeared since the modern incubators came in use, outside of the standard works on embryology. To John Champion, Berwick-on-Tweed, England, 1770, probably belongs the credit of first hatching eggs by the aid of fire. He used a room through which passed two heated flues, the eggs being placed on a large round table in the center. He claimed that as many of the eggs hatched as if they had

been sat upon by a hen. He says: "The two flue places do not open into the hatching room but into one adjoining, where the keeper sits and the coal is kept. By this means the eggs are free from smoke and dust, by which they might otherwise be greatly injured. The two rooms have a door communication, that the keeper may every now and then visit the eggs, and see if they are in the proper degree of heat."

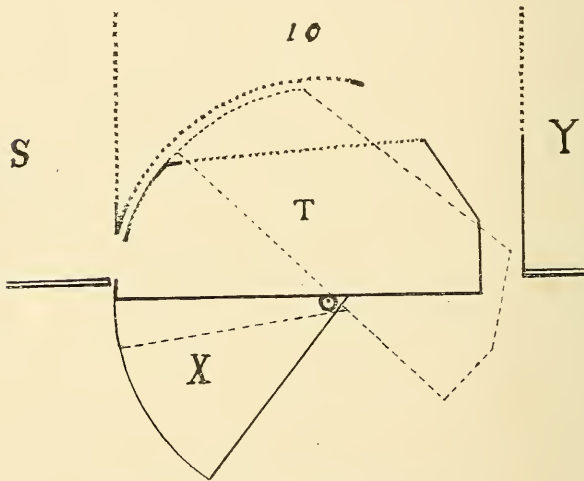

FIG. 144. TILT BOX—PARALLEL SYSTEM.

This experiment we shall refer to later as the type of what will eventually prove the most successful mode of artificial hatching on a large scale. The patent incubators such as are now on sale, or modifications thereof, from the size of a cook stove to a billiard table, with regulators attached, will always be of use for amateurs, families or ordinary raisers on a small scale, but the expense of the machines and the care involved in running them are so great where thousands of chicks are

wanted, that the adoption of an immense egg chamber holding many thousands of eggs and designed to be entered by the attendants, one of whom is always on duty night and day, a sitting room or waiting room being conveniently near, and personal supervision taking the place of or rather supplementing automatic regulators, will ultimately prevail, because proving the most feasible and economical.

From the year 1800 on, until about the middle of the century, there was a lull in experimentation till the late '60's and early '70's, when in consequence of the rage in this country for the introduced Asiatic and Mediterranean breeds of fowls and the general interest in poultry incited by the acquisition of these valuable races, there were some half a dozen hatching machines invented and put upon the market. Very crude affairs, though, they were, which long ago went down the stream of time, having however first served the useful purpose of offering hints for later inventors. The rage for incubators culminated in the early '90's. The multitude of incubator patents on file, the size of the manufactories where the principal machines are turned out, the extent of the advertising thereof, the elegance and costliness of the catalogs and the enormous sales effected, as well as the time and ingenuity involved in experiments connected with the improvement of the numerous styles of hatching machines, to say nothing of the time and care bestowed upon them by the hopeful purchasers, can be realized only by those who have made a broad survey of the matter. The last ten years have been especially prolific in styles of incubators.

Curiously enough, the skill spent in contriving the artificial brooders offered for sale has not kept pace with that given to incubators, although the fact that it is much easier to hatch chicks than to rear them has been evident all along. The notion which customers have



often had that homemade brooders would answer all purposes operated to limit demand for the bought article and probably somewhat diverted the attention of inventors and manufacturers from perfecting brooders. Be that as it may, the art of artificial hatching has

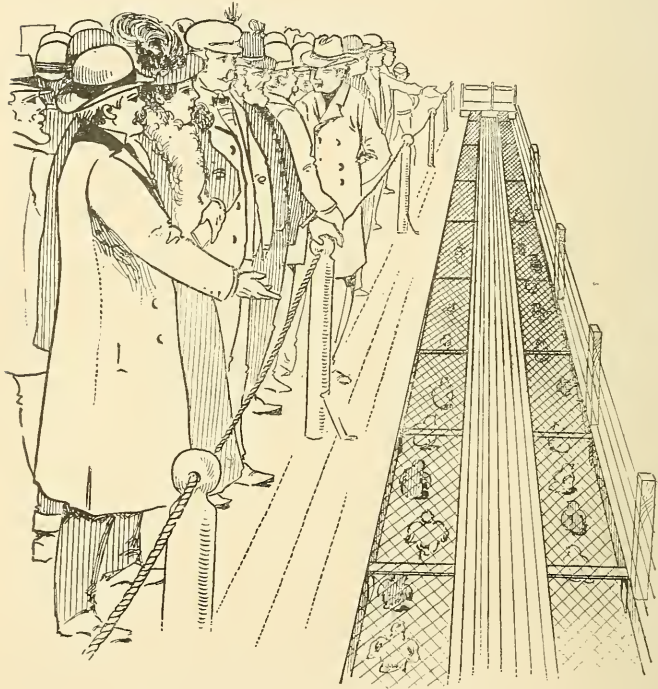

FIG. 145. WATCHING CHICKS AT EXERCISE.

developed much beyond artificial rearing, and the weakest point to-day in the artificial system appears in connection with brooders, as will be seen in later pages. Neither in hatching nor rearing must conditions be exactly thus and so to a hair's breadth. Considerable

latitude is allowable, both in the natural and the artificial processes. In fact, when wild birds of any species incubate and rear, there are fluctuations of weather and atmospheric conditions that would cause failure if it were necessary to maintain every requisite to an absolute nicety. On account of this latitude artificial hatching is not extremely difficult, although no human art has ever made or ever will make as perfectly regulated and operated a hatcher as is the live natural one.

Experts in the artificial process, especially if they are incubator manufacturers or dealers, sometimes insist that the artificial method beats the hen, and are fond of citing the cases of unfaithful birds deserting or breaking their eggs, etc. Granted that, although the habits of all wild species are uniformly exemplary in this regard, long domestication has impaired the incubating traits of some domestic breeds and utterly destroyed those of others, crossing with which from time to time has introduced uncertainties of results more or less into some flocks; yet the point is this, given the very best incubator, run by the very best operator, in the very best cellar, with the very best eggs; and compared with the very best hen, set on the very best eggs, in the very best nest, located in the most suitable place, and the hen is decidedly the most perfect. No man can ever construct a fabric that will equal a feather, or a mechanism which will control heat, moisture and ventilation as wonderfully as the mother hen's body with its feathered covering.

## CHAPTER XXVIII.

### REQUISITES OF A GOOD INCUBATOR.

To understand the points needed in an incubator, the changes which take place in the egg from the first to the twenty-first day of the hatching term should be studied. It is, however, not necessary to know all the details, which are of such wonderful complexity that to master them would need a lifetime. A farmer may fatten steers or raise wheat about as well (not quite) by attention to a few prominent principles, as if he was versed in all the intricacies of animal and vegetable physiology, and a few general considerations of heat, moisture and ventilation will enable an operator to run an incubator almost as successfully (not quite) as if he had taken so thorough a course in comparative and ornithological embryology that he could describe all the successive marvelous changes in the egg from the first to the last stage of incubation. The close study of these stages is to be recommended, however, because of the intellectual gratification in tracing out such matchless processes of nature, while, if no direct practical benefit inures to the poultryman from such study, indirect benefit he will be sure to receive on account of the increased admiration he will have for the wonderful masterpiece of nature, the egg, and the wonderful process of its incubation.

John Randolph said on the floor of congress that he would walk a mile to kick a sheep. There are too many poultry raisers who would walk two miles to kick a sitting hen, not appreciating the wondrous nature of her labors nor admiring her beautiful maternal instincts cel-

ebredated in the Book, where we read: "As a hen gathereth her chickens under her wings." The trouble has been, lo these many years, that very little ingenuity has been spent on contrivances for managing sitting hens, to minimize the trouble they cause their keepers, while inventive talent has compassed sea and land, earth and air in perfecting, so far as possible, substitutes for them.

In constructing an incubator the sitting hen is always, and properly, appealed to as a standard, and from her we learn that, in addition to the purely mechanical requisite of a changing position of the eggs; the three chief essentials of perfect hatching are heat, moisture, and a supply of pure air. The eggs must be right, however, in the first place, or the best incubator or mother hen in the world cannot turn out strong, healthy chicks. In the case of those hens which lay a great number of eggs, as was pointed out by the writer in the *American Agriculturist* in 1870, those eggs laid near the close of the laying term contain germs deficient in vitality. Mr. J. L. Campbell, who is always worth listening to, says:

"In a large flock of hens some of them are always right in the middle of a litter, and their eggs being in with the others will account for the fact that some good, strong chicks can be hatched right along all the time, and it is very well that this is so, but I shall never kick again when my hens want to take a rest when I want to hatch the eggs. In fact, I shall encourage them to do so whenever the eggs begin to hatch poorly. Why, it looks very reasonable that when a hen has laid a long time right along, day after day, something must be getting scarce, because the supply has a limit. This is proved by the fact that the hen finally has to stop. If ever I can get a flock of hens to average 250 eggs in a year I shall be happy, but I have a good bit to go yet to get there."

The matter of well vitalized eggs at the start, when using the incubator, and the importance of well-hatched chicks at the outset when employing the brooder, all operators are agreed upon. But there are many other things concerning which there are interminable disputes, notwithstanding a quarter of a century of experiments. One book published by an expert who has

devoted twenty years to artificial incubation says: "Take the eggs out from the egg chamber to turn them, to afford a change of air;" while another expert who has studied the matter an equal length of time insists that turning should take place inside the machine and all exposure to cool air religiously avoided. One master of the art says the temperature of the egg chamber should be  $102^{\circ}$  and another prescribes  $103^{\circ}$ . One recommends providing moisture by keeping shallow pans of water near the eggs during the whole term previous to the 18th day, while a third never supplies any moisture whatever, and a fourth would supply it or omit it according to the results of tests made between the twelfth and nineteenth days.

In regard to the method of turning eggs, there is a school of operators who insist that eggs must be gently rolled and that inverting the trays in which they are kept is unnatural and injurious, while another school advocates turning the trays as the quickest and easiest way, claiming that so long as the eggs are turned over it makes no difference how the revolution is accomplished. On the question of ventilation, one inventor exults in his method of a small, constant stream of air admitted near the bottom of his incubator and escaping at the top, and another, while providing apertures at the top, closes them with valves which open automatically, governed by a regulator, to allow heated air to escape when the temperature rises beyond a certain degree; and still another denounces all top apertures, claiming that in carrying off hot air they also carry off moisture and dry the eggs too much, and he would ventilate only very slowly and through holes in the egg chamber floor. A legion of incubator makers claim that the regulators to their respective machines govern the heat perfectly, leaving nothing to be desired, while one solitary individual in the United States, who makes and sells an incubator

and who has written the best book on incubation extant, stands up boldly and says there is but one style of regulator that will do perfect work and that is not on his own machine or any other, because it is too expensive, since it costs more than all the rest of a machine.

In regard to changes in the contents of the egg during incubation, one expert says none of the yolk is used to nourish the embryo till at or near the time when the former is drawn bodily into the latter during the latest stages of hatching, and another expert claims that while the white principally forms the chick, yet portions of the yolk enter from day to day into the white to replenish its diminishing substance and are afterwards used for the growth of the embryo.

As concerns the care of the incubator in general, many dealers represent that it is so easily managed that "a child can run it" successfully; while others insist that no hatching machine will succeed without considerable care and skill.

When we pass from the topic of hatching to rearing, some insist that not over 20 or 30 chicks should be put in one brooder; while on the other hand dealers are plenty who, to induce an expenditure of \$10 to \$20 or upwards for one of their death traps, represent that it will accommodate 50 to 75 or 100 chicks, and in some cases the figures are 200 or more to a brood. One, after wrestling for several years with bringing up chickens by hand, insists that top heat only in brooding is the thing. Another, after an equally extended experience and burying by the bushel chicks trampled to death, shuns top heat with the greatest persistence. Still another, after an experience of half an ordinary lifetime, uses top and bottom heat combined, while a fourth, grown gray in experiment in various localities from the Atlantic to the Pacific, says: "Side heat is as the hen, give me that and that alone."



If artificial hatching and rearing is so superior to the natural mode, as is persistently claimed by many advocates of the machines, including some who are not interested in their manufacture or sale, why should there be such contradictions? The fact that there are so many mutually destructive criticisms of methods proves that all is not plain sailing. The real truth is that the natural machine is as much superior to the mechanical incubator and the brooder as the construction of the human body transcends that of a watch or a dynamo. All that should be claimed in imitating the hen by a machine is that we may approach but never reach the perfect regulation of her animal heat and the ventilation afforded by those wonderful appendages, her feathers, with their matchless quality as non-conductors of heat, their almost impalpable weight and their innumerable valves or shutters. Besides furnishing an egg chamber with top and sides composed, as we may say, entirely of delicate shutters, nature has an engineer on duty day and night to attend these shutters in an emergency, and give them a greater motion than common. The art of man could never succeed to all eternity in making one like all the millions of shutters, as we have called them, or ventilation doors, each held by springs vastly more delicate than the hair spring of a watch and a millionth of a grain in weight.

Do not use a cheap incubator. A good one cannot possibly be constructed cheaply. Von Culin says :

“The great demand for incubators and brooders has tempted sash manufacturers, makers of show cases and others, to get out various boxes, cases, tanks and barrels, with various attachments, and call them incubators or hatchers. Some buy a lot of almost expired patents, and boom the new machine on the reputation of the old one, to which the patents originally applied, while the new machine possesses none of the good points of the old one, which to build would cost considerably more than the new one is sold for. Many of this class never had any merit, and went out of the market, but new ones bob up along the line, have their day of deceit and disappear. Watch for them.”

If there is any instance where saving at the spigot and wasting at the bung-hole will apply it is in bestowing valuable time, eggs and oil (and losing the season) on an incubator that gives you only worthless chicks or none at all, the latter much preferable.

There are two principal modes of heating. One is to warm air by a lamp, and the other is to warm a tank of water over the top of the air chamber, by a lamp, and warm the air by this tank. There is no moisture imparted to the air, of course, by the latter mode any more than by the former, since the tank must be perfectly water-tight, but the advocates of this method urge that the body of water is a protection against fluctuations of temperature. On the other hand the hot-air school say that by their system you can cool or warm quickly when you want to, which they claim is an advantage. It is certain that there are good incubators of both sorts, though fierce battles of words have been waged between the respective rival manufacturers of each. One objection to a tank is that if of cheap materials it rusts out in a few years and sooner or later encourages profanity by exasperating leaks, while if well made of durable materials the cost is an obstacle.

The time has passed away when any one or two or four or six makers can claim to offer the only good machines, any more than the production of excellent pianos, plows, cornshellers or mowers is confined to a small number of manufacturers. Mr. Campbell says in the *Poultry Keeper* :

“ My experiments have never been confined to the use of my own incubators. I have tried all the machines which were popular in their day but are never heard of now, and I have tried all the most popular ones of the present, and to sum up the whole matter all that I have learned by so doing is to find out that there is more in the operator than in the incubator, and very much more in the eggs than either.”

It may be asked how the would-be purchaser is to decide if the interested whoopings-up of the dealer are

to be disregarded. The reply is, visit some party, not an agent, who has run a machine successfully, and if more than one season so much the better. Be sure to find out the exact per cent hatched, and whether the younglings stand up and face the music or are simply "born to die." Learn the principles on which it operates as regards the three essentials, heat, air, moisture. If possible interview more than one operator using the same machine. If you cannot do this, examine the catalogues and cuts of the leading manufacturers and notice which gives a clear description of the modus operandi of their incubators. Pay no attention to their boasts but steer by what commends itself to your judgment in the machines themselves. On the matter of agents' representations the following is from that careful experimenter and able writer, Mr. W. H. Rudd :

"If beginners have a preference for any particular incubator we advise them if possible to see one of them in operation, or to correspond with some one who uses it, but if the person thus addressed is an agent for it or has a commission in view, we should in our own case, as the world now wiggles, take mighty little stock in his recommendation, or in any of his statements concerning it."

A few words may not be amiss in this connection regarding a test of the merits of an incubator by a public exhibition of hatching. The dealer or his representative appears in the neighborhood about twenty days before the show opens and starts one or two machines, at nearby convenient headquarters, loaded with the very best eggs procurable, tests them repeatedly up to the time the gaping crowd gather to see chicks come out, culls and selects from his machines on the side and carries the pipped eggs (each one of which has the kick of a mule in it, all the fair to medium ones though hatchable being rejected) to the show room, where a highly ornamented and gilded incubator stands, fired up ready to receive them, and make a hatch of 101 per cent, one egg being double yolked. The machine run by the sly-

est exhibitor of course stands highest in the estimation of the uninitiated. The catalogues of the manufacturers, each claiming their wares as the best, are suggestive of the emigrant who wrote to a friend on the auld sod: "America is a glorious country. There every man is as good as every other man and a—— sight better." A common error for an amateur or small scale operator is getting an incubator of too large a size. On this point that most trustworthy expert, Mr. C. Von Culin says:

"Many beginners are undecided as to what sized incubator to get. If we wanted a capacity of 300 eggs, we would get three incubators of 100 eggs capacity each; if 600 capacity, three of 200 eggs each; if 750, three of 250 each; if 1200 capacity, three of 400 each; if 1800 capacity, three of 600 eggs each. This is much better than getting one large incubator for all the eggs. It costs more for the several smaller machines than for one large one for all the eggs, but the advantages are: You can have fresher eggs for each incubator, you can sort the eggs if you have large quantities, and select those with shells of same kind and thickness for each incubator; you can place duck, turkey or goose eggs in separate machines, or use a different machine for each variety of hens' eggs. You can keep a record of each kind and quality; you will learn more about the amount of moisture for each class of eggs, and will soon become able to hatch all kinds of eggs equally well. If you make a mistake you will discover it more easily and can rectify it more readily; the result of a mistake or an accident will not be as expensive, and you will have a better chance to retrieve any loss which you may sustain through accident, carelessness or neglect of rules in hatching, for it would hardly be likely to affect but one machine, and as that one would contain only one-third of your full quota of eggs, you would have the other two-thirds left, even if all in one machine were ruined, and you would not be apt to repeat the performance (or non-performance) with either of the other two incubators."

With the above we agree as regards bought incubators, but, as we shall explain farther on, the incubator of the future for the large scale man will not be shipped to the customer at all; but will be so large that it will have to be constructed on his premises, and the same remark applies to the brooder of the future for the large poultry plant

Finally, having purchased your incubator, study the printed directions of the manufacturer very carefully. Do not be in a hurry. Take time to learn. Says Mr. J.

A. Hunt, whose success in artificial hatching we have never known excelled :

“When you receive your machine and get it set up and in running order, take a whole day if necessary to study it in its various parts. The regulating apparatus should receive particular attention; do not be satisfied in knowing that it does the work, but find out how it works, familiarize yourself with every part, as it may be very useful knowledge to you in future operations, for should your regulator through any accident or without accident fail to work, you will be better able to discover the difficulty and remedy it without delay.”

As regards the style of lamp, use none that is not as secure against accident as the best that can be bought for money, because buildings, incubators, eggs, chicks and all have in a number of instances burned, through defective lamps. See if insurance experts, who make a study of such things, approve the style of lamp. Use the best oil, 160° test, for to tolerate anything poorer in an affair of this kind is bad economy, and keep the lamps nicely trimmed.

The regulators furnished incubators are of various patterns and materials. A bar thermostat composed of metal and hard rubber makes on the whole the best regulator, but it never can be as reliable as the heat of the hen. Cyphers says :

“In running an incubator, the leading feature, and the hardest to secure, is an even temperature. This would not be the case had we a good regulator, but we have not. Not only have many hundreds of dollars been spent in experimenting, trying to get a good heat regulator for an incubator, but many thousands of dollars have gone in like manner to secure a heat regulator for other purposes that would be controlled by dry heat, and which would keep the temperature constant to a degree under all reasonable conditions. It is absolutely impossible to make such a regulator that will be delicate enough to hold the heat to a degree, powerful enough to do the necessary work, and simple and inexpensive at the same time. This has been and still is the aim of experimenters, but it must only meet with failure in the future, as it has in the past. Whatever means is employed to regulate the temperature of the hatching chamber, it is absolutely essential that it should be kept within narrow limits. The heat and atmospheric conditions must balance one another, and, if they do not, incubation cannot be carried to a successful exclusion. My meaning is simply this: Evaporation from the egg must be held at such a point



that the fluids in the embryonic structures are ample to keep the membranes moist up to the time of exclusion, and the rate of evaporation is not the same under any two degrees of temperature."

#### THE MOTHER HEN THE PATTERN.

What are the natural processes? The hen's nest is concave to keep the eggs close together, and shallow enough to prevent them from lying too deep, thus bringing the upper part of each egg containing the germ in close contact with her body or the feathers next her skin. Other feathers, especially those of her wings, are distended so as to form a wall, enclosing the egg on all sides and retaining the heat, the construction of the feathers being such that while all strong currents of air are prevented, yet the slightest movement of the hen causes the elastic down to operate like fans and drive out air from the nest, to be replaced by fresh air from outside. Indeed, there is a slight, exceedingly gentle circulation of air going on, strained through the labyrinth of the overlapping feathers, even when the hen is asleep. Also, through the natural law of diffusion, the poisonous gas thrown off from the embryo through the porous egg shell is forced out of the nest through the feathers independent of any circulation of air. It does not stay to become accumulated under the hen to the injury of the incipient chick; for the law above hinted at compels it to diffuse itself in all directions, and it will overcome gravity and rise, though heavier than the air with which it mingles, and will force itself through feathers as it cannot do through the walls of an incubator.

As the eggs at the middle of the nest become very warm to the touch of the hen she pushes them away by hooking her beak and the upper portion of her neck over those at the outside and pulling them along to take the place of the former. The operators in the Egyptian



hatching ovens use no thermometers but learn to distinguish different temperatures by the sense of feeling, and attendants on incubators and brooders sometimes learn to attain very great precision in judging temperature without a thermometer. The hen can do it without a thermometer and without learning how. We wink without learning how, because our ancestors did, and the hen knows when eggs are warm enough to take their turns in the outer ring, because her ancestors were living thermometers. The movements of the hen to roll her eggs give an increase of ventilation, and in very warm, damp weather when she is not rolling eggs she will occasionally bristle her feathers and open her wings a little to give her nest a slight airing, and if very hot and very damp will even stand upright a few seconds by spells. Then, if it grows still hotter, she will leave the nest entirely, sometimes remaining off for hours at a time. If, on the contrary, it is windy, she will stick closer than a brother, even when in need of food and water. In very cold weather she is especially faithful to her charge; for she not only refrains from standing up when rolling her eggs, but she does this while keeping her body unusually quiet and holding her feathers close. If the weather continues very cold she will remain on her nest three days or more without food. The tendency is for the eggs to assume positions in the nest with the small ends toward the center, although with all gallinaceous species of birds which sit on a dozen or fifteen or more eggs this order is not observed perfectly, as it is in the case of such other species as lay only from three to six. All eggs hatch best when the large end is the highest.

Nature being our instructor, we cannot excel her and may consider ourselves fortunate if we come somewhere near her. The most that can be claimed for artificial hatching and rearing is, that while it can never operate

so perfectly as the hen, its exemplar, yet it can when properly directed approach so near her work as to keep within the bounds of the fluctuations a well-vitalized egg or a well-hatched chick can undergo without serious injury. The fact that departures from the perfection of nature so wide as to be barely compatible with success, if not wholly fatal to it, are liable to occur, renders it advisable that the natural method should be adopted in general, and the artificial resorted to only under special circumstances, as, for example, at such times and places as do not afford sitting hens. The writer would not publish, regarding a good incubator, a parallel to the famous "volume" on the snakes in Ireland containing only six words: "There are no snakes in Ireland," or repeat to a party about to buy an incubator the advice of the redoubtable Mr. Punch to folks contemplating matrimony: "Don't;" for both incubators and brooders have their uses and on occasions are indispensable.

#### TEMPERATURE.

The correct degree of heat for the egg chamber of the incubator is found by taking the outside temperature of the sitting hen at the point of her contact with her eggs, near which, during what has been termed the sitting fever, a network of blood vessels becomes specially distended, capable of furnishing plentiful heat to be received by the eggs and nest. The internal temperature of the hen some distance from her skin is given by Charles A. Cyphers, whose close study and clear description of the process of incubation merit unstinted praise, as  $109^{\circ}$  to  $110^{\circ}$  at the beginning of her sitting term, decreasing slightly towards its close, to offset partially the development of heat within the eggs themselves consequent on the growth, blood circulation and breathing of the chicks.

The warmth imparted to the eggs it is difficult to ascertain with absolute precision, as eggs in different parts of the nest vary, and different parts of the same egg vary also. Cyphers found it  $102^{\circ}$ , others place it at from  $103^{\circ}$  to  $105^{\circ}$ . The writer could never find a temperature higher than  $102\ 1\text{-}2^{\circ}$ . At the start, it takes about forty-eight hours to heat the nest and eggs through and through sufficiently to raise the latter to their full temperature of say  $102^{\circ}$  or  $102\ 1\text{-}2^{\circ}$  or  $103^{\circ}$ . The air just above the eggs in an incubator must register about  $103^{\circ}$  in order that the eggs may reach  $102^{\circ}$ . The bulb of the thermometer should touch a fertile egg, as an infertile one is not a reliable indicator, and the glass should be set in wood, not in metal. The germ being always at the top of the egg, in close proximity to the hen's body, undoubtedly reaches  $103^{\circ}$ , even when the average temperature of the egg is a degree or half a degree less. Either  $102^{\circ}$  or  $103^{\circ}$  may be aimed at in the regulation of the incubator and if secured with a fair degree of precision all will go well so far as the requisite of heat is concerned. Before putting in the eggs, your incubator should be regulated and heated to the correct degree several days in order to be thoroughly warmed through. Then after putting in the eggs let the regulator severely alone during the first week. The eggs will cool off the machine at first, and then it and they will gradually warm up, and thus the natural process will be imitated in which, as we have seen, the eggs are not brought to the full standard heat suddenly. It has been recommended by some poultry men to run the temperature at  $98^{\circ}$  the first day and increase gradually for four days. But two considerations appear here: One being that although the eggs, shells excepted, are such a very poor conductor of heat that it takes two or three days for the hen to warm them and the nest through and through; yet the important part of the germ, being

uppermost and almost in contact with the hen, being separated from her only by the shell, which is a remarkably good heat conductor, gets to about  $100^{\circ}$  the first day; and the other consideration being that some hundreds of cold eggs suddenly put into a well warmed up air chamber, regulated to the correct temperature of  $102^{\circ}$  on a level with the eggs and  $103^{\circ}$  at the bulb of the thermometer, will lower the temperature of the air for awhile, so that, as our experiments, corroborated by those of others, have shown, no particular care need be taken to run lower at the start than later.

The eggs, or rather the embryo chicks, develop so much heat, beginning at about the eleventh day and then progressively till hatching is finished, that no more than one-half as much oil is consumed by the incubator lamp during the last half of the term as during the first. Hence the necessity of watching your thermometer and turning down the flame as an offset to the animal heat. When this heat is great the prospect is good for a good hatch, both as regards numbers and vigor.

When the chicks begin to pip,  $104^{\circ}$  is a good temperature, and when they begin to leave the shells it may be  $105^{\circ}$  without harm, but rather positive good, for the chicks being at first quite wet, evaporation makes them colder than the air of the egg chamber. Avoid at this stage the common error of opening the egg chamber door unless necessary. The effect of a blast of cool air on the wet bodies of delicate chicks is as if you should step out of doors in winter directly from a warm bath. The door may be opened perhaps twice in twenty-four hours, for a very brief time, to remove some of the empty shells which might otherwise cap over partly pipped eggs, hopelessly imprisoning the inmates, and also the older active, well-dried chicks should be removed and basketed or put under a warm brooder hover, lest they caper around over the limp, prostrate, wet ones.

Some operators advise a heat of  $106^{\circ}$  for the last stages of hatching and claim it is of no consequence if the chicks pant. But, although an adult fowl may go around panting on a summer day when the mercury stands at  $106^{\circ}$  or higher, and be apparently none the worse afterwards, the writer is quite sure that the same temperature injures delicate chicks, especially as they do not get as good a chance at a little fresh air as if in the nest, where every motion they make operates the ventilating fans of down. Man in his clumsy attempts to ventilate mechanically sometimes has a shaft run through a room to revolve fans for his comfort, but he could never attach millions of exceedingly minute fans to his incubator walls to be moved by the occupants. Thus do perfect cosmic provisions mock man's puny efforts.

## CHAPTER XXIX.

### CARE OF THE EGGS.

As we have seen, the hen changes the position of the eggs, thus varying the heat they receive, but under no circumstances can she ever make them too hot; unlike the artificial incubator which may be capable of reaching 105, 110 or 120°, thus killing the germs out and out, or, what is worse, causing imperfect chicks to be thrown on the unavailing care of their owner. Chicks may be hatched after a fashion and not be well hatched. The decree of nature is that the eggs may, from time to time, be held at a point several degrees below the normal maximum without material injury, thus allowing the sitting hen to forage for a living, but a decided departure above that normal is detrimental or positively fatal.

The effect of too much or too protracted cooling is to add to the whole term of hatching. The hen may be shut out of her nest for twenty-four hours in moderately cool weather and the eggs and nest become so chilled that no heat whatever can be detected by the sense of feeling, yet eleven eggs out of twelve may hatch—at the end of the twenty-second day, however, instead of the middle of the twenty-first, as the writer has repeatedly demonstrated. If the weather is decidedly summery, thirty-six hours of desertion may not be sufficient to extinguish life, a fact the ignorance of which has often led people to unnecessarily destroy partially hatched eggs. On the other hand the thorough heating through and through of eggs to 108°, a situation which, as before



noticed, is impossible in natural incubation, will ruin them. Stories are told of the heat in the incubator reaching 110 or 112° for a brief period without perceptible injury, but the air might reach that degree, and some portions of some of the eggs reach it nearly or quite; yet some of the germs in some of the eggs might be heated not more than 106° or thereabouts, not quite reaching the point of danger, since it ordinarily takes hours to equalize heat thoroughly between the air and the eggs.

It must not, however, be understood from what has been said that chilling, resulting in delayed hatching, carries no injury whatever to the chicks, for they are never quite perfect when brought out either ahead of or behind time. The eggs will endure greater variations of temperature in the air around them after the twelfth day than before. When eggs have been overheated they may be sprinkled with moderately cool water so that evaporation may check the heat without delay. If through any accident the temperature has been for hours a degree or two below 102° or 103°, the machine should be run an equal length of time as much above, so that the chicks may appear when due.

#### SHOULD EGGS BE COOLED?

The question of cooling the eggs for a short time daily, merits attention. Referring to our teacher, we find that the hen leaves her nest for two principal things, of which it is hard to tell which is the more important. She must have food and drink, and she must run, and if of an active, wingy kind, like the Games, she must jump and fly also, that blood circulation and a good head of vitality may be kept up, and the bowels may not fail of regular action. Food and exercise are what she leaves her nest for, and not to cool the eggs. Whatever cool-

ing they get is unimportant, or else a slight but necessary evil, as is evidenced by the care she takes to stick to her nest for days at a time in cold weather or indulge in very brief absences, while she treats herself to liberal vacations of several hours' duration when the mercury is in the nineties.

We have tried thorough coolings, moderate airings, and none at all, repeatedly, and with results always in favor of the latter, when every other condition was normal. We are aware that experiments of others have sometimes shown up in favor of cooling, but we are satisfied that in such cases it will be found, on close investigation, that the eggs had first been subjected to too much heat, or too much moisture, or both.

To cool several hundred eggs to a temperature of 80° or 85° or thereabouts, reduces the temperature of the egg chamber for quite a time when they are returned to it, as the thermometer and regulator will show you. But the warmth of the hen, whose blood has been quickened by her outing, till a fine glow has been established, very quickly brings back the heat of the important top parts, where the germs are, of the small number of eggs she has in charge, and the nest itself retains heat enough during her absence to keep the less important under parts warm. If the eggs are removed from the incubator to be turned, the machine should be closed at once, especially if the incubator room is cold, for the egg chamber would otherwise part with its warm air very fast during the turning of the eggs and the shifting of them from one part of the tray to another part. The operation of testing eggs should be performed in a room of the temperature of at least 70°, and 75° or 80° is better if the operator can stand it.

The eggs, first, last and all the time, should receive as little cooling as possible; for, although the passage of fresh air through the pores of the shell is indispensable,

fluctuations of the temperature of the egg are not necessary to secure it, as was formerly supposed. The beneficent oxygen of the air and the injurious carbonic acid gas, or carbon dioxide as the shorter and preferable term is, exhaled from the embryo as it grows, will exchange places through the shell and mix, urged by a force or tendency inherent in their nature. Chemistry teaches that this force needs no assistance from the alternate expansion and contraction of the contents of the egg consequent on heating followed by cooling, though poultry men once universally believed this assistance necessary.

#### TURNING THE EGGS.

While cooling the eggs is to be avoided, turning them is absolutely indispensable, as abundant experiments have shown. The hen does not turn them systematically at all. Her efforts are limited to shifting them from the outer edge of the nest to the center, and in accomplishing this purpose she necessarily turns them more or less. They may turn halfway over, or three-quarters, or perform one or more complete revolutions, and possibly, though not probably, land in the same position as before starting. There is no "this side up with care," but they take their chances, and, as the hen rolls some of them, if not all, several times in twenty-four hours, by the laws of chance they are prevented from always landing on the same side even if they sometimes do.

In addition to the rolling performed with her beak, she moves nearly all the eggs a little while settling down on returning from a foraging expedition, on which occasion she makes a careful though quite vigorous shuffling to give room for her feet and shanks. The hen, unless very tame, does not ordinarily meddle with her eggs when you are watching her, but when alone repeats her

fussing oftener than is commonly understood. Hence the practice, which is correct, of turning incubator eggs twice a day, this being none too often.

The structure of the egg, so well known nowadays as to hardly need repetition, is such that the minute germ spot which is the seat of life and around which the chick forms, rises always at the top of the egg whichever side up the latter may be placed, like a cork in a tight barrel of water when the barrel is rolled over. In nature, when the new-laid eggs are not gathered, but left in the nest, they are always turned a little, when the number has reached four or five, by the layer when making room for her feet as above described, and sometimes, but not always, she rolls the eggs with her beak like a sitter. The maternal instincts are so jumbled in some cases by the taint of the blood of a non-sitting breed introduced at some time, perhaps a long while ago, into strains of sitters, that adherence to the ancient hereditary proprieties is not always precise. As all gallinaeous birds prefer to make their nests in a shady and rather moist and cool place and afford their treasures some change of position, the artificial storage of eggs for hatching should be in a moderately cool and not over damp cellar, and they should also be turned at least once a day.

Rival manufacturers dispute over methods of turning eggs by the incubator operator. One says that they should be gently rolled, and not suddenly flopped by inverting the tray. But the vigorous shuffle of the hen's feet above remarked, and the fact that eggs often hatch well after having been carried a dozen miles by wagon over extremely rough and rocky roads, or two thousand miles by rail, shows that there need be little solicitude concerning the results of revolving an egg tray, especially as nobody goes at it hammer and tongs, owing to the fragile nature of its contents.

One celebrated machine, invented by a very eminent expert, has a clock attached which turns the eggs every twelve hours whether the attendant is in the room, or in the same county, or not. There are other machines contrived so that the attendant himself may work an apparatus to turn the eggs without taking them out of the egg chamber. There is considerable work involved in turning and otherwise thoroughly caring for a large number of eggs in an incubator, trimming the lamps, etc.—decidedly more work than is needed in caring for an equal number of eggs under hens and managing the sitting birds, provided the natural method is followed under a first-class system. Hence it is natural enough for incubator attendants to welcome labor-saving, egg-turning devices.

But whatever method of turning is followed there are certain steps which must never be omitted. The trays must be turned end for end, and if there are two trays these must change places every time the eggs are turned, while if there are four trays, each should, in the course of two days' routine, occupy each of the four corners of the egg chamber. Furthermore, and here is an important matter too often neglected, the eggs at the center of each tray must, at least once a day, and twice is better, be made to change places with those at or near its edges. There is a knack in doing this to reduce the bother to the minimum. First seize as many outer eggs as can be grasped in both hands, and place them on top of those at the center of the tray, then gently crowd the top layer down, rolling them from side to side meanwhile, to make them settle down and displace the others. This will roll every egg in the tray and fill the vacant places at the edges. Thus, the changing from the warmer to the cooler positions and the turning are accomplished at the same time, the trays being, of course, without partitions.

This systematic changing of trays and of the eggs within the trays is absolutely necessary to secure the best results both as regards the vigor of the chicks and the per cent hatched. For, be it remembered, there is a liability, and a very great liability as incubators go, of decided differences in the temperature of the various sides of the egg chamber compared with each other, greater differences when they are compared with the center, and still greater differences when the center is compared with the corners, these last being the coolest part of the machine. To hold the heat steady at the place the bulb of the thermometer occupies, is a different thing from holding it the same at all parts of the egg chamber. The cracks at the door, if there has been shrinkage, which is likely, considering the severe ordeal an incubator door has to undergo, and the necessary openings for ventilation, tend to make the air vary at different trays and different parts of the same tray. But if the maximum variation is no greater than between the center of a sitting hen's nest under normal conditions; if the operator shifts the eggs as faithfully as the hen does; if the average temperature for twenty-one days is the same in both cases, and if the eggs at the center of machine, or at the warmest point, wherever that is, never get too hot, then the incubator is all right so far as heat is concerned. It may be run thus accurately, but the chances are against it, and besides, in getting the heat right, which is only one of the requisites, the matter of moisture is liable to be made all wrong, as will appear when we treat the question of evaporation further on.

#### MOISTURE.

An egg is composed largely of water, the white alone being 78 per cent of water, and the whole egg originally about 74 per cent, a considerable part of which evapo-



rates during the hatching process when carried on by the hen. The shell is porous, permitting the escape of moisture. Although the normal situation for the nest, which is on the ground, is liable to be more or less damp, yet a spell of dry weather might dry up the eggs somewhat before sitting begins, and in some cases a nest of the common species of fowl, or of a grouse, quail, turkey or any other of the hen's gallinaceous congeners, is liable to be located on a sandy hillock among dry leaves, where very little moisture will reach it in the possible absence of rain and dew. In any case, the time after an egg is laid before the hatching of the same begins is, in a state of nature, only from a day or two to a fortnight or so, and the shell being but moderately pervious to moisture, no great diminution of water in its composition occurs.

After incubation begins, the heat of the hen's body not only dries the nest and the ground for a little distance under and around it, but by raising the eggs to the comparatively high temperature of about  $102^{\circ}$ , would in a little while render their contents too dry, except for a beautiful provision of nature consisting in the glazing of the shells. A few days after the hen begins to sit upon her eggs a secretion from her feathers or skin partially closes the minute pores of the shell. Incubator operators have tried to imitate this glazing by using oil from the oil gland at the rump of a fowl, and other substances, but have never succeeded. Some of the secrets of Mother Nature are very subtle and elusive. Take a dozen eggs and place them under a sitting hen and another dozen from the same lot and put them in an incubator. After the twelve under the hen have become well glazed, place them in a pail of water with the others from the incubator. The result will be that the last named will absorb water through the shell, and sink, while the glazed eggs still float. But while nature has

provided means of checking evaporation from the eggs by means of this glazing during the early stages of incubation, yet considerable drying out of the water in the egg is useful at the later stages, and accordingly the shell gradually dissolves away from the inside, the lime in its composition being used to form the bones of the embryo. Water must now escape quite fast or the chick will have no room to grow or breathe.

Often the incubator operator after testing the eggs and removing all but the promising ones and finding everything going well, apparently, up to the eighteenth day, finds finally a disheartening per cent dead in the shell. In such cases the embryos are almost fully developed and very large and moist, packing the shell tightly, they having been waterlogged, swelled and literally drowned. They appear so large and strong that the operator is puzzled to know what has happened to kill such promising, healthy looking chicks. Of course the true cause of such a state of things was that the water pans in the incubator contained too much evaporating surface.

Those people who claim that it is as easy as falling off a log to run a good, properly constructed incubator and that "a child can do it," should read the following statement of Mr. Rudd: "It is practically impossible to delegate the care of incubators to hired help. \* \* \* \* \* Although employing from five to eight men on the farm, some of our own family always take entire charge of the machines." And in regard to moisture, which is only one of several things which must be right, Von Culin says:

"Some one will say, 'what a lot of fuss about moisture! Let me give you the whole thing in a nutshell. Find out just what degree of humidity is needed in the egg chamber for each week or day, make slide covers for your moisture pans, place a moisture gauge in the egg chamber and hang up your moisture schedule beside the machine. When you want more moisture slide open the covers, and when you want less, close them. Isn't that simple?"

"Yes, dear friend, wiser heads than yours or ours thought of that years ago, but it would not work then, and it will not work now.

"Why? For various reasons; among them: The Great Ruler of the Universe will not permit us to slide the covers of His moisture pans; and while we are obliged to circulate fresh air in the egg chambers of our machines, we are obliged to have it more or less humid or dry, just as it comes from the breath of nature. The hygrometer is useful to experiment with, provided it is a good one, but few of those which are sold to poultry men are reliable. Still some one says, 'Well, I know that the humidity of the atmosphere varies some, but I still believe I can work it with the moisture gauge and the sliding covers on moisture pans.'

"Very well, we will ask you for one demonstration, and if you make that satisfactory, we will ask for one or two more—but one will probably be all you want at a time.

"Let us suppose that you conclude that you want thirty degrees of moisture in the egg chamber the first week, thirty-five the second and part of the third, with ninety degrees from the pipping of the first egg? All right. We will take for granted that your gauge is correct. Well, here we are at the beginning of the first week. You have not yet put any water in your pans but your moisture gauge indicates sixty-five degrees of humidity, and your thermometer one hundred and three degrees of temperature. What is the matter; why don't you reduce the humidity? You place another moisture gauge in the room where you operate your incubator, and you find that the humidity there is ninety degrees. You hang a gauge in the open air out of doors and it registers ninety-five degrees. You only want thirty degrees in the egg chamber; how are you going to reduce it to thirty?"

Allowing the incubator to approach a too high temperature and then reducing it by having valves opened by an automatic regulator, lowers the heat effectually, it is true, but at the same time carries off moisture at a great rate and the embryo is in danger of becoming too dry, a condition as fatal as the opposite one. Relying on ventilation to govern the temperature is dangerous. The regulator should check the heat when there is risk of too much, not by letting out warm air, which has received and holds moisture imparted by the eggs, and letting in cold air to suck still more moisture from them (for air in becoming warmed becomes thirsty; that is, its capacity for taking water is increased and it will dry out the eggs fast), but by lessening the flame of the lamp. The flame may be lowered by having the regulator work an apparatus to check the draft of the

lamp by dropping a thin, very light, circular metallic plate over the top of the chimney, or by turning down the wick or shortening it by a sliding tube, the method by lessening the draft being preferable because needing less power and therefore being more delicate and certain in its working. Now here we approach a difficulty. No matter how perfectly the heat regulator works there must still be some change of air or it will become impure, because the eggs exhale a poisonous gas, carbon dioxide or carbonic acid gas, when the embryos are growing, too much of which gas in the egg chamber would seriously impair or utterly ruin them.

Now, as the temperature of the air will vary outside the incubator, and the moisture it contains differs widely in different parts of the country, and at different times and seasons in the same section, it is evident that no hard and fast rules can be set for supplying moisture. Each operator should obey the instructions given by the manufacturer for the use of his machine, remembering that the admission of air to the eggs in cold weather or very dry weather will evaporate moisture from them faster than when the air is warm or damp outside. For it must always be kept in mind that warming a volume of air increases its thirst, as we may say; that is, it increases its affinity for moisture and makes it drink from the most available source of supply—from moisture pans or wet sponges if they are present, or if not, from the eggs. The only way to success is to use your reason. If you change the air but little and slowly, as the hen does, and if there is summer weather or mild spring weather, or if the locality itself is a moist one, as on a damp seacoast for example, or if the location is moist, a damp cellar for instance, you will need to have but little water in your incubator, or none at all, and everything will be all right so far as moisture is concerned. On the other hand if the weather is cold, or rather if the

room in which your machine is kept is cold, and you are in the arid or semi-arid region between the one hundredth meridian and the Sierras, you will need to supply more moisture than the directions accompanying your machine call for. Nothing in the world will answer except careful trials, changing the amount of water,—or rather the area of your shallow moisture pans, since the evaporation depends on the extent of surface exposed and not on the quantity of water,—according to results and surrounding conditions.

The care and skill, patience and judgment necessary to run an incubator are so great that those individuals possessing these qualities cannot afford to run one, as a general thing. They are wanted in other employments. Suppose you try what seems to be a reasonable quantity of moisture for your locality and for the number of rainy and foggy days that you have reason to expect at the season of the year, and you get a good hatch. It will not do for you to say: "Now I have found the correct notch and will stick to it." You can safely stick to it so long as the weather remains as before, but if the atmospheric conditions change, you must be governed by circumstances. Yet it is said, "a child" can run the machine. The fact is, the incubator dealers know that if the prospective customers were told that all is not plain sailing they would in many cases lose sales.

The hen, as we have seen, sticks to her job in cold weather, and it should be observed that in windy weather especially, when uncovered eggs would dry out the fastest, she broods her nest with unusual care and will endure hunger and thirst for days at a time rather than leave them for an instant. Who has not observed that there are times when if the sitting hen is removed from her charge she will immediately return in spite of a bribe of unusually tempting food offered her? Even the most timid hen will at such times fight you to get back

to her nest. At the same time the eggs are not smothered by this devotion, for the texture of her feathers is such that during high winds a little air will surely strain through them no matter how closely she broods, while the poisonous emanations will escape, and, unlike the incubator, she cannot possibly become hot enough under any circumstances to ruin the eggs, any more than the temperature of a human being in health can rise above a certain point. Her vital fires are absolutely limited as regards excessive heat. When the air is damp, warm and still, she leaves the nest at slight inducements and remains away quite a time, unless there are signs of an approaching storm, in which case she hurries to lay in a supply of food in the shortest time possible, and hastens back. Lest the reader think we are attributing too much to her powers of discernment, it may be remarked that not the sitting fowl alone, but animals generally possess a keen sense of impending storms. The swine will carry straw to their bed at such times, and all wild animals, whether birds or quadrupeds, are very active in hunting for food, which they devour with unusual greed, as if impressed with the urgency for laying up for a rainy day. Yet for this monitor, sensitive to coming atmospheric changes which man with all his intellect cannot discern, this engineer always on duty, this living thermometer, barometer, and aerometer, a wooden box is substituted and "a child can run it!"

As regards the superiority of the natural covering to the eggs, afforded by the hen's feathers, compared with the incubator walls, Cyphers, unlike numerous other writers who have a machine to sell, frankly acknowledges the inferiority of such walls, and points out with emphasis that the down and feathers control physical forces which exert an important influence over the embryonic development. He says :

"Other conditions being equal, the degree of humidity ordinarily existing in the atmospheric air is sufficient for successful incubation,



providing that the tension of the moisture in the two atmospheres remains the same, and that the rate of movement of the air surrounding the eggs exercises a more powerful influence on evaporation than the usual variations of humidity. In the construction of our hatching chamber, therefore, there are four features of vital importance to be considered, viz., a non-conducting wall that will protect the eggs from outward changes of temperature; a provision for maintaining the atmospheric air within the chamber in a pure state; the maintenance of as great a tension of aqueous vapor in the inner as in the outer atmosphere for their respective temperatures, and the control of the movement of the air around the eggs.

“In natural incubation the purity of the air surrounding the eggs is maintained by exchanges with the outer atmosphere through the wall or septum that intervenes. This wall is composed of down and feathers, which allow of a spontaneous diffusion of gases or vapors through them, while they are sufficiently dense to hold any current in check by frictional resistance. It is therefore obvious that the natural provision for maintaining the purity of the air around the eggs also provides, through the same medium, for the retention of warmth, for an equilibrium between the relative humidity of the two atmospheres, and for the control of the movement of the inner air. And as it is the nature of the fabric of which the wall is constructed that controls the physical forces of incubation, that is, the storage of warmth, and the purity, humidity and movement of the air surrounding the eggs, it is evident that we have not appreciated, or even understood, its function.”

#### VENTILATION.

This subject is, as we have said, intimately connected with the supply of moisture. Indeed the three factors, heat, moisture and pure air, are all closely related and act and react on each other, rendering perfect artificial incubation much more difficult than it would otherwise be; for in ventilating we may remove too much dampness as well as heat, and in warming newly introduced air we change its capacity for moisture, and make it “drink like a fish.” To hatch eggs in a good incubator is rather easy, though demanding some ability; to hatch them well so that they will be real good ones is moderately difficult, and to rear them in good shape, artificially, is decidedly difficult.

Nobody ever succeeded in hatching eggs the shells of which had been made air-tight by a coat of varnish, or eggs placed in a hermetically sealed chamber, showing

that ventilation is an absolute necessity. But if air is admitted to the egg chamber in currents, excessive evaporation is liable to result, and this is not all; for there is danger that some portions of the chamber will be cooled faster than the others. It is hard to warm an apartment, large or small, uniformly in every part at the same level, even when the air is at rest, and still harder when there are gusts and eddies of cold air.

The plant and animal both need oxygen. The latter while taking it in gives out carbon dioxide, a noxious gas, the excessive accumulation of which in the air around the animal would cause its death, though it is life to the plant. This gas is heavier than air, hence it was once believed that it would settle to the bottom of a room, as water seeks the bottom when it is placed in the same vessel with oil; but this notion was exploded when the law of the miscibility of gases was discovered. Through this law, gravity is overcome by a stronger force, which compels two gases to mix, and if one is much heavier than the other, this mixing power is all the stronger. Aside from any currents of air whatever in the air chamber, the carbon dioxide exhaled from the eggs becomes diffused through all the air in the chamber. Then if no more of this gas should be produced, the air and gas in the apartment would be in what is called an equilibrium. Now suppose the air in the incubator should contain a greater proportion of the poison than the air outside does, and suppose it were possible to heat and maintain the air outside, in the incubator cellar, on a level with the machine, at absolutely the same degree as on the inside of the latter, and a small door should be opened between the air chamber and the cellar; there would, of course, be such a perfect balance of temperature within and without the egg chamber that there would be no draft through this door. But now, although the heat is in equilibrium between the inside and out-

side of incubator, the gas is not, and portions of the poison will at once begin to move from the inside to the outside and their places will be taken by constituents of the air which will move from the outside to the inside, even in the absence of any draft whatever such as difference in temperature creates, and this process will go on until the air inside holds exactly the same per cent of poison as the air in the cellar. We are supposing, of course, that no more of the poison was formed within the eggs and exhaled meanwhile.

The above illustration shows what is meant by the miscibility of gases. If the carbon dioxide keeps coming from the embryo, as it will, then nature will keep removing it, independent of air circulation created by heat, if there are exits. The poison from the eggs under the hen is bound to escape through the millions of interstices in the downy portions of her feathers, no matter if these enfold her nest so closely in cold weather that the frictional resistance keeps the air from passing through. This wonderful law of diffusion sets inertia, gravity and friction at defiance, being more potent than they.

Manufacturers of the best modern incubators take a leaf out of nature's book, and, avoiding upward ventilation, make the egg chamber perfectly air-tight at top and sides. The purchaser should correct shrinkage of material at door and doorway, if any occur after the heat has had time to take effect, so that the door shall shut closely. The manufacturer also bores a set of small holes through the bottom of the egg chamber, these being furnished with buttons which may be turned over them as desired. These holes permit the escape of the poisonous carbon dioxide. This escape will be slow, but constant, and the excessive drying out of the eggs, which a current of air would cause, is avoided. For an incubator of this sort, perfectly air-tight at top and sides,

with half-inch holes bored in the bottom, Cyphers gives the following as the number of holes required for each hundred eggs to keep the air of the egg chamber reasonably pure :

“ For the first ten days of incubation, under an outer atmospheric temperature of from 50 to 70°, three holes; under an atmospheric temperature of from 30 to 50°, two holes. From the tenth day to exclusion, under an atmospheric temperature of from 55 to 70°, six holes; under an atmospheric temperature of from 40 to 55°, five holes; and under an atmospheric temperature below 40°, four holes. The number of holes given above is for a chamber which is opened morning and night. There is no way of shifting the position of the eggs or trays without opening the chamber, and unless their position is changed so as to equalize the heat received, it is impossible to successfully incubate a large number of eggs in one apartment.”

## CHAPTER XXX.

### THE INCUBATOR ROOM.

The best place for incubators is in a room part of which is underground. It may be excavated in the side of a bank so as to have earth outside the walls on three of its sides, and may also be covered with earth on top of a waterproof roof. On level ground, a good way is to excavate two or three feet, so that the floor of your cellar may be reached by steps outside, the walls being of stone or hard-baked brick laid in cement mortar, and banked up with earth to the eaves, where there should be good eave troughs. The roof may be of any usual pitch and shingled, and instead of being covered with earth the building inside may be kept free from the effects of the sun in summer and from cold in winter by making a tight, level floor over the main room from plate to plate so that there will be a V-shaped attic apartment, which should be first made rat-proof and mouse-proof, and then packed closely from top to bottom with hay or straw. This style the writer has found preferable to an earth-covered roof, because the cost is considerable if you make the latter water-tight, as it must be, and strong enough to support the weight of earth with an added burden of rain or snow.

The ideal incubator cellar should never be warmer than  $60^{\circ}$ , nor cooler than  $40^{\circ}$ . In a room above ground with a liability of the weather temperature crowding  $100^{\circ}$ , and chicks or ducklings nearly ready to break the shell, the animal heat will sometimes run the temperature up to  $108^{\circ}$  or  $110^{\circ}$ , even with the lights out, neces-

sitating sprinkling the eggs every few hours to prevent their ruin. Too much ventilation of your cellar should not be allowed, for with every admission of air, changes of temperature are liable to occur. Have just enough to keep the air reasonably pure. The floor should be preferably of carefully smoothed cement, permitting an occasional scrubbing. It is best to have windows enough so that the thermometers may be read easily and the windows should be doubled, or at all events cased and fitted very carefully, to guard against both ingress and egress of air. For egg testing, it will be found an excellent plan to have a side door leading to a small room, which may be warmed to the temperature previously directed.

#### THE INCUBATOR OF THE FUTURE.

The teasel, with its elastic natural hooks, cannot be equaled for cloth manufacturers' use in combing fine fibers of wool, by any artificial hooks or springs of the most delicate mechanism the art of man has yet produced in trials lasting through centuries, and as this is a triumph of merely a humble plant, so the feathers of the sitting bird of the animal kingdom, higher up in the scale of life, can never be equaled by human ingenuity. Incubators of ordinary size, holding a few hundred or a thousand eggs, but too small for the attendant himself to enter, have been made better and better for thirty years, till the best of these are hardly susceptible of further improvement, unless, indeed, a way is found to make the walls of the egg chamber of feathers or of some other material permeable to carbolic acid gas, yet resisting air currents, and so good a non-conductor as to retain heat well. There comes a time when an ordinary material product of man's skill reaches its culminating point. Plows, for instance, have been improved from the initial crooked root or snag of wood through numerous stages



to the polished steel implement of to-day, every promising curve of mould board having been tried meanwhile, until it is probable that the plows of a hundred years hence will not be a whit better than those we have, although it is likely that our descendants will propel theirs in ways we cannot even guess.

The incubator of the future will hold 15,000 or 30,000 eggs, or more, and will be large enough for the operators to go into. Perhaps the room will be quite high, and the floor supporting the egg racks will be arranged elevator style, so that it may be raised or lowered almost instantly to secure the desired temperature, a graduated scale on the wall showing how much the altitude must be changed to change the heat to a degree or a fraction of a degree. By relays of attendants, the heat, air and moisture will be governed personally every hour and every minute, instead of being left to blind machine regulation. Nothing but constant human supervision will ever conquer the difficulties that mark the gulf between the best incubators and the mother bird—for she is on duty all the time. We are told that John Champion in 1770 used a room he could enter. He was the first white “champion” of the large room plan, though this had been exploited by people of another complexion for hundreds and probably thousands of years previously. The wheel will come full circle and the artificial incubation of the twentieth century will revert to the primitive large apartment.

Let us see how the large room for eggs and the waiting room for the attendants, who keep constant watch of all the conditions, can be combined with the electric signal already in use by incubator operators to transmit news of temperature from their machine to their office or sleeping room, and with revolving fans such as have already been adopted in the construction of at least one mammoth incubator, and with a spraying machine to

govern moisture, which is a part of the same machine. Surely an attendant, clad to suit, or suited without a suit, can stay a short time in the egg room without particular discomfort. There are quite a considerable number of crafts which compel workmen to encounter a decidedly higher temperature, and cannot a man, if he can explore the region where the eggs are, and have enough of them in the works to pay for constant supervision, change the air by gentle currents with nicely adjusted fans moved by cunning machinery completely under his control? The incubating room can be located in the center of a still larger room, the latter being held at an almost absolutely even temperature. The walls of the outer room can be built in such a way as to shut out all influence of outside winds, dampness and dryness, heat and cold.

The large incubator room alluded to is at "Aratoma Farm," Stamford, Ct. The writer has never seen it nor communicated with its inventor or proprietor, nor with anybody connected with it, but has read a newspaper account of it. Everything points to the success of the idea. The big stores and factories run out the small ones, as the big fish eat up the little ones, and the box incubators will be devoured by the apartment incubator. Brooding hens, when properly managed, beat the small incubators, and by small we designate all that are customarily shipped by rail or wagon; but the mammoth incubator built where used will beat both. The highest talent can be afforded to run it, the highest degree of certainty in operation can be secured by it, at the minimum of cost for supplying heat, moisture and ventilation, because of the great number of eggs it will hold.

We have seen how the comparatively miserable, small, puttering incubator, in its attempts at letting out foul air, carried off dampness also and introduced cool air, which in becoming warmed robbed the eggs of their

normal moisture. Now the problem of warming dwellings and accomplishing ventilation at the same time has been solved satisfactorily by introducing a current of air into the room which is to be warmed. An exit register must first be opened at or near the bottom of this room to let some cool air out so that the warm air will have room to get in. This warm air is procured at first while cold from the pure air outdoors through a large pipe, and made to come in contact with a coil of pipes heated by hot water or steam, after which it ascends, by the lightness the heat gives it, to the room where it is wanted. Similar apparatus can be used in the mammoth incubator. The hot air and cool air also, led in through a separate pipe, can be forced anywhere by means of fan wheels run at high speed, and nicely adjusted registers can shut it off at will. The spraying machine can be brought to bear on the air that is being warmed, and as much humidity can be supplied as desired, and no more, at the pleasure of the operator, who may be guided by the air reservoir at the end of a fertile egg, as is done at Stamford, or employ a more artificial moisture gauge, such as is used by scientists.

It is not apparent that gentle currents of fresh air of just the right temperature can injure the eggs, provided it is just moist enough. Also if these currents are created but seldom, the amount of ventilation will prove sufficient, owing to the great bulk of the air enclosed in so large a room. The means at the command of the operators will enable them to change the air as often as called for by experience. The heat and humidity in a box, a parlor, or a big cathedral even, can be controlled to a nicety by the aid of modern appliances, if a man has nothing else to do but tend them, and in no other way.

If electricity, or animal magnetism, or some indispensable subtle or occult influence were bestowed upon the

eggs by the body or feathers of the sitting hen that could not be furnished by art, it might be impossible to construct the incubator of the future satisfactorily. But so far as is now known, not including the purely mechanical affair of change of position, the only requisites for hatching are heat, moisture and ventilation.

## CHAPTER XXXI.

### BROODERS.

Artificial brooding and rearing include three requisites—warmth, ventilation and exercise. In incubation there is exercise ; for the chick or embryo uses its limbs, or their rudiments, from the sixth day on, including the vigorous kicks which complete the hatching. But as this exercise takes care of itself, it is not included in the list of incubation requisites, although moisture is. Correspondingly, some moisture is needed in the air the chicks breathe, but this matter takes care of itself and is not included in the requisites, though exercise is. Heat and ventilation are two requisites common to both incubation and brooding.

If artificial hatching, as carried on in the ordinary commercial incubators, meets difficulty in regulating moisture, artificial brooding meets with a still greater difficulty in governing heat. If no regulator is used, the chicks are almost sure to suffer, at one time or another, from too much or too little heat, while if a regulator is used, adjusted to some particular degree of heat, as it must be, of course, if it is to be used at all, why every time the birds run under or out of the hover, they change the temperature, in spite of the regulator.

We will try to explain this matter fully because it is so seldom understood. The fact is, volumes have been written on incubators, compared with single pages on brooders. One book has one hundred and seven pages on the incubator and one-half a page on the brooder. Notwithstanding, common consent has been given by

experienced, practical operators to the proposition that it is much easier to hatch healthy chicks in an incubator than to keep them healthy afterwards in a brooder. As regards the beginner, often he has earnestly studied the construction and use of the hatcher, while taking it for granted that it was perfectly easy to run the brooder. Later he sends a communication for the question box of his poultry paper, asking why his chicks died off. If chicks become either seriously chilled or decidedly overheated at night, it always means injury and often means death in spite of all the benefit good food, pure air and exercise can give, though these will enable them to withstand more calamity in the shape of improper temperature than they otherwise could. Yet, notwithstanding the importance of proper heat, in the majority of cases the manufacturers have not provided a regulator for the brooder, and their customers have not insisted on having one. Every brooder regulator is limited in the exercise of its functions by the chicks interfering with its operation, but it is better than none at all, and two are better yet, as will be shown.

The matter will be the better understood by reference to the working of an incubator, the regulator of which is set, say, for  $102\ 1-2^{\circ}$ . After the first chill consequent on putting in the eggs has been overcome, the temperature runs passably even till the day when it begins to rise and finally gets too high, though the regulator has slowed the flame down to the minimum. Why? Because the incipient chicks are giving off animal heat. What does the operator do? He turns down the flame still more. Now supposing he has a good hatch, and when the chicks get dry, and old enough, he removes three-fourths of the number without changing the lamp at all, what will happen? The heat will go down rapidly, and the remaining chicks will be chilled half to



death. Now suppose, instead of one or two of this sort of fluctuations in ten days there were half a dozen of them or so in twenty-four hours. Suppose twenty or thirty chicks are suddenly put into the egg chamber and after awhile as suddenly withdrawn, and this process should be repeated over and over again. What can your regulator do now? It certainly cannot prevent extremes of heat and cold from being reached. The operator would have to attend to turning the wick up or down, over and over again.

Now apply this reasoning to the brooder. The regulator is set, we will say, for  $98^{\circ}$  and reaches and holds that temperature all right while the hover is empty, waiting for chicks. It is at dusk, and a half dozen come in. As soon as they settle down without exercise, their blood of course slackens in its speed and  $98^{\circ}$  does not feel warm enough, nature having regulated the hen's nest at  $103^{\circ}$ . Therefore, they huddle together if there is top and bottom heat, or stretch upward to try to reach the source of warmth if there is top heat only; and a current of cool air coming in near the floor under the curtain, they strive to get up in the world by trampling on their fellows, as people do, while if there is side heat they crowd toward the hot water tank or hot air drum. They are not very cold, but are just cool enough to be uncomfortable and they will keep in continual motion, scolding meanwhile, saying: "Keep still, won't you, and let a fellow go to sleep." As outsiders come in, one after another, lifting the curtain and letting in gusts of cold air, the temperature falls, we will say, to  $95^{\circ}$ , causing the regulator to turn on the heat full blast, and by the time the whole brood gets massed together, squeezing weak chicks in the center to death,  $98^{\circ}$  is again reached at the point where the thermostat is, for the curtain has ceased to admit cold air. Now the regulator shuts off a part of the heat, yet the chicks are still too cool and

therefore they keep in motion when they should have all been buried in slumber an hour ago.

In a little while the animal heat raises the temperature to  $103^{\circ}$  at the center and the chicks there drop off to sleep, crooning a contented lullaby in spite of some crowding going on by their fellows at the outside of the group, where it is  $99^{\circ}$  or so. The heat still rises because there are twenty-five, perhaps seventy-five, little furnaces under the hover, each  $108^{\circ}$  inside. By the time the air at the outer row of birds reaches  $103^{\circ}$ , and they squat down with the contented exclamation before referred to, it is probably  $106^{\circ}$  at the center, and rising, and the chicks there are soon awakened from their too short nap by close, hot, foul air, reeking with dampness from the dead bodies of a couple of their mates lying as flat as if an elephant had trod on them. These two were crushed in the preliminary struggle. Then begins the strife of those in the center to get out. The outer row grumble: "Keep still, won't you, and let a fellow sleep," and then they begin to crowd with all their might against those in the center. Now follows a battle by all hands, during which some of the combatants open the curtain flaps, either by running against them in the fight or by running out for a breath of fresh air, and so the center of the room is partially ventilated, as the air has been stirred up by the rumpus and cooled somewhat, and the sleepy inmates, having added one or two more to the list of dead, settle down again, the temperature having been by this time lowered sufficiently to be endurable, no thanks to the regulator, however.

But, alas, there is no rest for the weary. The same thing goes on over and over all night, the period between the maximum and minimum heat being perhaps of an hour's duration. The birds become exhausted for lack of sleep. The strongest do not get into the list of killed or wounded, but all, whether at the head or the foot as

regards comparative strength, will look as if they had been drawn through a woodpile backwards, after a few nights of such dissipation, and they will be very sleepy in the daytime. Their keeper, if a novice, will begin now to change their feed, but if somebody punched him with a sharp stick or dragged him out of bed by his heels every time he got fairly to sleep every night last week, his constitution would demand something besides a change from beef and potatoes to mutton and parsnips.

But somebody may advise to set the brooder regulator not at  $98^{\circ}$ , but enough lower than that to make allowance for the rise after the chicks are in. If the animal heat raises the temperature  $12^{\circ}$ , set your regulator at  $90^{\circ}$  and after awhile it will rise to  $102^{\circ}$ , the chicks will be comfortable then and sleep till morning, he says. This adjustment avoids some of the dangers inseparable from the  $98^{\circ}$  plan, but involves new ones. The chicks have a longer period of undisturbed rest after they once get to sleep under the  $90^{\circ}$  plan, but have to undergo a longer contest with the cold at the start. To fight for warmth while the heat is slowly rising  $12^{\circ}$  results in more severe and protracted chilling than when it is rising only four degrees. Also, there is another trouble. The animal heat is sufficient to run the hover up to  $102^{\circ}$  at a little after sundown when the evening is comparatively warm, but as morning approaches, the air outdoors lowers  $30^{\circ}$  and that inside the brooder house  $15^{\circ}$ , or if the early evening was still and the wind rises toward morning, the heat inside may fall  $20^{\circ}$ . Now the struggles at the start for the warmest place resulted in a sort of sifting process,—the weaklings got pushed to the outside,—and as morning approaches, those least fitted to withstand cold are exposed to it the most. As a mass, they are too cold now, if they were just right at the early part of the night, and if just right now, they were overheated then.

We have never succeeded as well at an adjustment at either  $98^{\circ}$  or  $90^{\circ}$ , as at  $94^{\circ}$ , a mean between the two, which mitigates some of the disadvantages of each, though all troubles cannot be escaped, no matter how you set your regulator. The nearest approach to perfection in automatic regulation of a brooder consists in having the air of the brooder house itself heated artificially and its temperature governed automatically to guard against the effect of fluctuations of the outside temperature during the night, and have a regulator attached to each brooder also, put at  $98^{\circ}$  as in the first instance, or  $99^{\circ}$  or  $100^{\circ}$  even, thus escaping the chilling when the birds go to bed. Also have another regulator attached to every brooder set at  $104^{\circ}$ , this one not being connected with the lamp at all, but with a thin, light lid over a circular opening one and one-half or two inches in diameter in the top of the brooder. Have numerous small holes in the curtain. Then, with a not too numerous brood there will be very little crowding, and as the temperature can never get below the notch of the lamp regulator, and never very much above the notch of the other regulator, there will be no disastrous chilling, at any rate.

The ill effects of a too cool hover when chicks are in the down are much greater, be it remembered, than of an overheated hover. For when the brood consists of a safe number of birds, the chicks can spread out to cool themselves, nature having taught them to do this, as may be ascertained by their avoiding close contact with the hen's body of a sultry summer night, and squatting close to the outer rim of her feathers, with their heads entirely outside.

This three-regulator plan, two for each brooder and one for the brooder house, approaches the perfection of natural brooding, but does not reach it, as will be shown further on in the description of the Brooder of the

Future. Objections on the score of expense are, of course, very apparent. There must be a furnace, a boiler and pipe system for the brooder house itself, either steam pipes or hot-water pipes, in addition to lamps for the brooders, and the house must be quite well built and reasonably free from crevices around the doors and windows, to meet the case of unusual cold, and winds especially, and the furnace fire carefully tended so that the regulator can change the furnace dampers to good effect. If the season of the year and the latitude permit the use of an equivalent number of brooding hens, the management of which, with their broods, is properly provided for, mind, their employment will be vastly less expensive than such a good, complete brooder system as is above described, with triple regulators.

In place of this plan of thorough automatic brooder regulation, personal supervision may be employed, but this must be done by a relay of help and kept up day and night in order to come in competition with the natural process of brooding. This would be so expensive, with a plant of small brooders and small broods, as to be afforded only when pursued on a large scale and helped out by very high prices for the product. The operator must pass up and down the lines of brooders, and,—guided by thermometers, or, better, by the sense of feeling which, after a little practice, becomes marvelously accurate in determining temperatures in many cases, and by the behavior of the chicks, for they will tell him unmistakably whether they are too hot or too cold or just right,—turn down a flame here and raise one there, eternal vigilance being the price of chickens. Expense again—less mechanism than in the triple regulator system, but more labor in attendance. Worst of all, while securing the right degree of heat, the ventilation of the hovers is bound to be lacking whenever the

heat is insufficient. One important thing must not be neglected,—the flame of the lamp must be fed by air conducted through a cold-air box communicating with outdoors, and the smoke and waste air from the lamp must be allowed to escape through a flue leading through the roof.



## CHAPTER XXXII.

### METHODS OF HEATING AND VENTILATING BROODERS.

When the rage for brooders began in the United States, brooders were all built to have heat distributed over the backs of the chicks, in alleged imitation of the hen. They are said to be "under" the hen at night. Now it is natural for chickens to feel the feathers of their mother upon their back, and when the ground is cool and damp, for instance after cold rains, and they feel chilly before becoming thoroughly warmed after going to bed, they will be found standing up at full height to get all the heat they can upon their backs, and will also crowd closely together and towards their mother to get warm. The empty artificial brooder, as commonly used, without even one regulator, to say nothing of two, the operator cannot venture to heat to  $103^{\circ}$ , the temperature at the outside of the hen's body; for the vital heat of the brood would soon make it so hot that they could not stay in it at all. He therefore aims generally at about  $90^{\circ}$  or  $92^{\circ}$  for quite young chicks. On first entering the hover, they elevate their backs as much as possible and stretch their legs to full length, even standing on tiptoe some of the time, especially if there are loose folds of soft cloth overhead to imitate the hen's feathers, or a tank or pipes of hot water, the radiant heat from which they plainly perceive is above them. Not content with stretching to the utmost towards the grateful warmth, the biggest, strongest fellows try to climb upon the backs of their companions to reach the heat, and some of the weaker ones are trampled to death, as described in previous pages, and their bodies form

platforms to stand on, the possession of which is fought for; fratricides fighting for the dead bodies of their brethren.

At this stage in the progress of brooder building the idea appeared of locating the source of heat supply somewhere else. The writer remembers being invited many years ago to the country seat of the then president of the New York State Poultry association, which was at the time holding an annual exhibition. On arriving at his place, after seeing his extensive poultry plant, the ruins of his brooder house, once the largest in America, destroyed by fire but a few weeks previously, were shown us and the proprietor said, pointing to a spot in the ashes: "There stood the first bottom-heat brooder ever built in America." Very soon after that, bottom heat was all the rage, and the parties adopting it said they found decidedly fewer chicks trampled to death and pressed as flat as a flounder, and also stealthy visits made by the owner in the silent watches of the night demonstrated that the former struggle, "upwards, upwards, still upwards," was not going on.

But the path was not yet strewn with roses. No regulator was attached to a brooder in those days, that we ever heard of, and if the bottom-heat brooder were too cool, the chicks would crowd, even if they did not trample, and if it were too warm, their legs and the under parts of their bodies were the first to become overheated. It is evident that in the natural order of things, the ground on which the chicks rest never is and never can be more than moderately warm, even when the hen has hovered over it all night, and is frequently decidedly cold, and sometimes frozen as solid as a rock, when she begins to brood. Weakness of the legs, general debility, a tendency to go to sleep in the daytime because resting so poorly at night, and various other symptoms gave warning that something was wrong.

Next followed the invention of side heat, one of the ablest advocates of which is the eminent expert, Mr. C. Von Culin, whose argument we will let him state in his own words :

“A brooder is supposed to take the place of a good hen. To do this successfully it must be made as nearly like a hen as possible. Now how is a hen built? Where does the heat come from? Where do the chicks hover? How do they get to and from the heat, and receive fresh air? Look at the illustration of a brooding hen, and see for yourself. Is not the heat which the chicks get from her principally side heat? By chance a chick may get caught under the breastbone or under the foot of a hen, but not often. The wings, feathers and down of the hen retain the greater part of the heat from the body. The brooding chicks can put their heads out for fresh air, instead of being crammed into a bunch and surrounded by from fifty to a hundred other chicks. If they are too warm they can get out, if not pinned down under the breastbone or foot of the hen. The heat from the hen certainly cannot be termed ‘bottom heat,’ nor yet ‘top heat.’ It is—as she squats down and her body is surrounded by the chicks—principally ‘side heat,’ with some top heat retained by her feathers.”

At about the same time that side heat was thought of, a combination of top and bottom heat was tried and its advocates became extremely numerous, its superiority to either top or bottom heat alone being very evident. In the combination plan a small part of the heat is distributed under the brooder floor to check the reaching upward, which, as we have seen, is so disastrous, but the most of the heat enters near the top of the hover and radiating downwards meets the heat which rises from the moderately warm floor, so that the brood chamber is warmed throughout. The choice lies between the combination and the side heat plans. One great advantage of the latter is that the chicks are in a thin line instead of in a bunch, preventing crowding, and they can always withdraw from the drum or tank by taking a couple of steps, nature having taught them to do this, just as they hug the body of their mother closely or withdraw from her, as regard for their comfort dictates under the varying conditions of wind and weather.

It is worth noticing that, owing to the fact that heat rises to the top of the hover, the side heat plan is really a combination plan as well as the other. One is a combination of top and bottom heat and the other is a combination of top and side heat. The writer unhesitatingly prefers the Von Culin plan to all others, provided that the broods are small, never exceeding thirty chicks, and twenty or less is better. This matter of size of the brood is very important; for when the source of comfort is at the side, the chicks will, if lacking in warmth even slightly, crowd towards it, and if numerous enough to form ranks three or four deep, crush the inner rank against the heat drum or tank and make it difficult for them to get out into the fresh air. There is a similar crowding closely to the body of the brooding hen, but her brood of the normal number of twelve to fifteen can all find room around her without a turbulent outer rank of malcontents to make misery. The drum of the Von Culin brooder has an external surface considerably greater than that of a hen, and a proportionate number of birds can gather around it comfortably. We have tried still larger drums to warm forty, fifty and sixty chicks respectively, and they would all work as well as the twenty-chick size if the chicks could be depended upon to always range themselves evenly around it. In fact, the drum might be as big as the Ferris wheel and serve to warm an almost innumerable number if they would all go to bed in single file with no crowding. With only a score or so of birds and a drum of a size to correspond, no large crowd in a riot is possible, while, of course, the greater the whole number the greater the throng that is liable to gather in one spot. A merit of the side heat, hot-air drum is that, as the chicks increase in size, bigger drums and covers can be substituted without changing the lamp or dividing the broods. A demerit is that since there is a difficulty in always gaug-

ing the heat of the drum to a nicety, it will overheat one side of a chick sometimes, after it has fallen asleep pressed snugly against it and the heat afterwards increases. Here the superiority of nature appears, as it does again and again, for the heat of the hen's body can never rise unduly. The side heat combined with the three-regulator plan will accomplish all that can be accomplished with a covered hover without constant supervision.

The two principal methods of warming hovers are—by hot water, either in pipes or tanks, and by hot air. The tank and hot-air styles are adapted to single brooders, each with its lamp or its gas jet. The pipe method is designed for long rows of brooders placed side by side, the hot water circulating through pipes placed over the birds (Fig. 136), or under them beneath the floor, or both, as may be preferred, the water being heated, of course, by means of a boiler over a furnace for coal or wood located at one end, or the center, of the brooder house, as convenient. This obviates the necessity of filling and trimming numerous lamps when there are many brooders, but there is the disadvantage of having to fire up just the same when there are but few chicks on hand as if the brooder house were being run to its full capacity. There is a further feature, which is, that the same heat is applied to all the broods. This may be an advantage under some circumstances and a disadvantage in others.

Single brooders are subdivided into the outdoor and indoor classes, the latter, of course, having no roof, as the roof of the brooder house in which they stand, answers. The outdoor brooders have a roof of their own, impervious to rain, and sides that may be closed in whole or in part, in case of strong winds or driving rain, or snow. The advantages of the outdoor brooder are that the chicks can, at the age of only a few days, have outdoor exercise, the weather admitting, without the

necessity for outside yards or roofed runways, of liberal area, or the exercising apparatus described in this book. The disadvantages, as compared with the indoor brooders are, that the attendant has to chase all over creation to do his work when brooders are scattered far enough from each other to keep the broods from mixing, and, worse than all the rest, the birds have to be confined in stormy weather to the narrow quarters of the brooder, a serious matter in parts of the country where rains are frequent.

#### VENTILATING THE BROODER.

If fresh air is necessary for the chick in the egg, still more is it absolutely necessary for the chick under the hover. How to get rid of poison exhaled by the lungs and still not subject the young birds to injurious drafts, is the problem, and it is not an easy one to solve either, without elaborate regulating apparatus or else constant supervision, both of which entail much expense. You can cheapen your arrangements and pitch in a lot of birds, expecting to have fifteen to twenty-five per cent die, and sell the rest. But the writer wants nothing whatever to do with any such barbarous practices. No attendant, who has the suitable make-up for a good attendant, can ever maintain zeal and enthusiasm when he has to officiate every day as undertaker and medical director. It would be amusing, were it not sad, to see how sedulously the owners of many brooder plants conceal their death rate statistics.

When the chicks receive their first warm coat of feathers, they are approximately like adult birds, which are capable of enduring changes of  $40^{\circ}$  in twenty-four hours without much harm, if they have plenty of exercise and are sound and vigorous in every respect: but the downy chick, especially at night, cannot withstand such vicissitudes. Yet the tender youngling needs pure air to



breathe as much or even more than the adult bird, and always the introduction of fresh, cool air interferes with the maintenance of steady heat. Of the two things, warmth and pure air, one is as important as the other. The earlier brooders all had covers or tops, two, two and a half, or three inches for the youngest birds, according to the breed, from the floor, and made adjustable so that they could be raised half an inch at a notch as the birds grew older. This cover was preferably removable for convenience in cleaning the floor of the hover and was made of boards with six or eight holes of one-half inch or three-fourths inch diameter bored through it for ventilation, some of which could be stopped with corks in cold weather if desired. But the use of this cover is always more or less antagonistic to a proper supply of both pure air and warmth, if the temperature of the brooder house is decidedly cooler than that of the hover. For if you close too many holes the air will be impure under the cover, shut in as it is by the curtain or fringe surrounding it, while if you open too many holes it will be too cool.

It is so natural to conclude from the example of the mother hen that young chicks must have something to touch their backs, that operators unanimously adopted tops to their brooders lined with sheepskin, with the wool on, or soft cloth depending in numerous folds. Says Von Culin :

“The flannel or woollen drapery which hangs down from the hover and helps retain the heat and gives a feeling of cosy comfort to the chicks is essential. Nature gives them side heat from the hen and soft covering, the feathers of the hen, and so must we if we want them to be comfortable and thrifty. Heated floor or ceiling is not enough. Would you like to heat a bedroom up to 70° or 80° and lie on the bed or floor with no covering? We think you would prefer to have the room at 30° or 40° and put on a few blankets.”

The above would at first seem to be conclusive, but after all, the brooder top is but a sorry imitation of the

cover which nature gives. Unlike the feathers, it is not furnished with millions of interstices for the air to strain through, nor will it permit the escape of the poisonous elements derived from the lungs of the birds. Mr. John Loughlin, proprietor of the largest broiler plant in the United States, conceived the idea of omitting the brooders, and put it in execution with great success, as success goes in artificial rearing.

His hot-water pipes have nothing whatever over them, and the chicks congregate at night between these pipes and the floor, several hundred in a brood. By having the whole of the brooder room well warmed, the crowding is reduced to a minimum. The absence of a top over the pipes does not make the chicks too cold, because the heat in the room, which contains thirty broods, is regulated with great care, and the room well ventilated. The thirty broods are of thirty different ages, ranging from one day to thirty days respectively. When past the latter age they are removed to another room, heated to a lower degree, and, like the first, without tops over the hovers. This first-mentioned large room, with many chicks, resembles, as regards heat, the Brooder of the Future which will be described later. Mr. Loughlin has shown how a thing may be done well, as such things go, by doing enough of it so that it will pay to hire hands to do it. Yet, at best, the death rate at his establishment is too great. Take all the brooder houses in the country, little and big, one-horse gig or six-horse coach, the trail of the serpent is over them all, so long as they fail to keep alive no more than seventy-five to eighty-five per cent of the innocents committed to them.

Unless the usual mortality of brooder chicks can be reduced, the artificial method of rearing is of questionable morality and a fit subject of investigation by the Society for the Prevention of Cruelty to Animals. A friend of ours in South Dakota says in a letter: "Out

on the wild cattle ranges to the northwest of here, ranchmen with hearts of flint breed cattle, to have them run all winter without hay or shelter, subsisting on the dried grass and running the risks of unusually severe weather. Every three or four years a blizzard or an ice storm that covers the grass, followed by zero weather, kills by cold, combined with hunger, one-tenth, or one-fifth, perhaps, of the whole. And once in five or six years, sometimes three-fourths or five-sixths. But taking the average of a series of years the business is profitable. Now for every steer that dies a lingering death, a score or more have their ears and tail frozen off and one or more of their feet horribly mutilated, but they live through it. Fancy the owner turning in his warm bed at midnight and listening to the storm! For my part I envy not the make-up of a man who is willing to get money that way. I would rather work by the day digging ditches. And on the same line concerning poultry, if the mortality of broiler chicks runs from fifteen or twenty to forty or fifty per cent in brooders, then, I say, to sheol with the brooders. Artificial rearing of chicks becomes, in such a case, an inquisition of torture to poor dumb brutes."

The coming generations will commiserate their predecessors for being so barbarous, when the time arrives that, except through accident, as, for example, the inroads of a weasel or predatory cat, the poultry keeper who makes poultry raising a business will no more expect to have young chicks die than nowadays the farmer expects to have his young calves or colts die. In our newer states there are no members of the society with the long name and everybody acts as he pleases towards dumb brutes and often pleases to act contemptibly, but in the older states the society flourishes, and the miscreant who abuses a horse, or maltreats a cat or dog even, unnecessarily, is sure to hear from it. This

shows that the growth of civilization is sure, even if slow, and justifies the prediction that when the world finds, as it will, that progress has rendered the avoidance of a big death rate in chicken raising comparatively easy, such an old-time massacre of the innocents will be frowned upon and considered disreputable in the highest degree, if not punished by fine and imprisonment.

## CHAPTER XXXIII.

### THE BROODER OF THE FUTURE.

As the cheapest thing for extensive artificial hatching will prove to be the large apartment, so the cheapest brooder the writer has already found to be a big room. "Hire a hall," was once a popular phrase, and it applies here. To have 1000 chicks in a brooder house, twenty-five in a brooder, will take forty of these, to hold which the house will have to be large anyway. As commonly constructed, the pens attached to the brooders would have to be quite small, necessitating restricting locomotion of the inmates. There might be forty outside yards, using up a great lot of building material (cost! cost!) but the chicks would have to be stived up closely in bad weather. The indoor exercisers might be provided, but there is "cost, cost," again. Now suppose the entire floor of a good sized room, built with high walls to enclose plenty of air, is accessible to each and every chick of the 1000 in all weathers. The first published account of an arrangement of this kind was given years ago by that veteran poultry raiser and author, and noble-hearted man, Mr. P. H. Jacobs, who reared some six hundred chickens in a not large room upstairs in Chicago, to the age of six weeks, with substantially no death rate. They were then removed to the country. There was a stove in the center of the room, where fire was burning constantly, and the birds ran in one flock all over the room by day, being separated at night into squads and lodged under hovers ranged at the walls. They had *runs*, literally, as the whole floor space of the

room was available for each, but when a brood is confined in a pen 3 or 4 ft. x 6 ft., as is unhappily often the case, there is no opportunity for the prisoners to get up full speed.

Now for a little improvement of the heating apparatus. Instead of the stove, use the combined hot-water and hot-air system, a method a better than which has never yet been found for warming dwellings, the same apparatus to answer for ten or more rooms, each of 1000-chick capacity. Have attendants on duty day and night, of course, to govern the temperature of the rooms absolutely and keep up a constant circulation of fresh air. The chickens in one of these big rooms must all run together in the daytime, and must be all of the same age and breed, so as to be of the same size and strength as far as possible. Any markedly inferior or superior birds to be culled out from time to time. The whole floor to be littered, and screened cracked corn or other fine feed stirred in. The whole space not occupied by the sleeping rooms to form one continuous exerciser. How to mix the ingredients? Perfectly simple. It may not be advisable to introduce a donkey or goat to the floor to draw a specially constructed diminutive hay tedder, with many tines set close together, to throw the chaff, excelsior, or short cut straw, for the operator can draw it himself. The chickens get in his way and are immediately annihilated? Not at all. The machine, together with the operator, must be enclosed, front, rear and on all sides, by a light movable frame attached to the tedder and covered with muslin, with a fringe of leather thongs, or tape, or narrow strips of heavy canvas, depending at the bottom in a way to always graze the ground. The writer operates such a screen and fringe out of doors, to keep chicks away while stirring straw to cover grain on the scratching grounds of half-grown chickens, by means of two wooden



handles, like wheelbarrow handles, only lighter, attached to a wide girded waist belt, leaving both hands free to distribute grain. In using the large hay tedder propelled by a team, for stirring straw on the scratching grounds of grown fowls, the driver uses one hand for the reins and scatters grain with the other, so much for each colonized flock, by measure, the entire outfit, horse, machine and all being enclosed with a muslin and fringe screen, the frame of which is attached to the machine and to the tips of specially built, extra long shafts in front of the horse. We are planning an attachment for both the large and small machines, the same for each—except they are of different sizes—comprising some of the features of a farmer's field seed drill, so that eventually we will not have to scatter grain by hand. Millet and Kaffir corn, to the raising of both of which so large a portion of our country is admirably adapted, work well in the large-room plan, and are good grains for chicks and fowls of all ages. Never allow the litter to become entirely destitute of feed, for in a good tight room, such as has been described, no rats or mice can ever be baited nights, and something to eat should always be ready for the chicks whenever they are willing to work for it.

“But the putting to bed of so many active, impetuous youngsters; there's the rub,” we fancy the reader exclaims. There is some work at this point surely, but no system whatever is entirely devoid of work. It will be noticed that feeding, watering, heating, ventilating, cleaning and providing exercise, as well as protecting against all manner of vicissitudes, are all accomplished at the very smallest amount of labor conceivable, there being so many in a room and so little space or distance to be traversed by the attendant; therefore considerable time can be afforded in putting the birds to bed. Not so very much time will be needed, either. On occasion, the 1000 birds can be penned with a reasonably even

division into ten flocks of about 100 each, in five minutes, if the pens are made right and the doors are of the right size and shape and move at a touch, or eight minutes and no hurry. Afterwards, in a little longer time each flock can be subdivided, by using another set of pens, into smaller flocks of any desired size to prevent crowding. The whole operation can be managed by any person with enough ingenuity to be fit to attend to chickens, without scaring them in the least or hardly letting them know that anything has been done to them. Of course he will shuffle slowly through the crowd of very tame birds, with short steps, and will be provided with a specially coveted dainty, that all will be greedy for, though well fed already, and 100 chicks will get into a pen quicker than one would think possible. There are no bad effects in having young birds sleep with strange bedfellows every night. It would upset the domestic feeling and check the yield of laying hens to consort with a changing crowd, but it makes little difference to chicks.

As regards the temperature of the sleeping places, it must be 103° first, last and all the time, in the air around the birds when they are very young. The operator's business is to hold the heat right. That is what he is for, and he is supposed to have every facility for doing it, being supplied with as perfect an apparatus as that which was explained in the description of the Incubator of the Future. He can start currents of air at will, coming from outdoors and warmed before admission. We said "sleeping places," not hovers, because we would, as practiced at the plant of Mr. Loughlin, have no covers over the hot-water pipes the chicks stay under o' nights. The floor they sleep on should be a little higher than the floor of the main room and made of wire cloth to let filth through and admit air from below for breathing. Thus, close air, exhausted of oxy-

gen and loaded with carbonic acid gas, will never be inhaled. The best brooder top in the world, no matter how well it is furnished with ventilating valves or shutters, and no matter whether these are operated by automatic regulators, or by personal supervision day and night, can never admit of such a constant supply of pure air as no top at all. When it is too warm and the valves are opened, there will be relief from the impure air of course. But suppose it is too cool. Why, the chicks will be in the same fix as a person is, who, on going to bed of a cold winter night in an unwarmed apartment, puts his head under the bedclothes to get warm, in which case carbonic acid gas accumulates rapidly. Or suppose it is neither too cold nor too warm under the hover but just at the correct notch. Why, the temperature is all right and the ventilation all wrong. The fact is, no matter how much of a stickler one is for imitating nature, he cannot imitate the hen's style of a hover top closely enough to make the imitating business work in this instance; and the best imitation of the hen's hover-top conditions is produced by no brooder top at all.

It being very desirable to have chickens run and flap their wings as well as scratch, the size of the room permits this, and a feed shelf or other form of feed dropper, as described in another part of this book, can be very easily fitted up at each of the opposite sides or ends of the main littered area. The trouble with the ordinary little indoor pens attached to single brooders is, that they are only 6 ft. x 8 ft., or 10 ft. x 12 ft., or such a matter, and a bird cannot get under full headway in such space, any more than a locomotive can run a mile a minute in a switchyard. A large room gives opportunity for running, flying, leaping and scratching, irrespective of the weather. Each room is supposed to communicate with a large yard outdoors, which should also have a feed dropper at each end. There is a special advantage in

allowing the birds outdoors only when the weather is just right. Often in winter there will be a short time in the middle of the day when the yard can be used to good advantage, when access to it nights and mornings would do more harm than good. In case of snow, paths can be opened by a snow plow and team moving through gates leading from one yard to another, whereas the labor of clearing small single brooder yards by hand is discouraging when one snowfall follows another.

# INDEX

	PAGE		PAGE
Alfalfa, for poultry	25	Chicks— <i>Continued</i>	
for tilt boxes	234	care of	124
Alley, sunken	75	and care of hens	243
Alternate system	212	calling the	163
Bearings, rounded	192	feeding young	100
Bell call, the	165	feeding young	123
Bin, for dry earth	33	feeding apparatus for	323
for earth	141	foes of	134
Bowel disease, cause of	236	grains for	324
test for	241	healthy	235
Breeders, houses for	51	litter for	323
overfat	120	mortality of brooder	257
Broiler business in New		number in flock	324
Jersey	256	shelter for	136
Broilers, profits in	256	strong, to get	130
Brooder, covers for	318	temperature for young	317
house, details of	213	trained to exercise	184
Brooders, indoor and out-		waterlogged	289
door	316	weaning	100
lining for	318	Clockwork for tilt boxes	199
mammoth	322	Close breeding, place of	119
methods of heating	316	Cold storage	14
old style	312	Combs, cutting	106
personal supervision	310	large, drawbacks of	106
regulator	306	Cook house	139
requisites of	304	Cooling not necessary	283
side heat	314	Coops, for chickens	97
ten to manage	231	moving the	99
top and bottom heat	314	small, for chickens	98
twenty to manage	232	A-shaped	135
uncovered	319	temporary	213
ventilating the	317	Colony plan	17
Brooding, theories on	269	Corn, value of	116
Buildings, protected, sum-		Cover for feed shelf	203
mer	50	Covers for brooders	318
special	139	Crops for colony plan	23
Business poultry keeping	5	Cyphers, on incubators	274
Car for transportation	76	on moisture	293
Cellar for incubators	83	Cylinders, duck, filling	189
Chaff for tilt boxes	234	feed	155
Chickens, by colony plan	19	for brooder house	220
on a small scale	229	homemade	193
coops for	97	operation of	156, 183
Chicks, at hatching time	279	spool	179
cause of dead	305	Disease, treatment of	144
early food for	132	Drag, homemade	20
critical time for	132	Dressing fowls, place for	141

	PAGE		PAGE
Dropper, feed	152	Gates for sitters	85
Drum, hot air	315	Grain, broadcasting the	90
Ducks, feed cylinder for	187	food, variety of	113
laying	186	for cylinder	155
Pekin	186	scattering for chicks	133
success with	186	Granary and cook house	139
Earth, preparing dry	29	Hammer, construction of	197
storing dry	32	homemade	205
supply of	16	moving the	204
Egg, composition of	287	operated indoors	199
route, an	8	Hammonton, experience at	257
Eggs, carrier for	28	Hand tilt boxes	230
cooling	281	Harrow, homemade	20
fertile	121	Hatching, by wholesale	66
fertile, to secure	55, 259	house described	83
glazed by hen	288	management of	123
overheated	292	poor, causes of	148
setting the	121	Hatches, large secret of	273
turning	268, 284, 286	Heating, methods of	142
Exercise, arrangement for	44	two modes of	271
for breeders	53	Hens, when to kill	108
for breeders, need of	149	Hospital, chicken	141
for chicks, need of	255	House, arranged for sum- mer	40, 47
importance of	46	Houses for breeders	51
in runways	177	House, for brooders	213
testing value of	255	for early pullets	47
to cure bowel disease	237	for feeding in winter	44
Exerciser, by alternate system	212	for layers	35
details of	152	for runways	25
for ducks	187	for sitters	62
indoor, parallel	217	for sitters, location	128
outdoor	172	interior devices for	39
simple	149	movable	22
Failure, cause of	246	protected	48
Feed box	43	winter	36
for chickens	99	winter care of	40
Feeding, by colony plan	20, 21	Hover, a cool	309
high pressure, mode of	109	Inbreeding, effect of	119
room	43	Incubation, and moisture	287
soft food	206	difficulties of	289
Feed, shelf and gate	86	natural process of	275
cover for	203	opinions on	269
pouch	196	Incubators, cheap	270
shelf, indoor	203	cellar for	83
shelf, operating	201	Incubator, cellar, the ideal	298
sieve	195	idea overworked	69
Fences, movable	51	lamp style of	274
Fence, wire netting	53	methods, various	268
Fertility, to secure	55	of the future	299
Floor, a dry	49	regulation of	290
construction of	227	regulators	274
spare, for chicken coop	137	requisites of	256
Food, kinds of	112	room	298
soft, place of	114	temperature of	277
Fowls, for breeding, sale of	250	ventilation of	294
for sitters	110	antiquity of	261
to an acre	111	compared	271



	PAGE		PAGE
Incubator— <i>Continued</i>		Poultry— <i>Continued</i>	
in Egypt	261	industry, divisions of	1
inferior to hens	265	in small flocks	4
not economical	122	in the south central states	2
old types of	261	plant of the future	246
public tests of	272	plants expensive	246
studying	274	Pullets preferred	108
under ground	298	Pure bred stock, sale of	250
Insects, to prevent	144	Railroad for poultry house	75
trap for	23	Range needed	111
Intensive plan	146	Ration, balancing the	114
Jacobs, P. H., experience		Regulation, double	309
of	322	Regulators, for incubators	274
Labor, cost of	248	plan of three	310
hired	248	Roads for poultry farm	28
Lamp, care of	311	Room, large for incubators	300
styles of	274	Roost for hatching house	96
Layers, and sitters	87	Root bin	141
breeds for	102	Runs, long, advantages of	59
condiments for	134	Runways, for breeders	57
feeding the	87	for chickens	24
producing	118	for outdoor exercise	172
selecting for	103	movable, for sitters	66
separating from sitters	89	series of	175
Leghorns, large combs of	104	Scraper, earth	29
Lice, killers, patent	145	Selection, for laying	119
on young chicks	124	of layers	103
Location, an ideal	9	Shades for fowls and chicks	136
a northern	12	Shade, temporary	45
a southern	10	Shaft, homemade	193
Locations compared	11	wooden	192
Machine for turning eggs	285	Shelf, feed	57
Machinery, for mixing	158	feed, operating	201
importance of	6	Shelter, winter	137
regulating labor	252	Shelves, changing the	90
time saved by	244	Shovel for dry earth	30
Mats, use of	49	Sieve, for feeding	195
Meat, need of	114	for indoor use	197
scraps, use of	117	operating the	197
Millet for chicks	235	Sitters, activity of	125
Mixing food and straw	150	apparatus for	77
Moisture, during incubation	287	best fowl for	70
Von Culin on	289	care of in detail	80
Movable houses	22	cost of	70
Nests, for sitters	63	fowls for	110
for sitters to make	122	habits of	275
marking the	89	handling the	95
Nursery apartment	141	houses for	62
Pens and runways	176	in mild climates	74
Pen, for moving fowls	42	in small pens	67
temporary for chicks	136	large flocks of	88
Perch	222	nest for	63
Pit for tilt box	229	program for	92
Platform for drying earth	31	to remove	128
Pouch, wire, for feeding	191	versus incubators	72
Poultry, business, competition in	245	Sitting, to encourage	111
		Sled for poultry farm	28
		Soft feed, giving	206

	PAGE		PAGE
Soil, kind of	14	Turning eggs,	284
Southern poultry raising	2	Underground fowl house	49
Spool for cylinder axle	179	Vegetable food,	45
Straw, stirring the	60	Ventilation	47
System for ten brooders	231	during incubation	294
Tank, for ducks	188	for chicken house	97
Tedder, use of	20	of chicken coops	134
Temperature, at hatching		of incubator cellar	299
time	280	of main building	143
for chicks, limits of	308	Vigor, sources of	121
governed automatically	309	to secure	54
in incubation	277	Vitality, need of	57
Testing eggs, room for	299	Von Culin on moisture	289
Thermostat	274	Wagon, for carrying earth	32
Tilt box	158	for poultry farm	27
axle for	190, 224	Watering fowls, wagon for	28
compound	222	Water supply	26
flap for	164	Weather strips	46
for brooder house	217, 220	Weight for feeding appa- ratus	211
for small yards	258	Western poultry farms	9
layer, to manage	234	Wild fowls, nature of	3
material for	234	Windbreaks	45
operating	159, 165	Windows, apparatus for	217
to turn	170	to open and close	219
wooden axle for	160	Winter, house for	36
Transportation facilities	14	quarters	45
Trap, for sitters	76	Wooden feeding apparatus	194
Trap setter	96	Work bench	141
Trays, changing the	287		
Trough for soft feed	207		

SENT FREE ON APPLICATION

# Descriptive Catalog of---

Containing 100 Svo. pages,  
profusely illustrated, and  
giving full descriptions of  
the best works on the fol-  
lowing subjects :

## RURAL BOOKS



Farm and Garden  
Fruits, Flowers, Etc.  
Cattle, Sheep and Swine  
Dogs, Horses, Riding, Etc.  
Poultry, Pigeons and Bees  
Angling and Fishing  
Boating, Canoeing and Sailing  
Field Sports and Natural History  
Hunting, Shooting, Etc.  
Architecture and Building  
Landscape Gardening  
Household and Miscellaneous

Publishers and Importers

## Orange Judd Company

52 and 54 Lafayette Place  
NEW YORK

BOOKS WILL BE FORWARDED, POSTPAID, ON  
RECEIPT OF PRICE

**Play and Profit in My Garden.**

By E. P. Roe. The author takes us to his garden on the rocky hillsides in the vicinity of West Point, and shows us how out of it, after four years' experience, he evoked a profit of \$1,000, and this while carrying on pastoral and literary labor. It is very rarely that so much literary taste and skill are mated to so much agricultural experience and good sense. Cloth, 12mo. . . . \$1.00

**Forest Planting.**

By H. Nicholas Jarchow, LL. D. A treatise on the care of woodlands and the restoration of the denuded timberlands on plains and mountains. The author has fully described those European methods which have proved to be most useful in maintaining the superb forests of the old world. This experience has been adapted to the different climates and trees of America, full instructions being given for forest planting of our various kinds of soil and subsoil, whether on mountain or valley. Illustrated, 12mo. . . . \$1.50

**Soils and Crops of the Farm.**

By George E. Morrow, M. A., and Thomas F. Hunt. The methods of making available the plant food in the soil are described in popular language. A short history of each of the farm crops is accompanied by a discussion of its culture. The useful discoveries of science are explained as applied in the most approved methods of culture. Illustrated. Cloth, 12mo. . . . \$1.00

**American Fruit Culturist.**

By John J. Thomas. Containing practical directions for the propagation and culture of all the fruits adapted to the United States. Twentieth thoroughly revised and greatly enlarged edition by Wm. H. S. Wood. This new edition makes the work practically almost a new book, containing everything pertaining to large and small fruits as well as sub-tropical and tropical fruits. Richly illustrated by nearly 800 engravings. 758 pp., 12mo. \$2.50

**Fertilizers.**

By Edward B. Voorhees, director of the New Jersey Agricultural Experiment Station. It has been the aim of the author to point out the underlying principles and to discuss the important subjects connected with the use of fertilizer materials. The natural fertility of the soil, the functions of manures and fertilizers, and the need of artificial fertilizers are exhaustively discussed. Separate chapters are devoted to the various fertilizing elements, to the purchase, chemical analyses, methods of using fertilizers, and the best fertilizers for each of the most important field, garden and orchard crops. 335 pp. . . . \$1.00

## Ginseng, Its Cultivation, Harvesting, Marketing and Market Value.

By Maurice G. Kains, with a short account of its history and botany. It discusses in a practical way how to begin with either seed or roots, soil, climate and location, preparation, planting and maintenance of the beds, artificial propagation, manures, enemies, selection for market and for improvement, preparation for sale, and the profits that may be expected. This booklet is concisely written, well and profusely illustrated, and should be in the hands of all who expect to grow this drug to supply the export trade, and to add a new and profitable industry to their farms and gardens, without interfering with the regular work. 12mo. . . . . \$ .35

## Land Draining.

A handbook for farmers on the principles and practice of draining, by Manly Miles, giving the results of his extended experience in laying tile drains. The directions for the laying out and the construction of tile drains will enable the farmer to avoid the errors of imperfect construction, and the disappointment that must necessarily follow. This manual for practical farmers will also be found convenient for references in regard to many questions that may arise in crop growing, aside from the special subjects of drainage of which it treats. Cloth, 12mo. . . . . \$1.00

## Henderson's Practical Floriculture.

By Peter Henderson. A guide to the successful propagation and cultivation of florists' plants. The work is not one for florists and gardeners only, but the amateur's wants are constantly kept in mind, and we have a very complete treatise on the cultivation of flowers under glass, or in the open air, suited to those who grow flowers for pleasure as well as those who make them a matter of trade. Beautifully illustrated. New and enlarged edition. Cloth, 12mo. . . . . \$1.50

## Tobacco Leaf.

By J. B. Killebrew and Herbert Myrick. Its Culture and Cure, Marketing and Manufacture. A practical handbook on the most approved methods in growing, harvesting, curing, packing, and selling tobacco, with an account of the operations in every department of tobacco manufacture. The contents of this book are based on actual experiments in field, curing barn, packing house, factory and laboratory. It is the only work of the kind in existence, and is destined to be the standard practical and scientific authority on the whole subject of tobacco for many years. Upwards of 500 pages and 150 original engravings. . . . . \$2.00

**Gardening for Profit.**

By Peter Henderson. The standard work on market and family gardening. The successful experience of the author for more than thirty years, and his willingness to tell, as he does in this work, the secret of his success for the benefit of others, enables him to give most valuable information. The book is profusely illustrated. Cloth, 12mo. . . . . \$1.50

**Herbert's Hints to Horse Keepers.**

By the late Henry William Herbert (Frank Forester). This is one of the best and most popular works on the horse prepared in this country. A complete manual for horsemen, embracing: How to breed a horse; how to buy a horse; how to break a horse; how to use a horse; how to feed a horse; how to physic a horse (allopathy or homoeopathy); how to groom a horse; how to drive a horse; how to ride a horse, etc. Beautifully illustrated. Cloth, 12mo. . . . . \$1.50

**Barn Plans and Outbuildings.**

Two hundred and fifty-seven illustrations. A most valuable work, full of ideas, hints, suggestions, plans, etc., for the construction of barns and outbuildings, by practical writers. Chapters are devoted to the economic erection and use of barns, grain barns, house barns, cattle barns, sheep barns, corn houses, smoke houses, ice houses, pig pens, granaries, etc. There are likewise chapters on bird houses, dog houses, tool sheds, ventilators, roofs and roofing, doors and fastenings, workshops, poultry houses, manure sheds, barnyards, root pits, etc. Cloth, 12mo. . . . . \$1.00

**Cranberry Culture.**

By Joseph J. White. Contents: Natural history, history of cultivation, choice of location, preparing the ground, planting the vines, management of meadows, flooding, enemies and difficulties overcome, picking, keeping, profit and loss. Cloth, 12mo. . . . . \$1.00

**Ornamental Gardening for Americans.**

By Elias A. Long, landscape architect. A treatise on beautifying homes, rural districts and cemeteries. A plain and practical work with numerous illustrations and instructions so plain that they may be readily followed. Illustrated. Cloth, 12mo. . . . . \$1.50

**Grape Culturist.**

By A. S. Fuller. This is one of the very best of works on the culture of the hardy grapes, with full directions for all departments of propagation, culture, etc., with 150 excellent engravings, illustrating planting, training, grafting, etc. Cloth, 12mo. . . . . \$1.50



# Edward Eggleston's Standard Works.

## The End of the World.

A love story by Edward Eggleston. In love with a Dutchman; An explosion; A farewell; A counter-irritant; At the castle; The backwoods philosopher; Within and without; Figgers won't lie; The new singing master; An offer of help; The coon-dog argument; Two mistakes; The spider spins; The spider's web; The web broken; Jonas expounds the subject; The wrong pew; The encounter; The mother; The steam doctor; The hawk in a new part; Jonas expresses his opinion on Dutchmen; Somethin' ludicrous; The giant great heart; A chapter of between's; A nice little game; The result of an evening with gentlemen; Waking up an ugly customer; August and Norman; Aground; Cynthia Ann's sacrifice; Julia's enterprise; The secret stairway; The interview; Getting ready for the end; The sin of sanctimony; The deluge; Scaring a hawk; Jonas takes an appeal; Selling out; The last day and what happened in it; For ever and ever; The midnight alarm; Squaring accounts; New plans; The shiveree. Price, postpaid . . . . . \$1.50

## The Hoosier Schoolmaster.

By Edward Eggleston. A private lesson from a bull-dog; A spell coming; Mirandy, Hank and Shocky; Spelling down the master; The walk home; A night at Pete Jones's; Ominous remarks of Mr Jones; The struggle in the dark; Has God forgotten Shocky? The devil of silence; Miss Martha Hawkins; The hardshell preacher; A struggle for the mastery; A crisis with Bud; The church of the best licks; The church militant; A counsel of war; Odds and ends; Face to face; God remembers Shocky; Miss Nancy Sawyer; Pancakes; A charitable institution; The good samaritan; Bud wooing; A letter and its consequences; A loss and a gain; The flight; The trial; "Brother Sodom;" The trial concluded; After the battle; Into the light; "How it came out." Price, postpaid, \$1.25. Library edition, price, postpaid. . . . . \$1.50

## The Mystery of Metropolisville.

By Edward Eggleston. Words beforehand; The autocrat of the stage coach; The sod tavern; Land and love; Albert and Katy; Corner lots; Little Katy's lover; Catching and getting caught; Isabel Marlay; Lovers and lovers; Plausaby, Esq., takes a fatherly interest; About several things; An adventure; A shelter; The inhabitant; An episode; The return; Swaney and his old love; A collision; Standing guard in vain; Sawney and Westcott; Rowing; Sailing; Sinking; Dragging; Afterwards; The mystery; The arrest; The temper; The trial; The penitentiary; Mr Lurton; A confession; Death; Mr Lurton's courtship; Unbarred; Isabel; The last; Words afterwards. Price postpaid . . . . . \$1.50



DEC 2 1899



LIBRARY OF CONGRESS



0 002 851 142 5

