

A11103 001437

NIST  
PUBLICATIONS

NAT'L INST OF STANDARDS & TECH R.I.C.



A11103001437

/Alaska arctic offshore oil spill respon  
QC100 .U57 NO.762 1989 V1989 C.2 NIST-PU

**A**

# ARCTIC OFFSHORE OIL SPILL RESPONSE TECHNOLOGY

---

## WORKSHOP PROCEEDINGS

Anchorage, Alaska  
November 29 - December 1, 1988  
*Nora H. Jason, Editor*



---

*Sponsored by Minerals Management Service, U.S. Department of Interior*

QC  
100  
.U57  
#762  
1989  
C.2

U.S. Department of Commerce  
National Institute of Standards and Technology

**NIST SP 762**

# T

he National Institute of Standards and Technology<sup>1</sup> was established by an act of Congress on March 3, 1901. The Institute's overall goal is to strengthen and advance the Nation's science and technology and facilitate their effective application for public benefit. To this end, the Institute conducts research to assure international competitiveness and leadership of U.S. industry, science and technology. NIST work involves development and transfer of measurements, standards and related science and technology, in support of continually improving U.S. productivity, product quality and reliability, innovation and underlying science and engineering. The Institute's technical work is performed by the National Measurement Laboratory, the National Engineering Laboratory, the National Computer Systems Laboratory, and the Institute for Materials Science and Engineering.

## *The National Measurement Laboratory*

---

Provides the national system of physical and chemical measurement; coordinates the system with measurement systems of other nations and furnishes essential services leading to accurate and uniform physical and chemical measurement throughout the Nation's scientific community, industry, and commerce; provides advisory and research services to other Government agencies; conducts physical and chemical research; develops, produces, and distributes Standard Reference Materials; provides calibration services; and manages the National Standard Reference Data System. The Laboratory consists of the following centers:

- Basic Standards<sup>2</sup>
- Radiation Research
- Chemical Physics
- Analytical Chemistry

## *The National Engineering Laboratory*

---

Provides technology and technical services to the public and private sectors to address national needs and to solve national problems; conducts research in engineering and applied science in support of these efforts; builds and maintains competence in the necessary disciplines required to carry out this research and technical service; develops engineering data and measurement capabilities; provides engineering measurement traceability services; develops test methods and proposes engineering standards and code changes; develops and proposes new engineering practices; and develops and improves mechanisms to transfer results of its research to the ultimate user. The Laboratory consists of the following centers:

- Computing and Applied Mathematics
- Electronics and Electrical Engineering<sup>2</sup>
- Manufacturing Engineering
- Building Technology
- Fire Research
- Chemical Engineering<sup>3</sup>

## *The National Computer Systems Laboratory*

---

Conducts research and provides scientific and technical services to aid Federal agencies in the selection, acquisition, application, and use of computer technology to improve effectiveness and economy in Government operations in accordance with Public Law 89-306 (40 U.S.C. 759), relevant Executive Orders, and other directives; carries out this mission by managing the Federal Information Processing Standards Program, developing Federal ADP standards guidelines, and managing Federal participation in ADP voluntary standardization activities; provides scientific and technological advisory services and assistance to Federal agencies; and provides the technical foundation for computer-related policies of the Federal Government. The Laboratory consists of the following divisions:

- Information Systems Engineering
- Systems and Software Technology
- Computer Security
- Systems and Network Architecture
- Advanced Systems

## *The Institute for Materials Science and Engineering*

---

Conducts research and provides measurements, data, standards, reference materials, quantitative understanding and other technical information fundamental to the processing, structure, properties and performance of materials; addresses the scientific basis for new advanced materials technologies; plans research around cross-cutting scientific themes such as nondestructive evaluation and phase diagram development; oversees Institute-wide technical programs in nuclear reactor radiation research and nondestructive evaluation; and broadly disseminates generic technical information resulting from its programs. The Institute consists of the following divisions:

- Ceramics
- Fracture and Deformation<sup>3</sup>
- Polymers
- Metallurgy
- Reactor Radiation

---

<sup>1</sup>Headquarters and Laboratories at Gaithersburg, MD, unless otherwise noted; mailing address Gaithersburg, MD 20899.

<sup>2</sup>Some divisions within the center are located at Boulder, CO 80303.

<sup>3</sup>Located at Boulder, CO, with some elements at Gaithersburg, MD.

NATIONAL INSTITUTE OF STANDARDS &  
TECHNOLOGY  
Research Information Center  
Gaithersburg, MD 20899

NIST  
20-000  
100  
100-100  
100  
100

*NIST Special Publication 762*

---

# *Alaska Arctic Offshore Oil Spill Response Technology Workshop Proceedings*

*Anchorage, Alaska, November 29–December 1, 1988*

---

Sponsored by:

Minerals Management Service  
U.S. Department of the Interior  
Reston, VA 22091

Nora H. Jason, Editor  
David D. Evans, Workshop Chairperson

Center for Fire Research  
National Engineering Laboratory  
National Institute of Standards and Technology  
Gaithersburg, MD 20899

Issued April 1989



**NOTE:** As of 23 August 1988, the National Bureau of Standards (NBS) became the National Institute of Standards and Technology (NIST) when President Reagan signed into law the Omnibus Trade and Competitiveness Act.

U.S. Department of Commerce  
Robert A. Mosbacher, Secretary

National Institute of Standards and Technology  
Raymond G. Kammer, Acting Director

---

Library of Congress  
Catalog Card Number: 89-600731  
National Institute of Standards  
and Technology  
Special Publication 762  
Natl. Inst. Stand. Technol.  
Spec. Publ. 762  
201 pages (Apr. 1989)  
CODEN: NSPUE2

U.S. Government Printing Office  
Washington: 1989

For sale by the Superintendent  
of Documents  
U.S. Government Printing Office  
Washington, DC 20402

TABLE OF CONTENTS

	<u>Page</u>
Executive Summary.....	v
Agenda.....	vii
Acknowledgements.....	ix
 INTRODUCTION.....	 1
 PANEL SUMMARIES:	
Mechanical Containment, Chairperson - H. Lichte.....	3
Mechanical Recovery, Chairperson - S. Hillman.....	7
Chemical Treatment, Chairperson - M. Fingas.....	9
In-Situ Burning, Chairperson - A. Allan.....	11
Readiness, Chairperson - D. Rome.....	15
 WORKSHOP PAPERS:	
Mechanical Containment and Recovery by H.W. Lichte.....	19
Chemical Treatment of Oil Spills by M.F. Fingas.....	27
In-Situ Burning of Oil Spills by D.D. Evans.....	47
Readiness Planning for Arctic Offshore Oil Spill Response by D.D. Rome.....	97
The Oil and Hazardous Materials Simulated Test Tank Program Efforts Arctic Oil Spill Response Technology Assessment and Development by E.J. Tennyson.....	103
Arctic Aspects of the Technology Assessment and Research Program of the Minerals Management Service by E.J. Tennyson.....	111
The Arctic and Marine Oilspill Program-AMOP by K.M. Meikle.....	117
Environmental Studies Research Funds by J.J. Swiss.....	133
Summary of the Alaska Clean Seas Research, Development and Engineering Program by R.V. Shafer.....	157
Alaska Arctic Offshore Oil Spill Response Technology by O. Angelvik.....	185
 LIST OF ATTENDEES.....	 197



## EXECUTIVE SUMMARY

Alaska Arctic Offshore Oil Spill Response Technology Workshop  
Anchorage, Alaska  
November 29-December 1, 1988

The objective of the Workshop was to provide a public forum to describe existing research programs, to identify future research needs and priorities to improve and to advance Arctic oil spill response capabilities, to present discussions of the state-of-the-art for all aspects of oil spill response under Arctic conditions and to provide information for the refinement of the existing Minerals Management Service (MMS) Technology Assessment and Research Program. The National Institute of Standards and Technology (NIST) served as the Workshop Coordinator on behalf of the MMS.

To achieve the Workshop objective, Keynote Speakers presented the current state-of-the-art in the following areas: Mechanical Containment and Recovery; Chemical Treatment; In-Situ Burning; Readiness. These presentations were followed by the status of several on-going efforts: the Technology Assessment and Research Program, the OHMSETT (Oil and Hazardous Materials Simulated Environmental Test Tank) Program, the Arctic and Marine Oil Spill Program, the Alaska Clean Seas Research and Development Program and the Norwegian Oil Spill Response (NOFO) Program.

After the Keynote Speakers' presentations in the general session, five Panels were formed from Workshop attendees and chaired by selected experts. The topical area for each Panel was the same as the above state-of-the-art papers. The goal of each Panel was to establish research needs and priorities within their area of expertise. Discussions by these Panels lead to recommendations of future research needs and testing and evaluating new techniques in specific environments representative of the Chukchi and Beaufort Seas. The major recommendations were:

- Large-scale tests (i.e., field tests) are necessary to replicate and validate innovations or to validate small-scale tests, to investigate the refinement of field measurement technique, to study the ignition and sustained combustion of emulsified oil measurements, and to investigate of the recovery of burn residue;
- small-scale tests (i.e., laboratory or test tank tests) are necessary to better understand a problem prior to large-scale testing, to investigate the ignition and sustained combustion of floating emulsified oil layers, to validate emissions from burning oils and other common air pollutants;

- research should be considered to improve current capabilities of recovering oil adhering to ice, and improving disposal techniques for oil-covered peat and other beach materials;
- chemical treating agents should be considered as a primary response tool in contingency planning, research is needed in such areas as biodegradability, toxicity, to quantify the amount of treating agent, to investigate their effectiveness in different water temperatures, to adapt existing technology to the Arctic environment;
- research on in-situ burning, e.g., oil spill burns in open water and broken ice are needed to measure burning rate, smoke emission, movement, and particulate deposition; techniques for recovering the burn residue from the water should be examined; laboratory investigations are needed to assess the feasibility of burning different oil-water emulsions and develop new techniques for burning enhancement; to address public concerns an analysis of the relative significance of oil spill burn emissions to other ordinary sources such as fireplaces, forest fires, and automobile engines was recommended;
- alternative techniques are necessary for acceptable disposal techniques, research is needed in such areas as incineration, landfilling, treatment products to solidify oil, investigation of injection/reinjection techniques into a pipeline or disposal well;
- remote sensing capabilities should be improved in the areas of reliably measuring the oil slick thickness, detecting oil in the presence of ice, and detecting sunken oil concentrations.

Although there may appear to be an overlap within individual Panel summaries, the combined research priorities and technological needs present a comprehensive view of the current Alaska Arctic offshore oil spill response technology. Recommendations for projects of a more administrative nature, e.g., a manual of transportation, logistics and support, are noted in individual Panel summaries. For more detailed information about each Panel, the reader is encouraged to review one or more Panel summaries of interest.

The Panel recommendations represent the combined input of the attendees and may serve as a working document for the MMS to refine their existing research programs.



WORKSHOP ON

# ALASKA ARCTIC OFFSHORE OIL SPILL RESPONSE TECHNOLOGY

SHERATON ANCHORAGE HOTEL, ANCHORAGE, ALASKA  
NOVEMBER 29-DECEMBER 1, 1988

## November 29

- 9 AM-12 Noon      Registration at Sheraton Anchorage Hotel  
9 AM-12 Noon      Panel Chairmen Caucus
- 1:00 PM          Welcome  
1:15 PM          Introduction by *Dr. David D. Evans*, Workshop Chairman,  
National Institute of Standards and Technology  
1:30 PM          *H. W. Lichte*, Keynote Speaker, Mechanical Containment  
and Recovery  
2:00 PM          *M. F. Fingas*, Keynote Speaker, Chemical Treatment
- 2:30 PM          Coffee Break
- 3:15 PM          *Dr. David D. Evans*, Keynote Speaker, In-Situ Burning  
3:45 PM          *Cdr. Dennis Rome*, US Coast Guard, Keynote Speaker,  
Readiness  
4:30 PM          Announcements; News Items
- Adjourn for the day

## November 30

- 7:30 AM-8:30 AM    Registration
- 8:30 AM          *Edward Tennyson*, Technology Assessment and Research Program,  
and the OHMSETT Program, Mineral Management Services  
9:00 AM          *Kenneth Meikle*, Arctic and Marine Oil Spill Program  
9:30 AM          *James J. Swiss*, Canadian Environmental Science Revolving  
Fund
- 10:00 AM          Coffee break
- 10:30 AM          *Richard V. Shafer*, Alaskan Clean Seas Research & Development  
Program  
11:00 AM          *Odd B. Angelvik*, NOFO Program
- 11:30 AM          Break for lunch

## November 30 (continued)

- 1:00 PM Participants will divide into five panels:  
Mechanical Containment - *H. W. Lichte*, Chairman  
Mechanical Recovery - *Sharon O. Hillman*, Chairwoman  
Chemical Treatment - *M. F. Fingas*, Chairman  
Is-Situ Burning - *Alan A. Allen*, Chairman  
Readiness - *Cdr. Dennis Rome*, Chairman
- 3:45 PM Coffee break
- 4:00 PM Workshop Chairmen will present 10 minute summaries of  
their progress
- 5:00 PM Announcements; News Items
- Adjourn for the day

## December 1

- 9:00 AM Workshop reconvenes and Panels resume discussions
- 10:30 AM Coffee break
- 11:00 AM Panels reconvene
- 1:00 PM Luncheon break
- 2:00 PM Individual panel presentations and discussion
- 4:00 PM Closing comments by Workshop Chairman  
Panel Chairmen submit their written summaries
- 4:30 PM Workshop closes

## ACKNOWLEDGEMENTS

No workshop is the effort of any one person. The energies and support of Ed Tennyson and John Gregory (MMS Reston Headquarters Office) and Jeff Walker and Tom Murrell (MMS Alaska OCS Region Office) helped mold the agenda and identify the speakers and participants. David Evans (NIST) did an outstanding job in keeping the speakers and panels focussed on the purpose of the Workshop. The Keynote Speakers, Panel Chairs, and Recorders provided the input for the Proceedings. Last, but not least, the editor would like to give special thanks to the numerous secretaries at MMS and NIST who provided assistance before, during and after the Workshop.



## INTRODUCTION

The Alaska Arctic Offshore Oil Spill Response Technology Workshop was held in Anchorage, Alaska, from November 29-December 1, 1988. The objective of the Workshop was to provide a public forum to describe existing research programs, to identify future research needs and priorities to improve and to advance Arctic oil spill response capabilities, to present discussions of the state-of-the-art for all aspects of oil spill response under Arctic conditions and to provide information for the refinement of the existing Minerals Management Service (MMS) Technology Assessment and Research Program. The National Institute of Standards and Technology (NIST) served as the Workshop Coordinator on behalf of the MMS.

To solicit public comments and recommendations on questions and issues relating to Arctic oil spill response capabilities, a Federal Register notice was published on July 25, 1988. Comments were sent to the MMS Reston Headquarters Office and Alaska OCS Region Office and, in turn, these comments were sent to the Panel Chairpersons so that the issues and recommendations would be addressed during the Panel sessions. A second Federal Register notice appeared on November 9, 1988 to announce the location and date of the Workshop.

To achieve the Workshop objective, Keynote Speakers presented the current state-of-the-art in the following areas: Mechanical Containment and Recovery; Chemical Treatment; In-Situ Burning; Readiness. These presentations were followed by the status of several on-going efforts: the Technology Assessment and Research Program, the OHMSETT (Oil and Hazardous Materials Simulated Environmental Test Tank) facility studies, the Arctic and Marine Oil Spill Program, the Alaska Clean Seas Research and Development, the Norwegian Oil Spill Response Organization. The next phase was for experts in the areas of Mechanical Containment, Mechanical Recovery, Chemical Treatment, In-Situ Burning and Readiness to lead the discussions and to summarize their Panel recommendations. The individual papers and recommendations of the Panels follow this Introduction.

This proceedings is the official transmittal of workshop information and recommendations to the sponsor, Minerals Management Service, Department of the Interior. It reflects the combined input of the workshop participants.

The statements and conclusions in this report are those of the authors and do not necessarily reflect the views of the National Institute of Standards and Technology.



## MECHANICAL CONTAINMENT PANEL

### Attendees

H. Lichte, Chair	W. Sackinger
L. Solsberg, Recorder	K. Meikle
W. Simpson	B. Ryan
J. Ruser	E. Tennyson
K. Hunt	

### Introduction

Three primary oil spill response techniques were identified as being worthy of consideration for future testing and evaluation. In order of priority, these were: Utilization of ice; containment booms; plunging water jet.

Each subject area was examined according to a number of response logistics concerns. In addition, seasonal conditions also were taken into account. The latter included slow and fast-moving ice (defined as having a velocity >1 knot) for each of winter, spring, summer and fall, as well as open water. Tracking oil spills also was identified as a subject area requiring further attention.

### Research Priorities

1. Utilization of ice;
2. containment booms;
3. plunging water jets.

### Utilization

#### 1. Ice as a Means of Containment

Floes could be maneuvered, as possible, using support vessels so that containment of slicks would result. Problems with this approach center around the dynamic nature of sea ice, usually involving an array of sizes and shapes which move at velocities contingent upon changing wind direction and currents. This makes judgment calls necessary for each situation involving the use of ice rather than documentation of specific methodologies that could be predictively applied. Slowly-moving ice in winter, spring and summer might afford the opportunity of using this technique.

#### 2. Water Spray

Four approaches based on the use of water spray were reviewed with general applicability to slower moving winter ice :

- a. Berm - Water/ice spray would be directed so as to create a low berm on the surface of the ice in a configuration impeding the flow of released oil. Placement of the berm might result in oil

seeping through cracks into the ice structure as critical pooling depths are reached. Research might then focus on distances from the oil release point where this technique is feasible or the possibility of using the spray to enhance encapsulation of the oil should it penetrate the ice matrix.

- b. Sorbent - Spray would be employed to take up oil much as any sorbent broadcast onto spilled oil would.
- c. Stabilizer - Water spray would be applied on sea ice overpassing a subsea blowout. The ice thus strengthened would be less prone to fracture during the winter months. Ultimately, in spring time, with the formation of melt pools and the upward migration of the contained oil through brine channels into the pools, ignition of the "fresh" slicks could be tried. Problems might be encountered in the logistics of applying sufficient spray due to ice moving at a rate that would not allow the buildup of the needed strength characteristics.
- d. Thickener/Insulator - Spray would be used to thicken ice. The resultant insulating layer is known to promote the formation of under-ice depressions which would tend to retain oil released from a subsea blowout. The insulating effects are well known and perhaps a combination of 2c and 2d might be investigated.

### 3. Creation of Open-water Lee

A boom or large diameter rope might be deployed in a catenary to entrap ice over a subsea blowout. Ice buildup would ensue, eventually resulting in the deflection of floes around the contained ice and the formation of an open water area in its lee. There, conventional containment and recovery hardware could be deployed to remove the oil. The technique could only be attempted in operable ice conditions as found on a year-round basis using vessels with appropriate ice-strengthened hulls and power plants.

#### Containment Booms

Five areas relating to conventional open-water containment barriers were discussed:

##### 1. Protocols

The need was foreseen to develop test protocols whereby booms could be evaluated for their performance in open-water Arctic conditions.

##### 2. Standards

A set of technical specifications should be precisely written for booms intended for application to the Arctic open-water offshore regime. The thermal response characteristics of materials (embrittlement temperature), grab tensile strength, tear resistance and other properties would form the basis for the standards.



### 3. Cross-Sectional Design

Tank or flume testing should be pursued in zero-ice conditions to ascertain optimum cross-sectional configurations for Arctic booms. The work should not repeat earlier investigations of boom loss mechanisms and other well-known phenomena.

### 4. Oil Tests

Field tests should be planned which concentrate on evaluating arctic booms primarily in terms of operational characteristics. Small slick releases during fall freeze-up are seen as being appropriate to provide the information sought.

### 5. Assessments in Ice Infestations

Again, field trials should be undertaken using the Arctic booms. In this case, however, oil would be contained in the open water area developing in the lee of an artificial gravel island. A fireproof boom also could be tested, safety allowing. Open-water tests might initially be conducted followed by spring or fall trials held in variable ice-encounter rate conditions. The use of lights and transmitters for the booms was noted in assisting in locating them.

## PLUNGING WATER JETS

Various configurations of plunging water jets could be used to deflect and concentrate slicks for subsequent recovery by conventional skimming gear. Off-the-shelf hardware comprises such systems which also offer advantages of being able to function in certain ice types which exist in most seasons and in high currents. Direct attachment of jets to skimmers also has been tried and could be further examined and tested.

## OTHER ISSUES

### 1. Tracking

It will be necessary in all seasons to track oil that has been released beneath ice and that remains entrapped in its structure or is released into the water. Radio-tracking Orion buoys and Argus buoys were identified as items that should be deployed and tracked in future Arctic work.

### 2. Bubble Barriers

The consensus of opinion was that past work has documented the limitations associated with bubble barriers. No further research and development is therefore recommended. Problems relate to mechanical failure and the influence of currents and sea ice which inhibit the desired effects.



## MECHANICAL RECOVERY PANEL

### Attendees:

S. Hillman, Chair	B. A'Atri
R. Schulze, Recorder	B. Eldridge
T. Murrell	P. Ferris
E. Hagstad	C. Cloutier
D. MacWatt	D. Morris
G. Reiter	E. Tennyson
B. Lerch	

### Introduction

The Panel has made recommendations for mechanical recovery of oil in various Beaufort Sea and Chukchi Sea conditions. Four areas for developing new or existing techniques in specific environments were discussed and are listed in order of importance: Oil/ice mixed field greater than 50 percent; shallow water/shoreline mechanical recovery; pack ice mechanical recovery; freeze-up.

### Research Priorities

#### Testing

1. Field work is necessary as large scale tests replicate and validate innovations;
2. laboratory work (i.e., test tanks) is necessary to better understand the problems and small-scale work is useful to inventors. However, the research effort does not replace the field (real life) conditions.

### Recommendations

1. Oil/mixed ice field greater than 50 percent
  - a. Existing methods and designs that fall into three categories:
    1. process in place to remove the oil;
    2. pick-up oil/ice, clean ice and recover oil;
    3. harness and/or deflect ice and use skimmers;
  - b. very little research has been conducted on how to clean oiled ice in the field.
  - c. do not move the ice when cleaning it. Energy requirements are excessive if the ice is cleaned on-board.
2. Shallow water/shoreline mechanical recovery
  - a. Water greater than 10 feet. A shallow ice breaker exists (The Russian River design is from \$10-30 million and there are several in use.);
  - b. water less than 10 feet. Breakup of ice may be done with controlled lightening, using electric power, high voltage capacitors (this also applies to other ice conditions). New

- amphibious ice designs should be considered as well as pontoon drag-line equipment;
- c. for the shorelines, peat can be used to collect the oil and it can then be burned; Canada has developed a hooded burner for this purpose.
3. Pack-ice
- a. Mechanical recovery cannot be done without support;
  - b. ships must be ice-strengthened, with ice-breaking capability and the ship's cooling system must be designed to avoid contamination;
  - c. over-the-front skimmers are preferable but other over-the-side, aft, etc. skimmers have certain applications;
  - d. the Finnish ice strengthened/brush design to collect oil in broken ice appears to be very acceptable.
4. Freeze-up
- a. Rapid daily freezing causes everything to freeze;
  - b. ice-breaking in shallow water until freeze-up supports on-ice work.

#### Additional Concepts

Controlled lightning may be used with 2 MM volts, high voltage charge capacitors in a series, to explode the ice. Other types of equipment would include the blowout control, the beach hood burner and the Finnish skimmer design. In addition, manufacturers and designers should visit the Arctic to gain a better understanding of the problem.

## CHEMICAL TREATMENT

### Attendees:

M. Fingas, Chair	J. Jeschke
N. Swanston, Recorder	J. Swiss
K. Durley	E. Tennyson
R. Goodman	

### Introduction

The Panel has made recommendations for chemical treatment of oil spills, as well as looking at the specific types of treating agents (TAs). The topic of remote sensing also was addressed by this Panel as the attendees felt all technological advances should be incorporated into the Proceedings.

### Research Priorities - Chemical Treatment

1. Open Ocean
  - a. Dispersant process;
  - b. dispersant field test effectiveness;
  - c. recovery agents--safe aerial application.
2. Solid Ice
  - a. Panel finds that no significant advances can be made with respect to additional research on TAs for use on solid ice.
3. Unstable Ice
  - a. Dispersant process;
  - b. dispersant field test.
4. Shore
  - a. Surface washing agents;
  - b. biodegradation;
  - c. gelling agents.

### Recommendations - Chemical Treatment

In order to ensure timely use in a response mode, all viable chemical treating agents should be considered as a primary response tool in contingency planning. This will ensure that adequate amounts of treating agents and application equipment are available in case of emergencies. In turn, it would be advantageous to expedite the approval process.

A training program is needed for potential users to become familiar with chemical treating agents (e.g., emulsion breakers). Broad participation and coordination is needed among regulators and users.

To ensure development of effective means to respond to spills, existing constraints should be liberalized to allow scientifically-sound field trials.

Various research needs have been identified for treating agents.

Gelling agents - Need improvement in:

1. Lower amount of agent required;
2. ensure improvements do not suppress burnability;
3. ensure non-toxicity of agent;
4. reduce amount of energy required to ensure that new materials work.

Dispersants - Develop means to determine effectiveness in field:

1. Evaluate past methods;
2. develop new methods.

Surface washing agents - Develop effectiveness test for cold and heated surface washing agents

Biodegradation - Adapt existing technology (i.e., southern land-farming techniques) to the arctic environment.

Recovery agents - Need to develop a safe aerial-application technique for recovery agents.

#### Research Priorities - Remote Sensing

1. Open Water
  - a. Ship-based system;
  - b. thickness measure;
  - c. sunken oil detection;
  - d. oil in water (particulate/dissolved)
  - e. characterize oil.
2. Solid
  - a. Remote detection in/under ice;
  - b. surface detection in/under ice.
3. Unstable Ice
  - a. Open water devices could work.
4. Shore
  - a. Remote detection.

#### Recommendations - Remote Sensing

Sufficient remote-sensing capability is needed to monitor slick motion and to support and/or guide countermeasures employed to respond to the spill.

Commercially available satellite imagery should be examined to determine its effectiveness in detecting oil spills.

## IN-SITU BURNING PANEL

### Attendees:

A. Allan, Chair	J. Pearce
D. Dickins, Recorder	L. Ethelbah
I. Buist	A. Sheets
D. Evans	R. Campbell
K. Saito	J. Stanger
O. Angelvik	W. Matumeck
G. Schultz	P. Devenis
F. Henicke	

### Introduction

A broad range of topics were identified and considered by the Panel. Out of this list of topics (for complete list, see "Topic Areas Discussed during Panel Session"), the key considerations were categories under two primary headings: Acceptability and Technology of Burning. Factors related to the "acceptability" of burning as a viable option were considered: products of combustion; perceived level of "control" during burning; proximity to people, equipment and biota; and perceived level of success. Factors related to the "technology" of in-situ burning also were addressed. Such factors included: methods of enhancing the burning process; refinement of ignition concepts and the various types of equipment available; refinement of the fire containment boom and the relationship and compatibility of in-situ burning with other response options.

### Research Priorities

1. Field tests - Large oil volumes
  - a. Offshore, open-water tests to gain experience and to refine field measurement techniques involving burning oil;
  - b. scaling (i.e., burn size) with respect to burn rates, intensity of burn, nature and amount of smoke and burn residue, fallout, etc.;
  - c. offshore, moving, broken ice tests to examine the above parameters and to evaluate fate and behavior of oil released into a variety of broken ice conditions;
  - d. feasibility of igniting and sustaining combustion of emulsified oils;
  - e. feasibility of recovering burn residue.
2. Laboratory work
  - a. Thermal requirements for burning and breaking down various water-in-oil emulsions (i.e., different oil types and percentages of water);
  - b. feasibility of igniting and sustaining combustion of floating emulsified oil layers;
  - c. procedures/equipment for enhanced burning (e.g., air and/or water injection);
  - d. comparative evaluation of emissions from the burning of various oils and other common air pollutant sources.

### 3. Studies

- a. Relative significance of burning versus other emission sources (e.g., fireplaces, forest fires, automotive engines, industrial smoke stacks);
- b. assessment of practical burning scenarios and strategies for arctic in-situ burning (or "operational windows"). Factors such as response time, personnel/equipment availability, staging location, etc., also should be investigated;
- c. development of public and government education programs with respect to safety, environmental impact and procedures for in-situ burning;
- d. assessment of requirements for permits to establish both simplified and practical means of conducting realistic offshore field tests.

### Low Priority Items

Devices for burning oil off the water. Open burning as a slick is far more efficient in processing large volumes of oil quickly (ca. 0.07/gal/ft<sup>2</sup>/min) than is burning through a floating device--the floating burner may clean up the burn (less smoke), but it will likely be slower and introduce additional hardware and operational constraints that can become sources for "breakdown", extra cost, complexity in planning, deployment and maintenance, etc. Burning in remote areas (even with a lot of smoke) should be kept simple, dependable and adaptable to a broad range of environmental conditions.

Additional research on melt pools (over solid ice) should be of low priority based on accomplishments to date. An exception would be the fate, behavior and combustibility of oil spilled into or beneath ice conditions typical of the late-season Chukchi Region. Differences in ice/water conditions in the Chukchi may significantly influence the timing and deployment of burning systems and techniques.

Subsea containment/burning systems. Well studied, these ideas (e.g., Sombrero) are too big, costly and difficult to deploy and to maintain to consider for further research and development at this time.

Laser ignition. Suggest no additional research on this technique in light of current proven ignition concepts.

### Additional Concepts

A wire mesh medium may be used in the apex of the fire containment boom to reduce entrainment and splashover, to heat the water and to introduce oxygen through vaporization and/or atomization at the oil/water surface during burn and radiate the heat back into the fire. This technique may also reduce smoke.

Radiation reflectors may be used along side of and/or on top of a fire containment boom to heat the oil and to enhance burning.



## Topic Areas Discussing During Panel Session

1. Products of combustion;
2. potential for burning under different environmental conditions;
3. government regulations, guidelines and checklists;
4. methods of enhancing burning;
5. feasibility of igniting/burning emulsions, weathered oils, etc.;
6. refinement of existing ignition concepts/equipment;
7. refinement of combustion processes;
8. importance of burn size on burn rate, efficiency, products of combustion, nature and amount of burning residue, etc.;
9. equipment storage and deployment concepts;
10. recovery/elimination of burn residue;
11. reignition of unburned oil/burn residue;
12. overlap/interaction with other spill response options;
13. equipment testing procedures;
14. refinement of existing fire containment systems;
15. feasibility of igniting and maintaining combustion over subsea blowout (with and without ice);
16. safety considerations involving spill ignition procedures and deployment of fire containment boom;
17. strategy/planning considerations involving in-situ burning;
18. incineration techniques;
19. methods for igniting and sustaining combustion of oil in tankers;
20. procedures for handling and deploying igniters;
21. relative significance of burning versus other activities involving air emissions;
22. thermal radiation effects upon animals, humans and equipment;
23. assessment of practical scenarios involving in-situ burning.



## READINESS PANEL

### Attendees:

D. Rome, Chair	M. Joseph
L. Ake, Recorder	J. Walker
L. Wright	K. Durley
B. McKenzie	J. Gregory
K. Gibson	R. Smith
R. Shafer	K. Gibson
B. Hutmacher	J. Janssen
J. Whitney	E. Benson
P. Bergman	G. Schultz

### Introduction

In planning for a response, the operator or person who activates the oil spill contingency plan must have an action plan which makes early decisions on the response strategy. In order to do this, the person must have a reasonable idea of what response options will have a good chance of success for cleaning up the oil and in what time frame. He/she then will know the performance characteristics of the equipment and at what times that equipment will be available for a primary, secondary and perhaps a tertiary response effort. The operator then can activate key people in the response organization, including the logistics and transportation coordinator, to get the response going.

In the design of a response structure, two key starting elements are windows of opportunity (i.e., the period during which a response option is viable) and performance criteria (i.e., how much is an option expected to affect). These two elements can drive research and development (R&D) in the response option areas (in-situ burning, mechanical cleanup and chemical treatment) because you have identified how and when they will be used. Research and development then can produce and package the equipment to satisfy the response.

Once the response options and equipment are identified, a transportation and logistics plan has to be developed which can deliver the response equipment and the necessary support organization. Maintaining the response structure throughout the effort requires additional supplies, manpower and maintenance support. In short, without a well-run logistics and transportation system, an entire response can grind to a halt.

During the spill response, surveillance and disposal also add significant transportation and technological burdens to it. The Panel discussed programs which can improve surveillance and identify disposal methods and sites. The Panel also discussed the utility of experimental oil spills in the ocean.

Specific areas of research or recommendations are provided for each general topic.

## Research Priorities

1. Refine windows of opportunity;
2. refine acceptable performance criteria;
3. refine disposal options;
4. refine transportation/logistics programs;
5. review utility of small-scale and large-scale experimental burns.

## Windows of Opportunity

Develop windows of opportunity for various response options (mechanical recovery, chemical treatment, in-situ burning, others) with consideration for the following factors:

- a. Specific types of oil to be encountered;
- b. open water to solid ice condition;
- c. trajectory modeling for oil, ice, oil/ice;
- d. physical/chemical characteristics of the oil which affect the success of a particular option;
- e. physical variables (seasonal variations, sea states);
- f. output should be "user friendly" (e.g., Field Operations Manual);
- g. develop bounds to the problem by considering both instantaneous and continuous releases;
- h. for specific areas which are environmentally critical, determine the effect on the windows of opportunity;
- i. factor in the expected efficiencies for response options.

## Performance Criteria

The Panel recommends that Minerals Management Service (MMS) evaluate the 1982 Performance Criteria developed for Outer Continental Shelf (OCS) development in the Beaufort Sea and consider:

- a. International criteria established by Norway, Japan, Canada, etc.;
- b. specific application to the Beaufort and Chukchi Seas;
- c. recovery equipment capability for a primary, secondary and tertiary response;
- d. determining requirements from an exploration vs. production perspective;
- e. response times (delivery of equipment/personnel);
- f. response structure (primary, secondary, tertiary);
- g. compatible communications;
- h. necessary support structure to maintain response;
- i. include operator input in any criteria.

## Transportation, Logistics and Support

The Panel recommends that someone develop an accurate transportation, logistics and support manual which will examine delivery systems to mount a major oil spill response and to determine expected response times. All evaluations or recommendations should be based on the windows of opportunity. This effort should result in a manual or computer program which assists responders in the logistics phase of the response. Factors that should be considered:

- a. Types and capacities of available transportation;
- b. actual or projected availability of resources;
- c. manpower requirements (number and type);
- d. transportation infrastructure which exists at the site and would be available;
- e. training required for utilization of available equipment;
- f. resources outside of the company inventory (Federal, state, local) and develop access times for these;
- g. support structure for response:
  1. fuel, maintenance, equipment storage;
  2. communications support;
  3. personnel support (shelter, food, medical);
  4. infrastructure of drilling/production platform and availability;
  5. involvement of local population in spill response and training;
  6. access of Alaska Fire Center personnel and equipment;
  7. contracting mechanisms in place to readily access equipment;
  8. identify areas of major support where equipment can be stated/supported (airport runway lengths, deep water ports, etc.);
- h. ensure that packaging and deliverability of response equipment is consistent with performance criteria;
- i. manual/program should be a joint industry/government project that also identifies areas of risk;
- j. ensure that surveillance requirements are factored into transportation needs.

## Disposal

The Panel recommends that MMS requires a manual of accepted disposal practices and disposal sites for state and local government approval. (It is suggested that the Environment Canada and Alaska Clean Seas manuals be used as guidelines.) Propose alternatives for:

- a. Incineration of both waste oil/oil debris;
- b. landfilling (encapsulating in permafrost);
- c. evaluate products that can create a temporary burn pit;
- d. injection/reinjection into a pipeline or disposal well;
- e. treatment products to solidify oils.

4

### Experimental Spills of Oil in Arctic Waters

The Panel recommends that MMS reviews the utility of controlled experimental spills. Evaluate the relative merits versus test-tank evaluations and deployment exercises (without oil).

## A Review of Mechanical Containment and Recovery

H.W. Lichte  
Mason & Hanger - Silas Mason Co., Inc.  
Lexington, Kentucky

### Abstract

The performance capability of mechanical containment and recovery equipment is reviewed to present baseline discussions for the workshop. Existing equipment, data, and experience indicates that in open calm water an oil recovery rate of 41 to 72% may be achieved. Performance will drop significantly in other sea states or ice infested waters. A typical advancing skimmer on site may recover a 100 barrel spill in eight hours, if it can store or concurrently off load the 6,300 gallons of collected oil/water emulsion. A typical offshore 600 foot skimming barrier on site may recover a 1,000 barrel spill in three hours, if it can concurrently pump to storage the 63,000 gallons of oil/water emulsion. The cold environment causes significant pump, storage, and people limitations.

Comments and recommendations submitted by invitation before the workshop as a result of the Federal Register announcement were good. The consensus for mechanical equipment is to keep improving on current designs, more field trials, and learning from other countries in cold climates. Two responders encouraged further development of a brush-type skimmer. One astute responder pointed to the need for developing cold climate hoses.

### Introduction

Mechanical containment and recovery continues to be the primary tool for clean-up of oil spills on water. The Alaska Arctic offshore oil spill response programs depend on the capability of skimmers, booms, pumps and other support equipment. Future research and development should focus on a baseline of ideal skimming capacity. This presentation is designed to catalyze discussion in the Workshop that may lead to suggestions for new R&D efforts.

Performance capability of equipment is always a controversial subject. The caveats put upon operations in the Arctic seem no more significant than those near the Equator. Sea state, physical properties of the spilled oil as it mixes with sea water, and the presence of ice or debris affects the performance. Site specific designs generally perform better.

Mechanical equipment, skimmers booms and associated hardware can and do well in the Arctic environment. The keystone to performance planning should be based upon the ideal skimming capacity and the inventory of available equipment. "We must take our hay bale and telephone pole vintage contingency plans and improve them to a point that will equate to, or almost to, the more efficient and reliable levels of response equipment and methodologies that exist today."

#### Performance Baseline

Mechanical containment and recovery performance can be no better than what there is to recover. Performance is dependent on spilled oil properties, water conditions, surface current speed relative to the recovery equipment, oil spill thickness and the equipment operators options. Rather than assume the various scenarios that may degrade or challenge performance, it is better to quantify the ideal recovery performance for a baseline. Performance can be quantified using three variables:

Throughput efficiency is the dependent variable of measured oil collected by the skimmer divided by the quantity of oil presented to and capable of being recovered by the skimmer. It is expressed as a percentage.

Recovery efficiency is the dependent variable of measured oil collected by the skimmer divided by the total fluids collected by the skimmer, oil, water, and emulsions. It is expressed as a percentage.

Oil recovery rate is the dependent variable of oil collection rate. It is usually expressed in gallons per minute.

Efficiency is based upon the amount of oil available for recovery. The oil recovery rate can be no better than the pump capacity available to the recovery system. To find the ideal mechanical skimming capacity, we first need to mathematically eliminate the sources of performance degradation such as oil character, sea state and floating ice. Now we can view the simple relationship of a pure oil slick of a known thickness and width floating on calm water with a known relative speed to the recovery system. Incoming oil (Q, gallons per minute) is equal to the slick thickness (t, millimeters) times the slick width (W, feet) times the advancing speed (V, knots) and divided by a unit conversion constant of 40.75.

$$Q = \frac{t \times W \times V}{40.75}$$

Figure 1 demonstrates trends of skimming capacity (incoming oil) increase as a function of encounter width (slick width) for a normal slick thickness of one millimeter and a skimmer advancing speed of one knot. If one selects the encounter width ordinate of a typical skimmer to be ten feet wide, you can see the abscissa at 25 gallons per minute. Thus, ideally the pump capacity need



not be more than 25 gallons per minute for a perfect skim. Further calculations reveal that a 100 barrel neat oil spill would require 2.8 hours to collect.

Table 1 illustrates the resultant calculations for estimating a 100 barrel spill on an ideal water surface. Clean-up time (T, hours) is equal to the spill quantity divided by the estimated efficiency (E, percent) with the appropriate unit conversions. Incoming neat oil is calculated as above at a one millimeter slick thickness and advancing at one knot.

$$T = \frac{100 \times 42}{Q \times 60 \times E}$$

Projecting these algebraic relationships in a combined worst case of a floating 50% oil/water emulsion (100 barrels), 50% throughput efficiency, and a 50% recovery efficiency, we can calculate the collection time to increase nearly an order of magnitude to 22 hours. The maximum gross system efficiency is thus calculated as the product of the possible performances to be 12.5%, 50% times 50% times 50%. Note there will be 200 barrels of fluid collected, 50 of which may be recovered oil.

Figure 1. Trends of Mechanical Containment Skimming Capacity

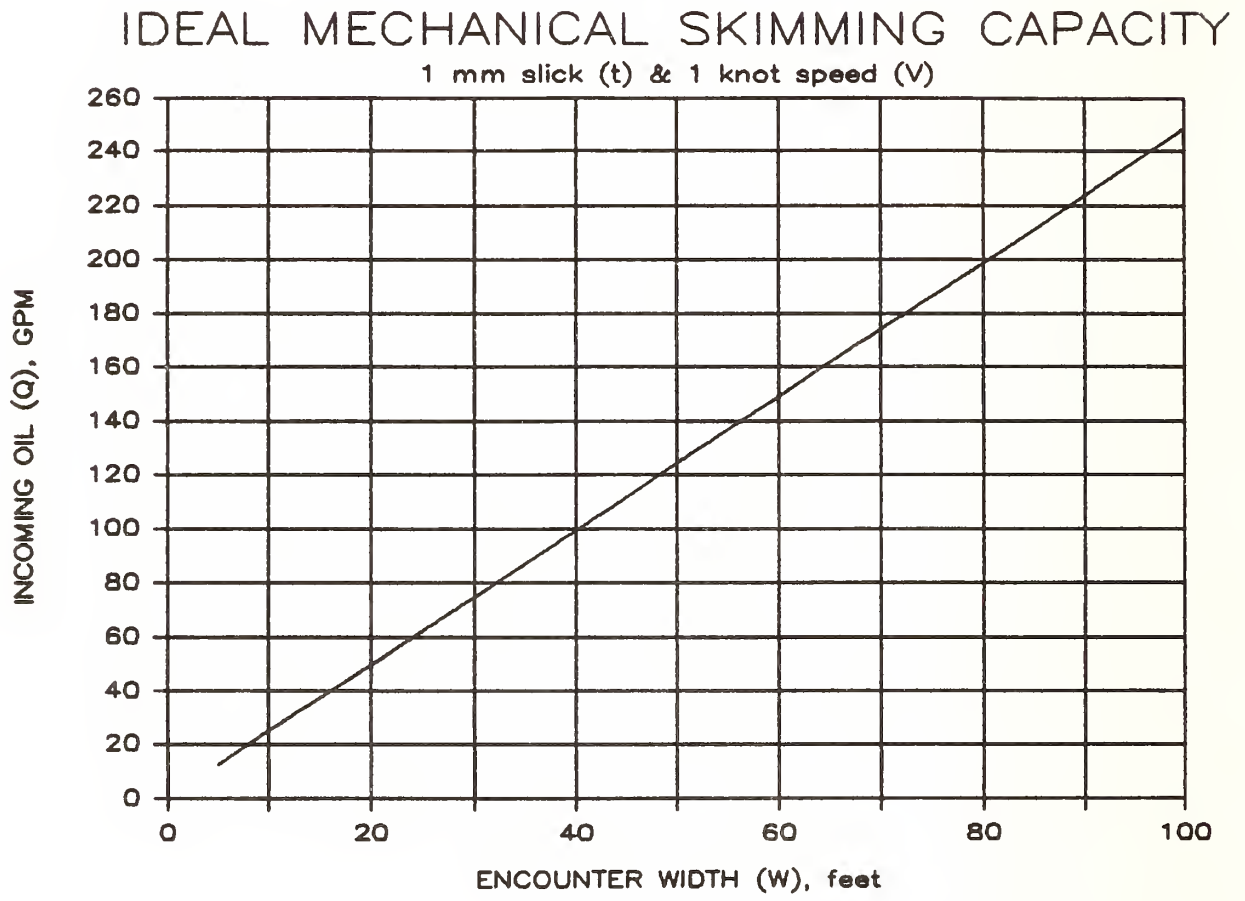

Table 1. Estimating a 100 Barrel Spill Clean-Up Time at 1mm and 1kt.

Skimmer Opening,	Incoming Oil/Emulsion,	Clean-up Time, hours.....			
		Gross System Performance Efficiency			
W (feet)	Q, (GPM)	100%	67%	50%	33%
5	12	5.6	8.4	11.2	17.0
10	25	2.8	4.2	5.6	8.5
15	37	1.9	2.8	3.8	5.8
20	50	1.4	2.1	2.8	4.2
25	62	1.1	1.6	2.2	3.3
30	75	0.9	1.3	1.8	2.7
35	87	0.8	1.2	1.6	2.4
40	99	0.7	1.0	1.4	2.1
45	112	0.6	0.9	1.2	1.8
50	124	0.6	0.9	1.2	1.8
55	137	0.5	0.7	1.0	1.5
60	149	0.5	0.7	1.0	1.5
65	162	0.4	0.6	0.8	1.2
70	174	0.4	0.6	0.8	1.2
75	187	0.4	0.6	0.8	1.2
80	199	0.4	0.6	0.8	1.2
85	211	0.3	0.4	0.6	0.9
90	224	0.3	0.4	0.6	0.9
95	236	0.3	0.4	0.6	0.9
100	249	0.3	0.4	0.6	0.9

## Suggested Reading

The Bibliography cites various publications readily available that illustrate a generous baseline state-of-the-art cross-section of quantitative data for mechanical containment and recovery. Unfortunately there is not much written for the ice-infested environment. This factor certainly is a driving force in the need for this Workshop.

## Pre-Workshop Response

The Minerals Management Service proposed four questions or issues as a focus for the Workshop. One, "Are there existing or new response techniques, equipment, or products, including chemical additives, which have the potential for arctic application but have not been tested or evaluated and which should be considered for future testing and evaluation? Two, "Are there new techniques or processes available which can be used to better test and evaluate equipment efficiency and effectiveness and which have not been used previously? Three, "Are there areas where continued research is unnecessary? Four, "What should the research priorities be in each category of detection, containment, recovery, and disposal for open water, solid-ice, and unstable ice conditions?

There were sixteen written responses prior to the Workshop that suggested various degrees of research and development programs. Only a few of these addressed or put emphasis on mechanical containment. More commonly they emphasized either dispersants or burning to combat oil spills in the Alaskan Arctic.

One equipment manufacturer suggested further development and field testing of his successful disc skimmer. He also pointed out the advantages to using a "snake-like" boom in ice infested waters. Another equipment manufacturer coincidentally with a major international oil company discussed the advantage of further developing a "brush type" skimmer. The same oil company had another good suggestion that of developing better oil transfer hoses for the harsh Arctic environment. Lastly, one common thread in all the written responses was the recommend-ation for more field testing, especially with oil.

## BIBLIOGRAPHY

- Belen, M. S., W. J. Lehr, and H. M. Cekirge, 1981. "Spreading, Dispersion and Evaporation of Oil Slicks in the Arabian Gulf." Proceedings of the 1981 Oil Spill Conference. American Petroleum Institute, Washington, D.C. p161.
- Blaikley, D. R., and G. F. L. Dietzel, A. W. Glass, and P. J. van Kleef, 1977. "Sliktrak - A Computer Simulation of Offshore Oil Spills, Cleanup, Effects and Associated Costs." Proceedings of the 1977 Oil Spill Conference. American Petroleum Institute, Washington, D.C. p45.
- Donohoe, M. J., 1981. "Contingency Plans: A Useful Tool or Bureaucratic Burden?" Proceedings of the 1981 Oil Spill Conference. American Petroleum Institute, Washington, D.C. p513.
- Fay, J. A., 1971. "Physical Processes in the Spread of Oil on a Water Surface." Proceedings of the 1971 Conference on Prevention and Control of Oil Spills. American Petroleum Institute, Washington, D.C. p463.
- Griffiths, R. A. and J. H. Milgram, 1977. "Combined Skimmer-Barrier High Seas Oil Recovery System." Proceedings of the 1977 Oil Spill Conference. American Petroleum Institute, Washington, D.C. p375.
- Lichte, H. W. and M. K. Breslin, 1978. "Testing Skimmers for Offshore Spilled Oils." Proceedings of the 1978 Offshore Technology Conference. Offshore Technology Conference, Houston, Texas, p247.
- Lichte, H. W., M. Borst, and G. F. Smith, 1981. "Tests of the Shell SOCK Skimmer Aboard USNS POWHATAN." EPA-600/2-81-216, NTIS PB-82 220849, U. S. Environmental Protection Agency, Cincinnati, Ohio, 81pp.
- Lissauer, I. M. and D. L. Murphy, 1979. "Oil Spill Forecasting - Where is it Going." Proceedings of the 1979 Oil Spill Conference. American Petroleum Institute, Washington, D.C. p649.
- Raj, P. K. and R. A. Griffiths, 1979. "The Survival of Oil Slicks on the Ocean as a Function of Sea State Limit." Proceedings of the 1979 Oil Spill Conference. American Petroleum Institute, Washington, D.C. p719.
- Schulze, Robert, 1986. "World Catalog of Oil Spill Response Products." Robert Schulze Environmental Consultant, Inc. Elkridge, Maryland, 308p.

Smith, G. F. and H. W. Lichte, 1981. "Summary of U. S. Environmental Protection Agency's OHMSETT Testing. 1974-1979." EPA-600/9-81-007, NTIS PS-81 163743, U. S. Environmental Protection Agency, Cincinnati, Ohio, 341pp.

Solsberg, L. B., 1986. "A Catalog of Oil Spill Containment Barriers." Report EPS 9/SP/1, September 1986, Environment Canada, Ottawa, Ontario, 207p.

## CHEMICAL TREATMENT OF OIL SPILLS

Merv F. Fingas  
Environmental Emergencies Technology Division  
Environment Canada  
Ottawa, Ontario

### Abstract

This paper is a review of 10 types of chemical treatments for oil spills. Gelling agents change oil to a solid or semi-solid form, but are not used because of the large amount of agent required. Biodegradation agents consist of bacteria, enzymes, fertilizers or combinations of these and are found to have low effectiveness in open water and on soils. Degradation is limited to a small fraction of the oil. Sinking agents cause the oil to be sunk to the bottom. They are not used because of ineffectiveness and because of the increased oil exposure caused by resurfacing of oil. A number of recovery aids have been proposed, but only Elastol has been tested and proven to function well under a variety of conditions. A number of water-in-oil emulsion preventers and breakers have been proposed, but none are commercially-available. Demoussifier developed by Environment Canada has been recently tested and found to be effective. Surface washing agents contain surfactants and because they are soluble in water, can only effectively be used on solid surfaces and as such have little application to oil spills. Dispersants contain surfactants which break up oil into small droplets in the water column. Dispersants are the most common treating agents and have been extensively tested and used. No undisputed documentation exists to show that dispersants have been very effective in field situations, but analytical means to measure effectiveness are poor. Dispersant action mechanisms are poorly understood and there exist a number of interferences to field effectiveness. A number of other treating agents have been proposed, but none are in current use. The main problem with most treating agents is their effectiveness and this is often dependent on molecular size and type. Oil has many molecular types and sizes, thus rendering treatment much less than totally effective.

### Introduction

A number of chemical agents have been commercially sold over the 20 years since the TORREY CANYON incident during which some of these chemical treatment concepts were first tried on a large scale. These chemical spill control agents can be classified as the following:

1. Dispersants,
2. Gelling agents,
3. Biodegradation agents,
4. Sinking agents,
5. Recovery aids,
6. Emulsion breakers and preventers,

7. Surface washing agents,
8. Herding Agents,
9. Combustion Promoters, and
10. Miscellaneous agents.

During the past twenty years many agents have come and gone. During the seventeen years of the life of the Environmental Emergencies Technology Division over 100 dispersants were tested for toxicity and/or effectiveness. Only 8 products still remain on the accepted list and only about 15 products are still being produced. The compendium on oil Spill treating agents prepared for the American Petroleum Institute in 1972 lists 69 dispersants and 43 beach clean-up agents, most of which are dispersants.<sup>1</sup> Only two of these are current commercial products, but both are produced in different formulations. Four gelling agents were tested by EETD and others; none remain on the market. The API compendium listed four different gelling agents. Over 50 biodegradation agents, including bacterial mixtures, enzymes or fertilizers have been proposed and only 5 of these, all very recent inventions, remain on the market. Ten sinking agents have been examined with none remaining commercial. The API compendium lists 18 sinking agents. One recovery aid of the several proposed, Elastol, still remains. Ten emulsion breakers and preventers have been on the market. None are commercially available at this time. Over 100 surface washing agents have been sold in the North American market. About 12 of these are still commercially available. A number of agents which have been sold for various purposes, but do not fit into the above categories, include those that help trace or detect an oil, those which are combinations of the categories described above, and those very vague items that are claimed to make oil disappear, become non-toxic, etc. It is estimated that over 100 of this category of agent has been offered at one time or another on the North American market. The total number of agents proposed world wide is estimated to be 600, of which only about 200 were ever tested in lab or field, even in a limited way. It is also estimated that only 35 agents actually are commercially available at this time. The bustle of activity in this field has left the buyer confused and skeptical of treating agents.

Many agents are offered to the potential buyer as a magic cure and some buyers expect miracles from the product. Demonstrations are often presented which show the product to work very effectively. One firm recently had an oil-disappearing demonstration, which they would only do in their own plant "to ensure proper conditions". Oil was poured into a glass of water, and the magic solution was added; this caused significant fizzing, and then the demonstrator drank the clear liquid, the oil supposedly having been reduced to elemental gas. Interestingly, this demonstration would not work in other laboratories. The firm is no longer in business.



The history of chemical agents and oil spills have left many, and especially the experienced, oil spill worker skeptical about any oil spill chemical control agent. Rarely a week goes by in EETD laboratories where we aren't approached by someone offering a new magic cure. The same is true of the potential customers of such products. Any new agents, even if it may have potential is treated with the same sort of skepticism, perhaps even disdain, reserved for the weekly 'snake oil'. A number of agents do however offer assistance in dealing with oil spills. No agent is a magic cure nor is there any agent that has wide applicability. All agents suffer from limited effectiveness with oil, especially with certain types of oil.

Effectiveness will remain the major problem with most treating agents. Effectiveness is generally a function of molecular size and type. Crude and refined oil products have a wide range of molecular sizes and composition. What is often effective for a small asphaltene is ineffective on the large asphaltene. What is effective on an aromatic compound may not be effective on a polar compound. Additionally, the composition of crude oils varies widely. This leaves little scope for a universally-applicable and effective spill control chemical.

#### Gelling, Biodegrading and Sinking Agents

Gelling agents are those agents which change liquid oil to solid. Also known as solidification agents, these agents consist of polymerization catalysts and cross-linking agents. Agents which are actually sorbents are not considered to be gelling agents. Three significant gelling agents were tested by Environment Canada and others in recent years:

1. The BP (British Petroleum) product which consisted of deodorized kerosene and a cross-linking agent,
2. A Japanese product consisting of an amine agent which formed a polymer, and
3. The solidification agent proposed by Professor Bannister of the University of Lowell, an agent which used liquefied carbon dioxide and an activating agent.

During tests conducted in the laboratory, all three agents functioned, but required large amounts of agent to effectively solidify the oil. Under some situations the oil became a semi-solid which would not aid in recovery. The BP agent worked better than the other agents and was tested in larger scale by the Canadian Coast Guard and the Canadian oil industry. In these large scale tests even more agent was required to solidify the oil, in fact up to 40% of the actual volume of the oil itself. This is double the laboratory requirement. Both requirements were deemed to be far in excess of what was actually practical in the event of a real spill.

Because of the large amount of agent required, gelling agents are not used nor stocked for use by spill responders.

Biodegradation agents are of four basic types:

1. those that contain mutant bacteria,
2. those containing enzymes,
3. those containing nutrient materials to foster biodegradation, and
4. those containing two or more of the above.

Laboratory tests on products utilizing mutant bacteria have shown an increased degradation rate. Treatments in impoundments or sewage-treatment facilities appear to have been effective. The rate of biodegradation is dependent on concentration and type of oil as well as temperature. Field tests have shown no beneficial effect, on water or on soil. In water, the bacteria is far too dilute to have significant effect. On soil, degradation is limited to certain components of the oil, and thus has no significant overall benefit. Again, the fact that oil consists of a large variety of chemical groups and a large variety of molecular sizes, is very significant in determining effectiveness.

Although a large number of enzyme agents have been examined, none of these survived initial laboratory assessment. None showed any effect on oil even under optimal conditions. Examination of some of these products showed that they were actually domestic laundry soap with enzymes. It is not certain at this time if any specific enzymes were ever designed for crude or refined oil breakdown, or even if this is possible.

Many agents have been proposed for assisting the microbial breakdown of oil. Most of the agents contain an oil-soluble fertilizer, others an ordinary fertilizer. Tests of these products in water have shown no benefit. However, on shorelines, the results are mixed. During the course of the BIOS experiments, oiled supratidal sediments were treated with fertilizer and these plots showed no increased degradation through five years of monitoring.<sup>2</sup> A test of one product on a real spill in British Columbia showed no increased degradation on oiled rocks treated with a fertilizer.<sup>3</sup> Tests on Arctic shorelines in Norway showed increased biodegradation.<sup>4</sup> A novel product which uses a surfactant to suspend fertilizer and make it more available to the oil has been tested on oiled plots and favorable results reported.<sup>5</sup> None of the tests have reported significant oil removals with fertilizer-enhanced biodegradation.

The variable but generally poor results have discouraged widespread use of biodegradation agents.

Sinking agents were used at the time of the TORREY CANYON with disastrous environmental results.<sup>6</sup> The use of lime to sink the oil en masse led to smothering of many bottom-dwelling organisms. In addition, the use of the agent actually increases exposure to oil. As the oil moves through the water on the sinking agent it dissolves in the water and also a certain percentage frees itself from the sinking mass and rises to the surface. During the passage through the water column the sinking oil mass and the resurfacing oil can encounter marine life. The increased hydrocarbons in the water increases

exposure. The sinking mass causes suffocation to bottom life and also exposes many bottom-dwelling organisms to oil. Problems do not end here. None of the agents are effective in holding the oil for a long period of time and the slowly leaching oil re-contaminates the water and the water surface over the few days after the initial sinking. A study on several sinking agents by Environment Canada showed that most agents retained only 20 to 40% of the oil after one hour and much less after 72 hours.<sup>7</sup>

No sinking agents are commercially available at this time and their use is generally forbidden by environmental regulatory agencies.

Burning agents are also not commercially available at this time. They consisted of two generic types, sorbents and pyrotechnical compositions. The sorbent types operated by collecting oil in thicknesses sufficient to burn and the pyrotechnical compositions release large amounts of heat on combustion, thereby aiding in flame propagation. Neither type functioned well in actual practice and were limited by the large amount of material needed to actually cause a beneficial effect.

Herding agents were proposed to stop or reverse oil spill spreading. Commercially-successful types such as Shell Oil Herder employed large-chain alcohols which have a greater spreading coefficient than oil on water and thus push oil films together. Tests and actual use of these products showed that utility was limited to absolutely calm waters.<sup>8</sup> There is little remaining use of herders at this time due to their limited application and operating spectrum.

#### Recovery Aids and Demoussifiers

A number of agents have been sold throughout the years for assisting in the recovery of spilled oil. None have been widely known or promoted except for Elastol. Earlier agents were not well tested nor were they sophisticated. One product was shredded peat moss and was claimed to improve the recovery efficiency of sorbent-surface devices. None of these earlier agents offered enough promise to warrant testing.

A number of agents were also available to break or prevent emulsions. Most agents were hydrophilic surfactants, that is with surfactants with an HLB (hydrophobic-lipophilic balance) of 12 to 19. Such surfactants have the ability to reverse the emulsion from water in oil to two separate phases. The problem with a surfactant with an HLB in this range is that the surfactant is more soluble in water than in oil and will quickly leave the system if there is sufficient water. Obviously such products cannot be successfully used on open water. Some recent products avoided this problem by using a lower HLB surfactant and accepting the resulting decrease in effectiveness. One recent product developed by Environment Canada does not use surfactant in the normal sense of the word. This product does not suffer the limitations noted above.

One study reviewed two commercial products, Exxon Breaxit and the Shell product, LA 1834 and a surfactant, sodium dioctyl sulfosuccinate.<sup>9</sup> All three products functioned in a limited way, but only the Shell product prevented the formation of emulsions over a wide range of oils and conditions. The Shell product and the Exxon product are not commercially available, but have been obtainable in small quantities for testing.

The United States Minerals Management Service and Environment Canada joined forces to evaluate two new and promising treating agents, Elastol, a recovery-enhancement agent, and Demoussifier, an emulsion breaker and preventer. Results of the extensive testing on these products have been widely published.<sup>10-15</sup>

Elastol is a white powder and renders oil visco-elastic making it adhesive to oil spill recovery surfaces. Elastol is composed of a non-toxic polymer, polyisobutylene. Demoussifier is a mixture of long-chain polymers which again have no measurable toxicity to humans or aquatic life. This product was developed at Environment Canada's River Road laboratories and functions both to break emulsions and prevent their formation.

The laboratory work on Elastol involved several different tests. The effect on a suite of different oils was determined by measuring the time to initiate change and the degree of elasticity formed. These oils included: Prudhoe Bay, Alberta Sweet Mix Blend, Norman Wells, Bent Horn, Hibernia, Tarsiut, Atkinson, Amauligak crudes, diesel fuel and a Bunker C Mix. All oils displayed viscoelastic properties when treated with doses of 600 to 6000 ppm Elastol. In general, more viscous oils tended to attain a higher degree of elasticity than non-viscous oils, but did so over a longer period of time. No simple correlation could be established between an oil property and Elastol effectiveness. Elastol effectiveness is enhanced by mixing and by higher temperatures, although the latter may be the effect of decreasing oil viscosity.

Under low mixing energy conditions, oils exhibited some degree of elasticity within 15 minutes of Elastol application. A high degree of elasticity was not observed until after one hour. Less viscous oils took less time to reach maximum elasticity and viscous oils more time. If left to weather, Elastol-treated oil became more elastic with the increasing viscosity of the oil. In fact, some samples left for 30-day periods became as elastic as rubber bands sold for stationery purpose. This effect has been ascribed to the effect of the increasing viscosity of the oil with weathering (evaporation) and not the progressive reaction of the Elastol.

Elastol causes a minor reduction in the rate of oil evaporation, but not significant enough to reduce its flash point. Elastol reduces slick spreading to a limited degree, especially at high concentrations. This effect, about 20%, is not believed to have a significantly useful benefit by itself in real applications. When Elastol is applied in very large doses, >1%, the slick would actually contract somewhat, but again, the

effect is too small to have any practical benefit. The addition of Elastol either had no effect or an inhibiting effect on the formation of water-in-oil emulsions, except in the case of the Amauligak and Tarsiut oils from the Beaufort Sea region. In two cases, the application of Elastol to emulsified oil actually led to some measurable de-emulsification. Application of Elastol to stable water-in-oil emulsions sometimes had little effect. Testing with the Demoussifier showed the Elastol has no effect on its operation and that both products could be used together.

Elastol reduces chemical dispersant effectiveness by as much as one order of magnitude. Elastol also reduces natural dispersion of oil into water by as much as 3 orders-of-magnitude. This property, while superficially appearing negative, is actually quite useful. If Elastol was used in situations where the aquatic life is very sensitive and important, it could reduce oil concentration in the water to threshold values.

Both Elastol and Demoussifier were tested on a large scale using the Esso test tank in Calgary, Alberta. Funding for this part of the program was provided by the U.S. Minerals Management Service, Environment Canada and Esso Resources. An application device was developed for both products as commercial ones did not exist. The application devices were tested in larger vessels before proceeding to the larger Esso facility, to ensure that application did not affect results.

In the large scale tests, two slicks were put out simultaneously in parallel booms. This permitted the simultaneous testing of a control and a treated slick under identical conditions. The first two days were devoted to the testing of demoussifier. The demoussifier prevented the formation of water-in-oil emulsions on both slicks and did so at treatment ratios as low as 1:2000 (500 ppm). Elastol was tested on the final two days. In the first of these tests, Elastol was added to a test crude oil at 4000 ppm and the test slick was released several hours later when the oil was highly elastic. Although not thick enough to burn, the high elasticity increased the recovery rate by a rotating disk skimmer. On the fourth day of testing, crude oil was treated with 2000 ppm of Elastol and recovered with a skimmer. The recovery rate was again high and exceeded the capacity of the pump to remove it. On this particular day, the oil in the untreated slick had formed an emulsion. This was treated with demoussifier as was the Elastol-treated slick. The demoussifier broke the emulsion in the untreated slick and no emulsion formed in the treated slick, nor were any other effects noted. It was concluded that Demoussifier and Elastol could be used together to enhance recovery and eliminate emulsion.

The tank scale tests showed that there were no scaling effects for either the Elastol or the Demoussifier. Both products worked well for the intended purpose. Elastol increased the visco-elasticity of the oil and greatly increased the skimmer recovery rate. Elastol, however, did not reduce the spreading or increase the thickness of the slick sufficiently to allow in-

situ burning. Demoussifier prevented the formation of water-in-oil emulsion and also broke emulsion already formed. Although demoussifier causes the oil to be less adhesive and lowers the recovery rate of skimmers, the two products can be applied together to achieve positive results.

The two products were then tested on a large scale offshore. The sponsors of this test included; U.S. Minerals Management Service, Environment Canada, Esso Resources and the Canadian Coast Guard. The field trail was conducted 50 miles offshore Nova Scotia. Five slicks of five-barrels each were laid for each of the products and each product was tested both pre-mixed and by application-at-sea, to confirm that application effects were not a factor. The treatments and results are summarized in Table 1.

TABLE 1 TREATMENTS AND RESULTS OF TRIALS

Trials	Slick	Sample 1					Sample 2					
		Treatment (ppm)	Time (min.)	Viscosity (cSt)*	Water Content	Elasticity	Comments	Time (min.)	Viscosity (cSt)*	Water Content	Elasticity	Comments
Demoussifier	1	1000	60	10 000	84%		No mousse formed	300	84 250	90%		No mousse noted
	2	250	60	2 700	54%		No mousse formed	300	62 250	93%		No mousse noted
	3	control	60	6 350	88%		Heavy mousse	270	320 000	95%		Heavy mousse
	4	post-4000	60	2 200	72%		Moderate mousse	pre-240 post-270	105 000 22 600	90% 78%		Heavy mousse Treatment broke mousse
	5	pre-1000	15	970	32%		No mousse formed	280	38 500	80%		No mousse formed
Elastol	6	3000	130	29 300		1.33	Moderately elastic	280	300 000		1.35	Highly elastic
	7	1000	145	32 250		1.28	Low elasticity	280	228 000		1.33	Moderately elastic
	8	control	135	187 000		0.99	No elasticity, widespread	290	242 000		0.99	No elasticity, widespread
	9	9000	120	93 000		1.99	High elasticity	330	696 000		2.63	Super elastic
	10	pre-3000	115	170 500		1.35	Moderate elasticity	315	156 000		1.57	Highly elastic

\* 1 cSt =  $1 \times 10^{-2}$  cm<sup>2</sup>/s

The demoussifier trials were performed by laying down a five-barrel oil slick, treating it with the product at the specified ratio, taking samples at subsequent intervals and measuring the water content and the viscosity. One slick was left untreated and then treated at the 240-minute interval to test the demoussifier's ability to break emulsion at sea. As can be seen by the large reduction in viscosity (105,000 to 22,600 cSt) over the 30-minute period between samples, the product worked well to break the emulsion. The product continued to work well over the five-hour test period to prevent the formation of emulsions. This is illustrated in Figure 1, by the strong correlation between the viscosity and the amount of treatment.

The water content of slicks was universally high, even in those slicks that did not form water-in-oil emulsions. Although water content is indicative of the formation of water-in-oil emulsions, the stability of the mixture would have to be determined because the unstable emulsions lose water over time. All slicks laid over the two-day period rapidly took up water,

although only slicks not treated with demoussifier during the first day formed stable emulsions.

The Elastol tests were performed in an analogous manner to that of the Demoussifier, with one control slick laid and one slick being pretreated to test the effect of at-sea treatment. The slicks were sampled periodically and both viscosity and elasticity were measured immediately on board ship. The elasticity of the treated slicks was significantly higher than that of the untreated slicks and corresponded to that experienced in the laboratory. In fact, as shown in Figure 2, it actually exceeded laboratory results at higher doses. This unexpected result is probably due to the better mixing achieved in the field situation.

Both agents functioned well in large-scale tests offshore. Both agents were shown to have beneficial effects when used for their intended purpose under all conditions tested.

#### Surface Washing Agents and Dispersants

The most common and most suggested treating agent are those containing surfactants as the major ingredient. These agents have been divided into two groups, dispersants and surface washing agents. The reason for this division will become readily apparent.

Surfactants have varying solubility in water and have varying actions toward oil and water. One parameter that has been used to characterize surfactants is the HLB or the hydrophilic-lipophilic balance.<sup>16</sup> A surfactant with an HLB of about 1 to 8 promotes the formation of water-in-oil emulsions and one with an HLB in the range of 12 to 20 promotes the formation of oil-in-water emulsions. Dispersants have HLB's in the range of 9 to 11. The HLB range as defined is only applicable to non-ionic surfactants, however ionic surfactants can be rated using an expanded scale and often have HLB's ranging from 25 to 40. They are strong water-in-oil emulsifiers, very soluble in water, relatively insoluble in oil, and generally work from the water to any oil present.

Such products have little applicability to oil on water because they rapidly disappear in the water column, having little effect on oil. However, because of their commonality and cheapness many ionic-surfactants are proposed as dispersants. It is these agents, that should be better classed as surface-washing agents.

Surface-washing agents then are surfactant-containing mixtures with high HLB's and are best suited to removing oil from solid surfaces such as roads and parking lots. EETD has been trying to develop an effectiveness test for such agents, but has had no success to date; no agent has performed better than water. Many such agents come onto the market each year, many are re-packaged industrial cleaners and have little utility in spills. Use on heavily oil-encrusted concrete has shown some value, but such applications are not typical of spills.

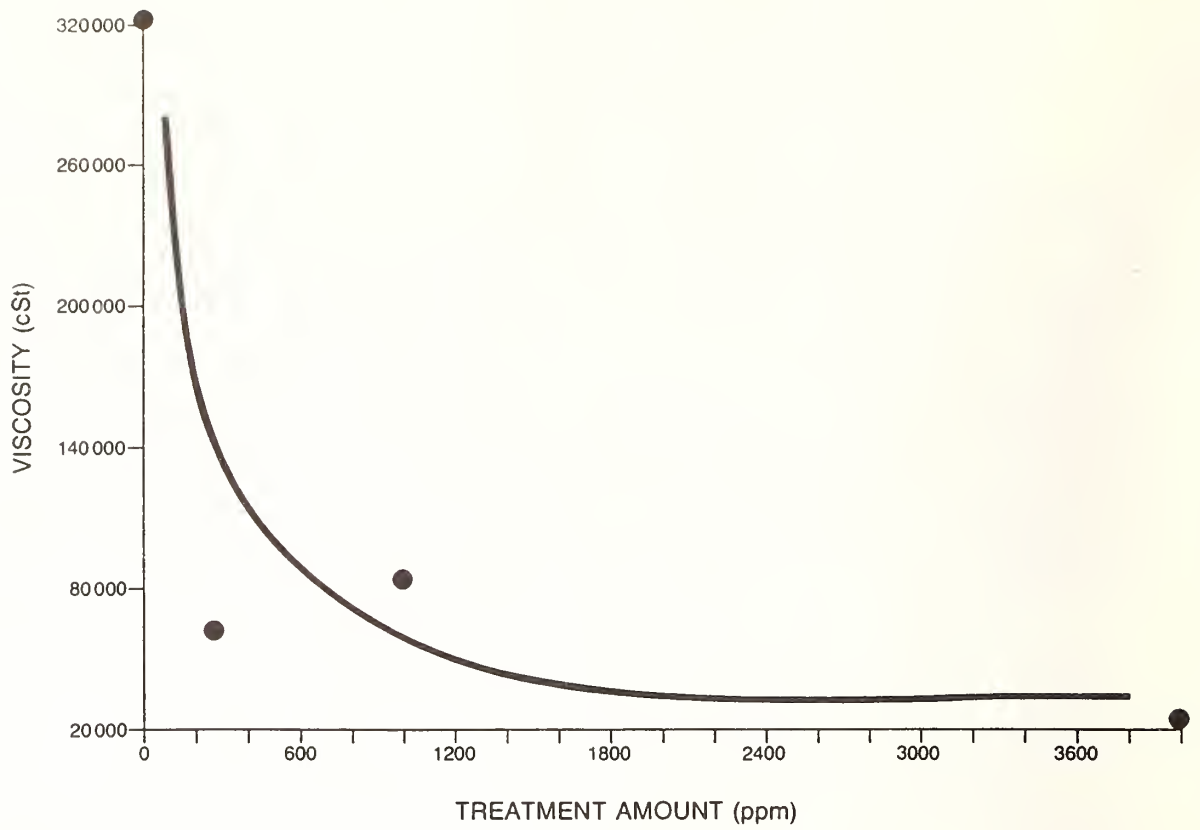

FIGURE 1 THE EFFECT OF DEMOUSSIFIER APPLICATION ON VISCOSITY

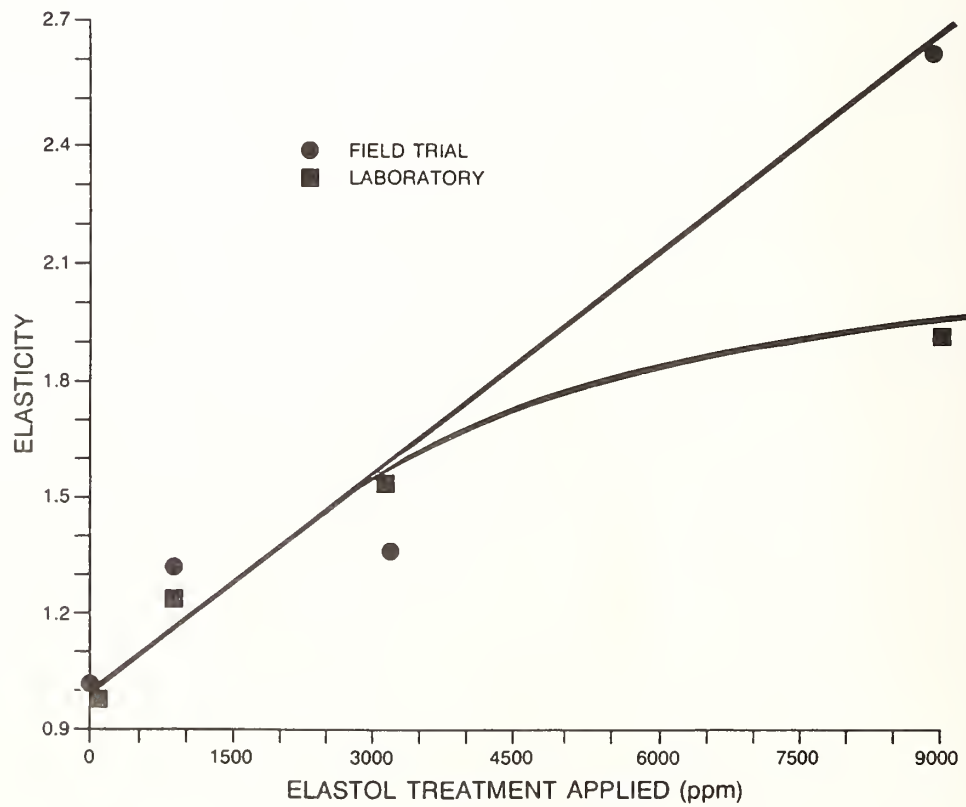

FIGURE 2 ELASTICITY OF OILS AFTER ELASTOL TREATMENT



Dispersants are the biggest class of oil spill treating agents and have perhaps generated the greatest amount of studies and discussion since the birth of the oil spill industry twenty years ago after the TORREY CANYON incident. Discussion is still as lively today and there still exists a polarization between dispersant proponents and opponents. Little has changed in the way of documentation. There is still no undisputed documentation on large-scale experiments or use to show that dispersants are effective or not. Similarly, no large scale biological experiments have convinced all environmentalists that the use of dispersants is safe in all conditions, although the evidence is becoming increasingly clear that dispersants cause little ecological damage above that by un-treated oil and that they could in fact minimize ecological damage if they were effective.

The U.S. Minerals Management Service led the support of a National Academy of Science study of the dispersant situation. The study, which began two years ago and used literature up to that point, has recently released its conclusions and will shortly release the entire report.<sup>17</sup> Two main questions were first answered about dispersants. The first, "do they do any good", is answered with a resounding "maybe". The reason is that only in a few tests were dispersants shown to be effective; in most others they were not. The two pages containing this answer are a politician's dream in circumlocution, but the fact remains that there is still no undisputed and well-documented case where dispersants have been shown to have effectiveness values above 50%.

The second major question, "Do they do any harm", was answered in a shorter, but similarly circumlocutory manner. The best interpretation of the answer is that dispersants will not cause harm.

A number of recommendations were also made:

1. That dispersants might be considered as a first-response option along with mechanical clean-up,
2. That a rapid decision-making process be put into place to allow use while oil is still dispersable,
3. That ecological assessments of dispersants be made at sites where the water is shallow to clarify differences between dispersed and untreated oil,
4. A large number of physical studies be undertaken to determine the physics and chemistry of dispersant action and interaction,
5. That biological research should employ realistic field concentrations,
6. That dispersant formulations should be made readily available to researchers,
7. That methods be developed to compare field and laboratory exposures,
8. That degradation rates of dispersed versus non-dispersed oils be examined,
9. That additional ecological studies in shallow waters

with defined circulation be conducted,

10. That studies of fur and feather insulation after exposure to dispersed oil, hatchability of eggs and effects of ingested oil be made, and

11. That remote sensing and other analytical equipment is needed to determine field effectiveness.

While useful, the recommendations should be taken in the context of the process by which they were developed. The weaknesses of the NAS recommendations include the following:

1. They are largely based on studies at least two years old,

2. They presume that the dispersant is intrinsically effective and that effectiveness problems are only in the use of the "effective" product,

3. Recommendations are somewhat based on consensus among committee members,

4. Personal biases and desires for funding of personal projects are evident, and

5. Few data are available for the application and effectiveness of dispersants, thus personal recollection and other less reliable sources had to be used.

The main report contains much useful information and represents a good collection of data on dispersants.

#### Dispersants - Field Effectiveness Trials

Over the past 12 years, 107 test spills have been laid out to test the effectiveness of oil spill dispersants.<sup>18</sup> These spills are summarized in Table 2. A number of smaller tests or other tests which were not documented have taken place but are not included here. Of the 107 slicks documented, 23 are controls used to establish a comparison. Percentage effectiveness is reported in 25 spills and the average for these is 30%. Values range from 0 to 100%. Most experimenters have not assigned effectiveness values because, as will be demonstrated in more depth later, effectiveness values are hard to assign.

The test results show clearly that dispersants are not highly effective, even under highly controlled experimental situations. Of greater concern than this is the methodology used to estimate effectiveness. Some experimenters simply estimated effectiveness, but most based their measure on integrations of water column concentrations relative to surface slick dimensions. This is not a correct means to perform the measure because the underwater concentrations have little positional relationship to the surface slick. Underwater dynamics of the ocean are very different than surface dynamics. Extreme cases of the positional variances between surface and sub-surface slicks have been illustrated by Brown and Goodman in controlled tank testing.<sup>19</sup> Their work has shown that the underwater plumes move in highly random fashions with respect to the surface slick and even two trials conducted on the same day will not have similar movement patterns.

TABLE 2 SUMMARY OF EFFECTIVENESS TRIALS

TRIAL NUMBER	YEAR	LOCATION	OIL TYPE	APPLICATION VEHICLE	CLAIMED EFFECTIVENESS
1	1976	NORTH SEA	EKOFISK	SHIP	0%
2			KUWAIT	SHIP	100%
3	1978	NEW JERSEY	MURBAN	HELICOPTER	-
4			LA ROSA	HELICOPTER	-
5			MURBAN	HELICOPTER	50%
6			LA ROSA	HELICOPTER	100%
7	1978	CALIFORNIA	NORTH SLOPE	HELICOPTER	-
8				AIRPLANE	-
9				HELICOPTER	-
10_11				SHIP	-
12				AIRPLANE	-
13-14				SHIP	-
15				ABOVE 3	-
16-18	1978	VICTORIA	NORTH SLOPE	SHIP	-
19	1979	LONG BEACH	PRUDHOE	CONTROL	0.50%
20				SHIP	8%
21				SHIP	5%
22				AIRPLANE	78%
23				AIRPLANE	45%
24				CONTROL	1%
25				AIRPLANE	60%
26				SHIP	11%
27				SHIP	62%
28-41	1979	FRANCE-PROTECMAR	1 LIGHT FUEL	ALL 3	-
42-49	1980	FRANCE-PROTECMAR	2 LIGHT FUEL	ALL 3	-
50	1981	FRANCE-PROTECMAR	3 LIGHT FUEL	AIRPLANE	50%
51				AIRPLANE	-
52				CONTROL	-
53	1981	NEWFOUNDLAND	ASMB	CONTROL	-
54				AIRPLANE	-
55	1982	NORWAY	STATFJORD	CONTROL	0.60%
56				SHIP	6%
57				SHIP	17%
58				CONTROL	3%
59				SHIP	19%
60				SHIP	22%
61				SHIP	2%
62	1982	NORTH SEA	ARABIAN	CONTROL	-
63-64				AIRPLANE	-
65-67	1982	FRANCE-PROTECMAR	5 LIGHT FUEL	SHIP	-
68-69				AIRPLANE	-
70				HELICOPTER	-
71				PREMIXED	-

TABLE 2 ctd. SUMMARY OF EFFECTIVENESS TRIALS

TRIAL NUMBER	YEAR	LOCATION	OIL TYPE	APPLICATION VEHICLE	CLAIMED EFFECTIVENESS
72				CONTROL	-
73-74	1983	HOLLAND	LIGHT FUEL	CONTROL	2%
75-76			STATFJORD	CONTROL	2%
77-79			STATFJORD	AIRPLANE	2%
80			LIGHT FUEL	AIRPLANE	2%
81			STATFJORD	PREMIXED	100%
82-83	1983	HALIFAX	ASMB	CONTROL	1%
84				HELICOPTER	2.50%
85				HELICOPTER	13%
86				HELICOPTER	10-41%
87				CONTROL	7%
88-89	1984	NORWAY	STATFJORD	CONTROL	-
90-92				AIRPLANE	-
93				PREMIXED	-
94	1985	FRANCE-PROTECMAR 6	LIGHT FUEL	CONTROL	-
95				SHIP-SPRAY	-
96				SHIP-AEROSOL	-
97				HELICOPTER	-
98-99	1985	NORWAY	STATFJORD	CONTROL	-
100				PREMIXED	-
101			EMULSION	PREMIXED	-
102-104	1986	BEAUFORT SEA	FEDERATED	CONTROL	-
105-107				HELICOPTER	-

Furthermore, all of the experimenters who used underwater concentrations to estimate field effectiveness also used the method of dividing the water into different compartments and averaging concentrations. Mathematically this is not appropriate and can result in effectiveness values that are much larger and range from twice to ten times greater than the actual values. Because of these factors underwater estimates of oil spill dispersant effectiveness are highly inaccurate and misleading.

Surface measures are also inadequate. Remote sensing does not provide a thickness measure and thus calculating volume is impossible. Numerous surface phenomena also interfere with the process of estimating slick volume. These have been detailed in a recent paper by Goodman and Fingas.<sup>20</sup>

In summary, field trials of dispersant effectiveness have not shown any quantitative or qualitative proof of high (>50%) dispersant effectiveness. Analytical means do not exist to accurately quantify dispersant effectiveness at field trial situations.

#### Dispersants - Actual Usage

Table 3 lists dispersant usage during some notable large spills.<sup>21,22</sup> Results are summarized from the noted references. The problem with actual spill data is that some observers may have reported seeing evidence of effectiveness and others directly the opposite. In none of the cases were any analytical means tried to quantify effectiveness or even to provide better estimates. Dispersants are used on a routine basis in countries like Great Britain and in many Arabic countries. Again no quantitative results are available to show effectiveness nor lack of such.

TABLE 3 HISTORICAL USE OF DISPERSANTS

SPILL EVENT	YEAR	COUNTRY	AMOUNT SPILLED{t}	DISPERSANT AMOUNT{t}	RESULTS
TORREY CANYON	1967	ENGLAND	119000	10000	LITTLE EFFECTIVENESS, ADVERSE ECOLOGICAL
OCEAN EAGLE	1968	PUERTO R.	12000	60	NO EFFECT
SANTA BARBARA	1969	USA	1000	32	NO EFFECT
ARROW	1970	CANADA	5000	12	NO EFFECT
PACIFIC GLORY	1970	ENGLAND	6300	?	LITTLE EFFECT
SHOWA MARU	1975	SINGAPORE	15000	500	LITTLE EFFECT
JAKOB MAERSK	1975	PORTUGAL	88000	110	LITTLE EFFECT
OLYMPIC ALL.	1975	ENGLAND	2000	220	LITTLE EFFECT
URQUIOLA	1976	SPAIN	100000	2400	LITTLE TO NO EFFECT
AMOCO CADIZ	1978	FRANCE	220000	2500	LITTLE EFFECT
ELENI V	1978	ENGLAND	7500	900	NO EFFECT
CHRISTOS BITAS	1978	ENGLAND	3000	280	LITTLE EFFECT
BETELGEUSE	1979	IRELAND	1000	35	NO EFFECT
IXTOC I	1979	MEXICO	500000	5000	LITTLE EFFECT
SIVAND	1983	ENGLAND	6000	113	LITTLE EFFECT

## Dispersants - Laboratory Studies

Few laboratory studies have been done on the process of dispersant action. The Mackay studies of recent years are the exception, but only begin to answer many of the questions which arise.<sup>23,24</sup> Recent studies have also indicated that dispersant action is very complicated and poorly understood.<sup>16</sup> In particular, we do not understand the mechanisms behind dispersant mixing with oil, its alignment at the oil/water interface, its subsequent partitioning from oil to water and its dynamics at the interface. These studies have also shown that there exist interferences to dispersant effectiveness including; dispersant herding of the oil, complete lack of mixing in some situations, accelerated weathering of oil by dispersant, and resurfacing of dispersed oil. Until some of these problems and mechanisms are understood or overcome, it will be difficult to assess the effectiveness potential of dispersants.

A number of laboratory studies have been performed to compare the test results from different apparatus and procedures. A review of these results show that there is poor correlation in effectiveness results between the various test methods.<sup>25</sup> A recent study by the present author has shown that lack of correlation is primarily a function of settling time allowed between the time that the energy is no longer applied and the time that the water sample is taken from the apparatus.<sup>26</sup> Another important factor is that of the oil-to-water ratio in the apparatus. When these two parameters are adjusted to be the same and to larger values, test results from most apparatus are similar. Results from more energetic dispersant effectiveness tests, such as the Mackay test and the Labofina or Warren Springs test, are somewhat higher, but when corrected for natural dispersion, these results are nearly identical to those from less energetic apparatus. Results from a series of tests and after having performed these corrections are shown in Table 4. The effectiveness results from all tests are nearly identical, especially when considering that the errors for measurement in the Mackay and Labofina tests are 10 percent or more. The fact that these values are nearly identical may imply that they have some meaning. Just the fact that this phenomena occurs also indicates that energy plays a lesser role than was previously thought. The high energy in the Mackay and Labofina tests only increases the dispersant effectiveness for those oils that disperse naturally.

## Dispersants - Summary

The state-of-the-art in dispersants is summarized as follows:

1. Effectiveness is the main issue of dispersant usage and it is increasingly evident that dispersant effectiveness may range in practice from about 10 to 30 %,
2. Analytical means for measuring oil dispersant effectiveness at sea is poor,
3. Dispersant effectiveness cannot be measured accurately using the oil slick as reference because of the different

OIL	DISPERSANT	EFFECTIVENESS IN DIFFERENT APPARATUS AFTER CORRECTION FOR NATURAL DISPERSION			
		DISPERSABILITY IN PERCENT			
		SWIRLING FLASK	FLOWING CYLINDER	LABOFINA MODIFIED	MNS MODIFIED
ADGO	9527	61	52	60	60
	CRX-8	42	40	59	61
	EN 700	67	59	58	70
AMAULIGAK	9527	48	38	56	44
	CRX-8	56	46	43	71
	EN 700	54	39	39	59
ASMB	9527	22	21	20	19
	CRX-8	28	31	22	41
	EN 700	43	43	51	56
ATKINSON	9527	7	18	20	7
	CRX-8	9	10	10	10
	EN 700	8	18	18	12
BENT HORN	9527	29	46	29	29
	CRX-8	27	37	27	51
	EN 700	44	51	19	42
FEDERATED	9527	39	35	41	35
	CRX-8	23	31	25	76
	EN 700	38	42	60	76
GEAR OIL	9527	29	18	18	12
	CRX-8	40	25	27	10
	EN 700	10	6	15	30
HIBERNIA	9527	6	12	12	6
	CRX-8	9	10	8	9
	EN 700	7	8	12	14
ISSUNGNAK	9527	24	22	21	20
	CRX-8	42	76	35	76
	EN 700	42	60	35	76
LAGO MEDIO	9527	7	8	18	14
	CRX-8	11	15	8	10
	EN 700	10	23	13	24
LUBE OIL	9527	13	19	20	24
	CRX-8	14	24	20	28
	EN 700	13	23	20	56
MOUSSE MIX	9527	9	15	22	30
	CRX-8	11	25	13	26
	EN 700	24	32	18	32
NORMAN WELLS	9527	41	55	43	39
	CRX-8	60	47	49	57
	EN 700	63	53	53	81
PANUK	9527	100	100	89	100
	CRX-8	93	100	85	100
	EN 700	100	100	87	100
PRUDHOE BAY	9527	7	13	27	14
	CRX-8	5	16	18	23
	EN 700	17	14	28	27
SYNTHETIC CRUDE	9527	57	50	58	63
	CRX-8	69	55	40	62
	EN 700	61	39	56	62

movement regimes of the surface slick and the plume, because of the unknown distribution of the plume and because a large number of data points are required to define the plume,

4. Remote sensing means to determine dispersant effectiveness do not yet exist nor is there a slick thickness-measuring capability,

5. Effectiveness of actual dispersant usage is not quantitatively documented and reports of effectiveness are very contradictory,

6. The toxicity, both short and long-term, of dispersants and dispersed oil does not seem to be a major problem or issue,

7. The operating processes of dispersants are poorly understood as are a number of competing processes, and

8. Laboratory effectiveness measures may be meaningful if done at high water-to-oil ratios and with settling times of 10 minutes or greater, such correction produces identical results except in highly energetic devices where correction for natural dispersion is also required, and

9. Dispersant effectiveness is not as energy-dependent as formerly thought.

#### References

1. Oil Spill Treating Agents: A Compendium, The American Petroleum Institute, Washington, D.C., API report no. 4150, 1972.
2. Owens, H., Shoreline Countermeasures - 1983 Results. Baffin Island Oil Spill Project Working Report 83-4, Environmental Protection Service, Environment Canada, Ottawa, 1984.
3. Roberts, D., The Biological Degradation of Bunker C Oil Induced by Clearwater P.M.D., Report for Environment Canada, Ottawa, Ontario, Unpublished Report, 1974.
4. Sendstad, E., L.J. Endal, I. Brattbakk and O.I. Ronning, "Studies on a Seven-Year-Old Seashore Crude Oil Spill On Spitzbergen", Proceedings of the Seventh Annual Amop Technical Seminar, Environment Canada, Ottawa, Ontario, pp. 60-74, 1984.
5. Ladousse, A., C. Tallec and B. Tramier, "Progress in Enhanced Oil Degradation", Poster Session presented at the 1987 Oil Spill conference, Abstract in proceedings page 625, American Petroleum Institute, Washington, D.C., 1987.
6. Brown, R.B., "Treatment of Oil Spills by Sinking - A Review of Requirements and Progress", Journal of the Institute of Petroleum., 57, 8, 1971.
7. Dick, J.G. and A. Feldman, Efficiency and Retentivity Testing and Performance of Sinking Agents in the Removal of Oil Spills, Report Number EPS 3-EC-75-1, Environment Canada, Ottawa, Ontario, 1975.
8. Nagy, E., Testing of Shell Oil Herder, Unpublished Report, Environment Canada, Ottawa, Ontario, 1974.



9. S.L. Ross Environmental Research Ltd., An Experimental Study of Oil Spill Treating Agents That Inhibit Emulsification and Promote Dispersion, Report Number EE-87, Environment Canada, Ottawa, Ontario, 1986.
10. Fingas, M. and E. Tennyson, "Evaluation of Two New Oil Spill Chemical Additives: Elastol and Demoussifier", Spill Technology Newsletter, Vol. 13, No. 2, p. 40-46, 1988.
11. Bobra, M., P. Kawamura, M. Fingas, and D. Velicogna, "Laboratory and Mesoscale Testing of Elastol and Brand M Demoussifier", Proceedings of the Eleventh Annual AMOP Technical Seminar, Environment Canada, Ottawa, Ontario, p. 391-415, 1988.
12. Laun, H.M., and R. Hingman, "Laboratory Tests of Elastol", Proceedings of the Eleventh Annual AMOP Technical Seminar, Environment Canada, Ottawa, Ontario, p. 417-442, 1988.
13. Bobra, M.A., P.I. Kawamura, M. Fingas and D. Velicogna, Laboratory and Tank Test Evaluation of Elastol, Environment Canada, Manuscript Report Number EE-94, Ottawa, Ontario, 1987.
14. Bobra, M.A., P.I. Kawamura, M. Fingas and D. Velicogna, Mesoscale Application and Testing of An Oil Spill Demulsifying Agent and Elastol, Environment Canada Manuscript Report Number EE-104, Ottawa, Ontario, 1988.
15. Seakem Oceanography, Field Test of Two Spill Treating Agents, Environment Canada, Manuscript Report Number EE-XX, in press, 1988.
16. Fingas, M., "Dispersant Effectiveness at Sea: A Hypothesis to Explain Current Problems With Effectiveness", Proceedings of the Eleventh Annual AMOP Technical Seminar, Environment Canada, Ottawa, Ontario, p. 455-479, 1988.
17. National Academy of Sciences, "Executive Summary", excerpts from the forthcoming publication on dispersants, National Academy of Sciences, Washington, D.C., main report in press.
18. Fingas, M.F., "Field Measurement of Effectiveness: Historical Review and Examination of Analytical Methods", Chemical Dispersants - Countermeasures For the 90's, M. Flaherty, Ed., ASTM 1084, American Society for Testing and Materials, Philadelphia, in press.
19. Brown, H.M. and Goodman, R.H., "Dispersant Tests in A Wave Basin", Proceedings of The Eleventh AMOP Technical Seminar, Environment Canada, Ottawa, Ontario, p. 501-514, 1988.
20. Goodman, R.H. and Fingas, M.F., "The Use of Remote Sensing in The Determination of Dispersant Effectiveness", Proceedings of The Eleventh AMOP Technical Seminar, Environment Canada, Ottawa, Ontario, p. 377-384, 1988.
21. Nichols, J.A. and Parker, H.D., "Dispersants: Comparison of Laboratory Tests and Field Trials with Practical Experience at Spills", Proceedings of the 1985 Oil Spill Conference, American Petroleum Institute, Washington, D.C., p. 421-427, 1985.
22. Burke, E., and R. Golob, "Dispersant Usage in Historic Oil Spills", Proceedings of the Conference on Oil and Chemical Spills, Hazardous material Research Institute, Rockville, Maryland, p.75-83, 1980.

23. Mackay, D., A. Chau, and K. Hossein, "Effectiveness of Chemical Dispersants: A Discussion of Recent Progress", Proceedings of the Sixth AMOP Technical Seminar, Environment Canada, Ottawa, Ontario, p. 151-153, 1983.
24. Chau, A., J. Sproule and D. Mackay, A Study of the Fundamental Mechanisms of Chemical Dispersion of Oil Spills, Report No. EE-81, Environment Canada, Ottawa, Ontario, 1987.
25. Fingas, M.F., M.A. Bobra and R.K. Velicogna, "Laboratory Studies on the Chemical and Natural Dispersability of Oil", Proceedings of the 1987 Oil Spill Conference, American Petroleum Institute, Washington, D.C., p. 241-246, 1987.
26. Fingas, M.F., D.L. Munn, B. White, R.G. Stoodley and I.D. Crerar, "Laboratory Testing of Dispersant Effectiveness: The Importance of Oil-to-Water Ratio and Settling Time", Proceedings of the 1989 Oil Spill Conference, American Petroleum Institute, Washington, D.C., in press.

## In-Situ Burning of Oil Spills

David D. Evans  
National Institute of Standards and Technology  
Gaithersburg, Maryland 20899

### Introduction

Response to oil spills, regardless of location, includes considerations of oil containment, recovery, disposal and the logistics of delivering response equipment. In Arctic waters changing ice conditions during freeze-up to solid ice cover and the reverse process of ice break-up provide an extreme range of conditions for operation of oil spill response equipment. In general, the logistics of equipment movement and the efficiency of oil recovery and disposal varies substantially for response techniques and equipment as the percentage of ice-cover in the water changes.

In-situ burning has a broad range of applicability in Arctic areas as the effectiveness is not hampered by ice conditions. A relative comparison of in-situ burning and on-site incineration to other response techniques was summarized in chart form by an oil industry task group [1] and is reproduced in Appendix A of this paper. This chart rates the applicability of burning as "good" over the entire range of conditions evaluated. Experimental burns of oil in ice leads (channels of water through ice) conducted by Brown and Goodman [2] and Smith and Diaz [3] have shown that removal efficiencies typically better than 50% and, in some cases, over 90% are possible. In tests in which oil pools were free to spread during burning, Buist and Twardus [4] report consumptions of 70 - 90%.

Burning has been used in response to accidental oil spills with varying success. In most cases, these spills resulted from accidents involving tankers or barges. Case histories of several accidents and results from large controlled burned tests prior to 1979 [5] are provided in Appendix B. One example of successful burning under emergency conditions was the 1977 Buzzards Bay, Massachusetts, spill in which 40% of the 5000 gallon fuel oil spilled was removed by burning from the water containing floating ice.

The use of burning to remove oil from the water produces a trade-off that must be evaluated by local authorities. As oil is removed from the water by burning, the atmosphere receives the products of the combustion. Research continues to clarify the effectiveness of the burning process and the characteristics of the combustion products thereby increasing the amount of information that can be used by local authorities to aid in their spill response decisions. This research also provides experience with oil spill combustion techniques.

This paper presents previous research and discussion of in-situ oil spill burning. Sources of research applicable to oil spill combustion are identified and the current understanding is summarized. Reproductions of information, particularly summaries of findings, from the research literature are included for the convenience of the reader. The rudiments of oil spill combustion are discussed to provide a basis for decisions about the

applicability of the broad range of available research in liquid fuel combustion to the particular problems of oil spill combustion in Arctic regions.

### Previous Research

A comprehensive resource document providing a wide range of technical information about oil spill burning is the 1979 U.S. Department of Energy (DOE) report, Combustion: An Oil Spill Mitigation Tool [5]. This report supplied an extensive review of research work available at the time of publication and an extensive discussion of issues associated with in-situ burning of oil spills. Appendix C of this report is largely drawn from the bibliography provided in the DOE report. This Appendix gives sources and abstracts of research closely associated with oil spill combustion in the Arctic. The applicable research in this area comes from national and international sources: academic, government, and industry.

In the DOE report, oil spill combustion is discussed in terms of the three broad categories of fuels instead of individual fuel properties. The three categories are determined based on ease of burning. The operational evaluation of ease of burning is determined by the combustion properties of the hydrocarbon compounds making up the crude oil mixture. A simple energy balance for a unit mass of fuel is used to determine a Net Energy which is defined as the difference between energy input to the fuel surface largely by radiation from the flame, and the energy necessary to evaporate the liquid fuel. This relationship is:

$$\text{Net Energy} = 0.02\Delta H_{\text{comb}} - \Delta H_{\text{evap}} - C_p (T_{\text{bp}} - T_{\text{amb}})$$

where  $\Delta H$  represents enthalpy change,  $C_p$  represents the specific heat of the fuel at constant pressure, and  $T$  represents temperature. The first term on the right-hand-side of the equation,  $0.02\Delta H_{\text{comb}}$ , represents an assumed energy input to the fuel surface from flame radiation equal to 2% of the heat of combustion of the fuel. The second term,  $\Delta H_{\text{evap}}$ , represents the energy needed to evaporate the liquid fuel at its boiling temperature. The third term,  $C_p (T_{\text{bp}} - T_{\text{amb}})$ , represents the energy required to heat the fuel from its initial ambient temperature,  $T_{\text{amb}}$ , to the boiling point temperature,  $T_{\text{bp}}$ . Three categories of fuel result from this analysis depending on whether the Net Energy is much greater than zero, approximately zero or much less than zero. These correspond to categories 1, 2, and 3 fuels respectively.

Crude oils which are mixtures of hydrocarbon compounds do not have well-defined boiling point temperatures or latent heats of evaporation. For crude oils or other mixtures of hydrocarbons, "breakeven points" in the distillation of the fuel are determined. At the breakeven point the Net Energy is zero. The crude oils are placed in categories according to the following:

Category 1: greater than 67% of the mixture by volume has positive Net Energy

Category 2: greater than 40% but less than 67% of the mixture by volume has positive Net Energy

Category 3: less than 40% (below 30%) of the mixture by volume has positive Net Energy

This provides a structure to begin to generalize results of research that often use different oils. In general, Category 1 fuels can be expected to burn easily under most conditions. Category 2 fuels can be expected to burn under some conditions. Category 3 fuels would not be expected to sustain burning without combustion promoters. The categories for various oil products and crude oils are given in table 1 based on an evaluation using an ambient temperature of 4.4°C [5].

As indicated by the analysis above, the fraction of energy released that can be recaptured by the burning surface is important in determining the ability to burn oil spills. Placement of oil within the three categories as described above was done based on 2% of the energy released returning to the surface of the burning oil. If the radiant heat captured by the oil can be increased by an additional 1% of the energy released, substantially more oils could sustain combustion [5].

The effects of variation in oil thickness on the water, ambient temperature, exposure time prior to burning, and wind velocity on the combustibility of an oil in all three categories are shown in figures 1 through 4 as presented in the 1979 DOE report [5]. Results show that in 1979 oil thickness below 3 mm were considered generally not burnable as were any spill subject to winds greater than 5 m/s. Research and development in the technology of oil burning since then has shown that improvements can be made that increase the range of known combustible conditions. Burning of oil spills involves the processes of ignition, flame spread, pool burning, and extinction. Major findings of recent studies are presented below.

### Ignition

Buist and Twardus [4] studied the process of oil slick ignition during the development of pyrotechnic igniters. They concluded that next to igniting the entire surface, the most efficient ignition technique is to ignite the periphery of the slick. The resulting flame spreads outward with the burning oil spread and inward aided by the fire induced air flow. Figure 5 shows the results of their research for both maximum time delay before ignition and number of igniters needed based on a 3 m spacing based on initial spill volume. The maximum ignition delay time increases with the 0.5 power of spill volume and the number of igniters with the 0.45 power of spill volume.

There are four principal igniter devices that have been used and studied for oil spill ignition.

1. Environmental Protection Service (EPS) Igniter, (Pyroid Igniter)

The unit contains a pyrotechnic device held between two layers of material that provides flotation (fig. 6). The 2 kg. igniter is 25 cm. square with a height of 13 cm. It is activated by pulling on a firing pin which strikes a primer cap. A 25-second delay is provided to permit manual tossing of the igniter and settling on the oil slick surface. The flame from the edge of the igniter lasts for 2 minutes [6].

## 2. Dome Igniter

This device consists of a wire-mesh basket filled with solid propellant and gelled kerosene suspended between two metal floats (fig. 7). The 0.5 kg. igniter measures approximately 30 cm x 18 cm x 11 cm. An electric ignition system starts the 25 cm long fuse wire which provides 45 seconds of delay before ignition. The solid propellant burns for about 10 seconds to ignite the gelled kerosene in the wire-mesh basket. The total burn time is 10 minutes [6].

## 3. Laser Ignition of Oil Spills (LIOS)

Two coupled lasers potentially can be used from a helicopter to heat and ignite oil spills. A laboratory system has been demonstrated to ignite crude oil pools. Actual helicopter mounted equipment, as pictured in figure 8, has not been built. The process of ignition is illustrated in figure 9. A continuous-wave (CW) carbon dioxide laser heats a portion of the oil surface to the flashpoint temperature. A more intense but smaller focused pulse laser beam provides the energy in the gases above the warm oil spot to initiate flaming. The system under design will be capable of igniting oil pools from a hover altitude of 20 m with an aiming angle of 0 - 49 degrees corresponding to 0 - 23 m travel distance along the ground [7].

## 4. Helitorch Igniter

The Helitorch is a proven igniter system commonly used by the forest services for controlled burning during fire-control operations. The system (fig. 10) releases burning gelled gasoline globules from a tank system weighing 243 kg. that can be suspended by cables below the helicopter and controlled from the cockpit. Typical burning globules ignited and released from the unit at heights of 18 m or less range from 60 - 120 ml and have burning times of 4 - 6 minutes [8].

## Flame Spread

Each of the igniters above provides for oil ignition in the immediate area around the device. Flame spread from this position eventually involves the entire slick. Buist and Twardus [9] investigated both oil spread on water and flame spread on oil. They found that burning oil did not spread on water faster nor farther than cold oil. Only in the case of diesel fuel at wind speeds less than 1 m/s did the flame spread not keep up with the spread of oil. Figure 11 shows test results for aged Alberta Sweet Mix Blend (ASMB) crude oil in a 0.25 m/s counterflow wind velocity.

## Burn Efficiency, Oil Burn Residue

The consumption of the oil spill by burning is of course the primary issue of interest. The efficiency of the burn is the percentage of the original oil that is removed by burning. Some oil residue remains in the water from all

burns, as the flame is always quenched by heat losses to the water surface when the oil layer is thin. Thus the burn efficiency is limited naturally below 100%. Burn efficiencies and oil residue data from 1 m and 2 m diameter oil pool fires [9] and spills in water channel between ice blocks (fig. 12) [3] are presented in tables 2 and 3 respectively. Burn efficiencies greater than 90% were obtained in the confined pool fires and 79% for the oil burned in ice channels. Based on experiments and analysis of unconfined oil slick burns, Buist and Twardus [4] proposed an equation for rough estimates of burn efficiency that used only initial spill volume ( $V_s$ ) as:

$$\text{Burn efficiency} = (1 - 1/3 V_s^{-1/5}) \times 100\%$$

Measured burn efficiencies from small and large scale unconfined burns (fig. 13) are compared with calculated burn efficiencies using a more complete model in figure 14 [4]. Two assumed velocities of the burning induced surface current ( $U_c$ ) are shown. The induced surface current acts to limit oil slick spread.

### Demonstration of Oil Spill Response Capabilities

An example of the continuing industrial research activity in Arctic oil spill burning is the cooperative work of four major oil companies operating in Alaska. In response to concerns of oil industry regulatory agencies about existing technical capabilities to clean-up oil spills in broken-ice conditions in the Alaskan Beaufort Sea, demonstration tests of oil spill response techniques and equipment were performed in 1983. These tests form the basis of an industry demonstration that allows for drilling in the Alaskan Beaufort Sea under Tier 2 regulations. Tier 2 permits unrestricted drilling with exception of locations outside the barrier islands during the fall bowhead whale migration. Six different tasks were addressed in the study, three of which dealt directly with oil spill combustion. These tests are typical of many efforts to evaluate equipment and response techniques and are included in this paper for that reason. Test descriptions and results were:

#### 1. In-situ burning of crude oil in the presence of scattered ice.

The in-situ burning of up to 288 gallons of fresh Prudhoe Bay crude oil was demonstrated in four separate tests in an onshore pit at Prudhoe Bay. The results of the four tests demonstrated that: 1) cold waters and ice can be beneficial in limiting the initial spread of oil; 2) the oil slicks are ignitable using helicopter deployment of igniters; 3) the oil slicks can be burned, even in scattered ice conditions, with consumption efficiencies of 55 - 85%; and 4) the unburned oil and burned oil residue can be removed using conventional oil sorbent materials [10].

#### 2. Burning of oil in a containment boom.

The in-situ burning of crude oil was demonstrated in an onshore pit at Prudhoe Bay. In these tests the burning oil was contained within an 2.4 m diameter area by a fire containment boom for the 10 minutes

necessary to consume the initial 25 mm thick layer. In the second burn test, oil was replenished at a rate of 2.5 gallons per minute, providing a continuous burn. In this test the boom became submerged on the downwind side after 45 minutes allowing burning oil to escape. Burn efficiencies of 90% and 95% were measured [10].

### 3. Deployment of a fire containment boom in the lee of a drilling island.

More than 500 feet of fire containment boom was positioned in a fixed containment mode in the lee of an offshore drilling island. The boom encountered moving broken ice (4 to 7 oktas) for more than 24 hours. A helicopter was used to transport and deploy 240 feet of wet boom in moving broken ice (up to 3 oktas). The boom drifted freely for 2 days. In both cases the boom survived the handling and ice exposures [10].

This same oil industry task group prepared reports assessing the state-of-the-art of oil spill response techniques for the Arctic [11]. Subsequent to that publication, the task group prepared a practical guide to oil spill response techniques that presents technical information about the relative effectiveness of method under conditions found in the Alaskan Beaufort Sea [1]. Guidance also is provided on logistical and manpower requirements, as well as recovery rates and efficiencies. Appendix A contains a chart giving the relative effectiveness of in-situ burning to other response techniques and copies of two technical information sections from this reference -- In-situ Burning with Natural Containment, and In-situ Burning with Fire Containment Boom.

Many of the oil spill research activities involving combustion, like those discussed above, are conducted in outdoor test facilities. Often these permit large and realistic tests but these tests are often susceptible to uncontrolled effects of weather. Large scale fire test facilities offer protected and instrumented spaces in which realistic size burns can be conducted under controlled conditions. Measurements from these research burns provide the best basis for understanding oil spill combustion. Results and understanding generated through controlled measurement in these specialized facilities usually can be generalized to conditions that occur in actual oil spill combustion situations. It is for this reason that the Center for Fire Research at the National Institute of Standards and Technology (NIST) [formally known as the National Bureau of Standards (NBS)] was asked to examine the technology of oil spill combustion under support from the Minerals Management Service, U.S. Department of the Interior. Starting in 1984, measurements and calculations were performed to understand the burning behavior of crude oil spills on water, the physical and chemical properties of the smoke produced in the burning, and the dynamics of the smoke plume flow.

An important result of these studies was an evaluation of polynuclear aromatic hydrocarbon (PAH) content of the crude oil, the smoke produced by burning the oil on water, and the residual oil left in the water after combustion. The question of what effect combustion of oil that contains PAH compounds would have on the net amount of these compounds remaining in the burn residue and carried in the smoke is important to analyze fully the consequences of the



combustion. Measurements of PAH compounds were performed by both NIST and Environment Canada on samples collected from 0.6 m diameter pool burns performed in the NIST large scale fire test facility. These measurements showed that:

1. The PAH concentration in the burn residue was equal to that of the original oil [12].
2. The total PAH content of the smoke was equal to or less than the mass of PAH compounds in the oil that was consumed in the combustion depending on the burning conditions [12,13].
3. In cases where the total mass of PAH compounds in the oil burned and in the smoke were the same, the distribution of PAH compounds in the smoke was shifted towards larger molecular weight species [13].

Based on these measurements, it appears that the total PAH content of the environment remains the same or is reduced by combustion of the crude oil spills on water.

#### Dynamics of oil spill combustion

The burning process for crude oil on water exhibits two distinct burning regimes. Initially the oil layer burns in a quiescent pool. For most crude oils the surface temperature of the vaporizing liquid is greater than the boiling point temperature of the water on which the oil is floating. As fuel is consumed the oil layer is heated in depth and is reduced in thickness. The thinner oil layer also allows more radiation from the flame to penetrate to the water layer. Both of these processes eventually produce boiling in the supporting water layer under the oil. At the onset of water boiling, there is a rapid transition to a much more intense burning. Boiling water churns the oil layer throwing water and oil droplets into the flame. The energy release rate and oil consumption rate increase from two to four times the pre-boiling rate. A secondary effect of the vigorous burning is that some water is injected into the flame. It is known from engine emissions studies that water injection into hydrocarbon flames reduces the smoke production [14]. Measurements during the burning of crude oil have shown that when the burning entered the vigorous burning regime, the smoke emission per unit fuel mass loss decreased by a factor of five [13].

Figure 15 shows mass loss rate histories for Alberta Sweet Blend Mix crude oil fires with initial thickness from 2 - 10 mm [13]. The thicker layers demonstrate clearly the two burning regimes. With regard to crude oil consumption, figure 15 shows that for the 2 mm and 3 mm thick layers of oil burned, approximately 65% of the oil burned was consumed during the vigorous burning period. Only 33% of the thicker 10 mm layer was consumed during a vigorous burning period. As smoke production during the vigorous burning period is substantially less per unit fuel mass consumed, the burning of the thinner slicks should produce less total smoke emission per mass of crude oil consumed.

The mass loss rate histories shown in figure 15 also demonstrate the rapid natural extinction of the oil spill fire. At some point in the combustion,

heat losses to the supporting water layer or mixing process due to churning of the oil layer by boiling water reduces the oil layer temperature sufficiently to prevent evaporation of the crude oil necessary to sustain burning. The flame is extinguished leaving an oil burn residue on the water. This residue is generally depleted in low temperature volatiles compared to the original oil. Referring to the classification systems for ease of burning, a Category 2 crude oil may produce a Category 3 burn residue.

### Closing

Despite the ability to describe the burning process, quantitative predictions of burning rates, transition to vigorous burning caused by boiling of the supporting water layer, and flame extinction conditions are not possible at this time. Measurements show that vigorous crude oil burning associated with boiling of the water supporting layer produces less smoke per unit mass of oil consumed and this smoke carries less total PAH species content than the oil burned. Thicker oil layers generally are easier to ignite and burn but thinner layers that induce boiling in the water are relatively cleaner burning.

All controlled research burns, equipment evaluation tests, and efforts to utilize combustion in response to spills increases the collective experience with the technique. This effort has improved the technology well beyond the expectations of 10 years ago. Hopefully, future efforts can continue this trend.

### REFERENCES

1. Oil Spill Response in The Arctic, Part 3: Technical Documentation, research administered by Shell Western E&P, Inc., Sohio Alaska Petroleum Company, Amoco Production Company, 1984.
2. Brown, H.M. and Goodman, R.H., "In Situ Burning of Oil in Ice Leads," Proceedings of the Ninth Annual Arctic and Marine Oilspill Program Technical Seminar, June 10-12, 1986, Edmonton, Alberta, Canada, Environment Canada, Ottawa K1A 0H3, 1986.
3. Smith, K.N. and Diaz, A., "In-Place Burning of Crude oil in Broken Ice: 1985 Testing at OHMSETT," Proceedings of the Eight Annual Arctic Marine Oilspill Program Technical Seminar, June 18-20, 1985, Edmonton, Alberta, Canada, Environment Canada, Ottawa K1A 0H3, 1985.
4. Buist, I.A. and Twardus, E.M., "Burning Unconfined Oil Slicks: Large Scale Tests and Modelling," Proceedings of the Eight Annual Arctic Marine Oilspill Program Technical Seminar, June 18-20, 1985, Edmonton, Alberta, Canada, Environment Canada, Ottawa K1A 0H3, 1985.
5. Thompson, C.H., Dawson, G.W., and Goodier, J.L., Combustion: An Oil Spill Mitigation Tool, U.S. Department of Energy, DOE/EV-1830-1, National Technical Information Service, Springfield, VA 22161, August 1979.

6. Allen, A., "Alaska Clean Seas Survey and Analysis of Air-Deployable Igniters," Proceedings of the Ninth Annual Arctic and Marine Oilspill Program Technical Seminar, June 10-12, 1986, Edmonton, Alberta, Canada, Environment Canada, Ottawa K1A 0H3, 1986.
7. Frish, M., Gauthier, V., Frank, J., and Nebolsine, P., "Laser Ignition of Oil Spills: Telescope Assembly and Testing," Proceedings - Eleventh Arctic and Marine Oilspill Program Technical Seminar, June 7-9, 1988, Vancouver, British Columbia, Canada, Environment Canada, Ottawa, K1A 0H3, 1988.
8. Refinement of Aerial Ignition Systems (Test and Evaluation of the Helitorch for the Ignition of Oil Slicks), Report prepared by, Spiltec, Anchorage, Alaska 99501, for Alaska Clean Seas, Anchorage Alaska, 99519, 1987.
9. Buist I. A., and Twardus, E. M., "In-situ Burning of Unconfined Oil Slicks," Proceeding of the Seventh Annual Arctic Marine Oilspill Program Technical Seminar, June 12-14, 1984, Edmonton, Alberta, Canada, Environment Canada, Ottawa, K1A 0H3, 1984.
10. Oil Spill Response in the Arctic, Part 2: Field Demonstrations in Broken Ice. Study administered and conducted by: Shell Oil Company, Sohio Alaska Petroleum Company, Exxon Company USA, and Amoco Production Company, 1983.
11. Oil Spill Response in the Arctic, Part 1: An Assessment of Containment, Recovery, and Disposal Techniques, draft report prepared by Industrial Task Group representing Amoco Production Company, Exxon Company USA, Shell Oil Company, Sohio Alaska Petroleum Company, 1983.
12. Evans, D., Mulholland, G., Gross, D., Baum, H., and Saito, K., Burning, Smoke Production, and Smoke Dispersion from Oil Spill Combustion, NISTIR report in preparation.
13. Evans, D., Mulholland G., Gross, D., Baum, H., and Saito, K., Environment Effects of Oil Spill Combustion, Report NISTIR 88-3822, National Institute of Standards and Technology, Gaithersburg, MD 20899.
14. Nazka, M.A. and Crookes, R.J., "Effects of Water Content on Pollutant Formation in a Burning Spray of Water-in-Diesel Fuel Emulsion," Twentieth Symposium (International) on Combustion, The Combustion Institute, Pittsburgh, PA 15213, p 2001-2010, 1984.

Table 1 Oil Products and Crude Oils by Combustibility Category [5]

CATEGORY NUMBER 1

<u>Oil products</u>	<u>Crude Oils</u>	
Motor Fuel Antiknock	Attaka, E. Kalimantan, Indonesia	Pennington, Nigeria
Compounds with Lead Alkyls	Tembungo, Malaysia	Melabin, E. Kalimantan, Indonesia
Gasoline and Flash Feed Stocks	Seppinggan, E. Kali- mantan, Indonesia	Qua Iboe, Nigeria
Jet Fuel No. 3	Poleng, Java, Indonesia	Hassi Messaoud blend, Algeria
Coal Tar	Labyan Light, (Samarang) Sabah, Malaysia	Beryl, U.K.
Kerosene and JR No. 1	Es Sidar, Libya	Bonny light, Nigeria
Jet Fuel No. 5	Serei light, Brunei	Arabian light (berri), Saudi Arabia
Fuel Oil No. 1 and 1D		Mubarek, Sharjah, UAE

CATEGORY NUMBER 2

<u>Oil Products</u>	<u>Crude Oils</u>	
Asphalt	Escravos, Nigeria	Brega, Libya
Jet Fuel No. 4	Trinidad blend, Trinidad Tobago	Murban, Abu Dhabi
Gas Oil	Bekapi, El Kalimantan, Indonesia	Arzew blend, Algeria
Fuel Oil No. 4	Arjuna, Java, Indonesia	Umm Shalf, Abu Dhabi
Fuel Oil No. 2 and 2D	Zakum, Abu Dhabi	Wallo export mix, West Irian, Indonesia
Fuel Oil No. 5	Hout, Neutral Zone	Qatar (Duckham), Qatar
Bunker C	Thistle, U.K.	Kerindingan, E. Kali- mantan, Indonesia
	Basrah, Iraq	
	Badak, E. Kalimantan Indonesia	Zueitina, Libya North Rumaila, Iran
	Mubarras, Abu Dhabi	Tyumen, USSR

Table 1 (continued)

CATEGORY NUMBER 2

<u>Oil Products</u>	<u>Crude Oils</u>
Statfjord, Normany	Cinta, Indonesia
Qatar Marine, Qatar	Ninian, U.K.
El Bundug, Abu Dhabi	Reforma (Cactus Reforma, Isthmus) Mexico
Sassan, Iran	Iranian Light, Iran
Piper, U.K.	Arabian Light, Saudi Arabia
Montrose, U.K.	Strip Blend 27.1 API, Iran
Forcados blend, Nigeria	Iranian Heavy, Iran
Zarzaitine, Algeria	Romashkinskaya, USSR
Ekofisk, Norway	Bunju, E. Kalimantan, Indonesia
Forties, U.K.	Lagomedio, Venezuela
Rostam, Iran	Dubai, Dubai
Bai Hassan, Janbur, Iraq	Bonny Medium, Nigeria
Kirkuk, Iraq	Tarakan (Pamusian) E. Kalimantan, Indonesia
Bu-Attifel, Libya	Ecuador (Oriente), Ecuador
Handil, E. Kalimantan, Indonesia	Cabinda, Cabinda, Angola
Darius, Iran	North Slope, USA
Oman, Oman	Mandji, Gabon
Sarir, Libya	
Gulf of Suez Blend Egypt	
Kuwait Crude, Kuwait	

Table 1 (continued)

CATEGORY NUMBER 2

<u>Oil Products</u>	<u>Crude Oils</u>
	Arabian Medium (Zuhof), Saudi Arabia
	Ratawi, Neutral Zone
	Fereidoon Bled, Iran
	Minas (Sumatran Light) Samatra, Indonesia
	Arabian Medium Saudi Arabia
	Burgan (Wafra) Neutral Zone
	Ekhabinskaya, USSR
	Anguille, Gabon
	Amna (High Pour), Libya
	Taching, China (PRC)
	Arabian Heavy, Saudi Arabia (Safaniya and Khafi)

CATEGORY 3

<u>Oil Products</u>	<u>Crude Oils</u>
Castor Oil	Gamha, Gabon
	Jatibarang, Jaba, Indonesia
Spray Oil	Eocene, Neutral Zone
	Klamono, Irian, Java Indonesia
Rosin Oil	Emeraude, Congo Brazzaville
	Duri, Indonesia
Diesel Oil	Cyras, Iran
	Boscan, Venezuela
	Bachequero, 16.8°API (Bachequero Heavy), Venezuela

Table 2  
Confined Pool Crude Oil Burn Test [9]

Oil Type	Oil Volume (l)	Pool Dia. (m)	Initial Oil Thickness (mm)	Residue Volume (l)	Residue Thickness (mm)	Burning Time (min)	Regression Burning Rate (mm/min)	Burn Efficiency+ %
ASMB	4	1	5.0	0.7	0.9	2:20	1.8	82
ASMB	6	1	7.6	0.85	1.1	3:15	2.0	86
ASMB	8	1	10.1	0.95	1.2	4:50	1.84	88
ASMB	10	1	12.7	0.95	1.2	6:40	1.7	90
ASMB	12	1	15.3	1.0	1.27	8:35	1.65	92
ASMB	16	1	20.3	1.0	1.27	11:42	1.63	94
ASMB	16	1	20.3	0.8	1.0	9:30	2.0	95
ASMB	17	1	21.6	0.8	1.0	10:00	2.0	95
ASMB	20	1	25.47	1.0	1.27	14:00	1.72	95
ASMB	32	1	40.7	0.9	1.15	19:00	2.0	97
Diesel	6	1	7.6	1.1	1.4	3:50	1.6*	82
Diesel	12	1	15.3	1.6	2.0	7:15	1.8*	87
Diesel	20	1	25.47	0.9	1.15	11:50	2.0	95
Diesel	12	2	3.8	4.2	1.33	2:20	1.0*	65
Diesel	20	2	6.36	4.1	1.3	3:00	1.68*	79
ASMB	10	2	3.18	1.7	0.54	1:35	1.74	83
ASMB	14.7	2	4.67	2.3	0.73	2:00	1.97	84
ASMB	20	2	6.36	2.7	0.859	2:19	2.39	86

\*Residue emulsified

+ $(\text{Oil Volume} - \text{Residue Volume} / \text{Oil Volume}) \times 100\%$

ASMB Alberta Sweet Mix Blend Crude Oil

Table 3 Test Results - Oil Burned on Water with Ice Cover [3]

Test No.	Test Fluid Description	Fluid Volume (liters)	Ice Coverage* (%)	Ignition/Burn Time (min:sec/min:sec)	Air Temp (C)	Water Temp (C)	Wind Speed (m/s)	Burn Efficiency (%)
1	Fresh Prudhoe Bay crude	35.6	76-81	0:15/11:31	5	4	2	72.4 ± 2.3
1R	Fresh Prudhoe Bay crude	29.0	84-86	0:15/24:03	-6	0	8	62.5 ± 3.8
1R2	Fresh Prudhoe Bay crude	35.6	82-89	0:06/13:45	-1	0	2	58.3 ± 2.4
4	Sparged Prudhoe Bay crude. Flash Point: 24C	35.6	75-84	0:15/15:50	-3	0	4	79.1 ± 2.2
5A	Emulsion 18% Bay water/82% fresh Prudhoe Bay crude	35.6	81-86	1st 0:17/2:30 2nd 0:21/15:45 3rd None**/33:04	4	0	6	9.6 ± 2.7
6A	Sparged Prudhoe Bay crude. Flash Point: 40C	35.6	75-80	0:13/9:21	7	0	6	61.9 ± 2.3
7A	Emulsion 8% Bay water/92% fresh Prudhoe Bay crude	35.6	79-85	1st 0:11/25:27 2nd 0:15/11:05 3rd 0:07/5:10	4	0	7	34.7 ± 2.5
8A	Sparged Prudhoe Bay crude. Flash point: 40C	35.6	78-84	0:07/8:07	-1	0	< 2	68.3 ± 2.3
9A	Fresh Amauligak crude	35.6	82-88	0:07/16:32	3	5	4	62.9 ± 2.4
10A	Sparged Amauligak crude. Flash Point: 38C	35.6	82-83	0:08/27:15	11	7	1	68.3 ± 2.4
11A	Emulsion-9% Bay water 91% fresh Amauligak crude	35.6	76-80	1st 0:08/21:32 2nd 0:10/4:58 3rd 0:43/17:11	12	7	5	51.7 ± 2.5

\* Range based on average ice coverage measurement ± standard deviation of measurements. Magnitude of range indirectly indicative of ambient light levels which affect the quality of video recording.

\*\* 3rd igniter placed while 2nd still ongoing.



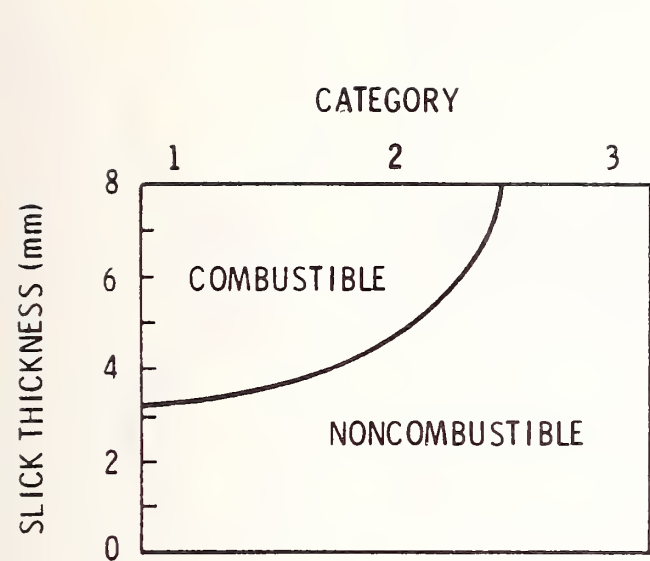

Figure 1 Effect of Oil Layer Thickness on Combustibility [5]

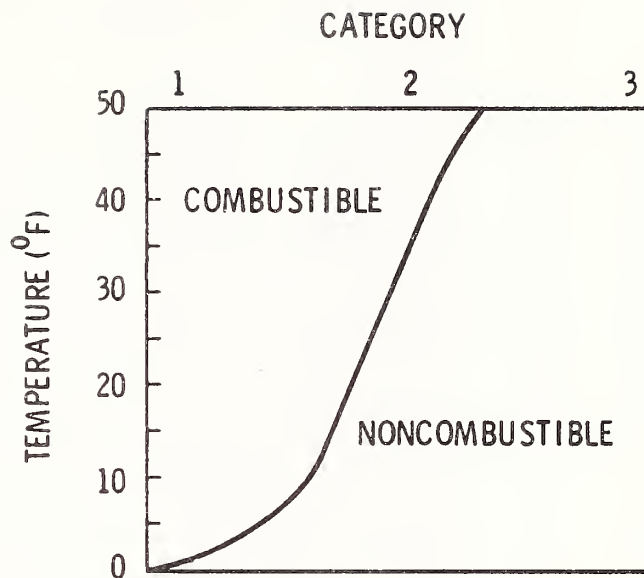

Figure 2 Effect of Ambient Temperature on Combustibility [5]

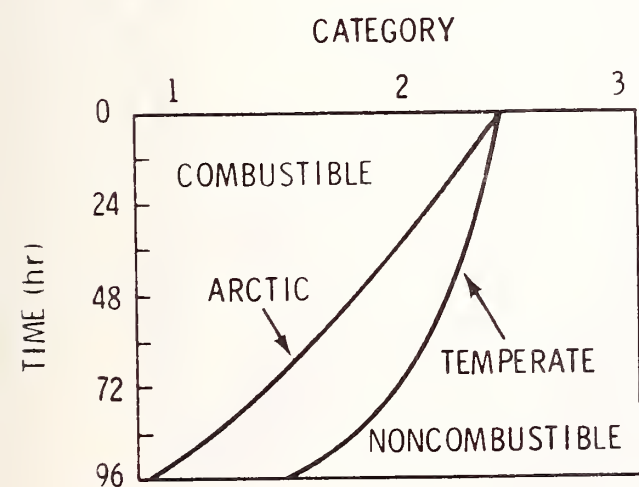

Figure 3 Effect of Time Delay on Combustibility [5]

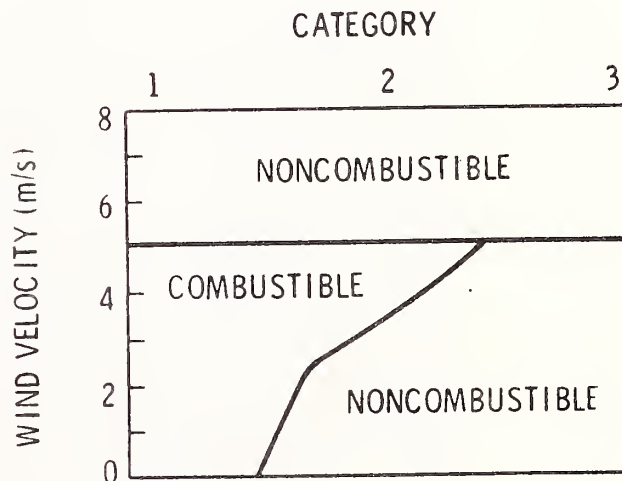

Figure 4 Effect of Wind Velocity on Combustibility [5]

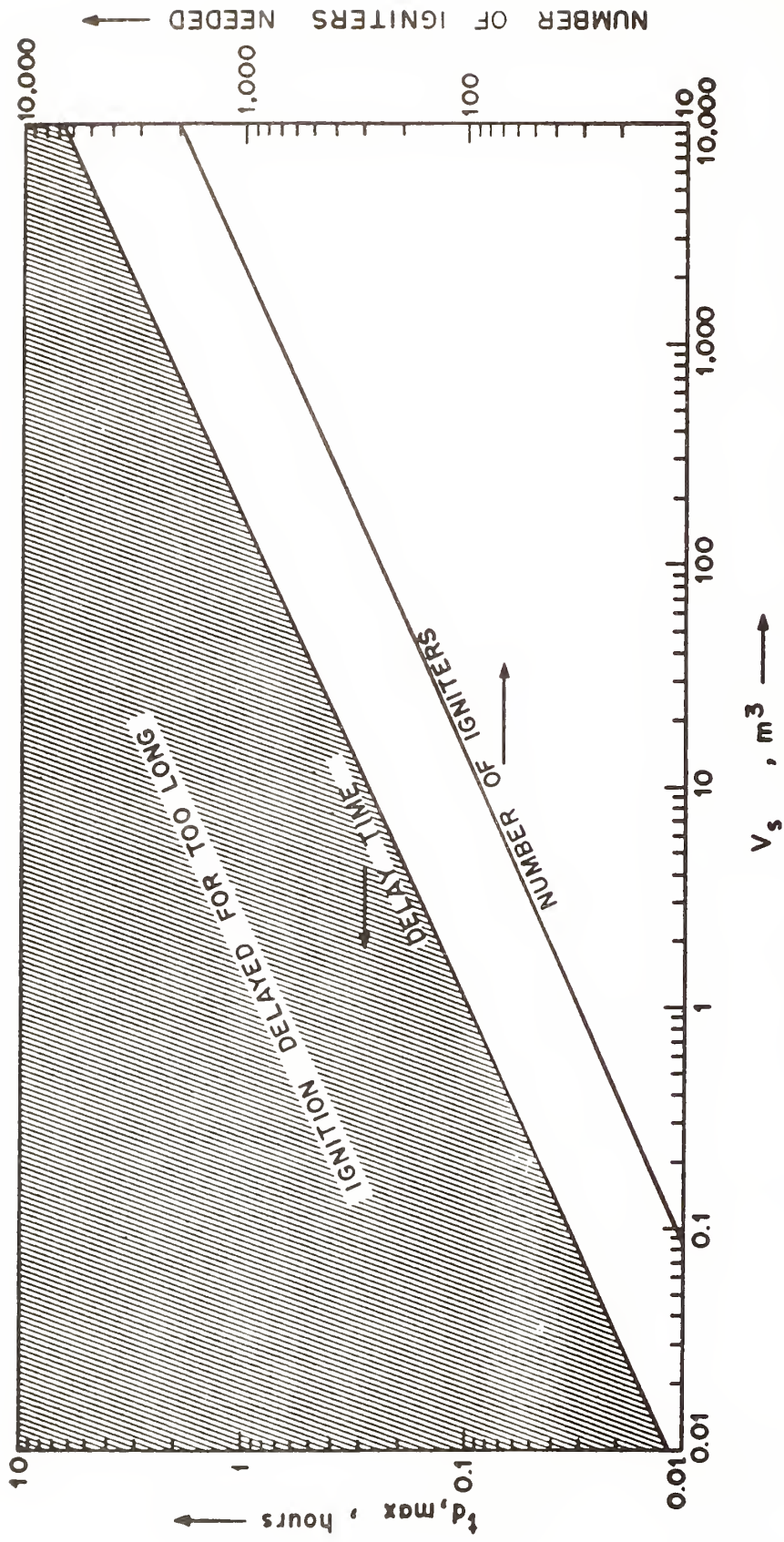
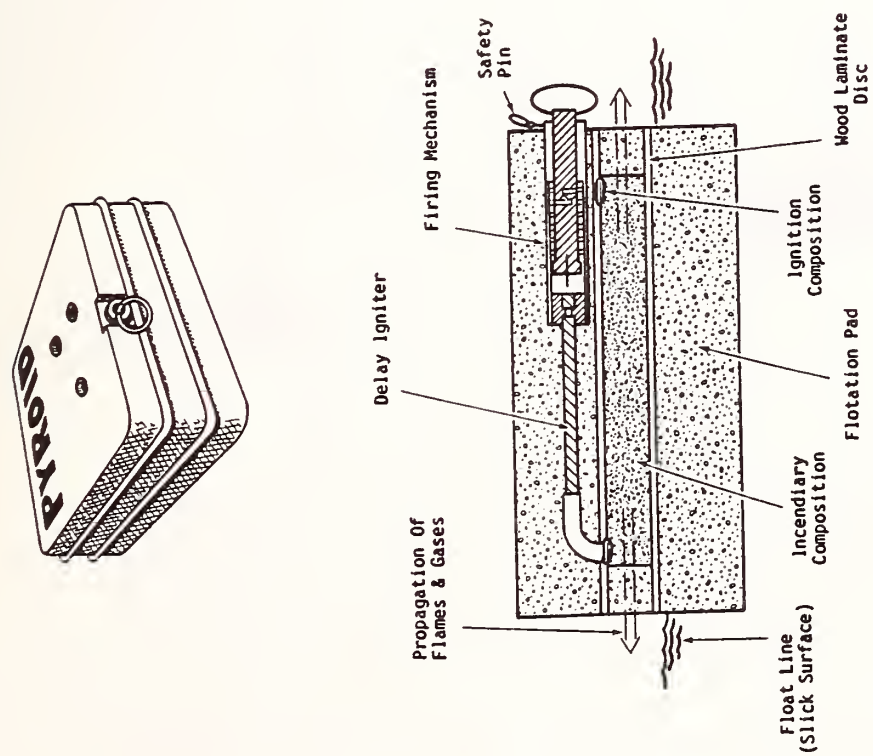

Figure 5 Maximum permissible ignition delay time and the number of igniters required at that time as a function of spill volume [4].



After: Twardawa & Couture, 1983.

Figure 6 Environmental Protection Service (EPS) igniter showing internal firing mechanism and pyrotechnic components [6].

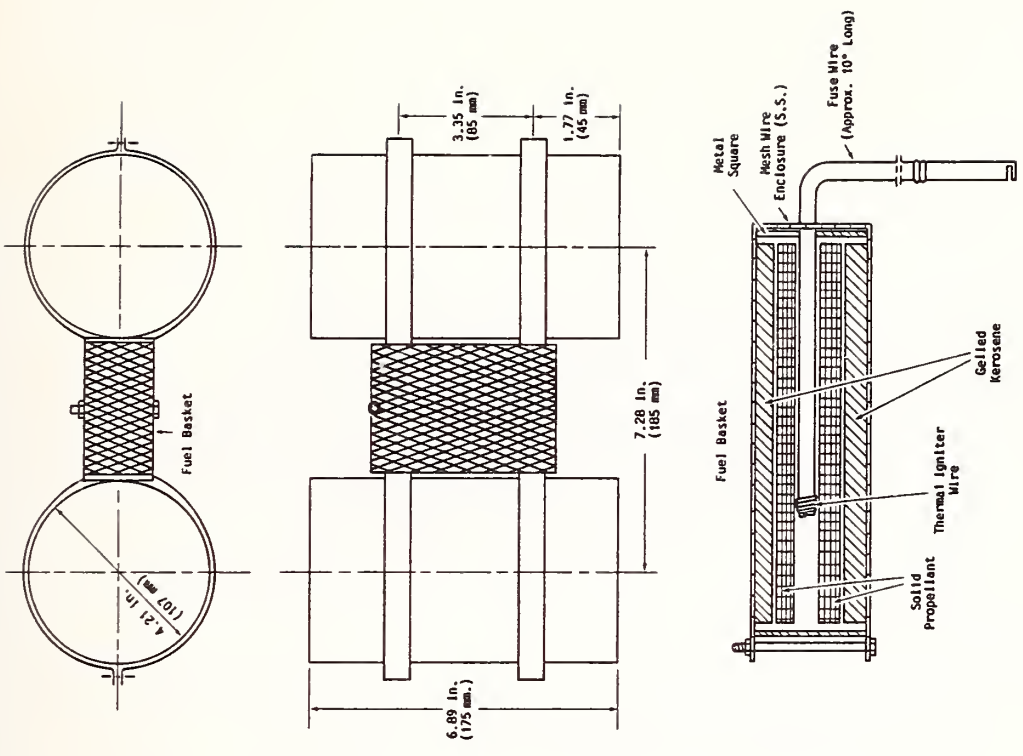

Figure 7 Basic design and internal components of the Dome igniter [6]

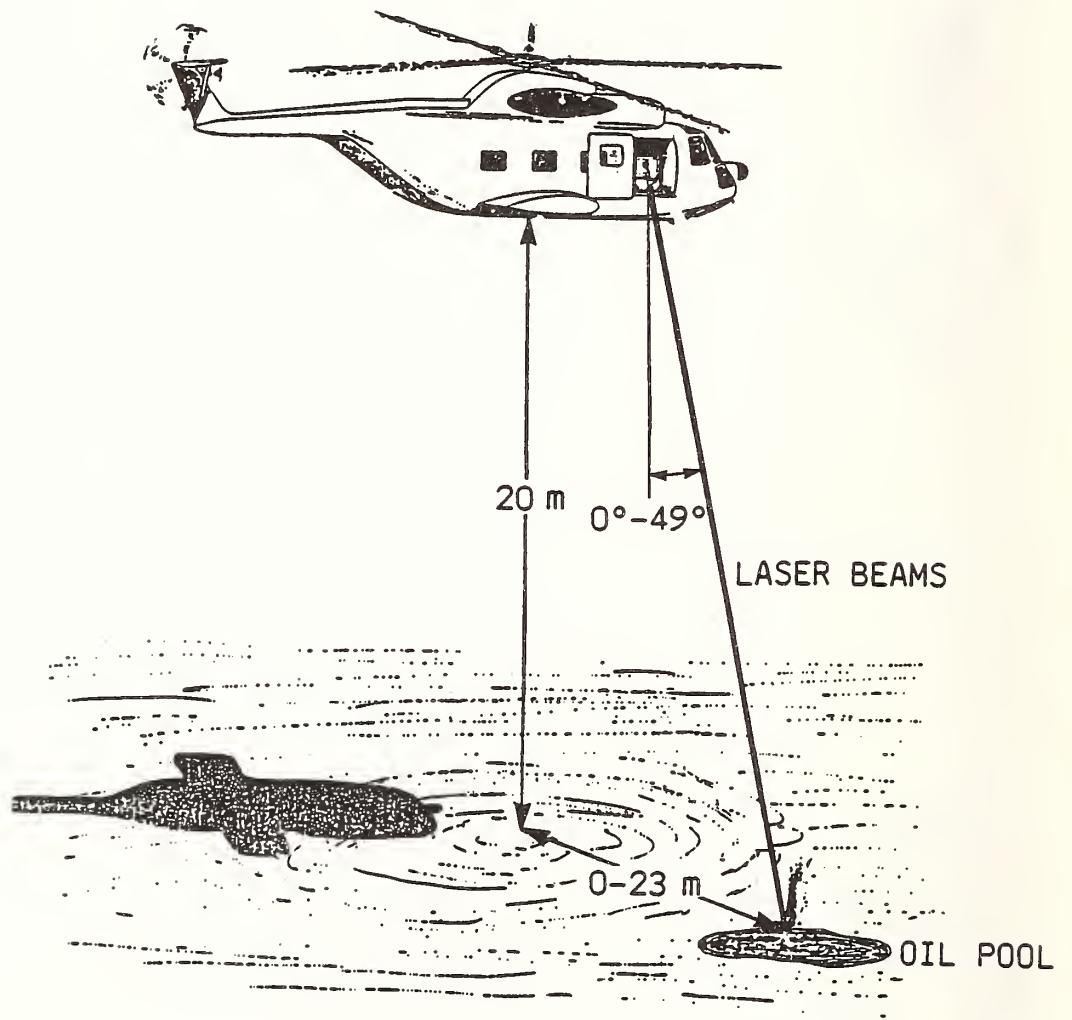

Figure 8 Illustration of airborne LIOS system [7]

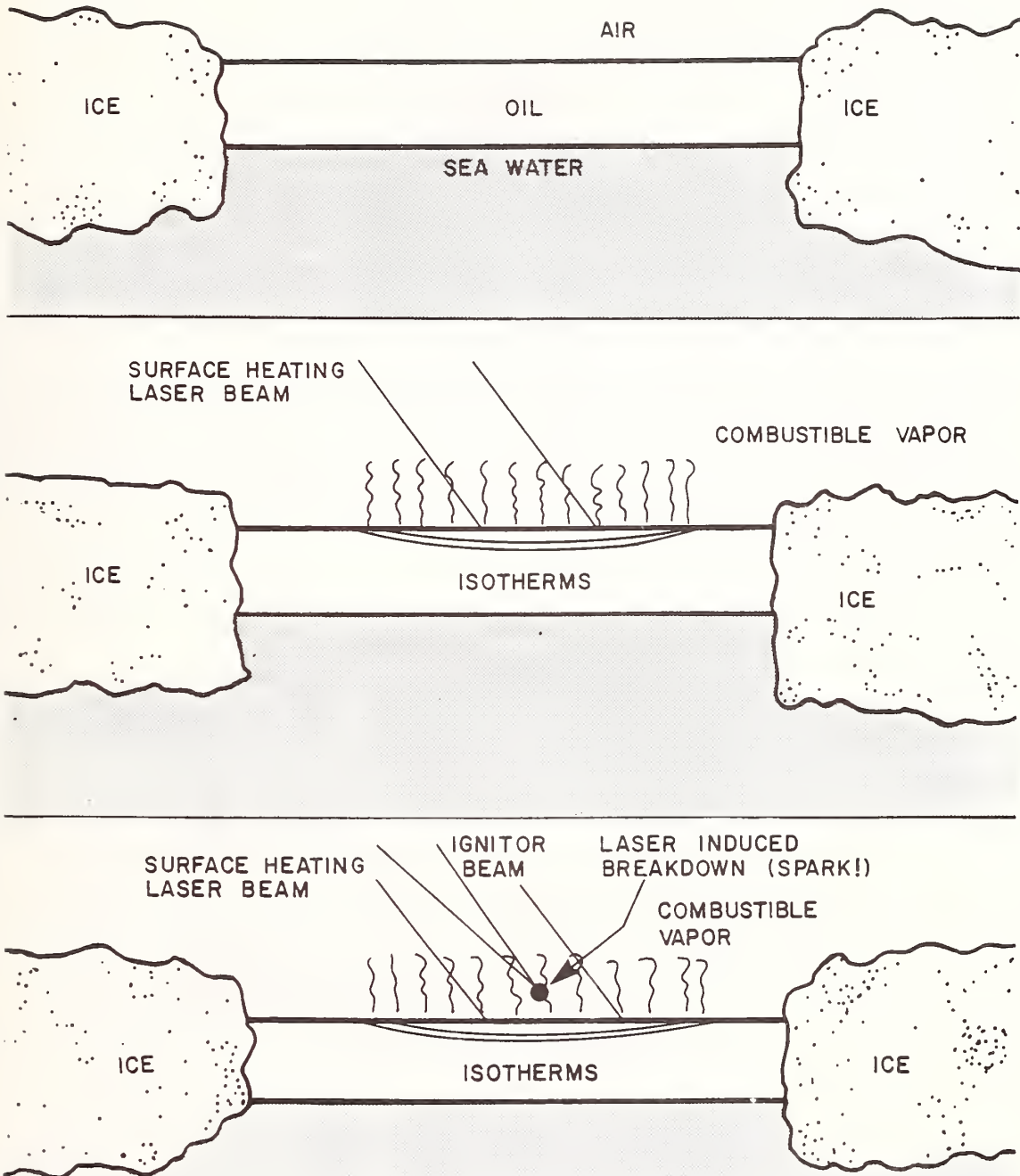

Figure 9 Process of oil spill ignition using LIOS [7]

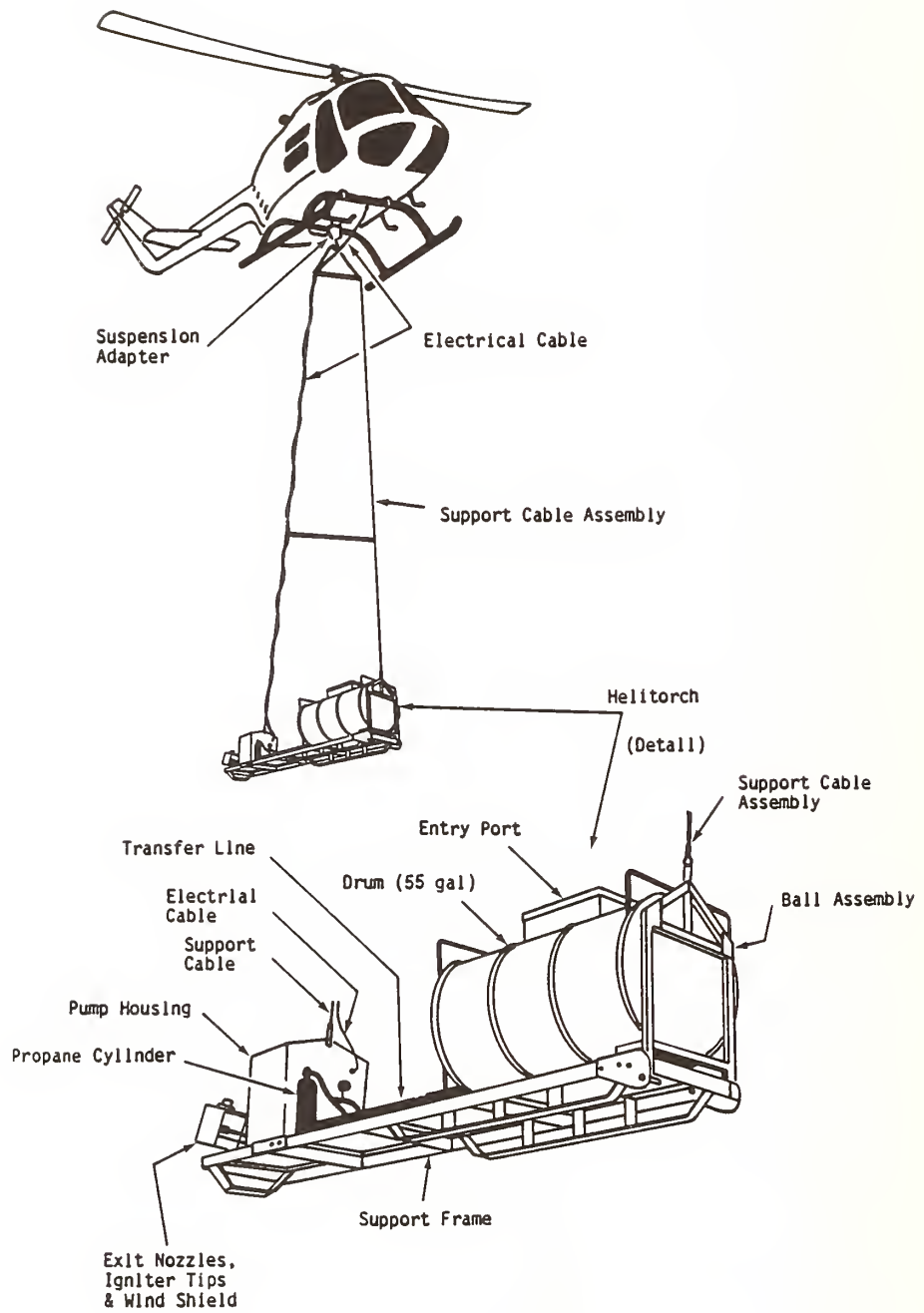

Figure 10 Helitorch igniter system [8]

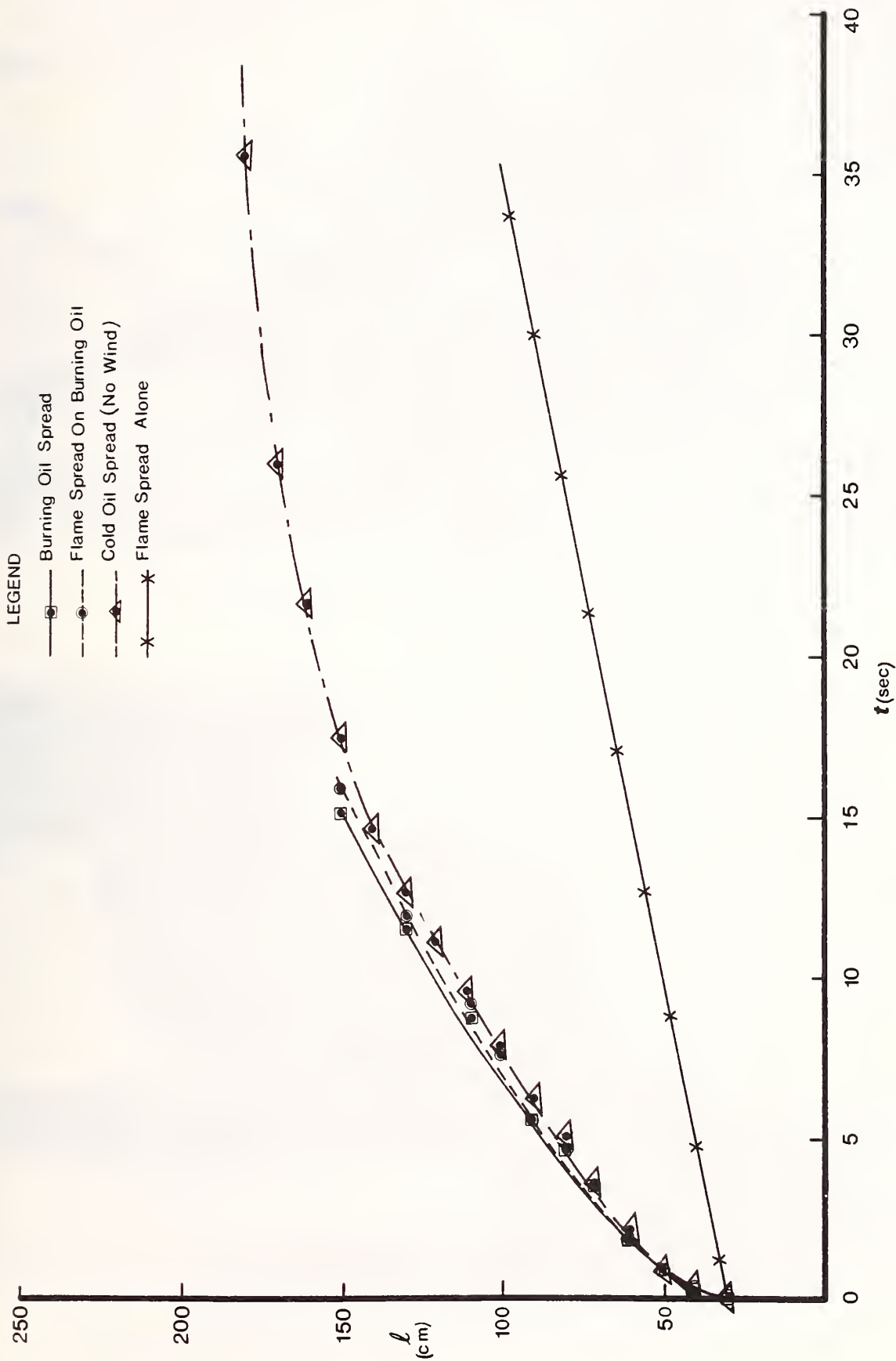

Figure 11 Oil and flame spreading (4 hour aged ASMB at 0.25 m/s wind speed) [9]



Figure 12 Demonstrating the burnability of an emulsion of 92% Prudhoe Bay crude oil and 8% bay water in tests at OHMSETT [3]

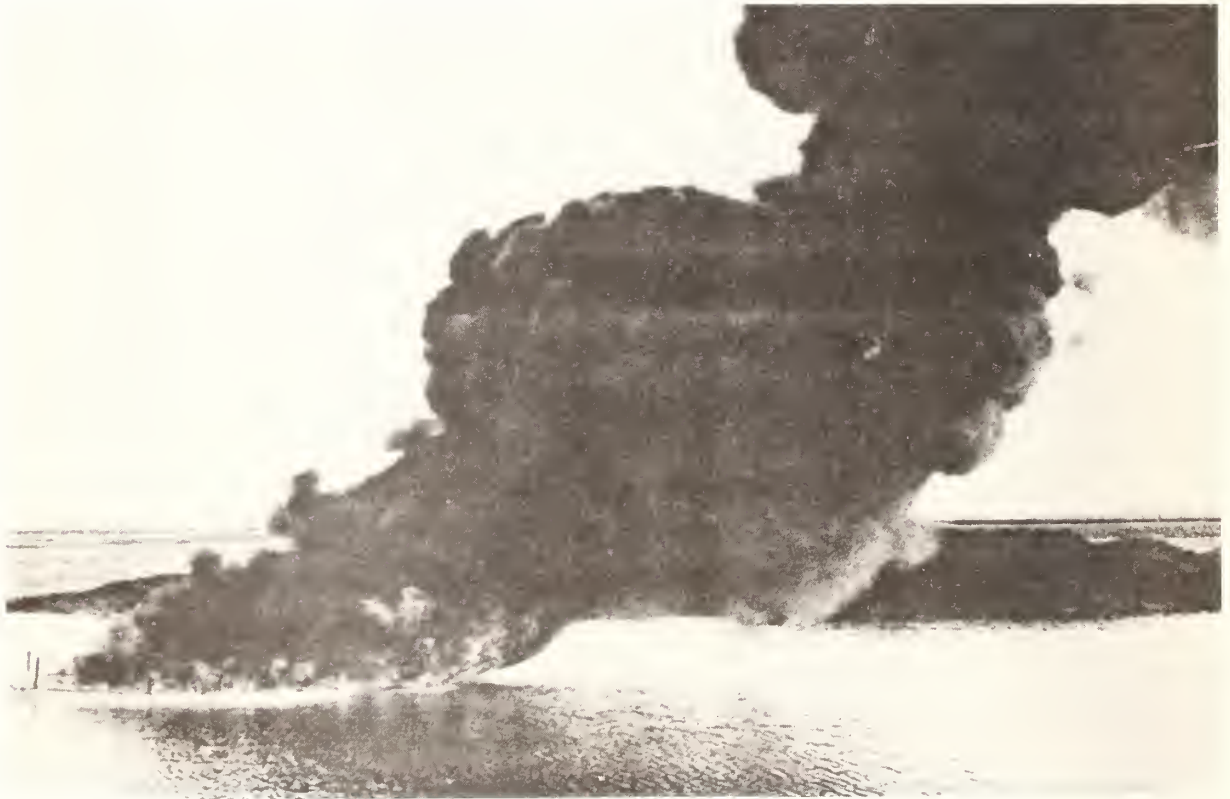

Figure 13 Large scale burn tests near Prudhoe Bay, Alaska [4]



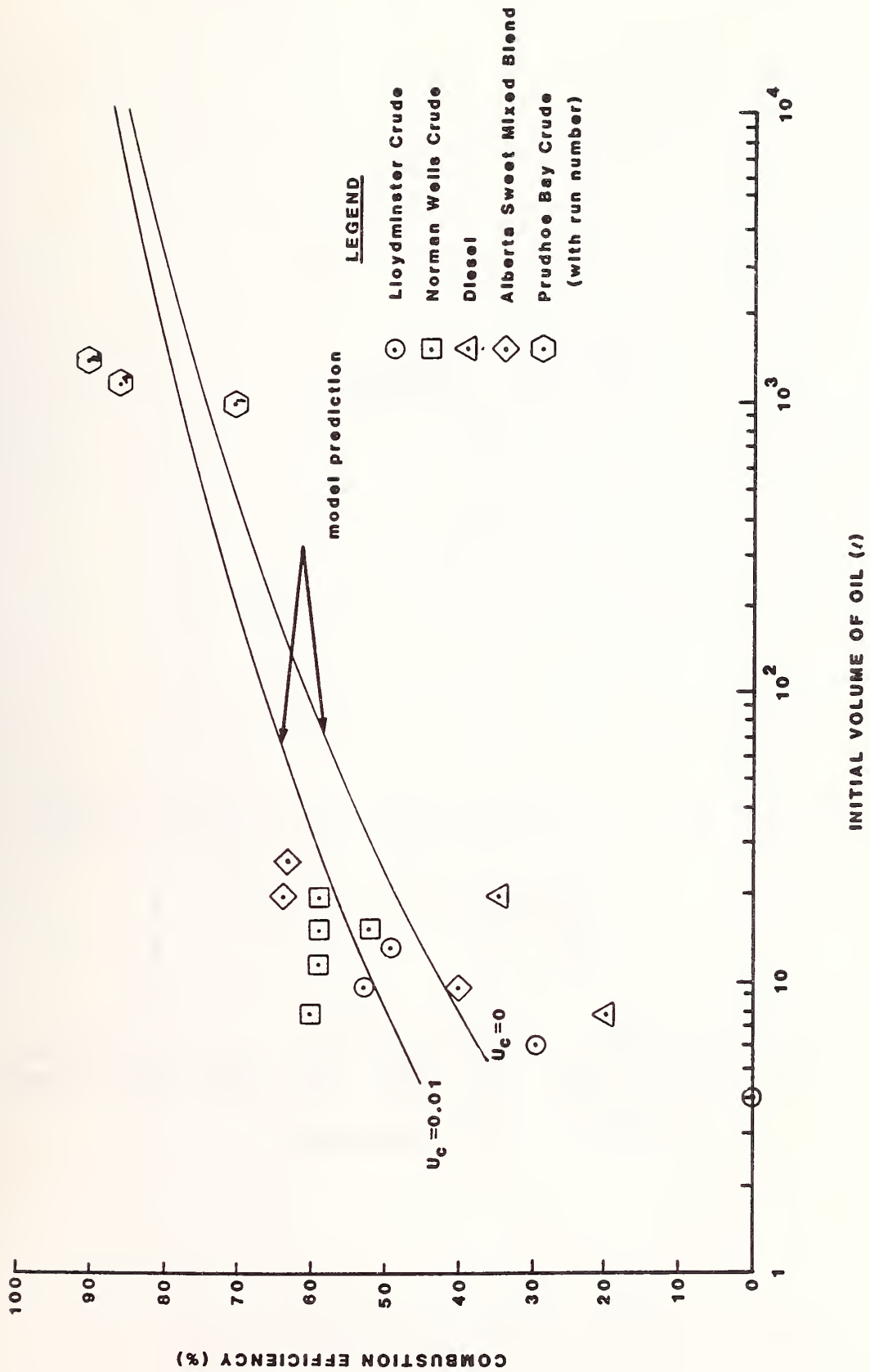

Figure 14 Oil spill combustion efficiency assuming instantaneous ignition [4].

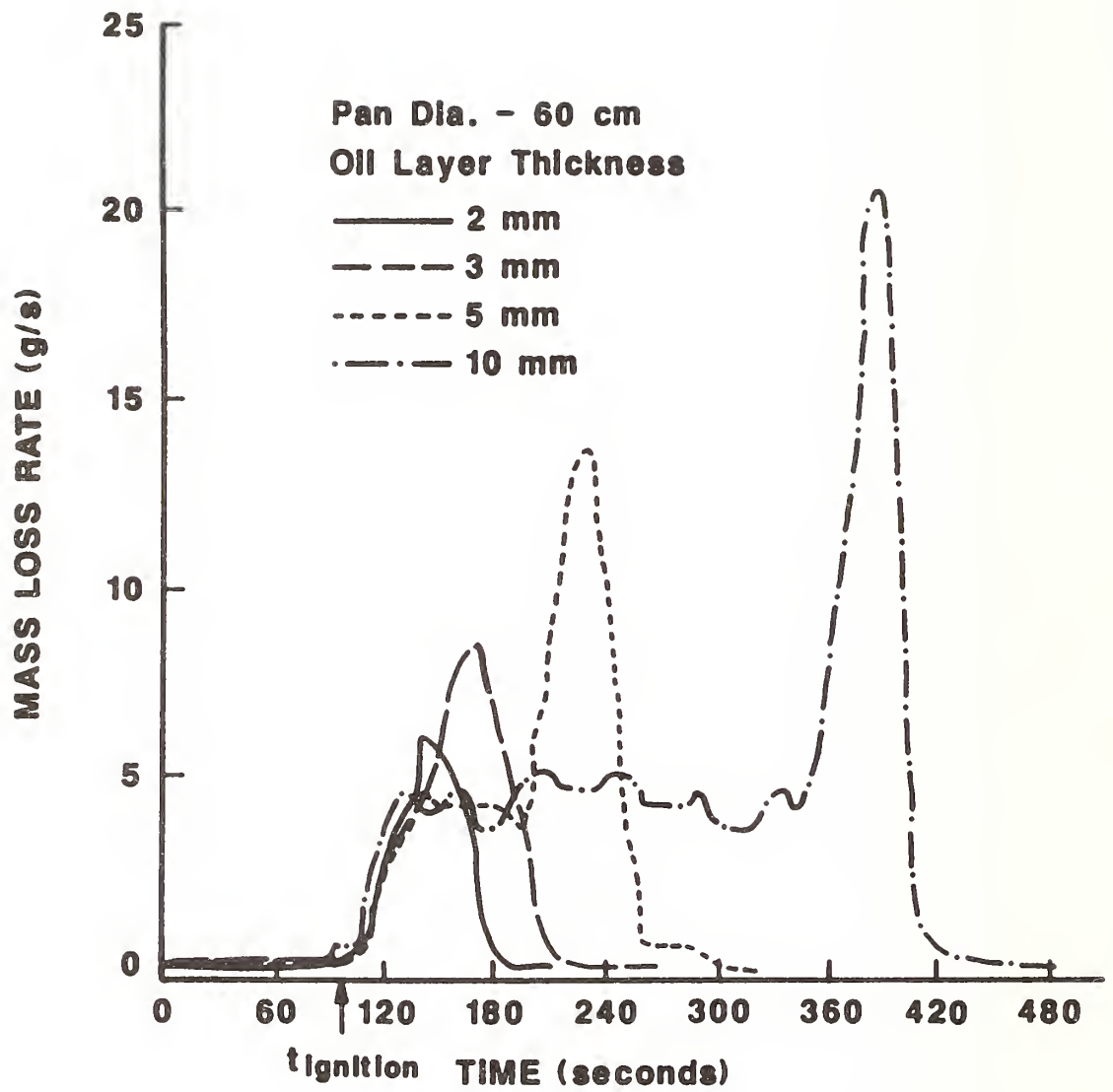

Figure 15 Effect of oil layer thickness on the mass loss rate history during burning

Appendix A

Applicability and Effectiveness of Burning  
as an Oil Spill Response Technique

Reproduced with permission from reference 1:

Oil Spill Response in The Arctic, Part 3: Technical Documentation,  
research administered by Shell Western E&P, Inc., Sohio Alaska  
Petroleum Company, Amoco Production Company, 1984.

ICE CONDITIONS		TECHNIQUES													
Period Type of Ice	Ice Coverage Typical Duration (For 20-50' depths, based on 23 yrs. of observations)	Breakup							Open Water			Freezeup	Winter		
		8 Oktas (100%) 6 Wks.	7 Oktas (87.5%) 2 Wks.	6 Oktas (75%) 2 Wks.	5 Oktas (62.5%) 1 Wk.	4 Oktas (50%) 1 Wk.	3 Oktas (37.5%) 3 Wks.	2 Oktas (25%) 3 Wks.	1 Okta (12.5%) 7 Wks.	1 Okta to Ice Free	New Thin, Broken or Slush Ice 4 Wks.	Solid Ice 29 Wks.			
Containment	Natural (incl. Ice & Snow Barriers) Conventional Booming Fire Containment Boom														
Recovery	Portable Rope Mops ARCAT Skimmer Vessel Skimmers Other Small Skimmers Manual Removal														
Disposal	In-Situ Burning Incineration On Site Dispersants														
Logistics	Vehicles: Amphib. & ACV Vehicles: Wheel & Track Tugs & Barges Aircraft														
Response	Primary Response Techniques & Logistics	Burning with natural ice containment igniters released from helicopters							Burning with tire containment booming ARCAT skimmer with collection booms, portable skimmers and manual removal from amphibious/air cushion vehicles, tugs, barges, and small boats. Towable bladders and incineration.			In-situ burning igniters with amphibious, ACVs, and helicopters	Manual removal; in-situ burn; incineration. Use all vehicles and aircraft		
	Additional Response Techniques & Logistics	Rope mop skimmers and manual removal from amphibious/air cushion vehicles and from tugs and barges. Storage and incineration on barges							Conventional sweep booming (avoiding ice). Backup self-propelled skimmers (avoiding ice). Dispersants (with low ice concentrations and good mixing energy).			ARCAT skimmer; small skimmers with vessels. Mark oiled areas and wait for solid ice.	Slots and augers; use small skimmers and direct suction. Wait for oil to surface in spring.		

## APPLICABILITY OF ARCTIC OIL SPILL RESPONSE TECHNIQUES

Good
  Fair/Limited
  Has Potential

NOTE: This chart is an updated version of the Industry Task Group's applicability chart and is not to be confused with previous versions dated March 1983 and August 1983. This latest chart contains several revisions based on the demonstrations conducted by industry in the summer of 1983 and on subsequent evaluations by the Task Group.

## IN-SITU BURNING WITH NATURAL CONTAINMENT

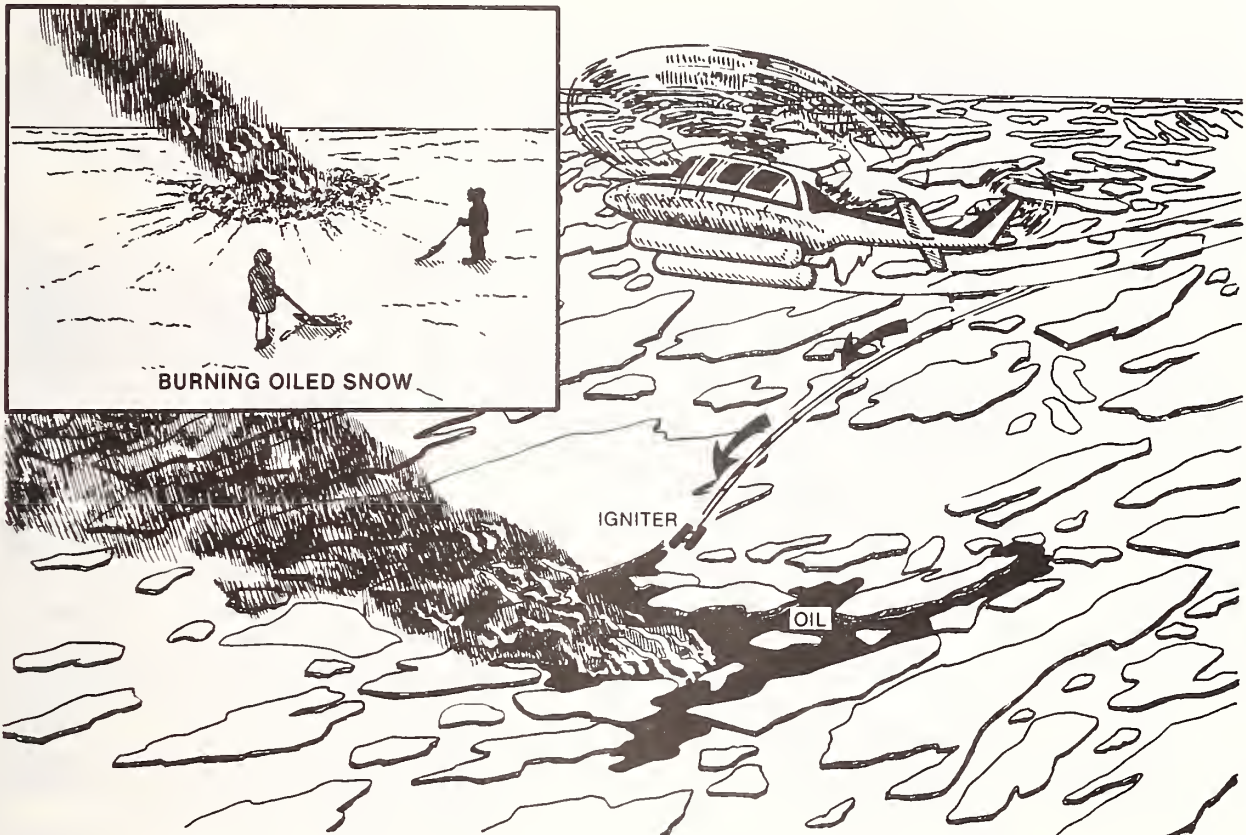

### DESCRIPTION

Under the influence of wind, oil will tend to drift with a greater speed (and at times a different direction) than individual ice pieces. Oil released in a broken ice field, however, can be herded by natural effects into concentrations that can support in-situ burning. Oil will tend to accumulate in leads and cracks, it can be herded by the wind and be concentrated in or against tightly packed ice fields, and it can accumulate against the windward sides of large floes. Oil entrained in solid ice

during the winter can migrate to the surface during the spring melt and accumulate in melt pools on the ice surface. In each of these modes of concentration, oil can be ignited by air-deployable igniters dropped from helicopters or, in some cases, from surface craft. Aerial monitoring of oil concentrations is essential to ensure that the heaviest and freshest oil is ignited as soon as possible. The proper government permits must be obtained for any burning of oil or oily debris.

### APPLICABILITY



Good
  Fair/Limited
  Has Potential
  Not Applicable

## IN-SITU BURNING WITH NATURAL CONTAINMENT

### PERSONNEL

Personnel requirements minimal, normally involving 1 or 2 people for ignition/monitoring teams. Nature and distribution of individual oil pools will dictate the total number of ignition/monitoring teams.

### EQUIPMENT

Helicopter(s)  
Igniters (several per oil pool as backup)

### PHYSICAL PARAMETERS

#### IN-SITU BURN RATE

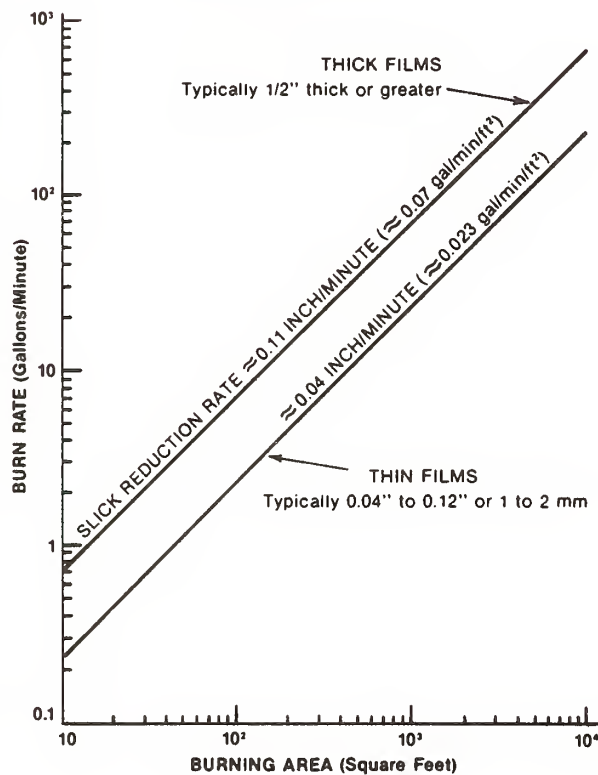

- Monitor oil and weather conditions — allow wind to herd oil into concentrations (in leads or melt pools; against large floes, gravel islands, etc.).
- The thicker the initial layer of oil prior to ignition, the smaller the percentage of burn residue.
- Winds can increase the burn rate; however, higher winds will not appreciably improve the burn efficiency.
- Winds in excess of 20 mi/hr ( $\approx 37$  km/hr) will make ignition very difficult and hamper combustion through excessive cooling of the fire.
- In-situ burning of oil/water emulsions is not normally practical.
- Aged, emulsified crude oil (>1 to 2 weeks exposure) can usually be burned but is difficult to ignite.
- Minimum thicknesses for ignition:
  - $\approx 0.04$  in. (1 mm) for fresh oil
  - $\approx 0.12$  in. (3 mm) for aged oil

**NOTE:** Use a burn rate of 0.11 in./min for thick oil concentrations ( $\geq 0.5$  in.).

### CONVERSION FACTORS

1 gal/min = 1.43 bbl/hr = 34.3 bbl/day  
 1 ft<sup>2</sup> =  $2.296 \times 10^{-5}$  acres =  $9.29 \times 10^{-2}$  m<sup>2</sup>  
 Oil at 0.1 in. thick = 41,400 bbl/mi<sup>2</sup> = 64.7 bbl/acre = 0.062 gal/ft<sup>2</sup>

### RELATED TECHNIQUES

In-Situ Burning with Fire Containment Boom

## IN-SITU BURNING WITH FIRE CONTAINMENT BOOM

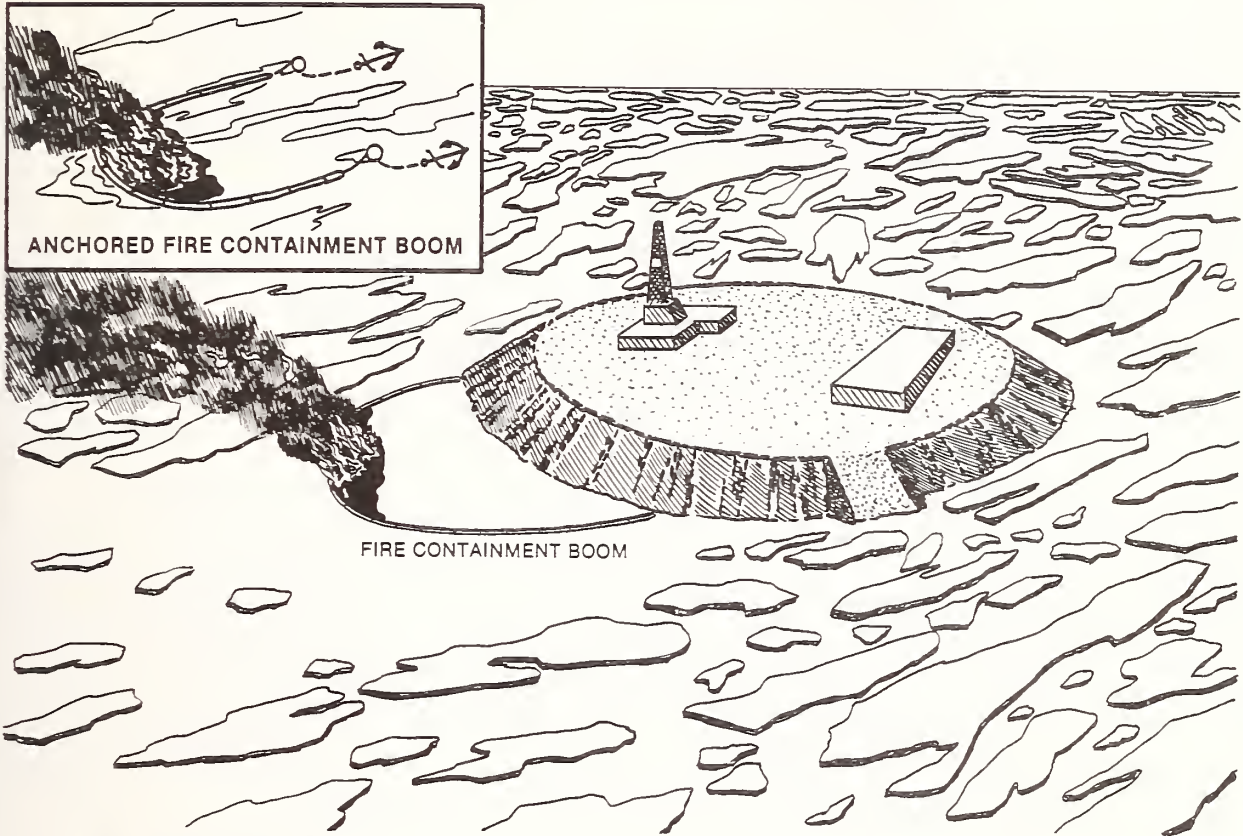

### DESCRIPTION

Fire containment boom can be used in several ways to provide concentrations of oil for in-situ burning. Two boats can tow the boom in a U-configuration to collect oil, and then the boom can be set adrift or anchored while the oil is ignited and burned in place. Fire containment boom can also be deployed in a free-drift mode among broken ice pieces by helicopters, air-cushion vehicles, or tugs to enhance natural wind-herding of oil for subsequent ignition.

If a blowout on a drilling island is ignited during heavy ice conditions, burning in the lee of the island can be enhanced with the use of fire containment boom. The

magnitude of the blowout and the intensity of the burn will determine whether or not it is feasible or safe to deploy the boom in the lee of the island. Small-boat operations and/or boom maintenance by personnel on foot must not be attempted unless it is possible to avoid contact with the oil and to remain at a safe distance from all burning and potentially ignitable vapors and materials. Deployment of the boom with self-anchoring shoreline connections may be necessary using helicopters without ground support. Multiple or replacement booms would be deployed in the same way. The proper government permits must be obtained for any burning of oil or oily debris.

### APPLICABILITY



 Good 
  Fair/Limited 
  Has Potential 
  Not Applicable

# IN-SITU BURNING WITH FIRE CONTAINMENT BOOM

## PERSONNEL

If fire containment boom is towed, a minimum of 1 operator and 1 crewman required per tow vessel. Boom deployment mode, nature of spill source, and variability of winds and currents will dictate the manning requirements during burn. Aerial spotter personnel may be needed for optimum positioning of the containment boom.

## EQUIPMENT

Towboats  
 Fire containment boom (typically 200 to 400 ft)  
 Igniters, line, floats, anchors, etc.  
 Spotter aircraft

## PHYSICAL PARAMETERS

### BURN AREA/BOOM LENGTH VS. ENCOUNTER RATE

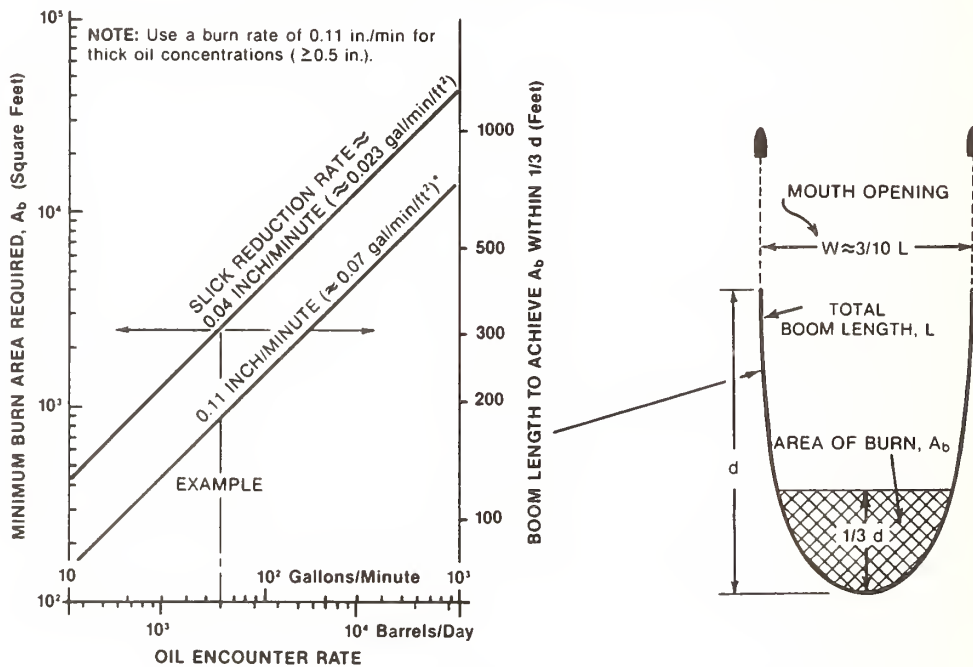

**EXAMPLE:** A U-boom configuration positioned downstream of a 2,000 bbl/day spill source would require a boom length of between 200 and 300 ft in order to provide the 2,500 sq ft needed for in-situ burning within the downstream third ( $1/3 d$ ) of the boom area. The suggested mouth opening ( $W$ ) in this example would be 90 ft.  $W$  could be increased, of course, depending on the approaching oil, the sea state, winds, and the desired burn concentration.

## CONVERSION FACTORS

1 gal/min = 1.43 bbl/hr = 34.3 bbl/day  
 1 ft<sup>2</sup> =  $2.296 \times 10^{-5}$  acres =  $9.29 \times 10^{-2}$  m<sup>2</sup>  
 Oil at 0.1 in. thick = 41,400 bbl/mi<sup>2</sup> = 64.7 bbl/acre = 0.062 gal/ft<sup>2</sup>

## RELATED TECHNIQUES

Containment Using Towed Boom Configurations  
 In-Situ Burning with Natural Containment



## Appendix B

### Case Histories of Attempts to Use Burning in Response to an Oil Spill

Reproduced from reference 5:

Thompson, C.H., Dawson, G.W., and Goodier, J.L., Combustion: An Oil Spill Mitigation Tool, U.S. Department of Energy, DOE/EV-1830-1, National Technical Information Service, Springfield, VA 22161, August 1979.

#### TORREY CANYON (March 1967)

Burning of the TORREY CANYON cargo was attempted after the ship had broken up. Attempts were made to light small oil slicks believed to be reasonably thick, using "oxygen tiles" (a pyrotechnic device containing sodium chlorate to provide an oxygen-rich flame). These attempts were unsuccessful probably because the highly flammable volatile fraction of the crude oil had already evaporated. Sodium chlorate devices were successful in igniting crude oil exuding from the ship. Bombing of the tanker with 1000-lb high explosive bombs produced fire in the tanker and in some surrounding patches. Aviation kerosene was jettisoned to feed the fires. Napalm bombs were also used to start fires. Approximately 160,000 lb of high explosives, 10,000 gallons of aviation kerosene, 3,000 gallons of napalm and several rockets were used in the burning operations.

#### ARROW (February 1970)

This Liberian-registered tanker spilled 16,000 tons of Venezuelan Bunker C fuel oil after it went aground in Chedabucto Bay, Nova Scotia. Environmental conditions at the time of the spill were: water temperature 0°C to 1°C; air temperature much lower, wind 40 to 50 mph, severe wave conditions and 100-foot water depth. A burn action was initiated using a wicking agent, "Seabeads." The product was used successfully on beaches and on isolated slicks in 1°C to 2°C water. Part of the spill was burned by using two drums of fresh oil and igniting them with "Kontax." Onshore oil deposits were ignited with napalm and a flame thrower and burned well.

#### OTHELLO AND KATELYSIA (March 1970)

Following a collision in Tralhavet Bay, Sweden, between 60,000 and 100,000 tons of Bunker C oil was trapped in packed ice. The extremely low water temperature excluded the use of dispersants, absorbents, and containment booms and this resulted in a decision to burn the oil. Following application from a tug boat of a combustion promoting chemical (Cab-O-Sil ST-2-O) a large quantity of the spilled oil was ignited and burned. The Cab-O-Sil chemical, now known as Tull-A-Nox 500, is a wicking agent composed of fine particles of fumed silica, surface treated with a silicone coating to render it hydrophobic.

The oil that was trapped in the ice was later burned after the thaw when the ice and oil separated. Some heavily contaminated ice was recovered with a grab bucket dredge and contained in barges until the ice thawed and the oil naturally separated and could be readily recovered.

#### U.S. COAST GUARD OIL SPILL TESTS (SUMMER 1970)

At Point Barrow, Alaska, the USCG conducted oil burning tests using 55 gallons of North slope crude for each test. Fresh and 6-day old crudes were ignited and burned well both on water and on ice. No difference in ignition and burning was noted when either glass beads or fumed silica burning agents were used. Environment conditions during the tests were: ice temperature, 0.3°C; water temperature, 1°C to 2°C; air temperature, 1°C to 4.8°C.

### DECEPTION BAY, QUEBEC (June 1970)

Oil and gasoline that escaped from five bulk storage tanks damaged by a slush ice avalanche was burned in the Western Hudson Strait. This involved oil on ice and oil contained by near shore ice. The remaining oil was pumped onto the ice from the water and burned. All of the ice was eventually cleaned up by repeated burn actions.

### ARGO MERCHANT (December 1976)

In this marine casualty, which occurred about 29 nautical miles southeast of Nantucket Island, Massachusetts, the USCG first attempted to burn the oil slick on December 27, 1976. Isolated boxes of Tull-A-Nox 500 charged with fuel were dropped from a helicopter and ignited with a timed thermite grenade. The isolated boxes burned but because of the lack of dispersal of the wicking agent, flame spread was not sustained and the burn was unsuccessful.

On December 31, 1976, at 1538 hours (16 days, 8.38 hours at the initial grounding of the vessel) an attempt was made to burn another slick originating from the stricken vessel. This slick was 90 ft by 120 ft in dimension, was elliptical in shape, of heavy tarry consistency, and 6 to 10 in. thick. The slick contained much debris such as 2 x 4s and other building material. As the vessel maneuvered alongside the slick the patch was broken up into several smaller patches. The Tull-A-Nox wicking agent was left in 11 plastic bags and was thrown on the slick near the center of a smaller 30 ft by 60 ft oil pancake. Some bags burst open on impact. Others were torn open with birdshot from a 12 gauge shotgun. In spite of the wicking agents advertised affinity for oil, its bulk density of 3 lb per cubic feet (comparable ash) allowed the wind to blow approximately 95% of it off the slick. As a result of the high loss rate of the initial 66 lb of wicking agent an additional 66 lb was charged with JP-4 and disbursed along the edge of the slick. It was very obvious at this stage that a continuous coating over the oil slick could not be obtained with the technique available. Sufficient wicking agent was dispersed to theoretically provide a 1/2 in. coating over the 30 x 60 ft oil pancake had 100% of it remained on the slick. Fifty-five gallons of JP-4 fuel were used to prime the slick.

Three cotton sheets were soaked in JP-4 and distributed on the slick. One was ignited using 30 minute railroad flares, and burned for 4 minutes. The heat source was insufficient to ignite the primer which was being mixed with water from the turbulence of the vessel. Unsuccessful attempts were made to ignite a wider region with flares. The demonstration was called off at this point.

The tests were deemed unsuccessful for the following reasons:

1. unable to disperse wicking agent without excessive loss (approximately 90%)
2. unable to main continuity of slick due to vessel propulsion turbulence
3. unable to sustain initial burn.

A total of 220 lb of wicking agent and 55 gallons of JP-4 aircraft fuel were expended on the burn test. The weather conditions during both burns were:

December 27, 1976 - winds 295 T/35 knots; seas 280 T/8 feet, barometer 29.58, visibility 2 miles with snow, air temperature 28 F.

December 31, 1976 - winds 350 T/5 feet, air temperature 30 F, visibility 3 miles and snowing.

BARGE B-65 (January 1977)

When this barge grounded in Buzzards Bay, Massachusetts, on January 31, 1977, two spills of No. 2 fuel oil, one of 10,000 gallons near the shore line and the other 5000 gallons were spilled offshore near the Cleveland Ledge Light. An attempt was made to burn the offshore spill that was crescent moon shaped and interwoven with floating ice. Sixty-six pounds of Tull-A-NOX 500 mixed with 12 gallons of kerosene, were dropped onto the slick from a helicopter flying at an elevation of 15 feet above sea level. Each bag of wicking agent was ignited by a 3 minute time delayed thermite fuse. Thirty minutes after ignition, forty-four pounds of wicking agent were dropped onto the spill. The oil ignited around each bag of wicking agent and two windblown flames ignited the surface slick for a distance of 35 ft from the ignition source. Some 2000 gallons of oil were burned in the response action.

AMOCO CADIZ

This incident posed a tremendous cleanup problem. Observers on scene indicated that burning was considered, but there was opposition expressed by local vegetable farmers.

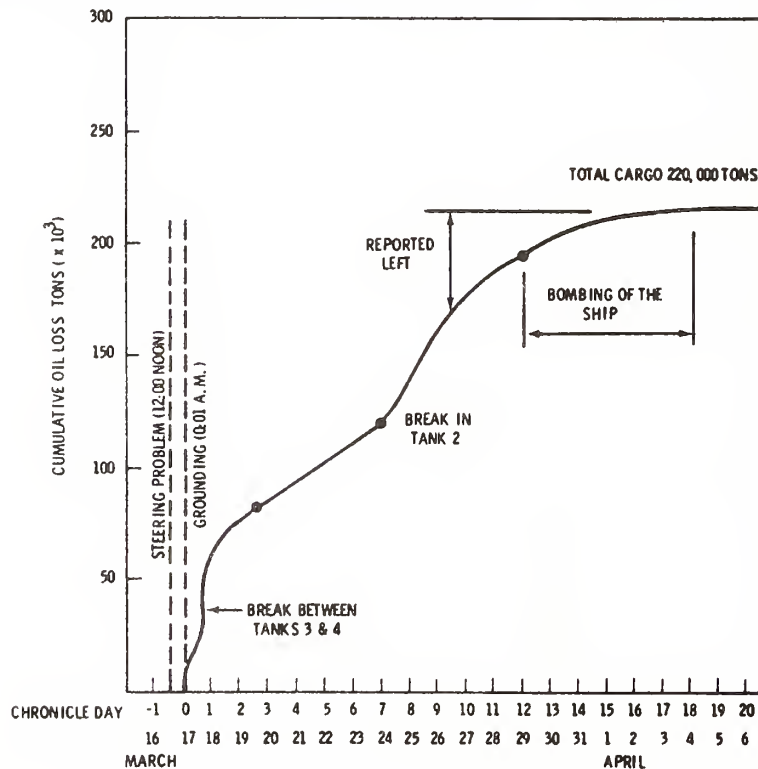

FIGURE B.1. Estimated Cumulative Oil Release from Amoco Cadiz Spill

Source: NOAA/EPA Preliminary Scientific Report, p. 233 Amoco Cadiz.

Those who were not in favor the burn because of soot fallout and tainting of crops found their crops tainted anyway by the intense hydrocarbon fumes moving inland from the contaminated shores. In time the ship was attacked by depth charges. Figure B.1 illustrates the events and shows the use of explosives on the ship. The intent of these bombing attempts was not to cause in situ burning, but are of interest to know that in 12 days the vessel was definitely regarded as a total loss and burning could then have been attempted without owner, etc. objectives. The owner was attempting throughout the incident's early days to locate pyrotechnic specialists.

NOTE: Comment

The evaluation of in situ burning also included consideration of the minimum amount of freeboard available (due to sea state) which rendered the opening of side vents unlikely. The paradox of the "last resort option" which burning is often considered is negated by conditions such as this. Burning without side vents has not been demonstrated, but may be practical when prevailing coastline winds create differential pressure at the deck surface. No responsible person can advise this last resort tactic without additional experience (after M.P. Holdsworth, August 24, 1978, personal communication).

#### KONTAX BURN TESTS

Successful oil burning was reported by the Dutch Government from tests conducted on July 1, 1969. These tests were conducted 25 miles at sea and on a beach. The tests were conducted on oil floating at sea simulating that resulting from a vessel collision. Studies were designed to ignite and burn confined oil floating at sea, to ignite and burn fresh and 12 hour weathered oil on a sandy beach. The oils involved were heavy and light Arabian crudes and test quantities ranged from 300 liters to 10 tons. The igniter material KONTAX was used in 25 kg plastic bagged form. The bags, being perforated on deck, were immediately tossed into the oil slick and upon contact with seawater caused extensive burning in the confined oil slick.

A 10 ton slick which was approximately 2,000 m<sup>2</sup>, 0.5 cm thick and free fixation was created. The Kontax was jettisoned into the slick and spontaneous combustion began with very heavy smoke. Flames were reported by Dutch observers to be 15 to 20 meters high and convection currents were very strong to the point that nonburning oil was drawn to the fire. Estimates of 99% to 90% reduction of this slick were noted. Details of weather and sea state were given. Ignition of oil on the beach was successful even when the oil was deliberately mixed into the wet beach sand. By evaluating the Dutch report and the manufacturer's literature, it would appear that a ratio of 1:100 KONTAX to oil by weight is an appropriate combustion promoter addition.

## Appendix C

### Bibliography of Studies Relevant to Oil Spill Burning

The majority of citations are taken  
from the bibliographies in references 5 and 11:

Thompson, C.H., Dawson, G.W., and Goodier, J.L., Combustion: An Oil Spill Mitigation Tool, U.S. Department of Energy, DOE/EV-1830-1, National Technical Information Service, Springfield, VA 22161, August 1979.

and

Oil Spill Response in the Arctic, Part 1: An Assessment of Containment, Recovery, and Disposal Techniques, draft report prepared by Industrial Task Group representing Amoco Production Company, Exxon Company USA, Shell Oil Company, Sohio Alaska Petroleum Company, April 1983

Affens, W.A. 1967. Flammability Properties of Hydrocarbon Fuels. Part 3. Flammability of Hydrocarbon Solutions in Air. Naval Research Laboratory, NRL Report 6617.

Equations have been derived which make it possible to predict overall flammability properties of mixtures from the properties of the individual components.

Allen, A. and Simpson, W. 1986 "Alaska Clean Seas and Evaluation of Fire Containment Boom", Proceedings of the Ninth Annual Arctic and Marine Oilspill Program - Technical Seminar, Edmonton, Canada, June 10-12, 1986.

Four fire containment booms have been tested and evaluated for their resistance to fire during 24-hr. exposures to burning crude oil. Seven individual burn tests were conducted. The performance of each boom was documented on videotape, and temperature profiles were recorded for each thermocouple. The results of these tests are summarized along with an overall assessment of each system's physical and operational strengths and weaknesses. Included is a summary of several tests conducted to evaluate the oil-holding capacity and wave-riding characteristics of each boom. These tests were conducted with and without an oil stimulant in waves up to 0.6 m (2 ft) in height and with currents of 0.2 m/sec to 0.6 m/sec (0.4 kt to 1.2 kt).

Arthur D. Little, Inc. 1969. Combating Pollution Created by Oil Spills. Report to the Department of Transportation. NTIS AD 696 635.

The types, use, and effectiveness of wicking agents for oil slick burning are discussed. Slicks should be thicker than 1/4", freshly spilled, and in relatively calm water for successful burning.

Berridge, S.A. et al. 1968. "The Properties of Persistent Oils at Sea." Institute of Petroleum Journal, 54 (539):300.

This paper discusses physical, chemical, and biological processes on oil spills. Evaporation is the major process, biological degradation is insignificant. Mixing affects the extent and rate of removal. Burning agents on ice pool slicks did not affect burning rate, but changed the residue. Average burning rates were 3-5 gal/min, with thicker slicks burning faster.

Blinov, V.I. and Khudyakov, G.N. 1957. "Certain Laws Governing Diffusive Burning of Liquids," Institute of Energetics of the Academy of Sciences, USSR, Academia Nauk, SSSR, Doklady, 113:1094-1098.

This paper on the natural burning of liquid petroleum products in pans is especially significant because of the wide range of pan size covered (0.37 cm to 22.0 m) which was sufficient to block out clearly the various burning regimes. Liquid burning rates and flame heights were measured. Flame shapes also varied with pan size.

Blokker, P.C. "Spreading and Evaporation of Petroleum Products on Water." 4th International Harbor Conference.

Based on lab-scale experiments and physical deductions, a procedure was developed to calculate the rate of spreading and evaporation of oil spillage on water. Due to the cooling effect of the water, fire risks are present with only very volatile oils (gasoline, crude oil). Quantitative methods are described.

Blumer, M. 1972. "Oil Contamination and the Living Resources of the Sea." Marine Pollution and Sea Life. FAO, Fishing News (Books) Ltd. London, England.

Oil spill countermeasures - detergents, dispersants, mechanical removal and containment, biological degradation, and combustion are compared. Oil burning using wicks or oxidants is more attractive than sinking. Combustion promoters are necessary for complete oxidation.

Brown, H.M. and Goodman, R.H. 1986 "In Situ Burning of Oil in Ice Leads", Proceedings of the Ninth Annual Arctic and Marine Oilspill Program - Technical Seminar, Edmonton, Canada, June 10-12, 1986.

A series of experiments was carried out at the Esso Research ice basin in Calgary, Canada to evaluate the critical parameters of burning oil in ice leads. This may be a useful spill cleanup technique in the Arctic under certain conditions. Twenty-five test burns of Norman Wells crude were carried out to study the effect of wind herding, oil weathering, oil thickness, and lead geometry on burning efficiencies. Burning efficiencies of up to 90% were measured where moderate winds herded the oil into long narrow leads. Burning in other lead geometries was less efficient as was burning in the presence of brash ice. Weathering of the oil up to 20% did not significantly effect the burns.

Brzustowski, T.A. 1985. "Study of the Burning of Unconfined Oil Slicks", Transactions of the Canadian Society for Mechanical Engineers, v 9, n 4, p. 192-199.

A model is developed here to describe the spreading and burning of an unconfined oil slick on water. In the model, the air flow into the flame induces a surface current on the water surrounding the slick. The current is directed inward toward the slick and inhibits its spread. It may be as high as 0.01 m/s, independent of slick size. The combustion efficiency (fraction of spilled oil burned) is calculated as a function of the volume of oil spilled (from  $10^{-2}$  m<sup>3</sup> to 10<sup>4</sup> m<sup>3</sup>) and of the time delay between the occurrence of the spill and the ignition of the slick. The slick cannot be ignited and will not continue burning if it is thinner than about 0.8 mm. It turns out that the combustion efficiency increases with increasing spill volume, and decreases with increasing delay time. There is a critical delay time beyond which combustion is quite uncertain. That critical delay depends only on the spill volume. In hours, it is of the order of 1/10 of the square root of the spill volume in m<sup>3</sup>.

Brzustowski, T.A. and Twardus, E. M. 1982 "Study of the Burning of a Slick of Crude Oil on Water", Proceedings - 19th Symposium (Int'l) on Combustion in Haifa, Israel, August 8-13, 1982, Combustion Publication Institute, Pittsburgh, PA, p. 847-854.

Observations of the burning of a slick of fresh crude oil on water, including photographs taken from underneath the slick, have shown that the combustion is very violent for much of the burning time, with burning drops of oil ejected from the flame. At the same time, the slick is violently disturbed and considerable flame radiation is transmitted through it. The violent combustion appears to be the result mainly of eruptive vaporization of the light fractions of the crude. A simple model of oil slick burning is presented. It is one-dimensional and quasi-steady, and does not include liquid-phase processes. It does incorporate heat loss to the water substrate, initial absorption of radiation, decreasing as the slick burns, and the effect



of wind on flame tilt and radiation heat feedback to the slick. The model predicts the minimum thickness for ignition, the unburned residue, the burning time, and the effect of wind on all three quantities.

Burgess, D. S., Strasser, A. and Grumer, J. 1961. "Diffusion Burning of Liquid Fuels in Open Trays," Fire Research Abstracts and Reviews, 3: 177-192.

This paper supports Blinov's and Khudyakov's findings that the burning rate above large pools is determined by the rate of radiative feedback from the flame to the pool of liquid. The paper also describes the effects of fuel temperature and wind on burning rate and suggests that burning rate may be predicted from the heat of vaporization and combustion of the fuel.

Castellucci, N.T. et al. 1972. Process for Burning a Combustible Liquid Using Cellular Ceramic Nodules. U.S. Patent 3661497.

Cellular ceramic nodules are spread on a combustible liquid and act as a wicking agent to sustain combustion.

Chemical Week, "Swedes Solve Oil Spill". April 15, 1970, p. 25.

Oil spilled from the tanker Othello was successfully burned using Cab-O-Sil ST-2-0. Because of the coldness of the waters and formation of ice-packs, use of dispersants, absorbents, or containment booms was impossible. Adding kerosene did not enhance burning.

Coupal, B. 1976. Controlled Combustion Tests Carried Out Near Rimouski. Environmental Protection Service, EPS-4-EC-76-2.

Combustion of oil (Ceuta Crude and Bunker C) on water with peat moss as a wicking agent and diesel fuel as a promoter was effective. Combustion efficiencies of up to 85% were achieved. Ocean burning tests are planned to include wave and current effects.

Day, T., Mackay, D., Nadeau, S. and Thurier, R. 1978. Emissions from In-Situ Burning of Crude Oil in the Arctic. Department of Chemical Engineering and Applied Chemistry, University of Toronto, Toronto, Ontario, Canada.

A postulated scenario defines the amounts of oil released, the size and number of burnable oil pools, and duration of burning. Estimates of soot, CO, SO<sub>2</sub>, and metals emissions are based on literature and experiments. Downwind concentrations of combustion products are calculated using conventional plume dispersion equations with superposition of plumes in time and space from a number of burning pools.

Day, T., Mackay, D., Naudeau, S., and Thurier, R. 1978. Characteristics of Atmospheric Emissions From an In-Situ Crude Oil Fire, A Report Submitted to the Environmental Canada Environmental Protection Service in fulfillment of DSS Contract No. KE-204-7-EP 126.

Oil combustion characteristics relating to emissions, Arctic atmospheric conditions, effect on smoke plume dispersion, and possible oil compositions are discussed. Emission behavior during cleanup can be treated as a set of "unit burns". Soot, SO<sub>2</sub>, CO<sub>2</sub>, CO, hydrocarbon, and metal concentrations can be calculated with this dispersion model.

Eidam, C.L. 1975. "The Casco Bay Oil Spill: Problems of Cleanup and Disposal." Conference on Oil Spill Control and Prevention, API, Washington, DC.

Clean up for a 100,000 gal oil spill in semi-arctic conditions centered on removal from the vessel, the boomed area, and the bay. Rocky shorelines were cleaned with high pressure hot water hoses. Beach sand and oil soaked debris were burned and the residue buried.

Energetex Engineering. 1978. Combustion Promoters. Interim Report, Prepared for the Environmental Protection Service, Department of Fisheries and Environment, Canada.

This report describes combustion promoters and their past use and effectiveness for in-situ burning of oil slicks. The materials described are classified according to their effects on the oil layer. Detailed information on properties, cost, and availability is also discussed.

Energetex Engineering. 1978. Testing of Air-Deployable Incendiary Devices for Igniting Oil on Water. Draft Report available from R&D Division, Environmental Branch, Environmental Protection Service, Department of Fisheries and Environment, Canada. To be published.

Field studies document the definite feasibility of using air deployable incendiary devices to ignite contained pools of oil. Crude oil (Norman Wells) 3 and 10 mm thickness burned when solid propellant, solid fuel and Kontax igniters were either static or air dropped (11.5 m) using chemical, electrical, or fusewire starters. Advantages and limitations for each system are given along with future research recommendations and a concise theoretical explanation of hydrocarbon pool burning.

Energetex Engineering. 1978. Development of a Continuously Burning Wicking Device for Burning Oil Slicks. Draft Report available from R&D Division, Environmental Emergency Branch, Environmental Protection Service. Department of Fisheries and Environment, Canada.

A portable oil slick burner was designed, built, and tested using a wicking system and a gaseous fuel to be used on Arctic oil spills. Test model was designed to operate at one half U.S. gallons per hour and incorporated drip-feed wicking, time delay ignition, and water cooling barriers to affect heat transfer. It is reported that the units can be built for about \$400.00.

Environmental Protection Agency. 1971. "Oil Pollution Control Technology." EPA Training Manual. NTIS PB 258600, p. 15-6.

Commercially available burning agents are tabulated. Wood and other debris caught in an oil slick are not too effective as wicking agents to start or sustain a fire. Oil can be burned if suitably thick, 5 mm.

Environmental Quality Systems. 1972. Waste Oil Recovery Practices. Maryland Environmental Service. p. 29.

Tabulated data of crude oil characteristics and analytical breakdown are compiled. API gravity, sulfur content, initial and end boiling points, and viscosity data are included. Data is also given for contaminated beach samples.

Evans, D., Baum, H., McCaffrey, B., Mulholland, G., Harkleroad, M., and Manders, W. 1986 Combustion of Oil on Water, NBSIR 86-3420, US National Technical Information Service, Springfield, VA 22161.

This report contains the results of measurements performed on both 0.4 m and 0.6 m diameter pool fires produced by burning a layer of Prudhoe Bay crude oil supported by a thermally deep layer of water. Both steady and vigorous burning caused by boiling of the water sublayer were observed. The measured energy release rate for steady burning was about 640 kW/m<sup>2</sup>. The emission rate, the size distribution, and specific extinction coefficient were measured for the smoke aerosol produced by the fires. Data were also obtained on the structure of the smoke aerosol by electron microscopy and on emission of CO and CO<sub>2</sub>. Analysis of the crude oil burn residue indicated selected depletion of the short chain alkanes and cyclo alkanes when compared to the fresh oil.

Evans, D., Mulholland, G., Gross, D., Baum, H., and Saito, K. 1988. Environment Effects of Oil Spill Combustion, NISTIR 88-3822, US National Technical Information Service, Springfield, VA 22161.

Experimentation and analysis have been performed to quantify the combustion of crude oil on water. The burning behavior of three crude oils -- Alberta Sweet, La Rosa, and Murban, were studied using 1.2 m diameter pool burns. In smaller 0.6 m diameter pool fires using Alberta Sweet, combustion products were collected for extensive chemical analysis. This analysis showed that about 10% of the crude oil was converted to smoke in the combustion process. The CO concentration was a factor of 25 lower than the primary gaseous product CO<sub>2</sub>, and the emission of NO and NO<sub>x</sub> were less than one thousandth the concentration of CO<sub>2</sub>. The PAH content of the smoke was enriched in the larger molecular weight species in comparison with the original fuel. A methodology was developed with which the downwind dispersal of smoke generated by one or more oil spill fires in close proximity may be predicted. Initial results that demonstrate the capability of the analysis are presented.

Freiberger, A. 1971. "Burning Agents for Oil Spill Cleanup." Prevention and Control of Oil Spills, API, Washington, DC, p. 245.

Currently available commercial burning agents are described with documented field test results and case studies. Containment is necessary for efficient burning. Primary effort is in developing igniters for the applied burning agents and reducing air pollution effects. Floating incinerators to contain, ignite, and reduce emissions from oil spills are currently being studied.

Gainer, G. and Mackay, D. 1976. "Burning of Oil," The Impact of Oil on the Freshwater Environment, Proceedings of a Workshop on Canadian Research Priorities, Publication No. EE2 of the Institute of Environment Studies, University of Toronto, Oct. 20-22.

A burner has been field tested that burns oil-contaminated materials like straw, moss, or wood. On ice, snow, or saturated ground, burning oil causes little environmental damage. This talk mainly outlined research needs in oil burning.

Gilmore, G.A. 1970. Analysis of Oil Spills and Control Materials, API, Marine Management Service, Washington, DC.

This contains a brief description of Cab-O-Sil Pyraxon application as combustion promoters. Burning is a viable option where temporary air

pollution is not a significant problem and there is no fire danger to the surrounding environment.

Glaeser, J.L. and Vance, G.P. 1971. A Study of the Behavior of Oil Spills in the Arctic, Coast Guard Report. NTIS AD 717 142.

This Arctic study includes data on spreading behavior of crude oil on ice and water surfaces, interaction of oil and ice, aging characteristics of oil, and effectiveness of burning and absorption for removal. Ninety to ninety-eight percent removal was achieved without burning agents at a rate of 4.5 gal/min.

Glottin, B. 1969. "The Disposal of Oil Produced During Offshore Well Tests on Wildcats Without Facilities," Offshore Technology Conference, Paper No. 1084, 2:133.

An oil-burning device has been developed for burning polluted oil on a drilling barge. Offshore well tests then can be conducted where no other oil disposal capacity exists. The burner is designed to protect the platform from the heat given off during combustion.

Hall, A.R. 1972. Pool Burning: A Review. Rocket Propulsion Establishment Technical Report 72/11.

This review covers literature on fundamental aspects of the combustion of liquid fuel at a free surface, including 1) influence of atmospheric conditions, fuel properties, container diameter, and partial venting on burning characteristics; 2) temperature distribution in the liquid; 3) heat transfer from flame to liquid; and 4) effect of water on burning.

Haroy Associates. 1978. A Preliminary Assessment of Beach Cleanup Techniques: A Quasi-Laboratory Assessment. Draft Report available from R&D Division, Environment Emergency Branch, Environmental Protection Service, Department of Fisheries and Environment, Canada.

This study evaluated the effectiveness of burning and sorbent techniques for cleaning off oil contaminated beaches in northern regions. The type of burn achieved, depth of penetration of oil, and amount of residue left were determined. Crude oils were used on fine gravel, sandy and mud flat beach soils. Twelve conclusions given relate to adequacy of burn being dependent upon an oil's ability to maintain a surface film as it penetrates the soil and reflooding to bring oil to surface was observed as not effective.

Hellman, H. and Marcincorowski, H.J. 1972. Experiments on Combating Accidental Release of Oil. Marine Pollution and Sea Life, FAO. Fishing News (Books) Ltd. London, England.

Emulsifiers and dispersant chemicals are generally not recommended because of pronounced toxic effects on marine life. Burning provides a viable option where the air pollution concerns are not as significant as water-land pollution. An alkali-metal carbide mixture enhances oil burning.

Herschmiller, D.W. and Revel, R.D. 1974. "Terrestrial Spillage of Oil in the Arctic," Water-1974: I. Industrial Wastewater Treatment, AIChE Symposium Series, Vol. 70.

Based on selected ecological considerations and environmental parameters, the applicability of oil spill technology to Arctic spills is presented. Contingency plans are developed. Burning is viewed as a fast, low cost alternative. Research needs are discussed.

Hillstrom, W.H. 1970. Ignition and Combustion of Unconfined Liquid Fuel on Water. Ballistic Research Laboratory Project No. 1T061101A91A. NTIS AD716578.

Activated carbon is used to enhance burning by forming an aggregated structure within the fuel lens and acting as a wick to draw the oil to the surface. A dose of 3-25% by weight was effective for different oils. Spreading coefficients for crude oil components are tabulated.

Holdsworth, M.P. 1968. "Control of Accidental Oil Spillage at Sea," Pollution Prevention, The Institute of Petroleum, The Elsevier Publishing Co., Ltd., London.

The author overviews ways to minimize tanker spillage and means of controlling oil spilled on the sea surface. The burning of both unrecoverable cargo in-situ and oil on the sea surface are briefly discussed. The author concludes that the burning alternatives are impractical.

Jerbo, A. Clearance of Oil from Frozen Rivers and Lakes, presented at the British Petroleum Arctic Conference.

The paper dealt with the methods used in Sweden to combat oil spills. Oil adsorbents, trawl nets, oil booms, and burning were mentioned. All compounds in oil do not burn; the residue may be more harmful than the oil itself. Phenols may be formed by combustion.

Koblanski, J. 1985. "Design Improvements in a Sonic Burner for the In Situ Combustion of Oil Spills", Proceedings - 1985 Oil Spill Conference (Prevention, Behavior, Control, Cleanup), Los Angeles, CA February 25-28 1985, API, Washington DC, p. 643.

Design improvements have been made in the Ocean Ecology sonic burner for removing oil slicks in situ. These improvements result in an increase in combustion efficiency, better control of the burn, and rapid ignition in extremely cold air and water. Automation and remote control have also been incorporated. Analysis of total input and output of the burner greatly aided in these improvements. Design was further modified to accommodate a fireproof boom. This small draft boom of superior design is extremely suitable for the Ocean Ecology system of in-situ burning. The results show that such viscous oils as No. 6 fuel oil can be easily combusted in areas as cold as the Beaufort Sea.

Kretschmer, D. and Odgers, J. 1985. "Combustibility and Incineration of Beaufort Crude/Seawater Emulsions", Proceedings - 1985 Oil Spill Conference (Prevention, Behavior, Control, Cleanup), Los Angeles, CA February 25-28 1985, API, Washington, DC, p. 19-23.

The use of certain incinerator to dispose of materials recovered from an oil spill was investigated for the Alaskan Beaufort Sea Oilspill Response Body (ABSORB). A series of combustion experiments was conducted in a prototype incinerator. Combustion rates, emissions, and temperatures were monitored during the experiments. Operating variables investigated included air flow rate, direction of air into the combustion chamber, waste feed rate, water spray over the combustion zone, and the slant of the combustion chamber's front wall.

Kruk, K.F. 1983. "Air Curtain Incineration Tests", Proceeding - 1983 Oil Spill Conference (Prevention, Behavior, Control, Cleanup), San Antonio, TX, February 28 - March 3, 1983, API, Washington, DC, p. 33-38.

The prototype incinerator (10'x10'x14') was able to burn pure oil, emulsions, and oil debris at "practical rates with low emissions" (p. 38). The system, which will be helicopter-transportable and capable of being field-assembled in less than one day, performed well at combustion rates exceeding 600 barrels per day. Oil with 20% to 30% water burned most efficiently.

Lamp'1, H.J. 1969. "Beach Cleanup." Prevention and Control of Oil Spills. API, Washington, DC, p. 229.

State-of-the-art beach cleanup is discussed briefly. Physical removal methods are most acceptable, as detergent or dispersant chemicals further contaminate the beach and in-situ burning is stated to be impractical. Future projects include portable incineration systems and froth flotation techniques.

"Licking the Oil Slick", 1970. Mech. Eng., v 92, n 6, p. 51.

The Cabot Corporation in Boston has developed a silica compound that can be applied in dry powder form to floating slicks. The chemical acts as a wick, drawing up oil by capillary action, insulating it from the lower temperature water, thus permitting combustion. Up to 98% of slick can be thus burned. The remaining 2% forms a hard floating crust that can be easily collected. The chemical has no known toxic effect on marine life or shore birds.

Logan, W.J. 1976. "EEB Activities in Arctic Oil Spill Countermeasures." Spill Technology Newsletter, I(4):15.

The feasibility of in situ burning to remedy oil spillage problems in the Southern Beaufort Sea is considered. Conventional equipment (i.e., booms and skimmers) can be used only in calm and light wind and wave conditions with less than 10% ice infestation. Burning can remove 90% of the oil without promoters and studies are underway to determine what substances may ease cleanup of burnt residues.

Lowthian, J.W. 1977. "Oil Spill Cleanup in the Beaufort Sea - Another Viewpoint." Spill Technology Newsletter, II(3):33.

The probability of a successful, complete burn is low because of the expected film thickness and the current state of ignition technology. The logistics of delivering igniters to many areas are also a problem.

Mackay, D., Day, T., Nadeau, S., and Thurier, R. 1979. "Emissions from In Situ Burning of Crude Oil in the Arctic", Water, Air, and Soil Pollution, 11(2), p. 139-152.

The effects of oil spill burning on air quality in the Beaufort Sea region of the Arctic are discussed. A scenario is postulated defining the amounts of oil released, the size and number of burnable oil pools, and the duration of the burning period. Estimates are made of the likely emissions of soot, CO, SO<sub>2</sub> and metals based on literature and some experimental work. Assumptions are made about plume rise and dispersion which permit downwind concentrations of emissions to be calculated and compared with air quality objectives. Although the calculated concentrations may contain significant error because of the many assumptions, the data demonstrate that concentrations of SO<sub>2</sub> and CO will be acceptably low; concentrations of soot and metals will often be undesirably high within 10 km of the fires, but will

be acceptably low at greater distances. Burning may be a method of substantially reducing the adverse environmental impact of oil spills in the Arctic.

Magnus, G. 1959. "Tests on Combustion Velocity of Liquid Fuels and Temperature Distribution in Flames and Beneath Surface of the Burning Liquid." (International Symposium on) the Use of Models in Fire Research, sponsored by The Committee on Fire Research, The Fire Research Conference, National Academy of Sciences, Washington, D.C., Nov. 9-10.

Tank fires of various sizes were studied. Effects of wind velocity, air temperature, humidity, and barometric pressure were noted. The specific burning rate of the liquid fuels was found to increase with surface area. Flame temperatures were measured within the tanks and were found to vary with liquid level and fire size.

Masliyah, J.H. and F.R. Steward. 1969. "Radiative Heat Transfer from a Turbulent Diffusion Buoyant Flame with Mixing Controlled Combustion," Flame, 13:613-625.

A mathematical model of a turbulent buoyant diffusion flame is used to calculate the radiative emission from the flame. Burning rates of a liquid fuel can be predicted from the radiative heat flux.

Maybourn, R. 1971. "The Work of the IP Working Group on the Burning of Oil," Journal of the Institute of Petroleum, 57(553).

This group concentrated mainly on problems associated with burning oil in situ in a tanker and on the sea surface. An igniter is necessary to start the burning. Residues of 15% or more of the original quantity of oil will remain.

Mayo, F. 1968. "Dealing with Oil Pollution on Water and Shores", Pollution Prevention, The Institute of Petroleum, The Elsevier Publishing Co. Ltd., London.

The paper discusses the proved methods of dealing with oil on inshore waters: dispersion, absorption, entrainment, and removal with mechanical devices. Burning does not seem to be effective unless suitable catalysts or oxidants can be developed.

McLean, A.Y. 1972. "The Behavior of Oil Spilled in a Cold Water Environment," Offshore Technology Conference, paper #1522, 2:129.

This paper deals with the way oil interacts with the cold water environment and the effect of these interactions on clean-up techniques.

McMinn, T.J. and Golden, P. 1973. "Behavioral Characteristics and Cleanup Techniques of North Slope Crude Oil in an Arctic Winter Environment." Prevention and Control of Oil Spills, API, Washington, DC, p. 263.

This paper deals with the physical fate and behavior of crude oil (spreading, aging, interactions with environment, effectiveness of cleanup) when spilled on ice and snow. Oil can be easily ignited with kerosene-soaked rags on snow and ice if the spill has not been snowed upon. Burning agents had no effect. Oil burning on ice is more successful than on snow (95% vs 80%).

McMinn, T.J. 1973. Crude Oil Behavior on Arctic Winter Ice, United States Coast Guard Project 734108. Washington, D.C. NTIS AD-754, 261.

The burning of oil on ice and snow is discussed. Under conditions of limited snowfall and wind velocity below 14 knots, 80% of spilled petroleum can be burned without promoters. Three burning agents, silicate beads, asbestos powder, and powdered calcium carbonate were determined to be of no benefit in Arctic burning conditions. If Arctic oil is not removed, it will become sandwiched in the ice cover only to thaw in the summer months.

Meikle, K.M. 1977. "Design and Development of Equipment to Aid in the Burning of Oil on Water", Spill Technology Newsletter, Sept/Oct 1977.

Two equipment ideas have been suggested to aid ignition, containment, and support of oil combustion on water. One is a buoyant net which would trap oil in its mesh, allowing it to be contained, ignited and burned in the net's openings. The other is a lightweight fireproof boom to contain the oil. Both could be used simultaneously.

Menagie, H.M. 1970. Kontax Burning Experiments, Water Control Division - Hook of Holland, Ministerie van Buitenlandse zaken Afdeling Vertalingen.

Kontax is a chemical that ignites spontaneously when spread on water. Both beach and open water burn testing results are reported here.

Modak, A.T. 1978. "Radiation From Products of Combustion," prepared for Factory Mutual Research, FMRC J.I OAOE6.Bu-1, RC 78-BT-28, October 1978. Presented at the Eastern Section Meeting of the Combustion Institute, Miami Beach FL., Nov. 29, 30 and Dec. 1.

This report presents simplified calculations and a computer program for radiative energy transfer in fires. Radiation from soot particles, carbon dioxide, and water vapor is the primary form of heat transfer in large fires. The radiative properties of these components exhibit very rapid variations with respect to the wavelength of radiation. These simplified calculations agree well with the more detailed and exact spectral calculations.

O'Rourke, C. 1976. "Oil Spill Cleanup in the Beaufort Sea." Spill Technology Newsletter, I(6):12.

This report by Canmar, a Canadian oil drilling firm, discusses contingency plans in the event of an oil well blowout. Ignition of the plume and containment of the burning oil is a primary cleanup measure. Non-emulsified heavy oils burn readily without promoters in the Arctic waters. Studies are underway to improve ignition techniques and fireproof booming.

Putnam, A.A. 1965. "A Model Study of Wind Blown Free-Burning Fires", Tenth Symposium (International) on Combustion, The Combustion Institute, Pittsburgh, PA, pp. 1039-1046.

Both point and area-source flames and line fires were exposed to cross winds to study free-burning fire modeling. With point and area-source flames, the flame height decreased slowly when initially exposed to the cross wind but decreased rapidly when the cross wind velocity increased. Experimental observations were related to the Froude number.



Ross, S.L. 1975. "Oil Spill Technology Development in Canada," Conference on Prevention and Control of Oil Spills, API, p. 329.

The organization and activity of the Canadian Environmental Emergency Branch is detailed. Burning is considered a promising option of cleanup of oil spills, particularly in Arctic conditions. Canadian spillage data is tabulated for the years 1971-73.

Smith, C.L. and MacIntyre, W. 1971. "Initial Aging of Fuel Oil Films of Sea Water," Prevention and Control of Oil Spills Conference Proceedings, API, Washington, DC, p. 457.

Evaporation and dissolution are the main mechanism of initial weathering. Rates of evaporation and relative importance of evaporation and dissolution for oil components are reported. During initial weathering, the rate of evaporation (by weight) is proportional to the percentage of volatile components.

Smith, N. K. and Diaz, A. 1985. "In-place Burning of Prudhoe Bay Oil in Broken Ice", Proceedings - 1985 Oil Spill Conference (Prevention, Behavior, Control, Cleanup), Los Angeles, CA February 25-28 1985, API, Washington, DC, p. 405-409.

Small-scale and large-scale experiments were performed at the U.S. Environment Protection Agency's Oil and Hazardous Materials Simulated Environmental Test Tank (OHMSETT) facility to explore the range of conditions in which oil slicks of Prudhoe Bay crude can be burned in broken ice and to determine the efficiencies of such burns. In laboratory experiments, the minimum slick thickness supporting combustion was found to be 2.5 mm on brackish water at temperature from 2 Degree to 6.5 Degree C. Four burn tests were performed in the OHMSETT tank with varying ice cover, volume of oil, and wave conditions. Study results are reported.

Struzeski, E.J. 1969. "Chemical Treatment of Oil Spills." Prevention and Control of Oil Spills, API, Washington, DC, p. 217.

The latest technical information is presented on the applicability and effectiveness of the chemicals and materials available for preventing and controlling oil spills. Special emphasis is on absorbing and gelling oil on the surface sinking oil, and burning it on open waters and shorelines. Burning is attractive and inexpensive for slicks thicker than 3 mm. FWPCA testing in 1969 is discussed.

Tam, W.K. and Purves, W.F. 1980. "Experimental Evaluation of Oil Spill Combustion Promoters", IEEE, Piscataway, NJ, p. 415-421.

Three petroleum fractions were burned floating on water in confined and unconfined layers, at two thicknesses and in various wave and ice conditions. Ten promoter materials were screened in an effort to improve the ease of ignition and the completeness of the burns. The test results continue to suggest that in-situ burning is a promising oil spill response technique.

Thornton, D.E. 1977. "Testing of Air-Deployable Incendiary Devices for Ignition on Water," Spill Technology Newsletter, Sept/Oct.

Incendiary devices and wicking agents are being developed for burning all spills on ice and snow.

Tom, G., and Purves, W.F. 1979. An Experimental Evaluation of Spill Burning Promoters. Draft Report available from R&D Division, Environmental Emergency Branch, Environmental Protection Service, Department of Fisheries and Environment, Canada.

A total of 395 combustion experiments were conducted in outdoor tanks during the winter of 1978. The program covered ten combustion promoters, three types of oil and two oil thicknesses. The ignition method was proved inadequate for Bunker C oil. Aged crude oils were burned both on water, in the presence of slush ice, in waves and under unconfined conditions. Test results continue to commend that in-situ burning is a promising method of disposing of Arctic oil spills. .

Tully, P.R. 1969. "Removal of Floating Oil Slicks by the Controlled Combustion Technique, Oil on the Sea," Proceedings of a Symposium on Oil Pollution of the Sea, Sponsored by MIT and Woods Hole, Cambridge, Mass.

Cab-O-Sil is recommended as an effective wicking agent that contains oil burning to a specified area. Burning with fumed silica (Cab-O-Sil) is effective with slicks down to 2 mm thick.

Twardus, E.M. 1979. A Study to Evaluate the Combustibility and Other Physical and Chemical Properties of Aged Oils. Draft Report available from R&D Division, Environmental Emergency Branch, Environmental Protection Service, Department of Fisheries and Environment, Canada. DSS File No. 03SS, KE204-8-1011.

Oil aging and the formation of water in oil emulsions were studied in Arctic spring conditions using Bunker C, marine diesel, and six crude oils. The igniter systems used demonstrated that these oils could be burned if oil thickness were 3-6 mm up to 4 weeks after release, except Bunker C which needed 10 mm combustion of without emulsions was reported possible, 20% water easily ignited with higher water content being harder to ignite, but once fully developed, combustion of w/o emulsion was very intense except for w/o emulsions which tended to foam.

Vaux, W.G., Weeks, S.A. and Walukas, D.J. 1971. "Oil Spill Treatment with Composted Domestic Refuse," Prevention and Control of Oil Spills, API, Washington, DC, p. 305.

The use of compost made from domestic refuse as a sorbent and combustion promoter is discussed. The material is readily available but only moderately effective. Burning is discouraged because of the sooty smoke and incomplete combustion.

Walkup, P.C. 1970. Oil Spill Treating Agents: Test Procedures: Status and Recommendations, Battelle, Pacific Northwest Laboratories.

This section discusses evaluation techniques and comparison parameters for combustion promoters. Surface disturbances, application techniques, product type, temperature and size of spill must all be addressed in a complete analysis. The dosage ratio, completeness of burning and residue removal, as well as flame stability are factors to be considered.

Warren Springs Laboratory. 1976. "UK Oil Clearance Techniques and Equipment", Petroleum Times, April 30, 1976.

This article briefly overviews burning, sinking, absorbing, physical containment, and dispersing as oil spill mitigation techniques. Burning oil

on water is considered to be generally ineffective. More attention is focused on dispersants, both on water and land.

Water Quality Laboratory. 1969. Chemical Treatment of Oil Slicks. Edison, New Jersey. NTIS PB 185947.

The effectiveness and potential pollution effects of chemicals and other materials used to disperse, sink, burn, or otherwise dissipate oil slicks are discussed. Burning is inexpensive and appears feasible using proper wicking agents which increase burning surface area and insulation from the water heat sink. Controlling the burning oil mass, ensuing air pollution, and disposal of residue appear to preclude the use of this course of action except in those situations where the oil is sufficiently distant from the shore and off-shore facilities.

Water Quality Office, EPA. 1970. Feasibility Analysis of Incinerator Systems for Restoration of Oil Contaminated Beaches, 15080 DXE 11/70. B5.

This article recommends using a three-stage rotary furnace to cleanse beach sands. A cost analysis is included. This report includes oil-water-sand thermodynamic data and spill experience. Burning oil pools and residues in coastal areas by torching or explosion was unsuccessful.

Westree, B. 1977. Biological Criteria for the Selection of Cleanup Techniques in Salt Marshes, Conference on Oil Spills, API, p. 231.

Spill cleanup in salt marshes may cause more damage than the oil itself. Techniques for cleanup were compared to the behavior of uncontained oil in the marsh and the potential for damage evaluated. Burning can be used in Spartina marshes.

Woinsky, S.G. 1972. "Predicting Flammable-Material Classifications," Chemical Engineering, Nov. 27, 1972.

Flammable-material classifications are used in selecting explosion-proof electrical equipment. This paper presents a method for predicting the classifications for single components and mixtures.

Woodyard, D. 1970. "Oil Slick Destroyed by Burning", Oceanology Intl.

A spill of Bunker C oil was successfully burned at sub-freezing temperatures with the aid of wicking agent. The fumed silica wicking agent is non-toxic to marine life, immune to the heat of an oil fire, and can induce a 90% oil burning efficiency.

Yumoto, T. 1971. "Heat Transfer from Flame to Fuel Surface in Large Pool Fires," Combustion and Flame, 17:108-110.

This study experimentally determined the ratio of radiation and convection transfers to total heat transfer from the flame to the fuel surface. This work was done in the heat transfer range where burning rate has a constant value regardless of pan diameter. The burning rate was found to be mainly dependent on radiation.



# READINESS PLANNING FOR ARCTIC OFFSHORE OIL SPILL RESPONSE

CDR DENNIS D. ROME  
U.S. COAST GUARD

## ABSTRACT

Since contingency planning for oil spill response was initiated, the plans have evolved into a standardized content and format. They provide an inventory of response resources, organization, general strategies and a means to activate them. However, all the plans fall short in the transition time from plan activation to on-scene cleanup. In order to improve the plans, a viable "action plan" should be added which will allow the primary decision makers on oil spill response, both government and private industry, to make informed choices on the type of response, equipment selection, and personnel necessary for an effective response. By identifying windows of opportunity for various response options (mechanical cleanup, chemical dispersants, chemical treatment and in-situ burning), performance criteria can be developed which will allow planners to develop a response structure(primary, secondary and tertiary) to get the appropriate equipment and personnel on scene as quickly as possible.

## INTRODUCTION

Beginning with the earliest plans, a format has evolved which has resulted in all plans looking alike. Minor changes are made for geographic areas and the cast of characters for each plan but they currently lack adequate information which will help an individual move from the initial notification and call out stage of a response to the on scene cleanup stage efficiently. Part of this shortfall is the lack of logistics planning for an offshore response. All the contingency plans have an inventory of materials and delivery systems available, but there is no assessment that the transportation resources will actually be available when the cleanup equipment has to be delivered. There is also a need to identify logistical needs beyond the first deliveries of equipment to insure that a response action can be maintained to completion. An example scenario of this which can frustrate all concerned parties is:

A dispersant application has been approved for a major oil spill in the Bering Sea. Both industry and government feel that the application must be made within the next 10 hours in order for the application to be effective. A C-130 Hercules aircraft is on the deck in Anchorage and ready to load an ADDS package(full) and fly to the spill scene. Their estimated time of arrival in the area is 7 hours. There is still enough daylight to apply two plane loads of dispersants if the dispersants can be delivered to the nearest airport to the spill. In order for the second application to be made, the cargo aircraft carrying the second (or third) load of dispersants must arrive no later than 1 hour after the C-130 has arrived at the spill scene. With the existing dispersant storage locations and cargo aircraft availability, there is simply no way more than one load can be applied. In fact, if there is any delay either at Anchorage or at the spill scene, there would not even be one application.

Planners and decision makers must be able to overcome logistical problems if they are to provide an effective response during their "window of opportunity" for a particular response option.

## WINDOWS OF OPPORTUNITY

During a major oil spill response, each spill response option will have an opportunity to be used at some time. The trick is to determine which options or combination of options provide the best opportunity for success as the spill progresses to completion. A concept, recently developed and presented by Alan A. Allen<sup>1</sup>, describe windows of opportunity for various response options (mechanical recovery, dispersant application and in-situ burning) with varying weather, sea state and oil thickness. A copy of Mr. Allen's graphical presentation of results is enclosed with this paper. This approach offers an opportunity to develop priorities for response options, types of equipment needed and the necessary logistics arrangements. For the purposes of the Alaska Arctic Offshore Oil Spill Response Technology Workshop, I propose that data collation or research needs to be done in the following areas:

- a. Gravity spreading of oil in open water Arctic conditions with time until the oil reaches an equilibrium thickness.
- b. Effects of ice leads on the thickness of oil with time.
- c. Development of a decision matrix (or graphical presentation) for response options which includes information from a. and b.

From the product of this work, planners can develop windows of opportunity for the various response options.

## PERFORMANCE CRITERIA

Once windows of opportunity are established, defining the response structure and the means to get the equipment/people/response organization to the site of the incident can be developed. In order to do this, performance criteria have to be established for immediate, secondary and perhaps tertiary efforts. Planners (Government and industry jointly) have to examine many factors to develop the response structure. Among these are: location of potential incident, statistical size of spill expected, location of industrial facilities(bases) nearby to stage, store and maintain equipment, logistical support structure in the vicinity, labor pool, economics, equipment lifetime, drills, etc.

As a start, I propose examining the performance criteria established for OCS activities<sup>2</sup> in the Beaufort Sea and adjusting as necessary. The summarized criteria are:

- a. Containment and Recovery Equipment Capability: Equipment will consist of "state of the art" technology. Contingency equipment and techniques should be effective for oil spills under, or on, solid ice cover. Equipment must be capable of operating in a minimum of 8-foot seas and 20 knot winds in open water conditions.
- b. Contingency Equipment Resources: Initial response contingency equipment and techniques must be capable of recovering, and storing or disposing of 1000 barrels of oil per day. Additional contingency equipment must be available in the event of larger oil spills.
- c. Response Time: initial response contingency equipment must be available, transported, deployed and operational in a minimum of 6 hours from spill occurrence. Additional support contingency equipment needed must be available within 48 hours.

---

<sup>1</sup>Allen, Alan A., 1988, "Comparison of Response Options for Offshore Oil Spills," in Proceedings of the Eleventh Arctic and Marine Oilspill Program Technical Seminar, Environment Canada, pp.289-306.

<sup>2</sup>Criteria for Approval of Oil Spill Contingency Plans, Beaufort Sea, USGS/USCG Memorandum of Understanding dated December 18, 1983.

d. Support Vessels/Vehicles: Vessels/vehicles needed for deploying and operation of contingency equipment must be available within 6 hours for initial response, 48 hours for support response. Personnel must be trained in the operation of the equipment and procedures used during the response.

e. Drills: Drills will be required, upon placement of the drilling platform on location, prior to drilling operations and every 6 months thereafter, or upon continuation of the drilling operation into a new seasonal environmental condition, whichever is first.

f. Dispersants: Equipment for applying chemical dispersant must be available for use within a 6 hour response time. Enough chemical dispersant will be maintained to continue application of dispersants until additional dispersants are available from secondary sources.

g. Authority: an operator's representative must be identified, who has the authority to order ignition of an uncontrollable well which is causing a massive spill event.

h. Dedicated pollution response personnel shall be provided and available to insure that the response requirements can be met.

i. A professional cleanup manager must be available to direct pollution response efforts.

## **TRANSPORTATION, LOGISTICS AND SUPPORT**

Once the windows of opportunity and performance criteria are developed, the most elusive part of spill response is transportation and logistics. This aspect of the response is where we fall down the most because of the inability to rapidly move the necessary resources (people and equipment) to the location where they will operate best. For the purposes of this workshop, I suggest that research/collation be done in the following areas:

a. Critically evaluate the availability of aircraft, vessels, barges, vehicles for use in a spill response. Companies which have them are required to keep them gainfully employed in other than oil spill response. Develop probabilities that a particular transportation vehicle will be available year round when called.

b. Identify the shortfalls in transportation and develop strategies to overcome them. Options such as purchase of additional resources, presiting or incentive clauses (retainers) could be explored to improve availability.

c. Examine the size and weight constraints of the transportation vehicle (particularly aircraft) and see what affect is has on design, construction and packaging of response equipment. Modular design of mechanical cleanup equipment can improve its ability to be moved.

d. For remote, Arctic environments identify:

1. Numbers and type of personnel needed on scene.
2. Shelter/food/clothing/medical requirements for personnel.
3. Transportation of personnel to and from support bases.
4. Work schedules/crew protection on scene

e. Design standard response packages which have predetermined weights, sizes, packages and can be readily assembled for rapid deployment for different modes of transport. Individual component weights should include the packaging.

f. Develop a logistics and support manual which can be physically tested annually.

## **SURVEILLANCE AND DISPOSAL**

Although these items place a heavy burden on transportation and logistics, they are important enough to merit separate discussion. They are integral parts of every response but are often the least considered prior to an oil spill.

Surveillance during a response places a heavy burden on available transportation assets. The various information requirements (public affairs, spill trajectory modeling, investigations, countermeasures effectiveness, dispersant applications, etc.) cannot be satisfied without intensive

surveillance. There are also many occasions where the conventional methods of surveillance do not work because of fog, extreme weather and darkness. The Arctic Offshore Oil Spill workshop should consider and develop specific programs for additional work as follows:

- a. Identify surveillance requirements and the transportation assets which would best meet those needs.
- b. Merge surveillance with other logistical needs and develop strategies to accomplish both.
- c. Develop strategies for surveillance using unconventional methods (drift buoys, remote sensing, etc).

Although some options for disposal of recovered oil and oily debris are presented in current contingency plans, one often encounters the statement, "Recovered oil and debris will be transported to a site and disposed of as designated by the State." This general umbrella means nothing in the State of Alaska since there are no designated disposal areas. Historically, disposal options have been developed as the spill nears completion. I suggest that the Workshop develop disposal options for remote Arctic areas which can be researched and presented to the State of Alaska as accepted practices.

## **RECOMMENDATIONS**

In order to improve the utility of oil spill contingency plans, I recommend that the Arctic Offshore Oil Spill Workshop develop recommendations which will turn them into Action Plans. This can be done by performing the following tasks:

- a. Develop "Windows of Opportunity" for various oil spill countermeasures in the Arctic.
- b. Develop performance criteria and a response structure for primary, secondary and tertiary activities.
- c. Develop a transportation and logistics manual which can get the equipment and people into position to be effective.
- d. Develop a surveillance program which will be timely and effective.
- e. Develop a disposal plan for remote Arctic responses which will be accepted by the State.

NOTE: The opinions or assertions in this paper are those of the author alone and are not to be construed as representing those views of the Commandant or the Coast Guard at large.



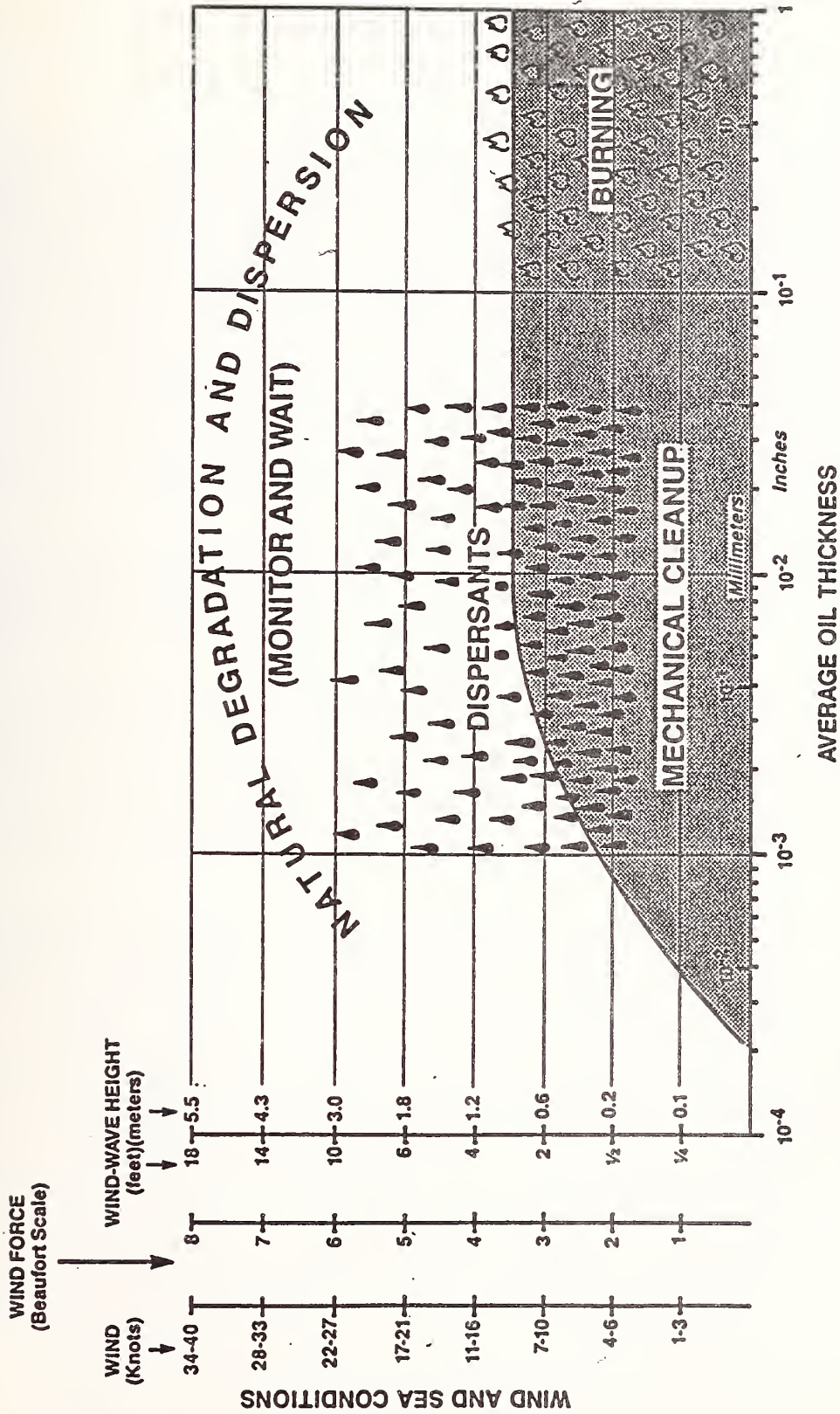

FIGURE 2: PRIMARY SPILL RESPONSE OPTIONS UNDER VARIOUS WIND/SEA CONDITIONS AND OIL FILM THICKNESSES

Reprinted from "Comparison of Response Options for Offshore Oil Spills," 1988 Proceedings of the Eleventh Arctic and Marine Oilspill Technical Seminar, Alan A. Allen.



The Oil and Hazardous Materials Simulated Test Tank Program Efforts  
Arctic Oil Spill Response Technology Assessment and Development

Edward J. Tennyson  
Technology Assessment & Research Branch  
Minerals Management Service  
Reston, VA

The Oil and Hazardous Materials Simulated Environmental Test Tank (OHMSETT) Program began tank evaluations of existing river, harbor, and near-shore class booms and skimmers in 1974. This test program was initially supported by the U.S. Environmental Protection (EPA) Agency, U.S. Coast Guard, U.S. Navy, and Environment Canada (EC). The Minerals Management Service (MMS), then the Conservation Division of the U.S. Geological Survey, joined as a funding member in 1978. Between 1974 and 1979 over 84 devices were tested under 73 separate research projects. These included experimental, prototype, and commercially available devices. These devices encompassed the oil spill response aspects of control, containment, recovery, detection, and measurement of floating oil and hazardous materials and were reported by Smith and Lichte [1]. A number of these devices are still available and stockpiled by various responders for open-water and broken ice applications.

Unfortunately no single reference is available for OHMSETT research after 1979. Individual projects have been described in the proceedings for the biennial Oil Spill Conferences and the annual Arctic and Marine Oil Spill Program Conferences.

The limitations of testing equipment in a tank of finite size was discussed by Griffiths [2] as part of the effort to assure that tank evaluations were realistic. It was determined that scaling effects induced by the tank walls were acceptable. He further concluded that containment booms failed below a relative velocity of 1.0 knot as a result of droplet shedding which represented a failure of the integrity of the oil slick. This failure was independent of the design of the boom.

Open-ocean tests are required for large ocean containment and recovery equipment. In 1980, OHMSETT personnel tested the Spilled Oil Containment Kit (SOCK) offshore of New Jersey in various sea conditions. During six days of sea trials, 50 cubic meters of crude oil were dumped into the mouth of the sock skimmer within a range of sea states. Thirty-two cubic meters of oil were recovered according to Lichte, et.al. [3]. The SOCK was found to recover oil varied inversely with increasing sea state. Recovery rates ranged from 33 cubic meters per hour in relatively calm seas (significant wave heights of 0.9 meters with a period of 5.5 seconds) to 12 cubic meters per hour (significant wave heights running to 1.4 meters with a period of 3.7 seconds). This was an excellent performance. Unfortunately, until 1987, apart from the AMOP skimmer test in the Beaufort Sea, no additional realistic at-sea evaluations have been conducted with available U.S. or Canadian equipment. The SOCK remains one of the few tested pieces of equipment and is not readily available to responders.

At-sea evaluations involving intentional dumping of significant amounts of oil have not been conducted in U.S. waters because of political sensitivity raised by tanker spills and because of the IXTOC blowout, among others. The U.S. EPA has been resolute in refusing to issue intentional ocean dumping permits for experimental spills.

The OHMSETT had designed a downward plunging water jet array to herd oil into various skimmers during testing. The herder was evaluated and the design optimized to develop a system shaped like a "V" which could herd and contain oil at speeds up to 6 knots in the presence of waves as described by Nash and Johnson [4].

The herder was capable of concentrating a 4.5-meter wide, 1-millimeter thick slick into a slick 0.6-meters wide by 8-millimeters thick. The process involves entrainment of air bubbles into the water column, the resurfacing of the bubbles, and the lateral currents generated by the resurfacing bubbles. The currents persist up to 60 seconds and rapidly carry the slick along. This process was patented by the OHMSETT and would be applicable in open water and broken ice conditions when air temperatures are above freezing. This technique also has the advantage of having no large oil spill control equipment in the water to catch on the ice. Between 1979-1980, the OHMSETT was involved in 12 equipment-performance evaluations, two new equipment development programs, and an experimental weathering program as presented in a summary by Farlow and Griffiths [5]. This brought the number of devices tested at the facility to over 100. The largest piece of equipment tested to date was the "Zero-Relative Velocity" skimmer (30 tons). It was evaluated in waves at towed velocities of up to 6 knots. The skimmer was successful but did not sell well because of its size, cost, and relative lack of control. The recovery rate of this device ranged from 384 gallons per minute in calm seas to 243 gallons per minute in a 1.2-foot by 31-foot wave. A second skimmer which showed promise for open water and light ice conditions was the Soviet harbor oil/debris skimmer Model 2550/4 which employed a ducted propeller to induce a surface current to carry oil over the lip of a weir into a sump where the oil and water were separated by a combination of filters and mechanical means. A third skimmer, the oil mop remote skimmer prototype, was tested. The skimmer, similar in design to the larger Arcat II employs a series of rope mops in contact with a slick, supported by a 1.9-meter long by 1.3-meter wide catamaran hull. The skimmer was able to recover a maximum of 2.6 cubic meters of oil per hour in calm wave conditions while being towed at velocities of up to 1 knot in slick thicknesses of 6 millimeters. This equipment had an oil/water recovery ratio of 96 percent leaving little water in the recovered fluids. It was not evaluated in ice. The Versatile Bennett Arctic skimmer was evaluated in smooth water and in waves. This skimmer was an air transportable version of the larger Bennett Mark 6E and was 7.92-meters long by 2.9-meters wide. The skimmer was designed for on-board or remote operation. The skimmer was tested to 4 knots, and the maximum recovery rate obtained by controlling the three sets of skimmer doors was 2 cubic meters per hour in calm water, at 9.0 knots tow speed in a slick 250-millimeters thick. This skimmer type could be used in ice-free leads. Sorbents manufactured by Swedish Petro-Fiber worked well with oil-to-water sorbent ratios of 5.1 to 10.1. The Clean Atlantic Associates Fast Response Open Sea Skimming System, which consisted of a Kepner SeaCurtain boom and a skimmer, was tested in a proprietary project at

OHMSETT. The equipment was later tested for seakeeping and handling without oil in the open ocean. The results of these trials are not available. Chemicals such as amine gelling agents also were evaluated. This process uses amine which is soluble in oil but not water to form a gell which can be more easily collected mechanically than untreated oil.

A cold weather test was conducted at OHMSETT of the capabilities of the U.S. Navy's MARCO Class V oil spill skimmer using highly viscous oil according to Kilpatrick and Saeker [6]. Particular attention was given to modifications of the skimming vessel to optimize recovery of heavy and highly viscous oils in near-freezing and subfreezing temperatures. These modifications included an improved scraper system for the collection belt, a spray manifold, an automatic water decanting system, and a system for heating the collected fluids to enhance oil-water separation. An Archimedes screw-type Destroil 150 pump was installed to transfer the collected oil into separate storage containers. Problems were encountered and corrected with the belt-roller collection system. These modifications significantly enhanced recovery of highly viscous oil.

The value of a cold-weather test facility was recognized in 1979-1980. Studies began to modify the OHMSETT facility which had previously been operating from mid-April to mid-November. The tank and supporting plumbing had been routinely drained during cold weather to minimize ice damage. The necessary modifications were begun in 1981 with direct support from the Conservation Division located in the U.S. Geological Survey -- later to become part of the MMS. Ice was allowed to grow in the full tank and ice resistance forces to towing of objects were measured. Specific modifications were begun on the filtration and pumping facilities, including heat-taping and insulation. Winter weather varies from  $-15^{\circ}\text{C}$  to  $4^{\circ}\text{C}$  with January averages around  $-2^{\circ}\text{C}$ , with winds typically 10-20 knots from the north to northwest. The wave maker and protective ice breaking techniques were evaluated. During the first test winter, oil emulsions with viscosities as high as 1,700,000 centistokes were tested with the MARCO Class V and the Troilboom (Destroil Skimmer systems).

The AMOP boom was evaluated during the early winter of 1980 at the OHMSETT facility as described by Meikle [7]. The boom was tested with Circo X heavy OHMSETT test oil which had a viscosity range from 2,600 to 4,200 centistokes. The boom performed as well as other conventional booms in the tank. This was one of the first boom performance evaluations in the tank. This project resulted in a standard tank test protocol.

A fireproof boom developed for Environment Canada was tested at the OHMSETT facility and reported by Meikle [8]. The boom was as effective as nonfireproof booms in containing oil in currents, and withstood the effects of fire. The cost of the boom was comparable to conventional equipment, and it was easily stored and repaired.

A series of evaluations on pump capabilities were conducted at OHMSETT and presented by Borst et. al. [9]. This evaluation involved internal and external gear, progressive cavity, centrifugal and diaphragm types with a range of oil types and degrees of weathering. The effects of these variables were documented. Skimmers are only as good as their transfer pump's capability.

A fireproof steel boom was evaluated for towing, stability, and oil holding characteristics following fire-endurance tests at another site according to Buist [10], The effects of waves and currents on in-situ burning also were evaluated. This stainless steel boom exhibited good seakeeping throughout the wave conditions in the tank and retained oil at tow speeds of up to 0.75 knots. Harbor chop significantly interfered with ignition and with sustained in-situ burning.

A major new initiative was begun in 1983 at the request of the MMS and EC to initiate a program of open-ocean testing for large offshore spill response equipment. The hypothesis that the ability of a boom or skimmer to follow wave conditions should be statistically related to its ability to contain or to recover oil was the basis for the program. Full operational lengths of boom would be required because length-wise tension is a major factor in compliance. Tension exerted while the boom is deployed in a "U" shape is an unknown function of length and relative current speed. In addition, most booms comply with increasing sea state to a point where the compliance rapidly begins to deteriorate. If compliance could be accurately measured and observations of oil holding could be synoptically made, the correlation could be defined. The project began by defining what measurements of boom behavior and sea and meteorological conditions would be required. Suitable booms were sought and efforts were made to increase the overall OHMSETT budget to accomplish the ultimate open-ocean verification of the correlation of behavior and oil holding. Those tests culminated in the intentional open-ocean oil spill of 18,000 gallons of Brent Crude offshore St. Johns Newfoundland in September 1987.

In the winter of 1983, OHMSETT tested an Oil Mop Pollution Control, Ltd. prototype Arctic skimmer in a range of broken ice concentrations according to Shum and Borst [11]. This catamaran-based rope mop skimmer is similar in design but smaller than the Arcat II. The skimmer could function in ice concentrations below 50 percent where individual ice pieces did not exceed half the between hull spaces. When either of these two conditions were exceeded, the ice jammed at the bow and prohibited oil contact by the rope mops. This marked the first full winter test season at OHMSETT.

The first efforts at defining boom behavior as a function of sea state were reported by Borst and Lichte [12]. This effort involved the mooring of five booms in Raritan Bay, New Jersey, for an extended period. Synoptic measurements were made of sea and meteorological conditions and video taping and digitizing of the boom behavior. Test results were found to be too subjective and the program was modified to include boom behavior measurements, i.e., free-board and draft. Data were stored in onboard data loggers.

In-situ burning was rigorously evaluated at the OHMSETT facility. Boundary conditions for successful burning were established for Prudhoe Bay and Amauligak crude oils using a range of ice concentrations from 75-90 percent under a range of weathering of the crudes from fresh to very heavily weathered.

Removal of 60-80 percent of the oils were routinely accomplished. Emulsions of Prudhoe Bay crude would not sustain combustion. Amauligak crude emulsions were burnable with repeated ignition with removal of 50 percent of the oil as reported by Smith and Diaz [13].

In-situ burning continued in 1986; Hibernia-A and Prudhoe Bay crudes were evaluated by Smith and Diaz [14]. Tests were conducted in a 42 square meter burn area in the tank. Ice concentrations were 60-75 percent. Flashpoints were elevated by sparging. Oil removal ranged from 65-75 percent of the original volume. Emulsions significantly lowered the burnability of the oils, preventing sustained combustion with Prudhoe Bay Crude and reducing the removal rate to 55 percent for Amauliguk crude emulsions.

The innovative high-speed water jet developed by EC (described in Kenneth Meikle in this proceedings [7]) was evaluated at OHMSETT in 1986 by Laperriere et. al. [15]. This concept was successfully tested in currents up to 1.5 knots, in winds up to 20 knots, and waves up to 0.15 meters high. The concept of operation is the creation of localized high-velocity winds created by high-pressure water jets oriented parallel to the water surface. These winds carry the oil and do not couple with deeper water flow. This results in a very efficient method to contain and to herd oil with relatively low power requirements. It holds promise for open and light broken ice conditions.

Work pertinent to open-water Arctic conditions was conducted in the OHMSETT facility in 1986. The major effort continued towards verification of the correlation of oil-holding and seakeeping characteristics of a open-ocean oil spill containment boom. The EPA announced its intention to close the facility in 1987 because of perceived shift of public interest away from oil spills in favor of on-land hazardous materials spills. The facility underwent a change of contractors during the same period and considerable momentum was lost. Nevertheless, the culmination of the open-ocean OHMSETT effort was conducted in September 1987 offshore of St. Johns Newfoundland. This multi-objective exercise was conducted to verify the correlation of a boom's ability to comply with wave conditions and its ability to hold oil. Additionally, the exercise was conducted to evaluate the existing capabilities of Canadian Coast Guard and industry to respond to an open-ocean oil spill of Hibernia-type crude oil. The exercise involved over 100 trained personnel, 5 major vessels, and a flotilla of small vessels and aircraft. The Canadian Coast Guard was instrumental in providing this massive logistical support. Several major findings resulted from this effort. The oil-holding-seakeeping correlation was verified, minimizing future requirements for spilling large amounts of oil to test containment booms. Existing oleophilic skimmers were not capable of recovering high wax Hibernia-type crudes. Containment capabilities were much better going downwind in higher wind conditions than had been previously possible utilizing the normal upwind containment mode. A new chemical was employed which significantly increased skimmer recovery. These findings were presented at the 1988 Arctic Marine Oil Spill Conference by Tennyson and Whittaker [16].

The final report writing and closing of the OHMSETT facility occurred during the first half of 1988.

## Reference

1. Smith, G. F., Lichte, H. W., 1981, "Summary of U.S. Environmental Agency's OHMSETT Testing," 1974-1979, Municipal Environmental Research Laboratory, Office of Research and Development, U.S. Environmental Protection Agency, Cincinnati, Ohio, 45268.
2. Griffith, R.A., 1981, "On the Flow Around Spill Cleanup Devices." Proceedings 1981 Oil Spill Conference (Prevention, Behavior, Control, Cleanup) March 2-5, 1981, Atlanta, Georgia, American Petroleum Institute, Environmental Protection Agency, and U.S. Coast Guard American Petroleum Institute, publication no. 4334.
3. Lichte, H. W., Borst, M., and Smith, G. F. 1981, "Open Ocean Skimmer Performance Tests," Proceedings 1981 Oil Spill Conference (Prevention, Behavior, Control, Cleanup) March 2-5, 1981, Atlanta, Georgia, American Petroleum Institute, Environmental Protection Agency, and U.S. Coast Guard, American Petroleum Institute, publication no. 4334.
4. Nash, J. H. and Johnson, M. G. 1981, "Coherent, Plunging Water Jets for Oil Spill Control," Proceedings 1981 Oil Spill Conference (Prevention, Behavior, Control, Cleanup), March 2-5, 1981, Atlanta, Georgia. American Petroleum Institute, Environmental Protection Agency, and the U.S. Coast Guard. American Petroleum Institute, publication no. 4334.
5. Farlow, J. S. and Griffiths, R. A. 1981, OHMSETT Research Overview, 1979-1980," Proceedings 1981 Oil Spill Conference (Prevention, Behavior, Control, Cleanup) March 2-5, 1981, Atlanta, Georgia, American Petroleum Institute, Environmental Protection Agency, and the U.S. Coast Guard, American Petroleum Institute, publication no. 4334.
6. Kilpatrick, R. D., and Saeker, A. J., 1981, "Testing of the Navy's Cold Oil Modifications to the MARCO Class V Oil Skimmer," Proceedings of the Fourth Arctic Marine and Oil Spill Program Technical Seminar, June 16-18, 1981, Edmonton, Alberta, Canada, Research and Development Division, Environmental Emergency Branch, Environmental Protection Service.
7. Meikle, K. M., 1988, "The Arctic and Marine Oilspill Program - AMOP," Alaska Arctic Offshore Oil Spill Response Technology Workshop Proceedings, November 29-December 1, 1988, Anchorage, Alaska.
8. Meikle, K. M., 1983, "An Effective Low-Cost Fireproof Boom" Proceedings 1983, Oil Spill Conference (Prevention, Behavior, Control, Cleanup), February 28--March 3, 1983, San Antonio, Texas. American Petroleum Institute, Environmental Protection Agency, and the U.S. Coast Guard, American Petroleum Institute, publication no. 4356.
9. Borst, M., Cochrell, R. J., and Lichte, H. W. 1983 "OHMSETT Pump Tests," Proceedings, 1983 Oil Spill Conference (Prevention, Behavior, Control, Cleanup). February 28-March 3, 1983, San Antonio, Texas, American Petroleum Institute, Environmental Protection Agency, and the U.S. Coast Guard, American Petroleum Institute, publication no. 4356.



10. Buist, I. A., Pistruzak, W. M., Potter, S. G., Vanderkay, N., and Mr. Allister, I. R. 1983, "The Development and Testing of a Fireproof Boom," Proceedings of the Sixth Arctic and Marine Oilspill Program Technical Seminar, June 14-16, 1983, Edmonton, Alberta, Canada. Technical Services Branch, Environmental Protection Service, Ottawa, Ontario, Canada.
11. Shum, J. S. and Borst, M. 1985, "OHMSETT Tests of a Rope-Mop Skimmer in Ice Infested Waters" Proceedings-1985 Oil Spill Conference (Prevention, Behavior, Control, Cleanup), February 25-28, 1985, Los Angeles, California. American Petroleum Institute, Environmental Protection Agency, and the U.S. Coast Guard. American Petroleum Institute, publication no. 4385.
12. Borst, M. and Lichte, H. W., 1985, "Standardizing Boom Test Procedures." Proceedings-1985 Oil Spill Conference (Prevention, Behavior, Control, Cleanup). February 25-28, 1985, Los Angeles, California. American Petroleum Institute, Environmental Protection Agency, and the U.S. Coast Guard, American Petroleum Institute, publication no. 4385.
13. Smith, N. K. and Diaz, A. 1985, "In-Place Burning of Crude Oil in Broken Ice, 1985 Testing at OHMSETT," Proceedings-1985 Oil Spill Conference (prevention, Behavior, Control, Cleanup), February 25-28, 1985, Los Angeles, California, American Petroleum Institute, Environmental Protection Agency, and the U.S. Coast Guard, American Petroleum Institute, publication no. 4385.
14. Smith, N. K. and Diaz, A. 1987, "In-Place Burning of Crude Oils in Broken Ice," Proceedings-1987 Oil Spill Conference (Prevention, Behavior, Control, Cleanup), Tenth Biennial, April 6-9, 1987, Baltimore, Maryland, American Petroleum Institute, Environmental Protection Agency, and the U.S. Coast Guard, American Petroleum Institute, publication no. 4452.
15. Laperriere, F., Whittaker, H., Yanagisawa, M. and Suzuki, I. 1985, "High Pressure Water Jet Testing for Oil Containment in Simulated Environmental Conditions." Proceedings of the Tenth Arctic and Marine Oil Spill Program Technical Seminar, June 9-11, 1987, Edmonton, Alberta, Conservation and Protection, Environment Canada.
16. Tennyson, E. J. and Whittaker, H. 1988, "The 1987 Newfoundland Oil Spill Experiment-An Overview," Proceedings of the Eleventh Arctic and Marine Oil Spill Program Technical Seminar, June 7-9, 1988, Vancouver, British Columbia, Technology Development and Technical Service Branch, Environmental Protection, Conservation and Protection, Environment Canada.



Arctic Aspects of the Technology Assessment and Research Program  
of the Minerals Management Service

Edward J. Tennyson  
Technology Assessment & Research Branch  
Minerals Management Service  
Reston, VA

The Technology Assessment and Research (TA&R) Program began its involvement in oil spill research as a result of the IXTOC blowout in 1979. This initial effort involved modeling of the subsurface blowout and developing various configurations of subsurface sombrero's or inverted cones which could be placed over the blowing well. Gas lift as a result of the blowout would lift the blowing oil and water to a collection point. Modeling at 1/4th scale indicated that 80 percent or more of the pollutants blowing out of a well could be collected by a properly designed and installed subsurface collector system as presented by Milgram [1]. This process could be used during open water or light-ice periods to mitigate a protracted gas and oil blowout. The high percentage containment and recovery potential of high-volume blowouts led to additional studies to design and evaluate a dedicated recovery system. The design criteria matched the flow rates of IXTOC at 30,000 barrels of oil and 765,000 cubic meters of gas per day. This project resulted in a packaged system utilizing a specially modified 120,000 dead-weight ton tanker capable of safely operating in the presence of a surface boil. The vessel could be either statically moored or dynamically positioned. The vessel was configured to degas and dewater the recovered oil with 14 days onboard storage provided. The project proved that such a collection project was feasible, but quite expensive. The high potential recovery efficiency, however, brought the recovered cost of a barrel of oil to less than a \$1.00 per gallon, which is less than current figures for recovered oil according to Brown and Root Development, Inc.

A second dedicated shipborne collection system was designed and analyzed by Stewart Technology Associates [3] by using surface collection. This vessel system would use a 90,000 dead-weight ton tanker, towing collection booms on each side having an 800-foot swath. The vessel would be capable of dewatering and storing the recovered oil and purifying and discharging the water recovered. This system also is costly but could operate as a conventional tanker between responses. The system would be limited to open-water application.

Both of these tanker-based response systems are envisioned for areas of high production over long periods of time as viable substitutes for multiple small response units.

The TA&R Program initiated investigations in 1984 at the National Bureau of Standards on the analysis and modeling of airborne pollutants generated by in-situ burning of spilled oil. This effort was a result of the highly successful OHMSETT burn program and has resulted in a number of significant findings pertinent to broken and solid ice and open-water conditions. This study has been described in Dr. Evan's paper in this proceedings. Briefly, the toxicity of the burn products is not significantly changed over the parent oil. Evans [4] indicated that burning could remove over 80 percent of the

spilled oil from the water surface given the absence of high concentrations of water in oil/water emulsions. This project has had support from Environment Canada (EC).

In September of 1986 the Minerals Management Service (MMS) entered into a Memorandum of Understanding with EC for joint participation in research related to oil spill response. Since then practically all of the oil spill responderelated research has had a cooperative base. Contract research has been jointly selected, funded, and managed by a close working MMS-EC management team.

One of the first projects jointly contracted was the continuation of the design and evaluation on an airborne laser ignition system for spilled oil. The energy generated by this system would be sufficient to ignite heavily weathered oil. The EC had made calculations for the necessary energy level to ignite and sustain combustion in highly-weathered oil. They have come to the conclusion that no existing system has sufficient energy to ignite weathered oils, though many oils while still fresh could be ignited by existing systems. At the present time, however, the capabilities of a laser system have been evaluated. A laboratory system has proven successful; the design of a helicopter compatible system has been completed; and the focusing of a dual laser system to ignite and maintain a flame have been evaluated. The refinement of the aiming system is planned for this year by Frish et. al. [5]. The concept of a helicopter-compatible laser system for igniting spilled oil in all Arctic conditions appears practical. The only other feasible approach is a hand deployable igniter which would be required in large numbers for a major spill. The laser ignition system will be described in more detail in Mr. Meikle's Proceedings paper.

A project which was started in 1979 initially involved investigations into the physics of well-fire suppression and extinguishment using water pressures and flow rates available on a rig. Extinguishment of 12,000 SCFM gas well fires were possible in 5 seconds, with 10 gallons of water injected external to the well annulus and along the axis of the wellbore. Partial fire suppression was documented at flow rates of 1/2 that which was necessary for extinguishment. Apparent radiation from the fire could be reduced by approximately 50 percent from gas fires and over 90 percent with liquid hydrocarbon flames according to Evans and Pfenning [6]. As an adjunct to early research efforts in this program, it was found that most of the liquid hydrocarbons were burned in the flame even during partial suppression. Well ignition may be considered by some to be a pollution mitigation measure for large persistent blowouts. Lack of funds has prohibited an evaluation of pollutant reduction during well fires and during partial suppression. The technique could prove to be a major mitigating tool coinciding with rig self-protection. The application of partial suppression or extinguishment may be limited to abovefreezing temperatures.

Oil submergence has been observed a number of times during recent spills. In several cases, apparently submerged oils heavily impacted shores. The recent Cook Inlet spill was just one example of the phenomenon. In 1987 the MMS joined an existing EC-funded study to model and analyze the effects of various components of weathering on selected oils. The intent is to develop a

predictive capability of spilled oil behavior based upon oil type, ambient temperatures, extent of sunshine, and other less important variables. Once the behavior and fate of weathered oil are understood, countermeasures can be developed to respond to these types of oil spills. Future research will address photo-oxidation, which is a major weathering factor on a number of heavy crude oils. This study has application during broken ice and open water conditions.

The TA&R Program committed the majority of 1987 oil spill research funds to support the joint Canadian-U.S. 1987 Newfoundland oil spill exercise. The objectives were to verify the correlation of the ability of open-ocean oil spill containment booms to seakeep with their ability to contain oil. The exercise also evaluated the capabilities of Canadian industry and the Canadian Coast Guard to respond to high wax crude oil spills similar to those which might occur during production in the Hibernia oil fields. The exercise involved the intentional spilling of 18,000 gallons of modified Brent crude oil approximately 25 nautical miles east of St. John's Newfoundland, in September 1987. It was the largest experimental spill in the North American continent on record. Five major vessels, over 100 trained personnel, a flotilla of small vessels, and a dedicated helicopter were employed. The oil was spilled when winds were below 10-15 knots and containment operations were carried out in the normal upwind mode, i.e., the vessels towed booms into the wind. The winds increased as predicted and as desired in the test plan to over 20 knots, which is commonly perceived to be the upper limits for open-ocean recovery. All three deployed booms lost oil by entrainment due to the inability to maintain tow velocities below 0.75 knots. After 4 attempts to contain oil in the normal upwind mode had failed, one pair of ships towing a containment boom were redirected downwind using the helicopter and a small boat to guide the containment efforts. Oil was successfully contained during the downwind effort when winds exceeded 25 knots. Therefore, it was concluded that the downwind approach when winds exceed 15-20 knots will improve capabilities significantly as described by Tennyson and Whittaker [7]. This also was observed during recovery attempts in the North Sea during the Ekofisk blowout. A weir skimmer recovered the high wax oil at design capabilities, however, the disc and drum oleophilic skimmers could not recover significant oil until a visco-elastic agent had been added to the oil to increase its adhesive properties. The correlation of the boom's ability to seakeep and its ability to contain oil was verified by Nash and Hillger [8]. This project will minimize the need to spill oil in large quantities to measure performance of open-ocean equipment. Further, it will provide a cost-effective performance evaluation protocol for offshore oil spill response equipment.

The EC has been in the forefront of developing sophisticated remote sensing capabilities for detecting spilled oil. The TA&R Program has joined in a new effort to develop a slick thickness measuring capability to augment present systems which are limited to indicating slick areas.

The OHMSETT facility ceased effective operation in 1987. The need for future evaluations of innovative procedures and technology under controlled and repeatable conditions continues. The TA&R Program has cofunded, with EC, an effort to identify a replacement facility in Canada where tests comparable to those accomplished at OHMSETT can be run. The TA&R has reviewed existing test

tanks in the U.S. and none are suitable. Canada possesses several large wave tanks where oil can be spilled, and this project is designed to assess their existing capabilities and the costs of necessary modifications to each.

The TA&R Program and EC have jointly funded an evaluation of an innovative oil spill chemical additive, "Elastol," which alters the physical properties of the oil to make it more recoverable by mechanical means according to Gershey and Batstone [9].

Two joint projects involving planning for future intentional oil spills have begun. The first experiment is planned in the Canadian Beaufort Sea to verify the in-situ burning research conducted at OHMSETT, the National Institute of Standards and Technology, and the Environment Canada and the Canadian industry. The second is envisioned for the Canadian west coast and will involve evaluation and modification of spill response procedures.

A joint current project involves optimizing an acoustic or pneumatic in-situ incinerator for burning of viscous weathered oil. This project is a continuation of efforts to design and evaluate a portable burning device for open-water and broken ice conditions. The incinerator has been successful in burning oils which would not sustain combustion in normal in-situ situations. The TA&R Program was instrumental in convincing the OHMSETT management team that a broad-based request should be written to the National Academy of Sciences to investigate the state of the art and knowledge with respect to use of dispersants on the open ocean. The request was accepted and the final report is expected to be published by the end of 1988. The TA&R Program will review the results and recommendations for future research projects.

The use of navigational shipboard radar has been investigated as an internal project by the TA&R Program. By modifying the tuning of normal shipboard radar, slicks have been tracked out to 12 miles on three separate occasions. This capability will be further evaluated as funding and opportunities permit. The basis for this project is that oil attenuates short period waves. Because these waves cause interference in normal radar operation, sophisticated filters have been developed to eliminate this interference or sea return. By adjusting the gain, sea return and filters on navigational radar, a clear depiction of the short period wave field can be received. Persistent areas of reduced sea return indicate the presence of oil. This has been documented with winds ranging from under 10 knots to over 30 knots by Tennyson [10]. A patent has been applied for on this usage.

### References

1. Milgram, J. H., 1982, "The Collection of Oil From Subsea Well Blowouts," presented at the Oil Spill Symposium, Oslo, Norway, December 1982.
2. Brown and Root Development, Inc., 1985, "Development of an Engineering and Cost Analysis of a Ship-Mounted Subsurface Collector System," December 2, 1985.
3. Stewart Technology Associates, 1987, "Development of an Engineering and Cost Analysis of a Ship-Mounted Surface Collector System."
4. Evans, D. and Pfenning, D., 1984, "Suppression of Gas Blowout Fires Using Water Sprays: Large and Small Scale Studies," American Petroleum Institute, Committee on Fire and Safety Protection, San Antonio, Texas, September 11-13, 1984.
5. Frish, M., Gauthier, V., Frank, J. and Nebolsine, P., 1988, "Laser Ignition of Oil Spills: Telescope Assembly and Testing," Proceedings of the Eleventh Arctic and Marine Oil Spill Program Technical Seminar, June 7-9, 1988, Vancouver, British Columbia, Technology Development and Technical Services Branch, Environmental Protection, Conservation and Protection, Environment Canada.
6. Evans, D., Mulholland, G., Gross, D. and Baum, H., 1988, "Burning, Smoke Production and Smoke Dispersion From Oil Spill Combustion," Proceedings of the Eleventh Arctic and Marine Oil Spill Program Technical Seminar, June 7-9, 1988, Vancouver, British Columbia, Technology Development and Technical Services Branch, Environmental Protection, Conservation and Protection, Environment Canada.
7. Tennyson, E. J. and Whittaker, H., 1988, "The 1987 Newfoundland Oil Spill Experiment, An Overview," Proceedings of the Eleventh Arctic and Marine Oil Spill Program Technical Seminar, June 7-9, 1988, Vancouver, British Columbia, Technology Development and Technical Services Branch, Environmental Protection, Conservation and Protection, Environment Canada.
8. Nash, J. and Hillger, R. W., "Preliminary Results of the Verification of Offshore Oil Spill Containment Boom Performance Evaluation Protocol," Proceedings of the Eleventh Arctic and Marine Oil Spill Program Technical Seminar, June 7-9, 1988, Vancouver, British Columbia, Technology Development and Technical Services Branch, Environmental Protection, Conservation and Protection, Environment Canada.
9. Gershey, R. and Batstone, B., 1988, "Field Tests of Elastol and Demusifier," Proceedings of the Eleventh Arctic and Marine Oil Spill Program Technical Seminar, June 7-9, 1988, Vancouver, British Columbia, Technology Development and Technical Services Branch, Environmental Protection, Conservation and Protection, Environment Canada.

10. Tennyson, E. J., 1988, "Shipborne Radar as an Oil Spill Tracking Tool," Proceedings of the Eleventh Arctic and Marine Oil Spill Program Technical Seminar, June 7-9, 1988, Vancouver, British Columbia, Technology Development and Technical Services Branch, Environmental Protection, Conservation and Protection, Environment Canada.



# THE ARCTIC AND MARINE OILSPILL PROGRAM - AMOP

K.M. Meikle, PEng.  
Environment Canada  
River Road Environmental Technology Centre  
Ottawa, Ontario, Canada K1A 0H3

## ABSTRACT

This paper summarizes the work done and currently in progress under the Arctic and Marine Oilspill Program (AMOP). Almost \$20,000,000 will have been spent over a 12-year period. A slick tracking buoy and a real-time onboard remote sensing display have been developed. The BIOS experiment provided valuable data on arctic oil spills and related countermeasures. Aspects of subsea blowout collectors have been determined and the influence of ice on oil behaviour and recoverability have been investigated. Heavy oil behaviour and the part played by photo-oxidation are being explored under one of several joint projects by Environment Canada and the U.S. Minerals Management Service. Arctic oil skimmers have been developed and a protocol for testing offshore oil booms has been validated in an offshore test using oil. A fireproof boom has been developed, as has a novel containment system that uses highpressure waterjets to induce an opposing wind. Devices for remotely igniting oil slicks have been developed or are in the process of being developed, including one that uses a laser. Two incinerators have been designed, an alternate to the OHMSETT is being investigated and two experimental oil spills are in the initial planning phase.

## 1. INTRODUCTION

The Arctic and Marine Oilspill Program, more commonly known as AMOP, began in April 1977. Initially, the focus was on the southern Beaufort Sea because studies triggered by an oil industry proposal to undertake offshore exploratory drilling had concluded that few proven countermeasures were available to deal with a blowout or any large oil spill in arctic waters (1, 2, 3). The AMOP is still an active program, albeit one with a more modest budget, and its primary objective continues to be to improve the technology for combatting arctic oil spills.

The funding for the first year (1 April 1977 to 31 March 1978) was \$1,685,000 and for the second year it was \$1,805,000. The allocation for the third year was reduced to \$835,000 as part of an overall government restraint program and it remained essentially constant at that level for the next few years. Since April 1986, the AMOP funding has been allowed to vary according to the priorities of the remaining needs in competition with those for chemical spill countermeasures. The budget for 1988/89 is \$700,000, including \$340,000 provided by the U.S. Minerals Management Service for joint projects. As of 1 April 1989, the 12-year total expenditure for the AMOP will have been almost \$20,000,000, of which approximately \$6,000,000 has

been contributed by industry, the U.S. Minerals Management Service (MMS) and others for specific cooperative undertakings such as the Baffin Island Oil Spill (BIOS) experiment and the sea trials of treating agents and oil booms that were performed off Canada's east coast in 1987.

Many papers have been published in the proceedings of the annual AMOP technical seminar and elsewhere, and a total of 148 reports have been produced covering the more than 70 separate studies that have been completed. The Environmental Emergencies Technology Division (EETD) of Canada's federal Department of the Environment (Environment Canada) is responsible for the overall management and direction of the AMOP, but joint projects are managed and directed by representatives of the funding agencies involved.

The remainder of this paper will describe some of the achievements realised under each of the following main headings: Detection and Tracking; Properties, Behaviour and Modelling; Remedial Measures other than chemical treating agents which are the subject of a separate paper by M. Fingas (4) and Disposal. It will also identify some of the things that must still be done before a recommendation would be made to terminate the program.

## **2. DETECTION AND TRACKING**

Because of the remoteness of much of Canada's coastal areas from population centres and potential operating bases and the added complications of ice and darkness in the Arctic, a considerable effort has been expended to evaluate and develop equipment to locate, identify and track oil spilled at sea. The following are some of the results:

### **2.1 Tracking Buoys**

One of the first devices to be developed was the slick-tracking buoy by Orion Electronics Ltd. in Nova Scotia. Sea trials of this floating battery-powered radio transponder have shown that its drift closely approximates that of oil (5,6,7).

### **2.2 Remote Sensing**

The more than \$400,000 expended on remote sensing has given us a good understanding of the strengths and weaknesses of the various techniques available, including the use of satellite imagery (8). Each has its limitations and a recommended outfit consists of a side-looking radar, an infrared-ultraviolet dual-channel linescanner, a laser fluorosensor, low-light-level television, an annotated colour camera and onboard realtime display equipment. The last item did not exist when the AMOP began and the first one was developed as a joint AMOP undertaking with the Canada Centre for Remote Sensing.

Another major joint undertaking was a six-year project with Esso Resources Canada Ltd to investigate the use of acoustic and radio-frequency technology for detecting

oil encapsulated in ice. The radio-frequency work was terminated after a series of theoretical studies had shown little or no potential for success (9,10,11). However, the acoustic studies have produced prototype hardware that has performed quite well in field tests (12).

Because of problems experienced using a commercially available towed fluorometer, EETD has built a prototype system of its own that has performed well in use. Details have not been reported but are available on request.

A recently completed remote sensing project has been an evaluation of sensors to detect chronic oil losses from offshore platforms. The funding was provided by the Northern Oil and Gas Action Program (NOGAP) of the Canadian Department of Indian Affairs and Northern Development. None of the several instruments tested were able to satisfy the requirement. However, the Wright and Wright Infrared Oil Film Monitor was deemed to have the potential to function adequately in that application if further development could make it suitable for operational use (13).

A joint project with the U.S. Minerals Management Service has been initiated to make a long-overdue comparison between existing remote sensing imagery and available surface observations in an attempt to find a way to discriminate between continuous and discontinuous slicks.

### **3. PROPERTIES, BEHAVIOUR AND MODELLING**

A prerequisite to the development of effective countermeasures for arctic oil spills is a sufficient knowledge of the conditions under which they must work and the attendant effect upon the properties and behaviour of the oil. The acquisition of that knowledge has proven to be a major and ongoing task that has so far consumed about \$9,000,000, almost half of the total amount that has been spent on the AMOP.

#### **3.1 The Baffin Island Oil Spill (BIOS) Experiment**

The almost \$7,000,000 BIOS experiment was by far the largest component of the properties and behaviour work. This 4-year international co-operative undertaking by government and industry has provided previously unavailable data on the short- and long-term fate and effects of crude oil stranded on an arctic shoreline compared to that of the same type of oil when chemically dispersed in the nearshore arctic environment. Data on the effectiveness of selected shoreline cleanup techniques has also been acquired in addition to the increased knowledge about the physical, chemical and biological processes operating in common arctic marine ecosystems.

The results provide no major ecological reasons to prohibit the use of dispersants on oil slicks in nearshore areas similar to the experimental site. They also provide no major ecological reasons for the cleanup of oil stranded on arctic shorelines, except where wildlife is present or their critical habitat is threatened, or in areas of human

use (14). A further 4 years of follow-on work has extended the knowledge of the long-term fate of stranded oil in arctic environments compared to that in a temperate situation (15,16,17).

### 3.2 Subsea Blowouts

Preliminary feasibility studies of the Sandome concept by Canadian Marine Drilling Ltd (18) followed by the attempt to capture escaping oil with the "Sombrero" subsea collection device during the 1979 Ixtoc blowout in the Gulf of Mexico were the basis for a series of AMOP studies (19,20,21,22,23). AMOP was also a minority contributor to a 1/4 scale plume and collector experiment performed by Professor J. Milgrim of the Massachusetts Institute of Technology for the U.S. MMS and the Office of Naval Research at Bugg Spring, Florida in April 1982, and that involvement proved to be the catalyst for the strong and continuing MMS/Environment Canada cooperative program that has evolved since then.

The AMOP studies have shown that it is technically feasible to effectively capture escaping oil near the seabed if conditions are sufficiently favorable. However, because the probability that such conditions will exist is so low and the cost of having a system available is so high, EETD does not consider subsea containment to be a practical countermeasure. The work currently in progress at the University of Calgary is being done to remove uncertainty regarding the amenability of the oil to countermeasures once it arrives at the sea surface; it may be that the size of the seabed opening controls oil droplet size to the extent that it may be the determining factor for the formation of a coherent slick instead of discrete globules.

### 3.3 Ice Influence

Various AMOP studies costing a total of almost \$900,000 have examined the influence of ice on the physical fate and behaviour of oil and gas. They range from the compilation of available information on ice type and extent into an arctic atlas (24) through theoretical analysis (25), the determination of ice dynamics from satellite imagery (26,27) and experiments in laboratories and test tanks (28,29) to field experiments involving the release of oil in ice-covered waters (30).

One of the important discoveries was the fact that, contrary to expectations, oil deposited under stationary multi-year ice can migrate to the surface and be so widely dispersed by natural processes that it is non-detectable after 5 melt periods. Another was that lead closure rates are rarely high enough to force oil onto the ice surface where it might be amenable to removal; normally leads either freeze over, in which case any oil present will be trapped within the ice, or the closure rate is so slow that oil will be forced under the ice and become equally inaccessible.

### 3.4 Photo-oxidation

Apart from a small study by Professor H.D. Gesser at the University of Manitoba that looked at ways to enhance the degradation of oil by ultraviolet light (31) the effect

of photo-oxidation on spilled oil behaviour has not had sufficient priority to be pursued further until recently. In the course of seeking a better understanding of the factors governing oil dispersion it became apparent that one of the keys might be the change in natural surfactant content resulting from photo-oxidation. That aspect is currently being explored in EETD's laboratory as a co-funded joint project with the U.S. MMS. Important preliminary observations include the facts that, for reasons as yet unknown:

- there is considerable variation in the susceptibility of oils to photo-oxidation;
- heavy oils that do photo-oxidize form a skin that flakes off and the flakes sink in synthetic seawater;
- there is a noticeable increase in the water-soluble component of those oils that photo-oxidize.

### 3.5 Oil Catalogue

Another item that deserves mention in this brief overview of some of the highlights of the work done under AMOP on the physical fate and behaviour of oil is the compilation of a catalogue of the properties of oils that could be spilled in Canada or adjacent waters (32). The Canadian oil industry has supported the project by providing data and representative samples of frontier oils as they are discovered, common pipeline blends, imported cargos and various products. The catalogue combines the data from industry and others with experimental data obtained in EETD's laboratory. That facility is uniquely equipped for such work because of the specialized equipment assembled during the past 5 years and the availability of walk-in temperature-controlled chambers where properties can be measured at low temperatures. The dispersion and emulsion-forming characteristics of the oil are two elements of the data presented and an expanded version of the catalogue will be available within the next few months. Like most of EETD's publications, copies are free but we retain the right to limit quantities at our discretion.

## 4. REMEDIAL MEASURES

Environment Canada has been working to improve spill countermeasures for 15 years and one of the first decisions was to focus attention on the problems peculiar to cold climate operations and to make maximum use of technology developed for spills elsewhere. Another of those initial decisions was to tackle the essentially ice-free and complete ice-cover situations first and to defer the problem of removing oil under intermediate conditions.

### 4.1 Arctic Oil Skimmers

Prior to the AMOP the majority of the effort devoted to remedial measures had been expended on performance evaluations either in enclosures set up adjacent to wharves or in open water. That work had shown that three types of skimmers being manufactured in Canada were potentially effective under near-freezing conditions but all required modification to correct problems. Initially, the objective for this

element of the AMOP was to develop and prove the necessary modifications to each type and to derive an arctic oil recovery vehicle on that basis. However, after the first year or so and having looked at platform options including hovercraft, it was concluded that special-purpose skimming vessels able to operate safely in the Arctic at reasonable distances from the few and widely separated support bases were possible but too costly. Work to that end was abandoned in favour of devices that could be deployed from offshore support ships or other vessels of opportunity such as barges.

By far the most successful skimmer development was that done in cooperation with Morris Industries Ltd. of Vancouver. Based on cold-room tests at the National Research Council in Vancouver and a series of tank-tests, including some at the OHMSETT in New Jersey under the auspices of the OHMSETT Interagency Technical Committee (OITC), improvements made to their oleophilic-disk models transformed the Morris products into industry leaders worldwide.

Prototypes of arctic variants of the Bennett/Versatile oleophilic belt skimmer and Oil Mop Pollution Control's rope mop were built and tested. The former was tested in the OHMSETT and then trials were done with oil at sea off Newfoundland with help from the Canadian Coast Guard (33). Shortly thereafter it was loaned to Dome Petroleum for a side-by-side comparison test against the Lockheed skimmer originally mounted on their oil recovery barge in the Beaufort Sea (34). The AMOP product was clearly superior and was purchased by Dome Petroleum and installed in place of the Lockheed model. Smaller derivatives were subsequently built and sold but so far there has been no market for the full-sized arctic model.

After simple stability trials alongside a Canadian Coast Guard base, the Oil Mop prototype was tested with oil in a refinery settling pond where it was confirmed that the modified rope-drive mechanism had cured the slippage problem experienced with other models. Testing in the OHMSETT was considered unnecessary because of the extent to which the basic mechanism had already been evaluated in that facility. The Canadian Coast Guard decided not to add it to their inventory because it was too large and cumbersome to be safely deployed from their ships at sea and there were no responses when it was declared surplus and offered for sale. Eventually it was scrapped, but not until it had performed one very useful function. Because of its similarity to the larger ARCAT II developed for use off Alaska, the AMOP prototype was loaned to the U.S. Coast Guard and tested by the OITC in the OHMSETT to investigate the extent to which drifting ice might degrade performance (35). With 50% ice cover or less, performance was comparable to that in ice-free conditions; at higher concentrations the ice blocked the inlet to the skimmer.

#### **4.2 Conventional Booms**

Nothing was done to further the development of conventional booms for several years because of the decision to focus on open-water situations and because of the substantial effort being expended by Norway and others to develop booms for offshore use. It was not until the Canadian Coast Guard specifically requested a

scaled-up version of the river model of the Bennett self-inflating "Zoom-Boom" to evaluate as an open-ocean replacement for their Vikoma SeaPacks that the AMOP ventured into that aspect of oil spill countermeasures development.

The end result was a 12-section boom 366m long combining the essentially similar designs of two manufacturers and packaged in a specially configured hull that could be transported by helicopter as a slung load and from which it could be remotely deployed while being towed by either a helicopter or a suitable work-boat. A section performed well in the OHMSETT but, when the full length was subsequently deployed at sea off Newfoundland in conjunction with the trials of the Bennett/Versatile arctic skimmer, the Canadian Coast Guard decided that it was not a suitable replacement for their Vikomas (32).

### **4.3 Fireproof Booms**

Prior work at Balaena Bay during the Beaufort Sea Studies had shown that confined floating oil could be burned-off in-situ (2). Therefore, one of the first projects under the AMOP was to determine the feasibility of constructing a fireproof boom to provide the necessary confinement in the absence of sufficient ice or other natural features. A variety of materials and approaches were considered and small scale tests indicated that fire-resistant booms were indeed feasible (36) but floating nets were ineffective. AMOP efforts to achieve a fireproof oil confinement capability were discontinued when the newly formed Arctic Petroleum Operators Association (APOA) embarked on the development of a fireproof boom for offshore use in the Beaufort Sea. Work was resumed within a few years however in a parallel effort to explore a concept that might result in a lighter and cheaper product. The GemEng boom with its ceramic-protected foamed-glass flotation was tested in the OHMSETT and its ability to hold oil matched that of previously tested conventional booms (37). It also withstood repeated and prolonged exposure to burning crude oil with only minimal and readily repairable damage. However, in both the tank test and subsequent deployments where it was subjected to moderate wave action, it sustained unacceptable structural damage despite several design changes (38). Work was discontinued for lack of sufficient market interest.

### **4.4 Waterjet Barrier**

Coincident with a tanker spill off Canada's east coast in 1979, a novel approach to controlling oil on water was proposed by a Mr. D. Christie of Vancouver. The concept was to use a horizontal array of highpressure waterjets to induce an airflow over the surface of the water to oppose the movement of the oil. The concept was outlined to the members of the OITC and it was decided that some exploratory work would be undertaken in the OHMSETT. That work showed that the airflow induced by highpressure waterjets in the proposed arrangement was indeed effective in moving oil on water. Of particular interest was the fact that the presence of waves that made conventional booms ineffective had no measurable effect on the ability of the jet-induced wind to move oil (39).

The AMOP funded the construction of a basic prototype consisting of two opposing arrays mounted on improvised floats. It was tested on the Mackenzie River at Norman Wells, NWT, in a cooperative undertaking with Esso Resources Canada Ltd. and its performance as a deflection barrier clearly surpassed that of conventional booms (40). Its ability to hold oil in the containment mode in a current was at least comparable to that of conventional booms and, although time did not permit making the necessary changes on that occasion, it seemed probable that it could be made substantially better in that mode too. The fact that it could be held in position without anchors and manoeuvred by pressure adjustments was a major advantage.

The improvised floats have since been replaced with custom-designed ones that minimize drag and make more power available for resisting current or increasing the span of the array. Optimum flowrate, pressure, spacing, height and other key design parameters have been determined through further experimental work in test tanks in Canada (41), and in Japan (42). Brief trials were conducted in ice in the harbour at Quebec City during a spring breakup under a joint project agreement with the U.S. Minerals Management Service and the indications were that the barrier is not effective for separating oil from drifting ice.

Under another joint project agreement with the U.S. Minerals Management Service, the utility of the waterjet barrier as a fireproof boom is being determined in an Ottawa-area test tank. An aspect of particular interest is whether the induced wind and the influence of the sprayed water will reduce the amount of smoke that is characteristic of oil-pool burns.

#### **4.5 Boom Test Protocol**

The largest experimental oil spill in Canadian waters was released off Newfoundland in the late summer of 1987 in cooperation with the Canadian Coast Guard and the U.S. Minerals Management Service. The primary purpose was to gain a realistic assessment of the capability of the Canadian Coast Guard's booms and skimmers to function in offshore sea conditions and the containment and recovery effort was one of the most successful on record (43). A secondary objective was to take advantage of the opportunity to deploy booms with oil in a pre-planned situation and validate a protocol developed by the OITC for assessing the capability of offshore booms to contain oil without having to spill it. Such a protocol is needed because of a desire to avoid the deliberate stressing of the environment by spilling oil at sea and the demonstrated impracticality of adequately assessing offshore booms in the confines of a test tank.

#### **4.6 Oil Slick Igniters**

Another project directly resulting from the aforementioned Balaena Bay experiment and the discovery that oil trapped in or under sea ice would surface on melt pools in burnable quantities as the ice warms in the spring was one to develop a means of igniting that oil from the air. Ice movement studies indicated that oil from a subsea blowout that continued throughout the winter in the Beaufort Sea



could be distributed over an area of some 16,000 sq.km., with burnable quantities of oil in perhaps 50,000 or more separate melt pools. Safety considerations aside, it would clearly be unrealistic to expect that people working on the ice surface could ignite all of them in the three weeks or so that would typically be available before breakup and escape of the oil. An igniter that could be dropped from a helicopter or slow-flying fixed-wing aircraft was developed with the cooperation and assistance of Canada's Defence Research Establishment at Valcartier, Quebec after tests had shown that the existing devices developed for fighting forest fires did not produce sufficient heat to ignite oil that had been subjected to the amount of weathering that could be expected (44).

#### **4.7 Laser Oil Slick Igniter**

Although air-dropped incendiary devices have been proven capable of igniting pooled oil, it was realised that they were still not an entirely satisfactory solution to the problem because of the associated logistics. The igniters have a shelf-life of 5 years, there are only a few places in North America that are equipped and approved to make such devices and the production capacity is limited even in an emergency situation. There are also transportation restrictions to further complicate the task of getting a sufficient number to the right place in time. Upon learning that Physical Sciences Inc. in Andover, Maryland had achieved some success igniting pooled oil with a laser in their laboratory, they were awarded an AMOP contract to establish the design criteria for such a system and were successful in doing so as was demonstrated in a small-scale trial under typical late-winter conditions. An engineering study has shown that an operational system could be installed in a helicopter using existing technology (45). Work is continuing under a joint project with the U.S. Minerals Management Service to build and test such a system. A laser focusing telescope has been built and tested (46) and an aiming and tracking system is being assembled. Concurrently, the Canadian Forestry Service is determining the laser power requirements to ignite typical Canadian bush.

### **5. DISPOSAL**

Two methods of disposal of recovered oil and oiled materials have been addressed under the AMOP.

#### **5.1 Burial**

Despite the recognized problems of operating land vehicles in the Arctic and the longterm damage to the tundra that can result, it was deemed prudent to be prepared for situations where there might be no other practical alternative along the shores of the southern Beaufort Sea. Selection criteria were established and possible sites were identified from aerial photographs of the terrain adjacent to the shoreline (47).

## **5.2 Incineration**

Over \$400,000 has been expended to develop a capability to incinerate oil in the Arctic and in other remote areas of Canada where it would be prohibitively expensive to transport oil and oil-contaminated materials to incinerators elsewhere. Simple wicking devices to collect and burn floating oil were found to be impractical (48). A prototype device that makes use of ultrasonic energy to herd, lift and atomize floating oil has burned-off emulsified crude oil under calm conditions with virtually no smoke. Subsequent experimental work at laboratory scale has established engineering tolerances and power requirements and a contract has recently been awarded under a joint project agreement with the U.S. Minerals Management Service to test the modified prototype in a tank under both calm and controlled wave conditions. An air-transportable pit incinerator has been developed for disposing of oiled combustibles and a rotary kiln assembled from readily available materials, including used oil drums and car wheels, has been built and tested in cooperation with PACE, the Petroleum Association for the Conservation of the Canadian Environment (49).

## **6. FUTURE NEEDS**

There are a number of important unknowns still to be resolved in addition to the dispersant and other treating agent unknowns mentioned in the previously referenced paper by M. Fingas (4). All are either in the process of being addressed under joint project agreements with the U.S. Minerals Management Service, or are expected to become the subject of such agreements.

### **6.1 Photo-oxidation/Heavy Oil Behaviour**

Discovery of the reason for the observed variability in the susceptibility of oils to photo-oxidation could lead to the availability of either an inhibitor or a promoter that would lessen the environmental impact of spilled oil.

### **6.2 Laser Ignition of Oil Slicks**

While key elements of the laser system have been developed and engineering feasibility has been demonstrated on paper, there will continue to be skepticism and uncertainty until a working system has been flown and its capability confirmed by the successful remote ignition of floating oil under conditions typical of an arctic spring. Informal discussions with the University of Tasmania have raised the possibility of a cooperative arrangement whereby they would make their laser available for that purpose and there is a possibility that forestry interests in both Canada and the United States will share part of the cost.

### **6.3 West Coast Experimental Oil Spill**

As evident from the recent public hearings on the proposed resumption of exploratory drilling off the British Columbia coast, the geography and characteristics such as the heavy driftwood accumulations peculiar to much of the

west coast of both Canada and the United States raise doubts regarding the effectiveness of oil spill cleanup techniques applied elsewhere. As the first step in what would of necessity be a multi-year undertaking, a study has been initiated to identify those uncertainties that can only be resolved by spilling oil in one or more controlled experiments and to define the essential characteristics of the test site or sites. Follow-on phases would be the identification of sites with those characteristics, site selection in consultation with all potentially affected parties, arranging for the funding, establishing baseline pre-spill ecological conditions, depositing the oil, applying selected countermeasures and monitoring the short and long-term effects.

#### **6.4 In Situ Burning of Oil in Leads and Drifting Ice**

Laboratory experiments and numerous burns in simulated ice conditions in the OHMSETT and other tanks have indicated that in situ burning is an effective way to remove floating oil confined by leads or drifting ice. To date however, there has only been one occasion where the technique has been applied in a real-world situation; in situ burning was used quite successfully to remove oil spilled to determine its physical fate and behaviour in pack ice off Canada's east coast (50). It remains to be confirmed that the small-scale results are a true indication of the effectiveness of in situ burning in other typical ice-forms where it is currently the primary if not the only countermeasure available. A study is being initiated for the first step which, like the one for the west coast experimental oil spill, will define the experimental needs sufficiently to identify possible locations and make selections in consultation with local inhabitants and other interested parties.

#### **6.5 Identification of Substitute Facilities for the OHMSETT**

EPA's decision to deactivate the OHMSETT and return the property to the U.S. Navy has eliminated the capability to assess the performance of new or improved oil skimmers and techniques under controlled conditions. Although seldom used in recent years for several reasons, not the least of which was the fact that it has been out of commission for maintenance, new and allegedly improved equipment and techniques continue to appear on the market. Elastol, the proprietary product that makes oil temporarily visco-elastic as an aid to its recovery by skimmers, could not be evaluated by direct comparison to the performance of those skimmers as determined previously in the OHMSETT. As the first step in a search for a viable alternative to the OHMSETT, a study has been let to find out the extent to which the OHMSETT capability could be matched by using existing tanks in Canada with and without modification and to estimate the cost of possible options. Assuming there are viable alternatives in Canada, subsequent studies will assess future test requirements and determine the funding available before proceeding with any modifications, equipment procurement, or arrangements for the use of any of the facilities.

## 7. REFERENCES

1. A.R. Milne and B.D. Smiley, "Offshore Drilling for Oil in the Beaufort Sea", Beaufort Sea Project, Victoria, British Columbia, 1976.
2. S.L. Ross, W.J. Logan and W. Rowland, "Oil Spill Countermeasures: The Beaufort Sea and the Search for Oil", Beaufort Sea Project, Victoria, British Columbia, 1977.
3. W.J. Logan, D.E. Thornton and S.L. Ross, "Oil Spill Countermeasures for the Southern Beaufort Sea", Environment Canada Report EPS 3-EC-77-6, February 1975.
4. Fingas, M.F., "Chemical Treatment of Oil Spills", Proceedings of the Alaska Arctic Offshore Oil Spill Response Technology Workshop, December 1988.
5. Fingas, M., "The Evaluation of an Oil Spill Tracking Buoy", Spill Technology News Letter Vol 2 (1), 1977.
6. Lea, B.N., "Field Evaluation of Oil Spill Tracking Devices", Environment Canada unedited report EE-28, February 1982.
7. Roddis, H.A.J., "A VHF Radio System for Tracking Drifting Buoys Automatically", Proceedings of the 5th AMOP Technical Seminar, June 1982.
8. O'Neil, R.A., "The Arctic Marine Oilspill Program (AMOP) Remote Sensing Study", Environment Canada report EPS 4-EC-83-3, March 1983.
9. Moorcraft, D.R. and Tunaley, K.E., "Electromagnetic Resonance in Layers of Sea Ice and Oil Over Sea Water", Proceedings of the 8th AMOP Technical Seminar, June 1985.
10. MacDougal, J.W. and Tunaley, J.K.E., "The Complex Permittivity of Crude Oil", Proceedings of the 9th AMOP Technical Seminar, June 1986.
11. Tunaley, J.K.E. and Moorcraft, D.R., "Aspects of the Detection of Oil Under Ice Using Radar Methods", Proceedings of the 9th AMOP Technical Seminar, June 1986.
12. Jones, H.W., Kwan, H.W., Hayman, T. and Yeatman, E.M., "The Detection of Oil Under Ice by Ultrasound Using Multiple-Element Phased Arrays", Proceedings of the 9th AMOP Technical Seminar, June 1986.
13. Guptill, F.W., "Evaluation of Wright and Wright Oil Film Monitor for Detection of Offshore Chronic Oil Discharges", Environment Canada unedited report EE-98, January 1988.
14. Sergy, G.A. and Blackall, P.J., "Design and Conclusions of the Baffin Island Oil Spill Project", ARCTIC Volume 40 Supplement 1, 1987.

15. Hope, D., Humphrey, B. and Owens, E.H., "Long Term Fate and Persistence of Stranded Oil at Cape Hatt, NWT and from the AMOCO CADIZ Spill", Environment Canada unedited report EE-84, June 1986.
16. Owens, E.H., "Field Observations of Stranded Oil in the Straits of Magellan, Chile 12 1/2 years after the METULA Spill", Environment Canada unedited report EE-89, May 1987.
17. Owens, E.H. and Humphrey, B., "Long Term Fate and Persistence of Stranded Oil from the BIOS Project, NWT, Canada and from the METULA Spill, Tierra del Fuego, Chile", Environment Canada unedited report EE-107, March 1988.
18. Chen, K.W., "A Study on the Feasibility of Underwater Containment of Subsea Oil Spills in Arctic Waters", Proceedings of the 2nd AMOP Technical Seminar, March 1979.
19. Anonymous, "Subsea Blowout Containment System Concept Analysis", Environment Canada unedited report EE-37, May 1982.
20. Gregory, G.A. and Fogarasi, M., "Three Phase Flow - Submarine Riser Study", Neotechnology Construction Ltd., September 1981.
21. Gregory, G.A., "Three Phase Flow - Submarine Riser Study Report No. 2", Neotechnology Construction Ltd., March 1982.
22. Topham, D.R., "The Modelling of Deep Oilwell Blowout Plumes, Including the Effects of Hydrate Formation", Proceedings of the 4th AMOP Technical Seminar, June 1981.
23. Rowe, R.D. and Bugg, J.D., "Bubble Behaviour at the Wellhead of a Subsea Blowout", Proceedings of the 11th AMOP Technical Seminar, June 1988.
24. Anonymous, "An Arctic Atlas: Background Information for Developing Marine Oilspill Countermeasures", Environment Canada report EPS-9-EC-78-1, August 1978.
25. Topham, D.R., "The Deflection of an Ice Sheet by a Submerged Gas Bubble", Environment Canada internal report, 1979.
26. Dickins, D., Dickinson, A. and Humphrey, B., "Statistical Description of Pack Ice in the Beaufort Sea, Lancaster Sound and the Labrador Sea", Environment Canada unedited report EE-62, May 1985.
27. Dickins, D., Dickinson, A. and Humphrey, B., "Pack Ice in Canadian Waters: Dimensions and Dynamics of Leads and Floes", Environment Canada unedited report EE-82, April 1986.

28. Wilson, D.G. and Mackay, D., "The Behaviour of Oil in Freezing Situations", Environment Canada unedited report EE-92, December 1987.
29. Buist, I. and Joyce, S., "Oil Spills in Leads: Tank Tests and Modelling", Environment Canada unedited report EE-95, December 1987.
30. Anonymous, "Site Visit of Oil Under Multi-year Ice at Griper Bay, NWT", Environment Canada unedited report EE-42, January 1983.
31. Gesser, H.D. and Turner, C.W., "Study on the Enhancement of the Photochemical Oxidation of Crude Oil by Sensitizers", Proceedings of the 1st AMOP Technical Seminar, March 1978.
32. Bobra, M.A. and Chung, P.T., "A Catalogue of Oil Properties", Environment Canada unedited report EE-77, March 1986.
33. Anonymous, "A Winter Evaluation of Oil Skimmers and Booms", Environment Canada report EPS 4-EP-84-1, February 1984.
34. Buist, I.A., Potter, S. and Swiss, J.J., "Arctic Field Testing of the Lockheed Clean Sweep and VEP Arctic Skimmer", Proceedings of the 6th AMOP Technical Seminar, June 1983.
35. Shum, J.S. and Borst, M., "OHMSETT Tests of a Rope-Mop Skimmer in Ice-infested Waters", Proceedings of the 1985 Oil Spill Conference, Los Angeles, February 1985.
36. Roberts, D., "Development of Oil Spill Burning Equipment", Proceedings of the 1st AMOP Seminar, March 1978.
37. Borst, M., "GemEng Lightweight Fireproof Boom: Oil Containment Testing at OHMSETT" Environment Canada unedited report EE-45, June 1983.
38. Laperriere, F., "A Lightweight and Low Cost Fireproof Boom", Spill Technology News Letter Vol 10 (1-3), 1985.
39. Meikle, K.M., "The Use of High-pressure Water for Spill Containment", Proceedings of the 6th AMOP Technical Seminar, June 1983.
40. Meikle, K.M., Whittaker, H. and Laperriere, F., "An Experimental High Pressure Waterjet Barrier", Proceedings of the 1985 Oil Spill Conference, Los Angeles, February 1985.
41. Anonymous, "High Pressure Water Jet Barrier - Design Optimization", Environment Canada unedited report EE-88, April 1987.

42. Laperriere, F., Whittaker, H., Yanagisawa, M. and Suzuki, I. "High Pressure Water Jet Testing for Oil Containment in Simulated Environmental Conditions", Proceedings of the 10th AMOP Technical Seminar, June 1987.
43. Tennyson, E.J. and Whittaker, H., "The 1987 Newfoundland Oil Spill Experiment", Proceedings of the 11th AMOP Technical Seminar, June 1988.
44. Meikle, K.M., "Incendiary Device for Oil Slick Ignition", Proceeding of the 4th AMOP Technical Seminar, June 1981.
45. Whittaker, H., "Laser Ignition of Oil Spills", Proceedings of the 1987 Oil Spill Conference, Baltimore, April 1987.
46. Frish, M., Gauthier, V., Frank, J. and Nebolsine, P., "Laser Ignition of Oil Spills: Telescope Assembly and Testing", Proceedings of the 11th AMOP Technical Seminar, June 1988.
47. Anonymous, "Oiled Debris Disposal Sites: Beaufort Sea Coast", Environment Canada Report EPS 3-EC-79-3, November 1979.
48. Thornton, D.E., "In Situ Burning", Spill Technology News Letter Vol 4 (3), June 1979.
49. Meikle, K.M. and Ewing, H.B., "Oil Spill Incinerator Development: An Update", Proceedings of the 3rd AMOP Technical Seminar, June 1980.
50. Anonymous, "Field Research Spills to Investigate the Physical and Chemical Fate of Oil in Pack Ice", Environmental Studies Revolving Funds Report No. 062, February 1987.





Environmental Studies Research Funds

Oil Spill Research

James J. Swiss  
Amoco Canada Petroleum Company Limited  
Calgary, Alberta, Canada

Natalie Moir  
Canada Oil and Gas Lands Administration  
Ottawa, Ontario, Canada

Abstract

This paper describes oil spill research conducted in Canada under the auspices of the Environmental Studies Research Funds (ESRF). It outlines the structure and function of the ESRF; provides information on the way research priorities were established; and describe some of the highlights of specific projects that were funded. Finally, the paper attempts to provide a linkage between the work that was done through the ESRF and proposed research priorities generated in response to the Minerals Management Service's request for information on Arctic oil spill response technology published in the July 25, 1988 issue of the Federal Register.

## 1.0 INTRODUCTION

Since 1983, the Canadian oil industry has been involved in a program known as the Environmental Studies Research Funds\*. This program requires that companies holding oil and gas interests on Canada Lands\*\* provide funding to support research studies into environmental and social issues related to petroleum exploration and development activities. The Funds have been supporting research into eight areas which include:

- . Bottom Sediment
- . Marine Environmental Effects and Monitoring
- . Icebergs
- . Oil Spill Research and Countermeasures
- . Ice Scour
- . Waves
- . Socio-Economic Issues (North, East and West)
- . Northern Terrestrial and Freshwater Environments

The purpose of this paper is to briefly describe the work that has been done through the Funds in the area of Oil Spill Research. It will provide an outline of the organization that was established to manage ESRF studies in general, and oil spill research in particular; describe how priorities for research have been established; outline the types of studies that have been conducted, including highlights of some of the more interesting projects; and indicate how this program may relate to the Minerals Management Service's plans for further work on oil spill response technology related to the Alaskan Outer Continental Shelf (OCS).

---

\* Formerly the Environmental Studies Revolving Funds

\*\* Frontier Lands in Canada under the jurisdiction of the Canadian Federal Government

## 2.0 BACKGROUND OF THE ESRF

Initiated in 1983, the Canadian Environmental Studies Research Funds (ESRF) is a program of funding for environmental and social studies related to oil and gas development on Canada's Frontier Lands (Figure 1). A focussed program, it deals exclusively with research to assist in decision-making related to oil and gas exploration and development. Funding for the ESRF is provided through levies on the oil and gas companies that hold interests on Frontier Lands. Administration of the program is provided by the Federal Government. The operation of the ESRF is a multi-disciplinary, cooperative effort among specialists from federal, provincial and territorial governments, the oil and gas industry, universities and the private sector.

Overall responsibility for the ESRF rests with the Ministers of Energy, Mines and Resources (EMR) and Indian Affairs and Northern Development (IAND). The ESRF Management Board provides advice to both Ministers and consists of 12 members, representing the Federal Government (departments of Fisheries and Oceans, Environment, Indian Affairs and Northern Development, and Energy, Mines and Resources, one representative each); the oil and gas industry (Canadian Petroleum Association, three representatives; Independent Petroleum Association of Canada, one representative); the Canada-Nova Scotia Offshore Oil and Gas Board (one representative); the Canada-Newfoundland Offshore Petroleum Board (one representative); and two members from the general public. The current Chairman of the Board is the representative from Environment Canada. The Board advises on the management of the ESRF, the content of the ESRF study program, the budget, and the levy rates applied to Frontier Lands.

To date, the bulk of the technical work of the ESRF has been performed by a series of Program Study Committees who have provided expert advice in the following priority subject areas: sediment transport; marine environmental effects and monitoring; icebergs; oil spill research and countermeasures; sea bottom ice scour; socio-economic issues east, north

# Map Of Canada Showing Canada Lands

Figure 1:

## Environmental Studies Revolving Funds Prescribed Regions

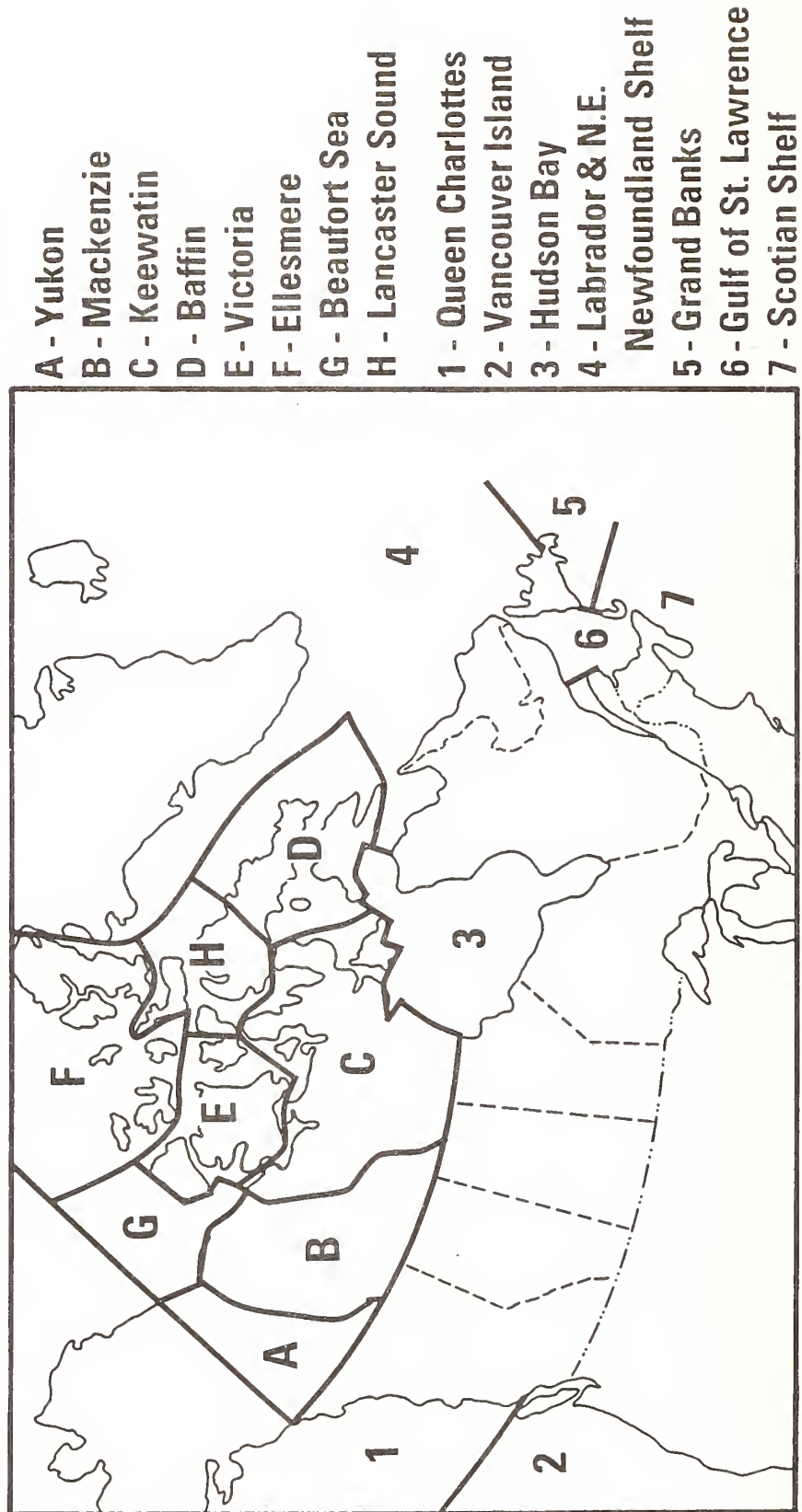

and west; waves; and Northern terrestrial and freshwater environments. These committees are comprised of scientific and technical experts from the oil and gas industry and the federal, provincial and territorial governments. Originally there were ten Program Study Committees; however, during a re-structuring of the program in 1986, it was recommended that the number be reduced to four (figure 2).

The Management Board and the Program Study Committees are supported by an administrative secretariat (three persons) that is responsible for day-to-day operations of the Funds.

ESRF studies are awarded through a competitive bidding process following publication of RFP's in the ESRF newsletter UPDATE. (Circulation 1400). Short lists are only used in situations where the expertise in a given area is very limited. Unsolicited proposals are rarely submitted to the ESRF. More than 80 per cent of ESRF studies are conducted by private sector consultants; the others are about evenly distributed among universities, governments, oil and gas companies and non-government organizations.

Monies spent in the various priority subject areas since the inception of the ESRF are shown in Table I. Work in the area of Oil Spill Research and Countermeasures has amounted to about 21 per cent of the total.

The 1988 budget (\$307,000) is not included in Table I as it consists of administrative and publication costs only. Future study priorities will be determined early in 1989, following the completion of an evaluation of the ESRF which is currently underway. There was no levy in 1987, due largely to greatly reduced industry activity on Frontier Lands.

The ESRF publication series currently includes 100 titles; 27 of these are in the area of Oil Spill Research and Countermeasures.

# ESRF Management Structure

Figure 2:

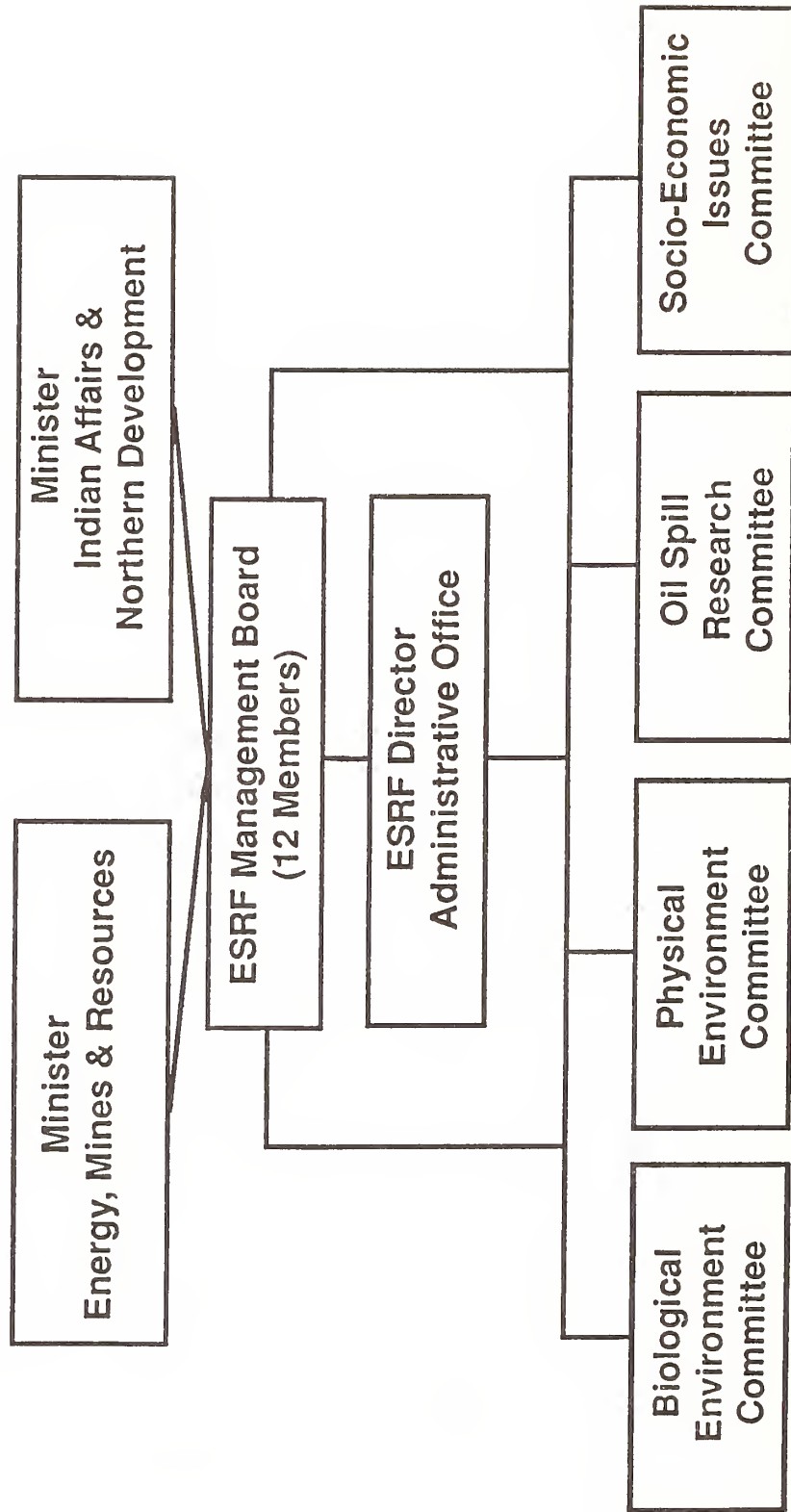

TABLE I

## ESRF STUDY BUDGETS BY YEAR

Priority Subject Areas	Year (\$000)***					
	1983	1984	1985	1986	1987 & 1988	Total
Sediment Transport (8)*	200	370	630	250	-	1,450
Marine Environmental Effects & Monitoring (19)	200	495	675	530	-	1,900
Icebergs (19)	1,000	1,030	400	1,050	-	3,480
Oil Spill Research & Countermeasures (33)**	1,300	1,375	525	-	-	3,200
Sea Bottom Ice Scour (13)	400	1,325	700	-	-	2,425
Social Issues - North (5)	100	380	300	-	-	780
Social Issues - East (8)	100	250	300	-	-	650
Social Issues - West (1)	-	100	-	-	-	100
Waves (12)	300	340	280	-	-	920
Northern Terrestrial (3)	-	-	50	-	-	50
TOTAL	3,600	5,665	3,860	1,830	-	14,955

\* Numbers in parentheses indicate the number of studies sponsored by each Program Study Committee.

\*\* Studies in Oil Spill Research and Countermeasures amount to approximately 21 per cent of the total.

\*\*\* Canadian currency.

### 3.0 OIL SPILL RESEARCH

The expert committee that was established to manage Oil Spill Research was known as the Oil Spill Research and Countermeasures Program Study Committee (PSC). This Committee consisted of 12 members; 5 from industry and 7 from government. It was responsible for establishing research priorities; developing requests for proposals (RFP's); soliciting proposals from the spill research community (industry, government, consultants); evaluating proposals and awarding contracts; and through a 'Scientific Advisor' overseeing the conduct of the projects.

Over the first four years of the program, 33 oil spill research projects were funded and carried out. These projects were those that the Program Study Committee and the ESRF Management Board deemed necessary to provide information for decision-making related to exploration and production activities on Frontier Lands.

The first responsibility of the Committee was to establish priority areas for research. This was done by identifying four general areas of interest, namely Countermeasures, Fate and Effects, Surveillance and Monitoring, and Contingency Planning. Within each of these general areas a more specific list of topics was generated. For example, the Countermeasures area listed the following items: Booms, Removal Devices, Ignition, Chemical, Disposal, Underwater Containment; Groundwater Cleanup. Similar lists were developed for each of the other three major areas. A complete list of topics for each area is shown in Appendix 1.

The need for research on these topics was evaluated using a matrix system which provided a score corresponding to the priority attached to a particular item. Priorities were established for each of the major environmental sectors (Marine, Freshwater, Terrestrial, Air). These sectors were further subdivided to consider factors such as the presence or absence of ice, shorelines, permafrost.



In order to provide an objective rating for items under review, each Committee member provided a score ranging from 1 (high priority) to 3 (low priority) or an indication that no further work was needed at present. These scores were then combined and averaged so that the resulting matrix identified the high to low priority items within each Study Area (Appendix II). Using this matrix, the high priority items were isolated and ranked. The level of funding available from the ESRF within the Oil Spill Area then determined how many of these high priority items could actually be funded in a particular year.

Based on this system, items identified as high priority in the first year of operation included:

- . Countermeasures:
  - Chemical treatment
  - Disposal
  
- . Fate and Effects:
  - Weathering
  - Biodegradation
  - Effects on organisms
  - Food chain effects
  
- . Surveillance and Monitoring:
  - Analytical techniques
  - Sampling techniques
  
- and . Contingency Planning:
  - Logistics
  - Training
  - Public communications

Once the final list of priority subjects was established and costing prepared, the material was presented to the ESRF Board for approval. A series of Requests for Study Proposals was developed and published in the ESRF newsletter 'Update' which was circulated to the research community as described above. In response to these RFP's, proposals were generated and submitted to the Committee for review and funding. These proposals were evaluated and ranked and the successful candidates' proposals were funded.

In order to ensure the scientific validity of the funded studies, a Scientific Advisor was identified (usually from the Committee) and this person worked closely with the study manager and the ESRF administrative office to ensure that the scientific aspects of each project were properly addressed and that the work was conducted in a timely and efficient manner.

Once completed, the projects were published as part of the ESRF Report Series and distributed widely to the Oil Spill community within Canada.

#### 4.0 PROJECT HIGHLIGHTS

As mentioned previously, a total of 33 oil spill research projects were conducted under the auspices of this program between 1983 and 1988 at a total cost of \$3.2 million (Canadian currency). Obviously, it would be impossible to summarize the results of each of these studies in this paper. However, a list of Oil Spill projects completed to date by the ESRF is included in Appendix III. We have selected four of these projects and provided a brief summary describing the contractor, objectives, results and conclusions. These four were chosen because they represent examples of the types of work undertaken within each of the high priority areas (Countermeasures, Fate and Effects, Surveillance and Monitoring, and Contingency Planning). The purpose of this review is not to provide an evaluation of the overall usefulness of the program, but to give an indication of the types of work undertaken.

Priority Area: Countermeasures  
Project: Beaufort Sea Dispersant Trial  
Contractor: Canadian Marine Drilling Company Ltd.  
Objective: To evaluate the effectiveness of aerially applied dispersants under Arctic conditions.  
Results and Conclusions: This study found that in general it is logistically possible to conduct an aerial dispersant application operation in the Arctic. There was some evidence, mostly visual, that dispersants produce the desired effect. However, the degree of uncertainty regarding dispersant effectiveness that remained after these trials were completed suggests that a decision to use dispersants be taken only after very careful consideration of other alternatives (Swiss and Vanderkooy, 1988).

Priority Area: Fate and Effects

Project: Field Research Spills to Investigate the Physical and Chemical Fate of Oil in Pack Ice.

Contractor: S.L. Ross Environmental Research Ltd. and  
D.F. Dickins Associates Ltd.

Objective: To determine the short-term behaviour and fate of oil spilled in pack ice conditions.

Results and Conclusions: This field trial was conducted in pack ice on Canada's east coast and indicated that: oil spreading was dramatically reduced in pack ice compared with that experienced in open water conditions; evaporation and subsequent property changes were predictable using available models; no emulsification occurred even under very dynamic conditions; temporary natural dispersion occurred near floe edges; little oiling of floes occurred and the most significant oil/ice interaction took place in brash and slush ice between the floes; no pumping of oil occurred and burning proved to be the most effective countermeasure technique (Ross and Dickins, 1987).

Priority Area: Surveillance and Monitoring

Project: Development of a Simple Remote Sensing System

Contractor: Esso Resources Canada Ltd.

Objective: To develop a simple remote sensing system that would incorporate infra-red, ultra violet and visual imaging into an easily deployable package for use in aircraft of opportunity.

Results and Conclusions: This project resulted in a remote sensing package that can be quickly and easily deployed in an available aircraft. It consists of infra-red, ultra violet and visual sensors and can be used to provide a definitive image of a slick at sea. The system has been used successfully in relation to several experimental and operational spills.

Priority Area: Contingency Planning

Project: The Development of a Canadian Oil Spill Countermeasures Training Program

Contractor: S.L. Ross Environmental Research Ltd.

Objective: To develop a comprehensive training program for oil spill countermeasures for the Canadian offshore oil and gas industry.

Results and Conclusions: This project resulted in the development of outlines for twelve training modules including the following:

Introduction to Oil Spill Behaviour	(1.5 hours)
Advanced Course in Oil Spill Behaviour	(8.5 hours)
Overview of Soil Spill Control Techniques	(2.5 hours)
Oil Spill Response Organization and Strategies	(2 hours)
Countermeasures Overview for Superintendents	(9 hours)
Surveillance and Monitoring Techniques	(17 hours)
Containment and Recovery Techniques	(5 hours)
Chemical Dispersion Techniques	(18 hours)
Shoreline Protection and Cleanup Techniques	(14 hours)
Disposal Techniques	(8 hours)
Hands-on Experience with Equipment	(16 hours)
Company Simulated Spill Response Exercise	(8 hours)

(S.L. Ross, 1987)

A review of the foregoing project descriptions indicates that a wide variety of studies have been undertaken as part of this program. Some were more successful than others, some raised more questions than they answered. As a general evaluation of the program, however, the authors feel that it provided much useful information when it was needed. Without this program, many of the questions facing the oil industry in the early eighties would still be unanswered. We feel that this program has contributed to resolving some of these issues.

## 5.0 FUTURE DIRECTIONS

We feel it is inappropriate to identify priority areas or projects for future work for a number of reasons. Instead, we have attempted to provide a linkage between projects identified in response to the Federal Register notice and oil spill research conducted under the auspices of the ESRF. In doing so, we have taken certain liberties in combining suggested projects and grouping them into the general priority categories used by the ESRF (Table II).

The projects from the Federal Register and relevant ESRF studies are listed below. This should provide those interested in pursuing any of these topics with a "starting point" based in the ESRF and perhaps a means to avoid some of the pitfalls in conducting similar research.

TABLE II

### OIL SPILL PROJECTS FROM THE FEDERAL REGISTER AND RELEVANT ESRF STUDIES

<u>Projects Identified in Response to 53FR27906 Request</u>	<u>Relevant ESRF Study Numbers</u> (See Appendix III)
<u>Countermeasures</u>	
- Storage and Disposal of Waste	*
- Test Methods for Prototype Equipment	062, 100, 095
- Ways to Reduce Labour Intensity	033
- Deployment and Retrieval Under Inhospitable Conditions	*
- Chemical, Incendiary, and Solidifying Agents	092, 051, 062, 100, 034 006, 074, 064, 082, 070, 095
- Chemical Dispersion in the Arctic	B, C, D, E, 092, 100, 095
- Dispersants in Fresh Water	**

\* No ESRF Projects identified.

\*\* Some work done by Canadian Prairie Regional Oil Spill Containment and Recovery Advisory Committee (PROSCARAC).

TABLE II (continued)

<u>Projects Identified in Response to 53FR27906 Request</u>	<u>Relevant ESRF Study Numbers</u> (See Appendix III)
<u>Countermeasures (continued)</u>	
- Further Development of Brush Skimmer	*
- Combination of Existing Techniques (e.g. elastomers and burning)	*
- Dealing with Burn Residue	062, 064
- Burning on Shorelines	074
- Improvement of Boom Storage	*
- Fire Containment Booms	***
- Burn Testing in Broken Ice	062, 074, 064
- Evaluation of Pumps and Hoses	*
- Recovery of Oil in Broken Ice	019, 018, 013, 062, 077, 064
- Encapsulating Oil in Ice Spray	*
<u>Fate and Effects</u>	
- Summarize Available Knowledge on Ice	019, 018, 013, 077
- Natural Dispersion	B, 062, 100, 031
- Fate of Oil in Broken Ice	019, 018, 062, 077
- Level of Effect Assessment	C, D, E
- Effects of Spilled Oil on Marine Life	**

\* No ESRF projects identified.

\*\* Some work done by Canadian Prairie Regional Oil Spill Containment and Recovery Advisory Committee (PROSCARAC).

\*\*\* Work in this area done by Canadian Offshore Oilspill Research Association (COOSRA).

TABLE II (continued)

<u>Projects Identified in Response to 53FR27906 Request</u>	<u>Relevant ESRF Study Numbers</u> (See Appendix III)
<u>Surveillance and Monitoring</u>	
- Detection by Remote Sensing	6, 7, 100, 072, 078
- Improve Remote Sensing by Satellite	019, F, 072, 078
- Improve Trajectory Models	019, 077
<u>Contingency Planning:</u>	
- Documentation of Techniques from other Countries	*
- Mechanisms for Information Exchange	*
- Dispersant Use Guidelines/Decision-Making (Computerized)	092
- Improving Training Standards	079

\* No ESRF projects identified.

In summary, we feel the Minerals Management Services' efforts to identify future OCS oil spill research needs and priorities is commendable. However, such a program should be implemented only after the needs of all interested parties (industry, government, private individuals) have been carefully considered. In the interest of furthering the state-of-the-art as well as avoiding costly duplication of effort, we would point out that there is a substantial body of knowledge in this area both in Canada and elsewhere. A wealth of background information exists and many lessons have been learned in other programs. Consulting this information prior to initiating new research would seem to be a prudent way to proceed.



## REFERENCES

- S.L. Ross Environmental Research Ltd. and D.F. Dickins Associates Ltd.  
1987. Field Research Spills to Investigate the Physical and Chemical Fate of Oil on Pack Ice. Environmental Studies Revolving Funds Report No.062. Ottawa 118p.
- Swiss, J.J. and N. Vanderkooy. 1988. Beaufort Sea Dispersant Trial. Environmental Studies Research Fund Report No.100. Ottawa 44 p.
- S.L. Ross Environmental Research Ltd. and L.C. Oddy Training Design Ltd.  
1987. The Development of a Canadian Oil Spill Countermeasures Training Programme. Environmental Studies Research Funds Report No.079. Ottawa 121p.

## APPENDIX I

### Complete List of Research Topics

#### Countermeasures

- . Booms
- . Removal Devices
- . Ignition and Burning
- . Chemical Treatment
- . Disposal
- . Underwater Containment
- . Ground Water Cleanup

#### Fate and Effects

- . Weathering
- . Movement
- . Biodegradation
- . Organisms
- . Food Chain
- . Ecosystem
- . Combustion

#### Surveillance and Monitoring

- . Remote Sensing
- . Modelling
- . Tracking
- . Analytical Techniques
- . Sampling Techniques

#### Contingency Planning

- . Support Documentation
- . Sensitivity Mapping
- . Decision Making
- . Analysis
- . Risk Analysis
- . Logistics
- . Training
- . Field Evaluations and Testing
- . Public Communications

APPENDIX II

Priority Matrix

APPENDIX II

OIL SPILL RESEARCH & COUNTERMEASURES

- N/A
- 1 high
- 2 medium
- 3 low
- v OK at present
- \* possibly not an ESRF responsibility

PRIORITY MATRIX

ITEM	AREA									
	Marine			Fresh Water				Terrestrial		Air
	Shore	Ice	Ice Free	Lakes	Rivers	Shoreline	Ice	Permafrost	Non-Permafrost	Atmos.
<u>Countermeasures</u>										
Booms (general)	v	3	3	v	2	v	3	-	-	-
Booms (fireproof)	2	3	2	3	2	2	2	-	-	-
Removal Devices	v	1	3	v	2	v	1	-	3	-
Ignition	3	2	3	3	3	3	2	-	v	-
Chemical	1	1	1	1	1	1	1	2	2	-
Disposal	1	2	2	1	1	1	1	-	-	-
Underwater Containment	-	1	1	3	2	-	3	-	-	-
Ground - water cleanup	-	-	-	-	-	-	-	-	-	-
<u>Fate &amp; Effects</u>										
Weathering	1	1	1	1	1	1	1	1	1	-
Movement	3	1	3	3	3	3	1	3	3	-
Bio-Degradation	1	3	1	1	1	1	3	1	1	-
Organism	1	2	1	1	1	1	3	1	1	-
Food Chain	1	1	1	1	1	1	3	1	1	-
*Ecosystem	1	3	3	3	3	1	3	2	2	-
Combustion		2					2			2
<u>Surveillance &amp; Monitoring</u>										
Remote sensing	2	1	2	2	2	2	1	1	1	v
Modelling	-	1	3	3	3	-	1	v	1	v
Tracking	-	2	1	1	1	-	2	v	1	v
Analytical techniques	1	1	1	1	1	1	1	1	1	v
Sampling techniques	1	1	1	1	1	1	1	-	-	v
<u>Contingency Planning</u>										
Support documentation	3	3	3	3	3	3	3	3	3	3
Sensitivity mapping										-
Decision-making	2	2	2	2	2	2	2	2	2	2
Analysis										
Risk Analysis	3	3	3	3	3	3	3	3	3	v
Logistic	? 1	1	1	1	1	1	1	1	1	-
Training	1	1	1	1	1	1	1	1	1	-
Field evaluation & testing	2	2	2	2	2	2	2	2	2	2
Public communications	1	1	1	1	1	1	1	1	1	1

APPENDIX III

ESRF Oil Spill Research Project List

<u>Report Number</u>	<u>Project Title</u>	<u>Contractor</u>
006	Effectiveness of the Repeat Application of Chemical Dispersants on Oil June 1985. 66 p.	S.L. Ross Environmental Research Ltd.
012	Shoreline Monitoring Programs for Oil Spills-of-Opportunity September 1985. 50 p.	Dobrocky Seatech Ltd.
013	Laboratory Testing of an Oil-Skimming Bow in Broken Ice. January 1986. 60 p.	Arctec Canada Ltd.
018	Testing of an Oil Recovery Concept for Use in Brash and Mulched Ice. January 1986. 43 p.	S.L. Ross Environmental Research Ltd.
019	Oil in Ice Computer Model. December 1985. 129 p.	Dome Petroleum Ltd.
031	Stranded Oil in Coastal Sediments: Permeation in Tidal Flats. April 1986. 23 p.	Dobrocky Seatech Ltd.
033	Practical Insights into Decision-making for Shoreline Cleanup of Oilspills May 1986. 44 p.	Dobrocky Seatech Ltd.
034	Development of a High Pressure Water Mixing Concept for Use with Ship-based Dispersant Application. May 1986. 51 p.	S.L. Ross Environmental Research Ltd.
051	Decision-making Aids for Igniting or Extinguishing Well Blowouts to Minimize Environmental Impacts. November 1986. 119 p.	S.L. Ross Environmental Research Ltd.
053	Oil Motion During Lead Closure. January 1987. 13 p.	Esso Resources Canada Ltd.
058	Countermeasures for Dealing with Spills of Viscous, Waxy Crude Oils. October 1986. 59 p.	S.L. Ross Environmental Research Ltd.
062	Field Research Spills to Investigate the Physical and Chemical State of Oil in Pack Ice. February 1987. 116 p.	S.L. Ross Environmental Research Ltd.

<u>Report Number</u>	<u>Project Title</u>	<u>Contractor</u>
064	In-Situ Burning of Oil in Ice Infested Waters. February 1987. 27 p.	Esso Resources Canada Ltd.
068	Mid-Scale Testing of Dispersant Effectiveness. April 1987. 82 p.	S.L. Ross Environmental Research Ltd.
069	Spills-of-Opportunity Research February 1987. 124 p.	Hatfield Consultants Ltd.
070	The Use of Chemical Dispersants in Salt Marshes. May 1987. 100 p.	P. Lane and Associates
072	Acoustical Methods for Measuring Thickness of Oil on Water. April 1987. 57 p.	Arctec Canada Ltd.
074	Removal of Stranded Oil from Remote Beaches by In Situ Combustion March 1987. 122 p.	Bennett Environmental Consultants. Ltd.
077	Analytical Modelling of Oil and Gas Spreading Under Ice. August 1987 57 p.	Arctec Canada Ltd.
078	Measurement of Oil Thickness on Water from Aircraft: A. Active Microwave Spectroscopy B. Electromagnetic Thermoelastic Emission. August 1987. 82 p.	Canpolar Inc.
079	The Development of a Canadian Oil Spill Countermeasures Training Program. May 1987. 194 p.	S.L. Ross Environmental Research Ltd.
082	Drop Size and Dispersant Effectiveness: Small-Scale Laboratory Testing. July 1987. 31 p.	S.L. Ross Environmental Research Ltd.
083	Microbial Degradation of Hydrocarbon Mixtures in a Marine Sediment Under Different Temperature Regimes. September 1987. 48 p.	Nova Scotia Research Foundation Corp.
086	Prototype, Mesoscale Simulator for the Study of Oil Weathering Under Severe Conditions. November 1987. 55 p.	Institut National de la Recherche Scientifique.

<u>Report Number</u>	<u>Project Title</u>	<u>Contractor</u>
095	Evaluation of Hovercraft for Dispersant Application - February 1988. 57 p.	D.F. Dickins Associates Ltd.
092	Guide to Dispersant Use Decision-making for Oil Spills in the Canadian Southern Beaufort Sea.	S.L. Ross Environmental Research Ltd.
100	Beaufort Sea Dispersant Trial	Dome/Amoco
A.	The Behaviour and Fate of Waxy Crude Oil Spills.	S.L. Ross Environmental Research Ltd.
B.	Hydrocarbon Chemistry Component - BIOS Project	Environment Canada
C.	Macrobenthos Component - BIOS Project	Petro Canada
D.	Microbiology Component - BIOS Project	Environment Canada
E.	Shoreline Component - BIOS Project	Petro Canada
F.	Simple Remote Sensing System	Esso Resources



SUMMARY OF THE ALASKA CLEAN SEAS  
RESEARCH, DEVELOPMENT AND ENGINEERING PROGRAM

Richard V. Shafer, P.E.  
Alaska Clean Seas

*ABSTRACT*

*Alaska Clean Seas, an oilspill response cooperative, has conducted and continues to pursue an active research and development program. Projects include development of oilspill detection and monitoring procedures and equipment, design and fabrication of special oilspill response equipment for use in arctic waters, research on oil/ice interactions, oilspill response equipment evaluations, various logistics-related investigations, waste disposal investigations, preparation of coastal resource manuals and spill trajectory models for areas of interest, research on spill response chemicals for use in cold waters, and research on in situ combustion.*

1. Introduction

Alaska Clean Seas (ACS) is a spill response organization sponsored by oil companies interested in petroleum operations in Alaskan waters. The organization has a commitment to investigate, acquire and maintain appropriate spill response equipment and materials, to provide spill contingency

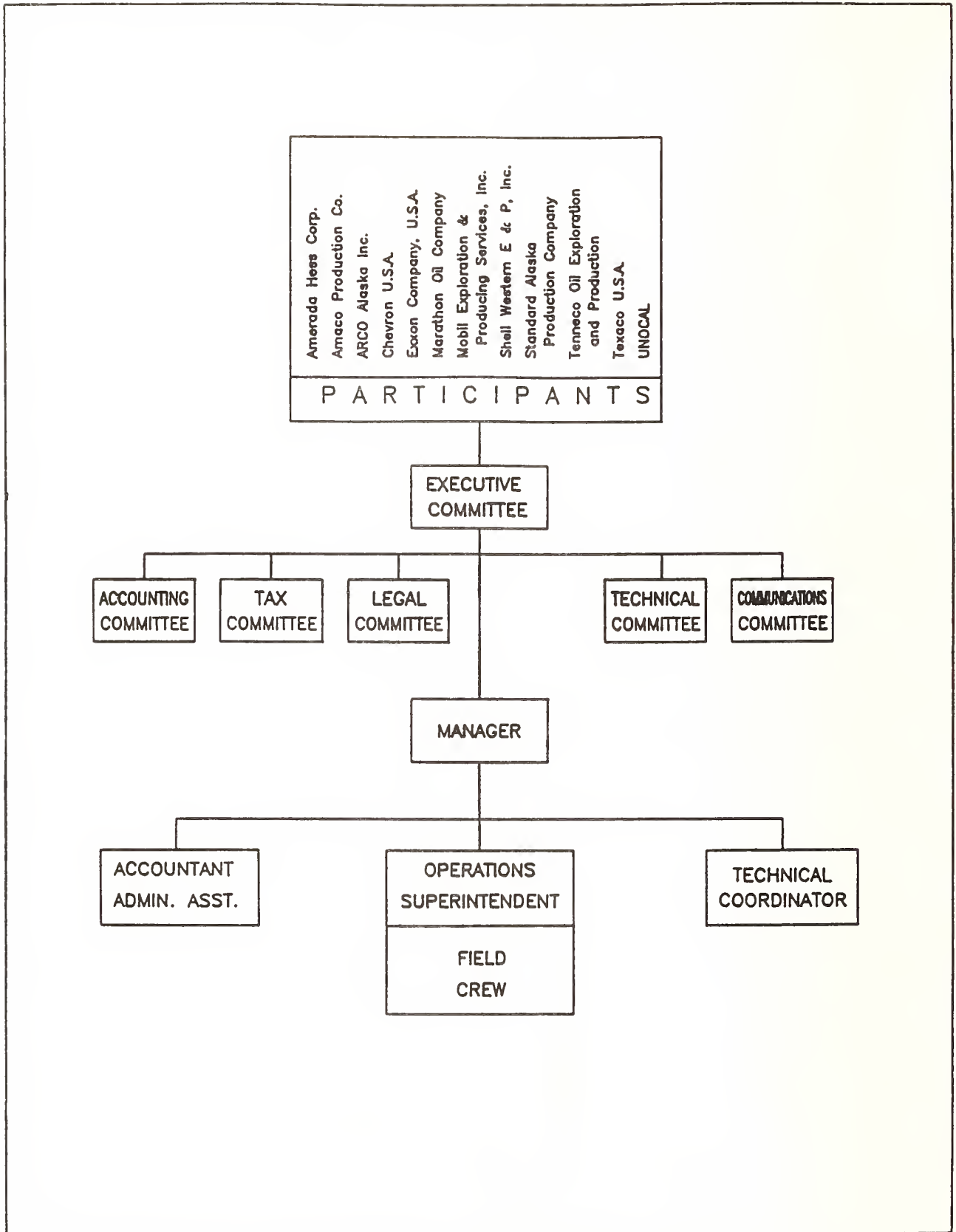

Figure 1. Alaska Clean Seas organizational structure

## ACS R&D PROGRAM

planning support for member companies, and to develop and maintain a training program for personnel of member companies and their contractors who may be involved in oil spill contingency planning and cleanup operations. Figure 1 depicts the present ACS organizational structure.

Since the inception of the organization, Alaska Clean Seas' member companies have year after year supported a very active research and development program focusing on the problems of spill response in arctic waters. ACS maintains close contacts with others working in this field through personal contacts and through regular participation at meetings and conferences, including the annual Arctic Marine Oil Spill Program (AMOP) Technical Seminars sponsored by Environment Canada, biannual meetings of the American Society for Testing and Materials (ASTM) Committee F-20, and the biennial Oil Spill Conference which is co-sponsored by the American Petroleum Institute, the U.S. Coast Guard, and the Environmental Protection Agency. The ACS Technical Committee annually examines many proposals and prospects for improving arctic spill response technology, and recommends for accomplishment those projects that are considered most likely to lead to better understanding and practical application. This paper briefly describes all of the R&D projects which have been undertaken by Alaska Clean Seas.

### 2. ACS R&D Projects That Are Complete.

Action has been completed on the research and development projects described below (Hillman and Shafer, 1983; Hillman, 1985; Shafer, 1986; Shafer, April 1987, June 1987):

#### 2.1. The ARCAT Design.

This project covered the design of the *ARCAT II*, a 65-ft catamaran spill response vessel that incorporates both a rope-mop skimming system and a weir skimmer. The vessel was built specifically for use during broken ice and open water periods in the Alaskan Beaufort Sea. Though the vessel was not designed as an ice breaker, hull sections were provided with extra strength to resist ice forces (Williams, 1982).

## ACS R&D PROGRAM

### 2.2. Experiments involving oil in ice.

Samples of oil (diesel fuel for some tests and hot Prudhoe Bay crude oil for others) were injected under various thicknesses of sea ice on various dates throughout the winter at a total of 15 offshore sites in Prudhoe Bay, and the behavior of the oil and its sea ice matrix was observed. Thermal insulation material was placed in selected areas on the ice surface to reduce freezing rates beneath. This provided for oil containment in inverted concavities in the lower surface of the sea ice. Research also involved laboratory observations of oil - ice interactions and field tests of oil detection and recovery techniques (Nelson and Allen, 1981, 1982; Allen and Nelson, 1981).

### 2.3. Coastal resource manuals for the Beaufort and Bering Seas.

ACS has published an extensive coastal resource manual for the Alaskan Beaufort Sea (Morson, *et al.*, 1983.) providing information on biological and cultural resources, and on how to protect them from an oil spill. A similar manual covering selected portions of the Bering Sea coast has also been published (Gusey, Hillman and Chamberlain, 1987).

### 2.4. Spill trajectory models for the Beaufort and Bering Sea areas.

ACS contracted for development of oilspill trajectory models covering petroleum exploration areas in the Beaufort and Bering Seas. These models will operate on an IBM-PCXT (or compatible) with a suitable printer and plotting device. The models can be used for contingency planning and for real-time prediction of oil spill movement (*Alaska Beaufort Sea Oil Spill Trajectory Analysis*, 1983; *Norton Sound Oil Spill Trajectory Model*, 1985; and *St. George Basin Oil Spill Trajectory Model*, 1984).

### 2.5. Investigations on the effectiveness of dispersants in cold water.

Various commercially available dispersants were tested in the laboratory to assess their ability to disperse Prudhoe Bay crude oil under low temperature conditions. In general, chemical dispersants were found to work under the conditions of the tests, but at reduced efficiency.

## ACS R&D PROGRAM

### 2.6. Research on the use of air-cushion vehicles for logistic support.

ACS sponsored a synthesis of available information on air-cushion vehicles, with emphasis on their utility for logistic and operational uses in the event of an oil spill in the Arctic.

### 2.7. Contribution to Canadian research on fireproof boom and air deployable igniters.

ACS contributed funds to support research on fireproof boom and air deployable igniters under development by Canadian operators (Pistruzak, 1981). These devices were developed to facilitate *in situ* combustion of spilled oil.

### 2.8. Flare burner experiments.

ACS tested and evaluated flare burner equipment on long-term loan from the U. S. Coast Guard. Flare burners can be used for environmentally safe disposal of spilled oil.

### 2.9. Oily refuse incineration research.

ACS examined various incinerator systems and incineration methods for arctic use. Incinerators can be used for safe disposal of oily debris accumulated during an oilspill cleanup operation.

### 2.10. Transfer and storage system evaluation.

ACS conducted evaluations of various pumps, hoses and temporary storage tanks for use in oilspill cleanup operations in the Arctic.

### 2.11. Development support for the Moorhead beach cleaning device.

ACS helped support the development of a prototype system for removal of oil from beaches.

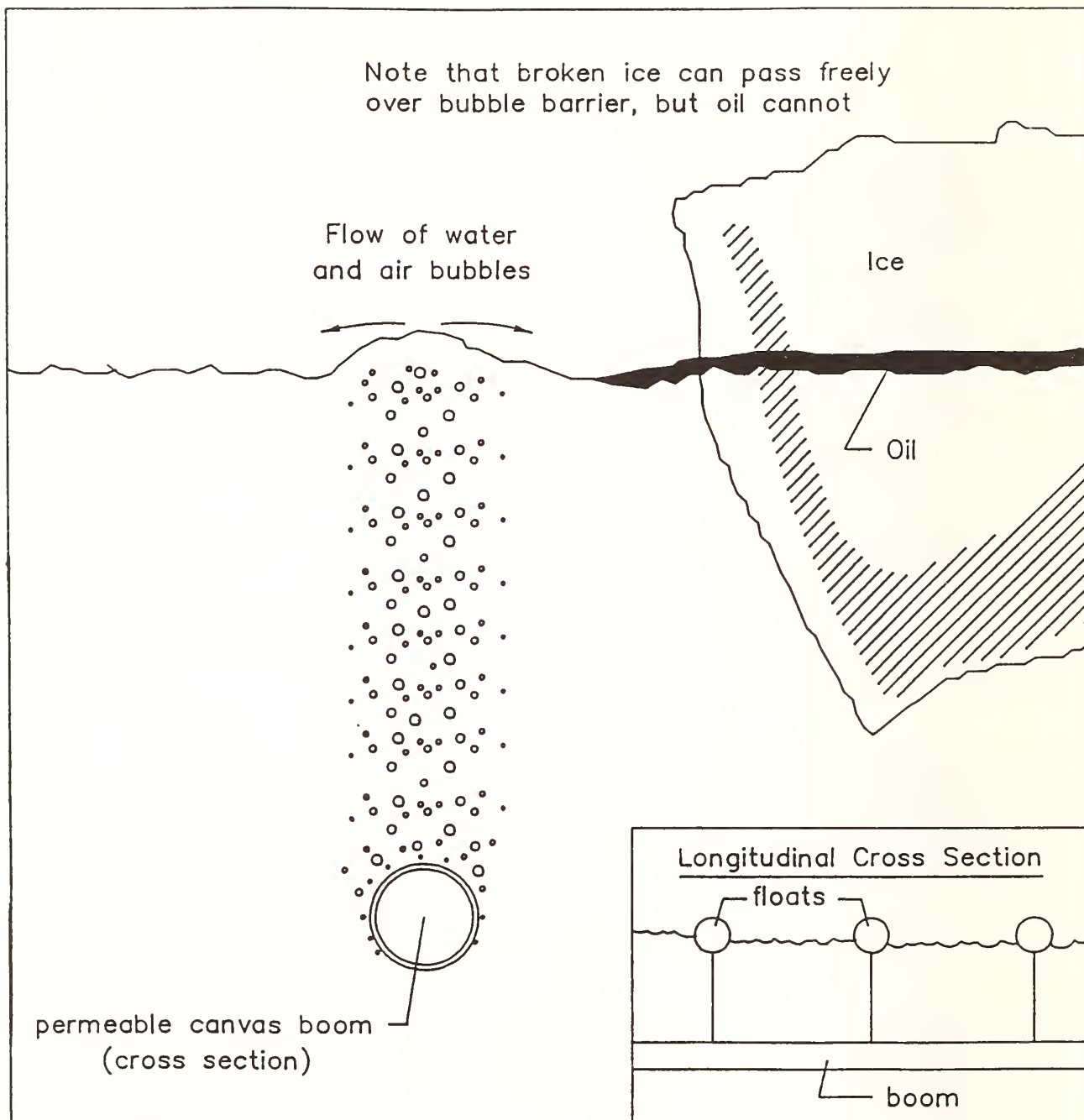

Figure 2. Bubble barrier.

## ACS R&D PROGRAM

### 2.12. Field and laboratory testing of three deep-draft containment booms.

ACS conducted evaluations of selected deep-draft spill containment boom systems.

### 2.13. Fire Containment Boom Assessment.

A number of special containment booms have been developed that are resistant to damage by fire. Such booms can be used to contain spilled oil while it is burned in place. They must be designed to contain spilled oil in a layer sufficiently thick to support combustion, while resisting the effects of heat well enough to functionally survive exposure to the burning oil. This project was conducted to assess survivability, containment capability, and other characteristics of various designs and configurations of fire containment boom, and it demonstrated that that several boom types are available that will survive a 24-hour exposure to burning oil and still be capable of containing the oil. (Allen, February 1986, Allen and Simpson, June 1986.)

### 2.14. Bubble Barrier.

This project was designed to evaluate application of a bubble barrier oil containment systems for use in the arctic. Initial test tank and open water experiments with a prototype bubble barrier were conducted outside of Alaska. Field tests were attempted at Prudhoe Bay during 1986 (Garlow, Steele and Williams, November 1986) and 1987 (Garlow and Steele, May 1988). Tests suggested that the bubble barrier concept would be useful for arctic applications (see Figure 2), however the prototype systems designed for this series of tests were found to be insufficiently durable, even for short exposures to the arctic environment. No decision has been made regarding further work on this concept.

### 2.15. Enhanced ARCAT Recovery (Plunging Water-Jet Boom).

A system of plunging water jets for installation on the *ARCAT* was designed, fabricated, and tested. As shown in Figure 3, this system provides a skimming swath width about seven times that of the *ARCAT* by itself.

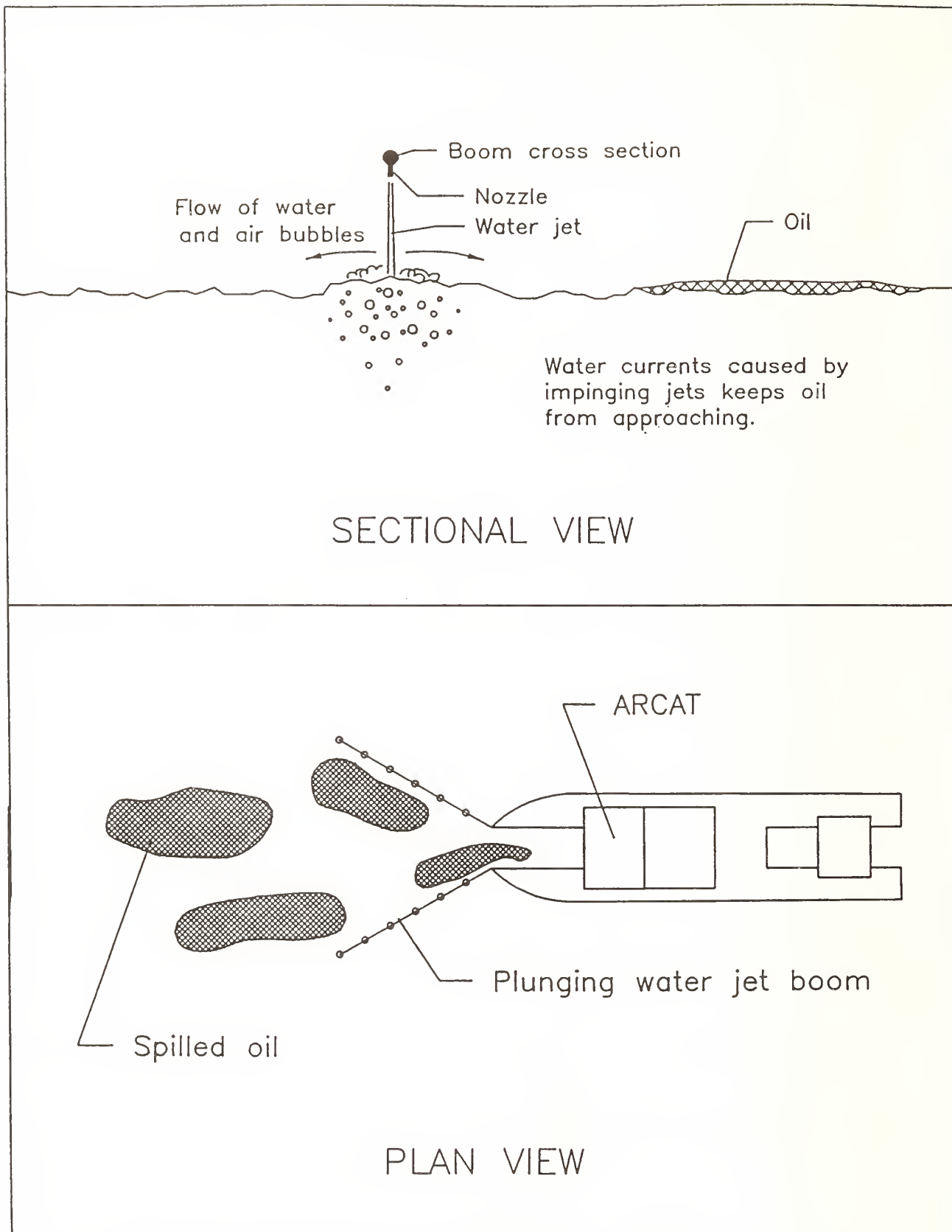

Figure 3. Plunging water jet boom system for ARCAT.



## ACS R&D PROGRAM

The system was successfully field tested on the *ARCAT* during the summer of 1986, and it is now ready for use in an actual spill response operation. (Garlow, Steele, and Williams, October 1986).

### 2.16. Air Deployable Igniters.

Alaska Clean Seas stocks air deployable igniters of a design developed by Canadian operators (with some financial support from Alaska Clean Seas--see Section 2.7). The purpose of these igniters is to initiate *in situ* combustion of spilled oil. Such igniters would ordinarily be applied to a spill area by dropping them by hand from a helicopter. The objective of this project was to review available information on alternative ignition systems, seeking a design with smaller size and weight, improved performance in thin or weathered oils, greater simplicity and safety of use, and lower cost. The results of this study (Allen, April 1986) provided the basis for decisions regarding further igniter research and development work.

### 2.17. Oil Spill Chemical Application Manual.

This project synthesized available information on spill response chemicals and various related environmental and logistical data into a comprehensive oil spill chemical application manual for use by response planners and managers concerned with operations in Alaska. (Allen, June 1986)

### 2.18. Logistics Support for U. S. Coast Guard Spill Trajectory Study.

Though ACS was not directly involved in this research, substantial logistical support was provided by ACS to the U. S. Coast Guard during the course of field work on a spill trajectory study. Alaska Clean Seas and member companies provided vessels and crews plus office space and living quarters for Coast Guard personnel to use while acquiring data for the study, and ACS retrieved various experimental equipment for the investigators. (St. Martin and Lissauer, 1986)

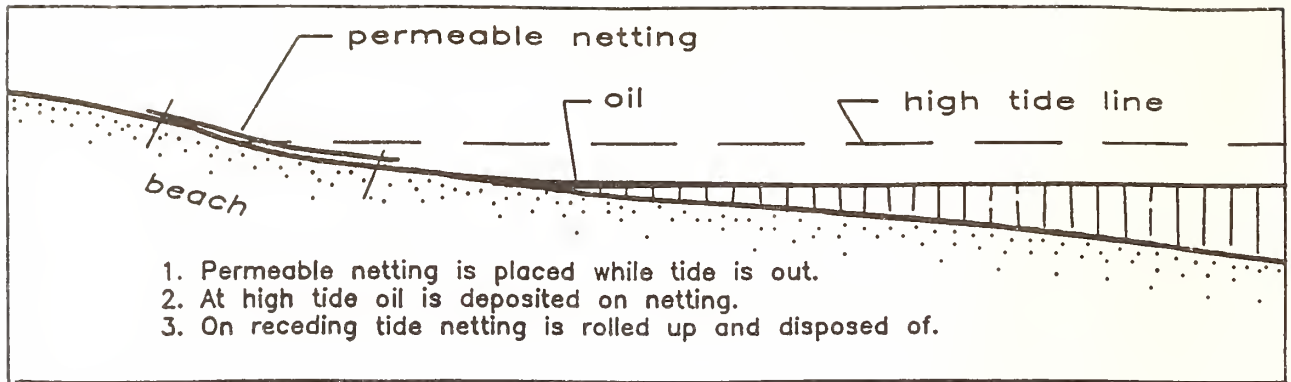

Figure 4. Section through beach showing shoreline protection scheme.

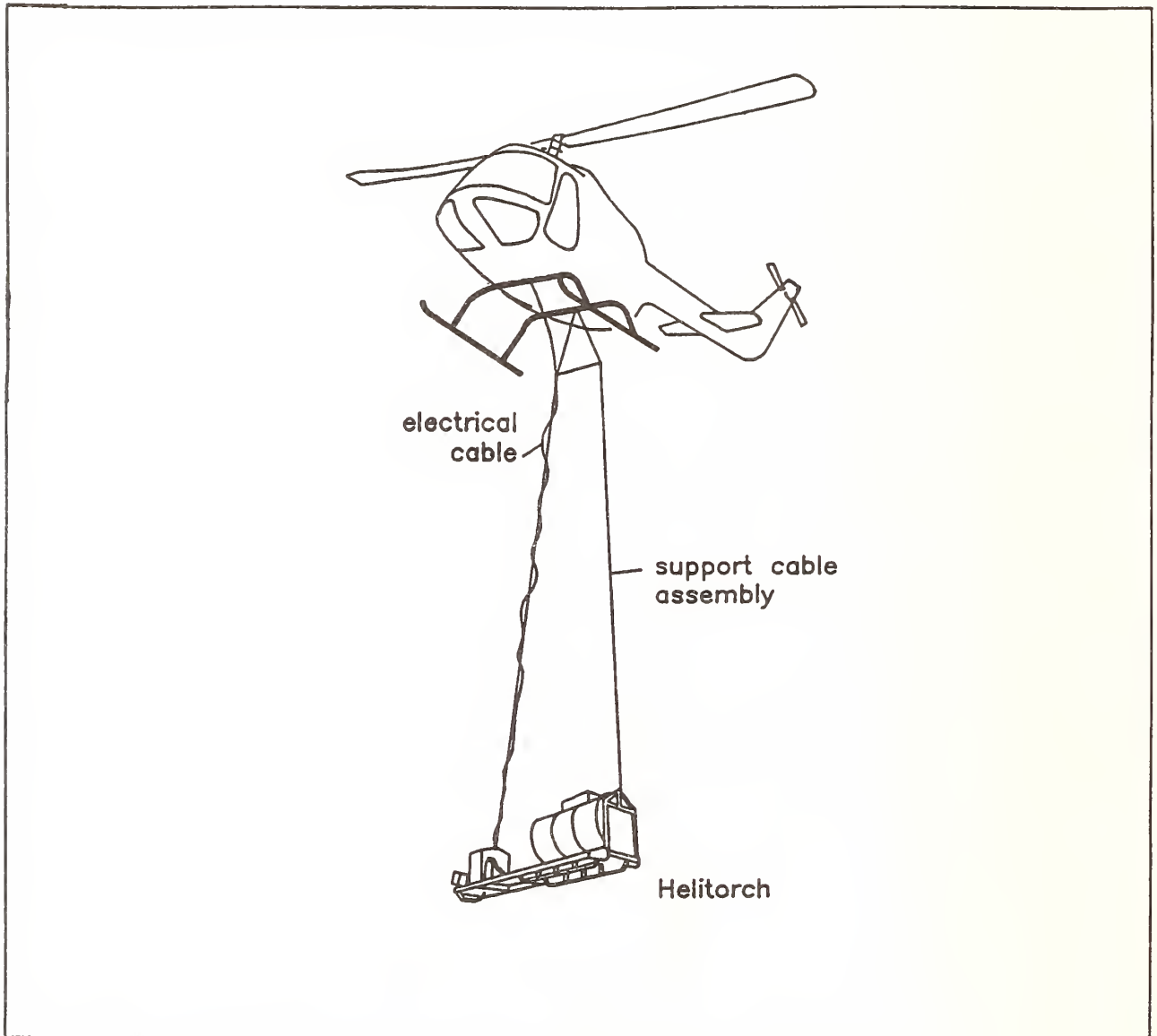

Figure 5. Helitorch system for ignition of spilled oil.

## ACS R&D PROGRAM

### 2.19. Shoreline Protection Using Porous Netting.

When an oil spill impacts a beach, the cleanup methods commonly used are labor intensive and frequently quite damaging to the environment. Moreover, conventional beach cleanup techniques can be slow, especially in remote areas; and the longer oil remains in a wildlife habitat, the greater the potential for biological harm. This project was designed to assess the concept of placing thin, lightweight, fine-mesh material to protect a threatened shoreline. The material could be delivered to remote shorelines by helicopter and quickly deployed by a small number of workers. Long sheets of this material would be applied at or near the next expected high tide elevation where most of the oil would be deposited. Figure 4 illustrates how such material might be deployed. When oil or oily emulsion is deposited on the shoreline it would settle on top of the porous material. The surface characteristics of the material must be designed to allow water to percolate through the fabric into the soil but to retain oil. On a receding tide, workers would roll up the material and retrieve it, thereby capturing virtually all of the oil or emulsion but not robbing any substantial quantity of beach material. The rolled up material would then be disposed of in an approved, environmentally safe manner.

Samples of various prospective material formulations and designs were applied to various natural and artificial shorelines, and recovery effectiveness and efficiency were assessed. The integrity of the material under cold conditions was considered, as was the objective of minimizing problems with wildlife entanglement. Tests concluded that burlap appeared to be the best material of those evaluated. Advantages of burlap are: 1) oil adheres to the wet fabric and is not drawn through, 2) water can easily pass through the fabric, 3) burlap is widely available in large quantities, and 4) burlap's cost is not prohibitive.

Keeping the material in place during use was found to be more difficult than originally anticipated, but this problem was overcome by use of a heavier anchoring system. Deployment and recovery of the material and anchoring system can be facilitated with mechanical equipment (Garlow and Steele, July 1988).

## ACS R&D PROGRAM

### 2.20. Refinement of Aerial Ignition System.

This project involved: 1) development and testing of innovative systems for igniting and burning oil *in situ*, 2) initial field testing of selected concepts under various conditions, and 3) larger scale tests of the most promising designs. The project identified the Helitorch ignition system, shown in Figure 5, as the most promising igniter for use in the Arctic, and extensive tests were conducted with this equipment (Allen, May 1987, June 1987). The Helitorch unit that ACS had leased for testing has now been purchased and is a permanent addition to inventory. ACS will cover this equipment in future training programs and contingency manual updates.

### 2.21. Dispersant Effectiveness Tests in Cold Water Conditions.

Laboratory work conducted in 1980 demonstrated that the dispersant chemicals presently stockpiled by Alaska Clean Seas are effective for use on Prudhoe Bay crude oil under arctic conditions. However, ACS considered that larger scale tests conducted in a wave basin would provide more realistic test conditions and provide a better basis for establishing procedures and practices. Experimental work was conducted in spring, 1987 (Brown and Goodman, July 1987).

### 2.22. Multiple boom Strategies for Use in Arctic Waters.

Virtually all booms have oil underflow losses when the local normal flow velocity vector exceeds 1 to 1.5 knots. In the presence of waves, underflow begins at lower velocities, and wind-driven choppy waves can also cause oil to splash over the tops of booms, particularly with low profile systems such as the more massive fire containment booms. Short-period waves also inhibit the ignition and subsequent incineration of oil, significantly reducing the effectiveness of the *in situ* burning disposal technique. In arctic waters the possibility of collision with moving ice threatens the structural integrity of the booms. A promising concept for extending the use of booms into these more severe conditions involves use of multiple boom arrays. The concept utilizes a configuration of specially designed booms placed upstream of the final boom. Such a boom assemblage was found to help establish a quiescent containment region, isolated from choppy waves and high current velocities. This portion of the boom system will accumulate a thick,

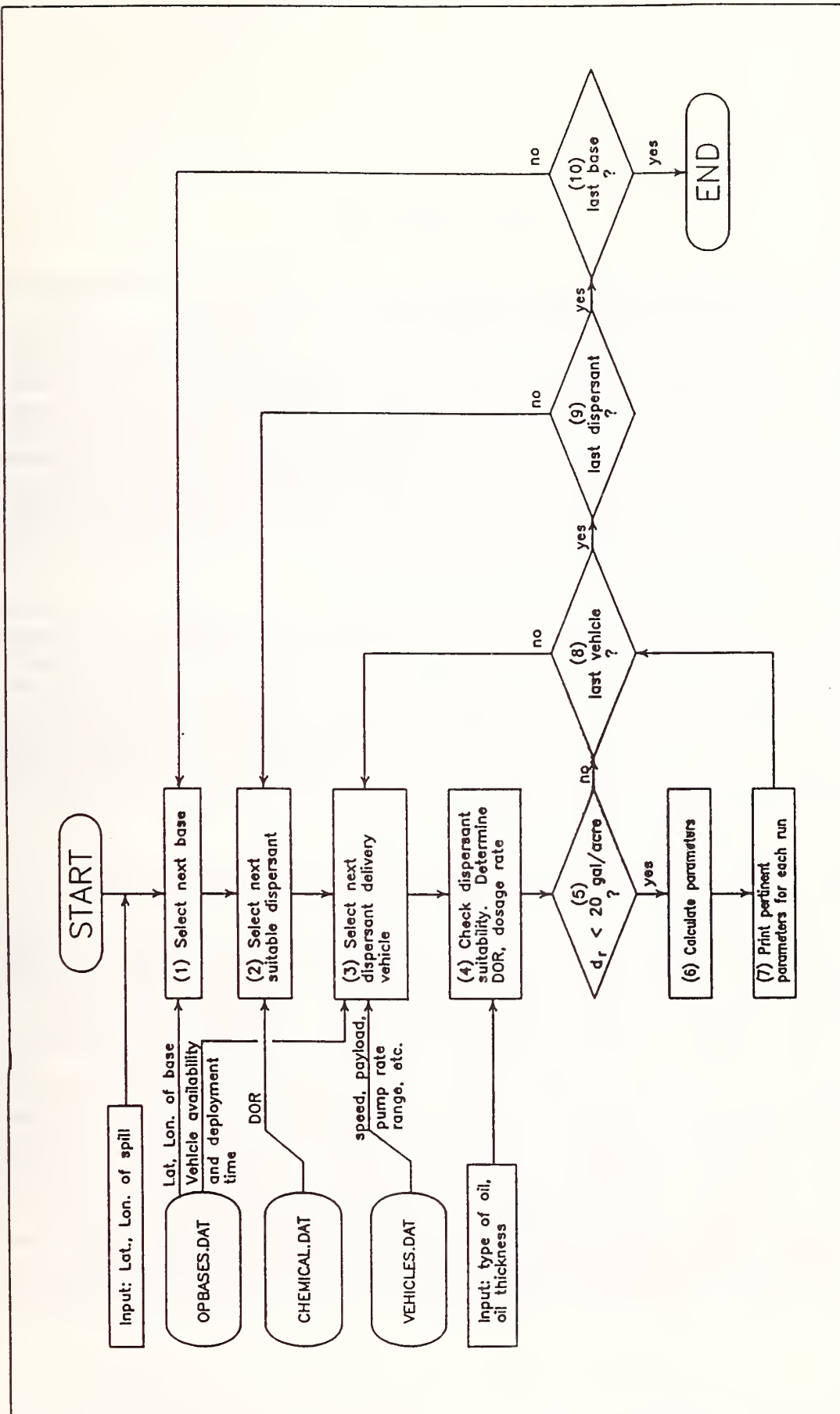

Figure 6. Flow diagram for CADA program.

## ACS R&D PROGRAM

relatively undisturbed pool of oil where skimming operations or *in situ* combustion can be conducted more effectively.

This project involved: 1) measurement of environmental loads and comparison of different controlled failure mechanisms for upstream boom elements, 2) exploration of other design issues such as the number, size, and spacing of boom units, and 3) the establishment of deployment guidelines. Tests were performed at the Shell wave tank at Westhollow Research Center in Houston, Texas. Selected multiple boom configurations were tested for performance under irregular wave conditions. Polybutylene pellets were used to simulate oil in preliminary tests, followed by confirming tests using a real oil with selected standard characteristics.

The best multiple boom configuration found during these tests consisted of a rear boom and a special single forward boom assembly constructed by placing three booms adjacent to one another and tying them together with nylon rope every few feet. Each of the three booms had a different size and mass, with the largest and heaviest boom used in the front and the smallest and lightest boom in the back. Each of the three booms were skirtless, since the presence of a skirt in the forward boom assembly was found to increase the underflow losses on the rear boom. (Wave Tank Tests of Multiple Arctic Oil Containment Booms, October 1987)

### 2.23. Computer Assisted Dispersant Application (CADA) planning system.

This project covered the preparation of a computer program to assist in the planning of dispersant application operations. The program is based on computation and decision systems described in the Alaska Oilspill Chemical Application Manual published by Alaska Clean Seas in 1986 (Allen, June 1986). The program is written in the programming language, Turbo Pascal.

As shown in Figure 6, the CADA software includes a central core program plus three computer database files: one file with pertinent data on potential dispersant operations staging bases, a second file with data on various dispersant and oil combinations, and a third file with data on various dispersant delivery systems. The core program will step the user through a series of questions and answers. It will draw on information input by the user together with data stored in the three database files to help identify the optimum combination of operating base location, dispersant chemical, and dispersant delivery system for a given oil spill. Pertinent information is

## ACS R&D PROGRAM

displayed on the computer screen and is printed out as well. In addition to the central core program, software is provided to load or modify information in each of the three database files (Shafer, September 1988).

### 2.24. Oil and Oily Debris Disposal Guidelines.

Under this project, written guidelines were prepared covering various options for disposal of oily debris associated with spill response operations in the Alaska Clean Seas areas of operation (*Guidelines for Disposal of Oilspill Response Waste Materials*, July 1988).

## 3. Ongoing ACS Research and Development Work

The projects described below are presently being undertaken on behalf of Alaska Clean Seas:

### 3.1. Detection of Oil Under Ice by Induced Fluorescence.

Present methods for detecting oil encapsulated within sea ice or trapped beneath it are either slow and inefficient, or virtually ineffective for thin deposits of oil. However, ACS has been pursuing a promising approach to detection of oil in ice involving the phenomenon of induced fluorescence.

Crude oil fluoresces strongly in the visible spectrum when it is illuminated with ultraviolet light. Conceptually, as shown in Figure 7, a compact, portable, pulsed ultraviolet light source, similar to a photographic strobe light, might be used to flash an intense beam of ultraviolet light onto a small area of the surface of the sea ice. The light would need to be sufficiently intense to penetrate several feet of snow cover and ice, and illuminate an underlying layer of oil. A suitable sensing device mounted adjacent to the ultraviolet light source should detect fluorescence from any oil present.

A high intensity UV flash system and a sensitive photodiode detector meeting ACS criteria were purchased. Several suitable optical filters for the light source and detector were also purchased. Unfortunately, the ultra-

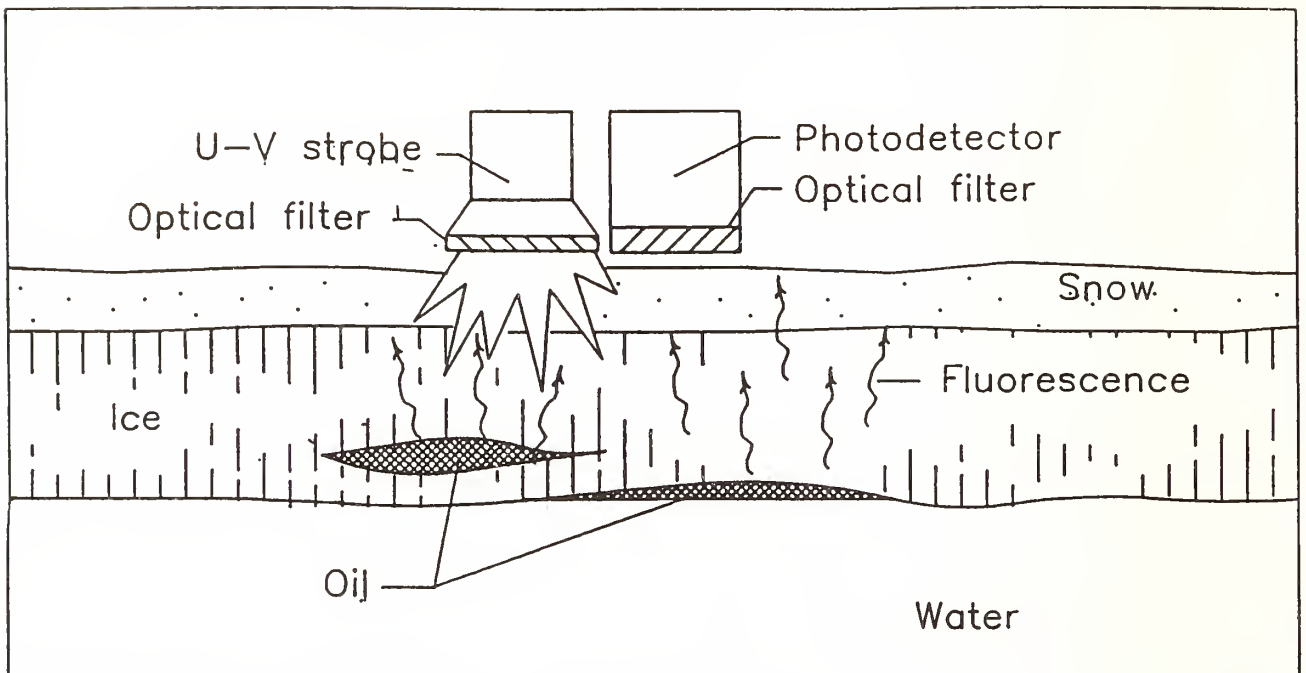

Figure 7. Through-ice oil detection system.

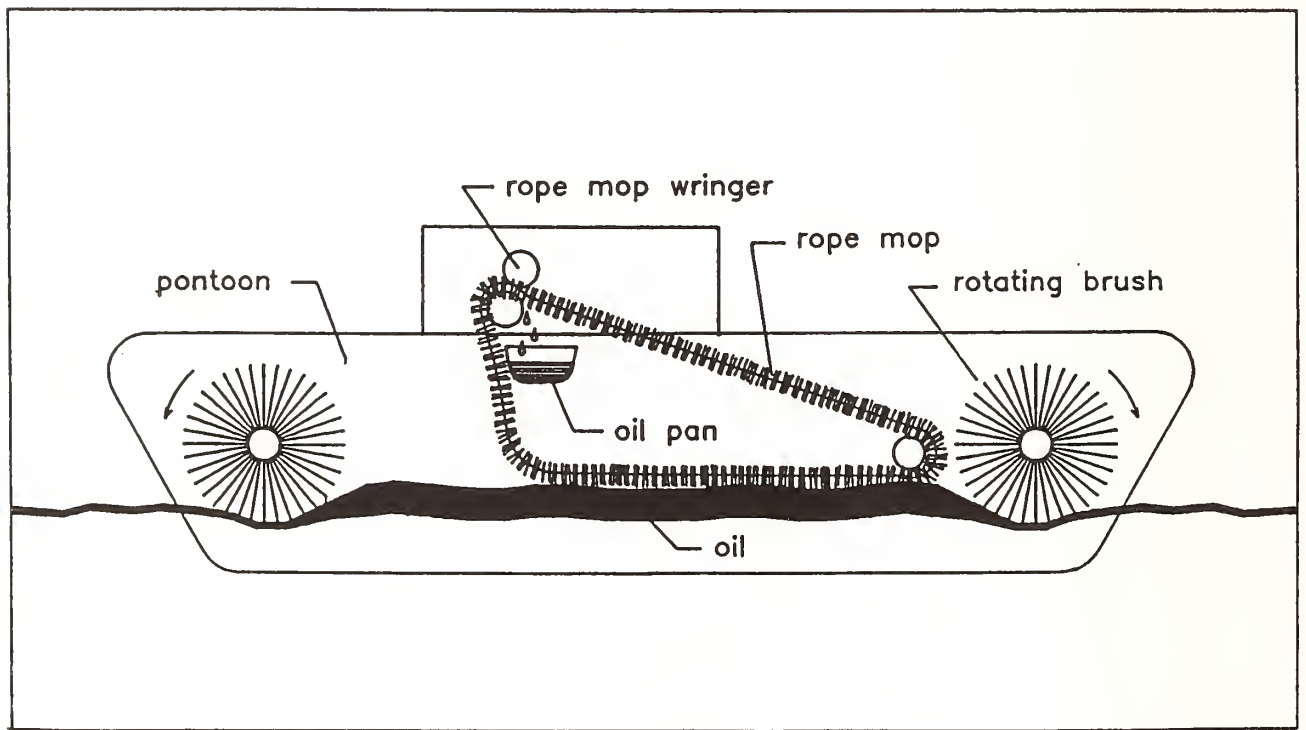

Figure 8. Rotating brush skimming system.



## ACS R&D PROGRAM

violet strobe unit failed during preliminary testing, and further work on this project was suspended while a replacement unit was acquired.

### 3.2. Salmon Tainting Study.

ACS joined with the Cook Inlet Response Organization (CIRO) in sponsoring a study of the potential for tainting of salmon as a result of the use of dispersant chemicals on an oil spill in salmon habitat. In this study salmonid specimens were placed in tanks containing seawater and dispersant-treated oil at concentrations typical of what fish would experience in an actual oilspill dispersion operation. Tanks containing: 1) plain seawater, and 2) seawater with undispersed oil provided experimental controls. Experimental work was performed under contract with the University of Washington. Chemical analysis was conducted by the University of Washington and by Chevron. Analysis of results and project writeup are under way, and completion of the project is expected in late 1988 or early 1989.

### 3.3. Development of a high-capacity rotating brush/rope mop skimmer for oil recovery in ice-laden waters.

Preliminary development work by Exxon Production Research on this new skimming system concept held promise, especially for use with viscous oils in arctic waters. The concept involves use of a rotating cylindrical brush to help move floating oil to a central collection point. As the rotating brush sweeps the water surface it generates a surface current that moves floating oil toward the brush. In various tests, oil many feet away from the brush was observed being "pulled" toward it. Equipment constructed and tested under this project used a system of rotating brushes to move oil toward a skimmer, where a system of rope mops was rigged to remove the oil from the water. (See Figure 8.) The system with rotating brushes as well as mops was found to be substantially more effective than a rope mop system alone. It should be noted that both the rotating brush and the rope mop units are highly compliant and are not damaged by repeated contact with floating solids such as ice.

## ACS R&D PROGRAM

### 3.4. Development of a high tensile strength containment boom.

Standard Alaska Production Company previously has conducted independent tests involving a special high tensile strength containment boom. The main component of the boom is a section of heavy duty conveyor belt material. During that earlier work, Standard developed and tested a system for connecting sections of the boom to one another. Under this project ACS accomplished the following: 1) two prototype boom sections were assembled, each using a somewhat different floatation system; 2) two tow plate/end connectors were fabricated; and 3) preliminary tests were conducted in the water at Prudhoe Bay. The boom assemblies were then allowed to freeze in place attached to a mooring buoy in Simpson Lagoon near Prudhoe Bay. Unfortunately, one of the boom sections with its attached towing assembly became separated and was lost, probably at the time of breakup. The cause of the separation is considered to be that a steel cable used as a hinge pin worked loose and fell out. Minor changes in connector design should prevent recurrence of this failure, and a revised design will be recommended as part of the report on this project. The remaining boom section did not appear to have been damaged by exposure to the winter ice environment in Simpson Lagoon.

### 3.5. Arctic Skimmer Prototype Development.

Under this project, the ACS staff developed and tested a prototype skimming device for use with the ACS vessel, *North Star* in broken ice conditions. The concept ACS tested involves a mechanical outrigger system that supports an ice deflector and a floating collection boom. A skimmer at the apex of the collection boom transfers collected oil to a separator tank on board the *North Star*. Oil from the separator tank is pumped to a floating bladder tank. The water phase from the separator tank is recycled back into the collection boom. (See Figure 9)

During 1987 the articulated outrigger system and the ice deflector were fabricated and installed on the *North Star*; the separator tank was fabricated and installed; and all connecting hoses were made up. A loop of containment boom was rigged between the outrigger and the side of the vessel, and a Morris disk skimmer was placed near its apex to pick up oil and transfer it to the separation tank on board. The assembled system was

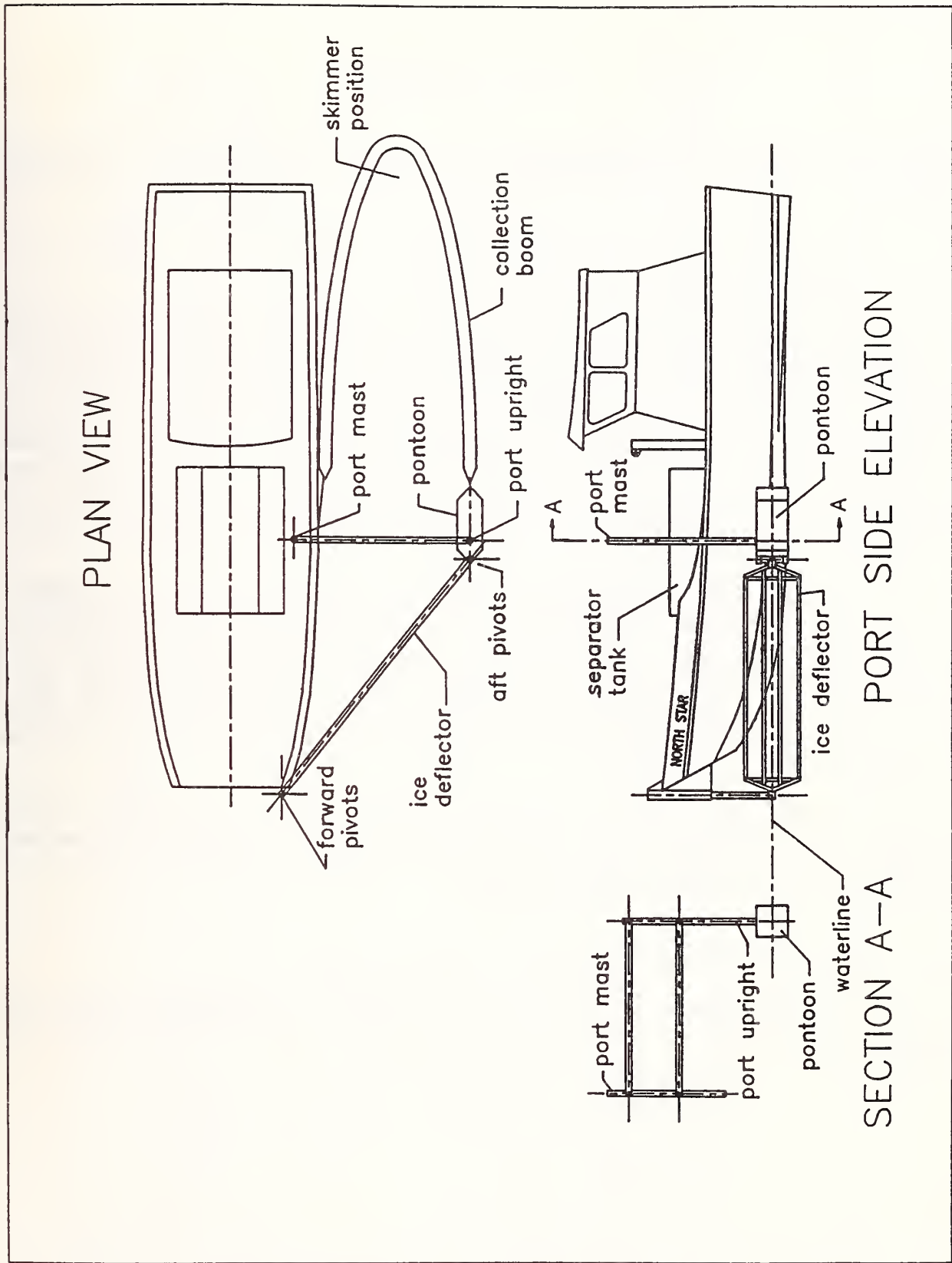

Figure 9. North Star workboat with arctic skimmer system installed.

## ACS R&D PROGRAM

tested in the water during two spill response exercises conducted in September, 1987 near the Endicott production facility (Shafer and Bowen, 1988).

### 3.6. Shallow Water Access Mop Platform (SWAMP).

Access to near-shore environments in the lagoonal systems south of the Beaufort Sea barrier islands is limited by shallow water. Under this project a shallow-draft pontoon hull skimming vessel was designed, assembled and tested. Project steps included: 1) design of system including hull, propulsion, skimmer, oil/water separator, transfer equipment, temporary storage, and life support subsystems (suitable commercially produced components were selected where available on market, otherwise components were designed from scratch); 2) procurement materials and components; 3) fabrication and assembly of vessel and ancillary equipment; and 4) operational testing.

The vessel has now been designed and constructed. As shown in Figure 10 it is a 27-ft catamaran design, fabricated in aluminum. Features include: 1) a rope mop skimming system with its own power generator; 2) a 4-ft x 6-ft pilot house; 3) a 70-horsepower outboard engine; 4) an A-frame system at the forward end of the vessel that can be used to support the rope mop unit's tail pulley in some configurations; 5) a specially constructed trailer to transport the unit between the ACS operations center/warehouse and the launching site.

The *SWAMP* was first launched in August, 1987. The vessel demonstrated good maneuverability and a cruising speed of 10 knots. It has been tested and evaluated during two spill response training sessions in September, 1987 (Shafer and Glenn, 1988).

### 3.7. Literature study on effects of *in situ* burning.

This project will provide a review of technical literature to assess the state of knowledge on the risks associated with *in situ* combustion of crude oil.

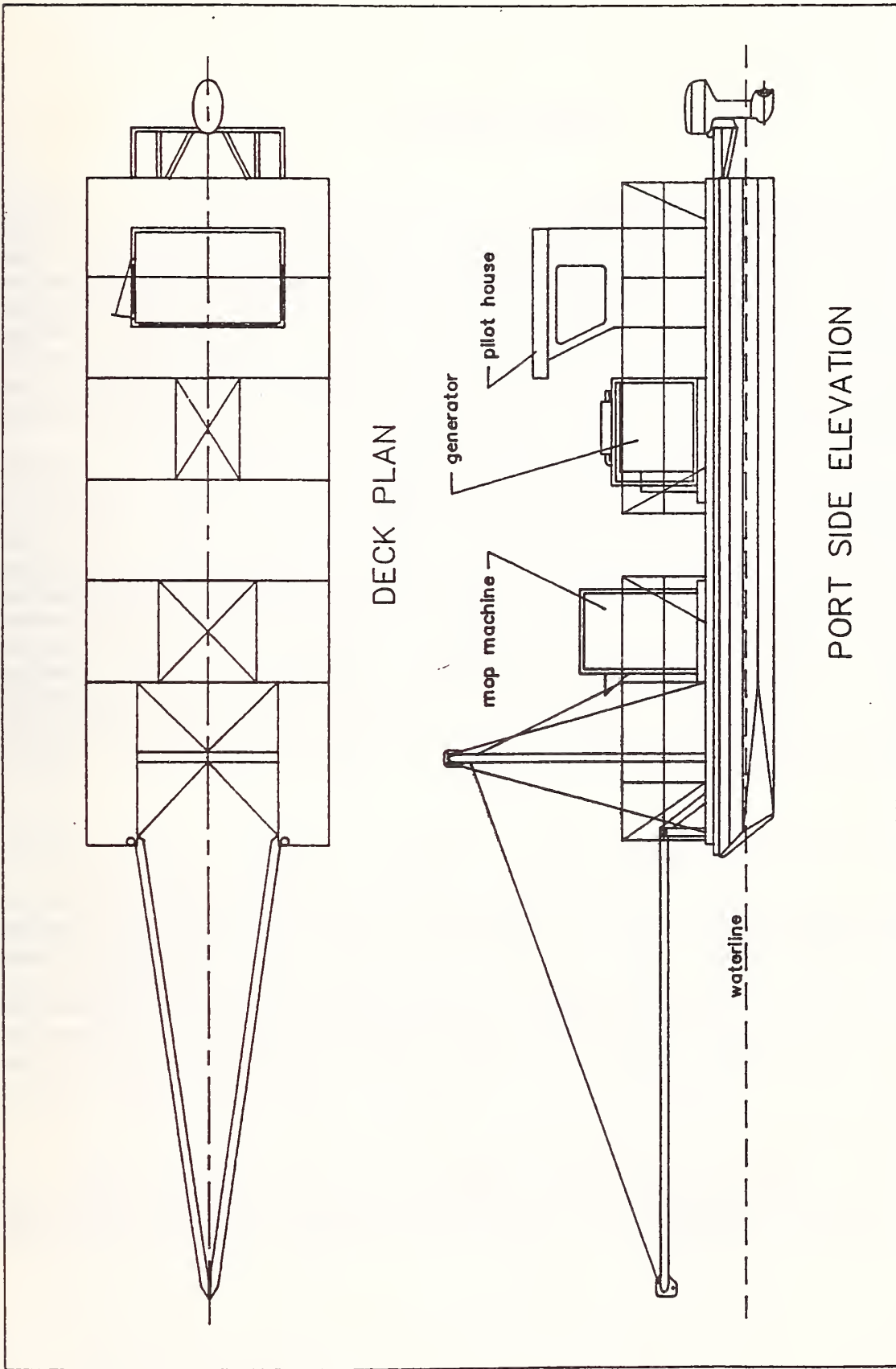

Figure 10. "SWAMP" oilspill skimming system.

## ACS R&D PROGRAM

### 3.8. Arctic Skimming System Phase 2.

As discussed in Section 3.5, during the 1987 phase of the arctic skimming system project, ACS designed, fabricated and tested an outrigger device on the port side of the *North Star*, providing structural support for an ice deflector and skimming system. The second phase of this project provides for design, fabrication and testing of an expanded version of the arctic skimmer device that has a second outrigger mounted on the starboard side, and a larger skimmer. A special hydraulic system has been installed in the *North Star* to provide power for a Destroil skimming system.

### 3.9. Effects of Elastol on Oil Skimmer Performance.

The purpose of this project is to assess the effectiveness of a newly-developed chemical additive, Elastol, for enhancing oil skimming operations. Experimental work is being performed by Esso Resources Canada, Ltd. at that company's wave basin at Calgary, Alberta, Canada. The program involves a series of skimmer effectiveness tests at or near freezing conditions. Disk and rope mop skimmers are to be used to recover samples of Prudhoe Bay and Endicott crude oils. Skimmer effectiveness with two different Elastol application rates will be compared with control tests in which no Elastol was applied.

### 3.10. Beaufort Sea/Chukchi Sea Trajectory Model.

This project was originally intended only to update the database of the existing ACS Beaufort Sea spill trajectory model. However, to provide coverage in the Chukchi Sea area, ACS is now considering expanding the scope of the project to provide a new computer model covering the entire Arctic Ocean coastline of Alaska, encompassing the Chukchi and Alaskan Beaufort Sea areas. The scope of this project is not yet firm, but we expect that the new model will be similar in structure and approach to the existing Bering Sea models.

### 3.11. Chukchi Sea Coastal Resources Manual.

ACS is also considering a project to prepare a new coastal resources manual covering the Chukchi Sea coastal area. It will likely be similar in

## ACS R&D PROGRAM

format to manuals sponsored by ACS for the Alaskan Beaufort Sea and portions of the Bering Sea (see Section 2.3). The new manual will probably include maps and text describing cultural and biological resources, plus site specific oilspill response recommendations.

### 4. Conclusion

The Alaska Clean Seas research and development program continues to help advance the state-of-the-art for oil spill response in arctic waters. Knowledge gained through this ongoing program is used to update contingency planning manuals and the ACS training curriculum to help member companies maintain and improve the quality and effectiveness of their spill countermeasures. Research also provides a rational basis for decisions on acquisition of new equipment to insure that the ACS inventory continues to be suitable for the tasks it might be required to do.

---

### REFERENCES

- Alaska Beaufort Sea Oil Spill Trajectory Analysis*, prepared for Alaska Clean Seas by Northern Technical Services; July 1983.
- Alaska Oil Spill Chemical Application Manual*, prepared by Spiltec for Alaska Clean Seas, 1986.
- Guidelines for Disposal of Oilspill Response Waste Materials*; Prepared by NORTEC, a division of ERT for Alaska Clean Seas; July 1988.
- Norton Sound Oil Spill Trajectory Model*; Prepared for Alaska Clean Seas by Applied Science Associates, Inc., January 1985.
- St. George Basin Oil Spill Trajectory Model*; Prepared for Alaska Clean Seas by Applied Science Associates, Inc., September 1984.

ACS R&D PROGRAM

- Wave Tank Tests of Multiple Arctic Oil Containment Booms*; Shell Development Company, Westhollow Research Center, Houston; October 1987.
- Allen, Alan A.; *Test and Evaluation of Fire Containment Boom*; Prepared by Spiltec under contract to Shell Western E&P, Inc. for Alaska Clean Seas; Anchorage, February, 1986.
- \_\_\_\_\_*Survey and Analysis of Air-Deployable Igniters*; Prepared by Spiltec under contract to Shell Western E&P, Inc. for Alaska Clean Seas, Anchorage, April, 1986.
- \_\_\_\_\_*Alaska Oil Spill Chemical Application Manual*; Prepared by Spiltec under contract to Standard Alaska Production Company for Alaska Clean Seas; Anchorage, June 1986.
- \_\_\_\_\_"Alaska Clean Seas Survey and Analysis of Air-Deployable Igniters"; *Proceedings of the Ninth Arctic Marine Oilspill Program Technical Seminar*; Environment Canada; June 1986.
- \_\_\_\_\_"Alaska Clean Seas Development of a Chemical Application Manual"; *Proceedings of the Ninth Arctic Marine Oilspill Program Technical Seminar*; Environment Canada; June 1986.
- \_\_\_\_\_*Refinement of Aerial Ignition Systems (Test and Evaluation of the Helitorch for the Ignition of Oil Slicks)*; prepared by Spiltec under contract to Shell Western E&P for Alaska Clean Seas; May 1987.
- \_\_\_\_\_"Test and Evaluation of the Helitorch for the Ignition of Oil Slicks", *Proceedings of the Tenth Arctic and Marine Oilspill Program Technical Seminar*; Environment Canada, June, 1987.
- Allen, A. A. and W. G. Nelson; "Oil Spill Countermeasures in Land Fast Sea Ice", *Proceedings of the 1981 Oil Spill Conference*; API, 1981.
- Allen, A. A. and W. Simpson; "Alaska Clean Seas Test and Evaluation of Fire Containment Boom", *Proceedings of the Ninth Arctic Marine Oilspill Program Technical Seminar*; Environment Canada; June 1986.
- Birchard, E. C. and R. Nancarrow; "The Minuk I-53 Artificial Island Oil Spill", *Proceedings of the Ninth Arctic Marine Oilspill Program Technical Seminar*; pp 375-378; Environment Canada; June 1986.



## ACS R&D PROGRAM

- Brown, H. M., and R. H. Goodman, *The Dispersion of Alaska North Slope Oil in Wave Basin Tests*; prepared by Esso Resources Canada Limited for Alaska Clean Seas; July 1987.
- Garlow, R. E., R. E. Steele, and R. E. Williams; *Development of a Water-Jet Boom for ARCAT II Skimmer Vessel*; Exxon Production Research Co., October 1986.
- \_\_\_\_\_*Development of a Bubble Barrier Boom for Oil Spill Containment in Broken Ice*, Exxon Production Research Co., November 1986.
- Garlow, R. E., and R. E. Steele; *Bubble Barrier Field Tests*, EPR.28PS.88; Exxon Production Research Co., May 1988.
- \_\_\_\_\_*Development of a Procedure for Shoreline Protection Using Adsorptive Netting*, EPR.36PS.88; Exxon Production Research Co., July 1988.
- Goodman, R. H., and J. W. Morrison; "A Simple Remote Sensing System for the Detection of Oil"; *1985 Oil Spill Conference*; pp 51-55; American Petroleum Institute; 1985.
- Gusey, W. F., S. O. Hillman, and D. W. Chamberlain; *ACS Alaskan Bering Sea Coastal Resources Manual*; Alaska Clean Seas, 1987.
- Hillman, Sharon O., "Arctic Spill Response Improvements: A 1985 Review of Arctic Research and Development", *Proceedings, 1985 Oil Spill Conference*, American Petroleum Institute, February 1985.
- Hillman, Sharon O., W. F. Gusey, and D. W. Chamberlain, "ACS Alaskan Bering Sea Coastal Resources Manual"; *Proceedings of the Tenth Arctic and Marine Oilspill Program Technical Seminar*, Environment Canada, June, 1987.
- Hillman, Sharon O., and Richard V. Shafer, "ABSORB: A Three Year Update in Arctic Spill Response", *Proceedings, 1983 Oil Spill Conference*, American Petroleum Institute, February, 1983.
- Morson, Barbara J., et al., *Alaskan Beaufort Sea Coastal Region*, Alaska Clean Seas, June, 1983.

## ACS R&D PROGRAM

- Nelson, William G. and Alan A. Allen; "Oil Migration and Modification Processes in Solid Sea Ice"; *Proceedings of the 1981 Oil Spill Conference*; API, 1981.
- \_\_\_\_\_ "The Physical Interaction and Cleanup of Crude Oil with Slush and Solid First Year Sea Ice", *Proceedings of the Fifth Arctic Oilspill Program Technical Seminar*, Environment Canada, 1982.
- Neve, Richard A. and Esther C. Wunnicke, *Final finding and Decision of the Commissioners Regarding the Oil Industry's Capability to Clean Up Spilled Oil during Broken Ice Periods in the Alaskan Beaufort Sea*, State of Alaska Departments of Environmental Conservation and Natural Resources, June 1984.
- Pistruzak, W. M.; "Dome Petroleum's Oil Spill Research and Development Program for the Arctic"; *Proceedings, 1981 Oil Spill Conference*; API, 1981.
- Ross, S. L., *Evaluation of Industry's Oil Spill Countermeasures Capability in broken ice conditions in the Alaskan Beaufort Sea*, S. L. Ross Environmental Research Limited, September 1983.
- St. Martin, J, and I. Lissauer; "Satellite Buoy Trajectories - 1982, 1985"; *Proceedings of the Ninth Arctic Marine Oilspill Program Technical Seminar*; Environment Canada; June 1986.
- Shafer, R. V.; "The Alaska Clean Seas Research, Development and Engineering Program"; *Proceedings of the Ninth Arctic Marine Oilspill Program Technical Seminar*; Environment Canada; June 1986.
- \_\_\_\_\_ "Alaska Clean Seas: Meeting Response Needs for 1987 and Beyond", *Proceedings, 1987 Oil Spill Conference*, American Petroleum Institute, April, 1987.
- \_\_\_\_\_ "Continuing the Program: Alaska Clean Seas Research, Development and Engineering"; *Proceedings of the Tenth Arctic and Marine Oilspill Program Technical Seminar*; Environment Canada, June, 1987.
- \_\_\_\_\_ *A Computer Assisted Planning System for Oilspill Response Chemical Applications*; Alaska Clean Seas; September 1988.

#### ACS R&D PROGRAM

Shafer, Richard V., and David Glenn; "Shallow Water Access Mop Platform (SWAMP)"; *Proceedings of the Eleventh Arctic and Marine Oil Spill Program Technical Seminar*, Environment Canada; pp 201-204; June 1988.

Shafer, Richard V., and Steve Bowen; "ARCTICKIM: An Oilspill Skimming System for Broken Ice and Shallow Waters"; *Proceedings of the Eleventh Arctic and Marine Oil Spill Program Technical Seminar*, Environment Canada; pp 205-208; June 1988.

Williams, R. E., "The ARCAT, ABSORB's New Catamaran Oil Skimmer", *Proceedings of the Fifth Arctic Marine Oilspill Program Technical Seminar*, Environment Canada, 1982.



Odd Angelvik  
Statoil, Norway

---

ABSTRACT

As the Norwegian Offshore Oil Industry is moving north into the Barent Sea and the Arctic areas, it will have to face problems related to oil spill response which we believe are very unlike those experienced so far in the North Sea.

The Arctic Area including the Barent Sea offers the Norwegian Oil Industry environment which in many ways are very much unlike the environment which the industry is used to work with in the North Sea.

Environmental conditions like darkness around the clock for almost 7 months of the year, ice in different conditions, very low air and sea temperatures, combined with strong wind which will create very rough working conditions for personnel who has to work outdoors.

In addition we do have a very complex current picture within the actual sea areas, which adhere to the other difficulties this area makes up for an effective oil spill response action.

The Norwegian Arctic area do also have very special and very vulnerable ecological and biological conditions, especially

around the ice edge, which again puts a heavy strain on the ability to handle an oil spill situation.

As a start a "working group" put together by NOFO began its work late in 1987. The work was completed in the spring of 1988 with a report that identified some of the problem areas and suggestions what to do about them.

The main items of problems and related work were:

- Evaluation of the suitability of booms.
- Evaluation of skimmers in cold and icy waters.
- Evaluation of methods of operations. Ships - working environment.
- Evaluation of oil weathering - Dispersion.
- Evaluation of the organizing of support functions.
- Evaluation of alternative methods for Oil Spill Response.

I expect that the results from this seminar will provide a valuable input to the large work we have ahead of us, and will be a help to achieve an Oil Spill Response Contingency for the Arctic which is of least at the same quality as we today have in the North Sea.

Odd Angelvik  
Statoil, Norway

---

As the Norwegian Offshore Oil Industry is moving north into the Barent Sea and the Arctic areas, it will have to face problems related to oil spill response which we believe are very unlike those experienced so far in the North Sea.

Before I identify the problems we will have to face and how we so far have planned to meet them, I will give a brief orientation of the present state-of the art technology which are used by the Norwegian offshore oil industry for Oil Spill Response Contingency in the North Sea and the Norwegian Ocean.

The Norwegian State Pollution Control Agency (SPCA) have issued the requirements which the Offshore Oil Spill Response Contingency are supposed to meet.

The requirements are:

- Any oil spill shall as far as possible be recovered by mechanical recovery equipment.
- The equipment shall be designed to handle an uncontrolled blow-out of 8.000 tons per day.
- The recovery systems shall function in 1.5 knot current and in wave heights up to 3 meters significant.

- The equipment shall be ready for use on site within 24 - 48 hours.
- The operator's contingency shall counter a spill as close to the source as possible.

In order to meet this requirements the oil companies operating in the Norwegian part of the North Sea established an Oil Spill Response Organization called NOFO (Norsk Oljevernforening for Operatørselskaper), which means Norwegian Oil Spill Protection Association for Operating Companies.

Today 14 oil companies operating on the Norwegian Continental Shelf are members of that organization.

The NOFO organization has on behalf of its members the following responsibilities:

- Purchase and maintenance of equipment
- Plan, establish and maintain contingency of equipment and personnel
- Planning and development of new equipment and systems for oil spill response
- Handle oil spill response matters towards authorities

To comply with the SPCA's requirements for response times and capacities, NOFO has purchased 14 NOFO Transrec systems, which consists of 500 metres ocean boom, 1 oilrecovery vessel, 1 towing vessel (trawler), 1 FRAMO/NOFO Transrec skimmer.

The FRAMO/NOFO Transrec Skimmer is developed in cooperation between NOFO and the producing company Frank Mohn. The 14 systems are distributed along the Norwegian coast at 5 bases located at Stavanger, Bergen, Kristiansund, Træna and Hammerfest. At each base there are established a contingency system of personnel to operate the equipment.



Contingency Agreements are established to ensure necessary ships to operate the equipment. The oil recovery vessels are ordinary supply ships which are modified to DnV Oil Rec. Class and prepared to carry the equipment of NOFO.

If and when an oilspill occurs the oil company in question is responsible for the clean-up and will take charge of the NOFO equipment and personnel and conduct the clean-up operation. The NOFO organization has existed since 1978 and has up to now functioned to the members' satisfaction.

Because of our good experience with the cooperation, our aim is to let the same organization extend its area for covering our Oil Spill Response Contingency also in the Arctic Areas.

NOFO has worked out a total plan for the contingency of the Norwegian Continental Shelf along the Norwegian Coast and is today discussing with SPCA to what extend and within which boundaries and what modifications do we have to make to get this plan extended and approved also for the Barent Sea and the Arctic Areas.

The Arctic Area including the Barent Sea offers the Norwegian Oil Industry environment which in many ways are very much unlike the enviroment which the industry is used to work with in the North Sea.

Environmental conditions like darkness around the clock for almost 7 months of the year, ice in differnt conditions, very low air and sea temperatures, combined with strong wind which will create very rough working conditions for personnel who has to work outdoors.

In addition we do have a very complex current picture within the actual sea areas, which adhere to the other difficulties this area makes up for an effective oil spill response action.

The Norwegian Arctic area do also have very special and very vulnerable ecological and biological conditions, especially around the ice edge, which again puts a heavy strain on the ability to handle an oil spill situation.

Based on the equipment that we have in our contingency today and relating to the special problems that we foresee when entering the Arctic areas its obvious that something has to be done about it.

As a start a "working group" put together by NOFO began its work late in 1987. The work was completed in the spring of 1988 with a report that identified some of the problem areas and suggested what to do about them.

The main items of problems and related work were:

1. Booms

Today we have 8.500 metres of booms in our contingency.

They are of different types and some of them are up to 10 years old. Operation of these booms are very time- and personell-consuming and they are not easy to maintain.

A research and test program will be established in order to find a boom design and fabrication which can withstand the conditions to be expected in the Arctic areas.

The program shall as far as possible give answer to the following questions:

- To what extend will booms be useful in areas where drifting ice may be expected.

- What temperature criteria should the design be based on, taking into account that the boom should roll off a winch, be blown up and deployed.

Icing must be evaluated both for the boom at sea, and for the boom and winch on deck as they will be exposed to overwater and spray from the sea.

- The boom must be very fast to deploy and recover due to the extremely quick change of weather. Specially a fast recovery will be necessary because of the very fast increasing winds created by polar lows in this area.
- Besides that the boom must be very rugged, it must have a "clean" design. It is also of great importance that simple damages can be repaired offshore.

Some of these statements are more or less contradictory, but then we will have to compromise, as we are used to in so many other situations in life.

The program shall recommend the best way of doing necessary compromises.

## 2. Skimmers

The skimmers that we use for offshore oil recovery today are designed for operations in the southern North Sea in areas without any occurrence of ice. A program similar to the one for the booms will also be established for the skimmers.

It is considered necessary to evaluate and produce answers to the following questions:

- Is it possible at all to operate the Transrec skimmer in areas with ice coverage, and if it is, what will be the limitations.

- To what minimum temperature is it possible to operate the Transrec, functionally, operationally and technically.

To propose modifications necessary to make the skimmer work under the expected conditions.

- To evaluate if other types of skimmers are more suitable in areas with a certain extent of ice coverage.
- Further, the very low sea and air temperatures and other climatic conditions which will create difficulties for inspection, maintenance and repair must be taken into account.

### 3. Oil weathering - Dispersion

- Investigate the effects of very low sea and air temperatures, together with all degrees of snow and ice conditions on an oil spill.
- The results of such an investigation will be necessary for the development of alternative equipment or the development of alternative methods of treating an oil spill.
- Further, we will have to investigate under which conditions will the use of dispersants be suitable and effective.

### 4. Operations - ships - working environment

- It is necessary to go through the operational conditions and evaluate if climate and weather conditions mean that known procedures and routines have to be changed.

- It is important to ascertain if the oil recovery part of the ships are sufficiently adjusted and aimed towards the requirements which have to be put up to those ships and equipment when supposed to operate in Arctic areas.

## 5. Support functions

The support functions are considered to be of the outmost importance for the success of an Oil Spill Response Action. In the Barent Sea with its great distances, darkness 24 hours a day, ice and difficult temperature conditions, the support functions will have to face great challenges.

The support functions are:

- Base services
- Communications
- Supplies
- Crew changes
- Transportation and storage of recovered oil
- Laboratory services
- Weather forecast
- Air surveillance

All those elements should be evaluated and proposals made for the organization and conduct of these support functions.

## 6. Alternative methods for Oil Spill Response

The methods available in Norway today are designed for operation in other environmental conditions than found in the Arctic.

Ice, darkness, weather conditions, special environment protection and biological conditions etc. will gradually as one moves into new areas extensively limit the possibilities for use of existing equipment.

When today's technology or modifications/improvements of today's technology are no longer sufficient for achieving an effective Oil Spill Response, one has to find alternative methods.

These methods must be useable logistic and be a part of a total system for Oil Spill Response in the Barent Sea and Arctic areas.

During this program it will be necessary to collect and evaluate the experiences made by other countries related to Oil Spill Response in Arctic areas.

In this context we are thinking especially of U.S.A. and Canada, which are considered to be the countries with most experience in exploration and production of Oil in the Arctic.

This will include an evaluation of existing or improved traditional technology combined with alternative methods and a possible new technology.

Areas with complete ice coverage or drifting ice in different amounts are considered the most acutal areas for such methods. Some of this work may require practical testing in ordere to make the evaluations credible and acceptable for the authorities.

The personnel and organizations representing the offshore oil industry in Norway think, (with a little proudness) that the contingency system and equipment we are using for Oil Spill Response in the North Sea today, are some of the best in the world.

However, we acknowledge that when moving into the Arctic we are facing another world. We realize that we have a great

lack of knowledge and experience related to Oil Spill Response in the Arctic.

I think that really realizing this is a major step towards solving the problems ahead of us.

I expect that the results from this seminar will provide a valuable input to the large work we have ahead of us, and will be a help to achieve an Oil Spill Response Contingency for the Arctic which is of least at the same quality as we today have in the North Sea.





LIST OF ATTENDEES

Larry Ake  
MMS  
12203 Sunrise Valley Drive  
Reston, VA 22091  
(703)648-7768

Alan A. Allen  
Spiltec  
10541 Treeline Ct.  
Anchorage, AK 99516  
(907)346-1932

Odd B. Angelvik  
STATOIL  
P.O. Box 300  
N-4001 Stavanger, Norway  
(04)808080

Paul R. Becker  
NOAA/OAD, Alaska Office  
701 C St., Box 56  
Anchorage, AK 99513  
(907)271-3032

Elizabeth A. Benson  
Div. of Govnmtl. Coord.  
Office of the Governor  
675 7th Ave, Station H  
Fairbanks, AK 99708  
(907)451-2819

Pamela Bergman  
Dept of the Interior - OEPR  
1689 C St., Room 119  
Anchorage, AK 99501-5126  
(907)271-5011

Ian A. Buist  
S.L. Ross Environ. Res., Ltd.  
346 Frank St.  
Ottawa, Ontario, K2P 0Y1, Canada  
(613)232-1564

Richard P. Campbell  
Alaska Branch/3M  
11151 Calaska Circle  
Anchorage, AK 99515  
(907)522-5200

Charles C. Cloutier  
Anti Pollution, Inc.  
P.O. Box 885  
Morgan City, LA 70381  
(504)384-9517

Bill D'Atri  
Unitech of Alaska  
1224 E. 76th Ave  
Anchorage, AK 99518  
(907)349-5142

Peter Devenis  
Gulf Canada Resources, Ltd.  
401 - 9th Ave SW  
Calgary, Alberta, T2P 2H7, Canada  
(403)233-4942

David F. Dickins  
DF Dickins Associates, Ltd.  
21 Water St., 503A  
Vancouver, BC, V6B 1A1, Canada  
(604)684-0516

R. G. Dragnich  
Exxon Co., USA  
P.O. Box 196601  
Anchorage, AK 99519-6601  
(907)564-3766

Kenneth E. Durley  
Alyeska Pipeline Service Co.  
1835 South Bragaw St.  
Anchorage, Ak 99512  
(907)265-8480

Barry Eldridge  
Cook Inlet Resource Org.  
P.O. Box 149  
Kenai, AK 99611  
(907)776-5129

Harold T. Enger  
Crowley Environmental Services, Inc.  
3400 E. Marginal Way So.  
Seattle, WA 98134  
(206)443-8566

Larry Ethelbah  
Bureau of Indian Affairs  
Room 349, Federal Bldg.  
P.O. Box 3-8000  
Juneau, AK 99801  
(907)586-7603

Dr. David D. Evans  
Natl. Inst. of Stds. & Tech.  
Bldg. 224., Rm. A345  
Gaithersburg, MD 20899  
(301)975-6897

Peter Ferris  
Dept. of Indian and Northern  
Affairs-Canada  
Ottawa, Ontario, K1A 0H4, Canada  
(819)994-7452

Merv Fingas  
Environmental Energies Tech. Div.  
River Road Environmental Tech. Center  
3439 River Road  
Ottawa, Ontario, K1A 0H3, Canada  
(613)998-9622

Paul Gates  
Dept. of the Interior-OEPR  
1689 C St., Room 119  
Anchorage, AK 99501-5126  
(907)271-5011

Karen J. Gibson  
MMS  
949 E. 36th Ave. Rm. 110  
Anchorage, AK 99508  
(907) 261-4613

R. H. Goodman  
Esso Resources Canada, Ltd.  
Research Department  
339-50 Ave SE  
Calgary, Alberta, T2G 2B3, Canada  
(403)259-0296

John Gregory  
MMS  
12203 Sunrise Valley Drive  
Reston, VA 22091  
(703)648-7752

Eric A. Haugstad  
URCA Environmental  
9413 Canton Turnpike  
Anchorage, AK 99515  
(907)349-1306

Frank Henicke  
Tenneco Oil Co.  
3201 C St.  
Anchorage, AK 99503  
(907)561-5458

Ben L. Hilliker  
Alyeska Pipeline Service Co.  
1835 S. Bragaw St.  
Anchorage, AK 99512  
(907)265-8174

Sharon O. Hillman  
Standard Alaska Production Co.  
900 E. Benson Blvd.  
Anchorage, AK 99508  
(907)564-5512

Kenneth F. Hunt  
Bureau of Land Management  
Box 30  
701 C Street  
Anchorage, AK 99513  
(907)267-1333

LCDR Bill Hutmacher  
USCG Marine Safety Office  
701 C St., Box 17  
Anchorage, AK 99516  
(907)271-5137

Rod Jackson  
US Fish & Wildlife Service  
605 E 5th Street  
Anchorage, AK 99501  
(907)271-2779

John H. Janssen  
State of Alaska  
Dept. of Env. Conser.  
1001 Nobel St., Suite 350  
Fairbanks, AK 99701  
(907)452-1714

Nora H. Jason  
National Inst. of Stds. & Tech.  
Bldg. 224, Rm. A252  
Gaithersburg, MD 20899  
(301)975-6862

Jerry Jeschke  
MMS  
949 E 36th Street  
Anchorage, AK 99508-4302  
(907)261-4508

Richard (Mark) Johnson  
Alaska Clean Seas  
12350 Industry Way  
Anchorage, AK 99502  
(907)345-3142

Mike Joseph  
MMS/GOM  
4300 Lucerne St.  
Metairie, LA 70006  
(504)736-2875

Charlie Kidwell  
SWEPI  
200 N. Dairy Ashford  
Houston, TX 77478  
(713)870-4443

Seppo Korppoo  
Wartsila Marine  
Italahenkatku 19A  
Helsinki, Finland  
(358)0-6924500

Carl H. Lautenberger  
EPA  
222 W 7th Ave., #19  
Anchorage, AK 99513  
(907)271-5083

D.W. Lerch  
Marco Pollution Control  
2300 W. Commodore  
Seattle, WA 98199  
(206)285-3200

H. Lichte  
Mason and Hanger-Silas Mason Co.  
Pantex Plant  
Bldg. 12-2B  
Amarillo, TX 79177  
(806)381-5485

Don MacWatt  
Arvik Environmental Service  
8797 Chemainus Rd. RRI  
Chemainus, BC, V0R 1K0 Canada  
(604)246-9355

Carol Ann Manen  
NOAA/NOS  
701 C St., Box 56  
Anchorage, AK 99513  
(907)271-3157

Warren Matumeak  
North Slope Borough  
P.O. Box 69  
Barrow, AK 99723  
(907)852-2611, x245

Bruce McKenzie  
Gulf Canada Resources, Ltd.  
401 - 9th Ave SW  
Calgary, Alberta, T2P 2H7, Canada  
(403)233-4800

Kenneth M. Meikle  
Environmental Emergencies Tech. Div.  
River Road Env. Tech. Ctr.  
3439 River Rd  
Ottawa, Ontario, K1A 0H3, Canada  
(613)998-9622

David E. Morris  
Morris Industries, Ltd.  
1527 Columbia St.  
N. Vancouver, BC V7J 1A3, Canada  
(604)986-2189

Tom Murrell  
MMS  
949 E 36th  
Anchorage, AK 99508-4302  
(907)261-4187

Mary Lynn Nation  
US Fish & Wildlife  
1011 E Tudor Rd.  
Anchorage, AK 99503  
(907)786-3519

Patrick Y. O'Brien  
Chevron Corporation  
P.O. Box 7924  
San Francisco, CA 94120-7924  
(415)894-9653

James L. Pearce  
American Marine, Inc.  
401 Shearer Blvd.  
Cocoa, FL 32992  
(407)636-5783

Gary A. Reiter  
Commanding Officer  
Pacific Area Strike Team  
Hanger 2, Bldg. 390  
Hamilton AFB, CA 94949-5082  
(415)883-3311

Cdr. Dennis D. Rome  
USCG  
P.O. Box 3-5000  
Juneau, AK 99802  
(907)586-7197

Rene Roussel  
USCG  
MSO Anchorage  
701 C Street  
Anchorage, AK 99513  
(907)271-5137

John R. Ruser  
Shell Western E&P, Inc.  
200 North Dairy Ashford  
Houston, TX 77079  
(713)870-4276

William J. Ryan  
Canadian Coast Guard  
P.O. Box 1300  
St. Johns, Newfoundland, A1C 5N5,  
Canada

Prof. William M. Sackinger  
Univ. of Alaska-Fairbanks  
Fossil Energy Research Council  
Fairbanks, AK 99775-0800  
(907)474-7865

Prof. Kozo Saito  
University of Kentucky  
Dept of Mechanical Eng.  
Anderson Hall  
Lexington, KY 40506-0046  
(606)257-1685

Hild Sandstede  
Greenpeace  
P.O. Box 104432  
Anchorage, AK 99510  
(907)277-8234

Greg Schultz  
U.S. Coast Guard  
1326 E. Cotati  
Cotati, CA 99428  
(415)883-3311

Robert Schultze  
Environmental Consultant, Inc.  
6145 Rockburn Hill Rd.  
Elkridge, MD 21227  
(301)796-0551

Richard V. Shafer  
Alaska Clean Seas  
P.O. Box 196010  
Anchorage 99519-6010  
(907)345-3142

Arthur M. Sheets  
4003 Garfield  
Anchorage, AK 99503  
(907)562-4652

Wayne F. Simpson  
Shell Western E & P, Inc.  
601 W. Fifth Ave., Suite 810  
Anchorage, AK 99513  
(907)276-2545

Rodney Smith  
MMS  
949 E. 36th Ave.  
Anchorage, AK 99508  
(907)261-4187

Elaine Snyder-Conn  
US Fish & Wildlife  
101 12th Ave.  
Fairbanks AK 99701  
(907)456-0323

Laurence Solsberg  
Counterspil Research  
300 - 1497 Marine Dr.  
W. Vancouver, BC, V7T 1B8,  
Canada  
(604)925-3144

Wade L. Srock  
Alaska Dept. of Natural Resources  
P.O. Box 107034  
Anchorage, AK 99510  
(907)762-2594

Jack Stanger  
Crowley Environmental Services  
4300 B St., Suite 507  
Anchorage, AK 99516  
(907)563-1114

Nancy Swanston  
MMS  
949 E. 36th Ave.  
Anchorage, AK 99508  
(907)261-4187

Jim Swiss  
Amoco Petroleum Canada, Ltd.  
700 2nd St., SW, 22nd Floor  
Calgary, Alberta, T2P 2H8, Canada  
(403)231-6944

Edward Tennyson  
MMS - Room 6A122  
12203 Sunrise Valley Drive  
Reston, VA 22091  
(703)648-7769

John D. Tremont  
MMS  
949 E. 36th Ave.  
Anchorage, AK 99508  
(907)261-4682

Gary Vequist  
National Park Service  
2525 Gambell Street  
Anchorage, AK 99503  
(907)257-2565

Jeff Walker  
MMS  
949 E. 36th Ave.  
Anchorage, AK 99508  
(907)261-4187

John Whitney  
NOAA  
Hazardous Materials Response Branch  
701 C St., Box 56  
Anchorage, AK 99513  
(907)271-3593

Mike Winfree  
Arco Alaska, Inc.  
P.O. Box 100360  
Anchorage, AK 99510  
(907)263-4603

Larry M. Wrigth  
National Park Service  
2525 Gambell Street  
Anchorage, AK 99567  
(907)257-2649

U.S. DEPT. OF COMM. <b>BIBLIOGRAPHIC DATA SHEET</b> <i>(See instructions)</i>	<b>1. PUBLICATION OR REPORT NO.</b> NIST/SP-762	<b>2. Performing Organ. Report No.</b>	<b>3. Publication Date</b> April 1989
<b>4. TITLE AND SUBTITLE</b> ALASKA ARCTIC OFFSHORE OIL SPILL RESPONSE TECHNOLOGY WORKSHOP PROCEEDINGS			
<b>5. AUTHOR(S)</b> Nora H. Jason, Editor			
<b>6. PERFORMING ORGANIZATION</b> <i>(If joint or other than NBS, see instructions)</i> NATIONAL INSTITUTE OF STANDARDS AND TECHNOLOGY (formerly NATIONAL BUREAU OF STANDARDS) U.S. DEPARTMENT OF COMMERCE GAITHERSBURG, MD 20899		<b>7. Contract/Grant No.</b>	<b>8. Type of Report &amp; Period Covered</b> Final
<b>9. SPONSORING ORGANIZATION NAME AND COMPLETE ADDRESS</b> <i>(Street, City, State, ZIP)</i> Minerals Management Service US Department of the Interior Reston, VA 22091			
<b>10. SUPPLEMENTARY NOTES</b> Library of Congress Catalog Card Number: 89-600731 <input type="checkbox"/> Document describes a computer program; SF-185, FIPS Software Summary, is attached.			
<b>11. ABSTRACT</b> <i>(A 200-word or less factual summary of most significant information. If document includes a significant bibliography or literature survey, mention it here)</i> <p>The Proceedings of the Alaska Arctic Offshore Oil Spill Response Technology Workshop contains papers by keynote speakers on the following topics: Mechanical Containment and Recovery; Chemical Treatment; In-Situ Burning; Readiness; the Technology Assessment and Research Program and the OHMSETT Program; the Arctic and Marine Oil Spill Program; the Canadian Environmental Science Revolving Fund; the Alaskan Clean Seas Research and Development Program; the NOFO Program. These papers served as a stimulus to the discussions that followed in the various Panel sessions. The Panels were organized into broad research areas: Mechanical Containment; Mechanical Recovery; Chemical Treatment; In-Situ Burning; Readiness. Each Panel summary is included in the Proceedings and these recommendations reflect the combined input from experts in the field. The Proceedings will serve as a working document to the Minerals Management Service (MMS) to identify their future research program.</p>			
<b>12. KEY WORDS</b> <i>(Six to twelve entries; alphabetical order; capitalize only proper names; and separate key words by semicolons)</i> chemical treatments; conferences; in situ burning; mechanical containment; mechanical recovery; oil spills			
<b>13. AVAILABILITY</b> <input checked="" type="checkbox"/> Unlimited <input type="checkbox"/> For Official Distribution. Do Not Release to NTIS <input type="checkbox"/> Order From Superintendent of Documents, U.S. Government Printing Office, Washington, D.C. 20402. <input type="checkbox"/> Order From National Technical Information Service (NTIS), Springfield, VA. 22161		<b>14. NO. OF PRINTED PAGES</b> 201	<b>15. Price</b>

# **NIST** *Technical Publications*

## *Periodical*

---

**Journal of Research of the National Institute of Standards and Technology**—Reports NIST research and development in those disciplines of the physical and engineering sciences in which the Institute is active. These include physics, chemistry, engineering, mathematics, and computer sciences. Papers cover a broad range of subjects, with major emphasis on measurement methodology and the basic technology underlying standardization. Also included from time to time are survey articles on topics closely related to the Institute's technical and scientific programs. Issued six times a year.

## *Nonperiodicals*

---

**Monographs**—Major contributions to the technical literature on various subjects related to the Institute's scientific and technical activities.

**Handbooks**—Recommended codes of engineering and industrial practice (including safety codes) developed in cooperation with interested industries, professional organizations, and regulatory bodies.

**Special Publications**—Include proceedings of conferences sponsored by NIST, NIST annual reports, and other special publications appropriate to this grouping such as wall charts, pocket cards, and bibliographies.

**Applied Mathematics Series**—Mathematical tables, manuals, and studies of special interest to physicists, engineers, chemists, biologists, mathematicians, computer programmers, and others engaged in scientific and technical work.

**National Standard Reference Data Series**—Provides quantitative data on the physical and chemical properties of materials, compiled from the world's literature and critically evaluated. Developed under a worldwide program coordinated by NIST under the authority of the National Standard Data Act (Public Law 90-396). NOTE: The Journal of Physical and Chemical Reference Data (JPCRD) is published quarterly for NIST by the American Chemical Society (ACS) and the American Institute of Physics (AIP). Subscriptions, reprints, and supplements are available from ACS, 1155 Sixteenth St., NW., Washington, DC 20056.

**Building Science Series**—Disseminates technical information developed at the Institute on building materials, components, systems, and whole structures. The series presents research results, test methods, and performance criteria related to the structural and environmental functions and the durability and safety characteristics of building elements and systems.

**Technical Notes**—Studies or reports which are complete in themselves but restrictive in their treatment of a subject. Analogous to monographs but not so comprehensive in scope or definitive in treatment of the subject area. Often serve as a vehicle for final reports of work performed at NIST under the sponsorship of other government agencies.

**Voluntary Product Standards**—Developed under procedures published by the Department of Commerce in Part 10, Title 15, of the Code of Federal Regulations. The standards establish nationally recognized requirements for products, and provide all concerned interests with a basis for common understanding of the characteristics of the products. NIST administers this program as a supplement to the activities of the private sector standardizing organizations.

**Consumer Information Series**—Practical information, based on NIST research and experience, covering areas of interest to the consumer. Easily understandable language and illustrations provide useful background knowledge for shopping in today's technological marketplace.

*Order the above NIST publications from: Superintendent of Documents, Government Printing Office, Washington, DC 20402.*

*Order the following NIST publications—FIPS and NISTIRs—from the National Technical Information Service, Springfield, VA 22161.*

**Federal Information Processing Standards Publications (FIPS PUB)**—Publications in this series collectively constitute the Federal Information Processing Standards Register. The Register serves as the official source of information in the Federal Government regarding standards issued by NIST pursuant to the Federal Property and Administrative Services Act of 1949 as amended, Public Law 89-306 (79 Stat. 1127), and as implemented by Executive Order 11717 (38 FR 12315, dated May 11, 1973) and Part 6 of Title 15 CFR (Code of Federal Regulations).

**NIST Interagency Reports (NISTIR)**—A special series of interim or final reports on work performed by NIST for outside sponsors (both government and non-government). In general, initial distribution is handled by the sponsor; public distribution is by the National Technical Information Service, Springfield, VA 22161, in paper copy or microfiche form.

**U.S. Department of Commerce**  
National Institute of Standards and Technology  
(formerly National Bureau of Standards)  
Gaithersburg, MD 20899

Official Business  
Penalty for Private Use \$300