

Triac

Contents

1	TRIAC	1
1.1	Physical operation	1
1.1.1	Triggering in Quadrant I	2
1.1.2	Triggering in Quadrant II	2
1.1.3	Triggering in Quadrant III	2
1.1.4	Triggering in Quadrant IV	2
1.2	Typical issues	2
1.2.1	Gate threshold current, latching current and holding current	3
1.2.2	Static dv/dt	3
1.2.3	Critical di/dt	3
1.2.4	Commutating dv/dt and di/dt	4
1.3	Snubber circuits	4
1.4	Application	4
1.5	Example data	4
1.6	Three-quadrant TRIAC	4
1.7	See also	5
1.8	References	5
1.9	Further reading	5
1.10	External links	5
2	Thyristor	6
2.1	Introduction	6
2.1.1	Function of the gate terminal	7
2.1.2	Switching characteristics	7
2.2	History	8
2.2.1	Etymology	8
2.3	Applications	8
2.3.1	Snubber circuits	9
2.3.2	HVDC electricity transmission	9
2.4	Comparisons to other devices	9
2.5	Failure modes	10
2.6	Silicon carbide thyristors	10
2.7	Types of thyristor	10

2.7.1	Reverse conducting thyristor	11
2.7.2	Photothyristors	11
2.8	See also	11
2.9	References	11
2.10	Further reading	11
2.11	External links	12
3	DIAC	13
3.1	SIDAC	14
3.2	See also	14
3.3	References	14
3.4	External links	14
4	Silicon-controlled rectifier	15
4.1	Construction	15
4.2	Modes of operation	16
4.2.1	Forward blocking mode	16
4.2.2	Forward conduction mode	16
4.2.3	Reverse blocking mode	16
4.3	Thyristor turn on methods	16
4.4	Application of SCRs	16
4.5	Compared to SCSs	16
4.6	Compared to Triacs	17
4.6.1	See also	17
4.6.2	References	17
4.7	Further reading	17
4.7.1	External links	17
4.8	Text and image sources, contributors, and licenses	18
4.8.1	Text	18
4.8.2	Images	18
4.8.3	Content license	19

Chapter 1

TRIAC

For the green vehicle, see [Triac \(car\)](#). For triiodothyroacetic acid, see [Tiratricol](#).

TRIAC, from **triode for alternating current**, is a

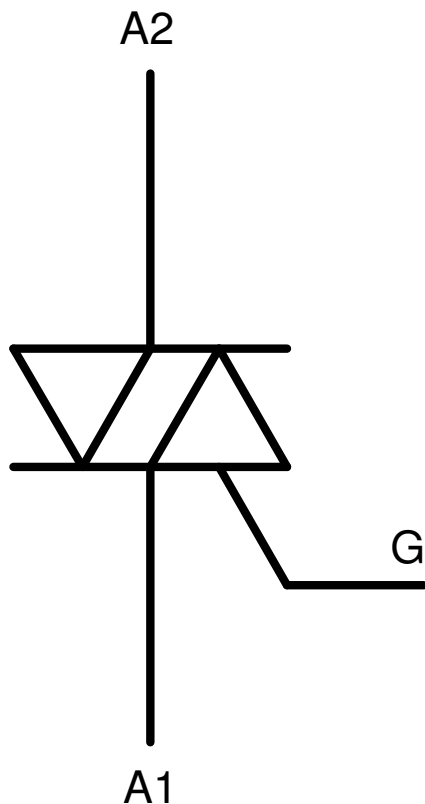

TRIAC schematic symbol

genericized tradename for an electronic component that can conduct current in either direction when it is triggered (turned on), and is formally called a **bidirectional triode thyristor** or **bilateral triode thyristor**.

TRIACs are a subset of thyristors and are closely related to silicon-controlled rectifiers (SCR). However, unlike SCRs, which are unidirectional devices (that is, they can conduct current only in one direction), TRIACs are bidirectional and so allow current in either direction. Another difference from SCRs is that TRIAC current can be enabled by either a positive or negative current applied to its *gate* electrode, whereas SCRs can be triggered only by

positive current into the gate. To create a triggering current, a positive or negative voltage has to be applied to the gate with respect to the MT1 terminal (otherwise known as A1).

Once triggered, the device continues to conduct until the current drops below a certain threshold called the holding current.

The bidirectionality makes TRIACs very convenient switches for alternating current circuits, also allowing them to control very large power flows with milliamperes-scale gate currents. In addition, applying a trigger pulse at a controlled phase angle in an A.C. cycle allows control of the percentage of current that flows through the TRIAC to the load (phase control), which is commonly used, for example, in controlling the speed of low-power induction motors, in dimming lamps, and in controlling A.C. heating resistors.

1.1 Physical operation

To explain how TRIACs work, one has to individually analyze the triggering in each one of the four quadrants. The four quadrants are illustrated in Figure 1, according to the voltage on the gate and the MT2 terminals with respect to the MT1 terminal. The MT1 and MT2 terminals are also commonly referred to as A1 and A2, respectively.^[1]

The relative sensitivity depends on the physical structure of a particular triac, but as a rule, quadrant I is the most sensitive (least gate current required) and quadrant IV is the least sensitive (most gate current required).

In quadrants 1 and 2, MT2 is positive, and current flows from MT2 to MT1 through P, N, P and N layers. The N region attached to MT2 does not participate significantly. In quadrants 3 and 4, MT2 is negative, and current flows from MT1 to MT2, also through P, N, P and N layers. The N region attached to MT2 is active, but the N region attached to MT1 only participates in the initial triggering, not the bulk current flow.

In most applications, the gate current comes from MT2, so quadrants 1 and 2 are the only operating modes.

1.1.1 Triggering in Quadrant I

Quadrant I operation occurs when the gate and MT2 are positive with respect to MT1. ^{Figure 1}

The precise mechanism is illustrated in Figure 3. The gate current makes an equivalent NPN transistor switch on, which in turn draws current from the base of an equivalent PNP transistor, turning it on also. Part of the gate current (dotted line) is lost through the ohmic path across the p-silicon, flowing directly into MT1 without passing through the NPN transistor base. In this case, the injection of holes in the p-silicon makes the stacked n, p and n layers beneath MT1 behave like a NPN transistor, which turns on due to the presence of a current in its base. This, in turn, causes the p, n and p layers over MT2 to behave like a PNP transistor, which turns on because its n-type base becomes forward-biased with respect to its emitter, (MT2). Thus, the triggering scheme is the same as an SCR. The equivalent circuit is depicted in Figure 4.

However, the structure is different from SCRs. In particular, TRIAC always has a small current flowing directly from the gate to MT1 through the p-silicon without passing through the p-n junction between the base and the emitter of the equivalent NPN transistor. This current is indicated in Figure 3 by a dotted red line and it is the reason why a TRIAC needs more gate current to turn on than a comparably rated SCR.^[2]

Generally, this quadrant is the most sensitive of the four. This is because it is the only quadrant where gate current is injected directly into the base of one of the main device transistors.

1.1.2 Triggering in Quadrant II

Quadrant II operation occurs when the gate is negative and MT2 is positive with respect to MT1. ^{Figure 1}

Figure 5 gives a graphical explanation of the triggering process. The turn-on of the device is three-fold and starts when the current from MT1 flows into the gate through the p-n junction under the gate. This switches on a structure composed by an NPN transistor and a PNP transistor, which has the gate as cathode (the turn-on of this structure is indicated by “1” in the figure). As current into the gate increases, the potential of the left side of the p-silicon under the gate rises towards MT1, since the difference in potential between the gate and MT2 tends to lower: this establishes a current between the left side and the right side of the p-silicon (indicated by “2” in the figure), which in turn switches on the NPN transistor under the MT1 terminal and as a consequence also the pnp transistor between MT2 and the right side of the upper p-silicon. So, in the end, the structure which is crossed by the major portion of the current is the same as Quadrant I operation (“3” in Figure 5).^[2]

1.1.3 Triggering in Quadrant III

Quadrant III operation occurs when the gate and MT2 are negative with respect to MT1. ^{Figure 1}

The whole process is outlined in Figure 6. The process happens in different steps here too. In the first phase, the pn junction between the MT1 terminal and the gate becomes forward-biased (step 1). As forward-biasing implies the injection of minority carriers in the two layers joining the junction, electrons are injected in the p-layer under the gate. Some of these electrons do not recombine and escape to the underlying n-region (step 2). This in turn lowers the potential of the n-region, acting as the base of a pnp transistor which switches on (turning the transistor on without directly lowering the base potential is called **remote gate control**). The lower p-layer works as the collector of this PNP transistor and has its voltage heightened: actually, this p-layer also acts as the base of an NPN transistor made up by the last three layers just over the MT2 terminal, which, in turn, gets activated. Therefore, the red arrow labeled with a “3” in Figure 6 shows the final conduction path of the current.^[2]

1.1.4 Triggering in Quadrant IV

Quadrant IV operation occurs when the gate is positive and MT2 is negative with respect to MT1. ^{Figure 1}

Triggering in this quadrant is similar to triggering in Quadrant III. The process uses a remote gate control and is illustrated in Figure 7. As current flows from the p-layer under the gate into the n-layer under MT1, minority carriers in the form of free electrons are injected into the p-region and some of them are collected by the underlying np-junction and pass into the adjoining n-region without recombining. As in the case of a triggering in Quadrant III, this lowers the potential of the n-layer and turns on the PNP transistor formed by the n-layer and the two p-layers next to it. The lower p-layer works as the collector of this PNP transistor and has its voltage heightened: actually, this p-layer also acts as the base of an NPN transistor made up by the last three layers just over the MT2 terminal, which, in turn, gets activated. Therefore, the red arrow labeled with a “3” in Figure 6 shows the final conduction path of the current.^[2]

Generally, this quadrant is the least sensitive of the four. In addition, some models of TRIACs cannot be triggered in this quadrant but only in the other three.

1.2 Typical issues

There are some drawbacks one should know when using a TRIAC in a circuit. In this section, a few are summarized.

1.2.1 Gate threshold current, latching current and holding current

A TRIAC starts conducting when a current flowing into or out of its gate is sufficient to turn on the relevant junctions in the quadrant of operation. The minimum current able to do this is called **gate threshold current** and is generally indicated by IGT. In a typical TRIAC, the gate threshold current is generally a few milliamperes, but one has to take into account also that:

- IGT depends on the temperature: The higher the temperature, the higher the reverse currents in the blocked junctions. This implies the presence of more free carriers in the gate region, which lowers the gate current needed.
- IGT depends on the quadrant of operation, because a different quadrant implies a different way of triggering (see here). As a rule, the first quadrant is the most sensitive (i.e. requires the least current to turn on), whereas the fourth quadrant is the least sensitive.
- When turning on from an off-state, IGT depends on the voltage applied on the two main terminals MT1 and MT2. Higher voltage between MT1 and MT2 cause greater reverse currents in the blocked junctions requiring less gate current similar to high temperature operation. Generally, in datasheets, IGT is given for a specified voltage between MT1 and MT2.

When the gate current is discontinued, if the current between the two main terminals is more than what is called the **latching current**, the device keeps conducting, otherwise the device might turn off. Latching current is the minimum that can make up for the missing gate current in order to keep the device internal structure latched. The value of this parameter varies with:

- gate current pulse (amplitude, shape and width)
- temperature
- control circuit (resistors or capacitors between the gate and MT1 increase the latching current because they steal some current from the gate before it can help the complete turn-on of the device)
- quadrant of operation

In particular, if the pulse width of the gate current is sufficiently large (generally some tens of microseconds), the TRIAC has completed the triggering process when the gate signal is discontinued and the latching current reaches a minimum level called **holding current**. Holding current is the minimum required current flowing between the two main terminals that keeps the device on after it has achieved commutation in every part of its internal structure.

In datasheets, the latching current is indicated as I_L , while the holding current is indicated as I_H . They are typically in the order of some milliamperes.

1.2.2 Static dv/dt

A high $\frac{dv}{dt}$ between MT2 and MT1 may turn on the TRIAC when it is off. Typical values of critical static dv/dt are in the terms of volts per microsecond.

The turn-on is due to a parasitic capacitive coupling of the gate terminal with the MT2 terminal, which lets currents into the gate in response to a large rate of voltage change at MT2. One way to cope with this limitation is to design a suitable RC or RCL snubber network. In many cases this is sufficient to lower the impedance of the gate towards MT1. By putting a resistor or a small capacitor (or both in parallel) between these two terminals, the capacitive current generated during the transient flows out of the device without activating it. A careful reading of the application notes provided by the manufacturer and testing of the particular device model to design the correct network is in order. Typical values for capacitors and resistors between the gate and MT1 may be up to 100 nF and 10 Ω to 1 k Ω .^[3] Normal TRIACs, except for low-power types marketed as *sensitive gate*,^[4] already have such a resistor built in to safeguard against spurious dv/dt triggering. This will mask the gate's supposed diode-type behaviour when testing a TRIAC with a multimeter.

In datasheets, the static dv/dt is usually indicated as $(\frac{dv}{dt})_s$ and, as mentioned before, is in relation to the tendency of a TRIAC to turn on **from the off state** after a large voltage rate of rise even without applying any current in the gate.

1.2.3 Critical di/dt

A high rate of rise of the current between MT1 and MT2 (in either direction) **when the device is turning on** can damage or destroy the TRIAC even if the pulse duration is very short. The reason is that during the commutation, the power dissipation is not uniformly distributed across the device. When switching on, the device starts to conduct current before the conduction finishes to spread across the entire junction. The device typically starts to conduct the current imposed by the external circuitry after some nanoseconds or microseconds but the complete switch on of the whole junction takes a much longer time, so too swift a current rise may cause local hot spots that can permanently damage the TRIAC.

In datasheets, this parameter is usually indicated as $\frac{di}{dt}$ and is typically in the order of the tens of ampere per microsecond.^[1]

1.2.4 Commutating dv/dt and di/dt

The commutating dv/dt rating applies when a TRIAC has been conducting and attempts to turn off with a partially reactive load, such as an inductor. The current and voltage are out of phase, so when the current decreases below the holding value, the TRIAC attempts to turn off, but because of the phase shift between current and voltage, a sudden voltage step takes place between the two main terminals, which turns the device on again.

In datasheets, this parameter is usually indicated as $(\frac{dv}{dt})_c$ and is generally in the order of up to some volts per microsecond.

The reason why **commutating dv/dt is less than static dv/dt** is that, shortly before the device tries to turn off, there is still some excess minority charge in its internal layers as a result of the previous conduction. When the TRIAC starts to turn off, these charges alter the internal potential of the region near the gate and MT1, so it is easier for the capacitive current due to dv/dt to turn on the device again.

Another important factor during a commutation from on-state to off-state is the di/dt of the current from MT1 to MT2. This is similar to the recovery in standard diodes: the higher the di/dt , the greater the reverse current. Because in the TRIAC there are parasitic resistances, a high reverse current in the p-n junctions inside it can provoke a voltage drop between the gate region and the MT1 region which may make the TRIAC stay turned on.

In a datasheet, the commutating di/dt is usually indicated as $(\frac{di}{dt})_c$ and is generally in the order of some amperes per microsecond.

The commutating dv/dt is very important when the TRIAC is used to drive a load with a phase shift between current and voltage, such as an inductive load. Suppose one wants to turn the inductor off: when the current goes to zero, if the gate is not fed, the TRIAC attempts to turn off, but this causes a step in the voltage across it due to the afore-mentioned phase shift. If the commutating dv/dt rating is exceeded, the device will not turn off.

1.3 Snubber circuits

When used with inductive loads such as electric fans, care must be taken to assure that the TRIAC will turn off correctly at the end of each half-cycle of the AC power. TRIACs can be very sensitive to high values of dv/dt between MT1 and MT2, so a phase shift between current and voltage (as in the case of a strongly inductive or capacitive load) leads to sudden voltage step that can make the device turn on in an unwanted manner.^[2]

Unwanted turn-ons can be avoided by using a snubber circuit (usually of the RC or RCL type) between MT1 and MT2. Snubber circuits are also used to prevent prema-

ture triggering, caused for example by voltage spikes in the mains supply.

Because turn-ons are caused by internal capacitive currents flowing into the gate as a consequence of a high voltage dv/dt , (i.e., rapid voltage change) a gate resistor or capacitor (or both in parallel) may be connected between the gate and MT1 to provide a low-impedance path to MT1 and further prevent false triggering. This, however, increases the required trigger current or adds latency due to capacitor charging. On the other hand, a resistor between the gate and MT1 helps draw leakage currents out of the device, thus improving the performance of the TRIAC at high temperature, where the maximum allowed dv/dt is lower. Values of resistors less than $1k\Omega$ and capacitors of $100nF$ are generally suitable for this purpose, although the fine-tuning should be done on the particular device model.^[3]

For higher-powered, more-demanding loads, two SCRs in inverse parallel may be used instead of one TRIAC. Because each SCR will have an entire half-cycle of reverse polarity voltage applied to it, turn-off of the SCRs is assured, no matter what the character of the load. However, due to the separate gates, proper triggering of the SCRs is more complex than triggering a TRIAC.

In addition to commutation, a TRIAC may also not turn on reliably with non-resistive loads if the phase shift of the current prevents achieving holding current at trigger time. To overcome that, pulse trains may be used to repeatedly try to trigger the TRIAC until it finally turns on. The advantage is that the gate current does not need to be maintained throughout the entire conduction angle, which can be beneficial when there is only limited drive capability available.

1.4 Application

Low power TRIACs are used in many applications such as light dimmers, speed controls for electric fans and other electric motors, and in the modern computerized control circuits of many household small and major appliances.

1.5 Example data

1.6 Three-quadrant TRIAC

A TRIAC which can only operate in quadrants I through III, and cannot be triggered in quadrant IV, has improved turn-off (commutation) characteristics.

These devices are made specifically for improved commutation when controlling a highly-inductive load, such as a motor or solenoid, an application where normal TRIACs have problems due to high voltage/current angles; as soon as they turn off due to the current falling to zero, they

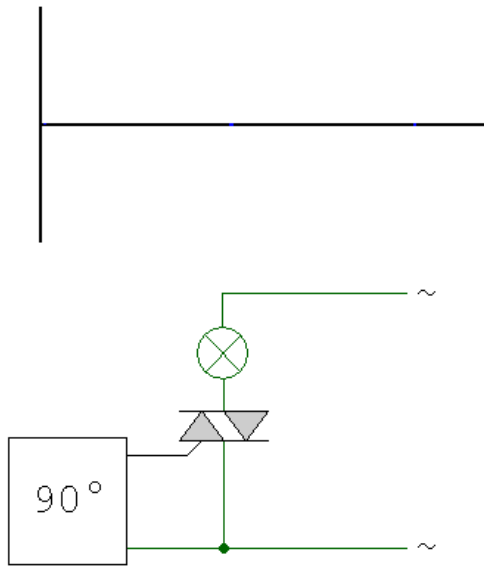

Typical use as a dimmer

experience a voltage spike which can turn them back on again. Most TRIACs' commutation with inductive loads can be improved by use of a snubber network, but these components are often designed to be able to dispense with need for such a circuit. This improvement is achieved at the expense of the ability to trigger the device in the 4th quadrant (negative voltage and positive gate current). However, this is usually no problem, because this trigger mode is seldom used since even normal TRIACs are least sensitive there.

The first were marketed by Thomson Semiconductors (now ST Microelectronics) under the name **Alternistor**, and now sells additional models under the trademark "SNUBBERLESS".

Littelfuse also uses the name "Alternistor". NXP Semiconductors calls them "High commutation" (**Hi-Com**) TRIACs.

1.7 See also

- Thyristor
- Diode for alternating current (DIAC)
- Silicon-controlled rectifier (SCR)
- Quadrac

1.8 References

- [1] "Thyristor Theory and Design Considerations", ON Semiconductor, available at www.onsemi.com/pub/Collateral/HBD855-D.PDF

- [2] M.D. Singh, K.B. Khanchandani, Power Electronics, Second Edition, Tata McGraw-Hill, New Delhi, 2007, pages 148-152
- [3] Application Note AN-3008, *RC Snubber Networks for Thyristor Power Control and Transient Suppression*, Fairchild Semiconductor, available at <http://www.fairchildsemi.com/an/AN/AN-3008.pdf>, pages 1-5
- [4] "2N6071A/B Series Sensitive Gate Triacs". Semiconductor Components Industries, LLC. Retrieved June 28, 2012.
- [5] "Philips Semiconductors Product specification Triacs BT138 series". 090119 nxp.com
- [6] "STMicroelectronics T3035H, T3050H Snubberless high temperature 30 A Triacs". st.com 100922

1.9 Further reading

- *Thyristor Theory and Design Considerations*; ON Semiconductor; 240 pages; 2006; HBD855/D. (Free PDF download)

1.10 External links

- A site about thyristors

Chapter 2

Thyristor

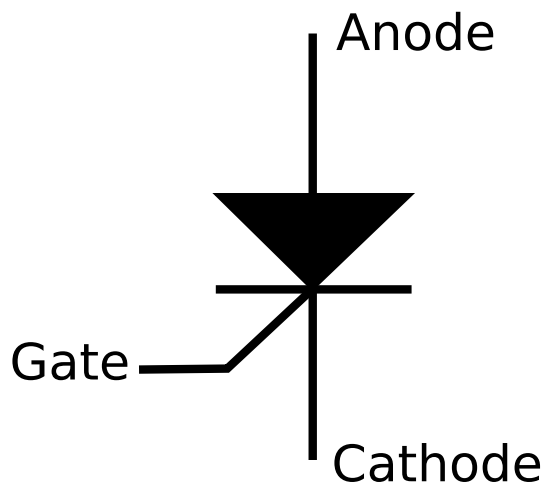

Circuit symbol for SCR

A **thyristor** is a solid-state semiconductor device with four layers of alternating N and P-type material. They act exclusively as bistable switches, conducting when their gate receives a current trigger, and continue to conduct while they are forward biased (that is, while the voltage across the device is not reversed). A three-lead thyristor is designed to control the larger current of its two leads by combining that current with the smaller current or voltage of its other lead - known as its control lead. In contrast, a two-lead thyristor is designed to 'switch on' if the potential difference between its leads is sufficiently large - a value representing its *breakdown voltage*.

Some sources define **silicon-controlled rectifiers** and thyristors as synonymous.^[1] Other sources define thyristors as a larger set of devices with at least four layers of alternating N and P-type material.

The first thyristor devices were released commercially in 1956. Because thyristors can control a relatively large amount of power and voltage with a small device, they find wide application in control of electric power, ranging from light dimmers and electric motor speed control to high-voltage direct current power transmission. Thyristors may be used in power-switching circuits, relay-



An SCR rated about 100 amperes, 1200 volts mounted on a heat sink - the two small wires are the gate trigger leads

replacement circuits, inverter circuits, oscillator circuits, level-detector circuits, chopper circuits, light-dimming circuits, low-cost timer circuits, logic circuits, speed-control circuits, phase-control circuits, etc. Originally thyristors relied only on current reversal to turn them off, making them difficult to apply for direct current; newer device types can be turned on and off through the control gate signal. A thyristor is not a proportional device like a transistor. In other words, a thyristor can only be fully on or off, while a transistor can lie in between on and off states. This makes a thyristor unsuitable as an analog amplifier, but useful as a switch.

2.1 Introduction

The thyristor is a four-layered, three terminal semiconductor device, with each layer consisting of alternately N-type or P-type material, for example P-N-P-N. The main

terminals, labelled anode and cathode, are across all four layers. The control terminal, called the gate, is attached to p-type material near the cathode. (A variant called an SCS—Silicon Controlled Switch—brings all four layers out to terminals.) The operation of a thyristor can be understood in terms of a pair of tightly coupled bipolar junction transistors, arranged to cause a self-latching action:

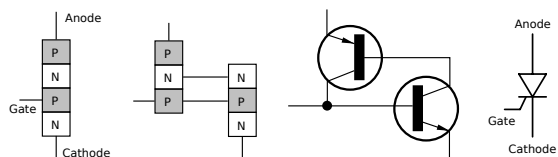

Structure on the physical and electronic level, and the thyristor symbol.

Thyristors have three states:

1. Reverse blocking mode — Voltage is applied in the direction that would be blocked by a diode
2. Forward blocking mode — Voltage is applied in the direction that would cause a diode to conduct, but the thyristor has not been triggered into conduction
3. Forward conducting mode — The thyristor has been triggered into conduction and will remain conducting until the forward current drops below a threshold value known as the “holding current”

2.1.1 Function of the gate terminal

The thyristor has three p-n junctions (serially named J_1 , J_2 , J_3 from the anode).

When the anode is at a positive potential V_{AK} with respect to the cathode with no voltage applied at the gate, junctions J_1 and J_3 are forward biased, while junction J_2 is reverse biased. As J_2 is reverse biased, no conduction takes place (Off state). Now if V_{AK} is increased beyond the breakdown voltage V_{BO} of the thyristor, avalanche breakdown of J_2 takes place and the thyristor starts conducting (On state).

If a positive potential V_G is applied at the gate terminal with respect to the cathode, the breakdown of the junction J_2 occurs at a lower value of V_{AK} . By selecting an appropriate value of V_G , the thyristor can be switched into the on state quickly.

Once avalanche breakdown has occurred, the thyristor continues to conduct, irrespective of the gate voltage, until: (a) the potential V_{AK} is removed or (b) the current through the device (anode–cathode) is less than the holding current specified by the manufacturer. Hence V_G can be a voltage pulse, such as the voltage output from a UJT relaxation oscillator.

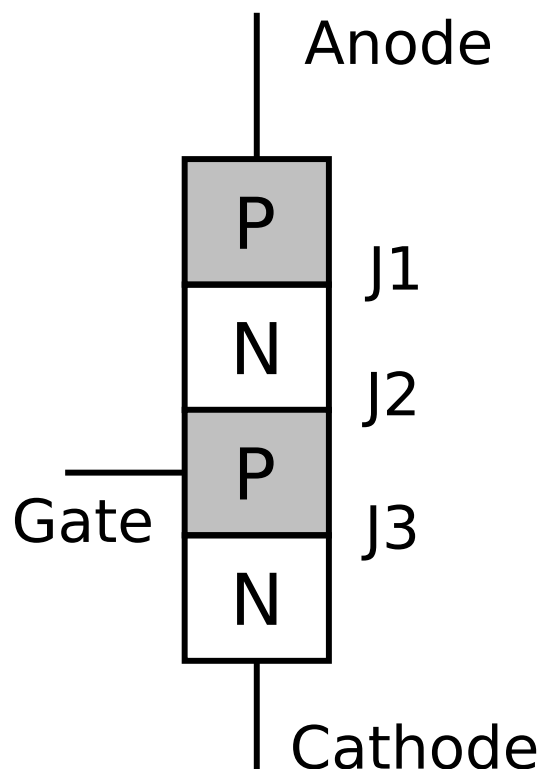

Layer diagram of thyristor.

The gate pulses are characterized in terms of gate trigger voltage (V_{GT}) and gate trigger current (I_{GT}). Gate trigger current varies inversely with gate pulse width in such a way that it is evident that there is a minimum gate charge required to trigger the thyristor.

2.1.2 Switching characteristics

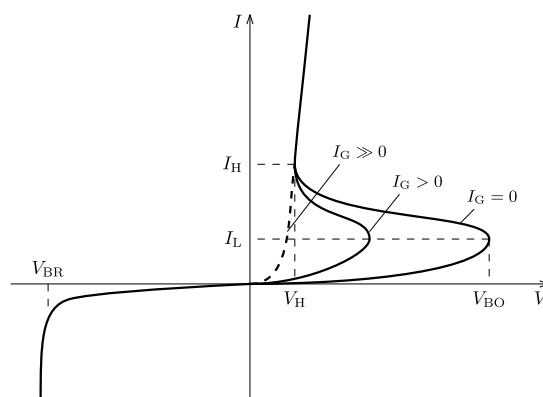

$V - I$ characteristics.

In a conventional thyristor, once it has been switched on by the gate terminal, the device remains latched in the on-state (*i.e.* does not need a continuous supply of gate current to remain in the on state), providing the anode

current has exceeded the latching current (I_L). As long as the anode remains positively biased, it cannot be switched off until the anode current falls below the holding current (I_H).

A thyristor can be switched off if the external circuit causes the anode to become negatively biased (a method known as natural, or line, commutation). In some applications this is done by switching a second thyristor to discharge a capacitor into the cathode of the first thyristor. This method is called forced commutation.

After the current in a thyristor has extinguished, a finite time delay must elapse before the anode can again be positively biased *and* retain the thyristor in the off-state. This minimum delay is called the circuit commutated turn off time (t_Q). Attempting to positively bias the anode within this time causes the thyristor to be self-triggered by the remaining charge carriers (holes and electrons) that have not yet recombined.

For applications with frequencies higher than the domestic AC mains supply (e.g. 50 Hz or 60 Hz), thyristors with lower values of t_Q are required. Such fast thyristors can be made by diffusing heavy metal ions such as gold or platinum which act as charge combination centers into the silicon. Today, fast thyristors are more usually made by electron or proton irradiation of the silicon, or by ion implantation. Irradiation is more versatile than heavy metal doping because it permits the dosage to be adjusted in fine steps, even at quite a late stage in the processing of the silicon.

2.2 History

The Silicon Controlled Rectifier (SCR) or Thyristor proposed by William Shockley in 1950 and championed by Moll and others at Bell Labs was developed in 1956 by power engineers at General Electric (G.E.) led by Gordon Hall and commercialized by G.E.'s Frank W. "Bill" Gutzwiller.

2.2.1 Etymology

An earlier gas filled tube device called a thyratron provided a similar electronic switching capability, where a small control voltage could switch a large current. It is from a combination of "thyratron" and "transistor" that the term "thyristor" is derived.^[2]

2.3 Applications

Thyristors are mainly used where high currents and voltages are involved, and are often used to control alternating currents, where the change of polarity of the current causes the device to switch off automatically, re-

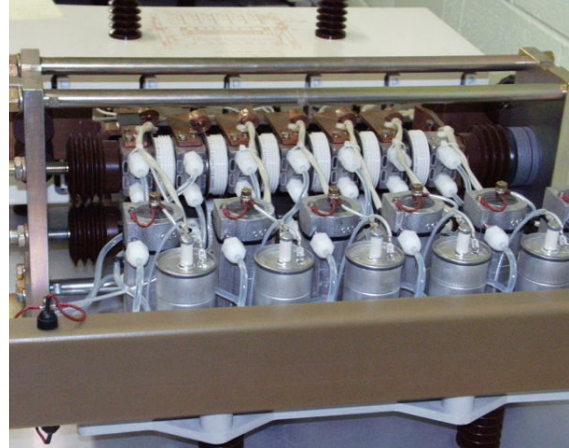

A bank of six 2000 A thyristors (white disks arranged in a row at top, and seen edge-on)

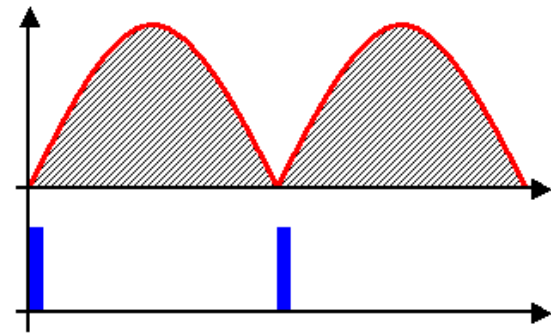

Load voltage regulated by thyristor phase control.
Red trace: load voltage
Blue trace: trigger signal.

ferred to as **Zero Cross** operation. The device can be said to operate *synchronously*; being that, once the device is triggered, it conducts current in phase with the voltage applied over its cathode to anode junction with no further gate modulation being required, i.e. the device is biased *fully on*. This is not to be confused with asymmetrical operation, as the output is unidirectional, flowing only from cathode to anode, and so is asymmetrical in nature.

Thyristors can be used as the control elements for phase angle triggered controllers, also known as phase fired controllers.

They can also be found in power supplies for digital circuits, where they are used as a sort of "enhanced circuit breaker" to prevent a failure in the power supply from damaging downstream components. A thyristor is used in conjunction with a Zener diode attached to its gate, and if the output voltage of the supply rises above the Zener voltage, the thyristor will conduct and short-circuit the power supply output to ground (in general also tripping an upstream breaker or fuse). This kind of protection circuit is known as a crowbar, and has the advantage over a standard circuit breaker or fuse that it creates a high-conductance path to ground for the damaging sup-

ply voltage and potentially for stored energy in the system being powered.

The first large-scale application of thyristors, with associated triggering diac, in consumer products related to stabilized power supplies within color television receivers in the early 1970s. The stabilized high voltage DC supply for the receiver was obtained by moving the switching point of the thyristor device up and down the falling slope of the positive going half of the AC supply input (if the rising slope was used the output voltage would always rise towards the peak input voltage when the device was triggered and thus defeat the aim of regulation). The precise switching point was determined by the load on the DC output supply, as well as AC input fluctuations.

Thyristors have been used for decades as lighting dimmers in television, motion pictures, and theater, where they replaced inferior technologies such as autotransformers and rheostats. They have also been used in photography as a critical part of flashes (strobes).

2.3.1 Snubber circuits

Thyristors can be triggered by a high rise-rate of off-state voltage. This is prevented by connecting a resistor-capacitor (RC) snubber circuit between the anode and cathode terminals in order to limit the dV/dt (i.e., rate of voltage change over time).

2.3.2 HVDC electricity transmission



Valve hall containing thyristor valve stacks used for long distance transmission of power from Manitoba Hydro dams

Since modern thyristors can switch power on the scale of megawatts, thyristor valves have become the heart of high-voltage direct current (HVDC) conversion either to or from alternating current. In the realm of this and other very high power applications, both electrically triggered (ETT) and light triggered (LTT) thyristors^{[3] [4]} are still the primary choice. The valves are arranged in stacks usually suspended from the ceiling of a transmission building called a valve hall. Thyristors are arranged into a diode bridge circuit and to reduce harmonics are connected in series to form a 12 pulse converter. Each thyristor is cooled with deionized water, and the entire arrangement becomes one of multiple identical modules forming a layer in a multilayer valve stack called a quadruple valve. Three such stacks are typically mounted on the floor or hung from the ceiling of the valve hall of a long distance transmission facility.^{[5][6]}

2.4 Comparisons to other devices

The functional drawback of a thyristor is that, like a diode, it only conducts in one direction. A similar self-latching 5-layer device, called a TRIAC, is able to work in both directions. This added capability, though, also can become a shortfall. Because the TRIAC can conduct in both directions, reactive loads can cause it to fail to turn off during the zero-voltage instants of the AC power cycle. Because of this, use of TRIACs with (for example) heavily inductive motor loads usually requires the use of a "snubber" circuit around the TRIAC to assure that it will turn off with each half-cycle of mains power. Inverse parallel SCRs can also be used in place of the triac; because each SCR in the pair has an entire half-cycle of reverse polarity applied to it, the SCRs, unlike TRIACs, are sure to turn off. The "price" to be paid for this arrangement, however, is the added complexity of two separate but essentially identical gating circuits.

Although thyristors are heavily used in megawatt scale rectification of AC to DC, in low and medium power (from few tens of watts to few tens of kilowatts) they have virtually been replaced by other devices with superior switching characteristics like MOSFETs or IGBTs. One major problem associated with SCRs is that they are not fully controllable switches. The GTO (gate turn-off thyristor) and IGCT are two devices related to the thyristor, which address this problem. In high-frequency applications, thyristors are poor candidates due to large switching times arising from bipolar conduction. MOSFETs, on the other hand, have much faster switching capability because of their unipolar conduction (only majority carriers carry the current).

2.5 Failure modes

Thyristor manufacturers generally specify a region of safe firing defining acceptable levels of voltage and current for a given **operating temperature**. The boundary of this region is partly determined by the requirement that the maximum permissible gate power (PG), specified for a given trigger pulse duration, is not exceeded.^[7]

As well as the usual failure modes due to exceeding voltage, current or power ratings, thyristors have their own particular modes of failure, including:

- **Turn on di/dt** — in which the rate of rise of on-state current after triggering is higher than can be supported by the spreading speed of the active conduction area (SCRs & triacs).
- **Forced commutation** — in which the transient peak reverse recovery current causes such a high voltage drop in the sub-cathode region that it exceeds the reverse breakdown voltage of the gate cathode diode junction (SCRs only).
- **Switch on dv/dt** — the thyristor can be spuriously fired without trigger from the gate if the anode-to-cathode voltage rise-rate is too great.

2.6 Silicon carbide thyristors

In recent years, some manufacturers^[8] have developed thyristors using **Silicon carbide** (SiC) as the semiconductor material. These have applications in high temperature environments, being capable of **operating at temperatures** up to 350 °C.

2.7 Types of thyristor

- **ACS**
- **ACST**
- **AGT** — Anode Gate Thyristor — A thyristor with gate on n-type layer near to the anode
- **ASCR** — Asymmetrical SCR
- **BCT** — Bidirectional Control Thyristor — A bidirectional switching device containing two thyristor structures with separate gate contacts
- **BOD** — Breakover Diode — A gateless thyristor triggered by avalanche current
 - **DIAC** — Bidirectional trigger device
 - **Dynistor** — Unidirectional switching device
 - **Shockley diode** — Unidirectional trigger and switching device
- **SIDAC** — Bidirectional switching device
- **Trisil, SIDACTor** — Bidirectional protection devices
- **BRT** — Base Resistance Controlled Thyristor
- **ETO** — Emitter Turn-Off Thyristor^[9]
- **GTO** — Gate Turn-Off thyristor
 - **DB-GTO** — Distributed buffer gate turn-off thyristor
 - **MA-GTO** — Modified anode gate turn-off thyristor
- **IGCT** — Integrated gate-commutated thyristor
- **Ignitor** — Spark generators for fire-lighter ckts
- **LASCR** — Light-activated SCR, or **LTT** — light-triggered thyristor
- **LASS** — light-activated semiconducting switch
- **Latchup**
- **MCT** — MOSFET Controlled Thyristor — It contains two additional FET structures for on/off control.
- **CSMT** or **MCS** — MOS composite static induction thyristor
- **PUT** or **PUJT** — Programmable Unijunction Transistor — A thyristor with gate on n-type layer near to the anode used as a functional replacement for unijunction transistor
- **RCT** — Reverse Conducting Thyristor
- **SCS** — Silicon Controlled Switch or Thyristor Tetrode — A thyristor with both cathode and anode gates
- **SCR** — Silicon Controlled Rectifier
- **SITh** — Static Induction Thyristor, or **FCTh** — Field Controlled Thyristor — containing a gate structure that can shut down anode current flow.
- **TRIAC** — Triode for Alternating Current — A bidirectional switching device containing two thyristor structures with common gate contact
- **Quadrac** — special type of thyristor which combines a DIAC and a TRIAC into a single package.

2.7.1 Reverse conducting thyristor

A reverse conducting thyristor (RCT) has an integrated reverse diode, so is not capable of reverse blocking. These devices are advantageous where a reverse or free-wheel diode must be used. Because the SCR and diode never conduct at the same time they do not produce heat simultaneously and can easily be integrated and cooled together. Reverse conducting thyristors are often used in frequency changers and inverters.

2.7.2 Photothyristors

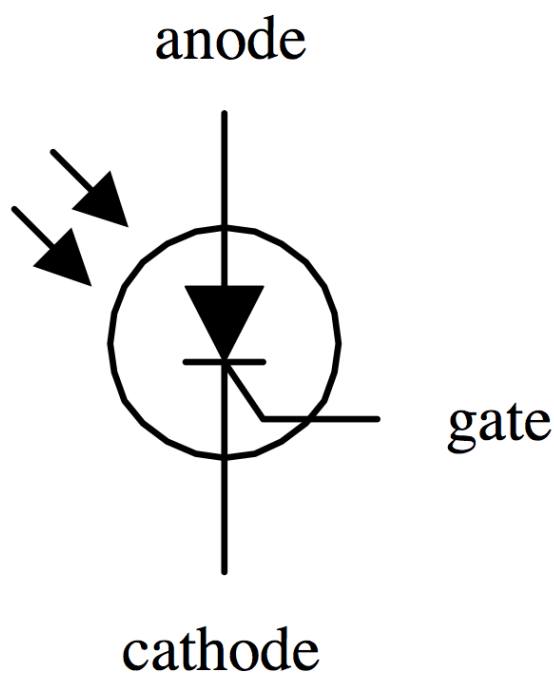

Electronic symbol for light-activated SCR (LASCR)

Photothyristors are activated by light. The advantage of photothyristors is their insensitivity to electrical signals, which can cause faulty operation in electrically noisy environments. A light triggered thyristor (LTT) has an optically sensitive region in its gate, into which electromagnetic radiation (usually infrared) is coupled via an optical fiber. Since no electronic boards need to be provided at the potential of the thyristor in order to trigger it, light triggered thyristors can be an advantage in high voltage applications such as HVDC. Light triggered thyristors are available with in-built over-voltage (VBO) protection which triggers the thyristor when the forward voltage across it becomes too high; they have also been made with in-built *forward recovery protection*, but not commercially. Despite the simplification they can bring to the electronics of an HVDC valve, light triggered thyristors may still require some simple monitoring electronics and are only available from a few manufacturers.

Two common photothyristors include the light-activated

SCR (LASCR) and the light-activated triac. A LASCR acts as a switch that turns on when exposed to light. Following light exposure, when light is absent, if the power is not removed and the polarities of the cathode and anode have not yet reversed, the LASCR is still in the 'on' state. A light-activated triac resembles a LASCR, except that it is designed for ac currents.

2.8 See also

- Latchup
- Quadrac
- Thyristor drive
- Thyristor tower

2.9 References

- [1] Christiansen, Donald; Alexander, Charles K. (2005); *Standard Handbook of Electrical Engineering (5th ed.)*. McGraw-Hill, ISBN 0-07-138421-9
- [2] <http://home.roadrunner.com/~{ }mathematikos/Etymology/thyristor.pdf>
- [3] "High Voltage Direct Current Transmission - Proven Technology for Power Exchange". Siemens. Retrieved 2013-08-04. lchapter= ignored (help)
- [4] "ETT vs. LTT for HVDC". ABB Asea Brown Boveri. Retrieved 2014-01-24.
- [5] "HVDC Thyristor Valves". ABB Asea Brown Boveri. Retrieved 2008-12-20.
- [6] "High Power". IET. Retrieved 2009-07-12.
- [7] "*Safe Firing of Thyristors*" on powerguru.org
- [8] Example: *Silicon Carbide Inverter Demonstrates Higher Power Output* in Power Electronics Technology (2006-02-01)
- [9] Rashid, Muhammad H.(2011); *Power Electronics (3rd ed.)*. Pearson, ISBN 978-81-317-0246-8

2.10 Further reading

- Wintrich, Arendt; Nicolai, Ulrich; Tursky, Werner; Reimann, Tobias (2011). [PDF-Version *Application Manual 2011*] (2nd ed.). Nuremberg: Semikron. ISBN 978-3-938843-66-6.
- *Thyristor Theory and Design Considerations*; ON Semiconductor; 240 pages; 2006; HBD855/D. (Free PDF download)

- Dr. Ulrich Nicolai, Dr. Tobias Reimann, Prof. Jürgen Petzoldt, Josef Lutz: *Application Manual IGBT and MOSFET Power Modules*, 1. Edition, ISLE Verlag, 1998, ISBN 3-932633-24-5. (Free PDF download)
- *SCR Manual*; 6th edition; General Electric Corporation; Prentice-Hall; 1979.

2.11 External links

- The Early History of the Silicon Controlled Rectifier — by Frank William Gutzwiller (of G.E.)
- THYRISTORS — from All About Circuits
- Universal thyristor driving circuit
- Thyristor Resources (simpler explanation)
- Thyristors of STMicroelectronics
- Thyristor basics

Chapter 3

DIAC

For other uses, see DIAC (disambiguation).

The **DIAC** is a diode that conducts electrical current

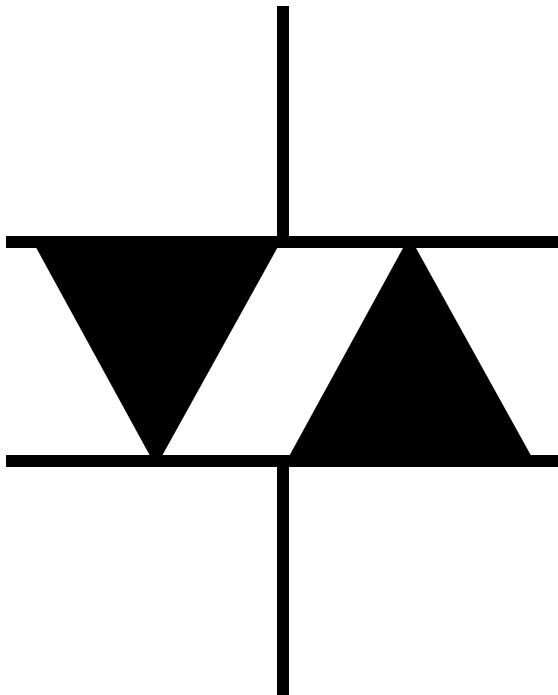

DIAC



Three-layer DIAC

only after its breakover voltage, V_{BO} , has been reached momentarily. The term is an acronym of *diode for alternating current*.

When breakdown occurs, the diode enters a region of negative dynamic resistance, leading to a decrease in the

voltage drop across the diode and, usually, a sharp increase in current through the diode. The diode remains in conduction until the current through it drops below a value characteristic for the device, called the *holding current*, I_H . Below this value, the diode switches back to its high-resistance, non-conducting state. This behavior is bidirectional, meaning typically the same for both directions of current.

Most DIACs have a three-layer structure with breakover voltage of approximately 30 V. Their behavior is similar to that of a neon lamp, but it can be more precisely controlled and takes place at a lower voltage.

DIACs have no gate electrode, unlike some other thyristors that they are commonly used to trigger, such as TRIACs. Some TRIACs, like *Quadrac*, contain a built-in DIAC in series with the TRIAC's gate terminal for this purpose.

DIACs are also called *symmetrical trigger diodes* due to the symmetry of their characteristic curve. Because DIACs are bidirectional devices, their terminals are not labeled as anode and cathode but as $A1$ and $A2$ or *main terminal* $MT1$ and $MT2$.

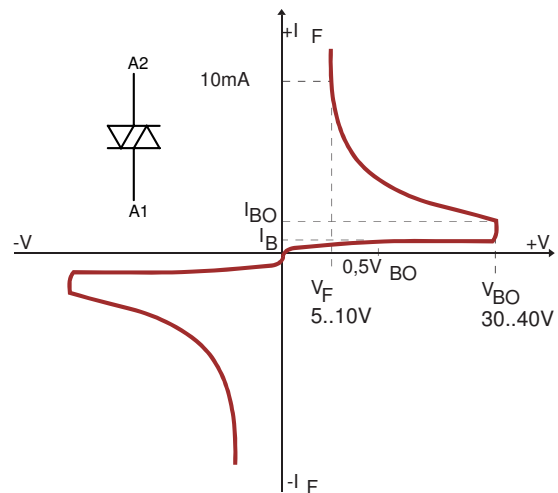

Typical DIAC voltage and current relationships. V_{BO} is the breakover voltage.

3.1 SIDAC

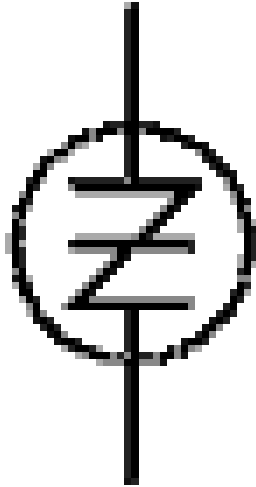

SIDAC

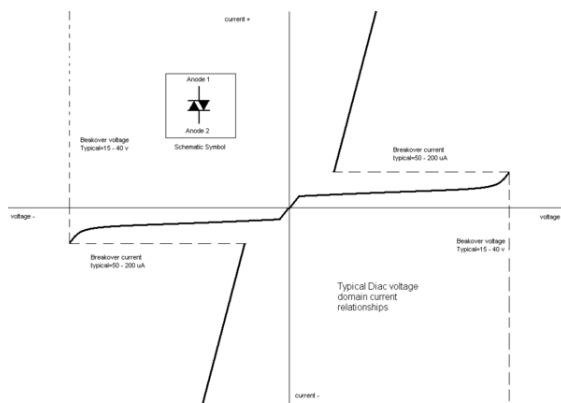

Idealized breakover diode voltage and current relationships. Once the voltage exceeds the turn-on threshold, the device turns on and the voltage rapidly falls while the current increases.

The **SIDAC** is a less common electrically similar device, the difference in naming being determined by the manufacturer. In general, SIDACs have higher breakover voltages and current handling.

The SIDAC, or *Silicon Diode for Alternating Current*, is another member of the thyristor family. Also referred to as a SYDAC (Silicon thYristor for Alternating Current), bi-directional thyristor breakover diode, or more simply a bi-directional thyristor diode, it is technically specified as a bilateral voltage triggered switch. Its operation is similar to that of the DIAC, but SIDAC is always a five-layer device with low-voltage drop in latched conducting state, more like a voltage triggered TRIAC without a gate. In general, SIDACs have higher breakover voltages and current handling capacities than DIACs, so they can be directly used for switching and not just for triggering of another switching device.

The operation of the SIDAC is functionally similar to that of a **spark gap**, but is unable to reach its higher temperature ratings. The SIDAC remains nonconducting until the applied voltage meets or exceeds its rated breakover voltage. Once entering this conductive state going through the negative dynamic resistance region, the SIDAC continues to conduct, regardless of voltage, until the applied current falls below its rated holding current. At this point, the SIDAC returns to its initial nonconductive state to begin the cycle once again.

Somewhat uncommon in most **electronics**, the SIDAC is relegated to the status of a special purpose device. However, where part-counts are to be kept low, simple **relaxation oscillators** are needed, and when the voltages are too low for practical operation of a spark gap, the SIDAC is an indispensable component.

Similar devices, though usually not functionally interchangeable with SIDACs, are the Thyristor Surge Protection Devices (TSPD), Trisil, SIDACtor®, or the now-obsolete Surgeactor. These are designed to tolerate large surge currents for the suppression of overvoltage transients. In many applications this function is now served by metal oxide varistors (MOVs), particularly for trapping voltage transients on the power mains.

3.2 See also

- Shockley diode
- Triode for Alternating Current (TRIAC)
- Silicon-controlled Rectifier (SCR)
- Trisil
- Quadrac

3.3 References

- *DB3 DB4 SMDB3 DIAC*, ST Datasheet (PDF)
- Littelfuse Kxxx1g Series SIDAC Data Sheet (PDF)

3.4 External links

- Strobe circuit containing a SIDAC

Chapter 4

Silicon-controlled rectifier

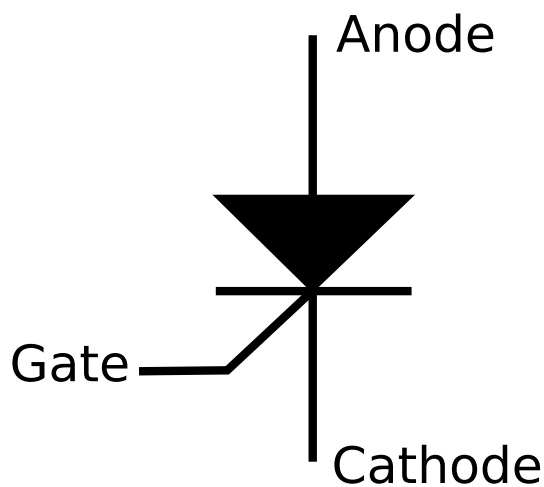

SCR schematic symbol



A high power SCR

A **silicon-controlled rectifier** (or **semiconductor-controlled rectifier**) is a four-layer solid state current controlling device. The name “silicon controlled rectifier” is General Electric's trade name for a type of thyristor. The SCR was developed by a team of power engineers led by Gordon Hall^[1] and commercialized by Frank W. “Bill” Gutzwiller in 1957.

Some sources define silicon controlled rectifiers and thyristors as synonymous,^[2] other sources define silicon controlled rectifiers as a proper subset of the set of thyristors, those being devices with at least four layers of alternating N and P-type material.^{[3][4]} According to Bill Gutzwiller, the terms “SCR” and “Controlled Rectifier”

were earlier, and “Thyristor” was applied later as usage of the device spread internationally.^[5]

SCRs are unidirectional devices (i.e. can conduct current only in one direction) as opposed to TRIACs which are bidirectional (i.e. current can flow through them in either direction). SCRs can be triggered normally only by currents going into the gate as opposed to TRIACs which can be triggered normally by either a positive or a negative current applied to its gate electrode.

4.1 Construction

The Silicon Control Rectifier (SCR) consists of four layers of semiconductors, which form **NPNP** or **PNPN** structures. It has three junctions, labeled **J1**, **J2**, and **J3** and three terminals. The anode terminal of an SCR is connected to the P-Type material of a PNPN structure, and the cathode terminal is connected to the N-Type layer, while the gate of the Silicon Control Rectifier SCR is connected to the P-Type material nearest to the cathode.^[6]

An SCR consists of four layers of alternating P and N type semiconductor materials. Silicon is used as the intrinsic semiconductor, to which the proper dopants are added. The junctions are either diffused or alloyed. The planar construction is used for low power SCRs (and all the junctions are diffused). The mesa type construction is used for high power SCRs. In this case, junction J2 is obtained by the diffusion method and then the outer two layers are alloyed to it, since the PNPN pellet is required to handle large currents. It is properly braced with tungsten or molybdenum plates to provide greater mechanical strength. One of these plates is hard soldered to a copper stud, which is threaded for attachment of heat sink. The doping of PNPN will depend on the application of SCR, since its characteristics are similar to those of the thyatron. Today, the term thyristor applies to the larger family of multilayer devices that exhibit bistable state-change behaviour, that is, switching either ON or OFF.

The operation of a SCR and other thyristors can be understood in terms of a pair of tightly coupled bipolar junction

transistors, arranged to cause the self-latching action:

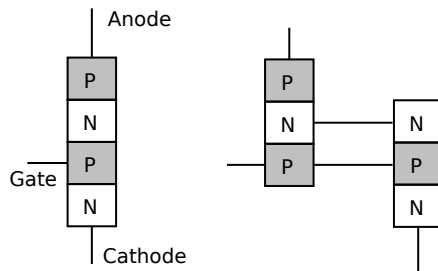

4.2 Modes of operation

There are three modes of operation for an SCR depending upon the biasing given to it:

1. **Forward blocking mode (off state)**
2. **Forward conduction mode (on state)**
3. **Reverse blocking mode (off state)**

4.2.1 Forward blocking mode

In this mode of operation, the anode is given a positive potential while the cathode is given a negative voltage, keeping the gate at zero potential i.e. disconnected. In this case junction **J1** and **J3** are forward biased while **J2** is reversed biased due to which only a small leakage current exists from the anode to the cathode until the applied voltage reaches its breakover value, at which **J2** undergoes avalanche breakdown and at this breakover voltage it starts conducting, but below breakover voltage it offers very high resistance to the current and is said to be in the off state.

4.2.2 Forward conduction mode

SCR can be brought from blocking mode to conduction mode in two ways: either by increasing the voltage across anode to cathode beyond breakover voltage or by applying of positive pulse at gate. Once it starts conducting, no more gate voltage is required to maintain it in the on state. There are two ways to turn it off: 1. Reduce the current through it below a minimum value called the holding current and 2. With the Gate turned off, short out the Anode and Cathode momentarily with a push-button switch or transistor across the junction.

4.2.3 Reverse blocking mode

SCRs are available with reverse blocking capability, which adds to the forward voltage drop because of the need to have a long, low doped P1 region. (If one cannot

determine which region is P1, a labeled diagram of layers and junctions can help). Usually, the reverse blocking voltage rating and forward blocking voltage rating are the same. The typical application for reverse blocking SCR is in current source inverters.

SCRs incapable of blocking reverse voltage are known as **asymmetrical SCR**, abbreviated **ASCR**. They typically have a reverse breakdown rating in the tens of volts. ASCRs are used where either a reverse conducting diode is applied in parallel (for example, in voltage source inverters) or where reverse voltage would never occur (for example, in switching power supplies or DC traction choppers).

Asymmetrical SCRs can be fabricated with a reverse conducting diode in the same package. These are known as RCTs, for reverse conducting thyristors.

4.3 Thyristor turn on methods

1. forward voltage triggering
2. gate triggering
3. dv/dt triggering
4. temperature triggering
5. light triggering

Forward voltage triggering occurs when the anode-cathode forward voltage is increased with the gate circuit opened. This is known as avalanche breakdown, during which junction J2 will breakdown. At sufficient voltages, the thyristor changes to its on state with low voltage drop and large forward current. In this case, J1 and J3 are already forward biased.

4.4 Application of SCRs

SCRs are mainly used in devices where the control of high power, possibly coupled with high voltage, is demanded. Their operation makes them suitable for use in medium to high-voltage AC power control applications, such as lamp dimming, regulators and motor control.

SCRs and similar devices are used for rectification of high power AC in high-voltage direct current power transmission. They are also used in the control of welding machines, mainly MTAW (Metal Tungsten Arc Welding) and GTAW (Gas Tungsten Arc Welding) process.

4.5 Compared to SCSs

A silicon-controlled switch (SCS) behaves nearly the same way as an SCR, aside from a few distinctions. Un-

like an SCR, a SCS switches off when a positive voltage/input current is applied to another anode gate lead. Unlike an SCR, a SCS can also be triggered into conduction when a negative voltage/output current is applied to that same lead.

SCSs are useful in practically all circuits that need a switch that turns on/off through two distinct control pulses. This includes power-switching circuits, logic circuits, lamp drivers, counters, etc.

4.6 Compared to Triacs

TRIACs resemble SCRs in that they both act as electrically controlled switches. Unlike SCRs, TRIACs can pass current in either direction. Thus, TRIACs are particularly useful for AC applications. TRIACs have three leads: a gate lead and two conducting leads, referred to as MT1 and MT2. If no current/voltage is applied to the gate lead, the TRIAC switches off. On the other hand, if the trigger voltage is applied to the gate lead, the TRIAC switches on.

TRIACs are suitable for light-dimming circuits, phase-control circuits, AC power-switching circuits, AC motor control circuits, etc.

4.6.1 See also

- Dimmer
- high-voltage direct current
- Gate turn-off thyristor
- Insulated-gate bipolar transistor
- Integrated gate-commutated thyristor
- Thyristor
- TRIAC
- Voltage regulator
- Snubber
- Crowbar (circuit)
- DIAC
- BJT

4.6.2 References

- [1] Ward, Jack. "The Early History of the Silicon Controlled Rectifier". p. 6. Retrieved 12 April 2014.
- [2] Christiansen, Donald; Alexander, Charles K. (2005); *Standard Handbook of Electrical Engineering (5th ed.)*. McGraw-Hill, ISBN 0-07-138421-9

[3] International Electrotechnical Commission 60747-6 standard

[4] Dorf, Richard C., editor (1997), *Electrical Engineering Handbook (2nd ed.)*. CRC Press, IEEE Press, Ron Powers Publisher, ISBN 0-8493-8574-1

[5] Ward, Jack. "The Early History of the Silicon Controlled Rectifier". p. 7. Retrieved 12 April 2014.

[6] <http://www.daenotes.com/electronics/industrial-electronics/silicon-controlled-rectifiers-scr>

4.7 Further reading

- ON Semiconductor (November 2006). *Thyristor Theory and Design Considerations* (rev.1, HBD855/D ed.). p. 240.
- G. K. Mithal. *Industrial and Power Electronics*.
- K. B. Khanchandani. *Power Electronics*.

4.7.1 External links

- SCR at AllAboutCircuits
- SCR Circuit Design

4.8 Text and image sources, contributors, and licenses

4.8.1 Text

- TRIAC** *Source:* <http://en.wikipedia.org/wiki/TRIAC?oldid=647929633> *Contributors:* Merphant, Heron, Glenn, Bemoeial, Dysprosia, Omegatron, Blades, Stefan Heinzmann, Mat-C, Micru, Chowbok, Adamrice, Canterbury Tail, Mike Rosoft, Ulflarsen, Imroy, Roo72, Cd4017, Plugwash, Linkoman, Russ3Z, Hooperbloop, Atlant, Snowolf, Wtshymanski, David Haslam, The Lightning Stalker, FlaBot, Krishnavedala, Bgwhite, WriterHound, KnightRider, SmackBot, Hydrogen Iodide, Unyoyega, Eskimbot, JorgePeixoto, Bluebot, Thumperward, EncMstr, DHN-bot, Chendy, Riflemann, Spickles, OrphanBot, Uiop, SashatoBot, CyrilB, Goblin, Thijs!bot, Czenek, N5iln, Electron9, Gdead, Behnam Ghiaseddin, JAnDbot, Rearete, Wlodzimierz, Tlim7882, UdovdM, Baljinderindia, Oliverkywu, VolkovBot, Gmoose1, TXiKiBoT, The Original Wildbear, Userper, SieBot, BotMultichill, Bentogoa, Simpliciter, Mild Bill Hiccup, Anon126, Egmontaz, Teslaton, Vitaltrust, Addbot, Grahamatwp, Yobot, Cfm001, KamikazeBot, DemocraticLuntz, Dwayne, JackieBot, MaterialsScientist, Xqbot, Shawnlower, Hi878, Akashvedi, Nedim Ardoğa, Mfwitten, DrilBot, Trappist the monk, 134RFMaster, Crati, EmausBot, WikitanvirBot, Tommy2010, Mkratz, Sbmeirow, Keesal, Teapeat, Marcelodin, ClueBot NG, Jakuzem, Filiwickers, Widr, Red Rover112, Glacialfox, Faizan, Cahhta, JaunJimenez and Anonymous: 98
- Thyristor** *Source:* <http://en.wikipedia.org/wiki/Thyristor?oldid=646391906> *Contributors:* Rjstott, Waveguy, RTC, Michael Hardy, Card, Glenn, Lommer, GRAHAMUK, Bemoeial, RickK, Dcsohl, Raul654, Iain.mcclatchie, Mat-C, Fudoreaper, Jackol, Utcursch, Slowking Man, Jossi, Drhaggis, Canterbury Tail, Brianhe, ArnoldReinhold, Tirthajyoti, Alistair1978, ESKog, Jaberwocky6669, Shanes, Duk, Foobaz, Bert Hickman, Hooperbloop, Avian, MatthewEHarbowy, Atlant, Glaurung, Wtshymanski, DV8 2XL, Gene Nygaard, Kinema, Joriki, Boothy443, Linas, Mindmatrix, Jyavner, David Haslam, Mgolden, FlaBot, Margosbot, Antikon, Chobot, Karch, Bornhj, Gaius Cornelius, Shaddack, NawlinWiki, Spike Wilbury, Kingpomba, Mikeblas, Fleet Pete, Bota47, Kelovy, Cassini83, Mike1024, HereToHelp, Meegs, Attilios, SmackBot, Steve carlson, C J Cowie, Unyoyega, Stifle, ASarnat, Mak17f, Thuringius, Chris the speller, Agateller, Droll, Weltanschauung, Riflemann, Dethme0w, Can't sleep, clown will eat me, Daler, Ugur Basak Bot, SashatoBot, Ali0th, GerhardK, Slogby, CyrilB, 16@r, Mattcain, Arkrishna, Dekuntz, ILOvePlankton, JoeBot, Fdp, Dlohcierekim, Grasshoppa, Biscay, CmdrObot, Sir Vicious, Zureks, MrFish, Cydebot, Pyrilium, Gimmetrow, Thijs!bot, Epbr123, Electron9, Drigz, KrakatoaKatie, AntiVandalBot, Luna Santin, Gaz Man, JAnDbot, Pi.1415926535, Igodard, MegX, Magioladitis, Soulbot, JaGa, Astgtciv, Gwern, GoldenMeadows, R'n'B, Aatomic1, Zuban42, Funandtrvl, VolkovBot, Ambrose H. Field, TXiKiBoT, Wikichesterdit, Canol, DocteurCosmos, CanOfWorms, Daltxn, Deebz86, RaseaC, Brianga, Wwwww 1999, BillGus, SieBot, Yintan, Juzaf, Oxyoron83, Liverpool649, ClueBot, The Thing That Should Not Be, Niceguyedc, BodhisattvaBot, Paul Vernaza, ZooFari, Nikhilb239, Addbot, Ramu50, Captain-tucker, Technicalpic, Cst17, SamatBot, Numb03-bot, Peridon, Lightbot, OIEnglish, ScAvenger, Luckas-bot, Gyro Copter, Jordsan, Stebanoid, Rubinbot, Jim1138, Piano non troppo, Пика Пика, Qiudan1984, MaterialsScientist, Vuse4, Norkimes, Xqbot, J JMesserly, Zhangzhe0101, Nedim Ardoğa, Cruiserbmw, Sae1962, LittleWink, Strenshon, Mikespedia, Akkida, Cyril8, Jauhienij, SchreyP, Bahnfreund, EmausBot, KurtLC, Wayne Slam, Sbmeirow, Styko, Marcelodin, MichelKopf, Mikhail Ryazanov, ClueBot NG, MelbourneStar, Snotbot, Clampower, Pragadeeshwaran.s, Calabe1992, Wbm1058, RA2OOOF, Altair, Trevayne08, IXYSGREEN, Sohil.agarwal, Mzharrison, Aloysius314, Sourishchandra, Telfordbuck, Magic33145, Cahhta, JaunJimenez and Anonymous: 220
- DIAC** *Source:* <http://en.wikipedia.org/wiki/DIAC?oldid=647571761> *Contributors:* Glenn, Andres, Omegatron, Stefan Heinzmann, Cyrius, Chowbok, Neutrality, Roo72, Martpol, Remuel, Hooperbloop, Rush3k, Atlant, Wtshymanski, Emvee, Kinema, The Lightning Stalker, Dermeister, David.Gaya, M7bot, Srleffler, YurikBot, Borgx, Hydrargyrum, Alynna Kasmira, Brandon, Tabby, Canley, SmackBot, Mattparko, Radagast83, SashatoBot, Soap, CyrilB, Wwlfie, Amalas, Tryforsure, Ilikefood, Pyrilium, Thijs!bot, BokicaK, Gdead, Behnam Ghiaseddin, MER-C, Lidnariq, R'n'B, Zuban42, VolkovBot, TXiKiBoT, CanOfWorms, Kbrose, Mgurunathan, Steven Zhang, ClueBot, 7, Addbot, Chamal N, Yobot, AnomieBOT, Kingpin13, Flewis, MaterialsScientist, LilHelpa, Xqbot, Bihco, RibotBOT, Nedim Ardoğa, Mfwitten, Chutznik, Milky.why, John of Reading, WikitanvirBot, Caspertheghost, Bkyahoo, Alirezabot, Iie151, JYBot, Frosty and Anonymous: 52
- Silicon-controlled rectifier** *Source:* <http://en.wikipedia.org/wiki/Silicon-controlled%20rectifier?oldid=651286607> *Contributors:* Rjstott, Maury Markowitz, Waveguy, Ronz, GRAHAMUK, Charles Matthews, Saltine, Taxman, Omegatron, Dcsohl, AnthonyQBachler, RedWolf, Giftlite, DavidCary, Micru, Vadmium, Grauw, Rich Farmbrough, Alistair1978, Dennis Brown, Smalljim, Duk, Hooperbloop, Alansohn, Atlant, Velella, Wtshymanski, Kinema, BillC, Triddle, MrSomeone, Chetandandgey, Wegsjac, BjKa, Krishnavedala, Gwernol, Fleet Pete, Phgao, Pstemari, Steveg, SmackBot, Hmains, JorgePeixoto, Chris the speller, EncMstr, Sbharris, Hgrosner, Trumpy, Microfrost, Squigish, Flyguy649, Zen611, Lpgeffen, DMacks, CyrilB, Beetstra, Fangfufu, Ace Frahm, Thogo, Avant Guard, Kchambers, Hanspi, Gordongoude, KOKIKOKI HTI, Dancter, WillMak050389, AntiVandalBot, Divitachawda, Magioladitis, JWGreen, Bothar, Bzero, Matt B., R'n'B, J.delanoy, Philip Trueman, Msdaif, Qxz, Gbuchana, Jackfork, Daltxn, Tomaxer, Quantpole, AHMartin, Biscuitin, Caltas, Saladas, ImageRemovalBot, MenoBot, Wdwd, ClueBot, The Thing That Should Not Be, JanInad, Mild Bill Hiccup, Yamazaki-kun, SpikeToronto, Zootboy, Versus22, Ginbot86, Avoided, Addbot, CanadianLinuxUser, Tongue and Groove, West.andrew.g, Lightbot, Snaily, Yobot, Gobbleswogglor, P1ayer, SwisterTwister, AnomieBOT, Jim1138, Harzem, Athabaska-Clearwater, Jmundo, Akashvedi, Zhangzhe0101, Nedim Ardoğa, Thematis, Chongkian, Shadowjams, I dream of horses, Niravadave0192, TimothyDexter, Reaper Eternal, KurtLC, Super48paul, Qrsdogg, Your Lord and Master, John Cline, Anirluph, Ccrome, Mpcanuz, Tolly4bolly, Sbmeirow, Mostafa.naghedi, Rmashhadi, Marcelodin, Xanchester, ClueBot NG, Satellizer, Clampower, Argha.hazra, Who.was.phone, Stingray225, Darknitesh, IXYSGREEN, Ekren, Frosty, MRDISABLED, Drekomani, Yammahi1991, JaunJimenez, Johnmasihabbishek, TheCoffeeAddict and Anonymous: 232

4.8.2 Images

- File:Commons-logo.svg** *Source:* <http://upload.wikimedia.org/wikipedia/en/4/4a/Commons-logo.svg> *License:* ? *Contributors:* ? *Original artist:* ?
- File:D3capas_sym.PNG** *Source:* http://upload.wikimedia.org/wikipedia/commons/b/b6/D3capas_sym.PNG *License:* Public domain *Contributors:* Own work *Original artist:* Antonio Pedreira
- File:Diac.svg** *Source:* <http://upload.wikimedia.org/wikipedia/commons/8/81/Diac.svg> *License:* Public domain *Contributors:* ? *Original artist:* ?
- File:Diacgraph.png** *Source:* <http://upload.wikimedia.org/wikipedia/commons/8/8b/Diacgraph.png> *License:* Public domain *Contributors:* Transferred from en.wikipedia Transfer was stated to be made by User:Multichill. *Original artist:* Original uploader was Lidnariq at en.wikipedia

- **File:Kennlinie_DIAC.svg** *Source:* http://upload.wikimedia.org/wikipedia/commons/1/14/Kennlinie_DIAC.svg *License:* CC BY 3.0 *Contributors:* Own work *Original artist:* wdw
- **File:LASCRsymbol.png** *Source:* <http://upload.wikimedia.org/wikipedia/en/6/6a/LASCRsymbol.png> *License:* CC-BY-3.0 *Contributors:* ? *Original artist:* ?
- **File:Manitoba_Hydro-BipoleII_Valve.jpg** *Source:* http://upload.wikimedia.org/wikipedia/commons/1/1c/Manitoba_Hydro-BipoleII_Valve.jpg *License:* Public domain *Contributors:* Own work *Original artist:* Original uploader was Wtshymanski at en.wikipedia
- **File:Nelson_Bipole_Thyristors.jpg** *Source:* http://upload.wikimedia.org/wikipedia/commons/3/34/Nelson_Bipole_Thyristors.jpg *License:* Public domain *Contributors:* Transferred from en.wikipedia; transferred to Commons by User:J JMesserly using CommonsHelper. *Original artist:* Original uploader was Wtshymanski at en.wikipedia
- **File:Nuvola_apps_ksim.png** *Source:* http://upload.wikimedia.org/wikipedia/commons/8/8d/Nuvola_apps_ksim.png *License:* LGPL *Contributors:* <http://icon-king.com> *Original artist:* David Vignoni / ICON KING
- **File:Regulated_rectifier.gif** *Source:* http://upload.wikimedia.org/wikipedia/commons/0/07/Regulated_rectifier.gif *License:* CC-BY-SA-3.0 *Contributors:* ? *Original artist:* ?
- **File:SCR.JPG** *Source:* <http://upload.wikimedia.org/wikipedia/commons/d/d1/SCR.JPG> *License:* Public domain *Contributors:* Own work *Original artist:* Antonio Pedreira
- **File:SCR1369.jpg** *Source:* <http://upload.wikimedia.org/wikipedia/commons/5/56/SCR1369.jpg> *License:* CC-BY-SA-3.0 *Contributors:* ? *Original artist:* ?
- **File:SIDAC.gif** *Source:* <http://upload.wikimedia.org/wikipedia/en/6/6d/SIDAC.gif> *License:* PD *Contributors:* ? *Original artist:* ?
- **File:TRIAC_Equivalent_Circuit.png** *Source:* http://upload.wikimedia.org/wikipedia/en/e/e9/TRIAC_Equivalent_Circuit.png *License:* CC-BY-SA-3.0 *Contributors:* Circuit created in gEDA
Previously published: www.turbo-electric.com as part of the Mass-EV electric car project.
Original artist: Grahamatwp
- **File:Thyristor.svg** *Source:* <http://upload.wikimedia.org/wikipedia/commons/c/c5/Thyristor.svg> *License:* CC-BY-SA-3.0 *Contributors:* ? *Original artist:* ?
- **File:Thyristor_I-V_diagram.svg** *Source:* http://upload.wikimedia.org/wikipedia/commons/f/f1/Thyristor_I-V_diagram.svg *License:* Public domain *Contributors:* Own work *Original artist:* Mikhail Ryazanov
- **File:Thyristor_circuit_symbol.svg** *Source:* http://upload.wikimedia.org/wikipedia/commons/9/93/Thyristor_circuit_symbol.svg *License:* CC-BY-SA-3.0 *Contributors:* Own work *Original artist:* Rifleman
- **File:Thyristor_layers.svg** *Source:* http://upload.wikimedia.org/wikipedia/commons/c/c2/Thyristor_layers.svg *License:* CC-BY-SA-3.0 *Contributors:* ? *Original artist:* ?
- **File:Triac.svg** *Source:* <http://upload.wikimedia.org/wikipedia/commons/d/d1/Triac.svg> *License:* Public domain *Contributors:* ? *Original artist:* ?
- **File:Triac_Quad_I.svg** *Source:* http://upload.wikimedia.org/wikipedia/commons/f/f9/Triac_Quad_I.svg *License:* CC0 *Contributors:* Own work *Original artist:* Krishnavedala
- **File:Triac_Quad_II.svg** *Source:* http://upload.wikimedia.org/wikipedia/commons/f/f6/Triac_Quad_II.svg *License:* CC BY-SA 3.0 *Contributors:* http://en.wikipedia.org/wiki/File:Triac_Quad_II.JPG *Original artist:* User:Vitaltrust
- **File:Triac_Quad_III.svg** *Source:* http://upload.wikimedia.org/wikipedia/commons/b/bd/Triac_Quad_III.svg *License:* CC BY-SA 3.0 *Contributors:* en.wikipedia.org/wiki/File:Triac_Quad_III.JPG *Original artist:* User:Vitaltrust
- **File:Triac_Quad_IV.svg** *Source:* http://upload.wikimedia.org/wikipedia/commons/d/d9/Triac_Quad_IV.svg *License:* CC BY-SA 3.0 *Contributors:* http://en.wikipedia.org/wiki/File:Triac_Quad_IV.JPG *Original artist:* User:Vitaltrust
- **File:Triac_Quad_I_like_SCR.JPG** *Source:* http://upload.wikimedia.org/wikipedia/commons/8/81/Triac_Quad_I_like_SCR.JPG *License:* CC0 *Contributors:* Own work *Original artist:* Vitaltrust
- **File:Triac_funktion.gif** *Source:* http://upload.wikimedia.org/wikipedia/commons/3/3b/Triac_funktion.gif *License:* GFDL *Contributors:* Transferred from de.wikipedia to Commons by User:Wdw using CommonsHelper. *Original artist:* Stefan Riepl (Quark48). Quark48 at de.wikipedia
- **File:Triac_structure.svg** *Source:* http://upload.wikimedia.org/wikipedia/commons/6/68/Triac_structure.svg *License:* CC0 *Contributors:* Own work *Original artist:* Krishnavedala
- **File:Wiktionary-logo-en.svg** *Source:* <http://upload.wikimedia.org/wikipedia/commons/f/f8/Wiktionary-logo-en.svg> *License:* Public domain *Contributors:* Vector version of Image:Wiktionary-logo-en.png. *Original artist:* Vectorized by Fvasconcellos (talk · contribs), based on original logo tossed together by Brion Vibber

4.8.3 Content license

- Creative Commons Attribution-Share Alike 3.0