

UNITED STATES
DEPARTMENT OF
COMMERCE
PUBLICATION



NBS TECHNICAL NOTE 579

Testing of Cover Glasses for Hemocytometer Chambers

**U.S.
DEPARTMENT
OF
COMMERCE**

National
Bureau
of
Standards

579
71
12

NATIONAL BUREAU OF STANDARDS

The National Bureau of Standards¹ was established by an act of Congress March 3, 1901. The Bureau's overall goal is to strengthen and advance the Nation's science and technology and facilitate their effective application for public benefit. To this end, the Bureau conducts research and provides: (1) a basis for the Nation's physical measurement system, (2) scientific and technological services for industry and government, (3) a technical basis for equity in trade, and (4) technical services to promote public safety. The Bureau consists of the Institute for Basic Standards, the Institute for Materials Research, the Institute for Applied Technology, the Center for Computer Sciences and Technology, and the Office for Information Programs.

THE INSTITUTE FOR BASIC STANDARDS provides the central basis within the United States of a complete and consistent system of physical measurement; coordinates that system with measurement systems of other nations; and furnishes essential services leading to accurate and uniform physical measurements throughout the Nation's scientific community, industry, and commerce. The Institute consists of a Center for Radiation Research, an Office of Measurement Services and the following divisions:

Applied Mathematics—Electricity—Heat—Mechanics—Optical Physics—Linac Radiation²—Nuclear Radiation²—Applied Radiation²—Quantum Electronics³—Electromagnetics³—Time and Frequency³—Laboratory Astrophysics³—Cryogenics³.

THE INSTITUTE FOR MATERIALS RESEARCH conducts materials research leading to improved methods of measurement, standards, and data on the properties of well-characterized materials needed by industry, commerce, educational institutions, and Government; provides advisory and research services to other Government agencies; and develops, produces, and distributes standard reference materials. The Institute consists of the Office of Standard Reference Materials and the following divisions:

Analytical Chemistry—Polymers—Metallurgy—Inorganic Materials—Reactor Radiation—Physical Chemistry.

THE INSTITUTE FOR APPLIED TECHNOLOGY provides technical services to promote the use of available technology and to facilitate technological innovation in industry and Government; cooperates with public and private organizations leading to the development of technological standards (including mandatory safety standards), codes and methods of test; and provides technical advice and services to Government agencies upon request. The Institute also monitors NBS engineering standards activities and provides liaison between NBS and national and international engineering standards bodies. The Institute consists of the following technical divisions and offices:

Engineering Standards Services—Weights and Measures—Flammable Fabrics—Invention and Innovation—Vehicle Systems Research—Product Evaluation Technology—Building Research—Electronic Technology—Technical Analysis—Measurement Engineering.

THE CENTER FOR COMPUTER SCIENCES AND TECHNOLOGY conducts research and provides technical services designed to aid Government agencies in improving cost effectiveness in the conduct of their programs through the selection, acquisition, and effective utilization of automatic data processing equipment; and serves as the principal focus within the executive branch for the development of Federal standards for automatic data processing equipment, techniques, and computer languages. The Center consists of the following offices and divisions:

Information Processing Standards—Computer Information—Computer Services—Systems Development—Information Processing Technology.

THE OFFICE FOR INFORMATION PROGRAMS promotes optimum dissemination and accessibility of scientific information generated within NBS and other agencies of the Federal Government; promotes the development of the National Standard Reference Data System and a system of information analysis centers dealing with the broader aspects of the National Measurement System; provides appropriate services to ensure that the NBS staff has optimum accessibility to the scientific information of the world, and directs the public information activities of the Bureau. The Office consists of the following organizational units:

Office of Standard Reference Data—Office of Technical Information and Publications—Library—Office of Public Information—Office of International Relations.

¹ Headquarters and Laboratories at Gaithersburg, Maryland, unless otherwise noted; mailing address Washington, D.C. 20234.

² Part of the Center for Radiation Research.

³ Located at Boulder, Colorado 80302.

OCT 20 1971

Not 579
4-1971
15752
971
by 2.

UNITED STATES DEPARTMENT OF COMMERCE
Maurice H. Stans, Secretary
NATIONAL BUREAU OF STANDARDS • Lewis M. Branscomb, Director



TECHNICAL NOTE 579

ISSUED SEPTEMBER 1971

Nat. Bur. Stand. (U.S.), Tech. Note 579, 7 pages (Sept. 1971)

CODEN: NBTNA

Testing of Cover Glasses for Hemocytometer Chambers

John S. Beers

Optical Physics Division
Institute for Basic Standards
National Bureau of Standards
Washington, D.C. 20234



NBS Technical Notes are designed to supplement the Bureau's regular publications program. They provide a means for making available scientific data that are of transient or limited interest. Technical Notes may be listed or referred to in the open literature.

CONTENTS

	Page
Introduction	1
Specification for Planarity	1
Test for Planarity	2
Equipment	2
Procedure in Testing	3
Interpretation of the Fringe System	3
General Rule for Counting Fringes	4
Prevention of Distortion	4
Determination of Limits	4
Availability of Additional Information	4
Appendix – An Alternate Interferometer	5

Testing of Cover Glasses For Hemacytometer Chambers

John S. Beers

If cover glasses used with hemacytometer chambers are not sufficiently flat, a volume error, causing erroneous blood cell counts, may be introduced in the chamber. This document describes a method of testing cover glasses for conformity to a planarity specification.

Keywords: Cover glass, test method for; hemacytometer; interferometry; planarity.

Introduction

A typical hemacytometer, figure 1, is a single piece of glass approximately 7 centimeters long, 3.5 centimeters wide and 0.5 centimeter thick. Four transverse grooves are cut in the glass as shown in the side view leaving three raised lands. A longitudinal groove bisects the center land and the two center lands thus created are ground down, lapped optically flat, and a 1 millimeter square ruled on each. The two lands adjacent to the ruled areas form the cover glass supporting surfaces. They are ground down so their upper surfaces lie in a plane precisely 0.1 millimeter above the ruled areas. Blood, accurately diluted in a pipette, is introduced into the chamber between the cover glass and the ruled surface, and the number of corpuscles present in the 0.1 cubic millimeter volume bounded by

the cover glass and the 1 millimeter square ruling are counted with the aid of a microscope.

An important dimension in a hemacytometer chamber is the depth from the plane of the surfaces supporting the cover glass to the plane of the ruled surface, measured at the center of the ruling. If the cover glass used with the chamber has a curved surface, the portion of the cover glass directly over the center of the rulings will not, in general, coincide with the plane of the supporting surfaces. Hence, a volume error is introduced in the chamber. The planarity specification for cover glasses limits one aspect of the volume error of chambers when in use. The purpose of this document is to describe a method for testing cover glass planarity. This method used at the National Bureau of Standards has proven to be practical, relatively simple, and accurate enough for its purpose.

Specification for Planarity

The specification for hemacytometer cover glasses, reproduced here, was established at the National Bureau of Standards many years ago and was incorporated into Federal Specification DD-G-426. Technological advances have substantially reduced the use of hemacytometer chambers. However, those that are used should meet the specifications. While the specification refers to the National Bureau of Standards precision seal to be marked on items which comply, this practice is only in effect for each chamber and its two accompanying cover glasses tested at NBS. Testing large groups of cover glasses was discontinued at NBS several years ago because manufacturers or inspection facilities can easily perform this sorting operation. Those who test cover glasses should state that procedures described in this document were followed.

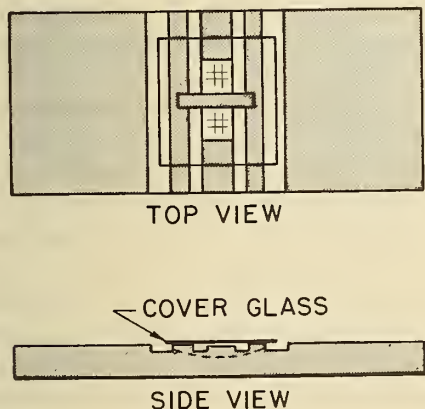

FIGURE 1. HEMACYTOMETER & COVER GLASS

SPECIFICATIONS FOR HAEMACYTOMETER CHAMBERS AND COVER GLASSES

CHAMBERS

1. The glass and the ruling of the chamber shall be free from visible defects interfering with the accurate use of the chamber.

2. The chamber shall be of the one-piece or solid type in which both the cover-glass supports and the ruled surfaces are integral with the glass slide.

3. The chamber shall be fully, correctly, and permanently marked on the glass slide with the nominal depth and either the name of the type or ruling or the area of the smallest squares, also the name of the manufacturer or responsible distributor.

4. The error in the depth of a chamber from the plane of the supporting surfaces for the cover glass to the ruled area shall not exceed plus or minus 2 percent (± 0.002 mm) for a chamber having a nominal depth of 0.1 mm, and ± 0.004 mm for one having a nominal depth of 0.2 mm). In the case of a chamber having a nominal depth of 0.020 mm, the error in depth shall not exceed plus or minus 5 percent (± 0.001 mm).

5. The error in the length of any side of a central 1-mm ruling shall not exceed plus or minus 1 percent (± 0.01 mm). In the case of a ruling not having a central 1-mm ruling, the error in the length of any side of each of the

1-mm squares of which it is composed shall not exceed plus or minus 1 percent (± 0.01 mm). In the case of any ruling not having a central 1-mm ruling and not subdivided into 1-mm squares, the error in the length of any side shall not exceed plus or minus 1 percent.

PLAIN COVER GLASSES

Cover glasses shall be free from visible defects and shall be plane on both sides within 0.002 mm.

REINFORCED COVER GLASSES

Reinforced cover glasses shall be free from visible defects and shall be plane within 0.002 mm over the entire side not having the reinforcement.

PRECISION SEAL

Each haemocytometer chamber and each cover glass which on test is found to pass the specifications is marked with a National Bureau of Standards precision seal. A polished surface on each slide suitable for the precision seal about 5 mm in diameter is desirable.

SERIAL NUMBER

It is recommended that each slide bear a permanent serial number.

NBS Form 80, Aug. 1, 1941

16-23908-1 GPO

Test for Planarity

Planarity testing of cover glasses uses the interference of light waves. The interference fringes produced when the cover glass is in contact with an optical flat and illuminated by quasi-monochromatic light are evaluated to determine acceptability. The cover glass surface being tested is the one in contact with the optical flat. A spectral light source is used having an intense radiation at one wavelength that predominates over the other radiations. Each of the two sides of the cover glass is tested in turn. The observed interference fringes represent contour lines on the cover glass surface in a manner similar to the contour lines on a topographic map.

Equipment

The following equipment is needed:

- (1) several optical flats
- (2) a monochromatic light source with power supply
- (3) a suitable housing for the above.

It is necessary to have at least three optical flats. Flats become scratched by burrs or sharp edges on the cover glasses and one or more reserves are needed.

Although glass optical flats can be used, those made of fused quartz do not scratch as easily. Flats 7 to 10 centimeters in diameter are a convenient size. Flatness within one fringe for the full diameter is sufficient for this work. With this degree of planarity over the whole surface the error over an area equal to that of a cover glass is negligible. A further advantage of having at least three optical flats is that their planarity can be verified. Two flats placed face to face and illuminated by quasi-monochromatic light should produce a set of parallel fringes. The curvature of these fringes is the measure of planarity. The third flat is then compared with each of the first two to eliminate the possibility that the first comparison involved two surfaces of equal but opposite curvature, a condition which would produce straight, equally spaced fringes because points along any single fringe are points of equal separation between the two faces being tested. A helium discharge tube is often used, however, a mercury discharge tube is equally useful. In either case the lamp can be operated from the usual 115V a.c. line by means of a transformer. The interference fringes should be viewed approximately perpendicular to the optical flat, that is, very nearly in a vertical direction, and a fairly uniform illumination is desirable over the cover glass surface. A housing similar to that shown in figure 2 will provide

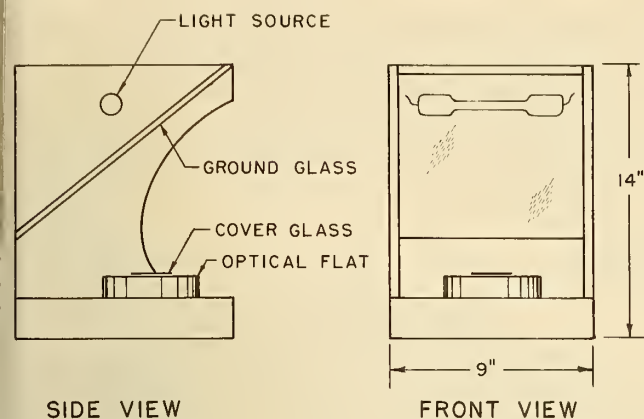

FIGURE 2

these conditions. Some optical supply houses and precision tool manufacturers carry suitable equipment for this test, and it may be unnecessary to construct a housing. For example, equipment for flatness testing of gage blocks can be used.

Procedure in Testing

(1) Cleanliness is of utmost importance. Clean the cover glass and the optical flat with alcohol, and dry with soft, lint free paper toweling or cloth.

(2) Dust the flat and cover glass with a camel's hair brush.

(3) Place the cover glass on the optical flat. A thin film of air is formed between them and a system of interference fringes will be seen through the cover glass.

(4) Move the cover glass around under light vertical pressure until the fringe system is approximately symmetrical. Count and evaluate the fringes as described below under sections headed "General Rule for Counting Fringes" and "Determination of Limits."

(5) Turn the cover glass over and repeat the process.

Interpretation of the Fringe System

(1) A series of fringes, parallel and very nearly equally spaced, indicates a wedge-shaped film of air between the flat and the cover glass, the apex of the wedge being parallel to the fringes. In figure 3, the apex could be at the upper left or lower right corner. If only a few of these parallel fringes are present, eight or less, the cover glass side in contact with the optical flat is sufficiently plane. Otherwise, move the cover glass around to see if the number of fringes can be reduced. Brush again, if necessary, to remove dust particles.

(2) A series of concentric circles indicates that the surface being tested is a portion of a sphere, the curved

surface being either convex or concave (figs. 4 and 5). When such a fringe system is seen, the cover glass should, in preparation for counting, be moved around until the fringe system is approximately symmetrical about the center of the cover glass.

(3) A series of curved fringes, resembling families of hyperbolas, represents some sort of saddle-shaped surface (fig. 6). Again the cover glass should be moved around until the best symmetry about the cover glass center is attained.

(4) A series of parallel fringes unequally spaced but symmetrical with respect to one of the fringes indicates a portion of a cylindrical surface, but this is seldom seen in the testing of cover glasses (fig. 7).

(5) A complex fringe system with many closely spaced fringes along one or more edges or corners but not extending into the central portion of the cover glass indicates either a raised or a rounded edge (fig. 8). Such

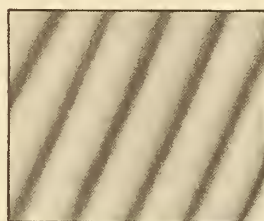

Fig. 3

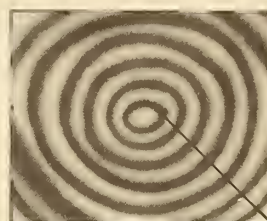

Fig. 4

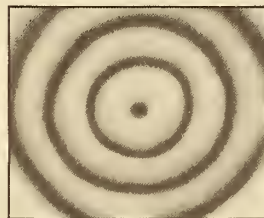

Fig. 5

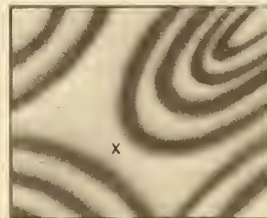

Fig. 6

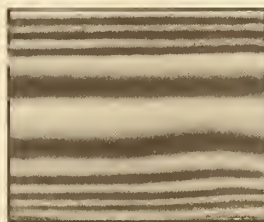

Fig. 7

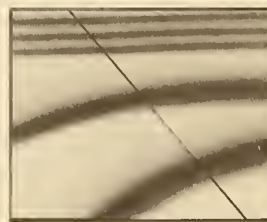

Fig. 8

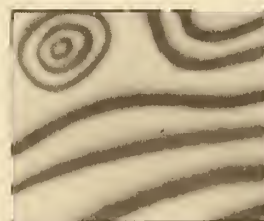

Fig. 9

a condition should be investigated carefully because the optical flat can be very quickly scratched if the edge is raised. Often the presence of the raised edge can be detected by the fingernail. A cover glass with a raised edge should be rejected. Also any cover glass with nicks along the edge should be discarded because particles of glass may come out of the nicked edge and scratch the optical flat or the hemacytometer chamber. A simple rule for checking in such cases is that fringes will move toward a "high" spot on a cover glass surface when pressure is applied at that point. If the edge is rounded rather than raised and is limited to a distance of about 1 millimeter, this effect is negligible as far as accuracy in use is concerned.

(6) A complex fringe system of parallel lines, circles, and hyperbolas means that the surface is not a simple geometrical shape (fig. 9). Its departure from planarity can, however, be estimated according to the general rule for counting.

General Rule for Counting Fringes

The general rule is to count fringes along a line approximately tangent to the center fringe in a direction to cut the largest number of fringes. This will usually be from the center toward one corner (fig. 4). If symmetry cannot be attained by trial and further dusting then the fringes must be counted in both directions along collinear lines from the pattern center and then averaged (fig. 6, with center at X). If the fringe system center is outside the cover glass area count the fringes along a line cutting the greatest number of fringes (fig. 8).

Prevention of Distortion

When moving the cover glass around on the optical flat, be careful not to exert pressure that will distort by

"wringing" the cover glass to the flat. This condition can be detected by a tendency of the cover glass to stick to the flat. Wringing distortion can be avoided by insuring that the cover glass slides easily. Keeping the cover glasses and flats completely dry will also minimize this effect.

Determination of Limits

The effective wavelength of helium light is the yellow 0.588 micrometer spectral line, and for mercury light it is the green 0.546 micrometer line. Therefore, in passing from one fringe to the next, there is a difference in separation of the surfaces of $1/2$ of $.0588 = 0.294$ micrometer with helium light, and $1/2$ of $0.546 = 0.273$ micrometer with mercury light. A tolerance of 2 micrometers is equivalent to $2/0.294$ or $2/0.273 = 7$ fringes. Hence, using the procedure outlined above, whenever more than 7 fringes are intersected along a tangent to a centrally located symmetrical fringe system, counting only between the center and the edge or corner, the cover glass should be rejected. If the fringe system is not symmetrical, count in both directions along a single straight line through the system center, and divide the total by two. The limiting number of fringes for the quotient is again 7.

Availability of Additional Information

The National Bureau of Standards will, on request, furnish information about sources of supply for the necessary equipment, or any other information that may be required.

Appendix

An Alternate Interferometer

A modification of the apparatus for cover glass testing is shown in figure 10. Scratching of optical flats is eliminated in this interferometer by supporting the cover glass on three matched steel spheres cemented to the optical flat in a triangular configuration. The two lenses cause light coming through the entrance aperture to fill a 5-centimeter circle on the optical flat. The plate glass and plate glass mirror allow viewing the

fringes in a perpendicular direction to the optical flat. Two fringe patterns are often seen when inspecting a cover glass in this interferometer. One of these patterns results from interference between the two faces of the cover glass and can be identified as the pattern that remains when a slip of paper is inserted between the cover glass and the optical flat. The pattern formed between the bottom cover glass face and the optical flat is the only one read.

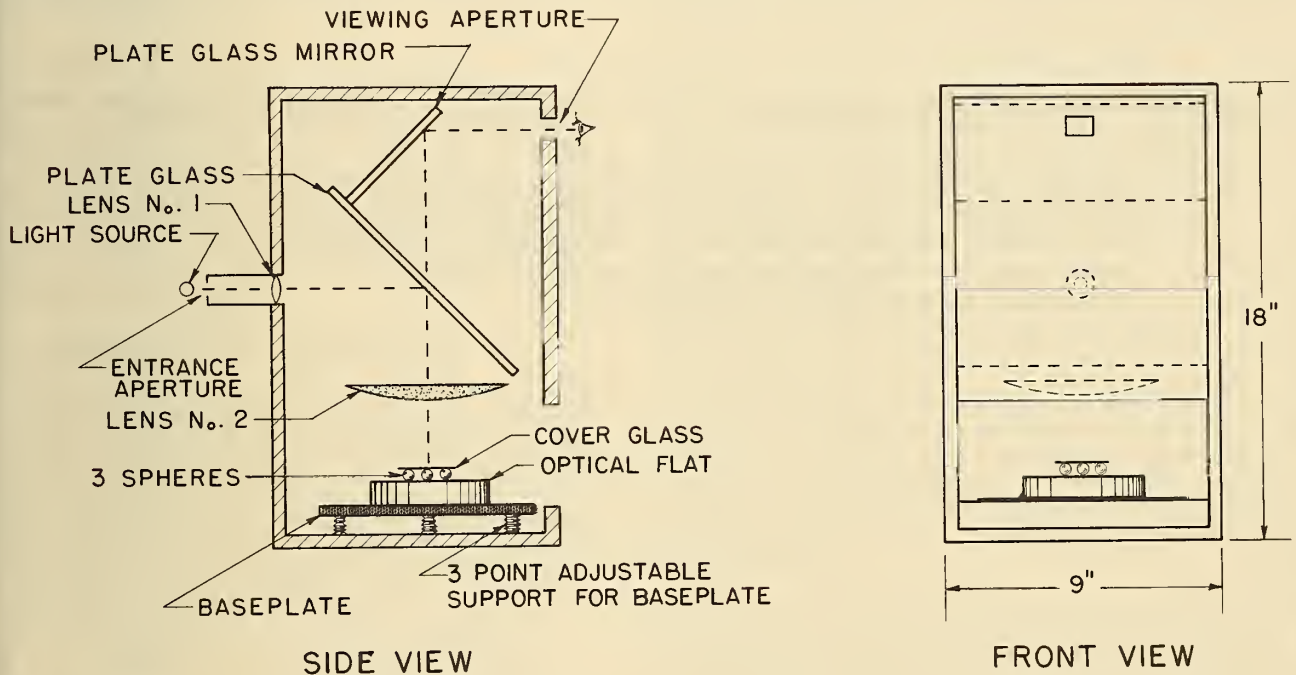

FIGURE 10

U.S. DEPT. OF COMM. BIBLIOGRAPHIC DATA SHEET	1. PUBLICATION OR REPORT NO. NBS-TN-579	2. Gov't Accession No.	3. Recipient's Accession No.
4. TITLE AND SUBTITLE Testing of Cover Glasses for Hemacytometer Chambers		5. Publication Date September 1971	
		6. Performing Organization Code	
7. AUTHOR(S) John S. Beers		8. Performing Organization	
9. PERFORMING ORGANIZATION NAME AND ADDRESS NATIONAL BUREAU OF STANDARDS DEPARTMENT OF COMMERCE WASHINGTON, D.C. 20234		10. Project/Task/Work Unit No. 2320190	
		11. Contract/Grant No.	
12. Sponsoring Organization Name and Address		13. Type of Report & Period Covered Final	
		14. Sponsoring Agency Code	
15. SUPPLEMENTARY NOTES			
<p>16. ABSTRACT (A 200-word or less factual summary of most significant information. If document includes a significant bibliography or literature survey, mention it here.)</p> <p>If cover glasses used with hemacytometer chambers are not sufficiently flat, a volume error, causing erroneous blood cell counts, may be introduced in the chamber. This document describes a method of testing cover glasses for conformity to a planarity specification.</p>			
<p>17. KEY WORDS (Alphabetical order, separated by semicolons)</p> <p>Cover glass, test method for; hemacytometer; interferometry, planarity.</p>			
<p>18. AVAILABILITY STATEMENT</p> <p><input checked="" type="checkbox"/> UNLIMITED.</p> <p><input type="checkbox"/> FOR OFFICIAL DISTRIBUTION. DO NOT RELEASE TO NTIS.</p>		<p>19. SECURITY CLASS (THIS REPORT)</p> <p>UNCLASSIFIED</p>	<p>21. NO. OF PAGES</p> <p>7</p>
		<p>20. SECURITY CLASS (THIS PAGE)</p> <p>UNCLASSIFIED</p>	<p>22. Price</p> <p>20 cents</p>

NBS TECHNICAL PUBLICATIONS

PERIODICALS

JOURNAL OF RESEARCH reports National Bureau of Standards research and development in physics, mathematics, chemistry, and engineering. Comprehensive scientific papers give complete details of the work, including laboratory data, experimental procedures, and theoretical and mathematical analyses. Illustrated with photographs, drawings, and charts.

Published in three sections, available separately:

● Physics and Chemistry

Papers of interest primarily to scientists working in these fields. This section covers a broad range of physical and chemical research, with major emphasis on standards of physical measurement, fundamental constants, and properties of matter. Issued six times a year. Annual subscription: Domestic, \$9.50; foreign, \$11.75*.

● Mathematical Sciences

Studies and compilations designed mainly for the mathematician and theoretical physicist. Topics in mathematical statistics, theory of experiment design, numerical analysis, theoretical physics and chemistry, logical design and programming of computers and computer systems. Short numerical tables. Issued quarterly. Annual subscription: Domestic, \$5.00; foreign, \$6.25*.

● Engineering and Instrumentation

Reporting results of interest chiefly to the engineer and the applied scientist. This section includes many of the new developments in instrumentation resulting from the Bureau's work in physical measurement, data processing, and development of test methods. It will also cover some of the work in acoustics, applied mechanics, building research, and cryogenic engineering. Issued quarterly. Annual subscription: Domestic, \$5.00; foreign, \$6.25*.

TECHNICAL NEWS BULLETIN

The best single source of information concerning the Bureau's research, developmental, cooperative and publication activities, this monthly publication is designed for the industry-oriented individual whose daily work involves intimate contact with science and technology—for engineers, chemists, physicists, research managers, product-development managers, and company executives. Annual subscription: Domestic, \$3.00; foreign, \$4.00*.

* Difference in price is due to extra cost of foreign mailing.

Order NBS publications from:

Superintendent of Documents
Government Printing Office
Washington, D.C. 20402

NONPERIODICALS

Applied Mathematics Series. Mathematical tables, manuals, and studies.

Building Science Series. Research results, test methods, and performance criteria of building materials, components, systems, and structures.

Handbooks. Recommended codes of engineering and industrial practice (including safety codes) developed in cooperation with interested industries, professional organizations, and regulatory bodies.

Special Publications. Proceedings of NBS conferences, bibliographies, annual reports, wall charts, pamphlets, etc.

Monographs. Major contributions to the technical literature on various subjects related to the Bureau's scientific and technical activities.

National Standard Reference Data Series. NSRDS provides quantitative data on the physical and chemical properties of materials, compiled from the world's literature and critically evaluated.

Product Standards. Provide requirements for sizes, types, quality and methods for testing various industrial products. These standards are developed cooperatively with interested Government and industry groups and provide the basis for common understanding of product characteristics for both buyers and sellers. Their use is voluntary.

Technical Notes. This series consists of communications and reports (covering both other agency and NBS-sponsored work) of limited or transitory interest.

Federal Information Processing Standards Publications. This series is the official publication within the Federal Government for information on standards adopted and promulgated under the Public Law 89-306, and Bureau of the Budget Circular A-86 entitled, Standardization of Data Elements and Codes in Data Systems.

Consumer Information Series. Practical information, based on NBS research and experience, covering areas of interest to the consumer. Easily understandable language and illustrations provide useful background knowledge for shopping in today's technological marketplace.

NBS Special Publication 305, Supplement 1, Publications of the NBS, 1968-1969. When ordering, include Catalog No. C13.10:305. Price \$4.50; foreign, \$5.75.

U.S. DEPARTMENT OF COMMERCE
National Bureau of Standards
Washington, D.C. 20234

OFFICIAL BUSINESS

Penalty for Private Use, \$300

POSTAGE AND FEES PAID
U.S. DEPARTMENT OF COMMERCE



