

SHOP WORK

JOINERY
-
CABINET.
MAKING
-
CARPENTRY



RUSCH-CONWAY



Class TT 185

Book .R85

Copyright N^o _____

COPYRIGHT DEPOSIT



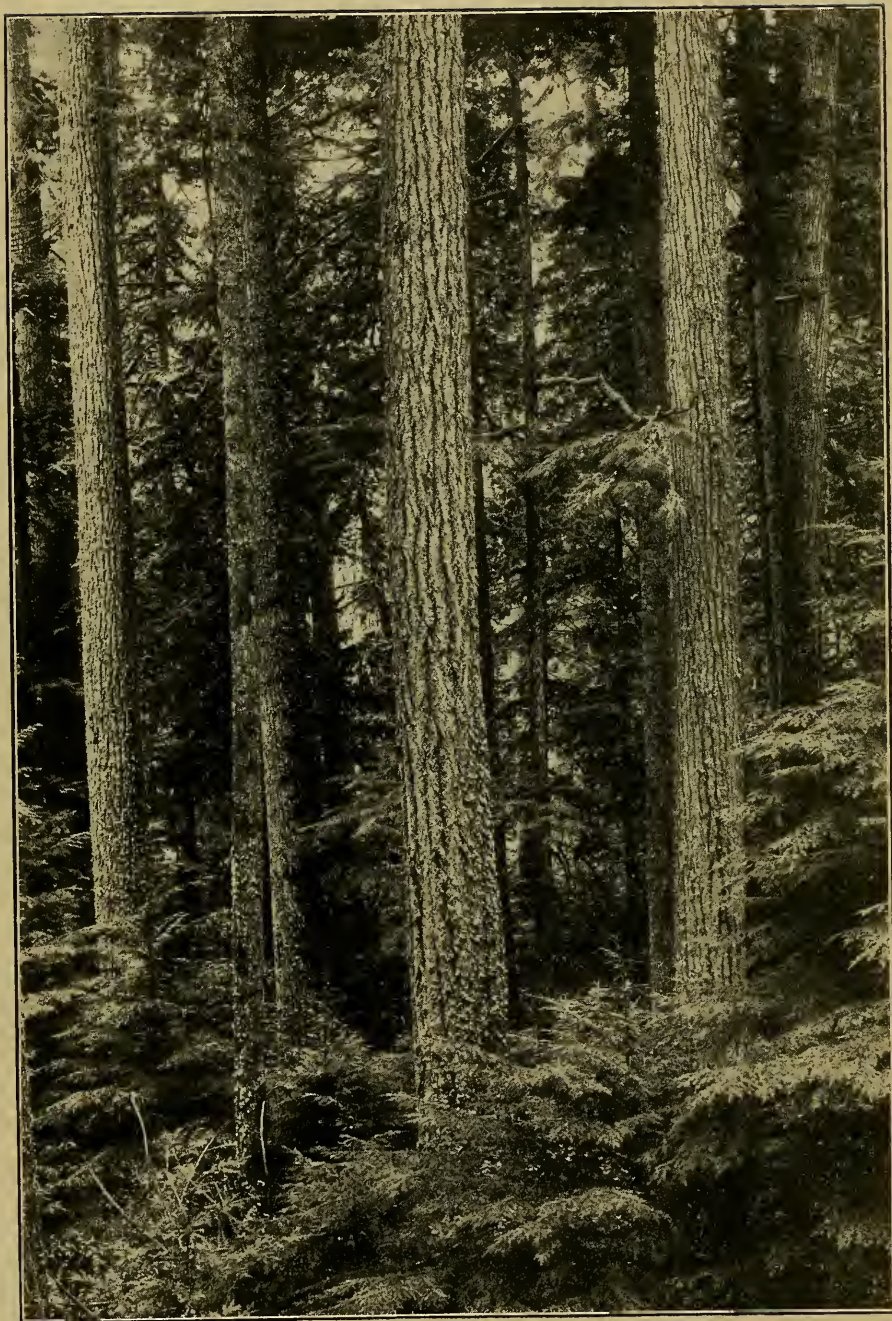

HEAVY STAND OF RED FIR WITH HEMLOCK UNDERGROWTH, PIERCE COUNTY, WASH.

SHOP WORK

Joinery — Cabinet-Making — Carpentry

BY

HERMAN F. RUSCH

*Director of Manual Training,
Oklahoma City, Okla.*

AND

CLAUD CARLTON CONWAY

*Director of Iron Work,
Oklahoma City High School, Oklahoma*



INDUSTRIAL BOOK & EQUIPMENT COMPANY,

INDIANAPOLIS

1918

TT185
A85

COPYRIGHT 1918

By

INDUSTRIAL BOOK & EQUIPMENT COMPANY,
Indianapolis.

OCT -7 1918

18-20528

©CLA503728

no 1

INDUSTRIAL AND VOCATIONAL TEXTS

BEING A SERIES OF TEXT-BOOKS DESIGNED FOR
USE IN THE ELEMENTARY AND SECONDARY
SCHOOLS, COLLEGES AND ACADEMIES OFFERING
COURSES OF INSTRUCTION IN THE TRADES, CRAFTS,
WAGE-EARNING PURSUITS AND HOME ECONOMICS.

Edited By

CHARLES KETTLEBOROUGH, PH. D.
Director, Indiana Legislative Bureau.

EDITOR'S PREFACE

The importance of industrial and vocational training has long since been recognized by the leading educators of the country and has now been formally installed in the public schools by the necessary statutory action of the federal government and most of the states. Its necessity has been emphasized and its introduction greatly facilitated by the acute exigencies produced by the World War. In the period of reconstruction and re-adjustment following the war, the amplification of courses of vocational instruction will doubtless be greatly accelerated. The complete and successful fruition of industrial training has been somewhat retarded by a lack of satisfactory scientific texts and other indispensable instrumentalities. In offering this series to the public, it is the confident belief of the editor that a rational approach to a knowledge of the fundamental principles and technique of the various trades, crafts and industrial pursuits will be afforded. This text, which is a treatise on shop work in its various aspects, has been compiled by Herman F. Rusch and Claud Carlton Conway. Both authors possess an accurate scientific knowledge of the principles of cabinet-making, carpentry and joinery, to which has been added extensive experience in the application of these principles to practical work, supplemented by a working knowledge of the most approved methods of imparting information to students. This treatise is put forth as the first of a series of texts dealing with industrial and vocational subjects in the confident belief that it will prove successful as a working manual in the subject to which it is devoted.

THE EDITOR.

AUTHORS' PREFACE

This book is the outgrowth of eighteen years of teaching in high schools and many more spent in practical construction work, in wood and iron, before our affiliation with industrial school work began. It consists of a compilation of such notes and lectures as we believe are important to the wood-worker. It is not intended in any way to supplant any of the work at the bench, but is designed to be used in connection with bench work to enable the student to approach his work more intelligently. The book is not designed as a self-instructor, but as a student's text to be used by the teacher, just as he would use a text in mathematics. To secure the best results in the use of any text, supplementary work must be done, and wood-working is no exception to the rule.

The work presented in this text is so designed as to require two years, working two hours per day, in its completion, and is intended as a ready reference for the pupil and the teacher. It will be observed that in this text cabinet-making follows joinery. It is not necessary that cabinet work should be taken before carpentry. If the student so desires, he may take either cabinet-making or carpentry or both, after he has finished joinery. All joint exercises should be worked out by the teacher in class demonstrations.

The following brief, synoptical analysis may be of service to the teacher in the development of the subject as a whole.

Part I deals exclusively with the tools used in manual training shops, and with illustrations relative to the correct positions. Chapter III, Development of a Project, is worthy of careful analysis, since it indicates a general method of approach and order of work, and since the constructive work involves the use of so many methods. Care must be taken that too many tools are not presented to the pupil at once. Do not take up the use of a new tool for the sake of the tool but for the sake of the exercise which calls for the use of that particular tool.

Part II outlines a course in bench work, beginning with a series of joints which are standard the world over. Just how many joints the pupil shall make is a matter the teacher himself must determine. They are arranged in an order such that there is a gradual rise from the simpler to the more difficult and complex joints. This continuity should be followed in the presentation. In this series of joints, the fundamentals of all joint construction, whether they are in cabinet-making, in common carpentry, or in bridge building, will be found. The extended list of suggested projects for construction should prove of

great value to the instructor. Just enough is presented on each project to start the student in its development.

Part III consists of a series of talks which cover a wide field in practical tool usage, and which present many other things of vital importance to the artisan. It gives information which may be applied daily by the mechanic. These talks should be taken up, not necessarily in the order given, but in the order best suited to the teacher's own course. For example, a demonstration is given on how to sharpen a plane iron. It would naturally follow that this would be the proper time to present the talk on "Abrasives"; or if the first lesson on sandpapering is before the class, the talk on "Sandpaper" should be given.

Part IV deals with miscellaneous topics as applied to shop work. The questions should be given in class, in oral recitations, so that each pupil may familiarize himself with the technical terms. The problems may be assigned for work outside of recitation, and others may be substituted to embody certain features of the pupil's own exercise under construction.

The glossary is intended for the use of those who are not familiar with certain technical terms and phrases.

There is no special reason for numbering the Blue Prints as they are, beginning with 400. It will be observed that the number of illustrative Figures is just under three hundred. To avoid duplication in numbering and to facilitate the location of the cuts, figures and drawings referred to were the only considerations observed in assigning numbers beginning with 400 to the Blue Prints. The letters B. P., which will be found at the end of the paragraphs in the chapter on Joinery, refer, of course, to the Blue Prints.

It is the belief of the authors that the working drawings, lectures, tool references, constructive information, suggested projects, questions and problems amply justify the publication of this book. If the book shall prove to be of material assistance in the unification of a course of study, embodying both practical and cultural training, it will have served its purpose. While we believe that the cultural side of industrial work should not be overlooked, yet "the search-light of practical experience should illuminate the dark places of theory".

In conclusion, the authors wish to acknowledge their obligations and indebtedness to the many persons whose generous contributions and suggestions have aided materially in making possible the publication of this work, and in particular to Helen Ferris, English critic, Oklahoma City High School, for valuable assistance in correcting and clarifying the English.

H. F. RUSCH.

C. C. CONWAY.

Oklahoma City, Oklahoma.

June 14, 1918.

SHOP ETHICS AND REGULATIONS.

No other department of educational work offers a better chance for the student to learn to work harmoniously with others than the Industrial Department. The following suggestions will help those who try to observe the proper ethics of work shops.

Be prompt to begin work, and work faithfully until quitting time.

Check your tool list and make sure all your tools are in the proper place. In case of shortage, report it at once to the instructor in charge, so you will not be held responsible for those missing.

Tools that are broken by carelessness are to be replaced by the students breaking them.

Each student must furnish the "individual equipment."

Borrow no private tools and be neat and considerate with the tools for general use. Return the tools for general use to their special rack or cabinet as soon as you are through with them. Lock up your private tools only.

Be deliberate and thoughtful. Work for quality, not quantity.

At the close of the period, put your tools away, brush the shavings to the end of the bench, have everything neat and in good order, so you will not be called back when you leave.

Both enjoy and make a business of your work.

Demonstrations of the uses of the woodworking machinery will be made, but no students will be permitted to ruin any of the machines, except the tool grinder, unless it is under the direct supervision of the instructor in charge.

The department is not responsible to any of the students in case of a breach of its regulations.

RESAWS.

It is easier to criticise than to create.

Courtesy costs little and buys much.

Confidence is the companion of success.

Many a man shortens his days by lengthening his nights.

To be successful, you must plan the start as well as the finish.

The devil tempts all men, but the idle man tempts the devil.

If you resent authority, you stand a small chance of assuming it.

Inspiration is more liable to strike a busy man than an idle one.

Failure is not the worst thing in the world; the very worst is not to try.

It is a little farther around the corners of a square deal, but the road is better.

A bold front is a good thing only when anchored to a stiff backbone.

Bad luck ruins one man in a hundred, good luck ruins the other ninety-nine.

The man of good judgment is like a pin, his head prevents his going too far.

The man who thinks ahead of his work is a sure winner over the one who works ahead of his think.

True efficiency will come only to the man whose heart is in his work, and will never come with discontent.

CONTENTS

Editor's Preface	v
Authors' Preface	vii
Shop Ethics and Regulations	ix
Resaws	xi

PART I—DRAWINGS, EQUIPMENT, PROJECTS AND ACCIDENTS.

CHAPTER I

WORKING DRAWINGS

Working Drawings—Scale—Blue Prints—Elevation—Lines—Plan of Work.....	3
--	---

CHAPTER II

SHOP EQUIPMENT

Tool and Machine Equipment—Bench Design and Construction—Vises—Bench Stop—Bench Dog—Bench Hook—Drawing Board, Triangles and T-Square—Bench Brush—Bench Types, Equipment and Methods—Historic Measures—Standard Yard—Metric Standard—Units—Linear Measure—Graduated Measuring Tools—Steel Square—Try Square—Rule—Marking Gauge—T-Bevel—Level—Wing Divider or Compass—Sloyd Knife—Awl—Saws—Ripsaw—Use of Handsaw—Backsaw—Use of Backsaw—Planes—Bench Planes—Block Plane—Cabinet Scraper—Burnisher—Draw Knife—Spoke Shave—Cornering Tool—Squaring Stock—Wood Chisel—Tang and Socket Firmer Chisels—Chisel Handles—Chisel Blades—Sharpening Tools—Halving Joints—Concave Surfaces—End Beveling—Beveling—Mortises—Circular Pieces—Mallets—Hammers—Driving Nails—Nail Sets—Pulling Nails—Carpenters' Pincers—Screw Drivers—Driving Screws—Vises—Hand Screws—Clamps—C-Clamps—Improvised Clamp—Use of Braces and Bits—Locating Centers—Securing Bored Stock—Boring Through—Depth Gauge—Ratchet—Tool Sharpening—Chisel Sharpening—Plane Iron Sharpening—Gouge Sharpening—Knife Sharpening—Cabinet Scraper Sharpening.....	5
--	---

CHAPTER III

DEVELOPMENT OF A PROJECT

Plans and Specifications—Construction of Rack—Parts—Laying Out the Back—Shaping the Back—The Support—The Arms—Cross Rail and Dowel—Assembling—Finishing	33
---	----

CHAPTER IV

MACHINERY

Woodworking Machinery—Universal Saw Bench—Band Saw—Surfacer—Hand Planer and Jointer—Lathes—Trimmer—Oil Stone Edge Grinder—Machine Tools—Wrenches—Oiler—Pliers—Snips—Safe Guards	40
---	----

CONTENTS

CHAPTER V

ACCIDENTS AND THEIR TREATMENT

Accidental Injuries—Wounds—Fractures—Burns and Scalds—Sprains----- 46

PART II—SHOP WORK.

CHAPTER I

JOINERY

Joints—Joint Types—Classification of Joints—Box Joints—Plain Butt Joints—Butt Joints, Blocked and Glued—Hopper Butt Joints—Rabbet Joints—Dove-tail Dado Joints—Plain Dado Joints—Multiple Dovetail Joints—Half Blind Dovetail Joints—Ledged Miter Joints—Miter and Butt Joints—Framing Joints—Butt Joints—Draw-Bolt Joints—Cross Lap Joints—Beveled Halving Joints—Lap-Dovetail Joints—Cogged Joints—Mortised and Tenon Joints—Blind Mortise and Tenon Joints—Doweled Mortise and Tenon Joints—Keyed Mortise and Tenon Joints—Open Mortise and Tenon Joints—Mortise and Tenon Joints with Relish—Trussed Mortise and Tenon Joints—Wedged Mor-tise and Tenon Joints—Fox-Tail Tenon Joints—Double Mortise and Tenon Joints—Single Dove-Tail Joints—Thrust Joints—Housed Brace Joints—Oblique Mortise and Tenon Joints—Bridle Joints—Scarf Joints—Splice Joints—Bird's Mouth Joints—Surface Joints—Plain Miter Joints—Splined Miter Joints—Stretcher Joints—Edge-to-Edge Joints—Stress—Tensional Stress—Compressional Stress—Transverse Stress—Computation of Stress... 51

CHAPTER II

CABINET MAKING AS APPLIED IN FURNITURE CONSTRUCTION

Furniture—Legs—Panel Leg—Mission Style Leg—Modified Mission Style Leg—French Leg—Turned and Fluted Leg—Back Legs—Rails—Straight Rails Curved Rails—Turned Rails—Chair Arms and Rockers—Shelving—Foot Boards—Panels and Paneling—Rabbeting—Panel Effects—Moulding—Batting Drawer Fronts—Tops—Cleating—Edging—Surfacing—Forms of Tops—As-sembling—Laying Tops—Designs—Ascertaining Cost—Specimen Bill----- 61

CHAPTER III

CARPENTRY

House Planning—Estimate of Cost—Procedure—Staking out for Foundation—Excavation—Foundation—Plates—Sills—Joists—Beams—Bridging—Studs—Floor Lining—Boxing—Cornice—Classification of Roofs—Rafters—Sheathing—Shingling—Comb-Boards—Window and Door Frames—Window Frames—Door Frames—Jambs—Grounds—Corner Strips—Siding—Base—Floor—Stairs—Pitch—Risers—Landing—Risers, Treads and Skirting Boards—Newel Posts, Hand Rails and Spindles—Well Hole—Porches—Scaffolding—Snapping Lines ----- 75

CHAPTER IV

BEADS AND MOULDINGS

Beads—Mouldings—Crown Mouldings—Intermediate Mouldings—Base Mouldings—Designation of Moulding Forms----- 89

CHAPTER V

VENEER AND ITS APPLICATION

Veneering—Sawed and Rotary Cut Veneer—Veneer and Solid Built Stock—Core Stock—Preparing Veneer—Veneering Regular and Irregular Surfaces—Veneer Designs—Veneering Cylinders and Cones—Panel Work Veneer----- 91

PART III—SHOP TALKS.

CHAPTER I

STEEL SQUARE

Steel Square—Scales and Tables—Essex Board Measure—Octagon Scale—Angle Cuts for Polygons—Brace Measure—Rise of Rafters—Run of Rafters—Pitch of Rafters—Rafter Cuts—Hip Rafters—Plumb and Side Cuts—Valley Rafters—Jack and Cripple Rafters ----- 97

CHAPTER II

SAWS

Special Handy Saw—Compass Saws—Scroll and Web Saws—Butcher Saws—Hack Saws—Band Saws—Circular Saws—Coping Saws—Cylinder Saws—Miter Box—Saw Construction—Material—Process of Manufacture—Tempering—Smithing—Grinding—Final Touches—Vanadium Saws—Saw Parts—Sharpening—Sharpening Rip Saws—Finishing—Sharpening a Two-Man Cross-Cut Saw—Sharpening Circular Saws—Sharpening Cut-off Saws—Sharpening Band Saws—History of Saw Sets—Use of Saw Sets----- 104

CHAPTER III

FASTENING DEVICES

Nails—Classification of Nails—Common Nails—Casing Nails—Finish Nails—Brads—Wrought Nails—Cut Nails—Standard Gauges—Screws—Sizes of Screws—Kinds of Screws—Lag Screws—Corrugated Steel Fasteners—Tacks—Glue—Glue Material—Liquid Glue—Glue Joints----- 113

CHAPTER IV

BRACES

Parts of Brace—Carpenters' Bit Brace—Chuck—Ratchet—Cranked Handle Swing—Cap—Reciprocating Drill—Breast Drills----- 119

CHAPTER V

AUGER BITS

Boring Tools—Cutting Action—Manufacture—Head, Nib, Lip and Spur—Sizes of Auger Bits—Resharpening of Auger Bits—Shanks—Dowel and Ship Bits—Extension Bit—Irwin Bit—Russell Jennings Bit—Ford Bit—Fostner Bit—Expansion Bit—Gimlet Bit—Counter and Gauge Sinks—Reamers—Screw Drivers—Spoke Pointers, Fore Augers, Hollow Augers and Dowel Sharpeners 121

CHAPTER VI

ABRASIVES

Grindstones—Composition—Truing—Speed of Stones—Oil Stones—Artificial Stones—Emery—Corundum—Carborundum—Speed of Artificial Stones----- 125

CHAPTER VII

SANDPAPER

Details of Manufacture—Strength—Glue—Ingredients—Process of Manufacture—Quality and Care—Steel Wool----- 128

CHAPTER VIII

FILES AND RASPS

Historical—Hand Cut Files—Machinery Cut Files—Sizes and Kinds—Features—Cuts—Length, Tang, Thickness and Kind—File Cleaners—Use of Files—Machine and Hand-made Files.....	131
--	-----

CHAPTER IX

FACTS ABOUT WOOD

Uses and Nature of Wood—Logging—Transportation—Sawmills—Timber—Milling—Seasoning—Warping and Cracking—Decay of Woods—Methods of Preservation—Strength of Timber—Grain—Markings—Board Measure—Tulip or Yellow Poplar—The White Ash—The Sugar Maple—American Elm—The Chestnut—The Hickory—Basswood—The American White Oak—Black Walnut—Western Red Cedar—Red Gum—The Redwoods—White Pine—The Longleaf Pine—The Shortleaf Pine—The Bald Cypress—Spruce—Douglas Fir—Birch	135
---	-----

CHAPTER X

FACTS ABOUT BRUSHES

Materials and Methods—Dusters and Artists' Brushes—Bristles—Care of Brushes	159
---	-----

CHAPTER XI

WOOD FINISHING

Purpose—Classes of Finishes—Exterior Finishes—Pigments—White Lead—Dutch Process—Carter Process—Linseed Oil—Chinese Wood Oil—Colors—Color Shades—Composition—Application of Paint—Interior Finishes—Stains—Stain Shades—Fuming—Fillers—Use of Liquid Fillers—Use of Paste Fillers—Application of Fillers—Shellac—Use of Shellac—Turpentine—Varnishes—Rubbing Varnish—Pitting of Varnish—Cracking or Checking of Varnish—Chilling of Varnish—Kauri Gum—Manilla Gum—Zanzibar Copal—Damar Gum—Filtering and Aging of Varnish—Uses of Varnish—Wax—Application of Interior Finishes—Natural Finish—Stains—Order of Application—Things to Remember	163
---	-----

CHAPTER XII

PERIOD FURNITURE

Furniture Types—Egyptian—Early European—Renaissance—Lines and Harmony—Jacobean—William and Mary—Queen Anne—Louis XIV, XV, and XVI—Chippendale—The Brothers Adam—Hepplewhite—Sheraton—The Empire Period—Mission Craft	174
--	-----

PART IV—QUESTIONS, PROBLEMS, GLOSSARY.

CHAPTER I

Questions	187
-----------------	-----

CHAPTER II

Problems	190
----------------	-----

CHAPTER III

Glossary	194
----------------	-----

PART I

DRAWINGS, EQUIPMENT, PROJECTS AND ACCIDENTS

CHAPTER I

WORKING DRAWINGS

Working Drawings.—Working drawings are exact projections or representations of objects, in whole or in part, usually reduced, but frequently enlarged, to a convenient scale; they are used for the guidance and convenience of one person who is developing problems created by another.

Scale.—The term “scale”, as used in mechanics, means the ratio or relative proportion of the size or linear dimensions of the parts of a drawing to the size or dimensions of the corresponding parts of the object represented. It will be seen quite readily that the working drawing of a house would be too large to be drawn on paper the actual size of the house, and that the details of a small machine so drawn would be too small to insure accuracy. Scales so drawn as to represent one-fourth and one-half of an inch to the foot, one-half size, one-fourth size, two and four times the size of the object are most commonly used.

Blue Prints.—In creating data, the working drawings or sketches become the plans, and the written descriptions of material, finishes and other necessary details are known as the specifications. In developing problems, it becomes necessary quite frequently to reproduce the plans. This is done by making prints which generally are shadows of the lines and characters of the original plans. In developing prints, a sensitive paper is placed in a printing frame behind the original drawing and exposed to the light. The length of exposure depends on the kind and disposition of the light, the character of the paper and the transparency of the material upon which the original drawing is made. The sensitive paper, after being properly exposed, is washed in water. The process thus observed develops an accurate reproduction of the original drawing known as a blue print in which the white lines are the shadows. Since blue print paper shrinks unevenly when drying, it is safer, whenever possible, to use the measurements given by the figures on the blue print or in the specifications than to scale the blue print.

Elevation.—It is often necessary to represent different sides of an object in the working drawings. This is done by revolving the object and drawing the view of the side presented. The outline of a side and

its modifications is called an elevation. There are end elevations, side elevations, and top elevations. C, in Fig. 1, represents an end elevation; B a side elevation; looking down upon an object develops the plan A or a top elevation.

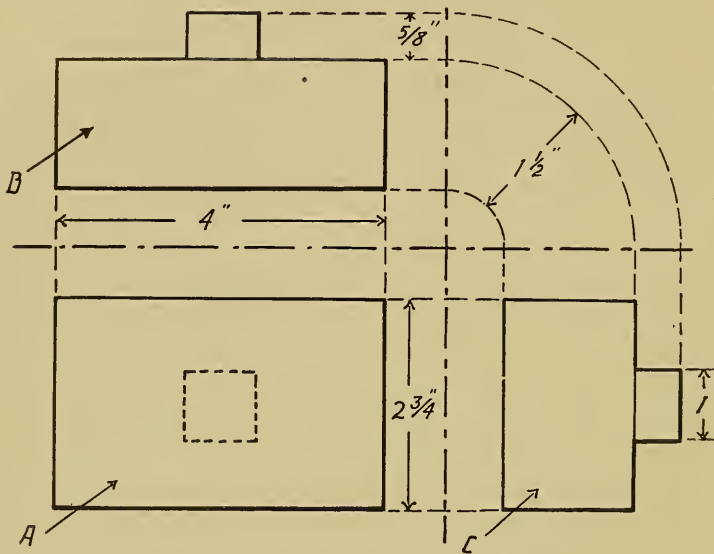

FIG. 1.—WORKING DRAWING.

Lines.—Each line used in a drawing has a distinct and well defined meaning. The lines used in common practice are represented below in Fig. 2. A is a solid line and indicates the visible edge of an object. B is a solid line, usually light, broken only for figures, as 8'-6", and has arrow-heads at its ends. These arrows indicate the measurements repre-

<p>A —————</p> <p>B ————— 8'-6" ————— </p> <p>C - - - - -</p> <p>D - - - - -</p> <p>E - · - - - -</p>	<p>senting 8'-6" (eight feet six inches). C is a dotted line used to indicate hidden parts. D is a dash line used in projecting the elevations and plans. E is a dash-and-dot line used as means of representing projection centers, revolving solids, etc.</p>
--	---

FIG. 2.—DRAWING LINES.

The lines are usually placed to the right and below the working drawings of the object. Point out these various lines as used in Fig. 1.

Plan of Work.—Much time and material will be saved by a careful study of the plans and specifications before the work on any project is started. Before beginning tool work on the material, be fully advised as to what to do and how to go about it.

CHAPTER II

SHOP EQUIPMENT

(Representing the equipment items for the average well equipped school shop. See Fig. 3.)

BENCH TOOLS.

Planes	Clamps
Jack	Draw Knife
Smooth	Spoke Shave
Block	Snips
Chisels (One inch; five-eighth inch; three-eighth inch; one-eighth inch).	Pincers
Tang	Pliers
Socket	Cornering Tool
Back Saw	Wrench
Try Square	Glass Cutter
Hammer	Nail Set
Marking Gauge	Awl
Rule	Dowel Plate
T-Bevel	Dowel Sharpener
Screw Driver	Sloyd Knife
Mallet	Cabinet Scraper
Bench Hook	Burnisher
Brush	Wing Divider
Drawing Board	Bit Braces
	Automatic Boring Tool
	Bits
	Saws
	Miter Box
	Rasps and Files
	Abrasives
	MACHINE EQUIPMENT.
	Universal Saw Bench
	Band Saw
	Wet Tool Grinder
	Jointer
	Surfacer
	Trimmer
	Wood Lathes

INDIVIDUAL EQUIPMENT FOR STUDENT.

Cap
Apron
Pocket Knife
Pencil
Plane Iron (Furnished by Department)
GENERAL TOOLS.
Steel Square
Level

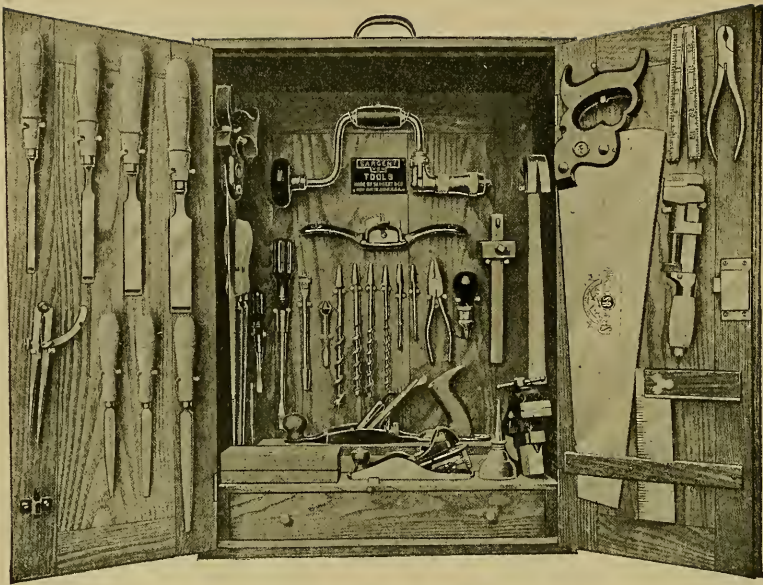

FIG. 3.—TOOL KIT.

THE WORK BENCH.

Bench Design and Construction.—In their essentials, work benches differ only in size and in the methods used in fastening the parts together. It is generally agreed that the most practicable work bench for manual training shops is a single (individual) bench, wholly inclosed, and equipped with individual lockers, tool locker, side and end vises, bench stop, bench dog and a tool recess. To insure absolute stability, the material used in constructing work benches should be clear, selected, hard wood—preferably maple. The rigidity of the bench is dependent on the design and construction of the frame. Therefore all joints should be doweled and glued and fastened with draw bolts. To prevent checking and warping, the top should be built of strips, securely fastened together, either by dovetailing or by dowels and glue, and firmly attached to the frame by means of lag screws. It is generally agreed that a top should be one and three-fourths inches or more in thickness as this will insure a solid working surface. In the construction of tops, two distinct plans are followed. One plan is to build the top of strips, from three-fourths to one and three-fourths inches in thickness, and as much as two or three inches in width, laid flat. The other plan necessitates the use of strips from three-fourths to seven-eighths of an inch in thickness and stood on edge, thus exposing the

edge grain for a working surface. The lockers should be nailed and glued. When completed, the work bench should be given an oil finish which will bring out the wood coloring and preserve the material. A coat of shellac should be applied occasionally to help preserve the wood. This bench, complete as described, presents a neat appearance in the room, is dust proof, and meets the demands of a modern shop. (See Fig. 4.)

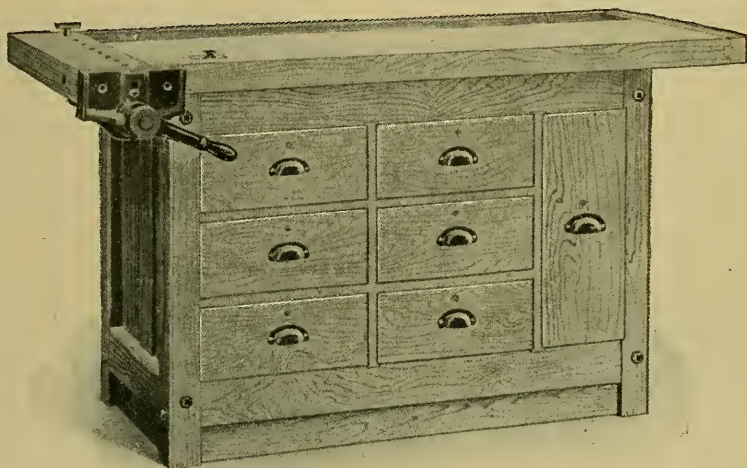

FIG. 4.—TYPICAL WORK BENCH.

BENCH EQUIPMENT.

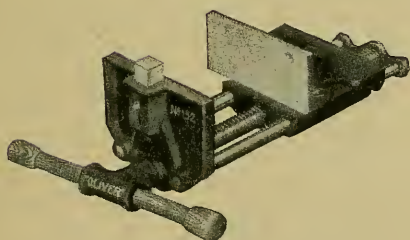

FIG. 5.—RAPID-ACTING VISE.

Bench Stop.—The bench stop is a device, rectangular in shape, made of metal, and so designed as to be raised and lowered by a spring, and when not in use remains level with the top of the bench. It is used to hold stock that is being surfaced. The stock is butted against the stop when raised. Small extensions on the stop sink into the end grain and hold the stock.

Each work bench should be equipped with vises, bench stop, bench dog, bench hook, a drawing board, a T-square and a bench brush.

Vises.—Each bench should be equipped with rapid acting side and end vises to hold stock that is being worked upon. (See Fig. 5.)

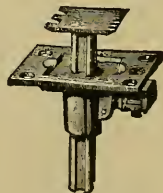

FIG. 6.—BENCH STOP.



FIG. 7.—BENCH
DOG.

Bench Dog.—The bench dog is a metal device, rectangular in shape, and is fastened in holes at regular intervals on the top of the bench. It is used in conjunction with the vises to hold the stock firm. (See Fig. 7.)

Bench Hook.—The bench hook is a tool designed to hold light stock and to prevent the scarring of the bench during the process of sawing. It consists of a board with a cross cleat screwed on each side at opposite ends. One cleat prevents the bench hook from slipping over the top of the bench and the other serves as a top for the piece being sawed.

Drawing Board, Triangles and T-Square.—A drawing board, 60- and 45-degree triangles, and a T-square are essential in every bench equipment. They are used in sketching, designing and in making working drawings.



FIG. 8.—BENCH BRUSH.

Bench Brush.—A bench brush is indispensable as a means of cleaning the top of the work bench. Brushes of the duster type, with handles, are the best for this class of work. Methods of manufacturing

brushes will be found in Chapter X, Part III, entitled "Facts About Brushes." (See Fig. 8.)

Bench Types, Equipment and Methods.—A common way to hold stock for sawing is illustrated in Fig. 9 where a board is placed on a pair of saw horses. This is a form of primitive bench still in general use for laying out and working up large stock. Fig. 10 shows a bench especially adapted for carpentry. It is long and provided with a wide skirting board in which are bored holes, A, for pins that help to steady long boards when planing. Fig. 11 is a bench used largely in school shops. It is provided with both side, A, and end, B, rapid acting vises; also a benchstop, C, a bench dog, D, and a tool recess, E. In order to do efficient sawing, the stock must be held firm, and Fig. 9 shows how it is fastened on saw horses. A in Fig. 9 shows the correct position of a saw in relation to the stock when ripping, and B shows the position of the saw when cross cutting. Fig. 10 shows a method of fastening a long board in a carpenter's bench and the position of the cross-cut saw, B. Fig. 11 shows how a board, F, may be held in a vise while cutting with a rip saw, G, and H shows the bench hook when used in connection with the back saw, I, while making a finished cut on a piece of stock, J.

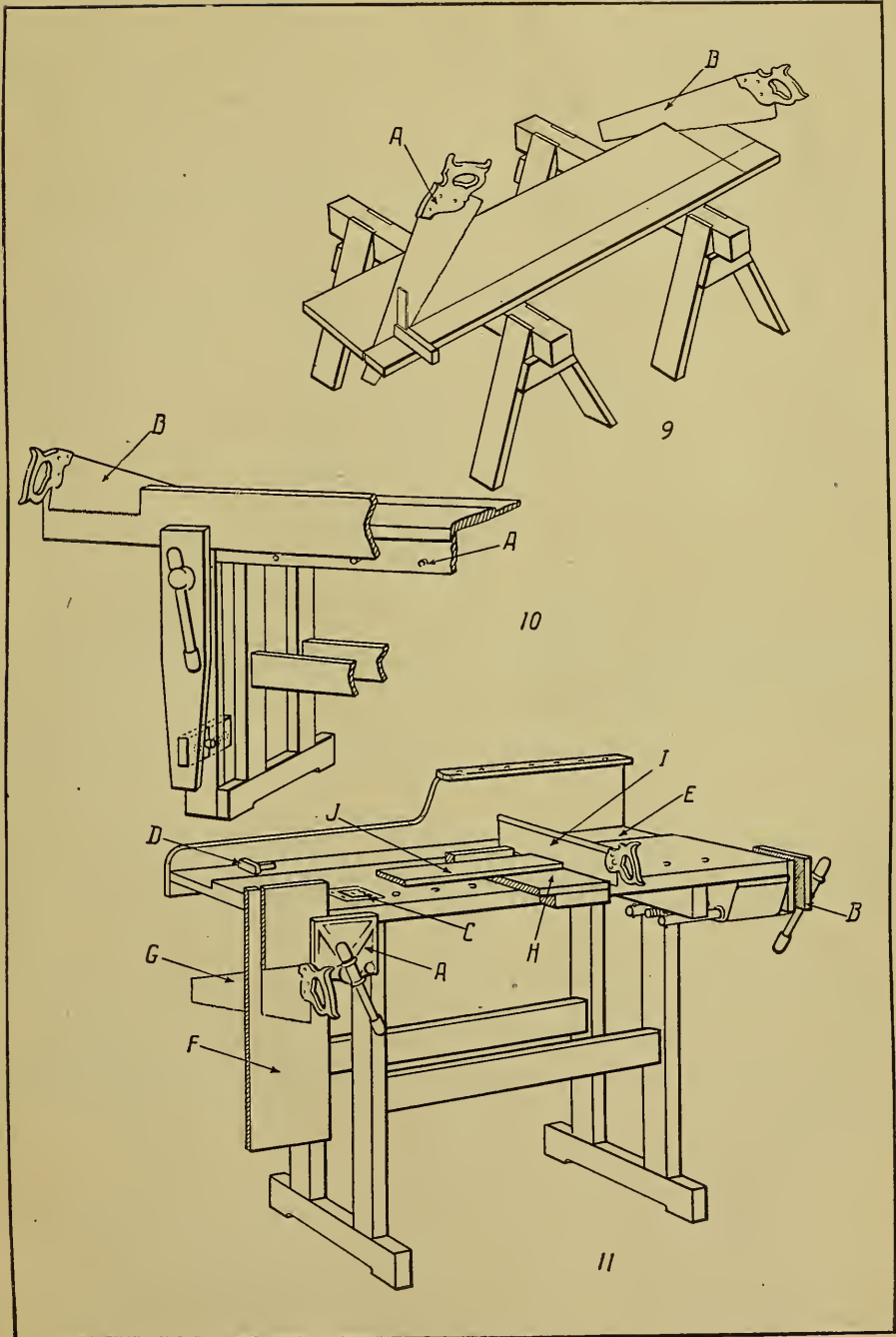

FIG. 9.—SAW HORSES. FIG. 10.—CARPENTER'S BENCH. FIG. 11.—SCHOOL SHOP BENCH.

MEASURES.

Historic Measures.—Formerly measurements and weights were compared with objects of indefinite lengths and varying weights. King Charles I commanded that the length of his arm should define a yard. Again, in the year 1266, the weight of an English penny was referred to as the weight of thirty-two wheat grains taken from the middle of the ear. Of course the length of King Charles' arm could have been taken as a yard, but if the standard had been lost, it would have been impossible to re-establish the measurement with any degree of certainty. As for wheat grains, they shrink in weight and size and are very seldom the same at maturity.

Standard Yard.—It became apparent that standards which could be replaced at any time should be established. To do this, a commission was appointed, and as a result of a great deal of experimental work with a swinging pendulum, the unit of measure, known as the yard, was established. The standard yard is made of platinum with gold plugs sunk near each end. Across each plug is a fine line, drawn at right angles to the yard. The distance between these parallel lines, when the temperature of the platinum is at 62 degrees Fahrenheit, is the United States and the English Standard yard. As all metals, including platinum, expand and contract in response to the changing temperature of the atmosphere, it is necessary to take the measurement at a positive degree of temperature. The original standard yard is preserved in England, and a number of exact reproductions are kept in the United States.

Metric Standard.—The metric standard, of which the metre is the unit, is the international standard, and is on file in the Weights and Measures Building in Paris. The ratio of the English Standard to the Metric Standard is as 36 is to 39.37.

Units.—Units are of two kinds—simple and derived. The yard is a simple unit; the square yard a derived unit. The relation which a derived unit bears to the simple unit is called its dimension of the derived unit.

Linear Measure.—For convenience and as a means of more accurate measuring, the English standard yard is divided into feet, inches, etc. The following is the linear table developed from the yard.

12 inches (")	-----	1 foot (ft.) (')
3 feet	-----	1 yard (yd.)
5½ yards	-----	1 rod (rd.)
40 rods	-----	1 furlong (fur.)
8 furlongs	-----	1 mile (mi.), or
1760 yards	-----	1 mile

Graduated Measuring Tools.—There are many tools in every day use which have graduations in inches stamped upon them. The steel square, rule, yard stick, try square, tape-line, etc., are the most common.

HAND TOOLS.

Steel Square.—The steel square is used in measuring lumber and laying off lengths as illustrated in Fig. 20. See Steel Square, Chapter I, Part III.

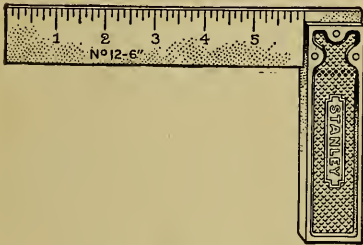

FIG. 12.—TRY SQUARE.

Rule.—The rule is made of wood, metal, ivory, or celluloid, ranging from six inches to five feet in length. The ordinary two-foot folding rule (Fig. 13) has the inch divided into sixteenths on one side and into eighths

on the other. It is a common practice to use the rule as a gauge for pencil lining as in Fig. 21. The rule is held in one hand—the finger serving as a gauge or guide. A pencil held at the end of the rule is drawn along the surface of the board leaving a line parallel to the edge

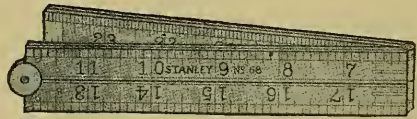

FIG. 13.—TWO FOOT FOLDING RULE.



FIG. 14.—MARKING GAUGE

The parts of the marking gauge are the head, bar, point, and thumbscrew. The bar has graduations on one side which permit the laying-off of definite measurements. To draw a line parallel to a given edge is not a simple operation. In untrained hands, the point of the gauge has a tendency to follow the grain of the wood, and the resultant line may not be true. To get the best results, with a little practice, hold

Try Square.—The try square is a contracted form of the square and is used extensively for testing and laying out work. In testing, the butt of the try-square is held against a surfaced side and the inside edge of the blade is brought to rest on the edge of the piece. If the blade touches all the way across the block of wood, the piece is square (See Figs. 12 and 26.)

Marking Gauge.—A marking gauge is a wood working tool used only to lay out work. It is used to draw lines parallel to a given edge and works best with the grain of the wood. The parts of the marking gauge are the head, bar, point, and

the head—tipped at a slight angle—squarely against the edge of the board thus giving cutting action. Mark very lightly at first until the line is established. Then, if necessary, a heavier line may be made with a second stroke. (See Figs. 25 and 14.)

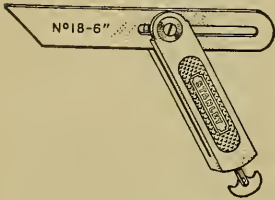

FIG. 15.—T-BEVEL.

T-Bevel.—It is necessary, in many classes of construction, to work to given angles, or build up work to fit an angle. In either case, the tool most commonly used for this purpose is a T-Bevel. The bevel is similar in construction to a try-square, except that it has no graduations on the blade, and the blade is free so that it may be set at any angle and locked with a thumbscrew. These angles and pitches are generally taken from the steel square. (See Fig. 22.) Bevels differ in size, form and material. Some are made entirely of metals; others of a combination of hard wood and metal. (See Fig. 15).

Level.—The level is a tool consisting either of a steel or of a wooden frame with a level glass inset. Levels are made in many lengths, and are sometimes equipped with a level glass on a protractor scale for special work. In case there are two glass insets—one set at an angle of 90 degrees to the other—the tool is called a plumb and level. Levels are used for testing perpendicular and horizontal surfaces during the process of building construction, in installing machinery, and in many other branches of engineering work. (See Figs. 23 and 16).



FIG. 16.—PLUMB AND LEVEL.



FIG. 17.—WING DIVIDER.

Wing Divider or Compass.—The wing divider is a tool used to divide lines, draw arcs, or transpose measurements. It is sometimes called a compass. For laying off a definite measurement with a pair of wing dividers, clamp one

leg to the wing, approximately correct, and adjust it to the correct measurement by the spring and thumbscrew attachment. Fig. 24 clearly illustrates one method of establishing angles. These angles may be established on a block and transposed to the work by the use of the T-Bevel. (See Fig. 17).

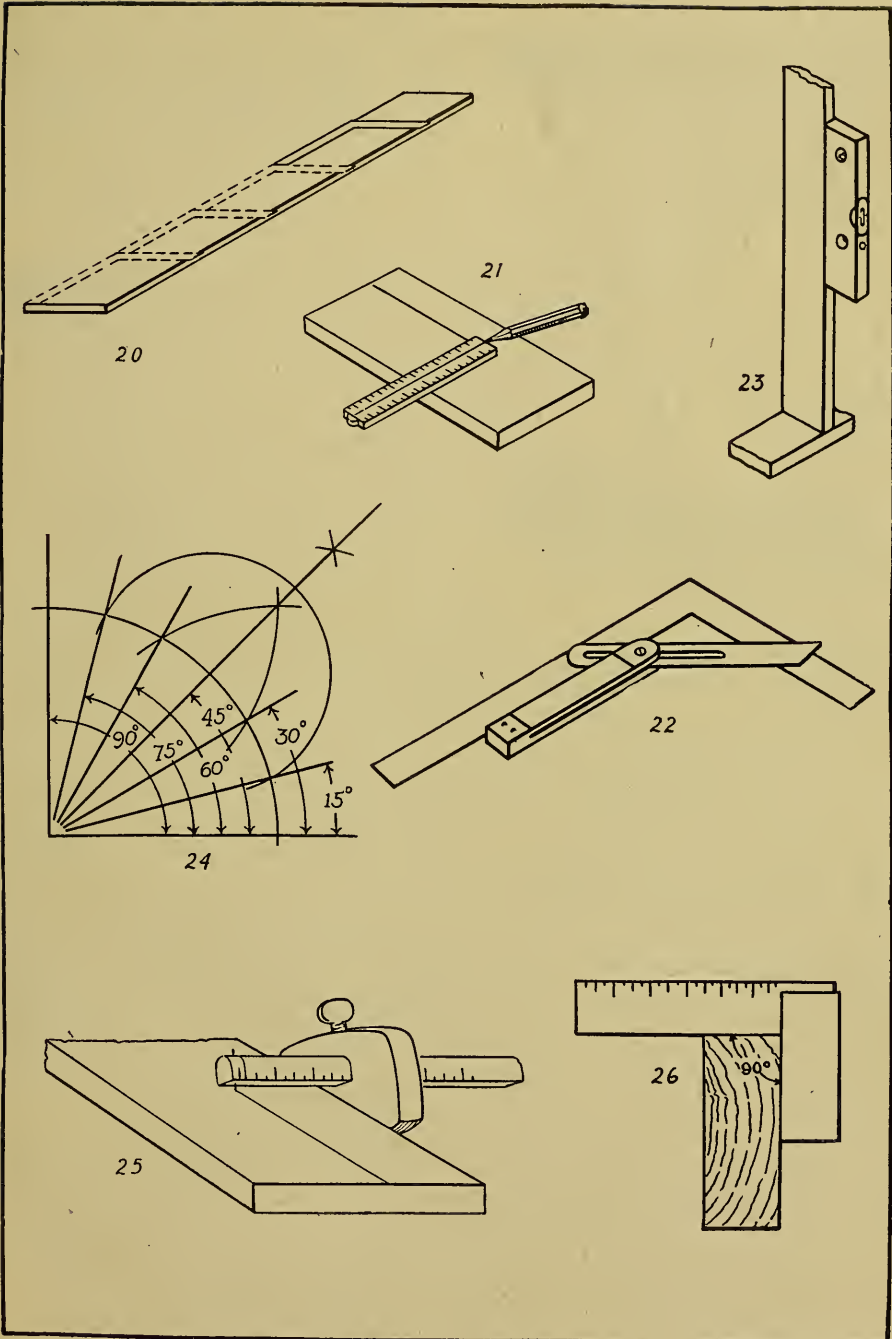

FIG. 20.—LAYING OFF LENGTHS. FIG. 21.—PENCIL LINING. FIG. 22.—DETERMINING ANGLES AND PITCHES. FIG. 23.—PLUMBING. FIG. 24.—ESTABLISHING ANGLES. FIG. 25.—ESTABLISHING LINES. FIG. 26.—TESTING WITH TRY SQUARE.



FIG. 18.—SLOYD KNIFE.

is used in conjunction with a try-square in most grades of fine work. (See Fig. 18.)

Awl.—The Awl, commonly called “Scratch Awl”, is a tool used to make fine lines, point off measurements, and to start holes for small nails or screws; it is especially adapted to enlarging holes in leather belting during the process of lacing. (See Fig. 19.)



FIG. 19.—AWL.



FIG. 27.—TYPICAL HAND SAW.

in length of blade. For all work of small and moderate size, the 20 or 22 inch saw shown in Fig. 27 is the most convenient. Hand saws are of two kinds—rip saws and crosscut saws.

Ripsaw.—The ripsaw, as the name indicates, is for cutting with the grain, or lengthwise of the board to be sawed. For pine or other soft wood, a ripsaw having three teeth, or four points to the inch, may be used; but for ordinary work, especially for hardwood, a ripsaw having six points, and a crosscut of nine points to the inch is recommended.

Use of Handsaw.—It is not the intention to suggest any work for practice in the use of the handsaw, as the correct use will be acquired gradually while cutting out stock for different articles required later. In general, it is well to say to the beginner: Do not press on or force the saw to cut too rapidly. Hold the saw firmly in the hand with the first finger pressed against the side of the handle and run it lightly and freely in the kerf, or cut. Take time to see that the line is followed exactly, thus avoiding all wasteful and crooked edges on the work, which must afterward be planed off. While sawing, be careful to stand in a position to saw the edge square with the surface of the board. This position may be tested from time to time by setting a try-square on the board and against the side of the saw, as shown at A, Fig. 9.

Sloyd Knife.—A sloyd knife is an excellent tool for laying out, whittling, or any other light work. It is made of high carbon steel, properly tempered, and is handled. The knife

Saws.—Saws of different kinds occupy an important place among the tools used on hand-work of all kinds, and of these the hand saws are of the first importance. Hand saws are made from 14 to 28 inches



FIG. 28.—BACK SAW.

the blade, thus making it possible to saw with exceptional accuracy. Backsaws are made in many sizes. A 10 or 12 inch backsaw is a convenient size for general use.

Use of Backsaw.—When using the backsaw, hold with one hand only. Never, under any circumstances, press on the saw with the other hand, but run the saw lightly on the wood. Should any trouble be found in starting the cut, first draw the saw backward against the finger of the left hand, which hand grips the block of wood being sawed. This steadies the saw and holds it firmly to the correct place for beginning the cut. Much trouble is sometimes experienced by

the beginner in starting the cut, the tendency being to cut too deeply into the wood, especially if the saw is sharp. This makes it hard to begin the cut close to the line, and often splits off a corner from the wood. To avoid this trouble, hold the handle of the saw high as shown in Fig. 29, drawing the saw backward toward the operator with a pulling stroke, and steadying the blade of the saw

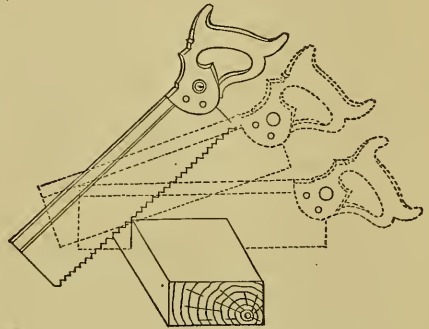

FIG. 29.—USE OF BACK SAW.

with the first finger of the left hand. This will make a slight kerf, which can be increased with a light pushing stroke. At each succeeding stroke, gradually lower the handle end of the saw until a horizontal position is gained. The sawing in all cases must be done with a light lifting stroke, without any forcing into the wood, using long steady

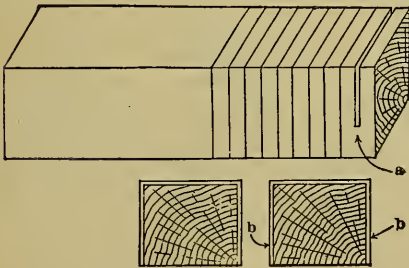

FIG. 30.—PRACTICE EXERCISE.

strokes so as to use the entire length of the saw, and to bring all of the teeth into use. To use a back-saw in such a way as to follow closely to the dimension line, and to do exact and closely fitting work, requires from the beginner a considerable amount of careful practice. To all

who wish to acquire skill in the use of this important tool, we recommend the following exercise for practice. Take any block of wood, about two inches wide, about one and three-quarters inches thick, and about eight to ten inches long, and with a try-square and a sharp pointed knife, lay out lines on the front, upper and back sides of the block as partially shown in Fig. 30. The knife cuts must be at least one-sixteenth of an inch deep, and one-fourth to three-eighths of an inch distant one from the other. Next, proceed to saw up the block in thin sections thus marked, sawing each time so that the saw kerf will be just outside of, and close to, the knife line as shown by the first partial cut at *a* in Fig. 30. Each saw-cut through the block should be true to each of the three lines. While the saw passes along one side (the outside) of the line, its teeth should not scratch the opposite side of the knife cut, but should leave the smooth, clean cut of the knife on the block, as shown at *b*, in Fig. 30. At the same time it should be so close as to leave no wood to be smoothed off with plane or chisel.

Planes.—To a woodworker the plane is one of the most important tools. It is made either of cast iron or wood. Besides the regular bench planes, there are many other planes used for special work, such as the router, rabbet, dado, beading and matching, circular, carriage maker's, tongue and groove, core box, scraper plane, etc. (See Fig. 31).

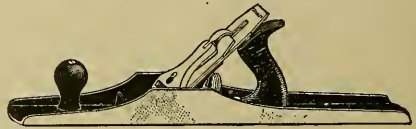

FIG. 31.—JACK PLANE.

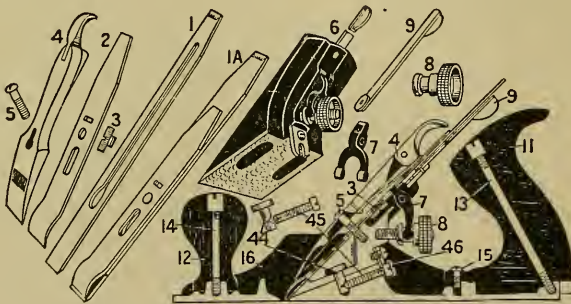

FIG. 32.—JACK PLANE AND PARTS.

- | | | |
|-----------------------|----------------------------|--------------------------|
| 1A Double Plane Iron. | 6 Frog Complete. | 13 Handle Bolt and Nut. |
| 1 Single Plane Iron. | 7 "Y" Adjusting Lever. | 14 Knob Bolt and Nut. |
| 2 Plane Iron Cap. | 8 Adjusting Nut. | 15 Plane Handle Screw. |
| 3 Cap Screw. | 9 Lateral Adjusting Lever. | 16 Plane Bottom. |
| 4 Lever Cap. | 11 Plane Handle. | 46 Frog Adjusting Screw. |
| 5 Lever Cap Screw. | 12 Plane Knob. | |

Bench Planes.—The bench planes commonly found in school shops are: Smooth, jack, jointer and block. The smooth plane is used for finishing or smoothing off flat surfaces, where the uneven spots are of slight area. Its short length will permit it to locate these irregularities, leaving the work with a smooth surface when it is finished. The jack plane is used to true up edges of boards in the rough and prepare them for the jointer. The jointer plane is a finishing plane for large surfaces and is invariably used to true up the edges of boards so that they can be closely fitted or joined together; hence the name. (See Fig. 32.)

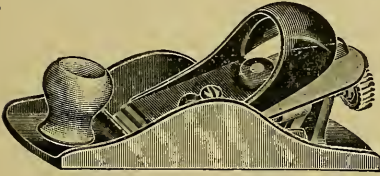
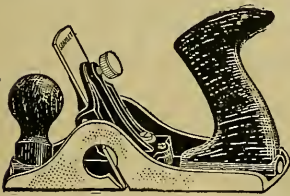

FIG. 33.—BLOCK PLANE.

Block Plane.—The block plane, which can easily be held in one hand, is used to plane the ends of boards. The cutter on the block plane rests on a seat, at an angle of 20 degrees, as against 45 degrees in the ordinary

bench plane, and the cutter bevel is made on the upper instead of the lower side. All iron planes have adjustable throats which permit of the opening or closing of the mouth as coarse or fine work may require. Experience has proved that the proper bevel for grinding the cutter is at an angle of about 25 degrees. This angle should be observed when regrinding or rehonoring the cutter. (See Fig. 33.)

Cabinet Scraper.—A cabinet scraper may be in the form of a plane or merely a thin piece of steel, usually rectangular, with rounded corners. It is used, as its name indicates, to scrape surfaces (as in Fig. 43) and is indispensable in working curly or twisted grain wood. (See Fig. 34.)



Adjustable.



Concave-Convex.



Convex.

FIG. 34.—CABINET SCRAPERS.



FIG. 35.—BURNISHER.

Burnisher.—A burnisher is a tool made of steel, variously shaped, with a hard, smooth, rounded end or surface, and is used to smooth, polish, and turn up edges. (See Fig. 35.)



FIG. 36.—DRAW KNIFE.

with folding handles protect the cutting edge and are best for tool kits. (See Fig. 36.)

Spoke Shave.—The spoke shave is somewhat similar to the draw knife. It is made either of wood or metal. Its blade, fastened in a frame, is adjusted with a set screw. The spoke shave is used for irregular work as shown in Fig. 45. There are a number of designs of spoke shaves, but their method of operation is identical. (See Fig. 37.)



FIG. 37.—SPOKE SHAVE.



FIG. 38.—CORNERING TOOL.

Cornering Tool.—A tool used to slightly bevel or round the corners of porch rails, stair treads, etc., is a cornering tool. It is made of a strip of sheet steel. (See Fig. 38.)

Squaring Stock.—In squaring stock, the following method should be observed. Fig. 39 represents a piece of stock to be squared. Use the smoothing plane over side A in the direction of the grain, and remove all rough places. Test with the square as in Fig. 40, or with any straight edge, to determine if the entire side A lies in the same plane. Then, using the jack plane, work side B to make it at right angles to side A. Test with a try square, as in Fig. 26, mark for width, as shown in Fig. 25, then plane side C in the same manner as you did side B, at right angles to side A. Test with try square as side B. Mark for thickness with marking gauge, as shown in Fig. 25, and, with a smoothing plane, work side D parallel to side A and at right angles to sides B and C. Using try square, measure for length and mark ends as shown in Fig. 41, then saw as shown by H, I, J, Fig. 11. When planing end grain, move the plane only part way across the end, stopping about one inch from the back edge as shown at arrow in Fig. 42. Reverse the plane and work back again, stopping about one inch from the first edge. This prevents the edges from splitting.

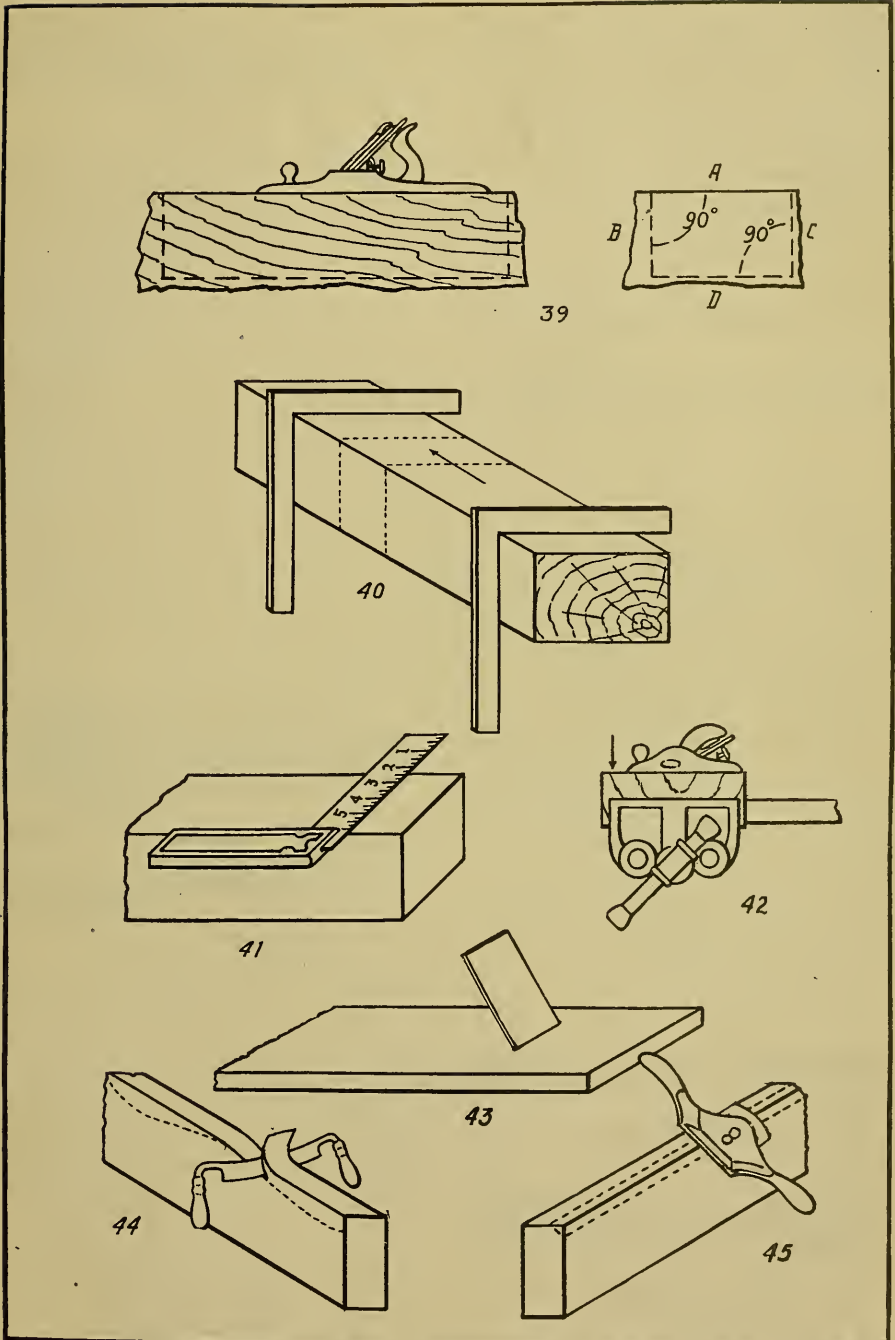

FIG. 39.—SQUARING STOCK. FIG. 40.—TESTING WITH SQUARE. FIG. 41.—MARKING END. FIG. 43.—USE OF CABINET SCRAPER. FIG. 44.—USE OF DRAW KNIFE. FIG. 45.—USE OF SPOKE SHAVE.

Wood Chisel.—No tool has yet been devised to replace the wood chisel, and for years to come it will be used universally for gaining, mortising, beveling and for reducing wood generally. Wood and steel are the materials necessary for the construction of chisels. The parts of the wood chisel are the socket or tang and bolster, according to classification, blade, cutting edge and handle.



FIG. 46.—TYPICAL WOOD CHISEL.



FIG. 47.—CHISEL TYPES. UPPER, TANG; LOWER, SOCKET FIRMER.

material for the tang set down in dies, while the socket firmer has the socket or barrel made of sheet metal rolled over a form to the proper shape and welded to a "mood" which is a piece of steel properly set down for welding purposes. Some of the sockets of the chisels and gouges are made by the boss and punch method, a process which involves the use of machinery. Socket firmer chisels are designed for heavy work. Tang chisels are lighter, better balanced, and better designed for cabinet work. Most of the carving tools, many flat chisels, and many of the gouges are of this type.

Chisel Handles.—The handles of chisels are made of wood, usually maple or hickory, highly polished, and very commonly capped with leather to prevent the shattering

Tang and Socket Firmer Chisels.—Wood chisels are of two kinds—tang and socket firmer, the names being derived from the way the handles are attached. The tang chisel has the shank, bolster and

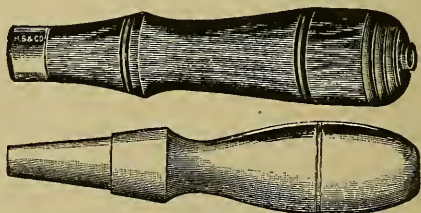

FIG. 48.—CHISEL HANDLES. UPPER, TANG; LOWER, SOCKET FIRMER.

of the wood by the blows of the mallet. In case the handle is for a tang chisel, there is a brass or iron ferrule slipped on the end. This goes over the tang to prevent it from splitting the wood.

Chisel Blades.—The blades of chisels may be of any width or length. Some have the edges of one side beveled. Other blades are worked over forms and are known

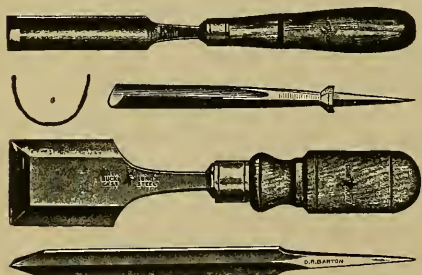

FIG. 49.—SPECIAL CHISEL TYPES. GOUGE, CARVING TOOL, BUTT CHISEL, CORNER CHISEL.

as gouges, corner chisels, turning chisels, carving tools, etc. Like many other tools, chisels are ground, tempered, polished and handled before they are ready for the market. (See Fig. 49.)

Sharpening Tools.—In sharpening any tool, care should be taken to keep it in the proper position, to retain the original bevel, and to keep from drawing the temper. The two first mentioned operations are very important, yet, even if they are done correctly, and the temper is drawn, the tool is worthless. Keep the tool as cool as possible while grinding, for, if it becomes hot, and the steel turns blue, the temper is drawn, and the tool is too soft to do satisfactory work. The sharpening of the wood chisel furnishes no exception to these rules. In addition, attention should be paid to the angles made by the various edges, each with another. The ordinary wood chisel should be ground with the cutting edge at 90 degrees to its long axis. A bevel should be made on one side only, and the plane of this bevel should make an included angle with the plane of the reverse side, of 15 to 30 degrees, the variation depending upon the class of work for which the chisel will be used. More chisels are ruined by over grinding than in any other way. Never grind one unless it is out of true, or the bevel has become rounded by whetting, and then only enough to make it true. Put the keen cutting edge on by the use of the oil stone and the leather strop. Never grind a tool on a dry stone.

Halving Joints.—Fig. 50 illustrates the method used with a chisel in reducing stock for halving joints. The work is carefully laid out, and the saw kerfs, A,A, are made. Saw kerfs prevent splitting. The chisel B is then started—about one-fourth of the depth of the saw kerfs—and upward—at a slight angle. This cut is to test the direction of the grain of the wood. This cut should be carried down on one side and returned cuts made from the back side. The edge of the chisel may be used for testing the trueness of the surface.

Concave Surfaces.—Fig. 51 shows the method commonly used to cut out concave surface on light short stock. Saw kerfs are made about an inch apart and the chisel is used in removing the stock. These cuts with the chisel—in a straight grained piece—should be made in the direction of the grain, as from A to C and from B to C.

End Beveling.—Fig. 52 shows the method used in cutting a bevel across the end of a piece. If the best results are desired, the tool must have a keen edge and be given a shearing position.

Beveling.—Fig. 53 illustrates the practice of laying out and making a bevel. The ends are first cut as at A, and the stock removed on the

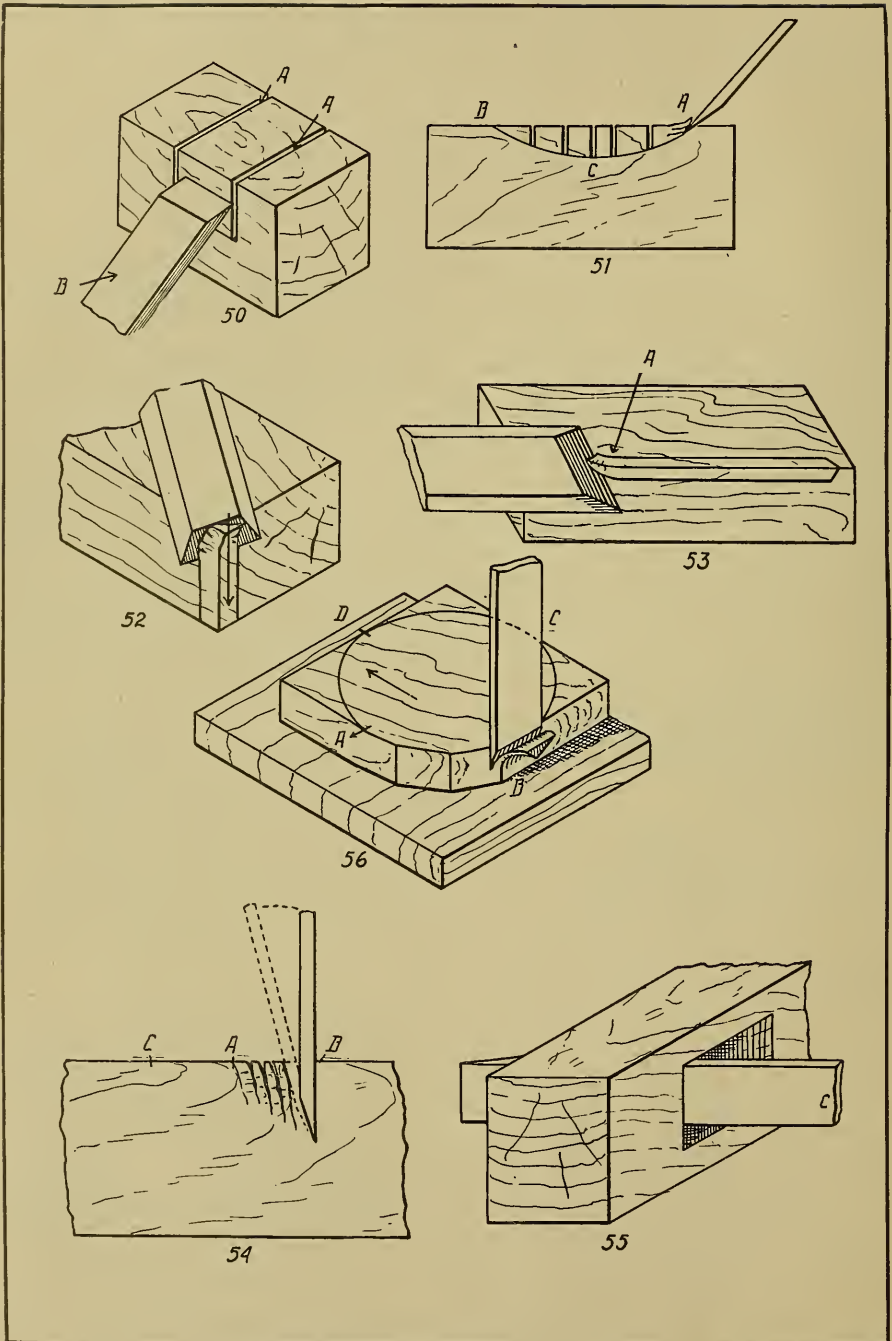

FIG. 50.—HALVING JOINTS. FIG. 51.—CUTTING CONCAVE SURFACE. FIG. 52.—CUTTING END BEVEL. FIG. 53.—CUTTING EDGE BEVEL. FIG. 54.—CUTTING MORTISE. FIG. 55.—TESTING MORTISE. FIG. 56.—CUTTING CIRCULAR PIECE.

edge with a chisel. Where the bevel runs the length of the edge, a jack plane may be used to advantage.

Mortises.—Fig. 54 illustrates the manner in which a mortise is cut with a chisel. The cut is started at A with a chisel which is a little narrower than the mortise, and cuts are made from side to side, each cut a little deeper than the one before, until the end is reached. The end cuts should be light, square, and the corners cut clean. The return cut from A to C may be made in the same manner. This will leave the mortise packed with fine chips about half way through the piece. The piece may then be turned over and the same method practised on the other side until all cuts are through, after which the chips may be forced out and the walls trued. This chisel as shown in Fig. 55 may be used to test the trueness of the walls.

Circular Pieces.—Occasionally it is necessary to cut out a circular piece of wood. This may be done by careful use of the chisel as illustrated in Fig. 56. As far as possible, the chisel cuts should be made with the grain of the wood, shearing cuts, as shown in Fig. 52, being made across the end grain. In case the grain runs in the direction of the arrow, it will be necessary to make the cuts from A to B, from A to D, from C to B and from C to D.

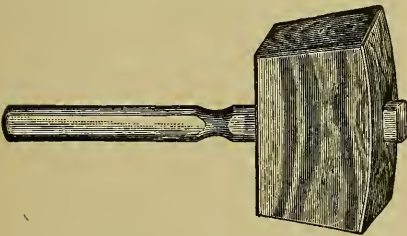

FIG. 57.—RADIAL FACE MALLET.

forms, but the best form for ordinary work is the one with the faces cut radial. (See Fig. 57.)

Hammers.—Hammers are designed to meet all classes of work such as driving nails, pounding metal and working in stone; they are most commonly found in forms suitable for the carpenter, blacksmith, machinist, mason and tinner. The materials used in constructing hammers are wood and steel. The stock of the hammer is

Mallets.—The mallet is a tool used for driving cutting tools which have wooden handles. Various materials are used in the construction of mallets, chief of which are wood, lignum-vitae, raw-hide, a combination of wood and metal, and rubber. Rubber mallets are used in setting up cabinet work. Mallets are manufactured in many

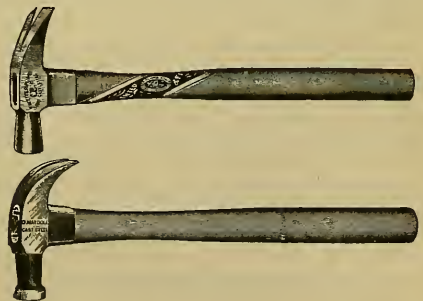

FIG. 58.—CLAW HAMMERS. BALL PEEN.
MAYDOLE.

of high grade crucible steel, forged into the proper shape, ground, tempered, and finally polished. The handles are put in afterwards.



FIG. 59.—HAMMER HANDLE.

Hammer handles should be straight grained and tough, and should be finished in such a way that they will not become sticky when held in a moist hand. In order to secure a straight grained piece of young, heavy hickory, trees are selected and cut into lengths suitable for turning into handles. These pieces are split—not sawed—into blanks and permitted to air dry, or season, for about six months before they are turned into proper shape. Air drying leaves them tough, while kiln drying makes the wood brittle. A common method of finishing handles is to hold them on sanding, filling, and polishing belts, each doing its work in turn.

Driving Nails.—It will be found that nails driven into wood at a slight angle—See Fig. 64—have a greater resisting capacity than those driven straight in. This is true because it is necessary either to bend the nails or to split the pieces held together in this fashion to separate them. In driving a nail, hold it at a slight angle, tap it lightly with the hammer to start it, follow with several sharp blows squarely on the head, thus forcing it into the material, until the top of the head becomes flush with the surface of the wood. Be careful not to mar the wood. Fig. 63 indicates the position of the hammer to the face of the wood to prevent scarring. Fig. 65 shows a method of toe-nailing one piece to another. Nails that are to be set should never be driven home with a hammer, but the head should be left partly above the surface of the wood; the nail then may be set with a nail set and hammer.

Nail Sets.—The nail set is made of tool steel and has its point cup shape to prevent it from slipping off of the head of the nail and scarring the wood.



FIG. 60.—NAIL SET.

Pulling Nails.—To pull a nail, place the claws of the hammer under the head of the nail and then place a block of wood under the eye of the hammer—to prevent the scarring of the material as well as to increase the leverage; pull the handle back over the block; if the nail is not clinched or rusted, it can be easily removed.

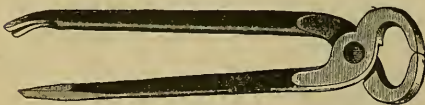

FIG. 61.—CARPENTER'S PINCERS.

Carpenter's Pincers.—Carpenter's pincers, which are used in cutting and pulling nails, should be made of good steel. The arrange-

ment of the jaws makes it possible to pull short broken nails with but little effort.



FIG. 62.—SCREW DRIVER.

Screw Drivers.—A screw driver is a tool used for turning screws into material. It is designed especially for this work, having a blade, A, Fig. 66, formed so that it will fit the slot B of the screw E, a shank, and a handle. The sides of the end of the blade should be parallel in order to prevent the scarring of the head of the screw. (See Fig. 67). Screw drivers with shanks from three to eighteen inches long are very common. Screw driver handles are made of wood, leather-washers, wood fibre and metal, all of which are designed to give the best possible grip to the hand. A very convenient form is that with the shank bent at right angles and a blade on each end.

Driving Screws.—To secure the greatest efficiency, screws must be driven home with care. Screws may be driven into soft wood with an ordinary screw-driver, but in tough or twisted grain or hard wood, it is best to bore a hole to receive the screw. In fastening two boards together with screws (See Fig. 66), bore a hole in the first board a little larger than the gauge of the screw D; bore a hole in the second piece the size of the short diameter of the threads of the screw, F. Countersink C in the first board to receive the head and slip the point of the screw through the first board and start it into the second. By revolving the screw E to the right—clock wise—the screw will pull the two boards together at that point. Care should be taken not to strip the threads in the wood, especially in the end grain. A little soap or grease on the point of the screw will cause it to enter the wood more easily. Some screws are designed to be driven with a hammer, but most screws in common use should never be more than well started with a hammer. To do more, one incurs the danger of closing the slot of a round head screw and the possibility of breaking off half of or the whole head of a flat head screw.

Vises.—To facilitate the better handling of wood during the process of construction, vises, handscrews and clamps are used. Vises are made of both wood and metal and are constructed in many forms. Probably the oldest and most used form is the wooden jaw vise, the one that has one jaw built to the bench. Rapid acting metal vises are very common and save much time in changing the stock in the vise. They are usually bolted to the bench and may have the jaws lined with wood to prevent the scarring of the piece to be held.

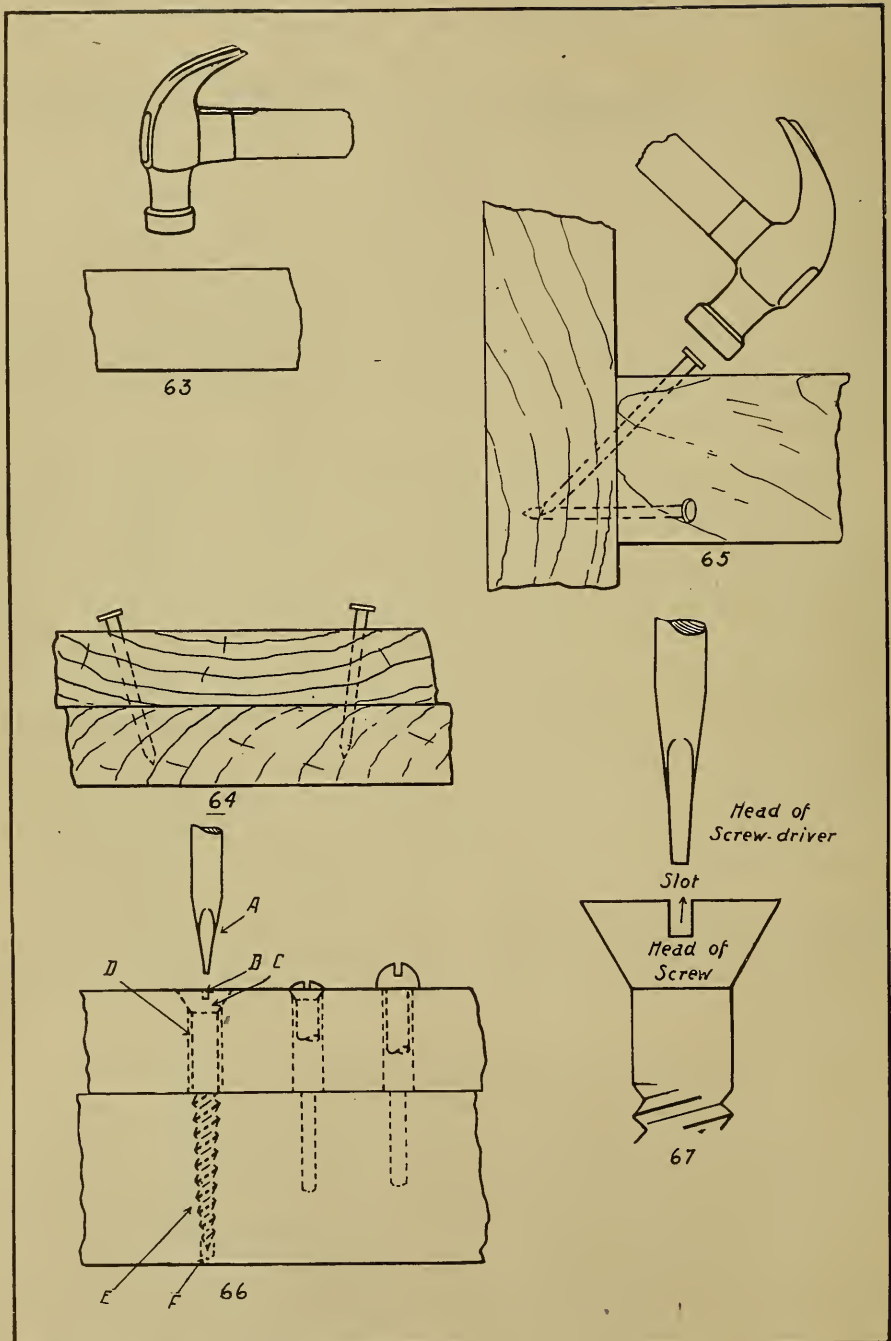

FIG. 63.—HAMMER POSITION. FIG. 64.—METHOD OF NAILING. FIG. 65.—TOE-NAILING.
 FIG. 66.—DRIVING SCREWS. FIG. 67.—ADJUSTMENT OF SCREW AND DRIVER.

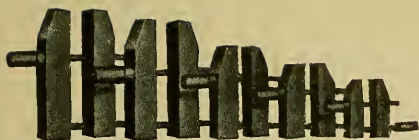

FIG. 68.—HAND SCREWS.

Hand Screws.—Hand Screws are used to hold pieces of wood together while laying out work, gluing, chiseling, etc. The jaws are made of wood, but the better and the more convenient hand screws have the spindles made of metal,

and so arranged that the jaws may be set at an angle for special work. In all cases where possible, the jaws should be worked in a parallel position, so as to distribute and gain the most pressure. (See Figs. 70 and 68.)

Clamps.—Like hand screws, clamps are used because of their capacity to hold wood together. The better clamps are made of steel and range in size from the small C-clamp to the carpenter's door and trestle clamp. These larger clamps are used in the gluing of table tops, and in clamping together large frames. The long clamps have a tail stop

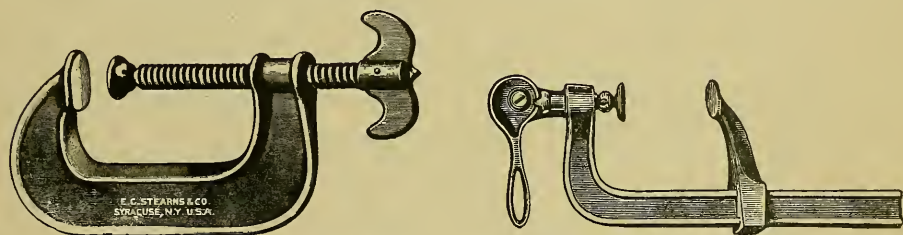

FIG. 69.—CLAMPS. C-CLAMP AND BAR CLAMP.

which slides the length of the steel bar. This makes the clamp quick acting. Most of the clamps are worked with a screw, but some of them secure their pressure by the use of an eccentric. Fig. 72 illustrates a method commonly used in clamping boards together with a carpenter's clamp. It is necessary to face the jaws A with the blocks B to prevent bruising the pieces C to be held.

C-Clamps.—The C-clamp, or screw clamp, is used most in holding work together temporarily while it is being laid out. It is also commonly used to hold work to the bench. (See Fig. 71.)

Improvised Clamp.—An improvised clamp is illustrated in Fig. 73 by which the pressure is secured by wedges. The boards to be glued, C and D, are backed against the strips B. Wedges A, A are driven up tight thus forcing the two boards tightly together. If the surface to be glued is wide, it will be necessary to put weights on the boards C to prevent their buckling.

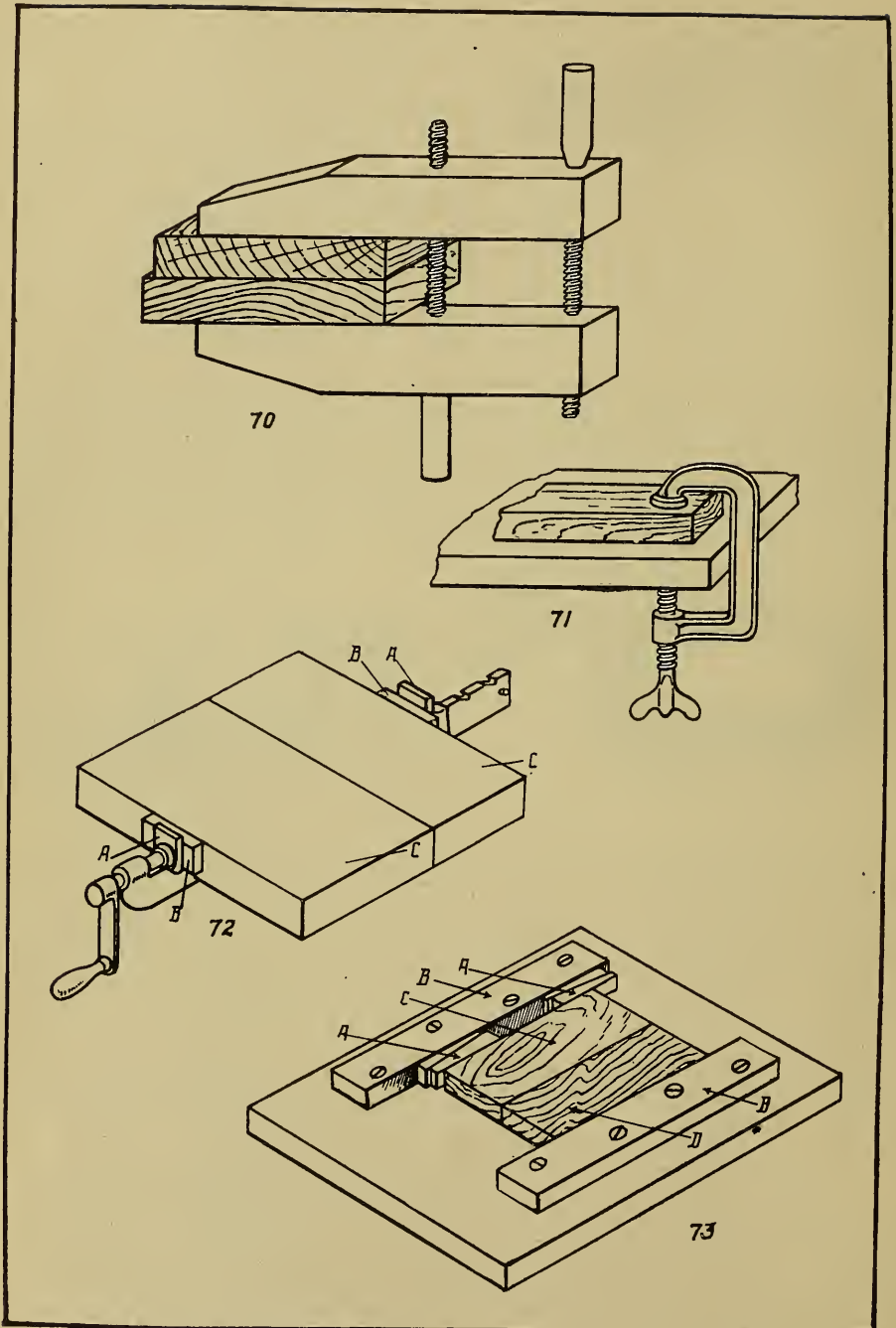

FIG. 70.—USE OF HAND SCREWS. FIG. 71.—USE OF C-CLAMP. FIG. 72.—USE OF BAR CLAMP. FIG. 73.—IMPROVISED CLAMP.

Use of Braces and Bits.—Braces and bits are thoroughly discussed in Chapters IV and V in Part III. However, a few illustrations here may not be amiss.

Locating Centers.—Fig. 74 shows the method of locating or laying out centers for bored work. The measurements for holes are always given to the center, unless otherwise specified, and usually from two directions. In case of a series of holes the measurements are given from center to center.

Securing Bored Stock.—Work to be bored should be held securely in a position most convenient to the workman, so as not to slip or bend and break the bit. This will materially assist in boring the hole true. Fig. 75 illustrates one method of shifting the cap of the brace so the bit is square to the place of the piece being bored. A try-square may be placed beside the bit to insure accuracy.

Boring Through.—Extreme care should be taken with finished pieces to prevent splitting on the back side by boring through. To prevent this, stop boring when the spur (See A in Fig. 76) has come through. Return the cut from the back side. Another method is to clamp a piece of scrap material securely behind the board and bore through into the scrap material. This will leave a clean cut hole.

Depth Gauge.—Fig. 77 illustrates the use of the depth gauge. This serves as a stop since it prevents the bit from feeding in farther than the distance to which it was adjusted. This gauge is used in boring deep mortises. The cuts should be overlapping. (See Fig. 78.) The overlapping cuts make the walls easy to true with a chisel.

Ratchet.—It is often necessary to bore a hole in a corner or close to an obstacle where it is impossible to get a full swing with the brace. This is done by the use of the ratchet. Fig. 79 illustrates a corner in which the cranked-handle moves through a quadrant of a circle.

Tool Sharpening.—In sharpening tools, care must be taken to retain the grind or bevel. If the original bevel has not been retained, the tool must be put on the grindstone as in Fig. 80. A shows an adjustable tool rest on which the tool is held while being ground. The stone must revolve in the direction of the arrow and against the cutting edge of the tool. It is not the function of the grindstone to sharpen tools, but to remove metal so the desired bevel may be given. Fig. 81 shows a tool, the bevel of which has not been retained, and which must be put on the grindstone and ground to the dotted line.

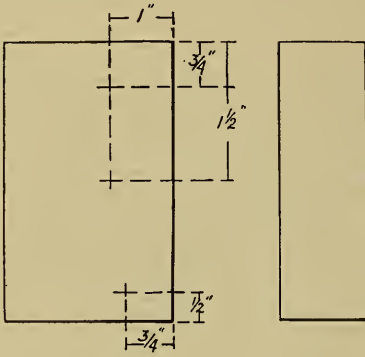

74



75

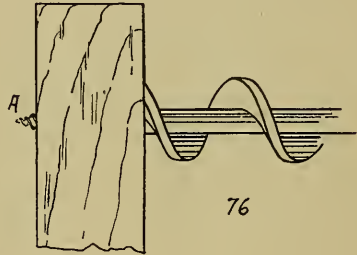

76

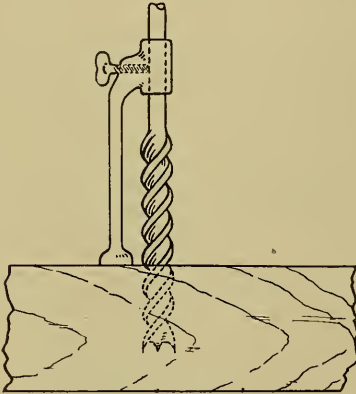

77

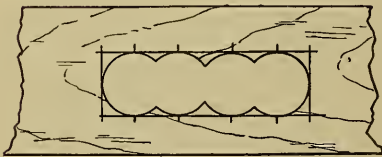

78

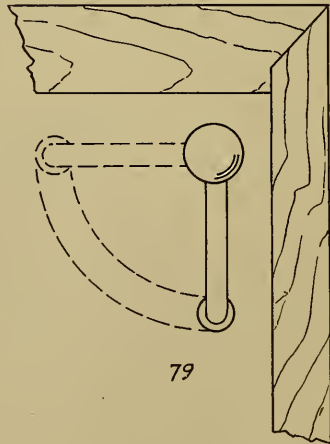

79

FIG. 74.—LOCATING CENTERS. FIG. 75.—STARTING BIT. FIG. 76.—BORING THROUGH.
FIG. 77.—USE OF DEPTH GAUGE. FIG. 78.—BORING MORTISE.
FIG. 79.—USE OF RATCHET BRACE.

Chisel Sharpening.—Fig. 82 shows how the chisel must be held on the oil stone to put on the cutting edge. Bear on the chisel when pushing it in the direction of the arrow. Fig. 83 shows how to lay the chisel on the oil stone when removing the wire edge that may have resulted from the operation in Fig. 80. Care must be taken that the oil stone retains its flat sides. However, if the surfaces become irregular, place it on the side of the grindstone and grind until the sides are flat.

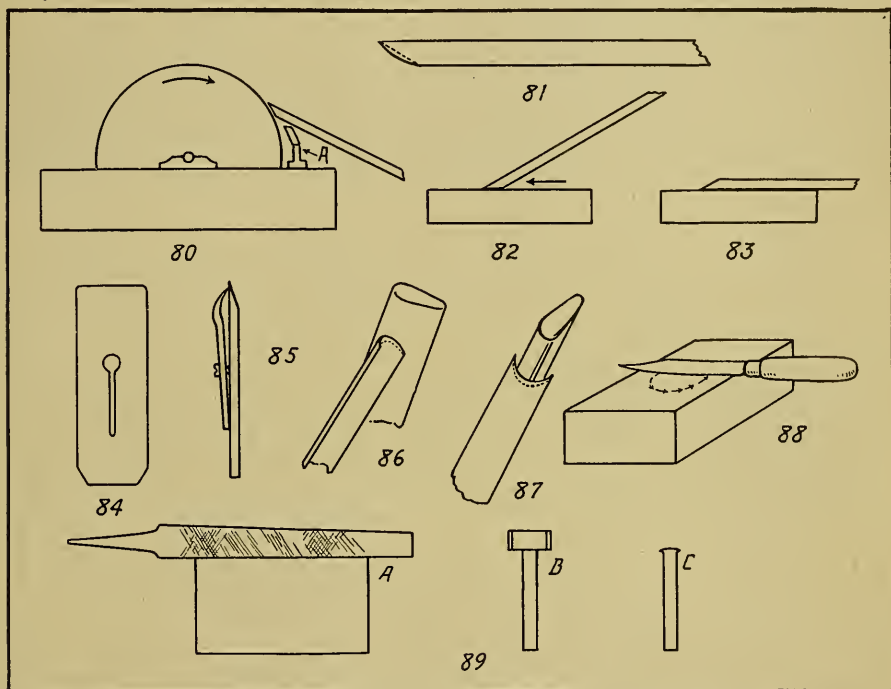

FIG. 80.—ADJUSTMENT OF TOOL TO GRINDSTONE. FIG. 81.—IMPROPER BEVEL. FIG. 82.—ADJUSTMENT OF TOOL TO OIL STONE. FIG. 83.—REMOVING WIRE EDGE. FIG. 84.—ROUNDED PLANE IRON EDGES. FIG. 85.—PLANE IRON AND CAP ATTACHED. FIG. 86.—SHARPENING OUTSIDE BEVELED GOUGE. FIG. 87.—SHARPENING INSIDE BEVELED GOUGE. FIG. 88.—SHARPENING KNIFE. FIG. 89.—SHARPENING CABINET SCRAPER.

Plane Iron Sharpening.—The bevel or grind on a plane iron is from $\frac{3}{16}$ " to $\frac{1}{4}$ ", depending upon the thickness of the tool and the character of the wood for which it is intended. The sharpening of the plane iron is the same as the chisel. Test the cutting edge for squareness with a try square. Fig. 84 shows the edges slightly rounded. This avoids ridges which would otherwise result from a square corner. Fig. 85 shows the plane iron cap fastened to the plane iron. How near the cap is to be set to the cutting edge is determined by the character of the work.

Gouge Sharpening.—Fig. 86 shows how a gouge beveled on the outside may be sharpened with a slip stone, and Fig. 87 shows how a gouge beveled on the inside may be sharpened with a slip stone.

Knife Sharpening.—To sharpen a knife, give it a circular motion—both clockwise and anti-clockwise—as shown in dotted circle, Fig. 88.

Cabinet Scraper Sharpening.—A, in Fig. 89, shows how to sharpen a cabinet scraper. Run the file horizontally along the edge of the scraper until the edge forms a right angle to the sides. If, during this process, a wire edge has formed, remove it on the oil stone. After this operation, run the burnisher across the edge of the scraper, forming a convex surface—a burr on each side of the edge, as shown in B and C of Fig. 89. The angle at which the scraper is used, is determined by the angle of the burr. (See Fig. 43.)

CHAPTER III

DEVELOPMENT OF A PROJECT

(A typical line of procedure to follow in the construction of any article.)

Plans and Specifications.—In making any project, the first and most important consideration is a clear understanding of what the piece is really to be. This should be followed by a knowledge of the purpose it is to serve, and lastly one should know definitely what parts are necessary for the construction of the whole. All of this information is, or should be, included in the plans and specifications.

Construction of Rack.—In this chapter, the article proposed for development and construction is a rack. The project was chosen neither for its intrinsic value when completed nor for its utility but because its construction involves the use of so many tools and the sequence of the operations is so clearly marked. The development of this project is a typical line of procedure. In this case the name itself indicates that it is to be a complete article, assembled and finished; perhaps to match some piece of furniture. The purpose which it is to serve is implied in the name. The plan (Fig. 90) shows the parts needed in its construction.

Parts.—This rack is composed of six parts:

- A—back (1)
- B—support (1)
- C—arms (2)
- D—crossrail (1)
- E—dowel pin (1)

These parts are carefully worked out and assembled so that the frame C D E swings on E as the bearing. F is a $\frac{1}{4}$ " hole bored at a point equidistant from the sides of the frame and one inch from the top so that the rack may be hung on a nail or hook.

Laying Out the Back.—The back should be of clear wood and of the same kind as the piece of furniture the project is designed to match. Dress this part to measurements $\frac{1}{2} \times 5\frac{1}{2} \times 7$ inches as given on the plans. The rule, saw, try-square, and plane will be all the tools necessary for this part of the work. The board is now ready for laying out the

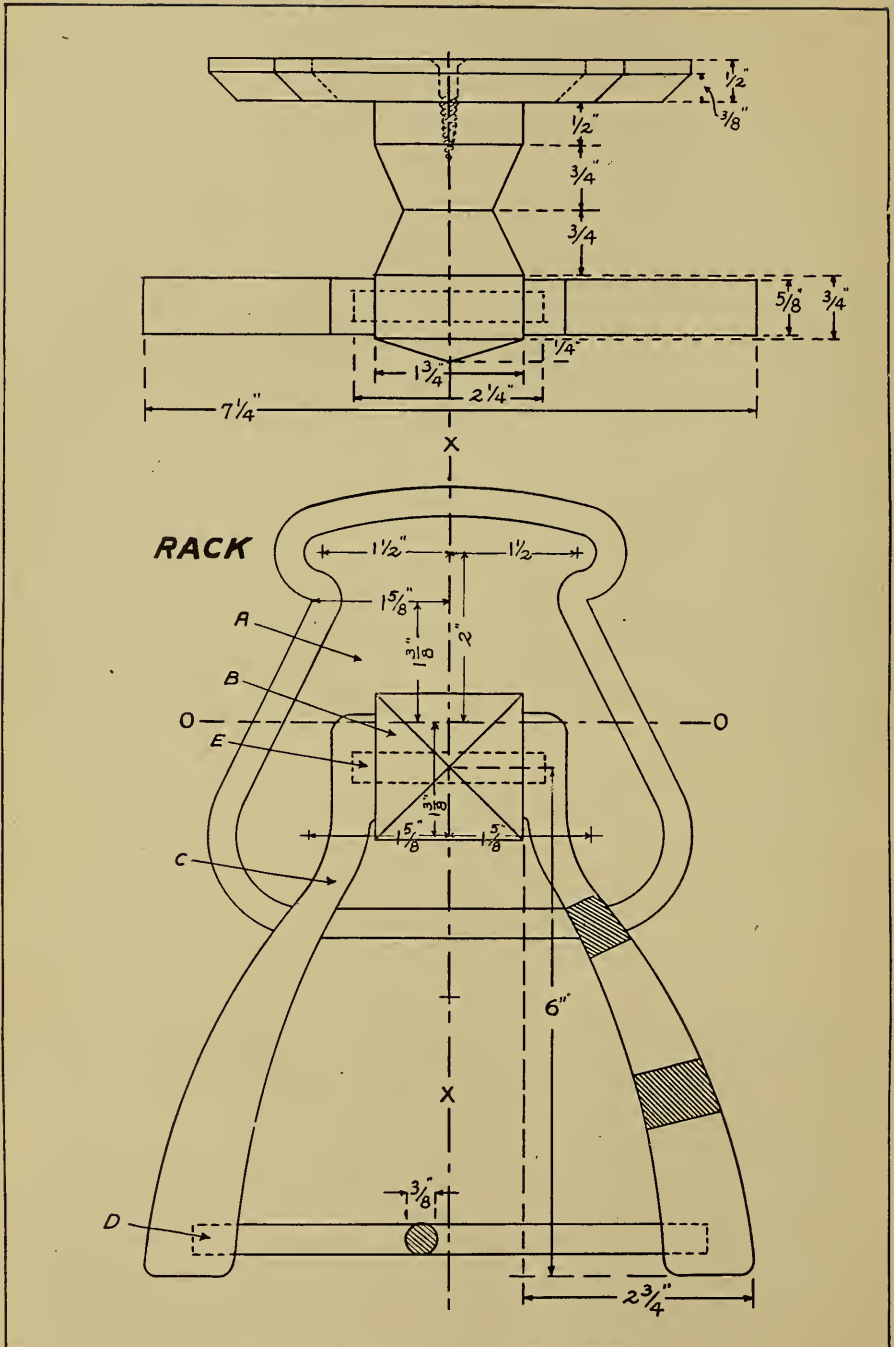

FIG. 90.—WORKING DRAWING OF A RACK.

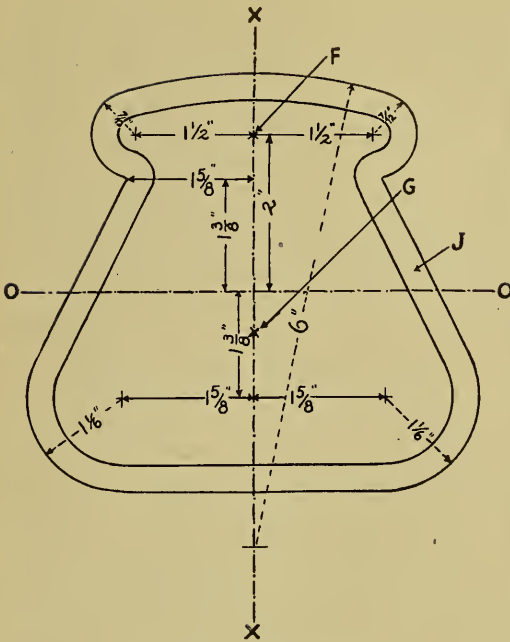

FIG. 91.—THE BACK.

design. (See Fig. 91.) The first step in making a layout for a design is drawing the center lines; from these center lines all centers are placed, as for centers of arcs, holes, etc. Draw both center lines, as XX and OO, the former running vertical, the latter horizontal. From line OO measure down one and three-eighths inches and draw a line parallel with line OO; on this line, from the intersection of line XX, each side of XX, measure off $1\frac{5}{8}$ inches. At these two points your large arcs will be swung. From line OO measure up 2" and draw a line parallel with line OO. On this line, each side of XX, measure off $1\frac{1}{2}$ ".

From these points the two small upper arcs are swung. On line XX measure up from intersection of line OO $1\frac{3}{8}$ ". Draw a light line parallel with line OO. On this line, each side of line XX, measure off $1\frac{5}{8}$ ". From these points draw lines tangent to large arcs. With compass point set at 6 inches, with one point on line XX produced, scribe the upper arc, being careful that this arc is tangent to the two small arcs. After scribing the four arcs with a light line, connect the arcs with tangent lines as shown in Fig. 91. The bevel, J, $\frac{3}{8}$ inch, should be laid out by the use of a fine pointed pencil and the hand, a finger of which serves as a guide or gauge. Making gauge lines will leave a scratch after the bevel is cut. Since the above provides for all the work to be laid out on this part of the project, the shaping may begin.

Shaping the Back.—The holes F and G in Fig. 91 may be bored with an ordinary auger bit, but extreme care should be taken not

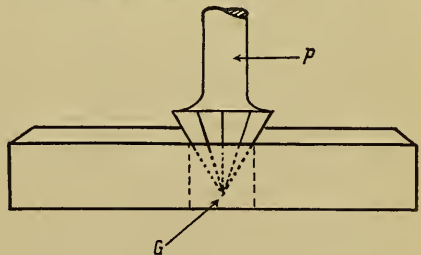

FIG. 92.—COUNTERSINKING FOR SCREW.

to split the back surface when the bit goes through. It is better practice to stop boring when the spur of the bit shows through, and to return the boring from the opposite side. Fig. 92 shows the use of the countersink P in reaming out the hole G. This forms a seat for the head of the screw which holds the support and back together. The beveled edges J in Fig. 91 may be cut with a smoothing plane, making the strokes parallel with the grain of the wood. The bevel edges across the ends may also be cut with the plane if the plane is turned so the plane iron will have a shearing cut with the grain of the piece.

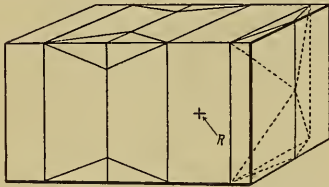

FIG. 93.—LAYING OUT THE SUPPORT.

the end show the picket point with which the support is embellished, and are shown in this cut to indicate that all of the work cannot be laid out at first as some of the piece is cut away exposing new surfaces. The work must be laid out after these cuts are made.

Fig. 94 shows clearly the method used in cutting a picket point which is formed by four triangular bevel surfaces meeting in a common point. The cuts are made with a saw, usually a back saw, as illustrated by S, removing the slab T. On the newly-exposed bevel surfaces, lines are drawn from the corners to the center of the ridge. These cuts are then made with a saw and the four triangular bevel surfaces are smoothed by the careful use of the plane. In cutting the bevel surfaces to form the neck on the support, the saw kerfs U are made $\frac{5}{16}$ inch deep on all four sides. The material is removed by the use of the chisel W, but extreme care should be taken to keep the surfaces of the bevels perfectly flat. The other end of the support rests on the

The Support.—Fig. 93 illustrates the manner in which the support B (Fig. 90) is laid out after it has been squared to the proper measurements. The intersection of the two lines at R in Fig. 93 indicates the center of the hole in which the dowel E (Fig. 90) is to be inserted. The dotted lines on

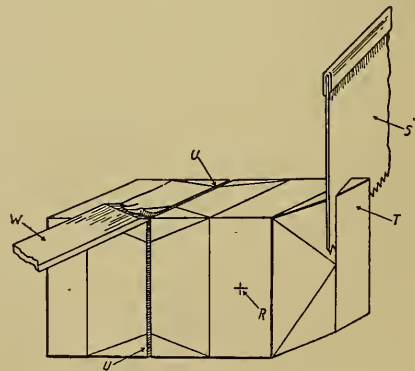

FIG. 94.—FORMING THE SUPPORT.

back piece just completed. On this end, draw diagonal lines from corner to corner. The intersection of these lines locates the center, at which a hole, equal to the short diameter of the screw thread, should be bored deep enough to receive the screw.

The Arms.—A careful study of the plan will reveal that the length of the arms (C in Fig. 90) is not given, but that the run and rise is. The run is $2\frac{3}{4}$ inches and the rise is 6 inches, plus $\frac{5}{8}$ inch, or $6\frac{5}{8}$ inches. It is best to make a cardboard pattern with the use of the steel square. Lay the square on the cardboard, and at the point $6\frac{5}{8}$ inches on the blade of the square, square out a line $\frac{3}{4}$ inch, and on the tongue at $2\frac{3}{4}$ inches make a mark. Scribe a line on the inside edge of the square forming the plumb and level cuts.

The curves may be developed free hand and the pattern may be cut out and used for both pieces. This as-

sure one of having the two arms similar. Brad two pieces of the right width and thickness together and tack the pattern on the face side as illustrated in Fig. 95. Saw kerfs X may be made at irregular intervals and the surplus stock removed with a chisel or draw knife, but a better way is by the use of a band or jig saw. (See B. P. 400.) All cuts of the chisel should be in the direction of the arrows. The saw kerfs prevent splitting.

The round corners may be formed with a chisel as shown in Fig. 96. The edge of the tool must have a shearing motion.

The centers for holes which receive the dowels and cross rails should be carefully laid out and bored.

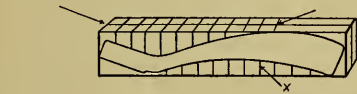

FIG. 95.—LAYING OUT THE ARMS.

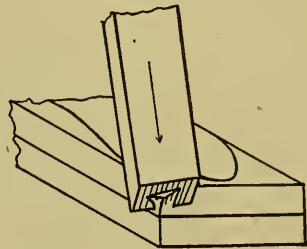

FIG. 96.—FORMING THE ARMS.

Cross Rail and Dowel.—The method used in making the cross rail (D Fig. 90) and the dowel, (E Fig. 90) are exactly identical and since they are the same size, $\frac{3}{8}$ inch, they may be made in one piece. First, square up a piece of the necessary length to $\frac{3}{8}$ inch. On each end, form an octagon, and run pencil lines

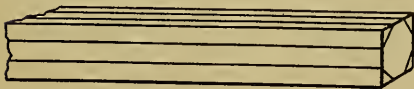

FIG. 97.—LAYING OUT THE RAIL AND DOWEL.

on the stock connecting the octagons. (See Fig. 97.) These corners may be removed by the use of a plane.

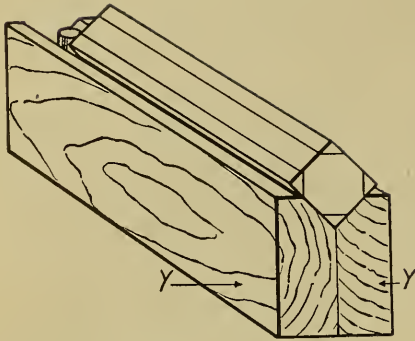

FIG. 98.—USE OF A CHUTE BOARD.

drilled in it as shown in Fig. 99. This illustration shows the method of driving the stock through. Care should be taken to hit the stock square with a mallet, and, if the stock is long, it should be held about the middle to prevent buckling. If the stock is well worked down, it will come

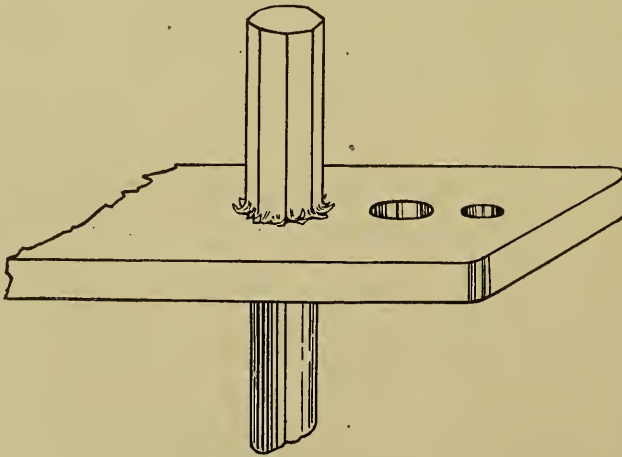

FIG. 99.—USE OF A DOWEL PLATE.

out clean, smooth and round. Improvised plates may be made by boring holes in hard wood. The piece may now be cut into suitable lengths for the cross rail and the dowel, or D and E in Fig. 90.

Assembling.—All of the pieces should be gone over carefully with sand paper to make them smooth and clean. Always sand paper with

the grain. The back A may be screwed to the support B, but the point of contact should be coated with glue. Care should be taken to see that the sides of the support and back are parallel before the screw is finally driven home. The dowel E should be made to rotate in the hole in the end of the support so that the frame formed by the arms, the cross rail and the dowel, will swing. This frame should be glued together in position, but no glue should find its way into the hole in the support. The frame should be free from wind. The work should set for twenty-four hours to permit the glue to dry. Then remove all glue streaks, bruises or scars with sand paper. The rack is now ready for finishing.

Finishing.—A very good finish for this rack is one coat of shellac (white) and two coats of wax. The shellac should be brushed on and given plenty of time to dry thoroughly. Then it should be worked down with fine, or worn-out, sandpaper until the surface is smooth. Over this add a coat of wax. This may be put on with a rag. When it sets, that is, when it has become dull and its solvent is partially or totally evaporated, it may be polished by rubbing with a soft rag. Another coat of wax may be added in the same manner.

CHAPTER IV

MACHINERY.

Woodworking Machinery.—For the rapid shaping and reproduction of similar forms, woodworking machinery is used. Machines designed for practically all classes of work are on the market, and new machines, as well as improvements on the old, are developed readily. Probably the most common machines used in industrial schools are the following:

- Saw bench with rip saw and cross-cut saw;
- Band saw;
- Surfacer;
- Hand planer and jointer;
- Speed lathes;
- Trimmer;
- Tool grinder.

These machines vary in form and size and in their equipment with special parts best suited for diversified kinds of work.

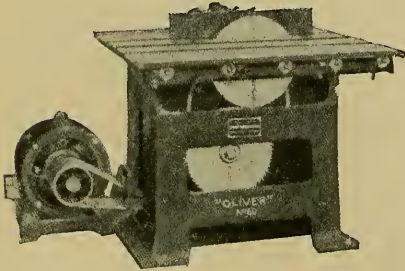

FIG. 100.—UNIVERSAL SAW BENCH.

Universal Saw Bench.—The rip saw is indispensable in a modern school shop. The accompanying cut (Fig. 100) shows a modern saw bench which can be fitted up with attachments for many classes of special work. The base is cast in one piece, making the machine rigid. The table, which is provided with a tilting mechanism, and is operated by hand, and which has a stationary and rolling section, is also made of

metal. This machine is provided with a yoke, having two arbors, on which the saws are mounted and revolved by a hand wheel, engaging worm and gear. The latter is protected by a dust-proof casing. The saw can be fitted with either direct motor or countershaft drive. The equipment consists of a rip saw, a cross-cut saw, a universal ripping fence, a miter cut-off gauge, a universal miter gauge, and a clearance block.

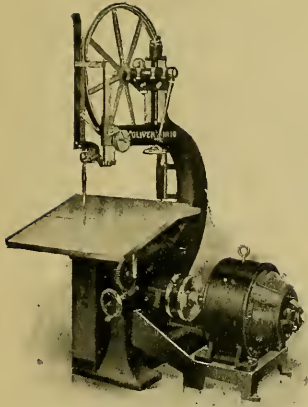

FIG. 101.—BAND SAW. -

Band Saw.—The band saw is a piece of woodworking machinery, consisting of a steel band, from whence the name is derived, which runs over two wheels in the same manner as a belt. It is used in pattern shops, saw mills, planing mills, and in wood novelty shops. It is used extensively for sawing curves, ripping, and sawing irregular work in general. With the band saw blade in motion, the wood is fed to it. The operator slides the wood over a table, which can be tilted to any angle, thus making it easy to hold and guide the piece of wood. The important parts which make up a band saw are the following:

Frame;	Saw tension;
Guide post;	Safety guards;
Wheels;	Special equipment for re-
Table;	sawing, etc.

Band saw blades are made in all widths, and in lengths suitable for the capacity of the machine. By capacity is meant the working clearance under the guide and between the blade and column. (See Fig. 101.)

Surfacer.—The surfacer is a machine which is used extensively by cabinet makers, pattern makers, and manufacturers of pianos, organs, vehicles, cars, doors, sashes, boats, blinds, and wood novelties of all kinds, for planing or surfacing stock. It does, on a large scale, the same kind of work which may be done with smooth and jack planes. It is a great time saver. The frame of the surfacer is made of cored section sides, and heavy ribbed girts, machine jointed and bolted. The bed is raised and lowered by a hand wheel.

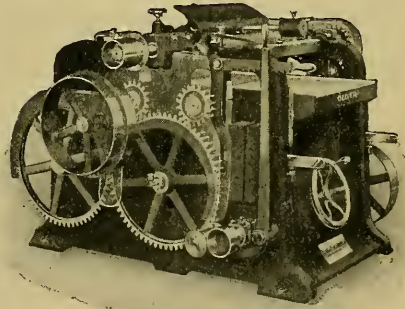

FIG. 102.—SURFACER.

The surfacer can be fitted with either direct motor or counter-shaft drive. The rough stock is fed through the machine by means of four rollers. The cylindrical head, which makes 5,000 revolutions per minute, cuts from beneath the surface, thus retaining the keen cutting

edge longer. Experience has proved that the knives should be ground at an angle of 42 degrees in order to obtain the best results. (See Fig. 102.)

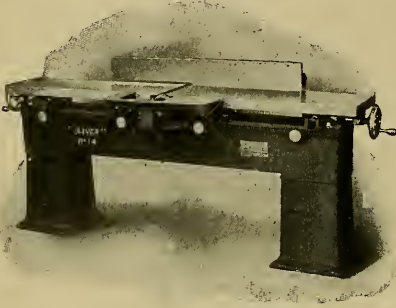

FIG. 103.—HAND JOINTER.

Hand Planer and Jointer.—The hand planer and jointer is used in all woodworking shops for dressing and joining wood. The principal parts of the machine are the following:

Bed;	Rabbeting at-
Tables;	achment;
Cylinder;	Fence;
Cylinder bear-	Pulley.
ings;	

The head, or cylinder, with two knives inset, should make about 5,000 revolutions per minute in order to develop the maximum cutting efficiency. The cutting blades, like those of the surfacer, cut from underneath the face of the wood, thus making it possible to work over finished material. The knives should be shielded as much of the time as possible. For all joint work, the line of the take-off table should be tangent to the circle described by the revolving knives. (See Fig. 103.)

Lathes.—Lathes are used extensively in school and pattern making shops in doing cylindrical and spherical work. They are either motor

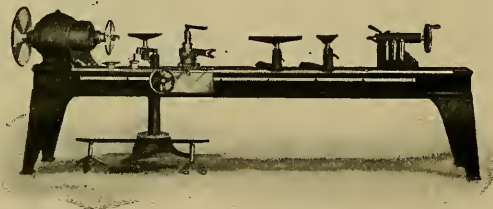

FIG. 104.—LATHE.

or belt driven, and the drive must be so arranged as to give variable speeds. The parts of the lathe are the following:

Bed;	Tail stock, in which is placed the
Head, in which is placed the live	dead center;
center;	Face plates; Tool rests.

A pattern maker's lathe is generally provided with a tool carriage, hand fed, which has a longitudinal and cross feed. All cylindrical and spherical work, with their variations, can be done on the lathe. The swing of the lathe is determined by the distance between the live center and the top of the bed, this being one-half the size of the stock worked. The distance between the centers determines the length of stock that can be worked. (See Fig. 104.)

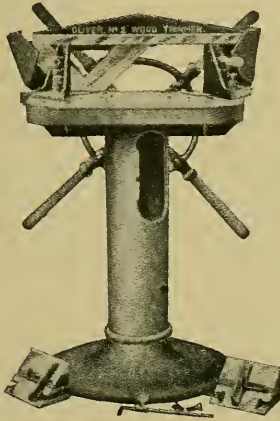

FIG. 105.—TRIMMER.

Trimmer.—The wood trimmer is a tool used in all pattern, cabinet and novelty shops for trimming the ends of small pieces of wood. The cutting is done by knives. These knives are forced through the wood which is held against a stop at the correct angle. The principal parts of the wood trimmer are the following:

Knife carriage;	Driving mechanism;
Gauges;	Trial gauges;
Bed;	Column.
Standard;	

The knives have a shearing motion which leaves a clean unbroken cut. The points of the knives should always be shielded, and only one person at a time should operate the wood trimmer. (See Fig. 105.)

Oilstone Tool Edge Grinder.—A tool grinder is indispensable in any shop, no matter whether natural or artificial stones are used. However, artificial stones must be used with the knife grinding attachment. Grinders with two wheels, one of medium and one of fine grit, are most desirable. The principal parts of the edge tool grinder are the following:

Base;	Knife grinding attachment;
Oil pan;	Driving mechanism;
Oil reservoir;	Wheels;
Wheels;	Special equipment.
Wheel arbor;	

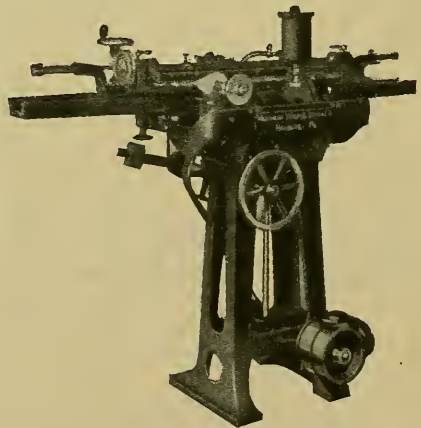

FIG. 106.—TOOL GRINDER.

New wheels should be thoroughly soaked with kerosene before using and a little added from time to time. They readily absorb the oil and will appear to be dry when not running, but the centrifugal force will bring the oil to the face of the wheel when the proper speed is reached. (See Fig. 106.)

Machine Tools.—In the upkeep of machinery, it is necessary to have tools for making adjustments, in order that the maximum efficiency of the machine may be developed and maintained. Wrenches, pliers, chisels, large screw drivers, scrapers and oilers are the tools most frequently used.

Wrenches.—Many machines have wrenches made for special work; but it will be found that the ordinary monkey wrench may be used to advantage on most woodworking machinery. This wrench is made in many styles and sizes and is used in turning nuts and lag screws. (See Fig. 107.)



FIG. 107.—MONKEY WRENCH.

Oiler.—The oiler, more commonly called the oil can, is indispensable in properly lubricating the moving parts of machinery. It is made in many sizes and some have long spouts, designed for oiling locomotives, etc. (See Fig. 108.)

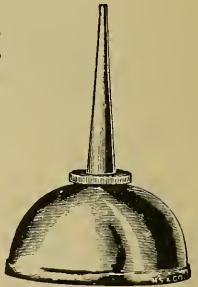

FIG. 108.—OIL CAN.

Pliers.—Pliers are used in cutting, twisting and handling wire or small nails. The jaws



FIG. 109.—PLIERS.

are made in many forms for special classes of work. Probably the most common and best adapted design for work in general is the pair with flat jaws. (See Fig. 109.)

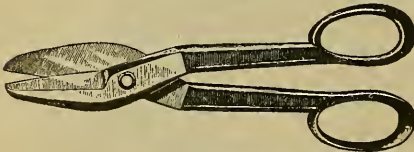

FIG. 110.—SNIPS.

Snips.—Snips are used by tinners, sheet metal workers, copper-smiths, etc., to cut metal rapidly and easily. They are made in many sizes and designs and must be easily operated to do efficient work. (See Fig. 110.)

Safe Guards.—Many machines are so designed as to protect the workman as much as possible; in fact many states require that the machinery be properly shielded. But even these safe guards will not

totally eliminate all of the accidents in industrial and manufacturing plants. Carelessness, working too rapidly, and taking big risks are, in a way, responsible for three-fourths of the accidents. The following suggestions should be carefully observed.

All gearing should be properly encased;

All old style set screws should be replaced with hollow set screws;

Hand jointers should be equipped with cylindrical heads and carefully shielded;

The band saw should be screened;

Table saws should be run in wooden shields;

Cleated floors, to prevent slipping, should be built in front of saws and planers;

Plenty of help should be employed in overhauling high piles of lumber or moving heavy pieces.

All these things have been found most essential and effective in preventing serious accidents.

REMEMBER!

SAFETY FIRST.

CHAPTER V

ACCIDENTS AND THEIR TREATMENT

Accidental Injuries.—Wounds, fractures, scalds, burns and sprains are the most common accidents likely to call for treatment in a school shop.

Wounds.—Wounds are divided into five classes: (1) Incised wounds, which consist of simple divisions of the fibers made by cutting instruments; (2) lacerated wounds, in which the edges of the wound are torn, usually irregularly; (3) contused wounds, those in which the edges are bruised (contused wounds are usually lacerated); (4) punctured wounds, inflicted with the point of a weapon; they are generally narrow and deep and are usually followed by much swelling and inflammation; (5) poisoned wounds, caused by the bites of animals, the stings of insects, etc. Wounds are dangerous, according to their character, i. e., whether incised, lacerated, poisoned or otherwise; the extent of the soft parts which they involve; the place where they are located in the body; the age, habits, surroundings and state of health of the patient; and the treatment they receive. The attendant consequences of a wound are pain, hemorrhage, displacement, loss of function and shock. The loss of function may be temporary or permanent and may manifest itself in stiffness, paralysis, deformities or death. As a precaution, scratches, bruises and light cuts should receive prompt and proper attention and more serious wounds should be carefully treated and dressed. In treating wounds, it is essential first of all to remove any accumulation of blood, dirt or other foreign matter by washing. When the wound is thoroughly cleansed place some absorbent cotton over the bleeding portion. The cotton may be moistened with an antiseptic such as dioxygen. Finally the wound should be carefully bandaged. If the wound is serious such as the severing of an artery, the bleeding may be controlled by a compress between the wound and the heart. In the latter event, a good physician should be called immediately.

Fractures.—Bones may be broken by force resulting from various causes. Fractures are either complete, simple, comminuted, compound, or impacted. The symptoms of fractures are pain, swelling, the crack felt or heard by the patient when the fracture occurs, abnormal mobility, displacement, crepitation, and loss of function and injury to the neighboring soft parts. The repair of fractured bones should be at-

tempted only by skilled surgeons. The treatment of the fracture, of course, consists, first, in restoring the broken ends to their natural position; and, second, bandaging and splinting to keep them in position.

Burns and Scalds.—Burns are produced by dry heat and scalds by hot liquids, but the lesions of both are essentially identical. The effects of burns or scalds vary with the degree of the injuries. If the injury to the patient is not severe, nothing but local treatment is required; if severe, all clothing near the injured part should be removed at once. It is imperative that all dirt, shreds of clothing, etc., be removed from the burned surface. If the burn is deep, it has been found satisfactory to immerse the burned part or the patient, as the case requires, in a warm bath. A solution, consisting of equal parts of lime water and linseed oil, applied to the burned surface, will give very satisfactory results.

Sprains.—A sprain results from the wrenching of a joint, causing some of the ligaments (the bands of tissue that unite the bones) to be torn or severely stretched. In many cases, the bones are also injured. In treating sprains, measures should be taken to prevent inflammation by restoring healthy action. A most valuable means of reducing the swelling and pain resulting from sprains, consists in wrapping the joint with cloths saturated with water as hot as can be comfortably endured. These fomentations should be continued for three or four hours. As soon as the pain and swelling have somewhat subsided, an elastic bandage should be placed around the joint. When the acute symptoms have disappeared, absorption should be promoted by systematic rubbing and the application of stimulating liniments.

PART II
SHOP WORK

CHAPTER I

JOINERY

Joints.—A joint, in wood craft, is the place where two pieces of timber are joined or united together. The joining may be edge-to-edge, as in Fig. 111;

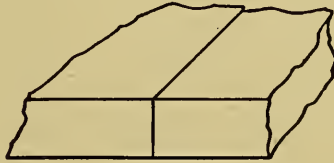

FIG. 111.—EDGE-TO-EDGE JOINT.

it may be in the direction of the length, as in Fig. 112;

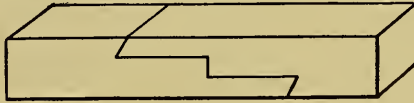

FIG. 112.—END-TO-END JOINT.

it may be at right angles, as in Fig. 113;

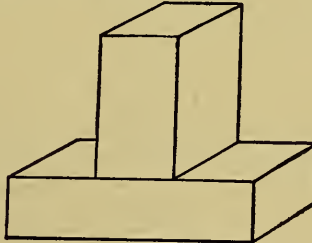

FIG. 113.—RIGHT ANGLE JOINT.

or it may be at an angle, other than a right angle, as in Fig. 114.

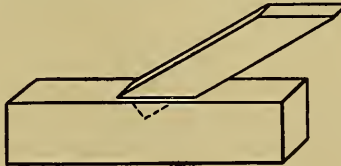

FIG. 114.—ANGLE JOINT.

Joint Types.—For the purpose of increasing the strength, effectiveness and rigidity of joints, adhesive and fastening devices, such as

glue, nails, screws, bolts, dowels, etc., are used. Before these modern fastening devices came into use, dowels, mortises and wedges, which are found in old wooden structures, especially in the hulls of old vessels which have been floating a half century or more, were used exclusively. The fundamentals of joint construction, with their manifold variations, which are found in modern joints, were evolved by necessity many years ago, and those types of joints and joint construction which have stood the test of centuries are now recognized by artisans the world over as standard and as suitable for all kinds of construction work, whether cabinet making, carpentry, shipbuilding or pattern making. As joints are designed for utility, they should be so constructed as to weaken the uniting pieces as little as possible; to distribute the load uniformly; to fit accurately without winding strain; and the supporting timber should be directly under, and perpendicular to, the load sustained. A careful study of the construction of joints and their application to practical problems will soon teach the beginner the proper proportions of joints, as well as the selection of stock for joint construction. In the description of the types of joints which follows, no attempt has been made to name and describe all joints, but all the fundamentals of joint construction are given and minor details may be varied to satisfy individual tastes or needs.

Classification of Joints.—In this treatise, joints are grouped, according to their use in practical construction work, under three divisions, namely, box joints, framing joints and surface joints.

BOX JOINTS.

Box Joints.—Box joints, as the name implies, are used in the construction of boxes and other similar articles such as cases, cabinets, hoppers, bins and filing cases. They are used mainly, however, in constructing boxes to be used in storing and transporting merchandise. In their general construction, box joints have return sides at right angles to each other. The method of forming the joint is largely determined by the use and strain to which it is to be put in commercial use.

Plain Butt Joints.—In common usage, a plain butt joint is formed by the end of one piece meeting or butting against the side of another at right angles, without overlapping. This is the joint commonly used by wholesale grocery houses in constructing boxes and cases. (See B. P. 401.)

Butt Joints, Blocked and Glued.—A butt joint blocked and glued is made like a plain butt joint, with the addition of an angle block which may be square as in Fig. 115, and which is glued in the corner to add firmness. The joint may be glued or nailed, or both. This joint is used

in cabinet work, furniture making and stair building. For wholesale dry goods and hardware houses, this joint is reinforced by cleats attached to the outer edges to withstand the rough handling in transportation. (See Fig. 116 and B. P. 402.)

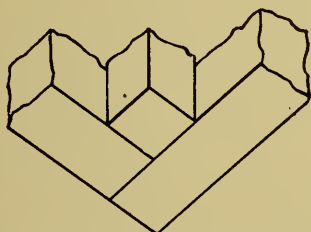

FIG. 115.—BUTT JOINT (BLOCKED AND GLUED).

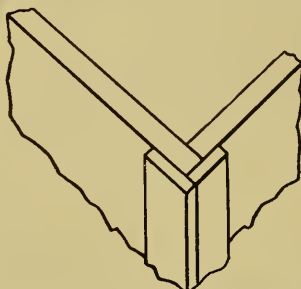

FIG. 116.—BUTT JOINT (CLEATED).

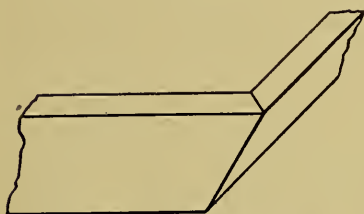

FIG. 117.—HOPPER JOINT.

Hopper Butt Joints.—A hopper butt joint is formed by two pieces which do not meet each other at right angles on account of the slant of the sides. It may be cut at a miter, as in Fig. 117. Hoppers are used for corn grinders, for grain drills, bins, chutes, elevators and flouring mills. (See B. P. 403.)

Rabbet Joints.—A rabbet joint is one in which the side of one piece is grooved to receive the end tenon of the other. This method of joining adds glue surface and therefore makes the joint stronger. This joint is used in box and drawer construction. It presents a neat, finished appearance. (See B. P. 404.)

Dovetail Dado Joints.—A dovetail dado joint has one of the pieces grooved on the side and the other piece has a tenon to fit the groove. This groove must have one or both sides cut at an angle and the tenon cut to match, as in Fig. 118. This joint prevents spreading. It is used in making china closets, book cases, in partitions for drawers and in filing cases. (See B. P. 405.)

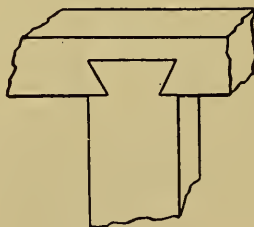

FIG. 118.—DOVETAIL DADO JOINT.

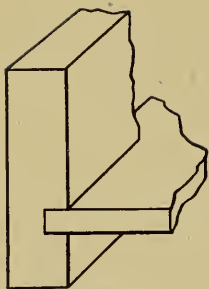

FIG. 119.—PLAIN DADO JOINT.

pieces alternate and fit one another. This joint is used in constructing tool chests, fine boxes for jewelry cases, etc. (See B. P. 406.)

Half Blind Dovetail Joints.—A half blind dovetail joint is one in which the projections of one piece do not show through the face side of the other. This joint is used to fasten the sides of drawers to the front. The blind dovetail shows no projections on either side, being on the order of a mitered joint. This style of joint is used in making fancy and highly finished boxes. (See B. P. 407.)

Ledged Miter Joints.—A ledged miter joint is one with rabbeting and mitering combined, the miter being on the outer edge to give the joint a finished effect. The large glue surface makes it a strong and durable joint. It is used for costly boxes. (See B. P. 408.)

Miter and Butt Joints.—A miter and butt joint is similar to the ledged miter joint, only more simple. It is used in joining pieces of different widths or thicknesses. (See B. P. 409.)

FRAMING JOINTS.

Framing Joints.—Framing joints are those applied in frame-skeleton-construction. They may be used in light framing such as desks, tables and taborets, as well as in heavy framing, such as house and barn construction, trestle work, shipbuilding, etc. These joints are formed by the timbers meeting each other at any angle desired or in the direction of the length.

Butt Joints.—A butt joint, under this division of joinery, is formed with heavier stock than box joints. It is fastened by nails set at an angle—toenailing—and by dowels, as in Fig. 120. This joint is used in carpentry for fastening the stud to the plate. (See B. P. 410.)

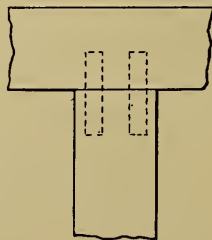

FIG. 120.—BUTT JOINT (DOWELED).

Plain Dado Joints.—A plain dado joint is used for shelf fastening, for the bottom of drawer construction and for water-tight boxes, tanks and ice boxes. (See Fig. 119.)

Multiple Dovetail Joints.—A multiple dovetail joint (through) is one in which the projections and indentations on the ends of the two

Draw-Bolt Joints.—A draw-bolt joint is a butt joint with a hole bored through the one piece into the end of the other and a bolt inserted to receive a nut which is put in from the side. It is a very strong joint and is used in bench making, wooden frames for machines, and farm implements. (See B. P. 411.)

Cross-Lap Joints.—A cross-lap joint is one in which both pieces are notched so that one fits into the other. The surfaces may or may not be flush. This mode of joining prevents side lashing. It is used in cabinet work and carpentry where timbers cross each other. (See B. P. 412.)

Beveled Halving Joints.—A beveled halving joint is the same as a cross-lap joint except that the joining is made at the ends and the adjoining cheeks are beveled to match. The pieces are held in place by nails. It is used in carpentry. (See B. P. 413.)

Lap-Dovetail Joints.—A lap-dovetail joint has a dovetail notch cut into one timber and on the other a projection—a tenon—to match. This mode of fastening prevents spreading. It is used in rig construction and in bridge and shipbuilding. (See B. P. 414.)

Cogged Joints.—A cogged joint is one with only parts of the notch cut on the lower piece, leaving a portion uncut. The upper piece is cut to fit the uncut portion of the lower. The joint prevents side lashing, is strong and is used in heavy framing. (See B. P. 415.)

Mortised and Tenoned Joints.—Joints of the mortised-and-tenoned type are of the same general construction. The tenon is made by cutting slabs from the sides at the end of the timber, leaving cheeks and shoulders. The cheeks are the sides of the tenon and the shoulders are the parts abutting against the mortised piece. The shoulders serve as depth gauges. The mortise is the hole cut to receive the tenon. In general construction, the rails are tenoned and the stiles are mortised to hide the grain of the wood.

Blind Mortise and Tenon Joints.—A blind mortise-and-tenon joint does not permit the tenon to project through the mortise. The cheeks may be cut on two, three or four sides. This joint is used in fastening studdings to plates. It is used extensively in furniture construction. (See B. P. 416.)

Doweled Mortise and Tenon Joints.—A doweled mortise-and-tenon joint (through) is one that has the mortise cut through one piece and the tenon cut equal to or more than the depth of the mortised piece. A pin or dowel is driven into a hole bored through both mortise and tenon

(when in position) to keep the tenon from pulling out. The tenon may have two or four cheek cuts. This joint is used in constructing wooden machine frames, bridges, wagons and window sash. (See B. P. 417.)

Keyed Mortise and Tenon Joints.—A keyed mortise-and-tenon joint is constructed the same as a doweled mortise and tenon joint except that the tenon projects far enough through the mortise to admit the insertion of a tapering key which draws the mortised piece firmly against the shoulder of the tenon. This joint is used in bench building and in furniture of the knock-down type. (See B. P. 418.)

Open Mortise and Tenon Joints.—An open mortise-and-tenon joint is one with the mortise cut through the side and end of the mortised piece. It may be made single or in series. When used singly, it is adapted for window screens, frames for panels, etc. Articles such as machine-made boxes are commonly fastened with this joint, used in series. (See B. P. 419.)

Mortise and Tenon Joints with Relish.—A mortise-and-tenon joint with relish is one in which a part of the tenon is cut shorter than the rest. This device adds glue surface and therefore strengthens the joint. This joint is commonly used where a rail is joined to a leg, as in table construction. (See B. P. 420.)

Trussed Mortise and Tenon Joints.—A trussed mortise-and-tenon joint is one in which both ends of the cheeks have shoulders. It is used in cabinet work on tea tables, taborets, etc., and for ornamentation. (See B. P. 421.)

Wedged Mortise and Tenon Joints.—A wedged mortise-and-tenon joint is one with the mortise cut wider on the outer edge than on the inner. Saw kerfs are cut into the end of the tenon to admit wedges, which, when driven home, will spread the tenon and fill the mortise. It is used in carpentry, also for fastening handles in axes, hammers, sledges, etc. (See B. P. 422.)

Fox-Tail Tenon Joints.—A fox-tail tenon joint is constructed the same as a wedged mortise-and-tenon joint, except that the tenon does not come through, but is blinded. It is used where the mortised piece is already a fixture and the tenoned piece must fit close to the mortised one. It is also used in strong door construction. (See B. P. 423.)

Double Mortise and Tenon Joints.—A double mortise-and-tenon joint is one which has two tenons and two mortises, side by side. It is used in constructing door frames. (See B. P. 424.)

Single Dovetail Joints.—A single dovetail joint (through) is similar in construction to a single open mortise-and-tenon joint. However, the sides of the mortise-and-tenon are cut at an angle. This angle or bevel, cut on the sides, keeps the joint from pulling apart in one direction. It is used in heavy framing. Machine-made boxes for packing small merchandise are constructed by using this joint in series. (See B. P. 425.)

Thrust Joints.—A thrust joint is formed by two beams meeting at an oblique angle. It is held in place by spikes, bolts or iron strappings. This joint is used in heavy timber construction to distribute the load and give stiffness to the frame. (See B. P. 426.)

Housed Brace Joints.—A housed brace joint is made by cutting a mortise into the timber at the desired angle to receive the brace. The housing of the brace prevents it from falling out if the timbers shrink for want of thorough seasoning. Its use is the same as a thrust joint. (See B. P. 427.)

Oblique Mortise and Tenon Joints.—An oblique mortise-and-tenon joint differs from the general mortise-and-tenon type only in that the timbers join each other at an oblique angle. This joint is commonly used to fasten braces in heavy frames. The tenon and mortise prevent the brace from working out of position sidewise, and the shoulders on the mortised and tenoned piece prevent the brace from slipping down when the load is applied. (See B. P. 428.)

Bridle Joints.—A bridle joint has a notch cut into one timber at an angle, leaving a tongue or cog in the notch, and the brace timber is cut to fit into the notched timber. The tongue prevents the brace from falling out sidewise, and the shoulder prevents the brace from slipping out when the load is applied. It is used in heavy framing. (See B. P. 429.)

Scarf Joints.—A scarf joint is formed where two timbers lap each other in the direction of the grain, with flush surfaces. This joint is so constructed as to resist tension and compression. A key is inserted to hold the timbers firmly together. The joint may be bolted or strapped with iron. It is used in heavy construction and shipbuilding. (See B. P. 430.)

Splice Joints.—A splice joint is one constructed similarly to a scarf joint, and its functions are the same. (See B. P. 431.)

Bird's Mouth Joints.—A bird's mouth joint has a notch cut at an angle to fit a piece on which it rests. This joint is used in rafter cutting and is determined by the pitch of the roof. (B. P. 432.)

SURFACE JOINTS.

Surface Joints.—Surface joints are used to unite pieces lying in the same plane to form large surfaces or frames. These surfaces may be circular or flat; paneled or lapped as in siding. In most cases these joints are formed by edge-to-edge contact, and in other cases the miter contact is used.

Plain Miter Joints.—A plain miter joint is formed by the junction of the beveled ends of the two pieces which are secured by glue or nails. It is used in picture framing, etc. (See B. P. 433.)

Splined Miter Joints.—A splined miter joint is the same as a plain miter with the exception that it has a slit cut across the end of the miter and a spline inserted. This prevents ripping and buckling, and therefore, increases the efficiency of the joint. It is used in heavy framing. (See B. P. 434.)

Stretcher Joints.—A stretcher joint is constructed the same as a slip joint. One or both sides may be mitered. B. P. 436 shows both sides mitered. They are used in making frames for stretching painters' canvas and lace curtains. (See B. P. 435 and 436.)

Edge-to-Edge Joints.—Edge-to-edge joints are used when large or wide surfaces are desired. The mode of fastening these joints is determined by their use.

A. A plain butt joint is used in the construction of pieces where there is little strain, as the tops of taborets, tea tables and articles of similar nature.

B. A rabbeted joint overlaps the edges with the side remaining flush. It is used in sub-floors and boxing of houses and granaries.

C. A spline joint is grooved on the adjoining sides with a spline inserted to prevent lateral rising. It is used in making water tanks, heavy tops and heavy floors.

D. A tongue-and-groove joint has one edge grooved to admit the tongue of the other edge. It is used in flooring, ceiling, partitions, etc.

E. A doweled joint has holes bored in the uniting pieces at intervals along the edges to admit the dowels or pins. If the boards are not well seasoned this device prevents cupping at the joint. This method of joining is used in gluing table tops.

F. A dovetail edge joint is similar to the tongue-and-groove joint, only the tongue-and-groove is dovetailed. It is used in building tops for benches, doors and patterns for cores.

G. A matched and beaded joint is a tongue-and-grooved joint with the beads. The beads serve the purpose of breaking wide plain surfaces. This joint is used for wainscoting and ceiling.

H. A lap siding joint is one with the edges overlapping to keep the water from getting into the cracks. It is used in putting lap siding on buildings, roofing for cheap sheds and for shingling. (See B. P. 437.)

RESISTING POWER OF WOODS.

Stress.—Stress is the force exerted in any direction or manner between contiguous bodies, and taking specific names according to its direction or mode of action.

a. *Tensional Stress.*—Stresses in wood construction may be applied in three different ways: Tensional stress which pulls in the direction of the grain of the wood, as in a wagon tongue, coupling pole, lifting rod on a windmill, rails, etc. (See Fig. 121.)

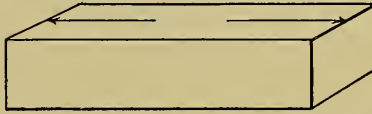

FIG. 121.—DIRECTION OF TENSIONAL STRESS.

b. *Compressional Stress.*—Compressional stress, which is pressure in the direction of the grain—reducing in length—as in pillars, studs, posts, supports, etc. (See Fig. 122.)

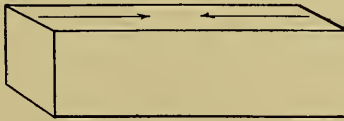

FIG. 122.—DIRECTION OF COMPRESSIONAL STRESS.

c. *Transverse Stress.*—Transverse stress which is applied across the grain and has a tendency to bend, as in joists, flooring, etc. (See Fig. 123.)

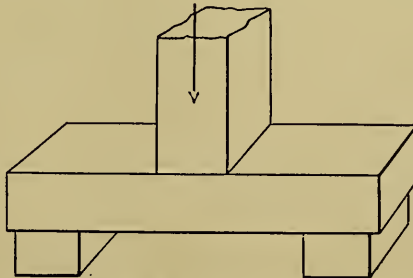

FIG. 123.—DIRECTION OF TRANSVERSE STRESS.

Computation of Stress.—Stresses are generally computed at so many pounds per square inch. The following table gives the average safe load or allowable working unit stresses, in pounds, per square inch of some of the common woods.

AVERAGE SAFE ALLOWABLE WORKING UNIT STRESSES IN POUNDS PER SQUARE INCH.

Recommended by the Committee on Strength of Bridge and Trestle Timbers, Association of Railway Superintendents of Bridges and Buildings.

Kind of Timber	Tension		Compression		Transverse	
	With Grain	Across Grain	With Grain		Across Grain	Extreme Fiber Stress
			End Bearing	Columns under 15 Diams.		
Factor of Safety	Ten	Ten	Five	Five	Four	Six
White Pine -----	700	50	1100	700	200	700
Yellow Pine (S)-----	1200	60	1600	1000	350	1200
Oregon Fir -----	1200	---	1600	1200	300	1100
Yellow Pine (N)-----	900	50	1200	800	250	1000
Spruce -----	800	50	1200	800	200	700
Hemlock -----	600	---	---	800	150	600
Cypress -----	600	---	1200	800	200	800
Cedar -----	800	---	1200	800	200	800
Chestnut -----	900	---	---	1000	250	800
Redwood (Cal.) -----	700	---	---	800	200	750
White Oak -----	1000	200	1400	900	500	1000

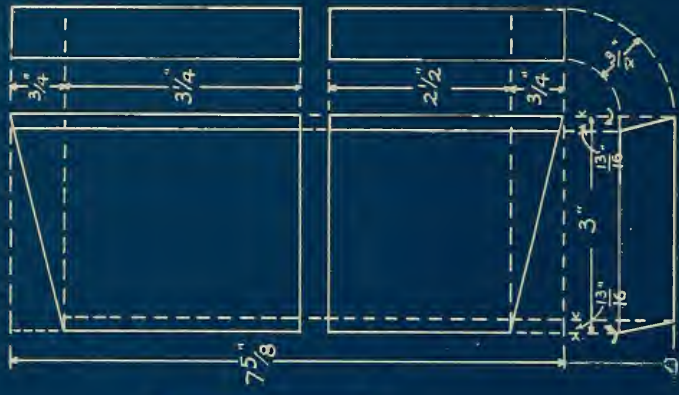

Hopper Butt Joint
403

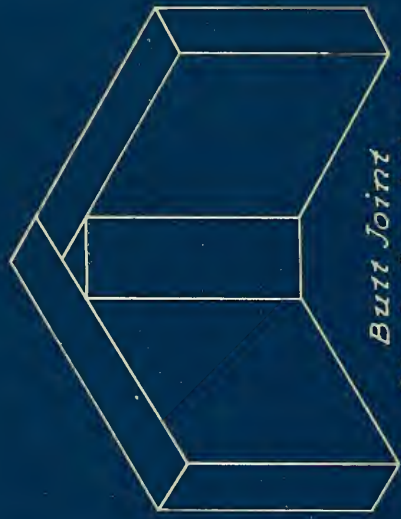

Butt Joint
Blocked and Glued
Scale 3/8" = 1"

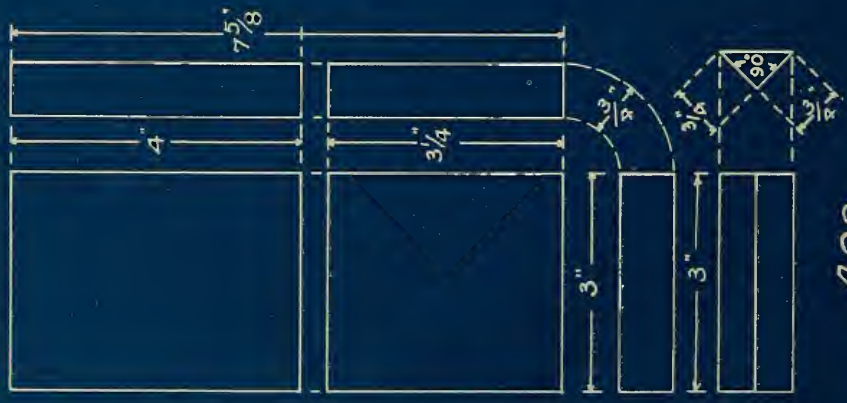

402

Rabbit Joint
Scale $\frac{3}{8}''=1''$

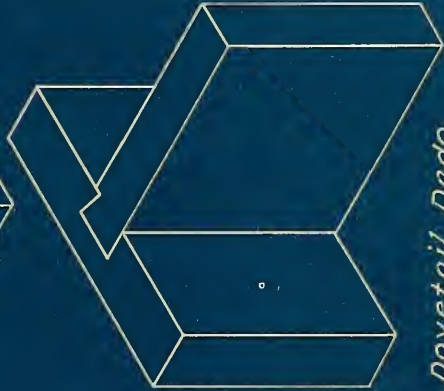

Dovetail Dado

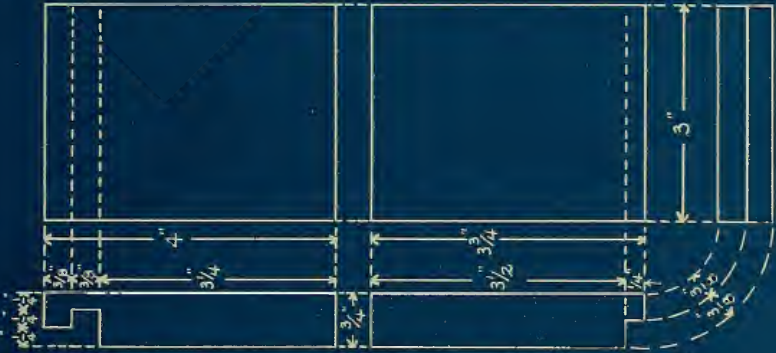

404

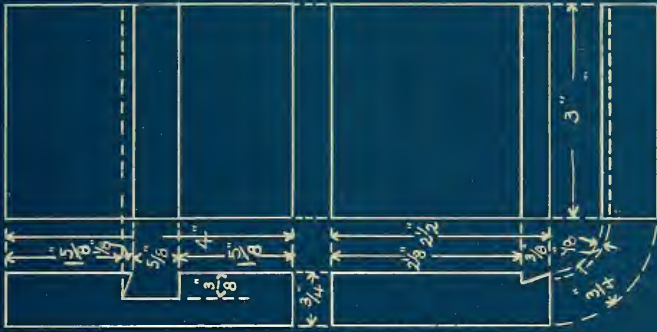

405

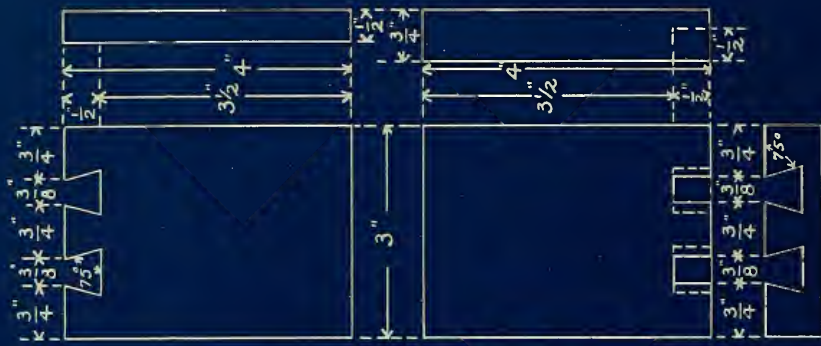

407



Multiple Dovetail
(Thru) $\frac{3}{8}$ "
Scale $\frac{3}{8}$ " = 1"

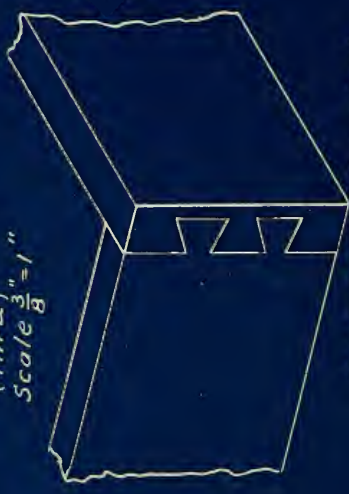

Half Blind Dovetail

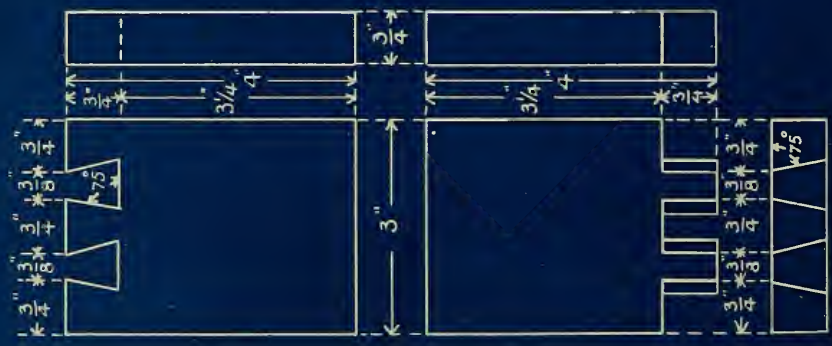

406

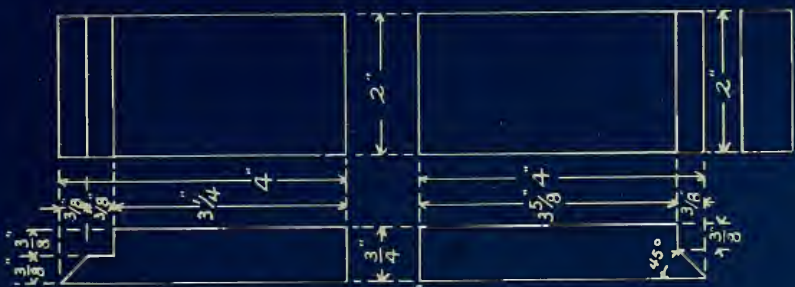

408



409



410

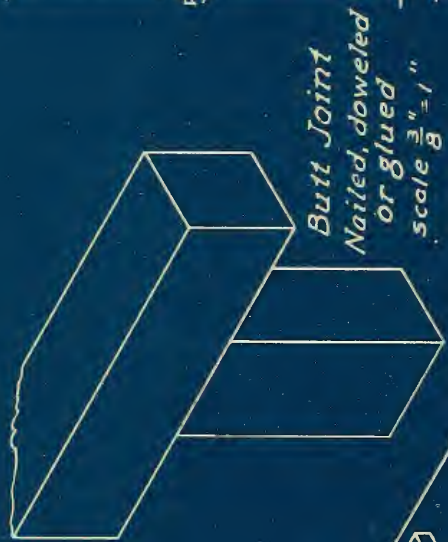

Butt Joint
Nailed, doweled
or glued
scale $\frac{3}{8}'' = 1''$

Draw-bolt Joint
Size of bolt $\frac{3}{8}'' \times 4''$

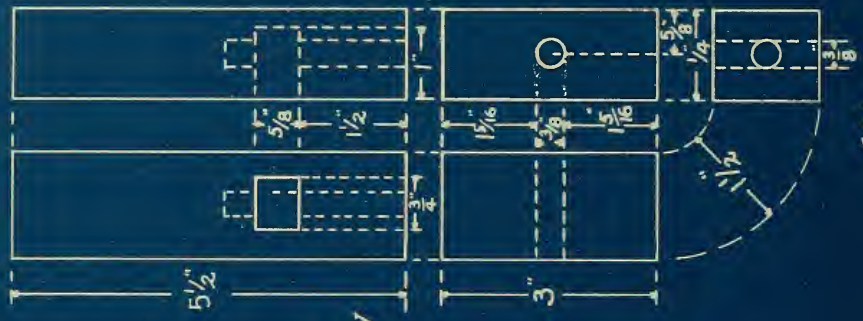
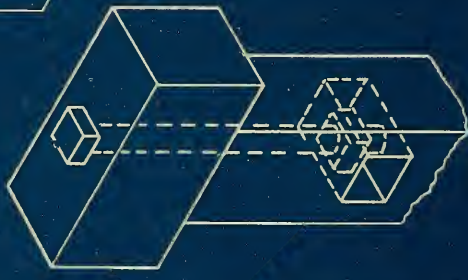

411



Cross-lap Joint
Scale $\frac{3}{8}'' = 1''$



Beveled Halving Joint

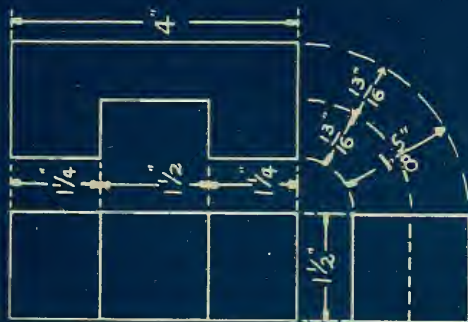

4/2

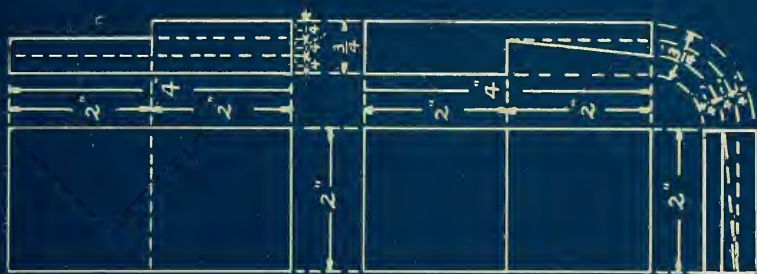

4/3

Lap Dovetail Joint
Scale $\frac{3}{8}'' = 1''$

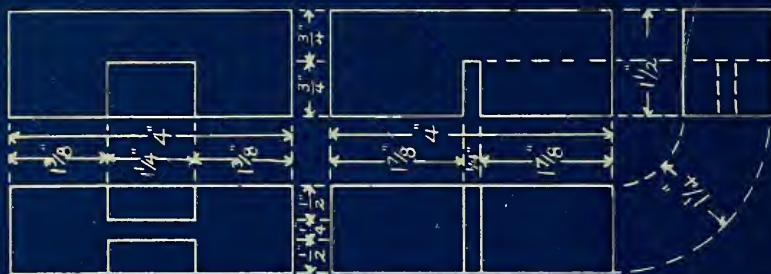

Cogged Joint

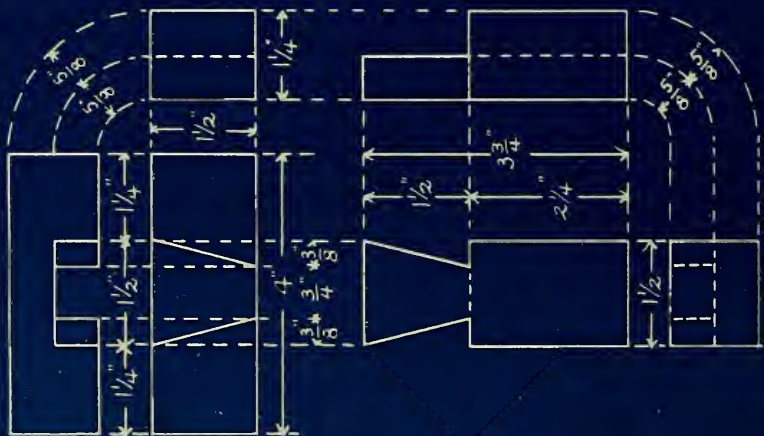

414

415

*Doweled
Mortise and Tenon
(Thru)
Scale $\frac{3}{8}'' = 1''$*



*Blind Mortise and
Tenon Joint*

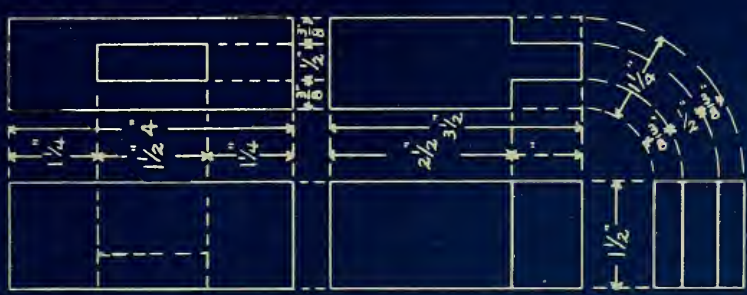

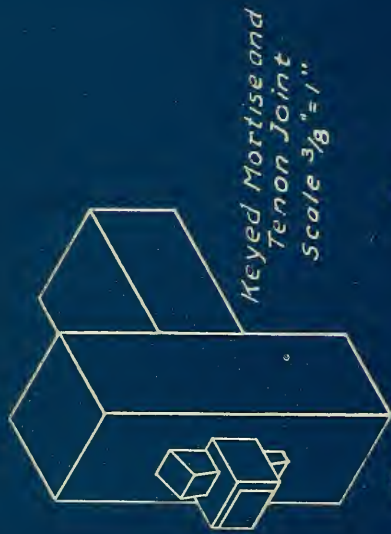

Keyed Mortise and Tenon Joint
Scale $3\frac{3}{8}$ " = 1"



Open Mortise and Tenon Joint

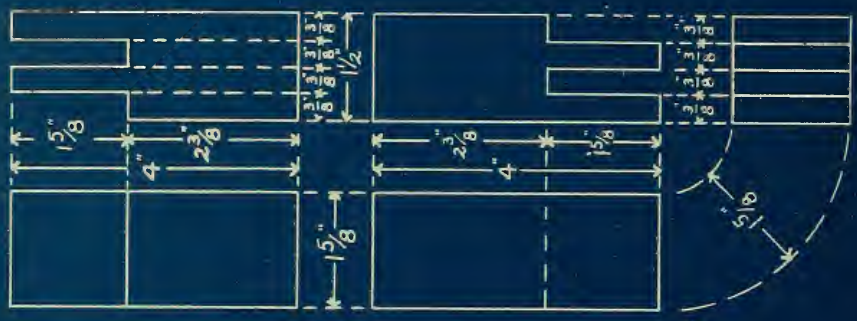

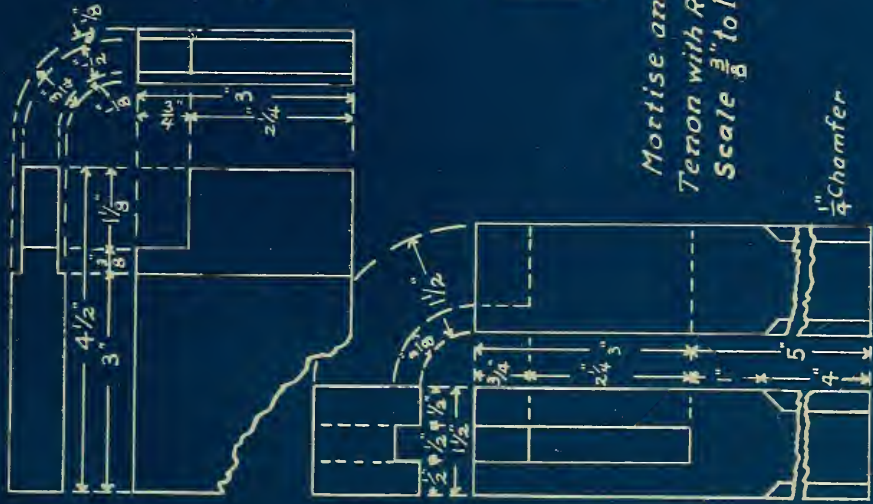

Mortise and Tenon with Chamfer
Scale $\frac{3}{8}$ " to 1"

$\frac{1}{4}$ " Chamfer

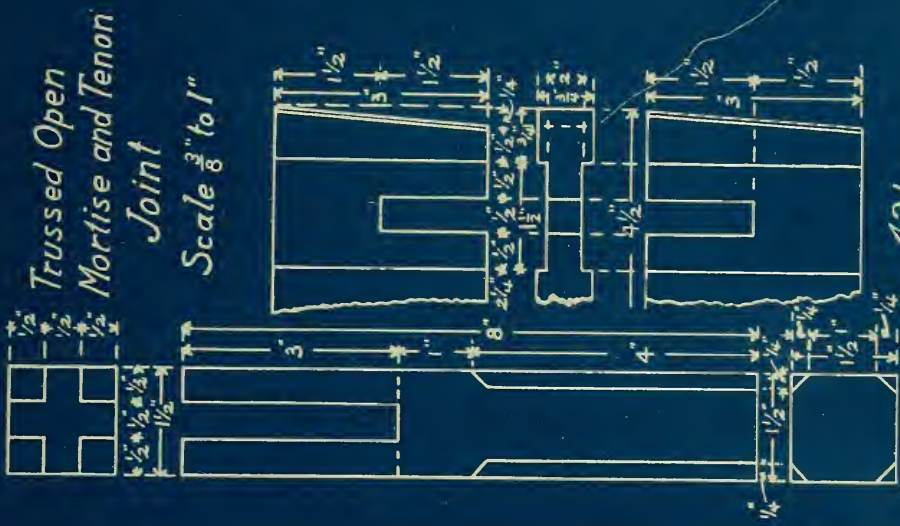

Trussed Open Mortise and Tenon Joint

Scale $\frac{3}{8}$ " to 1"

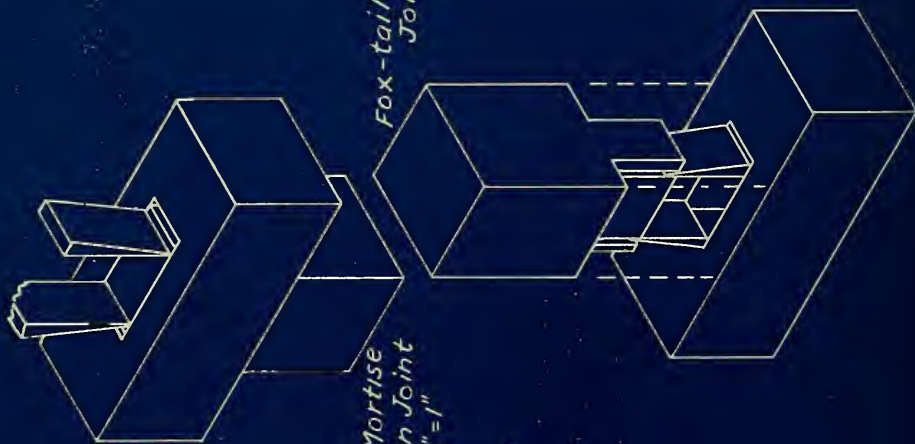

Wedged Mortise and Tenon Joint
Scale $\frac{3}{8}'' = 1''$

Fox-tail Tenon Joint

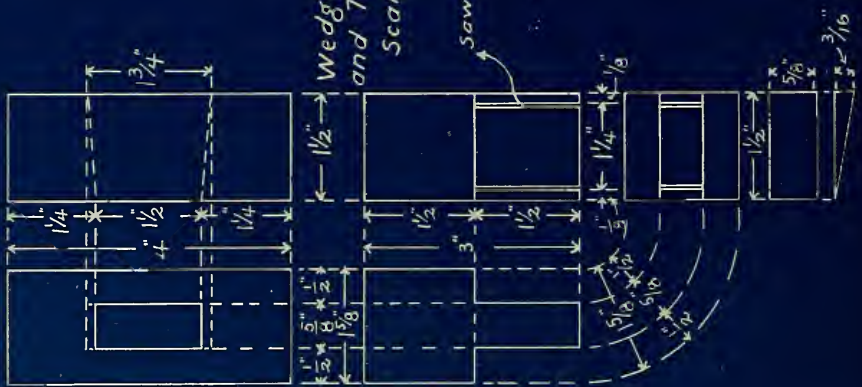

Saw Kerf



Saw Kerf

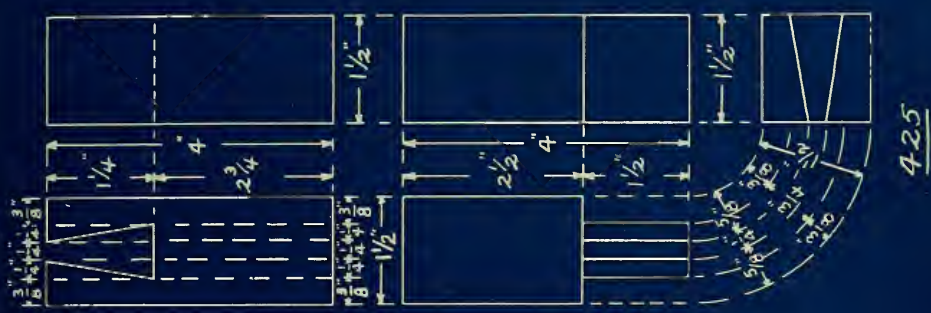

425

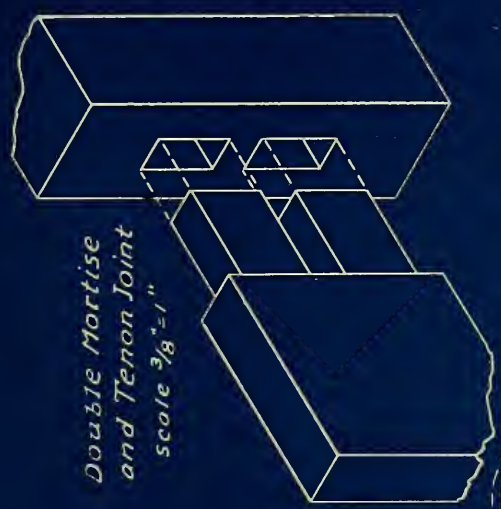

single Dovetail (Thru)

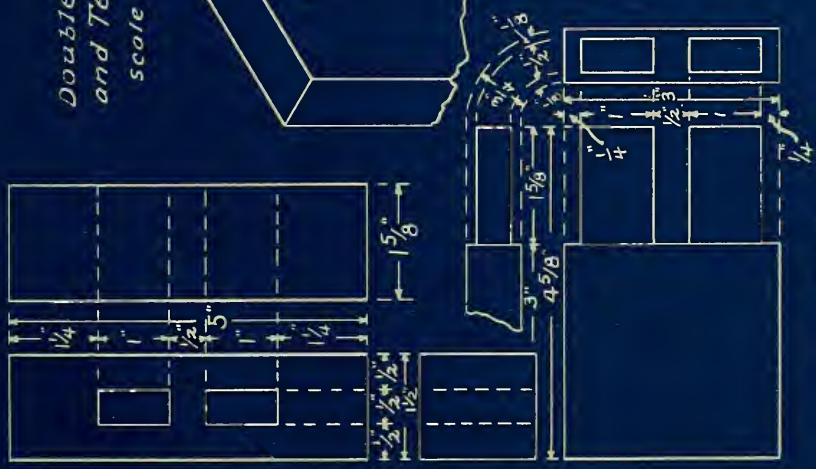

424



426

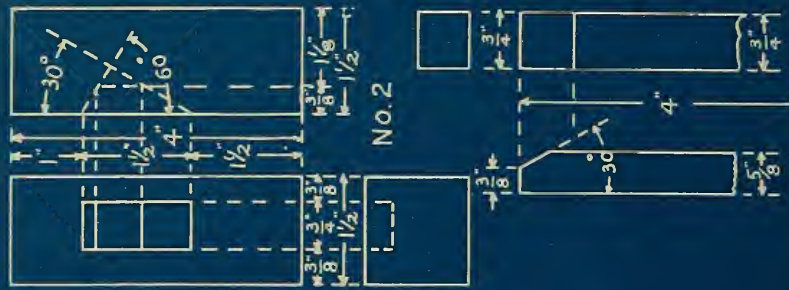
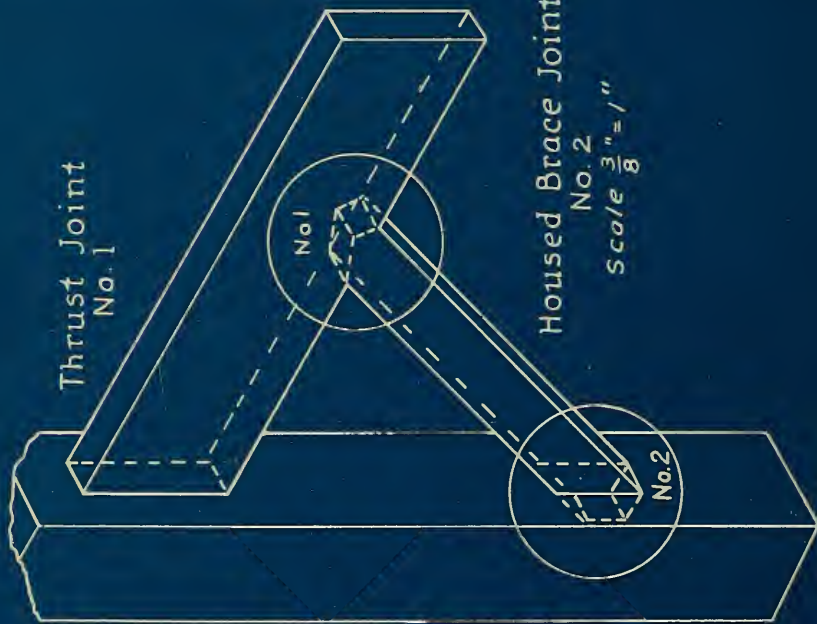

427

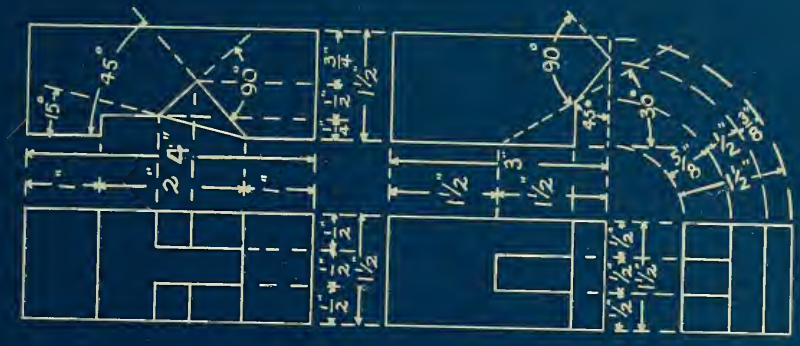

Bridle Joint
429

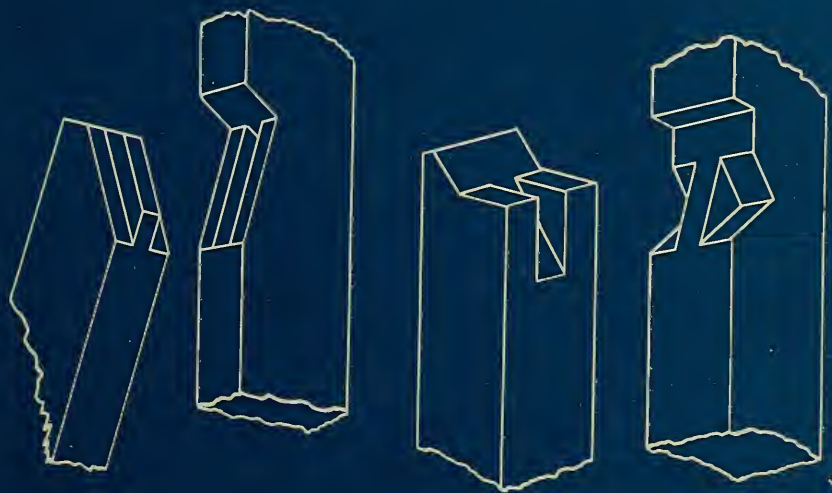

*Oblique
Mortise and Tenon Joint*
Scale $\frac{3}{8}'' = 1''$
428



430

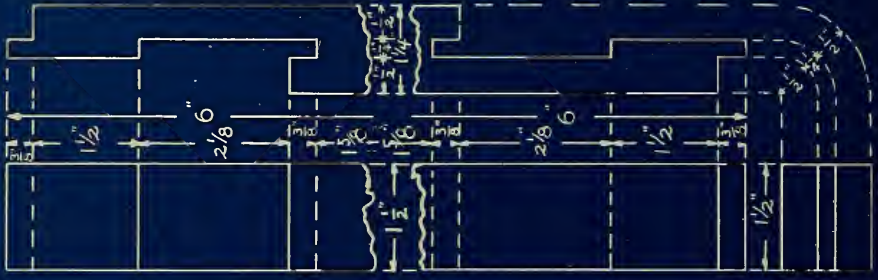

431

- 1 Stud
- 2 Plate (upper)
- 3 Rafter (common)
- 4 Joist (upper)
- 5 Rafter (plumb cut)
- 6 Rafter (level cut)

Scale $\frac{3}{8}'' = 1''$

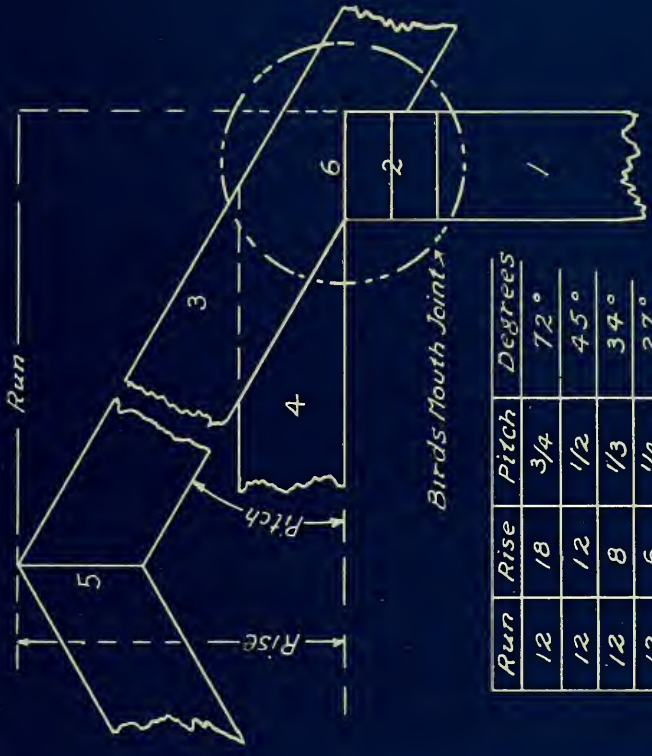

Run	Rise	Pitch	Degrees
12	18	$\frac{3}{4}$	72°
12	12	$\frac{1}{2}$	45°
12	8	$\frac{1}{3}$	34°
12	6	$\frac{1}{4}$	27°

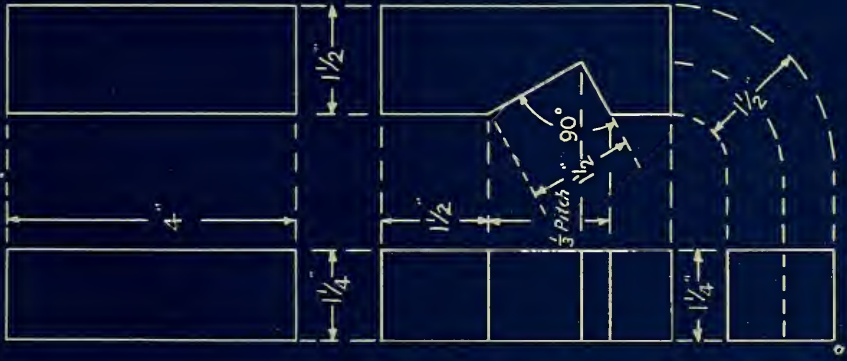

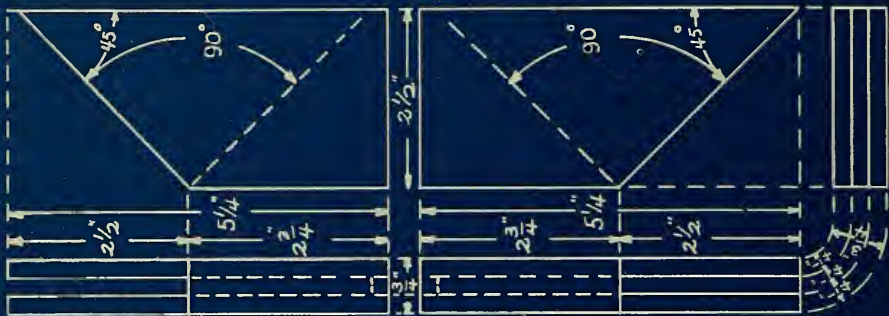

4-34



Plain Miter
scale $\frac{3}{8}'' = 1''$



Splined Miter

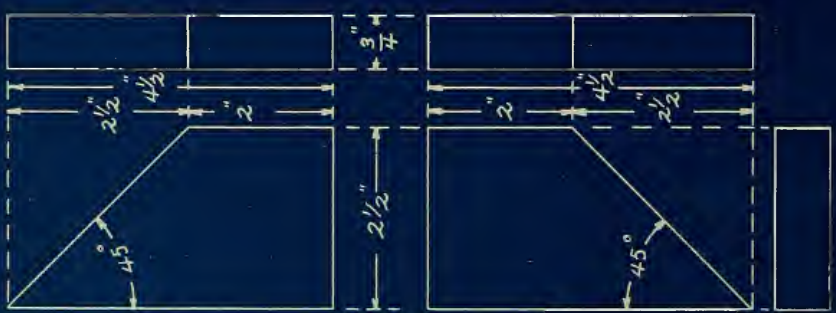

4-33



436



*Stretcher Joint
(One Side Mitered)
Scale $\frac{3}{8}'' = 1''$*

*Stretcher Joint
(Both sides Mitered)*

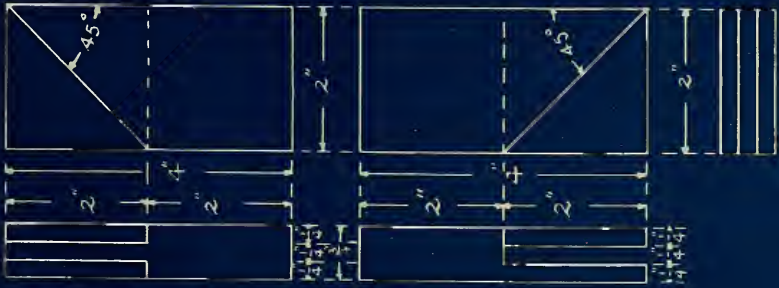

435

Edge-to-edge Joints
Scale 3/8" = 1"

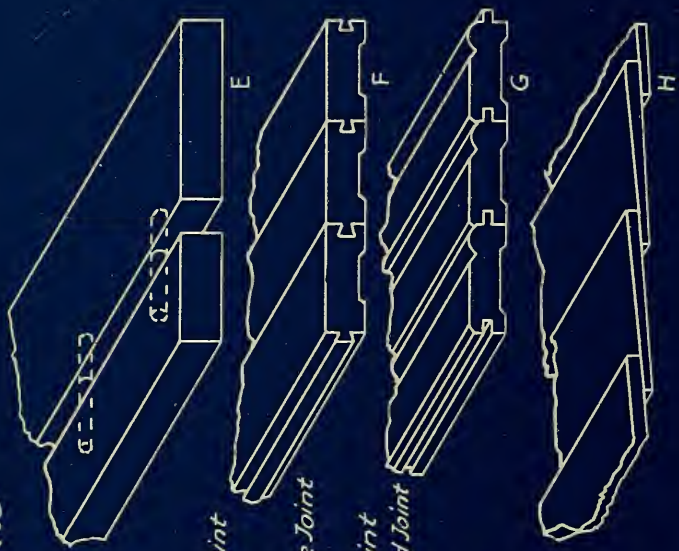

- A-Plain glued Butt Joint
- B-Rabbeted Joint
- C-Splined Joint
- D-Tongue-and-groove Joint
- E-Doweled Joint
- F-Dovetail Edge Joint
- G-Matched and Beaded Joint
- H-Lap Siding Joint

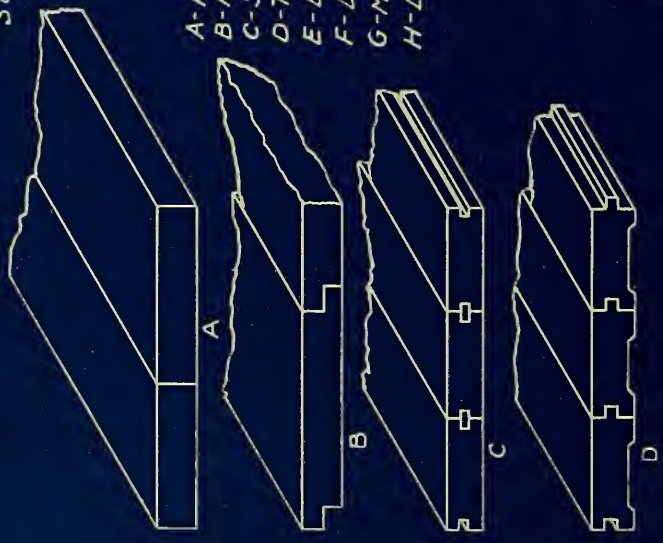

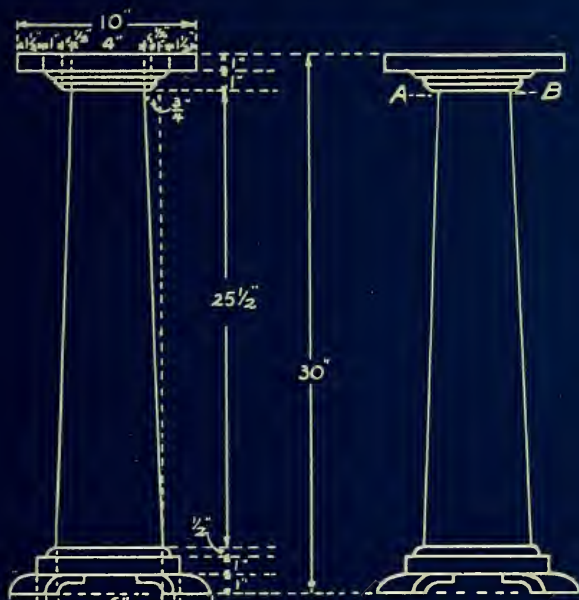

PEDESTAL

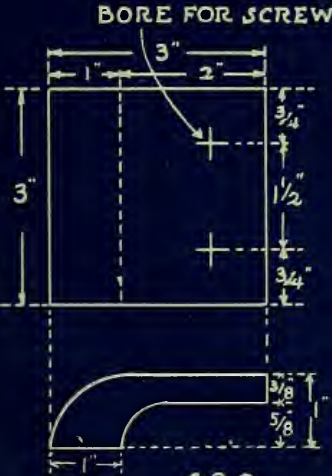

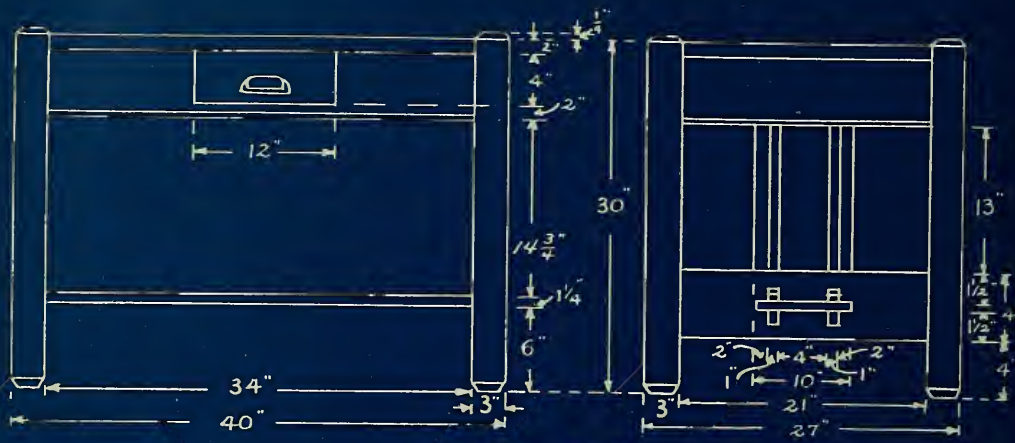

LIBRARY TABLE

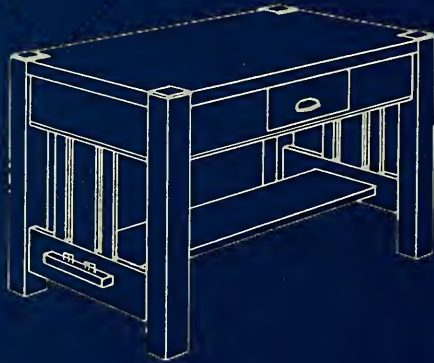

PANEL CONSTRUCTION

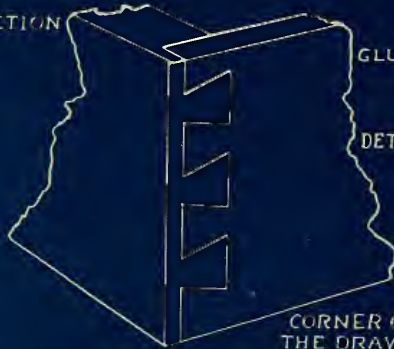

CORNER OF THE DRAWER

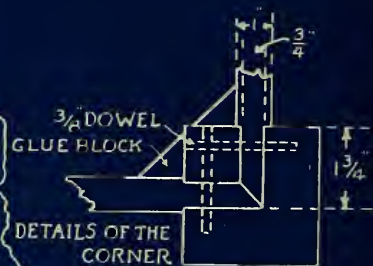

DETAILS OF THE CORNER



WEDGE

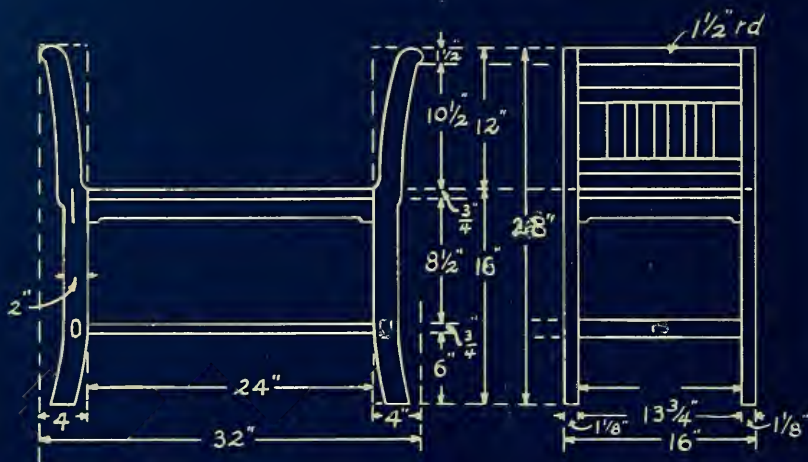

ROMAN SEAT

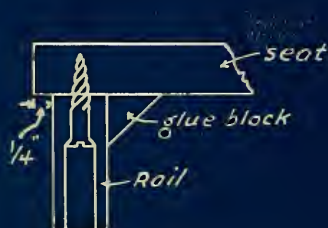
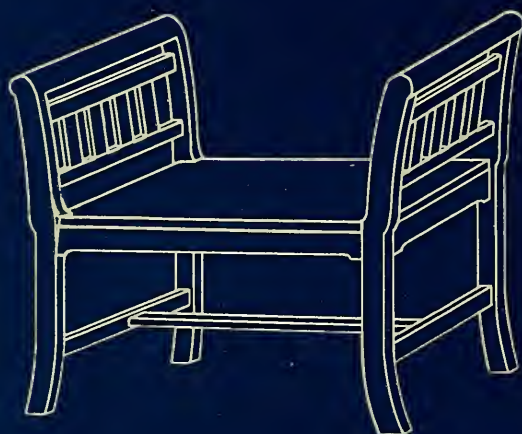

CHAPTER II

CABINET MAKING AS APPLIED IN FURNITURE CONSTRUCTION.

Furniture.—Any movable equipment for the house, either useful or ornamental, may properly be called furniture. Hence an ordinary kitchen stool is a piece of furniture just as much as a handsomely finished Chippendale table. The purpose the piece of furniture is intended to serve and the features needed to portray some historical period in furniture making, determine the design which is characterized and exemplified by the lines, trimmings, workmanship and finish. Often pieces of furniture are so similar in construction that it is a common practice to combine the features of two or more in a single article. Such combinations economize floor space and place the price of the one article within the reach of those who could not afford to buy the two or more if con-

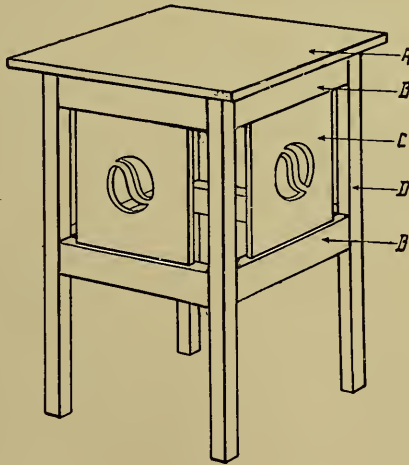

FIG. 124.—PARTS OF A PIECE OF FURNITURE.
A, TOP; B, RAIL; C, PANEL; D, LEG OR SUPPORT.

structed separately. The combination davenport and bed affords the most common example, while combinations of chairs and tables, chairs and sewing cabinets and music racks and bookcases are not at all uncommon. All pieces of furniture have legs, rails, panels and tops, although these parts are often modified in shape and proportion so as to

produce the various designs. The rails and legs form the frame of any piece of cabinet work, while the addition of a top and panels give it character. In the creation of pleasing patterns, care should be taken to see that the same idea of design is carried out in the entire piece, i. e., if the leg is curved in its length, or tapers, the rails, top and panels should be so fashioned as to harmonize with it. (See Fig. 124.)

Legs.—A suitable foundation or support is the first thing to be considered in the construction of any piece of furniture. Since the supporting timbers in cabinet work are the legs, they form the real foundation and should be given first attention. The legs of a piece of cabinet work may be of any length or diameter suitable for the article to be constructed. They may be of such length as to serve as a stile for a panel, as in the case of a chair, roll top desk, etc. Frequently they are modified to serve as a combination of pretty designs in foot stools.

Panel Leg.—A, in Fig. 125, illustrates the simplest kind of support. It is used for the ends of book-racks, stools, taborets and cellarets, and is a combination of a leg and a panel. Many pretty designs are cut in or built upon it, and sometimes a mould is used in forming a rectangle on the outside to give a more striking effect. The relief at the bottom adds stability in that it localizes the weight over rough floors and has a suggestion of the ancient Egyptian feature—the claw or foot. This feature may be made even more pronounced by gluing on blocks and shaping them with a hand turning saw. These ends are built into the frame by the use of screws and nails or by the use of keyed mortise and tenon joints.

Mission Style Leg.—B, in Fig. 125, is characteristic of the Mission Style. Its very appearance speaks stability. The stock for the leg is either solid, built up or veneered. If not properly seasoned, the solid stock is liable to cause trouble after the project is put together. If of hardwood, it makes a very cumbersome structure. The built-up piece is better than the solid because well seasoned pieces and prettier grain may be selected. The veneered leg is the best, as it is lighter in weight, is easier to work, and the veneer will show the same grain on all four sides. A light bevel should be cut around the bottom of these legs to prevent splitting in moving them around. Legs of this type are usually built into the frame by the use of the mortise and tenon joint.

Modified Mission Style Leg.—The leg illustrated by C, in Fig. 125, is a modified form of B. It is usually of solid stock and has a portion tapered. Square brass or bronze ferrules at the bottom give a very pleasing effect.

French Leg.—D, in Fig. 125, is commonly known as the French Leg, and should be built only in such patterns as have circular or elliptical tops or seats, and swelled or curved rails. Patterns using the French leg are usually void of panel effects. These legs are of many proportions and lengths. Carving found its way into these patterns, since the top swell and foot offered an exceptional opportunity for the wood carver. Glue, screws, dowel pins and light mortises and tenons are used in building up the frame of a structure including legs of this type.

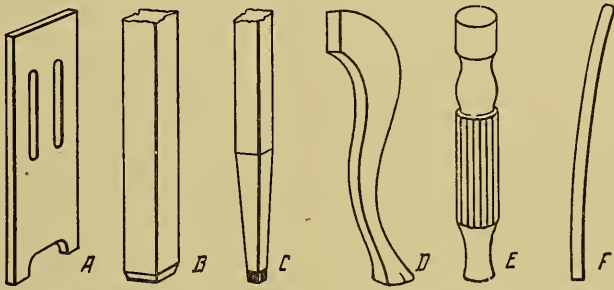

FIG. 125.—TYPES OF LEGS.

Turned and Fluted Leg.—E, in Fig. 125, is a turned and fluted leg. It is used in all kinds of furniture construction, including such forms as tables, stools, chairs, pedestals, etc. Modifications of this form of leg are found in the dining room pedestal-table in which the leg is split and spreads when additional leaves are added to the top. Glue, screws, dowel pins and light mortise and tenon joints are used in framing this into a piece of furniture.

Back Legs.—F, in Fig. 125, is the back leg of a chair, settee, etc. The upper part serves as a stile for the back panel, the lower part as a support for the seat. It is made flat or turned and is built into the frame by the use of dowels, round tenons, screws, etc. This curved back effect is typical of those designs introduced in the latter part of the seventeenth century for the purpose of rest and comfort.

Rails.—Those parts of articles of furniture which connect supporting timbers and stiles and which, as a rule, run in a horizontal plane, are called rails. There are front,



FIG. 126.—COMMON RAIL.

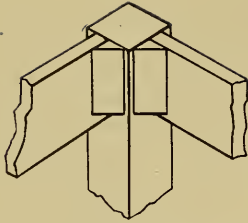

FIG. 127.—ANCHORING THE RAIL.

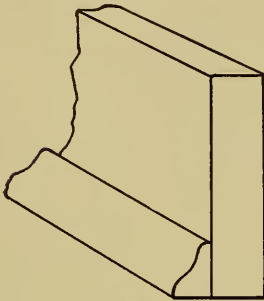

FIG. 128.—TRIMMING THE RAIL.

Curved Rails.—Curved rails are used for circular or elliptical tops, for tables or fronts, for sideboards, dressers, wash stands with curved fronts, and for backs of chairs. They are attached to the legs in the same manner as the straight rails. Swell or French legs usually predominate if curved rails are used in the frames of the structures. (See Fig. 129.)

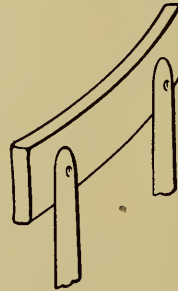

FIG. 129.—CURVED RAIL (BACK OF CHAIR).

Turned Rails.—Turned rails or spindles are used in the construction of stools, chairs, cribs, ladders, etc. If beads are turned on the rungs they should match those on the legs. Round tenons are turned on these rails and the rails are built up or assembled by inserting the ends into bored holes. (See Fig. 130.)



FIG. 130.—TURNED RAIL.

Chair Arms and Rockers.—Rails take many and widely different forms, but perhaps an arm of a chair and a rocker afford examples of

back, top and bottom rails, all of which are to be found in many modified forms. The most common type of rails is that shown in Fig. 126. This rail is either turned to fit the mortise in the legs, or doweled, or put on by the use of screws and draw bolts. It is a common practice to stiffen the joint by the addition of angle blocks as in Fig. 127.

Straight Rails.—Straight rails match square legs and will go well with turned or turned and fluted legs if a mould is cut on the lower outside edge of the rails. Openings are often cut in the rails to receive draws, sliding brackets, extension leaves, etc. (See Fig. 128.)

spindles are used in the construction of stools, chairs, cribs, ladders, etc. If beads are turned on the rungs they should match those on the legs. Round tenons are turned on these rails and the rails are built up or assembled by inserting the ends into bored holes. (See Fig. 130.)

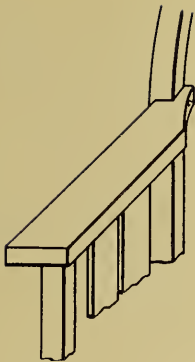

FIG. 131.—ARM OF A CHAIR.

the greatest dissimilarity. Classification of rails must be made according to use, and as arms and rockers connect supporting timbers, they are truly rails. (See Figs. 131 and 132.)

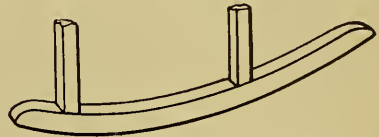

FIG. 132.—CHAIR ROCKER.

Shelving.—Stationary shelving in a magazine stand, if anchored to the legs, may be called rails; but as a general rule it is classified as multiple tops, especially if the frame is stiffened by the use of brackets.

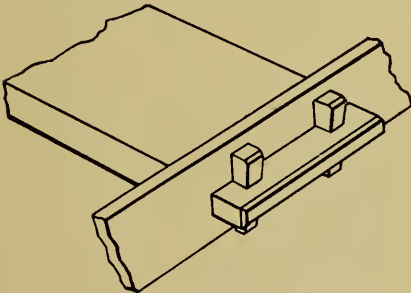

FIG. 133.—STRETCHER OR FOOT RAIL.

Foot Boards.—A very common form of bottom rail or stretcher, used especially in table building, is the foot board. As a rule, it runs between two cross rails, and is often anchored with keyed joints, as in Fig. 133. Other modifications of this type of foot board are such forms as the sub-top, used for magazines, papers, etc., which is built in place by notching a seat in the leg and then anchoring it either with a dowel or screw.



FIG. 134.—PANEL.

PANELS AND PANEL EFFECTS.

Panels and Paneling.—Paneling is the art of applying useful decorations in cabinet work by screening objects. Panels are found in doors, wainscoting, stairs, desks and many other classes of cabinet work. Panels are of many classes, including opaque and transparent

materials, and even just sufficient material to produce a panel effect. Panels are produced in three ways: By rabbeting, by moulding and by batting.



FIG. 135.—RABBETED PANEL.

Rabbeting.—By rabbeting is meant that the rails and stiles, in case of a door, are grooved enough to receive the edges of the panel. The panel itself may be thick, and cut down on the edge to fit the rabbet, as in Fig. 135, forming a raised panel, or it may be perfectly flat and made of cross laminated veneer, such as is used in office desks.

Drawer bottoms, in first-class construction work are set in as panels of this class.

Panel Effects.—Panel effects (Fig. 136) are produced by the method illustrated in Fig. 135. The slats are nailed together, then cut from one pattern and slipped into place before the end is finally put together. The grooves between the slats are filled with scrap pieces made to match the rails.

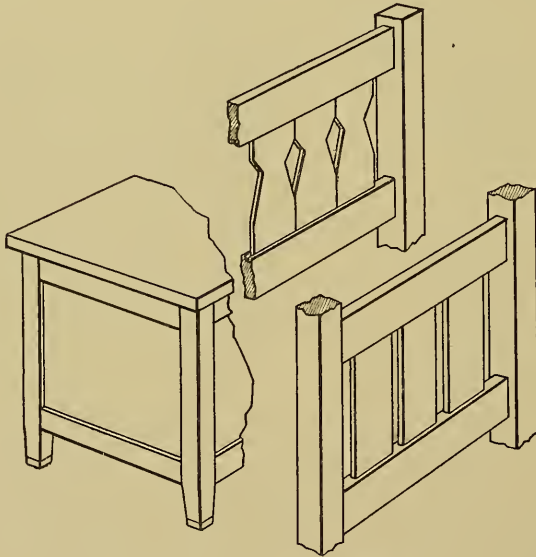

FIG. 136.—PANEL EFFECTS.

Moulding.—Moulding is a method of anchoring or holding the panel in place, and is a cheaper means of construction than rabbeting; moreover, it serves a purpose that rabbeting will not permit when once the frame is finished. That is, the panel may be removed

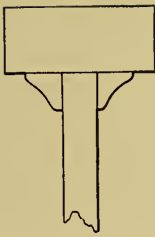

FIG. 137.—PANEL ANCHORED WITH MOULDINGS.

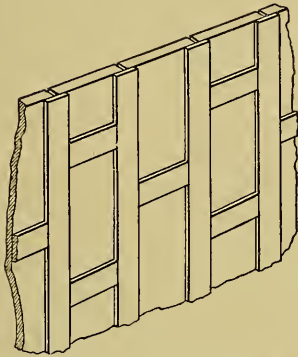

FIG. 138.—BATTED PANELS.

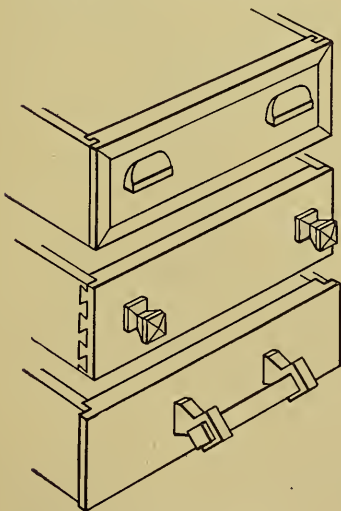

FIG. 139.—DRAWER FRONTS.

any time by taking out the moulding on one side. Moulding is a common way of putting glass in windows and doors and in building up the sides of bookcases. (See Fig. 137.)

Battling.—Battling is the method of producing a panel effect over flat surfaces by stripping boards with flat bats as illustrated in Fig. 138. This is the method used in paneling stairways, in constructing built-in seats, and in producing pleasing designs on unbroken surfaces. (See Fig. 138.)

Drawer Fronts.—Drawer fronts produce panel effects and are therefore classified as panels. Some are made to appear as raised panels and others are perfectly flat, except for the drawer pulls, which are made either of wood or metal and serve the purpose indicated by their name. Fig. 139 shows a collection of drawer pulls suitable for most styles of furniture. The sides and back should be dadoed to receive the bottom. The drawer should slide on dadoed or built-up cross-rails as guides, the flange on the front of the drawer serving as a stop. If the drawer front is flush with the face of the rail, glue blocks or stops are placed on the rails at the end of the drawer to prevent the drawer from sliding in too far.

TOPS AND MODIFIED FORMS.

Tops.—Tops, in their many forms, afford convenient places for writing, sitting, laying books, etc. They are made in shapes to har-

monize with the rest of the pieces of furniture, and, as a rule, are the most prominent. They are constructed of selected wood, the grain of which is often matched to form beautiful figures. Solid stock, built edge-to-edge, is the general plan of construction followed, but, in the more expensive tables and other articles of furniture, the tops are laminated and finished with a selected veneer both on the top and edges. Laminated pieces are lighter than solid stock and have but little tendency to warp. Great care should be exercised in the selection of the stock for a top. If the best results are desired, the stock should be thoroughly dry and of a similar grain, i. e., of a uniform texture and similar color. It will be necessary, in many cases, to rip off the sapwood in order to produce a uniform color, and to use narrow stock in quar-

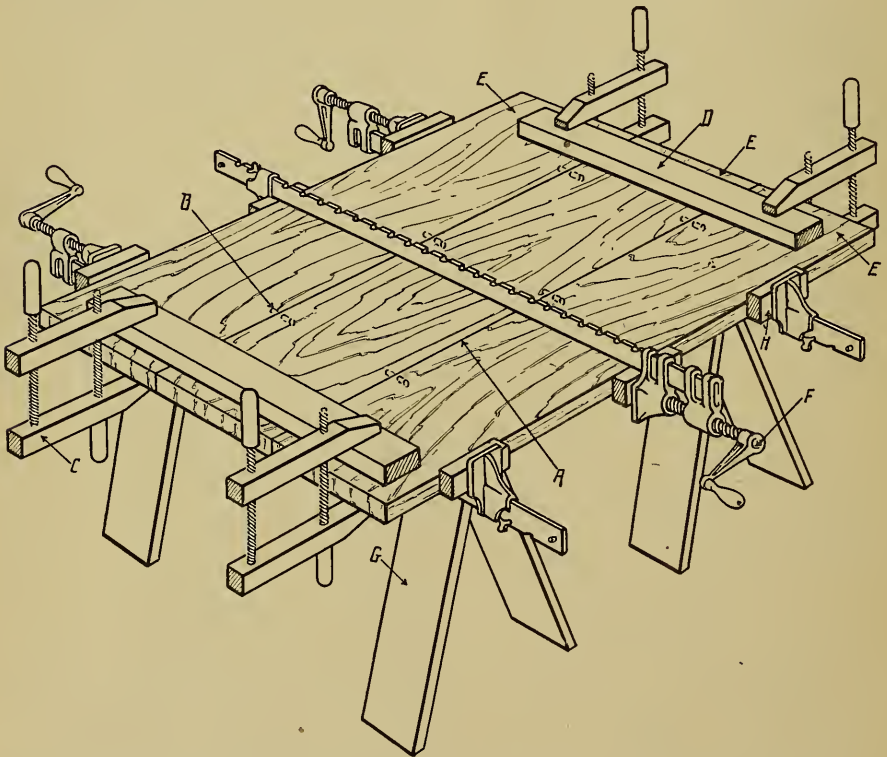

FIG. 140.—GLUING, SHOWING USE OF CLEATS, HAND SCREWS AND CLAMPS.

tered wood in order to produce a uniform flake. (See Fig. 140.) The building of a top should be carefully done. The edges, A in Fig. 140, must be perfectly straight and square in order to afford a perfect joint. This joint is usually put together with dowels, B in Fig. 140, the dow-

els serving as guides to keep the boards in alignment. Glue should be brushed on the dowels and edges much in the same fashion as a coat of paint is brushed on boards. The boards E to be glued may be pulled together lightly at first, then the cross-cleats D may be added and clamped in place with the hand-screws C which prevent the boards from buckling. Then pressure may be applied by the use of carpenter's clamps, F, equally distributed along the edge, but blocks should face the iron jaws in order to prevent scarring or bruising the edges. Gluing of large flat pieces is usually done on saw horses, or trestles, G.

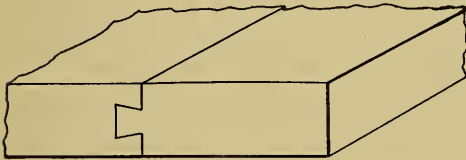

FIG. 141.—WEDGE DOVETAIL JOINT.

Another method of building up solid tops is to joint carefully the edges and plow a wedge dovetail joint. This was formerly done by machinery, but tools which will do this rapidly and accurately by hand are on the market. The dovetail tenon

is driven home. The parts form their own clamps while drying. Cleats to hold them straight should be placed at each end. All glue work should set for twenty-four hours before the clamps are removed.

Cleating.—It is often necessary to reinforce wide pieces in order to prevent warping. This is done by cleating. Three methods are employed, namely, common cleating, core cleating and spline cleating. A, in Fig. 142, shows the method commonly used in rough or hidden work. A stiff strip of wood is dressed, beveled and put on by the use of nails or screws. B, in Fig. 142, illustrates a method used in the making of cores for veneered doors, tops, etc. The corners are mitered, leaving a finished edge all the way around the piece. These strips are put on by the use of glue and screws. C, in Fig. 142, shows the common method used in cleating thin doors, sliding leaves, etc. They are usually made by feeding the end of the door into a circle saw and then cutting a spline to match.

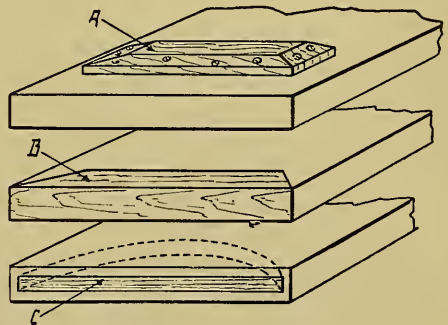

FIG. 142.—CLEATS.

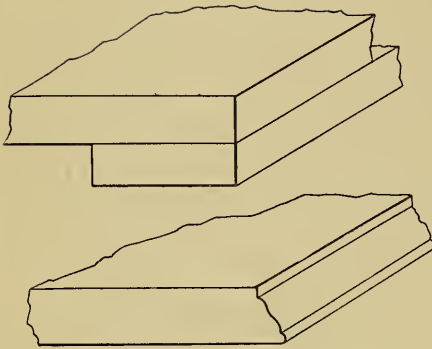

FIG. 143.—TRIMMING THE TOP.

Edging.—Adding strips, by gluing them on the edge of the bottom or cutting a base mould on the edge, will give to pieces such as tops, etc., the appearance of thickness.

Surfacing.—Surfacing means the act of reducing the stock so that every point in the surface will lie in a regular plane, so it will be smooth, true and free from defects. Surfacing is done by running the glued-up stock through

the planer and sizing it to a definite thickness; sometimes it is worked by hand. The latter process is primarily to free the piece of glue streaks. The surface should then be planed with a jack plane diagonally across (with the grain), until the surface is flat and free from wind. Then it should be dressed, with the grain, with a smoothing plane, leaving the surface smooth and true. Torn spots are likely to show up after the smoothing plane is used. These places should be carefully scraped until all the ragged fibers disappear.

Forms of Tops.—There are many forms of tops, so modified from the usual form that they assume different names. The lamp shade offers a suggestion. The surface is raised, and designs are cut into the sides, permitting the light to shine through. The width of the sides may be figured from the run and rise, as rafters, and the corner is the same as

a hip rafter, described under the "Steel Square", Chapter I, Part III. Ribs are sometimes used at the corners, into which the sides are paneled.

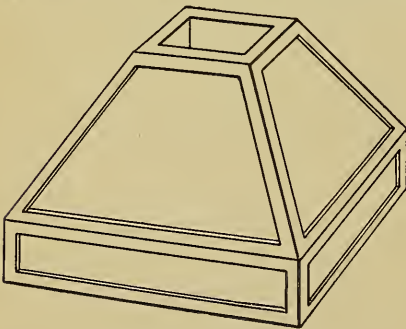

FIG. 144.—LAMP SHADE.

Cross-plyed chair bottoms, glued into comfortable forms, make another diversion from the flat top. Shelving, though often used as rails, is a series of tops usually called multiple tops. (See Fig. 144.)

ASSEMBLING.

Assembling.—The assembling of a piece of furniture is the building up of the frame and parts necessary for its completion. Of course the trimmings, such as mouldings, glass, hinges, locks and drawer pulls, are the final touches before it is finished. All the pieces for the frame should be properly proportioned, surfaced and tested to be sure they will fit together so that no trouble will be experienced after the glue is once spread. Ends of such pieces as tabourets, foot-stools, settees,

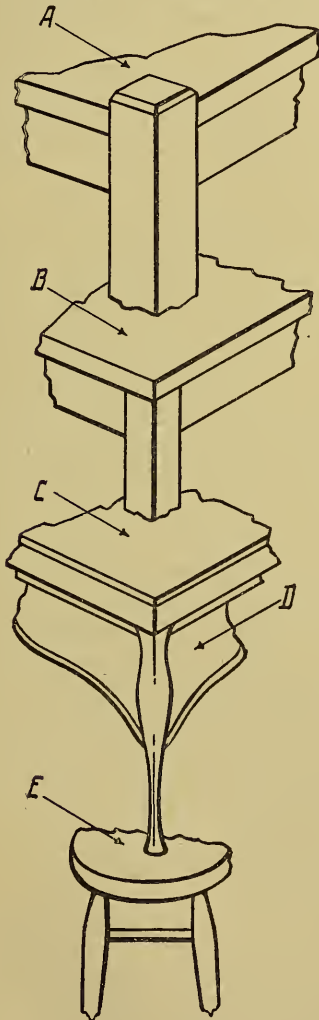

FIG. 145.—METHODS OF LAYING ON THE TOP.

davenports, tables, dressers, sideboards, etc., should be built up first. All panels should be set and the tenons driven home in a coat of glue. Clamps, such as the carpenter's handscrews, and screw clamps suitable for this work may be used. Care should be taken to keep the piece square and out of wind. These ends may be connected by rails, and clamped in the same manner as the ends. This forms the frame of the structure, to which the top, shelving, drawers and doors may be added. The doors are only swinging panels and may be hung on hinges any time after the frame is assembled. All shelving should be put in as soon as possible in order to help stiffen the frame. The top may be added any time after the frame is set, although it is often deferred long enough to build in shelving, drawer slides, partition panels, etc.

Laying Tops.—Tops are put on in many ways, but usually in a way most suitable to the pattern. As a rule, the edges of the top overhang the rails, forming a cornice effect. Fig. 145 presents several methods. A illustrates a common method of seating the top on the rails, allow-

ing an overhang and cutting it in between the legs. The tops of the legs, if of solid stock, are capped with a piece to match the grain of the table. These caps are made with rounded or beveled edges.

B shows a more common way of laying on a top. It has a pleasing appearance and permits the anchoring of the top, leaving the surface unbroken.

C shows the corner of a table, using the French leg. D is a sub-top and is joined to the legs by the use of dowel pins.

E shows a method commonly used in cheap chairs, stools, etc. The top of the legs have round tenons and are glued in holes bored in the bottom of the seat.

Anchoring the top to the frame is a particular job. The top must be so placed that the edges are parallel to the rails with equal projection on sides and ends, and it must be touching all along the rails to which it is to be fastened.

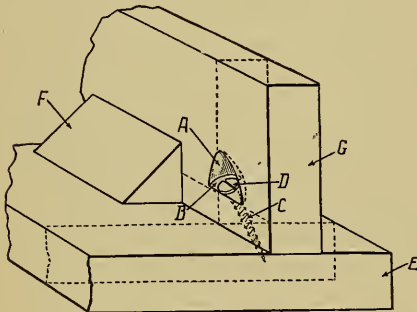

FIG. 146.—ANCHORING THE TOP.

Fig. 146 illustrates a very neat way of putting on the top with screws. It is easier, too, if the top and frame are turned upside down and the two clamped together. The rail, G, should have recesses cut as at A, with either a Fostner bit or with a gouge, forming a seat, B, for the head of the screw, D. Holes may be bored for the shank, C, of the screw, and a smaller hole started into the table top. The upper edge of the rail should be coated with glue and then the

screws driven home. Angle blocks, F, may be glued in the angle formed by the rail and top, E. These will stiffen the rails.

After the piece is entirely assembled it should be gone over carefully, removing any surface glue and touching up any bruised or scratched places that may have been made in the assembling. This should leave the piece ready for finishing.

PLANS AND SPECIFICATIONS

Designs.—The designs in cabinet work are usually optional, but one should remember that a large piece of work is not necessarily the text of good workmanship. The first step to take is to select the piece of furniture you want, i. e., a foot-stool, taboret, etc. Sketch, or show your cut to the instructor in charge, and if he approves, make a work-

ing drawing of the piece; also write out the specifications, setting forth the kind of wood to be used, how constructed, kind of hardware to be used, the kind of finish, how many coats of the various materials, how each coat is to be applied and worked. The complete plans and specifications should be gone over carefully with the instructor before the work is started. No change in the plans and specifications should be permitted after the work is once started, unless it is approved by the instructor, and the waste, if any, paid for by the student.

Ascertaining Cost.—To make out the lumber bill, classify the like materials, starting with the heaviest pieces first. That is, if there are four pieces 3 inches square and 20 inches long, also other sizes, with more than one piece of each size, group the bill so that it may be easily computed by combining the lengths of pieces of the same width and thickness, so as to eliminate as much waste as possible. Read over the wood finishes carefully, selecting just what you want. Class talks should be given on the cost of this material so that you will be able to make a conservative estimate as to the cost of the finished project. Figure the cost of the lumber, add the cost of the finish and hardware, allowing for any waste, and this should total the cost of the material for the piece.

Specimen Bill.—The following specimen statement of materials, construction, hardware, finish and cost is recommended, and should be attached to the working drawing of the pieces.

STATEMENT OF MATERIALS AND COST OF LIBRARY TABLE.

Material—

All wood to be kiln dried quartered red oak.	
Legs—One of 3"x3"x10', at 12c-----	\$.90
Top—One 1"x12"x10', at 12c-----	1.20
And strips for thickness.	
Rails and slats 1"x10"x6', at 12c-----	.60
Stretcher, 1½"x10"x3½', at 15c-----	.66
Drawer, ½"x12"x28", at 7c-----	.15
	\$3.51

The frame is to be put together with mortise and tenon joints, properly glued and doweled. The top is to be doweled and glued. Cleats, adding thickness, are to be screwed on the sides and ends. End grain

must show on the ends. The top is to be put on with screws, toed in through the inside of the rails, and glue blocks added.

Screws, nails and glue----- .15

Finish—

Light golden oak (dull gloss), one coat of stain, one coat of paste filler to match stain, two light coats of white shellac, each to be sanded down, two coats of wax.

Estimate cost ----- .90

Estimate material bill-----\$4.56

Time to construct----- hours

SUGGESTIONS FOR STUDENTS

The following pages present a series of projects arranged in the proper sequence with respect to the intricacy of the plans and to the complexity of the joints involved. The construction of these projects will afford practical application of the fundamentals presented in the subject-matter of the text. Line drawings with dimensions only are given, it being intended that the teacher exercise independence of thought in arranging his course. At the same time the student is given no aid which will rob him of his own initiative in making working drawings, in making up his bills of material and in estimating the cost of construction of the projects.

PLATE I

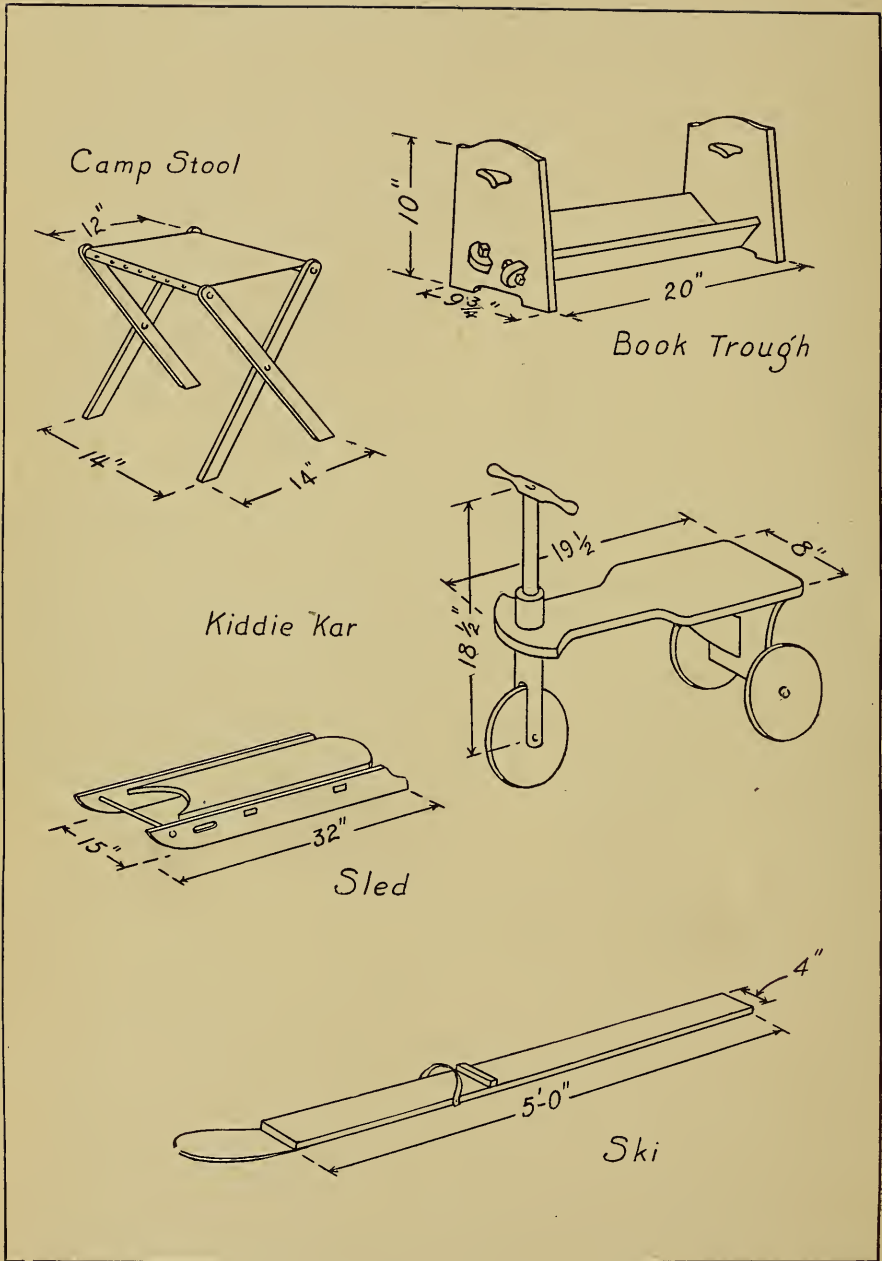

SUGGESTIONS FOR CHILDREN.

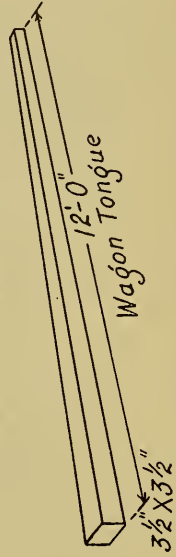
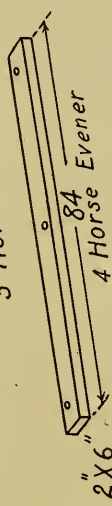
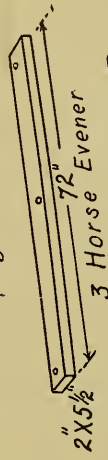
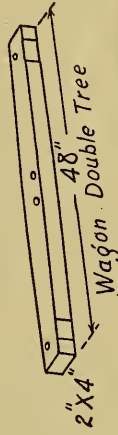
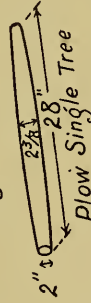
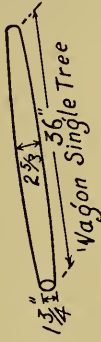
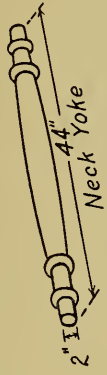
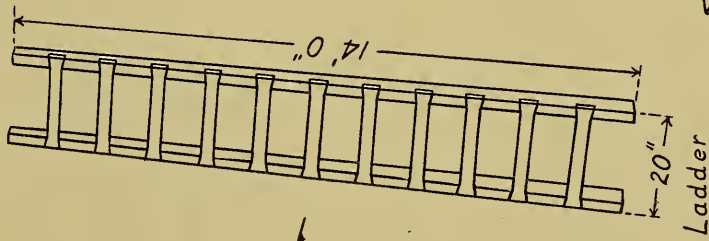
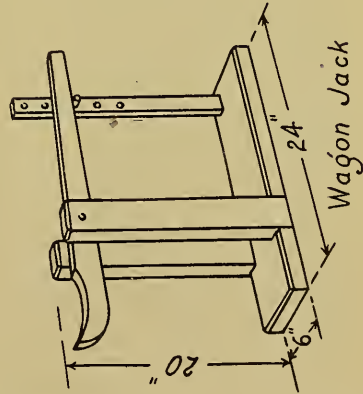
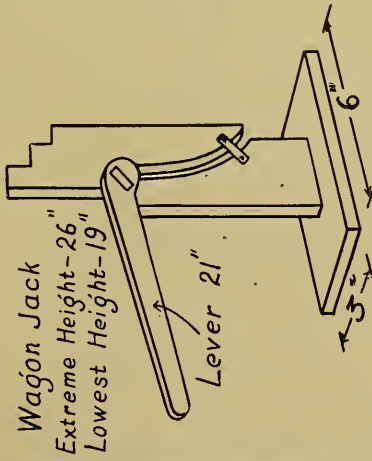

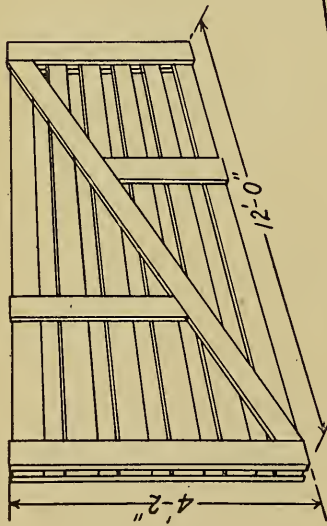

Farm Gate

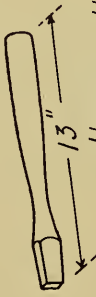

Hammer Handle

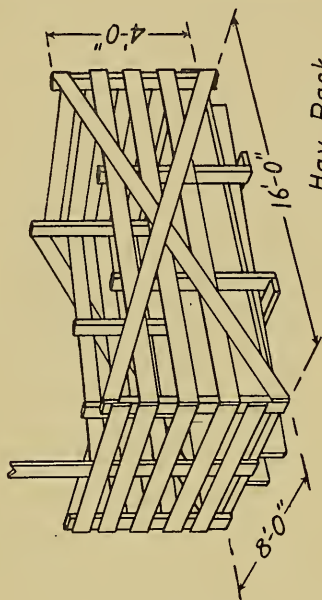

Hay Rack

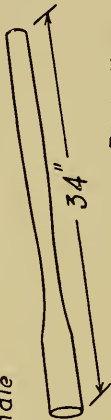

Pick Handle



Axe Handle



Wagon Box

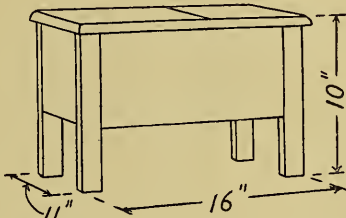

Blacking Case and Stool

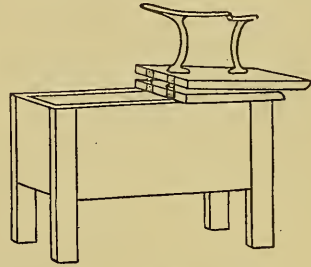

Saw Horse

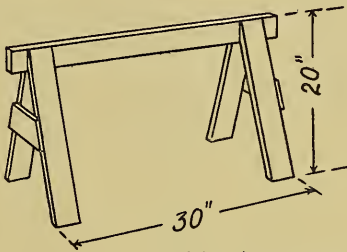

Chicken Feeder

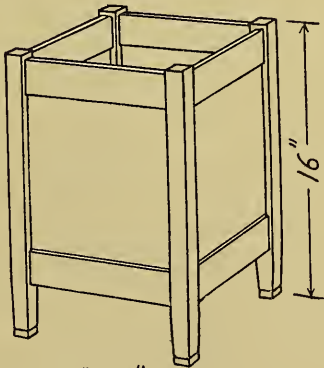
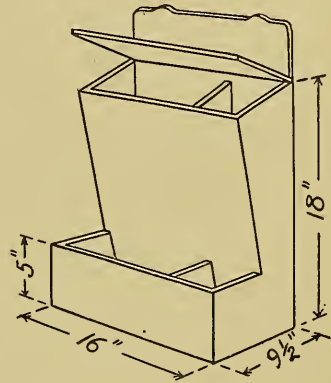

Top 12"X12"
Base 12"X12"

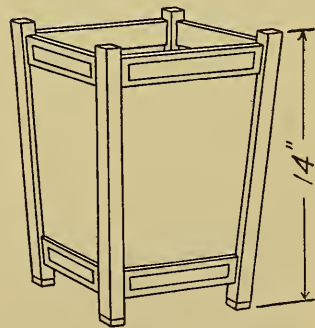

Top 12"X12"
Base 10"X10"

Waste Paper Baskets

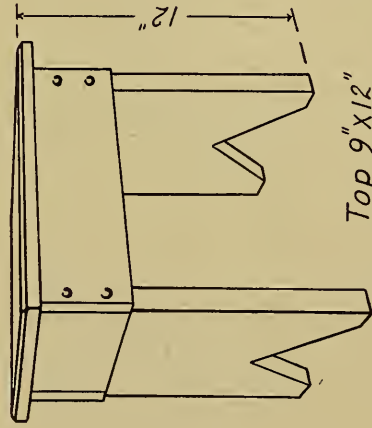

Top 9" X 12"

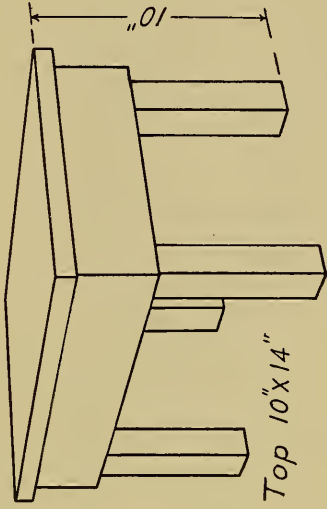

Top 10" X 14"

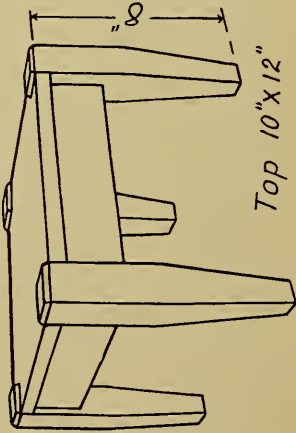

Top 10" X 12"

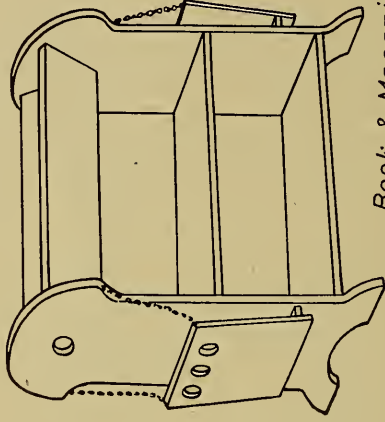

Book & Magazine Project



Top 12"X12"
Height 24"

Shaving Mirror

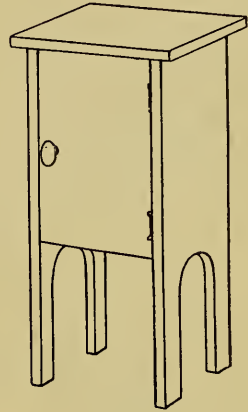

Top 12"X12"
Height 24"

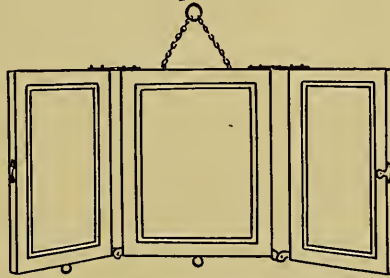

Top 9½" Dia.
Height 24"

Glasses 6"X10" & 8"X10"

Top 10"X14"
Height 24"

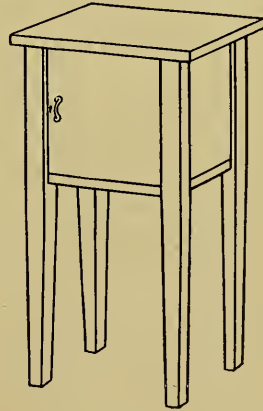
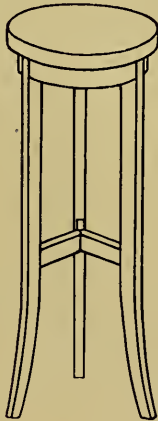

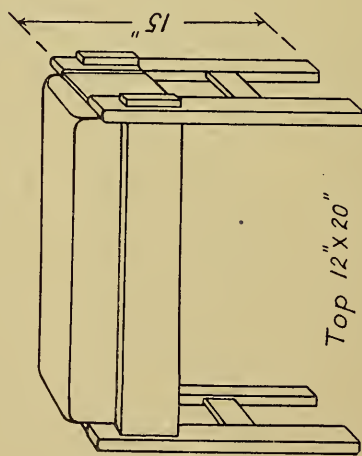
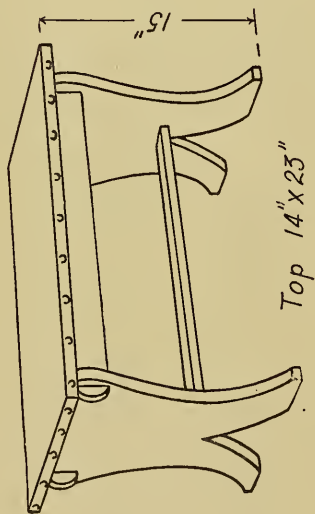
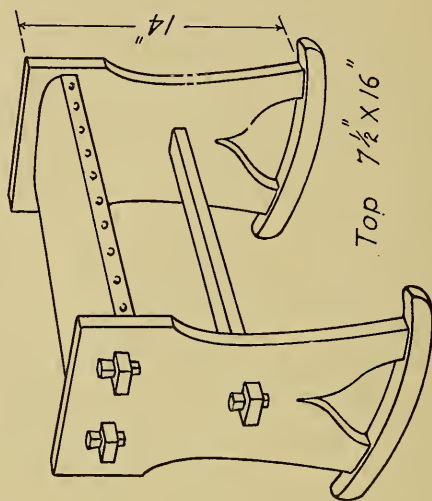
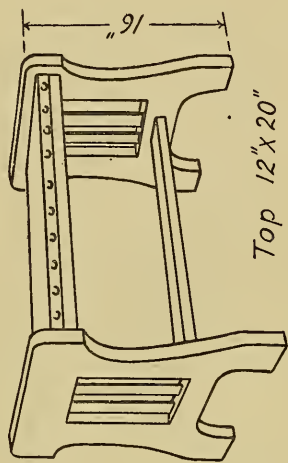

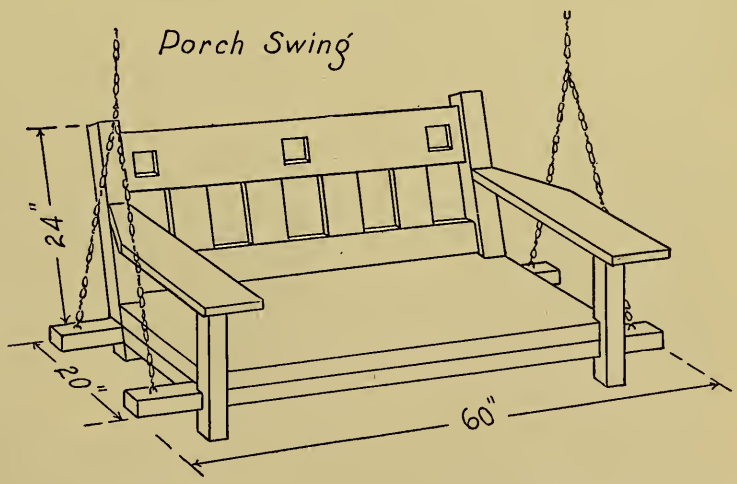
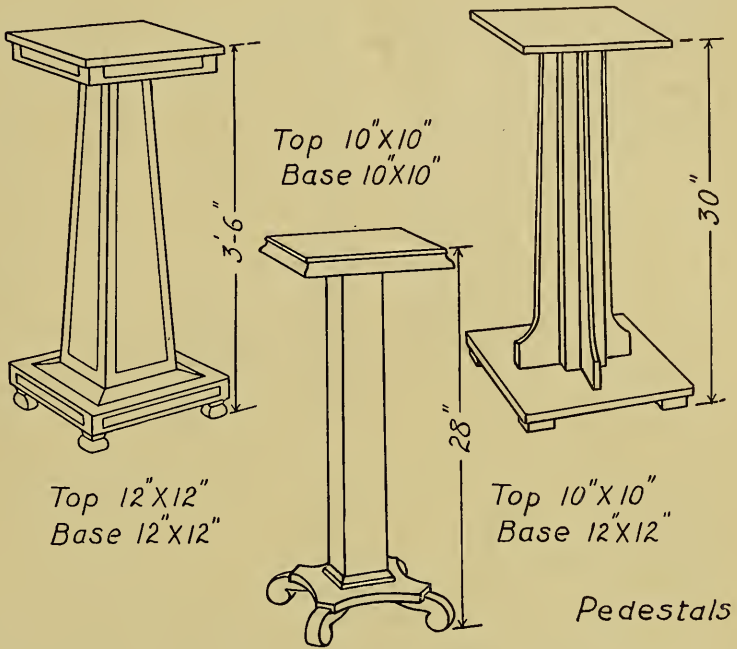

PEDESTALS AND PORCH SWING.

PLATE IX

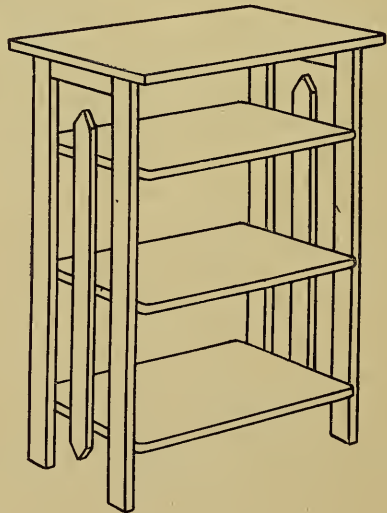
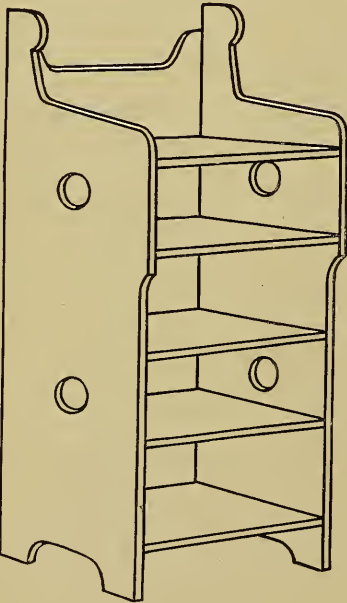
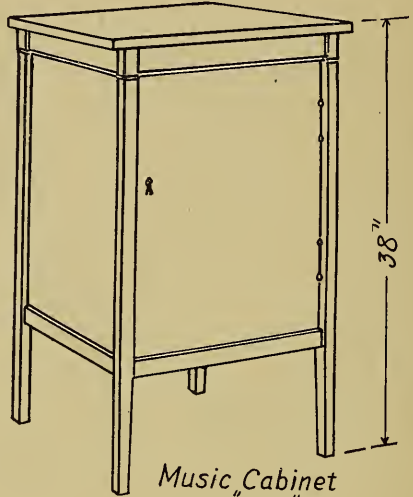
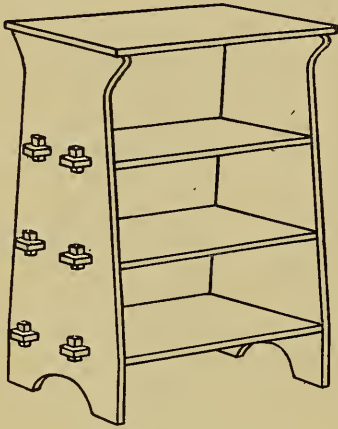

Book and Magazine Racks

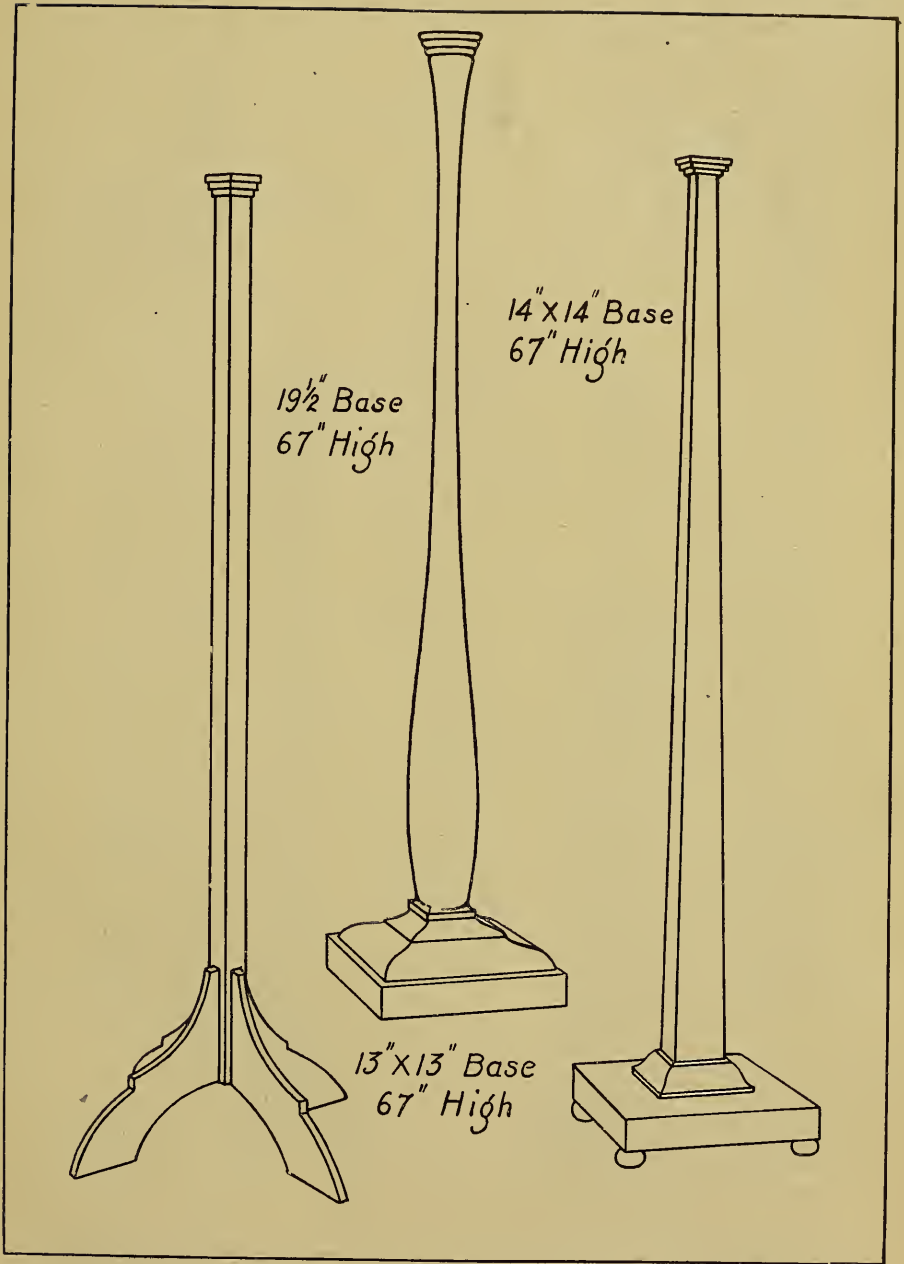

LAMP STANDARDS.

PLATE XI

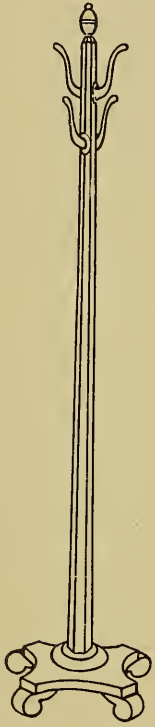

14" Base
6' High



10" Base
1 3/4" sq. Col.
6' High.



12" Base
1 1/2" sq. Col.
5-7" High

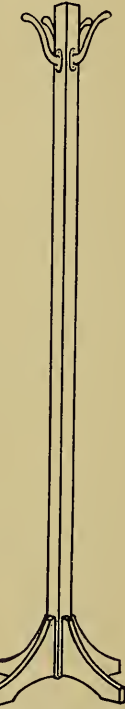
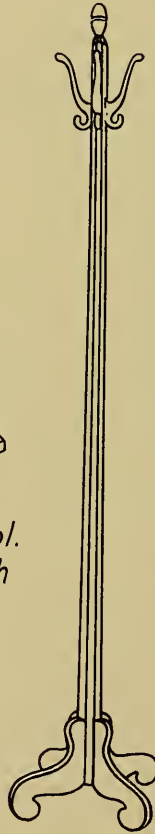

12" Base
2" sq. Col.
5' High

14" Base
6' High

Table Lamps

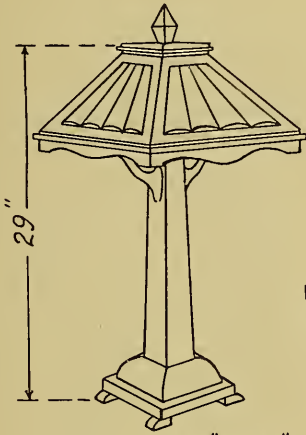

29"

Shade $18\frac{1}{2}'' \times 18\frac{1}{2}''$

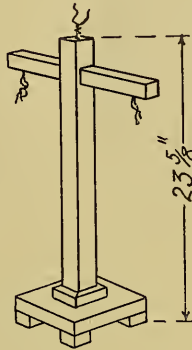

$23\frac{5}{8}''$

Cross-Bar $13\frac{1}{2}''$

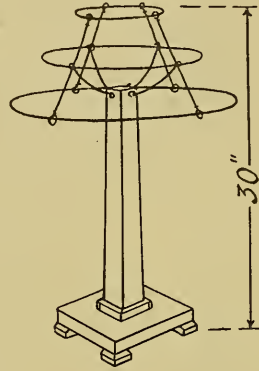

30"

Dia. 18"

Hall Trees



12" Base
6' Height

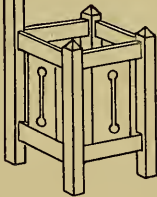

12" x 14" Base
5'6" Height

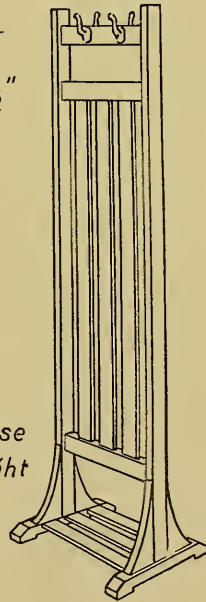
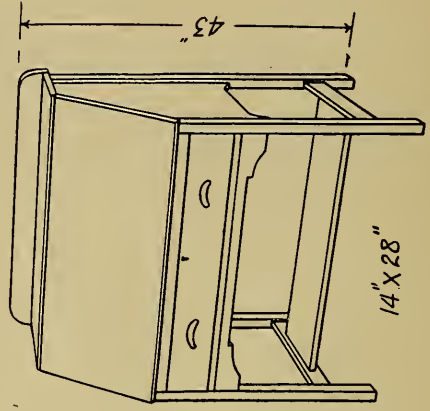
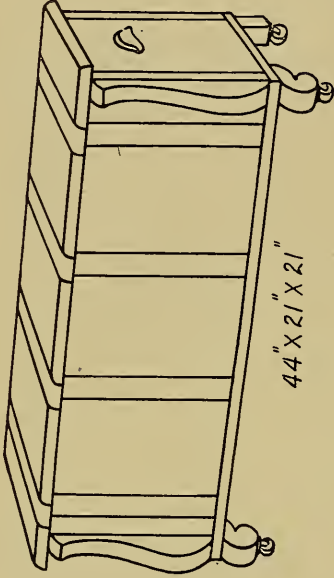
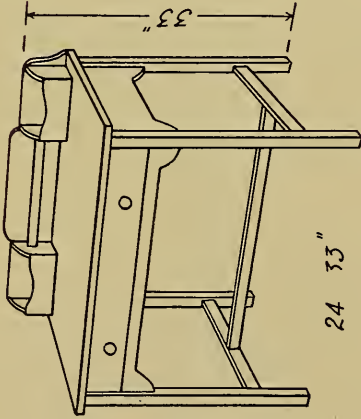
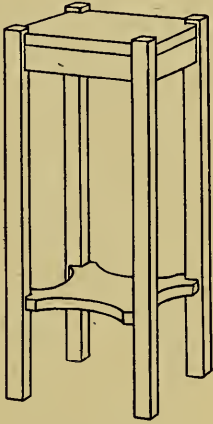
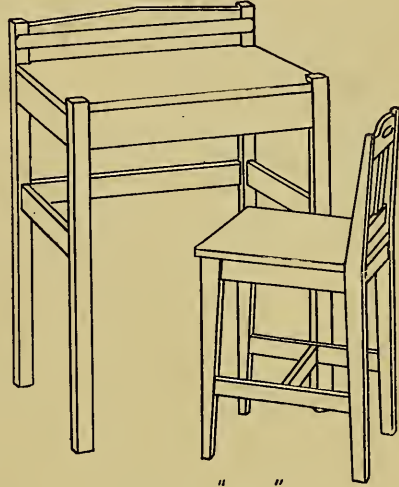

TABLE LAMPS AND HALL TREES.





Top 10" X 10"
Height 24½"



Top 16" X 22"
Height 30"

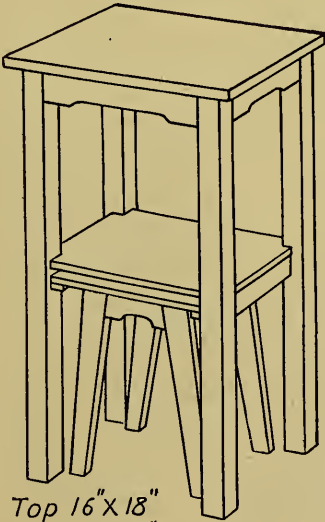

Top 16" X 18"
Height 30"

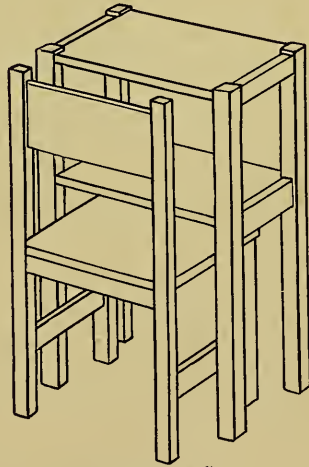

Top 16" X 18"
Height 30"

PLATE XV

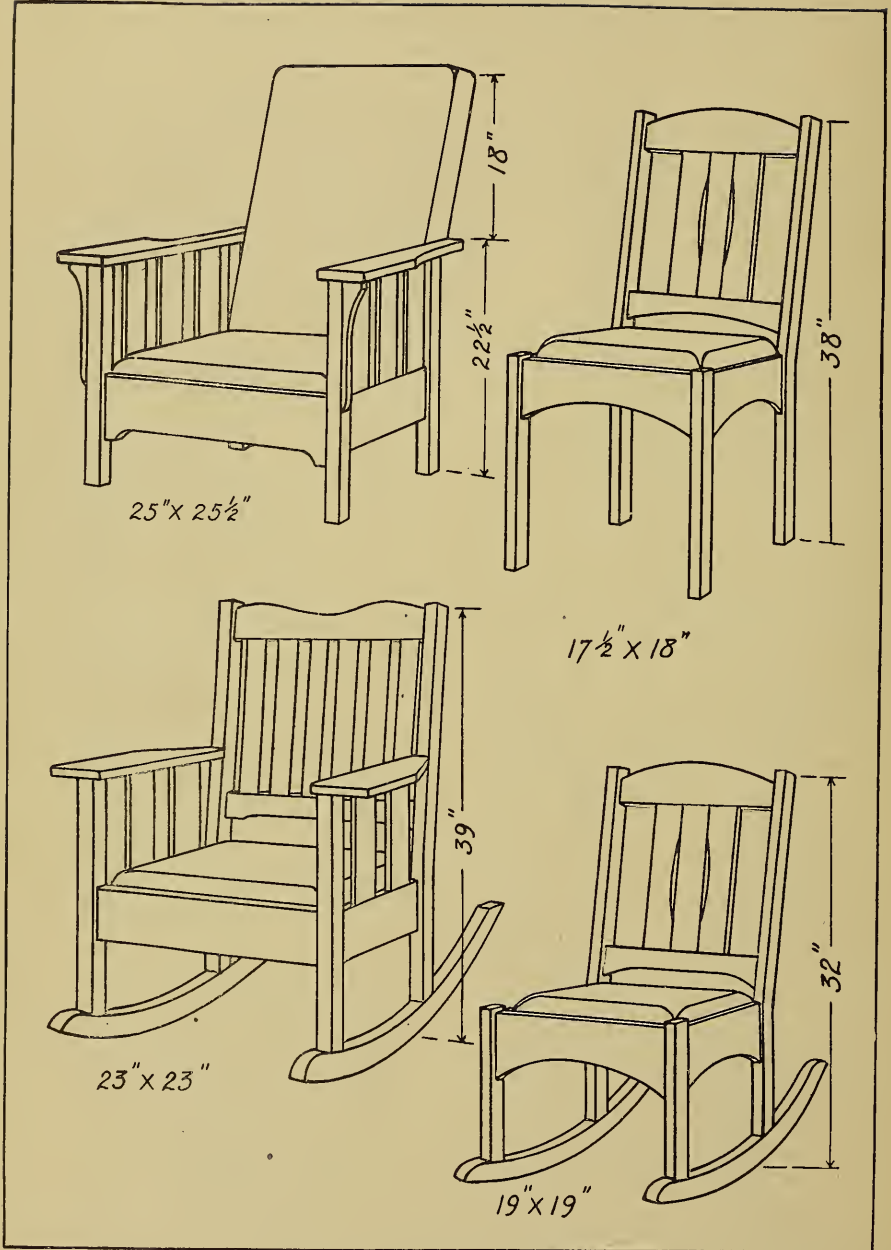

CHAIRS FOR THE LIVING ROOM.

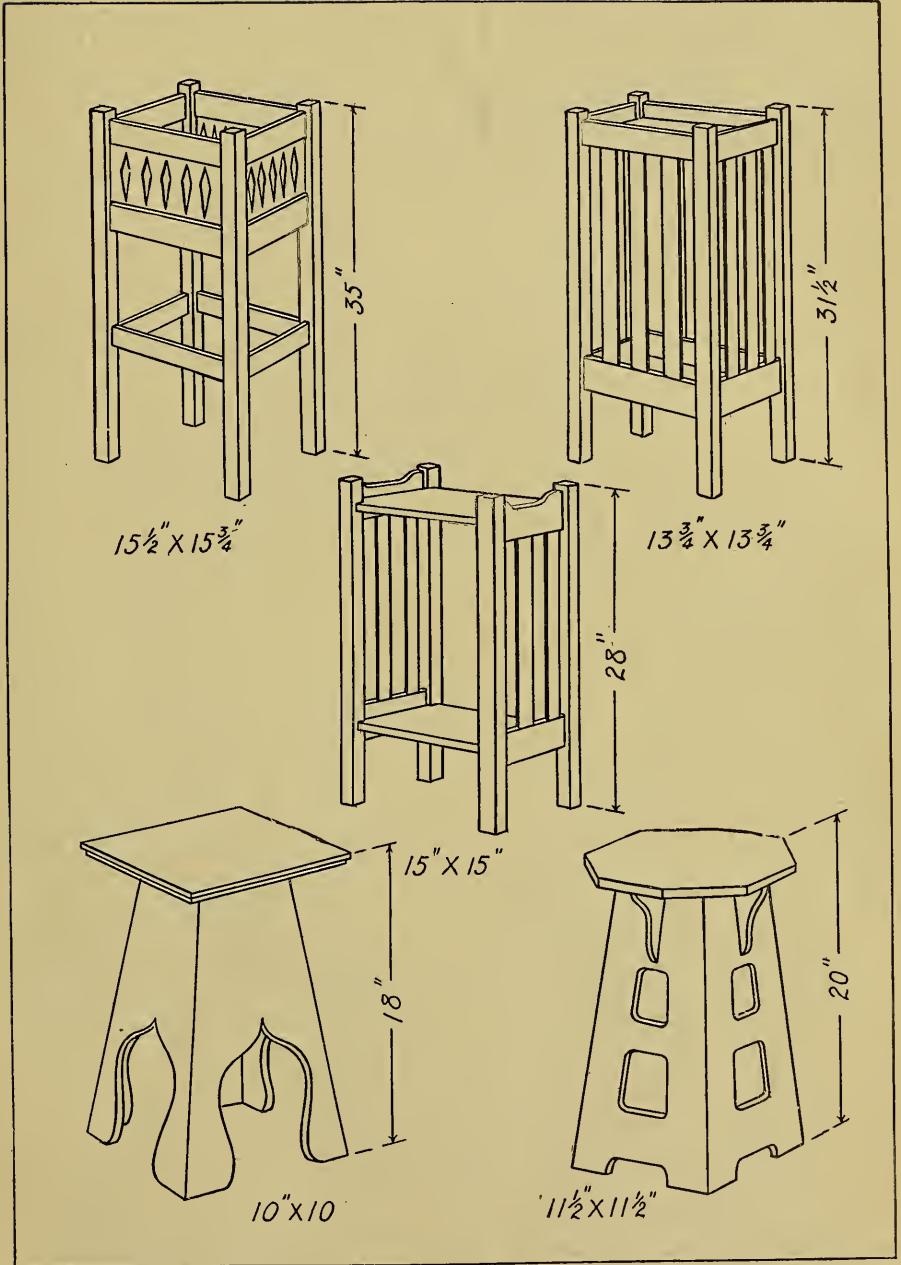

ADJUNCTS OF THE HALL.

PLATE XVII

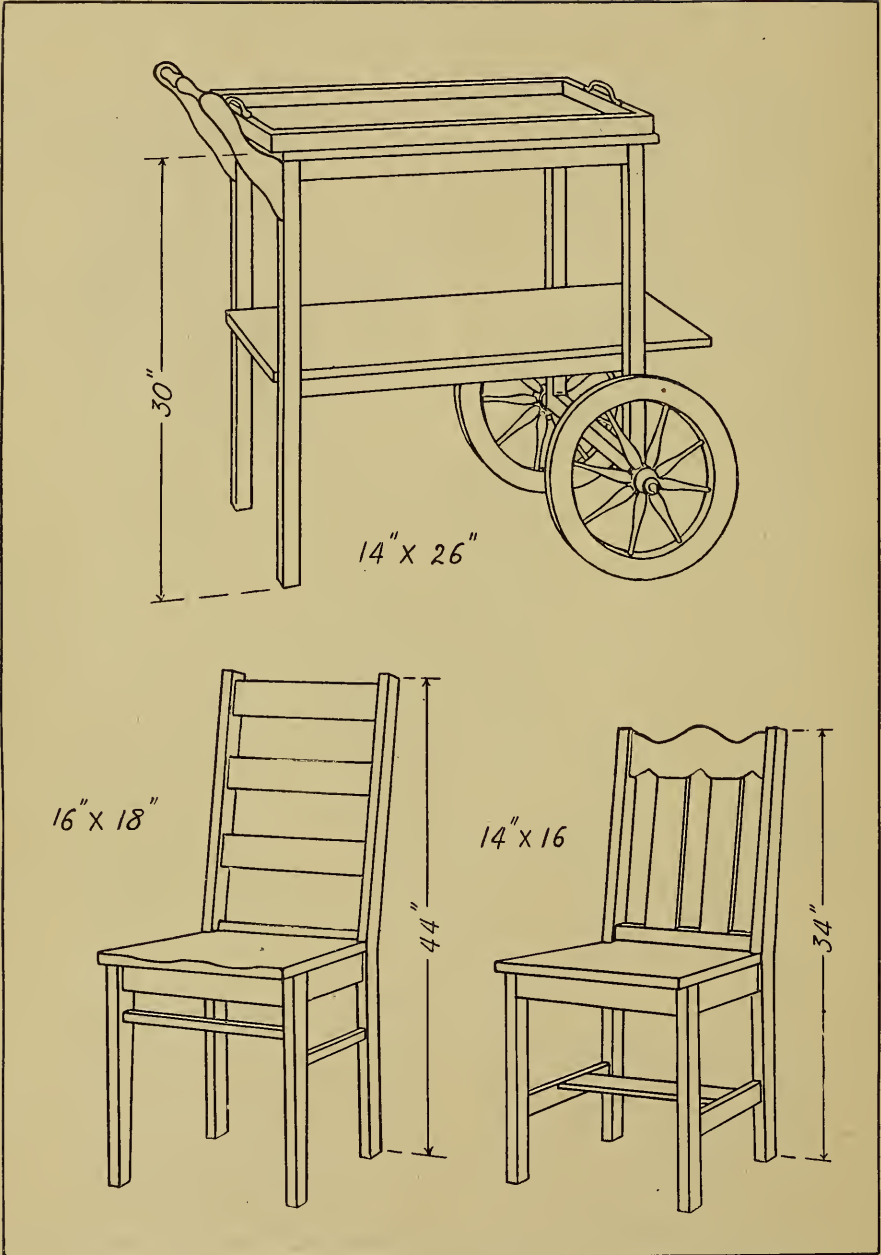

DINING ROOM PIECES.

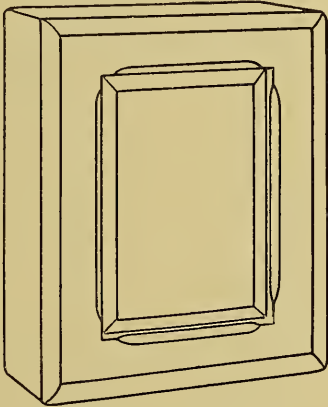

Medicine Cabinet
5"X15"X19"
Glass 12"X14"

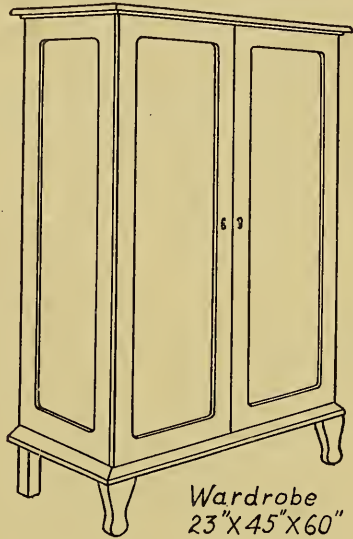

Wardrobe
23"X45"X60"



18" Panel
Height 67½"

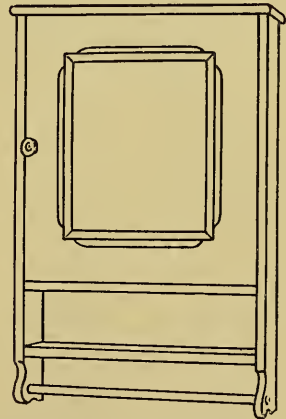

Medicine Cabinet
5"X20"X29"
Glass 12"X14"

PLATE XIX



Top 16"x36"

Height 21"



Top 15"x38"



Top 16"x38"

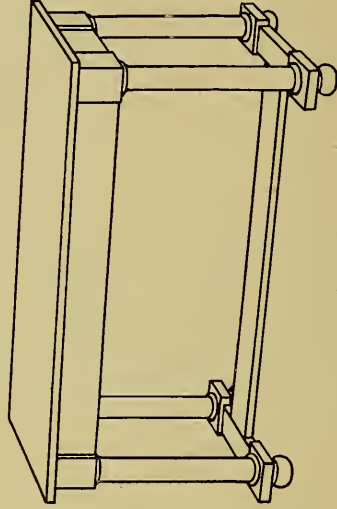

Top 16"x38"

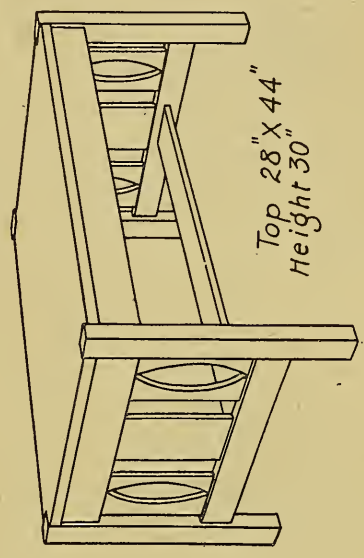
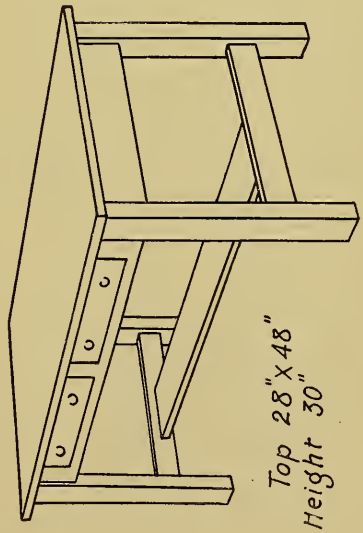
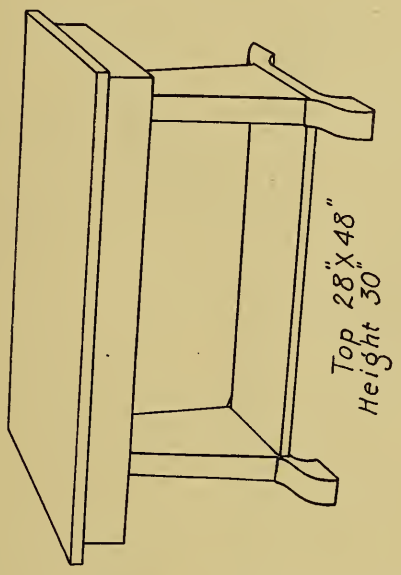
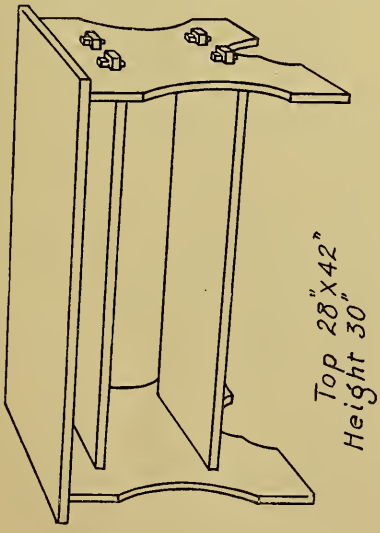

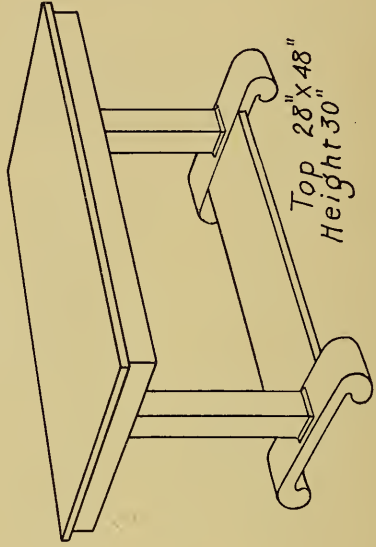
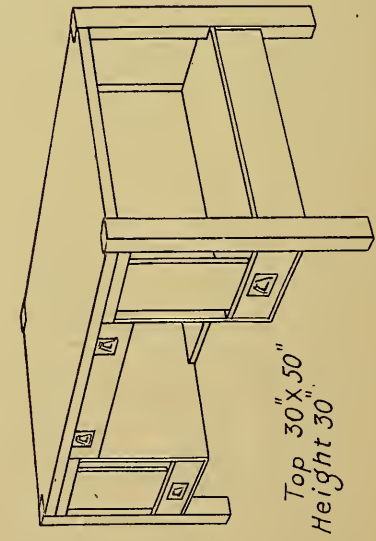
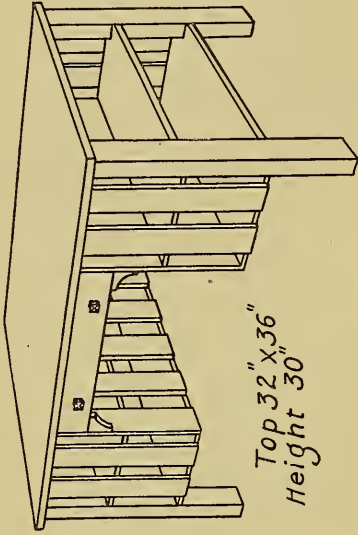
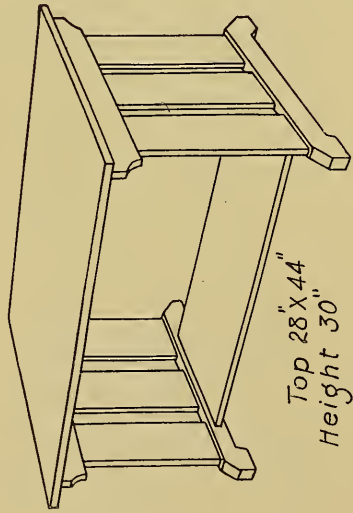

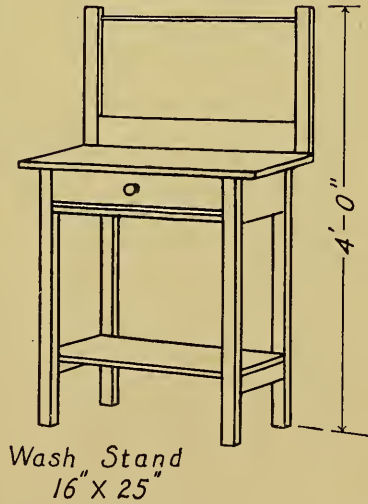
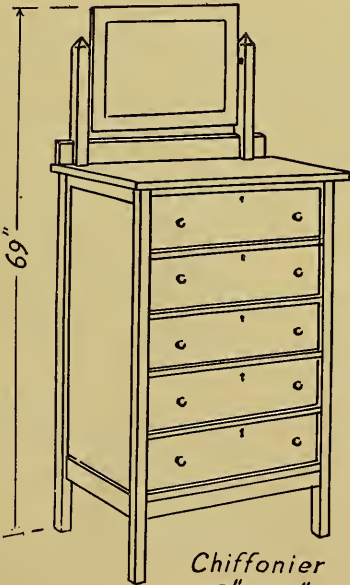
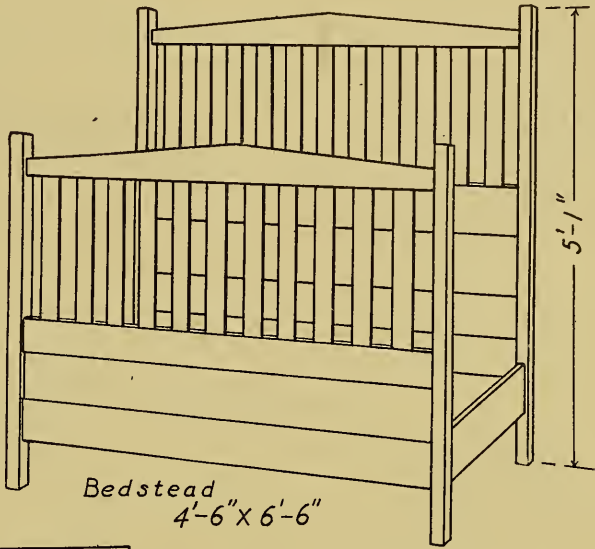
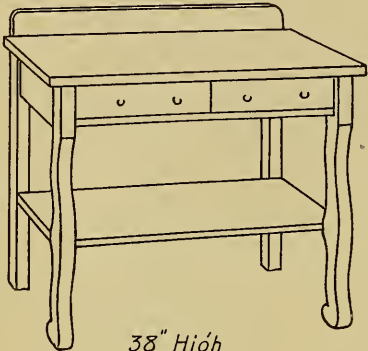
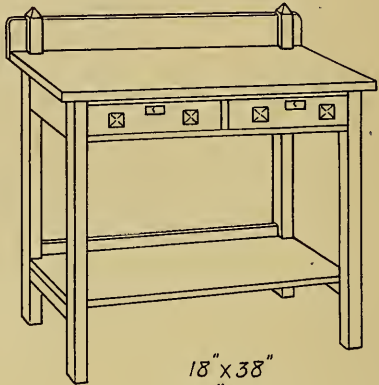

PLATE XXIII



38" High
20" x 42"



18" x 38"
39" High

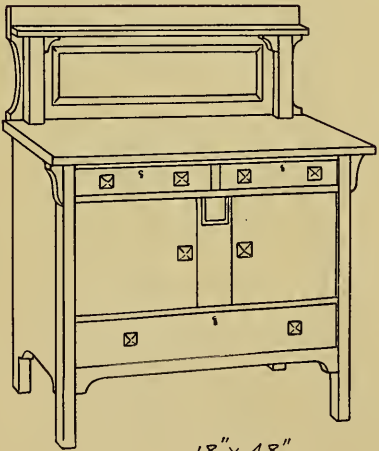

18" x 48"
54" High



21" x 50"
48" High

Floor or Walk Forms

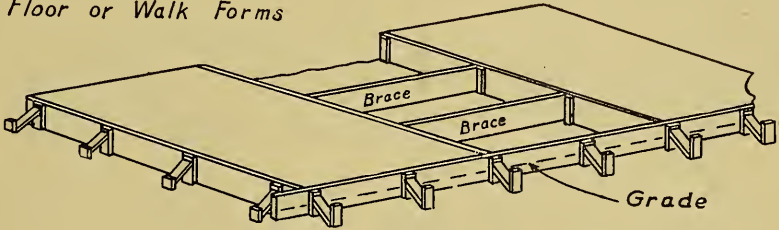

Forms For Concrete Fence Posts

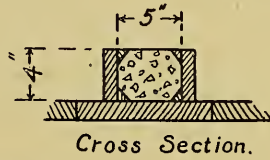
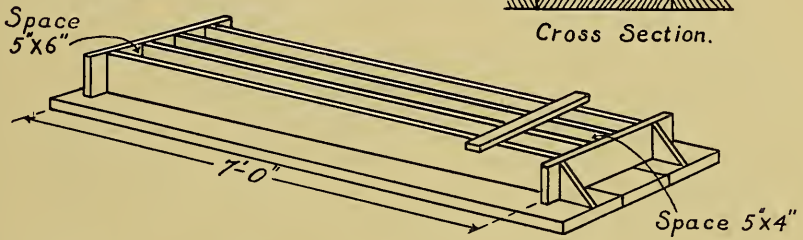

Hot Bed

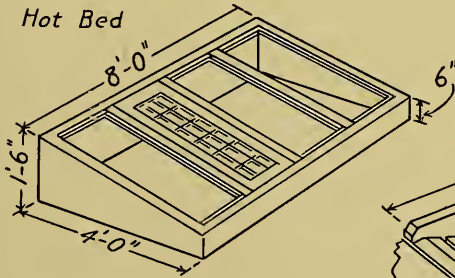

Section

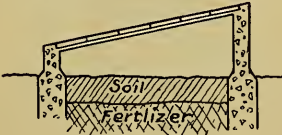

Concrete Hog Wallow

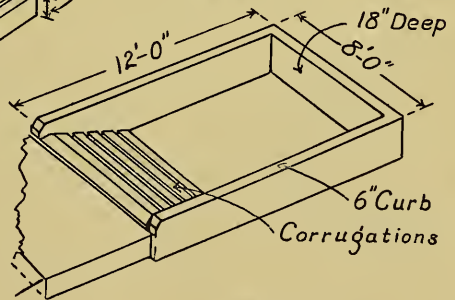

Section



PLATE XXV

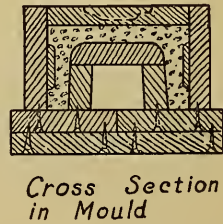
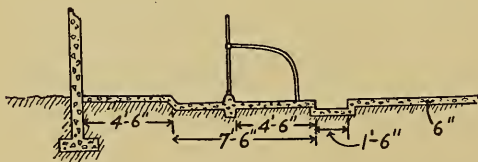
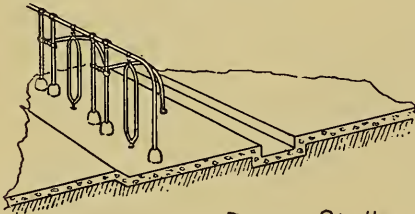
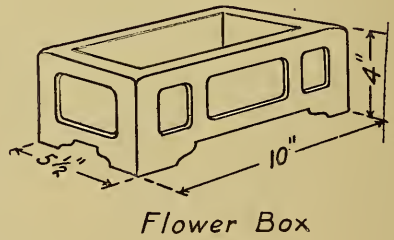
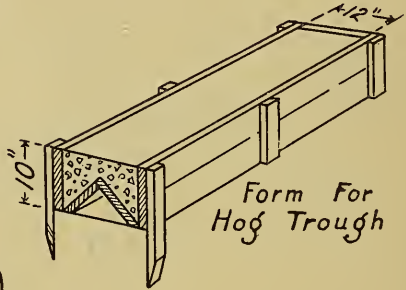
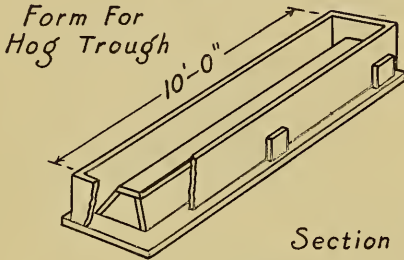
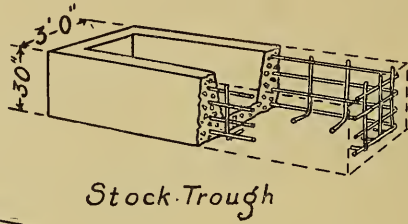
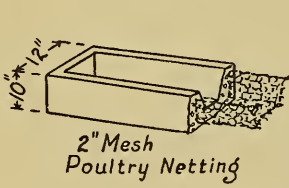

CHAPTER III

CARPENTRY

There are many things of vital interest even in the simplest house construction. To describe all, or even a single operation, in detail, is beyond the scope of this text. But to present carpentry—general wood-work as applied to house construction—so that the student may be able to plan, estimate and construct, as well as to talk intelligently of general construction, is the purpose of this chapter.

. *House Planning.*—To plan a house, one must be familiar with the parts that go to make up a house. The rooms should be so arranged as to afford the greatest convenience; the stairways and chimneys located; the plumbing, heating and electric wiring given due consideration; the porches, steps, doors and windows arranged in their proper order; and, in fact, the whole house should be planned to be healthful and convenient, and its general appearance pleasing. These ideas, sketched upon paper, become plans, and the written descriptions of materials, details, etc., are the specifications, which are, in turn, the working instruments in the hands of the builder.

Estimate of Cost.—To be able to estimate the cost of building, one must know how to read a blue print or working drawing and to interpret the specifications accurately; to make out a conservative lumber bill; to estimate the labor necessary for the construction; and to total the sub-contractor's bids on painting, plastering, plumbing, etc., not overlooking a single item necessary for the completion of the building. It is a common practice for contractors to let out—sub-contract—different parts of the work as the masonry, plastering, etc., and to accept bids on the work as part of the estimate for the construction of the house.

Procedure.—To insure durability in the construction of a house, one must be able to distribute the timbers, boards and other materials according to the plans and specifications so that they are rigidly and firmly anchored. The order of procedure in the construction of a house is complicated in that there are times when it is necessary for masons, carpenters, electricians, plumbers and steamfitters to be working at one time, i. e., when the framing of the house has reached a stage most

convenient for these various parts to be installed. However, by a little ingenuity on the part of the contractor or building superintendent, the work of each may progress without interfering with the work of others.

Staking Out for Foundation.—A very good start toward the erection of a house is to be sure that the front of the house is parallel with

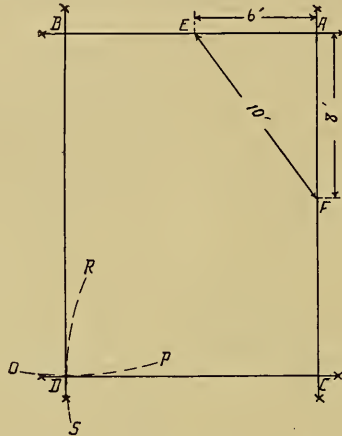

FIG. 147a. SQUARING THE FOUNDATION.

the street or highway on which it is located. In laying out the foundation of a house, begin by establishing the location of one corner of the proposed building at the proper distance from the street. Mark this

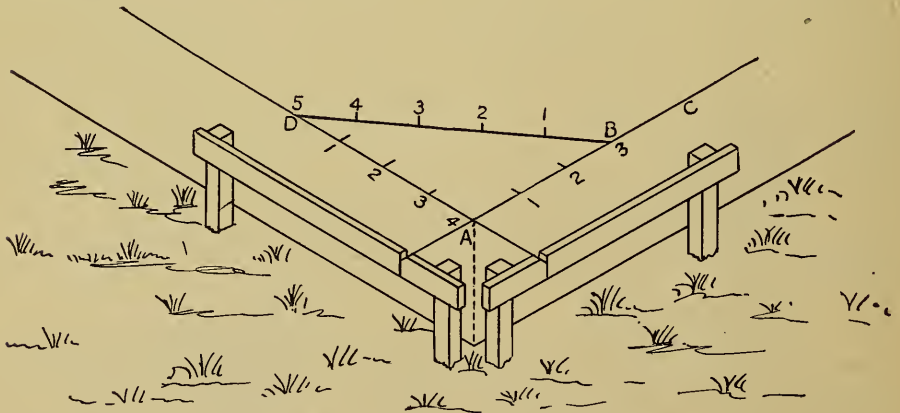

FIG. 147b. SQUARING THE FOUNDATION.

location by driving a stake. To this stake attach a line and run it past the next corner of the building and parallel with the street. Run a line back from the street from the first corner, A, in Fig. 147a, at right

angles to the line AB. To do this, measure 6 feet from A on AB and 8 feet from A on AC. Swing the line AC at C until the distance between E and F is 10 feet. This makes the front corner at A square. The other corners at B, C and D may be squared in the same way. Fig. 147b shows the same method except that the lines are fastened securely to batter boards. A cloth measuring tape is held with the zero mark at A, the point of intersection of the two lines. Measure out 3 yards to the point B and let out 9 additional yards of tape. While holding the tape at a point 5 yards from B secure the 9-yard mark at A. Draw the tape taut and a right triangle will be formed the sides of which are 3 yards, 4 yards and 5 yards, respectively. With this completed it will be a simple task to establish the lines square with each other. A method of squaring the corners by the use of a steel tape is to describe an arc, RS, with C as the center and the width of the building as the radius; describe a second arc, OP, intersecting the arc, RS, with B as the center and the length of the building as the radius. The intersection of the two arcs at D locate the back corner of the house with the walls, DB and DC, square to BA and CA, respectively. The lines should be run for all outside and inside walls, cellar excavation, footing, etc.

EXCAVATION AND FOUNDATION.

Excavation.—The excavation for the masonry work should be made deep enough to give a firm foundation, the depth depending upon the character of the soil. It is a common practice to make the trenches much wider than the thickness of the walls for the purpose of establishing a footing that will assist in distributing the weight of the structure over a greater surface. This arrangement retards the settling of the building which is quite common, especially in rainy weather.

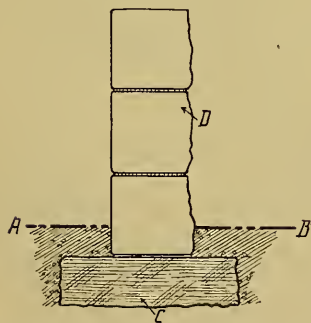

FIG. 148.—CROSS SECTION OF A FOUNDATION
A B, Ground Level C, Footing D, Wall

Foundation.—A foundation consists of two parts: Footing, C, and wall, D, in Fig. 148. The footing is usually made of a suitable concrete mixture; the wall is generally made of stone, brick or cement blocks. The walls should be plumb, and the top surfaces of those of the same height should lie in the same plane. Vents, properly screened, should be constructed in the walls for the purpose of giving a free circulation of air. These vents are usually placed near the top of

the foundation in opposite walls. If there is no basement, one opening should be left—usually under a porch—in order that the plumbing or wiring may be changed without the necessity of cutting into the finished foundation.

FOUNDATION FRAME.

Plates.—Plates, B, in Fig. 149, serve as the footing for the joists. They lie directly on the foundation and should be set in green, unset mortar. The snug articulation thus secured serves as a protection against cold winds. Good, straight, sound planks should be selected for the plates and they should be spiked securely to the sills.

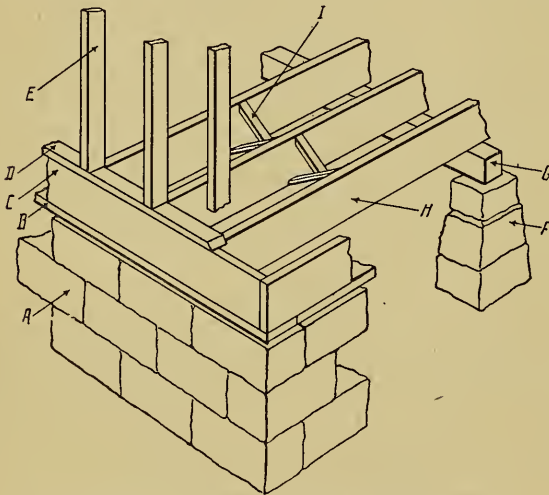

FIG. 149.—FOUNDATION FRAME. (BOX SILL.)

A—Foundation	D—lower plate	G—beam
B—foundation plate	E—stud	H—joist
C—sill	F—pier	I—bridging

Sills.—The sills, C, in Fig. 149, hold the joists in position and help to carry the load of the outside walls. They, too, should be of selected planks. The end joists become sills. The kind of construction as illustrated in Fig. 150 and Fig. 149, determines whether the sill will form a “T” with the plate (T-sill), or whether it will be the shape of a box (box-sill). The T-sill makes a stronger construction than the box-sill but the frame is a little harder to raise.

Joists.—The timbers which have their bearing upon the foundation plates and upon which the flooring is nailed, are called joists, H, in Fig. 149. The stiffness of the floors will depend largely on the dimensions and spacing of the joists and the length of the span. Lower joists are spaced either 16 or 24 inches from center to center. All joists, studs and rafters that are to be plastered over are spaced 16 inches from center to center.

Beams.—It is often necessary to support the ends of joists, over an excavation, broken foundation, etc., by the use of a beam, G, in Fig. 149. The beams are supported in turn by piers, F, in Fig. 149. Sometimes,

in the case of a long span of the joists, where they are to carry heavy loads, beams are secured by additional support.

Bridging.—To prevent the joists from buckling, and to assist in distributing the load, bridging, I, in Fig. 149, is nailed into place, between the joists.

FRAME OF HOUSE.

Studs.—The studs, F, in Fig. 150, when erected, serve as the frame of the house. Studs are divided into three classes: Studs for the outside walls, studs for partitions, and studs for bearing partitions. The length of the studs forming the outside walls is determined by the height of the ceilings, and the thickness of the second story joists. Studs for the outside walls are spaced 16 inches apart, and nailed in place by means of a lower plate, D, in Fig. 149, at the bottom, and a similar plate, called the upper plate, at the top. The upper plate is usually doubled, as it is the main bearing support for the roof. In case of a second story, a ribbon, G, in Fig. 150, usually 1"x4", is set in the inside edges of the studs, on the side walls, in order to afford a suitable footing for the second story joists. The ends of the upper joists are nailed directly to the studs. This stiffens the frame greatly and affords a nailing place for the flooring. Openings, K, in Fig. 150, are cut in the frame for all main entrances and windows, the sizes depending upon the size of the windows and doors to be set in. After the outside walls are raised, nailed in place, and plumbed, they should be securely braced by nailing strips of wood diagonally across the walls on the inside. These braces may be removed after the boxing is nailed on. Over the outside walls, boxing, building paper and siding are nailed. The inside walls are lathed and plastered. Bearing partitions serve as partitions and at the same time carry the load of the second story joists. Partition studding carry no load, as the walls run parallel to the run of the upper joists. They serve as room divisions only. Openings are cut in all inside partitions. Inside walls are lathed and plastered on both sides.

Floor Lining.—The floor lining, E, Fig. 150, may be laid when the structure has reached this stage. Floor lining or sub-floor lining, as it is sometimes called, is a layer of boards, usually boxing material, laid on diagonally across the entire building. This makes the house much stiffer and warmer. The bearing partitions may be laid over this sub-floor and the second story joists nailed in place. These joists should be spaced sixteen inches on center, the outside ends resting on the ribbon and spiked to the studs; the inside ends resting on the bearing partition and spiked to the joist coming from the opposite wall. Care should be

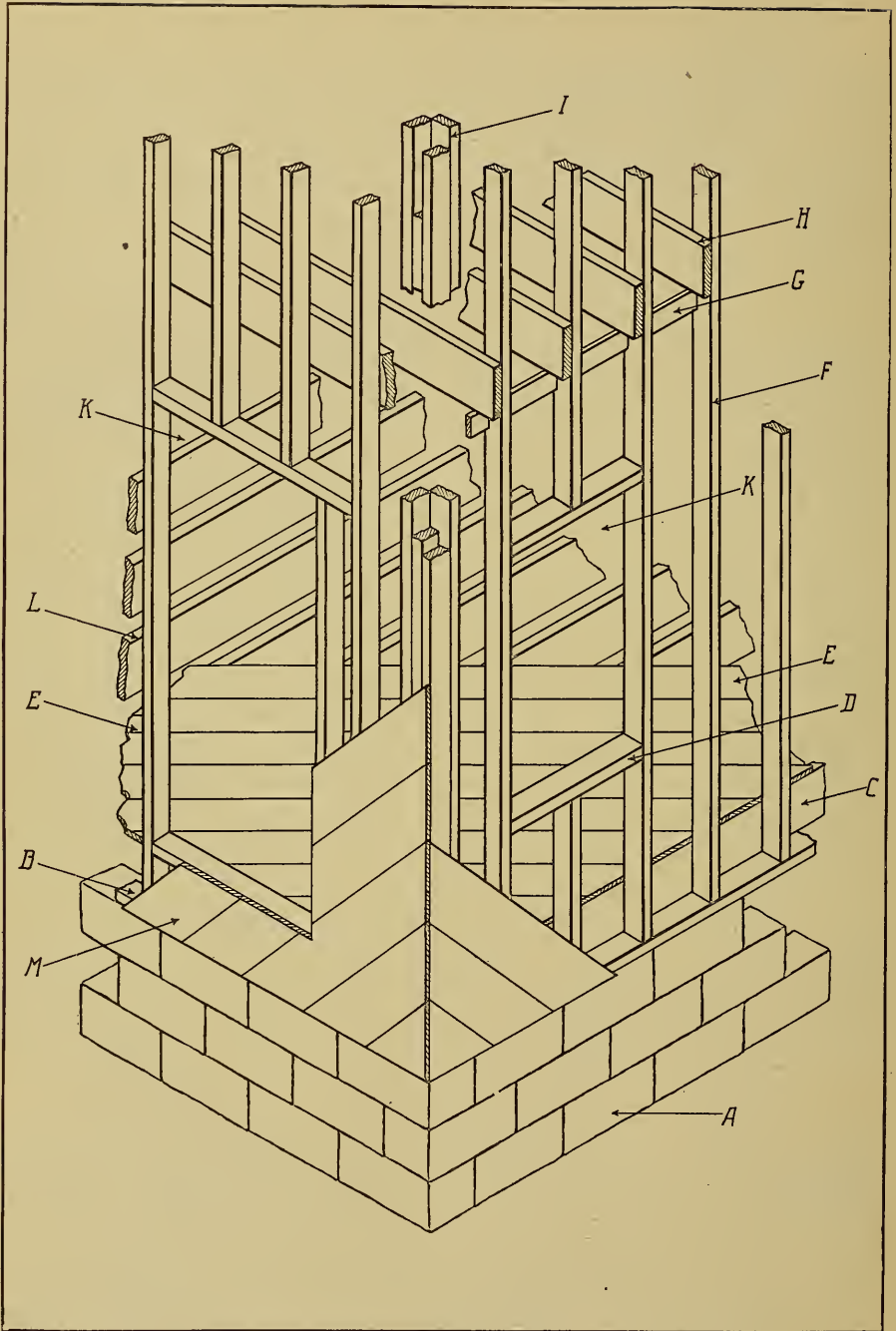

FIG. 150.—FRAME OF HOUSE (WITH T-SILL).

- | | | |
|-----------------------------------|----------------|-------------------|
| A—foundation | E—floor lining | J—end upper joist |
| B—foundation plate | F—stud | K—opening |
| C—sill | G—ribbon | L—lower joist |
| D—trimmer sill for window opening | H—upper joists | M—boxing |
| | I—corner post | |

taken to see that the walls are left absolutely straight. If the bearings of the upper story joists are far apart, it is advisable to cut in bridging between the joists before nailing on the floor lining. The bearing partitions on the second floor may be raised in the same manner as those on the first floor; then the ceiling joists are properly spaced and nailed in place, allowing a projection over the walls for the cornice.

Boxing.—Boxing, M, in Fig. 150, of rough boards, usually 1"x12", may be nailed on the outside of the frame when the building has reached this stage of construction. There are many ways of laying on boxing but perhaps the method most common is that of running it diagonally from the corners.

CORNICE.

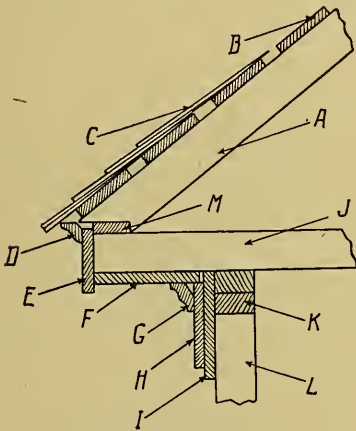

FIG. 151.—CORNICE.

- | | |
|------------------|----------------|
| A—rafter | H—frieze |
| B—sheathing | I—siding |
| C—shingles | J—joist |
| D—crown moulding | K—frame plate |
| E—facia | L—studding |
| G—bed | M—rafter plate |

Cornice.—The cornice consists of the following parts, which are shown in Fig. 151 by proper lettering: Plancia, F; frieze, H; facia, E; bed, G; and the crown moulding, D. These parts are run around the house in hip roofs and along the sides, and short returns on the ends, in gable end roofs. The plancia may be made of a single board, or it may be built of matched boards, as ceiling, flooring, etc. It is nailed directly to the projecting ceiling joists, all of which should be of the same length and in alignment. The frieze is usually a wide board, although a double frieze is sometimes used, and is nailed to the boxing, with its upper edge

against the plancia. The moulding cut in the angle formed by the plancia and the frieze is called the bed mould. Moulding gives a finished appearance to the cornice. The facia is usually a single board, nailed to the ends of the projecting joists and also to the edge of the plancia. The shingles overhang the facia, and, as a finish, a crown mould is cut in the angle formed by the facia and the shingles. Sometimes guttering is substituted for mould.

FRAMING OF THE ROOF.

Classification of Roofs.—Roofs may be classified according to shape. The three most common and distinct classes are the hip roof, gable end roof, and the gambrel roof. The difference is entirely in the design of

the roof, and different roofs therefore require different framing of the timbers necessary for the construction. These timbers are rafters, ridge, collar beams and braces. The timbers are finished over with sheathing, shingles and comb boards (see Fig. 152) to make the finished roof.

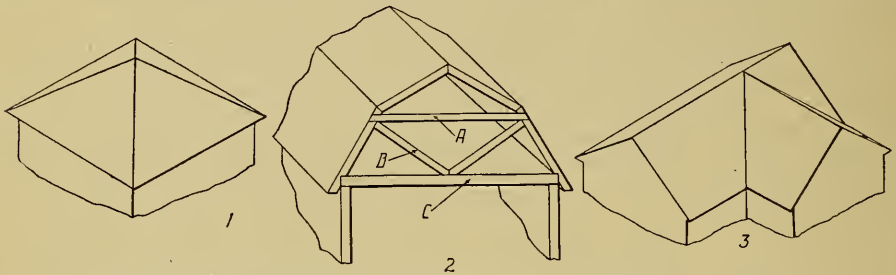

FIG. 152.—ROOF FORMS. (1) HIP ROOF; (2) GAMBREL; (3) GABLE.

Rafters.—The pitch of the roof, run and length of rafters, plumb and heel cuts are described under the “STEEL SQUARE” in Part III, but it will be well to observe that it is not necessary to place the rafters 16 inches on center unless they are to be plastered over. As sheathing cuts to advantage on even feet, it will be well to space the rafters at 24 inches and as it will be readily seen that a footing will be necessary for the rafters. This is made by nailing a ribbon, M, in Fig. 151, to the top of the projecting joists, J, in Fig. 151. A hook or shoulder at the heel cut of the rafters will assist materially in raising the rafters in place, as the rafters are usually nailed at the plumb cut first, and then raised in pairs. The shoulder will prevent the rafters from slipping over the ribbon. Sometimes the rafters are tied together by nailing a board across. These boards are called collar beams, A, in Fig. 152. Collar beams prevent the roof from spreading and braces, B, in Fig. 152, prevent the roof from sagging in the center.

Sheathing.—Sheathing, B, in Fig. 151, ties all the rafters together and serves as a base for the shingles. The better grade of houses have the sheathing water tight; but, as a general rule, narrow strips, 1"x4", are nailed on, leaving a space between the strips equal to the width of the strips. In the latter case, the estimate for the board feet necessary for the sheathing is equal to one-half the square feet in the roof surface.

Shingling.—Too much care in the shingling, C, in Fig. 151, of a house is almost impossible, as the shingles must stand the brunt of the weather. Shingles are easier to put on when damp, but if they are put on when dry they should be laid with some space between them to prevent buckling when they expand on getting wet. Shingles are laid on in

straight rows, commencing at the bottom with a double row, and breaking joints, exposing a part of the shingle to the weather. Usually four and one-half inches of the shingle is exposed on roofs, and more is exposed on the sides of the house if the specifications call for shingles on the outside walls. It will take nine hundred shingles laid four and one-half inches to the weather to cover one square. A square is the term or unit of measure used in determining the quantity of shingles necessary for a roof and contains one hundred square feet. Three pounds of shingle nails will lay one thousand shingles.

Comb-Boards.—Comb-boards serve as a divide; they also tie down the last few rows of shingles and prevent leakage at the ridge.

The house is now entirely enclosed, openings are cut, partitions set; the plumbers have run their stacks, vents, water and gas lines; the electricians have placed their wires for lights and bells, and put in their switches; and the lather may have started his work for the plasterer. The carpenters may now cut in the flue stands, make frames and jambs and get out the material for the stair-ways.

FRAMES AND JAMBS.

Window and Door Frames.—Outside window and door frames are alike in many respects. Several of the parts are similar and have similar names; the frames are set in openings in the same manner, and neither is trimmed until the plastering is done.

Window Frames.—Window frames consist of pulleys, stiles, header, sub-sill, sill, outside casing,

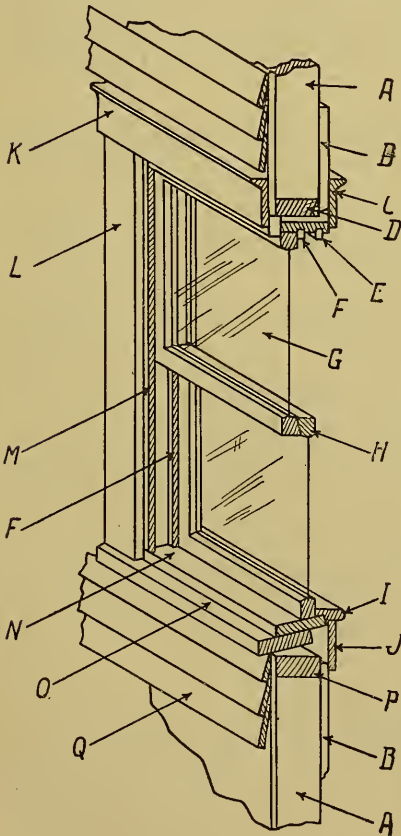

FIG. 153.—CROSS SECTION OF A WINDOW FRAME.

- | | |
|------------------------|-------------------------|
| A—stud | J—apron |
| B—lath and plaster | K—head casing (outside) |
| C—head casing (inside) | L—casing (outside) |
| D—opening header | M—blind stop |
| E—window stop | N—sill |
| F—parting stop | O—sub-sill |
| G—glass | P—trimmer sill |
| H—check rail | Q—siding |
| I—window stool | |

blind and parting stops. In the more expensive houses a weight box is built as part of the frame. This frame is properly set in an opening and afterwards trimmed with inside casing, window stool, apron and inside stop. The sashes are fitted and hung on weights, but care should be taken to hang the upper sash on weights heavier than itself so that it may be held in place. Pulley stiles are the sides of the frame. The header is dadoed into the stiles at the top and the sub-sill at the bottom. The sub-sill serves as a footing for the outside casing, also as a water table. The sill serves as a seat for the sash. The blind stop is nailed to the edge of the stiles, and the outside casing over the blind stop, leaving an offset. This offset is a seat for the blinds or screens. The parting stop, together with the blind and window stop, serve as guides for the sash. The parting stop is rabbeted into the pulley stiles. In this shape the frame is set in the opening, the outside casing being nailed into the boxing. The inside trim is added to give a pleasing appearance and to cover the rough edges of the plaster.

Door Frames.—Outside door frames have only the stiles and sill. The frame is trimmed with inside casing and threshold, and the door is then properly hung.

Jambs.—Jambs are inside frames for doors. They have only the stiles and header; the trim is added later.

Grounds.—Grounds are gauges for plastering. They are strips of wood usually three-fourths of an inch thick, nailed on the inside edge of the frames, on both edges of the jambs, and frequently across the studding, at the base, as a straight edge for the plasterer to work to.

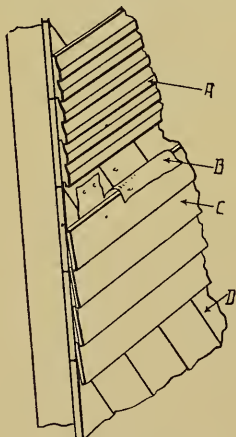

FIG. 154.—SIDING.

A—drop
B—building paper
C—lap siding
D—boxing

Corner Strips.—Corner strips or corner casings are nailed on the corners to afford a stop against which the siding may be butted. (See Fig. 153.)

Siding.—Siding is of two classes: Lap siding and drop siding. Lap siding is tapering in its cross-section, and is put on by lapping the bottom edge of one board over the top edge of another. Drop siding is milled so that the joint will turn water. Sid-

ing is nailed to the boxing over building paper, and is cut between casings and corner strips. It is the outside finish and should be of selected material. All siding should be on before the plastering is started.

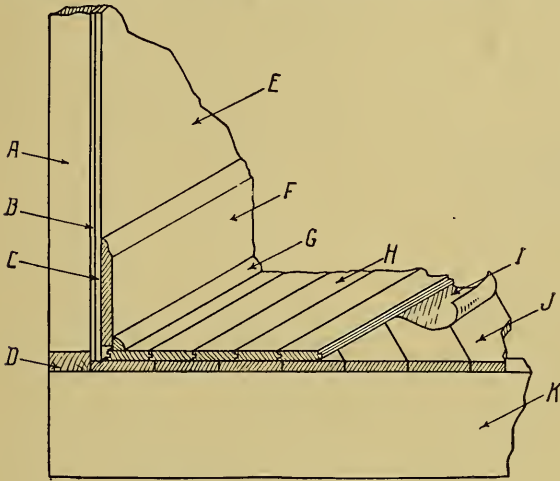

FIG. 155.—LAYING THE FLOOR.

- | | |
|---------------|-----------------------------|
| A—stud | G—base shoe |
| B—lath | H—flooring |
| C—plaster | I—building paper |
| D—lower plate | J—floor lining or sub-floor |
| E—wall | K—joist |
| F—base | |

Base.—The base F, in Fig. 155, is a protection to the plastering and should be nailed to the studding through the plastering before the finished flooring is put on. The central location of all studs should be marked with short lines on the floor-lining, and perpendicular to the walls, before the plastering is completed. There will then be no difficulty in nailing on the base. Allowance should be made for the thickness of the flooring, and a moulding-base-shoe is cut in the angle formed by the base and the floor.

Floor.—In laying the floor, H, in Fig. 155, extreme care should be taken to drive all joints up tight with a block, to prevent brusing, and to see that all boards are nailed down. Flooring is often finished after it is nailed in place by planing and then scraping.

STAIR BUILDING.

Stairs.—The first points to be determined in building stairs are approximate pitch, complete rise of stairs, complete run of stairs, the well-hole, and head clearance. The parts which make up the stairs are the stair horses, A; risers, B; treads, C; skirting boards, D, E; platform, F; newel posts, G; handrails, H; and spindles, I, as shown in Fig. 156. The stairway must be built as part of the house, and the pitch of the stairs will depend largely on the height of the second floor above the first floor, together with the run of the stairs, or that distance from the first riser to a plumb line dropped from the point of landing. In many cases the stairways are made winding or are cut into the ceiling of the next room in order to obtain a suitable pitch.

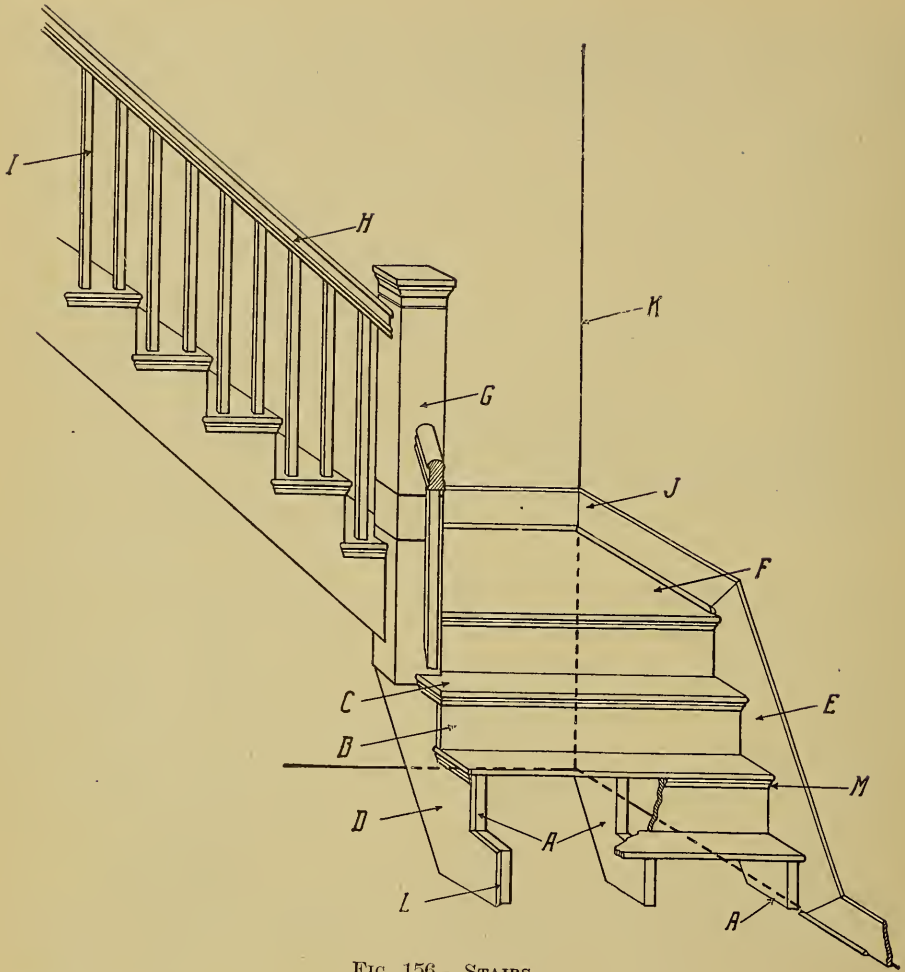

FIG. 156.—STAIRS.

- | | | |
|--------------------------|-------------------------|---------------------|
| A—stair horses | E—skirting board (back) | I—spindle |
| B—riser | F—platform | J—base |
| C—tread | G—newel post | K—corner of room |
| D—skirting board (front) | H—hand rail | L—mitered riser cut |
| | | M—moulding |

Pitch.—Pitch is the degree of incline, based upon the height of the riser and the width of the tread. Note the following table:

	Riser	Tread
Very steep pitch.....	12 inches	4 inches
Steep pitch	7 inches	7 inches
Medium pitch	7 inches	10 inches
Low pitch	6½ inches	11 inches

Risers.—Suppose that the height from the floor-lining on the first floor to the finished floor of the second story is just nine feet, four inches (9' 4") and that a riser of about seven inches is desired. It will readily be seen that there will be sixteen risers of seven inches each. There will be one less tread than the number of risers. Why? If a tread of 10 inches is to be used, it will take 15 treads of 10 inches each or $12\frac{1}{2}$ feet for the run of the sleepers.

Distance between floors divided by width of riser equals number of risers.

Number of risers, minus one, times width of tread, equals run of stairs.

Counting the landing as the sixteenth tread, in this case, the rise of sixteen risers and the run of sixteen treads forms a right angled triangle, the diagonal of which is the exact length of the sleepers, or as they are sometimes called, stair-horses. The pitch—7 on the tongue and 10 on the blade of the square—of the stairs will give the plumb and heel cuts of the sleepers as well as the cuts for the risers and treads applied in their order. It is a common practice to cut blocks the proper pitch and nail them to dimension stock, for sleepers. The sleepers should be exactly alike and in perfect alignment when in place.

Landing.—In case of a landing, extreme care should be taken to get the landing anchored so the risers will be the same height for the upper run as for the lower run.

Risers, Treads and Skirting Boards.—The sleepers carry the load, but on good stairs they are encased by risers, treads, and skirting boards. The front skirting board faces the front sleeper. The only difference between them is that the skirting board is of one inch stock and the riser cut mitred. The back skirting board serves as a base. The risers are next in order. They are mitred across the end to fit the skirting (front) board and nailed to the face of the sleepers. The treads should be a little wider than the cut of the sleepers in order to give an overhang. They are nailed to the sleepers. The front skirting board and the risers are nailed to them from underneath. A small moulding is often cut in the angle of the overhang on both the front and end of the treads. This gives a very pleasing effect.

Newel Posts, Hand Rails and Spindles.—Newel posts, hand rails, and spindles are the last pieces to be built in before the stairs are completed and ready to be turned over to the finisher. They serve as a fence and are always run around open well-holes as well as the face of a stairway. The newel posts are usually built up hollow.

Well Hole.—The well hole is the opening in the upper joist cut to make head room for the stairway. After the well-hole is cut and the sleepers are in place, the plastering is done before any finished (surfaced) lumber is nailed in place. This protects the finish from the plaster stains.

Porches.—The parts which make up a porch are joists, flooring, columns, ceiling joist, ceiling, cornice, rafters, sheathing, shingles, box and steps. These parts are built into the porch as they are into the main part of the house; only the column and box are extra items. It might be well to add that the porch floor should drop about one-fourth of an inch to the foot for drainage, and the flooring should be laid in oil or some other good wood preservative. The columns are the timbers that support the roof. Over the tops of the columns is built a U-shaped box which serves as a plate for the upper joist. It distributes the load of the roof to the various columns.

Scaffolding.—Scaffolding is used to render the various parts of the work accessible. It is used to stand on, and consists of a few boards laid across saw-horses, a long, narrow plank swung from the roof, or boards laid across supports which are in turn nailed at one end to corners, openings or blocks, and at the other end to light dimension stock.

Snapping Lines.—No other line of work offers a better field for the use of snapping lines than carpentry. A line is chalked by drawing it across a piece of colored chalk, held and turned in the hand, and it is then stretched over the desired place to be marked. By holding the ends to the surface and then pulling the center back in a line perpendicular to the surface and letting it "snap," the chalk will form a straight line. Chalked lines are used in laying shingles, cutting off lookouts, cutting off upper joist for the cornice, and in trimming porch floors.

CHAPTER IV

BEADS AND MOULDINGS

Beads.—Beads and mouldings are used for decorative rather than constructional purposes. It is the function of beads to conceal cracks by their shadows and break the large smooth surfaces on stock used for wainscoting, ceiling, etc. It is not practicable to use glued joints on wide surfaces, as the swelling and shrinking is so great that it is better, when

joining the boards, to tongue and groove them and use the bead to hide the crack, as in Fig. 157.

Mouldings.—Mouldings, which are larger and more complex than beads, give light and shade effects the same as the latter, and make more distinct certain prominent features of cabinet work. The common forms of mouldings are the ogee (Fig. 158) and the round nose (Fig.

159). From these two forms, all other designs of mouldings are evolved. Mouldings may be roughly classified under three divisions: Crown mouldings, intermediate mouldings, and base mouldings.



FIG. 159.—ROUND NOSE

Crown Mouldings.—Crown Mouldings are used for finishing the tops of wardrobes, sideboards, book cases, tops of door and window casings, etc. Fig. 160 illustrates a few possible forms.



FIG. 160.—CROWN MOULDS.

Intermediate Mouldings.—Intermediate mouldings, when used, are placed so as to be more or less on the level with the eye of a person standing or sitting. Caps for wainscoting, window stools, picture mouldings, etc., are of this class. (See Fig. 161.) Sometimes this class



FIG. 161.—INTERMEDIATE MOULDS



FIG. 163.—BASE MOULDS.

of mouldings is placed on the edge of table tops and articles of similar nature to give them the appearance of extra thickness. Note in Fig. 162 that the figures are of the same thickness but A appears to be thicker than B.

Base Mouldings.—Base mouldings, as the name indicates, are used at the foot or bottom of base boards in house construction, on base boards for cupboards, wardrobes, etc., as shown in Fig. 163.

Designation of Moulding Forms.—These forms do not go by names but by numbers which manufacturers use in common, and refer to as stock numbers. Small moulds are usually made of resawed strips which utilize material otherwise wasted. The strips are sized and then fed



FIG. 162.—COMPARISON OF TRIMMINGS.

through moulding machines (stickers) which have cutters mounted on revolving arbors. Heavier moulds, such as crown and base, are made in gang moulding machines, which cut the boards to the desired width and shape. Mouldings are

quoted at so much per hundred lineal feet.

CHAPTER V

VENEER AND ITS APPLICATION

Veneering.—Veneering is the art of overlaying or facing a piece of material with a thin layer of wood or other material to secure a better outer finish or decoration. It is generally employed in overlaying inferior wood with the leaf of superior wood and the outside veneer is attached by means of glue.

Sawed and Rotary Cut Veneer.—There are two kinds of veneer in general use: Sawed and rotary cut. Sawed veneer is so cut as to bring out the quartered effect, flake-like spots, on the leaf. It is more costly than the rotary cut, being thicker, and more lumber is wasted in cutting. Rotary cut veneer is produced by thoroughly steaming the log, then placing it in a suitable lathe with an automatically operated cutter. As the log turns in the lathe, the cutter removes a thin sheet of wood the length of the log. In fact, this sheet rolls off in the same manner as paper comes off a roll. By this method of cutting, the leaf is thinner than the sawed cut, and, there being no waste, it is therefore cheaper. It is used largely in core and cross banding work.

Veneer and Solid Built Stock.—The increased use of veneers by the woodworking industries proves the superiority of veneer built stock over the old method of solid stock. There are three reasons why the former is better than the latter. First, the heavier the stock, the more difficulty there is in holding it in shape, owing to the imperfect seasoning as well as the climatic conditions; second, a combined advantage of using waste material sawed into small pieces and distributing the working strain as compared with the solid board; third, the superior effect of design in the laying of the veneer.

Core Stock.—Core stock may be of any kind of wood, properly seasoned, well glued, and surfaced on both sides to the proper thickness. The side or sides to be veneered are toothed, a process which disturbs the fibre of the wood sufficiently to enable the glue to take a strong hold of the surface.

Preparing Veneer.—In preparing the veneer, make the side adjoining the core stock smooth, tooth it with a tothing plane, or sand it

with No. 3 garnet paper (sand with the grain). If garnet paper is used, care must be taken to see that all grains of garnet are removed before applying the veneer. If possible, have both core and veneer at working temperature, and apply the glue with a brush. Put on the veneer counterwise, and clamp firmly until all the surplus glue is squeezed out. It is well to place paper between the veneer and the heavy flat top or weight, an arrangement which helps to distribute the pressure uniformly. The paper absorbs any glue that may be forced through the thin veneer. If cross banding is desired, it should be done before the top or bottom of the core is veneered, as the top overlaps the cross band.

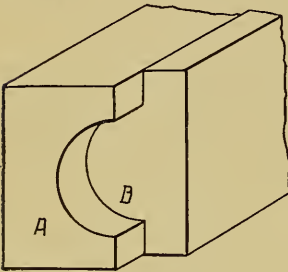

FIG. 164.—CORE AND CAUL.

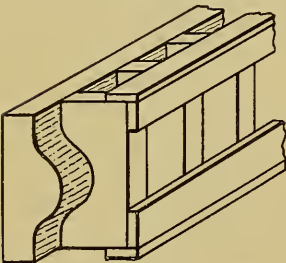

FIG. 165.—BUILT-UP CAUL.

Veneering Regular and Irregular Surfaces.—Besides veneering flat surfaces, which has just been described, there are many other regular forms to be veneered, such as swell drawer fronts, half round, ogee, cylinders, cones, etc. All irregular surfaces must have a caul, an opposite of the side to be veneered, as shown in Fig. 164. In this Figure, A represents the core stock and B is the caul. If the caul is small, it may be cut on the band saw, but if large, it must be built up from sections and placed at regular intervals over the core. These sections are fastened, one-half to three-fourths of an inch apart, to a piece of canvas or heavy paper which, with strips nailed to the back of these sections, helps to hold them in place and distribute the pressure uniformly. The canvas or paper side is placed against the veneered side as shown in Fig. 165. When the irregularities are too abrupt, the veneer must

first be made pliable by forming it over hot steam pipes or soaking it in water and then clamping it between the core and caul to dry. This prevents splitting and gives the desired form before gluing.

Veneer Designs.—In applying veneer, designs may be worked out in swell drawer fronts as shown in Fig. 166. In this figure A shows the veneer applied in one piece, horizontally to the half round drawer front; B shows the

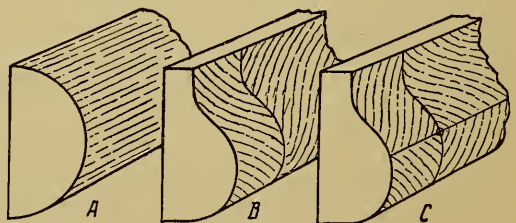

FIG 166.—SWELL DRAWER FRONTS.

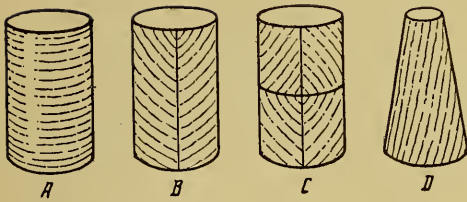

FIG. 167.—VENEERED CYLINDERS AND CONE.

veneer halved and the grain radiating from the horizontal center to the vertical; C presents a surface with the grain radiating from two lines which are at right angles to each other. These same effects may be worked out on cylinders and cones as shown in Fig. 167.

Veneering Cylinders and Cones.

—The device commonly used in holding veneer on cylinders and cones is made of sheet metal with blocks fastened to the ends. Clamps are placed on these blocks as shown in the cross section in Fig. 168. Jointing veneers on cylinders and cones may be done by over-lapping the edges and, with a thin bladed knife, cutting down the overlap as in Fig. 169.

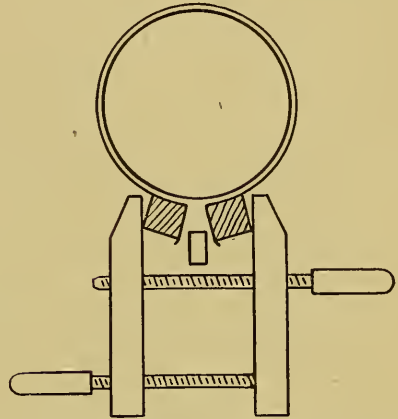

FIG. 168.—VENEER CLAMP FOR CYLINDERS.

Panel Work Veneer.

—Veneering is extensively used in panel work on desks, sideboards, seats and backs of chairs.



FIG. 169.—
VENEERING
A CYLINDER

The core stock in these panels is often built up of three or more thin layers or leaves, known in commercial use as three-ply, four-ply, etc. These layers are so placed that the grain in the adjoining sides cross each other. This arrangement prevents cupping and buckling and therefore the side or sides remain in the same place. Veneers may be put on the cores by heating a sack of sand and placing it on the glued surface and leaving until cold.

PART III
SHOP TALKS

CHAPTER I

STEEL SQUARE.

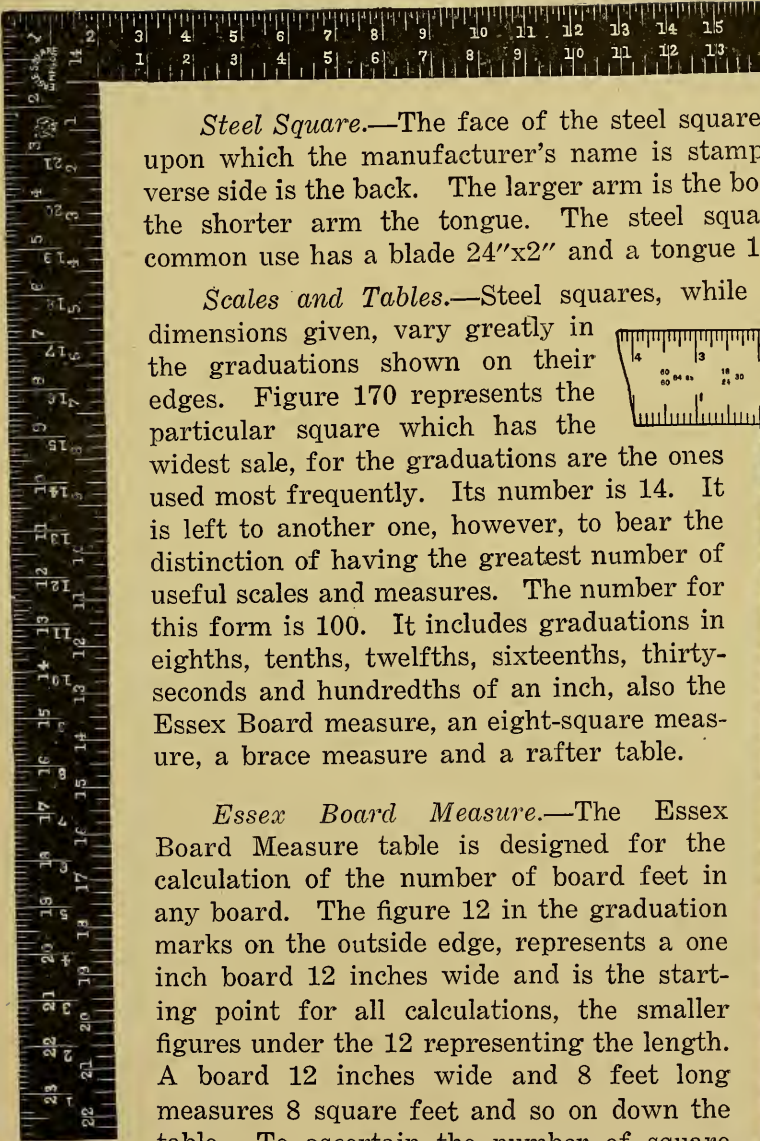

FIG. 170.—
STEEL SQUARE
No. 14

Steel Square.—The face of the steel square is the side upon which the manufacturer's name is stamped; the reverse side is the back. The larger arm is the body or blade, the shorter arm the tongue. The steel square in most common use has a blade 24"x2" and a tongue 16"x1½".

Scales and Tables.—Steel squares, while having the dimensions given, vary greatly in the graduations shown on their edges. Figure 170 represents the particular square which has the widest sale, for the graduations are the ones used most frequently. Its number is 14. It is left to another one, however, to bear the distinction of having the greatest number of useful scales and measures. The number for this form is 100. It includes graduations in eighths, tenths, twelfths, sixteenths, thirty-seconds and hundredths of an inch, also the Essex Board measure, an eight-square measure, a brace measure and a rafter table.

Essex Board Measure.—The Essex Board Measure table is designed for the calculation of the number of board feet in any board. The figure 12 in the graduation marks on the outside edge, represents a one inch board 12 inches wide and is the starting point for all calculations, the smaller figures under the 12 representing the length. A board 12 inches wide and 8 feet long measures 8 square feet and so on down the table. To ascertain the number of square feet in a board 8 feet long and 6 inches wide, find the figure 8 in the scale under the 12

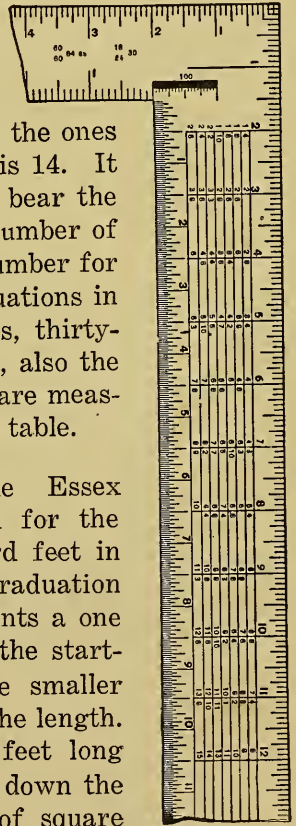

FIG. 171.—ESSEX
BOARD MEASURE.

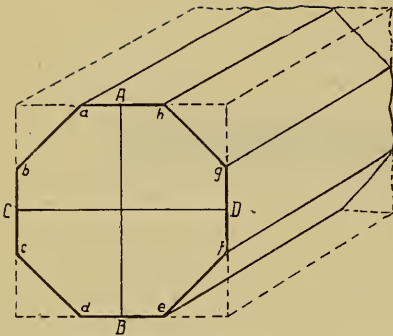

FIG. 172.—CUTTING AN "EIGHT SQUARE" STICK

inch graduation mark and pass the pencil along to the graduation mark 6, representing the width of the board; stop on the scale at 4, which indicates 4 feet, the board measure required. A board 1"x10"x14' equals 11 8/12 square feet and so on. In determining the number of board feet in a plank or timber, multiply the result obtained by the calculation on the square by the thickness of the piece.

Octagon Scale.—The Octagon Scale is along the middle of the face

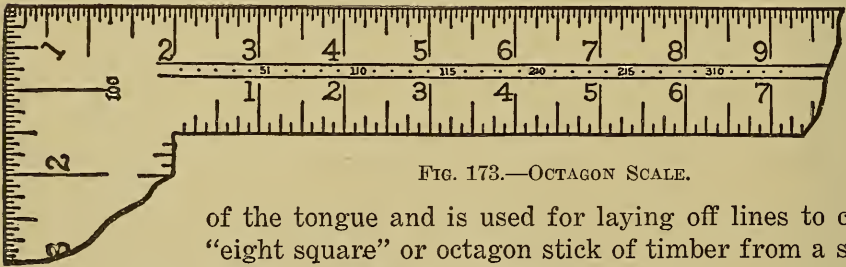

FIG. 173.—OCTAGON SCALE.

of the tongue and is used for laying off lines to cut an "eight square" or octagon stick of timber from a square stick. Suppose ABCD in Fig. 172 is the butt of a stick of timber 10 inches square. With dividers, take from the scale as many spaces (10) as there are inches in the width of the stock, and lay off points on both sides of A, B, C and D. Connect the points ab, cd, ef and gh. Dress off the corners to these lines and the stick will be octagonal.

Angle Cuts for Polygons (Example).—For a figure of six sides, place along the edge of a board, 16 5/8" on the body, and 9 5/8" on the tongue of the square. Mark along the tongue. Saw six pieces of equal length, having this angle cut at each end of each piece, and the pieces will fit together to make a six sided figure, the size depending upon the length of the pieces.

	Blade.	Tongue.
4 sides	12	12
5 "	18	13 1/8
6 "	16 5/8	9 5/8
7 "	17 7/8	8 5/8
8 "	18	7 1/2
9 "	16 3/4	6 1/8
10 "	18	5 7/8



FIG. 175.—BRACE MEASURE-STEEL SQUARE.

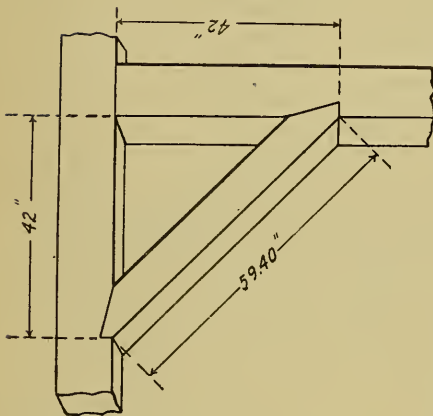

FIG. 174.—BRACE MEASURE.

Brace Measure.—The Brace Measure table is along the center of the back of the tongue and gives the length of common braces.

42

59.40 in the scale means that

42

if the run is 42" on the post, and the same on the beam, then the brace will be 59 40/100 inches, as shown in the diagram. (See Fig 174.)

RAFTER CUTTING AND ROOF FRAMING.

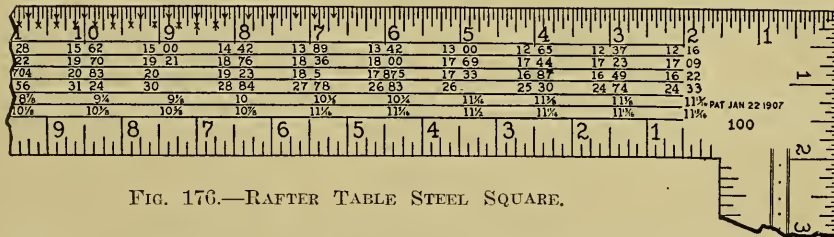

FIG. 176.—RAFTER TABLE STEEL SQUARE.

Rise.—The rise of the rafter is the distance found in following a plumb line from the center of the ridge to the level of the top of the plate. (See Fig. 177 and PO in Fig. 179.) The seeming discrepancy in the rise as shown in the two figures is brought about by the necessity of showing the exact vertex of the angle formed by the plate and the mid-line of the rafter.

Run.—The run is the shortest horizontal distance from this plumb-line to the outer edge of the plate. It is one-half the span of the roof which is the same as the width of the building. (See Fig. 177 and PX in Fig. 179.) The diagonal from the outside point on the plate to the nearest point in the central line of the top of the ridge is the length of the common rafter. (See Fig. 177 and OX in Fig. 179.)

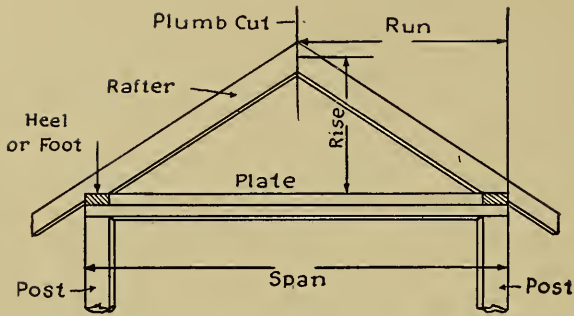

FIG. 177.—RUN AND RISE—COMMON RAFTER.

Pitch.—The angle of incline of the common rafter is called the pitch of the roof. The most common rafter pitches are given in the following table by the rise and run of the common rafter.

Pitch.	Run.	Rise.
1/6	12 ft.	4 ft.
1/4	12 "	6 "
1/3	12 "	8 "
5/12	12 "	10 "
1/2	12 "	12 "
5/8	12 "	15 "
3/4	12 "	18 "

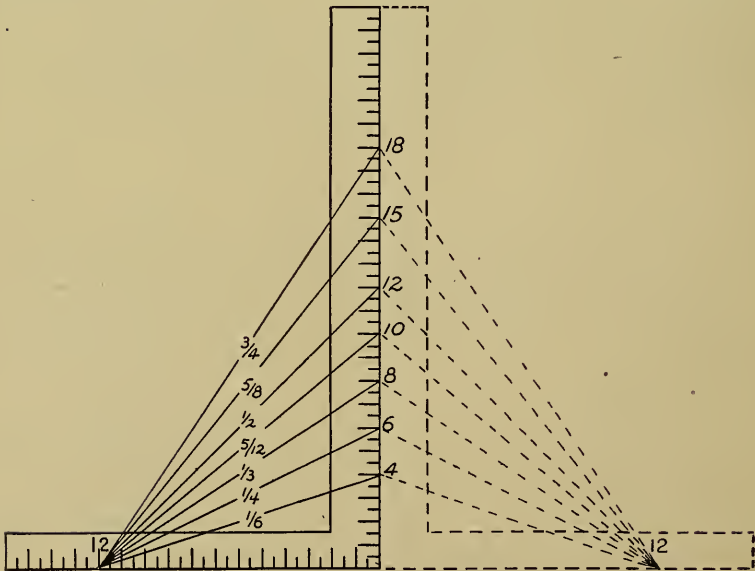

FIG. 178.—PITCH OF ROOFS.

To find the length of a common rafter by means of the rafter table, follow down the column headed by the graduation on the blade, which is the number of feet in the run, to the line having the desired pitch at the left end. The figures give the proper length. Following the table as explained will give the figures 14, 1, 8; or 14 feet, 1 and 8/12 inches, the length of the rafter.

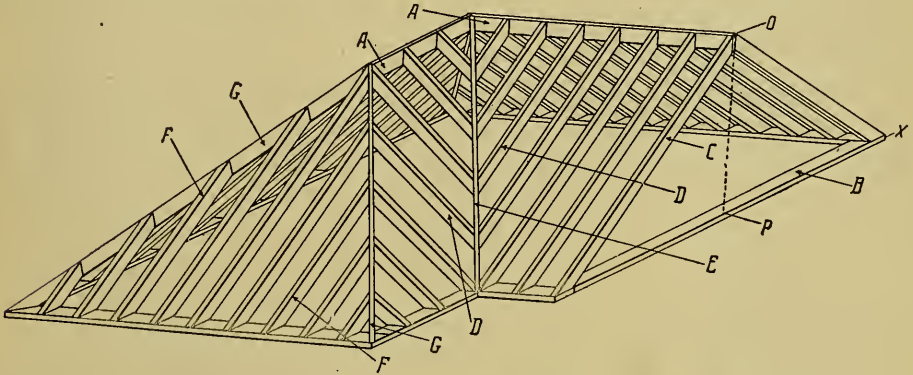

FIG. 179.—ROOF FRAME.

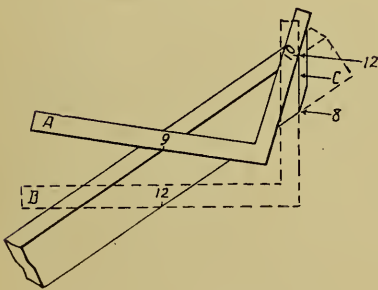

FIG. 180.—PLUMB AND HEEL OF RAFTERS.

(a) plumb cut (b) heel cut

Rafter Cuts.—The rafter ends are cut to roof angles to rest respectively against the ridge and plate. The cut against the ridge is called the plumb cut; the cut against the plate is called the heel cut. The rule given for finding plumb and heel cuts is to place the square upon the rafter so that a portion of one arm of the square represents the run, and a portion of the other arm, the rise, as in the following illustration: Mark at A for the plumb cut and at B for the heel cut. (See Fig. 180.)

The table giving the lengths is stamped upon the square, but in actual practice it is necessary to deduct for one-half of the ridge-board, and to add for any projection beyond the plate for eaves.

Hip Rafters.—The hip rafter, G in Fig. 179, represents the hypotenuse or diagonal of a right angled triangle, one side being the common rafter, and the other side that part of the plate lying between the foot of the hip rafter and the foot of the adjoining (common) rafter. The rise of the hip rafter is the same as that of the common

rafter. The run of the hip rafter is the horizontal distance from the plumb-line of its rise to the outside of the plate at the foot of the hip rafter. If the pitch is the same on both sides of the hip rafter the run of the hip rafter is to the run of the common rafter as 17 is to 12. For $1/6$ pitch, the common rafter run and rise are 12 and 4, while the hip rafter run and rise are 17 and 4. For the plumb and heel cuts of the hip rafter use the figures 17 and 4, 17 and 6, etc., the rise and run of the hip rafter.

Plumb and Side Cuts.—It is often necessary to nail the plumb cut to a ridge. This will necessitate a side cut on the hip to fit the ridge. The following table will give the proper angle for the common pitches:

Pitch.	Body.	Tongue.
$1/6$	7	$7\frac{1}{4}$
$1/4$	15	16
$1/3$	9	10
$5/12$	13	15
$1/2$	8	11
$5/8$	6	10
$3/4$	11	16

Lay off the top or plumb cut and then the side cut. Make one sawing do for both. Hip rafters should be cut in "rights and lefts" so that the side cuts will seat on the ridge. To find the length of the hip rafter, lay off on the blade of the square, the length of the common rafter (scaled to 1 ft. to the inch) and the distance between the foot of the hip to the first common rafter on the tongue of the square. Measure across and multiply by twelve. Deduction for thickness of ridge and extra length for overhang should be made.

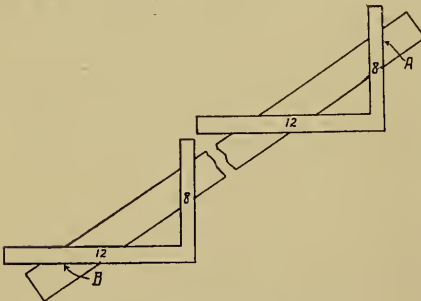

FIG. 181.—SIDE CUTS OF RAFTERS.

A—Square set for side cut.

B—Square set for plumb cut.

Valley Rafter.—The valley rafter, E in Fig. 179, is the hypotenuse of the right-angled triangle formed by the common rafter with the ridge, corresponding with the right-angled triangle formed by the hip rafter, common rafter and plate; therefore, the rules for the lengths and cuts for valley rafters are the same as for hip rafters. The side cuts are also the same as for hip rafters.

Jack and Cripple Rafters.—The jack rafters, F, in Fig. 179, are usually spaced either 16 or 24 inches apart, and, as they lie against the hip or valley and are equally spaced, the second will be twice as long as the first, the third three times as long as the first, and so on. The lengths for the shortest jack or cripples are given in the following table:

16 inches on center.	Pitch of roof.	24 inches on center.
16 $\frac{7}{8}$ inches	1/6	2 ft. 11 $\frac{1}{4}$ inches
17 $\frac{7}{8}$ “	1/4	2 “ 2 $\frac{7}{8}$ “
19 $\frac{1}{4}$ “	1/3	2 “ 4 $\frac{7}{8}$ “
20 $\frac{7}{8}$ “	5/12	2 “ 7 $\frac{1}{4}$ “
22 $\frac{5}{8}$ “	1/2	2 “ 10 “
2 ft. 1 $\frac{5}{8}$ inches	5/8	3 “ 2 $\frac{1}{2}$ “
2 “ 4 $\frac{7}{8}$ “	3/4	3 “ 7 $\frac{1}{4}$ “

The length of the jack and cripple rafters are given to the center of the hip or valley rafters. In using the foregoing table, make allowance for the thickness of the hip or valley rafters. A cripple rafter is one having “no foot,” or no foot on the plate, as D in Fig. 179. Cripples run between the ridge and valley rafters, and sometimes between hips and valleys. The cripple rafter’s length is that of the jack rafter plus the length necessary for the bottom cut which is a plumb cut like the top. Top and bottom cuts for cripples are the same as the top cut for jack rafters. The side cuts at the hip and valley are the same as the side cuts for the jacks. The following table gives the proper figures for the side cuts of jacks and cripples:

Pitch	Blade.	Tongue.
1/6	9	9 $\frac{1}{2}$.
1/4	9	10
1/3	10	12
5/12	10	13
1/2	12	17
5/8	10	16
3/4	10	18

All jacks and cripples should be cut in rights and lefts and allowance made on jacks for overhang for eaves. Deduction should be made from the foregoing scale for the thickness of the hip or valley rafters.

CHAPTER II

SAWS

The saw, in its different forms, is one of the most important tools for the wood worker. The three saws most commonly used, the rip saw, cross-cut saw, and back saw, are discussed in Part I, and only special saws, the making of saws, saw setting and filing, and the care of saws are treated in this chapter.

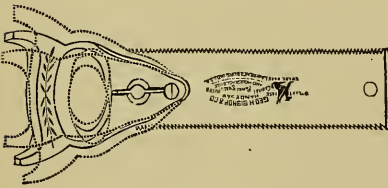

FIG. 182.—DOUBLE EDGE SAW.

Special Handy Saw.—Fig. 182 shows a handy-saw, adopted by manual training schools throughout the land, which has amply proved its worth. The handle acts on a pivot, and may be adjusted instantly for the use of either tooth. The blade is toothed on one side for cross cut and on one side for rip or dovetail sawing.

Compass Saw.—The compass saw is used for miscellaneous sawing. As the nature of the work for which compass saws are used consists of about as much cross-cutting as of ripping, and as a cross-cut saw will rip better than a rip saw will cross-cut, it is apparent that the shape of the teeth should be between the two. These saws are all ground thinner at the back side, the same as any hand saw. (See Fig. 183.)



FIG. 183.—COMPASS SAW.

Scroll and Web Saws.—Scroll and web saws are ground, filed and set in the same manner, and should have pitch, according to the work to be done. If more ripping than cross-cutting is done, as in large felloes, more pitch is given than in the compass saws, and *vice versa*, though these saws are almost universally run with a rip-saw tooth and have very little variation in the pitch.



FIG. 184.—BUTCHER SAW.

feam, or bevel, to tooth, with light even set, the same as in fine hand saws. (See Fig. 184.)

Hack Saws.—Hack saws are used for cutting metal, such as brass, iron or untempered steel, and should have a little finer teeth than the average butcher saw. They are so hard that none but the very best metal saw file will sharpen them. Like the butcher saw, the filing must be straight through with no bevel. (See Fig. 185.)



FIG. 185.—HACK SAW.

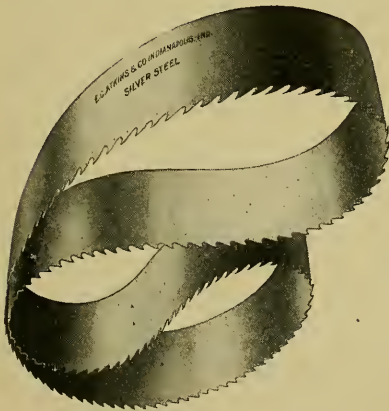

FIG. 186.—BAND SAW BLADE.

saws are used in cabinet shops and saw mills. (See Fig. 187.)

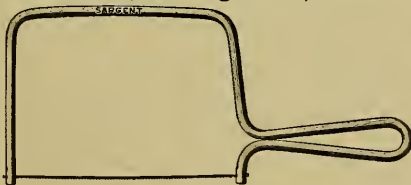

FIG. 188.—COPING SAW.

Coping Saws.—Coping saws are used for hand scroll and grill work. (See Fig. 188.)

Band Saws.—Band saws are used for machine scroll work and for band saw mills, and consist of continuous bands of steel running over two wheels like a belt. The large band saws used in saw mills are sometimes sharpened on both edges. (See Fig. 186.)

Circular Saws.—Circular saws are either rip or cross-cut saws. They are always mounted on an arbor and are usually power driven. Circular

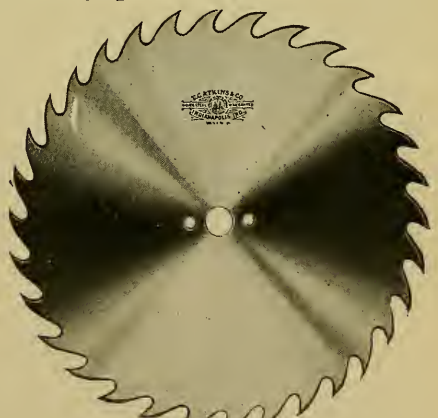

FIG. 187.—CIRCULAR SAW.

Cylinder Saws.—Cylinder saws are used for sawing spheres and discs. There are many other saws on the market for special work.

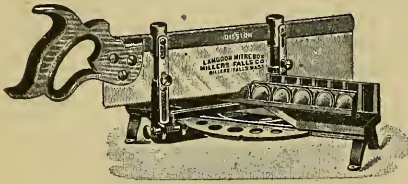

FIG. 189.—MITER BOX.

Miter Box.—A miter box consists of one solid casting, used as a base, and two uprights, used as guides for the saw, which works on a pivot, and on an arc with graduations. The uprights swing back and forth on this arc, at any angle between 90 degrees and 45 degrees; however, with a special attachment, the angle range is

much greater. This box is used in cutting miters, picture frames, mouldings of all styles, and in cutting kerfs to certain depths. (See Fig. 189.)

SAW MAKING.

Saw Construction.—There is perhaps no tool in a woodworking kit that is used as constantly as a saw. It is important, therefore, that the saws used should be of the very best quality in order that the workman may be able to do the greatest amount of work with the least exertion. From the very first, saw manufacturers had great difficulty in obtaining steel of uniform quality, free from flaws; having spared no expense in bringing the saw to its present state of perfection, this difficulty finally has been overcome. High grade saws are not made of high carbon steel, as is the general belief among woodworkers. They are put through a process that makes them flexible, and therefore they can be coiled like a clock spring without any injury whatever. Many saw manufacturers claim that they have a “secret process” by which they make their particular brand of saw flexible, and yet serviceable. Since the “processes” are secrets, no attempt will be made to divulge any “secrets.”

Material.—The Disston Saw Works was the first concern to manufacture saws from the raw material to the finished article. Its crucible steel plant was the first establishment to produce saw steel in America, and Disston saws are considered standard everywhere. The silver steel saw, manufactured by the Atkins Saw Works, is one of the highest grade saws on the market. Its steel is also prepared by a special process.

Process of Manufacture.—All steel for saws is rolled, then trimmed under shears, and cut into blanks, either for straight or hollow back saws. The next operation is that of cutting the teeth, which is done by machines of special design, the blanks being fed by hand.

Tempering.—The saw is then placed in a hardening furnace which is, at this time, generally heated by fuel, oil or gas; it is then taken out and plunged, edge first, into a special hardening bath.

Smithing.—Smithing is a process about which very little is known and which is not used in the manufacture of a great many cheaper saws, because it does not show. It does not add to the appearance of the saw. In the operation of smithing, the saw is tensioned so that the tight spots in the steel are opened up, permitting the saw to run true to the line. A boy shakes a thin piece of tin to hear it rattle. This is because certain portions of the metal have full spots that are looser than others. Looking across it, you will find ridges and hollows. Smithing removes these conditions and makes the saw run true.

Grinding.—The blades of saws are ground by taper grinding. The finished blades are about nineteen gauge, or $\frac{3}{64}$ of an inch (scant) thick along the entire tooth edge, one gauge thinner at the butt on the back, and four gauge thinner on the back at the point. They gradually taper throughout the entire blade toward the thinnest part. This, scientifically, renders them stiff, but gives the blade clearance, permitting them to drop easily into the cut without binding and enabling the saw to run free and easy with but little set.

Final Touches.—The saws then pass through the etching room, where the name and brand of the manufacturer are put on, then they are ready for the setting of the teeth. Each tooth is set by one or more strikes of the hammer. The teeth are then filed. This is done after the saw is set, so that no damage will be done to the teeth. The saw is then handled and ready for use.

Vanadium Saws.—Vanadium is an ore found in South America. It was found in small quantities at first, which made it impossible to use it in the manufacture of steel for high class work; but in recent years vast quantities have been found. It can be mined at a price which enables the steel manufacturers to use it in the manufacture of steel and for almost any kind of work. The Vanadium saw is a product of this ore. The element vanadium has, in fact, almost revolutionized the saw business.

GENERAL INFORMATION.

Saw Parts.—The elements of a saw tooth are its face or front, point, back and gullet. The channel cut by the saw is called the kerf.

The side inclination of alternate teeth is called set. The heel or butt of the saw is the end nearest the handle, and the opposite end is called the toe or point. Saws are designated according to the number of saw points to the inch.

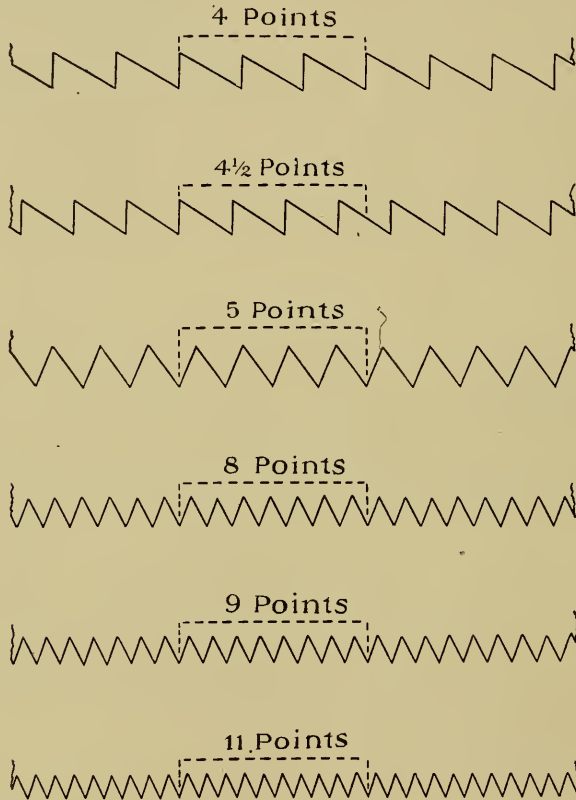

FIG. 190.—SIZE OF TEETH.

(There is always one more point than there are teeth.)

Figures 191 and 192 show the method of laying out rip saw teeth and cross-cut saw teeth. The angles for the teeth remain the same as in these figures for all sizes of teeth.

Rip saws usually have one less point to the inch at the heel than at the toe, and are listed according to the number of points at the heel. The number of points to the inch of the saw is usually stamped on the butt. The length of a tooth is its height from base to point. The pitch, rake or hook is the angle of the cutting edge of the tooth

to the line of points. The bevel or fleam is the angle of the front or back of the tooth to the side. The crown of the saw is the slight outward curve of the line of the points.

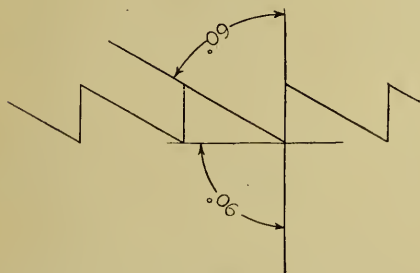

FIG. 191.—RIP-SAW TEETH, SHOWING ONE-HALF PITCH.

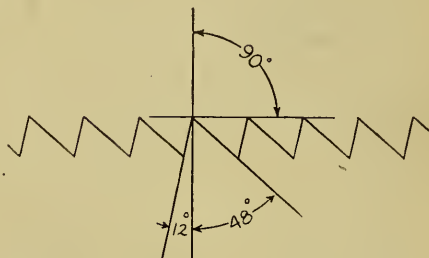

FIG. 192.—CROSS-CUT TEETH, SHOWING ONE-FOURTH PITCH.

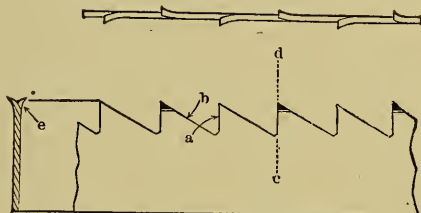

FIG. 193.—PARTS OF TEETH.

(a) front or throat; (b) back; (cd) pitch of tooth; (e) set.

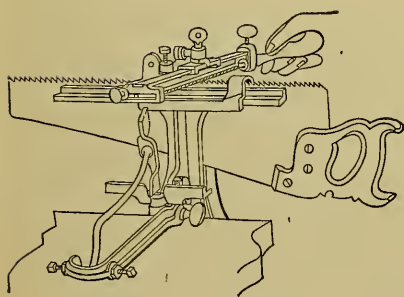

FIG. 194.—SAW CLAMP.

Sharpening.—Sharpening or fitting a saw consists of jointing, setting and filing the saw teeth so that the saw will cut fast, clean and smooth with the least expenditure of power. Jointing is the process by which the points of the saw teeth are made to lie in the same line. Setting is the process by which the teeth are alternately set to the right and left. Filing is the process of putting the proper shape, rake and fleam on the tooth. The saw should first be secured in a saw clamp, or held in a vise between two strips of board. (See Fig. 194.) First, joint the saw by running lengthwise lightly over the points of the teeth with a jointer or file until the teeth are all in the same line and have a slight crown. Second, set the saw. The depth of set should not be greater than half the length of the tooth; if it is greater, the body of the saw will be sprung or the tooth so weakened

as to cause it to be easily broken out. The width of set is determined by the work. For average work, about 1/100 of an inch on each side is sufficient; for hard work or dry wood, a little less; and for green, wet or soft woods, a little more. In any case, the saw should be given just enough set to clear. The best way is to go down one side of the saw and set the alternate teeth to one side, then, reversing the saw, set the remaining teeth to the other side. Care should be taken that the teeth are set in the same direction as they were originally. The set should be uniform, as the proper working of a saw depends on the setting. A sharp saw improperly set will not cut, but a dull saw properly set will. A hand saw should be set several times between filings. Third, file the saw. The saw should be filed from heel to toe, with a three-cornered file. No one saw will do all kinds of work, and a saw should be carefully selected for each class of work. The manner in which the teeth are filed should be noted when the saw is bought, and followed whenever the saw is sharpened.

Sharpening Rip Saws.—A slitting or ripping saw has its cutting edge at right angles to the fibre of the wood, severing it in one place, the throat wedging out the piece. A 4-point rip saw for soft wood, or a 5-point rip saw for medium hard wood should have rake in front and be filed straight across, filing one-half the teeth from each side after setting. For ripping hard and cross-grained woods, a finer tooth rip saw, with the teeth filed slightly beveled, is needed. (See Fig. 184.)

Finishing.—After the saw is set and filed, it should be laid on a flat surface and the sides of the teeth lightly rubbed over with an old file or oil stone to remove any feather edges. To sum up: The same principles of dressing apply throughout, whether the saw is coarse or fine toothed. The teeth on saws used for soft wood should have little or no pitch, should have a fleam back and front, and a large set; those for medium hard woods should have more pitch, less fleam on the back, and medium set; for hard woods, still more pitch, no fleam on the back, and a small set. Too much pitch and too heavy a set are bad, for they will cause a saw to take hold so keenly that frequently it hangs up suddenly in the thrust and kinks or breaks the blade. The usual amount of pitch is 60 degrees. When a cross-cut hand saw is properly fitted, a needle can be slid along the groove between the tooth edges.

Sharpening a Two-Man-Cross Cut Saw.—In sharpening a two-man cross-cut saw, first, pass a jointer over the teeth until it touches the shortest cutting tooth. Second, file down the raker teeth until they are the proper length. For very hard and dry wood the raker should



FIG. 195.—TEETH OF TWO-MAN CROSS-CUT SAW.

the class of work to be done. Hard wood requires less bevel than soft wood. Fourth, the angle of the set should extend about $\frac{1}{4}$ inch down from their point. The amount of set will depend on the class of work and the manner in which the saw is ground. Thin back saws require about $\frac{1}{100}$ inch set on each side of the saw; straight back saws, about $\frac{1}{50}$ inch.

Sharpening Circular Saws.—In the usual gauges (7, 8 and 9), of large circular saws, that is, those used in the ordinary manner on the average feed and timber, $\frac{3}{64}$ inch on each side of the saw is about the least set that should be used. Hard, dry and frozen timber requires less set; very soft, wet or green timber, more. Thin saws require as much set as thick ones. See that the saw is round, and if not round, joint and file the teeth until they are all of the same length, shape and size. If a saw sharpener is not available, the jointing can be done by holding a stone against the saw teeth while the saw is revolving at a moderate speed, taking care not to grind beyond the length of the shortest tooth. After jointing, file the teeth to a sharp point, using a gauge or templet, or, if none is handy, file as near to the original shape and size of the tooth as can be remembered. Next set the teeth about $\frac{1}{16}$ inch alternately to each side of the saw. Then file the teeth straight through or square to the side of the saw, on the fronts, and bevel each alternate tooth slightly on the back. If fit properly, a circular saw will saw easily and true until dull. It should be re-sharpened before it pulls hard, runs askew or heats up. A saw should be sharpened from two to four times in a full day's run. A saw properly set will stand from two to five filings before it requires resetting.

be $\frac{1}{100}$ inch shorter than the cutting teeth; for hard, green wood, $\frac{1}{64}$ inch, and for green wood, $\frac{1}{32}$ inch. Third, file each tooth to a keen cutting edge, taking care to preserve the original form and size of the teeth. The amount of bevel to the tooth depends upon



FIG. 196.—TEETH OF RIP SAW (CIRCULAR).

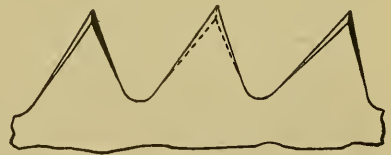

FIG. 197.—TEETH OF CUT-OFF SAW (CIRCULAR).



FIG. 198.—TEETH OF BAND SAW.

tooth and the gullet straight across, rounding out the gullet with either a gummer or a file.

Sharpening Band Saws.—After a band saw has been tensioned, it should be fitted. The setting and filing of the teeth is practically the same as a circular saw. The amount of set for a 14 gauge saw should not exceed $1/32$ inch on each side. The less set the better. Band saws should be resharpened frequently, a two and one-half hour's run being about the limit.

History of Saw Sets.—Saws were first set by a hammer and anvil, or by a hammer and punch, but these methods left no two teeth at the same angle, or depth of set. Besides, the frequent hammerings injured the teeth, and, if the steel was soft, sprung it so that the teeth dulled quickly; if hard, crystallized it so that they broke out easily. The notched plate saw set sprung the saw blade and set the teeth in a curve, and the chief fault of the lever saw sets was a lack of strength. The modern type of saw sets dates from 1878, when Charles Morrill invented a saw set, in which the power applied to the handles was multiplied and transmitted by a cam and without loss to the plunger. This saw set was an instant success, displacing all other types. In the Morrill saw sets the principal of compression is employed, making the steel stronger and more homogenous. (See Fig. 199.)

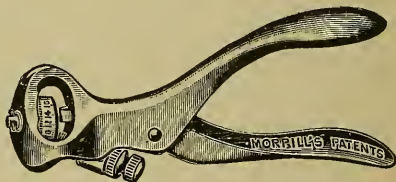
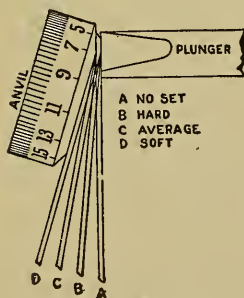

FIG. 199.—SAW SET.

FIG. 200.—SAW SET
SHOWING DEGREE
OF SET.

Use of Saw Sets.—Set the number on the anvil of the saw set to the point of the plunger corresponding to the number of saw tooth points to the inch. For example, if there are seven points, turn seven on the anvil to the point of the plunger. Then, placing the saw set on the saw, turn up the gauge screw until the desired amount of set is obtained. Lock the gauge screw and proceed to set the saw. (See Fig. 191.)

CHAPTER III

FASTENING DEVICES.

Nails.—Probably no other fastening device has passed through as great an evolution in the methods of manufacture, of materials involved, and of general shapes as ordinary nails. Originally, nails were cut from metal sheets by hand, and headed in a vise; an output of a few hundred was a competent day's work. Today nails are machine made. A steel wire is fed into an automatic machine which cuts the proper lengths, heads and points the wire into a perfect nail at such speed that the cost of the nail is greatly reduced and is no longer a luxury, but the most common of fastening devices.

Classification of Nails.—Nails are spoken of as "8-penny", "6-penny", etc. "Penny" is supposed to be a corrupt form of pound. An "eight-penny" nail means that a thousand nails of that particular kind and size weigh eight pounds; "six-penny" weigh six pounds per thousand nails, etc. This is an approximation only. Nails are classified according to the modes of manufacturing, size and use, as well as the material from which they are made. The nails most common to the journeyman are the common, casing, and finish nails, although these types are modified to meet all classes of work.

Common Nails.—The common nail is made of the larger wire, with a heavy flat head. It is stiff, with a wonderful pulling capacity, which adapts it for many classes of rough work. The larger sizes, that is, from 12d (or penny) to 60d, are called spikes, while the smaller ones from 3d to 6d are called box, shingle or lath nails. Like the finish and the casing nails, the common nail is cylindrical in shape, which minimizes the splitting tendency. (See Fig. 201.)



FIG. 201.—COMMON NAIL.

Casing Nails.—The casing nail is made and classified in the same fashion as the common nail. The real difference lies in the construction of the head. Casing nails have



FIG. 202.—CASING NAIL.

small, conical heads which adapt them for interior finish, floor laying and cabinet construction. (See Fig. 202.)

Finish Nails.—The finish nail is of finer gauge wire than the casing nail, has a very small head, and is used in cabinet work or any class of work where the heads should be “set” or where there is a likelihood of splitting the wood. By setting a nail is meant to drive the head below the surface of the wood



FIG. 203.—FINISH NAIL.

so that the head may be finished over. (See Fig. 203.)

Brads.—Any nails of the finish type that range from 1/4 inch to 2 inches in length are referred to as brads. They are used a great deal in trimming cabinet work with moulding and in any light work where there is a tendency to split the wood.

Wrought Nails.—Wrought nails are made of commercially pure iron. They are soft and may be clinched easily, which makes them in demand for car and barn door construction, as well as for hanging strap hinges.

Cut Nails.—Cut nails are cut from sheet metal and have two tapering sides. They are strong and will carry heavy loads, but will split the wood if not driven with the parallel sides of the nail parallel to the grain of the wood. They are generally used in the framing of heavy timbers and in heavy construction such as the building of wooden bridges, derricks, etc. (See Fig. 204.)



FIG. 204.—CUT NAIL.

Standard Gauges.—Nails are seldom bought by the gauge of the wire, but it is well to know that there is a standard gauge and that the

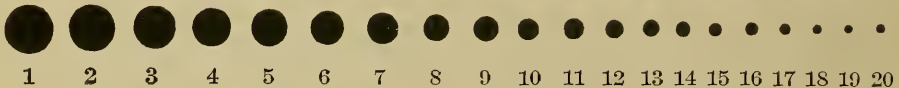

1 2 3 4 5 6 7 8 9 10 11 12 13 14 15 16 17 18 19 20

FIG. 205.—STEEL WIRE GAUGE.

diameter of the wire from which the nail is made is given in numbers which refer to the standard gauge. However, one must not forget that the gauge of the wire for nails is different from that for screws, in that the smaller the number of the gauge of the wire from which the nail is made the larger the nail is in diameter. (See Fig. 205.)

STANDARD STEEL WIRE NAILS.

Approx. No. to Lb.

Size	Length	Common	Finish	Casing	Fine
2d	1 inch	876	1351	1010	1351
3d	1 $\frac{1}{4}$ inch	568	807	635	778
4d	1 $\frac{1}{2}$ inch	316	584	473	473
5d	1 $\frac{3}{4}$ inch	271	500	406	----
6d	2 inch	181	309	236	----
7d	2 $\frac{1}{4}$ inch	161	238	210	----
8d	2 $\frac{1}{2}$ inch	106	189	145	----
10d	3 inch	69	121	94	----
12d	3 $\frac{1}{4}$ inch	63	113	87	----
16d	3 $\frac{1}{2}$ inch	49	90	71	----

Screws.—Like nails, screws are made by automatic machinery. The best screws have their threads cut, the cheaper ones have their threads made by the rolling process. The ordinary wood screws are put in cardboard boxes, one gross to the box, and in this way they reach the consumer.

Sizes of Screws.—The size of screws is indicated by their length in inches or fractions thereof, and by the diameter of the wire below the head. The diameter is expressed by a number which refers to the standard gauge. The size of the screw gauge ranges from 0, which represents a diameter of less than $\frac{1}{16}$ of an inch, to number 30, the latter representing a diameter somewhat greater than $\frac{7}{16}$ of an inch. The size of a screw two inches long and $\frac{1}{4}$ inch in diameter should be written, "2 inches, No. 15". However, screws of any length are made in many gauges.

Kinds of Screws.—Screws may be had either in bright, blue, or brass, although other finishes are not uncommon, and with flat or round heads. As a rule the shape of the head indicates the use for which the screw is intended. Flat-head screws are either countersunk and fin-

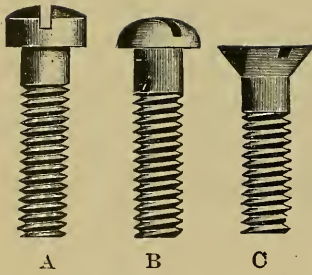

FIG. 206.—MACHINE SCREWS.

a—Flat Head; b—Oval Plumb-er's Head; c—Fillister Head.

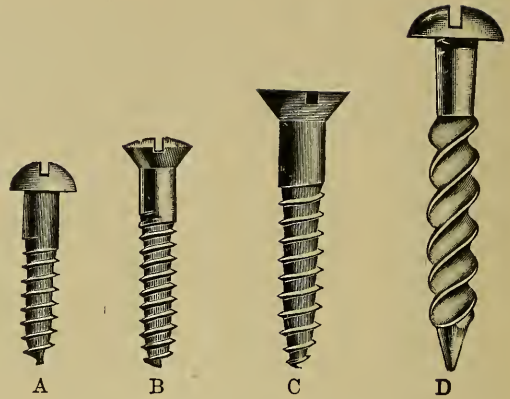

FIG. 207.—WOOD SCREWS.

a—Drive Screw (Round Head); b—French Head Screw; c—Flat Head Screw; d—Round Head.

ished over, or are placed where they will not show, while round-headed screws are used in cabinet construction where the heads will be visible. (See Figs. 206 and 207.)

Lag Screws.—A form of screw in very common use in framing heavy timbers and in anchoring machinery is the lag screw. It has threads like the ordinary screw, but has a square head which permits it to be driven with a wrench.

Corrugated Steel Fasteners.—Corrugated steel fasteners are used in pattern shops to hold the split patterns together during the process of turning. They are also used to lace joints, as in the bottom side of table, counter tops, etc. As the name indicates, they are made of thin sheet steel. This sheet has one edge sharpened; it is then corrugated and cut into lengths. The



FIG. 208.—CORRUGATED STEEL FASTENERS.

width of the steel, as well as the number of corrugations, determines the size of the corrugated steel fastener. A $\frac{1}{4}$ inch No. 6 would mean a fastener that is $\frac{1}{4}$ inch wide and six corrugations in length. (See Fig. 208.)

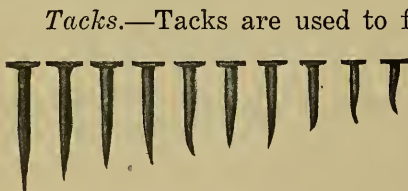

FIG. 209.—TACKS.

Tacks.—Tacks are used to fasten cardboard, leather, sheet metal, or any thin material to wood. They are made by machine and of many materials. Many tacks have fancy composition or metallic heads for use in upholstery work. Originally, the size of tacks was designated by

2 oz., etc., which meant that a thousand tacks of that particular size weighed two ounces. (See Fig. 209.)

SIZE OF TACKS.

1 oz.	3/16 Inch Long
2 oz.	1/4 Inch Long
3 oz.	3/8 Inch Long
4 oz.	7/16 Inch Long
6 oz.	1/2 Inch Long
8 oz.	9/16 Inch Long
10 oz.	5/8 Inch Long

Glue.—The making of glue and the process of gluing are two distinct vocations, yet they are so dependent on each other that, without a good knowledge of both, it would be very easy to fail in making a good glue joint.

Glue Material.—The materials used in making glue are equalled in number only by the purposes for which it may be used. The most common materials used are hides, horns, hoofs, bones and fish. Bones, hides, horns and hoofs accumulate at large packing plants. These scraps are washed in lime water, then boiled and skimmed. When the liquid reaches a certain stage, it is strained, drawn off, cooled in moulds, and then dried on nets. In this stage, i. e., in flakes or the flakes pulverized, it usually reaches the consumer; however, there is a great demand for a glue that is constantly ready for use, and hence the need for liquid glue.

Liquid Glue.—The flakes and pulverized glue must be changed into a liquid state. To do this a double boiler is used. The glue is placed in the vessel in which it is to be prepared and cold water is added, usually in the proportions of two parts of water to one of glue. However, no definite proportions can be given, as glue is worked at so many varying degrees of heat and the evaporation of water is so rapid that it would be impossible to secure the proper formula for a good working consistency without data as to the grades of glue, temperature during the process of cooking, etc. After the glue has soaked in cold water for several hours, the vessel is placed in the water jacket of the double boiler. The water jacket should be about two-thirds full of water. The temperature of the water in the jacket should be raised and it in turn heats the contents of the inner vessel. Care should always be taken not to scorch the glue by permitting the water jacket to boil dry, as this makes the glue absolutely worthless as an adhesive medium.

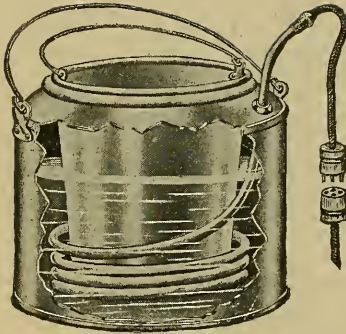

FIG. 210.—GLUE HEATER.

The glue should all go into solution, should be hot, not too thick or too thin, but should drip from a brush in a fine stream to be about the right consistency to develop the maximum of efficiency. Glue deteriorates after it has been heated. In fact, it loses about 90 per cent of its strength, that is, its value to work, after it has been melted and has stood over night; and it also lowers the quality of the fresh glue that may be added to it. (See Fig. 210.)

Glue Joints.—The most important things necessary for the proper holding of glue joints are: (1) fit; (2) freshly heated, properly prepared, good glue; and (3) freedom of the surfaces from grease. The first item is the most important of all. The fit of the two surfaces must be very carefully made, and the surface of the joint must be free from grease, as grease is the greatest enemy of glue. Do not use a thick solution for joint work. It congeals quickly and naturally will fail to penetrate the pores of the wood, giving a weak joint as a result. In every case the glue must be well worked into the pores of the wood with a brush, much in the same manner as a coat of paint. Heating of the wood will do no good, as the hot wood will absorb the water of the glue solution, leaving an inadhesive coat of glue at the surface of the joint. This will hold only a limited length of time. The spreading of the glue should be done as quickly as possible, and in a warm room free from draught. It is important that the glue be at the proper temperature when applied, as the molecules are then vibrating at their maximum speed, and will therefore penetrate better into the pores of the wood, thus making a better joint. It is best to test the pieces first, to make sure that they will go together, and to have all the clamps and hand screws ready that there will be no need of delay in placing the pieces under pressure after the glue is applied. The glued pieces should be left under pressure of the clamps about twenty-four hours.

CHAPTER IV

BRACES.

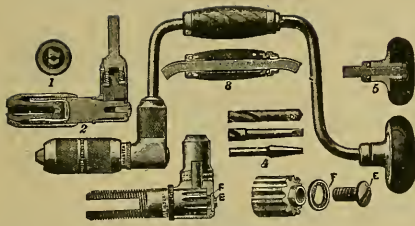

FIG. 211.—A BRACE.

Parts of Brace.—The parts of a brace are the following:

1. End of chuck.
2. Section of chuck and ratchet.
3. Handle.
4. Bit shanks.
5. Head or cap.
- E Screw.
- F Cup washer.

Carpenter's Bit Brace.—The carpenter's bit brace is so modified in form that it is impossible to make a sweeping statement as to what a bit brace really is, unless it be described as a tool to guide and drive a wood-boring tool by hand. Probably the oldest and simplest form of a bit brace was the "Fiddle Bow", a form of brace that is very seldom seen, yet one that is efficient for piercing small holes in light work. As the name indicates, it is made like a bow, the string of which is wound around the shank of the bit, and, as the bow is pulled back and forth, the bit is rotated, thus giving it cutting action. Probably the most common type of carpenter's bit brace is the one in which the chuck and cap are in axial alignment. A portion of the distance between them is in an offset—a cranked handle—and has a ratchet constructed between the chuck and cranked handle. By clamping the shank of the bit in a chuck and holding the axial line of the brace frame at the angle according to which the hole is to be bored into the piece, it is an easy matter to rotate the handle, thus forcing the spur of the bit to pull itself into the wood.

Chuck.—Usually, the chuck is constructed of two tongues, held at their inner ends by springs, and coned at their outer ends. There is a corresponding cone in the threaded sleeve, so that screwing up the sleeve firmly grips the tool shank and holds it true and independent of the squared end which fits into the inner portion of the tongue that drives it.

Ratchet.—The ratchet enables the operator to use the brace in a corner or any other place where it is impossible to get a full swing with the cranked handle. The ratchet can be set so that the chuck can be operated either to the right or to the left, or as an ordinary brace without the ratchet. This adjustment is accomplished by making a portion of a revolution of the sleeve which is between the chuck and the cranked handle.

Cranked Handle Swing.—The offset, or cranked handle, is the portion that determines the size of the brace. If the offset is small, it will take more power to revolve the bit in the wood than if the offset is large. The swing of the brace is equal to twice the length of the offset of the cranked handle, or equivalent to the diameter of the circle described by revolving the cranked handle.

Cap.—The cap is in alignment with the chuck and is used to guide the bit, as well as to supply a suitable point to apply pressure in the driving of drills, or bits without a spur.

SPECIAL FORMS OF BRACES.



FIG. 212.—RECIPROCATING DRILL.

Reciprocating Drill.—The reciprocating drill affords an interesting study, in that it has no cranked handle, but operates a wood piercing tool by forcing a handle down a helical groove in the stem of the tool. (See Fig. 212.)

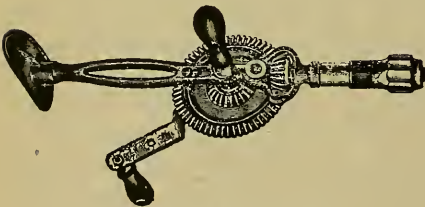

FIG. 213.—BREAST DRILL.

Breast Drills.—Breast drills, while designed for use in metal, offer another mode of driving bits. They are operated by a cranked handle attached to a bevel gear which, in turn, meshes with another bevel gear, attached to, and in a plane at right angles to, the spindle of the drill. (See Fig. 213.)

CHAPTER V

AUGER BITS

Boring Tools.—Tools used for making holes in wood and enlarging holes in metal are termed boring tools; while those for metals, except the tools for enlarging holes, are termed drills.

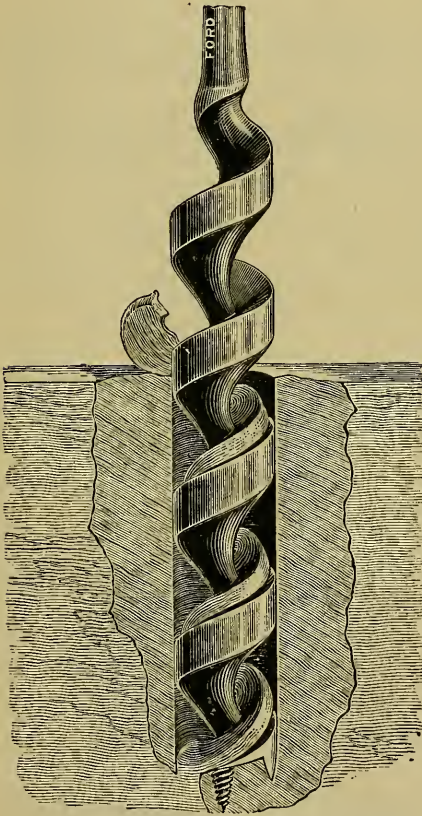

FIG. 214.—CUTTING ACTION OF A BIT.

or special work. It is difficult, therefore, to individualize and say that one bit is better than another. There are various ways of manufacturing auger bits, but perhaps the most common is the method of band twisting.

Cutting Action.—Wood-boring tools must have their edges so shaped that they will sever the fiber of the wood before dislodging it; otherwise the cutting edges will wedge themselves in the fiber. This is accomplished in cutting across the grain of the wood in two ways; either, by severing the fiber around the walls of the hole and in a line parallel to the axial line of the boring tool, and removing it afterward with a second cutting edge at a right angle to the axis of the boring tools; or else, by employing a cutting edge curved in its length, so as to begin to cut at the center and operate on the walls of the hole, gradually enlarging it, as in the operation of the gimlet bit.

Manufacture.—There are many auger bits on the market, all of which are of high-grade steel, properly designed, forged and tempered, each having its distinctive features, which adapt it either to general

Head, Nib, Lip and Spur.—The steel selected for bits is forged under heavy trip hammers and then twisted into the desired shape.



FIG. 215.—PITCH OF SPUR.

This is followed by the heading process, that is, the forming of the nibs, lips and spur. The nibs serve, while the bit is revolving in the piece of wood, as a pair of knives, in that they sever the fibre around the walls of the hole. The lips are like a pair of revolving chisels and lift the severed portion of wood out of the hole; the spur pulls the bit into the piece being bored. (See Fig. 215.)

Sizes.—Auger bits are measured in sixteenths of an inch, and the numerator of the fraction is stamped upon the shank; that is, a half-inch bit is stamped 8, the denominator, expressed in sixteenths, being implied. Gimlets are measured in thirty-seconds of an inch, and drills in thirty-seconds and sixty-fourths; in each case the denominator, expressed in thirty-seconds and sixty-fourths, is implied as in auger bits.

Resharpening of Auger Bits.—Care should be taken in filing auger bits not to change the cutting angles of the nibs and lips. The nibs should be filed on the inside and the lips only on the side toward the shank.

Shanks.—Different classes of work demand different shapes of bit shanks. General carpenter's work requires a square, tapering shank suitable for clamping in a brace jaw. Round shanks are used extensively for power boring machines. Nut shanks are used to fasten wood handles to bits. This kind of bit is used in framing green timbers.

Dowel and Ship Bits.—Bits are made to suit the requirements of the work to be done. A cabinet worker needs a short bit for dowel work, and hence the dowel bit has been devised. Dowel bits are usually short and range from $\frac{1}{4}$ to $\frac{1}{2}$ inch in diameter. A shipbuilder needs a longer bit than the ordinary commercial bit; accordingly, he is supplied with the ship auger, which is long and may be used in any stock diameter.

Bit Extension.—It is often necessary to bore a deep hole with a short bit. To do this, an extension, which is similar to the shank of a carpenter's bit on one end, and has a bit chuck to receive the tongue of the bit on the other, is used. (See Fig. 216.)



FIG. 216.—BIT EXTENSION.



FIG. 217.—IRWIN BIT.



FIG. 218.—RUSSELL JENNINGS BIT.



FIG. 219.—FORD BIT.

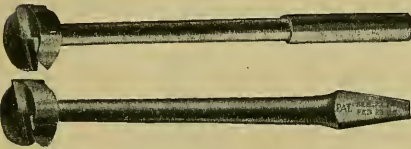

FIG. 220.—FOSTNER BIT.

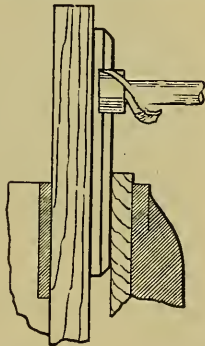

FIG. 221.—ACTION OF A FOSTNER BIT.

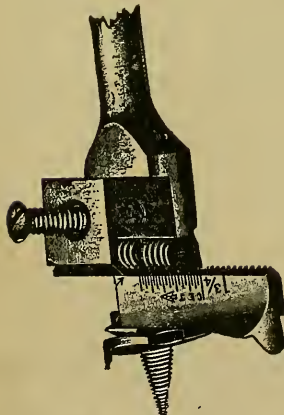

FIG. 222.—EXPANSION BIT.

Irwin Bit.—The Irwin bit is sometimes called the solid center bit. It is a fast borer, having a coarse pitch spur, and may be used for most classes of ordinary work. (See Fig. 217.)

Russell Jennings Bit.—The Russell Jennings bit is a band twisted bit that may be used in all classes of ordinary work. This bit, like the Irwin, is a double cutter, having two nibs and two lips. (See Fig. 218.)

Ford Bit.—The Ford bit differs from most auger bits in that it has but one lip and one nib. Its spur has a coarse pitch, hence it is a fast cutter. It bores well in the end grain of wood. (See Fig. 219.)

Fostner Bit.—The Fostner bit is fundamentally different from the twisted bit. It must be fed by force, as it has no spur. It is guided by its rim and hence it will bore almost any arc of a circle, regardless of knots, grain, etc. It is a slow borer but has no splitting tendencies. The Fostner bit is used in pattern making shops, for mortising, veneers, fancy scroll, and most classes of special work. (See Figs. 220 and 221.)

Expansion Bit.—The expansion bit may be said to have a compound head. It has a loose cutter—a combination of a nib and a lip—that slides in a slot, perpendicular to the axis of the shank. By sliding the cutter toward the center of the bit or away from it, the bit has a range of many size holes. Another bit of this type has a screw feed cutter which prevents the cutter from slipping while cutting through, thus avoiding a tapering hole. (See Fig. 222.)

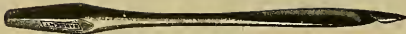

FIG. 223.—GIMLET BIT.

Gimlet Bit.—A gimlet bit is used in piercing wood for screws and nails, and for boring end grain in light pieces where there is danger of splitting the wood. (See Fig. 223.)

Counter and Gauge Sinks.—There are many special tools fitted with bit shanks to be driven with a bit brace that do not bore wood, but are termed bits. The counter sink,



FIG. 224.—COUNTER SINK.

FIG. 225.—COUNTER SINK
WITH GAUGE AT-
TACHED.

which is one of these special tools, is fitted with a square tapering shank and has a fluted conical point, with an included angle, usually of 60 degrees, on the opposite end. This bit is used in countersinking recesses for the reception of flat screw heads. The conical head of the screw seats in the recess cut out by the counter sink. (See Fig. 224.) Fig. 225 shows a sink with a gauge attached.

Reamers.—Reamers of all types are used as bits. They are so constructed as to enlarge a hole by shearing its walls.

Screw Drivers.—The screw driver bit is one of the most common tools driven by a brace. It is forged similar to the ordinary hand screw driver, except that its shank is fitted for a brace instead of a handle.

Spoke Pointers, Fore Augers, Hollow Augers and Dowel Sharpeners.—Spoke Pointers, fore augers, hollow augers and dowel sharpeners are used in carriage and wagon shops. As the name indicates, they are so constructed as to point spokes and cut around the end of a stick leaving a round tenon. Fore augers are used in reducing large spokes to smaller sized tenons. (See Fig. 226.)

FIG. 226.—DOWEL
SHARPENER.

CHAPTER VI

ABRASIVES

Grind Stones.—The material for grindstones comes from some of the large sandstone quarries, and the varying thickness of the strata makes it possible to secure many thicknesses for grindstones.

Composition.—The sandstone best suited for abrasive purposes is that which is composed of sharp quartz sand, bonded in a lime cement

or a silicate bond, of such matter and strength that it will yield the particles of sand that have become smooth by friction, and expose angular grains. These stones are cut into circular forms, mounted and driven toward the operator by hand or motive power. They are run in water, which acts as an agent for carrying off the heat generated by the friction of the stone and tool. The water also serves another purpose, that of keeping the pores of the stone open; otherwise the stone would become glazed and smooth which would seriously reduce the cutting efficiency, as well as increase the liability of burning or drawing the temper of the tool. Stones should not stand partly in the water, as water softens

the stone, and the wearing of the softened portion will naturally be more rapid than the rest. This uneven attrition will throw the stone out of true and make it almost impossible to do a good job of grinding. (See Fig. 227.)

Truing.—Probably the most commonly adopted plan of truing grindstones is by the use of a piece of pipe or the tang of a file, or both. The stone can be softened with water and roughed down with the tang of an old file. By using a piece of pipe the sand from the stone imbeds it-



FIG. 228.—TRUING DEVICE.

self in the soft metal of the pipe and acts, in truing up the grindstone, as stones cutting stones. Fig. 228 illustrates a modern truing device.

Speed of Stones.—A safe working speed of grindstones is one which will not throw water from the wheel by centrifugal force. For grinding woodworking tools, a speed of about 500 to 600 circumferential feet per minute is recommended.



FIG. 229.—OIL STONE IN CASE.

The stones are called oil stones because they cut better and faster when supplied with a coat of oil. (See Fig. 229.)

Artificial Stones.—The range of work for which the natural grindstone is used is limited, as it must be run slowly, and its cutting efficiency, at a safe operating speed, is too slow to be operated economically. Accordingly, our ever ready inventive genius created for us several abrasives which seem to meet all of the requirements to date, that is, they may be operated at high rate of speed, are fast cutters, are free from glazing, have different sizes of grit, and are uniform in work. These artificial stones are the emery, corundum, and carborundum stones.

Emery.—Emery is found in the form of rock and is crushed into different grades of fineness. This crushed rock is classified and collected by passing it through a series of sieves. The sieves over which this crushed rock passes range from 8 to 90 wires to the inch, and that portion which goes through a wire screen 40 wires to the inch, but too large to go through 41, is graded No. 40. A finer grade is produced by floating the dust on water. This grade is called "F. F.", that is, flour fine, and is used in making hones and grinding compounds for lenses. This material is then mixed with a suitable bond and placed in moulds to form wheels, scythe stones, slips, cones, etc., and is dried and baked at a high temperature. Such a compound is called an emery stone. (See Fig. 230.)



FIG. 230.—EMERY WHEEL.

Corundum.—Corundum is a mineral similar to emery and it is worked after the same fashion and into the same class of moulds as emery. It is lighter than emery, therefore, it can be run at a higher rate of speed and develops a greater cutting efficiency.

Carborundum. — Carborundum is an abrasive, similar in appearance to the emery and corundum. It is graded, moulded, and used in the same way, but the cutting particles are obtained by an entirely different process. Carborundum is the trade name for carbide of silicon, that is, a chemical combination of carbon and silicon. The element carbon is supplied by crushed coke and the element silicon by sand. Accordingly,

these two materials are mixed in certain proportions and loaded into the electric furnace. A little sawdust is added to the mixture to make it porous, so that certain gases, which form in heating the material, can escape. Hence those wonderful abrasive crystals, "near diamonds," are made of every day materials such as sand, coke and sawdust. This mixture is treated in a temperature of 7,500 degrees Fahrenheit, during which all the undesirable material is vaporized. After cooling, the crystalized mass is crushed, graded, and worked similar to the emery. Carborundum, like emery and corundum, is slightly brittle; consequently, when it comes in contact with metal, it breaks slightly, forming new crystals, and each new crystal gives new cutting edges. (See Fig. 231.)

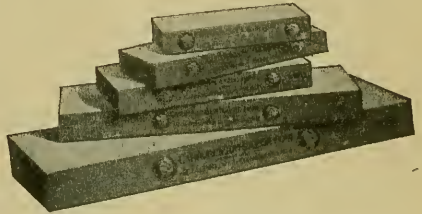

FIG. 231.—CARBORUNDUM STONE.

Speed of Artificial Stones.—Artificial stones, whether fine, medium or coarse, may be run dry or in water, the water serving the same purpose as it does with grind stones. There is no positive rule regarding the speed at which these wheels should run, as so many elements, such as bonds, etc., enter into the design, but, as a rule, they do the best work when run with a peripheral speed of from 4500 to 5000 feet per minute. High speed wheels should always be shielded.

CHAPTER VII

SANDPAPER

Details of Manufacture.—That there should be a great many details in the manufacture of sandpaper seems, at first thought, rather remarkable; but when one stops to consider the large variety of material which goes to make paper, the different ways of making it, the innumerable substances which are used in glue, and the wide range in their prices, not to mention the various factory methods, it is not strange. If the different grades of paper were limited to ten, and the glue to ten, we would still have one hundred possible combinations, without even considering the sand, grading, or care in manufacture. The process of making sandpaper has been specialized to a degree which seemingly allows but little possible improvement, and the product is so low in price that it is poor economy to use inferior paper, especially since quality is so important that it outweighs every other consideration.

Strength.—The most important quality of sandpaper is strength; not strength in one direction merely, but in every direction. Paper designed for sandpaper is of two kinds: cylinder and Fourdrinier. The cylinder paper has its strength all in one direction; the Fourdrinier paper has no grain, the fibres being distributed in such a manner that the strength is equal in every direction. Fourdrinier paper will not tear in a straight line. It is made in combinations of fibre in different thicknesses, according to the grit to be applied.

Glue.—Few people realize the adhesive power of the best glue, and sandpaper demands the very finest. It has to be specially made, and must be very elastic. When it is remembered that fine glue has cohesive power equal to and even superior to glass, the importance of the right glue can be easily understood. The glue acts not only as a binder, but aids materially in strengthening the paper.

Ingredients.—The term "sandpaper" is a misnomer, as sand is not used, the material being crushed flint rock, or quartz. Flint rock, when fractured, presents the sharpest edges procurable, whereas, natural sand, examined under a microscope, will be found to have a rounded

appearance, the cutting edges being considerably dulled by the action of wind and water. The garnet paper is made by the use of garnet ore, which is secured in the United States and abroad. It is not quite as sharp as flint rock, the particles fracturing at right angles, but the edges are more durable than flint. In grinding flint or garnet, the material, in the form of large chunks, is first passed through crushers, which are graduated to produce the desired grit. The material is then carried to sifting rollers, which are, in reality, skeleton cylinders, covered with fine bolting cloth. The material passes through the inside of the cylinders, which are placed at an angle, the larger pieces passing out at the opposite end, only the finest material being sifted through. The sifted product is then passed through a series of vibrating separators, which determine the different sizes with extreme exactness and uniformity.

Process of Manufacture.—All kinds of sand, emery paper, and emery cloth are made in rolls as large as those used in the printing of a daily paper. The process is continuous to such an extent that, while the paper is still coming from the roll at one end, the finished product is being rerolled at the other end. The first step in the process is the printing of the brand, which is done by passing the paper through a roller press. The paper next dips into the glue, which is applied very hot, rubber buffers preventing its spreading to the other side of the paper. From this it passes under brushes which distribute the glue evenly. It next passes under a shower of the grit desired, the surplus falling off by gravity at the first turn. A further application of a thin solution of glue gives an extra coating which thoroughly cements all the particles. From this the paper passes over a hot blast drier, and is suspended in long loops, traveling slowly for a considerable distance, to be finally rolled in a finished state. The sheets are cut by running the paper from the rolls through a cutter which drops them out, automatically counted, and delivered so that they can be easily assembled in quires and reams.

Quality and Care.—To determine the quality of sandpaper, tear it from each edge. Good paper will not readily tear straight. It does not tear cleanly, but the fibre pulls away, leaving an irregular edge. This characteristic should be the same, tearing from all four directions. When bent, the paper should give a good snapping sound, and when bent sharply, the particles should not loosen and drop off. Another test is to rub two pieces from the same sheet together. This is a very severe test, but good paper will give up its grit with extreme reluctance, not showing the paper beneath without considerable rub-

bing. Above all things, sandpaper should be kept in a dry place, away from an open window where there is the possibility of its absorbing moisture from the air. If the paper gets too dry, and cracks or breaks when fastening it to the drums, moisten the paper on the back before attempting to place it on the drums. This will do away with the trouble.

Steel Wool.—Steel wool is fine steel shavings. It is manufactured in many ways and in many degrees of coarseness. Steel wool is used in the finish room to work down coats of shellac, varnish, etc. It cuts rapidly and will expose the wood if care is not taken.

CHAPTER VIII

FILES AND RASPS

Historical.—In writing the story of files, one wonders at the little change that has been made in their construction since they were first put into use by the originators, supposedly the Swiss. The saying that necessity is the mother of invention seems to be true of files, as it is apparent, from the chronicles of the early makers of watches, who also seem to have been the Swiss, that files were put to universal use in southern Europe about four or five centuries ago. The shapes of files at that time, were about the same as they are today, except the tang, which resembled the Swiss pattern of today so far as the heel and tang are concerned, there being practically no heel. The tang, commencing from the width of the file and tapering to a point, was about one-third the length of the file itself. Soon after files appeared in southern Europe, traveling journeymen mechanics introduced them to England, and it was only a short time before factories sprang up all over the country; but it remained for Lancashire to manufacture them on a large scale and lead the world in that staple, until about a half century ago.

Hand Cut Files.—Up to that time all files were cut by hand. Blanks were forged to the proper shape, then the cutters, highly proficient, were seated in front of a block of wood, upon which rested a block of lead, and began the laborious task of cutting with chisel and hammer. There is little wonder that some teeth were cut deeper than others, and some not cut at all, when you consider that each tooth depended not only upon the skill of the operator but also upon the mental and physical condition of the hammer wielder as well.

Machinery Cut.—It remained for American ingenuity as well as necessity to invent machinery that, in cutting files, never varies the millionth part of an inch, and the diagonal cut upon the steel-blank is absolutely the same on every file. The operator still sits upon his seat before the block, but all his efforts are directed exclusively to feeding the ravenous machine that is ever hungry for more.

Sizes and Kinds.—There are more than 3,000 sizes and kinds of files, and to describe them all, or even any considerable part of them, would be beyond the scope of this chapter.

Features.—Files and rasps have three distinguishing features: First, length, which is measured exclusive of the tang; second, the kind or name, which has reference to the shape or style; third, the cut, which has reference not only to the character, but also to the relative degree of coarseness of the teeth.

Cuts.—The cuts with which all must be familiar are: The rasp—coarse, bastard, second cut and smooth; double cut—coarse, bastard, second-cut and smooth; single cut—coarse, bastard, second cut and smooth. (See Fig. 232.)



Rasp Coarse

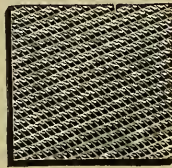

Double Cut Coarse

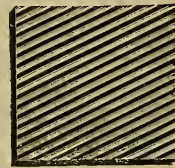

Single Cut Coarse



Rasp Bastard

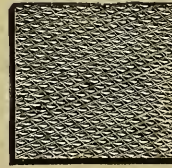

Double Cut Bastard

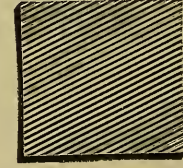

Single Cut Bastard

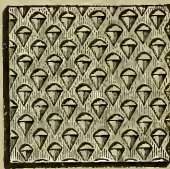

Rasp Second Cut

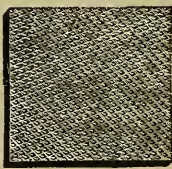

Dbl. Cut Second Cut

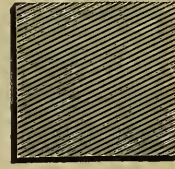

Single Cut Second Cut



Rasp Smooth

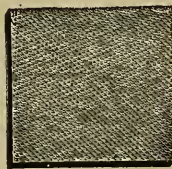

Double Cut Smooth

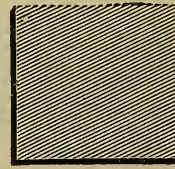

Single Cut Smooth

FIG. 232.—CUTS OF FILES.

Length, Tang, Thickness and Kind.—The length of a file is the distance between the heel and the point. The tang, or portion of the file prepared for the reception of the handle, is never included in the length. In general, the length of files bears no fixed proportion to either their width or thickness, even though they be of the same kind. By kind is meant the varied shapes or styles of files which are distinguished by certain technical names, as, flat, mill, half-round, etc. These kinds are divided, from the form of their cross sections, into three geometrical classes, namely: quadrangular, circular, and triangular sections, while odd and irregular sections are classified under miscellaneous sections. These sections are in turn, subdivided, according to their general contour or outline, into taper or blunt. Taper designates a file, the point of which is more or less reduced in size, both in width and thickness, by a gradually narrowing section extending to the point. Blunt designates a file that preserves its sectional shape throughout, from point to tang. (See Fig. 233.)

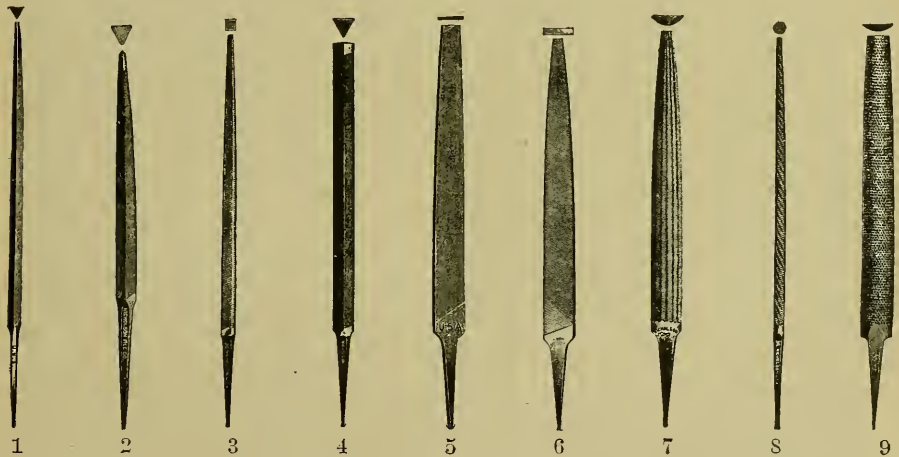

FIG. 233.—KINDS OF FILES.

(1) Slim Taper; (2) Taper; (3) Square; (4) Blunt Band; (5) Mill; (6) Flat Bastard; (7) Half-Round; (8) Round; (9) Half-Round Wood Rasp.

File Cleaners.—File cleaners, consisting of card, brush, and scorer together, or card and scorer alone, are used for keeping a file free from filings. The scorer is made of soft iron, and is used to remove the pins which fill up and clog the teeth, causing scratches in the work, if not removed. The brush will be found a most efficient annex to the card, especially upon finer files, and removes the filings much more effectually than can be done by the card alone. (See Fig. 234 and 235.)



FIG. 234.—FILE CARD.



FIG. 235.—FILE BRUSH.

Use.—Very few mechanical operations are more difficult than that of filing well. Unlike the tool fixed in the iron-planer, whose movement is guided by unyielding ways, the file must be guided by the hand, and the accuracy with which this is done will depend largely upon the skill and patience of the operator. While a perfect file is necessary to secure the best results in filing, knowledge as to the selection of the proper file for the work in hand and practice in handling are equally essential.

Machine and Hand-Made Files.—In conclusion, it is well to call attention to the fallacy of the old-fashioned idea that all things hand-made are pre-eminently the best. In the case of the file at least, this idea is without foundation. No hand-made file of today compares favorably with machine-made files. The machine-made file of today is as far superior to the old style hand-made file as the electric light is to the tallow candle. It is one of the most staple articles in the hardware store. The file is now, as ever, the same old reliable tool it was on its introduction, when the mechanical age, of which the present day is the apex, was ushering into the world.

CHAPTER IX

FACTS ABOUT WOOD

Uses and Nature of Wood.—Wood is now, has ever been, and will continue to be, the most widely useful material of construction. It has been at the base of all material civilization. In spite of all the substitutes for it in the shape of metal, stone, and other materials, the consumption of wood in civilized countries has never decreased. Although wood has been in use so long and so universally, there still

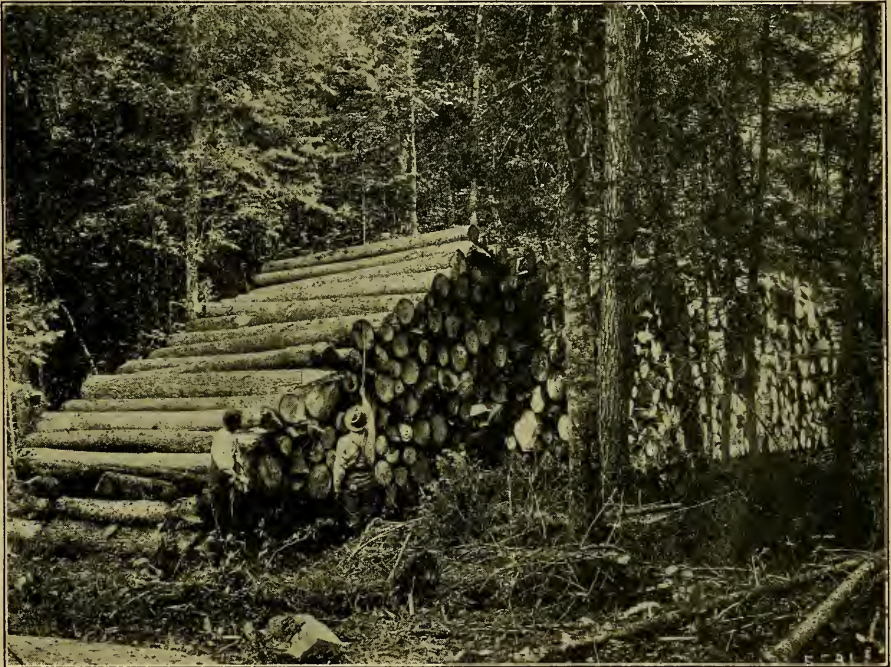

FIG. 236.—LOG SKIDWAY, SHOWING METHOD OF SCALING.

exists a remarkable lack of knowledge regarding its nature in detail, not only among laymen, but among those who might be expected to know its properties. Experience has been the only teacher, and notions—sometimes right, sometimes wrong—rather than well substantiated

facts, lead the wood consumer. Iron, steel and other metals are much better known in regard to their properties than wood. The reason for this imperfect knowledge lies in the fact that wood is not a homogenous material like the metals, but a complicated structure, and so variable that one stick will behave very differently from another stick, although cut from the same tree. Not only does the wood of one species differ from that of another, but the butt cut differs from the top log; the heart wood from the sapwood; the wood of the quickly grown sapling



FIG. 237.—TRANSPORTING LOGS BY TEAM.

of the abandoned field from that of the slowly grown old monarch of the forest. Even the manner in which the tree was sawed and the condition in which the wood was cut and kept influence its behavior and quality. It is, therefore, extremely difficult to study the material for the purpose of establishing general laws, and it becomes necessary to make specific inspection of the individual stick which is to be applied to a certain purpose.

Logging.—Logging or “felling” timber should be done as much as possible at the time when the tree has reached its maturity, if the maximum service the tree is capable of producing, is desired. The

age of maturity varies with different trees. The best season for felling timber is either in midsummer or midwinter. The conducting or growing cells during this season are less active, or practically dormant, and durable wood can be secured at this time. The ax and the saw are the tools used in felling trees. After the tree is felled it is cleared of branches and sawed into lengths and then taken to the saw mill.

Transportation.—Transporting logs to the mill is done first by drawing the logs to a railroad or a stream with a team of horses or oxen. If taken to a stream the logs are drifted to a sawmill, which usually stands near the stream or pond.



FIG. 238.—TRANSPORTING LOGS BY RAIL.

Sawmills.—Sawmills cut the logs into timber, planks or boards and these constitute lumber. There are two different types of saws used in sawmills, circular saws and band saws.

Timber.—Timber includes all large sizes, such as beams and joists. Planks are wide and always thicker than one inch. Boards vary in width and length, and are always one inch or less in thickness.

Milling.—Milling is the process followed up after the lumber leaves the sawmill and is properly seasoned. Two types of machines are used in milling—a planer, to surface the sides, and a jointer, to straighten and surface the edges.



FIG. 239.—LOG SLIDE.

Seasoning.—Seasoning lumber consists in removing the moisture. This may be done by air seasoning or kiln drying. Air seasoning is done by piling (sticking) the lumber in large square piles in the open air, with the layers separated by narrow strips. Thus by permitting the air to circulate freely through the pile, the lumber dries gradually and uniformly. The air drying is a slow process, but more satisfactory. The time varies with the species of wood and climatic conditions. From two to four years is considered sufficient for air drying. Water seasoning is done by permitting the timber to lie in water for a considerable time. This dissolves the sap in the pores and is replaced by water which readily evaporates when the timbers are laid out to dry. Water seasoned timber is used mostly for the spars of ships. Kiln drying is an artificial process used in seasoning lumber. The wood is placed in a chamber which is heated by steam or hot air and at a certain

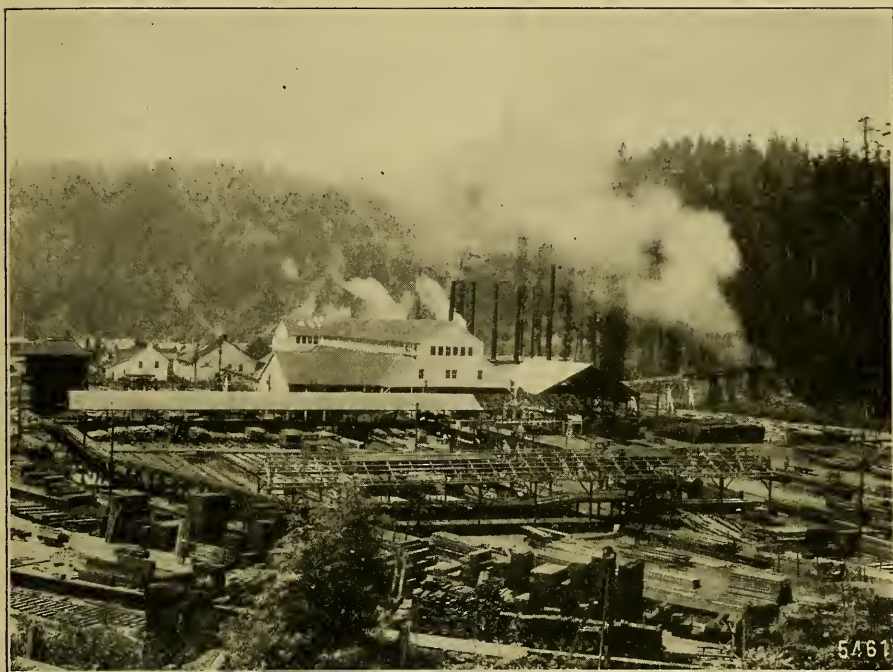

FIG. 240.—MILL OF THE PACIFIC LUMBER COMPANY, SCOTIA, CALIF.

degree of temperature. This rapid and forced process of drying is inferior to that of the open air, in that it dries the surfaces and ends too rapidly leaving the interior too moist.

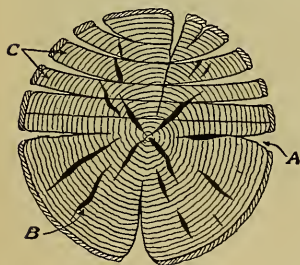

FIG. 242.—SHRINKING OF LUMBER.
(a) Crack; (b) Check;
(c) Warp.

Warping and Cracking.—Warping and cracking of wood is caused by the outer layers shrinking more rapidly than the center, or heart wood. In practically all cases, the crack runs parallel to the medullary rays, and across the annual rings. Boards cut from near the heart of the log do not warp as readily as those cut near the outer edge. The heart wood of board remains approximately straight, while the outer edge board has a tendency to warp and draw the wood together at right angles to the medullary rays.

Decay of Woods.—Decay of wood is caused by attacks of two forms of life. The breaking or sawing off of branches, thus leaving the wound exposed to the air, enables a fungus growth or a boring insect

to infest these unprotected places. Artificial preservatives are used successfully in arresting the decay of woods. Wood-tar and coal-tar are commonly used on wood adapted to out-of-door structures, because of their cheapness. Paints, also, are used on timber that does not come in contact with the soil.

Methods of Preservation.—Charring, resulting from exposing the wood in the fire until the whole surface is covered with a coat of charcoal, is very successful when applied to well seasoned lumber. Creosote is a liquid used extensively for dipping railroad ties, telegraph and telephone poles to prevent decay.

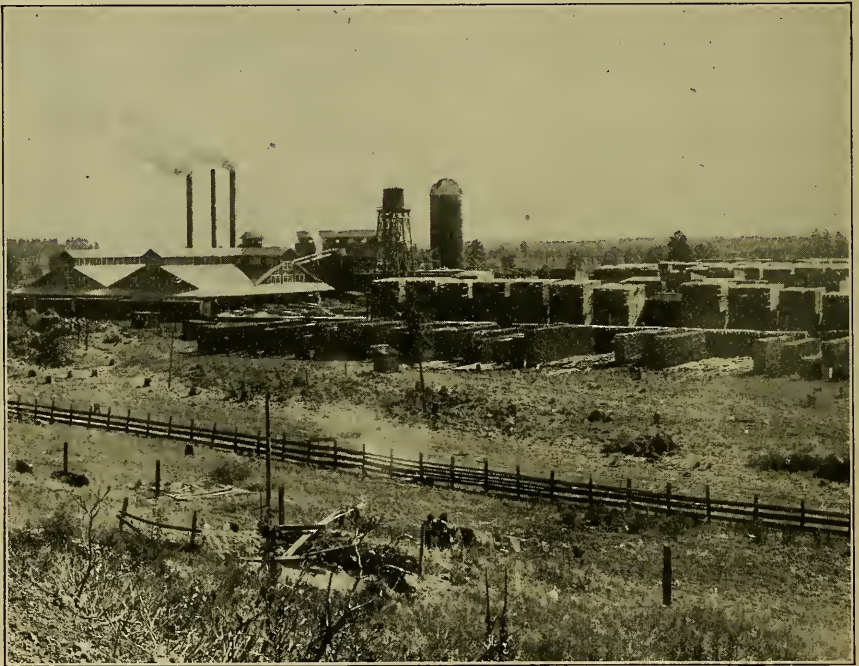

FIG. 241.—MILL AND YARD ON COCONINO NATIONAL FOREST, FLAGSTAFF, ARIZONA.

Strength of Timber.—The strength of timber is determined by its power to resist pressure, tearing, twisting and shearing of external force applied in any form.

Grain.—The terms “fine grained,” “coarse grained,” “straight grained,” and “crossed grained” are frequently applied in wood working. In common usage, wood is “coarse grained” if its annual rings are wide, “fine grained” if they are narrow; in the finer wood indus-

tries a "fine grained" wood is capable of high polish while a "coarse grained" wood is not, so in the latter case the distinction depends chiefly on hardness, and in the former on an accidental case of slow or rapid growth.

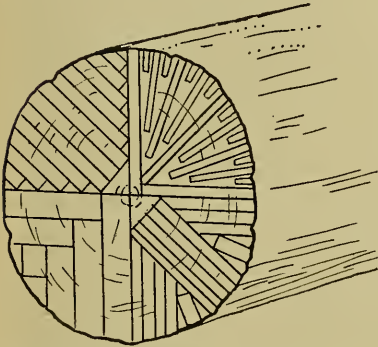

FIG. 243.—METHODS OF QUARTER-SAWING LUMBER.

Markings.—Markings on the board are determined by the way the board is cut out of the log. A plain sawed board is one that shows the annual rings approximately parallel, if the tree is straight grained. This kind of cut is used on all construction work. A bastard sawed board is cut tangential to the annual rings. This cut warps readily because the outer layer of wood is younger and newer. A bastard cut can never be made at the center or near the center of the log. Quarter-sawed wood is cut from a log that has been previously cut into quadrants. Each quadrant

is then cut at nearly right angles to the annual rings. This style of sawing is done on all material for high class cabinet and interior work, and reduces warping to a minimum, but is very wasteful in lumber. The cross section of a tree is composed of bark—a protective layer,—then follows the bast, cambium layer—zone of growth—sapwood and heartwood.

Board Measure.—Lumber is bought and sold by the 1000 feet (M), board measure, at so much per thousand. The term "board feet" means a piece of lumber whose flat surface contains 1 square foot and whose thickness is one inch or less. In common practice, lumber is always less in width and thickness than called for by the customer. This loss is due to sawing and dressing, i. e., planing of the stock. The standard length of lumber is 10, 12, 14, 16, 18 ft. and, if special lengths are desired, additional charges are made. Lumber in the rough is more nearly the full size than the dressed. In measuring the width of rough lumber, a fraction of an inch that is equal to or greater than a half inch is counted as a full inch; anything less than a half inch is discarded. If a common rough board is $8\frac{5}{8}$ in. wide, it is considered as an 9 in. board; if it is $8\frac{3}{8}$ in. wide, it is considered as an 8 in. board. Stock one-half inch thick is less per board foot than stock one inch thick. Ask a dealer the price per board foot of plain, red oak one inch thick, also the price of the same kind and grade of wood one-half inch thick. To find the number of board feet, multiply the number of boards by the

thickness in inches, by the width in inches, by the length in feet, and divide the product by 12.

Example: How many board feet in 7 boards, 1 inch thick, 6 inches wide and 16 feet long? $\frac{7 \times 1 \times 6 \times 16}{12} = 56$ board feet.

WOODS.



FIG. 245.—OUTLINE OF LEAF, BUD AND FLOWER OF TULIP OR YELLOW POPLAR TREE.

Courtesy American Forestry Magazine.

no tree from which the lumberman can secure such broad boards and planks of clear stuff that have so great an economic value for so many purposes. While neither so soft nor so strong nor so easily worked as white pine, it shrinks little when seasoning, does not warp, does not split when a nail is driven near the end, takes glue and stain well and actually presents a better surface for paint than pine. It yields the longest, clearest planks of all American hardwoods. Yellow poplar has long been a favorite material for furniture, though for highest grades it is not in the same class with mahogany, cherry, walnut and maple. The list of articles of furniture and finish into which it enters would include almost every piece in a well furnished residence, school, office or church, including chairs, mantels, benches, desks, tables, bedsteads, pianos, organs, book shelves, molding, paneling and many more. In some of these it is the outside exposed material which receives the polish or paint; in others it is the framework over which other woods are laid. Yellow poplar furnishes an excellent backing for veneer because it retains its shape and holds glue well. It is also an excellent veneer in the highest grade work.

Tulip or Yellow Poplar.—The tulip or yellow poplar is a large handsome tree, native of the Eastern United States from northern Florida to Massachusetts and the Great Lakes westward beyond the Mississippi. Ordinarily it grows to a height of 80 feet in the open, and in a forest to a height of near 120 feet, with a tall, straight, unbranched trunk. Its leaves are markedly different from all others and once recognized will never be confused with any other. It appears as though half of the leaf were cut away by cutting the apex off, leaving the remaining portion notched. It is angular, has four points and a sharp lobe on each side. Aside from the redwood of the Pacific slope there is

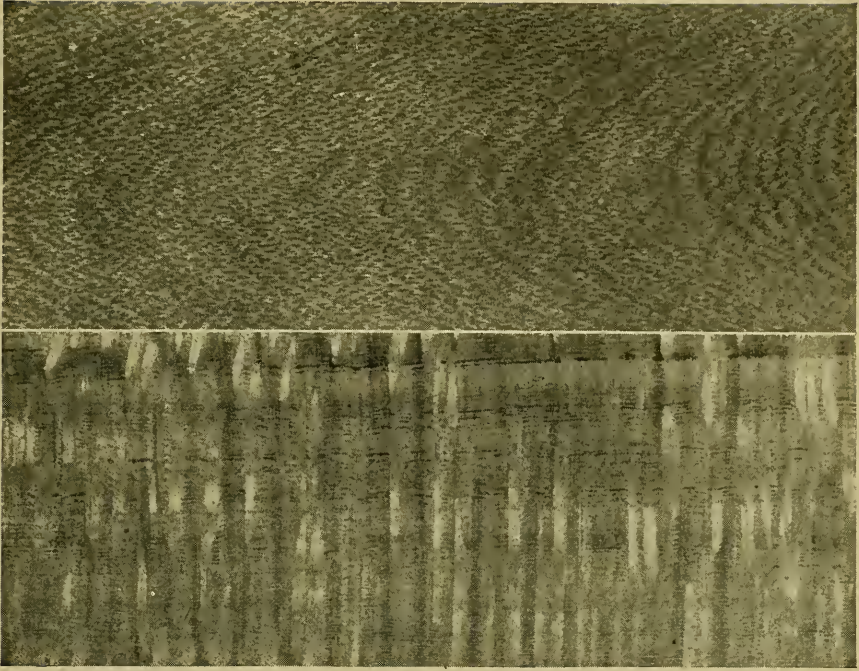

FIG. 244.—TANGENTIAL AND QUARTER-SAWED SILKY OAK.

Photographed from Specimens in "American Woods," Courtesy R. B. Hough, Lowville, N. Y.



FIG. 247.—THE WHITE ASH.

Courtesy American Forestry Magazine.

The White Ash.—The white ash is a tall, slender tree with a smooth bole which is often free from branches for more than half its length. Its home is in the eastern and central parts of the United States as far south as the northern limits of the Gulf coastal plain. For the variety of its uses white ash has no equal. The wood is heavy, even grained, hard and strong. Medullary rays are numerous and obscure. The heart wood is brown while the sapwood is often nearly white. It shrinks moderately, seasons with little drying, and takes a good polish. Handles of all descriptions, parts of vehicles, interior wood work, particularly car construction, parts of musical instruments and even some parts of aeroplanes employ white ash in their construction.



FIG. 246.—POPLAR, CHESTNUT AND WATER OAK IN COVE NATIONAL FOREST, GRAHAM COUNTY, N. CAR.

Photographed from Specimens in "American Woods," Courtesy R. B. Hough, Lowville, N. Y.



FIG. 248.—THE LEAVES, SEEDS AND FLOWERS OF SUGAR MAPLE.

Courtesy American Forestry Magazine.

The Sugar Maple.—The maple family has over seventy species, but the sugar maple is by far the most valuable. It is widely distributed through Eastern North America from Newfoundland to Texas, but the most abundant growth is found in the New England States, New York, northern and western Pennsylvania and westward through the region of the Great Lakes to Minnesota. The wood of the sugar maple is hard, heavy, fine grained and strong. It has a satiny surface which takes a high polish. Curly maple and bird's-eye maple are not distinct species but are merely common sugar maple with unusual marking caused by some exterior influence. The largest demand for maple comes from the industry which

turns out planing mill products. These include flooring, ceiling, wainscoting, stairwork and many other articles of interior house finish. No wood surpasses maple for flooring either in point of long service or in the ease with which it may be kept in repair. Atmospheric changes affect it very little so that its joints remain tight and sanitary. For stair treads, rails and balusters it is unsurpassed. Large quantities of rotary cut maple veneer are used on doors and in wainscoting and other parts of interior construction where panels are employed. The second greatest demand for maple comes from furniture makers. For enameled furniture, it has no equal as its surface takes the smoothest and finest polish and enamel adheres to it perfectly. Most maple furniture, however, is finished in the natural color. Chair factories demand this timber in enormous quantities. As a wood for parts of agricultural implements, for boot and shoe findings, musical instruments, and wooden ware, maple has no equal.



FIG. 249.—THE AMERICAN ELM.

Courtesy the American Forestry Magazine.

American Elm.—The American elm has a wider range than practically any other native tree. It is found in all of the United States east of the arid region bordering the Rocky Mountains and extends into the southern portion of Canada. The elm is conspicuous because of its popularity as a shade tree. It grows in almost any soil, but it is subject to many insect pests. Two distinct species, the white and the red, exist, but the latter is of little commercial importance. The white elm wood

enters into ship building, the cooperage industry and to some extent in furniture making. Recently elm has been finished to imitate some of the more expensive woods but this has been done by staining rather than by producing the figure. Elm's place is in cheap furniture or in the interior parts of the more expensive kinds. The wood is employed in the manufacture of kitchen tables and other furniture because of the ease with which it may be kept white by scrubbing.

The Chestnut.—Our native chestnut tree is one of our best known and best loved trees because of its beauty and its utility. It grows from southeastern Maine to southern Michigan and south to northern Virginia, southern Indiana and along the Appalachian mountains to northern Georgia, Alabama and Mississippi. Commonly, the mature trees

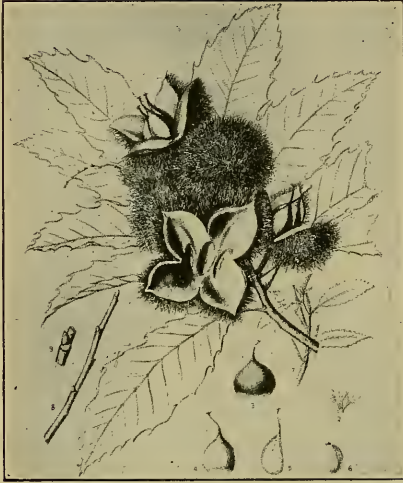

FIG. 250.—LEAF AND FRUIT OF CHESTNUT.

Courtesy of the American Forestry Magazine. It is very even grained and durable. It will outlast almost all the oaks and most other hardwoods, its durability being due to the high percentage of tannin which it contains. Its lightness, freedom from warping, durability and reasonable strength, together with its great abundance have given chestnut a great variety of uses. In carpentry its use is confined chiefly to interior work. It takes paint well and finishes attractively in the natural wood, but is too soft for flooring or other places where there is excessive wear. For furniture making it probably surpasses any one of the oaks in volume used, yet, with the exception of panels in wooden bedsteads, kitchen furniture and less expensive tables, little furniture is finished in chestnut. Its great use is as a core stock for veneers. There are two reasons for its popularity in the furniture industry. First, it is light, does not warp, is little affected by moisture and can be obtained in wide widths. Second, its open porous structure and its freedom from knots enables the glue which binds the veneer to take a good grip. Chestnut also has an advantage when used with oak in that its resemblance to that wood in plain section enables it to be finished on sides and ends of pieces of furniture whose tops are veneered with oak.

The Hickory.—The hickory is a characteristic American tree. The area in which it grows covers about one-third of the area of the United States, although all species are most usually found in one locality. "Tough as hickory" is a phrase suggesting the peculiar strength and elasticity of the hickory wood. It is heavy and strong but is not durable when exposed to the weather. It is noted for its flexibility and elasticity. Hickory has long been and will continue

are from 3 to 5 feet in diameter and from 60 to 90 feet in height, but there are numerous specimens much larger. The heartwood of chestnut is light brown in color while its sapwood is yellowish or whitish. Chestnut belongs to the same plant family as the oaks yet its wood can be easily distinguished from them by the apparent absence of medullary rays which are the markings that give such a pleasing appearance to quartered oak. These rays are present but they are not easily seen. Chestnut is neither a very strong nor a very hard wood, but



FIG. 251.—THE MOCKERNUT HICKORY.
Courtesy the American Forestry Magazine.

to be a favorite for handles of all kinds. Many modern farm tools could not dispense with the hickory that forms various parts of them.



FIG. 252.—THE LEAVES, FLOWERS
 AND SEEDS OF BASSWOOD.
Courtesy the American Forestry Magazine.

Basswood.—The natural range of the basswood is from New Brunswick south along the Alleghany Mountains to Alabama, and westward to eastern Texas, Nebraska, and southern Minnesota. The tree is commonest about the Great Lakes but attains to best development on the bottom lands of the Ohio River. The light brown wood is soft, straight grained, and easily worked but not durable. Large quantities

are used for house lumber, wooden ware, carriage bodies, panel work and paper pulp.



FIG. 253.—THE WHITE OAK.
Courtesy the American Forestry Magazine.

The American White Oak.—Both sentiment and intrinsic value have long given the oak the most important place among the hardwoods. At an early date it was associated with the gods. It is symbolic of strength, permanence and independence. Poets have sung its praise and have referred to it as "the builder oak, sole king of forests all." Nearly 300 species are known and many of these are commercially useful, but it is necessary to confine ourselves to the most important. The white oak is our most important oak and is one

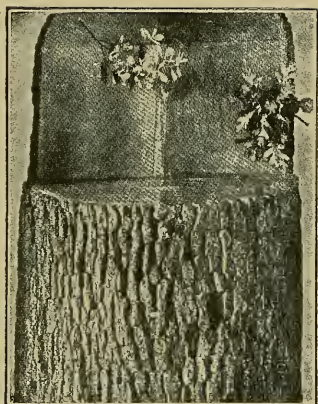

FIG. 254.—A WHITE OAK STUMP AND
SPRAY OF LEAVES.

Courtesy the American Forestry Magazine.

of the most widely distributed and most used hardwoods in the United States. While found through almost all the eastern half of the country it is most abundant in the central Mississippi and lower Ohio basins and on the western slopes of the Alleghany Mountains. To get an idea of the amount cut, it may safely be said that the annual output is two billion feet. In earlier times it was used for agricultural implements and for house frames, and furniture was made of it centuries before strains and fillers were known. Bridges, piling and ships have been, and are still, constructed of this material. About 1885 quarter-sawing became popular. This opened a new era for oak, for the process cuts the medullary rays in such a way that their broad surfaces are exposed. About one-fourth of all furniture made in the United States is of white oak. At present very little solid oak furniture is made except the cheapest or the most expensive kinds. Common chairs, bedsteads and tables are made of plain sawed material; the very expensive, deeply carved pieces are solid because only thick, solid pieces will show the carving. The medium priced oak furniture is practically all veneered.

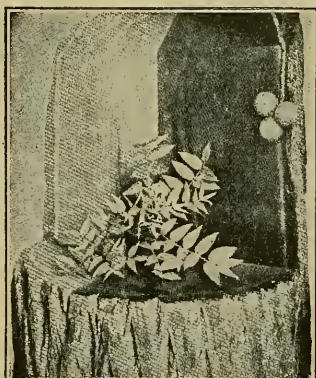

FIG. 256.—THE BLACK WALNUT.

Courtesy the American Forestry Magazine.

Black Walnut.—Black walnut is one of the most widely distributed and valuable of our deciduous trees. Although of fair size wherever found, black walnut attains its best development on the rich bottom lands in the basin of the Mississippi. By planting, the area in which it is common has been greatly increased. In its natural range, it occurs in scattered groups or as isolated individuals among other species. The wood of walnut is heavy, hard, strong and of coarse texture. The sapwood is narrow and whitish in color and the heartwood is a chocolate brown which

deepens with age and exposure. The wood shrinks moderately in drying and if care is taken, dries without checking. It works and stains well, takes a good polish and is valuable as a cabinet wood. Walnut was formerly used extensively for furniture and interior finish, for gun stocks, tool handles and carriage hubs. At present the supply is so small that it is being conserved for the manufacture of rifle stocks only.



FIG. 257.—THE WESTERN RED CEDAR.
Courtesy the American Forestry Magazine.

Western Red Cedar.—Next to Douglas fir, Western red cedar is the most important timber tree of the northern Pacific slope. Its ability to resist decay has won it many names. One tree which fell and over which others extended their roots was found in excellent preservation even though the living trees showed an age of 1500 years. Indians early used it in making canoes and today it is the greatest shingle wood we have. The wood is soft, straight grained, easily worked and little subject to checking. Only small quantities of the wood are used in house construction except for siding and shingles but it is used extensively for poles, piling and fence posts.

Red Gum.—Red gum is perhaps the commonest timber tree in the hardwood bottoms and drier swamps of the South. In most favorable conditions it reaches a height of 150 feet and a diameter of 5 feet. Red gum came into prominence in quite recent times. Owing chiefly to its tendency to warp and twist, and also to the fact that the supply of other hardwoods was so large, there was no incentive to work so low priced and supposedly unsatisfactory a wood as gum. However, with the supply of various finishing woods in use growing scarcer, red gum was looked to as a possible substitute. Certain objectionable qualities of red gum lumber have been eliminated by careful handling

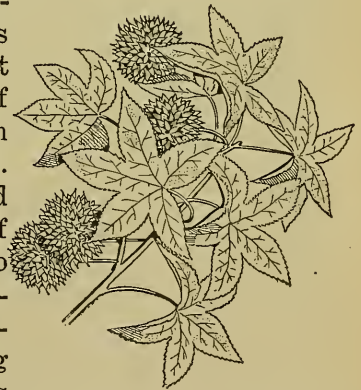

FIG. 258.—LEAVES AND FRUIT OF THE RED GUM.

and its beauty, adaptability and fine working qualities have promoted its use with great rapidity. The wood is about as strong and as stiff as chestnut; it splits easily and is quite brash; it is about as hard as yellow poplar and works about as easily; its structure is so uniform that it can be stained, painted or glued, without absorbing much of the material. One of the most important uses of red gum is for interior finish. It may be obtained in either plain or quarter-sawed lumber or selected for figure. The figure is different from the character of the figure in most woods. Ordinarily they are due to the medullary rays and the variations of annual rings. Gum's figure is due to neither, soil and situation being the determining factors. One-third of the whole supply of veneer is made from red gum. Especially is it used in panel work, both for interior decoration and for panels in many pieces of the best furniture.

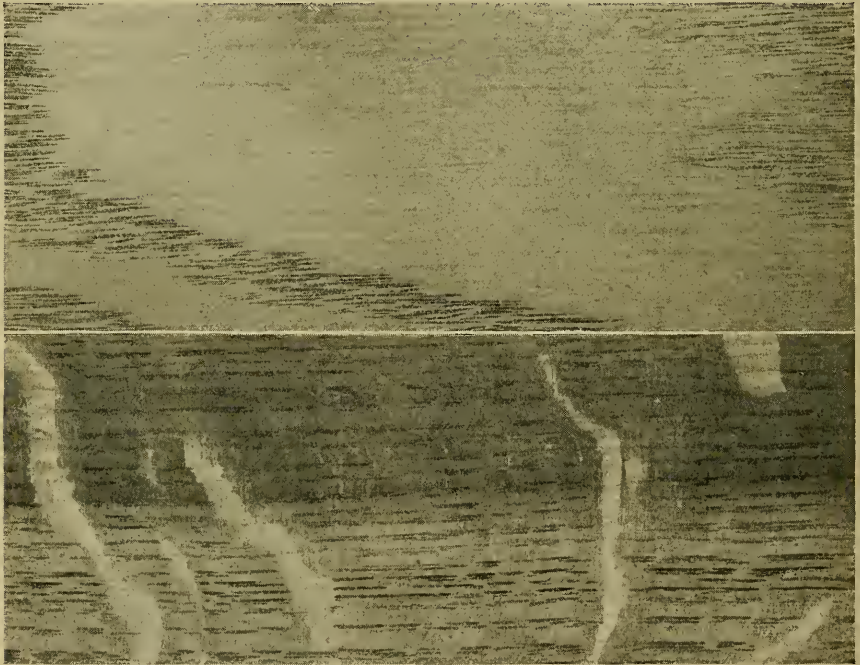

FIG. 255.—TANGENTIAL AND QUARTER-SAWED WHITE OAK.

Photographed from Specimens in "American Woods," Courtesy R. B. Hough, Lowville, N. Y.

The Redwoods.—The forest of redwoods are limited in area to the coast regions of northern California and the extreme southwest corner of Oregon. It is rarely found farther than 20 or 30 miles from the ocean and is limited to localities where heavy sea fogs are frequent. This family boasts of having the largest trees in the world. Redwood



FIG. 259.—THE RED WOOD.

Courtesy the American Forestry Magazine.

lumber was first cut in an extensive way about fifty years ago. Its chief use has been and still is for house construction. Being practically impervious to decay its use for exposed parts make it well fitted for exterior use. For interior use it has a wide range of possibilities. Since it is free from pitch, it is especially adapted to hold paint and enamel. However, the beauty of the grain is so great that it is now a common practice to finish the wood in its natural state. Redwood produces excellent imitations of rosewood and mahogany. It is easy to work and can be secured in boards of great length and width. The decorative effects of the natural wood are richly varied and the shades of color cover a wide range.

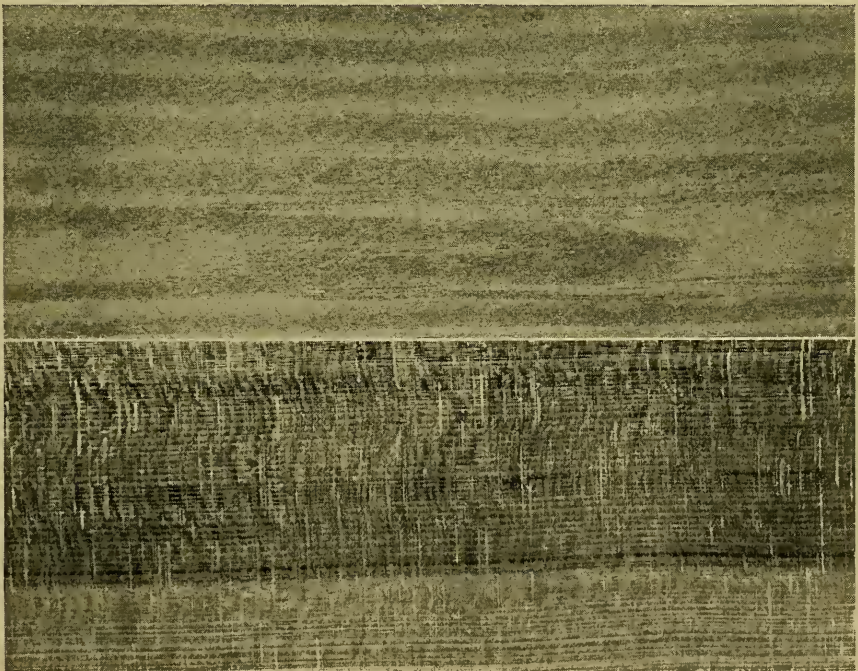

FIG. 260.—TANGENTIAL AND QUARTER-SAWED REDWOOD.

Photographed from Specimens in "American Woods," Courtesy R. B. Hough, Lowville, N. Y.

White Pine.—The habitat of the white pine is east and west 1800 miles, from Newfoundland to Manitoba. Approximately half of its range is in the United States and half in Canada. This species of pine has been the most important building wood in the world. Its softness and weakness have barred it from some places in modern manufacturing and its lack of figure has disqualified it for others, but its range of usefulness has been so wide and the supply so great that it held first place in forest materials during two and a half centuries. White pine has given good service everywhere. It has always been the wood of universal excellence for constructing houses, barns, and other buildings. The wood is less affected by moisture than other woods, it neither checks nor warps, holds paint and other finishes well and its soft even grain makes it an easy wood to work. For a long period it served as material for furniture and while not so well adapted for the various articles of furniture it served its purpose.

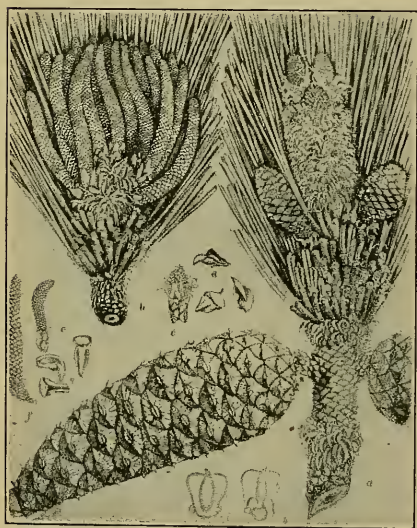

FIG. 261.—LONG LEAF PINE—MALE AND FEMALE FLOWERS.

Courtesy the American Forestry Magazine.

The longleaf pine is one of the three most valuable timber pines in the United States. The others are the white pine and the shortleaf pine. The longleaf pine is found from the foothills of the Appalachian Mountains to the coast from southeastern Virginia to central Florida, and thence westward in the Gulf States to eastern Texas. In this region it grows in a belt about 125 miles wide. It is a tall tree, free from branches for more than half its height. The wood is heavy, exceedingly hard and strong. It is usually fine-grained and durable, orange color, sometimes of a very deep shade. It has become popular with workers who demand timbers of exceptional size as it is common for one tree to furnish a log 70 feet long which can be squared to 15 inches. It is largely used for building, both framing, flooring and interior finishing; also bridging, railway ties, fencing, and for masts and spars.

The Shortleaf Pine.—The region of the natural growth of shortleaf pine extends from southeastern New York through the southern limits of



FIG. 262.—LONG LEAF PINE, GEORGIA.

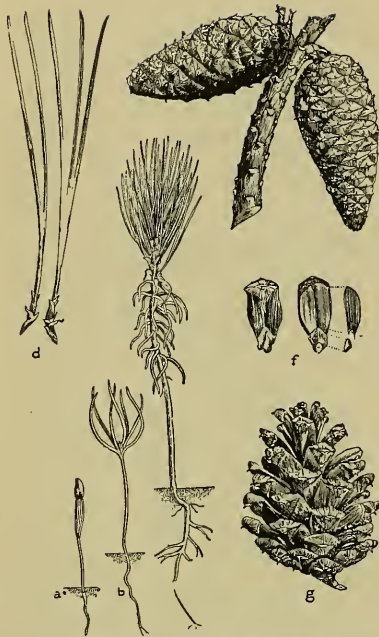

FIG. 263.—THE SHORLEAF PINE.
Courtesy the American Forestry Magazine.

Pennsylvania, Ohio, Indiana, Illinois, Missouri, and southward to eastern Texas and northern Florida. This species of pine grows to moderate proportions for a member of the pine family, the ordinary tree growing to a height of 80 to 100 feet with a diameter of 2 to 3 feet. Since it can grow rapidly in height when young trees are crowded together, trees in the woods have long, clean, straight trunks. While definitely restricted in its area, the good qualities of shortleaf pine are so varied and its adaptability so superior that its distribution extends through the whole world. More than 39 per cent of all lumber used in the United States is shortleaf pine. Its annual production—more than 14,000,000,000 board feet—is over three times as great as any other one wood. One of its best

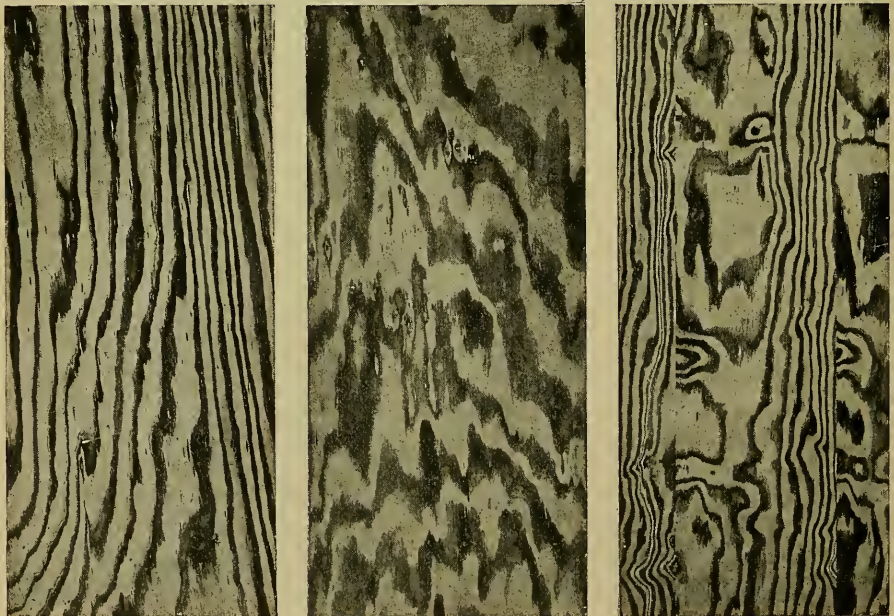

FIG. 264.—VENEER PANELS OF SHORLEAF PINE.
Courtesy of the American Forestry Magazine, Washington, D. C.

known uses is for interior finish, the grade of lumber used being manufactured from the thick, clear sapwood. So popular has it become that architects are specifying it and builders are using it more and more for the finest homes all over the country. It is demanded because of its grain and beautiful texture which particularly adapt it for fine joinery. No other wood offers such a wide choice in grain and figure. Shortleaf pine does not show knife marks in the milling process so it requires little labor to obtain a satisfactory surface. The wood hardens with age and its beauty is not surpassed by the hardwoods. Owing to the absence of pitch it takes paint well and it is an excellent base for enamel. For flooring it is unsurpassed for it meets all the requirements of strength, smoothness and staying qualities.



FIG. 265.—THE BALD CYPRESS.

Courtesy the American Forestry Magazine.

The natural range of cypress is a region made up of the Atlantic and Gulf Coastal Plains and extending up the Mississippi Valley to a point more than half way to Canada. Cypress has a variety of uses and for many it is preferred above other material. The key to its usefulness is its resistance to decay and the fact that it is easily worked. Great quantities are used for outside finish of buildings, ceiling, flooring, molding and finish. Abundant proof of its resisting qualities is given. In South Carolina a grave marker was so well preserved after 140 years' exposure to the weather that the letters could be easily read. Roofs of cypress shingles withstand centuries of exposure. A roof of cypress shingles placed on Mount Vernon was removed in 1913. Water pipe laid in New Orleans in 1798 was sound when dug up in 1914.

The Bald Cypress.—The interesting habits of the bald cypress invite attention. It is one of few cone-bearing trees which drop their leaves annually, it has the power to send up vigorous sprouts when the tree is felled—a rare thing in conifers—and it alone can live and thrive with its roots always submerged. Ten years ago cypress was “lumber.” Suddenly, it ceased to be just lumber, a piece of wood of specified dimensions, and became cypress, “The Wood Eternal.” Cypress was the first wood to be advertised nationally. It is necessary, therefore, to take into consideration the effect that intelligent advertising has had on the demand.



FIG. 266.—THE SPRUCE.

Courtesy the American Forestry Magazine.

Spruce.—The “North Woods,” a storied land so frequently described by writers, is the home of spruce. This forest stretches from the eastern provinces of Canada to Alaska. In the United States its growth is confined to portions of Maine, New Hampshire and Vermont, the Adirondacks and certain portions of the Appalachian Mountains. Spruce is an aristocrat among woods. Its outstanding characteristics are strength and lightness. With these qualities are combined elasticity and ability to withstand sudden strain and shock. This wood came into the market as a substitute for pine. Although it has had a place of its own as a lumber wood its chief use to 1914 was as a pulp wood, the length and toughness of fiber especially adapting it for that purpose. With the opening of the world war this wood suddenly



FIG. 267.—FELLING SPRUCE.

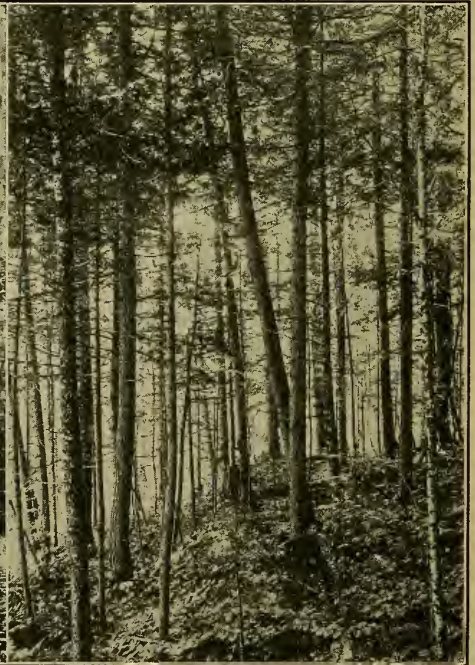

FIG. 268.—A VIRGIN FOREST OF SPRUCE.

sprang into prominence, for of all known materials including both wood and metal, it best meets the requirements for the supporting frame-work of air-craft wings. The demand is great but forests are measuring up to the task and are supplying practically all the spruce needed by the allies.

Douglas Fir.—Douglas fir is a western tree growing throughout the Pacific Coast region. Except the giant redwood no other tree of our continent attains larger size. It commonly grows from 4 to 6 feet in diameter and from 180 to 250 feet high, although many have been found much larger. The color of the wood is light red or yellow. The wood is heavy, hard and strong but usually is coarse grained and hard to work. It has a pleasing grain because of the marked contrast between its spring and summer rings of growth. It



FIG. 270.—DOUGLAS FIR.
Courtesy American Forestry Magazine.

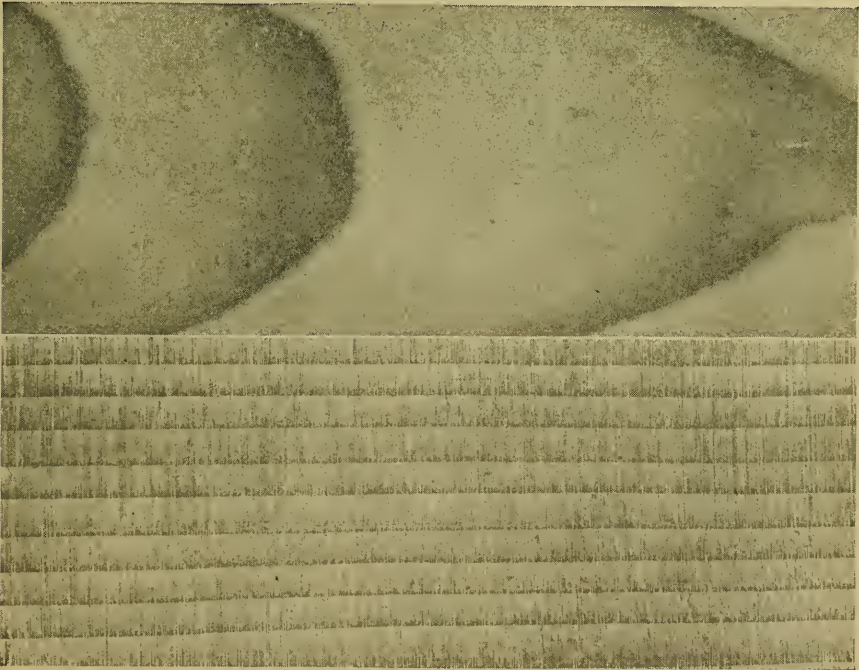

FIG. 269.—TANGENTIAL AND QUARTER-SAWED SPRUCE.

Photographed from Specimens in "American Woods," Courtesy of R. B. Hough, Lowville, N. Y.

has small medullary rays so quarter-sawing will not add to its beauty. The most common method of cutting is to cut the log into veneer using care to cut across the rings of growth at a very small angle. This exposes large irregular areas of the dark and light rings thus creating many irregular designs. Douglas fir is adapted to construction throughout. It has strength, durability and holds paint well. Fully fifty per cent of the cross arms used by telephone and telegraph companies are of Douglas fir. It is now used for boxes and heavy crates and recently has been found to be of exceptional value in the construction of wood pipes, stave tanks and stave silos.



FIG. 271.—THE BIRCH.

Birch.—The birch is a native of the greater part of Canada, its range extending into the states of the United States bordering on that country. There are several species but the sweet birch is of greatest importance. The wood is stiff and strong. Its most important use is for various kinds of furniture. The advantages of the wood for this purpose are that it is dense and even grained, has good milling qualities and will take and hold almost any kind of finish. Birch wood can be so treated as to imitate mahogany and it

can also be treated so that it closely resembles cherry. As a furniture wood, chairs of all descriptions consume the largest quantity of sweet birch, but tables, bookcases and filing cabinets are often made wholly or in part of this lumber.

CHAPTER X

FACTS ABOUT BRUSHES

Materials and Methods.—There are many methods employed in the construction of brushes and a variety of ways in reaching the same results in forms and details. Before the manufacturer can assemble and combine the parts that make a brush, much time and labor is given to the selection and preparation of materials. Bristles are washed clean and separated into sizes. Mixtures of different kinds, in the proper proportions, are prepared to make brushes suited to various purposes. For paint brushes, the mixture is different from that used in varnish brushes, and whatever kind the user demands should be made of the grade of bristles best adapted to his special purpose. The quantity of bristles for each brush is carefully weighed; this insures uniformity in respect to fullness, and enables the manufacturer to compute the cost of his product. Handles and woods used in brushes are of selected kinds, best adapted to their special purposes. The principal raw materials from which brushes are made are the products of distant countries. Eastern Germany, Russia, Siberia and China produce almost all the bristles and hair used in making brushes.* The manufacturer who buys at the source of production, obtains raw material cheaper than elsewhere. Misrepresentation as to the quality of brushes exists now to a greater extent than heretofore and cheap substitutes for bristles and other materials are mixed in brushes more extensively than formerly. It is to be expected that when a scarcity of any natural product develops and consequently when increased cost takes place, substitutes will be used. When substitutes are used and goods are sold under proper representation as to quality, the buyer knows what to expect. The use of horse hair as an adulterant of bristles has increased much lately and many tons are mixed with the bristles in brushes which are sold as all bristle brushes. White, gray or black horse hair is skillfully mixed with corresponding kinds of bristles so that the finisher rarely discovers the fact until he is using the brushes and then he wonders why the bristles

* At the present time, the bristle situation, like that of many other raw materials of foreign origin, is in a very uncertain condition. German bristles and hair are, of course, unobtainable; Russian goods are scarce and unreliable as to length and quality; and hence most of our present supply is obtained from China. After the conclusion of the World War, conditions will doubtless adjust themselves to normal.

are not as elastic and effective in working as they were formerly, and why the bristles wear so quickly. It may be interesting to know that while thousands of patents for brushes have been taken out in the United States during the past fifty years, there has been little change in the methods used in Great Britain and Europe. Not all of the brush inventions in the United States have been successful, but enough have been successful to make radical changes in the methods of making them and to result in great economy of materials and lower prices for better brushes to those who use them. Today, brushes with chisel ends are very common. Not many years ago they were a novelty, and the feature of pushing back bristles was a secret. The advantage to the varnisher of having his brush broken in when bought is readily seen. To make a chisel end brush, the bristles are actually pushed back, on the side of the brush, by a clever device, and the soft ends of the bristles are not cut off, as is often thought to be the case. One of the most useful features attached to brushes is the metallic bridle, rendering the old way of bridling with twine almost a lost art. Among the more recent inventions of note is the method of fastening the bristles in the ferrule so that they will not fall out and so that they can be used in all kinds of materials. In using this method, the bristles are first imbedded in soft rubber and then vulcanized or hardened so that it is impossible for them to fall out. The hard rubber cannot be dissolved by turpentine, benzine, alcohol, shellac, hot water or any liquid in which a brush may be used. Another method is to set the bristles in a steel band and then place it under high pressure. This device holds the bristles in place quite successfully.

Dusters and Artists' Brushes.—Painters' dusters and other kinds of dusters are made by methods entirely different from those used in making paint brushes. Knots of bristles are crowded into holes, which are bored in a hard wood block, after being saturated with cement pitch. Some kinds of brushes have their bristles fastened into the holes with copper wire, each tuft of bristles being forced tightly into a hole. Artists' brushes are of many kinds and practically all are made by drawing the bristles into tapering ferrules, each knot having been wound with cord and cemented. The business of manufacturing brushes requires expert knowledge of materials and methods of making, and details must be carefully worked out. There are only a few large successful brush manufacturers in the world.

Bristles.—A brush may be only a collection of crude, raw materials. When bristles leave the hog's back, they have only taken the first step towards brush construction. Many things must be done to the bristles.

before they will do the work that is expected of brushes. Bristles must be washed, straightened, and attached to handles by experts. They are as carefully and as expertly treated as any article which receives mechanical assistance before being put to its final service by an artist or artisan. Every bristle has a natural bend or curve which cannot be taken out of it. And therein lies an important secret of good brush making. The hair of each animal bends toward its tail, and when assembling brushes, skilled hands must arrange each bristle so that this natural curve, or bend, points to the center of the brush. If this is not done, it will not work well. This is true of the small, fine artist's pencil, as well as of the largest paint brush. When the artist's brush or pencil does not paint, or when the paint brush crawls and does not cling after once broken in, it is because the natural bend of the bristles is not properly pointed toward the center of the brush before locking them in the ferrule. Each bristle, too, has a large coarse end that is locked in the ferrule. The same skilled hands are required to see that this coarse end is not reversed and allowed to interfere with the working end of the brush. The large coarse end is solid but the thin end "with the flag" is split. If properly set this produces the very fine taper on the better grade brushes. Up to a certain point, hand work is efficient, but it cannot approximate the accuracy of machinery. Most of the machinery now in use is of the automatic kind. Russian bristles are considered the best for long stock purposes, as they are longer and have considerably more elasticity than most others; although many German bristles are found as long, the elasticity is not so great. Unscrupulous persons often substitute them for the genuine Russian. Climatic conditions are the direct cause of this difference. Nature provides the necessary coat for the climate, and hogs are no exception to this rule. Chinese bristles are replacing the rapidly depleting supply of Russian bristles. While Chinese bristles are not quite as long as Russian the quality as a rule is almost equal. Most of the brushes used in house-painting, varnishing and enameling are made from Chinese stock. The Russian stock, used mostly in kalsomine and other brushes, requires extra long length. Almost all bristles used now are black as the original white stock is almost unobtainable. Some of the finer hair used in artist's and fine painting and varnishing brushes comes from the colder countries. Ox hair comes from Siberia. The so-called camel's hair is nothing more than hair from squirrels' tails and comes mostly from eastern Germany and Russia. Wood-fibre is much used in the manufacture of cheap brushes, as for instance, the palm fibre known generally as palmetto. As stated before, the bristles are imported from foreign countries, since the bristles of the American hog are so short that it is

impossible to use them in making brushes. The American hog is not absolutely worthless as far as his bristles are concerned, as in the mortar for plastering is a place to use this otherwise useless commodity.

Care of Brushes.—Brushes in which the bristles are set in glue should never be used in a stain or paint made of water, as the water will dissolve the glue. Again if the bristles are set in cement, they should not be used in material in which alcohol is used. But a brush in which the bristles are set in rubber may be used for any purpose which does not injure the bristles themselves. Brushes should never be kept in too hot a place, or in excessive heat as they are liable to shrink and come apart, no matter how well they are made. Before using a new brush always remove the loose bristles which were too short to catch in the ferrule. Never put a new brush in water “to soak” as this will destroy the life of the bristles and cause them to become flabby and to twist out of shape.

CHAPTER XI

WOOD FINISHING

Purpose.—To preserve and beautify the wood is of prime importance in wood finishing; however, so much stress is frequently placed on the beautifying of the piece that the preservation of the wood, which is the essential feature, is often overlooked, and, as a result, the aesthetic effect will be short lived. To secure good results in wood finishing, the pores of the wood must be sealed to insure against warping, twisting, expansion, contraction or any physical change that may be effected by the fluctuation of the atmospheric conditions. The preservation of the wood must not be overlooked; but, while chemicals are applied to do this, other chemicals may be worked harmoniously with them to give a finished appearance that will be pleasing to the eye.

Classes of Finishes.—Briefly speaking, finishes may be divided into two classes: exterior and interior.

Exterior Finishes.—Exterior finishes are usually opaque, consisting of a pigment, or base, linseed oil, color matter and a little drier. This mixture is called paint. The pigment is stirred with the oil until it has gone into solution. Then enough oil or pigment is added to make the mixture a good working consistency, after which the colors are added. The colors are usually stirred into the paint, but a very common practice is to “box them in”, at the same time working the oil and pigment by pouring them back and forth from one container to another. If necessary, enough drier may be added to make the paint dry rapidly.

Pigments.—There are many paint pigments, all of which serve their purpose, and do it well, but the one in most common use, the one of the longest standing, and probably the best by actual test, is white lead.

White Lead.—The use of white lead is handed down to us by the Romans, but the Dutch are responsible for the scientific manufacture of this pigment. The Dutch Process is used largely today, although a better and quicker process, known as the Carter Process, is rapidly taking its place.

Dutch Process.—To change pig lead into white lead by the Dutch Process, the pigs are moulded into perforated discs or buckles. These

buckles are properly stacked in pots, the bottoms of which are covered with acetic acid, or vinegar; these pots are placed in a corroding house, which is lined with spent tan bark. The bark ferments, throwing off carbonic acid gas, and generating a heat that evaporates the acetic acid. The vaporized acetic acid, together with the carbonic acid gas, attacks the buckles and corrodes them into a white porcelain substance, called white lead. This substance is ground with high speed mill stones and passed through fine silk bolting cloth. This product is dried in copper pans, with exhaust steam, and the resulting product is the dry white lead of commerce. The dry white lead is mixed with linseed oil and ground by large burr mills to a paste form, and is called, "White lead in oil of commerce."

Carter Process.—The Carter Process, or the new process, is more modern and scientific than the old Dutch method, while the chemical construction is the same. Under the Carter Process, the corrosion is under perfect control at all times. The pig lead is pulverized and loaded into revolving cylinders or barrels. Into these cylinders the purified carbonic acid gas flows, and, at intervals, the lead is sprayed with a weak solution of acetic acid and water. As the cylinders revolve, the lead is shifted around, exposing every grain to the corroding agencies. This corroded lead is watched carefully, taken out at the proper time, and treated by the grinders to a process similar to the Dutch Process. The method of producing white lead by the Carter Process takes about fifteen days; while it takes from one hundred to one hundred and thirty days by the old Dutch Process.

Linseed Oil.—Linseed oil is produced from flax-seed and is the most valuable, with the exception of Chinese Wood Oil, of all the drying oils. The seed is crushed and ground to a fine meal, heated with steam and then submitted to an extreme hydraulic pressure, which eliminates the oil and leaves a solid mass, known as linseed cake. The latter is marketed as a live stock food. The new process of producing linseed oil is to take the crushed flax-seed and submerge it in naphtha, which, under gentle heat, extracts most of the oil from the meal. After this, it undergoes a process of distillation which separates the naphtha from the linseed oil. This is the most satisfactory and economical method known. Linseed oil for varnish makers' purpose is refined by a bleaching process which eliminates all foods, or albumen, leaving an almost water white oil which can be heated to 625 degrees Fahrenheit without the slightest discoloration. Ordinary commercial linseed oil will not stand this heat, as foods, or albumen, present in it, decompose and cause the oil to turn very dark.

Chinese Wood Oil.—Chinese Wood oil is the product of the tung tree in China. The fruit of this tree is a peculiar bottle shaped nut. When ripe the seeds are collected and the oil is extracted. It is used in preference to linseed oil in the making of the greater part of our varnishes. The Chinese and Japanese have known the valuable properties of this oil for many centuries and have used it on their boats as a wood preservative.

Colors.—Colors are divided into two classes: Pigment colors, such as are used in paints; and soluble colors, which are soluble in water, oil, or spirits. The latter thoroughly dissolving in their solvents, produce deep, but clear and transparent, colors. Pigment colors are made largely by the blending of clays and oxides, produced by heat in cupolas or ovens; while colors soluble in water, oil or spirits are bi-products of coal tar, and are classified as anilines.

Color Shades.—The application of all colors, whether pigment or soluble, is the same; that is, the blending of certain colors to produce certain shades. The colors most common to the painter and finisher are the following:

Burnt and Raw Umber,	Canary Yellow,
Burnt and Raw Sienna,	Crome Yellow,
Vandyke Brown,	Prussian Blue,
Tuscan Red,	Cobalt Blue,
India Red,	Chrome Green,
Para Red,	Bronze Green.
Drop Black,	Lamp Black.

By experimental work many pleasing shades may be worked out. These colors may be darkened by the addition of lamp black, or lightened by the addition of a "thinner".

Composition.—It will be seen, by chemical analysis, that ordinary house paints are made of such every day material as white lead, linseed oil, colors and a little drier.

Application of Paint.—When applying paint, be sure that the wood is free from water and dirt. Water is the greatest enemy an oil paint has. In painting houses, barns, etc., it is necessary that a quantity of linseed oil is added to the paint. The added oil serves as a filler. On new lumber all knots and sappy places should be given a coat of shellac before applying the paint. Puttying the nail holes, cracks, etc., is done next. This is done after the filler coat is applied so that the dry boards

will not absorb the oil in the putty and let it fall out. Two or three coats of paint are enough, depending on the consistency of the paint. Each coat of paint should be given plenty of time to dry before applying another but do not allow the building to stand too long between coats.

Interior Finishes.—The scope of interior finishing is far greater than exterior finishing, in that it embodies staining, shellacing, varnishing, waxing, and the working of these materials on floors, pianos, furniture, carriages, etc., as well as a knowledge of much of the material which goes to make up paints.

Stains.—Except in fuming, a medium by which wood may be colored is called a stain. In all cases, the grain and characteristics of the wood must show through the coloring. The wood coloring stains are the following:

Spirit soluble stains;
Water soluble stains; and
Oil soluble stains.

Water and spirit stains penetrate the grain of the wood better than oil stains, and water stains better than spirit stains, because spirits evaporate so rapidly that it has but little time to penetrate the wood. Care should be taken with water stains on thin veneer, because, if care is not taken, the water may weaken the hold of the glue and cause the veneer to blister. Any of these stains, especially the water stains, may raise the grain of the wood. If it does, take a piece of 00 sandpaper and sand off the thread-like fibers very lightly and color the filler to match the stain. However, a safe way is to raise the grain of the wood first. This may be done with a light coat of warm water, applied with a rag; a weak solution of alum water is still better. After the grain is raised, sand it down, dust off thoroughly and then the stain may be applied.

Stain Shades.—Stain shades may be had in any shade of brown, red, green, etc., and are marked as:

Golden Oak;	Mission Oak;
Weathered Oak;	Bog Oak;
Early English;	Fumed Oak;
Flemish Oak;	Mahogany.

Fuming.—Any wood that contains tannic acid and is unfinished, mellows with age. This is due to the chemical reaction of the free ammonia in the air with the tannic acid in the wood. To get the same results in a short time, the furniture is subjected to ammonia fumes, or

the ammonia is applied with a brush, and the piece is held in an air tight box until it reaches the right shade. This process, as the name indicates, is called "fuming".

Fillers.—Fillers are of two classes—liquid and paste. Liquid fillers are best adapted for close grained wood such as maple, gum, etc., and to classes of work where it is impossible to work with a paste filler, as on intricate carvings. The purpose of the filler, whether liquid or paste, is to positively seal and to level the pores with the surface of the wood so that there will be absolutely no chance for moisture to enter the wood. Its application is the most important operation in the finishing room, as it is the real preservative, as well as the base over which an artistic finish may be applied.

Use of Liquid Fillers.—A liquid filler is applied with a brush. Care should be taken to cover the entire surface with a light coat and to give it plenty of time to dry. This time varies according to the humidity of the air. Before another coat of filler can be applied the liquid filler must be worked down with steel wool or fine sand paper. This operation removes the dust particles which may settle on it while the filler is still sticky. Never use liquid filler on floors or surfaces exposed to the weather.

Use of Paste Fillers.—The paste filler is far superior to the liquid for open grain woods such as oak, ash, chestnut, etc. It will actually fill and level the pores of the wood with one application, if properly applied. The paste is worked into a solution by the addition of gasoline or turpentine, of a good working consistency, and is then applied to the surface and permitted to set long enough for the gasoline or turpentine to partially evaporate which leaves a thin film of the paste spread over the surface. This film should be worked into the pores by rubbing the surface across the grain of the wood and finished with a light stroke with the grain. Give this plenty of time to dry thoroughly and work with fine sandpaper before applying another finish coat.

Application of Fillers.—Fillers may be applied over any stain or dye, but should be colored to match the stain. In many cases the colors are mixed with the paste filler and applied on the bare wood, omitting the stain coat.

Shellac.—Shellac is a product of the East Indies, coming principally from Bengal and Siam. It is a resinous incrustation formed on the twigs and branches of various trees by an insect which infests them. This insect is closely allied to the cochineal insect, which yields a red dye color. The term "lac" in Sanskrit means 100,000, and is indicative of the countless hosts of these insects which make their appearance

twice a year, in July and December. These minute insects breed in myriads on the twigs and branches, and feed from the sap. The insects begin at once to exude the resinous secretion, which forms a cocoon, from which exudes the Lac Dye of commerce, over their entire bodies. Lac incrusts twigs, called "gatherers", are known in commerce as "Stick-Lac". The resin is crushed into small pieces, washed free from coloring matter, and is known as "Seed-Lac". When melted, strained through canvas, and spread out in thin layers, it is known as Shell-Lac. Shellac varies in color from dark amber to almost pure black, but is bleached by dissolving it in caustic potash and passing chlorine gas through it. This material is used in combination with copal varnishes, and from it is manufactured a very fast drying and durable material, used principally where quick results are desired.

Use of Shellac.—Owing to its peculiar nature of resisting oily materials, such as varnishes of all kinds, shellac is not a desirable material to use in combination with oil varnishes. A piece of finishing should be done either with shellac varnish exclusively, or oil varnish exclusively. Owing to their directly opposite natures, the two should never be mixed. For example: To finish a floor, say for instance, maple, if the work must be hurried through, by all means use a good quality of white shellac varnish. On darker woods use orange shellac varnish. If time can be spared, as it should be, owing to the far greater durability of oil finish for floors, use a floor finish of some reputable make, which has for its base linseed or Chinese Wood Oil. Shellac is also used in the manufacture of sealing waxes and cements. Shellac "sets" very quickly, and if a dark shellac is used, one must be very careful not to let the liquid lap by the strokes of the brush. When necessary to thin shellac, always use denatured alcohol.

Turpentine.—Turpentine comes from the swamp pines of North Carolina, Georgia and Alabama. What is known as Canada Balsam is also a turpentine. The last named material is of very heavy gravity—about the consistency of glucose—and is quite expensive and very little used in varnish making. Its principal use is for pharmaceutical purposes. Turpentine is separated from the resin by distillation, in combination with water solutions of alkaline carbonates. The water is removed further by distillation over calcium chloride. The specific gravity of turpentine is .865 as compared with water. It is the best solvent yet produced for gums except shellac gum as alcohol is used in dissolving the latter. It is used for a thinner of paints; as a solvent for oil soluble stains; with paste fillers as a medium for spreading the paste.

Varnishes.—In modern, progressive times, chemistry has entered extensively into the science and art of varnish making, in which industry gum copal, linseed oil, spirits of turpentine, naphtha and, in recent years, Chinese Wood and Soya Bean Oil, enter as the essential components of all varnishes, with the exception of those classed as “spirit varnishes”. The principal oxidizing agents used in producing the hard, quick drying properties in varnishes are the following: Oxide of manganese, borate of manganese, sulphate of manganese, red lead, litharge, sugar of lead and umber. In recent years, resinates of these materials, which have proved of great value to the varnish maker, have been placed upon the market. These materials are incorporated in the oil and, under continued, excessive heat, reaching as high as 600 degrees Fahrenheit, and continuing for a period of from six to ten hours, liberate their atoms of oxygen, which are completely taken up by the oil and which are then converted into what is known as drying or prepared oil, ready for use and amalgamation with the gums.

Rubbing Varnish.—Rubbing varnish should always be made of what is known as hard copal, such as Kauri, Zanzibar, North Coast or Benguela, and the foundation upon which it is laid must be good, hard-drying paste filler, or varnish that is absorbed by the pores of the wood, to make the surface for successive coats of the rubbing varnish. It is therefore very important that this foundation coat be thoroughly hard, or seasoned, before applying the first coat of varnish. If coats of rubbing varnish are applied prematurely, or over a soft foundation, there will be a tendency to sweat, or enamel, as it is sometimes called. The time required for the hardening of a rubbing varnish depends upon climatic conditions, temperature and the quantity of oil used, and varies from 7½, 10, and up to 15 gallons to the 100 pounds of gum, and depending on whether a quick, medium, or durable rubbing varnish is required.

Pitting of Varnish.—Pitting of varnish is due to moisture, the presence of albumen in the oil, too much drier in the oil, and too much body to the varnish when well spread.

Cracking or Checking.—Cracking of varnish is caused chiefly because the undercoat is not well seasoned or thoroughly hard. There is a tension underneath the top surface, or finishing coat, which the finishing coat cannot withstand. It is also caused by sudden changes of temperature, lack of oil, the presence of rosin, too much drier, or by the varnish as applied having too much body, or thickness.

Chilling of Varnish.—Chilling of varnish is principally due to its application to a cold surface, or in a room where the temperature is below 70 degrees Fahrenheit. To obtain the best results, varnish should be of the same temperature as the room in which it is used, and this temperature should never be under 70 degrees Fahrenheit.

Kauri Gum.—Kauri gum is the most important and most extensively used of any of the fossil gums. It is obtained from the Kauri tree which has its growth in New Zealand, in the northern island only. The Kauri tree attains a height of 160 feet and ranges from 5 to 12 feet in diameter. These trees are largely exported to Great Britain for use as ship masts. The exportation of the Kauri tree, together with that of the Kauri gum, forms one of the principal industries of New Zealand. About \$3,000,000 worth of Kauri gum is exported annually from that country. This material is dug from the ground at a depth varying from 6 to 18 inches, and is the product of an exudation from trees extinct for possibly a thousand years. The area over which the digging is conducted is perfectly barren. The supply of this gum is becoming more scarce each year.

Manilla Gum.—This gum, while not as hard as Kauri Gum, is used extensively because of the plentiful supply. In fact it is coming rapidly into favor for general use. The melting point is somewhat lower than Kauri Gum but a good varnish is made from it.

Zanzibar Copal.—Zanzibar Copal is the hardest and most expensive gum known to the varnish maker. This gum comes from the east coast of Africa, is fossil copal, and is found imbedded in the earth over a wide belt of the mainland coast, where not a tree is visible. It is dug from the ground at a depth of 4 feet and occurs in pieces varying in size from that of a small pebble to masses of several ounces, while pieces weighing from 4 to 5 pounds have been found. In this gum, perfectly preserved insects, such as flies, spiders, mosquitoes, and other forms of animal life, are sometimes found, though quite rarely. After freeing the gum from foreign matter, it is submitted to various chemical operations for the purpose of clearing the "goose-skin", the name given to the peculiar pitted-like surface of the fossil copal. This "goose-skin" effect is supposed to have been formed by the impression of the sand into which the resin fell in its soft, raw condition. The digging is conducted by the natives in a careless manner, owing to the fact that the work is done by untutored tribes. This makes the gum very difficult to obtain.

Many other gums are also used in making various varnishes such as Sierra Leone, Bengulla, Brazil, Accra, Congo, Kameron, Borneo, Singapore and Amber Colophony.

Damar Gum.—Damar gum comes from India and the islands of the East Indian Archipelago. It is the product of a huge pine tree which grows principally in Java, Sumatra and Borneo. This gum is very soft, has a very low melting point, and is readily soluble in turpentine, forming an almost colorless varnish. It is used principally in making white enamels and should not be used for any other purpose.

Filtering and Aging of Varnish.—The questions of the filtering and aging of varnish enter very seriously into the product of the varnish maker. When the varnish is being made, and while at a temperature of 300 degrees, it is passed through a filter press, under 90 lbs. pressure to the square inch, which forces the varnish through a series of 22 sheets of canvas duck of the thickness and texture of an ordinary sail, such as are used on vessels. Recent inventions have improved filtering devices. The most successful device now used is one which employs the principle of the cream separator. After passing through this process of filtration, the varnish is pumped into storage tanks and allowed to stand for at least six weeks before being offered to the trade, for the purpose of incorporating all of the various ingredients which enter into its formula. The highest grade varnishes, such as carriage, piano and railway varnishes, are aged six months before they are matured for use in these particular industries.

Uses of Varnish.—The varnish maker is called upon almost every day for some special varnish to meet the requirements of the almost numberless uses to which varnish is put. It is a fact well known that it is almost impossible nowadays to market any article manufactured by the carpenter or cabinet maker without calling upon the varnish maker for some particular finish or result necessary to be accomplished before the product is marketable. Some people have the erroneous impression that all varnish is drawn from the same tank. As a matter of fact, there are on file over 100 distinct standard samples of these products, which, in some cases, are sent out as made, and, in many other cases, are blended with other goods to meet the almost unlimited requirements and demands of twentieth century progress.

Wax.—Wax is a paste, based with Caranauba Wax and paraffin, and used in polishing. It should be put on either with a rag or a brush, and permitted to set until it becomes stiff and then polished by rubbing with rags or felt.

Application of Interior Finishes.—It is well to remember that a good finish over a poorly prepared piece of wood is next to impossible. The secret of wood finishing lies in getting the wood ready, as well as in the exercise of extreme care and patience which are necessary for the correct application of finishing material. The wood must be smooth, free from dust, and free from glue and water.

Natural Finish.—For a natural filler, paste or liquid filler should be used, depending on the grain of the wood, and should be applied carefully as described above in the section treating of fillers. Plenty of time should be given for the filler to dry thoroughly; the surface should then be sandpapered with 00 sandpaper, and two coats of white shellac, or more if necessary, should be applied, giving each coat plenty of time to dry. Each coat should be worked down with steel wool or sandpaper before applying another coat. Extreme care should be taken not to cut through to the bare wood with the steel wool, especially on colored pieces. After the last coat of white shellac is properly worked, the piece may be finished either with wax or with varnish. Two coats of wax, well rubbed, will produce a beautiful dull gloss; but the surface, to retain its lustre, should be rewaxed about every six months. Varnish may be applied similarly to shellac, but better results may be had by working it down with pumice and oil. Several coats of thin varnish, properly worked down, and with the final polish put on by rubbing with burnt flour, are required to obtain the looking glass polish.

Stains.—To stain wood properly, select any of the stains, as they are all put on in the same manner. Apply the stain to the wood with a brush and wipe to the desired shade with a rag, thus bringing out the grain of the wood. Follow this, after the stain is dry, with a filler, colored to match the stain, unless a liquid filler is used, in which case an orange shellac should be used. Permit this application to dry thoroughly and then sand lightly, being careful not to cut through the coloring. If desired, several thin coats of shellac may be applied, allowing each plenty of time to dry, and working each well before the next coat is put on. Shellac should never be applied in heavy coats. Always use shellac in very thin coats. It is advisable to use a good varnish wherever possible. The finish will last longer, hence it is more economical. A wax or varnish finish may be worked over this.

Order of Application.—The student will observe that the natural order of procedure in the finish room is as follows:

Color	{	natural.
		stained.
Filler	{	paste.
		liquid.
Body		shellac.
Finish	{	varnish.
		hard oil.
		wax.

THINGS TO REMEMBER.

That the wood must be in the best condition.

It takes time and patience to put on a good finish.

Wax should not be put on over a stain, as the solvent of the wax cuts the stain. Apply a light coat of shellac over the stain and then apply the wax.

The brush must be free from foreign material.

It is better to apply several thin coats of shellac or varnish than one thick coat.

Water is detrimental to any oil stain.

Glue will show through any stain.

Keep the piece worked upon in a warm place, free from dust.

When you are imitating woods with finishes, it is better to select a wood with a similar grain.

Never hurry the work. Give each coat plenty of time to dry, except the paste filler. This coat must be worked while it is soft as it sets very hard.

There are varnishes made for outside service.

For tables and chairs, use a varnish that sets hard and that will not show scratches easily.

Use only denatured alcohol to thin shellac.

Do not get shellac on the hands.

A varnish will not stick over a wax, but a wax will stick over a varnish.

Homemade stains are good, if mixed in a paste filler and applied as a filler.

When you are through, put away your stains, etc. Clean out the brush, and anchor it in a can of oil so that the weight of the brush will not be on the bristles.

CHAPTER XII

PERIOD FURNITURE

Furniture Types.—Within the scope of a single chapter it is impossible to go into detail regarding the development of the various types of furniture. A whole volume would not be sufficient to give a clear understanding of the subject since there are so many angles from which it may be viewed. Furniture making began simply to fill a need; yet along with the need came a disposition to regard it as an art. To find the reasons for the various types of furniture one must go to the history of the times in which the types were created. Various impulses led to the creation of these various types. One can readily see a reflection of the history of the period, suggestions of the social and economic conditions and everywhere evidence of the ability of the craftsmen who created the designs.

Egyptian.—Even in primitive times, furniture, though exceptionally crude, was used. Egypt has furnished many rare examples of her craftsmen's handiwork. The numerous excavations in that country have materially increased our knowledge of what the Egyptians really did. The artisans sought their inspirations for their designs from nature herself. Beauty was their goal. Vegetable forms were used as guiding impulses for exterior work while animal forms furnished the lines for household furniture. The claw foot, so frequently used on the legs of furniture, is a product of these times. Egyptian designs furnished the details for Greek and Roman furniture making while it was at its best.

Early European.—European styles prior to the thirteenth century furnished but little suggestion in the way of interior fittings. Every man's house at that age was a fortress. The chest, an absolute necessity, was the most valued piece of furniture, for it was the family's storehouse. Architecture flourished as an art before furniture

making. As a result, the first furniture designs harmonized distinctly with European buildings. For example, a back of a chair often took the design of a Gothic window.

Renaissance.—The renaissance brought with it new ideas in architecture and these were carried out in their furniture designs. The tables, cupboards, beds and chests were all treated more or less like miniature buildings. Consequently, the column and pilaster played important parts in furniture design. The fronts of presses and cupboards were treated as facades of palaces and temples. Both oak and walnut were used extensively because these woods, especially the latter, yielded, with beautiful effect, to the carver's chisel.

Lines and Harmony.—As previously stated, our chief interest in period furniture must necessarily lie in the study of lines and harmonies. In cabinet making it is not intended that one shall confine himself wholly to a type of fur-

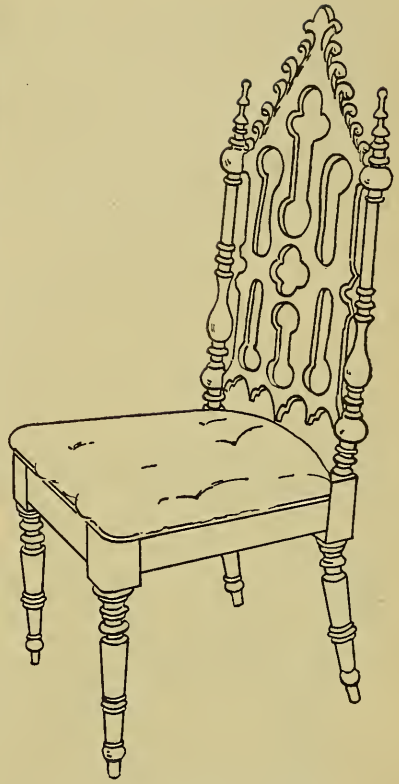

FIG. 272.—GOTHIC CHAIR.

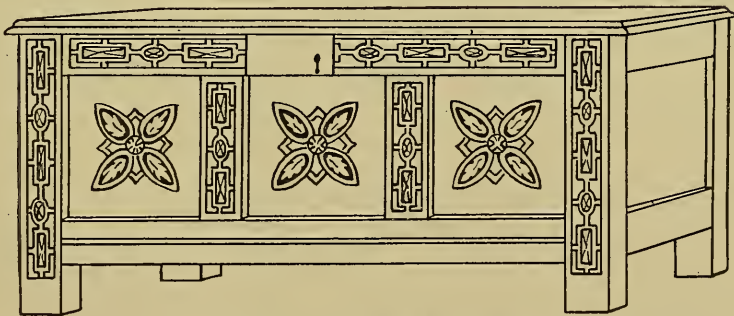

FIG. 273.—ELIZABETHAN CHEST,

niture which embraces nothing more than the work involving a series of joints. Pleasing lines, symmetry and decoration, are to receive proper attention with a view to embodying them in the projects created. It may not be possible or advisable to attempt to make an exact reproduction of a piece of period furniture but it is wisdom to reproduce as accurately as possible its characteristics so that the student also finds himself a real artisan rather than a shop worker only.

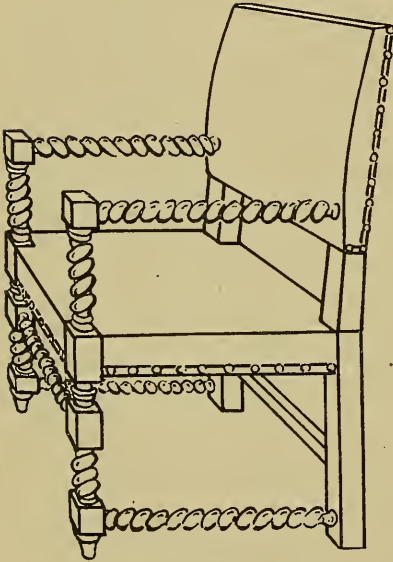

FIG. 274.—JACOBESAN CHAIR.

the course manners and the earnestness of the people. Straight lines predominated and the low forms were in keeping with the low-ceiled rooms. Heavy rails and posts were mortised and tenoned and frequently pinned together with wooden pins.

William and Mary.—The William and Mary period, 1688 to 1702, was of short duration. With the accession of these rulers in England we can see a marked increase in popular appreciation of refinement and simplicity. The queen had excellent judgment in mat-

Jacobean.—By the very nature of the furniture of the earlier times, reproduction is inadvisable. With the year 1603 begins a period where there is a type of furniture making, distinctly different from the preceding periods, which have now become obsolete. We refer to the Jacobean period which dates from 1603 to 1688. The furniture was stout, clumsy and severe in form, even though there was considerable ornament. It matched

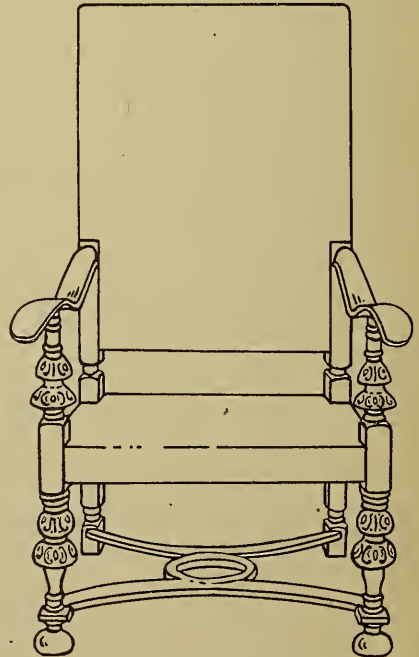

FIG. 275.—WILLIAM AND MARY CHAIR.

ters of furniture and decoration and her taste, through its influence in court circles, had great weight in determining styles for the whole kingdom. The contour of William and Mary furniture was distinctly different from any which preceded it. The curvilinear element came into play for the first time. Legs had inverted cup or spindle turnings. Stretchers between the legs were common. Seats of chairs were nearly square with a slight narrowing to the back. Backs were high and usually straight across. All cabinet work of the period was simple. There were no shaped fronts to complicate the joinery. Legs were always braced by stretchers so that the whole was quite substantial,

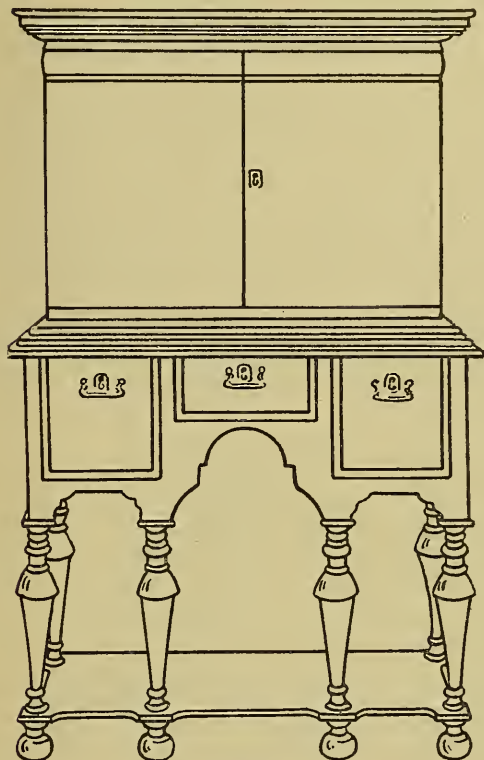

FIG. 276.—WILLIAM AND MARY CABINET.

Queen Anne.—With the reign of Queen Anne we pass to a period entirely different from the preceding ones. People seemed to have been possessed with a certain sturdy, wide-awake spirit. Modern England was begun. The modern spirit asserted itself especially in the evident desire and determination to improve conditions of domestic comfort. The change was noticeable in the houses of people of all classes. This demand for comforts and conveniences meant that chair and cabinet-makers were called upon, not alone

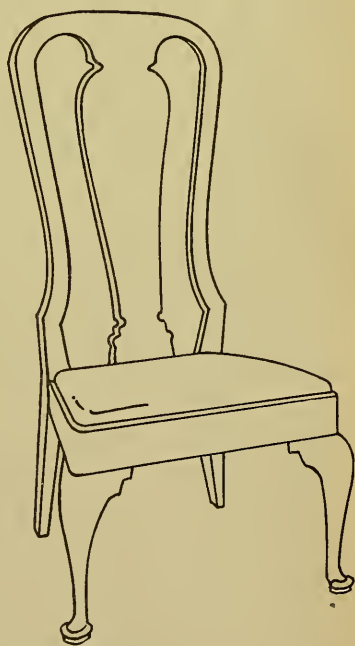

FIG. 277.—QUEEN ANNE CHAIR.

for increased production, but for changes in models and styles. The constructive features of the furniture are easy to see. The perpendicular legs with inverted cup-turnings were replaced with the cabriole leg and shaped stretchers went out of fashion. The typical Queen Anne chair is a strongly characteristic piece of furniture. The uprights of the back, a few inches above the seat, break at a sharp angle and curve inward only to swell again in a graceful curve at the top which goes over in a bow and joins without break of line to the other upright. A similar curve forms the leg. Stools were in popular use. They followed styles prevalent in chairs but they were often fitted with loose cushions.

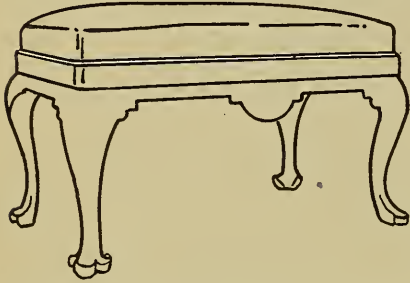

FIG. 278.—STOOL—PERIOD OF QUEEN ANNE.

Louis XIV, XV, XVI.—England was never able to escape the French influence in her furniture designs. At times the workmen copied very little, at other times they were carried away by French influence. To copy French types is impossible; they are too ornate. But since some of the period types so clearly reflect the political, social and economic history of France, they deserve at least brief mention. The reigns of the three Louis'—XIV, XV, XVI—produced furniture which, while possessing certain common characteristics, showed marked differences. When Louis XIV came to the throne he burst forth into extravagances which have never been equalled. His ministers supplied him with enormous sums and the greatest artists and craftsmen France produced put forth their best efforts to follow his plans. The workshops were in the Louvre and they not only supplied that structure

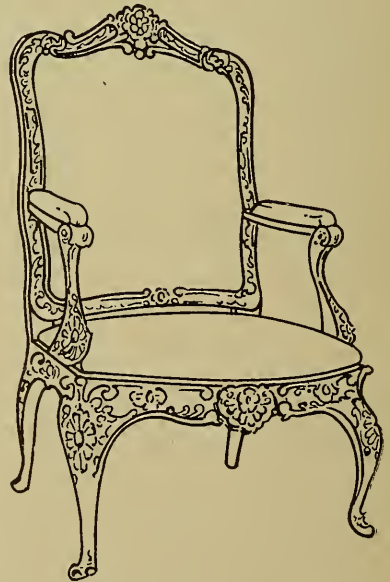

FIG. 279.—LOUIS XV CHAIR.

with furniture but the many other court buildings as well. Louis' idea of pomp was reflected in the lines of all this cabinet work. Lines were perpendicular or horizontal, giving a sternness and a touch of severity.

At Louis' death we find that his successor was able to put his personality into the furniture created in his reign. Every one quit the straight line. The ideal form of beauty was the female figure and its curves and lines were the ones used. There was an abundance of carving and little of the work gives one the idea of great stability. In the reign of Louis XVI the cabinet work had less decoration. Both the king and queen were cultured, enjoying simple pleasures and the quiet of home life. All this was reflected in the furnishings which adorned their palace and which were taken as types for the furniture of other homes.

Chippendale.—Previous to the time of Thomas Chippendale, furniture styles took the names of the historical periods in which they were created. The personality of the cabinet-maker was lost to view. Chippendale attached his name to the furniture he made. He was able to do this, for he was a business man as well as a cabinet-maker. He knew the art of advertising as it was then practiced and he made his workshop a meeting place for the folk for whom he worked. Moreover, he was the first one to publish a reliable book of furniture designs. From this time, it was the fashion for the best cabinet-makers to prepare books of designs, wherein they were sure to call attention to the styles which they themselves created. Chippendale did not create so many designs—he took existing styles and adapted them to his own tastes. In all of his furniture we note an advance in general shapeliness and grace of proportion. He used mahogany and since it was stronger, tougher and more elastic than the native woods, a heavy framework was unnecessary. His chairs were fitted with fretted backs often filled with Gothic designs. The top was usually square. Seats were of the square type with slight taper

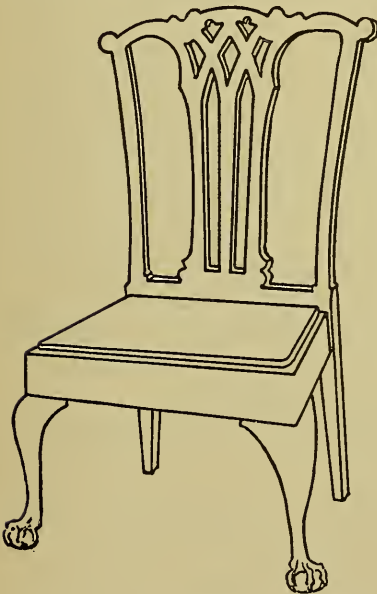

FIG. 280.—A CHIPPENDALE CHAIR.

toward the back. He rarely missed an opportunity to plan some ornamentation of which the letter C was a part. Many pieces of Chippendale furniture are in excellent condition today for he did his work so well. His joinery was without a fault and he knew exactly where to make the strongest parts so that the strains would be overcome.

The Brothers Adam.—The Brothers Adam were architects and designers and not makers of furniture. They created the designs; others did the work. Not content with prevailing styles they sought the classic types, chiefly Italian, and made these the framework of their own designs. Their success was largely due to their close attention to details. The

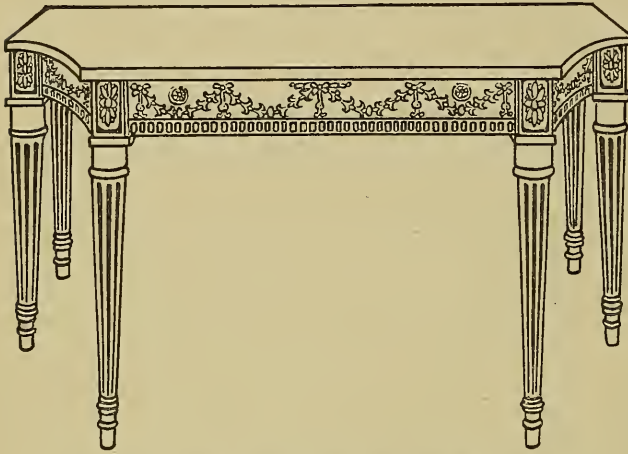

FIG. 281.—RANGE TABLE—BROTHERS ADAM.

The same care was given to the pattern of a chair that was used in the creation of the plans for a palace. Their influence was evident, for of all the leading cabinet makers who were their contemporaries, Chippendale was the only one who did not yield to their influence. The

Adam style was indeed new. Curving structural lines were practically dropped and a form almost angular came into use. All the furniture was lighter and more graceful in character. A vase or urn often adorned a piece of cabinet work. The typical Adam table was rectangular, semi-circular or semi-oval. Legs were either square or round and were fluted. The under framing was straight and decorated with swags or drops.

Hepplewhite.—There was no Hepplewhite period, for Hepplewhite lived and worked while Chippendale and the Brothers Adam were doing their work. It is possible, however, to characterize a style which was distinctly Hepplewhite's creation. While he copied from other designs he did add touches which gave them a distinct individuality. Frequently the Brothers Adam turned designs to him which, from a structural point of

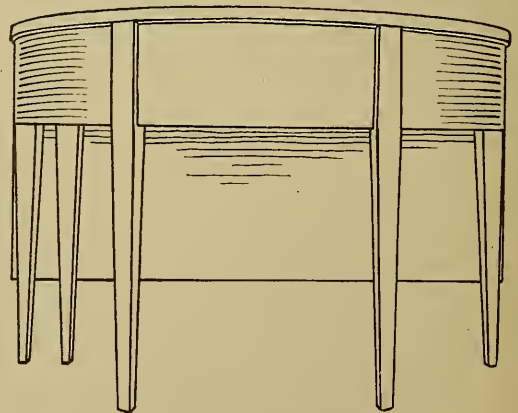

FIG. 282.—HEPPLEWHITE TABLE.

view, were not perfect. Hepplewhite made the needed changes, often adding something of his own: The whole Hepplewhite influence was for grace, lightness and beauty of contour. Partly because of his own personality, partly because of the influence of the Brothers Adam, the use of the straight line predominated. There were numerous curved drawers, but the top and bottom lines of the piece were horizontally straight and their side lines were vertically straight, so that all the curving had to be done in one direction. In his chairs, Hepplewhite was original in his patterns. The legs were square, tapered, and either flat or grooved. Seats were square. The backs took a variety of shapes, but the shield back was the most common form. Hepplewhite is credited with having used a great variety of woods in the construction of his furniture, being inclined to employ lighter and more common ones than his predecessors.

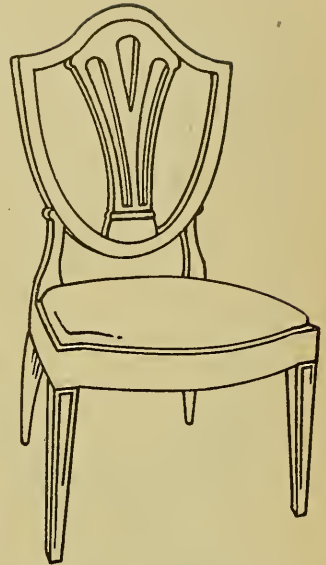

FIG. 283.—HEPPLEWHITE CHAIR.

Sheraton.—To speak of a “Sheraton Period” would be as incorrect as to speak of a “Hepplewhite Period,” for while Sheraton was putting forth his designs, the designs of Hepplewhite and the Brothers Adam were also occupying attention. However, at the very end of the eighteenth century there were a few years in which we must regard Sheraton’s as the influence which determined the style of English and American furniture. He was the champion of the straight line in furniture making. His chair designs are excellent examples, nearly all of which were made with rectangular backs. When not using vertical or horizontal lines, he employed diagonal lines with good effect. Legs were either square and tapered or were round turned and fluted. In all we note an excellent proportion. For decoration, Sheraton made

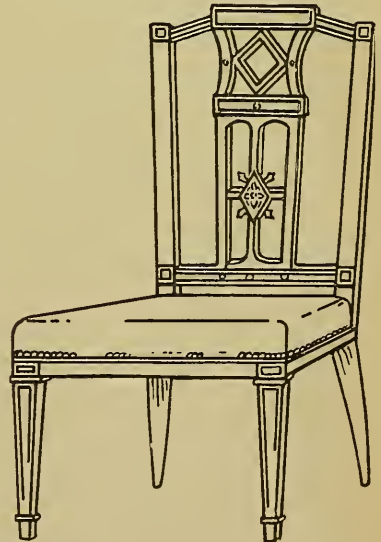

FIG. 284.—SHERATON CHAIR.

use of inlay and veneer. In one field he was distinctly a pioneer. Partly through taste, partly because of a demand, he gave considerable time to the creation of mechanical devices which made possible the building of combination pieces of furniture. Folding beds and couches, and washstands that might be converted into book cases were held in high esteem, and were eagerly sought for.

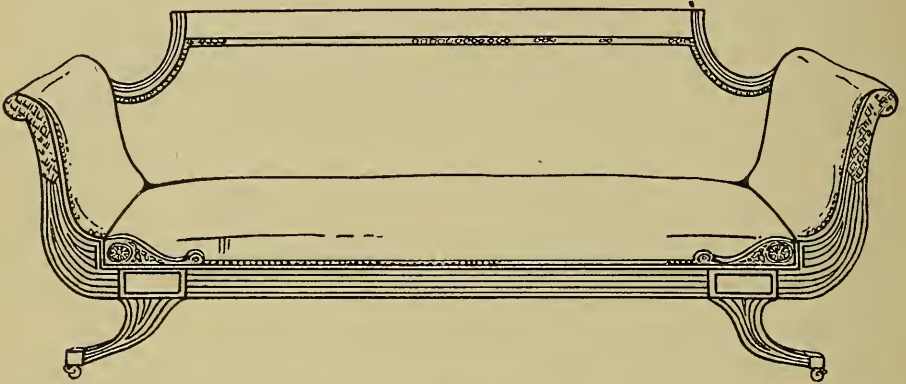

FIG. 285.—EMPIRE COUCH.

The Empire Period.—Again we must turn to France for the source of inspiration for designers and cabinet makers. Wholly unlike the style of the Louis', the French styles of this period were created, not because of social or economic conditions nor because of the individuality of the French cabinet makers, but they were determined by the Emperor. Napoleon saw the political necessity of creating a new style of national art and of furniture. He put the matter in the hands of the great French artists. In their work they were inspired by the pompous military spirit of the times, and seeking to achieve the heroic, they sometimes utterly failed to produce anything artistic. Nearly all of the furniture was heavily built, being often adorned with mouldings of meaningless patterns. While there was variety in the work produced, the sofas and couches were among the best pieces of furniture. There was variety of shape, but the lines of the backs were usually straight. Frequently the arms ended in a scroll and the legs turned outward. Decoration on the various pieces of furniture included carving, turning, veneering and painting. Despite the lack of dignity, grace and refinement in this furniture the glamour of the French court and the military spirit caused the English to lay aside their own designs and to imitate these. Sheraton once deplored the fact that no matter how artistic a piece of furniture might be, it received no consideration after the French influence began to be visible. Through an admiration

for all things French, the American people, at the beginning of the nineteenth century, adopted French modes in dress, manners and styles in furniture making. However, in the adoption of styles of furniture, Americans made distinct modifications to suit their own tastes.

Mission Craft.—Mission craft is a modification of furniture forms which in early times were used in the missions of the West and Southwest. Mission furniture was extremely heavy, being built on straight lines and without ornament. For years it was used without modification in California, being selected to harmonize with the bungalow type of house. At length, however, mission furniture was found to be impractical. It was entirely too heavy for the housewife to move, so a modification—mission craft—came into vogue. This held to the same structural lines, but the weight was considerably lessened. For years this type has been most popular in manual training shops. The lines are plain, the joinery is simple and there is an absence of ornament. Besides, there is little finish required, as it is desirable to finish the project in the natural color of the wood.

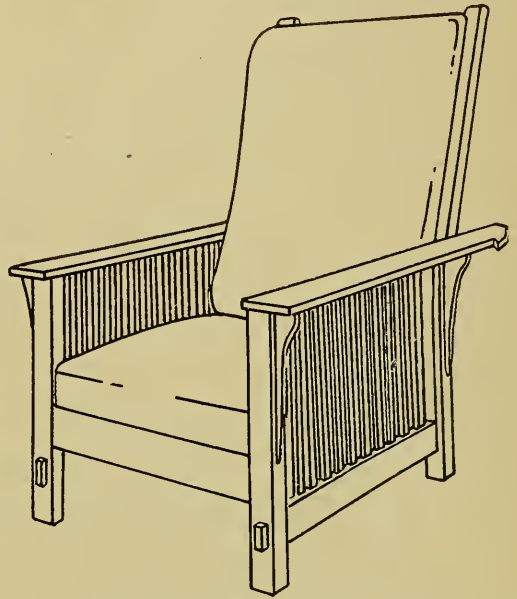

FIG. 286.—MISSION CRAFT CHAIR

PART IV

QUESTIONS, PROBLEMS, GLOSSARY

CHAPTER I

QUESTIONS

General Tools.

What tools do you consider necessary for a tool kit?

How must a plane be adjusted to enlarge its throat?

Name two kinds of chisels. How should chisels and plane irons be sharpened?

What is a T-bevel and how should it be used?

What are the essential features of a work bench? How should a bench be constructed?

Where do we get our standards of measurements? On what tools are the graduations stamped, and for what purposes are these tools used?

Name the different kinds of clamps and give their uses.

Saws.

Name the different kinds of saws, giving their uses. Tell how to joint, set and sharpen a cross-cut saw. How are saws made?

Describe a saw set, giving the principles of operation.

What are the real differences between a rip- and a cross-cut saw?

Bits.

Name the different kinds of bits, giving the construction of each.

Describe the cutting action of an auger bit. Of a gimlet bit.

How are the sizes of augers and gimlets designated?

What are the essential parts of the head of an auger bit? In what shapes are the shanks made?

Bit Braces.

Name the different parts of a carpenter's bit brace, giving their functions.

Name the different modes of driving bits.

Files.

For what purpose is a file made?

What is meant by the cut of a file? Name the cuts.

How are files classified according to kind?

By what is the length of a file determined?

Abrasives.

What is an abrasive?

What purpose does water serve in grinding tools?

Why are artificial stones so popular in factories?

How are artificial stones made?

Sandpaper.

How is sandpaper made?

What is the real difference between flint and garnet paper?

Of what importance is glue in the making of sandpaper?

Name the kinds of paper used in the production of sand paper.

When and how should sandpaper be used?

Brushes.

What materials are necessary for brush construction?

Where do the best bristles come from?

How are chisel brushes made? Dusters?

Woods.

How are the trees prepared for the sawmill?

What work is done in the sawmill?

Discriminate between timber, planks and boards.

How is lumber seasoned? How does this effect the wood?

What causes the wood to warp? What boards will warp the most?

What is a preservative and how is it applied?

Define plain, bastard and quartered wood. How are these cuts secured?

What is meant by "grain"?

How is lumber bought and sold?

What is a board foot?

Name five woods, giving uses for which they are well adapted. Why?

Wood Finishes.

What is the purpose of wood finishing?

What is white lead and how is it made?

Discuss linseed oil, turpentine and colors.

How are paints made?

What is a stain? Fumed wood?

Of what materials are varnishes made? Where do the gums come from?

Name two fillers and tell how they are applied.

What is shellac? Wax?

Why do we thin shellac with denatured alcohol?

Fastening Devices.

- Name the fastening devices.
 Why should a nail be driven at an angle?
 How should a screw be driven into hard wood?
 How are the sizes of nails determined? Of screws? Of corrugated steel fasteners?
 What advantage has a wire nail over a cut nail?
 How is glue made? How is hot glue prepared?
 Define toe-nailing.

Joinery, Cabinet-Making and Carpentry.

- What is a joint?
 How should joints be constructed?
 Define box-joints, surface-joints, framing-joints.
 What is meant by stress of timber?
 Name the four main divisions of cabinet pieces. Define assembling, anchoring the top, and panel effects.
 Name the parts of a door.
 What are glue blocks and how are they used?
 What are plans and specifications and how are they related?
 Name three distinct types of furniture.
 What caused radical changes in the forms of chairs, tables, etc.?
 How are mouldings made? How used?
 What is the difference between a bead and moulding?
 Name the timbers necessary for raising the frame of a house.
 How does a T-sill differ from a box-sill?
 Name two kinds of siding and tell how each is put on.
 What is meant by well-hole, tread, riser, skirting board, newel post and landing?
 Name the timbers necessary to raise a hip roof.
 Name the parts of a cornice. Of a window frame.
 How should wood be squared? Why?
 How should a shallow mortise be cut? A deep mortise?
 What should be the cutting action of a chisel across the end grain?
 What is a bevel? A chamfer? How should they be laid out?
 Name the different tools used for measuring.

Drawing.

- Name five lines used in mechanical drawing.
 How are the elevations and plans developed?
 Why is it necessary to have more than one view?

Machinery.

- Name the most important woodworking machinery.
 Describe the cutting action of saws. Of surfacers.

CHAPTER II

PROBLEMS

The rule for finding board measure is found in Chapter IX, Part III.

The following problems are merely suggestions of what is possible in this line for manual training shops. We would recommend that every exercise made in the shop be put in the form of a problem to determine the value of the material used.

1. How many board feet in a piece of lumber 1 inch thick, 10 inches wide and 8 feet long?

2. How many board feet in a piece of lumber $1\frac{3}{4}$ inches thick, 16 inches wide, and 14 feet long?

3. How many board feet in 23 pieces of lumber $\frac{3}{4}$ inch thick, $9\frac{3}{8}$ inches wide, and $12\frac{1}{2}$ feet long?

4. Find the total number of board feet in the following: 6— $\frac{1}{6}$ —12 (meaning 6 boards 1 inch thick, 6 inches wide, and 12 feet long).

10— $\frac{1}{8}$ —16.

4— $\frac{1}{2}$ / $\frac{10}{10}$ —14.

13— $\frac{2}{4}$ —18.

2— $1\frac{1}{2}$ / $\frac{12}{10}$ —10.

5. How many board feet in a piece 14 feet long, $9\frac{1}{4}$ inches wide, and $1\frac{3}{8}$ inches thick?

6. How many board feet will it take to construct a platform 15 feet wide and 24 feet long, if the stock is $1\frac{1}{2}$ inches thick and there is a waste of 7 board feet in squaring up the ends?

7. If a piece of lumber is $\frac{3}{4}$ inch thick, 12 inches wide at one end and 8 inches on the other, and 16 feet long, how many board feet does it contain?

8. A timber 8 inches thick, 10 inches wide, and 12 feet long, contains how many board feet?

9. How many board feet are there in five pieces of $1\frac{1}{4}$ -inch lumber whose widths are 6, $7\frac{3}{4}$, 9, $9\frac{1}{4}$, and 12 inches, respectively, and 14 feet long?

10. Find the number of board feet in a stack of lumber that is 8 feet, 6 inches wide, 11 feet, 3 inches high, and 16 feet long; the boards being 1 inch in thickness.

11. A wagon box whose inside measure is 3 feet, 3 inches wide, 26 inches high, and 12 feet long, contains how many board feet, if the boards are $\frac{1}{2}$ inch thick?

12. Inclose a 24-foot square with stock 1 inch by 8 inches by 16 feet. The inclosure is 4 feet, 8 inches high and has uprights, 2x4's placed every 6 feet with corners doubled. How many board feet does it contain?

13. At \$28.00 per M, how much will it cost for lumber for the inclosure in problem No. 12?

14. Find the surface of an enclosed manual training bench whose frame is 22 inches wide, 4 feet long, and 30 inches high; whose top is 2 inches by 2 feet, by 5 feet, 4 inches long.

15. At 14 cents per board foot for quartered white oak, how much will the following bill of material for a taboret cost?

1-----top -----	1"x18" x18"
4-----legs -----	2"x 2" x24"
4-----rails-----	1"x 2 $\frac{1}{2}$ "x14"
4-----rails-----	1"x 1 $\frac{1}{2}$ "x14"

16. What is the diagonal of a 12-inch square?

17. Find the diagonal of a rectangular piece of wood 8 inches by 12 inches by 18 inches.

18. How many lineal feet of $\frac{1}{2}$ inch by $\frac{1}{2}$ inch stock may be cut from a $\frac{1}{2}$ -inch by 12 inch by 12-foot board allowing $\frac{1}{16}$ inch saw kerf?

19. Find the largest square timber that can be cut from a 17-inch log.

All floor and ceiling lumber must be matched, that is, by tongue-and-groove joint. This matching causes waste and must therefore be considered in making the lumber bill. In general practice, it is customary to add one-fourth to the bill in flooring and ceiling that runs in widths from $2\frac{1}{2}$ inches to $5\frac{1}{2}$ inches. If more than one-fourth is added for waste, it will be so designated in the following problems:

20. At \$60.00 per M, how much will it cost for lumber to floor a room 24 feet 0 inches by 16 feet 6 inches?

21. Find the cost of flooring and wainscoting a house 328 feet 0 inches by 28 feet 0 inches. The house is divided into four equal sized rooms. The wainscoting is to be 4 feet, 0 inches high, and capped with a flat mould. The cost of flooring is \$72.00 per M, of wainscoting, \$46.00 per M, and the moulding \$2.65 per hundred lineal feet. Inside partitions to be 6 inches thick.

22. How many feet of cypress will it take to build a circular silo with a 6-foot radius and 26 feet high? The stock is $1\frac{1}{2}$ inches thick. Add 5 per cent for waste in cutting flooring and one-fourth for matching.

23. At \$38.50 per M, how much will it cost for the ceiling of a porch that is 9 feet wide and 31 feet, 6 inches long and whose rise is 4 feet?

24. A man wishes to lay a 4-foot board walk outside a city block that is 300 feet square. He uses 2-inch by 6-inch for the walk and 2 inch by 4 inch for the supports of which there are three to each board. Each board is fastened down with six 20d spikes. (Thirty spikes in a pound, at $3\frac{1}{2}$ cents per pound.) How much will it cost to lay this sidewalk at \$38.00 per M, allowing \$42.35 for labor?

25. How many board feet of solid sheathing is necessary to cover a gable end roof, if the spread of the rafters at the base is 28 feet and the pitch of the roof is $5/12$? Length of the ridge is 36 feet. $5/12$ pitch means that the roof rises $5/12$ the span of the base of the rafters.

26. How many bundles of 250 shingles each, will it take to shingle the foregoing roof?

27. How many cubic feet in a foundation wall 9 inches thick, 36 inches high and enclosing a rectangular building site 24 feet by 36 feet?

28. How many board feet necessary for 7-inch risers and 11-inch treads of a stairway built between floors 8 feet, 9 inches apart? The stairway is to be 40 inches wide.

29. If the rise of the stair horses is 9 feet, 4 inches and the risers are 7 inches and the treads are 11 inches, find the run of the stair horses.

30. If it costs 10 cents a cubic foot to complete a house, what will a building 28 feet wide, 36 feet long, 12 feet to the eaves, and a gable end roof that rises 12 feet above the eaves cost?

31. A house is 24 feet square and has two cross partitions at right angles to each other and both are one foot from the centre of the building. How many yards of plaster are necessary to cover the walls and ceiling in all four rooms? Let the ceiling be 8 feet high.

32. A gallon of paint covers 700 square feet. How much paint will it take to cover the walls of a barn 20 feet wide, 30 feet long and 16 feet high? Figure the gable ends triangular shape 20 feet wide and 8 feet high.

33. What safe load (tension strain) will a half-lap joint made of 4-inch by 4-inch white pine, carry?

34. How long will a roll of screening be that will screen three openings on a porch, using screening that is 42 inches wide? Openings, 36 inches by 8 feet, 36 inches by 12 feet and 36 inches by 6 feet. Count fractions of strips as whole strips.

35. A cylinder 2 inches by 6 inches is to be covered with veneer. Find the measurements of the veneer necessary to cover the cylinder.

36. A grindstone 6 inches in diameter makes 274 revolutions per minute. How far will a point on the circumference travel in a half hour?

37. A band saw has wheels 36 inches in diameter and 4 feet, 6 inches from centre to centre. How long a band saw blade is necessary to run over these wheels?

38. The cross-section of an oil can is a semi-circle. Its radius is 2 inches. How much oil will it hold?

39. A planer head rotates at a speed of 5,000 revolutions per minute. The head is directly connected with a 4-inch pulley, which in turn is driven by a 12-inch motor pulley. How many revolutions per minute does the motor make?

CHAPTER III

GLOSSARY OF TECHNICAL TERMS.

- Abrasive*—Medium by which material may be smoothed and reduced by friction.
- Adjustable Throat*—The opening through a plane which may be so regulated as to admit any sized shaving.
- Alignment*—True to a line.
- Ammonia (spirits of hartshorn)*—A pungent volatile gas used in fuming wood.
- Anchoring the Top*—Fastening; attaching to the rails.
- Annular*—Ring shaped.
- Arbors*—Spindles upon which cutters, stones and saws are mounted.
- Artificial Stones*—Manufactured stones, such as carborundum.
- Automatic*—Mechanically operated.
- Back Saw*—Small rigid bench saw, with heavy, reinforced back.
- Band Twisting*—To twist a flat bar; method of making bits.
- Bast*—A layer of wood.
- Beads*—Trimmings on boards to hide joints.
- Bench Dog*—Mechanical device, attached rigidly to bench, and used to butt stock against.
- Bench Hook*—Device used at the bench to hold small pieces of wood while sawing.
- Bevel*—A tool used to establish angles.
- Bevel Gears*—Gears which run at angles to each other.
- Blue Prints*—Usually working drawings; plans for construction, so developed as to expose white lines on a blue background.
- Bolster*—Seat for a chisel handle; part of a tang chisel.
- Boss*—A form.
- Brace Jaw*—Part of a brace chuck that holds a bit.
- Breast Drill*—A small portable drill.
- Bristles*—Hair from a hog's back.
- Burnisher*—A tool used for sharpening cabinet scrapers.
- Burr*—Metal, projecting from an edge.
- Cambium Layer*—The growing part of a stem of a plant.
- Carborundum*—An artificial stone used as an abrasive.
- Carter Process*—Quick process for forming white lead.
- Caul*—An opposite; used in gluing veneer on curved work.
- Celluloid*—Imitation ivory.
- Centrifugal*—Proceeding from the center.
- Chamfering*—The act of reducing stock to the plane of two edges on adjoining sides.
- Charcoal*—Charred wood.
- Charring*—Burning; scorching wood.
- Checking of Wood*—Cracks caused by shrinkage.

- Chisels*—Tools for paring or forming wood.
- Chucks*—Devices used for holding objects.
- Clamps*—Holding devices.
- Cleat*—A strip of wood used to stiffen a surface.
- Clinch*—To make firm; to hold; to bend a spent nail.
- Column*—A support.
- Coned*—Having been formed to each cross section at right angles to the axis, is a circle, and the longitudinal section at the center is a triangle.
- Compass*—Tool used in drawing circles.
- Compass Saw*—Saw used in sawing curves.
- Core Box*—Form for inner part.
- Cored*—Built up with parts hidden.
- Cornice*—Trim for overhang for roof of a house.
- Corrugated*—Bent into a series of alternate parallel ridges and grooves.
- Corundum*—Artificial stone.
- Countersink*—To ream a hole to receive the head of a screw.
- Cranked Handle*—Mechanical device for turning an object.
- Creosote*—A wood preservative.
- Cripple Rafter*—Timber forming part of a roof; a rafter with no bearing on the plate.
- Cross-Cut Saw*—One for sawing across the grain of the wood.
- Cross Feed*—Automatic regulation for advancing the cutting tool to and from the work.
- Cut of Files*—Character of files; relative comparison of their cutting ability.
- Cutting Efficiency*—Degree of ability to cut.
- Cylinder*—A geometrical figure whose transverse section is circular, and which does not change its diameter throughout its length.
- Disc*—Thin objects, circular in form.
- Double Cut*—Pertaining to a class of files.
- Dovetail*—Method of joining wood.
- Dowel*—A guide for bringing pieces of wood together.
- Dowel Plate*—A tool used in making dowels.
- Draw Bolt*—A bolt used in building heavy wooden frames.
- Drawing the Temper*—Reducing the toughness of steel by the use of heat.
- Driving Mechanism*—Medium by which energy may be transmitted
- Driving Home*—Forcing an object into the position intended for it.
- Emery*—A mineral used in the manufacturing of abrasives.
- Essex Board Measure*—Means for the rapid calculation of board feet.
- Exterior Finish, Paints, Etc.*—Media suitable for the preservation and decoration of wood.
- Felling Timber*—Cutting down trees.
- Felloes*—Parts forming the rim of a wheel.
- Ferrule*—Metal collar; used as a clamp for wood.
- Filler*—Chemical compound used in wood finishing.
- Fleam*—Side bevel of a saw tooth.
- Forged*—Formed while hot by hammering.
- Foundation Frame*—Part of the building resting on the foundation.

- Frame of the House*—Structure composed of dimension stock.
- Fourdrinier*—A machine used in making paper.
- Fuming*—Aging wood by the use of chemicals.
- Garnet paper*—A paper similar to sand paper; made of garnet.
- Gasoline*—A bi-product of crude oil.
- Gauge*—A measure.
- Gearing*—A means of transmitting energy by the use of cogged wheels.
- Gimlet*—A small bit for piercing wood.
- Glued*—Having been put together with an adhesive medium.
- Gouges*—Tools used in the forming of wood.
- Grain*—Direction of fiber.
- Hacksaw*—A saw used for cutting metal.
- Handsaw*—Term usually applied to all saws for wood, that are to be operated by hand.
- Helical Groove*—A groove generated with a constant lead around a cylinder.
- Hip Rafter*—Timber forming the conjunction of two sides of a roof—if no T or L is built at that point.
- Inset*—To set in.
- Interior Finish*—Stains, fillers, varnishes, etc., suitable for the preservation and decoration of the wood on the inside of a house.
- Joiner*—One who does interior woodwork.
- Jointer*—A machine for straightening the edges of boards.
- Joints*—The part or place where two or more pieces are joined or united.
- Kiln-drying*—Artificial method of drying wood.
- Kinds of Files*—Referring to the shape of the cross-section of the file.
- Kinks*—Short cuts to getting results.
- Lagscrews*—Large wood screws, driven with a wrench, and used in anchoring machines.
- Lathe*—A machine used in turning concave, convex, and cylindrical objects.
- Lips*—(Auger) Chisel-like blades which lift the shavings out of the hole being bored.
- Live Center*—Part of the equipment of a wood lathe that drives the wood.
- Master-keyed*—Controlled by one key.
- Meshes*—Openings formed by crossing strings or wires.
- Miter*—Cut at 45 degrees.
- Mood*—A form.
- Mortise*—A recess cut to receive a tenon.
- Motor Drive*—Method of transmitting energy.
- Moulding*—Specially formed wood for decorative purposes.
- Nibs*—(Bit)—Knife-like structures which sever the fiber of the wood.
- Nut Shanks*—Shanks of bits designed to be used with large wooden handles.
- Offset*—To set over.
- Opposite*—Form used in clamping veneer.
- Overhead Shafting*—A medium by which energy may be distributed.
- Paints*—Opaque finish; medium or pigment used to preserve or decorate.
- Panels*—Screens; parts of furniture, on stairways.

- Paraffin*—A biproduct of crude oil
Parallel—Objects spaced equally apart.
Periphery—Circumference.
Pitch—Degree of incline.
Plans and Specifications—Working drawings and details for the construction of buildings, etc.
Protractor—Instrument for establishing degrees.
Quadrant—Quarter of a circle.
Rafter—Part of the frame of a roof.
Rails—Stretchers connecting supporting timbers.
Rectangular—With all angles right angles.
Renaissance—Revival of learning.
Resin—A vegetable secretion.
Revolution—Complete turn around a fixed point.
Rigid—Made firm.
Ripping—Severing with the fiber.
Ripsaw—A saw designed to saw with the grain.
Rise and Run—Terms used in carpentry to indicate the degree of incline.
Rotate—To swing any number of degrees with a fixed point as center.
Sandpaper—Flint coated paper used in smoothing wood and wood finishes.
Sanding—Act of applying sandpaper.
Sapwood—Outer layer of wood of a tree.
Scale—Proportion.
Scraper Plane—Tool used in smoothing rough surfaces by scraping.
Seasoning of Lumber—Drying.
Set Screws—Screws serving as clamps in holding one piece to another.
Shearing Motion—Cutting action.
Smithing a Saw—Hammering a saw.
Snapping Lines—Establishing lines by the use of a line (cord) and chalk.
Specifications—Description of plans.
Spindle—Arbor.
Spoke Shave—A form of the plane used for special work.
Spur of the Bit—That part which leads the bit into the wood.
Stains—Transparent coloring.
Stair Threads—The parts of a stairway built to walk on.
Steel Wool—Steel shavings used to work down finish.
Strata—Layers; usually layers of stone.
Stress—Ability of material to withstand strain; applied pressure or pull.
Strips—Narrow pieces of wood and metal.
Tang—Part of a chisel.
Tempered—Toughened.
Tenon—A tongue cut to fit a mortise.
Threaded Sleeve—Part of a brace chuck.
Thumb Screw—Set screw driven by use of the thumb.
Tilting Table—Table which may be tipped at an angle.
Toenail—Fastening two pieces together with nails by driving them in at an angle.

Trestle—A support; saw horse.

Trestle Clamps—Clamps fastened to a trestle.

Try Square—Tool for testing squareness.

Turnery—Pertaining to the turning of wood.

Turpentine—An oil solvent.

Universal Saw Table—A saw table with many possibilities.

Upholstery—The art of applying cushions, trimmings and hangings.

Valley Rafter—Part of the frame of a roof.

Vanadium—A quality of steel.

Veneers—Thin layers usually of wood.

Vise—A holding device.

Warping—Bending, caused by unequal shrinking.

Waterjacket—An outer case of a glue pot.

Whetting—Removing metal by friction on stone.

Wing Dividers—A tool used to draw arcs and to transpose measurements.

Wood Finishing—The act of preserving and decorating wood.

Worm and Gear—Means of transmitting energy.

INDEX

Abrasives	125	Brads	114
Accidents and treatment	46	Brazil gum	171
Accra	171	Breast drills	120
Adam Brothers, furniture	180	Bridging	79
Aging varnish	171	Bridle joints	57
Air seasoning	138	Bristles	160
Amber Colophony	171	Brothers Adam furniture	180
Artificial stones	126	Brushes	159
Artists' brushes	160	Burnisher	17
Ash tree	143	Burns	47
Atkins saws	106	Butcher saws	105
Auger bits	121	Butt joints	52, 54
Awl	14		
		Cabinet scraper	17
Backsaw	15	Cabinet scraper sharpening	32
Bald cypress	155	Carborundum	127
Band saw	41, 105	Carpenters' pincers	24
Band twisting	121	Carpentry	75
Base	85	Carter Process	164
Base mouldings	90	Casing nails	113
Basswood	147	C-Clamps	27
Batting	67	Cedar tree	149
Beads	89	Charring	140
Beams	78	Chestnut tree	145
Bench dog	8	Chilling of varnish	170
Bench equipment	7	Chinese Wood Oil	165
Bench hook	8	Chippendale furniture	179
Bench plane	17	Chisels	20
Bench stop	7	Chisel blades	20
Bench tools	5	Chisel handles	20
Bench types	8	Chisel sharpening	31
Bengulla	171	Chuck of brace	119
Beveled halving joints	55	Chute board	38
Beveling	21	Circular saws	105
Birch	158	Clamps	27
Bird's-Eye Maple	144	Cleating	69
Bird's mouth joint	57	Cogged joints	55
Bits	121	Colors	165
Bit braces	119	Comb-boards	83
Black Walnut	148	Common nails	113
Blind mortise and tenon joints	55	Compass	12
Block plane	17	Compass saw	104
Blue prints	3	Compressional stress	59
Board feet	141	Computation of stress	60
Board measure	97, 141	Congo gum	171
Boring tools	121	Copal	170
Borneo gum	171	Coping saws	105
Boxing	81	Core stock	91
Box joints	52	Cornering tool	18
Brace and bits, use	29	Corner strips	84
Brace measure	99	Cornice	81
Braces	119	Corrugated steel fasteners	116

Corundum	127	Fractures	46
Cost accounting	73	Framing joints	54
Counter sink	124	French furniture leg	63
Cracking of varnish	169	Fuming	166
Creosote	140	Furniture	61, 174
Cripple rafter	103	Furniture legs	62
Cross-lap joints	55	Furniture tops	67, 70
Crown moulding	89		
Curly maple	144	Gable roof	81
Cut nails	114	Gambrel roof	81
Cylinder paper	128	Garnet paper	129
Cylinder saws	106	Gauge	11
Cypress	155	Gauge sinks	124
		Gauges of nails	114
Dado joints	53	Gimlet bit	124
Damar gum	171	Gimlets, measurement	122
Depth gauge	29	Glossary	194
Disston saws	106	Glue	117, 128
Door frames	83	Glue joints	118
Double mortise and tenon joints	56	Gouge sharpening	32
Douglas fir	157	Grain	140
Dovetail dado joints	53	Grinder	43
Dowel bit	122	Grinding saw	107
Doweled mortise and tenon joints	55	Grindstones	125
Dowel plate	38	Grounds	84
Dowel sharpeners	124	Guards	44
Draw bolt joints	55	Gum	149
Drawer fronts	67		
Drawing board	8	Hacksaws	105
Drawing lines	4	Half blind dovetail joints	54
Draw knife	18	Halving joints	21
Drills	120, 121	Hammers	23
Dusters	160	Hand planer and jointer	42
Dutch Process	163	Hand rails	87
		Hand screws	27
Edge-to-edge joints	58	Harmonies	175
Egyptian type furniture	174	Hepplewhite furniture	180
Elevation	3	Hickory	146
Elm tree	145	Hip rafters	101
Emery	126	Hip roof	81
Empire Period furniture	182	Hollow augers	124
Essex board measure	97	Hopper butt joints	53
European furniture	174	Housed brace joints	57
Expansion bit	123	House foundation	76
Extension bit	122	House frame	78
		House planning	75
Files	131		
File brush	133	Improvised clamps	27
File card	133	Individual equipment	5
File cleaners	133	Injuries	46
Fillers	167	Intermediate mouldings	89
Filtering varnish	171	Irwin bit	123
Finishers	172		
Finish nails	114	Jack rafter	103
Fir	157	Jacobean furniture	176
Floor	85	Jambs	84
Floor lining	79	Joinery	51
Ford bit	123	Joints	51
Fore auger	124	Joists	78
Fostner bit	123		
Fourdrinier paper	128	Kameron gum	171
Fox-tail tenon joints	56	Kauri gum	170

Keyed mortise and tenon joints	56	Plane iron sharpening	31
Kiln drying	138	Planer and jointer	42
Knife sharpening	32	Plates	78
Lag screws	116	Pliers	44
Lap-dovetail joints	55	Polygon cuts	98
Lathes	42	Porches	88
Ledged miter joints	54	Problems	190
Level	12	Project	33
Linear measure	10	Quarter-sawing	141
Lines	4	Queen Anne furniture	177
Linseed oil	164	Questions	187
Longleaf pine	152	Rabbet joints	53
Louis period furniture	178	Rack construction	33
Machine equipment	5	Rafters	82, 101
Machine tools	44	Rafter cutting	99
Machinery	40	Rafter pitches	102
Mallets	23	Rails	63
Manilla gum	170	Rasps	131
Maple	144	Ratchet	29, 120
Marking gauge	11	Reamer	124
Measures	10	Reciprocating drill	120
Measuring tools	11	Red Cedar	149
Metric standard	10	Red Gum	149
Mission craft furniture	183	Redwood	150
Mission style legs	62	Renaissance furniture	174
Miter and butt joints	54	Ripsaw	14
Miter box	106	Risers	87
Mortises	23	Roofs	81
Mortise and tenon joint	55	Roof framing	99
Mortise and tenon joints with relish	56	Round nose mouldings	89
Mouldings	89	Rubbing varnish	169
Multiple dovetail joints	54	Rule	11
Nails	113	Russell Jennings bit	123
Nail sets	24	Safe guards	44
Newel posts	87	Sandpaper	128
Nibs	122	Saw bench	40
Oak	147	Saw parts	107
Oblique mortise and tenon joints	57	Saws	14, 104
Octagon scale	98	Saw sets	112
Ogee mouldings	89	Scaffolding	88
Oiler	44	Scalds	47
Oil stones	126	Scale	3
Open mortise and tenon joints	56	Scarf joints	57
Painting	165	Scorer	133
Panels	62, 65	Screw drivers	25
Period furniture	174	Screw driver bit	124
Picket point	36	Screws	105
Pigments	163	Scroll saws	104
Pincers	24	Shanks	122
Pine	152	Sharpening saws	109
Pitch	86, 100	Sharpening tools	21, 29
Pitches of rafters	102	Sheathing	82
Pitting of varnish	169	Shellac	167
Plain butt joints	52	Sheraton furniture	181
Plain dado joints	54	Shingling	82
Plain miter joints	58	Ship auger	122
Plane	16	Shop equipment	5
		Shortleaf pine	152
		Siding	84

Sierra Leone -----	171	Trimmer -----	43
Sills -----	78	Truing -----	125
Singapore gum -----	171	Trussed mortise and tenon joints---	56
Single dovetail joints-----	57	Try square -----	11
Sloyd knife -----	14	T-square -----	8
Smithing saws -----	107	Tulip tree -----	142
Snapping lines -----	88	Turpentine -----	168
Snips -----	44		
Socket firmer chisel-----	20	Units of measure-----	10
Solid center bit-----	123		
Spindles -----	87	Valley rafters -----	102
Splice joints -----	57	Vanadium saws -----	107
Splined miter joints-----	58	Varnishes -----	169
Spoke pointer -----	124	Veneer -----	91
Spoke shave -----	18	Veneer designs -----	92
Sprains -----	47	Vises -----	7, 25
Spruce -----	156		
Spur -----	122	Walnut -----	148
Square -----	11, 97	Water seasoning -----	138
Squaring stock -----	18	Wax -----	171
Stains -----	166, 172	Web saws -----	104
Stairs -----	85	Wedged mortise and tenon joints---	56
Standard yard -----	.10	Well hole -----	83
Steel square -----	11, 97	White ash -----	143
Steel wool -----	130	White lead -----	163
Stretcher joints -----	58	White oak -----	147
Stress -----	59	White pine -----	152
Studs -----	79	William and Mary furniture-----	176
Sugar maple -----	144	Window frames -----	83
Surfacer -----	41	Wing divider -----	12
Surfacing -----	70	Wood -----	135
Surface joints -----	58	Wood finishing -----	163
		Woodworking machinery -----	40
T-Bevel -----	12	Work bench -----	6
Tacks -----	116	Working drawings -----	3
Tang -----	133	Working stress -----	60
Tang chisel -----	20	Wounds -----	46
Tensional stress -----	59	Wrenches -----	44
Thrust joints -----	57	Wrought nails -----	114
Tool grinder -----	43		
Tool sharpening -----	29	Yellow poplar -----	142
Tools -----	5	Zanzibar copal -----	170
Transverse stress -----	59		
Triangles -----	8		

LIBRARY OF CONGRESS



0 013 974 078 6

