

STANDARD AMERICAN PLUMBING

Hot Air,
Hot Water Heating,
Steam and
Gas Fitting

BY
The World's Greatest Authorities
MESSRS. CLOW & DONALDSON



ILLUSTRATED



Class TH6123

Book C4

Copyright N^o 1914

COPYRIGHT DEPOSIT.

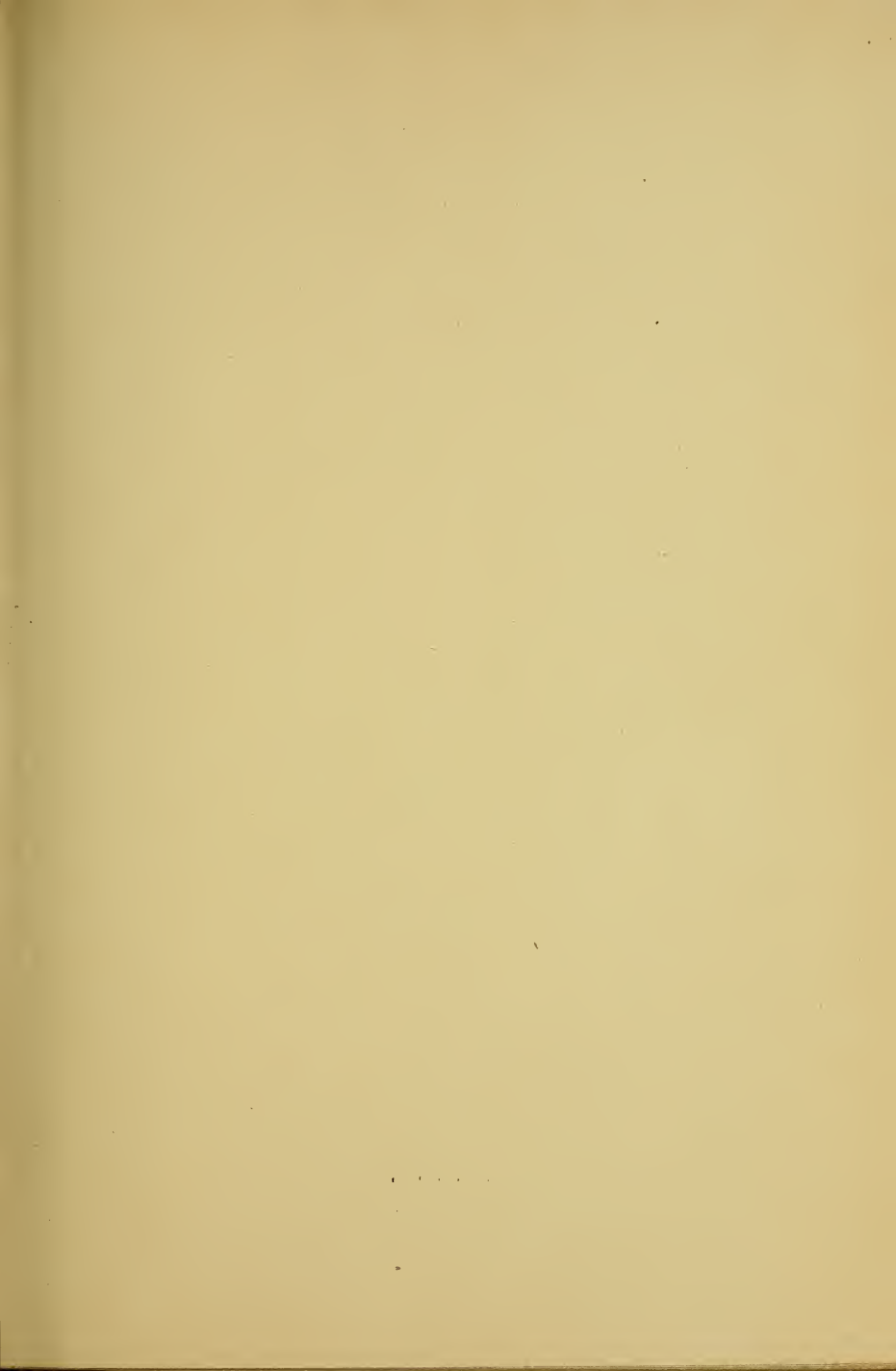



STANDARD AMERICAN PLUMBING HOT AIR AND HOT WATER HEATING STEAM AND GAS FITTING

Among the subjects this valuable book treats of are Sanitary Plumbing, covering details regarding the installation of hot and cold water drainage systems.

MODERN HOT WATER, HOT AIR AND STEAM HEATING

Heating systems, steam boilers, piping system, radiators, hot water heating, estimating, piping and fittings.

STEAM AND GAS FITTING.
WORKING DRAWINGS.

FULLY ILLUSTRATED

^B BY ^{Wilson} CLOW AND DONALDSON

SPECIAL EXCLUSIVE EDITION

PRINTED BY

FREDERICK J. DRAKE & CO.

EXPRESSLY FOR

SEARS, ROEBUCK & COMPANY
CHICAGO, ILL.

1914

TH6123
C7
1914

Copyright 1911
BY
FREDERICK J. DRAKE

Copyright 1914
BY
FREDERICK J. DRAKE & CO.

AUG 31 1914

14-15398

8300

©CIA380296

no1

PREFACE.

This book is a practical up-to-date work on Sanitary Plumbing, comprising useful information on the wiping and soldering of lead pipe joints and the installation of hot and cold water and drainage systems into modern residences. Including the gravity-tank supply and cylinder and tank system of water heating and the pressure-cylinder system of water heating. Connections for bath tub. Connections for water closet. Connections for laundry tubs. Connections for wash-bowl or lavatory. A modern bathroom. Bath tubs. Lavatories. Closets. Urinals. Laundry tubs. Shower bath. Toilet room in office building. Sinks. Faucets. Bibb-cocks. Soil-pipe fittings. Drainage fittings. Plumber's tool kit, etc., etc.

THE AUTHOR.

Preface to 1914 Edition

The chief object aimed at in this edition of Practical Up-to-Date Plumbing has been to eliminate from the former edition all matter not strictly up to date; retaining only that which conforms with modern methods of plumbing and sanitary laws. At the same time, a large amount of new matter has been added, owing to the fact that rules and regulations relating to plumbing and the disposal of sewage are constantly undergoing changes, and new and improved apparatus is being made use of. These conditions make it necessary that the plumber or plumbing contractor who desires to be successful in his calling should keep thoroughly posted, not only on standard rules and methods, but also on all modern requirements and regulations.

These, together with descriptions and illustrations of the latest improved apparatus for handling sewage, are presented in this edition.

A full and complete discussion of correct methods of installing the plumbing in buildings of various types, from the modest two story and basement cottage to the modern skyscraper, is given. The subject of joints and joint-wiping receives special attention, as does also sanitary plumbing, hot and cold water supply, etc. Modern methods of thawing frozen water-pipes by means of electric current are described.

HOUSE DRAINAGE.

The fact that plumbing during the past ten years has reached a most remarkable stage of development in the construction of improved systems of sewerage, house drains, ventilation and fixtures, is due to several causes.

In the first place, the manufacturers of plumbing supplies in their pursuit of commercial supremacy have employed a number of sanitary engineers, who by experimenting and investigation, have perfected systems and fixtures which are a preventative against the dangers of sewer gas and their subsequent results, such as typhoid, scarlet fever, dysentery, etc., coming as they frequently do from no apparent cause, as far as modern science will permit.

Secondly, good and safe plumbing has ceased to be a luxury. Its protection against the above mentioned diseases, and its safeguard to good health, have made it a necessity. Heretofore many earnest, well-meaning persons, not appreciating the importance of correct drainage and plumbing, were inclined to sacrifice this vital factor in their buildings, and even to-day the remark of some builder is often heard, to the effect that the balance of the house has cost so much more

than was originally intended, that no more money than is absolutely necessary can be expended for the plumbing. The knowledge and skill which is employed for the construction of the rest of the house, should be as carefully applied to the sewer, ventilation, bath and toilet rooms, and their fittings.

Modern knowledge has taken the place of ignorance and neglect, and the fixtures and systems, which were thought good enough ten years ago, are to-day branded as old, on account of their not being a proper safeguard against disease. Every builder should weigh these facts well, and make himself familiar with the dangers arising from putting in a poor system, as even the smallest leak will cause sickness and often death.

The first subject to be taken up in the plumbing line, is the house drain, which are the pipes which carry from the house the liquid and soil refuse. The accumulated waste from food, clothing and bathing, tends to decay, and must be removed promptly and properly, or disease will result. The sewer which conveys the matter from the dwelling, must be absolutely perfect. In all cases, the sewer pipe within the foundation wall, should be extra heavy cast-iron pipe, coated inside and out with hot asphaltum, and should run through the foundation wall, and the connection should be made to the vitrified sewer at least ten feet outside of the building wall. The connection be-

tween the iron and vitrified soil pipe should be carefully made at X and cemented tight with a good grade of Portland cement. A good idea is to incase the connection at X in a block of concrete, which will prevent the breaking of the joint at this point.

In the drawing Fig. 1 an installation is shown which is commonly used by a great many plumb-

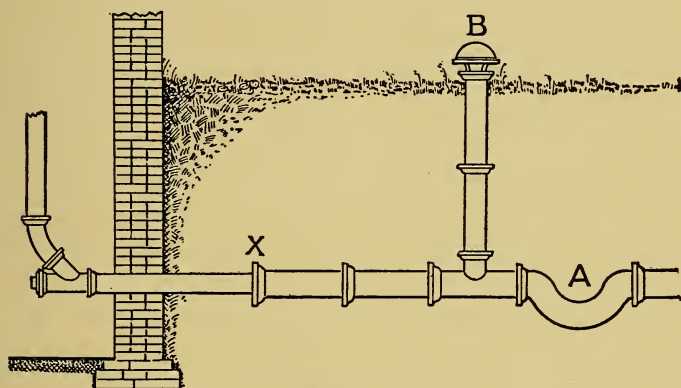

Fig. 1.

ers, but which has many disadvantages. The trap at A, which is placed in the connecting sewer, to prevent the ingress of foul gases from the main sewer, is in a poor location, on account of its inaccessibility. The vent opening to the fresh-air inlet at B ventilates the house system of drain pipes. This vent is often placed between the sidewalk and the curb, or in the front yard. The vent bonnet is very liable to become loose or

broken, which will permit of dirt, stones, and sticks falling into the opening so left, and choke the sewer, which necessitates digging down to the bottom to clean it out. Another objection to placing a vent in a position such as shown, is that grass and other vegetation is liable to grow up around and into it, thereby destroying its efficiency. When a main disconnecting trap must be located outside of the building and underground, there should be built a brick manhole around it for easy access. The manhole for this purpose, should be two feet and five inches in diameter at the base, and closed on the top with a limestone cover, three inches in thickness, with an eighteen-inch diameter round cast-iron lid, which should have a one-inch bearing on the stone all around.

The drainage system illustrated in Fig. 2 is a very excellent one for a residence. The fittings as shown are standard stock articles, and consequently reduce the cost to a minimum. In the ordinary residence, a four-inch pipe is sufficiently large enough to carry away all of the sewerage. A drainage pipe must not be so large, that the ordinary flow of water will fail to float and carry away the refuse which ordinarily accompanies water. The pipe should be laid to grade, or a fall of one foot in forty feet. Care should be exercised to allow a large enough opening in the wall where the pipes pass through it, and espe-

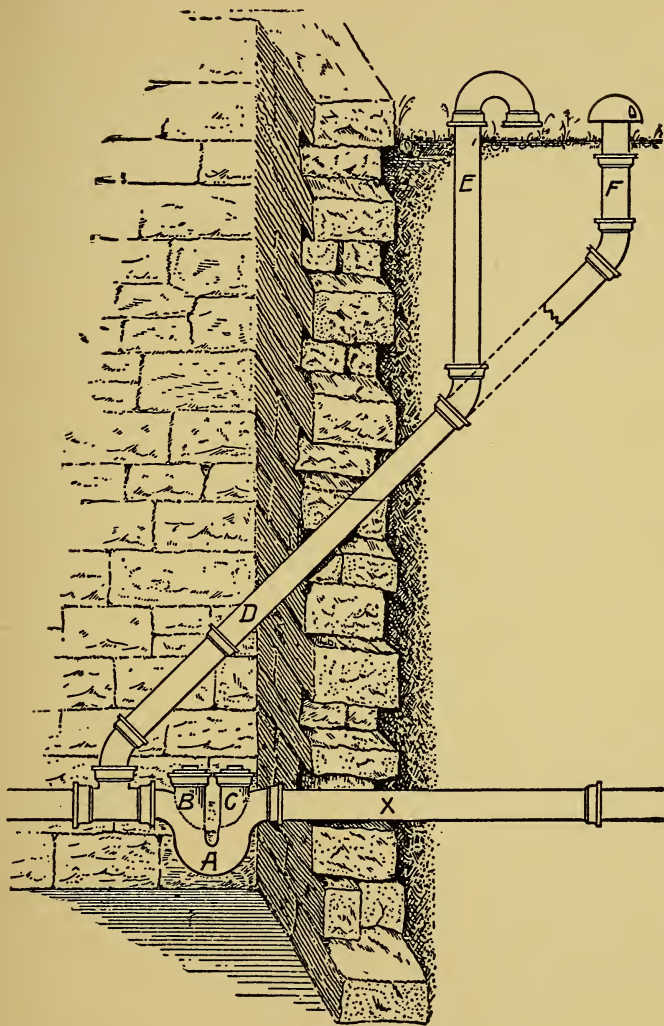

Fig. 2.

cially over them, to allow for setting of the wall without touching the pipes.

Extra heavy cast iron soil pipe, not less than four inches in diameter, coated inside and out with hot asphaltum, should be used in all cases for house drainage.

At A is shown a double-vent opening running trap. By calking a four-inch brass ferrule, with a brass-trap screw ferrule, into the hub at C, an opening which gives free access to the drainage system on the sewer end is obtained. Care should be taken in making this joint, and a good grade of spun oakum should be packed around the ferrule, with an iron yarning tool. The hub should then be run full at one pouring with soft molten lead, and then thoroughly calked with a blunt calking iron, which will make an absolutely air-tight joint. The trap-screw cover should be screwed tightly into the ferrule with a good pliable gasket. It is very necessary that this joint be hermetically sealed, as the pipe X will constantly be loaded with sewer-gas from the main sewer, and any defective work at this joint will allow the gas to escape into the basement. The vent opening at B is to be treated in the same manner, giving an opening which permits easy access to the trap.

The air vent pipe D is run at an angle of forty-five degrees, and the extension E, which is run to the surface in this particular instance, is run

close to the foundation wall, and the elbow calked on the top of the pipe, which prevents a possibility of any sticks, stones or other debris getting into same and retarding a thorough circulation. In order to have this drainage system properly vented, the fresh-air inlet pipe should be the same size as the drain pipe. Where it is impractical or impossible to run this fresh-air vent up close to the foundation wall and turn it over as shown, it can be run as shown by F, and when placed in the yard the inlet pipe can be capped with a regular air vent-cap fitting. Care should be taken in placing this fresh-air inlet, so that the chances of having it knocked off and broken will be as small as possible.

The extension piece in all cases should be long enough to permit of the opening in the vent-cap being, at least, eight inches above the ground. In the drawing the sewer or drain pipe is shown above the floor. In cases of this kind rests or supports should be provided at an interval of five feet, or in other words at every joint, to prevent the same from sagging and probably breaking the joints. When placed underground the top of openings B and C should be on a level with the flooring. In case of a shallow sewer in the street, the piping can be suspended from the ceiling, with a good heavy hanger supported by a joist clamp or swivel joint, which will permit the

hanger being shortened or lengthened after the pipe has been hung.

Connection to Main Sewer. The method of making this connection is generally regulated by local conditions, and the rules and regulations established by ordinance of the town or city in which the work is to be done. The connection of the house sewer to the main or street sewer should, if possible, always be made with a Y, or if there is no Y connection on the main available, then the house sewer should be laid in such a manner that it will strike the main sewer at an angle to the direction of flow of sewage in the main sewer. This will greatly facilitate the flow of sewage from house sewer into main sewer. The house sewer pipe should have an upward incline of $\frac{1}{4}$ inch per foot as it extends from the street main toward the building, and it should terminate at a point not less than 5 feet from the outside of the foundation walls, where connection is to be made with the cast iron soil pipe extending into the building.

Size of House Sewers. The size of the sewer leading from the building to the street main is governed by the quantity of sewage to be disposed of. In large installations it often becomes necessary to use more than one. Care should be taken, however, not to install too large a sewer, nor to give the same too much pitch or incline toward the street. There are two reasons for this: (1) If the sewer is too large it will not be flushed as it should be, since the water passing through it will reach only part way up its sides, thus allowing the floating matter to adhere to the sides, the result of which will sooner or later be an accumulation that will cause a stoppage of flow.

(2) If the sewer has too much pitch the water will rush through it so rapidly that the solid matter will be left behind and very likely be deposited on the bottom and sides of the pipe, thus forming an obstruction to the discharge of matter which follows.

The basic principle controlling the successful disposal of sewage through pipes is flotation; that is, the velocity of flow of the water should be such that the solid matter will be floated along with the water. It has been found by experiment, and also by practice, that an average velocity of 276 feet per minute will carry all matter from the sewer. In estimating the required size of sewer from house to street main a good rule to follow is to have the sewer pipe one size larger than the soil pipe.

Table 1 will facilitate calculations for fall required of various sized sewers in order to give the velocity of flow required to remove all matter from the pipes.

Size of Sewer	Fall, or Pitch Required	Velocity of Flow
2 inch	1 foot in 20 feet	276 feet per minute
3 "	1 " " 30 "	276 " " "
4 "	1 " " 40 "	276 " " "
5 "	1 " " 50 "	276 " " "
6 "	1 " " 60 "	276 " " "
7 "	1 " " 70 "	276 " " "
8 "	1 " " 80 "	276 " " "
9 "	1 " " 90 "	276 " " "
10 "	1 " " 100 "	276 " " "

TABLE 1.

FALL PER FOOT FOR VARIOUS SIZED SEWERS AND HORIZONTAL SOIL PIPES.

Rain Leaders. All down spouts, or rain water pipes leading to, and connected with the house sewer should be equipped with traps at their base. The required size for house drains for carrying away rain water is given in Table 2, the values given therein being based upon an average rainfall.

Size of Pipe	One-fourth Inch Fall Per Foot	One-half Inch Fall Per Foot
5 inch	3,700 sq. ft. of roof area	5,500 sq. ft. of roof area
6 "	5,000 " " " " "	7,500 " " " " "
7 "	6,900 " " " " "	10,000 " " " " "
8 "	11,600 " " " " "	15,600 " " " " "
9 "	11,600 " " " " "	17,400 " " " " "

TABLE 2.

SIZES OF HOUSE DRAINS TO CARRY RAIN WATER.

CAPACITY OF DRAIN PIPE UNDER DIFFERENT AMOUNTS
OF FALL.

Gallons per Minute.

Size of Pipe.	1-2 inch fall per 100 feet.	3 inch fall per 100 feet.	6 inch fall per 100 feet.	9 inch fall per 100 feet.
3 In.	21	30	42	52
4 "	36	52	76	92
6 "	84	120	169	206
9 "	232	330	470	570
12 "	470	680	960	1160
15 "	830	1180	1680	2040
18 "	1300	1850	2630	3200
20 "	1760	2450	3450	4180

Size of Pipe.	12 inch fall per 100 feet.	18 inch fall per 100 feet.	24 inch fall per 100 feet.	36 inch fall per 100 feet.
3 In.	60	74	85	104
4 "	108	132	148	184
6 "	240	294	338	414
9 "	660	810	930	1140
12 "	1360	1670	1920	2350
15 "	2370	2920	3340	4100
18 "	3740	4600	5270	6470
20 "	4860	5980	6850	8410

TABLE 3

CELLAR OR BASEMENT DRAINS.

Floor drains, when used in cellar or basement, should be connected to the leader side of a rain leader trap wherever it is possible. Some sanitary engineers go so far as to say that floor drains should never be used, their objection to them being that the floor is not washed often enough to furnish sufficient water to maintain a water seal at all times against sewer gas ingress, and their argument is well taken, but floor drains in a basement are very convenient, and should be part of a well-installed sanitary sewer system.

In case of a seepage of water through the foundation walls, during a rainy period, it is well to be provided with some means to carry the water away quickly, without having to resort to the laborious practice of pumping.

The evils of a floor drain are not so much due to their inefficiency, as they are to the care taken of them. The cemented floor basement of the modern home today is just as important to be kept clean as the bathroom, and the thorough housekeeper takes just as much pride in it, and realizes the necessity for having it so from a sanitary standpoint.

The old method of installing a floor drain or

floor outlet which consisted of placing a running trap in the line of drain pipe to the catch-basin, and running a piece of pipe to the floor level and simply closing the opening with a bar strainer grate is wrong. The grate, even when cemented into the hub end of the pipe, will in time become loosened, and dirt and other rubbish will soon clog up the trap and render it useless.

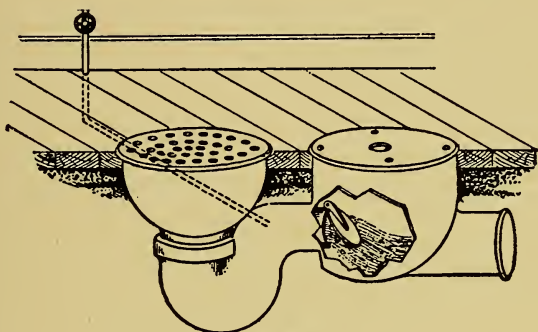

Fig. 3.

As before said, the great objection to a basement floor drain in the ordinary house, is that there is seldom sufficient water used on the basement floor, to maintain a perfect water seal in the trap. To neglect to see that the floor drain trap is not always filled with water and to argue against its installation on that point is wrong.

Floor drains should never be used without a back-water valve, which will prevent sewer water from backing up into the basement. A number

of different styles of floor drains are shown, which are built on the proper lines. The one shown in Fig. 3 is a combination floor drain and back-water gate valve. This accessible cleanout cellar drain flushing cesspool and back-water gate trap valve combination has much to be commended. It has a hinged strainer, through which seeping and floor waste water finds a direct outlet to the trap and sewer. The trap has a deep water seal, which is always desirable, and is always provided with a brass back-water gate valve or flap-valve which will not rust and which will close and hold tight against a back flow from the sewer. It also has a tapped opening to which a water supply pipe can be attached, and by means of a valve being placed on the pipe at some convenient point, the drain trap can be thoroughly flushed and cleansed by simply opening the valve for a few minutes at a time.

Another method oftentimes used to provide for a floor outlet to sewer is to run a piece of iron soil pipe from the trap on the sewer to the floor level, and to caulk into the hub of the pipe a brass ferrule or thimble with a brass screwed cover, which is screwed down tight against a rubber gasket, as shown in Fig. 4. An outlet of this character is only opened when occasion demands, by unscrewing and removing the cover until its need is past.

In Fig. 5 is shown an extra heavy cesspool suitable for barns, carriage room and places of

CELLAR OR BASEMENT DRAINS

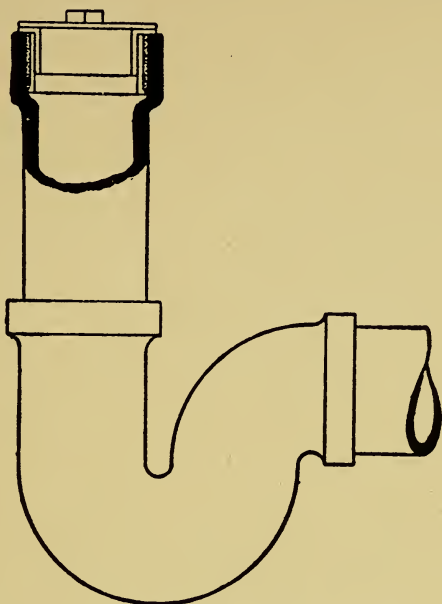

Fig. 4 .

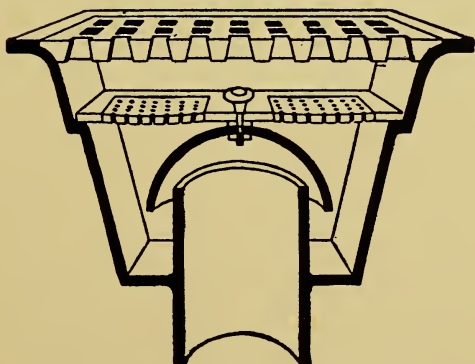

Fig. 5 .

like nature. The top is sixteen inches square, the body ten inches deep and has a four-inch outlet, suitable for caulking into the hub of a four-inch iron sewer pipe. The top cover or grating is heavy enough to permit of horses, wagons and carriages passing over it. The second grating or strainer is of finer mesh, which catches any obstacles which might clog up the sewer, it can be lifted out by the knob and easily cleaned at any time. The deep water seal in this trap is one of its good features, the bell or hood not only serves to maintain a water seal, but where used in stables is a shield over the outlet to prevent oats or grain of any description which might fall through the second strainer from getting into the sewer.

Care should be taken to prevent the bottom of the cesspool from filling up with fine strainings.

Fig. 6 is a combination floor strainer and back-water seal and is used in the hub of a sewer pipe which extends down to the trap placed in the sewer run. The rubber ball prevents the flooding of the basement from backing up of water, by being floated to seat above.

In Fig. 7 is shown a floor drain and trap, designed especially for hospital operating rooms and other places where it is desirable not only to cleanse thoroughly the floor, but also to remove all sediment from the trap itself for obvious sanitary reasons. The trap is of cast iron, and is enamelled inside. This gives it an impervious

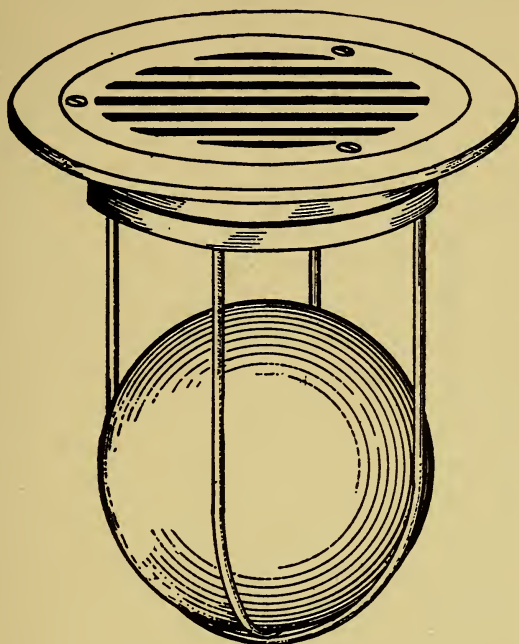

Fig. 6.

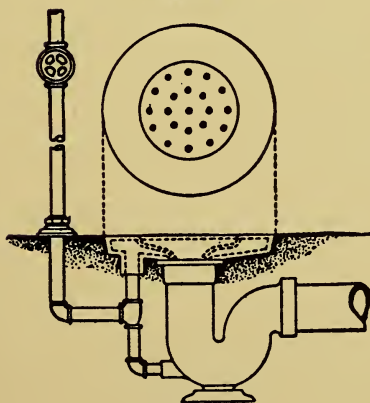

Fig. 7.

and smooth surface and prevents the trap from becoming coated and slimy. This trap is provided with heavy brass cast flushing rim and has a brass removable strainer.

In the sectional view is shown the method by which the water supply is connected to both the rim and trap, by means of which not only every portion of the body may be cleansed, but also all sediment removed from the jet inlet at the bottom.

The trap is built especially to maintain a deep seal and is three inches in diameter.

The roughing in of a system of plumbing requires the most careful measurements possible on the part of the plumber, owing to the fact that when this portion of the job is completed, the soil pipe is, or should be, in its proper location, the soil stack connected with it and extending through the roof of the building; also all branch soil pipes leading from the main stack to their proper locations, under, or near the various fixtures, so that when the floors are laid no changes will be required, for be it remembered that all roughing in must be completed before the floors of the building are put down. Fig. 8 shows a plan of the roughing in work to be done in the basement.

The soil pipe is shown, with its various branches, each having a certain function to perform, and it is easily seen that good judgment, and accurate measurements are necessary in order to bring each branch to its correct location.

Fig. 9 is a vertical section of a two-story and basement building, showing all parts of the plumbing system, including the main soil stack connected at its bottom end with the house drain pipe, while its top extends through the roof. A careful study of Figs. 8 and 9 will show that good work is required on the part of the plumber to locate each tee, and Y in its proper place.

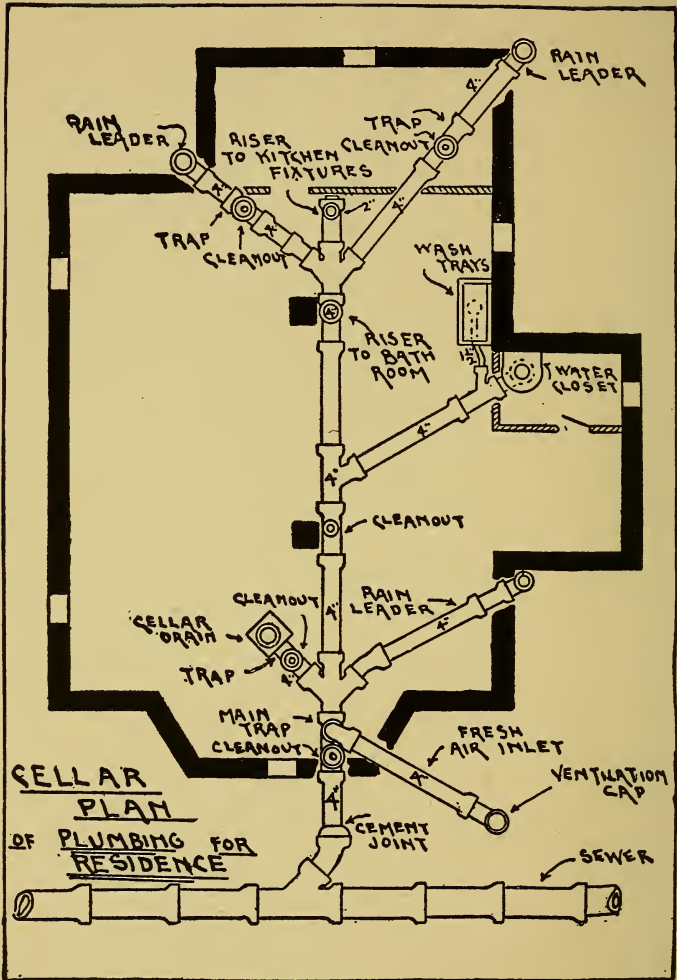

Fig. 8

In addition to the branch soil pipes which are to receive the discharge from the closets, there are vent pipes for the purpose of relieving the air pressure on the system, thus preventing siphonage, and maintaining a circulation of air throughout the entire system at all times. These pipes are clearly shown in Fig. 9. Then there are the water pipes which are to supply water to the various fixtures; and drain pipes for receiving the discharge from the different fixtures and passing the same on into the main soil stack. It is a good plan for the plumber to make a correct memorandum of all roughing in measurements, and preserve it for future reference.

Cutting Soil Pipe. As before stated, the soil pipe should be extra heavy cast-iron pipe. When the proper measurements have been taken, and memoranda made of the same, it will be next in order to cut the soil pipe into lengths to correspond with the measurements.

The best tools to use for this purpose are a diamond point cold chisel, and a machinist's hammer. Some workmen use a three wheel cutter for cutting this pipe, but there is always a liability of cracking the pipe with this tool, owing to the fact that the pipe is not of a uniform thickness. Having determined by measurement the point where the cut is to be made, mark it with a piece of chalk around the circumference of the pipe, then lay the pipe on the floor, placing a narrow piece of wood directly under the marked place, and proceed with the chisel and hammer.

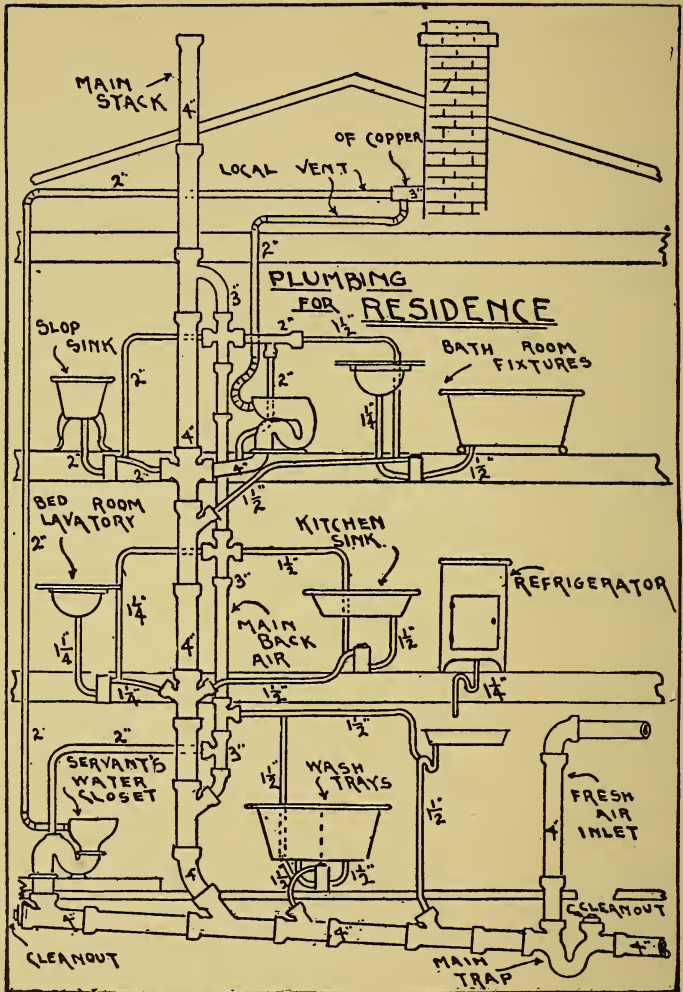

Fig. 9

Making Soil Pipe Joints. Joints that will not leak should be the motto of every good plumber, and this should apply, not only to joints that are visible, but also to those joints in the soil pipe which are in many cases entirely hidden from view, owing to their location. Special care should be exercised in making the joint which unites the cast-iron soil pipe with the vitrified sewer pipe just outside the walls of the building. There are several patented devices that may be used for making this joint, or it may be made by the same method as are the joints in the main sewer, that is by the use of cement.

The joints in the soil pipe proper, within the walls of the building should be made with oakum and melted lead, by first caulking the oakum tightly in the space provided for the joint, leaving a space of 1 inch to $1\frac{1}{4}$ inches in which to pour the lead, which should also be caulked after it has cooled. In caulking the lead due care should be exercised not to use a heavy hammer, since great pressure is brought to bear upon the hub, and there is danger of cracking it. In the making of a joint in a horizontal soil pipe greater skill is required than on a vertical pipe, and it becomes necessary to use an asbestos joint runner in pouring the lead.

Putty, or soft clay are sometimes used for holding the lead, but not as good results are obtained as with the asbestos, which can be clamped around the pipe tightly, leaving an opening at the top for pouring in the lead. Always pour the joint full at one pouring. If by accident, or mistake the joint is not poured full, at the first pouring, it becomes necessary to pick out the lead, and repour it. The lead used in making these joints should be entirely free from solder, or other metals, and it should always be hot when poured. It is good practice to place some pulverized resin in the space before pouring the lead. This will prevent any trouble from possible dampness. Table 4 gives the weight of lead and oakum required for soil pipe joints in various sized pipes.

Size of Pipe	Lead per Joint	Oakum per Joint
2 inch	1½ pounds	3 ounces
3 "	2¼ "	6 "
4 "	3 "	7 "
5 "	3¾ "	8 "
6 "	4½ "	9 "

TABLE 4.
LEAD AND OAKUM REQUIRED FOR SOIL PIPE JOINTS.

Fig. 10 shows the plumbing for a two tenement house, also method of using test plugs.

Fig. 11 shows the plumbing for a three tenement building.

Fig. 12 shows a method of running a long line of soil pipe on the cellar wall.

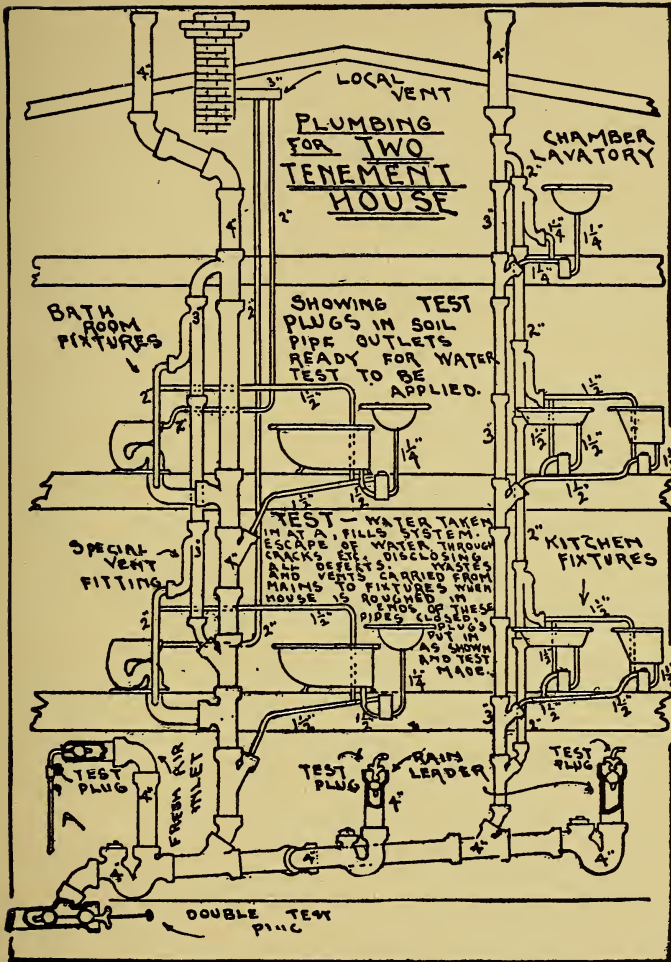

Fig. 10

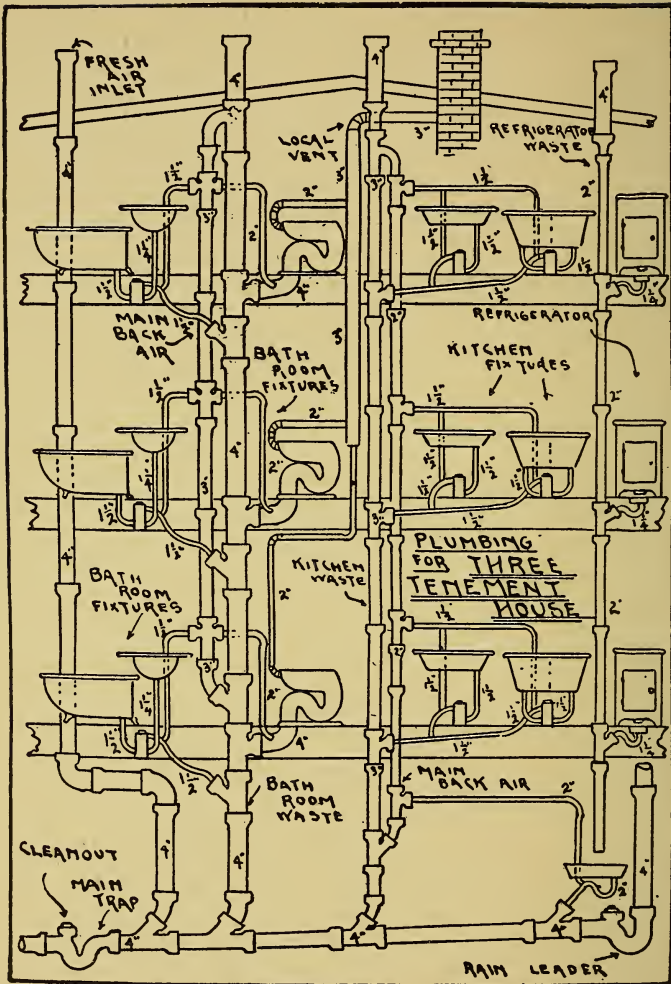

Fig. 11

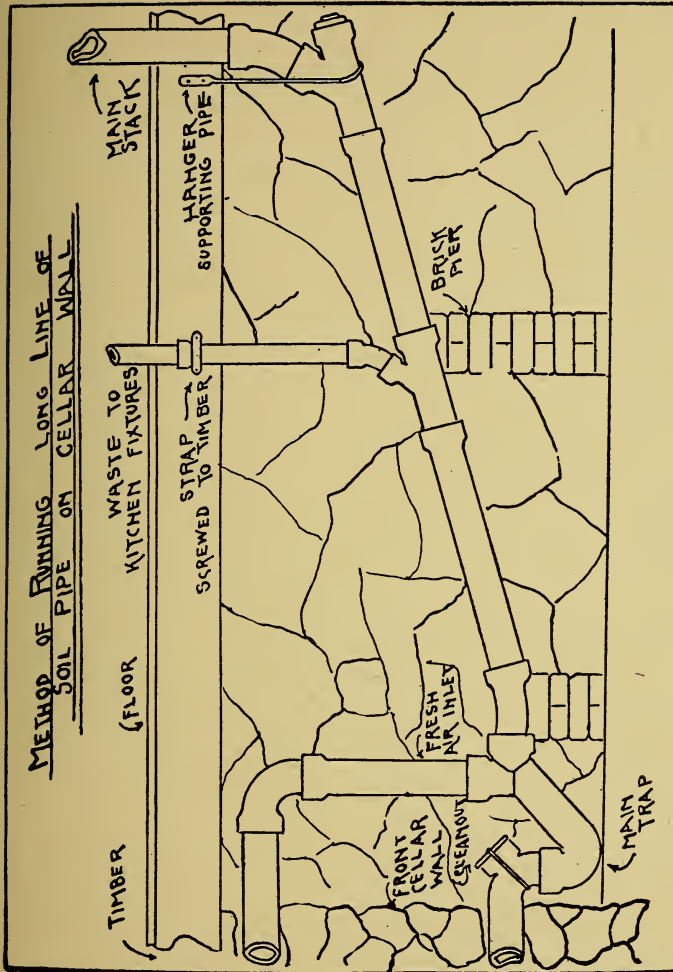

Fig. 12

Roof Construction. Reference to Figures 10 and 11 will show that the diameters of the main soil stacks are increased just under the roof, by means of an increaser, and the enlarged diameter continues through the roof. This is for the purpose of preventing the stack from becoming clogged with hoar frost in cold weather.

Figures 13 and 14 show several different methods of roof connections; called by plumbers, "roof flashings." These are for the purpose of preventing rain water from following down the outside of the pipe below the roof. Soil pipes should not be less than four inches in diameter, and both soil, and vent pipes should extend at least eight inches above the roof, and if, at this height the opening would be near the doors or windows of an adjoining building, these pipes should be extended so as to bring the opening to a point not less than fifteen feet from such doors or windows; and these openings should be not less than six feet from any ventilator, or chimney opening of the building they are installed in, or any adjoining building. Otherwise they are liable to be declared a nuisance. The increasers for enlarged diameter of these pipes should extend at least one foot below the roof, and the openings of these pipes must have no caps or cowles affixed to, or over their tops.

In many cities the connection of soil, or vent pipes with a chimney flue is prohibited.

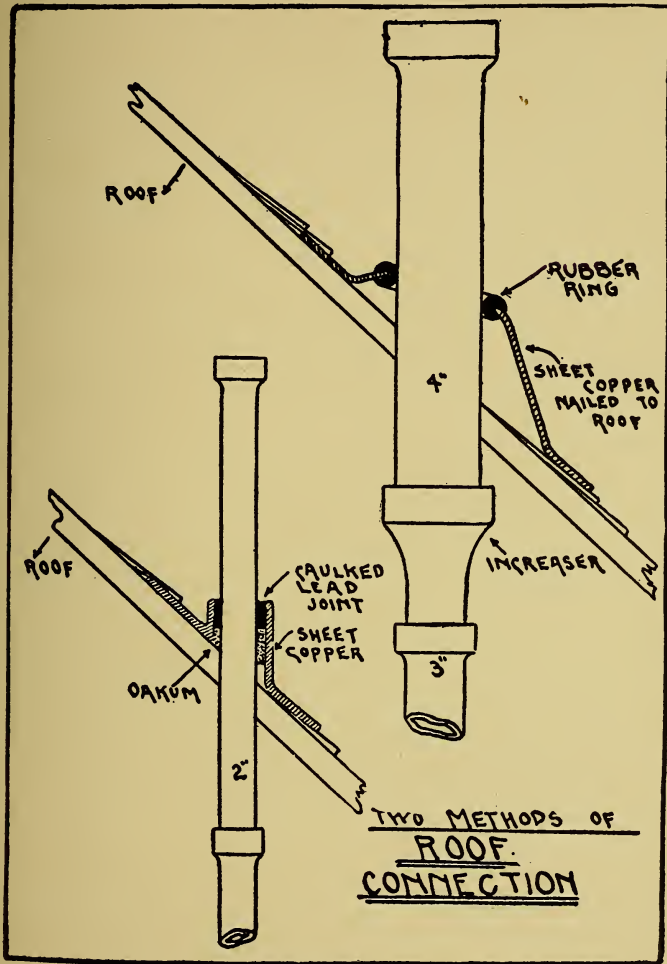

Fig. 13

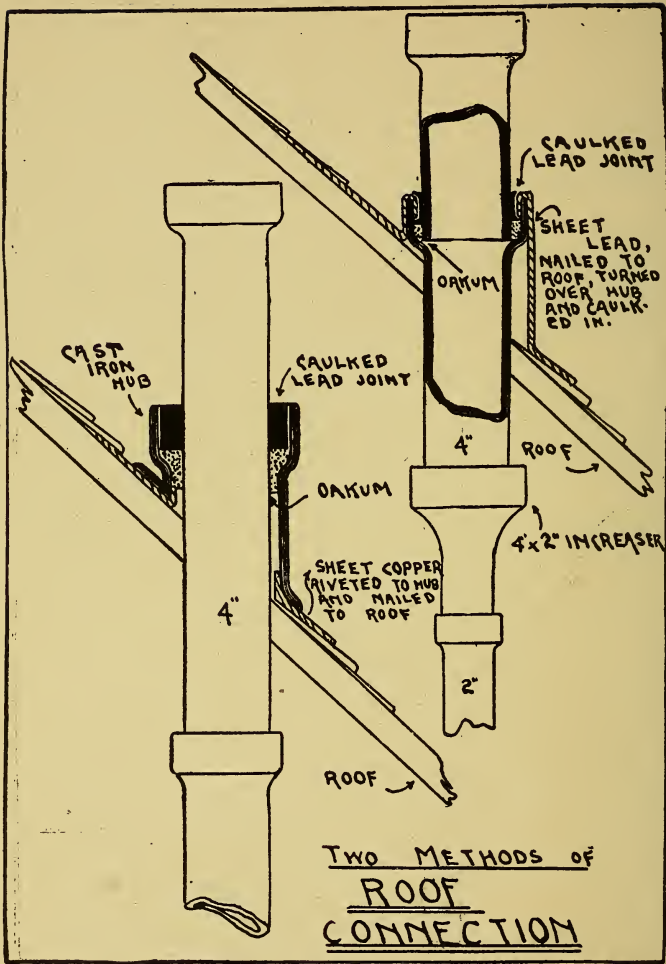

Fig. 14

Pipe Supports. The foot of every vertical soil, rain, or waste pipe should be permanently supported by a solid brick, stone or concrete pier properly constructed, by using cement mortar, or cement concrete, or if such material is not available, some other foundation equally as solid should be used. The weight of the vertical soil stack in most buildings is usually very heavy, and when not properly supported, there is danger of the pipe settling, the consequence of which would be the opening up of more or less of the joints, thereby causing leakage. In addition to supports at the bottom, these pipes should also be provided with floor rests at intervals of every second floor through which they pass. Soil pipes under the floor of the basement should be properly laid, relative to grade, and should also be provided with adequate supports that will not settle. In case these pipes are above the basement floor they should be supported on solid piers, or they may be suspended from above as shown in Fig. 12. Where horizontal pipes are to be supported by suspension, strap iron stirrups, and not hooks are to be used.

Fresh Air Inlets. Fig. 15 shows two methods for admitting fresh air to the basement soil pipe. Fig. 16 shows the roughing in plan for the basement of a store or office building; while Figures 17, 18 and 19 show the roughing in and plumbing of a Modern Engine House for the use of the Fire Department.

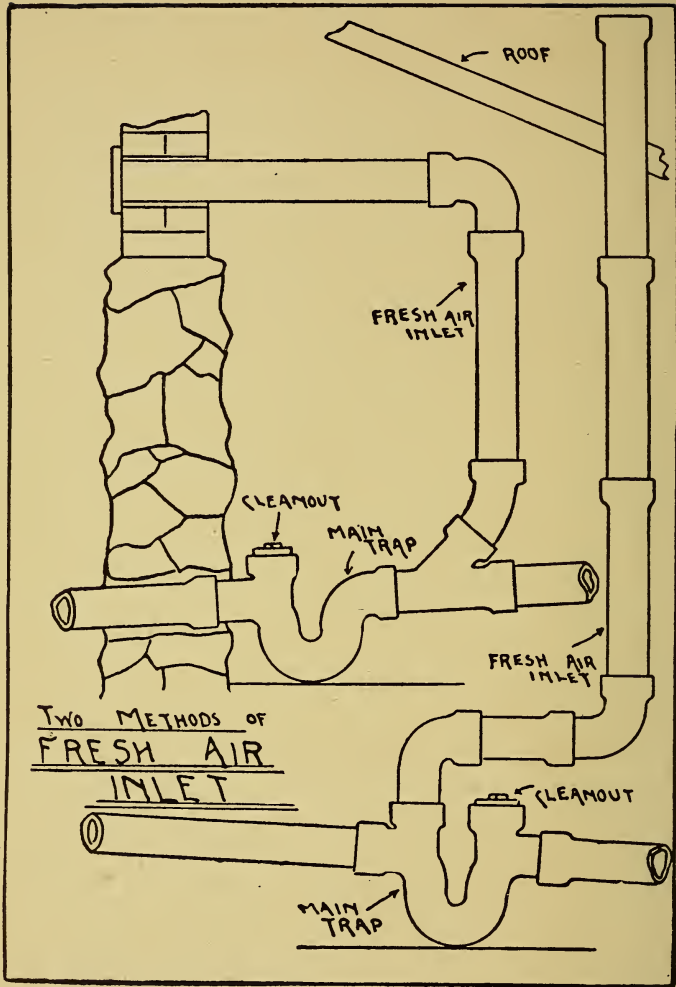

Fig. 15

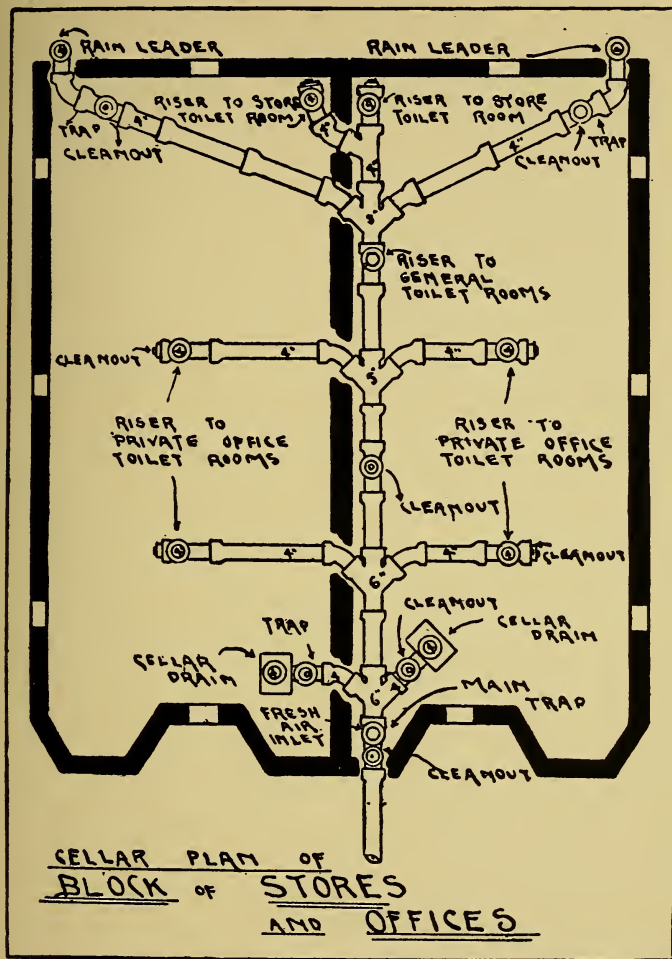

Fig. 16

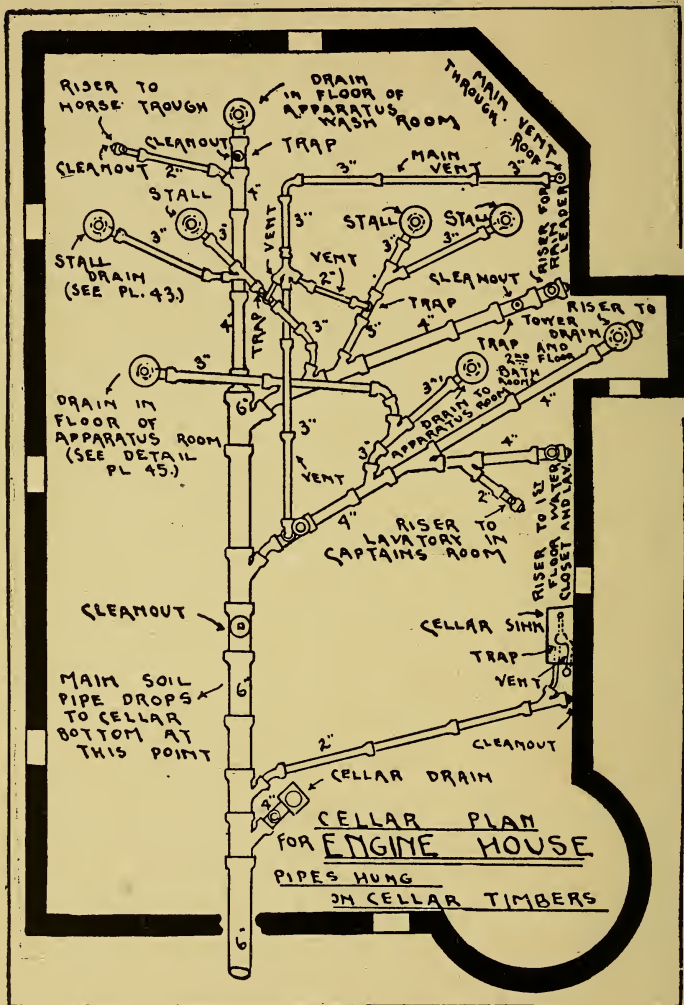

Fig. 17

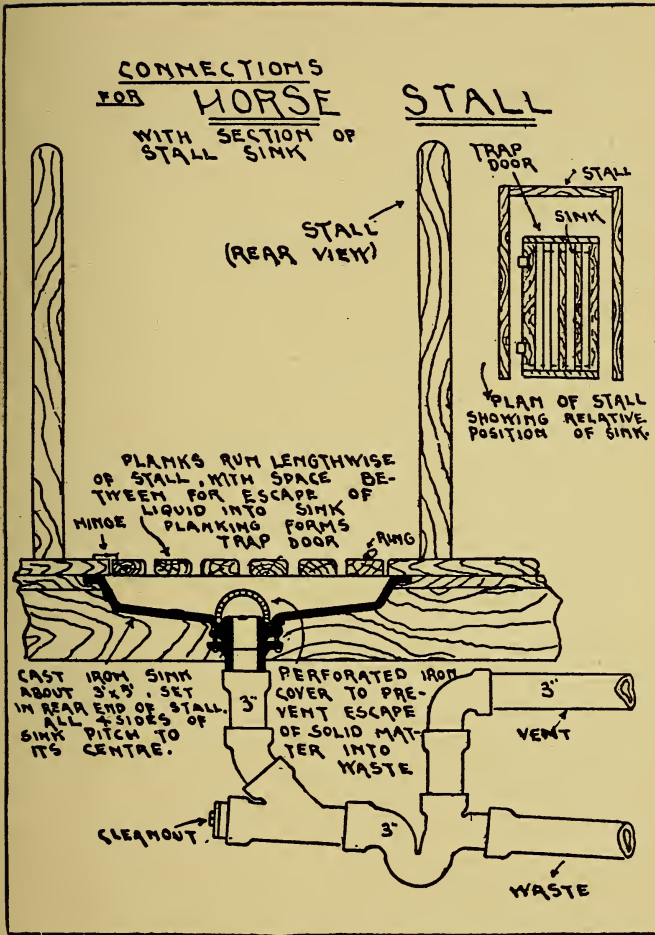

Fig. 18

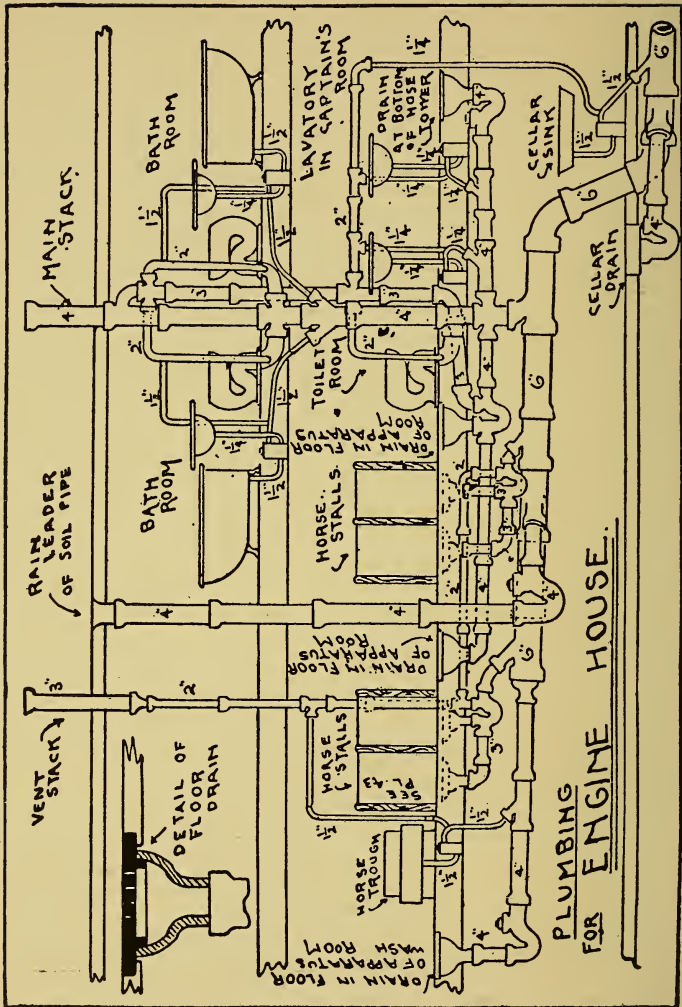

Fig. 19

Figure 20 shows the plumbing for a modern stable, and is self-explanatory. Figures 21 to 28 show enlarged views of the connections to the various fixtures required in the plumbing of a two-story and basement residence as shown in Fig. 9. These illustrations are self-explanatory, and need no further comment. It will be noticed that the work starts in the basement on the connections for the wash trays, and servant's water-closet, Fig. 21. Next come the fixtures on the first floor, consisting of the refrigerator, kitchen sink, and lavatory. These are shown in Figs. 22, 23, and 24. The waste, or drip pipe from the refrigerator, Fig. 24, should not be directly connected with any soil pipe, rain water lead, or any other waste pipe; but should discharge into an open, water supplied sink, or over a deep sealed trap, as shown in Fig. 24. It should be as short as possible, and should be disconnected from the refrigerator, or ice box by at least four inches. In buildings where refrigerators, or ice boxes are located on two or more floors, the waste and vent pipe should be continuous, and should run through the roof, care being taken also, that it does not open within six feet of an open soil, or vent pipe. The size of a waste pipe for refrigerators for two floors, or less should be at least one and one-half inches; two inches for three floors and over, and two and one-half inches for five floors and over.

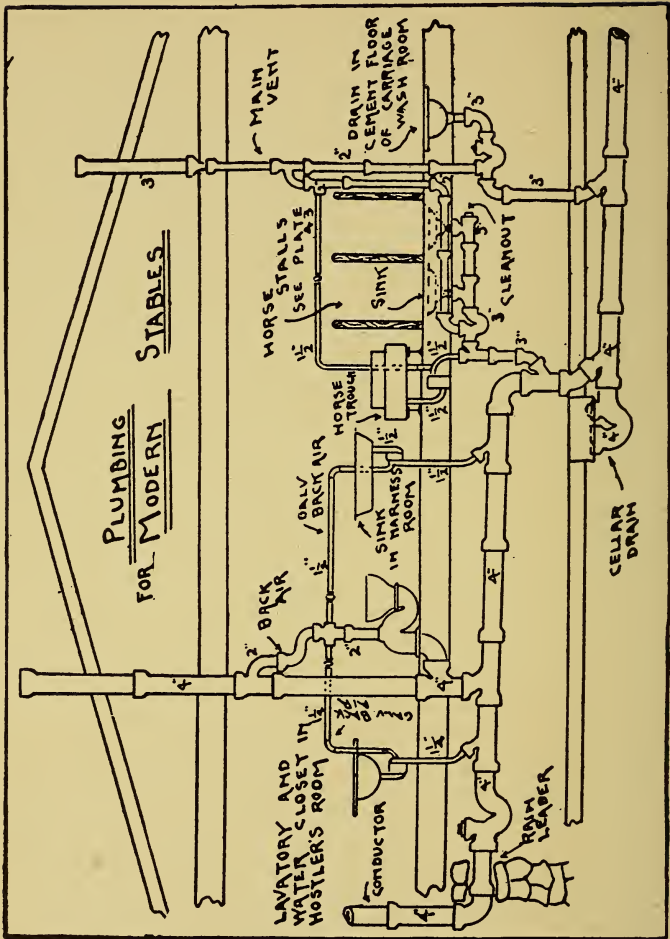

Fig. 20

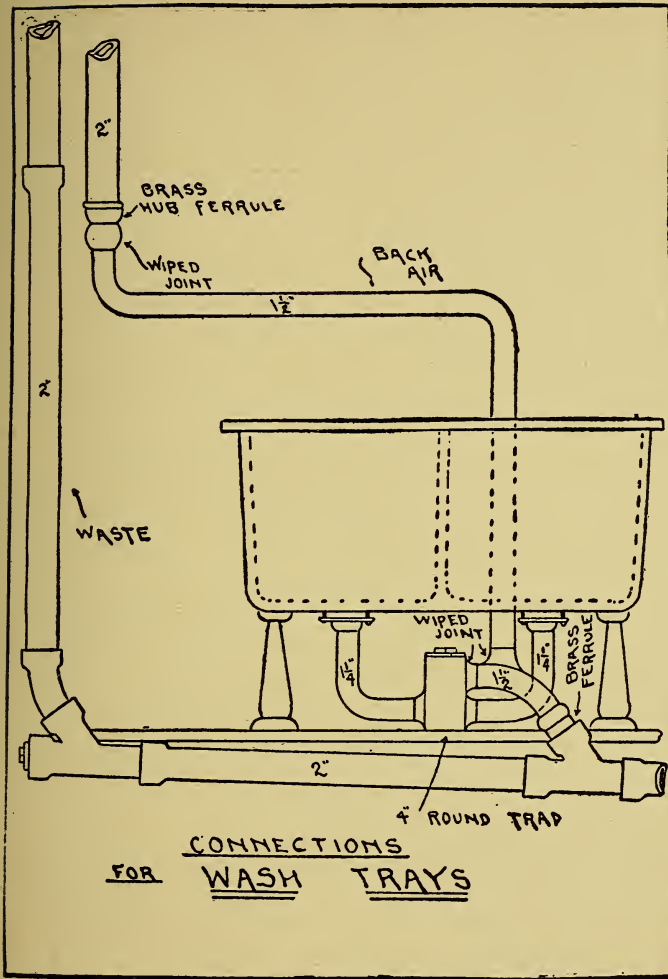

Fig. 21

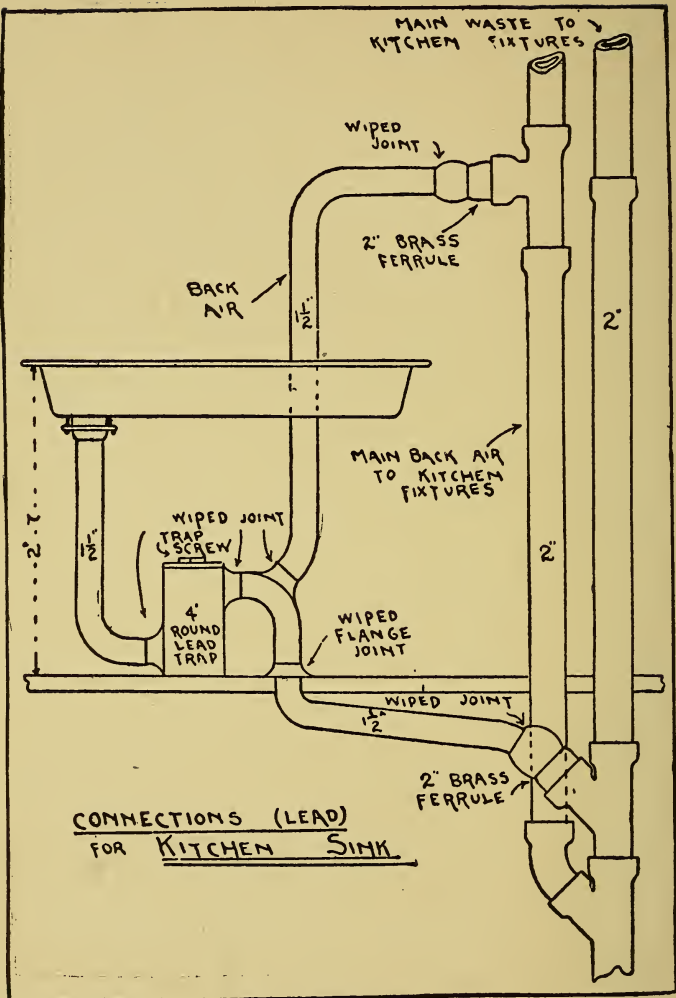

Fig. 22

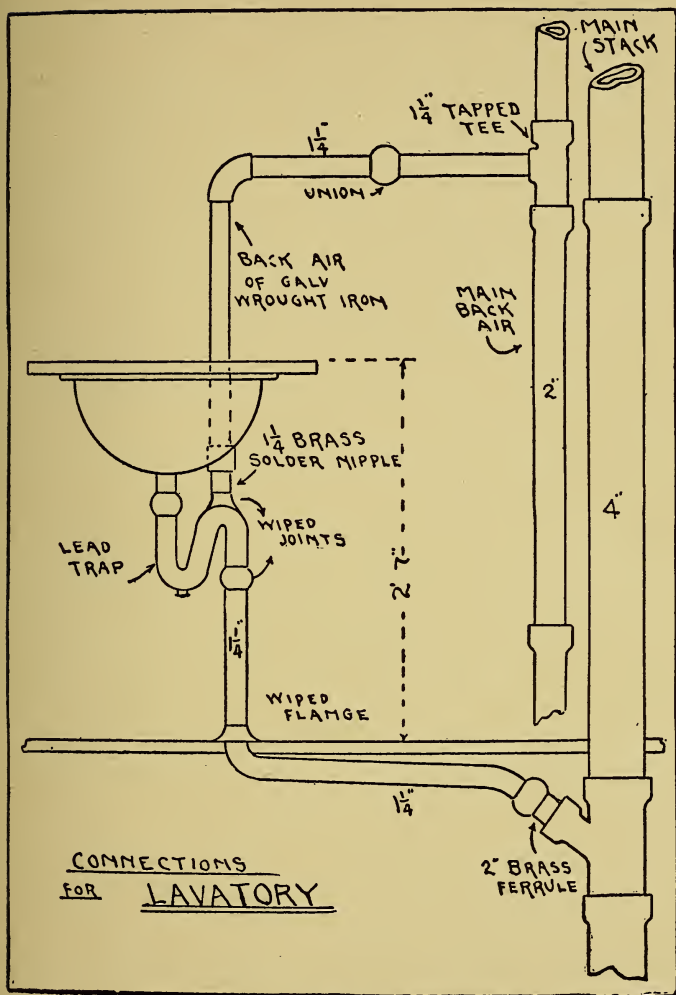

Fig. 23

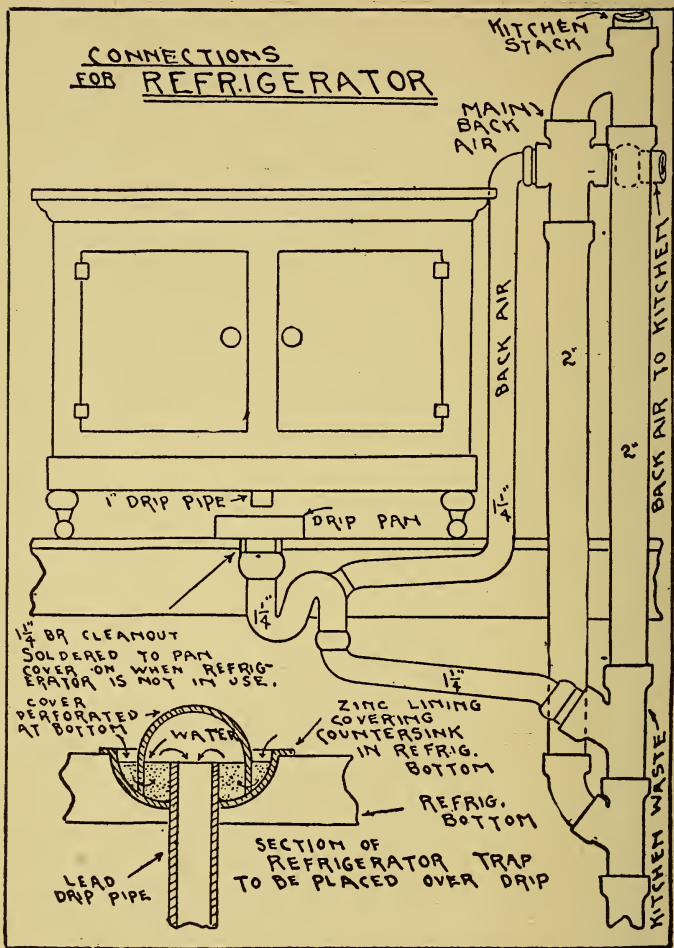

Fig. 24

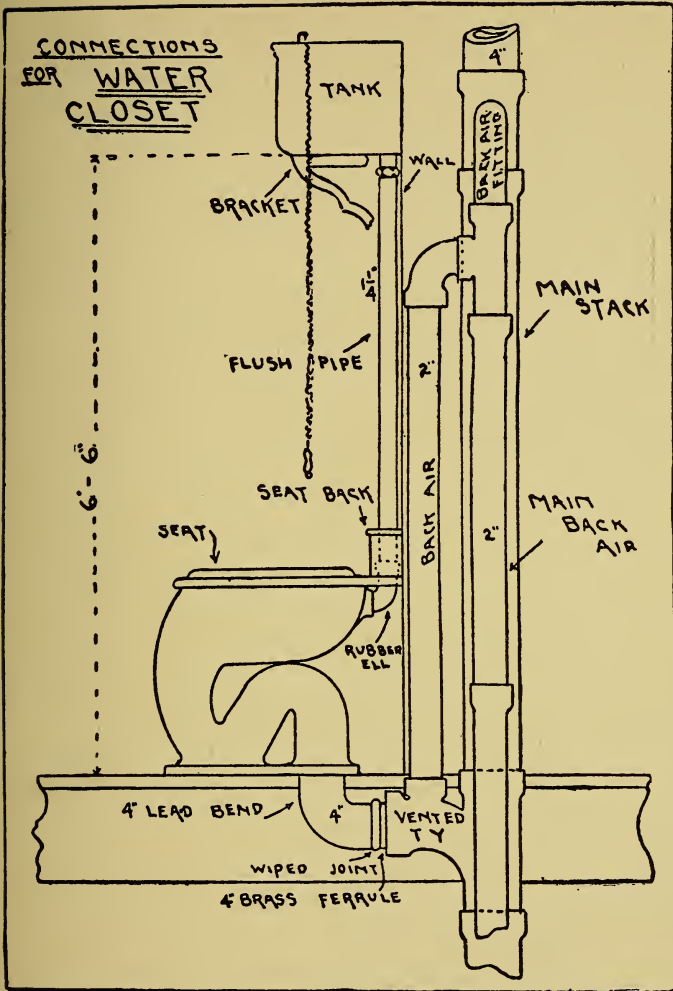

Fig. 25

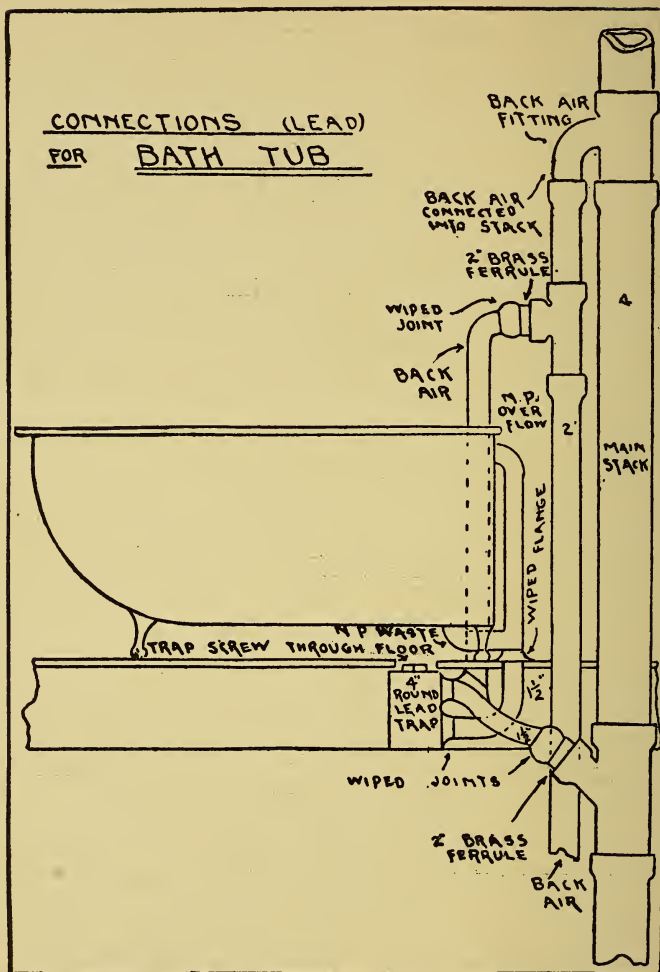

Fig. 26

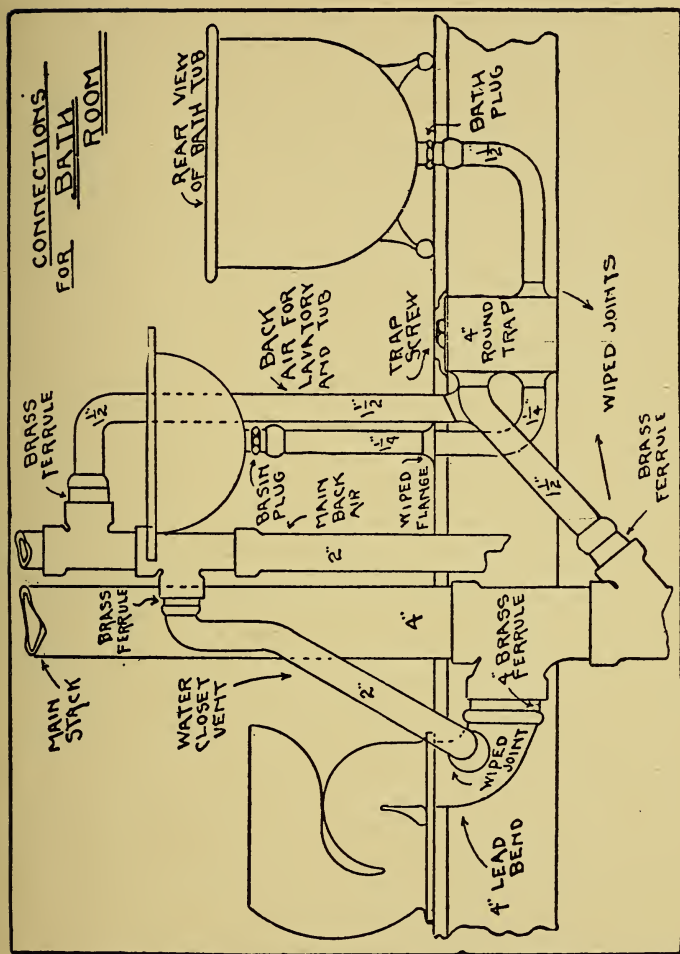

Fig. 27

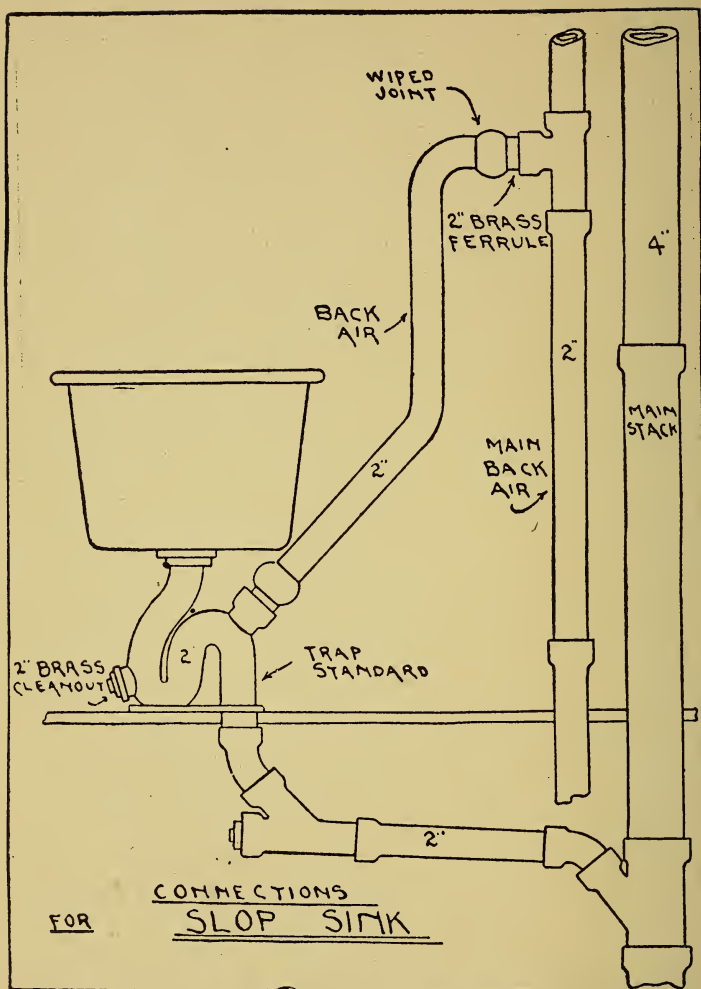

Fig. 28

TRAPS.

A trap is a device or fitting used to allow the free passage through it of liquids and solids, and still prevent the passage of air or gas in either direction. There are two kinds of traps used on plumbing fixtures known as syphon traps and anti-syphon traps. The simplest trap is the syphon trap—a horizontal pipe bent as shown in

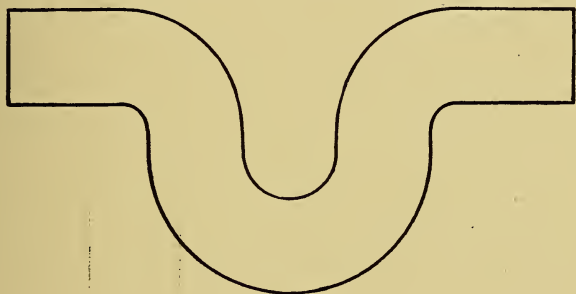

Fig. 29.

Fig. 29. This forms a pocket which will retain enough liquid to prevent air or gas from passing. The dip or loop is called the seal, and should never be less than one and one-half inches. This type of trap is what is known as a running-trap. This is not a good trap to use, and it is only capable of withstanding a very low back pressure.

The trap most generally used is what is known as the S trap, as shown in Fig 30. When this trap is subjected to a back-pressure, the water backs up into the vertical pipe, and naturally will withstand a greater pressure than the running-trap type—about twice as much.

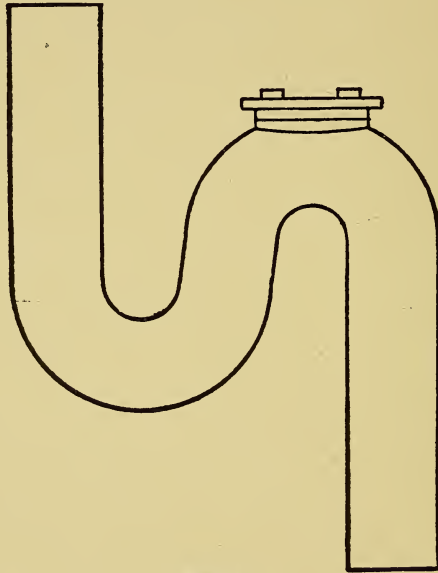

Fig. 30.

The trap shown in Fig 31 is what is known as a P trap, and in Fig 32 as three-quarter S trap, and has the same resisting power as the S trap.

A trap may lose its seal either by evaporation, self-siphonage or by suction. There is no danger

of a trap losing its seal in an occupied house from evaporation, as it would take a number of week's time, under ordinary conditions, to evaporate enough water to destroy the seal.

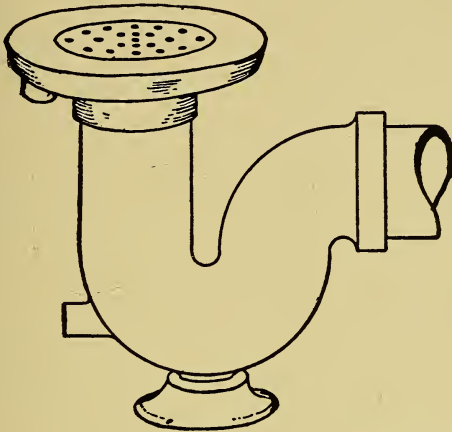

Fig. 31.

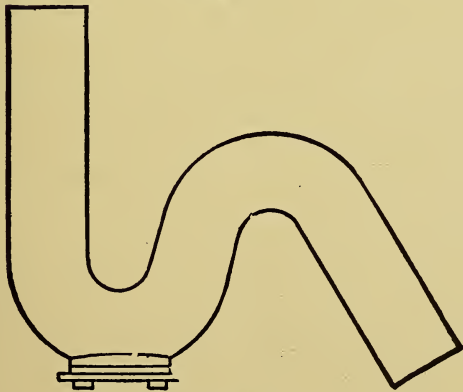

FIG. 32.

A trap can be syphoned when connected to an unvented stack, and then only when the waste pipe from the trap to the stack extends below the dip, so as to form the long leg of the syphon as in Fig. 33.

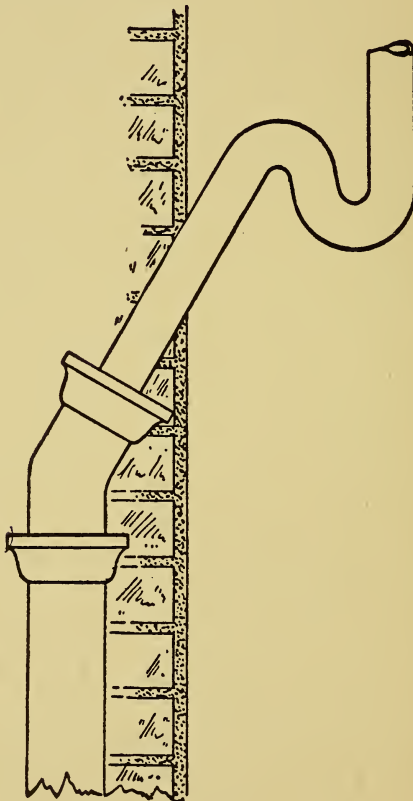

Fig 33.

When two fixtures are installed one above the other, with unvented traps and empty into one stack, the lower trap can be syphoned by aspiration. The water emptying into the stack at the higher point in passing to the trap inlet of the lower fixture, creates a partial vacuum which sucks the water out of the trap at the lower point. To prevent this, what is known as back-venting is resorted to, back-venting not only protects the trap against syphonage, but relieves the seal from back-pressure, by equalizing the pressure on both sides of the seal. All revent pipes must be connected to vent pipes at such a point that the vent opening will be above the level of the water in the trap.

In Fig. 34 two basins are shown connected to soil pipe with S traps and back—vented into the air-vent pipe, both connecting into the attic into an increaser, which projects through the roof. This drawing is given to illustrate the proper back-venting to prevent syphonage of basin traps, and when it is necessary to run separate stacks for wash basins, such as are sometimes installed in bedrooms, the main waste stack must be two inches in diameter and the vent pipe one and one-half inches, either cast iron or galvanized wrought iron.

Non-syphon traps are those in which the seal cannot be broken under any reasonable conditions. Some water can be syphoned from the best

of non-syphon traps made, but not enough to de-
stroy their seal. The commonest non-syphoning

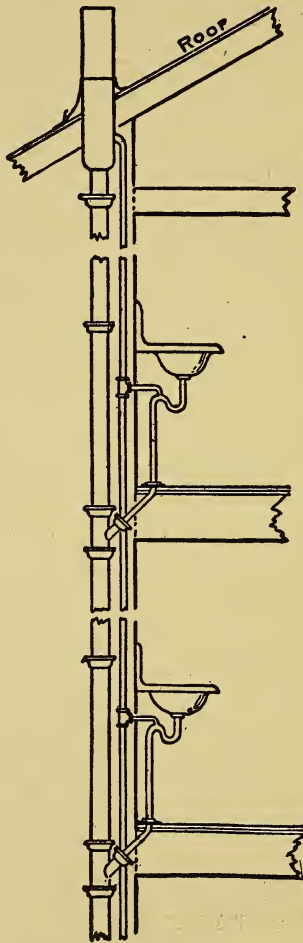

Fig. 34

trap is known as a drum trap, which is four inches in diameter and ten inches deep. Sufficient water always remains in this trap to maintain its seal, even when subjected to the severest of tests.

Fig. 35 shows a trap, which is the type generally used to trap the bathtub. This trap is provided

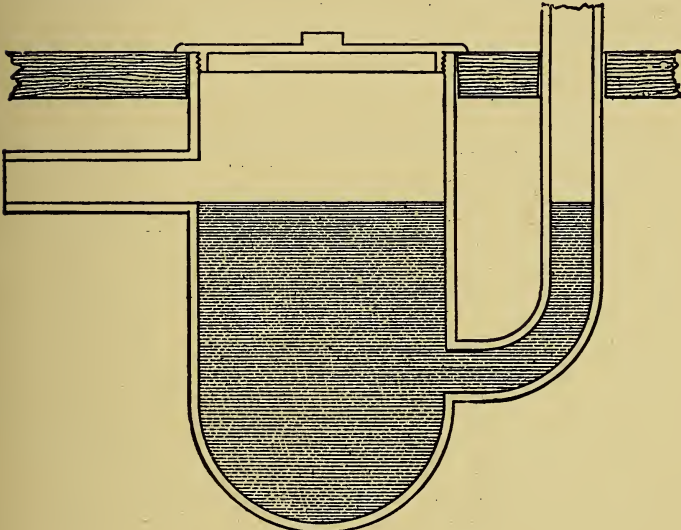

Fig. 35

with a brass trap-screw top for clean-out purposes, made gas and water tight against a rubber gasket. A trap of this kind would not be suitable for a lavatory, its principal fault being that owing to the enlarged body they are not self-cleaning, affording a lodging place for the depositing of sediment.

The non-syphon trap to be used is one in which the action of the water is rotary, as it thoroughly scours the trap and keeps it clean, such as is shown in Fig. 36. This trap depends upon an inner partition to effect this rotary movement, and is so constructed that its seal cannot be broken by syphonic action and is permitted by health

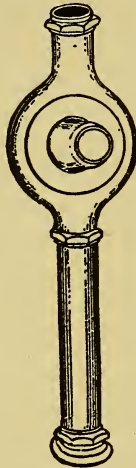

Fig. 36

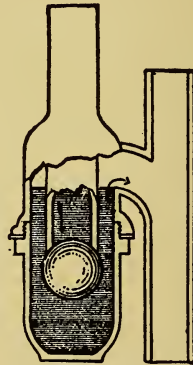

Fig. 37

and sanitary departments, where it is impossible to run a separate vent pipe to the roof.

One of the oldest traps is the Cudell trap, as shown in Fig. 38. The rubber ball being of slightly greater specific gravity than water rests on the seat and forms a seal when the water is not flowing through the trap. This ball prevents the seal

of the trap being forced by back-pressure, and acts as a check against back flow of sewerage should drain stop up, and provides a seal if water is evaporated.

Fig. 37 shows the old Bower trap. The water seal is maintained by the inlet leg, extending

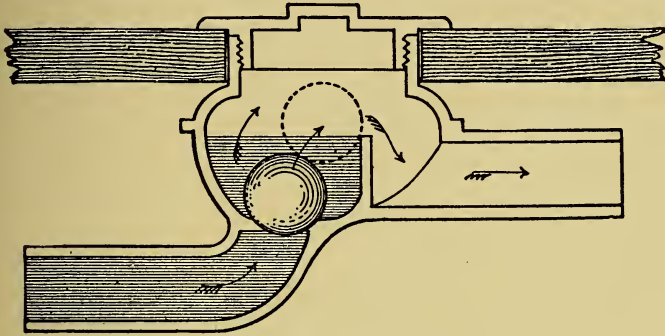

Fig. 38

down into the body below the outlet. The bottom of this trap is glass, brass or lead, whichever is desired, and can be unscrewed from trap and thoroughly cleaned.

SOLDER.

The composition and properties of solders are a matter of considerable interest to all metal workers, but the subject is of especial importance to plumbers, because on the quality and purity of solder depend in a large measure the reliability and good appearance of their work. Nothing is more annoying, nor is there anything so productive of bad work, waste of time, and consequent irritability and bad temper, as the trying to do good work with bad material, particularly if that material is wiping or plumbers' solder. Until recent years it was invariably the practice for plumbers to make their own solders, either from the pure lead and tin, or, old joints and solders were melted down, and tin added in proportion. Of late years it is becoming quite unusual for plumbers to know anything about solder-making. Plumbers consider it more economical to buy it, already made, from firms who make solder-making a branch of their manufacturing trade. Another advantage is, that if supplied by a firm of good standing it can generally be depended upon for purity and uniform quality.

Good plumbers' solder should consist of two

parts of lead to one of tin, but the proportions, of course, vary according to the quality of the constituent parts. Tin, for instance, varies very much in quality, and no fluxing or a superabundance of the tin will make good solder if this metal is of an inferior kind. It is, therefore, far the most economical in the long run to use tin of the very best quality.

As the exact proportions, as they are generally given, depend to a very great extent upon the condition of the two metals, it follows that the mere mixing of certain quantities of tin and lead does not necessarily make a composition that will serve the purpose that it is intended for, but a plumber with an experienced eye can detect at a glance the inferiority and usefulness of such solders when required for the execution of good work.

Although it is not absolutely necessary that a good solder-maker should be a plumber, it is important that he should have a considerable knowledge of the appearance of solder in proper condition. In the absence of a practical test, there are certain indications by which the solder may be judged, whether it is good or bad. The most common practice is to run out a strip of solder on a smooth level stone. As soon as the strip is nearly cold, the quality of the solder or the proper proportion of tin and lead can be determined by the appearance of both surfaces. It

is important, before running the solder out on the stone, that it should be at such a heat as to allow the solder to run freely. A temperature just below red heat is the most suitable for this purpose, if the solder is not hot enough, it will have a dull white look, whether it is good or bad.

If it is in good condition, it should have a clean, silvery appearance, bright spots should also form on the surface from an eighth to a quarter of an inch in diameter. As a rule, the larger the spots the finer is the solder, although some kinds of tin will not show large spots, however much is used. In such cases they should appear more numerous.

If the strip has a dull, dirty appearance and a mottled surface, it is evident the solder is not as pure as it should be. It probably contains some mineral impurities, which can generally be removed by well heating the solder in the pot, and stirring into it a quantity of resin and tallow. These substances have but very little, if any, chemical effects, either upon the solder or the foreign matters it may contain, but the action that seems to take place is that they combine with the lighter mineral matters by what may be called adhesive attraction, and cause them to rise to the surface, where they can be skimmed off. There are some earthy impurities that get into the solder, the specific gravities of

which are probably much lighter than the solder itself, but which will not rise to the surface until assisted by means of fluxes. It must be remembered that although tin has a specific gravity of 7.3 and lead 11.445, it is therefore, necessary to well stir the solder while it is being poured into the moulds, as the tin will continually rise to the top, yet if it were not stirred at all after it was once mixed, the lower portion would not be wholly deprived of tin, showing that the greater specific gravity of the one does not wholly displace the other. The same is true of certain impurities, which are not removed until they are washed out, as it were, by means of fluxes such as resin and tallow.

The greatest enemy to plumbers' solder is zinc. If the slightest trace of this metal gets into a pot of solder, it is almost a matter of impossibility to wipe joints with it, especially underhand joints.

When zinc is present, the strip of solder has a dull, crystallized appearance on the surface. The tin spots are also very dull and rough, and not at all bright and clean. When solder of this kind is being used for wiping, the first thing noticed is that a thick, dirty dross forms on the surface directly after it is skimmed. It is impossible to keep the surface clean for even a second. When it is poured on a joint, it sets almost instantly, and it matters not at what heat

it is used. As soon as one attempts to move it with the cloth, it breaks to pieces, and falls off the joint.

In the case of branch joints when an iron is used, the solder cools in hard lumps, and breaks away like portions of wet sand. There are two or three ways of extracting zinc from solder, one is to partly fuse it, and when it is nearly set to pulverize it until the particles are separated as much as possible. The whole is then placed in a pot or earthenware vessel and saturated with hydrochloric acid, commonly called muriatic acid. The acid dissolves the zinc and produces chloride of zinc; the latter can be washed out with clean water and the solder returned to the pot in a comparatively pure state. This method cannot be recommended as a certain cure, because of the difficulty there exists in dividing the particles to such an extent as to expose the whole of the zinc that may be contained in it, and considering the small amount of zinc that is sufficient to poison a pot of solder it is doubtful if the acid process is radical enough in its action to thoroughly eradicate the zinc without repeated applications.

Sulphur is the best thing to use for this purpose.

When a pot of solder has been found to be poisoned with zinc, it is heated to just below a red heat. Lump sulphur is broken up and gran-

ulated, it is then screwed up tight in three or four thicknesses of paper, and in this form is thrown into the pot and held below the solder with a ladle. As the paper burns the sulphur rises through the solder, combines with the zinc, and floats on the surface. The solder is well stirred so as to thoroughly mix the sulphur with the whole of the contents of the pot, the dross which is formed by this process is then skimmed off with a ladle and thrown away as useless.

In the case of the sulphur, although it is generally called a flux, the action that takes place is altogether different to that of resin and tallow. It may safely be inferred by reference to the results of chemical combinations that the zinc, having a great affinity for sulphur, as soon as it comes in contact, forms sulphide of zinc, this is really a substance similar to zinc blende, a common form of zinc ore. In this condition, the specific gravity being considerably reduced, it readily rises to the surface of the solder, where it can be skimmed off with a ladle.

The question naturally arises—why is it the sulphur does not combine with the lead to which it also has an affinity, and thus form sulphide of lead? If lead is heated only just above its melting point and then some sulphur is mixed with it, a substance would be formed similar to galena, or sulphide of lead. But if the temperature is raised several degrees higher the sulphide

gives up the lead, and either floats to the top or passes off in the form of gaseous vapor, chemically termed sulphurous anhydride. Therefore, by heating the solder containing zinc to a temperature just below redness, it is hot enough to prevent the sulphur combining with the lead and tin, but not sufficiently heated to cause the sulphur to give up the zinc, which fuses at a temperature of 773 degrees Fahrenheit, whereas lead fuses at 612 degrees Fahrenheit, and in combination with tin as solder at 441 degrees Fahrenheit. The difference in the melting points is in all probability the principal cause of the sulphur attracting the zinc and leaving the lead and tin comparatively unaffected.

Another method of extracting the zinc from solder is to raise the temperature to a very bright red heat, if this is continued long enough the zinc vaporizes and passes off in a gaseous state.

The latter is a very wasteful process because it cannot be done without a large proportion of the tin becoming oxidized. The oxide gathers in the form of a powder on the surface, and is what is commonly known as putty powder. One of the most common means of spoiling solder is the last mentioned.

The flowing of solder, especially that used with the copper-bit, depends to a large extent upon the fluxes that are used for tinning pur-

poses. For soldering lead only a very simple flux is necessary, namely, a little tallow and powdered resin. The same kind of flux is also very often used for tinning and soldering brass and copper, and there are many plumbers who use nothing else but a piece of common tallow candle, which seems to answer the purpose very well. For soldering iron, zinc, and tin goods, chloride of zinc, or what is commonly called killed spirit of salt, is generally used, although it is not necessary to kill the hydrochloric acid when zinc has to be soldered. Soldering fluids and preparations have been invented which have, to a very large extent, superseded the common fluxes. The disadvantage of spirit of salt is owing to the tendency it has to produce oxidation on iron, and chlorides on zinc, after the soldering is done.

It would be interesting to try and find out the reason why a combination of metals fuses at such a low temperature when compared with the fusing points of the component parts of the alloys. It is necessary to bear in mind the fact that all metals, and indeed all matter, are composed of minute particles or molecules, and that there is nothing existing that is a strictly solid uniform mass. It is also acknowledged that the molecules of different substances always assume a distinctive shape, and when metallic matter is crystallized, as it is said to be when it

becomes solid by the action of cold, these particles are attracted to each other by a force of more or less power according to the nature of the metal, whether it is said to be hard or soft.

Now the force by which these aggregations of minute particles are held together is what is called cohesive attraction, and the power of this force to hold the particles together depends to a very great extent upon the particular shape which these extremely small particles assume, and the amount of surface which they present to each other. It is very easy to conceive that if a number of bodies have mutual attraction for each other, the larger the surface that comes in contact the more force is there exerted one with the other. If, for instance, the particles take the form of spheres like a number of marbles, the surface in actual contact is comparatively very small indeed, the same would be the case if they were very irregular in form. But if each particle took the form of a cube, or some other regular body, the attraction would be greatly increased, as each of the particles approached and fitted into its proper place. It is not contended that the molecules are actually attracted into absolutely close contact, because, as a matter of fact, they are not. In every substance, however hard and solid it might appear to be, there are certain interstices between the particles which are called pores, the capacities

of which vary according to peculiar conformation of the particles, and the degree of affinity which one set of particles may have for others in the same mass. It follows then that as a rule the hardness or softness of any substance depends, according to the theory of cohesive attraction, upon the close and compact nature of the molecules, and the large or small spaces or interstices between them, that is, so far as the action of heat is concerned. If it is required to make a hard substance soft and pliable, some power is necessary to exert a reactionary influence upon the attractive force which causes the particles to cohere. Now the only powers that will effectually produce this result is heat, when heat is applied to nearly all metallic substances, the first thing it does is to enlarge the bulk by the almost irresistible force of expansion. The effect that heat has on a solid is to cause the particles to be thrown farther apart from each other by a repulsive force, overcoming to a certain extent the force of cohesive attraction. This repulsive action continues to increase as the temperature is raised, until the attractive force has to give way to the force of gravity.

The result is the particles will no longer cohere in a mass, but fall away from each other and become in a state of fluid, and if they are not kept together in a vessel of some kind during their high temperature they will run in any

direction by the influence of gravity like ordinary liquids. When a metal is in such a condition it is said to be melted or fused. There are some metals, zinc for instance, the particles of which are separated to a much greater extent than is the case with fusion only. For if the heat is applied so that the temperature is raised above fusing point, evaporation takes place, and the molecules are driven off in the form of vapor.

When two distinct metals are mixed together, such as tin and lead, the cohesive attraction is modified to a large extent, because the molecules of one have a comparatively small affinity for the other. Of course tin has a certain amount of affinity for lead, in fact, if there were no affinity between the two, solders would be useless on lead, because tinning could not be effected if such were the case. But what seems certain is, when the two metals are alloyed, the molecules are not held together by the same attractive force that is exerted when a metal is not alloyed, that is, the particles of one metal do not, by reason of their difference of construction or conformation, have the same affinity for each other as they do when they are not intermixed with other particles of a different nature.

Consequently, when such combinations of metals are subjected to the action of heat, the particles mutually assist each other to separate, and

gravitate like liquids to a level surface, with a much lower degree of temperature than is required to obtain the same effect when the metals are melted separately.

Then with regard to wiping solder, it retains its fluid and plastic state for a much longer time than lead or tin would before they are mixed, showing that the particles, probably for the same reason, do not solidify so quickly as they would in a separate state. If they did, joint-wiping would, of course, be impossible, for on the peculiar power that solder has to retain its heat, or rather the effects of heat, depends the success of the most important parts of plumbing work. An alloy of lead and tin contracts considerably in cooling, the result of this can be seen when a solder pot is placed on the fire. Before the bulk of the solder melts, but as soon as that part which is near the hottest part of the fire begins to fuse, the molten metal forces its way up to the top, between the sides of the mass of solder and the sides of the pot, this often continues until the top of the unmelted mass is covered with a melted layer which has forced its way there, showing that when the solder cooled it contracted into a smaller space than it occupied when it was in a fluid state. Consequently, when the lower part of the solder is melted first, the expansion that takes place forces it of necessity to the top, because there is not room for the

increased bulk in the space it was reduced to during the process of cooling. But if antimony, the fusing point of which is 840 degrees Fahrenheit, is added to lead and tin, the result is just the reverse, for on cooling this alloy expands. The latter alloy is generally used for casting types for printing, the proportions of which are two of lead, one of antimony, and one of tin, although a more expansive alloy is made of nine of lead, two of antimony, and one of bismuth. Then with regard to the hardness of metals, it is not always that the hardest metals require the highest temperature to fuse them. Tin, for instance, is much harder than lead, yet it fuses at a temperature nearly 200 degrees Fahrenheit lower than lead.

DECIMAL PARTS OF AN INCH.

1-64	.01563	11-32	.34375	43-64	.67188
1-32	.03125	23-64	.35938	11-16	.6875
3-64	.04688	3-8	.375		
1-16	.0625			45-64	.70313
		25-64	.39063	23-32	.71875
5-64	.07813	13-32	.40625	47-64	.73438
3-32	.09375	27-64	.42188	3-4	.75
7-64	.10938	7-16	.4375		
1-8	.125			49-64	.76563
		29-64	.45313	25-32	.78125
9-64	.14063	15-32	.46875	51-64	.79688
5-32	.15625	31-64	.48438	13-16	.8125
11-64	.17188	1-2	.5		
3-16	.1875			53-64	.82813
		33-64	.51563	27-32	.84375
13-64	.20313	17-32	.53125	55-64	.85938
7-32	.21875	35-64	.54688	7-8	.875
15-64	.23438	9-16	.5625		
1-4	.25			57-64	.89063
		37-64	.57813	29-32	.90625
17-64	.26563	19-32	.59375	59-64	.92188
9-32	.28125	39-64	.60938	15-16	.9375
19-64	.29688	5-8	.625		
5-16	.3125			61-64	.95313
		41-64	.64063	31-32	.96875
21-64	.32813	21-32	.65625	63-64	.97438

MELTING POINTS OF ALLOYS OF TIN, LEAD, AND BISMUTH.

Tin.	Lead.	Bismuth.	Melting Point in Degrees Fahrenheit.	Tin.	Lead.	Bismuth.	Melting Point in Degrees Fahrenheit.
2	3	5	199	4	1		372
1	1	4	201	5	1		381
3	2	5	212	2	1		385
4	1	5	246	3		1	392
1		1	286	1	1		466
2		1	334	1	3		552
3	1		367				

TABLE 5

WEIGHT OF TWELVE INCHES SQUARE OF VARIOUS METALS.

Thickness.	Wrought Iron.	Cast Iron.	Steel.	Gun Metal.	Brass.	Copper.	Tin.	Zinc.	Lead.
$\frac{1}{16}$	2.50	2.34	2.56	2.75	2.69	2.87	2.37	2.25	3.68
$\frac{1}{8}$	5.00	4.69	5.12	5.50	5.38	5.75	4.75	4.50	7.37
$\frac{3}{16}$	7.50	7.03	7.68	8.25	8.07	8.62	7.12	6.75	11.05
$\frac{1}{4}$	10.00	9.38	10.25	11.00	10.75	11.50	9.50	9.00	14.75
$\frac{5}{16}$	12.50	11.72	12.81	13.75	13.45	14.37	11.87	11.25	18.42
$\frac{3}{8}$	15.00	14.06	15.36	16.50	16.14	17.24	14.24	13.50	22.10
$\frac{7}{16}$	17.50	16.41	17.93	19.25	18.82	20.12	16.17	15.75	25.80
$\frac{1}{2}$	20.90	18.75	20.50	22.00	21.50	23.00	19.00	18.00	29.50
$\frac{9}{16}$	22.50	21.10	23.06	24.75	24.20	25.87	21.37	20.25	33.17
$\frac{5}{8}$	25.00	23.44	25.62	27.50	26.90	28.74	23.74	22.50	36.84
$\frac{11}{16}$	27.50	25.79	28.18	30.25	29.58	31.62	26.12	24.75	40.54
$\frac{3}{4}$	30.00	28.12	30.72	33.00	32.28	34.48	28.48	27.00	44.20
$\frac{13}{16}$	32.50	30.48	33.28	35.75	34.95	37.37	30.87	29.25	47.92
$\frac{7}{8}$	35.00	32.82	35.86	38.50	37.64	40.24	32.34	31.50	51.60
$\frac{15}{16}$	37.50	35.16	38.43	41.25	40.32	43.12	35.61	33.75	55.36
1	40.00	37.50	41.00	44.00	43.00	46.00	38.00	36.00	59.00

WEIGHT OF METALS. TO FIND WEIGHT IN POUNDS.

Aluminium	cubic inches	× 0.094
Brass	“ “	× 0.31
Copper	“ “	× 0.32
Cast-Iron	“ “	× 0.26
Wrought-Iron	“ “	× 0.28
Lead	“ “	× 0.41
Mercury	“ “	× 0.49
Nickel	“ “	× 0.31
Tin	“ “	× 0.26
Zinc	“ “	× 0.26

TABLE 6

HOW TO MAKE SOLDER.

Plumber's wiping solder, for use with the ladle and the soldering cloth, is made up by melting together pure lead and block tin in the proportion of 2 pounds of lead to 1 pound of tin. Plumber's fine solder is made of about equal parts of those two metals. Strip solder—used with the copper-bit—is made in the proportion of 2 pounds of tin to 3 pounds of lead. Gas-fitter's solder may be made in the proportion of 8 pounds of tin to 9 pounds of lead, tinsmith's copper-bit solder is 1 pound of lead to 1 pound of tin. The proportion of lead and tin may vary within certain limits without apparent effort on the solder.

Plumber's wiping solder, when in a bar, should have a clean grey appearance, and not be dirty-looking. The ends of the bar should be bright, and show several tin spots mottled over their surfaces. In use, the solder should work smooth, and not granular. The tin should not separate from the lead on the lower part of the joints. One test for the quality of solder is to melt it and then pour on to a cold but dry stone about the size of a dollar, and take note of the color and size and also the number and sizes

of the spots that appear, but the only reliable test is to make a joint and note the ease with which it can be worked. For making joints on lead pipes copper-bit solder made in thin strips is generally used. This is the kind used also for soldering zinc. Some plumbers prefer solder finer, others coarser than the usual average which is given above.

The usual method of making solder is as follows: An iron pot is suspended over a coke fire, to which enough broken coke is added to bank up all round the pot. Sheet-lead cuttings and scraps of clean pipe are put into the pot until it is rather more than half full. Preference is given to pig-lead over sheet, and to new cuttings over pipe, because the lead rolled into sheets is generally purer than that used for pipe. Some pipe is made of old metals which contain lead, tin, antimony, arsenic, and zinc, it is inadvisable to put such material in the solder-pot. The effect would be to raise the melting point of the solder, and in applying it to the joint to be soldered it would in all probability partially melt the lead. Moreover, the metals named do not alloy perfectly, but partake more of the nature of a mixture which partially separates when making a joint, some metals, especially zinc, show as small bright lumps on the surface. Joints made with such solder, which usually is called poisoned metal, are difficult to form, and

they usually leak when in water pipes. The appearance of such joints is a dirty grey, instead of bright and clean as when pure solder is used. From this it is clear that in making solder great care must be taken to exclude zinc from the pot. Zinc, lead, and tin do not alloy well, lead will unite with only 1.6 per cent of zinc, and above that proportion the metals are only mixed when melted, and on cooling partially separate.

Sufficient lead having been melted in the pot, about $\frac{1}{2}$ pound of lump sulphur, broken into pieces about the size of hickory nuts, is added, and the whole well stirred with a ladle, the sulphur unites with zinc and other impurities. The resultant sulphides are skimmed off in the form of a cake, more sulphur being added so long as sulphides continue to form. The bowl of the ladle, in the intervals of stirring, should be laid on the fire, to burn off any adherent sulphur. When sulphide ceases to be formed, a handful of resin is thrown into the pot, and the lead stirred. When the resin has burned, the lead is again skimmed, and a piece of tallow about the size of a hen's egg is put into the pot, the lead being again stirred and skimmed. In stirring the lead it is lifted up and poured back by the ladleful, a larger amount of lead being thus exposed to the action of the cleaning material.

Best block tin is now added in the required proportion, and after the molten mass has been

well stirred a little of the mixture should be run on to a stone to test its fineness. If it appears too coarse more tin is added, if too fine, more sheet-lead. Finally, a little resin and tallow having been added, the solder is skimmed and is then ready for use or for pouring into moulds. When plumber's solder is heated in an open pot, the surface exposed to the air combines with oxygen, and on heating to redness, the combination takes place more readily. The tin melts at a lower temperature than lead, and so its specific gravity is lighter, floats when melted, and so the solder becomes poorer when too highly heated, owing to the tin's oxidation. If the dross is melted with a flux, or with powdered charcoal, which will combine with the oxygen, the solder will again become fit for use, but it is sometimes necessary to add a little more tin.

Burning the solder must be carefully avoided. A pot of solder after it has been red-hot has always a quantity of dross or dirt collected on the top. This is principally oxide of tin and oxide of lead, the tin and lead having united with the oxygen in the atmosphere to form oxides of these metals. Lead being roughly 50 per cent heavier than tin, the tendency is for the tin in the molten mixture to form the upper layer of the solder—the part most exposed to the action of the atmosphere. When the solder

becomes red-hot, there is therefore more tin burned than lead. Hence the solder becomes too coarse, and more tin must be added. Zinc is the greatest trouble to the solder pot. Great care has to be taken to exclude it, or to get it out. It may get into the solder from a piece of zinc, having been put into the pot by mistake for lead, but more commonly brass, which is an alloy of copper and zinc, is the source of the zinc that poisons the pot, into which brass filings find their way whilst brass is being prepared for tinning. If the filing is done at the same bench as the wiping, splashes of metal may fall on the filings, which will adhere, and thus get into the pot. Solder that is poisoned by arsenic or antimony is beyond the plumber's skill to clean, but zinc can be extracted by stirring in powdered sulphur when the solder is in a semi-molten condition, and then melting the whole, when the combined sulphur and zinc will rise to the surface, and can be taken off in the form of a cake, the solder being left in good condition for use.

SOLDERING FLUXES.

The flux ordinarily used for plumber's wiping solder is tallow, generally in the form of a candle. No other fluxes answer this purpose so well, as they all spoil the wiping cloths, but different kinds of fluxes are required for different kinds of work. For a wiped joint, a tallow candle is rubbed over the parts. This is often used in making copper-bit joints, though for this latter purpose many plumbers prefer to use black rosin. Muriatic acid is employed as a flux for use when soldering, the acid—which is a powerful poison—being used for zinc or galvanized iron, and the killed acid for other metals, such as brass, tinplate, copper, wrought-iron, etc.

After tinning brass with fine solder, the copper-bit should be wiped quite clean, as the copper, uniting with some of the zinc in the brass, may affect the wiping solder. Some plumbers tin brass by holding it over the metal pot and pouring the solder on to it. This is bad practice, as the surplus solder, and any zinc with which it may have combined, fall into the pot. In cleaning solder, the sulphur must be used

with more care than when cleaning lead, or the tin will be burnt out as well as the zinc.

The method ordinarily adopted by plumbers for tinning iron is to file it bright and then coat the part with killed acid or chloride of zinc, or muriatic acid in which zinc has been dissolved, and then dip it into molten plumber's solder. Sometimes sal-ammoniac is used for the flux, or a mixture of sal-ammoniac and chloride of zinc. When wrought-iron pipes have been thus tinned, and then soldered joints made, they have been found to come apart after a few years, the pipe ends, when pulled from the solder, being found to be rusty. Although more difficult to accomplish, iron pipe ends filed and covered with resin, and then plunged into molten solder, from the surface of which all dross has been skimmed, and afterwards soldered together, have been known to last a considerable time. When tinning the pipes or making the joints, the solder must not be overheated, or failure will result.

PREPARING WIPED JOINTS.

One objection that is often raised to wiped joints is that they are too expensive, and require a large quantity of solder. Another is that they take up too much time, and when they are made they are said to be ugly, and have been described as a "ball of solder round a pipe." It seems very unfortunate that plumbers' work should be judged by its worst specimens, but, probably, this course of action is justified by the principle that the strength of the chain is limited to its weakest link. There is no doubt that if joints are carefully prepared and properly wiped the above objections would be groundless, and that for good substantial work there is no other kind of joint that is more suitable for the purpose.

In the process of making wiped joints no part is so important as the preparation. A joint may be wiped as nicely and as regularly as possible, but if the ends are not properly prepared and fitted, it will very often happen that the joint will leak by sweating, as it is called, the solder is generally supposed to be the cause, but more often it is the fault of the imperfect preparation of the ends of the pipe. We will

suppose, for instance, an upright joint on an inch service pipe. Fig. 40 is a sketch showing the way a joint of this kind is usually prepared. Very often one end barely enters the other, no care is taken to see that the ends fit properly together, and any space that may be left between the two ends is closed up with a hammer. As to shaving inside the socket end, this is thought quite unnecessary, if not a fault, for some think if the socket end is shaved inside, it will induce the solder to run through and partly fill up the pipe. There is no doubt it would do so if the ends do not fit; but that is just the thing that is most important, not only as regards the solder getting inside the pipe, but on it depends, to a very large extent, the soundness of the joint.

The general idea is that if the two ends of a pipe are shaved and placed together, and a piece of solder stuck round them, that is all that is required to make a joint. If the solder is not so fine as it ought to be, it is the cause of most of the leaky joints, and very often the joints are found broken right across the center, more especially in the case of joint on hot-water, service, and waste pipes. It has been remarked that the solder is generally blamed for all the failures. It is either too coarse or too cold, or else it must have got a piece of zinc in it. Otherwise, if the joint is made to brasswork, it is that

which has poisoned the solder. In short, everything gets blamed except the right cause.

It must not be supposed that joint-wiping can be taught by books. This can only be accomplished in the workshop or on a plumbing job. But as practice is very often greatly assisted by precept, probably a few hints on the matter of joint-wiping will be helpful to many who have not the opportunities to gain a very large or varied experience. In preparing a joint similar to the one mentioned, after the two ends are carefully straightened, the spigot, or what is generally called the male end, should be first rasped square, and then tapered with a fine rasp quite half an inch back from the end. A fine rasp is mentioned because the rasps that are used by many plumbers are far too coarse to properly rasp the ends of pipes. Generally the very coarse rasps are used, it is difficult to say why, except it is that they are cheaper than the fine rasps, but if the advantages of a fine rasp be taken into account, the extra cost would not be considered.

When preparing the ends of the pipe, great care should be taken to avoid the raspings getting into the pipes, these cause no end of time and trouble when they get into valves and other fittings, after the pipes are filled with water.

As a rule, it is the back stroke of the rasp that throws the raspings inside the pipe, espe-

cially when the pipe is being rasped horizontally, or with the end of the pipe pointing upwards. If possible, when the ends are being rasped, they should either be pointing in a downward direction, or else the rasp should not be allowed to touch the pipe in its backward stroke. Some plumbers place a wad or stopper in the end of a pipe when it is being rasped; this is a very good precaution to take, providing it is not forgotten and left in the pipe. After the spigot end has been rasped, it should be soiled about six inches long, but no farther towards the end than an inch from the rasped edge. Sometimes the soiling is taken right up to the end, but this is not a good plan, because, if it is soiled over the rasped edge, the shave-hook does not always take the soil out of the rasp marks, a point which is most important; and as it is quite unnecessary to soil farther than the line of shaving, the soil at the end is quite superfluous. Many plumbers soil the ends before they rasp them with the same object in view, but this is not a good plan, because very often in rasping the ends, the end of the rasp is likely to scratch the soiling, making it necessary to touch up the soiling again.

If the soil is good it is an advantage to rub it, after it is dry, with a piece of carpet or a hard brush, a dry felt will do. This makes the surface of the soil smooth and more durable, and

not so likely to flake off when the joint is wiped. The best soil is made from vegetable black and diluted glue with a little sugar, and finely ground chalk added. The proportion of the ingredients depends to a large extent on their quality. Lamp black and size are generally used, but if the black is not very good it is very difficult to make soil fit for use, it will rub or peel off and become a nuisance. Good soil, and a properly made soil pot and tool, are indispensable to a plumber who wishes to turn out a good quality of work. Any makeshift does for a soil pot with a great many plumbers. Some use an old milk-can or a saucepan. It is much better to have a good copper pot, with a handle. Most plumbers should be able to make a soil pot with a piece of sheet copper, otherwise a coppersmith would make one for a small sum. Before soiling the end of the pipe, it is always a good plan to chalk it well. This will counteract the effects of the grease that is nearly always found on the surface of new lead pipes. If the pipe is very greasy, it is still better to scour it well with a piece of card-wire before it is chalked and soiled. The scouring is not always necessary, but it is always best to carry a piece of card-wire in case of need.

When the end of the pipe has been properly soiled, it should be shaved the length required, that is, about half an inch longer than half the

length of the joint, thus allowing half an inch for socketing into the other end. Grease, or "touch," as it is called by plumbers, should immediately be rubbed over the shaved part to prevent oxidation. The socket end of the pipe should now be rasped square and opened with a long tapered turnpin—a short stumpy turnpin is not a proper tool for this purpose, although many of this kind are used. After rasping the edge of the pipe, the rasped part should be parallel with the side of the pipe, as shown at Fig. 39. It is not at all necessary for the edge of the socket end to project, nor to reduce the bore of the pipe in the joint; but if the ends are prepared, as shown at Figs. 40 and 41, it would be necessary to open the socket end an extraordinary width to get the same depth of socket, and then a much larger quantity of solder would be required to cover the edge, which would make the shape of the joint look ugly, and not make such a reliable joint either.

When the socket end is properly fitted, it should be soiled and shaved half the length of the intended joint. The inside of the socket should also be shaved about half an inch down and touched.

If the solder is used at a proper heat and splashed on quickly, so as to well sweat the solder in between the two surfaces where the ends are socketed, the joint is made, so far as the

soundness is concerned, independent of the wiping or the form and shape of the solder when it is finished. In fact, if a joint is prepared in a proper manner, it would be sound in most instances if the solder was wiped bare to the edge of the socket end. Of course, it would not

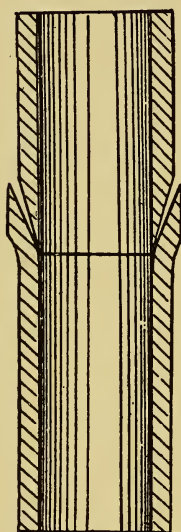

Fig. 39.

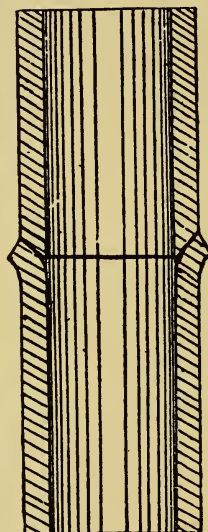

Fig. 40.

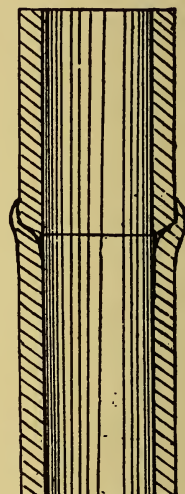

Fig. 41.

be advisable to do this, but still, a joint should and could be quite independent of the very large quantity of solder that is frequently used. But when a large amount of solder is seen on a joint, it can generally be taken for granted that the plumber that made it, when he prepared the

ends, took great pains to close up the edge of the socket end to the spigot end so that it fitted tight, so tight was this edge, that it prevented the slightest particle of solder getting in between. The consequence very often is, that if the plumber is not quick at wiping the joint, and keeps the solder moving until it is nearly cold, or at least cold enough to set, the whole of the solder on the joint will be in a state of porousness, or, in other words, instead of the solder cooling into a compact mass, the continual moving of it by the act of wiping causes the particles, as they become crystallized by cooling, to be disturbed and partially disintegrated. The result is, that under a moderate pressure the water will percolate through the joint and cause what is generally termed "sweating." Very often it is rather more than sweating, it can more correctly be compared to water running through a sieve. Under some conditions it is not a very easy matter to prevent this sweating, especially if the solder is very coarse, or is poisoned by zinc or other deleterious matters. The great advantage of leaving the socket end open is, that if the solder is used at a good heat, as it always should be when it is splashed on, it runs into the socket at such a heat that, when it cools, it sets much firmer than that part of the solder which has been disturbed by the forming of the joint.

JOINT-WIPING.

Joint-wiping forms an important branch in the art of plumbing. It is a part of the work which requires more care, skill and practice than any of the other branches, and on it depends the success or failure of some of the most particular jobs in sanitary plumbing. Many serious cases of disease have been traced to bad joint-wiping. It is not expected that a joint can under all conditions, be as perfectly symmetrical and well proportioned as if it had been turned in a lathe. The best workmen have to leave joints that they would be ashamed of, as far as the appearance is concerned, if they were made on the bench or in some convenient place. There are too many who seem to think that sound work is good work, and therefore never try to make their work look as creditable as it should. The different styles of joint-wiping are so numerous, that one could go to any length describing the many eccentricities and peculiarities that are displayed in this particular branch of the trade. Of course every one has his own peculiar ideas in most matters, and no person does a thing exactly like another.

After a helper has been at the trade for a

short time, his one great ambition is to wipe a joint. He seems to think that if he can only manage to get a small portion of solder to adhere to a piece of pipe, and then so manipulate it as to induce it to take the form of an egg or a turnip, as the case may be, he has done something to be proud of, and soon begins to think he ought to be a full-blown plumber. Another question with regard to joints is the proper lengths to make them. Some like long joints, others prefer short ones. The advocates of long joints say that short joints are ugly, and are not proportionate. They are often compared to turnips, and other things not quite so regular in shape. Those who are in favor of short joints say the long ones are not so sound, that they will not stand a great pressure, and are liable to sweat. It is ridiculous to make joints of enormous lengths, when a joint made more in proportion to the diameter of the pipe would not only be much stronger, but would look far neater, and generally require less solder. Then there is the question of wiping-cloths. A great many plumbers like a very thick cloth for wiping joints, but, on the other hand, as many more say they cannot wipe joints with thick cloths. Many plumbers who are used to thick cloths and can wipe joints as easily as possible, are quite beaten if they try to use thin cloths. The difference in the thickness of cloths is very great

in some cases. Very thin cloths are not suitable for making joints a nice shape. When a plumber gets used to a reasonably thick cloth he can make joints far better and easier than if he used thin ones. Generally, plumbers who use thin cloths make joints very short and lumpy, and bare at the ends, so that the shaving is shown about an eighth to three-eighths from the ends. But when thicker cloths are used it is much easier to make joints more like the proper shape. This is very important in all joint-wiping, because wherever the shaving is left bare, the pipe is weaker here than any other part, whereas, if a joint is properly made, this part of it should be the strongest. In a large number of instances, when a pipe is subject to much expansion and contraction, it will break at this weak point very soon after it is fixed. It would be difficult to say generally what should be a proper thickness for cloths, excepting that they should be in proportion to the width and length. Cloths for large joints should be much thicker than those used for small ones, because the larger the cloth is, the more difficult it is to keep it in the shape required for wiping the joint. If a cloth used for making a four-inch joint were made of only about six thicknesses of moleskin, it would be no more, or at least but little more, use than one generally used for three-quarter or one-inch joints, because when a small amount of sol-

der falls on it, the cloth would bend down and let the solder fall, so that the solder would not remain in the cloth except that caught in the middle, where the hand is under it. Consequently, there is much difficulty in getting up the great heat necessary to make a large joint. Then supposing it were possible to get up the heat sufficient to wipe the joint, it is useless to try to make the point as regular as would be the case if moderately thick cloth were used. The reason is, that when the cloth is hot it gives too much to the pressure of each finger, and therefore presses unequally on the surface of the joint, making it either bare at the edges and showing the tinning, or causing the body of the joint to be irregular and bad in shape, more especially at the bottom where it is nearly bare.

A cloth should be just thick enough to prevent the impression of the fingers having any influence on the body of the joint, but at the same time it should be thin enough to allow it to be bent the shape required without any great exertion. A cloth cannot be employed like a mould used by a plasterer to mould a cornice, if it could, it would not be so difficult, and require so much practice to make a joint as it does. Although there can be no doubt that suitable tools are indispensable to the workman, yet it must be remembered, by plumbers especially, that the cloth, however well made both in size and shape,

will not make a joint without it is manipulated by an intelligent and experienced hand.

Wiping Horizontal Joints. In the making of wiped joints one of the greatest mistakes that is generally made is that of using too thin cloths. It is very difficult, if not altogether impossible, to make a good shaped joint with a thin cloth. The joints shown at A and B in Fig. 42 are

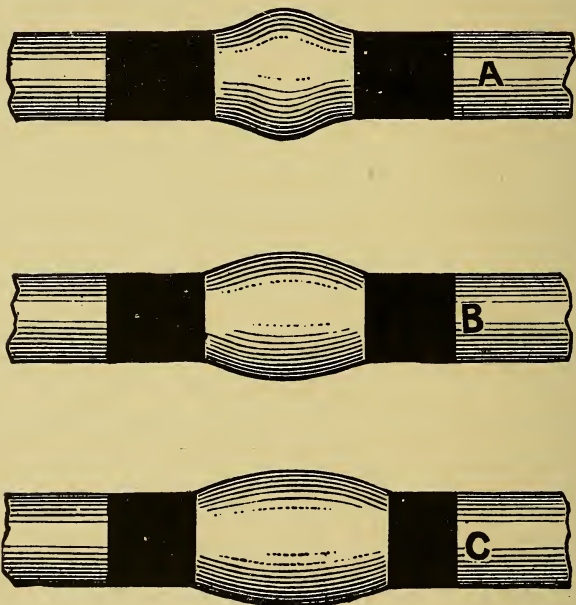

Fig. 42.

the kind of joint generally made with a thin cloth. By thin cloths are meant about five thicknesses of moleskin or ticking. Ticking,

however, is not nearly so suitable for the purpose as moleskin. Another objection to the use of thin cloths is their liability to get hot too quickly. Before the joint is finished it is almost impossible to hold the cloth on account of the intense heat. A cloth suitable to make a good wiped joint should consist of about eight thicknesses of moleskin. The width of a good cloth should be about an inch longer than the joint, and the length about the same or perhaps a little longer.

It will not be found a good plan to fold up the cloth out of one piece of material, as when the folds are at the sides, it is difficult to make the cloth bend as is required when in use. The better plan is to cut the cloth into pieces, of twice the length and exactly the same width as the cloth is required to be when finished. These should be folded once and then sewn together at the edge as shown in Fig. 43. To those who are in the habit of using thin cloths it will no doubt be found rather awkward at first to use thick ones, but a little practice will show that they are much more convenient to use and will turn out a better shaped joint as shown at C in Fig. 42. Thin cloths after they are hot get out of shape and give too much, with the result that the edges of the joint are often wiped bare. Another and very important advantage of thick cloths is that the joints may be made much

lighter, as it does not necessarily follow that because a large amount of solder is used on a joint it is any more sound or stronger than a lighter one.

When the solder on the joint is at such a heat as to make it difficult to keep it on the pipe, it should be patted round with the cloth, and the

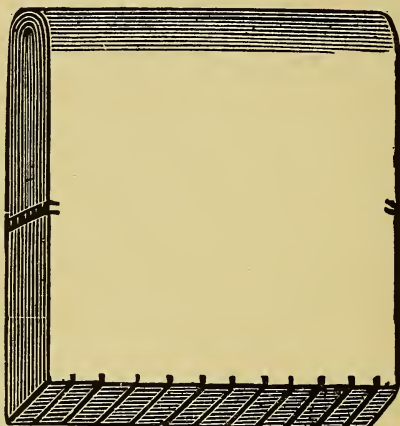

Fig. 43 .

surplus solder on the edges wiped off. The cloth should now be taken in the right hand, as shown in Fig. 44, and the wiping commenced at the back of the joint. While drawing the cloth upwards, the forefinger should be used to clean the edge nearest to it, after which the little finger should be used to clean the other edge. As soon as the edges are clean, the body of the

right joint as shown in Fig. 45, it is better to proceed by stages than to try to wipe the joint all at once. The first stage is to pour on the metal and tin the joint, that is, cause a film of solder to alloy with the surface of the pipe.

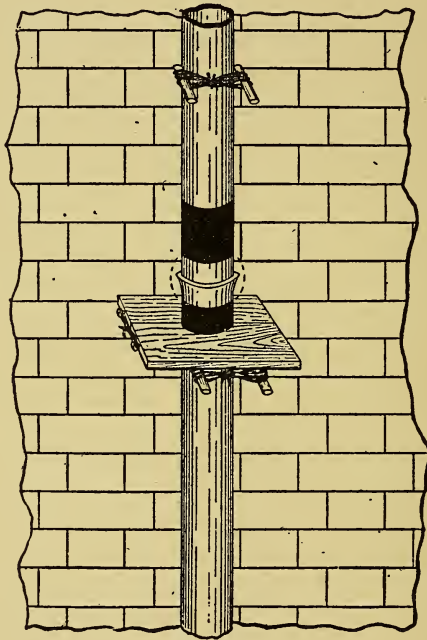

Fig. 45.

When the above described operation has been performed, the iron should be made hot, and the joint should be splashed by means of the splash-stick, until the pipe is hot enough and

sufficient solder is on it to allow of the wiping cloth to be used. Great care should be used in melting the solder, if allowed to get red-hot the solder deteriorates. The soldering-iron should be heated to the right temperature and the bit filed clean and bright. The solder should first be splashed on the shaved portion of the pipe and then on about two inches of the soiled part at each end of the pipe. The cloth should always be held under the place where the solder is being splashed on, to catch the surplus solder. As the solder runs down the sides of the pipe and is caught in the cloth, it is pressed up against the pipe to keep up the heat and also to tin the pipe.

As soon as the pipe has been well tinned, the solder should be formed into the shape of a joint. Begin at the top of the joint, and with the hot iron in one hand and the cloth in the other, rub the iron over the solder on the joint and wipe round with the cloth quickly and lightly, working downwards until the joint is finished. When the joint has partially cooled, it may be cleansed and brightened by rubbing it over with tallow and wiping off with a clean soft rag.

Wiping Branch Joints. Fig. 46 shows a badly shaped joint that is often made by the use of a thin cloth, while Fig. 46a shows a joint that may be much more readily made by the

use of a thick cloth. When everything is ready and the solder is at a suitable heat, it should be splashed on very carefully while at the same time the pipe should be warmed for a few inches

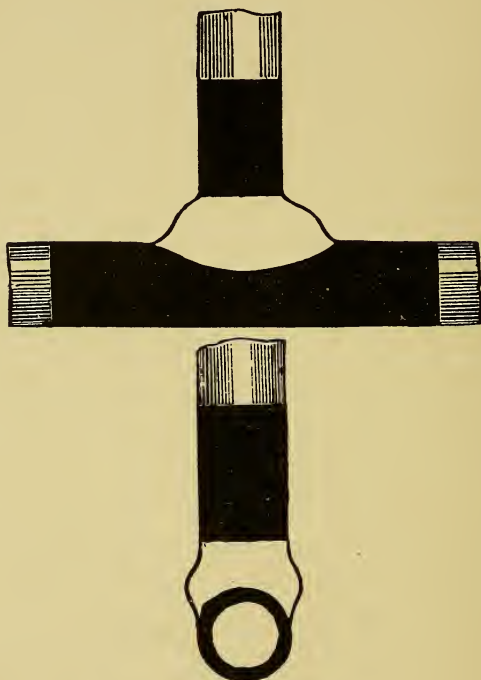

Fig. 46

each side of the joint with the solder. When the solder on the joint is at such a heat as to make it difficult to keep it on the pipe with continually drawing it up, take a small clean iron

at a dull red heat, and start wiping at one end of the joint. Carefully form the sides of the joint and wipe the solder as hot as possible by the continual application of the iron before each

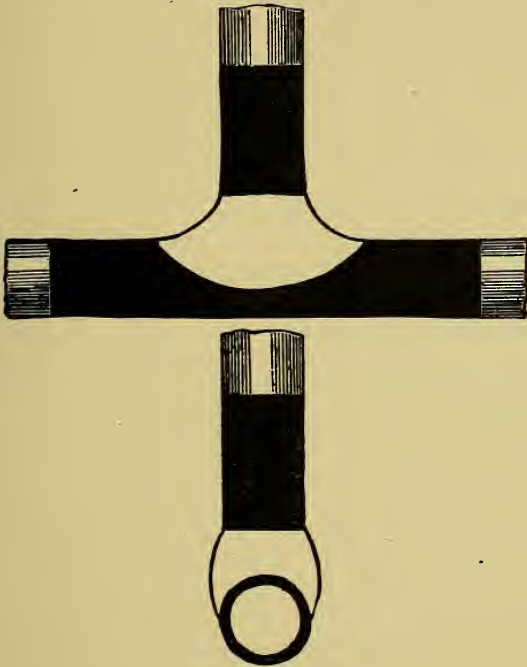

Fig. 46a

part of the joint is wiped. Finish the joint at the same end as it was started by drawing the wipe-off to the outside edge of the joint.

A lead pipe can be wiped to a cast iron pipe with a fair amount of ease, but the joint will not stand satisfactorily. The best way is to file clean the end of the cast-iron pipe and then coat it with pure tin, using sal-ammoniac as a flux. The pipe is then washed to remove the sal-ammoniac, and afterwards re-tinned, using resin and grease as a flux. A plumber's joint, $3\frac{1}{2}$ inches long for 4-inch pipes, is then wiped in the usual way. Great pains will have to be taken to make a good, sound, strong joint between the two metals. Nevertheless, in the course of time, it may be only a few years, the cast iron will come out of the solder. The first sign of decay will be a red ring of iron rust showing at the end of the joint. This rust will swell a little and cause the end of the soldering to curl slightly outwards. Eventually the rust will creep between the solder and the iron and destroy the adhesion of the one to the other. Only those metals that alloy together can be satisfactorily joined by soft soldering, and the solder should contain as great a proportion as possible of the metals that are to be united. The joint would, if out of doors, be subjected to temperatures ranging over 90° Fahrenheit, under such conditions the solder would expand .001251 inch, and the iron would expand .000549 inch, or less than half as much as the solder. The joint would therefore eventually become a loose ring on the iron pipe, but not on the lead pipe, as the

expansion of lead and solder do not differ materially.

Numerous experiments have been tried for overcoming the difficulty of wiping joints on ordinary tin-lined pipes, but the only method which has been found to approach success has been to insert a long nipple of tinned sheet iron, this method, however, has not been wholly successful with the ordinary make of tinned pipe. However, on a new kind of tin-lined pipe, wiped joints can be made very easily, without the tin lining melting.

It would often be a convenience if copper pipes could be united satisfactorily by wiping, but plumbers' wiped joints are of no use with copper tube, for the expansion and contraction will not permit them to remain sound, as many hot-water engineers know to their cost, brazed joints would be satisfactory, though troublesome to make. If copper pipe is thick enough to be threaded, have the fittings threaded also, and screw them together the same as with iron pipe, except that with long runs there must be expansion joints or other provision made for expansion. Even when a wiped joint on copper pipes is strongly made by sweating on a sleeve and then wiping a joint over the whole, it is doubtful if it would be permanent. It is very probable that electrolysis would set in, if the pipe is in damp ground. However, should circumstances

suggest that a wiped joint might answer, the work is done as described below.

Wiped joints on copper pipes are longer than wiped joints on lead pipes. Copper pipes 2 inches or more in diameter have joints from $3\frac{1}{2}$ to 4 inches long, 4-inch pipes have joints about 5 inches long, but it must be remembered that whilst reasonable length and thickness of joint are necessary to enable the copper pipe to withstand pressure and strain, the maximum time of service does not depend on the length or thickness of the joint as in lead pipe work. That which determines practically the life of the joint is the extent of pipe which is carefully tinned before making the wiped joint. If the interiors of the two pipe ends are tinned, say, for 6 to 8 inches, if the joint is cut open, in a few years' time, it is found that the tinning has diminished to 2 or 3 inches, a corroding action having taken place at the end of the tinning, for this reason it is advisable that the tinning be fairly thick, so as to retard the separation and ultimate failure of the joint. In tinning copper, first thoroughly clean it with dilute sulphuric acid or scour with sand and water, and then rinse it with chloride of zinc, known as killed spirits. Melt some pure tin, throw in sal-ammoniac as a flux, and dip the copper in the tin, or pour or rub the latter over the copper. In pipes forming a portion of a distillery plant it is especially im-

portant that untinned spots are not left on the interiors of the pipe ends, as at such spots the destruction of the tinning commences at once. The pipe is strengthened by putting one pipe within the other, and the corrosion of the tinning is arrested when it reaches the lap. If sufficient lap is given, the pipe may be handled before the joint is wiped—a great convenience. The pipe ends are placed together, when practicable, over the iron pot containing the molten solder, which is then poured continuously over the joint until a heat is got up. This practice is not possible with lead or brass pipes, because in the one case the lead would melt, and in the other the molten zinc would leave the brass and ruin the solder. When the pipes cannot be moved, a shovel is placed beneath the joint and the solder poured on rapidly. When a thorough heat has been obtained, the joint can be wiped, with the aid of a cloth and of the mushy solder from the shovel, in much the same way as a joint on a lead pipe is wiped.

AUTOGENOUS SOLDERING OR LEAD BURNING.

The art of lead burning has for many years been kept quite distinct from plumbing generally, it is nevertheless a branch of the trade, and one in which large numbers of plumbers are becoming very proficient. There is not required a large amount of skill or ingenuity in the execution of lead burning, because, as a matter of fact, when it is compared with first-class plumbing, it is not nearly so difficult to acquire. In most cases where lead burning was considered necessary, such for instance as lining large tanks in chemical factories especially for the manufacture of sulphuric acid, the lead was simply used in large sheets fixed with tacks to wooden framework and the edges burned together. Of late years, however, this method of burning the edges of lead together has been adopted for numerous other purposes, such as the lining of sinks for chemical laboratories, and lining cisterns in cases where the water attacks the solder.

The modern term for lead burning is "autogenous soldering." The word "autogenous" is rather an ugly one, and somewhat difficult to

define, it pertains to the word "autogeneal," which means "self-begotten or generating itself," neither of which is very appropriate to the process of lead burning. In fact the latter term is not strictly applicable, because the lead is not burnt, it is only fused. The most suitable term would be "fusing process." Instead of saying "the seams are burned," it would be better to say "the seams are fused," as this would correctly describe the action that takes place.

The simplest kind of lead burning is that known as flat seams, and which as a rule is the only kind that plumbers are likely to make use of. Professional lead burners of course are required to burn seams in many different ways, even horizontal seams overhead are sometimes necessary. When the seams of sinks and cisterns have to be burned, the joints should always be arranged about 6 inches from the angles. Because if the seams are arranged in the angles the flame of the blow-pipe is likely to catch the surface of the lead at the side and burn them through before the seam is formed. It is best also to butt the edges of the lead and not to lap them. Then when each edge has been shaved about a quarter of an inch wide, take a strip of shaved lead about half an inch wide and direct the flame on the end until a drop is melted and falls on the seam, at the same time the flame

should be directed towards the part of the seam to be burned, for the purpose of heating it. Then cause the flame to play upon the small drop of lead until that and the lead upon which it rests are fused, then draw up the flame quickly. This operation, owing to the intense heat of the airo-hydrogen flame, occupies much less time than it takes to describe it. So that the operator has to be quick in manipulating the blast if he wishes to avoid burning the lead over a much larger space than is desirable. It must not be supposed that a flowing seam like that produced by a copper-bit and fine solder can be formed by the burning process, this, under the circumstances, is not possible. Each wave has to be formed separately by a distinct application of the flame. The regularity of these waves will depend partly upon the skill of the operator, partly upon the quality of the blast and on the purity of the lead upon which it is being used: But like most other mechanical operations proficiency has to be attained by practice and experience. When it is found necessary to burn seams on the vertical side of a cistern, the lap is generally arranged in a slanting direction for the purpose of forming a ledge for the drops of molten lead to rest upon until they are fused into the seam, which is formed of a series of drops, instead of waves. A similar appearance

is obtained when seams are burned on an upright side of a cistern in a horizontal line.

Another very convenient way to produce a good flame for lead burning is to use compressed oxygen and coal gas. The oxygen can be obtained in steel bottles, this, being discharged under great pressure, is used for the blast instead of air, a bellows is therefore unnecessary.

When it is stated that a small sized blow-pipe of this kind with a supply of oxygen at the rate of 7 cubic feet per hour, and a gas supply through a quarter-inch pipe, will fuse a quarter-inch wrought-iron rod easily, the intense heat of the flame can be somewhat realized. Probably the oxygen method of burning would be rather costly where only small jobs of lead burning are occasionally required, but where there is a considerable amount to do the compressed oxygen would be far more preferable to the cumbersome and often troublesome hydrogen machine.

There is yet another method which has been adopted to a very large extent for lead burning, namely the use of a red-hot hatchet copper-bit.

The seam is placed, in the case of a pipe, on an iron mandrel, or if a flat seam, on an iron plate, and the hot copper-bit is drawn through, slowly fusing the lead together as it goes. A core or bed of sand will also answer the purpose.

It is, of course, a rough and ready way of

doing the work, and it involves a large amount of time and labor in cleaning off the seams. But it is nevertheless effectual, and, where more skilful means are not at hand, it often serves the purpose in a rough way. It would not, however, do for general application, in fact, in numerous instances where lead burning is required, it would not be at all practicable.

In conclusion, it may be well to point out that the idea of substituting the burning system for soldering generally in plumbers' work is not at all likely to be an accomplished fact. It is all very well for special purposes, but the art of soldering in the modern style is too well established to be ever superseded by the comparatively inartistic methods of lead fusing. Not only is lead burning not so attractive or so substantial in appearance as soldering, but it is not nearly so well adapted to general plumbers' work, and there does not at present seem any probability of it ever becoming a successful competitor.

DRAINAGE FITTINGS.

Soil and Waste Pipe Fittings. One-quarter and one-sixth, and one-eighth and one-sixteenth



Fig. 47.

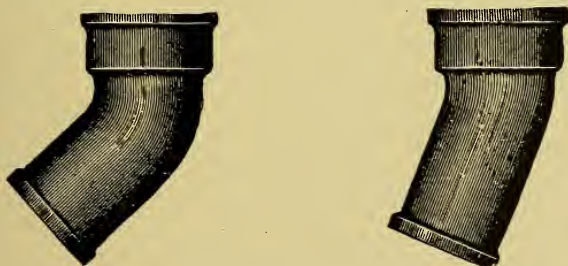

Fig. 48.

cast iron soil pipe bends or elbows are shown in Figs. 47 and 48 respectively, and long one-quarter and one-eighth bend in Figs. 49 and 50.

Quarter bends with heel and side outlets are shown in Figs. 51 and 52.

A long quarter turn or sanitary bend is shown in Fig. 53.

Figures 54, 55 and 56 show a T-branch soil pipe with left-hand inlet, a sanitary T-branch

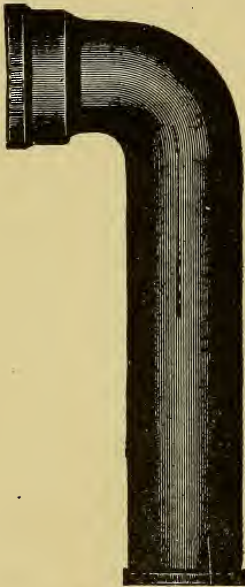

Fig. 49.



Fig. 50.

with right-hand inlet and a Y-branch with right-hand inlet, respectively.

A plain T-branch, a sanitary T-branch, a Y-branch and a half Y-branch are shown in Figs. 57, 58, 59 and 60.

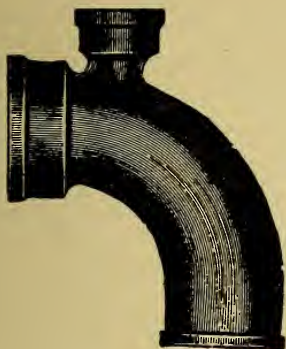

Fig. 51.

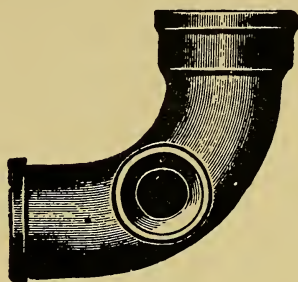

Fig. 52.

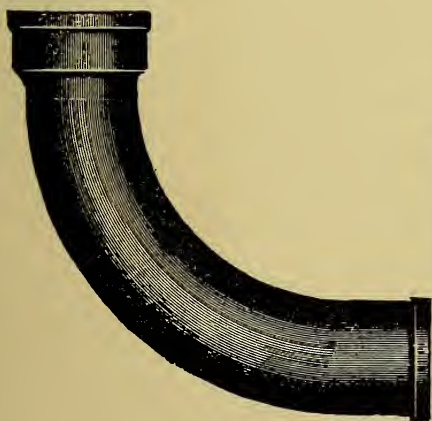

Fig. 53.

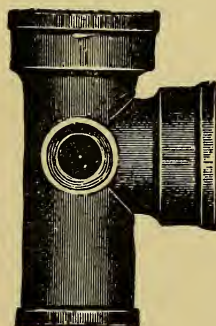

Fig. 54.

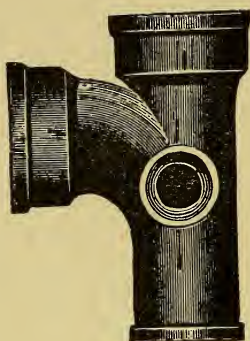

Fig. 55.

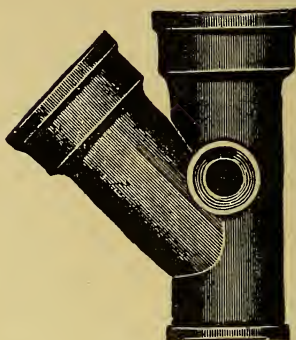

Fig. 56.

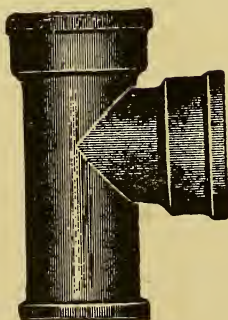

Fig. 57.

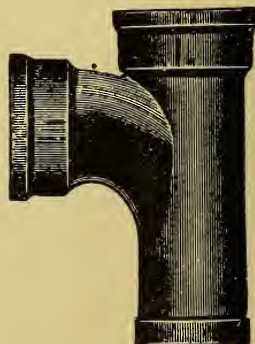

Fig. 58.

A plain T-branch, a sanitary T-branch, a cross and a sanitary cross all tapped for iron pipe are shown in Figs. 61 and 62.

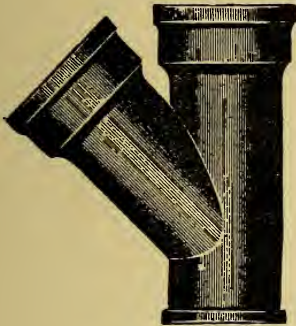

Fig. 59.

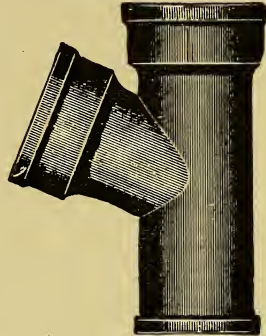

Fig. 60.

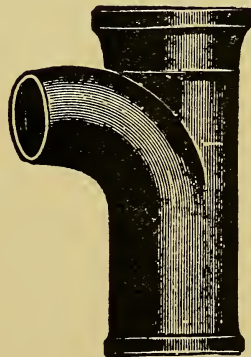
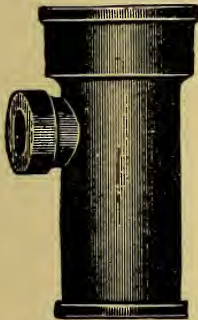

Fig. 61.

A plain cross, a sanitary cross, a double Y-branch and double half Y-branch are shown in Figs. 63, 64, 65 and 66.

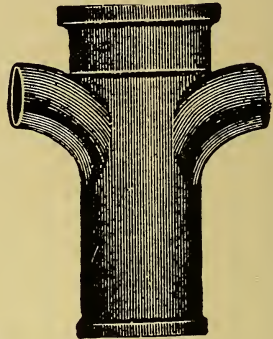
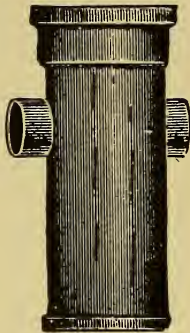

Fig. 62.

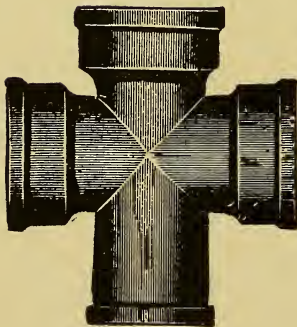

Fig. 63.

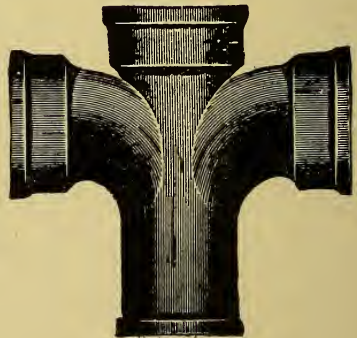

Fig. 64.

A ventilating cap and a Y-saddle hub are illustrated in Fig. 67, and half Y-saddle hub and a T-saddle hub in Fig. 68.

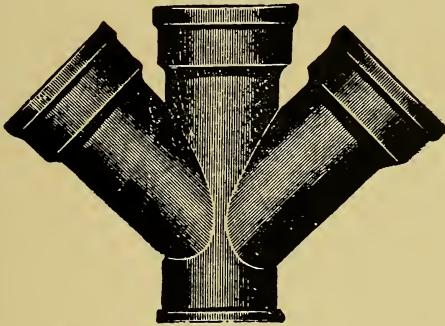

Fig. 65.

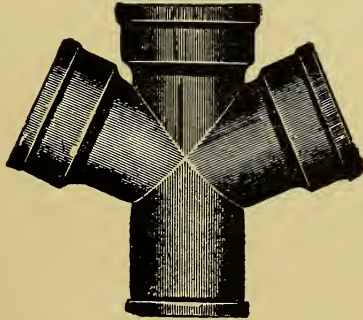

Fig. 66.

A ventilating branch tapped for iron pipe, an inverted Y-branch and a plain ventilating branch pipe are shown in Figs. 69, 70 and 71.

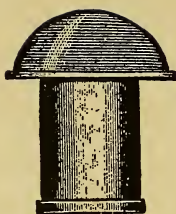

Fig. 67.

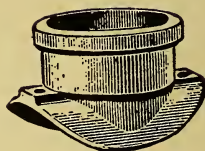

Fig. 68.

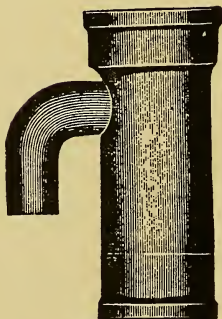

Fig. 69.

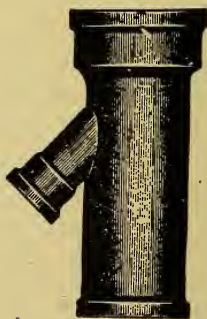

Fig. 70.

A T-branch, a sanitary T-branch and a Y-branch with trap-screw are shown in Figs. 72, 73 and 74.

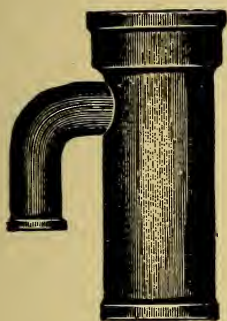

Fig. 71.

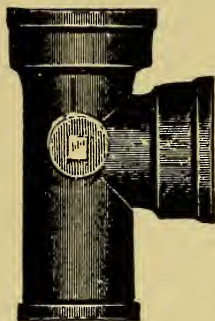

Fig. 72.

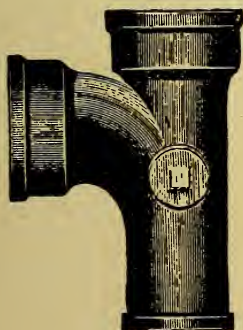

Fig. 73.

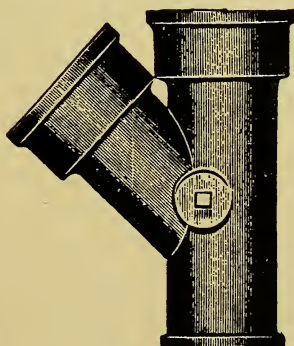

Fig. 74.

Traps. A running trap with hand-hole and cover, and one with two hub-vents are illustrated in Figs. 75 and 76.

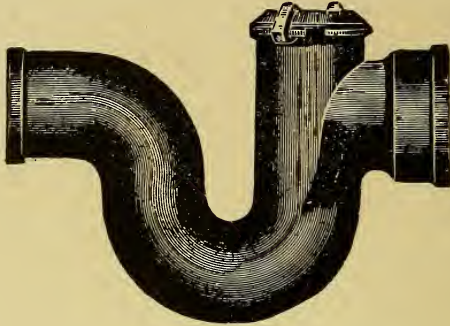

Fig. 75.

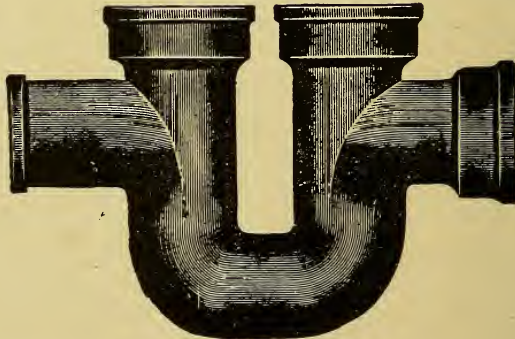

Fig. 76.

A full S-trap, a three-quarter S-trap and a half S-trap, are illustrated in Figs. 77, 78 and 79.

An S-trap, a three-quarter S-trap and a half

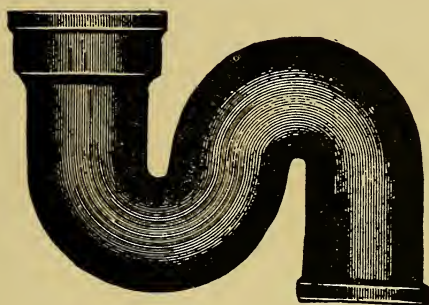

Fig. 77.



Fig. 78.



Fig. 79.

S-trap, all with hand-hole and cover, are shown in Figs. 80, 81 and 82.

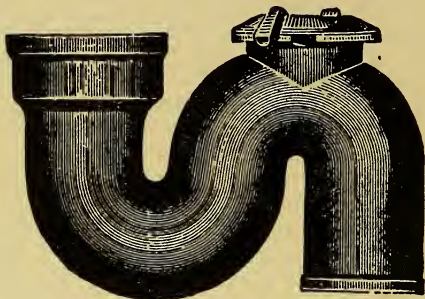

Fig. 80.

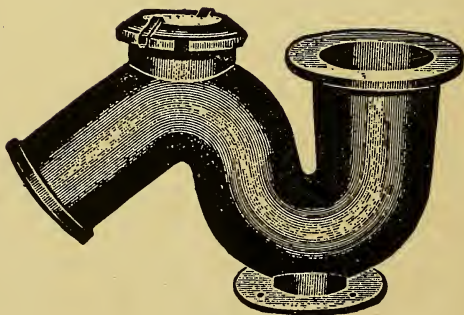

Fig. 81.

A full S-trap, a three-quarter S-trap and a half S-trap all with top vent are shown in Figs. 83, 84 and 85.

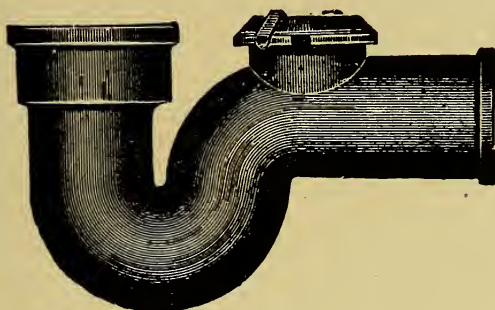

Fig. 82.

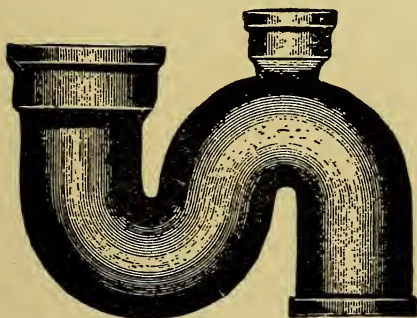

Fig. 83.

A plain running trap and a running trap with hub-vent are illustrated in Figs. 86 and 87.

Lead Traps. Traps with full S, three-quarter

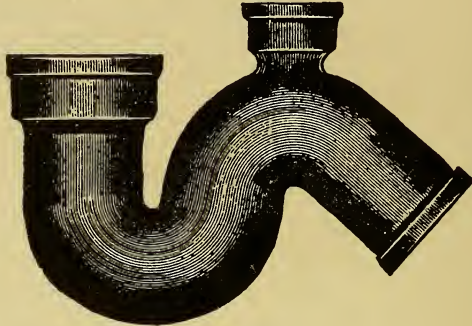

Fig. 84.

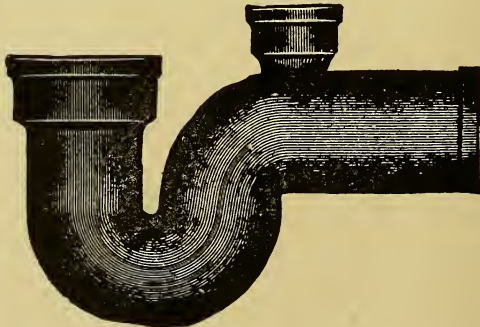

Fig. 85.

S, half S or P and running bends are shown in Fig. 88, both plain and vented.

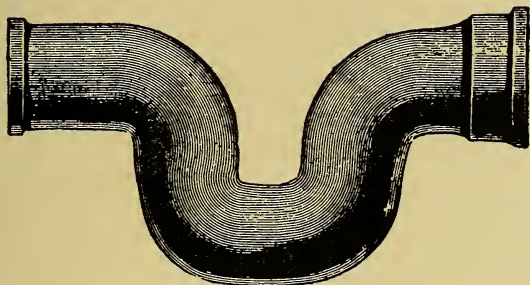

Fig. 86.

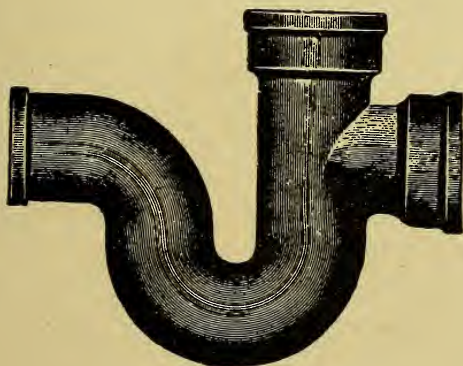

Fig. 87.

Lead Traps

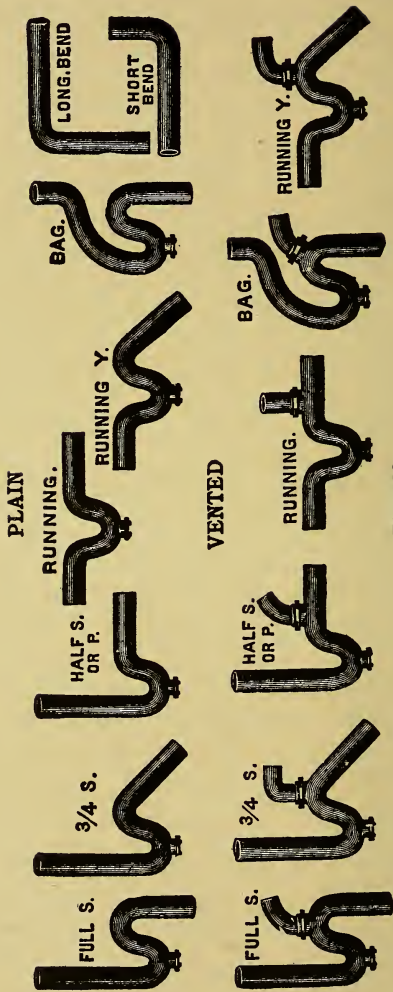
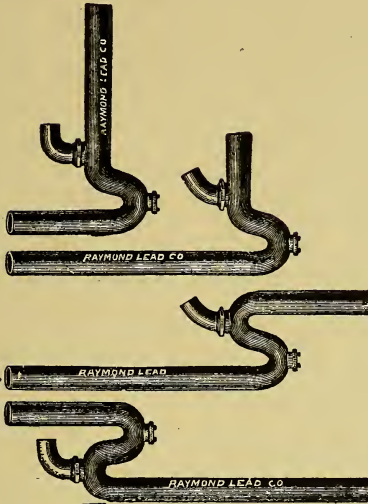
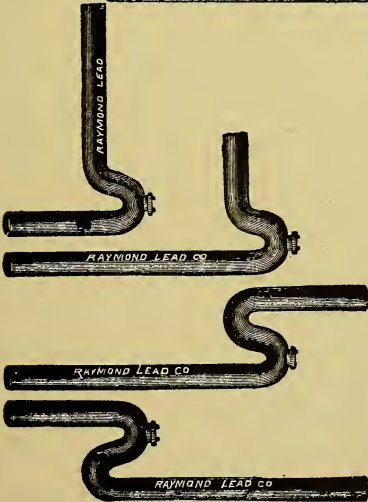

Fig. 88.

EXTRA LONG—Vented



EXTRA LONG—Plain



FULL S TRAPS

Fig. 89.

Extra long plain and vented S-traps are also shown in Fig. 89.

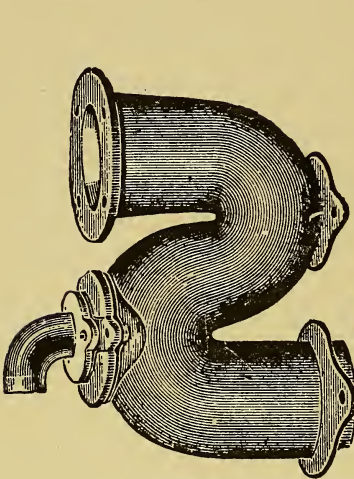

Fig. 90.

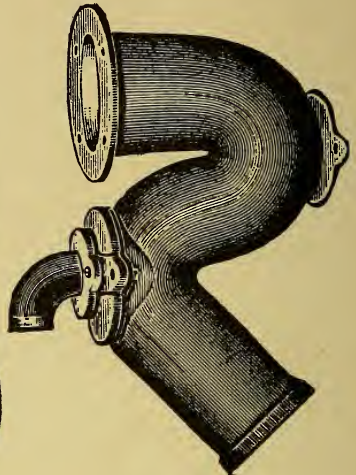

Fig. 91.

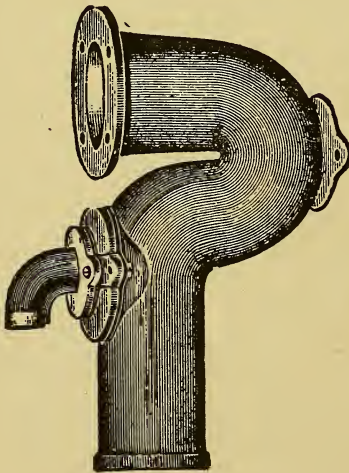

Fig. 92.

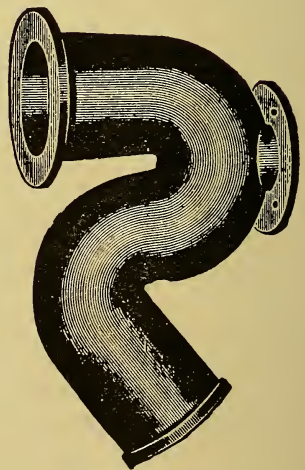

Fig. 93.

Hopper Traps. A high pattern S-trap for lead pipe connections is shown in Fig. 90, and a high pattern three-quarter and half S-trap for iron pipe connections in Figs. 91 and 92.



Fig. 94.



Fig. 95.

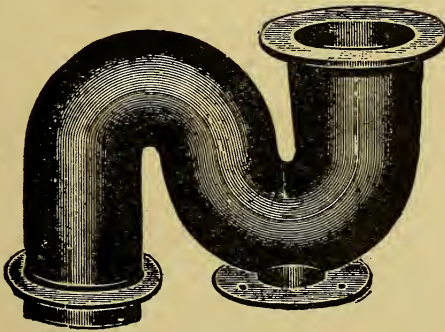

Fig. 96.

A plain three-quarter S high pattern hopper trap, a three-quarter S high pattern hopper trap with hub-vent and three-quarter S high pattern

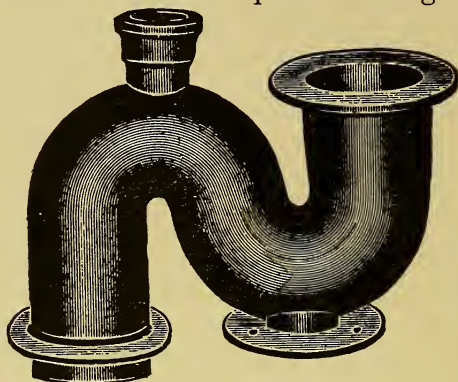

Fig. 97.

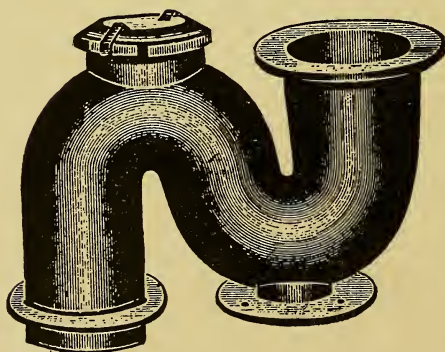

Fig. 98.

hopper trap with hand hole and cover, are shown in Figs. 93, 94 and 95.

A high pattern plain S-trap, a high pattern S-

trap with hub-vent and a high pattern S-trap with hand hole and cover, all for lead pipe connections, are shown in Figs. 96, 97 and 98.

The same style of S-traps only for iron pipe connections are shown in Figs. 99, 100 and 101.

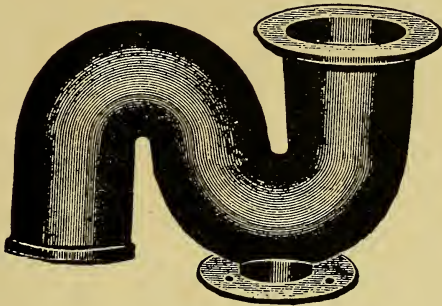

Fig. 99.



Fig. 100.

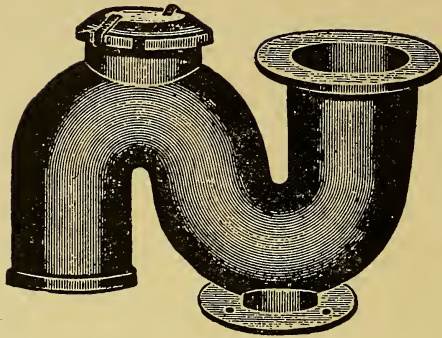

Fig. 101.

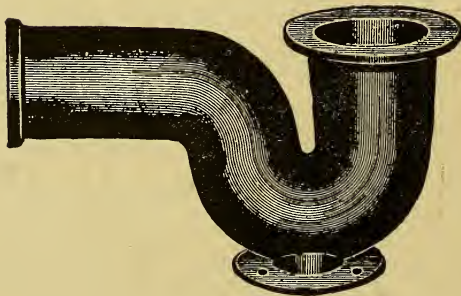

Fig. 102.

A half S-trap plain, a half S-trap with hub-vent and a half S-trap with hand hole and cover are shown in Figs. 102, 103 and 104.

Sewer gas and back water traps are shown in Fig. 105. They have hand holes and covers and

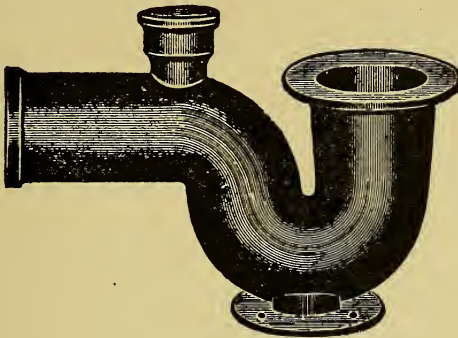

Fig. 103.

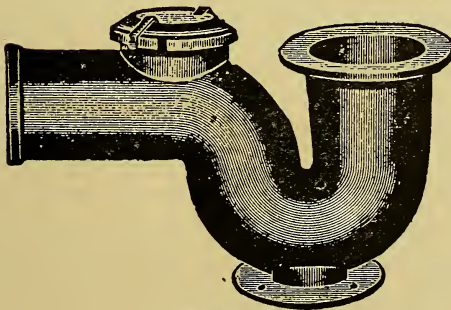

Fig. 104.

swing check valves to prevent any back flow of water.

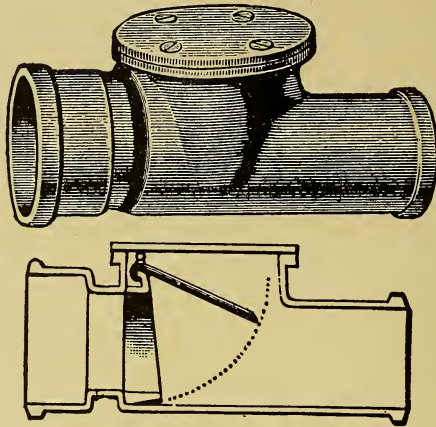

Fig. 105.

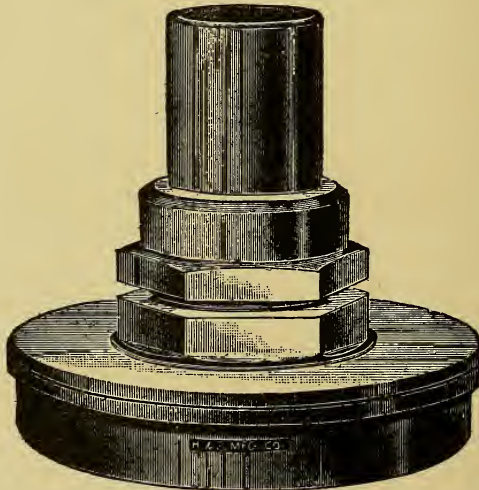

Fig. 106.

Brass trap caps with straight and bent couplings are shown in Figs. 106 and 107.

Cleanouts. Cleanouts with hand-hole and swivel cover, with hand-hole and bolted cover

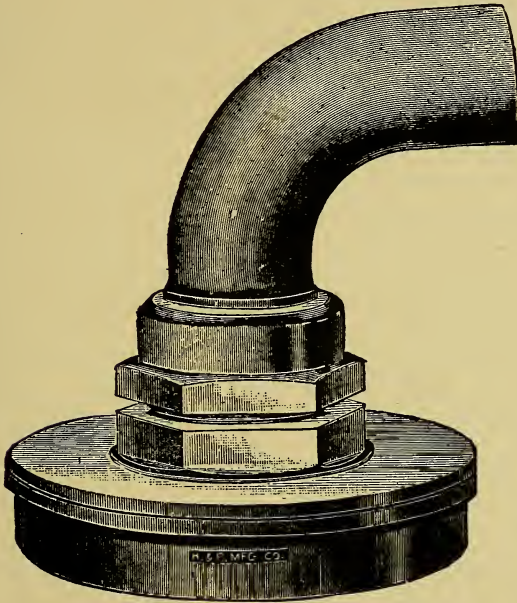

Fig. 107.

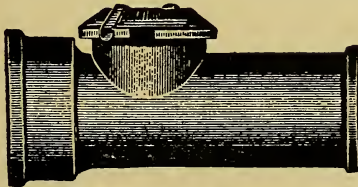

Fig. 108.

and with brass trap-screw are shown in Figs. 108, 109 and 110.

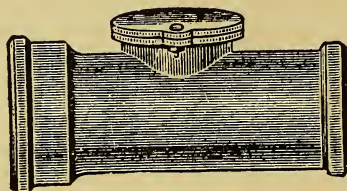

Fig. 109.

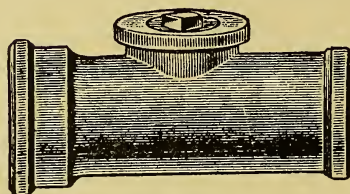

Fig. 110.

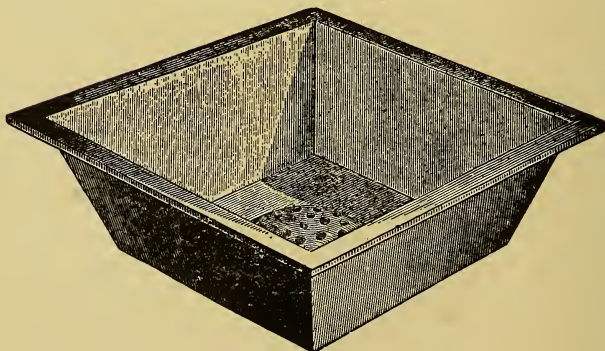

Fig. 111.

Cesspools. A hydrant cesspool for use with cellar or outdoor hydrants is shown in Fig. 111. A stable cesspool with bell-trap and grating is

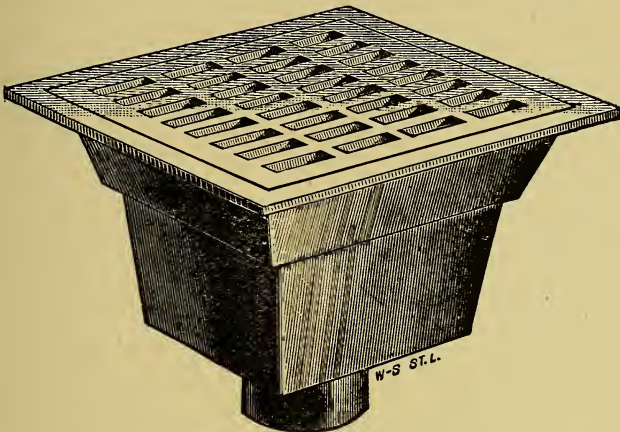

Fig. 112.

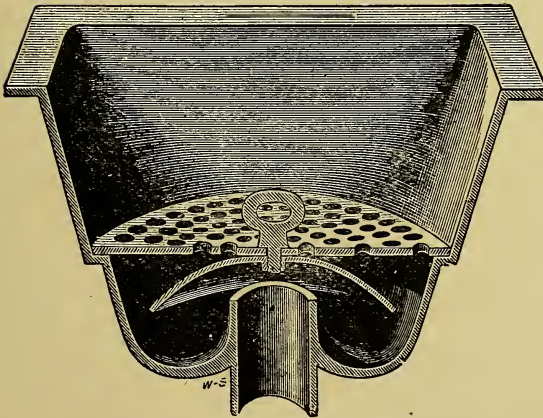

Fig. 113.

illustrated in Fig. 112, while Fig. 113 shows a slop sink with bell-trap and strainer. A cellar cesspool with bell-trap and grating of rectangular shape is shown in Fig. 114, while one of circular shape is illustrated in Fig. 115.

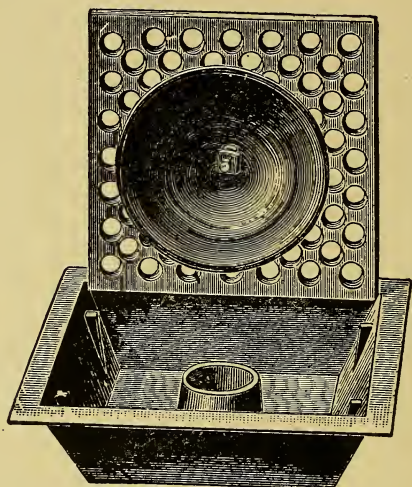

Fig. 114.

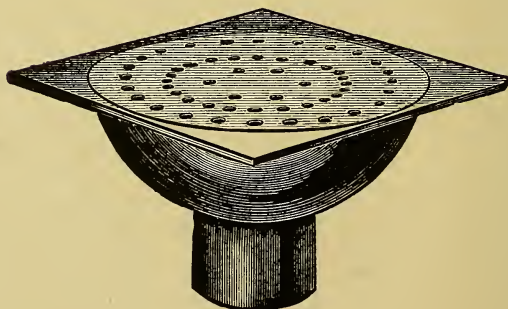

Fig. 115.

SANITARY PLUMBING.

The Bathroom. There are good reasons why a bathroom should be finished in the best manner in preference to any other room in the house. As a rule, the bathroom is more used than any other room in the house except the kitchen. It requires the best material to stand such constant use, and it is always economy to have the best material for purposes where hard usage or work is to be performed. Without a good finish, with the proper materials for this purpose, the bathroom cannot be kept in a sanitary condition. From the sanitary condition of the bathroom the sanitary condition of the entire house may be judged. Any person who pays attention to the sanitary condition of a house, can also tell the nature of the people who occupy it. Where the bathroom is neglected, scarcely any other part of the house will be in a proper sanitary condition.

A bathroom should be well lighted with windows, so that the sunlight may come in. It should be heated to a much higher temperature than any other room in the house, and should be thoroughly ventilated. The walls, doors, and casings should be of such material that they will

be proof against water and steam. The floors should never be covered with carpet, as it is a very unsanitary thing in any bathroom. Hard wood makes a good floor for a bathroom.

The bathroom of the modern house is often the most expensive room in the house, as today people who have both taste and means are spending large sums of money in securing the most sanitary fixtures for the bathroom and the highest degree of art in everything pertaining to the bathroom. Fig. 116 shows a bathroom in which all the fixtures are open work, a roll-rimmed porcelain lined bathtub with carved brass feet, and also screen shower attachment, a sitz bath of the same material and finish as the bathtub, a syphon closet with low down flush tank, a washbowl with nickel-plated legs and brackets as supports, also nickel-plated supply and waste fixtures.

Bathtubs. In Fig. 117 is shown a porcelain roll rim bathtub. This is a sanitary article in every manner, as it requires no woodwork about it, and as this bathtub is made entirely of one piece, there is no chance for dirt to lodge in any part of it. This bathtub will last a life-time; once properly set there will be no further expense for repairs. The porcelain bathtub is not without some fault or disadvantage; it is very heavy to handle. It is no easy matter to carry a bathtub of this kind up one or two

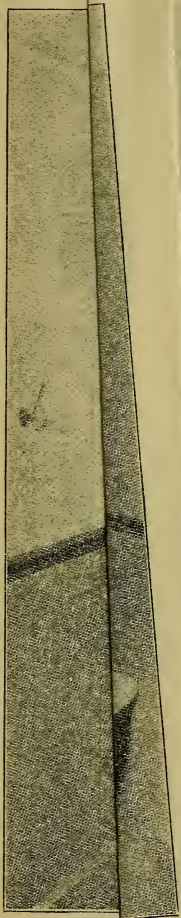

PHOTOGRAPH

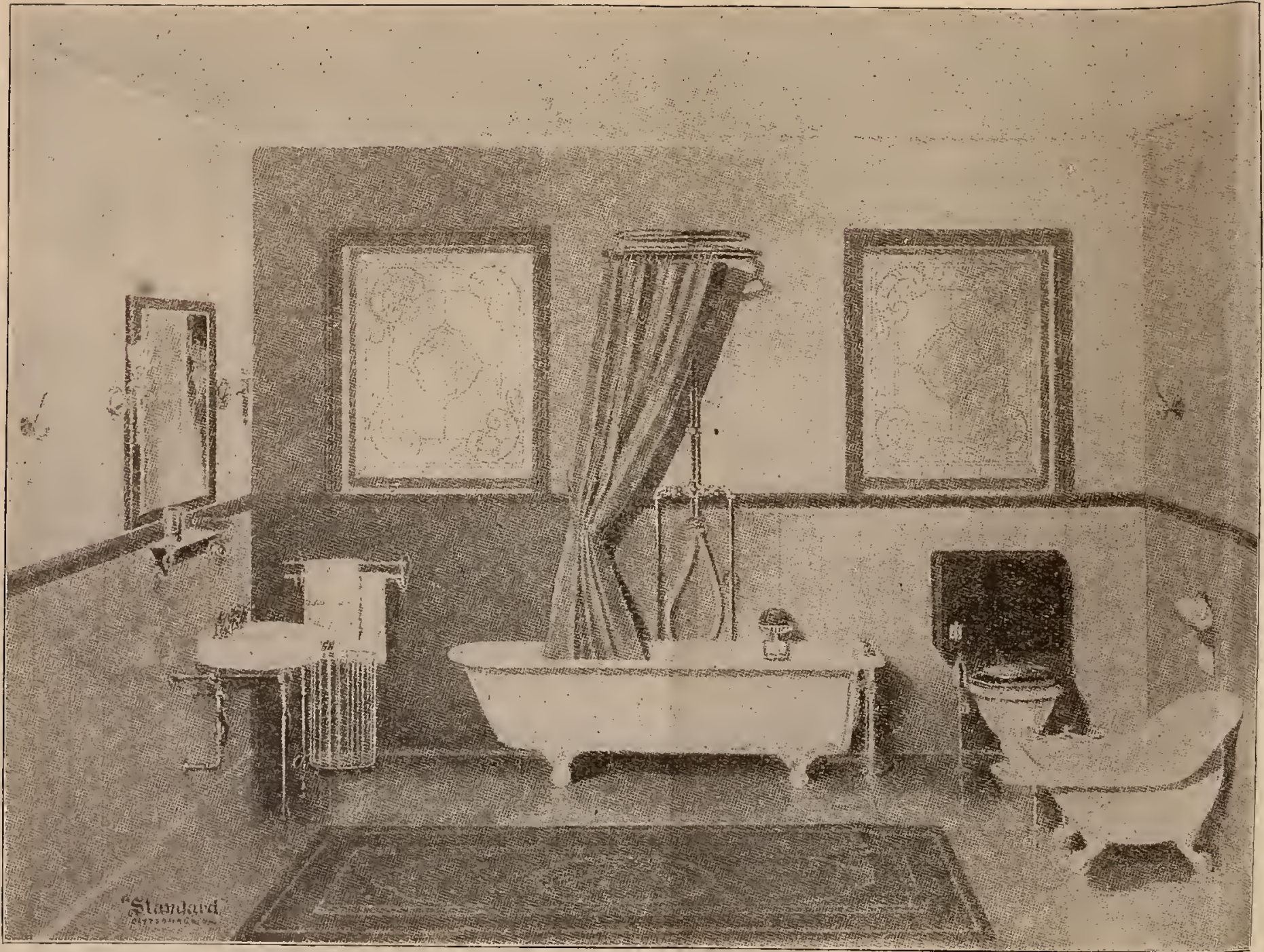

FIG. 116, BATHROOM



APR 1919

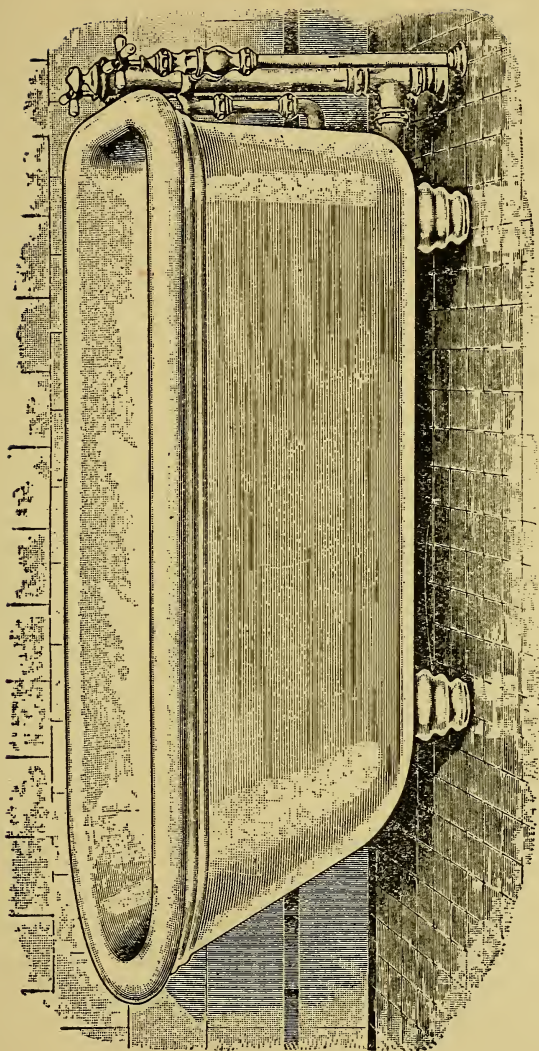

FIG. 117.

flights of stairs and land it safely to where it is to be set. It requires the greatest care in handling. In using the porcelain bathtub it has another bad point in being very cold to the touch until it has become entirely warm from the hot water.

What is styled a corner porcelain bathtub is illustrated in Fig. 118, the back and end of the tub are to be built into the wall, and the base sets into the floor. It is fitted with nickel-plated combination bell supply and waste fittings, which are connected directly to the bathtub itself.

Three styles of porcelain enameled bathtubs are shown in Figs. 119, 120 and 121, the supply and waste are connected directly to the bathtubs shown in Figs. 119 and 120, while the bathtub shown in Fig. 121 has only the waste and overflow connections on the tub.

A solid porcelain roll rim sitz bath is illustrated in Fig. 122. It is fitted with nickel-plated combination bell supply and waste fittings.

A porcelain enameled footbath is shown in Fig. 123, it is also fitted with nickel-plated combination bell supply and waste fittings.

Fig. 124 illustrates a combination spray and shower bath with rubber curtain and porcelain enameled roll rim receptor.

The proper sanitary plumbing connections for a bathtub are shown in Fig. 125. The cast iron soil pipe is 4 inches in diameter, the main air

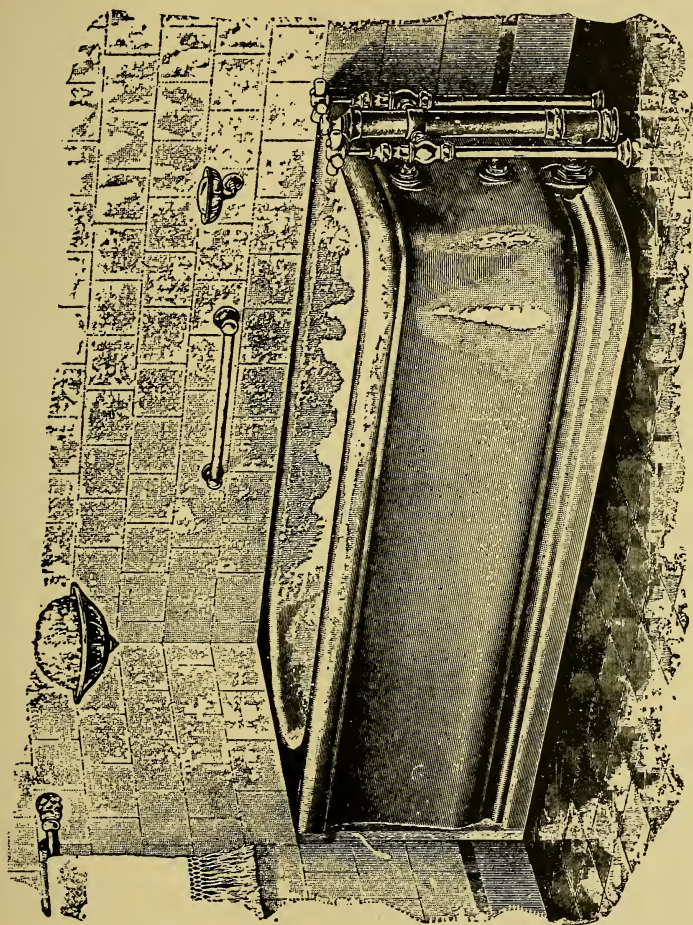

Fig. 118.



FIG. 119.

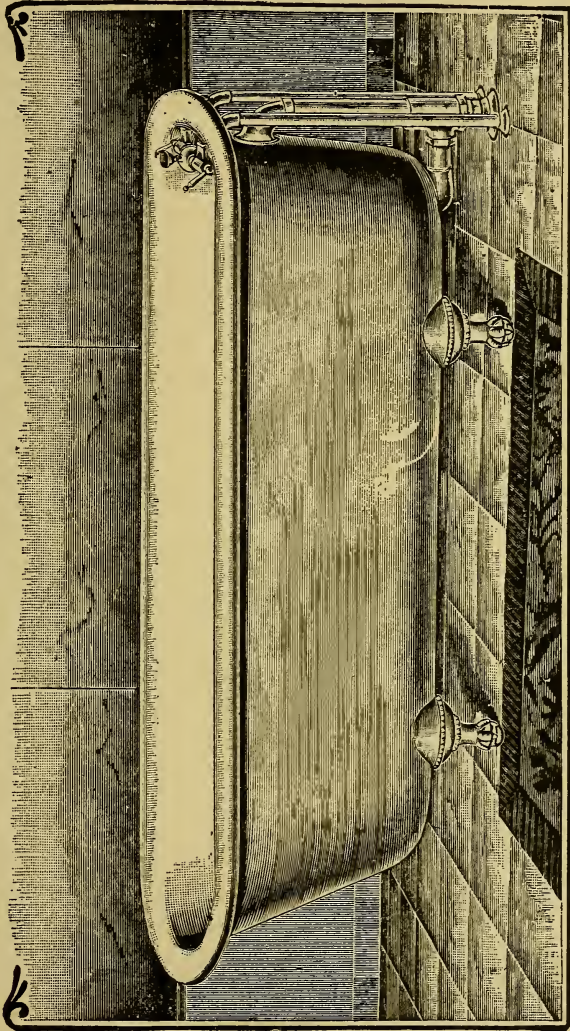

Fig. 120.

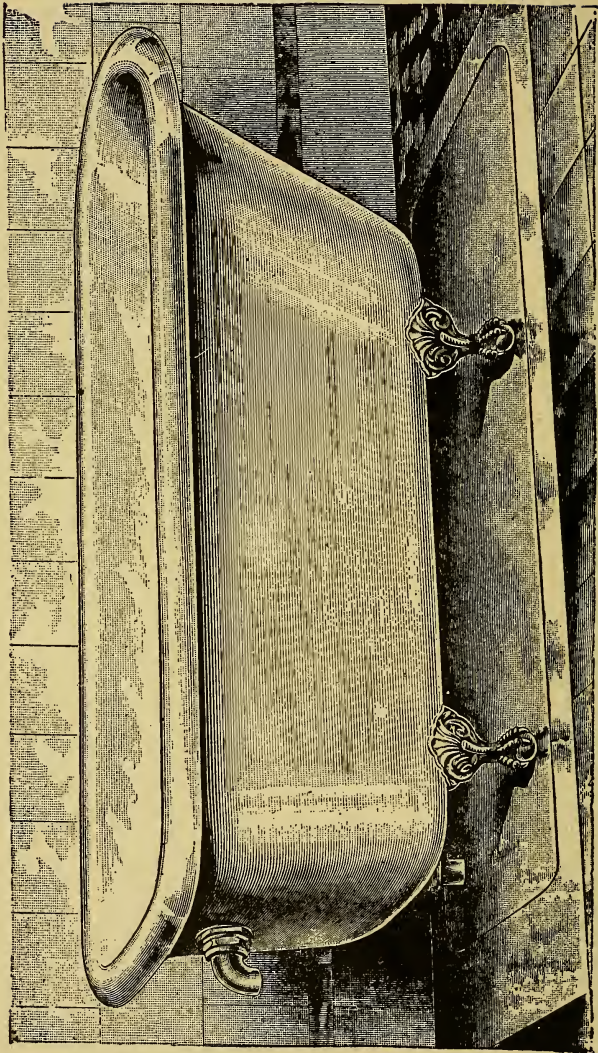

Fig. 121.

pipe 2 inches, and the air-vent pipe on the connection leading from the trap $1\frac{1}{2}$ inches; the waste and overflow from the tub are also $1\frac{1}{2}$ inches in diameter.

Water Closets. The washout closet is, perhaps, the best sanitary water closet, and they

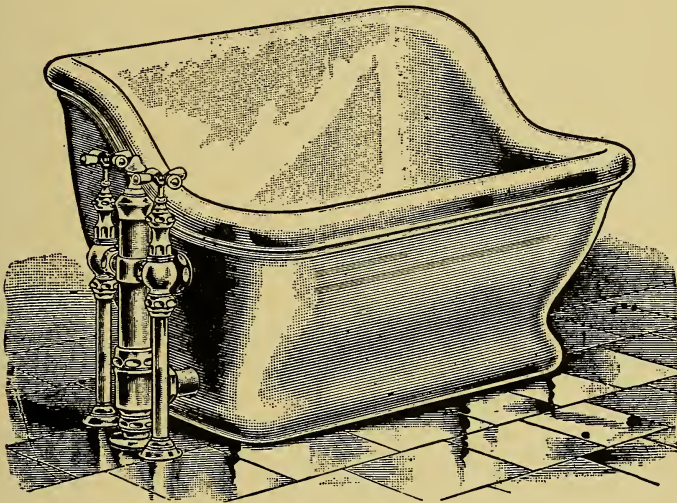

Fig. 122.

are made by nearly all manufacturers of sanitary fixtures. This closet is made with the bowl and trap combined in one single piece. The washout closet would be almost perfect if it were set up and connected as intended to be, and with a good local vent connected. The local

vent is the best possible thing that could be attached to a water closet, but, like all other arrangements, it must be made in such a way so that it will operate at all times and during every condition of the atmosphere. The local vent is

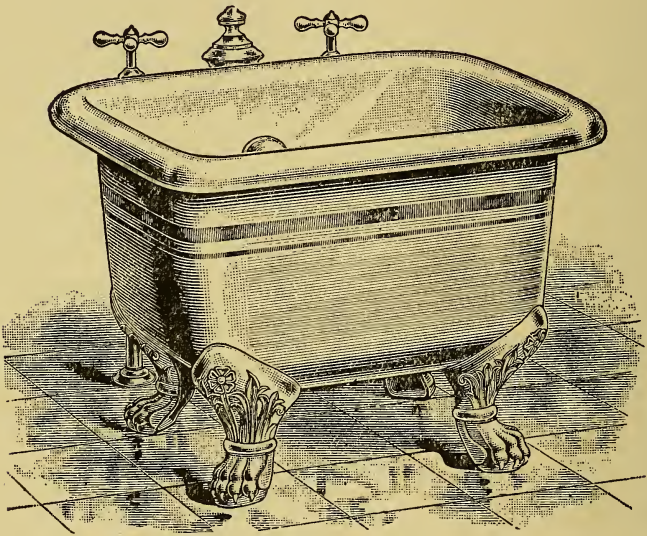

Fig. 123.

connected to the bowl of the closet for the purpose of taking away the air from the bowl of the closet in the room where it may be located, so that no foul odors while being used will pass from the closet to the room.

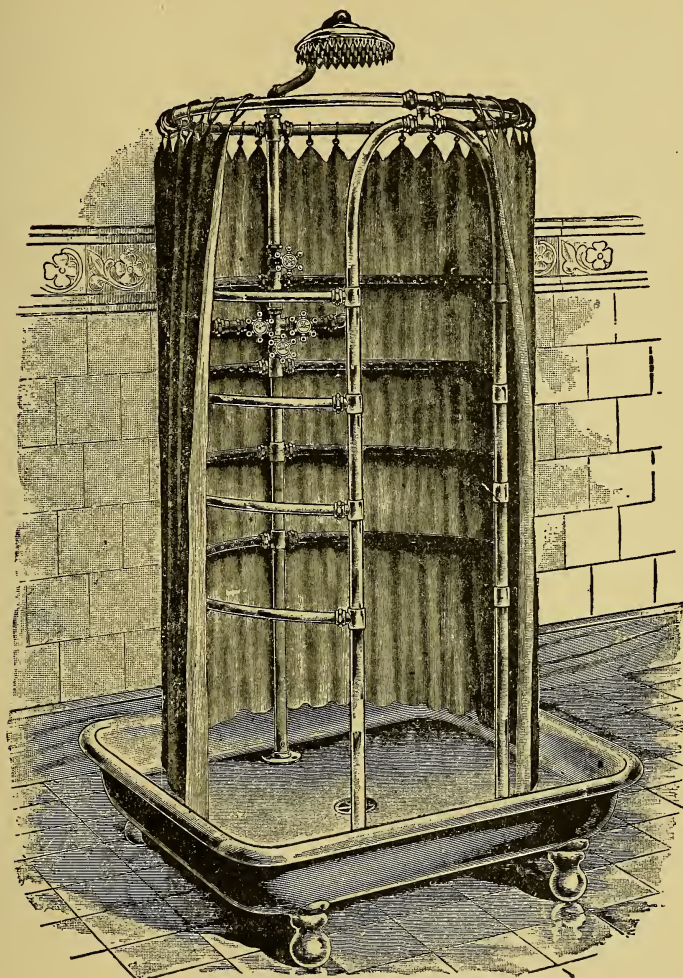

Fig. 124.

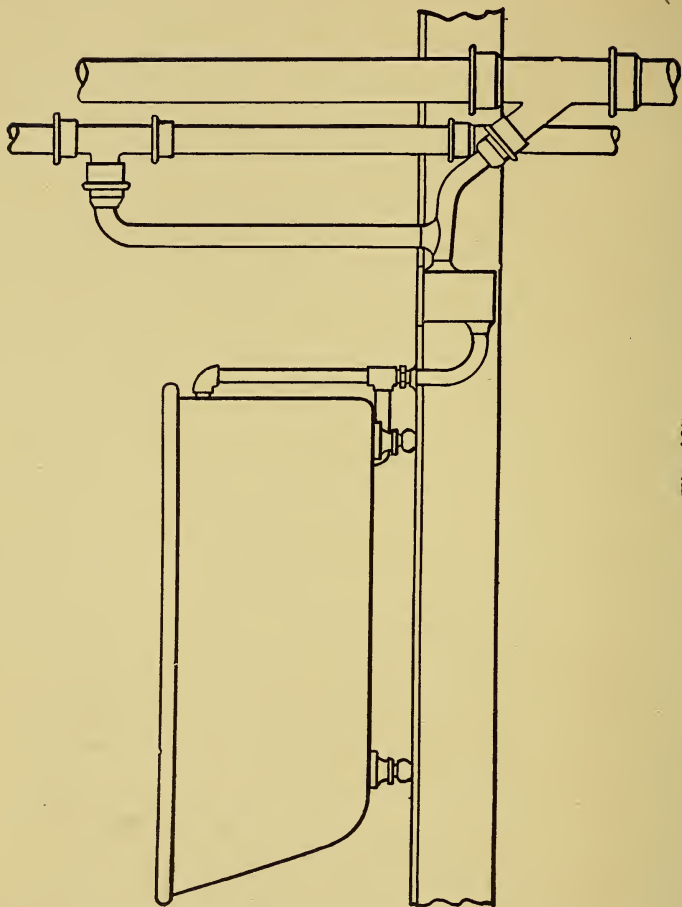

Fig. 125.

To make the local vent work satisfactorily at all times it will be necessary to arrange the pipes so that there would always be a suction in the pipe drawing from the point which is connected with the water closet bowl. This pipe can never be connected with the main ventilating shaft of the soil pipe, but must escape from the house by some other channel. In order to cause this local current of air to pass up and out of the house from the water closet bowl, it will be necessary to provide some artificial heat for this purpose. And where it is possible to connect to a chimney flue that is always warm when the house is occupied, the desired result may be had without any additional expense.

The washout closet is far from being an ideal sanitary fixture. It is an improvement over the hopper style of closet, yet its principle is not correct because it does not wash out. The objection to the washout closet is, that its bowl becomes filthy in a short time, and without having attached to it a local vent the bad odors from the bowl become unbearable. In the bowl of the washout closet there is too much dry surface, and the soil clings to it and cannot be washed off with the flow of water as it falls from the tank. The appearance of the inside of this closet is also very bad, especially the style of washout with the back outlet as shown in Fig. 126.

Fig. 127 shows a washout closet with front outlet.

A short oval flushing rim hopper water closet, with trap and air vent on the top of syphon is shown in Fig. 128.

Two styles of seat operated water closets are shown in Figs. 129 and 130, one with long hop-



Fig. 126.

per without trap and the other with short hopper and trap. The seat is normally kept open by the weight shown to the right, when depressed by the act of a person sitting upon the closet, the small arm or lever attached to the

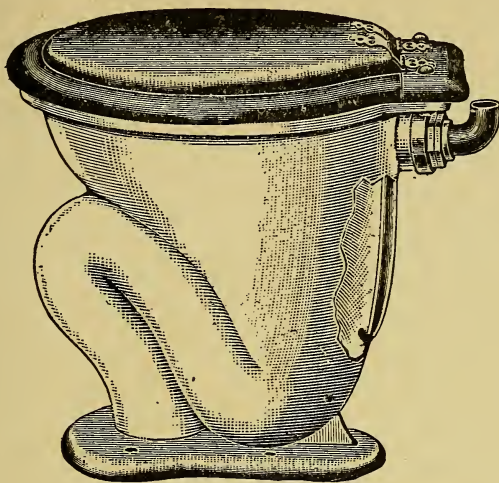

Fig. 127.

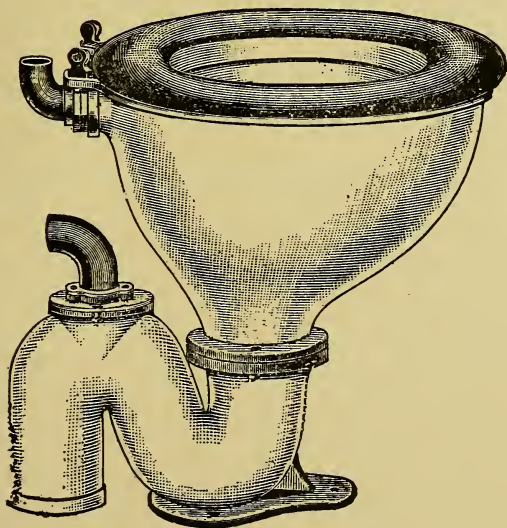

Fig. 128.

seat comes into contact with the plunger valve, causing the water to flow as long as the seat is down.

A syphon jet water closet with low down tank



Fig. 129.

is shown in Fig. 131. It is necessary with this style of tank to increase the diameter of the flush pipe in order to induce syphonage in the closet. With this increased opening a large quan-

tity of water is thrown into the closet, which is sufficient to make the syphon operate.

A prison water closet with short hopper and trap to wall connection is shown in Fig. 132. A



Fig. 130.

self-closing faucet is connected to the flushing rim.

A syphon jet closet set up complete with hard-

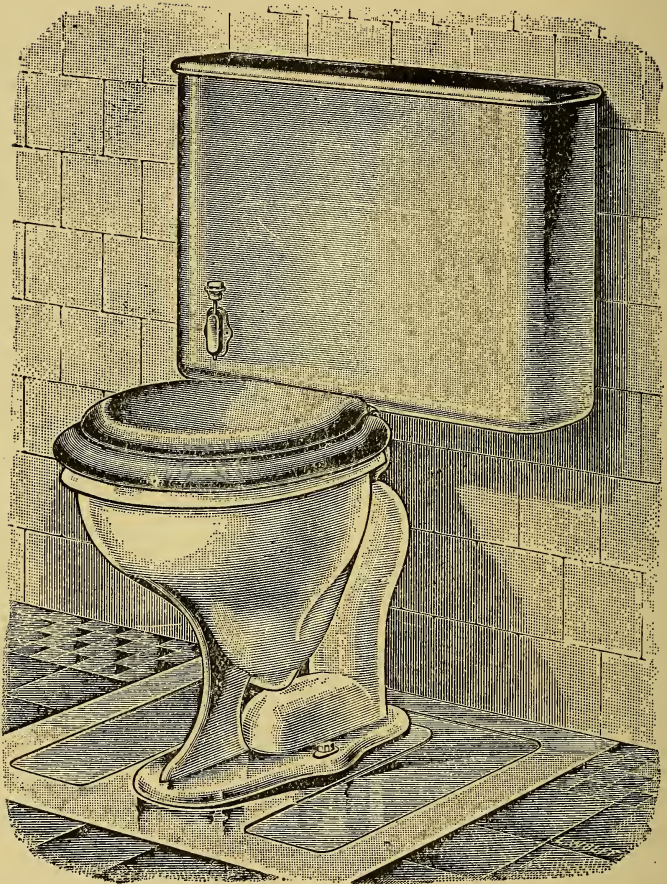

Fig. 131.

wood, copper-lined syphon tank and concealed water supply pipe is shown in Fig. 133.

Water closet seats with legs and with or without lid are shown in Figs. 134 and 135.

The proper sanitary plumbing connections for a washout water closet are shown in Fig. 136.

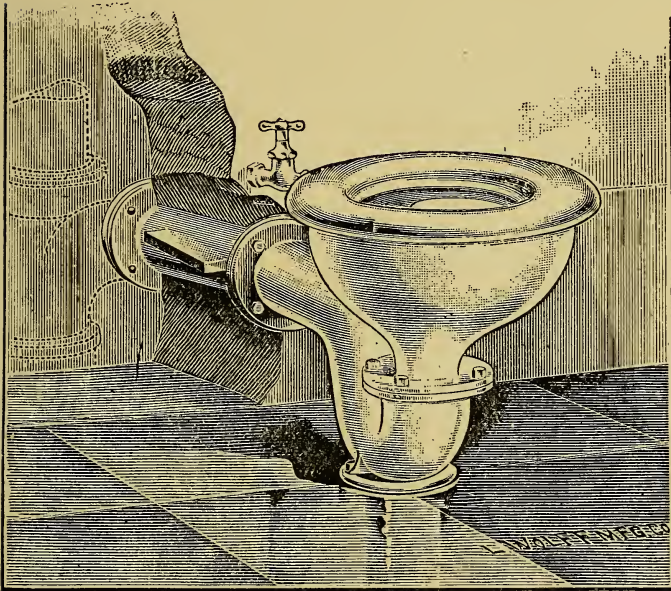

Fig. 132.

The cast iron soil pipe and the lead elbow which connects the trap of the closet with the soil pipe are both 4 inches inside diameter while the air-vent from the lead elbow and the main

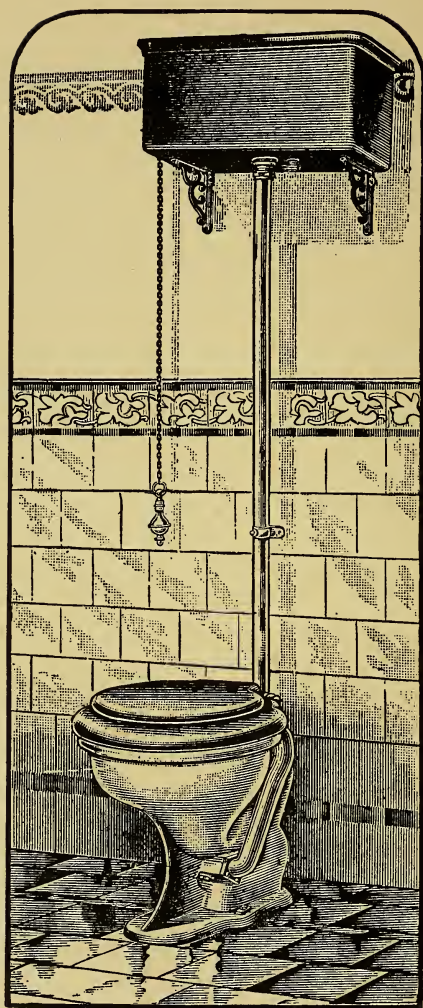

Fig. 133.

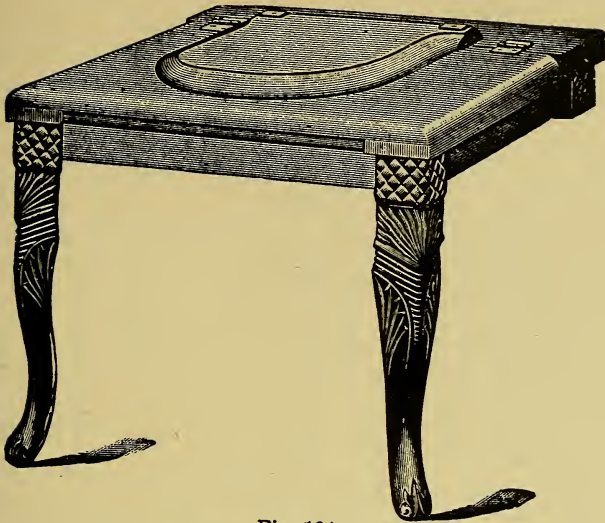

Fig. 134.

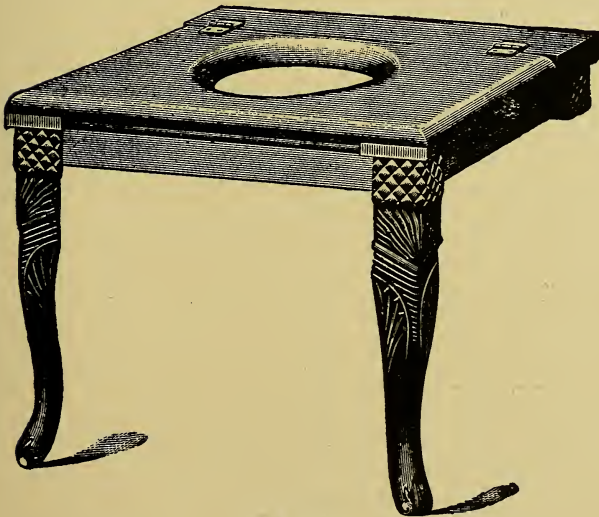

Fig. 135.

air pipe are 2 inches inside diameter. The air-vent pipe is of lead and the main air pipe of cast iron.

Urinals. A flat back porcelain urinal is illus-

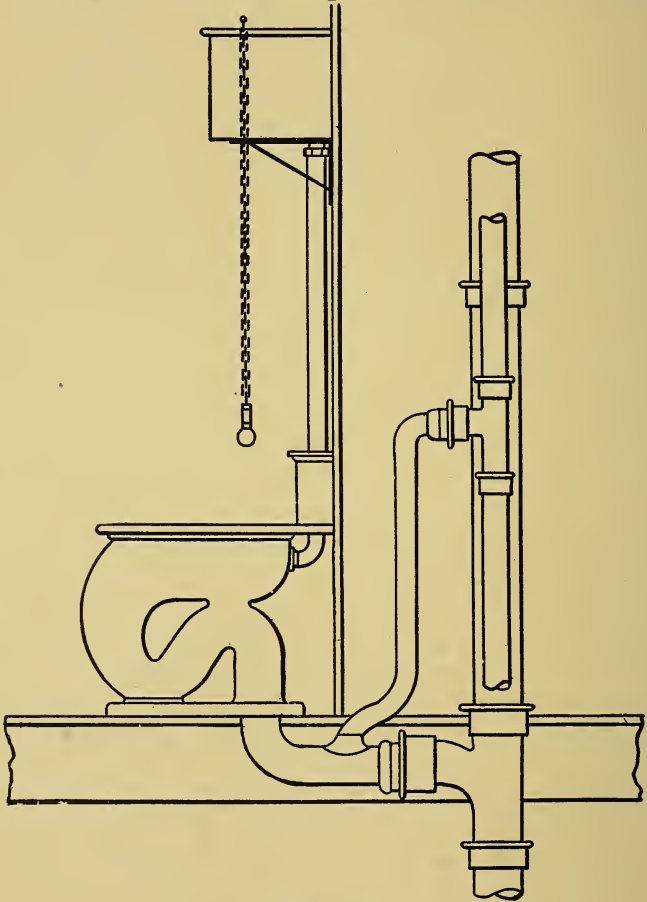

Fig. 136.

trated in Fig. 137, and corner porcelain urinals in Figs. 138 and 139. These are adapted for use in hotels and office buildings.

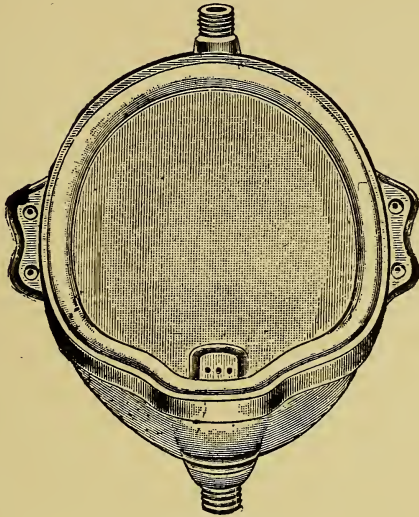

Fig. 137.

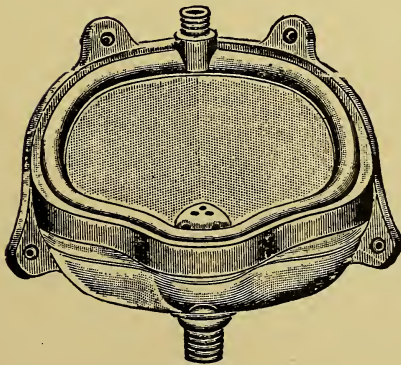

Fig. 138.

Individual stall urinals are shown in Figs. 140 and 141. The one shown in Fig. 140 has a plain stall with floor trough and spray pipe, while the one shown in Fig. 141 has urinal bowls or hoppers attached to the back wall. A complete toilet room containing closets, urinals and wash-bowls is shown in Fig. 142. This represents the interior of a toilet room in a hotel or office building.

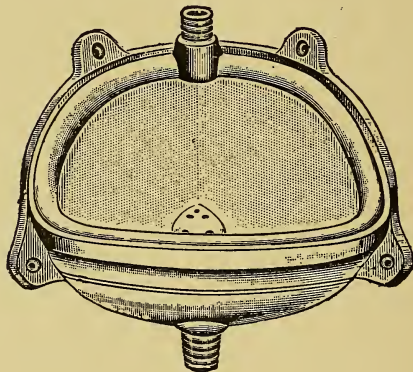

Fig. 139.

Washbowls. A job which requires experience and good judgment is the setting of porcelain washbowls to marble slabs. Although it may look like an easy job, no one can do this work well unless having had considerable experience. In setting washbowls to marble slabs there are some things to be considered, and to accomplish these things in a satisfactory manner there must

be some calculations made. To have a wash-bowl properly fitted to a marble slab it is necessary to grind the flange of the bowl so that it

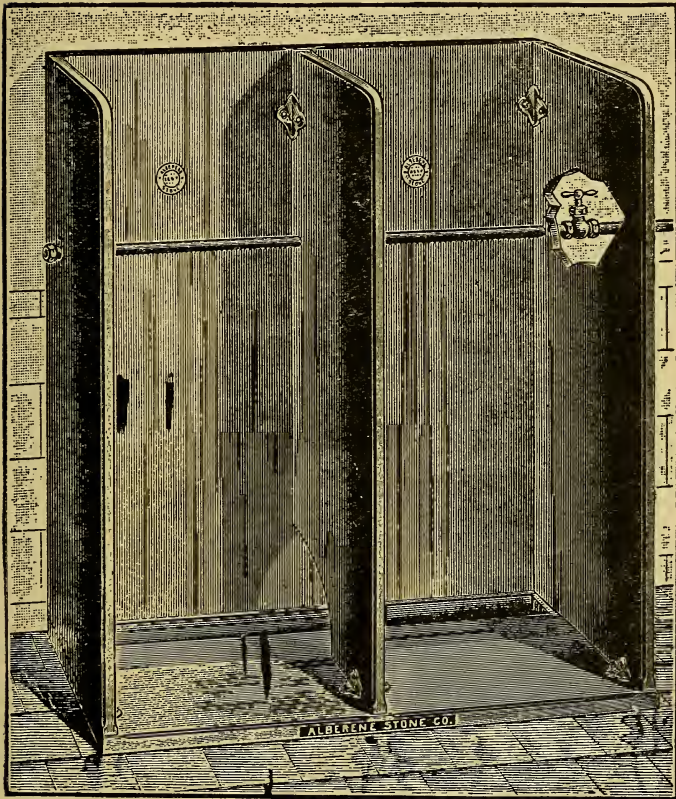

Fig. 140.

will lay level on the slab. This has to be done by rubbing the upper surface of the flange of the

bowl on the marble, using sand and water on the marble, until the top edge of the bowl is perfectly flat and level. This grinding action

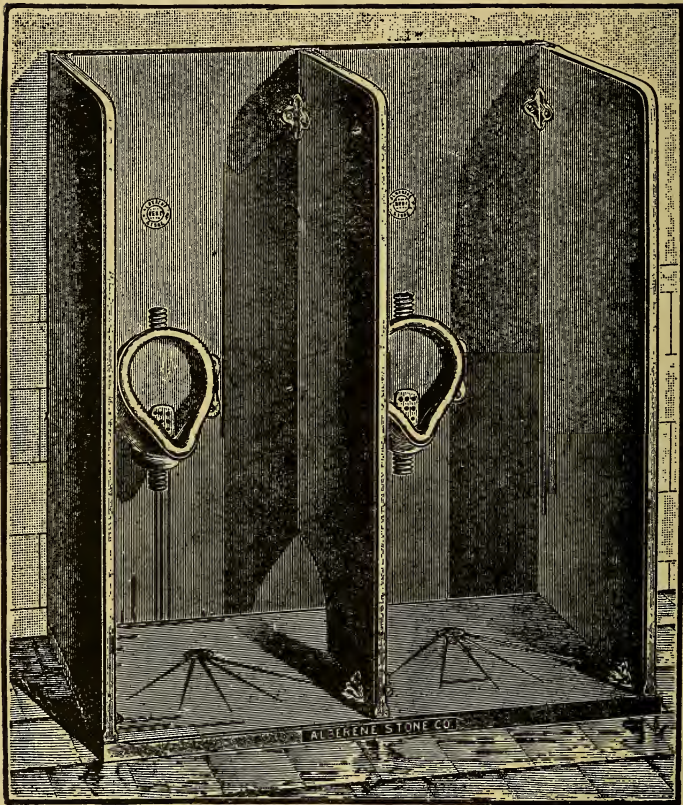

Fig. 141.

also takes off the glazed surface and allows the plaster-of-Paris to take hold of the procelain

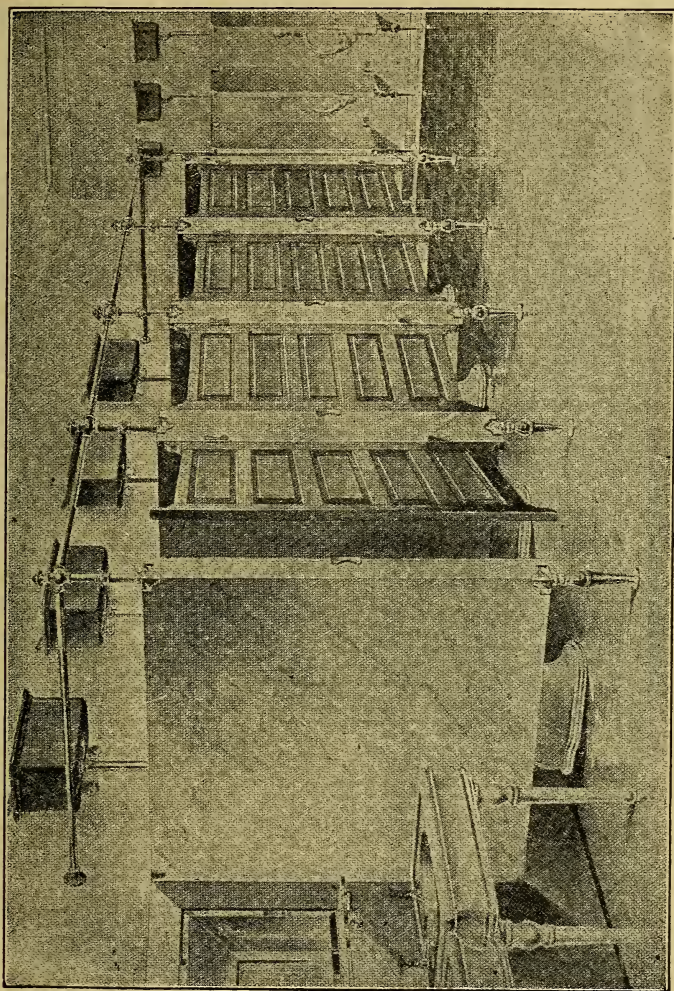

FIG. 142.

and make a perfect joint. The bowl must be set perfectly even all around with the hole in the slab. The less plaster used in setting bowls the better. It is a poor job that has to be filled up with a large amount of plaster. To get the position of the holes for the bowl clamps, it will be necessary to mark on the back of the slab the exact position of the edge of the bowl, then

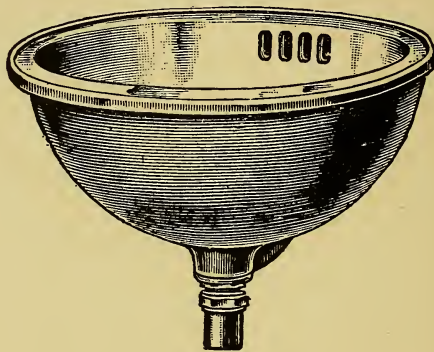

Fig. 143.

space off the distance and drill the slab for at least four clamps. In drilling the slab for the clamp holes the polished surface of the slab must rest on the floor, and in order not to scratch or injure it the slab should have under it a bed of some soft and clean material. The clamps should be well calked into the slab with melted lead, and made so that they will not shake nor pull out.

Independent bowls for attaching to marble

slabs are shown in Figs. 143 and 144. They are provided with brass plugs and coupling and rubber stopper for the waste.

A roll-edge washbowl with removable strainer at the overflow, nickel-plated plug and coupling and rubber stopper, and bronzed brackets is shown in Fig. 145.

A half-circle roll edge washbowl with high

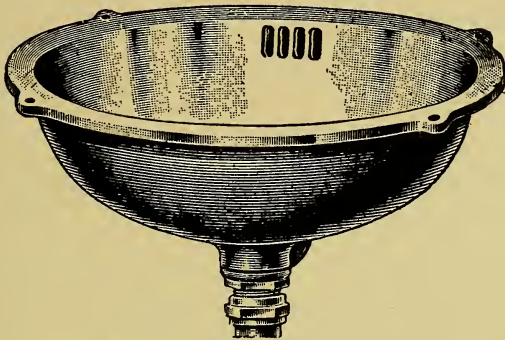

Fig. 144.

back and apron, cast in one piece, is shown in Fig. 146.

Fig. 147 shows a roll-edge oval washbowl with overflow with removable strainer, bronzed brackets, nickel-plated plug and coupling and rubber stopper.

A roll-edge corner washbowl with oval bowl, removable nickel-plated strainer, nickel-plated plug and coupling and rubber stopper is shown in Fig. 148.

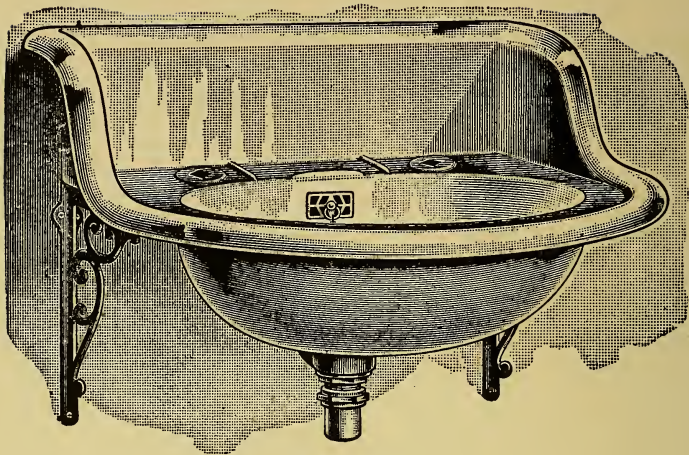

Fig. 145.

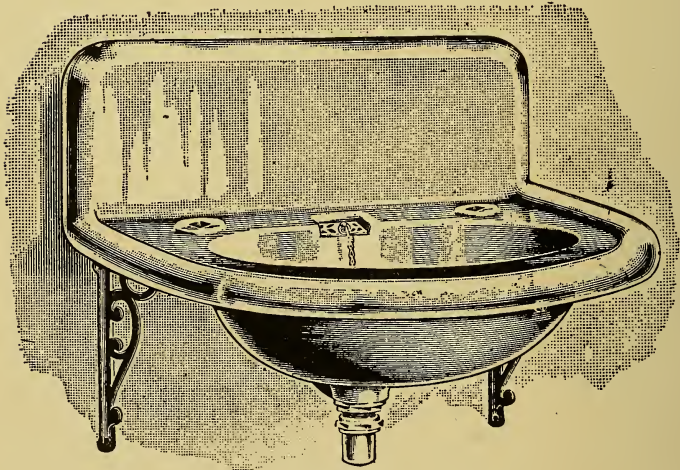

Fig. 146.

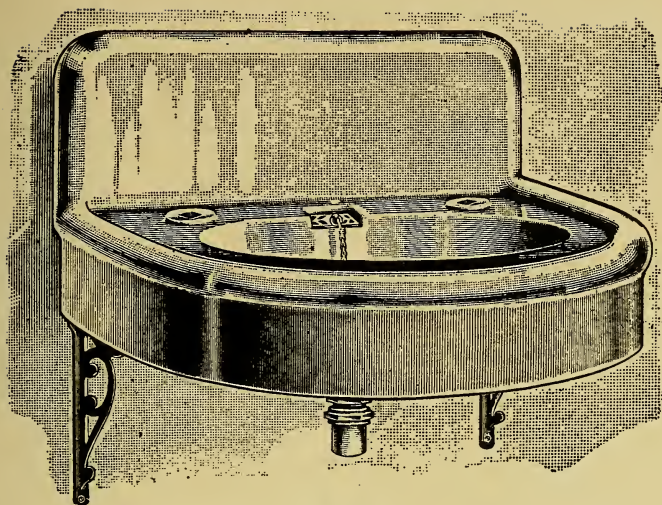

Fig. 147.

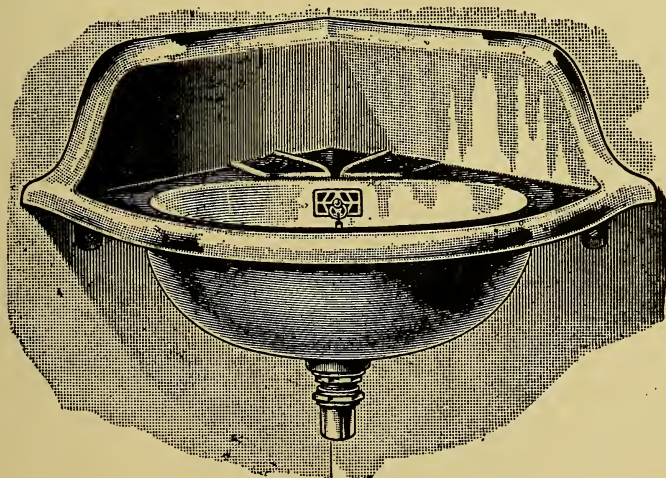

Fig. 148.

A roll-edge slab and bowl with ideal waste is shown in Fig. 149. It has a round bowl and high back.

A vertical cross section of the above bowl showing the ideal waste is given in Fig. 150.

The proper sanitary plumbing connections



Fig. 149.

for a washbowl are shown in Fig. 151. The cast iron soil pipe is 4 inches in diameter. The waste pipe from the bowl and the air-vent pipe from the top of the syphon are $1\frac{1}{2}$ inches and the main air pipe 2 inches in diameter.

Drinking Fountains. A solid porcelain double

roll edge drinking fountain with back and bowl in one piece is shown in Fig. 152. It has a self-closing faucet and nickel-plated drip-cup with strainer. A one-piece solid porcelain drinking fountain with roll-edge bowl is shown in Fig.

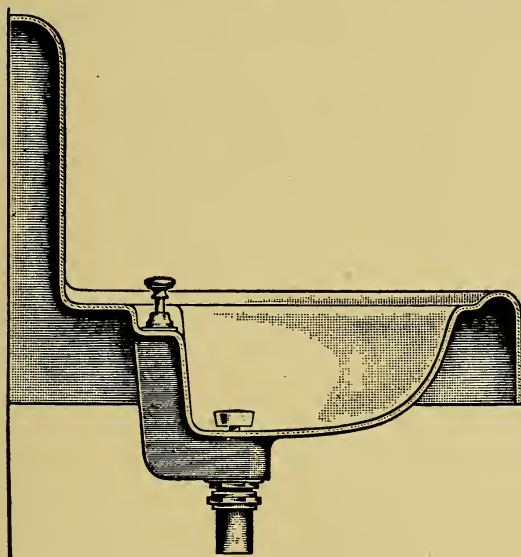

Fig. 150.

153. It has a self-closing faucet and nickel-plated half S-trap.

A marble drinking fountain is shown in Fig. 154, which has a counter sunk slab and high back, nickel-plated Fuller pantry cock, drip-cock with shield, nickel-plated supply pipe, and trap with vent and waste to wall.

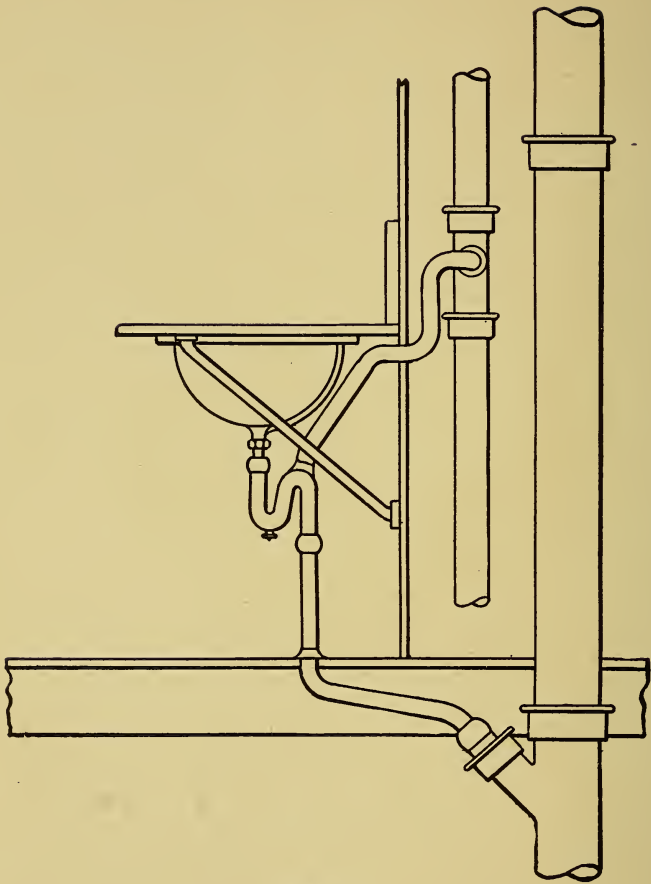

Fig. 151.

Drinking fountains of the type shown in Figures 152 and 153 are now prohibited by law in the public places of many cities; bubbling fountains being required instead.

Sinks. The enameled iron sink is a great advancement in sanitary improvements. When

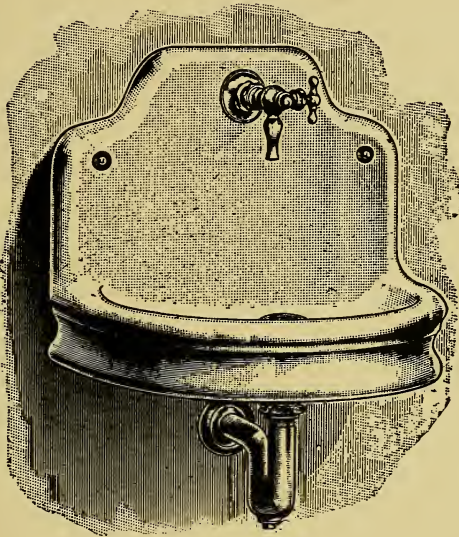

Fig. 152.

made properly and used for light work it is all that could be desired, because it is coated with a material which wears well, and is also proof against the action of gases or acids. It has a smooth finish and is easily kept clean, but it is not suitable for heavy or rough work. In the

larger sinks this enameled coating cracks off easily when heavy utensils are placed in it, which causes the sink to bend, and the enamel,

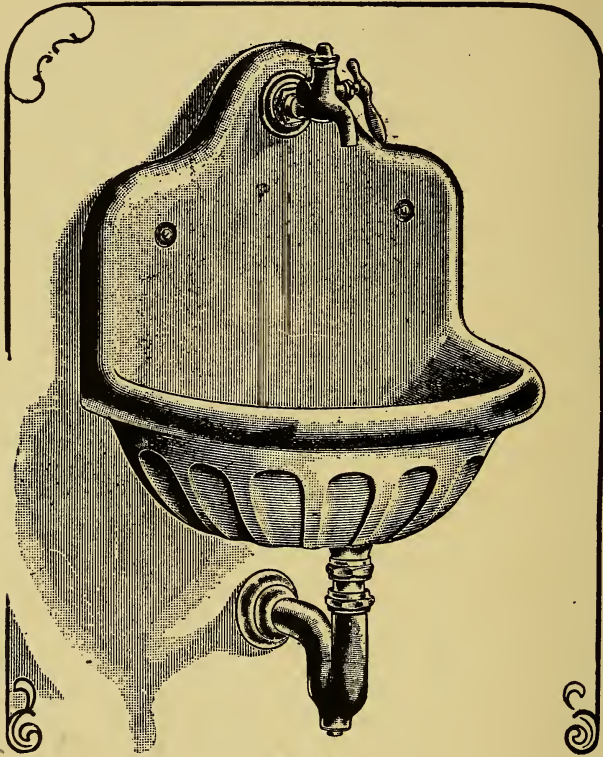

Fig. 153.

having very little elasticity, must naturally crack. It sometimes cracks by the uneven or sudden expansion and contraction of the iron.

The first step in the process of installing the water service system in a building is, to procure from the proper authorities a permit for the introduction or use of water in the building.

The tapping of the street main is done by workmen in the employ of the water department of the city, or town. A cock, called a corporation cock is screwed into the main, and to this cock a section of lead pipe, the length of which is governed by local rulings, is connected by means of a wiped joint. Lead pipe should in all cases be used for making this connection, for the reason that, owing to its pliability, there is much less danger of breakage caused by the settling of the main, or of the service pipe, than there would be were the connection made with wrought iron pipe which would be rigid.

The size of the service leading to the building will depend, of course, upon the amount of water that will be required; and if two or more distinct and separate buildings are to be supplied by means of branch, or sub-service pipes supplied by a single tap in the street main, each branch should be independently arranged with a stop cock and box on the curb line.

These stop cocks are for the purpose of shutting off the water when required, and each service pipe must be equipped with one, located within the sidewalk at, or near the curb line of the same.

The service pipe leading from the street main into the building must be laid below the frost line.

Stop Cock in Building. Each service pipe must also be provided with a stop-cock inside the building, placed beyond damage by frost, and so situated that the water can be conveniently shut off, and drained from the pipes, in order to prevent freezing in cold weather.

Service Pipes in Building. The main riser, from which branch pipes are carried to the various fixtures, should start in the basement at or near the shutoff cock; tee outlets being inserted at the proper locations under the ceilings of each room for connecting the branches to the fixtures on the floor above. These branches can also be connected, leaving their nipples extending through the floors at the proper locations for connection with the fixtures they are to serve. These nipples should then be capped over to prevent dirt or other foreign matter from getting into the pipe before a permanent connection is made to the fixtures. The caps should be screwed on tightly and left there until the piping system has been thoroughly tested.

Testing. After the risers, and branch pipes of the water service have been installed, and all openings either capped over, or plugged, the system should be thoroughly tested before any connections to fixtures are made. If the testing is done at the proper time, that is before the floors are laid, or plastering done, the leaks, if there are any can be much more easily discovered, and repaired than they could be if covered by floors or plastering. In fact the majority of large cities

and towns at the present day require by law that all plumbing in a new building shall remain exposed until after the job has been tested and passed upon by the inspector.

Methods of Testing. The entire plumbing system when roughed in must be tested by the plumber in the presence of the inspector of plumbing if there be such an official, or if there is no local inspector, the plumber should test the work nevertheless for his own satisfaction.

Water Test. This test should always be applied to new work before the connections are made to the fixtures. The water test is to be applied to all the soil, waste and vent pipes, as well as to the water service pipes. In the case of the soil, waste and vent pipes, all openings except those above the roof are to be closed by soldering them shut on lead pipe, and by plugs, or caps on iron or steel pipe. The entire system of piping is then filled with water, the filling to be done slowly, and when filled, every joint should be carefully examined for leaks, and if any are found they should be repaired at once. A leak in a caulked joint may often be stopped by additional caulking, but if a split pipe, or fitting is found, it will be necessary to replace it.

On some jobs the plasterers may be in a hurry to get along with their work, and in such cases the soil stacks can be tested in sections, by leaving out a length of pipe on each floor, and afterward inserting the same for the final test, care being taken to always leave the length of pipe out at some point where it will be easily accessible to insert.

Air Pressure Test. The air pressure test is applied by means of a force pump and a mercury column equal to ten inches of mercury. All openings in the system are to be closed with the exception of the one to which the force pump is connected.

The pump is then operated until the pressure of air in the system is sufficient to raise the mercury column to a height of ten inches. The pump is then stopped, and if the column of mercury remains permanently at that height the test is complete, but if the mercury column should gradually fall, it is an indication of a leak, and this should be investigated at once.

Smoke Test. After the completion of the work, and when the fixtures are installed the smoke test can be applied, and this is done by closing all openings, including those above the roof.

A device in which a heavy smoke may be generated by the burning of oily waste, or rags, is then connected to the system which is soon filled with the smoke, and if there are any leaks, they may easily be detected by the smoke which will escape through them.

Peppermint Test. This test may be applied in place of the smoke test, if preferred, at the time the job is completed. It is usually applied in testing alterations, or repair work; in fact it is the only test permitted in some localities, after extensions, or repairs of old systems. The peppermint test is made by using about five fluid ounces of oil of peppermint for each line of pipe up to

five stories and basement in height, and for each additional five stories or fraction thereof one additional ounce is to be used. All openings except those above the roof are to be closed. The oil of peppermint is then poured into the roof opening, and immediately after this pour in about one-half gallon of hot water for each ounce of peppermint oil, after which close the roof opening tightly with a plug. The mixture of oil of peppermint and water will then flow to every portion of the system of piping, and if there are any leaks the fumes of the peppermint will penetrate through them, and they can be detected by the odor of the peppermint present.

Testing the Water Service. After the water piping system has been installed, water pressure from the street main can be easily applied to the entire system of water piping, or it may be tested in sections if necessary while being installed, and the leaks if there are any will soon make themselves manifest.

Too much care cannot be exercised in the matter of testing all parts of an installation of plumbing in a building, for the reason that the health, and lives of the occupants of the building are in a great measure dependent upon the character of the work, and the quality of the materials used.

Wrought Iron Pipe. Table 7 gives the dimensions, thickness of metal, threads per inch, and other valuable details relative to wrought iron, or steel pipe in sizes running from one-eighth inch, up to fifteen inches inside diameter.

DIMENSIONS OF WROUGHT-IRON PIPE.

Nominal Inside Diameter.	Actual Outside Diameter in Inches.	Actual Inside Diameter in Inches.	Thickness of Metal in Inches.	Threads per Inch.	Length of Full Thread in Inches.
$\frac{1}{8}$.405	.270	.068	27	.19
$\frac{1}{4}$.540	.364	.085	18	.29
$\frac{3}{8}$.675	.493	.091	18	.30
$\frac{1}{2}$.840	.622	.109	14	.39
$\frac{3}{4}$	1.050	.824	.113	14	.40
1	1.315	1.048	.134	$11\frac{1}{2}$.51
$1\frac{1}{4}$	1.660	1.380	.140	$11\frac{1}{2}$.54
$1\frac{1}{2}$	1.900	1.610	.145	$11\frac{1}{2}$.55
2	2.375	2.067	.154	$11\frac{1}{2}$.58
$2\frac{1}{2}$	2.875	2.468	.204	8	.89
3	3.500	3.067	.217	8	.95
$3\frac{1}{2}$	4.000	3.548	.226	8	1.00
4	4.500	4.026	.237	8	1.05
$4\frac{1}{2}$	5.000	4.508	.246	8	1.10
5	5.563	5.045	.259	8	1.16
6	6.625	6.065	.280	8	1.26
7	7.625	7.023	.301	8	1.36
8	8.625	7.981	.322	8	1.46
9	9.625	8.937	.344	8	1.57
10	10.750	10.018	.366	8	1.68
11	11.75	11.000	.375	8	1.78
12	12.75	12.000	.375	8	1.88
13	14.	13.25	.375	8	2.09
14	15.	14.25	.375	8	2.10
15	16.	15.25	.375	8	2.20

TABLE 7

Taper of the thread is $\frac{3}{4}$ inch to one foot.

Pipe from $\frac{1}{8}$ inch to 1 inch inclusive is butt welded and tested to 300 pounds per square inch.

Pipe $1\frac{1}{4}$ inch and larger is lap welded and tested to 500 pounds per square inch.

TABLE OF QUANTITY OF WATER DELIVERED BY SERVICE PIPES OF VARIOUS SIZES UNDER VARIOUS PRESSURES.

Proportion of Head of Water (H) to Length of Pipe (L).

Gallons Per Minute.

Diameter of Pipe Inches.	H = 10 L.	H = 9 L.	H = 8 L.	H = 7 L.	H = 6 L.	H = 5 L.	H = 4 L.	H = 3 L.
$\frac{1}{2}$	19.8	18.7	17.7	16.5	15.3	14.0	12.5	10.8
$\frac{5}{8}$	34.5	32.7	30.1	28.9	26.5	24.4	21.5	18.9
$\frac{3}{4}$	54.4	51.7	48.7	45.6	42.2	38.5	34.4	29.8
1	111.8	106.0	100.0	93.5	86.6	79.0	70.7	61.2
$1\frac{1}{4}$	195.2	185.2	174.6	163.3	151.2	138.0	123.4	106.9
$1\frac{1}{2}$	308.0	292.1	275.4	257.6	238.5	217.7	194.8	168.7
2	632.2	599.7	566.4	538.9	488.1	447.0	399.8	346.3
$2\frac{1}{2}$	1104.0	1048.0	987.8	924.0	855.4	780.9	698.5	604.9
3	1745.0	1651.0	1560.0	1460.0	1351.0	1234.0	1103.0	955.5
4	3581.0	3397.0	3203.0	2996.0	2774.0	2532.0	2265.0	1962.0
5	6247.0	5928.0	5588.0	5227.0	4839.0	4417.0	3951.0	3406.0
6	9855.0	9349.0	8814.0	8245.0	7633.0	6968.0	6233.0	5391.0

Diameter of Pipe Inches.	H = 2 L.	H = $1\frac{3}{4}$ L.	H = $1\frac{1}{2}$ L.	H = $1\frac{1}{4}$ L.	H = 1 L.	H = $\frac{3}{4}$ L.	H = $\frac{1}{2}$ L.	H = $\frac{1}{4}$ L.
$\frac{1}{2}$	8.8	8.3	7.7	7.0	6.3	5.4	4.4	3.1
$\frac{5}{8}$	15.4	14.4	13.4	12.2	10.9	9.5	7.7	5.5
$\frac{3}{4}$	24.3	22.8	21.1	19.3	17.2	14.9	12.2	8.6
1	50.0	46.8	43.2	39.5	35.3	30.6	25.0	17.7
$1\frac{1}{4}$	87.3	81.6	75.6	69.0	61.7	53.5	43.7	30.9
$1\frac{1}{2}$	137.7	128.8	119.3	108.9	97.4	84.3	68.7	48.7
2	282.7	264.4	248.8	223.5	199.9	173.1	141.4	100.0
$2\frac{1}{2}$	493.9	482.0	427.7	390.4	349.2	302.4	246.9	174.6
3	780.2	728.8	674.8	615.9	555.5	477.1	390.1	275.8
4	1602.0	1496.0	1385.0	1264.0	1133.0	979.3	800.8	566.2
5	2791.0	2613.0	2420.0	2209.0	1976.0	1711.0	1394.0	987.7
6	4407.0	4122.0	3817.0	3484.0	3116.0	2693.0	2204.0	1558.0

TABLE 8

TABLE SHOWING PRESSURE OF WATER AT DIFFERENT ELEVATIONS.

Feet Head.	Equals Pressure per Square Inch.	Feet Head.	Equals Pressure per Square Inch.	Feet Head.	Equals Pressure per Square Inch.
1	.43	130	56.31	255	110.46
5	2.16	135	58.48	260	112.62
10	4.33	140	60.64	265	114.79
15	6.49	145	62.81	270	116.96
20	8.66	150	64.97	275	119.12
25	10.82	155	67.14	280	121.29
30	12.99	160	69.31	285	123.45
35	15.16	165	71.47	290	125.62
40	17.32	170	73.64	295	127.78
45	19.49	175	75.80	300	129.95
50	21.65	180	77.97	310	134.28
55	23.82	185	80.14	320	138.62
60	25.99	190	82.30	330	142.95
65	28.15	195	84.47	340	147.28
70	30.32	200	86.63	350	151.61
75	32.48	205	88.80	360	155.94
80	34.65	210	90.96	370	160.27
85	36.82	215	93.14	380	164.61
90	38.98	220	95.30	390	168.94
95	41.15	225	97.49	400	173.27
100	43.31	230	99.63	500	216.58
105	45.48	235	101.79	600	259.90
110	47.64	240	103.96	700	303.22
115	49.81	245	106.13	800	346.54
120	51.98	250	108.29	900	389.86
125	54.15			1000	433.18

TABLE 9

WEIGHT OF COPPER PIPES PER FOOT.

Bore in Inches.	Thickness of Metal in Parts of an Inch.					
	$\frac{1}{16}$	$\frac{1}{8}$	$\frac{3}{16}$	$\frac{1}{4}$	$\frac{5}{16}$	$\frac{3}{8}$
	pounds.	pounds.	pounds.	pounds.	pounds.	pounds.
$\frac{1}{2}$	0.426	0.946	1.561	2.270	3.075	3.973
$\frac{5}{8}$	0.520	1.185	1.845	2.649	3.547	4.540
$\frac{3}{4}$	0.615	1.324	2.129	3.027	4.020	5.108
$\frac{7}{8}$	0.709	1.514	2.412	3.425	4.493	5.676
1	0.804	1.703	2.696	3.784	4.966	6.243
$1\frac{1}{4}$	0.993	2.081	3.263	4.540	5.712	7.378
$1\frac{1}{2}$	1.182	2.459	3.831	5.297	6.857	8.514
$1\frac{3}{4}$	1.372	2.838	4.388	6.055	7.805	9.646
2	1.560	3.217	4.967	6.808	8.748	10.783
$2\frac{1}{4}$	1.750	3.591	5.531	7.566	9.694	11.918
$2\frac{1}{2}$	1.940	3.975	6.103	8.327	10.643	13.066
$2\frac{3}{4}$	2.128	4.352	6.668	9.081	11.590	14.190
3	2.316	4.729	7.238	9.737	12.534	15.325

WEIGHT OF BRASS PIPES PER FOOT.

Bore in Inches.	Thickness in Parts of an Inch.						
	$\frac{1}{16}$	$\frac{1}{8}$	$\frac{3}{16}$	$\frac{1}{4}$	$\frac{5}{16}$	$\frac{3}{8}$	$\frac{7}{16}$
	pounds.	pounds.	pounds.	pounds.	pounds.	pounds.	pounds.
$\frac{1}{4}$	0.22	0.53	0.94	1.43	2.01	2.68	3.44
$\frac{1}{2}$	0.40	0.89	1.47	2.15	2.91	3.75	4.70
$\frac{3}{4}$	0.58	1.25	2.01	2.86	3.80	4.83	5.95
1	0.76	1.61	2.55	3.58	4.70	5.92	7.25
$1\frac{1}{4}$	0.94	1.96	3.09	4.31	5.64	6.98	9.46
$1\frac{1}{2}$	1.12	2.34	3.67	5.01	6.49	8.05	9.71
$1\frac{3}{4}$	1.33	2.66	4.14	5.70	7.36	9.11	10.94
2	1.48	3.04	4.69	6.44	8.27	10.20	12.21
$2\frac{1}{4}$	1.65	3.40	5.23	7.16	9.17	11.27	13.46
$2\frac{1}{2}$	1.83	3.75	5.77	7.87	10.06	12.35	14.72
$2\frac{3}{4}$	2.01	4.11	6.31	8.59	10.96	13.42	15.97
3	2.19	4.47	6.84	9.31	11.85	14.69	17.42

TABLE 10

HOT WATER SUPPLY.

Cylinder System. In the cylinder system the principal difference from the tank system lies in the fact that the cylinder or reservoir of hot water lies beneath the draw-off pipes and not above them, as with the tank system. This being the case it is impossible to empty the reservoir unknowingly or accidentally, should the cold water supply be shut off.

Referring to Fig. 155, the flow-pipe proceeds from the extreme top of the waterback, and does not project through inside the waterback in the least degree. If it cannot be taken from the top, it must be connected to the side or back of the waterback as close to the top as it can be got, but the top connection should always be used if in any way possible. From the waterback the flow-pipe proceeds to the boiler and terminates five-eighths of the way up from the bottom. The pipe can enter the side of the boiler at the correct point, or it can come through lower down and be extended up inside with a bend and short piece of pipe together without making two holes.

The return pipe leaves the side of the boiler as close to the bottom as possible, or it can come from the bottom if desired. It then proceeds to

the waterback and enters either through the top or the side, terminating half-way down with a saddle boiler. Both of these pipes, the flow and the return, must have a rise from the waterback to the boiler of not less than 1 inch in 10 feet.

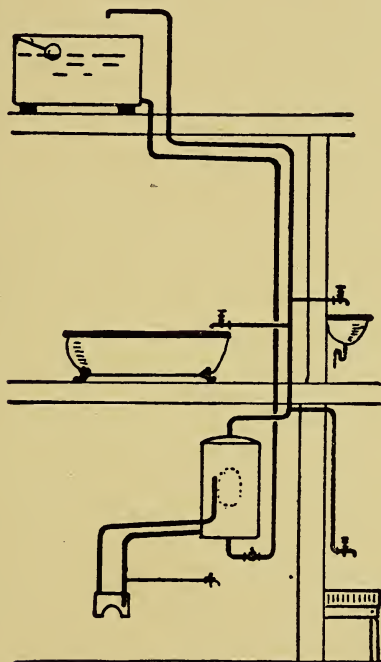

Fig. 155.

From the top of the boiler is carried the expansion pipe. This also should rise 1 inch in 10 feet from the boiler to its highest point. The

highest point can be above the cold-water cistern or through the roof.

The cold water supply to the system is a pipe direct from a cistern, as shown. This pipe must not be branched for any other purpose.

It is of the highest importance that the cold water supply pipe should be of full size, and not choked or reduced in bore anywhere. The out-flow at the hot water faucet is exactly in ratio with the down-flow of water through this pipe, less friction, therefore everything possible must be done to give the water full and free passage and lessen the friction. This is done by having the pipe of good size, using bends and not elbows, or lead pipe, and seeing that the stop-cock, if there be one, has a straight full way through it. The stop-cock should be put near the boiler, so that the man who cleans the waterback, or effects repairs, does not have to traverse the house to shut the water off and afterwards to turn it on. A tee should be put on the cold water supply connection, inside the boiler to spread the inflowing cold water over the bottom of the boiler. If this is not done the inflowing cold water will bore its way up through the hot water above, unless the pressure be quite low.

An emptying cock should be put somewhere beneath the boiler, but this cock must be provided with a loose key, so that only an authorised person can withdraw the water from the boiler.

The draw-off pipes are all taken from the expansion pipe as shown. This pipe should therefore be carried up by the best route to touch at the points where the faucets are, otherwise long single branches must be run. The expansion pipe, being a single tube, has no active or useful circulation in it.

It must never be forgotten that, on opening a faucet, on a secondary circulation, water will proceed from both directions to reach that faucet. The circulatory movements all cease, and quite a new action takes place. Water will come up from the top of the boiler and this will be hot. There will also be water coming up the secondary return, and the temperature of this will depend on whence it comes. If connected as shown in Fig. 156 then whatever water comes to the faucets will be hot, all there is of it, and when the temperature of the issuing water falls it may be known that the hottest has all been withdrawn. There have been several points at which the secondary return has been connected with bad results, notably at the bottom of the boiler, into the primary return (between the boiler and waterback), into the boiler, and even into the cold supply pipe just beneath the boiler. These are wrong, and only one position is correct, as shown in Fig. 156. The point is from 3 inches to 6 inches from the top of the boiler according to its size. The latter would

be for a 100-gallon boiler. A 50-gallon size would have the connection 4 inches from the top.

Tank System. The usual arrangement of this system of water heating apparatus is illustrated

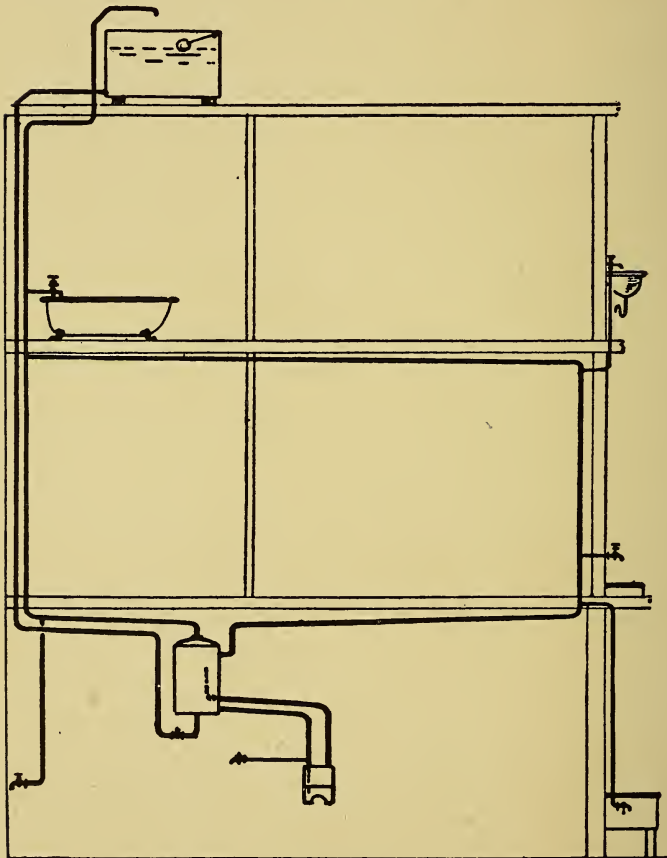

Fig. 156.

in Fig. 157. The flow pipe should proceed from the extreme top or highest point of the waterback, preferably from the top plate, and not project through to the inside of the waterback in the least degree. If it is impossible to connect

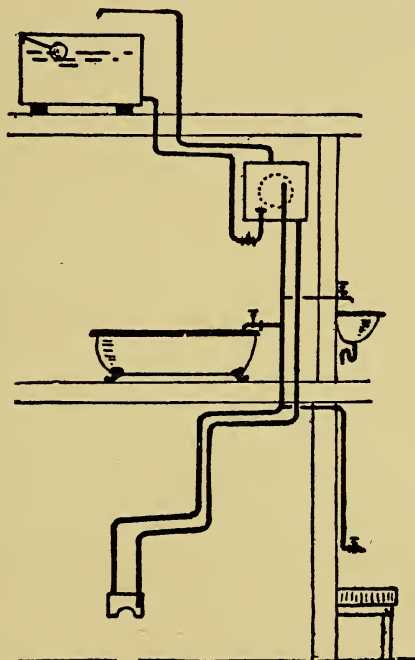

Fig. 157

the flow pipe in the top plate of the waterback it should be located in the side or back, but as close to the top as possible. From the waterback the flow pipe should proceed to the tank and ter-

minate in it about three-fourths of the way up, that is one-quarter of the height of the tank from the top. It may pass through the bottom and reach up inside as a stand pipe as shown in Fig. 157, or it may enter the side at the required height.

The return pipe should leave the bottom of the tank, being connected directly in the bottom or in the side of the tank near the bottom. It should never be more than an inch from the bottom. From the tank the return pipe should proceed directly to the waterback, and if entering the boiler through the top, should extend downwards, three-fourths the height of the waterback.

The draw-off pipes are taken from the flow pipe as shown. It therefore follows that the flow pipe should be carried in a direction which will bring it as near to all the faucets as possible. Instead of this, the most common practice appears to be to carry the circulating pipes by the most direct route from the waterback to the tank, and to consider the running of the branch pipes afterwards. There is no objection to the return pipe taking the shortest route, but the flow should be diverted to pass the work as near as possible. Failing this, there would have to be long single-pipe branches, and the fault of these is that so much cold water has to be drawn before the hot issues. This is not so much a fault at a bath, at which some cold water will probably be needed. At a lavatory

basin, however, the fault is very pronounced, the faucets being small and slow-running, and at no point is the quick arrival of warm water appreciated more than at this one.

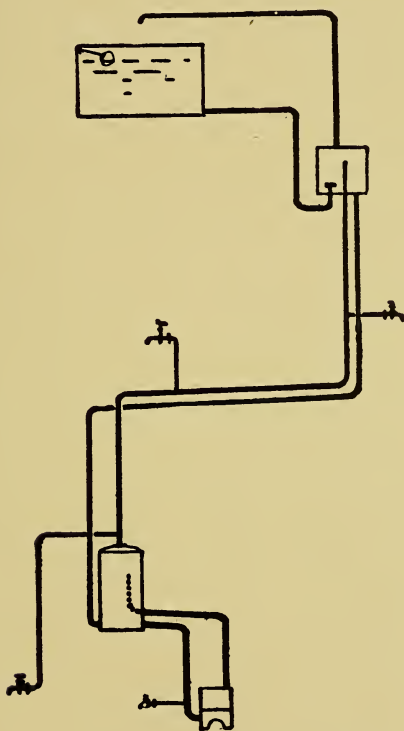

Fig. 158.

Cylinder-Tank System. This is simply a combination of the two systems previously described.

The tank system and the cylinder system both have good features which are retained in the cylinder-tank system, and also certain bad features which are eliminated in the combination system

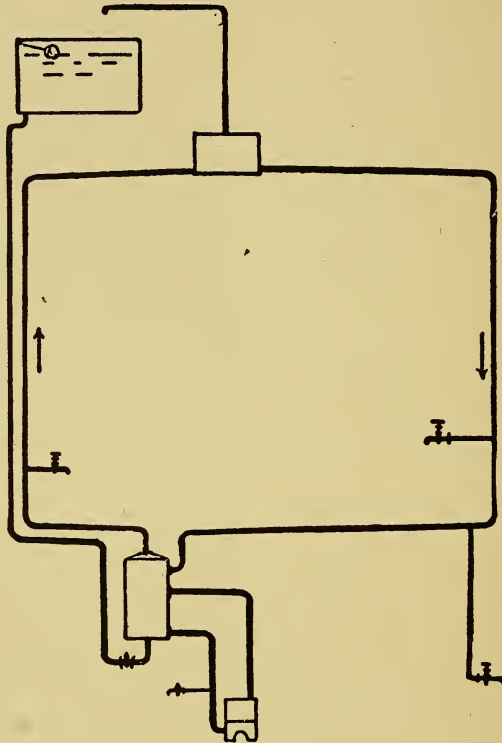

Fig. 159.

which may be here described briefly, the tank system ensures a good flow of water from the high faucets, while the cylinder system commonly has

a very unsatisfactory issue of water from any faucets that are near the top of the house. On the other hand, the cylinder system is safest where the cold water supply is at all uncertain, as the cylinder—the reservoir of the apparatus—cannot be emptied. The object of the cylinder-tank system is therefore to ensure a good outflow at all taps by having a store of hot water above them, and to have a store of water which cannot be exhausted unknowingly if the cold water supply fails.

Fig. 158 illustrates this system of apparatus in outline, and the parts need no general description more than that given already. As to the sizes of the tank and cylinder, the best practice for general requirements is to make them of equal capacity, and the two together should be no larger than one would be if alone. Thus, if a 50-gallon boiler would be the suitable size for a job erected on the ordinary cylinder system, then with the combined apparatus the boiler should be 25 gallons and the tank 25. In the cylinder-tank system illustrated in **Fig. 158**, the cold water supply is delivered into the tank directly from the cistern, while in the system shown in **Fig. 159**, the cold water supply is carried down to the cylinder.

WEIGHT AND THICKNESS OF SHEET LEAD.

Weight in Lbs. per Sup. Foot.	Thickness in Inches.	Weight in Lbs. per Sup. Foot.	Thickness in Inches.
1	0.017	7	0.118
2	0.034	8	0.135
3	0.051	9	0.152
4	0.068	10	0.169
5	0.085	11	0.186
6	0.101	12	0.203

TABLE 11

HOT WATER PLUMBING.

As the drawings shown in the article on Hot Water Supply are merely diagrammatic outlines of the different systems and are only intended to illustrate the principle of the circulation, which is involved in the heating of water for domestic use, further description and additional drawings are here given to illustrate the two systems of water heating in common use, viz.: the pressure-cylinder system and the gravity-supply tank and cylinder system.

In Fig. 160 is shown one of the simplest arrangements of the pressure-cylinder system for the successful heating of water for household use. The boiler, water-back and pipe connections are all plainly shown. In the boiler is a pipe extending down from the top and connected with the cold water supply, which it discharges in the boiler a short distance from the bottom. The distance down in the boiler which this pipe should extend depends upon the height that the pipe from the upper part of the water-back enters the boiler. The cold water supply should always enter the boiler at a considerable distance below the point of entrance of the pipe conveying the hot water from the water-back to the boiler.

The greater the distance that the hot and cold water pipes are apart in the boiler, the better will be the circulation and the less time it will take to heat a given amount of water.

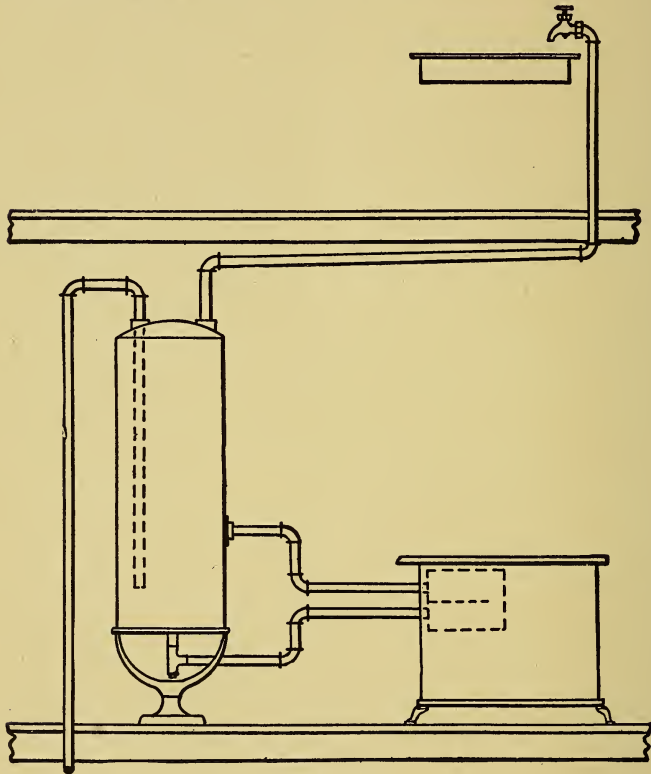

Fig. 160

The piping in the arrangement shown in Fig. 160 is designed to deliver hot water on the floor above that on which the boiler is located. If hot

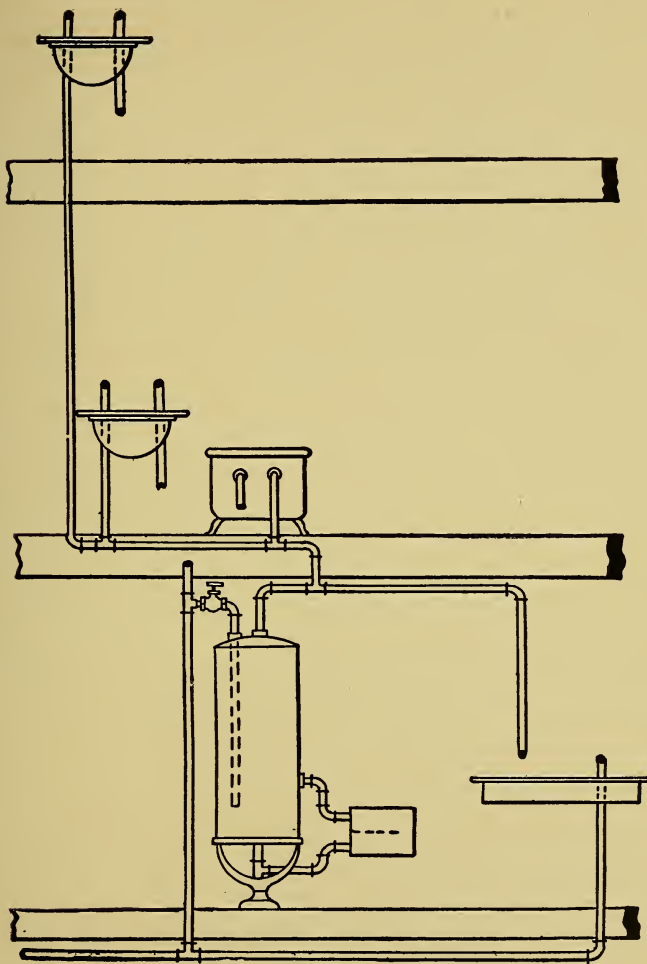

Fig. 161

water is desired on the same floor a connection can be made in the pipe leading from the top of the boiler to the faucet on the floor above.

Fig. 161 shows an arrangement of fixtures and piping to supply hot water on three floors by the pressure-cylinder system. Hot water is supplied to the kitchen sink on the ground floor, to a bath tub and wash bowl on the second floor and to a wash bowl on the third floor. The cold water supply pipe to the boiler is shown and the cold water connection to the kitchen sink, while the cold water pipes to the bath tub and wash bowls on the upper floors are omitted for the sake of simplicity.

Fig. 162 shows one of the simplest forms of the gravity-supply tank and cylinder systems, in which the boiler, water-back and hot water connections are all on the same floor. The cold water pipe goes to the floor above or to the attic as the case may be to the supply tank, where the supply of water is regulated by a ball float cock. An expansion pipe as shown should be provided in the hot water pipe leading from the boiler and arranged to discharge into the supply tank. In Fig. 163 a gravity-supply tank and cylinder system is shown, which is arranged to deliver hot water to the kitchen sink and also to a bath tub and wash bowl on the floor above. The cold water pipe is shown running up to the supply tank and also to the kitchen sink. For the sake of clearness and

to avoid confusion the cold water pipes leading to the wash bowl and bath tub are omitted.

It must be remembered that the kitchen boiler is not a heater, it is simply a reservoir to keep a

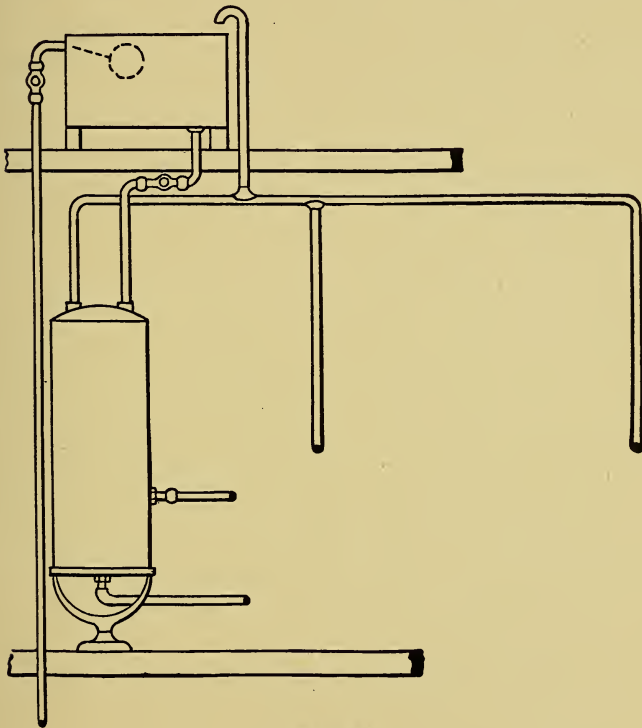

Fig. 162

supply of hot water on hand so that it may be drawn when required. By this arrangement hot water may be had long after the fire has been ex-

tinguished in the stove, as it stores itself by the law of gravitation at the upper part of the boiler, and is forced out by cold water entering below and remaining there without mingling with or

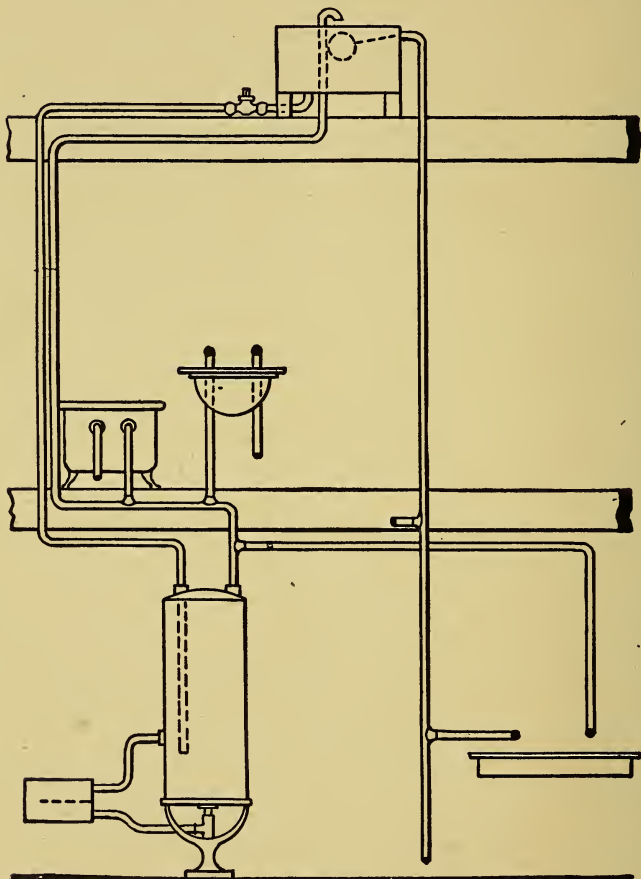

Fig. 163

cooling the hot water in the upper part of the boiler. It should be understood that the natural course of hot water, when confined in a boiler and depending for its motion on the difference between its temperature and the temperature of other water in the same boiler, is in a perpendicular or vertical direction. And consequently when the heating apparatus or pipes which have to convey the hot water from the water back to a boiler in which the hot water is to be stored in any position other than in a vertical position, friction is added which retards the flow of hot water just in proportion to the degree of angle from the vertical of the hot water pipes.

A noise in the pipes and water-back, and also a rumbling noise in the boiler indicates that there is something wrong, and which requires attention. These noises are produced by different causes, sometimes on account of the way the upper pipe from the water-back in the stove is connected to the boiler.

This pipe should always have some elevation from the water-back to where it enters the boiler. The more elevation the better the water will circulate. But the slightest rise in this pipe will make a satisfactory job. It should be a continuous rise if possible, the entire length from the water-back to the boiler.

Another cause of this noise comes from the water-back being filled, or nearly so, with scale,

which partly stops the water from circulating. Nearly all the troubles of this kind come from a bad circulation of water between the stove and boiler. If the trouble is allowed to continue very long without doing anything to improve it, it will grow worse, and perhaps stop up entirely. With the connections between the water-back in the stove and the boiler stopped up, what is to be expected? With a good fire in the stove under these conditions, an explosion of the water-back, which may blow the stove to pieces and, perhaps, kill some of the occupants of the house.

There are two conditions of things that will cause the water-back in a stove to explode. First, to have water in the water-back with its outlets or pipe connections stopped up, then have a fire started in the stove. The fire will generate steam in the water-back, and, having no outlet through which the steam might escape, an explosion must take place. The second way through which the water-back could explode is to have no water in the kitchen boiler, with a good fire in the stove and the water-back red-hot, then allow the water to be turned on suddenly into the boiler and water-back. Under these conditions steam would be generated faster than it could escape through the small pipe connections, and would naturally result in an explosion.

The different ways of connecting a water-back on any water heating device to an ordinary

kitchen boiler, are governed, to some extent, by the conditions in each individual case.

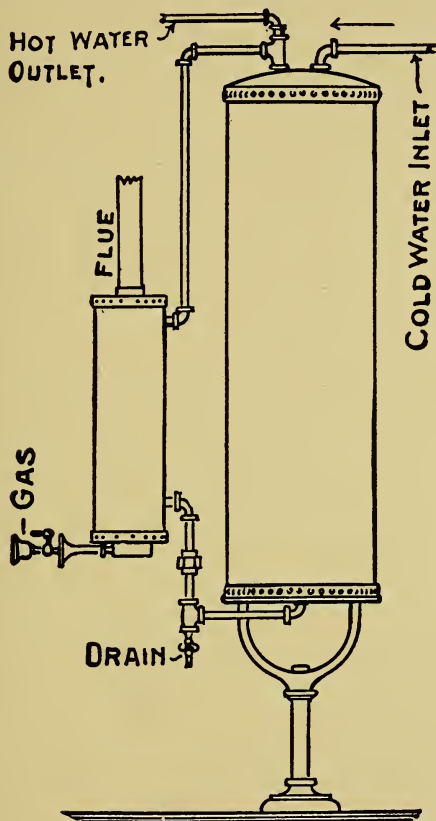

Fig. 164

In connecting a gas-heated water device, the connections should be made as shown in Fig.

164, which is known as a top connection, the particular reason being that it is possible, with a connection of this kind, to heat small quanti-

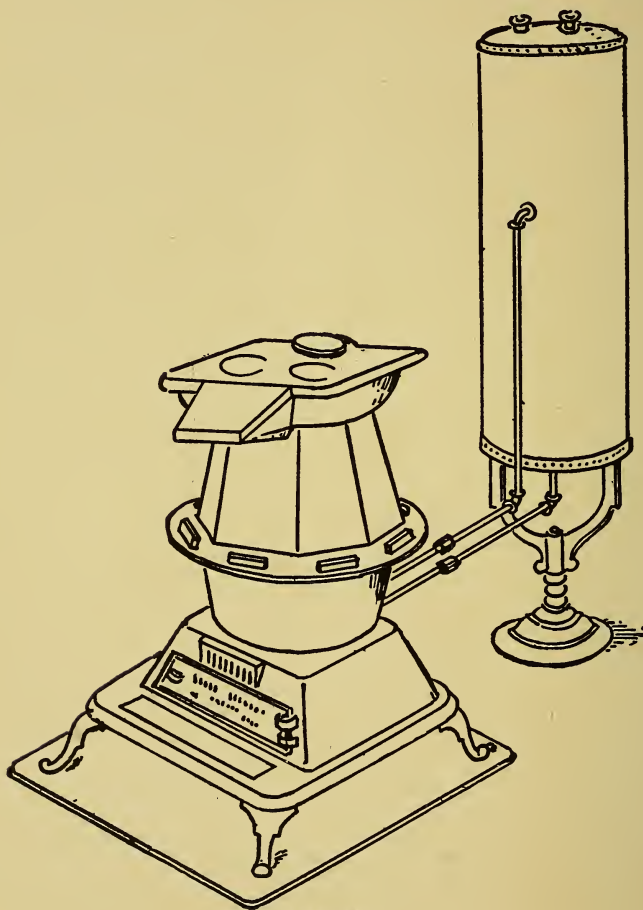

Fig. 165

ties of water and to heat it quickly, and water can be drawn within five minutes after lighting the gas the great advantage being the economy of fuel and time. A gas-heated water device should always be connected to a flue.

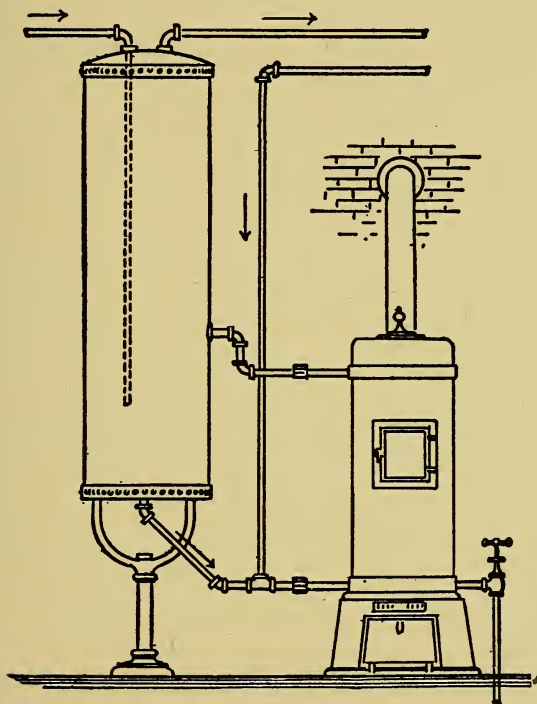

Fig. 166

When connecting a kitchen boiler to a water-back in a range, the connection should be made as shown in Fig. 165. As the range fire will

probably be kept burning all day, the question of fuel economy is not to be considered—the advantage of a connection of this kind is that it gives a large body of water from which to draw at all times.

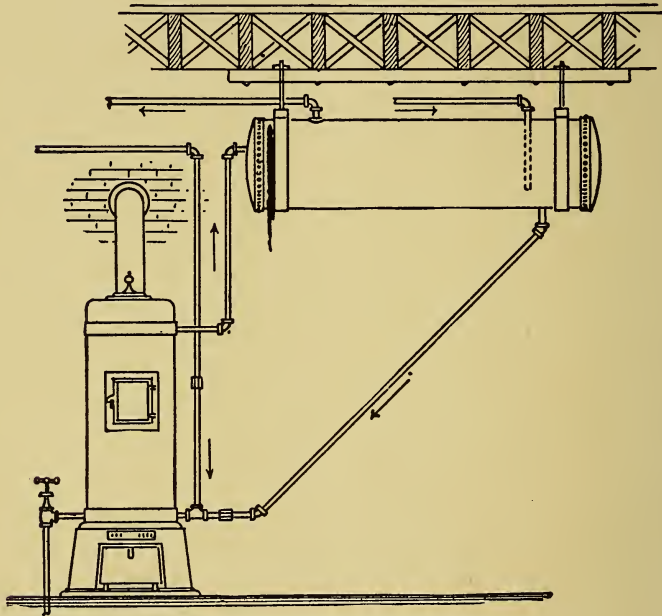

Fig. 167

Connections to vertical and horizontal boilers, when connected to independent water heaters are shown in Figs. 166 and 167.

Another device recently put on the market and

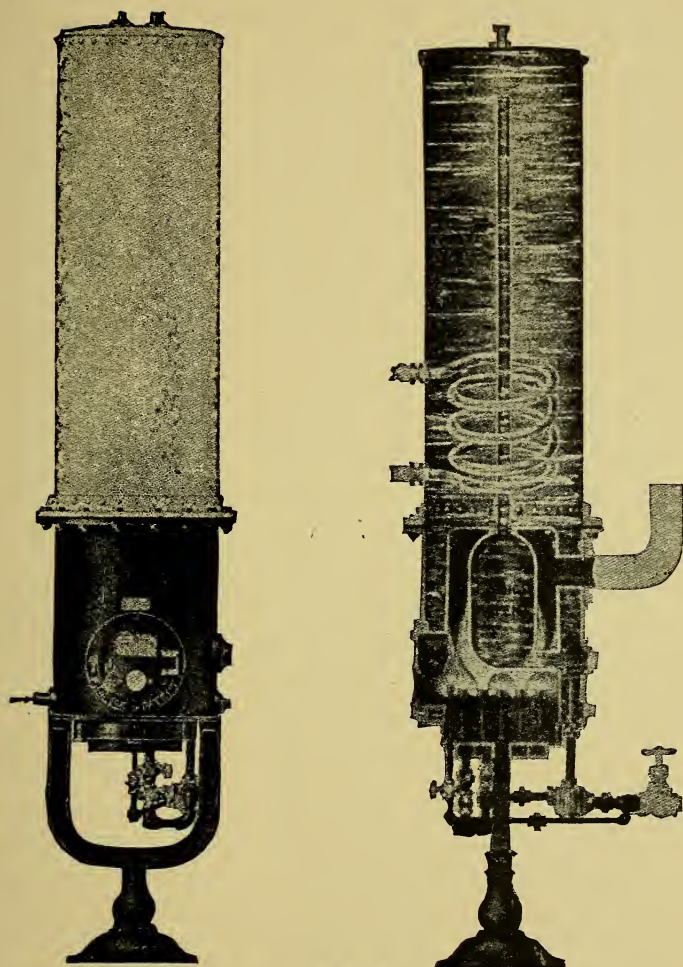

Fig. 168

shown in Fig. 168, is a combination reservoir and heater. This heater is unique in construction of water compartments inasmuch as all surfaces are exposed very advantageously to the flame. The central water compartment being directly over the flame and the pipe which carries hot water to the top of the tank enables it to supply hot water within a very short time. The gas supply is regulated by a thermostat, which automatically decreases the flow of gas when water is heated and automatically increases the flow of gas as soon as the hot water is drawn from the tank. Two clusters of blue flame gas burners, which are independent of each other, and can be used separately or both at the same time, furnish the heating medium. The advantage of this boiler, outside of the economy of fuel consumption, is that it requires little space for the installation and a great saving in the piping. Again the automatic gas regulating feature prevents the boiler from becoming over-heated and from its subsequent dangers, as the temperature of water is maintained at about 170 degrees Fahrenheit.

In the sectional cut a steam coil is shown whereby the water can be heated with steam, in case it is installed, where steam is available.

Plumber's Tools. The illustrations given in Figs. 169, 170 and 171, show a set of plumber's tools. The name of the tool is given with each

Blow Pipe

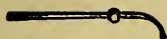

Round Iron



Pot Hook



Copper Hatchet Bolt



Copper Pointed Bolt



Ladle



Solder Pot



Torch



Wiping Cloths



Soil Cup



Tack Mould



Tack Mould



Tool Bags



Fig. 169

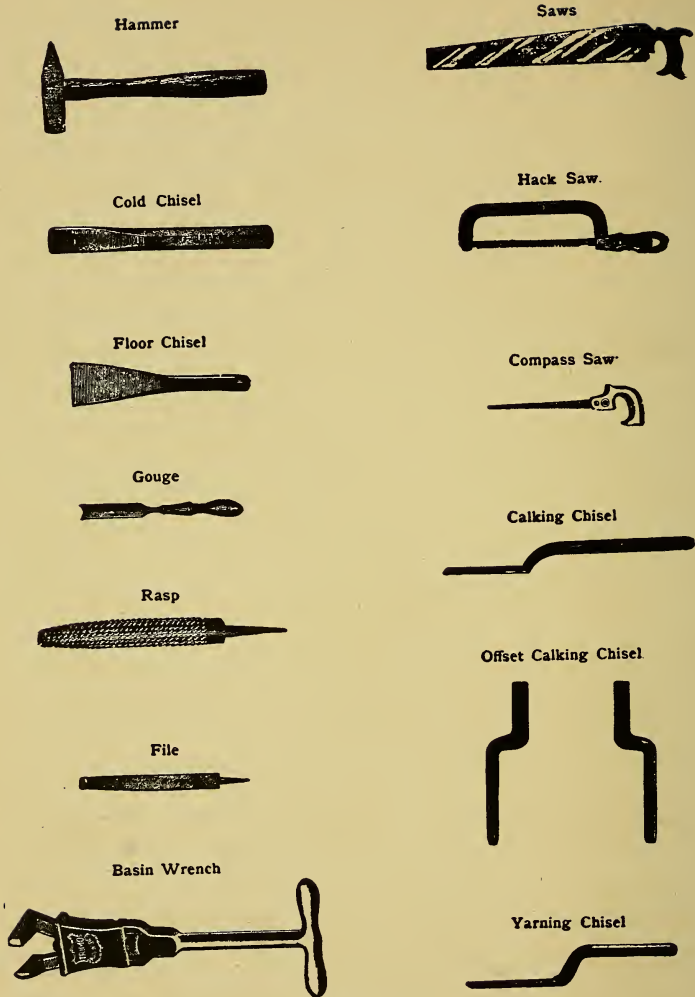

Fig. 170

illustration, making further information unnecessary.

A larger number of tools than those shown



Fig. 171

will sometimes be necessary for special work, or work that has to be done under difficulties.

Figs. 172 and 173 show two styles of plumber's blow-torches, and Figs. 174 and 175, two solder

pots. The air pressure is generated by means of rubber bulb in the solder pot shown in Fig. 174, and by means of a small hand pump in the one shown in Fig. 175.

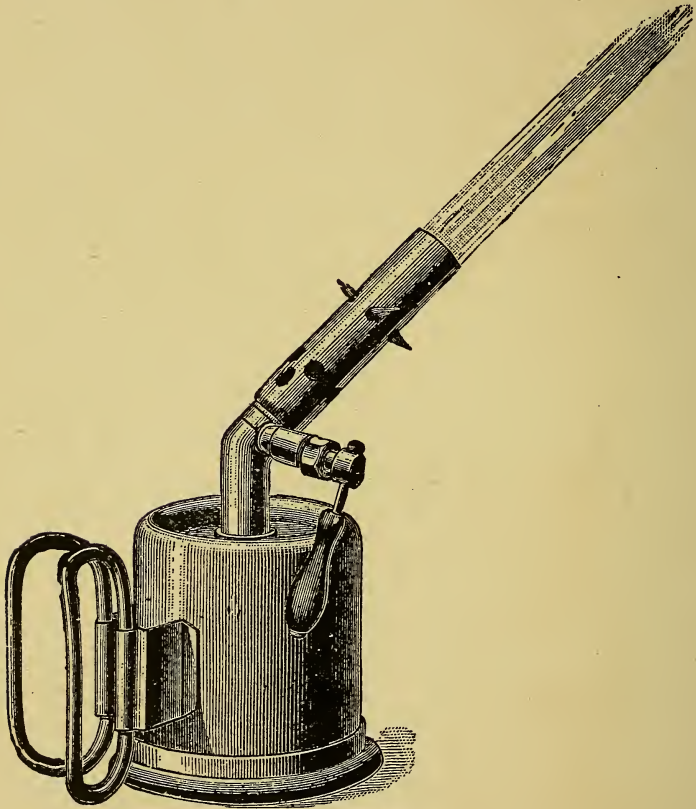

Fig. 172

A rubber force cup for cleaning bathtubs, washbowls and sinks is shown in Fig. 176.



Fig. 173



Fig. 174



Fig. 175



Fig. 176

A thawing steamer for thawing pipes that have been frozen during a cold spell is illustrated in Fig. 177.



Fig. 177

Traps. A trap is a vessel which contains water, its purpose is to prevent the passage of sewer gas and other foul odors from the sewer into the house, or to prevent the entrance through the house fixtures of gas and noxious odors that may be formed between the main trap and the house fixtures. The water seal of a trap should not be less than $1\frac{1}{2}$ to 2 inches.

The seal of a trap may be broken in different ways, viz: by syphonage, evaporation, back pressure and momentum or the action of the waste itself as it may pass off with considerable force.

A good trap should have a good seal, it should be non-syphonable, self-cleaning and have as few corners or places where dirt or refuse may collect as possible.

The S-trap and the drum or cylinder trap are two forms most used.

The back pressure or gas from the sewer will saturate the water in a trap with sewer gas, therefore all traps should be back-vented from the sewer side of the syphon and at the highest point of the same.

Traps should always be counter-vented, principally to prevent syphonage, to ventilate the plumbing system and to relieve back pressure.

Counter-venting. A counter-vent is a pipe by means of which a trap is supplied with air, to prevent the partial or total syphonage of the trap and also ventilate the plumbing system of the house.

Counter-vents from fixture traps should always be carried into the main air-pipe and higher than the top of the fixture or else directly through the roof.

The counter-vent from a water closet should always be vented from the highest point of the syphon and never from a lower point where the flushing action of the closet would throw waste matter into the entrance of the counter-vent or at any point where the waste would be liable to settle in the vent-pipe.

Caulking Joints. A ring of oakum is first forced into the joint, and then set with a caulking tool until hard. After the oakum is firmly caulked, an asbestos rope is placed around the top of the joint, leaving a small opening at the top for pouring the melted lead. The melted lead is then poured, and after cooling, firmly set down with the caulking tool, care being taken to thoroughly caulk the inner and outer edges of the lead circle. The lead in a 4-inch soil pipe should be about 1 inch deep.

PROPERTIES OF WATER.

A tasteless, transparent, inodorous, liquid, almost incompressible, its absolute diminution being about one twenty-thousandth of its bulk, possesses the liquid form only, at temperatures between thirty-two degrees and two hundred and twelve Fahrenheit. Chemically considered, it is a compound substance of hydrogen and oxygen, two volumes of hydrogen to one volume of oxygen. Water is the most powerful and universal solvent known.

The gallon is the unit of measure for water. The unit of water pressure is the pound per square inch, one gallon of water measures .134 cubic feet and contains 231 cubic inches and weighs about eight and one-third pounds, or sixty-two and one-third pounds per cubic foot

The above is figured at sixty-two degrees Fahrenheit, which is taken as a standard temperature.

The weight of a column of water of one inch area and twelve inches high, at sixty-two degrees Fahrenheit is .433 pounds, on

$$.433 \times 144 = 62.35 \text{ pounds per cubic foot.}$$

The pressure of still water, in pounds, per square inch, against the side of any pipe or ves-

sel, of any shape whatever, is equal in all directions, downwards, upwards or sideways. To find the pressure in pounds, per square inch, of a column of water, multiply the height of the column in feet, by .433, approximately one foot of elevation, is equal to one half-pound pressure per square inch.

The head is the vertical distance between the level surface of still water and the height in the pipe, unless caused by pressure such as by a pump, etc. Water pressure is measured in pounds per square inch, above atmospheric pressure, by means of a pressure gauge. To ascertain the height water will rise, at any given pressure, divide the gauge pressure by .433; the result is the height in feet.

Example: The pressure gauge on a supply pipe in a basement shows 25 pounds pressure. To what height will water rise in the piping throughout the building?

Answer: $25 \div .433 = 57\frac{1}{2}$ feet.

While water will rise to this height, sufficient head should be provided to furnish a surplus head of about ten feet above the highest point of delivery, to insure a respectable velocity of discharge.

It is frequently desired to know what number of pipes of a given size is equal in carrying capacity to one pipe of a larger size. At the same

velocity of flow, the volume delivered by two pipes of a different size is proportionate to the square of their diameters, thus: A four-inch pipe will deliver the same volume as four two-inch pipes.

Example:

$$2 \text{ inches} \times 2 \text{ inches} = 4 \text{ square inches.}$$

$$4 \text{ inches} \times 4 \text{ inches} = 16 \text{ square inches.}$$

$$16 \text{ inches} \div 4 \text{ inches} = 4 \text{ 2-inch pipes.}$$

With the same head, however, the velocity being less in a two-inch pipe, the volume delivered varies about as the square root of the fifth power. Thus one four-inch pipe is actually equal to 5.7 two-inch pipes.

Example: With the same head, how many two-inch pipes will it take to equal one four-inch pipe?

Solution:

$$2^5 = 2 \times 2 \times 2 \times 2 \times 2 = 32 \text{ and the } \sqrt[5]{32} = 5.7 \text{ nearly.}$$

In other words, the decrease in loss by friction in the four-inch pipe, in comparison with the two-inch pipes, is equal to 1.7 two-inch pipes over the actual square of their respective areas.

Water boils or takes the form of vapor or steam at 212 degrees Fahrenheit, at a mean pressure of the sea level, or 14.696 pounds per square inch. Water freezes, or assumes a solid form, that of ice, at 32 degrees Fahrenheit, at the ordinary at-

mospheric pressure, and ice melts at the same temperature. The point of maximum density is reached at 39.2 Fahrenheit, that is, water at that temperature occupies its smallest possible volume. If cooled further, it expands until it solidifies, and if heated, it expands.

Hardness of water is indicated by the easy manner with which it will form a lather with soap, the degree of hardness being based on the presence and amount of lime and magnesia. The more lime and magnesia in a sample of water, the more soap a given volume of water will decompose. The standard soap measurement is the quantity required to precipitate or neutralize one grain of carbonate of lime. It is commonly recommended that one gallon of pure, distilled water takes one soap measure to produce a lather, and, therefore, one is deducted from the total amount of soap measurements found to be necessary to produce a lather in a gallon of water, and in reporting the number of soap measurements or degrees of hardness of the water sample.

The impurities which occur in waters are of two kinds, mechanical and physical, dirt, leaves, insects, etc., are mechanical and can be removed by filtration. It is said that these impurities are held in suspension.

Solutions of minerals, poisons and the like are physical and are designated as those held in solution.

Freshening water to render it palatable is accomplished by aeration, that is, by exposing water to the action of the air, by passing air through it or raising it to an elevation built for that purpose, protected from dust and other impurities of the air, if the water is to be used for drinking purposes, and allowing it to run down an incline, which is slatted or barred, so as to break it up into small particles, and allow it to become saturated with air.

This process, however, is of no practical use for actual purification.

USEFUL INFORMATION.

One heaped bushel of anthracite coal weighs from 75 to 80 lbs.

One heaped bushel of bituminous coal weighs from 70 to 75 lbs.

One bushel of coke weighs 32 lbs.

Water, gas and steam pipes are measured on the inside.

One cubic inch of water evaporated at atmospheric pressure makes 1 cubic foot of steam.

A heat unit known as a British Thermal Unit raises the temperature of 1 pound of water 1 degree Fahrenheit.

For low pressure heating purposes, from 3 to 8 pounds of coal per hour is considered economical consumption, for each square foot of grate surface in a boiler, dependent upon conditions.

A horse power is estimated equal to 75 to 100 square feet of direct radiation. A horse power is also estimated as 15 square feet of heating surface in a standard tubular boiler.

Water boils in a vacuum at 98 degrees Fahrenheit.

A cubic foot of water weighs $62\frac{1}{2}$ pounds, it contains 1,728 cubic inches or $7\frac{1}{2}$ gallons. Water expands in boiling about one-twentieth of its bulk.

In turning into steam water expands 1,700 its bulk, approximately 1 cubic inch of water will produce 1 cubic foot of steam.

One pound of air contains 13.82 cubic feet.

It requires $1\frac{1}{2}$ British Thermal Units to raise one cubic foot of air from zero to 70 degrees Fahrenheit.

At atmospheric pressure 966 heat units are required to evaporate one pound of water into steam.

A pound of anthracite coal contains 14,500 heat units.

One horsepower is equivalent to 42.75 heat units per minute.

One horsepower is required to raise 33,000 pounds one foot high in one minute.

To produce one horsepower requires the evaporation of 2.66 pounds of water.

One ton of anthracite coal contains about 40 cubic feet.

One bushel of anthracite coal weighs about 86 pounds.

Heated air and water rise because their particles are more expanded, and therefore lighter than the colder particles.

A vacuum is a portion of space from which the air has been entirely exhausted.

Evaporation is the slow passage of a liquid into the form of vapor.

Increase of temperature, increased exposure of

surface, and the passage of air currents over the surface, cause increased evaporation.

Condensation is the passage of a vapor into the liquid state, and is the reverse of evaporation.

Pressure exerted upon a liquid is transmitted undiminished in all directions, and acts with the same force on all surfaces, and at right angles to those surfaces.

The pressure at each level of a liquid is proportional to its depth.

With different liquids and the same depth, pressure is proportional to the density of the liquid.

The pressure is the same at all points on any given level of a liquid.

The pressure of the upper layers of a body of liquid on the lower layers causes the latter to exert an equal reactive upward force. This force is called buoyancy.

Friction does not depend in the least on the pressure of the liquid upon the surface over which it is flowing.

Friction is proportional to the area of the surface.

At a low velocity friction increases with the velocity of the liquid.

Friction increases with the roughness of the surface.

Friction increases with the density of the liquid.

Friction is greater comparatively, in small pipes, for a greater proportion of the water comes

in contact with the sides of the pipe than in the case of the large pipe. For this reason mains on heating apparatus should be generous in size.

Air is extremely compressible, while water is almost incompressible.

Water is composed of two parts of hydrogen, and one part of oxygen.

Water will absorb gases, and to the greatest extent when the pressure of the gas upon the water is greatest, and when the temperature is the lowest, for the elastic force of gas is then less.

Air is composed of about one-fifth oxygen and four-fifths nitrogen, with a small amount of carbonic acid gas.

To reduce Centigrade temperatures to Fahrenheit, multiply the Centigrade degrees by 9, divide the result by 5, and add 32.

To reduce Fahrenheit temperature to Centigrade, subtract 32 from the Fahrenheit degrees, multiply by 5 and divide by 9.

To find the area of a required pipe, when the volume and velocity of the water are given, multiply the number of cubic feet of water by 144 and divide this amount by the velocity in feet per minute.

Water boils in an open vessel (atmospheric pressure at sea level) at 212 degrees Fahrenheit.

Water expands in heating from 39 to 212 degrees Fahrenheit, about 4 per cent.

Water expands about one-tenth its bulk by freezing solid.

Rule for finding the size of a pipe necessary to fill a number of smaller pipes. Suppose it is desired to fill from one pipe, a 2, $2\frac{1}{2}$ and 4-inch pipe. Draw a right angle, one arm 2 inches in length, the other $2\frac{1}{2}$ inches in length. From the extreme ends of the two arms draw a line. The length of this line in inches will give the size of pipe necessary to fill the two smaller pipes—about $3\frac{1}{4}$ inches. From one end of this last line, draw another line at right angles to it, 4 inches in length. Now, from the end of the 2-inch line to the end of the last line draw another line. Its length will represent the size of pipe necessary to fill a 2-, $2\frac{1}{2}$ - and 4-inch pipe. This may be continued as long as desired.

Discharge of water. The amount of water discharged through a given orifice during a given length of time and under different heads, is as the square roots of the corresponding heights of the water in the reservoir above the surface of the orifice.

Water is at its greatest density and occupies the least space at 39 degrees Fahrenheit.

Water is the best known absorbent of heat, consequently a good vehicle for conveying and transmitting heat.

A U. S. gallon of water contains 231 cubic inches and weighs $8\frac{1}{3}$ pounds.

A column of water 27.67 inches high has a pressure of 1 pound to the square inch at the bottom.

Doubling the diameter of a pipe increases its capacity four times.

A hot water boiler will consume from 3 to 8 pounds of coal per hour per square foot of grate, the difference depending upon conditions of draft, fuel, system and management.

A cubic foot of anthracite coal averages 50 pounds. A cubic foot of bituminous coal weighs 40 pounds.

Weights.

One cubic inch of water	weighs	0.036 pounds
One U. S. gallon	weighs...	8.33 “
One Imperial gallon	“ ...	10.00 “
One U. S. gallon	equals....	231.00 cubic inches
One Imperial gallon	“ ...	277.274 “ “
One cubic foot of water	equals	7.48 U. S. gallons

Liquid Measure.

4 Gills make 1 Pint	4 Quarts make 1 Gallon
2 Pints make 1 Quart	31½ Gals. make 1 Barrel

To find the area of a rectangle, multiply the length by the breadth.

To find the area of triangle, multiply the base by one-half the perpendicular height.

To find the circumference of a circle, multiply the diameter by 3.1416.

To find the area of a circle, multiply the diameter by itself, and the result by .7854.

To find the diameter of a circle of a given area, divide the area by .7854, and find the square root of the result.

To find the diameter of a circle which shall have the same area as a given square, multiply one side of the square by 1.128.

To find the number of gallons in a cylindrical tank, multiply the diameter in inches by itself, this by the height in inches, and the result by .34. To find the number of gallons in a rectangular tank, multiply together the length, breadth and height in feet, and this result by 7.4. If the dimensions are in inches, multiply the product by .004329. To find the pressure in pounds per square inch, of a column of water, multiply the height of the column in feet by .434.

To find the head which will produce a given velocity of water through a pipe of a given diameter and length: Multiply the square of the velocity, expressed in feet per second, by the length of pipe multiplied by the quotient obtained by dividing 13.9 by the diameter of the pipe in inches, and divide the result obtained by 2,500. The final amount will give the head in feet.

Example.—The horizontal length of pipe is

1,200 feet, and the diameter is 4 inches. What head must be secured to produce a flow of 3 feet per second?

$$3 \times 3 = 9; 13.9 \div 4 = 3.475.$$

$$9 \times 1,200 \times 3.475 = 37,530.$$

$$37,530 \div 2,500 = 15 \text{ ft.}$$

To find the velocity of water flowing through a horizontal straight pipe of given length and diameter, the head of water above the center of the pipe being known: Multiply the head in feet by 2,500, and divide the result by the length of pipe in feet multiplied by 13.9, divided by the inner diameter of the pipe in inches. The square root of the quotient gives the velocity in feet per second.

To find the head in feet, the pressure being known, multiply the pressure per square inch by 2.31.

To find the contents of a barrel. To twice the square of the largest diameter, add the square of the smallest diameter and multiply this by the height, and the result by 2,618. This will give the cubic inches in the barrel, and this divided by 231 will give the number of gallons.

To find the head in feet, the pressure being known, multiply the pressure per square inch by 2.31.

To find the lateral pressure of water upon the side of a tank, multiply in inches, the area of the

submerged side, by the pressure due to one-half the depth.

Example—Suppose a tank to be 12 feet long and 12 feet deep. Find the pressure on the side of the tank.

$144 \times 144 = 20,736$ square inches area of side.

$12 \times .43 = 5.16$, pressure at bottom of tank. Pressure at the top of tank is 0. Average pressure will then be 2.6. Therefore $20,736 \times 2.6 = 53,914$ pounds pressure on side of tank.

To find the number of gallons in a foot of pipe of any given diameter, multiply the square of diameter of the pipe in inches, by .0408.

To find the diameter of pipe to discharge a given volume of water per minute in cubic feet, multiply the square of the quantity in cubic feet per minute by 96. This will give the diameter in inches.

To find the weight of any length of lead pipe, when the diameter and thickness of the lead are known: Multiply the square of the outer diameter in inches, by the weight of 12 cylindrical inches, then multiply the square of the inner diameter in inches by the same amount, subtracting the product of the latter from that of the former. The remainder multiplied by the length gives the desired result.

Example. Find the weight of 1,200 feet of lead pipe, the outer diameter being $\frac{7}{8}$ inch, and the inner diameter 9-16 inch,

The weight of 12 cylindrical inches, 1 foot long, 1 inch in diameter, is 3.8697 lbs.

$$\frac{7}{8} \times \frac{7}{8} = 49-64 = .765625.$$

$$9-16 \times 9-16 = 81-256 = .316406.$$

.765625 — .316406 = .449219 \times 3.8697 \times 1,200 = 2,086 lbs.

Cleaning Rusted Iron. Place the articles to be cleaned in a saturated solution of chloride of tin and allow them to stand for a half day or more.

When removed, wash the articles in water, then in ammonia. Dry quickly, rubbing them hard.

Removing Boiler Scale. Kerosene oil will accomplish this purpose, often better than specially prepared compounds.

Cleaning Brass. Mix in a stone jar one part of nitric acid, one-half part of sulphuric acid. Dip the brass work into this mixture, wash it off with water, and dry with sawdust. If greasy, dip the work into a strong mixture of potash, soda, and water, to remove the grease. and wash it off with water.

Removing Grease Stains from Marble. Mix $1\frac{1}{2}$ parts of soft soap, 3 parts of Fuller's earth and $1\frac{1}{2}$ parts of potash, with boiling water. Cover the grease spots with this mixture, and allow it to stand a few hours.

Strong Cement. Melt over a slow fire, equal parts of rubber and pitch. When wishing to apply the cement, melt and spread it on a strip of strong cotton cloth,

Cementing Iron and Stone. Mix 10 parts of fine iron filings, 30 parts of plaster of Paris, and one-half parts of sal ammoniac, with weak vinegar. Work this mixture into a paste, and apply quickly.

Cement for Steam Boilers. Four parts of red or white lead mixed in oil, and 3 parts of iron borings, make a good soft cement for this purpose.

Cement for Leaky Boilers. Mix 1 part of powdered litharge, 1 part of fine sand, and one-half part of slacked lime with linseed oil, and apply quickly as possible.

To keep plaster of Paris from setting too quickly. Sift the plaster into the water, allowing it to soak up the water without stirring, which would admit the air, and cause the plaster to set very quickly. If it is desired to keep the plaster soft for a much longer period, as is necessary for some kinds of work, add to every quart of water one-half teaspoonful of common cooking soda. This will gain all the time that is needed.

To keep paste from spoiling. Add a few drops of oil of clove.

To make a cement that will hold when all others fail. Melt over a slow fire equal parts of rubber and pitch. When wishing to use it, melt and spread it on a strip of strong cotton cloth.

Bath for cleaning sheet copper that is to be

tinned. Pour into water sulphuric acid, until the temperature rises to about blood heat, when it will be about right for pickling purposes.

Making Tight Steam Joints. With white lead ground in oil mix as much manganese as possible, with a small amount of litharge. Dust the board with red lead, and knead this mass by hand into a small roll, which is then laid on the plate, oiled with linseed oil. It can then be screwed into place.

Substitute for Fire Clay. Mix common earth with weak salt water.

Rust Joint Cement. Mix 5 pounds of iron filings, 1 ounce of sal ammoniac, and 1 ounce of sulphur, and thin the mixture with water.

To tin sheet copper after it has been well cleaned. Take it from the bath. If there are any spots which the acid has failed to remove, scour with salt and sand. Then over a light charcoal fire heat it, touching it with tin or solder, and wipe from one end of the sheet to the other with a handful of flax, only going so fast as it is thoroughly tinned. If the tinning shows a yellowish color, it shows there is too much heat, which is the greatest danger, as tinning should be done with as little heat as is necessary to make the metal flow. When this is done, rinse off in clean water and dry in sawdust.

To give copper a red appearance as seen on bath boilers. After the copper has been cleaned,

rub on red chalk and hammer it in with a planishing hammer.

To tin soldering copper with sal-ammoniac. It will be found very handy to have a stick of sal-ammoniac in the kit for tinning purposes. After filing the heated copper bright, touch the copper with the sal-ammoniac and afterward with a stick of solder. The solder will at once flow over the entire surface. In this there is but one danger, the too great heating of the copper, in which case the burned sal-ammoniac will form a hard crust over the surface. Tin with as little heat as possible. Sal-ammoniac will be found of great value in keeping the soldering copper in shape by frequently rubbing the tinned point with it.

To Keep Soldering Coppers in Order While Soldering with Acid. In a pint of water dissolve a piece of sal-ammoniac about the size of a walnut. Whenever the copper is taken from the fire, dip the point into the liquid, and the zinc taken from the acid will run to the point of the copper and can then be shaken off, leaving the copper bright.

TESTS FOR PURE WATER.

Color. Fill a long clean bottle of colorless glass with the water. Look through it at some blank object. It should look colorless and free

from suspended matter. A muddy or turbid appearance indicates soluble organic matter or solid matter in suspension.

Odor. Fill the bottle half full, cork it and leave it in a warm place for a few hours. If, when uncorked, it has a smell the least repulsive, it should be rejected for domestic use.

Taste. If water at any time, even after heating, has a repulsive or disagreeable taste, it should be rejected. A simple, semi-chemical test is to fill a clean pint bottle three-fourths full of water, add a half teaspoonful of clean granulated or crushed loaf sugar, stop the bottle with glass or a clean cork, and let it stand in the light, in a moderately warm room, for forty-eight hours. If the water becomes cloudy, or milky, it is unfit for domestic use.

DIAMETERS, CIRCUMFERENCES, AREAS, SQUARES,
AND CUBES.

Diameter in Inches.	Circum- ference in Inches.	Area in Square Inches.	Area in Square Feet.	Square, in Inches.	Cube, in Inches.
$\frac{1}{8}$.3927	.01220156	.00195
$\frac{1}{4}$.7854	.04900625	.01563
$\frac{3}{8}$	1.1781	.11041406	.05273
$\frac{1}{2}$	1.5708	.196325	.125
$\frac{5}{8}$	1.9635	.30683906	.24414
$\frac{3}{4}$	2.3562	.44175625	.42138
$\frac{7}{8}$	2.7489	.60137656	.66992
1	3.1416	.7854	1.	1.
$1\frac{1}{8}$	3.5343	.9940	.0069	1.2656	1.42383
$1\frac{1}{4}$	3.9270	1.2271	.0084	1.5625	1.95313
$1\frac{3}{8}$	4.3197	1.4848	.0102	1.8906	2.59961
$1\frac{1}{2}$	4.7124	1.7671	.0122	2.25	3.375
$1\frac{5}{8}$	5.1051	2.0739	.0143	2.6406	4.291
$1\frac{3}{4}$	5.4978	2.4052	.0166	3.0265	5.3593
$1\frac{7}{8}$	5.8905	2.7611	.0191	3.5156	6.5918
2	6.2832	3.1416	.0225	4.	8.
$2\frac{1}{8}$	6.6759	3.5465	.0245	4.5156	9.5957
$2\frac{1}{4}$	7.0686	3.9760	.0275	5.0625	11.3906
$2\frac{3}{8}$	7.4613	4.4302	.0307	5.6406	13.3965
$2\frac{1}{2}$	7.8540	4.9087	.0340	6.25	15.625
$2\frac{5}{8}$	8.2467	5.4119	.0375	6.8906	18.0879
$2\frac{3}{4}$	8.6394	5.9395	.0411	7.5625	20.7969
$2\frac{7}{8}$	9.0321	6.4918	.0450	8.2656	23.7637
3	9.4248	7.0686	.0490	9.	27.
$3\frac{1}{8}$	9.8175	7.6699	.0531	9.7656	30.5176
$3\frac{1}{4}$	10.210	8.2957	.0575	10.5625	34.3281
$3\frac{3}{8}$	10.602	8.9462	.0620	11.3906	38.4434
$3\frac{1}{2}$	10.995	9.6211	.0668	12.25	42.875
$3\frac{5}{8}$	11.388	10.320	.0730	13.1406	47.634
$3\frac{3}{4}$	11.781	11.044	.0767	14.0625	52.734
$3\frac{7}{8}$	12.173	11.793	.0818	15.0156	58.185
4	12.566	12.566	.0879	16.	64.

TABLE 12

DIAMETERS, CIRCUMFERENCES, AREAS, SQUARES,
AND CUBES.

Diameter in Inches.	Circum- ference in Inches.	Area in Square Inches.	Area in Square Feet.	Square, in Inches.	Cube, in Inches.
$4\frac{1}{8}$	12.959	13.364	.0935	17.0156	70.1895
$4\frac{1}{4}$	13.351	14.186	.0993	18.0625	76.7656
$4\frac{3}{8}$	13.744	15.033	.1052	19.1406	83.7402
$4\frac{1}{2}$	14.137	15.904	.1113	20.25	91.125
$4\frac{5}{8}$	14.529	16.800	.1176	21.3906	98.9316
$4\frac{3}{4}$	14.922	17.720	.1240	22.5625	107.1719
$4\frac{7}{8}$	15.315	18.665	.1306	23.7656	115.8574
5	15.708	19.635	.1374	25.	125.
$5\frac{1}{8}$	16.100	20.629	.1444	26.2656	134.6113
$5\frac{1}{4}$	16.493	21.647	.1515	27.5625	144.7031
$5\frac{3}{8}$	16.886	22.690	.1588	28.8906	155.2871
$5\frac{1}{2}$	17.278	23.758	.1663	30.25	166.375
$5\frac{5}{8}$	17.671	24.850	.1739	31.6406	177.9785
$5\frac{3}{4}$	18.064	25.967	.1817	33.0625	190.1094
$5\frac{7}{8}$	18.457	27.108	.1897	34.5186	202.7793
6	18.849	28.274	.1979	36.	216.
$6\frac{1}{8}$	19.242	29.464	.2062	37.5156	229.7832
$6\frac{1}{4}$	19.635	30.679	.2147	39.0625	244.1406
$6\frac{3}{8}$	20.027	31.919	.2234	40.6406	259.084
$6\frac{1}{2}$	20.420	33.183	.2322	42.25	274.625
$6\frac{5}{8}$	20.813	34.471	.2412	43.8906	290.7754
$6\frac{3}{4}$	21.205	35.784	.2504	45.5625	307.5469
$6\frac{7}{8}$	21.598	37.122	.2598	47.2656	324.9512
7	21.991	38.484	.2693	49.	343.
$7\frac{1}{8}$	22.383	39.871	.2791	50.7656	361.7051
$7\frac{1}{4}$	22.776	41.282	.2889	52.5625	381.0781
$7\frac{3}{8}$	23.169	42.718	.2990	54.3906	401.1309
$7\frac{1}{2}$	23.562	44.178	.3092	56.25	421.879
$7\frac{5}{8}$	23.954	45.663	.3196	58.1406	443.3223
$7\frac{3}{4}$	24.347	47.173	.3299	60.0625	465.4844
$7\frac{7}{8}$	24.740	48.707	.3409	62.0156	488.3730
8	25.132	50.265	.3518	64.	512.

TABLE 12—Continued

DIAMETERS, CIRCUMFERENCES, AREAS, SQUARES,
AND CUBES.

Diameter in Inches.	Circum- ference in Inches.	Area in Square Inches.	Area in Square Feet.	Square. in Inches.	Cube, in Inches.
$8\frac{1}{8}$	25.515	51.848	.3629	66.0156	536.3770
$8\frac{1}{4}$	25.918	53.456	.3741	68.0625	561.5156
$8\frac{3}{8}$	26.310	55.088	.3856	70.1406	587.4277
$8\frac{1}{2}$	26.703	56.745	.3972	72.25	614.125
$8\frac{5}{8}$	27.096	58.426	.4089	74.3906	641.6191
$8\frac{3}{4}$	27.489	60.132	.4209	76.5625	669.9219
$8\frac{7}{8}$	27.881	61.862	.4330	78.7656	699.0449
9	28.274	63.617	.4453	81.	729.
$9\frac{1}{8}$	28.667	65.396	.4577	83.2656	759.7988
$9\frac{1}{4}$	29.059	67.200	.4704	85.5625	791.4531
$9\frac{3}{8}$	29.452	69.029	.4832	87.8906	823.9746
$9\frac{1}{2}$	29.845	70.882	.4961	90.25	857.375
$9\frac{5}{8}$	30.237	72.759	.5093	92.6406	891.666
$9\frac{3}{4}$	30.630	74.662	.5226	95.0625	926.8594
$9\frac{7}{8}$	31.023	76.588	.5361	97.5156	962.0968
10	31.416	78.540	.5497	100.	1000.
$10\frac{1}{8}$	31.808	80.515	.5636	102.5156	1037.9707
$10\frac{1}{4}$	32.201	82.516	.5776	105.0625	1076.8906
$10\frac{3}{8}$	32.594	84.540	.5917	107.6406	1116.7715
$10\frac{1}{2}$	32.986	86.590	.6061	110.25	1157.625
$10\frac{5}{8}$	33.379	88.664	.6206	112.8906	1199.4629
$10\frac{3}{4}$	33.772	90.762	.6353	115.5625	1242.2969
$10\frac{7}{8}$	34.164	92.885	.6499	118.2656	1286.1387
11	34.557	95.033	.6652	121.	1331.
$11\frac{1}{8}$	34.950	97.205	.6804	123.7656	1376.8926
$11\frac{1}{4}$	35.343	99.402	.6958	126.5625	1423.8281
$11\frac{3}{8}$	35.735	101.623	.7113	129.3906	1471.8184
$11\frac{1}{2}$	36.128	103.869	.7270	132.25	1520.875
$11\frac{5}{8}$	36.521	106.139	.7429	135.1406	1571.0098
$11\frac{3}{4}$	36.913	108.434	.7590	138.0625	1622.234
$11\frac{7}{8}$	37.306	110.753	.7752	141.0155	1674.5605
12	37.699	113.097	.7916	144.	1728.

TABLE 12—Continued

CHICAGO PLUMBING CODE.

The following extracts from the 1914 Plumbing Code of the City of Chicago, will, it is believed, be of material assistance to the student. Of course the rules and regulations controlling plumbing work in various cities differ more or less, according to conditions, but the bulk of the rules herein given will serve as a reliable guide to the plumber in his work, regardless of the locality in which the work is to be performed, and it is for this purpose that they are here inserted.

PLUMBING.

Permit for use of water.] All applications for permits for the introduction or use of water supplied by the city shall be made in writing upon printed forms furnished by the department of public works, the blanks to be specifically and properly filled in and signed by the owner or duly authorized agent of the owner, and no work whatever shall be done in the street, or outside a building, by any plumber or other person for the purpose of making any connection to or with any city water main or pipe until after the issuance of such permit. This restriction shall not prevent any person from rendering assistance in case of accident to water pipes occurring at night, or at any time requiring immediate action. In case of any

such accident prompt report thereof shall be made to the department of public works by the person rendering such assistance.

Tapping street main.] No person except the tappers employed by the department of public works shall be permitted under any circumstances to tap any street main or insert stop-cocks or ferrules therein. All service cocks or ferrules must be inserted at or near the top of the street main, and not in any case nearer than six inches from the bell of the pipe. The size of the cock to be inserted shall be that specified in the permit.

Lead pipe—kind permitted—weight required.] No lead pipe shall be used in any work done under the authority of a license or permit issued by the city, except such as is known to the trade as “strong,” and every lead pipe so used must weigh as follows:

Half-inch internal diameter.....	1¾	pounds	per	lineal	foot.
Five-eighths inch internal diameter...	2½	“	“	“	“
Three-fourths inch “ “	3	“	“	“	“
One inch “ “	4	“	“	“	“
One and one-fourth in. internal diam.	4¾	“	“	“	“
One and one-half in. “ “	6	“	“	“	“
One and three-fourths in. “ “	6½	“	“	“	“
Two inches “ “	8	“	“	“	“

No pipe shall be used for the purpose of street service of a different material or size from that herein specified, except by special permit, issued by the commissioner of public works.

Service pipe—joints.] All service pipes leading from street mains to the building line shall as far as practicable be laid in the ground to a depth of not less than five feet, and every such pipe shall be laid in such manner and be of such sur-

plus length as to prevent breakage or rupture by settlement, and all joints in such pipes shall be of the kind termed "plumber or wiped joints." The connections of pipe by the so-called "cup-joint" is prohibited.

Stop-cocks.] Every service pipe shall be provided with a stop-cock for each consumer, easily accessible, placed beyond damage by frost and so situated that the water can be conveniently shut off and drained from the pipes.

Stop-cock—location—shutoff box.] Such stop-cocks, unless otherwise specially permitted, shall be connected to service pipes within the sidewalk at or near the curb line of the same, and be enclosed in and protected by a cast-iron box with a cover having the letter "W" of suitable size cast thereon; such iron box shall be of form and dimensions satisfactory to the commissioner of public works and shall extend from service pipe to surface of sidewalk, and be of proper size to admit a stop key for operating the stop-cock.

Single tap for several buildings—dependent cocks required.] Whenever two or more distinct buildings or premises are to be supplied by means of branch or sub-service pipes supplied by a single tap in the street main, each branch shall be independently arranged with stop-cock and box on the curb line in the manner above described. All cocks used at the sidewalks by plumbers shall be of the kind known as "round water way."

Opening of streets—permit—deposit.] Before filling any trench the service cock in the street

main shall be covered with a suitable cast-iron box furnished by the city; the earth shall be well rammed under the main to a level with the top thereof; from thence the trench shall be filled in layers of not more than twelve inches in depth, and each layer thoroughly rammed or puddled to prevent settlement. This work together with the replacing of sidewalks, ballast and paving shall be done in all cases by the city. A sufficient sum of money shall be deposited with the city before the issuance of the permit for opening the street, to cover this expense.

No permit shall be granted for the opening of any paved street for the tapping of mains or laying of service pipes, when the ground is frozen to a depth of twelve inches or more, except when in the opinion of the commissioner of public works there is a sufficient emergency to justify it.

High pressure steam boiler—supply tank required.] All persons are prohibited from connecting pipes whereby high pressure steam boilers may be supplied with water direct from city water mains. All such boilers shall be provided with a tank or other receptacle of sufficient capacity to hold at least six hours' supply of water, which may be used in case of a pipe district being shut off for the repair of water mains or for the making of connections or extensions. In such cases the city will not be responsible for a lack of water for steam boilers, or for any purpose.

New plumbing—repairs—pipes and traps to be exposed till after tests.] In all buildings here-

after erected in the city, both public and private, and in all buildings already built or erected wherein any plumbing is installed or wherein any sewer-connected pipe shall be repaired or changed, except for minor repairs, on the sewer side of the trap, the drain, soil, rainwater, when rainwater pipes are within building, waste pipes, or any other pipe or pipes connected directly or indirectly to any drain, soil or waste pipe, and all traps, shall be placed within buildings and exposed to view for ready inspection and test, and shall remain so exposed until approved by the commissioner of health. In no case shall a trap be inaccessible at any time.

Metal connections — requirements — tests — tile sewers above ground prohibited.] All soil or waste pipes shall be connected to the tile sewer, if a tile sewer is laid within the building, and if the connection is made above the ground or floor, by a suitable metal connection, which shall make an air-tight and water-tight joint, without the use of cement, mortar, putty or other like material, and which can and shall be tested with water when in place, such metal connections shall be in view at the time of final inspection.

The entire fitting or piece which is used to connect the iron soil or waste pipe to the tile sewer shall be regarded as the metal connection. Metal connections which can be removed from the sewer and soil or waste pipes, after once in place without removing a portion of the iron soil or waste pipe, are prohibited. No such metal connection

shall be used which has not been submitted to and tested and approved by the chief sanitary inspector and the commissioner of health. No tile sewer shall be used above the ground or cement floor or where a cement joint is exposed to the air. One of each such approved types of metal connections shall be kept in the sanitary bureau of the department of health.

Connections outside buildings and under ground.] Outside of the building and under ground the connection between the soil or waste pipe and the vitrified tile sewer shall be thoroughly made with live Portland cement mortar, made with one part cement and two parts clean, sharp sand.

An arched or other proper opening shall be provided in the wall for the house drain to prevent damage by settlement. The opening around the house drain may be filled with pure refined asphaltum.

Drains connected with sewers—sizes—connections must be made by plumber.] It shall be the duty of every person or corporation connecting or causing to be connected any drain, soil pipe or passage with any sewer from any building, structure or premises, to cause such drain, soil pipe, passage or connection to be at all times adequate for its purpose and of such size and dimensions as to convey and allow freely to pass, whatever may properly enter the same.

All connections between metal pipes and between metal pipe and tile sewers shall be made by

a licensed plumber and in such manner as the commissioner of health shall direct.

Separate drainage for every building—exception.] Every building shall be separately and independently connected with a public or private sewer, when there is any such sewer in the street adjoining such building.

The entire plumbing and drainage system of every building shall be entirely separate and independent from that of any other building, except where there are two buildings on one lot, one in the rear of the other. If there is no sewer in the alley to which the rear building can connect, the sewer of the first building may be extended to serve such rear building.

Drainage of kitchen slops, etc.—water supply.] All connections with sewers or drains used for the purpose of carrying off animal refuse from water-closets or otherwise, and slop of kitchens, shall have fixtures for a sufficiency of water to be so applied as to properly carry off such matters.

Soil pipe—size—increaser.] Every water closet located within any building shall waste into a pipe not less than four inches in diameter. Such pipe shall be increased below the roof line as hereinafter provided and shall be carried through and above the roof.

Definition of terms.] In this article the term “main soil pipe” is applied to any pipe receiving the discharge of one or more water closets, with or without other fixtures, and extending through the roof.

The term "branch soil pipe" is applied to any pipe receiving the discharge from one or more water closets and with or without other fixtures and leading towards and connecting with the main soil pipe, but not necessarily extending through the roof.

The term "waste pipe" is applied to any pipe receiving the discharge from any fixture or fixtures other than water closets.

The term "house drain" is applied to the pipe within any building which receives the total discharge from any fixture or sets of fixtures, and may or may not include rain water, and which conducts or carries the same to the house sewer. The house drain, when rain water is allowed to discharge into it, shall be not less than six inches internal diameter.

The term "house sewer" is applied to the tile sewer, which shall be not less than six inches internal diameter, and which begins outside of the wall of a building and connects the house drain with the public sewer in the street.

The term "main vent" is applied to the vertical line of air pipe running through two or more floors to which the vent or revent pipes from the various floors are connected.

The term "vent pipe" is applied to any pipe provided to ventilate a system of piping, and to which the revents are connected.

The term "revent pipe" is applied to any pipe used to prevent trap siphonage and back pressure.

The term "soil vent" or "waste vent" is applied to that part of the main soil pipe or waste pipe which is above the highest installed fixture waste connection and extends through the roof.

When sizes of pipes are specified the internal diameters of the pipes are meant.

Iron pipes—quality—weights.] All soil, waste and vent pipes, except as hereinafter specified for lead branches and brass pipes, shall be either extra heavy cast-iron pipe coated with tar or asphaltum, or standard galvanized wrought iron pipe; provided, that wrought iron pipe coated with tar or asphaltum may be used for soil and waste pipes, but not for soil or waste vent nor for vent or revent pipes. All pipes shall be sound and free from holes, cracks, or defects of any kind.

The following weights per lineal foot will be accepted as complying with this chapter as to weight of extra heavy cast-iron pipe:

Diameter

2 inches	5½ pounds	per lineal foot				
3 "	9½	"	"	"	"	"
4 "	13	"	"	"	"	"
5 "	17	"	"	"	"	"
6 "	20	"	"	"	"	"
7 "	27	"	"	"	"	"
8 "	33½	"	"	"	"	"
10 "	45	"	"	"	"	"
12 "	54	"	"	"	"	"

Extra heavy cast-iron pipe shall have the mak-

er's name and the weight per foot clearly cast upon each section thereof.

The following weights per lineal foot are required for standard wrought iron pipe, galvanized, or tar-coated pipe:

Diameter

1½ inches	2.68 pounds per lineal foot.				
2	“	3.61	“	“	“
2½	“	5.74	“	“	“
3	“	7.54	“	“	“
3½	“	9.00	“	“	“
4	“	10.66	“	“	“
4½	“	12.49	“	“	“
5	“	14.50	“	“	“
6	“	18.76	“	“	“
7	“	23.27	“	“	“
8	“	28.18	“	“	“
9	“	33.70	“	“	“
10	“	40.00	“	“	“

Fittings—quality—cleanout fittings.] All fittings used for soil or waste pipe, except as hereinafter specified, shall be either extra heavy tar or asphaltum-coated fittings or extra heavy galvanized, cast or malleable iron, recessed and threaded drainage fittings. The burr formed by cutting the wrought iron pipe shall be carefully reamed out. Proper sized cleanout fittings shall be installed at each ninety degree intersection of soil or waste pipe.

Cleanouts—tapping pipes.] On soil or waste pipes four inches or more in diameter heavy brass cleanouts, not less than four inches in diameter,

shall be used. Where iron drain, soil, waste or vent pipes are drilled and tapped, brass plugs or brass soldering nipples shall be used.

Pipe joints to be filled.] All joints on cast-iron soil, waste or drain pipes and rain water leaders shall be so filled with picked oakum and molten lead and hand calked as to make them air and water-tight. The quantity of lead used shall be twelve ounces of fine soft lead for each inch in the diameter of the pipe.

Vertical lines of pipes—floor rests.] Vertical lines of soil, waste or other pipes, and rain water pipes when within buildings, shall be provided with floor rests at intervals of every second floor.

Pipe supports—pipe hooks prohibited.] The foot of every vertical soil, rain or waste pipe shall be adequately supported by brick, stone or concrete piers properly constructed by the use of cement mortar or cement concrete, or shall be otherwise equally well supported. Pipes under the basement floor or in the ground shall be properly laid, graded and supported. Pipes above the floor shall either be adequately supported or suspended.

The use of pipe hooks for supporting pipes is prohibited. At the foot of each soil or waste pipe shall be placed a cleanout fitting, which shall be accessible at all times.

Prohibited fittings.] No double hub or straight crosses shall be used on horizontal or vertical lines. The use of bands, saddles and sleeves is prohibited.

Buildings subject to vibrations—calked joints

prohibited.] Pipes with calked joints shall not be installed in buildings subject to vibrations from operating machinery or subject to other causes likely to loosen such calked joints.

Lead pipe—quality—not to extend within partitions.] Lead pipe of a quality equal to “extra light” shall be used for water-closet bends and as branches for vent, revent and waste pipe connections.

Lead pipe used for vent or revent connections shall not extend into or be used within partitions.

Lead pipe connections—wiped joints—brass pipes.] All connections between lead and metal pipes shall be made by heavy brass solder nipples, or heavy brass or combination ferrules which have been approved by the department of health. All solder connections shall be regulation wiped joints. If brass pipe is used it shall be drawn tubing of No. 18 B. and S. gauge.

Straight tees prohibited.] Straight tees for soil or waste pipes shall not be used.

Chimney ventilation of soil or waste pipes prohibited.] No brick, sheet metal, earthenware or chimney flue shall be used for a sewer ventilator or to ventilate any trap, soil, waste or other sewer-connected pipe or opening.

Iron pipe—where used.] Every soil, revent, vent and waste pipe shall be of iron, except as is specified herein for lead or brass pipe.

Vertical pipes through roof—increased how.] The vertical soil, waste or vent pipes (where the vent or continuous waste pipe is not reconnected

to a soil, waste or vent pipe below the roof) shall extend through and above the roof at least eight inches and have a diameter of at least one inch greater than that of the pipe proper; but in no case shall it be less than four inches in diameter through and above the roof.

The increasers shall extend at least one foot below the roof. No cap or cowl shall be affixed to the top of any such pipe or pipes.

Pipes above main building—nuisance.] Soil, waste and vent pipes shall be carried above the roof of the main building when otherwise they would open within fifteen feet of the windows or doors of such or adjoining buildings, and shall be not less than six feet from any ventilator or chimney opening of such or adjoining building or buildings; nor shall they be located so as to be a nuisance to the occupants of any building.

Soil and waste pipes to be extended—when.] Except in office buildings and factories, branches of soil or waste pipes of twenty feet or more in length shall be extended full size, increased and carried through and above the roof. Branches of waste pipes less than twenty feet in length shall be either carried full size and increased and carried through and above roof or returned full size to the main vent pipe.

Sizes of vent pipes.] Vent pipes into which the revent pipe of rows of fixtures are connected shall not be less than one and one-half inches in diameter for not to exceed three plumbing fixtures other than sink, urinal or water closets. For a

greater number of such fixtures the vent pipe shall be at least two inches in diameter.

Where the vents from water closets and other plumbing fixtures are connected into the same vent pipe, the size of the vent pipe shall be at least two inches in diameter from the main vent pipe to the point of connection to the vent of the other fixtures not requiring a two-inch revent.

Ejectors—sizes of vent pipes.] The soil or waste pipe leading to an ejector or other appliance for raising sewage or other waste matter to the street sewer, shall, where a water closet or closets are installed, be ventilated by a vent pipe not less than four inches in diameter. Where fixtures other than water closets are installed the waste pipe shall be ventilated by a vent pipe of the same diameter as the waste pipe. Soil vents, vents and revents for ejectors shall be installed according to the provisions of this chapter governing soil, waste, vent and revent pipes.

Horizontal waste pipes prohibited—amount of pitch.] Horizontal soil or waste pipes are prohibited. In all possible cases the pitch shall be one-fourth of an inch to the foot, making the grade in the direction of the outflow.

Drainage and vent fittings—prohibited vents.] Where rows of fixtures are placed in line where galvanized wrought iron pipe is used for vents or revents, galvanized iron, malleable or cast-iron fittings or cast iron drainage fittings shall be used.

All vent fittings shall be either galvanized, tarred or asphaltum coated.

Horizontal vent pipes unless practical shall not be used. Lines of soil, waste, or vent pipes shall be run in a thoroughly workmanlike manner. Trapped or sagged, or drops in, vents or revents are prohibited. No vent pipe from the house side of any trap shall connect to any sewer, vent pipe or soil or waste pipe.

Continuous vents—ventilation of traps—crown venting prohibited.] Trap revents shall be continuous where possible. Where the vent or revent pipes are continuous and traps are ventilated through the waste fitting, the center of the outlet of such fitting shall not be set below the water seal of the trap; and the trap shall not be more than three feet from the waste fitting.

No crown venting shall be permitted.

Size of soil and waste pipes.] The least diameter of soil pipe permitted is four inches. A vertical waste pipe into which a kitchen sink or sinks discharge shall be two inches in diameter, and at least three inches in diameter if receiving the waste of five or more floors, and shall have not less than one and one-half inch branches.

Trap prohibited—where.] There shall be no traps at the foot of soil or waste pipes, nor shall there be any trap upon the house drain or house sewer.

This section shall not prohibit the use of traps at the foot of rain water leaders or upon drains or sewers used exclusively for conducting rain water to a public sewer.

Trap revents—concealed partitions.] Every

water-closet, urinal, sink, basin, bath, and every laundry tub or set of laundry tubs, or any other plumbing fixtures shall be effectively and separately trapped and revented, except as hereinafter provided for anti-siphon traps.

All traps shall be protected from siphonage by special vent or revent pipes, except where anti-siphon traps are permitted. Such revented trap shall not depend upon any concealed partition for its water seal.

Connected wastes.] A connected waste pipe receiving the discharge of not more than two basins, set in line, may waste into a single trap, which shall not be more than two feet from the waste outlet of one of the fixtures.

Floor washes—prohibited traps—back water valve.] When floor washes are connected it shall be by means of a deep seal trap. Bell traps and cast-iron S. and P. traps having covers over hand holes on the sewer side of the trap, held in place by lugs or bolts, are prohibited. Where a floor drain is placed in a basement, it shall be protected from back sewage by means of some suitable and approved back water valve or stop. Covered floor gutters are prohibited.

Bath tub drum trap—revent.] Each bath tub shall be provided with a drum trap. Traps on bath tubs shall be placed in such a manner that the cleanout will be in plain view and above the floor. The drum trap shall be revented through either a "TY," a "Y," or a drainage fitting.

Traps—placing of—water seal.] Traps shall

be placed as near to the fixtures as possible, and in no case shall a trap be more than two feet from the waste outlet of its fixture.

All traps shall have at least a one and one-half inch water seal and they shall be set true with respect to their water level.

Waste pipe connection with closet bend, etc., prohibited—exception.] In no case shall a waste pipe from any fixture be connected with any water-closet trap, lead bend, vent or revent connection for same, except that a waste connection may be made to a lead bend in old or repaired work.

Water-closet revent—size.] Water-closets when placed within buildings shall have two-inch revents for each water-closet trap, except as hereinafter provided.

Sizes of vent pipes—revents.] The main vent pipe for traps of water-closets in buildings four stories or under shall be at least two inches in diameter and have two-inch revents, except that revents for the traps of other plumbing fixtures may be the same diameter as waste traps. In buildings more than four stories high and not more than six stories high, the main vent pipes for water-closets with or without other plumbing fixtures shall be at least two and one-half inches in diameter. In buildings more than six stories high and not to exceed eighteen stories, the main vent pipes for water-closets with or without other plumbing fixtures shall be at least three inches in diameter. In buildings more than eighteen stories high the main vent pipe for water-closets

with or without other fixtures shall be at least four inches in diameter. The main vent pipe for other fixtures than water-closets in buildings four stories and under shall be at least two inches in diameter. In buildings more than four stories high and not more than eight stories high the main vent pipes shall be at least two and one-half inches in diameter. In buildings more than eight stories high the main vent pipe shall be at least three inches in diameter, except that the diameter of the vent pipe may be reduced to two and one-half inches for the six lower stories; provided, that where the waste pipe for fixtures other than water-closets exceeds three inches in diameter the main vent pipe shall be at least three inches in diameter. The size of revent to traps of plumbing fixtures other than water-closets shall be at least the same size as waste to traps.

Vents—size of for twelve fixtures.] Where more than twelve closets are installed on any floor the vent pipe for the same shall be at least three inches in diameter with two-inch revents for traps.

For purposes of reventing, any four fixtures other than water-closets (where the same are placed on one floor) shall be taken as equal to one water-closet. This is to apply where water-closets are revented through the same vent pipe.

Vents in residences.] Vent pipes for water-closets in residences shall be two inches in diameter with same size branches, and for other fixtures not less than one and one-half inches in diameter with branches the same size as waste and

trap; except that the vent pipe for a kitchen sink shall be two inches in diameter.

Sizes of waste pipes in buildings over four stories in height.] Where fixtures other than water-closets are installed in a building more than four stories and basement or cellar high, having no soil pipe from ground in building to and through roof, and where the total number of fixtures wasting into one pipe exceeds six, the same shall waste into at least a two and one-half inch pipe, which shall be carried through the roof; except that where a battery of urinals and no water-closets are installed in any building (where a three-inch waste pipe is required) the same shall be carried at least three inches in diameter from the ground in the building up and through the roof.

Sizes of waste pipes in buildings four stories in height and under.] In buildings of four stories and under, where no water-closet is installed and where no sewer-connected soil pipe is carried from ground in building to roof, the fixtures if six or more in number shall waste into a pipe at least two and one-half inches in diameter, which shall be carried through the roof.

Where a smaller number of fixtures is installed the main waste pipe shall be two inches in diameter and carried through the roof, except that where a battery of urinals having a three-inch waste pipe is installed the waste pipe shall be carried at least three inches in diameter from the ground in the building up and through the roof.

Vents reconnected—connections prohibited with floors below.] All vents shall be either run separately through the roof or be reconnected to an increaser twelve inches below the roof, or they may be reconnected to the soil vent or main vent pipe not less than three feet above the highest floor on which fixtures are placed; provided, that no fixture or fixtures shall be placed on any floor or floors above and connected to the soil, waste, vent or revent pipes from the fixtures on floors below; nor shall any fitting or fittings for future connections be placed in any soil or waste pipe above the point of revent connection. Where fixtures are afterwards installed on other floors the vent and revent pipes of the fixtures already installed shall be rearranged to conform to the provisions of this chapter. Reconections will not be permitted where said vent pipes run through more than five floors.

Length of horizontal vents.] Except in office buildings and in factories, the vent pipes from any fixture or fixtures reconnected as hereinbefore provided, shall not span a horizontal distance to exceed twenty feet in length. In office buildings and factories this distance shall not exceed forty feet.

Vent pipe increased.] Where a vent pipe is carried independently through the roof it shall be increased as provided for in preceding sections.

Prohibited use for revents, etc.] No trap, revent or vent shall be used as a waste or soil pipe.

Revents for adjoining fixtures.] Where bath

rooms are located on opposite sides of a wall and directly opposite each other and on the same floor in any building and have a common soil or waste pipe in the same separating wall, the revents from fixtures in either or both of such bath rooms may connect into the same pipe.

Where two plumbing fixtures, other than water closets, waste into a double "Y" or double "TY" fitting, a single proper revent connected at or near the junction of the two waste lines forming a part of the fitting will be permitted.

Safe wastes.] All lead or other safes where necessary under fixtures shall be drained by a special pipe, the same to discharge into an open water supplied sink or into a deep seal trap, and in no case shall the safe be connected with any waste, soil or drain pipe or sewer. The ends of safe waste pipes shall be covered by flap valves.

Overflow pipes—how connected.] Overflow pipes from fixtures shall be in each case connected on the inlet side of the trap.

Refrigerator wastes—sizes—traps.] The waste pipe from a refrigerator or ice box shall not be directly connected with any soil, rain or waste pipe or with the drain or sewer, or discharge upon the ground. It shall discharge into an open water supplied sink or over a deep sealed trap and shall be as short as possible and disconnected from the refrigerator or ice box by at least four inches; and where refrigerators or ice boxes are placed in buildings and upon two or more floors, the waste and vent pipe thereof shall be continuous and shall

run through the roof and in no case shall it open within six feet of an open soil or vent pipe.

The size of a waste pipe for refrigerators for two floors or less shall be at least one and one-half inches, and two inches for three floors and over and under five floors, and two and one-half inches for five floors and over. Each refrigerator or ice box shall be provided with a suitable trap with an accessible trap screw or cleanout. Such trap shall be placed in the one and one-half inch waste pipe and shall be near the refrigerator or ice box. Such traps need not be separately revented.

House boilers—sediment pipes.] The sediment pipe from house boilers shall not be connected into the sewer side of any trap nor directly connected into any soil or waste pipe or drain.

Water-closets—flush tanks—purity of water.] All water-closets and urinals within any building shall be supplied from special tanks or approved automatically flushing valves having flush pipes at least one and one-quarter inches in diameter. The water from such tanks or cisterns shall not be used for any other purpose. The purity of such water and of water used in all other plumbing fixtures shall be equal to the purity of the water supplied through the Chicago waterworks system.

Automatic flush tanks for urinals.] Flush tanks for urinals shall be arranged for intermittent and automatic discharges. All urinals shall be flushed

at regular intervals not to exceed seven minutes each.

Cisterns for water-closets—siphon discharge—house tanks.] Where cisterns are used for water-closets they shall each have a siphon discharge. The valves of such cisterns shall be fitted and adjusted so as to prevent a waste of water. When the city pressure is not sufficient to supply such cisterns or plumbing fixtures with water, adequate pumps or house tanks shall be provided.

Water-closets within buildings—flushing rim bowls.] All water-closets within buildings shall have flushing rim bowls.

Water-closets within buildings—flushing discharge.] Water-closets and urinals within buildings shall not be supplied from any water supply pipes direct.

All water-closets within buildings shall be fitted with either siphon discharge flush or pressure tanks or approved automatically flushing valves not directly connected to the city water supply pipes.

All individual water-closets within buildings at each flush shall receive not less than four gallons of water into the closet bowl at each discharge, which shall be discharged in such time and with such force as shall thoroughly clean the closet bowl at each flush.

Long hopper closets—regulations.] Long hopper closets shall not be installed within any building hereafter constructed. Long hopper closets may be installed in a cellar or unfinished basement

of old or existing buildings only. A water-closet in a basement or in a yard may be flushed with a hopper cock or stop and waste cock buried to a depth of at least three feet below the ground. A long hopper closet of the last named construction shall be located at least eight feet distant from any dwelling.

A flushing rim water-closet may be placed adjacent to the outside wall of an existing building when the occupied floor of the building is not more than two feet above the ground level, in which case such closets shall be flushed by suitable flushing cistern, the flushing pipe from which shall be brought nearly to the level of the closet seat on the inside of the building.

Outside water-closets—where prohibited—regulations.] A water-closet shall not be installed on a porch or other like place. Outside water-closets may be installed for buildings heretofore erected only.

Water-closets when placed in the yard of any building heretofore erected shall be separately trapped and placed not less than eight feet from any dwelling or other place of abode and so arranged as to be conveniently and adequately flushed, and their water supply pipes and traps shall be protected from freezing. The compartments for such water-closets shall be adequately lighted and ventilated.

Water-closets under sidewalks, etc.] Where water-closets or other plumbing fixtures are placed under a sidewalk, street, alley or other like place,

adjoining and opening into the basement of any building, each and every fixture so placed shall be ventilated in the same manner as is provided for other plumbing fixtures in this chapter, and the water-closet compartments shall be adequately lighted and ventilated.

Places of employment—separate water-closets for men and women—number.] In all places of employment where men and women are employed, separate and sufficient water-closets shall be provided for males and females. Water-closets for men shall be plainly marked “Men’s Toilet” and water-closets for women shall be plainly marked “Women’s Toilet.”

In all places of employment, one water-closet shall be provided for every twenty-five males or less number, and one water-closet shall be provided for every twenty females or less number. Such water-closet facilities shall be furnished upon at least every second floor. Where there are employes in any basement, such basement shall be considered as one floor.

Water-closets in hotels and lodging houses.] In lodging houses and hotels hereafter erected or altered there shall be provided one water-closet for every twenty-five males or less number and one water-closet for every twenty females or less number. The number of water-closets required shall be determined from the number of lodging quarters provided. There shall be at least one closet on each floor. The general water-closet accom-

modations of a lodging house shall not be placed in the basement.

Separate closets in buildings used for both business and residence purposes.] In all buildings used jointly for residence and business purposes, separate and sufficient water-closets shall be provided for the use of families and for the use of employes and patrons of the place.

Toilet paper.] No paper other than what is commonly known as toilet paper shall be placed in any water-closet or allowed to enter any soil pipe.

House tanks—zinc and lead linings prohibited—overflow pipes.] Tanks in which water to be used for drinking or other domestic purposes is stored shall not be lined with zinc or lead.

The overflow pipes from such tanks shall discharge upon the roof or be trapped and discharged into an open sink. Such overflow pipes shall not be connected into any soil waste pipe or other sewer connected pipe; nor shall the drain or sediment pipe be connected into any soil, waste or other pipe directly connected with a sewer.

Rain water leaders—prohibited uses—when to be trapped—construction.] Rain water pipes or leaders shall not be used as soil, waste or vent pipes; nor shall any soil, waste or vent pipe be used for a rain water pipe or leader. Where a rain water leader opens near any window, door or vent shaft, or is so located as to render it likely to become a nuisance, if not trapped, it shall be

properly trapped far enough below the surface to prevent its becoming a nuisance or freezing.

Inside rain water leaders shall be made of extra heavy cast iron or tar or asphaltum coated wrought iron pipe or galvanized wrought iron pipe, with roof connections, made gas and water tight by means of heavy lead or copper drawn tubing, wiped or soldered to a brass ferrule, calked or screwed into the pipe. Outside rain water leaders may be of sheet metal, but they shall connect with the house drain by means of a five-foot length of cast iron pipe extending vertically at least four feet above the grade level.

Steam pipes—condensers—vents.] No steam, exhaust, blowoff, drip or return pipe from any steam trap shall connect with the sewer or with any house drain, soil, or waste pipe or rain water pipe. The water or steam of condensation from such pipes, before it shall enter any sewer or drain, shall be discharged into a suitable cast iron catch basin or condenser, from which a special vent pipe not less than two inches in diameter shall extend through the roof.

Blowoff pipes—how made—discharge.] Blow-off pipes from boiler or heating plants shall be either of extra heavy cast iron pipe or galvanized wrought iron pipe. No such blowoff or hot water pipe shall discharge directly or indirectly into any vitrified earthenware tile sewer within any building.

Temperature of water entering sewer.] No water of a higher temperature than one hundred

and twenty degrees Fahrenheit shall be permitted to enter any house sewer direct.

Area drains to be trapped—when.] When the area drains are connected to the house sewer or drain, they shall be effectively trapped. Such traps shall be protected from frost.

Cellar drainer—ground water.] Cellars and basements shall be kept free from ground or surface water, and where the same are too low to be drained into the sewer, the water therefrom shall be lifted by a cellar drainer or other device, approved by the chief sanitary inspector, and discharged into the sewer.

Floor washes in basements—building plans must indicate locations of backwater valves.] Floor washes for basements shall be provided with a deep seal trap, having a heavy strainer, and a backwater gate valve, or stop, accessible for cleaning.

No backwater valve shall be used which has not been approved by the chief sanitary inspector.

All building plans, where basement floor washes are connected, shall indicate where and what backwater valve or device is to be used.

Sumps—tight cover.] Sumps or rodding basins for sub-soil drains shall be provided with tight cast iron covers.

Wood sinks and tubs prohibited.] The installation of stationary wooden sinks and wooden laundry tubs is prohibited inside of any building used for human habitation. Such sinks and tubs shall be of non-absorbent material.

Catch basins prohibited within buildings—exceptions.] No catch basin or gravel basin shall be allowed within any building, except as provided for in the following sections.

Catch basin to intercept kitchen wastes—diameter.] Kitchen or other greasy wastes shall be intercepted by a catch basin or grease trap and thence conducted to the house sewer.

The vitrified tile sewer through which kitchen wastes are conducted shall be at least six inches in internal diameter.

Catch basins for kitchen wastes—construction—covers.] Catch basins for receiving such wastes shall be constructed either of brick, concrete or cast iron. If of brick or concrete, they shall be at least thirty inches in internal diameter at the base and may taper to not less than twenty-two inches internal diameter at the top.

Each catch basin shall be covered at the grade level with a stone, iron or cement concrete cover, having an opening of sixteen inches diameter, and fitted with an eighteen inch iron lid of a weight not less than eighteen pounds. No stone cover shall be less than three inches in thickness. No wooden catch basin cover shall be hereafter installed. If a wooden catch basin cover becomes rotten or defective so as to require repair or replacement, it shall be removed and replaced with a stone, iron or cement cover placed at the grade level.

Every concrete cover hereafter installed shall, if not reinforced as hereinafter provided, be made

at least three and one-half inches thick from a Portland cement concrete mixture consisting of one part cement, two parts limestone screening free from clay, and three parts number three crushed limestone such as will pass through a three-quarter inch sieve. The use of clean torpedo sand entirely free from dirt shall be considered the equivalent of the two parts of limestone screening in this mixture.

Every reinforced concrete cover shall be not less than three inches in thickness, made of the mixture above described, and shall be reinforced with two hoops of not less than gauge number ten wire, having the respective diameters of twenty and twenty-eight inches, and provided with at least eight cross connections of the same wire between the inner and outer hoops.

All covers shall be manufactured under shelter, protected from the sun, wind and frost, and shall not be removed from such shelter for at least two weeks after manufacture.

The walls of such catch basins, if of brick, shall be eight inches thick and laid in Portland cement mortar and plastered outside and inside with a half-inch coat of Portland cement mortar in proportion of one part of Portland cement and two parts of clean, sharp sand. The bottom shall be at least eight inches thick and of either brick laid in cement mortar or of Portland cement concrete. The brick used shall be hard burned sewer brick.

Where Portland cement concrete is used, the

walls shall be at least five inches thick, and the concrete shall be made of one part of live Portland cement, three parts of clean, sharp sand, and four parts of crushed stone free from dust and of sizes between one-fourth inch and one and one-half inches in largest diameter; and, in addition, the catch basins shall be plastered inside and out, as specified above for brick construction. Catch basins shall be made water tight. No re-tempered cement shall be used.

The bottom of catch basins shall be at least two feet below the invert of the outlet to the sewer.

The outlet shall be trapped to a depth of six inches below the invert of the outlet to the sewer to prevent the escape of grease, by a hood or trap of brick and cement mortar, or a hood of concrete or cast iron.

The invert of the inlet to the catch basin for kitchen wastes shall be not less than two and one-half feet above the finished bottom of the catch basin.

Catch basin dispensed with—grease trap.]

Where the building covers the entire lot, the catch basin for kitchen wastes may be dispensed with; provided, that a suitable sized grease trap of approved construction is installed and provided with a water jacket through which shall circulate the water that is drawn for the general kitchen use. Such grease traps shall at all times be accessible for cleaning.

Rain conductor connection—defective catch basins.] Rain water leaders may connect to catch basins. Such leaders shall connect to a catch basin when they conduct water from a gravel roof.

Defective and leaking catch basins shall be rebuilt according to the above specifications.

Number of urinals in factories.] In all places of employment, one urinal shall be provided for every seventy-five males or less number.

Urinals—construction—prohibited use.] The sides, back and base of every urinal stall placed within any building shall be of non-absorbent material. Urinal stalls having troughs set in the floors are prohibited. The top of the urinal base shall be set one and one-half inches above the finished floor level. Urinal troughs and sectional urinals, unless lipped and provided with suitable automatic flush tanks or approved intermittent and automatic flushing valves, are prohibited. No sectional urinals shall be placed within a building or compartment which is subject to vibrations.

Urinal flush—prohibited materials—separate trap and waste pipe.] Every urinal stall shall have an individual lipped sanitary bowl.

The use of cast iron, galvanized iron, sheet metal or steel urinal bowls and troughs is prohibited. Each urinal bowl shall be separately and independently trapped and shall have a waste pipe of at least two inches in diameter.

Automatic flushing of urinals—frequency.] Each and every urinal trough and urinal bowl

shall be intermittently and automatically flushed with at least one gallon water flush for each urinal bowl or two foot length of urinal trough and at intervals not to exceed seven minutes each during its period of use.

The flushing of all such urinal fixtures shall be by means of either approved intermittently and automatically operated flush tanks or by intermittently and automatically operated flushing valves protected against a vacuum by a ground seat check valve.

Urinal wastes—screens.] The waste pipe of a “battery” of not exceeding four urinals shall not be less than two inches in diameter. For batteries exceeding this number the waste pipe shall be at least three inches in diameter.

No wire or metal screen shall be placed in any urinal bowl, unless every part of such screen is thoroughly washed at each water flush.

Revent omitted—when.] Where a single water-closet or other plumbing fixture is located in a building or on the top floor of any building, and there is an adequate soil or waste pipe of undiminished size from ground (in building) to roof, the revent pipe may be dispensed with; provided, that for water-closets a non-siphoning trap, tested and approved by the chief sanitary inspector, or a closet of approved construction, is used for such work; and provided, further, that the trap of such fixture is located not more than five feet from such soil or waste pipe.

Revent omitted, when.] Where a toilet or bath room having not more than one closet and three other fixtures therein is located on one floor only or the top floor of any building, and such closet is set not more than five feet from the vertical soil pipe, the revent for the closet may be omitted; provided, that a closet of an approved construction is installed.

Vent pipes reconnected—exception.] Vent pipes shall be reconnected to main soil and waste pipes or drain by a “Y” branch below the lowest fixture, and in such manner as to prevent accumulation of rust. This shall not apply where there is a battery of fixtures on one floor only and no other fixtures on floors above or below.

Open Plumbing.] All plumbing fixtures shall be installed as open plumbing.

Prohibited closets—removal.] Pan, plunger, offset, washout-range closets and washout latrines shall not be allowed in any building; nor shall hopper closets be installed in any building hereafter erected. Such closets, when found to be a nuisance, shall be removed, or when the same are removed for repairs they shall not be again installed. In alteration work, pan and plunger closets shall be removed.

Range closets of types approved by the commissioner of health and the chief sanitary inspector may be installed in factories and workshops only, and such closets shall be installed in separate compartments as hereinbefore provided for water-closet compartments.

Reventing washout closets.] Where individual washout closets are installed they shall be revented above the floor line. Rubber connections or connections of like material shall not be used on any sewer connected pipe.

Prohibited fixtures not reinstalled.] No fixture shall be installed and no fixture shall be reconnected or reinstalled where it does not meet the requirements of this chapter.

Earthenware trap connections—how made.] All earthenware and closet traps shall be connected to waste or soil pipes by inserting heavy brass floor or wall flanges, not less than one-fourth of an inch in thickness where lead bends are used, and shall be soldered to the same and bolted to the trap flange.

Where brass or iron bends are used, brass or iron flanges not less than one-fourth of an inch in thickness may be used, and shall be screwed or calked to the same and bolted to the trap flange, and all such joints shall be made tight without the use of putty, cement, plaster, rubber or leather washers. The use of putty, cement, plaster, rubber, or leather washers is hereby prohibited in making all connections between traps of plumbing fixtures and soil or waste pipes.

No flange, iron bend or gasket connection shall be used until it has been approved under test by the chief sanitary inspector. One of each of the above type of gaskets, flanges and iron bends shall be kept on exhibition in the sanitary bureau of the department of health.

Slip joints—ground joints.] Slip joints shall not be permitted on the sewer side of any trap, unless the metal connection is required between the soil or waste pipe and tile sewers. Unions on wrought iron, soil, waste and vent pipes shall be made by means of metallic brass-seated ground unions, or flange unions with sheet lead gaskets, and made without other gaskets or packing.

Barn drainage—traps—catch basins.] Floor washouts, urinal gutters and wash racks in barns or stables shall be provided with deep seal traps, having heavy strainers. Such traps shall have a depth of seal of at least three inches and shall be located at the floor line. An adequate water supply shall be provided for flushing such gutters.

All liquid wastes from barns or stables shall be intercepted before entering the sewer by a catch basin placed outside of the building, which shall be either the catch basin which is constructed according to the specifications for such catch basins or a cast iron catch basin provided with bolted air-tight iron cover. Barn drains and wastes shall be ventilated by sufficient and proper vents through the roof.

Special permits—when issued.] Special permits will be issued by the chief sanitary inspector only.

Where special permits are issued, the location shall be inspected before the work is started, and duplicate plans in ink, in the name of the owner, agent or architect, shall be submitted and approved and placed on file. These plans shall show the proposed work, in plan and elevation. Such

plans shall be drawn on paper or cloth and drawn to a quarter inch to the foot scale.

The installation of any sewer connected fixture or of any sewer connected pipe or pipes other than those hereinbefore mentioned, or under any other conditions than those hereinbefore set forth, shall be as directed by the chief sanitary inspector, and the same shall be covered by special permits issued by him.

Plumber's notification — inspection — when.]

When the plumbing in any building is ready for inspection, the plumber in charge of the work shall immediately notify the commissioner of health in writing of such fact at least twenty-four hours in advance of inspection. Inspections will not be made the same day that notifications are received.

Inspection of repairs.] The following repairs and extensions to any part of the plumbing and drainage system in any building shall also be reported for inspection, viz.: where there is any change in any sewer connected pipe, and where such change is on the sewer side of the trap, except in the case of minor repairs.

Inspection—test.] The entire plumbing system, when roughed in, in any building, shall be tested by the plumber in the presence of the plumbing inspector and as directed by him, under either a water pressure or air pressure.

The water pressure test for plumbing shall be applied by closing the lower end of the vertical pipes and filling the pipes to the highest opening

above the roof with water. The air pressure test for plumbing shall be applied with a force pump and mercury column equal to ten inches of mercury. The use of spring gauges is prohibited. Special provision shall be made to include all joints and connections to the finished line or face of floors or side walls, so that all vents or revents, including lead work, may be tested with the main stacks. All pipes shall remain uncovered in every part until they have successfully passed the test. After the completion of the work, and when fixtures are installed, either a smoke test under a pressure of one inch water column shall be made of the system, including all vent and revent pipes, in the presence of the plumbing inspector and as directed by him, or a peppermint test made by using five fluid ounces of oil of peppermint for each line up to five stories and basement in height, and for each additional five stories or fraction thereof one additional ounce of peppermint shall be provided for each line.

All defective pipes and fittings or fixtures shall be removed and all defective work shall be made good so as to conform to the provisions of this chapter.

The tile drainage system inside any building shall be tested by the drainage layer or sewer builder, in the presence of the house drain inspector, by closing up the end of the drains two feet outside the building and filling the pipes inside the building with water to a height of at

least two feet above the highest point of the tile drainage system.

Water-closet and urinal compartment—ventilation.] Water-closets and urinals shall not be installed in an unventilated room or compartment. In every case the room or compartment shall be open to the outer air or be ventilated by means of an air duct or shaft or be mechanically ventilated.

Where a urinal, bath or water-closet compartment is mechanically ventilated, the air shall be changed at least four times per hour by exhausting the air from the compartment.

In the case of an extension or alteration of any existing plumbing system, the same, if new stacks are run, shall be tested when roughed in and when completed, as hereinbefore provided.

Peppermint test for alterations.] In other alteration work, a peppermint test, and only this test, shall be applied by using five fluid ounces of oil of peppermint for each line up to five stories and basement in height, and for each additional five stories or fraction thereof one additional ounce of peppermint shall be provided for each line.

Old work remodeled.] In remodeling work, the existing system of soil, waste and ventilating pipes shall be changed to make them reasonably conform to the provisions of this chapter.

Light and ventilation.] All urinal, bath or water-closet compartments, hereafter constructed in any building, shall be lighted and ventilated as hereinafter provided for in this chapter. Every water-closet or urinal compartment or bath room

in every now existing building, and every compartment in buildings hereafter erected, where the compartment is more than one story under ground, shall be separately ventilated by a window opening to the external air or by proper and adequate ventilating pipes, shafts or ducts running through the roof or to the external air, and providing for at least four changes of air for the entire compartment each hour. All such compartments shall be adequately lighted by either natural or artificial light.

Toilet compartments—separate.] The urinal, bath or water-closet compartments shall be separate compartments and shall be entirely separated from any other room, workshop, office or hall by a tight partition extending from floor to ceiling, and every door of every such compartment shall be provided with a door check to keep such door closed.

No window or other opening shall be made to open from any such compartment for the purpose of ventilation, into any adjoining room, office, workshop, factory, hallway or compartment of any kind.

Window area in toilet compartments.] In every building hereafter constructed, every such compartment, where there is not more than one story under ground, shall have a window not less than one foot wide and of an area of at least four square feet for a floor area of forty-five square feet or less, opening directly into the outer air,

or special light and air shaft, into which no other rooms or compartments, other than toilet compartments, are ventilated. For upwards of forty-five square feet of floor area there shall be a window area of at least one-tenth of the floor area. The windows in all cases are to be arranged so as to admit of their being opened at least one-half their height. The urinal, bath or water-closet compartments on the top floor of any building may be lighted and ventilated by means of a skylight and ventilator. The area of the skylight shall conform to the above specified areas for windows.

Fixtures to be kept in sanitary condition.] All such fixtures in such compartments as are referred to in the previous section shall be kept in a thoroughly clean and sanitary condition.

Ventilation into court.] Nothing herein contained shall be construed as preventing the ventilation of the above mentioned compartments into an outer, inner or lot line court.

Plans—plan and elevation, etc.] Building plans in duplicate shall be filed with the bureau of sanitary inspection before the original plans are approved. Such duplicates shall be on paper or cloth and drawn to a standard scale, showing how all rooms and compartments of the building are to be lighted and ventilated. They shall also show in plans and in at least one elevation all drains, soil, waste, vent and revent pipes within the building and the location of all plumbing fixtures within the building, the location of the catch basin

(in case one is necessary) outside of the building, and its connection to the drainage and sewerage system.

Fee before plans are approved.] Before plans are approved, the following fees for inspection shall be paid to the city collector:

When the building contains from one to six plumbing fixtures, the sum of fifty cents shall be paid for the inspection of each fixture, and for each and every additional fixture thereafter installed, or for which waste or vent fittings are installed, the sum of twenty-five cents shall be the fee for inspection.

Certificate of inspection.] When the plumbing in a building is completed, the plumber or his representative shall secure for the owner of such building, from the commissioner of health, a certificate of inspection, signed by the chief sanitary inspector and approved by the commissioner of health, certifying that the plumbing work has been properly inspected and tested as required by the provisions of this chapter.

Penalty.] Any person or corporation who shall violate any of the provisions of this chapter shall be fined not more than two hundred dollars nor less than twenty-five dollars for each offense; and a separate and distinct offense shall be regarded as having been committed each day on which such violation shall be allowed or suffered to continue after the first offense.

GAS WATER HEATERS.

Permit required to install or connect gas water heaters in bath room or lavatory.] No person, firm or corporation shall install or connect any hot water heater in a bath room or lavatory for heating water in the same by the use of natural or artificial gas as fuel, within the city of Chicago, without first having obtained a permit as hereinafter provided.

Application—permit—fee.] Any person, firm or corporation desiring to install or connect any water heater in a bath room or lavatory for heating water for use in such bath room or lavatory by the use of natural or artificial gas as fuel, shall file with the commissioner of health of the city of Chicago an application upon forms furnished by the department of health, containing the name of the applicant, the street number of the building in which the said heater is to be used (and if the building is an apartment building, the location of the apartment), the floor plan of the room, showing the proposed position of the heater, the location of the plumbing fixtures, the door and window openings, showing their dimensions, and the course of the gas duct or ventilating pipe to the outer air or to a chimney connection.

If such application is approved by the commissioner of health, it shall be the duty of the city clerk to issue a permit to the applicant upon the payment by him of a fee of fifty cents for every such heater desired to be installed or connected.

Structural requirements.] No person, firm or

corporation shall install or connect any such heater unless it be provided with a metallic hood to which there shall be connected a suitable ventilating pipe not less than two inches in diameter, which said pipe shall extend to a chimney flue or to the open air in such a way as to carry off all escaping gases or fumes from such heater. In case such ventilating pipe shall extend to the open air, it shall be provided with a cap or cowl so as to prevent a back draft. Every such heater shall be provided with a convenient and adequate means of access to the burners and heating surfaces, for the purpose of lighting and cleaning same. No such heater shall be set closer to the floor than twenty inches, measuring from the top of the burner. The use of a pilot light on such heater is hereby prohibited; provided, that nothing herein contained shall prevent the use of a pilot light on a large water heater automatically controlled by a thermostat and located elsewhere than in a bathroom or lavatory.

Duty of owner or person in possession of heater.]

It shall be the duty of the owner or person in possession or control of any premises where gas water heaters have heretofore been installed in bath rooms or lavatories to make such heaters comply with the requirements of this article, and it shall be unlawful for any person to use any such heater until it shall have been made to conform to the provisions of this article.

Penalty.] Any person, firm or corporation vio-

lating, failing or refusing to comply with any of the sections of this article shall be fined not less than twenty-five nor more than two hundred dollars for each offense.

ELECTRICAL THAWING APPARATUS

The use of the electric current for thawing frozen water pipes has been practically demonstrated during the last few years to be a reliable and economical means of alleviating one of the discomforts incidental to a rigorous winter. This method has placed within the reach of property owners a safe and inexpensive means of thawing frozen pipes, and thus quickly and cheaply relieving themselves of the discomfort and inconvenience caused by one or more frozen water pipes in the building. The old method of thawing frozen pipes by means of a torch is at once, slow and dangerous, very often resulting in setting fire to the building, whereas, with an electric thawing outfit the work may be done in much less time and without necessitating the removal or destruction of any portion of the woodwork or plastering.

Should the frozen pipe happen to be underground, it may be thawed with an electric outfit, without going to the trouble and expense of excavating the entire length of the pipe, as with the old method. All that is necessary is to connect the terminals of the electric circuit to the pipe at two points far enough apart to include the frozen portion of the pipe within the circuit. This means digging down to the pipe at only two places

and these excavations need be only large enough to permit a man to connect the wires to the pipe. In order that the student may get an idea of the construction and operation of this valuable adjunct to the modern plumber's equipment of tools, a description and illustrations are herein given of two styles of standard thawing outfits, as manufactured by the Westinghouse Electric and Mfg. Co., of Pittsburgh, Pa. Fig. 177 shows the one for heavy service, comprising a specially designed

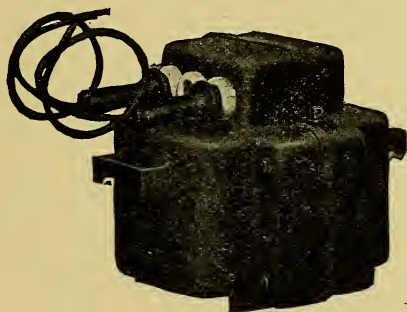

Fig. 177
Heavy Service Outfit
Choke Coil
Alternating Current

choke coil, which is to be connected in series with the primary of a 2,100 volt, 60 cycle, 125 cycle or 133 cycle transformer, as the case may be. The choke coil is mounted in a cast iron casing, which is provided with suitable carrying lugs. It is

portable, as it weighs but 200 pounds, although it may be, and often is mounted upon a wagon or sled. The leads are connected to the choke coil through the handles of two contact plugs which fit the five plug sockets arranged to allow current adjustment.

The secondary voltage can be decreased to approximately 95 per cent, 87 per cent, 75 per cent, 65 per cent and 50 per cent of the normal voltage by the insertion of the contact plugs in the proper sockets. The leads and handles of these plugs are insulated with a high test material guaranteed to resist successfully much greater potentials than it will ever be called upon to stand in actual service.

It is impossible to injure the transformer, or choke coil by making a wrong connection.

Fig. 178 shows the light service outfit. This device is intended for thawing house piping that may become frozen. It is enclosed in a cast iron case, consisting of top and bottom castings firmly bolted together.

Three plug sockets which are mounted in the top casting, are provided for obtaining the variation in secondary voltage of the transformer. The cables and handles of these plug contacts are also carefully insulated in order to avoid any possible injury to the operator. The low tension terminals are of sufficient size to receive cables of 60,000 circular mils. This equipment is intended to be used on nominal 2,100 volt, 60, 125 or 133 cycle

circuits. The secondary voltage can be adjusted for either 55 or 35 volts by means of the above

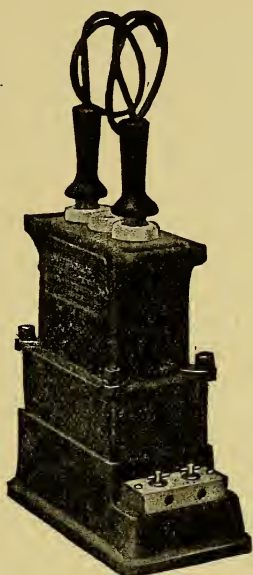

Fig. 178
Light Service Outfit
Alternating Current

mentioned plug contacts which are connected to taps on the winding of the primary.

A current of 100 amperes can be maintained for one-half hour without undue heating.

The insulation is specially prepared to withstand severe weather conditions.

No oil is used with this transformer, the laminations of the coils being exposed directly to the air. This device can be carried by one man, as it weighs but 100 pounds complete. Two substantial clamps for securing good contact with the pipe are included with the outfit.

Operation.—The outfit is brought as near to the frozen pipe as conditions will permit.

The high tension leads are then connected to the main line feeders. The low tension leads are attached to opposite ends of the section of pipe to be thawed. For service piping in buildings, one lead may be connected to a faucet, and the other to a convenient hydrant. When street mains are to be thawed, two hydrants are often used as connections, or, when this is impracticable, excavations are made which allow the leads to be connected directly with the pipe. The capacity of the transformer used with the heavy service outfit (Fig. 177) is from 15 to 25 K. W., adapted to a nominal 2,100 volt, 60, 125 or 133 cycle A. C. circuit. The transformer used with the light service outfit (Fig. 178) has a capacity of 5 K. W. adapted to the same kind of current as the larger equipment.

AUTOMATIC SEWAGE EJECTOR

Modern architecture is not satisfied with extending the building to a height of several hundred feet in the air above street level, but installs sub-basements at a depth which renders it necessary to use some other means than the force of gravitation for removing the sewage and drainage from the building.

One of the most efficient devices for accomplishing this work is the automatic ejector, of which there are several types.

The apparatus herein described and illustrated is known as the Shone System of Sewage and Drainage for buildings, and is in successful operation in many of the largest buildings in the United States.

The following data regarding this system is furnished by the Shone Company of Chicago:

The principles governing the operation of the Shone System are the same in all cases, the deep basements of city buildings and the long distances to which sewage has often to be conveyed from buildings in the country merely presenting varieties of the same problem.

In general, the system may be described as follows:

An air and water tight vessel, known as an "Ejector," is placed in a chamber provided for it, in such a position that all the sewage and

drainage of the building can flow to it by gravitation.

The sewers connect directly to the ejector, and as the latter can be placed at any depth required, there is no difficulty in obtaining sufficient fall to enable them to be made perfectly self-cleansing.

The ejector is furnished with an iron sewage discharge pipe, leading to the point of delivery or outfall, and it is also connected with a supply of compressed air which is constantly maintained.

As soon as an ejector is filled, the compressed air is automatically admitted and the sewage is forced out through the discharge pipe, whereupon the compressed air is cut off and fresh sewage again commences to fill the ejector.

The operation of emptying the ejector usually takes less than half a minute. The time it takes to fill depends upon its size and upon the amount of sewage coming down the sewers at any given moment.

In this manner the sewage is handled automatically and is ejected from the building as fast as it is produced, without coming in contact in any way with the air of the building.

When an ejector is in operation, it is perfectly inoffensive, and it is impossible to tell of what the liquid it is handling may be composed. It can and should be kept as clean as any other piece of machinery, and it is preferably located where it will be in plain view.

The Shone Pneumatic Ejector. Fig. 179 shows a sectional view of an ejector of the type usually

employed in buildings. It consists essentially of a closed vessel furnished with sewage inlet and discharge connections, of a diameter suitable to the

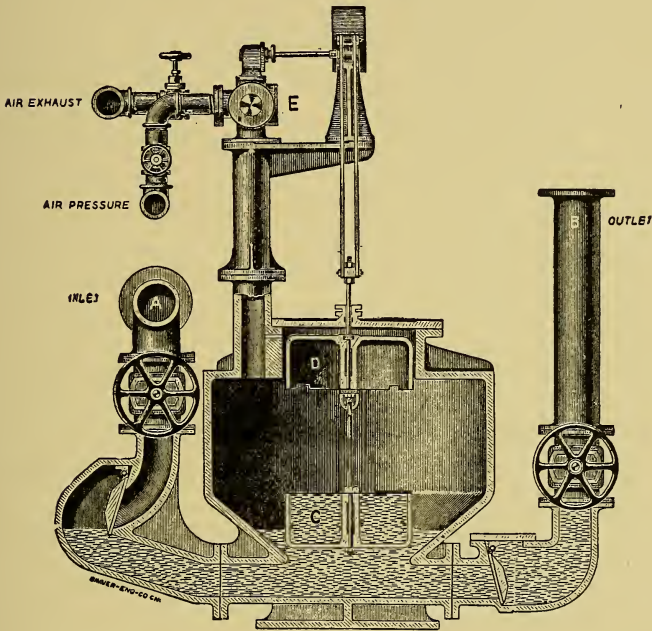

Fig. 179
Shone Pneumatic Ejector

size of the ejector and the amount of sewage to be pumped. The main sewer of the building is connected directly to the inlet pipe A, and the discharge pipe B is continued to wherever it is desired to deliver the sewage. In each of these connections is placed a check valve which permits

a flow in one direction only, that in the inlet pipe opening toward the ejector and that in the discharge pipe away from it.

On the cover of the ejector is placed the automatic valve E, to which is connected the air pressure pipe from a receiver which is kept constantly charged, and the air exhaust pipe leading to the outside of the building. This valve controls the admission of air to, and exhaust from the ejector.

Inside the ejector are hung two cast-iron bells, C and D, linked to each other by an iron rod, in reverse positions, as shown. The bronze rod to which the bell D is attached passes through a stuffing box and connects by means of links to a lever with a counterweight. The rising or falling of these bells operates the automatic valve E through a rock shaft connecting it with the center of motion of the lever, the counterweight being so adjusted as to balance their weight, except when the system is thrown out of equilibrium by the filling or emptying of the ejector as hereafter described.

As shown in Fig. 179 the bells are in their lowest position (the extent of their movement being limited to about $1\frac{1}{2}$ inches), the compressed air is cut off from the ejector, and the interior of the ejector is open to the atmosphere through the automatic valve, and air exhaust pipe.

The sewage, therefore, can flow through the inlet pipe A into the ejector, which it gradually fills until it reaches the bell D and commences to rise around it. When the latter is sufficiently sub-

merged for its buoyancy to overcome the friction of the parts, it raises both itself and the lower bell, to which it is attached, into their upper positions. The consequent movement of the lever throws over the automatic valve, thereby closing the connection between the inside of the ejector, and the atmosphere, and admitting the compressed air. The check valve in the inlet pipe falls upon its seat as soon as the ejector is filled, thus preventing any return in that direction, and the compressed air, acting upon the surface of the sewage in the ejector, immediately commences to drive it downwards, and out through the discharge pipe B. The sewage passes out of the ejector until its level falls to such a point that the lower bell C is sufficiently exposed for its weight to throw the system out of equilibrium in the opposite direction.

The bells consequently fall, which again reverses the automatic valve and returns it to its original position. The result of this action is, first, to cut off the supply of compressed air, whereupon the outflow of sewage ceases, and the check valve in the discharge pipe drops to its seat, and, secondly, to allow the compressed air within the ejector to escape to the atmosphere.

The sewage which has been ejected cannot return past the discharge valve, fresh sewage commences to flow into the ejector once more, and so the action goes on as often as the ejector is filled. The positions of the bells are so adjusted that the compressed air is not admitted until the

ejector is full, and is not allowed to exhaust until the ejector is emptied down to the discharge level; thus the ejector discharges a specific quantity each time it operates.

The principal objects which have been kept in view in the design of this machine are the capacity for handling rough, unscreened sewage, combined with certainty of action, simplicity, and durability. Although ejectors may be and frequently have been operated uninterruptedly for years with no attention whatever, such treatment is not to be recommended. Where continuous service night and day is required, as is usually the case, if there is only one ejector, it is difficult to give it the ordinary care that any machine should have, or to effect the repairs that must sooner or later become necessary, and which are likely to be needed all the sooner if it is not kept continuously in good condition. For this reason, as well as to supply reserve capacity in cases of emergency (such as the bursting of a water main, or flooding by fire engines), ejectors are generally installed in duplicate.

Ejectors are built in various sizes, from a capacity of fifty gallons per minute each up to as large as desired.

Air Compressing Apparatus. The air for the operation of the ejector is furnished by a compressor, which delivers it to an air receiver, the compressor being in all cases arranged to start and stop automatically as the pressure falls or

rises in the receiver in accordance with the demands being made by the ejector. The compressor is so proportioned as to be capable of supplying air at a suitable pressure and in sufficient volume to operate the ejector at its maximum capacity.

Compressors can be driven by steam, electricity or any form of power, the only essential being that the power shall be available at all times.

When steam is employed, a direct acting compressor is the most suitable for small plants. For the larger sizes, or where several ejectors are operated by one compressing plant, a duplex crank and fly-wheel compressor is generally used. The latter is much more economical in the consumption of steam, but the amount of power required to operate ejectors is usually so insignificant as to render the question of theoretical economy in the compressor altogether subsidiary to simplicity and ease of manipulation.

Where electricity is the motive power, a horizontal crank and fly-wheel compressor, driven by a slow speed compound-wound motor, is generally employed.

Fig. 180 shows such an arrangement, together with the automatic switchboard. As being more commonly employed than the single outfits, the whole apparatus is shown in duplicate, for as it also is generally required to be in constant operation night and day, there are the same advantages in a duplicate installation as have been already

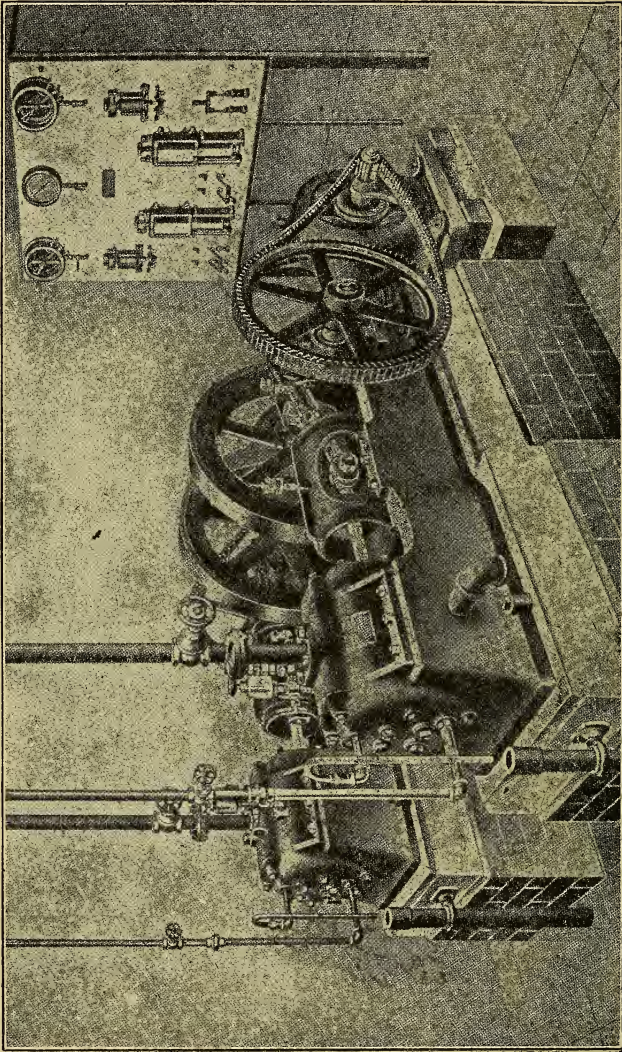

Fig. 180
Air Compressor

explained in the case of the ejectors themselves.

Each side of the switchboard controls its own motor, starting and stopping it automatically within any given limits of pressure, but there is a cross connection by means of which either side can be made to control both motors.

When the air pressure falls, an electrical connection is made through an adjustable contact point, which closes a magnetic switch. This completes the main circuit, and, through the intervention of an automatic starter which gradually cuts out resistance, starts the motor slowly without shock or undue strain. When the pressure has risen to the required amount, a connection is made with another adjustable contact point, which opens the magnetic switch and stops the motor.

Should a chance failure of current occur while the motor is running, the magnetic switch immediately opens, the automatic starter falls to its original position, and on the restoration of the current the motor is re-started slowly as in the first place.

The compressed air required in most buildings for some one or more of the many other purposes for which it is now employed, can be obtained from the compressing plant that operates the ejectors, provided the pressure required is about the same. For ordinary purposes, such as those of jewelers or other light manufacturers, or for blowing the dust out of electrical machinery, etc.,

it is only necessary to allow for the additional quantity required. Special apparatus, however, has generally to be provided for filtering, washing and drying the air used by doctors and dentists.

When the pressure required is materially greater than that needed to operate the ejectors (which seldom exceeds twenty-five pounds per square inch), it is not generally advisable to combine the two services, although one side of a duplicate plant is occasionally arranged so that it can produce a high pressure in a separate receiver, which is cross connected so that if need be, it can be changed over to run the ejectors.

As far as the action of the compressing machinery and ejectors is concerned, it is the same in all cases, but the details of location and arrangement vary somewhat in accordance with the different conditions existing in different classes of buildings.

Buildings in Cities. In buildings in cities the ejectors are usually located in some central position, and the compressing apparatus in the engine or machinery room. It is preferable to have the latter placed where it can be seen by the engineers in charge as they go about their duties, as the normal action of the compressing machinery is a sure index of the like action on the part of the ejectors themselves.

Installation. Fig. 181 shows a pair of ejectors in position, with their connecting pipes. The

discharge pipe from the ejectors can be led up to and along the basement ceiling and down to the street sewer, but it is preferable to lay it under the basement floor to the curb wall, and from there up into the street sewer. It should be run independently of all others, as in case of any obstruction in it, or the street sewer, the ejectors would be liable to force the sewage back up any pipes that might be connected to it. The air pressure, and air exhaust pipes have merely to be run in the most convenient manner, and require no special comment. The air exhaust pipe, however, which is for the purpose of providing a means whereby the exhaust air can escape to the outside of the building, needs seldom to be run the whole way independently, as it can generally be connected to the flue leading from the boilers to the chimney, or it may be connected to some vapor pipe, or ventilating duct. Wherever it is possible to spare the room, ejector chambers should be left open, or at least partially so, and surrounded by a coping and railing.

If necessary, however, the chamber can be entirely covered; merely an entrance being left which can be closed with an ordinary manhole cover. Ejector chambers are usually circular in form, and may be built in a variety of ways, but they are generally constructed either of brick laid in cement or of tank steel.

The latter form is used where the ground is bad, or where there is much water to contend with during construction, as unless conditions are

favorable, great care is required in the construction of brick chambers in order to make them water tight. A leaky chamber is a serious inconvenience, since the presence of water in it is

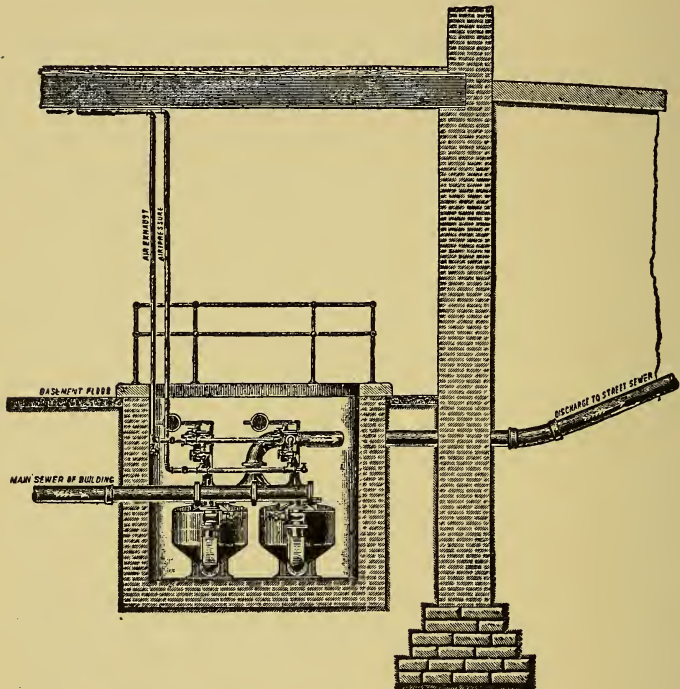

Fig. 181
Pair of Ejectors in Position

not only unsightly, but prevents ready access to the machines, and is a hindrance to keeping them in good condition.

A steel chamber is usually designed in the form of a cylinder with a convex bottom.

There should be a ring of angle iron around the top in order to stiffen it, and a suitable casting should be riveted to the side in order that a water tight joint may be made around the inlet pipe where it passes through to the ejectors. The steel shell is usually built complete, and then lowered in one piece onto a bed of concrete, after which it is grouted around outside with fine concrete, and a level floor inside of the same material.

In applying this system to a group of buildings the whole of the sewage and drainage of each building is collected into one sewer, and the ejectors are located at some central point to which each of these sewers can be brought with a good fall. It is preferable that the air compressing plant be located in the main engine or machinery room, where it can be cared for by the engineer in charge, and where it will at once give notice if everything is not operating properly. The air pressure pipe to the ejectors may be either cast or wrought iron.

DISPOSAL OF SEWAGE.

The disposal of sewerage in districts where there are no public sewers at hand is often a matter of difficulty. Formerly, it was believed that if a running body of water, river or creek, was at hand, into which the sewerage could be emptied, the question of adequate sewer systems was solved. Frequent epidemics of diphtheria and scarlet fever, have called forth careful investigation, which has proven that the pollution of streams contiguous to domestic water supplies with sewerage, is one of the greatest dangers to health. This subject is being more closely studied every year, which is probably due to the wide publicity given it in discussions and reports of health departments. It is the purpose to consider some of the best sanitary systems and appliances applicable to the convenience and health of country districts. A system which is adaptable for one place will not prove an adequate or effectual system for another. It lies with the plumber or builder to study the conditions as they exist, and to exercise a little common sense.

The old out-door closet, with its revolting stench and inconvenience, is rapidly disappearing. Private and public water service have made it

possible to install a modern bath room, even in the country, but the sewer disposal in most cases, is a puzzling proposition.

The primitive method of installing a leaching cesspool, which is a hole dug in the ground deep enough to allow five or six feet of space below the inlet end of the house drain pipe, and five or six feet wide, walled up with loose stones, the bottom left loose and filled with about a foot of small stones and the top walled over with a tight arch, and the earth filled in to the grade level thereby depending on the liquid to ooze away through the porous strata, has a great many disadvantages. In the first place, in communities where the neighbors depend on wells for their water supply, it is very dangerous, as it invariably pollutes the sub-soil in the neighborhood and contaminates the well water supply. On a farm where plenty of ground is available, if located at a good distance from the dwelling, and at a lower level in the opposite direction from the well, it may be used without causing any harm. In case such a cesspool is used, the arch should be built up to an opening, twenty inches in diameter, and run to the surface and closed with an inspection cover hermetically sealed by a rubber gasket.

The system of sub-surface irrigation for sewerage disposal has been very well thought of by our best sanitary engineers. It consists of two absolutely tight cesspools or concrete receptacles, as

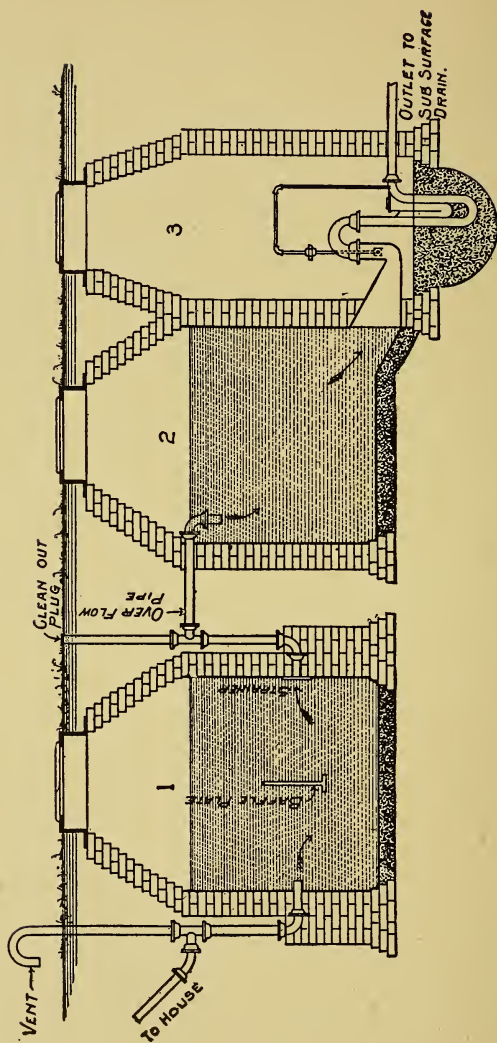

Fig. 182.

shown in Fig. 182, built circular in shape, arched over, and with extended manholes to the surface, with tight inspection covers, also provided with an air-vest opening for the escape of gases, one tank to receive the drain from the house and to retain the solids and grease. The other for the liquid sewerage, connected together with an overflow pipe in such a manner that the first basin is drained into the second, without disturbing the grease and scum in the top of the first one, with a baffle plate, as shown, to prevent an underflow current from carrying the solids through to the second basin.

In the drawing an inspection basin is shown with the syphon for emptying the liquid outside of the second basin. The advantage of this is that in case of the syphon failing to work properly, it is accessible without disturbing the other two tanks. Another very frequent construction, which, of course, avoids the expense of the inspection basin, is to place the syphon in the second tank and protect it with a wire screen. The advantage of having the inspection basin, of course, is obvious, and hardly needs to be further commented upon here. The opening from the syphon is run with a four or six-inch vitrified salt glazed sewer pipe with tightly cemented joints, to a point down grade, where it is connected with four by two inch Y branches to a series of two or three-inch porous drain tile, which should be laid in a

trench about ten inches deep, never deeper, on boards, with a very small fall about three or four inches per hundred feet, tiles to be laid with open joints, and joints to be covered with a half ring of vitrified clay or cup, to protect the same from filling up when buried. The liquid tank can be emptied in several ways, either with a sluice valve or a gate valve, both of which necessitates personal attention. The advantage of using the syphon is that it is automatic.

There are a great many different kinds of syphons on the market, and it is sometimes a matter of personal opinion as to which is the best. The liquid tank should not be emptied more often than once every twenty-four hours, which allows plenty of time for the ground to thoroughly drain, and to breathe in more oxygen, and then in a volume sufficiently large enough to fill all the drain pipes at once, to insure an even distribution. This system is, of course, preferably adapted to a porous or gravel soil. In places where clay soil conditions exist, the soil should be drained at least four feet below the level with porous drain.

COUNTRY WATER SUPPLY.

The procuring of a water supply in the country depends largely upon the surrounding conditions. Of course, when the source of the water supply is at a higher level than the house, a gravity system is the least complicated, and very often the cheapest. When the house is located at a reasonable height above the water supply, which could be made to supply an eight or ten-foot head, the hydraulic ram could be used. Rams will work, and work successfully, where the spring or brook is only three feet higher than the ram head, as the height or head increases the more powerfully the ram operates, and its ability to force water to a greater elevation and distance correspondingly strengthens. The best wearing results will be secured where the head or fall does not exceed ten feet; the head on the discharge pipe may be from five to ten times the head on the drive pipe. As a specific example: It might be said a fall of ten feet from brook or spring to the ram is sufficient to raise water to any point, say 150 feet above the machine, while the same amount of fall would also raise water to a point considerably higher, though the quantity of water discharged will be proportionately diminished as the height and distance increase.

Rule for Estimating Delivery of Water. Multiply the number of gallons supplied to the ram per minute by three, and this product by the number of feet in head or fall of drive pipe, and divide by four times the number of feet to be raised. The result is the number of gallons raised per minute. **Example:** With a supply of ten gallons per minute delivered to a ram under a head or fall of ten feet, how much water can be raised to an elevation of 100 feet?

$$\frac{10 \times 3 \times 10}{100 \times 4} = .75 \text{ gallons per minute.}$$

To obtain a water supply which will deliver water at any faucet in a house, yard or barn, it is necessary not only to pump the water, but to have some means of storing it under pressure. The elevated tank delivers it by gravity pressure, and, when used, should be placed at least eight to ten feet above the highest point from which the water is to be drawn, to insure a respectable velocity of discharge.

Compressed Air System. The principle of delivering water and other liquids by pressure of compressed air is very old, but it was not until recently that this principle was employed to furnish domestic water supply.

One of the greatest advantages of the com-

pressed air system is that it does away with the elevated tank, and there are a great many defects in the elevated tank system. If placed in the attic, it is not high enough to afford a sufficient pressure to be any protection against fire. Another objection is the weight of the tank, when filled with water, is very liable to crack the plastering and to leak. Another serious defect of the elevated tank, when placed in an attic or on a tower is the exposure to weather, in the winter it freezes and in the summer it becomes warm.

In the compressed air system the tank is placed either in the ground below the frost line or in the basement, and the water is pumped into the bottom of the tank with a force pump, which may be operated by hand, windmill, gas engine or hot-air engine. Another opening in the bottom delivers water to the faucet in the house, yard or barn. As the water is pumped into the bottom of the tank the air above it, not having an outlet, is compressed. This pressure is increased and maintained by an automatic air valve. It does away with the elevated tank, and delivers water at an even temperature all year around. The tank and pipes leading to and from it are protected from the weather. A pressure of fifty pounds is easily obtained, which equals the pressure from an elevated tank one hundred and ten feet high. This affords first-class fire protection and enables the country residents to have all the sanitary con-

veniences of a city home. A double system of this kind can also be installed, one for furnishing well or drinking water to the fixtures, and another one supplying soft water from the cistern.

In Fig. 183 a steel storage tank is shown buried in the ground below the frost line, water is pumped into it by hand or windmill. This pump forces both air and water into the tank at the same time. A connection run to the surface near the house to a yard hydrant with hose connection furnishes water for sprinkling and fire protection, another branch supplies water to the barn, under pressure.

In Fig. 184 a steel storage tank is shown placed in the basement and supplied with a hand pump. These two illustrations will serve to give some idea of the extent to which a system of this kind can be put to use. The tank is practically indestructible, and, unlike the elevated tank, requires no expense after it has been put in. When the tank is one-half full of water, the air which originally filled the entire tank will be compressed into the upper half of it and will exert a pressure of fifteen pounds to the square inch, and if a straight supply pipe was run from the bottom of the tank, this air pressure would force the water to a height of thirty-three feet. For ordinary elevation the best results are obtained by maintaining in the tank excess air pressure of ten pounds, that is, enough air to give ten pounds

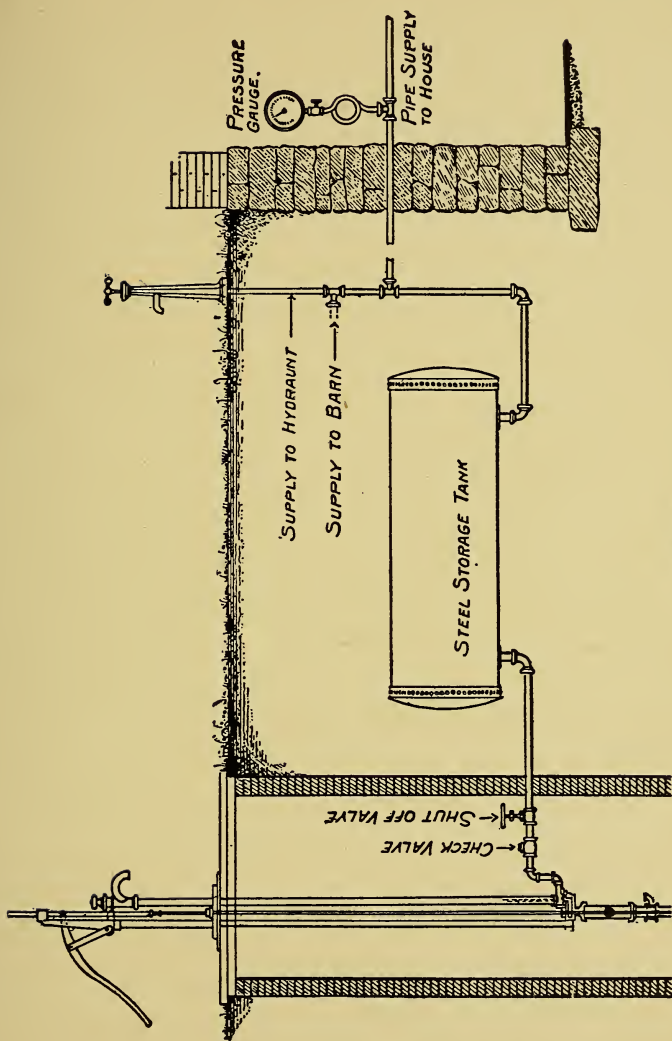

Fig. 183.

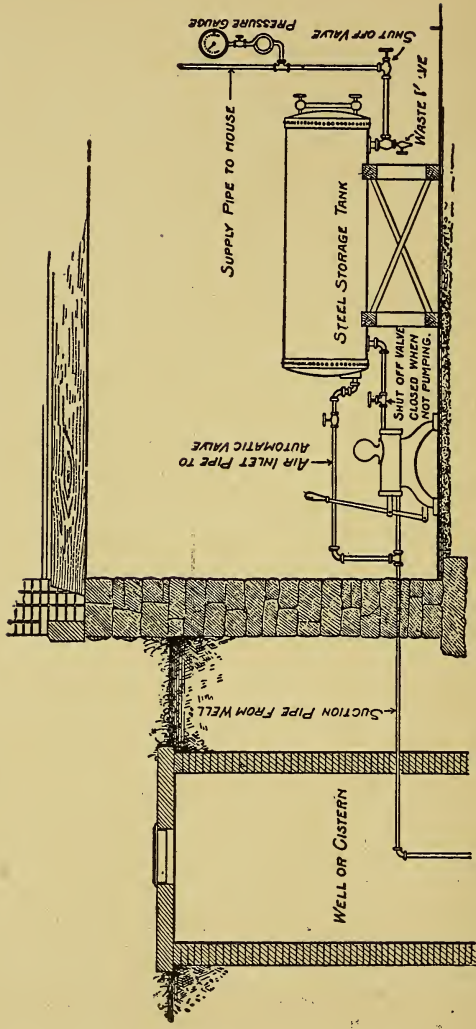

Fig. 184.

FIG. 185. THREE-PIECE SYSTEM

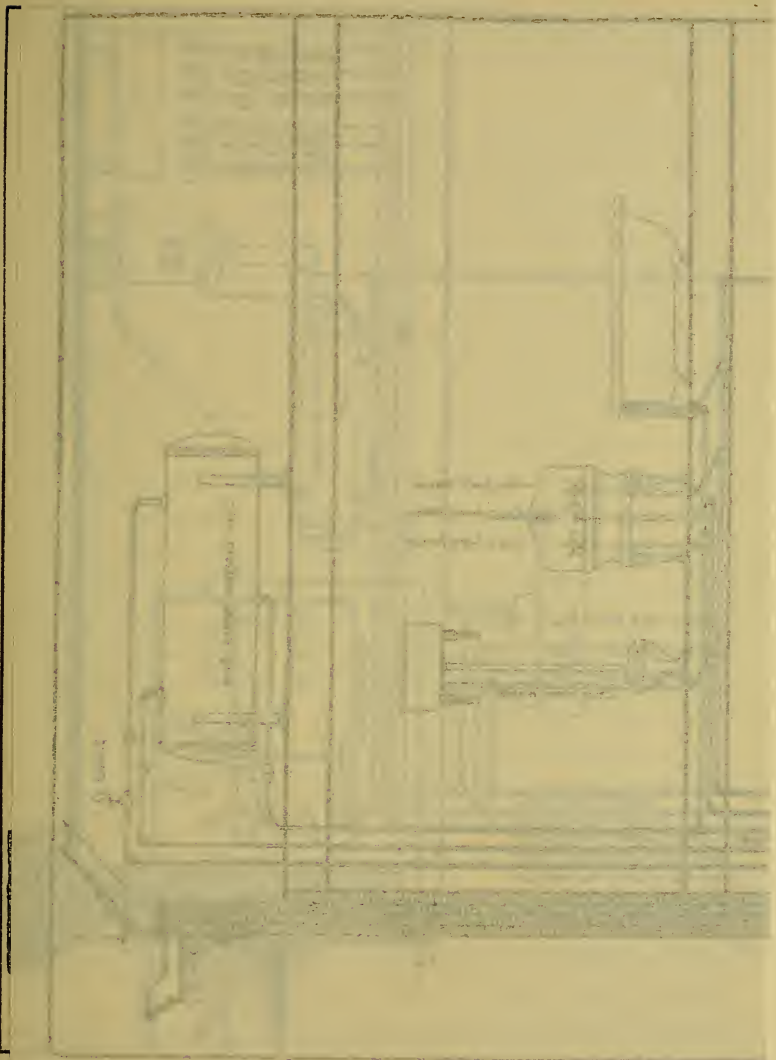
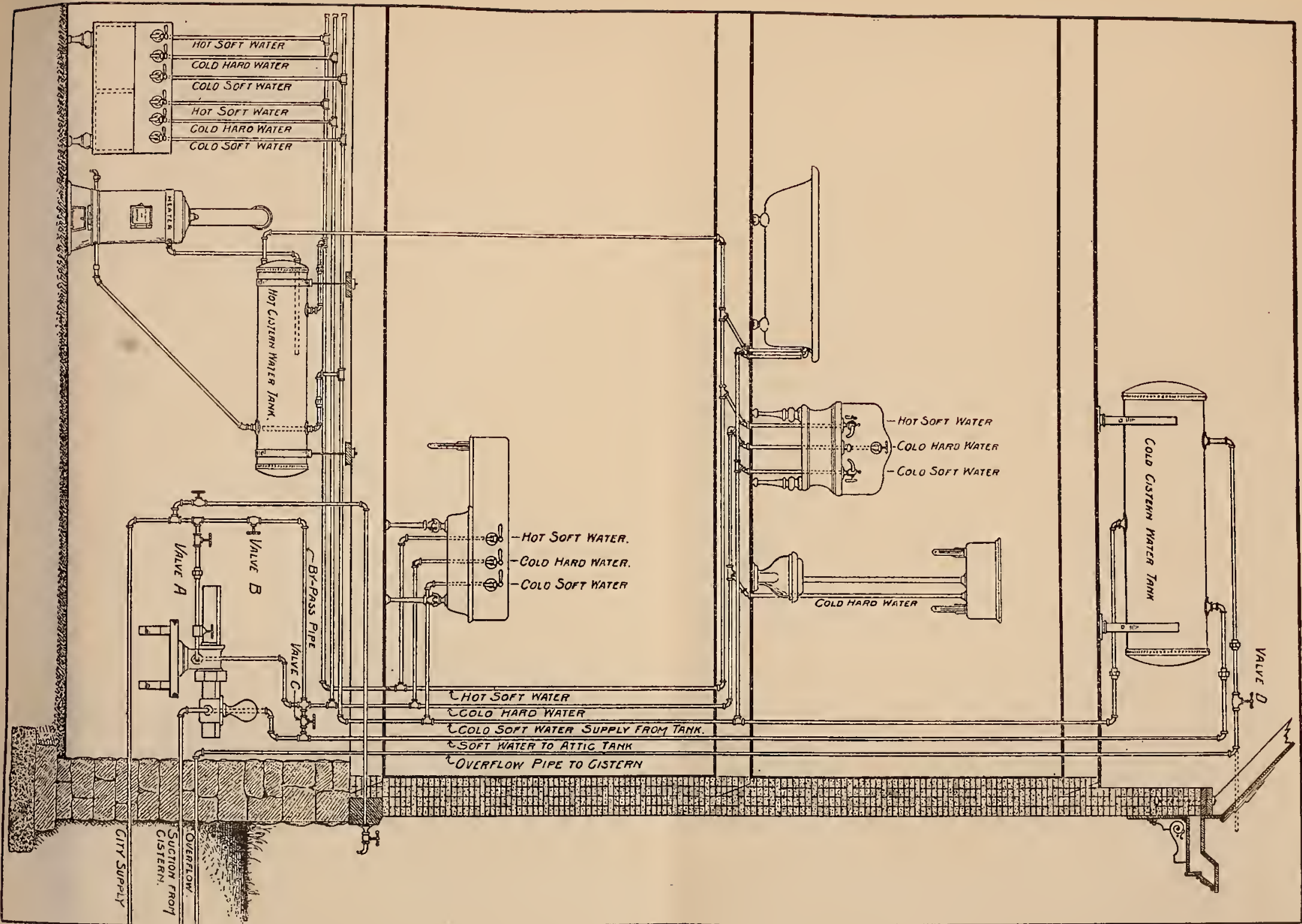
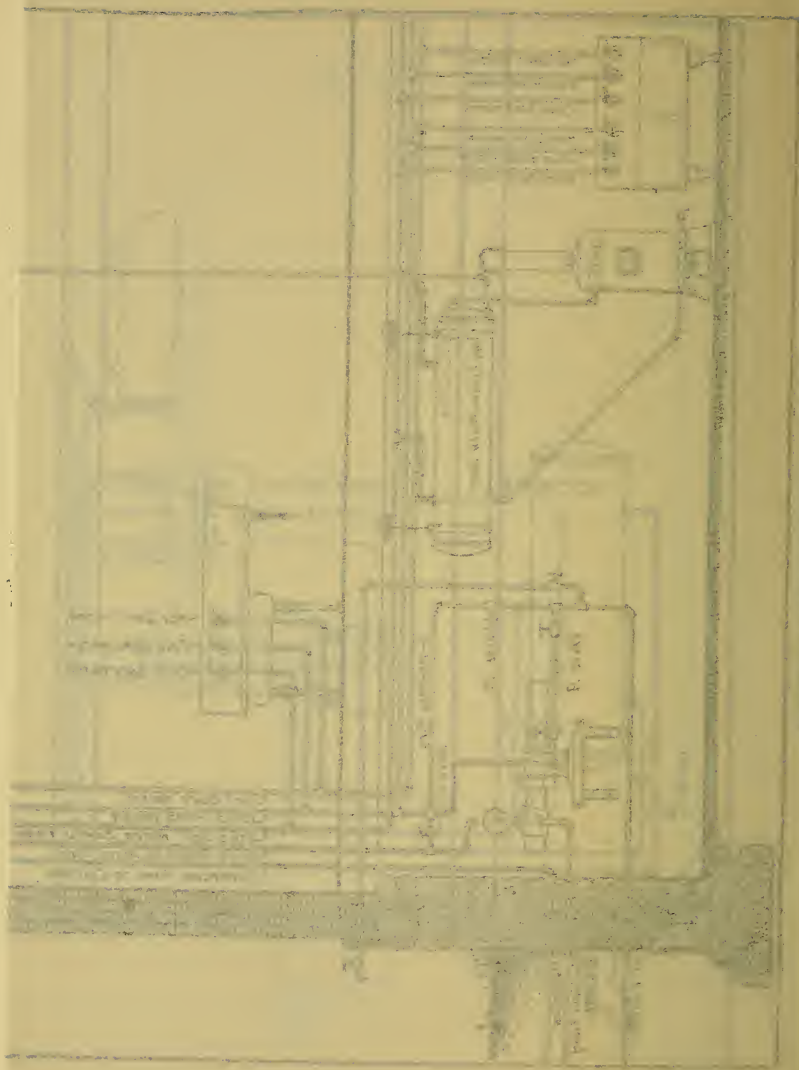

FIG. 185. THREE-PIECE SYSTEM





pressure when the tank contains no water. Thus equipped, a tank will deliver twice as much water as otherwise.

Most of the country towns at the present day are supplied with efficient water systems, and it is a very easy matter to install a hydraulic system which supplies hot and cold soft water to every fixture in the house automatically and all of the time. One of the principal objects desired in the hydraulic system is to utilize the waste water from the hydraulic pump so that there will be no loss, which is quite an item when the water is paid for at so much per thousand feet.

The system shown in Fig. 185 is a very simple and inexpensive one. The city water supply is run direct to the hydraulic pump, and the city water passing through it is piped direct to the fixtures at which cold hard water is desired. In the drawing this pipe supplies the closet tank and one faucet over the lavatory for drinking purposes in the bathroom, also one faucet over the sink and two connections to laundry tub, which is very convenient, as the cold water can be utilized for rinsing purposes, thereby saving a great deal of the soft water. The operation of the same is, that when any of these five faucets are opened, it permits the city water to pass through the pump and at the same time operate the pump, which pumps soft water from the cistern to the tank in the attic from which a pipe is run down to the base-

ment with branches taken off at the different floors to supply cold soft water, hence, to the hot water heater tank, from there on to the heater, back to the tank and around to the different fixtures supplying hot soft water. The return pipe prevents a dead end which necessitates wasting the soft water before the hot water begins to flow.

A method is shown whereby it is possible when the cistern is emptied to fill either the city water supply only with city water, or the entire system without its passing through the pump by the manipulation of three globe valves, designated as A, B and C. When the pump is pumping cistern water to the attic tank, valve B and C are closed, and valve A is opened. When the cistern is emptied, and it is desired to fill only the cold city water pipe with water, leave valve C closed, close valve A and open valve B, which permits the water to flow into the cold water pipe without passing through the pump. If it is desired to fill the entire system with city water, all that is necessary is to open valve C, which permits the water to flow up to the attic tank and down through the balance of the system. When this is done, valve D on the overflow pipe should be closed after the water begins to overflow, and not before, as the system would become air-bound.

An overflow pipe is shown leading from the attic tank to the cistern within the house. If it is possible to run this overflow pipe out onto the

roof so that the overflow will return to the cistern through the eavestrough and downspout pipe to the cistern, it is best to do so, as the cistern water then has a chance to become aerated. The pipe to supply the sill cock or yard hydrant for sprinkling purposes should be taken off at a point before the supply to pump, to prevent the unnecessary work of the pump when sprinkling. In case of a basement closet being installed, a connection can be taken from the city water supply pipe run to the laundry tub, three-quarter-inch galvanized iron pipe is sufficiently large enough for all of the main supply pipes with one-half-inch branches to the different fixtures. These hydraulic rams are manufactured so as to work, and work successfully, at as low a pressure as ten pounds per square inch.

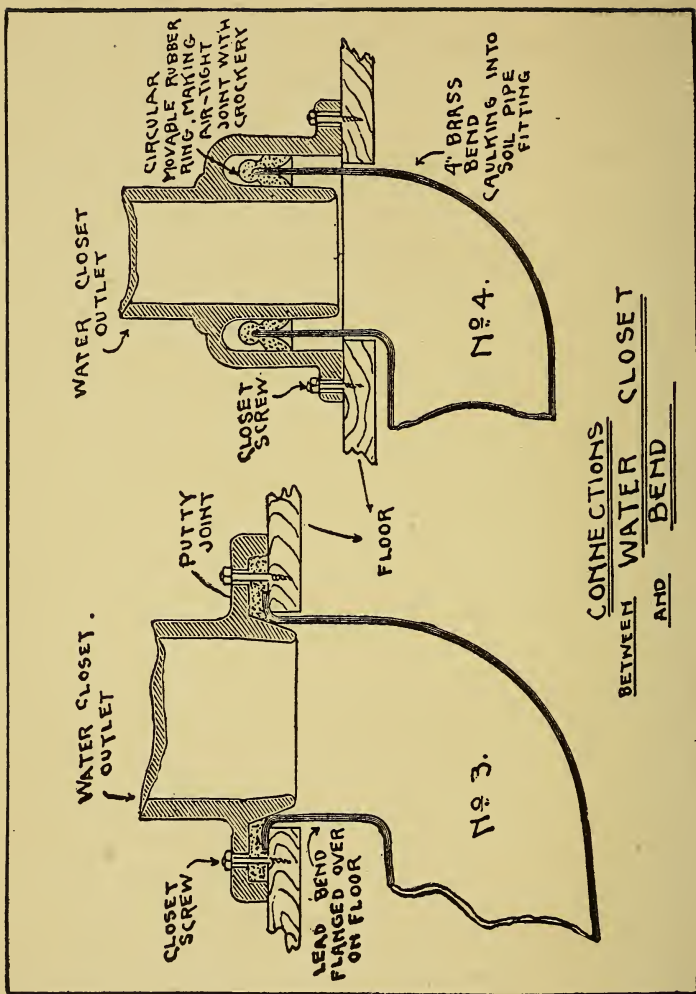

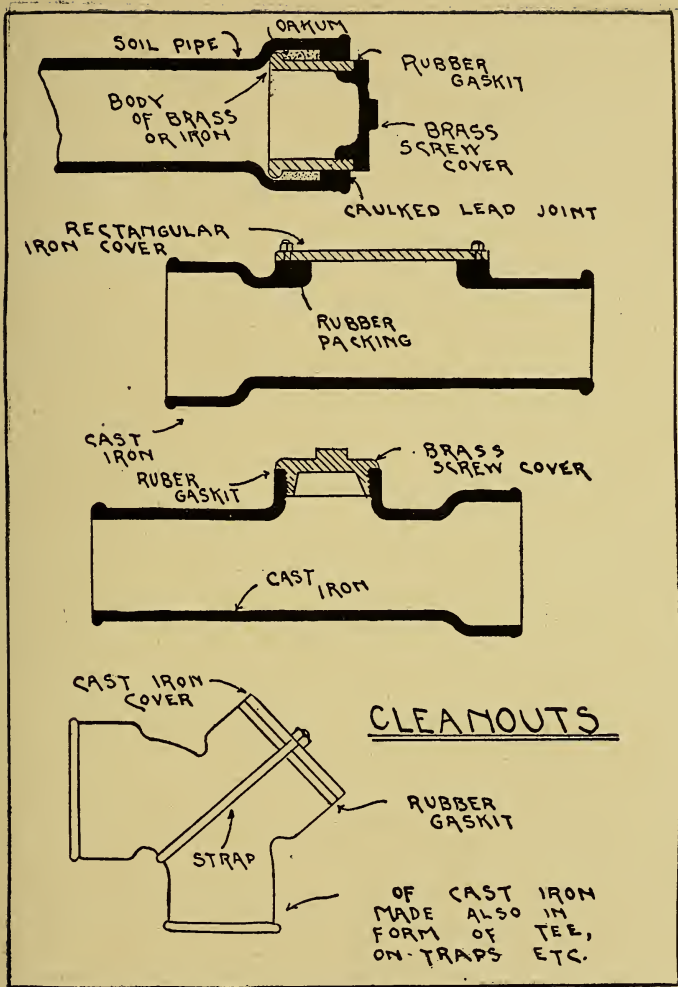

SECTIONS SHOWING
MANNER OF SHAPING
PIPES WHEN THEY ARE
TO BE JOINED BY
WIPED JOINT

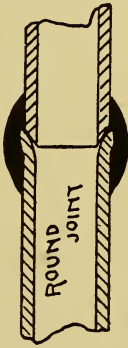

ROUND JOINT

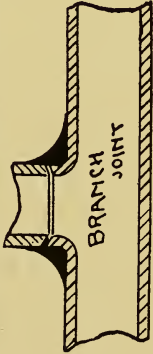

BRANCH JOINT

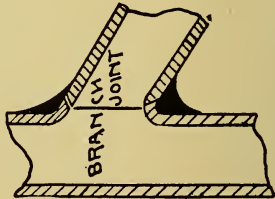

BRANCH JOINT

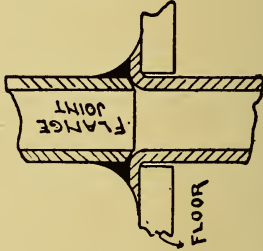

FLOOR

WIPED JOINTS
FOUND ON ROUND TRAP --

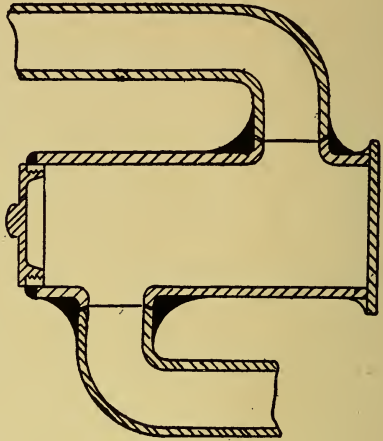

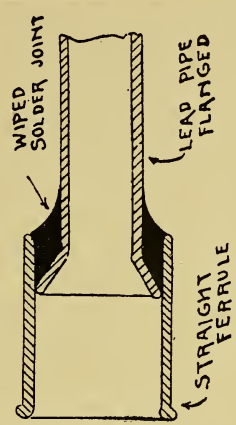
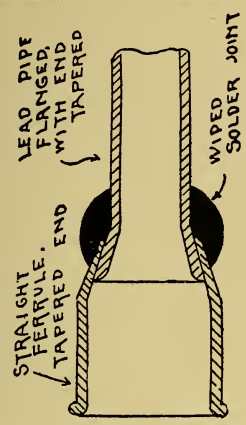

SECTIONS SHOWING
CONNECTION OF LEAD PIPE
WITH BRASS FERRULE

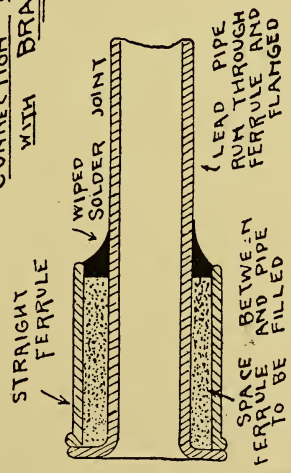
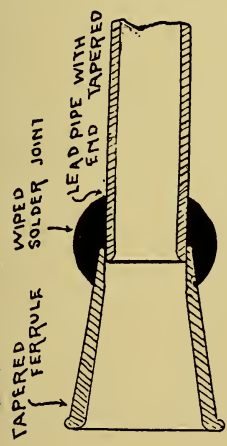

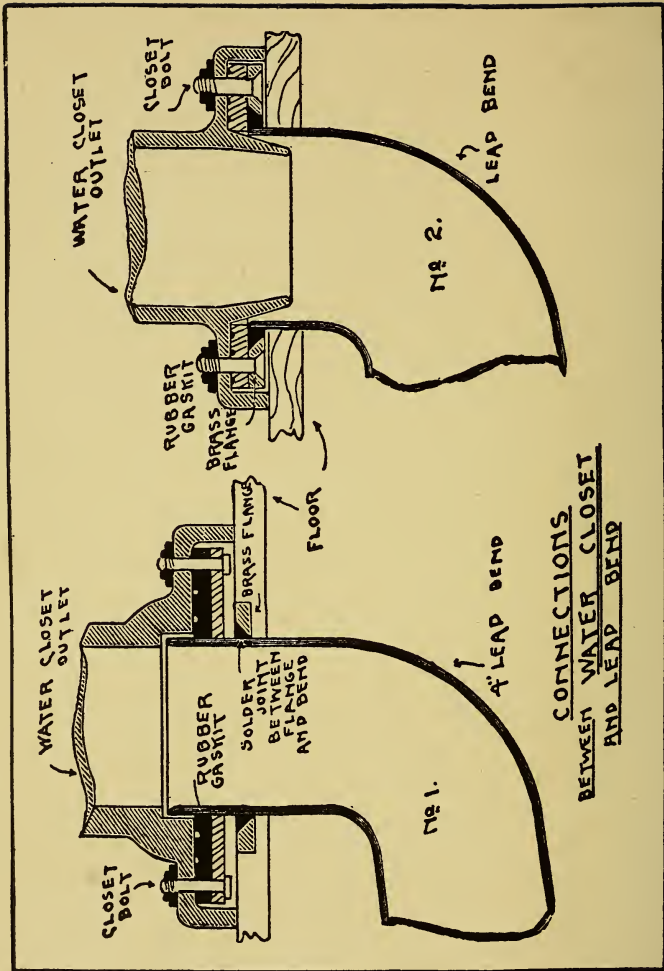

CONNECTIONS
BETWEEN WATER CLOSET
AND LEAD BEND

CONNECTIONS
FOR SITZ BATH

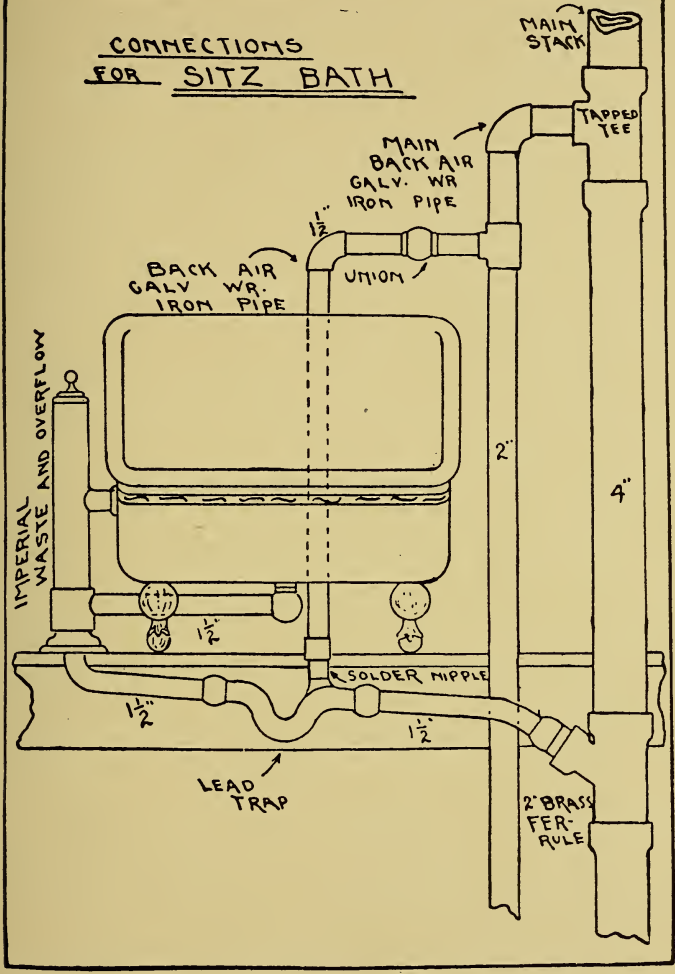

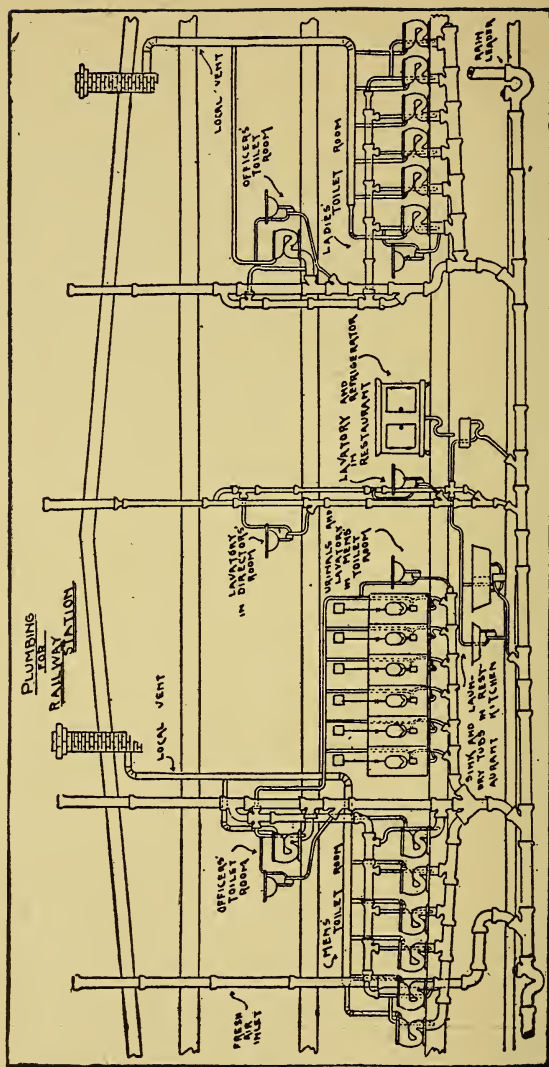

INDEX

A

	PAGE
Air composition of	227
Air compressibility of	227
Air vent pipe for house drain	12- 13
Autogenous soldering—lead burning.....	108-112
Burning vertical seams.....	110-111
Compressed oxygen and coal gas.....	111
Definition of term	108-109
Explanation of process	109-111
Most simple form of	109
Skill required in	108
Use of red hot copper bit.....	111-112
Where used	108
Automatic sewage ejector	291-303
Action of device	299-300
Air compressing apparatus	296-299
Construction of	293-296
For use in city buildings.....	300
Installation	300-303
Principles of operation	291-292
Shone pneumatic ejector	292-300
Sources of power for operating	297
Switch board and motor	297-299
Automatic syphon	308

B

Basement drains	18- 24
Backwater valve—function of.....	19- 20
Combination strainer and back water seal.	23
Deep water-seal for	22
Extra heavy for barns	20- 21
Installation—method of	18-19-20

	PAGE
Trap—necessity for	19
Types of basement drains	20-21-22
Branched joints—wiping of	101-103
Badly shaped joint	102
Joint made by using a thick cloth.....	101-103
Proper methods of making	102-103
Brass pipes—weight of per lineal foot.....	185

C

Cesspools	139-140
Circular	140
Hydrant	139
Rectangular—for cellar	140
Stable use	139-140
Slop sink—with bell trap and strainer....	139-140
Chicago Plumbing Code	241-285
Area drains—when to trap.....	268
Barn drainage	276-277
Bath tub—drum trap	256
Blow off pipes	267
Catch basins—where prohibited	269
Catch basins—for kitchen wastes	269-271
Catch basins—when to dispense with....	271
Cellar drains	268
Chimney ventilation	252
Connections outside of buildings	246
Connected wastes	256
Cleanouts—tapping pipes	250-251
Definition of terms	247-248-249
Drainage, and vent fittings.....	254-255
Drains connected with sewers.....	246-247
Earthenware trap connections.....	275
Ejectors	254
Fee—when to be paid	282
Fittings—quality—cleanout fittings.....	250
Fittings—prohibited	251

	PAGE
Chicago Plumbing Code—	
Floor washes in basement	268
Gas water heaters—permit to install.....	283
Gas water heaters—structural requirements	284
High pressure boiler—supply tank.....	244
House boilers—sediment pipes	262
House tanks—linings prohibited	266
Inspection certificate	282
Inspection test	277-278-279
Iron pipe—where used	252
Iron pipe—quality—weights	249-250
Lead pipe—kind permitted	242
Lead pipe—not to extend within partitions	252
Lead pipe—wiped joints—brass pipe.....	252
Long hopper closets	263-264
Metal connections—requirements	245-246
New plumbing—repairs	244-245
Old work remodeled	279
Open plumbing	274
Overflow pipes—connections of.....	261
Peppermint test for alterations.....	279
Permit for use of water.....	241-242
Pipe supports—hooks prohibited.....	251
Pipe joints to be filled.....	251
Pipes above main building.....	253
Plans—plan and elevation.....	281-282
Plumber's notification—inspection.....	277
Prohibited closets	274
Rain water leaders—where prohibited....	266
Rain water leaders—when to trap.....	266-267
Rain water leaders—connections.....	272
Refrigerator wastes—sizes—traps.....	261-262
Revent—omitted—when	273-274
Revented washout closets	275
Service pipe—joints	242-243
Single tap for several buildings.....	243

	PAGE
Chicago Plumbing Code—	
Slip joints—ground joints	276
Soil and waste pipes—when to extend....	253
Soil and waste pipes—sizes of.....	247-255
Special permits	276-277
Stop cocks	243
Steam pipes—condensers—vents	267
Straight tees—where prohibited	252
Tapping street main	242
Temperature of water entering sewer....	267-268
Trap—where prohibited	255
Traps—placing of—water seal.....	256-257
Trap revents—concealed partitions	255-256
Urinals—automatic flushing of.....	272-273
Urinals—automatic flush tanks for.....	262-263
Urinals—construction	272
Urinals—flush prohibited materials.....	272
Urinals—wastes—screens	273
Vent pipes—sizes of	253-254
Vent pipes—revents	257-258
Vent pipes—in residences	258-259
Vent pipes—lengths of horizontal.....	260
Vent pipes—reconnected	260
Vent pipes—reconnected—exceptions ...	274
Ventilation—water closet	279
Vertical lines of pipe—floor rests.....	251
Vertical pipes through roof.....	252-253
Waste pipes in four story buildings.....	259
Waste pipes—horizontal prohibited.....	254
Water closets—revent	257
Water closets—flush tanks.....	262
Window area in toilet compartments....	280-281
Water closets under sidewalks	264-266
Wood sinks and tubs—where prohibited..	268
Cleanouts—with brass trap screw.....	137-138
Cleanouts—with hand hole and cover....	137-138
Condensation—what it is.....	226

	PAGE
Country water supply	309-317
Compressed air system	310-315
Delivery of water—estimating.....	310
Hydraulic ram—operation of.....	309-310
Pumping apparatus	312-314
Steel storage tank—underground.....	312-313
Steel storage tank—in basement.....	313-314
Storage tank system	310-314

D

Delivery of water—rule for estimating.....	310
Diameters, areas, and circumferences of circles	238-239-240
Disposal of sewage	304-308
Automatic syphon	308
Concrete basins—system of	308
Epidemics—causes of	304
Leaching cesspool	305
Out door water closet	304-305
Pollution of drinking water supply	305
Sub-surface irrigation	305-306-308
Systems adapted to localities.....	304
Drain pipes—capacities of	27
Drain and trap for hospital operating rooms..	22- 24
Drainage fittings	113-140
Cross tapped for iron pipe	117-118
Double Y	118-119
Double half Y-branch	118-119
Half Y	118-119
Half Y-saddle hub	119-120
Inverted Y-branch	119-120
Plain cross	118-119
Plain T-branch—sanitary T-branch.....	117-118
Quarter bends, with heel and side outlets.	114-115
Sanitary cross	118-119

	PAGE
Drainage fittings—	
Sanitary cross tapped for iron pipe.....	117-118
Sanitary bend—long quarter	114-115
Soil and waste pipe fittings	113-121
Soil pipe bends— $1/16$ to $1/4$	113-114-115
T-branch soil pipe	114-115-116
T-saddle hub	119-120
T-branch, Y-branch—trap screw	121
Ventilating branch pipe—plain.....	119-121
Ventilating cap—Y-saddle hub	119-120
Y-branch—half Y-branch	114-117
Drainage pipe—size of	10- 12
Drainage pipe—method of laying	10- 12
Drainage system—correct installation.....	12
Drinking fountains—solid porcelain.....	172-175
Drinking fountains—marble	173-174

E

Electrical thawing device	286-290
Advantages in use of	286
Capacity of	290
Current required to operate	289
Weight of	290
Westinghouse heavy service outfit.....	287-288
Westinghouse light service outfit.....	289-290
Evaporation—explanation of process	225.
Equation of pipes	220-221

F

Fire clay—substitute for	235
Fire engine house—plumbing for.....	37- 40
Fresh air inlets	37 -38
Fresh air inlets for soil pipe	13
Friction of liquids in pipes	226-227

H

	PAGE
Hopper traps	130-137
Half S-trap, high pattern for iron pipe..	130-131
Half S-trap, plain with hub vent.....	134-135
Half S-trap, with hand hole and cover....	134-135
S-trap—high pattern for lead pipe.....	130-131
S-trap—plain for lead pipe	131-132-133
S-trap—high pattern hand hole and cover..	131-132
S-trap—high pattern, hub and vent.....	131-132
S-trap—high pattern, for iron pipe.....	133-134
Three-quarter S-trap—high pattern—hub vent	130-131
Trap caps—brass	136-137
Horizontal joints—wiping of	96
Horizontal joints—three examples of.....	96
Horse power—definition of	225
Horse power—pounds water required to pro- duce	225
Hot water plumbing	197-218
Combination reservoir and heater	209-210
Explosion of water back—cause of.....	204
Gas heated device—connections for..	205-206-207
Gravity supply tank system	200-201
Hot water—natural course of flow.....	203
Kitchen boiler—function of	201-202
Kitchen boiler—connections of	207-208
Noise in pipes—causes of	203-204
Simple system—hot water supply.....	197-198
System for supplying three floors.....	199-200
Vertical, or horizontal boilers—connections	208
Hot water supply	186-196
Cold water supply pipe—requirements of..	188
Cylinder system—advantages of	186
Draw off pipes—connections for.....	189
Draw off pipes—path of	192-193
Emptying cock—location of	188

	PAGE
Expansion pipe—function of	189
Expansion pipe—path of	187
Flow pipe—path of	186-187
Flow pipe—path of in tank system.....	191-192
Return pipe—path of	186-187
Return pipe—path of in tank system.....	192
Secondary return—location of.....	189-190
Sizes of tank and cylinder.....	195
Water circulation in system.....	189
House drain—function of	8
House sewer—connection of to main sewer...	14
House sewer—pitch of, toward main sewer...	14- 15
House sewer—size of—how determined.....	15
Hydraulic ram—operation of.....	309-310

J

Joint wiping	92-107
How to use the cloth	98- 99
Importance of skill in	92- 93
Length of joint	93
Thin cloth—objections to	97- 98
Wiping cloth—manipulation of	95- 96
Wiping cloth—making of	97- 98
Wiping cloth—material for	94- 95

L

Lead—fusing temperature of	68
Lead—specific gravity of	65
Lead traps—full S—half S—P.....	126-127-128
Liquid measure—table of	229

M

Manhole for house drainage system.....	10
Measurement of wrought iron pipe.....	224
Modern stable—plumbing for	41- 43

P

	PAGE
Pipe—area of—how to find.....	227
Pipe—copper—weight of per lineal foot.....	185
Pipe—to find number of gallons in one foot length	232
Pipe—to find weight of lead pipe when diam- eter and thickness are known.....	232
Pipe supports	37
Plan of piping for basement	25- 26
Plaster of paris—to prevent setting too quickly	234
Plumber's solder—how to make.....	77-78-79
Plumber's solder—burning—danger of.....	80- 81
Plumber's solder—zinc poisoned	81
Plumber's tools	210-212-216
Plumbing—recent improvements in	7- 8
Pressure—action of upon a liquid.....	226

R

Rain leaders	16
Roof connections	34-35-36
Roughing in	25- 52
Meaning of	25
Plumbing for two story residence.....	43- 52
Plumbing for modern stable.....	41- 42
Refrigerators—waste and vent pipes.....	43
Rubber force cup for cleaning bath tub.....	215
Running trap for house drain	12
Rust joint—cement for	235

S

Sanitary plumbing	141-176
Bathroom—construction	141-142
Bathtub—corner porcelain type.....	144-145
Bathtub—porcelain enameled	144-147-148
Bathtub—porcelain roll rim	142-144

	PAGE
Bathtub—sitz; with nickel plated fittings.	144-149
Bathtub—showing proper connections.	144-152
Bathtubs—types of	142-149
Footbath—enameled porcelain.....	144-150
Spray, and shower baths—rubber curtain..	144-151
Sewer—requirements of	8
Sewer pipe—materials—methods of laying....	8
Sewage disposal—basic principles of.....	15
Service pipes—table of capacities.....	183
Sheet copper—how to clean	234-235
Sheet lead—table, weights and thickness....	196
Sinks—construction and installation.....	175-176
Soil pipe	27- 37
Cutting of	27
Joints—materials required for.....	30
Making joints in	29- 30
Running long line of.....	30- 33
Under basement floor	37
Solder—for plumber's work	62- 76
Alloy that expands in cooling	74
Composition of plumber's solder.....	62- 63
Contraction in cooling	73- 74
Effect of heat on solids.....	71- 72
Expansion of solder when melting.....	73
Flowing of	68- 69
Fluxes for	69
How to judge good solder.....	63- 64
Indications of impure solder.....	64- 65
Result of mixing tin and lead.....	72- 73
Rule governing hardness of	71
Soldering fluids	69
Sulphur as a flux	66- 67
Zinc—detrimental to solder.....	65- 66
Zinc—how to extract from solder.....	66
Soldering copper—care of	236
Soldering fluxes	82- 83

	PAGE
Steam tight joint—how to make.....	235
Store, or office building—plan for plumbing of.	37- 39

T

Table—decimal parts of an inch.....	75
Table—fall per foot for sewers and soil pipes.	16
Table—melting points of various alloys.....	75
Table—to find weight of metals in pounds....	76
Table—weight of one square foot of various metals	76
Tanks—rule for finding capacities in gallons..	230
Thawing device—electrical	286-290
Three story tenement—plumbing for.....	30- 32
Tin—specific gravity of	65
Tinning iron—method of	83
Traps	53-61-122-218
Back venting—proper method of.....	57- 58
Bower trap	61
Counter vent	217
Caulking joints in	218
Cudell trap	60- 61
Drum trap	59
Full S-trap	123
Full S-trap—with top vent.....	125-126
Function of trap in sewer pipe.....	53
Half S-trap	123
Half S-trap, with hand hole and cover...	123-125
Half S-trap, with top vent.....	125-126
How a trap may be syphoned.....	56- 57
Kinds of traps for sewage.....	217
Loss of seal in a trap.....	54- 56
Non-syphon traps	57- 60
P-trap	54- 55
Purpose of traps	217
Running trap—hub vent	126-127
Running trap—hand hole and cover.....	122

	PAGE
S-trap—advantages of	54
S-trap, with hand hole and cover....	123-124-125
S-traps—extra long—plain and vented...	129-130
Self scouring trap	60- 61
Syphon trap	53
Three-quarter S-trap	54-55-123
Three-quarter S-trap, with hand hole....	123-125
Three-quarter S-trap, with top vent....	125-126
Trap for house drainage system.....	10- 11
Two-hub vent-traps	122

U

Upright joints—wiping of	99-101
Urinals	162-167
Complete toilet room—hotel, or office...	164-167
Corner porcelain urinal	163-164
Flat-back porcelain style	162-163
Individual stall urinals	164-165-166
Useful information	224-240
Air—volume of, in one pound.....	225
Anthracite coal—cu. ft. in one ton of....	225
Anthracite coal—wt., of one bushel.....	225
Area of pipe—how to find.....	227
Barrel—to find contents of	231
Boiler horse power	224
Boiler scale—how to remove.....	233
Circle—to find circumference of.....	230
Circle—to find area of	230
Circle—to find diameter from given area.	230
Circle—to find diameter of, to equal area of a given square.....	230
Cement—how to make	233-234
Cement—for iron and stone.....	234
Cement—for leaky steam boilers	234
Cleaning rusted iron	233
Cleaning rusted brass.....	233

	PAGE
Useful information—	
Cleaning marble	233
Coal required per sq. ft. of grate—lbs.....	224
Copper pipes—weight of, per lineal foot..	185
Delivery of water—rule for calculating..	310
Diameters, circumferences, areas of circles.	238-240
Evaporation of water	224
Equalizing pipes	228
Heat unit—definition of	224
Heat units required per horse power....	225
Heat units in 1 lb. anthracite coal.....	225
Rectangle—to find area of	229
Thermometers—comparison of	227
Triangle—to find area of	229
Water—expansion of, in freezing	228
Water—discharge of through given orifice at different pressures	228
Water—height of column for 1 lb. pressure per sq. in.	229
Water—number of gallons in 1 cu. ft.....	229
Water—pressure upon side of tank	231-232
Water—point of greatest density	228
Water—to find head in feet; pressure being known	231.
Water—to find pressure in lbs. per sq. in...	230
Water—to find required head for given ve- locity	230-231
Water—velocity of flow through pipe	231
Water volume and weight of 1 gallon....	228-229
Water—weight of one cubic inch.....	229
Wrought iron pipes—measurement of....	224

V

Vacuum—meaning of	225
Vent-opening—location of for house drain....	10
Vent-pipes—location of	27- 28

	PAGE
Vertical section for two story building.....	25- 28
Vitrified sewer pipe	8- 10
Connection with iron pipe	8- 9
Method of installation	9
Trap and vent opening	9- 10

W

Washbowls	164-172
Connections for	172-174
Drilling slab for clamp holes.....	168
Half circle, roll edge—high back.....	169-170
Independent bowls	168-169
Making joint between bowl and slab	165-168
Roll edge bowl—removable strainer.....	169-170
Roll edge oval bowl, with overflow.....	169-171
Roll edge slab and bowl—ideal waste....	172-173
Setting of bowls to marble slabs.....	164-168
Water	219-227
Boiling point of	221-227
Characteristics of	219
Composition of	219
Expansion of when heated	225-227
Expansion of when changed to steam....	225
Freezing temperature	221-222
Hardness of water	222
Head—meaning of explained	220
Impurities, poisons, etc., in water.....	222
Maximum density—point of	222
Pressure of, in pounds per sq. in.....	219-220
Pressure of, at different elevations	184
Purifying by aeration	223
Tests of for purity.....	236-237
Unit of measurement for.....	219
Weight of—per cubic foot	219-224
Water closets	149-162
Flushing rim—hopper style.....	154-155

	PAGE
Prison water closet	157-159
Seat-operated types	154-156-157
Syphon jet low down tank.....	156-158
Washout closet, with front outlet.....	154-155
Washout closet, connections for.....	159-162
Water pipes and fixtures	27- 28
Water service	177-240
Corporation cock	177
First step in installation of	177
Size of service leading to building	177
Service pipes in building	178
Stop cocks in building	178
Stop cocks—where required	177-178
Tapping street main	177
Testing the water service	179-181
Testing—with air pressure	180
Testing—with peppermint test	180-181
Testing—with smoke test	180
Testing—with hydraulic pressure	179
Wiped joints—preparation of.....	§4-91-104-105
Importance of care in	84
Joints for tin-lined pipes.....	105
Joints for copper pipes	105-106
Method of tinning copper	106-107
Method of strengthening copper pipe	107
Preparing pipe ends—three methods of..	90
Preparing pipe ends—care required in....	91
Rasping—instructions for	87- 88
Skill required in	86
Soil—best method of making	88
Soil—proper ingredients for.....	88
Soil pot and tool	88
Soiling a pipe—correct method of.....	88- 89
Solder—proper heat for.....	89
Tools required for	86
Wrought iron pipe—table of.....	181-182

**HOT WATER HEATING
STEAM AND GAS FITTING**

PREFACE

This work is a modern treatise on Steam, Hot Water and Furnace Heating, and Steam and Gas Fitting, which is intended for the use and information of the owners of buildings and the mechanics who install the heating plants in them. It gives full and concise information with regard to Steam Boilers and Water Heaters and Furnaces, Pipe Systems for Steam and Hot Water Plants, Radiation, Radiator Valves and connections, Systems of Radiation, Heating Surfaces, Pipe and Pipe Fittings, Damper Regulators, Fitters' Tools, Heating Surface of Pipes, Installing a Heating Plant and Specifications. Plans and Elevations of Steam and Hot Water Heating Plants are shown and all other subjects in the book are fully illustrated.

THE AUTHOR.

RELATIVE ADVANTAGES OF STEAM AND HOT WATER HEATING.

The first cost of a steam heating system is from 20 to 30 per cent less than that of a hot water system. This is due to the smaller sizes of pipes and radiators used on steam work. The cost of operation is however in favor of the hot water system.

When steam radiators are shut off they cool much more rapidly than hot water radiators. This proves to be an advantage in favor of the hot water system.

A steam plant requires much more attention and skill on the part of the operator than the hot water system. With regard to freezing, the preference is in favor of steam, and in large buildings this is often a matter of great importance. A hot water system may be run during mild weather with much less heat than a steam system which must always be brought to a temperature of 212 degrees Fahrenheit before any heat is felt.

HEATING SYSTEMS.

A steam or water heating system involves in its construction the following:

A steam boiler or water heater.

Pipe and pipe fittings.

Valves.

Radiators.

Air valves.

It also requires an expansion tank (water heating) for its successful operation.

A good chimney.

Good fuel.

Good management.

For heating a house or a small flat building the round sectional steam boilers or water heaters are unquestionably the best up to 1,500 square feet of radiation.

For capacities above this limitation, rectangular sectional steam boilers or water heaters are used.

Ventilation. Ventilation is a most important matter in connection with heating. All living rooms should be ventilated, and the greater the number of occupants the room contains, the greater should be the amount of ventilation required.

In the ordinary house, ventilation is obtained from the fresh air entering the rooms through the windows and doors, for the ordinary occupants of the rooms.

Under ordinary conditions, an adult requires about 1,000 cubic feet of air per hour.

The principal cause of the vitiation of the air in a room is the respiration of the occupants. Moisture and gases arising from the occupants of

the room also tend to make the air foul. Lighting and heating are other causes.

The air in a room is to some extent changed by diffusion, but preferably by the entrance through registers provided for the purpose, of fresh air that has been warmed, and by the outward passage through flues, of the foul air.

The foul air should leave a room near the floor. An open fireplace furnishes an excellent means of ventilating a room.

The foul air is heavier than the purer air, and therefore settles to the bottom of the room. By drawing the colder and therefore heavier air, which is at the bottom, the warmer air at the upper part of the room settles to fill this space, thus creating a circulation, and making the heating more effective.

Heat. In what is known as the molecular theory, all bodies are made up of rapidly vibrating particles, the hottest bodies being those whose particles move or vibrate with the greatest rapidity, and through the greatest distances. The conclusion is therefore reached that heat is not a substance, but a form of motion, and that this condition may be transferred from one body to another. This theory explains in a simple manner the various actions of heat.

Upon being heated, the particles of a body tend to repel each other, and as a result of the action of the heat the body expands, and this expansion if

carried far enough, finally produces a change in the state of the body, the point at which such change takes place varying with each different substance. As an example of this change a cake of ice when subjected to heat, melts and becomes water, and this water when subjected to further heat again changes its state and becomes steam.

Heat may be transferred from one body to another in three ways, by conduction, by convection and by radiation.

By conduction is meant the direct contact of one body with another. A heated bar of iron will transmit heat to another bar when in contact with it.

Heat is also transferred from one body to another by convection, by means of water or other fluids, which convey it from one point to another.

Heat is transferred from one body to another by radiation through such a medium as currents of air.

STEAM HEATING.

The low pressure gravity and the high pressure steam systems are the ones in general use.

The chief feature of the low pressure gravity system of steam heating is that all condensation turns to the boiler by gravity.

A pressure of steam below 10 pounds above the atmospheric pressure is low pressure steam.

The low pressure steam system is chiefly used in house heating, because it is safer than high pressure steam, and as it works at a lower pressure is more economical to use, and requires less attention.

Not less than a 1½ inch pipe should be used for a steam main, and this diameter should not be run for a greater length than 25 feet.

Regardless of the amount of work to be done, no steam riser less than 1 inch in diameter should be used.

If too small the pipes will sometimes cause the radiators to fill with water.

The steam main should be run as high as possible above the boiler. A distance of 18 inches or more should be allowed if conditions will permit of it.

Branches should always be taken from the top

of the steam supply mains or at an angle of 45 degrees, but never from the side.

Branches should not be taken from the side of the main, as water hammering and the forcing of condensed water from the main into the radiators may be result.

Branches should be run full size from the main to the risers and connected with the latter by a reducing elbow.

The horizontal branch should be one size larger than the riser, if more than 6 or 8 feet in length, as the circulation is not so strong on a horizontal as on a vertical line of pipe.

A steam main should have a pitch of at least 1 inch for every 10 feet of length.

Branches should have a pitch of at least 1 inch for each 5 feet.

Carelessness in the alignment of steam pipes is liable to form pockets or traps which will impede the circulation and cause hammering, due to the condensed water remaining in the pockets.

When necessary to make a direct rise in order to get over an obstruction or to increase the head room, the pocket formed should be dripped by a small pipe into the return.

STEAM BOILERS.

Experience has shown that steam boilers made of cast iron are the most reliable and most efficient for heating purposes. No other metals which can be used for this purpose deteriorate so little from corrosion as cast iron under like conditions. A cast iron steam boiler cannot explode. Being built up in sections they are easy to set up and involve the least amount of trouble and expense. In operation they are simplicity itself and their management is easily understood.

The capacity of a steam boiler should be at least 25 per cent in excess of the total duty required by the radiation and pipe system for direct radiation. When indirect radiation is used add 50 per cent to the above.

In locating a steam boiler, be sure and ascertain by careful measurements that will stand low enough so that the water line will be 18 inches or more below the lowest point of the steam mains.

The boiler should be placed on a solid foundation and as close as possible to the flues.

The proper size of coal to use in a given size of steam boiler is a very important factor to its successful operation. As a rule the best results have been obtained by the use of range or stove coal in

round boilers or heaters. For rectangular steam boilers good results have been obtained by the use of stove coal for the smaller sizes and egg coal for the larger ones. If bituminous or soft coal be

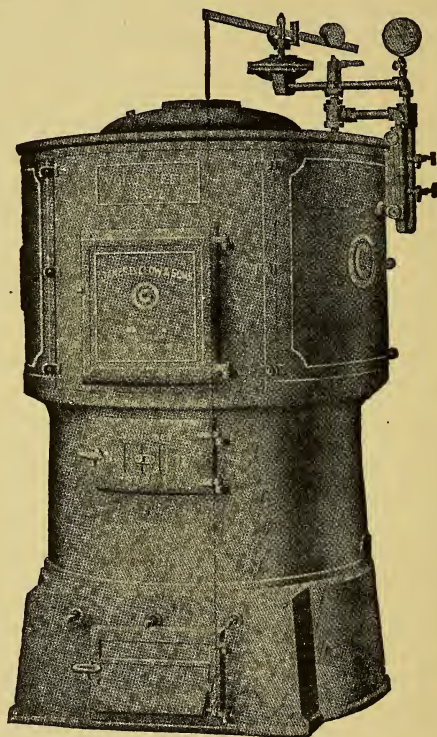

Fig. 1.

used instead of anthracite or hard coal, a boiler at least one size larger should be installed.

Round Steam Boilers. The boiler shown in Fig. 1 is entirely of cast iron construction, so arranged

as to amply provide for expansion and contraction. The only joints or connections are formed of heavy cast iron threaded nipples, making a perfect joint, with no possibility of leaks from any cause whatsoever and absolute freedom from all necessity of packing of any kind. The general construction of both steam boilers is as follows:

The circular base, or ashpit, which also forms the support for the grate, is substantially made of cast iron and gives a safe depth for accumulation of ashes. Resting on this is the firepot section, shown in Fig. 2. This section, being one complete casting in itself, and tested under heavy pressure before leaving the shop, is absolutely free from mechanical imperfections. In the center of the top of this section is a large opening, threaded to receive a nipple, which connects it with a closed section, shown in the right hand upper view, Fig. 2. This first, or intermediate section, is of less diameter than the top of the firepot section. On top of this closed, or intermediate section and attached to it in the same manner, as described for the connection of the firepot, there is an open section shown in the right hand upper view, Fig. 2, which is of the same diameter as the top of the firepot and entirely fills the jacket casings hereinafter described. On top of this is placed another closed section, and on top of this again comes the top section, which is either the steam dome, forming the steam boiler,

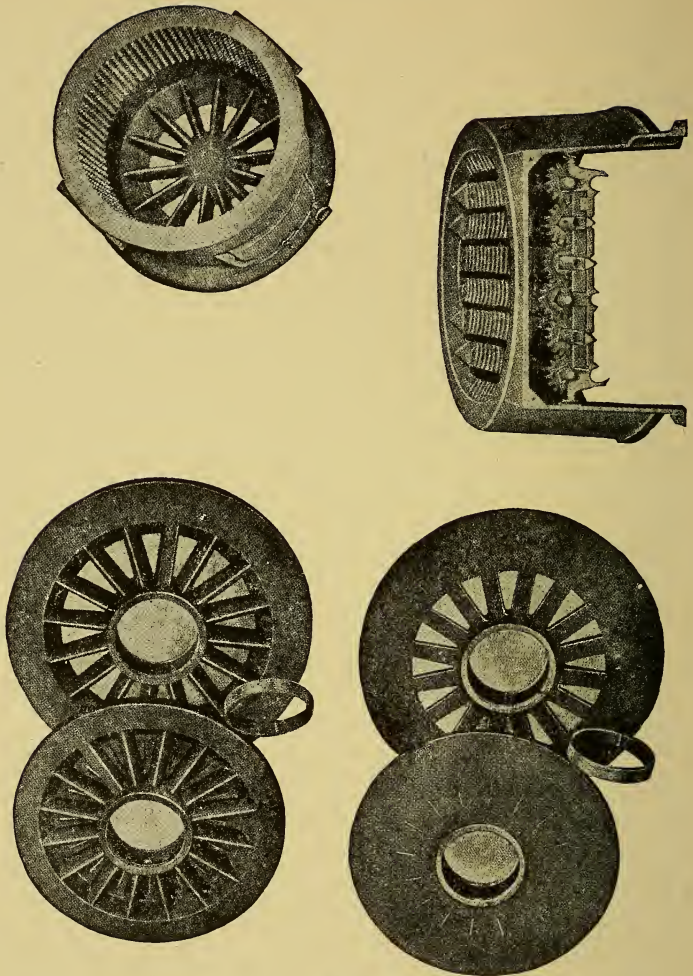

Fig. 2.

or the upper water section, forming the water heater, all connected together in the manner de-

scribed, with screw nipples, the top section, or dome, having the necessary tappings for the supply outlets for steam, or the flow outlets for water.

Casings. Extending from the outer edge of the top of the firepot section to the top of the upper section, or dome, there are cast iron casings, closely fitted joints. These casings are made in segments and are interchangeable and easily applied, with no possibility of rusting, wearing out or breaking. They form in themselves a perfect chamber for the retention of products of combustion, compelling these to follow such channels as will give best results.

Firepot. The firepot is circular in form, entirely surrounded by water, is made in one perfect casting, and free from any possible chance of leakages. The inner surface of the firepot has projecting into it all around the sides a multiplicity of iron points, just long enough to prevent the water contact from chilling the fire and making it possible to secure perfect combustion and a uniform fire around the edges as well as in the center. The firepots are of sufficient depth to insure a deep, slow fire, forming the best and most economical heat-producing proposition for low pressure heating.

Grate. The grate is of the triangular form and is at all times easily operated, and in its operation it pulverizes all clinkers before depositing in ash pit.

On all the larger size boilers the grates are fitted with a heavy bearing bar in the center, thus prolonging the life of the grate bars, as it prevents their warping.

Simplicity of the Grates. The construction of the grate is exceedingly simple, and admits of any one bar of the whole grate being changed without the assistance of skilled labor.

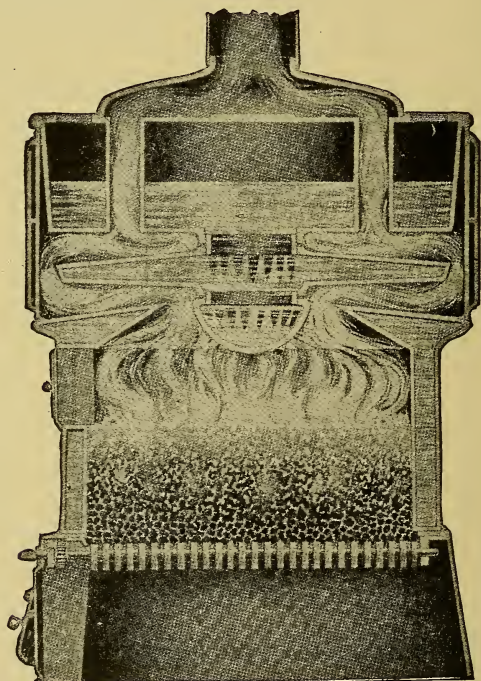

Fig. 3.

Fig. 3 shows a vertical cross-section of a steam boiler.

Rectangular Sectional Boilers. The vertical sectional type of steam boiler has been on the market and in all forms for a number of years. There are no new ideas that can be safely exploited in this line. The demand is for a simple, practical, easily handled device that will absolutely endure the work appropriated for it.

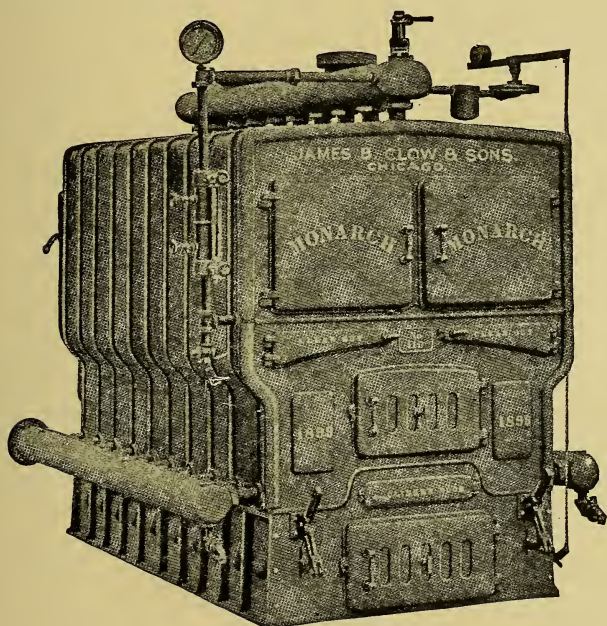

Fig. 4.

The boiler shown in Fig. 4 is strong, of good appearance, thoroughly accessible for cleaning, and, so far as can be determined from exterior appearances, a most satisfactory heater. The good opin-

ion already formed of the heater is further strengthened by reference to views of the intermediate and rear sections shown in Figs. 5 and 6. By reference to these cuts it will be seen that every possible advantage is taken of the fire surface, it being the belief that, unless great good is

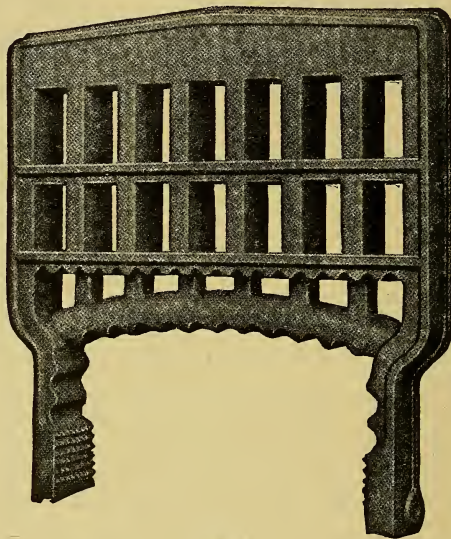

Fig. 5.

accomplished in direct contact with the fire, there will be but little assistance obtained from the flues.

Firepots. Firepots of the type of heaters are deep—to give a compact body of fire, and, besides, are covered with numbers of iron projections to prevent chilling contact of the fire with the ex-

posed water surface and yet secure such perfect combustion as will quickly impart to the water the heat from the fuel and permit of maintaining at all times a clear, even fire in every portion of the firepot.

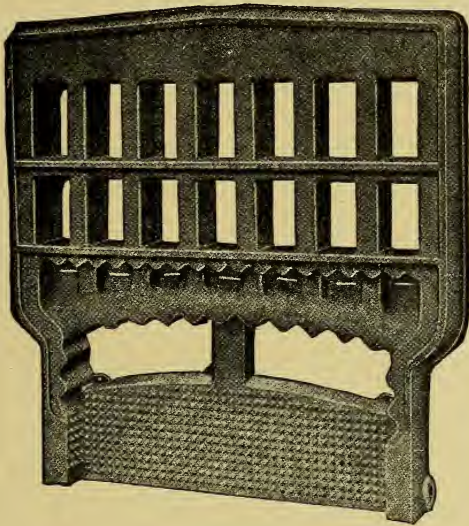

Fig. 6.

Boiler capacity. The capacity of the boiler should be at least 20 per cent in excess of the total duty imposed upon it by the radiation and pipe system.

Example: Let 600 square feet equal the total radiation, plus 25 per cent for the surface of the mains, plus 20 per cent excess boiler capacity, which is 900 square feet, the capacity of the boiler

required. The same result may be arrived at by adding 50 per cent to the radiation.

When direct-indirect radiation is used, an ad-

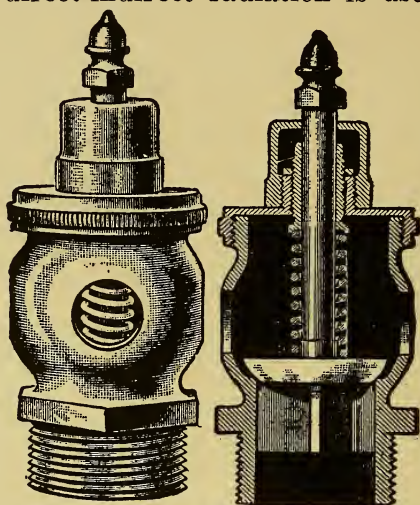

Fig. 7.

ditional $33 \frac{1}{3}$ per cent must be allowed, and when indirect radiation is used, add 50 per cent.

Example:

Total direct radiation	=	450	sq. ft.
One direct-indirect radiator	=	60	“ “
One indirect radiator	=	190	“ “
		600	“ “
25 per cent for surface of mains	=	112.5	“ “
$33 \frac{1}{3}$ per cent on direct-indirect	=	20	“ “
50 per cent on indirect radiator	=	45	“ “
		777.5	“ “
20 per cent excess capacity	=	155.5	“ “
Boiler capacity	=	933	“ “

Safety Valves. While not an absolute necessity, some form of low-pressure safety valve is generally used on the steam boiler of a low-pressure heating plant. Forms of low-pressure safety

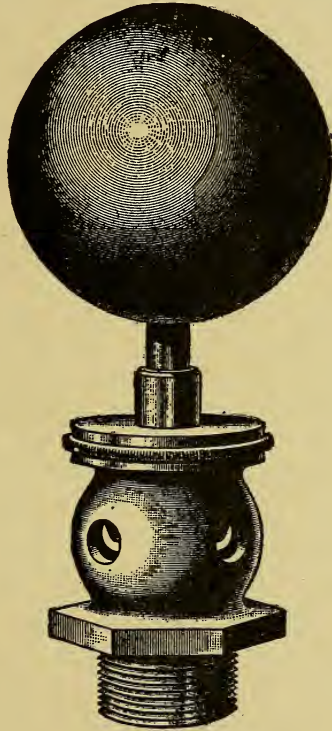

Fig. 8.

valves are shown in Figs. 7 and 8, the one shown in Fig. 7 is spring controlled and capable of adjustment for different pressures, while that shown in Fig. 8 has a ball weight instead of a spring

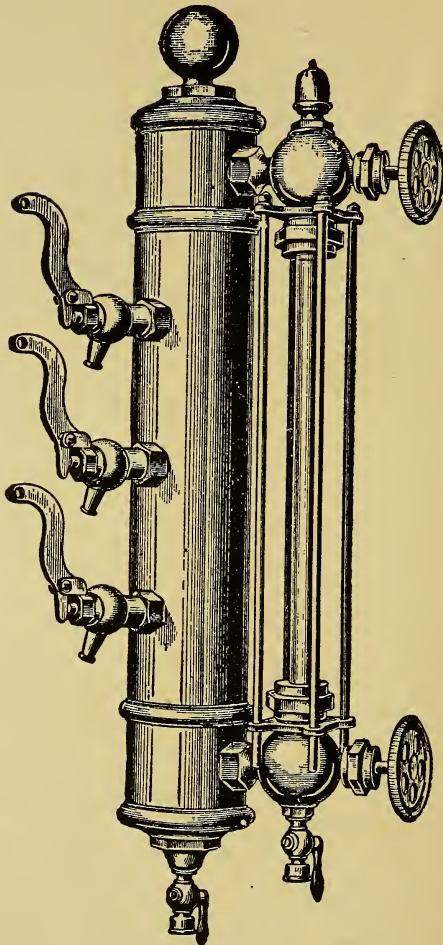

Fig. 9.

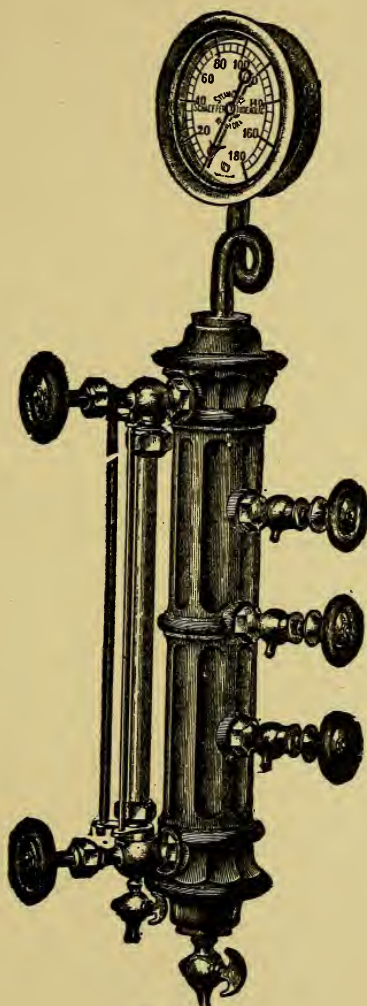

Fig. 10.

and is consequently non-adjustable except by changing the weight.

Water Column. Every steam boiler should be equipped with a water column with water gauge and try-cocks as shown in Fig. 9. A combination water column is shown in Fig. 10, with steam gauge on the top of the column.

Damper Regulator. While an automatic damper regulator is not as essential to a water heater as to a steam boiler, it is a very useful device, and when used prevents overheating and occasions great economy in fuel. An automatic regulator for a steam boiler is shown in Fig. 11. Check draft

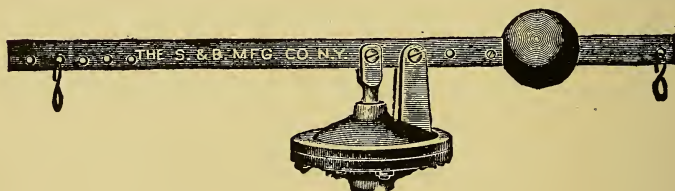

Fig. 11.

dampers, which are controlled by automatic regulators, are shown in Fig. 12.

The damper regulator consists of a hollow bowl formed by two castings bolted together, with a rubber diaphragm between them, the lower casting being connected to the steam space of the boiler by means of a short nipple. Through an opening in the top of the upper casting a plunger works, and across this plunger and connected to an upright lip on the edge of the diaphragm cast-

ing is a bar, from the ends of which chains connect to the draft door and check damper door of the boiler.

As the steam pressure rises, the pressure against the under side of the rubber diaphragm is transmitted to the plunger which is raised,

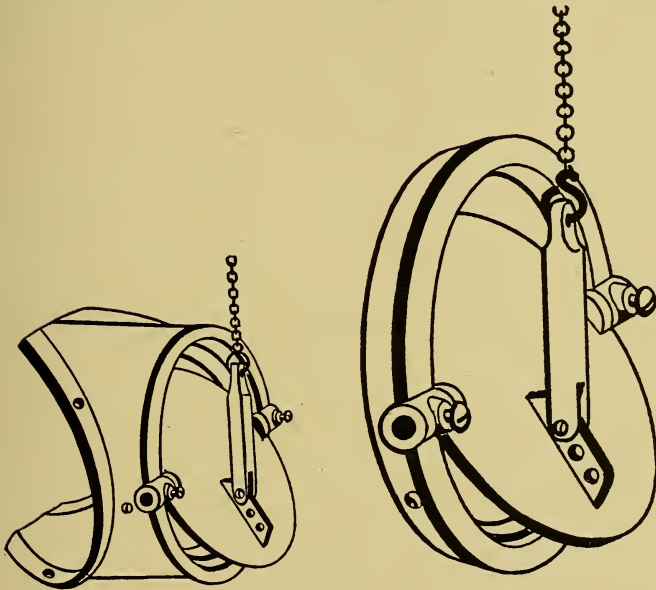

Fig. 12.

thereby operating the rod or lever, and the chains connecting with the draft and check damper doors. The sliding weight usually on the rod may be set so that the leverage may be smaller or greater, according to the pressure of steam carried on the apparatus, before the operation of

the doors will take place. By means of the damper regulator the rise and fall of temperature in the boiler may so regulate the draft that an even temperature may be obtained.

The chains should be so set that the draft door and check draft will each be closed when the regulator lever is level, and there is no steam in the boiler.

Pressure Gauges. The hollow spring in the gauge, shown in Fig. 13, is so shaped and arranged

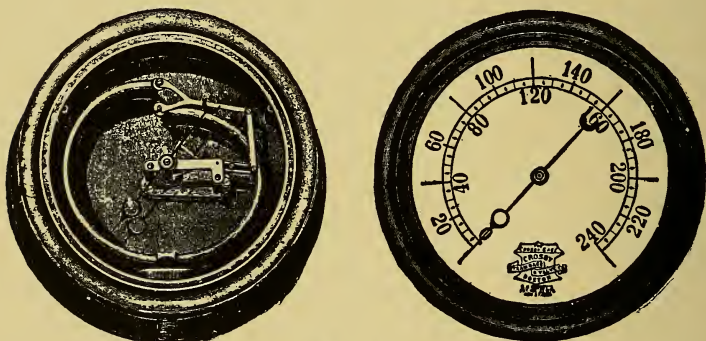

Fig. 13.

and the mechanism is such that the vertical as well as the horizontal movement of its free ends is fully utilized. It thereby permits the use of springs 100 per cent stronger than can be used in any other gauge, so preventing their settling under any pressure which may be indicated upon its dial.

The gauge shown in Fig. 14 may be used for

indicating either pressure or vacuum, as the case may be. It is graduated for pressure in pounds per square inch, and for vacuum in inches of mercury in column or pounds per square inch, as may be desired.

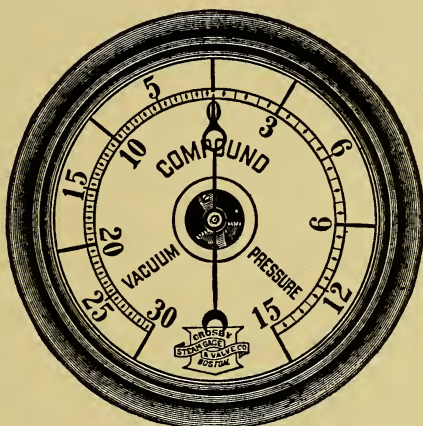

Fig. 14.

Smoke Pipes. Steam boiler smoke pipes range in size from about 8 inches in the smaller sizes to 10 or 12 inches in the larger ones. They are generally made of galvanized iron. The pipe should be carried to the chimney as directly as possible, avoiding bends, which increase the resistance and diminish the draft. When the draft is known to be good the smoke pipe may purposely be made longer to allow the gases to part with more of their heat before reaching the chim-

ney. Where a smoke pipe passes through a partition it should be protected by a double perforated metal collar at least 6 inches greater in diameter than the pipe.

The top of the smoke pipe should not be placed within 8 inches of exposed beams nor less than 6 inches under beams protected by asbestos or plaster. The connection between the smoke pipes and the chimney frequently becomes loose, allowing cold air to be drawn in, thus diminishing the draft. A collar to make the connection tight should be riveted to the pipe about 5 inches from the end, to prevent its being pushed too far into the flue.

Chimney Flues. Flues, if built of brick, should have walls 8 inches in thickness, unless terra cotta linings are used, when only 4 inches of brick work is required. Except in small houses, where an 8x8 flue may be used, the nominal size of the smoke flue should be at least 8x12, to allow a margin for possible contractions at offsets, or for a thick coating of mortar. A clean out door should be placed at the bottom. A square flue cannot be reckoned at its full area, as the corners are of little value. An 8x8 flue is practically very little more effective than one of circular form 8 inches in diameter. To avoid down drafts the top of the chimney should be carried above the highest point of the roof, unless provided with a suitable top or hood.

**Dimensions of Chimney Flues for Given Amounts of Direct
Steam Radiation**

Square Feet of Steam Radiation	Diameter of Round Flue	Square or Rectangular Flue
250	8 inches	8 in. x 8 in.
300	8 inches	8 in. x 8 in.
400	8 inches	8 in. x 8 in.
500	10 inches	8 in. x 12 in.
600	10 inches	8 in. x 12 in.
700	10 inches	8 in. x 12 in.
800	12 inches	12 in. x 12 in.
900	12 inches	12 in. x 12 in.
1000	12 inches	12 in. x 12 in.
1200	12 inches	12 in. x 12 in.
1400	14 inches	12 in. x 16 in.
1600	14 inches	12 in. x 16 in.
1800	14 inches	12 in. x 16 in.
2000	14 inches	12 in. x 16 in.
2200	16 inches	16 in. x 16 in.
3000	16 inches	16 in. x 16 in.
3500	18 inches	16 in. x 20 in.
5000	18 inches	16 in. x 20 in.

Fuel Combustion. Combustion is one form of chemical action, accompanied by the generation of heat. When such action takes place slowly the heat produced is almost imperceptible, but when it takes place rapidly, as in the burning of wood, coal, etc., the heat becomes intense. In the burning of ordinary fuel, the carbon and hydrogen of the coal combine with the oxygen of the air and produce combustion, without which no material results may be obtained from the fuel.

Combustion depends upon the presence of oxygen, without which it cannot take place.

Combustion is estimated by the number of pounds of fuel consumed per hour by one square foot of grate surface.

One square foot of grate will consume about 5 pounds of hard coal per hour, or about 10 pounds of soft coal, under a natural draft.

For $7\frac{1}{2}$ to 10 pounds of coal consumed, one cubic foot of water will be evaporated.

A fire of a depth of 12 inches will do more efficient work than one of less depth.

The use of too large coal is attended with large air spaces between the pieces, and this large amount of air is too great for the gases escaping from the combustion of the coal, allowing the gases to escape into the chimney flue unburned.

The use of too small coal is not advisable, as it packs down so compactly as to prevent the admission of the proper amount of air through the grate to produce good combustion.

Pipe Systems. The three systems of heating described: The direct, indirect and direct-indirect radiation, are governed by the same rules in the matter of piping and steam supply, requiring only special rules for proportioning the amount of heating surface and for the arrangement of air supply. There are the one-pipe and two-pipe systems, with several forms and combinations of each, and for the steam supply there are high and low-pressure systems, exhaust systems, gravity systems and vacuum systems.

The essentials of a heating system are: A source of steam supply, a system of piping to conduct the steam from the source of supply to the radiators, a series of radiators or radiating surfaces, a system of return pipes through which the condensed water from the radiators may be removed.

It may be more briefly stated that the prime requisites for a steam heating system are: The source of steam supply, the radiating surface and a system of pipes connecting them. Should, however, the supply and return pipes be embodied in the same system, it is just as important to arrange to dispose of the condensed water as it is to supply steam to the radiators.

One-pipe System. The simplest form of steam heating system is known as the one-pipe gravity return system. The steam is generated in the

boiler, flows through the pipes to the radiators, the condensed water as it is formed in the radiators draining out along the bottom of the pipes and back to the boiler by gravity, to be re-evapor-

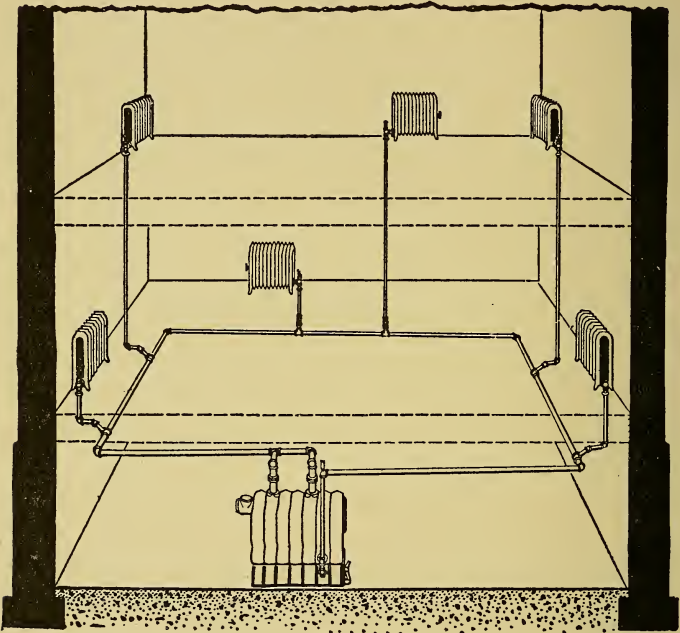

Fig. 15.

ated into steam. This system may be used only in a very small plant, and one in which the pipes should be made of large size and given a very decided pitch toward the boiler.

One-pipe System With Separate Return. In the system shown in Fig. 15 the main in the base-

ment is pitched so as to drain away from the boiler, and at its end a return pipe is connected and led back to the boiler, entering it below the water-line. In this manner the flow of the steam and the water of condensation is in the same direction in the mains, and upon the sudden condensation of steam, as occurs when turning steam into a cold radiator, the water falls down the risers against the current of steam, while in the main it is forced along in the same direction as the steam. If the mains are extensive they may be drained at different points. This system is extensively used for residences and buildings of only a few stories in height, and it has also been used in larger installations. In such a plant the risers as well as the mains must be of ample size, and the latter must have sufficient pitch and be thoroughly drained.

One-pipe Overhead System. This is the only system of single-pipe connection which is extensively used in high buildings, such as the modern office building, and is shown in Fig. 16. In this system the steam is conducted through a large main supply pipe to the attic of the building, or to the ceiling of the top floor, and from this the mains extend around the building to supply the risers. The risers are connected with the return mains in the basement. In this system the flow of steam and condensed water is everywhere in the same direction except in the connections to the

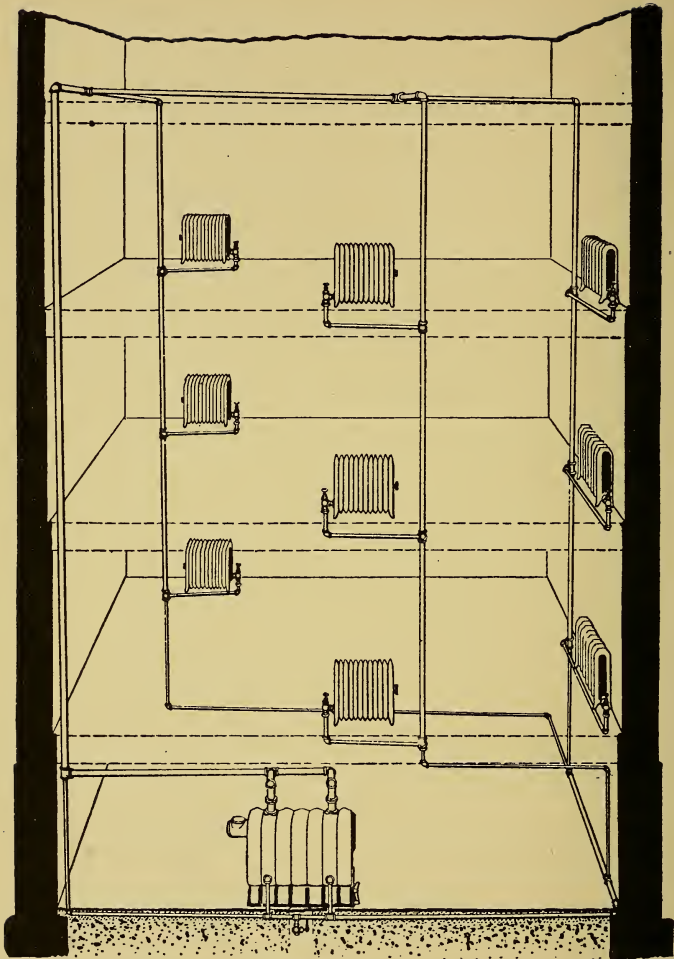

Fig. 16.

radiators, and the risers should be so arranged that these connections may be comparatively

short. This system has the very decided advantage over the ordinary one-pipe system that the condensed water which falls down the risers from the radiators does not, when it reaches the horizontal pipe at the bottom come into contact with the main current of steam, as the horizontal pipe is only a drain in which there is practically no steam and which is intended solely for the purpose of draining of the condensed water.

Two-pipe System. The two-pipe system is illustrated in Fig. 17 is much the same in all cases, but special adaptations of it are sometimes made to meet special conditions. There is a two-pipe overhead system in which steam mains are in the attic as well as in the one-pipe overhead, but there a separate set of return risers are provided which connect with the return in the basement. This system has been very little used.

The One-pipe Circuit Steam Heating System. In this system the steam pipe is run from the boiler vertically to the ceiling of the basement, from which point it pitches downward throughout its course around the cellar or basement, to a point at or near the rear of the boiler, where an automatic air vent is placed, and drop made with a pipe into the return opening of the boiler.

The one-pipe circuit system is used in buildings which are square or rectangular in shape.

When the building is of such shape that a one-pipe circuit will not do the work to advantage,

that is to say, in long buildings, where the boiler is set at or about the middle of the building, it is then desirable to run a loop in either direction.

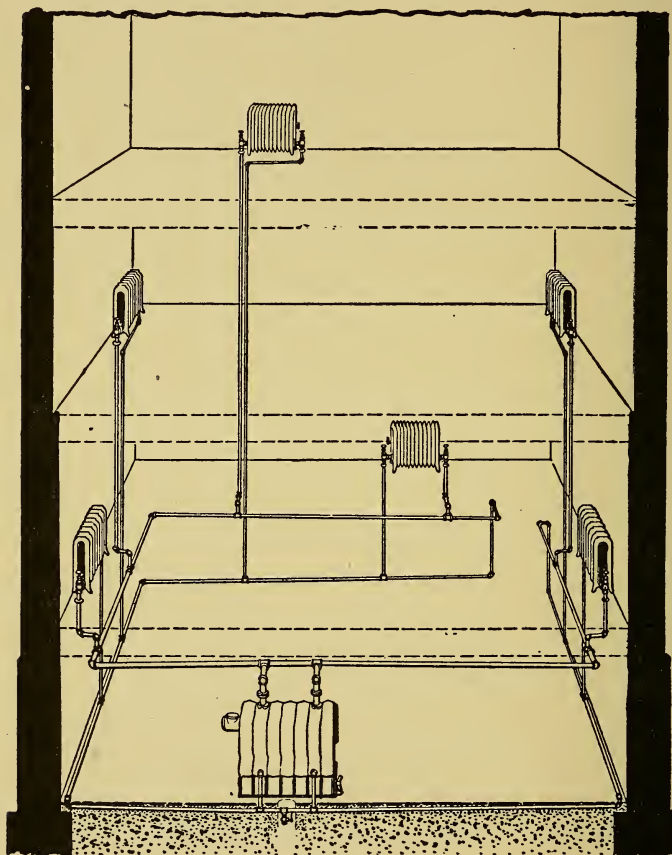

Fig. 17.

The Overhead Steam Heating System. In this system the feed pipe is carried vertically to the

ceiling of the top floor, or into the attic, and from this point branches are carried down to the different radiators.

This system is used in office buildings, school houses, factories, and often in residences, when a main can be carried up into an attic. Frequently, owing to the absence of a basement under the building, it is necessary to use the overhead system to heat the radiators.

The return pipes should enter the top of the flow end of the radiator, and return out of the bottom of the return end.

Some radiators on the one-pipe system may be connected as single pipe. Radiators on the overhead system may also be connected as on a one-pipe circuit system. Where this is done, the condensed water from the radiator returns into the drop or feed pipe.

Heating Surface. To estimate the amount of heating surface required to heat a room with steam to a temperature of 70 degrees Fahrenheit in zero weather with a steam pressure of from 2 to 3 pounds and ordinary conditions of exposure, the following rule is given, which is for direct radiation, and based upon the glass surface, exposed wall surface and cubic space:

1 square foot of radiation to 3 square feet of glass.

1 square foot of radiation to 10 square feet of wall exposed.

1 square foot of radiation to 150 cubic feet of space.

For each degree of temperature above or below zero, deduct from or add to $1\frac{1}{2}$ per cent of the radiation given by the above rule.

Example: Required the number of square feet of direct radiation for a room 10x10x10 feet, having two exposed sides and two windows $2\frac{1}{2}$ x6 feet.

Answer:

$$\begin{aligned} \text{Glass surface} &= 30 \text{ sq. ft.} \div 3 = 10 \text{ sq. ft.} \\ \text{Exposed walls} &= 200 \text{ " " } \div 10 = 20 \text{ " " } \\ \text{Cubic space} &= 1,000 \text{ cu. " } \div 150 = 6.6 \text{ " " } \\ \text{Total direct radiation} &= \underline{36.6} \text{ sq. ft.} \end{aligned}$$

Example: Required the number of square feet of direct radiation for the same room, with one exposed side and one window $2\frac{1}{2}$ x6 feet:

Answer:

$$\begin{aligned} \text{Glass surface} &= 15 \text{ sq. ft.} \div 3 = 5 \text{ sq. ft.} \\ \text{Exposed walls} &= 100 \text{ " " } \div 10 = 10 \text{ " " } \\ \text{Cubic space} &= 1,000 \text{ cu. " } \div 150 = 6.6 \text{ " " } \\ \text{Total direct radiation} &= \underline{21.6} \text{ sq. ft.} \end{aligned}$$

When indirect radiation is used, 50 per cent should be added to the above figures.

Reducing Size of Steam Mains. The proper reductions in the size of pipe depend on the character of the work to which the pipe is put.

It is customary to reduce the size of mains by

using reducing fittings tapped eccentric, or by using a reducing coupling tapped eccentric, the idea being to have a continuous fall of pipe without the formation of traps or obstructions for holding water at the points where reductions are made. It is customary to reduce the size of pipes for risers or radiator connections by using a reducing ell on the branch under the floor.

Eccentric fittings are so tapped as to bring the bottoms of the openings of different sizes at the same level on the fitting. When these fittings are used they allow a continuous fall of pipe without forming pockets for holding water at the points where reduction in size is made. This is of material benefit to a heating system.

Steam Mains. The proper size of steam mains for one and two-pipe systems are given in the accompanying tables:

Proper Size of Steam Mains:								
ONE PIPE SYSTEM								
Pipe Size in Inches	2	2½	3	3½	4	4½	5	6
Sq. feet of Radiation	200 to 350	350 to 500	500 to 750	750 to 1000	1000 to 1500	1500 to 1800	1800 to 2200	2200 to 3000
TWO PIPE SYSTEM								
Pipe Size in Inches	2	2½	3	3½	4	4½	5	6
Sq. feet of Radiation	500	750	1000	1500	2000	2500	3000	4000

RADIATION.

Direct Radiation. This consists of a heating surface in the form of a radiator or coil, which is placed directly in the room to be heated.

Indirect Radiation. Radiators in the room to be heated on the first or second floor are located in the cellar or basement, usually directly under the rooms to be heated. There is placed in the floor of the room to be heated, or in the side wall above the baseboard, a register and connection is made between this register and the radiator in the basement by means of tin or sheet iron pipe, for conveying the heated air into the room.

The indirect radiator is placed in a chamber into which fresh air is conveyed from outside, and to which the hot air flue to the register is connected.

The distance from the top of the radiator to the ceiling of the casing should be from 10 to 12 inches and from the bottom of the radiator to the bottom of the casing from 6 to 8 inches. The dimensions of the cold air inlet should be $1\frac{1}{2}$ square inches for each square foot of indirect radiation. The warm air outlet should be 2 square inches for each square foot of indirect radiation, which would be for a radiator containing 100 square feet of

radiation, 200 square inches of cross sectional area, or a duct 10x20 inches. The dimensions of the warm air register should be 50 per cent larger than those of the warm air duct, which allows for the contracted area caused by the register face. A warm air duct having 200 square inches of cross sectional area should have a register approximating 300 square inches.

Direct-Indirect Radiation. This system serves a double purpose, that of Direct Radiation and Ventilation, and is also placed in the room to be heated under windows, or close to the exposed walls.

The lower front part of the radiator is encased, having an opening at the bottom or back of the base for the introduction of cold air by means of a duct through the outside wall of the building.

On account of the cooling effect of the outside air passage between the coils of the radiator, increased heating surface to the amount of $33\frac{1}{3}$ per cent must be added to make it equivalent to direct radiation.

This system of radiation is seldom used in the heating of houses, being more necessary where ventilation is required in the heating of public buildings and schools.

Instead of placing all of the radiators at one point, it is well to divide it into two or more radiators, according to the size of the room. As heating with steam or hot water is accomplished by the

turning or circulation of the air in the room, it is well to divide and place the radiation at the most exposed points, in order to better heat the room.

In small houses a radiator placed in the lower hall, if sufficiently large, will heat the hall above, but in large buildings, where the hall space is large, the upper halls should have radiators placed in them.

A properly installed steam heating plant should be noiseless in operation and heat the rooms to 70 degrees in zero weather on from 2 to 3 pounds steam pressure, and show a circulation of steam throughout the system on a pressure of 1 pound, as indicated by the steam gauge.

A noiseless circulation in all radiators on a pound of steam or less indicates that the pipe system is of proper size and properly pitched, thereby avoiding low places, causing water pockets or traps. The proper heating of the rooms in which the radiation is placed on from 1 to 3 pounds steam pressure indicates that the heating surface or radiation is sufficient.

Radiators. Heating surfaces are divided into three classes: Direct radiation, Indirect radiation and Direct-indirect radiation.

Direct radiation covers all radiators placed within a room or building to warm the air, and are not connected with a system of ventilation.

The best place within a room to place a single radiator, is where the air is cooled, before or under

the windows, or on the outside walls. When the radiator is of vertical tube, or a short coil, which can occupy only the space under one window, and when, as often occurs, there are three windows, the riser should be so placed as to bring the line of radiators in front of, and under the windows where they will do the most good. When a small extra cost is not considered, to use two radiators and place one in front of each of the extreme windows.

When the room is large and has many windows, the heating surface, when composed of radiators, should be divided into as many units as possible.

Indirect radiation embraces all heating surfaces placed outside the rooms to be heated, and can only be used in connection with some system of ventilation.

All the heating surface is placed in a chamber, and the warmed air distributed through air ducts.

Figs. 18, 19 and 20 show two, three and four column forms of direct radiators, and Fig. 21 a two-piece hall or window direct radiator.

The indirect radiator is usually boxed, either in wood lined with tin, or in galvanized iron. The former is best when the basement is to be kept cool, as there is a greater loss by radiation through metal cases, otherwise the sheet metal is the best, as it will not crack.

Indirect radiators are usually hung from the ceiling in the basement under the rooms they are

intended to heat. A cold air duct is carried from an opening in the outside wall to the stack box.

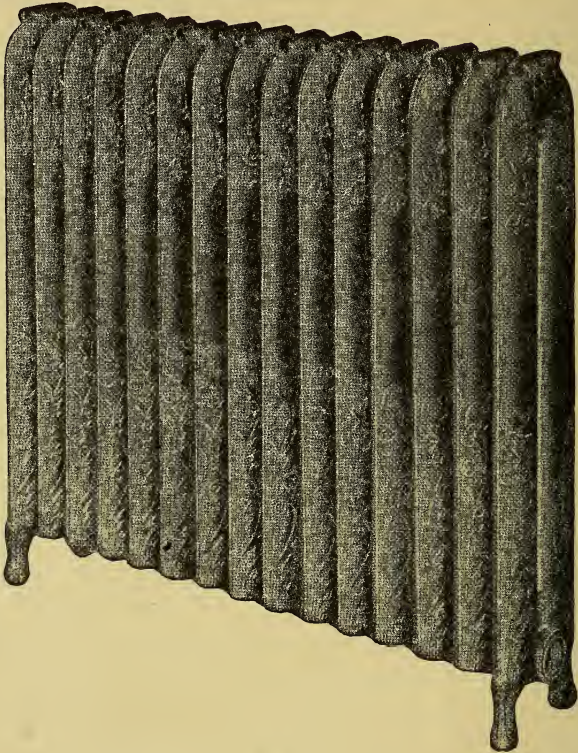

Fig. 18.

This duct must be provided with a damper, and its inlet covered on the face of the outside of the wall with a wire screen of small mesh.

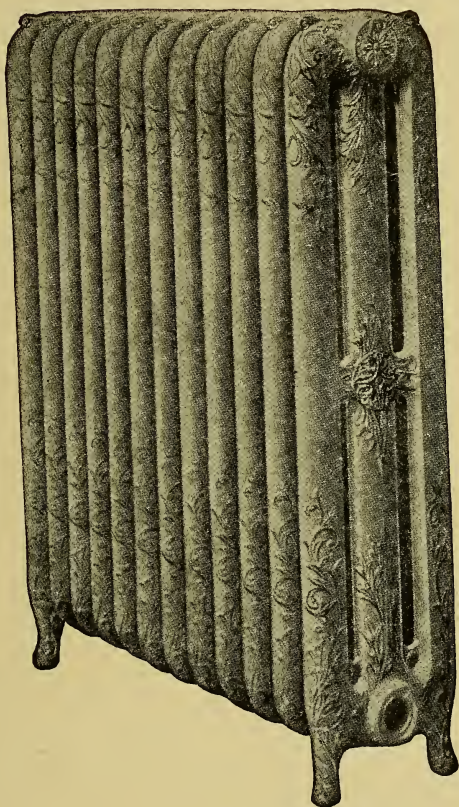

Fig. 19.

The box inclosing the radiator shown in Figs. 22 and 23 is made of wood lined with bright tin about half-way down. The sides of the box should

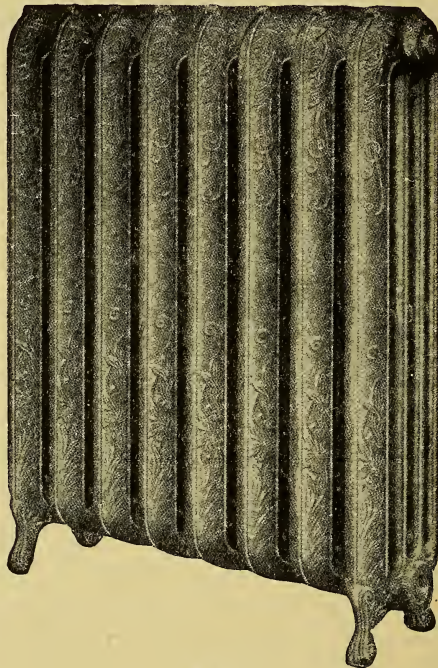

Fig. 20.

almost touch the hubs of the radiator on both ends, so that the cold air coming in through the duct will surely find its way up between the sections of the radiator, and not around the ends of it.

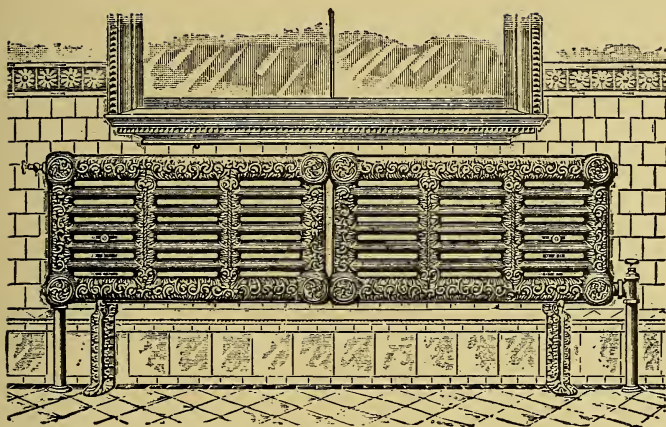

Fig. 21.

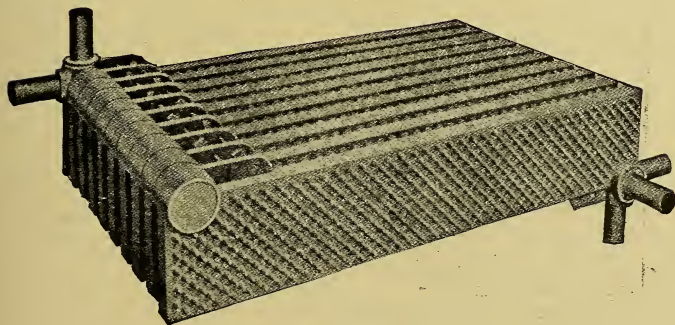

Fig. 22.

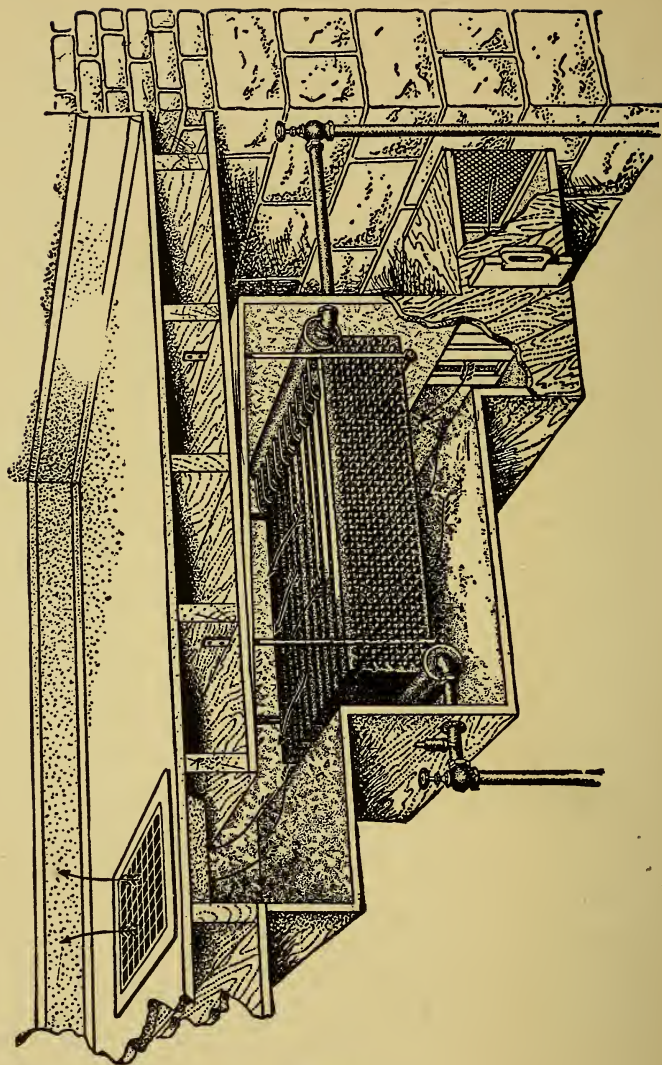

Fig. 23.

The radiator is shown connected for a two-pipe steam system.

The cold air duct is provided with a slide, so that the air may be shut off when it is not wanted, or when the radiator is turned off. The radiator

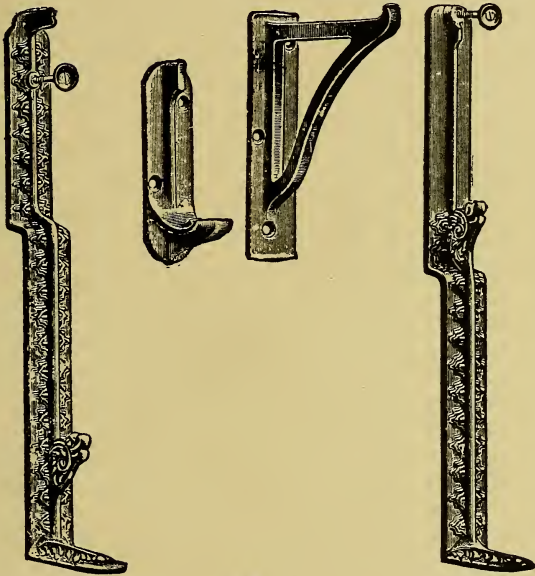

Fig. 24.

should be so hung in the box that the space above it is about one-third more than the space below; this provides for the expansion of the air after it has been warmed by contact with the radiator.

Brackets for supporting the hall or window types of direct radiator are shown in Fig. 24.

A direct-indirect form of radiator is illustrated in Fig. 25, in which the air is taken from the outside of the room to be heated and passes up between the sections of the radiator as shown, the front of the radiator being encased.

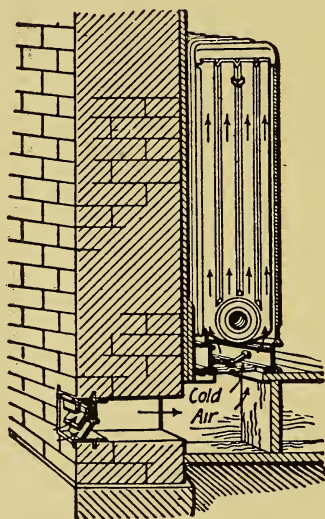

Fig. 25.

TWO COLUMN RADIATOR FOR STEAM OR HOT
WATER HEATING.

No. of Sec- tions.	Length in Inches.	SQUARE FEET OF HEATING SURFACE.					
		45 Inches High.	38 Inches High.	32 Inches High.	26 Inches High.	23 Inches High.	20 Inches High.
2	5	10	8	$6\frac{2}{3}$	$5\frac{1}{3}$	$4\frac{2}{3}$	4
3	$7\frac{1}{2}$	15	12	10	8	7	6
4	10	20	16	$13\frac{1}{3}$	$10\frac{2}{3}$	$9\frac{1}{3}$	8
5	$12\frac{1}{2}$	25	20	$16\frac{2}{3}$	$13\frac{1}{3}$	$11\frac{2}{3}$	10
6	15	30	24	20	16	14	12
7	$17\frac{1}{2}$	35	28	$23\frac{1}{3}$	$18\frac{2}{3}$	$16\frac{1}{3}$	14
8	20	40	32	$26\frac{2}{3}$	$21\frac{1}{3}$	$18\frac{2}{3}$	16
9	$22\frac{1}{2}$	45	36	30	24	21	18
10	25	50	40	$33\frac{1}{3}$	$26\frac{2}{3}$	$23\frac{1}{3}$	20
11	$27\frac{1}{2}$	55	44	$36\frac{2}{3}$	$29\frac{1}{3}$	$25\frac{2}{3}$	22
12	30	60	48	40	32	28	24
13	$32\frac{1}{2}$	65	52	$43\frac{1}{3}$	$34\frac{2}{3}$	$30\frac{1}{3}$	26
14	35	70	56	$46\frac{2}{3}$	$37\frac{1}{3}$	$32\frac{2}{3}$	28
15	$37\frac{1}{2}$	75	60	50	40	35	30
16	40	80	64	$53\frac{1}{3}$	$42\frac{2}{3}$	$37\frac{1}{3}$	32
17	$42\frac{1}{2}$	85	68	$56\frac{2}{3}$	$45\frac{1}{3}$	$39\frac{2}{3}$	34
18	45	90	72	60	48	42	36
19	$47\frac{1}{2}$	95	76	$63\frac{1}{3}$	$50\frac{2}{3}$	$44\frac{1}{3}$	38
20	50	100	80	$66\frac{2}{3}$	$53\frac{1}{3}$	$46\frac{2}{3}$	40

THREE-COLUMN RADIATOR FOR STEAM OR HOT
WATER HEATING.

Number of Sections.	Length in Inches.	SQUARE FEET OF HEATING SURFACE.			
		39 Inches High.	33 Inches High.	27 Inches High.	21 Inches High.
2	5	12	10 1-2	8 1-2	6 1-2
3	7 1-2	18	15 3-4	12 3-4	9 3-4
4	10	24	21	17	13
5	12 1-2	30	26 1-4	21 1-4	16 1-4
6	15	36	31 1-2	25 1-2	19 1-2
7	17 1-2	42	36 3-4	29 3-8	22 3-4
8	20	48	42	34	26
9	22 1-2	54	47 1-4	38 1-4	29 1-4
10	25	60	52 1-2	42 1-2	32 1-2
11	27 1-2	66	57 3-4	46 3-4	35 3-4
12	30	72	63	51	39
13	32 1-2	78	68 1-4	55 1-4	42 1-4
14	35	84	73 1-2	59 1-2	45 1-2
15	37 1-2	90	78 3-4	63 3-4	48 3-4
16	40	96	84	68	52
17	42 1-2	102	89 1-4	72 1-4	55 1-4
18	45	108	94 1-2	76 1-2	58 1-2
19	47 1-2	114	99 3-4	80 3-4	61 3-4
20	50	120	105	85	65

FOUR-COLUMN RADIATOR FOR STEAM OR HOT
WATER HEATING.

Number of Sections.	Length in Inches.	SQUARE FEET OF HEATING SURFACE.				
		42 1-2 Inches High.	38 1-2 Inches High.	32 1-2 Inches High.	26 1-2 Inches High.	20 1-2 Inches High.
2	8 1-2	19 1-3	16	13 1-3	10 2-3	8
3	12 1-2	29	24	20	16	12
4	16 1-2	38 2-3	32	26 2-3	21 1-3	16
5	20 3-4	48 1-3	40	33 1-3	26 2-3	20
6	24 3-4	58	48	40	32	24
7	28 3-4	67 3-3	56	46 2-3	37 1-3	28
8	32 3-4	77 1-3	64	53 1-3	42 2-3	32
9	37	87	72	60	48	36
10	41	96 2-3	80	66 2-3	53 1-3	40
11	45	106 1-3	88	73 1-3	58 2-3	44
12	49	116	96	80	64	48
13	53	125 2-3	104	86 2-3	69 1-3	52
14	57 1-2	135 1-3	112	93 1-3	74 2-3	56
15	61 1-2	145	120	100	80	60
16	65 1-2	154 2-3	128	106 2-3	85 1-3	64
17	69 1-2	164 1-3	136	113 1-3	90 2-3	68
18	73 3-4	172	144	120	96	72
19	77 3-4	183 2-3	152	126 2-3	101 1-3	76
20	82	193 1-3	160	133 1-3	106 2-3	80

Radiator Connections. Methods of connecting radiators used in steam heating plants are shown in Figs. 26 and 27.

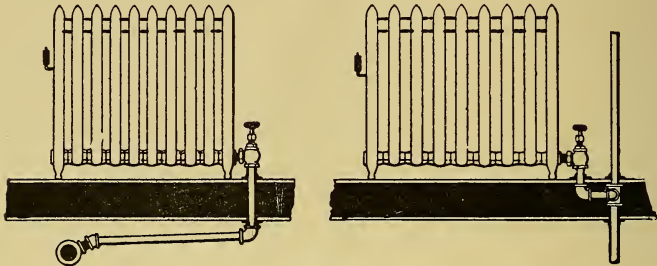

Fig. 26.

They should be made in such a manner as to allow for expansion and contraction in the branch

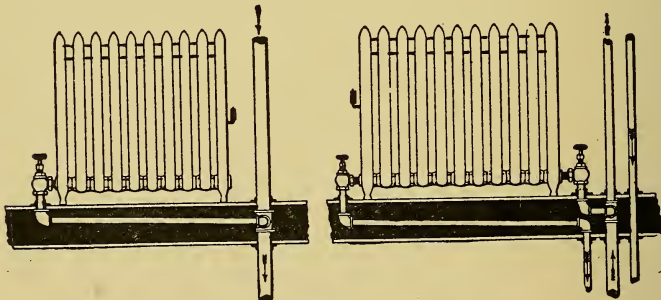

Fig. 27.

supply to the radiator. This provision is shown in the illustrations of radiator connections shown in Figs. 26 and 27.

When the overhead system is used, the radiators may be fed at the top of one end, and the return taken out of the bottom of the same or opposite end.

The circulation of water in either case is positive.

All radiator connections should be of sufficient area to give the best results.

Pipe Tap for Radiator Connections	
ONE PIPE SYSTEM	
Square Feet of Radiation	Size of Pipe Tap in Inches
20	1
25 to 50	1¼
50 to 75	1½
75 to 100	2
TWO PIPE SYSTEM—TWO TAPPINGS	
20	¾ x ¾
25 to 50	1 x ¾
50 to 75	1¼ x 1
75 to 150	1½ x 1¼

Air Valves. Automatic air valves have almost entirely superseded the use of hand operated air cocks. They are made with a composition disc, which is arranged to close the valve as soon as the hot steam comes in contact with it. They are pro-

vided with a screw attachment by which the valve opening can be adjusted after the valves are in place. The only disadvantage of the automatic air valve is that when steam is turned on, the entire radiator becomes heated. By means of the plain air cock the amount of the radiator heated can be regulated, especially when connected on a one-pipe system. The automatic air valve takes the circulation in the radiator entirely out of the hands of persons who are not acquainted with their principles, and in the case of indirect radiators is an absolute necessity.



Fig. 28.

Fig. 28 shows three forms of automatic air valves, and Figs. 29 and 30 four styles of hand operated air cocks.

Valves. Straightaway valves, commonly called quick-opening radiator valves, are best adapted to this work. Only one valve is used on a hot water radiator which is located in the supply pipe, as close to the radiator as possible. One valve is

used on a one-pipe steam system, and two on the two-pipe system. Valves should be used which have removable discs, such as the Jenkins disc valve. On one-pipe work the radiator valve should be placed on the flow pipe, and on two-pipe work on both flow and return pipes. To shut off a steam radiator the valve on the return should be closed

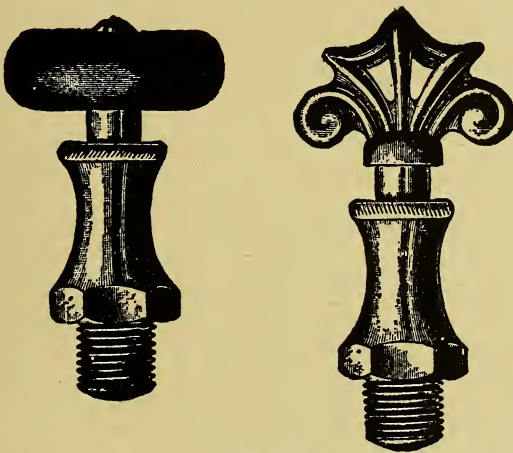

Fig. 29.

first, the supply valve last, and in all cases both valves should be entirely closed or entirely open. To turn on a steam radiator the supply valve should be opened first, then the valve on the return. The valves should be connected to close against the steam pressure, in order that the stuffing boxes may be packed or repacked while the

heating system is in operation. Gate valves should be used in the mains and risers for the reason that they have a full opening and do not impede the circulation.

Radiator Valves. The most commonly used form of radiator valve is the angle valve, with or without union connection, and with composition

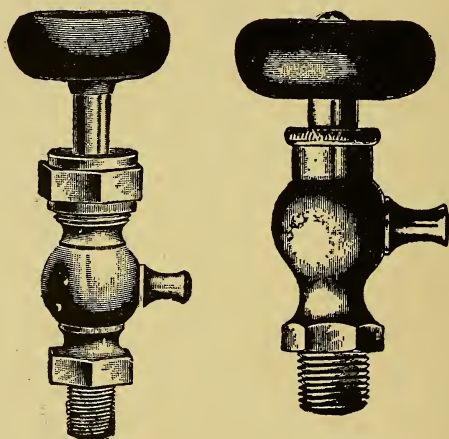

Fig. 30.

disc, wood wheel, rough body and nickel trimmings, as shown in Figs. 31 and 32.

Gate valves as shown in Fig. 33 are sometimes used when the radiator connections require them, especially on a down or overhead system of piping.

Angle valves with lock and shield as illustrated in Fig. 34 are much used in public buildings.

Globe valves if used in a steam heating system restrict the flow of both steam and condensed water. Their use should be avoided if possible.

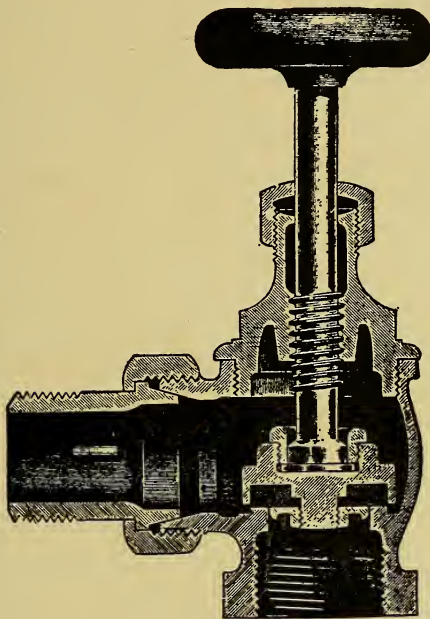

Fig. 31.

Figs. 35 and 36 show vertical cross-section and outside views of a globe valve.

Swing check valves should only be used on the main section of a two-pipe system, close to the boiler, or when the return is underground, to pre-

vent the boiler from being emptied from a leak or break in the return pipe.

An outside view and a vertical cross-section of a swing-check valve are shown in Fig. 37.

Corner radiator valves are generally used when



Fig. 32.

the radiator connections are above the floor line. Right and left-hand corner valves are shown in Fig. 38.

A brass plug-cock with square or flat head, as shown in Fig. 39, for blowing off the boiler, should always be installed either in the return pipe near

the boiler or in the boiler itself. It should not be directly connected with a pipe to the sewer, the end of the pipe should be in plain sight, so that

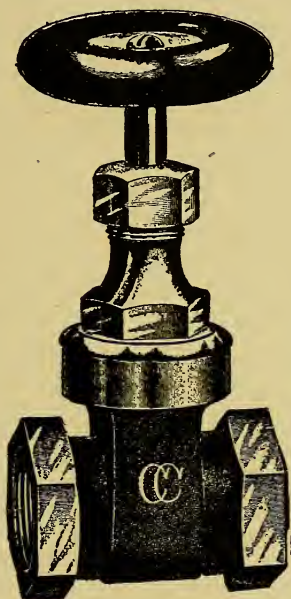

Fig. 33.

any leakage due to not closing the cock properly may be noticed.

Unsteady Water Line in Boiler. This trouble often results from grease in the boiler, the grease usually being present by reason of its use in the

construction of the piping and manufacture of the boiler and radiators. The grease rests on the sur-

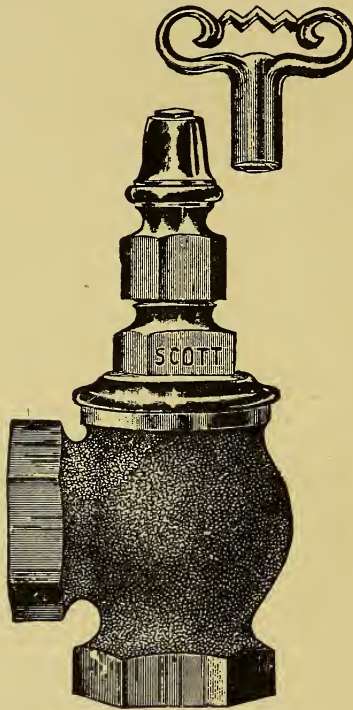

Fig. 34.

face of the water in the boiler, forming a scum, and when this occurs, the bubbles of air formed by the boiling water cannot reach the surface of the water

and burst off into steam. This causes a disturbance in the boiler, the bubbles seeking for an outlet naturally finding it in the connection to the water column, or gathering in such force under a

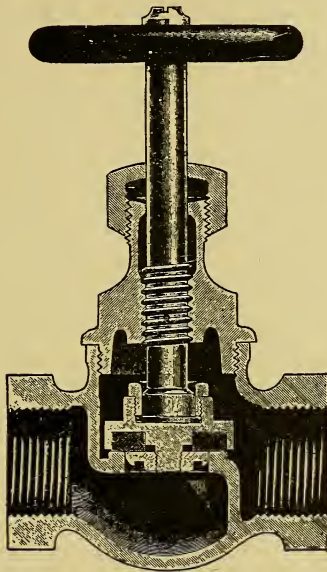

Fig. 35.

portion of the scum, that they break together, and with such force as to force water into the steam main, often causing a vacuum which will empty the water glass and water column connections entirely.

Blow the boiler off under pressure. This will usually remove most of the grease, if the unsteady line is due to grease. It may be necessary to repeat

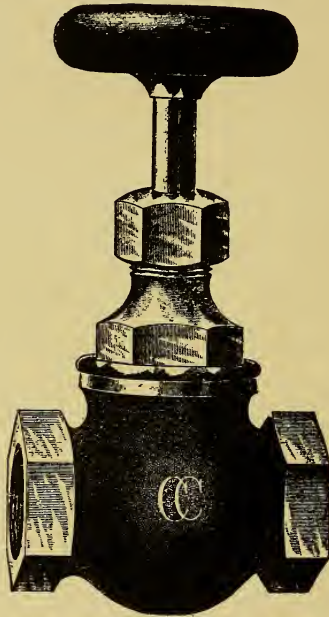

Fig. 36.

this operation several times, at intervals of a few days, before the boiler is entirely clean. If the cause be due to the construction of the boiler, it may be necessary to use an equalizing pipe, that is, to make a direct connection from an opening in

the top of the boiler to a return opening in the bottom of the boiler.

Starting a Steam Heating Plant. After all the connections are made, pack the radiator valves and attach the air valves. Fill the boiler to the water line and start the fire, allowing the entire system to fill with steam by opening all the valves. When the steam has blown freely out of all air valves,

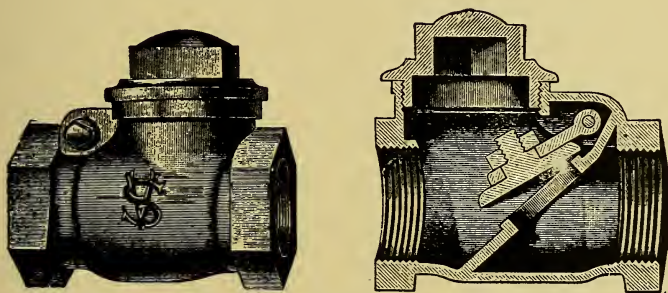

Fig. 37.

close the same, and if they are automatic adjust and regulate them, which may have to be repeated a number of times before they are in good working order. Carry the pressure of steam high enough so that the safety valve will blow off from 5 to 10 pounds. Inspect every portion of the system carefully, and if any leaks are found note the same and when the steam is down make the necessary re-

pairs. After the system is found tight, keep the boiler under fire several days, and then blow it off according to the following directions:

Close the main steam and return valves, or all

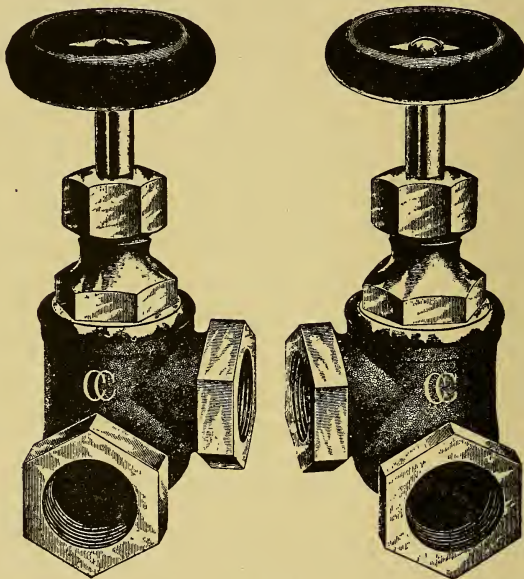

Fig. 38.

radiator valves. Make a good fire and get up a pressure of at least ten pounds. Open the blow-off valve, being careful that just enough fire is carried to maintain a pressure until the last gallon of water is blown out. Allow the fire to go out. Open

the fire and flue doors, and in about half an hour, close the blow-off valve, and refill boiler slowly to the water line, then open all radiator and main valves, and start the fire.

The boiler should be blown off within a week after it is installed and in operation.

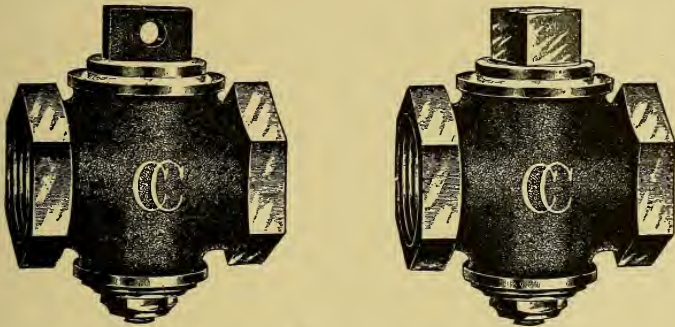

Fig. 39.

Steam Heating Plant. Figs. 40, 41 and 42 show the plans for a three-story and basement apartment building equipped with a one-pipe return system. The boiler, steam mains, piping to radiators and radiators are all plainly shown.

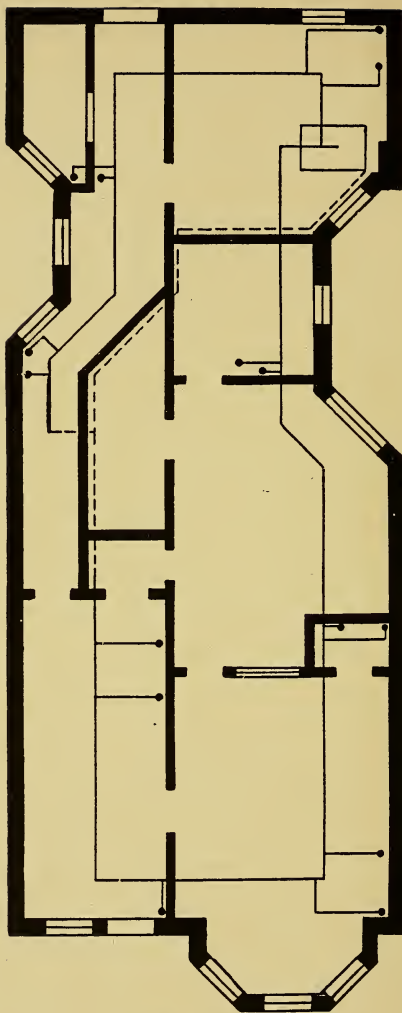

Fig. 40. Basement.

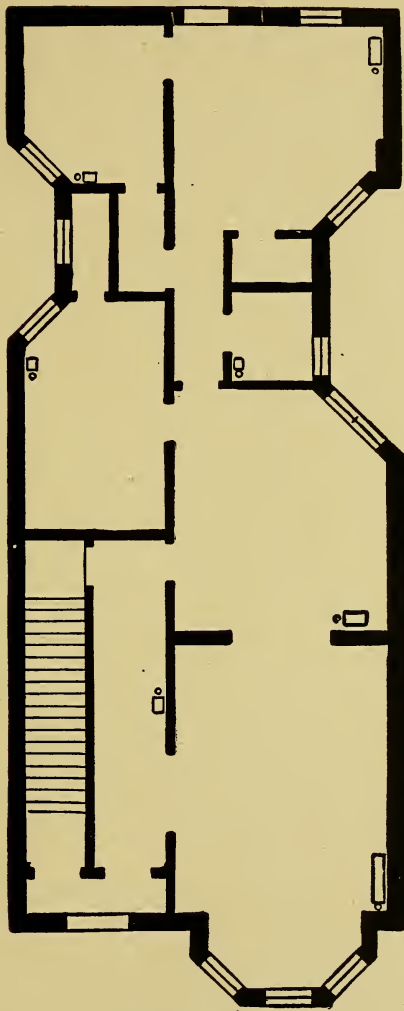

Fig. 41. First Story,

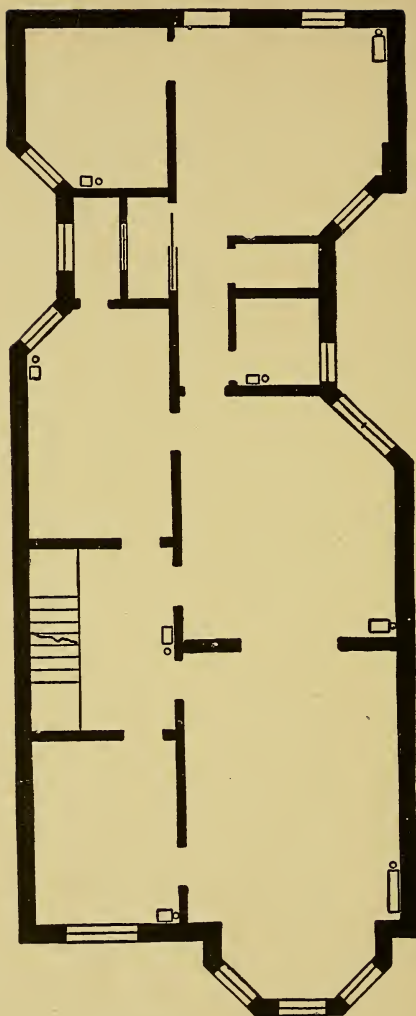

Fig. 42. Second and Third Story.

TEMPERATURE OF STEAM AT VARYING PRESSURES,
IN DEGREES FAHRENHEIT.

Gauge Pressure.	Absolute Pressure.	Temperature in Degr. Fahrenheit.
0	15	212
5	20	228
10	25	240
15	30	250
20	35	259
25	40	267
30	45	274
35	50	281
40	55	287
45	60	292
50	65	298
55	70	302
60	75	307
65	80	312
70	85	316
75	90	320
80	95	324
85	100	327
90	105	331
95	110	334
100	115	338
110	125	344
120	135	350
130	145	355
140	155	361
150	165	366

Estimating. Make a careful survey of the location, construction and exposure of the building to be heated, and take accurate measurements of the size of the glass surface and exposed walls of the rooms in which the radiators are to be placed.

Having ascertained the total amount of radiation, select a boiler having a rated capacity of 50 per cent in excess of the total radiation, which for the average system will allow for the duty imposed by the mains and provide a margin of 20 per cent.

Make a plan of the basement to scale, locate the boiler, and lay out the pipe system, putting down the size of the mains and the branches.

From the plan obtain the number of lineal feet of each size of pipe, including the risers, also the number and size of all fittings.

Allow one air valve for each radiator, and one for the end of the steam main.

The number and size of the floor and ceiling plates may be counted from the number and size of risers that will pass through the floors and the ceilings.

The length of pipe covering may be obtained from the size and number of lineal feet of pipe in the mains.

SPECIFICATION AND CONTRACT FOR A STEAM HEATING PLANT.

We hereby agree to furnish and install in your house, street, a Steam Heating Plant, under the conditions, and for the price hereinafter named, and in accordance with the following specifications:

Boilers. Furnish and set up in basement one No. — steam boiler, having a rated capacity of square feet, and provide same with a set of fire and cleaning tools.

Foundation. The owner is to provide a suitable brick or concrete foundation for the boiler.

Smoke Pipe. Connect the smoke collar of the boiler to the chimney flue by a-inch galvanized iron smoke pipe, provided with a choke damper.

Chimney. The owner is to provide a chimney flue of sufficient size and height to secure a proper draught.

Fittings. The steam main, risers and branches to the radiators to be of ample areas and properly graded and supported in basement by neat, strong hangers, secured to ceiling joists. All fittings to be of best grade cast iron, and reducing fittings to be used, not bushings.

F. & C. Plates. Where risers and radiator connections pass through floors and ceilings, protect the openings with neat bronzed or nickel-plated floor and ceiling plates.

Valves. Each radiator is to be furnished with a nickel-plated wood-wheel Disc Radiator Valve.

Air Vents. Each radiator to be provided with an automatic air valve.

HOT WATER HEATING.

The open tank, and the closed tank or pressure systems are in general use.

The open tank system is preferable to the closed tank system, as it may be more easily and safely operated.

In the open tank system a vent pipe is carried from the expansion tank through the roof or side of the building open to the atmosphere. The closed tank system is not vented, and is therefore under pressure and requires a safety valve.

In the closed tank system the water may be heated to a temperature above 212 degrees, the boiling point of the open tank system.

A safety valve should be placed on the expansion tank, with a pipe running from the open side of the valve to a sink or drain, in order that when sufficient pressure is raised to operate the valve, any overflow of water may be carried off without injury to the building.

Ten pounds is the proper pressure at which the safety valve should work on the closed tank system.

The piping for the closed tank or high pressure system may be somewhat smaller than for the open tank or low pressure system, but the piping should

be run and the connections taken off in the same manner for each system.

The mains should be pitched 1 inch for each 10 feet of length.

The mains in a hot water system should not be reduced too rapidly as branches are taken off, as the greater amount of friction in the smaller sizes of pipe will cause trouble.

Radiators may be heated by hot water on the same level as the boiler, or below it.

Under these conditions the circulation results from the weight of water above the low radiators. This depends on the fact that a column of water 2.32 feet in height will produce about 1 pound of pressure.

This may be done by carrying the flow pipe up so as to get a pressure from the weight of water above, to produce circulation.

A hot water system should be filled from the lowest point if possible, for the reason that the water will drive the air out of the system as it rises.

The air vents should all be opened to allow the air to escape, being closed as each radiator is completely filled with water.

Round Water Heaters. The heater shown in Fig. 43 is entirely of cast iron construction, so arranged as to amply provide for expansion and contraction. The only joints or connections are formed of heavy

cast iron threaded nipples, making a perfect joint, with no possibility of leaks from any cause whatsoever and absolute freedom from all



Fig. 43.

necessity of packing of any kind. The general construction of water heaters is as follows:

The circular base, or ashpit, which also forms the support for the grate, is substantially made of

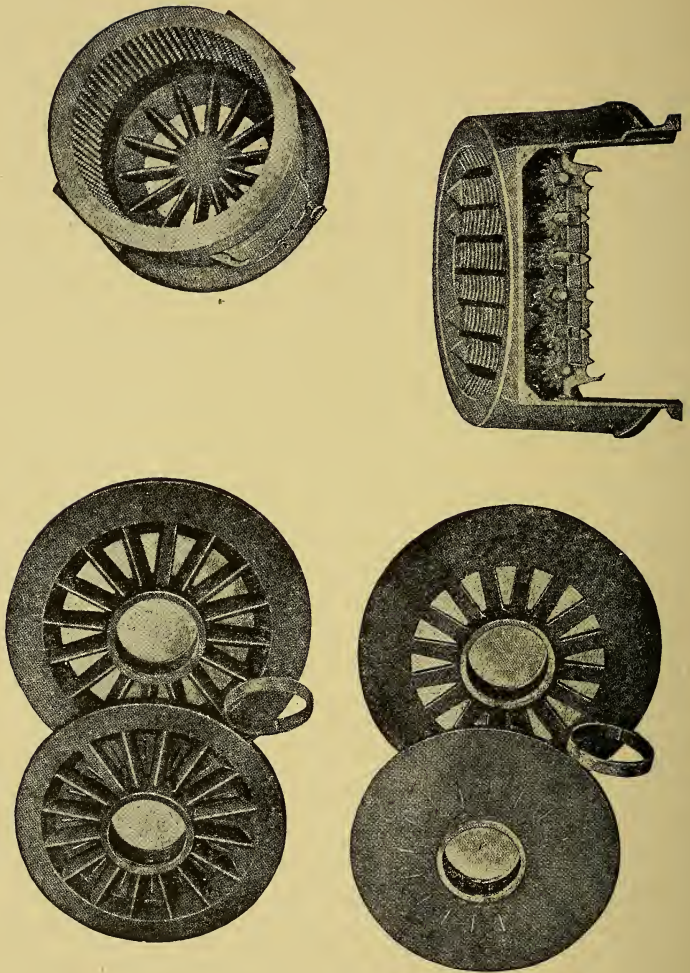

Fig. 44.

cast iron and gives a safe depth for accumulation of ashes. Resting on this is the firepot section, shown in Fig. 44. This section, being one complete casting in itself, and tested under heavy pressure before leaving the shop, is absolutely free from mechanical imperfections. In the center of the top of this section is a large opening, threaded to receive a nipple, which connects it with a closed section, shown in the right hand upper view, Fig. 44. This first, or intermediate section, is of less diameter than the top of the firepot section. On top of this closed, or intermediate section and attached to it in the same manner, as described for the connection of the firepot, there is an open section shown in the right hand upper view, Fig. 44, which is of the same diameter as the top of the firepot and entirely fills the jacket casings hereinafter described. On top of this is placed another closed section, and on top of this again comes the top section, which is either the steam dome, forming the steam boiler, or the upper water section, forming the water heater, all connected together in the manner described, with screw nipples, the top section, or dome, having the necessary tappings for the supply outlets for steam, or the flow outlets for water.

Casings. Extending from the outer edge of the top of the firepot section to the top of the upper section, or dome, there are cast iron casings, close-

ly fitted joints. These casings are made in segments and are interchangeable and easily applied, with no possibility of rusting, wearing out or breaking. They form in themselves a perfect chamber for the retention of products of combustion, compelling these to follow such channels as will give best results.

Firepot. The firepot is circular in form, entirely surrounded by water, is made in one perfect casting, and free from any possible chance of leakages. The inner surface of the firepot has projecting into it all around the sides a multiplicity of iron points, just long enough to prevent the water contract from chilling the fire and making it possible to secure perfect combustion and a uniform fire around the edges as well as in the center. The firepots are of sufficient depth to insure a deep, slow fire, forming the best and most economical heat-producing proposition for low pressure heating.

Grate. The grate is of the triangular form and is at all times easily operated, and in its operation it pulverizes all clinkers before depositing in ash pit.

On all the larger size boilers the grates are fitted with a heavy bearing bar in the center, thus prolonging the life of the grate bars, as it prevents their warping.

Simplicity of the Grates. The construction of the grate is exceedingly simple, and admits of

any one bar of the whole grate being changed without the assistance of skilled labor.

Fig. 45 shows vertical cross-section of a steam boiler.

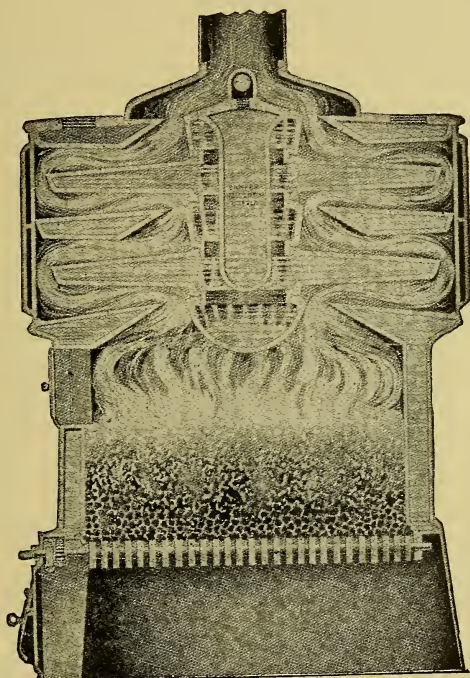

Fig. 45.

Rectangular Sectional Heaters. The vertical sectional type of steam heaters has been on the market and in all forms for a number of years. There are no new ideas that can be safely exploit-

ed in this line. The demand is for a simple, practical, easily handled device that will absolutely endure the work appropriated for it.

The heater shown in Fig. 46 is strong, of good

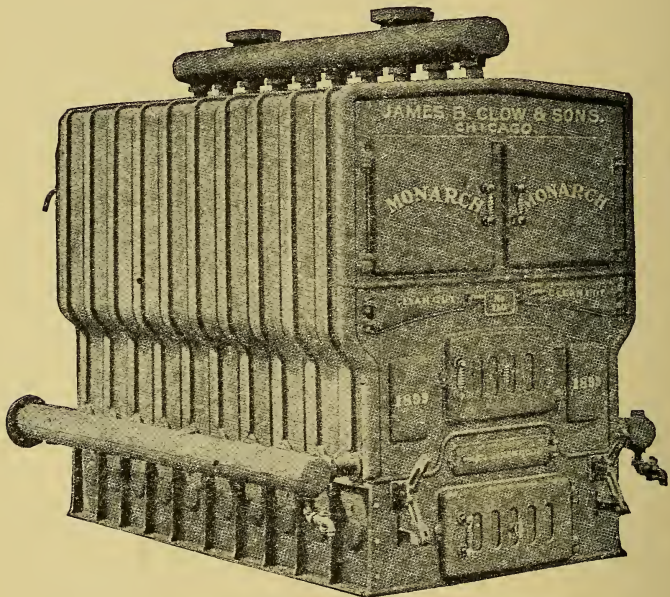

Fig. 46.

appearance, thoroughly accessible for cleaning, and, so far as can be determined from exterior appearances, a most satisfactory heater. The good opinion already formed of the heater is further

strengthened by reference to views of the intermediate and rear sections shown in Fig. 47 and 48. By reference to these cuts it will be seen that every possible advantage is taken of the fire surface, it being the belief that, unless great good is

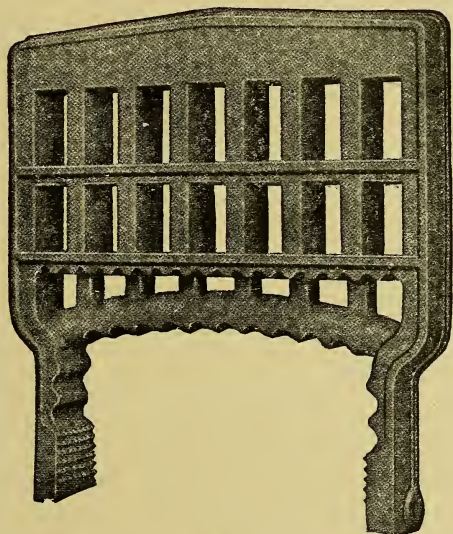

Fig. 47.

accomplished in direct contact with the fire, there will be but little assistance obtained from the flues.

Firepots. Firepots of this type of heaters are deep, to give a compact body of fire, and, besides,

are covered with numbers of iron projections to prevent chilling contact of the fire with the exposed water surface and yet secure such perfect combustion as will quickly impart to the water the heat from the fuel and permit of maintaining at all times a clear, even fire in every portion of the firepot.

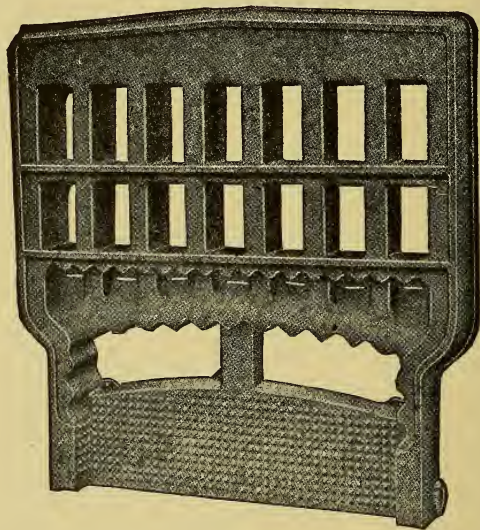

Fig. 48.

Heater Capacity. The capacity of the heater should be at least 20 per cent in excess of the total duty imposed upon it by the radiation and pipe system.

Example: Let 600 square feet equal the total radiation, plus 25 per cent for the surface of the mains, plus 20 per cent excess heater capacity, which is 900 square feet, the capacity of the boiler required. The same result may be arrived at by adding 50 per cent to the radiation.

When direct-indirect radiation is used, an additional $33 \frac{1}{3}$ per cent must be allowed, and when indirect radiation is used, add 50 per cent.

Example:

Total direct radiation=	450	sq. ft.
One direct-indirect radiator=	60	“ “
One indirect radiator=	190	“ “
	600	“ “
25 per cent for surface of mains=	112.5	“ “
33 $\frac{1}{3}$ per cent on direct-indirect=	20	“ “
50 per cent on indirect radiator=	45	“ “
	777.5	“ “
20 per cent excess capacity=	155.5	“ “
	933	“ “

Thermometers. A thermometer should be attached to every water heater as it not only registers the temperature of the water but it indicates to the attendant the required temperature of the water to be maintained for different conditions of the weather. It should be located in the top of the

heater or in the side near the top so that the closed brass chambers comes in direct contact with the

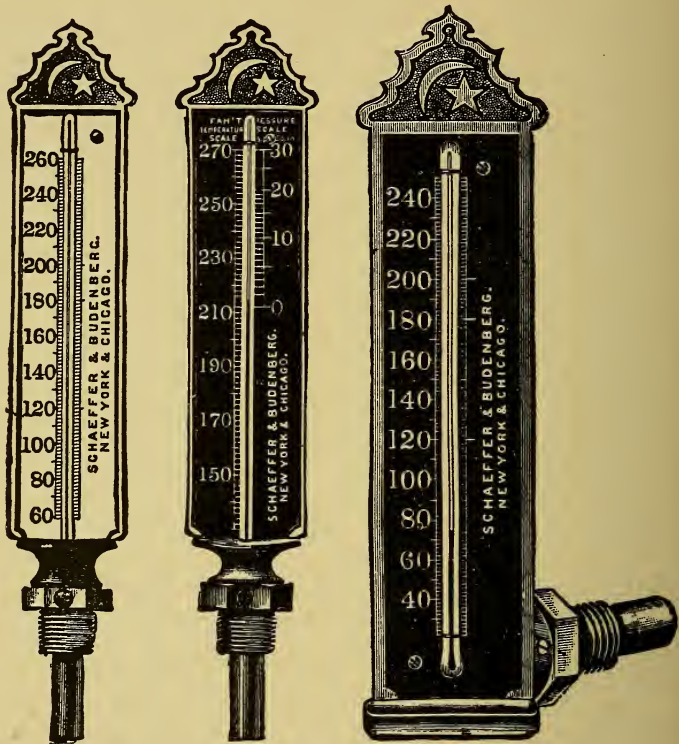

Fig. 49.

water circulation. Thermometers for use with water heaters are shown in Fig. 49.

Pipe Systems. The quadruple main hot water heating system shown in Fig. 50 when properly

installed will give very satisfactory results, and on account of the small size of the mains that are required it comes well within the range of the tool equipment of a heating contractor.

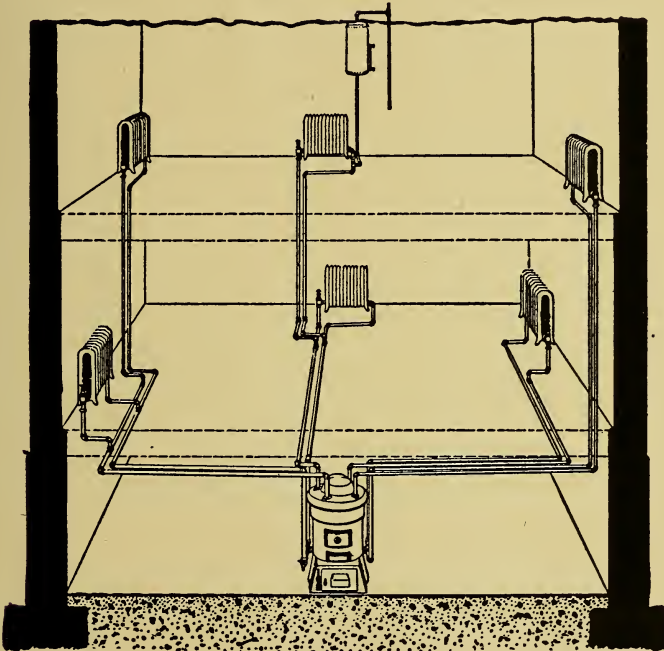

Fig. 50.

The double main system, as shown in Fig. 51, consists of flow mains starting from points on top of the boiler and running horizontally with a pitch of 1 inch or more in each 10 feet from the boiler.

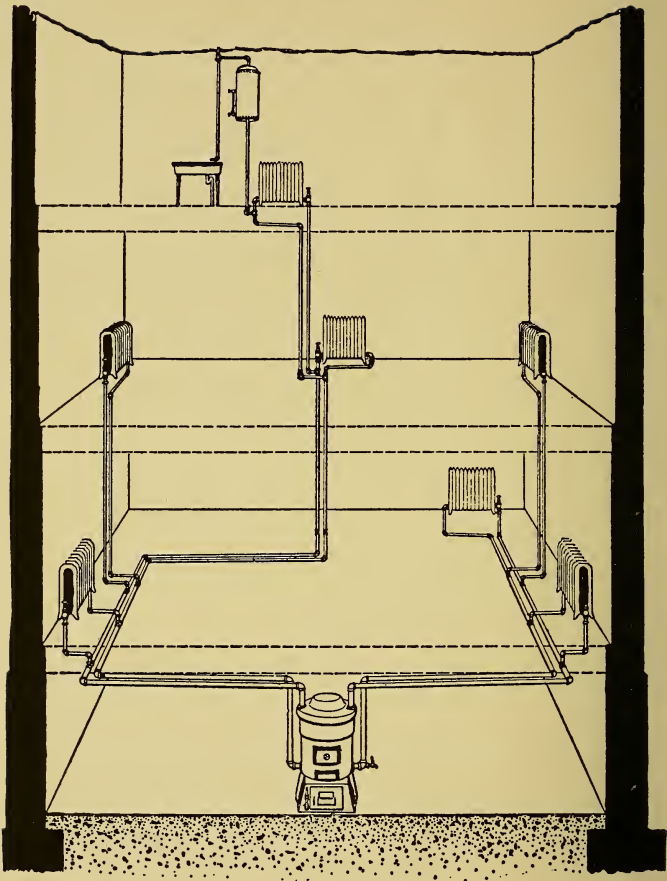

Fig. 51.

This is a system that is very much used and considered by many the best practice to follow.

The single pipe overhead or down-feed system

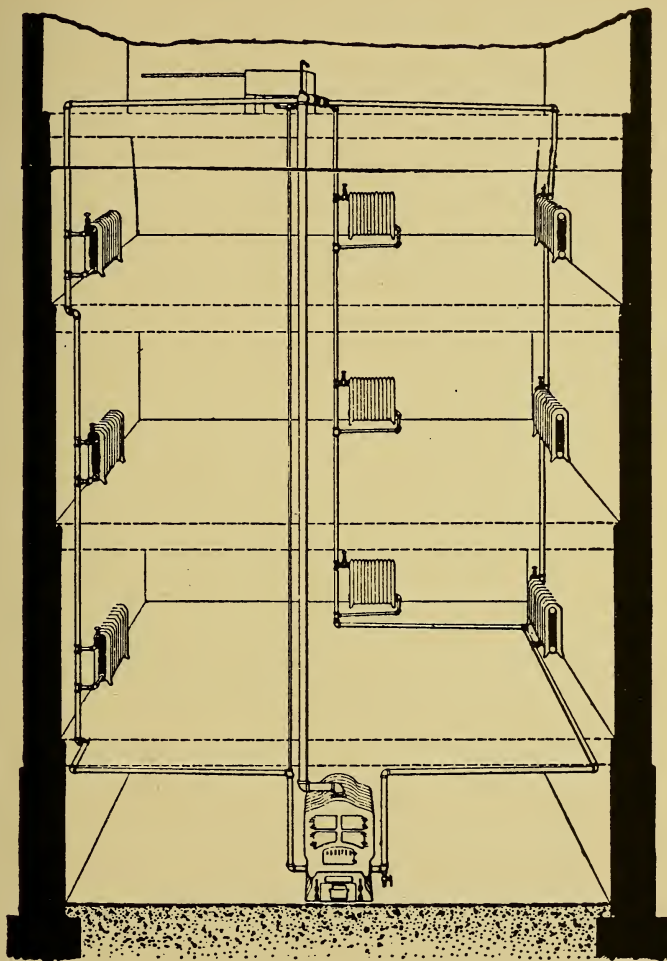

Fig. 52.

is much used in large office buildings. As illustrated in Fig. 52 a single feed or supply pipe runs from the top of the heater to a point some distance above the highest radiator. At this point the down-feed pipes branch out to the different sets of radiators. The expansion tank is connected to the system by a separate pipe at a point near the heater as shown. A vent pipe is also placed at the top of vertical supply pipe. The expansion tank should always be above the highest line of pipe.

Heating Surface. To estimate the amount of heating surface required to heat a room with hot water to a temperature of 70 degrees in zero weather, with the water at a temperature of 180 degrees at the heater and under ordinary conditions of exposure, the following rule is given, which is for direct radiation, and based upon the glass surface exposed wall surface and cubic space.

1 square foot of radiation to 1 square foot of glass.

1 square foot of radiation to 10 square feet of wall exposed.

1 square foot radiation to 150 cubic feet of spaced.

For each degree of temperature above or below zero, deduct from or add to, $1\frac{1}{2}$ per cent of the radiation given by this rule.

Hot Water Mains. The proper size of mains for hot water heating are given in the accompanying table:

Proper Size of Hot Water Mains.

Size of Main in Inches.	Sq. ft. Direct Radiation.
1½	175
2	300
2½	400
3	650
3½	900
4	1200
4½	1500
5	2000
6	2700
7	4000
8	5500

Radiator Connections. All radiator connections should be of sufficient size to give the best results.

Tapping of Direct Hot Water Radiators.

40	1 x 1
40 to 72	1¼ x 1¼
72 to 100	1½ x 1½
100 to 150	2 x 2

Tapping of Direct Hot Water Radiators. Two Pipe—Two Tappings.

20	¾ x ¾
20 to 40	1 x ¾
40 to 80	1¼ x 1
80 to 120	1½ x 1¼

Example: Required the number of square feet of direct radiation for a room 10x10x10 feet, having two exposed sides and two windows 2½x6 feet.

Answer:

$$\begin{aligned} \text{Glass surface} &= 30 \text{ sq. ft.} \div 1 = 30 \text{ sq. feet} \\ \text{Exposed walls} &= 200 \text{ sq. ft.} \div 10 = 20 \text{ " } \\ \text{Cubic space} &= 1,000 \text{ cu. ft.} \div 10 = \underline{6.6} \text{ " } \\ \text{Total direct radiation} &= 56.6 \text{ " } \end{aligned}$$

Example: Required the number of square feet of direct radiation for the same room, with one exposed side and one window $2\frac{1}{2} \times 6$ feet.

Answer:

$$\begin{aligned} \text{Glass surface} &= 15 \text{ sq. ft.} \div 1 = 15 \text{ sq. feet} \\ \text{Exposed walls} &= 100 \text{ sq. ft.} \div 10 = 6.6 \text{ " } \\ \text{Cubic space} &= 1,000 \text{ cu. ft.} \div 150 = \underline{6.6} \text{ " } \\ \text{Total direct radiation} &= 31.6 \text{ " } \end{aligned}$$

When indirect radiation is used 75 per cent should be added to the above figures.

RADIATION.

Direct Radiation. This consists of a heating surface in the form of a radiator or coil, which is placed directly in the room to be heated.

Indirect Radiation. Radiators in the room to be heated on the first or second floor are located in the cellar or basement, usually directly under the rooms to be heated. There is placed in the floor of the room to be heated, or in the side wall above the baseboard, a register and connection is made between this register and the radiator in the basement by means of tin or sheet iron pipe, for conveying the heated air into the room.

The indirect radiator is placed in a chamber into which fresh air is conveyed from outside, and to which the hot air flue to the register is connected.

The distance from the top of the radiator to the ceiling of the casing should be from 10 to 12 inches and from the bottom of the radiator to the bottom of the casing from 6 to 8 inches. The dimensions of the cold air inlet should be $1\frac{1}{2}$ square inches for each square foot of indirect radiation. The warm air outlet should be 2 square inches for each square foot of indirect radiation, which would be for a radiator containing 100 square feet of

radiation, 200 square inches of cross sectional area, or a duct 10x20 inches. The dimensions of the warm air register should be 50 per cent larger than those of the warm air duct, which allows for the contracted area caused by the register face. A warm air duct having 200 square inches of cross sectional area should have a register approximating 300 square inches.

Direct-Indirect Radiation. This system serves a double purpose, that of Direct Radiation and Ventilation, and is also placed in the room to be heated under windows, or close to the exposed walls.

The lower front part of the radiator is encased, having an opening at the bottom or back of the base for the introduction of cold air by means of a duct through the outside wall of the building.

On account of the cooling effect of the outside air passage between the coils of the radiator, increased heating surface to the amount of $33\frac{1}{3}$ per cent must be added to make it equivalent to direct radiation.

This system of radiation is seldom used in the heating of houses, being more necessary where ventilation is required in the heating of public buildings and schools.

Instead of placing all of the radiators at one point, it is well to divide it into two or more radiators, according to the size of the room. As heating with steam or hot water is accomplished by the

turning or circulation of the air in the room, it is well to divide and place the radiation at the most exposed points, in order to better heat the room.

In small houses a radiator placed in the lower hall, if sufficiently large, will heat the hall above, but in large buildings, where the hall space is large, the upper halls should have radiators placed in them.

Radiators. Heating surfaces are divided into three classes: Direct radiation, Indirect radiation and Direct-indirect radiation.

Direct radiation covers all radiators placed within a room or building to warm the air, and are not connected with a system of ventilation.

The best place within a room to place a single radiator, is where the air is cooled, before or under the windows, or on the outside walls. When the radiator is of vertical tube, or a short coil, which can occupy only the space under one window, and when, as often occurs, there are three windows, the riser should be so placed as to bring the line of radiators in front of, and under the windows where they will do the most good. When a small extra cost is not considered, to use two radiators and place one in front of each of the extreme windows.

When the room is large and has many windows, the heating surface, when composed of radiators, should be divided into as many units as possible.

Indirect radiation embraces all heating surfaces

placed outside the rooms to be heated, and can only be used in connection with some system of ventilation.

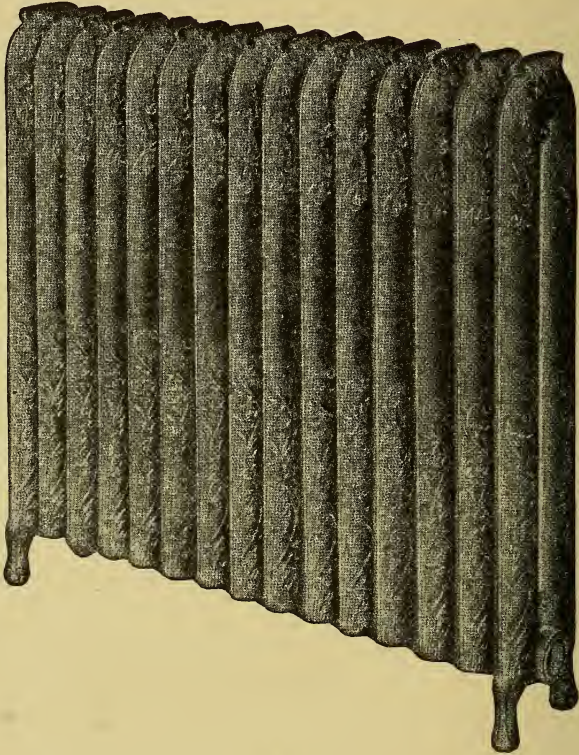

Fig. 53.

All the heating surface is placed in a chamber, and the warmed air distributed through air ducts. Figs. 53, 54 and 55 show two, three and four

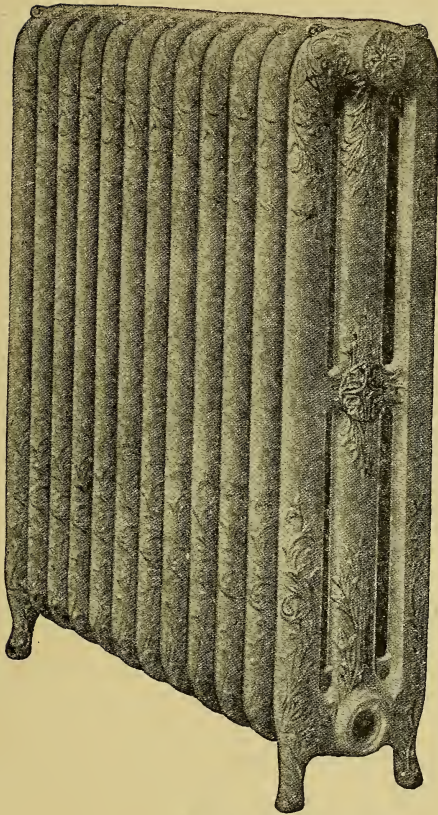

Fig. 54.

column forms of direct radiators, and Fig. 56 a two-piece hall or window direct radiator.

The indirect radiator is usually boxed, either in wood lined with tin, or in galvanized iron. The

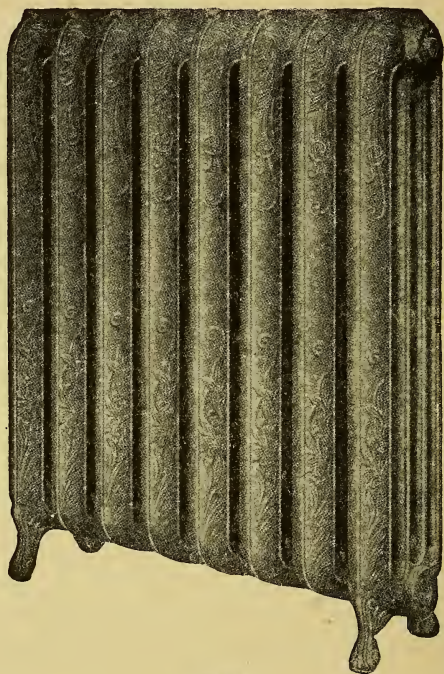

Fig. 55

former is best when the basement is to be kept cool, as there is a greater loss by radiation through metal cases, otherwise the sheet metal is the best, as it will not crack.

Indirect radiators are usually hung from the

ceiling in the basement under the rooms they are intended to heat. A cold air duct is carried from

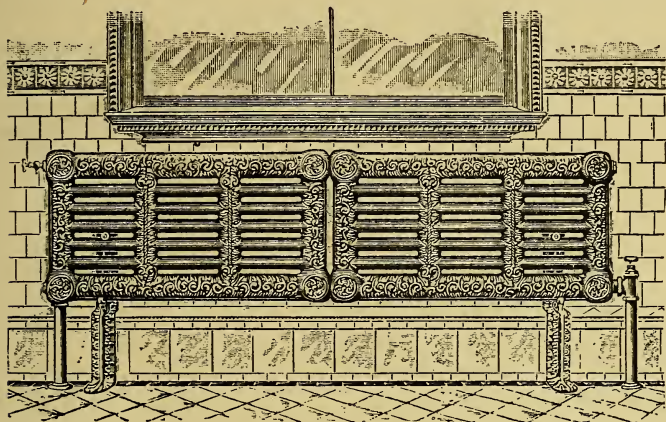

Fig. 56.

an opening in the outside wall to the stack box. This duct must be provided with a damper, and its

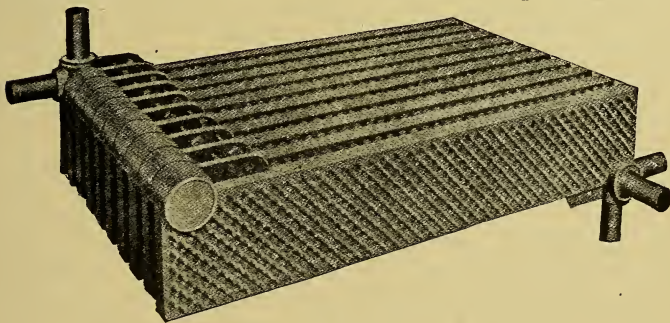

Fig. 57.

inlet covered on the face of the outside of the wall with a wire screen of small mesh.

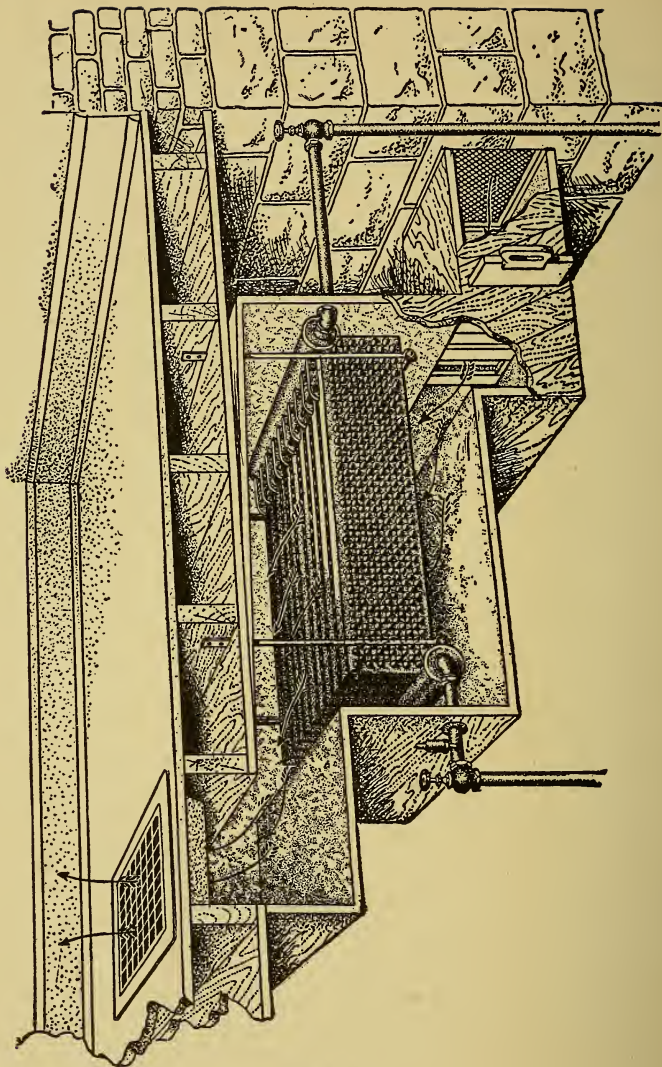

Fig. 58.

The box inclosing the radiator shown in Figs. 57 and 58 is made of wood lined with bright tin about half-way down. The sides of the box should almost touch the hubs of the radiator on both ends,

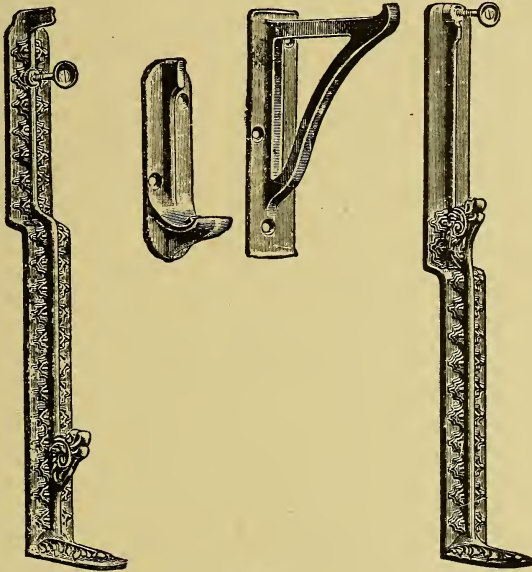

Fig. 59.

so that the cold air coming in through the duct will surely find its way up between the sections of the radiator, and not around the ends of it.

The radiator is shown connected for a two-pipe hot water system.

The cold air duct is provided with a slide, so that the air may be shut off when it is not wanted,

or when the radiator is turned off. The radiator should be so hung in the box that the space above it is about one-third more than the space below; this provides for the expansion of the air after it has been warmed by contact with the radiator.

Brackets for supporting the hall or window types of direct radiator are shown in Fig. 59.

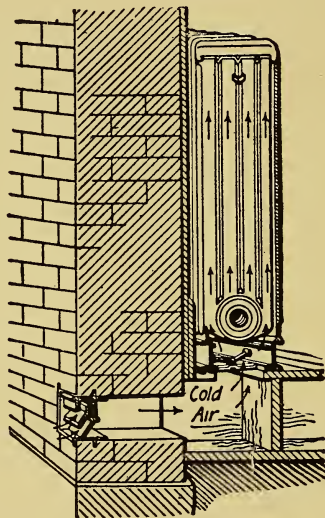

Fig. 60.

A direct-indirect form of radiator is illustrated in Fig. 60, in which the air is taken from the outside of the room to be heated and passes up between the sections of the radiator as shown, the front of the radiator being encased.

TWO COLUMN RADIATOR FOR STEAM OR HOT
WATER HEATING.

No. of Sec- tions.	Length in Inches.	SQUARE FEET OF HEATING SURFACE.					
		45 Inches High.	38 Inches High.	32 Inches High.	26 Inches High.	23 Inches High.	20 Inches High.
2	5	10	8	$6\frac{2}{3}$	$5\frac{1}{3}$	$4\frac{2}{3}$	4
3	$7\frac{1}{2}$	15	12	10	8	7	6
4	10	20	16	$13\frac{1}{3}$	$10\frac{2}{3}$	$9\frac{1}{3}$	8
5	$12\frac{1}{2}$	25	20	$16\frac{2}{3}$	$13\frac{1}{3}$	$11\frac{2}{3}$	10
6	15	30	24	20	16	14	12
7	$17\frac{1}{2}$	35	28	$23\frac{1}{3}$	$18\frac{2}{3}$	$16\frac{1}{3}$	14
8	20	40	32	$26\frac{2}{3}$	$21\frac{1}{3}$	$18\frac{2}{3}$	16
9	$22\frac{1}{2}$	45	36	30	24	21	18
10	25	50	40	$33\frac{1}{3}$	$26\frac{2}{3}$	$23\frac{1}{3}$	20
11	$27\frac{1}{2}$	55	44	$36\frac{1}{3}$	$29\frac{1}{3}$	$25\frac{2}{3}$	22
12	30	60	48	40	32	28	24
13	$32\frac{1}{2}$	65	52	$43\frac{1}{3}$	$34\frac{2}{3}$	$30\frac{1}{3}$	26
14	35	70	56	$46\frac{2}{3}$	$37\frac{1}{3}$	$32\frac{2}{3}$	28
15	$37\frac{1}{2}$	75	60	50	40	35	30
16	40	80	64	$53\frac{1}{3}$	$42\frac{2}{3}$	$37\frac{1}{3}$	32
17	$42\frac{1}{2}$	85	68	$56\frac{2}{3}$	$45\frac{1}{3}$	$39\frac{2}{3}$	34
18	45	90	72	60	48	42	36
19	$47\frac{1}{2}$	95	76	$63\frac{1}{3}$	$50\frac{2}{3}$	$44\frac{1}{3}$	38
20	50	100	80	$66\frac{2}{3}$	$53\frac{1}{3}$	$46\frac{2}{3}$	40

THREE-COLUMN RADIATOR FOR STEAM OR HOT
WATER HEATING.

Number of Sections.	Length in Inches.	SQUARE FEET OF HEATING SURFACE.			
		39 Inches High.	33 Inches High.	27 Inches High.	21 Inches High.
2	5	12	10 1-2	8 1-2	6 1-2
3	7 1-2	18	15 3-4	12 3-4	9 3-4
4	10	24	21	17	13
5	12 1-2	30	26 1-4	21 1-4	16 1-4
6	15	36	31 1-2	25 1-2	19 1-2
7	17 1-2	42	36 3-4	29 3-8	22 3-4
8	20	48	42	34	26
9	22 1-2	54	47 1-4	38 1-4	29 1-4
10	25	60	52 1-2	42 1-2	32 1-2
11	27 1-2	66	57 3-4	46 3-4	35 3-4
12	30	72	63	51	39
13	32 1-2	78	68 1-4	55 1-4	42 1-4
14	35	84	73 1-2	59 1-2	45 1-2
15	37 1-2	90	78 3-4	63 3-4	48 3-4
16	40	96	84	68	52
17	42 1-2	102	89 1-4	72 1-4	55 1-4
18	45	108	94 1-2	76 1-2	58 1-2
19	47 1-2	114	99 3-4	80 3-4	61 3-4
20	50	120	105	85	65

FOUR-COLUMN RADIATOR FOR STEAM OR HOT
WATER HEATING.

Number of Sections.	Length in Inches.	SQUARE FEET OF HEATING SURFACE.				
		42 1-2 Inches High.	38 1-2 Inches High.	32 1-2 Inches High.	26 1-2 Inches High.	20 1-2 Inches High.
2	8 1-2	19 1-3	16	13 1-3	10 2-3	8
3	12 1-2	29	24	20	16	12
4	16 1-2	38 2-3	32	26 2-3	21 1-3	16
5	20 3-4	48 1-3	40	33 1-3	26 2-3	20
6	24 3-4	58	48	40	32	24
7	28 3-4	67 3-3	56	46 2-3	37 1-3	28
8	32 3-4	77 1-3	64	53 1-3	42 2-3	32
9	37	87	72	60	48	36
10	41	96 2-3	80	66 2-3	53 1-3	40
11	45	106 1-3	88	73 1-3	58 2-3	44
12	49	116	96	80	64	48
13	53	125 2-3	104	86 2-3	69 1-3	52
14	57 1-2	135 1-3	112	93 1-3	74 2-3	56
15	61 1-2	145	120	100	80	60
16	65 1-2	154 2-3	128	106 2-3	85 1-3	64
17	69 1-2	164 1-3	136	113 1-3	90 2-3	68
18	73 3-4	172	144	120	96	72
19	77 3-4	183 2-3	152	126 2-3	101 1-3	76
20	82	193 1-3	160	133 1-3	106 2-3	80

Radiator Connections. Methods of connecting radiators used in water heating plants are shown in Fig. 61.

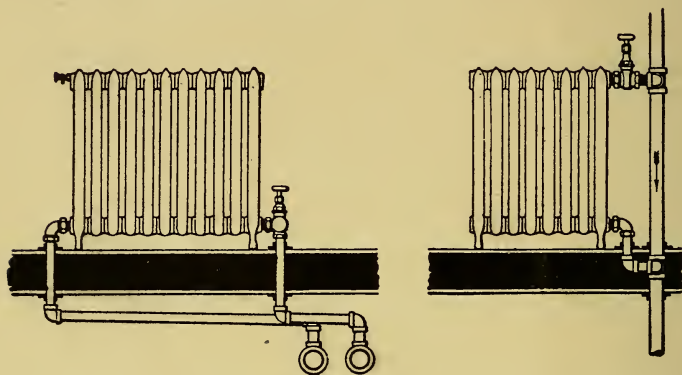

Fig. 61.

Radiator Valves. For use with hot water heating systems, angle radiator valves that have a full opening for a half turn of the wheel are usually employed. They have wood wheel, union connection and nickel-plated trimmings. This style of valve is illustrated in Figs. 62 and 63.

Angle valves with or without union connection, with wood wheel and nickel-plated trimmings, of the disk seat type are also used. They are shown in Figs. 64 and 65.

Gate valves as shown in Figs. 66 and 67 are used with down feed or overhead systems or when the radiator connections are made above the floor.

Globe valves as shown in Fig. 68 should not, if possible, to do without, be used in hot water heating systems, as their use interferes with the free circulation of the water.

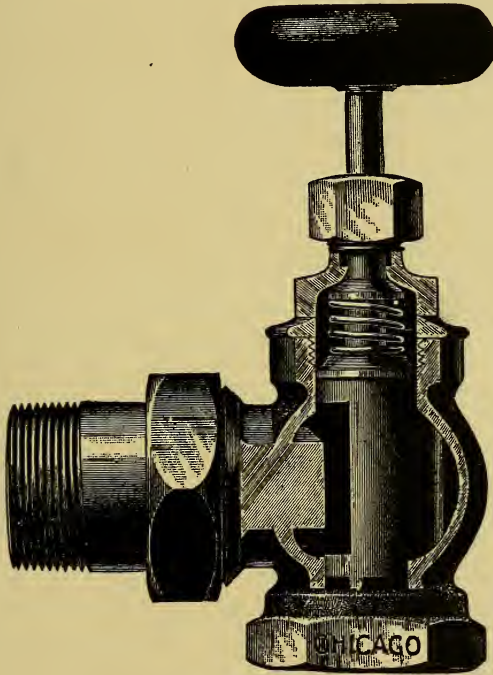

Fig. 62.

A corner valve for use when the radiator connections are above the floor is shown in Fig. 69; they are made both right and left-hand and with union connection.

A square or flat plug-cock should be always placed in the return pipe close to the boiler or in the boiler itself, as close to the bottom as possible.

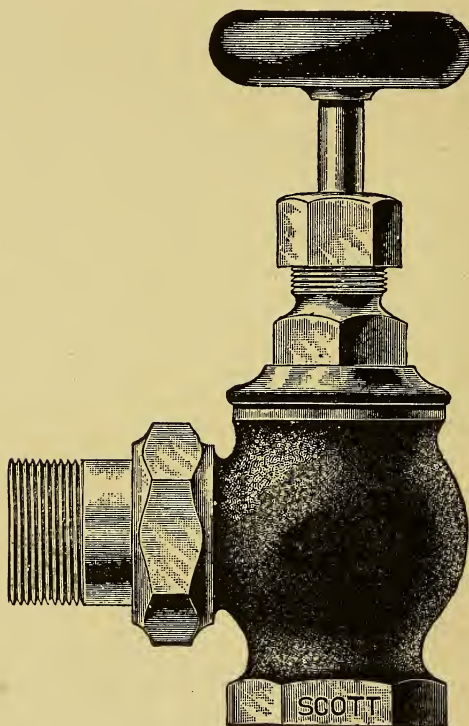

Fig. 63.

It should not have any direct connection to the sewer, but the discharge end of the pipe should be in plain sight so that any leakage due to negli-

gence in closing the cock may be quickly seen. Fig. 70 shows both square and flat-head plug-cocks.

The union-elbow shown in Fig. 71 is used to

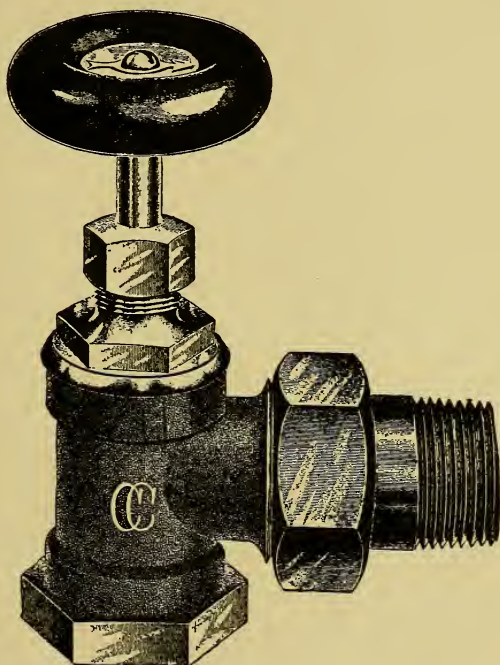

Fig. 64.

make the return connection from the radiation to the main. Check valves such as shown in Fig. 72 are sometimes used in the return main of a hot water heating system.

Check Valve. It is well understood that the common check valve is a very poor article when it is put to constant work, as it soon becomes pound-

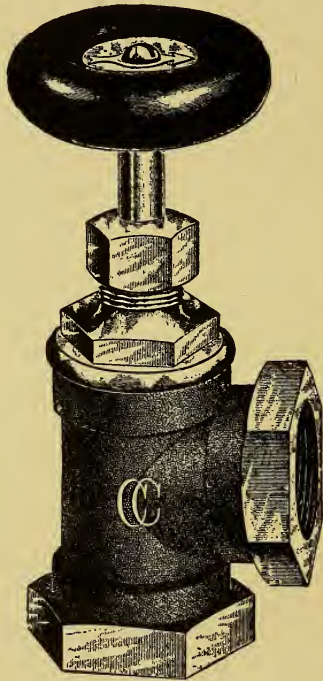

Fig. 65.

ed out of the seat, thereby leaking. It also wears oblong in consequence of the back pressure coming against the side of the feather, which back pressure prevents the valve from closing promptly,

thereby permitting considerable water to return to the pump.

The common valves are very much choked by

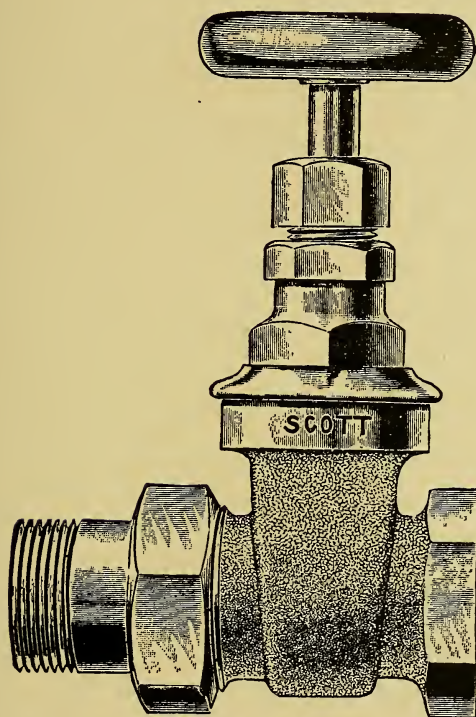

Fig. 66.

the guides, so that not more than two-thirds of their area is serviceable.

The cup pattern valve shown in Fig. 72 has a

much larger seat, a larger area, and is so constructed that the back pressure comes on the top of valve, thus preventing the side wear of the seat, and insuring prompt closing.

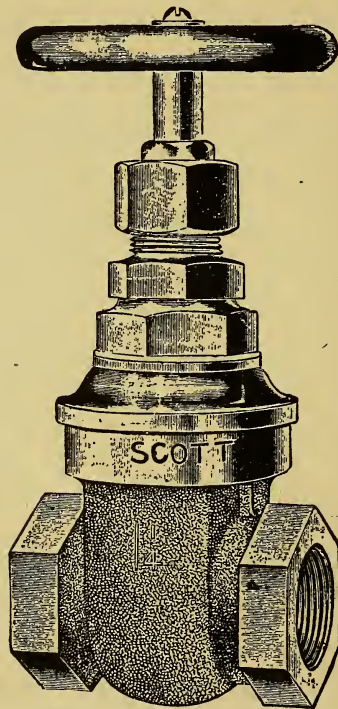

Fig. 67.

Expansion Tank. The purpose of an expansion tank is to provide for the increased bulk of the water in a hot water heating system, as water ex-

pands about one-twentieth of its bulk from 40 to 212 degrees Fahrenheit or to the boiling point of water. The expansion tank should always be

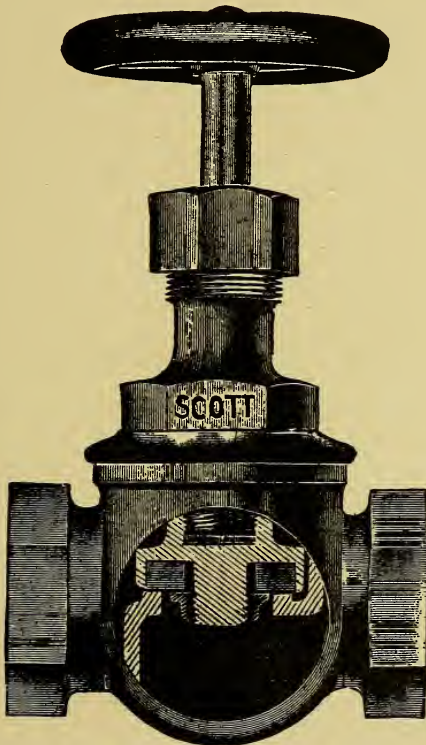

Fig. 68.

placed at the highest point of the system and near the ceiling at least 3 or 4 feet above the highest radiator or even higher if possible.

The expansion tank should not require more than one or two gallons per month to replenish the loss by evaporation. The overflow or vapor

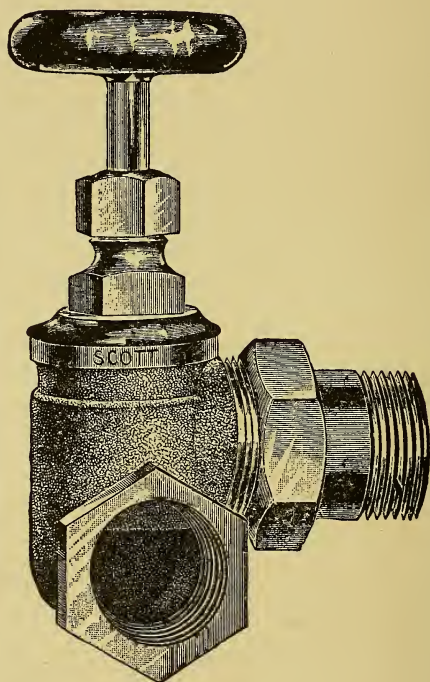

Fig. 69.

pipe should be carried to the nearest drain. The expansion tank should never be placed in an extremely cold place or an unheated room if possible. A stop-cock or globe-valve should never be placed in the pipe leading to the expansion tank.

The expansion tank should be located in a warm room, to prevent freezing.

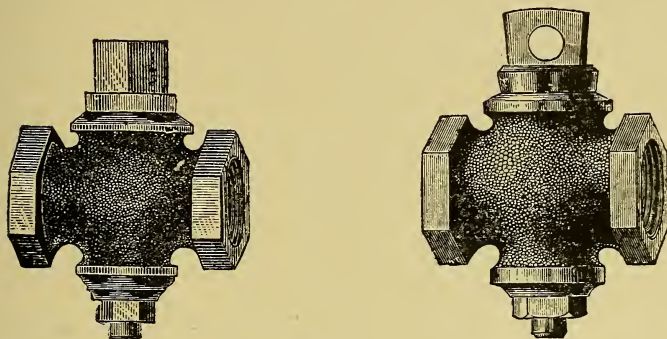

Fig. 70.

The overflow from the expansion tank should be carried through the roof, and on the end of the

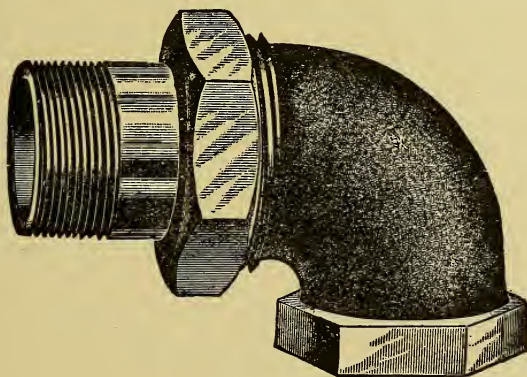

Fig. 71.

pipe a return bend should be placed, in order that the water may not run down the side of the pipe.

The expansion tank should hold from 1-20 to

1-30 of the amount of water contained in the entire system.

For the reason that when at the boiling point, the water in the system will occupy a considerably larger space than when cold.

At its boiling point, water fills a space about 5

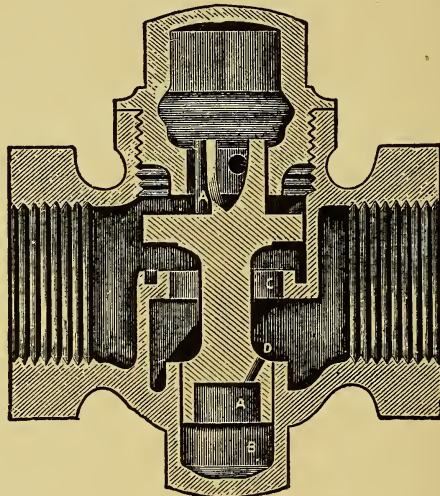

Fig. 72.

per cent. greater in volume than at its densest point, when cold. When cold, the water must fill the entire system. Therefore provision must be made to take care of this extra volume when the water is at the boiling point.

The expansion tank is provided for this purpose on all hot water heating systems.

When a wooden lead-lined tank is used and the water supply can be obtained from the city water main, a float device replenishes the water automatically.

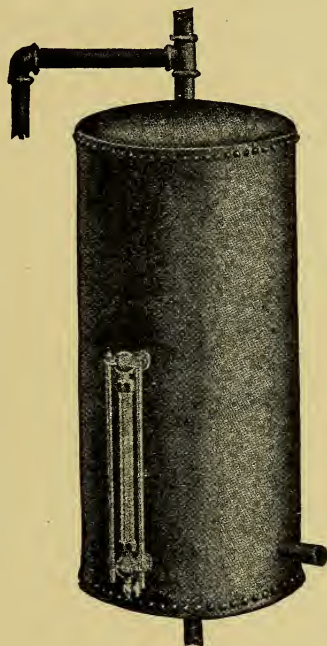

Fig. 73.

If there be no water pressure available the tank must be filled by hand through a funnel.

A galvanized steel expansion tank is shown in Fig. 73. The overflow pipe, vent and water supply openings are all clearly shown.

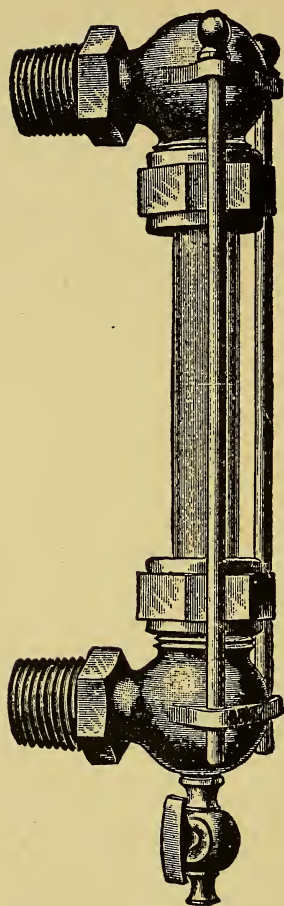

Fig. 74.

A water gauge for use on an expansion tank is illustrated in Fig. 74.

CAPACITY OF EXPANSION TANKS.							
No.	Diam. in Inches.	Capacity Gallons.	Sq. Ft. of Radiation.	No.	Diam. in Inches.	Capacity Gallons.	Sq. Ft. of Radiation.
0	16	8	250	5	31	32	1,300
1	17 $\frac{1}{2}$	10	300	6	32	42	2,000
2	20	15	500	7	37	66	3,000
3	23	20	700	8	39	82	5,000
4	25	26	950	9	40	100	6,000

Altitude Gauge. The gauge shown in Fig. 75 denotes the height of a column of water in a reser-

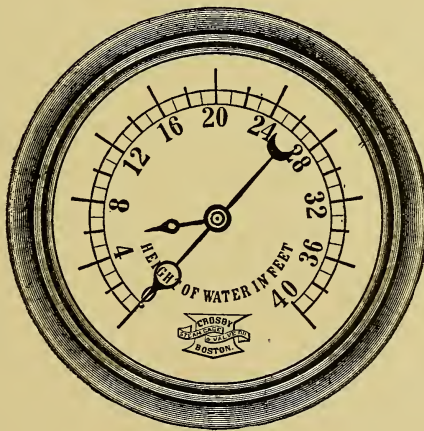

Fig. 75.

voir or tank used in connection with heating or wherever it is desired.

The adjustable hand indicates the number of

feet in height at which the water should be constant in the reservoir, and is so set by the user when the gauge is put up.

The hand operated by the gauge tube spring, which the pressure of the column of water actuates, shows in graduations on the dial marked in feet the actual height of water in the tank or reservoir and consequently the fluctuations in the height of water due to its use, and thus enables the user instantly to know whether the water column is of the required and proper height to be maintained. It is of great service and usefulness in this respect.

The gauge has two dials, the red one being moveable only by hand, the black one being connected with the mechanism of the gauge. When the system is first filled to the required height, the spring dial of the gauge shows the height in feet of the water in the system. The face of the gauge is then taken off, and the red dial moved to a point directly under the spring dial, and pointing to the same number on the gauge. As the water in the system evaporates by use, the spring dial drops away from the red dial, indicating less water in the system.

By the use of an altitude gauge at the boiler, the necessity of watching the expansion tank to know the amount of water in it, is avoided, as the gauge at the boiler registers the height of water in feet in the system.

APPROXIMATE RADIATING SURFACE TO CUBIC
CAPACITIES OF SPACE TO BE HEATED.

One Square Foot of Radiating Surface will Heat.	CUBIC FEET OF AIR.		
	In Dwellings, School-Rooms and Offices.	In Halls, Lofts, Stores and Factories.	In Churches and Large Audi- toriums.
With direct hot-water radi- ating surface.	30 to 50	60 to 80	90 to 150
With indirect hot-water radi- ation.	15 to 35	20 to 45	60 to 100
With direct hot-water radi- ating surface.	50 to 80	70 to 100	160 to 250
With indirect hot-water radi- ation.	40 to 50	55 to 75	100 to 150

Starting a hot water heating plant. The expansion tank should always be placed in position at the same time as the radiators.

After the system is erected and all connections made, each radiator valve should be packed. The air valves should be attached to the radiators, and should be shut off, preparatory to filling the system with water.

When either or both a hot-water thermometer or altitude gauge are to be used they should be attached at this time, provision being made for connecting them when erecting the mains.

Fill the system with water slowly until the heater and mains are full. If any leaks are discov-

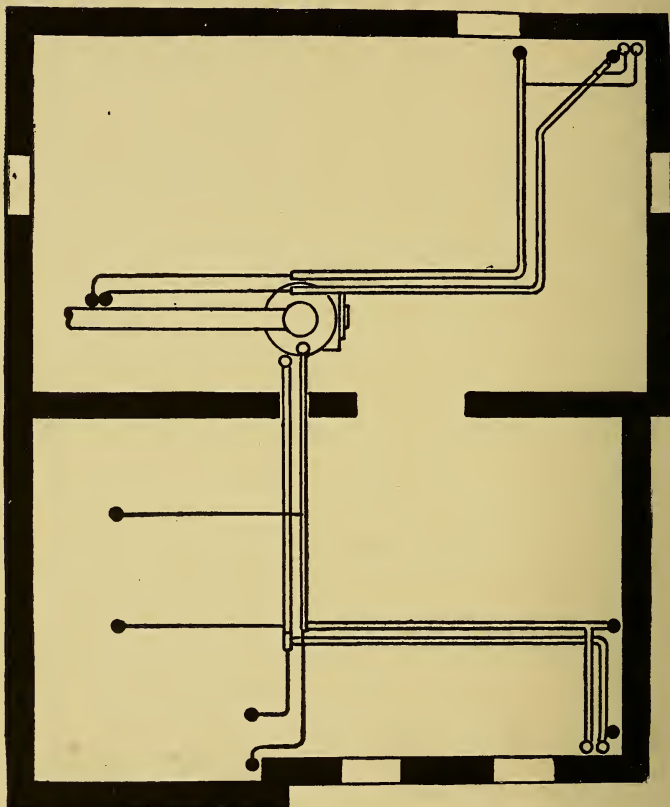

Fig. 76.—Basement.

ered, but not serious, continue to fill the system with water until the water can be drawn freely from the air valves on the first floor radiators.

Open all the radiator valves and start a slow fire, and when the system is tight, raise the tem-

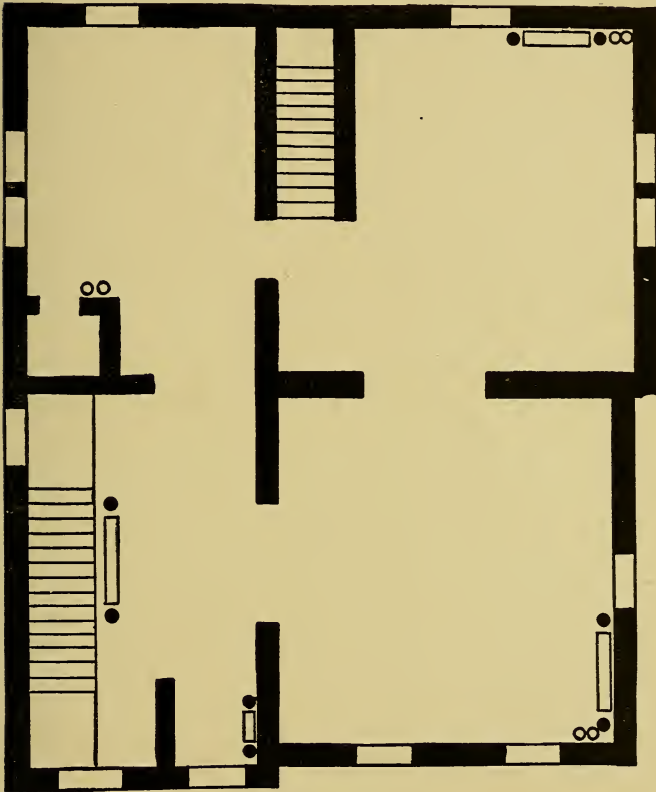

Fig. 77.—First Floor.

perature of the water to the boiling point, or 212 degrees Fahrenheit which should be easily done if all conditions are right.

After a day's test the fire should be let out, and the entire system drained, and all leaks that have

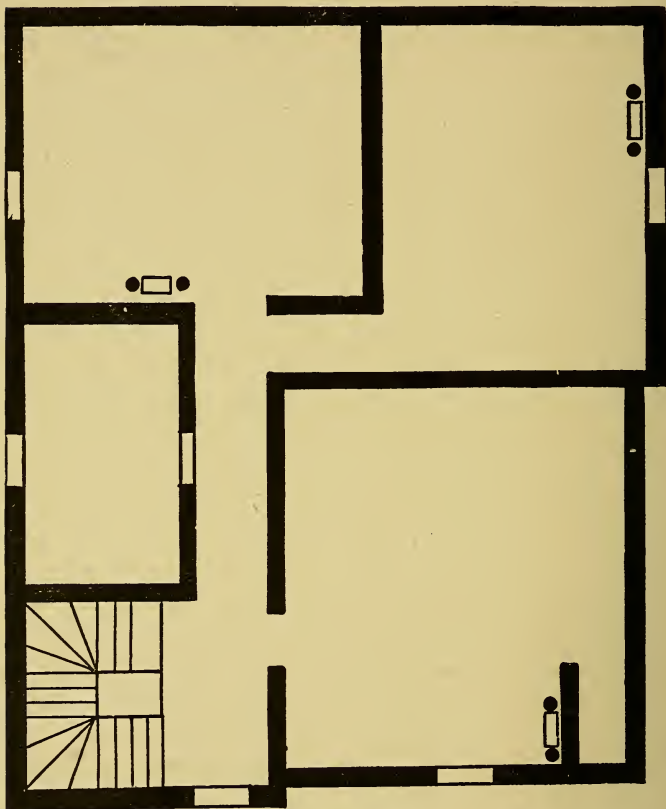

Fig. 78 —Second Floor.

been discovered repaired, when the system should be refilled with fresh water.

Hot water heating plant. The following illus-

trations shown in Figs. 76, 77 and 78 are the plans for a nine room house, heated by a double-main hot water system. The boiler, water, mains, piping to radiators, and the radiators are all plainly shown.

SPECIFICATIONS AND CONTRACT FOR A HOT WATER HEATING PLANT.

We hereby agree to furnish and install in your residence,.....Street, a Hot Water Heating Plant under the conditions, and for the price hereinafter named, and in accordance with the following specifications:

Boiler—To provide and set up in basement one No.....Hot Water Boiler, having a rated capacity of square feet, and furnished with a set of fire and cleaning tools.

Foundation—The owner is to provide a suitable foundation for the boiler of brick or concrete.

Smoke Pipe—The smoke collar of the boiler to be connected to the chimney flue by a .. inch galvanized iron smoke pipe, closely fitted and provided with a choke damper.

Chimney—The owner shall provide a chimney flue of proper size and height to secure sufficient draft.

Fittings—The mains, risers and branches to be of ample area, properly graded. The mains to be

supported in the basement by neat, strong hangers, secured to ceiling joists. All fittings to be of best grade cast iron to be used.

Floor and Ceiling Plates—Where risers and radiator connections pass through floors and ceilings, place bronzed or nickel-plated floor and ceiling plates.

Valves—Each radiator to be furnished with a nickel-plated wood-wheel, quick opening radiator valve.

Union Ells—The return end of each radiator to be provided with a nickel-plated elbow, with union coupling.

Air Vents—Each radiator to be furnished with a nickel-plated air valve, with key or wood-wheel.

Water Supply—The owner is to provide a connection in the water service pipe, near the boiler, for the water supply.

Expansion Tank—Provide and place in proper position a heavy galvanized iron expansion tank, complete with water gauge.

Altitude Gauge—Furnish and attach in proper position on boiler one 5-inch Altitude Gauge with stop cock.

Estimating. Make a careful survey of the location, construction and exposure of the building to be heated, and take accurate measurements of the size of the glass surface and exposed walls of the rooms in which the radiators are to be placed.

Having ascertained the total amount of radiation, select a heater having a rated capacity of 50 per cent in excess of the total radiation, which for the average system will allow for the duty imposed by the mains and provide a margin of 20 per cent.

Make a plan of the basement to scale, locate the heater, and lay out the pipe system, putting down the size of the mains and the branches.

From the plan obtain the number of lineal feet of each size of pipe, including the risers, also the number and size of all fittings.

Allow one air valve for each radiator.

The number and size of the floor and ceiling plates may be counted from the number and size of risers that will pass through the floors and the ceilings.

The length of pipe covering may be obtained from the size and number of lineal feet of pipe in the mains.

Smoke Pipes. Steam boiler smoke pipes range in size from about 8 inches in the smaller sizes to 10 or 12 inches in the larger ones. They are

generally made of galvanized iron. The pipe should be carried to the chimney as directly as possible, avoiding bends, which increase the resistance and diminish the draft. When the draft is known to be good the smoke pipe may purposely be made longer to allow the gases to part with more of their heat before reaching the chimney. Where a smoke pipe passes through a partition it should be protected by a double perforated metal collar at least 6 inches greater in diameter than the pipe.

The top of the smoke pipe should not be placed within 8 inches of exposed beams nor less than 6 inches under beams protected by asbestos or plaster. The connection between the smoke pipes and the chimney frequently becomes loose, allowing cold air to be drawn in, thus diminishing the draft. A collar to make the connection tight should be riveted to the pipe about 5 inches from the end, to prevent its being pushed too far into the flue.

Chimney Flues. Flues, if built of brick, should have walls 8 inches in thickness, unless terra cotta linings are used, when only 4 inches of brick work is required. Except in small houses, where an 8x8 flue may be used, the nominal size of the smoke flue should be at least 8x12, to allow a margin for possible contractions at offsets, or for a thick coating of mortar. A clean out door should be placed at the bottom. A square flue cannot be

reckoned at its full area, as the corners are of little value. An 8x8 flue is practically very little more effective than one of circular form 8 inches in diameter. To avoid down drafts the top of the chimney should be carried above the highest

Dimensions of Chimney Flues for Given Amounts of Direct Radiation

Square Feet of Steam Radiation	Diameter of Round Flue	Square or Rectangular Flue
250	8 inches	8 in. x 8 in.
300	8 inches	8 in. x 8 in.
400	8 inches	8 in. x 8 in.
500	10 inches	8 in. x 12 in.
600	10 inches	8 in. x 12 in.
700	10 inches	8 in. x 12 in.
800	12 inches	12 in. x 12 in.
900	12 inches	12 in. x 12 in.
1000	12 inches	12 in. x 12 in.
1200	12 inches	12 in. x 12 in.
1400	14 inches	12 in. x 16 in.
1600	14 inches	12 in. x 16 in.
1800	14 inches	12 in. x 16 in.
2000	14 inches	12 in. x 16 in.
2200	16 inches	16 in. x 16 in.
3000	16 inches	16 in. x 16 in.
3500	18 inches	16 in. x 20 in.
5000	18 inches	16 in. x 20 in.

point of the roof, unless provided with a suitable top or hood.

Fuel Combustion. Combustion is one form of chemical action, accompanied by the generation of heat. When such action takes place slowly the heat produced is almost imperceptible, but when it takes place rapidly, as in the burning of wood,

coal, etc., the heat becomes intense. In the burning of ordinary fuel, the carbon and hydrogen of the coal combine with the oxygen of the air and produce combustion, without which no material results may be obtained from the fuel.

Combustion depends upon the presence of oxygen, without which it cannot take place.

Combustion is estimated by the number of pounds of fuel consumed per hour by one square foot of grate surface.

One square foot of grate will consume about 5 pounds of hard coal per hour, or about 10 pounds of soft coal, under a natural draft.

For $7\frac{1}{2}$ to 10 pounds of coal consumed, one cubic foot of water will be evaporated.

A fire of a depth of 12 inches will do more efficient work than one of less depth.

The use of too large coal is attended with large air spaces between the pieces, and this large amount of air is too great for the gases escaping from the combustion of the coal, allowing the gases to escape into the chimney flue unburned.

The use of too small coal is not advisable, as it packs down so compactly as to prevent the admission of the proper amount of air through the grate to produce good combustion.

FURNACE HEATING.

Furnace Heating. Since 1 square foot of glass will transmit about 85 heat units per hour when the difference between the inside and outside temperature is 70 degrees, to ascertain the total loss of heat by transmission multiply the exposed glass surface by 85.

If the air enters through the register at 140 degrees, under zero conditions, it is plain that one-half the heat supplied is carried away by the air escaping at 70 degrees the other half being lost through the walls and windows. Therefore, twice the amount of heat lost by transmission must be supplied by the furnace.

As 8000 heat units are utilized per pound of coal burned in a well proportioned house heating furnace, with a maximum coal consumption of 5 pounds per square foot of grate surface per hour there are consequently $8000 \times 5 = 40,000$ heat units per hour per square foot of grate surface transmitted to the air passing through the furnace. Dividing the total loss of heat per hour (that is the total exposure in terms of the exposed glass surface) by 40,000 will give the required grate surface in square feet, from which the diameter of the fire pot in inches may be readily determined.

$$\begin{aligned} \text{That is:} \quad & \frac{\text{Total Exposure} \times 170}{40,000} \\ = & \frac{\text{Total Exposure}}{235} = \text{required grate surface.} \end{aligned}$$

Furnaces. In the furnace shown in the illustration at Fig. 79 the combustion drum from top to bottom consists of one sheet of steel, its seams being riveted until gas-tight so that where the sheet is lapped it is practically welded. The same gas-tight workmanship is maintained in the extra radiating drum and in the furnace throughout. Gas cannot get through the heating surface at any point. The material used is of the best quality low-carbon, steel plate, a metal that is uniform in texture and composition, and anti-corrosive, ductile, and possessed of a tensile strength of 60,000 pounds to the square inch. In a cold state it may be worked almost as copper plate may be, it may be flanged, double-seamed, twisted, drawn out, doubled up, and welded and the process may be continually repeated. A piece one-fourth of an inch thick may be drawn as thin as a piece of writing paper without cracking or checking. Containing less than one-fourth of one per cent. of carbon, mild in quality and homogenous in structure, it is absolutely impermeable to gases, and having a uniform expansive quality throughout its entire mass, it has neither fibre to tear nor sand to drop, as is the case in cast metals.

It may be said of the ordinary furnace that fuel

is put in at the door and heat let out at the smoke hole—let out either as soot and gases that have not

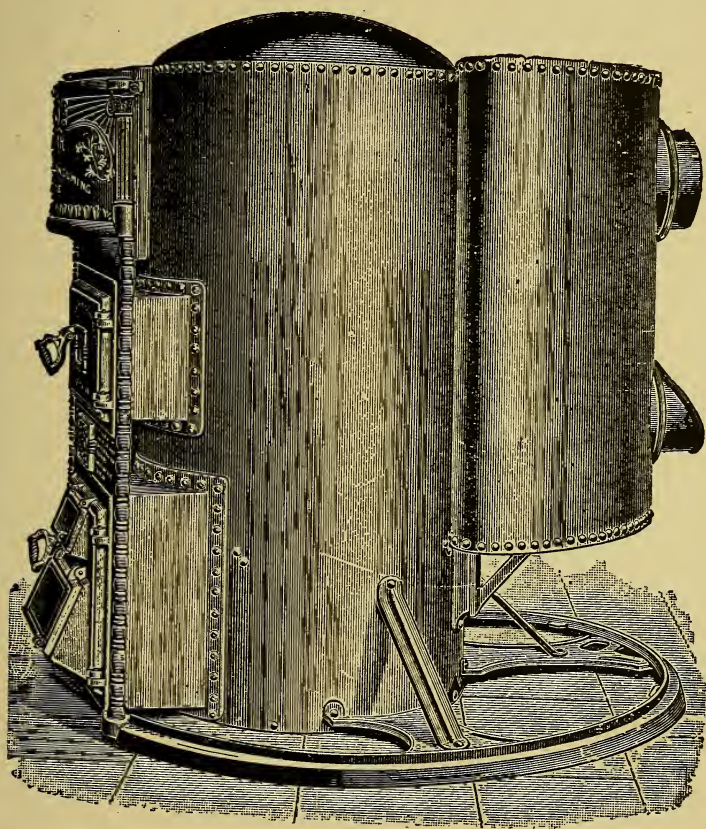

Fig. 79.

been ignited, or as heat that must be wasted through the flue, because efforts to retain it would

cause a choking of the smoke-passage. In other words, it has a practically direct draft because of its imperfect system of fuel combustion.

This is really a double furnace. Combustion takes place in the first, or fire drum, which in itself possesses a very great radiating surface. From this, before reaching the smoke outlet, the products of combustion have to enter and travel a long distance through the second drum. This drum, by actual measurement, contains more heating surface than some of the heaters upon the market contain altogether. This supplementary drum is made in two forms—crescent shape and round, the latter with an open center. The course of the products of combustion being such that heat is brought directly against every part of the inside of the surface, while the air passes against every part of the outside, so that there is not only long retention of the heat inside, but an effective use of it by contact with the air from the outside. A question always arising in the mind that whether or not, with such a long and indirect passage way, there will not be choking or clogging. There will not be. Herein is where the effective combustion is demonstrated. With a good smoke flue and with ordinary good care, this drum will not require cleaning oftener than once a year. More than this, the heating surface will remain practically free from soot-coating, so that it is always effective for service.

Fig. 80 is a partial sectional elevation of the furnace previously described, while Fig 81 shows

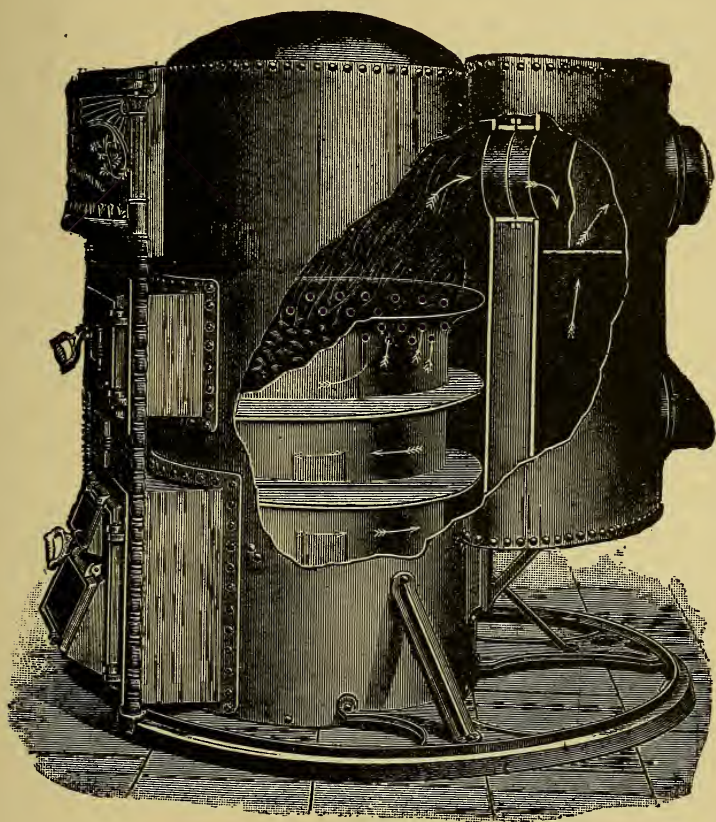

Fig. 80.

the same furnace with a water heating device which forms a portion of the fire pot as shown.

The water-back itself is shown in Fig. 82. An enclosed type of furnace with additional drum also

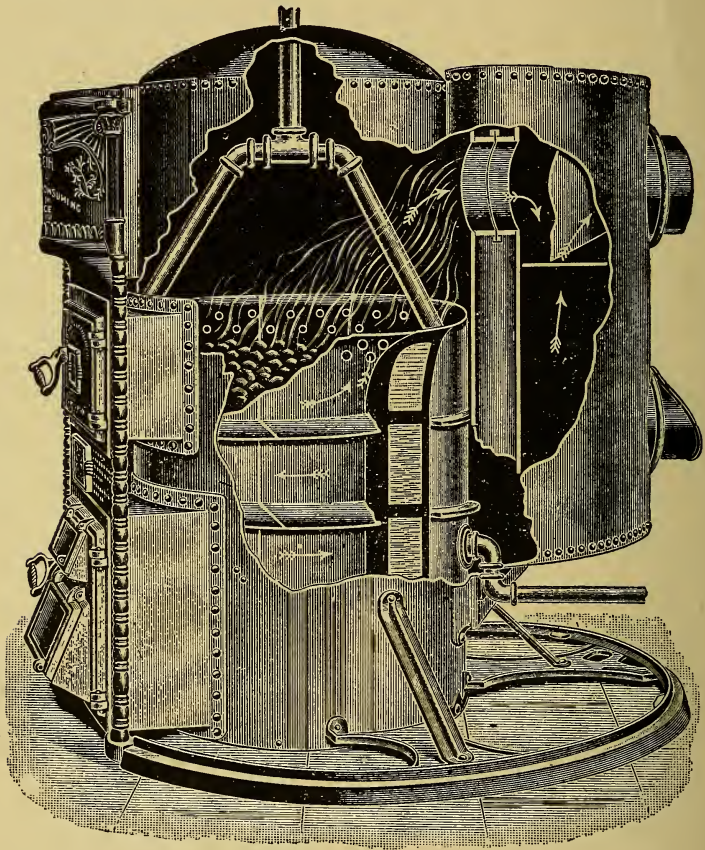

Fig. 81.

built in with the furnace proper is shown in Fig. 83. A water tank for furnishing hot water is also

provided as shown in the illustration. Check draft dampers for controlling the temperature of the furnace are shown in Fig. 84.

General instructions. To obtain proper results and to convey all the warm air that a furnace may produce, to the rooms to be heated, the following rules should be observed:

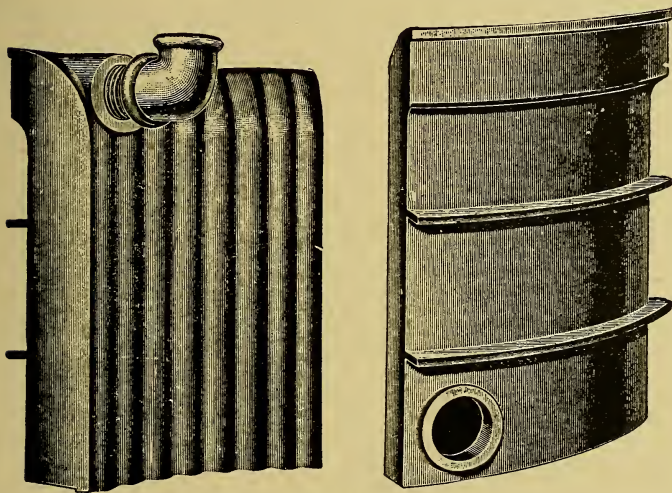

Fig. 82.

Put in a furnace of sufficient capacity.

See that the chimney is of proper size and has good draught.

If possible set the furnace under the center of the house, so as to equalize the length of the hot air pipes.

Hot air pipes should be of the proper size, with a good elevation from the furnace to the register, avoiding long runs and abrupt turns.

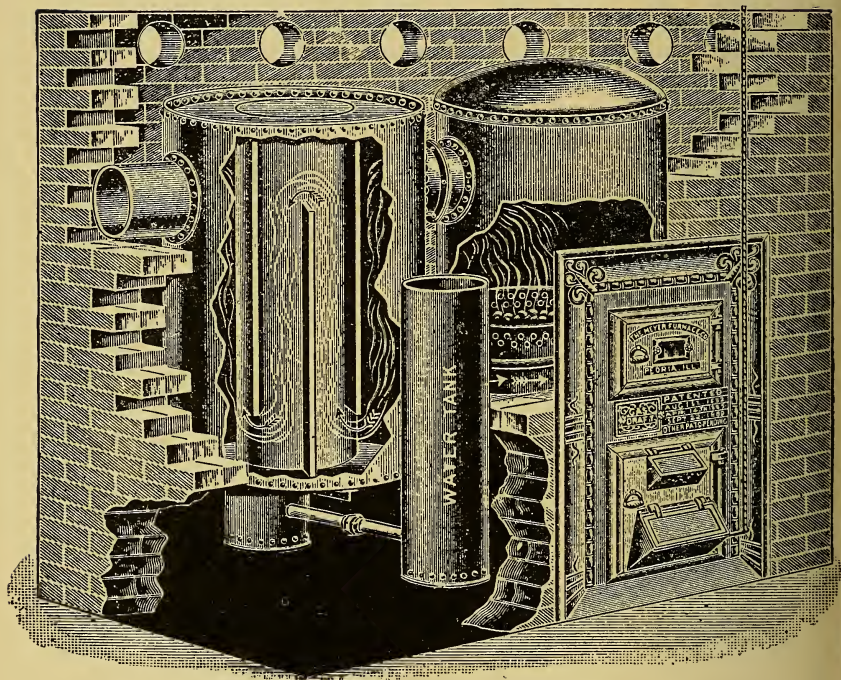

Fig. 83.

The cold air pipe, if taken from the living room, should be at least 85 per cent of the combined area of all the hot air pipes.

All holes or openings in the foundation must be closed to prevent the hot air from being chilled.

Good workmanship and practical application of the same always insures good results.

Proper Size of the Furnace. Some furnaces are

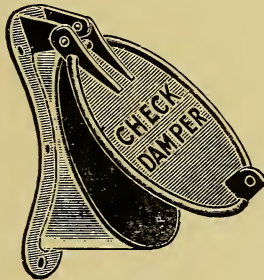
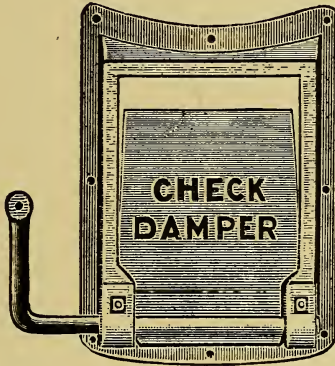

Fig. 84.

rated far above the amount of their actual heating capacities. Combining this with the fact that some dealers expect to sell a consumer only one furnace,

and therefore consider only the first profit and pay little attention to results, has led to the general demand of the prospective buyer to ask for a furnace of one or two sizes larger than the one figured on.

The table of capacities of furnaces are based on scientific figures and years of actual test and experience. Under reasonable conditions a furnace selected according to this rating will heat the building to the proper temperature.

Proper Size of the Chimney. The chimney should start from the floor of the cellar so as to allow for a clean out underneath the smoke pipe. It should continue in a straight line to at least 2 feet above the highest point of the roof, if necessary to offset, care should be taken not to contract the size, a 10 inch round or an 8 by 12 inch square is a good flue for almost any size of furnace. For a small furnace a straight chimney, with an 8 by 8 inch flue will answer the purpose.

A chimney 4 inches wide will seldom give satisfaction. As a great deal depends on a good chimney, this very important feature should never be overlooked.

Location of the Furnace. There may be conditions that make it impractical to set the furnace under the center of the house, but the best results are always obtained when it is possible to do so. If it be necessary to set the furnace toward one end of building, it is best to favor the north

and west. Drainage conditions often govern the depth of cellar. If possible it should be at least 7 feet under the joists.

Hot Air Pipes. There is no rule that would apply to the size of the pipe for certain rooms. The location of the furnace, the length of the pipes and the exposure of the rooms, also their use must be taken into consideration. Ordinarily 8 and 9 inch pipes are large enough for all second and third floor rooms. For first floor rooms, a reception hall with open stairway to second floor, a 12 inch pipe is the best adapted, but 10 inch may answer the purpose in most cases. For parlor, dining and sitting rooms of about 12 by 16 feet or 14 by 15 feet a 10 inch pipe will give good results, 8 and 9 inch should be used for bed rooms. If possible, avoid any bends or turns except an elbow at the furnace and another where it enters the register box or boot. A damper should be put in every hot air pipe close to surface.

All hot air pipes in the cellar should be covered with asbestos. This insures better heating, preserves the pipes and makes them absolutely safe.

Partition Pipes. Use of double pipes is advocated as the flow of air through them is better than if single pipes are used. The reason for this is that with the patented double pipes, the inside pipe has a straight, smooth surface, it does not buckle or warp, thereby reducing its size, but always retains an even and unobstructed passage

from the boot at the bottom to the register head or top.

The outside pipe prevents the inner one from becoming chilled, and also prevents any danger of setting fire to the woodwork by becoming overheated.

Cold Air. This is a very important feature, as an insufficient supply of cold air to the furnace means a lack of warm air in the house. There are different opinions as to the proper place to take cold air from, whether from the outside, from the living rooms, or from the cellar. If taken from the outside, the expansion of air is greater than if taken from the house. A smaller pipe can be used, and therefore costs less to install. The outside air being often very cold, it requires heavy firing to heat it to the required temperature. With good firing satisfactory results can be obtained, but with a low fire cold air may be admitted into the house without being properly warmed.

By taking air from the living rooms, the house can be heated at a minimum cost of fuel, the expense of installation is slightly higher, as it requires a larger pipe, also register faces and other fittings to connect the furnace. By using this method, either one or more pipes can be used. The area of this pipe or pipes should never be less than 85 per cent of the combined area of all the hot air pipes.

The best general results are obtained in this

way, for there is always a circulation, the air is taken out of the rooms, passed over the heated surface of the furnace, and warmed to the proper temperature.

There is only one item in favor of using cellar air, this is the expense of installation, as it costs very little to make the connection—in all other respects it is not advisable to use it.

Openings in Foundation. Great care should be exercised to see that all openings in the basement or foundation walls are properly closed during the cold season, as a current of cold air against any hot air pipes, acts as a damper to the proper flow of air through them.

Good Workmanship. Much depends upon a furnace being properly installed; it is often said that a poor furnace properly installed will give better satisfaction than a good furnace poorly put in.

DIMENSIONS AND HEATING CAPACITIES OF FURNACES.

No.	Height.	Diam.	Height of Radiator.	Height of Casting.	Diam. of Casting.	Weight	Heating Capacity.
	Ft. In.	Ft. In.	Ft. In.	Ft. In.	Ft. In.		Cubic Feet.
24	4—6	2—0	2—0	4—11	4—2	1200	9000 to 80000
28	4—10	2—4	2—4	5—2	4—4	1250	12000 to 25000
30	5—0	2—6	2—6	5—7	4—8	1450	20000 to 35000
33	5—0	2—9	2—9	5—7	5—0	1750	30000 to 50000
36	5—2	3—0	3—0	5—8	5—8	1950	60000 to 80000

THE LOSS OF HEAT BY TRANSMISSION WITH A DIFFERENCE
OF 70 DEGREES FAHRENHEIT BETWEEN THE INDOOR
AND THE OUTSIDE TEMPERATURE.

The loss in heat units per square foot per hour by trans-
mission for:

8-inch brick wall.	32
12-inch brick wall.	22
16-inch brick wall.	18
20-inch brick wall.	16
24-inch brick wall.	14
Single window.	85
Ceiling (unheated attic).	5
Floor (unheated basement).	4

WIND VELOCITY.

Wind.	Feet per Minute.	Miles per Hour.
Scarcely appreciable	90	1.02
Very feeble	180	2.04
Feeble	360	4.1
Brisk	1080	12.3
Very brisk	1800	20.4
High	2700	30.7
Very high	3600	40.1
Violent	4200 to 5400	47.8 to 61.4
Hurricane	6000	68.1

The United States Weather Bureau defines a gale as a wind blowing 40 miles per hour.

TABLE SHOWING THE PROPER SIZE OF FURNACE PIPES TO HEAT ROOMS OF VARIOUS DIMENSIONS WHEN TWO SIDES ARE EXPOSED.

Temperature at Register 140 degrees, Room 70 degrees, Outside 0 degrees. Rooms 8 to 17 Feet in Width Assumed to be 9 Feet High. Rooms 18 to 20 Feet in Width Assumed to be 10 Feet High. For Other Heights, Temperatures or Exposures Make a Suitable Allowance. When First-Floor Pipes are longer than 15 feet use one size larger than that stated.

		Length of Room.									
		8	9	10	11	12	13	14	15	16	
Width of Room.	8	8	7	7	7	7	7	7	8	8	8
	9		8	7	7	7	8	8	8	9	8
	10			8	7	7	8	8	8	9	8
	11				8	8	8	8	8	9	8
	12					9	8	8	8	9	8
	13						9	8	8	9	8
	14							10	8	10	9
	15								10	10	9
	16									10	9
										11	

One 12-inch pipe
 One 13-inch pipe
 One 14-inch pipe
 One 15-inch pipe
 One 16-inch pipe
 One 17-inch pipe

= two 9-inch pipes.
 = two 10-inch pipes.
 = two 11-inch pipes.
 = two 12-inch pipes.
 = two 12-inch pipes.
 = two 13-inch pipes.

In the space opposite the numbers indicating the length and width of room, the lower number shows the size pipe for the first floor, the upper number the size pipe for second floor.

For third floor use one size smaller than for second floor.

For rooms with three exposures increase pipe given in table in proportion to exposure.

For halls use pipe of ample size to allow for loss of heat to second floor.

THE APPROXIMATE VELOCITY OF AIR IN FLUES OF
VARIOUS HEIGHTS.

Outside temperature 32 degrees Fahrenheit. Allowance for friction 50 per cent. in flue one square foot in area.

Height of flue in Feet.	Excess of temperature of air in the flue over that out doors.											
	10°	20°	30°	40°	50°	60°	70°	80°	90°	100°	120°	140°
Velocity of air in feet per minute.												
5	77	111	136	159	179	199	216	234	250	266	296	325
10	109	156	192	226	254	281	306	330	354	376	418	460
15	133	192	236	275	312	344	376	405	432	461	513	565
20	154	221	273	319	359	398	434	467	500	532	592	650
25	173	248	305	357	402	445	485	522	560	595	660	728
30	189	271	334	390	440	487	530	572	612	652	725	798
35	204	293	360	423	475	527	574	620	662	705	783	862
40	218	311	386	452	508	562	612	662	707	753	836	920
45	231	332	408	478	538	597	650	700	750	800	887	977
50	244	350	432	503	568	630	685	740	790	843	935	1030
60	267	383	473	552	622	690	750	810	865	923	1023	1125
70	289	413	510	596	671	746	810	875	935	995	1105	1215
80	308	443	545	638	717	795	867	935	1000	1065	1182	1300
90	327	470	578	678	762	845	920	990	1060	1130	1252	1380
100	345	495	610	713	802	890	970	1045	1118	1190	1323	1455

The volume of air in cubic feet per minute discharged by a flue equals the velocity in feet per minute multiplied by the area in square feet.

Knowing any two of these terms, the third may be readily found.

$$\text{Velocity} = \frac{\text{volume}}{\text{area.}} \qquad \text{Area} = \frac{\text{volume}}{\text{velocity.}}$$

Example.—Find the area of a flue 20 feet high, that will discharge 3,000 cubic feet per minute, when the excess of temperature in the flue over that out doors is 40 degrees.

Opposite 20 in left hand column and under 40 on upper line is the number 319, representing the velocity in feet per minute. The volume $3,000 \div 319 = 9.4$ square feet, the required area. In estimating the effective height of a warm air flue from a furnace, consider the flue to begin 2 feet above the grate.

THE CAPACITY OF FURNACES TO MAINTAIN AN INSIDE TEMPERATURE OF 70 DEGREES WITH AN OUTSIDE TEMPERATURE OF 0 DEGREES.

Temperature of entering air, 140 degrees. Rate of combustion, 5 pounds of coal per square foot of grate surface per hour.

Average diameter of fire pot in inches.	Corresponding area in square feet.	Total exposure in square feet to which furnace is adapted.
18	1.77	1,110
20	2.18	1,370
22	2.64	1,655
24	3.14	1,970
26	3.69	2,310
28	4.27	2,680
30	4.91	3,080
32	5.58	3,500

STEAM AND GAS FITTING.

The Expansion of Wrought-Iron Steam and Water Pipes. To calculate the amount of expansion in the length of pipes, with different temperatures, take a pipe 100 feet long, containing cold water, or without either steam or water, and being at a temperature of about 32 degrees Fahrenheit. After heating the water in the pipe to 215 degrees, or 1 pound pressure of steam, the pipe will be found to be 100 feet $1\frac{1}{2}$ inches in length, with a rise in temperature from 32 degrees to 265 degrees, or 25 pounds pressure of steam, there will be an increase in length of $1\frac{8}{10}$ inches. From 32 degrees to 297 degrees, or 50 pounds steam pressure, the increase would be $2\frac{1}{10}$ inches. And again, a rise in temperature from 32 degrees to 338 degrees, or 100 pounds pressure of steam, will give an increase in length of $2\frac{1}{2}$ inches.

Wrought Iron Pipe. Wrought iron pipe is now almost exclusively used in heating plants. It is made at a number of factories, and being of standard sizes, pipe bought from different factories will be found to fit the same size of fittings.

It is manufactured from wrought iron of the proper gauge, which is rolled into the shape of the pipe and raised to a welding heat, after which the

edges are welded by being drawn through a die. The small sizes of pipe up to $1\frac{1}{4}$ inches are butt welded and $1\frac{1}{2}$ inches and larger sizes are lap welded.

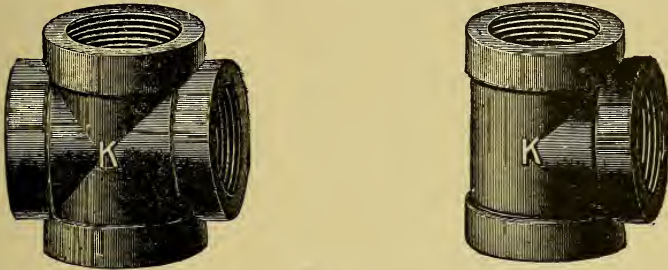

Fig. 85.

Fittings. Pipe fittings can be bought from the regular supply houses.

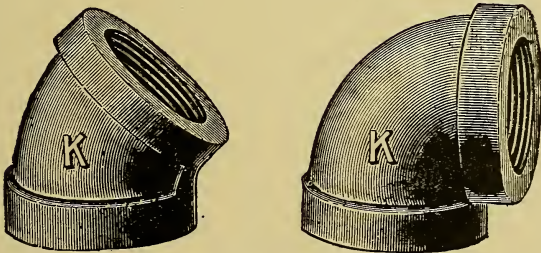

Fig. 86.

Fittings are mostly of cast and malleable iron, except straight couplings, which are usually of wrought iron. Elbows, tees and other fittings,

which can be procured of cast iron, are the best to use, owing to the fact that being of a harder metal than the pipe, and less elastic, they will not yield

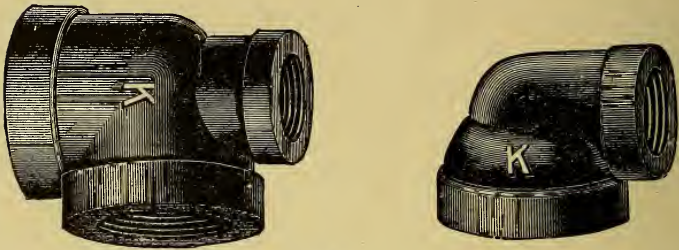

Fig. 87.

sufficiently to cause leakage when connections are made. All fittings should be closely examined for flaws before screwing on to the pipe.

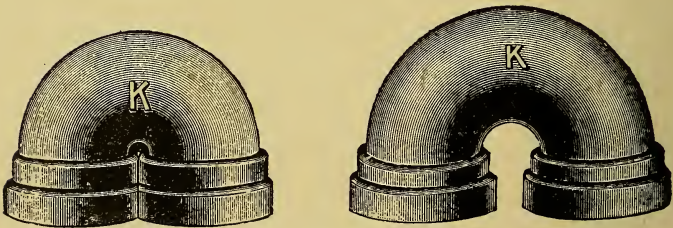
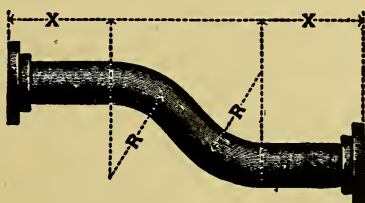
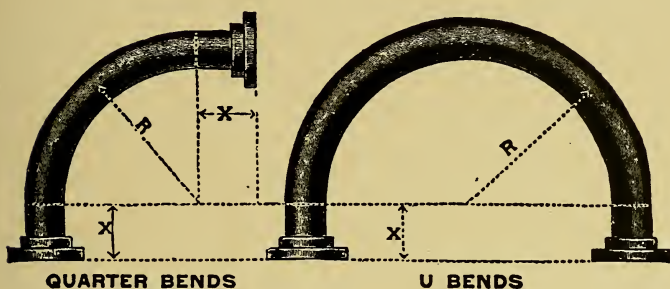

Fig. 88.

Standard cast iron fittings for use in installing steam and hot water heating plants are shown in Figs. 85, 86, 87 and 88.

Pipe Bends. The radius of any bend should not

be less than 5 diameters of the pipe and a larger radius is much preferable. The length X of



OFFSET BENDS

Fig. 89.

straight pipe shown in Fig. 89 at each end of bend should be not less than as follows:

- 2 $\frac{1}{2}$ -inch Pipe $X=4$ inches,
- 3 -inch Pipe $X=4$ inches,
- 3 $\frac{1}{2}$ -inch Pipe $X=5$ inches,
- 4 -inch Pipe $X=5$ inches,
- 4 $\frac{1}{2}$ -inch Pipe $X=6$ inches,
- 5 -inch Pipe $X=6$ inches,

6-inch Pipe X=7 inches,
7-inch Pipe X=8 inches,
8-inch Pipe X=9 inches,
10-inch Pipe X=12 inches,
12-inch Pipe X=14 inches,
14-inch Pipe X=16 inches,
15-inch Pipe X=16 inches,
16-inch Pipe X=20 inches,
18-inch Pipe X=22 inches.

Pipe Machines. The illustrations in Fig. 90 show two portable pipe-threading machines which are compact, moderate in cost, and efficient. For

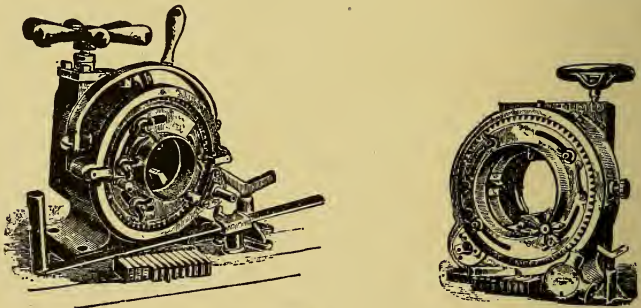

Fig. 90.

the larger sizes of pipe, covering a range of from $2\frac{1}{2}$ to 4 inches they will be found time-saving and convenient devices.

Tools. The tools shown in Figs. 91 and 92 will be found sufficient to meet the ordinary requirements for installing a steam or hot-water heating

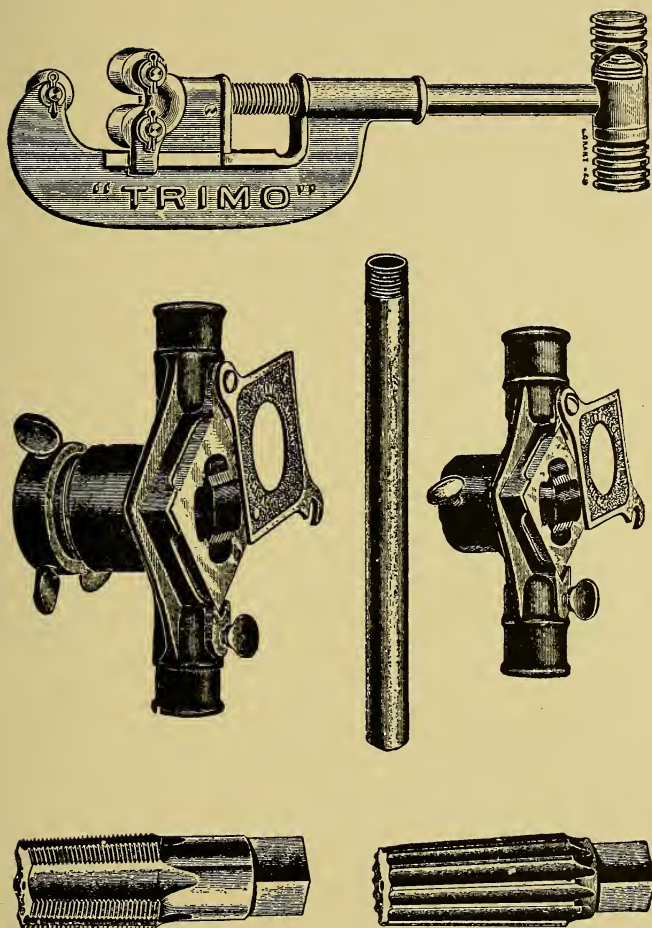

Fig. 91.

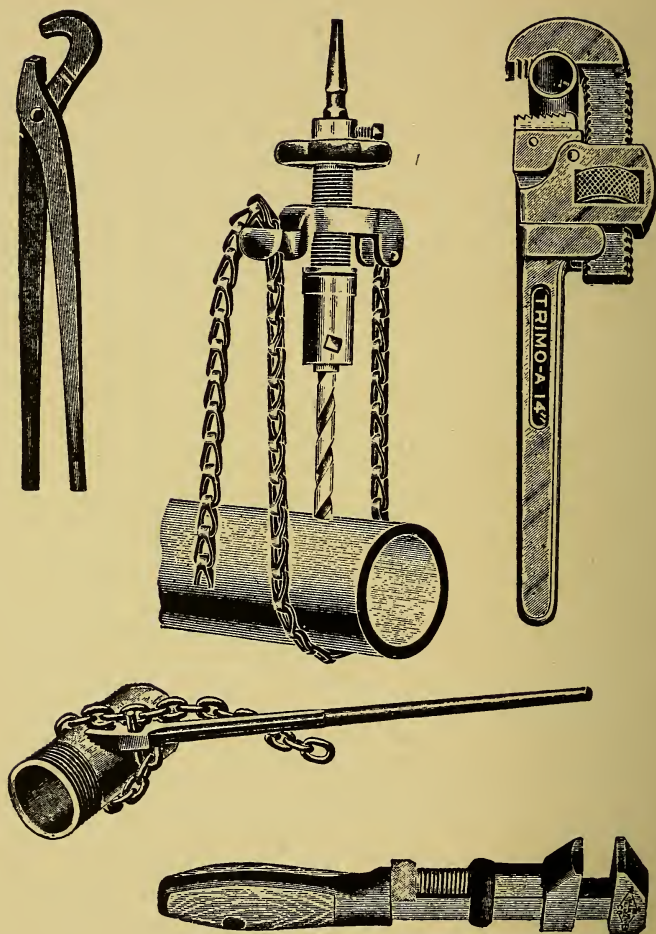

Fig. 92.

plant of ordinary size. The mains of larger size than 2 inches may be ordered cut to measurement.

The contractor should provide himself with two pipe vises as shown in Fig. 93, having a range of capacity from 2½ up to 4 inches inclusive. Such machines can be purchased at a very moderate cost.

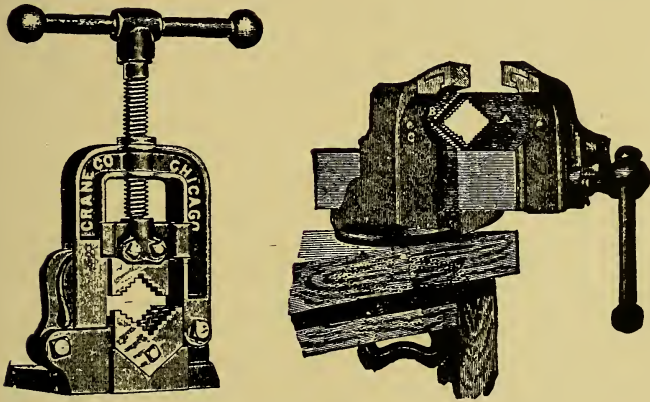

Fig. 93.

Gas Fitting. While electricity is making wonderful progress and particularly for lighting, still gas holds its own for domestic purposes. Illuminating gas is not entirely perfect, but when it is properly made, carefully delivered to the building and there properly handled, the results are so satisfactory that some time will elapse before anything else will take its place. The average house

is fitted for the use of gas, and the field of discovery in the use of gas for domestic purposes appears to be as great as that of electricity.

Gas Supply Pipe. The gas supply pipe should be connected to the main in the best possible manner. The pipe should be wrought iron, with fittings, if any, of malleable or wrought iron. Cast-iron fittings should not be used as they crack easily. The service pipe should be laid with an incline to the main in the street, as the earth which surrounds the pipe being cold causes some of the gas to condense and become liquid. With a fall in the supply pipe to the street the condensation can therefore flow back into the main pipe.

With the supply pipe laid in this way there will be no flickering of the gas or any unsteady pressure.

The gas supply pipe from the street main should never be less than one-inch pipe. The meter connection pipes should always be of one size larger than the meter couplings. All drops should be not less than $\frac{3}{8}$ -inch pipe.

Street Supply Pipe. It is necessary to have the house supply pipe rest on a solid foundation. It often happens that in excavating the trench for the supply pipe it is dug too deep, or it may be dug level, and as the pipe must be pitched back to the main, it will have to be blocked up. Do not block up a supply pipe on filled-in earth. Start the blocking from the bottom of the trench or from

the lowest excavated part. There is no special amount of pitch required for such pipes as the more pitch they have the less liability they will have to form a water trap. After the pipe is all laid, properly graded and blocked, test the pipe, for the purpose of ascertaining if there are any leaks, before the pipe is covered up. The pipe being found perfectly gas tight, the trench can now be filled up. It is a good plan to remain on the ground and superintend the work of properly filling the ditch as the average laborer who is engaged to do the filling of such ditches has not sufficient knowledge of the work to handle the pipe with the necessary care. It is not an unusual thing to find the gas supply pipe leaking badly, after being covered over, by allowing heavy stones to fall into the ditch by carelessness on the part of the laborers.

Frost in Pipes. The flow of gas is retarded by frost even where the supply pipe has sufficient pitch, if it be in too cold a place and not properly protected from the cold. This occurs generally in the main supply pipe where it passes under the sidewalk, and as a large amount of gas passes through the supply pipe, a large amount of moisture comes with the gas. It is this moisture which freezes to the sides of the pipe, like heavy frost on a window, but much coarser, and looks very much like coarse salt. It will keep on accumulating, gradually filling up the pipe toward the center

from all sides, until the pipe is entirely filled and the flow of gas arrested.

To remedy this difficulty the pipe should be covered with some felt or other material, dry sawdust may be also used and placed in a box around the pipe. By striking the pipe a sharp blow with a hammer the frost will fall from the sides of the pipe and lie at the bottom of the pipe. This does not clear the pipe entirely, but will allow the gas to flow through the upper part of the pipe. This frost cannot be blown back into the main and to clear the frost out entirely alcohol must be poured into the pipe at the meter connection, a half pint or more, which will melt the frost and carry the water which is formed into the main.

Fittings. Gas fittings should be of malleable iron in preference to cast iron as they are lighter and neater in appearance, besides being much stronger. Standard fittings for use in gas lighting work are shown in Figs. 94, 95 and 96. Union elbows and tees are shown in Fig. 97 and gas service cocks in Fig. 98.

Connecting a Meter. The gas pipes in the building, as well as the supply pipe from the street, should be tested before the meter is connected, to avoid the possibility of damaging the meter by any sudden pressure. The supply pipes should also be blown out so that the liability of dirt being carried into the meter by the gas will be obviated.

After connecting the meter care should be taken

to turn on the gas slowly until the pressure has had a chance to equalize on the distributing side. This prevents a sudden strain on the meter. A meter should not be set in a place warmer than 100 or colder than 40 degrees Fahrenheit, as the oil in



Fig. 94.

the meter diaphragms is very susceptible to heat or cold.

Reading a Meter. One complete revolution of a hand registers the number of cubic feet marked above the dial.

STREET ELBOWS



ELBOWS



DROP ELBOWS



DROP TEES



WALL PLATES



CHANDELIER HOOKS



FOUR-WAY TEES



CROSS OVERS



**REDUCING
COUPLINGS**



EXTENSION PIECES



Fig. 95.



STEAM AND GAS FITTINGS

ELBOWS

CAST IRON

STRAIGHT



REDUCING ELBOWS

CAST IRON



45° ELBOWS

CAST IRON

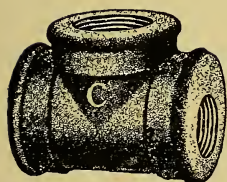

**ECCENTRIC
TEES**

CAST IRON



REDUCING TEES

CAST IRON



Fig. 96.

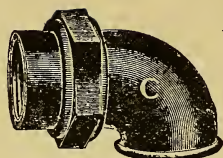

WITH FEMALE UNION

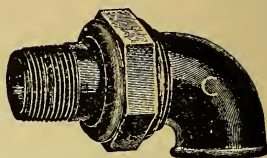

WITH MALE UNION

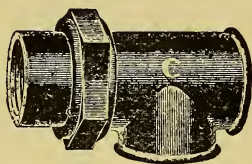

WITH FEMALE UNION

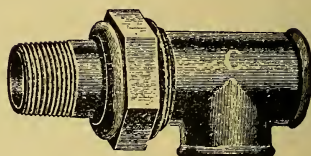

WITH MALE UNION

Fig. 97.

Put down the figures on each dial, that the hand has just passed, and add two ciphers. The num-

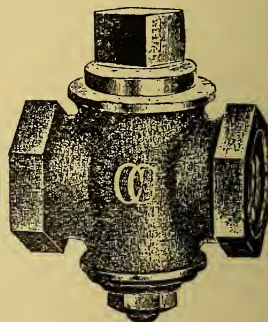
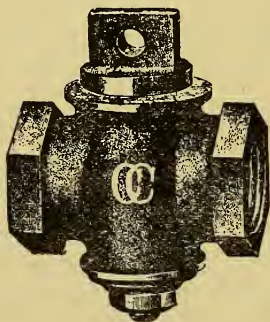

Fig. 98.

ber obtained will be the amount of gas in cubic feet that the meter has measure. From this amount

subtract the last reading of the meter and the result is the amount of gas consumed in the intervening period.

A type of meter and one of the most used is shown in Fig. 99, and the dial plate of a gas meter in Fig. 100.

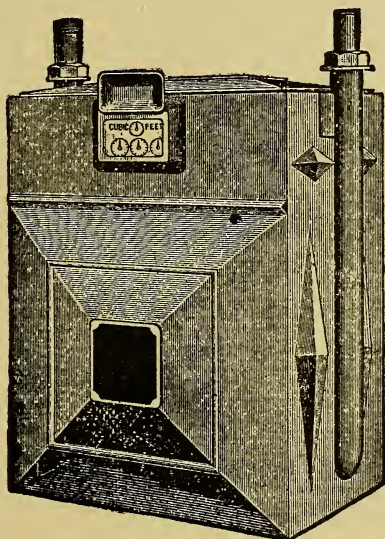

Fig. 99.

Blow-torch. In working around gas fixtures that are in place, the gas fitter should be very careful about the walls and ceilings and not blacken them with the blow-torch in case he has to heat a joint for the purpose of connecting. Proper tools should be at hand to do this work with, and in

place of using gasoline or some other kind of oil in the torch, the best kind of alcohol should be



Fig. 100.

used, so that there will be no smoke from it to dirty the walls or ceiling. Fig. 101 shows a gas

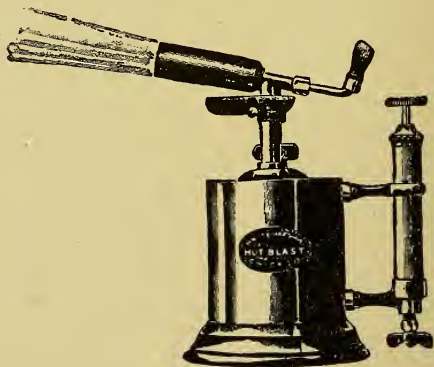

Fig. 101.

fitter's blow-torch, made in the best possible manner and adapted for many purposes.

Mantle Lamp. The mantle lamps of which there are a great many different varieties, resem-

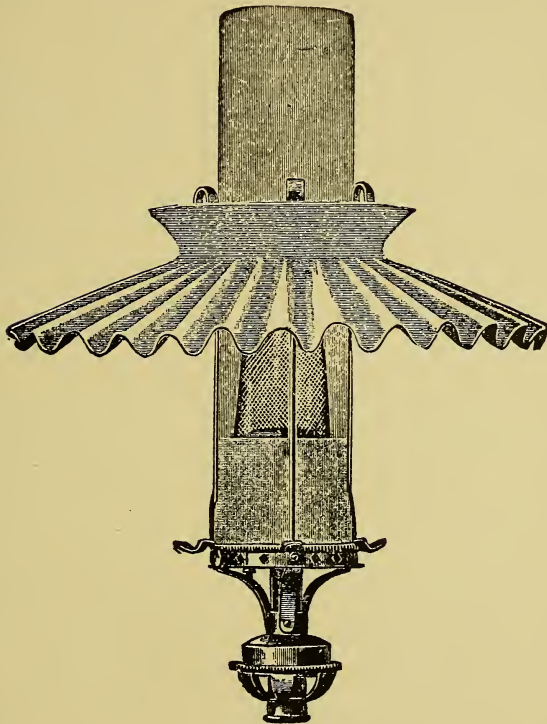

Fig. 102.

ble somewhat the old-fashioned round or Argand type of burner, but the manner in which the light is produced is entirely different in the mantle

lamp. The light produced by this lamp does not come from the flame itself, as in the case of an ordinary gas burner, but from the mantle, and is due to the intense heat to which it is subject by the action of the Bunsen flame within the lower end of the mantle. Fig. 102 shows one form of a mantle lamp.

In transferring a mantle from its box to the burner, take the two ends of the string in one hand and lift the mantle out of the paper tube. By holding the top part of the burner in the other hand and below the mantle, the latter can safely be lowered into position. Before fixing the chimney examine the mantle, as a faulty one will be exchanged by the dealer if returned before being lit. A mantle is made up of a regular series of loops, each row connected to the one above, and if at any point a loop does not join the row above, the mantle should be returned as faulty, as it is almost certain to develop a break as soon as used. Other faults, such as broken collars, broken suspending loops, fractured sides, and torn bottoms, are noticeable at a glance.

When lighting incandescent burners, the light should be applied from underneath the chimney, but above the screen which prevents lighting back. Some prefer to light from the top of the chimney, in which case the gas should be turned on sufficient time before the light is applied to allow the gas to expel all the air in the chimney,

so that little or no explosion shall take place, and the mantle may be free from consequent damage.

The breakage of mantles when in position may be avoided by attention to a few rules. Fix incandescent burners only on good sound and clear gas fittings. Where there is much vibration, use one of the anti-vibration frames now on the market, these frames are specially suitable for hanging lights, such as the arc lamps, etc. All pendants for the incandescent light should be supplied with loose joints, and they should never be screwed stiff, or the mantle will break if it gets the slightest knock. In draughty places, such as lobbies, passages, and corridors; a mica chimney is desirable, so as to avoid breakage of the chimney, and to preserve the mantle.

If a newly fixed burner gives an unsatisfactory light, either there may be an insufficient gas supply, or the mantle may be much too wide, perhaps both conditions exist. In the first case the mantle will be well lit all round the bottom. with the light getting worse towards the top. If two of the four air-holes in the Bunsen tube are covered by the fingers, the light will at once improve. Therefore, either reduce the amount of air admitted, or increase the quantity of gas supplied. To reduce the amount of air, unscrew the Bunsen tube and fix inside it a piece of card or tin to cover two opposite holes. To increase the gas supply, remove the burner from the fittings, and unscrew

the Bunsen tube, when the gas regulator nipple will be seen to consist of a brass tube having a metal top with small holes, which should be very slightly enlarged. Very handy for this purpose is a hat-pin, ground to a long taper and passed up from the under side. When a mantle is too wide, one side only is incandescent, the other side hanging away from the gas ring. This fault is, of course, easily seen before the burner is used, if, however, the mantle has been lit, the light can be improved by slightly lowering the mantle and, as this is tapered, presenting a smaller surface to the flame. Take off the mantle, lifting it by a wire under the suspending loop. Then place the wire across a glass tumbler with the mantle suspended inside. Take out the support, nick it with a file about $\frac{1}{2}$ inch from the plain end, and break it off, then replace the mantle.

It is noticed that the brilliant light given by a new burner does not last, the light after a fortnight probably commencing to decrease. If kept in use, the mantle top becomes coated with soot and a smoky flame issues. The burners go wrong in a much shorter time if used in a room in which a fire is constantly burning. The cause of this is simply dust, which is drawn in at the air-holes and carried up the Bunsen tube. It cannot pass away owing to the screen, to which it adheres, thus preventing the gas getting away quickly enough to draw in the proper amount of air. To

remedy this, take off the mantle and, with a small brush (an old nail- or tooth-brush), remove the dirt, blowing through the screen afterwards. Then replace the mantle, clean and replace the chimney, unscrew the Bunsen tube, and brush the nipple clean. Blow the dust from the tube and then refix the top. If the mantle is covered with soot, leave the gas half on until the soot is removed. To keep the burners at their best, this process should be done at least monthly. If the burners are in a dusty place they will require more frequent cleaning.

Failure of the bye-pass in arc lamps is a common fault, even in new burners. The bye-pass light may go out after the gas is turned on. In a new burner this is often caused by one of the two set-screws on the side of the burner being inserted too far; in this case, after unscrewing a complete turn, the burner will most likely work. It is sometimes necessary to take out both screws and to remove the grease adhering inside the end of the hole.

Gas Proving Pump. Considerable time will be saved by having a good force pump with which the supply pipe in the street and the house pipes may be tested. A gas proving pump is shown in Fig. 103.

Cleaning Gas Fixtures. If the gas fixtures cannot be kept covered in summer time, they can be kept clean by going over them every two or three

days with a soft, damp cloth, which must not be pressed hard against the fixture, as there will be danger of rubbing off the thin coat of lacquer. All that is to be taken off is the fly-specks, for if they are allowed to remain for more than two or three

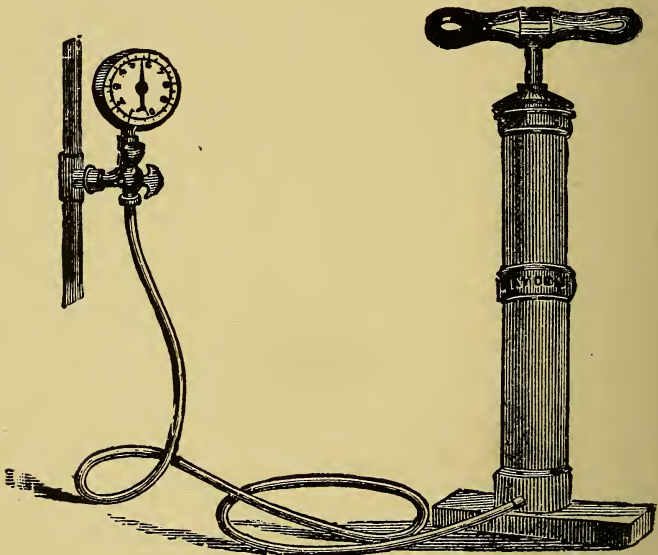

Fig. 103.

days they will eat in through the lacquer and also through the plating and then the more the fixtures are cleaned the worse they will look. No powder or polish of any kind should be used for the purpose of cleaning gas fixtures, as it will at once destroy the only protection a gas fixture has, that is

the coat of lacquer. After using a damp cloth to clean the fixture, dry each part at once with a soft, dry cloth, as it will injure the coat of lacquer to allow water to dry on the fixture. Even the moisture from the hand will sometimes leave a stain that can never be cleaned off.

FLOW OF NATURAL GAS THROUGH A ONE-INCH
CIRCULAR OPENING.

Pressure, Inches Water.	Cubic Feet per Hour.	Inches Mercury.	Cubic Feet per Hour.	Pressure, Pounds per Square Inch.	Cubic Feet per Hour.
2	2,041	1	5,168	5	17,186
4	2,897	2	7,632	6	18,989
6	3,542	3	9,305	8	21,778
8	4,116	4	10,552	10	23,388
10	4,563	5	12,019	12	25,479
		6	13,220	15	27,876
		7	14,182	20	33,027
		8	15,316	25	38,002
		9	16,025	30	42,762
		10	16,970	35	48,074
				40	52,761
				50	62,352
				60	71,125

HEIGHT OF COLUMN OF LIQUID TO PRODUCE ONE POUND
PRESSURE PER SQUARE INCH AT 62 DEGREES
TEMPERATURE.

Water	27.71
Machinery oil	30.80
Mercury	2.04

GAS BURNERS.

While much has been written upon the principle involved in obtaining a light from gas, very little is generally known as to what is required and what is the best means to adopt to secure the greatest amount of light at the least cost, and with the least vitiation of the atmosphere of the room where the light is required. Many and various improvements have been brought forward for the accomplishment of these objects, some require only a very slight alteration to the existing fittings and yet give very excellent results, while others secure a very high illuminating effect and at the same time not only remove the vitiated air which has been used to support the combustion of the flame, but at the same time carry off the air rendered useless for supporting life by the inspiration and absorption of the oxygen.

The principle which is involved in the burning of gas may with advantage be here mentioned. Coal gas contains many very different substances, about one-half of it is hydrogen, one-third marsh gas, and perhaps one-tenth is carbon monoxide.

The three gases mentioned in the statement are of no value as regards the light they will give by

themselves, but they are capable of giving a great heat when ignited, and this heat is utilised for the purpose of rendering white hot the small quantity of hydro-carbons in the gas, and it is this incandescence of the very finely divided carbon particles which makes the flame luminous.

When a gas burner is lighted, the rush of gas from the orifice of the burner causes a current of air to pass upon each side of the flame, and thus supply the oxygen necessary to support combustion, the portion of the flame nearest to the burner is almost non-luminous, and is, in fact, unignited gas enclosed in a thin envelope of bright red flame. That this is really unconsumed gas can be shown by placing the lower end of a glass tube into this portion of the flame and applying a light at the upper end, when the gas issuing from it is seen to burn with an ordinary flame. The reason that this portion of the gas is not luminous is that the quantity of oxygen which is able to get to the flame at this point is only sufficient to cause the outer portion to be in a state of incandescence. That there is solid carbon in the flame may be seen by inserting a piece of cold metal or porcelain in the white portion of the flame, which, by reducing the temperature of the carbon, becomes coated with soot upon the under side. The same effect takes place when the cold air is allowed to blow upon the surface of the flame, the excess of oxygen presented to the flame causing a cooling of

the heating gases and a consequent loss of light, as the particles of carbon are not then sufficiently heated to be made white hot and to give off light, and they then allow the carbon to pass off in the form of soot and to blacken the ceilings and paint of the rooms. This is more likely to occur with high quality gas, which contains more particles of hydro-carbons, and if there be an insufficient supply of oxygen to the flame a larger proportion of soot will be allowed to escape and settle upon the ceilings, etc. Another source of blackening of the ceilings is the nearness of the burners and the absence of a guard over them to deflect and spread the products of combustion over a large space. The real explanation of this effect is that aqueous vapour formed by the burning gas is condensed on the ceiling, and dust particles which are floating in the air are thereby caused to adhere to the ceilings. With high quality gases small burners should be used, so that the gas may be more thoroughly consumed.

It appears that the first burners were simply pieces of pipe with one end stopped up. In the centre of the end was drilled a small hole, and the light given off, principally owing to the shape of the flame, was very small. Then was invented the bat wing burner, which has a slot cut in the dome-shaped top, and this gave a flame somewhat of the shape of a bat's wing, hence the name. Then came the union jet, which is an arrangement very

generally in domestic use at the present day. It consists of a piece of brass tube plugged with a piece of steatite or porcelain with two holes in it drilled at such an angle that the two streams of gas issuing from them meet, and cause the flame of gas to spread and form a flame of horseshoe shape. One of the special points to be noticed in these burners is that the holes in them should be of comparatively large size, and the pressure of the gas when delivered from the burner reduced to the lowest point at which a firm flame can be maintained. This can be done best by means of what is known as a governor, which is in effect a self-acting valve which allows only just so much gas to pass as may be required.

Passing on to the more modern styles of burners, of which there are many patterns, such as the regenerative burners, it is found that all these embody the same principle, which is to use the heat generated by the flame to heat the gas supply and the air supply so that the cooling effect of the air, which causes the blue portion of an ordinary flat flame, is considerably reduced, and the particles of carbon are rendered more rapidly incandescent, and, being heated to a greater temperature, attain greater luminosity and are kept for a longer period at this white heat.

The earliest arrangement of such a burner was invented in 1854, and consisted of an argand burner with two chimneys, one outside of the other,

the air supply to the flame having to pass down between the two glasses, and so to become heated before it was led to the bottom of the burner. This answered very well, but the breakage of the chimney glasses was a considerable expense, and debarred many from adopting the system. This trouble is quite overcome in the modern regenerative burners, as the chimneys are made of metal and the burner is inverted, so that the flame is spread outwards instead of, as in the argand burner, upwards. The regenerative burner gives a light having four times the illuminating power of the flat-flame burner.

With the incandescent burners, quite a modern invention, the principle of admitting air to mix with the gas before lighting is employed as in the Bunsen heating burner, and this, while taking away the luminosity of the flame, causes it to give off a much greater amount of heat, this heat being utilised to render a mantle of rare earths incandescent or white hot. These mantles are made conical in shape, and when made white hot emit a most pleasing white light, which is about five or six times more intense than that given off by the ordinary flat flame burner.

With a properly arranged ventilating regenerative burner, consuming 20 cubic feet of gas per hour, and properly fitted, not only can all its own product of combustion be removed, but also the air vitiated by breathing can be removed at the rate of

more than 5,000 cubic feet per hour from the upper part of the room.

The comparative quantity of air vitiated by different illuminants giving the same amount of light is shown by the following table:—

Gas burnt in union jets.....	1
Lamp burning sperm oil	1.6
Lamp burning kerosene oil.....	2.25
Tallow candles	4.35

From this table it will be seen that kerosene lamps use up more than twice the amount of the oxygen of the air that gas does, while tallow candles use more than four times the amount.

For a light of 32 candle-power, tallow candles would vitiate as much air as would be required by about 36 adult persons, kerosene oil lamps as much as fifteen adults, while gas varied from an amount of air required for nine and a half adults when a batwing burner was used, to eight and a half when an argand burner was used. In these experiments not only was the quantity of oxygen consumed taken into consideration, but carbon dioxide and the water vapour were all taken account of.

Special attention must be directed to the necessity of having burners suitable to the quality of gas which is being used. It may be taken as a fairly general rule that the higher the illuminating power of the gas the smaller the burner should

be. With unsuitable burners, not only blackening of the ceilings, but a far lower state of efficiency as regards the illuminating power of the light obtained from a given quantity of gas will result.

The effect of using bad burners is primarily that the light capable of being developed from the consumption of a definite quantity of gas is not obtained, consequently more gas is burnt than necessity requires, in other words, gas is wasted, and with imperfect combustion, deleterious products are given off, vitiating the atmosphere and endangering health.

That the burners which are most economical in gas consumption are the most expensive at first cost is certainly the case to some extent, but the amount of the saving effected by their use quickly repays the first cost, and thereafter the money saved goes directly into the pocket of the user of the burner. The incandescent burner is the most economical burner that is at present known, and where gas is at a high price it is a very distinct advantage, as the quantity of gas required for a given amount of light is only about one-fifth of that used with the ordinary burner. Then comes the argand burner, which is superior to the union jet or flat-flame burner, but in all these an arrangement known as a governor is generally to be found, by which is regulated the quantity of gas that can find its way to the point of ignition,

and, if only just sufficient is allowed to pass so that none is wasted, gas is economised. These governors are also made for use with the ordinary flat-flame burner.

As has been said, the principal gas burners now in use are the flat-flame, argand, and incandescent. Flat-flame burners embrace the union jet, or fishtail, and the batwing. In the union jet or fishtail the gas issues through two apertures in a steatite plate inserted in the top of a cylindrical brass tube, threaded at its lower end for the purpose of attaching to a gas-fixture. The holes in the steatite tip through which the gas issues are inclined towards each other at an angle, so that the gas issues in two streams which unite into one flat flame at right angles to a plane passing through the two holes. One of the reasons of the adoption of steatite for the tip of the gas burner was the fact that it required a very high heat to harm it. Steatite is a natural stone found in various parts of the world, principally in Germany. Chemically it is a double silicate of magnesium, and a substitute for the natural substance may be obtained by mixing silicate of magnesium and silicate of potash. Natural steatite is of a very fine grain, and softer than ivory, it admits of being worked to a very fine polish, but after it has been burned in a kiln it becomes harder than the hardest steel, and will resist a very high temperature, about 2,000° Fahrenheit. In forming the steatite

into burner tips, the material is finely powdered, moistened with water, and kneaded into a plastic condition, after which it is moulded to the requisite shape and finally burnt to harden it. The diameter of the orifices in the steatite tips, through which the gas issues, differs in size, the aim being in each case to produce a flame of a thickness suited to the quality of the gas the burner is intended to consume.

The batwing burner resembles the fishtail or union in its general features, but differs in the manner in which the gas issues from it. In this form of burner the hollow tip is made dome-shaped and has a narrow slit cut across it and extending some little distance down. The slit varies in width to suit different qualities of gas. The batwing burner requires less pressure than the union jet, with the result that the gas issues with less force, so that the flame produced in burners of this class is not so stiff as that obtained with a union burner. Consequently it is necessary to employ globes with burners of this description in order to protect them from draught, which would cause them to flicker and smoke.

GAS STOVES AND FIRES.

An examination of the principles of gas stoves and a consideration of the advantages and disadvantages of these heating appliances, may appropriately precede any description of gas stoves themselves. A point often ignored in the heating of rooms is that a room will not feel warm until its walls reach the same temperature as the air which it contains. Until this occurs, the room will feel draughty, owing to the fact that the walls are depriving the air of the heat given out by the stove.

It is necessary to examine the conditions of the room or building to be heated before making any calculation as to the amount of gas required to heat it. Architects calculate the cubical contents of the room, and gauge from this the size and character of the heating appliances required. A better plan is to calculate the area of the wall surface, and, in ordinary dwelling-houses, allow that one-half a heat unit is absorbed by each square foot per hour for each degree Fahrenheit rise after the necessary warming up is complete.

The number of heat units generated per cubic foot of gas of sixteen candle-power, theoretically is 670 to 680, therefore, to raise the temperature

in a room which has been once warmed, it is necessary to allow a consumption of 1 cubic foot for every 1,300 square feet of wall surface. For the preliminary heating, however, considerably more than this is required, and as there should be a change of air in the room about every twenty minutes, practically three-fourths of the heat produced by the stoves passes away by ventilation, and consequently about four times the above-mentioned quantity of heat is required to raise the temperature of a room from the commencement, when it is at about the same temperature as the external air.

It was at one time recommended to fix a row of Bunsen burners in front of or underneath an ordinary coal fire-grate, filled either with black fuel, made of fireclay, or with small coke. It gave a very cheerful appearance, but it was found that the quantity of coke used, together with the consumption of gas, rendered the plan uneconomical. Many persons set a high value upon the cheerful appearance of this arrangement, and are willing to pay for it, and makers have brought forward improvements by which a saving of gas is effected. Still, gas fires in ordinary coal grates can only be recommended in preference to gas stoves when economy is not essential.

Stoves in which air passes over heated surfaces are more economical than ordinary gas stoves, but, on the other hand, they are more liable to

cause unpleasant odours through the heating of the dust particles. With these stoves, as also with hot-air and hot-water pipes, as distinct from grates, the heated air has a great tendency to rise to the top of the room, leaving the feet cold while the head is too warm. The same effect is noticed where enclosed stoves are set forward some distance into the room, but these stoves are very economical, and where fuel is dear this is a paramount consideration. One pound of coal burnt in an ordinary grate requires, for its proper combustion, 300 cubic feet of air having a temperature of 620° Fahrenheit, and 1 volume of gas for complete combustion requires 5½ volumes of air. In atmospheric or Bunsen burners the average mixture of gas and air is 1 volume of gas to 2.3 volumes of air, consequently, a further supply of air around the flame is necessary to cause complete combustion, and an analysis of the gases, taken from the centre of the glowing fuel, shows that often 10 per cent of carbon monoxide exists, and, should down-draughts occur, this must find its way unnoticed—for it has neither smell nor color—into the room, hence the necessity for ensuring a good draught from the stove. Curiously enough, however, the analyses of gases in the flue during the burning of the gas stove do not show a trace of this deadly gas. An average of some twenty-four stoves tested in this way showed the presence of 12 per cent of oxygen, 84 per cent of

nitrogen, and 4 per cent of carbonic acid, thus proving that all the carbon monoxide had been converted into carbonic acid before leaving the stove when burning in the proper manner. This shows conclusively that flues are a necessity with gas stoves in which Bunsen burners are in use, although they need not be so large as the usual coal-grate flue, but where flues are not possible, only such stoves as employ ordinary lighting burners and utilise the heat radiated from a polished surface should be fixed.

Where a smoky chimney exists, a gas stove will not cure it, unless the fault is due to a contraction of the flue, by which the flow of the draught is impeded. In that case a much smaller flue for carrying off the products of combustion being sufficient with a gas stove as compared with a coal fire, the trouble will probably disappear, but it would be well to ascertain the origin of the fault before recommending the adoption of a gas stove as a remedy.

GAS-FITTING IN WORKSHOPS.

In fitting workshops with gas, it is important that strong materials be employed and it is desirable to use iron pipes throughout. Where a row of benches is fixed upon each side of a workshop, it is usual to run a pipe along just below the ceiling, with tees between each window, from these a small pipe is carried down to either a single or double swing iron bracket. Some firms who make gas-fittings, supply iron brackets, but they can be made up quickly from the fittings and short pieces of iron pipe. Brass swivels wear considerably better than those that are made of iron, and do not corrode and stick in the working parts.

When the lights are to be located down the middle of a workshop where lathes or other machine tools are used, the only brass parts are the cocks and burner elbows, the ordinary iron tee being very suitable for the centre of the pendant. Where more than one floor is to be lighted, fix on the supply pipe a governor for regulating the quantity of gas delivered, otherwise the pressure due to the height of the upper floors will cause a lowering of the light in the ground floor or basement. It is also an advantage to have each floor separate-

ly supplied from the main, so that each floor may be shut off entirely without interfering with the others, and if a separate meter be supplied for each floor, the quantity of gas consumed in proportion to the work done after dark may be checked, and any escape noted. Where a pipe falls, a pipe syphon or syphon-box should be fixed, as the temperature is subject to extreme changes and the quantity of condensation is much greater than in private houses.

When the pipes are run through the floor and up the legs of the lathes or other machinery, it is usual to bend the pipe to the exact curves taken by the machine, and to fix the pipe in its place by means of bands of iron bent to the curve of the pipe, and fixed to the machine by two small set screws. These bands may also be found useful in fitting up houses where the nature of the wall or floor will not permit the use of the ordinary pipe-hook.

It is often found necessary to fit up in a workshop over each machine a bracket arranged so as to move in any direction to suit the convenience of the workman. One way of making these fittings is to make the elbows of the brackets of two double swing swivels—one upright and one on its side. Another way is to have two lines of pipes from the support, and to connect both at each end to double swivels, while between the upper and lower pipe, and laid at an angle, is a thin bar,

which is fixed on to the upper pipe, and can be clamped to the lower one when the exact position required has been obtained. This form of bracket is useful in drawing offices, where the burner and shade commonly in use cause the other pattern of bracket to gradually fall downwards on to the table, whereas the second arrangement always keeps parallel, and, if tightly clamped, cannot change its position without breaking the thin metal bar, which should be made sufficiently strong to withstand the strain due to the weight of the heaviest burner chimney and shade likely to be placed upon it.

In making brackets and pendants it is convenient to know a quick and efficient way to bend iron pipes. The exact shape required having been drawn full size upon paper the latter is tacked or posted on to a rough board. Strong cut nails are then driven in it to follow the desired curve, the nails being half the outside diameter of the pipe from the drawn line, so that the centre of the pipe, when bent, may lie directly over the drawn line. The iron pipe is heated in a forge fire or in a furnace, the latter heats the pipe equally over the length required. The end is inserted between the lines of nails, and, with the aid of a pair of pliers, is quickly made to follow the curves indicated by the nails. Nails are not necessary on the outer side of the curves, except at the starting point, where a firm grip of the pipe must be insured.

Where many pipes are to be bent to the same shape, the board is replaced by a square plate, with holes all over it, cast or wrought-iron curves replacing the nails. The saving in time and the accuracy of the bending soon repay the additional outlay. In bending iron pipe, proceed gradually, and make only small curves at a time, or the pipe will collapse.

For shop brackets, metal backs are found suitable. These metal backs are supplied with the fittings, and are drilled and countersunk ready for erection, space being left for the pipe to screw into the top of the swivel joint. A metal back makes a strong job, and answers every purpose where very neat finish is not necessary.

In all workshops ventilation is a prime requisite, and must be provided for, more especially where the rooms are low and a considerable number of workmen and gas lights are employed. Gas is an excellent draught inductor, an ordinary batwing or union jet burner consuming 1 cubic foot of gas per hour, when placed in a six-inch ventilating tube 12 feet long, will cause 2,460 cubic feet of air per hour to pass up the tube, and this induced draught can be easily adapted for the removal of the heated and vitiated air from the upper portion of the room. Each person present will give off per hour about 17.7 cubic feet of air, of which from .6 to .8 of a cubic foot will be carbonic acid (CO_2), the amount of CO_2 evolved from the com-

bustion of coal gas is equal practically to one-half the quantity of gas burnt, and an ordinary gas burner may be considered as being equivalent to at least three adults in its effect upon the atmosphere. The air space required in a workshop is 250 cubic feet for each person during the day and 400 feet at night. Again, 500 cubic feet of fresh air per person should be delivered into a room during each hour, and therefore the same quantity of vitiated air must be drawn away by some means, no method is more suitable or so effective as the one above proposed, in which a lighted gas burner is enclosed by a ventilating shaft. A well-constructed ceiling burner has an excellent effect upon the ventilation of a room, workshop, or hall, when a properly arranged vertical shaft, usually of sheet iron, is carried up through the roof, and will at the same time assist greatly in the general illumination of the shop.

USEFUL INFORMATION.

One heaped bushel of anthracite coal weighs from 75 to 80 lbs.

One heaped bushel of bituminous coal weighs from 70 to 75 lbs.

One bushel of coke weighs 32 lbs.

Water, gas and steam pipes are measured on the inside.

One cubic inch of water evaporated at atmospheric pressure makes 1 cubic foot of steam.

A heat unit known as a British Thermal Unit raises the temperature of 1 pound of water 1 degree Fahrenheit.

For low pressure heating purposes, from 3 to 8 pounds of coal per hour is considered economical consumption, for each square foot of grate surface in a boiler, dependent upon conditions.

A horse power is estimated equal to 75 to 100 square feet of direct radiation. A horse power is also estimated as 15 square feet of heating surface in a standard tubular boiler.

Water boils in a vacuum at 98 degrees Fahrenheit.

A cubic foot of water weighs $62\frac{1}{2}$ pounds, it contains 1,728 cubic inches or $7\frac{1}{2}$ gallons. Water

expands in boiling about one-twentieth of its bulk.

In turning into steam water expands 1,700 its bulk, approximately 1 cubic inch of water will produce 1 cubic foot of steam.

One pound of air contains 13.82 cubic feet.

It requires $1\frac{1}{2}$ British Thermal Units to raise one cubic foot of air from zero to 70 degrees Fahrenheit.

At atmospheric pressure 966 heat units are required to evaporate one pound of water into steam.

A pound of anthracite coal contains 14,500 heat units.

One horsepower is equivalent to 42.75 heat units per minute.

One horsepower is required to raise 33,000 pounds one foot high in one minute.

To produce one horsepower requires the evaporation of 2.66 pounds of water.

One ton of anthracite coal contains about 40 cubic feet.

One bushel of anthracite coal weighs about 86 pounds.

Heated air and water rise because their particles are more expanded, and therefore lighter than the colder particles.

A vacuum is a portion of space from which the air has been entirely exhausted.

Evaporation is the slow passage of a liquid into the form of vapor.

Increase of temperature, increased exposure of surface, and the passage of air currents over the surface, cause increased evaporation.

Condensation is the passage of a vapor into the liquid state, and is the reverse of evaporation.

Pressure exerted upon a liquid is transmitted undiminished in all directions, and acts with the same force on all surfaces, and at right angles to those surfaces.

The pressure at each level of a liquid is proportional to its depth.

With different liquids and the same depth, pressure is proportional to the density of the liquid.

The pressure is the same at all points on any given level of a liquid.

The pressure of the upper layers of a body of liquid on the lower layers causes the latter to exert an equal reactive upward force. This force is called buoyancy.

Friction does not depend in the least on the pressure of the liquid upon the surface over which it is flowing.

Friction is proportional to the area of the surface.

At a low velocity friction increases with the velocity of the liquid.

Friction increases with the roughness of the surface.

Friction increases with the density of the liquid.
Friction is greater comparatively, in small

pipes, for a greater proportion of the water comes in contact with the sides of the pipe than in the case of the large pipe. For this reason mains on heating apparatus should be generous in size.

Air is extremely compressible, while water is almost incompressible.

Water is composed of two parts of hydrogen, and one part of oxygen.

Water will absorb gases, and to the greatest extent when the pressure of the gas upon the water is greatest, and when the temperature is the lowest, for the elastic force of gas is then less.

Air is composed of about one-fifth oxygen and four-fifths nitrogen, with a small amount of carbonic acid gas.

To reduce Centigrade temperatures to Fahrenheit, multiply the Centigrade degrees by 9, divide the result by 5, and add 32.

To reduce Fahrenheit temperature to Centigrade, subtract 32 from the Fahrenheit degrees, multiply by 5 and divide by 9.

To find the area of a required pipe, when the volume and velocity of the water are given, multiply the number of cubic feet of water by 144 and divide this amount by the velocity in feet per minute.

Water boils in an open vessel (atmospheric pressure at sea level) at 212 degrees Fahrenheit.

Water expands in heating from 39 to 212 degrees Fahrenheit, about 4 per cent.

Water expands about one-tenth its bulk by freezing solid.

Water is at its greatest density and occupies the least space at 39 degrees Fahrenheit.

Water is the best known absorbent of heat, consequently a good vehicle for conveying and transmitting heat.

A U. S. gallon of water contains 231 cubic inches and weighs $8 \frac{1}{3}$ pounds.

A column of water 27.67 inches high has a pressure of 1 pound to the square inch at the bottom.

Doubling the diameter of a pipe increases its capacity four times.

A hot water boiler will consume from 3 to 8 pounds of coal per hour per square foot of grate, the difference depending upon conditions of draft, fuel, system and management.

A cubic foot of anthracite coal averages 50 pounds. A cubic foot of bituminous coal weighs 40 pounds.

PRESSURE OF WATER FOR EACH FOOT IN HEIGHT.

Feet in Height.	Pounds per Sq. In.	Feet in Height.	Pounds per Sq. In.	Feet in Height.	Pounds per Sq. In.
1	.43	15	6.49	50	21.65
2	.86	20	8.66	70	30.32
5	2.16	25	10.82	80	34.65
10	4.33	40	17.32	100	43.31

BOILING POINTS OF VARIOUS FLUIDS.

Substance.	Degrees.	Substance.	Degrees.
Water in Vacuum	98	Refined Petroleum	316
Water, Atmosph'c Pres.	212	Turpentine	315
Alcohol	173	Sulphur	570
Sulphuric Acid	240	Linseed Oil	597

Weights.

One cubic inch of water	weighs	0.036 pounds
One U. S. gallon	weighs...	8.33 " "
One Imperial gallon	" ...	10.00 " "
One U. S. gallon	equals....	231.00 cubic inches
One Imperial gallon	" ...	277.274 " "
One cubic foot of water	equals	7.48 U. S. gallons

Liquid Measure.

4 Gills make 1 Pint	4 Quarts make 1 Gallon
2 Pints make 1 Quart	31½ Gals. make 1 Barrel

Size of Pipe in Inches.	Sq. Ft. in one Lineal Ft.	Gallons of Water in 100 Feet in Length.
$\frac{3}{4}$.27	2.77
1	.34	4.50
$1\frac{1}{4}$.43	7.75
$1\frac{1}{2}$.50	10.59
2	.62	17.43
$2\frac{1}{2}$.75	24.80
3	.92	38.38
$3\frac{1}{2}$	1.05	51.86
4	1.17	66.13

To find the area of a rectangle, multiply the length by the breadth.

To find the area of triangle, multiply the base by one-half the perpendicular height.

To find the circumference of a circle, multiply the diameter by 3.1416.

To find the area of a circle, multiply the diameter by itself, and the result by .7854.

To find the diameter of a circle of a given area, divide the area by .7854, and find the square root of the result.

To find the diameter of a circle which shall have the same area as a given square, multiply one side of the square by 1.128.

To find the number of gallons in a cylindrical tank, multiply the diameter in inches by itself, this by the height in inches, and the result by .34. To find the number of gallons in a rectangular tank, multiply together the length, breadth and height in feet, and this result by 7.4. If the dimensions are in inches, multiply the product by .004329. To find the pressure in pounds per square inch, of a column of water, multiply the height of the column in feet by .434.

To find the head in feet, the pressure being known, multiply the pressure per square inch by 2.31.

To find the lateral pressure of water upon the side of a tank, multiply in inches, the area of the

submerged side, by the pressure due to one-half the depth.

Example—Suppose a tank to be 12 feet long and 12 feet deep. Find the pressure on the side of the tank.

$144 \times 144 = 20,736$ square inches area of side.

$12 \times .43 = 5.16$, pressure at bottom of tank. Pressure at the top of tank is 0. Average pressure will then be 2.6. Therefore $20,736 \times 2.6 = 53,914$ pounds pressure on side of tank.

To find the number of gallons in a foot of pipe of any given diameter, multiply the square of diameter of the pipe in inches, by .0408.

To find the diameter of pipe to discharge a given volume of water per minute in cubic feet, multiply the square of the quantity in cubic feet per minute by 96. This will give the diameter in inches.

Cleaning Rusted Iron. Place the articles to be cleaned in a saturated solution of chloride of tin and allow them to stand for a half day or more.

When removed, wash the articles in water, then in ammonia. Dry quickly, rubbing them hard.

Removing Boiler Scale. Kerosene oil will accomplish this purpose, often better than specially prepared compounds.

Cleaning Brass. Mix in a stone jar one part of nitric acid, one-half part of sulphuric acid. Dip the brass work into this mixture, wash it off with water, and dry with sawdust. If greasy, dip the

work into a strong mixture of potash, soda, and water, to remove the grease. and wash it off with water.

Removing Grease Stains from Marble. Mix $1\frac{1}{2}$ parts of soft soap, 3 parts of Fuller's earth and $1\frac{1}{2}$ parts of potash, with boiling water. Cover the grease spots with this mixture, and allow it to stand a few hours.

Strong Cement. Melt over a slow fire, equal parts of rubber and pitch. When wishing to apply the cement, melt and spread it on a strip of strong cotton cloth.

Cementing Iron and Stone. Mix 10 parts of fine iron filings, 30 parts of plaster of Paris, and one-half parts of sal ammoniac, with weak vinegar. Work this mixture into a paste, and apply quickly.

Cement for Steam Boilers. Four parts of red or white lead mixed in oil, and 3 parts of iron borings, make a good soft cement for this purpose.

Cement for Leaky Boilers. Mix 1 part of powdered litharge, 1 part of fine sand, and one-half part of slacked lime with linseed oil, and apply quickly as possible.

Making Tight Steam Joints. With white lead ground in oil mix as much manganese as possible, with a small amount of litharge. Dust the board with red lead, and knead this mass by hand into a small roll, which is then laid on the plate, oiled

with linseed oil. It can then be screwed into place.

Substitute for Fire Clay. Mix common earth with weak salt water.

Rust Joint Cement. Mix 5 pounds of iron filings, 1 ounce of sal ammoniac, and 1 ounce of sulphur, and thin the mixture with water.

Removing Rust from Steel. Mix one-half ounce of cyannide of potassium, $\frac{1}{2}$ ounce of castile soap, 1 ounce of whiting, adding enough water to form a paste, and apply to the steel. Rinse it off with a solution formed of one-half ounce of cyannide of potassium and 2 ounces of water.

COMPARATIVE VALUE OF COAL, OIL, AND GAS.

In good practice, with boilers of proper construction and proportioned to the work—

One pound of coal will evaporate 10 pounds of water at 212 degrees Fahrenheit.

One pound of oil will evaporate 16 pounds of water at 212 degrees Fahrenheit.

One pound of natural gas will evaporate 20 pounds of water at 212 degrees Fahrenheit.

One pound of coal equals 11.225 cubic feet of natural gas.

Two thousand pounds of coal (1 ton) equals 22,450 cubic feet of natural gas.

One pound of oil equals 18.00 cubic feet of natural gas.

One barrel of oil (42 gallons) equals 5,310.00 cubic feet of natural gas.

1.125 cubic feet of natural gas will evaporate 1 pound of water.

1.00 cubic feet of natural gas equals 860 Heat Units.

1,000 cubic feet of natural gas equals 860,000 Heat Units.

One ton of coal will equal 19,307,000 Heat Units.

One barrel of oil will equal 4,566.600 Heat Units.

In ordinary practice, about twice as much of the above fuels are required to evaporate the above amounts.

USEFUL KINKS.

Paint for Iron. Dissolve $\frac{1}{2}$ pound of asphaltum and $\frac{1}{2}$ pound of pounded resin in 2 pounds of tar oil. Mix hot in an iron kettle, but do not allow it to come in contact with the fire. It may be used as soon as cold, and is good both for outdoor wood and ironwork.

Recipe for Heat-Proof Paint. A good cylinder and exhaust pipe paint is made as follows:

Two pounds of black oxide of manganese, 3 pounds of graphite and 9 pounds of Fuller's earth, thoroughly mixed. Add a compound of 10 parts of sodium silicate, 1 part of glucose and 4 parts of water, until the consistency is such that it can be applied with a brush.

Rust Joint Composition. This is a cement made of sal-ammoniac 1 pound, sulphur $\frac{1}{2}$ pound, cast-iron turnings 100 pounds. The whole should be thoroughly mixed and moistened with a little water. If the joint is required to set very quick, add $\frac{1}{4}$ pound more sal-ammoniac. Care should be taken not to use too much sal-ammoniac, or the mixture will become rotten.

Removing Rust from Iron. Iron may be quickly and easily cleaned by dipping in or

washing with nitric acid one part, muriatic acid one part and water twelve parts. After using wash with clean water.

Making Pipe Joints. Never screw pipe together for either steam, water or gas without putting white or red lead on the joints.

Many times in taking pipe apart the joints are stuck so hard that it is impossible to unscrew the pipe; heat the coupling (not the pipe) by holding a hot iron on it, or hammer the coupling with a light hammer, either one will expand the coupling and break the joint so it can be easily unscrewed.

Annealing Cast Iron. To anneal cast iron, heat it in a slow charcoal fire to a dull red heat; then cover it over about two inches with fine charcoal, then cover all with ashes. Let it lay until cold. Hard cast iron can be softened enough in this way to be filed or drilled. This process will be exceedingly useful to iron founders, as by this means there will be a great saving of expense in making new patterns.

To make a casting of precisely the same size of a broken casting without the original patterns: Put the pieces of broken casting together and mould them, and cast from this mould. Then anneal it as above described; it will expand to the original size of the pattern, and there remain in that expanded state.

Preventing Iron or Steel from Rusting. The

best treatment for polished iron or steel, which has a habit of growing gray and lustreless, is to wash it very clean with a stiff brush and ammonia soapsuds, rinse well and dry by heat if possible, then oil plentifully with sweet oil and dust thickly with powdered quick lime. Let the lime stay on two days, then brush it off with a clean stiff brush. Polish with a softer brush, and rub with cloths until the lustre comes out. By leaving the lime on, iron and steel may be kept from rust almost indefinitely.

Loosening Rusted Screws. One of the simplest and readiest ways of loosening a rusted screw is to apply heat to the head of the screw. A small bar or rod of iron, flat at the end, if reddened in the fire and applied for two or three minutes to the head of a rusty screw, will, as soon as it heats the screw, render its withdrawal as easy with the screwdriver as if it were only a recently inserted screw. This is not particularly novel, but it is worth knowing.

Tinning Cast Iron. To successfully coat castings with tin they must be absolutely clean and free from sand and oxide. They are usually freed from imbedded sand in a rattler or tumbling box, which also tends to close the surface grain and give the article a smooth metallic face. The articles should be then placed in a hot pickle of one part of sulphuric acid to four parts of water, in which they are allowed to

remain from one to two hours, or until the recesses are free from scale and sand. Spots may be removed by a scraper or wire brush. The castings are then washed in hot water and kept in clean hot water until ready to dip. For a flux, dip in a mixture composed of four parts of a saturated solution of sal-ammoniac in water and one part of hydrochloric acid, hot. Then dry the castings and dip them in the tin pot. The tin should be hot enough to quickly bring the castings to its own temperature when perfectly fluid, but not hot enough to quickly oxidize the surface of the tin. A sprinkling of pulverized sal-ammoniac may be made on the surface of the tin, or a little tallow or palm oil may be used to clear the surface and make the tinned work come out clear. As soon as the tin on the castings has chilled or set, they should be washed in hot sal soda water and dried in sawdust.

Removing Scale from Iron Castings. Immerse the parts in a mixture composed of one part of oil of vitriol to three parts of water. In six to ten hours remove the castings, and wash them thoroughly with clean water. A weaker solution can be used by allowing a longer time for the action of the solution.

Cleaning Brass Castings. If greasy, the castings should be cleaned by boiling in lye or potash. The first pickle is composed of nitric acid one quart, water six to eight quarts. After

pickling in this mixture the castings should be washed in clear warm or hot water, and the following pickle be then used: Sulphuric acid one quart, nitric acid two quarts, muriatic acid, a few drops. The first pickle will remove the discolorations due to iron, if present. The muriatic acid of the second pickle will darken the color of the castings to an extent depending on the amount used.

Tinning Surfaces. Articles of brass or copper boiled in a solution of cyanide of potassium mixed with turnings or scraps of tin in a few moments become covered with a firmly attached layer of fine tin.

A similar effect is produced by boiling the articles with tin turnings or scraps and caustic alkali, or cream of tartar. In either way, articles made of copper or brass may be easily and perfectly tinned.

Protecting Bright Work from Rust. Use a mixture of one pound of lard, one ounce of gum camphor, melted together, with a little lamp-black. A mixture of lard oil and kerosene in equal parts. A mixture of tallow and white lead, or of tallow and lime.

How to Braze. Clean the article thoroughly and better to polish with sand paper. Fasten the parts to be brazed firmly together, so they will not part when heated in the fire. Place over a slow fire of charcoal or well coked coal. Place

on the parts to be brazed a small quantity of pulverized borax; as soon as this is done boiling and has flowed to all parts, then put on the spelter; when the spelter melts it will generally run in globules or shot. Jar the piece by gently striking with a small piece of wire; this will cause the spelter to flow to all parts.

Lead Explosions. Many mechanics have had their patience sorely tried when pouring lead around a damp or wet joint, to have it explode, blow out or scatter from the effects of steam generated by the heat of the lead. The whole trouble may be avoided by putting a piece of resin, the size of a man's thumb, into the ladle and allowing it to melt before pouring.

Sharpening Files. To sharpen dull and worn out files, lay them in dilute Sulphuric Acid, one part acid to two parts of water over night, then rinse well in clear water, put the acid in an earthenware vessel.

Soldering Aluminum. When soldering aluminum, it should be borne in mind that upon exposure to the air a slight film of oxide forms over the surface of the aluminum, and afterwards protects the metal. The oxide is the same color as the metal, so that it cannot easily be distinguished. The idea in soldering is to get underneath this oxide while the surface is covered with the molten solder. Clean off all dirt and grease from the surface of the metal with a little

benzine, apply the solder with a copper bit, and when the molten solder is covering the surface of the metal, scratch through the solder with a steel wire scratch-brush. By this means the oxide on the surface of the metal is broken up underneath the solder, which containing its own flux, takes up the oxide and enables the surface of the aluminum to be tinned properly.

Small surfaces of aluminum can be soldered by the use of zinc and Venetian turpentine. Place the solder upon the metal together with the turpentine and heat very gently with a blowpipe until the solder is entirely melted. The trouble with this, as with other solders, is that it will not flow gently on the metal. Therefore large surfaces cannot be easily soldered.

Another method is to clean the aluminum surfaces by scraping, and then cover with a layer of paraffine wax as a flux. Then coat the surfaces by fusion, with a layer of an alloy of zinc, tin and lead, preferably in the following proportions; Zinc five parts, tin two parts, lead one part.

The metallic surfaces thus prepared can be soldered together either by means of zinc or cadmium, or alloys of aluminum with these metals. In fact, any good soldering preparation will answer the purpose.

A good solder for low-grade work is the following: Tin 95 parts, bismuth five parts.

A good flux in all cases is either stearin, vaseline, paraffine, copaiva balsam, or benzine.

In the operation of soldering, small tools made of aluminum are used, which facilitate at the same time the fusion of the solder and its adhesion to the previously prepared surfaces. Tools made of copper or brass must be strictly avoided as they would form colored alloys with the aluminum and the solder.

Aluminum Solder. This consists of 28 pounds of block tin, three and one-half pounds of lead, seven pounds of spelter, and 14 pounds of phosphor-tin. The phosphor-tin should contain 10 per cent of phosphorus. Clean off all the dirt and grease from the surface of the metal with benzine, apply the solder with a copper bit, and when the molten solder covers the metal, scratch through the solder with a wire scratch brush.

Sweating Aluminum to Other Metals. First coat the aluminum surface to be soldered with a layer of zinc. On top of the zinc is melted a layer of an alloy of one part aluminum to two and one-half parts of zinc. The surfaces are placed together and heated until the alloy between them is liquefied.

Soldering Fluid. Take of scrap zinc or pure spelter about $\frac{1}{4}$ pound, and immerse in a half-pint of muriatic acid. If the scraps completely dissolve add more until the acid ceases to bubble and a small piece of metal remains. Let this

stand for a day and then carefully pour off the clear liquid, or filter it through a cone of blotting paper. Add a teaspoonful of sal-ammoniac, and when thoroughly dissolved, the solution is ready for use. Depending on the materials to be soldered, the quantity of sal-ammoniac can be reduced. Its presence makes soldering very easy, but, unless the parts are well heated so as to evaporate the salt, the joints may rust.

Etching on Iron or Steel. Take one-half ounce of nitric acid and one ounce of muriatic acid. Mix, shake well together, and it is ready for use. Cover the place you wish to mark with melted beeswax, when cold write the inscription plainly in the wax clear to the metal with a sharp instrument, then apply the mixed acids with a feather, carefully filling each letter. Let it remain from one to ten minutes, according to the appearance desired. Then throw on water, which stops the etching process and removes the wax.

Soldering Solution. An excellent method of preparing resin for soldering bright tin is given as follows: Take one and one-half pounds of olive oil and one and one-half pounds of tallow and 12 ounces of pulverized resin. Mix these ingredients and let them boil up. When this mixture has become cool, add one and three-eighths pints of water saturated with pulverized sal ammoniac, stirring constantly.

Softening Cast Iron. To soften iron for drill-

ing, heat to a cherry-red, having it lie level in the fire. Then with tongs, put on a piece of brimstone, a little less in size than the hole is to be. This softens the iron entirely through. Let it lie in the fire until cooled, when it is ready to drill.

Suggestions how to Solder. Clean the parts thoroughly from all rust, grease or scale, then wet with prepared acid. Hold the soldering copper on each part until the article is well tinned and the solder has flowed to all parts.

Watch-Makers' Oil that Will Never Corrode or Thicken. Take a bottle about half full of good olive oil and put in thin strips of sheet lead, expose it to the sun for a month, then pour off the clear oil. The above is a very cheap way of making a first-class oil for any light machinery.

Varnish for Copper. To protect copper from oxidation a varnish may be employed which is composed of carbon disulphide 1 part, benzine 1 part, turpentine oil 1 part, methyl alcohol 2 parts and hard copal 1 part. It is well to apply several coats of it to the copper.

Glue for Iron. Put an equal amount by weight of finely powdered rosin in glue and it will adhere firmly to iron or other metal surfaces.

Soldering or Tinning Acid. Muriatic Acid 1 pound, put into it all the zinc it will dissolve and 1 ounce of Sal Ammoniac, add as much clear water as acid, it is then ready for use.

Plaster of Paris. Common plaster that farmers

use to put on land and plaster of paris are the same thing, except plaster of paris is common plaster calcined. Many times it is difficult to get calcined plaster, and when it is procured it is badly adulterated with lime and unfit for many uses. To calcine plaster, or in other words, to make common plaster so it will harden, you have but to take the plaster and put it in an iron kettle and place it over a slow fire, put no water in it. In a few moments it will begin to boil and will continue to do so until every particle of moisture is evaporated out of it. When it has stopped boiling take it off, and when cold it is ready for use. Plaster treated in this way will harden much quicker and harder than any which can be bought ready prepared.

Hardening Small Articles. To harden small tools or articles that are apt to warp in hardening, heat very carefully, and insert in a raw potato, then draw the temper as usual.

Bluing Brass. Dissolve one ounce of antimony chloride in twenty ounces of water and add three ounces of pure hydrochloric acid. Place the warmed brass article into this solution until it has turned blue. Then wash it and dry in sawdust.

Drilling Glass. Take an old three-cornered file, one that is worn out will do, break it off and sharpen to a point like a drill and place in a carpenter's brace. Have the glass fastened on a

good solid table so there will be no danger of its breaking. Wet the glass at the point where the hole is to be made with the following solution:

Ammonia	6½ drachms
Ether	3½ drachms
Turpentine	1 ounce

Keep the drill wet with the above solution and bore the hole part way from each side of the glass.

Another solution is to dissolve a piece of gum camphor the size of a walnut in one ounce of turpentine.

Another method is to use a steel drill hardened, but not drawn. Saturate spirits of turpentine with camphor and wet the drill. The drill should be ground with a long point and plenty of clearance. Run the drill fast and with a light feed. In this manner glass can be drilled with small holes, up to 3-16 inch in diameter nearly as rapidly as cast steel.

Cement for Pipe Joints. Mix 10 parts iron filings and 3 parts chloride of lime to a paste by means of water. Apply to the joint and clamp up. It will be solid in 12 hours.

Removing Stains. To remove Ink Stains, wash with pure fresh water, and apply oxalic acid. If this changes the stain to a red color, apply ammonia. To remove Iron Rust from White Fabrics, saturate the spots with lemon juice and salt and expose to the sun.

Weight of Castings. If you have a pattern made of soft pine, put together without nails, an iron casting made from it will weigh sixteen pounds to every pound of the pattern. If the casting is of brass, it will weigh eighteen pounds to every pound of the pattern.

Ordering Taps and Dies. In ordering Taps and Dies, be sure and give the kind, exact size and thread wanted. Always remember you are writing to a person who knows nothing of what is wanted, therefore make the order plain and explicit. Never order a special Tap or Die if it can be avoided, as such will cost at least double that of regular sizes and threads.

Tapping Nuts. Always use good Lard Oil in cutting threads with a die or tapping out nuts. Poor cheap oil will soon ruin both die and tap.

Grindstones. Grindstones to grind tools should be run at a speed of about 800 feet per minute at its periphery, a 30-inch stone should be run about 100 revolutions per minute. When used to grind carpenters' tools a speed of 600 feet at its periphery, a 30-inch stone should therefore be run at 75 revolutions per minute.

White Metal for Bearings. White metal for bearings consists of 48 pounds of tin, 4 pounds of copper, and 1 pound of antimony. The copper and tin are melted first, and then the antimony is added.

Marine Glue. One part of pure india rubber

dissolved in naphtha. When melted add two parts of shellac. Melt until mixed.

To Soften Cast Iron. Heat the whole piece to a bright glow and gradually cool under a covering of fine coal dust. Small objects should be packed in quantities, in a crucible in a furnace or open fire, under materials which when heated to a glow give out carbon to the iron. They should be heated gradually, and kept at a bright heat for an hour and allowed to cool slowly. The substances recommended to be added are cast-iron turnings, sodium carbonate or raw sugar. If only raw sugar is used, the quantity should not be too small. By this process it is said that cast iron may be made so soft that it can almost be cut with a pocket-knife.

To Harden Files. To harden files dip the file in redhot lead, handle up. This gives a uniform heat and prevents warping. Run the file endwise back and forth in a pan of salt water. Set the file in a vise and straighten it while still warm.

Leather Belts. A leather belt is more economical in the end than a rubber one. When buying a leather belt it should be tested by doubling it up with the hair side out. If it should crack, reject it as it cannot realize the whole amount of power it should transmit. If it shows a spongy appearance it should be condemned at once, for it must be pliable as well as firm. The grain or hair side should be free from wrinkles and the

belt should be of uniform thickness throughout its length. It should be tested for quality by immersing a small strip in strong vinegar. If the leather has been properly tanned and is of good quality, it will remain in vinegar for weeks without alteration, excepting it will grow darker in color. If the leather has not been properly tanned the fiber will swell and the leather will become softened, turning it into a jelly-like mass.

To Cement Rubber to Leather. Roughen both surfaces with a sharp piece of glass, apply on both a diluted solution of gutta percha in carbon bisulphide, and let the solution soak into the material. Then press upon each surface a skin of gutta percha about one-hundredth of an inch in thickness, between a pair of rolls. Unite the two surfaces in a press that should be warm but not hot. In case a press cannot be used, dissolve 30 parts of rubber in 140 parts of carbon bisulphide, the vessel being placed on a water bath of a temperature of 86 degrees Fahrenheit. Melt ten parts of rubber with fifteen parts of rosin and add 35 parts of oil of turpentine. When the rubber has been completely dissolved, the two liquids may be mixed. The resulting cement must be kept well corked.

Drilling Holes in Glass. Holes of any size desired may be drilled in glass by the following method: Get a small 3-cornered file and grind the points from one corner and the bias from

the other and set the file in a brace, such as is used in boring wood. Lay the glass in which the holes are to be bored on a smooth surface covered with a blanket and begin to bore a hole. When a slight impression is made on the glass, place a disk of putty around it and fill with turpentine to prevent too great heating by friction. Continue boring the hole, which will be as smooth as one drilled in wood with an auger. Do not press too hard on the brace while drilling.

To Polish Brass. Smooth the brass with a fine file and run it with smooth fine grain stone, or with charcoal and water. When quite smooth and free from scratches, polish with pumice stone and oil, spirits of turpentine, or alcohol.

How to Make a Soft Alloy. A soft alloy which will adhere tenaciously to metal, glass or porcelain, and can also be used as a solder for articles which cannot bear a high degree of heat, is made as follows:

Obtain copper-dust by precipitating copper from the sulphate by means of metallic zinc. Place from 20 to 36 parts of the copper-dust, according to the hardness desired, in a porcelain-lined mortar, and mix well with some sulphuric acid of a specific gravity of 1.85. Add to this paste 70 parts of mercury, stirring constantly, and when thoroughly mixed, rinse the amalgam in warm water to remove the acid. Let cool from 10 to

12 hours, after which time it will be hard enough to scratch tin.

When ready to use it, heat to 707 degrees Fahrenheit and knead in an iron mortar till plastic. It can then be spread on any surface, and when it has cooled and hardened will adhere most tenaciously.

MEDICAL AID.

Things to Do in Case of Sprains or Dislocations.

The most important thing is to secure rest until the arrival of the surgeon. If the sprain is in the ankle or foot, place a folded towel around the part and cover with a bandage. Apply moist heat. The foot should be immersed in a bucket of hot water and more hot water added from time to time, so that it can be kept as hot as can be borne for fifteen or twenty minutes, after which a firm bandage should be applied, by a surgeon, if possible, and the foot elevated.

In sprains of the wrist, a straight piece of wood should be used as a splint, cover with cotton or wool to make it soft, and lightly bandage, and carry the arm in a sling. In all cases of sprains the results may be serious, and a surgeon should be obtained as soon as possible. After the acute symptoms of pain and swelling have subsided, it is still necessary that the joint should have complete rest by the use of a splint and bandage and such applications as the surgeon may direct.

Simple dislocation of the fingers can be put in place by strong pulling, aided by a little pressure on the part of the bones nearest the joint.

The best that can be done in most cases is to

put the part in the position easiest to the sufferer, and to apply cold wet cloths, while awaiting the arrival of a surgeon.

To Remove Foreign Substances from the Eye. Take hold of the upper lid and turn it up so that the inside of the upper lid may be seen. Have the patient make several movements with the eye, first up, then down, to the right side and to the left. Then take a tooth-pick with a little piece of absorbent cotton wound around the end and moistened in cold water, and swab it out. The foreign substance will adhere to the swab and the object will be removed from the eye without any trouble.

In Case of Cuts. The chief points to be attended to are: Arrest the bleeding. Remove from the wound all foreign substances as soon as possible. Bring the wounded parts opposite to each other and keep them so. This is best done by means of strips of surgeon's plaster, first applied to one side of the wound and then secured to the other. These strips should not be too broad, and space must be left between the strips to allow any matter to escape. Wounds too extensive to be held together by plaster must be stitched by a surgeon, who should always be sent for in severe cases.

Broken Limbs. To get at a broken limb or rib, the clothing must be removed, and it is essential that this should be done without injury to the patient. The simplest plan is to rip up the seams

of such garments as are in the way. Shoes must always be cut off. It is not imperatively necessary to do anything to a broken limb before the arrival of a doctor, except to keep it perfectly at rest.

Wounds. If a wound be discovered in a part covered by the clothing, cut the clothing at the seams. Remove only sufficient clothing to uncover and inspect the wound.

All wounds should be covered and dressed as quickly as possible. If a severe bleeding should occur, see that this is stopped, if possible, before the wound is dressed.

Treatment of Burns. In treating burns of a serious nature, the first thing to be done after the fire is extinguished should be to remove the clothing. The greatest care must be exercised, as anything like pulling will bring the skin away. If the clothing is not thoroughly wet, be sure to saturate it with water or oil before attempting to remove it.

If portions of the clothing will not drop off, allow them to remain. Then make a thick solution of common baking soda and water, and dip soft cloths in it and lay them over the injured parts, and bandage them lightly to keep them in position. Have the solution near by, and the instant any part of a cloth shows signs of dryness, squeeze some of the solution on that part. Do not remove the cloth, as total exclusion of the

air is necessary, and little, if any, pain, will be felt as long as the cloths are kept saturated. This may be kept up for several days, after which soft cloths dipped in oil may be applied, and covered with cotton batting. If the feet are cold, apply heat and give hot water to drink, and if the burns are very serious send for a doctor as soon as possible. The presence of pain is a good sign, showing that vitality is present.

Bleeding. In case of bleeding, the person may become weak and faint, unless the blood is flowing actively. This is not a serious sign, and the quiet condition of the faint often assists nature in stopping the bleeding, by allowing the blood to clot and so block up any wound in a blood vessel.

Unless the faint is prolonged or the patient is losing much blood, it is better not to relieve the faint condition. When in this state excitement should be avoided, and external warmth should be applied, the person covered with blankets, and bottles of hot water or hot bricks applied to the feet and arm-pits.

Watch carefully if unconscious.

If vomiting occurs, turn the patient's body on one side, with the head low, so that the matters vomited may not go into the lungs.

Bleeding is of three kinds: From the arteries which lead from the heart. That which comes from the veins which take the blood back to the heart. That from the small veins which carry

the blood to the surface of the body. In the first, the blood is bright scarlet and escapes as though it were being pumped. In the second, the blood is dark red and flows away in an uninterrupted stream. In the third, the blood oozes out. In some wounds all three kinds of bleeding occur at the same time.

Carrying an Injured Person. In case of an injury where walking is impossible, and lying down is not absolutely necessary, the injured person may be seated in a chair, and carried, or he may sit upon a board, the ends of which are carried by two men, around whose necks they should place his arms so as to steady himself.

Where an injured person can walk he will get much help by putting his arms over the shoulders and round the necks of two others.

LAP-WELDED STEEL OR CHARCOAL IRON BOILER TUBES.

Table of Standard Dimensions.

Diameter.		Nominal Thickness.	Wire Gauge.	Circumference.		Transverse Areas.			Length of Tube per Square Foot of		Nominal Weight per Foot.
External	Internal			External	Internal	External	Internal	Metal.	External Surface.	Internal Surface.	
Inches.	Inches.	Inches.	No.	Inches.	Inches.	Sq. In.	Sq. In.	Sq. In.	Feet.	Feet.	Pounds.
1	.856	.095	13	3.142	2.689	.785	.575	.21	3.819	4.462	.90
1 1/4	1.106	.095	13	3.927	3.475	1.227	.961	.266	3.056	3.453	1.15
1 1/2	1.334	.095	13	4.712	4.191	1.767	1.398	.369	2.547	2.863	1.40
1 3/4	1.56	.095	13	5.494	4.901	2.405	1.911	.494	2.183	2.448	1.66
2	1.81	.095	13	6.288	5.686	3.142	2.573	.569	1.909	2.11	1.91
2 1/4	2.06	.095	13	7.069	6.472	3.976	3.333	.643	1.698	1.854	2.16
2 1/2	2.282	.109	12	7.854	7.169	4.909	4.09	.819	1.528	1.674	2.75
2 3/4	2.532	.109	12	8.639	7.954	5.94	5.035	.905	1.389	1.509	3.04
3	2.782	.109	12	9.425	8.74	7.069	6.079	.99	1.273	1.373	3.33
3 1/4	3.01	.12	11	10.21	9.456	8.296	7.116	1.18	1.175	1.26	3.96
3 1/2	3.26	.12	11	10.996	10.241	9.621	8.347	1.274	1.091	1.172	4.28
3 3/4	3.51	.12	11	11.781	11.027	11.045	9.676	1.369	1.018	1.088	4.6
4	3.732	.134	10	12.566	11.724	12.566	10.939	1.627	.955	1.024	5.47
4 1/2	4.232	.134	10	14.137	13.295	15.804	14.066	1.838	.849	.902	6.17
5	4.704	.148	9	15.708	14.778	19.635	17.379	2.256	.764	.812	7.58

WROUGHT IRON AND STEEL STEAM, GAS AND WATER PIPE.

Table of Standard Dimensions.

Diameter.		Nominal Thickness.		Circumference.		Transverse Areas.			Length of Pipe per Square Foot of		Length of Pipe Containing One Cubic Foot.	Pounds per Foot.	Nominal Weight per Foot.	Number of Threads per Inch of Screw.
Internal	External.	Approximate Internal Diameter.	Inches.	Inches.	External.	Internal.	Sq. In.	Sq. In.	External Surface.	Internal Surface.				
$\frac{1}{8}$.405	.27	.068	1.272	.848	.129	.0573	.0717	9.44	14.15	2513.	.241	27	
$\frac{1}{4}$.54	.364	.088	1.696	1.144	.229	.1041	.1249	7.075	10.49	1383.3	.42	18	
$\frac{3}{8}$.675	.494	.091	2.121	1.552	.358	.1917	.1663	5.657	7.73	751.2	.559	18	
$\frac{1}{2}$.84	.623	.109	2.639	1.957	.554	.3048	.2492	4.547	6.13	472.4	.837	14	
$\frac{3}{4}$	1.05	.824	.113	3.299	2.589	.866	.5333	.3327	3.637	4.635	270.	1.115	14	
1	1.315	1.048	.134	4.131	3.292	1.358	.8626	.4954	2.904	3.645	166.9	1.668	11 $\frac{1}{2}$	
1 $\frac{1}{4}$	1.66	1.38	.14	5.215	4.335	2.164	1.496	.668	2.301	2.768	96.25	2.244	11 $\frac{1}{2}$	
1 $\frac{1}{2}$	1.9	1.611	.145	5.969	5.061	2.835	2.038	.797	2.01	2.371	70.66	2.678	11 $\frac{1}{2}$	
2	2.375	2.067	.154	7.461	6.494	4.43	3.356	1.074	1.608	1.848	42.91	3.609	8	
2 $\frac{1}{2}$	2.875	2.468	.204	9.032	7.753	6.492	4.784	1.708	1.328	1.547	30.1	5.739	8	
3	3.5	3.067	.217	10.996	9.636	9.621	7.388	2.243	1.091	1.245	19.5	7.536	8	

WROUGHT IRON AND STEEL STEAM, GAS AND WATER PIPE.
Table of Standard Dimensions.

Diameter.		Nominal Thickness.	Circumference.		Transverse Areas.			Length of Pipe per Square Foot of		Length of Pipe Containing One Cubic Foot.	Nominal Weight per Foot.	Number of Threads per Inch of Screw.
Actual	Approximate		External.	Internal.	External.	Internal.	External.	Internal.				
Inch.	Inches.	Inch.	Inches.	Inches.	Sq. In.	Sq. In.	Sq. In.	Feet.	Feet.	Feet.	Pounds.	
3½	3.548	.226	12.566	11.146	12.566	9.887	2.679	.955	1.077	14.57	9.001	8
4	4.026	.287	14.187	12.648	15.904	12.73	3.174	.849	.949	11.81	10.665	8
4½	4.508	.246	15.708	14.162	19.635	15.961	3.674	.764	.848	9.02	12.49	8
5	5.045	.259	17.477	15.849	24.306	19.99	4.316	.687	.757	7.2	14.502	8
6	6.065	.28	20.813	19.054	34.472	28.888	5.584	.577	.63	4.98	18.762	8
7	7.023	.301	23.955	22.063	45.664	38.738	6.926	.501	.544	3.72	23.271	8
8	8.625	.322	27.096	25.076	58.426	50.04	8.386	.443	.478	2.88	28.177	8
9	9.625	.344	30.238	28.076	72.76	62.73	10.03	.397	.427	2.29	33.701	8
10	10.75	.366	33.772	31.477	90.763	78.839	11.924	.355	.382	1.82	40.065	8
11	11.75	11.	36.914	34.558	108.434	95.033	13.401	.325	.347	1.51	45.028	8
12	12.75	12.	40.055	37.7	127.677	113.098	14.579	.299	.319	1.27	48.985	8

WROUGHT IRON AND STEEL EXTRA STRONG PIPE.
Table of Standard Dimensions.

Nominal Diameter.	Diameter.		Nominal Thickness.	Nearest Wire Gauge.	Circumference.		Transverse Areas.			Length of Pipe per Square Foot of Surface.		Nominal Weight per Foot.
	Actual.	Approximate Internal Diameter.			External.	Internal.	External.	Internal.	External.	Internal.	External.	
Inch.	Inches.	Inches.	Inches.	No.	Inches.	Inches.	Sq. In.	Sq. In.	Sq. In.	Feet.	Feet.	Pounds
1/8	.405	.205	.1	12 1/2	1.272	.644	.129	.063	.086	9.433	18.632	.29
1/4	.54	.294	.123	11	1.696	.924	.229	.068	.161	7.075	12.986	.54
3/8	.675	.421	.127	10 1/2	2.121	1.323	.358	.139	.219	5.657	9.07	.74
1/2	.84	.542	.149	9	2.639	1.703	.554	.231	.323	4.547	7.046	1.09
3/4	1.05	.736	.157	8 1/2	3.299	2.312	.866	.452	.414	3.637	5.109	1.39
1	1.315	.951	.182	7	4.131	2.938	1.358	.71	.648	2.904	4.016	2.17
1 1/4	1.66	1.272	.194	6 1/2	5.215	3.936	2.164	1.271	.893	2.301	3.003	3
1 1/2	1.9	1.494	.203	6	5.969	4.694	2.835	1.753	1.082	2.01	2.556	3.63
2	2.375	1.933	.221	5	7.461	6.073	4.43	2.935	1.495	1.608	1.975	5.02
2 1/2	2.875	2.315	.28	2	9.032	7.273	6.492	4.209	2.283	1.328	1.649	7.67
3	3.5	2.892	.304	1	10.096	9.085	9.631	6.569	3.052	1.091	1.328	10.25
3 1/2	4.	3.358	.321	0	12.566	10.549	12.566	8.856	3.71	.955	1.137	12.47
4	4.5	3.818	.341	0	14.137	11.995	15.904	11.449	4.455	.849	1.	14.97
5	5.563	4.813	.375	00	17.477	15.120	24.806	18.193	6.12	.687	.793	20.54
6	6.625	5.75	.437	000	20.813	18.064	34.472	25.967	8.505	.577	.664	28.58

WROUGHT IRON AND STEEL DOUBLE EXTRA STRONG PIPE.

Table of Standard Dimensions.

Diameter.		Nominal Thickness.	Nearest Gauge.	Circumference.		Transverse Areas.			Length of Pipe per Square Foot of		Nominal Weight per Foot.
Actual	Approximate			External.	Internal.	External.	Internal.	Metal.	External Surface.	Internal Surface.	
Inch.	Inches.	Inches.	No.	Inches.	Inches.	Sq. In.	Sq. In.	Sq. In.	Feet.	Feet.	Pounds
$\frac{1}{2}$.84	.298	1	2.689	.766	.554	.047	.507	4.547	15.667	1.7
$\frac{3}{4}$	1.05	.314	1	3.299	1.326	.866	.139	.727	3.637	9.049	2.44
1	1.315	.364	00	4.131	1.844	1.358	.271	1.087	2.904	6.508	3.65
$1\frac{1}{4}$	1.66	.388	00	5.215	2.78	2.164	.615	1.549	2.304	4.317	5.2
$1\frac{1}{2}$	1.9	.406	000	5.969	3.418	2.835	.93	1.905	2.01	3.511	6.4
2	2.375	.442	0000	7.461	4.684	4.43	1.744	2.686	1.608	2.561	9.02
$2\frac{1}{2}$	2.875	.560	$\frac{9}{16}$	9.032	5.513	6.492	2.419	4.073	1.328	2.176	13.68
3	3.5	.608	$\frac{5}{8}$	10.996	7.175	9.621	4.097	5.524	1.091	1.672	18.56
$3\frac{1}{2}$	4.	.642	$\frac{5}{8}$ X	12.566	8.533	12.566	5.794	6.772	.955	1.406	22.75
4	4.5	.682	$\frac{11}{16}$	14.137	9.852	15.904	7.724	8.18	.849	1.217	27.48
5	5.563	.75	$\frac{3}{4}$	17.477	12.764	24.306	12.965	11.34	.687	.940	38.12
6	6.625	.875	$\frac{7}{8}$	20.813	15.315	34.472	18.666	15.806	.577	.784	53.11

TABLE GIVING VELOCITY OF FLOW OF WATER
In Feet per Minute, Through Pipes of Various Sizes, for
Varying Quantities of Flow.

Gallons per Minute.	3-4 inch.	1 inch.	1 1-4 inch.	1 1-2 inch.	2 inch.	2 1-2 inch.	3 inch.	4 inch.
5	218	122½	78½	54½	30½	19½	13½	7¾
10	436	245	157	109	61	38	27	15½
15	653	367½	235½	163½	91½	58½	40½	23
20	872	490	314	218	122	78	54	30¾
25	1090	612½	392½	272½	152½	97½	67½	38½
30		735	451	327	183	117	81	46
35		857½	549½	381½	213½	136½	94½	53¾
40		980	628	436	244	156	108	61½
45		1102½	706½	490½	274½	175½	121½	69
50			785	545	305	195	135	76¾
75			1177½	817½	457½	292½	202½	115
100				1090	610	380	270	153½
125					762½	487½	337½	191½
150					915	585	405	230
175					1067½	682½	472½	268½
200					1220	780	540	306¾

TABLE GIVING LOSS IN PRESSURE
Due to Friction, in Pounds, per Square Inch, for Pipe
100 Feet Long.

Gallons Discharged per Minute.	3-4 inch.	1 inch.	1 1-4 inch.	1 1-2 inch.	2 inch.	2 1-2 inch.	3 inch.	4 inch.
5	3.3	0.84	0.31	0.12				
10	13.0	3.16	1.05	0.47	0.12			
15	28.7	6.98	2.38	0.97	0.27	0.06		
20	50.4	12.3	4.07	1.66	0.42	0.13	0.03	
25	78.0	19.0	6.40	2.62	0.67	0.21	0.10	
30		27.5	9.15	3.75	0.91	0.30	0.12	0.03
35		37.0	12.4	5.05	1.26	0.42	0.14	0.05
40		48.0	16.1	6.52	1.60	0.51	0.17	0.06
45			20.2	8.15	2.01	0.62	0.27	0.07
50			24.9	10.0	2.44	0.81	0.35	0.09
75			56.1	22.4	5.32	1.80	0.74	0.21
100				39.0	9.46	3.20	1.31	0.33
125					14.9	4.89	1.99	0.51
150					21.2	7.0	2.88	0.69
175					28.1	9.46	3.85	0.95
200					37.5	12.47	5.02	1.22

TENSILE STRENGTH OF BOLTS.

Diameter of Bolt in Inches.	Area at Bottom of Thread.	At 7,000 lbs. per square inch.	At 10,000 lbs. per square inch.	At 12,000 lbs. per square inch.	At 15,000 lbs. per square inch.	At 20,000 lbs. per square inch.
$\frac{1}{2}$.125	875	1,250	1,500	1,875	2,500
$\frac{5}{8}$.196	1,372	1,960	2,350	2,940	3,920
$\frac{3}{4}$.3	2,100	3,000	3,600	4,500	6,000
$\frac{7}{8}$.42	2,940	4,200	5,040	6,300	8,400
1	.55	3,850	5,500	6,600	8,250	11,000
$1\frac{1}{8}$.69	4,830	6,900	8,280	10,350	13,800
$1\frac{1}{4}$.78	5,460	7,800	9,300	11,700	15,600
$1\frac{3}{8}$	1.06	7,420	10,600	12,720	15,900	21,200
$1\frac{1}{2}$	1.28	8,960	12,800	15,360	19,200	25,600
$1\frac{5}{8}$	1.53	10,710	15,300	18,360	22,950	30,600
$1\frac{3}{4}$	1.76	12,320	17,600	21,120	26,400	35,200
$1\frac{7}{8}$	2.03	14,210	20,300	24,360	30,450	40,600
2	2.3	16,100	23,000	27,600	34,500	46,000
$2\frac{1}{4}$	3.12	21,840	31,200	37,440	46,800	62,400
$2\frac{1}{2}$	3.7	25,900	37,000	44,400	55,500	74,000

The breaking strength of good American bolt iron is usually taken at 50,000 pounds per square inch, with an elongation of 15 per cent before breaking. It should not set under a strain of less than 25,000 pounds. The proof strain is 20,000 pounds per square inch, and beyond this amount iron should never be strained in practice.

TABLE OF THE PROPERTIES OF SATURATED STEAM.

Gauge pressure in lbs. per sq. in.	Temperature in degrees F.	Total heat units from water at 32° F.	Heat units in liquid from 32° F.	Heat of vaporization in heat units.	Density of weight of 1 cu. ft. in lbs.	Volume of 1 lb. in cubic feet	Weight of 1 cu. ft. of water.
0	212.00	1146.6	180.8	965.8	0.03760	26.60	59.76
10	239.36	1154.9	208.4	946.5	0.06128	16.32	59.64
20	258.68	1160.8	227.9	932.9	0.08439	11.85	58.50
30	273.87	1165.5	243.2	922.3	0.1070	9.347	58.07
40	286.54	1169.3	255.9	913.4	0.1292	7.736	57.69
50	297.46	1172.6	266.9	905.7	0.1512	6.612	57.32
55	302.42	1174.2	271.9	902.3	0.1621	6.169	57.22
60	307.10	1175.6	276.6	899.0	0.1729	5.784	57.08
65	311.54	1176.9	281.1	895.8	0.1837	5.443	56.95
70	315.77	1178.2	285.6	892.7	0.1945	5.142	56.82
75	319.80	1179.5	289.8	889.8	0.2052	4.873	56.69
80	323.66	1180.6	293.8	886.9	0.2159	4.633	56.59
85	327.36	1181.8	297.7	884.2	0.2265	4.415	56.47
90	330.92	1182.8	301.5	881.5	0.2371	4.218	56.36
95	334.35	1183.9	305.0	879.0	0.2477	4.037	56.25
100	337.66	1184.9	308.5	876.5	0.2583	3.872	56.18
105	340.86	1185.9	311.8	874.1	0.2689	3.720	56.07
110	343.95	1186.8	315.0	871.8	0.2794	3.580	55.97
115	346.94	1187.7	318.2	869.6	0.2898	3.452	55.87
120	349.85	1188.6	321.2	867.4	0.3003	3.330	55.77
125	352.68	1189.5	324.2	865.3	0.3107	3.219	55.69
130	355.43	1190.3	327.0	863.3	0.3212	3.113	55.58
135	358.10	1191.1	329.8	861.3	0.3315	3.017	55.52
140	360.70	1191.9	332.5	859.4	0.3420	2.924	55.44
145	363.25	1192.8	335.2	857.5	0.3524	2.838	55.36
150	365.73	1193.5	337.8	855.7	0.3629	2.756	55.29
155	368.62	1194.3	340.3	853.9	0.3731	2.681	55.22
160	370.51	1195.0	342.8	852.1	0.3835	2.608	55.15
165	372.83	1195.7	345.2	850.4	0.3939	2.539	55.07
170	375.09	1196.3	347.6	848.7	0.4043	2.474	54.99
175	377.31	1197.0	349.9	847.1	0.4147	2.412	54.93
180	379.48	1197.7	352.2	845.4	0.4251	2.353	54.86
185	381.60	1198.3	354.4	843.9	0.4353	2.297	54.79
190	383.70	1199.0	356.6	842.3	0.4455	2.244	54.73
195	385.75	1199.6	358.8	840.8	0.4559	2.193	54.66
200	387.76	1200.2	360.9	839.2	0.4663	2.145	54.60
225	397.36	1203.1	370.9	832.2	0.5179	1.930	54.27
250	406.07	1205.8	380.1	825.7	0.5699	1.755	54.03
275	414.22	1208.3	388.5	819.8	0.621	1.609	53.77
300	421.83	1210.6	396.5	814.1	0.674	1.483	53.54

CHIMNEYS.														
Area Square Feet.	Diameter, Inches.	HEIGHTS IN FEET.												
		75	80	85	90	95	100	110	120	130	140	150	175	200
COMMERCIAL HORSE-POWER.														
3.14	24	75	78	81										
3.69	26	90	92	95	98									
4.28	28		106	110	114	117	120							
4.91	30		122	127	130	133	137							
5.59	32			144	149	152	156	164						
6.31	34			162	168	171	176	185						
7.07	36				188	192	198	208	215					
8.73	40					237	244	257	267	279				
10.56	44					287	296	310	322	337				
12.57	48						352	370	384	400	418			
15.90	54						445	468	484	507	526			
19.63	60							577	600	627	650	672		
23.76	66							697	725	758	784	815		
28.27	72								862	902	931	969	1044	
38.48	84								1173	1229	1270	1319	1422	
50.27	96									1584	1660	1725	1859	1983
63.62	108									2058	2102	2181	2352	2511
78.54	120										2596	2693	2904	3100

REDUCTION OF CHIMNEY DRAFT BY LONG FLUES.								
Total Length of Flues, in feet.	50	100	200	400	600	800	1000	2000
Chimney Draft, in per cent.	100	93	79	66	58	52	48	35

AREA OF CIRCLES.							
Diam.	Area.	Diam.	Area.	Diam.	Area.	Diam.	Area.
$\frac{1}{8}$	0.0123	10	78.54	30	706.86	65	3318.3
$\frac{1}{4}$	0.0491	10 $\frac{1}{2}$	86.59	31	754.76	66	3421.2
$\frac{3}{8}$	0.1104	11	95.03	32	804.24	67	3525.6
$\frac{1}{2}$	0.1963	11 $\frac{1}{2}$	103.86	33	855.30	68	3631.6
$\frac{5}{8}$	0.3068	12	113.09	34	907.92	69	3739.2
$\frac{3}{4}$	0.4418	12 $\frac{1}{2}$	122.71	35	962.11	70	3848.4
$\frac{7}{8}$	0.6013	13	132.73	36	1017.8	71	3959.2
1	0.7854	13 $\frac{1}{2}$	145.13	37	1075.2	72	4071.5
1 $\frac{1}{8}$	0.9940	14	153.93	38	1134.1	73	4185.4
1 $\frac{1}{4}$	1.227	14 $\frac{1}{2}$	165.13	39	1194.5	74	4300.8
1 $\frac{3}{8}$	1.484	15	176.71	40	1256.6	75	4417.8
1 $\frac{1}{2}$	1.767	15 $\frac{1}{2}$	188.69	41	1320.2	76	4536.4
1 $\frac{5}{8}$	2.073	16	201.06	42	1385.4	77	4656.6
1 $\frac{3}{4}$	2.405	16 $\frac{1}{2}$	213.82	43	1452.2	78	4778.3
1 $\frac{7}{8}$	2.761	17	226.98	44	1520.5	79	4901.6
2	3.141	17 $\frac{1}{2}$	240.52	45	1590.4	80	5026.5
2 $\frac{1}{4}$	3.976	18	254.46	46	1661.9	81	5153.0
2 $\frac{1}{2}$	4.908	18 $\frac{1}{2}$	268.80	47	1734.9	82	5281.0
2 $\frac{3}{4}$	5.939	19	283.52	48	1809.5	83	5410.6
3	7.068	19 $\frac{1}{2}$	298.64	49	1885.7	84	5541.7
3 $\frac{1}{4}$	8.295	20	314.16	50	1963.5	85	5674.5
3 $\frac{1}{2}$	9.621	20 $\frac{1}{2}$	330.06	51	2042.8	86	5808.8
3 $\frac{3}{4}$	11.044	21	346.36	52	2123.7	87	5944.6
4	12.566	21 $\frac{1}{2}$	363.05	53	2206.1	88	6082.1
4 $\frac{1}{2}$	15.904	22	380.13	54	2290.2	89	6221.1
5	19.635	22 $\frac{1}{2}$	397.60	55	2375.8	90	6361.7
5 $\frac{1}{2}$	23.758	23	415.47	56	2463.0	91	6503.9
6	28.274	23 $\frac{1}{2}$	433.73	57	2551.7	92	6647.6
6 $\frac{1}{2}$	33.183	24	452.39	58	2642.0	93	6792.9
7	38.484	24 $\frac{1}{2}$	471.43	59	2733.9	94	6939.8
7 $\frac{1}{2}$	44.178	25	490.87	60	2827.4	95	7088.2
8	50.265	26	530.93	61	2922.4	96	7238.2
8 $\frac{1}{2}$	56.745	27	572.55	62	3019.0	97	7389.8
9	63.617	28	615.75	63	3117.2	98	7542.9
9 $\frac{1}{2}$	70.882	29	660.52	64	3216.9	99	7697.7

To compute the area of a diameter greater than any in the above table:

RULE.—Divide the dimension by 2, 3, 4, etc., if practicable, until it is reduced to a quotient to be found in the table, then multiply the tabular area of the quotient by the square of the factor. The product will be the area required.

EXAMPLE.—What is area of diameter of 150? $150 \div 5 = 30$.
Tabular area of 30 = 706.86 which $\times 25 = 17,671.5$ area required.

CIRCUMFERENCE OF CIRCLES.

Diam.	Circum.	Diam.	Circum.	Diam.	Circum.	Diam.	Circum.
$\frac{1}{8}$.3927	10	31.41	30	94.24	65	204.2
$\frac{1}{4}$.7854	$10\frac{1}{2}$	32.98	31	97.38	66	207.3
$\frac{3}{8}$	1.178	11	34.55	32	100.5	67	210.4
$\frac{1}{2}$	1.570	$11\frac{1}{2}$	36.12	33	103.6	68	213.6
$\frac{5}{8}$	1.963	12	37.69	34	106.8	69	216.7
$\frac{3}{4}$	2.356	$12\frac{1}{2}$	39.27	35	109.9	70	219.9
$\frac{7}{8}$	2.748	13	40.84	36	113.0	71	223.0
1	3.141	$13\frac{1}{2}$	42.41	37	116.2	72	226.1
$1\frac{1}{8}$	3.534	14	43.98	38	119.3	73	229.3
$1\frac{1}{4}$	3.927	$14\frac{1}{2}$	45.55	39	122.5	74	232.4
$1\frac{3}{8}$	4.319	15	47.12	40	125.6	75	235.6
$1\frac{1}{2}$	4.712	$15\frac{1}{2}$	48.69	41	128.8	76	238.7
$1\frac{5}{8}$	5.105	16	50.26	42	131.9	77	241.9
$1\frac{3}{4}$	5.497	$16\frac{1}{2}$	51.83	42	135.0	78	245.0
$1\frac{7}{8}$	5.890	17	53.40	44	138.2	79	248.1
2	6.283	$17\frac{1}{2}$	54.97	45	141.3	80	251.3
$2\frac{1}{4}$	7.068	18	56.54	46	144.5	81	254.4
$2\frac{1}{2}$	7.854	$18\frac{1}{2}$	58.11	47	147.6	82	257.6
$2\frac{3}{4}$	8.639	19	59.69	48	150.7	83	260.7
3	9.424	$19\frac{1}{2}$	61.26	49	153.9	84	263.8
$3\frac{1}{4}$	10.21	20	62.83	50	157.0	85	267.0
$3\frac{1}{2}$	10.99	$20\frac{1}{2}$	64.40	51	160.2	86	270.1
$3\frac{3}{4}$	11.78	21	65.97	52	163.3	87	273.3
4	12.56	$21\frac{1}{2}$	67.54	53	166.5	88	276.4
$4\frac{1}{2}$	14.13	22	69.11	54	169.6	89	279.5
5	15.70	$22\frac{1}{2}$	70.68	55	172.7	90	282.7
$5\frac{1}{2}$	17.27	23	72.25	56	175.9	91	285.8
6	18.84	$23\frac{1}{2}$	73.82	57	179.0	92	289.0
$6\frac{1}{2}$	20.42	24	75.39	58	182.2	93	292.1
7	21.99	$24\frac{1}{2}$	76.96	59	185.3	94	295.3
$7\frac{1}{2}$	23.56	25	78.54	60	188.4	95	298.4
8	25.13	26	81.68	61	191.6	96	301.5
$8\frac{1}{2}$	26.70	27	84.82	62	194.7	97	304.7
9	28.27	28	87.96	63	197.9	98	307.8
$9\frac{1}{2}$	29.84	29	91.10	64	201.0	99	311.0

To compute the circumference of a diameter greater than any in the above table:

RULE.—Divide the dimension by 2, 3, 4, etc., if practicable, until it is reduced to a diameter to be found in table. Take the tabular circumference of this diameter, multiply it by 2, 3, 4, etc., according as it was divided, and the product will be the circumference required.

EXAMPLE.—What is the circumference of a diameter of 125?
 $125 \div 5 = 25$. Tabular circumference of 25 = 78.54, $78.54 \times 5 = 392.7$, circumference required.

PROPERTIES OF METALS.				
	Melting Point. Degrees Fahrenheit.	Weight in Lbs. per Cubic Foot.	Weight in Lbs. per Cubic Inch.	Tensile Strength in Pounds per Square Inch.
Aluminum	1140	166 .5	.0963	15000-30000
Antimony	810-1000	421.6	.2439	1050
Brass (average)	1500-1700	523.2	.3027	30000-45000
Copper	1930	552.	.3195	30000-40000
Gold (pure)	2100	1200.9	.6949	20380
Iron, cast	1900-2200	450.	.2604	20000-35000
Iron, wrought	2700-2830	480.	.2779	35000-60000
Lead	618	709.7	.4106	1000-3000
Mercury	39	846.8	.4900	
Nickel	2800	548.7	.3175	
Silver (pure)	1800	655.1	.3791	40000
Steel	2370-2685	489.6	.2834	50000-120000
Tin	475	458.3	.2652	5000
Zinc	780	436.5	.2526	3500

NOTE.—The wide variations in the tensile strength are due to the different forms and qualities of the metal tested. In the case of lead, the lowest strength is for lead cast in a mould, the highest for wire drawn after numerous workings of the metal. With steel it varies with the percentage of carbon used, which is varied according to the grade of steel required. Mercury becomes solid at 39 degrees below zero.

DECIMAL PARTS OF AN INCH.

1-64	.01563	11-32	.34375	43-64	.67188
1-32	.03125	23-64	.35938	11-16	.6875
3-64	.04688	3-8	.375		
1-16	.0625			45-64	.70313
		25-64	.39063	23-32	.71875
5-64	.07813	13-32	.40625	47-64	.73438
3-32	.09375	27-64	.42188	3-4	.75
7-64	.10938	7-16	.4375		
1-8	.125			49-64	.76563
		29-64	.45313	25-32	.78125
9-64	.14063	15-32	.46875	51-64	.79688
5-32	.15625	31-64	.48438	13-16	.8125
11-64	.17188	1-2	.5		
3-16	.1875			53-64	.82813
		33-64	.51563	27-32	.84375
13-64	.20313	17-32	.53125	55-64	.85938
7-32	.21875	35-64	.54688	7-8	.875
15-64	.23438	9-16	.5625		
1-4	.25			57-64	.89063
		37-64	.57813	29-32	.90625
17-64	.26563	19-32	.59375	59-64	.92188
9-32	.28125	39-64	.60938	15-16	.9375
19-64	.29688	5-8	.625		
5-16	.3125			61-64	.95313
		41-64	.64063	31-32	.96875
21-64	.32813	21-32	.65625	63-64	.97438

MELTING POINTS OF ALLOYS OF TIN, LEAD, AND BISMUTH.

Tin.	Lead.	Bismuth.	Melting Point in Degrees Fahrenheit.	Tin.	Lead.	Bismuth.	Melting Point in Degrees Fahrenheit.
2	3	5	199	4	1		372
1	1	4	201	5	1		381
3	2	5	212	2	1		385
4	1	5	246	3		1	392
1		1	286	1	1		466
2		1	334	1	3		552
3	1		367				

MELTING, BOILING AND FREEZING POINTS IN DEGREES
FAHRENHEIT OF VARIOUS SUBSTANCES.

Substance.	Melts at Degrees	Substance.	Melts at Degrees
Platinum	3080	Antimony	810
Wrought-Iron	2830	Zinc	780
Nickel	2800	Lead	618
Steel	2600	Bismuth	476
Cast-Iron	2200	Tin	475
Gold (pure)	2100	Cadmium	442
Copper	1930	Sulphur	226
Gun Metal	1960	Bees-Wax	151
Brass	1900	Spermaceti	142
Silver (pure)	1800	Tallow	72
Aluminum	1140	Mercury	39

Substance.	Boils at Degrees	Substance.	Freezes at Degrees
Mercury	660	Olive Oil	36
Linseed Oil	600	Fresh Water	32
Sulphuric Acid	590	Vinegar	28
Oil of Turpentine	560	Sea Water	27½
Nitric Acid	242	Turpentine	14
Sea Water	213	Sulphuric Acid	1
Fresh Water	212		

INDEX

	PAGE
Relative advantages of steam and hot water heating	7
Heating systems	7
Ventilation	8
Heat	9
STEAM HEATING	11
STEAM BOILERS	13
Round steam boilers.....	14
Casings	17
Firepot	17
Grate	17
Simplicity of the grates.....	18
Rectangular sectional boilers.....	19
Firepots	20
Boiler capacity	21
Safety valves.....	23
Water column	26
Damper regulator	26
Pressure gauges	28
Smoke pipes	29
Chimney flues	30
Fuel combustion	31
PIPE SYSTEMS	33
One-pipe system	33
One-pipe system with separate return.....	34
One-pipe overhead system.....	35
Two-pipe system	37

INDEX

	PAGE
One-pipe circuit steam heating system.....	37
The overhead steam heating system.....	38
Heating surface	39
Reducing size of steam mains.....	40
Steam mains	41
RADIATION	42
Direct radiation	42
Indirect radiation	42
Direct-indirect radiation	43
Radiators	44
Radiator connections	56
Air valves	57
Radiator valves	58
Unsteady water line in boiler.....	63
STARTING A STEAM HEATING PLANT	66
Steam heating plant.....	69
Estimating	74
Specification and contract for a steam heating plant	75
HOT WATER HEATING	77
Round water heaters	78
Casings	81
Firepot	82
Grate	82
Simplicity of the grates.....	82
Rectangular sectional heaters.....	83
Firepots	85
Heater capacity	86
Thermometers	87
PIPE SYSTEMS	88
Quadruple main water heating system.....	89
Double main system.....	89

INDEX

	PAGE
Single pipe overhead system.....	90
Heating surface	92
Hot water mains.....	92
Radiator connections	93
RADIATION	95
Direct radiation	95
Indirect radiation	95
Direct-indirect radiation	96
Radiators	97
Radiator connections	108
Radiator valves	108
Check valves	112
Expansion tank	114
Water gauge	120
Altitude gauge	121
STARTING A HOT WATER HEATING PLANT.	123
Hot water heating plant.....	126
Specifications and contract for a hot water heating plant	127
Estimating	129
Smoke pipes	129
Chimney flues	130
Fuel combustion	131
FURNACE HEATING	133
FURNACES	134
General instructions	139
Proper size of furnace.....	141
Proper size of chimney.....	142
Location of the furnace.....	142
Hot air pipes.....	143
Partition	143
Cold air	144

INDEX

	PAGE
Openings in foundation.....	145
Good workmanship	145
STEAM AND GAS FITTING	150
The expansion of wrought-iron steam and water pipes	150
Wrought-iron pipe	150
Fittings	151
Pipe bends	152
Pipe machines	154
Tools	154
GAS FITTING	157
Gas supply pipe.....	158
Street supply pipe.....	158
Frost in pipes.....	159
Fittings	160
Connecting a meter.....	160
Reading a meter.....	161
Blow-torch	165
Mantle lamps	167
Gas proving pump.....	171
Cleaning gas fixtures.....	171
GAS BURNERS	174
GAS STOVES AND FLUES	183
GAS FITTING IN WORKSHOPS	187
USEFUL INFORMATION	192
USEFUL KINKS	203
MEDICAL AID	220
TABLES	225

INDEX

TABLES.

	PAGE
Diameter of chimney flues for given amounts of steam radiation	31
Proper size of one and two-pipe steam mains.....	41
Square feet of heating surface in:	
Two-column steam radiators.....	53
Three-column steam radiators.....	54
Four-column steam radiators.....	55
Pipe tap for one and two-pipe steam radiator connections	57
Temperature of steam at varying pressure in degrees Fahrenheit	73
Proper size of hot water mains.....	93
Pipe tapping for hot water radiators.....	93
Square feet of heating surface in:	
Two-column water radiators.....	105
Three-column water radiators.....	106
Four-column water radiators.....	107
Capacity of expansion tanks.....	121
Approximate radiating surface to cubic capacities to be heated.....	123
Dimensions of chimney flues for given amounts of direct steam radiation.....	131
Dimensions and heating capacities of furnaces....	145
Loss of heat by transmission with a difference of 70 degrees Fahrenheit between the indoor and outdoor temperatures	146
Wind velocities	146
Proper sizes of furnace pipes to heat rooms of various dimensions	147

INDEX

	PAGE
Approximate velocity of air in flues of various heights	148
Capacity of furnaces to maintain an inside temperature of 70 degrees with an outside temperature of 0 degrees.....	149
Pressure of water for each foot in height.....	196
Boiling points of various fluids.....	197
Square feet of surface in one lineal foot of pipe of various diameters	197
Lap-welded steel or charcoal iron boiler tubes.....	225
Wrought iron and steel steam, gas and water pipe	226-227
Wrought iron and steel extra strong pipe.....	228
Wrought iron and steel double extra strong pipe.....	229
Table giving velocity of flow of water.....	230
Table giving loss in pressure.....	230
Tensile strength of bolts.....	231
Table of the properties of saturated steam.....	232
Areas of chimneys.....	233
Reduction of chimney draft by long flues.....	233
Areas of circles.....	234
Circumference of circles.....	235
Properties of metals.....	236
Decimal parts of an inch.....	237
Melting points of alloys of tin, lead and bismuth... ..	237
Melting, boiling and freezing points of various substances	238

Standard American Locomotive Engineering

COMPLETE IN ALL ITS BRANCHES

Including Railroad Signaling, Block Systems, Breakdowns,
Valve Setting, Air Brakes, with Complete
Questions and Answers.

By C. F. SWINGLE and W. G. WALLACE.

Over four volumes in one. Bound in full Persian Morocco, with flap, pocketbook style, stamped in gold. Full gold edges. 1,150 pages. Fully illustrated. Special, Exclusive Edition. Printed by Frederick J. Drake & Company expressly for Sears, Roebuck & Company. It contains:

MODERN LOCOMOTIVE ENGINEERING, Twentieth Century Edition, with Questions and Answers. By C. F. Swingle. Retail price \$3.00.

RAILWAY SIGNALING AND STATION WORK. By W. G. Wallace. Retail price \$2.00.

STANDARD EXAMINATION QUESTIONS AND ANSWERS, for Firemen. By W. G. Wallace. Retail price \$1.50.

MODERN AIR BRAKE PRACTICE, Its Use and Abuse, including the new E. T. Equipment. By Frank H. Dukessmith. Retail price \$1.50. And all the matter contained in the following two books, each one of which retails for \$1.50.

LOCOMOTIVE BREAKDOWNS. THE WAL-SCHAERT VALVE GEAR. Making full retail value of the Standard American Locomotive Engineering, \$11.00.

A VERITABLE ENCYCLOPEDIA OF LOCOMOTIVE ENGINEERING, including **BOILERS, VALVES, VALVE GEAR AND VALVE SETTING, AIR BRAKE PRACTICE, LOCOMOTIVE BREAKDOWNS, COMPOUND LOCOMOTIVES, RAILWAY SIGNALING, BLOCK SYSTEMS, QUESTIONS AND ANSWERS**, and **FULLY ILLUSTRATED**.

No. 3R9210. **STANDARD AMERICAN LOCOMOTIVE ENGINEERING**.

OUR SPECIAL PRICE \$2.85.

If by mail, postage extra, 22 cents.

SEARS, ROEBUCK & COMPANY, Chicago, Ill.

STANDARD AMERICAN ELECTRICIAN

A COMPLETE ENCYCLOPEDIA OF ELECTRICITY

By HORSTMANN and TOUSLEY

Four volumes in one. Bound in full Persian morocco, Pocketbook style, with flap. Stamped in gold. Full gold edges. 600 Pages. Fully illustrated. Special, Exclusive Edition. Printed by Frederick J. Drake & Company expressly for Sears, Roebuck & Company. The following four important works by Leading Electrical Authorities, SWINGLE, HORSTMANN and TOUSLEY are contained in this one volume.

MODERN ELECTRICAL CONSTRUCTION. Retail value \$1.50.

MODERN WIRING DIAGRAMS AND DESCRIPTIONS. Retail value \$1.50.

ELECTRICAL WIRING AND CONSTRUCTION TABLES. Retail value \$1.50.

DYNAMO TENDING FOR ENGINEERS. Retail value \$1.50.

Making the full retail value of the STANDARD AMERICAN ELECTRICIAN \$6.00

THIS COMPLETE AND AUTHORITATIVE WORK INCLUDES ELECTRICAL CONSTRUCTION, WIRING, DIAGRAMS AND DESCRIPTIONS, ELECTRICAL WIRING CONSTRUCTION TABLES, DYNAMO TENDING FOR ENGINEERS, and is PROFUSELY ILLUSTRATED.

No. 3R9230 STANDARD AMERICAN ELECTRICIAN.

OUR SPECIAL PRICE \$2.68.

If by mail, postage extra, 20 cents.

SEARS, ROEBUCK & COMPANY,
Chicago, Ill.

STANDARD AMERICAN CYCLOPEDIA OF STEAM ENGINEERING

Including Electricity for Engineers, Boilers, Steam Turbines, Refrigeration, Lubrication, Pumps, Valve Setting, Marine Engine, Mechanical and Machine Design and Questions and Answers for Stationary and Marine Engineers.

By CALVIN F. SWINGLE and OTHERS.

Four volumes in one. Bound in full Persian Morocco. Pocketbook style with flap. Stamped in gold. Full gold edges. 1,200 pages. Fully illustrated. Special, Exclusive Edition. Printed by Frederick J. Drake & Company expressly for Sears, Roebuck & Company. This work covers everything contained in the following volumes:

SWINGLE'S TWENTIETH CENTURY HAND BOOK FOR STEAM ENGINEERS AND ELECTRICIANS. By Calvin F. Swingle. Retail price \$3.00.

COMPLETE EXAMINATION QUESTIONS AND ANSWERS FOR MARINE AND STATIONARY ENGINEERS. By Calvin F. Swingle. Retail price \$1.50.

PRACTICAL MECHANICAL DRAWING AND MACHINE DESIGN SELF-TAUGHT. By Charles Westinghouse. Retail price \$2.00.

DYNAMO TENDING FOR ENGINEERS AND ELECTRICITY FOR STEAM ENGINEERS. By Henry C. Horstmann and Victor H. Tousley. Retail price \$1.50.

Making the full retail value of the STANDARD AMERICAN CYCLOPEDIA OF STEAM ENGINEERING, \$8.00.

INCLUDING

CARE AND MANAGEMENT OF STEAM ENGINES, BOILERS AND DYNAMOS, VALVES AND VALVE SETTING, MECHANICAL STOKERS, THE STEAM TURBINE, REFRIGERATION, PUMPS, AIR COMPRESSORS, SETTING STEAM VALVES, LUBRICATION, ELECTRICITY FOR ENGINEERS, COMPLETE ENGINEERS' CATECHISM, MECHANICAL AND MACHINE DRAWING, and PROFUSELY ILLUSTRATED.

No. 3R9200 STANDARD AMERICAN CYCLOPEDIA OF STEAM ENGINEERING.

OUR SPECIAL PRICE \$2.78.

If by mail, postage extra, 22 cents.

SEARS, ROEBUCK & COMPANY, Chicago, Ill.

American Blacksmithing, Toolsmiths'

AND

Steel Workers' Manual

By HOLMSTROM and HOLFORD.

Two volumes in one. 600 pages. Fully illustrated. Bound in silk cloth. Special, Exclusive Edition. Printed by Frederick J. Drake & Company expressly for Sears, Roebuck & Company. Contains:

MODERN BLACKSMITHING, RATIONAL HORSESHOEING AND WAGON MAKING. By J. G. Holmstrom. Retail price \$1.00.

CORRECT HORSE, MULE AND OX SHOEING. By J. G. Holmstrom. Retail price \$1.00.

TWENTIETH CENTURY TOOLSMITHS' AND STEEL WORKERS' MANUAL. By Holford. Retail price \$1.50.

BLACKSMITHING. It comprises particulars and details regarding the anvil, tool table, sledge, tongs, hammers, how to use them, correct position at anvil, welding, tube expanding, the horse, anatomy of the foot, horseshoes, horseshoeing, hardening a plowshare, babbitting, etc.

TOOLSMITHING AND STEEL WORKING. Covers composition of cast tool steel, heating, forging, hammering, hardening, etc. Tempering, welding, annealing, cause of tools cracking when hardening.

LINE ENGRAVINGS AND DIAGRAMS. The book is very fully illustrated and contains numerous working rules and recipes. Experienced blacksmiths, steel and tool workers, as well as beginners, will get pleasure and helpful suggestions from this book.

No. 3R9240 AMERICAN BLACKSMITHING TOOLSMITH AND STEELWORKERS' MANUAL.

OUR SPECIAL PRICE, \$1.62.

If by mail, postage extra, 22 cents.

SEARS, ROEBUCK & COMPANY,
Chicago, Ill.

Builders' Reliable Estimator

and

Contractors' Guide

By FRED T. HODGSON.

Two volumes in one, nearly 550 pages. Fully illustrated with diagrams. Bound in silk cloth. Special, Exclusive Edition. Printed by Frederick J. Drake & Company expressly for Sears, Roebuck & Company.

HODGSON'S MODERN ESTIMATOR AND CONTRACTORS' GUIDE, for pricing all builders' work. By Fred T. Hodgson. Retail price \$1.50.

THE BUILDERS' AND CONTRACTORS' GUIDE to correct measurement for estimating. By Fred T. Hodgson and W. M. Brown, C. E. Retail price \$1.50.

FIFTY HOUSE PLANS, showing perspective views and floor plans. Retail price \$1.00.

A COMPLETE GUIDE FOR PRICING ALL BUILDERS' WORK. It contains many tables, rules and useful memoranda. **GUIDE TO CORRECT MEASUREMENTS** is found in the second part of this work. This shows how all kinds of odd, crooked and difficult measurements may be taken, to secure correct results. Profusely illustrated.

No. 3R9120 BUILDERS' RELIABLE ESTIMATOR AND CONTRACTORS' GUIDE.

OUR SPECIAL PRICE \$1.45.

If by mail, postage extra per set, 23 cents.

SEARS, ROEBUCK & COMPANY,
Chicago, Ill.

Modern Painting, Hardwood Finishing and Sign Writing

Covering Every Branch of this Profession.

By ARMSTRONG, HODGSON AND DELAMOTTE.

Three volumes in one. Nearly 700 pages. Fully illustrated. Special, Exclusive Edition. Printed by Frederick J. Drake & Company expressly for Sears, Roebuck & Company. Contains:

THE PAINTER'S ENCYCLOPEDIA. By Geo. D. Armstrong. Retail price \$1.50.

THE UP-TO-DATE HARDWOOD FINISHER, including manipulation of wood of all kinds. By Fred T. Hodgson. Retail price \$1.00.

SIGN WRITING. By F. Delamotte. Retail price \$1.50.

Including

PAINTS AND PAINTING,
WOOD FINISHING,
MODERN UP-TO-DATE ARTISTIC
SIGN PAINTING,
AND PROFUSELY ILLUSTRATED.

No. 3R9150 MODERN PAINTING, HARDWOOD FINISHING AND SIGN WRITING.

OUR SPECIAL PRICE \$1.89.

If by mail, postage extra, 23 cents.

SEARS, ROEBUCK & COMPANY,
Chicago, Ill.

STANDARD AMERICAN
GAS AND OIL ENGINE, AUTOMOBILE AND FARM
ENGINE GUIDE

A Complete Encyclopedia of the Construction, Operation and Management of Gas Engines, Gasoline Engines, Automobiles, Farm Engines and Traction Engines, together with Complete Questions and Answers. By Stevenson & Brookes. Three volumes in one. Over 600 pages. Fully illustrated. Bound in Full Persian Morocco, with flap, pocketbook style. Special, Exclusive Edition. Printed by Frederick J. Drake & Company expressly for Sears, Roebuck & Company. Contains:

PRACTICAL GAS AND OIL ENGINE HAND BOOK, including stationary, marine and portable gas and gasoline engines. By L. Elliott Brookes. Retail price, \$1.50.

THE AUTOMOBILE HAND BOOK. By L. Elliott Brookes. Retail price \$1.50.

FARM ENGINES AND HOW TO RUN THEM, AND THE TRACTION ENGINE. By James H. Stevenson. Retail price \$1.00.

GAS AND OIL ENGINES. AUTOMOBILES.

FARM ENGINES, TRACTION ENGINES AND HOW TO RUN THEM.

HOW TO RUN A THRESHING MACHINE.

QUESTIONS AND ANSWERS.

THIS WORK IS PROFUSELY ILLUSTRATED.

No. 3R9220 Standard American Gas and Oil Engine, Automobile and Farm Engine Guide.

OUR SPECIAL PRICE \$2.19.

If by mail, postage extra, 22 cents.

SEARS, ROEBUCK & COMPANY,
Chicago, Ill.

CYCLOPEDIA

—OF—

Bricklaying, Stone Masonry, Concretes, Stuccos and Plasters

Covering Everything Connected with the Allied Trades

By FRED T. HODGSON.

Three volumes in one. 840 pages. Fully illustrated. Bound in silk cloth. Special, Exclusive Edition. Printed by Frederick J. Drake & Company expressly for Sears, Roebuck & Company. Contains:

THE TWENTIETH CENTURY BRICKLAYER'S AND MASON'S ASSISTANT. By Fred T. Hodgson. Retail price \$1.50.

CONCRETES, CEMENTS, MORTARS, PLASTERS AND STUCCOS. How to Make and How to Use Them. By Fred T. Hodgson. Retail price \$1.50.

DIAGRAMS AND PLATES. Retail price \$1.50. Bricklaying—Stone Masonry—Concretes and Cements—Mortars, Plastering and Stucco Work. There are 1,000 Illustrations and Diagrams.

No. 3R9130 CYCLOPEDIA OF BRICKLAYING, STONE MASONRY, CONCRETES, STUCCOS AND PLASTERS.

OUR SPECIAL PRICE \$1.62.

If by mail, postage extra, 21 cents.

SEARS, ROEBUCK & COMPANY,
Chicago, Ill.

MODERN MACHINE SHOP PRACTICE

— INCLUDING —

PATTERN MAKING and FOUNDRY PRACTICE

By BROOKES and HAND.

Two volumes in one. 800 pages. Fully illustrated. Bound in cloth. Special, Exclusive Edition. Printed by Frederick J. Drake & Company expressly for Sears, Roebuck & Company. Contains:

TWENTIETH CENTURY MACHINE SHOP PRACTICE. By L. Elliott Brookes. Retail price \$2.00.

PATTERN MAKING AND FOUNDRY PRACTICE. By L. H. Hand. Retail price \$1.50. This book is intended for the practical instruction of machinists, engineers, etc.

MODERN MACHINE SHOP PRACTICE. It clearly but concisely describes the properties of steam, the indicator, horse power, electricity, measuring devices, machinists' tools.

PATTERN MAKING AND FOUNDRY PRACTICE. Nearly every problem explained is taken from an actual pattern.

HUNDREDS OF ILLUSTRATIONS. These illustrations show views of the latest machines, the most up-to-date and improved belt and motor-driven machine tools, with full information as to their use and operation.

No. 3R9250 MODERN MACHINE SHOP PRACTICE, including PATTERN MAKING AND FOUNDRY PRACTICE.

OUR SPECIAL PRICE \$1.75.

If by mail, postage extra, 24 cents.

SEARS, ROEBUCK & COMPANY,
Chicago, Ill.

Easy Steps In Architecture

AND

Architectural Drawing

For Students, Carpenters and Builders

By FRED T. HODGSON.

Two volumes in one. 600 pages. Fully illustrated. Bound in silk cloth. Special, Exclusive Edition. Printed by Frederick J Drake & Company expressly for Sears, Roebuck & Company. Contains:

BUILDERS' ARCHITECTURAL DRAWING SELF-TAUGHT. By Fred T. Hodgson, Architect. Retail price \$2.00.

EASY LESSONS IN ARCHITECTURE. By Fred T. Hodgson, Architect. Retail price \$2.00.

FIFTY HOUSE PLANS. Retail price \$1.00.

MAKE A COMPETENT, SELF-SUPPORTING ARCHITECT OF YOURSELF. This work contains everything that is necessary for a complete, self-teaching course in architecture.

ARCHITECTURAL DRAWING SELF-TAUGHT. This part of the work is especially designed for carpenters and builders and other wood workers who desire to learn drawing at home.

MANY HUNDREDS OF FINE LINE ENGRAVINGS made especially for this work are drawn to scale, with twenty-five large, double folding plates.

No. 3R9140 **EASY STEPS IN ARCHITECTURE AND ARCHITECTURAL DRAWING.**

OUR SPECIAL PRICE \$1.45.

If by mail, postage extra, 25 cents.

SEARS, ROEBUCK & COMPANY,
Chicago, Ill.

Standard American Plumbing

Hot Air and Hot Water

Heating

Steam and Gas Fitting

By CLOW and DONALDSON.

Three volumes in one. Over 600 pages. Fully illustrated. Special, Exclusive Edition. Printed by Frederick J. Drake & Company expressly for Sears, Roebuck & Company. Contains:

PRACTICAL UP-TO-DATE PLUMBING. By Geo. B. Clow. Retail price \$1.50.

HOT WATER HEATING, STEAM AND GAS FITTING. By William Donaldson. Retail price \$1.50.

WORKING DRAWINGS. Retail price \$1.50. Among the subjects this valuable book treats of:

SANITARY PLUMBING.

MODERN HOT WATER, HOT AIR AND STEAM HEATING.

STEAM AND GAS FITTING.

WORKING DRAWINGS.

No. 3R9180 STANDARD AMERICAN PLUMBING, HOT AIR AND HOT WATER HEATING, STEAM AND GAS FITTING.

OUR SPECIAL PRICE \$1.62.

If by mail, postage extra, 21 cents.

SEARS, ROEBUCK & COMPANY,
Chicago, Ill.

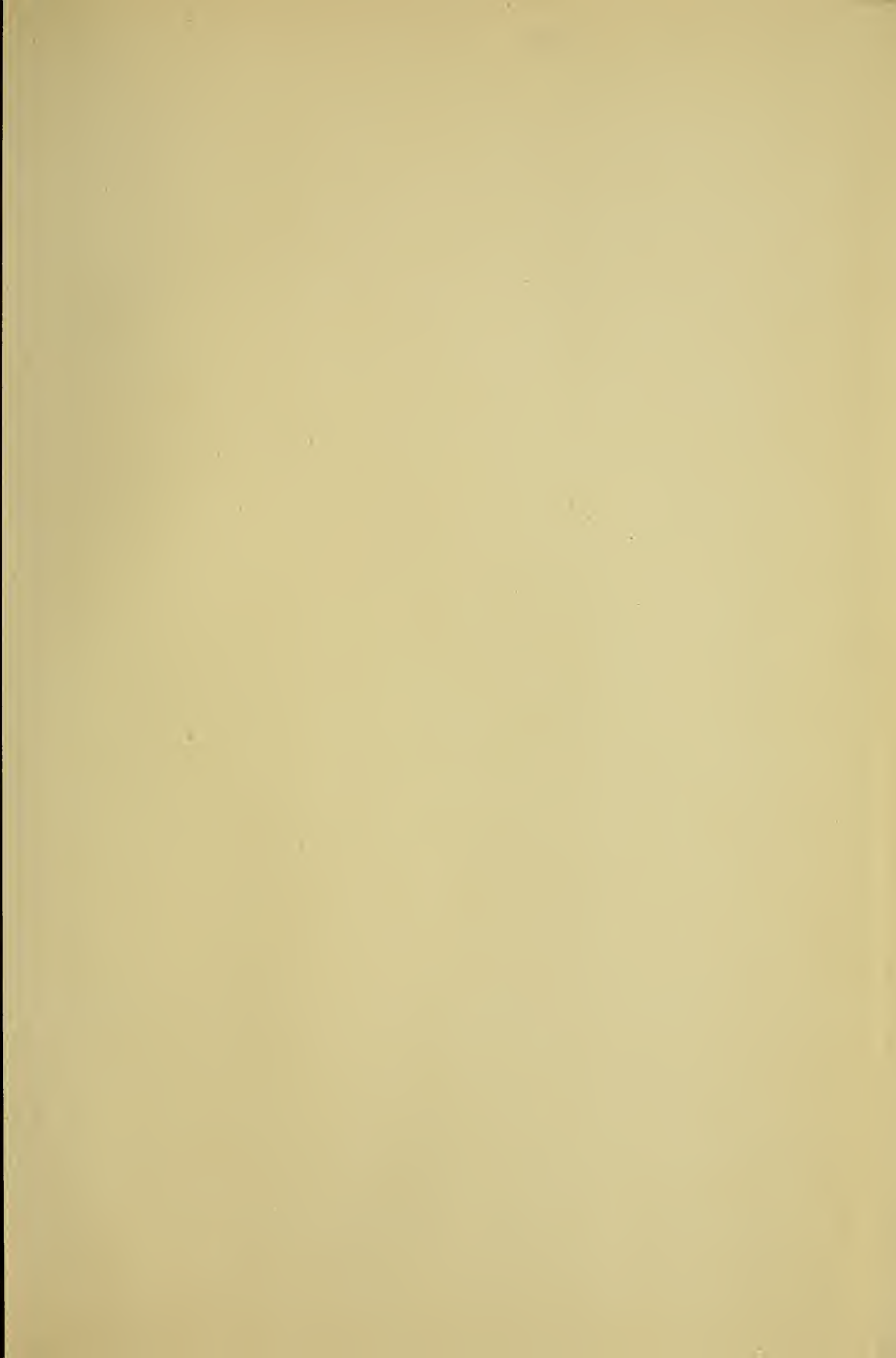

LIBRARY OF CONGRESS



0 021 231 224 1