

SB98
W6



Digitized by the Internet Archive
in 2007 with funding from
Microsoft Corporation

NEW WORK ON GARDENING.

In 1 vol. (pp. 764), illustrated by 383 Engravings, price 16s.

THE SUBURBAN HORTICULTURIST; adapted for the Use of those interested in the Formation and Management of either Large or Small Gardens, By J. C. LOUDON, F.L.S. &c. Conductor of *The Gardener's Magazine*, Author of *The Encyclopædias of Gardening, Plants, Agriculture, Trees and Shrubs, Cottage, Farm, and Villa Architecture, The Arboretum Britannicum, &c. &c.*

No pains have been spared towards rendering this work as complete as possible. It contains full instructions for the formation of gardens and their management, according to the most approved modes of practice. Extensive information will be found respecting the nature of soils and their improvement; the different kinds of manures and their application; the operations of Planting, Sowing, Budding, Grafting, and the various other modes of Propagation; Pruning and Training of Standard, Dwarf, Espalier, and Wall Trees. The formation of borders for Fruit Trees, the construction of Forcing Houses, Pits, and other structures for forcing and protection, and the various modes of Heating by Hot Water and otherwise, are treated of in full detail, as are likewise the Cropping and Particular Management of the Kitchen Garden, Forcing of the Pine Apple, Vine, Peach, Fig, Cucumber, and Melon. Lists and descriptions of the best varieties of Vegetables and Fruits are also included. Those who have a considerable knowledge of Gardening will find in this work much information to which they may advantageously refer; whilst it will enable such as are inexperienced to proceed with every probability of success.

From the following quotations, the work will appear to be particularly adapted for clergymen, and retired citizens or amateurs, who wish to be their own gardeners, and for emigrants.

"Mr. Loudon has made a most successful attempt to teach the science of gardening to the uninitiated; the instructions given respecting the various branches being so clear and intelligible as to be readily understood even by those totally ignorant of the subjects of which they treat; and, in addition to this, everything is illustrated by woodcuts admirably adapted to convey their exact meaning, particularly the operations of pruning, training, and propagation, which are exceedingly valuable parts of the work, and well worthy the attention of the most experienced. The volume before us will be found most invaluable to young gardeners, and those who know little of the science of gardening, and are either desirous of cultivating their gardens personally for health and recreation, or of directing their management upon the most approved principles, with a labourer only. For accomplishing either of these ends the practical directions are most ample and complete."

PAXTON'S MAGAZINE OF BOTANY, March 1843, p. 46.

"The novice in gardening will here find ample instructions in the various branches of labour, such as digging, trenching, mowing, &c. as well as for the propagation of plants by budding, grafting, inarching, and other methods. A considerable space is justly occupied with directions for planting, an operation too often considered of minor importance, but which, as daily experience proves, cannot be too carefully performed. Those sections of the work which relate to pruning and training are well worthy the perusal of even the practical gardener; were the rules therein inculcated, as well as those relative to the proper formation of borders, more strictly attended to, we should not have to lament the barren and unsightly state of fruit trees, which is so frequently observable."—DR. LINDLEY, in GARDENERS' CHRONICLE, Nov. 1842.

Published by William Smith, 113, Fleet Street.



THE
SUBURBAN HORTICULTURIST;

OR,

AN ATTEMPT TO TEACH THE SCIENCE AND PRACTICE OF

The Culture and Management

OF

THE KITCHEN, FRUIT, & FORCING GARDEN

TO

THOSE WHO HAVE HAD NO PREVIOUS KNOWLEDGE OR PRACTICE IN THESE
DEPARTMENTS OF GARDENING.

BY

J. C. LOUDON, F.L.S., H.S., &c.,

AUTHOR OF "THE SUBURBAN (ARCHITECT AND LANDSCAPE) GARDENER," CONDUCTOR OF
"THE GARDENER'S MAGAZINE," ETC. ETC.

ILLUSTRATED WITH NUMEROUS ENGRAVINGS ON WOOD.

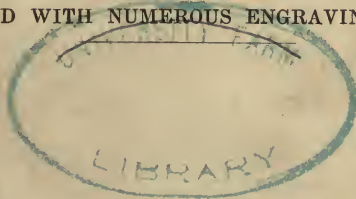

LONDON:

PRINTED FOR THE AUTHOR,

AND SOLD BY

WILLIAM SMITH, 113, FLEET STREET,

AND ALL BOOKSELLERS.

MDCCCXLII.

THE NEW YORK PUBLIC LIBRARY ASTOR LENOX TILDEN FOUNDATION

In the present edition 1000
copies have been printed
in order to bring the work
down

LONDON:

BRADBURY AND EVANS, PRINTERS, WHITEFRIARS.

to the present day

*same as that published
by Mr. Loudon under the
name of the Gardeners
Dictionary, & also for
the use of the*

P R E F A C E. *A design*

THE Author submits the following work to the public as by far the best Treatise on the Culture of the Fruit and Kitchen Garden which has hitherto been produced by his pen; because it contains all the latest improvements, while the Horticulture in the last edition of the *Encyclopædia of Gardening* was prepared in 1834. He has bestowed more than common care in compiling the present Treatise, and he has had the inestimable advantage of being assisted by Mr. Thompson, the superintendant of the fruit and culinary vegetable departments in the Horticultural Society's Garden. The selections and descriptions of fruits, and of culinary vegetables, have either been made by Mr. Thompson, or approved of by him.

*John
full
esh
M
B
P*

The Author has also had the assistance of various other practical gardeners, including Mr. Henry Charles Ogle, who prepared the Calendrial and General Index, and Mr. Lymburn, who furnished most of the Notes in the APPENDIX. The important note in p. 706, on the subject of charcoal, and the use of rough, rooty, turfy soil, and small stones in potting plants, is extracted from an article on this subject in *The Gardeners' Magazine* for November 1842, by Mr. James Barnes, gardener to the Right Hon. Lady Rolle, at Bicton, near Exeter.

It was originally intended to have included *Floriculture* in this volume; but as it would have swelled it to an inconvenient size, it has been thought advisable to publish *Suburban Horticulture* by itself, and leave *Suburban Floriculture* for a third volume. These two volumes, added to the volume entitled *The Suburban (Architect and Landscape) Gardener* already published, will form a complete cycle of SUBURBAN GARDENING.

In the mean time, till the *Suburban Floriculturist* is published, an excellent substitute will be found in the *Companion to the Ladies' Flower-garden*, by Mrs. Loudon.

Corrections, additions, and suggestions for the improvement of this work, are earnestly requested from its readers, with a view to assisting the author in rendering a future edition, should it be called for, as perfect as possible. In the mean time any additions, or discussions which may be of importance in themselves without reference to this volume, will be published under the head of "Retrospective Criticism," in the *Gardeners' Magazine*.

J. C. L.

BAYSWATER,
Nov. 1st, 1842.

CONTENTS.

	PAGE
NAMES OF THE FRUITS AND CULINARY VEGETABLES CULTIVATED IN BRITISH GARDENS, IN DIFFERENT LANGUAGES, &c.	xxiv
LIST OF ENGRAVINGS	xxviii
INTRODUCTION	1

PART I.

FACTS RELATIVE TO PLANTS, THE SOIL, MANURES, THE ATMOSPHERE, &c., ON WHICH HORTICULTURE IS FOUNDED	2
---	---

CHAPTER I.

PLANTS CONSIDERED WITH REFERENCE TO THEIR CULTURE IN GARDENS	2
--	---

SECT. I.— <i>The Analogy between Plants and Animals, considered with reference to Horticulture</i>	2
--	---

SECT. II.— <i>Classification of Plants, with a View to Horticulture</i>	8
---	---

22. E'xogens. 23. E'ndogens. 24. A'crogens. 28. Thalamifloræ.
29. Ranunculæcæ. 30. Cruciferae. 31. Malvæcæ. 32. Geraniæcæ.
33. Magnoliæcæ, &c. 34. Calycifloræ. 35. Leguminosæ. 36. Rosæcæ.
37. Umbellæcæ. 38. Compôsita. 39. Ericæcæ. 40. Rhamnæcæ,
&c. 40. Corollifloræ. 41. Scrophulariæcæ. 42. Labiæcæ. 43.
Epacridæcæ, &c. 44. Monochlamýdeæ. 45. Amentæcæ. 46. Coni-
feræ. 47. Plantaginæcæ, &c. 48. E'ndogens. 49. Orchidæcæ. 50.
Scitaminæcæ. 51. Iridæcæ. 52. Amaryllidæcæ. 53. Liliæcæ. 54.
Palmæcæ. 55. Graminæcæ. 56. Alismæcæ, &c. 57. A'crogens.
58. Filices. 59. Músci. 60. Lichènes. 61. A'lgæ. 62. Fúngi. 63.
Equisetæcæ. 66. Evergreens. 67. Subevergreens. 68. Persistent-
leaved plants. 69. Deciduous-leaved plants. 70. Ligneous plants.
71. Suffruticose plants. 72. Trees. 73. Shrubs.

SECT. III.— <i>Nomenclature of Plants with a view to Horticulture</i>	19
---	----

SECT. IV.— <i>Structure of Plants with a view to Horticulture</i>	20
---	----

80. Elementary organs. 81. Compound organs. 82. The root. 83.
The stem. 85. The bark. 86. The medullary rays or plates. 89.
Nodi. 90. Buds. 91. Leaves. 92. Hairs. 93. Flower-buds. 94.
Inflorescence. 95. The floral envelope. 96. The sexes of plants.
97. The ovulum. 98. The fruit. 100. The seed.

SECT. V.— <i>Functions of Plants with reference to Horticulture</i>	24
---	----

102. Germination. 103. Growth. 105. The stem. 109. Wood.
111. The bark. 113. Leaves. 115. Buds. 126. The Flowers. 129.
The sexes. 130. The fruit.

SECT. VI.— <i>The Geographical Distribution of Plants, and their sta- tions and habitations, with reference to their Culture in Gardens</i>	37
---	----

135. Temperature. 140. Physical circumstances. 142. Stations.
143. Light. 144. Water. 145. Soil. 146. Soils formed by particular
rocks. 147. Atmosphere. 148. Stations. 150. The habitations of
plants.

CHAPTER II.

	PAGE
SOILS CONSIDERED WITH REFERENCE TO HORTICULTURE	45
SECT. I.— <i>Origin and Kinds of Soils</i>	46
153. Sandy soil. 155. Clayey soil. 156. Lime. 157. Magnesia. 158. Iron. 159. Alluvial soils. 160. Peat. 161. Organic matter. 162. Loose naked sands or gravels. 163. Calcareous soils or gravels. 164. Loams. 165. Loams are the best soils. 166. Texture. 167. Subsoils. 168. The surface of soils. 169. The plants which grow on a soil.	
SECT. II.— <i>The Improvement of Soils, with a view to Horticulture</i> .	51
171. Draining. 172. Altering the texture and composition of soil. 173. Changing the inclination of the surface of soils. 174. Burning of soils. 175. Pulverising soils. 177. Rotation of crops.	

CHAPTER III.

MANURES CONSIDERED WITH REFERENCE TO HORTICULTURE	56
SECT. I.— <i>Organic Manures</i>	56
181. Fresh and tender vegetables. 182. Spent tanner's bark. 183. Peat soil. 184. Principal vegetable manures. 185. Animal manures. 186. Excrementitious manures. 189. Bones. 190. Vegeto-animal manures.	
SECT. II.— <i>Inorganic Manures</i>	69
194. Lime. 195. Mild-lime. 197. Carbonate of lime, or chalk. 198. Marl. 199. Gypsum. 200. Sea shells. 201. The rationale of the action of lime. 202. The most important uses of lime. 203. Lime compost. 204. Saltpetre. 205. Common salt.	
SECT. III.— <i>Mixed Manures</i>	64
207. Coal ashes. 208. Vegetable ashes. 209. Soot. 210. Street manure. 211. Composts. 212. Mixed manure in a liquid state. 213. Application of manures.	

CHAPTER IV.

THE ATMOSPHERE CONSIDERED WITH REFERENCE TO HORTICULTURE .	67
SECT. I.— <i>Heat, considered with reference to Horticulture</i>	67
219. Conduction of heat. 220. Radiation. 223. Dew, or hoar-frost. 224. Dew is never formed upon metals. 225. The formation of dew. 226. The effects of radiation. 227. Refrigeration. 228. Protecting plants. 229. The secondary effect which radiation has upon the climate. 230. The influence of hills upon the nightly temperature of the valleys. 231. Exalting the powers of the climate. 232. Houses for growing the plants of warm climates. 234. Increasing the heat of the atmosphere and the soil. 235. Frost. 236. Straw mats, bast mats, cloth, wool, or wood. 237. Wall trees. 238. Tender shrubs and trees. 239. A stream or river. 240. Watering. 241. Conclusions.	
SECT. II.— <i>Atmospheric Moisture, considered with reference to Horti- culture</i>	76
242. Existence of water in air. 243. Hygrometers. 244. Their utility. 245. Evaporation. 249. Vapour. 250. Rain. 251. Moisture of the free atmosphere. 252. Artificial climates unnaturally dry. 253. Drain of moisture. 255. Dryness of the atmosphere of hothouses. 256. Coolers of wet porous earthenware. 257. Plants in living rooms.	

SECT. II.—*Atmospheric Moisture, considered with reference to Horticulture—continued.*

258. Absorbent function. 259. A strict attention to the atmosphere. 260. Tropical plants. 261. The heat of the glass of a hothouse at night. 262. The skilful balancing of the temperature and moisture.

PAGE

SECT. III.—*The Agitation of the Atmosphere considered with reference to Horticulture* 83

263. Motion. 264. Perspiration. 265. Shelter. 266. Agitation of the air in plant structures. 267. To heat the air before it is admitted among the plants. 268. Effect on the human feelings. 269. The impression of an atmosphere saturated with moisture. 270. Mr. Penn's method of warming and ventilating. 271. Heating by pipes in the ordinary manner. 272. Greenhouses. 273. Pits and cucumber-frames. 274. Change of air and ventilation. 275. The climate, during the growing season. 276. Ventilators. 277. General principle.

SECT. IV.—*Light, considered with reference to Horticulture* 89

279. Light follows the same laws as heat. 280. Radiation of light. 281. Transmitted. 282. Refracted. 283. Disperses. 284. Perpendicular light. 285. The efficiency of light. 286. A due proportion between light and heat. 287. Absence of light.

CHAPTER V.

WORMS, SNAILS, SLUGS, REPTILES, BIRDS, &c., CONSIDERED WITH REFERENCE TO HORTICULTURE 93

SECT. I.—*The Earth-worm, considered with reference to Horticulture* 94

290. *Lumbricus terrestris*. 293. Natural uses. 294. Injury.

SECT. II.—*Snails and Slugs, considered with reference to Horticulture* 96

297. *Hélix aspersa*, and *H. nemoralis*. 298. Slugs. 299. Snails and slugs. 300. Snails and slugs are hermaphrodite and oviparous. 301. Natural uses of the snail. 302. Retires. 303. To destroy snails. 304. To destroy slugs.

SECT. III.—*Insects, considered with reference to Horticulture* 99

SUBJECT. I.—*Of the Nature of Insects, and their Classification* 99

306. Insects. 307. Winged insects. 308. Insects without wings. 309. Crabs and spiders. 310. Arrangement here given.

SUBJECT. II.—*Transformation of Insects* 101

311. Eggs. 312. Larvæ. 313. Nymphæ or pupæ. 314. Perfect insect.

SUBJECT. III.—*Food of Insects* 102

315. Nourishment. 316. Roots, stem, and branches. 317. Foliage. 318. Flowers. 319. Number. 320. Food. 322. Transformation. 323. Gluttonous. 324. No nourishment. 325. Eat

SUBJECT. IV.—*Distribution and Habits of Insects* 104

326. Distribution. 327. Water. 328. Land insects. 329. Other animals.

SUBJECT. V.—*Uses of Insects* 105

332. Uses. 333. Medicine. 334. Insects destroyed by other insects. 335. Consume dead animal substances.

SUBJECT. VI.—*Means contrived by Nature to limit the Multiplication of insects* 105

336. Continued rain. 337. Late frosts. 338. Inundations. 339. Enemies. 340. Insectivorous Mammalia. 341. Birds. 342. Wood-

SECT. III.— <i>Insects, considered with reference to Horticulture—</i> <i>continued.</i>	PAGE
pecker race. 343. Sparrow tribe. 344. Cuckoo. 345. Crows. 346. Insectivorous birds, sometimes granivorous. 347. Amphibious animals. 348. Equilibrium. 349. Beetles. 350. Ichneumonidæ. 351. Ants, and field or tree bugs.	
SUBSECT. VII.— <i>Means devised by Art for arresting the Progress of Insects in Gardens, or of destroying them there</i>	108
352. Insects may be destroyed in all their different stages. 353. Deterring the perfect insect. 354. Preventing the perfect insect from laying its eggs. 355. Catching the perfect insect. 356. Destroying the perfect insect. 357. Luring away the perfect insect. 358. Collecting the eggs of insects. 359. Preventing eggs from being hatched. 360. Collecting or destroying larvæ. 361. Collecting the pupæ, or chrysalids.	
SECT. IV.— <i>Amphibious Animals, considered with reference to Horticulture</i>	114
SECT. V.— <i>Birds, considered with reference to Horticulture</i>	115
364. Raptôres (seizers). Insessôres (perchers). 367. Rasôres (scratchers). 368. Grallatôres (waders). 369. Natatôres (swimmers). 370. The different modes of deterring birds. 371. The destruction of birds.	
SECT. VI.— <i>The smaller Quadrupeds, considered with reference to Horticulture</i>	120
372. Fèræ (wild beasts). 373. Glires (dormice). 374. Ungulata (hoofed animals).	

CHAPTER VI.

DISEASES AND ACCIDENTS OF PLANTS, CONSIDERED WITH REFERENCE TO HORTICULTURE	123
375. Canker. 376. To prevent canker. 377. Cure. 378. Gum. 379. Mildew. 380. Honey-dew. 381. Blight. 382. Flux of juices. 383. Accidents. 384. Other plant diseases.	

PART II.

IMPLEMENTS, STRUCTURES, AND OPERATIONS OF HORTICULTURE	127
--	-----

CHAPTER I.

IMPLEMENTS OF HORTICULTURE	127
385. Tools, instruments, utensils, machines, and other articles.	
SECT. I.— <i>General Observations on the construction and uses of the Implements used in Horticulture</i>	128
387. The mechanical principles on which they act. 388. Construction of implements. 389. Repairs.	
SECT. II.— <i>Tools used in Horticulture</i>	129
390. The common lever. 391. Perforators. 392. The dibber. 393. Picks. 394. Draw-hoes. 395. Scrapers. 396. Thrust-hoes. 397. Spades. 398. Turf-spades. 399. Turf-racers. 400. The trowel and the spud. 401. Transplanters. 402. Forks. 403. Rakes. 404. Besoms. 405. Beetles and rammers. 406. The mallet. 407. The garden hammer. 408. The garden pincers.	

	PAGE
SECT. III.— <i>Instruments used in Horticulture</i>	137
409. Garden knives. 410. Bill-knives, or hedge-bills. 411. Pruning-saws. 412. Pruning-chisels. 413. Shears. 414. The axe. 415. Verge shears. 416. Grass shears. 417. The short grass scythe. 418. Other instruments. 419. Chests of tools, and instruments.	
SECT. IV.— <i>Utensils used in Horticulture</i>	142
420. Earthenware pots for plants. 421. Porosity. 422. Earthenware saucers for pots. 423. Rectangular boxes. 424. Wooden tubs. 425. Watering-pots. 426. Money's inverted rose watering-pot. 427. Sieves and screens. 428. Carrying utensils. 429. Baskets. 430. Basket-making. 431. Carrying-baskets. 432. Measuring-baskets. 433. Baskets for growing plants. 434. Portable glass utensils. 435. Substitute for bell glasses. 436. Powdering boxes. 437. Other utensils.	
SECT. V.— <i>Machines used in Horticulture</i>	153
438. Wheelbarrows for gardens. 439. Rollers. 440. The watering engines. 441. Garden bellows. 442. The mowing-machine. 443. Other machines.	
SECT. VI.— <i>Miscellaneous articles used in Horticulture</i>	158
444. Articles for protection. 445. Mats of straw or reeds. 446. Wooden shutters. 447. Asphalte covers. 448. Oiled paper frames. 449. Oiled paper caps. 450. Wicker-work hurdles. 451. Props for plants. 452. The durability of wooden props. 453. Garden tallies and labels. 454. Nails, lists, and ties. 455. The garden line. 456. Ladders. 457. A levelling instrument. 458. Thermometers. 459. A hydrometer. 460. Other articles.	

CHAPTER II.

STRUCTURES AND EDIFICES OF HORTICULTURE	171
SECT. I.— <i>Portable, Temporary, and Movable Structures</i>	171
461. Wicker-work structures. 462. Portable substitutes for hand-glasses. 463. Canvas coverings. 464. Canvas shades to hothouses. 465. The common hotbed frame.	
SECT. II.— <i>Fixed Structures used in Horticulture</i>	176
SUBJECT. I.— <i>Walls, Espalier rails, and Trellis work</i>	176
466. Walls. 467. Direction and material. 468. The materials of walls. 469. The height of garden walls. 470. The foundations. 471. The copings of walls. 472. On the construction of walls. 473. Trellised walls. 474. Colouring the surface of walls black. 475. Flued walls. 476. Conservatory walls. 477. A substitute for a wall of brick. 478. Espalier rails. 479. Trellises and lattice-work.	
SUBJECT. II.— <i>Fixed Structures for growing Plants with Glass roofs</i>	187
480. Plant houses. 481. Situation. 482. The form. 483. Curvilinear roofs. 484. Ridge and furrow roofs. 485. Materials. 486. The law of the reflection of light from glass. 487. Iron roofs. 488. Heat. 489. Fermenting substances. 490. Fermenting materials and fire heat combined. 491. Heating from vaults, or from stacks of flues. 492. Flues. 493. The best materials for building flues. 494. The furnace. 495. On substitutes for smoke flues. 496. Steam. 497. Hot water. 498. The modes of heating by hot water. 499. A reservoir of heat. 500. The pipes. 501. The situation in which the pipes are placed. 502. The boiler. 503. The furnace. 504. Rogers's conical boiler and hot-water apparatus. 505. Rain-water. 506. To prevent the water in the apparatus from freezing. 507. Open gutters. 508. Retaining heat by coverings. 509. Atmospheric moisture. 510. Steaming. 511. Ventilation. 512. The agitation. 513. Light. 513. Water. 514. The different kinds of fixed structures for plants. 515.	

SECT. II.—Fixed structures used in Horticulture—continued.	PAGE
Pits. 516. The greenhouse. 517. The orangery. 518. The conservatory. 519. Botanic stoves. 520. The pine stove. 521. Forcing-houses. 522. A plant structure for all or any of the above purposes.	
SUBJECT. III.—Edifices used in Horticulture	224
523. Gardener's house. 524. Journeyman gardener's lodge. 525. The fruit-room. 526. Seed-room. 527. Root-cellar, and other conveniences. 528. Tool-house. 529. Open sheds.	

CHAPTER III.

OPERATIONS OF HORTICULTURE	227
SECT. I.—Horticultural Labours	227
SUBJECT. I.—Horticultural Labours on the Soil	227
531. Object of labours on the soil. 532. Marking with the garden line. 533. Digging. 534. Trenching. 535. Trenching ground that is to be cropped with culinary vegetables. 536. Operation of trenching. 537. Forking soil. 538. Hoing. 539. Raking. 540. Rolling. 541. Screening or lifting. 542. Other labours on the soil.	
SUBJECT. II.—Garden Labours with Plants	235
544. Sawing. 545. Cutting. 546. Clipping. 547. Clipping hedges. 548. Mowing. 549. Weeding. 550. Other labours with plants.	
SECT. II.—Operations of Culture	239
SUBJECT. I.—Propagation	239
§ 1. <i>On Propagation by Seed</i>	240
552. The seed. 553. Process of germination. 554. The period necessary to complete the process of germination. 555. The quantity of moisture most favourable to germination. 556. The water requisite to cause old seeds to germinate. 557. The depth to which a seed is buried in the soil. 558. The degree of heat most favourable for the germination of seeds. 559. The degree of heat which the seeds of plants will endure. 560. The degree of cold which seeds will endure. 561. Atmospheric air. 562. The influence of light. 563. Accelerating the germination of seeds. 564. Various experiments have been made to accelerate germination. 565. Electricity and alkalies as stimulants to vegetation. 566. The length of time during which seeds retain their vitality. 567. The length of time that seeds will lie in the ground without growing. 568. The season for sowing seeds. 569. The mechanical process of sowing. 570. Sowing seeds in powdered charcoal. 571. Sowing seeds in snow. 572. The discoveries daily making in chemical science.	
§ 2.— <i>On Propagation by Cuttings</i>	249
573. A cutting. 574. Selecting plants from which the cuttings are to be taken. 575. Selecting the shoot. 576. Shoots which have formed blossom-buds. 577. As general rules. 578. The time of taking off cuttings. 579. Preparation of the cutting. 580. The number of leaves which are left on the cutting. 581. Taking off a cutting. 582. Treatment of cuttings from the time they are made till they are planted. 583. Cuttings of succulent or fleshy plants. 584. The soil in which cuttings are planted. 585. The depth. 586. Planting cuttings. 587. The distance at which cuttings are planted. 588. After-treatment of cuttings. 589. The most proper form of bell-glass for covering cuttings. 590. Watering cuttings. 591. The temperature most suitable for cuttings. 592. Cuttings of hardy deciduous trees and shrubs. 593. Cuttings of hardy evergreens. 594. Cuttings of all the Coniferæ and Taxacæ. 595. Cuttings of hardy or half-hardy herbaceous plants. 596. Piping. 597. Cuttings of soft-wooded greenhouse plants. 598. Cuttings of hard-wooded greenhouse plants. 599.	

SECT. II.—*Operations of Culture—continued.*

PAGE

Cuttings of heath-like plants. 600. Cuttings of succulent plants. 601. Cuttings of the underground stems and roots. 602. Striking cuttings in water or moist moss. 603. Striking plants in powdered charcoal. 604. Propagation by joints and nodules. 605. A nodule. 606. Propagating by joints of the vine. 607. Propagation by bulbs and entire tubers and tubercles. 608. Propagating by bulb-bearing leaves.

§ 3.—*Propagation by Leaves* 266

609. The principle on which the propagation of plants by leaves is founded. 610. The conditions generally required for rooting leaves. 611. Rooting portions of leaves. 612. The plants usually raised by leaves in British gardens. 613. Propagation by the leaves of bulbs. 614. Rooting leaves and parts of leaves in powdered charcoal. 615. Leaves with the buds in the axils root freely. 616. Immature fruits have even been made to produce plants. 617. The essence of all the different modes of forming plants from cuttings. 618. To induce stems or shoots to produce leaves or growths from which cuttings may be formed.

§ 4.—*Propagation by Layers* 272

619. The theory of layering. 620. The operation of layering. 621. The state of the plant most favourable for layering. 622. Hardy trees and shrubs. 623. Shrubs with very long shoots. 624. Layering by insertion of the growing point. 625. Plum and paradise stocks. 626. Roses. 627. Hardy herbaceous plants. 628. Shrubby plants in pots kept under glass. 629. The soil in which plants are layered. 630. Hooked pegs. 631. The time which layers require to produce roots.

§ 5.—*Propagation by Suckers, Slips, Offsets, Runners, and Simple Division* 277

632. A sucker. 633. Stem suckers or slips. 634. Offsets. 635. Runners or stolones. 636. Simple division.

§ 6.—*Propagation by grafting, inarching, and budding* 280

637. The term graft. 638. The origin of grafting. 639. The phenomena of grafting. 640. The condition. 641. Anatomical analogy. 642. Physiological analogy. 643. The modifications effected by the graft. 644. The influence of the scion on the stock. 645. The uses of grafting. 646. The different kinds of grafting. 647. The materials used in grafting. 648. Grafting-clay. 649. Grafting-wax.

§ 7.—*Grafting by detached Scions* 287

651. Splice-grafting. 652. Splice-grafting the peach. 653. Cleft-grafting. 654. Cleft-grafting the vine. 655. Saddle-grafting. 656. Side-grafting. 657. Wedge-grafting. 658. Grafting the mistletoe. 659. Root-grafting. 660. Herbaceous grafting. 661. Grafting the pine and fir tribe. 662. Grafting the tree-peony. 663. Grafting on fleshy roots. 664. Herbaceous wedge-grafting. 665. Herbaceous grafting for shoots with opposite leaves. 666. Herbaceous grafting annual or perennial plants. 667. Grafting herbaceous shoots of succulents. 668. Grafting the melon. 669. The greffe étouffée.

§ 8.—*Grafting by approach or inarching* 297

671. Side inarching. 672. Terminal inarching. 673. Inarching with partially-nourished scions.

§ 9.—*Budding or grafting by detached buds* 300

675. The uses of budding. 676. Performing the operation. 677. Prepared wax for budding. 678. Plastic wax. 679. Shield-budding in the end of summer. 680. Shield-budding in June. 681. Shield-budding in spring. 682. Shield-budding without a bud or eye. 683. Budding with a circular shield. 684. Budding with a shield stamped out by a punch. 685. Budding with the shield reversed. 686. Budding with the eye turned downwards. 687. Shield-budding for resinous trees. 688. Budding with the shield covered. 689. Budding with a

SECT. II.—*Operations of Culture—continued.*

PAGE

square shield. 690. Shield-budding with a terminal bud. 691. Flute-budding, or tube-budding. 692. Flute-budding in spring. 693. Terminal flute-budding. 694. Flute-budding with strips of bark. 695. Annular budding. 696. The after-care of grafts by budding.

SUBJECT. II.—*Rearing* 308§ 1.—*Transplanting and Planting* 309

698. To transplant. 699. The uses of transplanting. 700. The theory of transplanting. 701. Seedlings. 702. Deciduous trees and shrubs, and perennial herbaceous plants. 703. Whether deciduous trees and shrubs ought to be transplanted in autumn or spring. 704. Different modes of transplanting large trees and shrubs. 705. Transplanting with large balls of earth. 706. Transplanting by shortening the roots, so as to induce them to throw out fibres. 707. Sir Henry Stuart's practice in transplanting large trees. 708. Pulling down the tree and raising it out of the pit. 709. Transporting and replanting the tree. 710. Transplanting by shortening the roots, without permitting them to throw out fibres at their extremities. 711. Transplanting by thinning and pruning the roots and branches. 712. The removal of large trees and shrubs. 713. Transplanting by heading-in, that is, cutting in the branches. 714. The staking or supporting of newly-transplanted trees, and the protection of their stems from cattle. 715. The machinery for moving large trees. 716. Transplanting evergreens. 717. The best season for transplanting evergreens. 718. The drying of the roots of evergreens. 719. Planting evergreens. 720. Transplanting evergreens with balls. 721. The machines and implements for transplanting large shrubs with balls. 722. Packing evergreens. 723. Methods of planting small plants. 724. Planting with the dibber. 725. Planting with the trowel. 726. Planting in drills. 727. Laying in by the heels. 728. Trench-planting. 729. Slit-planting. 730. Hole-planting. 731. Planting in pits. 732. Hole-planting, and fixing with water. 733. Planting in puddle. 734. Planting out plants which have been grown in pots. 735. Watering, mulching, and staking newly-planted plants. 736. Taking up previously to planting. 737. As a summary of general rules for planting.

§ 2.—*Potting and Repotting or Shifting* 329

738. To pot a plant. 739. The main object of growing plants in pots. 740. The disadvantages of growing plants in pots. 741. Potting. 742. The same soil which is suitable for the open garden is not always suitable for using in pots. 743. Bottom drainage. 744. The mode of sowing or planting in a pot. 745. Transplanting from the free soil into a pot or box. 746. Care of newly potted or shifted plants. 747. Shifting or repotting. 748. Seasons and times for potting and shifting. 749. The most difficult plants to manage in pots. 750. Growing hardy plants in pots.

§ 3.—*Pruning* 335

752. The specific principles on which pruning is founded, and its general effects. 753. Forest-trees. 754. Ornamental trees. 755. Ornamental shrubs. 756. Fruit-trees and shrubs. 757. Herbaceous plants. 758. Close pruning. 759. Shortening-in. 760. Fore-shortening. 761. Spurring-in. 762. Heading-in. 763. Lopping. 764. Close lopping. 765. Snag-lopping. 766. Lopping-in. 767. Cutting down. 768. Stopping and pinching out. 769. Disbarking. 770. Ringing. 771. Disbudding. 772. Disleafing. 773. Slitting and splitting. 774. Bruising and tearing. 775. Clipping. 776. Root-pruning. 777. Girdling and felling. 778. The girdling machine. 779. The seasons for pruning.

§ 4.—*Thinning* 349

781. Seedling crops in gardens. 782. Thinning plantations. 783. Thinning ornamental plantations.

5.—*Training* 351

SECT. II.—*Operations of Culture—Training—continued.*

PAGE

784. To train. 785. The principles. 786. Manual operations of training. 787. Training herbaceous plants. 788. Herbaceous and shrubby plants in pots. 789. Training hardy flowering shrubs in the open ground. 790. Evergreen shrubs. 791. Training fruit-trees. 792. The different modes of training bushes and trees in the open garden. 793. The different modes of training fruit-trees against walls or espaliers. 794. Dwarfs in the open garden. 795. Spiral cylinders. 796. Standards in the open garden. 797. The spurring-in system. 798. Conical standards. 799. Hayward's quenouille-training. 800. Fan-training. 801. Fan-training in the common English manner. 802. Fan-training according to Seymour's mode. 803. Fan-training in the wavy or curvilinear manner. 804. Wavy fan-training with two stems. 805. Wavy fan-training with a single stem. 806. Horizontal training. 807. Fan-training and horizontal training combined. 808. Perpendicular training. 809. Instruments and materials. 810. Comparative view of the different modes of training. 811. A standard tree.	
§ 6.— <i>Weeding</i>	378
813. A weed. 814. Annual weeds. 815. Perennial weeds. 816. Weeds in gravel-walks. 817. Weeds in lawns or on grass-walks. 818. Weeds in shrubberies and plantations. 819. Weeds in woods and park scenery. 820. Weeding ponds, rivers, and artificial waters.	
§ 7.— <i>Watering</i>	382
821. Water. 822. The specific purposes for which water is used in horticulture. 823. The ordinary sources from which water is obtained in gardens. 824. The distribution of water. 825. The ordinary mode of giving water to plants. 826. When it is proper to water, and how much water to give. 827. Whether plants should be watered over the leaves, or only over the soil in which they grow. 828. Watering plants in pots. 829. Aquatic and marsh plants. 830. Watering with liquid manure. 831. To economise the water given to plants.	
§ 8.— <i>Stirring the soil and manuring</i>	388
§ 9.— <i>Blanching</i>	389
§ 10.— <i>Protection from atmospherical injuries</i>	389
835. The object of shading. 836. Sheltering from wind. 837. The principles of protecting from cold. 838. Protecting from rain.	
§ 11.— <i>Accelerating vegetation</i>	391
839. Acceleration. 840. Artificial heat. 841. Hotbeds. 842. Preparation of materials for hotbeds. 843. M'Phail's hotbed or pit. 844. The formation of common hotbeds. 845. Ashes, tan, and leaves. 846. The nightly covering to hotbeds and pits. 847. Management of hotbeds and pits heated by dung.	
§ 12.— <i>Retarding vegetation</i>	395
§ 13.— <i>Resting vegetation</i>	396
849. In the natural state of vegetation. 850. Nightly temperature. 851. What the night temperature of a hotbed or hothouse ought to be. 852. Double glass roofs. 853. The annual resting of plants. 854. The natural period of rest in hardy plants. 855. The advantages of putting trees that are to be forced into a state of rest.	
§ 14.— <i>Operations of gathering, preserving, keeping, and packing</i>	401
856. Gathering. 857. Preserving. 858. Keeping fruits. 859. Packing and transporting plants and seeds. 860. Packing fruits and flowers.	
§ 15.— <i>Selecting and improving plants in culture</i>	403
862. Cultivation. 863. Selection. 864. Selecting from accidental variations. 865. Cross-breeding. 866. Precautions against promiscuous fecundation. 867. Fixing and rendering permanent the variety produced. 868. The production of double flowers. 869. Duration of varieties.	
§ 16.— <i>Operations of order and keeping</i>	409
871. Order. 872. Keeping. 873. Rules.	

CHAPTER IV.

	PAGE
OPERATIONS OF HORTICULTURAL DESIGN AND TASTE	411
875. Taking plans. 876. Carrying plans into execution. 877. Reducing a surface to a level, or to a uniform slope.	

CHAPTER V.

OPERATIONS OF GENERAL MANAGEMENT	412
879. General management of a garden. 880. On undertaking the charge of a garden. 881. The books to be kept by a gardener. 882. The ordering of seeds and plants. 883. The management of men and the distribution of work. 884. The wages of a gardener.	

PART III.

THE CULTURE OF THE KITCHEN, FRUIT, AND FORCING GARDEN	416
---	-----

CHAPTER I.

LAYING OUT AND PLANTING THE KITCHEN AND FRUIT GARDEN	416
SECT. I.— <i>Laying out the Kitchen Garden</i>	416
885. The situation and general management of the kitchen garden. 886. Trenching and levelling.	
SECT. II.— <i>The Distribution of Fruit-trees in a Kitchen Garden</i>	420
SUBSECT. I.— <i>Wall-fruit Trees</i>	422
888. Select list of fruit-trees adapted for walls of different aspects. 890. The distance. 891. For low walls. 892. Training. 893. Planting.	
SUBSECT. II.— <i>Fruit-trees for Espaliers and Dwarfs</i>	424
894. Espaliers. 895. Dwarfs or standards trained in the conical manner. 896. Espalier-rails. 897. A wooden espalier rail. 898. Espalier rails of cast iron. 899. Espalier rails of wrought iron. 900. Dwarfs. 901. Select list. 902. The plants. 903. Standard fruit-trees.	
SUBSECT. III.— <i>Fruit Shrubs</i>	429
904. Gooseberries and currants. 905. Select list. 906. Plants.	
SUBSECT. IV.— <i>Selection of Fruit-trees adapted for an Orchard</i>	430
907. A plantation or orchard. 908. The plants. 909. Select list. 910. Training. 911. Culture of the soil.	

CHAPTER II.

CROPPING AND GENERAL MANAGEMENT OF A KITCHEN GARDEN	434
SECT. I.— <i>Cropping</i>	434
913. The herbaceous vegetables grown in kitchen gardens. 914. General proportions of crops. 916. The quantity of seed.	
SECT. II.— <i>Rotation of Crops</i>	435
918. Successional cropping. 919. The object to be obtained by a system of cropping. 920. Successional cropping. 921. The simultaneous mode of cropping. 922. Modes of cropping. 923. Successional and simultaneous cropping combined. 924. Order of rotation. 925. Secondary crops. 926. Times of sowing and planting.	
SECT. III.— <i>Planting, Sowing, Cultivating, and Managing</i>	439
928. Management of the fruit-tree borders. 929. Management of the culinary crops. 930. Gathering, storing, and keeping of fruit. 931. Management of the fruit-room.	

CHAPTER III.

	PAGE
THE FORCING DEPARTMENT	442
SECT. I.— <i>Culture of the Pine-apple, and Management of the Pinery</i>	443
SUBJECT. I.— <i>Natural data on which the Culture of the Pine-apple is founded</i>	443
932. The conclusions to be drawn from these data. 933. Soil. 934. Water.	
SUBJECT. II.— <i>Culture of the Pine-apple in British Gardens</i>	444
935. Construction of the pit. 936. Kinds grown. 937. Watering and sprinkling. 938. Worms. 939. Heat, air, and moisture. 941. Jamaica pines. 942. Starting pine plants into fruit. 943. Air. 944. Propagation. 945. Bottom-heat. 946. As the season declines, the temperature is lowered. 947. Culture of the queen pine, so as to have the fruit ripe in February and March. 948. Sizes of the pots in which the plants are grown. 949. Culture of queen pines for early fruit. 950. Growing the pine-apple in beds of soil. 951. Fruiting suckers on the stools. 952. To grow the pine-apple to an extraordinary size. 953. Insects.	
SECT. II.— <i>Culture of the Grape Vine under Glass and on Walls</i>	452
SUBJECT. I.— <i>Natural data on which the Culture of the Grape Vine is founded</i>	452
954. The grape vine. 955. With respect to atmospheric moisture. 956. Soil. 957. Form of house.	
SUBJECT. II.— <i>Propagation, Pruning, and Training the Vine</i>	454
958. Propagation. 959. Pruning. 960. Training. 961. Essential points. 962. The long, or the renewal system of pruning. 963. The spurring-in method of pruning. 964. The fan-system of vine-training. 965. The Thomery system.	
SUBJECT. III.— <i>Culture of the Grape Vine under Glass</i>	457
966. Vine border. 967. Planting. 968. To raise the plants. 969. When planted in the vinery. 970. The sorts. 971. A diary of the course of culture applied to the grape vines at Oakhill. 972. Growing two or three crops of grapes in one house. 973. Growing three crops of grapes in one house together with pines. 974. Another mode of growing three crops of grapes in one house. 975. Keeping grapes.	
SUBJECT. IV.— <i>Growing the Grape on open walls, and on cottages</i>	464
976. Fruit-bearing powers of the vine. 977. Aspect. 978. Soil. 979. Manure. 980. Walls. 981. Propagation. 982. Pruning. 983. Training. 984. Mr. Hoare's mode of training. 985. Training the vine on the walls of cottages. 986. The appearance of a portion of the front of a house covered with vines in Mr. Hoare's manner. 987. The walls and roof of a cottage of the most irregular architecture. 988. Kinds of grapes most suitable for the open wall or for cottages.	
SUBJECT. V.— <i>Insects, Diseases, &c., of the Grape Vine</i>	472
SECT. III.— <i>Culture of the Peach and Nectarine under Glass</i>	472
SUBJECT. I.— <i>Natural data on which the Culture of the Peach is founded.</i>	472
989. The peach. 990. Natural and experimental data.	
SUBJECT. II.— <i>Culture of the Peach under Glass in British Gardens</i>	474
991. Construction of the peach-house. 992. Peaches and nectarines best adapted for forcing. 993. Plants and mode of training. 994. Pruning. 995. The summer pruning. 996. The fruit is thinned before and after the stoning season. 997. The peach border. 998. General treatment. 999. Insects and diseases. 1000. Peaches may be forced in pots.	

	PAGE
SECT. III.— <i>Culture of the Peach and Nectarine under Glass—</i> <i>continued.</i>	
SUBJECT. III.— <i>The details of a routine course of forcing the Peach</i> <i>for two years</i>	477
1001. Soil. 1002. Border. 1003. Planting. 1004. Forcing in the first season. 1005. Watering and fumigating. 1006. Summer pruning. 1007. Routine treatment during the first season. 1008. Winter treatment. 1009. Forcing in the second season. 1010. Applying a preventive composition. 1011. Forcing in February. 1012. March. 1013. Thinning the shoots and fruit. 1014. Stoning. 1015. Watering. 1016. Ripening. 1017. Duration of the crop.	
SECT. IV.— <i>Culture of the Cherry under Glass</i>	480
SUBJECT. I.— <i>Natural Data for the Culture of the Cherry</i>	480
SUBJECT. II.— <i>The practice of Cherry Forcing in British Gardens</i>	480
1019. The cherry-house. 1020. Kinds of cherries for forcing, pot- ting the plants, &c. 1021. Time of commencing to force. 1022. Progress. 1023. Insects. 1024. Thinning and stoning, &c. 1025. Treatment of the plants in pots after they are taken out of the house. 1026. To have a constant succession of cherries. 1027. Forcing cher- ries by a temporary structure. 1028. German practice.	
SECT. V.— <i>Culture of the Fig under Glass</i>	485
SUBJECT. I.— <i>Natural data on which the Culture of the Fig is founded</i>	485
SUBJECT. II.— <i>The forcing of the Fig as practised in British Gardens</i>	485
1031. The construction of the fig-house. 1032. The varieties best adapted for forcing. 1033. The time of beginning to force. 1034. The forcing of fig-trees in pots. 1035. Winter treatment.	
SECT. VI.— <i>On forcing the Plum, Apricot, Gooseberry, and other</i> <i>Fruit-trees, and Fruit-shrubs</i>	487
SECT. VII.— <i>Culture of the Melon</i>	487
SUBJECT. I.— <i>Natural and experimental data on which the Culture of the</i> <i>Melon is founded</i>	487
SUBJECT. II.— <i>Culture of the Melon as practised in British Gardens</i>	490
1038. The sorts. 1039. Very early melons. 1040. Seedlings. 1041. Cuttings. 1042. Planting out. 1043. General treatment. 1044. Persian melons. 1045. Culture of the melon in the open air. 1046. Insects and diseases. 1047. The red spider and the damp.	
SECT. VIII.— <i>Culture of the Cucumber</i>	494
SUBJECT. I.— <i>Data on which the Culture of the Cucumber is founded</i>	494
SUBJECT. II.— <i>Culture of the Cucumber in a Dung-bed</i>	496
1051. The formation of a dung-bed. 1052. The seed-bed. 1053. Soil. 1054. Seeds and treatment of the young plants. 1055. Raising plants from cuttings. 1056. Fruiting-bed. 1057. Ridging out the plants. 1058. A temporary lining. 1059. Air. 1060. Earthing-up. 1061. Linings of cucumber beds and their management. 1062. Water. 1063. Stopping. 1064. Moulding up. 1065. The covering at night. 1066. Setting or impregnating the fruit. 1067. To procure seed. 1068. Inlaying, or earthing in, the vines of the cucumber. 1069. When extraordinary fine fruit is desired.	
SUBJECT. III.— <i>Culture of the Cucumber in pits heated by dung linings,</i> <i>flues, or hot water</i>	503
1070. Of pits heated wholly or in part by dung linings. 1071. Pits to be heated by flues or hot water. 1072. A pit to be heated by a flue.	

	PAGE
SECT. VIII.— <i>Culture of the Cucumber—continued.</i>	
1073. A pit to be heated by hot water, and by a flue from the fire which heats the boiler. 1074. Corbett's cucumber pit. 1075. Green's cucumber pit. 1076. The advantages gained by this pit. 1078. The culture of the cucumber in pots. 1079. Construction of the cucumber house. 1080. Treatment of the plants.	
SUBSECT. IV.— <i>Culture and treatment of the Cucumber for Prize Exhibitions</i>	510
SUBSECT. V.— <i>Cultivation of the Cucumber in the open air</i>	510
1082. Cucumbers grown in the open air are commonly protected by hand or bell glasses. 1083. Increasing the atmospheric heat of the soil. 1084. Cucumbers against a south wall. 1085. Growing cucumbers on balconies, or in court-yards. 1086. Watering cucumbers in the open garden. 1087. Cucumber and melon culture compared.	
SECT. IX.— <i>Culture of the Banana</i>	512
SECT. X.— <i>Forcing the Strawberry</i>	514
1090. Data on which the forcing of the strawberry is founded. 1091. Routine practice in forcing Keen's seedling, and the old scarlet or Virginian strawberries. 1092. How grown and protected before forcing. 1093. After forcing. 1094. The Alpine strawberry.	
SECT. XI.— <i>Forcing the Asparagus, Sea Kale, Rhubarb, Chicory, and other fleshy roots</i>	516
SECT. XII.— <i>Forcing the common Potato, the sweet Potato, and other tubers</i>	519
1100. The common potato. 1101. A substitute for new potatoes. 1102. The sweet potato. 1103. O'xalis Dépei.	
SECT. XIII.— <i>Forcing Kidney Beans and Peas</i>	520
SECT. XIV.— <i>Forcing Salads, Pot-herbs, Sweet-herbs, and other culinary Plants</i>	521
1106. Lettuce, chicory, radish, cress, mustard, rape, parsley, chervil, carrot, turnip, onion, and similar plants. 1107. Small salading. 1108. Radish. 1109. To produce full-grown cabbage-lettuces throughout the winter. 1110. Perennial pot and sweet herbs.	
SECT. XV.— <i>Forcing the Mushroom</i>	523
SUBSECT. I.— <i>Data on which the Culture and Forcing of the Mushroom is founded</i>	523
SUBSECT. II.— <i>Forcing the Mushroom in British Gardens</i>	524
1112. The ordinary form of a mushroom-house. 1113. The spawn. 1114. To grow the mushroom. 1115. Growing the mushroom in a cellar. 1116. Management of the bed. 1117. Mushroom spawn. 1118. Gathering mushrooms. 1119. The duration of a crop of mushrooms.	

CHAPTER IV.

CATALOGUE OF FRUITS	526
1120. The fruits usually cultivated in British gardens. 1121. Arranged botanically. 1122. Geographically and horticulturally. 1123. Suitable for climates analogous to that of Britain. 1124. For climates analogous to that of the South of France. 1125. For climates sub-tropical, or tropical.	
SECT. I.— <i>Hardy or Orchard Fruits</i>	528
SUBSECT. I.— <i>The Apple</i>	528
1128. The uses of the apple. 1129. Properties of a good apple.	b

	PAGE
<i>SECT. I.—Hardy or Orchard Fruits—The Apple—continued.</i>	
1130. Varieties. 1131. Early dessert apples. 1132. Dessert apples to succeed early kinds. 1133. Early kitchen apples. 1134. Kitchen apples for winter and spring use. 1135. Cider apples. 1136. Dessert apples which may be used as kitchen apples. 1137. Kitchen apples which may be used as dessert apples. 1138. Apples for cottage gardens, where the soil and situation are favourable, and which may be used either for the table or the kitchen. 1139. Apples for training against the walls or on the roofs of cottages, or on the walls of cottage gardens. 1140. Apples for cottage gardens in situations liable to spring frosts. 1141. Apples for a cottage garden in an unfavourable climate. 1142. Apples adapted for walls of different aspects. 1143. Apples adapted for espaliers, dwarfs, or conical standards. 1144. Apples suitable for an orchard. 1145. Apples remarkable for the form of the tree, or the beauty of the blossoms or fruit. 1146. General principles of selecting varieties of the apple. 1147. Propagation. 1148. Soil and situation. 1149. Mode of bearing, pruning, and training. 1150. Spurring-in pruning. 1151. Pruning with reference to the entire tree. 1152. Gathering and keeping. 1153. Diseases, insects, casualties, &c.	
<i>SUBJECT. II.—The Pear</i>	545
1155. Uses. 1156. Properties of a good pear. 1157. The varieties. 1158. Dessert pears arranged in the order of their ripening and keeping. 1159. Kitchen pears arranged in the order of their ripening and keeping. 1160. Perry pears arranged in the order of their merits. 1161. A list of pears adapted for walls of different aspects. 1162. A list of pears for espaliers, dwarfs, or standards, trained conically or spurred-in. 1163. A list of pears adapted for an orchard, or being grown as standards. 1164. A selection of Pears where the space is very limited, or for cottage gardens. 1165. Pear-trees of forms adapted for landscape scenery. 1166. The propagation, nursery, culture, and choice of plants. 1167. Soil, situation, and final planting. 1168. The mode of bearing, pruning, and training. 1169. Gathering and keeping. 1170. The diseases, insects, and casualties.	
<i>SUBJECT. III.—The Quince</i>	551
1172. Varieties. 1173. Propagation, soil, and other points of culture and management.	
<i>SUBJECT. IV.—The Medlar</i>	552
1175. Varieties. 1176. Propagation, soil, and other points of culture and management.	
<i>SUBJECT. V.—The True Service</i>	552
1177. The true service. 1178. <i>Pyrus torminalis</i> . 1179. <i>Pyrus A'ria</i> var. <i>crética</i> .	
<i>SUBJECT. VI.—The Cherry</i>	553
1181. Use. 1183. Varieties. 1183. Dessert cherries, arranged in the order of their ripening. 1184. Cherries for preserving. 1185. Cherries adapted for being trained against walls of different aspects. 1186. Cherries adapted for espaliers or dwarfs. 1187. Cherries adapted for being grown as standards. 1188. Cherries for a cottage garden. 1189. Cherries for the north of Scotland. 1190. Propagation, nursery culture, and choice of plants. 1191. Soil, situation, and final planting. 1192. Mode of bearing, pruning, and training. 1193. Gathering and keeping. 1194. Diseases, insects, casualties, &c. 1195. A Dutch cherry garden.	
<i>SUBJECT. VII.—The Plum</i>	558
1197. Use. 1198. Varieties. 1199. Dessert plums arranged in the order of their ripening. 1200. Kitchen plums arranged in the order of their ripening. 1201. A selection of plums for walls of different aspects, espaliers and dwarfs, and for an orchard. 1202. Dessert and kitchen plums for a garden of limited extent. 1203. A selection of dessert	

SECT. I.— <i>Hardy or Orchard Fruits—The Plum—continued.</i>	PAGE
plums for a very small garden. 1204. Dessert and kitchen plums for a cottage garden. 1205. Propagation, nursery culture, and choice of plants. 1206. Soil, situation, and final planting. 1207. Mode of bearing, pruning, and training. 1208. Gathering, keeping, packing, &c. 1209. Insects, diseases, casualties, &c. 1210. The plum may be forced.	
SUBJECT. VIII.— <i>The Gooseberry</i>	560
1212. Use. 1213. Varieties. 1214. A selection of gooseberries for a suburban garden. 1215. The largest prize gooseberries. 1216. Gooseberries for a cottage garden. 1217. Large Lancashire gooseberries adapted for a cottage garden. 1218. Propagation, nursery culture, and choice of plants. 1219. Soil, situation, and final planting. 1220. Mode of bearing, pruning, and training. 1221. The growers of gooseberries for prizes. 1222. Gathering and keeping. 1223. Insects, diseases, and casualties. 1224. Forcing.	
SUBJECT. IX.— <i>The Red and White Currant</i>	566
1226. Use. 1227. Varieties. 1228. The propagation and future treatment.	
SUBJECT. X.— <i>The Black Currant</i>	567
SUBJECT. XI.— <i>The Raspberry</i>	567
1231. Varieties. 1232. Propagation, soil, and other points of culture. 1233. Gathering. 1234. Forcing. 1235. The cloudberry. 1236. The Nootka raspberry.	
SUBJECT. XII.— <i>The Strawberry</i>	570
1238. Use. 1239. Varieties. 1240. Selection of strawberries from the above classes in the order of their ripening. 1241. A selection for a small garden. 1242. A selection for a cottage garden. 1243. A selection for a confined, shady situation. 1244. Propagation, soil, &c. 1245. Culture. 1246. Culture in rows. 1247. Culture in beds. 1248. Mulching and watering. 1249. Culture of particular kinds. 1250. Retarding a crop. 1251. Accelerating a crop in the open garden. 1252. Gathering. 1253. Forcing.	
SUBJECT. XIII.— <i>The Cranberry</i>	576
SUBJECT. XIV.— <i>The Mulberry</i>	577
SUBJECT. XV.— <i>The Walnut</i>	578
1257. The Walnut. 1258. Pacane-nut hickory, and the shell-bark hickory.	
SUBJECT. XVI.— <i>The Sweet Chestnut</i>	578
SUBJECT. XVII.— <i>The Filbert</i>	579
SUBJECT. XVIII.— <i>The Berberry, Elderberry, Cornelian Cherry, Buffalo-berry, and Winter Cherry</i>	580
1261. The berberry. 1262. The Magellan sweet berberry. 1263. The Nepal berberry. 1264. The alder-tree. 1265. The cornelian cherry. 1266. The buffalo berry. 1267. The winter cherry	
SECT. II.— <i>Half-hardy or Wall-fruits</i>	582
SUBJECT. I.— <i>The Grape</i>	582
1270. A selection of grapes for early forcing. 1271. The selection of grapes grown at Hungerton Hall. 1272. A selection of grapes of various flavours and colours. 1273. Grapes for a late crop in a vinery. 1274. Grapes for a house in which pines are grown. 1275. Grapes with small leaves, and hardy; adapted for the rafters of a greenhouse. 1276. Grapes with small leaves, less hardy than the preceding selection, and fit for the rafters of a plant or stove. 1277. Grapes with small bunches and berries, adapted for being grown in pots or boxes. 1278. Grapes for a cottage garden where the climate is not very favour-	

	PAGE
SECT. II.— <i>Half-hardy or Wall-fruits—The Grape—continued.</i>	
able. 1279. Grapes suitable for the open wall, or for cottages. 1280. Propagation. 1281. Culture, pruning, training, &c. 1282. Pruning. 1283. Thinning. 1284. Setting the blossom. 1285. Growing grapes in pots. 1286. General treatment of the vine. 1287. Growing grapes for wine-making.	
SUBJECT. II.— <i>The Peach and Nectarine</i>	586
1289. Use. 1290. Properties of a good peach or nectarine. 1291. Varieties. 1292. Select peaches arranged in the order of their ripening. 1293. Select nectarines arranged in the order of their ripening. 1294. Peaches and nectarines for a wall to come in, in succession. 1295. Peaches for a cold late situation. 1296. A selection of peaches for forcing. 1297. Propagation and nursery culture. 1298. Soil, situation, &c. 1299. Mode of bearing, pruning, &c. 1300. Mr. Callow's mode of training. 1301. Shortening the young wood of the peach. 1302. In summer-pruning the peach. 1303. Thinning the fruit. 1304. Treatment of the peach border. 1305. Over-luxuriant peach trees. 1306. Old decaying peach trees. 1307. Protecting peach trees during winter and spring. 1308. Growing the peach on a flued wall. 1309. The acceleration of the ripening of a crop of peaches. 1310. Gathering. 1311. Diseases, insects, &c. 1312. The essential points of peach culture. 1313. Forcing the peach and nectarine.	
SUBJECT. III.— <i>The Almond</i>	595
SUBJECT. IV.— <i>The Apricot</i>	596
1316. Varieties. 1317. Apricots for walls of different aspects. 1318. Apricots for the walls of a cottage. 1319. Propagation, nursery culture, &c. 1320. Final planting, pruning, &c.	
SUBJECT. V.— <i>The Fig</i>	598
1322. Selections of the best figs for forcing, and for walls of different aspects. 1323. Propagation, culture, &c.	
SUBJECT. VI.— <i>The Pomegranate</i>	599
SUBJECT. VII.— <i>The Peruvian Cherry</i>	600
SECT. III.— <i>Tropical or Sub-tropical Fruits</i>	600
SUBJECT. I.— <i>The Pine-Apple</i>	600
1328. Pines cultivated chiefly for their high flavour. 1329. Pines cultivated chiefly for their large size. 1330. Culture.	
SUBJECT. II.— <i>The Banana</i>	601
SUBJECT. III.— <i>The Melon</i>	602
1334. Melons with red flesh. 1335. Melons with green flesh. 1336. Persian melons. 1337. Winter melons. 1338. Water melons.	
SUBJECT. IV.— <i>The Cucumber</i>	603
SUBJECT. V.— <i>The Pumpkin and Gourd</i>	604
SUBJECT. VI.— <i>The Tomato, the Egg-plant, and the Capsicum</i>	606
SUBJECT. VII.— <i>The Orange Family</i>	608
1347. The common orange. 1348. Bigarade, Seville, or bitter orange. 1349. The bergamot orange. 1350. The lime. 1351. The shaddock. 1352. The sweet lemon. 1353. The true lemon. 1354. The citron. 1355. Propagation and culture.	
SUBJECT. VIII.— <i>The Guana, Lo-quat, Granadilla, and other fruits little known in British Gardens</i>	611
1356. The guava. 1357. The lo-quat. 1358. The granadilla. 1359. The Indian fig. 1360. The pawpaw. 1361. The olive. 1362. Other exotic fruits.	
SUBJECT. IX.— <i>Remarks applicable to Fruit-trees, and Fruit-bearing Plants generally</i>	613

CHAPTER V.

	PAGE
CATALOGUE OF CULINARY VEGETABLES	616
1364. The culinary vegetables usually cultivated in British gardens. 1365. Classed Horticulturally and Economically. 1366. Propagation and seed-sowing. 1367. The selection of varieties. 1368. Whether a crop which is raised from seed ought to be sown where it is finally to remain, or sown in a seed-bed and transplanted. 1369. Soils. 1370. Proportion of each crop.	
SECT. I.— <i>Brassicaceous Esculents, or the Cabbage Tribe</i>	622
1372. The white cabbage. 1373. The couve tronchuda. 1374. Cabbage coleworts. 1375. The red cabbage. 1376. The savoy. 1377. Brussels sprouts. 1378. Borecole. 1379. Cauliflower. 1380. Broc- coli. 1381. The turnip cabbage. 1382. The Chinese cabbage. 1383. General culture and management of the cabbage tribe. 1384. Substi- tutes for the cabbage tribe.	
SECT. II.— <i>Leguminaceous Esculents</i>	630
SUBJECT. I.— <i>The Pea</i>	630
1386. Varieties. 1387. Culture. 1388. The earliest crops. 1389. Portable walls for early crops of peas, &c. 1390. The summer and autumn crops. 1391. Diseases, vermin, &c.	
SUBJECT. II.— <i>The Bean</i>	634
SUBJECT. III.— <i>The Kidney-bean</i>	635
1396. Varieties. 1397. Culture of the dwarf sorts. 1398. Culture of the twining sorts. 1399. Gathering. 1400. The lima bean. 1401. The common lentil. 1402. The white lupin. 1403. Substitutes.	
SECT. III.— <i>Radicaceous Esculents</i>	638
SUBJECT. I.— <i>The Potato</i>	638
1406. Varieties. 1407. Culture. 1408. For an early crop. 1409. The Lancashire practice. 1410. Gathering. 1411. Messrs. Chap- man's new spring potatoes. 1412. For a main or late crop. 1413. Young potatoes during winter. 1414. Selecting and preparing the sets. 1415. Greening potatoes for sets. 1416. Taking up and pre- serving a crop. 1417. Diseases, insects, &c.	
SUBJECT. II.— <i>The Jerusalem Artichoke</i>	646
SUBJECT. III.— <i>The Turnip</i>	647
1420. Varieties. 1421. Culture. 1422. In gathering. 1423. Pre- serving turnips through the winter. 1424. To save seed. 1425. Dis- eases, insects, &c. 1426. Forcing the turnip.	
SUBJECT. IV.— <i>The Carrot</i>	649
1428. Varieties. 1429. Culture. 1430. Gathering and keeping. 1431. Diseases and insects. 1432. Seed saving.	
SUBJECT. V.— <i>The Parsnep</i>	651
SUBJECT. VI.— <i>The Red Beet</i>	651
SUBJECT. VII.— <i>The Skirret, Scorzonera, Salsify, and Ænothèra</i>	652
1436. The skirret. 1437. The scorzonera. 1438. The salsify. 1439. The Spanish salsify. 1440. The tree-primrose.	
SUBJECT. VIII.— <i>The Hamburgh Parsley</i>	653
SUBJECT. IX.— <i>The Radish</i>	653
1443. Varieties. 1444. Soil.	
SUBJECT. X.— <i>Óxalis Déppeï, O. crenàta, and Tropæolum tuberòsum</i>	654

	PAGE
SECT. IV.— <i>Spinaceous Esculents</i>	656
SUBJECT. I.— <i>The common Spinach</i>	656
SUBJECT. II.— <i>Orach or French Spinach</i>	657
SUBJECT. III.— <i>New Zealand Spinach</i>	657
SUBJECT. IV.— <i>Perennial Spinach</i>	657
SUBJECT. V.— <i>The Spinach Beet, and the Chard Beet</i>	658
SUBJECT. VI.— <i>Patience Spinach</i>	658
SUBJECT. VII.— <i>The Sorrel</i>	658
SECT. V.— <i>Alliaceous Esculents</i>	659
SUBJECT. I.— <i>The Onion</i>	659
1462. Varieties and species. 1463. Propagation and culture. 1464. An autumn and winter crop of onions. 1465. A transplanted crop. 1466. The potato onion. 1467. The bulb-bearing onion. 1468. Treatment common to all the kinds. 1469. Diseases, insects, &c. 1470. The onion fly. 1471. Gathering the crop. 1472. To save seed.	
SUBJECT. II.— <i>The Leek</i>	663
SUBJECT. III.— <i>The Shallot</i>	664
SUBJECT. IV.— <i>The Garlic</i>	664
SUBJECT. V.— <i>The Chive</i>	664
SUBJECT. VI.— <i>The Rocambole</i>	664
SECT. VI.— <i>Asparagaceous Esculents</i>	665
SUBJECT. I.— <i>The Asparagus</i>	665
1481. Soil, and sowing or planting the asparagus. 1482. Routine culture. 1483. Gathering. 1484. Culture after gathering. 1485. The duration of an asparagus plantation. 1486. To save seed.	
SUBJECT. II.— <i>The Sea-Kale</i>	668
1488. Propagation and culture. 1489. Gathering. 1490. The culture after gathering. 1491. Diseases and insects. 1492. The duration of a plantation of sea-kale. 1493. To save seed. 1494. Forcing.	
SUBJECT. III.— <i>The Artichoke</i>	670
SUBJECT. IV.— <i>The Cardoon</i>	671
1498. Cookery of the cardoon. 1499. Varieties, propagation, &c.	
SUBJECT. V.— <i>The Rampion</i>	672
SUBJECT. VI.— <i>Substitutes for Asparagaceous Esculents</i>	672
SECT. VII.— <i>Acetariaceous Esculents</i>	673
SUBJECT. I.— <i>The Lettuce</i>	673
1504. Varieties. 1505. Propagation and culture. 1506. Lettuces as small salad. 1507. To save seed.	
SUBJECT. II.— <i>The Endive</i>	675
SUBJECT. III.— <i>The Succory</i>	676
1512. An excellent substitute for the succory.	
SUBJECT. IV.— <i>The Celery</i>	677
1514. Varieties. 1515. Propagation and culture. 1516. Transplanting into trenches. 1517. Blanching. 1518. Late spring celery. 1519. Taking the crop. 1520. Celeriac. 1521. Diseases, insects, &c. 1522. To save seed. 1523. The alisanders. 1524. The Naples parsley.	
SUBJECT. V.— <i>The Lamb's Lettuce, Burnet, the Garden Cress, Winter Cress, American Cress, and Water Cress</i>	681
SUBJECT. VI.— <i>Small Salads</i>	682
SUBJECT. VII.— <i>Substitutes for Acetariaceous Esculents</i>	693

	PAGE
SECT. VIII.— <i>Adornaceous Esculents</i>	683
SUBJECT. I.— <i>The Parsley</i>	684
SUBJECT. II.— <i>The Chervil, the Coriander, the Anise, Dill, Fennel, Tarragon, and Purslane</i>	684
SUBJECT. III.— <i>The Indian Cress, Borage, and Marigold</i>	686
SUBJECT. IV.— <i>The Horse Radish and Substitutes</i>	686
SECT. IX.— <i>Condimentaceous Esculents</i>	687
SUBJECT. I.— <i>The Rhubarb</i>	687
1551. Propagation and culture. 1552. Substitutes.	
SUBJECT. II.— <i>The Angelica, Elecampane, Samphire, Caper, &c.</i>	688
1559. Excellent substitutes. 1560. The ginger. 1561. The flowers of <i>Magnolia grandiflora</i> .	
SECT. X.— <i>Aromaceous Esculents</i>	690
1563. The common thyme. 1564. The lemon thyme. 1565. The sage. 1566. The clary. 1567. The common mint. 1568. The pennyroyal mint. 1569. The pot marjoram. 1570. The sweet marjoram. 1571. The winter marjoram. 1572. The winter savory. 1573. The summer savory. 1574. The sweet basil. 1575. The bush basil. 1576. The tansy.	
SECT. XI.— <i>Fungaceous Esculents</i>	691
1577. The garden mushroom. 1578. The truffle. 1579. The morel. 1580. Substitutes.	
SECT. XII.— <i>Odoraceous Herbs</i>	693
1582. The lavender. 1583. The rosemary. 1584. The peppermint.	
SECT. XIII.— <i>Medicaceous Herbs</i>	693
1586. The medicinal rhubarb. 1587. The chamomile. 1588. The wormwood. 1589. The rue. 1590. The horehound. 1591. The hyssop. 1592. The balm. 1593. The blessed thistle. 1594. The liquorice. 1595. The blue melilot.	
SECT. XIV.— <i>Toxicaceous Herbs</i>	694
1597. The tobacco. 1598. Propagation and culture. 1599. After management. 1600. Curing. 1601. The white hellebore. 1602. The foxglove. 1603. The henbane. 1604. Walnut leaves.	
SUPPLEMENTARY NOTES	697
A MONTHLY CALENDAR OF OPERATIONS	715
January, 715. February, 715. March, 716. April, 716. May, 717. June, 717. July, 718. August, 718. September, 719. October, 719. November, 719. December, 720.	
GENERAL INDEX	721
ERRATA	731

NAMES OF THE FRUITS AND CULINARY VEGETABLES CULTIVATED IN BRITISH GARDENS,

In Different Languages,

ARRANGED IN THE ORDER IN WHICH THEY ARE TREATED OF IN THE WORK.

Our present increased intercourse with Continental gardeners having introduced into Nurserymen's lists various Continental names for plants in general cultivation, it has been deemed advisable to give the following Tabular List. It will be found useful, not only to practical men, but to the readers of foreign gardening books—such as the *Bon Jardinier*, the *Garten Zeitung*, the *Verständige Gärtner*, of Dr. Lippold, the *Urocksische Hovenier*, &c.

HARDY, OR ORCHARD FRUITS.

ENGLISH.	SYSTEMATIC.	FRENCH.	GERMAN.	DUTCH.	ITALIAN.	SPANISH.	NATIVE COUNTRY.	PAGE
Apple	<i>Pyrus Malus L.</i>	Pommier	Apfelbaum	Appelboom	Melo or Pomo.	Manzana	Europe	528
Pear	<i>Pyrus communis L.</i>	Poirier	Birnbaum	Pereboom	Pero	Pera	Europe and Asia	545
Quince	<i>Pyrus Cydonia L.</i>	Coignassier	Mittelnbaum	Kweboom	Cotogno	Membrillo	Europe	551
Medlar	<i>Épyrus germanica L.</i>	Neflier	Mispelbaum	Mispelboom	Nespolo	Nespero	Europe and Asia	552
True Service	<i>Sorbus domestica L.</i>	Cornier	Sperberbaum	Sorbeboom	Sorbo	Serbal	Europe	553
Cherry	<i>Cerasus sivestris L.</i>	Cerisier	Kirschenbaum	Kereseboom	Cirtegis	Cerezo	Europe and Asia	558
Plum	<i>Prunus insititia L.</i>	Prunier	Fraumenbaum	Prunboom	Prugno	Cruelo	Europe, &c.	558
Gooseberry	<i>Ribes Grossularia L.</i>	Groseiller à maqueureau	Stachelbeerstrauch.	Kruisbessenboom	Uva-spina	Uva-crespas	Piedmont, &c.	560
Red and White Currant	{ <i>Ribes rubrum L.</i> , and <i>R. r. var. album.</i> }	Groseiller commun	{ Gemeine Jo-hannisbeere }	Aalbesenboom	Ribes rosso	Grosella	Europe	566
Black Currant	<i>Ribes nigrum L.</i>	Cassis and Poivrier	{ Schwarze Jo-hannisbeere }	Aalbesenboom	Ribes nero	Grosella negro	Europe	567
Raspberry	<i>Rubus idæus L.</i>	Framboisier	Himbeerstrauch	Frambozenboom	Roya ideo	Frambueso	Europe	567
Strawberry	<i>Fragaria L.</i>	Fraser	Erdbbeerfranze	Aardbezieplant	Pianta di fragola	Fresa	Europe, &c.	570
Cranberry	<i>Oxycoccus Pers.</i>	Airelle	Heidelbeere		Moro		Europe	576
Mulberry	<i>Morus nigra L.</i>	Mûrier	Maulbeerbaum	Moerbezieboom	Noce	Moral	Persia, &c.	577
Walnut	<i>Juglans regia L.</i>	Noyer	Kastanienbaum	Walnotenboom	Castagno	Noguera	Persia, &c.	578
Sweet Chestnut	<i>Castanea vesca W.</i>	Châtaigner and Marronier	Castanienbaum	Hazelnotenboom	Castagno	Castano	Europe	578
Rilbert	<i>Corylus Avellana L.</i>	Noisette	Nussbaum	Hazelnotenboom	Arellano	Castano	Europe	579
Berry	<i>Berberis vulgaris L.</i>	Epine vinette	Berberitzenstrauch.		Berbero	Berberis	Europe	580
Elder-tree	<i>Sambucus nigra L.</i>	Sureau	Hollunderbaum	Vlierboom	Sambuco	Sauco	Europe	581
Cornelian Cherry	<i>Cornus mas L.</i>	Cornouiller	Kornel Kirsche	Kornoelejeboom	Cornuolo	Cornojo	Europe	581
Buffalo-berry	<i>Shepherdia argentea Nutt.</i>	Graisse de Buffle		Winterkers	Cirtegio inverno	Alquequenje	Missouri, &c.	581
Winter Cherry	<i>Physalis Alkekengi L.</i>	Coquetet	Judenkirsche				Europe	581

HALF-HARDY, OR WALL FRUITS.

Grape	<i>Vitis vinifera L.</i>	Vigne	Weintrauben	Druif	Vigna	Vina	Asia	582
Peach	<i>Persica vulgaris Dec.</i>	Pêcher	Pfirschaum	Perzikboom	Persico	Alberchigo	Persia	586
Nectarine	<i>P. lævis Dec.</i>	Pêche lisse	Nectarpfirsich	Kale Perzik	Brugnolo	Especie de durazno	Persia	586
Almond	<i>Amygdalus L.</i>	Amandier	Mandelbaum	Amandelboom	Mandorlo	Almendro	Persia	593
Apricot	<i>Armeniaca vulgaris L.</i>	Abricotier	Aprikosenbaum	Abrikozenboom.	Albicocco	Albaricoque	Caucasus	595
Fig	<i>Ficus Carica L.</i>	Figulier	Feigenbaum	Vijgenboom	Fico	Higuera	Asia, &c.	598
Pomegranate	<i>Punica Granatum L.</i>	Grenadier	Granatenbaum	Granaatboom	Melagrano	Granado	Europe	599

TROPICAL OR SUB-TROPICAL FRUITS.

Pine-apple	<i>Ananassa sativa Lindl.</i>	Ananas	Ananas	Ananas	Ananas	Pina	South America	600
Banana	<i>Musa sapientum L.</i>	Banancier	Piang	Bananenboom			Asia, &c.	601
Melon	<i>Cucumis Melo L.</i>	Melon	Melone	Meloen	Mellone	Melon	Asia, &c.	602
Cucumber	<i>Cucumis sativus L.</i>	Concombre	Gurke	Komkommer	Citriuolo	{ Pepino or Co-hombró }	Asia, &c.	693

Pumpkin & Gourd	Cucurbita L.	Courge	Kürbis	Kauwoerde	Zucca	Calabaza	Asia	604
Tomato	{ Lycopersicum esculentum } <i>Dunal.</i>	Tomate	Liebes Apfel	Appeltes der liefje	Pomo d'oro	Tomate	South America	606
Egg-plant	Solanum Melongèna L.	Melongène	Tollapfel	Dolappel	Mclanza	Tomate	Africa	606
Capsicum	Capsicum L.	Piment	Spanischer Pfeffer	Spansche peper	Peberone	Naranja	South America, &c.	606
Orange	Citrus Aurantium L.	Oranger	Pomeranze	Oranjeboom	Arancio	Naranja	Asia	608
Lime	Citrus Limeña <i>Poit.</i>	Limettier	Susse Citrone				Asia	609
Shaddock	Citrus decumana W.	Pampelmousse	Pampelmoes				Asia	609
Lemon	Citrus Limbolum <i>Poit.</i>	Limoniër	Limonienbaum				Asia	610
Citron	Citrus Médica L.	Citronier	Citronenbaum				Asia	610
Olive	Olea Europea L.	Olivier	Oelibaum				Greece	612

CULINARY VEGETABLES.—BRASSICACEOUS ESCULENTS, OR THE CABBAGE TRIBE.

White Cabbage	{ Brassica oleracea var. ca- } pitata <i>Dec.</i>	{ Chou pommé, or Cabus } blanc	Weisser Kopfkohl.	Witte Kool	Cavolo	Berza	Britain	622
Red Cabbage	B. var. capitata rubra <i>Dec.</i>	Chou Pommé rouge	Rother Kopfkohl	Roodde Kool	Cavolo rosso	Berza colarada	Britain	623
Savoy	B. var. bullata major <i>Dec.</i>	{ Chou de Milan, or } { - pommé frisè }	Wirsing- or Herz Kohl	Savoije Kool	Cappuccio	Berza de Saboyá	Britain	623
Brussels Sprouts	B. bullata gemmifera <i>Dec.</i>	Chou de Bruxelles, or à jets	Sprossen Kohl	Spruit Kool	Cavolo aperto.	Col	Belgium	624
Borecole	B. acephala sabélica <i>Dec.</i>	Chou vert, or non pommé	Grüner Kohl	Roene Kool	Cavoli fiori	Berza florida	Britain	624
Cauliflower	B. Botrytis cauliflora <i>Dec.</i>	Chou-fleur	Blumen Kohl	Bloem Kool			Italy	624
Broccoli	B. Botrytis cymosa <i>Dec.</i>	Broccoli	Italienischer Kohl	Scotsche Kool	Broccoli	Brocoli	Italy	626
Turnip-cabbage	B. Caulis-rapa communis <i>Dec.</i>	Chou-rave	Kohl Rabi				Germany	627

LEGUMINACEOUS ESCULENTS.

Pea	Pisum sativum L.	Pois	Erbs	Erwt	Pisello	Guisante	Europe	630
Garden-bean	Vicia Faba L.	Fève de marais	Grosse bohne	Boon	Haba	Haba	Egypt	634
Kidney-bean	Phaseolus L.	Haricot	Turckse Bohne	Turckse Boon	Faguolo	Judias and Fasoles	South America	635
Lentil	Ervum Lens L.	Lentille	Linse.	Linze	Lenticcia	Lenteja	Europe	638

RADICACEOUS ESCULENTS.

Potato	Solanum tuberosum L.	Pomme de Terre	Kartoffel	Aardappel.	{ Tartufi bi- } { anchi, or } { Pomo di } Terra	Batatas Inglezas	South America	638
Jerusal. Artichoke	Helianthus tuberosus L.	Topinambour +	Erde apfel	Aardappel	Girasole	Giraol	Brazi	646
Turnip	Brassica Rapa L.	Navet	Rübe	Raap	Navone	Nabo	Britain	647
Carrot	Daucus Carota L.	Carotte	Möhre, or gelbe rübe	Gerle wortel	Carota	Chirvia	Europe, &c.	649
Parsnep	Pastinaca sativa L.	Panais	Pastinak	Pinksternakel	Pastinaca	Zemahoria	Britain	651
Red Beet	Beta vulgaris L.	Betterave	Rothe Rübe	Beetwortel or karoot	Barba bietola	Barbarraga	Europe	651
Skirret	Slum Sisarum L.	Chervis	Zuckerwürtzel	Suikerwortel	Sisaro	Chirvia-torresca	China	652
Scorzonera	Scorzonèra hispánica L.	{ Scorzonere } d'Espagne	{ Skorzonere } or { Skorzoncerwortel }	{ Schorzonere } or { Schorzoncerwortel }	Scorza nera	Escorzonera	Europe	652
Salafy	Tragopogon porrifolius L.	Salsifis	Haferwüzel	Boktsbaard	Sassifica	Barba Cabruna	England	652
Radish	Raphanus sativus L.	Radis and Rave	Reitig and Radies	Radys	Kafano	Kabano	China	653

SPINACEOUS ESCULENTS.

Common Spinach	Spinacia oleracea L.	Spinat	Spinazie	Spinazie	Spinace	Spinaca	Asia	656
Orach	Atriplex hortensis L.	Arroche	Melde	Melde	Atrepice	Armuelle	Tartary	657
Perennial Spinach	{ Chenopodium Bonus Hen- } ricus L.	Anserine	Gansevoet	Gansevoet	Anserino		Britain	657
Spinach Beet	Beta cicla L.	Bette or Poirée	Mangold kraut	Beet	Bietola	Acelga	Spain and Portugal	658
Patience Spinach	Rumex Paténtia L.	{ Rhabarbe des Moines, } { Oselle épinauds }	Spinazie geduld	Spinazie geduld	Romice		Italy	658
Sorrel	Rumex L.	Oseille	Sauerampfer	Zuring	Acetosa	Acadera	France and Italy	658

ALLIACEOUS ESCULENTS.

ENGLISH	SCIENTIFIC.	FRENCH.	GERMAN.	DUTCH.	ITALIAN.	SPANISH.	NATIVE COUNTRY.	PAGE.
Onion	<i>Allium Cypa L.</i>	Oignon	Zwiebel { Gemeiner Leuch or Porro Zwiebel }	Uijen	Cipolla	Cebolla	•	659
Leek	<i>Allium Porrum L.</i>	Porreau	Schalotte	Look or Prei	Porro	Puero	Switzerland	663
Shallot	<i>Allium ascalonicum L.</i>	Echalotte	Knoblauch	Chalot or Sjalotte	Scalogni	Escalonia or Chalote	Palestine	664
Garlic	<i>Allium sativum L.</i>	All	Schnittlauch	Knoflock	Aglio	Ajo	Europe	664
Chive	<i>Allium Schoenoprasum L.</i>	Civetie or Ciboulette	Rocemollem	Bieslook or Snyprei	Cipoletta	{ Cibollino de Inglaterra { Especie de Ajo } dulce	Britain	664
Rocambole	<i>Allium Scorodoprasum L.</i>	Ail d'Espagne		Wile knofook	Scorodopraso		Denmark	664

ASPARAGACEOUS ESCULENTS.

Asparagus	<i>Asparagus officinalis L.</i>	Asperge	Spargel	Aspergie	{ Asparago or } Spargato	Esparago	Britain	665
Sea-kale	<i>Crambe maritima L.</i>	Chou marin	Meerkohl	Zeekohl	Crambe marina	Col marina	Britain	668
Artichoke	<i>Cynara Scolymus L.</i>	Artichaut	Kardone	Artisjok	Cicofio	Cinauco	Europe and Africa	670
Cardoon	<i>Cynara Cardunculus L.</i>	Rapinonce	Rapunzel	Syaansche artisjok	Cardon	Cardo	England and Africa	671
Rampion	<i>Campánula Rapunculus L.</i>				Raperanzo		England	672

ACETARIACEOUS ESCULENTS—SALADS.

Lettuce	<i>Lactuca sativa L.</i>	Laitue	Gartensalat	Latuu	Lattuga	Lechuga	China	673
Endive	<i>Cichorium Endivia L.</i>	Chicorée des Jardins	Endivie	Andivie	Endivia	Endibia	England	675
Succory	<i>Cichorium Intybus L.</i>	Chicorée Sauvage	Gemeine Chicorie	Suikerei	Cicoria	Achioria	Britain	676
Celery	<i>A pium graveolens L.</i>	Celeri	Selerte	Selderij	Apio	Apio hortense	Britain	677
Alsanders	<i>Smýrniolum Olusatrum L.</i>	Maceon	Smýrnerkraut		Maercone		Britain	681
Lamb's Lettuce	<i>Valerianella olerifera Dec.</i>	Mâche	Actersalat	Pimperl	Valerianella	Pimpinella	•	681
Burnet	<i>Potérionum Sauguisorba L.</i>	Petite Pimprelle	Fimpernelle	Thunkers	Crescione	Mastuerzo	•	681
Garden Cress	<i>Leptidium sativum L.</i>	Cresson Alénois	{ Gemeine Garten } Kresse	Winterkers	{ Crescione } di Sorgenti	Berro	Britain	682
Winter Cress	<i>Barbarea vulgaris H.K.</i>	Cresson de Terre	Winter Kresse	Waterkers	Senapa	Mostazo	Britain	682
American Cress	<i>Barbarea præcox Dec.</i>	Cresson d'Amérique	{ Amerikanische } Kresse	Moesterd			Britain	683
Water Cress	<i>Nasturtium officinale H.K.</i>	Cresson de Fontaine	Brünnen Kresse	Repskool	Napo salvatico.	Naba silvestre	Britain	683
Mustard	<i>Sinapis alba L.</i>	Moutarde	Senf					
Rape	{ <i>Brassica Napus</i> var. oleif- ferus Dec.	Navette	Repskohl					

ADORNACEOUS ESCULENTS—GARNISHINGS.

Parsley	<i>A pium Petroselinum L.</i>	Persil	Petersilie	Peterselic	Petroselino	Perejil	Sardinia	684
Chervil	<i>Cherophyllum sativum L.</i>	Cerfui	Gartenkerbel	Kervel	Cerofio	Feritollo	Europe	684
Coriander	<i>Coriandrum sativum L.</i>	Coriandre	Anis	Koriander	Coriandro	Coriandro	Europe	685
Anise	<i>Trägium sativum Spr.</i>	Anis, or Boucage	Anis	Anijs	Anice	Anis	Egypt	685
Dill	<i>Anethum graveolens L.</i>	L'Anet	Dill	Dille	Aneto	Hinojo	Spain	685
Fennel	<i>Anethum Foeniculum L.</i>	L'Anet	Fenchel	Dille	Finochio	Finochio	Europe	685
Tarragon	<i>Artemisia Dracunculus L.</i>	L'Estragon	Prugon	Dragon	Dragocello	Serpentaria	Europe	685
Purslane	<i>Portulaca oleracea L.</i>	Pourpier	Purtlak	Porselein	Porecella	Verdolaga	Siberia	685
Indian Cress	<i>Tropaeolum majus L.</i>	Capucine	Kapuzinerblume	Borrasje kers	Fior Cappucino	Capuchina	South America	685
Borage	<i>Echium officinale L.</i>	Bourrache	Borrasje	Borrasje	Borrasje	Borraxa	Peru	686
Marigold	<i>Calendula officinalis L.</i>	Souci des Jardins	Ringelblume	Goudsloeem	Fiorencio	Calendula	Britain	686
Horse-radish	<i>Cochlearia Armoracea L.</i>	{ Cranson, or le grand } Raifort	Meerrettig	Rammenas	Ramolaccio	Rabano picante	France and Spain	686

CONDIMENTACEOUS ESCULENTS—TARTS AND PICKLES.

Rhubarb	Rhèum L.	Rhubarber	Rabarber	Rubarbaro	Ruibharbo	Tartary	687
Angelica	Angelica Archangelica L.	Engelwurtz	Engelwortel	Angelica	Angelica	England	688
Elicampane	Inula Helènum L.	Inule	Alant	Inulo	Ala	England	689
Samphire	Orthimum maritimum L.	Perce-pierres	Zevenkel	{ Finocchio } marino	Hincjo marino	England	689
Caper	Capparis spinosa L.	Caprier commun	Kaperboom	Cappero	Alcaparro	Europe	689
Ginger	Zingiber officinale L.	Gingembre	Gember	Gengiovo	Gengibre	East Indies	689

AROMACEOUS ESCULENTS—SWEET HERBS.

Common Thyme	Thym. Thymus vulgaris L.	Thimian	Geneene Thyme	Timo	Tomillo	Spain and Italy	690
Sage	Salvia officinalis L.	Salbey	Salie	Salvia	Salvia	Europe	690
Clary	Salvia Scabra L.	Scharlachkraut	Scharlei	Schiarea	Schiarea	Italy	690
Common Mint	Mentha viridis L.	Menthe des jardins	Munt	Erba Sta. Maria	Menta	England	690
Pennyroyal Mint	Mentha Pulegium L.	Poudiot	Pouty Minze	Puleggio	Puleggio	England	690
Pot Marjoran	Origanum Onites L.	Marjolane	Marjoran	Maggiorana	Mejorana	Sicily	691
Winter Savory	Satureja montana L.	Sariette	{ Kõlle, or Bob- } nenkraut	Santureggia	Azedrea	Europe	691
Sweet Basil	O'cymum Basilicum L.	Basile	Basilikum	Basilico	Albahaca	East Indies	691
Tansy	Tanacetum vulgare L.	Tanaisie	Rheinfern	Tanaceto	Tanaceto	Britain	691

FUNGACEOUS ESCULENTS—FUNGI.

Mushroom	Agaricus campestris L.	Champignon comestible	{ Essbare Blät- } terschwamme	{ Pratajuolo } bianco	Seta	Britain	692
Truffle	Tuber cibarium Sibth.	Truffe	Truffel	Tartufo nero	Criadilla de tierra	Britain	692
Morel	Morchella esculenta Pers.	Morelle	{ Essbare Mor- } gel	Pratajuolo	Yerba mora	Britain	692

ODORACEOUS HERBS—PERFUMES.

Lavender	Lavandula Spica L.	Lavendel	Lavendel	Lavandula	Eplieglo	Europe	693
Rosemary	Rosmarinus officinalis L.	Rosmarin	Rosmarin	Rosmarino	Romero	Europe	693
Peppermint	Mentha piperita L.	Menthe poivrée	Pfeffer Münze	Menta pepe	Menta pimentata	England	693

MEDICACEOUS HERBS—DOMESTIC MEDICINES.

{ Medicinal } Rhubarb	Rhèum palmatum L.	Rhubarber	Rabarber	Rubarbaro	Ruibharbo	693	
Chamomile	A'nthemis nobilis L.	Camomille	Kamille	Camomilla	Camomilla	England	693
Wormwood	Artemisia Absinthium L.	Absinthe	Aleem	Assenzio	Axenjo	Britain	693
Rue	Ruta graveolens L.	Rue	Ruit	Ruta	Ruta	Europe	694
Horehound	Marrubium vulgare L.	Marrube blanc	Andorn	Marrubio bianco	Marrubio	Britain	694
Hyssop	Hyssopus officinalis L.	Hyssop	Hyzop	Isoppo	Hisoppo	Europe	694
Balm	Melissa officinalis L.	Mélisse	Melisse	Melissa	Melissa	Switzerland	694
Blessed Thistle	Centaurea benedicta L.	Centaurée autorifrique	Cardobenedicten	Cardo santo	Cardo bendito	Europe	694
Liquorice	Glycyrrhiza glabra L.	Règlisse	Susholz	Regolizia	Regaliz	Europe	694

TOXICACEOUS HERBS.

Tobacco	Nicotiana Tabacum L.	Tabak	Tabak	Tabacco	Tabacco	South America	694
White Hellebore	Veratrum album L.	Ysaire blanc	Nieskruid	Veratro bianco	Eleboro	Denmark	696
Foxglove	Digitalis purpurea L.	Digitale pourpre	Fingerhut	Bacchera	Dedalera	Britain	696
Henbane	Hyoscyamus niger L.	Jusquiame noire	Bilsenkraut	Bacchamo	Beleo	England	696
Thorn Apple	Datura Stramonium L.	Pomme épineuse	Stechapfel	Pomo spina	Manzana espina	England	696

LIST OF ENGRAVINGS.

FIG.	TOOLS.	PAGE	FIG.	PAGE
12.	The common lever	130	236.	Godsall's budding-knife improved 302
13.	Knead lever and crow-bar	130	203.	Splitting-knife and opening pick, for using in cleft-grafting 290
14. 15.	Perforators	30	41.	Asparagus knife. 138
16.	Dibbers	31	42.	The scimitar bill-knife 138
17.	Potato-dibber	31	43.	Dress bill-knife 138
18.	Cast-iron sheaths for dibbers	31	48.	Garden-axe 140
19.	Picks	131	50.	Garden-scythes 140
20.	Draw-hoes	131	44.	Garden-saws 139
162.	The Leicestershire, or shifting-blade, draw-hoe	232	202.	Bow-saw for cutting off branches of trees 290
21.	Spanish hoes	132	45.	Pruning chisels 139
23.	Thrust hoes	132	46.	Shears for clipping hedges and box-edgings 139
381.	Sickle hoe	660	49.	Verge and grass shears 140
382.	Drill hoe	660	47.	Pruning shears 139
22.	Lawn scraper	132	243.	Punch used for punching out shield-buds 306
24.	Spades	133		UTENSILS.
25.	Turf spades	134	6.	A fly glass 111
32.	Transplanting spades	135	10.	Inverted flower-pot for catching mice 121
26. 27.	Verge-cutters or turf-racers	134	5.	Cap for covering the holes in the bottoms of pots 96
28.	Garden spud	134	65.	Pot carrier 148
29.	Trowels	135	51.	Sizes of flowerpots 142
30.	Daisy weeder	135	52.	Propagating pot 143
31.	Saul's transplanter	135	53, 54.	Pots with raised bottoms to prevent the entrance of worms 143
33.	Dung and tan forks	135	55.	Pot with channelled bottom, to facilitate the escape of water 143
34.	Digging forks	135	56.	Ornamental flowerpot, with the base serving as a receptacle for drainage water 143
36.	Garden rakes	136	259.	A double pot 331
35.	Daisy and grass rakes	136	57.	Pot with pierced rims and bands for introducing wire-work 143
383.	Drill-rake	660	333-342.	Sections of pots for pines 448, 449
37.	Beetles and rammers	136		
38.	Wooden mallet and garden hammer	137		
39.	Garden pincers	137		
324.	Weeding pincers	381		
335.	Orchardist's crook	441		
	INSTRUMENTS.			
40.	Garden knives	137		
95.	Grafting-knife, made to serve also for a budding-knife	286		

FIG.	PAGE	FIG.	PAGE
58. Blanching pot	143	108. Leather bearing straps	170
59. Isolating saucer	144	264. Wire frame work for climbing plants in pots	355
60. Annular water saucer	144	266, 267. Wire standard and rings for supporting climbing plants.	355
61. Plant box	145	270. Umbrella trellis for climbing plants	355
62. Sucker, kneed-spouted, and over-head watering-pots	146	271. Trellis over a walk	357
63. Money's inverted-rose watering pot	147	361. Netting for covering a cherry garden	557
64. Wire screen for soil, old tan, or gravel	147	373. Hooked stick for training prize gooseberry bushes	564
66—74. Baskets, and illustrations of the mode of making them	149, 151	374. Forked stick for training prize gooseberry bushes	564
75. Punnet baskets	152		
323. Trainer's basket	376		
76. Bell glasses	152		
78. Substitutes for bell glasses	152		
77. Cast-iron hand glass	152		
79. Mode of preparing hand glasses to serve as fly traps	111, 112		
MACHINES.			
79. Garden wheelbarrow	153		
80. Read's garden syringe	154		
81. Read's pneumatic hand-engine	154		
82. Section of Read's pneumatic hand-engine	155		
83. Read's barrow-engine	155		
84. Read's fumigating bellows	156		
85. Section of the canister of Read's fumigating bellows	156		
87. Powdering bellows	157		
86. Iron fumigating pot	156		
258. Shrub and tree transplanter	323		
261, 262. Side, and perspective view of the girdling machine	347, 348		
325, 326. Water-barrow and distributor	384		
MISCELLANEOUS ARTICLES.			
4. Eggs of the earthworm	95		
88. Wisps of straw used as protectors	158		
89. Mode of making straw mats	159		
90—93. Oiled paper cap for protecting flowers	162		
94. Props for climbers	163		
95. Cast and wrought iron props for supporting climbers	164		
96—99. Labels and tallies	165, 166		
100. Nailing wallet	167		
101. Iron reel and pin for a garden line	168		
102, 103. Portable ladder open and shut	168		
104, 105. Rule joint and orchard ladder	169		
106. Garden level	169		
107. Bridge plank for wheeling across box edgings	170		
		DIAGRAMS.	
		1. Part of the trunk of a debarked lime tree	31
		11. Mode of forming a triple fence for excluding cattle, sheep, and hares	123
		66—74. Illustration of the mode of making baskets	149—151
		130. Section of an iron sash-bar	191
		131. Section of a wooden sash-bar	191
		133. Vertical profile of part of a ridge and furrow roof	192
		134. Section of a dung bed, with a tube for supplying hot air	196
		155. Lap of glass panes puttied and painted	219
		161. Diagrams showing the angle which the blades of draw-hoes ought to make with the handle	232
		163. Section of the head of a garden rake	233
		253. Modes of protecting trees from cattle	318
		254. Mode of securing newly planted trees from the effects of high winds	319
		255—257. View, profile, and section of a tree guard	320
		328. Details of a mode of fastening coverings on frames	394
		359. Outline of a Pearmain apple	531
		270. The term oblate exemplified	554
		372. Section through a cherry garden covered with netting	557
		378, 379. Section and view of a prop for climbing plants	637
		380. Sections of ground prepared for planting potatoes	642
		MOVEABLE AND PORTABLE GARDEN STRUCTURES.	
		109. Wickerwork protector for low shrubs	171

FIG.	PAGE	FIG.	PAGE
110. Wickerwork protectors of various kinds	172	317. Section of a pit on M'Phail's principle	393
111—113. Details of a hand box, as a substitute for a hand glass.	172	332. Stake espalier rail	425
114. Iron bracket for supporting a temporary wooden coping	174	333. Cast-iron espalier rail	426
115. Apparatus for rolling up and letting down canvas shades	175	334. Strained wire espalier rail	427
322. Thatched hurdles for protecting plants in the open garden.	401	336. Section of a pine-pit at Oakhill	445
377. Cover for peas and other early crops	633	337. Section of a pit at Oakhill for fruiting Queen pines	448
FIXED GARDEN STRUCTURES.		356. Section of Corbet's cucumber pit	504
2. Section of a hothouse heated by hot-water according to Mr. Penn's manner	85	357. Section of Green's cucumber pit	506
3. Section of a hothouse heated by hot-water in the ordinary manner	86	358. Section of Ayres' cucumber house	508
116. A stone for fixing temporary rafters	179	HOT-WATER APPARATUS.	
117. Mode of fixing temporary rafters	179	140. A hot-water apparatus for circulation on a level	202
118. Plan of a hollow brick wall	180	141. Boiler and furnace for heating by hot water in rising and falling pipes	202
119, 120. Plan and end view of a brick wall $7\frac{1}{2}$ inches thick	180	142. Apparatus for circulating hot water below and above the level of the boiler	202
121. Longitudinal section of a flued wall	182	143. Syphon mode of circulating hot water	203
122, 123. Plan and section of a reed wall	183, 184	144. Hot-water pipe, and reserve cistern for hot water	203
124. Trellised arcade for fruit-trees	186	145. Section of a reserve cistern and hot-water pipes	204
125. Trellis for climbers	186	146. Perkins's double boiler	206
126. Plan showing the intersection of trellised walks	186	147. Roger's conical boiler	208
127. Steep-roofed house for winter forcing of plants in pots	189	148. Mode of setting Rogers's boiler	208
128. Curvilinear glass roofs	189	149. Rogers's boiler set with the chimney added	209
129. Ground plan of curvilinear plant house	190	150. Rogers's boiler with the heating pipe joined to it	210
132. Perspective view of the original ridge and furrow house at Chatsworth	191	151. Rogers's substitute for a stop-cock	210
135. Perspective elevation and section of a pinery heated by dung linings	196	666. Rogers's hot-water reservoir	210
136. Section of a vinery heated by dung	196	154. Zinc cisterns for double and single pipes	216
137. Section of a furnace and double flue	198	DIGGING, TRENCHING, AND RIDGING.	
138. Section of a greenhouse, with reserve flue and common flue	199	159. A plot of ground properly marked off for digging or trenching	229
139. Section of a common brick flue, with a zinc cistern over it	200	160. A plot of ground disadvantageously marked off for digging or trenching	229
156. Section of a span-roofed pit, with the roof over the path opaque	221	160*. A section showing the difference between proper and improper trenching	231
157. Ground plan of a pit to be heated in Mr. Corbett's manner	222	380. Section of ridges prepared for planting potatoes	642
158. Section of a pit to be heated by Corbet's system, or by smoke flues	222	PROPAGATION BY CUTTINGS, LAYERS, &c.	
		164. A shoot improperly, and one properly cut	236
		166. Prepared cutting of a Shaddock	254

FIG.	PAGE	FIG.	PAGE
167. A cutting of a Cape Heath prepared and planted	256	204. Rind-grafting	290
168. A cutting of an Epacris prepared and planted	256	205-207. Cleft-grafting the vine, rose, and camellia	291
169. A cutting of Acàcia alàta prepared and planted	257	208. Epiphyllum truncàtum grafted on Pereskia aculeàta	291
170. Forsyth's mode of striking cuttings	259	209, 210. Saddle-grafting	292
171. A cutting of Ròsa semperflòrens prepared and planted	259	211. Grafting the lateral branches of fruit-trees	292
172. A piping of a pink prepared and planted	261	212. Side-grafting the orange	293
173. A cutting of a pelargonium prepared and planted	261	213. Side-grafting the vine	293
174. A cutting of a fuchsia prepared and planted	262	214. Wedge-grafting	293
175. A cutting of a camellia prepared and planted	262	215. Herbaceous grafting the pine and fir tribe	294
176, 177. Eyes of vines prepared and planted	265	216. Grafting the tree peony on the tubers of the herbaceous peony	295
178, 179. The lower and upper half of the leaf of theophràsta rooted and sending up a shoot	268	217. Cleft-grafting the dahlia on its own tubers	295
180. Wedges inserted above and below buds to check the flow of the sap	270	218. Peg-grafting the dahlia on its own tubers	295
181. A ringed shoot, to accumulate sap at the base of the buds, &c.	270	219-223. Different modes of herbaceous-grafting	296
182. A shoot bent to cause the buds at the angles to break	271	BUDDING ILLUSTRATED.	
183, 184. Layering with the tongue made in the under and upper side of the shoot	273	237. The different steps in the process of shield-budding	303
185. A stool with shoots layered	274	238. Shield-budding the rose in spring	305
186. A petunia layered	275	239. Shield-budding the camellia in spring	305
187. A carnation layered	276	240. Shield-grafting without a bud	305
188. A cutting layered	276	241. Budding with a circular shield	305
189. A branch ringed, and prepared for rooting in a case	276	242. Budding by the aid of a punch	305
190. Branch layered in a tin case	276	244. Budding with the shield reversed	306
191. Branches of a coniferous plant pegged down, to force it to throw up a leader	279	245. Budding with a pointed shield for resinous trees	306
192, 193. Injured bulbs throwing up offsets	279	246. Budding with a double shield	306
593. Branch of a peach tree protected by fern	593	247. Budding with a square shield	306
GRAFTING ILLUSTRATED.		248. Budding with a terminal eye	306
194. Scion and stock illustrative of the principles on which they are united	280	249. Flute-budding the mulberry in spring	307
196. Splice-grafting in its different stages	288	250. Terminal flute-budding in spring or summer	307
197. The scion with its young shoots on and the heel of the stock cut off	289	251. Flute-budding with strips of bark	307
198. Splice-grafting with a tongue	289	252. Annular budding	308
199. Splice-grafting with a shoulder	289	INARCHING ILLUSTRATED.	
200. Splice-grafting the peach	290	224. A scion and stock prepared for inarching	298
201. Cleft-grafting	290	225. The scion inarched to the stock and bandaged	298
		226. Inarching with the scion and stock tongued and united but not bandaged	298
		227, 228. A stock and scion prepared for saddle inarching	299
		229. A scion and stock united by saddle inarching	299
		230-232. Stocks and scion prepared for inarching	299
		233. A large stock and small scion united by inarching	300

FIG.	PAGE	FIG.	PAGE
234. Inarching with the scion nourished by water	300	299—306. Progressive stages of wavy-training	369—372
235. The camellia inarched with the scion nourished by water	300	307—311. Progressive stages of horizontal-training	372, 373
DIAGRAMS ILLUSTRATIVE OF PRUNING AND TRAINING.			
260. Mode of causing a pear-tree to produce blossom buds	345	312, 313. Horizontal and fan-training combined	374
263. Mode of nailing a bent shoot straight	352	314. Horizontal and perpendicular training combined	374
265. Mode of training the grape-vine in pots	355	315—318. Progressive stages of half-fan training	374, 375
268. Mode of training climbers on a wall	355	319—322. Progressive stages of perpendicular-training	375, 376
269. A rose trained in the balloon manner	356	343—347. Progressive stages of pruning the vine	456, 457
272. Spiral training, first stage	359	348. The Thomery system of training vines	458
273. Plan of spiral training	559	349—355. Hoare's system of training the vine	469—472
274. Elevation of spiral training	360	360—368. Spur-pruning the apple exemplified	538—542
275—277. Progressive stages of the spurring-in system	360, 361	369. Method of training shy-bearing pears	550
278. Quenouille training	361	375. A trained prize gooseberry-bush	564
280. Conical training	361	PLANS OF KITCHEN GARDENS.	
281—284. Hayward's quenouille training	362	330. A plan containing one acre within the walls, and half an acre in the surrounding slip	419
285—288. Progressive stages of fan-training	363, 364	331. A plan containing one acre within the walls, and three-quarters of an acre in the slips	421
289—295. Progressive stages of Seymour's fan-training	365—368		
296—298. Wavy-training	368, 369		

THE

SUBURBAN HORTICULTURIST.

INTRODUCTION.

HAVING in a twin volume* treated of Gardening as an Art of Design and Taste, our object in the present work is to complete the subject of Suburban Residences, by treating of Gardening as an Art of Culture. We shall consider ourselves as writing for grown up pupils who have previously known little of the subject; and we shall embrace all that we think will be useful to the possessors of small gardens, whether in town or country, at home or abroad, and whether they belong to the retired citizen, the clergyman, the farmer, the mechanic, the labourer, the colonist, or the emigrant.

The possessor of a garden may desire to know the science and the art of its cultivation for several reasons. He may wish to know whether it is properly cultivated by his gardener; he may wish to direct its culture himself; he may desire to know its capabilities of improvement or of change; he may wish to understand the principles on which the different operations of culture are performed, as a source of mental interest; or he may wish to be able to perform the operations himself as a source of recreation and health. The two last are by far the most important purposes which this volume is intended to serve; and hence we shall give, as far as we find practicable, the philosophy of every operation of culture, as well as practical directions for the manner in which it should be performed. Some topics we shall illustrate by Notes, in an Appendix at the end of the work, and all the technical terms will be found explained in the General Index.

We shall commence with some preliminary chapters on Plants, Soils, Manures, and the Operations common to all the departments of garden cultivation; and we shall next treat, in succession, of the kitchen and fruit garden, the forcing garden, the flower garden, the shrubbery, and the pleasure grounds, including the ornamental plantations.

* The Suburban Architect and Landscape Gardener. 1839. 1 vol. 8vo.

PART I.

FACTS RELATIVE TO PLANTS, THE SOIL, MANURES, THE
ATMOSPHERE, &c., ON WHICH HORTICULTURE IS
FOUNDED.

CHAPTER I.

PLANTS CONSIDERED WITH REFERENCE TO THEIR CULTURE IN GARDENS.

IT is not our intention to enter into any scientific discussion on the nature of plants; but it is necessary that we should strongly impress on the mind of the reader who has little idea of their culture, that they are living beings, and quite as sensible of good and bad treatment as animals. Because a part of the leaves and branches of a plant may be cut off, and the remainder which is attached to the root will continue to live and grow, it seems to be inferred that a plant will bear any kind of treatment with impunity. Many persons purchase a plant and plant it in their garden, as they would purchase a piece of furniture and place it in a room, thinking that the one act requires no more care than the other. Many labourers, and even not a few gardeners, when planting a plant, insert it in the soil with little more care than they would a stick or a post, crowding all the roots into a small hole and then pressing the earth on them with their feet, with apparently no other end than placing the plant upright and keeping it firm. A person that knows anything of the nature of a plant, and of the manner in which it draws its nourishment, by the means of the points of fibrils so tender as to be rendered useless by the slightest bruise, and furnished with mouths or pores so small as only to be seen by means of a powerful magnifier, will feel this treatment to be barbarous and injurious. Another person, on the contrary, who knows the grateful return that every plant makes to him who bestows on it the operations of culture properly performed, will take a degree of interest in the operation of planting, and derive a degree of enjoyment from the future growth and development of the plant, of which a person ignorant of the subject can form no idea. As all men may be presumed to know something of the nature of animals, perhaps the easiest way of giving some knowledge of plants to those who have hitherto paid little attention to the vegetable kingdom, will be by first exhibiting the principal points of analogy between plants and animals, and next noticing the classification, nomenclature, structure, functions, geography, and habitations of plants.

SECT. I.—*The Analogy between Plants and Animals, considered with
reference to Horticulture.*

1. Plants are organised beings, that, like animals, depend for their existence on nourishment, warmth, air, and light. Their nourishment they derive from the soil, their warmth and air jointly from the soil and the atmosphere, and their light from the sun.

2. Plants resemble animals in having an organic structure endowed with life, and in requiring nourishment to enable them to continue to exist. They absorb this nourishment through the small tubular fibres of their roots, in the

same way as animals do theirs through the small tubes called lacteals, which convey it from their stomachs to their lungs. Plants differ from animals in being fixed to one spot, in having the principles of vitality and reproduction diffused over every part of their structure, and in thus being propagated by division, as well as by ova or seeds; in being without a brain or nervous system, and, consequently, incapable of feeling; and in light being as necessary to their existence as air is to that of animals.

3. The soil in which a plant grows is, in general, as essential to it as the stomach is to an animal. Food, before it can be absorbed into the system, must be reduced into a pulpy mass, consisting partly of nutritious matter soluble in water, and partly of refuse. This process, in regard to animals, is performed in the stomach, and is called digestion; and when it is finished, the lacteals suck the chyle from the mass, and convey it to the lungs, where it is assimilated to the blood, and thence is distributed through the frame, while the refuse is passed off in the form of excrement.

4. The food of plants is rotted, or undergoes the putrescent fermentation or some other species of decomposition, (a process similar to digestion,) in the soil; and is there brought, by the addition of water and gases, to a sufficient state of fluidity to enable the spongioles of the roots to absorb from it the part necessary for the nourishment of the plant. The matter absorbed is then carried up to the leaves, where it undergoes a process similar to that to which the chyle is subjected in the lungs of animals, and becomes the true sap of the plant, which contributes to its growth as blood does to the growth of animals.

5. When a plant or an animal is in a state of disease, no application to the leaves and branches of the one, or to the external members of the other, will be of much use, if the soil or the stomach be neglected. The stem and branches of a plant, and the external members of an animal, may be injured, mutilated, and even diseased; but if the soil of the plant and the stomach of the animal be invigorated, and placed in a healthy state, the whole plant or animal will soon recover from the injuries it had received, so as to perform all the functions necessary to its existence. The first step, therefore, in cultivating or in improving plants, is to improve the soil in which they grow; and in like manner the first step in improving animals is to improve the quality and increase the quantity of their food.

6. In all vertebrate animals there is a part at the back of the neck, between the spinal marrow and the brain, where a serious injury will occasion immediate death. There is a corresponding point in plants, between the root and the stem, which is called the neck, or collar; and at this point plants may be more readily injured than anywhere else. Most plants, also, may be killed by covering this point too deeply with soil. In all seedling plants, this neck or vital part is immediately beneath the point where the seed-leaves originate; and if the plant be cut over there when in a young state, the part which is left in the ground will infallibly die. In old plants, however, and particularly in herbaceous plants which have creeping stems, and also in various kinds of trees and shrubs, the roots, after the plant has attained a certain age, become furnished with adventitious buds; and, when the plant or tree is cut over by the collar, these dormant buds are called into action, and throw up shoots, which are called suckers. No suckers, however, are ever thrown up by the roots of a plant cut through at the collar while in its seed-leaves. The branches of a tree may be all cut off

close to the trunk, and the roots also partially removed ; but, if the collar remain uninjured, the plant, in suitable soil, and under favourable circumstances, will throw out new roots and shoots, and in time will completely recover itself. On the other hand, if the collar is cut off, the stem or trunk is left without roots, and the roots without a stem, or the power (in general) to throw up one.

7. There are some plants of the herbaceous kind (such as the horse-radish, for example) that do not suffer, even if their collar should be buried two feet, or even three feet ; but by far the greater number of plants (such as the hepatica, the common daisy, the common grasses, &c.) are killed by having the collar covered two or three inches ; and nothing is more injurious to woody plants, whether large or small. It is easy to destroy a large tree by heaping up earth round the base of its trunk ; and easy to prevent a small one from growing, by lifting it and planting it six inches or a foot deeper than it was before. Hence the great importance of not planting any plant deeper in the soil than it was before taking it up ; and hence also the reason why trees planted in deeply trenched ground, and especially fruit trees, often disappoint the planter. In planting these trees the soil immediately under and about them is more consolidated by treading and watering than the soil in the other parts of the plantation ; and hence it soon sinks below the general level, to maintain which level the gardener fills up the depression every year, till the collar of the tree becomes buried several inches beneath the surface. It is said that all the peach plantations throughout the United States have been for some years in a diseased state, without any person being able to account for the circumstance, or point out a remedy, till one man discovered it to be too deep planting. He proposed to divulge the secret to Congress for a million of dollars ; but while Congress were deliberating on the subject, the secret was made public by Mr. Bridgeman, in a pamphlet published in 1838. The soil in America, Mr. Bridgeman observes, is light ; and the trees, when planted in it, if not staked, are apt to be blown aside, or even blown out of the soil, by high winds. Hence, to avoid the trouble and expense of staking, they are planted deeper in the soil, by which they are held firm, without the aid of stakes, and this is the grand cause of unfruitfulness and disease in all trees, more especially in the peach. This deep planting, Mr. Bridgeman continues, is practised not only with fruit trees in America, but with all other trees and plants whatever ; and they are all injured more or less by it, according as the soil is more or less compact.

8. The cause why plants are so much injured by burying the collar has not, as far as we know, been physiologically and satisfactorily explained.

9. The next point of analogy between plants and animals which it may be useful to notice is that between the lungs and the leaves. An animal can no more live without its lungs than without its stomach. The stomach, as we have seen, is necessary for turning the food into chyle, and the lungs for turning that chyle into blood. Now, a plant can no more live and grow without leaves than an animal can without lungs. The use of the lungs is to expose the chyle to the action of the air, which they decompose, so that its oxygen may unite with the chyle, and thus change it into blood. The leaves of plants, which act to them as lungs, not only decompose air, but light, in the process of elaborating the sap ; and hence plants can no more live without light than without air or food, as light is necessary to turn their food into sap, or, in other words, to bring it into the proper state for

affording them nourishment. Hence, in the culture of plants, the great importance of solar light. An important difference, however, between the circulation of the sap in vegetables and that of the blood in animals is, that the former have no heart.

10. Plants and animals agree in requiring a certain degree of temperature to keep them alive; and the warmth of this temperature differs greatly in the different kinds both of plants and animals. Hence, the constitutional temperature of any plant to be cultivated being known, that temperature must be maintained by art; either by a suitable situation in the open air, or by its culture within a structure which admits the light, and is capable of having its atmosphere heated to any required degree. The temperature which any plant requires is ascertained by its geographical position in a wild state, making allowance for the difference produced in the habits of the plant by cultivation.

11. Plants agree with animals in requiring periodical times of rest. In animals, these periods are, for the most part, of short intervals of not more than a day; but, in plants they are commonly at long intervals, mostly of several months. In warm climates, the dormant period of plants commences with the dry season, and continues till the recurrence of the periodical rains, which are peculiar to the tropical regions. In temperate countries, the dormant season in plants commences with the cold of winter, and continues till the recurrence of spring. When plants are in a dormant state, they commonly lose their leaves, and, consequently, at that season, they are unable to make use of the nourishment applied to their roots; and hence the injury done to them when they are stimulated with nourishment and warmth, so as to occasion their growth during the period at which they ought to be at rest. Hence, also, arises the injury which plants receive, and especially bulbs, if the soil about them be kept moist by water when they are in a dormant state. Plants having no feeling, in the common sense in which the word is used, can neither experience pleasure nor pain; but they resent injuries, either negative or positive, by slow growth, or by becoming diseased. By their being fixed to the spot where they grow, they necessarily depend for their food, heat, air, and light, on the circumstances peculiar to that spot; and, hence, to increase their growth beyond what it would be if left to nature, additional food must be brought to them, and the warmth, airiness, and lightness of the situation increased. Hence, what is called vegetable culture, which, with plants in general, consists in stirring the soil, adding manure to it, regulating the supply of water by draining or irrigation, sheltering from the colder winds, and exposing to the direct influence of the sun's rays. If we imagine any one of these points attended to, and not the others, the plant will not thrive. Stirring the soil, and mixing it with manure, will be of little use, if that soil be liable to be continually saturated with moisture, either from its retentive nature, from springs from below, or from continued rains from above; or if it be continually without, or with very little, moisture, from its porous nature, the want of moisture in the subsoil, and the want of rain and dews from the atmosphere. Improving the soil without improving the climate (that is, without communicating a proportionate degree of warmth and light), will increase the bulk of the plant, but without proportionately bringing its different parts to maturity. For example, we will suppose two plantations of trees planted at the same time, on similar soil, and in the same climate; that in the case of the one plantation

the soil was trenched and manured, and in the other not ; and that the trees were planted in equal numbers in both plantations, and at the same distances. The trees in the prepared soil would grow rapidly ; and in the unprepared soil, slowly. After a certain number of years (say twenty), we shall suppose both plantations cut down—when the timber produced by that which had grown slowly, would be found hard, and of good quality ; while that produced by the plantation which had grown rapidly, would be found soft, spongy, and when employed in construction, comparatively of short duration. The reason is, that in this last case the rate of nourishment to the roots exceeded the natural proportion which nature requires in plants, between the supply of food to the roots, and of light and air to the leaves. Had the trees in the prepared soil been thinned out, as they advanced, so as never to allow their branches to do more than barely touch each other, they would have produced more timber than the trees in the unprepared soil, and that timber would have been of equal firmness and duration with timber of slower growth. It ought, therefore, to be strongly impressed on the minds of amateur cultivators, that though nourishment of the root will produce bulk of the top, or at least length of top, yet that it is only by abundance of light and air, that quality can be secured at the same time.

12. One very remarkable point of difference between animals and plants, is, that which has been before alluded to, viz., the much greater provision which nature has made for the propagation of the latter than of the former. Plants not only produce immense quantities of seeds, which are distributed by the winds and waters, by animals, and by various causes ; but they extend themselves by shoots, which run on or under the surface of the ground, as in the case of the strawberry, the raspberry, &c. ; and they produce buds, each of which, by human art, can be rendered equivalent to a seed, either by planting it (with a small portion of the plant from which it is taken) at once in the ground, or by inserting it in another plant of the same family. Hence, the great facility with which plants are multiplied both by nature and art ; with the exception of a few, in which the process of propagation by artificial means is comparatively difficult.

13. Another remarkable difference, also before alluded to, between plants and animals, is, the absolute necessity of light to plants during the whole period of their existence. There are many animals of the lower description, such as worms, to which light, so far from being necessary, is injurious ; and there are instances of even the more perfect animals having lived for several years without the presence of light, either natural or artificial. Light is not necessary for either the functions of the stomach, brain, or lungs, in animals ; but in plants, though it is equally unnecessary for the functions of the germinating seed, the root, and the collar, it is essentially so for those of the leaves ; and the leaves are necessary to the elaboration of the sap, and, consequently to the nourishment of the plant. A plant, therefore, from which the leaves are continually stripped as soon as they are produced, soon ceases to live. Small and weak plants, from which the leaves are taken off as they are produced, will die in a single season ; and this practice, continued for two seasons, will kill, or nearly so, the largest tree. If, instead of stripping a plant of its leaves, the leaves are produced in the absence of light, and light never admitted to them, the effect will be precisely the same. Seeds germinated, or plants struck from cuttings, in the dark, will not exist a single season ; nor will trees, or tubers, such as potatoes, placed in an apartment from which all light is excluded,

live more than two seasons. Hence, the importance of light to plants can scarcely be overrated; for, while it has been proved that plants, even of the most perfect kind, will live for many months, or even years, in glass cases in which very little change of air has taken place, there is no instance of plants, even of the lowest kind, such as ferns and mosses, living for any length of time without light. Without light there can be no green in leaves, no colour in flowers, and neither colour nor flavour in fruits.

14. Plants agree with animals in having a sexual system; but they differ from animals in having for the most part both sexes in the same individual. In the improvement of plants, as in the improvement of animals, the sexual system is a powerful agent; and what is called cross-breeding is employed with as great advantage in the vegetable as in the animal kingdom. It is remarkable, that the general laws and results by which the process of cross-breeding in both kingdoms is regulated, are the same; the two parents must be two varieties of the same or nearly allied species, and their qualities may be different, but must not be opposite; the preponderating influence, in point of character, is also with the male, and in point of bulk and hardness with the female, as it is in animals. Many of the finest varieties of fruits, culinary vegetables, cereal grains, and grasses, have been produced by cross-breeding. When cross-breeding is effected between what are considered different species, the offspring is a mule, or hybrid, which, in most cases, is incapable of maturing seeds, and generally, in the course of a few years, degenerates, or reverts to its original parentage. The purple laburnum, which was raised from a seed of the common laburnum, fertilised by *Cytisus purpureus*, is an example of a true hybrid. The flowers partake of the colour of that of both parents; and the plant, for two or three years, produced only flowers of this kind, which were never succeeded by seeds; but in the sixth year, in some plants, and seventh and eighth in others, branches of *Cytisus purpureus* were produced on some parts of the tree, and branches of the common yellow laburnum on others, the latter bearing seed. (See *Gard. Mag.*, vol. xii. p. 225; and *Arb. Brit.*, vol. i. p. 590.) There are, however, instances of mules or true hybrids producing fertile seeds; for example, *Epiphyllum Mastersiæ*, raised between *Epiphyllum speciosum* and *Cereus speciosissimum*, frequently produces perfect seeds, from which plants have been raised partaking of all the characters of the parent hybrid plant.

15. It would appear, from the case of the purple Laburnum, that a true mule or hybrid cannot always be propagated with certainty, even by portions of the plant, or by what is called extension; since it never can be certain whether the portion taken off for propagation will produce the mule or one of the parents. As it is uncertain what are, and what are not, very distinct species, many of the plants originated by cross-breeding, and considered mules, may in reality not be so; and may, consequently, prove permanent and improved varieties. Some mules, also, such as that between the sweetwilliam and the common pink, are much less liable to degenerate than others. As some of the most beautiful and useful plants in cultivation are cross-bred varieties or mules, particularly among Geraniums, Heaths, Roses, Gloxinia, &c., the subject well deserves the attention of the amateur, who will find it a source of useful amusement and recreation.

16. Plants agree with animals in the offspring, when it is raised from seed, bearing a general resemblance to the parent; but as, in every family, the children of the same parent differ individually in features, temper, disposition,

&c., so, among seedling plants, from the same seed-pod, no two plants will be found exactly alike; and some will occasionally differ considerably from all the rest. Nevertheless, it is an undoubted fact, that all seedling plants not only possess the character of the species from which they have sprung, but even, in by far the greater number of cases, some of the peculiarities of the individual. The seeds of any kind of cultivated apple, for example, will produce plants, the fruit of all of which will more or less resemble that of the parent; though perhaps some one or two among a hundred may be considerably different. Hence, by selecting from beds of seedling plants those which are in any way remarkably different from the rest, new varieties are procured; and, till within the last half century, (when artificial cross-breeding began to be practised by gardeners,) this was the only way in which an improved variety of any species of plant was procured. If the seeds of varieties did not produce plants closely resembling their parents, how could all the improved varieties of culinary, agricultural, and floricultural plants, be perpetuated? That the same law which governs herbaceous plants holds good in trees and shrubs cannot be doubted; and if the seeds of a variegated tulip are more likely to produce plants which shall have variegated flowers than those of a tulip of only one colour, so we should say the berries of a variegated holly are more likely to produce plants with variegated leaves than those of a green-leaved holly. If this law did not hold good in ligneous as well as in herbaceous plants, how are we to account for the different varieties of *Hibiscus syriacus* coming true from seed?

17. Plants, like animals, are subject to various diseases, as well as to be preyed on by insects, most of which live on plants till they have completed their larva state. Plants are also injured by being crowded by other plants, either of the same or of different species. When these spring up naturally around the cultivated plants, they are called weeds, and the cultivated plant is cleared from them by weeding; as it is in the case of being crowded by its own species, or by other cultivated plants, by thinning. Plants are also injured by epiphytes, which grow on the outer bark, such as mosses and lichens; and by parasites, which root into their living stems and branches, such as the mistletoe, &c.

18. The life of plants, like that of animals, is limited, but varies in regard to duration. Some plants vegetate, flower, ripen seed, and die, in the course of a few months, and these are called annuals; while others, such as the oak and some other trees, are known to live upwards of a thousand years. In both plants and animals decay commences the moment life is extinct; and in both they are ultimately resolved, first, into a pulpy or other homogeneous mass, fit for manures, and ultimately into certain gases, salts, and earths. After death, the decay both of animals and plants may be retarded by the same means; viz., drying, exclusion from the air, or saturating with saline or antiseptic substances.

SECT. II.—*Classification of Plants, with a View to Horticulture.*

19. The number of plants is so immense, and the diversity of their appearance so great, that without some kind of classification or arrangement it would scarcely be possible either to receive or retain any distinct notions respecting them. In communicating some positive knowledge of plants, therefore, the first step is to show the mode of simplifying this knowledge by throwing plants into classes, and other divisions or groups.

20. Plants have been classed according to the Linnean or Artificial System, and according to the Jussieuan or Natural System ; but the latter alone is of any use in a work like the present. By the Natural System plants are thrown into easily recognised groups, bearing a general resemblance, both in exterior appearance and in internal properties, and for the most part also requiring the same kind of culture. Hence we are enabled to speak of plants in masses, which greatly facilitates the discovery and recollection of their names, the acquiring of knowledge respecting them, and the communication of what we know of them to others.

21. All plants may be divided into three grand classes, founded on their structure. The first class is called *Dicotyledonæ*, from the seedlings having two or more seed-leaves, and also *Exogenæ*, from the growth being produced from the outside of the stem. The second class is called *Monocotyledonæ*, from the seeds producing only one seed-leaf, and also *Endogenæ*, from the growth being added from the inside of the stems. The third class is called *Acotyledonæ*, from the seedling plants being without proper seed-leaves ; *Celulares*, from their structure consisting entirely of cellular tissue ; and *Acrogens*, signifying increasing by additions to the extremity merely, and not by the formation of new matter internally or externally, throughout their whole length, as in endogens and exogens. We shall use only the terms *Exogens*, *Endogens*, and *Acrogens*.

22. *Exogens* are flowering plants, vascular in their structure, furnished with woody fibre and spiral vessels ; with stems mostly having distinct layers of wood and bark, and having pith ; the leaves being with branching lateral veins, and the seeds with two or more cotyledons. By far the greater number of European plants belong to this class, which is readily known, even when a fragment of a leaf or a stem is obtained, by the reticulated venation of the former, and the concentric circles of the latter.

23. *Endogens* are flowering plants with a vascular structure, furnished with spiral vessels, and imperfectly formed woody fibre ; they have leaves with longitudinal or parallel veins, but never reticulated ; and seeds with one cotyledon only, or if two, they are not placed opposite and even with each other, as in exogens, but one of them is placed at the side of the other in the disposition which botanists call alternate. This class includes all the immense order of grasses, and also hyacinths, tulips, narcissi, crocuses, irises, and most bulbs ; the well-known yucca or Adam's needle, and all palms. From a single fragment of the stem or leaf of an endogen, the class to which it belongs can be recognised with as great ease as in the case of exogens.

24. *Acrogens* are flowerless plants with a cellular structure, consisting either of cellular tissue alone, as in lichens and mosses, or with tissue and some few imperfect vessels, as in ferns. They grow by additions to the upper extremity only, as the name implies. Their seed is produced without apparent flowers ; it is not furnished with cotyledons, and it grows from any part of the surface of the plant ; on the under side of the leaf, as in most ferns, on the edges of the foliaceous thallus of lichens, and from the extremities on the sides of mosses. This class of plants is easily recognised by the general observer ; lichens, mosses, and fungi, being universal, and ferns frequent and readily recognised by the markings on the backs of their leaves.

25. Of these three classes of plants, the exogens are unquestionably the highest in the scale of organisation even to the general observer. The leaves of the endogens, at least of temperate climates, are almost all simple, and have little or no variety in their venation or margins. Those of the nume-

rous species which constitute our bulbous flowers have all ribbon-like leaves, differing in little except in length and breadth; and their floral envelopes, though splendid in point of colour, are generally more simple than those of exogens, being often of one piece or of one series of pieces; and there is also very little variety in their fruit. Compared with acrogens, however, endogens are still high in the scale.

26. To be able to refer any plant that may be met with to the class to which it belongs, is already a grand and useful step in the progress of botanical knowledge; and in the practice both of botanising and of vegetable culture, it is of more real use than a knowledge of the whole system of Linnæus. The moment one botanist or gardener tells another that a plant is an exogen, he forms a perfect idea of its structure, and even some idea of its culture; because the leaves of exogens are more numerous than those of endogens, and hence, with the exception of the grasses, they suffer less from transplanting and mutilation. The leaves of endogens, on the other hand, as of all the bulbous plants, are comparatively few, and therefore all of them require to be preserved uninjured. If they are cut off, either in their growing state or when fully formed, they are not renewed the same season; and the bulb not being nourished by them, will not flower the following year. Exogens, on the other hand, may have their leaves cut off without much injury, especially in the early part of the season, as they have an indefinite power of renewing them, and consequently, what would render an endogen flowerless the following year, would have little or no effect on an exogen. Grasses, however, are an order of endogens which possess the same properties of renewing their foliage as exogens, and hence a grassy surface may be cropped by cattle, or mown with the scythe all the summer, and yet live and thrive. But suppose a lawn composed of plants of hyacinth, tulip, narcissus, or crocus, the leaves of which are not unlike those of the grasses, to be mown when the leaves were fully grown, in that case the plants would not produce another leaf that season, and instead of a green lawn we should have the naked earth till the following spring.

27. These three grand classes of plants are divided into orders and tribes, genera, species, and varieties. The orders of plants indigenous or cultivated, in Britain, amount to upwards of 200, and the tribes to perhaps a third of that amount. The genera amount to upwards of 3,700, and the species to upwards of 30,700. (*Loud. Hort. Brit.*) The varieties of botanists are perhaps 1,000; and those of culinary vegetables, fruits, roses, and florists' flowers, may amount to perhaps 10,000. Now, though it is not to be expected that any individual can know, and bear in his mind the names of one-tenth of these plants, yet it is extremely desirable that he should be able to speak of any one of them, when he meets with it, whether it has been previously seen by him or not. For example, a very slight degree of attention to a plant seen for the first time, will enable any one to determine to which of the three grand divisions it belongs. Next, in each grand division there are two or three of what may be called popular orders, which orders any person may recognise almost at sight; and to these orders belong fully half the plants which are commonly met with in Britain, either in a cultivated or a wild state. A knowledge of the grand divisions of these popular orders, therefore, will be a grand step gained, and give the gardener or amateur a notion of a great number of plants. The grand divisions of Exogens are Thalamifloræ, Calycifloræ, Corollæfloræ, and Monochlamydææ.

THALAMIFLORÆ.

28. This is one of the subdivisions of Exogens, which is characterised by the petals of the flowers being distinct, and by the stamens being fixed to the receptacle. There are fifty-eight orders described under this subclass, in our *Hortus Britannicus*, of which those which will be most readily recognised by a general observer, or a beginner, are,—*Ranunculaceæ*, *Cruciferae*, *Malvaceæ*, and *Geraniaceæ*.

29. *Ranunculaceæ*.—Calyx with deciduous sepals; petals, 3-15; stamens numerous; carpels numerous and generally distinct; herbaceous plants, and a few of them suffruticose shrubs, natives of the temperate regions of both hemispheres; leaves alternate or opposite, generally lobed or much divided; flowers often large and showy; properties, acidity and causticity. Familiar examples of this order are, the Clematis, Anemone, Hepatica, Ranunculus, Hellebore, Columbine, Larkspur, Monkshood, and Peony.

30. *Cruciferae*.—Sepals and petals 4 each; the sepals deciduous, and the petals always arranged in the form of a cross. Stamens 4 long and 2 short; stigmas 2; fruit, a pod with seeds in a double line. Herbaceous plants, mostly annuals and biennials, natives of most parts of the world. Leaves alternate, all simple, and not much cut. Flowers yellow or white, rarely purple. Properties, antiscorbutic and stimulant, combined with acidity. Familiar examples are the Common Stock, the Wallflower, Honesty, Shepherd's Purse, Rocket, Cress, Cabbage, Mustard, Sea Kale, and Radish.

31. *Malvaceæ*.—Sepals and petals five each; the sepals generally with bracts upon them; the petals twisted before expansion, and unfolding spirally; the stamens numerous and united together, forming a cylinder round the pistillum; the fruit a ring of carpels, each single-seeded. Herbaceous plants, trees, or shrubs, natives of every part of the world. Leaves alternate, stipulate, more or less divided. Flowers for the most part showy. Properties, mucilaginous and wholesome. Familiar examples are, the Mallow, the Hollyhock, the Lavatera, the *Althæa frutex*, and the Cotton plant.

32. *Geraniaceæ*.—Sepals 5; petals 5; stamens 5-10, united together; carpels 5, united to a long elastic style attached at the top to the beak of the receptacle. Herbaceous plants or shrubs with stems tumid and separable at the joints; natives of various parts of the world; and the more showy species almost everywhere cultivated. Leaves simple, either opposite or alternate, often lobed and divided; frequently stipulate. Flowers showy and bright-coloured. Properties, astringent and aromatic or resinous. Familiar examples are, Geranium, Erodium, and Pelargonium.

33. Other orders belonging to this division, are,—

Magnoliaceæ, containing the Magnolia and other trees and shrubs, (of which, however, there are very few,) bearing a close resemblance to this well-known ornamental tree. *Berberidaceæ*—The Barberry, and similar shrubs. *Nymphæaceæ*—The Water-lily, and similar plants. *Papaveraceæ*—Plants with their flowers and fruits of the general structure of the poppy. *Fumariaceæ*—Plants resembling the common Fumitory. *Resedaceæ*—Mignonette, and similar plants. *Cistaceæ*—Cistus-like plants; easily recognised by their flowers, and for the most part by their rough leaves. *Violariaceæ*—Violet-like plants. *Caryophyllaceæ*.—Plants bearing a general resemblance to the pink. *Alsiniaceæ*—Chickweed-looking plants. *Linaceæ*—Plants resembling the common Flax. *Tiliaceæ*—The Lime trees. *Camel-*

liaceæ—The Camellias, including the Tea plant. *Aurantiaceæ*—The Orange trees. *Hypericaceæ*—Plants resembling and agreeing in characters with the St. John's Wort. *Aceraceæ*—Trees and shrubs resembling the Maple and Sycamore. *Hippocastanaceæ*—The Horse-chesnuts. *Tropeolaceæ*—The Indian Cress species. *Balsamaceæ*.—The Balsams.

There are a number of these orders such *Tiliaceæ*, *Camelliaceæ*, *Aceraceæ*, *Hippocastanaceæ*, &c., which include only one or two genera; and hence, while acquiring a knowledge of the order, a knowledge of the genera is obtained at the same time. To recognise these orders, it is necessary for a beginner to see the flowers; but after a little experience, most of them may be discovered by the leaves.

CALYCIFLORÆ.

34. This second subdivision of exogens consists of plants having several petals with stamens attached to the calyx. It includes about sixty orders, of which the more remarkable are, *Leguminosæ*, *Rosaceæ*, *Cactaceæ*, *Umbellaceæ*, *Compositæ*, and *Ericaceæ*.

35. *Leguminosæ*.—Sepals and petals five each; the petals papilionaceous, or arranged somewhat like the wings of a butterfly; stamens ten, mostly diadelphous, that is, in two bundles; fruit superior, that is, formed above the calyx, and generally becoming a pod. This is one of the most extensive orders of plants, consisting of herbs, shrubs, or trees; natives of most parts of the world. Leaves generally compound, alternate, stipulate, with the petiole tumid at the base. Flowers in most species yellow, showy. Properties farinaceous, resinous, and furnishing various dyes. Almost all the trees are either useful or ornamental, and many of the herbs are valuable agricultural and garden plants. Familiar examples, are the common Furze, Broom, Genista, Cytisus, Clover, Lucerne, Melilot, Indigo, Liquorice, Locust Tree of America, Acacia, Mimosa, Bladder-Senna, Astragalus, Saint-foin, the Tare, Bean, Vetch, Pea, Kidney-bean, Lupine, and Judas Tree. There is scarcely any person who does not know one or other of these plants.

36. *Rosaceæ*.—Sepals and petals four to five each; stamens numerous; carpels numerous; distinct, as in the bramble, or enclosed in a fleshy calyx, as in the rose. Trees, shrubs, and herbaceous plants, natives of every part of the world; many of them producing valuable fruits, and most of them having showy, and in many cases fragrant flowers. Leaves alternate, stipulate, simple, or compound. Flowers large, showy, often of bright colours. Properties, astringency, gum, and hydrocyanic acid. Familiar examples are, the Almond, Peach, Apricot, Plum, and Cherry, which form a sub-order called *Amygdalææ*, the fruit and leaves of all the species of which contain Hydrocyanic or Prussic Acid. The common *Spiræa frutex* and the yellow-flowered *Córchorus* are examples of another tribe; and the Raspberry, the Strawberry, the Potentilla, and the herb Agrimony, exemplify a third tribe. The Ladies' Mantle and the Burnet also represent a tribe; the Rose forms a tribe by itself; and the Hawthorn, Quince, Medlar, Apple, and Pear, represent the tribe *Pomáceæ*.

37. *Umbellaceæ*.—Sepals, petals, and stamens, five each; styles, two; fruit achenia or pendent seeds; flowers in umbels. Herbaceous plants, with fistular furrowed stems, natives chiefly of the northern parts of the northern hemisphere. Leaves alternate or opposite, usually divided or com-

pound; rarely simple, sheathing at the base. Flowers in umbels, white, pink, blue, or yellow, not in general very showy; the umbel surrounded by an involucre. Properties of the leaves, stems, and roots, frequently poisonous, as in the Hemlock, water Parsnep, &c.; but sometimes wholesome, as in the Parsley, Carrot, Parsnep, &c.; the properties of the fruit are usually warm, aromatic, and wholesome; gum is produced by some species. Familiar examples are, the Hemlock, Parsley, Caraway, Celery (the leaves of which are rendered wholesome by blanching), Angelica, Asafœtida, Fennel, Parsnep, Cow Parsnep, Carrot, Chervil, and Coriander. Every one is familiar with some plant or other of this order, which may be known from all others by the Umbels alone.

38. *Compositæ*.—Flowers compound, that is, numbers set closely together on a plate or disk; anthers united; seeds solitary, inferior, and mostly crowned with a pappus or plume. Herbaceous plants, rarely shrubs; natives of most parts of the world. Leaves usually simple, though often much divided, alternate, or opposite, without stipules. Stamens frequently showy, for the most part yellow. Properties various; in some astringent, in others resinous, mucilaginous, bitter, diuretic, emetic, &c. Familiar examples are, the Dandelion, the Lettuce, the Sow Thistle, the Endive, the Artichoke, the Burdock, the Thistle, the Everlasting, the Aster, the Golden Rod, the Daisy, the Groundsel, the Ragwort, the Marigold, the Chrysanthemum, the Chamomile, Tansy, Southernwood, Milfoil, and the Dahlia. All who have seen the latter flower and the common Daisy, may distinguish the plants of this order at a glance as readily as in the case of Leguminosæ or Umbellaceæ.

39. *Ericaceæ*.—Calyx and corolla four to five cleft; stamens eight to ten; the latter inserted under the ovary; anthers opening by pores; fruit four or five celled, a many-seeded capsule, or a berry. Shrubs or under shrubs, natives of Europe, North and South America, Asia, and very abundant in Africa, more especially in the neighbourhood of the Cape of Good Hope. Leaves simple, mostly evergreen, without stipules, rigid, entire, whorled or opposite, frequently small and linear. Flowers usually bright coloured and very showy. Properties astringent and diuretic, and in some poisonous. Familiar examples are, the Arbutus, Andromeda, Heath, Kalmia, Rhododendron, and Azalea. A beginner will more readily recognise this order by examining the flowers and fruit, than by the general aspect and habit of the plant.

40. Other orders belonging to this division, which are easily recognised by those who know the plant after which the order takes its name, are the following:—Rhamnaceæ, Calycanthaceæ, Granataceæ, Onagraceæ (including the *Œnothera* and *Fuchsias*), Philadelphaceæ, Myrtaceæ, Cucurbitaceæ, Passifloraceæ, Turneriaceæ, Cactaceæ, Crassulaceæ, Grossulaceæ, Saxifragaceæ, Araliaceæ, Caprifoliaceæ, Lobeliaceæ, Campanulaceæ, Gesneriaceæ, and various others. To recognise these orders it is necessary, in most cases, to see the flowers; but in the case of the Umbellaceæ, as already observed, the order may be recognised by the appearance of the flower-stems; and in *Cactaceæ* by the stems, and the entire plant. A number of the orders contain only one or two genera; and though the list has a formidable appearance on paper, yet in the garden the plants of several of the orders occupy but comparatively a small space.

COROLLEFLORÆ.

40. The characteristic of this division is—petals united; stamens fixed to the corolla. The most important orders are Scrophulariaceæ and Labiaceæ: both very readily distinguished.

41. *Scrophulariaceæ*.—Calyx and corolla irregularly four to five cleft; stamens two to four; fruit, a two-celled, many-seeded capsule. Herbs, undershrubs, and occasionally shrubs; natives of, and found in abundance in, all parts of the world. Leaves simple, opposite, whorled or alternate, with or without stipules. Flowers axillary or racemose, often showy. Properties, acridity and bitterness; sometimes purgative or emetic. Familiar examples are, Buddlea, Snapdragon, Scrophularia, Foxglove, Eyebright, Calceolaria, Schizanthus, and Veronica.

42. *Labiaceæ*.—Calyx tubular, five to ten parted; corolla lipped; stamens two to four; seeds four together, enclosed in a general seed-vessel, superior; flowers whorled. Herbaceous plants or undershrubs with four-cornered stems and opposite ramifications; natives principally of the temperate regions of both hemispheres. Leaves simple or compound, opposite without stipules; abounding in pores filled with aromatic oil. Flowers sessile, in axillary cymes. Properties tonic, cordial, and stomachic. Familiar examples are, Mint, Savory, Thyme, Pennyroyal, Hyssop, Germander, Rosemary, Day-nettle, Betony, Ground Ivy, Horehound, Lavender, Balm of Gilead, Balm, and Sage.

43. Other orders in this subdivision are:—Epacridaceæ, Cape and Australian shrubs resembling Epacris, and frequent in greenhouses, flowering in the winter. Myrsinacæ, Jasminacæ, Asclepiadaceæ, Gentianaceæ, Bignoniaceæ, Cobæaceæ, Polemoniaceæ, Convolvulaceæ, Boraginaceæ, Hydrophyllaceæ, Solanaceæ, Verbenaceæ, Acanthaceæ, Primulaceæ, and various others.

MONOCHLAMYDÆ.

44. Calyx and corolla not distinct; that is, the flowers have only a single envelope. The principal orders are Amentaceæ and Coniferæ.

45. *Amentaceæ*.—Flowers monœcious; that is, the male and female in separate catkins, but borne on the same plant; or diœcious, that is, the male and female on different plants. The stamiferous flowers in drooping catkins; fruit solitary, or aggregate; in some one-celled, enclosed in a sheathed capsule, as in the Oak, Chestnut, Beech, Hazel, and Hornbeam; in others with the fruit small and tufted with fine hairs, as in the Willow and Poplar; and in others two-celled, with small seeds not enclosed in the receptacle, and not clothed with hairs, as in the Birch and Alder. Trees, and some shrubs; natives chiefly of the temperate regions of both hemispheres. Leaves simple; flowers not showy.

46. *Coniferæ*.—Flowers in catkins generally erect; fruit a cone, as in Pines and Firs; sometimes with scales compressed so as to resemble a berry, as in the Juniper and Yew. Seeds naked. Trees, and some shrubs, natives of every part of the world; often called resiniferous trees. Every one has seen a Pine, a Fir, or a Cedar, and their cones; and the fruit of the Juniper and the Yew are not uncommon. The Coniferæ are frequently spoken of as in two divisions; the one the Abietinæ, or Pine and Fir tribe; and the other the Cupressinæ, or the Cypress and Juniper tribe.

47. Other orders belonging to this division are Plantagineæ, plants more

or less resembling the *Plantago*, or common Plantain. *Amaranthaceæ*, *Chenopodiaceæ*, *Begoniaceæ*, *Polygonaceæ*, *Lamaceæ*, *Proteaceæ*, *Thymeleaceæ*, *Euphorbiaceæ*, *Urticaceæ*, *Ulmaceæ*, *Juglandaceæ*, *Empetraceæ*. Of these the *Coniferæ* may generally be known by their foliage; but the others, for the most part, require to be seen in flower, at least by the beginner.

ENDOGENS.

48. *Endogens* have no general subdivisions like the *exogens*; but their principal orders, with a view to the general observer, are *Orchidaceæ*, *Scitamineaceæ*, *Iridaceæ*, *Amaryllidaceæ*, *Asphodelaceæ*, *Tulipaceæ*, *Palmaceæ*, and *Graminaceæ*.

49. *Orchidaceæ*.—Flowers of six sepals, irregular; stamen and style united. Herbaceous plants, often with the stems and leaves perennial; many of them epiphytes, that is, growing on the trunks and branches of trees. Leaves simple, quite entire, often articulated with the stem. The flowers of this order are so remarkable in their external appearance, that when once seen they are easily recognised, either in the indigenous Orchises of British marshes and chalky downs which grow in the soil; or in the tropical species kept in stoves, which for the most part grow on the bark of the trunk and branches of trees.

50. *Scitamineaceæ*.—Stem formed of the cohering bases of the leaves; never branching. Leaves simple, sheathing one another on the stem. Flowers in spikes, racemes, or panicles, with numerous bracts. Tropical herbaceous plants, of which the following are examples: the Ginger, the Indian Shot, *Alpinia*, *Hedychium*, Plantains, and Bananas.

51. *Iridaceæ*.—Flowers superior; stamens, three distinct, their anthers turned outwards. Herbaceous plants, chiefly bulbs, natives of the Cape of Good Hope, but many of them also of Europe. Leaves ensiform, equitant, or alike on both sides. Flowers terminal, in spikes, corymbs, or panicles; bright-coloured, large, and showy. Familiar examples are: *Iris*, *Ixia*, the Tiger Flower, *Gladiolus*, and *Crocus*. The latter flower is familiar to every one.

52. *Amaryllidaceæ*.—Flowers superior; stamens six, distinct; their anthers turned inwards. Bulbous-rooted herbaceous plants, natives of most parts of the world, with uniform leaves having parallel veins. Flowers with sheath-like bracts, large, bright-coloured, and showy. Familiar examples are: the *Amaryllis*, *Crinum*, *Bloodflower*, *Hypoxis*, *Narcissus*, *Snowdrop*, *Summer Snowflake*, and *Alstrœmeria*.

53. *Liliaceæ*.—Flowers inferior, of six divisions; stamens, six. Herbaceous plants with bulbous roots, natives of the temperate parts of the northern hemisphere. Familiar examples are: the *Lily*, the *Scilla*, the *Hyacinth*, *Fritillary*, *Dog's-tooth Violet*, *Tulip*, *Star of Bethlehem*, *Asphodel*, *Butcher's Broom*, *Solomon's Seal*, and *Lily of the Valley*. The *Tulip* and the *Lily* are familiar to every one.

54. *Palmaceæ*.—Flowers enclosed by a sheath, six-parted; stamens, six; fruit fleshy or baccate. Trees, sometimes low plants; always with simple stems, seldom if ever branched, and having the leaves in clusters at the top of the stem. Leaves large, pinnated or fan-shaped, folded before expansion; natives of tropical climates, and in Britain only to be seen in hothouses. Familiar examples are, the *Fan Palm*, the *Date*, the *Sago Palm*, and the *Zamia*.

55. *Graminaceæ*.—Plants with hollow, round stems, and mostly ever-green leaves. Sheaths of the leaves split on one side. Herbaceous plants, and sometimes trees and shrubs, natives of every part of the world, and familiar to all.

56. Other orders belonging to Endogens are: *Alisimaceæ* or Water Plantain-looking plants, natives of marshes or standing water. *Butomaceæ*, the flowering Rush, the most ornamental of British water plants; *Pistiaceæ*, the Duckweed; *Dioscoraceæ*, the Yam; *Tamaceæ*, the black Bryony, a twining plant occasionally found in hedges; *Smilaceæ*, the Smilaxes; *Bromeliaceæ*, the Pine Apple; *Commelinaceæ*, Spider Wort; *Typhinaceæ*, Cat's Tail; *Aroidaceæ*, the Arums; *Juncaceæ*, the Rushes; and *Cyperaceæ*, the Sedges, which are distinguished from the proper grasses by having solid stems.

ACROGENS.

57. *Acrogens*, or vegetables which grow from their upper extremities, contain the following principal Orders: *Filices*, *Musci*, *Lichenes*, *Algæ*, and *Fungi*.

58. *Filices*.—Plants often consisting of a single leaf called a frond, mostly without stems; the leaves are rolled up before expansion, and with equal-sized veins. Herbs, and sometimes trees, natives of every part of the world in moist shady situations. Familiar examples are: the common Polypody of the hedges, which is found also on pollards and large trees in moist situations, Maidenhair, the Brake, the Hart's Tongue, the *Osmunda*, the Ad-der's Tongue, and the Moonwort.

59. *Musci*.—Leafy cellular plants, with fruit in covered capsules.

60. *Lichenes*.—Frondose plants with seeds in receptacles of various kinds, of the same substance as the frond.

61. *Algæ*.—Cellular water plants, chiefly found in the sea; bearing fruit in bladders either attached to, or imbedded in, the surface of the frond or leaf-like plate. A common example of this order is the green hair-like *Conferva*, found in ditches and stagnant waters.

62. *Fungi*.—Succulent masses without leaves, veins, or fronds, and bearing their sporules, or substitutes for seed, in tubular cells. Familiar examples are the common Mushroom and Toadstool.

63. Other orders of *Acrogens* are *Equisetaceæ*, or plants resembling the common *Equisetum* or Horsetail, which to general observers is distinguished by its terminal catkin from the Mare's-tail, in which the flowers are axillary. *Characeæ* or floating water plants, consisting of a leaf and root; and *Lycopodiaceæ*, which are moss-looking plants, bearing a general resemblance to the common club moss. All these orders may be recognised without reference to flowers or fruit, and they are chiefly of botanical interest.

64. If the reader has profited from the preceding part of this section in the manner which we have wished him to do, he will have learnt, when endeavouring to describe a plant which he has seen, to another person who has not seen it; not to begin with the leaves and flowers and similar details, but with the general appearance of the plants, and the resemblance which it has to known plants, either single species or orders, tribes, or genera. It is in general of far more importance to be able to determine the order to which a plant belongs than its mere generic and specific name; unless, indeed, the knowledge of this serves as a key to books from which the natural order may be learned, and consequently something of the properties of the plant

ascertained. We therefore repeat our recommendation to grown-up pupils to begin their study of plants by looking at them in masses or groups; after which they may correct and render more definite the knowledge thus acquired, by a study of all the separate parts of plants. In like manner, if we were to recommend what we consider the best mode of getting a knowledge of grammar, we should begin with sentences; or of the exterior effect of buildings, we should recommend, first, attention to the outline and the general masses; and next, an examination of the doors, windows, cornices, and other details; and finally of the bricks or stones of the walls, and the slates or tiles of the roof. To a young person, on the other hand, we should recommend the contrary mode, in botany, in grammar, and in architecture.

65. Besides characterising plants according to the natural orders to which they belong; when cultivators are speaking of plants with a view to their art, they employ a number of terms which, though not rigidly scientific, are all more or less useful, as enabling us to speak of plants in groups or masses. The principal of these are as follow:

66. *Evergreens*.—Plants which retain their leaves green throughout the winter. The principal British evergreen trees, are the Coniferæ, the Evergreen Oak, and the Holly; but there are many evergreen shrubs. Evergreen herbaceous plants are not very numerous; but we have the Pink, Carnation, Sweetwilliam, many of the Saxifrages, Silenes, the perennial flax, some Campanulas, and all the perennial grasses.

67. *Subevergreens*.—Plants which retain their leaves green through the winter, and drop them in spring, so that they are for two or three weeks without leaves. The principal trees are the varieties of the Lucombe and Fulham Oak, Turner's Oak, *Quercus pseudo-suber*, and one or two others. Of shrubs there are a number; such as *Buddlea globosa*, *Aristotelia Macqui*, *Photinia serrulata*, *Cotoneaster frigida*, some kinds of *Genista*, *Piptanthus nepalensis*, *Ribes glutinosum*, &c. Subevergreen herbaceous plants are: *Cenothera biennis* and several other species, *Pentstemon*, *Chelone*, *Asters*, &c.

68. *Persistent-leaved plants* are such as retain their leaves after they have withered and become brown, till the spring. Examples of trees are, the Beech, Hornbeam, and Turkey Oak when young, *Quercus Tausin*, and sometimes the common Oak; and there are one or two shrubs, such as *Rhus Côtinus*, and some herbaceous plants, such as *Pulsatilla*.

69. *Deciduous-leaved plants* are those that drop their leaves in the autumn, which is the case with the great majority of plants, whether trees, shrubs, or herbs, in all extra tropical countries.

70. *Ligneous plants* are such as have woody stems and branches.

71. *Suffruticose plants* are such as have stems intermediate between woody and herbaceous; as, for example, the tree Peony, the Sage, the Carnation, the tree *Lavatera*, &c.

72. *Trees*, when young, are scarcely to be distinguished from shrubs, both coming up with a single stem; but a tree, if left to itself, ultimately becomes a plant with a single erect stem, and a branchy head. Thus the common mountain Ash, though it seldom grows above thirty feet high, is a perfect tree; while the common Laurel, which will attain the height of forty or fifty feet much sooner than the mountain Ash will thirty feet, never has an erect stem, and has generally several stems rising together. It is therefore considered a shrub. Trees are commonly divided into large, small, and

middle-sized. Most fruit trees are considered low trees; trees between thirty and fifty feet are middle-sized; and those of greater height large.

73. *Shrubs* are either large, as when they exceed twenty feet; small, if under four feet; or undershrubs if under two feet, such as the Thyme and Rosemary, and many Heaths. Shrubs climb by twining, as exemplified in the Honeysuckle; by clasping with tendrils or leaves, as in the vine, the five-leaved ivy, and the Clematis; or by elongation, as in the Lycium and Solanum dulcamara; or by attachment of the rootlets, as in the common Ivy. Shrubs are also distinguished as trailers when the shoots lie along the ground without rooting into it; as stoloniferous, when the shoots ramble along the ground, and root into it at certain distances, as in the Bramble; or creeping, when they root at every joint, as in some species of Rhus; and as recumbent, when the shoots recline without spreading or rooting, as in many species of Cytisus.

Herbaceous plants may also be similarly divided.

With reference to their habits, plants are called Alpines, or hill plants, or mountain, marsh, aquatic, bog, heath, wood, copse, hedge, meadow, or pasture plants. With respect to soil, a very common division is into peat-earth plants or American border plants (from the soil for American plants being generally peat), and common garden soil plants.

Herbaceous plants are also distinguished as florists' flowers, such as the Auricula, Tulip, Hyacinth, &c., which have been long cultivated by florists, who have laid down canons or rules, by which the merits of flowers are to be tested; border flowers, or such as are adapted for growing in a miscellaneous ornamental border; botanic plants, or such as are chiefly interesting to botanists; shrubby flowers, or such large coarse-growing species as are adapted for growing among shrubs; rockwork plants, or such as from their native habitation, and low compact habit of growth, are considered as adapted for rockwork; and pot plants, or such as for the same qualities are adapted for growing in pots. There are also lawn plants, or such as are adapted for growing singly on a lawn, as the Peony; and covering plants, such as the Verbena Melindres, which are adapted for covering beds and parterres with masses of flowers of the same colour. The common divisions of herbaceous plants into annual, biennial, perennial, bulbous, tuberous, ramose-rooted, and fibrous-rooted, it is unnecessary here to describe.

74. The uses of plants have given rise to several divisions; such as horticultural plants, agricultural, culinary, medicinal, tinctorial, pomological, and other edible fruit-bearing plants; graniverous, pasturage, and herbage plants; hedge plants, or such ligneous species as are adapted for growing as hedges; copsewood plants, or such as shoot up freely from the stool or collar when cut down, and are consequently adapted for copsewoods; seaside plants, or such as are adapted for standing the sea-breeze, &c.

75. Plants are also distinguished as having variegated foliage; anomalous foliage, in which plants having naturally simple or entire leaves, exhibit them occasionally much divided, as in the Fern-leaved Beech, Cut-leaved Lime, &c.; as having double flowers, which, in the earlier ages of gardening, was considered the greatest beauty which a plant could have; as being dwarfs, or lower than the normal size; or tall, as being higher than the normal size. Considered with reference to climate, plants are described as hardy, growing in the open air without protection; half-hardy, requiring some kind of protection; frame, requiring the protection of glass without

heat; greenhouse plants, requiring glass with heat; and hothouse plants, which may be either dry stove plants, such as Cacti, Aloes, Crassulas, &c., which require a high degree of heat with a dry atmosphere, or damp stove plants, such as the Orchidaceæ, which require a high degree of moist heat.

SECT. III.—*Nomenclature of Plants with a view to Horticulture.*

76. The principles on which plants are named ought to be known to the young gardener and the amateur; partly because they ought not to be entirely ignorant of anything closely connected with their pursuit, and partly because the names of plants sometimes indicate ideas respecting their nature and culture. The names of the grand divisions, as we have already seen, are compounded of Greek words, expressive of the structure or character of the division or subdivision. The names of the orders are, for the most part, without meaning in themselves, further than as being the names of certain genera which are considered as the types of the orders, all the plants of which have a close general resemblance to that genus in structure and properties. The same may be said of the names of tribes.

77. The names of the genera of plants, are chiefly compounded of Greek words signifying something respecting the plant, as *Chionanthus*, snow-flower, from the snowy whiteness of the blossoms, or *Gypsophila*, because the plant loves chalky soil; or they are commemorative of individuals, as *Smithia*, after Sir James Smith. Occasionally, but rarely, they are named after countries or a people, as in *Armeniaca* from Armenia, and *Araucaria* from the *Araucarians*, a people of Chili. By far the greater number of generic names are after persons, and those in this volume, and in all our other works, are distinguished by having the letters additional to the name in italics, as explained with other matters at the end of the Preface. Specific names are generally Latin adjectives, expressing some obvious quality of the plant; or proper names used adjectively, to signify the change that has taken place in removing the species from the genus, of which the adjective was the name; as for example, *Veronica Chamædrys*, indicates that *Chamædrys* was formerly the generic name of that species of *Veronica*. Commemorative names are also used as specific names, sometimes in the genitive case, as *Verbena Drummondii*, indicating that the plant was discovered or originated by Mr. Drummond; or with the addition of *ana* as *Verbena Tweediana*, indicating that the plant was named in honour of Mr. Tweedie. Specific names also often indicate the situation or the county where the plant is found naturally, as *palustris* growing in marshes, or *Edinburgensis* growing about Edinburgh.

78. The names of varieties of plants given by Botanists follow the same laws as those of species; but the names given by horticulturists and florists are sometimes indicative of properties, as large, small, &c.; but for the most part fanciful, and sometimes whimsical. In general, the names of culinary vegetables and fruits bear the name of the person who raised them, with the place where they were raised, with or without the addition of some adjective expressing their properties, as *Forest's Large Upsal Cabbage*, *Reid's New Golden Pippin*, &c. The names applied to varieties of gooseberries, florists' flowers, and roses, are for the most part given in honour of individuals; sometimes they indicate a quality, as *Brown's Scarlet Verbena*, and sometimes they imply a superiority, or a challenge, as the *Top-Sawyer gooseberry*, or *Cox's Defiance Dahlia*. The Dutch give their florists' flowers many high-sounding titles, which appear at first sight ridiculous; but in giving them

they intend at once to compliment their patrons, and to describe something of the nature of the flower, thus:—the letters W., Y., O., R., C., P., V., B., &c., when capitals, are understood to mean white, yellow, orange, red, crimson, purple, violet, blue; and hence, when a flower is named William the Conquerer, or Wonder of Constantinople, its colours are understood to be white and crimson; Charming Phillis, crimson and purple; British Rover, blue and red, &c. It is always desirable to know the meaning of a name, or even to know that it has no meaning; in the former case some positive ideas are obtained, and in both the memory is assisted.

SECT. IV.—*Structure of Plants, with a view to Horticulture.*

79. The anatomy of a plant furnishes us with numerous component parts, of which we can do little more than enumerate those more immediately connected with the practice of horticulture.

80. *Elementary Organs* consist of cellular tissue, or transparent vesicles, which adhere together so as to form a substance more or less compact, and which, in the leaves, fills up the interstices between the veins, and forms the parenchyma. Woody fibre is an elementary organ consisting of elongated tubes, which are found more or less in most plants, and especially in the wood and inner bark, among parenchymous matter. Spiral vessels—consisting of elastic tissue, twisted spirally within a membrane—are found in the medullary sheath, but rarely in the wood, bark, and root, and they scarcely exist in acrogens. Plants furnished with them are called vasculares; a term which includes both exogens and endogens: and plants without them are called cellulares, in which the acrogens are included. Other forms of elementary tissue are—the ducts, which are transparent tubes, marked with lines or dots; the cuticle, which is a thin skin, covering the leaf; and the stomata, which are pores scattered over the cuticle, or epidermis of the leaves. Grafting and budding are founded on the affinity of the elementary organs in different species.

81. *Compound organs* are combinations of the elementary organs, and consist of the axis and its appendages; two words which comprise the whole vegetable structure. The axis may be compared to the vertebral column of animals, and is formed by the development of a seed, a bulb, or other germ, or of a leaf-bud. An embryo is the origin of a plant contained within a seed, and it differs from a bulb or bud in being produced by the agency of sexes. When a seed or a bud is excited by its inherent vital action, the tissue of which it is composed, and which has the power of generating new tissue by the growth of one elementary vesicle out of another, develops itself in three directions, upwards, downwards, and horizontally. The part which descends is called the descending axis or root; the opposite part the ascending axis or stem; and the horizontal elongations, which are chiefly leaves and buds, are called the appendages of the stem.

82. *The root* begins to be formed before the stem; from which it differs anatomically, in the absence of spiral vessels, of pith, of buds, with certain exceptions, and of stomata. The uses of roots are to fix plants in the soil, and to absorb nutriment from it by their spongioles.

83. *The stem* is generated by the development of the plumule of the seed, and increased by the development of leaf-buds. If a ring of bark be cut off from the stem of an exogenous plant, below a branch or even at the base of a growing shoot of the current year covered with leaves, or if a ligature be

made round the stem in a similar situation, the part of the stem above the wound, or ligature, swells and increases in thickness, while that below it does not ; a proof that in exogenous plants, the matter by which stems are thickened, descends. Hence, when a shoot is cut through immediately below a leaf-bud, the portion of the shoot left, dies back to the next bud. Hence, also, has arisen the technical expression of "cut to the bud ;" which means, that in pruning or cutting off a shoot, the section should be made so close to a bud as that the wound may soon be healed over, and no stump left, as is the case in gardens where trees have been carelessly pruned. The greater the number of leaves on a shoot, or of leaf-buds on a stem or branch, the greater will be the diameter of the parts below the leaves, buds, or branches, and the contrary.

84. Stems are either exogenous, growing from the outside ; endogenous, growing from the interior ; or acrogenous, growing by elongation or dilation, and mostly without buds. Exogenous stems consist of the pith, a fungus-like matter, occupying the small cylindrical space in the centre of the stem, and never increasing in diameter ; of the medullary sheath, consisting of a thin cylinder of spiral vessels and ducts, immediately surrounding the pith ; and of the wood, which surrounds the medullary sheath, in the form of concentric layers, which layers are penetrated by projections from the pith called medullary rays. In general every concentric layer requires a year for its production ; and hence the age of a tree may be known by the number of rings shown in the section of the main stem. In woody stems of several years' growth, the interior of the wood is rendered hard by the deposition of secreted matter, and is called heartwood ; while the more recent exterior layers are known as soft wood or alburnum.

85. *The bark* surrounds the young wood, and like it consists of concentric layers, one being added yearly on the inside, between the previously existing bark and the alburnum. Every layer of bark consists of woody fibre, and ducts covered with parenchymous matter, the two former constituting the liber, or inner bark, and the latter the cellular integument, epidermis, or outer bark. The uses of the bark are to protect the alburnum, to serve as a channel for the descending sap, and sometimes as a medium for the deposition of the peculiar properties of plants.

86. *The medullary rays or plates* consist of compressed vertical parallelograms of cellular tissue, which connect together the different layers of wood, and serve, at least in trees that are without dead wood in the centre of their stems, as a communication between the pith and the bark. Between the liber and the alburnum, a viscid secretion is found in spring, which renders trees easily disbarked at that season, and this secretion is called cambium. It has been supposed to nourish the descending fibres of the buds, and to originate medullary rays.

87. Endogenous plants have stems, which offer no distinction of pith, medullary rays, wood, and bark ; the whole structure being composed of bundles of vascular tissue among a mass of cellular tissue, surrounded by a zone of cellular tissue and woody fibre : but as this exterior zone is not separable from what it encloses by any natural division, it is consequently not bark. Endogenous stems increase by the successive descent of new bundles of vascular tissue into the cellular tissue towards the centre of the stem, and these bundles of tissue gradually distend those previously formed, by which means the diameter of the stem is slowly increased in thickness, and its circumference in hardness. After this hardness has reached a certain

point, it can no longer be distended, and the diameter ceases to increase. Hence, generally, the life of an endogenous tree seems more limited than that of an exogen ; because it is well known that trees of the latter kind will live for an indefinite period, and even for centuries, after the interior of the trunks have become entirely rotten, and their circumference separated so as to form vertical sections, or fragments of trunks, with rotten wood on one side, and living bark and growing shoots on the other ; the increase both of bark and wood still going on. Endogens differ from exogens in commonly developing only a terminal bud, as in Palms, in which case the stem is of the same thickness throughout, and cylindrical ; but when several buds develop themselves, as in the stem of the Asparagus, and in that of the Bamboo, the stem becomes conical like the stems of exogens.

88. Though the normal direction of stems and branches is upwards, or at all events, above the surface of the ground, yet there are exceptions in the case of creeping roots, as in the Everlasting Pea ; in rhizomas, which are underground stems, as in the water-lily, and the common reed ; in tubers which are stems under the surface, as in the potato ; and in corms, as in the crocus, the root of which, though commonly called a bulb, is, botanically, a dilated stem.

89. *Nodi*, or knots, are the places where buds are formed, and *internodi* the spaces between them. Whatever is produced by a leaf bud is a branch, which, when in a growing state, is called a shoot. Leaf-buds sometimes are imperfectly developed so as to form a spine, with or without leaves, as in the common hawthorn ; and such spines are therefore imperfectly developed branches. All growths from the stems which are not the evolutions of leaf buds, as for example the prickles, are modifications of the cellular matter, and of the epidermis of the bark. The uses of prickles to the plant appear imperfectly understood.

90. *Buds* are either leaf-buds or flower-buds, and the former are either regular or adventitious. Regular leaf-buds are only found in the axils of the leaves, or in the axils of their modifications. Hence as scales, stipules, bracts, sepals, petals, stamens, and carpellas, are considered as metamorphosed leaves, adventitious buds are believed to exist on their axils ; though they are rarely developed in a state of nature and only sometimes by artificial processes. Regular buds alone develop themselves untouched by art or accident ; and hence, whatever may be the arrangement of the buds, the same will be that of the branches. Adventitious leaf-buds are found surrounding the bases of regular leaf-buds, and in general where there is an anastomosis of woody fibre. They are found in the roots of a number of plants, and sometimes on the margin of leaves, or at the base of their petioles ; they are never visible either on the root or stem till they begin to develop themselves and burst through the bark.

91. *Leaves* are expansions of the bark, and only found at the *nodi* of the stem. They are developed as the stem advances in growth, one above and after another, opposite, alternate, or verticillate, and in each of these modes with greater or less regularity. A complete leaf consists of a petiole or foot-stalk, a lamina or disk, and a pair of stipula or small side leaves at the base of the petiole. The lamina is sometimes wanting or changed in shape, and sometimes the petiole is extended, and instead of terminating in a lamina, it assumes a cylindrical wirelike figure, and becomes a tendril. The veins of leaves branch in all exogenous plants, with the exception of the Coniferæ and Cycadææ orders, the stems of which have an exogenous structure, while the

veins are parallel, like those of endogens. The veins of a leaf are in two strata, the one forming the upper, and the other the under surface; the former conveying the juices from the stem for elaboration, and the latter returning them when elaborated. Simple leaves have undivided laminae, or laminae divided, but not articulated; in the latter case it is a compound leaf, as in the Mimosa, and in what would, at first appearance, seem a simple leaf, the Orange. Some leaves have a power of producing leaf-buds, but commonly not till they have dropped off and lain some time on moist ground, as in Bryophyllum, Malaxis, and some tropical ferns.

92. *Hairs* are minute expansions of tissue, found occasionally in all parts of the plant above ground, but chiefly on the under surface, and they are intended for the purposes of secretion, for the control of evaporation, and for the protection of the surface on which they are placed.

93. *Flower-buds* consist of floral envelopes and sexes, and they either proceed from the axillæ of common leaves, or from those of bracts or floral leaves. The floral envelopes are connected with the stem by a peduncle. The modes in which flower-buds are arranged on a stem, which are various, are called the forms of inflorescence; and the order in which they expand is called the order of expansion.

94. *Inflorescence* is the ramification of that part of the plant bearing the flowers, and it is in general either terminal, that is, at the end of the branch; or axillary, proceeding from the axils of the leaves. Both these kinds of inflorescence assume a great many different forms which cannot be here detailed.

95. *The floral envelopes* consist of the calyx and corolla, both of which are generally present, but sometimes only one, which in that case is considered the calyx; and sometimes both are wanting, as in apetalous flowers. The divisions of the calyx are called sepals, and those of the corolla petals.

96. *The sexes of plants* consist of the male organs, or stamens, and the female organs, or pistillum, with a process, usually an annular elevation, which occurs between them, referred by former botanists to the nectary, but now called the disk. The pistillum occupies the centre of the flower within the stamens, and it consists of three parts, the ovarium, the style, and the stigma. The ovarium is the lowest part, and encloses the ovula or young seeds, in one or more vacuities called cells; the stigma is the summit of the pistillum, which is connected with the ovarium by the style. This last part is sometimes wanting, but the ovarium and stigma are always present. Those parts of the pistillum which remain, and continue growing after the floral envelopes and the stamens have decayed, are called carpels, which are sometimes united, as in the Poppy, and sometimes separated, as in the Ranunculus.

97. *The ovulum* is the infant seed united to the interior of the carpella, by the placenta, to which it is attached by the funiculus, podosperm, or umbilical cord.

98. *The fruit*, in a strict botanical sense, is the mature pistillum, but in a less strict sense, it is applied to the pistillum and floral envelopes, taken together and united in one general mass. All fruit, excepting those of the Coniferæ and Cycadeæ, which have no ovarium, indicate upon their surface some traces of a style, and wherever this is the case, what are apparently and commonly called seeds, as the grains of corn and other grasses, are properly fruits. When the pistillum has become mature fruit, what was the ovarium takes the name of pericarpium.

99. Fruits are either simple, proceeding from a single flower, as in the poppy, rose, strawberry, apple, &c., or compound, formed out of several flowers, as in the mulberry, the fig, and all the Coniferæ. When simple fruits are formed of a single carpellum, they are called follicles, as in the peony; legumes, as in the pea; drupes, as in the peach; akenia, as in the strawberry; cariopsis, as in corn; or utricles, as in the chenopodium. The capsule is a many-celled dry pericarpium, as in the poppy; the silique is a pod, consisting of two or four carpella, as in the cabbage tribe, and all the Cruciferæ. The nut or gland is a dry, bony, one-celled fruit, enclosed in an involucre, cupula, or cup, as in the oak; the berry is a succulent fruit, the seeds of which lose their adhesion when ripe, and lie loose in the pulp, as in the grape and the gooseberry; the orange is also a berry separable into an epicarp, or outer skin, and endocarp or central part in which the seeds are fixed, and a sarcocarp or fleshy substance between the epicarp and the endocarp; the pome consisting of two or more inferior carpella united, as in the apple; and the pepo is a pulpy fruit in which the seeds are embedded, but their point of attachment never lost, as in the cucumber. Of all these fruits, the most remarkable are the pine-apple, which is a spike of inferior flowers grown together into a fleshy mass; the fig, which is the fleshy hollow dilated apex of a peduncle, in the interior of which the flowers are arranged, each flower containing a one-seeded pericarpium; the cone of the Abietinæ is an indurated amentum; and when reduced in size, and its scales so firmly adhering as almost to resemble a berry, it is called a galbulus, as in *Thuja* and *Juniperus*.

100. *The seed* is a mature ovulum, and consists of the integument or testa, the albumen or perisperm, and the embryo, which consists of the cotyledons, the radicle, the plumula, and the collar or neck. As all ovula are enclosed within an ovarium, and all seeds are matured ovula; hence there can be no such thing as naked seed, excepting in Coniferæ and Cycadææ, in which the ovula are destitute of every covering, and exposed naked to the influence of the pollen. In consequence of some ovula rupturing the ovarium in the course of their growth, the seeds become naked, as in *Leóntice thalictróides*; while in some, as in *Reseda*, the ovula are imperfectly protected by the ovarium, and in that case also the seeds are naked. When a seed is separated from the placenta, and the umbilical cord is removed, a scar appears on the point where it was attached, which is called the hilum or umbilicus. It is very distinct in the common bean, and in all the Leguminosæ. The hilum always represents the base of the seed, or that part whence the roots proceed; and hence it ought to be placed undermost when the seed is committed to the soil. In curved seeds, however, as in the *Mignonette*, the apex and base are brought together; and in sowing such seeds they should be laid on their side. There is much to study on the subject of seeds, both with a view to a scientific knowledge of plants and to their culture, and we must therefore recommend the reader to study either *Lindley's Outlines of the First Principles of Botany*, or his *Introduction to Botany*, 3rd edit., 1839; the last being by far the most complete work of the kind extant.

SECT. V.—*Functions of Plants with reference to Horticulture.*

101. The development of a plant takes place in consequence of the elasticity, excitability, and hygroscopicity of its tissue; and it requires the

presence : 1. of "substances containing carbon and nitrogen, and capable of yielding these elements to the growing plant ; 2. of water and its elements ; and 3, of a soil to furnish the inorganic matters, which are likewise essential to vegetable life." (Liebig, p. 4.) A summary view of the whole process of vegetable development is thus given by Professor Henslow : "Plants absorb their nutriment by their roots ; this nutriment is then conveyed through the stem into the leaves ; there it is subjected to a process by which a large proportion of water is discharged ; the rest is submitted to the action of the atmosphere, and carbonic acid is first generated and then decomposed by the action of light. Carbon is now fixed under the form of a nutritive material, which is conveyed back into the system ; and this material is farther elaborated for the development of all parts of the structure, and for the preparation of certain secreted matters which are either retained within or ejected from the plant." (*Descriptive and Physiological Botany*, p. 176.) This short passage comprehends the essence of all that can be said on the subject of vegetable development ; but for the purposes of horticulture it will be useful to go more into detail and to consider vegetable development under the form of germination, growth, function of the leaves, action of the flowers, and maturation of the fruit and seed.

102. *Germination*.—The seed containing an embryo plant, its development is effected by its being placed in suitable circumstances for that purpose. These are moisture, warmth, the absence of light, and contact with air ; to which may be added, with a view to cultivation, the presence of soil. The undeveloped seed is principally composed of concentrated carbon, and in the act of germination, this carbon, by the absorption of water, is converted into mucilaginous matter, which is decomposed and rendered soluble by the oxygen of the atmosphere. Thus it appears that the first act of germination is to reverse the process of maturation ; and hence, the reason why all seeds, if sown fresh, when they are nearly ripe, will germinate more speedily than when fully ripe ; and when fully ripe, sooner if sown immediately than if kept for months or years. The soluble mucilage of the cotyledons supplies the embryo plant with nourishment till it is able to extract food from the soil, after which it absorbs this food from the soil, by the points of its radicles. Seeds will not germinate without the presence of oxygen. In nitrogen, or in carbonic acid gas, if moistened with water, they will swell, but not vegetate. Hence seeds excluded from the atmosphere and from water, may be preserved from decay for an indefinite period ; but it does not follow that during the whole of this period they will retain their vital principle. The presence of light is not only unnecessary to the germination of seeds, but injurious, and hence in horticulture they are always more or less buried in the soil, generally to a depth equivalent to the diameter of the seed. The temperature required to germinate seeds, varies from 32° to 80° or 90° ; and some seeds, such as those of the *Robinia Pseud-acacia*, and of some species of Australian *Acacias*, may be immersed in water at the boiling point, and kept for some minutes in it without destroying vitality. The seeds of no plant will vegetate under 32°, because below that degree water freezes, and consequently could not be absorbed by the tissue of the seed. The common annual grass (*Poa annua*) will vegetate at, or very slightly above, that temperature, as will the Chickweed, (*Alsine média*), the common Day Nettle, (*Lamium rubrum*), and various others. The process of malting barley is exactly the same as that of germinating a seed. By moistening the barley, it swells, the starch of the cotyledon is changed

into sugar, and being absorbed by the embryo, the radicle is protruded at one end of the grain or seed, and the plumule or commencement of the stem is elongated at the other.

103. *Growth* in plants is effected, not as in animals by the expansion of all the parts of the embryo, but by additions to it. Thus roots and stems lengthen by matter added to their extremities, and are thickened by layers of matter deposited on their surface, in the case of exogenous plants; and in the interior of their stems and roots in the case of endogens. In the embryo, the root first begins to move by the extension of all its parts, but immediately after it is protruded into the soil, and the young stem is elevated into the air, the root ceases to increase by the general distension of its tissue, and grows by the addition of new matter to its point. Hence the extreme delicacy of the points of young roots, which, like all the newly formed parts of vegetable matter, are extremely hygrometrical, absorbing water like a sponge, and hence are called spongelets or spongioles. Roots, from their organic structure, are not permeable by water throughout their whole length, and it is only by means of the spongioles at the extremities of the small fibres that they absorb nourishment. In general, the buds of plants have a power of producing roots from their base, in a manner analogous to seeds; but much greater care is required on the part of the cultivator to bring about this process, and with many plants it will not succeed. In some, it may be effected by taking off a mature bud, and placing it in the soil, like a seed; but in most plants, it is requisite to preserve a portion of the stem along with the bud, as in striking vines by buds; in others it is requisite to have a plate of the bark, with or without a portion of the soft wood, as in propagating by budding on the living plant; and in some a leaf or leaves are requisite. Roots are also protruded from all parts of the stems of some plants, as of most kinds of Willow; and from the joints immediately under the buds of most plants. On this last property depends the art of propagating plants by cuttings, inserted in the soil. In some plants cuttings of the matured wood without leaves will emit roots; but in many others, and indeed in most plants, roots are most freely produced from cuttings of unripe or partially ripened wood, with the leaves on, and in a growing state. And even in those cases in which roots are produced from cuttings having no leaves, if leaves are not speedily produced, the roots will decay, and the cuttings will die. In short, the connexion between leaves and roots is as intimate in cuttings, whether of stems, branches, or tubers, as it is between the radicle and the plumule of the seed. A portion of the tuber of a Dahlia, which has no bud, will produce roots, and we have known those to live and the tuber to remain fresh for upwards of a year without leaves having been protruded; ultimately, however, the roots decayed, and the tubers soon afterwards rotted. Though roots are most active, and most essential to the progress of the plant in the growing season, yet they continue to perform their office even in the winter season, unless the soil which contains them should be frozen. In this case they are much injured, and the spongioles are ruptured and destroyed; but when the growing season returns, new spongioles are formed, commonly branching out from the fibres in a greater number than before. This result is sometimes produced by overpowerful liquid manures poured on the roots of plants, which destroy the spongioles, and cause the fibres to throw out a greater number. As plants absorb their food chiefly, and almost entirely, by their roots, and as it has been proved that in general the spongioles have no power of selection, it follows that plants may

be poisoned in the same manner as they are nourished ; and hence it has been found that solutions of opium, mercury, arsenic, and even common salt, presented to the roots of plants, will destroy their vital powers. In general the roots of plants are not furnished with buds, and hence roots cannot be used in propagation in the same manner as branches ; nevertheless, there are numerous exceptions, and some extensive orders of plants, such as the Rosàcææ, Campanulàcææ, Cruciferæ, and some of the Amentàcææ, have roots abounding in adventitious buds, and if these roots are cut into portions, and planted in the soil with the part of the root which was next the stem uppermost, and their points exposed to the air, or very slightly covered, they will produce plants. This, however, is never the case with the roots of annuals or biennials ; and hence, in Cruciferæ, while the common Sea-kale produces buds in abundance from the cuttings of the roots, the same thing never takes place in the common Cabbage. The nature of plants in this respect is very different ; for while the fasciculated tubercles of the Dahlia, if deprived of the plate which produces the buds, have no power of originating fresh buds, yet the tubers of the common Pæony so treated, produce them freely.

104. Every plant contains nitrogen in its albumen and gluten, and it has been found that this elementary principle abounds in a particular manner in the spongioles of the roots, and in all the newly-formed parts of plants, and that those seeds germinate the earliest which contain the largest quantity of nitrogen. Hence the great value of animal manures to plants, all of which contain nitrogen ; but especially those of carnivorous animals. (*Lieb.* p. 190.)

105. The *stem* of plants is not protruded so early as the root ; but as soon as the latter is in a state of action, and has penetrated a few inches into the soil, the seed-leaves appear above the surface, and from the centre of these is originated the stem. Both the roots and stems of plants, when first originated from seed, are perpendicular to the earth's surface, or in other words, they extend in the direction of radii from the earth's centre. The root, which penetrates downwards, always avoids light, and the stem, which rises upwards, as constantly seeks the light, and avoids darkness. There are some apparent exceptions to this law ; as, for example, in the Mistletoe, the seeds of which, when deposited on the underside of a branch, send their radicles upwards, and their stem downwards ; and this may perhaps also be said of some orchideous epiphytes ; but in general, few laws are so universal as that of the ascending and descending axis of a plant being always in the direction of a radiating line from the centre of the earth.

106. The stem at first is a mere point, scarcely so large as to be recognised as a bud ; but as soon as it feels the effect of the nutriment impelled into it by the growing root, it becomes developed, enlarged, furnished with leaves, and solidified. From being a small portion of cellular tissue, possessing neither strength nor tenacity, it becomes by the formation of woody matter, a slender rod or shoot, sufficiently firm and tough to require an effort to separate it from the root ; and, in a short time, it adheres to the latter so firmly as when drawn up forcibly to pull the entire plant out of the soil.

107. Before the formation of leaves on the stem, it is quite succulent, and without *woody fibre* ; but as soon as the leaves appear, woody matter is deposited in the form of tubes of extreme fineness, which originating in the leaves, pass downwards through the cellular tissue, and are incorporated with it, so as to add to its bulk, strength, and flexibility. The first woody matter

arises from the base of the seed-leaves, and is in general in very small quantity; but as soon as the proper leaves appear, the quantity of woody matter formed is considerable, even during the first growing season.

When this woody matter first penetrates the cellular tissue of the infant stem, it forms a little circle within its circumference, and thus separates the interior of the stem into two parts. These parts are the bark or exterior portion, and the pith or central part; and between these, at least in all exogens, there is a third portion which constitutes the wood.

108. Organically, the stem may be said to consist of two parts—the cellular tissue, which is not, from its nature, capable of increasing by growth more in one direction than in another, and the woody fibres which are transmitted from the leaves through the stem, and down into the roots. In speaking of the construction of stems, the cellular tissue, in them, is called the horizontal system; and the woody fibres, as they increase longitudinally by the addition of new fibres or tubes having the same lengthened direction as themselves, are called the perpendicular system.

109. *Wood*, in exogenous plants, consists chiefly of the perpendicular system, while the pith in the centre of the stem, and the bark on its circumference, are chiefly formed of the horizontal system. The bark communicates with the pith by the continuation of the cellular tissue through the woody fibres; and the cellular tissue seen among these woody fibres in the section of a tree made smooth by the plane, is called the medullary rays, from the pith in plants being supposed analogous to the medulla of animals. Hence the section of the trunk of a tree has been compared to a piece of cloth; the horizontal system, or medullary rays, representing the woof, and the woody system the warp.

110. When a stem is injured by the removal of a portion of the bark of such a depth as to reach the wood, the wound is healed over; first, by the cellular matter oozing out of the last formed wood, and granulating on the surface; and secondly, by this cellular matter being penetrated by the fibres of the perpendicular system. Rings of bark are frequently cut from the stems of trees for the purpose of checking the returning sap, either to cause the tree to produce blossoms, or for the purpose of inducing the stem or branch to throw out roots along the upper edge of the part from which the bark has been taken. The immediate effect of the process is the protrusion of granulated matter, or cellular tissue, along both sides of the wound, but especially on the upper side. Now, if the wound be surrounded with a quantity of moss, tied firmly on, and kept moist, the perpendicular system, or ligneous fibre, will penetrate through the granulated matter, and become roots; while no roots whatever will be protruded from the granulated matter on the under side of the wound; thus proving, firstly, the truth of the theory of the perpendicular system; and secondly, that roots, in growing plants, are formed by the protrusion of woody fibre through cellular matter. The first process of nature, when a cutting is formed and planted in the soil, is to protrude cellular matter round the edges of the section of its lower extremity; this protruded matter, or callosity, as it is termed by cultivators, sometimes remains for several months before it undergoes any change; but ultimately, if the cutting succeeds, the perpendicular system passes through it and appears in the form of roots, and the cutting is established as a plant. If a cutting be planted in the soil in an inverted position, though the portion in the soil be cut and prepared as in cuttings treated in the usual

manner, yet in general it will neither produce a callosity nor roots; though there are some exceptions, as in the willow tribe, and of these if the cutting is prepared at both ends, and laid horizontally in the soil, then at both ends callosities, and ultimately roots, will be formed. Hence a shoot of a willow inserted in the ground at both ends, being bent for that purpose, so as to form an arch, will root at both ends; but this is a result that will happen in the case of very few plants.

111. The *bark* consists of two parts; the outer bark, formed entirely of cellular matter, and resting on the liber or inner bark; and the inner bark, which consists partly of woody, and partly of cellular matter. The latter ultimately becomes wood, and the former ultimately hardens, cracks, and sometimes falls off. No wound in the outer bark can be healed or filled up, but the reverse is the case with wounds in the alburnum. The wood in all exogenous plants of the tree kind is distinguishable into the heart wood, or that which is mature, and the soft wood or alburnum, which is wood in a young and growing state. The heart wood is for the most part of a darker colour than the soft or young wood, which is generally white, till by age its tubes and vessels become thickened with matter deposited by the sap in its ascent to the leaves, when it darkens in colour, at least in most trees. When the sap absorbed by the spongioles enters the solid matter of the plant, it passes upwards through the alburnum to the leaves, and being elaborated there, it descends through the liber, communicating horizontally by means of the medullary rays, with both the old and the young wood. Wherever it penetrates, it deposits cellular matter, till at last in the old wood the pores become completely filled up and hardened.

112. The stems of all plants, and especially of exogenous trees, have, beginning at the centre, pith, old wood, medullary rays, alburnum, liber or inner bark, and outer bark. The medullary rays connect all the parts of the section of a stem, or branches, horizontally; and the ligneous fibres, which penetrate all the parts excepting the pith, connect them longitudinally, and complete the vegetable structure. In all plants whatever these parts exist; but in many herbaceous plants, especially annuals, and others of short duration, they are not easily defined; the wood, alburnum, and liber, often appearing in one homogeneous body; and the bark and the pith only being quite distinct. The root stem differs from the stem above ground in being without pith, without visible buds, and without an outer bark; or at all events without a bark which cracks and decays, like that of the stems and branches. There are exceptions in the case of some root stocks of herbaceous plants, such as those of the Colchicum and the Crocus; but nevertheless this holds true in the underground stems or tubers of the Potato, in the fasciculated tubercles of the Dahlia, and in most other tuberous-rooted plants.

113. *Leaves* are formed on the surface of stems at certain distances, and in a certain order in each species of plant; and at the base of the petiole of each leaf, there is a bud either visible or latent; in either case ready to be called into action and produce a new stem, shoot, or branch, when the necessary excitement is given. If the leaves are removed from a growing stem as soon as they appear, no buds are formed in their axils; or if the germs of them have existed there, they die for want of the nourishment of the leaf. Hence, by taking off every leaf as soon as it is protruded from an over vigorous-growing shoot of the current year, that shoot may be prevented

from maturing its buds and wood, and consequently deprived of the power of growing vigorously the following season; and this is found a better mode of treating excessively luxuriant trees than cutting off such over-vigorous shoots, which would only throw more vigour into the heart of the tree. By taking off the incipient leaves the tree is allowed to exhaust itself of all its superfluous force. See Beaton in *Gard. Mag.* 1837, p. 203.

114. In general, buds are rarely found except in the axils of the leaves; but occasionally they are formed in the spaces of the stem between the leaves, more or less distant from the base of the leaf, or from the joints whence leaves are produced. They are also, as we have before observed, sometimes found in roots, though never visible in them to the naked eye; and they are also produced in some cases on leaves, as in *Kalanchède* (*Bryophyllum*) *crenata*, and in *Cardamine hirsuta*. Buds of this kind are said to be dormant or adventitious. When the bud of any stem has been once matured, if rubbed off, one or more other buds will arise from its base; and this will take place though the operation be repeated an indefinite number of times, provided the plant be furnished with leaves in some other part of its stem above the point whence the buds were rubbed off, so that the shoot or stem may be continued in a growing state. Thus the regular visible buds of vines are frequently cut entirely out, but still the adventitious buds throw out shoots with such vigour, other circumstances being favourable, as to produce abundance of fruit the same season.

115. *Buds* are of two kinds, leaf-buds and blossom-buds. It is only the former that can produce shoots, or by which, under ordinary circumstances, a plant can be propagated directly. But if a blossom-bud be taken off and inserted in a living plant by the usual operation of budding, though only blossoms will be produced the first year, yet the dormant leaf-buds will the second year produce shoots. In practice this does not hold good alike in all plants, but it is the case with many of the *Rosaceæ*, for example in the Peach. The nodule is a concretion of embryo buds found in the bark of various trees, and especially of the common Elm, the Birch, some of the Poplars, and the Olive; and by fragments of which these trees may be propagated.

116. All bulbs are buds, and the scales of which they are composed are abortive or imperfectly developed leaves; consequently, as at the base of every leaf there is a bud, so must there be, at the base of every scale of a bulb, a bud either regular or adventitious. Hence, by cutting over the bulb of a common Hyacinth about the eighth of an inch above the plate to which the scales are attached, a number of buds and young leaves will be produced from between the bases of the scales, and by these buds the plant may be increased.

117. The stem of a plant may be considered as the base, receptacle, or habitation of the leaves and buds; by means of which they are exposed to the air and light, without being too much crowded, and are thus enabled to elaborate the sap sent to them by the roots, and to form buds and seeds for the continuation of their species. The watery matter absorbed by the spongioles ascends the stem by the soft wood, dissolving in its ascent a part of the starch or sugar which it finds there, and hence becoming denser as it ascends; its specific gravity increasing till it reaches the summit of the stem and branches. As it ascends it enters the leaves, where it is elaborated in consequence of the action of light on their upper surface, and it is then returned to the stem by

the vessels in the under surface of the leaves, whence it descends to the roots, not however by way of the alburnum, where it would meet with and interrupt the ascending sap; but by way of the inner bark, communicating horizontally, as we have before observed, with the interior of the stem by means of the medullary rays. Hence, the great importance of the alburnum and the inner bark to plants; the former in conveying sap from the root to the leaves, and the latter in returning it from the leaves to the stem, branches, and roots. Hence also we find that trees will live, and even thrive, with the interior of their trunk entirely rotten, provided the alburnum, the inner bark, and the leaves, are in a healthy state. The alburnum is constantly changing into hard wood, and the inner bark as constantly into hard bark or outer bark. As the heart wood when thoroughly hardened may be removed without injury to the growth of the tree, so also may the thoroughly hardened outer bark. The hard wood is to the tree what the bones are to an animal, the chief source of mechanical support; and the outer bark being a non-conductor of heat, protects the inner bark and the alburnum from too great cold, and in hot climates from too much heat, in the same manner as the outer coverings of animals.

118. Though the sap of plants circulates in general by rising through the alburnum, and descending through the inner bark, yet such is the effect of vitality, and the simplicity of their structure, that the sap can be made both to rise and fall by the alburnum, and to rise and fall also by the inner bark. Instead of ascending from the roots to the branches, it can be made to enter by the branches and descend to the roots. To prove the truth of the first of these assertions, the trunk of a tree has been sawn through in opposite directions in such a manner that there could not, by any possibility, be direct linear communication between the portions below and above the wound, and yet the tree has lived. The wood of the shoot of a willow has been extracted at the peeling season, and the shoot being supported by a stake, has grown, and in the course of the first summer filled up the cavity left by the removal of the wood. That the sap will both ascend and return, not merely by the alburnum, but by wood of a considerable degree of age and hardness, is proved, among other instances, by a Lime-tree in the royal gardens at Fontainebleau, which continues to live and produce leaves every

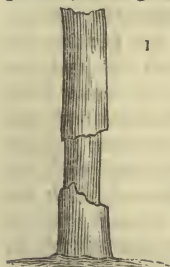

Part of the trunk of a Lime Tree growing at Fontainebleau in 1840.

year, though a large portion of the stem has been without bark for thirty years. Fig. 1 is from a sketch made by M. Poiteau, a scientific cultivator and physiologist, in whose company we examined this tree in July, 1840. To prove that the sap will enter by the branches and descend to the leaves, take a ligneous plant growing in a pot, and elevating it on a post between two trees of the same or of allied kinds, inarch the extremity of a branch of each tree into the plant in the pot, and in two years cease to supply water to the earth in the pot, and at last shake this earth away from the roots, and leave the plant suspended between the two trees. We have not seen this done, but

we have seen branches which had inosculation with other branches cut through, and being left attached by the inosculation, live for several years. Some curious experiments bearing on this subject, by Mr. Niven of Dublin, will be found in the *Gardener's Magazine*, 1838, p. 161.

119. The cause of the motion of the sap is a subject which has occasioned much discussion. The general opinion is, that it is in motion, to a certain

extent, in winter as well as in summer; but that an extraordinary absorption by the roots, and consequent ascent through the alburnum, takes place with the development of the buds, in consequence of the stimulus of heat in spring. The swelling of the buds, and the expansion of the leaves, decompose a quantity of sap in the same manner as the swelling of the embryo of the seed (102); a portion is fixed in the plant, and a portion given off into the atmosphere; and to supply the consumption thus occasioned, the office of the spongioles of the roots is called into extraordinary action, and nature, always stronger than strong enough, produces a superabundant supply.

120. The leaf of the plant is an organ of so much importance, that there can be no growth beyond the first development of the seed without it. No mode of treatment will compensate to a plant for the want of leaves, and the most vigorous plant that exists may be destroyed in a short time by the removal of all the leaves as soon as they appear. The important consequences that result from this fact, are not sufficiently known to many gardeners, and they require particularly to be impressed on the minds of amateurs. We have seen in a preceding paragraph how trees may be weakened, and particular shoots killed, by the removal of leaves. The most powerful weeds, for example, Perennial Thistles, Docks, Ferns, Rushes, and all similar plants, may be killed in grass lands on the same principle; that is, by the removal of the leaves as soon as they appear, and before they are developed.

121. The normal form of a leaf consists of an expanded part called the disk, and a narrow prolongation called the petiole (91); but some leaves are solid and cylindrical, and others are so modified as to appear like scales; for example, in bulbs, the bracts in the fruit of the pine-apple, spines in the common thorn, tendrils in the vine; and, consequently, all these organs or appendages ought to have buds, either visible or adventitious, in their axils. This is accordingly found to be the case. Shoots have been produced where the tendrils of a vine have been cut off; and in the fruit of the pine-apple, every bracteal leaf having a "pip" or flower in its axil, has produced a sucker. (*Couel.*) The disk of the leaf is considered as an expansion of the inner bark (91); its veins are the continuation of the ligneous fibres of the bark, and its cellular substance of the horizontal system or cellular tissue of the trunk. The woody tissue which forms the veins of leaves, as already observed, is arranged in two layers; one forming the upper surface of the leaf, by which the sap is elaborated; and the other, the under surface, by which the elaborated sap is returned to the inner bark. The two plates of layers may be readily seen in a leaf which has been matured, and afterwards anatomised, by the alternate action of water and the atmosphere. The upper layer has its vessels in communication with the interior of the stem, while the under layer communicates only with the inner bark; the upper one maintains a connexion with the soft wood, in order to receive the sap from it, while the under one is connected with the inner bark, in order to return the sap through it to the stem and roots.

122. The two plates of vessels and cellular matter which form the disk of the leaf, are covered with a thin skin or epidermis. This epidermis, when the leaf is beginning to expand, abounds with innumerable minute cavities filled in that early stage with fluid; but ultimately, when the leaf is fully grown, these cavities become dry. In plants indigenous to moist and shady places, the epidermis is thin; but in those growing naturally in hot, dry, exposed situations, it is very hard and thick. It varies, indeed, not only with

the natural habitations of plants, but with their natures. In all, whether thick or thin, it is pierced with numerous pores, called stomata, which cannot be seen with the naked eye, but through which the leaf inhales and exhales gases, and perhaps watery matters. The stomata are generally largest and most abundant in aquatic or marsh plants, or plants adapted by nature for shady places, and which can procure at all times an ample supply of liquid food; and they are, on the contrary, fewest and least active, in warm, open, airy situations, where liquid food is less abundant. Thus it appears that the structure of a leaf being adapted to the particular situation in which the plant naturally grows, it may serve to indicate what sort of culture may be most suitable for plants of which we have previously known but little. It is evident, however, that this criterion must be of rather difficult application in practice, excepting by gardeners who are scientific botanists, and have been in the habit of using powerful microscopes.

123. There are some plants which produce no leaves, or in which the leaves are so small, and drop off so soon after they are formed as to leave no traces of them on the bark. Instances of this kind are found in the genera *Cactus*, *Epiphyllum*, *Opuntia*, *Stapelia*, and even, but in a much less degree, in some species of *Asparagus*, *Spartium*, and *Génista*. In all such cases, the functions that are in other plants, performed by the leaves, are performed in these plants by the bark. The functions of the leaves, and of the green parts of the bark, and of the plant in general, are to absorb carbonic acid, and with the aid of light and moisture, to appropriate its carbon. Carbonic acid may enter the plant by the roots, by the leaf, and by the green parts of its bark. When either of these parts is exposed to the action of the sun, the carbonic acid is decomposed, oxygen is given off, and the carbon is fixed in the leaf or bark. The escape of the oxygen may be proved by immersing a leaf in water, and exposing it to the sun. If a leaf be immersed in water in the shade, little or no air will be given off, and that little will be found to be carbonic acid gas. Plants, it has been found, decompose carbonic acid during the action of solar light on the leaves during the day, and form it again in the shade and during night; and hence, in a healthy plant, the decomposition of carbonic acid and the liberation of oxygen during the day, and the absorption of oxygen and the liberation of carbonic acid gas during the night, are perpetually going on while the plant has leaves, or is in a growing state. The healthiness of a plant, other circumstances being alike, is in proportion to the quantity of carbonic acid decomposed during the day, and this will depend on the quantity of light it receives during the same period. Plants which naturally grow in shady situations form exceptions to this general principle; probably, because the powerful action of the sun on their leaves would cause them to perspire water in too great abundance.

124. In conclusion, it may be observed, that all the matters assimilated by plants, whether of a general kind, such as carbon, or of a specific nature, such as acids and alkalis, resins, oils, &c., are effected by the action of light on the leaves; and hence, as we have said before (9), the treatment of the leaves of plants is of far greater importance than the treatment of any other part whatever.

125. The action of the leaf generally ceases when the part of the stem to which it is attached is matured, or when the fruit which is nearest to it is ripened. At that period the leaf commonly changes colour, ceases to decom-

pose carbonic acid, and yielding to the chemical influence of the oxygen of the atmosphere, it dies and drops off. Those leaves are called deciduous (69), which fall off in the autumn after the maturation of the shoots of the current year; those are called persistent (68), which remain on in a withered state till the following spring; and those evergreen (66), which remain attached and green till the following summer, or later. Some of these evergreen leaves, as for example in certain species of *Coniferæ*, remain on for several years.

126. *The flowers* of plants generally consist of the following parts:—1st, The floral envelopes consisting of the calyx or exterior covering, which is generally green; and the corolla or interior covering, which is commonly of some other colour than green; 2d, The organs of reproduction, comprising the stamens and pistil; and 3d, The germen or rudiment of the fruit and seed. In general, the calyx and the corolla are present in every flower, and also both sexes are contained in the same flower. But there are numerous exceptions; some flowers having a calyx without a corolla, as in *Atrágene*; others having the calyx coloured, so as to resemble a corolla, as in *Fúchsia* and many bulbs; many being without any floral envelopes, as in the Willow; and the sexes being, in many cases, on different plants, as in *Maclúra* and *Salisbúria*, *Populus* and *Salix*. No flower in a natural state, however, is to be found in which there is not present one or other of the sexes, excepting double flowers, which are monstrosities, and those of some hybrids, which are anomalies.

127. The floral envelopes may be considered as making the nearest approach to common leaves; and in many plants, particularly such as are in a high state of cultivation, they assume the appearance of leaves; as, for example, in some varieties of Rose. In many plants the sexes are also changed into leaves, and this is the mode in which most double flowers are produced. Occasionally both the floral envelopes and the sexes are turned into leaves, as is found occasionally in wet seasons in the flowers of the common Parsley. In the earlier stages of the progress of gardening in Britain, when few plants were introduced from foreign countries, the great object of the curious cultivator was to produce double flowers, and other monstrosities; and hence we have double-flowered varieties of most of the ornamental herbaceous plants that have been long in cultivation, and even of some trees and shrubs, such as the double-blossomed cherry, double-blossomed hawthorn, double-blossomed peach, &c.

128. The art of causing plants to produce flowers sooner than they would do naturally, is one of great importance to the cultivator. The principle on which it is founded seems to be that of causing a greater accumulation of nutritive matter in the particular part of the plant intended to produce flowers than is natural to that part; or in the case of annual plants, to concentrate the nutritive matter of the entire plant, by growing it in a dryer soil than that which is natural to it. Hence by ringing any particular branch of a tree, blossom-buds will be formed on the part of the branch above the ring, while shoots more watery than usual will be formed below it. Hence, also, by grafting a shoot from a seedling tree on the extremities of the branches of a full-grown tree of the same species, blossoms will be produced some years sooner than would have been the case had the branch remained on its parent plant. In this way new kinds of fruit, raised from seed, may be proved much sooner than if the seedling plants were left a sufficient

number of years to produce blossoms. Sometimes blossoms are produced, which from defect, or want of vigour, prove abortive; and when this is the case, by removing from the plant all the blossom-buds before they expand, for one or more years in succession, more vigorous blossoms will be produced, and the production of fruit ensured. This is the reason why on fruit trees, a defective crop is generally succeeded by an abundant one, and the contrary; and why double-blossomed trees or herbs, which yield no fruit, produce abundance of blossoms every year.

129. *The sexes* consist of the stamens and pistils, of each of which there are one or several, and often a great many in every flower. The use of the stamens is to fertilise the rudimentary seeds which are contained in the germen, or lower part of the pistillum. Fertilisation is effected by the pollen of the anther applied to the stigma on the summit of the pistillum, in consequence of which an embryo plant, or ovulum (100), is generated in the ovarium. In general the pistil of every flower is fertilised by pollen from the stamens of the same flower; but it occasionally happens in nature by the action of bees or other insects, and in gardens by the instrumentality of man, that the stigma of the flower of one species is fertilised by the pollen of the flower of another species. The conditions of success are, for the most part, that the two species should, at least, belong to the same genus, and in this case the produce is said to be a hybrid. When it is effected by two varieties of the same species, the plants produced are said to be crossbreds. The latter generally produce fertile seed, but the former only sometimes.

130. *The fruit* succeeds to the flower, the germen or base of the pistillum growing and increasing in size, after the floral envelopes and the stamens have decayed and dropped off. In some cases, the calyx is retained till the fruit is ripe, (but without increasing in size,) when the fruit is said to be inferior; as in the Apple, where the remains of the calyx form what is called the eye, in the upper part of the fruit: whereas in the Peach, and all superior fruits, only the upper part of the pistillum is seen in that position. The superior fruit adheres to the shoot on which it grows by the base of the pistillum alone, while the inferior fruit adheres to it by the base of the entire flower. For this reason inferior fruits are supposed to be less likely to drop off in consequence of frost during the blossoming season, or other adverse causes, than superior fruits; and hence, other circumstances being the same, a crop of Apples, of Pears, Quinces, Haws, Hips, Medlars, Currants, Gooseberries, Melons, and Cucumbers, ought to be more certain than a crop of Strawberries, Raspberries, Peaches, Plums, Apricots, Cherries, Grapes, or Figs.

131. So long as the fruit is green, it possesses to a certain extent the physiological action of a leaf, and decomposes carbonic acid under the influence of light; but as soon as it begins to ripen, this action ceases, and the fruit is wholly nourished by the sap elaborated by the leaves. Thus the fruit has, in common with the leaves, the power of elaborating sap, and also the power of attracting sap from the surrounding parts. Hence we see that where a number of fruits are growing together, one or more of them attract the sap or nutriment from all the rest, which in consequence drop off. As the food of the fruit is prepared by the leaves under the influence of solar light, it follows that the excellence of the fruit will depend chiefly on the excellence of the leaves; and that if the latter are not sufficiently developed, or not duly exposed to the action of the sun's rays, or placed at too great a distance from

the fruit, the latter will be diminutive in size, and imperfectly ripened, or may drop off before attaining maturity. Hence the inferiority of fruits which grow on naked branches, or even on branches where there is not a leaf close to the fruit ; as in the case of a bunch of grapes, where the leaf immediately above it has been cut off, or in that of a gooseberry, where the leaf immediately above it has been eaten by a caterpillar. Hence it is evident that the secretions formed by the fruit are principally derived from the matter elaborated in the leaf or leaves next to it, and as the sap of all the leaves is more or less abundant, according to the supply received from the roots, the excellence of fruits depends ultimately on the condition of the roots, and the condition, position, and exposition of the leaves. As a proof that the fruit has a specific influence on the matter it contains, independently of the influence of the leaves, we have only to taste the leaf of an apple or a peach, and compare it with the taste of the fruit. The sweetness of fruits under ordinary circumstances is increased by warmth and light, and acidity is increased by the opposite qualities. An abundant supply of water to plants ripening their fruits, diminishes the intensity both of sweetness and acidity, as well as of all other secretions ; and hence the advantage of withdrawing water from plants in forcing-houses, or from fruit-bearing plants generally, at the ripening season.

132. The grand object of nature in producing fruit is to nourish the seed, and there appears to be no other intention with most fruits in a wild state ; but the art of man has, by enlarging and improving fruits by culture, rendered them in a superior degree suitable for his nourishment, without in general rendering them less fit for the nourishment of the seed. As, however, in a wild state, the seeds of pulpy fruits must necessarily germinate in the decayed mass of pulp after the fruit is dropped and rotted on the surface of the ground, so in a state of high culture it has been recommended to bury the whole of the fruit, as of a peach for example, with the seed, when a young plant is intended to be produced. (*Beaton.*) As the fruit attracts its food from the stem through the fruit-stalk, so the seed attracts its nourishment from the interior part of the fruit ; and hence in all covered seeds, or what are commonly called fruits, the seed never can be separated from its envelope, without being destroyed, till it is perfectly ripe. Seeds in a young state are found to be of a mucilaginous consistency, like gum ; but as they ripen, more carbon is deposited, and the gummy mucilaginous substance assumes the condition of flour or starch, which ultimately becomes nearly as hard as wood. This is a wise provision of nature for the preservation of the seed. In the immature or mucilaginous state of the seed, heat and moisture easily decompose it, and consequently unripe seeds do not keep well ; though when seeds are sown, it is necessary, before they germinate, that their solid part should be again decomposed and made soluble. Hence well-ripened seeds are so much more easily preserved than those which are imperfectly ripened ; and hence also the reason why unripe seeds, provided only their embryo be perfected, will germinate more quickly than ripe seeds ; the starch of the ripe seed having to be again reduced to mucilage, before it can become soluble food. (*Lymburn.*) All seeds, when ripe, are dry and firm, and they retain their vitality a greater or lesser length of time according to their natures. In general oily seeds are the most perishable, and starchy seeds the most tenacious of life. There are, however, exceptions in the case of oily seeds, as in the common Cabbage, the seeds of which will retain their

vitality for ten or twelve years. Melon and Cucumber seeds, which are mucilaginous, may be kept for thirty or forty years; Kidney Beans for nearly a century; but not Scarlet Runners, which will not keep above two years; a remarkable circumstance, since the two species are so nearly allied as to be considered by some to be only varieties. The seeds of many Leguminosæ, and particularly those of warm climates, where their carbon is concentrated to the hardness even of wood, as in the Australian Acacias, will keep an unknown period; as a proof of which, all France continues to be supplied with seeds of the common Sensitive Plant from a bag which was sent to Paris, we believe, above sixty years ago. In general the younger and more vigorous the seed, the stronger will be the plant produced, and the contrary. Hence when it is wished to have plants of a vigorous-growing species, of more concentrated growth than usual, seeds weaker from being smaller and less abundantly nourished, or from being dried by long keeping, are chosen; and when very vigorous plants are desired, the largest and freshest seeds are selected. Thus in the case of plants producing their flowers in corymbs, the seed is chosen from the summit of the corymb, as the first flowers open there, which, as well as the seeds which follow them, are always the largest. In general the first-formed flowers of all plants are the strongest, and the seeds produced by them the largest and most vigorous of growth.

133. In this section there is necessarily some repetitions of facts stated in preceding parts of this chapter; but it became necessary to do so in order to connect the process of development with structure. The reader who is desirous of studying the subject more in detail is recommended to consult *Lindley's Principles of Horticulture*, and Lymburn, Beaton, and Niven, in the *Gardener's Magazine*; from which source, and our own observation and experience, this section has been chiefly compiled.

SECT. VI.—*The Geographical Distribution of Plants, and their stations and habitations, with reference to their Culture in Gardens.*

134. By the geography of a plant is to be understood the latitude and longitude in which it abounds in a wild state; by its station or "habitat," the particular soil or situation in which it is found; and by its habitation, the particular range of country to which it is limited. In a general view, the vegetation of the globe is distributed over its surface, varied according to its latitude, its inequalities of elevation, and its differences in regard to soils and moisture. The subject is of great importance to gardeners, because the culture of all plants must necessarily be more or less founded on a knowledge of the climate and station in which they are found wild. In the natural distribution of plants on the earth's surface, the different species are found only in particular situations, which they prefer to others. Some prefer exposure to the full influence of the light and air; others the shade of rocks or of trees; some grow on mountains, some in plains, some in bogs or marshes, some on the banks of rivers; some in the running water of rivers, others in the still water of lakes; some in salt marshes, and others in the sea. Each of these different localities, in any one country, is characterised by a difference in physical circumstances; such as more or less elevation above the level of the sea; a greater or less exposure to light; a soil more or less compact in texture; abounding more or less in water; or composed of particular earths. All this is independent of temperature,

which varies with the latitude and the elevation in which plants grow, and considerably also with the nature of the soil, its condition with respect to water, and its exposure and shelter. The degree of temperature required by different plants varies exceedingly—from that of the cold regions of the frigid zone, through the temperate regions of both hemispheres, to the torrid zone. For the culture of the first description of plants, a shady situation, and a soil kept constantly moist, in order that it may be kept continually cool by evaporation, constitutes the artificial or garden station; while to produce a garden station for plants of the warmer regions the various kinds of artificial climates produced in plant houses are necessary. Hence the great importance to cultivators of a knowledge of the natural stations of the plants they cultivate, as well as of the structure and functions of plants generally. It will, therefore, be useful to notice briefly the external circumstances which influence the natural distribution of plants; and these may be reduced to temperature, light, water, soil, and the atmosphere.

135. *Temperature* has by far the most important influence on the distribution of plants; because it would appear, that each species is so constituted as to thrive only within certain limits of heat and cold, and that any excess beyond these limits is injurious to it. Hence the geographical boundary of any species is restricted by the extremes of temperature which the plant will bear, and yet bring its seeds to maturity.

136. The temperature of any place depends principally upon its *latitude*, and its *elevation* above the sea. From the poles to the equator, the temperature gradually increases; and measuring from the level of the sea into the air, the heat gradually decreases, till we arrive at a point, which is to be found on the mountains of all countries, where water exists only in a state of ice or snow. Hence, in forming an estimate of the temperature of any place, the latitude of that place, and its elevation above the sea, are to be jointly considered. From actual experiment, in the neighbourhood of London, by Green the aéronaut, it has been found that when the air was 74° at the surface of the earth, at an elevation of about 3000 feet, it was 70° ; at 10,000 feet, 69° ; and at 11,293 feet, 38° . The difference in time between making the first observation and the last was about 27'. According to De Candolle, heat decreases in France at the rate of one degree of latitude for every 540 feet of altitude; so that the temperature of a place 3240 feet above the level of the sea in 45° N. lat. equals that of a place in about 51° N. lat. on a level with the sea. In the middle of the temperate zone, Humboldt found that the mean heat of the year diminished at the rate of 2° N. lat. for every 600 feet of altitude. From the powerful influence on temperature produced by elevation, arises the great variety of plants which are found between the base of a mountain and its summit; though there are a vast number of plants in all countries that will grow indifferently on plains and on mountains as high up as plants will vegetate. There are a few plants, however, that have their range of elevation and of latitude comparatively limited; as, for example, the Sweet Chestnut, the Olive, the Mulberry, and the Fig.

137. According to Humboldt, the geographical parallels of latitude do not indicate corresponding degrees of heat either in the old and new world, or in the northern and southern hemispheres. In the former, heat diminishes more rapidly as we recede from the equator; and in the latter beyond the parallel of 34° , corresponding latitudes indicate a greater degree of cold in

summer, but of warmth in winter. Hence, Humboldt arrives at this conclusion: "That the lines of equal mean heat, which may be called isothermal, are not parallel with the equator, but intersect the geographical parallels at a variable angle." The mean annual heat of the same latitudes, in the new and old worlds, are shown in the following table:—

Latitude.	Mean heat of the Year in the		Difference.
	Old World.	New World.	
0°	80°	80°	0°
20	77	77	0
30	70	67	3
40	63	54	9
50	50	38	12
60	40	24	16

Thus it is found that the old world is warmer than the new, and that the heat of America does not decrease from Florida to the Gulf of St. Lawrence in the same ratio that it does in Europe from Egypt to Scandinavia. In general, the summer temperature of North America, as far as 40° N. lat., is about 4° higher than in Europe, under the same isothermal parallel; which accounts for Magnolias, Rhododendrons, Anonas, and other trees extending so far to the north as latitude 36°, where the summer heat scarcely differs from the mean annual heat of the equator.

138. A certain degree of difference is sometimes found in the vegetation of a country according to its *longitude*; but as this is occasioned almost entirely by the nature of the face of the country, or its situation relatively to the ocean, longitude by itself cannot be considered as having any influence whatever either upon temperature or vegetation.

139. The mean heat of any situation does not enable us to judge of what particular species of plants will live there; for the mean temperature found may be deduced from such extremes of heat and cold as would suit but few plants, as in the case of certain northern regions; or it may be made up from moderate limits in which many plants will live; as, for example, from the summers and winters of Ireland, or of the sea-coast of the middle of Europe. Thus the constitution of a plant which may be very well suited to the mean temperature of a place, may not be adapted to its extreme differences. Hence many plants which will live in the open air at Belfast, would perish in the winters of Edinburgh; and many which would live there, owing to the dryness of the air, and the moderate degree of cold from the proximity of the sea, would perish in Yorkshire, where the air is not only more highly charged with moisture, but much colder. Hence the mean annual temperature of any place is of much less consequence with respect to the stations of plants, than the mean monthly temperature, and the extremes of each month. In general, "the western parts of continents are more nearly equable in their temperature throughout the year than the eastern, and the southern hemisphere than the northern; and evergreens are found to affect the former, and deciduous trees the latter description of climate." (*Henslow.*) In all those parts of the world where the sea never freezes, the temperature is higher, and much more equable than the temperature of inland situations in the same degree of latitude; and hence plants which mature their fruit or ripen their wood at Edinburgh in the open air, require protection at

Warsaw and Moscow, though these cities are nearly in the same parallel of latitude as Edinburgh.

140. Among the *physical circumstances* which affect the distribution of plants, the temperature of water merits notice. In many parts of the northern regions, water exists during great part of the year in the form of ice; and hence, as it cannot be imbibed in that state by the roots, no plants can live in such regions, excepting those lowest in the scale, such as lichens, &c.; or such annuals as flower and ripen their seeds during the summer of these regions, though it does not extend longer than two or three months. Hence barley and other corns can be ripened in the north of Sweden and Russia, where no perennial or ligneous plants, equally tender, could live throughout the year. In countries which are early in autumn covered with snow, many herbaceous plants will live through the winter that could not exist without this covering, which serves as an excellent non-conductor of heat. The bark of trees is also a bad conductor; and as the roots of trees penetrate much deeper into the soil than frost, and as a slow circulation is carried on in their trunks and branches throughout the whole winter, the sap they contain is prevented from being frozen by the heat they obtain from the subsoil. "The internal parts of large trees retain a temperature which is about equal to that of the subsoil at one-half the depth of their roots." (*Henslow.*) Whenever the sap in the vessels of a plant freezes, they become ruptured and the plant dies; and were it not for the supply of heat obtained from the subsoil by the trees, and the protection of herbaceous plants by the covering of snow, there could be neither trees nor perennial herbs in the more northern regions of our hemisphere.

141. Supposing the temperature of the subsoil and of the trees growing on the surface to be the same, then in high latitudes that temperature will be higher than the atmosphere during winter; and in low latitudes where the atmosphere is of a high temperature, that of the trees will be lower during summer; for the bark, which by its non-conducting properties retains heat in high latitudes, excludes it in low latitudes from penetrating into the wood of the tree. Von Buch found that the temperature of the subsoil is principally affected by the infiltration into it of the surface waters; and hence, in the frigid zones where the surface is in a state of ice or snow during winter, no infiltration can take place; and thus the mean heat of the subsoil in high latitudes will be higher than the mean heat of the atmosphere. In those latitudes, however, where the surface water seldom freezes, the infiltration will continue during great part of the winter, and will reduce the mean temperature of the subsoil below the mean temperature of the atmosphere. In those countries in low latitudes where rain falls during the coolest season of the year, the subsoil will be more cooled than in those places where it falls both in hot and cold weather. "Hence the mean temperature of springs throughout the central and northern parts of Europe, as far as Edinburgh, are much the same as the mean temperature of the air; whilst from the south of Europe to the tropic of Cancer, the difference is gradually increasing in favour of the atmosphere; but from the latitude of Edinburgh northwards, the difference increases in favour of the subsoil. The consequence is, that certain plants which naturally belong to the more temperate parts of our zone, are enabled to extend themselves further north and south than they could do if the mean temperature of the soil and air were everywhere the same." (*Henslow.*)

142. The temperature of the natural *stations* of plants is always such as to enable the species to continue itself by seeds ; but as, in a state of culture, plants can be propagated by various modes which do not require the production of either flowers or fruits, it follows that in any given natural station a great many plants may be cultivated by art, which could not exist there in a state of nature ; and which, if introduced by art, and not continued by the same power, would perish with the life of the individual. Hence the immense number of species, from all parts of the globe, which will grow in the open air in Great Britain, and which, if the island were to relapse into a state of barbarism, would for the most part disappear. Hence, also, by the artificial climates of our plant structures, we can grow and propagate all the plants of the world, though there are many that for want of space cannot attain their natural magnitude in such structures. The mere fact, however, of our being able to grow tropical plants in air artificially heated, shows that temperature has a greater influence on vegetation than any other element of growth.

143. The influence of *light* on the distribution of plants is very considerable. As heat and moisture are the chief agents in calling the vegetable germ into existence, so, the plant once developed, light is the grand stimulator of vitality ; causing, by its influence on buds and leaves, the absorption of the sap by the roots, and the exhalation of water and decomposition of carbonic acid by the leaves. It is probable, as Professor Henslow conjectures, that each species requires a different degree of light as well as of heat ; and though no general laws have yet been discovered on this subject, we find that succulent, resinous, or oily plants, and all plants with needle leaves, prefer situations where they can obtain much light ; while almost all evergreens, except such as are needle-leaved, prefer situations somewhat shaded. As the density of air is diminished as we ascend in the atmosphere, so the intensity of light is increased ; and it has been supposed that as high elevations correspond with high latitudes in regard to heat, they ought to correspond also in regard to light ; though this has not, as far as we know, been determined by facts. But it is clear, from what has been stated, that in any given latitude the plants which grow on plains receive less light than those on mountains ; and that the two extremes, in any country, are the sea-shore and the line of perpetual snow. The mean distribution of light is unquestionably much more equable in all latitudes than the mean distribution of temperature ; but the extremes, in its mode of distribution, are remarkably different. Plants in the northern regions generally are covered with snow more than half the year ; and those which reach above the snow, such as the trees, have perpetual sunshine for several weeks together during summer, and the absence of the sun for a similar period during winter. In all countries where snow falls, and rests on the country for some weeks or months, the mean degree of light received by herbaceous plants, such as the pasture grasses, must be considerably different from the mean light received by the same species in climates where snow is unknown ; but as in all cases in which light is so entirely excluded from plants in a natural state, vegetation is dormant, or nearly so, plants escape uninjured. From these facts, some valuable deductions may be drawn as to the light which plants require, or may dispense with, in a state of culture.

144. The influence of *water*, whether in the soil or in the atmosphere, on

the distribution of plants, if not so great as that of temperature, is in some cases more striking. In general, plants are as differently constituted in respect to water as they are in regard to temperature. The quantity of water absolutely necessary for the nourishment of a plant varies according to its tissue. Plants with large and soft leaves, with little or no pubescence, with many pores or stomata, and with the texture of the entire plant loose and spongy, require most water; and accordingly this is the description of plants which is found in marshes, and in lakes or rivers. Plants having their general texture firm and succulent, clothed with pubescence, and having few stomata, grow in dry warm stations. Trees and herbaceous plants, with roots which penetrate into the soil, require least water on the surface, and best resist extreme drought; and next to these, those that have succulent leaves and few stomata, because they evaporate but little moisture from their surface. Some plants live entirely on water, floating on its surface; and others immersed in it, and attached to the soil at the bottom of the lake or river: in some, as in river-plants, the water is constantly in a state of motion; while in lake-plants it is always at rest, except on the surface. In general, all aquatic and marsh plants require the water to be pure; but in salt marshes, salt steppes, and on the sea-shore, it is strongly impregnated with sea-salt or soda, in which only a small number of vegetables will live.

145. The influence of *soil* on the distribution of plants is universally acknowledged; though the difference in the selection of soils by plants depends much more on the condition of that soil with respect to water, than on its chemical properties. By soil, is to be understood that upper coating of the earth's surface, composed of earths or the rust of rocks, and organic matters; and the capacity of this coating for water will depend on the elevation or depression of its surface, on its texture, and on the nature and texture of the sub-soil. The relative proportions of the primitive earths do not appear to have much influence on the distribution of plants; but when a soil has any decided character, such as when it consists almost wholly of sand, of chalk, or of clay, the influence is considerable. In general, the greatest number of species are commonly found on soils having a loose sandy surface; because their seeds being blown there, or otherwise conveyed, from the plants on adjoining soils, readily take root; whereas on chalky and clayey soils, from their greater hardness, and also from their surface being generally more clothed, the seeds which fall on them do not so readily vegetate. Many of the plants which spring up in sandy districts perish for want of moisture, or are blown out by the winds; but they are nevertheless continually renewed by the seeds furnished from adjoining surfaces. Those which are indigenous to gravelly soils, much exposed, are chiefly low, compact, or trailing plants, which offer but a small surface for the wind to act on, or such as have deeply-penetrating roots. Chalky and clayey soils, on the other hand, from their firm, compact texture, are adapted only to such species as have small fibrous roots, and which do not require any great depth of soil.

146. A few plants appear to prefer the *soils formed by particular rocks*, such as limestone, chalk, granite, and slate; yet the same plants which prevail on these rocks are frequently found abounding in districts of a totally different geological character. Thus according to De Candolle, although the box in France is very common on calcareous surfaces, it is found in equal abundance on such as are schistous or granitic. The sweet chestnut grows equally well in limestone soils and clays, in the volcanic

ashes of *Ætna*, and in the sand of Calabria. The plants of *Aira*, a calcareous mountain, grow equally well on the argillaceous rocks of the Vosges, or the granitic Alps. But though the kinds of earths in which plants grow naturally, seem of no great importance, yet the presence of metallic oxides and salts, such as sulphate of iron or copper, or sulphur alone, or alum, or other similar substances in a state to be soluble in water, are found to be injurious to all plants, of which the *maremmes* of Tuscany, and some parts of Derbyshire, are examples. As a general result of the facts which have been collected relative to the influence of soil on the distribution of plants, it may be stated that the chemistry and the geology of soils have much less influence on plants than their temperature, moisture, and texture; and that it is often a very bad method of culture to imitate exactly the soil in which a plant is found growing.

147. The influence of the *atmosphere*, considered with reference to its chemical composition, and the gaseous matters which may be suspended in it, or its motion as wind on the distribution of plants, is not supposed to be great; or at all events, that influence is not yet so far understood as to be reduced to any general law. Its difference of density at different elevations, produces, as we have seen, a corresponding increase in the intensity of light, and it is also found that humidity decreases as we ascend. This last result must be attended with some effects on plants; but as the ratio of the decrease of humidity has not been determined, its effects, separated from those of temperature and light, are not sufficiently understood. De Candolle remarks, that the rarification of the atmosphere by elevation may diminish the quantity of oxygen for absorption by the leaves, and may at the same time facilitate evaporation; but the precise result of these conditions is unknown.

148. The following are the principal *stations* of plants which require to be known by the cultivator, and all of which he can imitate by art.

1. *Marine plants*, which grow in or on the surface of the sea, and which, though practicable, it has rarely been attempted to cultivate by art.

2. *Maritime districts*, as the sea-shore, where the soil is more or less impregnated with salt, which must be absorbed by the roots of plants, while those parts which are above ground must be affected by the spray and sea-breezes. Some are absolute sea-shore plants, such as *salicornia*, but others grow equally well on the sea-shore and in inland situations, as the *Eryngium campéstre* and the common Thrift.

3. *Saline steppes*, where the soil is impregnated with salt, but where the foliage is not influenced by a saline atmosphere.

4. *Aquatic plants*, or such as grow in fresh-water rivers and lakes, either immersed and rooted in the soil forming the bottom on which the water rests, or floating on the surface and sending down roots so as to touch the soil; in some cases scarcely doing so, as in *Lémna*. This kind of habitation is imitated by artificial ponds or currents, or by basins in which the surface of the water is kept in motion by jets or fountains.

5. *Marshes*, bogs, and fens, easily imitated by suitable soil kept constantly saturated with water.

6. *Meadows and pastures*, the plants inhabiting which may generally be cultivated in common soils and situations.

7. *Cultivated lands*, of which the same may be said.

8. *Rocks*, which are chiefly the habitations of cryptogamic plants, and

which, in artificial culture, require the rock or stones for some species to be kept dry, and in others to be kept moist by artificial springs of water.

9. *Sandy soils*, in inland situations, dry or moist, which are easily imitated, and in which a greater or less number of plants will grow according to the supply of water. Bulbous plants are particularly adapted for such soils, because they are driest in summer when the bulb is at rest. When dry, sandy soils are warmer than any others.

10. *Forests, copses, and hedges*, the plants of which include trees and shrubs, deciduous or evergreen, and the plants which grow in their shade. Among these are some few which grow under the constant shade of evergreen trees, as the *Pyrola* in Pine-groves, and others which require light in winter and spring, and are found growing only under deciduous trees, as the common *Scilla nutans* and many bulbs, the Cowslip, and various other plants found under the shelter of hedges. Climbing and twining plants are commonly found in stations of this description.

11. *Mountainous or Alpine regions*, the plants of which include such as grow on mountains of moderate height, which are clothed with vegetation to their summits, and are consequently subject to greater drought in summer than in winter; and those which grow on mountains, the summits of which are covered with perpetual snow, which, from its melting partially in summer, keeps the surface-soil of the mountain moister at that season than during winter. It is evident, however, that much must depend on the soil of the mountain; for a peaty or clayey soil will be kept in a state of greater moisture than one which is composed chiefly of sand, and a deep soil will retain more moisture than a thin stratum on rock. In the culture of mountain plants, therefore, the particular kind of soil in which they are found naturally, and its condition with regard to moisture, are of much greater importance than its elevation. In short, it is found that the mountain plants of the Highlands of Scotland may, with scarcely any exceptions, be cultivated with success in the botanic gardens of Edinburgh and Glasgow, which are on a level with the sea.

12. *Subterranean stations* are either dark caverns where some species of acrogens are found, or, as in the case of the truffle, the interior of the soil itself. The culture of the truffle is still a desideratum in horticulture.

13. *Living or dead trees or other plants* constitute a station. Parasitic plants, such as the Mistletoe and the Dodder, root into the stems of living trees, and their dissemination can be effected by art as well as by nature. Epiphytes or pseudo-parasites grow either upon dead or living vegetables, but without deriving any nourishment from their vital parts. Of these, we have in Britain the common Polypody, a fern found on the rough bark of old trees, especially Oaks in moist climates, as about the lakes of Cumberland and Westmoreland; and on old Pollards in many situations. There are also numerous mosses, lichens, and fungi, which live on the outer bark of old trees in temperate regions, and an immense number of Orchidaceæ which have their stations on trees in tropical climates; and the culture of which in British stoves has recently called forth an extraordinary degree of ingenuity among gardeners.

149. To these stations botanists have added some others; such as the rubbish near human dwellings, which is supposed to have an attraction for certain plants from containing nitrogen; roadsides, &c.: but with a view to culture, these and several which have been mentioned, are of no great importance.

Some stations, on the other hand, are absolute ; such as maritime, marine, aquatic, marsh, subterranean, and parasitic, and cannot be dispensed with in our attempts at cultivation.

150. "*The habitations of plants*" is an expression used to denote the range of country throughout which any particular species is found distributed ; the stations being those soils or situations in that country in which alone, or chiefly, the plant is found. (134). For example, a plant may be an inhabitant of mountains, and its station on these mountains may be a peat-bog. The habitations of plants are much less certain than their stations ; for the limits in latitude and longitude within which plants occur, have little relation to those in which, judging from the stations and climate in which they are found, they might extend themselves. Thus we have certain species growing in a particular station and temperature in the northern hemisphere, which are not to be found in stations and temperatures of exactly the same kind in the southern hemispheres. On the other hand, there are some species, such as certain grasses, which are found extensively distributed on both hemispheres ; while some few plants, such as the *Strelitzia*, have their habitations so limited as to be found only in one or two stations of very confined extent. Plants of this kind are called solitary, while those which grow in immense masses are said to be social. Those which have been long in cultivation are said to be domesticated ; but this term is not applied to such plants as have been introduced into gardens without undergoing any change in their habits there.

CHAPTER II.

SOILS CONSIDERED WITH REFERENCE TO HORTICULTURE.

151. IN the last section of the preceding chapter we have seen, that though plants are less absolute in the choice of soils than of climates, yet that in the cultivation of plants, soils are much more under our influence than any other element of culture. The term soil is applied to that thin stratum on the surface of the ground which is occupied by the roots of the smaller herbaceous vegetables ; on uncultivated surfaces it varies in depth with the nature of the soil and the plants growing on it ; but on lands in cultivation, the soil extends to the depth usually penetrated by the implements of culture. The principal materials of which soils are composed, are earths formed of the debris of different kinds of rocks, combined with organic matter derived from decomposed vegetables or animals. Earths without organic matter will only support plants of the lowest grade, such as lichens and mosses ; and where soils are found supporting the higher classes of plants, endogens and exogens, their vigour will generally be found to be greater or less according to the proportion of organic matter which the soil contains. This organic matter, when supplied by art, is called manure, and constitutes the food of plants ; while the soil may be compared to a stomach, in which that food is digested. The subject of manures will be most conveniently treated in our next chapter. Here we shall confine ourselves to the consideration of soils, and treat, first, of their origin and kinds, and secondly, of their improvement.

SECT. I.—*Origin and Kinds of Soils.*

152. The earthy part of all soils must necessarily have been derived from the debris of rocks, and the organic part from the intermixture of decayed vegetable or animal matter. The earthy mass so produced varies in colour, but, from containing humus and mould, (161) it is always darker in a greater or less degree than subsoils, which in general are without organic matter. Soils also contain mineral salts and metallic oxides, some of which are beneficial, others harmless, and some few injurious, to plants. The chemical constitution of a soil can only be known by analysis, which cannot, in general, be depended on, unless performed by professional or experienced chemists*; the mechanical state or texture of a soil is ascertained by digging up a portion of it; and its actual fitness for plants, by examining the species growing on its surface. The rock or geological formation, the earth of which forms the basis of any soil, will frequently be found to constitute the substratum on which that soil rests; but this is frequently not the case, because the earths of many soils have been held in suspension by water in a state of motion, and by that means have been transported to a great distance from the rocks of which they are the debris. From this suspension of the earths of soils in water, and their transportation to a distance, we are able to account for the circumstance of several different kinds of earths being almost always found in the same soil. Thus in alluvial deposits, on the banks of rivers, we find the earth of various rocks of the country through which the river has taken its course; and as such soils are always the most fertile, we may conclude that a mixture of various earths in a soil is to be preferred to any one kind of earth alone. From the earth of the alluvial deposits of every country being formed of the debris of the various rocks of that country, and from every country containing nearly the same kinds of rocks, hence the alluvial deposits on the banks of all the larger rivers of the world consist nearly of the same earths. But as the rocks or geological formations from which the earths of soils are washed away still remain in their places, and are of many different kinds, it follows that there must be as great a variety in the upland soils of a country as there is uniformity in those of the lowlands, and of the banks of rivers. Thus there are between twenty and thirty geological formations in England, which form the substratum or bases of soils, and each of which must consequently be more or less different in its composition.† For all practical purposes, however, soils may be characterised by their prevailing primitive earths; and hence, they are reduced to sands and gravels, clays, chalky and limestone soils, alluvial soils, and peat-bogs.

153. *Sandy Soil.*—Silica, which is the basis of sandy soils, is, perhaps, the most universal of all earths; and there is scarcely a species or variety of rock in which it does not abound more or less. Silica is found perfectly pure in rock crystal, and tolerably so in what is called silver sand, and also in the sand of some rivers and of the sea. The practical test of the earth, when tolerably pure, is, that when moistened it cannot be formed into

* At the Museum of Economic Geology, attached to the board of Woods and Forests, Craig's-court, Charing Cross, London, an analysis of a pound of soil, sent from any part of the country, will be made by Mr. Richard Phillips, one of the best analytical chemists in Europe, for a fee of about 20s.

† See *Morton on Soils*. 2d edit. 12mo. 1840.

a plastic mass, or consolidated by pressure, whether in a moist or dry state, so as to form a compact solid body. Hence all sandy soils are loose, never present a firm surface, and are never covered with a compact clothing of grass or other herbaceous plants. Such soils, from being without cohesion, are incapable of retaining moisture; and as they are readily permeable by both moisture and air, they powerfully promote the putrefaction of organic matter, whilst they as readily permit it to be washed away from them by rains, or to escape in the form of gas. Hence, in manuring sandy soils no more should be applied at once than what can be consumed by the crop of the current year; and hence, also, they should be cultivated to a greater depth than other soils, in order that there may be a greater mass of material for retaining moisture. One great advantage of a sandy soil over all others is its natural warmth. This arises from its greater looseness and porosity, in consequence of which the atmosphere penetrates into it more rapidly, and to a greater depth, than in the case of any other soil. Hence, in the absence of sunshine, a sandy soil will be raised to the temperature of the atmosphere, to the depth of several inches, by the mere penetration of the air among its particles; while a firm compact soil, the earthy basis of which is clay or chalk, could not be heated to the same depth without the direct influence of the sun's rays. Sandy soils are also more easily penetrated by water than any others, and hence they are sooner raised or lowered to the temperature of the rains which fall on them than a clayey or calcareous soil. As the water never rests on sandy soils, they are never cooled down by evaporation; the reverse of which is the case with clayey and calcareous surfaces. Sandy soils being much less cohesive than soils in which clay or lime prevails, they are much more easily laboured; and being always loose and friable on the surface, they are better adapted for the germination of seeds. Sandy soils may be made to approach alluvial soils by the addition of clay and calcareous earth, either taken from clayey or calcareous surfaces, or from subsoils in which these earths abound; but the former source is greatly preferable, from the earths being already in combination with organic matter.

154. Whatever has been said of sandy soils is applicable to gravelly soils; in some particulars in a greater, and in some in a lesser degree. The small stones of which the greater part of gravel consists, being better conductors of heat than the particles of sand, it follows that gravels are both easier heated and easier cooled than sands; they are also more readily penetrated by rain, and more readily dried by filtration and evaporation. Like sands, they are improved by the addition of clay and chalk, or by alluvial soil; and they require also to be cultivated to a greater depth than clays or chalks. A gravelly soil isolated so as not to be supplied with water from higher grounds, is of all others the most suitable for a suburban villa (*Sub. Arch. and Landscape Gard.* p. 16); and therefore, though not so suitable for a kitchen-garden as a sandy or loamy soil, yet as a sufficient portion of soil, whatever may be its earths, may always be improved so as to render it fit for the cultivation of vegetables, a gravelly or sandy soil for building on should never be rejected.

155. *Clayey Soil.*—Alumina, which is the basis of clayey soil, is the most frequent of earths next to sand. It is found nearly pure in the ruby and sapphire; tolerably so in the blue or London clay, but more so in the white plastic clay, which is found between the London clay and the upper chalk, and which is used for making tobacco-pipes. This soil relatively to water is the very reverse of sand; for while in nature, sand and water are never found

chemically combined, in clay they are never found chemically separate. Hence, though clay when prepared by the chemist, and kept apart from water, appears as a light dry powder, scarcely different to the eye from pure sand or pure lime, yet in soils it forms an adhesive mass, the particles of which cannot be permanently separated excepting by burning to expel the water held in fixation. When clay is burnt and reduced to powder, it becomes for all practical purposes sand, and in that state it may be employed to great advantage for reducing the cohesive properties of stiff clay. Relatively to heat, clays do not admit the atmosphere between their particles, and an unimproved clayey soil is generally a cold one—partly because the heat penetrates with difficulty into it, and partly from the evaporation which during great part of the year is going on from its moist surface. The obvious improvement of clays is by the addition of sand or gravel; and when the clay does not contain lime, by the addition of that material, either in a caustic or mild state, or as chalk.

156. *Lime*, or the basis of chalk and limestone rock, is much less common as a soil than either clay or sand; though there are scarcely any soils which are naturally fertile that are absolutely without it. Lime is found in a state of carbonate in white or statuary marble, and more or less so in chalk-rock; and in some limestone-rocks. Lime is never found pure in a state of nature, but always combined with carbonic acid and water, which are driven off from it by burning, leaving the earth in the caustic state called quicklime. In this state lime rapidly reabsorbs water and carbonic acid from the atmosphere, or from any other material which comes in contact with it containing these elements. Hence its use in a caustic state in promoting the putrefaction of imperfectly decomposed organic matter in soils, and in attracting carbonic acid and moisture from the atmosphere. Relatively to the retention of water, a limey or chalky soil may be considered as intermediate between a sandy and a clayey soil, without becoming so tenacious as clay on the one hand, or parting with water so readily as sand on the other. Hence the use of lime or chalk in reducing the tenacity of stiff clays, and increasing the absorbent powers of sandy soils, and improving their texture. A calcareous soil is improved by sand and clay, especially if laid on in sufficient quantity to destroy the tenacity and compactness of its texture.

157. *Magnesia*, for all practical purposes, may be considered as lime; it is not very common in soils, and though it is said to be inimical to vegetation under some circumstances, yet this appears very doubtful.

158. The *iron* of soils is mostly found in a state of rust, or oxide. There is scarcely any soil without it; but it is never very abundant in soils naturally fertile. In a dry state the oxide of iron is insoluble in water, and not injurious to vegetation; but when in consequence of saline substances in the soil, or applied to it, a salt of iron is produced, the iron becomes soluble in water, is taken up by the roots of plants, and is very injurious to them. Iron in this state is termed hydrate, and its evil effects are to be counteracted by caustic lime, with which it forms an insoluble compound.

159. *Alluvial soils* have been already described as composed of very fine particles of the debris of several kinds of rocks, which have been held in suspension by water, and deposited in plains, or along the banks of rivers, along with organic matter also held in suspension. The earthy character of this soil must necessarily always partake of the character of the rocks of the country in which it is found.

160. *Peat* or *bog* is composed of partially decayed vegetable matter, soft, light, and spongy to the touch; and the very reverse of sand with respect to water, holding that element like a sponge, so as, in its natural state, to be totally unfit for the growth of vegetables, except those of the lowest grade.

161. The *organic matter* in soils in its solid state may be considered as carbon, which is found pure in the diamond, and tolerably so in the charcoal of wood. In soils it is found in various states of decomposition, from recent woody fibre to humus, which is woody fibre in a state of decay. The proportion of organic matter varies exceedingly in different soils. In barren sands there is scarcely a trace of it, while in fertile soils it varies from 10 to 30 per cent.; and peat-bogs which have been drained and cultivated contain often 80 or 90 per cent. Humus, according to Professor Liebig, exercises its influence on vegetation "by being a continued source of carbonic acid, which it emits slowly. An atmosphere of carbonic acid, formed at the expense of the oxygen of the air, surrounds every particle of decaying humus. The cultivation of land, by stirring and loosening the soil, causes a free and unobstructed access of air. An atmosphere of carbonic acid is, therefore, contained in every fertile soil, and is the first and most important food for the young plants which grow in it. The property of *humus*, or woody fibre, to convert surrounding oxygen gas into carbonic acid, diminishes in proportion as its decay advances; and at last a certain quantity of a brown coaly-looking substance remains, in which this property is entirely wanting. This substance is called mould (152); it is the product of the complete decay of woody fibre, and constitutes the principal part of brown coal and peat." (*Organic Chemistry*, p. 47.)

For practical purposes, all the soils ordinarily met with may be reduced to the following:—

162. *Loose naked sands or gravels*, without either clay or calcareous matter, and almost destitute of vegetation on the surface; exemplified on some parts of the sea-shore, and in Hounslow and other extensive heaths.

163. *Calcareous soils or gravels*, containing little or no clay or organic matter, and almost without vegetation on the surface; found on the sea-shore in some places, and on the surface of chalky districts.

164. *Loams*.—Rich sandy loams consist of sand, clay, and more or less of calcareous soil, with organic matter; they never become hard on the surface after rains followed by drought, and never retain water to such an extent as to prove injurious to vegetation. Vegetation commences some weeks earlier in sandy loams than in clayey loams, in the same climate, or even in the same garden; and during summer plants on such soils will be in advance of those on clays; so much so, as Mr. Lymburn has observed, as to attain maturity a month earlier. Clayey loams consist of clay with a proportion of sand and organic matter; they produce large crops, but become hard and baked on the surface after heavy rains followed by drought. Stiff adhesive clays contain in their composition little or no sand or lime, and are almost without organic matter. All clayey loams are later than sandy loams.

165. *Loams are the best soils*, and are characterized according to the earths which prevail in them, as a sandy loam, &c.; according to their degree of friability, as a free loam, a stiff loam, &c.; or according to both, as a free calcareous loam, &c. These soils, with reference to geology, are generally found on the sides of valleys, along the bases of hills or mountains, or

on the banks of upland rivers. Mechanically, they are of a texture easily penetrated by all the implements of culture, and not liable to become hard on the surface, and crack after heavy rains followed by drought; chemically, they contain clay, sand, calcareous matter, and humus; and with reference to vegetation, produce abundant crops in all ordinary seasons, with moderate supplies of manure.

166. In general, much more depends on the *texture* of a soil and its capacity for retaining or parting with water and heat, than on its chemical composition. Soils have been found consisting chiefly of clay, others chiefly of calcareous earths; some, in America, without calcareous earths; and all producing good crops for a series of years. Nevertheless, it has been found that no soil will remain fertile for many years that does not contain lime in some form naturally, or is not liberally supplied with manure containing animal matter, one ingredient of which is lime in a state of phosphate or sulphate.

167. *Subsoils*.—Next in importance to the texture of a soil, is the nature of the subsoil or substratum on which it rests; because on the texture and other circumstances of this subsoil depends, in a great measure, the capacity of the surface-soil for retaining or parting with water or heat. The worst subsoils are those of clay kept moist by subterraneous water; and the best, those of clay resting on gravel or porous rock; because these retain a useful degree of moisture, and admit of increasing the surface-soil to any depth which may be required for culture. Sandy and gravelly subsoils, with but a thin coating of surface-soil over them, are not sufficiently retentive of moisture; and chalky subsoils are generally cold.

168. *The surface of soils* has, perhaps, as powerful an influence on their natural fertility as the subsoil; because on the inclination of the surface depends, in a considerable degree, the moisture retained by the soil, and consequently its fitness for the growth of plants. Too steep a slope throws off the rain with too great rapidity, and thus deprives the soil of a sufficient supply of water during dry seasons; while a flat surface will retard its drainage and occasion loss of heat by evaporation. The colour of the surface of a soil exercises some influence on its heat. A dark-coloured soil will be sooner heated by the rays of the sun than a light-coloured soil; but it will also part with its heat more rapidly when the sun does not shine. A white soil, such as we sometimes find on chalky or marly subsoils, is the longest of all soils in being warmed, because by all white surfaces the rays of light and heat are reflected, while by all black surfaces they are absorbed. Hence, taking into consideration colour, texture, and aspect, a dark sandy soil, on a surface exposed to the south or south-east, must be the warmest of all soils; and a moist white clay of compact texture, similarly exposed, the coolest. It may be thought that such a soil would be colder on a surface exposed to the north than on a southern exposure; and this will be the case when the soil is in a dry state, but not when it is supplied with moisture from the subsoil; because, in the latter case, the cold, produced by evaporation, is great in proportion to the warmth of the atmosphere. The aspect is not only of importance with reference to the influence of the sun in warming or cooling the soil, but also as to its effects in maturing the produce which grows on it.

169. *The plants which grow on a soil* are the surest indications, to a practical botanist and cultivator, of the actual state of that soil with reference to culture; though they do not always indicate the improvement of which the

soil is susceptible. Marshy soils are indicated with considerable certainty both by herbaceous and ligneous plants, and also very dry soils; but the earths of fertile soils cannot be so readily inferred from the plants growing on them. Thus thorn-hedges will be found growing vigorously alike on clays, sands, and chalks; though never on these soils, or on any other, when they are either very dry, or saturated with water. Some few plants, when found in their native stations in considerable quantities, may be considered absolute in respect to the earths of the soil in which they grow; such as the *Tussilâgo Fârfara*, which always indicates clayey soil; *Clématis Vitálba*, calcareous soil; *Arenâria rùbra*, sandy soil; *Rùmex Acetòsa*, ferruginous soil; *Vaccínium uliginòsum*, peaty soil; *Salicòrnia herbàcea*, saline soil; *Cáltha palústris*, marshy soil, &c. :—but by far the greater number of plants only indicate the state of a soil relatively to water and organic matter. In short, nature may be said to have only three kinds of soil relatively to plants; the dry, the moist, and the fertile.

SECT. II.—*The Improvement of Soils, with a View to Horticulture.*

170. Having seen, in the preceding section, that the permanent fertility of a soil depends mainly on its condition relatively to water and heat, it follows that the improvement of soils must be principally directed to increase their capacity for absorbing and retaining these elements in the degree most suitable for vegetation. The principal operations for this purpose are: draining, to withdraw superfluous water from soils; and mixture and pulverization for improving their texture, in order to admit more readily the moisture and the heat of the atmosphere.

171. *Draining* is the principal means for altering the condition of a soil with reference to water. Soils are affected by rains from above and springs from below; and the former are carried off by open gutters, and the latter by covered channels. All draining is founded on the well-known hydrostatic law by which all fluids have a constant tendency to arrange themselves in a horizontal position. Hence, to carry off water, either from a surface or a subsoil, it is only necessary to form channels above or under ground in an inclined position. The kind of drains, and the number employed in any given case, will depend on the texture of the soil and the inclination of the surface. Flat surfaces and retentive clays require the greatest number of drains, and inclined surfaces and porous soils the smallest number. There are very few soils that may not be improved by draining; and it is almost unnecessary to observe, that, where draining is requisite and not performed, the application of other modes of improvement will be made in vain.

172. *Altering the texture and composition of soil* by the addition of other soils is the improvement next in importance to that of draining, and requires only to be mentioned to be understood. Too sandy soils will be improved by the addition of clay, and the contrary; and both clay and sand by the addition of lime; because without alkaline matter no soil can be permanently fertile. Though on a large scale the expense of this kind of improvement is too great to be generally adopted, yet in the case of the grounds of small country residences it is practicable at a moderate expense. To ascertain the proportion of one soil that must be added to any other soil so as to perfect its texture, can only be determined by experiment. The first thing to fix on is the depth to which the soil is to be cultivated. In kitchen gardens

this may be between two and three feet ; but in pleasure-grounds, where the surface is to be chiefly in grass, nine inches or one foot in depth will suffice. " It is astonishing," Mr. Rham observes, " how small a portion of pure alumina will consolidate a loose sand, and convert it into a good loam, the parts of which, when moistened, will adhere and form a clod in drying." (*Jour. Ag. Soc.* vol. ii. p. 51.) If we take an extreme case, and suppose that any given soil is so sandy as to require the addition of one sixth its bulk of clay, or so clayey as to require one sixth its bulk of sand, then, in the case of kitchen gardens where the soil is three feet deep, every square foot of the clayey surface will require the addition of half a cubic foot of sand ; and in the case of a lawn where the soil is a foot in depth, every square foot of sand will require the sixth of a cubic foot of clay. To cover a statute acre with soil to the depth of one inch requires 121 cubic yards. Hence to add two inches to the soil of a garden of one acre, exclusive of the space occupied by the walks, would require 242 cubic yards or cart-loads, which, at 2*s.* each, amount to 24*l.* 4*s.* The cost, however, will depend chiefly on the distance from which the soil is to be brought. A case is mentioned in the *Journal of the Agricultural Society of England*, vol. ii. p. 67, in which a white sand varying in depth from one to four feet, and so barren that it never had been cultivated to profit, had the surface improved to the usual depth penetrated by the plough (nine to twelve inches), by laying on clay at the rate of 150 cubic yards to the acre. The clay being dug from the subsoil, the expense was not more than 5*l.* 10*s.* per acre. It frequently happens that a sandy or gravelly soil is incumbent on a bed of clay, and the contrary ; in either of which cases the supply of the required soil may be obtained by digging pits, or sometimes even by deep trenching. The earth thus obtained will generally be without organic matter, but that can be supplied afterwards by manuring. Where the soil required for the improvement of another soil can be obtained in the state of surface soil, the effects produced will be more immediate from the organic matter which such soil contains ; but even when it is obtained from the subsoil, the change in the condition of the soil to which the new soil is applied will soon be rendered obvious ; though not so much the first year, as it will be in two or three years afterwards, when the amalgamation of the two soils is more complete. Much of the effect of adding one soil to another will depend on their intimate mixture ; and this can be best effected by repeated trenchings or diggings in dry weather, when both soils are as nearly as possible in a state of dry powder. This point is of great importance, particularly when the soils mixed together contain a good deal of organic matter, because if a very intimate mixture of both soils is not effected, they will, from the difference in their specific gravities, in a few years separate into two different strata. There is, indeed, a constant tendency to do this in all soils under culture, and more especially in all such as have been improved by admixture. This takes place in consequence of the softening of the soil by rains, by which the particles are in a manner held for a time in suspension, and the heaviest gradually take a lower place than those which are lighter. Hence the necessity of digging or trenching such soils occasionally to the depth to which they have originally been improved. This is required even in artificial soils laid down in grass ; for supposing a clayey soil to have received a considerable admixture of lime or chalk, and sand, with rotted stable dung, and the whole to have been incorporated in a state of fallow, and afterwards sown with grass seeds,

then in seven years the black matter or mould remaining of the dung will be found among the roots of the grass at the surface, the sand in a stratum three or four inches below the surface, and the lime at the bottom of the artificial soil. By placing the same mixture in a flower-pot, and watering it frequently during a year, the pot being plunged in the soil, the same result will take place sooner, and be more conspicuous. If the pot be kept constantly immersed in water to within an inch of the brim, the result will take place in the course of a few days. These facts ought to be kept constantly in mind by whoever would improve soils by admixture; if they are not, disappointment is very likely to ensue. When soils mixed together are comparatively without organic matter, and when the particles of which they are composed are very small, the mixture becomes more intimate; the particles of the one soil filling up the interstices among the particles of the other, and the amalgamation as it may be termed is then so complete that the earths will never afterwards separate. In this way pure sands may be improved by the admixture of pure clays, or by marls or chalks. The words pure and amalgamate are here used, not in a chemical, but in a popular sense.

173. *Changing the inclination of the surface of soils* is a mode of improvement that may frequently be adopted on a small scale, by arranging a steep slope into narrow terraces, and a broad slope into level platforms. The former mode has been practised from time immemorial in the Land of Canaan, and in other countries of the East, and the latter is common in France and Italy, in order to admit of surface irrigation without waste of water. By this last mode, a field or garden is arranged into different platforms, which may either be on the same or on different levels. In the former case, the water is let into one platform after another; or, if there is an abundant supply, into several at the same time; in the latter case the supply of water is conducted to the highest platform, which is first watered, and the others follow in the order of their elevation. Arrangements of this kind are not so important in British gardens as they are in those of warmer climates; but still they might in many cases be advantageously introduced with a view to watering summer crops.

174. *Burning of soils* has been resorted to as a means of altering their texture, destroying injurious substances, and changing or forming others which may act as a manure. Burning is useless on siliceous sands containing little or no vegetable matter; but on all soils containing chalk, lime, or clay, it may be practised with advantage. By burning calcareous or chalky soils, the same effect is produced as if quicklime had been procured and added to the soil; and by burning clayey soils the same result is obtained as if sand had been procured and mixed with them. The effect of burning clay is totally different from that of burning sand or lime. On sands and gravels burning can have no effect, except that in some cases it renders the particles smaller. Burning lime drives off the carbonic acid and the water, and renders the lime caustic and well adapted for decomposing organic matter; but the lime has no sooner lost its water than it begins to attract it again, and after a certain period will be found in the same state of combination with water and carbonic acid as it was before. Clay, on the other hand, when once the water is driven off by burning, will never regain it, but remains for ever afterwards in a state which, with reference to its mechanical effect on a soil, is exactly the same as that of sand. This is a fact, the great importance of

which in the improvement of clayey soils, and indeed of all soils which are of too compact a texture, is not duly appreciated. It is evident that, by means of draining and burning, any clayey soil may have its texture as much improved as can be desired; and though the expense of this may, in many cases, be too great for application on an extensive scale, yet it may always be adopted in kitchen gardens; and often over the entire surface of the grounds of small villas. It is indeed only by this kind of improvement that the heavy clayey soils of many of the small villas in the neighbourhood of London can be at all rendered comfortable to walk on after rains in summer, and throughout the whole of the other seasons; or suitable and agreeable for the cultivation of culinary vegetables and flowers. Clayey soils often contain iron, and the operation of burning them, by forming an insoluble compound of iron and alumina, lessens the risk of the iron ever becoming noxious to the plants. Burning also destroys the inert vegetable fibre; and thus it at once produces ashes containing vegetable alkali, and supplies the soil with a portion of humus; without both of which, according to Liebig, no soil can bring plants to maturity. Where a strong clayey soil is covered with a healthy vegetation, as of pasture or wood, it may not be desirable to burn the surface soil, on account of the quantity of organic matter which it contains; but it may still be very desirable to burn such a portion of the clayey subsoil as may be sufficient, when reduced to a sandy powder, to render the surface soil of a proper texture. In this case the surface soil should be removed to the depth to which it has been cultivated, and a portion of that below taken up in lumps, and dried and burned. The burning is performed on the spot by the aid of faggot-wood, or any description of cheap fuel. The burned lumps being reduced to a powder, and scattered equally over the soil when also in a dry and powdery state, the whole should then be intimately mixed together by repeated diggings and trenchings. As an example of the strong clayey soil of a garden having been improved by burning, we may refer to that of Willersley Castle, near Matlock, which the gardener there, Mr. Stafford, has rendered equal in friability and fertility to any garden soil in the country. "When I first came to this place," says Mr. Stafford, "the garden was for the most part a strong clay, and within nine inches of the surface; even the most common article would not live upon it; no weather appeared to suit it—at one time being covered by water, at another time rendered impenetrable by being too dry. Having previously witnessed the good effects of burning clods, I commenced the process, and produced in a few days a composition three feet deep, and equal, if not superior, to any soil in the country." (*Hort. Reg.* vol. i. p. 210.) The success was here greater than can be expected in every case, because the clay contained a large proportion of calcareous matter.

175. *Pulverizing soils* comes next in the order of improvement, and is effected by trenching, digging, and other modes of reversing the surface and mixing and transposing all the different parts. By changing the surface, fresh soil is exposed to the action of the weather; by changing the position of all the parts, new facilities for chemical changes are produced; and by loosening the whole mass of the soil, air and rain are more readily admitted, and greater freedom is given to the growth of the roots. By loosening soil the air is admitted among its particles and confined there, and hence it becomes a non-conductor of heat, and is consequently warmer in winter and cooler in summer than if it were in one firm mass. By the con-

finement of air in the soil, the heat imparted to it by the sun during the day is retained, and accumulates in all free open soils to such a degree as sensibly to raise their temperature over that of the air, especially during night. From thermometrical observations made at different places, it appears that the mean temperature of the soil, at about one foot below the surface, is somewhat higher naturally than the mean temperature of the atmosphere on the same spot; and hence we may reasonably suppose that, by draining and pulverization, the temperature of the soil may be permanently increased as well as that of the atmosphere. From experiments made by Mr. Thompson, in the garden of the Horticultural Society of London, it appears, that "in the valley of the Thames, the maximum mean of terrestrial temperature, at one foot below the surface, has been found to be 64.81° in July, which is the hottest month in the year: but that the greatest difference between the mean temperature of the earth and atmosphere is in the month of October, when it amounted, in the two years during which the observations were made, to between three and four degrees; and that, in general, the mean temperature of the earth, a foot below the surface, is at least one degree, and more commonly a degree and a half, above the mean of the atmosphere. In these cases, if the terrestrial temperatures be compared with those of the atmosphere, it will be found that in the spring, when vegetation is first generally set in motion, the temperature of the earth not only rises monthly, but retains a mean temperature higher than that of the atmosphere by from one to two degrees; and that in the autumn, when woody and perennial plants require that their tissue should be solidified and their secretions condensed, in order to meet the approach of inclement weather, the terrestrial temperature remains higher in proportion than that of the atmosphere, the earth parting with its heat very slowly." (*Lindley's Theory of Hort.*, p. 97.) In hot countries the sun often heats the soil to such a degree as to be injurious to the roots of cultivated plants, and pulverization is there resorted to to diminish the force of its rays, which, as it is well known, are less effective on a porous and spongy than on a solid substance. This, as Chaptal informs us, is one of the uses of pulverization even in the south of France.

176. The free admission of atmospheric air to soil is also necessary for the decomposition of humus, or organic matter, by which carbonic acid is formed; and atmospheric air is also a great source of nitrogen, which has been lately found in all plants (104), and more especially in the spongioles of the roots. The soil also, when loosened, becomes a rapid conductor of water; and, supposing the texture of the soil to be suitable for culture, it will retain a sufficient quantity of moisture for the purpose of vegetation, and allow the escape of what is superfluous by filtration into the subsoil, or into the underground drains which have been formed as a substitute for a porous substratum. The mere act of pulverising any soil has a tendency to improve its texture, more especially if the operation be frequently repeated. In summer, by exposure of a soil to the air, the particles are separated by the evaporation of the water in their interstices by heat; and by exposing a soil to the frosts of winter, the particles are separated by the expansion of the water in the form of ice. Clayey soils containing iron are in an especial manner improved by exposure to the atmosphere; the iron being still farther oxidised, and thus acting like sand in separating the particles, as well as being less likely to be rendered soluble by the addition of saline matters.

177. Soils are improved by the modes in which they are cultivated ; as for example, by the order in which crops are made to succeed each other, by fallowing, by resting, and by the manner in which water is applied to growing crops ; but these subjects will come under notice when we are treating of the practice of Horticulture.

CHAPTER III.

MANURES CONSIDERED WITH REFERENCE TO HORTICULTURE.

178. THE improvement of the composition and the texture of a soil, and of its condition with reference to water and heat, will have but little effect on the plants cultivated in it, without the addition of manure ; for this article, it must be borne in mind, is the food of plants, while the soil is only the stomach, or laboratory, in which that food is digested and rendered fit for being taken up by the spongioles of the roots. In order to determine what substances are suitable for becoming manures, it is useful to know what are the constituent elements of plants. Of these we shall find that some elements are common to all plants whatever, such as carbon with oxygen and hydrogen in the proper relative proportions for forming water, and nitrogen ; while some elements are only found in particular plants, such as certain salts, earths, and metallic oxides. Every plant, therefore, may be said to have its general or common food, and its specific or particular food ; and hence, in this point of view, manures may be classed as common and specific. The most perfect manure for any plant would therefore seem to be, that plant itself in a state of decomposition ; but as the purpose for which plants are cultivated is to supply food, clothing, and various constructions and contrivances, for animals, hence, in a state of civilisation, it is among these, and from animals themselves, that we must seek for the most suitable manure for plants. The various substances which have been used for manures may be classed, with reference to their effect on plants, as general and specific ; and with reference to the soil, as improving, enriching, and stimulating. Improving manures are such as, while they afford positive nourishment or stimulus, add some permanent matter to the soil ; such as lime, chalk, marl, bones, &c. Enriching manures are such as supply only nourishment to plants ; such as stable manure, and every description of organic matter ; and stimulating manures are such as serve to aid in the decomposition of, or otherwise operate on, the organic matter. As some manures, however, partake in an equal degree of more than one of these properties, such as lime, which is both a stimulating and improving manure, the most convenient arrangement of manures will be organic, inorganic, and mixed.

SECT. I.—*Organic Manures.*

179. *Organic manures* must obviously be either of animal or vegetable origin. Purely vegetable manure is exemplified in leaf-mould, malt-dust, rape-cake, spent tanner's bark, some kinds of peat, and green vegetables when they are buried in the soil in a living state.

180. Leaf-mould is perhaps the most universal manure for garden plants, because, when thoroughly decomposed, the most tender kinds will live in it,

and all the more vigorous-growing vegetables will grow in it most luxuriantly. Hence, mixed with fine sand, leaf-mould is used as a substitute for heath-soil, for growing many of the Cape and Australian shrubs; and alone, or mixed with common garden soil, it is used for growing melons and pine-apples.

181. *Fresh and tender vegetables* dug into the soil, produce an immediate effect, from the facility with which they undergo fermentation, and thus supply soluble matter for the spongioles. Sea-weed is still more readily decomposed than recent land or garden plants, in consequence of the mineral alkali which it contains; and hence this manure is stimulating as well as enriching. Malt-dust is valuable for the saccharine matter which it contains, and rape-cake for its albumen and oil; but these manures are only occasionally to be met with. Straw, haulm, and in general all the stems and leaves of herbaceous plants, and the shoots with their leaves on of trees and shrubs, form valuable manure when decayed; more especially, if from the saccharine matter which they contain, or the addition of stable manure or of animal matter, they can be made to heat and promote fermentation. Nevertheless, without fermentation, they form useful garden manures; or moulds, which, like leaf-mould, may often be substituted for heath-soil.

182. The least valuable truly vegetable manure is *spent tanner's bark*, which, consisting entirely of woody fibre impregnated with tannin, not only contains no soluble matter, but the tannin, in as far as it can be taken up by the spongioles, seems to prove injurious. Nevertheless, as every addition of organic matter to a soil must ultimately increase its fertility, spent tanner's bark may be used with a view to distant effects; and in stiff soils its mechanical action will be immediate, by rendering such soils for a time more open. From the porosity and lightness of this material, it is an excellent non-conductor of heat; and hence, when laid on the surface of the ground as a covering to the roots of tender plants, it protects them better from the frost than a more compact covering, such as coarse sand, or than coverings which are great absorbents of moisture, such as leaves or half-rotten litter, or any other covering of this kind which does not act as thatch. Rotten tan, however, being peculiarly favourable to the growth of fungi, should be used with great caution when applied about young trees, and more especially Coniferæ.

183. *Peat soil* is of two kinds, that formed in peat bogs by the growth of mosses, and that found in valleys, or other low tracts of country, which, being formed of overthrown and buried forests, consists of decayed wood. The latter being the remains of a much higher class of plants than the former, must contain a greater variety of the constituent elements of plants, and must consequently be a better manure. Peat from bogs cannot be used till it has been reduced, either by time or fermentation, to a fine mould or a saponaceous mass; the former result is obtained by exposure to the air, and repeated turnings during several years, and the latter by fermentation with stable dung. A load of this material, mixed with two loads of partially dried peat, will commence the putrefactive process, in the same manner as yeast commences fermentation in dough; and, in the one case as in the other, additions may be made by degrees of any quantity, so that two loads of stable-dung may be made to produce twenty, a hundred, or in short an unlimited number of loads of fermented peat. The peat of decayed wood is commonly reduced to mould by exposure and turning, and then applied to the soil, with or without lime. Both kinds of peat are frequently burned for the sake of their ashes.

The ashes of the peat of wood are always found richer in alkaline matters than those of the peat of moss, and on this account they form an article of commerce in the neighbourhood of Newbury in Berkshire, and in Holland.

184. The *principal vegetable manures* which are formed in suburban villas are, the mould of collected leaves swept up in autumn, and in all seasons when they fall; the mould of grass mown from lawns, and either rotted by itself, or on dung-casings to pits; and the mould from the common vegetable rubbish heap; that is from a heap on which all decaying or refuse vegetable matters are thrown as taken from the garden, and sometimes, also, including the leaves of trees and short grass. This heap is, or should be, placed in the reserve ground of all gardens. The grass mown from lawns, however, is most economically added to casings of dung to aid in producing heat by fermentation, as it is laid on dug surfaces round the roots of plants during summer to retain moisture. The leaves also are generally best kept by themselves, for the purpose of decaying into leaf-mould. In whatever way these vegetable materials are made use of, the gardener ought to have a vigilant eye to see that none of them are lost.

185. *Animal manures* require much less preparation than those derived from plants, from their greater tendency to the putrefactive process. The kinds of animal manures are chiefly excrement; urine; coverings of animals, such as hair, wool, feathers; entrails of animals, such as blubber, the contents of the abdomen of fish; entire animals, such as fish, vermin; parts of animals, such as hair, bones, &c.; or articles manufactured from parts of animals, such as woollen rags, old leather; or any article manufactured from skins, hair, wool, feathers, horn, bone, &c. Of all these manures by far the most valuable is nightsoil, next urine, and thirdly bones. The different excrements and urines of animals rank in value according to the kind of food with which the animal is nourished, and within this limit according to its grade; and hence the most valuable animal manure is that of man, the next that of horses as abounding with ammonia and nitrogen. The manure of the horse ranks before that of the cow or the sheep; and the manure of highly-fed animals before that of those which are lean.

186. *Excrementitious manures*, including urine, should never be applied to crops in a recent state, because from the abundance of ammoniacal salts which they contain, or perhaps from some other reason not understood, they are found in that state injurious to vegetation; but when these manures are fermented they are the most powerful of all, producing an immediate effect on the plants. It is a remarkable fact that the recent urine of sheep is not injurious to grass lands, while that of horses and cows commonly injures the grass on the spot where it falls, which however recovers and becomes of a darker green than before in the year following. The loss of excrementitious manures in the large towns in England is immense, and while they are lost to the soil, they are poisonous to the fishes of our rivers, and injurious to those who drink their water. The great advantage of urine or other liquid manure is, that its manuring elements are consumed by the plants in a few months, and hence an immediate return is made on the capital employed; whereas, when solid excrementitious manures are employed, a period of two or three years must elapse before complete decomposition ensues. (*See Sprengel on Animal Manures, in Jour. Eng. Ag. Soc., vol. i. p. 473.*) Liquid manure, also, from the ammonia which it contains, when poured on the soil destroys worms, snails, &c., as effectually as lime-water.

187. In every suburban villa, arrangements should be made for collecting all the liquid manure into two adjoining tanks, and mixing it there with water; one tank to be kept filling and mixing, while the other is fermenting and being emptied. Where urine cannot be got, excrement and water form the best substitute. The fermented liquid may either be poured direct on the soil of the garden, among growing crops, at the roots of fruit trees, or on the naked soil, with or without other manure, and more especially with straw, or other vegetable matters, for the purpose both of enriching them and promoting fermentation.

188. Hair, wool, feathers, leather, horn, rags, &c., decompose much more slowly than excrementitious or vegetable manures; but they are exceedingly rich in gelatine and albumen, and are therefore very desirable where the object is duration of effect, as well as luxuriance. Dead animals of every kind, including fish, make excellent manure; and when there is any danger anticipated from the effluvia which arises during decomposition, it is readily prevented by covering or mixing the putrid mass with quicklime. In this way nightsoil and the refuse of the slaughter-houses in Paris, Lyons, and other continental towns, are not only disinfected, but dried under the name of *poudrette*, and compressed in casks, so as to form an article of commerce. Sugar-bakers' scum, which is obtained from sugar refineries, consists of the blood of cattle and lime; it can be sent in a dried and compressed state to any distance, and forms a manure next in richness to bones. In gardens it may be used as a top dressing to culinary vegetables, and as an ingredient in the composition of vine borders. Animalized carbon consists of nightsoil of great age; it is sent to different parts of Europe from Copenhagen, where it has accumulated during ages in immense pits and heaps, which some years ago were purchased from the city by an Englishman. It is an exceedingly rich manure.

189. *Bones*, though a manure of animal origin, depend for their effects a good deal on their mineral constituents. Next to nightsoil, bones are perhaps the most valuable of all manures. Chemically they consist of gelatine, albumen, animal oils, and fat, in all about 33 per cent.; and of earthy matters, such as phosphate of lime, carbonate of lime, fluuate of lime, sulphate of lime, carbonate of soda, and a small quantity of common salt. In consequence of the animal matters which they contain, crushed bones when laid in heaps very soon begin to ferment, and when buried in the soil previously to being fermented in heaps, the putrescent fermentation goes on with great rapidity. In gardens they should seldom be used without being broken small and fermented in heaps for several months. Bones are valuable as a specific manure, because they contain phosphate of lime, which is an ingredient common to a great many cultivated plants both of the field and of the garden. Bone manure, if used on the same soil for a number of years, is found to lose its effect; the reason of which is inferred from one cause of their excellence, viz., that the animal matter which they contain acts as a ferment or stimulus to the organic matter already in the soil, by which means this organic matter becomes sooner exhausted than otherwise would be the case. The remedy for this evil obviously is, to discontinue the use of the bones, and to supply putrescent manure, such as stable-dung.

190. *Vegeto-animal manures* consist of a mixture of animal and vegetable substances, such as the straw used as litter in stables or farmyards, and the excrements and urine of the animals which are kept in them. It may be

classed according to the kind of animal to which the litter is supplied; and hence we have horse-dung, cow-dung, the dung of swine, sheep, rabbits, poultry, &c. All these manures require to be brought into a state of active fermentation, and reduced to a soft easily separated mass, before being applied to the soil. This is effected by throwing them into heaps, and occasionally turning these heaps till the manure becomes of a proper consistence.

191. In horticulture, advantage is generally taken of the heat produced by manures of this kind, in forming hotbeds, and in supplying heat to pits by what are called linings, but which are properly casings, of dung placed round a bed of dung, tan, or soil, supported by walls of open brickwork. The dung so placed can be taken away at pleasure, and applied to the soil when it has undergone a proper degree of fermentation; whereas, the dung of which hotbeds is formed cannot be removed without destroying the bed and the crop on it; and hence it is generally kept till the fermenting process is carried much farther than is necessary, and often so far as to be injurious. Hence, in gardens, wherever economy of manure is an object, common hotbeds ought never to be made use of, but recourse had to exterior casings, such as those already mentioned, or to other modes of heating.

192. In many suburban villas, almost as much manure is lost as would suffice for enriching the kitchen-garden, and producing vegetables for the whole family. To save every particle of fluid or solid matter capable of becoming manure, the first step is to construct two or more large tanks for the liquid manure, and to form a system of tubes or gutters for conveying to these tanks all the soapsuds and other liquid refuse matters furnished by the mansion and offices, including the stables, unless they are at a distance. Similar tanks should be formed adjoining every cottage and dwelling belonging to the villa; such as the gardener's house, gatekeeper's lodge, and also in the back-sheds and in the frame and reserve ground of the kitchen-garden. In short, no water ought to be allowed to escape from the manure tanks but such as is perfectly pure; for all dirty water, with or without excrementitious matters, will ferment in a degree of heat not much greater than that of the subsoil, even in winter; and all fermented liquids contain one or more of the constituent elements of plants. The second step to be taken with a view to saving manure is, to form a vegetable rubbish heap, on which all waste parts of plants and the remains of all crops, including mown grass when not otherwise used, clippings of hedges, summer prunings of trees, &c., are to be thrown as collected, left to ferment, and turned over occasionally. To this heap, lime, dung, or rich earth may be added, and the whole frequently turned over and well mixed. The third step is, to collect the cleanings of ponds, wells, ditches, hedge-banks, and similar earthy matters, and mix them with quicklime, turning the heap occasionally, as directed in the next section.

SECT. II.—*Inorganic Manures.*

193. *Inorganic or mineral manures* are chiefly, lime in a state of chalk or carbonate, gypsum or sulphate, marl in which carbonate of lime is mixed with clay, saltpetre, kelp or mineral alkali, and common salt. The organic manures, as we have seen, act by supplying plants with the elements of which they are constituted, viz., carbon, oxygen, hydrogen, and azote or nitrogen; but the mineral manures contain none of these elements, and hence, according to most agricultural chemists, they must act beneficially on some other

principle. This principle may be stated to be the rendering more soluble of the organic matters already in the soil in most instances, and in some cases rendering soluble matters insoluble, so as to diminish excessive fertility, and prepare a reserve of the fertilising principle for future use. Quicklime, for example, effects the first of these objects, and slaked lime the second. According to some writers, inorganic manures also act specifically; alkaline matters being found in all, and some sorts in many plants.

194. *Lime.* This is by far the most important of all the mineral manures. It is applied to soil in the form of quick or hot lime, mild or slaked lime, and chalk or carbonate. Quicklime is procured by burning chalkstone or lime rock till the water and the carbonic acid gas are driven off. Immediately after burning, it forms what is called quicklime; and in this state, when laid on the soil, having a powerful attraction for water (200), it assists in the conversion of woody fibre and other organic matters into the substance called humus, forming humate of lime, which again is rendered soluble and fit for supplying the food of plants by the action of the carbonic acid gas in the soil, or supplied to it by water or the atmosphere.

195. *Mild lime.* When water is thrown on quicklime, it becomes what is called slaked, falls down into a fine white powder, and, re-absorbing great part of the water which had been driven off by burning, it becomes what chemists call hydrate of lime; and soon after, from the absorption of carbonic acid gas, it becomes what is called mild lime. The use of lime in this state is partly the same as that of caustic or quicklime; and partly, also, when there is a superabundance of soluble manure, so as to cause crops to become too rank, to lessen the putrescence of organic matter by the formation with it of humate of lime. In short, quicklime may be said to increase the solubility of inert organic matter, and mild lime to render less soluble organic matter already in a state of solubility.

196. The application of lime to soil may also be useful in cases where there is not already a sufficient portion of that earth; but, to ascertain this, a chemical analysis of the soil should be previously made. The smallest quantity of quicklime added to a soil in which little or none previously existed, will effect a great permanent improvement; and the same may be said of a small quantity of clay added to a soil in which that ingredient did not previously exist. (172.)

197. *Carbonate of lime, or chalk,* in its native state, differs from unburnt limestone in being of a much softer texture, and more easily acted on either mechanically or by the weather. When burned, it of course becomes lime, and may be used either in a caustic or mild state; but in chalky countries it is most commonly laid on land in its natural state, and left to pulverise by the influence of the weather. It is supposed to have no effect upon inert vegetable fibre, and to be incapable of generally uniting with humic acid; so that it appears to be destitute of the two properties of caustic and mild lime, viz., that of rendering insoluble matter soluble, and the contrary. Its beneficial effects are attributed to its altering the texture of soil, and to its property of retaining water without at the same time becoming adhesive. Hence it may be used both on sands and clays, to render the latter more friable without diminishing its retentive powers, and the former more absorbent without adding to its tenacity. Chalk, also, may be considered as a specific manure, since carbonate of lime is an ingredient in almost all the plants which have hitherto been analysed by chemists.

198. *Marl* is carbonate of lime mixed with clay at the rate of from twenty to eighty per cent of carbonate, with alumina, silica, and more or less of the oxide of iron. Its action on the whole is similar to that of chalk, though it is more adapted for sandy and peaty soils than for clays. It is found from experience that it is injurious when spread on soil before being exposed for some months to the action of the atmosphere; though the reason of this has not yet been explained.

199. *Gypsum*, which is sulphate of lime, is a calcareous compound which occasionally produces extraordinary effects as manure, though the rationale of its action does not appear to be thoroughly understood. All animal manures contain more or less of sulphate of lime as one of their constituents; and this mineral compound has also been found in wheat, in clover, saintfoin, lucern, and many other leguminous plants, and in various pasture grasses. Hence it may in part be considered as a specific manure, and it has been so treated by Grisenthwaite in his very ingenious *Essay*, who contends that no manure that does not contain gypsum is fit for wheat. It is said to have little effect except upon light sandy, gravelly, or chalky soils.

200. *Sea shells* are very abundant on some shores, and may be either burned into lime or laid on without burning. Immense quantities are collected on the shore at Whitstable, in Kent, and are laid on the soil without burning between Canterbury and Dover, where the soil is chiefly clayey. They are so much preferred to chalk or lime that they are fetched three times the distance.

201. The *rationale of the action of lime* in its different states is thus given by Sir Humphry Davy. "When lime, whether freshly burned or slaked, is mixed with any moist fibrous vegetable matter, there is a strong action between the lime and the vegetable matter, and they form a kind of compost together, of which a part is usually soluble in water. By this kind of operation, lime renders matter which was before comparatively inert nutritive; and as charcoal and oxygen abound in all vegetable matters, it becomes at the same time converted into carbonate of lime. Mild lime, powdered limestone, marls or chalks, have no action of this kind upon vegetable matter; by their action they prevent the too rapid decomposition of substances already dissolved; but they have no tendency to form soluble matters. It is obvious from these circumstances that the operation of quicklime, and marl or chalk, depends upon principles altogether different. Quicklime, in being applied to land, tends to bring any hard vegetable matter that it contains into a state of more rapid decomposition and solution, so as to render it a proper food for plants. Chalk, and marl, or carbonate of lime, will only improve the texture of the soil, or its relation to absorption, acting merely as one of its earthy ingredients. Quicklime, when it becomes mild, operates in the same manner as chalk; but in the act of becoming mild, it prepares soluble out of insoluble matter. It is upon this circumstance that the operation of lime in the preparation for wheat crops depends; and its efficacy in fertilising peats, and in bringing into a state of cultivation all soils abounding in hard roots, or dry fibres, or inert vegetable matter. The solution of the question, whether quicklime ought to be applied to a soil, depends upon the quantity of inert vegetable matter that it contains. The solution of the question, whether marl, mild lime, or powdered limestone, ought to be applied, depends upon the quantity of calcareous matter already in the soil. All soils are improved by mild lime, and ultimately by quicklime, which do

not effervesce with acids; and sands more than clays." (*Agricultural Chemistry*, 6th edit., p. 304.)

202. In the case of suburban villas, the *most important uses of lime* are, first, the formation of lime-water for the destruction of insects, snails, worms, &c.; and secondly, the formation of lime composts to be used as manure. For both these purposes lime must be obtained in its caustic state. In preparing *lime-water*, a very small quantity of lime in powder will be found to saturate many gallons of water; and, by letting this settle a few minutes till it becomes clear, the plants or the soil may be watered with it without leaving any coating of lime, which only takes place when the lime is applied in a state of mixture and solution. The causticity of the liquid, owing to the alkali which it contains, lacerates the tender skins of caterpillars, earth-worms, snails, and slugs.

203. *Lime compost* is formed of caustic lime, at the rate of from sixteen to twenty-four bushels of lime to three times that quantity of earth taken from hedge-banks, cleanings of ditches or ponds, scrapings of roads, or even from the surface of any soil which is somewhat different in its nature or texture from the soil on which the compost is to be laid. Even the substratum of any soil, where good, may be used, and afterwards laid on the surface soil. The compost should lie from nine to twelve months, and be turned over in that time twice or thrice. In every part of Britain this manure may be formed at a moderate expense; and though it is better adapted for fields than gardens, yet in many cases, and particularly where manure is scarce, it will be found a valuable resource. (See *Jackson's Agriculture*, published by Chambers, p. 47.)

204. *Saltpetre*, or muriate of potash, when analysed, consists of oxygen, nitrogen, and potassium. Saltpetre is found in almost all plants, and especially those which are cultivated in rich soils. As a manure it sometimes produces extraordinary effects on grass lands and corn crops; but its action is not understood, and it has been but little used in horticulture. Nitrate of soda produces nearly the same results as saltpetre. From some experiments with this salt lately detailed in the *Journal of the English Agricultural Society*, vol. i. pp. 418 and 423, it appears to have increased the produce of corn crops, but not more so than saltpetre.

205. *Common Salt*, or the chloride of sodium, consists of nearly equal parts of chlorine and sodium; but when dissolved in water a portion of the water is decomposed, its hydrogen unites with the chlorine to form muriatic acid, and its oxygen with the sodium to produce soda. Hence salt in a dry state is chlorate of soda, and dissolved in water it becomes muriate of soda. Its action in the soil depends on the effect which the muriate of soda has on the carbonate of lime; the latter, as we have before observed, being found in almost all soils. By the contact of these two salts, their acids and bases are interchanged, and the compounds which are the result are carbonate of soda and muriate of lime. Hence, as chalky soils abound more in carbonate of soda than any others, salt is supposed to be most beneficial to them. Salt applied in large quantities, it is well known, destroys plants; and hence it has been used in gardening, both in a dry and liquid state, to kill weeds and worms in gravel-walks, which it does most effectually. It has been used also for washing salads and other vegetables when gathered for the kitchen, when they are supposed to contain snails, worms, or insects. It forms a direct constituent of some marine plants, and plants of saline marshes or

steppes; and, applied in small quantities, it appears to hasten the decomposition of organised matter in the soil. As a manure, however, it requires to be applied with very great caution; and, in gardens, is perhaps safest when used in walks for the purpose of killing weeds and worms.

206. In suburban villas calcareous manures are often required for the improvement of lawns and other grass lands; and a stock of quicklime, unslaked, should always be kept in a cask, or other closed vessel, to be ready for use with water. Where lime is not at hand, common potash or American pearlsh dissolved in water, or urine especially that of cows, will have the same effect on insects as lime-water; but they are more expensive.

SECT. III.—*Mixed Manures.*

Mixed Manures include coal ashes, vegetable ashes, street manure, soot, and vegetable or vegeto-animal composts.

207. *Coal Ashes* are of very different natures in different parts of the country; the constituents of coal varying in the quantity of clay and lime, and also of sulphur and iron, which it contains. Many persons object entirely to coal ashes as a manure, considering them poisonous rather than beneficial. The portions of coal which contain iron or other metallic ores are converted by burning into hard porous masses, which, when buried in the soil, absorb moisture, and consequently soluble organic matter; and as the spongioles of the roots cannot be supposed to penetrate into cinders or scoria, that soluble matter must remain there till it is washed out by rains or set free by the disintegration of the cinder. Supposing this to be the case, the principal benefit to be derived from coal ashes would appear to be that of increasing the friability of stiff clayey soils.

208. *Vegetable Ashes* are obtained by burning weeds, leaves, prunings, or roots of woody plants, and in general of all kinds of vegetable matter not readily decomposed by fermentation. The burning of vegetable substances must necessarily dissipate the whole of the oxygen, hydrogen, and nitrogen which they contain, together with more or less of the carbon, according to the degree in which the burning mass is exposed to the action of the atmosphere. Hence in burning wood for charcoal, the pile of logs is covered with earth or mud to prevent the production of flame, and consequent decomposition of the carbon, by the action of the oxygen of the atmosphere. The burning of vegetables, however, does not destroy the fixed saline ingredients which they contain; and hence vegetable ashes, as manure, will be valuable as containing salts which are either of general or specific use to plants, and also as containing more or less carbon. If one kind of plant only were burnt at a time, then the ashes of that plant would form a specific manure for plants of the same kind; but as a number of kinds are generally burned together, their ashes must contain salts of various kinds, and they may be considered as being useful to plants generally. Among these ashes there is always a large proportion of vegetable alkali (carbonate of potass); and this, when mixed with soil, combines with insoluble organic matter and renders it soluble; and hence vegetable ashes form a useful manure for all soils, since potass is of almost universal existence in plants. It is therefore not only a general manure by its action on organic matter, but a specific constituent of plants. Soda, which exists but in few plants, differs from potass in not being a specific manure, its action being limited to increasing the

solubility of organic matter already in the soil ; and in performing this office, it is found to be more efficient than potass.

209. *Soot* is composed of the various volatile matters derived from the burning of coal or wood, together with carbon, and earths which have been mechanically carried up the chimney with water in the form of smoke. From experiment it appears that soot owes its value as a manure to the saline substances which it contains ; and these are chiefly the carbonate and sulphate of ammonia, together with a small quantity of a bituminous substance. The fact of carbonate of soda proving useful as a manure is undoubted, though it is difficult to explain in what manner it acts, unless, like saltpetre, it stimulates the roots. Soot when applied in gardens is generally strewed on the surface, and it is considered as annoying snails, slugs, and worms ; though by no means killing them, as is frequently supposed. Its effects are rarely perceptible after the crop to which it is applied ; and therefore, like liquid manures, soot affords a quick return for the capital employed in it.

210. *Street manure*, or that which is swept up in the streets of towns, consists of a great variety of matters, animal, vegetable, and mineral. In the manner towns are now kept, it is small in quantity and of little value ; but formerly it was among the richest of all manures. When collected in quantities, even though containing a large proportion of earth and coal ashes, it ferments powerfully, and will continue giving out heat throughout a whole summer. For this purpose it has been used in forcing-gardens as a substitute for tanners' bark and stable-dung ; and it has the advantage of not subsiding so much as those materials. Wherever it can be obtained, it may be applied to all soils ; and when obtained from towns still under the old system, it may rank next to nightsoil and bones.

211. *Composts* of vegetable or vegeto-animal matter and earth are of various kinds. The most common in gardens is that produced by rotten leaves or vegetable refuse mixed with sand or with some other earth, or with stable-dung : composts of bones are likewise formed in this manner, and also of peat, where that material abounds. Peat composts have been already mentioned.

212. *Mixed manure in a liquid state* consists of the urine of animals, soap-suds, the foul water of kitchens and other offices, waste surface or rain water, and drainings of dunghills. The most advantageous way of employing it is by applying it, after being properly diluted and fermented (182), directly to growing crops. It may also be profitably employed by throwing it on heaps of vegetable matter, such as moss, leaves, straw, or any vegetable refuse matter whatever not containing woody matter of several years' growth. In this way, Jauffret, a French agriculturist, proposed to create immense quantities of manure by fermenting weeds and other refuse collected by hedge-sides, or on commons or wastes. The fermentation of such matters does not take place without the aid of animal manure or stable-dung ; but, when once commenced, it can be continued for an indefinite period by adding to the heap. If the liquid manure and the excrementitious matter accumulated in every large establishment, independently altogether of the stable manure, were collected and fermented, we have little doubt it would suffice for all the kitchen-garden crops ; the refuse of these crops and the weeds of the garden being added and fermented. It is highly probable that every individual animal produces as much manure as would raise the vegetables necessary for his support, because in the nourish-

ment of animals, as of plants, nothing is annihilated, but merely changed : what escapes into the atmosphere is counterbalanced by what is absorbed from it ; and what is embodied in the animal during life, is restored to the soil at its death.

213. *Application of Manures.*—Too much manure is injurious to all crops whatever, by increasing the proportion of watery matter, and by producing such an exuberance of growth as to prevent the maturation of the parts, the formation of blossom-buds, and the setting of fruit. It is particularly injurious to corn-crops ; produces more sap than can be properly elaborated in the leaves, and hence disease. In this case the evil is counteracted by the application of lime or common salt.

214. All mineral manures ought to be employed in a dry and powdery state, and if possible, when the soil is equally dry and powdery ; and all moist manures, when the soil is somewhat drier than the manure. Other circumstances being the same, spring is better than autumn for applying manures, because the winter might wash them away, &c. ; but universally, the proper time is immediately before sowing or planting the crop. Calm weather is better than windy weather, and bulky manure ought no sooner to be laid on than buried in the soil. Exhausting land of the manure which it contains by over-croppings, is like depriving a commercial man of his capital.

215. In consequence of the great value of manures in increasing the amount of the produce of land, many ingenious persons have contrived mixtures which, in small bulk, they allege will produce extraordinary effects ; and this idea seems to have been long since indulged by some writers. Lord Kaimes, nearly a century ago, thought the time might come when the quantity of manure requisite for an acre might be carried in a man's coat-pocket ; a recent author speaks of "a quart of spirit sufficient to manure an acre ;" and even Liebig says, that "a time will come when fields will be manured with a solution of glass (silicate of potash), with the ashes of burned straw, and with salts of phosphoric acid prepared in chemical manufactories, exactly as at present medicines are given for fever and goitre." (*Organic Chemistry*, p. 188.) To those who believe in the homœopathic hypotheses of medicine such speculations will not appear unreasonable ; and there may be some truth in them, on the supposition that the soil to which these small doses of spirit, or of silicate of potash, are to be applied, are to act as stimulants to the organic matter already in the soil ; but to ordinary apprehensions it seems difficult to conceive how bulk and weight of produce can be raised without the application of a certain degree of bulk of manure. All deference, however, ought to be paid to the opinions of philosophers who, like Liebig, have profoundly studied the subject. (*See the notes to this chapter in our Appendix.*)

216. All the manures mentioned in this section are easily obtained by the possessors of suburban villas. Soot and ashes are produced on their own premises ; compost may be formed by the mixture of various articles collected or procured ; liquids abound, and have only to be collected and properly fermented ; and street manure may in general be purchased from the nearest town. It cannot be too strongly impressed on the possessor of a country residence who wishes to make the most of it, that no particle of organic matter, whether animal or vegetable, and no drop of water, with whatever it may be discoloured, ought to be left uncollected or allowed to run to waste.

CHAPTER IV.

THE ATMOSPHERE, CONSIDERED WITH REFERENCE TO HORTICULTURE.

217. THE influence of the *atmosphere* on the geographical distribution of plants has been noticed in a preceding chapter (147), and we shall here consider the subject with reference to the culture of plants in gardens, taking as our guide, Daniel's Essay on Climate with regard to Horticulture, (*Hort. Trans.* vol. vii.,) *Daniell's Meteorological Essays*, and examining also what has been written on the subject in subsequent works. Among the latter may be mentioned *Howard's Climate of London*, *Hutchison's Treatise on Meteorological Phenomena*, *Murphy's Meteorology*, and two excellent articles on the latter two of these works in the *Athenæum* for 1837, p. 561 and 580.

The atmosphere on every part of the globe consists of the same constituent parts, to wit, carbonic acid gas and water in a state of vapour about 1 part, oxygen 23, and azote or nitrogen 76, reckoning by weight. The aqueous vapour and carbonic acid gas are variable admixtures; but in all cases they bear only a very small proportion to the other ingredients. All the variations, therefore, which are found in the atmosphere in different countries, and at different times in the same country, depend upon the modifications impressed upon it by heat, moisture, motion, and light.

SECT. I.—*Heat, considered with reference to Horticulture.*

218. *Heat*, like light, is found to be capable of radiation, reflection, transmission through transparent media, and refraction; but it is radiated, reflected, transmitted, and refracted, in a different manner and degree from light. Thus it appears that both light and heat can be transmitted through either gaseous, fluid, or solid media, provided they are transparent. Any opaque body is to light, however, an impenetrable barrier; but to heat, or to its conduction, neither opaqueness nor solidity affords resistance. On the contrary, heat is conducted more rapidly by solid than by fluid or gaseous bodies; a fact which will be noticed in treating of artificial coverings for protecting plants. A solid body will obstruct the radiation of heat, as is familiarly exemplified in the case of the common fire-screen. The diffusion of heat by conduction and radiation is what chiefly concerns the horticulturist.

219. The *conduction of heat* is effected by the contact of bodies heated in different degrees, when the tendency to equal diffusion immediately raises the temperature of the one body and lowers that of the other. This takes place with different degrees of rapidity, according to the nature of the bodies in contact. If thermometers be placed on metal, stone, glass, ivory, and earth, all heated from the same source, we shall find that the thermometer placed on the metal will rise soonest; next, that placed on the stone; next, that on the glass; then that on the wood; and lastly, that on the earth. The conducting power of bodies is generally as their density. The greatest of all conductors of heat are metals; and the least so, spongy and light filamentous bodies. Silk, cotton, wool, hare's fur, and eider-down, are extremely bad conductors of heat, and hence their value as clothing. (*Library of Useful Knowledge*, art. *Heat*, p. 23.) They give us a sensation

of warmth, not by communicating heat to the skin, but by preventing its escape into the air, in consequence of their non-conducting properties. The power which these bodies have of stopping the transmission of heat depends on the air which is stagnated in their vacuities; for when the air is expelled by compression, their conducting power is increased. Hence, in covering plants or plant structures with leaves, litter straw, mats, or other light, porous bodies, the less they are compressed the more effective will they be found in preventing the escape of heat by conduction. All tight coverings, whether of animals or plants, retain very little heat, when compared with loose coverings; and hence mats, when drawn tightly round bushes, or nailed closely against trees on walls, are much less effective than when fastened over them loosely, and do not retain nearly so much heat as a covering of straw. Coverings of sand, ashes, or rotten tan, applied to the ground, or to the roots of herbaceous plants, are, for the same reason, much less effective than coverings of leaves so applied; and these, again, are much less so than coverings of litter or long straw. The heat of the trunks of trees is prevented from escaping to the extent it otherwise would do by their bark, which is a powerful non-conductor (140), and the heat of the ground by a covering of snow, which, by its spongy, porous nature, contains a great deal of air. Without this covering, the herbaceous plants of the northern regions could not exist; nor would spring flowers, such as the aconite, snow-drop, crocus, daffodil, &c., in the climate of Scotland, come nearly so early into bloom.

220. Heat is diffused amongst bodies not in contact by the process called *radiation*, in consequence of which property a person standing near any body heated to a higher temperature than himself will experience a sensation of warmth. The radiation of heat from any body proceeds from its surface in every direction in straight lines, in the same manner as the divergent rays of light from an illuminated body, as, for example, a lighted candle; and rays of heat, like rays of light, may be reflected from polished surfaces, and transmitted and refracted through transparent substances, and even polarised. But though it be true that heat, in proceeding from a body, begins by radiating from it at right angles and in straight lines, yet this can only be strictly said of heat which is radiated perpendicularly into the atmosphere. Thus, from a pipe of water equally heated, the heat tends to radiate at right angles from its surface in all directions; yet none but those rays which proceed from the uppermost part of the convex surface of the pipe will preserve their perpendicularity. All the other rays, from their first contact with the air, will be deflected upwards, being in fact carried in that direction by the heating effects which those rays themselves produce upon the particles of air on which they impinge. The property of radiation, however, is that which chiefly concerns the horticulturist; and the following description of this phenomena is given by Mr. Daniell, the author of by far the best essay which has yet appeared on climate, as connected with horticulture.

221. *Radiation* of heat is the "power of emitting it in straight lines in every direction, independently of contact, and may be regarded as a property common to all matter. Co-existing with it, in the same degrees, may be regarded the power of absorbing heat so emitted from other bodies. Polished metals, and the fibres of vegetables, may be considered as placed at the two extremities of the scale upon which these properties in different substances may be measured. If a body be so situated that it may receive just as

much radiant heat as itself projects, its temperature remains the same; if the surrounding bodies emit heat of greater intensity than the same body, its temperature rises, till the quantity which it receives exactly balances its expenditure, at which point it again becomes stationary; and if the power of radiation be exerted under circumstances which prevent a return, the temperature of the body declines. Thus, if a thermometer be placed in the focus of a concave metallic mirror, and turned towards any clear portion of the sky, at any period of the day, it will fall many degrees below the temperature of another thermometer placed near it out of the mirror; the power of radiation is exerted in both thermometers, but to the first all return of radiant heat is cut off, while the other receives as much from the surrounding bodies as itself projects. This interchange amongst bodies takes place in transparent media as well as in vacua; but in the former case the effect is modified by the equalising power of the medium." This description is clear and satisfactory; but it must not be supposed, that though the balance of temperature will not be disturbed from the effects of radiation when the body is completely enclosed, yet that it may not be so by the other law of heat, conduction.

222. "Any portion of the surface of the globe which is fully turned towards the sun receives more radiant heat than it projects, and becomes heated; but when, by the revolution of the axis, this portion is turned from the source of heat, the radiation into space still continues, and, being uncompensated, the temperature declines. In consequence of the different degrees in which different bodies possess this power of radiation, two contiguous portions of the system of the earth will become of different temperatures; and if on a clear night we place a thermometer upon a grass plat, and another upon a gravel walk or the bare soil, we shall find the temperature of the former many degrees below that of the latter. The fibrous texture of the grass is favourable to the emission of the heat, but the dense surface of the gravel seems to retain and fix it. But this unequal effect will only be perceived when the atmosphere is unclouded, and a free passage is open into space; for even a light mist will arrest the radiant matter in its course, and return as much to the radiating body as it emits. The intervention of more substantial obstacles will of course equally prevent the result, and the balance of temperature will not be disturbed in any substance which is not placed in the clear aspect of the sky. A portion of a grass plat under the protection of a tree or hedge will generally be found, on a clear night, to be eight or ten degrees warmer than surrounding unsheltered parts; and it is well known to gardeners that less dew and frost are to be found in such situations than in those which are wholly exposed. There are many independent circumstances which modify the effects of this action, such as the state of the radiating body, its power of conducting heat, &c. If, for instance, the body be in a liquid or aëriiform state, although the process may go on freely, as in water, the cold produced by it will not accumulate upon the surface, but will be dispersed by known laws throughout the mass; and if a solid mass be a good radiator but a bad conductor of heat, the frigorific effect will be condensed upon the face which is exposed. So upon the surface of the earth absolute stillness of the atmosphere is necessary for the accumulation of cold upon the radiating body; for if the air be in motion, it disperses and equalises the effect with a rapidity proportioned to its velocity." (*Hort. Trans.* vol. vi. p. 10.)

223. All the phenomena connected with *dew* or *hoarfrost* have been ex-

plained by Dr. Wells on these principles. The deposition of moisture is owing to the cold produced in bodies by radiation, which condenses the atmospheric vapour on their surfaces. The deposition of dew takes place upon vegetables, but not upon the naked soil, because the latter is a bad radiator as well as a bad conductor of heat. The fibres of short grass are particularly favourable to the formation of dew. Dr. Wells says that dew is "never formed upon the good conducting surfaces of metals, but is rapidly deposited upon the bad conducting surfaces of filamentous bodies, such as cotton, wool, &c." There would appear to be some mistake in the assertion, that dew is never formed on metals; for any one may prove the contrary by breathing on the blade of a knife. It is true dew is seldom found on bright surfaces, such as metals or glass, in the form of drops, as it is on rough and pointed objects like wool, grass, &c.; but there can be no doubt of its existence on these bodies, though in a less conspicuous form. Were this not the case, the law of the deposition of water from air would not be universal. This law is, that moisture, or deposition of moisture, including that modification of it called dew, is deposited more or less on all bodies in absolute contact with the air, whenever the temperature of the air is higher than that of the body with which it is in contact.

224. In remarking that *dew is never formed upon metals*, Mr. Daniell observes, "it is necessary to distinguish a secondary effect which often causes a deposition of moisture upon every kind of surface indiscriminately. The cold which is produced upon the surface of the radiating body is communicated by slow degrees to the surrounding atmosphere; and if the effect be great and of sufficient continuance, moisture is not only deposited upon the solid body, but is precipitated in the air itself; from which it slowly subsides, and settles upon everything within its range.

225. "*The formation of dew* is one of the circumstances which modify and check the refrigerating effect of radiation; for, as the vapour is condensed, it gives out the latent heat with which it was combined in its elastic form, and thus, no doubt, prevents an excess of depression which might in many cases prove injurious to vegetation. A compensating arrangement is thus established, which, while it produces all the advantages of this gentle effusion of moisture, guards against injurious concentration of the cause by which it is produced."

226. "*The effects of radiation* come under the consideration of the horticulturist in two points of view: the first regards the primary influence upon vegetables exposed to it; the second, the modifications produced by it upon the atmosphere of particular situations. To vegetables growing in the climates for which they were originally designed by nature, there can be no doubt that the action of radiation is particularly beneficial, from the deposition of moisture which it determines upon their foliage: but to tender plants artificially trained to resist the rigours of an unnatural situation, this extra degree of cold may prove highly prejudicial. It also appears probable, from observation, that the intensity of this action increases with the distance from the equator to the poles; as the lowest depression of the thermometer which has been registered between the tropics, from this cause, is 12° , whereas in the latitude of London it not unfrequently amounts to 17° . But however this may be, it is certain that vegetation in this country is liable to be affected at night from the influence of radiation, by a temperature below the freezing point of water, ten months in the year; and even in the two

months, July and August, which are the only exceptions, a thermometer covered with wool will sometimes fall to 35° . It is, however, only low vegetation upon the ground which is exposed to the full rigour of this effect. In such a situation, the air which is evolved by the process lies upon the surface of the plants, and from its weight cannot make its escape; but from the foliage of a tree or shrub it glides off and settles upon the ground."

227. "Anything which obstructs the free aspect of the sky arrests in proportion the progress of this *refrigeration*, and the slightest covering of cloth or matting annihilates it altogether. Trees trained upon a wall or paling, or plants sown under their protection, are at once cut off from a large portion of this evil, and are still further protected if within a moderate distance of another opposing screen." (*Ibid.* vol. vi. p. 12.)

228. Almost all the modes in practice of *protecting plants* are founded on the doctrine of radiation, and hence the gardener should keep constantly in his mind the fact, that all bodies placed in a medium colder than themselves are continually giving out their heat in straight lines, and that these straight lines, when the body is surrounded by air, may always be reflected back on the body from which they emanate by the slightest covering placed at a short distance from them; while, on the other hand, if this slight covering is applied close to the body, instead of reflecting back the heat, it will carry it off by conduction: that is, the heat will pass through the thin covering closely applied, and be radiated from its surface. Hence, in covering sashes with mats, a great advantage is obtained by laying straw between the mats and the glass, or by any other means of keeping the mat a few inches above the frame. Hence also when the branches of trees are to be protected by mats, they will be rendered much more efficient if first surrounded by straw, fern, or some other light body which contains in its interstices a good deal of air. It should be borne in mind, Mr. Daniell observes, "that the radiation is only transferred from the tree to the mat, and the cold of the latter will be conducted to the former in every point where it touches. Contact should therefore be prevented by hoops or other means properly applied, and the stratum of air which is enclosed will, by its low conducting power, effectually secure the plant. With their foliage thus protected, and the roots well covered with litter, many evergreens might doubtless be brought to survive the rigour of our winters which are now confined to the greenhouse and conservatory." The practice thus recommended in 1824 is now, 1841, generally adopted in the management of plants on conservative walls.

229. "*The secondary effect which radiation has upon the climate* of particular situations is a point which is less frequently considered than the primary one which we have been investigating, but which requires perhaps still more attention. The utmost concentration of cold can only take place in a perfectly still atmosphere: a very slight motion of the air is sufficient to disperse it. A low mist is often formed in meadows in particular situations, which is the consequence of the slow extension of this cold in the air, as before described; the agitation of merely walking through this condensation is frequently sufficient to disperse and melt it. A valley surrounded by low hills is more liable to the effects of radiation than the tops and sides of the hills themselves; and it is a well-known fact that dew and hoarfrost are always more abundant in the former than in the latter situations. It

is not meant to include in this observation places surrounded by lofty and precipitous hills which obstruct the aspect of the sky, for in such the contrary effect would be produced. Gentle slopes, which break the undulations of the air without naturally circumscribing the heavens, are most efficient in promoting this action; and it is worthy of remark and consideration, that by walls and other fences, we may artificially combine circumstances which may produce the same injurious effect."

230. "But the influence of hills upon the nightly temperature of the valleys which they surround is not confined to this insulation; radiation goes on upon their declivities, and the air which is condensed by the cold, rolls down and lodges at their feet. Their sides are thus protected from the chill, and a double portion falls upon what many are apt to consider the more sheltered situation. Experience amply confirms these theoretical considerations. It is a very old remark, that the injurious effect of cold occurs chiefly in hollow places, and that frosts are less severe upon hills than in neighbouring plains. The leaves of the Vine, the Walnut-tree, and the succulent shoots of Dahlias and Potatoes, are often destroyed by frost in sheltered valleys, on nights when they are perfectly untouched upon the surrounding eminences; and the difference, on the same night, between two thermometers placed in the two situations, in favour of the latter, has amounted to thirty degrees."

231. "Little is in the power of the Horticulturist to effect in the way of *exalting the powers of the climate* in the open air; except by choice of situation with regard to the sun, and the concentration of its rays upon walls and other screens. The natural reverberation from these and the subjacent soil is, however, very effective, and few of the productions of the tropical regions are exposed to a greater heat than a well-trained tree upon a wall in summer. Indeed, it would appear from experiment that the power of radiation from the sun, like that of radiation from the earth, increases with the distance from the equator; and there is a greater difference between a thermometer placed in the shade and another in the solar rays in this country, than in Sierra Leone or Jamaica. This energy of the sun is at times so great, that it often becomes necessary to shade delicate flowers from its influence; and I have already pointed out (227) a case in which it would be desirable to try the same precaution with the early blossom of certain fruit-trees. The greatest power is put forth in this country in June, while the greatest temperature of the air does not take place till July. The temperature of summer may thus be anticipated a month in well-secured situations." (*Ibid.* p. 16.)

232. The construction of *houses for growing the plants of warm climates*, or for forcing, is founded chiefly on the doctrine of radiation, as well as on that of producing heat by combustion or fermentation. The roof and sides of a frame or a hothouse serve the purpose of reflecting back the heat of the bodies within, whether that heat is only such as the soil enclosed naturally affords, or whether it is generated artificially. But though the roofs of hothouses reflect back great part of the heat which is radiated to them, yet a great part also is conducted through the glass to its outer surface, and thence radiated into the free air. To prevent this waste of heat, without diminishing the quantity of light transmitted through the glass, is a desideratum in hothouse building. In Russia double sashes are used, and while the plants within are in a dormant state little injury is sustained by them; but in green-

houses and botanic stoves in this country, where the plants are kept growing throughout the winter, this mode of saving heat would, for many purposes, exclude too much light.

233. The power of man over the heat of the free atmosphere is comparatively limited. Nevertheless, as heat is carried off from the surface of the ground, and from all other objects, by wind, by radiation, and by evaporation, it follows that heat may be saved from the wind by shelter, and in being radiated into the air by a partial covering of the ground, on a large scale, by scattered standard trees, or, on a smaller scale, by covering beds or borders with straw; and it may be saved from being carried off by evaporation by under-draining, surface-draining, and by such a composition of the soil as will readily admit the infiltration of water, so as to render it at all times, except during rains, tolerably dry. Other modes of increasing the heat of the atmosphere have been mentioned (231), or will readily occur; but perhaps those of most practical value are shelter and adding to the dryness of the soil.

234. A distinction is to be made between *increasing the heat of the atmosphere and the soil*, and preventing the waste of the heat which they already contain. This, also, is to be effected chiefly by counteracting radiation. Mr. Lymburn, a scientific cultivator of great experience, has the following excellent observations on this subject:—"The great effort," he says, "should be to retain (if possible) the heat which was accumulated near the plants through the day. If water be near, it has a tendency to assume the state of vapour, and rob the air of its heat; the sap of the plant may be more abundant, also, from this cause, and increase the expansion of the fluids by frost, which may end in the bursting and laceration of the vessels, and be the cause of death. When a clear cold night succeeds to a wet day, if the night is long and the atmosphere does not get cloudy, the heat radiates upwards from the earth and plants into the cold air, while the evening at first is comparatively warm. The cold is also greatly accelerated by the evaporation of moisture: it is calculated that it takes above 800° of heat to convert water into steam; and though vapour does not require so much, part of the vapour being chemically attracted by the atmosphere, still the consumption is great. From these causes the earth and plants by degrees get so cold, from having parted with their heat, that their temperature descends below the freezing point. In spring and autumn the air is comparatively warm, and the nights not so long; and hence spring and autumn frosts seldom take place till near sunrise: and if a cloud happens to settle above any portion of the earth about that time, before the earth has been cooled down to the freezing point, it prevents the farther radiation of the heat upwards; and hence we often find places lying contiguous and below the cloud to be saved from frost at one time, while at another they will be much hurt. Where plants partially cover one another, they help to prevent radiation; and when one plant is more covered with moisture than another, or growing more vigorously, more full of watery sap, and the bark more tender, from these and other causes one plant is often, to all appearance, unaccountably killed, while another is left unhurt.

235. In order to protect plants from *frost*, we should study to have the plants themselves and the earth around as dry as possible towards the evening. The situation for plants liable to be hurt by spring and autumn frosts should be as much elevated as possible, in order to have the benefit of the wind in dispersing the cold heavy air and bringing forward the warmer; in

low situations the cold air, being heavier, collects, and not being benefited by the dispersion of the wind and bringing forward a warmer air, plants are much more liable to be hurt by slight frosts in such situations. Wherever it is possible, when the clearness and coldness of the air indicate a tendency to frost, plants that are worth the expense should be covered with the best non-conducting substances we can fall in with. Metals are the worst, if polished and bright in the colour: however, they are better non-conductors than when dark-coloured and rough; wood is still better; but, unless when saturated with moisture, woollen, next to furs and eider-down, is the best of any, from the confined air retained between the hairs of the wool.

236. Whatever covering is used, whether *straw mats, bast mats, cloth, or wool, or wood*, they should be elevated above the surface to be covered, so as to contain as much confined air as possible. Confined air is one of the worst conductors of heat; the covering will not radiate or give out heat till the confined air and covering are both heated above the state of the atmosphere; and the transmission of heat will take place more slowly through the confined air than anything else. Thus, for very little trouble, by elevating our coverings, we surround our plants or plant-structures with a substance which is very retentive of heat, and increases the power of the covering in an immense degree. The heat has most tendency to ascend upwards, and this should be most guarded against; but it will also escape by the sides: and to confine the air and heat completely, the plant or plant-structure must be covered all round from the external air. A perfectly air-tight covering would be with difficulty either procured or applied; but apertures in direct communication with the external air, may be guarded in such a manner as to prevent the escape of heat. Thus, if we suppose four coverings of woollen netting, with the meshes of 1-10 in. square open, and exactly as much space between the meshes closed; then these four covers would afford comparatively little protection if placed so as the openings would be directly over each other; but by alternately placing over each other the open and the closed parts, the egress of heated air, as well as the ingress of cold air, would be very much interrupted. The warm air would have to deviate three times from its direct upward tendency, which its greater elasticity, derived from the heat, imparts to it; and the cold air would have to turn as often from the course in which, by gravitation, it would otherwise proceed downwards. The currents of both the internal and external air would thus be impeded, and the interchange of temperature reduced to the very slow process resulting from mere contact.

237. *Wall-trees* should have a broad coping of wood on the wall, to prevent the ascent of heat; and woollen nets drawn down before tender peaches, &c., in cold nights, and carefully removed in good weather through the day, are a great help, when not left on in all weathers. The wall, for tender fruit-trees, or other tender plants, is best built of porous materials, as bricks, which retain the heat from the confined air better than stone; and they should be built with hollow chambers for the same purpose. Where painting is needed, white is the best colour. To prevent the bad effects of cold east winds in the spring, causing the sap to descend in standard fruit-trees, and destroying the blossom when expanded by the check it gives to the ascent of the sap that should nourish it, the stems and branches should be bound with straw ropes, and the ground mulched.

238. Various situations should be chosen to protect *tender shrubs and*

trees, according to the nature of the plant. For those that spring early, and are apt to be nipped by spring frosts, a north border and cold soil are best to retard their time of starting till the danger from frost is less : for those that suffer from want of the wood being ripened sufficiently, as many American plants which have a warmer summer in their native situation to ripen the wood, as also for those that suffer by autumn frosts before the wood is ripened, a south exposure and warm dry early soil are best : in dry soils there is not so much wood made, but that which is made is more easily ripened ; and the more sun, the more likelihood that the wood will be ripened before frost sets in. In some late wet autumns, some of the hardest of our trees have been killed : transplanted Birch, after being some years transplanted ; Oaks, that were apparently sound, dying down half their length in the ensuing spring ; and seedling American Oaks dying off in the ensuing summer, after having begun to grow ; thus showing that even the hardest of our trees may be affected, from their wood not being sufficiently ripened in a cold wet autumn.

239. The presence of a *stream or river* is generally allowed to increase the tendency to slight frosts in spring and autumn. The surface of the *water*, as it condenses by cold, descends to the bottom, and a warm stratum succeeds to the surface ; and so far the tendency is towards heating rather than cooling the air : but the great evaporation that takes place through the day, and early in the evening, robs the air of so much caloric, that fields situated near shallow rivers, streams, or bogs, have generally been found most liable to frost ; near the sea, or near great bodies of deep water, the first-mentioned effect of a succession of warmer strata to the surface prevails, and we have less tendency to freezing.

240. *Watering* in the morning early, if the frost has not penetrated to the juices of the plant, may, by washing off the cold dew, prevent the frost from penetrating ; and covering from the sun may save a plant partially hurt from the excessive change of temperature, if a bright sunny day succeed the frosty night : but no power on earth can recover the plant if the juices have been exposed by freezing till the vessels are burst, which may be known by the change of colour in the leaves by the suffusion of the sap. If some of the most tender leaves only are hurt on the young growths, the plant may survive ; if the wood is generally young and succulent, as in seedlings, Dahlias, &c., the whole plant generally perishes, unless where there is an old ripened root or wood to renew vegetation. Some plants, as Beech, that throw out or evolve most of their young buds in spring, are apt to perish, even though some years old, before the latest buds can spring : the Oak, Ash, &c., that have always spare buds, are not so apt to perish." (*Gard. Mag.* vol. xvi. p. 430.)

241. The general *conclusions* to be drawn from the observations contained in this section are : 1, that the heat of the soil and of the free atmosphere may be increased by diminishing evaporation, so as to receive a greater advantage from the rays of the sun ; and 2, that it may be preserved by checking radiation. The means for diminishing evaporation are draining, improving the constituent parts of the soil, and shelter from cold winds ; and the means of diminishing radiation are simply coverings placed over the soil, or the plant about which the heat is to be retained.

SECT. II.—*Atmospheric Moisture, considered with reference to Horticulture.*

242. *The existence of water in air*, even when the latter is in its driest, coldest, and purest state, is easily proved; and the quantity of aqueous vapour which it holds in suspension has been ascertained by experiment. It varies with the temperature, increasing as the heat is greater, in something like a geometrical ratio. "At 50° Fahr. air contains about 1-50 of its volume of vapour; and as the specific gravity of vapour is to that of air nearly as 10 to 15, this is about 1-75 of its weight. At 100°, and supposing that there is a free communication with water, it contains about 1-14 part in volume, or 1-21 in weight." (*Davy's Ag. Chem.* 6th ed. p. 198.) Water is also held in the atmosphere in a grosser form than that of elastic vapour; for example, as mist, fog, or clouds, which three forms only differ in their appearances, and not in their nature. Mists are those clouds near the surface of the ground; and fogs are only more dense mists, or, perhaps, mists diffused to a greater height in the atmosphere. Mists are of a floating nature, and the air is often seen clear above and below them; but fogs are generally more dense, and they pervade the atmosphere to a greater extent. It will be found afterwards that it is of some importance to bear in mind the distinction between water held in suspension in the atmosphere in the state of invisible elastic vapour, and held in suspension in the state of steam, mist, or fog: in these latter states it is frequently found in greenhouses in the winter season, and in frames and pits, where the heat is communicated through the moist soil by a bed of fermenting dung laid below it.

243. To measure the quantity of elastic vapour in the atmosphere, *Hygrometers* have been invented, and the degree of moisture is indicated in these instruments by what is called the dew-point. The best hygrometer is that of Daniell; but as some nicety is required in its use, a substitute has been found in two common thermometers. The mode of rendering these a substitute for a hygrometer is thus explained by Mr. Wailes:—"The dew-point is that degree of temperature, in any place, at which moisture is deposited from the surrounding atmosphere upon any object of that particular temperature; and it depends, of course, upon the humidity of the air. If, therefore, the air is very moist, the slightest depression of the heat of the body in it will cause dew to form; and, on the contrary, if very dry, it will require a considerable fall of temperature to produce that result. Hence it is that the cold produced by evaporation of a liquid will be proportioned to the hygrometric state of the surrounding medium; and by measuring that degree of cold, we readily ascertain the degree of humidity. The common thermometer is the best instrument for the purpose of showing the temperature; and we have only to keep its bulb wet with some evaporating liquid of the same temperature as the medium it is suspended in, to measure the degree of cold produced by such evaporation, and thereby to find the dew-point." (*Gard. Mag.* vol. xv. p. 506.) Two thermometers being obtained and placed together, one must have the bulb dry to mark the temperature, and the other the bulb wet to indicate the cold produced. The bulbs of both thermometers should be covered with a fold of white silk or muslin, in order that both may be on a par, with respect to the reception of heat from the atmosphere in which they are placed, and pure water must be supplied to one of them from a phial or other vessel placed near it, by a thread of floss silk acting as a siphon.

The cover of the moistened bulb and the silk thread must be renewed occasionally. The greater the difference between the heat indicated by the moistened thermometer and the dry one, the greater will be the want of atmospheric moisture. A table, with explanatory observations, will be found in our Appendix. Mason's hygrometer, which Mr. Newman informs us was in use upwards of thirty years ago by Sir H. Davy and others, (though recently brought into notice by Mason,) contains two common thermometers mounted side by side, with a glass fountain for water fixed between them; it is a very neat instrument; but the mode of using two thermometers above described is sufficient for all ordinary purposes. Still though the hygrometric state of the air may be known by a dry and a moistened thermometer, such as that bearing the name of Mason, the latter showing a depression corresponding with the rapidity of evaporation at the time, yet it is allowed by all who have studied the subject maturely, that the results are not so much to be depended on as when obtained by means of Daniell's hygrometer.

244. Having described the means which may be resorted to in order to ascertain the hygrometric state of the atmosphere, we shall now give an example of the *utility* of that knowledge for horticultural purposes. We shall suppose that the grape is to be forced in a vinery; and we shall first imagine the plant growing under the most favourable circumstances in its native country, at the time of its flowering; enjoying a temperature of 70° or 80° through the day, with 8° or 10° of dryness, according to the hygrometer of Mason or Daniell. At night, whilst the air has still a genial warmth, it is also charged with a refreshing moisture, or, in other words, it is in a state of saturation. The leaves expand, and the shoots become rapidly extended. The conditions under which this takes place, in the native country of the grape, we would wish to imitate in its artificial culture in our vineries. In a vinery we can, even in cold weather, command heat, and the degree of dryness through the day will not be much in excess; but when night comes, although we can still keep up the heat, the moisture is diminished instead of being increased. More fire-heat being required, the air in contact with the hot flues, or hot-water pipes, ascends upwards in consequence of its increasing elasticity, till it reaches the cold glass; the latter condenses the vapour which the air contains, just as the refrigerator of a still condenses, by its coldness, the spirituous or other vapour contained in the worm; and the condensed vapour may be seen trickling down the glass roof. The portions of air thus successively drained of moisture being also cooled by contact with the glass, become specifically heavier, sink and give place to a fresh supply of warmer air, which in its turn descends, likewise deprived of its moisture. Herein we have discovered the source of an evil, the amount of which may be accurately ascertained by means of the hygrometer; and it will sometimes, under such circumstances as are stated, indicate as much as 20° of dryness, or the double of what the vine naturally had in the day, instead of being in the natural state of saturation at night.

245. "The amount of *evaporation* from the soil, and of exhalation from the foliage of the vegetable kingdom," Mr. Daniell observes, "depends upon two circumstances,—the saturation of the air with moisture, and the velocity of its motion. They are in inverse proportion to the former, and in direct proportion to the latter. When the air is dry, vapour ascends in it with great rapidity from every surface capable of affording it; and the energy of

this action is greatly promoted by wind, which removes it from the exhaling body as fast as it is formed, and prevents that accumulation which would otherwise arrest the process." Over the state of *saturation* the horticulturist has little or no control in the open air; but over its velocity he has some command. He can break the force of the blast by artificial means, such as walls, palings, hedges, or other screens; or he may find natural shelter in situations upon the acclivities of hills. Excessive exhalation is very injurious to many of the processes of vegetation, and no small proportion of what is commonly called blight may be attributed to this cause. Evaporation increases in a prodigiously rapid ratio with the velocity of the wind, and anything which retards the motion of the latter is very efficacious in diminishing the amount of the former: the same surface which, in a calm state of the air, would exhale 100 parts of moisture, would yield 125 in a moderate breeze, and 150 in a high wind. The dryness of the atmosphere in spring renders the effect most injurious to the tender shoots of this season of the year, and the easterly winds especially are most to be opposed in their course. The moisture of the air flowing from any point between N.E. and S.E. inclusive, is to that of the air from the other quarter of the compass in the proportion of 814 to 907, upon an average of the whole year: and it is no uncommon thing in spring for the dew-point to be more than 20 degrees below the temperature of the atmosphere in the shade, and the difference has even amounted to 30 degrees. The effect of such a degree of dryness is parching in the extreme, and if accompanied with wind is destructive to the blossoms of tender plants. The use of high walls, especially upon the northern and eastern sides of a garden, in checking this evil, cannot be doubtful; and in the case of tender fruit-trees, such screens should not be too far apart.

246. When trees are trained upon a wall with a southern aspect, they have the advantage of a greatly exalted temperature; but this temperature, in spring, differs from the warmth of a more advanced period of the year, or of a more southern climate, in not being accompanied by an increase of moisture. In this extremely dry state of the atmosphere, the enormous exhalations from the blossoms of tender fruit-trees which must thus be induced cannot fail of being extremely detrimental; the effect of shading the plants from the direct rays of the sun should therefore be ascertained. The state of the weather referred to often occurs in April, May, and June, but seldom lasts many hours. Great mischief, however, may arise in a very small interval of time, and the disadvantage of a partial loss of light cannot be put in comparison with the probable good effect of shading, by mats or canvas, at the distance of a foot or two from the wall." (*Idem.*)

247. Mr. Daniell "kept a register of the weather, and has seen, in the month of May, the thermometer in the sun at 101°, while the dew-point was only 34°: the state of saturation of the air, upon a south wall, consequently, only amounted to 120°; a state of dryness which is certainly not surpassed by an African harmattan. The shelter of a mat on such occasions would often prevent the sudden injury which so frequently arises at this period of the year." With great submission to Mr. Daniell, who must necessarily know so much more of the subject than we can do, we cannot help thinking that this statement must be somewhat exaggerated. In this country we certainly have the sun frequently sufficiently powerful in summer to raise the thermometer in the free air, at a distance from the wall, to 101°, whilst the air

in the shade may, perhaps, be only 60° , and the dew-point 50° . We should in this case say, that the degree of dryness was 10° , and not 51° , as would be the result of subtracting 50° from 101° , as Mr. Daniell has done 30° from 150° . Supposing a screen were put so as to intercept the sun's rays from the thermometer, the latter would soon fall, and it would be found that the temperature of the air was really not 101° , and therefore that the latter number should not have been taken for the purposes of giving the difference or degree of dryness.

248. "Some of the present practices of gardening," Mr. Daniell continues, "are founded upon experience of similar effects; and it is well known that cuttings of plants succeed best in a border with a northern aspect protected from the wind; or if otherwise situated, they require to be screened from the force of the noon-day sun. If these precautions be unattended to, they speedily droop and die. For the same reason, the autumn is selected for placing them in the ground, as well as for transplanting trees; the atmosphere at that season being saturated with moisture, is not found to exhaust the plant before it has become rooted in the soil.

249. Over the absolute state of *vapour* in the air we are wholly powerless; and by no system of watering can we affect the dew-point in the free atmosphere. This is determined in the upper regions; it is only, therefore, by these indirect methods, and by the selection of proper seasons, that we can preserve the more tender shoots of the vegetable kingdom from the injurious effects of excessive exhalation." (*Hort. Trans.*, vol. vi. p. 7.)

250. Over *rain*, we may be said to have little influence; but though we cannot prevent rain falling from the clouds, we can prevent it from falling upon particular plants or objects. By copings, we can protect fruit trees against walls from perpendicular rain, and thus preserve the bloom on the surface of fruit which would otherwise be washed off by it. The roofs of plant-structures of every kind, and even the surface of the ground, may be protected from rain by thatching or covering with any body that will carry off the rain at particular points, or channels, whence it may be conveyed away in underground drains. By these and other means the soil of a garden in a wet climate may be kept much drier, and consequently warmer, than it otherwise would be. Some situations are more liable to rain than others, such as the vicinity of woods and hills, and places exposed to the Western Ocean generally. Those, on the other hand, which are exposed to the Eastern Ocean have rains less frequently; but these rains have a better effect on vegetation, because the soil, from the less frequency of rain, being generally drier, is warmer to receive them.

251. Though we have little or no power over the *moisture of the free atmosphere*, we may be said to have the perfect command of the *atmospheric moisture of hothouses*. Till within the last twenty or thirty years the principal points attended to in the atmosphere of hothouses were heat and light; but meteorological and chemical researches having proved, as we have seen (242 and 253), that with every increase of temperature in the open air there is always an increase of aqueous vapour, this condition began to be imitated in hothouses in which tropical plants were cultivated. "Capt. Sabine, in his meteorological researches between the tropics, rarely found, at the hottest period of the day, so great a difference as 10 degrees on the temperature of the air and the dew-point; making the degree of saturation about 730, but most frequently 5 degrees, or 850; and the mean satura-

tion of the air could not have exceeded 910." If the hygrometer were consulted in hothouses as commonly managed, Mr. Daniell observes, "it would be no uncommon thing to find in them a difference of 20° between the point of condensation and the air, or a degree of moisture falling short of 500." The causes of the dryness of our artificial climates has been admirably pointed out by Mr. Rogers.

252. "The causes whose constant operation renders our *artificial climates unnaturally dry* are principally two: the condensation of moisture on the glass, and the escape of heated and damp air through the crevices of the building, the space which it occupied being constantly supplied by dry external air. A third drain of moisture formerly existed in the absorbing surfaces of brick flues, which drank up the moisture of the air in contact with them, and carried it off with the smoke into the outer air. The very general use of hot water in iron pipes has removed this nuisance, and we have now only to contend with the two first mentioned.

253. Some idea of the *drain of moisture* by the escape of heated air may be formed from the following considerations. The capacity of air for moisture, that is to say, the quantity of water which a cubic foot of air will hold in invisible solution, depends upon its temperature, and increases with it in a rapid ratio. It is doubled between 44° and 66°. The consequence is, that every cubic foot of air which escapes at the latter temperature carries off with it twice as much moisture as it brought in. Where the difference of temperature is greater, the drain becomes greater also: air entering at 44°, and escaping at 80°, carries off three times as much as it brought in; escaping at 90°, four times. Now the escape of air from our best glazed buildings is considerable at all times, even when the lights are closed; and if the glazing be defective, and the laps be not puttied, it is very great indeed. The amount of moisture thus abstracted cannot be very easily estimated, varying exceedingly according to the height and construction of the building heated.

254. There exists, however, another *drain of moisture*, constantly affecting all hothouses, however perfectly constructed, and however cautiously ventilated: viz., the condensation on the glass. In this case the expenditure is capable of pretty accurate calculation. It has been ascertained by experiment, that each square foot of glass will cool $1\frac{1}{4}$ cubic foot of air as many degrees per minute as the temperature of inner air exceeds that of outer air; that is to say, if the temperature of outer air be 44°, and of the house 66°, for every square foot of glass $1\frac{1}{4}$ cubic feet of air will be cooled 22° per minute; and the moisture which this air held in solution, in virtue of its 22° of heat, will be deposited on the glass, and will either drain away out of the house or fall in drip. The greater the difference between the temperature of internal and external air, the greater will be the amount of condensation; and be it observed, that the capacity of air for moisture does not increase simply in the arithmetical ratio of its temperature, but by a scale considerably more rapid, so that the expenditure of moisture at high temperatures is much greater than at low temperatures, for equal differences between internal and external air." (*Gard. Mag.* vol. xvi. p. 282.)

255. This *dryness of the atmosphere of hothouses* Mr. Daniell has shown to be frequently accompanied by an injurious degree of *cold* to the roots of plants. "The danger of overwatering most of the plants, especially at particular periods of their growth, is in general very justly appreciated; and in

consequence the earth at their roots is kept in a state comparatively dry ; the only supply of moisture being commonly derived from the pots, and the exhalations of the leaves is not enough to saturate the air, and the consequence is a prodigious power of evaporation. This is injurious to the plants in two ways : in the first place, if the pots be at all moist, and not protected by tan or other litter, it produces a considerable degree of cold upon their surface, and communicates a chill to the tender fibres with which they are lined. The danger of such a chill is carefully guarded against in the case of watering, for it is one of the commonest precautions not to use any water of a temperature at all inferior to that of the hot air of the house ; inattention to this point is quickly followed by disastrous consequences. The danger is quite as great from a moist flower-pot placed in a very dry atmosphere."

256. "The custom of lowering the temperature of fluids in hot climates, by placing them in *coolers of wet porous earthenware*, is well known, and the common garden pot is as good a cooler for this purpose as can be made. Under the common circumstances of the atmosphere of a hot-house, a depression of temperature, amounting to fifteen or twenty degrees, may easily be produced upon such an evaporating surface. But the greatest mischief will arise from the increased exhalations of the plants so circumstanced, and the consequent exhaustion of the powers of vegetation. Some idea may be formed of the prodigiously increased drain upon the functions of a plant arising from an increase of dryness in the air, from the following consideration. If we suppose the amount of its perspiration, in a given time, to be 57 grains, the temperature of the air being 75°, and the dew point 70, or the saturation of the air being 849, the amount would be increased to 120 grains in the same time if the dew-point were to remain stationary, and the temperature were to rise to 80 ; or, in other words, if the saturation of the air were to fall to 726."

257. "The cause why *plants in living rooms do not thrive* so well as those which are kept in plant structures, is chiefly owing to the extreme dryness of the air, while a constant drain upon the leaves and the soil of the pots is maintained for moisture. Hence the fibres in the inside of the pots are alternately moistened and dried, and cooled and heated, and the leaves are deprived of their water by evaporation instead of by perspiration."

258. "Besides the power of transpiration, the leaves of vegetables exercise also an *absorbent function*, which must be no less disarranged by any deficiency of moisture. Some plants derive the greatest portion of their nutriment from the vaporous atmosphere, and all are more or less dependent upon the same source."

259. "These considerations must be sufficient," Mr. Daniell imagines, "to place in a strong light the necessity of a *strict attention to the atmosphere* of vapour in our artificial climates, and to enforce as absolute an imitation as possible of the example of nature. The means of effecting this is the next object of our inquiry."

260. "*Tropical plants* require to be watered at the root with great caution, and it is impossible that a sufficient supply of vapour can be kept up from this source alone. There can, however, be no difficulty in keeping the floor of the house and the flues continually wet, and an atmosphere of great elasticity may thus be maintained in a way perfectly analogous to the natural process. Where steam is employed as the means of communicating heat, an occasional injection of it into the air may also be had recourse to : but this

method would require much attention on the part of the superintendent, whereas the first cannot easily be carried to excess." It is true that damp air or floating moisture of long continuance would also be detrimental to the health of the plants, for it is absolutely necessary that the process of transpiration should proceed; but there is no danger that the high temperature of the hothouse should ever attain the point of saturation by spontaneous evaporation. The temperature of the external air will always keep down the force of the vapour; for as in the natural atmosphere the dew-point at the surface of the earth is regulated by the cold of the upper regions, so in a house the point of deposition is governed by the temperature of the glass with which it is in contact. In a well-ventilated hothouse, by watering the floor in summer, we may bring the dew-point within four or five degrees of the temperature of the air, and the glass will be perfectly free from moisture; by closing the ventilators we shall probably raise the heat ten or fifteen degrees, but the degree of saturation will remain nearly the same, and a copious dew will quickly form upon the glass, and will shortly run down in streams. A process of distillation is thus established, which prevents the vapour from attaining the full elasticity of the temperature. This action is beneficial within certain limits, and at particular seasons of the year; but when the external air is very cold, or radiation proceeds very rapidly, it may become excessive and prejudicial. It is a well-known fact, but one which I believe has never yet been properly explained, that by attempting to keep up in a hothouse the same degree of heat at night as during the day, the plants become scorched; from what has been premised it will be evident that this is owing to the low temperature of the glass, and the consequent low dew-point in the house, which occasions a degree of dryness which quickly exhausts the juices." Much of this evil might be prevented by such simple and cheap means as an external covering of mats or canvas; or by still slower conductors of heat, such as straw mats, or "thatched hurdles;" the latter, from the direction of the straws, throwing off the rain, and, from their tubular construction, retaining a large proportion of stagnated air, and hence forming an excellent non-conductor.

261. "*The heat of the glass of a hothouse at night cannot exceed the mean of the external and internal air, and taking these at 80° and 40°, 20° of dryness are kept up in the interior, or a degree of saturation not exceeding 528. To this in a clear night we may add at least 6° for the effects of radiation, to which the glass is particularly exposed, which would reduce the saturation to 434°, and this is a degree of drought which must be nearly destructive. It will be allowed that the case which I have selected is by no means extreme, and it is one which is liable to occur even in the summer months. Now by an external covering of mats, &c., the effects of radiation would be at once annihilated, and a thin stratum of air would be kept in contact with the glass, which would become warmed, and consequently tend to prevent the dissipation of the heat. But no means would of course be so effective as double glass, including a stratum of air. Indeed, such a precaution in winter seems almost essential to any great degree of perfection in this branch of Horticulture. When it is considered, that a temperature at night of 20° is no very unfrequent occurrence in this country, the saturation of the air may, upon such occasions, fall to 120°; and such an evil can only at present be guarded against by diminishing the interior heat in proportion. But by materially lowering the temperature, we communicate a check which is*

totally inconsistent with the welfare of tropical vegetation. The chill which is instantaneously communicated to the glass by a fall of rain and snow, and the consequent evaporation from its surface, must also precipitate the internal vapour, and dry the included air to a very considerable amount, and the effect should be closely watched." (*Hort. Trans.*, vol. vi. p. 23.)

262. "*The skilful balancing of the temperature and moisture of the air,*" says Dr. Lindley, "in cultivating different kinds of plants, and the just adaptation of them to the various seasons of growth, constitute the most complicated and difficult part of a gardener's art. There is some danger in laying down any general rules with respect to this subject, so much depends upon the peculiar habits of species, of which the modifications are endless. It may, however, I think, be safely stated, that the following rules deserve especial attention :—

(1.) Most moisture in the air is demanded by plants when they first begin to grow, and least when their periodical growth is completed.

(2.) The quantity of atmospheric moisture required by plants is, *cæteris paribus*, in inverse proportion to the distance from the equator of the countries which they naturally inhabit.

(3.) Plants with annual stems require more than those with ligneous stems.

(4.) The amount of moisture in the air most suitable to plants at rest, is in inverse proportion to the quantity of aqueous matter they at that time contain. Hence the dryness of the air required by succulent plants when at rest." (*Theory of Hort.*, p. 153.)

SECT. III.—*The Agitation of the Atmosphere considered with reference to Horticulture.*

263. The *motion of the atmosphere*, known as wind, and varying in gradation from the gentlest breeze to the most furious tempest, is, to a certain extent, under the control of the horticulturist. He cannot, indeed, agitate the air at pleasure, but he can lessen the agitation, when it is produced by nature, by shelter; and he can take advantage of it when it is wanted, by exposure; and, in hothouses, he can even create agitation. The use of wind in the economy of nature seems to be to carry off impure exhalations from particular spots, and to equalize in the atmosphere the diffusion of gaseous matters, and of moisture and temperature. The free action of the wind on the surface of the ground assists in drying it when moist, because air has a great capacity for water; and it promotes the vigour of plants, and especially of trees, by the motion which it produces in their stems, branches, and leaves. In some cases it may do good by carrying off insects, and in others injury by bringing them. The fact that the motion of the stems and leaves of trees by wind increases their diameter, is doubted by some, though according to others it is easily proved by observing what takes place in fruit-trees trained against walls, as compared with the same species growing as standards. If, say those who are of the latter opinion, the deposition of woody matter in the stems and branches depended on the number and exposure to the sun of the leaves, then wall-trees must necessarily have a thicker stem than standard-trees; but as the contrary is the case, and as the only difference in the circumstances in which standard and wall-trees are placed is, that the standards are subject to be put in motion by the wind, to that cause we must attribute the greater thickness of their stems and branches. It is added, that tying the

stems of transplanted trees firmly to stakes impedes the growth of that part of their stems which is below the tie ; and that trees, after being fixed two or three years in this way, have their stems rapidly increased in thickness when set at liberty. De Candolle mentions a tree, which had been tied up in such a manner that it could only move from north to south, which at last formed a trunk the horizontal section of which was elliptic. The effect of motion on plants generally, he considers to be increased evaporation, and a more rapid movement of the descending sap. (*Phys. Végétale*, t. iii. p. 1178.)

264. By greatly increasing the *perspiration* of the leaves and other parts of plants, wind renders them less watery ; and when this is not carried to an injurious extent, plants are by that means rendered firmer, drier, and better adapted for being packed and sent to a distance. Hence greenhouse plants grown in pits, where the atmosphere is continually moist, are less adapted for being sent to a distance than such as have been grown in open, airy greenhouses ; and such as have been grown in houses heated by brick flues, are better than those which have been grown in houses heated by hot water. In like manner trees grown in nurseries, situated on high dry situations, exposed to the wind, must necessarily have their wood harder and better ripened, than such as are grown in moist sheltered valleys. The uses of wind in the open air may be reduced to that of drying surfaces, and that of putting plants in motion ; and the evils attending wind result from these two properties being carried to an excess. All the advantages to be obtained from wind in the open air in horticulture are to be obtained by exposure ; and all the disadvantages are to be counteracted by shelter. In plant structures the imitation of wind, by the agitation of the air, will have the same effect as in the external atmosphere, but in a diminished degree. It is also of use, by rendering air at a high temperature more agreeable to the human feelings than when it is in a stagnant state ; though some (268) consider that this is to be principally attributed to the air being saturated or nearly so with moisture.

265. *Shelter*, as every gardener knows, is produced by means of walls, hedges, plantations, and other screens, placed at right angles to the direction of the wind ; but the force of the wind is most powerfully reduced, not by opposing a strong barrier, such as a wall, but by an elastic, partially open, body, such as a hedge or a thin plantation. The most effectual mode of sheltering any territorial surface, whether level or hilly, is by scattering over it single trees. In this way, a park or pleasure-ground in the most exposed situation may be sheltered in every part of its surface. In this way also an orchard or plantation of fruit-trees, the trees being equally distributed over the ground, produces its own shelter ; but as a kitchen-garden, if planted with standard fruit-trees so as to produce shelter, would be unfit for the culture of culinary vegetables, the best mode of sheltering it is by crossing it with walls and hedges at such distances as may produce the desired shelter in the given situations. A very efficient shelter for culinary vegetables may be produced by sticking in branches of young trees, four or five feet in length, like pea-sticks, all over the surface on which they are grown ; or by intersecting the surface with lines of wicker-work hurdles, which could be put down and taken away at pleasure. By throwing the compartments of a kitchen-garden into squares of ten or twelve feet on the side, by wicker-work hurdles, an effective shelter would be produced ; and by covering these squares with netting, resting on the hurdles, a great deal of the heat radiating from the ground would be returned to it. Hedges of thorn, hornbeam, or

other plants, may be made to grow on a base of two feet, and trained so as to taper on the sides regularly to a top not thicker than an inch, at a height of six or eight feet from the ground. Such hedges would form an elegant and most effective shelter, provided they were at all times neatly kept. The subject of shelter and exposure, however, in the open air is so well understood, that any further observations seem unnecessary.

266. The *agitation of the air in plant structures* has only lately been attempted; but, as a substitute for this, a partial renewal of the air, by opening the sashes or ventilators of such structures, has long been in practice. This, under many circumstances, particularly in houses for tropical plants and for forcing fruits, is very injurious to the plants, though it has been found impossible to dispense with it to a certain extent. The injuries sustained by the admission of the external air into a hothouse are greater or less according to the difference of temperature, and, consequently, as we have seen (252), of moisture. When the external air enters a hothouse in which the air is at a high temperature, it rushes in with considerable velocity, driving out by the pressure of the atmosphere the hot and vaporous air by which the plants are surrounded, and becoming heated and charged with moisture, at the expense of the earth in the pots and the foliage of the plants (270).

267. The only complete remedy for this evil is to *heat the air before it is admitted among the plants*, by causing it to pass through a system of heated tubes; and to saturate the heated air, as it passes through those tubes, with moisture, by placing among them a number of vessels of water. As this mode, however, is somewhat difficult and expensive in the attainment, a better practice is to put the air of the house in motion, admitting to it only occasionally a small portion of the external air. This is done in a very satisfactory manner by the mode of heating recently introduced by Mr. Penn. By this mode the air is continually circulating from one side of the house to the other, ascending on one side and descending on the other, from back to front; one half of every revolution being among the plants, and the other half through a drain or tunnel under the floor, the bottom of which is covered with water, which, by the heated air passing over it, is kept at the same temperature as that of the house. Fig. 2 is the section of a house heated in Mr. Penn's manner, in which *a* is the chamber containing the heating pipes; *b* a small opening in the front wall for occasionally admitting fresh air; *c* the drain from back to front, having the bottom covered with water, through which drain the air passes, as shown by the direction of the arrows in the figure.

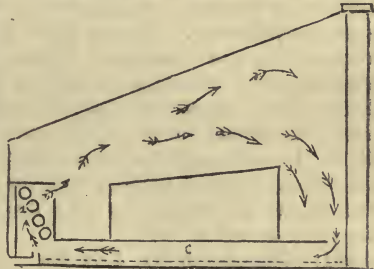

Fig. 2. Section of a Hothouse heated by hot water according to Mr. Penn's manner.

268. A sensible effect on the human feelings, produced by the atmosphere of hothouses heated according to Mr. Penn's principle, is, that a high temperature, say of 80° or 90°, can be breathed in as agreeably, and for as long a period, as one of 60° or 70° not in motion. This result is partly attributed to the motion given to the air; since, in the hottest days of summer, the heat which would be oppressive in still air, is rendered not only bearable but even agreeable, if the air is put in motion by a breeze. In like manner the

absence of heat is much more severely felt when the air is in motion, than when it is at rest. Captain Parry and his companions, when in the Polar regions, could endure a degree of cold when the air was still, that, when it was put into motion, they found to be quite intolerable. It is certain, however, that a part of the agreeable effect produced by the motion of the air in Mr. Penn's hothouses is owing to the moisture which it contains; for the human feelings in a hothouse heated to 80° , in which no attempt has been made to saturate the air with moisture, are much less agreeable than in one at the same temperature in which the paths are kept moist with water. Every one must be aware of this who has felt the heat of a stove heated by brick flues, as compared with one heated by hot water; for though no water may escape from the pipes to moisten the air, yet no moisture is absorbed by them from the air of the house. In a house heated by flues, on the contrary, the clay of the bricks in the flue covers, and the lime by which the sides of the flues are plastered, having, as we have seen (155 and 156), a great chemical attraction for water, abstract it from the air of the house, and give it that peculiar dryness which is so unpleasant to the skin, and so oppressive to the lungs. Alluding to this dry heat, Mr. Daniell says:—

269. "To the human feelings *the impression of an atmosphere saturated with moisture* is very different from one heated to the same degree without this precaution; and any one coming out of a house heated in the common way, into one well charged with vapour, cannot fail to be struck with the difference. Those who are used to hot climates have declared that the feel and smell of the latter exactly assimilate to those of the tropical regions."

270. The excellence, Mr. Rogers observes, "of Mr. Penn's method of *warming and ventilating* buildings appears to consist in the very uniform degree of moisture which it produces in the atmosphere. The heated air which enters the hothouse has already received a dose of moisture nearly sufficient to saturate it, and has not to seek its moisture among the plants, as is generally the case. In most plant houses the pipes are placed under the front shelves, at a considerable distance from the floor, and the atmosphere is moistened by syringing the plants, or throwing water on the floor and shelves. How greatly the state of an atmosphere so produced differs from that of Mr. Penn's houses, a little consideration of the annexed sketch will show. It is the section of a house heated by pipes under the front shelves; and it must be borne in mind that the capacity of air for moisture varies with its temperature, so that air which was saturated at 56° , becomes very dry when heated to 70° .

271. The sketch fig. 3 is the section of a house *heated by pipes in the ordinary manner*, under the front shelves. The arrows (numbered) indicate the course of the current of air. At No. 1 the air comes heated from the pipes *p*, and extremely thirsty; at No. 2 it finds moisture among the plants, and rising from the damp and warm shelf (slate, of course); at No. 3 it has parted with some of its heat; it is now supersaturated, and is parting

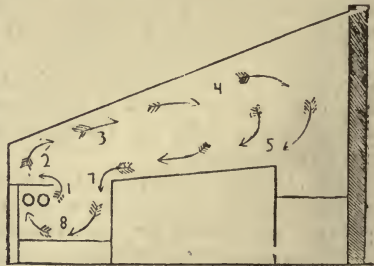

Fig. 3. Section of a Hothouse heated by hot water in the ordinary manner.

with the moisture deposited on the glass ; at No. 4 it is in the same state ; at No. 5 it has ceased to lose heat or moisture ; at No. 6 and 7 the same ; at No. 8 it again comes within the influence of the pipes, and is heated, becoming again very dry. Now the air which descends to the floor (8) in the first place, is a small and feeble current, and secondly, is nearly saturated, so that it can take up little moisture ; and what little it does get is because the floor, being slightly warmed by the radiation of the pipes, warms, and at the same time moistens, the air ; but, nevertheless, the air at No. 1, in which air a visitor walks, is anything rather than saturated. My belief is that air nearly saturated is always agreeable to the feelings. Dry air, which is absorbing moisture, is anything but agreeable. Hence the unpleasant sensation in orchidaceous houses. Now it is unnecessary to show how Mr. Penn's plan obviates all these defects, and produces a uniformly saturated atmosphere which must be wholesome alike to plants and men." (*Gard. Mag.* vol. xvi. p. 273.) Corbett's mode of heating, by circulating water in open gutters (which can be closed at pleasure), is said to keep the air of those houses in which it is employed more effectually saturated with moisture than any other mode. (*See Gard. Mag.* 1841, p. 57, and *Gard. Gaz.* 1841, Jan. 23.)

272. Though too much moisture can scarcely be admitted into the atmosphere of plant structures kept at a high temperature, yet this is not the case with houses in which the degree of heat is not much greater than that of the open air ; for example, *Greenhouses*. In these houses the object of the gardener is frequently more to exclude frost than to increase the heat already there ; and consequently, when the thermometer in the open air ranges between 40° and 50°, no fire heat is required. In this case, however, if the air is not agitated by some artificial process, it becomes surcharged with moisture or damp, not in a state of elastic vapour, but as steam or fog. This excess is favourable to the growth of mould or fungi on the surface of the soil in the pots ; and being, from the excess of water, unfavourable for the respiration of the leaves, it occasions them to decay and drop off. In cases of this kind, it is more desirable to introduce dry air than moist air ; but as the air of the external atmosphere is generally not drier than that of the house, it is found desirable to employ heat so as to raise the temperature of the house, and this raised temperature having an increased capacity for heat, the water which was before in a state of mixture with the air is now changed into elastic vapour ; the consequence is, that the air of the house becomes dried, the growth of fungi checked, and the leaves of the plants no longer decay and drop off. Some persons are of opinion that Mr. Penn's system of circulating the air is only applicable to houses where fire heat is constantly used, and that for greenhouses and conservatories it is nearly useless. An experienced and scientific gardener, however, is of a directly contrary opinion. "In addition to its use in forcing-houses, where it may be deemed indispensable," he says, "I would adopt it in the greenhouse in preference to all other modes of heating. Greenhouse plants invariably do well while we can admit plenty of air, or while we can maintain a current to counteract the effects of damp. But there are sometimes months together that we cannot open a sash to effect this, without admitting air injuriously cold, or saturated with moisture ; it is then we are doomed to see many of our tender favourites pine, droop, and die ; and then that the advantage of an independent atmo-

sphere, circulating at pleasure, and of any desired quality of heat and moisture, become of incalculable value. Admitting damp to be the greatest enemy that tender plants have to encounter during winter; that a current of air dispels that damp as effectually, and much more safely, than fire heat (the least excess of which is always hurtful and often fatal), the conclusion is, that plants in a damp state are really more benefited by the application of fire heat, from the commotion it creates in the air, than from any trifling addition it may make to the temperature. Hence the great utility of Mr. Penn's apparatus, with which the same quantity of fuel will create a tenfold current, giving at all times the power of maintaining sufficient heat to keep plants in a state of health without the possibility of injuring them. Some persons suppose that plants will thrive better in a lower circulating medium than they will do in a higher stagnated one (that is, that they will do as well in a current of air heated to 60°, as they would where it is stagnated and heated to 70°); then I reply that we know that plants of a more hardy nature will bear much more heat with the air in a state of circulation than they will when it is stagnant. Therefore, with an atmosphere so truly under our control as that produced by Mr. Penn, we may reasonably expect an approximation in the habits of plants, that will render the division of structures, however desirable under any circumstances, less a matter of absolute necessity than it has hitherto been. It is, I think, not improbable that this may be the case to an extent that will render greenhouse grapes equal to the present forced fruit." (*Gard. Mag.* vol. vi. 2d series, p. 641.

273. *Pits and cucumber frames*, which are kept at a high temperature during winter, frequently have the air within surcharged with moisture to such a degree at that season as to endanger the health of the plants. The ordinary remedy for this evil is to admit a portion of the external air during bright sunshine; but a safer mode, if it can be adopted, is to admit the external air through tubes heated by being bedded in dung or tan, or by being placed in contact with the flues or hot-water pipes by which the pit is heated. By this means, the admitted air has its capacity for moisture greatly increased, and it will absorb and change the steam contained in the atmosphere of the pit and the dew-drops on the grass and framework into elastic invisible vapour. Where hot water is used as the sole means of heating pits, if Mr. Penn's system be adopted, the air will be kept constantly in motion, and very little danger will arise from the damp, as will be afterwards shown when we come to treat of the construction of pits.

274. In all plant structures *change of air and ventilation* are least necessary when the plants are beginning to grow, and most so when they are coming to maturity. The reason is, that at this latter period plants are more abundantly covered with leaves than at any other; and these leaves being fully expanded, more air is required to enable them to perform their respiratory functions. It is also found that increased ventilation and a drier air are of great advantage to the maturation of the fruit; but by dryness of the air must be here understood not so much the absence of invisible elastic vapour as of steam, or watery exhalations not held in a state of combination. "When grapes begin to colour," says Mr. Duncan, a scientific and experienced gardener, "it is of as much importance to obtain a dry atmosphere as it was, previously, to have a moist one; because the change effected in grapes while ripening is produced under the full influence of light, heat, and dryness: and it is well known that grapes grown in dry

heat, in properly managed houses, acquire a flavour superior to those grown in plant houses, where the air is kept moist for the sake of the plants." In corroboration of this, the same gardener mentions an instance in which "in forcing an old house of vines a continual current of air was admitted at the end where the fire entered, in order to maintain the temperature at both ends of the house nearly alike. At the end of the house where so much air was admitted, invariably, till the present year, the most abundant, finest, and best coloured grapes, have been produced; but in the present year the case has been materially different, in consequence of one of Dr. Arnot's stoves being placed at the other end of the house, by which the necessity of admitting air at the usual place, and to the usual extent, became unnecessary. The difference in the colour and quality of the grapes between the two ends of the house is now inappreciable." (*Gard. Mag.*, vol. i., *third series*, p. 25.) It will be observed, that in this case the air was heated before entering the house, which the writer represents as essentially necessary. "Good grape-growers," Mr. Duncan adds, "seldom admit a current of air directly from the atmosphere, except in extremely warm weather, and, even then, never through a doorway, unless it be situated at the back of the house, where the temperature is in general higher than in front: to admit air in front, unless in very mild weather, would be most injurious to the plants."

275. It is certain that in all countries *the climate, during the growing season*, is moist, and at the ripening season comparatively dry, and hence the practice of withholding water from fruit-bearing plants under glass, when the fruit is ripening, is in direct imitation of nature. It is also natural to suppose, that in the ripening season in the open air, when the surface of the soil is dry, the atmosphere over it will be less saturated with vapour than when the soil is moist; and hence, the recommendation of dry air for the maturation of fruits is also natural. The effect of this air must be greatly to increase the perspiration of the leaves, which is probably favourable to the increased action of solar light, in the production of the saccharine matter, and the peculiar odoriferous properties of fruits. Where growth, and not the maturation of fruit, is the object, more water in the leaves appears necessary, probably to aid in the production of carbon.

276. It will be obvious, from the foregoing remarks, that the mode of admitting air to hothouses, by a range of *ventilators* in front, and a correspondent range at the back, must be highly injurious to the plants in the winter season; and, indeed, more or less so at all seasons, when there is much difference between the temperature of the open air and that of the house to be ventilated.

277. Indeed, cultivators may lay it down as a *general principle*, that neither water nor air ought to be given to plants at a much lower temperature than that of the soil in which they grow, or the air by which they are surrounded.

SECT. IV.—*Light, considered with reference to Horticulture.*

278. *Light*, as we have seen (143), is one of the most important agents in the growth of plants. It is to light they owe their green colour, and the maturation of their fruits. When plants are grown in situations where they obtain no light, as in dark cellars, instead of that beautiful variety of colours, and of properties, which they present when grown exposed to the

air and the sun, they consist only of a colourless, inodorous, insipid mass ; so much so, that when they are dried and burned they do not give out flame. The carbon contained in all plants, and which of course is in greatest abundance in such as have woody stems, is entirely the result of the action of light on the leaves, by which plants are enabled to decompose carbonic acid, and thus to fix its carbon in their structure and expel its oxygen. (*Dec. Phys.* vol. i. p. 47.) Fruits before they are ripe are acid ; that is, their hydrogen and carbon are combined with an excess of oxygen ; but they are rendered saccharine by the action of light, which occasions the evolution of the oxygen, and the fixation of carbon, by which the vegetable acid is converted into sugar. In a word, no plant, nor any part of a plant, can be brought to perfection without light ; but it deserves also to be remarked, that in the cultivation of plants for the use of man, it is sometimes not desirable to bring all the parts of a plant to perfection ; and in these cases, the absence of light is as necessary as its presence is in others. For example, in the case of the Celery and other plants, the stalks of which, when rendered green by light, are disagreeable to the taste and even poisonous ; but which, by excluding the light, are rendered wholesome and agreeable : the same may be said of the tubers of the Potatoe, and of the stalks and leaves of Cardoons, Endive, &c.

279. Light, to a certain extent, *follows the same laws as heat*. It is received by radiation from the sun, reflected by smooth surfaces, transmitted and refracted by transparent substances, such as water and glass ; concentrated by reflection from concave surfaces, and dispersed by reflection from surfaces which are convex. All these properties of light are rendered more or less available in horticulture. Light, however, differs from heat in the impossibility of retaining it after the absence of the sun ; whereas heat can be retained by enclosing heated bodies in non-conducting mediums, and by reflecting it back to the surfaces from which it is radiated (218).

280. The *radiation of light* is greatest when the radiating rays strike the surface at a right angle, and least when the angle is most oblique : because, in the former case, the rays are reflected on every side, and consequently the surrounding objects are illuminated proportionately ; and in the latter case the greater number of rays pass off at one side, and illuminate less effectively the surrounding medium. The reflected rays are always returned from the surface on which they radiate, at an angle equal to the angle of incidence ; and if the reflecting surface be a plane, the reflected rays will be parallel to each other : if the surface be convex, they will be divergent, and consequently dispersed ; and if it is concave, they will be convergent, and hence concentrated. Smooth and shining surfaces reflect most light, and rough and dark surfaces least ; and with respect to colour, white reflects almost all the rays of light which fall on it, and black absorbs them all.

281. When light falls on a transparent medium, a portion of the rays is *transmitted* through it, and a portion is reflected from its surface. The latter portion follows the same laws as the light which is reflected from opaque surfaces ; and the portion which passes through it is refracted—that is, it leaves the transparent medium at a different angle from that on which it fell upon it ; and by this change the light is also weakened, so as at a very short distance from the surface of the transmitting medium, as of glass for example, to be dispersed and transfused in the atmosphere, in which state in hothouses it has no longer the same power on the vital energies

of plants. We are not aware that the cause of the inefficiency of light after it has passed through glass and reached a certain distance, has been fully explained; but the fact is well known to gardeners, who, in hothouses, invariably place the plants they wish to thrive best at the shortest distance from the glass. As the quantity of light which passes through glass at the roof of hothouses is, all other circumstances being the same, greatest when the plane of the roof is at right angles to the plane of the sun's rays; hence, the slope of the roof is, or ought to be, adjusted to the direction of the sun's rays at that season of the year, when its light is most wanted. As in houses for early forcing, the greatest deficiency of solar light is in the winter season, when the sun is low, so the roofs of such houses are made steep, in order that the sun's rays may be received at a larger angle. Summer forcing houses, on the other hand, have less steep roofs, so as to receive most benefit from the sun in April, May, and June, when forced fruits are ripening. A greenhouse, in which no fruit is ripened, but in which abundance of light is required all the year, has commonly perpendicular glass to receive a maximum of light during winter; and a sloping roof of glass at an angle of 45° ; which is found favourable for the admission of light at every season, as well as for throwing off rain, &c. This subject, however, will receive more attention when we come to treat of the construction of hothouses.

282. The light of the sun, after it has passed through the clouds, is *refracted*, to a certain extent, in the same manner as when it passes through glass or water; and if plants were kept constantly under a cloud, but at some distance from it, and if the space in which they grew were enclosed by clouds on every side, we believe the effect on the plants thus enclosed would not be materially different from that produced by an enclosure of glass. In the open air, however, clouds are not stationary; and even where a succession of clouds covers growing plants for several days together, the space on which the plants grow is open on every side for the access of reflected and transfused light. This prevents the etiolation and want of colour which are found in plants in the back parts of hothouses having shed-roofs; but which are never found in nature, even on the north side of walls; except to a very small extent. Hence plant structures which are enclosed by glass on every side, and which are circular in the plan, are more likely to produce an equalization in the growth and appearance of the plants within, than such as have glass on one side, and a wall or opaque body on the other.

283. As an isolated body, such as a cone or small hill, *disperses* light most extensively when the sun shines, so when the sun is obscured by clouds the same body receives most of the reflected light transfused in the atmosphere, because it is exposed to the atmosphere on every side. For the same reason the summits of all bodies in the free atmosphere receive more light than their sides; and hence the trees in dense forests, and the thickly-standing corn plants in cultivated fields, continue to grow and thrive though they receive little benefit from light, except from that which strikes on the tops of the plants. Hence the great importance of perpendicular light to plants under glass, and the advantages of conical, domical, angular, or ridge and furrow roofs, to plant structures; because they receive from the atmosphere the transfused light on every side. Hence also, if only a certain quantity of glass were to be allowed for the construction of a plant house, the most beneficial application of it would be in the roof. In the construction of conservatories about sixty years ago, it was customary to have opaque

roofs; and even about the beginning of the present century half the roof on the south side of conservatories, as for example at Southgate Lodge, was frequently formed of glass, and the remaining half, on the north side, was opaque as before: but this remaining half was placed at such an angle as to allow the rays of the sun when highest in the firmament, and consequently whenever it shone throughout the year, to reach the back wall. This, it was thought by the architects of those days—Mr. Nash, for example, who introduced this practice—would answer every purpose of a roof entirely of glass, and at the same time would be warmer and more economical. It was soon found, however, that not only the plants on the back wall, but all those that were deprived of perpendicular light, did not thrive much better than in opaque-roofed conservatories.

284. From what has just been observed, the necessity of *perpendicular light* will, we trust, be strongly impressed on the mind of our readers; and, also, the necessity, when plants in hothouses are intended to look well on every side, of having every side of the hothouse of glass. A third axiom to be kept in mind is, that a convex glass roof, or one with an irregular surface, is, all other circumstances being alike, preferable to a roof in which the glass is all in one plane.

285. Though art has little power in increasing the quantity or intensity of light, whether direct from the sun or transfused in the atmosphere, yet it possesses a considerable degree of power in increasing *the efficiency of light* on plants, of such light as there may be in the atmosphere. Thus, by spreading out the branches of a tree against a wall exposed to the south, much more light as well as heat is brought to act upon the leaves, than if the tree were a standard in the free air; because, in the latter case, there would be neither the benefit of the reflection of the wall, nor that resulting from the circumstance of every leaf being exposed to the direct influence of the sun's rays when it shone. In like manner, herbaceous plants or shrubs may be planted or trained on surfaces sloping to the south; and on surfaces elevated and freely exposed rather than in low and confined situations, in which light is obscured by surrounding objects or by aqueous vapour. The light thrown on the leaves of a plant in the open air may be increased by surrounding it on the north, and part of the east and west sides, by a wall or other upright surface painted white, or covered with glazed tiles or tinned iron. Practically, however, the grand means of increasing the efficiency of such light as there may be in any given situation on plants, is by training them against walls, espaliers, or on the surface of the ground; or, for those that cannot be conveniently so trained, by removing all other plants and objects which are so near them as either to obstruct the sun's rays or to interfere with circumambient radiation. To insure the full effect of the radiation of transfused light upon a plant, it ought to have a free space around it, in width on every side at least equal to its own height. No timber tree, which has not at least this space, can receive from light the full influence which it ought to have on its horizontal branches; and hence (278) the trees in dense forests must necessarily produce timber inferior in bulk to those of the same kinds in the same climate and soil, which are grown as single trees in parks, or in hedge-rows.

286. In plant-structures a *due proportion between light and heat* ought, as much as possible, to be preserved, because this is always the case in nature, where both depend on the sun. It is not in our power to increase the natural light of the atmosphere; for the great disadvantage to which horticulture

is subject in this climate, as Mr. Daniell has observed, is the uncertainty of clear weather; but artificial warmth can be supplied or withheld at pleasure. "After trying everything that I had seen recommended for the shrivelling of grapes," says an experienced scientific gardener, "and feeling fully convinced in my own mind, that want of light was one of the causes of this evil, I thought I would try what effect proportioning the heat to the light would do. This I did, and after several years' practice, I can assert that the success has been beyond my expectation." (*Gard. Mag.*, vol. vi., *second series*, p. 529.)

287. The *absence of light*, as we have before mentioned (278), is necessary to render certain bitter or unwholesome parts of plants fit for culinary purposes; and the diminution of light is frequently had recourse to, when the habitation of plants which grow in shady places is to be imitated, and when the perspiration from the leaves of plants is to be diminished. In all cases of rooting plants from cuttings which have the leaves on, the diminution of perspiration, by shading them from the direct rays of the sun, is necessary, till the cuttings have taken root; and this is also more or less the case with all rooted plants which are transplanted with the leaves on, for some days after transplanting. When plants are in a dormant state, and without leaves, no light is requisite to maintain them in a healthy state; and even such evergreens as are in a state of comparative rest require very little. Hence Orange-trees and other greenhouse evergreens, may be kept through the winter in an opaque-roofed conservatory; and deciduous plants, which have lost their leaves, may be kept through winter in houses or in cellars into which no light is admitted. Plants which naturally grow in the shade (122), are not here taken into consideration.

CHAPTER V.

WORMS, SNAILS, SLUGS, REPTILES, BIRDS, &c., CONSIDERED WITH REFERENCE TO HORTICULTURE.

288. THE natural uses of plants are for the support of animals, and hence every plant, whether in a wild state or in cultivation, is more or less liable to their attacks. The most universal enemies to plants in British gardens are insects, snails, slugs, and earth-worms; but they are also subject to be devoured or injured by reptiles, birds, and some quadrupeds. With the introduction of new species and varieties of plants, the refinements of garden cultivation in forcing-houses, and the cultivation of tropical plants in stoves, the attacks of ordinary insects have been more severely felt, and several new species have been introduced. Hence, to prevent the increase of insects and other garden vermin, or to destroy them after they have commenced their attacks, has become an important element in garden-culture.

289. Till about the end of the last century very little attention was paid to *garden vermin* by horticultural writers. Birds were considered to be the chief enemies of gardeners, and they were directed to be scared away or shot at on account of the injury they did to the rising seeds, or the ripe fruit which they ate or destroyed. The injuries done by insects of whatever kind

then passed under the general term of blight. The scientific study of insects had then made little or no progress in this country; and it does not appear to have been then known that birds, though injurious to gardens to a limited extent, are yet on the whole, by living in great part on insects, slugs, worms, &c., the gardener's best friends. Neither does the use of certain reptiles, such as the frog and toad, and even of quadrupeds, such as the weazel, appear to have been understood in gardens by the gardeners of the past generation. In the present day, however, this branch of garden management, like every other, has been subjected to scientific inquiry, and the object of this chapter is to generalize the results; leaving details relative to particular species of garden vermin till we come to treat of the plants by which they are chiefly affected. The order which we shall follow will be that of worms, slugs, snails, insects, reptiles, birds, and quadrupeds.

SECT. I.—*The Earth-Worm, considered with Reference to Horticulture.*

290. *Lúmbricūs terrèstris*, L., the common earth-worm, has a body composed of numerous narrow rings, of a reddish colour, and shining from a viscid substance, which forms a sort of protecting sheath to its body, and facilitates its progress through the soil. It is without eyes; and its blood is aerated by means of a series of small vesicles along its sides, which open externally by very minute pores. The mouth consists of two lips, the upper one of which is elongated somewhat like a proboscis, and therefore admirably fitted for boring through the soil. "The œsophagus or gullet is a wide membranous canal, continued straight down for half an inch, and ending in a dilated bag or reservoir, to which succeeds a muscular stomach or gizzard, disposed in the form of a ring. The intestine is constructed at each segment of the animal by a series of ligaments or partitions, connecting it to the parietes of the body, and swells out the intermedial spaces when distended by the particles of earth." The nervous system consists of a series of small ganglions close to each other. Worms are oviparous; though, under certain circumstances, they are supposed to hatch their eggs internally. The eggs are white, round, rather larger than white mustard-seed, pellucid, and laid in clusters of a dozen or more together. The accouplement of worms takes place in spring during the night, or shortly after rain, and always out of the soil. "Earth-worms creep at a good pace by means of muscular contraction and dilation, acting on the rings, which carry on their under-sides certain bristle-like processes; these last operate as feet. The power of elongation is considerable, and the anterior part of the animal acts as a sort of awl in penetrating the earth." (*Penny Cyc. art. Lúmbricūs.*)

291. The habits of the earth-worm appear to have been very imperfectly understood by naturalists. They are always most abundant in moist rich soil, and they are found more or less in every country in the world. During the severe weather of winter they descend deep into the soil, so as to be out of the reach of frost; and during summer and very dry weather at other seasons they also withdraw to a considerable depth, appearing on the surface after rain, and more especially during the night. The food of worms is evidently the vegetable matter contained in the soil, and they reject the soil from which they have abstracted the nourishing part in the form of casts. It does not appear that they devour any part of the plants; though they lacerate the fibrous roots by passing and repassing through them in search

of fresh food. Worms are particularly injurious to plants in pots ; as, from the small space to which the roots are confined, they are continually liable to be torn asunder by the worms passing through the earth ; and thus the mass of roots frequently falls in two when the plant is turned out of the pot, instead of remaining in a solid ball. When this is the case, the plant has generally become sickly ; as, from the spongioles at the extremity of the roots being torn off, the plant is unable to obtain its proper food. The excrement of the worm is never voided except on the surface of the ground, and it is so placed as to form a covering to the hole by which it retreats into the interior of the soil. At certain seasons of the year, more particularly when the weather and the surface of the ground are dry, the slimy matter of the worm adheres to leaves, straws, and other light substances, which it drags after it to the orifice of its holes ; where, on entering, it leaves them so as to stop up the passage as effectually as worm-casts. We are uncertain how far this mode of stopping the orifice of the passages is matter of accident or of design ; and therefore, like many other points of the natural history of the worm, it is open to observation and correction.

292. The most remarkable property in the organization and functions of the worm is that of reproducing a part of its body after being mutilated. It is generally believed that when a worm is cut into pieces by the spade every portion of it becomes a perfect individual ; but it has been proved that it is only the portion which has the head and the organs of generation attached, and which must necessarily include more than one-half of its length ; which lengthens, survives, and forms a new anus. (*Bosc.*) The duration of the life of worms is uncertain.

293. The *natural uses* of the worm appear to be to serve as nourishment to moles, hedgehogs, frogs, toads, snakes, lizards, birds, fishes, and some kinds of insects. It is also said by naturalists that worms are useful to plants by penetrating the soil, loosening it, rendering it permeable to air and water, and even adding to the depth of the soil by bringing up its worm-casts to the surface. This last opinion, however, we conceive to be entirely erroneous. Soil is not loosened by boring through it, but rather rendered firmer in the parts not bored through ; and so far from surface soil being rendered permeable by water in consequence of the bores of worms, it is rendered less so, the worm-casts deposited on the orifices of the bores always being water-tight ; so much so, indeed, that when lawns where worms abound are to be watered by lime-water in order to destroy them, the first step is to brush away the worm-casts with a long flexible rod, or remove them by a rake, in order to let water enter the bores ; it having been found from experience, that when this operation is neglected, the lime-water sinks into the soil without producing much effect. With impervious loomy subsoils, resting on gravel, the case is otherwise ; and under such circumstances worms may be useful, by permitting the escape of water where it would otherwise be retained. With respect to worms adding to the depth of the soil (an opinion first promulgated, we believe, by Mr. Charles Darwin), we believe it to be entirely a delusion, as we have endeavoured to show in the *Gardener's Magazine*, vol. xiv. p. 95.

294. The *injury* done by worms in gardens we hold to be very considerable. By their casts they disfigure walks and lawns, and by cutting through the roots they injure more or less all plants whatever, and particularly those which are weak, (to which worms always attach themselves more than

believe, by Mr. Charles Darwin), we believe it to be entirely a delusion, as we have endeavoured to show in the *Gardener's Magazine*, vol. xiv. p. 95.

294. The *injury* done by worms in gardens we hold to be very considerable. By their casts they disfigure walks and lawns, and by cutting through the roots they injure more or less all plants whatever, and particularly those which are weak, (to which worms always attach themselves more than to healthy plants,) and plants in pots. Seedlings of all kinds are much injured by them, because when the point of the taproot is cut through the seedling has no other resource, and, unless it be vigorous enough to throw out lateral roots, it dies.

295. *To destroy worms* is fortunately a very simple process; for such is the tenderness of their skin, that watering them with any caustic or bitter liquid deprives them of life in a few minutes. The cheapest caustic liquid is lime-water, which is made by dissolving quicklime, at the rate of half a pound of lime to twelve pints of water, and letting it stand a few minutes to clear. Before pouring it on the soil from a watering-pot with a rose on, the worm-casts ought to be removed, and the effects of the water will soon become obvious by the worms rising to the surface, writhing about there, and in a few minutes dying. To hasten their death, some more lime-water should be poured on them after they come to the surface. The quantity of lime-water required will depend partly on the depth of the soil and the number of worm-casts in a given space, and partly on the state of the weather. Least will be required in shallow soils moderately dry, and most in deep soils either very wet or very dry. Where lime is not at hand, potash, soda, or urine, may be used; and a decoction of the leaves of Walnut-trees, of those of Hemp, Tobacco, or Potatoes, after being partially dried and fermented, will have the same effect. Hand-picking may also be resorted to; but this requires to be performed in the night-time, when the worms are on the surface of the ground, or immediately after rain. Worms in pots may either be removed by striking the sides of the pots, which will disturb the worms and cause them to rise above the surface; or by turning out the ball on one hand, and picking off the worms, which seldom fail to come to the outside.

296. *To prevent worms from entering pots*, a small cap (fig. 5, of the natural size) has been invented by Mr. Barron, which, when placed over the hole in the bottom of the pot, will permit the escape of water and effectually prevent the entrance of worms. It has been in use at the gardens at Elvaston Castle for several years.



Fig. 5. Cap for covering the holes in the bottoms of pots.

SECT. II.—*Snails and Slugs, considered with reference to Horticulture.*

297. The only *snail* which interests the gardener is the *Hélix aspérâ* of naturalists; for that which they have named the garden snail (*H. horténsis*) is rather a field than a garden species. The former is much the larger of the two, and has a dull shell marked with three faint mottled brownish bands, and a white rim round the aperture; while the shell of the latter is glossy, distinctly banded with vivid colours, and the oral rim is brown.

298. The *slugs* which frequent the garden are the *Limax agr stis*, *L. cinereus*, and *L.  ter*. The *L. agr stis*, the commonest, is of a greyish colour, and from one to two inches long; the *L. cinereus* is, on the contrary, from three to five inches in length, of a greyish or dusky colour, with darker spots and stripes; and the *L.  ter* is easily known by the jet black and wrinkled skin of its back.

299. Both *snails and slugs* are furnished with tentacula placed in front of the head, and which, by a singular process, can be drawn entirely within it. The mouth is armed above with a semi-lunar horny jaw, having its outer or cutting edge furnished with one or several serratures. On the right side or neck of the snail and slug there are three apertures, that nearest the head being the respiratory orifice, the next the anus, and the third the exit for the organs of generation. Snails and slugs crawl on the flat sole which constitutes their foot and belly, and which is very muscular: but progression is principally performed by a pair of muscles which extend from the tail to the fore part of the belly, running along the middle of the foot.

300. *Snails and slugs are hermaphrodite and oviparous*. They deposit their eggs under clods of earth, loose stones, or in the ground, in which the parent digs, with its foot, a circular hole about an inch deep. The eggs vary from twelve to thirty in number; they are white, oval or round, about the size of a common shot, with a smooth soft skin, which is entirely membranous in the slug, but in the snail contains innumerable minute calcareous grains, always in a crystalline state, and usually of a rhomboid figure. They are, in ordinary seasons, hatched in about three weeks after being laid; but the time is regulated much by temperature, so that in cold seasons it is greatly retarded. The young issue from the egg in the likeness of their parents, active and furnished with every organ; and the young snails have even then a shell fitting their size and strength. The length of life of the snail or slug cannot be determined. The shell of the snail is usually completed before the termination of the second year, when the animal may have been said to have reached maturity. The snail and the slug are very patient of injury, often recovering from severe wounds; repairing their broken shells, and reproducing such parts of their bodies, posterior to the neck, as may have been cut away. In winter, snails and slugs retire under stones, clods, or into the crevices of walls: the slugs become merely less active than usual, but the snails hibernate; and to protect them from annoyance during this dead sleep of a winter's continuance, they seal up the apertures of their shells with a horny membrane. (Abridged from an article in *Gard. Mag.* for 1841.)

301. The *natural uses of the snail* appear to be to serve as food for reptiles, birds, and the smaller quadrupeds, such as foxes, badgers, weazels, hedgehogs, &c. The blackbird and thrush are remarkably fond of them, and may be seen and heard flying off with snails in their bills, and afterwards lighting on trees, and breaking the shells against the branches. There is some apparent reason for supposing that the worm is more useful than injurious to plants, but none that we know of in favour of the snail being useful either to gardeners or farmers.

302. The snail *retires* under the cover of foliage or some other protection from the sun and dry air during the day, and comes abroad to feed during the night, after rain, or when the weather is cloudy. It selects in preference tender seedling plants, or the leaves of maturer plants which

have become tender and somewhat sweet by incipient decay. Snails are very fond of greasy matter; and where a snail has been killed by crushing, its remains are preyed on by living snails, which crowd to it in numbers. About the end of autumn, when the weather begins to grow cold, the snail retires into sheltered places, where it will be protected from the weather during winter. Where there are evergreens, such as the Box or the Ivy, it resorts to them; or if these be wanting, it will retire under loose stones, or rubbish of any kind, such as branches, spray, leaves, or litter; and if no other covering is at hand, it has a power of burying itself in any soil not too hard on the surface. Whatever has been said of the habits of the snail will apply to those of the slug; and the uses and the natural enemies of the two animals are exactly the same.

303. To *destroy snails* in gardens, the only effectual mode is hand-picking, either in the evening, early in the morning, or immediately after rain. Empty flower-pots reversed and distributed over the surface, if an opening under the rim is left on one side by making a small depression in the soil, will attract a great number of snails; and the more so if some greased cabbage-leaves or slices of turnip, carrot, &c., be placed under the pots. In the course of the autumn, winter, and early in spring, all their hiding-places should be searched, and the animals taken out and destroyed by crushing, or by giving them to swine, which are said to be very fond of them. Hedgehogs and weazels being their natural enemies, may be kept in gardens, and poultry which do not scratch, such as the turkey, duck, &c., may be admitted occasionally; though no mode of subduing the snail but hand-picking is to be depended on.

304. To *destroy slugs* in gardens, less labour is required than in destroying snails; because, their bodies being comparatively unprotected, they are liable to be operated on by any caustic or bitter liquid as readily as worms. Cabbage-leaves in a state of incipient decay, with the side which is to be placed next the soil rubbed over with greasy matter of any kind, or even with the bruised bodies of recently-killed slugs, distributed over any surface, will attract them in great numbers during the night; and if the leaves are examined every morning, and the slugs which are found destroyed, the piece of ground so treated will soon be freed from them. Pea-haulm being very sweet when in a state of incipient decay, forms a powerful attraction to slugs; and if handfuls of it are distributed over a piece of ground in the same manner as cabbage-leaves, the little heaps of haulm may be examined every morning, and the slugs shaken from them and then destroyed by watering with lime-water. Thin slices of turnip or potatoe placed under inverted empty flower-pots form an excellent attraction, as do the dead bodies of slugs themselves, some parts or the whole of which are greedily devoured by the living animals. Where slugs are very abundant in a soil not covered with plants so large as to shelter them, as for example with rising seedlings, the slugs may be destroyed by watering the soil thoroughly with lime-water, or tobacco-water, late in the evening or early in the morning. Abundance of water should be applied, in order that it may sink into the soil, which the slugs penetrate a foot or more in depth, according to its state of pulverization. Quicklime has been laid round plants to protect them from snails and slugs; but it soon becomes mild and of no use as a protection. Coal-ashes and sawdust annoy slugs by sticking to their foot, but they will not be deterred by this annoyance so effectually as to starve

for want of food. Soot is also a great annoyance to slugs; but to keep them from a plant, it requires to be frequently and liberally renewed. "A stout, coarse, horse-hair line, such as is used for hanging clothes out to dry, coiled round the stems of wall-fruit trees, and stretched along the wall, will operate as a protection to the fruit from both snails and slugs, in consequence of the bristly surface presented to them, and which they shrink from encountering. Care must of course be taken that they do not get under it." (*Penny Cyc., Limax.*) No gardener ought to rest content with merely protecting his plants or fruits from snails and slugs; because while they are in the garden, as they must live, if they are debarred from attacking one plant they will only have recourse to another. Nothing short of extermination, therefore, ought to satisfy him, and this he may accomplish by enticing the larger slugs into empty pots, or under cabbage-leaves or haulm; and by soaking thoroughly with lime-water the soil which he supposes to contain young slugs or eggs.

SECT. III.—*Insects, considered with reference to Horticulture.*

305. The number of *species of insects* in the world greatly exceeds that of all other animals and plants put together, and the power which some insects have of multiplying themselves, such as the plant lice for example, is almost incredible. As by far the greater number of insects live on plants, some on several species, and others on only one, the importance of some knowledge of the natural history of insects to the gardener is sufficiently obvious. The subject, indeed, is one of great extent; nevertheless every gardener may readily acquire, from books and observation, such a knowledge of it as will suffice for the purposes of his profession. We shall therefore lay before him the essence of that part of it which more especially relates to the insects which infest British gardens. We shall notice in succession the general nature of insects, their different stages of life, their nourishment, propagation, duration, their natural enemies, and, above all, the means employed by art to mitigate the evils which they occasion, or to destroy them. We shall take as our guide Kollar, from whose treatise we have abridged great part of the article; and the whole has been revised for us by J. O. Westwood, Esq., Secretary to the Entomological Society.

Subsect. 1. *Of the Nature of Insects and their Classification.*

306. *Insects* are animals which have a body consisting of one or more divisions, articulated feet, and a head conspicuously distinct from the body, on which are placed two movable horns, called antennæ. They breathe through airholes, which are situated on the sides of the body; the greater number have wings in their perfect state, and only a proportionably small number are entirely without them. With the exception of certain groups, all perfect insects have six feet, and their bodies are divided into a head, thorax, and abdomen, by notches or incisions; hence the name *insect*, derived from the Latin word *insecare*, to cut or notch. Before they attain their perfect state they are subject to various transformations, which are called metamorphoses. For the sake of perspicuity the very numerous class of insects, the most extensive in the whole animal kingdom, has been divided into two principal divisions—the winged, and the wingless.

307. *Winged insects* are divided into the following orders:—

(1.) *Coleóptera* (Beetles; Sheath-wings). Six feet, and mostly four wings, the anterior pair of which are horny, in the form of a covering for the two posterior wings, which are sometimes wanting. They have upper and lower jaws (mandibles and maxillæ) for gnawing or chewing: their under wings are transversely folded. Examples—the may-bug, the long-horns (*Cerambycidae*), stag-beetles, ground-beetles (*Carábidæ*), weevils, &c.

(2.) *Orthóptera* (Straight-wings). Six feet; four wings, the two anterior of a leathery substance, serving as covers to the posterior, which are folded both longitudinally and transversely, but more generally only longitudinally, (whence the name straight-wings,) and which lie, when at rest, concealed under the others. They have upper and lower jaws (or mandibles and maxillæ) for chewing. Examples—the earwig, the black-beetle, the cockroach, the field-cricket, the migratory locust, and the green grasshopper.

(3.) *Hemíptera* (Half-wings). Six feet; four wings, the two anterior forming hard coverings with membranous ends, or resembling the lower ones, but being larger and stronger. Instead of upper and lower jaws, the organs of the mouth are formed of bristles, inclosed in an articulated sheath, of a cylindrical or conical shape, and forming a projecting beak or sucker. Examples—the field and tree bugs, house bugs, cicadæ, and aphides.

(4.) *Neuróptera* (Net-wings). Six feet; four membranous naked wings, upper and lower jaws for chewing; the wings are delicately veined, the under nearly the size of the upper, or even broader in diameter. Examples—the dragon-fly, or *Libéllula*; lace-fly, or *Hemeróbis*; and day-fly, or *Ephéméra*.

(5.) *Hymenóptera* (Membrane-wings). Six feet; four membranous wings, upper and lower jaws; the posterior wings smaller than the upper. In the abdomen of the female of most species is a sting, or ovipositor. Examples—the saw-flies (*Tenthredínidæ*), *Sirex gigas*, gall-fly, bees, wasps, humblebees, and ants.

(6.) *Lepidóptera* (Scale-wings). Six feet; four membranous wings, covered with small, coloured, mealy, shining scales or feathers. Instead of the upper and lower jaws, two hollow filaments exist, which together form a spirally rolled tongue. Examples—butterflies, moths, and hawk-moths.

(7.) *Rhipíptera* (Fan-wings). Six feet; two membranous wings, folded like a fan; on the anterior part of the thorax are situated two small, bent, hard, movable bodies, like wing-covers. The masticatory organs consist of simple bristle-shaped mandibles, and two palpi. To this order belong two genera of parasites living on wasps and bees.

(8.) *Díptera* (Two-wings). Six feet; two membranous expanded wings, generally with two movable organs, called poisers or balancers, and which are situated behind the wings. The organs of the mouth consist of a sucker formed of a variable number of bristles, which are enclosed in an unarticulated sheath; terminated in a double lip. Examples—gnats, midges, house-flies, ox and horse breeze-flies, &c.

308. *Insects without wings* consist of the following orders:—

(9.) *Myriáopoda* (Thousand-feet, Millepedes). They have more than six feet, twenty-four at least, and upwards, which are placed on a series of rings, extending the whole length of the body; each ring has generally two pairs. The first, and sometimes also the second pair, form parts of the mouth. Examples—the centipede, *inlus*, and scolopendra.

(10.) *Thysanúra* (Fringe-tails). Six feet; on the under sides of the

abdomen are situated flat movable appendages like pro-legs, and at the extremity is a forked apparatus, by which the body can raise itself and move by leaps. Example—the sugar-louse (*Lepisma saccharinum*.)

(11.) *Parasita* (Parasites). Six feet; no other organs of sight except simple (instead of composite) eyes; the mouth is mostly internal, and consists of a snout, which contains a retractile sucker, or it forms a cleft with two lips, two mandibles, and hooks. Examples—the different species of lice.

(12.) *Suctòria* (Suckers). Six feet, of which the posterior are the longest, and adapted for jumping. These undergo a transformation, and acquire organs of motion which they had not at first. The mouth consists of a sucker, which is enclosed in a cylindrical sheath, and is formed of two articulated pieces. Example—the flea.

309. *Crabs and spiders*, which Linnæus included among insects without wings, are now formed into two distinct classes —Crustacea and Arachnida.

310. The *arrangement here given* is that of Kollar; but other authors differ in their views of the subject. By some the earwig is formed into an order distinct from the Orthóptera. The *Thríps* is separated as an order from the Hemíptera, the caddice-flies (*Phryganea*) from the Neuróptera and the horse-flies (*Hippobosca*) from the Díptera. In a popular point of view the arrangement of Kollar may be considered as sufficiently detailed.

Subsect. 2. *Transformation of Insects.*

The greater number of insects properly so called, with the exception of some without wings, change their form several times during their life in so striking a manner, that a person unacquainted with entomology would be inclined to consider one and the same insect, in different periods of its existence, as entirely different animals.

311. Insects, in general, are produced from *eggs*; a few species alone, in which the eggs are developed in the body of the mother, are viviparous; for example, the aphid. Shortly after pairing, the female lays her eggs, which are often stuck on, and covered with, a sort of glue, to preserve them from the weather, instinctively in the place best adapted to their development, and which offers the proper food to the forthcoming brood. The white-thorn butterfly and the golden-tail moth lay their eggs on the leaves of fruit-trees or other leafy trees, and the latter covers them over with a gold-coloured covering of silk. The common lackey-moth (*Bómbyx neustria*) fastens them in the form of continuous rings round the stems of the fruit-trees; and the gipsy-moth (*Bómbyx díspar*) fastens them in a broad patch on the stems of trees or on paling, and covers them with a thick coating of hair. The winter-moth (*Geómetra brumata*) lays them singly on the buds of the leaves and flowers; the printer-beetle (*Bóstrichus typógraphus*) introduces them between the bark and the albumen, &c.

312. Most insects are developed from the eggs in the shape of worms, which are called *larvæ*. The larvæ of butterflies, which are always provided with feet, are called caterpillars; those of beetles and other insects, grubs; and, when they have no feet, maggots. In this state, as their bodies increase, the insects often cast their skin, and not unfrequently change their colour. Many winged insects (*e. g.* cimices, cicadæ, grasshoppers, and dragon-flies), in their larva state, very much resemble the perfect insect; they only want the wings, which are not developed till after the last change of the skin. The larva state is the period of feeding, and at this period insects are usually

the destructive enemies of other productions of nature, and objects of persecution to farmers, gardeners, and foresters.

313. The *nympha* or *pupa* state succeeds that of larva. In this state insects for the most part take no nourishment (with the exception of the Orthopterous, Hemipterous, and part of the Neuropterous species, which vary but little in form from the larva), and repose in a death-like slumber. The body is covered with a skin more or less transparent, through which the limbs of the perfect insect are more or less apparent. To be safe from their enemies, or from the weather, the larvæ of many insects, particularly moths, prepare for themselves a covering of a silky or cottony texture; many burrow in the soil, or form themselves a nest of moss, leaves, grass, haulm, or foliage; many even go deep into the earth, or bury themselves in decayed wood, or conceal themselves under the bark of trees, &c.

314. After a certain period, which is fixed in every species of insects, and which can either be hastened or retarded according to circumstances, the *perfect insect* appears from the pupa. It is usually furnished in this state with other organs for the performance of its appointed functions. It is incumbent on the perfect insect to propagate its species, therefore the organs for this purpose are only perfected at this period of their lives. The male insect seeks the female, and the female the most suitable place for laying her eggs; hence most insects are furnished with wings. Food is now a secondary consideration, consequently, in many, the feeding organs are now less perfectly developed than in the larva state, or very much modified and suited for finer food, as for example in butterflies, which, instead of the leaves of plants, only consume the honey out of their flowers.

Subsect. 3. *Food of Insects.*

315. Insects, like other animals, derive their *nourishment* from the vegetable and animal kingdoms; but a glance is sufficient to show, that they possess a much wider field of operations than the others. While the other animals make use for their subsistence of only a small portion of the inexhaustible treasures of the vegetable kingdom, and reject the rest as insipid or noxious, the insects leave perhaps no vegetable production untouched. From the majestic oak to the invisible fungus, or the insignificant wall-moss, the whole race of plants is a stupendous meal, to which the insects sit down as guests. Even those plants which are highly poisonous and nauseating to other animals are not refused by them. But this is not yet all. The larger plant-consuming animals are usually limited to leaves, seed, and stalks: not so insects, to the various families of which every part of a plant yields suitable provender. Some which live under the earth attack roots, others choose the stem and branches, a third division live on the leaves, a fourth prefers the flowers, while a fifth selects the fruit or seed.

316. Even here a still further selection takes place. Of those which feed on the *roots, stem, and branches*, some species only eat the rind, like the bee-hawk-moth (*Sphínx apifórmis*); others the inner bark and the albumen, like the Tórtrix *Wæberiana*, and the injurious bark-beetle; and a third division penetrates into the heart of the solid wood, like the goat-moth (*Cóssus lignipérda*), and the family of the long-horned beetles (*Cerambycidæ*).

317. Of those which prefer *foliage*, some take nothing but the juice out of the veins (aphides, in all their states); others devour only the substance of

the leaves, without touching the epidermis (mining caterpillars); others only the upper or under surface of the leaves (many leaf-rollers, *Tórtrices*); while a fourth division devours the whole substance of the leaf (the larvæ of many other Lepidopterous insects).

318. Of those which feed on *flowers*, there are some which eat the petals (the larvæ of *Nóctua verbásci*, the mullein-moth, *N. linàriæ*, &c.); others choose the farina in a perfect state (bees, the rose-chaffer, *Cetònia*, the *Leptùridæ*, &c. &c.); and a still greater number the honey from the nectaries (most perfect Lepidopterous insects, wasps, and flies). There are also insects which, not satisfied with any existing part of the plants as such, cause injury to one part or another, by occasioning a peculiar body or excrescence in which their young live, as the various sorts of gall insects and other sorts of flies. But insects are not confined to plants alone in their living and unused state. The death-watch, or ticking-beetle (*Anòbium*), feeds on wood which for years has been used in our dwellings, and in various articles of furniture and utensils.

319. From what has been said it will appear, that a single plant can support a host of various sorts of insects on its different parts; whence it also appears, that the *number* of insects greatly exceeds that of plants.

320. An equal variety in the *food* of those insects which live on animal matter may also be pointed out. Some live as parasites on the skin of other animals, not excepting even insects themselves, suck their blood, and are a burdensome torment to the animals: to these belong the different sorts of lice (bird and sheep lice), ticks, and mites. Others attack man and the larger animals only for a short time, and draw blood—gnats, midges, autumn-flies, breeze-flies, bugs, and fleas. Some breeze-flies (*Æ'stridæ*) penetrate through the skin into the flesh of the red deer and horned cattle, others live in the stomachs of horses and asses, and one sort in the frontal sinus of sheep. The *Ichneumónidæ* feed on the flesh of the larvæ of other insects, and often greatly contribute to the extirpation of noxious insects.

321. The *Carábidæ* and other carnivorous beetles devour their prey entire, immediately after killing it; while the *Címices* and *Hemeròbii* only suck out the juices. The larvæ of the stinging-gnat and other flies which live in water devour whole swarms of infusoria alone. A great number live on carrion and the excrements of animals, and thus diminish and destroy the corruption proceeding from such matter: to these belong chiefly the blue-bottle fly, horse-beetle, carcass-beetle, and dung-beetle. Many feed upon prepared animal matter, and become very prejudicial to household economy. Many moths live entirely on hair, leather, wool, and feathers.

322. With the various *transformations* of insects their economy is also changed, and consequently their abode is also varied: the caterpillar requires very different food from the butterfly; the maggot, from the beetle and fly. The larva of *Sirex gigas* feeds on wood, while the perfect insect preys on flies. The larva of the May-bug or cockchaffer lives on roots and tubers; the beetle, on leaves.

323. Many insects are very *gluttonous*, and often consume more food in a day than is equal to the weight of their bodies. Thus the maggot of the flesh-fly, according to Redi, becomes 200 times heavier in the course of twenty-four hours. Caterpillars digest in one day from one third to one fourth of their weight; and hence it is apparent that a comparatively small number of caterpillars can entirely strip a tree in a few days.

324. Opposed to this gluttony of caterpillars, some insects in their perfect state appear to take *no nourishment*, such as the day-flies (*Epheméridæ*), and the breeze-flies (*Æstridæ*); the latter of which, in their larva state as maggots, feed on the flesh of horned cattle and red deer. Even among the *Lepidóptera*, many of those which spin cocoons, especially *Bombýcidæ*, seem to take no nourishment in the perfect state.

325. Many insects only *eat* in the day, others in the evening, and a third division, such as the caterpillars of the night-moths, only in the night. Most of them seek their own food; but a few, namely, the larvæ of bees, which live in communities, humble bees, wasps, and ants, are fed by the perfect insect. Many stow away their food; others, indeed the greater number, live without making any previous supply of food. The larvæ of the caterpillar-killing kinds of wasps (*Sphégidæ*), of wild bees, and of a few other insects, are provided by their parents with a stock of provisions sufficient for their nourishment in the larva state.

Subsect. 4. *Distribution and Habits of Insects.*

326. The *distribution* of insects is in exact proportion to the diffusion of plants; the richer any country is in plants, the richer it is also in insects. The polar regions, which produce but few plants, have also but few insects; whereas the luxuriant vegetation of the tropical countries feeds a numerous host of insects. With respect to their habitation, insects are divided into those which live upon land or water.

327. Those which live in the *water* either never leave that element, or are able to live at will either in the water or on the earth, at least for a short time; for example, many water-beetles. Many live at certain periods of their development in water: at others, on land; such as many sorts of flies, and all the dragon-flies, which as larvæ and pupæ live in water, but as perfect insects on land, or in the air.

328. *Land insects* live in the earth, under stones, in decayed wood, in putrid animal substances, &c. Of these some pass their whole lives in these places, others only during a particular period of their development. The larvæ of the dung-beetle live deep under the ground, while the perfect insect inhabits the excrement of animals; many of the larvæ of flies live in carrion or excrement, while the perfect insect flies about in the open air. A very great number choose the different parts of plants for their abode, as the roots, bark, inner bark, alburnum, wood, pith, buds, flowers, leaves, and fruit. They change their abode in every new stage of their development. Thus the bark-beetle, which in the larva state lived under the bark, swarms in its perfect state upon the trees; the curculio of the apple-trec, the larva of which infests the bottom of the apple blossom, crawls on the trees, or on the surrounding ground; the mining-moth, which as a larva lives under the cuticle of the leaves, flutters in its winged state about the flowers and leaves.

329. A small number live upon *other animals*, on the skin, such as lice, or in the inside of the body, as the ox and horse breeze-flies (*Æstridæ*). The two latter leave their first abode before entering the pupa state, which they effect in the earth, and hover as flies round the animals to deposit their eggs upon them.

330. Most insects live *solitarily*, either without any definite dwelling, or they construct for themselves a house composed of various kinds of vegetable

or animal matter; for example, many caterpillars. A few species live *in society*, such as bees, ants, wasps, &c.

331. By obtaining a general knowledge of the *abodes* of insects, it is evident that the observer of the economy of insects will be able more satisfactorily to combat many that are injurious to him; as thus he can, with little trouble, greatly diminish or entirely annihilate those which he has ascertained to live in society, or in places of easy access.

Subsect. 5. *Uses of Insects.*

332. There are among insects no very inconsiderable number from which man derives, in many respects, immediate and important *uses*. We need here only to mention the bees and the silkworm. The different sorts of gall-nuts, ingredients so essential to dyeing and the manufacture of leather, are the productions of several insects, namely, the gall-flies, which wound with their ovipositor various parts of oaks, &c., in order to deposit their eggs in the cavity, and which produce these useful excrescences. The most durable and most beautiful red (cochineal) we owe to a small insect, the *Coccus cacti*. Another, nearly allied to the above-named insect, *Coccus manníparus*, is supposed to have saved the lives of the Israelites in their journey out of Egypt, for they would have died of hunger if they had not been provided with manna,—a sweet nutritive substance, which is regarded as identical with the material which, in consequence of a wound caused by this insect on the *Támarix gállica mannífera*, trickles on the ground.

333. The *Canthárides*, or Spanish blister-flies, are an essential article of *medicine*. Many insects accomplish the fructification of different plants. Whole nations in other quarters of the globe live on locusts. Many mammalia, a number of birds, amphibious animals, and fishes, live entirely on insects.

334. A great number of these creatures even live upon other species of insects, and *destroy* them: thus preventing the hurtful from preponderating, and disturbing the balance in the economy of nature. To these belong chiefly the *Ichneumoníidæ* and spiders.

335. Lastly, how many diseases are obviated, particularly in warm climates, by insects speedily *consuming dead animal substances*, and thereby preventing the generation of noxious gases!

Subsect. 6. *Means contrived by Nature to limit the Multiplication of Insects.*

336. Many appearances in nature, even such as at first cause anxiety and care, on account of their injurious consequences, are found to be in many respects highly beneficial and salutary, although we may not always understand them. Thus, *continued rain*, which in many respects is extremely hurtful, contributes greatly to diminish the number of noxious insects, and for a series of years renders them entirely innocuous. This continued rain may, for example, take place at the pairing time of certain insects, which will greatly obstruct them; or at the time when the insects are in the caterpillar or larva state, when thousands die in consequence of bad weather, and our fields, orchards, and woods are cleared of a dangerous enemy for many years. Thus in the spring of 1832, after *incessant rain*, Kollar saw the caterpillars of the white-thorn butterfly (*Papilio crataegi*), which for many years had not only stripped all the hedges, but also done considerable

injury to the fruit-trees, dying by thousands, as if of a dropsy. The caterpillars swelled, became weak, and died. If they did attain the pupa state, they suffered from the same evil, and the perfect insect was very rarely developed, on which account the gardens in the following years were entirely spared.

337. *Late frosts* are also very beneficial, as they entirely destroy many insects in their larva state. Kollar had an opportunity early in the summer of 1833 of observing great devastations on the fir-trees in the neighbourhood of Vienna, by a species of saw-fly (*Tenthredo rufa Klug*). The larva of this insect had attacked certain parts of a young forest of Scotch pine, and the question was how their ravages were to be prevented from increasing next year. Fortunately, in the month of May, a moderate frost set in, and thousands of these larvæ were seen hanging to the twigs, as if scorched. In this manner their increase was limited for the future.

338. A multitude of insects are also destroyed by *inundations*, particularly such as undergo their transformations in the earth, or live upon it in all their stages, more especially if the inundation happens when they are near their final transformation. In meadows the different species of May-bugs (*Melolonthidæ*) suffer by this means; in kitchen gardens, the mole-cricket; in orchards, the pupa of the small winter-moth (*Geometra brumata*), when the water overflows the gardens late in the autumn, at the time when the moth is usually developed from the pupa lying in the earth. Besides the means of preserving an equilibrium by storms, and the effects of the elements, nature employs a multitude of others, although not so speedy and efficient, to the same end.

339. To these belong the *enemies* of the destructive insects, which we meet with in all classes of the animal kingdom. Among the mammiferous animals the bats hold a conspicuous place for their destruction of insects. We only see them flying about in the twilight, precisely at the time when many moths leave their hiding-places and hover round the flowers. As they live almost entirely on insects, they no doubt devour great numbers of the hurtful sorts; and perhaps it is to be ascribed to this circumstance that fruit-trees standing near houses, churches, barns, &c., suffer less from insects than isolated trees. Bats do not confine themselves to moths, but eat the beetles which fly about in the evening; and, among others, some of the weevils injurious to the flowers and buds of fruit-trees, as the *Curculio* (*Anthonomus*) *pomorum*, and *pÿri*. These creatures, as they do no injury, should therefore be carefully preserved.

340. To the *insectivorous mammalia* also belong various sorts of mice, the mole, badger, hedgehog, squirrel, fox, and wild swine. Whether the benefits derived from them in this way counterbalance the mischief which many of these creatures cause, it is difficult to determine. At all events, the squirrel and the hedgehog deserve to be spared.

341. *Birds* contribute much more than the mammiferous animals to the destruction of injurious insects. Many caterpillars know instinctively how to conceal themselves from the birds which prey on them; in many their covering of stiff hair acts as a protection against their enemies; others remain all day between rolled-up or flatly-united leaves, and only go out to feed at night; others find sufficient protection in the buds, into which they soon penetrate. Gregarious caterpillars live while they are changing their skin, and when they are going into the pupa state, in webs, in which they

are inaccessible to birds. Others live under the bark of trees, and even deep in the wood. Notwithstanding these and other obstacles, a great number are yearly devoured by the birds, particularly during the breeding season. In winter a multitude of birds, driven by hunger into the villages, diligently search the branches of trees for the eggs of many sorts of moths that are glued to them, and which yield a scanty sustenance to these frugal animals. Réaumur states that the green-finch tears open the strong nest of the yellow-tail-moth (*Bómbyx chrysothoræa*), and consumes the young caterpillars.

342. Among the birds of the *woodpecker race*, the green and red woodpeckers (*Picus víridis* and *májor*), the nut-hatch (*Sitta cæsia*), and the tree-creeper (*Cérthia familiãris*), may be considered the most useful. Although these birds seek beetles chiefly, and consequently contribute to the diminution of the long-horned and weevil tribes of beetles, they also consume a number of caterpillars; but it must be acknowledged, that they also devour the honey-bee.

343. Among birds of the *sparrow tribe*, the starling deserves particular notice. It lives in summer chiefly in pastures, but comes in spring and autumn in great flocks to the meadows and orchards, where it devours a great number of insects, pupæ, and larvæ. The chaffinch is a determined consumer of caterpillars and moths' eggs. The titmice are particularly useful, viz. the ox-eye and tom-tit; then the goldfinch, redbreast, and red-start, and also the wagtails.

344. The *cuckoo* also particularly deserves to be spared; it not only devours many of the smaller smooth-skinned larvæ, but even consumes the hairy caterpillars of many moths, particularly of the *Bombýcidæ*. On examining the intestines of a cuckoo, in the month of September, Kollar found therein, besides the remains of various insects, a great quantity of the skins of the caterpillar of the large *Bómbyx pini*, which is one of the largest European species, and has very stiff hair. The inner coat of the stomach was entirely covered with hair, but a close inspection with the magnifying-glass showed that the hair was not the hair of the stomach of the cuckoo, as some ornithologists suppose, but only the hair of the caterpillars. This bird may therefore be of very essential service when there is a superfluity of the caterpillars of the lackey or processionary moths (*Bómbyx neustria* or *processionæa*).

345. It is sufficiently known that great service is rendered by the whole race of *crows* to meadows and fields. Their favourite food consists of the larvæ of the cockchafer, which are thrown up by the plough, and which they also draw out of the earth with their strong beaks. It is a wonderful provision of nature, that exactly at the time that the insects injurious from their great numbers appear, the greatest number of the insectivorous birds have hatched their broods, and their voracious young are ready to be fed upon them.

346. *Insectivorous birds* are also sometimes *granivorous*, and feast readily on our fruit, particularly cherries; but the injury they cause in this respect is not to be compared to the use they are of in destroying insects. At least we never hear of universal devastation caused by birds, though we do by insects.

347. Among *amphibious animals* which destroy insects, lizards hold a conspicuous place. Grasshoppers are the favourite food of many species. Frogs and toads also devour many insects.

348. Besides mammalia, birds, and amphibious animals, Nature, to restore the *equilibrium* among her creatures, and particularly to prevent the preponderance of some sorts of insects, makes use chiefly of insects themselves, namely, those which feed upon others, and which by degrees obtain a superiority over those that are hurtful to us.

349. Thus many sorts of *beetles*, particularly of the family of ground-beetles (*Carábidæ*), destroy a multitude of the pupæ of moths lying in the earth. Many flies, allied to our house-fly, but much larger, lay their eggs in living caterpillars and destroy them. But the most useful are the *Ichneumoníidæ*. The females of this numerous family, 1300 species of which Professor Gravenhorst has described in Europe alone, lay their eggs entirely in the bodies of other insects.

350. The manner in which these *Ichneumoníidæ* accomplish their work of destruction is highly curious and interesting. All the species are furnished at the end of the body with an ovipositor, composed of several bristles attached together, with which they pierce the larvæ of other insects, and introduce their eggs into the flesh of the wounded animals. In some this sting is longer than the whole body, sometimes more than an inch long, namely, in those species which seek the objects of their persecution in the interior of trees or wood that has been much and deeply perforated by the insects which reside within. They perceive, either by their sense of smell or by their antennæ, that their prey is at hand, and introduce their eggs, not without difficulty, into the bodies of the larvæ living in the wood. Some attack caterpillars feeding openly on plants, others perforate the various excrescences, or gall-nuts, which also contain larvæ: there are even many species, scarcely visible to the naked eye, which lay their eggs in the eggs of other insects, such as butterflies, and thus anticipate their destruction. The eggs are hatched within the body of the living insect, and the young parasites, in the most literal sense, fatten on the entrails of their prey. At last the wounded caterpillar sinks, the enemies escape through the skin and become pupæ; or the caterpillar, notwithstanding its internal parasites, enters the pupa state, but instead of a butterfly, one or more *Ichneumoníidæ* appear. To these wonderful animals we often owe the preservation of our orchards, woods, and grain.

351. Besides the above-mentioned *Ichneumoníidæ*, *ants*, *field or tree bugs*, and many sorts of *spiders*, contribute greatly to the extirpation of various insects.

Subject. 7. *Means devised by Art for arresting the Progress of Insects in Gardens, or of destroying them there.*

352. *Insects may be destroyed in all their different stages*; in some, however, with greater ease than in others. Some can only be taken or killed when in the perfect state, from the difficulty of discovering their eggs, or from their small size, or from the short period which elapses between the hatching of the insect and its maturity; for example, the aphides. Others can only be destroyed in the perfect state, with great difficulty; such as the different butterflies. A great number of the insects which infest British gardens are only to be destroyed in the larva state; while some, such as the gooseberry-moths, may be destroyed in every stage. We shall briefly indicate the different practices which may be had recourse to in different stages, for deterring or destroying insects, by the gardener; leaving particular

details till particular insects come to be mentioned, when treating on the culture of the plants which they attack. We shall commence with operations connected with the perfect insect, and take in succession the eggs, the larvæ, and the pupæ.

353. *Deterring the Perfect Insect.*—The perfect winged insect may, in some cases, be deterred from approaching plants by covering them with netting or gauze, the meshes of which are sufficiently small to exclude the insect, but not too small to prove injurious to the plant by excluding light and air. Wasps and flies are in this manner excluded from vineries and peach-houses while the fruit is ripening. Bunches of grapes against the open wall are also protected by putting them in bags of woollen netting or gauze. Choice plants in pots are sometimes protected from wingless insects by placing the pot containing the plant in the midst of a saucer which surrounds the pot with water, which it is found the insect will not cross. The stems of plants, such as dahlias and gooseberries, are sometimes protected by a zone of glutinous matter, on wool, tow, or paper, over which the insect will not venture. A remarkable mode of deterring some insects from entering houses by the windows is described in the *Architectural Magazine*, vol. ii., as practised in Italy, and known even in the time of Herodotus. This is simply to place before the openings of the window a net of white or light-coloured thread, the meshes of which may be an inch or more in diameter. The flies seem to be deterred from entering through the meshes from some inexplicable dread of venturing within. If small nails be fixed all round the window-frame at the distance of about an inch from each other, and thread be then stretched across both vertically and horizontally, the network so produced will be equally effectual in excluding the flies. It is essential, however, that the light should enter the room on one side of it only; for if there be a thorough light either from an opposite or side window, the flies pass through the net without scruple. (W. Spence in *Transact. Entomol. Society*, vol. i.) It would appear to be a general principle, that winged insects may be deterred by meshes of such a size as will not admit them with their wings expanded, and also that insects will not enter from bright light into darkness, more especially if deterred by the slightest obstacle, such as the threads stretched across before large openings in Italy.

354. *Preventing the Perfect Insect from laying its Eggs.*—Insects may be prevented from laying their eggs on plants within reach by surrounding them with a netting or other screen; or, in some cases, by sprinkling the plant with some liquid containing a very offensive odour. Thus moths are prevented from laying their eggs on gooseberry-bushes by hanging among them rags dipped in gunpowder and tar; and probably there are various cheap liquids that might be used in the case of fruit-trees, and perhaps even forest-trees, and possibly for deterring butterflies from depositing their ova on the cabbage tribe. Insects which deposit their eggs in the soil cannot easily do so when the soil is very hard, and may therefore be enticed to deposit them in portions of soil made soft on purpose. Thus boxes or large pots filled with rotten tan, sunk in the soil, form an excellent nidus for the eggs of the cockchafer, and will prevent that insect from laying them in the common soil of a garden. Hoeing or digging patches of soil here and there throughout the garden or plantation will have a similar effect, to a certain extent; and after some weeks, when the larvæ are some lines in length, the soil may be sifted, and the insects taken out and destroyed. While

loosening the naked soil serves as a trap for the cockchafer, covering that soil with straw is found to act as a defence against them; and hence one of the principal uses of mulching in the rose-gardens and tree-nurseries in the neighbourhood of Paris.

355. *Catching the Perfect Insect*, so as to prevent it from depositing its eggs.—Though this cannot be done to any great extent with winged insects, such as the butterfly, moth, and some flies, yet it may be employed in the case of the cockchafer, the rose-beetle, &c., which may be collected by children; and in the case of wingless insects, such as wood-lice, ants, and earwigs, which may be enticed into hiding-places by food, or by other means. Hay, mixed with crumbs of bread, and tied up in little bundles,—or, what is better, stuffed into empty flower-pots or boxes,—will attract wood-lice; and the material may be taken out daily, and the insects destroyed, after which it may be replaced, occasionally adding some fresh gratings of cheese. Ants may be entrapped by sweetened water put in narrow-necked bottles and sunk in the soil; or, better, by moist sugar, mixed with hay, and put loosely into flower-pots in the same manner as for wood-lice. Earwigs may be caught by placing hollow bean-stalks in their haunts, to which they will retire in the day-time, when they can be shaken out of the stalks into a vessel of water. A simple and effectual trap for both wood-lice and earwigs is composed of two pieces of the bark of any soft rough-barked tree, such as the elm, placed inside to inside, so as to leave in the middle between them a very slight separation, tying the two pieces of bark together by a wand or twig, part of which is left as a handle, and laying the trap where the insects abound. They will retire between the pieces in the day-time, which can be quickly lifted up by the twig and shaken over a vessel of water. No bait is required for this trap, the more tender part of the bark being eaten by the wood-lice and the earwig. The same bark-trap will also serve for millepedes, beetles, and, to a certain extent, for ants. The most effective mode of destroying ants in frames or hothouses is by placing toads in them. One toad will be sufficient for a frame or a hothouse. The toad places himself by the side of an ant-path, and by stretching out his tongue as the insects pass him, draws them in and devours them. Mr. Westwood suggests to us, that, where ants abound, it is most advisable to watch for the period when the winged males and females swarm; when this is perceived, they should be destroyed by beating them down with the spade, and turning up the nest. By this means the coupling of the sexes is prevented, as well as the formation of fresh colonies.

356. *Destroying the Perfect Insect*.—This is effected in the open air by the use of washes or decoctions in the case of the aphides; or, in the case of the wasp, by hot water being poured into its nest, or sulphur being burnt in it; or by pouring salt and water into ants' nests; or by lighting a fire over the holes of burrowing insects, &c. In plant-houses, the perfect insect, such as the red spider, the green fly, &c., is destroyed by fumigation with tobacco-smoke, accompanied at the same time by steaming, which is found to condense the oil of the tobacco on the leaves of the plants. The perfect insect is also destroyed in hothouses by the sublimation of sulphur, which may be mixed with lime or loam, and washed over the heating flues and pipes, or placed on a hot stone or plate, or in a chafing-dish. Dusting the leaves of plants under glass with sulphur, in a state of powder, is found to destroy the red spider. Beetles, wood-lice, ants, and other crawling wingless

insects, are also destroyed by tempting them with food containing poison. A remarkable but very efficient mode of destroying the vine-moth in France has been discovered by Victor Audouin, which might in many cases, we have no doubt, be adopted in British gardens. This mode is founded on the practice of lighting fires during the night in vineyards, to which the moths are attracted and burn themselves. M. Audouin has modified this practice in a very ingenious manner, which has been attended with the most effective results. He places a flat vessel with a light on the ground, and covers it with a bell-glass besmeared with oil. The pyralis, attracted by the light, flies towards it; and, in the midst of the circle which it describes in flying, it is caught and retained by the glutinous sides of the bell-glass, where it instantly perishes by suffocation. Two hundred of these lights were established in a part of the vineyard of M. Delahante, of about four acres in extent, and they were placed about twenty-five feet from each other. The fires lasted about two hours; and scarcely had they been lighted, when a great number of moths came flying around, which were speedily destroyed by the oil. The next day the deaths were counted. Each of the 200 vessels contained, on an average, 150 moths. This sum multiplied by the first number gives a total of 30,000 moths destroyed. Of these 30,000 insects, we may reckon one fifth females, having the abdomen full of eggs, which would speedily have laid, on an average, 150 eggs each. This last number, multiplied by the fifth of 30,000, that is to say, by 6000, would give for the final result of this first destruction the sum of 900,000. On the 7th of August, 180 lamps were lighted in the same place, each of which on an average destroyed 80 moths, or a total of 14,400. In these 14,400 moths there was reckoned to be, not only one sixth, but three fourths, females: but, admitting that there was only one half females, or 7200; and, multiplying this by 150 (the number of eggs that each would have laid), we have a total of 1,080,000 eggs destroyed. Two other experiments were made on the 8th and 10th of August, which caused the destruction of 9260 moths. (*Gard. Mag.* vol. xiii. p. 487.)

357. *Luring away the Perfect Insect.*—Attracting the perfect insect from the plant or fruit by some other kind of food to which they give the preference, and which is of less value to the gardener, may perhaps sometimes be effected. Thus honeyed water in narrow-mouthed glasses, such as fig. 6, is used to entrap wasps and flies from wall-fruit; and decayed fruit or small portions of meat, placed under hand-glasses in the following manner, may be used for a similar purpose;—Take a common hand-glass,—the hexagonal or

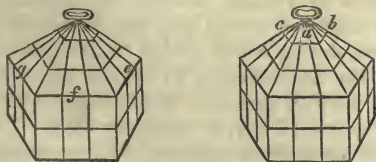

Fig. 7. Hand-glasses prepared for making a fly-trap.

any other form Fig. 6. Fly-glass will do (fig. 7); remove in the apex the whole or part of three of the panes, *a, b, c*. Then take a second hand-glass, which must be of the same form as the first, and place it on the roof of the first, so that the sides of the one may coincide with the sides of the other; next stop all the interstices between the bottom of the one and the eaves of the other, at *e, f, g*, with moss, wool, or any suitable substance,

which will prevent the entrance or exit of flies. The bottom hand-glass must rest on three pieces of bricks, fig. 8, to form an opening underneath. The appearance of the trap when completed is simply that of one hand-glass above another, fig. 9. Fragments of waste fruit are laid on the ground, under the bottom hand-glass, to attract the flies, which, having once entered, never descend again to get out, but rise into the upper glass, and buzz about under its roof, till, fatigued and exhausted, they drop down, and are seen lying dead on the roof of the under glass. One of these traps, placed conspicuously on the ground before a fruit-wall or hothouse, acts as a decoy to all kinds of winged insects. (*Gard. Mag.* vol. ii. p. 152.)

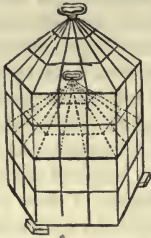

Fig. 9. Hand-glasses arranged as a fly-trap.



Fig. 8. Plan of a fly-trap.

358. *Collecting the Eggs of Insects.*—The eggs of insects, after being deposited on the bark or leaves of plants, may sometimes be collected by hand; for example, when they are laid in clusters or patches, so as to form a belt round the twig, as in the lackey-moth; or when they are covered with fibrous matter, as in the *Bómbyx díspar*, which lays its eggs in large circular or oval spots, containing 300 or more each, on the bark of trees or hedges, and covers them with a yellow wool. The eggs of the yellow-tail-moth are laid on the leaves of fruit-trees, in a long narrow heap, and covered with gold-coloured hair, whence the scientific name *Bómbyx chrysorrhœa*, which makes them very conspicuous; but the leaves may easily be collected, and the eggs destroyed. The satin-moth, *Bómbyx sálícis*, which, in its larva state, feeds on the leaves of willows and poplars, often stripping entire trees, when it becomes a perfect insect, lays its eggs in July, in small spots like mother-of-pearl, on the bark of the tree; and as they are conspicuous, they may easily be scraped off. Practical men in general are too apt to undervalue the effects of hand-picking, whether of the eggs or larvæ of insects; not reflecting that every insect destroyed by this means, is not only an immediate riddance of an evil, but prevents the generation of a great number of other evils of the same kind. Circumstances have forced this on the attention of the French cultivator, and the following facts will place the advantage of hand-picking in a strong light. In 1837, M. V. Audouin, already mentioned, was charged by a commission of the Académie des Sciences, to investigate the habits of a small moth, whose larva is found to be exceedingly injurious in vineyards in France. During the month of August, women and children were employed during four days in collecting the patches of eggs upon the leaves, during which period 186,900 patches were collected, which was equal to the destruction of 11,214,000 eggs. In twelve days from twenty to thirty workers destroyed 482,000 eggs, which would have been hatched in the course of twelve or fifteen days. The number of perfect insects destroyed in a previous experiment, by an expensive process, was only 30,000. (*Gard. Mag.* vol. xiii. p. 486.) Many insects, however, deposit their eggs singly or in very small quantities, or in concealed places; and the eggs being in these cases very small, cannot be removed by art.

359. *Preventing Eggs from being hatched.*—Eggs, after being deposited, may

sometimes be destroyed, or prevented from hatching, by the application of washes, or a coating of glutinous adhesive matter, such as gum, glue, paste, soft soap, sulphur, and clay, or in some cases clay alone. A mixture of lime and water will not always have the effect of preventing the hatching of the eggs; because, when the egg begins to vivify and swell with the heat of the spring, the lime cracks and drops off. This, however, is not the case when the lime is mixed with soft soap, which renders it elastic. Water raised to the temperature of 200° will destroy the eggs of most insects; and when these are deposited on the bark of the trunk of an old tree, or the well-ripened branches of a young hardy tree, water at this temperature may be applied freely. For young shoots in general the temperature should not exceed 130° or 150°. It should be remembered that insects, in depositing their eggs, always instinctively make choice of places where the newly-hatched insect will find food without going far in search of it. Hence they never lay them on walls, stones, glass, boards, or similar substances; and therefore the attention of gardeners, when searching for ova, should be directed much more to the plants which nourish the insects, than to the walls or structures which shelter the plants. (See 311.)

360. *Collecting or destroying Larvæ.*—Insects are much more injurious to plants in their larva state than they are in any other; because, as we have already seen (312), it is in this stage of their transformations that they chiefly feed. With the exception, however, of several of the wingless or crawling insects, and certain bugs and beetles, larvæ are in general not difficult to discover, because, for the most part, they live on those parts of plants that are above ground; but some live on the roots of plants, and these are among the most insidious enemies both of the gardener and the farmer. The *ver blanc*, or larva of the cockchafer, in France, and that of the wire-worm, in England, are perhaps the most injurious of all underground larvæ, and those over which the cultivator has least power. Underground larvæ may be partially collected, but not without much care and labour, by placing tempting baits for them in the soil. As they live upon roots, slices of such as are sweeter and more tender may be deposited at different depths and at certain distances, and the places marked, and the soil being dug up once a day, the insects may be picked off and the baits replaced. Slices of carrot, turnip, potato, and apple, form excellent baits for most underground larvæ. Such as attack leaves—as, for example, those of the gooseberry—may be destroyed in immense quantities by gathering the leaves infested by them, as soon as the larvæ become distinguishable from the leaf by the naked eye. Instead of this being done, however, it too frequently happens that the larvæ escape the notice of the gardener till they are nearly full grown, and have done most of the mischief of which they are capable. Hand-picking has been found most serviceable in preventing the injury caused by the black caterpillar on the turnip leaves, which, in certain seasons, has proved destructive of the entire crop. It may also be applied to the destruction of the cabbage caterpillars. Here, also, we may notice the beneficial effects of picking out and destroying young onion plants infested by the grub of the onion-fly. This ought to be done as soon as the plants appear sickly, because the grubs arrive at maturity in a very short time; and, by destroying the plant, future generations of the fly are prevented. Grub-eaten fruit ought also to be picked up as soon as it falls to the ground, before the enclosed grub has time to make its escape into the earth, and which it would do in a very short

time, the fruit not falling until the grub has arrived at its full size. The larvæ of some kinds of saw-flies envelop themselves in a kind of web in the day-time, and only go abroad to feed during the night. Webs of this sort may be seen in great numbers, in the early part of summer, on thorn hedges, fruit-trees, spindle-trees, and a great many others; and they might readily be collected by children or infirm persons, and thus myriads of insects destroyed. The larva may be destroyed, both in its infant and adult state, by dashing against it water in which some caustic substance has been dissolved, such as quicklime or potass; or a bitter or poisonous infusion may be made, such as tobacco-water. While the larvæ are not numerous, or the plants infested by them are tender and highly valued, they ought to be collected by hand; and in the case of the larvæ of mining insects, in which the larva is concealed within the epidermis of the leaf, there is no way of destroying them but by gathering the leaves, or crushing the insects between the finger and thumb.

361. *Collecting the Pupæ or Chrysalids.*—Insects may be destroyed in the pupa state by collecting their chrysalids or cocoons, when these are placed above ground, as is most commonly the case with those of moths and butterflies. These are commonly deposited in crevices in the old bark of trees, or in sheltered parts of walls or buildings; rarely on young shoots or in the tender parts of plants, because, when the perfect insect comes forth, it no longer requires such food. Often the larva descends into the soil, there to undergo its pupa state; and in some cases it may be destroyed by watering the soil with boiling water, or by deep trenching; the surface soil, containing the insects, being placed in the bottom of the trench. As the eggs and chrysalids require the presence of air for their vivification and maturity no less than the seeds of vegetables, they are consequently, when deposited in the soil, always placed near the surface; and hence they may be destroyed either by heaping earth on the surface, or by trenching or digging down the surface soil, so that the eggs or pupæ may be covered at least to the depth of six inches. How long vitality will be retained under such circumstances is uncertain. In destroying the cocoons of insects, care should be taken not to destroy those of the insect's enemies, such as the cocoons of the spider, or those of the ichneumon flies. These are sometimes deposited in heaps on the bark of trees, and are individually not larger than the egg of a butterfly. The gardener ought to be able to recognise them, because they are his best friends.

This general outline will be sufficient to show the necessity of every gardener, who would be a master of his profession, studying the natural history of insects, and more especially of those which are known to be injurious or useful to him, whether in the open garden or in plant-structures. It is only by such a study that he can be prepared to encounter an insect which he has never heard of before, and that he will be able to devise new modes of counteracting the *progress of, or destroying*, already known insects. For this purpose we recommend to his study the work of Kollar already mentioned, and next Mr. Westwood's Introduction to the modern Classification of Insects.

SECT. IV.—*Amphibious Animals, considered with reference to Horticulture.*

362. The frog, *Rana temporaria L.*, and the toad, *Bufo vulgaris Flem.*, are found useful in gardens, because they live upon worms, snails, slugs, and

terrestrial insects. The toad being less active than the frog, and being capable of living a longer period without food, is better adapted for being shut up in frames, or kept in stoves. Both prefer a damp and shady situation; and where they are intended to breed, they should have access to a shallow pond, or shady ditch. The ova of the frog is deposited in clusters in ditches and shallow ponds, about the middle of March; and the young, or tadpoles, are hatched a month or five weeks afterwards, according to the season: by the 18th of June they are nearly full-sized, and begin to acquire their fore feet; towards the end of that month, or the beginning of the next, the young frogs come on land, but the tail is still preserved for a short time afterwards. The common toad is a few days later in spawning than the frog. Its ova are deposited in long necklace-like chains in shallow water in shady ponds or ditches. There is one species, *B. Calamita Laurent*, the Natter-Jack, which inhabits dry localities, and is a much more active animal than the toad, but much less common.

363. The common Eft, *Lacérta palústris L.*, and *L. aquáticus L.*, are occasionally met with in gardens in damp situations; and they live upon aquatic insects, snails, worms, &c.; but nevertheless, from their disagreeable appearance, we cannot recommend their introduction. On the contrary, we think they ought to be destroyed either by art, or by their natural enemies, such as the turkey, weazel, &c. The ova are deposited on aquatic plants about the same time as those of the toad.

SECT. V.—Birds, considered with reference to Horticulture.

Birds are, upon the whole, much more beneficial than injurious to gardens; and being also larger animals and more familiar to every person living in the country than insects, very little requires to be said respecting them. We shall briefly notice the commonest English birds of the different orders; taking as our guide Jenyns' *Manual of British Vertebrate Animals*.

364. *Raptòres (Seizers)*.—Birds with feet formed for grasping: food, entirely animal substances. This order includes the eagle (*Aquila L.*) and falcon (*Fálco L.*), which may be considered injurious to gardens by scaring away other birds which are useful. It also includes the sparrow-hawk (*Accípiter fringillàrius Will.*), which preys upon the smaller birds and quadrupeds, and also on amphibiæ; on which account it may be considered as partly injurious and partly useful. This may also be said of the kite (*Mílvus Ictínus Sav.*) The kestrel, or wind-hover hawk (*Fálco Tinnúnculus L.*) is peculiarly valuable for killing beetles, and it also destroys slugs and snails. It is peculiarly fit for a garden, because cats dare not venture to attack it. The white owl, or barn-owl (*Stríx flámmea L.*), with tawny yellow plumage, white underneath, is one of the most valuable birds of this order, because it feeds principally upon mice, snails, and slugs, and occasionally devours other small animals, such as rats, and sometimes, but rarely, fish. It is common in every part of the kingdom; it comes abroad about sunset, and collects its food during the night. It may be known from the tawny owl or wood-owl by screaming in its flight, but never hooting like that species. "If this useful bird caught its food by day," Mr. Waterton observes, "instead of hunting for it by night, mankind would have ocular demonstration of its utility in thinning the country of mice, and it would be protected and encouraged everywhere. It would be with us what the

ibis was with the Egyptians. When it has young, it will bring a mouse to the nest about every twelve or fifteen minutes. But in order to have a proper idea of the enormous quantity of mice which this bird destroys, we must examine the pellets which it ejects from its stomach in the place of its retreat. Every pellet contains from four to seven skeletons of mice. In sixteen months from the time that the apartment of the owl on the old gateway at Walton Hall was cleaned out, there has been a deposit of above a bushel of pellets." (*Essays on Nat. Hist.* 3rd edit. p. 13.) The tawny owl (*Strix Aluco Temm.*) with reddish-brown plumage, is found only in woods, where it builds in the hollows of old trees, or amongst ivy. It preys upon various small quadrupeds and birds; it comes abroad only during the night, and has a clamorous and hooting note. By destroying small birds, this owl becomes injurious to the gardener as well as useful, and therefore he ought chiefly to encourage the barn-owl. For this purpose a picturesque tower might be formed in some retired situation in the flower-garden or shrubbery, or on one of the angles of the kitchen-garden wall, like a watch-tower, where it would prove ornamental; and a brood of young owls might be brought to it, and supplied abundantly with mice till they were full-grown, and able to provide for themselves. The time to procure the young birds is about the end of April; or the eggs might be procured and hatched in the bark-bed of the stove, &c. There are some other species of owl occasionally found in England, but they are too rare to be of any practical use.

365. *Insessôres (Perchers)*.—Birds with feet adapted for perching: food, chiefly insects and the smaller quadrupeds, but partly fruits and seeds. This order includes a number of birds which are interesting to gardeners. The shrikes (*Lanius L.*), of which there are two species, feed on small birds, mice, snails, and insects. The fly-catchers (*Muscicapæ L.*) feed on insects taken on the wing; and among these the cultivated or hive-bee does not escape. The water ouzel (*Cinclus aquaticus Bechst.*) feeds on aquatic insects, and is capable of diving for them. The missel-thrush (*Turdus viscivorus L.*) lives on insects and berries, particularly on those of the mistletoe. The field-fare (*T. pilaris L.*) feeds on haws and other berries, and also on insects and worms. The song-thrush (*T. musicus L.*) feeds on berries, insects, and snails; as does the blackbird and the redwing (*T. iliacus L.*) The red-breast (*Sylvia Rubécula Lath.*) feeds on insects and worms; and also, when the food is scarce, on seeds or crumbs of bread. The black-cap (*Sylvia atricapilla Lath.*) lives chiefly on insects; the wag-tail (*Motacilla, L.*) on aquatic insects. The titmouse (*Parus L.*) lives chiefly on insects, but will also eat seeds. The greater titmouse (*P. major*), when hard pressed for food, lives upon the honey-bee; and, according to Mr. Main, sometimes destroys great numbers of them. The bird "seats himself at the door of the hive, and taps with his bill to provoke the bees to come forth. The first bee that comes out is instantly seized by the middle and carried off to a tree, and there beaten against a branch till it is nearly dead. The bird then separates the head and thorax, which it swallows, from the abdomen, which it rejects, as containing the sting, and then flies back for another victim." (*Ladies' Mag. of Gard.* vol. i. p. 52.) The bearded titmouse, an inhabitant of fenny districts, lives on snails and other land molluscæ. The lark (*Alaúda L.*) feeds on insects and small seeds. The bunting (*Emberiza L.*) feeds principally on seeds. The Cirl bunting, found in Devonshire and some of the adjoining counties, is said to feed on

the berries of the *Solanum Dulcamàra*. The chaffinch, the house-sparrow; the tree-sparrow, and different other species belonging to the genus *Fringilla*, feed on insects and seeds; sometimes on berries; and when food is scarce, on the buds of trees. They also eat the anthers of Crocuses and other spring flowers. In severe winters the buds of the Gooseberry and Currant tribe are sometimes devoured by the common house-sparrow; and this even in the neighbourhood of London, where it might be supposed this bird would find food at all seasons. The bullfinch, cross-bill, and starling, live on insects and worms, and occasionally grain. The raven (*Córvus Córax L.*) lives on mice, rats, poultry and other animals, as well as on carrion. The carrion crow (*C. Coròne L.*) and the hooded crow (*C. Córnix L.*) have similar habits. Mr. Waterton considers the carrion crow as merely a variety of the raven; "he rises long before the rook, and retires to rest later than that bird. Indeed, he is the first bird on wing in the morning, and the last at night, of all our non-migratory, diurnal British birds. He feeds voraciously on ripe cherries, and in autumn eats walnuts; but he destroys many worms and caterpillars; though when his young are in the nest, he seizes game and young poultry wherever he can find them." (*Essays on Nat. Hist.*) The rook (*Córvus frugílegus L.*) lives principally on the grub of the cockchafer, the wireworm, and other insects; but will occasionally devour corn; and, during the winter season, is very destructive to turnips. The jackdaw (*C. Monédula L.*), the jay, and the magpie, feed on a great variety of animal and vegetable substances. The woodpecker (*Picus L.*), of which there are several species, feeds on ants and other insects; more especially on the larva of the timber-eating species, which it extracts by means of its long tongue, after having perforated the wood with its bill. Neither the titmouse nor the woodpecker, Mr. Waterton observes, ever bore into the hard and live wood. The wryneck (*Yúnx Torquílla L.*) lives principally on ants; and the common creeper (*Cérthia familiàris L.*), which is generally dispersed through the country, and is remarkable for the great facility with which it climbs up the trunks of trees, feeds entirely on insects. The nuthatch (*Sitta europæa L.*) lives occasionally on insects, but principally on nuts, which it breaks with its bill after having firmly fixed them in the crevices of old trees. The cuckoo feeds principally on caterpillars and other insects. The swallow and the martin feed entirely on insects taken on the wing; they appear about the end of April or beginning of May, and depart in October. The goatsucker (*Caprimúlgus L.*) lives on insects, particularly on cockchafers, which it seizes on the wing, and on butterflies; but this bird is more frequently found in solitary woods than in gardens or frequented places.

366. The greater number of birds which frequent gardens belong to this order; and while they do good by devouring insects, snails, and worms, they are also to a certain extent injurious, by eating fruits and attacking newly-sown or germinating seeds. The singing-birds are the best for destroying soft-winged insects, such as moths and butterflies. Of all the birds of this order, perhaps the hedge-sparrow is the most harmless, and the house-sparrow the most mischievous. The former lives upon the seeds of weeds or other plants that lie upon the surface of the ground, and it rarely attacks buds; while the house-sparrow scratches up newly-sown seeds and crops the tops of seedling plants when they are just penetrating through the surface of the soil, such as peas: it also eats the smaller fruits, and,

when other food is wanting, attacks buds. The robin devours currants, more especially about the time the young robins leave the nest, in June, when the currants are beginning to ripen. Blackcaps, whitethroats, and bullfinches, eat currants, strawberries, and raspberries; and of the latter fruit, bullfinches are particularly fond. Gooseberries, being too large for the soft-billed birds, as soon as they ripen are attacked by blackbirds and thrushes; and the fondness of these birds for ripe cherries has long been notorious. The wren and the fly-catcher are purely insectivorous; and the tomtits, though they sometimes destroy buds, yet are far more useful than injurious, from the number of caterpillars which they devour.

367. *Rasòres* (*Scratchers*).—Birds with feet not formed for scraping: food, chiefly seeds and terrestrial vermin. The ringdove, and different other species of doves, live on all kinds of grain and seeds, and, during severe weather, on the leaves of turnips and other cultivated plants; and some of them occasionally eat the smaller snails and slugs. This is the case with the domestic pigeon; though it more frequently lives on peas and grain. The turkey lives on snails, slugs, worms, lizards, frogs, and terrestrial insects, together with corn and seeds of almost every other kind. The peacock lives on similar food, and will even attack small snakes. The Guinea pintado, the domestic cock, and the pheasant, are omnivorous, eating roots as well as animals, fruits, and seeds. The corn of *Ranunculus bulbòsus*, where it abounds, is greedily eaten by the pheasant. The grouse (*Tétrao L.*) frequents woods of pines, birch, and juniper, and feeds on the berries of the latter, and on the buds and tender spray of the two former. The black grouse feeds on berries, and on the tops of heath and birch. The common partridge feeds on seeds and insects, and especially on the pupæ of ants. Few of these birds concern the gardener, except the turkey, peacock, and pheasant, which may be useful in pleasure-grounds in picking up vermin.

368. *Grallatòres* (*Waders*).—Birds with legs adapted for wading: food, chiefly animals and grain. The plover (*Charadrius L.*), of which there are several species, haunts moors and other open districts, and lives on worms and insects. The heron feeds principally on fish and small reptiles. The stork, which sometimes appears in Suffolk, lives on reptiles, insects, small quadrupeds, such as mice, rats, &c., and might be usefully domiciliated in gardens; as might the crane, as an ornamental object, and because it feeds on aquatic plants, worms, and small reptiles. The woodcock (*Scòlopax L.*), a winter visitant, lives on insects and worms; as does the snipe. The water-hen (*Gallinula Lath.*), and the coot (*Fùlica L.*), feed on aquatic insects, seeds, and vegetables. The birds of this order may be said scarcely to concern the gardener.

369. *Natatóres* (*Swimmers*).—Birds with feet adapted for swimming, omnivorous. The goose (*Anser Briss.*), of which there are several species, and the swan (*Cýgnus Meyer*) live upon grain of all kinds, aquatic vegetables, and grass. The common gull (*Làrus cànus L.*) is an inhabitant of the sea-coast, but frequents inland districts during the winter months, where it lives upon worms, snails, and small fish. As it does not touch seeds or vegetables of any kind, it is kept in gardens in various parts of Scotland. The common duck (*Anas Bòschas L.*) feeds naturally on aquatic insects and vegetables, fish, and molluscous animals, and is the most useful bird of this order for occasional admission into gardens. Ducks, however, when placed in a garden to destroy vermin, require to be withdrawn once a day, and

either starved, or fed with grain, before being sent back again to eat the vermin.

As a *general conclusion* to be drawn from this section, the gardener will learn on the one hand to be cautious how far he destroys birds of any kind; but he will also, on the other, watch the operations of birds, and when he finds them committing depredations on newly-sown seeds, on seeds coming through the ground, on flowers, or on fruits, have recourse to some mode of deterring without destroying them.

370. *The different modes of deterring birds* may be reduced to the following:—Excluding by netting, or other coverings, supported at a few inches' distance from the rising seedlings, fruit, flower, or plant to be protected; setting up scares, of different kinds, such as mock men or cats, mock hawks or other birds of prey, miniature wind-mills or clapper-mills; lines with feathers tied at regular distances, placed at a few inches' distance above the rows of newly-sown peas, or other seeds sown in drills; over rows of crocuses or other dwarf spring flowers, or over beds or entire compartments. A system of dark worsted threads, placed in front of wall-trees at a few inches' distance from the leaves, will scare away most birds; because, taking the worsted string for a twig, and lighting on it, it turns round by the grasp, and sinking at the same time by the weight, the bird falls, and if this happens to him on a second attempt, he will be deterred for the future. The following scare is founded on an idea given by Mr. Swainson in the *Encyclopedia of Agricul.* 2d edit., p. 1112:—Let poles, ten or twelve feet high, be firmly fixed in the ground, in conspicuous parts of the garden, each pole terminating in an iron spike six or eight inches long; pass this spike through the body of a dead hawk in the direction of the back-bone: it will thus be firmly secured, and give the bird an erect position; the wings being free, will be moved by every breeze, and their unnatural motion will prove the best scarecrow either for ravenous or granivorous birds, more particularly the latter. Cats are found useful in walled gardens as scares to birds, as well as for other purposes. R. Brook, Esq., of Melton Lodge, near Woodbridge, in Suffolk, has four or five cats, each with a collar and light chain and swivel, about a yard long, with a large iron ring at the end. As soon as the gooseberries, currants, and raspberries, begin to ripen, a small stake is driven into the ground, or bed, near the trees to be protected, leaving about a yard and a half of the stake above ground; the ring is slipped over the head of the stake, and the cat being thus tethered in sight of the trees, no birds will approach them. Cherry trees and wall-fruit trees are protected in the same manner as they successively ripen. Each cat, by way of a shed, has one of the largest-sized flower-pots laid on its side, within reach of its chain, with a little hay or straw in bad weather, and her food and water placed near her. A wall of vines between 200 and 300 yards long, in Kirke's Nursery, Brompton, the fruit of which, in all previous seasons, had been very much injured by birds, was one year completely protected from them, in consequence of a cat having voluntarily posted herself sentry upon it. (*Hort. Trans.* 2d series, and *Gård. Mag.* vol. xii. p. 429.) A stuffed cat has also been found efficacious. Crows and rooks are, in some parts of the country, deterred from lighting on sown wheats by pieces of rag dipped in a mixture of bruised gunpowder and tar, and stuck on rods, which are placed here and there over the field, and the rags renewed every three or four days. Of course this scare only operates where the birds have been previously accustomed to be shot at. The most certain mode of scaring

away birds, however, is to set boys or other persons to watch and sound a wooden clapper all round the fruit, or seeds, which may be ripening, or germinating.

371. *The destruction of birds* is most judiciously effected by traps, or by poisoning, because neither of these modes operates like the gun in scaring away others. "The report of fire-arms is terrible to birds; and, indeed, it ought never to be heard in places in which you wish to encourage the presence of animated nature. Where the discharge of fire-arms is strictly prohibited, you will find that the shiest species of birds will soon forget their wariness, and assume habits which persecution prevents them from putting in practice. Thus the cautious heron will take up its abode in the immediate vicinity of your mansion; the barn-owl will hunt for mice under the blazing sun of noon, even in the very meadow where the hay-makers are at work; and the widgeons will mix, in conscious security, with the geese, as they pluck the sweet herbage on your verdant lawn; where the hares may be seen all the day long, now lying on their sides to enjoy the warmth of the sun, and now engaged in sportive chase, unbroken in upon by enemies, whose sole endeavour is to take their lives." (*Essays on Nat. Hist.*, 3d ed. p. 251.) One of the simplest bird traps, and one also of a very effectual description, is to smear some of the twigs of the trees in which they are expected to alight with bird-lime. Every country boy can suggest the modes of collecting birds together by regular supplies of food, which may be poisoned by arsenic, or netting may be so contrived as to be pulled down over the birds and secure them.

SECT. VI.—*The smaller Quadrupeds, considered with reference to Horticulture.*

A few of these deserve notice, partly as the enemies of gardens, and partly as the subduers of other garden enemies; and in order that none deserving notice may escape, we shall take them in scientific order.

372. *Fèræ (Wild Beasts)*.—The badger (*Mèles Cuv.*) burrows in the ground and comes abroad in the night to feed, devouring indiscriminately animal and vegetable substances. The martin (*Mustela Foina L.*) inhabits the vicinity of houses, and preys on poultry, game, rats, moles, &c. It breeds in hollow trees. The polecat (*M. Putorius L.*) is a common inhabitant of woods and plantations in all parts of the country, and preys on game, poultry, eggs, and all the smaller quadrupeds, amphibia, snails, slugs, and worms. The ferret (*M. Furo L.*), considered by some as the polecat in a domesticated state, is employed to destroy rabbits and rats. The weazel (*M. vulgaris Gmel.*) is common in the vicinity of barns and outhouses. It devours young birds, rats, mice, moles, frogs, toads, lizards, snakes, snails, slugs, &c. Mr. Waterton, after recommending this animal to farmers, says: "But of all people in the land, our gardeners have most reason to protect the weazel. They have not one single word of complaint against it—not even for disturbing the soil of the flower-beds. Having no game to encourage, nor fowls to fatten, they may safely say to it, 'Come hither, little benefactor, and take up thy abode amongst us. We will give shelter to thy young ones, and protection to thyself, and we shall be always glad to see thee.' And fortunate, indeed, are those horticultural enclosures which can boast the presence of a weazel; for neither mouse, nor rat, nor mole, can carry on their projects with impunity whilst the weazel stands sentinel over the

garden. Ordinary, and of little cost, are the apartments required for it. A cart-load of rough stones, or of damaged bricks, heaped up in some sequestered corner, free from dogs, will be all that it wants for a safe retreat and a pleasant dwelling. Although the weazel generally hunts for food during the night, still it is by no means indolent in the day-time, if not harassed by dogs or terrified with the report of guns." (*Essays, &c.* p. 302.) The otter, which inhabits the banks of rivers, lakes, and marshes, swims and dives with great facility, and is destructive to fish, on which it preys. The fox and the wild cat prey on birds and small quadrupeds. The domestic cat is too well known and too useful where rats, mice, or birds are to be deterred or destroyed, to require further notice: but where birds are to be preserved or encouraged, cats are their greatest enemies. "Cats amongst birds," Mr. Water-ton observes, "are like the devil amongst us: they go up and down seeking whom they may devour. A small quantity of arsenic, about as much as the point of your penknife will contain, rubbed into a bit of meat, either cooked or raw, will do their business effectually." The mole (*Tálpá europæa L.*) burrows beneath the surface, but never to a great depth, throwing up hillocks at intervals. It feeds on worms and the larvæ of insects, and, according to some, on roots. It breeds twice a year, in spring and autumn; and as it carries on its operations chiefly in the night-time, the runs and hills may be watched early in the morning, and the animals dug out wherever they give signs of movement. They may also be taken by traps, of which there are several kinds; or poisoned by putting a little arsenic in worms, or in pieces of meat; or by the use of nux vomica. They may also be caught by sinking in their runs narrow-mouthed vessels of water, into which the animals will descend to drink without being able to get out again; or these vessels may have false covers similar to those set in the runs of rats. The shrew (*Sòrex L.*), of which there are three species, inhabits gardens, fields, and hedges-rows, and preys on insects, and also on vegetable substances. It may be caught by a water-trap in the same manner as the mole, or by an inverted flower-pot sunk in the soil, and slightly covered with litter or leaves, fig. 10, or subdued by employing some of its natural enemies. The hedgehog (*Erinàceus L.*) resides in hedges, thickets, &c., remaining concealed in the day-time, but coming abroad at night in quest of worms, snails, slugs, and even frogs and snakes. It also lives on roots and fruits. Hedgehogs are occasionally kept in gardens for destroying frogs, toads, lizards, snails, slugs, and worms; and in kitchens, for devouring beetles, cockroaches, woodlice, and other terrestrial insects. Care is requisite, however, that they are not annoyed by cats, which, though they cannot devour them, will, if not prevented, soon force them to quit a habitation which is not natural to them. The spines of the hedgehog are soft at its birth, and all inclining backwards; but they become hard and sharp in twenty-four hours. The bat, of which there are several species indigenous, lives entirely on insects caught on the wing. It forms the natural food of the owl. The dog, which belongs to this order, is well known in gardens and country residences for his property of watching and attacking rats and other vermin.



Fig. 10. Inverted flower-pot, for catching mice.

It also lives on roots and fruits. Hedgehogs are occasionally kept in gardens for destroying frogs, toads, lizards, snails, slugs, and worms; and in kitchens, for devouring beetles, cockroaches, woodlice, and other terrestrial insects. Care is requisite, however, that they are not annoyed by cats, which, though they cannot devour them, will, if not prevented, soon force them to quit a habitation which is not natural to them. The spines of the hedgehog are soft at its birth, and all inclining backwards; but they become hard and sharp in twenty-four hours. The bat, of which there are several species indigenous, lives entirely on insects caught on the wing. It forms the natural food of the owl. The dog, which belongs to this order, is well known in gardens and country residences for his property of watching and attacking rats and other vermin.

373. *Glîres (Dormice)*.—The common squirrel feeds on birds, acorns, nuts, and other fruits; and though he is very ornamental in woods, he should be but sparingly admitted into pleasure-grounds. The dormouse lives on similar fruit to the squirrel, and builds in the hollows of trees. The field-mouse may be caught and subdued in the same manner as the shrew. The field-mouse in the Forest of Dean had become so destructive in 1813, that after trying traps, baits with poison, dogs, cats, &c. with little success, at last the plan of catching it by holes was hit upon. These holes were made from eighteen inches to two feet long, sixteen or eighteen inches deep, about the width of a spade at the top, fourteen or fifteen inches wide at the bottom, and three or four inches longer at the bottom than at the top. The object was to get the bottom of the hole three or four inches wider every way than the top, and the sides firm, otherwise the mice would run up the sides and get out again. The holes were made at twenty yards apart each way, over a surface of about 3200 acres: 30,000 mice were very soon caught, and the ground was freed from them for two or three years. As many as fifteen have been found in a hole in one night; when not taken out soon, they fell on and ate each other. These mice, we are informed, used not only to eat the acorns when newly planted, but to eat through the stems of trees seven and eight feet high, and an inch and a half in diameter: the part eaten through was the collar, or seat of life. (*Billington's Facts on Oaks and Trees, &c.* p. 43.) The black and the brown rat are omnivorous, and the latter takes occasionally to water and swims readily. Both are extremely difficult to extirpate, and the various modes of entrapping them are too numerous and well known to require description here. The hare feeds entirely on vegetables, and is very injurious where it finds its way into gardens and young plantations. It eats the bark of several trees, and is particularly fond of that of the Laburnum. Various mixtures have been recommended for rendering the bark of young trees obnoxious to the hare, and an ointment composed of powdered sloes and hogs'-lard is said to prove effectual. Stale urine of any kind, mixed up with any glutinous matter that will retain it on the bark, has also been recommended. The rabbit is more injurious to gardens than the hare, because it is much less shy, and much more prolific. It may be deterred from injuring the bark of trees by the same means as the hare, and from eating pinks, carnations, and other evergreen herbaceous plants, by surrounding them with a tarred thread supported by sticks at the height of six or eight inches from the ground; or by a fence, formed of wires about eighteen or twenty inches long, placed upright, with the tops pointing outwards, the wires being connected by one horizontal wire at the bottom and another at the middle. When hares or rabbits are to be excluded from pleasure-grounds, a wire-wove fence is requisite; and where it is intended that the effect of the irregularity of the margin of the plantation should not be impaired by the formality of a fence the lower part of which is as close as basket-work, and consequently more like a fence of boards painted green, than an invisible fence, which it is commonly called, the mode is to have three parallel lines of fences, two or three yards apart. The outer fence may consist of iron posts and rods, no closer together than is necessary to exclude horses, cattle, and deer; the second fence should be such as will exclude sheep; and between this fence and the outer one there may be several large bushes, or low trees, with branches reaching to within the height of a sheep from the ground. The third fence need not be more

than two feet high, with an iron wire about a foot higher along the top, and with the wires sufficiently close together to exclude hares and rabbits; and between this fence and the sheep-fence there may be several shrubs, with their branches resting on the ground. Thus, by the distribution of the

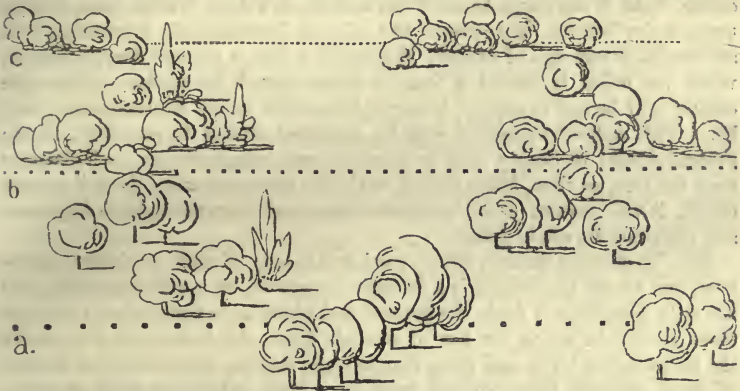

Fig. 11. Triple fence : a, for excluding cattle ; b, sheep fence ; c, hare and rabbit fence.

materials which commonly form one fence into three fences, the outer margin of the plantation may be made to appear as free and irregular as if there were no fence at all. See fig. 11.

374. *Ungulata* (*Hoofed Animals*).—The ox, the sheep, the goat, the deer, the horse, the ass, and the hog, belong to this order; and the means of protecting gardens against them, or of using the animals or their manure so as to become subservient to gardens, are well known, and already pointed out in the *Suburban Architect* and *Landscape Gardener*, and in our chapter on Manures, p. 56.

CHAPTER V.

DISEASES AND ACCIDENTS OF PLANTS, CONSIDERED WITH REFERENCE TO HORTICULTURE.

THERE are various diseases and accidents to which plants are liable, some of which come little under the control of the gardener, and others he can avert or subdue. The principal diseases which affect garden-plants are the canker, mildew, gum, honeydew, and flux of juices.

375. The *canker* chiefly affects fruit-trees, and of these perhaps more particularly the apple; and some apples are constitutionally more liable to disease than others,—for example, the Ribston Pippin. The canker exhibits itself in small brown blotches, which afterwards become ulcerous wounds, on the surface of the bark, and soon extend on every side, eating into the wood, and sooner or later becoming so large as ultimately to kill the tree. The causes generally assigned are, the unsuitableness of the soil, the unpropitiousness of the climate, and the unfavourableness of the seasons; and here the

matter generally rests. Now, though we cannot make a soil just as we would wish, still its improvement is within our influence; and though we cannot change the climate in our neighbourhood, we can at least accommodate our operations to its character. A tree planted in a proper manner, with its collar little, if anything, beneath the surface, in a deep friable loam, resting upon a dry bottom, and where the climate is moderately favourable, will seldom show any sign of canker. Whenever a tree is planted deep,—that is, when the collar is buried a foot or more beneath the surface,—there the canker will be apt to appear, however favourable other circumstances may be. This aptness to canker will be increased almost to certainty, if the ground should be deeply dug, or trenched, and supplied with rank manure near the tree, as then, being forced to obtain its nourishment from a greater depth, it will require a higher temperature and more sunlight to inspissate and elaborate its crude juices.

376. To *prevent canker*, where good soil is only of very moderate thickness, and where the subsoil is a ferruginous gravel, or a stiff cold clay, it is not only necessary to drain the ground and plant upon the surface; but the trees should be set on the top of mounds from six inches to a foot above the surrounding level, and from four to eight feet in diameter; the bottom of these mounds being covered with some hard substance, such as stone, slate, &c., to prevent the roots descending, and to lead them out as it were in a horizontal direction. No manure whatever should be incorporated with the soil, unless it should be very poor indeed: but it may be applied as a mulching round the mound, which will tend to keep the roots sufficiently moist and also near the surface. If these points were attended to, we should hear little of canker, unless in places naturally very damp, where more than a fair average of rain falls; or where, from the prevalence of clouds, there is a deficiency of sunshine. In such places the shoots grow so luxuriantly during summer, that they are yet soft and spongy, and filled with crude juices in the end of autumn. The frost sets in, freezes these juices, bursts the sap-vessels, and the decay of the shoots, or brown blotches, and ultimate canker, are the consequence. The only preventive in such cases is to plant on hillocks, and in soil made light and poor: the wood will then be less luxuriant and better ripened.

377. What has been said respecting the prevention of canker will also apply to its *cure*. No scrubbing, scraping, or anointing will be of the least use. Cutting down the trees and allowing them to shoot afresh may be of benefit, if the canker has been produced by one very unfavourable season; grafting them with hardier sorts will succeed, if the evil arises from unfavourableness of climate; but neither of these methods will be of permanent benefit, when the evil proceeds from soil or deep planting. In such cases, where the trees are very bad, the best method is to destroy them gradually, and plant young ones in a proper manner, leaving some of the old trees until the young ones commence bearing. If the trees are not very old, nor yet too far gone, it will be advisable to take them up carefully, cut away all the cankered wood, plaster up all the wounds with a compound of clay and cow-dung, plant them in fresh soil on hillocks, and give no manure unless what is supplied for mulching. Such trees will generally become quite free of disease and bear splendid crops. A number of years ago, in a large kitchen-garden in the neighbourhood of London, a great number of fruit-trees were dispersed in the different quarters in a miserable state from canker. The

gardener appropriated a quarter in the garden for the reception of these trees ; had the ground thrown into wide and high ridges : on the top of these ridges the trees were planted, and last summer they presented a fine healthy appearance, and were well stocked with good fruit. The soil was a stiff clayey loam.

378. The *gum*, by which is meant an extraordinary exudation of that secretion, takes place chiefly in stone-fruit trees, such as the Peach, Cherry, Plum, &c., from a cut, bruise, bend, or other violent disruption of the tissue, or by injudicious pruning ; often, however, without any visible cause. The gum on the young shoots of Peach-trees is analogous to the canker on Apple-trees, and seems to be caused by a cold wet soil, or a cold wet climate. Trees subject to this disease will live many years, and bear abundantly, though sometimes they are destroyed by it. For the gum we know of no remedy.

379. *Mildew* appears in the form of a whitish coating on the surface of leaves, chiefly on those of herbaceous plants and seedling trees. Deficiency of nutriment is favourable to the production of mildew ; it seems also to prefer glaucous-leaved plants, as the Swedish Turnip, Rape, and Peas, which are particularly subject to it in dry weather. Some varieties of fruit-trees are more liable to mildew than others ; for instance, the Royal George and the Royal Charlotte Peaches are often attacked, when other sorts, growing contiguously, are free from the disease. The mildew is supposed to be produced by innumerable plants of a minute fungus, the seeds of which, floating in the air, find a suitable nidus in the state of the surface of the leaf, and root into its stomata. This favourable state for the appearance of the disease seems to be promoted by various circumstances. It sometimes proceeds from a tenderness in plants, produced from sowing or planting too thick. It exhibits itself in a season of dry weather, when the leaves become in a languid state, produced often by the roots being prevented from drawing moisture from below ; by injudicious surface watering. It also shows itself after a season of wet weather, if the drainage is defective, and the leaves have become surcharged with crude juices. More especially does it present itself in either of these circumstances, when the roots and branches of a plant are placed very differently relatively to moisture and temperature. For instance, it is very apt to make its appearance in a peach-house, if the border should be cold and wet, and the top of the tree in a warm arid atmosphere. The same effect will be produced when the atmosphere is genial and moist, and the border allowed to become too dry. Cucumbers grown in Pine stoves, will often become much infested with mildew in the winter months ; because unless the pines should be in fruit, they will neither enjoy the requisite temperature, nor a sufficiently moist atmosphere. In many cases, also, the disease proceeds from the soil being exhausted ; from containing too much inert carbonaceous matter, or becoming soured or sodden from want of drainage. In such cases trees are often completely cured by replanting properly in fresh soil. The best temporary specific for arresting the disease, is washing the affected parts with a composition of water and flower of sulphur. If the plants are tender, it will be advisable to shake the sulphur in a state of powder on the affected parts when dry. In both cases it will be necessary to guard against bright sunshine, by partial shading. In some cases the labour of sulphuring may be dispensed with, by at once cutting off the affected leaves and shoots. Where the mildew is liable to be produced by drought, it may frequently be prevented by copiously watering the soil, by which the late Mr. Knight

prevented this disease from attacking his late crops of Peas. The rust in corn crops is produced by a fungus in the same manner as the mildew; but as it chiefly concerns the agriculturist, we refer the reader to Professor Henslow's *Report of the Diseases of Wheat, Jour. Ag. Soc. Eng.*, vol. ii. p. 1.

380. *Honey dew* is a sweet and clammy exudation from the surface of the leaves of plants during hot weather, and it is supposed to be occasioned by the thickening of the circulating fluids in the leaf, which being unable to flow back into the bark with their accustomed rapidity, the sugary parts find their way to the surface. The disease is common in the Oak, Beech, Thorn, and in many other plants. Hitherto no remedy has been applied to it in general cases, as though it weakens plants it seldom kills them. When, however, it appears on plants in a state of high cultivation, for instance, in a peach-house, or on a peach-wall, no time ought to be lost in applying the syringe or garden-engine, and even rubbing it off the leaves if necessary, otherwise the shoots or branches affected will be apt to be destroyed. Some persons suppose the honey dew to be occasioned by the aphides, as the exuviae of those insects are often found on leaves affected with this disease.

381. *Blight* is a term which is very generally applied to plants when under the influence of disease, or when attacked by minute fungi or insects. In some cases the continued action of dried air, and cold frosty winds, preventing the flow of the sap, may bring on a disease which might be called blight, exclusive of either the action of insects or of fungi; but by far the greater number of instances of what is called blight are produced by these two causes. In general the fungi may be destroyed by the application of powdered sulphur, and the insects by some of the different means that have been already pointed out (352 to 361).

382. *Flux of Juices*.—Under this term are comprehended the bleeding, or flow of the juices of the vine and other plants, when accidentally wounded, or pruned too early in autumn, or too late in spring; and the discharge of the descending sap, or the cambium, in a putrid state between the bark and the wood, which frequently happens in elm-trees, and is incurable. The flux of the rising juices seldom does much injury, and may generally be prevented by pruning before the sap is in motion.

383. The *accidents* to which plants are liable are chiefly confined to the plants being broken or bruised, and the general remedy is amputation of the parts. When the section of amputation is large, it is best to cover the wound with some adhesive composition, which will exclude the weather, and not impede the growth of the bark over the wound; but this subject will be noticed more in detail when we come to treat of pruning.

384. A number of *other plant diseases* have been described and named by writers on Botany, but they are of very little interest to the practical gardener, because they rarely occur when plants are properly treated, or occur only in old age, or in a state of natural decay; or because, when they do occur, they seldom admit of any remedy. Those diseases to which some plants are more liable than others, will be mentioned when these plants are treated of; for example, the rot in the Hyacinth, the dropsy in succulents, the blistering of the leaves in Peach-trees, &c.

PART II.

IMPLEMENTS, STRUCTURES, AND OPERATIONS OF
HORTICULTURE.

CHAPTER I.

IMPLEMENTS OF HORTICULTURE.

385. WITH the progress of gardening a great many *tools, instruments, utensils, machines, and other articles*, have been invented and recommended; and some of these are without doubt considerable improvements on those previously in use; while, on the other hand, many would be rather impediments than otherwise in the hands of an expert workman. The truth is, that for all gardening in the open air, and without the use of pots for growing plants, or walls or espaliers for training trees, the only essential instrument is the spade. There is no mode of stirring the soil, whether by picks, forks, or hoes, which may not be performed with this implement. It may be used as a substitute for the dibber, or trowel, or perforator (in planting or inserting stakes); instead of the rake and the roller in smoothing a surface and rendering it fit for the reception of the smallest seeds; and after these are sown, the spade may be employed to sprinkle fine earth over them as a covering, by which indeed that operation may be performed more perfectly than by "raking in." The only garden operation on the soil which cannot be performed with the spade, is that of freeing a dug surface from stones, roots, and other smaller obstructions, which are commonly "raked off;" but as the removal of small stones from the soil is of very doubtful utility, and as at all events these and other obstructions can be hand-picked, the rake cannot be considered an essential garden implement. The pruning-knife might in general be dispensed with in the training of young trees, by disbudding with the finger and thumb; but as the branches of grown-up trees frequently die or become diseased, and require cutting off, the pruning-knife may be considered the most essential implement next to the spade; and with these two implements the settler in a new country might cultivate ground already cleared so as to produce in abundance every vegetable which was found suitable to the climate and soil.

386. But though a garden of the simplest kind may be cultivated with no other implements than a spade and a knife, yet for a garden containing the improvements and refinements common to those of modern times, a considerable variety of implements are necessary or advantageous. Some of these are chiefly adapted for operating on the soil, and they may be designated as tools; others are used chiefly in pruning and training plants, and may be called instruments; some are for containing plants or other roots, or for conveying materials used in cultivation, and are properly utensils; while some are machines calculated to abridge the labour of effecting one or more of these different purposes. We shall arrange the whole in groups according to their uses, previously submitting some general observations.

SECT. I.—*General Observations on the Construction and Uses of the Implements used in Horticulture.*

Implements may be considered with reference to the mechanical principles on which they act, the materials of which they are constructed, their preservation and their repairs.

387. All tools and instruments, considered with reference to the mechanical principles on which they act, may be reduced to the lever and the wedge ; the latter serving as the penetrating, separating or cutting, and sometimes the carrying part ; and the former, as the medium through which, by motion, force is communicated to the latter. All the different kinds of spades, shovels, and forks have their wedges in the same plane as the levers ; all the different kinds of picks, hoes, and rakes have their wedges fixed at right angles to the levers. The blades of knives and saws are no less wedges than the blades of spades or rakes, only their actions are somewhat more complex ; every tooth of the saw acting as a wedge, and the sharp edge of a knife consisting of a series of teeth so small as not to be visible to the naked eye, but in reality separating a branch by being drawn across it, on exactly the same principle as the saw. The series of combinations which constitute machines, when analysed, may be reduced to levers, fulcrums, and inclined planes ; and utensils depend partly on mechanical construction, and partly on chemical cohesion. It is only by understanding the principles on which an implement is constructed that that part can be discovered where it is most vulnerable when used, or most liable to decay from age. In all tools and instruments the vulnerable point is the fulcrum of the lever, or the point where the handle is connected with the blade or head. Another reason why failure generally takes place in that part is, that the handle is there generally pierced with a nail or rivet, which necessarily weakens the wood by breaking off or separating a number of the fibres. In general, the power or efficiency of any tool or instrument, supposing it to be properly constructed, is as its weight taken in connexion with the motion which is given to it by the operator. Hence strong-made implements of every kind are to be preferred to light ones ; and this preference will be found to be given by all good workmen.

388. In the construction of implements, the levers or handles are for the most part made of wood, and the wedges or operating parts of iron or steel. The wood in most general use for handles in Britain is ash ; and next to the ash, oak : but for lighter tools, such as the hoe, rake, the scraper, besom, &c., pine or fir deal is sufficient. Handles to implements are of four kinds : first, cylindrical and smooth from one extremity to the other, as in the hoe, rake, &c. ; second, cylindrical, or nearly so, but dilated at one or at both extremities, as in the pick, hatchet, &c., such handles being called helves ; third, cylindrical and smooth, but with a grasping piece at one end, as in the spade, shovel, &c. ; and fourth, angular or rough throughout, as in the pruning-knife, hammer, hedgebill, &c. The reasons for these forms of handles are to be found in the manner of using the implements : one hand of the operator is run rapidly along cylindrical handles, as in the hoe and rake ; in the dilated handles, one hand slides along between two extremities till it reaches the dilated part of the head, which wedges firmly into the hand ; and, this dilated part being in the direction of the operating part of the tool, adds considerably to its strength. This is the case in the pick, and

in the hatchet, in which implements, without the dilations at both extremities of the handle, as well as in some degree in the middle part, it would be difficult for the operator to bring down an oblique blow with sufficient accuracy. Without the cross-piece or perforated handle of the spade, the operator could not easily lift a spitful or turn it over; and hence we find, that in using the Flemish and other Continental spades, that have no grasping piece at one end, the operator never attempts to turn over the spitful, but merely throws it from him in such a manner that the surface falls towards the bottom of the furrow. No pruning-knife or hedgebill could be grasped firmly in the hand if it were cylindrical; and unless these instruments are held firmly, it is impossible to cut obliquely with sufficient precision. The iron of all instruments should be of the best quality, and the cutting edges of blades, and sharp perforating points, should be of steel for greater hardness and durability.

389. Next to the importance of having implements properly constructed, is that of keeping them constantly in good *repair*. For this purpose the iron or steel parts require to be occasionally sharpened on a grindstone or by other means; or to have additions of iron or steel welded to them by the blacksmith or cutler. All implements, when not in use, should be kept under cover in an open airy shed or tool-house; some, as the spade, pick, &c., may rest on the ground; others, as the scythe, rake, &c., should be suspended on hooks or pins; and smaller articles, such as trowels, dibbers, &c., placed in a holster rail. This is a rail or narrow board fixed to the wall in a horizontal direction, an inch or two apart from it at the lower edge, and somewhat farther apart at the upper edge. Other small articles may be laid on shelves, and pruning-knives kept in drawers. No implement ought to be placed in the tool-house without being previously thoroughly cleaned; and all sharp-edged implements, such as the scythe, hedgebill, &c., when laid by and not to be used for some time, should have the blades coated over with grease or bees'-wax, and powdered over with lime or chalk to prevent the grease from being eaten off by mice, as well as by combining with it to render it more tenacious, of a firmer consistence, and less easily rubbed off. In coating the blade of a scythe or hedgebill, or the plate of a saw, with wax or grease, it should be first gently heated by holding it before a fire; and afterwards the wax or grease should be rubbed equally over every part of it, and the powdered chalk or lime dusted on before the grease cools. When the instruments are again to be brought into use, the blades should be held before the fire, and afterwards wiped clean with a dry cloth. The same operation of greasing should also be applied to watering-pots laid by for the winter, when these have not been kept thoroughly painted. Every implement ought to have its proper place in the tool-house, to which it should be returned every day when work is left off. In well-ordered establishments, fines are agreed on between the master and his men, to be imposed on all who do not return the tools to their proper places in due time, and properly cleaned.

SECT. 2.—*Tools used in Horticulture.*

By tools are to be understood implements for performing the commoner manual operations of horticulture, and they may be included under levers, picks, hoes, spades, forks, rakes, and a few others of less consequence.

390. *The common lever*, fig. 12, is a straight bar of wood shod with iron, or

of iron only, and is used for the removal of stones or large roots, which rest on, or are embedded in the soil. The advantage gained is as the distance from the power, applied at *a*, to the fulcrum *b*; and the force of the power is greatest when it is applied at right angles to the direction of the lever. The handspoke, or carrying lever, belongs to this species of tool, and is simply a pole, tapering from the two extremities to the middle, by means of one or two of which, tubs or boxes, or other objects, furnished with bearing hooks, can be removed from one place to another. Two of these poles, joined in the middle by cross-bars or boards, form what is called the handbarrow—a carrying implement occasionally useful in gardening. Sometimes, to render a detached fulcrum unnecessary, the operating end of the lever is



Fig. 12. *The common lever.*

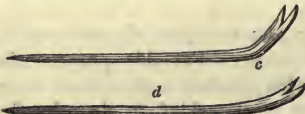

Fig. 13. *Knead lever and crowbar.*

bent up, so that the elbow or angle, fig. 13, *c*, serves as a fulcrum. When the operating end terminates in claws, like those of a common hammer, it is termed a crowbar, *d*, and is extremely useful for forcing up stakes or props which have been firmly fixed in the ground. Sometimes the upper extremity of the bent lever and crowbar are made pointed and sharp, so as to serve at the same time as perforators, as shown in both the knead lever and crowbar. Every garden ought to have one of these tools; and perhaps the most generally useful is the knead lever, forked at the extremity, fig. 13, *c*.

391. *Perforators*, fig. 14, are straight rods of iron, or of wood pointed with iron, for making holes in the ground, in which to insert stakes for supporting tall or climbing herbaceous plants, standard roses, climbing roses, or other shrubs, and young trees. The pointed iron rod, with a solid ball at top, *e*, *i*, is most in use for inserting pea-sticks, and the smaller props in dug gardens, as well as for inserting branches in lawns to shelter tender shrubs in the winter time, or to prevent small plants from being trodden upon. The wooden stake, pointed with iron, *f*, is used for making holes for larger posts for protecting or supporting trees in parks and pleasure-grounds. It is driven in with a wooden mallet, and afterwards pulled out by passing an iron bar through the ring at *g*, one man taking hold of each end of the bar. The other bars are inserted by alternately lifting them up and letting them drop down, and they are pulled up either by hand or, in the case of fig. 14, *h*, by passing a stick or handle through the eye at the top. The solid ball *i*, is for the purpose of adding to the weight of the rod, and which, of course, when lifted to considerable height, adds greatly to its power in falling.



Fig. 14. *Perforators.*

The perforator, fig. 15, having a handle *i*, and a hilt for the foot, *k*, is chiefly adapted for amateurs and ladies.



Fig. 15. *Perforator for amateurs.*

392. *The dibber*, fig. 16, is a perforator for inserting plants, and sometimes also for depositing seeds or tubers in the soil. It is most suitable for planting seedlings, because these have a tap root, and few lateral fibres. Dibbers

are very commonly formed of the upper part of the handle of a spade, as *l*, after the lower part has been broken, become decayed, or is no longer fit for use. This is sometimes shod with iron, which renders it more durable when it is to be used in stiff or gravelly soils. Sometimes a piece of a kneed branch is formed into a dibber, as shown at *m*.

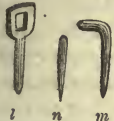

Fig. 16. Dibbers.

For planting cuttings of the shoots of shrubs or herbaceous plants, either in the open ground or under glass, small dibbers, *n*, are used, some for inserting cuttings of heaths, not thicker than a quill; but these the



Fig. 18. Cast-iron sheaths for dibbers.

gardener forms for himself. The potato-dibber, fig. 17, has a hilt for the foot, and a handle and shank as long as that of the spade. For the potato and other larger dibbers, cast-iron sheaths, fig. 18, are sometimes fitted to the lower extremities, to render them more durable.

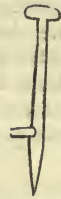

Fig. 17. Potato-dibber.

393. *Picks*, fig. 19, combine the operation of perforating with that of separating, breaking, loosening, and turning over; and the pickaxe adds that of cutting. As the blow given by the pick on the soil, or on a root, is almost always given in a vertical direction, the helve is made cylindrical, excepting where it joins the head, and here it is dilated, so as to wedge into the hand of the operator, and serve to guide the direction of the stroke. The common pick is shown at *a*, the pickaxe at *b*, and the mattock at *c*. The

narrow pointed end of the common pick is used for penetrating into the hardest soils; and the broad or chisel end for separating and turning over softer soils. The pickaxe *b* is for separating and turning over soft soils containing numerous roots of trees; those roots lying in a direction at right angles to the operator, being cut off with the chisel at one end of the prongs, and those roots lying

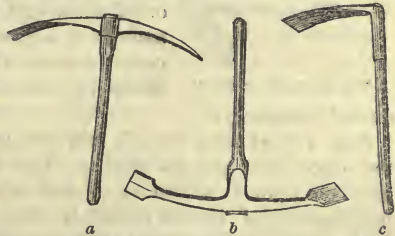

Fig. 19. Picks.

in the opposite direction, by the chisel at the opposite end. The pick *c*, frequently called a mattock, and a grubber, or grubbing-axe, is principally used for grubbing up small trees or bushes. The pick *a* is essential to the toolhouse of the commonest garden, being frequently required for loosening gravel walks, where repairs or alterations are to be made, or more gravel to be added.

394. *Draw Hoes*, figs. 20 and 21.—The common draw hoe, and all its varieties, are merely picks of a lighter kind, with the prongs dilated into blades. They are used for penetrating, moving, and drawing the soil, for the purpose of disrooting weeds, forming furrows in which to sow seeds, or drawing the earth up to plants. For light, easily-worked soils, the blade may be broad and narrow in depth; for

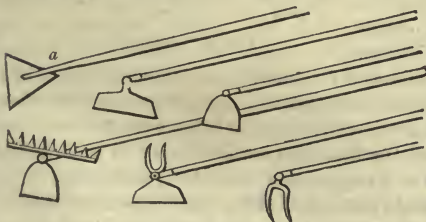

Fig. 20. Draw hoes.

stronger soils, it should be less broad, and the iron should be thicker; and for thinning seedlings, such as onions, lettuce, or turnips, the blade need not be more than two inches broad. The triangular hoe, fig. 20, *a*, is useful in light soils, and for separating, by its acute angles, weeds which grow close to the plants, to be left, and also for thinning out seedlings; but for loosening the soil among seedling-trees, or other plants growing close together on strong soil, the pointed or Spanish hoe or pick, fig. 21, deserves the preference.

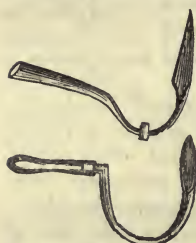

Fig. 21. Spanish hoes.

One of these tools has a short handle, and is used for stirring the soil in narrow intervals among the plants sown broadcast in beds; the other is worked with a long handle, like a common draw-hoe; and it has a cross-piece on the neck of the blade, which serves as a guide to the operator in directing the blade perpendicularly downwards, instead of to one side, when it might materially injure tap roots. In France and other parts of the Continent, there is an almost endless variety of hoes and hoe-picks, a number of which will be found figured and described in the *Gard. Mag.*, and in the *Encyc. of Gard.*, 3d ed., 1832. Sometimes a draw hoe and a rake, or a draw hoe and a hoe pick, are fixed back to back, as shown in fig. 20; but these instruments are not much used. The common draw hoe, also shown in fig. 20, will suffice for most garden purposes.



Fig. 22. Lawn-scraper.

395. *Scrapers*, fig. 22, are narrow pieces of board, or of sheet-iron, fixed to a long handle in the same manner as a draw hoe, and used to scrape the worm casts from lawns or walks. Where worms are kept under by the use of lime-water, these tools are scarcely necessary.

396. *Thrust hoes*, fig. 23, may be considered as intermediate between the draw hoe and the spade. The common form is shown at *a*, and a modification of it at *e*; but *b*, the blade of which is of steel, and sharp on every side, so as to cut either backwards or forwards, or on either side, is a more efficient implement; though in the hands of a careless operator it is liable to wound the plants, among which it is used for loosening the soil, or cutting up the weeds. Booker's hoe, *c*, is a very powerful implement, but liable to the same objection; as is Knight's hoe, *d*. Thrust hoes are best adapted for light soils, and for cutting over annual weeds; they are also most suitable for hoeing between plants in rows, where the branches reach across the intervals; because no vertical stroke being ever given by the thrust hoe, as with the draw hoe, the branches are less likely to be injured. The hoes *a* and *e* are, perhaps, the strongest and safest for general use.

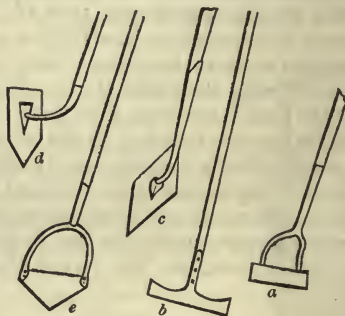

Fig. 23. Thrust-hoes.

397. *Spades*, fig. 24.—The spade consists of the grasping-piece or handle, or upper extremity, *a*; the shaft, which joins the handle to the blade *b*; the hose, or part of the blade into which the handle is inserted, *c*; the hilts,

which are two pieces

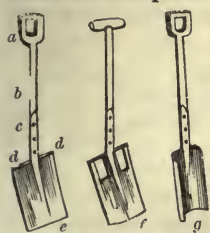

Fig. 24. Spades.

of iron which crown the upper edge of the blade for the purpose of receiving the foot of the operator, *d, d*; and the blade, *e*. As the hilt or tread projects over the blade, however useful it may be in saving the soles of the shoes of the operator, it is found in many soils to impede the operation of digging, by preventing the blade from freeing itself from the soil which adheres to it. Hence, in some parts of the country, instead of a hilt being put on the spade to save the shoes of the operator, a plate of iron about two inches broad, with leather straps, called a tread, is tied to his shoe,

and effects the same purpose, while the spade requires much less cleaning. The spade *e* is for free easily worked soil, and is that most frequently used in gardens; *f*, having the lower edge of the blade curved, enters more easily into stiff soil, while the upper part of the blade on each side of the hose being perforated, no soil can adhere there, and therefore spades of this form clean themselves, and in working are always quite free from soil. The spade, *g*, has a semicylindrical blade, and is without hilts; it is chiefly used in executing new works, such as canals, drains, ponds, &c., in strong clayey soil. In consequence of the cylindrical form of the blade, and the lower extremity of it being applied to the soil obliquely, it enters the ground as easily as the blade of the spade *f*, while the sides separate the edges of the slice of earth from the firm soil; and, after it is lifted up, serve as a guide in throwing it to a distance. There is a variety of this spade in which the blade, instead of being semi-cylindrical, is a segment of a cylinder, and rather broader at the bottom or cutting edge than at the tread. This breadth at the entering edge diminishes friction on the sides of the upper part of the blade, by preventing them from pressing hard against the earth while passing through; in the same manner as the oblique setting of the teeth of a saw prevents friction on the sides of the blade. This spade also, from the greater breadth of the lower part of its blade, lifts more completely the loose soil at the bottom of the furrow. It is chiefly used in engineering works, and in digging or trenching stiff soil. The handles of spades are almost always formed of sound root-cut ash, and their blades of good iron pointed with steel. The blade is not set exactly in the same plane as the handle, but at a small angle to it, in consequence of which, when the blade is inserted in the soil, the elbow formed between the blade and the handle serves as a fulcrum; and the handle being thus applied to the lever at a larger angle, has considerably more power in raising up the spittleful. Were the blade fixed to the handle in the same plane, and the blade inserted in the soil perpendicularly, the first exertion of the operator would be employed in gaining that angle, which, in the former, is produced for him by the manner in which the handle is joined to the blade. In the Flemish and other continental spades, the blade is always fixed on in the same plane as the handle; but in these cases the blade is longer than it is with us, and it is always entered at a considerable bevel; and besides, the soil is generally lighter than in Britain, and requires less exertion to penetrate and separate it.

Shovels are seldom required for garden purposes, the broad blade of the spade, fig. 24, *e*, serving as a substitute.

398. *Turf-spades*, fig. 25, are used for the purpose of paring very thin

layers of turf from old pastures, for forming or repairing lawns or pleasure-grounds, laying grass edgings, collecting turf for forming composts for plants, and for other purposes. One form, *h*, frequently called a breast-plough, from the handle being pressed on by the breast, has the edge of the blade turned up so as to separate the strip of turf to be raised, from the firm turf: another form, *i*, is used after the turf has been cut or lined off into ribbons or bands, by the tool called a turf-racer.

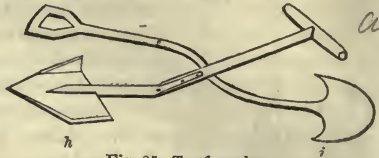

Fig. 25. Turf-spades.

399. *Turf-racers*, or verge-cutters, fig. 26, are tools used either for cutting grassy surfaces into narrow strips to be afterwards raised up by the turf spade, or for cutting the grass edgings or verges of walks. The common verge-cutter, *k*,

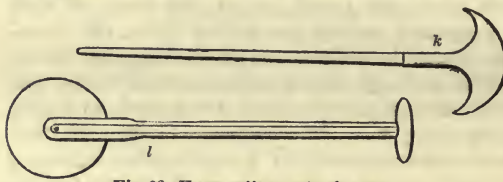

Fig. 26. Verge-cutters or turf-racers.

fixed to a handle by an axle, and operating by being pushed along before the operator. It is well adapted for cutting off the spreading shoots or leaves of grass edgings which extend over the gravel, without paring away any part of the soil. As the edges of these tools are very easily blunted, they require to be made of steel, and frequently sharpened. M'Intosh's wheel verge-cutter, fig. 27, is designed for cutting grass verges on the sides

of walks. The common verge-cutter, *k*, has a sharp reniform, or crescent-shaped blade; and the wheel verge-cutter, *l*, is a thin circular plate of steel, with a sharp-edged circumference,

of walks. With this instrument a man may cut as much in one day as he would cut in four or five days with the common verge-cutter without wheels. Bell's verge-cutter, instead of a wheel, has a broad bent plate of iron, through the middle of which the cutting coulter are inserted, and fixed and adjusted by screws. It is described and figured in *Gard. Mag.* vol. xiv. p. 177. In cutting turves from a piece of grass land, the line is first stretched in order that the cutting may be performed in a perfectly straight direction. This is also the case in cutting the verges of straight walks, but in cutting those of curved walks the eye alone serves as a guide. In gardens and pleasure-grounds of moderate extent, a sharp-edged common spade may be used as a substitute for the turf-spade, and also for the turf-racer and verge-cutter.



Fig. 27. M'Intosh's wheel verge-cutter.

400. *The trowel and the spud*, the latter of which is also used as a spade cleaner, belong to this group of tools. Though the spud, fig. 28, can hardly be considered as a fit tool for a professional gardener, yet, with a suitable handle, it forms a most convenient walking-stick for the amateur gardener; because by it he may root out a weed, or thin out a plant, wherever he sees it necessary. The transplanting trowel, fig. 29, *a*, is a very useful tool wherever careful and neat gardening is practised; because



Fig. 28.

Garden spud.

because



Fig. 29.
Trowels.

by two of these, one in each hand, growing plants can be taken up with balls, put temporarily into pots, and carried from the reserve ground to the flower beds and borders, where they can be turned out into the free soil, without sustaining any injury. The trowel *b* is used for taking up plants and to lift soil as a substitute for the hand, in potting plants. A trowel with a flat blade and a forked point is sometimes used for raising up weeds from gravel or grass, and is called a weeding-trowel. The weeding-hook, which is a narrow strap of iron forked at the lower extremity, and a wooden handle at the other, is also used for raising weeds. There is a variety of this, with a fulcrum, for rooting daisies and other broad-leaved weeds out of lawns, fig. 30. The use of the fulcrum is to admit of a long handle which renders it unnecessary for the operator to stoop. Some of these tools have short handles, to adapt them for infirm persons and children.



Fig. 30. Daisy-weeder.

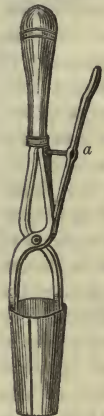

Fig. 31. Saul's transplanter. 1820 ; who used it extensively on his farm for transplanting turnips.

401. *Transplanters*, figs. 31 and 32. — These tools are used as improved substitutes for the transplanting trowel. In Saul's implement, fig. 31, the blades are opened by pressure on the lever *a* ; and in the spade transplanter, fig. 32, the blades are pressed together by moving the sliding-piece, *b*, downwards ; and when the plant is carried to its place of destination, they are opened by moving it upwards. Both these transplanters are more adapted for amateurs than for professional gardeners, and the manner in which they are to be used is sufficiently obvious from the figures. Transplanters of this kind are generally supposed to be of French origin, but we are informed that the instrument of which fig. 31 is an improvement was an invention of the Rev. Mr. Thornhill, vicar of Staindrop, in the county of Durham, about



Fig. 32.
Transplanting spade.

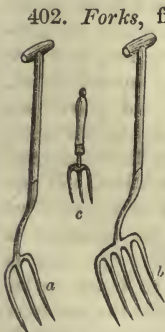

Fig. 33. Dung and tan-forks.

402. *Forks*, figs. 33 and 34.—The forks used in gardening are of two kinds ; broad-pronged forks, fig. 34, for stirring the soil among growing plants, and as a substitute for the spade in all cases where that implement would be liable to cut or injure roots ; and round-pronged forks, fig. 33, for working with littery dung, *a*, or for turning over tan, *b*. There are hand-forks of both kinds, fig. 33, *c*, and fig. 34, *d*, for working in glass-frames, hotbeds, or pits. The digging-fork is almost as essential to every garden as the spade ; and, wherever there are hotbeds, dung linings, or tan, the dung-fork with three prongs, fig. 33, *a*, and the tan-fork with five prongs, *b*, cannot be dispensed with.



Fig. 34. Digging-forks.

The three-pronged digging-fork, see fig. 34, is used for shallow digging, or pointing fruit-tree borders, and also for taking up potatoes ; and the

two-pronged fork is for stirring the soil in narrow intervals between rows, and also for digging up carrots, parsnips, horse-radish, &c.

403. *Rakes*, figs. 35 and 36, are used for freeing the surface soil from



Fig. 35. Daisy and grass rakes.

stones and other obstacles, for raking off weeds or mown grass or fallen leaves, and for covering in seeds. The common garden rakes, used for raking soil and gravel, differ chiefly in size.



See fig. 36. The daisy-rake, fig. 35, *a*, has broad teeth, lancet-pointed, sharp at the edges, and set close together; and it is used for tearing off the heads or flowers of daisies,

plantains, dandelions, and other broad-leaved plants, which appear in grass lawns, in the early part of the season; and thus it renders the necessity of mowing less frequent. The short grass rake, fig. 35, *b*, is formed of a thin piece of sheet-iron, cut along the edge so as to form a sort of comb, and riveted between two strips of wood, as shown in the figure. It serves for raking off cut grass, and also, to a certain extent, as a daisy-rake.

404. *Besoms* are used in horticulture for sweeping up mown grass, fallen leaves, and for a variety of purposes. The head or sweeping part is formed of a bundle of the spray of birch, broom, or heath, and lately the suckers of the snow-berry have come into use for this purpose. The handle is formed of any light wood, such as willow, poplar, or deal. One or more besoms are essential to every garden, and they require to be frequently renewed. For lifting matters collected together by the broom or grass rake, two pieces of board are used by the operator, one in each hand, by which the smallest heap of leaves or grass can be quickly and neatly lifted up, and dropped into a basket or wheel-barrow. The pieces of board may be about 18 in. long, from 6 in. to 9 in. broad, and $\frac{3}{4}$ in. thick.

405. *Beetles and Rammers*, fig. 37, are useful tools even in small gardens, for beating down newly-laid turf edgings; for ramming and consolidating the

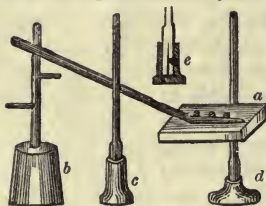

Fig. 37. Beetles and rammers.

soil about posts and foundations, and for a variety of other purposes. For example, where part of a gravel walk is taken up and relaid, unless the newly moved soil and gravel are consolidated, or rammed down, to the same degree as the old part, there will be a depression in that part of the walk, which will increase after the sinking in of rain, and thus require continual additions. In fig. 37, *a* is the common turf beater or beetle, the head or beating part of which is commonly made of a block of wood, though it would be much better of a plate of cast iron, because that would be heavier; *b* is the common wooden beater, which is also used as a rammer, the whole of which is formed of wood; *c* and *d* are two rammers, in which the heads are formed of cast iron, and which are very superior tools, invented by Anthony

Strutt, Esq. To retain the handle in the socket, a slit is made in the handle, and a small wedge entered in it, and afterwards it is driven home till it assumes the appearance shown in the section at *e*. The great art in consolidating turf or gravel with the beetle or rammer, is to bring down the tool in such a manner as that the face of the head may be perfectly parallel to the surface to be acted upon. When the operator does not succeed in this, he will be warned of it by the jar which the tool will transmit through his hands.

406. *The mallet*, fig. 38, *a*, is formed of a piece of any tough wood, such as elm or oak, or of fir, though in the latter case it should have a ring at each end to prevent its splitting. It is used for driving posts, and there is a smaller or hand mallet for using with the pruning chisel, and as a substitute for a hammer in driving in short stakes. In using a mallet, as in using the beetles, the centre of the striking part of the head should always be brought

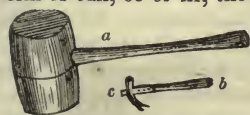

Fig. 38. *Wooden mallet and garden hammer.*

down on the centre of the stake or other object to be struck; otherwise the full power of the tool will not be obtained, and a jar on the hands of the operator will be produced.

407. *The garden hammer*, fig. 38, *b*, is used for nailing wall-trees, and for a great variety of purposes, and it differs from the common carpenter's hammer in having a projecting knob, *c*, in the head, to serve as a fulcrum in drawing out nails from walls, without injuring the young shoots. Considered by itself, the common hammer may seem an insignificant tool; but viewing it as including all the different kinds of hammers used in rendering metals malleable, and in joining constructions and machines of various kinds together, by means of nails and pins, it appears one of the most important of all implements. See Moseley's *Illustrations of Mechanics*, p. 238.

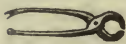

Fig. 39. *Garden pincers.*

408. *The garden pincers*, fig. 39, besides the pincing part, have a clawed handle for wrenching out nails, and are useful in gardens for this and a variety of other purposes. Some have a knob, which enables them to be used also as a hammer.

SECT. III.—*Instruments used in Horticulture.*

Instruments are distinguished from tools by having sharp cutting edges, and being adapted for operating on plants rather than on the soil; and they are also generally smaller than tools, and have for the most part handles adapted for grasping. Those used in horticulture are chiefly knives, bills, shears, and scythes.

409. *Garden Knives*.—Three kinds of knives are required in every garden, the cabbage-knife, a large rough handled instrument, with a hooked blade, for cutting and trimming Cabbages, Cauliflowers, Turnips, and other large succulent vegetables, when gathered for the kitchen; the pruning-knife,



Fig. 40. *Garden knives.*

fig. 40, *a*, for cutting the branches and twigs off trees and shrubs, forming cuttings, &c.; the budding-knife, *b*, and the grafting-knife, *c*, used in performing the operations of budding and grafting, and also in making smaller cuttings. Where heaths and other small-leaved plants

are propagated by cuttings of the points of the shoots, a common pen-knife is requisite, as well as a pair of small scissors for clipping off the leaves; but these instruments are so familiar to every one that it is unnecessary to describe

them. Formerly garden-knives were distinguished from those in common use by having blades hooked at the points, for more conveniently hooking or tearing off shoots or leaves; but this mode of separating shoots or branches being found to crush that part of the shoot which was left on the living plant, and by that means render it liable to be injured by drought or by the absorption of water, a clean draw-cut has been resorted to as not liable to these objections; and this requires a blade with a straight edge like those of the pruning-knives now in general use. All knives which are used by the practical gardener should be without moveable joints, and they should be carried in a sheath in the side-pocket, that no time may be lost in searching for them in other pockets, or in unfolding of the blade from its case. At the same time the master gardener and the amateur ought to carry a folding pruning-knife in his pocket for occasional use, in correcting the faults or supplying the omissions of his workmen. There are folding pruning-knives combining in the same handle a saw, a chisel, a file, a screw driver, &c., but these are for the most part more curious than useful. The asparagus-knife, fig. 41, has a blade about eighteen inches long, hooked and serrated, and is used for cutting the young shoots of Asparagus when in a fit state for the table. It is thrust into the soil so as, when drawing it out, to cut the shoot from two to five inches under the surface, according to the looseness of the soil, and the taste of the consumer for asparagus more or less coloured at the points. Where green Asparagus is preferred to what is thoroughly blanched, such a knife is hardly requisite, as the buds may be cut off by the surface with a common cabbage-knife.

Fig. 41. *Asparagus-knife.*

410. *Bill-knives* or *Hedge-bills* are large blades fixed to ends of long handles for cutting off branches from young trees, and for cutting up the sides of hedges instead of shears. The advantages in using them in preference to shears is, that they have a clean smooth section instead of a rough one, which, as already observed, admits drought and moisture, and also stimulates the extremities of the branches to throw out numerous small shoots, and these, by thickening the surface of the hedge, exclude the air from the interior, in which, ultimately, the smaller shoots die, and the hedge becomes thin and naked. The most complete set of instruments of the bill kind is that used in Northumberland, and described by Blaikie in his *Essay on Hedge-row Timber*. One of these instruments, fig. 42, ought to be in every

Fig. 42. *The scimitar bill-knife.*

garden-tool house. The handle of this bill-knife, or scimitar, as it is called, is four feet in length, and the blade eighteen inches in length, the former deviating from the direction of the latter to the extent of six inches, as

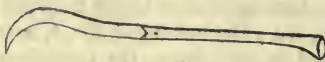
Fig. 43. *Dress bill-knife.*

shown by the dotted line in the figure; this deviation is made in order to admit the free action of the operator's arm, while he is standing by the side of a hedge, and cutting it upwards. Fig. 43 is what is called a dress-bill for cutting the sides of very small hedges, or such as are quite young.

411. *Pruning Saws* are of different kinds, but they may be all reduced to draw saws, fig. 44, a, and thrust or common saws, such as those in common

use by carpenters. Draw-saws have the teeth formed so as to point to the operator, fig. 44, *b*, and only to cut when the blade is drawn towards him. Thrust-saws have the teeth or serratures formed at right angles to the edge of the blade, so as to cut chiefly when pushed or thrust from the operator, but partly also when drawn towards him. The draw-saw is always used



Fig. 44. Garden-saws.

with a long handle, and is very convenient for sawing off branches which are at a distance from the operator. In both these saws the line of the teeth is inclined about half the thickness of the blade to each side, as shown at *d*; the advantage of which is, that the blade passes readily through the branch without the friction which would otherwise be produced by the two sides of the section. Draw-saws being subjected to only a pulling strain, do not require so thick a blade as thrust-saws; and, for that reason, they are also much less liable to have the blades broken or twisted, and are less expensive.

412. *Pruning chisels* are chisels differing little in some cases, fig. 45, *e*, from those of the common carpenter, fixed to the end of a long handle, for the purpose of cutting off small branches from the stems of trees at a considerable height above the operator. The branch should not be larger than $1\frac{1}{2}$ in. in diameter at the part to be amputated, otherwise it cannot be so readily struck off at one blow. In performing the operation two persons are requisite: one places the chisel in the proper position and holds it there, while the other, with a hand-mallet, gives the end of the handle a smart blow, sufficient to produce the separation of the branch. If properly performed, the section does not require any dressing; but sometimes there are lacerations of the bark, which require to be trimmed off with the hooked part, *g*, of the chisel, *f*.

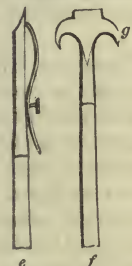

Fig. 45. Pruning-chisels.

413. *Shears*, in regard to their mode of cutting, are of two kinds: those which separate by a crushing cut, as in the common hedge-shears, fig. 46,



Fig. 46. Shears for clipping hedges and box edgings.

the grass-shears, and verge-shears; and those which separate by a draw or saw cut, as in the pruning-shears, fig. 47. The common hedge-shears is used in gardens for topiary work, cutting hedges of privet, and other small-leaved slender-twigged hedge-plants, which do not cut so readily with the hedge-bill; and it is more especially used for clipping box edgings. The pruning-shears, fig. 47, have one blade, which, by means of a rivet, moves in a groove, by which means this blade is drawn across the branch in the manner of a saw, and produces a clean or draw-cut; that is, a cut which leaves the section on the tree as smooth as if it had been cut off by a knife. There are instruments of this kind of various sizes, from that of a pair of common scissors, for pruning roses or gooseberry bushes, to such as have blades as large as those of common hedge-shears, with handles four feet long, which will cut off branches from two to three inches in diameter. All of them may be economically used in gardens, on account of their great power,



Fig. 47. Pruning-shears.

and the rapidity and accuracy with which operations are performed by them. Fig. 47 shows two instruments commonly known as Wilkinson's shears, which are well adapted for pruning shrubs, and for the use of amateurs. Roses are better pruned by instruments of this kind than by knives, as unless the latter are kept very sharp, the softness of the wood, and the large quantity of pith it contains, yield to the knife, and occasion too oblique a section, in consequence of which the shoot dies back much farther than if the section were made directly across.



Fig. 48. Garden axe.

414. *The Axe*, fig. 48, can scarcely be dispensed with in gardens, for the purpose of sharpening props or other sticks for peas, &c.; and a larger axe, as well as a common carpenter's saw, may be required where branches are to be broken up for fuel for the

hot-house furnace, or other fires.

415. *Verge-shears*, fig. 49, *a*, are shears of the crushing kind used for clipping the edges of grass-verges, which they do without cutting the soil, as is commonly the case when any of the different descriptions of verge-cutters already described (399) are used. The blades of these shears operate in a vertical plane, or what is called held edgewise.

416. *Grass-shears*, fig. 49, *b*, are used instead instead of the scythe for clipping the grass round the roots of shrubs or other flowering plants on lawns; but as they are very apt to go out of order, the common hedge-shears is generally used in preference; the stooping necessary in using the hedge-shears being found by the operator less laborious than that of keeping the blades of the long-handled shears in a cutting position. The blades of these shears work in a plane parallel to the surface of the ground, from which they are supported behind by two castor wheels, or in other words, they work flat-wise.

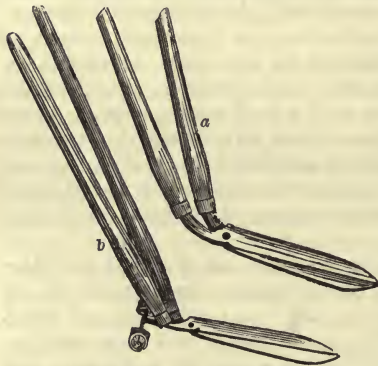

Fig. 49. Verge and Grass-shears.

417. *The Short-grass Scythe*, fig. 50, *c*, is essential wherever there are grass-verges on lawns, because though in many cases the mowing machine may be used on broad surfaces, it is not so convenient for verges and small irregular places as the scythe. The blade of the scythe cuts exactly on the same principle as that of the saw, and it requires to be frequently sharpened by a hand-stone or whet-stone, as well as occasionally ground. The blade of the garden-scythe requires to be fixed to the handle in such a manner as that when the handle is held by the operator standing upright, the plane of the blade shall be parallel to the plane of the ground. In the case of field-

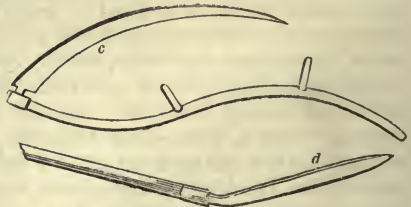

Fig. 50. Garden-scythes.

scythes, where the ground is rough, the plane of the blade may be very nearly in the same plane as that of the handle; by which means the inequalities of the ground's surface will chiefly be struck by the back of the blade, and never by its edge. The daisy-knife or daisy-scythe, fig. 50, *d*, is a two-edged blade, lancet-pointed, and is used for mowing off the heads of daisies, clover, and other exogenous plants in lawns, which renders less frequent the necessity of mowing with the scythe. In using this instrument, the handle, which ought to be angular, is held firmly with both hands, and the blade, which ought to be at least four feet from the operator, is moved rapidly to the right and left parallel to the plane of the surface, the operator advancing as in mowing.

418. *Other Instruments.*—There are several other instruments which are occasionally used by amateurs; such as the averruncator, which may be described as a cutting-shears fixed to the extremity of a long handle, and operated on by means of a cord and pulley. Its use is to enable a person standing on the ground to thin out branches in standard fruit trees, which it readily does, though frequently with a considerable loss of time. An amateur however, who prunes his own orchard, will find this a useful instrument; though, if he has an attendant, the hooked pruning-chisel, fig. 45, *f*, is preferable. The grape-gatherer, or flower-gatherer, consists of a shears fixed at the extremity of a long handle, and which clips and holds fast at the same time. It is occasionally useful for gathering flowers from the upper parts of stages in green-houses, or from plants against walls, or on poles, that cannot be conveniently reached by hand; it is also used for gathering grapes which cannot be otherwise conveniently reached. There is also an instrument of this kind without a long handle, called a flower-gatherer, which clips off a flower and holds it at the same time, and is used by ladies in gathering roses. Scissars with long handles, for thinning grapes, are required where that fruit is cultivated to the highest degree of perfection. The fruit-gatherer is an amateur's instrument, of which there are several varieties; but they are very little used. Instruments for scraping the moss or bark off trees, gouges for hollowing out wounds in their trunk or branches, climbing-spurs, and some other instruments belonging to this section, and perhaps more fanciful than useful, will be found described in the *Encyclopædia of Gardening*, edition 1831.

419. *Chests of Tools and Instruments*, for amateurs, are made up by the ironmongers; and one sold by Messrs. Cottam and Hallen, Winsley-street, Oxford-street, for three guineas, contains the following articles:—Tools, 1 draw-hoe (fig. 20), 1 triangular draw-hoe (fig. 20, *a*), 1 thrust-hoe (fig. 23, *a*), 1 rake (fig. 36), 1 trowel (fig. 20, *b*), 1 hammer, (fig. 33, *b*), 1 pruning-chisel (fig. 45), 1 pruning-shears, 20 inches long, 1 ditto, a foot long (fig. 47), 1 clipping-shears for hedges and box-edgings (fig. 46), 1 shears for clipping and holding flowers, 1 shears for thinning grapes, 1 pruning-knife (fig. 40, *a*), 1 budding-knife (fig. 40, *c*), 1 draw-saw (fig. 44, *a*), and 1 handle in two parts, which, when joined, form a length of four feet, for screwing into those tools and instruments which require a handle of that length. The box which contains these articles is 1 ft. 10 in. long, 10 in. wide, and 6 in. deep. Among the disadvantages attending the use of these implements are: the loss of time that is incurred in screwing on and unscrewing the handle, the liability of the screws to become rusty and unfit for use, and the lightness of the implements, with the exception of the shears, by which they

are not so effective as they ought to be. To a working gardener or amateur, therefore, they are altogether out of the question; but for ladies emigrating to other countries, they may serve as an inducement to gardening recreations.

SECT. IV.—*Utensils used in Horticulture.*

Garden utensils are vessels for containing growing plants; for carrying different articles used in culture, such as soils, water, &c.; for preparing soil or other matters, such as the sieve; and for protecting plants. The principal are the plant pot or box, the watering-pot, the basket, the sieve, and the bell glass.

420. *Earthenware pots for plants* are made by the potter in what are called casts, each cast containing about the same quantity of clay, and costing about the same price, but differing in the sizes of the pots so much, that while in the first size there are only two pots to a cast, in the tenth size there are sixty, as in the following table:—

				Inches diam.	Inches dep.
1st size has 2 to the cast, called			twos, being	18	12
2d	4	"	fours	12	10
3d	6	"	sixes	9	8
4th	8	"	eights	8	7
5th	12	"	twelves	7	6
6th	16	"	sixteens	6	7
7th	24	"	twenty-fours,	5	6
8th	32	"	thirty-twos	4	5
9th	48	"	forty-eighths	3	4
10th	60	"	sixties	2	2½
11th	80	"	thumbs or eighties,	1½	2

These are the sizes of the London potters; but at Liverpool the sizes and the proportions are somewhat different. The sizes are from No. 1, which is 20 in. in height and diameter, to No. 37, which is 2 in. in height and diameter, as shown in fig. 51. About London the sizes of pots in most

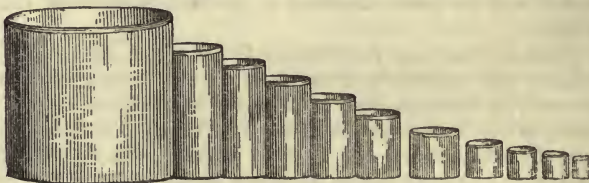

Fig. 51. *Sizes of garden pots in Liverpool.*

general use are, twenty-fours, which are 5 in. in diameter and 6 in. deep; thirty-twos, which are 4 in. in diameter and 5 in. deep; and forty-eights, which are 3 in. in diameter and 4 in. deep. When pots in which plants have been grown are to be laid aside for future use, they should be thoroughly cleaned within, because the smallest particles of earth adhering to the inner surface of the pot, when the pot is again filled with fresh soil, will, by the rough surface produced, cause that soil so to adhere to the sides of the pot, that the ball of earth, when the plant is to be shifted, cannot be turned out of the pot without being broken in pieces. The garden pots in common use

about London are generally made between a fifth or a sixth part narrower

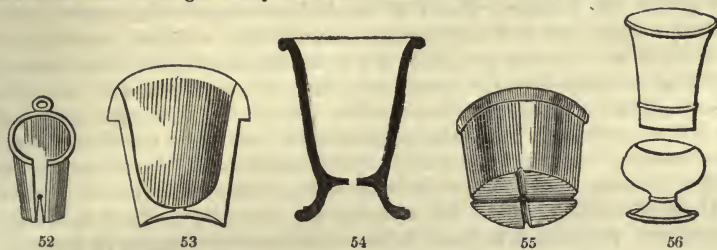

Fig. 52. Propagating-pot.

Fig. 53. Pot with raised bottom, to prevent the entrance of worms.

Fig. 54. Pot with raised bottom, to prevent the entrance of worms.

Fig. 55. Pot with channelled bottom, to facilitate the escape of water.

Fig. 56. Ornamental pot, with the base serving as a receptacle for drainage-water.



Fig. 57. Pot with pierced rims and bands for introducing wirework.

for training climbers, as in fig. 57. There is also what is called a blanching-pot (fig. 58), which is placed over plants of sea-cale, rhubarb, &c., for blanching them,

at bottom than at top ; but for particular purposes, such as that of growing hyacinths, pots are made almost equally wide throughout, and deeper than usual in proportion to their width. For striking cuttings, or growing seeds, there are pots made broad and shallow, sometimes called pans or store pots. There are also pots for aquatics, made without holes in the bottom to permit the escape of water ; others for marsh plants, without holes in the bottoms, but with holes in the sides half way between the bottom and the top, so as to retain the lower half of the soil in a marshy state. There are pots made with a slit on one side (fig. 52), for the purpose of introducing the shoot of a plant to be ringed in order to cause it to produce roots—(a small wooden box is much better, as being less porous) ; others with a large hole in the side for the same purpose ; some with concave bottoms, with the intention of putting the water hole out of the reach of worms (figs. 53 and 54) ; others (fig. 55) with grooves in the bottom to prevent the retention of water by the attraction of cohesion, when the pot stands on a flat surface ; and there are pots fixed within pots, so that the space within the outer and the inner pot shall be water-tight, in order to contain water or moist moss, so as to keep the soil in the inner pot of comparatively uniform moisture and temperature. There are pots made in two parts (fig. 56), the lower serving as an ornamental base—so as to give the pot a somewhat classical character—and at the same time as a receptacle for the water that drains through



Fig. 58. Blanching-pot.

having a moveable top, which can be taken off at pleasure, to admit light or to gather the produce. Boxes of boards, however, are found more economical. There are also square-made pots, which, it is alleged, by filling up the angles left by round pots, allow of a greater quantity of soil being obtained in a given space in beds or shelves under glass; and pots with one side flattened, and with a pierced ear or handle, to admit of hanging the pot against a wall or a trunk of a tree. Many other fanciful pots might have been figured and described; but in the general practice of gardening all these peculiar pots (figs. 52 to 58) may be dispensed with; and, in truth, with the exception of the last forms (figs. 57 and 58), they are only found in the gardens of some amateurs. It is useful, however, to know what has been done or attempted in this way, in order to prevent a waste of time in repeating similar contrivances.

421. From the *porosity* of the material of which common earthenware plant-pots are made, it is evident that when the soil within the pot is moist, and the pot placed in a warm dry atmosphere, the evaporation and transpiration through the sides must be considerable; and as evaporation always takes place at the expense of heat, this must tend greatly to cool the mass of soil and fibrous roots within (252 and 257.) This may be prevented by glazing the exterior surface of the pot; but as this would add to the expense, and be chiefly useful in the case of plants in pots kept in rooms, it is seldom incurred. To prevent evaporation in rooms the double-pot is sometimes used, or single pots are surrounded by moss, or cased in woollen cloth or bark of trees: in plant-houses, the atmosphere is, or ought to be, so nearly saturated with moisture by other means, as to reduce the evaporation from the pots to a degree that cannot prove injurious. From the bad effects of this evaporation in warm countries may be traced the practice in these countries of growing plants in wooden boxes, which was probably instinctively hit upon, without any reference to principles. The advantage which earthenware pots have over boxes is, that they can be made round, by which means shifting is effected with much greater ease than it can be with any rectangular utensil.

422. *Earthenware saucers for pots* are made and sold on the same principle as pots, viz.: in casts; a cast of saucers for sixties or thumbs costing

as much as a cast for thirty-two, or sixes. Saucers are chiefly used in living rooms, or in other situations where the water which escapes from the hole in the bottom of the pot would prove injurious; and to prevent this water from oozing through the porous material of the saucer, it is sometimes glazed on the inside. There are also saucers, or

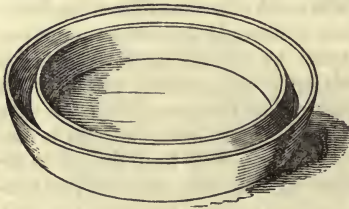

Fig. 60. Annular water-saucer.



Fig. 59. Isolating-Saucer.

called, made with raised platforms in the centre, for the pots containing the plants to stand in; in some cases, in order that they may stand dry and not be liable to be entered by earth-worms; and in others, in order to surround them with water, and thus isolate them from the attacks of creeping insects, such as wood-lice, ants, &c. Utensils of this kind are also used for supporting boards in the open garden,

so as to isolate them, and of course the pots which stand on them, from wingless insects, snails, worms, &c. Fig. 59 shows one of these utensils, which might easily be substituted by a common saucer and whelmed pot. An annular saucer, fig. 60, for containing water, is used either for protecting plants in pots or plants in the open ground; and if lime-water or salt-water is used, they will prove a very effectual protection from snails, slugs, wood-lice, ants, and other creeping wingless insects. A very ingenious substitute for this utensil has lately been invented by Mr. Walker, of Hull. It is founded on the galvanic principle of alternate plates of zinc and copper producing a galvanic shock, and is therefore called the Galvanic Protector. Take slips of zinc four or five inches in breadth, in order to inclose the plant or bed to be protected, as with a hoop; but in addition to the mere rim or frame of zinc, rivet to it, near the upper edge, a strip of sheet-copper one inch broad, turning down the zinc over this so as to form a rim, composed of zinc, copper, and zinc. The deterring effect is produced by the galvanic action of the two metals; and thus, when the snail or slug creeps up the rim of zinc, it receives a galvanic shock as soon as its horns or head touch the part where the copper is inclosed, causing it to recoil or turn back. A more beautiful application of science in the case of deterring insects is rarely to be met with, and it will not cost more than 6*d.* a lineal foot. (*Gard. Chron.* vol. i. p. 115, and 165; and *Gard. Mag.* 1841.)

423. *Rectangular boxes* for growing plants are commonly formed of wood, but sometimes slate is substituted. Wood, however, as a better non-conductor both of heat and moisture, deserves the preference. A neat and most convenient plant-box was invented by Mr. M'Intosh, fig. 61, and used by him for growing orange-trees.

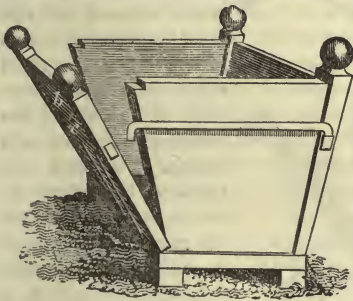

Fig. 61. Plant-box.

It differs from the orange-boxes used in the gardens about Paris in having the sides tapered a little, and also in having all the sides moveable. Two of the sides are attached to the bottom of the box by hinges, and are kept in their places by iron bars hooked at each end, which slip into hasps fixed in the sides, as shown in the figure; the other sides, which are not hinged, lift out at leisure, being kept in their places at bottom by two iron studs, which drop

into holes in the bottom. These boxes afford greater facilities than the French orange-boxes for the gardener to take them to pieces, without disturbing the trees, whenever he wishes to examine or prune their roots, to see whether they are in a proper state as regards moisture, or to remove the old, and put in fresh soil. The inside of these boxes can also be painted, or covered with pitch, as often as may be judged necessary; which will of course make them much more durable, and the trees may be removed from one box to another with the greater facility.

424. *Wooden tubs* are very commonly made use of on the Continent to grow orange-trees, and they are made of different heights and diameters from one to two or three feet. When the roots of the trees are to be examined, or old soil to be removed and fresh soil added, the cooper is sent for, who separates the staves, and after the gardener has finished his operations, replaces

them again and fixes the hoops. In the warm summers of France and Italy, as already observed, it is found much better to grow plants in wooden boxes or tubs, than in any description of earthenware vessel.

425. *Watering-pots* are made of tinned iron, zinc, and sometimes of copper. There are a variety of sizes and shapes in use in British gardens: for plants under glass, which are placed at a distance from the spectator, pots with long spouts are required; and for pots in shelves over the head of the operator and close under the glass, flat pots with spouts proceeding from the bottom, and in the same plane with it, are found necessary. Watering-pots have been contrived with close covers, containing valves to regulate the escape of the water through the spout, by the admission or exclusion of the atmosphere at pleasure; but these are only required for particular situations and circumstances. The watering-pot very generally fails at the point where the spout joins the body of the pot, and the two parts ought therefore to be firmly attached together, either by separate tie-pieces, or by one continuous body, which may be so contrived as to hold the roses of the pot when not in use, as exemplified in Money's pot, to be hereafter described. The rose is generally moveable; but as, after much use, it becomes leaky, it is better, in many cases, to have it fixed, with a pierced grating in the inside of the pot over the orifice of the spout, as in metal tea-pots. This grating, Mr. Beaton suggests, should be moveable, by being made to slide into a groove like a sluice, in order that it may be taken out and cleaned occasionally. Fig. 62, *a*, represents a watering-pot with a kneed spout, for watering plants,

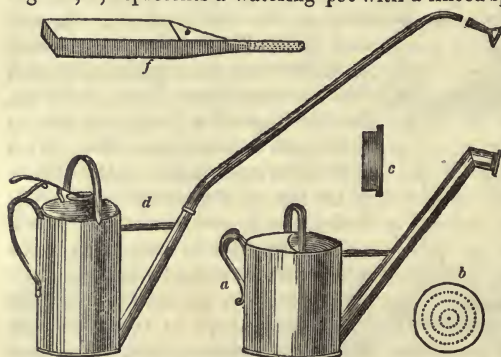

without spilling any water between pot and pot; because, by means of the knee or right angle made at the extremity of the spout, the running of the water is instantly stopped by quickly elevating it, which is by no means the case when the spout is straight throughout its whole length: *b* shows the face, and *c* the

edge of a very fine rose of copper for screwing on the end of the kneed spout, for watering seedlings. Fig. 62, *d*, shows a sucker watering-pot, by which the objects effected by the kneed pot are attained more completely. There is a sucker or valve in the lid, by which the air is perfectly excluded; and when this valve is shut, not a particle of water can escape; but when it is slightly raised by the pressure of the thumb of the hand by which the operator holds the pot, the water instantly escapes, and can be stopped in a moment: *f*, an overhead watering-pot, for watering plants close under a glass roof, and above the head of the spectator.

426. *Money's Inverted Rose Watering-pot*, fig. 63, has the spout made of copper, and in three distinct parts; so that it serves instead of three different pots; and when furnished with common roses as well as with inverted ones, no other pot need be required for a small garden.

The first and largest spout, *a*, is fixed to the body of the pot in such a manner as not to get easily out of repair: this is effected by filling up the angle between the spout and the pot by a hollow compartment, with iron sides, *b*, in the top of which are two openings, *c*, and *d*; the larger, *c*, for holding the middle piece of the spout when not in use, or the larger rose; and the other, *d*, for holding the smaller rose. The larger rose, *e*, is used without the middle piece of the spout, and it delivers the water upwards; and the smaller rose, *f*, which can only be used with the middle tube of the

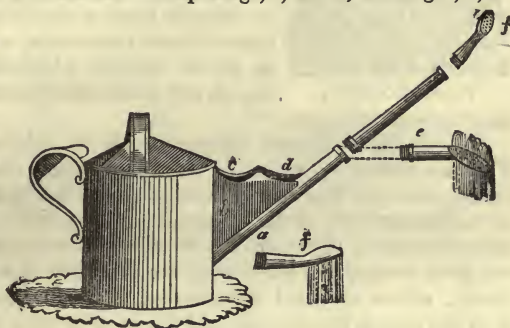

Fig. 63. Money's inverted-rose watering-pot.

spout, delivers the water downwards, exactly over the object or space to be watered. The screw-joints by which the roses are attached to the spouts are perfectly water-tight, and being made of copper are not liable to rust and get out of repair. The advantage of using the roses in inverted positions is, that the action of the water is more definite; and of using them with the face of the rose upwards, that the shower produced comes down more gently. For watering small seeds in pots, the holes in the roses ought not to exceed the fiftieth part of an inch in diameter. One watering-pot of this description may be kept for select purposes, and for the use of amateurs or ladies; but for open air gardening the common zinc watering-pot, with a fixed rose, is quite sufficient; adding, for more refined purposes, the pot fig. 62, *a*.

427. Sieves for sifting soil, and screens of wire for separating the larger stones and roots from soil to be used in potting, are required in most gardens. The screen, fig. 64, is not only used for mould, but also for gravel, and some-

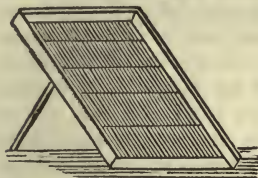

Fig. 64. Wire screen, for soil, old tan, or gravel.

times for tan. It consists of a wooden frame filled in with parallel wires half an inch apart, surrounded by a rim of three or four inches in breadth, and supported by hinged props, which admit of placing the screen at any required angle. The soil to be screened must be dry and well broken by the spade before it is thrown on the screen. For gravel two screens are some-

times required; one with the wires half an inch apart, to separate the sand and small gravel from the stones; and another, with the wires one inch apart, to separate the larger stones from the smaller ones; those which pass through the screen being of the fittest size for approach-roads and carriage-drives; while the largest stones which do not pass through are adapted for common cart roads. In small gardens sieves may be substituted for screens. The smallest may have the meshes a fourth of an inch in diameter, and the larger half an inch. The wire of the smaller sieves should always be of copper, but of the larger sieves and of screens it may be of iron.

428. Carrying utensils are sometimes wanted in gardens, though flower-pots, baskets, and wheelbarrows, form very good substitutes. The mould-scuttle is a box of any convenient shape of wood or iron, with a hoop-formed

handle, for carrying it; sometimes it is formed like the common coal-scuttle, but rectangular. The pot-carrier, fig. 65, is a flat board about eighteen inches wide and two feet long, with a hooped handle, by means of which, with one in each hand, a man may carry three or four dozen of small pots at once, which is very convenient in private gardens where there are many alpiners in pots, and in nurseries where there are many seed-



Fig. 65. Pot-carrier.

lings or small cuttings.

429. *Baskets*.—Several different kinds of baskets are used in gardens. They are woven or worked of the young shoots of willow, hazel, or other plants, or of split deal or willow, or of spray; but by far the greater number of baskets are made of the one year's shoots or wands of the common willow, *Sàlix viminalis*. They are for the most part used for carrying articles from one point to another, though some are employed as a substitute for a garden wallet, others are used for growing plants; some for protecting plants from the sun or the weather, and others as utensils for measuring by bulk. As every gardener and country labourer ought to understand the art of basket-making for ordinary purposes, in order to fill up his working time during inclement weather, we shall first shortly describe that operation.

430. *Basket-making*.—One year's shoots of the common willow, or of some other species of that family, are most generally used. The shoots are cut the preceding autumn, and tied in bundles, and if they are intended to be peeled, their thick ends are placed in standing water to the depth of three or four inches; and when the shoots begin to sprout in spring they are drawn through a split stick stuck in the ground, or an apparatus consisting of two round rods of iron, nearly half an inch thick, one foot four inches long, and tapering a little upwards, welded together at the one end, which is sharpened so that the instrument may be readily thrust through a hole in a stool or small bench, on which the operator sits. In using it, the operator takes the wand in his right hand by the small end, and puts a foot or more of the thick end into the instrument, the prongs of which he presses together with his left hand, while with his right he draws the willow towards him, by which the bark is at once separated from the wood: the small end is then treated in the same manner, and the peeling is completed. Every basket consists of two parts: the framework of the structure, and the filling in or wattled part. The principal ribs in common baskets are two: a vertical rib or hoop, the upper part of which is destined to form the handle; and a horizontal hoop or rim, which is destined to support all the subordinate ribs on which the wands are wattled. The two main ribs are first bent to the required form, and made fast at their extremities by nails or wire. They are then joined together in their proper position, the one intersecting the other; and they are afterwards nailed together, or tied by wire at the points of intersection. The operation of wattling is next commenced, by taking the small end of a wand, and passing it once or twice round the cross formed by the points of intersection; after which one, or perhaps two secondary ribs, are introduced on each side of the vertical main rib. The wattling is then proceeded with a little further, when two or more secondary ribs are introduced; and the process is continued till a sufficient number of subordinate ribs are put in to support the wattling of the entire structure. The whole art, as far as concerns the gardener, will be understood from the following figures:—

Fig. 66 shows the handle and rim of what is called the Scotch basket, made fast at the points of intersection.

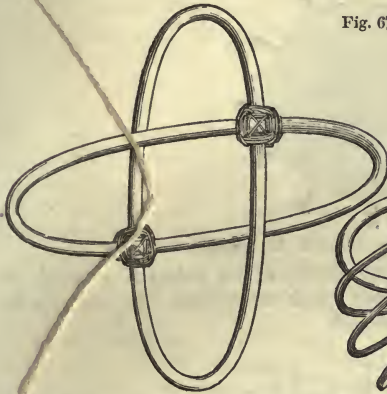

Fig. 66. Handle and rim of a Scotch basket.

Fig. 67. Handle, rim, and ribs of a Scotch basket.

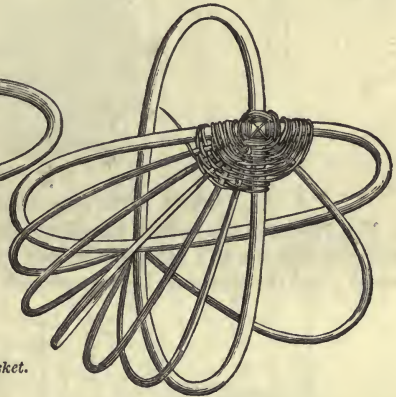

Fig. 67 shows the same skeleton, with the ribs of one side added, and the wattling or woven work commenced.

Fig. 68 represents the commencement of what is called the English mode of basket-making; in which three parallel rods of two or three feet in length, according to the intended diameter of the bottom of the basket, are laid flat on the ground, and three other rods of the same length laid across them at right angles, as at *a*; and next the weaving process is commenced, as at *b*.

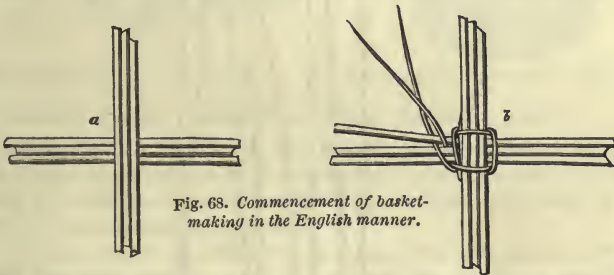

Fig. 68. Commencement of basket-making in the English manner.

Figs. 69 and 70 show the progress of weaving the bottom; the latter being what ultimately becomes the under side, and the former the upper side.

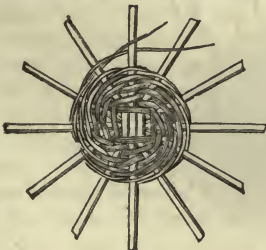

Fig. 69. Upper side.

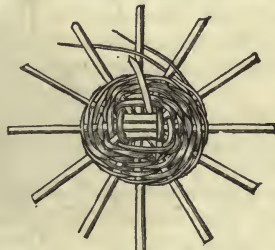

Fig. 70. Under side.

Fig. 71 shows the bottom complete, the under side of it being uppermost.

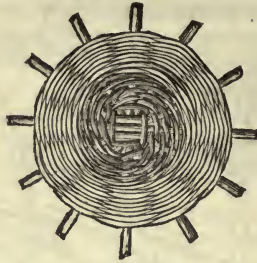

Fig. 71. *Bottom of the English basket complete.*

Fig. 72 shows the bottom turned upside down, the points of some of the radiating ribs cut off; some of the rods which are to form the side ribs inserted; and the side weaving commenced.

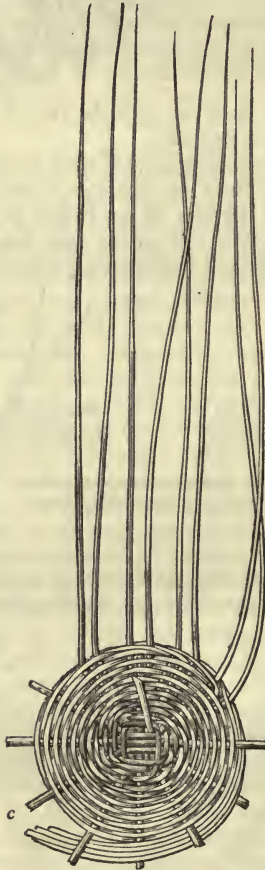

Fig. 72. *Side weaving commenced on the English basket.*

Fig. 73 shows the basket nearly completed, with part of the rim finished, and the rod on which the handle is to be formed inserted.

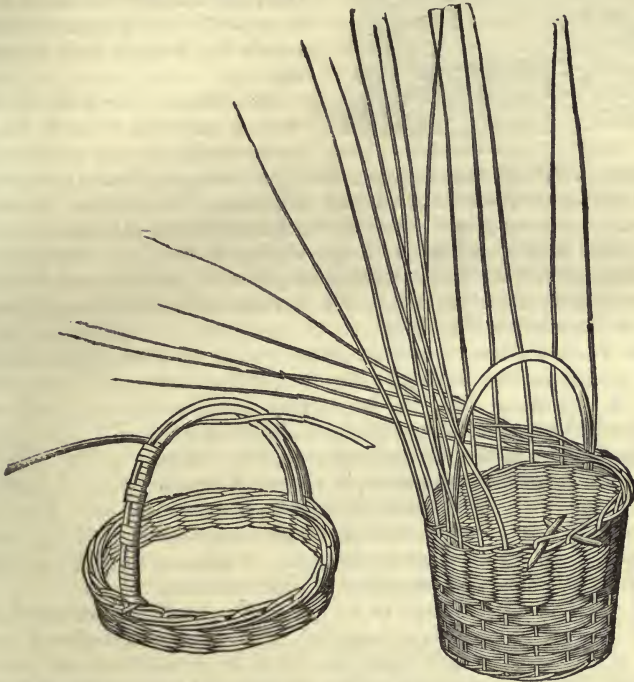

Fig. 73. *The English basket nearly complete.*

Fig. 74. *Working the sides of the English basket.*

Fig. 74 shows the rim completed and part of the handle plaited.

Further details will be found in the *Arboretum Britannicum*, vol. iii. p. 1471, but those above given will be sufficient to enable any person of ordinary ingenuity to construct every kind of wickerwork, whether baskets or hurdles, that can be required for a garden.

431. *Carrying-baskets* of different sizes are required in gardens for carrying plants for being transplanted, seeds, sets or roots for planting, vegetables or fruits from the garden to the kitchen, and for a variety of other purposes. A basket for hanging before the operator when pruning or nailing wall trees, is sometimes made of wands, and occasionally of split wood; but a leathern wallet, to be hereafter described, is greatly preferable. Larger and coarser baskets than any of these are used for carrying soil, manures, tanner's bark, weeds, &c., and are commonly called scuttles, creels, &c.

432. *Measuring-baskets* are formed of particular dimensions, the largest seldom containing more than a bushel, and others half-bushels, pecks, and half-pecks. There are also pint baskets, punnets, pottles, and thumbs, which are utensils in use in the London fruit and vegetable markets for containing the more valuable vegetables, such as mushrooms, early potatoes, forced kidney beans, and the more choice fruits. The bushel basket is generally made of peeled wands, but the others of split willow wood, or split



Fig. 75. Punnet basket.

taken up in the following autumn ; the object being to take up fruit-trees or other tender shrubs with a ball, and with most of the fibres. At present baskets for growing plants are chiefly used in orchidaceous houses, the basket being filled with moss ; but as they are found to be of very short duration, wire baskets are substituted, earthenware pots with perforated sides, or a sort of open box formed of short rods, laid over one another, at the angles, somewhat in the manner of a log-house.

434. *Portable Glass Utensils* for plants are chiefly of two kinds : the bell-glass, fig. 76, and the hand-glass, fig. 77. Bell-glasses vary in dimensions from the large green bell-glass, eighteen inches in diameter and twenty inches in height, used in the open garden for protecting cauliflowers in winter and cucumbers in summer, to the small crystal bell, three inches in diameter, and two inches high, for covering newly-planted cuttings. Whenever the propagation of tender plants by

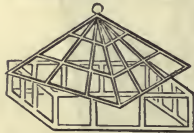

Fig. 77. Cast-iron hand-glass in two parts, the roof and sides.

cuttings, or by the greffe étouffé, is attempted, bell-glasses are essential. The common hand-glass is formed either square, or of five or more sides on the plan, and with the sides commonly eight or twelve inches high. The framework is of lead, cast-iron, tinned wrought-iron, copper, or zinc ; the last is much the cheapest, and also the lightest, and when kept well painted, it will last as long as cast-iron, which with the moisture of the soil soon becomes rusty at the lower edge. Cast-iron hand-glasses being very heavy, are commonly formed in two pieces ; and when the form is square, as in fig. 77, air is very conveniently given by changing the position of the covering part, as shown in the figure.

435. The following *substitute for bell-glasses* may be readily adopted by any gardener who can get pieces of broken window-glass from his frames or hothouses, and who has a glazier's patent diamond, which differs from the

deal. Fig. 75 represents a punnet manufactured in the latter manner, the construction of which will be understood by any person who understands the English mode of basket-making.

433. *Baskets for growing plants* were a long time in use in the open garden, being plunged in spring, and



Fig. 76. Bell-glasses.

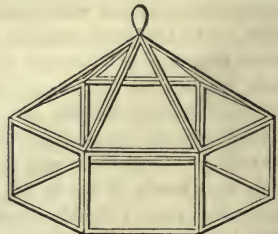
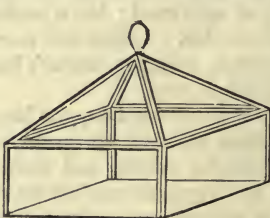

Fig. 78. Substitutes for bell-glasses.

common diamond in this, that any person can cut with it. Having procured the diamond and several pieces of broken window-glass, cut the latter into figures appropriate in size and form for the sides of four or six-sided prisms, as shown in fig. 78. When the pieces of glass are properly cut out by a wooden or card pattern, join them together with strips of tape, about three-eighths of an inch wide, made to adhere to the glass with India-rubber varnish. After the glass is formed, varnish over the tape, and the whole will be found firm and durable. A loop may be formed at top either of the tape or of wire, so as to lift them by. Glasses of this sort may be made from six inches to a foot in diameter, and will at all events be found useful for striking cuttings or protecting rising seeds. An excellent substitute for hand-glasses will be described under the section on structures.

436. *Powdering-boxes* for plants are required for dusting them with powdered lime, sulphur, coarse snuff, powdered charcoal, fine sand, &c. One of the most convenient forms is that of the common dredge-box, but for the light powders an appendage to be hereafter described may be added to the common bellows. All powders intended to rest on the leaves of plants should be dusted over them when they are moist with dew, or by having been previously watered.

437. *Other Utensils.*—We have omitted to mention some used in very extensive gardens, botanic gardens, and nurseries; such as the glazed packing-box; the earthenware shelter, which may be described as an inverted flower-pot, with the sides perforated with holes, or with a large opening on one side; plant-shades of various kinds; utensils for entrapping or destroying vermin; bulb-glasses; cast-iron pots for burning tobacco; and a few other articles not in general use, or readily substituted by others of a more simple and economical kind.

SECT. V.—*Machines used in Horticulture.*

Machines differ from other horticultural implements in being less simple in their construction, and in their action, enabling the operator to abridge labour. The principal gardening machines are the wheelbarrow, roller, watering engines, garden-bellows, and transporting or transplanting machines.

438. *Wheelbarrows for gardens* are of two kinds: one of large dimensions for wheeling littery dung, tan, short grass, leaves, haulm, or weeds; and another of moderate size (fig. 79), for wheeling soil and gravel. They are

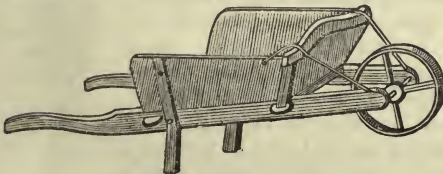

Fig. 79. *Garden wheelbarrow.*

generally constructed of wood, with the wheel also of wood and shod with iron; but some wheelbarrows are formed entirely of cast and wrought iron; they are, however, too heavy for wheeling anything, excepting littery dung or other light matters, and they are far from being so durable as a wooden barrow, when the latter is kept well painted. Some dung and tan barrows have the body or box attached to the handles or levers, commonly called trams, by moveable iron bolts, so that it can be readily taken off and carried by two men into places where the entire barrow with its wheel could not be admitted; for example, in filling the bark pit of a stove with tan or leaves. There is a third kind of barrow used by engineers, in deep cuttings, which has shallow sides of an equal height on every side of the bottom of

the barrow; it is well suited for carrying heavy subsoil, or stony materials, but is not required in gardens. For general purposes, a middle-sized barrow, between the dung barrow and the mould barrow, like that of which we have given a figure, is sufficient.

439. *Rollers* are essential in even the smallest garden, for compressing and smoothing gravel walks and lawns. They are formed of solid cylinders of stone, or hollow cylinders of cast iron, and a very convenient width is four feet. Cast iron rollers are always easiest to draw, from the greater diameter of the cylinder. The operation of rolling is most effective after the soil or

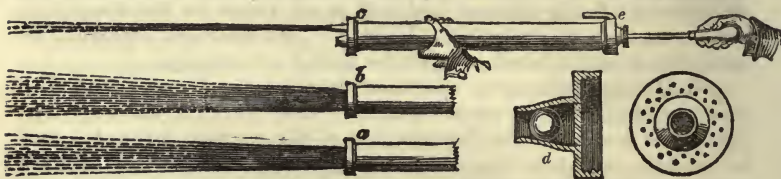

Fig. 80. Read's garden syringe.

gravel has been softened by recent rains, but is at the same time sufficiently dry on the surface not to adhere to the roller.

440. *The watering engines* used in gardens are the syringe, the hand-engine, and the barrow-engine. There are several kinds of syringe, but the best at present in use is decidedly that of Read (fig. 80). Its two points of superiority are, a ball-valve, *d*, which can never go out of repair, and an air-tube, *e*, which allows the air above the piston to escape during the operation of drawing in water, by which means the labour of syringing is greatly diminished. There is a cap, *a*, for washing away insects from wall-trees, and throwing lime-water on gooseberry bushes and other standards in the open garden, and for water-pines overhead; a cap, *b*, for sprinkling plants in forcing-houses, which throws the fluid in a light and gentle moisture almost like dew, and which is also used for washing the leaves of trees and plants when frost-nipped in the cold nights that often prevail during the spring, and which operation should, of course, be performed before sun-rise. There is also a cap, *c, d*, which is used when great force is required, more particularly in washing trees against walls; and this cap is also used in dwelling-houses for extinguishing fires. Trees against walls are frequently covered with netting, and when it becomes necessary to syringe these, the netting, when the cap, *b*, is used, requires to be removed, but with the cap, *c, d*, it may be kept on. For all small gardens this syringe will serve as a substitute for every other description of watering engine. Read's pneumatic engine (figs. 81 and 82), the former to a scale of $1\frac{1}{2}$ in. to 1 ft., differs from Read's hand-syringe in effect, by forcing out the water in one continuous stream, and thus at once combining the character of a syringe and of an engine. By this engine, a volume of air is compressed to an indefinite extent, by the working of the piston for forcing out the water, and without any sensible increase of labour to the operator. The manner in which this is effected will be understood by the section, fig. 82, in which *a* is the piston and cylinder, as in Read's syringe; *b*,

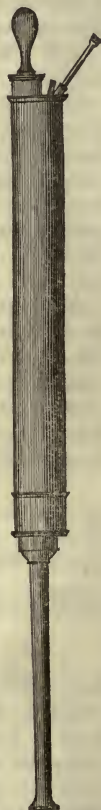

Fig. 81. Read's pneumatic hand-engine.

a case in which this syringe, and also the discharge-tube (*c*), are enclosed; *d*, a small hole in the side of the discharge tube; and *e*, a valve at the bottom of the discharge tube: *f* is a ball-valve to the suction tube, by which the water is drawn up from a watering-pot, pail, or any other vessel.

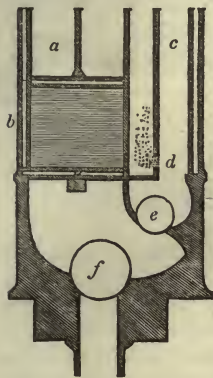

Fig. 82. Section of Read's pneumatic hand-engine.

On the motion of drawing up the piston (*a*), the water enters by *f*; while, by pushing down the piston, the valve at *f* is closed, and the water is forced up the valve at *e*, into the discharge tube; but as some more water is forced into this tube than can pass through it, it escapes by the small opening at *d* into the vessel of air in which the working barrel and the discharge tube are encased. As the air cannot escape from this vessel, it is necessarily compressed by the water which enters through the small opening at *d*; and, consequently, when the piston, *a*, is drawn up, and no longer forces up the water in the discharge tube, *c*, the action on that tube is kept up by the expansion of the compressed air which shuts the valve at *e*, and, consequently, forces the water along *c*. The great beauty of this arrangement is, that no exertion of the operator is lost; nor can he exert himself without producing

a corresponding result; for if, by rapid and powerful action, he drives much water into the air vessel, the greater degree in which the air is compressed will force the water with the more rapidity through the discharge tube, *c*. This engine is 3 ft. long, and $2\frac{1}{4}$ in. in diameter; it weighs only between 5lb. and 6lb.; works with remarkable ease, and is so little liable to go out of repair, that Mr. Read warrants it to last a lifetime. Read's barrow engine, fig. 83, is an oval copper vessel, containing twenty-six gallons, particularly adapted for large conservatories and forcing houses. It will pass through a door-way two feet wide, and is so portable that it may be carried up or down stairs by two men. The great power of this engine depends on the air vessel, indicated by a dotted circular line, in the body of the engine, in which all superfluous force is employed in condensing air, as in Read's pneumatic engine, so as to form a reservoir of power; and in the proximity of the bent fulcrum, *a*, to the handle or lever, *b*, by which the weight *c*, being brought near to the fulcrum, the power applied at *b* is proportionably increased. In most engines of this kind there is no pneumatic reservoir, and the distance between the weight, *c*, and the fulcrum, *a*, is much greater. The construction of the piston, valves, &c., is similar to that of Read's hand-engine, so that this barrow-engine is not only a machine of great power, but not liable to go out of repair. Mr. Read, who has been attending to this subject the greater part of his life, considers this engine as his masterpiece.

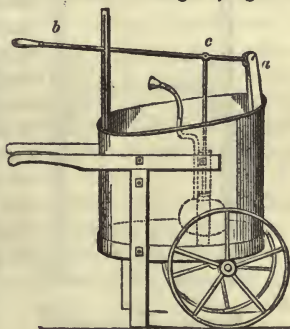

Fig. 83. Read's barrow engine.

441. *Garden-bellows.* Bellows are used in gardening for dusting plants with powdery substances, such as quicklime, powdered tobacco leaves, sulphur, &c., and for fumigating them with tobacco-smoke. Read's fumigating-bellows (figs. 84 and 85) answers both purposes. It consists of a pair of

bellows, fig. 84, *a*, to which is attached a canister, *b*, with a moveable nozzle, through which the smoke escapes, *c*. The details of the canister are

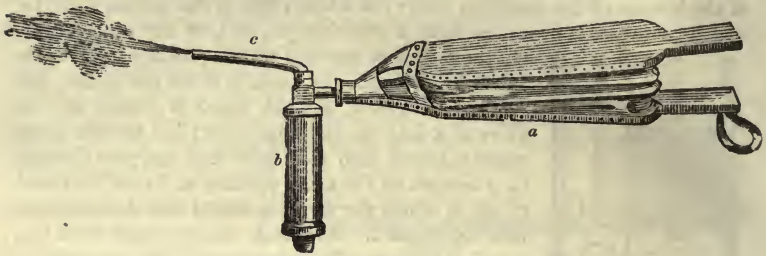

Fig. 84. *Read's fumigating bellows.*

shown in the section, fig. 85, which is one third of the natural size. In this section *d* is the bottom socket or cap; *e*, the plunger, which keeps down the tobacco; *f*, the nozzle of the bellows; and *g*, the tube by which the smoke escapes, unscrewed to show the ball-valve.

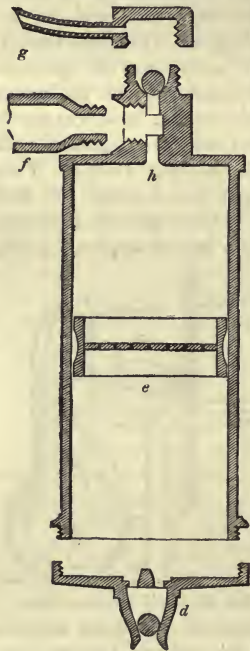

Fig. 85 *Section of the canister of Read's fumigating bellows.*

such as fig. 86, may be used. It is made of sheet-iron, holds about three pounds of tobacco, and is placed on the outside of the house, with the smoke-tube entering it through a hole made on purpose in the front wall or front glass. In this figure *a* is the handle by which the pot is carried, *b* the pipe by which the

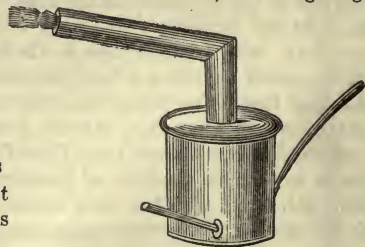

Fig. 86. *Iron fumigating-pot.*

smoke is introduced to the house, and which is attached to a moveable lid, and, *c*, a tube to which the bellows is applied, and which enters the pot immediately under a perforated moveable bottom. A substitute for a pot of this kind is often formed by two flower-pots, a smaller one being placed upside down within a larger, and the tobacco placed in the former. In fumigating plants in houses, it will be found advantageous to fill the house at the same time with steam, by watering the pipes or flues, or by other means. The steam condenses the oil of the smoke, and leaves it on the leaves and points of the young shoots in the form of globules of oil, on the surface of the globules of water. A pair of common bellows may be rendered fit either for

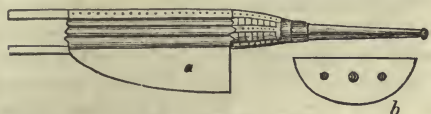

Fig. 87. Powdering-bellows.

powdering plants or fumigating them, by substituting a piece of tinned iron, fig. 87, *a*, resembling in shape those tin scales used in the retail of meal, in the flat end of which,

b, are two small valves $1\frac{1}{4}$ of an inch in diameter, with a hole between them, to which a screw cap is fitted for introducing the dust or the tobacco to be burnt. It is evident that the air which enters through the valves by the up-stroke of the bellows, raises the dust or smoke in the interior, which is ejected by the down-stroke; and, by repetition, the whole powder introduced, or the whole smoke produced by the ignition of the tobacco-leaves, will be thrown out. (*Gard. Mag.* vol. iii. p. 30.) We consider this to be much the best description of garden-bellows for dusting plants with sulphur.

442. *The mowing-machine* is used for shearing lawns, where the surface is smooth and even, and kept free from worm-casts and all matters that would interfere with the cutting part of the machine, which is formed exactly on the model of the engine for shearing the surface of woollen-cloth described in *Ure's Dictionary of Manufactures*, p. 1324. The machine crops and collects at the same time in a box the grass cut by it, and is altogether very complete in its action where the lawn to be cropped is suitable; but for ordinary garden purposes most gardeners seem to prefer the short grass-scythe, and leave the mowing-machine to the amateur, for whom it forms an excellent exercise.

443. *Other machines.*—In the *Encyc. of Gard.* will be found described various machines for transporting large boxes or tubs containing plants, such as Orange-trees; machines for transporting and for transplanting large trees, for regulating temperature, for entrapping or detecting the enemies of gardens, and for some other purposes; but few of these are adapted for the present work. It may be stated here, that the principle on which all the best machines for transporting plants in large boxes or tubs, or transplanting large trees with balls to their roots, is the same: viz. two windlass axles are supported on four props, which rise out of two horizontal beams, and the box or tree being raised by means of the windlasses, is retained in that position till it is conveyed to its destination, either by means of two horizontal beams, by manual labour, as if they were the levers of a hand-barrow; or by placing wheels under them, in the manner of a cart or waggon. The best machine of this kind for removing Orange-trees in boxes, is that used at St. Margaret's, near London, and described in the *Gardener's Magazine*, vol. x. p. 136. From the description of this machine it is obvious that it will answer either for transporting trees in boxes, or trees or shrubs with large

balls; though, to convey the latter to any distance over rough roads, larger wheels would be requisite than those which belong to the machine referred to. See our Appendix.

SECT. VI.—*Miscellaneous Articles used in Horticulture.*

In complete gardens, containing all the varieties of plant-structures, a number of articles are required for the purposes of cultivation and high keeping which can neither be classed as implements nor structures. Even in the smallest gardens, mats for protection, props for support, nails and ties for fastenings, and tallies for naming and numbering plants, are essential.

444. *Articles for protection.*—Bass mats, woven from ribands or strands of the inner bark of the lime-tree, and imported from the Baltic, are in general use, both to protect from the cold by counteracting radiation, and to shade from the sun. Canvas, bunting, and netting of different kinds, and oiled paper frames, are used for the same purposes. Netting of straw ropes, formed by first stretching ropes as weft at regular distances, and then crossing them by others as woof, are sometimes used to protect wall-trees. Another mode of protecting trees by straw ropes, is by placing poles against the wall, in front of the trees, at from four feet to six feet asunder; thrusting their lower ends into the earth about eighteen inches or two feet from the wall, and making them fast at top to the coping, or to the wall immediately under it; straw or hay ropes are then passed from pole to pole, taking a turn round each, and leaving a distance of about eighteen inches between each horizontal line of ropes. Straw ropes may also be used to protect early rows of peas or other plants, by first hooping over each row, and afterwards passing three or four ropes from hoop to hoop. Of course they act by checking radiation, and their influence will be greatest when they are placed between a foot and eighteen inches from the wall, the amount of heat reflected back diminishing in a geometrical ratio according to the distance of the covering from the body to be protected. Wisps of straw tied to a string, fig. 88, and hung in lines one above another in front of a wall, are also used for the same purpose as straw ropes, and in sheltered places are perhaps better.



Fig. 88. *Wisps of straw for being used as protectors.*

445. *Mats of straw or reeds* are used for protecting plants in the open garden, and also for covering glazed sashes, whether of pits, frames, or hothouses. Every gardener ought to know how to construct these, in order to be able to employ his men within-doors in severe weather. The following directions are given by P. Lindegaard, late gardener to the king of Denmark, who used them extensively, and who states, that they produce a considerable saving of fuel, afford a great security from accidents, such as breaking glass, and not only retain heat much better than bass mats, but, from their greater porosity, allow the steam of moist hotbeds to pass off more readily. When a heavy fall of snow takes place during the night, bass mats are not so easy to get cleaned and dried the next morning as straw mats, because they retain the moisture, and get frozen and stiff by the frost penetrating through them; and hence the next evening they cannot be put on again without the risk of breaking the glass. Mr. Lindegaard found four hundred straw mats sufficient to cover four hundred lights, for which if he had used bass mats, about twelve hundred would have been required. These mats are made of

rye or wheat straw, or of reeds, and only in the winter time, when the weather is unfit for working out of doors. They are made in frames in the following manner:—An oblong square (fig. 89) is formed of four laths, along

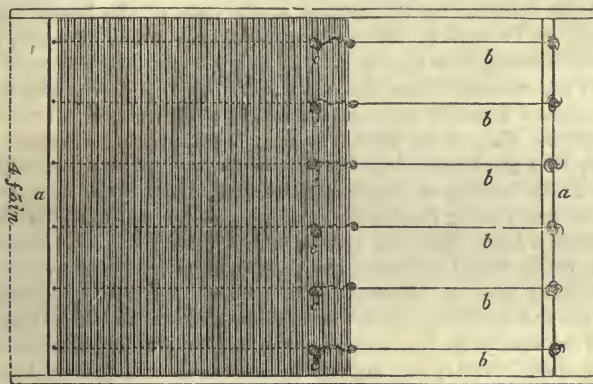

—6f2vn—
Fig. 89. Mode of making straw mats.

the two ends of which, *a, a*, are driven as many nails as you wish to have binding cords, *b, b*, of which the usual number is six to a width of four feet, as the strength of the mat depends chiefly on the number of these cords. The cords are of tarred rope-yarn; on these the straw, or reeds, is laid in handfuls, and bound to each longitudinal cord by other cords, which, for greater convenience, are made up in little balls, *c, c*. These cords are also of tarred rope-yarn. When a mat is finished, the cords are tied together at the top or finishing end, the mat is then detached from the frame, and its sides chopped straight with an axe. These mats are more conveniently made by two men than by one man; and by placing the frame upon a raised plank or bench, than by placing it on the ground, and obliging the men to stoop. When straw is used, that of rye is the best, and will last, even in Denmark, three years: reeds last longer. In the most severe weather these mats are rolled on the glass lengthways of the mat; that is, from top to bottom, by which the direction of the straw is at right angles to that of the sash bar, which prevents the glass from being broken; and over this covering, in very severe weather, reed mats may be laid with the reeds in the same direction as the sash bar, so that the water may run off them as it does off the thatch of a house, and keep the mats below quite dry. Where reeds cannot be got, mats of rye or wheat straw may be substituted; because it is evident, that having the straws or reeds laid in the direction of the slope of the glass, must be attended with great advantages by throwing off the rain instead of absorbing it. (*Gardener's Magazine*, vol. v. p. 416.) The usual dimensions of these mats are six feet by four feet, because that size answers for covering frames and pits of the ordinary dimensions; but when they are to be used for covering the sloping glass of hothouses, they should be made of sufficient length to reach from the coping to the ground, covering the front glass or front parapet. A ring of twisted wire should be placed exactly in the centre of the upper end of each mat, and to this ring a cord should be attached, for the purpose of being passed over a pulley to be fixed on the coping-board, or on the back wall

immediately under it, or on the top rail of the uppermost sash of the roof. This cord must be at least twice the length of the mat, in order that, when the mat is drawn down and rolled up, the end of the cord may be within reach of the operator on the ground at the front of the house. Another ring ought to be fixed to the centre of the lower end of the mat, for the purpose of fastening it to the front sill when it is drawn over the roof. When the mats are removed from the roof, and rolled up during the day, the cord is loosened from the ring, and lies on the roof, ready to be refastened to it, to draw the mats up the next evening. A second layer of mats might be drawn up over the former, in a direction across the sashes, so as to throw off the rain in the manner of thatch, by attaching a cord to one corner of each end of the mat, passing these cords over two pulleys, and laying on the mats like tiles on a roof. Drawing up two mats, however, the one immediately over the other, would be much less trouble, and would, excepting in the cases of heavy rains or thawing snows, keep out the cold sufficiently well. Where the roof is divided by wooden rafters, the mats should be exactly the width of the sash, so as to fit in between them: but where it is not so divided, the mats should overlap one another in the manner of slates—that is, one half the number of mats should first be drawn up, leaving half the width of a mat between each, and afterwards the remaining half should be drawn up so as to cover the intervening spaces, and overlap a foot over the mat at each side. It is much to be regretted that mats of this kind are so little used in England, especially in country places, where straw is abundant and cheap; for being made at a time when little other work can be done, and of a material of very little value, and retaining heat much better than any other covering, they would prove a great saving of fuel and of the labour of attending on fires, as well as insure the safety of plants. Mr. Shennan, a gardener of great experience, who used these mats extensively, observes, in the *Gardener's Magazine* for 1827, that he considers the revival of the old system of covering with straw or reeds, and the system of heating by water, as the greatest improvements that have been introduced into the forcing department in his time.

446. *Wooden shutters* form an excellent covering for the sashes of pits and frames; and though they are more expensive at first, yet from their great durability when kept well painted, they are found by market-gardeners to be the cheapest of all coverings in the end. Boards do not retain heat so effectively as reeds or straw, but they exclude rain and wind better than that material; and by being kept an inch or two above the glass by the cross-bars which bind the boards together, a space is left sufficient to check radiation, and to prevent the escape of heat by conduction. If boarded shutters could be kept about six inches from the glass, and air excluded from entering at top and bottom and at the sides, radiation would be effectually returned, and less risk of the escape of heat by conduction incurred than when the boards touch the sash-bar; but this would require great care in excluding the air from the sides and ends. All the frames and pits in the gardens at Syon are covered by boarded shutters, and all those in the extensive forcing-ground of Mr. Wilmot of Isleworth. Narrow shutters of this kind might be contrived for hothouse roofs, so as to produce a great saving of heat. Canvas would, in many instances, repel wet and check radiation as well as deal boards, and might be put on much quicker; but the great objection to it is its liability to be disturbed by high winds,—unless, indeed,

it is attached to wooden frames, which occupy as much time in taking off and putting on as wooden shutters, and are much less durable.

447. *Asphalte covers* have lately been used for protecting glass roofs, and promise to be a very suitable, and, at the same time, cheap and durable material. The following account of a trial of this article at Dalkeith, near Edinburgh, by Mr. M'Intosh, is abridged from the *Gardeners' Chronicle* of Feb. 13th, 1841. Pocock's patent asphalte roofing is sold in pieces 16 in. by 32 in., at $4\frac{1}{2}$ d. each, or about $1\frac{3}{4}$ d. the square foot. Its weight is only sixty pounds to the hundred feet square. It has been exposed to severe frost and to a heat of 220° without injury: being a non-conductor of heat, it is alike useful for protecting from cold and for shading from the sun. In texture the material resembles the improved patent felt, and appears to be a combination of hair and long fibrous substances, intimately united by excessive pressure, which gives it strength, durability, and an even surface; and being saturated with an asphaltic composition, it is completely waterproof. Mr. M'Intosh has used it to cover 300 feet in length of cold pits; and he has also a number of shutters made of the same material for covering the lights of forcing pits. Frames are formed of a top and bottom rail, and two side-rails, $1\frac{1}{4}$ inches thick by $2\frac{1}{2}$ inches broad: to the top and bottom rails two pieces of wood, $1\frac{1}{4}$ inches by $1\frac{1}{2}$ inches, are fastened, and another of like size at the middle of the frame across it, attached to the side-rails. To these the asphalte covering is secured by copper tacks, but iron or tin tacks, made warm and cooled in oil, will answer as well; thus forming shutters 6 feet by 4 feet, weighing 24lbs., and costing 6s. each, that is, 2s. 3d. for asphalte covering, 2d. for tacks, and 3s. 7d. for timber and labour. These waterproof shutters Mr. M'Intosh finds vastly preferable to Russia mats, and has no doubt they will last for ten or twelve years, if not longer; for while not in use, they can, after being well dried, be stored in a dry, airy loft or shed. From the nature of the material they will not take oil paint with advantage; but may, perhaps, be improved if thinly coated with tar and strewed over with white sand every three or four years. It is evident that temporary coverings to plants against walls, or in the open garden, might as readily be formed of these asphalte covers as of boarded shutters.

448. *Oiled-paper frames* were formerly much used, both as protection from cold, and as shades from the sun. They are made by gluing paper to a wooden frame, divided into panes in the manner of a window by narrow thin laths. The paper used is what is called fine cartridge, but unsized: printers' demy will do. A ream of this consists of 480 sheets, each 1 ft. 10 in. by 1 ft. 5 in.; so that the panes of the frame should be made of the latter dimensions. They are oiled with common linseed oil boiled, and mixed with a little white lead, being previously pasted on with a paste made of starch boiled up with a little glue. Frames of this kind may be used with advantage as a substitute for glazed frames in covering newly-sown seeds, or in striking cuttings; for though oiled paper excludes light, it is a powerful conductor of heat. Oiled-paper sashes have been also extensively used for growing cucumbers and melons, and, above all, for protecting fruit-trees while in blossom. For the latter purpose the length of the frames may be made in lengths equal to nearly the height of the wall, and each frame hinged on one side to a temporary rafter, and kept fast at the other by a turn button of wood. When the frames are to be kept open, they can be tied to stakes in a simple and expeditious manner, such as will readily occur to every gardener.

449. *Oiled-paper caps* are also constructed for protecting or shading herbaceous plants in the open garden, and more especially for protecting the young shoots of Dahlias when newly planted out in spring, and their flowers, from the frost of autumn. In low situations, near water, Dahlias are generally blackened by frost five or six weeks before this takes place in high grounds; but by the use of such caps as we are about to describe, the plants may be protected from perpendicular frosts until the roots are ripe. A cap or head for this purpose is shown in figs. 90 to 93. Fig. 90 represents the

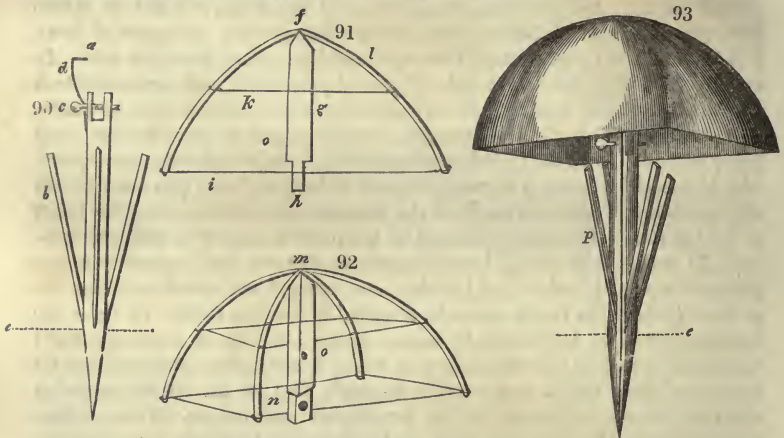

Figs. 90 to 93. Oiled paper cap for protecting Dahlias and other flowers.

stake which supports the cap, in which *a*, *d*, represents a hooked wire attached to the stake, and adapted to an eye in the stem of the cap, to make sure of holding the latter fast; *b*, shows the four side branches to which the Dahlia-shoots are tied; *c*, a wooden peg for fastening the tenon of the cap into the mortise of the stake; and *e*, the surface of the ground. Fig. 91 is a geometrical elevation of one side of the frame of the cap, in which is shown, *f*, the summit where the two ribs that form the four angles of the cap cross each other, into which the stem, *g*, is inserted; *h*, shows the edge of the mortise; *i*, the lower wire; *k*, the upper wire; and *l*, one of the ribs. Fig. 92 is a perspective view of the skeleton of the cap, in which *m* represents the point where the two ribs cross, and the hole in the tenon for the peg, *c*, in fig. 90; and *o*, the eye for the hook, *d*. Fig. 93 is a perspective view of the stake and cap represented inserted in the ground, in which *p* represents the side branches, to which ought to be attached the stems of the dahlias; and *e*, the surface of the ground. The size of the caps is about eighteen inches on the side, and the length of the stake is four feet; but in constructing them the workman will, of course, adjust the length of the stake and the diameter of the cap to the height and breadth of the plant to be protected. These caps are the invention of Mr. John Turnbull (*Gard. Mag.* xiii. p. 212), who says they will endure for many years with but little repair. A cap of wickerwork, for the same purpose, is described in the *Gardeners' Chronicle*, vol. i. p. 181. It consists of an inverted shallow basket, to which is attached a tube made of the same material, through which the Dahlia stick is passed; and a peg being inserted between the stick and

the tube, it is thus firmly fixed at any height required. It measures twelve inches in diameter in the widest part, and is three inches and a half in depth.

450. *Wicker-work hurdles* are useful in gardens for sheltering low plants from high winds, for placing horizontally over seedlings to protect them from birds, and, in various positions, for shading plants. They are constructed of upright stakes fixed in the ground, or in holes in a board, at regular distances of from four inches to eight inches, according to the size of the materials and the dimension of the hurdle, and these stakes are filled in or wattled with small rods, wands, or spray. When kept dry, they will last three or four years, if the stakes are made of willow, or of any of the soft woods; and from four to six or seven years, if they are made of hazel, oak, ash, or any of the hard woods.

451. *Props for plants* vary in form, dimension, and material, from the small wires used for supporting hyacinths in water-glasses, and the sticks of six inches in length, used for supporting plants in pots, to cast-iron rods of six or eight feet in length, and pillars for roses and other climbers, formed of the stems of young fir-trees, of from ten to twenty feet in length, as in fig. 94. All the varieties of wooden props may be reduced to four kinds:—1. Straight rods with the bark on, but with all the side branches cut off, varying in size from the shoot of one year to the stem of a fir of twenty years' growth. These are used for every purpose, from the tying up of plants in pots to the support of lofty climbers, including between these extremes tying up dahlias and standard roses. 2. Branches or stems, with all the side branches and branchlets retained, used for the support of climbing annual stems, such as peas, kidney-beans, tropæolums, &c., but only suitable when these plants will grow in the open ground; when grown in pots, wire frames, or a regular framework of laths, are more in accordance with the artificial state in which the plants are placed. 3. Wooden rods, formed out of laths or deal by the gardener or carpenter, regularly tapered and pointed, and in some cases painted. These are chiefly used for choice plants in pots, but partly also in the open garden. 4. Iron rods, from short pieces of wire to rods of cast or wrought iron, for supporting dahlias, standard roses, and other plants, and with or without spreading heads for climbers. Fig. 95 shows a variety of these rods, which may be had of the principal London ironmongers. All iron work, before being used in the open air in gardens, would be rendered more durable if thoroughly heated and painted over with oil, the effect of which is, to prevent the action of the atmosphere on the surface of the iron, by carbonising it. After this operation painting may be dispensed with, excepting for ornament. It is in general, however, better to paint them, and the colour should be black, blue-black, or some very dark shade of green. A light green, and white, are of all colours the most to be avoided in an artistical point of view; because the first is too like nature, and the second is too glaring and conspicuous.



Fig. 94. Props for climbers.

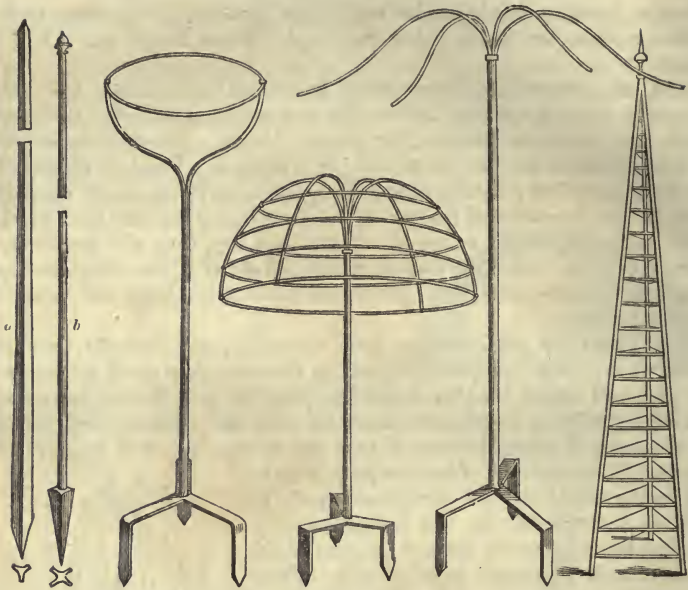

Fig. 95. Cast and wrought iron props for supporting climbers.

452. The durability of wooden props may, perhaps, be increased by soaking them in Burnett's anti-dry-rot composition; or if they are made of deal, by first kiln-drying them, and afterwards soaking them in linseed oil. After the oil is thoroughly dried, which will require two or three weeks, the sticks may be painted. Sticks of red deal, treated in this manner, will remain good for upwards of twenty-five years. (*Hort. Reg.*, i. p. 301.) Mr. Masters is of opinion (*Gard. Mag.*, xv. p. 321) that the duration of hop-poles may be doubled by kyanising; but little benefit has been yet derived from it in the case of props for garden plants. Mr. W. H. Baxter (*Gard. Mag.*, xv. p. 542) found kyanising of little or no use.

453. *Garden tallies and labels* are articles by which names or numbers are attached to plants, and they are of many different kinds. The materials are wood, iron, zinc, lead, or earthenware, and the forms are still more various than the materials. The most durable are those of lead, with the name or number stamped with a steel punch or type, and rendered conspicuous by having the letters filled in with white lead paint. The most common are made of wood, with the numbers, in imitation of the Roman numerals, cut with a knife. To form tallies to receive numbers of this description, take firm ash rods, about an inch or an inch and a half in diameter; saw them into lengths of ten or twelve inches; point the lower end rather abruptly, and either plane or cut with a knife a surface sufficient to receive the number required on the upper half. This kind of tally may be made during winter and wet weather, when little else can be done, and a stock kept on hand for use, if required. They are found to last eight or ten years, according to the situation in which they are placed. Sometimes the number is written or painted, and the writing is in ordinary

cases done with a black-lead pencil on a smooth surface, on which a little white lead has been previously rubbed in with the finger, which, when written on in a moist state, is found greatly to increase the durability of the impression. Sometimes Indian ink is used on a white painted ground, which, being a body colour, presents a more conspicuous and durable impression than common ink, which is only a stain. The most durable letters, next to impressions stamped in lead, are those in black oil-paint on a white ground. For plants in pots, a tally, formed of wood, cut with a common knife from thin laths, rubbed with white lead, and written on with a black-lead pencil, is one of the most convenient and economical forms and materials. Fig. 96, which consists of a shank of wire with the head of wood, is a form for pots, as the wire does not injure the roots: the plate is $2\frac{1}{2}$ inches long and $1\frac{1}{4}$ inches broad, and about a quarter of an inch thick; the piece of iron wire is about three-sixteenths of an inch thick, and is painted black, while the wooden plate is painted white. These tallies are very conspicuous and very durable. For herbaceous plants, or low shrubs, or trees in the open air, the tally, fig. 97, is very neat and durable, and much more economical than would at first sight appear. It is formed of cast-iron, with a head of the same metal, in which is a sunk panel, into which the label with the name is placed, and afterwards covered with a piece of glass neatly fitted in, and puttied like the pane of a window. The label should be a slip of wood, lead, pewter, or earthenware, as not being liable to rust, shrink, or warp, from drought or moisture. Previously to putting in the labels, the tally should be carbonised by heating it nearly red-hot and immersing it in oil, as is practised with gun-barrels to render them impervious to the action of the atmosphere. This being done, a coat of paint may be dispensed with, or the iron-work may be painted black, and the paint on which the name is written white; or the label may be simply rubbed over with a little white lead, and the name written with a black-lead pencil. In the Glasgow Botanic Garden these tallies have been used extensively for the last fifteen years. The label is there formed of wood, and the writing by a black-lead pencil, after previously rubbing in a little white lead. For plants in greenhouses or stoves, very neat porcelain tallies



Fig. 96. Wooden label, with a shank of iron wire.

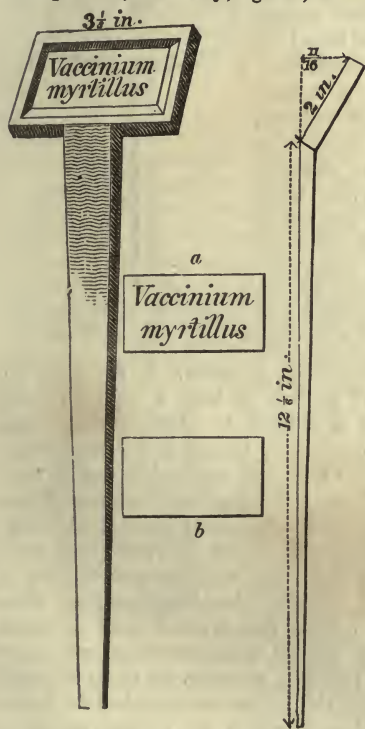

Fig. 97. Cast-iron tally, with the label of wood placed in a sunk panel, and covered with a piece of glass secured by putty.

Fig. 97. Cast-iron tally, with the label of wood placed in a sunk panel, and covered with a piece of glass secured by putty.

are made at the potteries, and they are perhaps the handsomest of all. They cost from 2d. to 3d. each, and readily receive black paint, China ink,

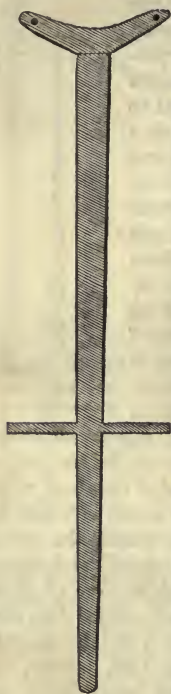

Fig. 98. Cast-iron shank and disk of a tally for trees and shrubs on firm ground.

or common ink, without any previous preparation: in the open air, however, they are very liable to be broken. For alpine or other herbaceous plants in pots in the open air, no tally is better than strips of sheet lead, about an eighth of an inch thick, with the name at length stamped in with steel type,—an operation which the gardener may perform in inclement weather. For large tallies for trees, bricks, moulded with a sloping face and a sunk panel to contain a label of lead, zinc, or wood, may be used; or tallies of heart-of-oak, previously steamed to draw out the sap, and afterwards boiled in linseed oil, painted black, with the name in white; or a tally formed of a cast-iron shank, riveted to a plate of lead, on which the name is stamped, the shank and plate being painted black, and the letters filled in with white lead. This tally was used by Mr. Glendinning in the Bicton Arboretum; the cast-iron shank is shown in fig. 98, and the tally

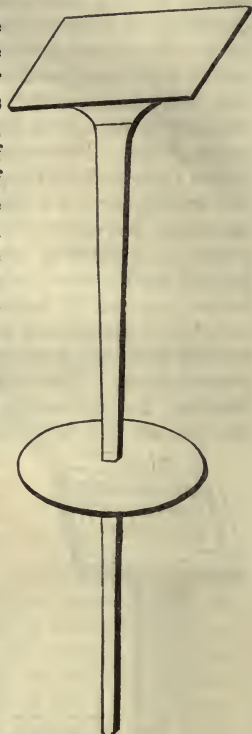

Fig. 99. Tally of cast-iron, with a label of lead, for naming trees on firm ground.

complete, with the label of lead riveted on, is shown in fig. 99. In the Goldsworth Arboretum, instead of a plate of lead, a plate of porcelain is used, on which the name is painted in black in oil. An improvement on this kind of tally consists in having a disk or circular plate cast on the shank, about a foot below the name-plate, as in figs. 98 and 99, which prevents the tally from sinking into the ground, and always keeps it upright. Perhaps the most economical and durable tally for plants in pots is a small strip of zinc, about three quarters of an inch broad and six inches long, on which the name may be written with a black-lead pencil, after rubbing on a little white-lead paint, or with Indian ink on dried white paint, or on the naked metal with prepared ink, which is sold on purpose. The neatest, least obtrusive, and most durable tally for this description of plants is undoubtedly strips of sheet lead, with the names stamped in, and the letters distinguished by being filled with white lead. Temporary labels to plants are written on strips of parchment, or narrow slips of wood, and tied to them with twine, or sometimes, when the plants are to be sent to a distance, with copper or

metallic wire. In all cases of writing or painting names or numbers on permanent tallies, the words or figures may be rendered more conspicuous and durable by painting them over when dry with mastic varnish, or with boiled oil. Instead of painting tallies black, Mr. Nesfield prefers a very dark lead colour, composed of ivory black (not lamp black) and flake white, mixed with boiled linseed oil. His reason for disapproving of a pure black ground is founded on the fact, that certain colours, having a greater affinity for water than for oil (such as blacks, umbers, and ochres), are liable to be affected by damp, unless they are held together by a powerfully oleaginous vehicle, with a small portion of white lead. The lettering Mr. Nesfield recommends to be done with Paris white, mixed with nearly equal parts of copal varnish and nut oil, avoiding turpentine, because it soon evaporates, and causes the colour to look dead and chalky. The white should be used as thick as it will flow from the pencil, because the letters in that case will be so much more opaque; and the varnish should be mixed with only a small quantity at a time, on account of its setting very rapidly. Turpentine must be entirely avoided, except for cleansing pencils, as it soon evaporates, while the varnish remains and hardens as it becomes older. Colours of the best quality requisite for painting and lettering labels are to be had of Messrs. Robertson & Miller, 51, Long Acre, London, whose prices are, for flake white, per bladder, weighing $\frac{1}{4}$ lb., 1s.; ivory black, per $\frac{1}{4}$ lb., 1s.; oil, per pint, 2s.; copal varnish, per pint, 6s. Two 1s. bottles of copal varnish will be sufficient for an immense quantity of lettering.—(*Gard. Mag.* vol. xiii. p. 58.)

454. *Nails, lists, and ties*, are wanted in every garden. Cast-iron nails, about an inch and a half in length, and the lists from the selvages of woollen cloth, are in general use for fastening the branches of trees to walls, and no materials have hitherto been devised which have been found better or cheaper. The nails, previously to being used, are heated nearly to redness, and thrown into oil, for the reason before mentioned (453); and old lists, before they are used a second time, are boiled in water, to destroy any eggs of insects that may be deposited on them. The most common material in use for ties are strands of bast matting, and these are rendered much more durable when previously steeped in soft soap and water. For large branches, ties of the smaller shoots of willows or of clematis are sometimes used; and on the Continent, the smaller branches are tied with rushes or the twigs of

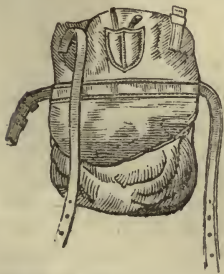

Fig. 100. *Wallet for putting on when nailing wall-trees from a ladder.*

broom collected in the winter season, and preserved in bundles so as to retain a certain degree of moisture to prevent them from becoming brittle, and at the same time not to rot them. In this country tarred twine of different degrees of thickness, and bast matting procured by unravelling a mat, are almost the only ties in use. Metallic wire and small copper wire have been recommended, but they are only fit for tying labels to trees sent out of nurseries to a distance. A leathern wallet, fig. 100, is found of great use in pruning and nailing wall-trees, when the operator is standing on a ladder. It is suspended from his shoulder by straps, and contains a large pocket for the shreds, nails, and hammer, and two small pockets over it for a knife and sharpening-stone.



Fig. 101. Iron reel and pin for a garden-line.

455. The garden-line, fig. 101, consisting of an iron reel, *a*, knob for winding it up, *b*, iron pin, *c*, and a hempen cord of any convenient length, is an essential article; as is a measuring-rod, marked with feet and inches, for laying off dimensions; and a Gunter's measuring-chain, for use on a large scale. A pocket foot-rule and a measuring-tape are also useful.

456. Ladders of different kinds and lengths are required for use in the open garden and in hothouses. Figs. 102 and 103 represent a light folding ladder, the sides of which may be constructed of yellow deal, and the rounds or treads of oak. It is used in hothouses and also in the open garden, and may be of any length, from fifteen to thirty feet. When the ladder is open, for use, it has the appearance shown in fig. 103, *d*; when half shut, of *e*; and

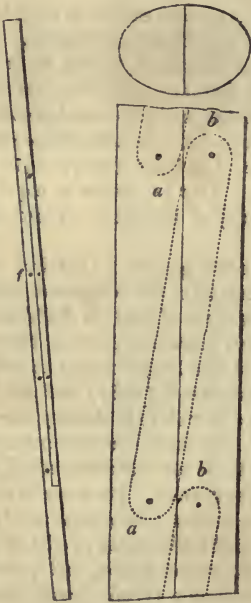

Fig. 102. Portable ladder shut.

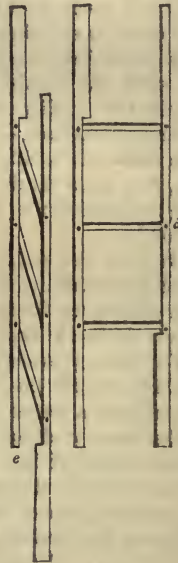

Fig. 103. Portable ladder open.

when entirely shut, of fig. 102. The section of each of the sides, or styles, is a semi-oval; their junction, when the ladder is shut up, forms an entire oval in the section, as shown in fig. 102. The rounds, or treads, are cylindrical; and, when the ladder is shut up, they fall into grooves, hollowed out, of the same form; half of the groove of each round being in one style, and half in the other, as indicated by the dotted lines, *a*, *b*, in fig. 102. The ends of each of the rounds turn on iron pins; one end rests on a shoulder, as at *a*, while the other end is suspended from below the shoulder, and turns on an iron or brass pin, as indicated by *b*. The ends of the iron pins which pass through the styles are slightly riveted. In every description of plant-houses, vineries, verandas, conservatories, aviaries, &c., a folding-ladder of this kind

is a most convenient article; because, when shut up, it may be carried through a house much easier than a common ladder. For working among climbing plants under glass, it is found to be particularly useful, as it may be introduced in places where there is not room for a common ladder. For pruning standard trees out of doors, it is particularly convenient, because it can be thrust through the branches like a round pole, so as not to injure them; and when once it has got to the desired place or position, it can be opened, when the styles will press the branches on one side without injuring them. Orchard ladders for pruning standard fruit-trees, or gathering their fruit, are of various kinds, some with two legs to give them stability, and others forming a triangle, with horizontal pegs in each leg for supporting plants, which cross from one leg to the other, and on which the operators stand. Fig.

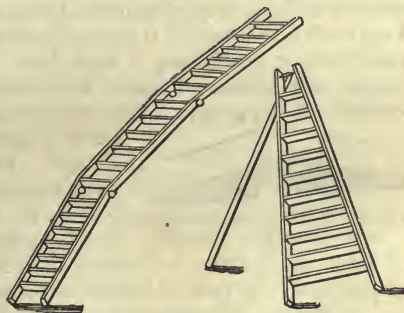

Fig. 104. Rule-joint ladder. Fig. 105. Orchard ladder.

104 is what is called a rule-joint ladder, for painting and repairing curvilinear glass roofs. The ladder fig. 105 is in common use in the south of France and Switzerland, for gathering cherries.

457. A *Levelling Instrument* of some kind is occasionally required in gardens; for example, when box edgings are to be taken up and replanted, it is necessary to have the ground of exactly the same level on both sides of the walk, and this can only be done by levelling across. The use of the level implies also the use of poles, borning pieces, and other articles belonging to surveying, which, as every one who can take levels must necessarily be familiar with, we do not stop to describe. Fig. 106 is a more convenient form for a garden level than that used by bricklayers; because, by the curvature on the underside, the operator can more readily level across

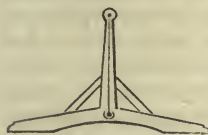

Fig. 106. Garden level.

raised gravel walks.

458. *Thermometers* are requisite, more especially where there are plant structures of any description; and it will be very desirable to have terrestrial thermometers for ascertaining the temperature of the soil in the open garden, as well as of the soil, and of tan or dung beds, under glass. It is true that a knowledge of the temperature of the soil in the open garden will not often enable us to increase that temperature, but it will assist us in accounting for particular effects; and sometimes, as in the case of coldness produced from the want of drainage, or from a non-conducting covering repelling the rays of the sun, we have it in our power, by removing the cause, to remedy the evil. To ascertain the temperature of the soil with reference to plants growing in it, the bulb of the thermometer should be sunk to such a depth as may correspond with the great mass of the roots, or between eight inches and a foot. For plant-houses, a registering thermometer is a very desirable instrument, as a check upon the attendants in the absence of the master, and more especially in the night-time. That of Six is considered the best, and requires no explanation.

459. An *Hygrometer* of some kind is almost as necessary as a thermometer, more especially now, when, as we have seen (251), the importance of keeping the atmosphere of plant structures saturated with moisture is beginning to be understood.

460. *Other articles* of various kinds are required in gardens, of which it will be sufficient to enumerate those which are most important. A grindstone is essential in every garden; because, unless tools and instruments are kept at all times sharp, it is impossible that operations can either be properly performed, or a sufficiency of work done. Whetstones are also necessary for scythes and knives. Portable shoe-scrapers of cast-iron, for using when coming off dug ground in wet weather on the gravel walks. One or more



Fig. 107. *Bridge plank for wheeling across box or other edgings.*

bridge-planks, fig. 107, for wheeling across box edgings. Common planks for wheeling on when the soil is soft, or when injury would be done by the sinking of the wheels; and trestles for raising them as scaffolding. Some hundreds of bricks and flat tiles for forming traps for birds or mice, and for a variety of purposes.

A pair of leather bearing-straps for relieving the arms in wheeling or in carrying hand-barrows, fig. 108. Old fishermen's-netting, for protecting rising seeds from birds, and for covering currant or cherry trees for the same purpose, or for protecting wall trees, or for shelter. Live moss, commonly sphagnum, for packing plants and for other purposes. Lime unburnt, but broken into small pieces, in order to be burnt in the hothouse fires, to supply quicklime as wanted for making lime-water: quicklime will answer, if kept compressed in a cask or box, so as to exclude the air. Potash, for using as a substitute for quicklime, in preparing a caustic fluid for destroying worms, snails, &c. Refuse tobacco, tobacco paper, or tobacco liquor, from the tobacco-nist's, or tobacco of home growth, for destroying insects. Sulphur in a state of powder, for destroying the mildew, and for sublimation to destroy the red spider. Soft soap, tar, gum, glue, &c., for suffocating the scale, and for coating over the eggs of insects to prevent their hatching. Gunpowder, for bruising and mixing with tar to deter insects by smell. Bird-lime, for entrapping birds. Baskets, hampers, boxes, and cases of various kinds, for packing vegetables and fruits, and sending them to a distance. A cabinet or case for the office, or for the seed-room, for containing seeds; another for bulbs, if collections of tulips, &c. are grown. Canvas for bags, which may be used as a substitute for boxes for containing seeds. Paper of different kinds, twine and cord, cotton, wool, hay, fern-leaves, the male catkins of the beech, or sweet chesnut, to aid in packing fruit. Straw, reeds, tan, common sand, pure white or silver sand, oyster-shells as coverings to the holes in bottoms of pots; pieces of freestone, for mixing with peat soil used in growing heaths; leaves and leaf mould, grafting-wax, grafting-clay, common paint, and probably various other articles which we cannot recall to mind,—might be enumerated under this head. But it is scarcely necessary to observe, that no gardener ought to confine himself to those implements of his art, which have hitherto been in use, whether as regards the con-

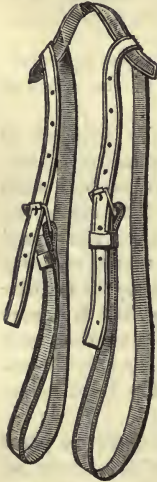

Fig. 108. *Leather bearing-straps.*

struction of particular instruments or utensils, or their number and kinds, for particular operations. Let him at all times think for himself; and if he can devise any tool, instrument, or utensil, for performing any operation better than those hitherto in use, let him not fail to do so. Such are the variety of operations required in extensive gardens, where a great many different kinds of culture are carried on, that this power of invention in the gardener becomes essentially requisite, and is, in fact, called forth by the circumstances in which he is placed.

CHAPTER II.

STRUCTURES AND EDIFICES OF HORTICULTURE.

STRUCTURES and edifices are required in horticulture for the more perfect cultivation of hardy plants, or for bringing them earlier to perfection; for the protection of exotics that will not endure our winters in the open air; for preserving and keeping horticultural articles; for the enclosure and defence of gardens, and for gardeners' dwellings.

SECT. I.—*Portable, Temporary, and Moveable Structures.*

Portable structures are such as can be readily moved about by hand, such as the common hand-glass, or substitutes for it, wicker-work protectors, &c.; temporary structures are such as are taken to pieces every time they are removed from place to place, such as temporary copings, canvas screens, &c.; and moveable structures are those which can be removed entire, such as the common hotbed frame.

461. *Wicker-work structures* for protecting plants may be of any convenient form. Fig. 109 consists of a rim about two feet high and a semicircular cover for taking off during fine days: it has been used at Britton Hall to protect half-hardy Rhododendrons. Fig. 110 shows various forms which have been used for protecting tender plants during winter, at Abbotsbury, in Dorsetshire: *a* is a semicircular hurdle, to protect plants trained against a wall, especially if newly planted and exposed to a sunny or windy quarter; *b* is a double semicircular hurdle, or split cylinder, with loops on each side forming hinges or clasps. This is useful to put round the stems of young trees whose branches are too spreading to allow of a circular hurdle being passed over them from above. It is used as a protection against hares and rabbits in a shrubbery; *c* is a large cylindrical basket to cover tall shrubs, with a vizard, or window, to be turned towards the sun or away from the wind, but to admit air. These three forms are chiefly adapted for permanent defences in the winter season; the following are for use in spring: *d* is the simple form of basket or circular hurdle, close on every side and at top, intended to protect low bushes, or growing herbaceous plants

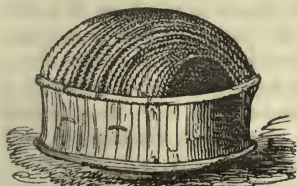

Fig. 109. *Wickerwork protector for low shrubs.*

coming into flower; *e* is a bell-shaped wicker case with a handle, for covering during the night plants that shoot early in spring. All these forms are constructed of stakes of hazle, oak, or other wood, strong and pointed so as to be firmly fixed in the ground, and the wattled work is of willow wands or young shoots of hazel, snowberry, or whatever can be most conveniently got from the woods. Those structures used for the more tender plants may be filled with straw or hay, provided the plants are on a lawn where grass-seeds dropping from the hay will not prove injurious; or they may be covered with mats or canvas. Besides these forms, which may be made of any size, according to that of the plants to be protected, small semiglobular, close-wove chip baskets, not above a foot high, are used at Abbotsbury as shades for delicate Alpine plants in sunny or windy weather. Where baskets of this kind

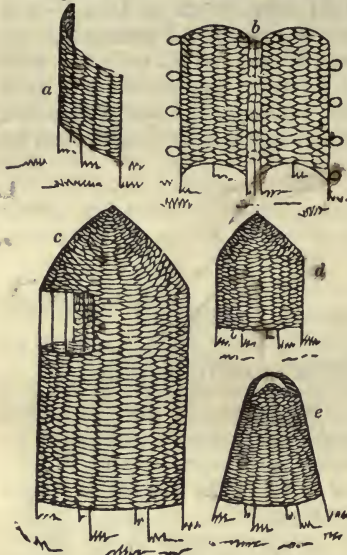
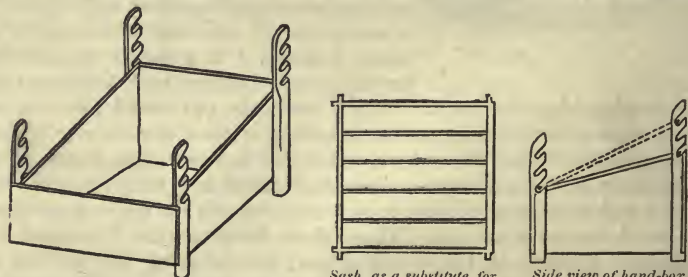

Fig. 110. Wickerwork protectors of various kinds.

cannot be conveniently procured, very good substitutes may be found in bass mats, canvas, or oil-cloth, supported by rods forming skeletons of suitable sizes and shapes.

462. *Portable substitutes for hand-glasses.* — Hand-glasses, from their great liability to breakage and the quantity of glass they contain compared with the ground they cover, become very expensive articles. A common square hand-glass, it has been shown by Mr. Forsyth, *Gard. Mag.* 1841, contains seven square feet of glass to light or shelter two and a quarter square feet of ground, being a little more than three times as much as is really necessary for the plants usually cultivated under them: hence he proposes to substitute boards well painted, pitched or tarred, to increase their durability, in place of upright glazed sides to the hand-glass; and instead of a conical or pyramidal roof, to employ a square cast-iron sash, twenty-four inches on the side. Fig. 111 shows the sash glazed with small panes, say



Hand-box, as a substitute for a hand glass.

Sash, as a substitute for a hand-glass.

Side view of hand-box.

four inches and a half wide, on account of their cheapness, and greater

strength than larger-sized panes. The frame, fig. 112, may be six to nine inches high in front, and from fifteen to eighteen inches high at back. These small sashes, when not wanted for hand-glasses, or rather hand-frame coverings, Mr. Forsyth proposes to use as roofing to peach-houses, vineries, &c., and for various other purposes; and he anticipates, and we think with reason, great economy from their adoption in gardens. Fig. 113 is an end view of the box, showing the uprights at the angles for supporting the sash, either close over the box, or raised to different heights to admit more or less air. By means of the notched uprights, the sash may either be raised six inches above the box at top and bottom, or it may be raised three or six inches at the back, and not raised, or raised only three inches in front, so as to admit more or less air at pleasure, and yet throw off the rain; the sash being in any of these cases held firm in its place, so as not to be liable to be disturbed by wind. The pivots which fit into the notches are square, in order to admit of their being mounted on rafters of different kinds, so as to form coverings to frames, pits, or even forcing-houses. Supposing, says Mr. Forsyth, a bed of violets, running east and west, in the open air, twelve feet long and three feet six inches wide: drive seven notched pegs two feet apart down the centre of the bed to stand one foot above ground, and seven down each side at the same distance apart, but only four inches out of the ground: then, to make the sides and gable ends, take a piece of turf four feet by four feet, shaped out with the edging-iron, and taken up with the turving or floating spade, an inch and a half thick, of the proper shape, so that it may be set on edge and kept so by a peg on each side, and having the green side out; when the lights are put on with every alternate one higher than and embracing the iron edges of the two under it, you will have a very elegant little flower-house, which a labourer might erect in an hour with sixpennyworth of building materials, and the finished structure would have thus every other light hinged and ready to admit air or allow of watering and gathering flowers like a complete forcing-house. We regard this as promising to be one of the most useful and economical inventions that have been introduced in horticulture for some time. This box may be used in the open ground for forcing sea-kale, rhubarb, and for a variety of other purposes. See *Gard. Mag.* 1841.

463. *Canvass coverings* for glazed structures or detached plants require for the most part to be in framed panels, as well to keep them tight as to throw off the rain, and to prevent them from being blown and beat about by the wind. To render the canvass more durable, it may be oiled, tanned, or soaked in Kyan's or in Burnett's anti-dryrot composition. When applied to cover the glass sashes of frames or pits, it should be in panels in wooden frames of the size of the sashes; and this is also a convenient and safe mode of forming temporary structures for protecting standard plants or trees; but by suitable arrangements, to be hereafter described, canvass or netting for protecting walls may be hooked on and fastened without wooden frames. This is done in a very efficient manner in the garden of the Horticultural Society of London, to protect a peach-wall. The stone coping of this wall projects over it about an inch and a half, with a groove or throating underneath. Coping-boards nine inches broad, fitted to join at their ends by means of plates of iron, are supported on iron brackets built into the wall. Fig. 114 shows one of these brackets, in which *a* is an iron which is built into the wall, the thickness of a board below the stone coping; and *b*, the

hole for the iron pin which secures the wooden coping. To these brackets the coping-boards are secured by broad-headed iron pins, passing through corresponding holes, *b*, in the board and bracket, a slip of iron, or "spare-nail," being then introduced through an eye in the lower end of the pin. The upper edge

of the board is slightly bevelled, so as to fit as closely as possible to the under side of the coping of the wall, in order effectually to obstruct the radiation of heat, and the ascent of warm air. From this coping, woollen netting of various kinds, common netting, such as fishermen use, bunting, and thin canvass, have been let down, and tried experimentally, in the course of the last fifteen years; and we are informed by Mr. Thompson, that after repeated trials, the thin canvass was found the preferable article for utility, appearance, and duration. This description of fabric costs about 4*d.* per yard, procured from Dundee. It requires to be joined into convenient lengths, or into the whole length of the wall to be covered, and bound with tape at top and bottom, and to have loops or rings sewed to it at top, by which it is secured to small hoops screwed to the upper side of the coping-boards. These hooks serve also for attaching the ends of pieces of twine, which are stretched down to pegs driven in a line four feet from the bottom of the wall. These twine-rafters are stretched at intervals of twelve feet, and support the canvass at a uniform slope, the appearance being that of an elegant light roof, reaching to within three feet of the ground. The coping-boards are put up before the blossom-buds of the peach-trees have swelled so much as to exhibit the tips of the petals; and before the most forward buds open, the thin canvass (or netting, if that should be preferred) should be attached to the hooks. The covering is generally put up about the beginning of March, and it remains on without being opened or altered, till all danger from frost is over, which is generally, in the climate of London, about the middle of May. The coping is entirely removed at the same time as the canvass, because the trees are found to thrive much better when exposed to perpendicular rains and dews. The canvass is found to be of great utility in bright sunny weather, when the trees are in full blossom; for the peach and other stone fruit, which in their native country blossom at an early period of the season, whilst the air is yet cool, do not succeed so well in setting when the blossoms are exposed to as much as 100°, which they frequently are, against a south wall. The thin canvass admits also plenty of air; while woollen netting, which it might be thought would admit still more air, was found to render the leaves too tender, in which case they suffer from the intensity of the light when the netting is removed. Common thread netting is not liable to produce this effect, being much more airy; and this netting has the advantage, when not placed farther than a foot from the wall, of admitting of the trees being syringed through it. Very little syringing, however, is required till the trees are out of blossom, and none while they are in blossom; and when the space between the canvass and the wall is nine inches wide at top, and four feet wide at the bottom, as in the Horticultural Society's garden, the syringing can be very well performed in the space within. Perhaps it would be an improvement in the case of the Horticultural Society's wall to have the coping as much as eighteen inches wide, as no frost, unless very severe indeed, would injure the blossoms of fruit-trees

Fig. 114. Iron bracket for supporting a temporary wooden coping.

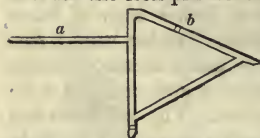

trained against a wall with such a projection; but the iron fastenings for such a coping would require to be much stronger than for nine-inch copings, on account of the greater power which the wind would have over them.

464. *Canvass Shades to Hothouses.*—A very complete mode of rolling up and letting down canvass over the roofs of hothouses was put in practice in the kitchen-garden at Syon by Mr. Forrest; and as it is equally well adapted for covering awnings for tulip-beds or other florist's flowers, and for a variety of other garden purposes, we shall here give such details as will enable any intelligent blacksmith or carpenter to construct the apparatus. The canvass is fixed to a roller of wood, fifty or sixty feet in length, the length depending on the diameter of the pole or rod, fig. 115, *a*, and the toughness

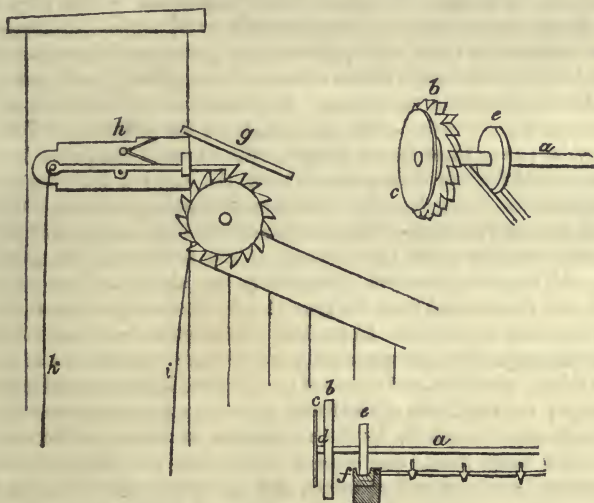

Fig. 115. Apparatus for rolling up and letting down canvass shades.

of the timber employed, as well as the dimensions and strength of all the other parts. On one end of this rod, and not on both, as is usual, a ratchet-wheel, *b*, is fixed, with a plate against it, *c*, so as to form a pulley-groove, *d*, between, to which a cord is fastened; and about three inches further on the rod is fixed a third iron wheel, about six inches in diameter and half an inch thick, *e*. This last wheel runs in an iron groove, *f*, which extends along the end rafter or end wall of the roof to be covered. The canvass or netting being sewed together of a sufficient size to cover the roof, one side of it is nailed to a slip of wood placed against the back wall—that is, along the upper ends of the sashes; the other side is nailed to the rod, *a*. When the canvass is rolled up, it is held in its place under a coping, *g*, by a ratchet, *h*; and when it is to be let down, the cord, *i*, of the roll is loosened with one hand, and the ratchet cord, *k*, pulled with the other, when the canvass unrolls with its own weight. The process of pulling it up again need not be described. The most valuable part of the plan is, that the roll of canvass, throughout its whole length, winds up and lets down without a single wrinkle, notwithstanding the pulley-wheel is only on one end. This is owing to the weight of the rod, and its equal diameter throughout.

465. *The common hotbed frame* is a bottomless box, commonly six feet wide, and three, six, or eighteen feet in length, formed of boards from one to two inches in thickness. The height at the back may be two feet, and in front one foot. The bottom should be level, so that the sides and the sashes laid on the frame may slope from back to front. A three-light or three-sashed frame is divided by two cross bars or rafters, so as to leave a space between them from two feet nine inches to three feet for the width of the sash. It is placed either on the open ground, or on a mass of heating material, according to the purpose for which it is wanted, and, excepting for particular purposes, facing the sun. As the great object of frames is to increase temperature without excluding light, the soil on which they are placed, or the dungbed or other means of heating which they cover, ought to be as dry as possible, either naturally or by artificial drainage; and the glass ought to be clear, and so glazed as to permit as little air as possible to escape between the laps. When common crown glass is used, small panes are found to be less liable to breakage than large ones of this kind of glass; but when the sheet window-glass is used, from its greater thickness, the panes may be two or three feet in length, without much danger of breakage. The boards used for the frame should be of the best red deal; and if, after being prepared for fitting together, they are thoroughly dried on a kiln, and afterwards soaked with train-oil in the manner which we have described (452) for preparing wooden props, the duration of the frame will be greatly increased. All frames and sashes, when not in use, should be kept in an open airy shed, and there raised from the ground a few inches by supports of bricks or other suitable materials. In gardens where cucumbers and melons are grown extensively, there are commonly one or more small frames with single lights for raising seedlings, and others of two or three lights for winter or early spring crops; the smallness of the frame allowing a greater command of the heating material beneath it, by the application of outside casings of warm dung. The back, front, and ends of frames are generally permanently fixed together by tenons and mortices, and by being nailed to posts in the four inner angles; but in some cases the back and sides are fastened together by keyed iron bolts, which readily admit of separating the frame into pieces, and laying these away under cover, and in little space, when not required for use. From the short duration of frames, and from the great quantity of dung required to heat them, as well as from the waste of heat incurred in preparing that dung, frames are now, in most British gardens, being replaced by pits, which may be called fixed frames, with brickwork substituted for wood.

SECT. III.—*Fixed Structures used in Horticulture.*

The fixed structures required in gardens are chiefly walls, espalier rails, trellis and lattice-work, and structures for containing growing plants.

Subsect. 1. *Walls, Espalier-rails, and Trellis-work.*

466. *Walls* are used for the protection of gardens, and also as furnishing surfaces on which fruit-trees and ornamental plants may be trained, with a view to producing increase of temperature and protection from high winds: they may be considered in regard to direction, material, height, foundation, coping, and general construction.

467. *Direction and material.*—Boundary walls take the direction indicated by the form of the ground to be enclosed ; but walls built purposely for training trees, in the interior of a garden, are varied in direction according to the aspects which are considered most desirable. A wall in the direction of east and west, gives one side of the wall fully exposed to the sun for the finer fruits, or for fixing against it glass structures : while the north side of the wall may be employed for inferior fruits, for retarding crops, as well of fruit against the wall, as, in some cases, of vegetables on the border. A wall in the direction of north and south furnishes two good aspects for the secondary fruits, such as apricots, plums, and the finer pears. Walls have been built in a curvilinear direction, but no advantage has been found from them excepting a saving of material, in proportion to the length of the wall, the curves having the same effect in resisting lateral pressure as buttresses ; but walls in situations exposed to high winds, built with projections at right angles, of the height of the wall and the width of the border, but somewhat sloped down from back to front, have been found beneficial in checking the course of the wind when in a direction parallel to the wall. Screen walls of this kind are frequently built at the exterior angles of the walls of kitchen-gardens ; and sometimes they occur at distances of from 100 to 200 feet along walls having a south aspect ; and in the case of east and west winds they are found very beneficial. Walls with piers at regular distances, allowing room for one trained tree between every two piers, have also been found beneficial from the shelter afforded by the piers, which at the same time greatly strengthen the wall, and admit of its being built thinner. In general, however, a straight wall, without projections of any kind, is most convenient, most suitable for training, and for protecting by temporary copings, and most agreeable to the eye.

468. *The materials of walls* are brick, stone, mud, and wood ; but the first is by far the best. Brick retains warmth, in consequence of its much greater porosity than stone ; forms a very strong wall with comparatively little substance, from the rectangular shapes of the bricks, and the firmness with which mortar adheres to them ; and it is the best of all walls for training on, from the small size of the bricks and the numerous joints between them. Add also, that from the porosity of the bricks, nails may even be driven sufficiently far into them to hold branches, as securely as nails driven into the joints. Stone walls are good in proportion as they approach to brick walls. For this reason, if the stone is not naturally porous and a bad conductor of heat, the walls should be built of extra thickness, and the stones should not be large, nor so rough as to make coarse joints. The warmest walls of this kind are such as are of sufficient thickness to allow of the interior of the wall being built without mortar, in consequence of which much air is retained, and heat is not readily conducted from the warm side of the wall to the cold side. A stone wall, with a facing of bricks on the warm side, forms the next best wall to one entirely of brick ; and next to this, a stone wall stuccoed, plastered over with a mixture of stone lime and sharp sand, or coated over with Roman cement of good quality. Walls formed of earth or mud are still better non-conductors than brick walls ; but though they are warm, yet as surfaces for training trees on they are attended with several disadvantages. They cannot conveniently be built high, and whatever may be their height, they require the coping to project farther than is beneficial to the plants trained on them at any other season than in early spring ; and

they require a trellis on which to fasten the plants. Nevertheless the vine and the peach have been successfully grown against such walls at various places in the neighbourhood of Paris, though they are now rapidly giving way to stone walls. These walls are commonly built without mortar, excepting to close the outside joints, or to plaster over the surface of the wall as a substitute for a trellis, which is always used when this is not done. The grapes at Thomery, near Fontainebleau, are chiefly grown on trellised walls of this kind; and the peaches at Montreuil, near Paris, are chiefly on stone walls stuccoed. Walls formed of boards are frequent in the north of Europe, where timber is abundant; but, except when the boards are five or six inches in thickness, they are very cold. In Holland, and more particularly in Sweden, when such walls form the backs to hothouses, they are thatched from top to bottom. In Britain, were it not for the expense of the material, boarded walls might in many cases be adopted instead of brick; more especially in the case of walls built in the direction of north and south, because in them the air is of nearly the same temperature on both sides: whereas in an east and west wall, the heat produced by the sun on the south side is being continually given out to the much colder north side. Boarded walls two or three centuries ago afforded the only means, in the neighbourhood of London, of forcing the cherry, the only fruit which at that time was attempted to be produced out of season. The boarded wall or fence was placed in the direction of east and west, the cherries planted against it on the south side, and casings of hot dung on the north, close to the boards. To derive the full advantage from the south side of an east and west wall, it ought to be of greater thickness than a south and north wall under the same circumstances; because, from the much greater cold of the north side, the south side is continually liable to have the heat abstracted from it in that direction. A south and north wall, on the other hand, can never become so hot on either side as an east and west wall does on the south side; and as it receives its heat equally on both sides, so it loses it equally. Where a south and north wall is thin, and consequently cold, it might become worth while, when it was desirable to retain as much heat on the south side as possible, to thatch it on the north side during the winter and spring months. The great advantage of covering with some protecting material the north sides of walls in spring, when trees are in blossom, may be inferred from the case of trees trained against dwelling-houses, which invariably set their blossoms better than trees against unprotected garden-walls.

469. *The height of garden-walls* may vary according to the object in view, but it is rarely necessary to be more than twelve or fifteen feet, or less than six feet. In kitchen-gardens the highest wall is generally placed on the north side, as well to protect the garden from north winds as to admit of a greater surface for training on exposed to the full sun, and to form, if necessary, a back sufficiently high for forcing-houses. The east and west boundary walls are commonly made two or three feet lower than the north wall, and the south wall somewhat lower still. The usual proportions in a garden of three acres are 17, 14, and 12; for gardens of one acre, 14, 12, and 10; that part of the north wall against which the forcing-houses are placed being in small gardens raised somewhat higher than the rest. Twelve feet is found to be a sufficient height for peach and apricot trees; but for pears and vines it may be one half more; and indeed for vines there is scarcely any limit.

470. *The foundations* of garden-walls should be at least as deep as the ground is originally dug or trenched. The wall is sometimes supported on arches; but this is not in general desirable, more especially in walls built in the direction of east and west, because the roots of the trees planted on the one side of the wall are liable to extend themselves to the border on the opposite side, which not being exposed to the same temperature as that on the other side, the excitement which they receive from atmospheric temperature must necessarily be different, and consequently unfavourable to growth and the ripening of fruit and wood.

471. *The copings of walls*, for ordinary purposes, should not project more than two or three inches, because a greater projection would deprive the leaves of the trees of perpendicular rains in the summer season; and in spring the trees can be protected from the frost by temporary wooden copings, as already mentioned (463). In order to admit of fixing these wooden copings securely, iron brackets should be built into the wall immediately under the coping: or, where temporary rafters are to be fixed to the wall for supporting sashes, stones, such as fig. 116, may be built in, to which

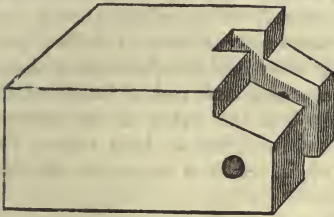

Fig. 116. Stone for fixing temporary rafters.

the rafters may be fitted and fixed by a tenon and pin, as indicated in fig. 117. Along the front border, or row of stone or iron posts, not rising higher than the surface, may be permanently fixed, on which a temporary front wall or plate, for the lower ends of the rafters, may be placed. The garden-walls for arrangements of this kind should be flued.

Stones for fixing rafters can only be wanted on the south sides of east and west walls, because glass is seldom placed before walls with any but a south aspect. Iron brackets, to support temporary copings, may be placed on all aspects except that of the north. The permanent coping is generally formed of flagstone, slate, artificial stone, tiles or bricks, and raised in the middle so as to throw the rain-water equally to each side; and in the case of stone, a groove or throating is formed underneath, an inch within the edge, to prevent the water from running down and rotting the mortar. Where the coping is very broad, and formed of flagstone, it is sometimes hollowed out along the middle, so as to collect the rain-water, from which it is conveyed to a drain along the foundation of the wall by pipes; but this mode is only necessary in the case of conservatory walls. Where no trees are planted on the north side of an east and west wall, the coping is sometimes bevelled, so as to throw the rain-water to the north side as in fig. 117; but this can never be advisable where trees are trained there.

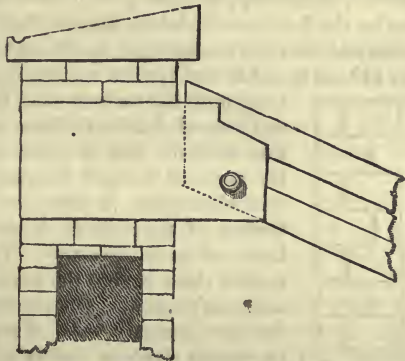

Fig 117. Mode of fixing temporary rafters.

Where no trees are planted on the north side of an east and west wall, the coping is sometimes bevelled, so as to throw the rain-water to the north side as in fig. 117; but this can never be advisable where trees are trained there.

472. In the construction of walls they are generally built solid ; but when the wall is formed entirely of brick, a saving of material is obtained, as well as a warmer wall produced, by building them hollow. There are various modes of effecting this, but one of the simplest is that shown by the plan fig. 118, in which a wall fourteen inches wide, with a vacuity of five inches and a half, may be built ten or twelve feet high with little more than the materials requisite for a solid wall nine inches wide. Such walls may be carried to the height of ten or twelve feet without any piers,

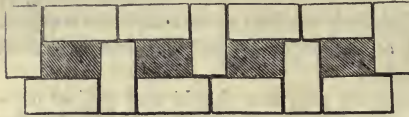

Fig. 118. Plan of a hollow brick wall 14 inches wide and 12 feet high.

and one advantage attending them is that they can be built with a smooth face on both sides, whereas a solid nine-inch wall can only be worked fair on one side. A still more economical wall may be formed by placing the bricks on edge, which will give a width of twelve inches that may be carried to the height of ten feet without piers. Walls of both kinds have been employed in the construction of cottage buildings, as well as in gardens. (See *Encyc. of Cottage Architecture*, p. 168 to 172, where several kinds of hollow walls are described.) A very strong wall, only seven and a half inches in thickness, may be formed of bricks of the common size, and of bricks of the same length and thickness, but of only half the width of the common bricks, by which means the wall can be worked fair on both sides. The bricks are laid side by side, as in fig. 119, in which *a* represents the first course, and *b* the second course.

The bond, or tying together of both sides of the wall, is not obtained by laying bricks across (technically, headers), but by the full breadth bricks covering half the breadth of the broad bricks, when laid over the narrow ones, as shown in the dissected horizontal section, fig. 119, at *b*, and in the vertical section, fig. 120. Besides the advantage of being built fair on both sides, there being no headers, or through and through bricks, in these walls, when they are used as outside walls the rain is never conducted through the wall, and the inside of the wall is consequently drier than the inside of a wall nine inches in thickness. These walls are adapted for a variety of purposes in house-building and gardening, in the latter art more especially. The only drawback that we know against them is, that the narrow or half-breadth bricks must be made on purpose. For the division walls of a large garden, or for the boundary wall of a small one, such walls with piers projecting eighteen inches or two feet, to enable the walls to be carried to the height of ten or twelve feet, might be economically adopted : the space between the piers ought not to be greater than can be covered by a single tree. It must be acknowledged, however, that piers are not desirable in fruit-walls, because when the wall is newly built it cannot so soon be covered with trees, the piers standing in the places where temporary trees would be planted. Piers, however, on conservatory walls may be turned to good account, both as assisting in supporting the temporary copings or



Fig. 119. Plan of a brick wall 7 1/2 inches thick.

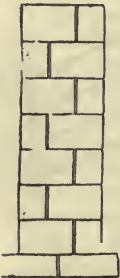

Fig. 120. End view of a 7 1/2 in. thick brick wall.

acknowledged, however, that piers are not desirable in fruit-walls, because when the wall is newly built it cannot so soon be covered with trees, the piers standing in the places where temporary trees would be planted. Piers, however, on conservatory walls may be turned to good account, both as assisting in supporting the temporary copings or

glass, and as heightening architectural effect. Walls are almost always built perpendicularly to the horizon, but they have been tried at different degrees of inclination to it, in order to receive the sun's rays at right angles when he is highest in the firmament during summer; but though some advantage may probably have been obtained from such walls at that season; yet the great loss of heat by radiation during spring and autumn would probably be found greatly to overbalance the gain during summer. Nicol informs us that he constructed many hundred feet of boarded walls which reclined considerably towards the north, in order to present a better angle to the sun, but he does not inform us of the result; a German gardener, however, has found advantage from them. (See *Nicol's Kal.* p. 149, and *Hort. Trans.* vol. iv. p. 140.)

473. *Trellised walls.*—Where the surface of a garden wall is too rough, or is formed of too large stones to admit of conveniently attaching the branches of trees to it, by nails and shreds, it becomes necessary to fix to the wall trellis-work of wood or of wire. The laths or wires are generally placed perpendicularly six or eight inches apart, because the branches are generally trained horizontally, or at some angle between horizontal and perpendicular. Wires stretched horizontally, however, and screwed tight, form the most economical description of trellis; and if occasionally painted, they will last a number of years. Trellis-work of wood is more architectural, and the branches are more readily fixed to them by ties, which are apt to slide along the small wire unless the double operation is performed of first attaching the tie to the wire, and then tying it to the shoot of the tree. The colour both of the wire and the woodwork should not differ much from that of the stone of the wall, otherwise it will become too conspicuous.

474. *Colouring the surface of walls black,* with a view to the absorption of heat, has been tried by a number of persons, and by some it has been considered beneficial; but as the radiation during night and in cloudy weather is necessarily in proportion to the absorption during sunshine, the one operation neutralizes the other. If, indeed, we could insure a powerful absorption from a bright sun during the day, and retain the radiation by a canvass or other screen during the night, a considerable increase of temperature might probably be the result; but the number of cloudy days in our climate in proportion to those of bright sunshine is not favourable to such an experiment.

475. *Flued walls* are either built entirely of brick, or with one side of brick and the other of stone; the latter being the north side of east and west walls. In the case of north and south walls which are to be flued, the thickness is equal on both sides, and the wall is built entirely of brick. The flues, which are generally from six to eight inches wide, commence about one foot above the surface of the border; the first course is from two to three feet high, and each successive course is a few inches lower, till the last flue, within a foot of the coping, is about eighteen inches high. The thickness of that side of the flue next the south should, for the first course, be four inches, or the width of a brick laid flatways; and for the other courses it is desirable to have the bricks somewhat narrower, on account of the heat being less powerful as the smoke ascends. All the bricks, however, whatever may be their width, must be of the same thickness, in order to preserve uniformity in the external appearance of the wall. As where garden walls are to be built a large supply of bricks is requisite, no difficulty need occur in getting

such a quantity as might be requisite for the flued walls made of any convenient width. To prevent the risk of overheating the trees by the flues, trellises are sometimes applied against them for training on; but where the wall is properly constructed, and only moderate fires kept, they are unnecessary. A great improvement in flued walls has been made by Mr. Shiells, gardener at Erskine House, Renfrewshire, who, though the garden is in one of the worst climates of Scotland, has been singularly successful in ripening grapes, figs, peaches, &c., on these walls without the aid of glass. Mr. Shiells places the furnace, as usual, at the back of the wall, about eighteen inches from it, and two feet below the surface of the ground. To prevent the roots of the trees on the south side of the wall from being injured by the heat, a wall of four-inch brickwork is carried up opposite the furnace with a two-inch cavity between them. From the furnace the smoke and heated air enter the wall at *c*, in fig. 121, over which, at *a*, there is a damper, by

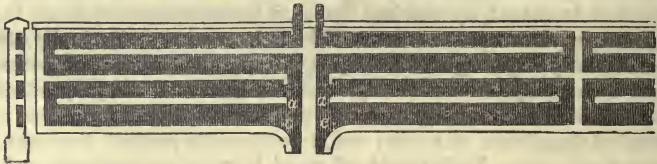

Fig. 121. Longitudinal section of a flued wall.

means of which the heat throughout the whole wall is regulated. When this damper is drawn about four inches, a sufficient portion of the smoke and heated air pass through the two under flues to produce the necessary degree of heat in them; while another portion of the smoke and heat rises directly to the third flue, by which it, and the fourth or upper flue, are heated a little more than the two lower ones. This Mr. Shiells considers a great advantage, because the upper part of the wall is more exposed to the cold air, and less benefited by the reflection of heat from the ground than the lower part; besides, the shoots there are generally more luxuriant and spongy, and would be later in ripening than those on the lower part of the wall, if they did not acquire an extra degree of artificial heat. Sometimes, therefore, it is desirable to warm only the upper part of the wall, and this is readily done by withdrawing the damper, when the whole of the smoke and heated air will rise direct to the third flue; and thus, more especially if only a small fire is made, the desired result will be obtained without warming the lower part of the wall at all. By reducing the communication between the first and the second flue at *a*, to about thirty square inches, the damper may be dispensed with; because in that case a sufficient portion of the heat would rise direct through this opening to the third flue, and so heat as effectually the upper part of the wall as the lower part; but by retaining the damper, the heat can be regulated more effectually. The depth of the first or lowest flue is two feet six inches; of the second, two feet; of the third, two feet three inches; and of the fourth, one foot six inches: the width of all of them is seven inches and a half. The bottom of the lowest flue is about one foot above the surface of the ground, and the top of the upper flue within seven inches of the coping: the total thickness of the wall is about one foot nine inches; viz., the width of a brick in front, the length of a brick behind, and the remainder for the width of the flue. About two yards of the front of the wall at the warm end of the flues is built rather thicker on

the front side, to prevent any risk of the heat injuring the trees, which thickness is taken partly off the width of the flue and partly off the back part of the wall. The flues are not plastered, and in each there are four places for cleaning it out, 9 in. wide and 1 ft. deep; each of these is filled in with four bricks lengthways, not laid in mortar, but only pointed on the outside, so as to be readily taken out to free the flues from soot. There are twelve divisions of flued wall at Erskine House; four planted with peach and nectarine trees, three with the finer pears, two with apricots, one with cherries, one with figs, and one with vines. Fires are applied both in spring and autumn, and the trees are covered by double or single netting at both seasons, according to circumstances.—See *Mr. Shiells, in Gard. Mag.* 1841.

476. *Conservatory Walls.*—Flued walls for growing half-hardy or greenhouse shrubs require a somewhat different arrangement from those intended for fruit-trees; chiefly because in the former case it is necessary, in order to preserve the plants through the autumn and winter, to keep the border from perpendicular rains, at least to the width of three or four feet. For this purpose a temporary roofing is made to project over the border, immediately from under the fixed coping. This temporary roofing may be formed of hurdles thatched with straw, or reeds fixed by hooks close below the coping of the wall, and resting on a front rail, supported by posts at regular distances. The posts may either be poles with the bark on let into the ground, or prepared from sawn timber and let into fixed stone bases. The straw on the hurdles should be disposed lengthways in the direction of the slope, in order to throw off the rain; and the eaves ought to drop on a broad gutter of boards or tiles, or on a firm path from which the water may be carried off in drains, so as not to moisten that part of the border which is under the hurdles. The border should be thoroughly drained, and an under-ground four-inch wall may be built at the same distance from the wall as the bases to the posts, on which wall these bases may be placed. In order to enjoy the full advantage of flues to a conservatory wall, instead of thatched hurdles, glass frames should be used during the autumn, so as to admit the light at the same time that rain was excluded, and afterwards the glass might be covered so as to retain heat; or it might be substituted by thatched hurdles. The glazed box-covers of *Mr. Forsyth* (462) may be used for this purpose in a variety of ways which it is unnecessary to describe.

477. *A substitute for a wall* of brick or stone, much used in Holland, may be formed by reeds inclosed in a double trellis. One erected at Hylands, in Essex, the plan of which is shown in fig. 122, and the section in fig. 123, may

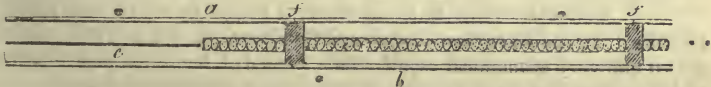
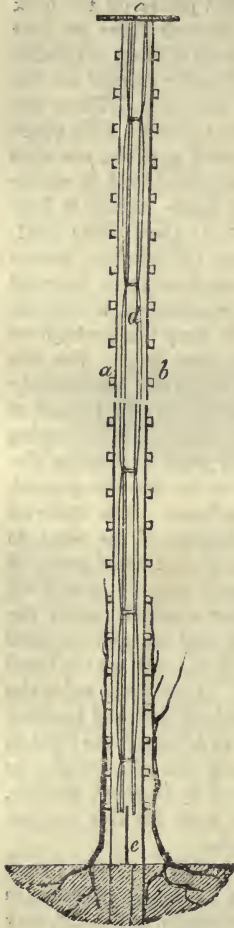

Fig 122. Plan of a reed wall.

be described as ten feet high, and consisting of a double trellis, *a, b*, composed of horizontal laths about eight inches apart; a coping-board, *c*, nine inches broad; the reeds placed endwise within the trellis, *d*, and supported about a foot from the ground to keep them from rotting; this interval of a foot being filled up with slates, placed on edge, *e*. The trellis rods are nailed to posts, fig. 123, *f*, and by taking off a few of these rods on one side, the reed mats can be taken out and removed. Russian mats would no doubt answer very well, and last a long time, and they might be taken out with

still less trouble.



Section of a reed wall.

Straw mats (445) would also do, where reeds could not be got; and heath, as being of a dark colour and very durable, would make the best of all structures of this kind. Peaches, grapes, and other fruits, ripen just as well on these structures as on brick walls, both in Holland and England. Where a wall of this kind is in the direction of east and west, it might consist of only a single trellis on the south side, and be thatched from top to bottom on the north side. Possibly, also, the asphalté roofing might be used as a protection to the thatch, on the north side.

478. *Espalier-rails* are substitutes for walls, commonly placed in borders parallel to walks. The commonest form is nothing more than a row of perpendicular stakes driven into the soil, about eight inches apart, centre from centre, about five feet high, and connected by a rail at top. When the stakes are of larch with the bark on, or when they are of oak with their lower ends charred, they last five or six years; but in general they are of shorter duration, and continually requiring repair. Framework of prepared timber well painted, supported from the ground by sockets of stone, are much more durable, and still more so espalier rails formed entirely of cast-iron. In every case, however, when either wooden or cast-iron framework is used, the stones which support it ought to be raised two or three inches above the surface of the ground, not only because this is more architectural, but because it contributes to the preservation of the iron or the wood. When the stone bases are to support timber, the posts should not be let into the stone, because in that case water is apt to lodge and rot them; but the stone should be bevelled from the centre, and a dowel of iron or wood inserted in it, so as to pass into the lower end of the post. If the post is let into the stone, it should be set in lead, pitch, or

asphalté. In the *Suburban Landscape Gardener*, pp. 231 and 232, we have shown two very economical espalier rails formed of hoop iron and iron wire, which we have had in use upwards of fifteen years, without requiring any other repairs than that of being once coated over with gas liquor. A very light and elegant espalier rail, and perhaps the most economical of any, consists of iron standards let into blocks of stone, strong wires being stretched through standards; and at the extremities of each straight length the standards are braced by stay bars, and a connecting bar, holding the two together; the upper end of the stay bar being screwed to the main post. The triangle thus formed at each end of a straight line of trellis admits of straining the wires perfectly tight. A structure of this kind was first used as an espalier for trees at Carclew, in Cornwall; but it has been frequently put up in various

parts of the country in pleasure-grounds, to separate the lawn from the park, by Mr. Porter, of Thames-street, London, and others, at a charge of from 2s. to 5s. a yard, according to circumstances. The chief difficulty in erecting this fence is to strain the wires perfectly tight; but this is effected by screws and a peculiar apparatus which it is unnecessary here to describe. Those who wish to study the details will find them in the *Gard. Mag.* vol. xvi. p. 16. Fences or espalier rails of this description are most easily erected when in a straight line; but by means of under-ground braces, either of iron, wood, or stone, they may be erected on any curve whatever. Where effect is any consideration, the braces should in every case be concealed under ground. When trellis-work is placed against walls, or against any object which it is desired to conceal, it may be wholly covered by the plants trained on it; but where it is placed in any position by which it will be seen on both sides (such as when it forms the supports to a verandah, or a summer-house, or a trellised arcade over a walk), the surface must not be entirely covered by the plants; because it is desirable that leaves and blossoms should be seen on both sides, and this can only be done effectively by the partial admission of direct light through the interstices or meshes of the trellis-work. A trellised walk closely covered with the most ornamental roses will show no more beauty to a person walking within, than if it were covered with the most ordinary plants; but let partial openings be made in the covering of roses, and their leaves and blossoms will be seen hanging down over the head of the spectator, forming a perspective of flowers and foliage, instead of one presenting only the branches and the footstalks, and backs of the leaves.

479. *Trellises* and *lattice-work* are constructed either of wood or iron, or of both materials combined; and though lattice-work, by which we mean trellis-work with the meshes or spaces between the intersections smaller than is usual for the purposes of training, is chiefly required in ornamental structures, yet it is occasionally used for supporting fruit-trees, and for culinary plants, such as Cucumbers. In order to render trellis-work durable and architectural, it ought never to rise directly out of the soil, but always be supported either by the wall or frame against which it is placed, or when it is independent, by bases of stone. This is almost always neglected both in kitchen and ornamental gardens, in consequence of which the construction is unsatisfactory to the artistical eye, and the posts, or other parts which rise out of the soil, decay long before the superstructure. Where espalier-rails of this, or of any other kind, are put up in flower-gardens for supporting shrubs which come early into flower, such as the *Pyrus japónica*, *Wistària sinénsis*, China roses, &c., they may be easily protected by a moveable coping of boards, like an inverted gutter, which can be dropped on or taken off in a very few minutes. Trellis-work in kitchen-gardens is commonly employed against walls, to which it is attached by iron bolts through the wall, or by holdfasts driven into it; and the laths are about an inch square, and placed vertically, and let into horizontal bars of larger dimensions, placed three or four feet apart, and fixed to the wall in the manner just mentioned. The distance of the laths from the wall need not be above half an inch, as that is sufficient to allow the ties to be passed behind them and the wall. In order to economise space in small gardens, Mr. Alexander Forsyth proposes to cover the walks with trellis-work for the support of fruit-trees. "Every species of hardy fruit-bearing tree and

shrub," he says, "may be trained on curvilinear trellises, as in 'figs. 124 and 125, over the walks and thoroughfares of the garden; which walks, when

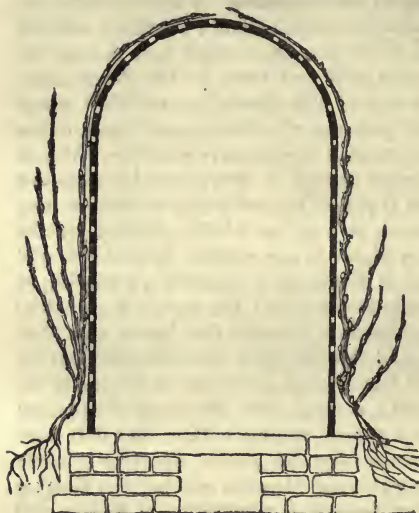

Fig. 124. Trellised arcade for Fruit-trees.

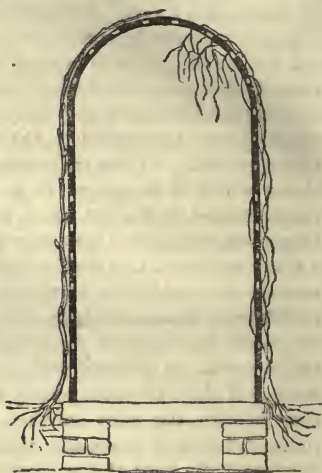

Fig. 125. Trellis for Climbers.

once properly drained, paved, and trellised with cast-iron arches and wire rods, will remain cost-free, painting excepted, for twenty years; at the end of which term, independently of the increase of fruit, and of the grateful shade and pleasing promenade that they will afford, they will be found cheaper than the walks made of gravel, in the same way that a slated roof is far cheaper in the long-run than one thatched. Besides the difference in daily comfort and annual expenditure in walks paved with slate, slabs, or flag-stone, at all seasons clean, and ready to be traversed by the foot or the wheelbarrow alike in frost and in thaw, there will be no more danger of dessert strawberries or garnishing parsley, when grown as edgings, being mingled with the coal-ashes in the walks; no more cleaning and rolling of gravel; and no planting and clipping of box." Fig. 126 shows the plan of the paving

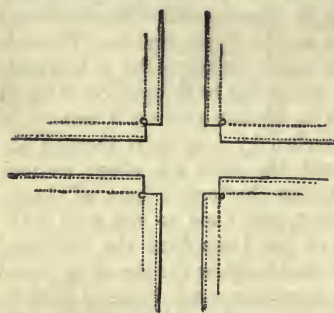

Fig. 126. Plan showing the intersection of trellised walks.

and pillars at the intersections of the walks, with the small foot-paths outside, for conducting the culture of the compartments. In open, airy situations where hedges for shelter are desirable, trellises of this sort might frequently be adopted as substitutes both in kitchen and flower gardens. Single lines of trellis-work, or even of frames to be filled in with wire network, might also be adopted as sources of shelter in spring; and in summer they might be covered with kidney-beans, peas, gourds, tomatoes, nasturtiums, &c. The wire netting

to fit into such framework can be made by common country workmen and their families, as is the case in various parts of Norfolk, both with hempen and wire netting, for hare and rabbit fences, and for folding sheep.—(See *Gard. Mag.* vol. xv. page 222.)

Subsect. 2. *Fixed Structures for growing plants with glass roofs.*

480. *Plant-houses* are required in gardens for forcing the productions of the open air into maturity earlier than would otherwise be the case; for retarding these productions, as in ripening grapes late and preserving them through the winter hanging on the tree; and for the growth of plants of warm climates. Hence it follows that all the requisites for growing plants in the open air in their natural climate must be imitated in plant-houses. As the grand difference between one climate and another lies in difference of temperature (135), hence one principal desideratum in hothouses is to supply heat, without which nothing can be done either in forcing hardy plants, or in preserving those of warm climates. Next to heat, moisture is the most important agent in growth (140, 144), and that element is readily supplied both to the soil and the atmosphere; but though heat and water are sufficient to induce growth, it cannot be continued or perfected without the influence of light, and unfortunately this is only in a very limited degree at the command of art. All that can be done in plant-houses with reference to light is, so to construct them as to admit the degree of light which is produced in the atmosphere of the particular climate and locality; and this, as every one knows, is effected by roofing plant-houses with glass. For growing certain fungi, and for forcing some roots, very little light is necessary; and where ripened crops of fruit are to be retained on the trees and retarded, light, at least direct solar light, may be in a great measure dispensed with. The retention or production of heat therefore, and the admission of light, are the great objects to be kept in view, in deciding on the situation, form, and construction of hothouses.

481. *Situation.*—In choosing a situation with reference to the surrounding country, the north side of a sheltered basin, on the south side of a hill and open to the south, with a dry warm soil, is to be preferred. The object of this choice is to have as little heat as possible carried off, either by the evaporation of surface water, or by N., N. E., or N. W. winds. If the surface of the soil is hard and smooth so as to carry off the winter rains and thawing snows, without allowing them to sink into and cool the soil, so much the better. It is seldom, however, that these conditions can be fulfilled to their utmost extent; because not only such situations are not frequent in nature, but that even where they do exist, the situation for the hothouses is determined by the artificial circumstances connected with the house, offices, and grounds. For ornamental structures the situation chosen is generally some part of the pleasure-ground, or flower-garden, not far from the dwelling-house; and forcing-houses are generally placed in the kitchen-garden, or in some place intermediate between it and the stable offices (*Sub. Arch. and Landscape Gardener*, p. 412). Wherever the situation may be, the soil and sub-soil ought to be rendered perfectly dry by drains so placed as to intercept all subterraneous water, from whatever direction it may come; and by surface-gutters, or the surfaces of walks, &c., so arranged as to carry off the water of cold rains and thawing snows, without allowing it to sink into and cool the soil. The next point is to produce artificial shelter, by walls, or other buildings, so placed as to check the winds which blow from cold quarters

without obstructing the south and south-east winds, and the morning and evening sun. The amount of heat carried off by winds which are at a lower temperature than the surface they pass over, is great in proportion to the velocity of the wind, and the moisture of the surface, and hence the much greater ease with which the temperature of a greenhouse may be kept up when it is placed in a sheltered, rather than in an exposed situation; for example, in the concave side of a curvilinear wall, rather than against a straight wall.

482. *The Form.*—The most perfect form for the admission of solar light and heat is that of a semi-globe of glass, because to some part of this form the sun's rays will be perpendicular every moment while he shines, and at every time of the year; and by it a maximum of light will be admitted at those periods when he does not shine (281); but this form excepting under particular circumstances, that, for example, in which there was a double glass dome, or in which only a temperature of a few degrees above that of the open air was required to be kept up, would occasion too great a loss of heat, either for economy or the health of the plants; for when heat is rapidly conducted away and rapidly supplied by art, it is found extremely difficult to obtain a sufficient degree of atmospheric moisture for healthy vegetation (267 to 271). For these reasons a semi-dome is preferable to a semi-globe, because the glazed side being placed next the sun the other side may be opaque, so as to reflect back both heat and light, and it may be made so complete a non-conductor as not to allow the escape of any heat. There is an objection, however, to the general adoption of the semi-dome, because it is found (281) that the rays of light after passing through glass-roofs, lose their influence on the plants within in proportion to their distance from the glass. Hence for general purposes a long narrow house is the best; and hence also herbaceous plants are grown best in pots in frames; and were it not for the quantity of glass that would be required, all shrubby and climbing plants would be grown to the highest degree of perfection if trained on trellises parallel to the glass roofing, and at no great distance within it. In pits and frames, herbaceous or low plants are nearer the glass than they can ever be in large houses, in which, unless they are placed on shelves close under the roof, they are either at a distance from the glass, as in the body of the house, or they present only one side to it, as when they are placed near the front glass. There is another reason in favour of narrow houses where perfection of growth and economy is an object, which is, that a considerable portion of the heat by which the temperature of hothouses is maintained, is supplied by the sun. The power of the sun therefore will be great on the atmosphere within, inversely as its cubic contents, compared with the superficial contents of the glass enclosing it. Thus, suppose one house to be twenty feet high and twenty feet wide, and another to be twenty feet high and only ten feet wide, the contents of the former will be exactly double that of the latter; at the same time, instead of containing double the surface of glass on its roof, it will contain scarcely one third more; being nearly in the proportion of twenty-eight for the house of double volume, to not fourteen, or one half, but twenty-two, for the one of half the internal capacity. In the wide house every square foot of glass has to heat upwards of seven cubic feet of air; in the narrow house only about four and a half feet (*Gardener's Magazine*, volume xiii. page 15). There are, however, plant-houses erected not merely for growing plants, but for walking into in order to enjoy them; and in these, other considerations interfere with

rigid economy both in heating and lighting. The form of plant-houses, therefore, must be determined by the object in view, and the means at command. For early and for late forcing, narrow houses with upright glass, or glass at a very steep slope, are preferable, as giving but a small volume of air to be heated, and as admitting the sun's rays at a right angle, at those seasons when he is low in the horizon, and above it only for a short time. For summer forcing the angle of the roof may be larger, and of course its slope less steep; for greenhouses and plant stoves, in which plants are to be grown all the year, there should be a portion of the roof with the glass very steep, or upright front glass, for admitting the sun's rays in winter. The roofs of such houses may be at a large angle, say from 35° to 45° with the horizon, which is more favourable for throwing off rain, and also for resisting hail, than a flatter surface. For growing herbaceous plants and young plants, and for the general purposes of propagation, whether by seeds, cuttings, or layers, a low flat house, in which the glass shall be near to all the plants, as in pits and frames, is the most convenient form; though, when fruits are to be ripened in such houses in the winter season, the flatness of the glass, and consequent obliquity of the sun's rays to it, is a great disadvantage. Hence, when such plants can be conveniently grown in pots, as in the case of strawberries, or bulbous or other flowers, it is desirable to have very steep glass, and to place the plants on shelves immediately within it, as practised by Mr. Wilmot, and other market-gardeners, in such structures as fig. 127; or, when the plants are climbers, as the cucumber and melon, training them up trellises parallel to the glass, and at a short distance within it, as in Ayres' cucumber-house.

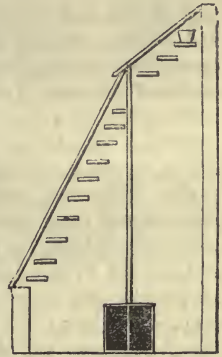

Fig. 127. Steep-roofed house for winter forcing of plants in pots.

483. *Curvilinear roofs.*—The ordinary form of the roofs of plant-houses is that of a right-lined plane, like the roof of any other building, but they have been also formed with curvilinear roofs, which, as compared with roofs having upright glass with standards and wall-plates, more especially when the sash bar is of iron, admit much more light. The ends of plant-houses are generally vertical planes, but in curvilinear houses they are sometimes of the same curvature as the front, which adds greatly to their beauty, as well as being favourable to the admission of the sun's rays, morning and evening, and to the transmission of diffused light when the sun does not shine (282). The only disadvantages attending curvilinear ends to plant-houses, is, that the doors cannot be placed in these ends without some intricacy of construction; but when such houses are placed against walls, as in fig. 128, they may be

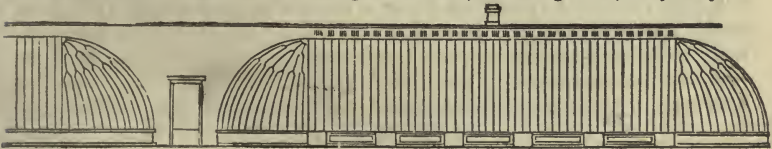

Fig. 128. Curvilinear glass roofs.

entered through a door made in the wall, to a recess taken from the back shed, as shown by fig. 129, in which *a, a*, represent the plans of portions of

two curvilinear houses, *b, b*, back sheds to these houses; and *c*, lobby common to both. These houses may be ventilated by openings in the upper

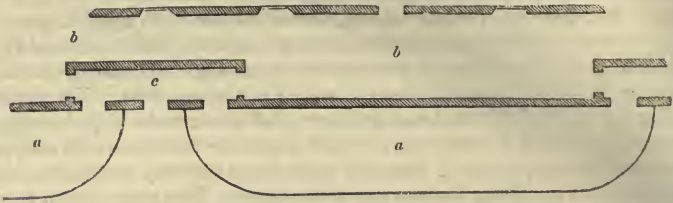

Fig. 129. Ground plan of a curvilinear plant-house, with the entrance through a lobby in the back walls.

part of the back wall, the orifice within being covered with pierced zinc, and wooden shutters moving in grooves sympathetically. Where a lobby cannot conveniently be made in the back shed, one door may be made in the centre of the front of each house, as at Messrs. Loddiges'; and where the end is semicircular, a door might be made in it in a similar manner, or with a projection brought forward so as to form a porch: the mode represented in fig. 129 is, however, greatly preferable, as occasioning no obstruction to light.

484. *Ridge and furrow roofs*.—Roofs formed in the ridge and furrow manner, and even glass sashes so formed for pits, were tried by us many years ago—(*Encyc. of Gard.* 1st edit.)—and the idea has been improved on, and applied in the happiest manner, by Mr. Paxton, at Chatsworth; and adopted by Mr. Marnock in the Sheffield Botanic Garden; Jedediah Strutt, Esq., at Belper; William Harrison, Esq., Cheshunt; John Allcard, Esq., Stratford-green; and at various other places. The advantages of this description of roof are:—1. That the roof does not require to be raised so high behind, in proportion to its width, as in flat roofs; because the descent of the water does not depend on the general slope of the roof, but on the slope of the ridges towards the furrows; and the water in these furrows, being confined to a narrow deep channel, and in a larger body than ever it can be on the glass, passes along with proportionate rapidity.—2. That the morning and afternoon sun, by passing through the glass at right angles, produces more light and heat at these times of the day, when they are, of course, more wanted than at mid-day.—3. The rays of the sun striking on the house at an oblique angle at mid-day, the heat produced in the house at that time is less intense than in houses of the ordinary kind, in which it is often injurious, by rendering it necessary to admit large quantities of the external air to lower the temperature.—4. More light is admitted at all seasons, on the principle that a bow window always admits more light to a room than a straight window of the same width (283).—5. The panes of glass, if crown glass be employed, may be smaller than in houses the roofs of which are in one plane, and yet from there being a greater number of them, admit an equal quantity of light; from their smallness, also, they will cost less, and be less liable to be broken by the freezing of water between the laps.—6. By the employment of sheet window-glass, which is much thicker than crown-glass, panes of three or four feet in length may be used, so that only one pane need be required for each division, and consequently no lap being required, no breakage by frost can take place, and no heated air can escape.—And 7. That wind will have much less influence in cooling the roof, because the sides of the ridges will be sheltered by their summits. Mr.

Paxton, to whom the merit of this mode of roofing is entirely due, has also adopted an improvement in the construction of the sash-bar, viz., having grooves for the panes instead of rebates (see figs. 130 and 131);



Fig. 130. Section of an iron sash-bar, with grooves for the glass.

the advantages of which grooves are, that less putty is required, and that what is used does not so readily separate from the wood, and thus admit the wet between the wood and the putty. The roofs of such houses are entirely fixed, and ventilation is effected either by having the perpendicular ends of the ridges moveable on hinges, or by the front glass and ventilators in the back wall. The expense of this mode of roofing is doubtless greater

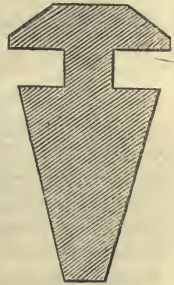

Fig. 131. Section of a wooden sash-bar, with grooves for the glass.

than by the common flat mode, but not so much so as might be expected, because the sash-bar can be formed lighter, and where crown-glass is used the panes may be much smaller. For plant-houses the advantage of admitting the sun's rays perpendicularly, early in the morning and late in the afternoon, will much more than compensate for any additional expense. In an architectural point of view, the merits of this mode of roofing are perhaps as great as they are with reference to culture: the roofs being lower, are less conspicuous, and the common shed-like appearance is taken away by the pediments which form the ends of the ridges, and appear in a range as a crowning parapet to the front glass. Indeed, if it were desirable, the tops of the ridges might be made perfectly horizontal, and all the slope that was necessary for carrying the water from back to front, or to both the sides, given in the gutters between the ridges, as is done in roofing common buildings of great width. Fig. 132 is a perspective view of a house

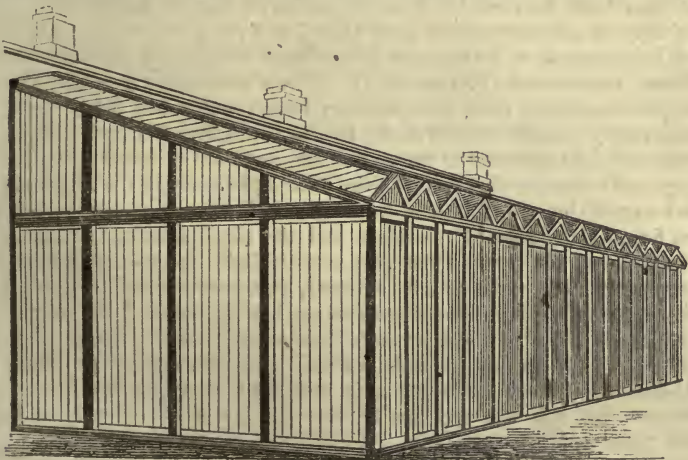

Fig. 132. Perspective view of the original ridge and furrow house at Chatsworth.

erected by Mr. Paxton at Chatsworth, and fig. 133 a vertical profile of part of two ridges of the roof. It will be observed that the sash-bar is not in a

direction parallel to the pediments, but oblique to it. This is done to prevent the water from running down on one side of the glass, which it would do in consequence of the general slope of the ridge from the back to the



Fig. 133. Vertical profile of part of a ridge and furrow roof.

front if the bars were placed at right angles to the ridge. The angle at which the bars are fixed will vary with that formed by the slope of the ridge, and the mode of determining it, is to place the bars so that the lap of the glass, which is in square panes, may form, when the panes are fitted in their places, lines truly horizontal. There are many persons, however, who attach no great importance to causing the water to run down the middle of the glass instead of one side; and they will, of course, place the bars for holding the glass, parallel to the pediments, in order to avoid the short bars at the ends of the ridges, as seen in fig. 133. For more minute details respecting this mode of construction, we refer to *Paxton's Magazine of Botany*, vol. ii. p. 80; and *Gard. Mag.* vol. xx. p. 452, and also for 1841.

435. The *materials* used in the construction of plant-houses differ in nothing from those used in other buildings, excepting that where as much light as possible is required to be admitted, the framework for containing the glass is formed of iron or other metal, as supplying the requisite strength with less bulk than wood. The proportion of opaque surface of an iron roof may be estimated at not more than 7 or 8 per cent., while in a wooden roof it is upwards of 20 per cent.; both roofs being in one plane and of the ordinary construction (279 and 281.) Where sheet-glass is employed, and the panes made of more than ordinary length and width, as in the large conservatory recently erected in the Horticultural Society's garden, the proportion of light admitted in the case of iron roofs will be found still greater. Ridge and furrow roofs, if we take the area of the bases of the ridges as the total area of the roof, and then deduct from it the space occupied by the bars forming the sides of the ridges, and the ridge-pieces and gutters, will not appear to admit the same proportion of light as a roof in one plane; but the practical result will be different, in consequence of the sun's rays being twice in the day perpendicular to one half of the roof, the advantage of which to the plants will far more than compensate for the obscuration produced by the greater proportion of sash-bars, which operating chiefly at mid-day and in very hot weather, is rather an advantage than otherwise. To prove this, it is necessary first to know the law of the reflection of light from glass.

436. *The law of the reflection of light from glass* was calculated by Bouguer, a French philosopher, in 1729, and is exhibited by the following figures; the first line representing the angles of incidence, and the second the number of rays reflected, exclusive of decimal parts.

Angle of incidence 85° , 80° , 70° , 60° , 50° , 40° , 30° , 20° , 10° , 1° .

Per centage of rays reflected. 50, 41, 22, 11, 5, 3, 2, 2, 2, 2.

Now if we suppose a roof in one plane with the sun shining on it at six o'clock in the morning, and at six o'clock in the afternoon, at an angle of 85° , which would be the case in March and September, fully one half the rays which fell on the roof would be reflected; while, in the case of a ridge and furrow roof, if he shone on half the roof, that is on one half of each of the ridges, at any angle with a perpendicular not exceeding 30° , at the same periods, only 2 per cent. of the rays would be reflected. Suppose, then, the area of the entire roof taken as one plane to be 100 square yards, and, to facilitate calculation, that only 100 rays fell on each yard, then the total number which would enter through the roof in one plane would be 50,000, while those which would enter through the ridge and furrow roof would be 99,000, or very nearly double the number. If we compare a roof in one plane with the framework in wood, with a similar one with the framework of iron, and take the space rendered opaque by the wood at 21 per cent., and by the iron at 7 per cent., then the greater number of rays admitted at all times by the iron roof over the wooden one will be as three to one.

487. *Iron roofs* have been objected to from their somewhat greater original expense, from their supposed liability to break glass by contraction and expansion, and from the iron being liable to conduct away heat in winter, and to become hot to such a degree as to be injurious to the plants in summer. With respect to expense, that is, we believe, now considered the chief objection; but though it may be greater at first, yet it is amply compensated for by the greater durability of iron houses, when properly constructed, and when the iron is never allowed to become rusty for want of paint. As a proof of the durability of iron houses, we may refer to the iron Camellia house at Messrs. Loddiges', erected in 1818, and the iron houses in the Horticultural Society's garden, which were erected, we believe, in 1823. The breakage of glass supposed to result from the contraction or expansion of the metal was at one time considered a very weighty objection; but the severe winter of 1837-8 did not occasion so much broken glass in iron as it did in wooden houses. A bar of malleable iron 819 inches in length, at a temperature of 32° , only increases in length one inch, when heated to 212° ; but this difference of 180° of temperature is more than plant-houses are liable to; indeed 50° or 60° are as much as is necessary to be taken into account. If we suppose the iron-work is fitted at a period of the season when the temperature is 55° , then 50° lower would be within 5° of zero, and 50° higher would be 105° ; extremes which the iron roof of a hothouse will seldom exceed. Now, according to the above data, a bar ten feet in length would extend or contract, by the addition or reduction of 50° of heat, 1-25th of an inch as nearly as possible. An iron sash-bar, half-an inch thick between the two edges of the glass, would not expand in thickness, from 50° of heat, much more than one six-thousandth part of an inch. It may easily be conceived, therefore, that the lateral expansion of sash bars, which are in general not quite half an inch in thickness, by any heat which they can receive on the roof of a hothouse, will never have any effect on the glass between them. To guard against all risk of breakage from this cause, however, it is only necessary not to fit in the panes too tightly. Indeed, the objection may now be considered as given up by all experienced hothouse-builders. The liability of

iron to conduct away heat in winter, and to attract too much in summer, is also found to be an objection more imaginary than real. It is true that iron, from its being a powerful conductor, is liable to undergo sudden changes of temperature, which must doubtless render it less congenial to plants that come in contact with it than wood or brick; though plants do not appear to suffer when the iron is in small quantities, such as the rods to which vines are attached under rafters, wire trellis-work, &c.; but when the rafters are of iron, and when plants are trained round the iron pillars used in supporting hothouse roofs, it may readily be conceived that they will be injured by them. This will also be the case, more or less, when tender plants are grown close under the glass in hotbeds or pits covered with iron sashes. Indeed, when we consider the much greater weight of iron sashes than wooden ones, and the constant occasion that there is for moving the sashes of pits and hotbeds, we would recommend them in most cases to be made of wood. The injury done to plants in the open air by iron coming in contact with them, can only take place when the iron is of considerable thickness; because we do not find it in the case of cast-iron espalier-rails, or of dahlias, roses, and other open-air plants tied to iron stakes. In plant-houses it probably takes place after the iron has been highly heated by the sun, and then watered, when the chill produced by evaporation will contract the vessels and chill the juices. The greatest objections that we know to iron roofs are the expense and the difficulty of forming them with sliding sashes, which shall not rust in the grooves in which they slide: but this last objection can be obviated, either by forming the styles and rails, or outer frame of the sash, of wood, and the rafters of iron, or the reverse. In the greater proportion of plant-houses, however, sliding sashes in the roof may be dispensed with, air being admitted during winter through apertures in the upper angle of the house in the back wall, or by raising a hinged sash in the upper part of the roof; and in the hottest weather in summer, by these and the sliding sashes, or other openings in front. The materials used in the interior of plant-houses, such as shelves for supporting pots of plants, pathways for walking on, walls for enclosing tan or other fermenting matter in pits, are bricks, flagstones, slates, wood, and cast-iron. The paths are sometimes covered with open gratings of cast-iron, which admit of the soil under them being occupied with the roots of vines, climbers, or other plants. Mr. Paxton prefers a flooring formed of loose pieces of board laid across the path; each piece as long as the path is wide, and about four inches broad, with a one-inch space between. One advantage of this plan is, that the dust and other matters lying on the paths when they are swept, descend immediately without raising a dust in the house to disfigure the leaves of the plants, and encourage the red spider, which dust deposited in the leaves is always found to do.

433. *Heat.*—The natural heat of the locality is retained in plant-structures by the roof and sides forming a covering which repels radiation from the ground; and it is increased in them at pleasure, by fermenting substances applied within or externally, by the consumption of fuel, and the conveyance of the heat so produced in smoke and hot-air flues, by steam, or by hot water in pipes or cisterns. In every mode of supplying heat artificially, the following desiderata ought to be kept constantly in view:—1. To maintain a reservoir of heat which shall keep up a sufficient temperature for at least

twenty-four hours, under ordinary circumstances, in the event of the supply of heat from the consumption of fuel, or the action of the sun, being discontinued from neglect or accident, or by cloudy weather.—2. To provide means of speedily increasing the supply of heat, when the sudden lowering of the external temperature, or the action of high cold winds, or a cold humid atmosphere among the plants, requires it.—3. To provide the means, by an adequate surface of flue, or steam, or hot-water pipes, of supplying a sufficiency of heat in every house, according to the temperature required, not merely under the ordinary external temperature, but when that temperature shall fall as low as 10° , or in situations exposed to very high cold winds to zero.—4. To make arrangements for supplying atmospheric moisture in proportion to the supply of heat, and for withdrawing this moisture at pleasure.—5. Where no means can be provided for supplying extra heat on extraordinary occasions, to provide the means of conveniently applying extra external coverings for the same purpose. It is proper to remark, that in every plant-structure there is a reservoir of heat and of moisture, to a certain extent, in the soil in which the plants are grown, whether that soil is in pots or in a bed; and that all the paths, shelves, and other objects within the structure, being heated to the proper degree, part with their heat, whenever the air of the house falls below the temperature of these objects. This source of heat might be considerably increased in houses where there is abundance of room: for example, below a greenhouse stage, by placing objects there of moderate dimensions and separated from each other; such as parallel walls of four-inch brick-work, flag-stones set on edge two or three inches apart, or slabs of slate set on edge one inch apart. These, by presenting a great extent of surface, would absorb a powerful reserve of heat, and give it out whenever the other sources of heat were defective.

489. *Fermenting substances*, such as stable-dung, tanner's bark, leaves, &c., are either applied in masses or beds under the soil containing the plants, as in the common hotbed; or in casings or linings exterior to the soil or structure to be heated, as in M'Phail's and other pits. A steady reservoir of heat is thus provided, and instead of an extra supply for unexpected cold nights, extra coverings of bast mats or mats of straw are provided, for retaining heat that would escape through the ordinary covering. An additional supply of heat for extra cold weather may also be obtained by different means. Where exterior casings of dung are employed, if the heat of the dung is admitted through a pigeon-holed wall to an inside flue with thin covers; or if the dung is brought into close contact with thin plates of stone or slate, instead of the pigeon-holed wall, which, like the flues, is made to enclose the soil containing the plants; then by keeping a part of these warm surfaces generally covered with soil, or with boards, or by any other means which shall operate as a non-conductor, when extra heat is wanted unexpectedly, all that is necessary is to take off the non-conducting covers. Even in the case of a common hotbed, heated only by the bed of dung beneath the plants, extra heat may be provided for by bedding a plate of stone, slate, zinc, or cast-iron, on the dung, in one or more places of the interior of the frame, according to its size, and covering these with boards, supported at the height of two inches or three inches above them, so as to enclose a stratum of air, to act as a non-conductor; the sides being closed by a rim previously formed of cement, or brick-on-edge, on the stone or slate, or by a rim two or three inches deep, cast on the edges of the iron. By taking off the wooden covers, an extra

supply of dry heat will immediately be obtained, which may be rendered moist at pleasure by pouring on water. Another mode of obtaining an immediate extra supply of heat from a dung-bed, is, by sinking in it, when first made, an iron pipe of three or four inches in diameter, with the two extremities turned up, and covered by flower-pot saucers. The length of the tube may be nearly equal to that of the bed, and the one end must be sunk a few inches deeper than the other, as in fig. 134. It is evident that by taking off

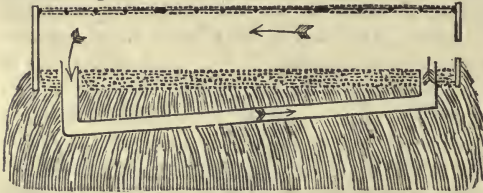

the corners of this pipe there will be a draught created in it, in consequence of its sides being heated by the dung; and an extra degree of heat will by this means be brought into the atmosphere of the bed. This

Fig. 134. Section of a dung-bed, with a tube for supplying hot air.

plan might also be adopted for putting the air of a plant-bed in motion, without the admission of the external air.

490. *Fermenting materials and fire-heat combined.*—In pits and low-forcing houses heated chiefly by dung, provision is frequently made for the supply of extra heat, by the addition of smoke-flues or hot-water pipes. Fig. 135 is a

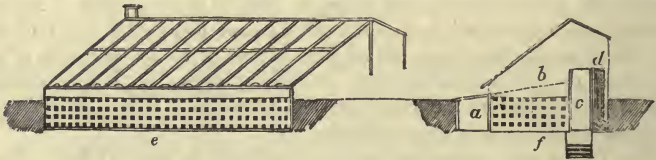

Fig. 135. Pinery heated by dung linings.

perspective elevation and section of a house, in which a bed of leaves within is heated by a dung lining placed on the outside of a pigeon-holed wall, and

extra heat is provided for by three turns of a flue, one above the other, in the back path: *a*, is the pit in which the dung-lining is placed and covered with a hinged shutter; *b*, the surface of the bed of leaves, in which pine-apples, or cucumbers, or melons may be grown, or strawberry plants or flowers forced; *c*, door; *d*, flues; *e*, front pigeon-hole wall; and *f*, end pigeon-hole wall. Fig. 136 shows a mode of applying dung under a bed of soil without coming in immediate contact with it, and by which no heat whatever produced by the dung is lost; *a*, is the bed of soil in which

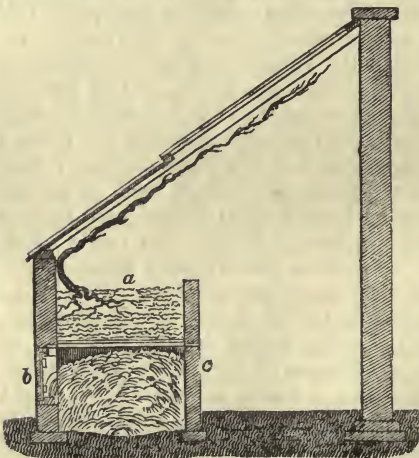

Fig. 136. Section of a vinery heated by dung.

the vines are planted, and which is supported by cast-iron joists and Welsh slates; and *b* shows the openings furnished with shutters by which the dung is introduced. Beds on the same plan, but wider, have been used for growing pine-apples and melons, and for various similar purposes. An extra supply of heat from the dung may be obtained by having panels of slate in the inside wall, *c*, to be kept covered by wooden shutters, except when extra heat is wanted; or by tubes, as in fig. 134; or it may be rendered unnecessary by extra coverings. The first forcing which we read of in the history of British gardening was effected, as Switzer informs us, by placing casings of hot dung against the north side of walls of boards, against the south side of which cherries were trained.

491. *Heating from vaults, or from stacks of flues.*—The oldest and simplest mode of applying fire-heat to hothouses, was by means of a pit in the floor, or a vault under it. The vault was of the same length and breadth as the floor, with the chimney at one end; or it occupied a smaller space in the centre of the floor, with a stack of flues rising over it, and forming a mass of heated material in the body of the house. The fire was of wood and made on the floor; or of charcoal or coal, and made in an open portable iron cage, like that used by plumbers, when soldering joints in the open air, with a plate of iron over it to act as a reverberator, and prevent the heat from rising directly to the roof. The flue by which the smoke escaped had its lower orifice on a level with the floor of the vault, so that the air and smoke did not enter it until they had parted with most of their heat. These modes are capable of great improvement, and in various cases would perhaps be found more eligible and economical than any other, by a gardener who is aware of the importance of connecting with them an efficient means of supplying atmospheric moisture: by placing cisterns of water over the hottest part of the floor, or by having dripping fountains formed on the syphon principle, by inserting the ends of strips of woollen cloth in open vessels of water, and placing these in different parts of the house. See on this mode of heating, Mr. Forsyth, in *Gard. Mag.* for 1841.

492. *Flues.*—As the mode of heating by vaults could only be adopted when the plants were to be grown in pots or boxes, as soon as the practice of forcing fruit-trees trained against walls, and having their roots in the border or floor of the house, was introduced, flues in the wall against which the trees were trained, and afterwards detached flues along the front of the house, became necessary; and when these last are properly constructed, and the dry heat which they produce is rendered moist by placing water over them, they form a convenient and economical mode of heating. The flue is always most efficient when carried along the front and ends of the house, because the air immediately within these is more liable to be cooled by the external air than that next the back of the house, the back being generally a wall of brick or stone. Where the house is glass on every side, as well as on the roof, the flues will be most efficient if carried round it, for obvious reasons; while the air immediately under the roof, in every case, will be kept sufficiently warm by the natural ascent of the heated air from the flue, in whatever part it may be placed; though when the flues are placed in the lower part of the house, there will be a greater circulation than when they are elevated; and this arises from the greater number of particles which must be put in motion by the ascent of warm, and the descent of cold air. The quantity of flue requisite for heating a house to any required temperature has not been

determined. One fire with a flue in front, and a return in the back, is generally found sufficient for a greenhouse of thirty feet or forty feet in length, and from twelve feet to fifteen feet in width, and two fires, one entering at each end, for a stove or forcing-house of similar dimensions; the flues in both cases being twenty inches high, and twelve inches wide, outside measure. Perhaps one square foot of flue for every two feet in length of iron hot-water pipes, found according to the rule given in Art. 500, would be a near approximation to the quantity wanted, reckoning the top and sides of the flue, but not the bottom. The furnace or fireplace from which the flue proceeds should be one or two feet lower than the level of the bottom of the flue, in order to assist in creating a draught, as that depends on the length and height of the space allowed for the heated air to ascend before it is allowed to escape into the atmosphere; and the flue generally terminates on the top of the back wall, for the same reason. The fireplace is generally formed behind the back wall for the sake of concealment: but when this is not an object, the best situation is at one end of the house, in a sunken area, which can be covered with shutters; because the smoke and heat not receiving the check given by a turn in the flue made so near the furnace as it must necessarily be when it enters from behind the house, the heat is more equally diffused along the front. A very desirable arrangement for flues, where it is practicable, is to have two from the same furnace, with the power of throwing the whole or any part of the smoke and heated air into either flue at pleasure, which is easily effected by a damper at the

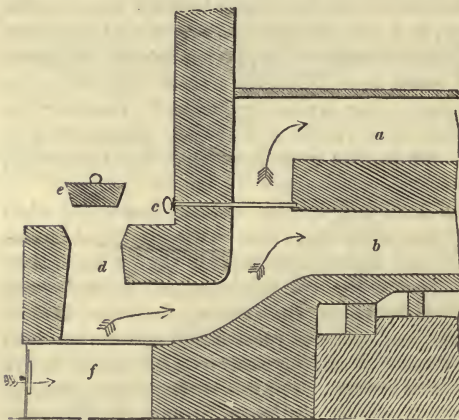

Fig. 137. Section of a furnace and double flue.

throat of the flue, close to the furnace, as shown in fig. 137, in which *a*, is the upper or extra heat flue; *b*, the under or reserve flue; *c*, the damper; *d*, the furnace; *e*, the cover to the feeding hopper; and *f*, the ash-pit. One of the flues should be conducted through a solid mass of brickwork or masonry, or through a box or bed of sand, in order to produce a reservoir of heat; and the other flue should have thin covers and sides, and be quite detached, in order

to furnish an extra supply of heat, when the external air suddenly became much colder than usual, or at particular times to dispel damp, &c. Both flues ought to be near the front of the house, and, in most cases, the one might be over the other. Wherever flues are sunk below the level of the floor, they will be found to give out their heat very slowly; or, if given out, to lose it in the adjoining ground, from the want of a current of air to carry it off. But this may generally be supplied by underground cross drains, as in fig. 138, in which *g* is the floor of the house; *h*, the reservoir flue, three feet broad, which is sunk so that its top is on a level with the floor; *i*, an air-drain from the back of the house; *k*, an upper flue for additional heat; *l*,

front path ; *m*, front shelf ; *n*, stage ; and *o*, path on the upper part of the stage for watering the plants.

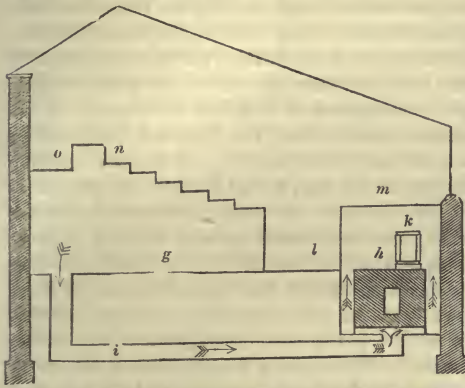

Fig. 133. Section of a greenhouse, with reserve flue and common flue.

493. *The best materials for building flues are bricks and paving tiles, the latter for the bottom and top, and the former for the sides. The advantages of bricks over stone are their greater adhesion to the mortar—their narrowness, by which little space is occupied, and their being greater non-conductors than stone, by which means the heat is more equalised throughout the length of the flue than it would be by the use of that material. A slight disad-*

vantage attending the use of bricks and tiles arises from the earth of which they are made ; clay absorbing and entering into chemical combination with the moisture of the atmosphere, especially when the latter is at a high temperature. This evil, however, can always be counteracted by placing water over the flues, or in some other hot part of the house. For this purpose, the covers of flues, whether of tiles or stone, ought to be made with sunk panels to contain water ; or, what is much better, a shallow cistern of iron, lead, or zinc, as in fig. 139, may be placed over them for the same purpose. In Germany the flues are sometimes entirely covered with plates of cast-iron ; and if these were formed with turned-up edges, they would serve at once as covers and cisterns. Flues are always detached from the ground, by being built on piers, either connected by low flat arches, or so close together as to be joined by the square tiles which form the floor of the flue. Neither the inside of the flue nor its outside ought to be plastered, when it is desired that they should give out a maximum of heat at a minimum of distance from the furnace ; but when the flue is to be of great length, plastering either in the inside or outside, or both, by rendering the walls of the flue greater non-conductors, tends to equalise the heat given out. Plastering is also useful to prevent the escape of smoke from the joints, which is liable to take place where the materials and workmanship are not of the best quality, and to prevent the absorption of moisture by the bricks. Narrow flues are preferable to broad ones, as occupying less horizontal space in the house, and also because as flues part with their heat chiefly from their upper surface, it is better equalised by a narrow flue than a broad one. Hence also narrow, deep flues are found to “draw” better than broad, shallow ones. The ordinary dimensions of narrow flues are eight inches in width, and fifteen inches in depth, which is formed by tiles one foot square for the bottom, and ten inches square for the covers, and three paving-bricks, which are only two inches thick, on edge, for each of the sides, as in fig. 139. The joints of the sides and covers are formed by lime putty, and the bottom tiles are set on bricks on edge. In fig. 139, *a* is the brick on edge, which supports the one-foot tile *b*, which forms the bottom of the flue ;

c is the smoke chamber, and *d* the zinc cistern, over the ten-inch tile cover.

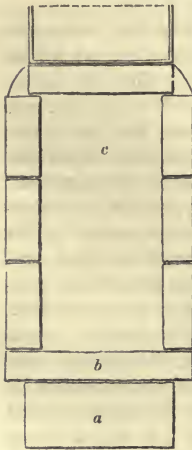

Fig. 139. Section of a common brick flue, with a zinc cistern over it.

The inside plastering should be of the best mortar, mixed with lime, but without sand, as being less liable to crack.

494. *The furnace*, when built in the usual manner, should have double iron doors to prevent the escape of heat; and the fuel-chamber should be about double the area of that portion of it which is occupied by the bars or grate, in order that the fuel not immediately over the grate may burn slowly. A damper in some accessible part of the flue, and as close to the furnace as is practicable, affords a convenient means of regulating the draught; and there ought always to be a register valve in the ash-pit door for the same purpose. Where cinders, coke, or anthracite coal only are burnt, no horizontal opening to the grate containing the fuel is necessary. It may be put in by an opening at the top, as in fig. 137, which will contain a supply for any length of time, according to the height and width of the opening and the bars of the grate can be freed from ashes by a hooked poker applied from the ash-pit. By this kind of construction less heat is lost than by any other. Indeed, this kind of fireplace, with a reserve flue, will be found

by far the most economical mode of heating hothouses; but it will not answer where the practice is to depend on the sudden action of the flue, which is produced by stirring up the fuel: in lieu of this, the damper must be drawn so as to admit the heated current into the extra heat flue. Whatever may be the construction of the furnace, no air ought ever to be admitted to the fire, excepting through the grating below it; because air admitted over the fuel can serve no purpose excepting that of cooling the flue; unless in very rare instances, where it might assist in consuming the smoke. Where this object is a desideratum, Witty's smoke-consuming furnace, described in *Gard. Mag.* vol. vii. p. 483, which roasts or cokes the coal, before it is put on the fire, may be had recourse to. This and various other details, however, must be left to the bricklayer or mason employed. All flues ought to have flag-stones of the width and height of the interior of the flue, or iron doors built into them at the extremities of each straight-lined portion, which may readily be taken out or opened in order to free the flue from soot; an operation which will require to be performed at least once a year in all houses, and in stoves twice a year, or oftener, according to the kind of fuel used.

495. *As substitutes for smoke-flues*, earthenware pipes, or can-flues, as they are called, have long been in use in Holland and France; and as the fuel used in these countries is almost always wood, which produces little soot in comparison with coal, they are found to answer as perfectly as brick flues. When they are only occasionally employed, the entire surface of the pipes is exposed; but when they are used constantly, as in houses for tropical plants, they are embedded in a casing of dry sand, which forms a reservoir of heat capable of being increased to any extent, even to that of the entire floor of the house, over which a flooring for plants may be placed. Pipes of this kind might also be conducted through a bed of small stones, so as to form a very effective mass of heated material as a reservoir, while a portion of naked pipe might serve for raising the temperature on occasions of extra-

ordinary cold. In country situations, where wood for burning is not very dear, or where coke from coal could be readily obtained, can-flues might be economically employed for drying up the cold damp of greenhouses, and for a variety of purposes.—We have said more on the subject of smoke-flues than may be thought necessary at the present time, when they are being so generally substituted by hot-water pipes; but our object is to prevent our readers from being so completely prejudiced against flues as not to have recourse to them in particular situations and circumstances. The principal reason why so much has been said against smoke-flues is, that gardeners till lately were not fully aware of the importance of supplying moisture to the atmosphere of plant-houses in proportion to the supply of heat, and of having reserve flues, in consequence of which excessive heat would not become so frequently requisite, and noxious gases would have less chance of being driven through the top and sides of the flue into the atmosphere of the house.

496. *Steam* was the first substitute for flues employed in this country; and, under some circumstances, it may deserve a preference to either flues or hot water. For example, where the heating apparatus must necessarily be at a great distance from the structure to be heated, steam can be conducted to it in a tube not more than an inch or two in diameter, which may be so encased in non-conducting matter as to occasion far less loss of heat than if either smoke or hot water were employed. The disadvantages attending the use of steam in ordinary cases are, the necessity of heating the water to the boiling-point, by which more heat is driven up the chimney and lost than if the water were raised to only half that temperature, and the want of a reservoir of heat when the steam is not in action. The last disadvantage has been supplied by passing the steam-pipes through brick flues filled with stones, through pits or other large masses of stones, or through tubes, cisterns, or tanks of water. By arrangements of this kind, steam can be made both to supply heat permanently and expeditiously. The various details of these modes of heating by steam will be found in the *Gard. Mag.* vols. viii. and ix.; and in the *Encyc. of Gard.* edit. 1832, p. 593.

497. *Hot water* is the medium of heating plant-structures now generally adopted, and it is without dispute far preferable to any of the preceding modes. Water is such an excellent carrier of heat, that a house warmed by hot-water pipes is not hotter at one end than at the other, which is almost always the case when smoke-flues are employed: none of the heat which the water derives from the fuel is lost, as in the case of flues, which when coated internally with soot convey a great part of the heat out at the chimney-top; no sulphureous or other disagreeable effluvia is ever given out by hot-water pipes when they become leaky, as is the case with flues when they are not air-tight; and the hot water in the pipes serves as a reservoir of heat when the fire goes out; but smoke-flues, when the fire goes out, are rapidly cooled from within by the current of cold air which necessarily rushes through them till it has reduced the temperature of their tops and sides to that of the open air. Whether heating by hot water is more economical than heating by smoke-flues, will depend chiefly on the kind of apparatus employed; but in general we should say that it was not attended with any advantages of this kind. Mr. Rogers is of opinion that with a well-constructed and well-managed apparatus, the saving of fuel may amount to 25 per cent. over well-

constructed and well-managed flues; but he allows that in a large proportion of the hot-water apparatus now in use the consumption of fuel greatly exceeds that of common furnaces. The cause of the circulation of water in pipes is the same as that which produces the ascent of the air in flues, viz.: difference of specific gravity produced by heat. In water, the particles at the bottom of the boiler being heated, become lighter and rise to the surface, while their place is taken by cold particles from the water in the boiler itself, or in the pipes that communicate with it, which are heated in their turn and ascend to the surface of the water in the boiler and the surface of that in the upper pipe. In like manner, the air heated by the consumption of the fuel in the furnace becomes lighter, and ascends along the flue, while its place among the fuel is supplied by cool air, which enters through the grating beneath it to supply combustion. Neither air nor water will move along readily in very small flues or pipes: for smoke-flues seven inches by ten inches are the smallest dimensions, and hot water does not circulate so rapidly in pipes under two inches in diameter as to give out heat equally throughout their whole length.

498. *The modes of heating by hot water* are very numerous, and it would occupy too much room in this work to enter into a detailed description of them, which however is the less necessary as the best modes are sufficiently known for all ordinary purposes by most ironmongers; and those who wish to make themselves masters of the subject will have recourse to Hood's *Practical Treatise on Warming Buildings by Hot Water*, published in 1837. The simplest form of applying this mode of heating is by having one boiler to each house in a recess in the back wall, or in some other situation where it will be out of the way, and an upper or flow-pipe proceeding from it on a level with an under or return-pipe, also on a level. Fig. 140 will

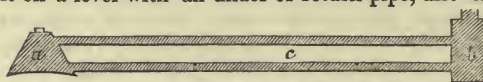
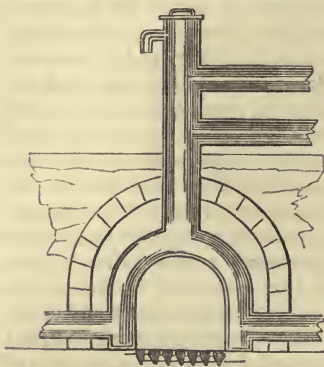

Fig. 140. A hot-water apparatus for circulation on a level.

give an idea of this mode of circulation, *a* representing the boiler, *b* a cistern at the extreme

end of the house to serve as a reservoir, and *e* the flue and return-pipes. When the water is to be circulated in pipes on different levels, or above the level of the boiler, or in different levels, but never below the level



141

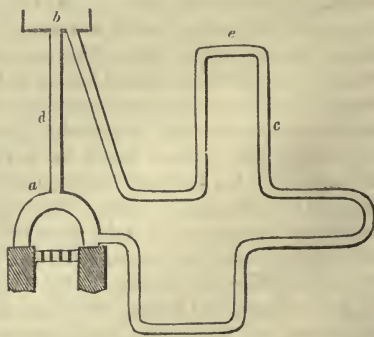

142

Fig. 141. Boiler and furnace for heating by hot water in rising and falling pipes.

Fig. 142. Apparatus for circulating water below and above the level of the boiler.

of the bottom of the boiler, then a closed boiler is requisite ; or one open, but carried to a height equal to that of the highest point in the line of the pipes, as in fig. 141 ; and when water is to be circulated below the level of the boiler, a closed boiler with particular arrangements (see Hood's Treatise, figs. 10 and 11, pp. 44, 45) may be employed, or the form of open boiler shown in fig. 142 may be resorted to. In this figure, *a* represents the boiler, *b* an open cistern at its top, in which the orifice of the heating-pipe terminates. Now it is obvious that when the water passes from the orifice of the boiler into the orifice of the pipe, the circulation must go on from the difference in the specific gravity between the water in the pipe at *c*, and that at *d*, provided that a small open pipe be placed at *e*, to admit of the escape of the air which will accumulate in that part of the pipe. Hot water has also been circulated on the syphon principle with great success by Mr. Kewley ; the advantage of which mode is, the rapid communication of heat along the whole length of the pipe, in consequence of which it is never necessary to raise the water in the boiler to so high a temperature as by any of the other modes ; and hence this mode of heating is the most economical of all in the consumption of fuel. Fig. 143 will give a correct idea of the



Fig. 143. Syphon mode of circulating hot water.

system: *a e e* represent the two legs of the syphon ; the upper leg commencing at *e*, being that through which the heated water ascends, and the lower leg being that by which it returns. The disadvantage of this system is, that after the pipes have been some time in use, they become leaky, and the slightest leak, by admitting the air, instantly empties the syphon ; nor is the leak easily discovered afterwards. The syphon mode of heating, were it not for this disadvantage, would deserve the preference over every other. Hot water has also been circulated in hermetically-sealed pipes by Perkins ; but this mode is attended with great danger, and the heat produced is much too high for the plants. All these, and other modes of heating, will be found impartially examined in Hood's Treatise.

499. A reservoir of heat is very readily formed in heating by hot water, whatever may be the kind of apparatus adopted, by placing a cistern or series of cisterns at different parts of the house, either close to or at any convenient distance from the water-pipes, and connected with them by smaller pipes, having stop-cocks to interrupt the connexion at pleasure. When it is desired to heat the house with as little loss of time as possible, all connexion between the pipes and the reservoirs should be cut off by turning the stop-cocks ; and as the house becomes sufficiently heated, the connexion ought to be restored by opening the upper and under stop-cock of one cistern at a time. In some cases, the cistern might be a long trough about the bulk of a common flue, placed parallel with and close to the

pipe, as in fig. 144, in which *a* is the pipe, *b* the cistern, and *c* the connecting pipes

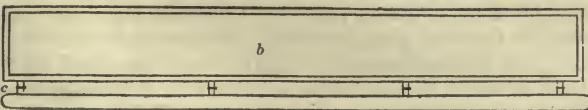

Fig. 144. Hot-water pipe, and reserve cistern of hot water.

with stop-cocks. Fig. 145 is a cross section of the pipes and reserve cistern,

which requires no explanation. Where the circulating pipes are below the level of the floor of the house, and where there is to be a raised pit for containing plants, a tank or cistern might be formed under it of the length and width of the pit, and of a depth equal to the distance between the upper and lower heating-pipes; and with this tank the pipes might

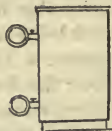

Fig. 145. Section of reserve cistern and hot-water pipes.

communicate by means of stop-cocks; so that whenever there was more heat in the pipes than was wanted for heating the air of the house, it could be transferred to the reservoir tank. To save the expense of stop-cocks where the cisterns could be wholly or partially uncovered, the orifices of the connecting pipes might be stopped by plugs; and when the reservoir tank is above the level of the heating-pipes, the connexion between them might be made by means of syphons with stop-cocks.

500. *The pipes* employed are generally of cast-iron, and round, as being more conveniently cast; but any other metal and form will answer; and when there is no great pressure on the pipes earthenware may be used, the joints being made good with cement; and at the angles, where elbow-joints would be necessary, small cisterns could be employed, or elbows of earthenware might be made on purpose. For obtaining a large heating surface, flat cast-iron pipes have been used in some cases, placed vertically, and in others horizontally; but round pipes of four inches in diameter are in most general use. When the object is to obtain a supply of heat in the shortest time, then the boiler and pipes should be of small capacity; and this is generally desirable in the case of greenhouses, where heat is occasionally wanted for a few hours in damp weather, not for the sake of raising the temperature, but for drying up cold damp: nevertheless, even in greenhouses it is desirable to have a reservoir of heat for supplies in very severe weather. In stoves in which fire-heat is employed the greater part of the year, both boiler and pipes may be of large capacity; and this should also be the case in early forcing-houses. Whatever mode of heating or kind of pipes may be adopted, the pipes should always have a gradual ascent from the place where they enter the house, or are intended first to give out heat, towards the farther extremity; otherwise, the circulation will be less rapid, and consequently the heat less equally distributed. The quantity of pipe required to heat any house depends on various circumstances; such as the form and construction of the house, the temperature that is to be kept up in it, and the temperature of the external air. Various calculations have been made on the subject by different engineers, and more especially by Mr. Hood, who says, "It may be taken as an invariable rule, that in no case should pipes of a greater diameter than four inches be used, because, when they are of a larger size than this, the quantity of water they contain is so considerable, that it makes a great difference in the cost of fuel, in consequence of the increased length of time it will require to heat them, which is four and a half hours for four-inch pipes, three and a quarter hours for three-inch pipes, and two and a quarter hours for two-inch pipes, supposing the water to be at 40° before lighting the fire, and the temperature to which the water was raised, 200°. Pipes of two or three inches diameter therefore are to be preferred from greenhouses, conservatories which only require fire-heat to be applied occasionally." After calculating the loss of heat from exposed surfaces of glass under different circumstances and situations, Mr. Hood gives the following rules for

determining the quantity of pipe as a sufficient approximation for ordinary purposes:—"In churches and very large public rooms, which have only about an average number of doors and windows, and moderate ventilation, by taking the cubic measurement of the room, and dividing the number thus obtained by 200, the quotient will be the number of feet in length of pipe, four inches in diameter, which will be required to obtain a temperature of about 55° to 58° . For smaller rooms, dwelling-houses, &c., the cubic measurement should be divided by 150, which will give the number of feet of four-inch pipe. For greenhouses, conservatories, and such-like buildings, where the temperature is required to be kept at about 60° , dividing the cubic measurement of the building by 30, will give the required quantity of pipe; and for forcing-houses, where it is desired to keep the temperature at 70 to 75° , we must divide the cubic measurement of the house by 20; but if the temperature be required as high as 75° to 80° , then we must divide by 18 to obtain the number of feet of four-inch pipe. If the pipes are to be three inches diameter, then we must add one-third to the quantity thus obtained; and if two-inch pipes are to be used, we must take double the length of four-inch pipe.

"The quantity of pipe estimated in this way will only suit for such places as are built quite on the usual plan." (*Treatise, &c.*, p. 125.) The above calculations for heating are made on the supposition that the lowest external temperature will be 10° ; but in situations "exposed to high winds, it will be prudent," Mr. Hood observes, "to calculate the external temperature from zero, or even below that, according to circumstances; and in very warm and sheltered situations, a less range in the temperature will be sufficient." Local circumstances, therefore, may require from 5 to 10 per cent. to be added to, or deducted from, the length of pipe found according to the foregoing rules. As a proof of the soundness of Mr. Hood's calculation, we may state that the great stove at Chatsworth is heated at the rate of one superficial foot of heated pipe to thirty cubic feet of air; and the temperature kept up during the severest weather of the winter of 1840-41, was 60° , though there were frequently from 20° to 35° of frost during the night. This house is sixty feet high, with glass on all sides, exposing a surface of 60,000 feet, and enclosing 1,050,000 cubic feet of air. The quantity of coal consumed was about two tons per night. (*Gard. Chron.* April 17, 1841, p. 243.)

501. *The situation in which the pipes are placed* is, in general, what we have stated to be that most suitable for smoke flues, (492), viz., along the front and ends of houses placed against a back wall, and entirely round, detached, or span-roofed houses. In the case of pits or frames with flat roofs, the pipes may be either placed in front or in the middle, always bearing in mind that heated air ascends, and that the quantity heated in a given time, will, all other circumstances being alike, depend on a regular supply to the heating body, by a current distinct from that by which the heated air escapes. Such a current is formed by the cross drains adopted by Mr. Penn, and exhibited in various other sections of plant-structures given in this work. For the same reason it is desirable, when practicable, and under certain circumstances, to confine the pipes on each side, so that the air which passes up among them may not escape without being heated. To illustrate the effect of this arrangement, we may take Perkins's double boiler, and compare it with the common boiler. It would not occur to any person who had not reflected on the subject, that water could be boiled any sooner in one boiler than another,

both boilers being of the same dimensions, made of the same material, set in the same manner, and with a fire beneath them of the same power. Yet such is the case; and this exactly on the same principle that we recommend confining the sides of hot-water pipes, and supplying the air to be heated from a distinct channel. Suppose we have a common boiler, such as is used in common wash-houses, then place another boiler within it, of such a size as to leave only a few inches between the inner boiler and the outer boiler all round, and support it in this position by stays, as shown in fig. 146; let this



Fig. 146. Perkins's double boiler.

inner boiler have a hole in its bottom about one-third of its diameter, and let its rim be two inches below the level of the water to be heated. These arrangements being made, and the heat applied below, a circulation instantly takes place and continues, the water coming into contact with the heated bottom and sides of the outer boiler, rising rapidly to the surface, and descending through the inner boiler, which thus necessarily contains the coldest portion of the liquid. — (*Gardener's Magazine*, vol. xvi. page 325.) The heat communicated by the fire to the bottom and sides of the outer boiler, is rapidly carried off by the current that is created, exactly on the same principle that wind, which is a current of air, cools any body exposed to it more rapidly than air at the same temperature but quite still. The under-ground drains should either have vacuities at the sides and over the top to prevent them from absorbing much heat, or they may be carried through the bottom of the tau-pit, where there is one. In general, we would not cover the heating-pipes, nor would we adopt the upright tubes which Mr. Penn originally used, but has since dispensed with. There may be situations and circumstances where it would be more desirable to have the heat of the pipes or flues carried off by radiation with the usual degree of slowness rather than by conduction; such, for example, as when the attendant on the hothouse was likely to be a long time absent, or when some danger from overheating was anticipated; and this can always be attained by covering the orifices by which the air enters to the cross drains. It is proper to state, that at the present time the opinions of a number of persons are against the use of air as a carrier of heat in hothouses, on account, they say, of the difficulty of maintaining it in exactly the proper state of moisture. This, however, can be effected without difficulty, by keeping the bottoms of the cross-drains covered with water, or by having cisterns of water over the pipes, or both. A few years' experience is probably required to set the matter at rest; in the mean time, the reader who wishes to examine both sides of the question, may consult the *Gard. Mag.* for 1840-41, and the *Gard. Chron.*, more especially an article by Mr. Ainger, April 3d, page 212. Our opinion is, that the power of producing motion in the air, even though it should be only wanted occasionally, and obtainable at an extra expense of heat, is of so much value for setting blossoms, equalizing heat and moisture in some cases, drying up damp in others, or producing a feeling of coolness, that no plant-structure of large dimensions, and where fire heat is employed, ought to be without it. To explain the manner in which the motion of heated air in hothouses produces a sensation of coolness, without being altered in its temperature, we make the following quotation from Lardner's *Cyclopædia*: "The air which surrounds us is generally at a lower temperature than that of the body. If the air be calm

and still, the particles which are in immediate contact with the skin acquire the temperature of the skin itself, and having a sort of molecular attraction, they adhere to the skin in the same manner as particles of air are found to adhere to the surface of glass in philosophical experiments. Thus sticking to the skin, they form a sort of warm covering for it, and speedily acquire its temperature." Agitation of the air, however, "continually expels the particles thus in contact with the skin, and brings new particles into that situation. Each particle of air, as it strikes the skin, takes heat from it by contact, and being driven off, carries that heat with it, thus producing a constant sensation of refreshing coolness."

502. *The boiler* for heating by hot water need never be large, because no advantage is gained by having a large quantity of water in it, further than that of acting as a reservoir, which will be more conveniently and economically placed within the house. A boiler of small capacity, and with a large superficies for the fire to act on, will be the most economical in first cost, and also in fuel. "The extent of surface which a boiler ought to expose to the fire should be proportional to the quantity of pipe that is required to be heated by it;" and Mr. Hood has calculated a table, which, like various others in his excellent work, will be referred to by the intelligent inquirer, or by the gardener who intends to direct the construction and putting up of his own heating apparatus. By this table it appears:

That $3\frac{1}{2}$ square feet of surface of boiler exposed to the fire will heat 200 feet of 4-inch pipe; or 266 feet of 3-inch pipe; or 400 feet of 2-inch pipe.

That 7 square feet of surface of boiler will heat 400 feet of 4-inch pipe; 533 feet of 3-inch pipe; and 800 feet of 2-inch pipe; and so on in the same ratio.

"A small apparatus," Mr. Hood observes, "ought perhaps to have rather more surface of boiler, in proportion to the length of pipe, than a larger one; as the fire is less intense, and burns to less advantage, in a small than in a large furnace." (p. 71.)

503. *The furnace* for a hot-water apparatus has also been subjected to calculation by Mr. Hood. For generating steam, an extremely brisk fire and rapid draught are required; but a very moderate draught will suffice for heating a boiler where the temperature of the water is rarely required to be above 180° or at most 200° . The following observations on the construction and management of furnaces are valuable both with respect to a hot water apparatus and the furnaces to common smoke flues. "The heat should be confined within the furnace as much as possible, by contracting the farther end of it, at the part called the throat, so as to allow only a small space for the smoke and inflamed gases to pass out. The only entrance for the air should be through the bars of the grate, and the heated gaseous matter will then pass directly upward to the bottom of the boiler, which will act as a reverberator, and cause a more perfect combustion of the fuel than would otherwise take place. The lightness of the heated gaseous matter causes it to ascend the flue, forcing its passage through the throat of the furnace with a velocity proportional to the smallness of the passage, the vertical height of the chimney, and the levity of the gases, arising from their expansion by the heat of the furnace." (p. 77.) After giving a table of the area of bars required for pipes of different dimensions and lengths, Mr. Hood observes: "In order to make the fire burn for a long time without attention, the furnace should extend beyond the bars both in length and

breadth ; and the coals which are placed on this blank part of the furnace, in consequence of receiving no air from below will burn very slowly, and will only enter into complete combustion when the coal which lies directly on the bars has burnt away." (p. 80.)

504. *Rogers's Conical Boiler and Hot-water Apparatus* is believed to be the most perfect and generally applicable in the case of houses of moderate dimensions that has yet been invented, and as such we shall describe it somewhat in detail. It is the result of a series of experiments made by John Rogers, jun. Esq., F.R.S., &c., with the assistance of Mr. Shewin, ironmonger, Sevenoaks, Kent, who manufactures the apparatus for sale. The boiler was originally formed of tinned iron, afterwards of copper, and lastly it was cast in iron in one piece.

Fig. 147 is a front view of the boiler as at present constructed in cast-iron.

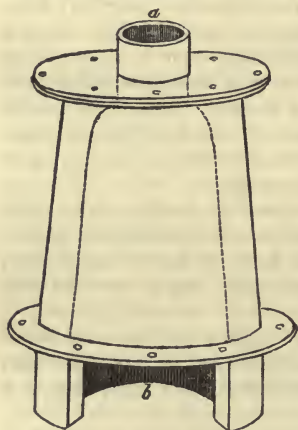

Fig. 147. Rogers's conical boiler.

The interior, a sugarloaf-shaped cone (indicated by the dotted lines), being the furnace, which is filled with fuel through its upper orifice, *a*. A circular fire-grate is fixed just within the bottom of the boiler ; and the aperture *b*, seen in front, is intended solely to remove clinkers which may form, or fuel when the fire is extinguished ; at other times it is closed with a fire-brick plug, and should never be opened except when absolutely necessary. For a side view of the boiler see fig. 150, where it is represented as attached to a range of pipe ; *f* and *r* are the flow and return pipes, and *d* a flange for examining and cleaning the boiler when necessary. Into this flange is fixed a small pipe, which, being connected upwards with the supply cistern *e*, and downwards with the cock or tap *h*, serves to fill and empty the apparatus.

The supply cistern *e* acts also as an expansion cistern, to receive the volume of water increased by heat.

Fig. 148 shows the most convenient mode of setting the above, exhibited by

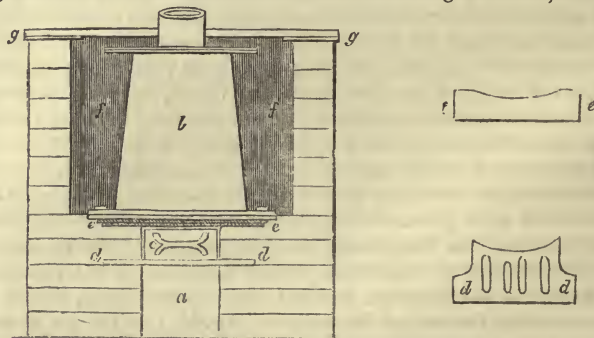

Fig. 148. Mode of setting Rogers's conical boiler.

a front view. A solid base being built with an aperture in its centre open to

the front, as high as the desired depth of the ash-pit, the boiler is fixed upon it, and the brick-work carried up to its lower flange or rim. The side-walls should then be raised, in four-inch work, level with the top of the boiler, as represented in fig. 148: *a* is the ash-pit, *b* the boiler, *c* the aperture in front of the boiler, closed with fire-brick, *ee* and *dd* two bars, one supporting the fire-brick plug, and the other fitting to the rim of the boiler to support a slate which closes the front as in fig. 149; *ff*, fig. 148, is the chamber around the boiler, filled with sawdust as a non-conductor of heat; and a layer of sawdust extends over the top of the boiler, under the slate slab *gg*, which is fitted over the brickwork, an aperture being cut in it to allow the throat of the furnace to pass through.

Fig. 149 gives the same view farther completed: the front of the chamber

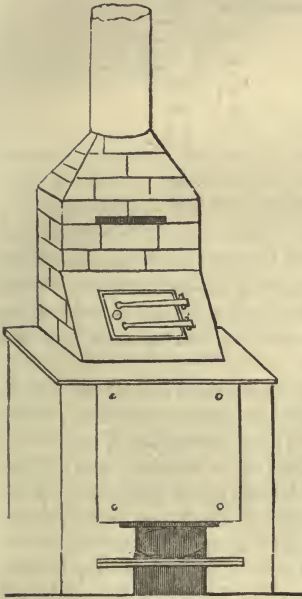

Fig. 149. Rogers's boiler set, with the chimney added.

is closed with a slab of slate, and on the slab which covers the boiler is erected a chimney, having a feeding-door, through which fuel is supplied, placed in its sloping face directly over the mouth of the furnace. This chimney must not exceed four or five feet in height, and its area must in no case exceed the area of the mouth of the furnace. That here represented, viz., a brick base, with a piece of four-inch iron pipe about three feet in length, will probably be found most convenient, unless a moveable chimney be preferred. This chimney should be fitted with a damper just below the iron part, to give greater command of the draught. The aperture of the boiler, which is closed with fire-brick, and the front of the ash-pit, should also be closed by a door or blower, having a regulator to admit or exclude draught. A blower is preferable to a door, as hinges are always liable to rust, and then break or strain; and it is important to be able to close the ash-pit pretty accurately.

Fig. 150 shows the relative position of the boiler and pipes, and the mode of attaching and arranging them. In the first place, the whole of the pipes should, if possible, be above the boiler. One foot is sufficient, but when convenient, the higher the better. When two or three-inch pipe is employed, the pipes may rise uniformly about one inch in twenty feet, from *a* and *b* to *c*; on which, being thus the highest point of the pipes, an air-cock is placed. But if four-inch pipes be employed, it is better that *a* should be the highest point, and the air-cock placed there; and that the pipes should fall uniformly one inch in twenty feet from *a* to *c*, and from *c* to *b*: indeed this is generally the best arrangement, where not inconvenient. From *b* the return-pipe, *r*, should descend either perpendicularly, or with as steep an inclination as possible, to the bottom of the boiler. The supply cistern, *e*, must be so placed that its bottom is not lower than the highest point of the pipes. The top of the steam-valve, *v*, should be level with the top of the supply cistern. Just

below the valve, on the steam-pipe, may be fixed a small cock, *k*, connected with a pipe laid into the house, by which, whenever the water boils, the house

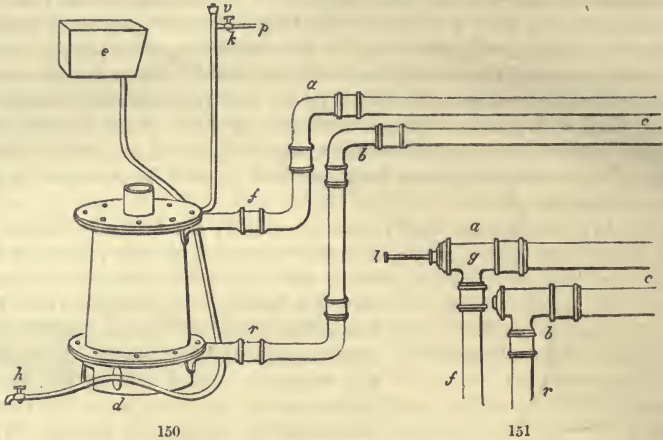

Fig. 150. Rogers's boiler, with the heating-pipe joined to it.
Fig. 151. Rogers's substitute for a stop-cock.

may be steamed. In small apartments this will happen pretty frequently, but in large houses, in order to insure this advantage, a stopcock or sluice should be placed on the flow-pipe, *f*, by which, the circulation being intercepted, the water in the boiler may at any time be raised to the boiling point in a few minutes.

Fig. 151 represents a contrivance which is not liable to any of the defects of stopcocks, which impedes the circulation less than any except large sluices, and which is comparatively unexpensive. The hollow plug *g*, fig. 151, is fitted with a valve, perfectly watertight. This valve is opened and shut by the handle sliding through a stuffing-box in the end of the plug. By closing it the gardener may at any time cause the water in the boiler to boil, when, by opening the cock *k*, he admits as much steam to the house as may be desired. A small pewter pipe, three-eighths of an inch in diameter, is sufficiently large to conduct steam into the house; and its flexibility renders it very convenient. Where this arrangement is adopted, the supply-cistern must be larger than is otherwise necessary, and should contain ten or twelve gallons. The steam-pipe, also, should be placed on the top of the boiler, and be of sufficient diameter to allow the water and steam to separate, that the former may not be blown out through the pipe along with the steam; and the valve should be loaded with a few ounces of lead.

Fig. 152 exhibits the apparatus, with the addition of a reservoir; this in small pits is very desirable. The letters indicate the same objects as in fig. 150, except *m*, the reservoir, which may be formed of thin copper in the form of a cylinder, and should be packed in a wooden or brick case, in sand or sawdust, which supports its shape, protects it from accident, and prevents the heat from escaping. All the communication pipes in this case may be of lead, and fitted with union joints, which renders the fitting exceedingly easy. In Mr. Rogers's apparatus a lead pipe of an inch and a quarter in diameter supplies forty feet of radiating surface, and his reservoir contains about four

times as much as the pipes. Reservoirs may be made of iron, but, though rather less expensive, they are so heavy and unwieldy that they could hardly

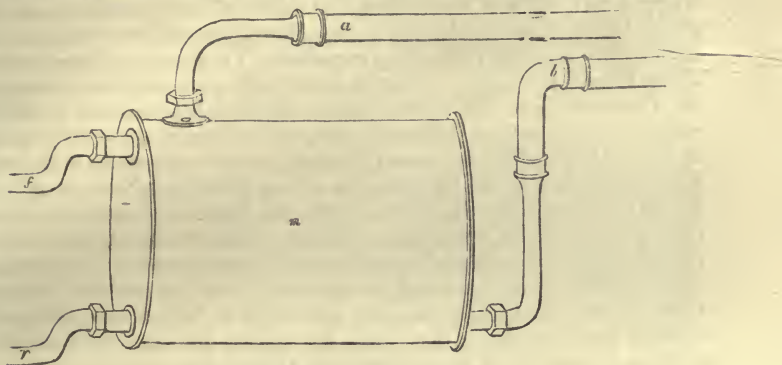

Fig. 152. Rogers's hot-water reservoir.

be used; and the expense of attaching the pipes would greatly exceed the cost of copper. Mr. Rogers has a seventy-two gallon reservoir, a cylinder four feet long by two feet in diameter, which cost complete, with two one-fourth-inch union joints, £5. 5s.

The foregoing directions will enable any intelligent gardener to plan and put up an apparatus for himself.

It remains to say something respecting fuel: any sort except wood and caking coal may be employed. The best of all is anthracite or Welsh coal, but a little coke is necessary to light it; the next best is coke; and next to this, cinders. Mr. Rogers arranges them thus, in the order of their strength; but for ordinary purposes nothing is better than cinders—nay, even coke breeze, or small refuse coke, the value of which is next to nothing, may be burnt in these furnaces, but in that case they require eight or ten feet of chimney. Where it is required to produce strong heat rapidly, coke must be employed; but it is not a good fuel to maintain heat, as it allows too much draught, and burns away. Welsh coal has not this fault, and is a very durable fuel, peculiarly well suited to these boilers. When the fire is first lighted it should be allowed to burn brisk and clear, till the fuel in the bottom is well ignited; it may then be filled up to the throat of the furnace, when it will last through the night. In filling, care, of course, must be taken that the fuel is not so small and dusty as to stop the draught. Where cinders are used they should be well sifted. The proper management of these boilers may be best secured by explaining the principle upon which they are constructed. As fuel cannot be consumed without air, if a furnace be constructed of considerable depth, and filled with fuel, and air be admitted only at the bottom, that fuel alone is consumed which lies immediately on the bars, and first receives the draught of air. The fuel above, provided it transmits the air, becomes red-hot, or nearly so, but does not consume until that below it is destroyed. In this manner, one of these conical furnaces being lighted and filled with fuel, that portion in the upper part of the furnace which cannot burn absorbs the heat of the burning fuel below, and radiates or transmits it to the water on every side. So perfect is this absorption of heat, that for several hours after the furnace has been filled up with cinders, though there may be a fierce fire

below, little or no heat escapes by the chimney, the whole being taken up by the surrounding water. The economy, therefore, of fuel in such an apparatus is very great: and it is also evident that excess of draught must be carefully guarded against, so much only being allowed as will consume the fuel steadily, which is easily learned by experience. The necessity, also, of keeping the aperture in front close, so that air enters the furnace only through the ash-pit, is hence evident. The water, it will be observed, is in close and immediate contact with the red-hot fuel on all sides, no black smoking coals intervening, as in most kinds of boilers; hence the great power in proportion to their size. Economy of fuel is not, however, the sole or principal advantage of these boilers; their great recommendation is the long duration of steady heat which they insure without attendance. When properly managed, they may be depended upon for maintaining heat twelve hours untouched. This to many amateurs, who do not command the services of a resident gardener, is invaluable. In the next place, they are applicable to houses and pits on the smallest possible scale; a three-light pit may be kept at a temperature as uniform as that of the largest hothouse, without any trouble by night. It was for a purpose of this kind that Mr. Rogers was originally led to devise them, and he has for three years past cultivated *Orchideæ* in a small house not twelve feet square in this manner. Mr. Rogers's gardener does not live on the premises; and the temperature, as ascertained by a double self-registering thermometer, rarely varies 5° during the night.

It is to be observed, that, as the quantity of heat produced depends upon the quantity of fuel consumed, each boiler must contain, at one charge, fuel sufficient to supply the pipes to which it is attached with heat for twelve hours; it is therefore necessary that the size of the boilers be proportioned to the work they have to do. They are cast in the following sizes, which have been found most generally useful:—

10-inch furnace, working	40 ft. to 60 ft.	4-inch pipe,	price £4 10s.
13-inch do. do.	60 ft. to 120 ft.	do.	price 6 0s.
15-inch do. do.	120 ft. to 200 ft.	do.	price 7 10s.*

Where the quantity of pipe exceeds the above amount, two boilers have hitherto been employed; but there is no reason why an eighteen-inch should not be cast, if a sufficient demand arose for them; boilers of this size have been found very effective in copper; and a twenty-one inch, cast in iron for Mr. Wilmot of Isleworth, worked exceedingly well. The numbers affixed to the boilers above are such as they will work properly and efficiently at all times. Some boilers of the above dimensions have been found to do a good deal more work than is here allotted to them; but this has only been by increasing the draught, and producing more intense combustion, a great deal of heat at the same time escaping by the chimney. When thus employed, the peculiar advantages of these boilers are lost; fuel is burnt to waste, and consumed so rapidly that they do not maintain their heat as long as is desirable. Duration of heat and economy of fuel are considered by Mr. Rogers as paramount objects.

The only case in which stronger draught may be allowed is where the fire works into a flue in the house: but the objection of the rapid consumption of fuel is not thus removed; nor can this arrangement be generally recom-

* The fittings, comprising doors, dampers, &c., all things, in short, peculiar to the apparatus as above described, vary from 1*l.* 5*s.* to 1*l.* 15*s.*, according to the size, and the articles required. The appendages for steaming the house are not included in this estimate.

mended, though sometimes convenient. When the ten-inch boiler is employed to small quantities of pipe, it must be fitted with a reservoir, as in fig. 152. In this manner it may be made to work as low as fifteen or twenty feet of four-inch pipe. Four-inch pipe is taken as a standard, because each foot of it contains about one square foot of radiating surface. Of three-inch, one third more; and of two-inch, double the quantity, may be considered as the equivalents of the above amounts.

These boilers are so constructed that they can be cleaned out; and, if necessary, they can be taken to pieces, to remove any calcareous deposit which may in time take place in them. It is, however, particularly desirable, in these, as in all hot-water apparatus, that nothing but pure rain or pond water should be employed. Where the boilers are employed for steaming, this precaution is particularly important, otherwise calcareous incrustation must take place. To prevent leaves, dirt, &c., getting down the pipe of the supply cistern, it should be guarded by a double cap of pierced zinc; one moveable, that the gardener may cleanse it if clogged, and the other fixed.

The advantages of these conical boilers are no longer matter of speculation or experiment. Very many have been erected in the course of 1839 and 1840, and are highly approved; although few of them possess all the advantages which experience has since combined in the form now described. They are peculiarly adapted for those purposes where perpetual heat is required; for plant-stoves, pineries, and forcing-frames; also for small propagating-houses, or preserving-pits. To pits in general, from their small size, and from the small expense incurred in setting them, a recommendation not heretofore noticed, they are peculiarly applicable, and have been extensively applied.—*Gard. Mag.*, 1840, p. 139.

505. *Rain-water* should, as we have just seen, always be used in hot-water apparatus; for hard-water deposits a sediment or incrustation, which if not removed, will form a coating of several inches in thickness, which acting as a powerful non-conductor, will allow the bottom of the boiler to become red-hot without sufficiently heating the water it contains; and ultimately, from the cracking of the deposit in consequence of the greater expansion of the red-hot iron, the water comes in contact with the red-hot metal, and an explosion takes place. (See *Gard. Mag.* vol. ix. p. 206.) Hence the necessity of having all boilers where hard-water is to be used constructed so as to admit of being readily cleaned out. As the deposit consists of calcareous matter, it may be removed by a weak solution of muriatic acid aided with a slight mechanical agitation: but it is much better to prevent its taking place by using only soft water.

506. *To prevent the water in the apparatus from freezing*, salt may be added to it; but this may be rendered unnecessary in the case of horizontal pipes by drawing off a portion of the water, so that they shall not be quite full, because in that case the water has room for that expansion which takes place when it passes into ice. The quantity of salt put into water to keep it from freezing, Mr. Hood observes, may vary from $3\frac{1}{2}$ per cent., the quantity contained in sea-water, which will not freeze when it is above 28° , to 35 per cent., the greatest amount of common salt which water will hold in solution. With 4.3 of salt, water freezes at $27\frac{1}{2}^{\circ}$; with 6.6 per cent. of salt, at $25\frac{1}{2}^{\circ}$; and at 11.1 per cent., $21\frac{1}{2}^{\circ}$. The effect which would be produced in cast-iron pipes and boilers by any of these quantities of salt, Mr. Hood states, would not be of much importance. As salt does not evaporate when

a sufficient quantity was once added for the purpose required, the waste which takes place can be supplied by fresh water. (*Hood's Treatise*, p. 167.)

507. *Open gutters* have been employed, either partially or wholly, instead of closed pipes, for circulating hot water in hothouses, and by a number of gardeners this is considered a very superior mode where great atmospheric moisture is required. The earliest apparatus of this kind is one which was put up in Knight's Exotic Nursery, Chelsea, in 1830, and described in the *Gardener's Magazine* for that year, pp. 374 to 376. It has since been erected by Mr. Weekes at several places, and a patent was taken out for some modifications of it by Mr. Corbett in 1838. Instead of the upper or flow-pipe, an open gutter of iron, wood, slate, or stone, is employed; it is placed on a level, from the boiler to the furthest point where it is carried, and it commonly returns to the boiler in a closed pipe. It can be carried over doors or similar interruptions by syphons, and under them by inverted syphons; and the open gutter has covers which can be taken off and on at pleasure to diminish or increase the quantity of vapour admitted to the atmosphere of the house. (*Gard. Mag.* 1838.) There is an apparatus of this kind in Pontey's Nursery, Plymouth; the boiler is one of Shewin's (Rogers's, 504) largest-sized conical ones, which appears to answer admirably. From the boiler the water flows in an open gutter, formed of slabs of slate, (jointed very neatly together), to the further end of the house, from which point it returns in a four-inch iron pipe back to the boiler. From having the gutter open they have a very humid heat, but by the use of slate covers they can regulate it so as to have little or much vapour, as circumstances may require. (*Gard. Chron.* Jan. 2, p. 6.) At Cowley, near Exeter, Mr. Corbett's open system has been put up, and the gardener there finds it the most simple and efficacious means of heating that he has tried. For orchidaceous houses he particularly recommends it, and he has found it far superior to close pipes in the pine stove. Mr. Glendinning also considers it the best of all systems. It combines, he says, the simplicity of the good old level system with the grand advantage of diffusing through the house, without trouble, any quantity of moisture required, or entirely withholding it. The circulation of the water in the gutters is quite as rapid as by any other system, if not more so, even when left entirely open. The invention is divested of all intricacy, as the water may be exposed to full view from its leaving the boiler until its return, and the apparatus is not liable to go out of repair. Its effectual application to every description of forcing-house is at present without a parallel; as, by the partial or entire removal of any number of covers, an unvarying degree of moisture, always governed by the temperature maintained, can, with the greatest ease and accuracy, be communicated. This alone, to practical men, will secure to it a decided preference. Red spiders, thrips, and all other insects, will be readily subdued; and an atmosphere, at once invigorating and refreshing, at all times maintained. (*Gard. Mag.* 1841, p. 57.) The opinion of Mr. Rogers is thus expressed:—"For Orchideæ, melons, and cucumbers, I should think it excellent; for stove-plants, at certain seasons, equally so; but, for other garden purposes, its utility must depend upon the power of completely covering the troughs, and regulating the escape of moisture. For greenhouses, as well as for forcing grapes and pines, it would require two or three years' experience to satisfy me of its advantages; especially for the two latter purposes. Heat is often employed in gardens more to dry than to warm buildings; as, in greenhouses

and late vineries, during damp weather in autumn. It is also necessary to obtain dry heat to ripen the wood of all forced plants; and, though I have no experience of pines, I do not imagine they will ripen to be good for any thing, except at a high temperature and pretty dry atmosphere. In all these cases, then, it is absolutely necessary to prevent the escape of moisture from the troughs. If this can be done, the only remaining objection is the difficulty and inconvenience of obtaining a perfect level for the troughs." (*Gard. Mag.* 1841, p. 152.) Where the level system of heating can be adopted, open gutters would appear to be preferable to closed pipes, as rendering more certain the supply of moisture to the atmosphere of the house, and superseding entirely the use of cisterns, except in botanic stoves, for growing aquatic plants.

508. *Retaining Heat by Coverings.*—Whatever mode of heating plant-structures may be adopted, it should be constantly borne in mind that it is incomparably better for the health of the plants to prevent heat from escaping by non-conducting coverings during nights, than to allow it to be continually given off into the atmosphere, and as continually supplied by fire-flues or hot-water pipes. Where coverings cannot be applied, and a high temperature must be kept up, reserve sources of heat, and abundant supplies of water to maintain atmospheric moisture, are the only means by which the plants can be kept healthy. "A weakly growth," Mr. Paxton observes, "is the sure consequence of a high temperature maintained by fire-heat, whatever plan of artificial heating be adopted." He therefore recommends, in all cases where practicable, the use of external coverings, by which, at Chatsworth, a difference of from 10° to 15° is gained, and two-thirds of the fuel that would otherwise be necessary is saved. (*Gard. Chron.* Jan. 16, p. 40.)

509. *Atmospheric Moisture.*—The necessity of proportioning moisture to temperature, and the causes which render the climates of our plant-structures unnaturally dry, have already been pointed out (251 to 257). To give an idea of the quantity of moisture requisite for an atmosphere at a high temperature, Mr. Rogers has shown that a vinery twenty-five feet long by thirteen feet six inches wide in the roof, maintained at 65° when outer air is 35° , will condense on the glass in twenty-four hours $35\frac{1}{2}$ gallons of water. (*Gard. Mag.* 1840, p. 232.) In devising the best method of procuring a constant supply of moisture for the air of a hothouse proportionable to the expenditure, Mr. Rogers finds the end may be most effectually attained by placing cisterns on the heating-pipes. As the temperature of the water in these cisterns would vary with that of the pipes, the evaporation from them would be greatest when the pipes were hottest; when the greatest degree of artificial temperature was being obtained, and consequently the greatest drain upon it by condensation. The cisterns may be made of zinc, with their bottoms fitted to the curvature of the pipes, at least six inches deep to the top of the pipes, and of the same lengths as the space between the rings by which the pipes are joined. Where two pipes are placed side by side on the same level, the form shown in fig. 153 may be adopted, and a single pipe may have cisterns fitted to it in the same manner, or it may be made to embrace the sides of the pipe and cover it entirely with water, as in fig. 154. In some cases shallow cisterns are cast on the pipes, but their power is insufficient, and in general zinc cisterns may be considered the best. Cisterns so placed on pipes heated to 200° will contain water at 140° to 145° ; but this

will not be the case unless they are properly fitted, and luted on the pipes with wet sand; for the smallest interstice is found to make a great difference

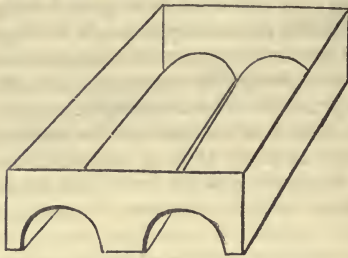

Fig. 153. Zinc cistern for double pipes.

in the heat transmitted. Mr. Rogers finds that cisterns fixed in this manner with water, at a temperature of from 120° to 145° , evaporate about three quarters of a gallon per square foot of



Fig. 154. Zinc cistern for a single pipe.

surface in twenty-four hours. The proportion which he employs in an orchidaceous stove is about one square foot of evaporating surface to ten square feet of glass, and in stoves and forcing-houses, he is of opinion (*Proceedings of the Horticultural Society*, 1840, p. 149) that there ought to be one square foot of water for every fifteen square feet of glass. If houses heated by flues had this proportion of cistern placed over them, we should no longer hear so much of the dry disagreeable atmosphere produced by this mode of heating. It is almost unnecessary to observe that the cisterns will be most effective where the flues are most effective; or that, as the covers of flues have not interruptions like the joints of pipes, the cisterns may be made of any length. Slate cisterns placed above the pipes may be advantageously used for increasing the moisture, serving at the same time as a reservoir of heat, and of water for watering the plants, and also for growing aquatics; but as the water in such cisterns will seldom exceed the temperature of 80° to 85° , a much larger surface is required than in the case of zinc cisterns accurately fitted to the curvature of the pipes. On smoke-flues the water in such cisterns will rise to a much higher temperature than on pipes, because the slate bottoms will come in close contact with the entire surface of the covers of the flue.

510. *Steaming*, that is, the discharging into the atmosphere of a house, in large quantities, the steam of water heated to the boiling-point, has been adopted as a means of producing atmospheric moisture; but it is objectionable on account of the high temperature of the steam, excepting in large houses where the volume of air affords room for the steam to part with heat, so as to be converted into vapour before it reaches the plants. Steaming may also be useful in combination with fumigation, or the diffusion in the atmosphere of matters noxious to insects. Mr. Rogers proposes the following method of using steam in such a manner as not to prove injurious to plants. "A shallow cistern, about six inches deep, and carrying at least four square feet of area, with a false bottom of wire or pierced zinc about one inch from the real bottom, being provided, the steam-pipe from the boiler should be introduced so as to discharge itself between the real and false bottom; the cistern should now be filled with water nearly to its brim, and the steam laid on. The water will soon be raised to a pretty considerable temperature, and yield an abundant supply of innocuous vapour." The use of the false bottom is to prevent the water from boiling up and flowing over before it is converted into steam.

511. *Ventilation.*—Plants do not require large supplies of fresh air for the purpose of respiration like animals, because while the latter speedily render air impure, by depriving it of oxygen, and giving off carbonic acid, by the former oxygen is given off, and the carbonic acid of the atmosphere inhaled. A very small supply of air, therefore, is sufficient for any plant-structure, as far as the growth of plants is concerned, provided the air of the house be tolerably pure; but where the air is heated by smoke-flues or by fermenting stable dung, it may be charged with sulphureous or other noxious gases; and, in such cases, a frequent mixture of fresh air may be necessary. In greenhouses, and pits, and frames, where there is a large proportion of earthy and moist surface to a small volume of air, the latter may become too moist, and fresh air may be required to dry it; while in every description of plant-structure it may be required to lower the temperature. Hence, for houses heated by smoke-flues, and for pits and frames heated by fermenting dung, a greater power of ventilation becomes requisite than for houses heated by hot water, in which, under ordinary circumstances, noxious vapours cannot be produced, or the temperature raised much above 80° or 90° . In many cases the small quantity of fresh air required for such houses will find its way into the house through crevices in the roof or sides, and by the occasional opening of doors by the going in and out of the gardener. Where larger supplies of fresh air are requisite, a portion of the roof or sides, or of both, must be made to open, and the extent to which this is effected will depend on the dimensions of the house, its uses, and other circumstances. The common purpose for which ventilation is employed, is to lower the temperature of the house, and this is generally done by opening sashes in front, and in the upper part of the roof, thereby creating a draught of cool air through the house, most injurious to vegetation, by the sudden chill which it produces, as well as its dryness (252, 266, 267). Only a small quantity of outer air is at most seasons requisite for lowering the temperature of a hothouse, and this can be admitted by opening sashes or ventilators in the upper part of the roof. In roofs with sliding sashes, the upper sashes along the whole line of roof may be let down uniformly, if the house be at an equal temperature throughout, and rather more at the hottest part, if it is of unequal temperature. The width opened need seldom exceed half an inch or an inch in the winter time; but in summer it may be much larger, according to the temperature to be kept up in the house, and other circumstances. If the roof should be a fixed one, then a narrow opening might be made in the upper angle of the roof along the whole length of the house; and the cover to this opening might be raised simultaneously and uniformly by lines and pulleys or other means, which need not be detailed. A portion of the heated air of the house will escape by this opening, while a portion of the outer air will enter to take its place, mixing as it descends with the heated air, and becoming, by this means, heated to a certain extent before it reaches the plants. The great object in ventilating houses which are kept at a high temperature is to avoid thorough-draughts, which are always produced when ventilators in the front and back are opened at the same time. Even in houses kept at a low temperature, such as greenhouses and conservatories, it is always desirable in the winter season to admit the air from the roof only, and not from the sides. In summer, when the temperature of the outer air is as high as that of the house ought to be, openings may be made in every direction at pleasure. In stoves the precaution of covering the openings of the upper part of the roof,

by which air is given, with wire netting, might be taken, which, while it excludes wasps and flies in summer, would in winter act like Jeffrey's Respi- rator, in abstracting the heat from the heated air which escaped, and im- parting it to the cold air which entered ; or the double tube recommended by Dr. Arnott in his *Treatise on Warming and Ventilating*, might be adopted, and probably with much more success than it can be in dwelling-houses. In hot- beds it is customary to leave openings for the escape of moist vapour during the whole of the night ; this is generally done by raising the sashes behind, but, as by this mode the steam from the dung is sometimes driven in, some gardeners have a narrow opening in the upper part of the sash, with a lid to fit to it, hinged along the upper edge. The only difficulty that can occur in ventilation, is in the case of houses heated to a high temperature by brick flues not air-tight, and in which the atmosphere is unavoidably more or less charged with noxious gases ; but in this case, unless provision has been made for heating the air before it enters the house, we know of no better mode than opening the top sashes or ventilators more or less during the finest part of every day ; and if the parts to be opened are covered with very fine wire netting, it is presumed no chill will be given to the plants, and no greater dryness created than can be readily moistened by the water evaporated from the cisterns over the flues. The external air may be heated in the winter season before it is allowed to enter the house, by enclosing a part of the pipes or smoke flues, in a trunk or box with a communication at the lower part of one end with the open air, and at the upper part of the other with the air of the house. So long as the pipes are kept at a temperature considerably above that of the house, fresh air will flow in, and a corresponding quantity will be displaced by the accidental crevices of the roof.

512. *The agitation of the air in the house, with or without the introduc- tion of fresh air, may be effected by cross drains in Mr. Penn's manner, but omitting the covering of the pipes, and the upright tubes, and placing the pipes in the front of the house, or round it when it is glass on all sides. The cross drains, also, we would form of double sides and covers ; or of earthenware tubes nine or ten inches in diameter, placed within other earthenware tubes four inches wider, in order to retain a vacuity between them ; or, for a similar reason, the tubes may be placed in brick drains. The use of the vacuity is to prevent the loss of heat, which would ensue from its absorption by the sides of the drains, when they were at a lower tempe- rature than the air of the house which passed through them. The inner tube may be covered with water, as in the case of the common brick drain used by Mr. Penn.*

513. *Light is one of the elements of culture as essential as heat (278). When the object is merely to grow plants without fruiting them, the propor- tion of glass may be small, provided it be pretty equally distributed over the roof ; but when the object is to produce flowers and fruit, the proportion of glass to the wood or metal of the roof ought to be greater. In nurserymen's houses for growing plants, the most economical size of panes, or width be- tween the sash bars, is five inches or six inches by three inches ; and the ordi- nary breadth for houses in which plants are to be flowered is from seven to nine inches. The panes in the latter case are generally made square, and in glazing one is made to lap over the other from one-eighth to one-fourth of an inch. In general one-eighth of an inch is quite sufficient ; the broader the laps, the greater is the quantity of water which they retain, and the more*

liable is the glass to breakage when the water so retained becomes frozen. This lap is sometimes entirely, and sometimes partially, rendered air and water tight by putty. In the former case it prevents the water which condenses on the inside of the glass from escaping to the outside; and in the latter, while it allows the condensed water to escape, it also retains, by the attraction of cohesion, as much as fills the space between the lap; and this water in severe weather is apt to freeze, and by its expansion when undergoing that operation, the glass is broken. By having the laps unputtied, not only is there great danger from breakage by frost, but much heated air escapes during cold weather, and rain is apt to be blown into the house during high winds in certain directions. It is better, therefore, in the opinion of most scientific gardeners, to putty the laps and render them water-proof; to accomplish which in an efficient and economical manner, Mr. Forsyth proposes a lap three-eighths of an inch broad, (in our opinion a greater breadth than is necessary), with the space between filled in with soft putty in the usual manner, and then carefully to paint the joinings of the glass, both the under lap and the over lap, and also the putty between, in the following manner:—Let the upper edge of the paint on both sides of the lap run in the direction of *d*, *e*, in fig. 155, thus directing all the water which

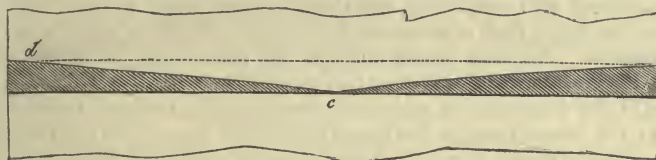

Fig. 155. Lap of glass panes puttied and painted.

condenses on the inside or falls on the outside down the centre of the squares. The only disadvantage attending close-puttying the lap is, that the condensed water, when the roof is very flat, sometimes drops on the plants: but if the house is kept at a proper temperature, the water that drops in this manner will do little injury, and will be speedily taken up by the dry air which has just parted from it. In particular cases, where the drip falls on a plant, it may be directed to a point where it will do no injury, by a simple process pointed out by Mr. Rogers, viz., to fix at places where the drip will do no injury, small pieces of cobblers' wax or putty, which, by interrupting the descendant current, will cause it to drop down. The drip, however, is much more common from the bars between the glass than from the glass itself, and to these Mr. Rogers's plan is peculiarly applicable. One great argument for puttying the laps is, that the moisture of the atmosphere, though it may be condensed on the glass, is not, if proper means are taken to retain it at the bottom of the sloping glass, allowed to escape from the house, but must be reabsorbed by the air which deposited it, somewhat in the same manner that takes place in growing plants in closed glass cases. These cases being air-tight, when the temperature within is greater than that without, moisture is deposited on the glass, and after some time runs down and settles along the inside of the rim; whence, when the temperature within is raised to the same height as before, it is again taken up and held in suspension in the form of elastic vapours. In the case of air-tight stoves, nearly the same process must be constantly going on; but few have hitherto been built sufficiently air-tight for this purpose. One of the greatest improve-

ments that have taken place in the glazing of plant-structures of every description, is the introduction of sheet window-glass, which, while it is nearly as thick and strong as plate-glass, is not much dearer than crown-glass. The thickness of this glass varies from one-eighth of an inch to something more than one-sixteenth, and either thickness may be used in lengths of from two feet to five feet. In the grand conservatory at Chatsworth, the panes are three feet nine inches in length, that being the length of the side of the ridge, and they are six inches in width, so that no occasion is required for a lap. Ridge and furrow houses, when this kind of glass is used, may be made nearly air-tight. In the grand conservatory in the Horticultural Society's garden, the same kind of glass is used, and the panes are sixteen inches by twelve inches. This house is remarkably well glazed, and the laps are all puttied. Indeed, if this were not the case, it would be almost impossible to heat such a lofty structure with glass on all sides; but this glass being very even, as well as thick and strong, the laps are not more than three-sixteenths of an inch, and do not retain any water, which, indeed, from the temperature within being seldom greater than that without, is not often deposited on it.

513. *Water* is commonly supplied to plants in hothouses by hand; but pipes, pierced with small holes, have been arranged under the roof, which in turning on water from a cistern above the level will throw down a shower at pleasure. For lofty houses, such as the palm stoves of Messrs. Lodiges, the inventors of this system, this mode of watering is very eligible, and it might also frequently be adopted in conservatories attached to dwelling-houses, the cistern being in the upper part of the house. As a luxury, the noise of the artificial shower, and the drops of rain, in a warm summer's evening when all is arid without, will more than compensate for the expense. As water should never be applied to plants at a lower temperature than the mean of the atmosphere which they grow in, there should be a cistern in every house, of sufficient capacity to supply all the water which can be wanted at any one time, placed over the flues or hot-water pipes in such a manner as soon to be heated by them. In plant-houses these cisterns may be used to a certain extent for growing aquatics; but in this case only a small portion of water should be taken from the cisterns at a time, so that the addition of cold water may not chill the plants. To prevent the rose of the watering-pot from being choked from the leaves or other matters in such water, watering-pots with the grating described by Mr. Beaton (425) should be used.

514. *The different kinds of fixed structures for plants*, are—the pit, the greenhouse, the orangery, the conservatory, the botanic stove, the pine stove, and the forcing-house; and we shall conclude this section by shortly noticing the characteristic features of each of these, and their varieties.

515. *Pits* are low buildings with glass roofs, but without glass in the sides or ends. The angle of the roof is between 15° and 25° with the horizon, and the surrounding walls are generally built of brick, and hollow, or in some kinds of pits, they are pigeon-holed, or with thin panels to admit the heat of exterior casings. The provision for heating varies from the mere power of retaining natural heat, by coverings of glass or other materials, to 70° or 80° , or upwards of artificial heat, which may be supplied either by fermenting materials alone, by these and fire-heat combined, or by fire-heat alone. The cold pit is without any artificial source of heating, and in some

its walls are of turf or earth ; and instead of glass sashes, frames of reeds, or boards, or thatched hurdles, or other coverings, are substituted. The cold pit is used for protecting plants in pots not in a growing state, or for preserving culinary vegetables from the frost. In warm situations and dry soil, it has a thick mound of earth, or thick wall of turf, which in either case should be coped so as to be kept as dry as possible. Even in the case of brick pits, an outer casing of dry turf prevents to a very great extent the effects of frost, and sudden changes of temperature. The casing may also be made of boards, where great neatness is an object, leaving a cavity to be filled with coal-ashes, charcoal, dry sand, or other non-conducting materials. In pits of this kind, with glass sashes instead of opaque covers, many hard-wooded greenhouse plants, such as camellias, myrtaceæ, heaths, &c. may be served through the winter without any artificial heat, care being taken to adapt the nightly coverings to the weather. The usual width of such pits is from six to eight feet ; height of the back wall, three to five feet ; and of the front wall, two to three feet. A pit to be heated by a bed of tan within, and exterior cases of dung, may be of the same or larger dimensions, with the back and front wall pigeon-holed or panelled, (490), and with boarded covers to protect the linings from rain and wind, hinged to the wall-plate. Instead of exterior linings for supplying extra heat, flues or hot-water pipes may be introduced along the front and ends, or entirely round the pit ; sometimes with a platform of boards over them for plants in pots, or even for a bed of soil, but more frequently separated from the bed of tan by a narrow wall, or by a partition of slates or flag-stones. The width of the bark-bed in such pits is seldom less than five or six feet, and eighteen inches of additional width is necessary for the front flue, or six-inch pipes ; and double these widths if the flues or pipes are carried round the house. For the more convenient management of pits, they are sometimes constructed sufficiently high behind to admit of walking upright there ; and a passage for that purpose is left at the back, of three or four feet in width, and a door made in one end. The roof over the passage is generally opaque and sloping to the north, as in fig. 157. To the

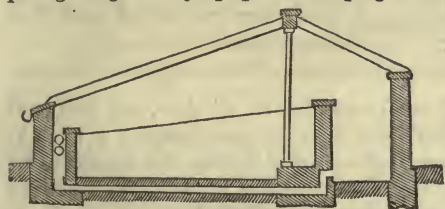
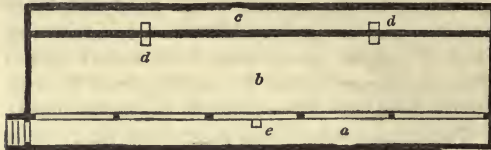

Fig. 156. Span-roofed pit, with the roof over the path opaque.

possessor of a small garden, and an amateur, this is a very desirable description of pit, as in it he may grow almost everything, provided he does not attempt too many kinds of culture at once. The form is very economical, from there being as much surface of pit as there is covering of glass ; and the interior is very comfortable to work in, as the operator need not stoop. If the ends were made of glass, it would be an improvement, by admitting the morning and evening sun : it would then, however, be entitled to be called a small house, instead of a pit. The sashes of all pits are made to slide between rafters which are fixed to the plates of wood, which form, partially or wholly, the copings to the walls. There should be a bolt to each sash for fixing it when shut, and also when let down for giving air, in order that there may be no risk of its being blown off by high winds ; and all the sashes ought to admit of being readily taken off, for the purpose of taking out, and putting in dung, tan, or other materials. When the pit is ten or twelve feet in width the sashes may be in two lengths,

the one sliding over the other; the upper sash sliding on ledges formed in the rafters, so as to render it independent of the lower sash. In general, short sashes for pits last much longer, and occasion much less breakage of the glass than long ones, from their leverage being so much less. The roofs of all pits ought to have coverings, and the best material, in our opinion, is boards, as, where glass is so flat as it generally is in pits and frames, it is apt to get dirtied by straw mats, unless these are put over a covering of bass mats. Fig. 157 is an excellent plan of a pit or small house, with a span-roof all of glass,



- a*, Back path.
b, Bark pit, 50 ft. long in the clear.
c, Exterior pit for dung casing, to revive the heat.
d, Gratings to drains.
e, Stink-trap to drain.

Fig. 157. Ground plan of a pit to be heated in Mr. Corbett's manner.

designed by Mr. Glendinning, for general purposes, and heated by Corbett's hot-water apparatus. Mr. Corbett's system appears to be better adapted for pits than for larger and longer houses, where its heating power would probably not be sufficient, or be unequal from the slowness of the circulation in consequence of the water-troughs being necessarily on a dead level. Mr. Glendinning's pit, however, may be heated by any mode, not even excepting a smoke flue. Fig. 158 is a section of this pit, showing :

- f, f*, Glass roof. *g*, Bark pit.
h, Back path.
i, Pit for dung casing. *k*, Drain.
 Hinged cover of ledged boards, to protect the dung from the rain and wind.
m, Ground line.
n, Suspended shelf for strawberry pots.
o, Slate shelf for pots.
p, Stink-trap communicating with the cross-drain (*q*), which leads to the main or barrel-built drain (*k*).
r, Corbett's hot-water apparatus.
s, Hollow wall of bricks on edge.

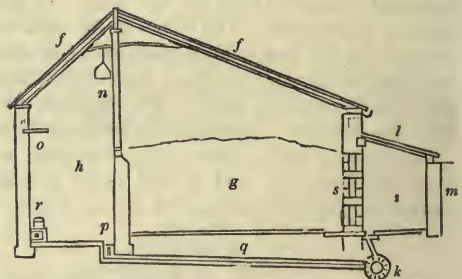

Fig. 158. Cross section of a pit to be heated on Corbett's system, or by smoke-flues.

Pits or low houses have been formed with glass on all sides, and span roofs (see *Gard. Mag.* vol. vii. p. 290); but from the great quantity of glass in proportion to the surface of floor enclosed, they become too expensive for general purposes, and, unless furnished with a warm covering, the extensive surface of glass occasions an injurious degree of radiation.

516. The greenhouse is a light, airy structure, with a glass roof at an angle of 35° or 40° with the horizon, and upright glass in front and at the ends; and with the means of heating sufficient to keep out frost, and in humid weather to dry up damp. The plants are grown in pots placed on a stage, or range of shelves rising one above another from a path in front, to within six or seven feet of the upper angle of the back wall. Between the front path and the upright glass, there is a broad shelf on a level with the lowest shelf of the stage, for small plants that require to be near the light. All the front and roof sashes are made to move, because it is frequently necessary to admit a free circulation of the external atmosphere; and coverings are seldom applied, because a very little fire-heat is found to exclude the frost.

This is the common or normal form of the greenhouse, when it is placed against a wall, or the side or end of a dwelling-house, and facing the south or some point between south-east and south-west; but much more elegant forms, of the curvilinear or ridge and furrow kind (483 and 484), may be adopted, and where the expense of fire-heat is not an object, it may face the east or west, or be constructed of glass on all sides. For placing against a wall in a flower-garden we should prefer a curvilinear structure, with ends of the same kind, and an architectural entrance, either in the back wall, as in fig. 129, p. 190, or in front; but against a dwelling-house, and on a small scale, we should recommend the ridge and furrow construction, as from the ease with which the roof may be partially or wholly concealed, it is the most easily rendered architectural.

517. *The orangery* is an architectural building, more like a living-room than a plant-structure, with large windows and narrow piers in front and at the ends, and with an opaque roof. It is used for preserving orange-trees and other large plants which are in a dormant state during winter; and the power of heating is about the same as that for the greenhouse; but, from the roof being opaque, less extent of flue or hot-water pipe is required. Plant-structures of this description are chiefly wanted in large establishments; but as architectural appendages to a house they may sometimes be advantageously introduced in small villas, the area of the orangery being used in the summer time, when the orange-trees and other plants usually kept in it are set in the open garden, as a place for prolonging the beauty of plants in bloom, and for other purposes.

518. *The conservatory* differs from the orangery and the greenhouse in being more lofty and architectural, and in having the plants growing in a bed of soil which forms the floor of the house. As the plants in a conservatory are generally kept growing through the winter, a power of heating is required greater than that of the orangery; and when it is joined to a dwelling-house, and is to be frequently walked in by the inmates, greater than that of a greenhouse. The temperature during the night should not be under 45°, nor need it be raised higher during bright sunshine than 55° or 60°. The forms, and other particulars relative to the construction and adaptation of conservatories, have already been given in the *Suburban Architect and Landscape Gardener*.

519. *Botanic stoves* are of various kinds; but with respect to temperature and moisture they may be reduced to the dry stove, the damp stove, and the intermediate or bark stove. The first requires abundance of light and a power of heating from zero to 60° in the winter season, and is chiefly used for growing succulents; the second requires less intensity of light, but a power of heating equal to 80° in the winter season above the external air; for although such will seldom be required, yet it is better to have too much than too little heating power. In the damp stove there must also be a power of saturating the atmosphere with moisture at all seasons; as it is chiefly used for growing Orchidaceous plants and ferns. The intermediate or common botanic stove requires the same power of heating as the last, but more light and much more space, as it is used for growing the trees and shrubs of tropical climates. These are commonly kept in pots, and very frequently plunged in a bark-bed, whence this kind of house, before the use of damp-stoves, was called the bark-stove, to distinguish it from the dry-stove.

520. *The pine stove* is a low structure, always with a bark or other bed

in which the pots are to be plunged, and differing in little from a large pit (515), excepting that it is generally arranged so as to admit of growing crops of grapes as well as pines. The glass roof is generally placed at some angle between 25° and 35° , and the power of heating should be equal to 70° during winter. A power of communicating atmospheric moisture should be at command as in the common botanic stove.

521. *Forcing-houses* are chiefly employed for bringing forward early crops of grapes, peaches, cherries, or other fruits, and for producing early culinary vegetables of different kinds, or flowers. The power of heating varies with the season of forcing and the kind of fruit to be forced; but it should not be less than 60° , with a command of atmospheric moisture. Sometimes the trees are trained on trellises one or two feet within the glass; and sometimes they are partly trained under the glass, and partly on the back wall. In either case, the narrower the house, the more readily is it heated either by fire or the sun. As these details vary with the kind of trees and plants to be forced, they belong more properly to the next division of this work. See *Practice of Horticulture, Forcing-Garden*.

522. *A Plant-structure for all or any of the above purposes*.—The pit, fig. 157 in p. 221, or that shown in figs. 158 and 159, p. 222, will answer for any one of the purposes for which orangeries, greenhouses, and stoves are erected. Orange-trees and similar plants, in a dormant state, may be preserved through the winter in such pits with ample coverings, and scarcely any artificial heat; greenhouse plants, with very little heat; dry-stove plants, with a little more heat; damp-stove plants, with increased temperature and moisture; other stove plants, till they attain a certain size; pine-apples, to the highest degree of perfection; and fruit-trees trained to trellises under the glass may be forced, as may be also every description of culinary vegetable, not excepting mushrooms, which may be grown in a portion of the bark-bed, or in shelves against the back wall, or in arched recesses or vaults under the tan of the pit. In short, there is nothing in the way of culture that may not be carried on to the highest degree of perfection in these pits, provided that all the large-growing plants are trained on trellises close under the glass; but the airy elegance of the greenhouse, the grandeur and picturesque luxuriance of the conservatory, and the tropical aspect of the lofty botanic stove, are not to be expected from them.

Subsect. 3.—*Edifices used in Horticulture.*

The edifices required in horticulture are chiefly the head gardener's house, the journeyman gardener's lodge, the fruit-room, the seed and herb-room, the root-cellar, the tool-house, and the potting and working sheds.

523. *The gardener's house*, wherever there are many plant-structures, should be as near the garden as possible; but it should by no means form an object in the scenery of the garden. Like what the house of every man ought to be, the occupant should possess it as his castle for the time being. It may be wholly or partially veiled by trees; but within whatever boundary it is placed perfect liberty should prevail; and this cannot be the case where the inmates are either constrained to remain in-doors, or when they go out be forced into contact with their superiors, to the annoyance of both parties. Besides a kitchen and sleeping-rooms, the gardener's house should contain at least one good parlour. All the fixtures and

principal articles of furniture should be the property of the proprietor of the garden, and valued to the gardener on his entering on the situation, and again valued on his leaving it; he paying any difference in value which may have been occasioned by use. This is not the general practice, though it is fast spreading, and deservedly so, because it must occasion less pain to a considerate master to part with a married servant under such circumstances, and less inconvenience to the gardener when he leaves his place, without perhaps knowing where he shall find another.

524. The *journeyman gardener's lodge*, and all the other edifices mentioned, are generally included in the sheds behind the different plant-structures; because they tend to keep the latter warm, and because the high back wall of the hothouses existing at any rate, they can be erected there more economically than anywhere else. It has been observed, however, by a number of gardeners, both in England and Scotland, that living-rooms at the back of hothouses are not healthy; and that those that are situated at the back of stoves are still more unhealthy than those at the back of greenhouses, or other plant-structures where less heat is required. Damp and want of ventilation are the probable causes; for which reason we should recommend the journeyman-gardener's rooms to be separated from the back wall of the plant-house against which they are built by a vacuity, communicating above and below with the open air. The floor should be raised at least a foot above the general surface, and should have an ample vacuity below it, which on the one side may communicate with the vacuity between the walls, and on the other with the open air. This will ensure a current of air through both these vacuities, which will be sufficient to carry off damp, and to prevent the ill effects of the excessive heat from the plant-structure. Another point which ought to be attended to in the construction of living-rooms behind hothouses is, to have larger windows and more of them than is usual; and always to have them carried up within a few inches of the ceiling, in order that air may be admitted from the top as well as from the bottom of the window. See note in the *Appendix*.

525. The *fruit-room* should have a double roof, or roof with a ceiling, a hollow front wall, and double doors and windows, so as to maintain an equable temperature. It should be divided into at least two apartments, so completely separated from each other as to prevent the air of that in which the early ripening fruits are placed from contaminating that in which the late ripening sorts are deposited. Both apartments should be fitted up with broad shelves of open work of white deal, or of some wood without resin or other qualities that would give a flavour to the fruit; and there ought to be bins or portable boxes for preserving fruit packed in sand, fern, hay, bran, kiln-dried straw, leaves or blossoms of the beach or chestnut, or other materials. The fronts of the shelves should have a narrow ledge, on which temporary labels can be pasted, indicating the names of the fruits, and when they ought to be fit for use, &c. Where fruit is to be frequently packed for sending to a distance, there should be a third apartment for containing the packing materials, and for packing in. Where there is danger from damp or heat, the back wall and floor can have vacuities as in the journeyman's room, with stoppers to the outlets, to be used in severe weather.

526. The *seed-room* should adjoin the fruit-room at one end, and the tool-house at the other. It should contain a cabinet fitted up with drawers for seeds; an open airy case, with drawers for bulbs; shelves for catalogues,

a book-case, partitioned off, because moths are apt to be introduced along with some kinds of seeds, for a garden-library, unless this is kept in the head gardener's house as a part of his furniture; a press for compressing dried herbs into cakes, to be afterwards wrapped up so as to be air-tight in paper, and kept in drawers to be taken out as wanted for the kitchen; and a variety of minor articles, some of which have been mentioned (389), and others will occur in practice.

527. *Root-cellar and other conveniences.*—Underneath the fruit or seed-room, if the soil is dry, there may be a cellar for preserving dahlia-roots, bulbs, potatoes, &c.; though, on a small scale, the seed-room and some part of the sheds may serve as substitutes. A mushroom-house, and a house for forcing rhubarb and succory, and for producing early potatoes by a particular process which may be carried on in the dark, may also form part of the back sheds; and a supply of water by a pump or well, or by a large cistern, supplied by an hydraulic ram, or other means; and conveniences for liquid manure, lime-water, &c., &c., must not be forgotten. In short, whatever is wanting for the cultivation and management of a garden, exclusive of plant-structures and the gardener's house, should be provided for in the back sheds; and, as a general principle, it may be laid down that every plant-structure that has a back shed should have a direct communication with it by means of a door in the back wall. By means of this communication much time is saved in conveying articles from the shed to the house, and the contrary; fires can be more promptly attended to, and, above all, plants in pots can be taken into the shed and examined or shifted, without exposing them to the open air.

528. The *tool-house* should adjoin the seed-room, and should be fitted up as before indicated (389). The potting-sheds should contain, facing the windows, benches for potting on, and ample space for pots, crocks, potting trowels, stakes, ties, tallies, bell-glasses, and a variety of other articles. Soils are in general fresher, and in a better state, when kept in the open air; but still there ought to be bins for sand, peat, leaf-mould, and some other kinds in constant use.

529. *Open Sheds.*—A portion of the sheds open in front ought to be set apart for tanner's bark, and other portions for hotbed-frames and such like portable structures, or articles that would be injured by exposure to the weather when not in use; one for sticks for peas, props for plants, mats, coal or wood for fuel, and for other purposes. In short, there can hardly be too much shed-room; for besides all the ordinary purposes mentioned, a portion of it may be sometimes required for preserving deciduous greenhouse plants through the winter for which there is not room in the plant-structures, such as large Fuchsias, Brugmansias, pomegranates, and many other plants which are turned out into the open garden during summer. If there is no regular mushroom-house, that vegetable may be grown in the open shed, on dung ridges covered with hay and mats. Tart rhubarb and sea kale, may be forced there, protected by mats supported on hoops; peas and beans for early crops may be germinated before being transplanted into the open garden; and indeed there is no end to the objects that may be effected within open sheds, while on their roofs onions may be dried in wet seasons; a practice very general in Scotland and in the north of England.

CHAPTER III.

OPERATIONS OF HORTICULTURE.

THE operations of Horticulture are very numerous, but they may be all included under operations in which strength and mechanical skill are chiefly required in the operator; those which imply a considerable degree of knowledge of vegetable physiology; those in which to a knowledge of plants and their culture requires to be added some acquaintance with the principles of design and taste; and those in which is required a knowledge of the general principles of business. The first may be called Horticultural Labours; the second, Operations of Culture; the third, Operations of Horticultural Design and Taste; and the fourth, Operations of General Management.

SECT. I.—*Horticultural Labours.*

530. *Labours* differ from operations in being of a coarser and commoner kind, and hence requiring but a small portion of that skill which may be strictly considered as professional: they are, in short, such as every person living in the country ought to be able to perform, either as a matter of business, as in the case of the working man; or as a matter of recreation, as in the case of a man of wealth or leisure. All mechanical labours may be resolved into the elementary movements of lifting, carrying, drawing, and pushing; and in whichever way these are combined, or to whichever implements they are applied, the result will depend on the quantity of matter in the implement, and the rapidity or motion with which it is lifted, carried, drawn, or pushed.

SUBSECT. I.—*Horticultural Labours on the Soil.*

531. *Object of labours on the soil.*—Before any labour on the soil is commenced, the labourer, or his director, ought to bear in mind the relations of the soil to heat, air, and moisture, as laid down in Part I., chap. ii. The objects for which the soil is laboured are, pulverization, to render it more readily penetrated by the roots of plants, and by heat, air, moisture, and sometimes by frost; to allow superfluous moisture to escape into the subsoil; to mix the upper and lower parts of the upper stratum of soil together; to mix the coarser and finer parts together; to add or mix in earths or manure; to free the soil from root or perennial weeds, stones, or other objects unfavourable for culture; and to destroy surface or annual weeds. The grand sources of heat to soil are the sun and the atmosphere, including rain at a higher temperature than the soil; and the sources of cold, or of the abstraction of heat are, rain at a lower temperature than the soil, frost, snow, ice, and where draining has been neglected, subterraneous water. The greatest degree of cold produced by these causes, excepting the last, will always be found on the surface of the soil, and the best mode of supplying the heat that has been abstracted will be by leaving the surface to the action of the sun and of the air. By digging or trenching down a cold surface heat is abstracted from the soil, the natural temperature of which will in that case be lowered; and thus a plant grown in a soil so treated, will be, in so far as bottom heat is concerned, worse than if it were in a state of nature, in which heat abstracted by the air is always restored by it. The average temperature of the surface soil in most countries is believed to be nearly the

same as that of the atmosphere; but by considering all the causes that contribute to the warmth of a soil, there can be little doubt but in many cases its average temperature might be increased. The colour and texture of some soils is better adapted for absorbing heat than others, and the inclination of the surface of soil is of as much importance in deriving heat from the direct action of the sun's rays, as we have just seen (482) the surface of glass roofs to be. Hence the advantage of laying up soil in narrow ridges, which, when in the direction of east and west, very soon become much drier and warmer on one side than on the other. Rain, though in the cold season it abstracts heat from the soil, yet in spring and summer, being of the temperature of the atmosphere, it communicates heat more effectually than air, because, under ordinary circumstances, it penetrates deeper, in consequence of its greater specific gravity; and as it requires 289 times as much coal to heat one cubic foot of water as would be required to heat the same bulk of air to the same degree, so is the quantity of heat which water of a given bulk will give out to soil greater than what will be communicated by the same bulk of air. Water, in a frozen state, though injurious as abstracting heat, is in many cases favourable by contributing to the pulverization of stiff soils, which are laid up in a rough state, in order to expose as large a surface as possible to be cooled and frozen during winter, and to be thawed and heated during spring. The retention of moisture by pulverization is an important object of labouring the soil. All properly cultivated soils hold water like a sponge, while in unlaboured soils the rains either never penetrate the surface, or they sink into the subsoil and are lost, or are retained by it and prove injurious. Wind, like rain, will communicate heat or abstract it from soil, according to its temperature and the rapidity of its motion; but as in either case it carries off moisture in proportion to its dryness and velocity, it is in general in cold climates much more favourable than hurtful for soils, considered apart from the plants which grow in them. If possible no operation should be performed on the soil excepting when it is in a dry state, and when the weather is also dry. Moist soil cannot be dug without first treading on it, and thus making it into a kind of paste or mortar, which renders it unfit for being pierced by the fibres of plants, and prevents it from being penetrated either by moisture or air; and water in the form of ice or snow, if dug in, abstracts that heat from the soil which, as we have already seen, it ought to derive direct from the atmosphere. "A pound of snow (newly fallen) requires an equal weight of water heated to 172° to melt it, and then the dissolved mixture is only of the temperature of 32° . Ice requires the water to be a few degrees warmer to produce the same result. When ice or snow is allowed to remain on the surface, the quantity of heat necessary to reduce it to a fluid state is obtained chiefly from the atmosphere; but when buried so that the atmospheric heat cannot act directly upon it, the thawing must be very slowly effected by the abstraction of heat from the soil by which the frozen mass is surrounded. Instances have occurred of frozen soil not being completely thawed at midsummer when so buried. But this is not the whole of the evil:—the moisture of the air which fills the interstices of the soil will be continually undergoing condensation as it comes in contact with the cold portions, and these will be found in a very saturated condition, even after they have become thawed."—(Robert Thompson in *Gard. Chron.* Feb. 6, 1841, p. 89.) All these and similar facts ought to be kept constantly in mind while performing the operations of digging, trenching, forking, hoeing, raking, and rolling.

532. *Marking with the garden line* is an operation preparatory to various others, and it consists in stretching and fixing the line or cord along the surface of the ground, or sometimes, as in clipping edgings and hedges, at some distance above it. When the direction is straight, two fixed points at the extremities are sufficient; but when it is curved, a number of intermediate stakes or pins are requisite to bend and fix the line to the proper curvature. Also, when the line is raised from the ground, as when stretched for cutting straight the top of a hedge, it must be supported at a sufficient number of intermediate points, otherwise a deflection will take place more or less in proportion to the distance between the extremities of the line, its degree of tension, and weight of materials. The ground or plants are next marked, cut, or clipped, in the direction of the line.

533. *Digging.*—The use of the lever and the pick, the former in moving large obstacles, such as stones, and the latter for perforating and raising up hard soils or subsoils, may be considered as preparatory operations for the more perfect pulverization and mixture of the soil by digging. Previous to performing this operation, if the surface is uneven, it should be levelled; but as we are treating of garden digging, we shall suppose that the surface is already in a fit state to be dug. The first step is to fix on those parts of the plot where the operation is to commence and finish; which being done, a trench is to be opened at the former place, and the earth wheeled or carried to the latter. In most gardens where there is to be a regular course of cropping, the compartments are rectangular, and these are easily divided into smaller figures of the same kind for temporary purposes, the number of which divisions, with a view to digging or trenching, for reasons which will presently appear, must always be even. For example, a piece of ground of a square form, fig. 159, *a, b, c, d*, may be thrown into two parallelograms, *a, f*, and *e, d*, and the soil taken from the trench opened from *a* to *e* can be laid down from *e* to *b*, where the operation will be finished. Had the plot been divided into three parallelograms, as in fig. 160, the soil must have been removed from *g* to *h*, which would

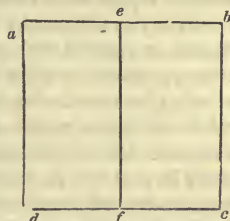

Fig. 159. A plot of ground properly marked off for digging or trenching.

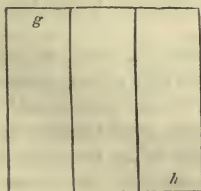

Fig. 160. A plot of ground disadvantageously marked off for digging or trenching.

have more than doubled the labour of wheeling. A fourfold division would not, however, have been liable to the same objection, which confirms the rule, that the division ought always to be into equal numbers. Where a plot is circular or oval it may be divided into zones, and an irregular plot may be thrown into figures approaching as near as may be to regularity. In digging for pulverization and mixture, the surface is reversed by the operator, and broken at the same time, so that a new surface is exposed to the air. When a crop is to be sown or planted, this surface is broken more or less fine according to the kind of crop, and in very dry weather in summer, it is sometimes raked smooth as the digging proceeds, to lessen the evaporation of moisture. When the ground is not to be immediately cropped, it is commonly "rough dug," that is, laid up in unbroken spitsfuls, so as to present as large a surface as possible to the action of the weather; and afterwards, when a crop is to be intro-

duced on ground which has been "rough dug," it is "pointed," or slightly dug and smoothed on the surface. "Double digging" is in horticulture what subsoil ploughing is in agriculture; the surface soil is kept on the surface, but the bottom of the trench is dug over as the work proceeds, and the soil turned over, but still kept in the bottom of the trench. By many this is called "bastard trenching." "Baulk digging" is an operation for rapidly exposing a large surface to the atmosphere, and consists in taking out a line of spitfuls and laying them on a line of firm ground, so that only half the ground is moved. It is only used where economy is a main object, and where the soil being tenacious, will be much benefited by exposing a large surface to the frost. When soil, compost, or manure is to be dug in, it is previously distributed over the ground in heaps, by the aid of the wheelbarrow, and spread over the surface in moderate portions at a time, if loss will be sustained by evaporation; but if soil, such as sand or burnt clay, or a compost of lime and earth, is to be dug in, the whole may be spread over the soil at once; as the drier it becomes before being dug in, the better it will mix with the soil (*see* 172). In every description of digging the trench should be in a straight direction, from one side of the plot to the other, and equally wide throughout; or if curved, the same curvature should be maintained throughout; for if the trench is increased in length, it becomes lessened in capacity, and the soil can neither be moved to the proper depth, nor sufficiently mixed. It is unnecessary to repeat what we have introduced as a general rule, *viz.*, that digging ought never, if possible, to be performed when the soil is wet, or the surface frozen, or covered with snow or ice; but it may be proper to add, that small stones or roots, or other rough porous bodies, ought seldom to be picked out of soils; because the former retain moisture, and tend to consolidate light soils; while the latter retain air, and have a tendency to lighten such as are too compact. Hence the practice occasionally resorted to, of mixing pieces of freestone in peat soil, in which heaths are grown; and of digging in sawdust, spent-tan, or decayed branches and spray chopped up, in strong clays. Stones also having a greater capacity for heat than soil, form a source of that element, when the soil has been cooled by rain or other means. When stones lie on the surface of the soil they absorb more heat during the day than the soil will do, and give out more during the night, till they become of a lower temperature than the atmosphere, when dew is deposited on them, and hence they become a source of moisture as well as of heat.

534. *Trenching.*—The object of trenching is to increase the depth of soil fit for plants, by which means it becomes a larger reservoir of air, moisture, and of manure, and in the case of plants which do not permanently occupy the soil, it admits of entirely changing the surface, so as to bring up fresh soil every time the ground is trenched. The plot to be trenched is marked out by a line, exactly in the same manner as in digging; but instead of a narrow furrow which suffices for that operation, a trench at least as broad as the depth to which the ground is to be moved, say from two to three feet, is marked off and opened, the soil being wheeled to the place of finishing, as in digging. The next point to determine is, whether the whole of the soil to be moved is to be equally mixed together; whether the subsoil only is to be mixed, and the surface soil still kept on the surface; or whether the surface is to be laid in the bottom of the trench, and the subsoil laid on the top.

535. *In trenching ground that is to be cropped with culinary vegetables for*

the first time, the whole of the soil turned over should be equally mixed together, manure or compost being added and incorporated at the same time. When the ground of a kitchen garden has been originally trenched in this manner to the depth of three feet, a fresh surface may be exposed for cropping every year, by the following practice, recommended by Mr. Nicol:—"Take three crops off the first surface, then trench three spits deep, by which the bottom and top are reversed, and the middle remains in the middle; take three crops off this surface, and then trench two spits, by which the top becomes the middle, and the middle the top; and take also three crops off this surface, and then trench three spits, by which that which was last the middle, and now top, becomes the bottom, and that which is now the bottom, and was the surface at first, now becomes surface again, after having rested six years. Proceed in this manner alternately, the one time trenching two spits, and the other three; by which means the surface will always be changed, and will rest six years and produce three." (*Nicol's Scotch Gardener*, 2d edit., p. 202.)

536. *In the operation of trenching*, when the object is to reverse the surface, the firm soil is loosened, lifted, and thrown into the trench in strata, which, when completed, will hold exactly the reverse positions which they did in the firm ground; but when the object is to mix the soil throughout, or when the surface soil is to be kept uppermost, the face of the surface of the moved ground must be kept in a sloping position, in order that every spittle thrown on it may be deposited in the proper place, with a view to mixture. The simplest and best mode of trenching, with a view to this object, and provided only one man is to be employed for every other object of trenching, is to line out the ground into an even number of strips of three or four feet broad; to open a trench at one end of one of the corners of the plot, and to proceed from one end to another of the strips till the whole plot has been gone over. This mode saves much wheeling of soil, and where the plot is already level, and care is taken to leave no firm ground between the strips, it is then unobjectionable. Where the spade only is used in trenching, the operator stands on the surface of the firm ground; but where the pick is rendered necessary, he for the most part stands in the bottom of the trench. "Ridge trenching" is the term applied when the surface of the moved soil, instead of being smoothed and levelled, is laid up in the form of a ridge, in order to benefit by exposure to the atmosphere. Whatever mode of trenching may be adopted, it is of great importance that the bottom of the trenches should either be level, or form one or more regularly inclined planes, in order to carry off the superfluous water of the surface soil. In a very retentive subsoil, if the bottom is trenched irregularly, the places marked *a*, *b*, *c*, in fig. 160*, would retain



Fig. 160* Section illustrative of good and bad trenching.

stagnant water injurious to the roots of trees, &c.; but if the bottom were loosened so as to form a regular slope, as from *d* to *e*, the water would gradually follow that direction.

537. *Forking soil* is simply stirring the surface with the broad-pronged fork, (fig. 34, in p. 135,) which is greatly preferable to the spade for working among the roots of growing crops. For working with litter or dung, the forks with round-pointed prongs are used; the rotundity of the prongs diminishing friction, both in inserting the fork in the dung, and in discharging the forkful.

Soil cannot be stirred with advantage by the fork when in a moist state, but littery dung may be turned during rain.

538. *Hoeing* is a mode of stirring the soil on the surface, and at the same time cutting up weeds or thinning out crops; and it is effected either by the draw hoe or the thrust hoe. Soil is also drawn up to, or taken away from, plants; and drills, or narrow furrows, are drawn by the former tool, of which there are several kinds, more or less adapted for these different purposes. In no kind of draw hoe should the plane of the blade form a right angle with the handle, as at *a*, in fig. 161; but it should always be within a right angle,

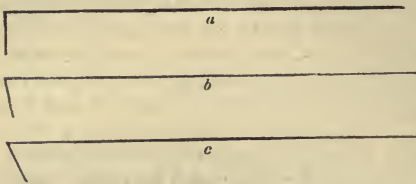

Fig. 161. Diagrams showing the angle which the blades of draw hoes ought to make with the handles.

more or less, as at *b* or *c*. If the ground be soft the angle should be more acute than when it is hard, or when its surface is much matted with weeds. This variable angle should be provided for, partly in the formation of the eye or socket of the hoe, and partly by the application of a small wedge, the heel

of which should be turned up, like those used for scythe-handles, in order that it may be driven out at pleasure. In short, the angle which the handle forms with the blade should be such, that when the latter is inserted in the soil to the required depth, the blade, in being drawn towards the operator, may retain that depth with the least possible exertion to his muscles in guiding it; for whatever muscular exertion is required in this way, beyond what is necessary for overcoming the resistance of the soil, is a waste of power. When the blade is properly set, little more is necessary than simply drawing the tool; but if badly set, it requires pressing down, or raising up, as well as drawing; or, in order to keep the blade in a proper cutting direction, one of the arms of the operator must be elevated or depressed out of its most effective position, which is, when the hands are never much below or above the centre of his body. The handle of the draw hoe should be held in such a position by the operator, as that the plane of the blade should coincide with the plane with which it cuts the soil to the proper depth, and with the least exertion of bodily labour; and this plane will generally be found to be at some angle between 50° and 65° with the horizon. For this reason the handle of a hoe ought to be considerably shorter for a short person, or for a person stooping, than for one who is taller, or works in an upright posture; or, in

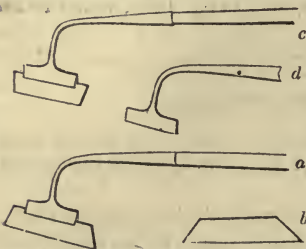

Fig. 162. The Leicestershire or shifting-blade draw hoe.

lieu of this, the short person should hold the handle nearer to the blade. For the purpose of cutting weeds, or thinning out crops in light sandy soil, a hoe with a broad blade may be used; and of these the best that we know is the Leicestershire or shifting-blade hoe, the blades of which are pieces of the blade of an old scythe. This hoe is shown in fig. 162, in which *d* is the head, consisting of a socket for the blade, and a tubular socket or hose for the handle, without the blade; *b*, one of the blades not inserted in the socket; *c*, the socket with the kind of blade

inserted which is used for general purposes, and more especially for hoeing between rows of drilled crops; and *a*, a socket with the blade *b* inserted, which is used chiefly for thinning turnips.—(See farther details of this hoe in *Gard. Mag.* for 1841, p. 311.) For working in strong soil, a hoe with a narrow stout blade is required; and for very stiff soil, the Spanish hoe (fig. 21, in p. 132) is the best tool. For hoeing, with a view to cut weeds, the different descriptions of thrust-hoes are the most effective tools, especially among tall plants, but they are not calculated for stirring the soil to any depth. A thrust-hoe with a shifting blade, like the Leicestershire draw-hoe, would doubtless be a valuable implement.

539. *Raking* is an operation used for separating the surface of soil from stones, roots, and other extraneous matters; for rendering even dug surfaces or gravel; for covering seeds; for collecting weeds, leaves, or mown grass; and, in general, for smoothing, covering, and collecting. The teeth of the rake are placed at nearly a right angle to the bar to which they are riveted, and somewhat bent towards the handle, so that when the operator keeps the handle at an angle of 45°, the teeth will pass through the soil at nearly that angle, and consequently penetrate to nearly the whole length. The teeth of iron rakes should be made with a small shoulder, neatly formed, so as to rest flatly against the under side of the bar in which they are riveted. The holes made in this bar for their reception should be widened below to admit

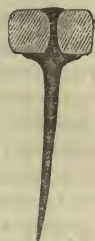

Fig. 163. Section of the head of a garden-rake, showing how the teeth should be inserted in it.

a thickening next the shoulder of the tooth, as shown in fig. 163, for there the stress lies, and there, in nine cases out of ten, the breakage occurs in the teeth. The rest of the perforation should be narrow, in order not to weaken the head-bar, a slight countersink only being required for the rivet or clench on the upper side. The neck of the tooth is exposed to a force, tending to bend or fracture it across; but when once the neck is secured, the remaining part which passes through the head-bar has only a longitudinal tension. The two principal uses of raking are to prepare the soil for receiving seeds, and to render clean and even, surfaces among plants which have been recently hoed to destroy weeds.

Raking is the operation which gives the finish to most others that are performed on the soil, and without which, and the besom, no garden could be kept in high order. One of the most common purposes to which raking is applied, is covering small seeds sown broad-cast; and this operation requires more care and skill in the operator, than any other which is performed with the rake. If the ground has been raked previously to sowing the seeds, its surface will be ribbed or covered with very small furrows left by the teeth of the rake, at regular distances and of uniform depth: the seed being scattered evenly over the surface, will fall one-half in the furrows, and one-half on the small ridges between them: if in raking afterwards the teeth of the rake could be made to split the ridges between the furrows and do nothing more, the seed would be perfectly and equally covered; but owing to various causes, and principally to the unavoidable treading of the soil by the feet of the operator, it is next to impossible to effect this; and in consequence of more raking being required in the hard and depressed places than in the soft ones, as well to loosen the soil as to raise it to the proper level, the seed there becomes too deeply covered; and a part being drawn from the places from

whence the extra covering is taken, the seedling plants rise very irregularly. There are various modes of preventing this from taking place, the more common of which, when the surface of the soil is dry, is to "tread in" the seed by going over the plot with a kind of shuffling movement, holding the feet close together. Another mode is to roll the ground with a roller, more or less heavy according to the nature of the soil; and a third is to form the ground into beds with narrow paths between, and to cover the seed with soil taken out of these paths. Perhaps the best of these modes for general purposes and on a large scale, is treading in, or rolling in, which is preferable to treading; because raking in alone, if the soil is very dry and loose, even though the seeds should be covered equally, will admit the access of air and light to many of them in a greater degree than is favourable for germination (See *Sowing*, 552.) In raking off weeds, and in raking off short grass or leaves, the rake requires to be held in such a position as that the teeth shall form a much more acute angle with the horizon than in raking dug soil; because the object in raking off grass or leaves is not to stir the soil, but merely to remove what is on its surface. All raking, excepting that of gravel, and newly mown grass, should be performed in dry weather. Wet weather is the most favourable for raking gravel, because if stirred in a wet state, and rolled afterwards when dry on the surface, it binds better; and wet weather is most suitable for raking grass, because the leaves when wet adhere better together than when dry.

540. *Rolling* is applied to walks to render their surface smooth, firm, and impervious to rain, and it is always most effective when the gravel is moist below and moderately dry above. When dry gravel is laid over the bottom of a walk that is in a very wet or puddled state, rolling should not be attempted till the whole is uniformly saturated, either by rain, which is preferable, or artificially; otherwise it will long remain unconsolidated. Grass lawns are also rolled to render the surface of the soil smooth and even, for which purpose they are previously raked or scraped to destroy such inequalities as are produced by worm casts, or other accumulations that would interfere with the scythe, the uniform pressure of the roller, or the uniform smoothness and colour of the lawn. The scraping and raking are best performed in dry weather, and the rolling as soon after rain as the surface has become somewhat dry. Rolling dug grounds in order to break and reduce a cloddy surface, or to press in and cover newly sown seeds, can only be performed to advantage when both soil and weather are dry. *Beating*, which in many cases effects the same object as rolling, is also most effective when the body of the soil is moist and the surface dry; and the same may be said of *Ramming*, and of every other mode of consolidating soils, turf, or gravel.

541. *Screening or lifting* soil or gravel is best performed when these materials are dry; but excepting for sowing seeds, or planting very small or tender plants or cuttings, sifted soil is seldom wanted, it being found that pieces of turf, roots, and stones in soil are useful to plants, as forming vacuities for air, or for accumulations of decaying vegetable matter; or, more especially in the case of freestone, sources of moisture.

542. *Other labours on the soil* are either not peculiar to horticulture, such as picking, shovelling, sweeping, inserting stakes by perforators (391); or they are peculiar to particular departments of gardening, such as cuffing, which is a nursery labour, forming loam edgings, which is a local practice, &c.

SUBJECT. 2.—*Garden Labours with Plants.*

543. *Garden labours with plants* may be reduced to sowing, cutting, clipping, mowing, and weeding; all of which may be performed at most seasons, and during moist weather as well as dry. In the first three of these labours, it must be borne in mind that growing trees and large shrubs should not be deprived of their branches when the sap is rising in spring, on account of the loss of that fluid which would be sustained at that season; that wounds can only be healed over when made close to a bud or shoot; and that the healing process proceeds from the alburnum and cambium, and not from the bark. For the operations of weeding and mowing with the scythe, wet weather is preferable to dry; but the grass requires to be dry when the mowing machine is employed. Clipping may be performed in wet weather.

544. *Sawing* is the most convenient mode of separating large branches, because it effects the separation with less labour than cutting with the axe or the bill, and also with less waste of wood. In sawing off large branches, whether close to the trunk, or at a distance from it, it is advisable to cut a notch in the under side of the branch, or to enter the saw for a few inches in depth there, and in the same plane with the proposed saw cut, in order to prevent the bark from being torn down when the branch is sawn through and drops off. It is also advisable to smooth over the section with a chisel or knife, in order that it may not retain moisture; and to cover the entire wound with a cataplasm of some sort, or with putty, or with paint, in order to exclude the air, and by that means to facilitate the process of healing.

545. *Cutting* and sawing are essentially the same operation; for the common saw is formed of a series of wedges cut in the edge of a thin plate of steel, and the knife only differs in having these wedges so small and so close together as not to be perceptible to the naked eye; the asperities produced in the edge of the knife by sharpening, acting in the same manner as the teeth of the saw. The blade of the knife thus becomes a sawing wedge. When a wedge is entered and equally resisted on both sides of the body separated, they are equally fractured; but when it is so entered that the resistance is more on one side than on the other, the fracture will be greatest on that side which offers the least resistance. On these facts are founded the operation of cutting living plants, whether with the axe, the bill, the chisel, or the knife. As in cutting living plants a smooth unbruised section will less interfere with the vital energies of the plant, and consequently will be more easily healed over than a rough one; hence, in all cutting or amputating, the rough or fractured section ought to be on the part amputated. In separating a branch, or cutting through a stem, with an axe, bill, or chisel, the operation is effected by the obliquity of the strokes of the instrument to the direction of the body to be cut through, and with a knife by drawing it more or less obliquely across the shoot; but principally by the non-resistance offered by the part of the shoot to be cut off. Hence, all shoots cut from living plants ought to have the cut made in an outward direction from the stem or root of the plant; because if the reverse of this practice were adopted, as is sometimes done in plashing hedges, the fractured section would be left on the plant. Every cut made in a living plant ought to be sufficiently near a bud or a shoot to be healed over by its influence, and the section made should never be more oblique than is necessary to secure its soundness and smoothness. In general,

therefore, the separation of all branches from living plants ought to be made by cutting or sawing across at very nearly a right angle to the direction of the stem, or branch, in order that it may be the more rapidly healed over. When due attention is not paid to this rule, and the cut is made very obliquely to the line of the shoot, a wedgelike stump is left protruding beyond the bud or branch as in fig. 164, *a*, which never can be

healed over, and which, consequently, soon decays, and disfigures and injures the tree, by retaining water and bringing on the rot; but when the cut is made not more than the thickness of the branch above the bud or shoot, and nearly directly across as at *b*, the wound is healed over completely and in the shortest possible time. It must be observed, however, that the distance of the cut above the bud must depend in a great measure on the porosity of the

wood of the shoot, and the proportion of its diameter which is occupied by the pith; for if the raspberry and the vine were cut close above the bud, the shoot would dry up beyond the bud, and prevent it from developing itself. Hence, in all such cases, and even sometimes in common fruit-trees, it is customary to make the first cut an inch or more above the bud; and when the shoot has grown and produced two or three perfect leaves, to cut off the remaining stump. This would be the best mode in every case, but as it occasions double labour, the risk of its not being attended to induces most persons to cut near to the bud at once. For the pruning of all branches, or the cutting over of all stems under two inches in diameter, the pruning shears which cut nearly directly across, and of which there are different sizes for branches of different degrees of thickness, are greatly to be preferred to the knife, bill, or axe. (See fig. 47, p. 139.)

546. *Clipping* in gardening is chiefly applied to hedges, and to the edgings of walks or beds, when composed of dwarf box or under shrubs. The common hedge shears differ from the pruning shears in crushing the shoot which is clipped, on both sides of the section (see p. 139), and hence clipping is not a desirable mode of pruning plants in general; nor from the want of mechanical power are the common hedge shears applicable to any shoots, except those of one, or at most two years' growth. In clipping box or other edgings which are in a straight direction, a line is generally stretched close alongside the box at the height to which it is to be clipped. The top of the edging is then clipped down to the proper height, after which the line is taken up, and stretched along the centre of the top of the edging; and the width of the top being determined on, the sides are cut accordingly, leaving the edging somewhat wider at the bottom than at the top. The height and width of edgings vary according to the width of the walks, or beds, and the taste of the gardener; two inches wide and three inches high are ordinary proportions; but some gardeners prefer having their edgings smaller, as less likely to harbour vermin. The ordinary time for clipping edgings is the spring; before the shoots of the season are made; but many gardeners prefer waiting till the shoots have been completed, and clip in June, after which the plants put out one or two leaves at the points of most of the shoots, which thus obliterate the marks of the shears on the other leaves. With box this appears to be decidedly the best mode. Where lines of edgings are not straight, they are of course clipped by the eye

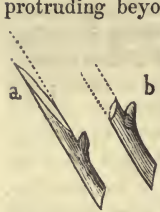

Fig. 164. *a*, shoot improperly cut; *b* a branch cut properly.

without the application of the line ; a matter of no difficulty to an expert operator.

547. *Clipping hedges* is generally performed by the eye without the aid of the line ; but in the case of architectural hedges in gardens laid out in the geometrical style, both the line and the plummet are occasionally resorted to, to prove the exactness of the work. In the case of lofty hedges, for example, the beech and hornbeam hedges at Bramham Park, Yorkshire, and the holly hedge at Moredun, near Edinburgh, scaffolding is requisite, and this is adjusted to different heights ; the operation of clipping commencing at the bottom of the hedge, and being continued upwards in successive breadths, much in the same way that mowing is performed by several men following one another at regular distances. Hedges are generally clipped in the summer season ; immediately after the growth of the year has been completed. In some parts of the country instead of the hedge-shears, (fig. 46, in p. 139) the hedge-bill (fig. 42, in p. 138) is used. In this case, the ends of the shoots which form the surface of the hedge are not bruised as in clipping ; and hence they are not liable to rot, or to produce an exuberance of small shoots, which, from the greater stimulus, are always more abundant from a fractured section, than from one cut smoothly over. That this result will take place is known to every cottager who has been in the habit of splitting the upper ends of the stumps or stems from which cabbages or other kale have been cut, in order to induce them to throw out sprouts. The width of a hedge at the base need seldom exceed two feet in gardens ; but where a strong fence is required, or where the height exceeds twelve or fifteen feet, three feet in width at least, will be required at the base ; for the closest and best clothed hedges are found to be those whose section forms the sides and base of a pyramid. If the sides are perpendicular the hedge sometimes gets naked at the bottom ; but if is wider at top than at bottom, no art will prevent it from getting every year more naked, till, at last, plashing, or otherwise securing the gaps, must be resorted to, and then its beauty as a live fence is gone. Another advantage is gained by sloping the sides of hedges, and that is, in respect of keeping them clean ; for when so cut the twigs at bottom, sharing in the dews and light, thrive and grow so close to the ground that few weeds can rise below them. Again, in fields, the uniformity of surface which can be maintained with ease in hedges cut on the sloping principle, prevents animals from readily attempting to leap or make a breach in them. If they observe the appearance of a breach they make towards it, and, crowding together at the spot, the foremost is "put to the horn," if he attempts to turn away. Of two evils he finds it perhaps the best alternative to dash forward through the hedge, leaving an easier passage for those behind him ; some of them being hurried after him by force, and others by a sort of instinct. If a stone fence is built of a uniform height, a hare will not readily leap over it of her own accord ; but if the wall be heightened excepting in some places, the hare will attempt these apparently more easy places without hesitation, and certainly without being aware that those places are not in reality lower than they were formerly.

548. *Mowing*, like cutting, may be described as a species of sawing ; and it is perhaps the most laborious work which the gardener is called on to perform ; every muscle of the human frame being by this kind of labour

called into severe action. In mowing corn or long grass, the blade of the scythe may be moved along in a direction in which the plane of the blade forms an acute angle with the surface of the ground; but in mowing short grass, the blade requires to be kept parallel to the surface, and, when the grass is kept very short, even to be pressed against it. The motion requires to be rapid and uniform, and the edge of the scythe to be kept very sharp by the frequent use of the whetstone. In the case of mowing lawns which contain scattered trees and shrubs without any dug space round them, the use of the grass-shears is required to cut the grass which comes in contact with the stems and branches. (416 and 417.) Mowing is chiefly used in lawns and pleasure-grounds, to keep the surfaces of grass short, smooth, and green; but it is also employed to destroy weeds on grassy surfaces, and at the bottom of pieces of water, by cutting them over, as soon as they have advanced an inch or two in height in the spring, and repeating the operation, with every trifling increase of growth during the season, and every succeeding one, till the roots cease to have the power of throwing up leaves. The scythe for mowing at the bottom of water ought to have an iron handle, in order that it may pass more readily through the water from its small diameter, and sink readily from its weight; and it must not be forgotten that the time at which weeds must be mown is not when they are an inch or two above the surface of the water, but every time that they are an inch or two above the bottom of the pond or river. In mowing lawns, the mowing machine (442.) is often used on a large scale; and the common hedge-shears on a small scale for shortening the grass at the roots of shrubs or trees, which the mowing machine or scythe cannot conveniently reach.

549. *Weeding* is simply the pulling up of weeds, or any plants that are out of place; and it is generally effected by the hand, more or less aided by weeding implements of the different kinds before described (400); to which we may add, the Guernsey weeding prong (described in the *Gardener's Chronicle*, vol. i. p. 66), which appears well adapted for preventing stooping, and the touching the weeds and grubbing in the soil with the fingers. The head of this implement (fig. 165), is in the shape of a claw hammer; with the one end flattened into a chisel, an inch wide, and the forked or clawed end, consisting of two flat sharp prongs by which the weeds are grubbed up and lifted at the same

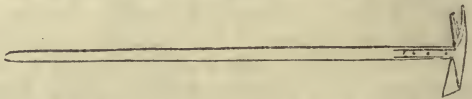

time. The length of the head from the extremity of the chisel end to that of the prong end is nine inches, and it is attached to a handle five feet long. A great part of the labour of weeding may in most gardens be performed by women and children; and it will not only be lightened, but their hands will be kept clean, by the adoption of the Guernsey prong.

550. *Other labours with plants* might be enumerated, but they are either such as are common to arboriculture, agriculture, and other arts, or belong more properly to garden operations. We may, however, here notice splitting the stocks or roots of trees; as, though it belongs properly to the forester, it is yet a labour which a gardener may have occasionally to practise. It is effected by entering a wedge always more or less in the direction of the fibres of the wood. This wedge must be struck with a heavy iron hammer, with a

sufficient force to overcome the inertia of the mass constituting the wedge. With a heavy wedge and a light hammer no effect will be produced; because the impulse of the latter has not sufficient power to overcome the inertia of the former.

SECT. II.—*Operations of Culture.*

Operations of garden culture may be arranged under the heads of propagation, rearing, preservation, and amelioration.

SUBJECT. I.—*Propagation.*

551. *Plants are propagated* either by seed, or by division: the latter mode including cuttings, joints, leaves, layers, suckers, slips, budding, grafting, and inarching. All the modes of propagation by division are founded on the principle—that a bud, whether visible or latent, is essentially the same as a seed, and will consequently produce a plant; and that, as there is a bud, either visible or in an embryo state, in the axil of every leaf, it follows that for every leaf a plant contains, a young plant may be originated by art. This, however, is not done with equal ease in every species, and perhaps with some it may be almost impracticable; but it holds good with the great majority of plants, and may therefore safely be laid down and acted on as a general principle (12, 114 to 116). There is an important difference between propagating by seed, and propagating by any of the other modes known to gardeners: viz., that in propagating by seed, the species in the abstract is propagated, while in propagating by any of the other modes, the species is continued with the habits of the individual parent. Thus, a shoot taken from a weeping ash, and grafted on a common ash, will produce a tree like the parent; while a seed taken from a weeping ash will not in general produce a weeping plant, but an upright growing one like the species. Nevertheless this does not always hold good, even in such trees as the weeping ash, and the weeping oak; and it does not hold good at all in the case of trees in a high state of culture, such as fruit trees; or in the case of herbaceous plants in a highly artificial state, such as the culinary vegetables of our gardens, and the principal agricultural plants of our farms. The weeping ash was an accidental sport (16); but notwithstanding this, out of many hundred plants raised from seed collected from a weeping tree by a nurseryman at Berlin, one or two were found to exhibit the weeping characters of the parent; and when we consider that all the common weeping ash trees in Europe have been propagated from one tree, that at Gamblingay, in Cambridgeshire, and that this tree is a female, so that the blossoms, when fertile seeds have been produced must have been fecundated by the male blossoms of some adjoining common ash, the small proportion of weeping plants raised is not surprising. The acorns produced by a celebrated weeping oak at Moccas Court, in Herefordshire, produce plants almost all of which have the branches drooping, though this tree is not farther removed from nature than the weeping ash, both having been found accidentally in a wild state. The stones of a green-gage plum, and the seeds of a golden pippin apple, will unquestionably produce plants, many of which will bear varieties of the green-gage and golden pippin; and though these may vary from the fruit of their parents, yet they will not vary more than the produce of a wilding, such as a crab apple, or a wild plum, will sometimes do from its parent.

The seeds of the cultivated varieties of cabbage, peas, wheat, oats, &c. it is well known, produce plants in all respects like their parents, or in horticultural language "come true." The seeds of trees, however, are not so much to be depended on, as those of herbaceous plants, and especially of annuals, in a high state of culture; for a kernel out of the same apple which produced the Ribstone pippin produced another tree, the fruit of which proved little better than a crab. From these facts we consider it safe for the gardener to adopt it as a principle, that the seeds of trees, as well as of herbaceous plants, will not only reproduce the species, but, to a considerable extent, also the variety; though we cannot depend on this mode for reproducing the variety, with the same certainty as we can on propagation by division.

§ 1. *On propagation by seed.*

552. *The seed* as we have seen (132), is of a mucilaginous consistency when young, and it becomes more or less solid when matured. Before germination can take place, the solid part of the seed must be rendered again mucilaginous, and soluble in water; and this is effected by the moisture and heat of the soil, and the oxygen of the atmosphere. The absence of light, or at least, of much light, is also favourable to germination, but not essential to it; for though, when seeds are sown, they are generally covered in proportion to their size, in order to maintain an equal degree of moisture, and to keep them in darkness, we also sow the smaller seeds, such as those of ferns and heaths, on the surface, and maintain the requisite moisture by means of a close covering of glass, only moderating the light by placing them in the shade. That the want of moisture prevents the germination of seeds, though every other requisite should be present, is known to every gardener; and indeed, were it otherwise, it would be next to impossible to preserve seeds from one season to another, since, though it is in our power to keep them dry, it is scarcely practicable to prevent the access of air and heat. That the want of air has an effect in preventing the germination of seeds is proved by the following experiment. If a number of seeds be put in a bottle with from ten to twenty times their bulk of water, and all communication with the surrounding atmosphere be cut off, so that the water may not absorb any oxygen from it, the seeds will not germinate, though placed in a temperature suitable for germination; but if the same experiment be repeated with a proportionately larger quantity of water, the seeds will find in the air which it contains sufficient oxygen to enable them to germinate. (*Gard. Mag. for 1841, p. 482*). That seeds will not germinate without the presence of a certain degree of heat, is rendered evident by the fact of self-sown seeds lying in the soil all the winter, and only vegetating when the temperature becomes sufficiently high in the spring.

553. *Process of germination.* The first change which takes place in the germinating seed is seen immediately after the absorption of water, when its substance becomes softer, often assumes a greenish tint, and tastes sweetish. After this a lengthening of the radicle takes place, which receives its nourishment from the cotyledons, or the albumen. It then penetrates the testa or husk, through the micropylus or hilum, (a very small hole in the husk of the seed, which corresponds with the point of the radicle,) and ruptures it at this spot, so that the embryo now bursts forth. The young plant is then nourished by the aliment laid up in the cotyledons, or in the albumen of the seed, till the root begins to branch. Hence, it

often happens, that when the cotyledons are fleshy, and are destroyed by insects or otherwise, the young plants are irretrievably lost. As soon as the testa or husk becomes soft and tender, the seed absorbs the surrounding moisture, and generally germinates very quickly, if it be not too old. If the husk be, on the contrary, hard, or, as in many cases, stony, the moisture penetrates only through the micropylus, and is communicated to the feculent part by the root. In these cases the seeds lie sometimes very long in the ground without germinating; the absorption of moisture going on, in general, too slowly to effect a quick and strong development, which is absolutely necessary to burst those firm husks or shells which are bound together, as it were, by sutures. These seeds are often lost when they lie for many years; and, to make sure of their germination, artificial means should be applied. To cause a rapid germination of the seeds of the acacia, soaking them in boiling water has been applied of late years with success; but, in general, this is a very unsafe means, and may do more injury than good. The safest and best way is to cut or file the hard shell, which it is only necessary to penetrate at one spot to the albumen or cotyledons. From this spot the seed imbibes the requisite quantity of air and moisture, the radicle is quickly developed, and, with the help of the swollen tissue within it, bursts the sutures of the husk. In this way many hard-shelled seeds of monocotyledonous and dicotyledonous plants, such as *cánna*, *pæônia*, *acácia*, *àbrus*, *erythrina*, *cássia*, *schòtia*, *guilandina*, *adenanthèra*, *bauhinia*, and *cæsalpínia*, have been made to germinate in a short time, mostly in from ten to twenty days. If the seeds be old, they should, after cutting, be laid for a few days in lukewarm rain-water, and, if they have any life remaining, this will stimulate it. Something similar also takes place with seeds which, besides the testa, or husk, are also enclosed in a pericarpium, or outer-covering. They lie either in fours, at the bottom of a dry hollow cup, as in the *labiàtæ* and *boragíneæ*; or they are single, or several, surrounded with a thick fleshy cup, as in many species of the *rosàcææ*; or single, or in twos, covered with a dry cup, as in *compósitæ*, *umbellíferæ*, and their allied species. Lastly, in the *gramíneæ*, we find them only surrounded with the pericarpium, as true *caryopsi*. Many of these germinate as easily as naked seeds; but this depends, in some measure, on the capacity or incapacity of the husk to absorb water in a natural state. We find seeds hard and stony only among the *rosàcææ*, as in *ròsa*, *prùnus*, *cotoneáster*, *méspilus*, *cratægus*, &c., and these require cutting or filing, if intended to germinate quickly. The remainder are divided, according to their formation, into two groups; those possessing albumen, in which the embryo lies, and those that do not. This division is useful, for the cotyledons always imbibe the water first and easiest, whereas the albumen is less hygroscopic; and hence the germination of those seeds which have none, but whose interior is entirely filled with the embryo and its cotyledons, as in the *boragíneæ*, *labiàtæ*, *compósitæ*, &c., will be more easily effected. The *gramíneæ* and *umbellíferæ*, on the contrary, possess albumen: in the former, the embryo lies outside of the albumen, on which account they easily germinate; whereas, in the latter, the embryo is entirely surrounded by the albumen, for which reason, with the exception of most of the annual or biennial sorts, they are more difficult to vegetate. As these seeds cannot be cut with advantage, it is usual to sow them late in autumn, with other difficult-growing sorts; so that when the universal period of germination comes, in the spring, they may be sufficiently pene-

trated with moisture. This method is very well suited for sowing on a large scale; but as the seed often perishes during the winter, and the earth becomes soddened, or thickly covered with moss, the preferable way for valuable seeds which are to be raised in the open air, is to sow them in the spring, after they have been soaked for some days previously in warm water (*Regel in Gard. Mag. for 1841, p. 485*). Seeds that are to be raised under glass, with the aid of artificial heat, may be sown at any time.

554. *The period necessary to complete the process of germination varies in different seeds, though all attendant circumstances may be alike. The grasses generally vegetate most rapidly, and they are quickly followed by some of the cruciferous and leguminous plants; umbelliferous plants are generally slower, and rosaceous plants still more so. Adanson gives the following table of the period of germination in several seeds tried by himself in France.*

	Days.		Days.
Wheat, millet	1	Purslane	9
Strawberry blite, beans, mustard, kidney beans, turnips, radishes, and rocket.	3	Cabbage	10
Lettuce, and aniseed	4	Hyssop	30
Melon, cucumber, gourd, and cress	5	Parsley	40 or 50
Horse radish, leek	6	Cow-wheat, almond, chestnut, peach, and peony	One Year
Barley	7	Rose, hawthorn, hazel, nut and cornel	Two Years
Orache	8		

(*Fam. des Plantes, vol. I. p. 84.*)—The same author found that the seeds which germinated in twelve hours in an ordinary degree of heat, might be made to germinate in three hours by exposing them to a greater degree of heat; and that seeds transported from the climate of Paris to that of Senegal, have their periods of germination accelerated from one to three days. On the same principle seeds transported from a warmer to a colder climate have their period of germination protracted till the temperature of the latter is raised to that of the former. The seeds of annuals generally germinate quicker and with more certainty than those of perennial plants; and they generally retain their power of germination much longer.

555. *The quantity of moisture most favourable to germination must depend on various circumstances, such as the degree of heat with which it is accompanied, the vital power of the seed, and the nature of the species. The seeds of aquatic plants vegetate when immersed in water, and the plants live, and attain maturity in that element; but those of land plants, though they will vegetate in water, yet if the plants be not removed immediately after germination, they will become putrid and die. In general, the most favourable degree of moisture for newly sown seeds, is that which a free soil holds in its interstices. Clayey soil will retain too much moisture for delicate seeds, and sand too little; but an open free loam will attract and retain the proper quantity for all seeds, excepting those which are very small and very delicate; and for these a mixture of peat, loam, and fine sand, will retain just moisture enough, and no more. With all delicate seeds it is better rather to have too little moisture than too much; and with all seeds whatever, it is of great importance to preserve the degree of moisture uniform. For this purpose, in the open garden, newly sown delicate seeds are shaded or covered by different means, such as sowing them on the north sides of hedges or walls, interposing hurdles placed upright or horizontally, between the sown seeds and the sun, covering with mats, or branches, or litter, or, in the case of very small*

seeds, with moss. The more tender kinds are also sown in frames, or under hand or bell glasses, by which evaporation is prevented or checked, and a steady degree of moisture effectually maintained.

556. *The water requisite to cause old seeds to germinate* should be more gradually given to them, than that given to vigorous young seeds; because the power of absorbing water in old seeds is not diminished in the same proportion as their power of decomposing it. When old seeds are placed in moist soil, they are consequently very liable to rot; more especially, if the temperature be not somewhat higher than new seeds of the same species usually require. Hence, old seeds should be sown in a much drier soil than new seeds, and should be supplied with water much more sparingly, or left to absorb it from the atmosphere. Very old seeds will, however, sometimes germinate quickly by being steeped for some days in warm water; and M. Regel mentions an instance of this, with regard to some very old seeds of *Umbelliferae*. In the botanic garden at Bonn, in the spring of 1838, four pans were sown with seeds, full ten years old, of *Férula tingitana*, L., in which the embryo seemed entirely dried up, and only those in two of the pans were previously soaked. The latter sprang up all together in from ten to twenty days, while of those in the other pans, which were left for trial, only a few plants came up in one pan in the spring of the following year, the rest of the seed having all rotted.—(*Gard. Mag.* for 1841, p. 485.)

557. *The depth to which a seed is buried in the soil* has, for its chief object, the maintenance of a due degree of moisture, but another purpose is to exclude the light, and to give the future plant a better hold of the ground; though there is no seed whatever that will not vegetate on the surface, if that surface be kept uniformly moist and shaded. It may be assumed that every seed will vegetate and establish itself in the soil, if buried to its own thickness; but the experience of gardeners proves, that some large seeds, such as leguminous seeds, nuts, &c., make better plants when buried much deeper.

558. *The degree of heat most favourable for the germination of seeds* may be considered as that best adapted for the growth of the parent plants; and, hence, if the native country of any plant is known, it may be assumed that the seeds will germinate best in the temperature of the spring, or growing season of that country. Some seeds of cold climates, such as those of the common annual grass, chickweed, groundsel, &c., will germinate in a temperature little above the freezing point; but, in general, few northern plants will germinate under 40°, and the most favourable temperature for germinating Dr. Lindley states to be—for the seeds of cold countries, from 50° to 55°; for seeds of greenhouse plants, from 60 to 65°; and for seeds of the plants of the torrid zone, 70° to 80. (*Theory of Hort.*, p. 166). It may be remarked that though the seeds of warm countries will not vegetate in the temperature of cold countries, yet that the reverse of this does not hold true, as may be observed in the germination of British weeds in our stoves; but the plants thus produced, unless immediately removed to the open air, remain weak and sickly.

559. *The degree of heat which the seeds of plants will endure* has already been slightly noticed. Certain leguminous seeds, as those of some acacias, may be subjected to the boiling point for a few minutes without injury; others may be allowed to steep and cool for twenty-four hours in water heated to 200°. The seeds of *Acacia Lophantha* were subjected to boiling water for five minutes, and the plants raised from them were exhibited before

the Horticultural Society, some years ago, by Mr. Palmer of Bromley, Kent. Messrs. Edwards and Colin found that wheat, barley, and rye could germinate between 44° and 45° ; that they were killed by remaining three days in water at the temperature of 95° ; that in sand and earth, at 104° , they lived for a considerable time; but that at 113° most of them perished; and that at 122° all of them perished; but it was found that a higher temperature could be borne by these and other seeds for a shorter time. At 143° , in vapour, wheat, barley, kidney-beans, and flax retained their vitality for a quarter of an hour; in dry air these seeds sustained no injury at 167° ; but in vapour, at this temperature, they all perished. Dr. Lindley mentions the very remarkable case of the germination of the seeds of a raspberry, which had been picked from a jar of jam, and which, consequently, must have been subjected to the temperature of the boiling point of the syrup, which is 230° .

560. *The degree of cold which seeds will endure* differs according to the species, their native country, and their condition in respect to moisture. Dry seeds stand so high a degree of cold, that even the lowest temperature of the frigid zone does not injure them; but if they have imbibed any moisture they freeze according to the degree of growth which may have been excited, and the degree of cold to which they had been accustomed in their native zone.

561. *Atmospheric air*, as we have seen (102), is as necessary to the germination of seeds as moisture and heat; and this is the principal cause why seeds buried to a certain depth in the soil do not vegetate. It also affords a reason for having the surface of the soil, in which seeds are sown, porous, and exposed to the action of the atmosphere, and to rain-water, which contains more air than the water of wells. Hence the rapidity with which seeds spring up in the open ground after the first warm spring showers. Hence, also, the propriety of giving fresh air to hot-beds, and to hand and bellglasses covering sown seeds, even though they have not come up. Old seeds are found to germinate sooner in pure oxygen than in atmospheric air: doubtless, because less efforts are required by the vital powers of the seed to assimilate the oxygen with its carbon, so as to form carbonic acid.

562. *The influence of light* on the germination of seeds has been already alluded to (552). Bright light is found to be universally unfavourable; because it has a tendency to decompose carbonic acid, and fix carbon; whereas, as we have seen (553), the first step in the progress of germination is to render carbon mucilaginous and soluble in water, so to change it into carbonic acid. Light, therefore, ought to be excluded from all seeds which it is wished should germinate freely.

563. *Accelerating the germination of seeds.* In ordinary practice this is chiefly effected by the application of a higher degree of heat, as by placing pots of sown seeds in hot-beds, or by immersing seeds in tepid water, or by cutting or paring nuts, or gently fermenting them in heaps of sawdust, as is done with chestnuts, walnuts, acorns, almonds, &c., by the Paris nurserymen. On a large scale, both in the field and the garden, the most common resource is steeping in warm water for a few hours, which is found to bring up the seeds of barley, turnips, beets, parsnips, onions, &c., when the soil in which they are sown is very dry, much sooner than would otherwise be the case; this is found to prevent them from becoming a prey to insects or birds. The sowing of some seeds before they are perfectly ripe has also been found to promote their early vegetation; but the experience of gardeners in this mode of acceleration is at present very limited.

564. *Various experiments have been made to accelerate germination with different degrees of success.* These all proceed on the principle that germination cannot take place until the carbon of the seed is changed into carbonic acid; and as this can only be done by extraordinary supplies of oxygen, the agents employed are such as have the power of supplying that substance in greater abundance than water or air, from which, under ordinary circumstances, the plant obtains it by decomposition. Humboldt was the first to observe that watering with chlorine induced speedy germination; and, as, according to the observations of Göppert, iodine and bromine, in conjunction with hydrogen, produce a similar effect, it appears that both these matters, as well as the oxalic and other acids frequently applied for that purpose, hasten the process of assimilation. It cannot be denied that all these substances accelerate germination; but to the practical gardener they must be considered as experiments unfit for general practice, for the young plants thus called into existence most frequently become sickly through the excitement, and die off, which cannot surprise us, as the same effect is seen when plants of cold climates are reared too warmly, and are not placed in a cooler situation after germination. Dr. Lindley, after quoting the experiments of Mr. Otto of Berlin, who, by employing oxalic acid, made seeds germinate which were from twenty to forty years old, and the statement of Dr. Hamilton, that he had found a like advantage from the use of this acid (see the details in *Gard. Mag.*, viii., 196 and x., 368, 453), makes the following remark, applicable also to the employment of a diluted solution of chlorine, as tried by Humboldt:—Theoretically it would seem that the effects described ought to be produced, but general experience does not confirm them; and it may be conceived that the rapid abstraction of carbon, by the presence of an unnaturally large quantity of oxygen, may produce effects as injurious to the health of the seed, as the too slow destruction of carbon in consequence of the languor of the vital principle. (*Theory, &c.*, p. 174.)

565. *Electricity and alkalis as stimulants to vegetation.* "It has been ascertained," Mr. Lymburn observes, "that electricity is connected with all transformations or changes of organic substances, either as cause or effect; when electricity is present, it accelerates or causes chemical decomposition; and, according to Dr. Carpenter, when chemical decomposition takes place, electricity is always developed; though, perhaps, in most instances, it is absorbed again by the new state of the compound. M. Maltuen, in experiments made some years ago with seeds, found that they germinated much sooner at the negative or alkaline pole of a galvanic battery, than at the positive or acid pole; and, following up these discoveries by enclosing seeds in phials of alkalis and acids, he found they germinated quickly in the former, and with difficulty, or sometimes not at all, in the latter. Connected with the same subject are the recent experiments of Dr. Horner, on the differently coloured rays of the spectrum; the violet or deoxidising end produces a chemical effect, similar to the negative or alkaline pole, and the red end produces the opposite or acid effect, by the retention of the oxygen. Guided by these theoretical opinions, I was induced to try their effects on some very old spruce fir seed in 1836, which had been three years out of the cone; the year before, 1835, some of the same seed did not produce one-sixth part of a crop, and I had good reason to suppose it would be worse the next. The year before, when the seed was damped to accelerate germination, it had a musty fungous smell; and the seed leaves came up yellow, and, hanging by the ends in the

ground, had not strength to free themselves from the soil. In 1836, however, after being damped, I added quicklime in the state of powder, which, besides furnishing an alkali, has a great affinity for carbonic acid, which is necessary to be extracted from the starch before it can be made soluble, and which produces heat by concentration of the oxygen and carbon when being extracted. After the seed was thoroughly damped, I sprinkled it with the powder of lime, and kept it damp by the use of a watering-pan, for ten or twelve days; at the end of which time it had swelled off plump, and had all the sweet smell of the sugar formed in healthy seed when malted in this way: and, when deposited in the ground, it was not long in pushing up its seed leaves, as healthy, upright, and dark green in the colour, as the first year it was sown; and the seedling plants were strong and healthy. The reasons why I preferred lime were, its cheapness, and the affinity of quicklime for carbonic acid: as to its alkaline properties, soda is much more powerful, but lime seemed to be that which had produced most effect in the experiments of M. Payen and others on the same subject. The seed must be carefully kept damp till sown, as the dry powder is apt to corrode; and seeds do not suit well to have their dormant powers brought into action without being sustained, which, if far forward and severely checked, may destroy life altogether. Since I experimented as above on the spruce fir seed, I have not had any other seed so long kept to make trial of; I have, however, tried lime on magnolias and other weak-growing seeds difficult to start, and found them to germinate sooner, and make stronger plants than usual. Some others who have tried it have also found it of benefit. It is to seeds containing their albumen principally in the form of starch, that it will be of most benefit; and to those which have been hurt by long keeping dry, or being exposed to great heat: those which have been spoiled by dampness have their food decomposed and spoiled. It is difficult, also, to say how far the drying can be endured without being prejudicial, and when the organised tissue, the seat of life, may have its powers of resuming vital activity so far trenched on as to be considered dead. After this has taken place, any stimulus that can be applied can only hasten consumption, as the vital force which should preside over and direct the chemical force has fled."—(*Gard. Mag.* for 1841, p. 520.)

566. *The length of time during which seeds retain their vitality* varies exceedingly in different species; and the difference in this respect, even in the plants in common cultivation, as every seedsman knows, is very considerable. It is remarkable that the seeds of annual plants not only germinate in general quicker and with more certainty than those of perennials, but, also, that they retain their power of germination much longer. The greater part of the seeds of perennial plants and trees, when well kept, preserve their germinating powers for a long time; while certain oily seeds, like those of dictamus, magnolia, and myristica, &c., decay soon after ripening. Melon seeds have been known to retain their vitality for nearly half a century, kidney-beans for a century, and the seeds of the sensitive-plant upwards of sixty years.

567. *The length of time that seeds will lie in the ground without growing*, is not less remarkable than the difference in their retention of vitality. Many seeds, which, when sown in spring, come up soon afterwards, will not come up the same year if sown in autumn. This is the case with many common annuals, which when sown immediately after ripening either do not come up at all that year, or come up sparingly and sickly. In May

1838, M. Regel, of Berlin, gathered seeds of *Draba præcox*, and sowed them in pots which were kept in a cold pit. Only two plants came up that year, of very stunted growth, and they never attained sufficient strength to flower; while next spring the remaining seeds came up very thick and strong, and flowered in the space of four weeks. On the other hand, the seeds of the greater portion of biennial plants, if sown immediately after ripening, come up freely, become strong plants before winter, and flower the following year. This is also the case with a great number of annual plants, especially those of California, which in their native country spring up before winter, and are preserved through that season by a covering of snow. The seeds of *cratægus*, *mespilus*, *ilex*, *prunus*, *cerasus*, and some others, if sown immediately after being gathered, will in part come up the following spring, but chiefly in the second spring, though some will not germinate till the third or fourth season. If these seeds, instead of being sown immediately after gathering, are dried and sown the same autumn, none will come up till the spring of the second year. This holds good also with the seeds of a number of trees and shrubs, among which may be mentioned *daphne*, *ribes*, *rubus*, *rosa*, *potentilla*, *berberis*, *pæonia*, &c. De Candolle mentions a sowing of tobacco which continued to send up plants in sufficient numbers to form a crop every year for ten years. It is a common occurrence to find plants, especially annuals, springing up in ground newly brought into cultivation, after it had been used many years for other purposes. Thus, a field of grass, that was ploughed up near Dunkeld, in Scotland, after a period of fourteen years in turf, yielded a considerable crop of black oats without sowing. Mustard-seed has sprung up in the fern lands, which must have lain there upwards of a century; and white clover, it is well known to every agriculturist, springs up, on the application of lime in soils, where it had not been before seen in the memory of man. In pulling down old buildings, seeds capable of germinating have been found in the clay used as mortar. The seed of *Veronica hederæfolia*, *L.*, after heavy rains, has been known to spring up on the surface of fields, where previously no trace of that plant was to be found. At Gottingen, M. Regel found *Alsine Segetalis*, *L.* come up in great profusion, which had not been found there for more than twenty years. He also found *Rumex maritimus*, *L.*, and *Cyperus fuscus*, *L.*, thickly overspreading the bottom of a pond that had been dried the year before—no trace of these plants being to be found in the neighbourhood, and the pond having, for many years, been kept full of water (*Gard. Mag. for 1841*, p. 480).

568. *The season for sowing seeds* is, in nature, when they are ripe, but in artificial culture it varies according to the object in view. The spring, however, is the most favourable period for germination, because at this season the vegetable kingdom awakens from the sleep of nature. Seeds removed from foreign countries, and also the seeds of any rare indigenous plant, should be sown as soon as they are removed or gathered, in a soil and situation favourable for germination and growth. For a succession of crops of annual culinary plants, or annual flowers, the gardener sows at different periods; and in the case of biennial plants, he sows in the autumn. The following are the results of experiments made by Mr. G. Gordon, of the Hort. Soc. Garden, upon raising plants from seed:—"All seeds from North America and California should be sown in the autumn as soon as ripe; to defer the sowing them till the spring may in all cases be disadvan-

tageous, excepting the case of annuals; that Mexican and Chilian seeds succeed best if sown in spring; that with regard to Europe, and the north of India, trees and shrubs should be sown in the autumn, and annuals or perennials in the spring; that all seeds, of whatever kind, should be sown in dry soil, and not watered till they begin to vegetate; in the case of old or sickly seeds, to water them at the time of sowing is to ensure their destruction by rotting; that shading is to be preferred to watering; and that one of the best constructions for the purpose is a pit glazed with double sashes like one in the Society's Garden; finally, that all seedlings should be potted or transplanted as soon as possible, except bulbs (*Proceedings of the Hort. Soc. for 1840*, p. 176).

569. *The mechanical process of sowing* is very simple; whether the seeds are sown broad-cast, that is, distributed equally over an even surface, or deposited in drills or regular furrows, they are delivered from the hand, and not, as in agriculture, from sowing machines. Some rough seeds, such as those of the carrot, are mixed with sawdust or sand, to separate them so that they may drop singly, and other very small seeds, such as those of rhododendrons, and other ericacea, are mixed with fine sand to prevent them from falling too thickly. The smallest seeds of all, such as those of the ferns, and of some of the hardy orchideæ, are sown on the surface of pots or pans filled with well drained peat and sand, and placed in a shady place and covered with glass. American tree seeds of small size are generally sown in pans or boxes as soon as received, and kept under glass in a cold pit, and shaded during sunshine till they vegetate. Cape and Australian seeds, and in general all seeds from warm climates, are sown as soon as received in a mixture of loam, peat and sand, and placed in a temperature similar to that of the growing season in the country they came from.

570. *Sowing seeds in powdered charcoal* has been tried in the Botanic Garden at Munich with extraordinary success. Seeds of cucumbers and melons sown in it germinated one day sooner than others sown in soil, and plunged in the same hotbed; becoming strong plants, while the others remained comparatively stationary. Ferns sown on the surface of fine sifted charcoal, germinate quickly and vigorously; and it seems not improbable, that this material may be found as useful in exciting seeds difficult to germinate, as it is in rooting cuttings difficult to strike.

571. *Sowing seeds in snow.* This practice originated at Munich five or six years ago, and the following account of it was given by M. Lucas in the *Garten Zeitung* for 1841, and translated in the *Gardener's Magazine* for the same year:—"For five years past I have been very successful in sowing seeds in snow that are considered difficult to germinate; such as the following alpine plants: gentiana, ranunculus, anemone, &c.; and in this manner I raised several hundred young gentianas in Messrs. Hague's establishment at Erfurt. In our gardens in the north of Germany, it is a well-known practice to sow the auricula in snow, and this spring the idea struck me of making the same trial with exotic seeds, which are generally more difficult to germinate; I therefore sowed a few of the seeds of New Holland plants, principally of the papilionaceous and mimosa kinds, also erica, rhodoraceæ, cactaceæ, cucurbitaceæ, &c., all of the most distinct families. I filled the pots with earth the most suitable to each kind of plant; I then put a layer of snow, then the seed, and covered it with another layer of snow. I set them in a box covered with glass, and placed it in one of the houses at a tempera-

ture of from 60° to 65° Fahr., in which the snow melted. I was not deceived in my expectations; some acacias, such as *A. subcœrulea* and *A. Cunninghami*, and several mammillarias, such as *M. uncinata*, germinated in the course of two days. These seeds not only germinated well, but in rapidity surpassed my expectations; and I even succeeded in raising *crotalaria purpurea* in this manner, which I had never been able to do before by any other method. When the snow had melted on the latter, I did not cover the seed with a little sandy earth as I had done with the others, but waited till the germ had fairly made its appearance, when I put the sand on; and, from the success of both, I consider the practice is established as generally useful. When newly fallen snow is not to be had, that which is frozen in ice-cellars, and easily preserved till the month of June, will do equally well." (*Gard. Mag.* for 1841, p. 303.)

572. *The discoveries daily making in chemical science*, promise to throw much light on the germination of seeds; but as they do not seem to be matured, and as much is expected from Liebig's edition of *Turner's Chemistry*, not yet published, we have deferred giving an epitome of the new doctrines on the subject of germination, till the preparation of our Appendix.

§ 2.—*On Propagation by Cuttings.*

573. *A cutting* is a portion of a shoot containing either leaf-buds, or leaves in the axils of which buds may be produced. It must at least be of sufficient length to have two buds or two joints—one at the lower extremity to produce roots, and another at the upper end to produce a shoot. A portion of a stem with only one bud is not considered a cutting, but is technically an eye or joint. Though propagation by cuttings is the most general of any of the artificial modes, yet it is not applicable to stemless plants, such as the Primula family, nor to the greater number of monocotyledons, which are chiefly bulbous plants, without leafy stems. It is applicable, however, to all woody plants, and to all herbaceous plants which send up stems bearing leaves; and it is the principal mode of propagation employed with woody plants kept in pots under glass. It is almost unnecessary to state that the cause of success is to be found in the analogy between a cutting and a seed; the bud being the embryo plant, and the alburnum of the cutting containing the nutriment which is to support the development of the bud, till it has formed roots sufficient to absorb nutriment from the soil. The roots formed by the cuttings are protruded from the section at its lower extremity, and are, in fact, a continuation of the alburnous process, which, had the cutting not been separated from the plant, would have been employed in adding to its young wood and inner bark. Every cutting must either contain a stock of alimentary matter in its alburnum, as in the case of cuttings of ripened wood without leaves, or it must contain healthy leaves, capable of elaborating alimentary matter from the moisture absorbed from the soil joined to the alburnous matter already in the cutting. All cuttings may be divided into two kinds: those made and planted when the plant is without its leaves, as in the case of the common gooseberry or the willow; and those made of shoots with the leaves on, as in the case of all evergreens and of many greenhouse plants, such as the geranium, the fuchsia, heaths, &c. In both cases the cutting, after being planted, is excited by heat, and supported by the moisture absorbed from the soil. In the case of the leafless cutting the buds are swelled, and in proportion as they develop

their leaves, roots are protruded from the lower end of the cutting, just as the radicle is protruded from a seed ; while the moisture absorbed by the cuttings with the leaves on enables the leaves to continue performing their functions and ultimately to send down organisable matter to the lower end of the cutting, which sooner or later protrudes from it in the form of roots. In the progress of this process, the organizable matter in many species first appears as a callosity on the lower end of the cutting, sometimes covering only that portion of it from which the roots are protruded, viz., between the bark and the wood, as is often seen in the cuttings of roses and gooseberries, and sometimes covering the entire section, as in cuttings of geraniums and fuchsias. Though by theory all leafy-stemmed plants may be propagated by cuttings, yet in practice this is found very difficult to effect with some species, and with a few that mode of propagation has never yet been accomplished ; but this applies to so very few, that the exception hardly merits notice. Indeed such is the rapidly increasing skill in gardeners, that in a very short time there will probably be no exceptions whatever. The German gardeners have lately rooted cuttings in charcoal which could never be rooted before by any means.—(*See Gard. Mag. for 1841.*)

574. *Selecting plants from which the cuttings are to be taken.*—Every plant from which cuttings are taken ought to be healthy, because in a diseased state the cutting cannot perform the functions necessary to produce roots ; and besides, excepting in the case of variegated plants and a few others, it is not desirable to propagate disease. It is found from experience, that cuttings taken from the lower branches of plants which are near the soil, root more readily than such as are near the summit of the plant and are surrounded by drier air ; doubtless because the tissue of the wood which contains the nutriment is in a more concentrated and hardened state in the latter case than in the former. Hence the practice of putting plants which are difficult to strike into a warm moist atmosphere, and keeping them there till they have produced shoots sufficiently soft in texture to ensure their rooting. Hence cuttings of evergreens, such as the holly and laurel, strike more readily after a wet season than after a dry one, and better in the Irish nurseries than in those of England or France. Hence also the practice of nurserymen of forcing plants in pots for a few weeks before cuttings are taken off, in order to get young growing wood, or placing green-house plants in the open air during summer, in order to get succulent wood. The latter practice is sometimes used in the case of heaths, and the former in the case of the finer sorts of China roses, dahlias, and a great many green-house plants. On the same principle is founded the growing of plants from which nurserymen intend to propagate, in pits to which very little fresh air is given, and which are kept perpetually moist, so that all the wood produced, whether by the top or side branches, is equally soft and fit for making cuttings. Perhaps the most successful propagator of house plants by cuttings in Britain is Mr. Cunningham, of the Comely Bank Nursery, Edinburgh, and his success is principally owing to his growing the plants, from which the cuttings are to be taken, in a close, moist, warm atmosphere. Mr. Cunningham's plant-structures have in general no front glass, and indeed for the most part may be considered as pits ; many of them, however, on a very large scale. The closeness, it is obvious, is produced by giving very little air at any time, and none except when the temperature is raised to an extraordinary degree by sun heat. The moisture is

produced by watering every part of the house; and it is so great that the surface of the walls, of the stone shelves, and of the pots, is everywhere covered with lichens, mosses, hepaticæ (such as marchantia), and even fungi. The warmth, it is needless to state, is produced by hot-water pipes or flues, and by the sun; and it is carried to a considerable degree further than is ever done in growing plants for any other purpose than propagation. In short, every plant in Mr. Cunningham's propagating-houses enjoys the same close, still, moist, warm, unchanging atmosphere, which it would do if placed under a bell-glass. The more rare plants which are to be propagated are planted in a bed of sandy peat and leaf-mould, or of some such soil, where they are found to grow much more freely than in pots, and speedily to produce shoots, which are taken off in a young and tender state, and struck in sand. Various modes are adopted to induce the plants which are to be propagated from, to protrude young shoots, such as when they have small leaves, like heaths, &c., by bending down, twisting them, &c.; and in the case of plants having larger leaves, such as the *Státice arborea*, or some of the more rare fuchsias, by cutting a notch in the stem above every bud, and inserting a wooden wedge in the notch to keep it open, in consequence of which the ascending sap being checked, every bud protrudes a shoot, which is taken off in a tender state, with or without the base of old wood from which it sprang, according to circumstances. In some cases the shoot is taken off, and the base left to produce other shoots from the latent buds; in other cases, the shoot and its base are taken off together, and occasionally, before taking off the shoot and its base, a notch is made below the bud as well as above it, and the lower notch as well as the upper one is kept open by a wedge, till a callosity is formed on the upper edges of the lower notch, from which roots are very readily protruded, after the cutting (with its base attached) has been taken off and planted in sand. A stranger, in passing through Mr. Cunningham's propagating-houses, is at first oppressed with the excessive moisture of the atmosphere, and wonders that none of the plants damp off; but this seems to be prevented by the high temperature.

575. *Selecting the shoot.*—The wood of the present or of the past year is almost invariably chosen for cuttings. In the case of plants which are not difficult to strike, a portion of the young shoot is cut off at any convenient distance from the branch from which it proceeded, and of such a length as may be considered most convenient for forming a plant. Thus in the case of willows, gooseberries, currants, &c., from nine to eighteen inches is considered a suitable length; and the points of the shoots of these and other kinds of easily rooting plants are cut off, as not being sufficiently ripened to have strong buds, or as containing too many small buds. In plants somewhat difficult to strike, lateral shoots are chosen, and these are often drawn or "slipped" out of the wood, so as to carry with them the axillary formation of the bud and the vessels of the leaf. This is the only way in which shoots covered with a woolly tissue, such as several gnaphaliums and helichrysums, can be made to root. This method is also very successful with plants that are difficult to root, and that have leaves surrounded with prickles, such as *Mutisia ilicifolia*, *Berklèya grandiflora*, *Logània floribunda*, *latifolia*, &c.; also with those the leaves of which have stalks with very strong veins, or their circumference is very strongly defined, such as *Bánksia grándis*, *Berklèya ciliàris*, the different species of *Daviesia*, *Chorózema ovàta*, &c.; or those that have winged stems, such as *Acàcia alàta*. The reason of the

success is, that the heel being formed by the first growth of the lateral, consists of wood more or less ripened; and consequently, when it is planted, it is less likely to be damped off by the moisture of the soil than younger wood. When the heel is too ripe, the cutting will not strike.

576. *Shoots which have formed blossom buds* ought in general to be avoided; because it frequently happens that all the assimilated nourishing matter has been laid up for their future support, and no root formation can take place. Many plants that have flower-buds at the points are, therefore, very difficult to propagate by cuttings; such as *Blairia ericoides*; whereas, with some others, it has very little influence, as *Erica tenella*, and several species of *Phýlica*.

577. *As general rules*, it may be stated that cuttings made of the ripened wood of deciduous plants that have a large pith, succeed best when taken off with a portion of the preceding year's wood; such as the gooseberry, currant, vine, fig, honeysuckle, elder, hydrangea, spiræa, syringa, philadelphus, &c. Cuttings of hard wooded plants difficult to strike, such as *Erica*, *Epacris*, *Burtônia*, are best made from points of the shoots cut off where the wood is beginning to ripen, as in *Erica pinguis*, *aristata*, *ferruginea*, *Hartnellii*, *cerinthoides*, *empetrifolia*, *picta*, *lasiculata*, *vérnix*, &c.; or from lateral shoots made from wood of the same year, as in almost all the more easily growing species of *Erica*, left; such are *Erica margari-tæca*, *rùbens*, *ramentæca*, *mucòsa*, *ténera*, *tenella*, *scabriúscula*, *Persóluta*, *pellúcida*, and all those of a similar growth. Cuttings of soft wooded plants, or of plants with woolly bark, such as *Manulea*, *Mutisia*, *Gnaphalium*, &c., are best made of lateral shoots beginning to ripen at the lower end, and drawn out from the main shoot with a heel. Cuttings of soft stemmed plants which are easily rooted, such as *Dàhlia*, *Petùnia*, *Geranium*, &c. may be cut off from any growing shoots where the tissue is somewhat firm, but moderately strong shoots will be found the best.

578. *The time of taking off cuttings* depends much on the nature of the plant to be propagated. In the case of hardy deciduous trees and shrubs, such as the gooseberry, poplar, &c., any period between the falling of the leaf in autumn, and the swelling of the buds in spring, will answer; but the autumn is preferable, because more time is given for the cutting to accommodate itself to its new situation and circumstances before the growing season. This it does by cicatrising the wounded section, and thus preventing it from absorbing moisture in excess when the growing season commences. If the cutting be not taken off till spring, the buds on it will have been supplied with moisture from the roots, and the sudden cutting off of this supply will materially check the growth of the buds. Cutting of hardy evergreens not difficult to strike, such as those of the box, laurel, &c., may be taken off in the ripened wood in the autumn rather than in spring, for the same reason as given in the case of deciduous cuttings of ripened wood. Cuttings of house plants, whether deciduous or evergreen, such as *Fúchia*, *Alóysia*, *Camèllia*, &c., may be taken off at whatever season the wood ripens. Cuttings which are taken off in a growing state, or when the plants have nearly completed their growth, such as those of heaths, diosmas, epacris, &c., and indeed the greater number of house shrubs, must necessarily be taken off when the plants are in a growing state, which is generally in spring or in the beginning of summer, or if not in a growing state naturally at that season, they can be rendered so by a slight

degree of forcing. The advantage of taking off cuttings in spring is, that they can be well rooted before winter, and that as the days are then lengthening, and the solar heat increasing, less artificial heat is required; whereas when cuttings of growing shoots are made in autumn, artificial heat, or at least protection from frost, is required during winter, and the want of light and the presence of damp at that season often occasions their death.

579. *Preparation of the cutting.* Before the cutting is taken from the plant, the propagator should determine in his mind the length which will be most suitable. In the case of fruit shrubs, such as the gooseberry, a long cutting is desirable in order that the bush may be raised from the ground, so that its fruit may be kept clean; but in the case of shrubs which are allowed to form suckers, as the honeysuckle, or of trees which are to be formed by training up a single stem from the cutting, as the poplar, the length is of less consequence; though the larger the cutting is the greater the quantity of nourishment which it contains for the buds. The length of cuttings made with the leaves on depends partly on the number of leaves which the cutting will support, and partly on the proportion of firm wood which is required on the lower end of the cutting, which varies in different plants, and can only be ascertained by experience. In the case of some cuttings which are difficult to strike, such as those of the orange tribe and the camellia, the cutting is made of such a length as that its lower extremity may touch the bottom of the pot, or of a sandstone placed there, or even a mass of sand. The use of the contact with the pot does not appear to be altogether understood, though it is probable from the fibres of plants always clinging to porous stones within their reach, that the pores may contain aqueous or gaseous matter in a state more acceptable to the spongioles than common soil.

580. *The number of leaves which are left upon the cutting.* "The number of leaves which are left upon the cutting has much to do with the success of the propagator. When we take a cutting from its parent tree, we deprive it of the supply of nourishment which it formerly received; but notwithstanding this, its leaves, being still acted upon by the atmosphere, give out the moisture which they contain, and have drawn from the vessels of the plant which supplied them before the separation took place. If we could by artificial means still supply the leaves with this nourishment, the best plan would be to leave the whole of them on the cuttings, to elaborate sap, and send down roots for their more complete support. But we cannot do this, and therefore we must only allow as many leaves to remain upon the cutting, as we can supply with nourishment. Any one may convince himself of the truth of these remarks by the following simple experiment:—Take such a plant as *Petunia violacea* for example; make one pot of cuttings from it nine inches long, and let all the leaves remain upon them; make another set three inches, and allow only three or four of the top leaves to remain; water both pots well, and place them side by side in a damp frame. The difference will soon be apparent—those cuttings with all the leaves left on them will soon flag, while the others will scarcely be affected, and will go on performing their functions. This will be particularly apparent if the cuttings, from carelessness, or any other cause, are neglected. (*R. F. in Gard. Chron.* for 1841, p. 467.) The cuttings of Cape Heaths and such like plants, observes the same

intelligent gardener, are generally made quite short, not exceeding one inch, one inch and half, or two inches in length; in order that the whole of the leaves which are left on may be supplied with food, and have their energies brought into action. The lower leaves of a cutting, when they can be kept on, have more influence on the formation of roots than the upper ones, because they expose a larger surface to the action of light; and hence, when from their long petioles, or any other cause, they are not likely to rot, they should always be kept on. The leaves which are small and closely set, such as those of *Erica*, *Brúnia*, &c., when covered with soil, soon begin to rot, and endanger the cutting, and they ought therefore to be taken off. This ought always to be done with a very sharp-pointed pair of scissors, and the greatest possible care should be taken not to lacerate the bark by the operation, or to bruise the end of the cutting in cutting it across with a knife. The cuttings of *Pelargoniums*, on the other hand, may be of any length and covered with leaves; but short cuttings make the handsomest plants.

581. *In taking off a cutting*, regard should be had to the healing of the section left on the plant, and therefore the cut ought to be made upwards or outwards, so as to leave a smooth unfractured section that will speedily heal over. The lower end of the shoot taken off in this case will be more or less fractured, and must therefore be cut a second time. The cut on the lower end of the cutting should be made with a very sharp knife, so as not to crush in any degree the vessels of the shoot, and thereby prevent them from cicatrizing, and forming a callosity. The cut should not be made through the joint, because the roots seldom proceed from the joint itself, but rather from its base, beneath the point of insertion of the petiole of the leaf. Shoots that have opposite leaves should be taken off by cutting across at a right angle with the direction of the shoot, either immediately under the base of the petiole, or where its combined vessels distinctly reach the stem. Shoots that have alternate leaves should have the knife inserted on the opposite side of the bud, under the node, and the cut should be performed in a slanting upward direction from the base, or under that of the point of the insertion of the leaf, so as to convey away its combined vessels in as perfect a state as possible, which produces the same effect as when a lateral shoot is torn off and then cut clean. This practice is found very successful with many cuttings, such as those of *camellias*, and similar plants. The lower ends of stout cuttings of plants somewhat difficult to strike, such as the *Orange*, are sometimes cut direct across, so as to rest on the bottom of the pot, and sometimes they are in



Fig. 166. Prepared cutting of a Shaddock.

addition split up for an inch or two, and the wound kept open with a wedge. This has been found by long experience greatly to facilitate the rooting of such cuttings, probably by increasing the surface by which absorption of moisture takes place, and at the same time insuring only a moderate supply of moisture; and perhaps, creating a greater demand for the action of the leaves to cicatrize the wound with granulous matter. See fig. 168, in which a cutting of shaddock is not only slit up at the lower end at *a*, where it is cut off immediately below a joint, but tongued or cut at the first joint at *b*.

582. *Treatment of cuttings from the time they are made till they are planted.*—In general, cuttings are no sooner made than they are inserted in the soil where they are to remain till they strike root; but there are several exceptions, as appears by the following extract from M. Regel, already quoted from:—As the crude sap in the cutting is not raised by endosmose, but by the process of evaporation, care must be taken that the surface of the cut does not become dry before being put in the earth, and air get into the lower end of the vessels; for, as soon as this takes place, only very strong shoots are capable of drawing up moisture, as has been proved by the experiments of various philosophers. The cuttings should therefore be stuck in wet sand, if they cannot immediately be put where they are intended to remain, although it were better to avoid this. If, however, they are such as ought to lie a day or two, in order to insure success, such as some banksias, acacias, &c., it ought to be in a damp place; and the precaution must be taken, if possible, to cut them again before planting. If cuttings of *Dryandra*, some banksias (*B. integrifolia*, *B. Baüeri*, *B. média*, *B. Calèyi*, &c.), most of the long-leaved acacias (*A. longissima*, *A. péndula*, *A. brevifolia*, *A. glaucéscens*, *A. longifolia*, *A. micracántha*, &c.), and some sorts of *Diósma* (*D. didica*, *formosa* and *umbellata*), be stuck in the earth immediately after being taken from the parent plant, the inner bark will become black in from fourteen days to four weeks, and the cutting will perish.—This phenomenon appears to be in close connexion with the form of the leaves of these plants, as those of the acacias have very small stomata, while those of the dryandras have none at all. In their stead, on the under side of the leaves of the latter plants are small dimples, lined with short hairs, which the diosmas also possess. Now, as the crude nourishing matter is drawn up through the open wood in its existing state, and received by the cutting, while the spongioles of the roots only imbibe it in a very thin solution, it appears that the above-named plants, on account of the peculiar formation of their leaves, cannot elaborate in any great quantity this gross nourishing matter; and hence arise stagnation of the juices, and the before-mentioned appearances. The good effect of leaving these cuttings lying, and thus interrupting the growing process, appears to be the prevention of the superabundant rise of the crude nourishing matter; and this is the more probable, as it is usual, for the same purpose, to rub over the section with a piece of clay.

583. *Cuttings of succulent, or fleshy, plants* must also lie for a time before planting, and on no account in a moist atmosphere, that the surface of the cut may be sufficiently dried. They retain so many watery particles in their cellular tissue, that, when this is neglected, the face of the cut soon rots. The species of the families *Melocactus*, *Echinocactus*, *Mammillaria*, *Opúntia*, *Cèreus*, &c., have an extremely thick bark, and a fine epidermis, with very few stomata; on which account the process of evaporation is so

slow, that they remain alive for a long time without receiving external nourishment. The dried cuttings of these plants, therefore, are generally planted in dry earth, and set in a bed or house filled with warm air, and are not watered till they have formed roots from the nourishing matter accumulated in themselves. The roots can scarcely ever penetrate the thick bark, and are produced on the section between the wood and the bark. In some of the *Opúntia* and *Cereus* species, however, they come out of the bark at the side. The other succulent and fleshy plants, such as the *Aloe*, *Hawórtia*, *Sempervivum*, *Mesembryanthemum*, *Crássula*, *Plumièria*, and its congeners, as well as all the *Cácti*, which form side roots, may be watered as soon as they are planted. Lastly, plants with milky juice require similar treatment, as they are equally liable to damp off.—As soon as a part of one of these plants is cut off, the milky juice exudes in great quantities, covers the whole surface of the cut, and hardens like caoutchouc, by which the vessels are all stopped up, and the ascension of the moisture prevented. In the Munich garden, cuttings of *Ficus*, and the dry roots of *Euphórbia*, are put in water, where they remain twenty-four hours before they are planted in the earth. The same end is also attained when they are put in dry sand immediately after being cut, and afterwards the sand and the milky juice cleared away; but the succulent and very milky euphorbias must lie for some time.”—*Garten Zeitung*, May 23rd, 1840.

584. *The soil in which cuttings are planted depends on the greater or less facility with which they emit roots.* Cuttings of hardy trees and shrubs that root easily, are planted in common garden soil; those that are somewhat difficult, in sand or sandy loam on a base of garden soil; and those which are most difficult in sand covered with a hand-glass. Cuttings of house plants are almost always planted in pots or boxes well drained, and the drainage covered, first, with a layer of good soil, or leaf mould, or peat, according to the soil which the plants to be propagated naturally prefer; next



Fig. 167. A cutting of a Cape Heath, prepared and planted; the dotted line in this and the following figures of cuttings, representing the surface of the soil in the pot.



Fig. 168. A cutting of an *Epacris* prepared and planted.

with a stratum of sand, in which the cuttings are planted. The sand retains as much moisture as is necessary for the existence of the cutting, and no more, so that its lower end is not likely to rot; and the stratum of soil below the sand supplies nourishment to the roots as soon as they penetrate through the sand. The cuttings of Cape Heaths, and almost all plants whatever which are difficult to root, are planted in sand, which is quite free from soil, metallic oxides or salts, and of a pure white colour.

585. *The depth to which cuttings are planted varies according to the length and thickness of the cutting, but in general it should not be more than six or eight inches.* On taking up large cuttings, or truncheons of willow or poplar which have been inserted in the ground in order to grow, it will be found that all the roots they have made are within little more than a foot of the surface, and that none have been produced from their lower ends; more especially if the soil in which they stand should be compact and moist. The same thing will be found to take place with gooseberry cuttings, and those of

common trees and shrubs, which have been planted more than nine inches or ten inches in depth. This is quite analogous to what takes place with seeds; when buried below a certain depth there is no sufficiency of either heat or air to cause them to germinate; and the same want of heat and air, and probably excess of moisture, prevents roots from being emitted from the lower ends of cuttings when inserted in the soil to a much greater depth than that at which seeds would vegetate. Hence all delicate cuttings, such as those of heaths, diosmas, acacias (fig. 169), epacrisis, &c., succeed best when not planted in sand more than from half an inch to an inch in depth. Some heaths root best when the cuttings are not above three quarters of an inch in length, with not more than a third of that length in the soil.

586. *In planting cuttings* it is of importance to make them quite firm at their lower ends, by pressing the sand or soil to them with the dibber used in planting them; or in the case of large cuttings, such as those of common laurel, which are planted in trenches, by pressure with the foot. In the case of Cape Heaths and such like cuttings planted in sand, the dibber or pricker, which need not be larger than a knitting needle, is taken in the right hand, while the cutting is held in the left, and the hole being made the cutting is inserted, nearly as deep as the leaves have been clipped off, and the pricker is again applied to close the sand round it, as closely and compactly as possible, without bruising the cutting. Large cuttings are planted precisely in the same manner, but with a larger dibber. Large cuttings of kinds which are somewhat difficult to strike, when not planted in pure sand, are made to touch and press against the bottom or sides of the pot, which is found to facilitate their rooting—probably on the principle already mentioned (581).

587. *The distance at which cuttings are planted* varies according to the size of the cutting, its leaves (either on the cutting, or to be produced from its buds), the season of the year, the length of time they require to root, and other circumstances. The object is to root as many cuttings as practicable in a limited space, and consequently to plant them as close together as can be done without incurring the risk of rotting or damping them off. Keeping these objects in view, it is obvious that cuttings which strike in a short time during spring or summer may be planted closer than those which require a longer period, or are put in in autumn or winter; and that short cuttings, such as those of heaths, may always be placed closer together than long cuttings. All cuttings whatever that are planted with the leaves on, require to be immediately well watered, in order to settle the soil about them; and all those that are in a growing succulent state, and are at all difficult to strike, should be immediately covered with a hand-glass or bell-glass; for, though the cutting receives as much moisture through the face of the cut as it loses in ordinary circumstances by evaporation, yet no sooner is it placed in very dry air or in a draught, or exposed to the sun's rays, than a disproportion takes place between the demand and supply. When this is the case, more watery particles are lost through evaporation, than are raised in the body of the wood, which is very easily perceived in large soft leaved cuttings. On this account plant structures are required, in which the outer



Fig. 169. A cutting of the young wood of *Acacia alata*, prepared and planted.

air can be excluded, a moist temperature maintained, and in very warm sunshine a dense shade can be given. Even in these houses, bell-glasses should be placed over the more difficult cuttings, to protect them from all such external influences as might destroy them before they have made their roots.

588. *After treatment of cuttings.*—The hardiest sorts in the open garden, such as gooseberries, &c., require no particular treatment whatever, and need not even be placed in a shady situation; but those which root less freely, such as box, holly, juniper, &c., succeed best when planted in a shady border, in a sandy soil. Cuttings planted in pots or boxes require to be placed not only in a shady situation, but for the most part under glass, in order to diminish evaporation from the soil as well as from the cuttings. All the more delicate sorts of cuttings, such as heaths and most house plants, require to be covered with a bell-glass, and shaded during bright sunshine. In close moist warm atmospheres, such as that maintained in the propagating pits of some nurserymen (see 574), most kinds of cuttings will strike without bell-glasses over them; but in general, these glasses are requisite, in order to maintain a steady moist atmosphere. All cuttings with the leaves on require to be looked over frequently, supplied with water when it is wanting, and such leaves as decay taken off, as well as any dead or dying cuttings removed.

589. *The most proper form of bell-glass for covering cuttings* is that which gradually tapers from the base to the top; as from glasses of this shape the moisture, which adheres to the inside in the form of drops, runs gradually off, without the dropping so injurious to cuttings. This disadvantage is found in all other forms more or less; such as those that are round at the top, or cylindrical with the top bluntly truncated. The enclosed air under the glasses will soon lose its oxygen through the respiring process of the plants within, and also be vitiated by other exhalations; and, if it is not changed, it generates mouldiness, and the cuttings lose their fresh appearance. For this reason the glasses, if possible, should be daily ventilated and wiped; or, what is still better, as it will entirely renew the air, dipped in a vessel of cold water, and well shaken before being put on again, so that too many drops of water may not remain on the glass. In an extensive establishment this operation requires too much time, and therefore round holes, of about from $\frac{1}{2}$ in. to $\frac{3}{4}$ in. in diameter, should be made in the tops of the glasses; and these will prove very serviceable, if the pans stand on hotbeds or other heated surfaces. In small gardens, where the cuttings are placed with other plants on the bed or shelf close under the front glass, bell-glasses, without holes, would be preferable. When the ground is warmed to about 55° Fah., it is better, with some few exceptions, such as the *Laúrus* species, to place the glasses inside of the pots, so that the temperature within may not rise too high; but when the warmth is not so great, they may, without injury, be placed on the outside of the edge of the pot.

590. *Watering cuttings* is an operation requiring great care and judgment. The object is, to maintain as uniform a degree of moisture in the soil as possible, without occasioning mouldiness on its surface or rotting the leaves. Hence, the water is in some cases poured on the soil in such a manner as not to touch the leaves of the cuttings, and in others a reservoir of water is formed by placing a small pot in the centre of a larger one, the water being

left to ooze slowly through the porous sides of the pot, as shown in fig. 170, in which *a*, *d*, is a No. 60 pot, with the bottom closed up with clay, put into one of larger size; *b*, the drainage in the larger pot; *c*, the sand or soil in which the cuttings are inserted; and *d*, the water in the inner pot, which is prevented from escaping through its bottom by the clay stopping at *a*. Mr. Forsyth, the inventor of this mode of striking cuttings, proposes it to be used with hardy plants, such as pinks and wall-flowers, under hand-glasses or frames, in the open air, as well as for all manner of house-plants. The advantages, he says, are the regularity of the supply of moisture, without any chance of saturation; the power of examining the state of the cuttings at any time without injuring them, by lifting out the inner pot; the superior drainage, so essential in propagating, by having such a thin layer of soil; the roots being placed so near the sides of both pots; and the facility with which the plants, when rooted, can be parted for potting off, by taking out the inner pot, and with a knife cutting out every plant with its ball, without the awkward but often necessary process of turning the pot upside down to get out the cuttings. A common mode of supplying water, when the bell-glass is placed within the rim of the pot, is to pour on the water between the glass and the rim. However, where there is a sufficiency of heat, and the pots are properly drained, no harm results from watering over the tops of the cuttings, as the heat soon evaporates the water that falls over the leaves. No water but rain-water should ever be used, either for seeds or young cuttings.

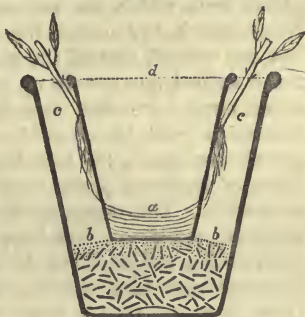

Fig. 170. Forsyth's mode of striking cuttings.

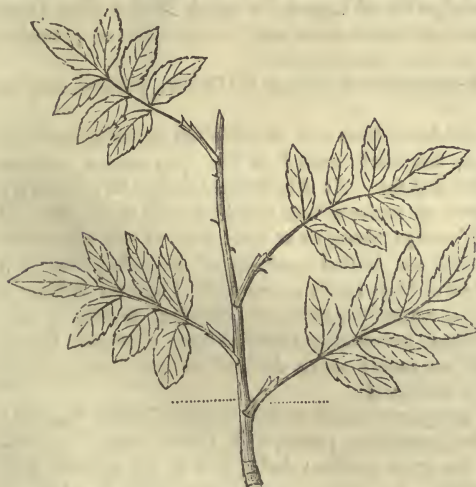

Fig. 171. A cutting of *Rosa sempervirens* prepared and planted.

591. The temperature most suitable for cuttings may reasonably be expected to be that which is most suitable for the parent plants, when in the same state as to growth as the cutting. Hence, for all hardy plants the temperature of the open air will generally be found sufficient, though when they begin to grow a somewhat higher temperature than what is natural to them will be advantageous. This, however, will be of no use, but rather injurious, when cuttings are planted without leaves, or when evergreens with ripened wood are put in; for a certain time is required for every cutting to accommodate itself to its new situation. As a general rule for the tem-

perature at which cuttings should be kept, that in which the respective plants from which the cuttings are taken are found to produce shoots of freest growth, is doubtless the best. The bottom heat should nearly equal, but not exceed, that of the atmosphere. If the shoot has, however, been much excited into growth by heat, in order to obtain the cutting (574), the latter must have that heat kept up in its new situation, otherwise its vegetation will be checked. For cuttings of all the difficult-rooting greenhouse plants, the best heat for the soil is from 53° to 60° Fah.; for those of hothouse plants from 60° to 68° Fah., which should be as regular as possible. This regularity is of great moment to insure the success of the cuttings; for if they are kept at a cooler temperature the greater part of them form a callosity, but, for want of the necessary heat to assimilate the deposited nourishing matter, do not form roots. The callosity continues to grow in many species, such as *Quercus*, *Hækea*, and *Protæa*, and often becomes of so considerable a size, that it not only covers the face of the cut with a thick layer, but also penetrates between the wood and the bark. When this is the case, and the callus is not cut away, no roots are made, and the cutting often remains several years without dying. Where the propagation of house-plants by cuttings is carried on extensively, a pit or house should be formed on purpose, in which there should be a bed of gently fermenting matter, such as tan or leaves, or, what will in general be found preferable, of sand, or coarsely-powdered charcoal, heated by the vapour of hot water from below. Where dung beds are employed, great care is necessary to prevent the exhalations rising from the dung to contaminate the air of the bed, which would destroy most cuttings. In general, all cuttings whatever ought to be kept in what may be called the winter temperature of the plant, for some time after they are planted, and only put into their spring temperature when they have formed a callosity, and are ready to grow. The cool period for cuttings put in without leaves, or with leaves, but with ripened wood, will, of course, be much longer than those put in with leaves, and in a growing state, such as geraniums, petunias, dahlias, and even heaths.

Cuttings of the plants in common cultivation in British gardens may be classed as under:—

592. *Cuttings of hardy deciduous trees and shrubs*, such as the gooseberry, currant, willow, poplar, &c., are easily rooted in the open garden, and the same may be said of the vine and fig. As it is desirable that the gooseberry and currant should not throw up suckers, and should have a clean stem, all the buds are cut clean out, except three, or at most four, at the upper end of the cutting. The cuttings are planted erect, about six inches deep, and made quite firm by the dibber at their lower extremity. Cuttings of honeysuckles, syringas, ampelopsis, artémisia, atrágene, atríplex, bácharis, berchèmia, bignònia, calycánthus, ceanòthus, chenopòdum, clematis, China roses, fig. 171, and the like, are rather more difficult to root, and succeed best in a shady border and a sandy soil.

593. *Cuttings of hardy evergreens*, such as the common laurel, Portugal laurel, laurustinus, arborvitæ, evergreen privet, and a few others, may be rooted in common soil in the open garden; being put in in autumn, and remaining there a year. Cuttings of *dupleureum*, *búxus*, *juniperus*, *rhámnus*, holly, sweet bay, aucuba, &c., require a shady border and a sandy soil. They are put in in autumn, of ripened wood; but young wood of these and

all the kinds mentioned in this and the preceding paragraph will root freely, if taken off in the beginning of summer, when the lower end of the cutting is beginning to ripen, and planted in sand, and covered with a hand-glass.

594. *Cuttings of all the Coniferæ and Taxaceæ* may be taken off when the lower end of the cutting is beginning to ripen, and planted in sand, with a layer of leaf mould beneath, in pots well drained, in the month of August or September, and kept in a cold frame, from which the frost is completely excluded, till the growing season in spring, when they may be put into a gentle heat. It is not in general necessary to cover these cuttings with bell-glasses. *Taxodium* is an exception, as it roots best in water.

595. *Cuttings of hardy or half-hardy herbaceous plants*, such as pinks, carnations, sweet-williams, wall-flowers, stocks, dahlias, petunias, verbenas, rockets, and in general all herbaceous plants that have stems bearing leaves, root readily in sand under a hand-glass, placed in a shady border, or in a gentle heat, if greater expedition is required. All the cuttings must be cut through close under a joint, or in the case of pinks, carnations, or sweet-williams, the operation of piping may be performed.

596. *Piping* can only be performed with plants having tubular stems, and it is only with a few of these that gardeners are accustomed to practise it. The operation is performed when the plant has flowered, or soon afterwards, when it has nearly completed its growth for the season. The shoot chosen is held firm by the left hand, to prevent the root of the plant from being injured, while with the right the upper portion of the shoot is pulled asunder, one joint above the part held by the left hand. A portion of the shoot is thus separated at the socket formed by the axils of the leaves, and the appearance is as in fig. 172. Some propagators shorten the leaves before planting, but others leave them as in the figure. The soil in which the pipings are to be planted being



Fig. 172. A piping of a pink prepared and planted.

rendered very fine, mixed with sand and then well watered, the pipings are stuck in without the use of a dibber or pricker, and the operation is completed by a second watering, which settles and renders firm the soil at the lower end of the piping.

597. *Cuttings of soft-wooded greenhouse plants*, such as pelargoniums, fig. 173, fuchsias, fig. 174, brugmansias, maurandyas, and all other soft-wooded plants, being cut off where the wood is beginning



Fig. 173. A cutting of the rose-scented pelargonium, prepared and planted.

to ripen, and planted in sand or sandy loam, or sand and peat, root readily,



Fig. 174. A cutting of a fuchsia prepared and planted.

with or without a bell or hand-glass, in a shady situation, and in a greenhouse temperature. Cuttings of these and all other soft-wooded plants may be divided into one or more lengths; it being only essential that there should be two joints, one for burying in the soil to emit roots, and the other kept above the soil to produce a shoot. The cuttings of soft-wooded plants which root best, are laterals, which are of average strength.

598. Cuttings of hardwooded greenhouse plants, such as camellias, myr-

tle, evergreen acacias, and most Cape and Australian shrubs with comparatively broad leaves, are more difficult to root than soft-wooded greenhouse plants. The cuttings are made from the points of the shoots, after the spring growth has been completed, and before the young wood is thoroughly ripened. If put in in February or March, such cuttings will be fit to transplant in July or August. Sometimes they are put in in autumn, or the beginning of winter, in which case they will not root till the following spring, and must be kept cool till that season. In either case, all the leaves must be kept on, except one, or at most two, on the lower end of the cutting, which need not be planted more than an inch in depth, and should in general be covered with a bell-glass.

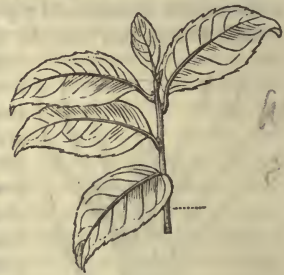

Fig. 175. A cutting of the young wood of a camellia, prepared and planted.

599. Cuttings of heath-like plants, such as *Erica*, *E'paeiris*, *Diósmá*, *Brúnia*, &c., are among the most difficult to root. They should be taken from the points of the side shoots early in spring, when the plants have nearly ceased growing; not be more than from an inch to two inches in length, and cut clean across at a joint, and the leaves clipped or cut off for about half an inch upwards from the lower end of the cutting. Thus prepared, they should be planted in pure white sand, with a little peat soil as a substratum, and the whole well drained. The pot should then be covered with a bell-glass, and placed in a frame, or in the front of a greenhouse, and shaded during sunshine. See figs. 167 and 168.

600. Cuttings of succulent plants, such as Cactuses, *Cereuses*, *Euphorbias*, *Mesembryanthemums*, *Crassulas*, *Stapelias*, and the like, require to lie a few days before being planted, in order to dry the wounds; after which they may be inserted in pots containing a mixture of peat, sand, and brick rubbish, well drained; after which the pots may be set on the front shelf of a warm greenhouse, and occasionally watered, but shading will be unnecessary.

601. Cuttings of the underground stems and roots. A great many plants, both ligneous and herbaceous, may be propagated by cuttings of the underground stems, as in the liquorice; and of the roots, as in the common thorn,

and most of the Rosaceæ. The roots should be those of healthy plants, rather young than old, and in general from half an inch to one or two inches in thickness. They may be cut into lengths of from three to six or nine inches, and planted in free soil, with the tops just above the surface. Care must be taken that the upper end of the cutting, or that which was next the stem before it was separated from the plant, be kept uppermost, for if that is not done, the cutting will not grow. This is the case even with cuttings of the horse-radish and sea-kale; but if cuttings of the roots of these and similar plants are laid down horizontally, and but slightly covered with soil, they will protrude buds from what was the upper end before removal, and send out roots from the lower end. All roses may be propagated by cuttings, and all fruit-trees which are seedlings, or have been raised by cuttings or layers. The Robínia, Acácia, Gledítchia, Coronilla, Gymnocladus, and many other leguminosæ; Ailantus, Catalpa, the balsam Ontario and Lombardy poplars, the English elm, the mulberry, the Maclura, various other ligneous plants, and all plants whatever that throw up suckers, may be increased by cuttings of the roots; as may a great number of herbaceous perennials. The best time of taking them off is when the plants are in a dormant state, and all that is required is a clean cut at both ends.

602. *Striking cuttings in water or moist moss.*—All marsh plants having leafy stems, whether ligneous or herbaceous, will strike root in water, and still better in vessels containing moss kept thoroughly moist. Besides marsh plants, a great many others will root in this way, which, indeed, seems the most ancient mode of artificial propagation. Cuttings of southernwood have been rooted in phials of water in cottage windows in Scotland from time immemorial. Balsams also, and many other plants, may be so rooted, but not any plant that is difficult to strike in sand. The chief difficulty attending this mode of propagation is the transference of the rooted cuttings from the water to the soil, which can hardly be done without a severe check. The only mode is to saturate the soil thoroughly with water before inserting the plants in it, and to keep it well soaked afterwards till the plants have begun to grow.

603. *Striking plants in powdered charcoal.*—The use of sifted charcoal dust, or, in other words, of charcoal in a state of powder, with the particles not much larger than those of common sand, appears to have been first adopted for rooting cuttings in the Royal Botanic Gardens at Munich, by M. G. Lucas, in 1839. The details at great length will be found in the "Gardeners' Magazine" for 1841, translated from the *Garten Zeitung*. It may be sufficient here to state that powdered charcoal is used as a substitute for sand, and that it answers best when it has for some months been exposed to the air and weather; also that it differs from sand in not only facilitating the rooting of cuttings, but in supplying them with nourishment after they are rooted, and consequently no under stratum of soil becomes necessary, as is the case where sand is used. The rationale of this practice has been given in the *Garten Zeitung*, by Dr. Buchner (see *Gard. Mag.*, 1841, p. 252), and the following summary is from a work recently published in London:—"It is essential to the rapid growth of a plant that carbonic acid should be taken up by its roots as well as by its leaves. The carbonic acid may be furnished in two ways; either the soil may absorb it from the atmosphere, or the decay in some of the matter contained in it may disengage this product. It is a remarkable property, possessed by several

porous substances, of absorbing gases, and especially carbonic acid gas, to the amount of many times their own bulk. Of all these, charcoal is one of the most powerful in this respect, and it has been found that many plants may be grown in powdered charcoal, if sufficiently supplied with water, more luxuriantly than in any other soil. The charcoal itself undergoes no change, but it absorbs carbonic acid gas from the air; this is dissolved by the water, which is taken up by the roots, and thus it is introduced into the system. In such cases the plant derives its solid matter as completely from the atmosphere alone as if its roots were entirely exposed to it, for not a particle of the charcoal is dissolved; and it, therefore, affords no nutriment to the plants." (*Vegetable Physiology, in a Popular Cyc. of Nat. Science, p. 117.*) In the *Gardeners' Magazine* lists will be found of cuttings of a great many different species which had rooted in charcoal much sooner than they usually do in sand or soil; and from the most recent accounts it appears that the practice is still carried on in Germany with success. We would therefore strongly recommend its introduction into British gardens.

604. *Propagation by joints and nodules.* This mode of propagation is founded on the principle, that every bud, whether visible or adventitious, is capable of being made to produce a plant; and it only differs from propagating by cuttings, in the buds or joints being taken off the plant with a smaller quantity of nutritive matter attached to them. Plants are also propagated by inserting the buds under the bark of other plants; but this mode, which is called budding, will form the subject of a separate section. As bulbs are only buds, nature may be said to employ this mode of propagation in the case of some species of bulb-bearing plants, such as *Allium* and *Lilium*, in which the buds frequently drop from the stems on the soil, and root into it. All the offsets of bulbs are of course buds, and may be employed in propagation; the nutriment to the young plant being supplied from the scales, which eventually elongate into leaves, and the roots proceeding from the plate or base to which these scales are attached. The buds, with the exception of bulbs, which are taken from the stems, branches, or roots of plants, for the purpose of being rooted in the soil, always contain a portion of the stem or root, to supply them with nourishment till they are able, by the roots they form, to abstract it from the soil. In the case of the vine, a joint is commonly taken; but in that of the potato, a single bud, with a portion of the underground stem or tuber attached, is found sufficient. There are very few plants, besides the vine and the potato, which are at present propagated by rooting buds or joints in the soil, though there can be no doubt that this mode is applicable to a great number of plants with which it has not yet been tried. It is probable, also, that all or many of those plants which can be propagated by cuttings of the roots might be increased by small portions of these, so short as to be considered more in the nature of joints than cuttings. For example, root-cuttings of the common thorn and sea-kale are commonly made of several inches in length; and it is known that, if they are laid down lengthwise, and covered with an inch of soil, they will produce roots at one end of the cutting and shoots at the other. Now, by shortening the cutting to an inch, or half an inch, and treating it in the same manner, it is probable the same result would take place, though the plants produced might be weaker. It is true this would be nothing more than propagating by very short cuttings; but rooting plants from joints may be so designated. The advantage of propagating by

buds or joints is, that a plant is produced from every bud or joint ; whereas, in propagating by cuttings, at least two buds, and commonly several, are required. The plants raised by buds, on the other hand, are commonly weaker than those raised by cuttings, from having a smaller supply of nutritive matter for their support during their infancy.

605. *A nodule*, as we have seen (115), is a concretion of embryo buds, such as may be frequently seen in the matter extravasated from the joints of pelargoniums and the stumps of old elms and poplars, olives and mulberries, occasioned by the returning sap not flowing freely to the root. These nodules are seldom used for the purpose of propagation, except in the case of the olive ; but there can be no doubt that they might be employed for this purpose, and would answer, were it not that the plants which produce them are in general very readily propagated by cuttings. The only remarkable instance of propagation by this mode that is on record is practised in Italy with the olive. The old trees are commonly found to contain swellings or nodules in the trunk, called *uovole*, and these being separated, are planted in the soil in the manner of bulbs, and produce plants. The operation of separating is performed with a sharp pen-knife, and the mother plant does not seem to suffer the slightest injury by the operation. (*Gard. Mag.* vol. vii. p. 663.) This no doubt might be practised with the nodules of all plants, and we believe it has occasionally been done with those of the white poplar, the mulberry, and the pelargonium.

606. *In propagating by joints of the vine* it is reasonable to suppose that the larger the portion of wood attached to the joint the stronger will be the plants produced. Mr. Knight found that the buds of the vine, wholly detached from the alburnum, were incapable of retaining life ; but that a very few grains of alburnum were sufficient to enable a bud to form minute leaves and roots, such as would have been produced by plants raised from seeds. By increasing the quantity of alburnum, the shoots produced from the buds increased in the same proportion ; and when the bud had a piece of two years' old wood, a foot long, attached to it, the growth was nearly as strong as it would have been if the bud had remained on the parent tree. Joints of the vine are preferred to cuttings for propagation, because they form plants more easily managed in pots than are larger cuttings or layers ; and they are preferred to layers also, because they are always furnished with roots in due proportion to their shoots, whereas plants raised from layers have frequently, from not being separated from the parent plant at the proper time, very strong shoots and very few ill-ripened roots. In preparing joints of the vine, about half an inch of the wood is left above and



Fig. 176. *A joint of a vine prepared in the common manner, and planted.*

below the bud, as in fig. 176 ; but this and all other plants that are so propagated are found to root better when the shoot is cut through, so as to separate about one-third part of the pith, as shown in fig. 177. By this latter mode of treatment plants have been raised from buds and half-joints of *camellia*, *poinsettia*, *euphórbia*, *brugmánsia*, and other species. Mr. Murray observes of the *lychnis coronária*, the flower-stem of which has opposite leaves, that not only will individual joints strike, but if each joint be split into two vertically, two distinct plants may be obtained. (*Gard. Chron.* for 1841,



Fig. 177. *A joint of a vine, in which two-thirds of the shoot and pith are removed previous to planting.*

p. 297.) There can be no doubt that a great number of plants, both ligneous and herbaceous, may be propagated by joints or half-joints, though cultivators have hitherto made comparatively few trials.

607. *Propagation by bulbs, and entire tubers and tubercles*, is effected simply by separating them from the parent plant, and inserting them in the soil about the same depth at which they are found on the parent plant, or a little deeper in very light soil, and not quite so deep if in very heavy soil. A phenomenon, Decandolle observes, common to all tubers is this: that while in the seed the radicle or descending part pushes first, in the tuber, on the contrary, the ascending part or plumule is first developed, and the roots appear a short time afterwards. The potato and the Jerusalem artichoke are often planted by entire tubers, as well as by separating them into eyes or sets. The same may be said of the tubers of the anemone and the ranunculus. The tubercles or small tubers of *saxifraga granulata*, *adóna moschatellina*, and of many species of *óxalis*, are propagated by planting the tubers entire. The offsets of all bulbs are also planted entire, and, as already observed, they may be considered as buds; though they differ from ordinary buds, in which the nutritive matter is laid up in the albumen of the plant, by having it deposited at the base of the leaves or scales of which the bulb is composed.

608. *Propagating by bulb-bearing leaves*. The leaves of *maláxis paludosa* bear little bulbs at their extremities; several sorts of *állium* originate bulbs in the axils of the bracts; and in some ferns, such as *asplénium bulbíferum*, and *Woodwárdia rádicans*, bulbs are found at the extremities of the leaves, which when these touch the soil, grow, throw down roots, and produce young plants. Bulbs, or germs analogous to them, are found in *marchántia polymórpha*, and on many arums and dioscoreas, by all of which the plants may be propagated; taking care, in difficult cases, to preserve the soil, on which the bulbs are placed, uniformly moist, shaded, and at a somewhat higher temperature, and the atmosphere, by means of a bell-glass, in a greater degree of moisture, than is required for the parent plant.

§ 3. *Propagation by Leaves.*

This mode of propagation is of considerable antiquity, though it has not till lately been much practised. It is said by Agricola, (*L'Agricuteur Parfait*, &c., ed. 1732) to be the invention of Frederick, a celebrated gardener at Augsburg, and to have been first described by Mirandola, in his *Manuale di Giardinieri*, published in 1652. Subsequent experiments by C. Bonnet, of Geneva; Noisette, Thouin, Neuman, and Pepin, of Paris; Knight, Herbert, and others, in England; and quite recently by Lucas, in Germany, have proved that there is no class of plants which might not be propagated by leaves. It has been tried with success with cryptogamous plants, with endogens and exogens; with the popular divisions of ligneous and herbaceous plants, annuals, biennials, and perennials, and with the leaves of bulbous plants and palms.

609. *The principle on which the propagation of plants by leaves is founded* is considered by some as the organisability of the sap of the plant, and by others as founded on the universal diffusion through the plant of embryo buds. "That the vital power residing in the latex or blood of the plant," Mr. Lymburn observes, "is sufficient to form buds, no one can doubt who has observed the matter extravasated at times from the stems of geraniums, dahlias, &c., and the stumps of old trees. At first it is only a mass of cellular matter, but gradually begins to thicken on the surface, and get of

a red and green colour ; vessels are seen to be produced and buds organised, which, if placed in favourable circumstances, will evolve into shoots. I have seen the buds literally crowded together like bees in a hive. Dr. Carpenter says, that the blood of animals, even when altogether separated and spread out, has been seen to organise vessels, from the strength of the vital principle." This seems also to have been Mr. Knight's opinion. It is, however, of less consequence to adopt either theory than to follow a practice which has been found successful by cultivators, and which takes place in nature in the leaves accidentally broken and left on moist soil of cardamine hirsuta, the common water-grass, sedums, and other succulent-leaved plants, and probably various others, independently of those which root by the leaves in consequence of these producing bulbs, as in the case of Woodwardia radicans (608).

610. *The conditions generally required for rooting leaves* are, that the leaf be nearly full grown ; that it be taken off with the petiole entire ; that the petiole be inserted from an eighth to half an inch, according to its length, thickness, and texture, in sandy loam, or in pure sand on a stratum of rich soil ; and that both the soil and the atmosphere be kept uniformly moist, and at a higher temperature than is required for rooted plants of the same species. The leaves of such succulents as cacalia, crassula, cotyledon, kalankoe, portulaca, sedum, sempervivum, cactus, and similar plants, root when laid on the surface of soil, with the upper side to the light, and the soil and atmosphere is kept sufficiently close, moist, and warm. The first change that takes place is the formation of a callosity at the base of the petiole ; after which, at the end of a period, which varies greatly in different plants, roots are produced, and eventually, at an equally varying period, a bud from which a leafy axis is developed. M. Pepin states that rooted leaves of Hoÿa carnòsa, and those of several kinds of Aloe, did not produce a bud till after the lapse of ten or twelve years. The leaves before they emit roots must be slightly shaded to prevent excessive perspiration during sunshine, but afterwards they may be fully exposed to the light.

611. *Rooting portions of leaves.* It appears that some leaves will throw down roots with only a part of the petiole attached, and that others will even root from the mid-rib when the leaf is cut through. In 1839, M. Neuman, of the Paris Garden, seeing the theophràsta latifòlia (Clavija ornàta, D. Don) growing so well from cuttings of leaves, conceived the idea of cutting several of them in two, and treating them in the same manner as entire leaves. Accordingly, he cut a leaf in two, and planted both parts in the same pot, treating them exactly alike. In about three months, the lower half of the leaf (fig. 178) had made roots, but the upper half had none ; though, some time afterwards, when it became necessary to separate the cuttings, M. Neuman found that the upper part of the leaf had also made roots (fig. 179), but that these roots were much shorter than those of the lower half. The rooting of the two halves of a leaf of the theophràsta, so hard and dry as every one knows these leaves to be, appearing to him an interesting circumstance, he continued to pay attention to them for six months. He wished to ascertain if they would produce buds as in other cases, for he was in hopes they would, as he remarked that the roots increased in the pot. At last in the seventh month, for the first time, he saw at the extremity of his two half leaves, buds appearing, as well formed as those proceeding from the base of the petiole of an entire leaf. In June, 1840, these two

cuttings had become beautiful and healthy plants, which it was impossible to distinguish from others produced from entire leaves.

We see from this experiment that it requires double the time to produce a bud from the upper part of a leaf, that it requires for the lower half to produce one; and that, in propagations by leaves, it is not always necessary to take the heel or lower end of the petiole with the leaf, which sometimes injures and deforms the shoots. M. Neuman's experiment proves further,

that wherever cambium can be formed, there are at the same time a number of utricules or germs of buds formed, from which a new plant will be developed when the parent is placed in favourable circumstances. From this circumstance, in short, we may conclude that all the veins may serve for the reproduction of plants. The dots in fig 179 show the parts of the upper half-leaf which were cut off to allow of its being put into a small pot; and this proves that it is only the middle rib (or prolongation of the petiole), which is required for reproduction. Half leaves



Fig. 178. The lower half of the leaf of theophrasta rooted and sending up a shoot.



Fig. 179. The upper half of theophrasta rooted and sending up a shoot.

of various plants have been rooted in charcoal in Germany (603).

612. The plants usually raised by leaves in British gardens are comparatively few, and chiefly gesneras, gloxinias; bulb-bearing leaves, such as bryophyllum; some succulents, such as sempervivum, and a few others. Leaves of the orange, the hoya, the aucuba, the camellia, ficus elásticus, the clianthus, the common laurel, and a few more, are occasionally rooted, but more as matter of curiosity than for the purpose of increase.

613. Propagation by the leaves of bulbs has been successfully effected by the Hon. and Rev. W. Herbert, who first tried it, in 1809, by setting a cutting of a leaf of a Cape Ornithogalum. "The leaf was cut off just below the surface of the earth in an early stage of its growth, before the flower-stalk had begun to rise; and it was set in the earth, near the edge of the pot in which the mother plant was growing, and so left to its fate. The leaf continued quite fresh, and on examination (while the bulb was flowering) a number of young bulbs and radical fibres were found adhering to it. They appeared to have been formed by the return of the sap which had nourished the leaf. Thereupon two or three more leaves were taken off and placed in like situations; but they turned yellow, and died without producing any bulbs. It appeared to me then, and it was confirmed by subsequent experience, that in order to obtain a satisfactory result the leaf must be taken off while the plant is advancing in its growth. I found it easy thus to multiply some bulbs that did not willingly produce offsets. I afterwards tried, without cutting the leaf off, to make an oblique incision in it under ground, and in some cases just above ground, attempting, in fact, to raise bulbs by layering the leaf. This attempt was also successful, and some

young bulbs were formed on the edge of the cut above ground as well as below. I tried cuttings of the stem of some species of *Lilium*, and obtained bulbs at the axil of the leaf, as well as from the scales of the bulb; and that practice has been since much resorted to by gardeners, though I believe it originated with me. I raised a great number of bulbs of the little plant which has been successively called massonia, scilla, and hyacinthus corymbosus, by setting a pot full of its leaves, and placing a bell-glass over them for a short time. A bulb was obtained with equal facility from a leaf of a rare species of *Eucomis*; and experiments with the leaves of *Lachenalias* were equally successful. I apprehend that all liliaceous bulbs may be thus propagated; but the more fleshy the leaf, the more easily the object will be attained." (*Gard. Chron.*, for 1841, p. 381.)

614. *Rooting leaves and parts of leaves in powdered charcoal.* Leaves and parts of leaves of the following plants were rooted in charcoal, by M. Lucas, of Munich, in 1389. Half-leaves of *Pieréschia*, *Poliánthes mexicàna* *Zuccar.*, and leaves of *Euphórbia fastuòsa*, in a short time filled their pots so full of roots that they were obliged to be repotted.

In from eight to fourteen days leaves of *Cecròpia palmàta*, *Oxalis mandioccàna*, *O. purpùrea*, *Euphórbia fastuòsa*, *Cýclamen indicum*, *Lophospérmum scándens*, *Martýna craniolària*, *Begonia monóptera*, *B. bulbífera*, *Ipomœa supérba*, *I. spec. e Corcovado*, *Mesembryánthemum tigrinum*, *Gésnera latifòlia*, *G. atrasanguínea*, *Sinníngia guttàta*, *Piper piereskiæfòlium*, all sorts of *Gloxínia*, even calices and mere flower-stems, pieces of leaves of *Convól-vulus Batàtas*, *Peiréschia grandifòlia*, *Poliánthes mexicàna*, and warts of the large-warted *mammillaria*.

In three weeks the tops of the leaves of *Agàve americàna fol. var.*, leaves of *Jacarànda brasiliénsis*, bundles of leaves of *Pínus excélsa*, leaves of *Mimòsa Hoústoni*, and *Cypèrus vaginàtus*.

In five weeks, whole and half-cut folioles of *Encephalártos cáffer* and *Zàmia integrifòlia* produced a number of roots from the surface of the cuts.

Many leaves have not yet made roots, but for a considerable time have formed callosities; such as *Laúrus nítida*, *Bignònia Telfáiria*, *Carolínea prínceps*, *Ardísia*, *Gardènia*, *Adansònia digitàta*, *Dracæna*, &c. As experiments that did not succeed, we may mention portions of the leaves of *Amarýllis* and *Crinum*, of ferns, of tropical *Orchídeæ*, of *Dasylírium* and *Héchtia*, *Tillándsia*, *Pandànus*, *Phórmium ténax*, of tropical tuberous-rooted *Aróideæ*, old leaves of the *Agàve*, and some others which, partly through rötting by wet, or other mischances, were prevented from growing.

615. *Leaves with the buds in the axils root freely* in the case of many species. The buds and leaves are cut out with a small portion of the bark and alburnum to each, and planted in sandy loam, so deep as just to cover the bud; the soil being pressed firmly against it, and the back of the leaf resting on the surface of the soil. Covered with a bell-glass and placed on heat, in a short time the buds break through the surface of the soil, and elongate into shoots. The late Mr. Knight tried this mode with double camellias, magnolias, metrosideros, acacias, neriums, rhododendrons, and many others, some of which rooted and made shoots the same season, and others not till the following spring.

616. *Immature fruits have even been made to produce plants.* M. Thouin planted fruits of the *Opúntia Túna*, which were about three fourths ripe, with their peduncles entire, in pots of sand almost dry, and covered them

with a bell-glass, placing the pot on a hot-bed. In eighteen days, callosities appeared at the base of the peduncles, which soon became roots, and a few days afterwards little protuberances appeared on the summits of the fruit, which, at the end of two months, became shoots. The same result took place in the case of the fruits of *Opúntia polyánthos*, and *Mammillària simplex*. (*Cours de Culture, &c., tome II., p. 551.*) Some or the whole of the parts of the flower are frequently metamorphosed into leaves, and even shoots, in warm, moist seasons, and from these there can be no doubt plants could, in many cases, be raised by taking them off and treating them as cuttings.

617. *The essence of all the different modes of forming plants from cuttings may thus be stated.* Wherever a joint of the ripened wood of a plant, or of the unripened wood, with a leaf or leaves, can be procured, it is probable that a rooted plant may be produced by proper treatment; that in many cases, especially where the leaves are large, a bud with a leaf attached will



Fig. 180. Wedges inserted above and below buds to check the flow of the sap, and excite them to produce shoots.

produce a plant; that in a number of cases plants may be produced from leaves alone, and that in some cases they may be even produced from parts of leaves, from the calyxes, and other parts of flowers, and from immature fruits. That to render more certain the rooting of a cutting or a bud, or even a leaf, it is advisable partially to separate it from the parent plant some days, weeks, or, in some cases, months, before it is entirely taken off, by cutting a shoot half through immediately under a joint or leaf, and keeping the wound open, if necessary, with a wedge, as in fig. 180, b, or by ringing under each bud, as in fig.

181, c. That, in regard to soil, the safe mode is to plant in pure sand, with a layer of the soil in which the plant delights below; and, in regard to light, that the cuttings should in all cases, when they are under glass, be placed as close to it as possible. Finally, that in regard to woody plants, those with the leaves on, and the wood half-matured at the lower end of the shoot, will root more readily than shoots of ripened wood without the leaves. *Camellia* shoots of the season, put in in July or August, will be rooted by December, while those not put in till September, will not root till the following spring. That the rooting of cuttings with the leaves on depends very much on the action of light, is proved by the following experiment, made by M. Caie:—A pot of cuttings of *Monsòà incisifòlia* was placed in a close pit, at two feet from the glass; another at two feet three inches; and a third at two feet six inches. The cuttings in the first pot were rooted, but very little advanced in growth; those in the second were elongated in the tops, but had only callosities at the lower ends of the cuttings; and those of the third pot were grown as high or higher than those of the second, but without either callosities or roots. (*Gard. Chron.* vol. i., p. 782.)



Fig. 181. A shoot ringed to accumulate sap at the base of the buds, and prepare them for throwing out roots when they are taken off and planted.

618. To induce stems or shoots to produce leaves or growths from which cuttings may be formed, various modes have been adopted, the object of all of which is to stimulate the normal or latent buds. The most common mode with plants in pots or under glass, is by an increase of temperature and atmospheric moisture; but there are modes which are applicable to all plants whatever, the object of which is to interrupt the ascending or descending sap. When the ascending sap is accumulated by art at a joint, and can no longer pass freely onwards, it stimulates the buds which exist there, either normal or adventitious, to develop themselves, and the sap thus escapes organised into the form of leaves or shoots; while the interruption of the descending sap, more especially under a joint or bud, produces an accumulation or callosity there, which, sooner or later, is organised into roots. To accumulate the ascending sap at any point, the shoot may be bent to one side from that point; and it may be bent back again from a second point, and if the shoot is long, the operation may be repeated, so as to leave it in a serpentine or zigzag form from every exterior angle in which, as at *a, a*, in fig. 182, a bud will be developed.

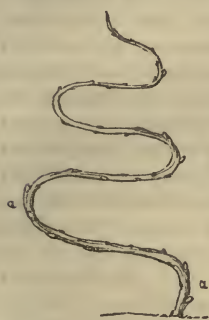

Fig. 182. A shoot bent to cause the buds at the angles to produce shoots.

Where the shoot cannot conveniently be bent, a notch may be made in it immediately above a bud, so deep as to penetrate the alburnum; or in the case of more slender shoots, the knife may be merely inserted above the bud, or above several buds, so as to penetrate into the alburnum, and the wound kept open by inserting wedges in them, as in fig. 180, *a*. Some days or weeks afterwards, according to the nature of the plant, a notch or cut may be made under the bud, in order to interrupt the sap returned by the leaf, and thus form a callosity there for the production of roots. In this way all the buds or joints on a tree or shrub of almost any size may be prepared; and if a tree so treated could be covered with moss kept moist, leaving

only the buds, or the joints, or points from which buds were expected, exposed to the light; or if it could be laid down on the surface of soil kept moist, and very slightly covered with soil, or laid down flat on the surface of water, so as just to touch it, a rooted plant, or at least a shoot, would be produced from every bud or joint. In preparing buds in this manner, however, it must always be borne in mind, either that the plants require to be kept in a close, moist atmosphere, or to have the wounds covered with moss or soil; for if they are exposed to dry air, they will frequently neither cicatrise, nor emit roots, in consequence of the excessive evaporation which will necessarily take place.

Even the petioles of large leaves may be prepared before they are taken off, by being cut half through near the base, by which means they will form a callosity there, and root more rapidly when planted. The roots of plants which contain latent buds may be stimulated to develop them by the exposure of portions of them to the light, or by bending, or twisting, or cutting notches in them, in the same manner as in stems. Piercing the stems or roots by a longitudinal cut through a joint, and keeping the wound open with a wedge or splinter, or driving pegs or nails through them, will facilitate both the formation of roots and the development of buds; and various other modes of exciting buds, and causing the protrusion of roots, will occur to the

gardener who understands what has been already said on the subject. It is only necessary to bear in mind that when the ascending sap is to be interrupted by cutting, the knife must penetrate into the alburnum, and that when roots only are the object in view, it is only necessary to penetrate the bark.

§ IV. *Propagation by Layers.*

619. *The Theory of Layering is founded on the following facts:—*The sap absorbed from the soil by the roots rises to the buds and leaves chiefly through the alburnum; for though it has been proved, by the transmission of coloured fluids from the roots upwards, that a communication is maintained throughout the whole stem, yet the greatest flow of sap, whether ascending or descending, takes place through the youngest layers, whether of wood in ascending, or inner bark in descending. A decortication may therefore be made with little or no interruption resulting to the ascent of the sap. The elaborated fluid, in returning from the leaves, descends by the inner bark, depositing in its progress an organised layer of alburnum, a portion of this extending to the extremities of the roots, where it protrudes in the form of spongioles. From those facts it will appear evident that although ringing does not interrupt the upward flow of sap, because the incision does not reach the vessels in which it proceeds, yet that the descent is prevented by the chasm formed by the operation; on the brink of this chasm it accumulates, and under favourable circumstances a callosity is formed, or mass of cellular substance protruded, which by degrees assumes a granulated form, and these granulations ultimately elongate into spongioles; or the teguments above the incision, being rendered soft by the earth or other suitable moist covering, are ruptured, and afford egress to the nascent roots. From this the principle of the operations of ringing, applying ligatures, twisting, tonguing, or splitting the parts about to be laid, will be easily understood.

620. *The operation of layering*, like that of forming cuttings, is chiefly applicable to plants having leaf-bearing stems; and the advantage which a layer has over a cutting is that it is nourished, while roots are being formed, by the parent plant; whereas the cutting has no other resource than the nutritive matter laid up in it, or that produced by the functions of the leaves. Hence, layering is one of the most certain modes of propagation, by division, though it is in general slower than any other mode. In whichever way layering is performed it consists in the interruption of the descending sap at a joint of a stem, or shoot, and placing it under circumstances favourable for the production of roots. The interruption is most successful when it takes place immediately under a bud or joint, when the shoot is more or less matured, and when it penetrates into the alburnum; though, if the alburnum is penetrated too far, the ascent of the sap will be interrupted, and the supply to the buds or leaves will be insufficient to develop them, or keep them from flagging. The descending sap may be interrupted either wholly by cutting off a ring of bark, or partially by a cut or notch, by driving a peg or nail through it, by a slit kept open, by twisting the stem at a joint, by strangling it there with a wire, by bending it so as to form an angle, by pressure by laying a stone on it, or by attracting it by heat and moisture. The latter mode of causing a branch to protrude roots may often be observed in nature, in the case of the lowest

branches of trees and shrubs that rest on the soil, and by their shade keep it moist, which, after some time, root into it. Whatever mode of interrupting the sap be adopted, the wounded part of the layer from which roots are expected to proceed must be covered with soil, moss, or some other suitable material kept moist, or it must be partially or wholly immersed in water. Layering, from the certainty which attends it, was formerly much more extensively employed as a mode of propagation than it is at present; the art of rooting cuttings being now much better understood, and being chiefly adopted in house and in herbaceous plants; and layering being confined in a great measure to hardy trees and shrubs, of which it is desired to produce plants that will speedily produce flowers, or that cannot otherwise be so readily propagated.

621. *The state of the plant most favourable for layering* is the same as that most suitable for propagation by cuttings (574 to 576). The wood and bark should be soft and not over ripe, and this is most likely to be the case with lateral shoots produced near the surface of the soil, or in a moist atmosphere. The worst shoots are such as are stunted and hide-bound, though there are no shoots whatever, unless such as are in a state of disease, that will not root by layers, if sufficient time be allowed them. Layers, like cuttings, may be made either of ripe wood in the autumn or spring, or of growing wood any time in the course of the summer; the only condition, in the latter case, being that the part of the shoot where the sap is interrupted be somewhat mature, or firm in texture.

622. *Hardy trees and shrubs*, with reference to layering, may be divided into two kinds, those which, when cut down, throw up shoots from the collar, that is, technically, which stole, such as most kinds of deciduous trees and shrubs; and those which do not stole, such as all the coniferæ. The former are planted and cut down, and layers made of the young shoots which proceed from the collar; while the latter are either laid entirely down, and their branches extended along the surface of the soil, and the extremities of all the shoots layered, or such side branches as can be bent down to the soil are made fast there by hooked pegs, and their shoots layered. When the shoots to be layered are small, they are frequently twisted or slit through at the point where the roots are to be produced; but when they are



Fig. 183. *Layering with the tongue made in the underside of the shoot.*

strong the knife is entered beneath a joint, and the shoot cut half through, and the knife afterwards turned up half an inch or more, so as to form what is technically called a tongue (fig. 183, *a*), and the shoot being bent down and its point turned up, the wound is kept open as at *b*; the shoot being kept down by a hooked peg, or by a portion of a twig, first twisted to render it tough, and next doubled, as at *c*, one or more buds being left on the layer, *d*, the wound being kept open by the bent position of the shoot. When the shoots are small or brittle, in order to lessen the risk of breaking them by tonguing below, the incision is made above, and the tongue kept from uniting

by giving the layer a twist when pegging it down, as shown in fig. 184, in which *e* is the tongue made in the shoot before being laid down, *f* the position taken by the tongue after the layer is fixed in its place, and *g* the peg which keeps the layer down. The dotted line in this and the preceding figure indicates the surface of the soil. Layers are always buried in the soil, and secured there, and the soil pressed firmly against them. The plant furnishing the shoots which are layered is called a stool, and as it generally furnishes a number of shoots, these are laid down radiating all round it, as in fig. 185, and the soil formed into a circular basin, the better to retain water about the rooted parts of the layers. Layers that are difficult to root are laid into pure sand with good soil beneath, as is done with cuttings difficult

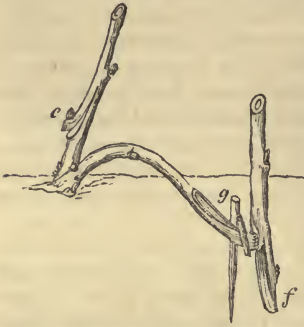

Fig. 184. Layering with the tongue made in the upper side of the shoot.

to strike; and the shoots laid down and layered are commonly shortened to one eye above the soil, in order that there may be only one stem to the plant to be produced. See figs. 183 and 184.

In former times when few trees were propagated in nurseries, excepting limes and elms, the shoots produced from the stools were not laid down, but after two years' growth the shoots were earthed up, and after remaining on two years longer, they were slipped off and found to have a sufficient supply of roots to ensure their independent existence, after, however, being cut in and headed down. Some shrubs, such as hibiscus, vitex, are still so propagated in French nurseries. Sometimes the circumference of the stool was split or fractured to excite the buds; and in Genoa, at the present day, young orange trees are frequently cut down within a few inches of the soil, and the stock and root split into four parts, which, after a year, can be separated into as many distinct plants.

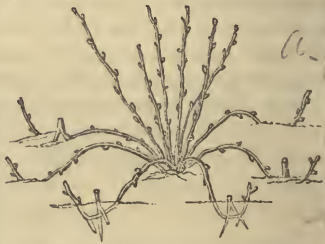

Fig. 185. A stool with several of the shoots layered.

623. *Shrubs with very long shoots*, such as clematis, tecoma, vitis, wistaria, honeysuckle, &c., are stretched along the surface, and every joint, or every alternate joint, prepared for rooting; so that one shoot produces half as many plants as it contains joints, or even a plant for every joint. The joint in this case is not tongued but bruised, pierced, or slit, or simply pressed down to the moist soil by a hook, peg, or small stone—the latter having the advantage of retaining moisture, as well as checking the return of the sap. Shoots which continue growing all the summer, such as those of the wistaria, are laid as they extend in length; and when the parent plant is placed on moist heat, under glass, and near it, it is incredible the number of rooted layers that may thus be obtained in one season. After such layers are formed, a ring of bark may be taken off between each layer, which will prevent the sap returned from the leaf which is left growing at each joint, from being sent down to the parent root, and force it to go to the nourishment of the roots sent down from the separate joints.

624. *Layering by insertion of the growing point.*—Shoots of the bramble will emit roots by the usual mode of twisting and pegging down; but if the growing point of the shoot is merely inserted in the soil to the depth of an inch, an astonishing quantity of roots will be produced in the same season, more, in fact, than in two years by the other mode. The gooseberry, the *Aristolochia*, and the common nightshade, treated in the same way, succeed equally well; and doubtless many other species might in like manner be easily and quickly propagated.

625. *Plum and Paradise stocks* for fruit trees are raised in large quantities, by a somewhat similar mode. The shoots of the stool are pegged down flat on the surface, and covered entirely over, to the depth of half an inch, with loamy soil. This is done early in spring, and in the course of the summer every bud sends up a shoot which roots at its base, and at the end of autumn is fit to be taken off as a separate plant. The tree peony is sometimes propagated in this manner, but with this difference, that a ring of bark is taken off between each bud. A great many trees and shrubs might, doubtless, be rapidly propagated by this mode.

626. *Roses*, with the exception of the kinds of Indian origin, are generally propagated by layers, which in the nurseries are made both in spring and autumn, and sometimes at both seasons, on the same stool. The shoots being brittle are generally twisted, or slit through, and the slit kept open with a fragment of stick or stone. When they are tongued the tongue is generally made on the upper side of the shoot, fig. 184, which greatly lessens the risk of breaking the shoot when bending it down.

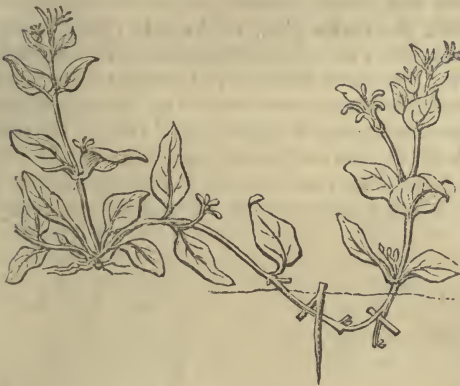

Fig. 186. *A petunia layered.*

627. *Hardy herbaceous*

plants seldom require to be propagated by layers, but the practice is occasionally resorted to for the sake of getting stout plants in a shorter time than by cuttings. The *Petunia* is frequently layered, fig. 186, and also the *Verbena*, and even the *Chrysanthemum*; and this is also the case with the *carnation*, fig. 187, and with some other hybrids, or varieties belonging to the same genus. The shoots are chosen when of sufficient length, which is generally when the plant is coming into flower, and the lower leaves being cut off, the knife is entered beneath a joint, passed half through the shoot, and continued half an inch or more upwards, kept open, if necessary, by a splinter of wood, and pegged down and covered with sandy loam, or sand and leaf mould. Some herbaceous plants which propagate readily by cuttings are layered, as a mode requiring less care after the operation is performed than cuttings, as well as being more certain of success. Sometimes a shoot separated from a plant is layered, the lower end of the shoot being inserted in a vessel of water to supply it with moisture, while the rooting process is taking place, as in fig. 188.

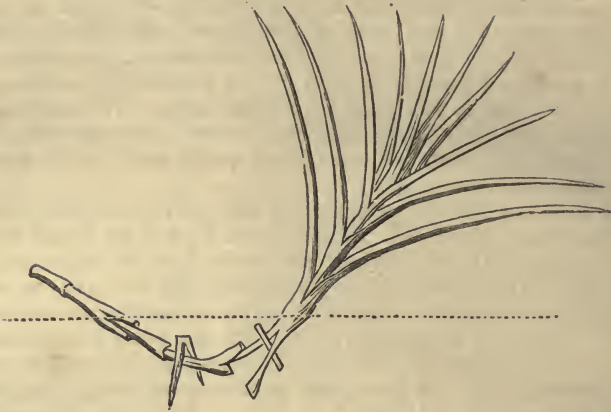

Fig. 187. *A carnation layered.*

628. *Shrubby plants in pots kept under glass* may either be layered by laying down the entire plant on its side (622), or by placing pots under it, or raising pots among its branches, and layering the shoots into these. The shoot may either be laid down into the pot, or brought up through a hole in its bottom, or in its side (fig. 52, in p. 143); a tin case filled with soil or moss may be suspended from the plants, and the shoots ringed, as indicated in figs. 189 and 190; or a ring of bark being taken off, the wounded part may



Fig. 188. *Layering a cutting.*



Fig. 189. *A branch ringed and prepared to be rooted in a tin case without separating it from the tree.*



Fig. 190. *Different branches layered in tin cases.*

be enveloped in a mass of loam covered with moss, a mode practised by the Chinese; or with moss alone. The moss, in either case, may be kept moist by suspending near it, and somewhat higher, a vessel of water with some worsted threads, connecting the water with the moss, and acting as a syphon. The threads ought to have small weights tied to their ends, in order to keep them to the bottom of the vessel of water, in order that the supply may go on as long as it contains any; one thread will be enough for every layer. This mode, however, in the present day is more a matter of curiosity than of utility. Most plants when ringed beneath a joint will root into moss alone, when placed in a warm moist atmosphere; they will also root in water when so ringed, provided the plant be in a growing state.

629. *The soil in which plants are layered* should, in general, be that in which the parent plants naturally thrive best, but with a mixture of sand, or with the wounded part entirely enveloped in sand or powdered charcoal, to prevent it from retaining too much water, which would prevent the wound from protruding granulous matter, and cause it to rot. Plants which grow in heath soil, such as most of the Ericaceæ, and all other hair-rooted plants, must be layered in sand or in heath soil, but almost all others will root freely in sandy loam. Where the soil and the season are not naturally moist, layers, even in the open garden, require artificial watering, or, at least, are much benefited by it. Mulching may also be advantageously employed in order to retain moisture.

630. *Hooked pegs* were formerly considered as essential articles for fixing down the layers, but the general practice at present is to take a piece of the shoot from the stool, or any waste piece of shoot about a foot in length, or longer if the soil be very loose, and twisting it in the middle so as to prevent it from breaking when bent, to double it like a lady's hair-pin over the shoot, as shown at *c*, in fig. 183. The layers of herbaceous plants are sometimes kept down by short loops of bass-mat put over them, and their ends made fast in the soil with a small dibber.

631. *The time which layers require to produce roots* varies in different plants, from one to two, and even, in some cases, three or four years. The process of rooting is facilitated by increased heat and moisture, and by ringing below the tongue, or wounded or bent part from which the roots are expected to protrude; but this operation can only be safely performed where the parent plant is in vigorous health, because, otherwise, it would weaken the root, and prevent it from sending up sap to nourish the layer. In taking off layers which are difficult to root, it is a safe mode not to cut through the layer at once, but by degrees, at intervals of several weeks. In the case of stools in the open air the butt ends of the shoots from which the layers have been taken are cut off close to the stool, to make room for a second succession of layers, which are made annually from the upright shoots produced during the preceding season. In the case of layers taken from plants in pots, the stumps left after the layer is taken off should be cut to a leaf-bud, in order that a shoot may be produced to supply the vacancy made in the head of the plant by the removal of the layer.

§ V. *Propagation by suckers, slips, offsets, runners, and simple division.*

632. *A sucker* is properly a shoot sent up from the under-ground part of the stem, from latent buds there existing, or from adventitious buds on that part of the stem, or on the horizontal roots. Those proceeding from

the upright stems, may be called stem-suckers or slips. A cutting of a gooseberry or currant, if planted without removing any of the buds, will send up shoots from that part of the stem which is under ground, as well as that which is above it; and the former are properly stem-suckers. It is commonly said that plants raised from suckers are more apt to produce suckers than such as are raised from cuttings; and the reasons are, that the sucker has always more buds at its base, unless in the case of a cutting which has been slipped off with a portion of the joint from which it protruded. It is also to be observed that plants which naturally produce suckers, such as the plum, or the everlasting pea, will produce them in whatever manner they may be propagated, though, doubtless, not so soon when they are propagated by cuttings of the extremities of the branches as from suckers, more especially if the buds on that part of the cuttings which are to be buried in the soil are cut clean out, as is frequently done in the case of cuttings of gooseberries and currants. Many herbaceous plants are propagated by root-suckers; a number of shrubs, such as the lilac, the spiræa, the raspberry, &c., and some trees are occasionally so propagated, such as the white, trembling, and balsam poplars, the English elm, &c. The suckers of herbaceous plants are chiefly taken off in spring and autumn, when they are in a growing state, and those of ligneous plants late in autumn, when the sap is dormant; but suckers of both kinds may be taken off at any season, provided those which are in a growing state are put into a moist atmosphere and shaded.

633. *Stem-suckers or slips* may be described as shoots which proceed from the collar, or above it from the lower part of the stem, and which have few or no roots, unless the stem has been earthed up. Heading down plants, or otherwise rendering the top inadequate for the due appropriation of the supply of sap furnished by the roots, favours the production of stem-suckers. The tendency is also induced in consequence of any sudden check given to the foliage, such as that arising from excessive drought, or the depredations of insects, more especially if the roots are at the same time growing in rich, moist soil. These shoots, being drawn or slipped off, are planted and treated as cuttings, and they are found to root more readily than shoots taken from the plant at a greater distance from the root. To produce slips on the lower parts of stems they may be cut down, and in the case of plants in pots stimulated by an extra supply of heat and moisture. The stumps of pine-apple plants are sometimes so stimulated after the fruit has been gathered, and slips or suckers are in that case produced by the buds which had remained dormant in the axils of the leaves. The base of such plants as the banana, when treated in a similar manner, are attended with similar results; and by destroying the growing point or central bud of such plants as *Yucca*, *Dracæna*, and *Zamia*, and also of *Mammillaria*, and other *Cactaceæ*, and of all bulbs, slips, suckers, or offsets, will be produced from the latent buds in the axils of the leaves. By earthing up, these shoots may generally be made to emit roots before being separated from the parent plant; or they may be slipped off without roots, and treated as cuttings. Cuttings or layers from the branches of coniferous plants sometimes continue growing a number of years before they throw up a leading shoot; but this result may be obtained much sooner than it otherwise would be by pegging down the entire plants, when a stem-sucker will be produced, as in fig. 191, in consequence of the check given

to the ascending sap by the acute angle formed by the bend, after which all the other branches of the plant may be cut off close to the stem-sucker.



Fig. 191. The branches of a coniferous plant pegged down to force it to throw up a stem-sucker as a leader.

Cuttings of the side branches of *Cunninghãmia lanceolata* have by this treatment made as good plants as seedlings; and we believe it has also been successful with *Araucãria excelsa*.

634. *Offsets*.—An offset is a term for the most part confined to the small bulbs, corms, tubers, or underground stems, which are formed at the side of the base of large ones, and by which the plant producing them may be propagated. They are very readily observed in the hyacinth, tulip, and crocus, in which they afford the only means of propagation, excepting by seed. All offsets have a natural tendency to separate from the parent bulb, excepting when they are very small and young; in which case they are left adhering to the parent bulb or tuber for another growing season. When offsets are to be separated, the bulb, when it is in a dormant state, is taken up, and the offsets are removed and planted by themselves, at various depths, according to the size and nature of the offset;

and bearing in mind that all bulbs are buds, and consequently that they would all grow if placed on the surface of moist soil, and pressed firmly against it, without any covering of soil. Offsets may be produced from bulbs, by searing or otherwise destroying their central bud by mutilation, or by cutting them over a little above the plate, from which proceed the scales, as in the hyacinth, and the concentric coats, or rudiments of tubular leaves, as in the onion; the buds in both cases being in the axils of the members. Sometimes the frost destroying the outer scales of a bulb will stimulate the buds in their axils to develop themselves (fig. 192); and sometimes, when the scales are very closely compressed at top, the buds in their axils will be developed, and will protrude below (fig. 193). A bulb of *Crinum canaliculatum*, cut over a little above the plate, was found by M. Syringe to throw out no fewer than forty offsets. Practices of this kind are rendered unnecessary with tubers, or underground stems, which containing numerous buds distributed over them, as in the potato, the anemone, &c., are propagated by division; but those roots which are commonly called tubers, as the ranunculus and the dahlia, are naturally increased by offsets, and the production of these can in general be forwarded by destroying the central bud, by which several latent ones are developed.



Fig. 192. The buds in the axils of the scales of a bulb developed in consequence of injuries sustained by the scales from frost.

635. *Runners* or *stolones* are long slender shoots, with joints at distant intervals, which are protruded from the collar of perennial herbaceous or sub-herbaceous plants, such as the strawberry, many grasses,

and will protrude below (fig. 193). A bulb of *Crinum canaliculatum*, cut over a little above the plate, was found by M. Syringe to throw out no fewer than forty offsets. Practices of this kind are rendered unnecessary with tubers, or underground stems, which containing numerous buds distributed over them, as in the potato, the anemone, &c., are propagated by division; but those roots which are commonly called tubers, as the ranunculus and the dahlia, are naturally increased by offsets, and the production of these can in general be forwarded by destroying the central bud, by which several latent ones are developed.



Fig. 193. Buds developed below in consequence of the scales being closely compressed at top.

some saxifrages, potentillas, &c. The joints of these plants rest naturally on the ground, send down roots, and upwards leaves or shoots; and being separated from the internodi of the stolones, constitute rooted plants. Very little assistance from art is required in this mode of propagation; but the soil may be loosened and enriched, and the joint pressed firmly against the soil, by pegging it down with a hooked peg, or by laying a small stone on each side of the joint. The principal plant propagated in this manner in gardens is the strawberry.

636. *Simple division* is an obvious mode of propagating all herbaceous perennials, not bulb-bearing, and all shrubs which produce numerous suckers. The most common mode is to take up the entire plant, and separate it into as many stems as have roots attached; or if only a few plants are wanted, these may be taken off the sides of the plant without greatly disturbing the interior of the root stock.

§ VI. Propagation by grafting, inarching, and budding.

637. The term *graft* is in England generally confined to one mode of performing that operation, viz., grafting with detached scions; but it is our intention in this article to use it, in the continental sense, as a generic term, including, also, inarching, or grafting with attached scions, and budding or grafting by means of a bud attached to a plate of bark. The principle on which all these operations are founded is the phenomenon of the union of newly generated tissues when in the act of being generated. No union can take place between the parts of plants previously formed, but only when these parts are in the act of forming. Thus two shoots or branches may be selected, and by means of similar sections be most accurately joined, and placed under the most favourable circumstances for uniting, as in fig. 194,

representing a stock and a scion; yet when the two are bound together, though a union ultimately does take place, not one particle of the existing tissue at the time of grafting becomes united with similar tissue brought in contact with it. Close contact is all that takes place with regard to these surfaces of the scion and stock, for a vital union only occurs when nascent tissues meet. The parts *a, a*, which are alburnum of the preceding year, never unite. The vital union is formed solely by the coalition of newly generated tissues, thrown out by such parts as have the power of generating them. This power does not exist in the heart-wood, nor in the outer bark, but only in the alburnum, or rather the substance imbedded between it and the inner bark, constituting the cambium, represented by the lines, *b, b*. If the sections are placed against each other, so as the inner barks coincide, the scion may perhaps derive an immediate supply

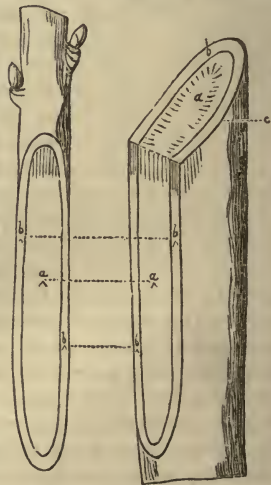

Fig. 194. Scion and stock to illustrate the principle on which they are united.

of moisture; but it does so only in a mechanical way, and a piece of dry sponge might as truly be said to have formed a connexion from its absorbing moisture, in consequence of being placed on the top of a stock, as the scion

that only takes up moisture as above-mentioned. When, however, new tissue is formed by the parts, *b, b*, of the respective sections, and when the portions so formed protrude so as to meet, they immediately coalesce, forming a connecting chain of vessels between the buds of the scion and the roots of the stock. If an old grafted tree is cut down, and all the wood cut away to the original portions which existed at the time of grafting, it will be found that the sections similar to *a, a*, made by the grafting-knife, are only mechanically pressed together; and may be easily taken asunder. Instances frequently occur of the inner bark of the scion being placed out of contact with that of the stock, and a union nevertheless ensues; but this takes place in consequence of the cellular substance protruding from the respective alburnums over the surface of old wood, which it only covers, as soon as the new-formed tissue of stock and scion touch each other, a union is then formed.

638. *The origin of grafting* is of the most remote antiquity, but whether it was suggested by the adhesions of the parts of two plants, frequently seen in a state of nature, or by the appearance of one plant growing on another, as in the case of the mistletoe, it is impossible to divine. Theophrastus and other Greek authors mention the graft; and upwards of twenty modifications of it have been given by the Roman Varro. The principal modern author on the subject is M. Thouin, of Paris, who has described and figured more than a hundred kinds, and M. Tschudy, of Metz, who was the inventor of the art of grafting herbaceous plants, and ligneous plants in an herbaceous state. The theory of grafting was first given in a lucid manner by the celebrated De Candolle in his "*Physiologie Végétale.*" From these works, and our own observations, we shall first treat of what is common to grafting inarching, and budding, and next treat of these modes separately.

639. *The phenomena of grafting* are thus explained by De Candolle:—The shoots springing from the buds of the scion are united to the stock by the young growing alburnum, and, once united, they determine the ascent of the sap rising from the stock; and they elaborate a true or proper juice, which appears evidently to redescend in the inner bark. This sap appears to be sufficiently homogeneous in plants of the same family—to be, in the course of its passage, absorbed by the growing cellules near which it passes, and each cellule elaborates it according to its nature. The cellules of the alburnum of the plum elaborate the coloured wood of the plum; those of the alburnum of the almond the coloured wood of the almond. If the descending sap has only an incomplete analogy with the wants of the stock, the latter does not thrive, though the organic union between it and the scion may have taken place; and if the analogy between the alburnum of the scion and that of the stock is wanting, the organic union does not operate, and as the scion cannot absorb the sap of the stock, the graft does not succeed. In the case of the mistletoe, which may be considered as a natural graft, there is an analogy between the two alburnums, but none between the barks; whence it follows that, though the mistletoe can very well unite itself with the alburnum of the tree on which it grows, yet the descending sap formed by the bark of the mistletoe does not enter the bark of the tree which bears the parasite, and therefore cannot nourish it. This is the cause of the impoverishment of branches of trees on which the mistletoe has fixed itself, and perhaps the possibility of that parasite living on trees of every natural family, and which possibility M. De Candolle attributes to the identity of the ascending sap. (*Phys. Vég.*, vol. ii., p. 814.)

640. *The conditions* essential to the success of the graft are the exact coincidence of the alburnum and the inner bark of the scion with those of the stock. The graft is effected in two forms: that of a cutting or scion, which consists of wood and bark with buds (as in grafting and inarching), and that of a bud, which consists of a shield of bark, containing a bud or buds, but deprived of its wood, as in budding. In the case of the scion it is essential to success that its alburnum coincide exactly with that of the stock; and in the case of the bud it is essential that the disk of bark to which it is attached should be intimately joined to the alburnum of the stock by being placed over it, and gently pressed against it by means of ligatures. The buds of the scion and of the shield are supplied with sap from the alburnum of the stock, and develop themselves in consequence. As a proof that it is the ascending sap which supplies the nourishment in both cases, the scion and the bud succeed best when the stock is cut over almost immediately above the graft; and when the scion or the shield are placed immediately over a part of the stock which contained buds. The success of a scion or a bud placed in the internodia of the stock where no normal buds can exist, will therefore be much less certain than if it were placed on the nodia; because the vessels which conducted the descending sap to the original buds are ready to supply it to those which have taken their place. Hence in the case of the graft, fig. 194, the stock is cut sloping, and so as to have a bud on or near the upper extremity of it, in order to prevent the stock from dying down behind the graft; and the section *a*, against which the scion is to be placed, is made at the lower part of the sloping section, in order to insure abundance of sap at its upper extremity as well as at its lower; for were there no bud to expend the sap, it would cease to be impelled through that part of the stock, which would consequently die. By the end of August the scion and stock will be united, and the section at the top of the latter healed over perhaps as far as *c*; and if the heel, or part above *c*, is then cut off, the stock will probably be completely healed over by the end of the season.

641. *Anatomical analogy.* Plants can only be budded or grafted on one another within certain limits, and these depend on the anatomy or organic structure of the tissue, and the physiology or vital functions of the organs of the plant; but the anatomy of the cellulose and the structure of the vessels are so delicate and difficult to observe, that the differences between plants in these respects are not sufficient to enable us to arrive at any practical conclusion from examining their organisation, and hence our only guide in this matter hitherto has been experience. From this it is found that as plants of the same natural family have an analogous organisation, they alone can be grafted on one another with any prospect of success; though the success of the operation even within this limit will not always be complete; partly, perhaps, from some difference in organic structure, as in the case of the apple and pear, which can only be united for a few years, but chiefly on account of the physiological differences which may and do frequently exist. Hence it follows that the greater part of what is recorded by the ancients, respecting the grafting of plants of one family on those of another totally opposite, such as the jessamine on the orange, the vine on the walnut, &c., is without foundation in fact. The mistletoe is the only exception to the general laws of grafting, as it seems to grow equally well on plants of many different families, and this is accounted for from the mistletoe only attracting

watery or non-elaborated sap, which it does not return to the plant on which it grows by the bark, as in the case of other grafts; and hence, says De Candolle, the necessity of plants in general having a natural analogy between the scion and the stock, is founded on the descent of the sap by the bark, while the mistletoe, which absorbs the watery sap and returns nothing, can live on all exogens of which the ascending sap is of a watery consistence. As a proof that plants of the same natural family may be grafted on one another, De Candolle succeeded in grafting the lilac and the fringe tree on the ash, the fringe tree on the lilac, the lilac on the phillyrea, and the olive on the ash and the privet; and though these grafts did not live a long time, on account of the physiological differences of the species, yet their having succeeded at all sufficiently proves the anatomical analogy of plants within the same natural order. This analogy is greater between plants of the same genus; more so still between individuals of the same species, and most so between branches of the same individual.

642. *Physiological analogy.* In a physiological point of view, the epochs of vegetation are the principal points to be attended to, and hence no plant can be grafted on another which does not thrive in the same temperature. Two plants in which the sap is not in motion cannot be successfully united, because it is only when cellular tissue is in a state in which it can form accretions that a vital union can be formed, and a reciprocal activity must exist both in the stock and scion. Hence evergreen trees seldom succeed for any length of time when grafted on deciduous kinds. The analogy of magnitude is also of some importance, for if a large growing tree is grafted on one naturally of small stature, the graft, by exhausting the stock, will ultimately deprive it of life; and when a small or weakly growing species is grafted on a large vigorous one, it receives too much sap, and ultimately perishes from superfluity, as the other did from insufficiency. The analogy of consistence also merits notice. Soft woods do not associate well with hard woods, nor ligneous plants with such as are herbaceous, nor annuals with perennials. An analogy in the nature of the sap is also requisite, experience having proved that plants with a milky sap will not unite for any length of time with plants the sap of which is watery. Thus the *A'cer platanoides*—the only species of *A'cer* which has milky sap—will not graft with the others; and numerous as are the species of tree on which the mistletoe grows, it is never found on those which have a milky sap.

643. *The modifications effected by the graft,* is a subject of great practical interest to the cultivator. The graft neither alters the species, nor the varieties, but it has some influence on their magnitude and habits, and on their flowers and fruit. The apple grafted on the paradise stock becomes a dwarf, and on the crab stock, or a seedling apple, a middle-sized tree. The size of the stock here seems to influence the size of the graft; but in the case of the mountain ash, which is said to grow more quickly when grafted on the common thorn, than when on its own roots, the stock is naturally a smaller plant than the tree grafted on it. The habit of the plant is sometimes altered by grafting. Thus *A'cer eriocarpum*, when grafted on the common sycamore, attains in Europe double the height which it does when raised from seed. *Cérasus canadensis*, which in a state of nature is a rambling shrub, assumes the habit of an upright shrub when grafted on the common plum. Various species of *Cytisus* become greatly invigorated when

grafted on the laburnum, as do the different varieties of *Pyrus Aronia* when grafted on the common thorn; the common lilac attains a large size when grafted on the ash; and *Tecoma radicans*, when grafted on the *Catalpa*, forms a round head with pendent branches, which are almost without tendrils. The hardness of some species is also increased by grafting them, as in the case of the *Eriobotrya japonica* on the common thorn, and the *Pistacia vera* on the *P. Terebinthus*; the *Quercus virens* is rendered hardier by being grafted on the evergreen oak; but in other cases, the species are rendered more tender, as when the lilac is grafted on the phillyrea. Those species that are rendered hardier by grafting have probably tender roots, and by being placed on such as are hardier, they suffer only from the cold at top, instead of being injured by the effects of cold both at root and top; or if they grow more stunted, they will also be less susceptible of cold. The period of flowering is well known to be accelerated by grafting; and hence, both in the case of fruit-trees and ornamental trees and shrubs, the shoots of seedlings are frequently grafted on the extremities of the branches of old trees; in consequence of which, they blossom several years sooner than if left on their own roots. The mountain ash, and the different varieties of *Pyrus Aria*, produce double the number of fruits when grafted, to what they do on their own roots. The increase of the size of fruits, more especially of kernel fruits, is said by Thouin to be often from a fifth to a fourth part, but the number and size of seeds produced is diminished. The flavour as well as the size of fruit is said to be altered by the graft. Thus pears are said to become gritty on quince or thorn stocks; and the greengage plum to vary in flavour, according to the kind of plum-stock on which it is grafted; producing insipid fruit on some stocks, and fruit of the most delicious flavour on others; the cherry also when grafted on the *Cerasus Mahaleb*, on the wild cherry, on the bird cherry, or on the common laurel, will produce fruit very different in flavour on each. The duration of trees is greatly altered in certain cases by the graft; the apple on the paradise stock is generally shorter lived than on the crab-stock; while the *Pavia*, grafted on the horse-chestnut, has its longevity increased. The period of leafing and flowering is also occasionally changed by the graft, the general effect of which is to produce a somewhat earlier vegetation; because the graft, by arresting the descent of the sap, produces in some measure the effect of ringing. Thus far as to the influence of the stock upon the scion.

644. *The influence of the scion on the stock* is very limited, and as far as experience has hitherto gone, it consists only in communicating disease. The only proof of this is the fact of the bud of a variegated common jasmine having been inserted in a species without variegated leaves, and having communicated its variegation to the entire plant, both above and below the graft. This, De Candolle observes, is in accordance with the theory of Moretti, that variegation, being a disease, can be propagated in a tree in every direction. We are not aware, however, that there is any example on record of a variegated holly having communicated its variegation to the stock; or in fact, of any other variegated plant having done so but the jasmine, which, however, is a fact placed beyond doubt.

645. *The uses of grafting*, in addition to those of all the other modes of increasing plants by extension, are—

1. The propagation of varieties or species, which are not increased freely by any other mode; such as pears and other fruit-trees, oaks and other forest-trees, and several species of *Daphne* and other shrubs.

2. The acceleration of the fructification of plants, more especially of trees and shrubs, which are naturally a number of years before they come into flower. For example, a seedling apple, if grafted the second year on the extremities of the branches of a full-grown apple-tree, or even on a stock or young tree of five or six years' growth, will show flowers the third or fourth year; whereas, had it remained on its own root, it would probably not have come into flower for ten or even twenty years. To obtain the same result with climbers that flower only at their extremities, the tips of the shoots of seedlings are taken off and grafted near the root; and when these have extended an inconvenient length, the tips are again taken off and re-grafted; and after the operation has been performed several times, the plant at last produces flowers in a much shorter time than it otherwise would have done, and in a comparatively limited space.

3. To increase the vigour or the hardiness of delicate species or varieties, by grafting them on robust stocks, such as the Mexican oaks on the common oak, the china roses on the common dog-rose, the double yellow rose on the china or musk-rose, the Frontignan grape on the Syrian, &c.

4. To dwarf or diminish the bulk of robust species, such as grafting the pear on the quince or medlar, the apple on the doucin or paradise stock, the cherry on the perfumed cherry, &c.

5. To increase the fruitfulness and precocity of trees. The effects produced upon the growth and produce of a tree by grafting, Knight observes, "are similar to those which occur when the descent of the sap is impeded by a ligature, or by the destruction of a circle of bark. The disposition in young trees to produce and nourish blossom-buds and fruit is increased by this apparent obstruction of the descending sap; and the fruit of such young trees ripens, I think, somewhat earlier than upon other young trees of the same age, which grow upon stocks of their own species; but the growth and vigour of the tree, and its power to nourish a succession of heavy crops, are diminished, apparently by the stagnation in the branches and stock of a portion of that sap, which in a tree growing upon its own stem, or upon a stock of its own species, would descend to nourish and promote the extension of the roots."

6. To preserve varieties from degenerating, which are found to do so when propagated by cuttings or layers, such as certain kinds of roses and camellias.

7. By choosing a stock suitable to the soil, to produce trees in situations where they could not be grown if on their own roots; for example, the white beam-tree will grow in almost pure chalk, where no pear-tree would live; but grafted on the white beam-tree, the pear, on a chalky soil, will thrive and produce fruit.

8. To introduce several kinds on one kind. Thus one apple or pear tree may be made to produce many different kinds of apple or pear; one camellia a great many varieties; one British oak, all the American oaks; and even one Dahlia, several varieties of that flower.

9. To render diœcious trees monœcious; that is, when the tree consists of only one sex, as in *Negundo*, some maples, the poplar, willow, *Maclura*, *Salisburia*, &c., to graft on it the other sex, by which means fruit may be matured; a knowledge given of both forms of the species, both forms introduced into small arboretums; and in the case of fruit-trees, such as the *pistacia*, the necessity of planting males rendered no longer requisite.

10. The last use which we shall mention is that of renewing the heads of trees. For example, if a forest or fruit tree is cut down to the ground, or headed in to the height of ten or twelve feet, and left to itself, it will develop a great number of latent buds, each of which will be contending for the mastery; and the strength of the tree, and the most favourable part of the season for growth, will be in some degree wasted, before a shoot is singled out to take the lead; but if a graft is inserted either in the collar or stool, or in the amputated head, it will give an immediate direction to the sap, the latent buds will not be excited, and the whole concentrated vigour of the tree will be exerted in the production of one grand shoot.

646. *The different kinds of grafting* may be classed; as, grafting by detached scions or cuttings, which is the most common mode; grafting by attached scions, or, as it is commonly termed, by approach or inarching, in which the scion, when put on the stock, is not at all, or is only partially, separated from the parent plant; and grafting by buds, in which the scion consists of a plate of bark, containing one or more buds. The stock on which the scion is placed, is, in every case, a rooted plant, generally standing in its place in the garden or nursery; but sometimes, in the case of grafting by detached scions, taken up and kept under cover, while the operation is being performed. The two first modes of grafting are performed when the sap is rising in spring; and budding chiefly when it is descending, in July and August. Under particular circumstances, however, and with care, grafting in every form may be performed at any period of the year.

647. *The materials used in grafting* are the common knife (fig. 40a in p. 137) for heading down stocks; the grafting knife and budding knife (fig. 40a and c in p. 137 and fig. 195); ligatures of different kinds for tying on the

Fig. 195. Grafting-knife, with the portion of the back of the blade from + to + ground to a cutting edge, so as to make it serve also for a budding knife.

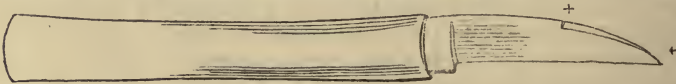

scions, and grafting clay or grafting wax for covering them. The ligatures in common use are strands of bast matting, or of other flexible bark; but sometimes coarse worsted thread is used, or occasionally shreds of coarse paper, or cotton cloth, covered with grafting wax. When bast mat is used, it may be rendered water-proof, by passing it first through a solution of white soap, and next through one of alum; by which a neutral compound is formed insoluble in water. These prepared shreds, before being put on, are softened, by holding them over a small vessel of burning charcoal, which the grafter carries with him; and when grafting wax is employed, instead of grafting clay, it is kept in an earthen pot, also placed over live charcoal, and the composition taken out and laid on with a brush. There are compositions, however, which become soft by the heat of the hand, or by breathing on them.

648. *Grafting clay* is prepared by mixing clay of any kind, or clayey loam, fresh horse or cow-dung, free from litter, in the proportion of three parts in bulk of clay to one of dung; and adding a small portion of hay, not, however, cut into too short lengths, its use being analogous to that of hair in plaster. The whole is thoroughly mixed together, and beaten up with water, so as to be of a suitable consistency and ductility for putting on with the

hands, and for remaining on in wet weather, and dry weather, without cracking. The beating is performed with a beetle or rammer (fig. 37 in p. 136), on a smooth hard floor under cover, turning over the mass, and adding water, and then beating afresh, till it becomes sufficiently softened and ductile. The process of beating must be repeated two or three times a day for several days; and it should be completed from three weeks to a month before the clay is wanted; care being taken to preserve it in a moist state, by covering it with mats or straw. The grafting-clay used by the French gardeners is composed of equal parts of cow-dung, free from litter, and fresh loam, thoroughly beaten up and incorporated.

649. *Grafting-wax* is very generally used on the Continent, instead of grafting-clay. There are various recipes for composing it, but they may all be reduced to two kinds:—1. Those which being melted, are laid on the graft in a fluid and hot state with a brush; and 2, those which are previously spread on pieces of coarse cotton, or brown paper, and afterwards wrapped round the graft in the same manner as strands of matting. The common composition for the first kind is one pound of cow-dung, half a pound of pitch, and half a pound of yellow wax, boiled up together, and heated when wanted in a small earthen pot. For the second kind, equal parts of turpentine, bees-wax, and rosin are melted together.

§ VII.—*Grafting by Detached Scions.*

650. *Grafting by detached scions* is the most common mode, and it is that generally used for kernel-fruits, and the hardier forest-trees. It is performed in a great many different ways, as may easily be conceived, when we consider that the only essential condition is the close connexion of the albumum of the scion with that of the stock. Upwards of forty modes of grafting by detached ligneous scions have been described by Thouin; but we shall confine ourselves to a few which we consider best adapted for general use. The time for grafting hardy trees and shrubs by detached scions in England is generally in spring, when the sap is rising; but the vine, if grafted before it is in leaf, suffers from bleeding. In Germany and North America, grafting is frequently performed in the winter time on roots or stocks which have been preserved in sheds or cellars; and the scion being put on and tied and clayed over, the grafted stock is kept till the spring, and then taken out and planted. Where scions are grafted on roots, this practice is sometimes followed in British nurseries, as in the case of pears and roses. Plants under glass may be grafted at almost any period; and herbaceous grafting, when and wherever performed, can, of course, only succeed when the shoots of the scion and stock are in a succulent or herbaceous state. In all the different modes of grafting by detached scions, success is rendered more certain, when the sap of the stock is in a more advanced and vigorous state than that of the scion; for which purpose the scions are generally taken off in autumn, and their vegetation retarded, by keeping them in a shady place till spring; and the stock is cut over a little above the part where the scion is to be put on, a week or two before grafting takes place. The manual precautions necessary to success are: to fit the scion to the stock in such a manner that the union of their inner barks, and consequently of their albumums, may be as close as possible; to cut the scion in such a manner, as that there shall be a bud or joint at its lower extremity, and the stock so that there shall be a bud

or joint at its upper extremity ; to maintain the scion and the stock in the proper position for growth, and in close contact, by a bandage of narrow shreds of matting or cloth ; to exclude the air by a covering of clay or grafting-wax ; and, in addition, when the graft is close to the surface of the ground, by earthing it up with soil ; and when the scion is making its shoot, to tie it to a prop if necessary ; to remove the clay or grafting-wax, when the scion has made several leaves ; to remove the bandage by degrees, when it appears to be no longer necessary ; and to cut off the heel on the upper part of the stock at the proper time, so as that it may, if possible, be healed over the same season. The modes of grafting detached scions adapted for general use, are : splice-grafting, whip-grafting, cleft-grafting, rind-grafting, saddle-grafting, side-grafting, root-grafting, and herbaceous grafting.

651. *Splice-grafting*, tongue-grafting, or whip-grafting, is the mode most commonly adopted in all gardens where the stocks are not much larger in diameter than the scion ; and it has the advantage of being more expeditiously performed than any of the other modes described in this section. The stock is first cut over at the height at which the scion is to be put on (fig. 196 *a*), and a thin slice of the bark and wood is then cut off with a



Fig. 196 *Splice-grafting in its different stages.*

very sharp knife, so as to leave a perfectly smooth, even surface (*b*) ; the scion, which should at least have three buds, and need never have more than five (the top one for a leading shoot, the next two for side shoots, in the case of fruit-trees, and the lower two to aid in uniting the scion to the stock), is next cut, so as to fit the prepared part of the stock as accurately as possible, at least on one side ; then a slit or tongue, as it is technically termed, is made on the scion, and a corresponding one in the stock (*c*). All being thus prepared, the scion is applied to the stock, inserting the tongue of the one into the slit of the other (*c*) ; then the scion is tied on with matting (*d*) ; and, lastly, it is clayed over (*e*) ; and sometimes, in addition, it is earthed up, or covered with moss, to serve as a non-conductor of heat and moisture. In earthing up the graft, the loose surface soil should be used at the grafting season, as being drier and warmer than that which is less under the immediate influence of the sun. When the scion is placed on the stock with the right hand, the ribbon of bass by which it is tied, is brought round the graft from right to left ; but when the scion is put on by the left hand, the bast is brought round from left to right ; the object in both cases being to make sure of the exact coincidence of the inner bark of one side of the scion, with the inner bark of

one side of the stock. The ball of clay which envelops the graft should be about an inch thick on every side, and should extend for nearly an inch below the bottom of the graft, to more than an inch over the top of the stock, compressing and finishing the whole into a kind of oval or egg-shape form, closing it in every part, so as completely to exclude air, light, wet, or cold. The ball of clay will not be so apt to drop off, if the matting over which it is placed is rendered a fitting nucleus for solid clay, by previously smearing it over in a comparatively liquid state. This envelope of clay, with the earthing up, preserves the graft in a uniform temperature, and prevents the rising of the sap from being checked by cold days or nights; and, therefore, earthing up ought always to be adopted, in the case of grafts in the open garden, which are difficult to succeed. The next best resource is a ball of moss over the clay, or of some dry material, such as hay, tied on from within an inch of the top of the scion to the surface of the ground, so as to act as thatch in excluding rain and wind, and retaining heat and moisture. When the scion and the stock are both of the same thickness, or when they are of kinds that do not unite freely, the



Fig. 197. The scion with its young shoots on, and the heel of the stock cut off.

tongue is sometimes omitted; but in that case, more care is required in tying. In this, and also in other cases, the stock is not shortened down to the graft; but an inch or two with a bud at its upper extremity is left to insure the rising of the sap to the scion, as in fig. 194; and after the latter is firmly established, the part of the stock left is cut off close above the scion, as shown in fig. 197. When the stock is not headed down till the scion is about to be put on, it is essentially necessary to leave it longer than usual, in order to give vent to the rising sap, which might otherwise exude about the scion, and occasion its decay. In the case of shoots having much pith, such as those of the rose, the scion is often put on the stock without being tongued into it, as in fig. 198, in

which the scion in the one case, *b*, is without a bud on its lower extremity, and is therefore less likely to succeed than *c*, which has a bud in that position. Sometimes a notch is cut on the scion immediately under a bud, and this notch is made to rest on the top of the stock, as in fig. 199; and in such cases, when the scion and stock are about the same diameter, the summit of the latter is certain of being healed over the first season.



Fig. 198. Splice-grafting without a tongue.

In the case of the fruit-trees mentioned, the buds of the scion on the back and front are removed, leaving two on each side, and a

652. *Splice-grafting the peach.* In splice-grafting the shoots of peaches, nectarines, and apricots, and other tender shoots with large pith, it is found of advantage to have a quarter of an inch of two-years old wood



Fig. 199. Splice-grafting with a shoulder.

leader; and when these have grown six or eight inches, their extremities are pinched off with the finger and thumb; by which means each shoot will

throw out two others, and thus produce in autumn a finely-shaped tree, with ten branches. Such trees will bear two or three fruits the second year from the graft.—*Gard. Mag.*, vol. iii. p. 150.



Fig. 200. Splice-grafting the peach.

a 653. Cleft-grafting, fig. 201, requires less care than splice-grafting, and seems to have been the mode in most general use in former ages. It is now chiefly adopted when the scion is a good deal larger than the stock, and more especially when grafting stocks of considerable height, or heading down old trees. The head of the stock being cut over horizontally with a saw (fig. 202), a cleft is made



Fig. 201. Cleft-grafting.

in it, from two to three inches in length, with a stout knife or chisel, or with the splitting-knife (fig. 203). The cleft being kept open by the knife or chisel, or the pick-end of the splitting-knife,

one or two scions are inserted, according to the diameter of the stock; the scions being cut into long wedge shapes, in a double sense, and inserted into the slit prepared for them, when the



Fig. 202. Bow saw for cutting off branches of trees.

knife or chisel being withdrawn, the stock closes firmly upon the scions, and

holds them fast. The graft is then tied and clayed in the usual manner, and the whole is frequently covered with moss. When the stock is an inch or

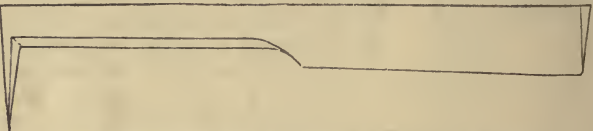

Fig. 203. Splitting-knife and opening pick for using in cleft-grafting.

more in diameter, three or more scions are frequently put on at equal distances from each other round the circumference, and this is called *crown-grafting*. Cleft-grafting with one scion is in general not a good mode, because if the split has been made right through the stock, it is in danger of being injured by the weather before it is covered with wood by the scion. If the cleft is made only on one side of the stock, the evil is mitigated; but there still remains the tendency of the scion in its growth to protrude the wood all on one side. In crown-grafting headed-down old trees, the scion is generally chosen of two-years old wood, and it is some-



times inserted between the inner bark and the alburnum, as in what is called *rind-grafting* (fig. 204). In rind-grafting, great care must be taken to open the bark of the stock without bruising it, which is done by the spatula end of the grafting-knife. The scion is prepared without a tongue, and inserted so that its wood may be in contact with the albur-

num of the stock. As in this case both edges of the alburnum of the scion come in close contact with the alburnum of the stock, the chances of success, other circumstances being alike, are increased. In cases of this kind also, a longitudinal notch is sometimes cut out, instead of a slit, and the scion cut to correspond. Sometimes also the scion is prepared with a shoulder, more especially when it consists of two-years-old wood, and this mode is called shoulder-grafting.

654. *Cleft-grafting the vine* is shown in fig. 205, in which *a* is a bud on the scion, and *b* one on the stock, both in the most favourable positions for success. The graft is tied and clayed in the usual manner, excepting that only a small hole is left in the clay opposite the eye of the scion, for its development. In grafting the vine in this manner, when the bud *b* on the stock is developed, it is allowed to grow for ten or fourteen days, after which it is cut off; leaving only one bud and one leaf near its base to draw up sap to the scion till it be fairly united to the stock. The time of grafting is when the stock is about to break into leaf, or when they have made shoots with four or five leaves. By this time the sap has begun to flow freely, so that there is no danger of the stock suffering from bleeding; though if vines are in good health and their wood thoroughly ripened, all the bleeding that usually takes place does little injury. In Flanders the rose is frequently grafted in the cleft manner, the scion, if possible, being of the same diameter as the stock (fig. 206, *a*); or the cleft in the stock is made so near one side of the cross section as that the bark of the wedge part of the scion may fit the bark of the stock on both sides (*b*). Sometimes a shoulder is made to the scion (*c*), in order that it may rest with greater firmness on the stock; and the wedge part of the scion, instead of being part of an internode, as at *d*, is, when practicable, selected with a bud on it, as at *e*. The camellia is sometimes cleft-grafted, with only a single bud on the scion (fig. 207, *a*), which is inserted in the stock *b*, just when the sap is beginning to rise, and being tied, it is found to take freely without claying. *Epiphyllum truncatum* is frequently cleft-grafted on *Pereskia aculeata*, as shown in fig. 208.



Fig. 205. Cleft-grafting the vine.



Fig. 206. Cleft-grafting the rose.



Fig. 207. Cleft-grafting the camellia.

655. *Saddle-grafting* (fig. 209) is only applicable to stocks of moderate size, but it is well adapted for standard fruit-trees. The top of the stock is cut into a wedge shape, and the scion is split up the middle, and placed astride on it, the inner barks being made to join on one side of the stock as in cleft-grafting. The tying, claying, &c., are of course performed in the usual manner. Fig. 210 represents a mode of grafting practised in Herefordshire after the usual season for



Fig. 208. *Epiphyllum truncatum truncatum* grafted on *Pereskia aculeata*.

grafting is over, and when the bark may be easily separated from the stock. The scion, which must be smaller than the stock, is split up between two and three inches from its lower end, so as to have one side stronger than the other. This strong side is then prepared and introduced between the bark and wood, as in rind-grafting; while the thinner division is fitted to the opposite side of the stock. Mr. Knight, who describes this mode of grafting, says, that grafts of the apple and pear rarely ever fail by it, and that it may be practised with success either in spring, or with young wood in July, as soon as that has become moderately firm and mature (see *Hort. Trans.*, and *Encyclo. of Gard.*, ed. 1835, p. 653). Saddle-grafting, in whichever



Fig. 209.
Saddle-grafting.



Fig. 210. Herefordshire saddle-grafting.

way performed, has the advantage over all others of the scion to receive the ascending sap of the stock, and at the same time without causing it to deviate from its natural course; which it is made to do to a certain extent, when the scion is put on one side of the stock only, as in splice-grafting and side-grafting.

656. *Side-grafting* is nothing more than splice-grafting performed on the side of a stock, the head of which is not cut off. It is sometimes practised on fruit-trees to supply a branch in a vacancy, or for the sake of having different kinds of fruits upon the same tree; but it is better for the latter purpose to graft on the side branches, because, in consequence of the flow of the sap not being interrupted by being headed down, the success of this kind of grafting is more uncertain than almost any other mode. In grafting the lateral branches of fruit-trees, it is always desirable, in order to ensure success, to have corresponding buds in the scion and the stock, as in fig. 211. What the French call veneer-grafting, fig. 212, is



Fig. 211. Grafting the lateral branches of fruit-trees.

a variety of side-grafting, in which the scion *e* is prepared to fit into the stock *f*, which has a notch at the lower extremity of the incision, for the scion to rest on. This mode of grafting is practised with orange-trees, camellias, &c., in pots; and after the operation is completed, the grafted plant is plunged in heat, and closely covered with a bell-glass. Fig. 213 is a peculiar mode of side-grafting the vine, which is performed in

November, when both scion and stock are in a dormant state, in which the scions *a* and *b*, being prepared as in the figure, and inserted and bandaged, instead of being clayed, they are surrounded with a mass of mould. About a month afterwards the plant is plunged in a mild heat, and in about three weeks the buds from the scions will be seen emerging from the mould with which they are surrounded. (See *Gard. Mag.*, vol. xii., p. 172.)

657. *Wedge-grafting* (fig. 214), which is a modification of side-grafting, has been very successful in grafting *Cèdrus Deodàra*, on the cedar of Lebanon. The scions, *c*, are chosen of the preceding year's wood, from three to five inches in length, and they are inserted in either one or two-years old wood, as may be convenient, and as near the top of the stock as is practicable,

in order to gain height. The slit in the stock is cut through the pith, and from 1 to $1\frac{1}{2}$ inches in length; and the graft being tied, is coated over with grafting-wax, as being lighter than clay, and not so liable to bend down the shoot. Entire cedars of Lebanon at Elvaston Castle have had the extremities of their shoots grafted in this manner with *Cèdrus Deodàra*, by Mr. Barron, the inventor of this mode. (See *Gard. Mag.*, vol. xiv., p. 80.)

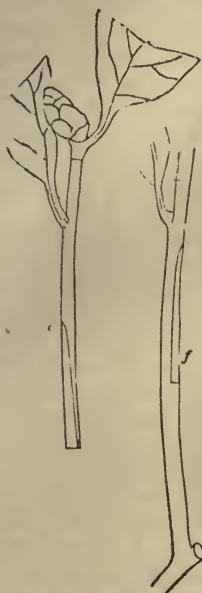

Fig. 212. Side-grafting the orange.

The roots of thorns, peas, and crabs, as already observed, are frequently grafted in-doors, and taken out and planted so deep, that only the upper part of the

658. *Grafting the mistletoe* has been successfully performed in the wedge manner by Mr. Pit, farmer and grafter, near Hatfield, in Herefordshire. To be attended with success, there must be a joint let into the soft wood of the stock, or a scion taken off with a heel, and the heel of the preceding year's wood inserted. (See *Gard. Mag.*, vol. xiii., p. 207.)

659. *Root-grafting* is merely the union of a scion to a root, instead of to a stem. It is sometimes practised in nurseries, by grafting the apple and the pear on the roots of thorns, tree peonies on herbaceous peonies (see herbaceous grafting, 662), stove passion-flowers, Japan clematises, &c., on the common sorts, and with various other stove and greenhouse plants, especially climbers. The greatest care is requisite to prevent any particles of soil from getting in between the scion and the stock, for which purpose the upper part of the latter is sometimes washed with water before the operation is performed. The

roots of thorns, peas, and crabs, as already observed, are frequently grafted in-doors, and taken out and planted so deep, that only the upper part of the scion appears above ground. Another mode where a thorn hedge is taken up, or a row of seedling pear or crab stocks is transplanted, and a portion of the roots left in the soil, is to graft on them where they stand, and afterwards to earth-up the graft—a mode which would doubtless be very successful.

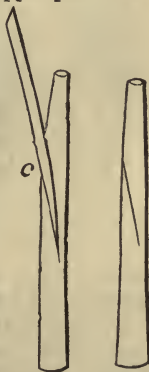

Fig. 214. Wedge-grafting.

660. *Herbaceous-grafting* is applicable either to the solid parts of herbaceous plants, or to the branches of ligneous plants when they are in a herbaceous state. Baron de Tschoudy, of Metz, the inventor of this method, and M. Soulange Bodin, of Fromont, have grafted the melon on the cucumber, the tomata on the common potatoe, the cauliflower on the broccoli and the borecole; and on the tender-growing shoots of various forest-trees, and of azaleas and other shrubs, hardy and tender, they have grafted successfully allied species. This mode has been extensively employed for the last fifteen



Fig. 213. Side-grafting the vine.

years in the forest of Fontainebleau, in grafting the *Pinus Laricio* on the *P. sylvestris*; and many hundreds of plants of pines and firs of different kinds, and of Indian azaleas, have been so propagated at Fromont. The trees thus grafted by Baron Tschoudy may still be seen in the botanic garden at Metz, and on his own estate in the neighbourhood; and these and the pines at Fontainebleau prove this mode of grafting to be particularly applicable to the *Abietinæ*. The following mode of grafting the pines at Fontainebleau is extracted from the second volume of the *Gardener's Magazine*, and some further observations on the practice will be found in the *Arboretum Britannicum*, vol. iv., p. 2129, and in the *Gardener's Magazine* for 1841, p. 402.

661. *Grafting the Pine and Fir tribe*.—The proper time for grafting pines is when the young shoots have made about three quarters of their length, and are still so herbaceous as to break like a shoot of asparagus. The shoot of the stock is then broken off about two inches under its terminating bud, the leaves are cut or lipped off from twenty to twenty-four lines down from the extremity, leaving, however, two pairs of leaves opposite and close to the section of fracture, which leaves are of great importance to the success of the graft. The shoot is then split with a very thin knife between the two pairs of leaves (fig. 215), and to the depth of two inches; the scion is

then prepared (b), the lower part being stripped of its leaves to the length of two inches is cut and inserted in the usual manner of cleft-grafting. They may also be grafted in the lateral manner (c). The graft is tied with a coarse thread of woollen, and a cap of paper is put over the whole to protect it from the sun and rain. At the end of fifteen days this cap is removed, and the ligature at the end of a month; at that time also the two pairs of leaves (a) which have served as nurses are removed. The scions of those sorts of pines which make two growths in a season, or, as the technical phrase is, have a second sap, produce a shoot of five or six inches the first year; but those of only one sap, as the Corsican pine, Weymouth pine, &c., merely ripen the wood grown



Fig. 215. Herbaceous grafting the pine and fir tribe.

before grafting, and form a strong terminating bud, which in the following year produces a shoot of fifteen inches or two feet.

We have described this mode of grafting at greater length than we otherwise should have done, because it is little known in this country, and because we think it ought to be adopted in a great many cases for the multiplication of plants now propagated with difficulty by cuttings, or reared, after being so propagated, so slowly as to exhaust the patience of the propagator or amateur. For example, the pine and fir tribe, though they may all be increased by cuttings, yet these cuttings grow very slowly, and though they ultimately become good plants, many kinds as much so as if they had been raised from seeds, yet if the kinds to be propagated had been grafted on the points of the budding shoots of pines, or firs of five or six years' growth, they would have grown with incomparably greater rapidity and

vigour, and would have become trees of twenty feet in length, before cuttings had attained the height of three feet.

662. *Grafting the tree Peony* on the roots of the herbaceous species is performed from the middle of July to the middle of August, and will be easily understood from fig. 216, in which *a* represents a triangular space in

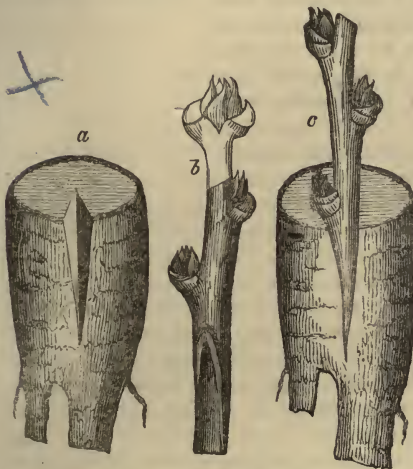

Fig. 216. *Grafting the tree peony, on the tubers of the herbaceous peony.*

the tuber or stock; *b*, the scion, the lower end of which is cut so as to fit the cavity in the stock; and *c*, the scion fitted to the stock. It is not necessary that there should be more than one bud on the scion, for which reason the upper part of *b* might have been inserted in *a*, in the cleft manner. The graft being tied with bast, and covered with grafting-wax, the whole is inserted into a bed of tan, leaving only about half an inch of the scion above the surface. The tubers throw out roots by the end of September or the beginning of October, and are then taken up and potted, and placed in a cold frame, where they remain through the winter.

The following kinds of herbaceous grafting are in use in France and Belgium:—

663. *Grafting on fleshy roots*, as in the dahlia and peony, may be performed either with a growing shoot (fig. 217), or with a dormant eye, as in fig. 218. The former mode requires no explanation; by the latter,



Fig. 217. *Cleft-grafting the dahlia on its own tubers.*

on the neck of a barren tubercle a small hole is made, in which the bud is inserted, but in such a manner as that its base shall be perfectly on a level with the surface of the tubercle, and the edges are covered with grafting-wax. The tubercle is then planted in a pot, care being taken not to cover the bud, and the pot is plunged in heat under glass. When the plant has taken, it may, if hardy, be turned out into the open border.



Fig. 218. *Peg-grafting the dahlia on its own tubers.*

664. *Herbaceous wedge-grafting* (fig. 219) is effected by paring the scion into a wedge shape, and inserting it into a corresponding slit in the stock. It succeeds well both with trees and herbaceous plants, more especially

when the plants are in pots so as to be plunged in heat and covered with a bell-glass.

665. *Herbaceous-grafting for shoots with opposite leaves* (fig. 220). In



the middle of the shoots, between two opposite eyes, an angular and longitudinal incision is made, and a small portion of the stem cut out from one side to the other. The scion is cut to fit this opening, and it is inserted as in the figure, and bandaged in the usual manner.



Fig. 219. *Herbaceous wedge-grafting.*

666. *Herbaceous-grafting — Annual or Perennial plants* (fig.

Fig. 220. *Herbaceous-grafting with stems having opposite leaves.*

221). The period chosen for this mode of grafting is that of the greatest vigour of the plant, that is, some days before its going into flower. The stem of the stock is cut through



above a leaf, as near as possible to its petiole, and a slit downwards is made in the section. A shoot is then taken off near the root of the plant to be increased, the end of which is cut into a wedge shape, and is inserted in the slit made in the stock, taking great care of the leaf on the latter; for it is that which must nourish the scion until it has taken thoroughly, by keeping up the circulation of the sap. A bandage is applied at the juncture, covered with grafting wax as before. When the graft has taken, which is ascertained by its growth, the ligature is removed, and also the old leaf, and the shoots from the stock below the graft.

Fig. 221. *Herbaceous-grafting annuals or perennials.*

667. *Grafting herbaceous shoots of succulents* (fig. 222). Take a young shoot, and cutting its base to a point or wedge, insert it in a hole or slit made in the stem or leaf of the stock.

668. *Grafting the melon* (fig. 223). On the stem of a cucumber, or any



other plant of the family of Cucurbitacæ, but having some analogy with the melon, choose a vigorous part of a shoot having a well-developed leaf. In the axil of this leaf an oblique cut is made, of half its thickness. The point of a melon shoot, so far developed as to have its fruit quite formed, is then cut off, and pointed at its end, two inches



Fig. 222. *Herbaceous-grafting succulents.*

below the fruit. It is in-

Fig. 223. *Herbaceous-grafting the melon.*

serted in the cleft made in the stock, always taking care to spare the leaf until the scion has taken. The remaining part of the operation is performed in the usual manner, with ligatures and grafting-wax. This mode of grafting succeeds pretty well; but it has not hitherto been applied to any useful end. Tomatoes may be grafted in this manner on potatoes; and it is said that potato plants thus treated, produce good crops, both of potatoes and tomatoes.

669. *The greffe étouffée*, or stifled graft, is so named, not from any particular mode of performing the operation, but because the plants so grafted are closely covered with a bell-glass, so as completely to exclude the surrounding air, and placed in moist heat, while the union between the scion and the stock is going on. It is only applicable to plants of small size, and in pots; but for these, whether hardy, as in the case of pines, firs, and oaks, or tender, as in the case of orange-trees, camellias, rhododendrons, &c., it is the most expeditious of all modes of grafting. The operation is very commonly performed in the cleft mode, the stock being in a growing state with the leaves on, and being cut over close to a leaf which has a bud in its axil, and so as to slope away from it. Great care is taken not to injure the leaf and bud on the stock, as on these, in a great measure, depends the success of the operation. The stock is split to a depth equal to two-thirds of its thickness, and the scion prepared is inserted, made fast with a shred of mat, or with worsted threads; and the upper part of the stock not covered by the scion is coated over with grafting-wax. The pot containing the plant is then plunged in heat, and closely covered with a bell-glass, which must be taken off and wiped every second day, and left off an hour or two, if at any time the plants appear too moist. Side-grafting and inarching are also employed by those who practise the *greffe étouffée*, more especially in autumn. After the scion is inserted, and bound close to the stock, the pot containing the stock is half buried in a horizontal position, on a bed of dry tan, or dry moss; and the grafted part covered with a bell-glass, stuffed round the bottom with tan or moss, so as to prevent any change of air taking place within the bell-glass. The graft is kept thus closely covered for from two to four weeks, according to the season, when the scion will, in general, be found perfectly united to the stock. Air is now admitted by degrees; and after a week or two more, the glass is removed altogether, the pot set upright in a gentle heat, and the upper part of the stock neatly cut off close above the scion.

§ VIII.—*Grafting by approach or inarching.*

670. *Grafting by approach* differs from grafting by detached scions, in the scion or shoot not being separated from the plant to which it belongs, and by which it is nourished, till a union takes place. For this purpose, it is necessary that the two plants which are to form the scion and the stock be planted, or, if in pots, placed adjoining each other, so that a branch of the one may be easily brought into close contact with the stem, or with a branch of the other. A disk of bark and alburnum is then removed from each at the intended point of union, and the parts being properly fitted to each other, so as the inner barks of the respective subjects may coincide, as in the case of grafting by detached scions, they are bandaged and covered with clay or grafting wax. This being done, in a short time, in consequence of the developement of cambium, the alburnum of the scion and that of the stock become united, and the scion may be cut off below the point where it is united with the stock, leaving the former to be nourished only by the latter. This kind of grafting is the only sort that takes place in nature, from the crossing of the branches of trees (more especially where they are crowded together in hedges), when, by the friction between them, the alburnum is laid bare, and if a season of repose takes place when the sap is rising, the parts adhere and grow together. This is not uncommon in

beech trees, and in beech and hornbeam hedges; and it is even occasionally imitated by art in young hedges of these, and of several other kinds of trees or shrubs, in order to make a very strong hedge. The principal use, however, of grafting by approach, is to propagate plants of rarity and value, which it is found difficult to increase by any other means, and of which it is not desirable to risk the loss of any part, by attempting an increase by means of detached scions or cuttings. Inarching may be performed with various organs of plants; but in horticulture it is chiefly confined to stems, branches, and roots; and all the different forms may be included under side-inarching, terminal inarching, and inarching by partially nourished scions. The season for performing the operation is principally in spring when the sap is rising; but it may be effected at every season, except during severe frost or extreme heat. No other instrument is necessary than the grafting knife, and the graft may often be secured from the sun and air by bandages, without the aid of moss, clay, or grafting wax.

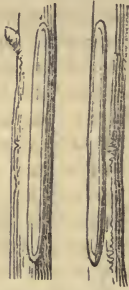

Fig. 224. A scion and stock prepared for inarching.

671. *Side inarching* may be effected either with or without tongueing. In the latter case, the incisions in the scion and the stock are of the simplest description (as shown in fig. 224, and in fig. 225, *a*), and the parts being bound together with matting, as at *b*, and covered by clay or moss, are left to form a union. Side-inarching with a tongue is represented in fig. 226, in which *a* is



Fig. 225. The scion inarched to the stock and bandaged with matting.

the stock prepared with an under tongue, and *b*, the scion, with an upper tongue for inserting into *a*; *c* is the scion and the stock united. One of the purposes, though perhaps more curious than useful, to which De Candolle and Thouin say that



Fig. 226. Inarching with the scion and stock tongued and united, but not bandaged.

this kind of grafting may be applied, is to increase the number of roots to a tree. Thus, if a tree be planted in the centre of a circle, and three or more of the same, or of allied species, be planted in the circumference, so that their tops may be at a suitable distance for inarching to the centre tree; then, after the union has been effected, if the parts of the side trees be cut off above the graft, all the sap sent up by their roots will go to the nourishment of the tree in the centre. When the root of one tree is to be inarched into that of another, with a view of strengthening the tree to which the latter belongs, this mode of inarching is the one generally adopted.

672. *Terminal inarching* consists in heading down the stock, and joining the scion to it, either in the manner of splice-grafting, cleft-grafting, or by

saddle-grafting, as exemplified in figs. 221 to 223. The stock is cut off in the form of a wedge, as in fig. 227, and the scion is cut upwards, half-way through, for a sufficient length, as in fig. 228; then the scion is placed upon the stock as in fig. 229, and bound on with bast and clay as usual, a ring of



Fig. 227. A stock prepared for saddle-inarching.



Fig. 228. A scion prepared for saddle-inarching.

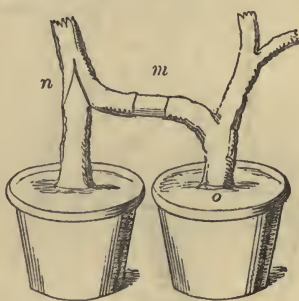

Fig. 229. A scion and stock united in the manner of saddle-inarching.

bark being taken off between the graft and the root, as in fig. 229, *m*, which

causes the returning sap to flow through the graft into the stock *n* instead of into its own root, *o*. This mode is recommended for grafting whenever the stock and the scion are of the same size, or very nearly so; but when the stock is twice the size of the scion, the following modification of it is preferable:—the top of the stock is cut off slanting from one side only, as in fig. 230; then a long tongue is made to the scion, about one-third of its thickness, as in fig. 231, and as much of the bark and wood is cut from the back and front of the stock as will correspond with the width of the tongue on the scion; when the stock is ready to receive the graft, it will appear like fig.



Fig. 230. A stock cut over for inarching when it is twice the size of the scion.

232, *q*: there is also a piece cut off the bark of the stock at *r*, fig. 232, but it is not seen in the figure. Then the scion is placed

across the middle of the stock, as in fig. 233, and bound with bast-mat and clay as usual; after which a ring of bark is taken off at *s*, in fig. 233, in the same manner as directed for fig. 229.

673. *Inarching with partially-nourished scions* appears, at first sight, to belong to the preceding section, but it is placed here because the scion has an auxiliary support from moist soil or water, till it adheres to the stock. This mode is applicable either to the side or crown manner of inarching, and it only differs from them in the inferior end of the scion being inserted in a vessel of water, as in figs. 234

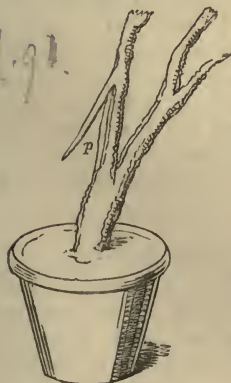

Fig. 231. A scion prepared for inarching when it is only half the size of the stock.

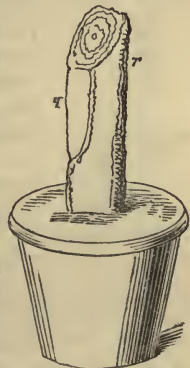

Fig. 232. A stock prepared for inarching when it is twice the size of the scion.

Fig. 233. A scion and stock united in the manner of inarching.

and 235, or in a pot of moist earth. The vessel of water must be removed

from time to time, and the base of the submerged scion renewed by paring a slice off its extremity, and replacing it again in the water. If the stock be headed down, a bud must be left in it at its upper extremity, in order to attract the sap to the graft. The finer sorts of camellias are sometimes grafted in this manner, as indicated in fig. 235.

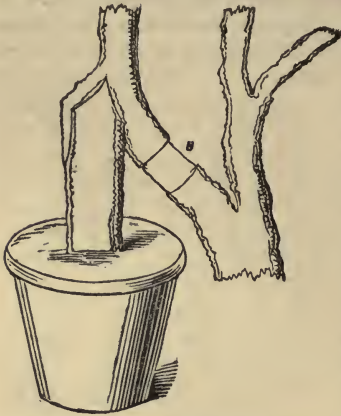

Fig. 233. A large stock and a small scion united by inarching.

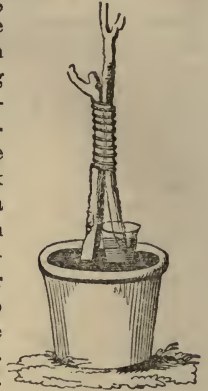

Fig. 234. Inarching with a scion nourished by its lower extremity being inserted in a vessel of water.

In some cases, when it is desired to prevent evaporation, instead of claying or mossing, the graft is covered with a piece of paper tied on below and above the parts operated on, so as completely to enclose them. Some persons, instead of a vessel of water, insert the lower part of the scion into a pot of soil kept moist, or into a potato or a turnip.



Fig. 235. The camellia inarched, with a scion partially nourished by a phial of water.

A great many different kinds of inarching have been described by M. Thouin, which, if not useful, are at least curious: such, for example, as uniting a number of different stems of different species of the same genus, and afterwards allowing only one shoot to expend all the sap drawn up by the different stocks; the object being to ascertain whether the different saps supplied would make any difference in that of the scion, which, however, was found not to be the case. Another mode that used to be practised in Continental nurseries, and sometimes formerly in England, was to raise a plant in a pot, on a platform, between two trees of allied species, as of a thorn between two pear trees, and, after inarching a branch of each tree into the thorn, when the union was complete, to remove the scaffolding, shake the roots of the thorn out of the flower-pot, and leave the plant suspended with its roots in the air.

§ IX.—Budding or Grafting by Detached Buds.

674. Budding consists in transferring a portion of bark containing one or more buds, and forming the scion, to the wood of another plant forming the stock, a portion of the bark of the stock being raised up or taken off to receive the scion. The buds of trees are originated in the young shoots in the axils of the leaves; and when the bud begins to grow, its connexion with the medullary sheath ceases; or, at all events, the bud if detached and properly placed on the alburnum of another plant, will

become vitally united to it. On these facts the art of budding is founded. This mode of grafting is chiefly applicable to woody plants, and the scion may, in general, be secured to the stock, and sufficiently protected there, by bandages of bast-mat or thread, without the use of grafting clay or wax. The union between the scion and the stock takes place, in the first instance, in consequence of the exudation of organisable matter from the soft wood of the stock; and it is rendered permanent by the returning sap from the leaves of the stock, or from those of the shoot made by the bud. All the different modes of budding may be reduced to two:—shield-budding, in which the scion is a piece of bark commonly in the shape of a shield, containing a single bud; and flute-budding, in which the scion consists of a ring or tube of bark containing several buds. In both modes the bark of one year is chosen in preference; and the operation is more certain of success when the bud of the scion is placed exactly over the situation of a bud on the stock. The shield may, however, be placed on the internodes, or a piece of bark without buds may be put on as a scion, and yet a vital union may take place between the parts, because the medullary rays exist everywhere in the wood, and it is by them, during the process of organisation, that the layer of wood of one year in a growing state is joined to that of the year before. A disk or shield from which the visible bud has been removed will also succeed, and the latent buds may remain dormant for years, and yet be developed afterwards. In the year 1824 we placed several buds on the branches of a fig-tree, and, from some accidental cause, though the shield adhered in every case, yet most of the visible buds were destroyed, and only one of the latent buds was developed. Twelve years afterwards, when the fig-tree received a severe check, in the winter of 1837-8, the development of a second latent bud from one of the shields took place. When the bud is placed on the stock, its point is almost always made to turn upwards, as being its natural position; but in budding the olive, and other trees which are liable to gum, the bud is made to point downwards, and the success is said to be greater than when the common mode is adopted. There are two seasons at which budding is practised, viz.:—when the sap rises in spring; when the bud inserted is developed immediately, in the same manner as in detached ligneous scions; and in the end of summer, when the sap is descending, the operation being then performed with a bud formed during the preceding summer, which does not develop itself till the following spring. The former mode is called by the French, budding with a growing eye; and the latter, budding with a dormant eye. In budding, the stock is not generally cut over in the first instance, as in grafting by detached ligneous scions; but a tight ligature is frequently placed above the graft, with the intention of forcing a part of the ascending sap to nourish the graft.

675. *The uses of budding*, in addition to those of the other modes of grafting, are, to propagate some kinds with which the other modes of grafting are not so successful, as, for example, the rose. To perform the operation of grafting with greater rapidity than with detached scions, or inarching, as in the case of most fruit-trees; to unite early vegetating trees with late vegetating ones, as the apricot with the plum, they being both in the same state of vegetation during the budding season; to graft without the risk of injuring the stock in case of want of success, as in side-budding, and in flute-budding without heading down; to introduce a number of species or varieties on the same stem, which could not be done by any other mode of

grafting without disfiguring the stock, in the event of the want of success ; to prove the blossoms or fruits of any tree, in which case blossom-buds are chosen instead of leaf-buds ; and, finally, as the easiest mode of distributing a great many kinds on the branches of a tree, as in the case of roses, camellias, and fruit-trees.

676. *In performing the operation*, mild, cloudy weather should be chosen, because during hot, dry, windy weather, the viscous surfaces exposed to the air are speedily dried by evaporation, by which the healing process is retarded ; besides, the bark never rises so well in very dry, windy weather as it does in weather which is still, warm, and cloudy, but without rain. The first step is to ascertain that the bark of the scion and that of the stock will separate freely from the wood beneath them ; then procure the cutting from which the shields or tubes of bark are to be taken. If the budding is to be performed in spring, the cuttings from which the buds are to be taken should be cut from the tree the preceding autumn, and kept through the winter by burying their lower ends in the ground, in a cool, shady situation, as in the case of grafting by detached scions. When these cuttings are to be used, their lower ends should be placed in water, to keep them fresh, while the operation of cutting shields or rings from them is going on. If, on the other hand, the budding is to be performed in summer, which is almost always the case in Britain, then the cutting from which the buds are to be taken is not cut off the parent tree till just before the operation is to be performed. The cutting should be a shoot of the current year's wood, which has done growing, or nearly so, and its leaves should be cut off, to prevent the waste of sap by evaporation, as soon as it is taken from the tree ; the end of the cutting should then be put in water to keep it fresh, and the buds taken off as wanted. When the leaves are cut off, care should be taken to leave part of the petiole of each, to handle the shield or ring by when putting it on the stock. A slit is next made in the stock, or a ring of bark taken off ; and the shield or ring from the cutting, containing a bud or buds which are ripe or nearly so, is introduced in the manner which will be described in treating of the different modes of performing the operation. Tying the bud on the stock generally completes the operation, though sometimes grafting-wax is employed to cover the junction of the shield or ring. In British gardens the grafting-knife is commonly used for budding, but its sharp point is found in delicate cases to injure the soft wood ; for which reason, on the Continent, a knife is preferred which has a rounded extremity ; and these knives, which are manufactured by Preist, Oxford-street, and other cutlers, are now coming into use in England. An improvement on these knives is shown in fig. 236, in which the point of



Fig. 236. *Godsall's budding knife improved.*

the blade is curvilinear and is two-edged, and the handle has a neck or narrow part, which may be firmly grasped by the little finger when tying on the ligature, instead of the usual butcher-like practice of putting the knife in the mouth. Instead of having a separate knife for budding,

a portion of the back of the common grafting-knife, viz. from + to + in fig. 195, p. 286, may be sharpened by the cutler, so as to be used as a blade for making the downward slit, while the cross slit can be made with the common edge. Scions for budding may be sent a considerable distance by letter, if the leaves are cut off and the scion closely wrapped up in oiled paper, or coated over with mastic. Scions may also be immersed in honey, in which they will keep for two or three weeks. When bulk is not an objection, they may be packed up in long grass, or in moist moss, or in several folds of moistened brown paper, and covered with drawn wheat-straw, to serve as a non-conductor of heat and moisture.

677. *Prepared wax for budding* may be composed of turpentine, bees' wax, resin, and a little tallow melted together. It may be put on in the same manner as grafting-clay, but should not be more than a quarter of an inch in thickness; or it may be very thinly spread upon cotton cloth, and used in shreds, like sticking-plaster. In this last state it serves both as a ligature for retaining the escutcheon or scion in its place, and as a covering for excluding the air. In very delicate budding and grafting, fine moss or cotton wool are frequently used as substitutes for grafting-clay or grafting-wax, the moss or cotton being tied firmly on with coarse thread or fine strands of bast-matting.

678. *Plastic wax*, or grafting-wax, which the heat of the hand, or breathing on, will render sufficiently soft for use, is thus prepared:—Take common sealing-wax, of any colour, except green, one part; mutton fat, one part; white wax, one part; and honey, one-eighth of a part. The white wax and the fat are to be first melted, and then the sealing-wax is to be added gradually in small pieces, the mixture being kept constantly stirred; and lastly, the honey must be put in just before taking it off the fire. It should be poured hot into paper or tin moulds, and kept slightly agitated till it begins to congeal.

679. *Shield-budding in the end of summer* is almost the only mode in use in British nurseries, where it is generally performed in July or August. A cross cut and slit are made in the stock, in the form of the letter T, and if possible through a bud (fig. 237, *a*). From a shoot of the present year



Fig. 237. The different steps in the process of shield-budding.

deprived of its leaves, a slice of bark and wood, containing a bud, *b*, is then cut out, and the wood is removed from the slice by the point of the knife. This is done by holding the shield by the remains of the leaf with one

hand, and entering the point of the knife at the under extremity of the shield, and between it and the thumb; and then raising and drawing out the wood by a double motion outwards from the bark, and downwards from the upper to the lower extremity of the shield. The bud being now prepared, as at *c*, the bark on each side of the slit in the stock is raised up by the spatula end of the budding-knife, and the shield inserted beneath it; its upper part being cut straight across, as at *d*, so as to admit of its joining accurately with the inner bark of the stock, as at *e*, so as to receive its descending sap. A bandage of soft matting is now applied, so as to exclude the air from the wounded parts, and to show only the bud and the petiole, as at *f*, and the operation is complete. At *f*, the bud is shown developing its leaves, and at *g* it has produced a shoot of some length, which is tied for a short time to the upper part of the stock; but that part of the latter which is shown by dotted lines is cut off in July.

The portion of wood left attached to the base of the bud should generally be about a third of the length of the shield; the latter being from an inch to an inch and a half in length, and the eye should be situated about a third from the top. Spines, prickles, and leaves should be carefully cut off or shortened. Sometimes in taking out the splinter of wood from the scion, which is done with a quick, jerking motion, the base of the bud which is woody is torn out also, leaving a small cavity, instead of an even surface; the surface, when the bud is in a proper state, being either quite even, or only gently raised above the surrounding bark, in consequence of the woody base of the bud being left in. When the woody base of the bud has been torn out, so as to leave a cavity, it is safest not to use the bud, but to prepare another; though when the cavity left is not very deep, and a small portion of wood is seen in it, the bud will sometimes grow. Only those buds must be taken from the scion that are nearly mature; which is readily known both by the size of the bud and by the full expansion and firm texture of the disk of the leaf, in the axil of which it grows.

680. *Shield-budding in June*.—Roses of some kinds may be budded at almost any period from June to October. In budding in June, Dr. Van Mons first deprives the young shoots, from which he proposes to take buds, of their leaves, and fifteen days afterwards he finds the buds sufficiently swelled to allow of their being taken off and inserted. The shoots from such buds frequently flower the same year; but this may be rendered certain by pruning off all the branches of the stock. A rose scion is, he says, seldom too dry to take, if the woody base of the bud be left about a third of the length of the shield, as there is then a portion of the alburnum of the scion, as well as a portion of its inner bark, brought into close contact with the alburnum of the stock. Dr. Van Mons has budded successfully from rose-cuttings that had remained in a drawer fourteen days.

681. *Shield-budding in spring* may be exemplified by the Belgian practice with the rose. For this purpose, scions are cut before winter, and stuck into the ground till the moment in spring when the bark of the stock will rise, or, technically speaking, run. To prepare the bud, a transverse cut should be first made into the wood, a little below an eye (fig. 233, *a*), which incision is met by a longer cut downwards, commencing at a short distance above the eye (*b*), care being taken that a portion of wood is removed with the bark (*c*). The bud is then inserted into the bark of the stock which is cut like an inverted T (*d*), and the horizontal edges of the

cut in the stock and of the bud must be brought into the most perfect contact with each other (e), and then bound with waterproof bast (f), without, however, applying grafting-clay.

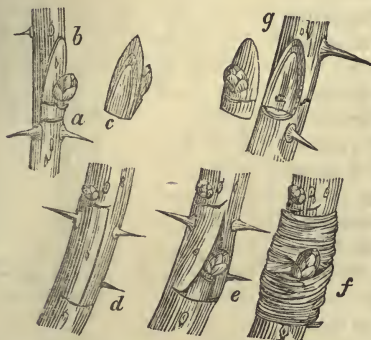

Fig. 238. Shield-budding the rose in spring.

Eight days after the insertion of the bud, the stock is pruned down to the branch above on the opposite side, and this branch is stopped by being cut down to two or three eyes; all the side-wood is destroyed as it appears; and when the bud has pushed its fifth leaf, the shoot it has made is compelled to branch, by pinching off its extremity; it will then flower in September of the same year. The rose may also be budded in spring, without waiting till the bark separates, by placing the bud with some wood on it in a niche made in the stock as at (g), similar to what would be formed by taking an eye off it, for budding in the manner above described; the bud is fitted exactly in the niche, with a slight pressure, and then tied on as usual. The camellia may also be budded in this manner in spring by taking a bud with the wood in from the scion, and substituting it for a corresponding piece cut out of the stock, as in fig. 239.

682. *Shield-budding without a bud or eye* (fig. 240) is used simply to cover a wound or blemish in one tree by a portion of the live bark of another.

683. *Budding with a circular shield*, with a portion of wood attached, (fig. 241,) is employed to equalise the flower-buds over a tree, by removing some from places where there

are too many to other places in which there are too few. With the point of a penknife, in spring, cut a small cone of bark and wood containing a bud, and insert it in an orifice made in the same manner, securing the edges with grafting-wax.

684. *Budding with a shield stamped out by a punch* (fig. 242) is considered excellent for budding old trees, the thick and rugged bark of which is not suitable for being taken off with the budding-knife. With a mallet the punch (fig. 243) is driven through the bark of the scion, and then through that of the stock, and the piece which comes out of the former is inserted in the cavity formed by the piece taken out of the latter.

685. *Budding with the shield reversed* (fig. 244) is almost the only manner of budding used in the south of Europe, particularly at Genoa and Hières, to propagate orange-trees. It is said also to be suitable for trees having abundant and gummy sap.

686. *Budding with the eye turned downwards.*—By this method the buds



Fig. 239. Shield-budding the camellia in spring.



Fig. 240. Shield-grafting without a bud.



Fig. 241. Budding with a circular shield.

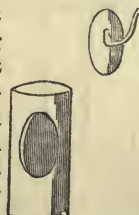

Fig. 242. Budding by the aid of a punch.

are forced to grow in a direction opposite to that which they would have taken naturally; but they soon resume their usual position; and the desired end, viz., that of increasing the size of the fruit by stagnating the returning sap, is thus by no means attained. De Candolle says, that this mode of budding is used advantageously in the case of the olive, and of trees which produce a great deal of gum; but that he sees no reason for its superiority over the ordinary mode. —



Fig. 243. Punch used for punching out shield-buds.

(*Phys. Veg.* vol. ii. p. 300.)

687. *Shield-budding for resinous trees* (fig. 245) is said to succeed with the *Abietinæ*, and with all trees that have a gummy and very abundant sap.



Fig. 244. Budding with the shield reversed.

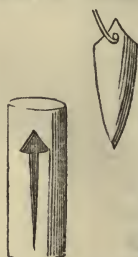

Fig. 245. Budding with a pointed shield for resinous trees.

688. *Budding with the shield covered* (fig. 246).—The shield being inserted in the usual manner, another with an orifice in it, to admit the bud of the first, is laid over it, and is bandaged in the usual manner, or covered with grafting-wax. The object of the double shield is to lessen the effect of drying winds.

689. *Budding with a square shield* (fig. 247) is an old practice which has lately been revived with some modifications (*Gard. Mag.* for 1839, p. 165), in which the bark, raised

up on the stock to make room for the shield, is tied over it; the shield being previously shortened, so as to reach only to the under side of the bud; and between the two barks, the petiole of a leaf is inserted, the disk of which is intended to protect the bud from the sun. The strip of bark being peeled down from the stock, instead of being raised up from it by the spatula of the budding-knife, is found

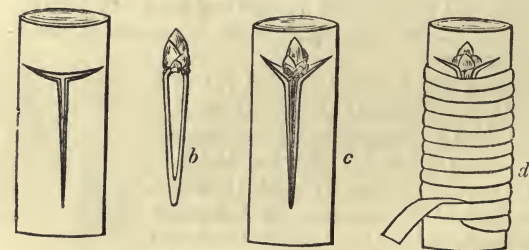

Fig. 248. Budding with a terminal eye.

to lessen the risk of injuring the soft wood; and this appears to be the chief recommendation of this mode of budding.

690. *Shield-budding with a terminal bud* (fig. 248) is supposed to produce a more vigorous shoot than when a lateral eye is used; and it is, therefore, recommended for supplying a leader to a shoot that has lost one. The stock is cut as at *a*, and the bud is prepared as at *b*, inserted as at *c*, and tied in the usual manner, as at *d*.

691. *Flute-budding, or tube-budding.*—There are several modifications of this mode of budding, which is a good deal used on the Continent for trees which are difficult to take, such as the walnut and the chestnut; and for several oaks, as well as for the white mulberry. It is generally performed in spring; but it will also succeed in autumn. The shoot from which the buds are to be taken, and that on which they are to be placed, must be of the same diameter, or nearly so; and a ring being removed from each, that from the stock is thrown away, and the one from the scion put on in its stead. Sometimes this is done without shortening the stock or branch, when it is called annular, or ring-budding; and sometimes the stock is shortened, and the ring put on its upper extremity, when it is called flute-budding, or terminal tube-budding.



Fig. 249. *Flute-budding the mulberry in spring.*

692. *Flute-budding in spring.*—The scions are taken off in autumn, or early in winter, and preserved through the winter in a cool shady situation, in the same manner as is done in grafting by detached scions, and in spring shield-budding. Fig. 249, which requires no description, shows the mode of spring terminal flute-budding the white mulberry, as it is practised in the Royal nurseries at Munich. When the ring of the scion is too large, a portion is cut out of it longitudinally, so as to admit of its being pressed closely and firmly to the stock; and when it is too small, it is slit up so as to admit of its being put round the stock. The tube is tied on with matting, and the summit of the stock is covered with grafting-wax.

693. *Terminal flute-budding* in the South of France (fig. 250).—The head of the stock being cut off, a ring of bark, two inches or three inches long, is removed. A shoot is then taken from the tree to be increased, of exactly the same thickness as the stock, and a ring or tube of bark is taken off the thick end (without being split longitudinally), not quite so long as the piece of bark taken off the stock, but provided with several



Fig. 250. *Terminal flute budding in spring or summer.*

good eyes. The tube thus formed is placed upon the stock, in the room of the one removed,

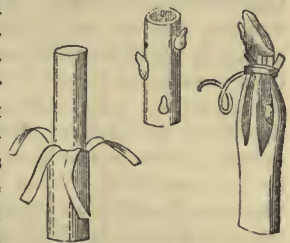

Fig. 251. *Flute-budding with strips of bark.*

and care is taken to make the two edges of bark join below. The part of the stock which projects over the ring of the bark is next split into shreds, and brought down over it all round, in the same manner as when secured by grafting-wax or clay. This mode of budding is chiefly employed in the South of France for propagating walnuts, chestnuts, figs, mulberries, and other trees with thick bark and abundant pith.

694. *Flute-budding with strips of bark* (fig. 251).—The head of the stock is cut off, but instead of removing a ring of bark, as in the preceding mode, it

is cut longitudinally into four or five strips, each two inches or three inches long, and turned down as in the figure, being left still attached to the tree. From a shoot of the tree to be propagated, a tube of bark is taken, furnished with four or five eyes, rather shorter than the strips, though longer than in tube-budding. When the tube of the scion is slipped on the stock, the strips of bark are raised over it, and fastened at the top by a ligature. Sometimes the end of the stock is cut obliquely, and the straps are brought up as at *a*, in which case the top of the stock is not cut into shreds, and turned down over the tube of bark, as in flute-budding in the South of France (692). A curious experiment by this mode of budding, consists in placing rings of the bark of different allied species, one above another, without allowing any of the buds to develop themselves. On cutting down the stem of a tree so treated, some years afterwards, it will be found that under each kind of bark is a portion of its proper wood, proving that the wood is deposited by the inner bark from the returning sap, and that the bark has the power of so modifying this sap, as to produce the particular kind of wood of the species to which it belongs, without the aid of any leaves of that species.

695. *Annular budding* (fig. 252) is performed either at the principal movement of the sap in spring, or at the end of its principal movement in August. In either case the top of the stock is kept on; and if the ring of bark containing a bud or buds taken from the scion is larger than the space prepared for it on the stock, a piece must be taken from it longitudinally, so as to make it fit exactly. In Belgium this mode is considered particularly suitable for hard-wooded trees, which are difficult to increase by any other mode.



Fig. 252. *Annular budding.* 696. *The after-care of grafts by budding* consists, in all cases, in removing the bandages or plasters as soon as it is ascertained that the buds or scions have adhered to the stock. This may generally be known in two or three weeks, by the healthy appearance of the bark and its bud or buds, and by the dropping off of the petiole, which in the case of the death of the bud withers and adheres. The next operation is to head-down the stock to within an inch or two of the bud, the stump being left for a week or two as a prop, to which the shoot produced by the bud of the scion may be tied, till it acquires vigour enough to support itself. The stump is then cut off in a sloping direction, close above the bud. In general, any buds which develop themselves on this stump should be rubbed off; but in the case of very weak scions, one or more buds may be left on the stump to draw up the sap till the graft has taken. When budding is performed in spring, the stock should have been headed down before the ascent of the sap; but in autumn-budding, as no shoot is produced till the spring following, heading down is deferred till that season, and takes place just before the sap is in motion. Where a number of grafts by buds are introduced on one stem or on one branch, heading down can, of course, only take place above the uppermost bud; and in terminal flute-budding, it is performed as a necessary part of the operation.

SUBJECT. II.—*Rearing.*

697. *The operations of rearing* in horticulture are those which are required to bring plants to that particular state of bulk, succulence, colour, or flavour, for which they are cultivated in gardens and garden scenery. These operations may be included under transplanting, planting,

potting, pruning, training, thinning, weeding, watering, stirring the soil, blanching, shading, sheltering, and protecting.

§ I.—*Transplanting and Planting.*

698. *To transplant* is to take up a plant with its roots, and to replant it again in such a manner that it shall continue to grow. In some cases the roots are taken up enveloped in soil and entire, as in transplanting plants in pots; and in others they are divested of soil, and more or less mutilated, as is the case in all other modes. In whatever manner a plant has been originated, whether by seeds or by some modification of division, the first step in carrying on its cultivation is most commonly transplanting.

699. *The uses of transplanting* are:—1. To afford more room for the growth of the top, and for stirring and manuring the soil about the roots. 2. To produce immediate effect in scenery, by placing trees or shrubs in particular situations. 3. To supply deficiencies in plantations already made. 4. By repeatedly transplanting, to limit the extent of the main roots, and to increase the number of fibrous roots, within a limited distance of the stem of the plant, and thus to fit it for being removed, with all its roots, when of a large size. 5. To retard the growth and flowering of certain plants, and by that means to increase the bulk and succulency of their foliage; and, 6. To inure plants to particular soils and situations.

700. *The theory of transplanting* is founded on the functions common to all plants, of growing when placed under favourable circumstances, whether by accident or design; of renewing within certain limits the parts of which they have been prematurely deprived, and of having annually a season of repose. Thus, annual plants, and others of small size, and of only a few months' growth, may be taken up without injuring their fibres or spongioles, and if replanted immediately their growth suffers no interruption; while trees, shrubs, and other large plants, which when taken up have their roots mutilated and the functions of their spongioles interrupted, have a power of protruding new spongioles, so as to renew the growth of their leaves and branches, provided this mutilation take place during the period when the plant is in a state of repose. When plants are in a state of active growth, a constant perspiration is taking place from their leaves, which is supplied by the absorption of the moisture in the soil by the spongioles of the roots; and when this supply through the roots is cut off by the destruction of the spongioles, the leaves wither, and the plant dies or becomes greatly injured: but there is a period in the growth of every plant, in which the leaves either drop off, as in deciduous plants, or cease to be in a state of activity, as in evergreens; and it is only in this state that the operation of transplanting can be successfully undertaken with large plants. Even when trees are without their leaves, perspiration is going on to a certain extent through the bark, and absorption to supply this waste must necessarily be taking place at the same time through the spongioles; for though the functions of all plants are annually in a dormant state, yet they are never wholly inactive; and, hence, even in transplanting trees without their leaves, the effects of more perspiration by the bark than the roots can supply must be guarded against. This is more especially the case in transplanting evergreens, in which the functions of the leaves, and, consequently, of the spongioles, are carried on to a limited extent, even through the winter. As the perspiration both of the leaves and bark is greatly dependent on the moisture or dryness of the

atmosphere, it follows that on the state of the weather at and after transplanting, a good deal of the success of the operation must depend; and as the kind of weather bears close relation to the season of the year, that also requires to be taken into consideration. All plants, considered with reference to transplanting, may be divided into three classes, viz., those which can be transplanted in a state of active growth, and with their leaves on, which are chiefly seedlings, and other small plants, and plants in pots; those which can only be transplanted with success when without their leaves, as deciduous trees, and herbaceous perennials of more than a year's growth; and those which are transplanted when their leaves are on, but in a comparatively dormant state, as evergreens.

701. *Seedlings* and such small plants as can be taken up with all their fibres and spongioles uninjured, and planted immediately, may be removed at any season which admits of the progress of vegetation; though their success will be most certain when the atmosphere is warm and cloudy, and the soil moist rather than dry; as under such circumstances the absorption carried on by the spongioles will be very slightly interrupted, and the perspiration of the leaves not checked. In performing the operation, the plants are raised out of the soil by a flat-pointed stick, or trowel, or a spade; or when the soil is moist, stout seedlings, such as those of the hardier varieties of the cabbage tribe, may be drawn out by the hand; and they are replanted in holes made for them by the same implements; and after the insertion of the plant, the hole is filled up with soil gently pressed to the roots, and, if necessary, water is given. Tender plants, when thus transplanted, are covered with a hand-glass or frame, to preserve a moist atmosphere around them; or if in pots, they are plunged into a hotbed for the same purpose, and also to stimulate their roots. The hardier annuals, on the other hand, such as seedlings of the cabbage tribe, may be transplanted with less care, since when they flag or fade, their leaves soon recover again, in consequence of fresh spongioles being emitted by the main or tap root. It is even asserted by experienced gardeners, both in Britain and on the Continent, that plants of the cabbage tribe grow faster, when in transplanting they have been kept sufficiently long out of the soil to cause their leaves to fade; the plants, in this case, De Candolle observes, pumping up moisture rapidly in proportion to the degree in which their interior tissue has been deprived of it. During moist weather, or where there is an opportunity, by means of coverings, of preserving a moist atmosphere round plants, and excluding the direct rays of the sun, herbaceous plants of considerable size, with the leaves on, may be transplanted; but in ordinary weather, and without the aid of protection, this is difficult in proportion to the number and size of the leaves, the thinness of their texture, and the number of their stomata. The evaporation, in cases of this kind, being greater than the absorption by the spongioles, it requires to be lessened by cutting off a portion of the disks of the leaves, by thinning them out, or by cutting them off altogether. In general, this latter treatment can only be practised with impunity in transplanting young plants that have fleshy roots, such as the Swedish turnip, the rhubarb, &c. In transplanting seedlings, the top or main perpendicular root is generally shortened to increase the number of lateral spongioles, more especially in the case of vigorous-growing plants. The object of this shortening is, in some cases, to cause the roots to derive their chief nourishment from the upper and richest part of the soil; and in others, that the plant by having abundance of

roots in a limited space may be the better adapted for being again transplanted. In the operation of transplanting tap-rooted seedlings, it is found of use either to cause the soil to press equally against every part of the root; or if it presses more upon one part than another, that that part shall be the lower extremity. The reason of this is, that the pressure, wherever applied, stops the returning sap; and when it is not applied at the lower extremity, the part of the root below where it takes place ceases to increase in thickness, or to protrude fibres. Transplanting in pots will form the subject of a separate section.

702. *Deciduous trees and shrubs, and perennial herbaceous plants*, can only be safely transplanted when in a dormant state. This dormant state is indicated by the fall of the leaf, at which period the roots, stem, and branches contain a greater accumulation of nutritive matter than they do at any other season of the year, and not being in a state of activity, they can exist in a great measure without the assistance of the spongioles. They are, therefore, in a fitter state for being transplanted than they can be at any other period, and the success will in general be in proportion to the number of roots that are taken up entire. In the case of herbaceous plants, and of trees and shrubs under five or six feet in height, this can be accomplished without difficulty; but with larger plants the roots are unavoidably more or less mutilated, and the growth of the transplanted plant for the first year, or probably for some years afterwards, is much less vigorous than if the roots had been taken up entire.

703. *Whether deciduous trees and shrubs ought to be transplanted in autumn or spring*, is a question respecting which gardeners and foresters are of different opinions. That of Miller and of most gardeners is, that immediately after the fall of the leaf in autumn is the best season, provided the soil be dry; but that for a very wet soil it is better to wait till the end of February, or till the period immediately preceding the rise of the sap. Some gardeners recommend transplanting "early in autumn, soon after the leaves begin to fall, but while a considerable quantity yet remain in a mature and efficient state." In this case it is alleged that "by the action of the mature leaves which remain, the injuries which the roots may have sustained will be speedily repaired; new roots will be immediately produced, and the plant will then become established before winter, and prepared to grow with nearly if not quite its usual vigour in the following spring."—(*Gard. Chron.* vol. i. p. 811.) In the neighbourhood of London, wall-fruit trees are frequently transplanted in this manner. Early in autumn is undoubtedly the best time, considered physiologically; because then, whether the plants are with or without some of their leaves, the wounds made in the roots begin to cicatrise, and to protrude granulous matter, and in many cases even spongioles, immediately; and by the time spring arrives, the plant, if it has been taken up with most of its roots, will grow with as much vigour as if it had not been transplanted. For obvious reasons, the next best season to that immediately following the fall of the leaf, is the remainder of the autumn, and the winter months during open weather. There may be local reasons why the beginning of spring may be preferable to autumn; but such reasons can never apply generally. A second argument in favour of autumn-planting, is the dampness of the atmosphere which prevails at that season, and during winter; by which the perspiration through the bark is lessened, and the demand made on the roots to supply the waste is consequently diminished. In spring, not only

is the sun more powerful, but drying winds generally prevail, which have a constant tendency to drain the young branches of a tree of their moisture. These drying winds are much more injurious to newly transplanted evergreens than to deciduous trees, as will afterwards appear.

704. *Different modes of transplanting large trees and shrubs.*—To lessen the injuries which every large tree must receive in transplanting, from the mutilation of its roots, six different modes of performing the operation have been adopted: viz., 1. by retaining large balls of earth attached to the roots; 2. by previously preparing the roots, so as to furnish them with new fibres and spongioles; 3. by previously shortening the roots, and treating them so as to heal over and granulate the wounds made in their extremities; 4. by simply thinning and pruning the roots and the branches at the time of transplanting; 5. by removal without previous preparation; and 6. by shortening the roots and heading in the branches.

705. *Transplanting with large balls of earth.*—In this case the head of the tree is generally preserved entire, and the ball of solid soil is made so large as to include as many of the roots as possible. When carefully planted in fresh rich soil, consolidated by watering, and secured by stakes, by guy ropes, or by any other means, if the tree survives the first summer, the quantity of foliage which it will produce will return a large quantity of sap to the roots, and thus occasion the production of numerous fibres and spongioles, and the tree will continue to live and grow; but whether with the same vigour as it did before being transplanted, will depend on the quantity of roots, in proportion to the head, taken up in the ball—on the kind of tree, on the moisture or dryness of the climate and of the season, and on the state of the soil and the nature of the situation. In general, more depends on the climate and on the soil than on the situation. No large tree taken up from a moist soil will thrive if transferred to a dry one; and, on the contrary, a tree taken up from a dry soil, that would do little good when transferred to another dry soil, will yet thrive if planted in a soil that is moist. No tree taken up and transplanted with all its branches in the manner described could exist through the ensuing summer in the dry climate of the South of France; but in the moist, warm atmosphere of Devonshire, and the humid region of the west of Scotland, trees taken up with all their roots and branches, as far as practicable, and transplanted with ordinary care, seldom fail to grow, and in a few years to acquire the same vigour as they had before transplanting. (See *Nash in Gard. Mag. for 1838*, p. 507.)

706. *Transplanting by shortening the roots, so as to induce them to throw out fibres.*—This is effected by digging a circular trench round the tree, one or two, or even three or four years before transplanting, cutting off all the roots which extend as far as the trench, and filling it up with prepared soil, or with the surface soil and subsoil mixed. The distance of the trench from the stem of the tree may vary with its size, the kind of tree, and other circumstances; but a good general rule would be, where the tree is to stand from two to four years, to make the diameter of the circle included within the trench of as many feet, as the diameter of the trunk of the tree at the surface of the ground is in inches. Thus, for a tree with a stem six inches in diameter, the trench should be made at the distance of three feet from it on every side; and for one of eighteen inches in diameter, the distance of the trench from the stem should be nine feet. The width and depth of the trench should

also be proportionate to the size of the tree, and to the period which is to intervene between its preparation and removal. It is evident that where the tree is to stand three or four years after its roots are cut, more room should be left for the extension of the fibres, than when it is to stand only one year; unless, indeed, the roots could be confined, as if in a pot, by the hardness of the outer side of the trench; in which case they might after removal be spread out at length. It is evident also that when a tree is to stand only one year after making the trench, the trench should not only be made narrower, but at a greater distance from the stem, in order that a greater length of old root may be taken up to serve in lieu of the new roots, made when the tree stands three or four years before removal. The width of the trench can never conveniently be made less than eighteen inches, and its depth should not be less than two feet, in order to cut through the lower roots; since it is chiefly by the fibres that will be produced by these, that the tree will be supplied by fluid nutriment to support the perspiration of its leaves the first year after transplanting. In making the trench, it is not, in general, desirable to undermine the ball of earth, so far as to cut through the tap-root, because this main root is necessary as a source of nourishment, in the absence of so many lateral roots.

707. *Sir Henry Steuart's practice in transplanting large trees* belongs to this division of the subject; and as it has been attended with success at Allanton, where the trees, which had been transplanted from ten to twenty years (which we examined in August 1841), are still continuing to thrive, we shall give a short outline of Sir Henry's process. In selecting the trees to be transplanted, he endeavours, if possible, to take only those, the stems and branches of which have been exposed to the free air and weather on every side; but as he cannot always get such trees, his next resource is trees which stand in the margins of plantations. Supposing one of these to be 25 feet high, a trench 30 inches wide is opened round it at a distance of three and a half feet, if it is meant to stand for four years or upwards after the operation; and at the distance of six feet or seven feet, if it is meant to stand only two years. If the tree is to stand four or more years, the trench is cut to the full depth of the subsoil, in order to get somewhat underneath the roots. If the subsoil be wet, a drain is made from the trench, after which the soil and subsoil are returned, well broken and mixed together. If the tree is to stand only two years, the same method may be followed, but with this difference,—that on the sides most exposed to the wind, which in this island are generally the south-west, two or perhaps three of the strongest roots should be left uncut, and allowed to pass entire through the trench, so that when taken up at length, they may act as stays against the winds.—(*Planter's Guide*, 2d ed. p. 219.) In taking up the tree for removal, the greatest care is used to preserve the minutest fibres and the spongioles entire; and to accomplish this, a new trench is made exterior to the old one, so as not to injure any of the new fibres which have been protruded into the prepared soil. A pointed instrument or a pick is employed for picking out the soil from among the young roots; and care is taken that the operator never strikes across the roots, but as much as possible in the line of their elongation, always standing in the right line of divergence from the tree as a centre. The picking away the soil from the roots may reach within three, four, or five feet of the stem, according to the size of the tree; and a ball of earth, with two or three feet broad of the sward adhering to it, should be

left undisturbed round the collar. The tree may now be pulled over, and raised out of the pit; and the following is Sir Henry's Steuart's mode of effecting these two operations.

708. *Pulling down the tree and raising it out of the pit.*—“A strong but soft rope, of perhaps four inches in girth, is fixed as near to the top of the tree as a man can safely climb, so as to furnish the longest possible lever to bear upon the roots; taking care, at the same time, to interpose two or three folds of mat, in order to prevent the chafing of the bark. Eight or nine workmen are then set to draw the tree down on one side. Or it is a good way, if you have an old and steady-pulling horse, to employ him in this business. For it is plain, that one stout horse, acting forcibly on the rope, will do more than twenty men, even if so great a number could get about it; and moreover, he will save some manual labour in excavating, by giving an effectual pull, at a much earlier period of the work. Next to an old and steady horse, for a high-mettled one is not at all adapted for such an operation, heavy oxen are to be preferred; for these have been known to drag timber out of plantations where horses were defeated, in consequence of the rugged nature of the surface. Horses make one very spirited pull, but rarely a second, if they have been checked by the first. Oxen, on the other hand, appear less sensitive, and bear steadily and slowly onward by the mere force of gravity, and without recoiling like horses. The tree being drawn down, it is next forcibly held in that position, until earth be raised to the height of a foot or more, on the opposite side of the pit, so that, as soon as it is liberated, it springs up, and stops against the bank thus formed. On this, the workmen proceed to lighten the mass of earth with the picker, laying bare the roots as little as possible, but still necessarily reducing the mass to manageable dimensions. The tree is then pulled down on the opposite side, and a foot of earth forced up, in a similar manner; and the same thing being repeated once or twice, it is gradually raised to even a higher level than that of the adjoining surface. In this manner, by a method extremely simple, and not less expeditious, whatever it may appear in the narrative, it becomes quite an easy, instead of a formidable undertaking, to draw the tree from the pit.”—(*Planter's Guide*, 2d ed. p. 243.)

709. *Transporting and replanting the tree.*—The machine used by Sir Henry consists of a strong pole and two wheels, with a smaller wheel occasionally used, which is fixed at the extremity of the pole, and turns on a pivot. The pole operates both as a powerful lever to bring down the tree to a horizontal position, and in conjunction with the wheels as a still more powerful conveyance to remove it to its new situation. The wheels of the machine are brought close up to the body of the tree, and the stem laid along the pole, with the largest branches uppermost, in order that no branch or root of considerable length should be suffered to sweep the ground during the time of transportation. The tree thus attached to the pole is drawn to its destination by a horse or horses, and placed upright in a shallow pit, which is, if possible, opened and prepared a twelvemonth beforehand by trenching and mixing manure, and exposing the soil in the bottom of the pit to the influence of the weather. The tree is so placed that the largest boughs are presented to the most stormy quarter of the wind, even though this should require it to be placed in a reversed position relatively to the sun than it was before, which Sir Henry Steuart as well as Decandolle think of no consequence. After upwards of thirty-five years' experience, Sir Henry

found no disadvantage from this change of position; but, on the contrary, as the tree presents the side containing the longest and most vigorous branches to the storm, it ultimately, he says, produces a better balanced head. The transplanted tree, after being set upright, and the soil carefully rammed into all the cavities about the roots, is held in its position, not by posts or stakes above ground, or by horizontal poles under it, but by forming a circular bank of earth on the extremities of the main roots. This bank, Sir Henry says, if properly executed, will by its weight furnish such resistance to the action of the top of the tree, that a stout man, on applying himself to a rope tied to the upper part of the stem, will generally be unable to displace the root, notwithstanding the length of the lever by which he operates. For more minute details we must refer to Sir Henry's work. The great success which attended his operations at Allanton may, we conceive, be chiefly owing to the care with which they were performed, to the circumstance that the trees were always prepared for three or four or more years beforehand, and the extraordinary moistness of the climate in that part of Scotland. It is a common practice in England to prepare the trees only one year before removal; in which case, as Sir Henry very justly observes, "the fresh fibres being nearly as tender as the roots of an onion or a cabbage, can neither be extricated nor handled without sensible injury." In the case of shrubs, however, one year will be found sufficient for many kinds that rapidly emit a great number of roots.

710. *Transplanting by shortening the roots, without permitting them to throw out fibres at their extremities.*—This mode is the invention of Mr. Munro, a scientific forester of great experience, and is described in the *Quarterly Journal of Agriculture*, vol. v. p. 183, and in the *Gardener's Magazine* for 1841-42. Mr. Munro had been in the habit of transplanting from three hundred to five hundred trees annually by cutting a trench round the roots, and filling it with prepared soil, allowing the tree to remain for one or two years to form fibrous roots. The young roots were protruded in clusters round the ends of the amputated roots, but they were so tender as to be much injured by the spade in the process of lifting, and by the atmosphere when removing. A pit of large dimensions was also required, which added much to the labour; a tree, the roots of which formed a ball only about four feet in diameter, requiring a pit eight feet in diameter to allow of the fibres being laid out at full length, besides a foot of moved soil beyond them all round to encourage their growth. A much more economical and equally efficient mode is suggested by the following experiment:—Mr. Munro selected a handsome oak, about twenty-five years old, and having dug out a circular trench round it, leaving a ball of earth four feet in diameter, he cut off every root which projected into the trench with a saw, and smoothed it over with a pruning knife. The object was, in place of encouraging the growth of fibres at the extremities of the amputated roots, to have the fibres formed within the ball of earth all along the old root. To accomplish this end, he left the trench empty and roofed it in with boards, covering up any opening between them with withered grass, and then putting over the whole an inch of soil, so as completely to exclude light and change of air. In this situation the tree remained for one year, having no lateral communication with the surrounding soil. The operation was performed in the winter of 1824, and in that following the roofing was taken from the trench, and the ball of earth reduced to a proper dimension for removing the tree, when the

old roots were found not only furnished with fibres in the interior of the ball, but the fibres were matted sufficiently to retain enough of soil to protect the roots at the time of removal; and, what was of nearly equal importance, callosities were formed at the ends of the amputated roots ready to throw out spongioles as soon as they were surrounded by moist soil. This mode, we believe, has not been much practised, excepting by Mr. Munro, but we consider it excellent in theory; and by using branches and litter, or branches and turf, as a covering, or leaving the trenches quite open, as has been done in subsequent trials, it will be found greatly more economical than Sir Henry Stuart's method. It is obvious that the growth of the tree must be greatly checked by this mode of preparation, which will consequently have the effect of rendering it capable of living on a limited quantity of food, and therefore much better adapted for removal. The only objection that occurs to us is, that in the case of previous preparation for two or three years, too many fibrous roots will be protruded into the ball, more, perhaps, than can be nourished in that limited bulk of soil, even after the tree is transplanted. If, however, the tree is prepared only one year previous to removal, the objection will not apply to the same extent, if at all.

711. *Transplanting by thinning and pruning the roots and branches* is the most common mode, and in a moist soil and climate it is generally attended with success. The trees are taken up by cutting a trench round the roots about the same distance as in preparing trees by the first mode (695); the ends of the roots are sawn off and cut smooth, and the top is thinned of its branches, and pruned more or less, according to the size of the tree, and the soil, situation, and climate in which it is to be planted. When the tree is of considerable size, say nine inches or a foot in diameter, it must necessarily be deprived of the greater number of its effective roots; and in this case, unless in a very moist climate and soil, the safest mode is to cut off at least half of the branches of the head, covering the sections left by amputation with grafting-clay or grafting-wax. If trees are transplanted in this manner immediately after the fall of the leaf, the wounds of the roots very soon begin to heal over, and by the time spring arrives they are ready to throw out fibres and to support the leaves protruded by the branches left, which in their turn nourish the fibres of the roots by the returning sap. The second year the roots will be more vigorous, and the buds on the branches will probably elongate into shoots of an inch or two in length. In this way the tree will gradually recover a certain degree of vigour, and it will ultimately become either a stunted tree or a vigorous healthy one, according to the quantity of nourishment afforded by the soil (see *Pruning*). In some cases large trees can be removed without preparing the roots, and without cutting off any, or at least very few, of the branches: but in such cases it will be found that, from some cause or other, the roots are mostly near the surface and the soil moist, and that a great proportion of the roots can be taken up along with the tree. A great many trees, such as spruce, firs, alders, limes, elm, and beech, from fifteen to forty feet high, were transplanted at Chalfont House, in 1799, by Mr. Main. They grew on a thin stratum of rich bog earth, reposing on a bed of moist gravel. When a tree had a trench dug round it at the distance of three or four feet, the whole mass of roots rose together, leaving the gravel clean and bare; and the consequence was, that with very little lopping, the trees, being planted in a similar soil and subsoil all lived, and soon began to grow vigorously (*Gard. Mag.* vol. iv. p. 118)

When this mode of transplanting large trees with the branches on is adopted in a dry soil, the success will be very different, even though the ground should be mulched round the transplanted trees, and the stem and main branches closely wrapped round with straw ropes to lessen evaporation. The most suitable trees for planting out with no other preparation than thinning or pruning the branches, are those whose roots and heads have been properly thinned and pruned by cultivation in a nursery. Such trees may be planted out at greater ages and sizes than trees taken from plantations of a few years' growth, and will both strike fresh roots more certainly and grow faster; but these last may be taken up, when from ten to twenty or twenty-five feet high, and planted out with full success, provided the two following particulars are observed: first, to get up as much root as possible; next, to reduce the branches down to due proportion with the root which has been got up. A great part of the root is unavoidably lost in the taking up of the tree, and it is the most efficient part, being the extreme fibres. The root has thus lost its natural proportion to the head, and is now insufficient to supply it with moisture. Trees planted out in this state often, after having put forth their leaves, die suddenly, and others which continue to live will fall into a languid state and die off gradually, or recover their vigour very slowly. (*Sir Chas. Monk in Hort. Trans. and Gard. Mag.* vol. v. p. 148.)

712. *The removal of large trees and shrubs* without previous preparation has been carried to a greater extent at Arlington Court, in Devonshire, than it has been anywhere else that we have heard of; and a detailed account of the manner in which the operation is performed by Mr. Nash, the gardener, will be found in the *Gardener's Magazine* for 1838, p. 507. The trenches at Arlington are dug round the tree at ten or twelve feet from the stem, or farther if necessary, so as to take up as far as practicable the whole of the roots and fibres; and none of these or of the branches are cut off, excepting such as have been injured by the operation of moving. Isolating the roots of a large tree in its ball of earth, and rendering this ball portable by soaking it with water during frost, and moving it when it is a frozen mass, is sometimes resorted to with good effect; and encasing small balls with plaster of Paris, where that substance is abundant, has been occasionally practised by amateurs.

713. *Transplanting by "heading in," that is, cutting in the branches.*—This is the general practice throughout the Continent; for there, such is the heat and dryness of the air in early spring and summer, that the roots of newly-transplanted trees are far from being able to support the perspiration which takes place from the leaves. The practice is of the most remote antiquity, and Professors De Candolle and Thouin both allude to it, as in general use, and attended with success; though they both allege that it is carried too far when the main stems of pyramidal trees, such as pines and firs, are shortened; the consequence of which is a branching head instead of a conical one, as may be seen in those remarkable rows of spruce-firs which line some of the avenues at Meudon. The mode of treating headed-in trees practised in Belgium is described in an early volume of the *Gardener's Magazine*, and again in that work for 1841. The trees, whether oak, ash, elm, poplar, or other leafy kinds, are taken from the nursery when they are fifteen feet or more in height, and about the thickness of a man's arm; the lateral branches are all cut off close to the stem, to the height of six or seven feet from the collar; the top is also cut off in a slant-

ing direction, at about ten feet from the roots ; and the remaining branches are shortened to from three to six inches, the cut being made close above a bud. The trees are taken up in March and April, (in England, immediately after the fall of the leaf would be a better time,) without balls of earth, and not remarkably carefully, but precisely after the ordinary manner practised in our nurseries, and they are planted in holes about three or four feet square. The first year they grow but little ; the second year they may be said to commence their growth, when the uppermost shoot is trained for the leader. As the tree progresses, it is pruned every year, if necessary, in winter or early in spring, cutting out all the cross and unequal branches, and thinning those that are or may become crowded. It may be thought that trees treated in this manner would all become round-headed, and that they would only have about ten feet of straight timber ; but this does not necessarily follow, unless that form be really desired. On the contrary, the straightest and most beautifully attenuated timber is obtained by timely training the upper shoot to a stick tied to the stem ; or if the uppermost shoot is emitted a few inches below the summit, which is sometimes the case, it may be tied to the dying point, till it is fixed in an unchangeable erect position. By attending to this, and by thinning the branches, without shortening them, for a few years, they will become completely subordinate to the trunk (*Gard. Gaz.* for 1841, p. 791). This we consider to be the safest mode of transplanting trees in exposed, bleak situations in Britain ; more especially on the sea-coast, and in mountainous districts.

714. *The staking or supporting of newly-transplanted trees, and the protection of their stems from cattle,* require to be carefully attended to ; and we shall therefore shortly notice the different modes of doing both. Fig. 253 shows the common modes of protecting trees which are to have clear stems to the height of eight or ten feet, from deer, horses, or cattle ; the main posts being made of oak or of larch, or of any other wood charred on the part which is buried in the soil, and for nine inches or a foot above the ground's surface. For trees which are intended to have their branches sweeping on the ground, such as cedars, pines, silver firs, &c., circles of iron hurdles fastened together with bolts and nuts should be employed ; enlarging the circle as the branches extend themselves, by introducing additional hur-

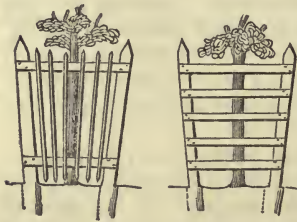

Fig. 253. *The most general modes of protecting recently-planted single trees from cattle and deer.*

dles. These hurdles being always only a few feet from the branches, are scarcely perceptible at a very short distance, and therefore are no deformity in the landscape : as may be seen at Goodwood, Bicton, and many other places. Trees which have had all the branches cut off in the Belgian manner, require no staking, because the wind has no branches on which to act ; and their stems may be protected from cattle by tying thorns or other branches round them ; or laths or straight rods, or even pieces of old bark ; using as a tie, wire or tarred thread. Small trees, with the branches on, may be tied to stakes with bands of hay, and their stems protected in the manner just mentioned. Trees of thirty or forty feet in height may be supported by guy ropes ; or if the roots are strong and of some length, they may be kept in their places by

horizontal poles placed over them, and tied to them, concealed under, or level with, or immediately above the surface of the ground; the ends of those poles being made fast to stakes, so as to cross over the roots and hold them tightly down. Fig. 254 shows a plan and elevation of a newly-

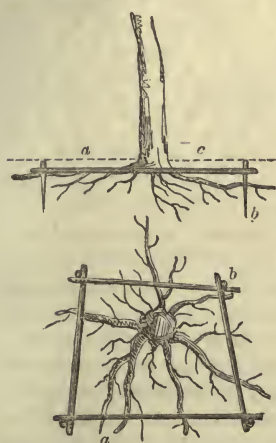

Fig. 254. *Plan and elevation of a newly-moved tree, secured from high winds by underground fastenings.*

removed tree, the roots of which are fastened down in this manner by means of the rods *a*, and stakes *b*; the latter being securely nailed to the former, and the whole covered with soil, as shown by the dotted line *c*. Trees of moderate size may also be secured against high winds, by inserting a stout stake in the soil in the bottom of the pit in which the tree is to be planted, of sufficient length to reach four or five feet above the surface; securing it firmly there before planting the tree, and afterwards placing the stem of the tree close to it, and fastening it by some soft tie. Three larch poles fixed in this manner, so as to form a triangle, converging at top to the thickness of the stem of the tree, the tree being planted in the centre, would serve at once as a firm prop, and as a protection from cattle. Another mode is to cover the surface of the ground for four or more feet round the tree with a mulching of large rough stones. This mode, which

was first used by Sir Charles Monk, in Northumberland, and has been adopted in various parts of Scotland, is one of the best that can be adopted in a country where stone is abundant; because it not only renders stakes and bandages unnecessary, but retains the moisture in the soil, and acts as a fence in keeping horses and cattle at a distance from the tree (*Gard. Mag.* vol. v. p. 148). The stones are in large lumps, not built up high, but packed close to each other, and set on edge, so as to make a tabular, but very rugged surface, round the foot of the tree. This mulching is extended in ordinary cases to the distance of four feet, which is sufficient for cattle and common horses; but against high-bred horses, which are disposed to attack everything of wood, the stones are not a sufficient fence unless they are packed with a surface very rugged, and extended six feet round the tree. Horses and cattle are also kept at a distance from the trees by a series of horizontal rails, forming a tabular polygon round the tree fifteen or eighteen inches in height, and ten feet in diameter (see *Gard. Mag.* vol. vi. p. 47). Fig. 255 shows the general appearance of a tree fenced round in this manner. Fig. 256 is a vertical profile of the horizontal frame-work; and fig. 257 is a cross section. In this section the posts are shown, inclined a little outwards, the better to resist pressure from cattle or sheep in that direction. These short posts, or stumps, as they may be called, are formed of pieces of young larch-trees or oak branches, from which the bark has been taken, and they are driven in so as to be from fifteen to eighteen inches above the ground. The rails which are fastened to the posts are of the thinnings of young plantations, or of any other suitable material. The advantage of this fence is its economy, requiring only short pieces of not very stout timber, and its inconspicuousness when seen at a distance. Other modes of staking and protecting

trees will be found in the *Suburban Architect and Landscape Gardener*, 1st ed. p. 555.

715. *The machinery for moving large trees* has been noticed (443 and 709),

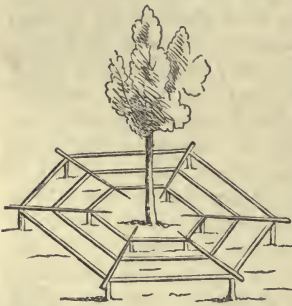

Fig. 255. *Isometrical view of the tabular tree-guard.*

towhich it may be added that trucks or sledges, poles and ropes, require to be abundantly provided; though for ordinary purposes, a pair of high wheels and an axle for

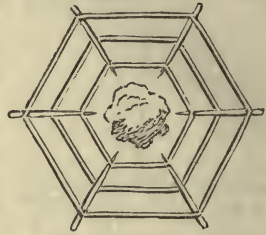

Fig. 256. *Vertical profile of the tabular tree-guard.*

large trees without balls, and a sledge with an iron bottom, to be afterwards described, for shrubs with balls, is all that is essential.

716. *Transplanting Evergreens.*—There is scarcely any residence in the country in which it is not frequently necessary to transplant evergreen shrubs, sometimes from changes or new arrangements, and sometimes on account of the plants crowding each other. Evergreen trees, such as those of the pine and fir tribe, are also occasionally transplanted, though much less frequently than shrubs. The most readily transplanted evergreen trees of arge size, are the spruce fir and the yew; the former having numerous

fibrous roots near the surface, and the latter having also numerous fibrous roots growing together, and consolidating the soil immediately round the tree into a compact mass. Spruce firs, yews, and hollies of large size have, for some years past, been transplanted at Elvaston Castle by Mr. Barron, with scarcely a single failure, though the spruce firs were from sixty to eighty feet in height, and many of the yews were above a hundred years old. Evergreen shrubs of all sizes have also been transplanted



Fig. 257. *Cross section of the tabular tree-guard.*

with the greatest success in the New Botanic Garden of Edinburgh, by Mr. McNab, of whom

Mr. Barron is a pupil, and from whose excellent pamphlet on the subject we shall chiefly compile the remainder of this article.

717. *The best season for transplanting evergreens* is still a debated point among gardeners, though it is now generally agreed that autumn and winter are preferable to spring or summer. On the Continent, spring appears to be preferred, just before the rising of the sap, when the leaves of the past year are ready to drop off; but it must be recollected that there are comparatively very few evergreens cultivated on the Continent, which are sufficiently hardy to endure the open air, with the exception of pines and firs, the narrow leaves of which suffer much less from drying winds than those of broad-leaved evergreens, such as the holly, the laurel, the arbutus, &c. Miller (during whose time there were comparatively but few evergreens, to what there are at present) recommends planting the common and Portugal laurels

in October, as the best season; the arbutus in September; the holly in autumn, in dry land, but in wet land in spring; and the laurustinus at Michaelmas—but also in spring, with balls of earth, or at the end of July, or beginning of August, if rain should happen at that season. In general, Miller recommends autumn and spring, or summer, for transplanting evergreens, but disapproves of winter. At Cheshunt, in Hertfordshire, a great many evergreens were moved every year for a number of years, in consequence of additions and alterations in the grounds; and Mr. Pratt, the gardener, in an account of his practice given in the *Gardener's Magazine*, states that “the best period for the operation is the middle of summer; that is to say, in July and August, after the growth of the spring shoots. The plants may then require a little shading with mats, if the sun is powerful; and they should have plenty of water; but they will make roots during the remaining part of the year, and will grow the next spring as if they had never been transplanted. Those removed in the winter often remain without making new shoots the whole of the following year.”—(*Gard. Mag.* vol. xi. p. 135.)

Mr. McNab, on the other hand, “in opposition to the opinion of a great proportion of the practical horticulturists in the country,” asserts, “that the seasons usually recommended for planting evergreens, viz., spring or autumn, are far from being the best, and are, in fact, under most circumstances, the very worst seasons which can be selected.” Mr. McNab recommends “late in autumn, winter, or very early in spring; that is, any time from the middle of October till the middle of February; and, in general, the beginning of this period as the best; that is, from the middle of October till the middle of December; always providing that the weather and the ground are favourable; that is, supposing there is no frost, no drying wind, nor much sunshine, and that the ground is not too much saturated with wet, either from continued rain, or from the nature of the soil. One of the principal things to be attended to in planting evergreens, is to fix on a dull day for winter-planting, and a moist day for spring and autumn-planting.” The reason why dull or moist weather is so essential a condition is, that the process of perspiration continues to go on in evergreens throughout the winter, excepting, perhaps, in the most severe weather; and that when the atmosphere is saturated with moisture, the perspiration is reduced to its minimum. Evaporation also proceeds in an increasing ratio with the temperature, all other circumstances being the same. Thus, when the temperature is 80°, the quantity evaporated from a given surface will be three times greater than when the temperature is only 40°, the degree of dryness in the air being the same in both cases. So long as the leaves remain on a plant in a healthy state, their functions are performed in a greater or less degree, and they draw upon the roots accordingly; so that evergreens, as they never lose their leaves, may be said to be in a growing state all the year; and were the growth not much slower in autumn and winter than it is in summer, it would be as difficult to transplant evergreen trees, even at that season, as it is to transplant deciduous trees in summer with the leaves on. The first effect of separating a plant from the soil, is to cut off the supply of sap to the leaves; and as, notwithstanding this, perspiration and evaporation will still continue, it follows that these leaves must fade, unless the perspiration is either checked by a moist atmosphere, or supplied by watering the roots. That the atmosphere in Britain is nearly saturated with moisture from October to February inclu-

sive, is satisfactorily proved by the tables drawn up by Mr. Robert Thompson, of the Horticultural Society's Garden, and published in their *Transactions*; of one of which an abstract will be found in our Appendix.

718. *The drying of the roots of evergreens* Mr. McNab considers to be one of the greatest injuries which they can suffer. If they are allowed to dry when out of the ground in spring, he says, it is scarcely possible to prevent their suffering considerably, and showing this injury for a long period after they are planted. "Half a day's sun in spring or autumn will do more harm immediately after planting, than a whole week's sun, from morning to night, in the middle of winter. At that season we can always plant (except during severe frosts, or in a very drying wind) with perfect certainty of success; whereas, in spring or autumn, there is a great risk of failure, except we can get a few dull days, or moist days after planting; and this is quite uncertain." (*Hints, &c.*, p. 18.) It is commonly thought that evergreens planted in winter can push out no roots till spring; but Mr. McNab finds the contrary to be the case. "During the winter we often have intervals of a week or a fortnight, and even sometimes three weeks, of mild weather; and in such weather the roots of many evergreens do grow. Let any person that has a few duplicates of different kinds of evergreens to spare, plant or lay them in by the heels, and soak them well with water, any time during the period I have recommended as the best for planting; let him take these same plants up again in the end of March, April, or beginning of May following, and he will find they will have made a considerable number of fresh roots between the time he put them in, and the time he took them up. Every nurseryman knows, that of the cuttings of some sorts of evergreens put into the ground, as is usual, in September or October, many will have made roots during the winter, as will easily be seen by taking some of them up in March, April, or May."—(*Hints, &c.*, p. 19.)

719. *In planting evergreens*, "whether in a dull day, a wet day, or a dry day, it is very necessary to keep in view the expediency of keeping the plants for as short a time out of the ground as possible; if only a few minutes, so much the better. In all seasons, situations, and soils, the plants should be well soaked with water, as soon as the earth is put about the roots. As soon as the plant has been put into its place, the earth should be filled in, leaving a sufficient hollow round the stem, and as far out as the roots extend, to hold water, which should then be poured in, in sufficient quantity to soak the ground down to the lowest part of the roots; in short, the whole should be made like a kind of puddle. By this practice, which is particularly necessary in spring and autumn-planting, the earth is carried down by the water, and every crevice among the roots is filled. Care must always be taken to have as much earth above the roots of the plants as will prevent them from being exposed when the water has subsided." Mr. McNab finds "the best plan is to take an old birch broom, or anything similar, and laying it down near to the root, to cause the water to be poured upon it; this breaks the fall of the water, and prevents the roots from being washed bare of such earth as may adhere to them; in this way time is saved, for the water may be poured out in a full stream from a pail, a water-pot, or even from a spout or pipe, in the water-cart, or barrel, where the situation is such that this can be brought up to the plant. After the first watering has dried up, the earth should be levelled round the stem of the plant, and as far out as the water has been put on, but not trodden;

if the plants are large, a second watering is sometimes necessary; but in ordinary-sized plants, one watering is quite sufficient; and after remaining twenty-four hours, more or less, according to the nature of the soil, the earth about the stem, and over the roots, should be trodden as firm as possible; and, after treading, should be dressed with a rake. Where this is practised, and the planting done in winter, in cloudy weather, there is scarcely a chance of any dry weather afterwards injuring them; but if this method, or something similar, is not practised, there will be a great risk of failure every year, in planting evergreens, particularly when they are planted at the usual times recommended; that is, in spring or autumn." Mr. McNab recommends "always to water evergreens when planted, whether the work be done in wet weather, dull weather, or dry; or whether the situation in which they are planted is wet or dry, sheltered or exposed; because the watering, in the manner recommended, fills up the holes that may be in the earth about the roots, and consolidates the whole mass much better than treading could do." In tenacious soils, treading is positively injurious; and in no case should the soil be rendered more compact than it is found to be in ground that has been a few weeks trenched.

720. *Transplanting Evergreens with balls.*—In transplanting evergreens it is desirable to leave as much earth about the roots as possible; but when treated in the way recommended, the greater part of the earth that may be about the roots is of importance, rather in preserving them from injury during the operation, than for any value it may have after the plant has been put into the ground. This is, however, speaking of ordinary-sized plants, that is, from one to two and a half, or three feet high; if much larger than this, Mr. McNab "never could move them with success, without keeping a large ball of earth about their roots, and keeping it as entire as possible."—(*Hints, &c.*, p. 26.)

721. *The machines and implements for transplanting large shrubs with balls* need not be on such a large scale as those for transplanting large trees. Those used by Mr. Pratt, already mentioned, are, a hand-barrow formed of sheet-iron, of which fig. 258, *a*, represents the upper side, *b*, the under side, and *c*,

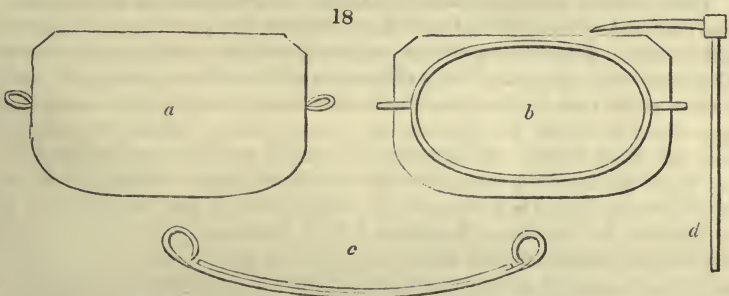

Fig. 258. Machine for transplanting large shrubs with balls.

a longitudinal section; a pick, *d*, like that used by Sir Henry Stuart; a truck with low wheels; and a common hand-barrow, with wooden levers and planks. There are three sizes of the sheet-iron hand-barrow, viz., four feet, by two feet six inches; three feet, by one foot nine inches; and two feet two inches, by one foot three inches; they are all rounded at the corners, a little

turned up at the ends, and are strengthened by flat-iron bars underneath, carried round near the edges. These iron bars are welded into handles at each end, and the handles are kept above the ground by the ends of the irons being turned up. The ground is opened at a distance from the stem, regulated by the size and nature of the plant intended to be removed, and the fibres are carefully tied up, as they are met with, to the stem of the plant. By the use of the pick, *d*, the plant is completely undermined on three sides, leaving the remaining side undisturbed till the iron, *a*, is put under the roots, when that side is cut down, and the plant falls upon the iron; and if not sufficiently in the middle, it is easily slipped into the centre. If the plant be large and heavy, an inclined plane is dug on the most convenient side of the hole, and a rope being put into the iron handles, the plant is hauled out. A short strong board is in some states of the ground used for this purpose, instead of the inclined plane. The plant may then, if not too heavy, be carried on a hand-barrow, which admits of the application of the strength of six men, two between the handles, and the other four on the outside. Heavier plants, which are to be carried any distance, are lifted on a truck with low wheels, made strong for the purpose; and if too heavy for this mode, as many boards as are wanted are laid down in succession, and the plant is hauled by the iron upon these boards to the place where it is to be planted. The plant is invariably hauled into the new hole on the iron, which is not removed till its proper position is ascertained; this prevents the disturbance of the ball of earth or roots. The plant is then lifted a little on one side and the iron drawn out, earth is then filled into the level of the fibres, which are untied and laid out straight, and the plant is earthed up. The heaviest plants, Portugal and other laurels, eight feet and nine feet high, and six feet or seven feet in diameter, which cannot be lifted by any strength that can be applied without injury to the ball of earth and roots, are thus moved with great ease and expedition, with large balls of earth, and without any disturbance of the roots; and, consequently, the plants invariably proceed in their growth, often without experiencing the slightest check."— (*Gard. Mag.* vol. ii. p. 134.)

722. *Packing Evergreens.*—In removing evergreens, even of small size, and whether of the pine and fir tribe, or shrubs, the same care is requisite not to expose their roots to the air, and to plant them as soon as possible after they have been taken up. For this reason all evergreens, except the commoner kinds, such as the Scotch and one or two other pines, the commoner spruce and silver firs, the common and Portugal laurel, the box, the juniper, &c., should be kept by the nurseryman in pots; and we would strongly recommend purchasers of evergreens to bear this in mind. When evergreen shrubs are to be sent to a distance, they ought to be packed in such a way as to prevent the roots from becoming dry, by surrounding their balls or pots with moist sphagnum, and leaving their tops loose, and never tied together, as is done in packing deciduous shrubs. Mr. McNab recommends them to be "packed in hampers, with strong rods or stakes forming a cone round the top, and this cone covered with a mat." The branches should never be tied close together, because in this state, if they are long in the journey, there is a great risk of the leaves dropping off soon after they are unpacked; and when this is the case, with the best management, it will be long before the plants recover. But we refer the reader to Mr. McNab's pamphlet, which ought to be in the hands of every gardener.

723. *Methods of planting small plants.*—We have seen that in transplanting all large plants, a pit is opened of dimensions proportionate to the size of their roots, and this is also the case in planting single plants of small size; but when small plants are planted in numbers together, different modes are adopted for the sake of expedition, and to save labour. Such of these modes as are in general use, we shall shortly describe, premising that in almost every case when plants are planted in considerable numbers in gardens, they are placed in rows, but that in plantations and shrubberies they are generally planted irregularly or in groups. The rows should in almost every case be placed in the direction of north and south, for reasons easily understood; when we consider the influence of the sun on the soil between the rows and on the sides of the plants in this case, as compared with rows in the direction of east and west. All small plants, as well as large ones, when transplanted, are not inserted deeper in the soil than they were before being taken up.

724. *Planting with the dibber* we have already (392) mentioned as suitable for seedlings and very small plants. The soil ought to have been previously dug, or stirred by some other means, so that the fibres of the young plant may strike readily into it. In performing the operation, a hole is made with the dibber with one hand, then the root of the plant is inserted to the proper depth, and held there by the leaves, or stem, with the other hand, while, by a second movement, the dibber is inserted by the side of the hole in such a manner as to press in one of its sides to the root of the plant, taking care that the pressure on the roots shall be greatest at its lowest extremity, and that it should be such as to hold the plant so fast that when slightly pulled by one of its leaves it does not come up. Large seeds, bulbs, and cuttings of tubers, or of roots without leaves, as of the potato, Jerusalem artichoke, &c., are frequently planted with the dibber, which, in these cases, is furnished with a blunt point (fig. 18, in p. 131). Newly-rooted small cuttings, on the other hand, are planted with small pointed sticks (fig. 16, *n*, in p. 131). All common seedlings, such as those of the cabbage tribe, are planted with the large dibber, and most small seedlings with the small one.

725. *Planting with the trowel.*—The trowel is entered in the soil perpendicularly, so as to open a hole, against one side of which the plant is placed, and the soil returned and firmly pressed against it if the soil be dry, or gently if it be moist. Very succulent seedlings, or transplanted plants, such as balsams or geranium cuttings, when turned out into the open border, are planted by this mode.

726. *Planting in drills.*—The drill is drawn with a draw-hoe, fig. 20, in p. 131, and large seeds such as beans, or sets such as cuttings of the potato, are placed along the bottom at regular distances, pressing them against the soil, and drawing the soil over them with the hoe. Root-stocks such as those of the asparagus, and root-cuttings such as those of the sea-kale and horse-radish, are sometimes planted in this manner.

727. *Laying in by the heels* is a temporary mode of planting, in which a notch or trench is made in the soil, sufficiently deep to cover the roots of the plants which are to be laid in it, but not their tops. An opening or trench is made, as if the land were to be dug, and the roots of the plants are laid in the furrow, with their tops standing out in a sloping direction; after which the digging is continued till the roots are covered, and the soil is then pressed down with the foot, and another trench pre-

pared. This mode of planting is employed wherever more plants are taken out of the ground than can be immediately planted, and it is founded on the necessity of avoiding the great injury which the fibres and spongioles of plants sustain by exposure to the air.

728. *Trench-planting* is the most common mode, next to planting with the dibber. It is used in transplanting most kinds of trees in the nursery, and most kinds of edgings of single lines of plants. The spade is inserted perpendicularly along the line, and a trench is opened of the required depth, perpendicular on one side and sloping on the other; and the plants are placed against the perpendicular side with one hand, while, with a spade in the other hand, or by the foot, some soil is drawn over their roots; after which the trench is filled up by the spade, the surface levelled, and the line lifted and placed at a suitable distance, for a second trench. In general, this mode of planting is carried on simultaneously with digging or trenching; trenching being used for plants having very large roots, such as rhubarb, sea-kale, horse-radish, &c. In planting box and other edgings to walks, by shallow trenches, the ground along the line of the intended edging is first dug to a uniform depth and width, and the soil is well broken, so as to be of an equal degree of fineness; it is then compressed by treading or beating, so as to be rendered uniformly firm along the intended line of plants. The line being now stretched, a notch or trench is made along it, generally on the side next the walk, perpendicular to the surface, and of the depth of the roots of the box or other plants. The box is now laid in against the perpendicular side of the trench, using both hands, while the roots are covered with soil by drawing it up against them, with a spade or the foot, so as to keep the plants in their place. The remaining quantity of soil necessary to support the plants, and to earth them up as high on the walk side as on the border side, is then brought forward with the spade, and the work is completed by firmly treading the soil to the plants with the foot.

729. *Slit-planting* is effected by inserting the trowel or the spade perpendicularly, moving it backwards and forwards an inch or two, and then withdrawing it. In the open slit thus left a plant is inserted, and the sides brought together, when the slit is not deep, by treading with the foot; but, when it is deep, by inserting the trowel or spade on one side, so as to press one side of the slit against the other throughout its whole depth. Young forest-trees are frequently planted in this manner on unprepared soil, and sometimes seedlings with long taproots in gardens.

730. *Hole-planting*.—Two men, or a man and a boy, are required for this operation. The ground being dug or trenched, and the width of the rows and the distance between the plants in the rows fixed on, a hole is opened by the man, and the soil thrown aside; a plant is then placed in the hole by the boy, and held there till its roots are covered by a spadeful of soil, which is taken out, so as to form the second hole. The plant is held upright, while the soil is being thrown in over the roots, and it is afterwards fixed by pressure with the feet. A third hole is opened, and a second plant inserted in the same manner till the work is completed.

731. *Planting in pits*.—A pit is dug somewhat larger than the estimated size of the roots which are to be placed in it; and, if in garden or trenched soil, it may be made immediately before planting; but if in firm uncultivated soil, as is frequently the case in forest-planting, it should be made

some months, or even a year or more before, in order that the soil in the bottom or sides of the pit, and that which has been taken out, and is to be returned to it, may receive the benefit of the weather (709). When the pit is dry, the soil in the bottom is loosened; and before planting, a portion of the surface soil taken out is thrown in and mixed with it, and raised up so as to form a slight long convex surface in the centre of the pit, the apex of which shall be nearly level with the surface of the ground. On this cone the plant is placed, with its roots spread out regularly on every side; the soil is then thrown in over them, and in doing this the soil should be made to fall either perpendicularly, or spread so as not to reverse the direction of the fibres, as is too frequently done when the soil is thrown with a force from the circumference of the hole towards the stem. The plant being gently shaken, if necessary, to settle the soil among the fibres, the whole is finished in the form of a cone, rising a few inches above the adjoining surface; having been previously consolidated by treading with the feet. This is the most general mode of planting transplanted trees of from five feet to ten feet in height, whether in the garden, the orchard, the pleasure-ground, or a plantation of forest-trees. In all these departments great care is requisite that the collar of the plant, when the operation is finished, should stand somewhat above the general surface of the ground; because, otherwise, the sinking of the soil, which must inevitably take place, would bury it underneath the surface; and the evils of this have already been shown (6).

732. *Hole-planting and fixing with water.*—Pits are prepared as in the last mode; and while one man holds the tree in the proper position, the roots having been previously spread out, a second man throws in soil, and a third pours in water from the spout of a watering-pot, held as high above his head as his arms will reach, in order to add to its force in falling on the soil, and settling in about the roots of the plant. This is an admirable mode of planting those trees that have numerous fibrous roots; particularly if the trees be from ten feet to twenty feet, or twenty-five feet in height.

733. *Planting in puddle.*—The pit being dug in the usual manner, water is poured into it, and soil stirred in till the pit is half full of mud, or puddle. The roots of the tree are then inserted, and worked about, so as to distribute them as equally as possible through the watery mass. More puddle, previously prepared, is then thrown in, and the roots again shaken, and the whole is finished with dry soil. This mode is well adapted for trees of from ten feet to twenty feet in height, when planted in a dry sandy soil; but it is not suitable for a soil with a retentive bottom, as that would retain the water, and rot the roots.

734. *Planting out plants which have been grown in pots.*—In preparing the pit, regard should be had to the probable length of the roots coiled round the inside of the pot; and a sufficient surface of soil should be prepared on which to stretch them out. Unless this is carefully done, the plant, if it has numerous roots matted together, will make little more progress in the free soil than what it did in the pot; because the check given to the descending sap by the numerous convolutions of the fibres, prevents them, so long as they remain in that state, from requiring the strength of underground branches, which they would otherwise do. This attention to spreading out the roots of plants transplanted from pots is more especially necessary in all those kinds which do not make vigorous tap-roots, such as the

pine and fir tribe ; but it should not be neglected in any class of plants whatever. It frequently happens, that the roots of pines and firs, which have been three or four years in pots, when stretched out, are six or eight feet in length ; and these ought to be planted in a shallow pit, not less than from twelve to sixteen feet in diameter. On the other hand, in places of limited extent, where it is desirable to keep trees and shrubs of diminutive size, they may be planted in the pots, or with the balls undisturbed, in order to keep them stunted or dwarfed.

735. *Watering, mulching, and staking newly-planted plants* should, in general, never be neglected where the plants are of large size ; not so much to supply moisture to the fibres, as to consolidate the soil about the roots ; and in the case of evergreens, which are all the year in a growing state, it should be copiously supplied (718) for both purposes. Where it is considered requisite to continue the watering after the plant has been planted, a pan or basin should be formed round it, of somewhat larger diameter than the pit in which the plant was placed, into which the water may be poured so as to ensure its descent to the roots. To lessen evaporation from this basin, or from the soil round newly-planted plants, it may be mulched ; that is, covered with any loose open material, such as litter, leaves, or spent tanners' bark ; or, in firm soil, with reversed turf, small stones, large gravel, or tiles. The last three materials have the advantage of speedily evaporating the water which falls on them in consequence of their smooth surfaces ; and hence, they are used in the case of mulching geraniums, and other tender succulent-stemmed plants, when planted out during summer, to prevent their stems from rotting off between wind and water. All newly-planted plants that are in danger of having their roots disturbed by the wind, require to be tied to stakes, or otherwise securely fixed ; the different modes of doing which have been already mentioned. The best description of stake is that which, while it keeps the roots of the plant perfectly firm and secure, allows the top and the upper part of the stem, supposing the latter to be flexible, to be put in gentle motion by the wind.

736. *Taking up previously to planting.*—It must be constantly borne in mind that the food of plants is taken up by the delicate extremities or spongioles of their fibres, which the slightest tear or bruise will destroy ; that these mouths will only act when the soil in which they are placed is in a moist state, and that they are easily rendered useless to the plant by being kept for any length of time exposed to dry air. Hence, in taking up trees, and, particularly those of small size, such as are grown for sale in the nurseries, the roots should be separated from the soil with the greatest care, by previously loosening it at a distance from the stem, and never forcibly drawing the roots out of the soil till this has been done, as is too commonly practised in nurseries. It is true we cannot expect to remove all the fibres of a plant of any size uninjured, but by great care we may save the principal part of them. For this purpose a round-pronged blunt fork should generally be used for taking up trees instead of a spade, and the roots, as soon as they are out of the soil, should be covered with a mat, or some other protecting material, to prevent them from being dried by the air. When a tree has remained some years in the same situation, its main roots will have penetrated so deep into the soil, and its lateral roots have extended so far in a horizontal direction, that both will require to be cut ; but this ought always to be done as far from the main stem of the plant as possible ; and in propor-

tion to the number of distant fibres cut off by this means, care should be taken of those which are within reach, and which may be removed uninjured. Whenever trees of numerous roots are removed, some of them can hardly fail to be broken or bruised, and they should be smoothly cut through above the injured part, in order that they may be speedily healed over. Care should be taken in spreading out the roots to allow none to cross one another; and if this cannot be avoided by any other means, recourse must be had to amputation. Cross roots do little harm when young, but, as in the case of branches, they gall one another as they get large. All young and rapidly-growing plants require a larger proportion of fibrous roots, compared with their bulk, than large plants, and these roots are also nearer to the main stem; and, hence, a young tree can always be taken up with a greater mass of fibres than an old one. When the tops of plants are secured from evaporation, the roots may be kept comparatively dry; but when the top is fully exposed to drying winds, the roots should be kept moist; and in the case of newly-transplanted trees it is useful to sprinkle water on the tops to prevent the bark from absorbing the returning sap. Where it is not convenient to supply water, the stems and principal branches may be tied round with straw ropes, or covered with moss.

737. *As a summary of general rules for planting*, it may be stated that early in autumn, when the soil has not parted with its summer heat, is the best season for trees and shrubs, and open-air plants generally, with the exception of annuals; that roots should be placed by art as much as possible in the same position in which they would be by nature, that is, with the collar at the surface, and the points of the roots and fibres more or less under it, and in a descending, rather than in an ascending, direction; that the hole or pit in which plants are placed should always be made larger than the roots which it is to contain; and in the case of large plants convex at bottom and not concave, that the plant being placed on the centre of this convexity, and the roots spread out in every direction, the soil, finely pulverised, ought to be gently thrown over them, either by dropping it perpendicularly, or throwing it in a direction from the centre to the circumference; that the plant should not be pulled from side to side or up and down, in order to settle the earth about the roots, as was formerly practised with that view, but the effect of which was to break, bruise, or double the fibres; and, finally, that the soil should be settled about the roots by one thorough watering at the time of planting, and that this watering, in the case of deciduous trees, at least, need not in general be repeated.

§ II. *Potting and Repotting or Shifting.*

738. *To pot a plant* is to sow or plant it in a pot, box, or tub; and to re-pot or shift it, is to turn it out of one pot or box, and replace it in the same or in another, with the addition of fresh soil. The mass of soil and roots which is to be shifted is termed a ball. If the object is to add fresh soil, without using a larger pot, then a proportionate quantity must be removed from the ball or mass containing the roots of the plant to be repotted; but if the object be to add fresh soil without disturbing the roots, the mass or ball of soil and roots is simply placed in a pot a size larger than that from which it was taken, and the vacant space between the ball and the pot filled

up with soil. If the object should be to grow the plant in a smaller pot than that in which it was before, then the ball must be considerably reduced, so as to be somewhat smaller than the pot in which it is to be placed, in order to allow room for some fresh soil. The implements, utensils, &c., necessary for potting are : a bench or table, either fixed or portable, and which must be perfectly level ; pots, tubs, or boxes ; broken pots, oyster-shells, or other materials for drainage ; proper soils, a trowel, a small dibber, a spade, and a watering-pot and water.

739. *The main object of growing plants in pots* is to render them portable, by which a greater command is obtained in the application to them of the agents of growth and culture, and by which they can be transported at pleasure from one place to another, whether for purposes of use or ornament. A plant in a pot may be kept dry or moist, placed in heat or in cold, in the shade or in the sun, in the open garden, the plant-house, or in the living room, at pleasure. By limiting the size of the pot or box, and the quantity of soil in it, the plants can be grown of much smaller size than when they are planted in the free soil ; and hence the great number of exotic trees and shrubs which can be maintained within a very limited space in plant-structures. In consequence of the roots of each plant being confined to its own pot, the weakest-growing sorts can be grown side by side by the strongest, without injury to either. Were there no means of growing hothouse and greenhouse plants but by planting them in beds or borders under glass, a very few plants would soon fill the largest house, and though they might be pruned both at top and at root to keep them within bounds, yet this could never be done so effectually as by placing each plant in a separate pot or box, by which its growth is on the one hand limited by the quantity of soil in the pot, and on the other not checked or suffocated by the interference of the roots of any other plants which may adjoin it. There are various other advantages which result from growing plants in pots, such as stunting the entire plant by the limited supply of nourishment, and thus causing it to produce flowers at an earlier age, and when of a smaller size, than it would do in the free soil ; enabling us to transfer plants in pots to the free soil at any season, and without interrupting their growth ; to pack and send them to a distance, without injury to their roots ; to grow them in particular kinds of soil, to subject them to experiments, and in the case of seedlings grown in pots either singly or in quantities, to transplant them with the whole of their fibres and spongioles.

740. *The disadvantages of growing plants in pots* are : the constant attendance which is requisite to preserve the soil in a uniform state of moisture and temperature, and to remove the plant from one pot to another when additional space for the roots becomes requisite, or when the soil contained in the pot becomes impoverished. We have seen (255 to 257, and again in 421) in what manner plants in pots, the sides of which are exposed to the air, are deprived of heat and moisture, and of the former to such a degree as to reduce the temperature of the soil of the pot considerably lower than that of the atmosphere in which it is placed ; and there can be no difficulty in conceiving how the soil in the pot is impoverished. The loss of heat and moisture are to be counteracted by plunging the pot in soil or other earthy matter, or by encasing it in any non-conducting material, or placing one pot within another, and filling the interstices with moist moss or any other

material which will retain moisture, fig. 259. The exhaustion of the soil is remedied by re-potting, or in some cases by the application of

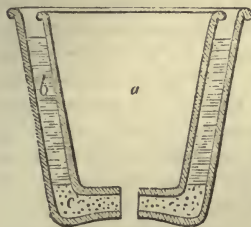

Fig. 259. One pot placed within another, for the purpose of retaining the soil in the inner pot in a moist state.

manure; either solid on the surface of the soil, in the pots, or in a liquid state poured on the soil, or contained in a saucer in which the pot is placed. Notwithstanding all these resources, plants in pots, excepting those naturally of small size, never grow so luxuriantly as those in the free soil, and therefore this mode of growing plants is adopted for convenience, or to make up for defects in climate, or want of space in plant-structures, and not in general to bring plants to a higher degree of perfection.

741. *Potting.*—Plants are either sown in pots, planted in them when newly originated from seeds, cuttings, or other modes of propagation; or removed to them from the free soil when of considerable size. When a rooted plant placed in a pot has begun to grow, its fibres extending in every direction, soon reach the sides of the pot, where, being checked, they are compelled to follow its sides, till, after a short time, they form a net-work between the pot and the earth which it contains; so firmly enveloping the latter, that when turned out, it remains entire as one solid body, or, as it is technically called, ball. As the roots in young plants are commonly few, and proceed in direct lines from the stem of the plant to the sides of the pot, it happens when the ball is large, and the plant of rapid growth, that the interior of the ball contains few roots, and, consequently, that the soil there is, in a great measure, lost to the plants. To prevent this from being the case, plants when first potted are planted in pots of the smallest size, by which the full benefit of the whole of the soil in the first pot is certain of being obtained; while there is no danger of this being the case when the plant is shifted into larger pots, because each time that this is done there is only a thin stratum of soil introduced between the ball and the pot. Another reason why plants are first potted in the smallest sized pots in which they can be planted, is, that the drainage is more perfect, and that the soil is more readily penetrated by heat, whether of the atmosphere, or of the material in which it may be plunged. When a large mass of rich, soft, finely-sifted soil is brought together and compressed, as it always is in a pot, it parts with water so slowly as to become sodden for want of air; and in that case it rots the spongioles of the fibres, and even the fibres themselves. A small portion of soil, on the other hand, retains less moisture, is readily pierced by the roots, and kept comparatively open by them; and hence the fibres and their spongioles are uninjured. If, instead of rich, soft, soil, readily compressed, a comparatively poor, sandy soil were used, the smallest plants might be planted in the largest pots, without any danger of rotting the roots; though with great want of economy in regard to soil, space, and future management. By beginning with small-sized pots, and shifting into others, gradually increasing in size, the full benefit of all the soil put in the pot will have been obtained, and the plant stimulated by every fresh addition to its roots, to increase its leaves and shoots.

742. *The same soil which is suitable for the open garden is not always suitable for using in pots.*—Every gardener must have observed that soil that will remain sufficiently open for the roots of plants in the quarters of

a kitchen-garden, or even when placed in a hotbed, becomes too compact when used in pots, even though it receives as much watering in the one case as in the other. The fact is thus explained by a correspondent :—When the nature of the soil is such as that the cohesion of its particles is greater than that which is formed between the soil and sides of the pot, it loses hold of the latter, and becomes concentrated by every withdrawal of moisture, leaving an almost clear cavity between it and the sides of the pot, and this cavity being readily filled with water, the soil is prevented from expanding in a degree proportionate to the force that would be necessary to displace the water. In addition to this, the fibres of the plant tend to bind it together, and it ultimately becomes so much solidified that it either refuses to take in sufficient moisture ; or, if it does, it retains it so as to prevent the ingress of a fresh supply ; whilst at the same time the water so retained becomes impure, and consequently injurious to the health of the plant. A similar quantity of soil in the quarter from which the above soil is supposed to be taken will be found in a very different state ; for there it is kept from contracting on any central portion by its cohesion with the soil in the circumference. Hence the necessity of using such soil for plants in pots as is not too cohesive ; or at all events weakening its cohesive power by mixture with sand, peat, turf, or other substances that may be found to answer the purpose, and at the same time afford congenial nourishment to the plants. And as glazed pots afford less hold for the soil than those with a rougher surface, it is probable they are on that account objectionable.

743. *Bottom Drainage.*—Whether plants are put in small or large pots, the first point which requires to be attended to is to cover the hole in the bottom of the pot with some description of material which will readily allow of the escape of water, and if possible prevent the entrance of earth-worms, (296). The article commonly used is fragments of broken pots, which being always, excepting in the case of pot-bottoms, portions of a curved surface, never can cover the hole so closely as to prevent the escape of water. One crock, somewhat larger than the hole, is placed over it, and over that is placed a layer of smaller pieces, in depth more or less according to the size of the pot and the degree of drainage wanted ; and to prevent the soil which is to be placed above from being washed down into this drainage, it is commonly covered with a layer of fibrous or turfy matter obtained from turfy soil, or with live moss. In the case of small plants requiring nothing more than ordinary care, a single crock, or in large pots a single oyster-shell, placed over the hole in the bottom of the pot is generally found sufficient ; but in very delicate plants, a fourth, a third, or even half the pot is filled with drainage. This, as we have seen (584), is more particularly the case in planting cuttings in pots.

744. *The mode of sowing or planting in a pot* has nothing peculiar in it. A small dibber, fig. 16 n, in p. 131, is commonly used for planting seedlings of the smallest size ; the pot being previously drained, and filled full of soil gently pressed down. In planting larger seedlings, or rooted cuttings, the pot is drained, filled one-third or one-half with soil, raised a little in the middle, and while the plant is placed on this soil and held upright with one hand, the fibres are spread over the somewhat conical surface of the soil with the other ; and afterwards the same hand is employed in taking up soil with a trowel and filling it in over the roots, shaking up the latter a little, till the pot is full. The pot is now taken up with both hands, and set down with a jar once or twice

on the potting bench, so as to consolidate the soil in the pot. A little soil is next added or taken off, so as to leave the pot filled to the rim; and a little water is then given, unless the soil is considered already sufficiently moist for the state of the plants. The potted plants, if in leaf, are placed in a still atmosphere, with or without heat and shade, as may be deemed necessary. If they are without leaves very little extra care is necessary, farther than setting the pots on a level surface, that the plants may grow erect and that the pots may retain water; the surface being composed of materials which will not admit of worms rising through it, and ascending the pots through the holes in their bottoms, which they are very apt to do. When pots are plunged in the free soil, they are not nearly so liable to be penetrated by worms as when they stand on its surface.

745. *In transplanting from the free soil into a pot or box*, the plant, if in leaf, is commonly taken up with a ball adjusted to the size of the pot; and to fit such plants for removal, their main roots are frequently cut by the spade, a week or two before taking up, at a short distance from the stem, so as that the wounded parts may be within the limits of the ball. This lessens the check to vegetation which would otherwise be given by taking up the plant, and may be usefully applied in the case of many plants which are removed from the open border to the green-house late in autumn.

746. *Care of newly potted or shifted plants.*—As the absorption of moisture by the spongioles is necessarily checked by the disturbance of the roots, occasioned by taking up the plants and replanting them, so must also be the perspiration of the leaves by the diminished supply of moisture. To lessen this perspiration, therefore, where there is danger of it proving injurious, the plants must be placed in a still humid atmosphere, by watering the surface on which the pots are set, and then covering them with mats, or by placing them in a close frame, and if necessary, shading them from the sun, and supplying extra heat. The more delicate kinds may be placed for a short time on a hot-bed, but the hardier plants will succeed very well if merely sheltered by being hooped over and shaded by any slight covering for a day or two, taking care to remove it at night, and during still, cloudy weather; while the hardiest merely require the shade of a hedge or a wall. The most difficult plants to manage, after being potted, are large herbaceous plants, or large-leaved free-growing greenhouse plants, which have been grown during summer in the open garden, such as stocks, dahlias, brugmánsias, &c. These are very apt to lose their leaves after being taken up and potted, whether kept in the open air or in a frame or pit. The only mode of averting this evil is to begin early in the autumn to check their growth, by cutting off all their main roots at a short distance from the stem, and repeating the operation once or twice before taking up; by these means the growth will be checked, and they will produce no more leaves before being taken up than they are able to support after being potted.

747. *Shifting or Re-potting.*—In re-potting in the same pot, the ball or mass of soil and roots being turned out of the pot, the soil is shaken away from the roots either wholly or in part; the greater part of the roots more or less cut in, but leaving a few with their fibres and spongioles, to support the plant till it produces new fibres, and the pot being properly drained, the plant is potted much in the same way as it would be planted in the free soil; care being taken that the soil is properly introduced and settled among

all the roots. In shifting from a small pot into a larger one, the larger pot being drained and prepared, the ball is turned out of the smaller pot by turning it upside down, and while holding it in that position, with the ball resting on the palm of the left hand, with the stem of the plant between two of the fingers, striking it gently against the edge of the potting bench, so as to cause the ball to separate from the pot. The ball being now in the left hand, and turned upside down, remove the drainage from it with the right, then reverse it, and place it in the larger pot, filling in the vacant space all round with fresh soil, gently compressing it by working it in with the trowel or a wooden spatula. In shifting from a large pot to a smaller, the ball being taken out of the large pot must either be reduced equally on every side and on the bottom, by paring off a portion of the roots and soil, including of course almost all the spongioles, or the soil must be shaken off from the roots entirely, the roots cut in, and the plants inserted in the smaller pot among fresh soil. In shifting plants from one pot to another, care should in general be taken not to place the collar of the stem deeper in the new pot than it was before in the old one, excepting in the case of plants which root readily from the stem, such as balsams and a few others; but in general, in pots as in the open ground, the stem should rise from a gentle eminence, and the ramifications of the upper roots, where they depart from the stem, be seen above the soil. By this means the descent of the sap to the roots is not checked by the pressure of the soil on the collar, and the ramifications of the roots become much stronger, and covered with a thicker bark.

748. *Seasons and times for potting and shifting.*—Small plants may be potted at any growing season; but the most favourable are spring and autumn, and the least so mid-winter, even under glass, owing to the absence of light. Shifting also may be performed in any season; but the most suitable for established plants is just before they commence their annual growth; while young rapidly-growing plants may be shifted from time to time as long as they continue growing. Slow-growing woody plants are seldom shifted oftener than once a year, unless it is desired to accelerate their growth; but rapid-growing plants, such as pelargoniums, and such annuals as the balsam, cockscomb, &c., are shifted many times in a single season, beginning, more especially in the case of the balsam, with a pot of the smallest size, such as No. 11, which is $1\frac{1}{2}$ inches in diameter (420), and gradually increasing the size as the plant advances in growth, till from being 2 inches high in a pot of the same height in April, it is 3 feet or 4 feet high in a pot 1 foot in diameter in June or July. By heat and frequent shifting for upwards of a year, pelargoniums are grown so as to form bushes 3 feet or more in diameter in pots of not more than 8 inches or 10 inches across. Pine-apples are grown to a large size in comparatively small pots, but the soil employed is rich and frequently supplied with liquid manure.

749. *The most difficult plants to manage in pots* are the hair-rooted kinds, such as all the Ericacææ, and many Cape and Australian shrubs, requiring sandy peat soil, which must be well drained, and kept uniformly moderately moist, but never either soaked with water, or very dry. The drainage must be so perfect as to prevent the possibility of water stagnating in the soil; and while the nature of this soil, sand and peat, readily permits the water to pass through it to the drainage below, the porous sides of the pot incessantly carry off moisture by evaporation, and the more so as heaths require to be kept in a rather dry atmosphere. The roots of heaths, and

indeed all hair-like roots, are as readily destroyed by over-dryness as by moisture, and hence the continual risk of danger to this description of plants when grown in pots. To guard against the extremes of dryness and moisture, the pots when small are sometimes plunged in sand or moss, or placed in double pots; or when the plants are large, shifted into wooden boxes (423), which not being great conductors both of heat and moisture, are more congenial to the roots of all plants. To guard against excess of moisture on the one hand, and the want of it on the other, two very ingenious and useful practices have been introduced into the culture of heaths and heath-like plants in pots, by Mr. M'Nab. The first is, always to keep the collar of the stem of the plant a few lines above the general surface of the pots, in consequence of which it is always dry, and not liable to be chilled by evaporation, or rotted off by the stagnation of moisture; and the second consists in mixing with the soil fragments of any coarse, porous stone, from one inch to four or five inches in diameter, such as freestone, which retaining more moisture than the soil, gives it out to the latter when it becomes too dry; and thus a temporary neglect of watering is not attended with the sudden destruction of the plant, which without these reservoirs of moisture it often is. To counteract the effects of evaporation from the sides of pots, and of sudden changes of atmospheric temperature, the French gardeners very generally employ wooden boxes, even for small plants. Glazed pots have also been proposed to be employed in this country, as in China, by Mr. Forsyth (*Gard. Chron.*, 1841, p. 499); but they have not yet been sufficiently tried to admit of our generally recommending them. Mr. Knight is of opinion that, though some plants are injured by having the sides of their pots fully exposed to the air, yet that the taste and flavour of the peach and nectarine, and still more of the strawberry, are greatly improved by it, as well as the period of the maturity of their fruit accelerated. (*Hort. Trans.* vii., p. 258.)

750. *Growing hardy plants in pots*, and especially the more rare kinds of trees and shrubs, for the purpose of transport, and to insure success when they are finally planted out, is one of the most useful purposes to which the potting of plants can be applied. We have already (722) recommended all the more valuable evergreens, and especially those of the pine and fir tribe, only to be purchased in pots; and the same observations will apply to such deciduous trees and shrubs as make few fibrous roots, such as the *Magnolia*, and to most rare and valuable herbaceous plants. The care requisite to be taken in transplanting into the open ground plants which have been some years in pots, has also been enlarged on (734). Either the fibrous roots of plants which have for some time been grown in pots should be stretched out at full length, or, if they are too brittle for that purpose, a portion of them should be left as they are to absorb nourishment, and a portion shortened or pruned, in order to produce new fibres to become roots, branching out in every direction. When this is neglected, more especially with trees or shrubs which produce chiefly surface-roots, such as the pine and fir tribe, or which produce few roots, such as the *Magnolia*, they will often, after being transplanted into the free soil, remain in a stunted state for many years.

§ III. *Pruning.*

751. *Pruning* consists in depriving a plant of a portion of its branches, buds, leaves, bark, or roots, in order to produce particular effects on the

part of the plant which remains. The different kinds of pruning may be included under knife-pruning, which is applied to small branches; lopping, which is applied to large branches; clipping, which is applied to small shoots in masses; and disbudding, disleafing, and disbarking, which are applied to buds, leaves, and bark. Girdling and felling may also be included in this section. The instruments necessary for these operations are chiefly the pruning-knife, the bill, the saw, the cutting-shears, and the clipping-shears; but there are some other instruments, such as the pruning-chisel, the averruncator, the girdling machine, &c., which are occasionally used for peculiar purposes (see figs. 40 to 50, in pages 137 to 142).

752. *The specific principles on which pruning is founded, and its general effects*, are these:—The nutriment of plants is absorbed from the soil by their roots, and formed into leaves, branches, flowers, and fruit, by their buds; by operating on the buds and roots, therefore, we can regulate what is produced by them. If the stem and branches of a plant contain a hundred buds, by removing half of these the shoots or fruits produced by the remainder will be supplied with double their former supply of nourishment; and if all the buds be removed but one, the whole of the sap sent up by the roots will be modified by that single bud, provided care be taken to remove other buds as they appear. On the other hand, when the whole of the buds of a tree are so abundantly supplied with sap from the roots as to produce chiefly leaves or shoots without blossoms, then by cutting off a portion of the roots the supply of sap is lessened, a moderate degree of vigour is produced, and instead of barren shoots, blossom-buds appear. By these means the growth of plants is controlled by pruning. Pruning has not the power to increase the vigour of an entire plant, because it cannot increase the quantity of food taken up by the roots; but it can diminish the vigour of the entire tree by cutting off part of the roots, or it can increase the vigour of particular parts of the tree, by amputating the branches, or taking off the buds at other parts. Pruning can prevent trees from producing flowers, and hence increase their general vigour and longevity. It can modify the general form of trees as well as increase particular parts of them, and it can add to the vigour of stunted or diseased trees by concentrating their sap, or directing it to a few buds instead of a great many. One of the most useful effects of pruning is to cause the development of dormant or adventitious buds, which is effected by amputating the shoot, branch, or stem, close above any point where visible buds are usually situated, though they may now be wanting there.

753. *In forest-trees* pruning is of the greatest use in modifying the quantity of timber produced. Thus by commencing when the tree is quite young, and shortening the side branches and encouraging the leading shoot, the whole of the timber produced is thrown into a main stem; whereas had no pruning been employed, great part of the wood might have been distributed in branches of little use, excepting as fuel. On the other hand, should crooked timber be desired, pruning by destroying the leading shoot, and encouraging those that have a suitable direction, tends to attain the end in view; and by the aid of training this end can be completely effected. Trees which are stunted in their growth from being hide-bound (a disease which is brought on by the sudden exposure of trees to the weather after they have been drawn up by shelter, and in the case of young trees by being planted of too large a size in proportion to their roots), may in general be made to shoot vigorously by being cut down or headed-in.

On the other hand, trees which are in particular situations, where it is feared they will grow too large, may be arrested in their growth, or stunted by amputating the larger roots.

754. *For ornamental trees* pruning is chiefly employed to remove diseased branches, because much of the effect of these trees depends on the development of their natural form and character, which pruning with a view to timber has in general a tendency to counteract; but for all ornamental trees, grown chiefly for their flowers or fruit, pruning can be as usefully applied as in the case of fruit-trees; and where ornamental hedges and other verdant architectural structures are to be grown, pruning by the bill or the shears is essential.

755. *For ornamental shrubs* pruning cannot be dispensed with, since many of them are grown for their flowers, which are produced much stronger and of brighter colours when the shoots are thinned out, or shortened, or both; and when the plants are prevented from exhausting themselves by the removal of decaying blossoms, so as to prevent them from maturing their seeds. Every one knows the value of pruning to the rose, and to all shrubs with double blossoms, and shrubs with large blossoms, such as the Magnolia or the passion-flower.

756. *Fruit-trees and shrubs* are above all other plants benefited by pruning, which is indeed by far the most important part of their culture. The most general object of pruning is to create an abundant supply of sap during summer by the production of leaf-shoots, by which the general strength of the tree is augmented, and to limit the distribution of this sap when it ascends from the roots in the following spring, by diminishing the number of buds. The effect of this is to increase the vigour of the shoots or fruits produced by these buds; and if this be done in such a manner as to obtain also the greatest advantages from light and air, the pruning will have answered its purpose. If a fruit-tree were not deprived every year of a part of the wood or the buds which it produces, its shoots and fruits would gradually diminish in size, and though the fruit would be more numerous it would be deficient in succulence and flavour, as we find to be the case in old neglected orchard trees. The application of pruning to fruit-trees differs so much according to the species of tree that the subject can only be properly treated by taking each class separately. Thus kernel fruits which are produced on wood of two or more years' growth, require to be pruned in a different manner from such fruits as the peach, which is produced from the shoots of the preceding year; or the grape, which is produced from the shoots of the current year. The production of blossoms, or the enlargement of fruits and the acceleration of their maturity by ringing, is a species of pruning peculiarly applicable to fruit-trees.

757. *To herbaceous plants* pruning is applicable, not only when they are being transplanted, when both roots and top are frequently cut in, but also to fruit-bearing kinds, such as the melon tribe, the tomato, &c. Pruning is even useful to the cabbage tribe when it is wished that, after the head is cut off, the stem should throw out sprouts, which is found to be accelerated by splitting it down an inch or two. The topping of beans, and the picking off of potato blossoms, are operations belonging to pruning; as are the cutting off of withered flowers for the sake of neatness, or to prevent the production of seed, and even the mowing of grass lawns. Having noticed the uses of pruning in culture, we shall next shortly describe the different kinds in use in

British gardens and plantations. These may be included under close-pruning, shortening-in, fore-shortening, spurring-in, heading-in, lopping, snag-logging, lopping-in, stopping, pinching out, disbarking, disbudding, disleafing, slitting, bruising or tearing, root pruning, girdling, and felling.

753. *Close pruning* consists in cutting off shoots close to the branch or stem from whence they spring, leaving as small a section as possible in order that it maybe speedily healed over. In performing the operation care should be taken to make the wounded section no larger than the base of the shoot, in order that it may be healed over as quickly as possible; and at the same time to make it no smaller, because this would leave latent buds which would be liable to be developed, and thus occasion the operation to be performed a second time. This mode of pruning is only adopted where the object is to produce stems or trunks clear of branches or of any kind of protuberance, as in the case of standard trees in gardens, especially fruit-trees, and in the case of forest-trees, grown for their timber. If the branch cut off is under an inch in diameter, the wound will generally heal over in two seasons, and in this case the timber sustains no practical injury; but if it is larger, it will probably begin to decay in the centre, and thus occasion a blemish in the timber. Mr. Cree's mode of pruning forest-trees grown with a view to the production of straight timber, which appears to us to be decidedly the best, is an application of this mode. Mr. Cree commences his operations before the tree has been taken from the nursery, and continues them till he has obtained a clear trunk, of such a height as he thinks the kind of tree will produce of a useful timber size, in the climate and soil where it is planted. He cuts off no branches whatever till the tree has attained the height of from sixteen to twenty feet, with a stem of from fifteen to eighteen inches in circumference at the surface of the ground; but during the growth of the tree to that height he shortens in the side branches whenever they extend farther than between three and four feet from the trunk. In consequence of being thus shortened, these shoots do not, so long as they are allowed to remain on the tree, attain a greater diameter at their departure from the trunk than about an inch. The tree having attained its sixteenth, eighteenth, or twentieth year, its head forms a narrow cone, clothed with branches from the ground to the summit. Its pruning is now commenced by taking off one tier of branches annually, commencing with the lowest, cutting close to the stem, generally just before midsummer, that the wound may be partially healed over the same season, and continuing to do this annually till the stem has grown and been cleared to the required height. While the process of clearing the stem is going on below, that of shortening in the side branches is going on above, so as to preserve the narrow conical shape, and prevent any of the branches which are to be cut off from attaining a greater diameter than an inch. The trunk being at last cleared to the proper height, the head over the cleared part is left in the form of a cone, and no longer touched with the averruncator. The head now, by degrees, takes its natural form, and continues growing in that form till the tree is felled. The detail of this mode of pruning will be found given by Mr. Cree in the *Gardener's Magazine* for 1841; and a mode nearly similar is described by Mr. Main in the volume of the same work for 1832. We have only to repeat that we consider this system as by far the most efficient for pruning forest trees, where the production of timber in a clean straight stem is the object. The quantity of timber produced will not be so great as in the case of

a tree standing alone, and throwing out its branches uncontrolled on every side, because the quantity of foliage produced, and properly exposed to the light, will not be nearly so great; but it must be recollected, that the timber produced will be in a more useful form, and besides, that Mr. Cree's tree is supposed to form one of a close plantation. When we consider this last circumstance, it must, we think, appear obvious, that by no other mode of pruning could an equal quantity of foliage be exposed to the light in so limited a space, and consequently so large a bulk of timber be produced in that space.

759. *Shortening-in* is the term applied when side shoots are shortened at the distance of from two to four or five feet from the stem, the cut being always made to a bud (545). Exceeding that distance it is called *fore-shortening*, and is chiefly applicable to timber-trees in hedge rows; and under that distance it is called *spurring-in*. We have seen the use of *shortening-in*, in connexion with close pruning, in the case of forest-trees, in the preceding paragraph. In the culture of fruit-trees, it is applied in connexion with *spurring-in*, to produce trees of conical forms with branches which, never being allowed to attain a timber size, are prolific in fruit-bearing spurs. Whenever the branches exceed two inches in diameter, they are cut off within an inch of the stem, and one of the young shoots which are produced there is trained to take its place. See § V. *Training*.

760. *Fore-shortening*.—When the lateral branches of a standard tree extend further than is desirable, a portion of their extremities is cut off; the cut being always made close above a branch of sufficient thickness to form a leader of sufficient strength to keep the branch alive and healthy, but not so strong as to cause it to produce much timber, or in any way to come into competition with the trunk of the tree. The object is to prevent the lateral branches of the trees from injuriously shading the plants under them; and hence it is chiefly used in the case of trees in hedge-rows.

761. *Spurring-in*.—The apple, the pear, the cherry, the plum, and other fruit trees, or fruit shrubs, produce what are called spurs, or very short shoots or knobs, covered with blossom-buds, naturally, and the object of spurring in pruning is to produce these knobs artificially. This can only be done with lateral shoots, to which the sap is not impelled with the same vigour as to the growing point, because the great object in producing spurs is to obtain blossom-buds, and these are never produced on the most vigorous shoots. A lateral shoot of the present year being produced may be shortened to two or three visible buds, either in the beginning of summer after that shoot has grown a few inches in length, or in the following winter; but the former is in general the better season, because it is not desirable to encourage the production of wood and consequently of sap, but rather to lessen their production, so as to produce stunted branches, which are in fact the spurs. The second and third years the shoots produced are shortened in the same manner as they were the first, and it will generally be found that the leaf-buds left on the lower ends of the shoots when cut down, will the year after become blossom-buds. As by the process of continually shortening the shoots, the spurs in a few years become inconveniently large, they are from time to time cut out and new spurs formed by the same process as before; and finally, after a certain time, the entire branch bearing the spurs is cut out close to the main stem of the tree, and renewed, as spurs are, by a young shoot produced from its base. It must be confessed, however, that

pruning has but little to do with the production of spurs that are prolific in blossoms : that depends far more on adjusting the nourishment supplied by the root to the demands of the fruit-bearing branches, to the mode of training, the kind of tree, and other particulars, which, when attended to, spurs are produced naturally. This subject, therefore, can only be properly treated when giving the culture of particular trees.

762. *Heading-in* is cutting off all the branches which form the head of a tree close to the top of the stem, leaving however their base to produce buds. This is done with what are called polled or pollard trees periodically, for the sake of the branches produced as fagot or fence wood, and with fruit trees when they are to be re-grafted (653). It is also done with stunted forest trees, for the sake of concentrating the sap into a few main shoots, instead of distributing it over a great many ; and it is done in transplanting trees of considerable size intended to form avenues, or single trees in parks (713). The branches, if under two inches in diameter, are cut off clean with a bill (410) at one stroke ; or if they are larger, they are first sawn off, and afterwards the section is made smooth with the bill-axe or the knife, but generally with what is called the bill-knife.

763. *Lopping*.—This term is very generally applied to heading-in, but it is also as generally used to signify the cutting off large branches from the sides of stems, and in this sense we shall here treat of it. Lopping is performed by foresters in three manners, two of which are highly injurious to the timber of the trunk of the tree, and the other not so. The first injurious practice is that of

764. *Close Lopping*, by which a large wound is produced, the surface of which not only never can unite with the new wood which is formed over it, because, as we have seen (637), growing tissue can only unite to growing tissue, but the wood in the centre of the wound will, in all probability, begin to rot before it is covered over, and consequently the timber of the trunk will be more or less injured. Even if, by covering the wound with composition to exclude the weather, the surface of the section should be prevented from rotting, still there would be a blemish in the timber, in the form of a distinct line of demarcation between the new wood and the old. The second injurious mode of lopping is, that of cutting off side branches at from six inches to a foot, or even two feet, from the trunk, which is called,

765. *Snag Lopping*.—By this mode there can be no efficient source of returning sap, the wounds can never heal over, and are certain, in connexion with the stumps on which they are made, to rot and disfigure and deteriorate the timber much more than in the case of close lopping.

766. *Lopping-in*.—The only mode of lopping large branches from the sides of the trunks of trees, without injuring the timber in these trunks, is to shorten them to a branch of sufficient size to heal the wound at its base, or at all events to maintain the growth of the whole of the part of the branch left, and prevent any decay from reaching the trunk. Clean timber, that is timber free from knots, will not be produced by this mode, but sound timber will be the result, which is much more valuable than the apparently clean and sound timber that would have been produced by close lopping, and letting the tree stand till the wounds were covered with new wood and bark. If the branch had not been lopped, it would have continued to increase in diameter in as great a ratio as the stem ; but when lopped so as to produce only as much foliage as keeps the part left alive, such part will increase very

little; and as the stem increases, the proportion which the diverging sound knot bears to the straight timber of the stem will be less and less. If trees, when planted together in masses, were pruned in Mr. Cree's manner, there never could be any occasion for lopping; but as this practice will probably always be more or less required for neglected trees, or for trees in particular circumstances, *lopping-in* should always be adopted where the value of the timber is an object; *close lopping* when the object desired is a clean stem, without reference to timber; and *snag lopping* when the object is, as in *snag lopping* the English elm, to produce a thick growth of young shoots, to be periodically cut off as faggot or fence wood, or for sticking peas.

767. *Cutting down* the stem or trunk of a tree to the ground is an important operation, because in some cases, such as that of resinous or needle-leaved trees, it kills the tree, while in others, or what are called trees that stole, which is a property of most broad-leaved trees, it affords the means of renewing the tree. Thus coppice woods, which consist of trees and shrubs cut down periodically, have their stems and branches repeatedly renewed from the same root or collar. Thorn hedges are also frequently renewed by cutting down to the ground; but perhaps the most valuable application of the practice is to young stunted forest trees when finally planted out. The slow growth of a tree which is stunted appears to depend on the thinness of the alburnum, and consequent smallness of its sap channels, the result of which is, that the sap rises slowly and in smaller quantities than it otherwise would do; and, hence, that a proportionately smaller quantity is returned from the leaves through the bark. But by cutting over the stem just above the collar, the whole force of the sap accumulated in the roots will be employed in the development of some latent buds in the collar, and one of the shoots produced by these buds being selected and the others slipped off, an erect stem will be produced of five or six feet the first season, and the sap vessels in this shoot being large, and abundantly supplied from the root, the plant will grow freely ever afterwards. The cut, which may be made with the pruning knife, or with the large pruning shears, should be made close to the surface of the ground and nearly horizontal, by which it will be more speedily healed over than if made oblique; and in order to point out the stools or stocks of the plants so cut over in the beginning of summer, when the ground is probably covered with weeds, the stem of every tree may be stuck in within an inch or two of its root-stock. The oak, the ash, the elm, and the sycamore, among timber trees, and the hawthorn among hedge-plants, are greatly benefited by this mode of pruning after they have been three or four years planted out where they are finally to remain. Fruit-trees cannot generally be so treated, because the graft is for the most part only a few inches above the surface of the soil; but even with fruit-trees, when they are stunted, there is no better mode of restoring them to vigour than by cutting them down to the graft.

768. *Stopping and pinching out*.—When the point of a shoot is cut off, or pinched out, while that shoot is in a growing state, it is said to be stopped; that is, the shoot is prevented from extending in length, and the sap which was before impelled to its growing point is now expended in adding to the largeness or succulence of the leaves or fruits which may be on the shoot, or in swelling or developing the buds, or in some cases changing them from leaf buds into flower buds. In the case of the young shoots of the fig, stopping occasions the development of fruit, and Mr. Knight in this way, his plant being kept in

a stove, obtained three crops of figs from the same tree in the course of one year. Three crops of grapes from the same vine have also been obtained by the same means (*Ann. Hort. Soc. Paris*, tome ii. p. 361), a practice, it would appear, known to Pliny. The principal uses of stopping, however, are to promote the setting and swelling of fruit, either on the shoot of the current year, as in the case of the vine and the melon, or at its base, as in the case of the peach. By stopping the stem of the tobacco-plant, and of the basil, above the third or fourth leaf, the leaves acquire an extraordinary degree of magnitude and succulence, and the same result is sometimes produced with common spinach and the curled parsley. By stopping flower-bearing shoots after they have shown their flower buds, and removing these, as in the case of annual flowers, the strawberry, the raspberry, the rose, &c., the blossoming and fruit-bearing seasons are retarded; as they are accelerated by stopping all the shoots on a plant that are not blossom-bearing. The growing point of monocotyledonous plants, such as palms, Yúcca, and even bulbs, is sometimes seared out with a hot iron, (which by charring it prevents its putrefaction,) to occasion the production of side suckers for propagation; and the same thing has been done with the side suckers and crown of the Pine-apple plant, to throw the nourishment which would have gone to the increase of these parts into the fruit. Much of the winter pruning of trees might be prevented by stopping the shoots early in summer, provided the state of the tree did not require that the shoots should be allowed to grow their full length in order to send down nutriment to the increase of the roots, in consequence of which greater vigour is in turn imparted to the stem and branches. In this case of pruning, as in every other, the state of the tree, and a variety of circumstances connected with it, require to be taken into consideration.

769. *Disbarking* includes two distinct operations: the removal of coarse loose outside bark to admit of the swelling of the inner bark and the alburnum by the returning sap, and the removal of a ring of both outer and inner bark, with a view to the interruption of the returning sap. The removal of old bark is an operation chiefly performed with old fruit trees in orchards, for the sake partly of getting rid of lichens and mosses, and partly to remove crevices which might harbour insects. It is also practised on the stems of old vines for the latter purpose; one effect of removing the loose outer bark of any stem, being to increase its susceptibility of suffering from changes of temperature and moisture, it may therefore often be more injurious than useful. Disbarking for the tanner consists in removing the whole of the bark, and is best performed in spring, when in consequence of the abundance of ascending sap, the bark separates easily from the wood.

770. *Ringing*.—This operation consists in taking off a narrow ring of bark from a stem or branch, or even from a root, the object of which is to check the returning sap and force it to expand itself among the leaves, flowers, or fruit, which are situated above the incision. The ring of bark taken off varies in width from a sixteenth to half an inch or an inch, and its depth is always equal to that of both outer and inner bark. In general the width of the ring taken off should not be greater than the tree has the power of recovering with bark, during the same or the following year. The operation may be performed at any season, but its effects will only be rendered obvious when the plant is in leaf; because at other seasons there is little or no sap elaborated to be returned. Compressing the bark by a ligature of wire or cord, or by a mass of Roman cement put on like the clay of a graft, produces

the same effect as ringing. In the case of fruit trees it is frequently executed on the branches to produce blossom buds, and by the same means seedling plants are sooner thrown into blossom than they otherwise would be. On some trees and shrubs it has been found much more efficient than on others; it has little effect on stone fruits; and while it succeeds on the gooseberry, it is said not to do so on the currant. Knight, Ward (777), and Pollini (*Dec. Phys.* I. p. 151) found that it increased the specific gravity of the wood above the incision, as compared with that below it, at the rate of one to nine in some cases, and more in others. We have seen (617) that ringing is favourable to the production of roots from cuttings, and it seldom fails to effect the setting of fruits when performed on branches just before they are coming into blossom. Judiciously applied, it may often serve as a substitute both for root pruning and top pruning.

771. *Disbudding* is the removal of buds early in spring, just when they are beginning to develop their leaves, and is commonly performed with the finger and thumb; the object being to lessen the number of shoots or of blossom buds to be produced. By lessening the number of blossom buds, it will add to the strength and probability of setting of those which remain, and the same increase of strength will take place in respect to the shoots, whilst, at the same time, the number of these is reduced to an approximation of that which can ultimately be retained for training. By applying this mode of pruning judiciously on such trees as the peach, apricot, and plum, especially when trained against walls, the use of the knife may be in a great measure dispensed with, excepting for cutting out diseased or decaying shoots. Disbudding is one of the most important summer operations in the management of wall-trees. "It is necessary to bear in mind that on the quantity of foliage with which a tree is furnished, depends the increase in diameter of the stem and branches, the extension and increase of roots, and the production of fruit; and, yet, that no more leaves should be retained than can be fully exposed to light. In the case of a healthy tree, not one-half of the shoots and foliage it naturally produces could be thus exposed when trained against a wall. If all the branches of a round-headed standard tree were disposed in a flattened or fan-like manner against a wall, they would be greatly over-crowded; for, instead of a surface equal to that of a sphere, the foliage would be reduced within a diametrical section of the same, affording a surface of only one quarter of that which they formerly had. Hence, it is evident that a considerable reduction of shoots produced by wall-trees must be effected in some way or other. This is partly done by shortening and thinning at the winter pruning, and partly by the process of disbudding in summer. In removing the buds care should be taken not to injure the bark of the shoot. The buds ought not to be all disbudded at the same time; the fore-right ones should be first removed, and the others successively, at intervals of several days, in order not to check the circulation of sap by a too great privation of foliage at once."—(*Gard. Chron.* for 1841, p. 380.)

772. *Disleafing*.—By taking the leaves off a growing shoot as fast as they are unfolded, no buds are matured in their axils; and thus while the superfluous vigour of the tree is expended, no sap is returned to the root. Disleafing in this manner the summer's shoots of a tree as they proceed in growth, Mr. Beaton, by whom the system is detailed, (*Gard. Mag.* for 1837, p. 204,) found the simplest mode of reducing the strength of an over-luxuriant tree. By this method, in three years, he reduced healthy, vigorous

young pear-trees to the point of starvation. When a tree fills the space allotted to it against a wall, and shows a disposition to still further growth, by throwing up strong vertical shoots above the wall, and luxuriant breast-wood on the main boughs; instead of checking this disposition by any of the ordinary modes of pruning, Mr. Beaton assists the tree to throw off the superabundant sap, by disleafing the breast-wood and vertical shoots; and in the winter pruning he displaces all the buds on such shoots, even those on the points, after which they die off by degrees and are cut out. If trees are not very luxuriant indeed, one year of this treatment will reduce them to a moderate degree of strength. As buds are only formed in the axils of leaves, probably much disbudding and pruning might be saved by disleafing as soon as the leaves are developed; but it must always be borne in mind that every leaf has not only the particular office to perform of nourishing the bud in its axil, but the general one of contributing to the nourishment of all that part of the tree which is between it and the farthest extremities of the roots. Hence, in particular cases, where it is desirable to give additional vigour to the roots, instead of disleafing or disbudding a weak tree, all the leaves and shoots which it produces; even the breast-wood and upright shoots, which the French call *gourmands*; ought to be encouraged within certain limits. Disleafing is frequently practised with fruit-bearing plants, both ligneous and herbaceous, with a view to admit the sun and air to the fruit, and sometimes also to assist in ripening wood by stopping growth. It may be applied in various instances to killing perennial weeds, both on the ground and in water, by cutting their leaves off the moment they appear, and before they are even partially developed. Docks, thistles, rushes, horse-tail, and such weeds in pastures, might be destroyed in this mode at less expense than by any other. Even couch-grass, that pest of gardeners in a superlative degree, may be so destroyed, notwithstanding its creeping underground stems, if no green leaves are allowed to be formed; as might the bulrushes, bur reeds, common reeds, and other weeds which rise up from the bottom of ponds; care being taken to repeat the operation as long as the weeds continue to grow, and never to let them exceed an inch or two in height. The scythe proper for this purpose has been mentioned (548). Grass lawns are sometimes for the sake of economy only mown three or four times a year, in consequence of which the grasses always throw up a vigorous foliage; but a much greater economy of labour, at least, would be to mow double that number of times, in consequence of which the plants would be so reduced that in the course of a year or two there would be comparatively little to mow.

773. *Slitting and splitting* may be classed under modes of pruning, the first being occasionally employed to relieve hide-bound trees, a practice of doubtful utility, and the second to stimulate stems to the production of roots or shoots. Hide-bound trees are relieved by slitting the bark longitudinally from the collar as high up the stem and along the branches as may be considered necessary. The lower extremities of cuttings are sometimes slit up (581); and shoots are split or fractured to excite buds (622). The stocks or stumps of cabbages and pine-apples are occasionally split, experience having proved that the operation excites them to the production of sprouts or suckers, as it does also in bulbs (634).

774. *Bruising and tearing* off the stems of plants from their roots are in some cases found to be more effective than cutting them off with a smooth section. This is the case with ferns, docks, and perennial thistles in pas-

ture-lands. When these are cut smoothly over with the scythe, they are said to spring up again, at least after the first cutting; but the stems being bruised or torn off, are said to die down to the root, and not to reappear; probably from exposing a much greater surface of the sap-vessels to the action of the air, and thus diminishing their contractile power. Bruising the leaves of melons by beating them is a Dutch practice, said to increase the fruitfulness of the plants, which it may probably do by checking their luxuriance; but the effect of the old practice of beating the heads of walnut-trees when the fruit is ripe is of much more doubtful efficacy. A very full crop of pears was obtained by the Rev. John Fisher, of Wavendon, in Buckinghamshire, from trees which before had not borne at all, by twisting and breaking down the young shoots (fig. 260) late in the

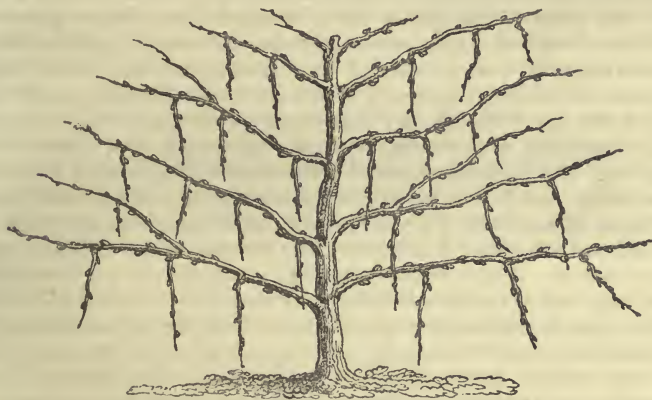

Fig. 260. A pear-tree with the young shoots twisted, broken, and fastened down, to stagnate the sap, and cause them to produce blossom-buds.

autumn, when the wood had become tough, and after the sap had retreated. Mr. Fisher found this practice succeed with branches on which ringing had been tried without success, and he states that the pendent branches continued perfectly healthy.—(*Gard. Mag.*, vol. iii. p. 175.)

775. *Clipping* is a species of pruning that was formerly much more general in gardening than it is at present, though as the ancient architectural style of hedges and avenues is gradually coming into vogue, the practice will again become frequent. At present clipping is chiefly confined to common hedges and box-edgings, the modes of dressing which by the shears have been already described (546, 547).

776. *Root-pruning*.—As the nourishment of a plant is absorbed from the soil by the roots, it is evident that the supply will be diminished by partially cutting off its source. The effect of cutting through the stronger roots of trees is analogous in its first effects to that of ringing; with this difference, that the returning sap is stagnated throughout the whole tree, instead of being stagnated only in the parts above the ring. The amputated root, however, having the power of throwing out fibres, soon finds a vent for the descending sap, and the analogy between root-pruning and ringing in a short time ceases. The operation may be performed so as to effect a two-fold result. Its immediate effect is to check the luxuriance of wood shoots,

and induce the formation of fruit buds. If judiciously performed, the operation will not be carried so far as to reduce too much the vigour of the tree, and prevent the second result, that of pushing a number of fibrous roots from those amputated; for in defect of these, the health of the tree must decline under the load of, in that case, imperfectly nourished fruit. With a view to the production of a greater number of fibrous roots, old trees may be subjected to a cautious root pruning; but it must not be performed on subjects unable to bear the shock, or on those in which the power of throwing out fresh roots is very weak. If, however, it is found that fresh roots have been emitted from one amputation, others may be performed as the roots resulting from each preceding operation come into action. Root-pruning is generally performed with a sharp spade, and generally only on the main roots, at the distance of several feet from the stem, according to the magnitude of the tree. Mr. Crace (*Gard. Chron.* 1841), to check the luxuriant growth of dwarf pear trees, and retain them of a fit size for his small garden, prunes the roots annually, leaving them each time about an inch longer than before. "He does not leave the roots with their ends wounded as they would be if chopped through with a spade; but he cuts all the larger roots obliquely with a sharp knife, so as to leave a clean slanting wound, three inches or four inches long, with its face downwards. The effect of this, he says, is to cause the wound to send forth a fan of fine fibres from its whole circumference. The young fibrous roots of a plant proceed in all cases from the surface of the wood, and not from the bark; they only pierce the bark when they seem to grow from it. When the root is crushed by the blow of a blunt tool, all the part exposed to the blow is killed, and soon decays. That decay may either proceed no further than the vicinity of the injury, or, as will happen more frequently than we suppose, it will spread and infect the sound parts in contact with it. In either case, the production of young fibrous roots can only take place by forcing them through the bark which lies over the wood from which they have to spring. But when the wound at the end of a root is clean, decay will not take place; and the surface of the wood will produce fibres from that part which is in contact with the earth. No resistance is offered to this process; on the contrary, from the moment that the fibre begins to form, it finds itself in contact with the earth, where its food resides, and there, imbibing vigour from the soil, it immediately contributes to the general system something of that organizable matter out of which more fibres are to be produced."—(*Gard. Chron.* 1841, p. 763.)

Though root-pruning is chiefly employed to check the luxuriance of young fruit-trees and throw them into blossom; yet it may be employed for these purposes with all trees and shrubs whatever, and even with some kinds of herbaceous plants. The dahlia may be rendered more productive in blossoms, either by ringing the stem just above the root stock, or by cutting through the main roots just beneath it. The Chinese, it is well known, are celebrated for their dwarf or miniature trees, and these are formed of the extremities of the branches of very old trees rooted by the process shown in fig. 190, page 276, and afterwards planted in shallow pots, in very poor soil; and as the roots are produced, they are cut or burnt, so as to cramp the growth to any degree required.

777. *Girdling and Felling.*—From the following account of the effects of this operation, it would appear to deserve being generally adopted before trees are felled. It is very general in America, not for the sake of improv-

ing the timber, but to destroy life and facilitate the destruction of the tree. We give the account of the process in the words of the author, W. Ward, Esq. of Chester. "Mr. Monteath, in his *Forester's Guide*, strongly recommends the disbarking of trees in the spring, before they are to be felled; and the effect in hardening the timber is certainly very great; but, in a hot summer, the exposed alburnum is apt to split more or less. A better mode has been found to be that of merely cutting out clean, a rim, about four inches in width, of the bark, close to the ground; which, in larches, seems to cause the turpentine to be wholly incorporated in the wood, instead of passing down to the roots; and, in fact, it so totally alters the condition of the trees, that the workmen complain of their being much more difficult to saw. Another result appears also very interesting. On February 9, 1831, a section was cut from a larch that had been girdled, as above mentioned, in the spring of 1830, and which then weighed 6540 grains. On March 21 it weighed 4990 grains, having lost 1550 grains. A similar section, cut at the same time, from an ungirdled larch, weighed, on February 9, 5610 grains, and, if it had lost by evaporation only in the same proportion as the other, should have shown, when weighed on March 21, a loss not greater than 1330 grains; instead of which, it then weighed only 3330 grains; thus showing a loss of 2280 grains, nearly double the proportion of the former. The effect of this process in establishing the straightness of the wood is, moreover, very beneficial. A ladder made from a larch so treated will be useful; whilst one not so seasoned will twist so as to be quite worthless."

778. *The girdling machine.*—"I have adopted a simple contrivance by which the girdling is effected readily, and with precision, of which fig. 261 will give

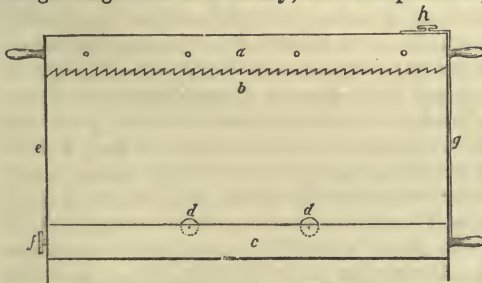

Fig. 261. Side view of the girdling machine.

some idea. In this figure, *a* is a piece of wood, two feet long, four inches wide, and two inches thick, having two saws screwed on it, one on the top and the other at the bottom, so as to be perfectly parallel at the distance of six inches from each other, and projecting about three quarters of an inch; *b* shows

the uppermost saw; *c* is another piece of wood of the same dimensions, having four small rollers projecting opposite to the saws; *d d* show the uppermost two of these rollers; *e* is a slip of tempered steel fixed to *a*, at one end, and set to *c*, at any requisite point, by a screw nut, *f*, passing through different holes made in *e*, at about one inch distance; *g* is a leather strap fixed at one end to *c*, and fastened to *a*, by a button, *h*, by suitable holes. Fig. 262 is a perspective view of this machine. The bark, after being girdled by the saws, may be taken off with any chisel, about three or four inches broad in the mouth. Allow me to add, that even with the common pine, (*Pinus sylvestris*), I find the process of girdling extremely beneficial. About ten years since I had a pine-tree, which had been so treated, sawn into boards, and made into a large door, which, though in a very exposed place, has stood as well as any foreign deal. I conceive that by girdling, the whole

of what would otherwise be mere alburnum, becomes similar to the heart wood ; and this may be one reason why the boards made from such trees

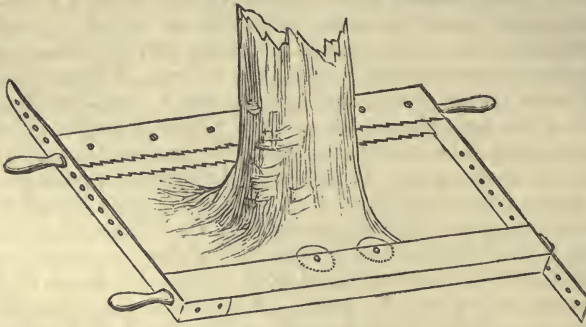

Fig. 262. Perspective view of the girdling machine.

are found not to warp. Before I girdled, I never could have a ladder made of larch that would continue straight for a month ; but now I have them made durably perfect. — *Gard. Mag.* xii. 408.

779. *The seasons for pruning vary according to the object in view.* Where wood is to be cut out or buds removed, so as to throw strength into the remaining parts of the tree, the sooner the operation is performed after the fall of the leaf the better ; because as the sap is more or less in motion, and consequently impelled to all the buds throughout the whole of the winter, that which would have been employed on the shoots and buds cut off is saved, and those which remain are invigorated by it. Next to autumn, winter is to be preferred for the same reason ; but in this season mild weather should always be chosen, because the frost, if severe, will seize on the moisture of newly-made wounds, and rupture their surface. In pruning forest-trees, large branches should never be cut off in autumn, because as they cannot heal over till the following summer, decay will commence on the surface of the wound. Spring, just before the rising of the sap, is a better season ; but better still, a fortnight before midsummer, at which period the returning sap will commence to deposit a coat of alburnum on the lips of the wound. The worst season in which any description of wood-pruning can be performed is the spring just before the expansion of the leaves, when the sap is rising with the greatest vigour. The slightest wound made in many plants both ligneous and herbaceous at this season, especially young vigorous ones where the sap-vessels are large, occasions a great loss of sap, which must necessarily weaken the plant, unless speedily checked by the only effectual mode in which this can be done, the expansion of the leaves. For disbudding and ringing, spring is the most suitable season, at least for the latter practice, because, as we have before observed, nothing is gained by ringing before the leaves begin to expand. Buds which are to be removed should remain as short a time after they are formed by the leaves as possible ; but as the labour is much greater in taking them off in autumn and winter when they are small, than in spring when all their parts are more or less expanded, the operation is generally deferred till the latter season. For disleafing, it is necessary to commence as soon as the leaves begin to expand, and continue it as long as they are produced. The advantages of pruning just before midsummer are, that the wounds may be partially healed over the same season, and that the sap which would have been employed in maturing the shoots cut off is thrown into those which remain. The disadvantages

are, that the sap which would have been elaborated by the leaves cut off, and which would have added to the strength of the tree and its roots, is lost. In the case of trees already sufficiently strong this is no disadvantage, but in the case of those which are too weak it is a positive loss. The summer season is found better than any other for pruning trees which gum, such as the cherry and the plum, provided too much foliage is not thereby taken away; and it is also considered favourable for resinous trees. The autumn, on the other hand, is considered the best for trees that are apt to suffer from bleeding, such as the vine, the birch, and some species of maple. Evergreens may be pruned just before Midsummer, or in spring, before they have begun to develop their buds.

§ IV. *Thinning.*

780. *Thinning* is an operation founded on a general knowledge of the laws of vegetation and on the habits and bulk of particular plants. Its object is to allow sufficient space to entire plants, or to the parts of plants, to attain certain required dimensions and particular properties. When plants stand too close together for attaining these purposes, whether from want of nourishment at the root, or light and air at the top, they are thinned out; and when branches, leaves, flowers, and fruit are too numerous on an individual plant to be properly nourished, and exposed to the sun and air, they also are thinned out. As this last operation is effected by pruning, it requires no farther notice in this article, which is confined to the thinning out of entire plants by uprooting them. Thinning by uprooting is performed by the hand alone, when the plants are small; and when they are larger, by the aid of the trowel, spade, pick, or other implements (393, 397, and 400). The subject may be considered with reference to seedling crops in gardens, and transplanted crops in plantations. Transplanted crops in gardens, being generally of short duration, are placed at such distances at first as mostly to render future thinning unnecessary. One general rule in thinning is that the plants to be removed, when they cannot be taken away all round the plant to be left, should be taken from the east and west sides of it, in consequence of which it will receive the sun and air on two sides instead of on one, which would be the case if thinning took place only on the south side; while if it were limited to the north side, air would be admitted, but no sun.

781. *Seedling crops in gardens.*—To make sure of a sufficient number of plants, and of their distribution over every part of the surface in broadcast crops (569), or along every part of the row in crops sown in drills, much more seed is sown than is required for the number of plants requisite for a crop. As soon as the plants from these seeds make their appearance, and are considered safe from accidents or insects, all or the greater part of those which are not judged necessary for producing a crop are pulled and thrown away, hoed up and left to die on the spot, or in some cases taken up by the trowel or spade and transplanted elsewhere. The distance at which the remaining plants are left depends on their nature and habit, on the richness or poverty of the soil, and on the kind of crop required. For example, in thinning out an autumnal crop of turnips, the distances between the plants left will be much less than in thinning out a spring crop; because in the latter case, the plants being destined to benefit by the warmth and light of summer, their roots will attain a much larger size than those of the autumn-sown crop. On the other hand, an autumnal crop of spinach will be thinned

so as to leave the plants wider apart than in a spring crop ; because in the latter case the plants, from their nature, run very speedily to seed, producing much smaller radical leaves than they do during the slow vegetation of autumn. Again, a turnip crop, whether of spring or autumn, will be left thicker on a poor soil than on a rich one ; because the latter will raise the plants individually to a larger size, and thinner in the shade, and late in autumn, than at midsummer, in order to admit of the wider spreading of the leaves, to compensate, by breadth of surface exposed to the light, for what the season is deficient in solar brilliancy. It will readily be conceived that crops that have few or narrow leaves and perpendicular roots, such as the onion, require less thinning than such as have broad-spreading leaves, such as the turnip ; and that those which have tap-roots, like the carrot, do not require so much surface soil as those which have spreading roots, and creeping or trailing shoots, such as the New Zealand spinach. Thinning seedling herbaceous plants may take place at any season ; but when they are to be cut out with the hoe and left to die on the spot, dry weather and a dry state of the soil should be chosen ; and when they are to be pulled up by hand, or taken up by the roots with a tool for transplanting, a moist state of the soil and cloudy or rainy weather are essential, in order that the fibres may receive as little injury as possible in parting from the soil.

782. *Thinning plantations.*—Timber trees when planted in masses are placed much closer together than they are intended to be finally, partly to shelter one another, and partly to profit by the trees which are to be from time to time thinned out. By planting moderately thick, the nutriment contained in the soil is much sooner turned into wood than it would be if only the few trees were planted which are finally to remain ; and by these trees standing near together they are drawn up with straight stems, so that the timber produced, even by young trees so treated, is of some use. By increasing the distance between these trees by thinning, the source of nourishment to the roots of the trees which remain is increased, and the space round the branches for light and air enlarged, so that by degrees, with every successive thinning, larger timber is produced. At what time the thinning of a plantation ought to commence, how long it ought to be continued, and at what distances the trees ought finally to stand, will depend on the kind of tree, the kind of plantation, the soil and situation, and the climate. In the case of a plantation where the object is to produce straight timber, the first point to determine is the probable height to which the kind of tree to be planted will attain in the given locality ; and then to obtain from the experience of others, or from observation of natural woods in similar localities, the distance required to enable a tree to attain that height. A tree in a sheltered valley and on deep rich soil not much above the level of the sea will attain double or triple the height which it will on a hill at a distance from the sea ; the temperature in the latter situation being much lower, the soil generally poorer, and the wind greatly stronger. The subject of timber plantations not forming a prominent feature in this volume, we shall only add that experienced planters have laid down certain rules for thinning timber plantations, and that the best of these we consider to be those of Mr. Cree, published in the *Gardener's Magazine* for 1841, and applicable to every situation from the level of the sea to an altitude of 1800 feet. Supposing the height which the trees in a plantation of round-headed kinds are supposed to attain is eighty-five feet, and that they have been planted at the distance of about

four feet, tree from tree, and pruned in Mr. Cree's manner (758) ; then the first thinning should commence when the trees are thirteen feet six inches high, and the trees thinned so as those that remain may stand at twice the former distance from each other, or 8 feet apart each way. The second thinning should take place when they are between 24 and 25 feet high, when the trees should be left so as to be 16 feet apart each way, thus leaving 170 to the acre. The third thinning should take place when the trees are between 47 and 48 feet high, when only 42 trees should be left to the acre to attain the height of 85 feet ; and these must accordingly stand at the distance of 32 feet apart each way. It is not pretended that these rules should in all cases be exactly followed ; on the contrary, they are only given as approximations, the result of extensive experience and scientific reasoning for round-headed trees ; for poplars and coniferous trees, the final distance is too great. See Mr. Cree's table in the *Gardener's Magazine* for 1841, p. 553, and also some excellent observations on the subject in the *Gardeners' Chronicle* for 1842, p. 19, and in various other parts of that journal and in the *Gardener's Magazine*. A forester should be well impressed with the importance of light, air, moisture, and shelter as regards vegetation ; and he should closely observe the density which the various trees will bear that are under his charge. In all extensive plantations some trees will be seen suffering from being too close : he should learn from cases of the kind how to proceed to thin others that he can easily foresee are approaching a similar condition. As a *beau-idéal* guide when to commence thinning, we should say, Always about to touch, but never touching.

783. *Thinning ornamental plantations.*—As the object of these is to display the natural character of the trees, either of their heads at a distance, as in masses or groves of trees only, or singly, or in groups of trees among under growths, or on smooth turf, it is obvious that thinning is of as much importance to the desired result as in timber plantations. It is equally so in plantations of shrubs, especially flowering shrubs, where the object is to show the individual character of the shrub, and also the beauty of its blossoms and fruit. Every tree and shrub has two characters, both of which are natural to it ; the one when it grows up in a mass of other trees or shrubs of the same kind, or of other kinds, and the other when it grows up singly. In the former case the stem or stems are always straight and comparatively free from branches to some height, while in the latter it is generally clothed with branches from the ground, or a short distance above it, upwards. The thinning, therefore, of an ornamental plantation will depend on the natural character to be imitated. An open grove where the trees have clear trunks to half or two thirds of their height, affords a delightful retreat for walking in, in the hottest weather of summer ; and this is also the case with an avenue where the trees have been properly thinned and pruned to the height of fifteen feet or twenty feet ; while a lawn studded with trees and shrubs singly or in small groups, and with their lower branches resting on the ground, affords views from a gravel walk or a drawing-room window peculiarly characteristic of an English pleasure-ground.

§ V. Training.

784. *To train* a plant is to support or conduct its stem and branches in some form or position, either natural or artificial, for purposes of use or ornament. It is effected partly by pruning and thinning, but chiefly by pegging down to the

ground, tying and fastening to rods, stakes, or trellises, or nailing to walls (466). The articles more immediately required are hooked pegs, ties, nails, and lists (452), with props of various kinds (451 and 452), and ladders (456).

785. *The principles upon which training is founded vary according to the object in view, but they all depend more or less on these facts:—that the sap of a plant is always impelled with the greatest force to its highest point; that, in general, whatever promotes this tendency encourages the production of leaves and shoots, and whatever represses it, promotes the formation of blossom buds. When a plant is to be trained over the surface of the ground, it must be borne in mind, that, as the tendency of the sap is always to the highest bud, the shoots pegged down should be allowed to turn up at the points, in order to promote their extension. When the object is to induce blossoms or fruitfulness, a contrary practice should be followed, and the points of the shoots kept down, or in the case of upright-grown plants, trained horizontally, or even in a downward direction. This should also be done when the object is to restrain over-luxuriance, and a contrary practice when a weak or sickly plant or tree is to be invigorated. When the object is to economise space, the plants are trained against a trellis, as occupying length, but very little breadth; and when it is to increase temperature, they are trained or spread out against a wall, which prevents the conduction of heat and moisture from the branches, by acting as a screen against winds; and increases heat by reflecting the rays of the sun during the day, and giving out heat during the night, and whenever the atmosphere is at a lower temperature than the wall.*

786. *Manual operations of training (454).—The tie or the list, by which the shoots are fastened to the trellis or wall, should be placed in the internode, and always immediately behind a bud or joint; because when tying or nailing takes place in the summer season, and near the points of the growing shoots, the latter sometimes elongate after being fastened, and if this elongation is prevented from taking place in a straight line by the fastening being made immediately before a bud or leaf, instead of being made immediately behind it, the shoot will be forced into a curved direction, and the bud and its leaf injured. Ties, which in this country are commonly of bast, are gently twisted before being tied into a knot, in order that it may be the firmer, and the bast not liable to be torn during the operation of tying. Osier ties, which are sometimes used for espalier trees, are fastened by twisting together the two ends, and turning them down in a manner sooner and easier done than described. In fastening shoots with nails and shreds, when any restraint is required to retain the shoot in its position, the pressure must always be against the shred and never against the nail, as the latter would gall the shoot, and in stone fruits generate gum. The shred ought never to be placed in the hollow of a bend in the branch to be attached; for there it is worse than useless. On the contrary, the shreds should be put on so as to pull the external bends inwards towards the direct line, in which it is desirable the branch should be trained. In fig. 263, the straight direc-*



Fig. 263. Bringing a bent shoot into a straight direction by nails and shreds.

tion in which it is desired to train the shoot is indicated by the dotted lines; *a* represents the shreds and nails put over the shoot to bring it to its place over the dotted lines, and *b*, dotted lines indicating the points which will be covered by the shreds and nails when the shoot has been rendered straight, by drawing both shoots from *a* to *b*. The nails used, whether of cast or wrought iron, should have round shanks and small round heads, as being less likely to injure the branches than sharp-angled nails. Nails an inch in length are sufficient for ordinary branches, but twice that length is necessary for very large ones. Cast-iron nails are most generally employed, and they are so cheap, and, besides, not liable to bend in the points, that they are generally preferred to nails of wrought iron. They seldom break when being driven into mortar joints; and if they do so when drawing them out, it is perhaps cheaper to buy new cast-iron nails than to point and straighten wrought-iron ones. Boiling nails in linseed-oil prevents, or, at all events, greatly lessens their rusting. Nails should in general be driven into the joints, and not into the backs, because the joints are easily repaired. They should never be driven far in, and in summer training a much slighter hold of the wall will suffice than in winter training, because in the latter case the shoots will not be moved for a year; for if they hold at the time of nailing, they become faster as they begin to rust; the oxide requiring an additional space to that required by the metal on which it is formed. Before a nail which has been some time in a wall is attempted to be drawn out, it should receive a tap with the hammer (407), by which it will be loosened, and be more likely to separate without breaking. Shreds of woollen are preferred to those of any other cloth or to leather, as being softer and less influenced by the weather. Their length should be such as to contain a shoot double the size of that for which they are intended, in order that they may never compress the shoot so much as to impede the returning sap, and their breadth may be from half an inch to three-quarters or one inch. They should be folded up a little at each end, so that in driving the nail through the shred it will pierce four times its thickness, and be in no danger of tearing, as it often does when the nail passes through only twice its thickness. When a shoot is merely to be nailed to the wall, without requiring constraint on either side, then the nails are placed alternately; but when a crooked branch is to be nailed in, two or more nails in succession will frequently be required on the same side. In driving the nails, they should incline with their heads downwards to prevent water as much as possible from hanging on them, as the rust produced is often injurious, especially to fruit. The list, as already observed, should always be placed on the internodes, and the branches should be fastened quite close to the wall, in order not to lose the benefit of its heat. The colour of the lists is a matter in which gardeners have different tastes. The late Rev. W. Marshall, an ardent lover of horticulture, preferred scarlet lists: others select those of a grey colour; some choose black; and a few mix various colours together, which is perhaps the most picturesque mode. Brown and black, however, being least conspicuous, generally obtain the preference. Shreds will last two or three years; but every time they are taken off to be put on again they should be boiled, to destroy any eggs of insects there may be on them. Trained fruit-trees are generally loosened from the wall at the time of winter or spring pruning, when the wall can be cleaned and coloured if necessary, and the tree washed with

a composition for the destruction of insects. The renailing is in general performed immediately afterwards; though some, in order to retard the blossoming of the tree next spring, tie the branches to stakes at some distance from the walls. This, however, can only be safely performed with the very hardiest kinds of trees, and even with them must be attended with danger during severe winters, unless in very sheltered situations. In refixing a trained tree, place all the leading branches in their proper positions first, beginning at the lower part of the tree, so as to make sure of covering the bottom of the wall. The main branches being placed, lay in the young wood, beginning also at the bottom of the wall, and at the further extremity of the branch, and working up to the main stem. We shall now describe the different kinds of training, commencing with the simplest, and concluding with the different forms employed in training fruit-trees.

787. *Training herbaceous plants* in beds or borders is in some kinds effected by fastening them down to the surface of the ground, or to rock-work, or a surface of pebbles, by means of pegs, loops of matting, (630,) or other material used as ties; or by laying on the shoots small stones. Twining flowers, such as the common convolvulus, or twining esculents, such as the scarlet runner, only require straight rods, or branches with upright shoots, such as those of the beech, placed close by the plants, or at most the point of the shoot when it is beginning to extend, slightly tied to the rod or branch. Branches are in general to be preferred to straight branchless rods for herbaceous climbers, because by offering a number of interruptions to the ascent of the climbing stem, they encourage it to divaricate, and consequently to produce a greater number of flowers and fruit within a limited space. Tendrilled climbers, such as sweet peas, and those with rambling stems, such as the nasturtium, are also supported by branches placed in a circle round each patch, or along each side of a row, of the height to which the plants are expected to grow; or straight hazel rods are inserted in the soil obliquely so as to touch at top and bottom, and cross in the middle, so as to form lozenge-work; or wires may be supported by iron or wooden rods in any desired form. Tall-growing plants with stems having terminal flowers, and which do not branch, such as some asters, when they cannot support themselves, require to be loosely inclosed by three or four rods placed close to the roots at bottom, and spreading outwards at top, and connected by twine; or, in some cases, a slender rod may be placed to each stem. On no account should such clusters of stems be tied together in bunches, a common practice among slovenly gardeners, as the compression rots the leaves and lessens the size of the flowers. Plants having branchy stems, such as the *Lupinus mutabilis*, and the *Baptisia*, if they require support, should have a stake to each stem, thinning them out where they are so numerous as to produce a crowded appearance. Florists' flowers, such as the carnation, the dahlia, &c., require particular kinds of stakes, and the greatest care in tying.

788. *Herbaceous and shrubby plants in pots* being in a highly artificial state, when they require training should have straight rods, or symmetrical frames of laths, or of wire-work. Pelargoniums when of large size are trained by means of straight terminal shoots of willow or hazel, so as to radiate their branches from the pot, and form a regular hemisphere of foliage and flowers, close but not crowded. Various training frames have been adopted for ornamental climbers in pots: one is shown by fig. 57 in

p. 143. A common mode for the Fuchsia, the pelargonium, the Maurándia, the Petúnia, &c., and also for the grape, is shown in figs. 264 and 265, which

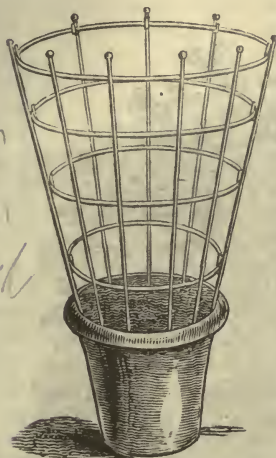

Fig. 264. Wire-frame work for climbing-plants in pots.

are formed of rods and rings of stout wire, as shown in figures 266 & 267, the whole being painted green, or of the colour of bark, according to



Fig. 265. Frame-work for training the grape-vine when grown in pots.

the taste of the gardener or his employer. In training slender climbers or twiners, such as Kennèdia rubicúnda, nails are driven into the wall near the ground (fig. 268, a), and three or four feet above it (b), close to which the plant is placed; strings are drawn from the lower nails to those above, and the stems of the plant twined round them.

789. Training hardy-flowering shrubs in the open ground.—Trailing and creeping shrubs seldom require any assistance from art, excepting when they

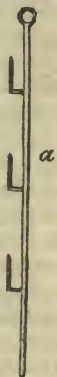

Fig. 266. Wire-standard for supporting rings, so as to form the frame-work shown in fig. 264.

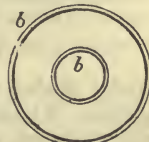

Fig. 267. Wire-rings shown in fig. 264.

are made to grow upright on posts, trellises, or walls. In general all creepers that are trained upright, and all climbers, whether by twining, tendrils, hooks, rootlets as the ivy, or mere elongation as in the Lycium and the climbing roses, when they are to form detached objects, should be trained to stakes with expanded tops, such as those shown in fig. 95 in page 164, as by this means ample heads are formed, which, in the case of the honeysuckle, the clématis, the rose, &c, exhibit splendid masses of blossom. Fig. 269 is a portrait of a climbing rose, trained down from a ring which forms the top to an iron rod, as shown in one of the figures in p. 164. This is called the balloon manner of training, and was first applied to apple-trees. When the rod is fixed in the ground, the ring at the top should stand an inch or two higher than the graft at the top of the stock, or than the head formed on the stem of the plant, if it should not have been grafted. Six or eight of the strongest shoots are then to be selected, and tied to the ring with tarred twine; and if, from their length, they are liable to blow about, their ends are at-

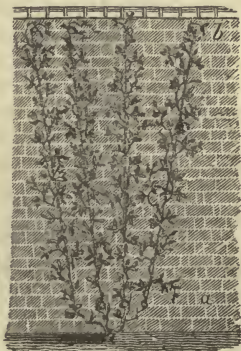

Fig. 268. Mode of training herbaceous climbers on a brick wall.

they are liable to blow about, their ends are at-

tached to twine, continued from the wire to pegs stuck in the ground, as shown in the figure. When it is desired to cover the stem of a spreading-



Fig. 269. Portrait of a *Bizarre de la Chine* rose, trained in the balloon manner.

headed climber with the foliage and flowers of a different plant, the taste of which is questionable, as they never grow so freely in such a situation where they are shaded and the roots of the plants starved, then, fig. 270,

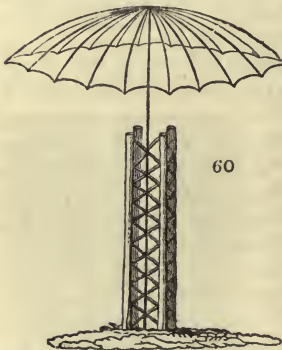

Fig. 270. Prop with umbrella top for spreading headed climbers, and for training other plants round their stems.

which was used on the lawn of George IV.'s cottage at Windsor Park, may be used. Climbing roses may also be advantageously displayed on such props as fig. 94, in p. 163, and more slender climbers, as well as standard roses, and other shrubs, trained to single stems, may be tied to stakes of larch, oak, ash, or sweet chestnut, or to cast-iron stakes, such as those shown at *a* and *b* in fig. 95, in p. 164. When climbers or other flowering plants are trained on arched trellises, covering walks, it must be borne in mind that if the display of the flowers is an object, the trellis-work must not be continuous, but rather of arches springing from piers of trellis-work, or pilasters, at short distances from each other, so as to admit the light between.

When this is neglected, the plants will only look well on their outer surface. The laburnum, when trained over an arched trellis of this kind, has a splendid effect when in flower; but when the trellis is continuous, the blossoms have a pale, sickly appear-

ance, as we witnessed some years ago at a country seat, where the trellis of which fig. 271 is a section was covered with laburnum; the low table trellis *a, a*, being clothed with ivy. The contrast between the dark green ivy and the yellow blossoms would have been effective, had the latter enjoyed the benefit of light.

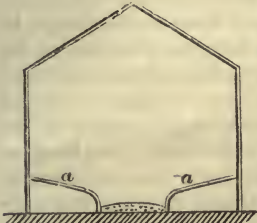

Fig. 271. Section of a laburnum trellis over a walk, with table trellises, *a, a*, for ivy.

790. *Evergreen shrubs* require very little training, excepting in the case of fastigiate-growing species in situations exposed to high winds, or shrubs that are to be shorn into artificial shapes. The evergreen cypress, and the upright variety of arbor vitæ, are apt to have the side-shoots displaced by high winds or heavy snows, for which reason these branches are frequently tied loosely to, or rather connected by tarred twine with, the main stem.

When evergreen shrubs are to be shorn into common shapes, such as cones, pyramids, piers, pilasters, &c., little or no training is required; but when they are to be grown into more artificial shapes, such as those of men or animals, the figure required is constructed of wire or trellis work, and being placed over the plant, the shoots are confined within it; and if the plants are healthy, and in a good soil and situation, the figure is speedily formed. The best shrubs for this kind of ornament are those which have narrow leaves, such as the yew, the juniper, the arbor vitæ, and the spruce fir. One of the figures, the most readily formed by any of these plants, is a hollow vase, which only requires a series of hoops tied to ribs, and the latter attached to a stake placed close by the main stem of the plant. In selecting plants for being trained into figures of men and women, it is usual to use variegated varieties to represent the female forms.

791. *Training fruit-trees*.—By far the most important application of training is to fruit-trees, whether for the purpose of rendering them more prolific, improving the quality of the fruit, growing fruit in the open air which could not otherwise be grown, except under glass, or confining the trees within a limited space. Fruit-trees are trained either as protuberant bushes or trees in the open garden, or spread out on flat surfaces against walls or espaliers. In either case the operation is founded on the principle already mentioned—that of suppressing the direct channel of the sap, by which it is more equally distributed over the tree, the tendency to produce over-vigorous shoots from the highest part is diminished, and the production of flowers from every part increased. We find that trees in a state of nature always produce their first flowers from lateral branches, to which the sap flows less abundantly than to those which are vertical; and the object of training may be said to be, to give all the parts of a tree the character of lateral branches. With a view to this, certain rules have been derived from the principle of the suppression of the sap, which it may be useful to notice as of general application to every mode of training:—

1. Branches left loose, and capable of being put in motion by the wind, grow more vigorously than those which are attached; and hence the rule to nail or tie in the stronger shoots first, and to leave the weaker shoots to acquire more vigour. Hence also the advantage of training with fixed branches against walls, as compared with training with loose branches in the open garden, when greater fruitfulness is the object.

2. Upright shoots grow more freely than inclined shoots. Therefore when two shoots of unequal vigour are to be reduced to an equality, the weaker must be elevated and the stronger depressed.

3. The shoots on the upper side of an inclined branch will always be more luxuriant than those on the lower side; therefore preserve, at the period of pruning or disbudding, only the strongest shoots below, and only the weakest above.

4. The lower branches of every tree and shrub decay naturally before the upper branches; therefore bestow the principal care on them, whether in dwarf bushes in the open garden, or with trees trained on espaliers or walls. When they are weak, cut them out, and bring down others to supply their place; or turn up their extreme points, which will attract a larger portion of sap to every part of the branch.

792. *The different modes of training bushes and trees in the open garden* are chiefly the conical form for tall trees or standards, and some modification of the globe or cylinder for dwarfs; but it may be remarked that unless these and all other artificial forms are constantly watched to check the tendency to return to nature, they are much better dispensed with. By careful attention some of these artificial forms will bring trees sooner into a bearing state, and a greater quantity of fruit will also be produced in a limited space; but if the continued care requisite for these objects is withdrawn for two or three years, the growth of the tree, while returning to its natural character, will produce a degree of confusion in the branches that will not be remedied till all the constrained branches have been cut away. Wherever, therefore, fruit is to be grown on a large scale, and in the most economical manner, in orchards or in the open garden, it is found best to let every tree take its natural shape, and confine the pruner and trainer to such operations as do not greatly interfere with it. These are chiefly keeping the tree erect with a straight stem, keeping the head well balanced, and thinning out the branches where they are crowded or cross each other, or become weak or diseased. There are however many persons who have small gardens, and who have leisure or means to attend or to procure attention to all the minutiae of culture, and to these some of the modes of training protuberant dwarfs and standards may be of considerable importance, by bringing the trees into a bearing state sooner than would be the case if they were left to nature, and by producing much fruit in little space.

793. *The different modes of training fruit-trees against walls or espaliers*, may all be reduced to three forms or systems;—the fan or palmate form, which is the most natural mode, and that most generally applicable; the horizontal system, which is adapted to trees with strong stems, and of long duration; and the perpendicular system, which is chiefly adapted to climbers, such as the vine. Trees trained by any of the above modes against a wall or espalier are much more under the control of art than can ever be the case with trees or bushes in the open garden; because in the latter case, the whole tree as well as its branches are at all times more or less liable to be put in motion by the wind, whereas against a wall they are fixed, and have not the aid of motion to increase their thickness. For these reasons, and also because flat training is applied to trees which as protuberant bushes in the open garden would scarcely produce fruit at all, flat training cannot be dispensed with. In making choice of a mode of flat training, the nature of the tree, the climate, soil, and the object in view, must be jointly taken

into consideration. Trees of temporary duration, which naturally produce numerous divergent branches, such as the peach and the apricot, are best adapted for fan training, where the climate is favourable; but in a cold climate an approach to the horizontal manner may be preferable, by lessening the quantity of wood produced and thus facilitating its ripening. The horizontal system of training produces the greatest constraint on nature, and is therefore adapted for fruit-trees of the most vigorous growth, and of large size, such as the pear and apple, which are almost always trained in this manner, whether on walls or espaliers. For plants producing shoots having little or no tendency to ramify, and which are of short duration, such as the vine, climbing roses, &c., the perpendicular manner is the most natural and the easiest; nevertheless, by disbudding and training, plants of this kind can be made to assume the fan form, and thus be rendered more productive in blossoms and fruit, than if trained in a manner which is more natural to them; and in the case of the vine, even the horizontal system may be adopted, because its shoots are of great duration. We shall first describe the methods of training dwarfs and standards in the open garden, and next the different modes of flat training on walls and espaliers.

794. *Dwarfs in the open garden* are trained in the form of hollow bushes, concave, or shaped like cups, urns, goblets, or barrels, the form being in every case produced by training the shoots to a frame-work of rods and hoops. Dwarfs are also trained in the form of globes, balloons, cylinders, low cones, pyramids, triangles, and sometimes with the branches in regular stages like a girandole. Most of these forms are also capable of being varied by training the shoots which compose their form vertically, horizontally, obliquely, or spirally; and also by tying down the current year's shoots as soon as they have ceased elongating, in the manner of quenouille training, to be afterwards described. All dwarfs, whether to be left to nature or trained artificially, are grafted on stocks naturally of humble growth; such as the quince or the mountain-ash for the pear, the doucin or paradise for the apple, the Mahaleb for the cherry, the myrobolan or the sloe for the plum, &c.

795. *Spiral cylinders*.—Of all these different modes of training dwarfs, that which best deserves adoption in a small garden is the spiral cylinder, the training of which is thus described by Mr. Hayward:—"Prune and manage the tree so that it shall form from three to six branches of as nearly equal size as possible, within about six or eight inches of the ground, as in fig. 272; and as soon as the branches are grown from three to five feet long, fix six rods or stakes into the earth for supporting them, in a circle about the root, as in



Fig 272. *Spiral training, first stage.*

fig. 273, the centre dot marking the root, and the others the rods. Each branch is then to be brought down, and being fixed to the rod near its base, the branch is to be carried round in a spiral manner, on such an elevation as will form an inclination of about fifteen degrees, and each branch is to be fixed in the same manner, one after another; thus all



Fig 273. *Spiral training, plan.*

will move in the same direction, one above the other, like so many cork-screws following in the same course, as shown in fig. 274. As from this position of the branches the point bud of each

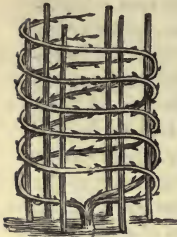

Fig. 274. *Spiral training, elevation.*

leader will present the most vertical channel for the sap, the strongest shoot will form there, and thus afford the means of continuing the leaders to a great height and for a great length of time, without crossing or obstructing each other, or throwing out useless collaterals ; at the same time, by the depressed position of the leading branches, enough sap will be pushed out on their sides to form and maintain vigorous fruiting spurs. As trees trained in this manner need never exceed the bounds allotted them on a border or bed, a greater number of trees may be planted, and a greater quantity of fruit produced, in a given space, than can be the case when they are trained in any other manner. But as pear and apple trees on free stocks may be

found to grow too rude and large after a few years, those best answer which are grafted on dwarf-growing stocks ; that is, pears on quince stocks, and apples on paradise stocks. However, to keep dwarf trees from growing too luxuriant and rude, it is a good practice to take them up and replant them every three or four years ; if this is done with due care as soon as the leaves are off the trees in the fall of the year, it will not injure them nor prevent them bearing a full crop of fruit the following year.—(*Inquiry into the Fruitfulness and Barrenness of Plants and Trees, &c.* p. 238.)

796. *Standards in the open garden* are, in France, sometimes trained with heads in similar shapes to those we have mentioned as adopted for dwarfs ; but those in most general use, where the natural form is departed from, are the spurring-in system, the conical or pyramidal system, to either of which may be applied the quenouille system ; a term which is sometimes applied to the distaff or conical form of the tree, and sometimes to the mode of tying down the current year's shoots, like the fibres of flax on a distaff, so as to stagnate in them the returning sap. Trees trained in any of these manners are generally grafted on dwarfing stocks so as to keep their growths within moderate bounds.

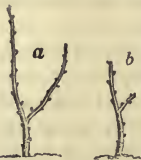

Fig. 275. *Spurring-in, first and second stage.*

797. *The spurring-in system.*—Choose a tree that has a leading shoot in an upright direction, fig. 275, *a* ; having planted it, shorten the side shoot, leaving only two or three buds, and shorten also the leading shoot, according to its strength, so that no more buds may be left on it than will produce shoots, as at *b*. The first summer the produce in shoots will be as at fig. 276, *c* ; and if before Midsummer the leading shoot be shortened as at *d*, it will probably throw out side shoots the same season, as at *e*. At the winter pruning all the side shoots may be shortened to two or three buds, and the leading shoot to such a number as it is believed will be developed.

These are to be shortened as at *f* ; and the process of shortening is to be repeated every year till the tree has the appearance of fig. 277 ; or until it has



Fig. 276. *Spurring-in, progressive stages.*

attained the height required, or which the kind of tree is calculated to attain.

798. *Conical standards*, or, as they are erroneously called, pyramidal

standards, may be produced from trees partially spurred-in; but the most general mode is to cut in the side branches, as shown in fig. 278, which represents several successive stages; while fig. 279 shows the tree brought to its regular shape; and fig. 280, the same tree with the branches of the current year tied down in the quenouille manner. The best example of this mode of training which we have seen in England, was in the Horticultural Society's garden in 1830; and in France, in the Royal Kitchen Garden at Versailles, in 1840. There were in the latter garden, in that year, two hundred trees trained in the conical manner, with the current year's shoots tied down



Fig. 277. Spurring-in completed.

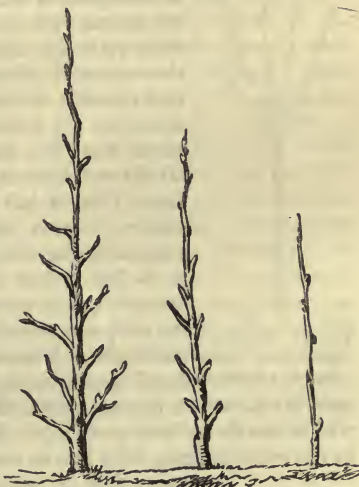

Fig. 278. Quenouille training, progressive stages.

en quenouille. They had attained the height of from six to twelve feet before the branches were bent down; but the effect of this was to cover the shoots with blossom, buds, and to produce most extraordinary crops. From the experience of French gardeners, it would appear that trees trained in the conical manner and *en quenouille* do not last longer than ten or twelve years. Copper wire is used for tying down the branches, and the lower ends of the wires are attached to the stouter branches, to the main stem, to hooked pegs stuck in the ground, or to a wooden frame fixed a few inches above its surface.



Fig. 279. Quenouille or conical training completed.

799. *Hayward's quenouille* training. — Take a plant with four or five strong shoots of



Fig. 280. Conical training with the summer shoots tied down.

three feet or four feet long, on a stem of four feet or more high

(fig. 281); "let a small hoop be bent round the bottom of the trunk, and all the branches brought regularly down and fixed to it, as in fig. 282; the consequences, if not guarded against, will be as explained in 792. As several of the uppermost buds on the base of each branch will probably throw out strong wood shoots, one of them, that is placed in the best situation to admit of being bent down to supply the place of the parent branch when worn out, should be selected, and all the rest rubbed off close; and as the shoot that is left will grow large and strong, in order that it may be better adapted for bending, it should, as soon as it is five inches or six inches long, be



Fig. 281. Hayward's quenouille training, first stage.

found necessary to cut out the old branches, these, by a half-twist, may be brought down without danger of breaking, and the bend will be less abrupt and unsightly. By the same rules, trees may be trained in the same manner, with two or more tiers, as in fig. 284.



Fig. 283. Hayward's quenouille training, stakes, showing two successive shoots.

tied down. Trained in this manner, whenever it may be found necessary to cut out the old branches, these, by a half-twist, may be brought down without danger of breaking, and the bend will be less abrupt and unsightly. By the same rules, trees may be trained in the same manner, with two or more tiers, as in fig. 284. The success of this mode of training depends upon due attention being paid to the disbudding or rubbing off useless shoots in the spring, and taking due care of those which are intended either to carry on and extend the tree, or to succeed and occupy the place of the old bearers. It will," he concludes, "be found extremely well adapted to apple-trees on paradise-stocks, pear-trees, on quince-stocks, cherry-trees, &c.; and also to peach-trees in pots; and it is a most economical mode, as it requires no stakes."—(*Gard. Mag.* vol. vii. p. 441.)

300. *Fan-training* is chiefly adapted for trees trained against walls, and more especially for the peach and apricot. There are several modifications of the fan form, and five different varieties may be pointed out. The first is the equal fan, in which there are a number of main branches all radiating from the graft of the tree; in the case of dwarfs, all the branches radiate from the horizontal line upwards, but in the case of standards against walls, or what in Scotland are called riders, they radiate downwards as well as upwards; and this forms the second, or what is called the stellate-fan manner of training. The third mode is called the open fan, or the Montreuil training, in which there are two main branches laid into the right and left of the centre, at an angle of 45° , and the wall is covered by subordinate branches from these and their laterals. The great advantage of this mode of training is, that whenever the wall gets naked below, it can be covered by bringing down the two main

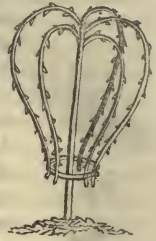

Fig. 282. Hayward's quenouille training complete.



Fig. 284. Hayward's double quenouille training.

branches and their subordinates. An improvement on this mode of training as applied to the peach-tree was made by Dumoutier, and is described by Lelieur, in his "Pomone Française;" another, by Sieulle (a cultivator at Montreuil, to whom we were introduced, in 1819, by M. Thouin), is described in Neill's *Horticultural Tour*, and in the first edition of our *Encyclopædia of Gardening*; and a third improvement has been recently made in the Montreuil training, by F. Malot, a cultivator at Montreuil, which consists in first covering the lower part of the wall, by preventing any shoots from being produced from the upper sides of the two main branches till the part of the wall below them is covered. This mode is described in the *Annales d'Horticulture de Paris* for 1841, and in the *Bon Jardinier* for 1842. A fourth mode of fan-training, is what is called Seymour's, which, on principle, appears to be the most perfect of all modes of training, and to which the nearest approach made by the French gardeners is that called the *Palmette à la Dumoutier*, alluded to above. A fifth mode is the curvilinear fan-training of Mr. Hayward, which is good in principle; but which has not yet been much adopted, notwithstanding some excellent points which it exhibits. If we describe the common English mode of fan-training, Seymour's mode, and Hayward's mode, the other variations will be readily understood. In fact, there can be no difficulty with any mode of training, provided the operator possesses beforehand a clear conception of the form to be produced, and bears in mind the power of buds, and the influence on that power of elevation and depression.

801. *Fan-training in the common English manner.*—The following directions for this mode of training are by an excellent practical gardener:—The maiden plant is to be headed down to four eyes, placed in such a manner as to throw out two shoots on each side, as shown in fig. 285. The following season

the two uppermost shoots are to be headed down to three eyes, placed in such a manner as to throw out one leading shoot, and one shoot on each side; the two lowermost shoots are to be headed down to two eyes, so as to throw out one leading shoot, and one shoot on the uppermost side, as shown in fig. 286. We have now five leading shoots on each side, well placed, to form our future tree. Each of these shoots must be placed in the exact position in which it is to remain; and as it is these shoots which are to form the leading character of the future tree, none of them are to be shortened. The tree should by no means be suffered to bear any fruit this year. Each shoot must now be suffered to produce, besides the leading shoot at the extremity, two other shoots on the uppermost side, one near to the bottom, and one about midway up the stem; there must also be one shoot on the undermost side, placed about midway between the other two. All the other shoots must be pinched off in their infant state. The tree will then assume, at the end of the third year, the appearance shown in fig. 287. From this time it may be allowed to bear what crop of fruit the gardener thinks it able to carry; in determining which he ought never to overrate the vigour of the tree. All of these shoots, except the leading

Fig. 285. Fan-training, first stage.



Fig. 286. Fan-training, second stage.

ones, must at the proper season be shortened, but to what length must be left entirely to the judgment of the gardener, it, of course, depending upon the vigour of the tree. In short-

ening the shoot, care should be taken to cut back to a bud that will produce a shoot for the following year. Cut close to the bud, so that the wound may heal the following season. The following season each shoot at the extremities of the leading branches should produce, besides the leading shoot, one on

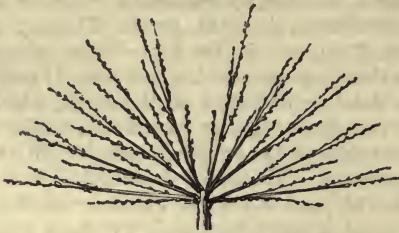

Fig. 287. Fan-training, third stage.

the upper and two on the under part, more or less, according to the vigour of the tree; whilst each of the secondary branches should produce, besides the leading shoot, one other, placed near to the bottom; for the grand art of pruning, in all systems to which this class of trees are subjected, consists in preserving a sufficient quantity of young wood at the bottom of the tree; and on no account must the gardener cut clean away any shoots so placed, without well considering if they will be wanted, not only for the present, but for the future good appearance of the tree. The quantity of young wood annually laid in must depend upon the vigour of the tree. It would be ridiculous to lay the same quantity of wood into a weakly tree as into a tree in full vigour. The gardener here must use his own judgment. But if any of the leading shoots manifest a disposition to outstrip the others, a larger portion of young wood must be laid in, and a greater quantity of fruit than usual suffered to ripen on the over-vigorous branch. At the same time a smaller quantity of fruit than usual must be left to ripen on the weaker branch. This will tend to restore the equilibrium better than any other method. Fig. 288

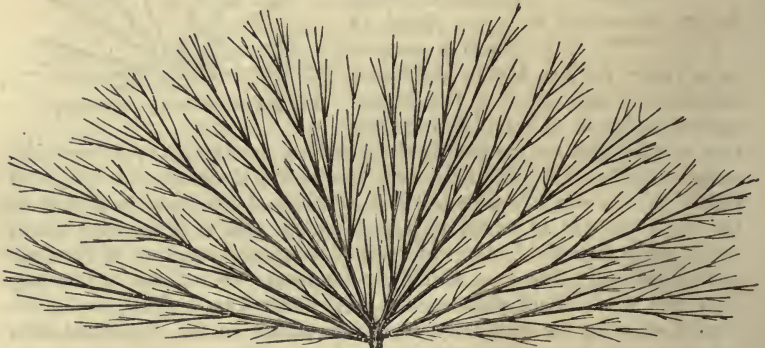

Fig. 288. Fan-training, complete.

presents us with the figure of the tree in a more advanced state, well balanced, and well calculated for an equal distribution of sap all over its surface. Whenever any of the lower shoots have advanced so far as to incommode the others, they should be cut back to a yearling shoot: this will give them room, and keep the lower part of the tree in order. In

nailing, care must be taken not to bruise any part of the shoot; the wounds made by the knife heal quickly, but a bruise often proves incurable. Never let a nail gall any part of the tree: it will endanger the life of the branch. In nailing in the young shoots, dispose them as straight and as regular as possible: it will look workmanlike. Whatever system of training is pursued, the leading branches should be laid in in the exact position they are to remain; for wherever a large branch is brought down to fill the lower part of the wall, the free ascent of the sap is obstructed by the extension of the upper and contraction of the lower parts of the branch. It is thus robbed of part of its former vigour, whilst it seldom fails to throw out immediately behind the part most bent one or more vigorous shoots. To assist the young practitioner in laying in the leading branches of the tree, the following method may perhaps be acceptable. Drive a nail into the wall, exactly where the centre of the tree is to be, then with a string and chalk describe a semicircle of any diameter, divide the quadrant into 90° ; the lower branch will then take an elevation of about 12° , the second of about $27\frac{1}{2}^{\circ}$, the third about 43° , the fourth $58\frac{1}{2}^{\circ}$, and the fifth about $74\frac{1}{2}^{\circ}$. A nail should then be driven into each of these points, and the chalk rubbed off.—(*G. M.* ii. p. 144.)

302. *Fan-training according to Seymour's mode.*—Head down the maiden plant to three eyes, as shown in fig. 289, *a*. Three shoots being produced, the



Fig. 289. *Seymour's fan-training, progressive stages.*

second year head down the centre one to three eyes, and leave the two side shoots at full length, as at *b*. Rub off all the buds on the lower side of the two side-branches, and leave only on the upper side a series of buds from nine inches to twelve inches apart. When these buds have grown five inches

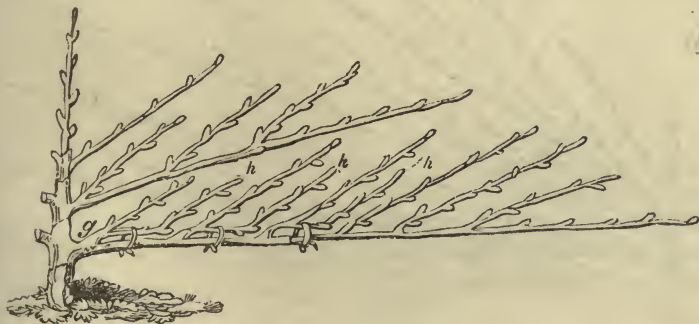

Fig. 290. *Seymour's fan-training, third stage, in summer.*

or six inches, stop the shoots produced, but still allowing the leading shoot

to extend itself. At the end of the summer of the second year, there will be four side shoots, and six or more laterals, as at *c*. In the following spring, the laterals *d*, which had been nailed to the wall, are loosened and tied to their main shoot, as at *e*, and the upright shoot or main leader shortened to three buds, as at *f*, or if the tree be very vigorous, to five buds. At the end of the third summer, the number of laterals will be doubled on the two lower branches, as shown in fig. 290: a new lateral having sprung from the base of the one tied in, as at *g*, and another from its extremity, as at *h*. In the pruning of the spring of the fourth year, the original laterals, now of two years' growth, which had borne fruit, are cut off close to the branch, and the young laterals which had sprung from their base are loosened from the wall, and tied down to succeed them, as at fig. 291, *i*. The other

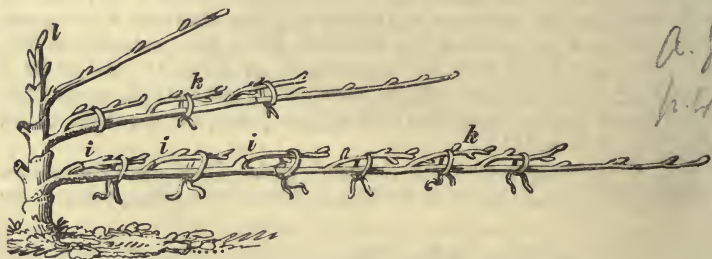

Fig. 291. *Seymour's fan-training, third stage after the winter pruning.*

laterals produced are tied in, as at *k*, and the upright shoots shortened, as at *l*, as before. This method of pruning and training the peach, its author, Mr. John Seymour, describes as truly systematical, as all the principal

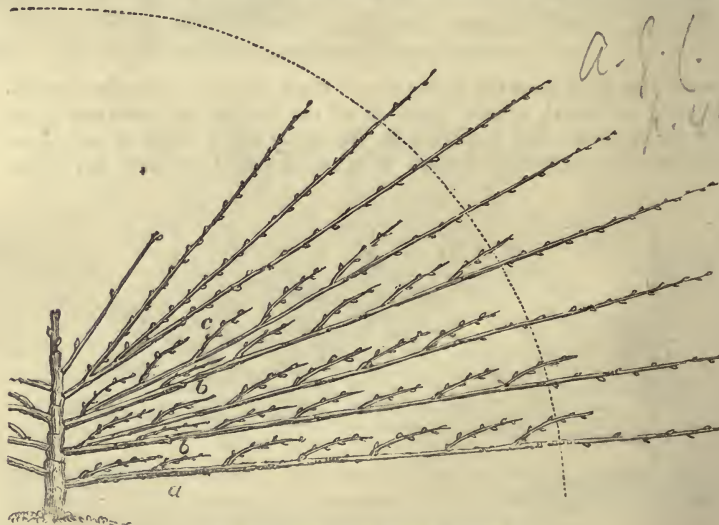

Fig. 292. *Seymour's fan-training, fifth year.*

leading shoots are trained by a line stretched from the setting on or origin

of the shoot to beyond its extreme length, and the distance of the leading shoots from one another is regulated by a semicircular line, at about ten feet from the stem, as shown in fig. 292. On this line is marked off the distances between the shoots, which are ten inches each. The lateral shoots are laid in about a foot asunder, as at *a*, in this figure. In the third or fourth year, and



Fig. 293. *Seymour's fan-training, sixth year.*

sometimes in the second, instead of laying in all the side shoots at full length, some of them are shortened, so as to get two leading shoots from as many side shoots as may be necessary to fill the wall, as shown at *b, b*. If the double side shoots thus produced are strong, they may be laid in their whole length; but if weak, they must be cut short to give them strength. Occasionally a side shoot may be made to produce three others, as at *c*; so that there never can be any difficulty in producing a sufficient number of leading shoots to furnish the wall. Fig. 293 is a por-

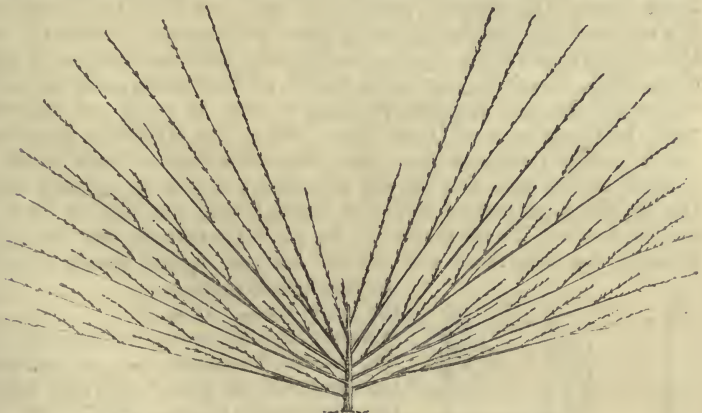

Fig. 294. *Seymour's fan-training, in progress for a low wall.*

trait of one-half of a Vanguard peach of six years' growth, taken in March,

1826. This tree, we are informed, still exists in Carleton Hall Gardens, where it covers nearly eight hundred square feet of wall, and is universally admired. It will be evident, we think, to every gardener, that this mode of training is not so well adapted for low walls as for such as are high. For high walls it is recommended to train the tree in form of the fig. 294, till it reaches the top of the wall, and afterwards to change the position of the shoots in the manner shown in fig. 295, encouraging the shoots produced

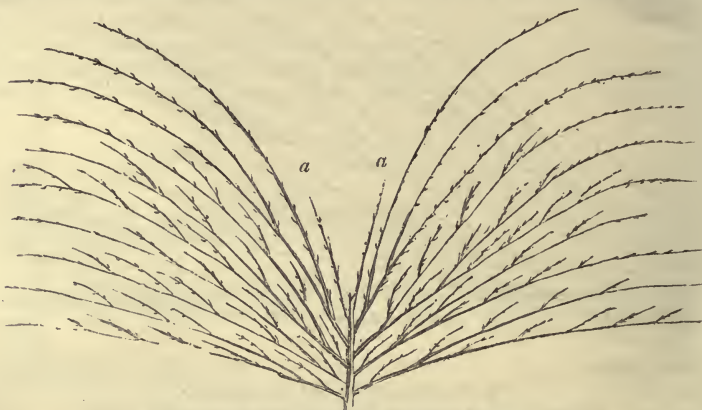

Fig. 295. *Seymour's fan-training, suited to a low wall.*

from *a, a*, to throw out branches to fill the centre of the tree. (*Ibid.* vol. vi. p. 437.) There can be no doubt that this is a very systematic and beautiful mode of training, but being more difficult than the common fan mode, it has not been generally adopted by gardeners. Its perfect symmetry ought strongly to recommend it to the amateur of leisure.

803. *Fan-training in the wavy or curvilinear manner.*—This mode of training was first described and its advantages pointed out by Mr. Hayward, in his *Science of Horticulture*, published in 1822; but it had been in practice to a certain extent long before, which shows its foundation in nature. Mr. Callow, to whom the idea was suggested by the lower branches of some large elms, which, though they projected ever so far horizontally, still had their extremities inclined upwards, practised it with the peach and nectarine nearly half a century ago. (*Gard. Mag.*, 1834, p. 38.) This mode of training, which we shall describe from Mr. Hayward's very scientific work, is founded on the fact, that the sap will always flow in the greatest quantity to the most vertical buds; so that a branch bent like an inverted syphon, however low the centre may be, yet if the extreme point be turned upwards, the buds there will produce vigorous upright shoots, however distant they may be from



Fig. 296. *Illustrating the principles of wavy-training.*

the main stem. If a branch be fixed in a vertical position, the strongest shoot will be produced at the point bud *a*, in fig. 296, as it will also if the shoot should be bent, as shown at *b* and *c* in the same



Fig. 297. *Illustrative of wavy-training.*

figure. Again, if a branch be fixed in a horizontal position, as in fig. 297, the strongest shoot will be produced from the most vertical bud near the base of the shoot, as at *d*, and the shoot produced from *e* will be the weakest ; but by turning up the point of this horizontal shoot, as at fig. 298 *f*,

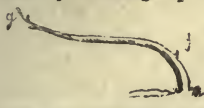

Fig. 298. Illustrative of wavy-training.

nearly as strong a shoot will be produced as if the branch had been fixed in a vertical position, even though the bud at *g* should be at



Fig. 299. Wavy-training, first stage.

a considerable distance from the main stem of the plant. The bud at *f*, in this example, will also make a strong shoot. It is easy to conceive how these facts may be taken advantage of in training trees on flat surfaces. All the main branches, which in the common mode of fan-training, and also in Seymour's mode, are laid in at an angle of 45°, are by Hayward's mode laid in much nearer the horizontal position, but always with their extreme points turned up. Trees may be trained in this manner either without a main stem, which constitutes the slightest deviation from common fan-training, and which has been found greatly preferable to it by Mr. Callow, Mr. Glendinning, and others ; with one main stem, or with two main stems, both of which modes have been tried and proved by Mr. Hayward.

304. *Wavy fan-training with two stems.*—Suppose that the object is “to cover a space of wall of sixteen feet in length and twelve feet high, and at the same time to provide a length of stem of eight feet from the root for the sap to pass through to prepare it for fructification (which is required by the peach tree), we must obtain a plant with two equal stems, growing from the same base, of four feet each ; for by each taking one-half of the sap supplied, and passing it over four feet, both surfaces together will be equal to one stem of eight feet high ; and in order to bring the fruiting part of the tree as near the earth as possible, and to fill the lower part of the wall or trellis, we must bend each of the stems down, as in fig. 299 ; and all the buds being removed, but three at each extremity, *h, h*, (and it must be remembered that



Fig. 300. Wavy-training, first stage.

unless this is particularly attended to, it will be almost impossible to succeed in training a tree in this manner,) those will take the full quantity of sap supplied by the root, and form shoots of proportionate strength, and those shoots during the summer may be trained upwards, as in fig. 300.

The following winter the side-branches must be brought down to their proper position to the right and left, as in fig. 301. If the horizontal branches are four feet long, or of the full length required to fill the space of sixteen feet allowed, the points of those branches must be laid flat, as at *i*, on the left-hand side of 301 ; but if they are required to grow longer, the points must be turned up, as on the right-hand side, *k*. The next object must be to manage the centre shoots, or stems, which are to furnish horizontals, so as to cover



Fig. 301. Wavy-training, third stage.

the upper part of the wall. There are two modes of effecting this: the one to bend the leading branch in a serpentine form, as represented at *k*, in fig. 301, and form the bends so that they may present a wood bud on the upper side of each, at from four inches to nine inches apart, which will place the horizontals from nine inches to eighteen inches apart on each side; all other buds but these being removed, they will be furnished with sufficient sap to form horizontals of due length the following year, and also a centre shoot to form the stem, to be managed in the same manner to produce horizontals the following year; and so on every year, until the tree has attained the height of the wall. The other mode of proceeding with the stem is to train it in an upright direction, and to cut it off, or shorten it, as at *i*, in the last figure, from nine inches to eighteen inches every year; rubbing off all the buds, except the three which are best placed at the end to furnish two horizontals and a leader for the following year. This is not only the most simple, but perhaps the most certain, mode of providing horizontals of due strength, and at the distances wanted. Indeed this mode of shortening the centre branch must be adopted with all fruit trees, except the peach. The peach tree, with care and attention, may be trained on the serpentine plan, so as to place the horizontals with great regularity. When it is thus trained, there is this advantage,—the current of the sap being checked in the buds, a larger portion is sent into the horizontals, and the sap is more equally divided; they are thus sustained in greater luxuriance at the lower part of the tree, and sometimes two tiers of horizontals may be obtained in one year. But as almost all other trees are prone to form their shoots at the ends of the last year's shoots, the bending will not always force out shoots where wanted. In order to secure this, therefore, the leading shoots must be shortened every year, down to the place where it is desired to form the horizontals; and even by this mode of forcing out branches (by shortening), the upright flow of the sap may be checked by bending the leader each year from one side to another, on an inclination of about 45° , as in fig. 302,

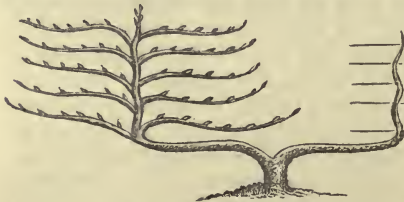

Fig. 302. *Wavy-training, fifth year*

which as indicated by the numbers 1 to 5, is of five years' growth. Proceeding in this manner, a tree will advance in height only by a tier of horizontals each year, and hence it will appear to fill the upper part of the wall but slowly; but it must be

considered, that the time you lose in covering the upper part of the wall, you gain in width on the lower part. It may also appear on a superficial view, that by extending the branches so long, and rendering them so naked of shoots, for the first year or two, you lose so much time; but it is not so in reality, for by this mode you lose no time in cutting back the stem, as by the usual mode. By the common mode of training, two or more years are lost before it is attempted to produce bearing wood. Moreover, by laying down the first branches to such lengths, you obtain a space sufficient, the second or third years, to dispose of every inch of wood the tree makes, without crowding it too closely together; and indeed the means of appropriating to a profitable purpose all the nutriment extracted from the soil by

the tree. From a tree trained in this manner above seven hundred perfectly ripened peaches have been gathered the fifth year of training, all growing within six feet of the surface of the border. When a tree is full grown, it will have the appearance of fig. 303. Particular attention must

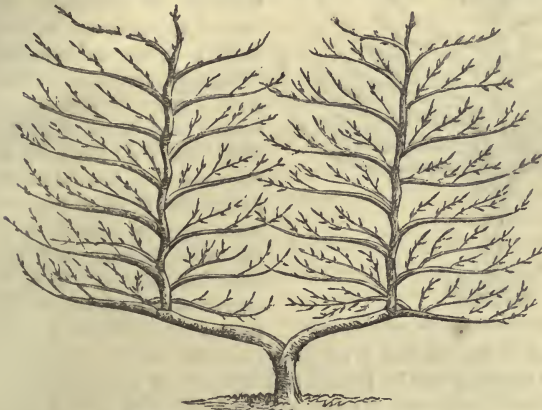

Fig. 303. *Wavy-training, completed.*

be paid to the rubbing off all or most of the "shoots, as soon as they appear in the spring, from the front and under sides of the horizontals, as well as from all other parts of the tree where young wood is not wanted."—
(*Hayward on the Fruitfulness and Barrenness of Plants and*

Trees, &c., 1834.) To Mr. Hayward's directions, the observations which we have made on some trees trained in this manner enable us to suggest, that a sufficient number of shoots and leaves should be left on the main stems, for the purpose of strengthening them and the roots. For this purpose, it will be advisable to leave some shoots on the stems, even where they are not ultimately wanted, till such time as the ramification of the top affords a sufficient breadth of foliage for strengthening them. The stems, in their naked state, are also liable to be scorched by the rays of the sun, unless they are protected, either by a covering or screen of some kind, or by training down some of the shoots, so as that the foliage may overhang them. A similar objection may be made to Hitt's mode of training with two stems, which may be considered the parent of Mr. Hayward's mode.

805. *Wavy fan-training with a single stem* will readily be understood. On planting, if the stem is without branches, cut it back to three buds; but if it has already three shoots, shorten the centre one to nine inches or a foot, according to the kind of tree, and leave only three buds at its upper extremity, laying in the side shoots as in fig. 304. In like manner after next



Fig. 304. *Wavy-training with a single stem, first stage.*

year's growth shorten the centre shoot, and lay in the two side shoots as before, and proceed in this manner till the wall is filled, or till the tree has the appearance of fig. 305. It is necessary to observe, with reference to this figure, that the length of stem is for the purpose of admitting a single

shoot of a vine, to be trained horizontally below it, a mode which Mr. Hayward finds to be productive of early and abundant crops. In wavy fan-training with a single stem which is short, Mr. Hayward observes, "It will be difficult to prevent the horizontal branches near the centre of the tree from

becoming naked of bearing wood, because the sap cannot pass through a sufficient space of bark to prepare it for fructification, until it is a great distance from the trunk.



Fig. 305. A half rider trained in the wavy manner.

But this defect may in a great measure be remedied, if, instead of being cut back to make it throw out branches to form the tree from a short stem, a stem of four or five feet be bent down as in fig. 306; and if all the buds, as they push out, be rubbed off, except the three at the end, those may be trained up in the same manner as if the stem had been cut back or shortened, and afterwards the stem or centre may be treated in the same manner as the one that is cut back; the difference will then be, that the centre of the tree will be formed four feet on one side of the root, instead of being immediately over it; but as the sap will thus have a space of four feet of bark to pass, the tree will produce its bearing wood in greater abundance near the stem, and fill the wall more equally with fruit."— (*Inquiry, &c.* p. 228.)

306. *Horizontal training* is in a great measure confined to Britain, for it is not generally approved of on the Continent, more especially in France. It was first systematically described by Hitt, and is practised either with one or two stems, and either with the upright stem straight, or in a zigzag direction to stimulate the lateral buds to develop themselves. From this upright stem



Fig. 306. Illustrative of wavy-training with a long stem.

the branches proceed at right angles, generally at nine inches apart for apples, cherries, and plums, and from ten inches to a foot, or eighteen inches for pears.

A maiden plant with three shoots having been procured, the two side ones are laid in horizon-



Fig. 307. Horizontal training, first stage.

tally, and the centre one upright, as in fig. 307; all the buds being rubbed off the latter but three, viz., one next the top for a vertical leader, and one on each side as near the top as possible, for horizontal branches. In the course of the first summer after planting, the shoots may be allowed to grow without being stopped. In the autumn of the first year the two laterals produced are



Fig. 308. Horizontal training, second stage.

nailed in, and also the shoots produced from the extremities of the lower laterals; the centre shoot being headed down as before, as shown in fig. 308. But in the second summer, when the main shoot has attained the length of ten inches, or twelve inches, it may be stopped; which if the plant is in proper vigour will cause it to throw out two horizontal branches, in addition to those which were thrown out from the wood of the preceding year. The tree will

now be in its second summer, and will have four horizontal branches on each side of the upright stem as in fig. 309; and by persevering in this system



Fig. 309. Horizontal training, third stage.

four horizontal branches will be produced in each year, till the tree reaches the top of the wall, when the upright stem must terminate in two horizontal branches. In the following autumn the tree will have the appearance of fig. 310; supposing an apple tree be the plant to be trained, and that it

consists of a single shoot from a bud. Let it be planted early in autumn, and next spring head it down to seven buds. "Every bud pushing two or

three shoots, the third and fourth, counting upwards, must be rubbed off when they are three inches in length; the uppermost shoot must be trained straight up the wall for a leading stem, and the remaining four horizontally along the wall. The leading shoot

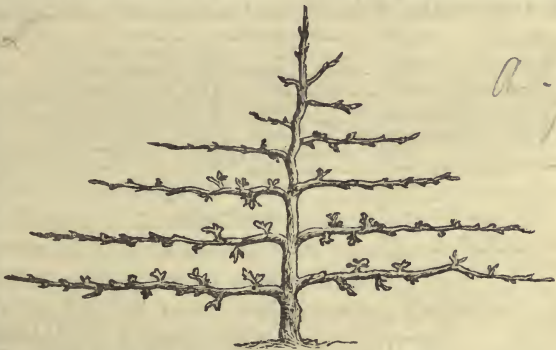

Fig. 310. Horizontal training, fourth year.

a. / 1
350

having attained about fifteen inches in length, cut it down to eleven inches. From the shoots that will thus be produced select three, one to be trained as a leader, and two as side branches. In the second autumn the tree will have the appearance of fig 311. Proceeding in this way for seven years, the tree

will have reached the top of a wall twelve feet high. With weak trees, or trees in very cold, late situations, this practice will not be advisable, as the wood produced from the summer shoots would be too weak, or would not ripen; but in all ordinary situations the plan will succeed."—(*Harrison on Fruit-trees*, chap. xx.)

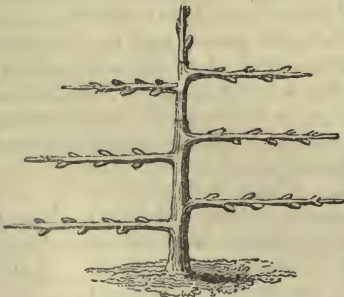

Fig. 311. Horizontal training, the apple.

the wall is filled. It is alleged also that heading-down does not always produce two lateral shoots, and also that it has a tendency to make the

807. *Fan-training and horizontal training combined.*—In training trees horizontally, we have seen that a considerable period must elapse before the

shoots already produced grow more rank than is desirable: by the following method practised by Mr. Green of Stepney, this inconvenience is avoided, and the wall is much sooner filled in height with shoots:—Suppose the wall to be under twenty feet long, and that it is intended to train a pear-tree

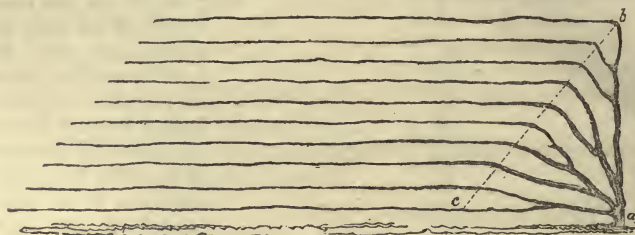

Fig. 312. Horizontal training and fan-training combined.

against it; plant the tree at one end of the wall, and then proceed as follows: Let the situation of the tree be at *a*, in fig. 312; stick a nail in the wall at *b*,

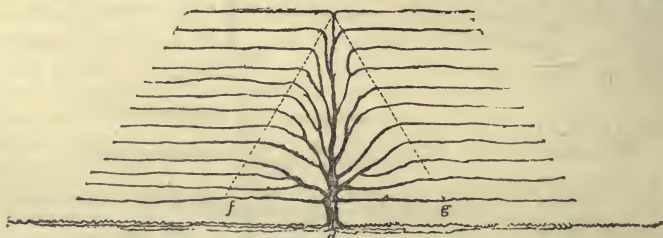

Fig. 313. Horizontal and fan-training combined.

and another nail at *c*, and strike a line on the wall from *b* to *c*; then train

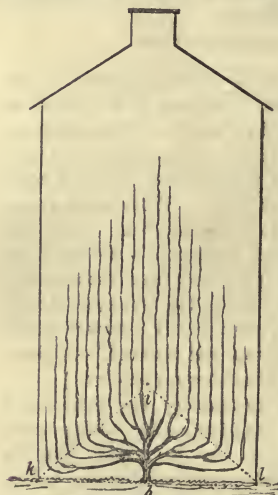

Fig. 314. Horizontal and upright training combined.

all the shoots to one side after the fan manner, and bend the whole of the shoots into a horizontal position, as soon as they reach the line that is drawn from *b* to *c*; after which continue to train them horizontally. If the wall is from thirty to forty feet in length, plant the tree in the middle of it as at *d*, in fig. 313, and proceed as follows:—Stick a nail in the wall in the centre, near the top, at *e*; stick another nail at *f*, and another at *g*; then strike a line from *e* to *f*, another line from *e* to *g*; train the tree in the fan manner until the shoots reach the lines drawn upon the wall, and then bend them horizontally. If the wall is higher than it is wide, proceed as follows:—Plant the tree in the middle of the wall at *h*, in fig. 314; stick one nail at *i*, one at *k*, and one at *l*; strike the lines as before; but, instead of spreading out the shoots horizontally, train them perpendi-



Fig. 315. Half-fan training, first stage.

cularly. This process answers well for pears, vines, or any other rank-growing tree.—(*G. M.*, vol. viii. p. 539.) A similar mode of training has



Fig. 316. *Half-fan training, second stage.*

been adopted by Mr. Smith of Hopeton House, for the finer apples and best late pears, and is thus described by him: fig. 315

represents a tree one year from

the graft, newly planted, and afterwards cut down to two buds on each shoot.

Fig. 316 represents the same tree two years old, and fan-trained. Fig. 317, the same tree three years old, cut back

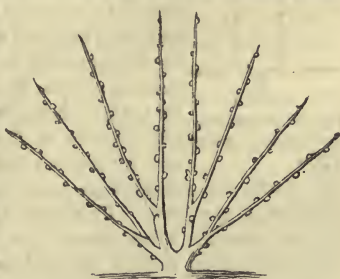

Fig. 317. *Half-fan training, third stage.*

and fan-trained. Fig. 318, the same tree, six years old, fan-trained; the

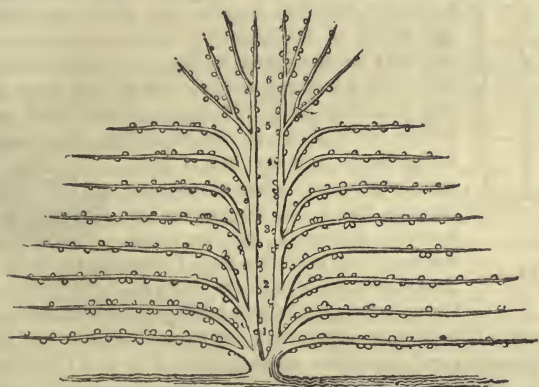

Fig. 318. *Half-fan training, sixth year.*

shoots brought down in a curvilinear form to the horizontal direction; and the different years' growth marked one, two, three, four, five, six. The centre is still trained in the fan form, and the branches are brought down yearly; until the tree reaches to the top of the wall, where the fan-

training terminates, and the branches are trained forward horizontally. Nothing more is necessary than to keep the trees in good order, and to encourage the leading shoots.—(*G. M.* x. p. 267.)

308. *Perpendicular training* is comparatively little used, excepting for climbing shrubs, such as roses, the vine, and the gooseberry and currant, when trained against a wall or espalier rail. The principle is to have two horizontal main stems on the lowest part of the wall or trellis, and to train from these upright shoots at regular distances. Sometimes four horizontal main stems are used—two at the bottom, and the other two half way up the wall or espalier; but this mode is chiefly adopted with the vine. With the exception of the latter plant and the fig, when trained in this way, the main horizontal branches are very short, seldom in the case of the rose, gooseberry,

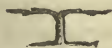

Fig. 319. *Perpendicular training, first stage.*

or currant, extending more than two feet or three feet from each side of the stem. A young plant with two shoots may have these shortened to one foot each in length, and tied to the lower bar or wire of the trellis, as in fig. 319. This being done in autumn, next year two upright shoots will be produced, and an

addition made to the horizontal shoots, as in fig. 320. The third year, two other upright shoots, or if the plant is in a vigorous state, four will be produced, as in fig. 321; and this will generally be found sufficient horizontal extension for a gooseberry, currant, or rose. See fig. 322. The six upright shoots now established



Fig. 320. Perpendicular training, second stage.

will advance at the rate of from nine inches to a foot in a year, if



Fig. 321. Perpendicular training, third stage.

the plants are gooseberries or currants, but a great deal faster if they are climbers of any kind. This mode of training is frequently combined with the fan manner, when vines, roses, Wistarias, or other luxuriant climbers, are to be trained against the gable ends of houses, as shown in fig. 313.

809. *Instruments and materials.*—In addition to those mentioned (784) as required for training in general, we may add for training against walls and trellises,—a pair of scissors for clipping the shreds; a hammer, with a shaft of sufficient length, that when hung on one round of the ladder by the head, the other may rest on the round below so as not to fall through; a leathern wallet, such as that figured and described in p. 167, or in default of it a basket, fig. 323, about twelve inches long, six inches broad, and six inches deep, with loops to put a belt through on one side, that it may hang before the operator, having the side on which the loops are made bending to rest the better against his body, and a division in the middle for two different sorts of shreds

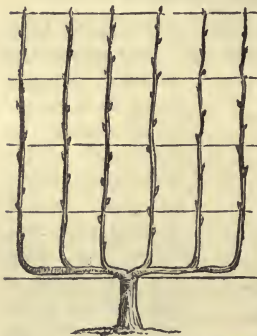

Fig. 322. Perpendicular training complete.



Fig. 323. Trainee's basket.

—the longer of these should be an inch or more in breadth, and the shorter, for the bearing shoots of peaches and nectarines, about a third of an inch (Hitt); a deal plank to tread upon, with a strap at each end to drag it along either way, or to lift it with one hand; a small pair of pincers for drawing out nails in places where the hammer cannot be so conveniently employed, and a pair of pliers, if wire is used as ties; a key or narrow saw (fig. 202, in p. 290) for taking off old branches; a mallet, and a chisel about two inches broad at the mouth, for the same purpose; to which we may add a couple of step-ladders, on which a plank may be placed at different heights parallel to the wall for the operator to stand on, by which he will do much more work, and with much greater ease to himself. In cutting branches of trees trained against walls, the cut or wounded section should always, if possible, be on the under side of the branches, or next the wall; and in the case of espaliers, it ought to be on the under side.

810. *Comparative view of the different modes of training.*—It is well to understand the various methods of training detailed in the foregoing pages; and knowing them, any modification may be adopted which circumstances may require, provided the general principles are kept in view. Ornamental shrubs are easily managed, because they have not a tendency to rear themselves by forming a strong stem; but with regard to fruit-trees, the case is otherwise. These, it is well known, if left to nature, form one strong stem,

supporting a top which reaches the height of twenty, thirty, or forty feet, or more. In order to attain this, the sap rushes, whilst the tree is young and vigorous, towards the leading shoot; and if lateral branches are occasionally produced, the flow of sap is not strongly directed towards them compared to that which is impelled towards the more upright part. At length, however, a ramification does take place, in comparison with which the leading shoot becomes less and less predominant, till it becomes ultimately lost amongst its compeers. A tolerably equal distribution of sap then results, and a conical or spherical top is formed bearing fruit, not generally in the concavity, where it would be greatly excluded from light, but at the external surface, where the fruit itself and the leaves immediately connected with the buds producing it can be fully exposed to light, air, and dews. It was remarked that lateral branches were occasionally produced on the stem in the progress of its ascent. When the top is formed, these are placed at great disadvantage, owing to their being overshadowed, and they are then apt to decay, the tree assuming the character of a large elevated top supported on a strong naked stem. This is the natural disposition of trees, and to this it is necessary to attend in order that it may be counteracted where the natural form of the tree cannot be admitted. It should be borne in mind that the disposition to form an elevated naked stem is still strongly evinced in dwarf trees; although subdivided, yet each branch possesses its share of the original disposition, and its lower and horizontal shoots are left to become weak in comparison with the upper and those that are vertical.

811. *A standard tree*, from its being least restrained from attaining its natural habit, requires least management in regard to training, as has been already explained. When trained in any dwarf form, attention is in the first place required towards counteracting the disposition to form one large elevated stem by stopping the leading shoot. In this and other processes in pruning and training, it is necessary to be aware of the nature of the buds on different parts of the shoot, and the effect of cutting near or at a distance from the base. Where a shoot is shortened, the remaining buds are stimulated, and those immediately below the section seldom fail to produce shoots, even although they would have otherwise remained dormant. The lowest buds on the base of a shoot do not generally become developed, unless the shoot is cut or broken above them. They remain endowed with all their innate vital power, although comparatively in a state of repose; but should the shoot on the base of which these buds are situated be destroyed or amputated, very soon they are called into vigorous action, producing supplementary shoots much stronger than could be obtained from any other buds more remote from the base. Were these buds as prone to development as others, a mass of shoots and foliage would be produced in the central parts, where the foliage could not have a due share of light, an arrangement that would prove bad. They must be looked upon as being placed in reserve for furnishing wood shoots, whenever the pruner chooses to stimulate their development by amputating the portion of shoot above them.

812. From this view of the properties belonging to the lowest situated buds, it is evident they are the most unlikely to become fruit-buds. These are formed towards the extremities. In some cases they are terminal; but generally about two-thirds from the base is the situation where fruit-buds are first formed, and in some kinds of fruit-trees are developed into blossom the following season, and in others the basis of a spur is established. This

spur sometimes continues slowly to elongate for years before it produces fruit. As the strongest shoots are obtained from buds near the bases of shoots, and as all horizontally trained branches grow weak compared with those that have a more vertical position, it follows that all horizontal branches and those approaching that direction should be obtained, as far as circumstances will permit, from buds situated near the base. Hence in horizontal training, say a foot apart between the tiers of branches, it is not well to encourage two tiers in the same season; for in that case the tier that proceeds from buds two feet from the base of the current year's shoot, has a much less substantial origin than those that are produced from buds only a foot from the base. The formation of two tiers should therefore never be attempted whilst the lower part of the wall is being furnished; for the lower horizontals have a tendency to become ultimately weak, and on this account it is requisite that their origin should be well established. Towards the top of the tree, where the sap flows with greater force, two tiers are less objectionable. According to the principles of Seymour's training, the originating of the side branches from buds near the base of the vertical central shoot is well provided for, and this ought to be kept in view in every mode of training adopted. In order to furnish well the lower part of a tree, it is necessary to procure strong branches, and these can be best obtained from the lower part of a strong central shoot; and in order that this shoot may have sufficient strength, it must have a vertical position. If no central shoot is retained, one of three evils must result: either the central part must remain open as the tree increases, with half fans on each side; or a shoot to produce others to fill the centre must be encouraged from one side, thus upsetting the balance of the tree; or, to avoid this, two or more vertical or nearly vertical shoots must be allowed, the divarications from which cannot be kept clear of each other, whilst likewise a great proportion of shoots must inevitably be placed nearly or quite perpendicular, relatively with which the horizontal branches below are situated at an infinite disadvantage as regards the distribution of sap. Trees commenced to be trained in nurseries have often the objectionable form imposed upon them of an open centre, being deprived of an upright shoot and set off like a V; and similarly objectionable are the Montreuil and other modes on the same principle. With skilful management, these modes do succeed in France; but in the rich soil and humid climate of Britain, the flow of sap cannot be equalised by any mode that admits of a competition between vertical and horizontal branches. One upright is necessary for furnishing side branches; but being annually cut back for this purpose, it does not gain any increasing ascendancy, and forms but a slight exception to the whole flow of sap being directed to the growth of the side branches; and in consequence of this, these branches will become so well established, that they will be capable of receiving a due share of sap to enable them to continue healthy, instead of dying off, as is their tendency when the vigour of the tree is wasted in exuberant wood induced by permitting shoots, either intentionally or through neglect, to follow their natural disposition to grow up into stems, wherever they can avail themselves of a favourable, that is, an upright position, for appropriating an abundant supply of sap. (*Gard. Mag.* 1842.)

§ XI.—Weeding.

813. A *weed* is any plant which comes up in a situation where it is not

wanted. It may be either an absolute weed, such as are all plants of no known use ; or a relative one, such as a useful plant where it comes up and is not wanted among other useful plants, or on walks, walls, &c. Weeds are injurious by depriving the soil of the nutriment destined for other plants ; by depriving other plants of the space they occupy, as in the case of weeds in beds of seedlings, and of broad-leaved plants on lawns ; by their shade, when they are allowed to grow large ; and by their mere existence, as when they appear on gravel-walks. In those parts of gardens where the soil is kept constantly pulverised on the surface, the most numerous weeds consist of annual plants ; but among the grass of lawns, and sometimes among crops which remain in one place for more than a year, perennial weeds also make their appearance. The seeds of weeds are brought into gardens by stable dung, by birds, by the wind, by fresh soil brought in for the renewal of borders, for compost, &c., and by some other sources ; and they are perpetuated there by being allowed to come to maturity and shed their seeds. The obvious mode of preventing the existence of all absolute weeds, whether annual or perennial, would be to prevent all weeds, whether in gardens or fields, from ripening seeds, by cutting them down before they come into flower ; and this, we think, ought to be made an object of national concern for the sake of the agriculture of the country, even more than for its gardening. Prices per peck or per bushel might be offered for the unopened flower-buds of different weeds, according to their bulk or frequency, to be paid by parish-officers to such children and infirm persons as might find it worth while to collect them, nothing being paid for those buds which have been suffered to expand. This practice, we are informed, exists in some parts of France and in Bavaria ; but to be effective in any country it ought to be general. In the mean time, all that can be done is to destroy weeds as fast as they appear.

814. *Annual weeds* among growing crops are readily destroyed in dry weather by hoeing, and leaving them, if very young, to die where they have grown ; but if large, they may be raked off and wheeled to the compost ground, where mixed with soil or with other putrescent matters, they will be speedily decomposed and rendered fit for manure. Wherever casings of dung or other fermenting materials to hotbeds are in use, weeds, if laid on them or mixed with them, will assist in aiding fermentation ; or when digging and trenching are going forward, they may be buried in the soil at once. In hoeing up annual weeds, it is sufficient, as far as regards their destruction, to cut them over beneath the seed-leaves, which commonly rest on the surface of the ground ; but as the object of hoeing is commonly not only to destroy weeds but to stir the soil, the hoe ought to be thrust in much deeper in order to attain both objects. In moist soils and in moist weather, care must be taken not to hoe so deep as partially to bury the weeds, which in that case, instead of being destroyed, may be said to undergo a kind of transplantation. Weeds among broadcast crops which stand thick on the ground, such as onions, spinach, &c., require to be pulled up by hand ; and for this purpose a moist state of the soil is preferable, but not so much as to occasion poaching by the feet of the weeder, unless indeed the plants should be in beds, where they may be weeded immediately after the heaviest rains.

815. *Perennial weeds*, except when they are quite young and not far advanced beyond the seed-leaf, when they may be treated as annuals, require more care to eradicate than annual weeds. Their roots generally must be

raised up by a fork, weeding-hook, spade, trowel, or some other implement, which penetrates deeper than the hoe; and great care must be taken with underground stems, such as those of the couch-grass, the small field convolvulus, the hedge nettle, and others, to take up every joint, otherwise the result will merely be the propagation of these weeds by division. Among growing crops, the two-pronged fork (fig. 34, in p. 135) is the only safe instrument for eradicating root-weeds, for reasons which we omit, because like many other reasons which we do not give, we consider them sufficiently obvious to the reader who has perused the preceding chapters of this work with due attention.

816. *Weeds in gravel-walks* should always be taken out by weeding, and never, in our opinion, by hoeing and raking; and for amateurs, who do not wish to stoop, there is the implement, fig. 30, in p. 135, as well as the Guernsey weeding-prong, fig. 165, in p. 238. Salt has been used to destroy vegetation on walks, but its effects do not last above a year, as the first winter's rain washes it into the subsoil; besides, the attraction of salt for moisture has been found (*Gard. Chron for 1841*, p. 846) to encourage the growth of mosses and other cryptogamic plants to such an extent, as to give the walks a slimy, slippery surface after rain, and during winter and spring. Sulphate of copper (the blue vitriol of druggists) effectually destroys moss and other plants, is more durable in its effects than salt, and is not attended with the same humidity and attraction for the seeds of cryptogamic plants. It must not be forgotten, in using salt and other compositions for destroying weeds on walks in kitchen-gardens and shrubberies, that the roots of wall and espalier trees generally find their way under gravel, and consequently that if such mixtures are used for two or three years in succession, they may destroy the trees as well as the weeds. In some gardens, in order to destroy weeds in walks at the least expense, the walks are hoed and raked, and frequently left in this state without being rolled. In wet climates and retentive soils, where walks are covered with loose rough gravel in order that they may be walked on immediately after rain, as is the case in some country residences in Scotland, this is proper; but where walks are made of binding gravel or sand, we consider this practice in bad taste, because it confounds the character of the surface of the walk, which to walk comfortably on ought to be firm, even, and smooth, with that of the dug border, which ought to be always more or less rough to facilitate the admission of air and moisture to the roots of the plants. In a shady shrubbery walk, or a gravel-walk through a wood, the appearance of moss is to our eyes much less offensive than would a surface hoed and raked, however free the latter might be of vegetation.

817. *Weeds in lawns or on grass-walks* include all the broad-leaved plants which spring up among the proper grasses, not even excepting the clovers, commonly sown with them to give the grass a better hold of the scythe in mowing. All these broad-leaved plants, and even all broad-leaved grasses, such as the cocksfoot, ought to be weeded out if it is intended to have a perfect lawn, which to be so ought to resemble a piece of cloth in uniformity of texture and appearance. The worst weeds in lawns are those which have very broad and flat reclining leaves, which the scythe is apt to pass over, leaving them to feed the roots, such as certain species of plantago, dandelion, &c.; and these are the more difficult to eradicate, because they have tap-roots, furnished with adventitious buds which seldom fail to be developed, unless the

roots are cut over two or three inches beneath the surface. The common daisy is very troublesome in lawns by the breadth of the tuft formed by its leaves; but being a fibrous-rooted plant it is easily eradicated, and provided none are allowed to ripen seed, a lawn may soon be cleared of them. In lawns not frequently mown, the daisy rake (fig. 35, in p. 136) or daisy knife (fig. 50 *d*, in p. 140) ought to be employed to cut off the flowers before they expand.

818. *Weeds in shrubberies and plantations.*—So long as shrubberies are annually dug, the weeds are kept under by hoeing and raking; but when these operations have ceased, and the shrubs do not cover the whole of the surface, the interstices generally exhibit coarse grasses and rampant weeds; and it is not a little remarkable that this is often found to be the case in grown-up shrubberies, where the walks are kept clear of weeds, and their edgings carefully trimmed, as if the eye of the spectator were not directed to the scenery on each side. If the object were a fac-simile imitation of a natural wood, then every weed that came up might be allowed to grow and flourish; but as we are referring to shrubberies, which are always artificial plantations, and chiefly of foreign plants,—in these, we say, no herbaceous plant ought to be allowed to grow up and flourish, that is, not as artificial as the trees and shrubs among which it appears. If therefore the shrubbery in its young state contained flowers as well as shrubs, and is to maintain a picturesque character, the flowers may be allowed to exist till the encroachment of the shrubs destroys them; but if the character to be maintained is the gardenesque (in which every plant should stand free, with sufficient room to display its natural shape), then no more herbaceous plants ought to be allowed to exist than can attain a proper size and degree of perfection. All the others interfere with the character to be maintained, and ought therefore to be treated as weeds. The manner in which these are removed in shrubberies and plantations which have ceased to be dug is chiefly by mowing, which ought to be done three or four times in the course of summer. Where shrubberies are properly managed, digging, or at least hoeing, among the plants will not cease till the shrubs have nearly or altogether covered the ground, in which case very few weeds will appear. In many cases, the ground may be covered with low evergreens, such as ivy, tutsan, periwinkle, spurge, laurel, &c., when the larger shrubs and trees may stand at a considerable distance apart, and yet little or no weeding become necessary. When large weeds only are to be pulled out of shrubberies, this may sometimes be done with weeding pincers (fig. 324) after the weeds have thrown up their flower-stems; but the evil, both in regard to exhausting the soil and appearance, is in that case in a great measure already effected, therefore the best mode is to cut them over a few inches beneath the surface with the weeding spud (fig. 28, in p. 134), as soon as they make their appearance in spring.



Fig. 324. Weeding pincers.

819. *Weeds in woods and park scenery* are chiefly destroyed by mowing; and it has been found, as already mentioned (774), that bruising and tearing off the stems often destroy the root more effectually than cutting with the scythe. In thick woods consisting of trees and under growths, the ground is generally so effectually covered with the bushes that no weeds can make their appear-

ance; but in groves of trees, and in plantations formed in Mr. Cree's manner, there will always be spaces more or less liable to throw up rampant weeds, which in merely useful plantations ought to be mowed and left to decay on the spot, for the sake of the manure which they will afford to the trees. In cultivated or smooth park scenery, all coarse weeds should be got rid of, so as to present a smooth turf; but in rough forest park scenery, all the plants which it produces should be allowed to grow as being appropriate: of these, the large fern or brake (*pteris aquilina*) is peculiarly characteristic.

820. *Weeding ponds, rivers, and artificial waters*, in garden and park scenery, is often very expensive by its being necessary to empty and clean out the bottom and sides of the excavation. Much of this trouble and expense might be rendered unnecessary in many cases by mowing over the weeds in the bottom of the water, when they first make their appearance there in early spring, and repeating the operation at short intervals till the roots are destroyed from the want of elaborated sap sent down by the leaves. (See more on this subject in par. 548.) It should be constantly borne in mind, that all weeds and all plants whatever may be effectually destroyed by depriving them of their leaves as fast as they are produced (113).

§ XII. *Watering.*

821. *Water*, whether as a source of nutriment or a medium of affecting various other objects, is one of the most important agents of culture. A certain degree of moisture in the soil is essential to the existence of plants; because no food can be absorbed by the roots that is not held in solution by water, and because the decomposition of water, and its perspiration from the leaves and bark are continually going forward. Plants require a certain degree of moisture at their roots not only when in active growth, but when in a state of comparative rest, because even then perspiration is going on with those parts which are above the ground, and with the roots themselves when plants are taken up for transplanting. In the season of growth the demand for water is greatly increased, and it diminishes as the period of growth advances, and the power of decomposition and evaporation ceases. If water in excess is given at this period of the growth of a plant, its parts become distended in consequence of the absorption by the spongioles still going on, while the power of decomposition and perspiration by the leaves is diminished; it becomes sickly, its leaves assume a yellow colour, and if the excess of water is not soon withdrawn from the soil, death ensues. By pulverizing soils and increasing their depth, their capacity for holding water is increased, while by underground draining it cannot be retained in excess. By these means, and by the addition of manures acting mechanically and keeping the soil open, a great facility is afforded to the extension of the roots, and the vigour of the plants is increased in proportion, but at the same time the power of the roots to exhaust the soil of water becomes greatly increased. If under such circumstances a proportionate supply of water is not afforded at the proper time, either by nature or art, the growth of the plant will fall much short of what it might be; of which examples may be seen both in garden and field crops, by comparing the crops of a moderately wet summer with those of a very dry one. It may be concluded, therefore, that the full benefits of stirring the soil, draining and manuring, cannot be obtained without a command of water.

822. *The specific purposes for which water is used in Horticulture* are numerous. In general it may be applied wherever a stimulus is wanted to growth, unless indeed the soil be already sufficiently moist. It is given to newly sown seeds, or newly planted plants; for the purpose of setting blossoms, swelling fruits, increasing the number and succulency of leaves; conveying manure held in suspension; conveying matter for destroying insects, or parasitic fungi, such as the mildew; or poisoning plants on walls or gravel walks; for causing substances in powder to adhere to plants, as in applying sulphur and other articles; for clearing the leaves and stems of plants from dust or other foreign matters; for accelerating vegetation when the water is warmer than the soil; for retarding it when it is cooler; for thawing frozen plants; for forming steam or dew in plant structures; for rooting cuttings of some kinds of plants (602); for growing aquatics, for heating plant structures, and for producing fountains and other aquatic ornaments. Water in the form of snow, forms a valuable protection to low plants when they can be covered by it, acting as a non-conductor of the heat of the soil, and preventing it from escaping into the atmosphere; and water as ice is an object of the gardener's care, the filling of the ice-house being generally committed to him. On the quantity of rain or snow which falls in any country, and on the proportions which fall in different seasons of the year, depends, as we have already seen, (140 to 144,) the natural vegetation of that country, its agriculture, and all that part of its horticulture which is carried on in the open garden.

823. *The ordinary sources from which water is obtained in gardens* are chiefly wells, and the collection of rain water in cisterns; but it occasionally happens that a natural stream passes through or near the garden, or that water is conveyed to it by pipes or drains from some abundant source. In whichever way water is supplied it ought always to be exposed in a pond or basin, so as to be warmed by the sun to the same temperature as the surface of the soil before being used; unless indeed the object be to retard vegetation by its coldness, which can very seldom be the case. Some very interesting experiments were made by Mr. Gregor Drummond, in 1826, on the comparative effects of spring water and pond water, in lowering or raising the temperature of the soil of a peach border, which it may be useful to quote.

1. "The first experiment was made on the 10th of May. At the depth of 18 inches the temperature of the border was 64°, and that of the spring-water used 46°. In twenty-four hours after, the temperature of the border was reduced to 52°, or had lost 12°. At the same time the temperature of the soil being 64° as above, and heat of the pond water 67°, the soil at the close of twenty-four hours was 66°, or instead of losing 12°, had gained 2°.

2. "June 20th the second watering was given. The temperature of the border at the depth of 18 inches was now 74°, and that of the spring water 52°. In twenty-four hours the border was reduced to 58°, or had lost 16°.

"At the station where the pond water was used the temperature of the border at the above-mentioned depth was 77°, and that of the water 82°. In twenty-four hours the temperature of the border was 80°, or had gained 3°.

3. "The third and last watering was performed on the 28th of July. The temperature of the border at 18 inches below the surface was 72°, and that of the spring water 57°. In twenty-four hours the border was reduced to 61°, or had lost 11° of temperature. At the pond water station the border at the depth of 18 inches was 78°, and the water itself 74°. In twenty-four

hours the temperature of the border was still 78°, or had suffered no change of temperature from the watering it had undergone.

“It is very clear from these facts, that whilst spring water greatly cooled the soil, that from the pond exerted no such operation, but on the contrary often raised its temperature.”—(*Hort. Trans.*, vol. ii. 2nd series, p. 57.)

Hence in our opinion every complete kitchen garden, and every flower garden whatever, ought to have a basin, or basins of water in a central situation fully exposed to the sun. In every plant structure there ought to be a cistern to receive the rain water which falls on the roof; and if convenient, another for pond or well water, which should only be used when there is a deficiency of rain water. In plant structures where little air is given, and the atmosphere kept constantly moist, as in the propagating houses of Mr. Cunningham of Edinburgh (574), the water which falls on the roof is found abundantly sufficient for every purpose for which it is required within throughout the year.

324. *The distribution of water in gardens is in some cases effected by open surface gutters of hewn stone, as was the case in the gardens at Douglas Castle, in Kirkeudbrightshire, in 1804 and for many years afterwards, and in others by leaden pipes under the surface, the gutters or pipes communicating with small basins, or sometimes with sunken casks, conveniently distributed over the garden. When these basins do not exceed eighty feet or one hundred feet apart every way, the entire surface of the garden may be watered from them by means of a portable engine, (fig. 83 in p. 155). In some cases a cistern or reservoir is placed on an eminence exterior to the garden, or in a tower connected with its walls or its plant structures; and the water is conveyed by pipes to different places throughout the garden and hot-houses, from whence it may be drawn into watering pots or engines by means of cocks; or leathern hose may be screwed on to the cocks, and the water, in consequence of the elevation of the cistern or basin, distributed at once among the plants. In some instances where the basin is considerably higher than the top of the walls, the water is delivered with such force from the orifice of the hose, as to wash the trees as effectually as is done by a syringe or an engine. Gardens situated on declivities are favourable for this kind of arrangement, which is not unfrequent in the north of England and in Scotland. Where there is an abundant supply of water from a source 40 or 50 feet above the level of the garden, a series of pierced pipes might be distributed over it, about the height of the walls, and thus a shower over any part of the garden commanded at pleasure, on the same principle as in the hot-houses of Messrs. Loddiges. (513.)*

325. *The ordinary mode of giving water to plants is by watering pots (425*



Fig. 325. *Watering-barrow for strawberries.*

and 426) and by watering engines (440). On a large scale it is sometimes conveyed in barrels on carts, and distributed over lawns, and plantations of straw-



Fig. 326. *Water-distributor for the watering barrows.*

berries or other low plants in rows, by the same means as in watering roads; or by such barrels as fig. 325. To this barrel is joined the perforated cylinder fig. 326, which projects about two feet from one side; a plug *b* prevents the escape of the water till the barrel is wheeled to the

proper spot; this plug has a cord *a*, attached to which a slip of wood *c*, is suspended; and the moment the operator enters between the rows of plants to be watered, he pulls the string, and as he wheels along the barrel, the water rapidly escapes, watering two rows at a time. In this manner the strawberries in the market gardens in the neighbourhood of London are watered, when they are in blossom. When the leaves of plants are to be cleaned from dust or other matters that water alone will bring off; or when liquid compositions, such as lime water, tobacco water, sopy water, &c., are to be thrown on them, the syringe or engine is used, and when water is applied to small plants, or very small seeds newly sown, recourse is had to a small watering pot with a very fine rose.

326. *When it is proper to water, and how much water to give*, must be determined by the circumstances in which the plant is placed. In nature the atmosphere is very rarely otherwise than saturated with moisture, when it rains; but as artificial watering is a substitute for rain, it must not be withheld when the plant requires it, on account of atmospheric dryness. As the nearest approach to the state of the atmosphere in which nature supplies water, the afternoon or evening may be chosen when the air is both cooler, and somewhat moister than during sunshine. As in soils that are stirred on the surface, the greater part of the roots are always at some depth, the quantity of water given should be such as will thoroughly moisten the interior of the soil, and reach all the roots. A slight watering on the surface, unless the soil is already moist below, will not reach the fibres, and will soon be lost by evaporation. When a less quantity of water is supplied than will saturate the soil to the depth of from nine inches to twelve inches, "it often," Mr. Hayward observes, "does more injury than good to plants; for when in want of water the roots penetrate deep, and under such circumstances a small quantity of water on the surface checks the capillary attraction of moisture from below; and thus the roots that are grown deep, which are those on which the plant is made to depend in times of great drought, are deprived of their supply of water, and the plant exerts its efforts to throw out horizontal fibres; by the time these fibres are formed and the young shoots extended, the supply of water on the surface again fails, and they are again checked, and perhaps destroyed: thus the efforts of the plant being uselessly exhausted between the two extremes of a supply and a deficiency of water, it naturally declines in its growth, and hence arises the general opinion that watering in dry weather injures, more than it benefits plants." (*An Inquiry, &c.*, p. 53.) Most water is required by plants that are in a vigorous state of growth and have a large breadth of foliage; least by those which have nearly completed their growth; and in general none by plants in a dormant state, excepting in such cases as that of watering grass lawns in summer to stimulate vegetation, or irrigating meadows after they have been mown for the same purpose. In the case, however, of excessive dryness, some degree of moisture must be afforded to such plants as are liable to become desiccated even though dormant. Succulent plants, for example, will bear a great degree of dryness, through a protracted period; whereas others that perspire more through the bark would be completely dried up if equally exposed to drought. The application of water to plants in pots in a dormant state is one of the commonest and most injurious errors committed by persons unacquainted with the principles of culture. It does comparatively little harm to plants in the free soil in the open garden, but to plants

in pots, and especially to those having suffruticose stems, such as the pelargonium, or to hair-rooted plants, such as heaths, and to all bulbs, it is extremely injurious, and often destructive of life. In the first case more water is absorbed by the roots than can be decomposed by the leaves; in the second case the roots are suffocated and rotted from their delicacy; and in the third, rotting takes place from mere organic absorption; for when the leaves of bulbs decay, their roots decay also, and consequently they cannot absorb water by their spongioles; while absorption by the tissue still going on, the vessels become surcharged and burst, and the bulb rots. Hence in the case of bulbs, and such like plants in pots, the soil in which they are kept should contain no more moisture than what is necessary to keep the bulb, tuber, or corm, in a succulent state; but in proportion to the dryness in which bulbs are kept at this season, should be the abundance of the supply of water when they begin to grow. All bulbs will be found to flower in their natural habitats, either during, or immediately after a rainy or moist period of the year, as is the case with our wood hyacinths in spring, and with the colchicum in autumn; and much more strikingly so with the bulbs and corms of Africa, which grow and flower only in the rainy season. When plants are ripening their fruit, a diminished supply of water increases the flavour, because at that period of growth the power of decomposing it is diminished; and if it is absorbed without being decomposed, the effect will be to render the fruit watery without flavour; to crack it in some cases, to burst it in others, and in the case of all keeping fruits to shorten the period for which they may be kept. The same effects are produced by excess of water on bulbs, such as those of the onion; on roots and tubers, (underground stems,) such as the turnip and the potato; and even on leaves, such as those of the lettuce and the cabbage, which in wet cloudy seasons are never so highly flavoured as in seasons moderately moist, when succulency and flavour are combined. Water should sooner be withdrawn from tender plants than from hardy ones in vigorous growth, and when practicable, it should be withdrawn from all plants in a growing state in time to admit of their ripening their wood.

27. *Whether plants should be watered over the leaves or only over the soil in which they grow* depends on the state of the plant, the temperature in which it is placed, the time of the day, the season of the year, and other circumstances. Plants in a state of vigorous growth, in a suitable temperature in spring or summer, and in the afternoon or during cloudy weather, are better watered over the top, in order to make certain of clearing their foliage; but late in autumn or during winter, when growth even in hothouses is or ought to be slow, owing to the deficiency of light, plants should be watered chiefly at their roots; and while the most abundant supplies might be given in the former case, in the latter they ought to be moderate, because the vital powers of the plant are comparatively weak, and because a cold damp atmosphere, which watering over the top at that season might produce, would, by obstructing the perspiration of the leaves, occasion their decay. In general, all plants, whether in the open air or in plant structures, ought to be watered over head during spring, summer, and the early part of autumn, unless they are in a dormant state, or there is some specific reason why what water they do receive should be given at the root. On the other hand, all plants in houses not undergoing forcing, and all plants whatever in the open air during the latter part of autumn, during winter, and in the early part of spring,

should be watered only at the root. Watering over the top should in general never be performed during bright sunshine; yet there are various plants with which this may be done with impunity, such as all the grasses; and in the royal kitchen-garden at Versailles the Alpine strawberry is watered over head during bright sunshine throughout the whole summer, without any inconvenience being found to result to the plants. (*G. M.*, vol. xvii., p. 387.) Watering during summer should in general be performed in the afternoon or evening, because at these periods less will be carried off by evaporation than during the day; while during winter and spring, watering ought to take place during the morning, that during the day the surface of the ground may be warmed and dried by evaporation and infiltration. In general, watering over the top is only necessary with plants in leaf; but plants, and especially trees, which have been newly transplanted, may be advantageously watered over the top to diminish evaporation from the bark, which without being so moistened might (736) lessen the amount of sap returned by it to the root.

323. *Watering plants in pots* requires much more consideration on the part of the waterer than watering in free soil. When the plant is in a dormant state, though it must not receive so much water as to excite it into growth, or distend its parts more than is necessary to prepare it for active vegetation, yet still it must receive as much as to prevent the soil from being so dry as to extract moisture from the roots. As a test for this being the case, the soil in the pot, when opened or stirred up on the surface, ought to have a fresh appearance, neither moist nor dry; nearly dry in the case of bulbs and tubers, and nearly moist in the case of dormant deciduous plants. Another difficulty in watering plants in pots is to ascertain that the water given has penetrated the whole of the soil in the pot. The ball or mass of soil is frequently so filled with roots, or from its nature and treatment so compact (742), as not to be readily permeable by water, which in that case, after merely moistening the surface, escapes between the ball and the pot; while the operator, seeing the water escaping from the bottom of the pot, concludes that the mass of soil has been thoroughly penetrated and saturated by it. Many greenhouse plants, particularly oranges, camellias, and heaths, are killed by this mode of deceptive watering, which may be traced to this cause, viz., that when once soil is thoroughly dried so as to become like dust, it loses the power of capillary attraction, and resists the entrance of water unless accompanied by extraordinary pressure. Soil containing peat-earth is peculiarly liable to this kind of dryness when watering in proper time has been neglected; and hence the value of Mr. McNab's mode (749) of mixing with such soil pieces of broken freestone. To ascertain when the water has penetrated the mass of soil in a pot, it is common to thrust into it, not far from the stem of the plant, a round pointed stick, and to make sure of moistening the interior, to pour in water in the hole so formed. In loamy soils, or soils containing a large proportion of sand, this mode will suffice for saturating the ball; but in the case of heath-soil, it becomes necessary to immerse the pot and the plant in a vessel of water, so that the soil shall be six inches or a foot under its surface, and thus receive a pressure sufficient to cause the escape of the contained air. Another class of evils in watering plants in pots arises from their not being sufficiently drained, which may arise either from the operation having been improperly performed in potting or shifting, or from the crevices among the drainage

having become choked up by the washing down of the soil. In this case, the water, not escaping freely from the pot, produces all the evils of stagnation already mentioned (821); the spongioles burst and the fibres rot, the leaves become yellow and drop off, and the bark, being distended by moisture, separates from the wood, the plant in the meantime being killed. Nothing is more common than cases of this kind in the greenhouses and window-gardens of amateurs; and it is very frequent also in collections of plants in pots, such as alpiners, under the care of regular gardeners, whose workmen or apprentices water them indiscriminately, with little or no regard to the state of the plant or the soil in the pot. The obvious manner of preventing this evil is, whenever there is the slightest suspicion of overwatering, to turn the plant out of the pot, examine the drainage, which will come out with the ball, and take it off and replace it with fresh materials. It would be well also, in the case of all plants that are likely to be overwatered, to use a larger proportion of sand in the soil, and to put extra drainage in the bottom of the pot, and also to introduce among the soil a considerable proportion of fragments of freestone.

829. *Aquatic and marsh plants*, being grown in water, or in soil saturated with it, form exceptions to the treatment required for plants in general; nevertheless it has been observed of these that they always grow with most vigour when the atmosphere is moist, whether produced in hot-houses by watering over the top, or in the open air by rain. The cause, De Candolle thinks, may be in part traced to the state of the electricity of the atmosphere during rain; and perhaps something also may be due to the temporary cessation of excessive evaporation.

830. *Watering with liquid manure* is necessarily confined to the soil, and is most advantageous when given to plants in a growing state; because, though at other seasons a portion of it would still be absorbed by the roots, yet the greater part would be washed into the subsoil. See § xiii.

831. *To economise the water given to plants*, more especially in the open air, the surface is sometimes mulched with fibrous or littery matter, or even with small stones or pebbles. Both materials retain moisture and heat; while stones or pebbles, by becoming soon dry, prevent surface-damp, and reflect much heat during sunshine. The strawberry is sometimes mulched with straw, and sometimes with tiles or slates, or pebbles, for the double purpose of retaining moisture and keeping the ripening fruit clean; and the surface of the ground in the rose nurseries about Paris is sometimes mulched with straw, to save watering, and prevent the rose-beetle from depositing her eggs in the soil.

§ XIII. *Stirring the Soil, and Manuring.*

So much has already been said on these subjects that it is only necessary here to advert to the chapters in pages 45 and 56, and to page 227.

832. *Stirring the soil* is advantageous by the admission of air, rain, and heat to the roots of plants, by promoting evaporation in moist soils, and by retaining moisture in such as are dry. In the latter case the dry loose soil on the surface acts as a mulching or non-conductor to the soil below; and in the former it acts by exposing a greater number of moistened particles to the air than could be the case if these particles were consolidated. The celebrated agriculturist Curwen found that an acre of pulverised soil eva-

porated 950 lbs. of water in an hour, while the same soil and the same extent of surface not pulverised, scarcely evaporated anything.

833. *Manuring.*—Permanent manures, such as stable dung and other solid substances, are for the most part incorporated with the soil when it is dug or trenched before being cropped, and it is generally thought that most advantage may be obtained from them when they are deposited near the surface. Temporary manures, such as soot, bone-dust, and other powders, waste yeast (one of the richest of manures), and liquid manures, such as decoctions of dung, and solutions of salts of different kinds, are most advantageously applied on the surface of the ground, and to growing crops.

§ XIV. *Blanching.*

834. *The operation of blanching,* or depriving the leaves and stems of plants of their green colour, is effected by excluding light from the growing plant, in consequence of which it is produced without colour, and without that portion of its flavour which depends on colour. The tubers of potatoes are blanched naturally, because in general they are produced under the surface of the soil, or they are shaded by the foliage of the plant. The points of the shoots of asparagus are blanched, in Britain, by covering the crowns of the plants with a stratum of light loose soil, and on the Continent by the same means, or by placing covers of different kinds over them, as is done in this country with the sea-kale and tart rhubarb, by the use of the blanching-pot (fig. 58, in p. 143). Celery is blanched as it grows, by drawing up earth so as to cover the petioles of the leaves; and this operation is performed from time to time as long as the plants continue to advance in height. The leaves of the chardoon are blanched in a similar manner, and sometimes by tying them round with ropes of hay or straw. The interior leaves of the common cabbage, and of the cabbage-lettuce and endive, are blanched naturally, but the process is sometimes heightened by tying up the leaves, and sometimes by coverings. In general, perennial plants in which the nutriment for the leaves of the coming year have been deposited in the roots during the year preceding, such as the asparagus, sea-kale, chicory, &c., may be blanched by covering them entirely either with soil or some kind of utensil; while annual plants, the leaves and every part of which is the produce of the current year, require to have the operation performed by degrees as the leaves advance in size, whether by tying up, earthing up, or by both modes. By the operation of tying up, two effects are produced: the inner leaves as they grow, being excluded from the light, are blanched; and being compressed, in proportion to their number and the degree of growth which takes place after tying up, the head of leaves becomes at once tender and compact. Perennial and biennial plants with ramose roots may be blanched on a large scale, by placing the roots in soil, in a cellar or dark room; but this cannot be done with annual plants, which must be grown in light, and blanched as they grow. Gourds, cucumbers, and apples, are sometimes blanched by growing them in opaque boxes or cases; or they are grown with pale stripes, by partially covering them with strips of paper or cloth, made to adhere by gum or paste.

§ XV. *Protection from Atmospheric Injuries.*

The great number of plants cultivated in this country, even in the open air, many of them from climates very different from ours, have given rise

to a variety of contrivances to protect them from atmospherical injuries. The most effective of these is without doubt that of forming for such plants artificial climates, such as the different kinds of hot-beds and hot-houses; but there are also various contrivances for protecting plants growing in the open air or against walls, and it is to these that we at present intend to confine our attention. They may be included under shading from the sun, sheltering from wind, and protecting from rain or from cold. Most of these operations are founded on the doctrine of radiation, which has been treated in so much detail in chap. iv., p. 67, that very little more requires to be said on the subject.

835. *The object of shading* is to lessen evaporation from the soil or from plants, or to exclude light or heat. It is effected by interposing some opaque medium, or even glass in some cases, the purest of which as we have seen (486) excludes a certain portion of light, between the objects to be shaded and the direct rays of the sun, and this medium differs in its texture and other properties according as it is intended to be temporary or permanent. Mats and canvas are the common articles for temporary shading in the case of plants under glass; but for plants in the open garden, hurdles of wicker-work, or frames filled in with beech or birch branches, screens of reeds are used, or the plants are placed in the north, east, or west sides of walls or hedges. Sometimes also they are planted under trees; but as this kind of shade excludes rain and dew, it is only adopted in particular cases. A slight degree of shade is produced by forming the surface of ground into narrow ridges in the direction of east and west, and sowing or planting the crop on the north side of the ridge. On the same principle, crops in rows in an advanced state are made to shade seedling crops sown between them, when shading them is desirable. Oil paper-caps, and other articles for shading individual plants have been figured and described (449), and also canvas shades for hot-house roofs (464). Some of the most severe injuries which plants trained against walls sustain in this country is by the powerful action of the sun in early spring, succeeded by extreme cold; but by judicious shading such evils may be greatly mitigated or altogether avoided.

836. *Sheltering from wind*, the principles of which have been pointed out (265), is effected on a large scale by plantations, and in gardens by walls, hurdles, wicker-work covers (461), hand-glasses, and other articles described and figured in sect. vi., p. 158.

837. *The principles of protecting from cold* have been described at length in our chapter on the atmosphere (p. 67), and the different materials and contrivances for this purpose have been enumerated in the section (p. 158) just referred to. Coverings for the surface of the ground include dead leaves, litter, straw, sawdust, spent tan, rotten dung, coal ashes, coarse sand, spray, and branches of trees or shrubs, &c. Coverings for standard plants in the open garden include temporary roofs of thatch, boards, canvas, wicker-work, bark, or manufactured materials, such as pitched paper, asphalte sheeting, &c. Coverings for walls include branches with the leaves on, such as those of the silver or spruce-fir, of the beech, birch, or hornbeam, cut before the wood is ripened, in consequence of which the leaves will adhere to the shoots, and being dead and without moisture, they are better non-conductors than green leaves, straw or hay ropes, rope-netting, canvas, bunting, woollen-netting, oiled paper-frames, wicker-work, hurdles, &c. By referring to p. 173, it will be seen that thin canvas has been found the

preferable article for protecting wall fruit-trees in the Horticultural Society's garden, after fifteen years' experience.

838. *Protecting from rain* requires the application of some description of temporary roofing, impervious to water. For beds or borders in the open garden, frames or hurdles, thatched with drawn wheat straw or reeds, may be employed, and these will also protect standard plants; or projected from the tops of walls, and supported by props in front, they will protect from rain both the tree and the border in which they are planted, (see 476).

§ XVI. *Accelerating Vegetation.*

839. The *acceleration* of the growth of plants may be effected by the position in which they are placed relatively to the rays of the sun, by withdrawing moisture, by sheltering from cold winds and rains, by the choice of early varieties, by pruning, and by the application of artificial heat. For crops of herbaceous vegetables in the open garden, the most general modes of acceleration are to cover with hand-glasses, or other portable frames with glass roofs (462); and to sow or plant in borders on the south side of east and west walls, and as near to the wall as circumstances will admit. Next to walls, the south sides of hedges or espalier rails are selected; or, in default of either of these, ridges in the open garden, in the direction of east and west, are thrown up, their sides forming an angle of 45° , and on the south side of these the crop is sown or planted. The growth of early peas and early potatoes is frequently accelerated in this manner, and also the ripening of strawberries, and the growth of spinach, lettuce, and other culinary plants; and Mr. Errington, a scientific gardener of great experience, says that all early crops whatever may be thus produced within one week of those on a south wall border. The different modes of protection from cold and rain, mentioned in the preceding section (834 to 835), are subservient to acceleration; and dry warm soil, culture in pots by which the plants are rendered portable, and the selection of early varieties, are obvious adjuncts. The ripening of fruit, more especially on ligneous plants, may be hastened by ringing, after the blossoms are fully expanded, or even after the fruit is set. Mr. Williams, of Pitmaston, found that ringing vines, not only ripened the fruit earlier, but rendered the berries larger, and of higher flavour. Of two vines growing together against a wall, the one ringed shortly after the blossoming season ripened its fruit perfectly in the beginning of October, while the fruit on the other vine which was not ringed was destroyed by frost. The rings of bark taken off were rather less than a quarter of an inch in width (*Hort. Trans.*, iv., p. 55). It is probable also, that the fruit of herbaceous plants, such as the tomato or the capsicum, or the seeds of tender annuals, such as the Zinnia and the Thunbergia, may be accelerated by ringing or constricting the stems by tying, to check the return of the sap.

840. *Artificial heat* for the purpose of acceleration is applied by means of fermenting substances, as in hot-beds (465 and 489), the combustion of fuel, as in hot walls (475) and hot-houses of various kinds, whether heated by flues, hot-water, or steam (480). The different kinds of hot-houses and pits, and their general management, have been already given (480 to 522); and we shall here confine ourselves to what concerns hot-beds and pits heated by fermenting materials.

841. *Hotbeds* are chiefly made of stable-dung; but tanners' bark, leaves

of trees, and especially oak-leaves, mown grass, weeds, clippings of hedges, and almost every other article capable of putrescent fermentation, may be used either alone or with stable-dung. Tanners' bark, or oak-leaves, are found the preferable fermenting materials for hot-beds in hot-houses, because they undergo less change in bulk, and retain their heat longer than dung or any other fermentable substance that can be readily obtained in equal quantities. Leaves do not produce such a powerful heat as bark, but they have this advantage, that when perfectly decayed, they form a rich mould, which is useful both as soil and as manure; while rotten tanners' bark is found rather injurious than useful to vegetation, unless it be well mixed with lime or with earth, or left till it is thoroughly decayed into mould. When it ceases, therefore, to be used in the hot-house or hot-bed, it is employed in the open garden as a surface-mulching, to keep in heat or moisture.

842. *Preparation of materials for hotbeds.*—The object being to get rid of the violent heat which is produced when the fermentation is most powerful, it is obvious that preparation, whether of leaves, tan, and stable dung, must consist in facilitating the process. For this purpose, a certain degree of moisture and air in the fermenting bodies are requisite; and hence the business of the gardener is to turn them over frequently, and apply water when the process appears impeded for want of it, and exclude rain when it seems chilled and retarded by too much water. Recent stable-dung generally requires to lie a month in ridges or beds, and be turned over in that time thrice before it is fit for cucumber beds of the common construction; but for M'Phail's hotbeds, or for linings or casings, or any description of hot-bed or pit, no time at all need in general be given, but the dung formed at once into linings. Tan and leaves require in general a month to bring them to a proper degree of heat; but much depends on the state of the weather and the season of the year. Fermentation is always most rapid in summer; and if the materials are spread abroad during frost, it is totally impeded. In winter, the process of preparation generally goes on, under cover from the weather, in the back sheds; which situation is also the best in summer, as full exposure to the sun and wind dries too much the exterior surface; but where sheds cannot be had, it will go on very well in the open air. A great deal of heat is undoubtedly lost in the process of fermentation; and some cultivators have recently devised plans to turn it to some account, by fermenting dung in vineries which are just beginning to be forced, or in vaults under pine-pits or plant stoves. The latter mode seems one of the best in point of economy, and is capable of being turned to considerable advantage, where common dung-beds are extensively used; but the most economical plan of any is undoubtedly that of employing M'Phail's pits, or such as are constructed on similar principles.

843. *M'Phail's hotbed or pit* consists of two parts, the frame and lights of which are of wood, and not different from those used for growing cucumbers, or other ordinary purposes, and the basement on which the frame is placed, which is flues of brickwork, with the outer wall uniformly perforated, or as it is commonly called pigeon-holed, as shown in fig. 135, in p. 196. Against these perforated flues linings of dung are formed, the steam of which enters the flue, and heats the earth inclosed. The chief objections to this plan are the first cost and the greater consumption of dung, which some allege is required to keep up the proper heat. Its advantages are, that hot dung may

be used without any preparation, by which much heat is gained ; and that in the winter months, when a powerful artificial heat is required, which (in the case of common hot-beds) is apt to burn the plants, they are here in the coldest part of the soil, and cannot possibly be injured by any degree of heat, which can be communicated by dung. Fig. 327 is a section of a pit on

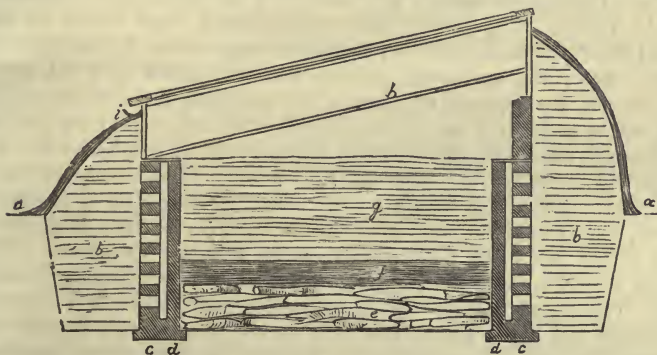

Fig. 327. Cross section of a pit on M'Phail's principle, with variations.

this principle, with some improvements: *a a* is the surface of the ground ; *b b*, excavations for the dung-casings, $2\frac{1}{2}$ feet deep, 18 inches wide at bottom, and 2 feet wide at the ground's surface ; the greater width at top being to prevent the dung from shrinking from the side of the excavation as it sinks ; *c* is the outer perforated wall, a brick in width ; *d*, the inner wall of brick set on edge, and tied to the outer wall with occasional cross bricks ; *e*, is a layer of billet wood 1 foot in thickness to admit of the heat penetrating from each side, or the same object may be effected by a layer of loose stones ; *f*, a covering of fagot wood, over which a layer of turf or litter is placed to prevent the soil from sinking into and choking up the interstices in the layer of billet wood ; *g*, the bed of soil ; *h*, a trellis for vines, melons, or other plants, at one foot from the glass ; *i*, a gutter for receiving the water from the glass, and which should conduct it through a small pipe, either at one end, or in the middle to a small barrel, or to a cistern of slate or other material sunk in the soil of the pit in front. The preferable situation is mid way between either end, in order that the vapour of the water may be equally diffused in the atmosphere of the pit. By keeping the upper surface of the dung of the form shown in the figure, it will throw off the rain, which may be conducted away in small surface gutters.

344. *The formation of common hotbeds* is effected by first making out the dimensions of the bed, which should be six inches wider on all sides than that of the frame to be placed over it, and then, by successive layers of dung laid on by the fork, raising it to the desired height, pressing it gently and equally throughout. In general, such beds are built on a level surface ; but Mr. Knight's forms a surface of earth as a basis, which shall incline to the horizon to the extent of 15° ; on this he forms the dung-bed to the same inclination ; and, finally, the frame, when placed on such a bed, if, as is usual, it be deepest behind, will present its glass at an angle of 20° , instead of six or eight, which is undoubtedly of great advantage in the winter season. This seems a very desirable improvement where light is an object, which it must

be, in a high degree, in the case of the culture of the cucumber and melons, as well as in forcing flowers. Sometimes a stratum of faggots or billet wood is placed on the ground as a foundation for the dung, which keeps it from being chilled; and if here and there the stratum is carried up vertically for a foot in width and 18 inches in height, it will facilitate the entrance of heat when casings are applied, or of cold air, if the heat of the bed should be found too great. The ends of these vertical strata, when not to be used, should be covered with litter to prevent the escape of heat by them.

345. *Ashes, tan, and leaves.*—Ashes are often mixed with the dung of hotbeds, and are supposed to promote the steadiness and duration of their heat, and to revive it if somewhat decayed. Tan and leaves have also been used for the same purpose; and it is generally found that about one-third of tan and two-thirds of dung will form a more durable and less violent heat than a bed wholly of dung. The heat of dung-beds is revived by linings, or collateral and surrounding walls, or banks of fresh dung, the old dung of the bed being previously cut down close to the frames. These linings, as before observed, require less preparation than the dung for the beds. The dung-bed being formed, and having stood two or three days with the frame and lights placed over it to protect it from rain, is next to be covered with earth, of quality and in quantity according to the purpose to which it is to be applied. In severe weather, the sides of the bed are often protected by hurdles of straw or faggots, which tend to prevent the escape of heat.

346. *The nightly covering to hotbeds and pits* may be of boards, or of bast-mats, or reed or straw mats; and the following mode of retaining the covering will be found neat as well as economical:—Three pieces of iron of the form of fig. 328, *a*, are screwed on to the end of the frame, one piece at

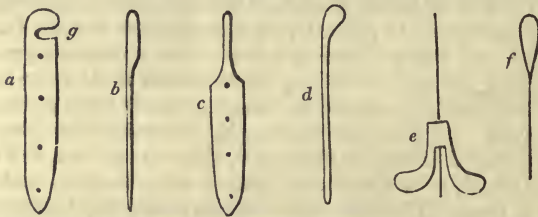

the top, another at the bottom, and the other in the middle, so that the top of the iron is about two inches above the light; on the opposite end three pieces of the form of *c*, are screwed on at the same distances as *a*; *b* is a side view of *a*, and *d* is a side view of *c*. A wire, three-eighths of an inch in diameter, and rather longer than the frame it is intended for, must be made with a loop at one end (*f*), to place over the iron *d*; the other end must be fitted with a thumb-screw (*e*), to screw up the wire when it is placed in the notch *g*, which should be counter-sunk in the centre. Small hooks should be driven in the frames, either front or back, to lay the wires in when not in use. (*G.M.*, 1842, p.109).

347. *Management of hotbeds and pits heated by dung.*—As the body of air inclosed is small, its temperature is easily raised too high by the sun, and depressed too much by high winds or very cold nights. The artificial supply of heat from the fermenting material not being under control is another cause of overheating, and hence the constant attention required to give or take away air during the day, and to regulate the coverings put on at night. Much mischief, as has been already observed, is produced by

over-covering, and yet, for the reasons which we have just mentioned, it would be very unsafe to leave a hotbed uncovered during any of the nights of winter or early spring; though later in the season, or where plate-glass is used, covering at night might be dispensed with. The covering should not be drawn over the linings so as to confine the steam; which in that case would find its way into the frame to the injury of the plants. The temperature and moisture to be kept up in hotbeds vary with the kinds of plants, and the object in view.

§ XVII. *Retarding Vegetation.*

348. *The different modes of retarding vegetation* being in many cases the opposite of those for its acceleration, the subject may be similarly arranged. As on the south side of ridges of ground, in the direction of east and west, plants are accelerated by meeting the rays of the sun at a larger angle, so on the north side of such ridges, as well as on the north side of walls and hedges, they will be retarded by the exclusion of the sun's direct influence. Opaque coverings, put on in winter or in early spring, are also effective, more especially when of some thickness, by excluding the stimulus of light, and presenting a thicker mass to be penetrated by atmospheric heat. Thus herbaceous perennials, such as asparagus, rhubarb, sea-kale, and other plants which do not retain their leaves during winter, may, by a thick covering of leaves or litter put on in January, when the soil is at the coldest, be prevented from vegetating for a week or a month later than the same plants on a surface sloping to the south, without any covering, and with the soil dry and loosened about the collars of the plants. The production of blossoms and fruit may in many cases be retarded by taking off the flower-buds at their first appearance in spring or early summer, as is often done with roses, strawberries, and raspberries, which when so treated flower and fruit a second time in the autumn. Even the common hardy fruit-trees,—the apple, pear, cherry, &c.,—when so treated will blossom and set their fruit a second time in the same year, but it will not ripen from the length of time required. Currants and gooseberries, and even pears and apples on dwarfs, are preserved on the trees till Christmas, by matting them over; and the season of wall-fruits and of grapes in hothouses are preserved by excluding the sun and preserving the air dry. In general, all exogenous perennial herbaceous plants, when cut over as soon as their flower-buds are formed in spring, will spring up again and produce flowers a second time in autumn; but this does not happen with endogens, excepting in the case of grasses and a few other plants. Retarding no less than accelerating may be effected by changing the habits of plants; and thus, as plants which have vegetated early one season are likely also to vegetate early the season following, so plants which have continued to grow late in autumn one year will be later in vegetating in the following spring, and continue to grow later in the autumn. There is a considerable difference in the natural earliness and lateness of vegetation in all plants of the same species or variety raised from seed, and hence, early and late varieties may always be procured by selection from the bed of seedlings. By this means have been obtained all the earliest and latest varieties in cultivation both in fields and gardens. Seeds or plants procured from cold and late soils and situations, and brought to earlier ones, continue for a time to be late from habit, and the contrary; and hence the practice of farmers in cold, late districts procuring their seed-

corn and potato-sets from low, warm districts, and the contrary. When plants are grown in pots, they can generally be more effectually either accelerated or retarded than by any other means; because they may be at pleasure transferred to a coal-cellar, to an ice-house, or to a forcing-house. Thus fruit-trees and flowering shrubs in pots, put into an ice-house in January, will have their vegetation retarded for any length of time, as no growth can take place where the temperature is under the freezing-point. Plants so treated, if not retained too long, may be made to vegetate at any season that is desired, but the transition from the temperature of the ice-house to summer-heat must be very gradual, in order that the buds may be fully distended with sap before they are developed. Fruit or vegetables which would spoil or advance too far if left on the plants, such as peas, cauliflowers, cucumbers, peaches, &c., may be retained several days in the state required in the ice-house, or in a room adjoining it, and even for a certain period in a cool cellar or shed. The earliest potatoes are obtained by some gardeners by keeping them in a place so cool as to prevent vegetation for two seasons: that is, the produce of the summer of one year is to be planted in the December of the year following. The German gardeners, by retarding the roots of the ranunculus in this manner, are enabled to produce it in flower all the year, and the same thing might be effected with various bulbs. The flowering of annual plants is easily retarded by sowing them late in the year; and on this principle the gaiety of the flower-garden is preserved in autumn, and culinary productions, such as spinach, lettuce, &c., obtained throughout winter.

§ XVIII. *Resting Vegetation.*

849. *In the natural state of vegetation* all plants experience a more or less lower degree of temperature during the night than during the day. In the tropics the difference is but little, particularly as regards plants that grow in the shade. It, however, increases from the torrid to the frigid zone; and therefore artificial temperature should be regulated accordingly. Tropical plants are injured by a greater discrepancy of temperature than occurs in their native regions. There the temperature independent of direct sun heat is next to uniform. But in the case of such plants as the vine, the fig, and the peach, the natural habit of which extends to a latitude as high as 45°, a considerable range of temperature is necessary. They enjoy, in summer, a long day of high temperature—indeed a tropical heat; but at night a tropical temperature is not maintained. These plants, and others having corresponding habitats, require not only a temperature lower by night than by day, but also lower in winter than in summer. Tropical plants, on the contrary, are injured by having a wintering imposed upon them, a condition they are never naturally placed in. In particular situations, even in extra-tropical countries, plants may be found growing where the temperature varies little, owing to shade and shelter, the vicinity of springs, &c., but these are only the exceptions.

850. *Nightly temperature* requires to be considered chiefly with reference to plants under glass. The fear of too low a temperature within being produced by the cold without, has naturally led gardeners to bestow particular care on covering up hotbeds, and raising the temperature of the air in hothouses in the evenings. In consequence of this, it often happens that when the temperature of the external air has not fallen so low during the night as was

expected, the temperature under glass becomes greater than was intended. The effect of this on plants is to produce elongation without sufficient substance; great in proportion to the length of the night, the absence of light, and the want of atmospheric moisture. Mr. Knight, who has the merit of first having called the attention of gardeners to the night temperature of hothouses, observes that "a gardener, in forcing, generally treats his plants as he would wish to be treated himself; and consequently though the aggregate temperature of his house be nearly what it ought to be, its temperature during the night relatively to that of the day is almost always too high." The consequences of this excess of heat during the night are, I have reason to believe, in all cases highly injurious to the fruit-trees of temperate climates, and not at all beneficial to those of tropical climates; for the temperature of these is, in many instances, low during the night. In Jamaica, and other mountainous islands of the West Indies, the air upon the mountains becomes, soon after sunset, chilled and condensed, and, in consequence of its superior gravity, descends and displaces the warm air of the valleys; yet the sugar-canes are so far from being injured by this sudden decrease of temperature, that the sugars of Jamaica take a higher price in the market than those of the less elevated islands, of which the temperature of the day and night is subject to much less variation. In one of Mr. Knight's forcing-houses, in which grapes are grown, he always wishes to see its temperature, in the middle of every bright day in summer, as high as 90°; "and," he adds, "after the leaves of the plants have become dry, I do not object to ten or fifteen degrees higher. In the following night, the temperature sometimes falls as low as 50°; and so far am I from thinking such change of temperature injurious, I am well satisfied that it is generally beneficial. Plants, it is true, thrive well, and many species of fruit acquire their greatest state of perfection, in some situations within the tropics where the temperature in the shade does not vary in the day and night more than seven or eight degrees; but in these climates, the plant is exposed during the day to a full blaze of a tropical sun, and early in the night it is regularly drenched with heavy wetting dews; and consequently it is very differently circumstanced in the day and in the night, though the temperature of the air in the shade at both periods may be very nearly the same. I suspect," he continues, "that a large portion of the blossoms of the cherry and other fruit-trees in the forcing-house often proves abortive, because they are forced, by too high and uniform a temperature, to expand before the sap of the tree is properly prepared to nourish them. I have therefore been led during the last three years to try the effects of keeping up a much higher temperature in the day than in the night. As early in the spring as I wished the blossoms of my peach-trees to unfold, my house was made warm during the middle of the day; but towards night it was suffered to cool, and the trees were then sprinkled, by means of a large syringe, with clean water, as nearly at the temperature at which that usually rises from the ground as I could obtain it; and little or no artificial heat was given during the night, unless there appeared a prospect of frost. Under this mode of treatment, the blossoms advanced with very great vigour, and as rapidly as I wished them, and presented, when expanded, a larger size than I had ever before seen of the same varieties. Another ill effect of high temperature during the night is, that it exhausts the excitability of the tree much more rapidly than it promotes the growth or accelerates the maturity of the fruit; which is, in conse-

quence, ill supplied with nutriment, at the period of its ripening, when most nutriment is probably wanted. The muscat of Alexandria, and other late grapes, are, owing to this cause, often seen to wither upon the branch in a very imperfect state of maturity; and the want of richness and flavour in other forced fruits is, I am very confident, often attributable to the same cause. There are few peach-houses, or indeed forcing-houses, of any kind in this country, in which the temperature does not exceed, during the night, in the months of April and May, very greatly that of the warmest valley in Jamaica in the hottest period of the year: and there are probably as few forcing-houses in which the trees are not more strongly stimulated by the close and damp air of the night, than by the temperature of the dry air of the noon of the following day. The practice which occasions this cannot be right; it is in direct opposition to nature."—*Physiological and Horticultural Papers*, p. 217.

851. *What the night temperature of a hotbed or hothouse ought to be as compared with that of the day, can only be determined by experience; because plants under glass are so far removed from plants in the free air, that the same difference which takes place in the latter case may not in the former case be advisable. Nevertheless it is clear from the experience of gardeners that a very great fall during the night is seldom or never attended with bad effects, provided there has been sufficient heat and light during the day. Much of the evil of a high temperature during night, especially where opaque coverings are used, must be owing to the absence of light. A scientific gardener of great experience observes, "Without extreme caution in the application of coverings to prevent the escape of heat, the worst effects will soon become apparent. I find that, upon the shutters being put on, the internal temperature is raised about five degrees or thereabouts in ordinary circumstances; in cases of cold rain or high winds, more; therefore the injury they cause may probably proceed from this: the plants are inclosed in total darkness, with an almost instantaneous and most unnatural increase of temperature, which is in some measure maintained through the night, and the same amount of depression takes place when the coverings are removed and light admitted in the morning. In houses heated by combustion this can in some measure be guarded against, but in those heated by fermenting substances, such as hotbeds, the evil becomes aggravated; and therefore to structures heated by such materials I cannot see the utility of this application, as economy here cannot be the motive; materials capable of maintaining a sufficient temperature during a sunless winter's day will in all cases be sufficient during night, when a fall of temperature is so beneficial; yet these structures are covered more than all others, the evils not becoming so apparent, possibly because the plants there contained are generally but of annual growth. The debilitating effect of covering houses heated by fire is particularly perceptible in vineries, probably from the position that the plants occupy in the house. Thus, were economy not a material object, and were heating power at command, I certainly should add no covering to the glass roof."*—*G. M.* 1842, p. 106.

852. *Double glass roofs* would evidently form the least objectionable nightly covering to plant-structures of every kind; and next to this the use of damaged plate-glass, instead of common crown glass, as from the much greater thickness of the former far less heat would be allowed to escape by conduction. The use of plate glass in cucumber and melon frames, and also in greenhouses and forcinghouses, has of late years been adopted by several

persons, and the glass being much less liable to be broken, and requiring no covering during nights, it is found to be on the whole more economical than common glass, and much better for the plants.

853. *The annual resting of plants* is effected, as we have seen, either by cold or by dryness, and both these causes can be imitated in a state of culture, either separately or combined. Plants in the open garden may be safely left to the influence of the seasons; but half-hardy plants against walls, or in borders by themselves, may be brought to a state of rest by thatching the ground so as to prevent what rain may fall on it from sinking in; the lateral supplies being cut off by surface gutters or underground drains. The supply of sap by the roots being thus reduced, growth will gradually cease, and the parts will be matured, and at once enabled to resist the winter and vegetate with redoubled vigour the following spring. It may be observed here that the shoots of a tree which is to be protected from frost during winter, do not require to be ripened to the same degree with shoots which are to be exposed to the action of frost in the free atmosphere; because buds, like seeds, will vegetate provided the embryo be formed, even though they should not be matured. Plants which have been forced have their period of rest brought on naturally by the maturation of the plant, and artificially by removing the glass with which they are covered, and exposing them to the free action of the atmosphere, which at that season being dry, is much more favourable for evaporating the watery part of the sap than it is later in the autumn; and hence peach-trees which have been forced, have almost always better-ripened wood, containing more blossom-buds, than peach-trees on the open walls. In the case of peach-houses, vineries, &c., the glass roof is removed and the plants left in their places; but where vines are grown in a hothouse or greenhouse along with other plants that require artificial heat throughout the year, the shoots are withdrawn and exposed to the common atmospheric temperature for three or four months. Greenhouse plants, such as natives of the Cape of Good Hope and Australia, are brought to a state of rest, partly by lowering the temperature of the greenhouse and partly by withholding water. The last mode is that which is most to be depended on, because in most greenhouses there are some plants in flower at every period of the year, and for these a greater degree of heat must be kept up than would suffice alone, for throwing greenhouse plants into a state of rest. All tropical plants are brought to a state of repose by dryness, and this is readily imitated in hothouses, in consequence of the plants being in pots. There are some tropical plants, however, which though in certain localities they have what almost amounts to a short cessation of growth, yet in a state of culture they succeed better without it. Of these plants the pine-apple is one which when kept in a state of active growth till it has produced its fruit, brings it to a far larger size than when allowed a period of repose; and this would appear to be practicable with all ligneous plants that are without buds; such as most endogens, in which class of plants buds are chiefly found among herbaceous species in the form of bulbs.

854. *The natural period of rest in hardy plants* may be varied or changed by withholding moisture, even without reference to temperature. We see this taking place both with trees and herbs in dry seasons: when wood is ripened, leaves drop off; and grass fields become brown, in July and August, which in moist seasons would have continued growing till October or November. By imitating these effects in gardens, the operations of accelerating

and retarding may be greatly facilitated; and the imitation is easy when plants are kept in pots. Ligneous plants may be thrown into a state of rest by stripping them of their leaves, when the wood of the year is nearly ripe, and at the same time shortening back the shoots to matured buds. Vines against walls in the open air, when treated in this manner, come into leaf the year afterwards somewhat earlier than vines in the same circumstances, but not so treated; but when the practice of early pruning is continued every year, the habit becomes fixed, and in a few years they will be found to break earlier by ten days or a fortnight. Even pruning after the leaves drop in autumn, as we have seen, has a tendency to produce an earlier development of the buds than when that operation is deferred till spring; because the number of buds to be nourished during winter being smaller, they are swelled to a larger size (779), and the more ready to be developed. In general, whatever tends to ripen the wood in ligneous plants, and mature the leaves in herbs, tends to bring the plant into a state of repose; and hence the value of walls, dry borders, dry soils, and warm exposures. It may even be affirmed, that with plants under glass the period of repose may be changed from what it is in their native countries to what is most suitable for ours. Thus the natural period of rest for plants which are natives of the Canaries is from April to October, and of growth and maturation during our winter and early spring, when we are most deficient in solar light; but there can be little doubt that, by the application for a series of years of a system of acceleration and retardation, plants, natives of the Canaries, might be induced to flower during our summers, and undergo their period of rest during our winters. We do not say that the object would be worth attempting, but merely that we think it is practicable.

855. *The advantages of putting trees that are to be forced into a state of rest*, and thus rendering them as excitable as possible previously to the application of artificial heat, have been forcibly pointed out by Mr. Knight. The period which any species or variety of fruit will require to attain maturity, under any given degrees of temperature, and exposure to the influence of light in the forcinghouse, will be regulated to a much greater extent than is generally imagined, by the previous management and consequent state of the tree, when that is first subjected to the operation of artificial heat. Every gardener knows that when the previous season has been cold and cloudy and wet, the wood of his fruit-trees remains immature, and weak abortive blossoms only are produced. The advantages of having the wood well ripened are perfectly well understood; but those which may be obtained, whenever a very early crop of fruit is required, by ripening the wood very early in the preceding summer, and putting the tree into a state of repose as soon as possible after its wood has become perfectly mature, do not, as far as my observation has extended, appear to be at all known to gardeners; though every one, who has had in any degree the management of vines in a hothouse, must have observed the different effects of the same degrees of temperature upon the same plant in October and February. In the autumn, the plants have just sunk into their winter sleep; in February, they are refreshed and ready to awake again: and wherever it is intended prematurely to excite their powers of life into action, the expediency of putting these powers into a state of rest early in the preceding autumn appears obvious. (*Hort. Trans.* vol. ii. p. 368.) Mr. Knight placed some vines in pots in a forcinghouse, in the end of January, which ripened their

fruit in the middle of July; soon after which the pots were put under the shade of a north wall in the open air. Being pruned, and removed in September to a south wall, they soon vegetated with much vigour, till the frost destroyed their shoots. Others, which were not removed from the north wall till the following spring, when they were pruned and placed against a south wall, ripened their fruit well in the following season in a climate not nearly warm enough to have ripened it at all, if the plants had previously grown in the open air. Peach-trees somewhat similarly treated unfolded their blossoms nine days earlier, "and their fruit ripened three weeks earlier than in other trees of the same varieties." (*Hort. Trans.* vol. ii. p. 372.) Pots of grapes which had produced a crop previously to Midsummer were placed under a north wall till autumn; on the 12th of January, they were put into a stove and ripened their fruit by the middle of April. (*Hort. Trans.* vol. iv. p. 440.)

§ XIX. Operations of Gathering, Preserving, Keeping, and Packing.

856. *Gathering.*—The productions of horticulture are in part enjoyed as scenery, and in part as articles of cookery, and other parts of domestic economy; and the gathering of articles for the latter purposes forms a part of the duty of the gardener. All crops are taken from the plant when mature, as in the case of ripe fruits or roots; or they are cut from it when the plant is in a growing state, as in gathering herbs or cabbages; or the entire plant is taken up, as in the case of turnips, carrots, &c. In all these cases the part of the plant to be gathered should not have been moistened by rain, and the weather at the time should be dry. Wherever the knife requires to be used in gathering, the operation may be considered as coming under pruning, and should be performed with the same care in respect to buds and wounded sections. In gathering fruit, care should be taken not to rub off the bloom, particularly from cucumbers, plums, and grapes. When ripe seeds are gathered, the capsules or pods should be perfectly dry, and they should be spread out afterwards in a shaded, airy shed or loft, or on a seed-sheet in the open air, till they are ready to be rubbed out, cleaned, and put up into paper bags till wanted.

857. *Preserving.*—Culinary vegetables may be preserved in a growing state by placing moveable covers, such as thatched hurdles, over them in the open garden, as indicated in fig. 329; or they may be preserved in a living

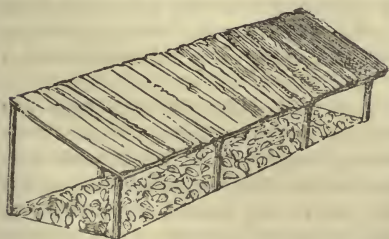

Fig. 329. Low-roof thatched hurdles for protecting plants in the open garden.

state by planting them in soil, in pits or frames, to be covered during severe weather; or they may be planted in soil, in light cellars, the windows being opened in the day-time,—a practice common in the colder countries of the Continent. Aromatic herbs, such as mint, thyme, &c., may be preserved by first drying them in the shade, and next compressing each kind into small packets, and covering these with paper.

Aromatic herbs, and also pot-herbs, such as parsley, celery leaves, chervil, &c., may be preserved by drying in an oven, and afterwards, tying up in paper. Flowers and leaves, and also ripe fruit, may be preserved in dried sand by

the following process:—The articles are suspended in a cask or jar, by threads attached to cross-sticks, fixed immediately within the position of the lid. This being done, pure white dry sand is poured slowly in till it surrounds all the articles suspended, which become as it were immersed in it. When the flowers or fruits are to be taken out, the plug is removed from a hole in the bottom of the vessel, and as much of the sand allowed to run out as uncovers as many of the fruit or flowers as it is desired to take out at one time. This mode of preserving is given in some French and Italian authors; but we believe it is very seldom put in practice. Roots, tubers, and bulbs are preserved in soil or in sand, moderately dry, and excluded from frost; and some kinds, which have coverings which protect them from evaporation, such as the tulip and the crocus, are kept in cool dry shelves or lofts, or in papers till the planting season. Potatoes, turnips, carrots, &c., are preserved with most flavour by leaving them where they have grown, covering the ground with litter, so as to exclude frost, and admit of their being taken up daily as wanted. Towards the growing season they should have a thicker covering to exclude atmospheric heat; or a portion should have been taken up in autumn, and buried in sand or soil, in a cool cellar, in order to retard vegetation as long as possible. The roots mentioned, and also onions, will keep upwards of a year without rotting or vegetating, if mixed with sand and buried in a pit in dry soil, the upper part of which shall be at least five feet under the surface of the ground, so as effectually to exclude air and change of temperature. Henderson, an eminent gardener at Brechin, makes use of the ice-house for preserving “roots of all kinds till the return of the natural crop.” “By the month of April,” he says, “the ice in our ice-house is found to have subsided four or five feet; and in this empty room I deposit the vegetables to be preserved. After stuffing the vacuities with straw, and covering the surface of the ice with the same material, I place on it case-boxes, dry-ware casks, baskets, &c., and fill them with turnips, carrots, beet-root, celery, and in particular potatoes. By the cold of the place, vegetation is so much suspended that all these articles may be thus kept fresh and uninjured, till they give place to another crop in its natural season.”

358. *Keeping-fruits*, such as the apple and pear, are preserved in the fruit-room, in shelves, placed singly so as not to touch each other; the finer keeping-pears may be packed in jars or boxes, with dried fern, or with kiln-dried barley-straw; and baking apples and pears may be kept in heaps or thick layers on a cellar-floor, and covered with straw, to retain moisture and exclude the frost. But the subject of keeping fruits will be recurred to in treating of the fruit-garden.

359. *Packing and transporting plants and seeds*.—Rooted plants and cuttings, and other parts of plants intended to grow, may be preserved for weeks, and, under certain circumstances, even for months, in moist live moss, the direct action of the air and the sun being excluded; and in this medium also they may be packed and sent to any distance within the temperate hemispheres, but not in tropical regions, on account of the extreme heat. Plants that are to pass through these regions are planted in soil, in boxes with glass covers, and being occasionally watered, they are transferred from India to England with a very moderate proportion of loss. Seeds are in general most safely conveyed from one country to another in loose paper packages, kept in a dry airy situation, so as neither to be parched with dry

heat nor made to vegetate by moisture ; but some seeds which are apt soon to lose their vitality, such as the acorns of American oaks, may be packed in moist moss, in which they will germinate during the voyage ; but if planted in soil as soon as they arrive, they will suffer little injury. Nuts and other large seeds may probably preserve their vitality by being allowed to germinate in masses of moderately dry soil, as Mr. Knight suggested might be done with the seeds of the mango. The roots or root-ends of plants or cuttings are enveloped in a ball of clayey loam, wrapped up in moist moss, or in the case of cuttings or scions of ligneous plants, stuck into a potato, turnip, or apple, and sent to any distance ; or, as already observed (676), they may be inclosed in moistened brown paper, or wrapped up in oiled paper, and sent by post. Mr. Knight found that shoots containing buds of fruit-trees might be preserved in a vegetating state, and sent to a considerable distance, by reducing the leaf-stalks to a short length, and inclosing the shoot in a double-fold of cabbage-leaf, bound close together at each end, and then inclosing the package in a letter. "It was found advantageous to place the under-surface of the cabbage-leaf inwards, by which the inclosed branch was supplied with humidity, that being the perspiring surface of the leaf, the other surface being nearly or wholly impervious to moisture."—(*Hort. Trans.*, vol. iv., p. 403.)

360. *Packing fruits and flowers.*—Firm fruits, such as the apple and pear, and flowers either in a growing state in pots, or cut for nosegays, are easily packed ; but grapes, peaches, strawberries, &c., are with more difficulty sent to a distance without being injured. To pack such fruit, and also the more delicate flowers, a box is suspended within a box, in such a manner that the inner case can never touch the outer one. This mode is "found better than any other for insuring the safe transport of delicate philosophical instruments, and is equally adapted to ripe fruit. Having packed the fruit in an inner case with soft cotton, or whatever may be deemed best for the purpose, let that inner case be suspended within an outer one by lines or cords. Suppose, for instance, that the outer case is two or three inches clear all round the inner case, and the eight cords proceeded from the eight outer corners of the one, and were fastened to the eight internal corners of the other case. In this way, whatever side was uppermost, the inner case would be suspended from the four upper cords, the four lower ones serving only to steady it and to prevent its swinging against the outer case. If the whole be turned upside down, the functions of the cords become reversed, so that they must all be strong enough to perform either office, about which, however, there is no difficulty. A still better plan, for those who have frequently very choice specimens of fruit to transmit, would be to insulate the inner case by spiral springs, with the additions of small portions of felt or woollen cloth, to limit the vibrations ; the springs would be very cheaply made, and would avoid the repeated trouble of packing or tying ; but the cords will do extremely well."—(*Gard. Chron.*, vol. i., p. 485.)

§ XX. *Selecting and improving Plants in Culture.*

361. All the plants in cultivation that are remarkable for their value as culinary vegetables, fruits, or flowers, are more or less removed from their natural state ; and the three principal modes by which this has been effected, are, increasing the supply of nourishment, selection from seedlings, or acci-

dental variations, and cross-breeding. "Nature," Mr. Knight observes, "has given to man the means of acquiring those things which constitute the comforts and luxuries of civilised life, though not the things themselves; it has placed the raw material within its reach, but has left the preparation and improvement of it to his own skill and industry. Every plant and animal adapted to his service is made susceptible of endless changes, and as far as relates to his use, of almost endless improvement. Variation is the constant attendant on cultivation, both in the animal and vegetable world; and in each the offspring are constantly seen, in a greater or less degree, to inherit the character of the parents from which they spring."—(*Knight's Physiological Papers, &c.* p. 172.)

862. *Cultivation*, then, is the first step in the progress of improving vegetables. It is almost needless to state that this consists in furnishing a plant with a more favourable soil and climate than it had in a wild state; supplying food by manure to as great an extent as is consistent with health and vigour; allowing an ample space for its branches and leaves to expand and expose themselves to the action of the sun and the air; guarding the plant from external injuries, by the peculiar kind of shelter and protection which it may require, according as the object may be the improvement of the entire plant, of its foliage only, of its flowers, or of its fruit. All cultivation is founded on the principle that the constitution and qualities of plants are susceptible of being influenced by the quantity and quality of the food with which they are furnished, and that the constitution and qualities so formed can be communicated to their offspring. The seeds of plants abundantly supplied with food, and growing in a favourable climate, will produce plants of luxuriant foliage, and larger than usual in all their parts; while the contrary will be the case with seeds produced by plants grown in a meagre soil, and in an unfavourable climate. Seeds produced in a hot climate will produce plants better adapted for that climate than seeds from a climate that is cold, and the contrary; and hence also the seeds of plants grown in a poor soil and ungenial climate will succeed better in that soil and climate than plants raised from seeds produced under more favourable circumstances. Hence, in improving plants by cultivation, the experiments ought to be made in the soil and climate for which they are intended. "No experienced gardener," Mr. Knight observes, "can be ignorant that every species of fruit acquires its greatest state of perfection in some peculiar soils and situations, and under some peculiar mode of culture. The selection of a proper soil and situation must therefore be the first object of the improver's pursuit; and nothing should be neglected which can add to the size, or improve the flavour, of the fruit from which it is intended to propagate. Due attention to these points will in almost all cases be found to comprehend all that is necessary to insure the introduction of new varieties of fruit, of equal merit with those from which they spring; but the improver, who has to adapt his productions to the cold and unsteady climate of Britain, has still many difficulties to contend with: he has to combine hardiness, energy of character, and early maturity, with the improvements of high cultivation. Nature has, however, in some measure pointed out the path he is to pursue; and if it be followed with patience and industry, no obstacles will be found which may not be either removed or passed over. If two plants of the vine, or other tree of similar habits, or even if obtained from cuttings of the same tree, were placed to vegetate during several successive seasons in very different

climates ; if the one were planted on the banks of the Rhine, and the other on those of the Nile, each would adapt its habits to the climate in which it were placed ; and if both were subsequently brought in early spring into a climate similar to that of Italy, the plant which had adapted its habits to a cold climate would instantly vegetate, whilst the other would remain perfectly torpid. Precisely the same thing occurs in the hothouses of this country, where a plant accustomed to the temperature of the open air will vegetate strongly in December, whilst another plant of the same species, and sprung from a cutting of the same original stock, but habituated to the temperature of a stove, remains apparently lifeless. It appears, therefore, that the powers of vegetable life in plants habituated to cold climates are more easily brought into action than in those of hot climates ; or, in other words, that the plants of cold climates are most excitable : and as every quality in plants becomes hereditary, when the cause which first gave existence to those qualities continues to operate, it follows that their seedling offspring have a constant tendency to adapt their habits to any climate in which art or accident places them.”—(*Knight's Horticultural Papers*, p. 172.)

863. *Selection.*—An individual wild plant being thus improved, the next step is to sow its seeds under the most favourable circumstances of soil and situation, and from the plants so produced to select such, or perhaps only one, or even a part of one, which possesses in the highest degree the qualities we are in search of. This plant being carefully cultivated, its seeds are to be sown, and a selection made from the plants produced as before. In this manner one generation after another may be sown and selections made till the desired properties are obtained. In the case of annual plants the object may be attained in a few years, but in the case of trees, and especially fruit-trees, a number of years are requisite. Mr. Knight, who has had more experience in raising new fruits by selection from seedlings than perhaps any person ever had before his time, has the following instructive observations:—“When young trees have sprung from the seed, a certain period must elapse before they become capable of bearing fruit, and this period, I believe, cannot be shortened by any means. Pruning and transplanting are both injurious ; and no change in the character or merits of the future fruit can be effected, during this period, either by manure or culture. The young plants should be suffered to extend their branches in every direction in which they do not injuriously interfere with each other ; and the soil should just be sufficiently rich to promote a moderate degree of growth, without stimulating the plant to preternatural exertion, which always induces disease. The periods which different kinds of fruit-trees require to attain the age of puberty are very varied. The pear requires from twelve to eighteen years ; the apple, from five to twelve or thirteen ; the plum and cherry, four or five years ; the vine, three or four ; and the raspberry, two years. The strawberry, if its seeds be sown early, affords an abundant crop in the succeeding year.”—(*Physiological Papers*, &c. p. 178.)

864. *Selecting from accidental variations*, or as they are technically termed, sports. Among a great number of seedlings raised in gardens, or of plants in a wild state, some entire plants, or parts of plants, will exhibit differences in form or colour from the normal form and colour of the species. Among these peculiarities may be noticed double flowers, flowers of a colour different from those of the species, variegated leaves, leaves deeply cut where the normal form is entire, as in the fern-leaved beech ; and even the entire plant

may be of more diminutive size, or its shoots may take a different direction, as in fastigate and pendulous-branched trees. All these, and many other accidental variations, which, as we have seen (551), cannot generally be reproduced from seed, may be perpetuated by cuttings, or some other mode of propagating by division.

865. *Cross-breeding*.—This process is effected by fecundating the stigma of a flower of one plant with the pollen from the flower of another of the same species, but of a different variety. Sometimes fecundation may be effected with the pollen of a different species, and in that case the produce is said to be a hybrid, while in the other the result is merely a cross or a cross-bred variety. The mode of performing this operation has been very well described by Mr. Hayward. "Supposing," he says, "for instance, you have two geraniums producing differently-shaped leaves and differently-coloured blossoms—or two apple-trees, bearing apples of different sizes, colours, and qualities, and it be desired to produce geraniums of differently-shaped leaves and differently-coloured flowers, and apples of different sizes, colours, and qualities, that is, different from either of the two plants or trees which you possess: the mode of effecting this is to select a blossom of the plant from which you wish to obtain the seed; when it is just on the point of opening and exposing the anthers, take a pair of scissors, and, gently forcing open the petals of the blossom intended to bear the seed, cut off the stamens, and remove the anthers, and then leave the blossom thus operated upon for a day or two, or until the petals are quite expanded, and the pistil arrived at a state of maturity; when it is in this state, select a blossom of the plant with which it is desired to impregnate the prepared female blossom, and when this is in a state of maturity, and in a state to part with its pollen or farina freely, take a small camel's-hair pencil, collect the farina on the point, and place it on the stigma or crown of the pistil of the prepared blossom. This operation may be performed, with an equal chance of success, on plants of all descriptions." (*An Inquiry, &c.* p. 120.) "New varieties of every species of fruit," Mr. Knight observes, "will generally be better obtained by introducing the farina of one variety of fruit into the blossom of another, than by propagating from any single kind. When an experiment of this kind is made between varieties of different size and character, the farina of the smaller kind should be introduced into the blossoms of the larger, for, under these circumstances, I have generally (but with some exceptions) observed in the new fruit a prevalence of the character of the female parent; probably owing to the following causes. The seed-coats are generated wholly by the female parent, and these regulate the bulk of the lobes and plantule: and I have observed, in raising new varieties of the peach, that when one stone contained two seeds, the plants these afforded were inferior to others. The largest seeds, obtained from the finest fruit and from that which ripens most perfectly and most early, should always be selected. It is scarcely necessary to inform the experienced gardener that it will be necessary to extract the stamina of the blossoms from which he proposes to propagate, some days before the farina begins to shed, when he proposes to generate new varieties in the manner I have recommended."—(*Knight's Physiological Papers*, p. 177.)

866. *Precautions against promiscuous fecundation* require to be taken both in the case of flowers the seeds of which are to be sown for the purpose of selection, and in those which have been cross-fecundated. In the former case, the plants should as much as possible be isolated from all others of the

same, or of allied kinds ; and in the latter something more should be done. The reasons are, that in both cases the farina of adjoining flowers of the same kind is in all probability floating in the atmosphere, and will adhere to whatever stigmas of its own species it may light on ; and secondly, that bees and other insects which frequent flowers carry off the pollen from one to another, and thus produce accidental cross-fecundation, which would render nugatory that which was attempted by art. The only mode to guard against pollen floating in the atmosphere is by placing the plants from all others of the same kind, though what distance is required is uncertain. For the cruciferæ generally most space is required ; varieties of cabbages and turnips having been adulterated when at the distance of upwards of a mile, in an open country and in the direction of the prevailing winds. To guard against the effects of bees and other insects, the blossoms when selected and fecundated by art may be surrounded by coarse gauze, or inclosed in a case of glass, till the blossom begins to fade. To strengthen the embryo seeds, the plant may be pruned in such a manner as to throw an extra share of sap into the branch, stem, or pedicel on which the flower is situated. Thus, if the fecundated flower form part of a spike, the upper part of the spike may be cut off ; a corymb or an umbel may be thinned out ; the suckers may be taken from a sucker-bearing plant, such as the raspberry ; the runners from the strawberry ; the offsets from a bulb, the tubers from a potato, and so forth.

367. *Fixing and rendering permanent the variety produced* is effected, in general, by one or other of the modes of propagation by division (551). Improved varieties of fruit-trees are generally perpetuated by grafting ; fruit-shrubs, such as the gooseberry, by cuttings ; perennials, by division, offsets, or suckers, &c. ; improved annuals and biennials, and some perennials, are perpetuated by seeds, which forms an exception to the general rule. What we have already advanced on this subject in the paragraph last quoted renders it unnecessary to dwell on it here, farther than to notice a practice, the result of the experience of cultivators, the rationale of which it is difficult to explain. This is the transplantation of culinary biennials, such as the turnip, carrot, parsnep, beet, cabbage, cauliflower, onion, and many such plants, after they are full grown, previously to their being allowed to send up their flower-stems. By this practice the variety is said to be prevented from degenerating ; and if so, it may probably be on account of the greater part of the nourishment to the seeds being furnished by the store laid up in the plant, and but only a small portion taken from the soil. It is certain that transplanted plants do not produce nearly so much seed as they would have done if not transplanted ; and it is equally certain that in the case of the turnip, when the bulb is of a moderate size, and even small rather than large, much stronger flower-stems are sent up, and more seed produced, than when it is large. The reason probably is that the roots below the unswelled bulb are stronger, not having yet fulfilled their functions, and hence are enabled to draw a larger proportion of nourishment from the soil.

368. *The production of double flowers* is a subject not yet thoroughly understood by physiologists. As double flowers are seldom found in a wild state, they appear to be the result of culture, and yet there is scarcely any well-authenticated instance of culture having produced them. It is certain, however, that double flowers degenerate into single ones when culture is

withdrawn, and that extraordinary supplies of nourishment and moisture, as in moist and warm seasons, produce flowers more double than in dry seasons. Mr. Munro, a scientific practical gardener, endeavours to account for the production of double flowers, by supposing that there is one fluid or sap of plants destined for growth, and another for reproduction; and that double flowers are produced when the latter sap is in excess. He concludes, therefore, that by reducing the number of seed-pods in a plant, those left would be so amply nourished by the excess of the reproductive sap, as to produce double flowers. To prove this he selected a number of single scarlet ten-week stocks, and as soon as he observed five or six seed-pods fairly formed on the flower-spike, every succeeding flower was pinched off. From the seeds saved in this manner he had more than 400 double flowers from one small bed of plants (*G. M. for 1838*, p. 122). De Candolle states that Mr. Salisbury assured him that by putting plants with single flowers in a very rich soil, and fixing ligatures round the stem near the neck, he obtained seeds which produced double flowers (*Phys. Veg.*, p. 734); but this as a general principle he considers very doubtful. One thing is certain, that seeds saved from semi-double flowers frequently produce flowers which are double; and it would also appear that from the authority of gardeners, seeds from single flowers which have been growing among double ones, more frequently produce double flowers, than seeds from plants which have not been so circumstanced.

869. *Duration of varieties.*—All the plants of a variety which have been procured by division, for example all the plants of any particular variety of grape, apple, or potato, being in fact only parts of one individual, it has been argued by Mr. Knight, that when the parent plant dies all the others must die also; or to put the doctrine in a more general form, that all varieties are but of limited duration. This opinion, though it has been adopted by many persons, has not met with the approbation of Professor De Candolle, who says that the permanence of the duration of varieties, so long as man wishes to take care of them, is evident from the continued existence of varieties the most ancient of those which have been described in books. By negligence, or by a series of bad seasons, they may become diseased, like some of our varieties of apple or potato; but by careful culture they may be restored and retained to all appearance for ever. We are not sure that De Candolle's theory will hold good with the finest fruits and florists' flowers. The species might be recovered, but we question whether in many instances that will be the case with the variety. Perhaps a hypothesis might be devised which would coincide with both authorities. It would coincide with that of De Candolle, if Mr. Knight had spoken with reference to actually wild varieties only; but with regard to improved varieties, as they are understood in a horticultural point of view, they are doubtless prone to decay in proportion to their degree of departure from that physiological perfection which enables the wild variety to maintain itself continually on the surface of the globe, independent of the care of man. A wild variety will produce seed under favourable circumstances, but many highly improved varieties, in a horticultural sense, do not perfectly mature their seeds under any circumstances whatever; and therefore must be physiologically imperfect, and being so, *a priori*, if it be admitted that imperfection is a principle of decay, it will not be denied, that no plant

imperfectly constituted can carry on its functions but for a more or less limited time, even under the most favourable circumstances.

870. We have dwelt longer on this subject than may appear necessary, because we consider the civilisation of wild plants by cultivation, the originating of new varieties of those already in our gardens from seed, or of wild plants from accidental variations, among the most interesting and rational amusements which can engage the amateur. There is a great deal of enjoyment in displaying our power over plants in propagating them, by cuttings, leaves, and the different modes of grafting and budding; but greater still is that of creating new kinds of fruits or flowers by cross-fecundation, or improving a wild plant so as entirely to change its character. As examples of what may be done, we may, among culinary vegetables, refer to the common carrot, which in five generations from seed, in as many years, has been brought from a wild state to be fit for the table, by M. Vilmorin; and among flowers to the heartsease, which in the course of the last twenty years has by cross-breeding and selection, been raised from a flower with thin crumpled petals and irregular shape, to one of our most symmetrical and flat firm-petalled florists' flowers. We conclude by reminding the amateur that the blossoms or fruits produced by newly-originated plants the first or second year, are often inferior to what the same plant will produce when it has acquired a greater degree of vigour; and that to do justice to new varieties of herbaceous plants, they should be allowed to flower at least two years, and ligneous plants to flower and fruit, three or even four years, before they are rejected.

§ XXI. *Operations of Order and Keeping.*

871. By *order* is to be understood that relation of objects to one another, which shows that the one follows the other as an obvious or natural consequence. Thus, suppose that on entering a kitchen-garden we observe a border along the walk separated from the larger compartment by a continuous espalier rail; this rail we naturally expect will be continued all round the garden, or if interrupted it will be by some obvious and satisfactory cause. Suppose the line of railing discontinued without any obvious reason; in that case we should say there was a want of order. Still more so should we be struck with a want of order, if the walk were bordered by dwarf fruit-trees, not in a straight line or in a line parallel to that of the walk, but sometimes nearer and sometimes farther from it, and with the trees also at irregular distances in the line. There is a secondary meaning in which the word *order* is used among gardeners, which has reference to keeping; and thus a border of flowers or other plants confused with weeds would be said to be disorderly, or not in order. In the former case, the term refers to design, and in the latter to management; and it may be easily conceived that the unfavourable impression on a stranger is much graver in the case in which it is of a permanent nature, than in the other where it is only temporary. Neatness, as applied to horticultural scenes and objects, may be considered as synonymous with cleanliness.

872. The term *keeping* in horticulture relates to the degree of order and neatness which are maintained in management; and hence the expressions, badly kept, highly kept. A garden that is in high order and keeping must have been correctly laid out and planted at first, and cultivated and managed with great care afterwards. This care must not be devoted merely to some particular department, or to some object under the gardener's charge, but

must extend to everything according to its importance. In a kitchen-garden, the system of managing the wall and espalier fruit-trees, and of cropping the compartments, demands the first attention, because the result will not only influence the most conspicuous features in the garden, but also increase or diminish the quantity and quality of the produce.

873. The following *rules* may perhaps be of some use, if impressed on the mind of the young gardener, and if insisted on being kept by workmen by the master or the amateur :—

1. *Perform every operation in the proper season and in the best manner*, on the principle that “whatever is worth doing at all is worth doing well.” Nothing can be more annoying to a person who is desirous of having his garden kept in the highest order, than to see the slovenly manner in which some gardeners thrust plants into the soil, tie them up when they require support, and hack and cut at them when they require pruning. “Cut to the bud” is a precept too often disregarded by such persons; among whom we have known excellent growers of crops, both in the open air and under glass.

2. *Complete every operation consecutively*.—The neglect of this is a very common fault. For example, the wall-trees are receiving their summer pruning, and as this occupies a day or two, or is necessarily performed at intervals, so as not to deprive the trees of too much foliage at once, the shoots cut off are left on the ground till all the trees have been gone over. The same mode of proceeding is followed in every other operation. We allow that, on the principle of the division of labour, this is the most economical mode, but on the principle of high keeping it is objectionable; and in the event of changes of weather, such as a fall of rain, it may, in the case of neglecting to rake off weeds the same day in which they are hoed up, defeat the intention of the operation.

3. *Never, if possible, perform one operation in such a manner as to render another necessary*.—It is a common practice with many gardeners, when weeding borders or trimming plants, to throw the weeds or trimmings on the gravel-walks, thereby occasioning the labour of sweeping them up, as well as soiling the gravel of the walk. There is scarcely a practice more to be condemned than this, both with reference to economy of time and to high keeping. The walk is disfigured by the weeds and trimmings perhaps for a whole day, and when they are swept off it is found that the gravel has been disturbed and is discoloured. In all cases of weeding borders and pruning shrubs, or hedges, close to walks, the weeds and prunings should be put at once into a wheelbarrow or basket.

4. *When called off from any operation, leave your work and your tools in an orderly manner*.—Do not leave a plant half planted, or a pot half watered, and do not throw down your tools as if you never intended to take them up again. Never leave a hoe or a rake with the blade or the teeth turned up, as if you intended them as man-traps. Never stick in a spade where it will cut the roots of a plant; but if you must stick it in among plants, let its blade be in the direction of the roots, not across them.

5. *In leaving off work, make a temporary finish, and clean your tools and carry them to the tool-house*.—Never leave off in the midst of a row. Never leave the garden-line stretched. Never show an eagerness to be released from work. Never prune off more shoots, pull up more weeds, or make more litter of any kind than you can clear away the same day, if not the same hour.

6. *Never do that in the open garden or in the hothouses, which can be equally well done in the reserve ground or in the back sheds: potting and shifting, for example.*

7. *Never pass a weed or an insect without pulling it up or taking it off, unless time forbid. Much might be done in this way towards keeping down weeds, were it not for the formality of some gardeners, who seem to delight in leaving weeds to accumulate till a regular weeding is required.*

8. *In gathering a crop, take away the useless as well as the useful parts.—Never leave the haulm of potatoes on the ground where they have grown. Take up all the cabbage tribe by the roots, unless sprouts or second crops are wanted; and carry every kind of waste to the reserve or the frame ground, to rot as manure or mix with dung linings.*

9. *Let no plant ripen seeds, unless these are wanted for some purpose useful or ornamental, and remove all the parts of plants which are in a state of decay.—The seed-pods of plants should not be allowed even to swell, unless the seeds are wanted for some purpose, because being the essential result of every plant, they exhaust it more than any other part of its growth, and necessarily always more or less weaken it for the following year.*

874. To these rules many others might be added, but it is not our wish to render gardeners mere machines. One great object of the young gardener ought to be to cultivate his faculty of seeing, so that in every garden he may be able to detect what is worth imitating, and what ought to be avoided. There is nothing tends more to this kind of cultivation than seeing the gardens of our neighbours, in which we may often detect those faults which exist in our own, but which, from having become familiar to us, we had not been able to see in a similar light. Without a watchful and vigilant eye, and habits of attention, observation, reflection, and decision, a gardener will never be able to be a complete master of his profession.

CHAPTER II.

OPERATIONS OF HORTICULTURAL DESIGN AND TASTE.

WE have introduced the title of this chapter, chiefly for the sake of showing that we have not forgotten any part of our subject, and that the whole of what would have been treated of here has already been given in the *Suburban Architect and Landscape Gardener*. In order, therefore, to keep this work within certain limits, we shall only here give an outline of what would otherwise have been treated of in detail.

875. *Taking plans of gardens, garden-buildings, or of any part of them, or of garden implements, or of modes of performing operations, ought to be understood by every gardener who aspires to eminence in his profession, and by every amateur who wishes to improve his own garden by what he sees in those of others.*

876. *Carrying plans into execution by transferring them from paper to ground, or in whatever manner they require to be realised, is equally neces-*

sary to be understood by both the gardener and the amateur; and for this purpose, and that of the preceding paragraph, some knowledge of geometry, land-surveying, and drawing is requisite. We would recommend *Pasley's Practical Geometry and Plan-drawing*, 8vo. 16s., and *Crocker's Land-surveying*, 8vo. 12s.

877. *Reducing a surface to a level, or to a uniform slope*, is one of the most common operations required of a gardener in forming a garden or laying out grounds. For this purpose he must have learnt the use of the spirit-level or of the common mason's level, so as to be able to stake out level or regularly sloping lines on irregular surfaces. We recommend, as the best work on this subject for the practical gardener, *Jones's Principles and Practice of Levelling*, 1840, 8vo. 4s.

878. The laying out of walks, roads, lawns, and the formation of pieces of artificial water, fountains, rockwork, and various other works that fall more or less under the superintendence of the gardener, are given at length in the volume referred to.

CHAPTER III.

OPERATIONS OF GENERAL MANAGEMENT.

879. *The general management of a garden*, whether it includes the pleasure-ground, and all the scenes which come under the gardener's department in an extensive country residence, or merely a few rods of ground for growing culinary crops and flowers, requires such constant attention throughout the year, that gardeners have wisely invented calendars to remind them of their duty, monthly and even weekly. An abbreviated calendar of this kind will be found at the end of our volume, and we shall here confine ourselves to giving some hints on general management.

880. *On undertaking the charge of a garden*, the first point to determine is, the number of hands required for its cultivation, and how many of these men are to be professional gardeners, as journeymen or apprentices, and how many common country labourers or women. It is scarcely possible to keep a garden in the highest order, however small it may be, without a professional gardener in constant attendance; or without a garden-labourer, directed by the amateur; who in this case may be supposed to perform all the more delicate operations of propagating, pruning, training, &c., himself. Where only one professional gardener is kept, he will frequently require a labourer to assist in operations that cannot well be done by a single person, or that require to be done quickly; or of one or more women, to assist in weeding, gathering crops, or keeping down insects. Though as a general and permanent practice we do not advocate the employment of women in out-door work, yet in the present state of things in this country there are generally to be found women glad to accept the remuneration for working in a garden, and the healthiness of the employment in good weather is a recommendation to it.

881. *The books to be kept by a gardener* in a small place need not be more, as far as the business of the garden is concerned, than an inventory-book of the

tools, &c. ; a cash-book, in which to enter what he pays and receives ; and a memorandum-book, to enter the dates and other particulars of orders given to tradesmen, &c., of sowing main crops, of fruit-ripening, and such other particulars as his master may require, or as he may think useful. Such books should be furnished by the master, and consequently be delivered to him when they are filled up. In some gardens a cropping-book is kept, in which on one page is registered the date, and other particulars of putting in the crops ; the page opposite being kept blank, to enter the dates when they begin to be gathered, and how long they last. In all large gardens a produce-book is kept, in which every article sent to the kitchen every day in the year is recorded. There are various modes of keeping books of this kind, but one of the simplest and best appears to us to be the following :—A list, or *kitchen-bill*, is printed of all the culinary articles which the garden is supposed to produce in the course of the year ; and a similar list, or *dessert-bill*, of all the dessert articles. On these lists, every morning, the gardener marks such articles as are in season, or as he can supply, and sends the kitchen-bill to the cook or steward, and the dessert-bill to the housekeeper, who put their marks to every article which are wanted for that day. The bills are carried back to the gardener, who puts them into the hands of his foreman ; who sends the articles to the kitchen in the course of the forenoon with the bills, which are signed by persons receiving the articles, and returned to the gardener ; who preserves them, and has them bound up in a volume at the end of the year. This book forms an excellent record of garden-produce for future reference. See a form of kitchen-bill and also of dessert-bill, in *G. M.*, for 1841, p. 9.

882. *The ordering of seeds and plants* is one of the most important duties of the head-gardener ; the difficulty being to determine the exact quantity of seed required, which is of some importance when the garden is at a considerable distance from the seedsman. Abercrombie's *Seed Estimate* is a useful memorial for this purpose, and a year's experience in any garden will enable the gardener to give his future orders with sufficient exactness. Some seeds in most gardens are saved by the gardener, particularly flower-seeds ; and many kinds of plants are now propagated by him which, were they to be procured from nurserymen, would increase the expenses of even a small garden to such an amount as to put such gardens out of the reach of thousands who now enjoy them. Gardeners also exchange many articles with one another, by which means their gardens are much enriched at little or no expense to their master ; and thus the richer any garden is in plants or seeds, the more likely are these riches to be increased, from there being a greater number of articles to exchange. Hence also the great advantage of employing a good professional gardener, who in many situations saves far more than the amount of his wages, by propagation and exchanges.

883. *The management of men and the distribution of work* are the great points to which a head-gardener ought to direct his daily attention. The work of every day ought to be foreseen the day before, subject, however, to changes in the weather, against which other work should be provided. A general idea of the labours and operations of the coming week should be formed the week before, and communicated to the foreman, who ought to receive his directions every evening for what is to be done the following day. For this, and all other matters of general management, gardeners' calendars are of the greatest use as remembrancers ; but the gar-

dener's principal dependence must be on his own knowledge and experience. Unless he think and act for himself, as if no calendar had been in existence, he will never succeed; and if this may be said of a professional gardener, it applies still more forcibly to the amateur.

881. *The wages of a gardener.*—Something may here be expected to be said on this subject, and we shall observe:—1. That there cannot be a greater mistake than to suppose that the products and enjoyments of a garden, however small, can be obtained without the services of a really good professional gardener; and 2. that all the difference between a garden-labourer, who perhaps can barely read and write, and who can neither spell nor pronounce botanic names, is not above £20 or £30 a-year. No man would think of giving a garden-labourer, to whom he committed the management of his garden, less than a guinea a-week with his lodging, and some other perquisites, such as spare vegetables, fuel, &c. Now, for £70 or £80 a-year, a scientific professional gardener may be engaged; one who can understand and reason upon all that is written in this volume, as well as carry all the practices described into operation, and who in consequence will elicit more enjoyment from a quarter of an acre than a man who has no scientific knowledge will do from any extent of ground, and means without limits. We by no means set down £70 or £80 as adequate wages for such a person; we know many gardeners who receive £100, and some £150 and £200 a-year, with a house, coals, candles, and various other perquisites. We merely state that such is the salary at which a scientific gardener may be engaged at the present time. But let us not be supposed to undervalue the garden-labourer. Wherever an amateur is his own head-gardener, there the garden-labourer is his fittest assistant, and far better adapted for his purpose than a professional gardener, whose superior knowledge and skill might discourage him in his operations. The wages of a professional gardener, it must be allowed, are but small, compared with the amount of knowledge and the steady attention which the exercise of his profession requires; but wages in this, as in every other case, depends on demand and supply, and it would serve little purpose here to discuss the subject of increasing the one or diminishing the other. This much it may be useful to observe that gardening, when studied scientifically, is a profession which tends to elevate the mind, and confer intellectual enjoyments of a much more exalted character than mere money-making can ever do. This, we think, is proved by the excellent moral character of almost all professional gardeners, and by the high degree of intelligence and scientific knowledge which many of them acquire. There are few persons, we believe, who have a more extensive personal knowledge of British master-gardeners than we have, and we also know a good many on the Continent; and we must say that, as a body, we have the very highest respect for them. They are almost all great readers; and in consequence of this, the intellectual and moral powers of many of them have been developed in a manner that commands our utmost veneration. There is scarcely a science or an art which some master-gardener of our acquaintance has not of his own accord taken up and studied from books, so as to obtain a respectable degree of knowledge of it. We know a number who have taught themselves several languages, and one of the best Hebrew scholars in Scotland, as we are informed by a clergyman (a good judge), is a gardener, who taught himself that language without the assistance of a master. We know gardeners that excel in almost

every department of mathematics and geometry. Some are scientific meteorologists, naturalists in all the departments, and a number are good draftsmen. Many Scotch gardeners dip into metaphysics, and we have long known one whose library contains all the best English works on the subject, including those of Reid, Kames, Stuart, Monboddo, Drummond, and many others, besides translations. The development of so much talent among gardeners is no doubt owing to the nature of the profession, which excites thought; to the isolation of their dwellings and the necessity of their staying at home in the evenings to look after hothouse fires, and very much also to the kind indulgence of their masters, who, with very few exceptions, allow them the use of whatever books they want from their own libraries. Most employers also make presents of books to their gardeners; and some, of which Lord —— is the most magnificent example that we know, have established in their gardens, libraries, with mathematical instruments, globes, and maps. Another more recent yet grand cause of the development of the minds of gardeners is the practice, which has become general among them within the last twenty years, of writing for the press. The *Transactions of the Horticultural Society of London*, and the *Memoirs of the Caledonian Society*, first called forth this talent, which, as the gardening books in existence previously to the first edition of our *Encyclopædia of Gardening* will show, had been confined to very few persons. The grand stimulus to writing, however, was given by the *Gardener's Magazine*, a work most liberally supported by the contributions of gardeners; and how generally this has called forth the talent of writing among both masters and journeymen will appear by the abundance of communications which continue not only to be supplied to that periodical, and several others which appear monthly, but to two weekly gardening newspapers. Amateurs also have very generally become writers on horticultural subjects; and from the different views which many of them take from those held by practical men, the discussions they often elicit prove highly instructive to all parties. What we greatly admire in all this intellectual progress is, that gardeners still maintain their modesty of deportment and that high moral character, which commands the respect of their employers and of all who know them.

PART III.

THE CULTURE OF THE KITCHEN AND FRUIT GARDEN.

CHAPTER I.

LAYING OUT AND PLANTING THE KITCHEN AND FRUIT-GARDEN.

SECT. I. *Laying out the Kitchen-Garden.*

885. *The situation and general arrangement of the kitchen-garden* have already been treated of in the *Suburban Architect and Landscape Gardener*, but previously to entering on its culture and management, we shall here recapitulate the main features. *The situation* relative to the other parts of a residence, should be as near the house as is consistent with other details. In general the kitchen, stable-offices and kitchen-garden should be on one side of the mansion or dwelling, and so placed as to admit of intercommunication without bringing the operations or operators into the view of the family or their visitors. As the stable-offices are generally near the kitchen-offices, so the kitchen-garden may be near the stables; and in such a situation it will generally be found that the kitchen-garden is less seen from the windows of the mansion, than if it were placed at a much greater distance. A very little reflection will convince any one that this must necessarily be the case. Relatively to *surface*, one which is level, open, and airy, is the best; because it is least liable to be affected by high winds. The next best surface is one gently sloping to the south, or south-east; and the worst is one sloping to the north-east. The surface of a hill is to be avoided on account of its exposure to high winds; and equally so one in a valley on account of the cold air which descends from the adjoining heights and settles there. *The extent* is regulated by the wants of the family, and may vary from a quarter of an acre to several acres; every thing depending on the quantity and quality of the produce required. *The best soil* is a loam, rather sandy than clayey, on a subsoil moderately retentive. *The form* of the garden should be rectangular, as better adapted than any other for the operations to be carried on within. *The area* is enclosed by walls, in general forming a parallelogram with its longest side in the direction of east and west, in consequence of which the greater length of walling has a surface exposed to the south. When the situation is such as to require artificial shelter, plantations are formed exterior to the garden for this purpose, but they should never, if practicable, be nearer the walls than 100 feet or 150 feet; for though science has not yet satisfactorily assigned the reason, yet it is certain that nothing is more injurious to culinary vegetables and fruits, than the exclusion of a free current of air in every direction. The sole object of shelter ought to be to break the force of high winds. *Water* should never be wanting in a garden, and as we have already observed (823) it should always be exposed in a basin for some time before being used. The garden *walls* should if possible be of brick; or if they are formed of stone, or of mud or compressed earth, which in some parts of the country

make excellent walls, retaining much heat and lasting a long time, they ought to be covered with a wooden trellis on which to train the trees. It has been recommended by Hitt and others to build the walls on piers, for the sake of allowing the roots of the trees to extend themselves on both sides of the wall. As however the branches of the trees are constrained so ought to be the roots, in order that the one may be proportionate to the other. Besides, as there are generally trees on both sides of every garden wall, it does not appear that, under ordinary circumstances at least, anything would be gained by this mode of building walls, excepting the saving of a small proportion of materials. Where walls are not built of brick, stone or earth, they may be formed of boards, which when properly seasoned and afterwards saturated with boiling tar, will endure many years, and produce as much heat in the summer season as brick or stone. They are indeed colder in winter and spring, but that circumstance is often an advantage by retarding the blossoming of the trees, and lessening the risk of their being injured by spring frosts. If a cavity were formed by the boarding, and filled with pounded clinkers, or charcoal, or coke, much heat would be absorbed from the sun heat, and thus form a source for giving out heat at night. Where the walls are formed of brick they may always be built hollow, (472) to save material; and as very little additional expense will be required to form the hollows into flues (475) or channels for hot-water pipes, such an arrangement should not be neglected in the colder parts of the island. The *walks* in the interior of the garden are laid out in a direction parallel to the walls, and *espalier rails* are commonly formed parallel to the walks. Exterior to the walls, a narrow portion of ground is inclosed which is technically called *the slip*, the object of which is to admit of getting the full benefit of the wall on the outside as well as within.

886. In *trenching* and *levelling* the surface of the kitchen-garden, care must be taken to form a complete system of underground *drainage*; not only by having drains formed of tiles to carry off subterraneous water, but by having the surface of the subsoil parallel to the exposed surface, both being inclined towards the situation of the drains; so that the water in sinking down from the surface may not rest in hollows (526). The best situation for these drains will generally be under the walks. The depth of the soil of a garden should seldom be less than two feet, this depth being penetrated by the roots of even the smallest kinds of culinary vegetables when growing vigorously. The depth of the soil, however, ought to bear some relation to its quality, and to the climate. A loamy or clayey soil in a humid climate need not be trenched to the same depth as if it were in a warm and dry climate; because the use of the soil to plants being to retain moisture, a small body not liable to lose by evaporation, may be as effective as a larger one so constituted as to lose a great deal. The *borders for fruit-trees* form an important part of the kitchen-garden, and should always be prepared with a due regard to the soil, the climate, and the kinds of trees to be planted. The bottom should generally be prepared so as to prevent the roots from penetrating into the subsoil: though as this naturally limits the supply of water to the roots in dry seasons, and consequently gives occasion for artificial waterings, a better mode than making the borders very shallow, is never to dig them, and to spread the manure always on the surface. By this means the roots will not be forced downwards, as they necessarily must be when the surface is loosened and exposed to the drying influence of the

sun and winds, or the exhaustion of crops of vegetables. The subsoil of the borders, however, ought in every case to be drained. *In planting fruit-trees in the kitchen garden*, we would on no account whatever introduce standards, or any description of fruit-tree, in those parts of the open garden which are to be cropped with herbaceous vegetables; because such trees injure the surrounding crops by their shade, and never produce much fruit, or fruit of good quality, in consequence of their roots being forced down into the subsoil by the necessary stirring of the soil among the herbaceous crops. We have enlarged on this subject elsewhere, (*Sub. Gard.* 1st ed. p. 202,) and we therefore only add that we recommend no fruit-trees to be planted in the kitchen-garden excepting against the walls, against espalier rails, in rows along the walks, or in compartments by themselves. It may be objected to what we recommend, that it is contrary to the practice of market-gardeners, who in general grow fruit-trees among their culinary crops; but to this we reply, that the fruit of such trees, and the flavour of the crops which grow under them, must necessarily be far inferior to that of fruit grown on trees which draw their nourishment from the surface of the soil, and of vegetables which enjoy the full benefit of the sun and air. Market-gardeners know this, though their customers may not. A *forcing department*, a *frame ground* and a *reserve ground*, are accompaniments to every complete kitchen-garden, and even the smallest has at least a reserve and frame ground. The two latter accompaniments are generally placed exterior to the walls of the garden, in that part of the slip which is nearest the stables, and the forcing department is sometimes placed there also; though more generally it consists of glass structures placed against the north wall of the garden. The best outer fence for a garden is a sunk wall, the ditch in which it is built serving as a main drain, into which all the drains in the interior may discharge themselves. The wall of this fence may be carried up three feet or four feet above the surface of the ground, to render it more formidable as a fence, without at the same time producing too much shelter and shade in the slip. In many places it is customary to surround the slip with a shrubbery bounded by a hedge, which has a very good effect for a few years while the trees are young, but when they grow large they produce an injurious degree of shelter and shade. The main entrance to a kitchen-garden should always be so placed as to look towards the main feature within, this feature necessarily being the south side of the north wall, not only because that wall supports the hot-houses when there are any within the garden, but because on it are grown the finest fruits. As an example of a kitchen-garden arranged agreeably to the foregoing observations, but combining also a flower-garden, as being frequently required in a suburban villa, we refer to fig. 330. It contains one acre within the walls, and half an acre in the slips; and the following references will explain the details.

- | | |
|--|---|
| <ol style="list-style-type: none"> 1. Flower-garden. 2. Conservatory. 3. Green-house. 4. Forcing-house for flowers. 5. Back-shed. 6. Area for setting out green-house plants in summer. 7. Culinary departments with espaliers. | <ol style="list-style-type: none"> 8. Espalier-borders. 9. Pond, surrounded with a stone margin. 10. Forcing department. 11. Water-basin. 12. Ranges of pits for melons, cucumbers, &c. 13. Pine-stove. |
|--|---|

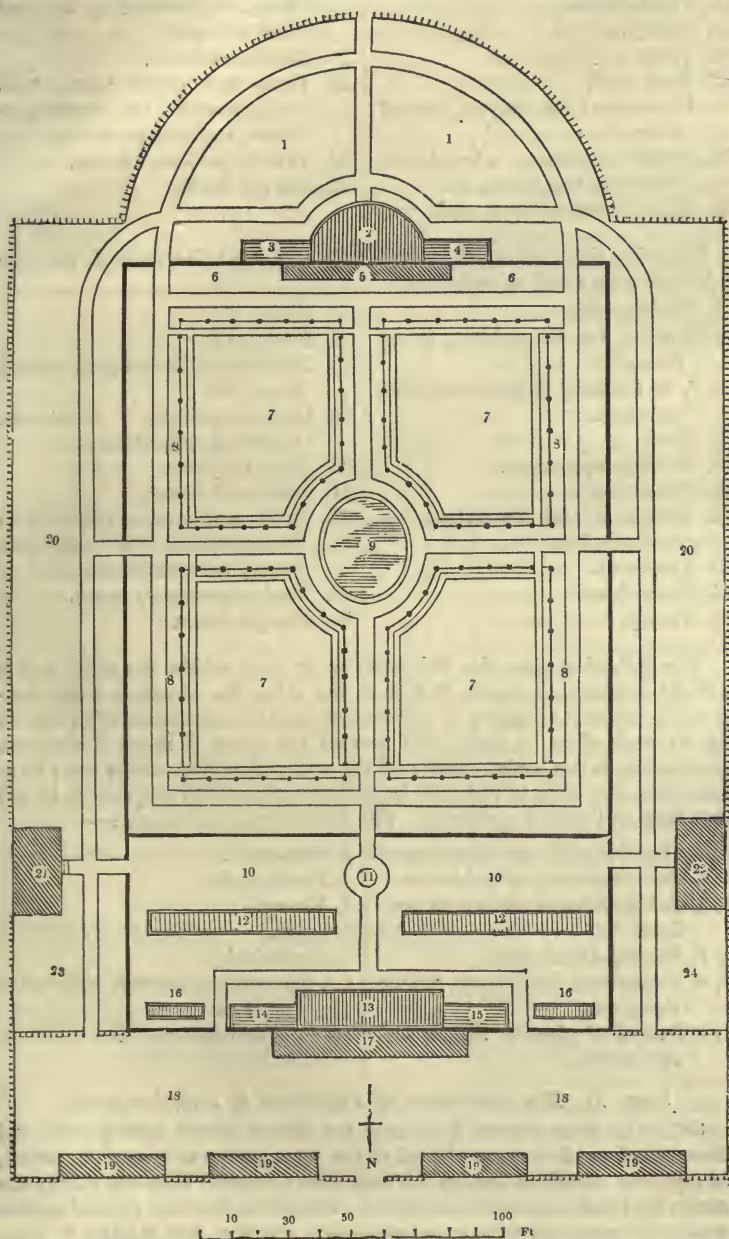

Fig. 330. Plan of a kitchen garden containing one acre within the walls, and half an acre in the surrounding slips.

- | | |
|---|--|
| <p>14. Peach-house.
 15. Vinery.
 16. Pits.
 17. Back-shed.
 18. Department for compost, mixing dung, &c.
 19. Mushroom-sheds, tool-house, wintering vegetables, &c.
 20. Slips, bounded by a sunk wall</p> | <p>fence, surmounted by an open iron railing.
 21. Gardener's house.
 22. Fruit and onion room, with lodging-room for under-gardener, and seed-room over.
 23. Yard to gardener's house.
 24. For pot-herbs.</p> |
|---|--|

Supposing the flower-gardens and hothouses are to be omitted, then the references may stand as under :—

- | | |
|---|---|
| <p>1. Fruit-garden.
 2, 3, 4, 5. To be omitted, if not desirable.
 6, 7, 8. Culinary departments with espaliers.
 9. Pond.
 10. Forcing department.
 11. Water-basin.
 12. Ranges of pits, for melons, cucumbers, &c.
 13. Pine-stove.
 14. Peach-house.
 15. Vinery.</p> | <p>16. Pits.
 17. Back-shed.
 18. Department for compost, mixing dung, &c.
 19. Mushroom-sheds, tool-house, wintering vegetables, &c.
 20. Slips, as before.
 21. Gardener's house.
 22. Fruit and onion room, with lodging-room for under-gardener, and seed-room over.
 23. Yard to gardener's house.
 24. For pot-herbs.</p> |
|---|---|

The following plan, fig. 33I, contains an acre within the walls, and is without a gardener's house, or slips at the sides, the situation being supposed to render it necessary to conceal the walls by a plantation of evergreen shrubs made close to them. To prevent the roots of these shrubs from penetrating to the borders inside of the walls, their foundations must be at least three feet deep in the most impervious subsoil, and deeper still on soil that they will readily penetrate. The following are references :—

- | | |
|---|---|
| <p><i>a, a</i>, Fruit-garden, the border next the outer fence for pot-herbs.
 <i>b, b</i>, Culinary departments with espaliers.
 <i>c, c</i>, Forcing department.
 <i>d, d</i>, Department for compost, mixing dung, &c.
 <i>e, e</i>, Ranges of pits for melons and cucumbers.</p> | <p><i>f</i>, Pine-stove.
 <i>g</i>, Peach-house.
 <i>h</i>, Vinery.
 <i>i, i</i>, Pits.
 <i>k</i>, Back-shed.
 <i>l, l</i>, Sheds for mushrooms, or for other purposes.
 <i>m, m</i>, Water-basins.</p> |
|---|---|

SECT. II. *The distribution of Fruit-trees in a kitchen-garden.*

887. The more delicate fruit-trees are always placed against walls, and those which are less so are planted in the open garden as standards, dwarfs, or espaliers. South of London the trees planted against walls are chiefly the grape, fig, peach, nectarine, and apricot. Sometimes there are planted against walls of a south aspect, one or two choice plums, a few cherries to come into early bearing; and on the north side of an east and west wall, some Morello cherries and sometimes currants, to come in late; the fruit being

covered with netting, to preserve it from birds and so retain it on the trees till Christmas. North of London, pears, and apples of the finer kinds, are

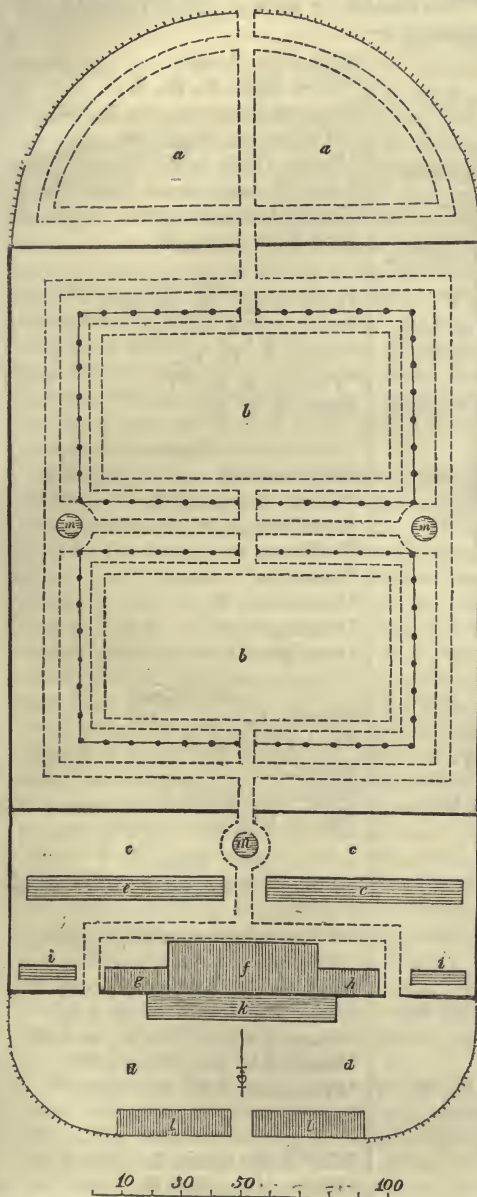

Fig. 331. Plan of a kitchen-garden, containing one acre within the walls, and three quarters of an acre in the slips, at the two ends.

trained against walls; and north of York, even the mulberry, which in Scotland never ripens fruit as a standard. Nuts, such as the walnut, sweet chestnut, and filbert, are almost always grown as standards; but the crops of the two former are very precarious north of York, and but rarely ripened in Scotland. The only suggestions that can be given for selecting the trees which require a wall in any given situation are, to observe what has been done in gardens in the same locality or in similar localities. The lists given consist of varieties which have all been proved to be of first-rate excellence, and are, with few exceptions, the same as those, for the selection of which, we had the assistance of Mr. Thompson, by permission of the Horticultural Society. In choosing from these lists for a garden in the north of Scotland, the grapes and the figs will be rejected altogether for the open walls, because they would not ripen there; while for a garden in the south of England the apples and pears would be rejected, because there the fruits would ripen sufficiently well in the open garden, as espaliers, dwarfs, or standards. We shall here give only the names of the kinds selected; other particulars will be found in our fruit catalogue.

SUBJECT. I. *Wall Fruit-trees.*

888. *Select List of Fruit-trees adapted for walls of different aspects, those marked * deserving the preference :—*

Apples.

- *Golden Pippin, S., S.E., or S.W.
- *Ribston Pippin, E. or W.
- *Nonpareil, S., S.E., or S.W.
- *Herefordshire Pearmain, E. or W.,
or S.E.
- Court of Wick, E. or W.
- Reinette du Canada, E. or W., or S.E.,
or S.W.
- Newtown Pippin, S.E. or S.W.
- *Cornish Gillyflower, S.E. or S.W.
- *Court-pendu Plat, S.E. or S.W., or
E. or W.
- *Golden Harvey, S.E. or S.W. or E.
or W.
- Scarlet Nonpareil, E. or W.
- Hughes's Golden Pippin, E. or W.
- *Pearson's Plate, E. or W.

Pears.

- *Jargonelle, S.E. or W.
- *Marie Louise, E., W.
- Gansel's Bergamot, E., W.
- Duchesse d'Angoulême, E., W.
- *Beurré Diel, E., W.
- *Hacon's Incomparable, E. or W.
- *Glout Morceau, S.E. or W.
- *Passe Colmar, S.E. or S.W.
- Nélis d'Hiver, S.E. or W.
- Beurré d'Arenberg, S.E. or W.
- Colmar, S.E. or W.
- *Easter Beurré, S.E. or W.
- *Beurré Rance, S.E. or W.

Cherries.

- *May Duke, S., E., W.
- *Royal Duke, S., E., W.
- *Knight's Early Black, S., E., W.
- *Elton, S. E. W.
- *Florence, E. or W.
- *Early Purple Guigne, S., E., W.
- Black Tartarian, S., E., W.
- Late Duke, E., W., N.
- *Morello, E., W., N.

Plums.

- *Royale Hâtive, S.E.W.

Drap d'Or, E. or W.

- *Green Gage, S., E., W.
- *Coe's Golden Drop, S., E., W.
- *Washington, S., E., W.
- *Purple Gage, S., E., W.
- Ickworth Impératrice, E. or W.
- Kirke's Plum, E. or W.
- Drap d'Or, S., E., W.

Apricots.

- *Large Early, S., E., W.
- *Moorpark, S., E., W.
- *Royal, S., E., W.
- *Turkey, S., E., W.
- Breda, E. or W.

Peaches.

- Early Anne, S.
- *Grosse Mignonne, S.
- Royal George, S.
- *Noblesse, S.
- *Malta, S.
- *Bellegarde, S.
- *Barrington, S.
- *Late Admirable, S.

Nectarines.

- *Elruge, S.
- *Violet Hâtive, S.
- White, S.
- Pitmaston Orange, S.
- Duc de Tello, S.

Figs.

- *Blue or black Ischia, S.E., S., or
S.W.
- *White or brown Ischia, S., S.E., or
S.W.
- Black Genoa, S.E., S., or S.W.
- White Genoa, S.E., S., or S.W.
- *Brown Turkey, S.E., S., or S.W.
- *Brunswick, S.E., S., or S.W.
- *Pregussata, S.E., S. or S.W.

Grapes.

- *The Early Black, S.
- *White Muscadine, S.
- Grove End Sweet Water, S.
- Pitmaston White Cluster, S.

Esperione, S.
Black Hamburgh, S.
Grisley Frontignac, S.

ably well on the open wall in the climate of London in fine seasons.

The Mulberry is sometimes planted against a west wall.

The last two grapes ripen remark-

889. Of all these different kinds of fruits, with the exception of the fig and the grape, both short-stemmed and long-stemmed trees are to be procured in the nurseries. The former, that is, the dwarfs, are for filling up the lower parts of the wall, and ultimately also the upper part; and the latter, the standards or riders, are for filling up the upper part till the dwarfs are so far advanced as to take their place, when the riders are taken up and thrown away. Riders therefore should always be of early-bearing sorts. The plants may be procured either one year grafted, or one, two, or three years trained, the latter trees being double or treble the price of the former, but filling the wall much sooner. As riders are but of temporary duration, it is customary to procure them three or more years trained, that they may bear fruit immediately. When the walls are under twelve feet high it is scarcely necessary to plant riders; for if three years trained trees are planted, the wall will be covered to the top in seven years.

890. *The distance* from each other at which the trees should be planted depends on the species of tree, the climate, the height of the wall, and to a certain extent also on the width of the border. The following distances are calculated for the dwarfs on a wall twelve feet high, with a border twelve feet wide, in the climate of London:—Peaches, nectarines, and figs, fifteen feet to twenty feet; apricots, fifteen feet for the early sorts, and eighteen feet to twenty-four feet for the late strong-growing sorts, as apricots and plums do not bear pruning so well as other wall-trees; cherries and plums, fifteen feet to twenty feet, or the stronger-growing plums, such as the Washington, twenty-four feet; apples on dwarfing stocks, fifteen feet—if on free stocks, from twenty-five feet to thirty feet; mulberries, from fifteen feet to twenty feet. Vines may be planted among the other trees at thirty feet or forty feet distance, and a single stem from each plant trained up to the coping of the wall, and then horizontally close under it, where if pruned in the spurring-in manner (797) it will bear abundantly, and produce more saccharine fruit than if it had been treated like a fruit-tree. If however the situation is favourable for vines, they may be planted from ten feet to fifteen feet apart, and trained either in the perpendicular manner (808), or horizontally with upright laterals, or in the fan manner; or several plants may be introduced together, and trained in Mr. Hoare's manner, or in the Thomery system, to be afterwards described. One rider, peach, cherry, or plum, may be introduced between every dwarf, if the latter should be maiden plants; but if they are dwarfs three or four years trained, riders are unnecessary excepting on walls above twelve feet high.

891. *For low walls* the distances above given may be increased one-fourth, when the height of the wall is only nine feet, and one-half when it is six feet. The mode of training for walls under nine feet should generally be the half-fan manner, shown in fig. 318 in p. 375. The intervals between the trees may be filled up for three or four years with gooseberries or currants; each plant trained to a single upright stem, and spurred in. By thus having only one shoot from a plant, the top of the wall will be reached by

that shoot in three or, at most, four years; and as the permanent trees encroach on the temporary ones on each side, the latter can be taken out one at a time, so as never to leave an unseemly blank on the wall.

892. *Training*, in the case of walls twelve feet high and upwards, should be the fan manner for the peach, nectarine, early apricots, and figs; the half-fan for the stronger apricots, plums, cherries, the more delicate pears, and the mulberry; and the horizontal manner for the apple and the greater number of pears.

893. *Planting*.—The plants should be placed on hillocks higher or lower according to the depth which the ground has been moved in preparing the border, in order that in two or three years, when the ground shall have finally settled, the collar or part of the stem whence the first roots proceed shall be between two inches and four inches above the general surface of the ground. The distance of the collar from the wall, when newly planted, should be for the more delicate-growing trees, such as the peach, from six inches to nine inches; and for the more vigorous-growing kinds, such as the apple, pear, and cherry, from nine inches to a foot. We say nothing as to the season of planting, or the mode of performing the operation, these and every part of culture generally applicable to ligneous plants, having been treated of in detail in those parts of the work with which the reader is supposed to be already familiar.

SUBJECT. II.—*Fruit-trees for espaliers and dwarfs.*

894. *Espaliers* are commonly planted in lines parallel to the main walks in kitchen-gardens; and next to the boundary-wall, and the correctly-edged and highly-kept gravel-walks, there is nothing which so much characterises the garden of a private gentleman, and distinguishes it from that of the market-gardener. No person, we think, who has a cultivated feeling for regularity and harmony of forms and lines, can think a walled kitchen-garden complete without espalier-railings bordering the walks. Lines of dwarf fruit-trees, or of fruit-shrubs, such as the gooseberry and currant, are so far good; but they are far from having the effect of espalier-railings. Their forms bear no relation to that of the walls, whereas the espaliers are counterparts of them, and keep up the harmony of form. There is commonly an espalier-rail on both sides of all the walks, excepting the surrounding one next the wall-border. On that border espalier-trees are not generally planted, though there are some exceptions. The espalier-rail is generally placed at three feet or four feet distant from the walk, and on the inner side of the rail there is commonly a foot-path, two feet wide, at two or three feet distance; so that these trees have a space eight feet wide, which may be considered as exclusively devoted to their roots. If the main walks are of flag-stone, supported on piers, or if they are formed of a thin layer of gravel on good soil, then we may add half the width of the walk, in addition to that already mentioned. If the six feet of border is not dug and cropped, but only slightly manured on the surface, and once a year gently stirred with the three-pronged fork, the trees will bear abundantly; but if the ground is dug and cropped, or if flowers are grown on it, the crop, from the roots being forced to descend to the subsoil, and to produce more wood than they can properly ripen, and the trees being thus forced to take a habit of luxuriance rather than of fruitfulness, the fruit produced will be few and without flavour.

895. *If dwarfs or standards trained in the conical manner are substituted for espaliers, the stems of the trees should be five feet or six feet from the walk, and the path in the inside should be at an equal distance from them.* This will give a border of ten feet or twelve feet in width, besides the width of the path; and if the ground is not dug and the trees carefully trained, an immense quantity of fruit will be produced. If the trees are standards, trained in the spurring-in manner, the line of trees need not be farther than three feet from the walk, and the footpath in the inner side may also be at three feet distance, which will give a border six feet in width. As the spurred-in trees will grow twelve feet high, and if on dwarfing-stocks, and the border not dug, will bear abundantly, we know no mode in which so much fruit can be produced on so limited a surface of ground, excepting always the espalier mode, by which the trees do not occupy above a foot in width. In order to prevent the roots of espaliers, dwarfs, cones, and all other border-trees from extending among the culinary vegetables, they may be cut off every three or four years about a foot from the inner path, and the soil being there enriched, abundant nutriment will be supplied to keep the trees in a bearing state.

896. *Espalier-rails* are variously constructed. The simplest mode is to drive in stakes, which may be of young larch trees, or of any other young wood disbarbed and steeped in Burnett's composition, at two feet apart, with temporary stakes of a slight description between; the latter being for the purpose of training forward the growing shoot of each horizontal branch from one permanent stake to another, during the growing season. Thus in fig. 332, Nos. 1, 2, 3, and 4, represent permanent stakes, and *a*, *b*, temporary ones. These latter may be removed from between Nos. 1 and 2 when they are no longer of any use there, and placed between Nos. 2 and 3 till the growing shoots obtain a bearing on the stake No. 3, when they may be removed to the space between Nos. 3 and 4, and so on.

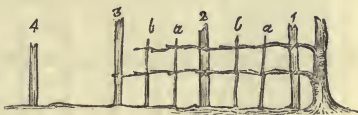

Fig. 332. *Progressive Espalier-rail.*

Another mode is to drive in stakes of the proper height, and eight inches or nine inches apart, beginning at the centre of each tree, and extending them on each side as the tree advances in growth. In the first stage of training, the stakes require to stand as close together as twelve inches or fourteen inches, and to be arranged in regular order to the full height of five feet, with a rail slightly fastened on the top of them for neatness' sake, as well as to steady them. If stakes of small ash, Spanish chesnut, or the like, from coppices or thinnings of young plantations, be used, they will last for three or four years, provided they are from one and a half to two inches in diameter at a foot from the bottom. They need not be extended further, in the first instance, than the distance to be considered probable the trees may reach in three years' growth: at that period, or the following season, they will all require to be removed, and the new ones may be placed on each side, to the extent that the trees may be thought to require while these stakes last, finishing the top, as before, with a rail. As the trees extend their horizontal branches and acquire substance, the two stakes on each side of the one that supports the centre leader of the tree can be spared, and removed to any of the extremities where wanted. And as the tree extends further and acquires more substance, every other stake will be found sufficient; and the centre

stake can be spared also, after the leader has reached its destined height and is of a sufficient substance to support itself erect. When such a form of training is completed, and the branches of sufficient magnitude, about six, eight, or twelve stakes will be sufficient for the support of the horizontal branches, even when they have the burden of a full crop of fruit. At any other time, about six stakes to each tree will be all that are necessary.

397. *A wooden espalier-rail*, of great neatness and durability, is formed of stakes of young larch-trees, or spruce firs, charred at the lower ends, driven two feet into the ground so as to stand five feet high, and connected by a rail at top, forming a cap to the uprights. The larch-trees should be girdled (777) a year before being cut, and it has been found that they will last longer if not deprived of their bark. There are many handsome espalier-rails of this kind in Scotland; for example, at Yester, in East-Lothian. When the Scotch pine is used for stakes the bark should be removed, as it does not adhere like that of the larch and the spruce fir.

398. *Espalier-rails of cast-iron* consist of a top and bottom horizontal rail, into which upright rails are fixed at from six inches to nine inches apart, with standards at every ten feet or twelve feet, which are let into blocks of stone, firmly fixed in the soil, as shown in fig. 333. *Wrought wooden espalier-rails* are also formed in the same manner as cast-iron rails, and the standards let into iron sockets, which are fixed in stone posts.

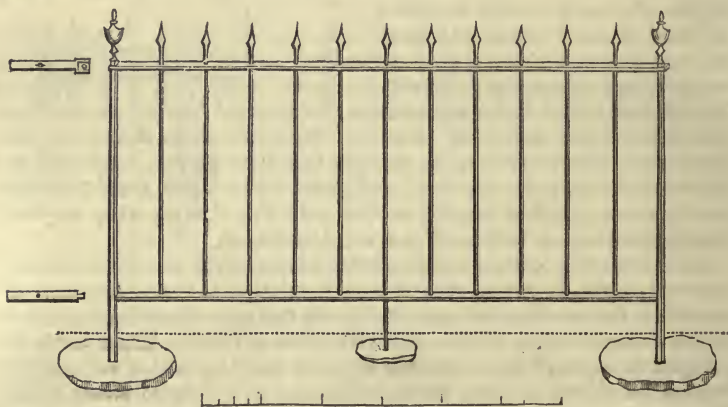

Fig. 333. *Cast-iron Espalier-rail.*

399. *Espalier-rails of wrought-iron* may be formed of hoop and wire iron, either single or double, as shown in figs. 67 to 69 in p. 231 and 232, of the *Sub. Arch. and Landscape Gardener*; or of strained iron-wire, as shown in fig. 334. This forms by far the handsomest, cheapest, and if occasionally painted, will doubtless also form one of the most durable of espalier rails. It was first erected in the kitchen garden at Carclew, and a full account of the manner of putting it up will be found in the *Gardener's Magazine* for 1839. The total cost at Carclew was from 1s. 6d. to 2s. per linear yard. Strained wire may be put up in this manner, either for espaliers or pleasure-ground fences, not only in straight lines, but in curves of every description. This is effected by means of underground braces, or underground perpendicular

posts, and these posts may be either of stone or of cast-iron, and they may be built into masses of masonry where the soil is soft, or has been moved, several feet in depth. No brace need ever appear above ground, as at *b, b*, in fig. 334; nor should the posts ever appear to rise out of the naked soil, as do *a, a, a*, in the figure, but always out of a block of stone. Where the soil is on turf, this block, which may be six inches square, need not rise more than an inch above the surface; but where the ground is to be dug, as in a kitchen garden, the upper surface of the block may be nine inches, or a foot square, and may rise two inches, or three inches above the surface of the soil.

The reasons for a stone base are as follow:—All materials which have been prepared for the purposes of construction are considered as thus rendered subject to the laws of architecture; and the first law is, that every superstructure must have an architectural base, on which it is placed. Thus, speaking with reference to design, every perpendicular line must rest upon a horizontal one; and speaking with reference to materials, this horizontal line must be of the same, or of a kind analogous to that of the perpendicular; of a kind which must at all events be equally, if not more firm and durable than it is. Live wood, that is, growing trees, may rise out of soil, but never architectural wood, that is, squared posts, which ought always to rise out of stone. If this be true of wood, of course it must be much more so of iron, which, though harder than either wood or stone, yet is not nearly so durable as the latter material, which consequently forms a proper base for it to rest on.

Espalier-rails and pleasure-ground fences of this kind are put up in the best and most economical manner by Porter and Co., of Thames-street, London; and by Cottam and Hallen, of Winsley-street, Oxford-street.

900. *Dwarfs* may be allowed to take their natural shape, but they harmonise much better with the regularity and symmetry of a walled garden when they are trained in regular shapes, which may be formed of wooden rods, stakes with the bark on, or iron-wire. Trees spurred in, or trained in the conical manner, require no framework as guides. It is scarcely necessary to add that all dwarfs, and all standards to be trained in the conical manner or spurred in, should be grafted on dwarfing stocks.

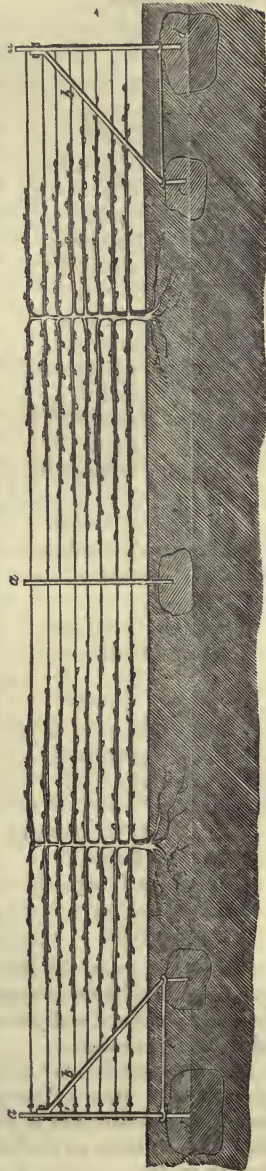

Fig. 334. Strained wire Espalier-rail.

901. *Select list* for espaliers, dwarfs, or standards trained, conically or spurred in; none are marked * as being preferable, as the whole are nearly of equal merit:—

Dessert Apples.

Oslin.
King of the Pippins.
Wormsley Pippin.
Golden Reinette.
Hughes' Golden Pippin.
Court of Wick.
Ribston Pippin.
Adams's Pearmain.
Pearson's Plate.
Golden Harvey.
Court Pendu Plat.
Reinette du Canada.
Braddick's Nonpareil.
Old Nonpareil.
Scarlet Nonpareil.
Boston Russet.
Downton Nonpareil.

Kitchen Apples.

Dumelow's Seedling.
Royal Russet.
Alfriston.
Brabant Bellefleur.
Kentish Codlin.

Pears.

Jargonelle.
Citron des Carmes.
Dunmore.
Hessel.
Beurré de Capiaumont.
Flemish Beauty.
Duchesse d'Angoulême.
Marie Louise.
Beurré Bosc.

Louise Bonne (of Jersey).
Napoléon.
Glout Morceau.
Nelis d'Hiver.
Hacon's Incomparable.
Chaumontel.
Passe Colmar
Knight's Monarch.
Ne plus Meuris.
Beurré Diel.
Easter Beurré.
Beurré Rance.

Cherries.

*May Duke.
*Morello.
*Kentish.
Royal Duke.
*Elton.
Knight's early Black.
Bigarreau.
Late Duke.
Florence.

Plums.

Royale Hative.
*Green Gage.
Orleans.
*Fotheringham.
*White Magnum Bonum.
*Blue Perdrigon.
Purple Gage.
Washington.
Ickworth Impératrice.
Coe's Golden Drop.
Kirke's.

Other fruit-trees, the mulberry, quince, medlar, service, and filbert, are sometimes introduced as espalier trees or dwarf standards, especially where there is no orchard, and perhaps some varieties of walnut and sweet chestnut might be so introduced.

902. *The plants* may be procured either one year grafted or some years trained. All those to be planted on espaliers should be trained in the horizontal manner; and in planting, the greatest care must be taken to place the plants on hills, so that when the ground has finally settled, their collars may be an inch or two above the surface. The distance at which they are placed from the espalier-rail may be from six inches to nine inches, and the distance from plant to plant may be as follows:—

To be trained as espaliers,—apples on crab stocks, twenty to thirty feet; cherries, fifteen to twenty feet; pears on free stocks, twenty-five to thirty feet—on dwarfing stocks, twenty to twenty-five feet; plums, twenty to twenty-five feet; mulberries, twenty to thirty feet, with gooseberries or currants as temporary plants between; quinces, medlars, and services, fifteen to twenty feet; and walnuts and sweet chestnuts, where they are tried on espaliers, thirty to forty feet.

To be trained as dwarfs,—apples and pears, ten to fifteen feet; cherries and plums, ten to twelve feet.

903. *Standard fruit-trees* we would on no account admit in the open garden, for reasons already given. If we made any exception, it would be in favour of a mulberry; but in that case we would surround it with a circle of turf, which, while it would save the dropping fruit from being injured, would prevent the ground from being dry. If in any case it were absolutely required to have standard fruit-trees in a walled garden, we would place them in a compartment by themselves, and never dig or crop the ground under them. This would be to plant an orchard within a walled garden, to which we see little objection except that it would require a greater extent of walling than if the orchard were exterior to the walls.

SUBSECT. III.—*Fruit-Shrubs.*

904. *Gooseberries and currants* are frequently planted as espaliers or dwarfs along the margins of walks; but to train these fruits on espaliers is to produce them at an unnecessary expense, unless the saving of room is a material object; and as dwarfs they are in general too low to make an effective separation of the walk and its border from the interior of the compartment. They are therefore, in our opinion, much better cultivated in plantations by themselves. The distance may be ten feet between the rows, and six feet between the plants in the row. Gooseberries and currants require an open airy situation, and a cool moist loamy soil.

Raspberries prefer a situation somewhat shaded, as in a west or east border; or for a late crop in a north border.

The *Cranberry*, where it is grown as a fruit-shrub, requires a peat soil kept somewhat moist, and with the bilberry and some other wild fruits may be conveniently placed in the slip.

905. *Select list of fruit-shrubs*, those marked * being preferable, especially for small gardens:—

Gooseberries, Red and Small Sorts.

*Red Champagne.

*Raspberry.

*Rough Red.

Red Turkey.

Small dark rough Red.

*Scotch best jam.

Miss Bold's.

Large Sorts.

*Boardman's British Crown.

Melling's Crown Bob.

*Keens's Seedling.

Hartshorn's Lancashire Lad.

Red Rose.

*Leigh's Rifleman.

*Farrow's Roaring Lion.

*Red Warrington.

Gooseberries, White, Small Sorts.

*White Crystal.

*White Champagne.

*Early White.

White Damson.

*White Honey.

*Woodward's White smith.

Large Sorts

*Dixon's Golden Yellow.
 Prophet's Regulator.
 Prophet's Rockwood.
 *Wellington's Glory.
 *Taylor's Bright Venus.
 *Cleworth's White Lion.
 *Saunders's Cheshire Lass.
 Stringer's Maid of the Mill.
 Cook's White Eagle.

Gooseberries, Green, Small Sorts.

*Early Green Hairy.
 *Hepburn Green Prolific.
 *Glenton Green, or York Seedling.
 *Pitmaston Green Gage.
 Green Walnut.

Large Sorts.

Lovart's Elisha.
 Hopley's Lord Crewe.
 Parkinson's Laurel.
 *Collier's Jolly Angler.
 Briggs's Independent.
 *Massey's Heart of Oak.
 *Edwards's Jolly Tar.
 Large Smooth Green.

Gooseberries, Yellow, Small Sorts.

Sulphur.
 *Yellow Champagne.
 *Early Sulphur.
 *Rumbullion.
 *Hepburn Yellow Astor.

Currants, Red.

Red Dutch.
 *Knight's Large Red.
 *Knight's Early Red.
 *Knight's Sweet Red.

Currants, White.

*White Dutch.
 *Champagne, which is pale red or flesh-coloured.

Currants, Black.

*Naples.
 Grape.

Raspberries.

Early Prolific.
 *Red Antwerp.
 *Yellow Antwerp.
 *Twice-bearing.
 *Barnet.
 Cornish.

906. *Plants* of gooseberries and currants may be procured from the nurseries, of one, two, or three years' growth; care should be taken not to plant them too deep; if against espaliers, they are trained in the perpendicular manner (808); but if in compartments, or along walks, as dwarfs, they are best left to take their natural shapes; thinning out the branches so as to give free access of light and air to the interior of the bush. Raspberries being suffruticose plants, the wood formed in one year dying down the next, can only be procured of one year's growth, and they require little pruning except that of shortening the shoots. Their management, and that of the gooseberry and currant, will be found in our *Fruit Catalogue*.

SUBJECT. IV.—*Selection of Fruit-trees adapted for an Orchard.*

907. Few kitchen-gardens can produce a sufficient supply of apples, pears, and nuts within the walls, and therefore it commonly happens that a *plantation* or *orchard* is formed either in the slip, or in some spot adjoining the kitchen-garden. This plantation should always be separated from the culinary departments by some appropriate line of demarcation. This may frequently be a dwarf wall, on which, if the aspect is suitable, young fruit-trees may be trained for the purpose of removal, to fill up occasional blanks in the principal walls. In the plan, fig. 330, in p. 419, the semicircular plot at the south end of the garden might be separated from the walled garden by a dwarf wall, at the same distance from the main wall as the side fences are distant from the main side walls, and the space so walled-off would form a very convenient area for the orchard; provided it were suitable in all

other respects. Sometimes the trees are distributed in groups over a lawn or paddock, so as to constitute the main part of the woody scenery of a small villa. They are also occasionally mixed in with ornamental trees and shrubs; a most incongruous assemblage in our opinion, and one which can never form an efficient substitute for an orchard. In whatever situation standard fruit-trees are planted, the subsoil should be rendered dry, and the surface soil put into good heart by manure. A loamy soil on a dry firm clayey or loamy, or rocky, subsoil, is preferable to a sandy soil on gravel, more especially for apples; but pears and cherries will grow on a drier and lighter soil, provided it be of some depth. Wherever the common hawthorn grows luxuriantly with a clear healthy bark, there orchard fruit-trees will thrive.

908. *The plants* may be dwarfs, if the plantation is to be exclusively devoted to fruit-trees, and the ground neither cropped nor laid down in grass; but standards are preferable, as admitting more light and air. A very convenient and economical mode is to plant rows of standards and dwarfs alternately: the dwarfs, being on dwarfing-stocks, come first into bearing, and may be removed as the branches of the standards extend themselves. Gooseberries, currants, and raspberries may be planted in the intervals, and retained there for two or three years; but they ought to be removed as soon as they are in the slightest degree shaded by the trees. As this is very generally neglected, we should prefer having no fruit-shrubs at all, but leaving the surface naked to be occupied entirely by the roots of the dwarfs and standards. All the plants ought to be set on little hills, more especially if the subsoil is such as to be readily penetrated by the roots, or if the ground has been previously trenched; the great object being to preserve the roots near the surface. The distances at which the trees may be planted are:— For standards, apples, and pears, from thirty feet to forty feet in a medium soil; or in a thin soil and exposed situation, from twenty-five feet to thirty feet; and in a rich soil, from forty feet to fifty feet. Cherries and plums, from twenty-five feet to thirty-five feet, according to soil and situation. For dwarfs on free stocks, one-half the above distances will suffice; and where dwarfs on dwarfing-stocks are to be planted among standards, three dwarfs may be planted for every standard: that is, there may be a row of dwarfs between every two rows of standards, and a dwarf alternating with every standard in the row. The standards, if they have been two or three years grafted, will probably require to be supported by stakes, to which the stems a short distance below the head ought to be carefully tied with hay-bands. Sheathing the stems of standard trees, especially when they have been late planted or have not abundance of roots, should not be neglected, for reasons already given. The sheathing, which may be of moss, fern, or straw, tied on with matting, or simply of straw or hay ropes wound round, may be left on till it drops off of itself. Mulching (831) is also of great use in late planting.

909. *Select list* of standard fruit-trees, adapted for an orchard or plantation subsidiary to a kitchen-garden; those marked with † being preferable:—

<i>Apples.</i>		†Oslin.
†Early red Margaret.		Duchess of Oldenburgh.
†Irish Peach.		White Astrachan.
†Summer Golden Pippin.		†Kerry Pippin.

Dutch Codlin.
 Kilkenny Codlin.
 †Manks Codlin.
 †Keswick Codlin.
 Alexander.
 †Hawthornden.
 Hollandbury.
 †Wormsley Pippins.
 †King of the Pippins.
 †Blenheim Pippin.
 †Golden Reinette.
 †Fearn's Pippin.
 †Hughes' Golden Pippin.
 †Claygate Pearmain.
 Hicks's fancy Gravenstein.
 †Court of Wick.
 †Pearson's Plate.
 †Beachamwell.
 †Dutch Mignonne.
 Scarlet Pearmain.
 †Ribston Pippin.
 Golden Pippin.
 †Margil.
 †Syke House Russet.
 Sam Young.
 Barcelona Pearmain.
 †Maclean's Favourite.
 †Pennington's Seedling.
 †Adams's Pearmain.
 †Hubbard's Pearmain.
 †Herefordshire Pearmain.
 †Golden Harvey.
 Coe's Golden Drop.
 †Court Pendu Plat.
 †Boston Russet.
 Lamb Abbey Pearmain.
 †Reinette du Canada.
 †London Pippin.
 Newtown Pippin.
 †Braddick's Nonpareil.
 †Downton Nonpareil.
 †Old Nonpareil.
 †Scarlet Nonpareil.
 †Cornish Gilliflower.
 †Dumelow's Seedling.
 †Royal Russet.
 †Alfriston.
 †Bedfordshire Foundling.
 †Brabant Bellefleur.
 Sturmer Pippin.
 †Rhode Island Greening.

Hambledon Deux Ans.
 Gloria Mundi.

Pears.

†Citron des Carmes.
 †Ambrosia.
 †Dunmore.
 †Althorp Crassane.
 †Summer St. Germain.
 †Flemish Beauty.
 †Marie Louise.
 †Duchesse d'Angoulême.
 Doyenné Blanc.
 Doyenné Gris.
 †Beurré de Capiaumont.
 Fondante d'Automne.
 †Autumn Colmar.
 †Beurré Diel.
 †Bon Chrétien Fondante.
 Louise Bonne (of Jersey).
 †Beurré Bosc.
 †Hacon's Incomparable.
 †Thompson's.
 †Napoleon.
 †Winter Nélis.
 †Glout Morceau.
 †Passe Colmar.
 †Knight's Monarch.
 Ne Plus Meuris.
 †Easter Beurré.
 †Beurré Rancé.

Obs.—A greater quantity of the last six varieties should be planted than of any of the other sorts. In fact, being the latest keeping sorts, the supply will chiefly depend on them for the half of the season; and consequently a proportionate number of trees of these varieties should be planted. Formerly many gardens had not a single winter or spring pear, though they possessed a superabundance of autumn ones. In future this will certainly be provided against; more especially if the proper means be resorted to for preserving the fruit during winter and spring: that is, packing them in earthenware vessels, or large new garden pots, and placing them in a cool, dry cellar.

Cherries.

- †May Duke.
- †Royal Duke.
- †Knight's early Black.
- †Elton.
- †Downton.
- †Bigarreau.
- †Black Eagle.
- Early Purple Guigne.
- †Late Duke.
- †Kentish.
- †Morello.
- Büttner's October Morello.

Plums.

- †Royal Hâtive.
- †Green Gage.

Dessert Plums.

- †Purple Gage
- †Washington.
- †Coe's Colden Drop.
- †Jackworth Impératrice.
- White Impératrice.
- †Kirke's.
- †Coe's fine late Red.
- †Drap d'Or.
- †Drapée Rouge.
- †Nectarine.
- Virgin.

Kitchen Plums.

- Shropshire Damson.
- Orleans.
- †Early Orleans.
- Mirabelle.

910. *Training.*—All the trees may be allowed to take their natural shapes, taking care, by pruning them for some years after they are planted, to give their main branches an upright direction, diverging from the main stem at an angle not greater than 45°, that they may be the better able to support a load of fruit. With many kinds, however, such is the divergent or pendulous character of the branches that this direction cannot be given to them, in which case the object should be, to increase the number of main branches so as to lessen the load to each. This is particularly necessary in the case of apples and pears.

911. *Culture of the soil.*—Where fruit is the main object, the soil ought never either to be cropped with vegetables or laid down in grass, because in both cases the trees are deprived of nourishment. In the case of grass, air is excluded; and in orchards where culinary vegetables are grown, the roots are prevented from coming up to the surface, and being forced into the sub-soil, feed there on a more watery nutriment, which produces shoots of spongy wood without blossom-buds, and in many cases infested with canker. Where the surface is kept in grass, there is less danger from canker and spongy shoots, provided the trees have been planted on hills; but in this case, from want of nourishment, the fruit will be smaller and less succulent. If, however, the soil is naturally good, and occasionally manured on the surface, more and better flavoured fruit will be produced in such an orchard than in one cropped with culinary vegetables. As no orchard can be pastured unless each separate tree is inclosed, which, where the ground is properly covered with trees, would probably cost more than the pasture was worth, it will in general be found better, where grass must be introduced, to mow it and supply manure, till the stems of the trees are so large as to be able to protect themselves. It is almost unnecessary to observe, that as soon as the branches of the trees approach within two feet or three feet of each other, the branches of the temporary trees should be shortened in (759), and soon after removed by degrees, so as at all times to leave a clear space of five feet or six feet round the head of every tree.

CHAPTER II.

CROPPING AND GENERAL MANAGEMENT OF A KITCHEN-GARDEN.

912. The fruit-trees and fruit-shrubs being planted, the former against the walls and espalier-rails, and the latter in plantations by themselves in the compartments, the remaining part of the garden is devoted to herbaceous vegetables. The number of these required to be grown in every kitchen-garden is considerable, and, as we have seen (177 and 535), the soil ought to be managed and the crops sown or planted according to some preconceived system. With respect to the soil, this consists in changing the surface in the manner explained (536), in stirring and manuring it, weeding, watering, &c., on the principles detailed in 832, 813, and 821; and we shall now explain the system of cropping and rotations.

SECT. I. *Cropping.*

913. *The herbaceous vegetables grown in kitchen-gardens* are of two kinds: perennials which remain several years in the ground, such as asparagus, seakale, rhubarb, horse-radish, artichokes, and perennial sweet herbs, and strawberries. The first of these crops remains on the same piece of ground seldom less than ten or twelve years, and the others are renewed generally about half that period or oftener. The other and by far the more numerous crops are annuals or biennials, and many of them only remain on the ground during a part of the year. The proportion of the perennials being fixed on, little more trouble is required with them; but the annuals being numerous and of short duration, the proportionate quantities that require to be sown or planted to supply the demands of the kitchen, and yet to be in due proportion to the extent of the ground to be cropped, and the kinds of crops which ought to succeed each other, require the constant exercise of the gardener's judgment. The first point is to determine the proportion of different crops, and the next is their succession: though the proportions will depend to a certain extent on the peculiar taste or wants of the family, and whether they reside on the spot or at a distance—whether they have a farm for growing the winter supply of potatoes, &c., yet some rules or hints may be devised which are generally applicable.

914. *General proportions of crops.*—The greatest breadth of surface in almost every garden requires to be sown with peas; but as this crop only lasts at an average about six months, a second crop may be planted on the same ground in the same year. The cabbage tribe, including cauliflower, bróccoli, savoys, Brussels sprouts and borecoles, occupy the next greatest space in most gardens, and they very generally succeed the crops of peas. Turnips are perhaps the next most extensive crop, unless indeed the main summer crops of potatoes are grown in the kitchen-garden, which is not desirable where they can be grown on the farm; the potato being a crop that, for some reason or other which we do not pretend to explain, is seldom found so mealy and high-flavoured when grown in a garden as when grown in a field. There are next several crops, each of which have nearly an equal claim for space, viz.—carrots, onions, beans, kidney-beans, celery, and winter spinach. Jerusalem artichokes and red-beet crops may come next in the order of space required; and then leeks, garlic and shallots, salsafy

and scorzonera. Lettuce, endive, radish, cress, mustard, chervil, parsley, and other summer salading, garnishings or herbs, may in general be grown among other crops, or in the front margin of wall-borders.

915. In determining the extent of each crop, the nature of the produce must be taken as a guide. It would be of little use to have a less quantity of any crop than would not at a single gathering produce a dish sufficient for a family of several persons. This for such articles as asparagus and peas requires considerable breadth of ground; but this breadth once planted and in bearing, will afford several or perhaps many gatherings during the time it is in season. On the other hand, where a succession of crops of turnips or carrots is wanted, if only two or three square yards were sown each time, that space would afford one or two dishes. For such articles as salsafy and scorzonera, which in most English families may perhaps not be asked for above two or three times in a season, a very small surface will be sufficient. When a gardener enters on a new place, before he determines on the extent of particular crops, he ought to consult the cook or housekeeper as to the style of cookery, the ordinary amount of company, and the seasons when extraordinary supplies are wanted, with the periods when vegetables and fruits require to be sent to a distance, with other particulars bearing upon the kind of crops to be grown. Having formed general ideas on the extent of each crop, he will next be able to determine on a system of succession, or, as it is called, rotation.

916. *The quantity of seed* for crops, proportioned as above described for a garden of an acre and a quarter, may be as follows:—Peas, thirty quarts; white cabbage of different kinds, six oz.; savoys, one and a half oz.; Brussels sprouts, two oz.; cauliflowers, three oz.; broccoli, seven oz.; borecoles, two oz.; red cabbage, one oz.; kohlrabi, one oz.; turnips, white, eight oz.; yellow, two oz.; early potatoes, one bushel; carrots, seven oz.; onions, eight oz.; beans, broad, six qts., narrow, three qts.; kidney beans, three qts.; scarlet runners, two qts.; celery, three oz.; Flanders spinach, one qt.; summer spinach, two qts.; Jerusalem artichoke, one peck; red beet, four oz.; parsneps, four oz.; leeks, two oz.; garlic, half lb.; shallots, three lbs.; salsify, half oz.; scorzonera, half oz.; lettuce, Cos, five oz., cabbage, three oz.; endive, two oz.; radish, three pts.; cress, one pt.; mustard, one qt.; parsley, two oz.

SECT. II. *Rotation of Crops.*

917. Crops in horticulture are made to follow each other according to two distinct plans or systems, which may be termed successional cropping and simultaneous cropping; the former is generally followed in private gardens, and the latter in market gardens.

918. *Successional cropping* is that in which the ground is wholly occupied with one crop at one time, to be succeeded by another crop, also wholly of one kind. For example, onions to be followed by winter turnips, or potatoes to be followed by borecole. *Simultaneous cropping* is that in which several crops are all coming forward on the ground at the same time. For example, onions, lettuce, and radishes, sown broadcast; or peas, potatoes, broccoli, and spinach, sown or planted in rows.

919. *The object to be attained by a system of cropping* is that of procuring the greatest quantity and the best quality of the desired kind of produce, at the least possible expense of labour, time, and manure; and in order that

this object may be effectually obtained, there are certain principles which ought to be adopted as guides. The chief of these is to be derived from a knowledge of what specific benefit or injury every culinary plant does to the soil, with reference to any other culinary plant. It ought to be known whether particular plants injure the soil by exhausting it of particular principles; or whether, as has been lately conjectured by De Candolle, and as some think proved, the soil is rendered unfit for the growth of the same or any allied species, by excretions from the roots of plants; while the same excretions acting in the way of manure, add to the fitness of the soil for the production of other species. The prevailing opinion, as every one knows, has long been, that plants exhaust the soil, generally, of vegetable food; particularly of that kind of food which is peculiar to the species growing on it for the time being. For example, both potatoes and onions exhaust the soil generally; while the potato deprives it of something that is necessary to insure the reproduction of good crops of potatoes; and the onion of something which is necessary for the reproduction of large crops of onions. According to the theory of De Candolle, both crops exhaust the soil generally, and both render it unfit for the particular kind of crop: but this injury, according to his hypothesis, is not effected by depriving the soil of the particular kind of nutriment necessary for the particular kind of species; but by excreting into it substances peculiar to the species with which it has been cropped, which substances render it unfit for having these crops repeated. Both these theories, or rather perhaps hypotheses, are attended with some difficulty in the case of plants which remain a great many years on the same soil; as, for example, perennial-rooted herbaceous plants and trees. The difficulty, however, is got over in both systems: by the first, or old, theory, the annual dropping and decay of the foliage are said to supply at once general nourishment and particular nourishment; and by the second, or new, theory, the same dropping of the leaves, by the general nourishment which it supplies, is said to neutralize the particular excretions. A wood of the pine or fir tribe standing so thick that their roots will form a net-work under the surface, will not poison each other; but remove these trees, and place a new plantation on the same soil, and they will not thrive; owing, as we think, to the principles most conducive to the growth of coniferous trees being exhausted, as is explained chemically by Liebig. The practical inference from either theory is much the same—that is, a change of crops; which is also in conformity with the experience and observation of those who believe in the old theory. The rules adopted by the best gardeners are as follow:—

1. Crops of plants belonging to the same natural order or tribe, or to the natural order and tribe most nearly allied to them, should not follow each other. Thus, turnips should not follow any of the cabbage tribe, sea-kale, or horseradish; nor peas, beans.

2. Plants which draw their nourishment chiefly from the surface of the soil should not follow each other, but should alternate with those which draw their nourishment in great part from the subsoil. Hence, carrots and beets should not follow each other; nor onions and potatoes.

3. Plants which draw a great deal of nourishment from the soil should succeed, or be succeeded by, plants which draw less nourishment. Hence a crop grown for its fruit, such as the pea; or for its roots or bulbs, such as

the potato or the onion ; should be followed by such as are grown solely for their leaves, such as the common borecole, the celery, the lettuce, &c.

4. Plants which remain for several years on the soil, such as strawberries, rhubarb, asparagus, &c., should not be succeeded by other plants which remain a long time on the soil, but by crops of short duration ; and the soil should be continued under such crops for as long a period as it remained under a permanent crop. Hence, in judiciously cropped gardens, the strawberry compartment is changed every three or four years, till it has gone the circuit of all the compartments ; and asparagus beds, sea-kale, &c. are renewed on the same principles.

5. Plants, the produce of which is collected during summer, should be succeeded by those of which the produce is chiefly gathered in winter or spring. The object of this rule is, to prevent two exhausting crops from following each other in succession.

6. Plants in gardens are sometimes allowed to ripen their seeds ; in which case two seed-bearing crops should not follow each other in succession.

These rules, and others of a like kind, apply generally to both systems of the successional crops ; and they are independent altogether of other rules or principles which may be drawn from the nature of the plants themselves ; such as some requiring an extraordinary proportion of air, light, shade, moisture, &c. : or from the nature of the changes intended to be made on them by cultivation, such as blanching, succulency, magnitude, &c. We shall now notice the two systems separately.

920. *Successional cropping*.—The plants calculated for this mode of cropping are such as require, during almost every period of their growth, the fullest exposure to the light and air, and remain a considerable time in the soil : these are, the turnip, the onion, the potato, the carrot, &c. If any of these crops are raised and brought forward under the shade of others, they will be materially injured both in quality and quantity ; though at the same time, while they are merely germinating, shade will not injure them. Hence successional cropping may be carried on in breadths of 20 or 30 feet, between rows of tall-growing articles, without injury ; which approximates this manner of cropping to the simultaneous mode, which, wherever the soil is rich, is by far the most profitable.

921. *The simultaneous mode of cropping* is founded on the principles that most plants, when germinating, and for some time afterwards, thrive best in the shade ; and that tall-growing plants, which require to receive the light on each side, should be sown or planted at some distance from each other. Hence, tall-growing peas are sown in rows 10 or 12 feet apart ; and between them are planted rows of the cabbage tribe ; and again, between these are sown rows of spinach, lettuce, or radishes, &c. Hence, also, beans are planted in the same rows with cabbages (an old practice in the cottage gardens of Scotland), and so on. The great object, in this kind of cropping, is to have crops on the ground in different stages of growth ; so that, the moment the soil and the surface are released from one crop, another may be in an advanced state, and ready, as it were, to supply its place. For this purpose, whenever one crop is removed, its place ought to be instantly supplied by plants adapted for producing another crop of the proper nature to succeed it. For example, where rows of tall marrow-fat peas have rows of broccoli between them, then the moment the peas are removed, a trench for celery may be formed where each row of peas stood ; and between the rows of broccoli

in the places where lettuces were produced early in the season, may be sown drills of winter spinach.

922. Of these two *modes of cropping*, the first is the one best calculated for poor soils, or for gardens where the supply of manure is limited; the second cannot be prosecuted with success, except in soils which are light and extremely rich. It may be proper to observe here, that a system of cropping can be carried to a much higher degree of perfection in a commercial garden, on a large scale, than in a private one; because in the former whenever one crop is in perfection, it is removed and sent to market at once; whereas, in a private garden, it is removed by dribblets. Hence in small gardens, where labour and manure are of less consequence than economising the extent of surface, it will often be found desirable to have a small reserve garden, with several frames, pots, and other requisites. As soon as one plant, or a few plants of any crop in a condition for gathering, are removed, the soil should be stirred, and a plant or plants (which should have been some days before potted in preparation) should be turned out of the pot, its fibres being carefully spread out, and water supplied, so as to make it commence growing immediately. The use of potting is to prevent the plant from experiencing the slightest check in its removal; and in autumn, as is well known, the loss of a single day, by the flagging of a plant, is of the utmost consequence.—(*G. M.*, vol. xii. p. 481.)

923. *Successional and simultaneous cropping combined*.—The following is from an excellent article on cropping, published in the *Gardeners' Chronicle*. The writer divides kitchen-garden crops into—1. Perennial or stationary crops—2. Rotation crops, which include all the principal annual crops, and—3. Secondary crops, such as salads, spinach, &c., which are usually sown in vacancies between rotation crops.

924. *Order of rotation*.—1st year, peas and beans, succeeded by broccoli, savoys, winter greens, collards, spring cabbage; 2nd year, carrots, parsneps, beet, scorzonera, and salsafy; 3rd year, onions, cauliflowers, turnips, succeeded by spinach, spring onions, and other secondary crops; 4th year, savoys, broccoli, winter greens, red cabbage, leeks; 5th year, potatoes; 6th year, turnips, cabbage, broccoli; 7th year, celery; 8th, French beans, &c.—(*Gard. Chron.*, 1841, p. 180, *with additions*.)

925. *Secondary crops* are those of the shortest duration, such as lettuce, radishes, small salads, annual herbs, and very early peas and beans (sown in November), very early cauliflowers, very early turnips, and early potatoes, all of which will require a warm south border.—(*Ibid.*)

926. *Times of sowing and planting*.—Peas and beans should be sown from February to June; the first crop of peas will be clear for early broccoli in the end of June, and for the other seasons until September for later broccoli, savoys, borecole, Brussels sprouts, collards or coleworts, and spring cabbage; this crop should have a slight coat of manure. Broccoli ground will be cleared of early sorts by winter, and should be ridged up all winter for a crop of carrots, which should be sown as early as possible; the later broccoli, colewort, sprouts, &c., will make way by April or the beginning of May for beet, parsneps, scorzonera, and salsafy. 1st year, carrots, beet, and parsneps, will be clear in the beginning of November, when the ground must be again ridged up for winter, and have a good coat of dung, ready for cauliflowers, onions, garlic, and shallots; 2nd year, the two latter being planted in November, and also the principal crops of turnips sown

in the end of March and April. Cauliflowers, onions, and turnips, will be clear from July to September; the cauliflowers and shallots, &c., in July;—for autumn, spinach and endive; the onions for winter spinach, and the turnips for spring onions, winter lettuce, and other secondary crops. Spinach, endive, and spring onions will be clear by the end of May for savoys, winter greens, red cabbage, cauliflowers, and leeks, all of which require a moderate coat of manure. Savoys, winter greens, red cabbage, &c., will be ready for early potatoes in April and May. Potatoes will make way in July and August for turnips, spring cabbage, late broccoli, and such crops, if wanted. Turnips, cabbage, broccoli, may be cleared in May for celery, and cardoon trenches—if all the ground is wanted; but if not, the cabbage may be allowed to remain for sprouts during all the summer. The intermediate spaces between the trenches may be planted with lettuce, or any other secondary crops; dung must be given for celery, of course. Celery and similar crops will in part make way in autumn, when the ground should be ridged up for winter, and the remainder as soon as the entire crop is clear; the ground will then be ready for French beans, scarlet runners, cauliflowers, cucumbers, and tomatoes, in the end of April or beginning of May. French beans will be clear by November, when the ground should be again ridged up all winter to be ready for peas and beans, as at first begun. This will make eight or ten years between the return of the principal crops to the same place; and by judicious management of the secondary crops (925) among the rotation crops, every space of ground between one crop and the other may be occupied to advantage during the intervals of cropping.—(*Gard. Chron.* for 1841, p. 180.)

SECT. III. *Planting, Sowing, Cultivating, and Managing.*

927. In general all crops should be planted or sown in rows from south to north, in order, as already observed (723), that the sun may shine on every part of the soil between the rows, and equally on every side of the plants in the row. Beds, also, such as those of asparagus, should be made in the same direction and for the same reasons. When asparagus, sea-kale, and rhubarb are to be forced in the open garden by hot dung, the alleys or paths between the beds should be of double the usual width, and all the beds intended to be subjected to a course of forcing should be placed together. The secondary perennial crops, such as mint, thyme, sage, savory, perennial marjoram, rue, &c., should always be planted together, and in an open airy situation, and not, as is frequently the case, in the shade.

928. *Management of the fruit-tree borders.*—The wall-borders, the borders in which the espaliers are planted, and the ground among plantations of fruit-shrubs or fruit-trees, should on no account be cropped or even deeply dug, for reasons which we need not repeat. The soil may be loosened on the surface in spring with a three-pronged fork, and in autumn a top-dressing of putrescent manure may be given and slightly turned in with the spade, or left on the surface till the spring-stirring. If the borders are narrow, and the trees, after having filled it with their roots, appear to require additional nourishment, a trench may be cut along the front of the wall-border next the walk, three feet or four feet in width, and of such a depth as to cut through all the roots, not, however, deeper than eighteen inches. A part of the soil taken out of the trench may be removed altogether, and a rich compost of rotten dung and leaf-mould mixed with the

remainder and filled in; or if mixed with good maiden loam, so much the better. This is in imitation of a plan, long followed with success, by the Lancashire growers of prize gooseberries; all the difference being that they use an excessively rich compost (see *Gooseberry*, in our FRUIT CATALOGUE), which we do not think would be so suitable for peaches, apricots, &c., as for that fruit and the vine. Where the tree trained on espaliers appeared to require a similar treatment, we would take up a narrow trench between the espalier and the walk, or on the other side of the espalier just beyond the footpath; and where dwarfs or standards seemed to require additional nourishment, we would dig a circular trench round them, at three feet or four feet from the stem; and in all these cases fill it up with rich compost. It might be advisable to do this work by degrees rather than all at once, by taking out every third yard, in the case of wall and espalier borders, and the third part of a circle in the case of dwarfs and standards. The second yard might be taken out in two years, the third in two years more, and at the end of the sixth year the operation might be recommenced, because the rich soil would very soon be filled with fibrous roots. In this operation, as in every other of the kind, the gardener or the amateur must exercise his own judgment, bearing in mind that the object is not to produce luxuriant branches, but blossom-buds.

929. *Management of the culinary crops.*—All culture must necessarily consist in the application of general practices, or in the performance of such operations as are required by particular species or for particular objects. The former are given in the different subsections on the operations of culture (p. 239 to p. 411), and the latter will be found when treating of the culture of each particular culinary plant in our catalogue of CULINARY VEGETABLES.

930. *Gathering, storing, and keeping of fruit.*—“The principles on which a fruit-room ought to be constructed are, darkness, a low and steady temperature, dryness to a certain point; for apples are found to keep best, as regards appearance, in a rather damp atmosphere, but for flavour a moderately dry air is preferable, and exclusion of the external air. If the light of the sun strikes upon a plant, the latter immediately parts with its moisture by perspiration, in proportion to the force exercised on it by the sun, and independently of temperature. The greatest amount of perspiration takes place beneath the direct rays of the sun, and the smallest in those places to which daylight reaches with most difficulty. Now, the surface of a fruit perspires like that of a leaf, although not to the same amount. When a leaf perspires while growing on a tree, it is immediately supplied with more water from the stem, and thus is enabled to bear the loss produced by light striking on its surface; but when a leaf is plucked it withers, because there is no longer a source of supply for it. So it is with a fruit: while growing on the tree, it is perpetually supplied by the stem with water enough to replace that which is all day long flying off from its surface; but as soon as it is gathered, that source of supply is removed, and then, if the light strikes it ever so feebly, it loses weight, without being able to replace its loss. It is thus that fruit becomes shrivelled and withered prematurely. Light should therefore have no access to a good fruit-room.”

“Temperature should be uniform. If it is high, the juices of the fruit will have a tendency to decompose, and thus decay will be accelerated; if, on the contrary, it is below 32°, decomposition of another kind is produced, in con-

sequence of the chemical action of freezing. In any case, fluctuations of temperature are productive of decay. A steady temperature of from 40° to 45°, with a dry atmosphere, will be found the best for most kinds of fruit. Some pears of the late kinds are better for being kept in a temperature as high as 60°, for this ripens them, renders them melting, and improves their quality very essentially. We do not, however, conceive that the general construction of the fruit-room ought to be altered on their account; we would rather make some special arrangement for such cases." (*Gard. Chron.* vol. i. p. 611.)

The air should be kept moderately dry, but ventilation should not be used except for the purpose of removing offensive smells, arising from the putrefaction of the fruit. Ventilation by continual currents of air carries off from fruit the moisture which it contains, and thus acts in the same way as light, in producing shrivelling, and destroying that plump appearance which gives its beauty to fruit. Another reason against ventilation is, that an equable temperature is scarcely to be maintained when the air is constantly changed. The sweating of fruit throws so much moisture into the air that ventilation is necessary to remove it; but the sweating ought always to be carried on in a place provided on purpose.

Great care should be taken in gathering, handling, and storing the fruit, placing each kind by itself, and keeping wall fruit apart from standard fruit. Gather in baskets, and place them on the shelves side by side with their eyes downwards. When gathering and stowing are completed, shut the room as close as possible, and only open it when the fruit is wanted. (*Ibid.* p. 61.) The best mode of packing fruit which is to be sent to a distance, has been already given, (360,) and the ordinary modes, as they have nothing peculiar in them, need not be described.

931. *Management of the fruit-room.*—The general principles of gathering and keeping fruit have been already laid down (356). No fruit ought to be allowed to drop from the tree, nor should it be beaten down or shaken off. Except in wet or late seasons, it ought not to be gathered till it is quite ripe, which in stone fruits and berries is known by its softness and fragrance, in kernel fruit by the brown colour of the seeds, and in nuts by the opening of the husks. It ought in every case to be gathered by hand; and in addition to ladders of different kinds there is the orchardist's crook, fig. 335, the use of which is to take hold of one branch with the hook, and draw it

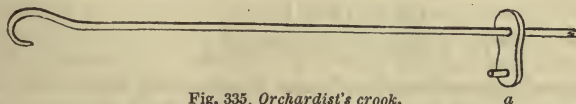

Fig. 335. Orchardist's crook.

towards the operator; and then, by putting the sliding piece, *a*, over

another branch, that branch is held in that position by the obliqueness of the line of pressure, which prevents the sliding piece from moving: thus leaving the operator free to use both hands in gathering the fruit. The fruit ought to be put into baskets, placing each kind in a basket by itself, and laying it in so gently as to run no risk of bruising it; and not only keeping each kind of fruit by itself, but keeping wall fruit apart from standard fruit, because the former will be soonest fit for the table. The fruit laid on shelves should be placed with their eyes downwards, and so as not to touch each other; but baking apples and pears may either be spread on a cool floor, or laid in heaps and covered with a blanket to produce a gentle fermentation, by

which the fruit is deprived of a portion of its moisture, and is thought by many gardeners to keep better, while others disapprove of it as giving the fruit a bad taste. In whatever manner fruit is placed in the fruit-room or fruit-cellar, the doors and windows of the apartments should be kept closely shut, so as to keep the atmosphere of as uniform a temperature and moisture as possible. It should, as we have already observed (930), never be lower than 40° , nor higher than 45° , if possible in close mild weather to keep it so low, with the dew point indicating a very slight degree of dryness occasionally. There are, however, exceptions, such as in the case of ripening off, or keeping such kinds in that temperature which experience proves to be most conducive for producing fine consistence and flavour. This requires one or more separate compartments having a command of heat, wherein the temperature may be graduated as circumstances may require. The external air ought only to be admitted when that within is rendered offensive by the decomposition of the fruit. If at any time the temperature should fall below 32° , still no artificial heat ought to be applied, but thawing allowed to take place in the dark, when the weather changes as gradually as freezing had done. Table apples and pears which are expected to keep for some months, are kept on shelves singly, or in shallow drawers, or packed in boxes, jars, or pots, with dried fern or kiln-dried straw. New garden pots are found to answer remarkably well for keeping fruit, any damp being readily absorbed by the dry, porous, unglazed materials of which they are usually composed. Fruits which are thus packed do not require to be examined till the time when they are expected to be fit for the table, which should always be marked, along with the name, on the label attached to the jar or box; but fruits exposed to the air on the open shelves require to be examined almost every day, in order to remove those which exhibit symptoms of decay. Walnuts, sweet chesnuts, and filberts, may be kept in boxes or casks, placed in the fruit-cellar on account of its low but uniform temperature. Summer fruit, such as peaches, nectarines, plums, are seldom kept more than a day or two in the fruit-room, but they are sometimes kept in the ice-house for a week or more, but with some loss of flavour.

CHAPTER II.

THE FORCING DEPARTMENT.

THE principles of constructing plant-houses, together with those of culture in artificial climates, having been already given (480 to 522), we proceed to show their application to the pinery, vinery, peach-house, fig-house, cherry-house, cucumber and melon pits and frames, and the forcing in frames and pits of such culinary vegetables as it is desired to have produced out of season. We have already seen (488 to 508) that artificial heat may be applied in plant structures by dung or other fermenting substances, by hot water, by steam, or by smoke-flues; or by two or more of these modes of heating combined. Fermenting substances are almost always the safest, and hot water generally the best; but, as we have observed (492), the same result may be obtained by smoke-flues, and is still obtained in many parts of the country, though not without extra care on the part of the gardener.

With respect to the form of house where low plants, such as pines, melons, cucumbers, strawberries, or kidney-beans, are to be grown or forced, low structures, such as pits or frames, are generally found most eligible; but where trees, such as the pine, peach, fig, &c. are to be grown, houses of the ordinary height of garden-walls are preferred, at least for general crops. The reasons are obvious in both cases.

SECT. I. *Culture of the Pine-apple, and Management of the Pinery.*

We shall first give the natural data on which the culture of this plant is founded, and next the routine practice of one of the most successful growers of the present day. The botanical and horticultural history of the pine-apple, and an account of the principal varieties cultivated in Britain, will be found in our *Fruit Catalogue*.

SUBJECT. I. *Natural data on which the culture of the Pine-apple is founded.*

The pine-apple is an evergreen monocotyledonous plant, a native of countries tropical or bordering on the tropics, and found in low situations on or near the sea-shore, or on wide rivers. It grows almost always on sandy soil, dry on the surface, but moist at the depth of a foot or two beneath. It is indigenous, or cultivated, in various similar situations, as in South America, at Rio Janeiro; in the West Indies, at Grenada; and in Africa, at Sierra-Leone. As an evergreen monocotyledonous plant, it is without buds, and consequently not intended by nature to be long, if at all, in a state of repose; as a native of the sea-shore, it is not calculated for enduring a great difference of temperature between summer and winter; and as a native of the sea-shore within the tropics, it is calculated for growing in a high temperature throughout the year. The temperature of various places at or near the equator, as given by Humboldt, exhibits an average of about 83° for the warmest month, and 72° for the lowest; thus giving a difference between the summer and winter heat adapted for the pine-apple of only 11° . But in the small island of Grenada, in the West Indies, where the pine-apple luxuriates, the temperature in the shade never exceeds 85° and never falls below 80° ; thus giving a difference of only 5° . It is clear, therefore, that there ought to be very little difference between the summer and winter temperature of the pine-apple. With respect to soil, in the neighbourhood of Rio Janeiro, it consists chiefly of a calcareous sand, always dry on the surface, but always moist beneath, in consequence, we suppose, of the vicinity of the sea or the river, and the attraction of cohesion between the particles of sand; but this water can never be altogether stagnated, owing to the rise and fall of the tides. The temperature of the soil in Grenada during summer, and at one foot beneath the surface, we are assured on good authority (*Gard. Mag.*, vol. vi., p. 438,) is 85° . With respect to the water of the atmosphere in the countries where the pine-apple thrives, there is generally a dry season and a rainy season—the latter much shorter than the former. In the dry season there are heavy nightly dews; and the rainy season, which is like the spring of temperate climates, produces such an exuberance of growth as to throw the plants into fruit. In the neighbourhood of Rio, there are heavy rains at intervals from October to April; the suckers from the roots are taken off in April or May, which is about the end of their summer, and planted in the fields from one foot and a half to two feet from each other. The strongest of them produces fruit in the following year, which weighs between 3 lbs. and 4 lbs. each; and those which do not fruit

the second year, produce fruit the third year, often weighing from 10 lbs. to 12 lbs. each.—(*G. M.*, iii. 443.)

932. *The conclusions to be drawn from these data*, and which are at the same time confirmed by the experience of the successful and unsuccessful growers in England, are,—that the temperature of the pine-stove ought never to be more than a few degrees lower than 80° in summer, or a few degrees lower than 70° in winter. As our days are much shorter in winter than they are between the tropics, a lower temperature ought to be allowed for that season, because growth in the absence of light would be of no service to the plant from its immaturity. In winter, therefore, 70° may be adopted as the standard heat of the atmosphere, and in summer the temperature may vary between 80° and 90°, or in the fruiting-house from 90° to 95°. With respect to the temperature of the soil, as the soil in all countries, at a short distance under the surface, is found to average 2° or 3° higher than the atmosphere, owing to earth having a greater capacity for heat than air, and parting with it more slowly, if we allow a bottom-heat of between 75° and 80° in winter, and between 85° and 90° in summer, we shall probably be in accordance with what takes place in nature.

933. With respect to *soil*, it is almost unnecessary to say that plants in a wild state are not always found in a soil that is best adapted for bringing them to a high degree of perfection, but rather in one that is best adapted for their propagation, in consequence of the surface of the soil being frequently moved, or renewed, or rendered moist. Experience has proved that the pine-apple will thrive in any free loamy soil, well enriched with mild manure, or in sandy soil so enriched, or in peat-soil; the latter being that in which it is generally grown, and that to a high degree of perfection, in the neighbourhood of Paris.

934. With respect to *water*, it is clear that, if a proper heat is kept up, that element of growth may be liberally supplied both at the root and by watering over the head in the evenings. The great art is to keep the plants continually in a state of vigorous growth till the fruit is cut, when nature intended that the parent stock should die; and therefore if it die leaving a crown or a sucker, these should be treated as new plants, and urged on to the production of fruit, till they die in their turn; and so on for ever. The plants may be planted in beds of soil or in pots. The latter is the most convenient mode, and that best adapted for artificial culture, because more completely under the control of the cultivator. From what has been stated, the grand cause of the *want of success* in the culture of the pine-apple with many persons will be sufficiently obvious. The temperature during winter is kept too low, by which means the vital energies of the plants are so far injured that they are never fully recovered. There are various other causes of failure, but this, we are convinced, is the principal one, because many gardeners apply the doctrine of rest to the pine-apple in the same way as they do to other plants.

SUBJECT. II.—*Culture of the Pine-Apple in British Gardens.*

The most abundant crops of pines raised in the shortest time, and in the most economical manner, that we have seen in the neighbourhood of London, have been at Oakhill, near East Barnet; and the following account of the practice there was furnished to us on purpose for this work by Mr. Forsyth,

now of Alton Towers, but at the time this account was drawn up, journeyman gardener under Mr. Dowding at Oakhill.

935. *Construction of the pit.*—Our nursing and growing departments are pits, 7 feet deep at back, 6 feet wide, and sloping at an inclination of 1 foot in three, heated by fermentation, having no fire-heat apparatus. Our principal fruiting pits (fig 336) are each 40 feet long, heated by one fire, and

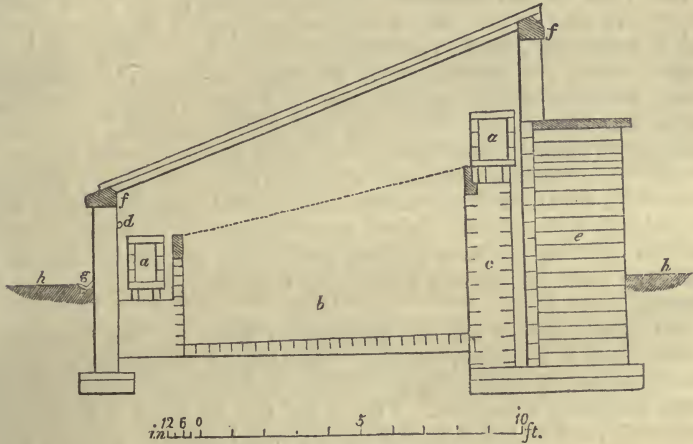

Fig. 336. Section of the pine pit at Oakhill.

- | | |
|---|--|
| <p>a, a, Flues
 b, Bark-bed.
 c, Rubble brickwork raised of a sufficient height to support the flue.
 d, Steam pipe for occasional use.
 e, Arches, supporting the pathway,</p> | <p>occasionally filled with fermenting matter.
 f, f, Coping stones to the walls.
 g, Gutter to receive the water from the sashes.
 h, h, Ground line.</p> |
|---|--|

supplied with steam, conducted along the front wall, a little above the flue, through an iron pipe of one inch bore from a portable boiler. The sashes, composed of a wooden frame with copper sash bars, and glazed with crown glass, are supported on cast-iron rafters. Shutters, composed of reeds fixed in a wooden frame to fit on each light, which are used in cold nights, give our pits the appearance of thatched cottages. As fermenting ingredients we use for linings, tan, dung, and leaves; and for beds in the pits, tan only. As fuel, we use coke from the gas works with a little coal and brushwood in kindling, and wet coal ashes in moderating the fires. This is far preferable to coals, being a cheaper and cleaner fuel, and making more efficient and easier-managed fires.

936. *Kinds grown.*—Our stock consists of nearly equal numbers of green and black pines; we generally have about 1200 plants, and we fruit about 500 annually. The sorts we cultivate are, Queens, Providences, Jamaicas for the principal stock, and Antiguas, Envilles, Brown and Striped Sugarloaves, Globes, and Antigua Queens; but of these latter sorts, we have only a few specimens.

937. *In watering and sprinkling* we use pure water, pumped into a leaden cistern, and exposed at least one day to the sun in summer; and from tanks, &c., in a tepid state, from the forcing-houses, in winter.

938. *Worms.*—We destroy worms in the pots by watering with lime-water, in the proportions of one bucketful of lime to three of water; and in the tan around the edges of the bed, by stirring powdered lime into the infested tan. Insects have been eradicated from young pine plants here by immersing them thirty-six hours in water medicated with soft soap, in the proportion of four ounces to a gallon.

939. *Heat, air, and moisture.*—We are extremely careful at all times to supply any want of heat, air, or moisture, and control their extremes; as also to remove all obstacles that might hinder the full action of light, especially in winter: to effect which we are obliged, sometimes more than once during winter, to take off the lights, and clear away a green glutinous substance that collects inside about the laps of the glass; using a scrubbing-brush and a piece of coarse flannel, with plenty of water, for the purpose.

940. We never tie up the leaves of pines in moving the plants, being persuaded that the leaves of any well-grown pine plant cannot be tied up without injuring them: neither can the height of a plant be so well reversed, nor the side that has been inclining towards the sun so well reversed in plunging, when the leaves are tied up, as when they stand in their natural position.

941. *Jamaica Pines* are esteemed here as being the best for maturing perfect fruits in the winter months. The plants of this species are of lazy growth, impatient of disrooting and shifting, and not easily started into fruit before they attain a good size. Their fruits, also, are heavy in proportion to their bulk; and unlike many others, they will swell their pips flat at all seasons. During the time that our pine plants are without roots, whether crowns, suckers, gills, or stools fresh potted, or plants disrooted, we prefer keeping them in a close, moist, atmosphere, at a temperature not under 65° by night, nor over 90° by day, shading them from the scorching rays of the sun, with a bottom-heat (at least till the roots have reached the sides of the pots) of 100°. Late suckers have been successfully wintered here, struck in a layer of half-spent bark, on a bed of good tan, in a pit near the glass. The greatest defect in this system is, that the plants are apt to get down too far from the glass, unless the frame or pit be moveable, and made to sink and follow them. Good Jamaica suckers generally mature their fruit here in two years, Providences about two months less, and Queens in from sixteen to eighteen calendar months.

942. *In starting pine plants into fruit* we simply increase the temperature, keeping up a moderate supply of moisture; the starving, parching, and scorching system of starting pines, formerly practised, being now, by all good cultivators, generally discarded; for examples are not wanting of large pine plants which had been thus starved, &c., whilst the fruits were ready to emerge from their sockets, showing crowns, on straw-like foot-stalks, without a pip at all.

943. *Air.*—In winter we often admit fresh air into our pine-stoves for other purposes than counteracting heat: as to prevent drawing and blanching, by allowing the condensed steam to escape, and to dry the plants.

944. *Propagation.*—The fruits having been cut (say off Providence plants), and no suckers appearing, we shake them out of the pots, pick off a few of their lower leaves, and shorten the rest; then cut off two inches or three inches of the stump to which the old roots are attached, and pot the stools in 32-sized pots, and treat them as suckers, when they will pro-

duce two or three races of suckers; and by this method we generally increase our stock of the shy-breeding black sorts. By cockscomb-like crowns (that is, several crowns grown together), also, we increase the Providence tribe rapidly. From gills (suckers on the foot-stalk of the fruit), potted in thumbs or 60-sized pots, after a length of time, we obtain good plants. Suckers, crowns, or gills, being got, are laid in some convenient space in the stove to dry, for a few days; after which we pare off the ragged part of the stumps of suckers, and pick off as many of the lower leaves of both crowns and suckers as seem necessary, in order to fasten the plant in the pot, and then pot them in pots proportioned to their sizes; if above a foot long, in 32-sized, and so of the rest to a gill of an inch long in a thumb-pot. The soil used for this purpose is generally pure loam, with about one-eighth of silver-sand. Being potted, they are wintered as detailed of our practice for Queens (949), and in the month of March every rooted succession pine-plant not in a fruiting-pot is turned out of its pot, and has its roots examined and shortened according to its age and sort, and the end it is expected to serve. Young plants of green pines we disroot freely; older ones now about to be shifted into fruiting-pots, expected to mature fruit late in autumn if the roots are lively, are potted now, preserving their balls entire; Providences, Envilles, &c., we disroot moderately, carefully cutting off any dead or sickly roots, and, by means of a pointed stick, removing all sodden and wasted soil. In shifting Jamaicas, we are careful to preserve every living fibre of root, yet we displace from their balls all drainage and worthless soil before repotting them.

945. *Bottom-heat.*—Being potted, they are plunged about two-thirds in a bottom-heat of not less than 95°, and the temperature of their atmosphere gradually increased (say March 22, 65° at sunrise; and April 11, 70° at sunrise; the maximum, June, 90°). As to the time of shifting again, that the state of the plants must determine: say June 1, and again, the middle of August; a uniform bottom-heat of not less than 90° being kept up throughout—maximum of atmospheric temperature 100°, minimum 70°. In the evenings of bright sunny days, we sprinkle the internal surface lightly with a fine rose to resemble a heavy dew.

946. *As the season declines the temperature is lowered*, and the standard for winter is fixed at 60°, say November 1; the fruiting-pits are filled with the best of the plants in fruiting-pots that were potted in August, the bark-bed having been previously filled with tan (if not all new, new being far preferable, at least all good), warm and well trodden, and the pots plunged about two inches, with tan laid up between them, to be levelled around the pots as the heat declines without disturbing the plants. When they are wanted to start into fruit, expected to be matured by June 1, we begin by increasing the minimum temperature, say on Dec. 10, to 65°; on 17th, to 70°; and on 31st, to 75°, which temperature is maintained till the fruits appear emerging from their sockets, with a rise of 4° by day with artificial heat, or with sun-heat 16°. The fruits being in sight (say Jan. 10), we reduce the night-heat to 72° till they have done flowering (say March 5), keeping the atmosphere moist, and supplying them with plenty of water at their roots, and reducing the temperature (fire-heat being injurious to fruit swelling) to 70° minimum, maximum 110°, by close and moist heat. We raise the bottom-heat if possible to 110°, moistening the dry surface of the bed, and filling in more fresh tan between the pots, to facilitate which the pots

are plunged in rows across the bed. During the time that the fruits are swelling, sprinkling is particularly attended to; as the fruits begin to change colour, plenty of air is admitted, and all sprinkling is dispensed with. Under this mode of culture are obtained splendid specimens of fruit at all seasons, which, though inferior in size to the twelve or fifteen pound specimens grown elsewhere, may rank as a generally fine crop with that of the first cultivators of the day, taking the age of the plants into consideration. The fruits of 100 plants contained in a pit here, weighed, when cut, each from 5 lbs. to 7 lbs.—(*G. M.*, vol. xi. p. 258.)

947. *Culture of the Queen pine so as to have the fruit ripe in February and March.*—At this season Queen pines are worth two-thirds more in the market than they are in July and August.

Pit.—Fig. 337 is a section of the pit, and figs. 338 to 342 are sections of the pots in which the culture about to be described was carried on.

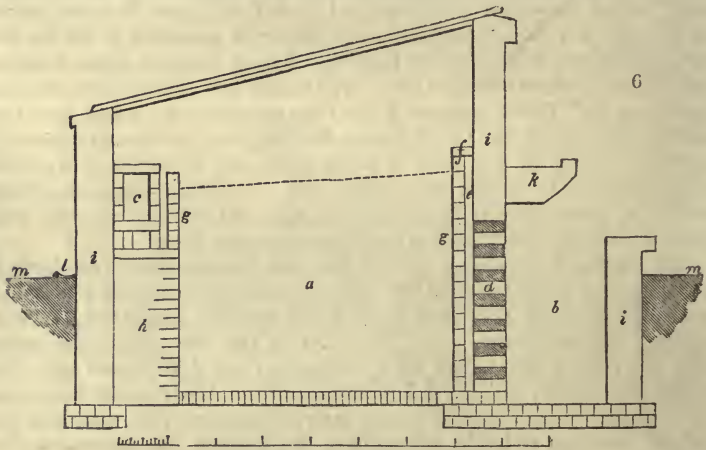

Fig. 337. Section of a pit for fruiting Queen Pines at Oakhill.

- | | |
|--|---|
| <p>a, The bark-bed.
 b, Pit for linings.
 c, Fire-flue along the front and both ends.
 d, Open brickwork.
 e, Open cavity.
 f, Tile cover of open cavity, with plug-holes.</p> | <p>g, g, Walls of bark-bed.
 h, Rubblework.
 i, i, i, Brick walls, coped with stone.
 k, Stone bracket supporting a plank for walking on.
 l, Gutter to receive the water from the sashes.
 m, m, Ground level.</p> |
|--|---|

948. *Sizes of the pots in which the plants are grown.*—The sections (figs. 338



Fig. 338.

A No. 48 pot.

to 342) represent the different kinds of pots employed. Fig. 338 is a No. 48, $5\frac{1}{4}$ inches wide at top, $2\frac{3}{4}$ inches wide at bottom, and $4\frac{1}{4}$ inches deep. Fig. 339 is a No. 32, $6\frac{3}{4}$ inches wide at top, $3\frac{3}{4}$ inches wide at bottom, and $5\frac{1}{2}$ inches deep. Fig.



Fig. 339. A No. 32 pot.

340 is a No. 24, $8\frac{1}{2}$ inches wide at top, 5 inches wide at bottom, and $6\frac{3}{4}$ inches deep. Fig. 341 is a No. 16, $9\frac{3}{4}$ inches wide at top, $5\frac{1}{2}$ wide at bottom, and 8 inches deep.

Fig. 342 is a No. 12, $11\frac{1}{4}$ inches wide at top, $6\frac{1}{2}$ inches wide at bottom, and $10\frac{1}{2}$ inches deep.



Fig. 340. A No. 24 pot.

Though it seldom happens that a Queen pine plant can go through all these sizes if well grown, yet it is considered necessary to give the dimensions of the complete set of pots used at Oak Hill, as they are often referred to both in this and in the preceding

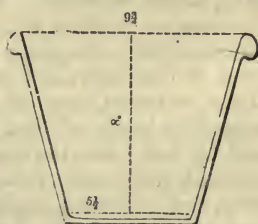

Fig. 341. A No. 16 pot.

949. *Culture of queen pines for early fruit.*—The suckers being from twelve inches to twenty inches in length, and proportionately strong, were taken off the stools in the beginning of August; and having lain exposed, in the pine-stove, in that state about a week, were dressed and potted in No. 32-sized pots, in poor light soil, and plunged two-thirds the depth of their pots in a bark bed, in which a thermometer inserted that depth stood at 80° . Till the roots had reached the sides of the pots we did not water the soil, but syringed the plants overhead at shutting up in the evenings of warm days, about twice a week.

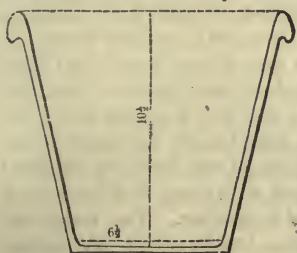

Fig. 342. A No. 12 pot.

As the plants increased, they were watered at their roots, as they appeared to be in want of that element. The temperature of the house by day was not allowed to exceed 80° , and till about the middle of September would generally be found about 65° a little before sunrise; using no artificial heat (besides the bark-bed) as long as the natural temperature of the atmosphere exceeded 55° , at which temperature (viz. 55°) we kept the house by night during the winter months, till the third week in March, when we shook the plants out, and shortened their roots about one-half, and repotted them in the same-sized pots prepared as follows:—The pots, if not new (new ones being preferable), being well cleaned, an oyster-shell about the size of a penny is placed over the hole, around which broken bones (such materials being best), or potsherds broken to about the size of kidney-beans, and sifted to exclude the dusty particles, are laid about half an inch deep; over which is placed a layer, about a quarter of an inch deep, of the thready part of half-decayed loamy turf; and the remaining space is filled up with the following compost: turfy loam chopped to the size of walnuts, bruising it as little as possible, six parts; night soil, one part; leaf mould, one part; and silver sand, one part. The plants being potted in this compost, were plunged in a bark bed, in a dung-heated pit, two-thirds of the depth of their pots (at which depth a thermometer inserted stood at 90°), shading them from the more powerful rays of the sun, and keeping them as close as possible, yet not allowing the temperature to exceed 90° , the minimum by night being generally from 65° to 70° . In the course of about fourteen days, we exposed the plants to the full sun; from which time they required to be plentifully supplied with water, and the greatest attention to be paid to the watch-sticks (sticks stuck in the bark, to be occasionally taken out

and felt, to ascertain the heat), lest the roots, on reaching the sides of the pots, should be burned. At this stage we gave air at 80°, and allowed the temperature to rise to 95°. As the season advanced, we sprinkled the plants overhead more frequently: in April, about once a week; in May, about once in four days; and in the hottest weather, every other evening. In June, we turned them out of the pots, leaving their balls entire. We then potted the largest of them in No. 12-sized pots, leaving the surface of the soil $1\frac{1}{2}$ inch below the top of the pot; the balls of the rest we partially reduced, and potted in No. 24-sized pots. The bark bed was then forked over, and made good by sifting out the rotten bark from the top and sides, and adding fresh at the bottom. After the bed had been well trodden and levelled, we replunged the plants in it about two-thirds the depth of their pots, keeping them close and shading them, &c., as before. The temperature at sunrise was now about 75°; the maximum by day was 100°, giving air, as before, at 80°. The second week in August, we shifted the plants in No. 24-sized pots into No. 12's, top-soiling at the same time those already in 12's. The pots of the latter size at this time were full of roots; and their lower leaves confining young roots in their sockets, we displaced them, and replunged the pot about three inches deep in a heat which at that depth was 100°, plunging and treating the plants newly potted as we did those potted in June. The plants being now finally stationed in the finishing pit above described (fig. 337), on a bark bed $4\frac{1}{2}$ feet deep, with dung and fire-heat at command, showed fruit generally on the 1st of September. The maximum by day, with plenty of air, was now 110°, and at sunrise about 80°. About Sept. 20th, several of the plants were in flower. As the season declined, we lowered the temperature, our standard for the winter being 60° at sunrise, and the maximum by day 90°. In cloudy damp weather, we fired by day to 65° or 70°, for the purpose of giving air to carry off the damp. When a dry sunny day occurred, we generally seized the opportunity to sprinkle the plants overhead with clean water, in a tepid state, in the early part of the day, for the purpose of dislodging the mouldiness that settled on the fruit from the closeness and humidity of the atmosphere. As the fruit began to colour, towards February, more fire-heat and more air were given. The maximum by day, with sun-heat and a flue seldom cold, was now 100°, and at sunrise 60°. Under this mode of treatment three specimens were grown, which were exhibited at the gardens of the London Horticultural Society on May 10, 1834, along with three dishes of grapes, for which their gold medal was awarded to Mr. Dowding. (*Idem*, p. 24.)

950. *Growing the pine-apple in beds of soil.*—This has not been much done in Britain; but in Munich, in 1828, it had been practised for five years in the royal kitchen-gardens there. It is attended with far less trouble than any other mode of pine culture, and has this immense advantage,—that as there are suckers on the stems in all stages of growth, fruit is produced at all seasons of the year. At Munich, the court-gardener, Mr. Lang, informs us (*G. M.* v. 430) that he had practised the mode of growing pine-apples in beds of soil in low pits for five years, and had cut ripe fruit from the plants every month in the year during the whole of that period. The only objection that can be brought against this mode is, that the fruit is not very large; but we can affirm, from having seen the fruit thus produced at Munich, and also in the royal forcing-ground at Versailles, that it is of a very fitting size for a small family. By the aid of hot water, peat soil,

abundant surface-manuring, and earthing up, a greater weight of fruit might perhaps be grown in a limited space and time by this mode than by any other. The source of bottom heat might be a tank of water or of liquid manure, of the same length and breadth as the interior of the pit, and over this the soil might be supported on a flooring of pierced tiles, so as to admit of the roots passing through them into the liquid manure. Or, it might be a bed of stones or coarse gravel, heated by steam, a mode which has been successfully employed in various parts of the country. (See *G. M.* vi. p. 50.) Whichever mode of heating be adopted, all the minor details will readily occur to those who have perused the preceding chapters of this work.

§51. *Fruiting suckers on the stools*, and retaining the suckers on the stools for some months or weeks after the fruit has been cut, are practices occasionally resorted to for the sake of gaining time, and of employing the vigour remaining in the old stock. Sometimes the suckers are earthed up, and retained on the stock till they produce their fruit; and sometimes they are taken off and potted, and being supplied with abundant heat and moisture, soon show fruit afterwards. Mr. Marsland, of Stockport, has been very successful in his treatment of the pine in this manner, and the following extract will give a good idea of his practice:—"In November, 1819, as soon as the fruit had been cut from the pine-plants, which were then two years old, all the leaves were stripped off the old stocks, nothing being left but a single sucker on each, and that the strongest on the plant. They were then placed in a house where the heat was about 60°, and they remained till March, 1820. At this period the suckers were broken off from the old stocks, and planted in pots from eight to twelve inches in diameter, varying according to the size of the sucker. It may be proper, however, to observe that the length of time which the young sucker is allowed to remain attached to the mother plant depends, in some degree, upon the kind of pine: the tardy fruiters, such as the black Antigua and others, require to be left longer than the queen and those which fruit readily. After the suckers had been planted, they were removed from the house, where they had remained while on the old stock, to one in which the temperature was raised to 75°. Immediately upon their striking root, the largest of the suckers showed fruit, which swelled well, and ripened between August and November, being on the average ten months from the time the fruit was cut from the old plant, and seven months from the time the sucker was planted. The fruit so produced, though, as may be expected, not of the largest description, I have invariably found to be richer and higher flavoured than that grown on older plants. The suckers of inferior strength will not show fruit in the same season, but in the following they will yield good fruit, and strong suckers for a succeeding year's supply. Those suckers are to be preferred which are produced on plants that have ripened their fruit in November; for those taken from plants whose fruit is cut in August, or earlier, are apt to show fruit in January or February, while yet remaining on the mother-plant. But whenever this happens, the sucker should be broken off immediately upon being perceived, and planted in a pit so as to form a root of its own to maintain its fruit." (*Hort. Trans.* vol. iv. p. 392.)

§52. *To grow the pine-apple to an extraordinary size*.—Begin with a healthy vigorous sucker or crown, and supply it with abundant nutriment, heat, and light, in so far as the two latter elements are under control, shifting it frequently from the smallest-sized pot to the largest, and gradually

increasing the temperature from 70° to 90° or 95°, with atmospheric moisture in proportion. In this way queen pines have been grown to the weight of five or six pounds, and New Providence pines from twelve pounds to fifteen pounds.

953. *Insects*.—Where a proper temperature and atmospheric moisture are kept up, the pine will be little troubled with insects; but in consequence of careless treatment they are sometimes infested with a species of coccus, which is got rid of by immersing the plants, when being shifted, in a mixture of soft soap, sulphur, and tobacco water. The proportions do not seem of much consequence, for they are very different with different gardeners. Mr. Dall takes 4 lbs. of soft soap, 2 lbs. flower of sulphur, 1 lb. of leaf tobacco, and 2 oz. of nux vomica, and boils them in eight gallons of rain water. After shaking the plants out of the pots and trimming their roots, he washes them well with this mixture, and also the sides and ends of the interior of the pit, and all the inner part of the house, excepting the roof. Mr. Glendinning takes—sulphur, 2 lbs.; soft soap, 2 lbs.; tobacco, 1½ lbs.; nux vomica, 2 oz.; camphor, 1 oz., dissolved in a wine-glassful of spirit of turpentine; and boils the whole in eight gallons of water for an hour. When the mixture has fallen to 120°, he immerses each plant in it separately, keeping the liquid as near as possible to that degree of heat. (*Practical hints on the culture of the pine-apple*, p. 51). Plants subjected to the mixture either of Mr. Dall or Mr. Glendinning have an unsightly appearance for some months afterwards; but when they commence growing, the new part of their foliage assumes the usual healthy, vigorous hue. Where there is room in the pine pit for laying down a quantity of fermenting horse-dung, the steam produced is perhaps the best destroyer of every description of insect and it does no injury to pines. This was Baldwin's remedy.

II.—Culture of the grape-vine under glass and on walls.

SUBJECT. I.—Natural data on which the culture of the grape-vine is founded.

954. *The grape-vine* is a deciduous ligneous climber, indigenous or cultivated in a considerable portion of the temperate parts of the northern hemisphere. It is found wild in Greece, Turkey in Asia, and Persia, the Morea, and near the Black and Caspian Seas, and in many other places; but the countries in which it is found in the highest degree of perfection are Armenia and Syria. In Armenia and Syria, judging from their latitudes, the mean temperature of the coldest winter month in the region of vine culture is probably between 45° and 50°, and the mean temperature of the warmest summer month between 75° and 80°. It is certain, however, that the vine will bear a much lower winter temperature than 45°; for on the hills in Germany, where several kinds are cultivated with success, and the vines are every winter buried under the snow, the temperature for two or three months cannot be much above 32°. It is also found in our forcing-houses that the vine will bear a summer temperature of between 70° and 80°. It may, we think, be assumed that the vine is not calculated to sustain uninjured a winter temperature much below 40°; and this is confirmatory of the excellence of the practice of British gardeners, in wintering the shoots of vines grown under glass under some kind of protecting cover: such as between outer and inner front sashes, or tied loosely up in mats or in thatch, so as to keep them quite dry without excluding the air.

955. *With respect to atmospheric moisture*, it can only, as far as we know,

be stated on general principles, that when the vine is in a growing state the air must be kept moist, more particularly in the evenings and during night. This may always be effected by syringing the plants before shutting up the house in the afternoons, and when the sun goes off a south wall, and by watering the soil. When the fruit is ripening, the air should be drier; not only because growth being completed, less moisture is wanted, but because excess of moisture, either in the soil or in the atmosphere, is known to be injurious to the flavour of all fruits.

956. The *soil* in all countries where the vine is cultivated successfully is dry, and experience has proved that it admits of being enriched to an almost unlimited extent. The temperature of the soil may be determined from general principles to be a degree or two higher than that of the atmosphere; "therefore the most favourable climate for the vine lat. 35°, which passes through Syria, will have a mean terrestrial temperature of 67°. In spring, when vegetation begins in the vine, it may be estimated at not lower than 60°. By the time the blossom expands it will have reached 70°, or nearly so; and 80° will certainly be within the limits of its summer temperature."—(*Penny Cyc.*, art. *Grape-Vine*.) "The mean temperature of the earth in the climate of London is about 51°, from which that of spring-water differs little throughout the year. In winter, when early forcing of the vine is commenced, the border in which the roots are extended will sometimes be below 40°, and if we even say 45°, whilst the vine has its branches and blossoms in a temperature of 75°, still we have a disparity of 30°! These conditions are not by any means transient, for the earth retains its state of winter cold till late in the spring. In summer, from the greater length of the days at this season than in more southern latitudes, the earth acquires a tolerably high and nearer corresponding temperature; but before this occurs the crop of grapes has received checks which more favourable circumstances cannot remedy. To this disparity of temperature between the root and the top of the vine may be certainly ascribed the *bad setting*, *spotting*, and *shrivelling* of grapes."—*Ibid.* A writer in the *Gardeners' Magazine*, vol. xiii. p. 16, has forcibly illustrated the importance of a corresponding atmospheric and terrestrial temperature, and he concludes by recommending all exterior vine-borders to be securely thatched, so as to exclude all rain and melting snow during winter and spring, and not to remove the covering till the temperature of the natural rain which falls on the border is 60°. The thatching, he says, if put on in time in autumn, will preserve a temperature in the soil through the winter of between 45° and 50°, and the rain falling on the soil at a temperature of 60° will part with 10° of its heat, and, after moistening the soil, pass off by the drainage. Repeated showers at an increased temperature, aided by the effect of the sun, will gradually raise the temperature of the border from 45° or 50° to 75° or 80°, according to the warmth or coldness of the summer. The process, he says, may be greatly accelerated by stirring the surface, or inverting it by digging where it has been well heated by the sun's rays, so as to turn up a fresh portion to their influence. A considerable degree of heat might thus be as it were "worked in," and the remainder of heat required would be effected by the percolation of showers and the direct influence of the sun. The effect of melting snows and early spring rains, at probably 40°, in cooling the soil, shows the necessity of choosing a porous and naturally thorough-drained soil for vineyards in countries having cold winters; because as it is imprac-

ticable to prevent the snow from melting or the spring rains from falling and cooling the soil, the only mode of counteracting the evil is so to arrange that the water shall be carried rapidly off by the subsoil. Every shower which succeeds will be at a somewhat higher temperature, at least till mid-summer, and as it filtrates through the soil will leave in it a portion of its heat, till showers falling at 70°, or upwards, will leave the soil at that temperature.

957. *Form of house.*—It is almost unnecessary to observe that the vine may be cultivated in any form of structure with a glass roof, from a cucumber-frame to a house; the most common form and dimensions of which in use in British gardens are as follow:—Length, thirty feet; width, fourteen feet; height at back, nine feet, at front, two feet. The end and front walls to be on arches, and the whole to be heated by one fire. The furnace to have a door one foot square, and the sides of the fuel-chamber to be of Welsh lumps; and the rise from the bars of the furnace to the bottom of the flue to be eighteen inches. The flue to run two feet from the front-wall, and to return within two and a half inches of the back-wall, with a chimney in the back-wall over the furnace. The flue to be eighteen inches deep, with the covers and bottoms of one-foot tiles. Doors at each end of the house, or at the fire-end, if but one door. Rafters fixed; the sashes moveable in two lengths, lapping in the middle; the top lights to be one inch wider than the lower ones, and the lower ones to run up and down in a groove formed in the rafter under the top light, so that the top and bottom lights may run free of each other. A trellis of wire to be fixed to the rafters fifteen inches from the glass, and the vines to be planted between the front-wall and the flue. If hot water is employed instead of smoke flues, then the pipes may be placed in exactly the same situation as the flues; they may be four inches in diameter, and there may be two upper pipes and two lower ones; one of the upper pipes and one of the lower ones may form a distinct circulation from the other two, so that when only a small degree of fire heat is required, the circulation may be stopped in half the extent of piping. For early forcing, the house, if still to be managed with one fire, may be somewhat narrower and the roof steeper. In houses of this kind the vines are wintered, not by withdrawing them, but by the removal of the sashes.—(*G. M.*, xvii. 310.)

SUBJECT. II. *Propagating, Pruning, and Training the Vine.*

958. The vine is commonly *propagated* by eyes or cuttings (606) and sometimes by layers, and a year may generally be gained by procuring rooted plants from the nurseries. To make sure of having the sorts true to their names, however, many gardeners raise their own plants. On the Continent the vine is generally propagated by cuttings of from a foot to two feet in length, taken off with a piece of the preceding year's wood attached; and this used also to be the custom in this country, till about the time of Speachley.

959. In *pruning* the vine never cut close to the eye, because the wood being spongy, dies back more or less, and consequently injures the bud; but cut in the middle of the internode, which leaves a sufficient space for the wood to die back before it reaches the bud. The cut ought to slope away from the eye, in order that in case of bleeding the eye may not be injured. The summer pruning of the vine consists almost entirely in stopping the

laterals, pinching off the tendrils, and when the fruit is beginning to ripen cutting off portions of the leaves, or sometimes entire leaves, to admit the sun's rays to the fruit. In taking off leaves, the French very seldom remove the petioles, but only the disk, or a portion of it.

960. *Training*.—There are three modes in common use for pruning and training the vine:—The long, or renewal system, by which the largest fruit is obtained; the short, or spurring-in system, by which the greatest number of bunches may be grown in a limited space; and the fan system, by which the plant is made to ramify and spread out its branches, so as to have the general appearance of a common fruit-tree. There are several other modes of training the vine, because, as we have seen (793), the vine may be trained in every form adapted for common fruit-trees; but we shall only notice the Thomery system, chiefly used in France, though in a less perfect form it is adopted on the walls of cottages in some parts of England. The vine differs from all other fruit-trees in this, that pruning cannot be dispensed with even for a single year; this arises from the much greater quantity of wood produced than is necessary for a crop of fruit. A peach-tree, or any other tree, if totally neglected, may continue to bear annually high-flavoured fruit on the outsides of its branches, because there they would be exposed to a sufficiency of light and air; but the bunches of grapes on a vine which had been left for a few years to itself, would be so shrouded in leaves and shoots as to be small and without flavour.

961. The *essential points* to be borne in mind when pruning and training the vine, whatever mode be adopted, are to shorten the wood to such an extent as that no more leaves shall be produced than can be fully exposed to the light; to stop all shoots produced in summer that are not likely to be required in the winter pruning, at two or three joints, or at the first large healthy leaf from the stem where they originate; and to stop all shoots bearing bunches at one joint, or at most two, beyond the bunch. As shoots which are stopped generally push a second time from the terminal bud, the secondary shoots thus produced should be stopped at one joint; and if at that joint they push also, then a third stopping must take place at one joint, and so on as long as the last terminal bud continues to break. Bearing these points in mind, nothing can be more simple than the pruning and training of the vine.

962. *The long, or the renewal system of pruning*, is by many gardeners, and also by Clement Hoare, the author of the best *Treatise on the vine* which has ever been published, considered as decidedly preferable to all the other modes. It recommends itself, he says, "by its simplicity; by the old wood of the vine being annually got rid of; by the small number of wounds inflicted in the pruning; by the clear and handsome appearance of the vine; and by the great ease with which it is managed, in consequence of its occupying but a small portion of the surface of the wall."—(*Practical Treatise, &c.*, p. 95.) Supposing a cutting planted where it is finally to remain, in autumn or in early spring, then in the autumn following it may be cut down to three good eyes, as in fig. 343.

The second year rub off all the buds but the terminal one, the shoot produced by which is to be cut down to three good eyes, as in fig. 344.

The third year allow only the two uppermost buds to push; and in autumn head down the strongest one to six feet or eight feet, for bearing fruit the following year, and the weakest to three good eyes, as in fig. 345. If

the wall or trellis is low, the system need not be carried farther; the long shoot will produce the fruit-bearing shoots of next year, after which it will



Fig. 343. *Renewal pruning, first year.*

be cut out, and its place taken by the shoot produced from the short shoot; which, having produced its fruit, will be cut away in its turn, to make room for the young shoot that will have been produced on the other side; and thus the operation might be carried on for a number of years.

The fourth year. Supposing the wall or the trellis to be of the usual height, then the fourth year bunches will be shown at every joint of the long shoot, but it will weaken the vine too much to allow more than two or three to come to maturity. Two shoots will be produced from those cut down, and probably



Fig. 344. *Renewal pruning, second year.*

a third from the base of the stock. These, in autumn, when the leaves have dropped, should be cut down, as in fig. 346. The house or the wall we may now suppose filled from top to bottom; the fruit in the lower part of the wall or house being produced by the young wood *a, b*, and that in the upper part from the young wood *c, d*, in fig. 346.



Fig. 345. *Renewal pruning, third year.*

The fifth year, the crop being produced on *a, b*, and *c, d*, a shoot will have been produced from *b*, which will reach the top of the wall and take the place at the winter pruning of the long shoot, *b, c, d*, while the shoot from *e* will take the place of *a, b*, as shown in fig. 347. Next year the shoot from *e* becomes the main shoot, and the shoot from *f*, the secondary shoot—the middle one being cut out; and thus the alternation of shoots may go on for a great number of years.

963. *The spurring-in method of pruning* consists in retaining only one shoot the entire height of the wall or trellis, and shortening the laterals at every winter's pruning to two or three eyes; or when the vines are very strong, cutting the laterals entirely off, leaving the young fruit-bearing shoots to be produced from the adventitious buds at their base. In general every alternate bud is cut out, so as to have only half the number of laterals as the shoot has produced buds; and sometimes two buds are cut out for one that is left, when the vine is of a sort that has a large leaf or a large bunch; the object being to prevent the shoot from being too much crowded by laterals.

964. *The fan-system of vine-training* is effected by shortening the shoots as they advance in growth during summer, so as to cause them to divaricate and produce the appearance of a common fan-trained fruit-tree. It is sometimes used in vineries where one plant fills the whole house, and requires no farther description.

965. *The Thomery system* of training is chiefly calculated for the open



Fig. 346. *Renewal pruning, fourth year.*

wall. The vines are planted at a short distance from the wall, and only two branches are allowed to proceed from each main stem. The length of these branches is greater or less, according to the strength of the soil. At Thomery, where the soil is poor, the ordinary length of a main branch is about four feet; but on the royal grape-wall at Fontainebleau, the branches are from five feet to six feet in length, the soil being richer and more liberally supplied with manure. Fig. 348 represents a portion of a mud-wall, eight feet high, covered with a trellis, on which vines are trained, according to the Thomery system. The fruit is produced on the short lateral shoots, which are shortened in at the winter pruning to two or three buds; and each shoot produced by a bud is allowed to mature two bunches of fruit. Nothing can be more perfect than this system of pruning and training, as it appears at Thomery; since it makes certain of covering every part of the wall with wood equally strong, and equally supplied with nutriment from the roots, because every plant has an equal extent of branches, eight feet, supplied from one stock or root. An imperfect imitation of this mode of training may be seen on the cottages of some villages in Hampshire, particularly in Broughton and Stockbridge.—(See *Scott, in Gard. Mag. for 1842.*)—On asking the opinion of an eminently scientific English gardener of the Thomery mode of pruning and training the vine, his answer was: “It will not do in this climate and soil. When followed strictly, the two arms, each four feet in length, do not give sufficient extent; for the eyes may all break prematurely. In my opinion, the best mode of training vines on a wall, is to lay in all the shoots at an angle of 45° , or even with a greater slope, if the soil is very rich, or the variety of grape which is grown is of very vigorous growth.”



Fig. 347. *Renewal pruning, 5th year.*

SUBJECT. III.—*Culture of the Grape-Vine under Glass.*

The grapes grown at Oakhill having been long equally celebrated with the pine-apples grown there, we shall adopt Mr. Forsyth's account of the mode of proceeding, first giving a general treatise, and next a diary of a course of culture.

966. *Vine-border.*—Loamy turf that has been pared quite thin, and stacked in narrow tiers, for one year at least, three parts, and one part of the following mixture:—any dry, well aerated animal manure, that can most conveniently be got, such as horse-droppings, or those of cattle, deer, or sheep, without litter, laid in alternate layers with old plaster or old building lime mortar (the older the better); no matter if there be a few brickbats in it. Let the whole be well pounded and mixed with the dung, which ought to be in a proper state, as to moisture, to ferment a little; after which let it

be frequently turned, always keeping it rather dry; it may then be wheeled into the bed or border. The loam when put into the bed or border should be in pieces about the size of bricks and half-bricks, brought from the stacks

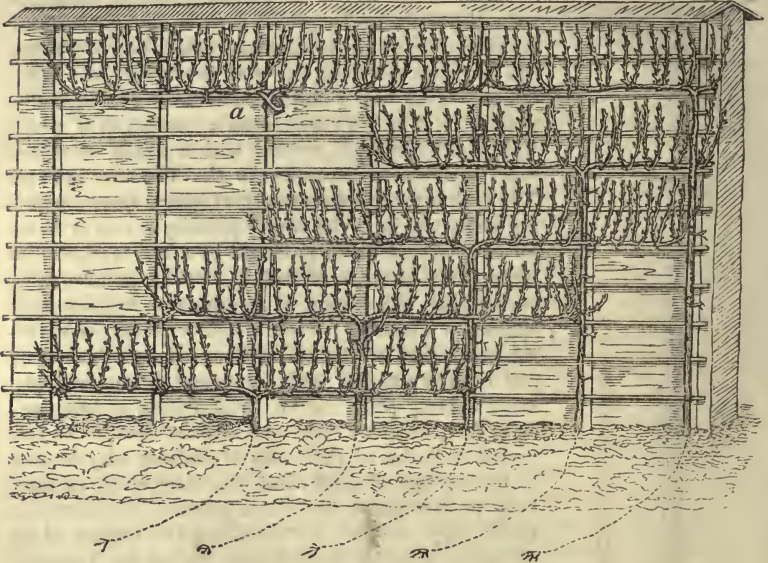

Fig. 348. Vines trained according to the Thomery system.

or tiers where they were originally piled, mixed with the manure, and laid once for all in the place where they are finally to remain, without any turning, chopping, or pounding whatever, which only injures the loam, and renders it too compact, and too much akin to puddle, for vine-roots to prosper in. About 16 feet wide, and from 2 feet 6 inches to 4 feet deep, may be considered a moderate width and depth for a vine-border, on a substratum of draining, at least one foot deep.

967. *Planting.*—On the top of this the vines reared in the manner hereafter stated may be planted. If out of doors, plant the vines 3 feet from the front of the house, just covering the root-ball of each about 2 inches, over which place a hand-glass. This will keep off rain and concentrate heat. Then lay the cane about 2 inches under ground, till it enters the aperture or arch into the house, and over this place another hand-glass; or, instead of hand-glasses, a layer of hot dung or leaves, 1 foot thick and 6 feet wide, may be laid along it. It is presumed that the border has been made in autumn, in which case this planting is to be done in February, especial care being taken that the border does not get either too wet or too dry. In the former case thatch it, and in the latter mulch it with fermented dung from old linings or the like, and water it with clean water.

968. *To raise the plants,* get some eyes from plants which you have seen and proved, cut them at half-an-inch above and below the eye, (606), and insert them singly in pots (of the size 60) about half-an-inch under the soil, about Christmas. Keep them growing in a moist heat, (say 60° Fahr.,) and shift

them regularly as they require it, training their stems against the wall or trellis in the hothouse. With good culture, in twelve months, they will have stems as thick as the little finger, with 4 feet of well-ripened cane, and plenty of vigorous roots.

969. *When planted in the vinery*, let them be grown in a like heat till autumn, when the house may be uncovered to ripen the wood; but care must be taken to prevent their freezing. In winter cut back till you find the wood of a firm texture and good size. Under good culture from 6 feet to 9 feet of firm short-jointed wood may be got. It is always better to leave the canes rather short than otherwise. The leader may be stopped 5 feet or 6 feet beyond where it is expected to be cut to in the winter pruning. When you commence growing in the spring, which should not be too early (say Feb. 15th,) let the temperature be low, (say 50° Fahr.,) and the atmosphere moist, that the vines may break at all the eyes. The canes, for this purpose, ought to be laid quite level; and, as soon as the shoots have been protruded from the eyes, the canes may be fixed to the trellis, and the temperature increased; but by no means allow them to bear fruit yet (unless, perhaps, a cluster on each vine to prove the sorts). If it is intended to force for early fruit the third year, to save repetition, reference may be had to the "Diary of Forcing," hereafter given (971.) To have grapes in their proper season, begin to excite the vines in the middle of March, by keeping the temperature about 50° or 55° Fahr.; if it will keep at this without fire heat, so much the better. When the vines are coming into flower, 60° Fahr. would do them good; and after that is over, and the fruit thinned, they will do very well at 55° Fahr. as a minimum, and at 85° Fahr. as a maximum, of sun heat. The fruit should be borne on lateral shoots or spurs, which should be stopped at one joint beyond the fruit; and spurs in the winter pruning should be cut back to one eye. The following may be considered as a summary of culture for three years:—

Jan. 1, 1836. Vine eyes potted.	Feb. 14, 1838. Vines excited.
Nov. 1, 1836. Vine border finished.	Sept. 1, 1838. Vines uncovered.
Feb. 14, 1837. Vines planted.	Jan. 1, 1839. Canes pruned.
Jan. 1, 1838. Canes winter-pruned, or cut back.	March 15, 1839. Vines excited.
	July, 1839. The fruit ripe.

970. *The sorts preferred at Oakhill*, are—Muscat of Alexandria, Dutch Sweetwater, White Frontignan, White Muscadine, Black Hamburgh, Black Prince, Black Frontignan for vineries, and Black Espérione and White Muscadine for walls,

971. *A diary of the course of culture applied to the grape vines at Oakhill.*—The vinery is 34 feet long, 16 feet wide, with 2 feet of mason-work, and 2 feet of upright glass in front, and the roof is at an inclination of 27°. The whole interior is heated by a surface of hot-water piping, equal to 312 square feet. A tan pit, erected on piers of brickwork, occupies the centre floor of the house, except only a space of 3 feet 4 inches all round, which is taken up by the pathway and hot-water apparatus. At the back wall of the house the soil is prepared to the depth of 6 feet; and at the further extremity of the border (16 feet wide) there are 3½ feet of soil, comprised of equal parts of the following earths:—Turfy loam, (the top spit of a very old undisturbed piece of pasture occupied as a rickyard,) two parts; rotten dung, one part; lime rubbish, one part; gritty mud, (the same as road-drift,) one part. The

vines are planted inside, there are twelve plants, and they are kept single-stemmed to the top of the house. When pruned the spurs are cut back to one bud. The sorts cultivated are, Black Hamburgh and Dutch Sweet-water.

1833. Nov.	Maxim. by day.	Minim. at night	DIARY.
	DEGS.	DEGS.	
8	—	—	The vinery open, the wood ripe, not pruned. We have had two slight frosts.
9	60	45	The vines pruned; the vinery shut up; no artificial heat applied.
12	—	—	Vines pared; the loose and rough bark only taken off.
16	60	45	Tan-pit filled with new tan, (twelve loads). Soil, pathway, &c., kept wet.
19	—	—	Vines washed with soap-suds by means of a painter's sash-brush, the suds being in a tepid state.
22	60	50	Vines anointed with a mixture of soft-soap, and black and white sulphur dissolved in warm soap-suds; the mixture applied to the vines at about 100° of heat. Vines laid down on the tan, and moistened with a fine syringe twice a day. The tan forked every other day.
25	—	—	Forked the border about 3 inches deep; laid on turfy loam and old lime mortar about 2 inches deep; then old hotbed dung, well rotted, 2 inches; the roots being near the surface, having been planted as shallow as possible.
26	—	—	Walls whitewashed with lime and sulphur.
27	—	—	Laid leaves on vine border, 1 foot thick; and fresh hot dung, 1 foot; protected the above from rains, &c., by reed covers used at other times for pine pits.
30	—	—	The floor dressed with a coat of road-drift for the sake of sprinkling.
Dec. 1	65	55	Fire heat applied, and all the steam that can be raised produced.
8	67	56	Sprinkling of pipes and pathways performed at all times, for the sake of steam and moisture; the heat of dung on border, 70°.
15	69	57	Weather favourable; the nights often 50° or 52°, seldom under 40°; we have had only four frosts, the most intense as low as 26°.
22	70	58	Buds perceived to be swelling; heat of dung on border 90°.
29	72	59	Cease to syringe vines; the sprinkling of soil, pipes, and path, continued.
1834. Jan. 5	74	61	Buds breaking generally; heat of dung on border, 96°.
12	76	63	Weather wet and windy; nights, 45° to 50°.

1834.	Maxim. by day.	Minim. at night.	
Jan.	DEGS.	DEGS.	DIARY.
15	78	64	Shoots 2 inches long.
17	78	75	
19	79	66	Heat of dung on border, 65°.
20	79	67	
21	80	68	Largest spurs 1 foot long ; flower-buds as large as mustard-seeds (white) ; bunches, 1 inch.
3	81	69	Shoots topped at one joint above fruit ; if a lateral is produced it is topped beyond one leaf ; if it break again, top it again beyond one leaf.
25	82	70	
29	83	71	In dull days when the weather is cold, and there is not sunshine, give a little air, keeping the temperature at 74°.
Feb.			
1	83	72	Dung on the border nearly cold.
8	84	73	The flowers of one bunch (near the hot-pipes) expanded ; the first that have been.
12	—	74	
15	85	75	The vines in flower generally.
19	—	76	Began to thin a bunch or two.
22	85	76	Was thinning all day (at the top of the house.)
Mar.			
8	85	74	The berries of all set now ; those of the Hamburgh as large as hazel-nuts ; those of the old St. Peter's, the size of peas of the early frame kind ; for the sake of the Dutch Sweetwater, maintained 76° instead of 74°, the proper temperature for the Hamburgh. After shutting up at night the tan-pit is forked sometimes, and sprinkled every night. The pipes are sprinkled at least eight times in twenty-four hours.
	85	73	Began to give air always when the temperature is 4° above that of the night heat.
12	85	72	Dung, leaves, &c., cleared off the border, to admit sun-heat, &c. ; the border forked over.
14	—	—	Finished shouldering the Hamburgh, and thinning the Sweetwater and St. Peter's (neither of the two latter wants shouldering much). All spurs tied to wires ; laterals cut clean out ; bunches supported.
29	85	72	Sweetwaters discovered to be changing colour for ripening.
April			
12	83	72	First berry of the Hamburgh beginning to change colour ; moisture withdrawn ; plenty of air admitted ; border watered with dung water (dry weather).
18	—	—	About half of the berries of the Hamburgh red-

1834. April	Maxim. by day.	Minim. at night.	DIARY.
	DEGS.	DEGS.	
			dened; about one-third of those of the Sweetwater perfectly ripe; the berries generally, each $3\frac{1}{4}$ inches round.
22	—	—	All watering of the soil for the vine roots, and sprinkling of the house to prevent dust, &c., performed when plenty of air is given, that <i>shanking</i> (shrivelling) may not be induced in the berries; the border watered with drain-water; fruit swelling rapidly.
24	—	—	Cut fruit of Sweetwater.
May 1	—	—	Three days past have been cloudy and rainy. To colour the fruit of the Hamburg we used firing to 77° by day, (with front air, if rainy,) and 72° by night, allowing ingress to a little air all night, the laps of glass being puttied.
6	—	—	The fruit of the Hamburg in high perfection, many of the berries each $3\frac{1}{2}$ inches, and in some few, 4 inches round.
7	—	—	The fruit of the St. Peter's changing colour; and berries in a bunch a little brown.
	81	70	Grapes exhibited at the gardens of the London Horticultural Society, for which the large gold medal was awarded. A little air left all night when thermometer stands above 50° out of doors; otherwise shut from ten till four.
16	—	—	The soil well watered to prevent the leaves decaying, and, consequently, unnatural hardening of the wood, which ought to be ripened in a deliberate manner, aided by the shade and surface of the leaves, according to the order of nature. The leaves are now of amazing size, green and vigorous, measuring, independently of the foot-stalks, $18\frac{1}{2}$ inches by 15 inches; and this not in a solitary instance.
30	—	—	Soil inside the house, and border outside, watered.
June 7	—	—	Grapes again exhibited at the gardens of the London Horticultural Society, along with six pines. Both were accounted the best productions exhibited, and prizes were awarded as such.
9	80	—	Ceased to make fires. With a supply of air left as above, the temperature stands usually above 65° .
20	—	—	The fruit of the Hamburg fine; that of the

1834.	Maxim. by day.	Minim. at night.	DIARY.
June	DEGS.	DEGS.	
			St. Peter's ripe; the leaves still green and vigorous. All possible air admitted by day, when fine. Protected from rain for the sake of the fruit only. Shut up close from dusk till dawn.
July			
1	—	—	Fruit all cut. Left open with lights on.
10	—	—	Lights off. The lights being off, no culture of any kind is given, except occasional waterings in very dry weather, to prevent a sudden and unnatural termination of the processes which actuate growth.

972. *Growing two or three crops of grapes in one house.*—The grape is so desirable a fruit, and one so well adapted for the dessert at every season of the year, that wherever there is only one vinery, various plans have been adopted, and that with perfect success, to produce two, or even three, crops of grapes in it in one year; and there can be no doubt that four crops might be grown. It is not uncommon in pine stoves to have two vines for each rafter planted outside the house, and when one, after having produced its fruit, is withdrawn, to introduce the other. If two crops can be so grown there is no reason why three should not, provided the border be extensive enough to admit of keeping the roots of each vine apart; which may be done by vertical underground partitions. The front sashes must of course be made to take out entirely at pleasure; or if there are no front sashes, then the lower sashes of the roof must be made to take out or lift up, so as to admit of withdrawing, and reintroducing the vines without injuring them. We shall state the practice at Hungerton Hall, in Lincolnshire, and at another place in Essex.

973. *Growing three crops of grapes in one house together with pines.*—The pine pit is built on arches, so that there is a free current of air under it from back to front, which, however, can be stopped at pleasure. A movable partition of boards, or in part of sashes not in use, is placed on the back wall of the pit, so as in effect to shut it in completely up to the roof. In the space between the back wall of the pit and the back wall of the house, that is, in the back path, the vines for the first crop are planted, and trained immediately under the glass. The back wall is flued; the lower flue being contiguous to the roots of the vines, which places the period of commencing their growth completely in the power of the cultivator. Here the more delicate and perfumed grapes, such as the Purple and White Constantia, and the Grizzly Frontignan, ripen their fruit in April; and when it is all cut in May, the vertical partition is put up, and remains so till December, when it is taken down, and forcing in this back part commences. The second or intermediate crop is obtained from plants planted in the front path and trained up the rafters. They produce their fruit, which is chiefly the Hamburgh, Sweetwater, and Muscat, in June and July; and when it is all gathered in August the vines are taken out, and others planted in the front border introduced in their place. This crop ripens in September and October, and the

vines are taken out in December, when those growing in the back path are begun to be forced by taking down the temporary partition. It is necessary to observe that the front flue is not, as is usual, between the path and the front wall of the house, but between the path and the front wall of the pit, and that there is a double partition of glass in front, between which the vines are wintered. Various minor details it is unnecessary to enter into.

974. *Another mode of growing three crops of grapes in one house.*—This was practised for ten years at a place in Essex, a part of which time it was under the care of a journeyman, who sent us the following account of it. The house was 45 feet long and 18 feet wide, a pit occupied the centre in which pines were fruited. The flue entered the back of the house at one end, and was carried round the front of the pit, and under the back pathway into the chimney at the same end the flue entered. Vines were planted in the front pathway next the pit, one under each rafter. These produced the first crop of grapes. They were begun to be forced in the beginning of February, and they were ripe by the middle or latter end of June. Those for the second crop were planted outside the house in the front. They were introduced into the house in the latter end of March, or the beginning of April, and trained under the roof over the front flue and pathway, as well as up some of the rafters: these ripened their fruit in August. The vine producing the last crop was planted at the front corner of one end outside. It was carried with a single stem up the end rafter to the back wall, where it was trained just under the coping to the full length of the house. Laterals from the main stem were left so as to come in under each rafter to which they were trained. This vine was taken in about the beginning of September, by entirely removing the end of the house for the purpose, the end being replaced as soon as the vine was properly fixed. About this time the vines which had produced the first crop of grapes were taken across the flue and wintered outside the house till the February following. Grapes have been cut from the vine against the back wall, up to the 8th of February, and they were then in excellent condition. Our correspondent has known it ripen off upwards of 300 bunches, with the berries well swelled and coloured and never shrivelled. The kind was the Black Hamburgh Valentines.—(*G. M.* 1841, p. 74.)

975. *Keeping Grapes.*—Ripe Grapes may be retained on the branches for several months, provided the air of the house be kept dry and cool. To absorb moisture from the air without heating it, the floor of the house is sometimes covered with dry sand, coal ashes, decayed granite or trap stone. Grapes may also be preserved for an indefinite period by cutting off the bunches with a joint or two of wood below the bunch, and applying hot sealing-wax so as completely to shut out air from the wound. The bunches are then suspended in a cool, airy room, and will keep from October till May. Care must be taken that they are neither exposed to heat nor damp, nor to a current of very dry air.—(*G. M.* 1841, p. 646.)

SUBJECT. IV. *Growing the Grape on open Walls, and on Cottages.*

South of London this might be practised to a great extent, and the grapes brought to a high degree of perfection, as has been proved by Mr. Clement Hoare, whose excellent *Practical Treatise on the Cultivation of the Grape Vine on open Walls*, we most strongly recommend to all who intend to cultivate this fruit in the open air. In the southern counties of England, where vines are grown on cottages, Mr. Hoare is of opinion that five times the

quantity of grapes of superior flavour might be annually produced on the same extent of surface; and that for every square foot of cottage wall on which vines are now trained, there are now twenty that are either entirely vacant, or occupied in a useless manner. As a general result of his calculations, he says, that for every pound of grapes now grown, one hundred pounds might be annually produced on the existing surface of walling. "Every moderate-sized dwelling-house having a garden and a little walling attached to it, may, with ease, be made to produce yearly, a quarter of a ton weight of grapes, leaving a sufficient portion of its surface for the production of other fruit." (p. 19.) The grand error which prevails in the culture of the vine on walls and cottages consists in the mode of pruning, which is far from being sufficiently severe. Nine parts out of ten of the current year's shoots, and all those of the preceding year, should if possible be cut off; and this is so different to what is required for other fruit-trees, that few persons have the courage to attempt it.

976. *Fruit-bearing powers of the vine.*—This Mr. Hoare has ascertained by experiment from the quantity of fruit which any vine can produce without checking its growth or injuring its vital powers. After a great many experiments, performed between 1825 and 1830, Mr. Hoare ascertained that if two and a half inches be deducted from the circumference of the stem of any vine measured just above the ground, the capability of the plant will be equal to the maturation of 10 lbs. of grapes for every remaining inch of girth. No vine is considered fit to bear until its stem measures three inches in girth. For every pound weight of grapes extracted from a vine before it has grown to that size, 10 lbs. will be lost during the next five years. Having calculated the weight of grapes which a stem may be allowed to produce, the next point is to determine what weight will be produced by the shoot developed by a single bud. This Mr. Hoare has ascertained to be, for those sorts of grapes usually cultivated on the open wall, half a pound weight for every good bud; the two bottom buds on every shoot being rejected, as seldom producing blossom-bearing shoots. Thus, "if the stem of a vine measure five inches in girth, its capability is equal to the maturation of twenty-five pounds weight of grapes, and therefore the number of buds to remain after pruning will be fifty," (p. 38.) Nothing can be more definite, satisfactory, or easily understood than this system, which has now stood the test of nearly twenty years. It is, however, to be understood that, where the climate is sufficiently congenial to mature a more luxuriant production of wood, the fruit-bearing power of the vine is infinitely greater.

977. *Aspect.*—Warmth and shelter are the grand requisites. The perspiration of the foliage of the vine is so great that it is carried to an injurious extent by the slightest wind. Mr. Hoare has found that, during the space of twenty-four hours, when the wind has blown briskly, the shoots exposed to its influence have not perceptibly grown at all, while, shortly afterwards, the wind having entirely sunk away, the same shoots have grown upwards of three inches in the same space of time, the temperature of the air in a sheltered situation being alike during each period," p. 41. The best aspects for vines on the open wall in the south of England are those which range from the E. to the S.E. both inclusive; and the next best from S.E. to S. Those which range from S. to W. are good, provided they are sheltered; but N. or W., though they may sometimes produce tolerable grapes, yet are very

uncertain both for the ripening of the grapes and of the wood. E. by N. Mr. Hoare finds a very good aspect. On a wall facing this point the sun shines till about eleven o'clock in the morning, and Mr. Hoare has for many years past brought several sorts of grapes, including the Black Hamburgh, to great perfection in this aspect. It would thus appear that if a cottage, the general outline of the ground-plan of which is a square or a parallelogram, is placed so that a south and north line shall form a diagonal to it, vines may be planted against every part of the walls and trained over the whole of the roof. We have shown in the Supplement to the Encyclopædia of Cottage Architecture (§ 2237) the immense importance of placing every cottage so as to have the diagonal a south and north line, without reference to the front or any of the sides being parallel to the adjoining road or street. "We wish it to be distinctly understood, that it forms no part of our plan to have either the front or the back of the cottage next to, and parallel with, the road; on the contrary, we prefer, in almost every case of single cottages, to have next the road an angle of the building, by which the views across the road will be oblique, instead of being direct; as the former, in every case, exhibits a longer perspective, which must consequently contain a greater number of objects."—(*Supp. Cott. Arch.*, p. 1138). The walls and roofs of cottages so placed, north of London, may be covered with the apple, pear, cherry, plum, and, in some cases, the apricot; and those south of London may be covered with the grape vine.

978. *Soil*.—Light, rich, sandy loam, not more than eighteen inches in depth, on a dry bottom of gravel, stone, or rock, forms the most desirable soil and subsoil for the vine. Mr. Hoare truly observes, that "one of the principal causes of grapes not ripening well on the open wall in this country is the great depth of mould in which the roots of vines are suffered to run, which, enticing them to penetrate in search of food below the influence of the sun's rays, supplies them with too great a quantity of moisture; vegetation is thereby carried on until late in summer, in consequence of which the ripening process does not commence till the declination of the sun becomes too rapid to afford a sufficiency of solar heat to perfect the fruit," (p. 47.) It is hardly possible, Mr. Hoare observes, to form the vine border of materials too dry or porous. Stones, brickbats broken moderately small, lumps of old mortar, broken pottery, oyster-shells, and other materials which retain air and heat, and permit heavy rains to pass quickly through, should be mixed up with two-thirds of light rich soil, such as the sweepings of roads, or the top spit of a field of good arable land. The border should never be cropped or digged, and only stirred occasionally with a fork to the depth of two inches, to admit the sun and air. Where borders cannot be prepared for vines, they may be planted in pits eighteen inches square, and eighteen inches deep, filled up with suitable soil; and if the situation is dry, the roots will soon push themselves into some suitable place; for, as Mr. Hoare observes, the roots of the vine possess an extraordinary power of adapting themselves to any situation in which they may be planted, provided it be a dry one.

979. *Manure*.—As the vine border once properly made ought never to be disturbed, it follows that the manure incorporated with the soil at making should be of a permanent nature, decomposing from time to time to supply the nutriment extracted by the plants. Top-dressings and liquid manure may also be added when the border is made, or at any subsequent period.

Some of the best permanent manures are bones, horns and hoofs of cattle, bone-dust, the entire carcasses of animals, cuttings of leather, woollen rags, feathers, and hair. Bones Mr. Hoare considers by far the most valuable manure that can be deposited in a vine border, and he recommends their being buried in the soil whole, and as fresh as possible, and of every size from the smallest bone of a fowl to the largest bone of an ox, (p. 58.) Excess of manure deteriorates the flavour of grapes, and produces an excessive and unnatural growth of long-jointed wood, with nothing but leaf-buds. We may here notice a manure for the vine recommended by Mr. Hayward. This gentleman has tried a great variety of compounds as food for plants, and has found that one quart of cider, or cider-grounds, added to two gallons of water, brings a grape vine to a more perfect prolific state than anything else. This mixture must be supplied in such quantity as will saturate the earth, like water, to the depth of the roots, and all over the surface occupied by the roots. It must only be given once in the year in June; and if repeated the second year, its good effects will be sustained for several years afterwards without further supplies. The apple and pear, and the fig, are alike benefited by this compound.—(*Gard. Chron.*, vol. i. p. 413.)

980. *Walls*.—In an unsheltered situation, exposed to W. and S.W. winds, Mr. Hoare has never seen prime grapes produced much higher than eight feet from the ground; but in sheltered situations, and in S. and S.E. aspects, grapes may be matured at any height from the ground. The lower part of the wall, however, will always enjoy an increased degree of warmth from the reflexion of the ground. Hence grapes growing within two or three feet of the bottom of a wall facing the south will, in general, ripen from ten days to a fortnight earlier than those growing on the upper part of it. It may be observed, that the higher the wall the warmer will its southern aspect be, and the colder its northern aspect. There is a disadvantage, however, in training grapes near the ground, as it respects their remaining on the vine after being ripe. If grapes can be kept perfectly dry, they will hang on the vine and improve in flavour for a long time after they are ripe; but if dampness or moisture of any description reach them, the consequences are quickly seen in the decay of the berries. After the middle of October, therefore, it will be found a difficult matter to preserve grapes that hang within two feet of the ground, on account of the damp exhalations that continually arise from the soil at that period of the year," (p. 68.) Blackening the surface of a wall, Mr. Hoare finds productive of a considerable increase of heat as long as the sun shines upon it; but while that surface is in the shade, it parts with the heat so rapidly as soon to become colder than if it had not been blackened. Hence he would only blacken walls with an aspect due south, because the absence of the sun from such walls is so much less that the wall has not time to cool, and the heat produced by blackening on a clear day, when the sun is in the meridian, is frequently from 10° to 20° more than that on a wall which has not been blackened, (p. 71.) Projecting copings to vine walls preserve the shoots from late frosts in spring, and the blossoms from cold dews and heavy rains; they also keep the grapes in good condition for some time after they have become ripe; they prevent the escape of heat, and are convenient for fastening netting, bunting, &c. to, when it is necessary to protect the fruit from birds and insects. The disadvantages of copings are, that they exclude light, air, dew, and rain, which are very beneficial from the time the fruit

has set till it begins to ripen. The width of the projecting part of the coping Mr. Hoare regulates by the height of the wall and its aspect. "If the height be less than four feet, and the aspect south, the coping ought not to project at all, as the light and solar heat excluded by it will be a serious drawback on the healthy vegetation of the vines. But if the wall be four feet high, then the coping may project as many inches; and if this width be increased an inch for every foot that the wall increases in height up to twelve feet, the principal advantages arising from the protection which a coping affords will be secured, in conjunction with the smallest portion of its disadvantages," (p. 73.) If the aspect be east or west, the coping must be as narrow as possible, as every inch of projection in these aspects causes a considerable diminution in the duration of sunshine on the face of the wall. At the same time a coping that projects less than four inches is calculated to do more harm than good, as the drip will fall on the blossoms and the fruit. Movable wooden copings (463 and 471) produce, Mr. Hoare observes, all the benefit of fixed copings, without any of their disadvantages. All garden walls whatever should have iron brackets built in immediately under the stone coping, in order to admit of temporary wooden copings being applied at pleasure. Temporary copings should be applied, from the 21st of March to the middle of May, to protect the young shoots, from the first expanding of the buds until the berries are well set; and again from the berries showing symptoms of ripening till the fruit be all cut from the vines.

981. *Propagation*.—Mr. Hoare prefers cuttings containing two buds taken off in autumn, and planted in spring in the open garden, and sometimes where they are finally to remain. The uppermost bud of the cutting must have an inch of the blank wood remaining beyond it, and the lower end must be cut transversely, just below the bud. Bury the upper bud about a quarter of an inch, and press the soil quite firm to the lower one. Keep the soil moist by soap-suds or liquid manure.

982. *Pruning*.—Mr. Hoare, as we have already seen (962), gives a decided preference to the long system of pruning; his objections to the other modes being founded on the quantity of proper juice required annually to clothe the naked old wood with a new concentric layer of alburnum, thereby lessening the quantity of juice sent down to the roots. Naked vine branches are consumers, but not producers; therefore the grand object of pruning should be to leave a sufficient supply of bearing-shoots on the least possible proportionate quantity of old wood. Tried by this test, the long method will be found preferable to all others. Prune as soon after the 1st of October as the gathering of the fruit will admit; and never prune in March, April, or May.

983. *Training*.—From a main stem, one horizontal shoot to the right and another to the left, are maintained of a sufficient length to produce all the bearing wood required for the age of the vine, the height of the wall, &c. These shoots are laid in about a foot above the surface of the soil, and the vertical shoots which proceed from them are trained in a serpentine form, to check the too rapid ascent of the sap. "If a summer shoot, every time it is nailed throughout the season, be bent or pointed in a different direction to that in which it grew at the preceding nailing, the vigour of its growth will be checked, and the sap will immediately accumulate and expend itself in forming round, short-jointed wood, and in the development

of the finest description of fruit-buds. This is the key to the production of large bunches of fruit, which are not the necessary consequence of very large-sized bearing shoots, but rather of sap that has been accumulated and highly elaborated by slowness of growth in combination with full exposure to the sun's rays," (p. 106.) In nailing, linen or cotton shreds are by some preferred to woollen ones, as being less retentive of moisture; but, on the other hand, they produce a greater chill, in consequence of the more rapid evaporation which they afford; and they should in general be from three-fourths of an inch to one inch and a half in breadth, according to the size of the shoot.

984. *Mr. Hoare's mode of training.*—Figs. 349 to 353 will give an idea of Mr. Hoare's mode of training, with some variations. Fig. 349 shows a vine of two years' growth, cut down to two eyes; but of the shoots produced from these eyes, one is rubbed off when the other is firmly established, so that only one is matured. In November this shoot is cut down to two eyes, as in fig. 350. The shoots produced next summer are treated as before, one only being left to come to maturity, and that one is cut down in the November of the fourth year to three eyes, as in fig. 351.

Next year three shoots will be produced, but as soon as two are firmly established in June or July, the other is cut off, and two only are allowed to come to maturity. Tendrils, or any appearance of bunches, are pinched off as soon as they appear, and the shoots, in the last week of August or first week of September, are stopped. The vine will now be four years of age, and have stood three years on the spot where it is finally to remain. The girth of the stem at the surface of the ground will be three inches, and the plant may be permitted to bear fruit for the first time; say not more than 5lbs. weight. For this purpose, Mr. Hoare cuts down the two shoots to the seven lowermost buds on each; and having trimmed the shoots, they are to be nailed to the wall in a horizontal position, as in fig. 352. This being done in November, then, in the February following, cut out of each shoot the first, second, fourth, fifth, and sixth buds, leaving the third and seventh buds on each shoot, to produce shoots, as at *a, b, c, d*, in fig. 352. In the course of the summer these four buds will produce four shoots, which may either be trained upright, as at *a*, or, as Mr. Hoare prefers, in a serpentine manner, as at *b*; or, as a correspondent suggests (965), they may be trained in a sloping direction, as at *d*. The



Fig. 349. Mr. Hoare's mode of training, second year—from the cutting.



Fig. 351. Mr. Hoare's mode of training, fourth year.

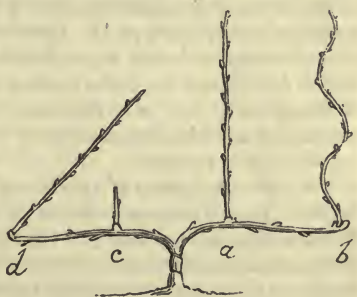

Fig. 352. Mr. Hoare's mode of training, with variations, fifth year.

object of the curvilinear training, and also of the sloping direction, is to equalise the breaking of the buds—the sap in vines, as every one knows, being otherwise apt to expend itself chiefly at the extremities of the shoots.

If more bunches are shown than, at the rate of $\frac{1}{2}$ lb. each, will produce

5lbs., pinch them off as soon as they appear, or as soon as the berries are set. Supply the plant with liquid manure during the summer; stop the shoots in the first week of September, and after the fruit is gathered cut back the

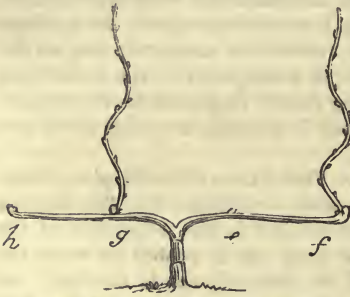

Fig. 353. Mr. Hoare's system of training established.

shoots at *f* and *g* in fig. 353, to within a foot or 18 inches of the main stem, and cut the others to the lowermost bud, as at *e* and *h* in fig. 353. The vine is now prepared for being treated according to a regular system, which consists in "alternately fruiting two shoots, and training two at full length for bearing wood in the following year." Mr. Hoare considers it advisable not to let the vine extend itself farther on the wall, but, instead of this, to plant a sufficient number of plants to cover the wall or house,

with plants having two arms, as in the figures 354 and 355, and seen more in detail in fig. 348; the only difference being, that in the latter figure the bearing wood is kept quite short. Vines treated in the manner recommended by Mr. Hoare, with arms each $2\frac{1}{2}$ feet in length, may have the bearing shoots of any length under 8 feet or 10 feet; and as the annual increase in the girth of its stem will be about $\frac{1}{2}$ an inch, it may be allowed to mature an additional 5 lbs. of fruit annually, till the produce amounts to 60 lbs., which is the greatest quantity which will be produced annually from 50 square feet of walling.

985. *In training the vine on the walls of cottages*, exactly the same system ought to be pursued as in training it against walls, with these differences, that a greater length of stem will generally be required, and that the length of the arms will vary exceedingly. In order, however, to equalise the production of fruit, and maintain a sufficient degree of vigour in the vines, the length of the bearing wood ought to be shortened in proportion as the length of the arms is increased beyond $2\frac{1}{2}$ feet each from the main stem. It is of no great consequence, as Mr. Hoare observes, what the length of the stem of a vine may be before it reaches the point where the arms originate, and which Mr. Hoare terms the fruiting point; and this length of stem, even if it should be 20 feet, or 30 feet, can easily be attained in three years by not cutting off more from the extremity of every year's shoot than what may not be thoroughly ripened.

986. *The appearance of a portion of the front of a house covered with vines in Mr. Hoare's manner* is shown in fig. 354, in which there are seven different plants, marked *a* to *g* in the figure. The plant *a* has a long stem, and arms rather shorter than usual for covering a portion of the wall equal to the height of the bed-room windows; *b* covers a space equal to the height of the parlour windows; *c* covers the space between the parlour and the bed-room windows: it has arms exceeding the usual length, every shoot bearing shoots in the Thomery manner; *d* has a very short stem, and long arms, with short bearing shoots, for covering the space between the sill of the parlour windows and the plinth; *e* has a stem which reaches above the bed-room windows, with very long arms and short shoots, in the Thomery manner,

for covering the space between the bed-room windows and the roof. The other half of the front is shown covered with fruit trees; *h* may represent an apple, a cherry, or a plum; *i* and *k*, pears; and *l* may be the same as *h*.

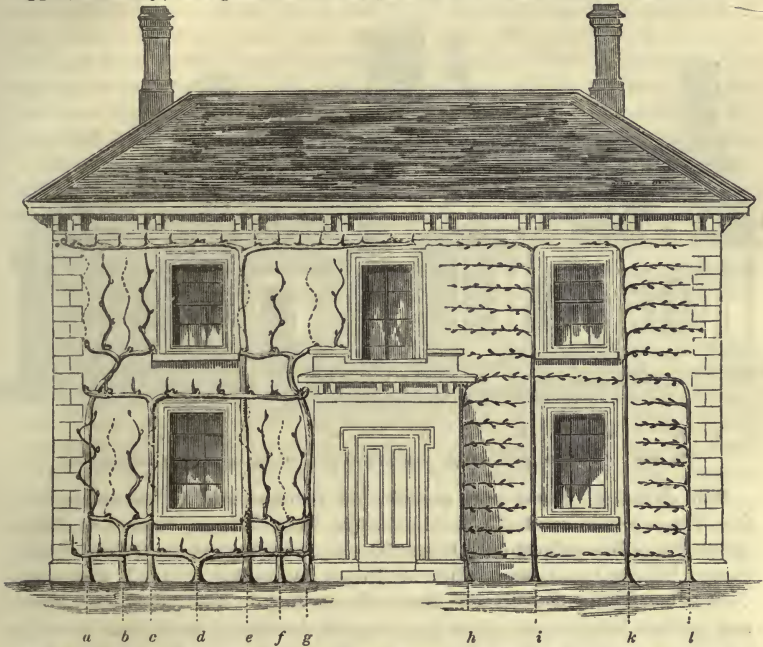

Fig. 354. The front of a plain house, covered with grape vines on the left side, and other fruit trees on the right side.

Vines may be planted against houses in streets, as we see in many villages and country towns, the roots running under the foot pavement, and even under the street, for no fruit tree is less particular in regard to soil, provided that it be on a perfectly dry bottom. Of course the bearing arms of vines grown in streets should be at such a height from the ground as to be out of the reach of mischievous persons. For a variety of other details we must refer to Mr. Hoare's work; what we have selected from it, taken in connexion with the contents of preceding sections, will enable any gardener or amateur to grow grapes on open walls or on cottages to a high degree of perfection, wherever the climate is suitable. The only objection which we have ever heard made to Mr. Hoare's system is, the very limited extent of branches which he allows; for it is alleged that, in moister situations and richer soils than that in which his practice lay, so much shortening would break the eyes prematurely.

987. The walls and roof of a cottage of the most irregular architecture may be covered with vines or fruit trees on the same principle as we have just exhibited on the front of a plain house. In the perspective view, fig. 355, thirty-five plants are shown, with stems and arms so adjusted as to cover two sides of the building. To avoid confusion, only the stems and arms are shown, and the position of the spurs whence the bearing wood is produced. It will be observed that the stems *a, a*, are long for the purpose of covering

the upper part of the roof; and *b, b*, for covering the upper part of the gable: *c, c*, are for covering the lower part of the roof; *d, d*, the upper part of the wall; and *e, e*, the lower part. The other stems speak for themselves.



Fig. 355. Two sides of a cottage, covered with vines, trained in Mr. Hoare's manner.

988. *Kinds of grapes most suitable for the open wall or for cottages.*—Mr. Hoare recommends Black Hamburg, Black Prince, Espérione, Black Muscadine, Miller's Burgundy, Claret Grape, Black Frontignan, Grizzly Frontignan, White Frontignan, White or Royal Muscadine [? Syn.], Malsley Muscadine, White Sweetwater, Early Black July. For handsome, large, and well-set bunches, no white grape equals the Royal Muscadine for walls or cottages; and the Black Prince ripens better than the Black Hamburg.

SUBJECT. V. *Insects, Diseases, &c.*

When the vine is properly cultivated, it is little subject to insects; but under glass it is occasionally infested with the red spider, and with one or two species of coccus. The former may be destroyed by washing the flues or hot-water pipes with a mixture of quick-lime and sulphur, and shutting up the house; and the latter, by washing the wood, after the leaves have dropped, and the whole of the interior of the house, with soft-soap, which may also be mixed with sulphur. There is little danger, however, from either of these insects, if the air of the house is kept sufficiently warm and moist. The fruit, when ripe, is liable to be attacked by birds, wasps, flies, &c., which may be excluded by netting or wire-gauze; but on the subject of insects we refer to what has already been stated in subject. VII., p. 108. Bleeding, the result of pruning at an improper season, may in general be left to cure itself by the expansion of the foliage.

SECT. III.—*Culture of the Peach and Nectarine under glass.*

SUBJECT. I.—*Natural data on which the culture of the Peach is founded.*

989. *The peach* (*Amýgdalus pérsica L.*) is indigenous in Persia, where it attains a high degree of perfection, and where Dr. Royle informs us, both the free and cling stone varieties are known. It is also found in various parts of Turkey in Asia, in India in different parts of the Himalayas; and it is

cultivated in China, Japan, North America, and in most parts of Europe. Its range in Persia and Asiatic Turkey appears to be between 30° and 40° of north latitude; but very little is known of the temperature or moisture of the climate in these and other regions where the peach is indigenous. Judging from general laws, it would appear that the winters are severe, the springs cold or temperate, and the summers warm rather than hot; but the average temperature, or the extremes of heat and cold of these seasons, in the countries mentioned, have not yet been ascertained. Our data for the culture of the peach, therefore, must chiefly be taken from the practice in countries where it is successfully cultivated, and in no country is it more so in the open air than in the neighbourhood of Paris, or under glass than in England. The writer of the article PEACH in the Penny Cyclopædia, from facts which we presume have been obtained in the Horticultural Society's Garden, gives the following data, on which the practice of forcing the peach may be safely founded.

990. *Natural and experimental data.*—If the mean temperature of February amount to 40° and that of March to 44° or 45°, the peach-tree will be in full flower against a wall with a south aspect about the last week in March; and the general crop will be ripe in the last week of August, or first week of September, provided the mean temperature of April be 49°, May 55°, June 61°, July 64°, and that of August 63°. The period required for the maturation of the fruit from the time of flowering is, on the open wall, five months; but it may be reduced to *four* by means of fire-heat and the protection of glass. It cannot, however, be advantageously diminished any further. This fact being borne in mind, it is easy for the gardener to know at what time to commence forcing his peaches in order to obtain a crop in a given month.

From the natural climate and habit of the peach-tree, it is obvious that when forced it must be flowered under a comparatively low degree of temperature. It cannot therefore be well forced simultaneously with the vine; for the temperature of March, which in this climate serves to bring the peach into flower, does not unfold the buds of the vine, this being only effected a month or six weeks farther in the season by a mean temperature of 55°. The peach may be subjected at first to a temperature of 45°, but not exceeding 55° till the flowering is over, after which it may be gradually raised to 60°, and not exceeding 65°, till the substance of the stone is indurated; and after this crisis from 65° to 70° may be allowed. This is to be understood as referring to the application of fire-heat. Even in the total absence of the latter, sun-heat will frequently raise the temperature much higher; but in this case a large portion of air should be supplied, not, however, all at once after the temperature of the house is found too high, but gradually as the temperature increases. Air should be always freely admitted through the day when the weather is at all favourable.

Light is so essential, that unless peaches be trained near the glass, the fruit will neither acquire due colour nor flavour. Vicissitudes of dryness and moisture must be avoided. The roots should be well supplied with water before the fruit begins to ripen off, because at a later period none can be applied without deteriorating the flavour.

The management of the peach-tree can only be correctly understood by those who are aware of the disposition of its buds and its mode of bearing. The leaves on the shoots of the current season are produced either singly, in pairs, or in threes from the same node. In the course of the summer, or

early part of autumn, a bud is formed in the axil of every individual leaf, and these are termed single, double, or triple eyes, or buds, according as one or more are produced at each node. In the following season, these buds develop themselves, either as flower-buds or young shoots; and, previously to pruning, it is necessary to distinguish the one description from the other. The flower-buds are plump and roundish; the wood-buds are more oblong and pointed, and one of these is generally situated between two flower-buds in the case of triple buds occurring at the same node. It is therefore expedient in pruning to shorten a shoot to these triple eyes, or in their absence to a leaf-bud, but never to a fruit-bud only; for no shoot could be prolonged from it, nor would the fruit attain perfection, owing to the want of leaves in immediate connexion with its footstalk. The mode of bearing is solely on shoots of the preceding summer's growth.—*Penny Cyclopædia*, vol. xvii., p. 346.

SUBJECT. II.—*Culture of the Peach under Glass in British Gardens.*

991. *Construction of the peach-house.*—The form of the peach-house need not differ much from that of the grape-house, but in general it is made narrower and not so high at the back wall. Mr. Torbrun, an experienced forcing gardener, recommends, length 30 feet, width 12 feet, height at back 9 feet, at front 2 feet. The front and end walls, and flues, to be on arches. The flue to be within 3 feet of the front and end walls, and to be returned interiorly, leaving between the flues a vacuity of 6 inches or a foot. A trellis to be fixed to the rafters 15 inches from the glass, and the trees to be planted between the front wall and the flue. The sashes, in two lengths, to lap in the middle. The top-lights to be 1 inch wider than the lower ones; and the lower ones to run up and down in a groove formed in the rafter under the top light, so that the top and bottom lights may run free of each other. The doors at each end, or one at the furnace end. The rise from the furnace to the floor of the flue should be 18 inches. The situation of the chimney-top should be in the back wall over the furnace; or if the coals produce a great deal of dense smoke, the chimney may be carried up in the front wall of the back shed. If the heating is to be effected by hot water, the pipes may be at exactly the same distance from the front and end walls as that above-mentioned for flues, in case of their being used. (957.)

992. *Peaches and nectarines best adapted for forcing.*—The nectarine is a variety of the peach, and of both there are what are called cling-stones, in which the flesh adheres to the nut or stone, and free-stones, in which the flesh parts from the stone readily. The sorts of peaches best adapted for forcing are—* Grosse Mignonne, * Royal George, Red Magdalen, Royal Charlotte, * Bellegarde, Barrington, and Late Admirable. These sorts ripen in the order in which they are placed; the two latter kinds being late peaches, are only proper to be planted where a prolonged succession is required. The Bellegarde is not so subject to the attack of mildew as many others are that have serrated glandless leaves. The best sorts of nectarines for forcing are the Elruge and the * Violet Hâtive. All the above are free-stone fruits, cling-stones not being favourites in this country; though in Italy and North America, where the summers are much warmer, they are preferred.

993. *Plants and mode of training.*—Time is gained by procuring from the nurseries, or from the open walls of the same garden, trees which have been

three or four years trained, which may be removed in November. The fan mode of training, already described in sufficient detail (801), is unquestionably the best for forced peaches. In lofty or wide houses it may be necessary to introduce riders in order more speedily to cover the upper part of the trellis, and these also should be three or four years trained; but where the peach has been properly treated on a garden-wall, and its roots encouraged to run near the surface of the border, trained trees of almost any size may be transferred from the open wall to the forcing-house at once, so as even to bear a tolerable crop of fruit the first year. Mr. Errington removed a tree from a wall to a trellis in a forcing-house, where it covered 480 square feet, and ripened eight dozen of peaches the same year in which it was planted.—(G. M. 1842, p. 123.)

994. *Pruning*.—The winter pruning of the peach under glass should take place immediately after the fall of the leaf. The young shoots on the lower branches should be cut back to two or three buds, that the trellis may be furnished from the bottom with young wood. The shoots on the upper or farther extended branches may be shortened back to half or one-third of their lengths, according to their strength, provided they have been well ripened, and are free from canker; but if the tree be anywise diseased, they should be cut so far back as to get rid of the cankered or mildewed part. The riders need not be pruned so much as the dwarfs; the object being rather to throw them into a bearing state, than to cause them to push very strong shoots, which would not be fruitful. If they make moderately strong shoots, and if these be well ripened in autumn, a good crop may be expected on them next year. “Unless peach-trees be very strong,” Mr. Thompson observes, “the shoots should be more or less shortened, according to the vigour of the tree. If this be not attended to, it will be impossible to prevent the bearing wood from becoming naked at the base. The setting and stoning of fruit situated at or near the extremity of a three-year-old branch, having, perhaps, only leaves on the part produced during the last season, is, indeed, very precarious.”

995. *The summer pruning* consists in pinching off all foreright shoots as they appear, and all such as are ill placed, weakly, watery, or deformed, leaving a leader to every shoot of last year, and retaining a plentiful supply of good lateral shoots in all parts of the tree. If any blank is to be filled up, some conveniently placed strong shoot is shortened in a very early stage of its growth to a few eyes, in order that it may throw out laterals. All luxuriant shoots should be stopped as soon as their tendency to over-luxuriance is observed, in order that the sap, which would otherwise be wasted, may be forced into the adjoining shoots and branches.

996. *The fruit is thinned before and after the stoning season*.—There should be a preparatory thinning soon after the fruit is set, leaving, of course, a sufficient number in case of imperfection that may only become apparent at the period of stoning; because most plants, especially such as have overborne themselves, drop many fruit at that crisis. When this is over, the thinning should be effected with great regularity, leaving the fruit retained at proper distances; three, four, or five, on strong shoots; two or three on middling, and one or two on the weaker shoots; and never leaving more than one peach at the same eye. The fruit on weakly trees should be thinned more in proportion.

997. *The peach border* will be partly within the house, but chiefly on

the outside, where it may extend ten feet or twelve feet from the front wall. The usual depth in medium soils and situations is from two feet to three and a half feet; but eighteen inches, or two feet, is much safer, for reasons before given (836). The bottom should be previously thoroughly drained, and covered with a stratum of gravel, broken bricks, or other similar materials, to conduct away superfluous water. The best soil is a fresh loam from an old pasture, mixed with numerous fragments of freestone (828). No stable-dung need be added, unless the soil should be considered poor. "The peach," Mr. Errington remarks, "as well as most other tender fruit-trees, is planted in borders far too deep as well as too rich." The borders should be pointed and forked up after pruning, and a little well-rotted dung or compost added where deemed necessary. The part of the borders on the outside may, in addition, be covered with dung; and, after forcing is commenced, those in the inside may be occasionally watered with liquid manure; but no manure whatever is required till such time as the trees are in a bearing state.

998. *General treatment.*—From the rise of the sap, it occupies, in some sorts, about four months to make mature fruit; in the later varieties, five months; and, when much of winter is included in the course of forcing, the time is proportionally lengthened. To ripen moderately early kinds by the end of May, begin to force on the 21st of December. Little is gained by commencing sooner. Abercrombie directs to begin with a temperature of 42° minimum, 45° maximum, from sun-heat; and rise in a fortnight to 45° minimum, 50° maximum, from sun-heat, giving plenty of air; in the progress of the second fortnight, augment the temperature from three to eight degrees, so as to have it at the close up to 53° minimum, 56° maximum, from sun-heat, admitting air in some degree daily. When the trees are in blossom, let the heat be 55° minimum, 60° maximum. Continue to aim at this till the fruit is set and swelling. When the fruit is set, raise the minimum to 60°, the artificial maximum to 65°, in order to give fresh air; when the sun shines, do not let the maximum, from collected heat, pass 70°, rather employing the opportunity to admit a free circulation of air. A constant stream of fresh air is to be admitted before beginning to force, and plenty of air during sunshine throughout the whole progress of forcing. While the fruit is in blossom, steaming the flues or hot-waterpipes must be substituted for watering overhead; at the same time, the roots may be watered now and then gently, avoiding such a copious supply as might risk the dropping of the fruit to be set. An important point to be attended to in watering is, as we have seen (823), to let the water be warmed to the same temperature as the air of the house. When the fruit is ripening, its flavour is improved by direct exposure to the sun and air, by the removal of the glass, at least during the day. When it is quite ripe, the border should be covered with moss, or some soft substance, or nets suspended under the trees, to prevent those which drop off from being bruised; but the best flavour is obtained by gathering the fruit a day before it is dead ripe, and ripening it for twenty or thirty hours in the fruit-room.

999. *Insects and diseases.*—The red spider is the grand enemy to the peach-tree; but it is also attacked by mildew, the aphid, thrips, chermes, and sometimes even by the coccus. Their ravages become apparent by the leaves curling up, and often by the ends of the shoots becoming bunched and clammy, which retards their shooting. In this case it is advisable to

pick off the infected leaves, and cut away the distempered part of the shoots. Further to check the mischief, if the weather be hot and dry, give the trees a smart watering all over the branches. Garden-engines, such as Read's (440), will perform the watering much more effectually than common watering-pot. It should be applied two or three times a week, or even once a day. The best time of the day is the afternoon, when the power of the sun is declining. These waterings will clear the leaves, branches, and fruit from any contracted foulness; refresh and revive the whole considerably; and conduce greatly to exterminate the insects. The green fly is the principal enemy; and if it appears before the leaves are curled up, or the ends of the shoots have become clammy, the remedy should be applied, viz.: a slight syringing to damp the leaves, and then a good sprinkling with tobacco-dust.

1000. *Peaches may be forced in pots* in a peach-house, vinery, or even in a pine-stove; but the plants must be well established in the pots by three years' culture previous to forcing (*Ibid.* 1841, p. 321). It may be well to observe that the peach to be grown in pots, or to be transplanted when of two or more years' growth, must be worked on plum-stocks, on account of the much greater number of fibrous roots which these stocks produce than almonds; the latter are generally employed as stocks to the peach in France and Italy, being found to answer well in these countries, where the peach is seldom transplanted, and where the soil and climate are much dryer and warmer than in Britain.

SUBJECT. III.—*The details of a routine course of forcing the Peach for two years.*

The following article, by Mr. P. Flanagan, F.H.S., gardener to Sir Thomas Hare, Bart., at Stow-hall, Norfolk, is one of the best that has yet been published on the subject of which it treats. It appeared in the fifth volume of the *Horticultural Transactions*. Mr. Flanagan first describes the plan he follows in planting the trees, and then details his system of management during the first season; after which he gives the mode of treatment in the second season, which last is equally applicable to all future years:—

1001. "The *soil* which I generally use for peaches and nectarines, whether in houses or on open walls, is the top spit of a pasture of rich yellow loam, if it can be procured, without adding to it any manure whatever; but if the soil be poor or sandy, it should have a little rotten dung mixed with it. If convenient, this mould should be laid up in ridges five or six months before it is wanted, and turned over twice or thrice during that time.

1002. *Border*.—"When the house is ready, the borders, both inside and outside, should be cleared to the depth of three feet, and be well drained, as well as paved at bottom with slate or flat tiles, to prevent the roots of the trees entering the bad soil which may be at bottom. This being done, the new earth must be wheeled into the cavity of the border, and every layer of it that is put on should be well trodden down, until the whole is filled up, allowing a few inches above the level for settling, which will be, however, very trifling.

1003. *Planting*.—"The best season for planting is the latter part of autumn or beginning of spring. And the most expeditious way of furnishing a house is, to plant clean well-worked maiden plants, previously grown in good stiff loam, and trained against a wall three years before they are taken

for such purpose. At that age they will have gained such strength, and got so well established in the soil, that they can be removed with large balls, and with the greatest safety, into the places where they are to remain; they will scarcely feel their removal. I generally place a compost of three parts loam, and one part rotten dung, immediately round the roots, in order to encourage the plants to strike more freely into the border.

1004. *Forcing in the first season.*—“In the first season, the commencement of the forcing is in the second week in February, when the lights are put on the house. I begin to add a little fire-heat in the last week in the month, and gradually increase this as the spring advances. I obtain a temperature of from 53° to 55° from fire; and I do not allow the sun-heat to exceed 75°. The heat at night is kept uniform by means of a moderate fire, and in the day by the admission of air.

1005. *Watering and fumigating.*—“The trees during the first summer should have frequent bottom waterings, and be well syringed with clear water two or three times a week; this will greatly promote their growth and keep them clear of insects. Should the green fly, or red spider, make their appearance, two or three strong fumigations with tobacco, and frequent syringing, will keep the trees clean.

1006. *Summer pruning.*—“If the trees appear to make luxuriant shoots in any part, when bearing wood is wanted, the shoots should be stopped at the third or fourth leaf; and if they are still inclined to grow strong, they must be stopped a second time: this will obtain kindly wood. Two or three times in the spring the whole should be looked over, and the shoots moderately thinned out, leaving those which are most kind and well placed at regular distances for the next year's bearing. The first thinning of the young shoots should be just after the fruit is set, and when they are eight or ten inches long: when at that length, they must be laid in at such distances as to admit the sun and air to ripen the wood destined to bear in the ensuing season.

1007. *Routine treatment during the first season.*—“The principal business of the first season is to keep the young wood regularly laid in, to attend to the top and bottom waterings, and to the free admission of air at all opportunities. If all this has been done, and the plants have been kept clean, they will in this season have made plenty of good bearing wood for the next year, and they will have nearly covered half the extent of trellis within the house.

1008. *Winter treatment.*—“I generally take off the whole of the sloping lights for the winter months, and cover the borders and flues with five or six inches of light litter, to prevent severe frosts doing injury to either.

1009. *Forcing in the second season.*—“The glass should be put on in the last week in January, the house be well cleaned all over; and the flues, as far as possible, should be white-washed; and then the trees should be pruned. I have not laid down any rules for the winter pruning, as almost every gardener seems to have a method peculiar to himself of performing this work.—[See the article “Peach,” in our *Fruit Catalogue*.]

1010. *Applying a preventive composition.*—“Previous, however, to tying the trees to the trellis, I have the whole of their stems, but not the bearing wood, washed with a composition, formed of one pound of soft-soap, one ounce of tobacco, and a little flowers of sulphur, to which is added as much boiling-water as will make the whole of the consistence of paint. This

composition is carefully applied with a painter's soft brush whilst it is milk-warm. The process of cleaning should never be omitted at the pruning season, as it prevents the trees ever contracting the brown scale. When the trees are tied to the trellis, the borders must be dug; this gives the house a clean and neat appearance.

1011. *Forcing in February.*—"In the first week in February the house is shut up every night, and plenty of air given in the day; in the beginning of the second week, moderate fires are made, just to keep the heat by fire from 45° to 50° , not exceeding 70° of sun heat; in the third week, the fire heat is gradually increased from 50° to 55° , and not exceeding 75° sun heat. By this time the trees will be getting into blossom. Whilst they are in bloom I neither sprinkle nor steam the house, for I consider that sufficient moisture arises from the earth in the house at this stage of forcing. I admit plenty of air every day, when the wind is mild, and in a favourable quarter. "When the petals have all dropped, and the fruit is fairly set, I give the trees a gentle syringing on a fine morning, with clean water, and if any green flies appear, they have two or three smokings with tobacco, as directed before; this will totally destroy the insects.

1012. *March.*—"At this period (March) particular attention must be paid to the regularity of heat, which may be progressively increased a degree or two as the season advances, but I do not allow it to exceed the last-named temperature until the fruit is perfectly stoned, when I increase it from 55° to 60° at night, and from 77° to 80° of sun heat. At the medium of these the temperature should continue during the remaining part of the season.

1013. *Thinning the shoots and fruit.*—"Attention must be paid to the thinning of the young shoots, as directed in the first year's management, and when the young fruit are about the size of damsons, they should then be moderately thinned for the first time, leaving a sufficiency for selecting a full crop by subsequent thinnings, which should be performed at two or more different periods.

1014. *Stoning.*—"It is to be observed that a few days before, and a few days after, the crops begin to stone, is the most critical period in forcing, and if strict attention is not paid at that time to the due regulation of heat, and to the free admission of air at all opportunities, a great portion of the fruit will fall off. I have often seen three parts of the crops of peaches and nectarines thus lost.

1015. *Watering.*—"The borders within the house must be occasionally watered, after the stoning, until the fruit has arrived at full size, and begins to change colour, then all watering should be left off, both with the syringe and on the borders.

1016. *Ripening.*—"When this crop of fruit begins to ripen, which will be about the second week in July, I gradually expose the house to the open air on fine and dry days, by drawing down the lights as much as convenient in the day, and shutting them again in the evening. It is this which gives the fruit both flavour and colour.

1017. *Duration of the Crop.*—"This crop thus produced furnishes the table from the second week in July until the middle of August, then a second house should become ripe, and continue to yield a supply until the fruit comes in on the open wall. The above practice is the result of many years' experience."—(*Hort. Trans.*, vol. v., p. 62.)

SECT. IV.—*Culture of the Cherry under Glass.*SUBJECT. I.—*Natural Data for the Culture of the Cherry.*

1018. *The Cherry in its wild state* being indigenous to Britain, and as a cultivated fruit brought to as high a degree of perfection in our climate as in any other, very little requires to be said on the subject of natural data for culture. The cherry is cultivated in Italy and the fruit attains a large size, but in point of flavour it is inferior to the fruit of the same varieties grown in England, or in central Germany. The cherry is forced in all the northern countries of Europe, and as it produces fruit in the open air in three months from the time of blossoming, it is ripened earlier in forcing-houses than the fruit of any other tree. The temperature and moisture to be imitated are those of April, May, and June. The general practice in British Gardens is to begin at 40°, and throughout the first week to let the minimum be 40°, and the maximum 42°, giving plenty of air. By gradual advances in the second, third, and fourth week, raise the course to 42° min. 45° max. In strong sunshine, admit air freely, rather than have the temperature above 52°, by collecting the warm air. In the fifth and sixth week, the artificial minimum may be gradually elevated to 45°, but the maximum should be restrained to 48° from fire-heat, and to 55° from sun-heat, until the plants are in flower. After the blossoms are shown, and until the fruit is set, aim to have the heat, from the flues or water-pipes, at 48° min. 52° max. At this stage, maintain as free an interchange of air as the weather will permit; and when the sun-heat is strong, do not let the temperature within exceed 60°. As the fruit is to be swelled and ripened, the requisite heat is 60° min. 65° max.

The art of forcing cherries has been carried to a high degree of perfection in the Royal Gardens at Kew and at Hampton Court; and we shall, therefore, give a transcript of the practice at these places, as furnished to the *Gardener's Magazine* by Mr. W. Lawrence, who was several years journeyman in the gardens at Hampton Court.

SUBJECT. II.—*The practice of Cherry Forcing in British Gardens.*

When cherries are required at the earliest period at which they can be produced in a forcing-house, which is about the middle of March, it is desirable to have a stock of plants in pots; because the entire plant being under the command of the forcer, can be excited much more effectually than if its roots were in the cold soil, and only its head exposed to the action of the warmth of the house.

1019. *The cherry house* may be thirty feet long, fourteen feet wide, twelve feet high at the back, and seven feet high in front. The ends should be of glass, and both ends and front should be placed on brick walls two feet high supported by arches. The front sashes may either be hung on hinges at the tops, or at the sides, to open outwards; or they may be made to slide in grooves. The roof sashes should be in two lengths; the lower ones to pull up, and the upper ones to let down. As cherries require a great deal of air, and this often during wet weather, above the upper sashes there should be a projecting flashing of lead, to exclude the rain when the sashes are let down an inch or two. The heating may either be by flues or by hot water; and in either case one furnace or one boiler, with the flue or pipes going round the house immediately within the front and ends, will be sufficient.

1020. *Kinds of cherries for forcing, potting plants, &c.*—The May Duke is decidedly the best cherry for forcing. The Morello forces well, but requires more time to bring it to maturity; and, though it looks well in the dessert, it is not so agreeable to eat. The plants for potting should have been three or four years worked, and should be such as are well furnished with blossom-buds. The soil used in potting may be loam, such as that in which melons are grown; to which, if necessary, one-fifth part of thoroughly rotten dung may be added; bearing in mind that too rich a soil makes the shoots too luxuriant, and causes them to gum. The season for potting is September and October, or any time before forcing; but the trees will do quite well for late forcing, if they are not taken up and potted till they are just about to be put into the house. After potting, before setting the trees in the house, it is necessary to watch the operations of the sparrows, which are very apt to pick off the buds of cherries in the winter season, probably in search of the eggs or larvæ of insects. If the trees potted are standards, they may be set on the ground, or on a low stage; and if they are dwarfs, upon a higher stage, so as, in either case, to bring their heads within eighteen inches of the glass. They may be set so close together as that their heads may be within a few inches of touching each other.

1021. *Time of commencing to force.*—For the first crop shut up the house and begin lighting fires about the middle of December. The thermometer, for the first fortnight, should be kept at about 60° during the day, and 50° during the night; syringing the trees morning and evening with water that has stood some days in the house, and keeping constantly one or two of the sashes open a few inches at the end of the house next the fire, in order to moderate the temperature there. The second fortnight the heat is allowed to rise to 60° during the night, and to 70° during sunshine. The trees in pots should be watered, when they require it, at the root; but for any that may be planted in the ground, the watering over-head will be sufficient. When the trees come into bloom, the temperature must be lowered to 50°, or even lower, both by night and day, except during sunshine, when the heat may be allowed to rise a few degrees higher. During all this time air must be admitted more or less, both during mild nights and by day; but especially in the day-time, and during sunshine. When fine weather prevails at the time the trees are coming into bloom, a comparatively greater heat is required at night than during the day; because if they are kept cool at night, the heat of the day is apt to expand the flowers before the stalks have grown to their natural length; and, if so, although all the flowers might set, (which is not the case when they are short-stalked,) it would be impossible for a full crop to swell off, as there would not be space enough for the cherries to expand. Watering must be withheld from the tops of the trees during the time they are in blossom, but given as required for their roots, and the floor kept moist by sprinkling it morning and evening. No water should be poured on the flues, because a powerful steaming at this season would destroy the blossom.

1022. *Progress.*—Trees begun to be forced in the middle of December will come into blossom in the middle of January, set their fruit about the end of the month, and stone it about the middle of February.

1023. *Insects.*—After the leaves expand, it very often happens that a caterpillar, or some black fly, makes its appearance; these are sometimes scarcely to be met with in the day-time, but on going into the house at night

the caterpillar will be found crawling on the leaves and eating them. Fumigation with tobacco, and hand-picking, are the only remedies for these insects. Ants sometimes make their appearance when the trees are in blossom; and though they are not so injurious to the cherry as they are to the peach, yet still they ought to be destroyed, by pouring tobacco water into their nests. Till the ants' nests are destroyed, the insects may be prevented from getting at the blossoms, by tying pieces of paper round the stems of the trees, and coating them over with a mixture of tar and grease: the paper should be of a coarse spongy kind, so as to absorb the tar, and prevent it from running down the bark of the stem when the temperature of the house is high—or yarn may be used instead of paper. In either case, as soon as the tar becomes hard, the ants will walk over it, and, in that case, it must be renewed. When the trees are in blossom, it will facilitate the setting of the fruit if bees can be introduced, which may easily be done, by setting in a hive, or, what is preferable, by fixing a hive immediately in front of the lower part of one of the front sashes, and so as to touch it, and having an entrance for the bees at the back of the hive, as well as the usual one in front of it. Corresponding with this back entrance, a small hole may be cut in the bottom rail of the sash, and a stopper or slide fitted to it, through which the bees may be admitted to the cherry-house at pleasure.

1024. *Thinning and stoning, &c.*—When the fruit is fairly set, it should be thinned out with the grape scissors, removing from one-fourth to one-third of the cherries, according to the vigour of the tree, and the number of fruit it has set. When once the fruit is set it is not liable to be injured by cold, as in the case of peaches and grapes. On the contrary, cherry trees, in pots, have been turned out into the open garden, by way of experiment, after the fruit was set; and the frosts, which damaged the leaves, had no effect at all upon the fruit, except to retard its growth. After the fruit has begun to stone, (which is generally about a fortnight after it is set,) the trees should be watered freely at the roots, but in eight or ten days, when the kernel begins to harden, the quantity of water may be diminished. The temperature of the house, except in sunshine, should never exceed 60°, either by night or by day, from blossoming up to the time of stoning; but in three weeks after setting, when the stoning will generally be found completed, and the pulp of the fruit beginning to assume a pale red, the temperature may be raised to 70° at night, and even to 70° or 80° in the day, during sunshine, and when abundance of air is given. After the fruit is ripe, water should be withheld till it is gathered. In every stage of the progress of the cherry in a forcing-house, the plants may be watered with liquid manure, which is found to strengthen their leaves and buds without injuring the flavour of the fruit.

1025. *Treatment of the plants in pots after they are taken out of the house.*—Immediately after the crop is gathered the trees should be taken to a cool, rather shady situation, set on the ground, and the pots surrounded up to the rim with rotten tan, saw-dust, or any similar materials, to keep them cool, and in an equable degree of moisture. If, on the other hand, a second crop of cherries should be wanted late in autumn, the soil in the pots should be allowed to be quite dry for a month; and, by afterwards watering it freely, and placing the trees in the house about the end of August, and treating them in the same manner as was done in early spring, they will ripen their fruit in October or November. Such trees, however, will not be again fit to

force for two or three years to come ; and they should, therefore, be turned out of the pots into the free soil, and allowed at least two years to recover themselves, when they may be again re-potted and forced. While in the open ground, all the blossoms produced should be picked off as soon as they appear, to prevent them from weakening the trees. In the cherry, as in most trees that produce their blossom on the wood of the preceding year, or on spurs, the blossom-buds expand first, and next the barren or wood-buds. The latter continue growing till the petals of the flowers drop off, when they receive a check, and scarcely grow at all, till the fruit is set and begins to swell ; after which they grow rapidly, and complete the shoots of the year, by the time the fruit is stoned.

1026. *To have a constant succession of cherries* from the middle of March till July, as soon as the trees of one house have come into blossom, those of the next should have artificial heat applied, and the temperature and management will be in every case the same as that which has been above described. It may be observed here, that cherry-houses, with the trees planted in the ground, are much less suitable, not only for early forcing, but for main and late crops, than cherry-trees planted in pots. The cherry cannot, like the peach and the nectarine, be forced for a number of years together ; and hence, as a house in which the trees are planted in the ground must, every three or four years, have a season of rest, the house during that season, having the sashes taken off, is in a great measure of no use.—(*Gard. Mag.* vol. xiv. p. 41.)

1027. *Forcing cherries by a temporary structure.*—Where a portion of wall (especially with a southern aspect), already well furnished with May-dukes, perfectly established, and in a bearing state, can be spared for forcing, a temporary glass case may be put up against it ; the flue may be built on the surface of the border, without digging or sinking for a foundation ; neither will any upright glass or front wall be requisite ; the wooden plate on which the lower ends of the rafters are to rest may be supported by piles, sunk or driven into the soil of the border, one pile under every, or every alternate, rafter. The space between the plate and the surface of the soil should be filled by boards nailed against the piles, to exclude the external air, for the plate must be elevated above the level of the surface from eighteen to thirty inches, or whatever height may be sufficient to let the sashes slip down, in order to admit fresh air. This structure will suit well for cherries, for such structures have been erected for forcing peaches with good success, as well as for maturing and preserving a late crop of grapes.—(*Torbron in Hort. Trans.* vol. iv. p. 117.)

1028. *German practice.*—In the Royal Gardens at Potsdam, cherries are frequently forced so as to be ripe by the end of February ; the gardener there, Mr. Fintlemann, being remarkably successful in this department of forcing. The plants are potted a year before they are forced. They are potted in autumn, and the roots protected from frost through the winter by being covered with litter.

In the following spring the blossom buds are broken off as soon as they appear ; and, by the end of June, all the shoots which have pushed freely have their points pinched off, so as to leave not more than six buds, which buds by that operation become blossom buds.

Before the plants are taken in they must at least have sustained 14° Fahr.

of cold, otherwise they are found to break very irregularly: The blossoms are thinned out; so much so, that where fifteen have appeared, not more than three have been allowed to expand. The construction of the house in which the forcing is commenced varies according to the season. When the trees are taken in, in December and January, the glass of the roof must be much steeper than when they are not taken in till February and March.

Heat is communicated by flues, commencing with 46° Fahr. The trees are frequently sprinkled with lukewarm water; and the roots, which ought to have been kept quite dry for some time before the plants are taken in, are well soaked with warm water. Mr. Fintlemann boils one-half of the water, and mixes it with the other half; and he uses water of this temperature till within fourteen days of the trees coming into blossom.

When the buds break out into bloom, watering overhead with lukewarm water is left off, but the stems are kept moist by rubbing them two or three times a day with a wet brush. During the blooming season the temperature is raised from 46° to 67°, every third day, 2¼° more heat being added. Abundance of air is given, and shade during bright sunshine. In boisterous weather gauze is placed over the openings through which the air is admitted, the advantage of which in moderating the violence of the wind, Mr. Fintlemann is well assured of, after eight years' experience. To cause the blossoms to set, the branches and spray are frequently put in motion, but care taken not to move the main stem, by which the fibrous roots might be injured.

When the fruit is setting and swelling, the temperature must be kept between 54½° and 65¾°.

When the fruit is stoning, the temperature is lowered to 59° for two or three weeks, during which period the house must be shaded in bright sunshine, and the plants watered overhead once or twice a day.

When the stoning is completed and the fruit begins to swell, the temperature is again raised to 65°, and no more shade given, in order that the fruit may acquire a high flavour through the operation of the sun's rays; to facilitate the action of which on the fruit, the superfluous leaves are removed. By this practice, plants begun to be forced in December commonly produce ripe cherries in February; but Mr. Fintlemann has sometimes had them even in January, though without a good flavour.

Recent experience has taught Mr. Fintlemann that cherries will force remarkably well in sawdust, or chopped moss, mixed with some powdered unburnt lime. Plants grown one year in two years old sawdust, and a little powder of lime, put into the forcing-house on the 16th of January, gave a ripe fruit by the end of February.

The kind of cherry forced by Mr. Fintlemann is the same as our May Duke; and some of the points of his practice, such as shortening the shoots to produce blossom-buds, thinning blossoms, the previous exposure to cold, and the use of warm water, seem worthy of the imitation of the British gardener.—*Gard. Mag.*, vol. iii. p. 65.

At the same time it must be borne in mind, that the atmosphere in Prussia, and on the Continent generally, is much clearer than in Britain, and that there are few days in which the sun during the short time which he is above the horizon does not shine brightly. Hence as far as light is concerned in forcing, the British gardener can never contend with the German one.

SECT. V.—*Culture of the Fig under Glass.*SUBJECT. I.—*Natural Data on which the Culture of the Fig is founded.*

1029. *The Fig (Ficus Cáríca, L.)* is a native of Asia and the sea-coast of Africa, and it is cultivated on the shores and islands of the Mediterranean, in Italy, and in the South of France; but, like the olive, never far from the sea-side, or at great elevations. The soil is generally light, but superincumbent on a subsoil, which is supplied with water within the reach of the roots. It would thus appear that the fig is not intended by nature to endure a severe winter, a great degree of drought, or a very hot summer; and this conclusion is in accordance with the succulence of its wood, the retention of young fruit on its shoots throughout the winter, and its broad succulent leaves. The spring and summer temperature suitable for the grape vine has been found to answer for the fig, but the latter requires a moister atmosphere, and more water at the root when in a growing state, and the temperature should not be below 40° during winter. It is the nature of the fig to produce two crops in the year, both when it is cultivated in the open air, and when it is under glass. The first crop, which is produced on the points of the shoots of the last year, ripens in Italy in May and June; and on walls in the climate of London in September and October. The second crop is produced on the shoots of the current year, and ripens in Italy in October; but in the open air in this country it never ripens at all, excepting a few of small size, which remain on through the winter, and constitute the first crop, just mentioned, of the following summer. Under glass, the first crop ripens at various periods between March and June, according to the time of commencing to force; and the second crop, which in the open air never attains maturity, is under glass that which is most to be depended on. The first crop under glass ripens in four or five months from the time of commencing to force, and the second crop in six or eight months. The fruit of the fig is what is called a common receptacle for the flowers, but turned up in a turbinate or top shape, so as to inclose the florets and completely exclude them from view. The fig, both in fig countries and in British gardens, is apt to drop its fruit prematurely; and in Italy and Greece the process of caprification is employed to counteract this tendency. It consists in placing among the branches of cultivated fig trees, branches of the wild fig, or even fruit that has dropped off wild trees, in which a kind of gnat abounds, and which enters the fruit on the cultivated tree, and passing over the anthers distributes the pollen over the stigma. The utility of this practice is doubted by many; at all events, it is neither practised in France nor Britain, but as a substitute for it, ringing the branch immediately behind the fruit has been found successful in some British gardens.

SUBJECT. II.—*The forcing of the Fig as practised in British Gardens.*

1030. *The Fig* is not a favourite fruit in Britain, though since the peace of 1814 the taste for it has considerably increased. It is most generally forced in pots, either placed in pits, or in peach-houses, vineries, or even pine-stoves; and as the plants bear two crops in a year, it is not difficult to have a supply of fruit at most seasons; the chief dependence, however, is on the second crop, or that produced on the wood of the current year.

1031. *The construction of the Fig-house* may be the same as that of the peach-house (991); but the leaves being large, the trellis may be placed

from six inches to a foot farther from the glass. The *soil* of the border should be light, sandy, and thoroughly drained.

1032. *The varieties best adapted for forcing* are Pregussata, Figue blanche, or White Marseilles, and Brown Turkey, or Ashridge forcing, to which may be added the Nerii, which, it is said, requires less heat than the other varieties. The plants may be trained in the fan manner, and the mode of pruning should be such as to favour the production of young wood over every part of the tree. For this purpose a portion of the old wood requires to be cut out every year, from those parts of the tree where young wood has ceased to be produced freely; and as this is seldom the case at any great distance from the root, most old fig-trees consist of a number of main branches proceeding direct from the root in the manner of suckers. Very little pruning is required for the fig; but by pinching out the points of the shoots after the fruit appears, its progress is hastened, and the chance of its setting increased. The fruit is very apt to become yellow, and drop off before it is fully swelled; but this, it has been found by Sir Charles Monck (*Hort. Trans.*, vol. i., second series, p. 395), may be prevented by taking off a ring of bark immediately behind the fruit. By attending to this practice when it becomes necessary, the fig, Sir Charles Monck observes, may be forced to produce abundant crops of fruit, and bring them to perfect maturity.

1033. *The time of beginning to force the fig* is commonly the same as that for forcing the grape or the peach, and the temperature is also much the same as that for the vine, or somewhat intermediate between it and the peach. The apricot, peach, plum, and cherry vegetate in March or the beginning of April; but the vine and the fig require the temperature of May to bring them into vegetation even when growing against a south wall. Hence, when forced, they require a proportionately higher temperature to bring them into leaf.

The first crop of figs, which is that produced on the points of the shoots of the last year, will ripen in May or June; but the second crop will not ripen before September, though, as it does not ripen all at once, it will last till December. The only difficult point in forcing the fig is to preserve the embryo fruit formed on the points of the shoots of the current year, so as that they may ripen as a first crop in the next year. The fig will thrive at a greater distance from the glass than either the vine or the peach, and also, according to Miller, with less air than any other fruit-tree. It is very subject to the red spider, which should be kept under by watering copiously over the leaves; or, if that is not sufficient, by washing the flues or hot-water pipes with a mixture of flowers of sulphur and lime.

1034. *The forcing of fig trees in pots* is perhaps the best mode, at least for small establishments, because, by having an abundant stock of plants, fruit may be obtained nine months in the year, as indeed it is at Preston-hall, in East-Lothian, where forty varieties are cultivated under glass. M^cPhail says, figs may be ripened at an early season, by planting them in pots, and setting them into a hot-house or forcing-house. "The plants should be low and bushy, so that they may stand on the curb of the tan-bed, or they may be plunged in a gentle tan-heat, or in a bed of leaves of trees. The best way to propagate plants for this purpose is to take layers or slips which have good roots: plant them in pots in good earth, one plant in each

pot, and plunge them in a bed of tan or of leaves of trees, in which is a very gentle heat: a brick bed will answer the purpose very well; or they will do in the forcing-house, if there be room for them. Let them be put into the house in the latter end of February or beginning of March, and keep them sufficiently watered. When they are two years old, they will be able to bear fruit; the pots in that time having become full of roots. In the month of November or December, turn the plants out of the pots, and with a sharp knife pare off the outside of the ball, by which the plant will be divested of its roots matted against the inside of the pot: then place them into larger pots, filling up the vacancy round the balls with strong loamy earth. During the winter, let them be kept in the green-house, or in a glazed pit of a like temperature, till the month of February; which will be a means of preventing the fruit from falling off before it comes to maturity. In this manner let them be treated every year, till the plants become too large for the pots; then set them into the forcing-house, where it is intended they shall ripen their fruit.”—(*Gard. Rem.*)

1035. *Winter treatment.*—The glass of the fig-house should not be taken off during winter, because it is an important object to preserve the embryo fruit that are to produce the first crop in the following year. Hence, wherever it can be accomplished, the sea-side temperature of Genoa or Naples, which is rarely under 38° or 40°, ought to be maintained in the fig-house throughout the winter months. This is most conveniently and economically done when the plants are kept in pots or tubs, as they can then be removed to a shed or cellar, as is the practice in Germany.

SECT. VI.—*On forcing the Plum, Apricot, Gooseberry, and other Fruit-trees and Fruit-shrubs.*

In Germany, and more especially Russia, it is customary to force all our hardy fruit-trees and fruit-shrubs, including even the currant and raspberry. The plants are invariably kept in pots; and, when the fruit is ripe, the pot and the entire plant is placed on the dessert-table. The forcing is generally carried on in the same house with various culinary vegetables, and being ripened without the natural quantity of light and air, it is, as far as we have tasted it, when in these countries in 1813 and 1814, without much flavour. Plums and apricots are occasionally forced in Britain; they are planted in pots, and placed in pits, or in any forcing-house where there is room. The temperature and treatment of the peach-house, it will readily be conceived, is most suitable for them.

SECT. VII.—*Culture of the Melon.*

SUBJECT. I.—*Natural and experimental data on which the Culture of the Melon is founded.*

1036. *The melon* (*Cucumis Mèlo*, L.) is an herbaceous trailing or climbing annual, indigenous or cultivated in great part of the warmer districts of Asia or Africa from time immemorial. In the warmer parts of Europe, it has been cultivated at least from the time of the Romans. The melon is extensively cultivated in Armenia, Ispahan, and Bokhara, and very generally in Greece, Italy, and the shores of the Mediterranean. It succeeds in the open air as far as 43° N.; and its culture extends within the tropics, but only when it is abundantly supplied with moisture. Its extremes of tem-

perature may be 70° and 80° for atmospheric heat, and some intermediate degree, perhaps 75°, may be suitable for the soil. The atmosphere in the countries where the melon is most successfully cultivated is so dry that the plants depend almost entirely on surface irrigation and on dews. The soil in which the melon is found to thrive best is a fresh loam, rather strong than light, such as may be obtained from an alluvial meadow which is flooded during the winter season. In Persia, pigeon's dung is used; but in Britain stable-dung, which has been thoroughly rotted, is commonly more or less mixed with the soil; but it is not desirable to introduce manure to such an extent as to produce the same degree of luxuriance in the shoots which might be desirable under a tropical sun. The melon in this country requires all the light which it can receive, and therefore the plants must have their shoots trained close under the glass, for which purpose a trellis is found superior to the surface of the soil; for unless this is the case, and abundance of air is admitted, the fruit produced will be of very inferior flavour. Early crops of the melon are with difficulty obtained in Britain, on account of our cloudy atmosphere, by which evaporation from the foliage is checked, and mildew and other diseases are produced. Late crops, it may easily be supposed, are less liable to be affected in this way, from the greater degree of light and heat admitting of more abundant ventilation. The varieties of the melon belong to two races: the Persians and the Cantaloups. The former are cultivated in this country with great difficulty, requiring a very high temperature, a dry atmosphere, and an extremely humid soil. The Cantaloups, which are so named from a place of that name in the neighbourhood of Rome, are cultivated throughout Europe with great success, and nowhere more so than in England.

1037. *Summary of culture for the Cantaloup melons.*—The following summary is evidently by the author of the article "Peach," in the *Penny Cyclopædia*; at all events it is unquestionably the most scientific abridgement of melon-culture which has hitherto appeared:—"About four months may be allowed, on an average, for the period between the sowing of melons and the ripening of the fruit. The middle of January is found to be early enough to sow; and the young plants are so exceedingly tender that accidents are then very likely to occur to them. It is on this account necessary to make successive sowings, in order to be prepared for replacement, if requisite, and also for continuing the supply throughout the summer. A sowing for the latest crops will require to be made in April. Melons may be grown by means of frames on hotbeds (489 and 841), or in pits (515), heated according to some of the various modes of hot-water application, now so generally adopted; but whatever be the form of the pits or the mode of heating adopted, one point of essential importance is to have the sashes glazed with the British sheet glass, as being much clearer than the best crown glass, and as admitting of being used in panes of any length under five feet, and consequently requiring very few or no laps. The seeds are sown in pans, or in small pots, and transplanted into other small pots when their seed-leaves are about half an inch broad. It is best to put only a single transplanted melon into each pot. While this is done in a separate frame, that which is intended for their future growth and fruiting is prepared for their reception by placing small hills, rather more than a foot high, of light rich mould below each sash, and nearer to the back of the frame than the front. Care must be

taken that this mould be of the proper temperature before the young plants are introduced, which is to take place when they have made a few rough leaves. As the roots extend, more soil should be added, of a gradually stronger nature; and ultimately the roots should have a depth of about fifteen inches of such soil. The soil should never be introduced in a cold state; and if there be no means for previously bringing it to the temperature of at least 70°, it should be put into the frame in small quantities. When water is required, it should never be much below the above-mentioned temperature, nor should it exceed 78°. It should not be applied when the air of the frame is at a high temperature from sun-heat. Shading is necessary immediately after watering, when the sun's rays have any great degree of power: unless this precaution is attended to, scorching will be induced, and the red spider will be likely to attack the foliage. With regard to pruning and training the runners or vines of melon plants, it is necessary that a sufficient number of these for filling the frame should be made to ramify as close to the base of the main stem as can be conveniently effected, by pinching off the top of the latter when it has made a few joints, or four leaves above the cotyledons; and the laterals, which in consequence become developed, may be again subdivided by a similar process. Blossoms of a monoecious character will soon after make their appearance. The male blossoms, or at least a portion of them, must be retained for the purpose of fertilisation, till the requisite quantity of fruit is fairly set, after which those shoots which have only male blossoms may be dispensed with, in order to afford more space for the foliage connected with the fruit. The extremities of the fruit-bearing vines are stopped by pinching at the second or third joint above the fruit. The vines must afterwards be kept regulated so as not to over-crowd the frame with more foliage than can be duly exposed to the light. The regulation should be early and frequently attended to, so as not to have occasion to remove many vines from the plant, or divest it of much foliage at any one time. A piece of slate or tile is placed under each fruit, for the purpose of keeping it from the damp soil. The heat must be fully maintained, or even considerably increased, as the fruit approaches maturity, in order to allow the admission of a more free circulation of air; but if, at the same time, the bottom-heat be allowed to decline, the plants will become diseased, and fall a prey to the mildew or to the red spider."—*Penny Cyc.*, vol. xv. p. 85.

To these excellent observations we have only to add, that the trellis referred to in the preceding paragraph (1036) is raised from a foot to eighteen inches above the soil, and within from ten inches to fourteen inches of the glass. The trellis is formed in panels of the same size as the lights, and rests on projections from the front or back of the frame, or pit, or is suspended by hooks. The trellis may either be formed of wire fixed to a wooden frame, and forming meshes five inches square to admit passing the hand through to the soil beneath; or it may be formed of laths three quarters of an inch broad, and half-an-inch thick, also formed into squares, and nailed at the intersections. In general laths are preferable to wires, on account of their forming a flat surface for the fruit to rest on. The trellis is not introduced to the frame or pit till the plants are grown sufficiently high to admit of their tops being brought through it. The shoot having been brought through the middle of the trellis, and grown three joints above it, remove two joints with the finger and thumb, which will cause the plant to

throw out fresh shoots. Of these the top ones must be preserved, and stopped at every other joint; and such as present themselves lower down the stem must be taken off. When those retained get sufficiently long, they must be tied down to the trellis with care, and after making two clear joints each they must be stopped back to one. In general four shoots, trained towards the four corners of the trellis till they reach within a foot of the outer edge of the bed, will be sufficient. There they must be stopped. They will now produce laterals, which should be thinned, three or four only being left on each of the four main shoots, and the others should be taken off close to the main stem out of which they grew.—(*Mills's Treatise, &c., p. 60 and p. 7; and Duncan on the Melon, p. 44.*)

SUBJECT. II.—*Culture of the Melon as practised in British gardens.*

The following article was written for this work by Mr. Forsyth, though it has appeared in the 16th volume of the *Gardener's Magazine*:—

1038. *The sorts* I should cultivate are, a few Rocks, for their look at table at expensive entertainments; Green-fleshed, as being economical and fashionable (a middle-sized fruit about two lb. weight being considered the best); and Persians, such as the Sweet Ispahan and Hoosainees, for their rich aqueous pulp, and as by far the most delicate and delicious of the melon tribe.

1039. *Very early melons* may be grown in pots, one plant in each, to mature one fruit, in the pine-stove, or in a house or pit on purpose, where a wholesome high temperature is maintained of 75° or 80°; the fruit may be supported by being laid on a small earthenware saucer, inverted into a larger one suspended from the roof.

1040. *Seedlings.*—Melons planted out on a ridge, on a bed of tan, dung, or leaves, under glass, may be advantageously cultivated in the following manner. In any house, pit, or frame, where an atmosphere as above described is maintained, sow some seeds in thumb-pots, one seed in each pot, which must be kept near the glass after the plants are above-ground, and be allowed a free circulation of air, in order to rear the plants as robust and short-stemmed as possible; but, though I detail the process of rearing seedlings, I must not be understood to mean that they are equal to those raised from cuttings, which process I shall here detail:—

1041. *Cuttings.*—In an atmosphere as above described, let the cutting-pots, prepared in the following manner, be placed half a day previous to their being used, in order that the mould may be warm, to prevent a check by cold soil to the bottom of an exotic cutting. If provided with a small crystal bell-glass, or a small hand-light closely glazed, either of these may be used; but if provided with neither, which is nothing uncommon, you can doubtless command as much glass in square or fragment, as will cover the mouth of a 48-sized pot.

The cuttings should be taken from the extremities of the healthiest vines, cut close below the third joint from the tip, and inserted in thumb-pots filled with leaf-soil and loam mixed, about half an inch below the surface of the soil; and these placed in the bottom of a 48-sized pot, and the cavity between the two pots stuffed with moist moss, and the glass laid over the top of the outer pot, which ought to be plunged in a hotbed up to the brim: this is an improvement in striking cuttings which I have never made known before, nor have I ever seen it practised by any one else. It is a

common way to fill a pot three-fourths full of soil, and in that to insert the cuttings under a pane of glass; and I have no doubt, when those that have practised that mode come to see this simple improvement, so much more workmanlike, and applicable not only to melon cuttings, but to all sorts of cuttings, exotic, greenhouse, and hardy, they will feel nowise reluctant to relinquish the old way. The advantages of this mode are, when the cuttings get up to the glass, which they generally do before they have struck root, the outer pot can be changed for one a little deeper, and the moist moss serves the twofold purpose of conducting heat and moisture; and, as the heat of the tan or dung bed will be 30° or 40° above that of the atmosphere of the house or pit (a good tan bed will range about 110° at six inches deep), it will be communicated through the outer pot to the atmosphere around the cuttings, thereby accelerating their striking root: this high atmospheric heat is an advantage possessed in common with the old system over the bell-glass propagating pot.

1042. *Planting out.*—Plants being reared, either from seeds or cuttings, healthy and robust, are, let us presume, in 32-sized pots, about nine inches high, with leaves as large as the palm of the hand. The hotbed being made up to within eighteen inches of the glass, and a ridge of loamy turf, mixed with one-fourth its quantity of dung, pulverised to a mould, being laid along the centre of the bed, about twelve or fourteen inches deep, a day or two previous to the planting of the melons, and all fears of offensive steam from the bed or linings being guarded against, the plants may be turned out of the pots along the centre of the ridge, about one foot apart for a bed nine feet wide, or for a six-foot bed about fifteen inches apart, with a fine sweet moist heat, such as could be breathed comfortably, about 75° to 85° . Excess in quantity of heat is not so much to be feared as inferior quality of heat. A strong heat will rarify the air and cause ventilation; to facilitate which, a small aperture should be left open, say a quarter of an inch, at the top of every light, and this eighteen or twenty hours out of the twenty-four. The time that I should shut up close, would be at uncovering in the morning (which should be done as soon as it is light); and after syringing or steaming them in the evening, when no more air is wanted for the day heat.

1043. *General treatment.*—Plants raised from cuttings show fruit with less vine than those reared from seeds; and this is the best remedy, in conjunction with keeping them rather dry at the roots, for the ever-crying evil, that the “vines have run all over the bed without showing fruit.” I should prefer leaving a plant reared from a cutting entire, without stopping, until it shows fruit; those raised from seed must be topped, as they generally draw up weak and long-jointed, if left entire. I should top them for the first time as soon as they show the rough leaf, and again as they advance, say when they have made two feet of vine, in order to produce fruitful laterals. When fruit appears, they must be carefully managed to prevent sudden atmospheric changes; and, during the time that they are in flower, water overhead must be dispensed with, and gentle vapour only occasionally raised, to nourish the leaves, for it would be injurious to keep the flowers too moist at this time. Every female blossom must now be carefully impregnated; and, as soon as the fruits are set and beginning to swell, plenty of moisture and a closer atmosphere will be of the greatest service till they are swelled full size, when moisture at the root, and also vapour on the leaves, must be finally dispensed with. As soon as a reasonable number of fruits are

swelling favourably, say three to six on a plant, the rest, with every leaf and lateral, for which some good reason is not pledged, must unsparingly be discarded, leaving always one leaf, or perhaps two, beyond every fruit; and let every fruit be elevated on an inverted earthen saucer. To grow very early melons dry heat is indispensable, as every leaf, in moist weather, ought to be carefully dried once every day; and, in hot weather, every leaf ought to be as carefully moistened, by means of vapour or syringing. Before the fruit appears, and also when it is ripening off, a well ventilated atmosphere is best; but, whilst the fruits are swelling, closeness and humidity will be found to answer the purpose best. An occasional dusting of powdered charcoal and lime, mixed with sulphur and Scotch snuff, will go far to prevent the ravages of insect enemies.

The bed must be soiled over to the same depth as the ridge was originally made, at different times, as the progress of the roots shall dictate; and the roots must be supplied with soft well aerated water, as the firmness or flaccidity of the leaves must determine. As little shading as possible should be given, as the plants should be inured to the full sun as soon as possible; the minimum heat may be 70° , and the maximum 90° , though 100° would do no harm, even with the lights close, provided the laps and crannies about them were closed, or with the lights not closed, provided the transition were not rapid.—A.F. These directions are equally applicable to melons trained on a trellis, or on the surface of the ground.

1044. *Persian Melons* are very subject to burst; but Mr. Knight found that by raising the points of the fruit higher than the stems, so as to give it an elevation of 30° , not one fruit failed to ripen in a whole and perfect state.—(*Hort. Trans.* vol. i. 2nd series, p. 90.)

1045. *Culture of the melon in the open air.*—In the climate of London a late crop of melons may be raised on beds of dung in the open air, the plants when newly turned out being protected by hand-glasses. The customary mode is to have the beds flat, about four feet wide and two feet and a-half high; and when the heat declines, casings of hot dung are applied, first on one side, and, when that casing has ceased to be effective, on the other. The better mode, however, is to form the bed in the direction of east and west, with the north side supported by boards, so as to be perpendicular, and three feet six inches or four feet high, and the south side sloping at an angle about 40° east and west, and open to the south. The situation must be well sheltered from the north. Whichever description of bed is used, the plants may be raised from seeds or cuttings in April or May, and turned out in the first week of June. The plants should not be raised on bottom heat, because the transition to the open air is found to give them such a check as to turn the leaves yellow, and the entire plant sickly. There are two decided advantages in growing the melon in ridges sloping to the south: the first is, that the sun's rays are received at a much larger angle, in consequence of which the temperature is raised from 10° to 15° higher than it is in the shade; and the next is, that a larger, and consequently a more effective, casing can be applied behind. The only disadvantage is the difficulty of maintaining a uniform degree of moisture in the soil, which must, therefore, be frequently watered, and always with water at a temperature of 65° or 70° . To retain the moisture, as well as to reflect the heat, the sloping face of the bed may be covered with flat tiles or slates, but not overlapping, because that would conduct off the water. When the plants are

first inserted in the bed they are closely covered with hand-glasses, but as soon as they have begun to grow the glasses are raised on bricks, so as to allow the shoots to advance from beneath them ; and these shoots are carefully pegged down to preserve them from being deranged by the wind. The first fruit from such beds is generally cut in August, and they will continue productive till the plants are destroyed by frost in October. A thin covering of canvas during nights would no doubt contribute to the vigour of the plants by checking radiation.—(*Williams in Hort. Trans.*, vol. v., p. 364, and *Mills's Treatise*, p. 67.)

1046. *Insects and Diseases.*—The aphid, the red spider, and the thrip, are the greatest enemies to the melon, and if once the plants are overrun with any of them, it is scarcely possible to restore them to health. The aphid may be destroyed by fumigating with tobacco, or the paper in which it is packed, and the rope with which it is bound, on its importation to this country. Any of these will do, and each must be a little moistened when it is used. The best method of doing it is with the fumigating bellows, the muzzle being introduced through a perforation in the front of the frame or pit, nearly on a level with the surface of the mould ; the sashes should be covered with mats at the same time, to prevent the escape of the fumes. The operation should always be performed in the evening, and renewed the following one ; not a drop of water, from any source, should be allowed to touch the plants the next day. The frames are to be kept closed and shaded, so far as can be done without injury, and not opened until the latest desirable period.—(*Duncan on the Melon*, p. 69.) The increase of the red spider, and thrip, may be prevented, in a great degree, by a well-ventilated atmosphere, and a due degree of care in syringing occasionally in the afternoons ; but if these insects should become numerous, they may be destroyed by syringing with water, to which one-fourth part of tobacco water has been added. The wood-louse is a constant enemy to the melon, and is most effectually kept under by keeping a toad or two in the frames. If they should become exceedingly numerous, a flower-pot, laid on its side, with some dry hay in it, renewing it when it becomes damp, is an excellent trap. The canker is a frequent disease in the melon, generally occurring at the point where the plants emerge from the soil. Mr. Duncan applies a little air-slaked lime, as fresh as can be obtained, to the wounded part : it does not cure the disease, for it is incurable, but it retards its progress. The rotting of the stems from damp, want of light, or too free a use of the knife, is nearly as fatal as the canker, and like it is incurable ; but where it takes place at a distance from the root, an increase of heat, by adding linings, and the free admission of air and light, will cause new shoots to be produced. Mildew, our readers are aware, may always be checked by powdering with flowers of sulphur.—(*Duncan*, p. 73.)

1047. *The red spider and the damp*, the one as bad as the other, in melon frames, may be kept under by covering the surface with clean gravel, about three-fourths of an inch deep. The roots find their way to the surface of the mould, and form a matted texture under the gravel, where, being more accessible to the warm air of the frame, by means of which a corresponding temperature, as regards the roots and tops, is maintained, whilst the roots are, at the same time, kept moist, the plants grow so vigorously as to overcome every enemy. The practice is common in the neighbourhood of Doncaster.—(*Gard. Mag.*, vol. iii., p. 218.)

SECTION VIII.—*Culture of the Cucumber.*SUBJECT. I.—*Data on which the Culture of the Cucumber is founded.*

1048. *The cucumber* (*Cucumis sativa*, L.), is an annual, climbing by tendrils, or trailing on the surface of the ground, a native of the East Indies, and probably of many parts of Asia and Africa. It has been cultivated in the old world from time immemorial for its fruit, which is used in an unripe state, alone, or in salads, and for salting and pickling. The cucumber will bear a tropical heat, for it grows abundantly in many tropical countries. In the lower regions of India, the mean annual temperature may be reckoned as high as 80°; the thermometer indicating rarely so low as 70° in the hottest period of the season. The cucumber thrives well where the heat of the nights is more oppressively felt by Europeans than that of the days. As a wide difference does not occur in the diurnal and nocturnal temperatures of tropical countries, where the cucumber grows spontaneously, it is not necessary that a great variation should, in this respect, be imposed upon it when under artificial treatment. In order to be tender when cut for use, it requires to be grown rapidly, and, therefore, requires as much heat and moisture as can be safely applied. If the native plants of colder climates are forced night and day in a uniformly high temperature, a drawing, or weakness, soon becomes evident; but no such signs are exhibited by the rigid leaves of the pine-apple, although grown in a uniform temperature of 80°, provided they have not less than eleven or twelve hours' light out of the twenty-four. The cucumber will grow side by side with the pine-apple; and also naturally in a much higher latitude; but in that case its growth is limited to the summer season, when nearly a tropical heat is maintained. If the nights are cold, although the days may be warm, cucumbers growing on ridges in the open air, in this climate, invariably become diseased and attacked by mildew. A temperature ranging between 70° and 80° of artificial heat is suitable for the growth of the cucumber; if sun-heat is likely to raise the temperature much higher, air should be copiously, yet gradually, afforded; and, presuming that the plants are in good health, and their roots well established, enough of moisture being present, they will bear 90° or more of sun-heat without injury.

1049. *In cultivating the cucumber in first-rate British gardens*, the object is to have a supply of fruit throughout the year. This may be effected in dung-beds (841), but more conveniently by some description of pit heated by flues or hot water, or by a house constructed on purpose, with a steep glass roof. The plants may be raised either from seeds or cuttings. The best varieties for early culture are the Syon House, Hort's Early Frame, Weedon's Cucumber; and for large fruit to be exhibited at horticultural shows, Allen's Victory of Suffolk, the Roman Emperor, and some others which it is unnecessary to enumerate, as new sorts are continually coming into fashion, and old ones losing their reputation. The soil cucumbers prefer is light and rich, but they will grow in poor soil watered with liquid manure. Sandy-peat has been found suitable for dung-beds in the winter season, because water passes rapidly through this soil, without so much being retained by it, especially on the surface, as to cause the plants to damp off. The shoots of the cucumber are commonly allowed to trail on the ground; but they are much less likely to damp off when trained on trellises within 8 inches or 10 inches of the glass, as practised since 1790 in a cucumber house

at Knowlesley, and recently adopted in common frames and pits by Mr. Weedon. To concentrate the vigour of the plant, the shoots are stopped repeatedly as they advance in growth, by pinching out the growing point with the finger and thumb. Shoots bearing fruit are generally stopped at the second joint beyond the fruit, as soon as its blossom has begun to fade, in order to throw more of the sap into the fruit. Cucumbers require a great deal of ventilation, and the best growers make it a point to have the foliage thoroughly moist during every night, and thoroughly dry during a portion of every day, during the whole of the plant's existence. The cucumber will live either in the open air or under glass, at a temperature of 50°, and it will grow and produce fruit at 60°, but not vigorously and abundantly at a lower temperature than between 75° and 80°—and with this the bottom-heat should correspond. With abundance of light, air, and frequent watering, it will grow vigorously in an atmosphere of from 85° to 90°, saturated with moisture for at least a portion of every 24 hours. The foliage of the plants ought always to be kept within a few inches of the glass; and in the winter season all the light ought to be admitted that the state of the atmosphere admits of, and especially the morning sun. For this reason the glass over cucumbers, (and melons also,) should never be covered till it is nearly dark, and always be uncovered at daybreak. The cucumber requires an ample supply of water, which should be pond or rain water, and always of the same temperature as the soil in which the plants grow; or a degree or two under it, as falling rain is generally a degree or two lower than the temperature of the atmosphere through which it falls. Liquid manure may be advantageously used when the soil is poor, or when it is limited in quantity, as in the case of cucumbers grown in pots. As the cucumber, like the melon, has the stamens and pistils in different flowers, artificial fecundation is by most gardeners considered necessary, or at least conducive to the swelling of the fruit; but by others, and among these some of the best cultivators, it is considered of no use, excepting when seed is required. Many persons prefer cucumbers which have not been fecundated, on account of the much smaller size of the seed integuments, which never contain kernels; though, on the other hand, some prefer fecundated cucumbers, alleging that the kernels of the seeds communicate a superior flavour. It is found that seed is produced most freely from plants grown in rather poor soil, and in the open air against a wall, rather than under glass. Hence the greater quantity of seeds found in cucumbers grown on dung-ridges in the open air, and the much greater quantity found in cucumbers grown in the sandy soil of Sandy in Bedfordshire, and sent to the London market for pickling and stewing, than in cucumbers grown in houses. Without abundance of seeds, cucumbers for pickling or stewing would be good for nothing. Cucumbers grown for seed are of course always allowed to attain maturity, in which state they are of a yellow colour. The seed is taken out, washed and dried, and preserved for use, and it is generally considered that, for early crops, seeds which are several years old produce plants less likely to run to foliage, and consequently more prolific in blossoms. Some of the best modern cultivators, however, think the age of the seed of no consequence; and some preserve it in the fruit till it is wanted for sowing. The cucumber is liable to the same insects and diseases as the melon, which are to be subdued by the same means. Want of sufficient bottom heat, and watering with cold hard water, are the general causes which produce the mildew, canker, and

spot; and want of atmospheric moisture encourages the red spider and the thrip, and to a certain extent also, the aphides.

1050. These are the general principles of cucumber culture. Within the last two years, treatises have been published on the cultivation of the cucumber by Mills, Duncan and Ayres; and a few years before by Allen, Smith, and Weedon. These works treat of the culture of the cucumber in dung-beds, in pits of different kinds, in stoves, and vineries, in the cucumber-house, and in the open air; and the following subsections derived from them will, we trust, supply all that is wanted by the Suburban Horticulturist for routine practice.

SUBJECT. II.—*Culture of the Cucumber in a Dung-bed.*

1051. *The formation of a dung-bed* for general purposes has been already given (841 to 847). For the purpose of growing cucumbers in mid-winter, great care is necessary to prepare the dung properly, so that by reducing its heat there may be no danger of an excess, or what is termed a “burning heat,” after the bed is made up. When this burning heat takes place, the bed becomes dry and mouldy to within a few inches of its surface, from which a noxious vapour arises, which, together with the excessive heat, speedily destroys the plants. Mr. Mills, whose treatise is very full on this mode of cucumber culture, directs to turn over the dung which is in preparation for a cucumber bed, once a week for six or eight weeks. (*Treatise on the Cucumber, &c.*, p. 12.)

1052. *The seed bed* requires to be first formed. It should be 3 feet high at the back, and 2 feet 6 inches in front; and when the lights are put on, eight or ten days should elapse before sowing the seeds. During this time the surface of the bed should be forked over every other day, about a foot deep, watering it if it should appear too dry, and admitting sufficient air to allow the steam to pass off freely, “In order to prove whether or not the bed be sweet, shut the lights down close for three or four hours; then take a lighted candle in a lantern, push down one of the lights, and put the candle and lantern into the frame, and if the candle be not put out by the excess of moisture, but should continue to burn, the bed will be in a fit state to receive the plants or seeds.” (*Ibid.* p. 14.)

1053. *Soil.*—Cucumbers will grow in any light rich soil. M'Phail used leaf mould alone; Aiton uses light loam and rotten dung, of each one-third, and the remaining third composed of leaf mould and heath soil; Mr. Mills began in 1811 to use sandy peat, the turfs being chopped moderately small with the spade but not sifted. Peat soil is not so rich as leaf mould; but Mr. Mills finds that when placed on sweet fermenting dung, the roots will penetrate through it, and help themselves to food when the plants require it. “I have tried numerous experiments with soils,” he says, “variously mixed, from the year 1811 to the present time; and I am perfectly satisfied that *peat* alone is *best*, and I am now (January 1841) using it on dung-beds.” (*Ibid.* p. 15.)

1054. *Seeds and treatment of the young plants.*—Seeds must be proved before sowing, by putting them into a basin of water for about two hours, when those that are good will sink to the bottom, and the rest may be thrown away. Nine seeds may be sown in a pot, 9 inches in diameter, filled with sifted peat well drained, on Michaelmas-day, if for early fruit. The seeds should be placed round the pot near the outside, covered half an inch,

and the whole pressed down moderately firm. The pot may then be plunged half its depth into the dung-bed, or into a layer of old half-spent tan spread on its surface. The temperature should be from 60° to 70° without sun, and from 75° to 80° during sunshine. Plenty of air should be given during the day, and a little all night. The plants will appear in four or five days, and when they are clearly above the soil, the pot may be lifted up and set on the surface of the bed. A lining will now require to be put round the bed, so as to increase the temperature of the interior, which it will do even if formed of half-decayed litter or damaged hay, or in short anything that will ferment a little but not much. When the plants show the third leaf, reckoning the cotyledons two, they may be potted off singly into pots, 3 inches in diameter, either new or well cleaned in the inside, in order that the balls may turn out entire and freely when the plants are to be transplanted. The soil used should be moderately fine but not sifted, and a piece of turf should be placed over the crock at the bottom of the pot for drainage. The plants should be inserted so deep in the pot as that the seed-leaves should just be a little above the level of the rim, and the soil should be within an inch of the rim, in order to allow of adding a little more when the roots show themselves above the surface. The afternoon is generally preferred for potting, because too much light is apt to cause the leaves to flag. The tops of the plants, when set in the bed, should be within 6 or 8 inches of the glass, and as they increase in height the pot should be lowered, so as always to keep the plants about the same distance. Water may be applied whenever it appears wanting, there being much less danger in watering peat soil than in watering leaf mould, because the former only retains a very moderate quantity. When the heat of the bed falls below 70° some fresh lining may be added, more especially if the weather be dull and wet, the object being to dry the plants once a-day: a fine moisture appearing on them in the morning is a sign of health. "When the third leaf gets perfectly developed, a leading shoot will rise from the base of its petiole, which, as soon as it is clearly formed, should be pinched off; its removal will give strength to the plant, and will cause it to throw out fresh shoots from the base of the seed-leaves. These shoots are allowed to grow until they are two joints in length, when they must be stopped by being pinched off with the finger and thumb to one joint." (*Ibid.* p. 20.) The plants should be shifted into pots 6 inches in diameter, as soon the balls are filled with roots, using the same soil and drainage as before. Each plant should have three good shoots, which should be stopped at every joint, one joint at a time, and not all at the same time, which would check the progress of the plant. On that account a second leader should never be stopped till a shoot is seen coming forward on the one stopped previously.

1055. *Raising plants from cuttings.*—Instead of raising cucumber plants from seed, they may be raised from cuttings, and thus kept on from year to year. The method of striking them is as follows:—Take a shoot which is just ready for stopping, cut it off just below the joint behind the joint before which the shoot should have been stopped, then cut smooth the lower end of the shoot or cutting, and stick it into fine leaf or other rich mould about an inch deep, and give it plenty of heat, and shade it from the rays of the sun till it be fairly struck. By this method, as well as by that of laying, cucumber plants may readily be propagated. Mearns, when gardener at Shobden Court, near Leominster, propagated his cucumber plants for a

winter crop in this way, and found, "that the plants raised from cuttings are less succulent, and therefore do not so readily damp off, or suffer from the low temperature to which they are liable to be exposed in severe weather; that they come into bearing immediately as they have formed roots of sufficient strength to support their fruit, and do not run so much to barren vine as seedlings are apt to do." He advises the cuttings to be taken from the tops of the bearing shoots, and planted in pots nine inches deep, half filled with mould. They should then be watered, and, the tops of the pots being covered with flat pieces of glass, they should be plunged into a gentle bottom-heat. "The sides of the pot act as a sufficient shade for the cuttings during the time they are striking, and the flat glass, in this and in similar operations, answers all the purposes of bell-glasses. The cuttings form roots, and are ready to pot off in less than a fortnight."—(*Hort. Trans.*, vol. iv., p. 411.) Mr. Duncan considers plants raised from seed as best, through every period of winter, from November to March; and cuttings during the interval between these months. Cuttings, he says, form the most prolific plants, and are not so luxuriant as seedlings.—(*Cucumber Culture, &c.*, p. 26.)

1056. *Fruiting bed.*—The dung should be prepared as for the seed bed. The size of the frame may be 12 feet long, and 4 feet wide, the height at the back 2 feet, and in front 1 foot 6 inches; the lights should be glazed with sheet glass, one pane to each division. If the bed is made in an excavation, it should be sufficiently large to allow of the dung being 3 inches wider than the frame all round; with an additional space of 18 inches in width for linings, which will require a space 15 feet 6 inches long by 8 feet wide. Where there is a proper melon ground, however, such an excavation will be unnecessary. "Commence the erection of the bed by laying on the ground, nine inches or a foot thick, brushwood, or the loppings of trees, 4 feet 6 inches wide, and 12 feet 6 inches long; on the wood lay a little long litter to keep the dung from falling into it, as this would stop the drainage, and prevent the bottom heat from working under the bed. Upon the litter place your manure, carefully shaking it as you proceed, and keeping the surface regular, by beating it down with a fork as you advance, but do not tread it. The manure should be 4 feet or 5 feet high at the back, independently of the wood, and 6 inches lower in front. When the bed is finished, put on the frame, and keep the lights carefully closed till the heat rises, then give air, in order that the rank steam may pass off; fork over the surface every other day, as directed for the seed-bed, and as the heat decreases give less air. If the dung with which the bed has been made has undergone the preparation directed, it will be fit to receive the plants in about fourteen days. Before transplanting, however, prove the sweetness of the manure with a candle and lantern, as pointed out for the seed-bed; and, if satisfied on this important point, from 12 inches to 18 inches thick of peat-earth may be put on, to form the hillocks for the reception of the plants, taking care that as little as possible of the surface of the bed be covered therewith, for the less heat there is confined under the mould, the less liable will the roots be to receive injury."

1057. *Ridging out the plants.*—After the mould has been in the frame twenty-four hours, it will be sufficiently warm for the plants to be ridged out. To do this, make a hole in the top of each hillock, and place the pot containing the plant in it; you will then be able to judge as to the proper

distance it should be from the glass, which may vary from 6 inches to 9 inches. Having determined this point, turn out of the pot, by reversing it, the plant with its ball of earth entire, and, holding the surface of the mould in one hand, and the pot with the other, gently tap the rim against the edge of the frame, when the plant will drop out without losing any portion of the earth, or injuring the roots, if the pot was properly cleaned previous to its being planted. Then drop the plant into the hole in the hillock, and press the mould firmly round the ball of roots; the earth of which should be in the same state of moisture as that into which it is to be planted, otherwise it will not properly receive the watering, when poured upon it, as it will require to be once or twice, from a pot without the rose, until the roots extend themselves into the fresh soil; after which the whole of the hillocks should be watered, from a watering-pot with the rose on, whenever requisite, choosing a fine sunny morning for the watering, that the surface may become moderately dry by the afternoon. The seeds for these plants should be sown on the 29th of September, and the plants should be ridged out on the 1st of November.—(*Mills's Treatise, &c.*, p. 26.)

1058. *A temporary lining*, as directed for the seed-bed, should now be applied for the purpose of increasing the heat so as to carry off excessive moisture during the finest portion of every day, by evaporation, but at the same time not to raise a burning heat.

1059. *Air*.—A little air must be given during twenty hours out of the twenty-four, regulated as follows:—When you uncover the bed in the morning, the night air must be taken away, as the external air coming in contact with the glass will cause a depression of the internal heat, but the closing down the lights will sufficiently counteract its bad effects. Should the heat of the bed be low, and an increased warmth be requisite, let the unoccupied surface of the bed be forked over, about 6 inches or 8 inches deep, either back or front, and from this a fine steam will arise, which will be greatly beneficial to the plants; and, when air is afterwards given, it will materially assist in drying them, which, as before remarked (1058), is necessary to be done, if possible, during the day. In an hour or two after uncovering in the morning, let a little air be given, reference being had to the state of the weather; and again let it be gradually increased, after the lapse of a similar period, up to twelve o'clock in the day. About one, lower in part; and at three or four o'clock shut down till six, when you should again give air, the heat then should be about 70°, and the plants dry. At eight or nine regulate for the night, according to the heat, and so let it remain until the next morning, unless there should be a sudden change in the weather, when the lights may be shut down.—(*Ibid.* p. 29.)

1060. *Earthing up*.—The hills of earth being small, every part of them will be filled by the roots in the course of a week or ten days, and the roots will show themselves on the surface. They should therefore be covered with about two inches of fresh soil, previously warmed to the temperature of the bed, by being spread out on the parts not occupied by the hills. The linings must be occasionally turned to keep up the heat; and when the inside of the frame becomes dry it should be sprinkled with water when the air is taken away in the evening, by which a healthy steam will be generated for the plants during the night. When a dry bottom heat prevails, and the dung looks white and mouldy on the surface of the bed, it should be forked over, and watered with water about the same temperature as the

bottom heat ought to be, and cold should be carefully guarded against immediately afterwards, by giving air sparingly, so as not to promote too rapid an evaporation. If the temperature of the bed, with the dung in a dry mouldy state, does not exceed 75° , the plants will not be destroyed, more especially if air is given night and day to allow the impurities which rise from dung in such a state to pass off into the atmosphere. "Too much bottom-heat," Mr. Mills observes, "there cannot be, if it is moist and sweet." It will not destroy the roots of the plants, provided no more of the surface of the bed is covered with soil than the space occupied by the hillocks. The heat of the dung will then escape freely, and as the roots in the hillocks are above the dung they will not easily be injured by pure heat. Some persons form the hills on a flat basket, so as to be able to remove them if the bed should be overheated, or should become in other respects unsuitable: others, as Mr. Smith, place the plants over an air-chamber or vault, the sides of which are formed with dung; while Mr. Duncan places his plants over a well formed in his dung-bed, two feet in diameter, under the centre of each light, communicating with exterior linings or casings, by transverse trenches.

1061. *Linings of cucumber beds and their management.*—The following directions by Mr. Mills are the most complete that we know of on the subject of dung-linings; and they may be studied with advantage with respect to the use and management of exterior casings or linings of fermented matters generally:—"Linings should be turned over once in 8 or 10 days, to keep them in a regular state of fermentation, especially from November to February, inclusive. They should not, however, be all turned at once; and if the back lining is turned, I will suppose, on the first or second, the frontage should be done on the fifth or sixth; so that one half is turned in five days. The ends will not require turning so often, provided the heat keeps up to what is necessary, according to the season. To dry the inside of the frame in December, January, and February, let the linings be 4 inches or 5 inches above the level of the surface of the bed, which will be sufficient; in March and April they may be lowered in proportion to the increased power of the sun's heat. It may appear unnecessary to some persons to have the linings turned so often; but I beg to remark, that on the lively heat emanating from them the well-doing of the plants depends, especially when the heat of the bed begins to decline; and in proportion as attention is bestowed on them, will be the success of the cultivator. If they are allowed to lie undisturbed until they heat themselves dry, they become useless; and the same effect is produced if they get overcharged with moisture. In both cases, if not rendered entirely useless, they will take so long a time to recover their heat, as to render them next to valueless; for where a warmth is requisite, in addition to that of the bed, the plants may be lost in the interval between the turning and re-rising of the heat. During the operation of turning, should there appear any part too much decayed, let it be removed, and its place filled with fresh linings, which should be put on the top of the old, in order to draw up the heat from it, and to keep up a good warmth round the frame; besides, when the new linings are above the bed, there will be no danger of their rank steam getting to the plants. When the linings are again turned, the fresh manure applied must continue at the top; and, if necessary, some more must be added to it, in order that the right height may be preserved. It must, however, be observed that the

new linings should never be allowed to mix with the old ones until they have become quite sweet; for you must, on no account, allow rancid heat to be confined at the bottom of your linings. Attention to these directions must be continued until June, if it is desired to keep the plants in a healthy state; and although after the month of March the turnings need not be quite so frequent, a good warmth must be kept up, or the plants will not swell off their fruit kindly. Indeed, at an advanced period of the season, the roots will have got down into the dung, and so soon as that ceases to heat, they will perish from excess of moisture.”—(*Mills's Treatise*, p. 36.)

1062. *Water*.—“Watering frequently, and in small quantities, as before observed, is the proper way to keep the plants in a sound state; but in the winter months, from the moisture of the fermenting material, and of the outer air, and the absence of solar heat, they will require but little from the water-pot. The surface of the bed, near the frame, will occasionally become dry from the heat of the linings passing upwards through it; and when that occurs, let it be sprinkled with water through a fine-rosed pot, just before covering up; and on fine mornings, about ten o'clock, give to the soil in which the plants are growing a little water in a tepid state. In November, December, and January, little water will be wanted, but in February, March, and April, more may be given; always, however, in the morning, and only when there is a prospect of the plants becoming dry by covering-up time. It is a bad practice to water late in the afternoon, even in April, May, and June. In dull weather never water the plants, but the mould only.”—(*Ibid.* p. 37.)

1063. *Stopping*.—“Keeping the cucumber plants regularly stopped is of the utmost importance; and it should always be done with the finger and thumb, because, when a knife is used, the wound does not heal, and the lateral generally dies back to the next joint. The shoots should never be suffered to get into a crowded state, otherwise they will become weak and unfruitful; and their fruit, such as they will bear, will be of a small and inferior kind. Four good breaks or runners, stopped alternately, will be ample; and two fruit are as many as a strong plant ought to swell at one time.”—(*Ibid.* p. 38.) In order to keep the fruit from curving as it proceeds in growth, oblong cases lined with glass are employed; or glasses made on purpose might be advantageously used.

1064. *Moulding up*, is another point which demands special attention, and which must be done, if the grower means to excel in his undertaking. As the roots show themselves through the hillocks of earth, let them be covered with an inch or two of the soil recommended, placing more between the hillocks than elsewhere. This is done in order that the hillocks may meet and form a ridge along the middle of the bed by the end of December; but care should be taken to keep the sides clear of mould, to admit of the heat of the linings rising through them, to give that lively heat within the frame, which is usually called top-heat, and which is necessary for the plants, as it causes them to dry in the day, during the most unfavourable weather, and yet gives them steam moisture by night. The whole of the bed should not be covered with earth until the end of March; more particularly the front of it, for a breadth of at least 3 inches or 4 inches, because this being the lowest part of the bed the heat ascends to the highest part. (*Ibid.* p. 39.)

1065. “*The covering at night* is the next point to be dealt with. As soon

as the heat of the bed declines to about 65°, and when all danger of overheating is passed, use a single mat, and then a little hay, spreading it on the glass about one inch thick ; and commencing about the 20th of November. This covering should be thickened as the cold increases ; and when the weather is very severe, double mats should be used. When the season turns, the days lengthen ; and as the sun's heat, during the day, aids in warming the bed within the frame, discontinue the covering by degrees down to a single mat, as at the commencement. Air must be given, more or less, every night from October to the first or second week in March"—(*Ibid.* p. 40) ; because, from the large heating surface in proportion to the small volume of air to be heated, an excess of temperature, when the sashes were closed during a whole night, could hardly fail to be the result.

1066. "*Setting or impregnating the fruit* has been practised by me early in the season ; and I believe it to be necessary, notwithstanding all that has been said against it, till about the 1st of March. Some have attributed the irregular swelling of the fruit to this operation ; but this is a mistake, it being want of strength in the plants, or their carrying too many fruit at one time, which occasions the irregularity."—(*Ibid.* p. 40.)

1067. *To procure seed*, Mr. Mills invariably raises plants specially for that purpose ; which, he says, should be grown as strong as possible, and not allowed to mature fruit till the roots extend to the outside of the frame ; after which they will be able to swell off, and bring to perfection two fruit each ; taking care that the handsomest be preserved, and that they be impregnated four or five times each, previous to the closing of the blossom. They should not be cut under six or eight weeks, then put into a cool room for a month, when they may be opened, the seed taken out, washed and dried ; those only which sink being retained.—(*Ibid.* p. 41.)

1068. *Inlaying, or earthing in, the vines of the cucumber*, though still practised by some, "is now seldom resorted to by experienced growers, and is worse than useless ; for as soon as the buried portions take root the original roots perish ; and, in the place of one good plant, there will be a dozen weak ones."—(*Ibid.* p. 41.)

1069. *When extraordinary fine fruit is desired*, allow the plant to mature one only ; but a succession should be permitted, so that the after-fruit do not follow too closely on the first. By this plan the growth will be rapid, provided the plants are in health ; and the fruit be much better flavoured than if grown slowly. When long in swelling off, the fruit frequently becomes hard and bitter, and is therefore worthless. From 75° to 80° are as high as the plant will bear to advantage ; and in that temperature fruit will grow faster than in a higher one ; the pruning and stopping being attended to as previously laid down."—(*Ibid.* p. 42.) The foregoing directions by Mr. Mills are, we believe, among the best extant for growing the cucumber on dung beds, and we have given them at greater length than we otherwise should have done, because they contain instructions on various points equally applicable to the other modes of cucumber culture treated of in the following Subsections. Mr. Mills's directions respecting preparing the dung, making the beds, and applying and working the linings, show the mode of culture on dung beds to be exceedingly expensive and troublesome ; so much so, that we do not wonder at the mode by linings to brick-built pits (843), or by pits or houses heated by hot water or flues (490, 515, &c.), being generally preferred by modern gardeners.

SUBSECT. III.—*Culture of the Cucumber in pits heated by dung linings, flues or hot water.*

1070. *Of pits heated wholly or in part by dung linings*, there are a great variety of forms, chiefly differing in the construction of the exterior wall through which the heat is communicated to the bed of soil or fermenting material within. One of the most common, and most generally useful, is that known as M'Phail's pit, already figured and described (843). The principal advantage of these pits is, that dung casings may be applied with little or no previous preparation, and thus much heat, that in the preparation of dung for common hotbeds is lost, is here turned to account. The treatment of the plants within the bed is exactly the same as that described in the preceding subsection, and no better directions can be given for managing the linings than those of Mr. Mills (1061).

1071. *Pits to be heated by flues or hot-water*, are as various in their construction as those to be heated by dung linings; some forms have already been given (515, 935, and 947), and we shall in this subsection describe three other forms.

1072. *A pit to be heated by a flue* built by the late eminent horticulturist, Mr. Knight, is thus described. The back wall is nearly 9 feet high, and the front wall nearly 6 feet high, inclosing a horizontal space of 9 feet wide; and the house is 30 feet long.—The fireplace is at the east end, very near the front wall, and the flue passes to the other end of the house within 4 inches of the front wall, and returns back again, leaving a space of 8 inches only between the advancing and returning course of it; and the smoke escapes at the north-east corner of the building. The front flue is composed of bricks laid flat, as I wished to have a temperate permanent heat, and the returning flue of bricks standing on their edges, as is usual; the space between the flues is filled with fragments of burned bricks, which absorb much water, and gradually give out moisture to the air of the house. Air is admitted through apertures in the front wall, which are 4 inches wide, and nearly 3 inches in height; and which are situated level with the top of the flues, and are 18 inches distant from each other. The air escapes through similar apertures near the top of the back wall. These apertures are left open, or partially or wholly closed, as circumstances require. Thirty-two pots are placed upon the flues described above, each being 16 inches wide at least, and 14 inches deep; but they are raised by an intervening piece of stone and brick out of actual contact with the flues. Into each of these pots one melon plant is put, which in its subsequent growth is trained upon a trellis, placed about 14 inches distant from the glass, and each plant is permitted to bear one melon only. Each might be made to bear more, but if they should be as large as Ispahan melons when perfect are, they would certainly be of inferior quality. The height from the ground, at which the trellis is placed, is such that I can with convenience walk under it, and of course discover, without difficulty, the first appearance of red spiders, or other noxious insects.—(*Hort. Trans.* vol. i. Second Series, p. 86.) This pit was used by Mr. Knight for the culture of Persian melons, but it is evidently well adapted for the culture of cucumbers, underneath which sea-kale, rhubarb, or various other articles, might be forced.

1073. *A pit to be heated by hot water and by a flue from the fire which heats the boiler*, is thus described by Mr. Torbrön. It is almost unnecessary to add that it will answer as well for melons as for cucumbers, and indeed if

the pit was filled with proper soil and vines planted in it, there could not be a better house for an early crop of grapes. Length, 30 feet; width, 8 feet; height at back, 7 feet, at front, 4 feet. A flue to run first to the front, and return under the back wall, with cavities of $2\frac{1}{2}$ inches. The space between the flues to have gutters for the pipes from a boiler, with a power of filling and emptying the gutters at pleasure; so as to have a command of either dry or moist air, as either may be wanted. The floor of the pit may be supported on arches, or it may be made of planks, or of slates or tiles, resting on joists. The pit to be filled with mould, sand, or sawdust, according as it may be desired to grow the plants in pots or in the free soil. A trellis may be made to hook on the rafters, on which to train the plants. The upper surface of the pit to be two feet from the glass, and the trellis to be one foot from the glass. (*Gard. Mag.* 1841, p. 311.)

1074. *Corbett's cucumber-pit*, Fig. 356, is heated with hot water circulated in open troughs, which, however, have covers for being put on when a dry heat is wanted. The mode of heating by water in open gutters, as we

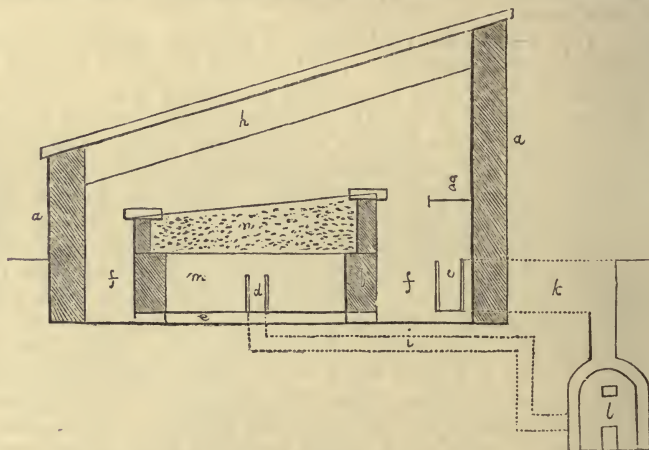

Fig. 356. *Cucumber or Melon Pit, heated by hot water in open troughs.*
The scale $\frac{1}{4}$ of an inch to a foot.

- | | |
|---|--|
| a, Outer walls. | g, Shelf for plants. |
| b, Walls of the pit. | h, Trellis for training the plants. |
| c, Gutters, or troughs for heating the atmosphere. | i, Descending return-pipe, which is a common 6-inch pipe. |
| d, Troughs under the soil in the open chamber (m), which is air-tight, resting on the openings (e), which convey the cooled air from the front walk to the trough at the back, to be heated; these openings being introduced at regular distances of 4ft. or 5ft. | k, The trough at entering, which is closed from the boiler till it reaches c. |
| f, Walks round the bed. | l, Shewin's conical boiler, or the modifications of it by Stephenson or Weeks. |
| | m, Air-chamber; the air of which is always at the point of saturation. |
| | n, The soil, or other material, in which the plants are planted. |

have seen (515), is strongly recommended by Mr. Glendinning, as it is by Mr. Lymburn on account of the great radiating powers of water, which are equal to those of lamp-black, which is to polished iron as 100 is to 15. Mr. Duncan, from whose *Treatise on Cucumber Culture* the section, fig.

356, is taken, also says Corbett's mode is "the most economical plan of heating yet discovered, and deserving the support of every one interested in horticulture, especially the cucumber grower."

"The troughs," Mr. Duncan observes, "are arranged so as to produce both bottom and top heat, accompanied with proper moisture, or a dry air at pleasure, by putting on the covers to the troughs. The air in the confined chamber under the bed is always at the point of saturation, and a circulatory movement of the air of the pit, exterior to the chamber, is always maintained by drains, passing from the front path, under the troughs in the chamber, to the troughs in the back path, at the bottom of the back wall, as shown in the section." (*Cucumber Culture*, p. 22.) The soil Mr. Duncan recommends is vegetable mould during winter, with a mixture of maiden loam during summer.

1075. *Green's cucumber pit*, and also one in use at Mawley Hall, described in the *Gardener's Magazine* for 1841, p. 262, are both heated by hot-water, with some of the pipes laid in troughs of water, and may be safely recommended as far superior to any modification of hot-water pits, unless we except Mr. Corbett's. Mr. Green's pit is thus described by himself:—"The walls are built of 9 inch brickwork, 5 feet high in the back, and $2\frac{1}{2}$ feet in front, and the space enclosed is 5 feet wide in the clear, and 36 feet long, covered with nine lights, and divided into three compartments. A trough of brickwork is carried along the middle of the bottom from end to end. This trough is constructed by first laying a bottom of two bricks thick, one foot wide, and then forming the two sides of the trough with bricks on edge; the whole being so cemented as to hold water. The pit is heated with hot water by means of a branch of $2\frac{1}{2}$ inch pipes proceeding from the boiler which heats a stove at a short distance. The hot water flows along the back and front of the pit, above the level of the bed of soil, but the return pipes are placed beneath the bed in the trough just described, which is filled with water, or partly so, as circumstances may require, by means of a small pipe that leads to the outside. Another small pipe is laid in the bottom of the trough for letting off the stagnant water, and for emptying the trough occasionally; for in very dark damp weather, a drier heat is required. The soil that I grow my plants in is collected at least six months before it is wanted for use, and consists of turf not more than 3 inches thick, of strong maiden loam, built up in narrow ridges, with a layer alternately of an equal quantity of fresh horse-dung, and a good portion of straw. When wanted for use it is chopped up with a spade, is not sifted, and one-third of well decayed leaf-mould is added. In order to have a succession of fruit, it is requisite to sow the seed at three different times, the 1st and 20th of September, and the 5th of November. The first and second sowing I fruit in No. 2 pots, and the third I plant out. Before placing the plants in the fruiting pots, I first put a quantity of large potsherds at the bottom, with some large pieces of turf and dung, in order to insure a good drainage. The plants are placed sufficiently deep to leave three or four inches at the top of the pot, so that the plants may be earthed up as they advance in growth. When the pots are filled with roots, a good supply of water is given of the same temperature as that of the air they are grown in. I place one plant in the centre of each light, taking care that the bottom of each pot is about four inches above the water in the trough and the return pipe. The branches are trained on a temporary trellis, and the fruit is allowed to hang down.

From the plants sown on the 1st of September I cut the first-fruit on the 4th of November ; from that date to the 4th of December I have cut from three lights, or three plants, forty beautiful fruit of the Syon House kind, varying from twelve to fifteen inches in length. The same plants will continue bearing till about Christmas. I have just (Jan. 10th) begun to cut from the second sowing, which will continue bearing through March. The plants of the first sowing are thrown away at Christmas, and plants of the third sowing are planted out in their place. When I plant in a bed, I form the bottom of the bed by laying some strong stakes across the trough, and covering them with any rough boards. The stakes so laid will leave a cavity round the back and front of the trough, so as to allow the heat and moisture to rise from the bottom. The plants are put out in a narrow ridge, and earthed up in the usual way as they advance in growth, and the branches are trained upon a trellis, in the same way as for the plants in pots. These plants will bear well through the spring and summer months. As soon as the first three lights can be spared, I introduce shelves fifteen inches from the glass, and fill them with strawberry plants ; and the pit answers equally well as for cucumbers, only for strawberries the bottom-heat is not wanted."

1076. *The advantages gained by this pit over any pit that I have ever seen or heard of, are, firstly, a great saving of labour and dung, which last at all times makes a very littery and unsightly appearance ; secondly, the having a sufficient command of top-heat in severe and changeable weather ; thirdly, the return pipe being buried, or partly buried, in water, gives a sufficient bottom-heat, moist or dry, at pleasure ; and fourthly, the vapour which can be produced from the trough admits of keeping the air at any degree of moisture required. By these means, the plants become so healthy and strong that a good crop of fine fruit is certain.—(Gard. Chron. for 1841, p. 36.)*

1077. Messrs. J. Weeks and Co., who erected Mr. Green's pit, have obligingly furnished us with a section of it, fig. 357, to a scale of $\frac{1}{6}$ of an inch to a foot.

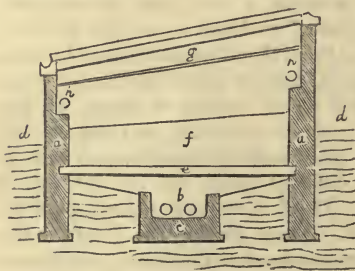

Fig. 357. Mr. Green's Cucumber Pit.

Scale $\frac{1}{6}$ of an inch to a foot.

- a a, Outer walls.
- b, Hot-water pipes, laid in a trough of brickwork (c), which can be filled with water, and emptied at pleasure.
- c, Trough of brick-work.
- d d, Ground level.
- e, Joists of wood or iron, forming the floor of the pit.
- f, Bed for planting or plunging, in which there may be upright tubes, chimney pipes, or flower-pots with the bottoms out, at regular distances, so to admit at pleasure the moist air from the chamber below.
- g, The trellis.
- h h, Hot-water pipes for top-heat.

SUBSECT. IV.—Culture of the Cucumber in Pots, in a Pinery, Vinery, or in a Cucumber-house.

1078. *The culture of the cucumber in pots has been reduced to a regular system by Mr. W. P. Ayres, whose Treatise on the Cultivation of the Cucumber in Pots (1841, 3s. 6d.), is not only the cheapest of six treatises*

which have been published on the same subject, but in our opinion the best. Mr. Ayres's great object is the production of "quantity" of fruit rather than fruit of large size; "a dozen fruit of moderate length," he says, "may be grown in the same time that it takes to prepare the plant and produce one or a brace of fruit of unusual dimensions." "In every garden where either pines are grown or vines forced early, frame-forcing of cucumbers may be entirely dispensed with, and fruit of superior quality, in greater quantity, and at a fiftieth part of the expense, produced." (*Pref.*) The principal features in which Mr. Ayres's book differs from those which have gone before it, is in advocating a lower temperature at night and in dull weather; in taking greater advantage of light; in not stopping the leading shoot till the plants are fully established; and his using water of the same temperature as the soil the plants grow in. The principle of maintaining a lower temperature at night is not to be disputed; but a proper distinction should be made between tropical plants—inhabiting regions where the usual difference between the temperatures of day and night is but little—and plants of higher latitudes, where a difference of 20° or 30° is not unusual. In the case of plants kept generally in a temperature of 80°, or say in a mean of 75°, a reduction of 5° will affect them as much as a reduction of 10° or 15° would others habituated to a mean temperature of 50°. A rustic in this country would scarcely feel a difference of 15° lower temperature, whereas a negro would feel miserably cold if he were placed in a temperature as much as 15°, or even 10°, below 75°, or any other higher degree at which he might have previously found himself comfortable. If a range of 20° is necessary to effect the requisite firmness of tissue in plants of this climate, the same effect would be produced by a range of less than 10° as regards the highly-excited plants of the tropical regions.

"Cucumber pits and frames have the sashes generally placed at an angle of 15°, which is 13° too low to obtain the full solar power in June, when the sun is at his greatest altitude, 60° too low for December, and 36° too low for March and September." To cut cucumbers through the winter, from November to February, in pits or frames heated by fermenting materials only, is almost an impossibility, let them be attended ever so closely. The reason of this is the atmosphere of the pit being too moist, the plants absorb more aqueous matter than they can decompose and assimilate, and consequently, their digestive energies being impeded, the leaves become covered with mildew and other fungi, which consume their juices, choke their respiratory organs, and general debility, if not death, ensues. This is the cause of so many young plants damping off in dull weather, but keep them in an atmosphere which can be kept moist or dry, in accordance with the absence or presence of light, and no such effect will be produced; thus proving the superiority of a heating apparatus, that will place the hygrometric state of the atmosphere under the control of the attendant, and explaining the reason of cucumbers growing so much better in houses heated by fire, than in dung pits, in the winter season.—(p. 8.)

1079. *Construction of the cucumber house.*—The grand point to determine is the slope of the glass, so as to obtain a maximum of solar influence in midwinter. "To obtain the perpendicular rays of the sun in December, it would be necessary in latitude 53° to place the glass at an angle of 75° 28'; in January, 71° 52'; in February, 62° 29'; and in March, 51° 41'." As the sun has but little influence from the autumnal to the vernal equinox, Mr.

Ayres prefers securing the perpendicular rays in March and September, and therefore places his glass at an angle of 51° . At this angle he loses much of the sun's power in the summer, but that is of no consequence in a cucumber house.

Fig. 358, to a scale of $\frac{1}{4}$ of an inch to a foot, is a copy of the section given by Mr. Ayres; in which *a*, "is the tan-bed in which the pots containing the plants are plunged; *b*, is the trellis to which the plants are trained; *c*, is the pathway under which is a flue, with the pipe of an Arnott's stove passing through it, and *d*, is the ground line. Arnott's stove must stand in a vault accessible from without about a foot below the level of the bottom of the flue, to secure a good draught to the fire. The flue should be divided into four equal compartments, the first and third of which, by keeping the pipes wholly, or partially immersed in water, might be made to produce moist heat, while the others will produce dry heat; so that by tilting or removing the covering tiles of any of the compartments, the humidity of the atmosphere will be placed quite under the command of the attendant. The cost of the stove and piping to heat a house of the above dimensions, and 20 feet long, would not be more than 4*l.* 10*s.*, and in the most severe weather, with the assistance of the bark bed, it would maintain a temperature of 65° or 70° for about sixpence per day; and in ordinary weather, it would not cost more than from eighteenpence to two shillings per week. A stove of this kind, with Welsh coal, would not require attending more than four times in twenty-four hours. Hot water would be preferable to a stove, but it would be more expensive, both in the erection and subsequent management." (P. 4). A hot-water apparatus, as Mr. Ayres observes, would be more expensive in the first instance, but once well put up it is

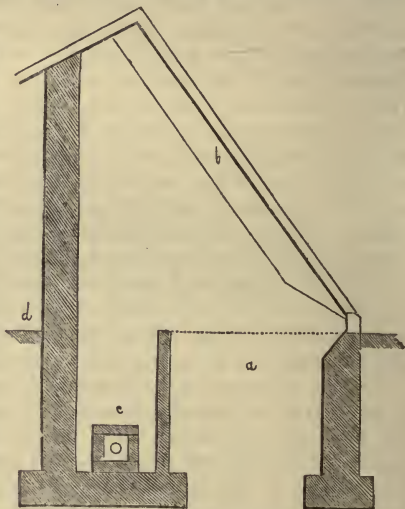

Fig. 358. Mr. Ayres' Cucumber-house.
Scale $\frac{1}{4}$ of an inch to a foot.

not liable to get out of order for a series of years. Explosive gases are often formed in Arnott's stove; and altogether its management is precarious.

Such a house as fig. 358 might be heated by hot water by Corbett's open gutters at very little expense, for the gutters might be of wood, or of the cast-iron eaves guttering used for projecting roofs. The pit might be filled with tan or leaves for plunging the pots in in winter and spring, and in summer with soil in which the plants might be grown without pots. The glass in Mr. Ayres' house is fixed, the sash bars being inserted into the wall plates at top and bottom; and air being admitted through holes a foot square along the top of the back wall, protected by coarse canvas. The expense of erecting a house of this kind would be little more than that of erecting a brick pit of the same length. The glass, which ought to be of the new

sheet kind, in panes from three feet to four feet in length, may be covered with wooden shutters, reed or straw mats, or Pocock's asphalted roofing, placed two inches distant from the glass. The great advantage of this house is, that let the weather be what it will the plants can always be properly attended and treated.

1080. *Treatment of the plants.*—The cucumber, Mr. Ayres observes, will grow in any soil, even old tan or brick rubbish, provided liquid manure is supplied. He uses turfy loam two parts, thoroughly decomposed dung two parts, leaf mould two parts, and very sandy turfy peat two parts. The whole thoroughly incorporated immediately before using, but not sifted. Manure water is prepared by steeping two pecks of sheep or deer dung, one peck of pigeon's dung, and half a peck of soot, in a hogshead of boiling rain water; in two days it will be fit for use. When applied, it is diluted with rain water, and used alternately with clear water from March to October. The great secret of keeping the cucumber in vigorous growth in pots, Mr. Ayres continues, is the use of manure water. The plants should be raised from seed sown on the first of August, so as to be fit for planting in fruiting pots in the first week of September. These pots should not be less than sixteen inches wide, and eighteen inches deep. Two plants should be placed in each pot, but the leading shoot must not be stopped, but be allowed to grow until it reaches the top of the house. "On this, success in pot culture mainly depends, for if the plants are stopped, they are thrown into a bearing state before they are sufficiently established, and the consequence is early fruit, but a short-lived plant; but if the plants are allowed to grow to the length of ten or fifteen feet before the leading shoot is stopped, a great quantity of true sap will be generated, and the plant will consequently be better able to support a crop than if it had been allowed to bear fruit before it was properly established" (p. 12). The temperature which Mr. Ayres approves of is 60° through the night, 65° in dull, and 70° in clear weather, by fire heat; and 80°, 90°, or even 100° with plenty of atmospheric moisture and air in sunny weather. The two shoots from the two plants in each pot are to be trained to the trellis at one foot nine inches apart; and when they begin to send out laterals these must be stopped at one joint above the fruit. Impregnation or setting the fruit Mr. Ayres believes does neither good nor harm, for he has cut scores of fruit, the flowers of which never expanded. If the fruit grows crooked, he places it in glass tubes or narrow troughs, which mould it into the proper form; or he suspends a small weight by a piece of bast to the end of each fruit, a practice which appears to have been first adopted by Mr. Robert Fish. For various other details we must refer to the work itself, which indeed ought to be in the hands of every cucumber grower, whether on dung beds, in pits in the open garden, or in a cucumber house. We may observe here that cucumbers were, we believe, first grown in a cucumber house on a trellis under the sloping glass about the end of the last century by Mr. Butler, the Earl of Derby's gardener. The roots of the plants were in a bed of soil, and as they ceased to bear they were renewed one or two at a time, so that there was a perpetual crop throughout the year. In 1806 we first saw this cucumber house with an abundant crop, and in 1819, when we again saw it, the same gardener informed us that the house had never been without fruit since the period of our former visit.

SUBSECT. IV.—*Culture and Treatment of the Cucumber for Prize Exhibitions.*

1081. *The largest growing varieties* are chosen, of which Allen's Victory of Suffolk, the Roman Emperor, Snow's Horticultural Prize, and Duncan's Victoria, appear to be among the best. The plants must not be allowed to set fruit till they have attained considerable strength. The fruit is put into cylinders of glass or tin to protect the prickles and bloom. Every means is employed to encourage vigorous growth, and rather a higher temperature is maintained than in ordinary culture. "In the event of fruit being ready to cut before the time wanted, they should be divided three parts across their foot-stalk, and secured to the trellis to prevent falling. By this means they will keep fresh and stationary several days, much better than by cutting or entirely separating them from the plant. If necessary to carry or send them to a distance, they should be packed nicely in a box made for the purpose, in the largest nettle leaves that can be got, or in cucumber leaves, but by no means in smooth leaves, which are certain to rub off the bloom. They may then be folded in tissue-paper, and wrapped in wadding, and placed in narrow boxes of well-thrashed moss (see 860). By these means the spines, powdery bloom, and partially withered blossom at the end of the fruit are preserved, without which no cucumber can be considered handsome, or well grown. In being exhibited they should be put in dishes in pairs or leashes, on a little clean moss, or on vine leaves, and the brace or leash should always be of the same sort, and if possible of the same length, and of a kind having a pure black spine."—(*Duncan's Cucumber Culture*, p. 81.) When cucumbers have lost their bloom, the blossom at the end of the fruit, or even some of their prickles, or when they have not grown quite straight, all these defects used formerly to be supplied by art. A bloom was put on the fruit by laying it on a wire frame in a close box, and with a powder-puff charging the air of the box with a powder formed of perfectly dry magnesia, minutely calcined. Half-decayed blossoms were stuck on the point of the fruit with a little gum; and prickles were inserted into small holes made with the point of a pin. Crooked cucumbers were rendered straight by placing them in a damp cellar, and there, by two strips of wood, one applied to each side, gradually effecting the object in view. All these processes will be found described in detail in the *Gardeners' Magazine* for 1828, p. 36; since which exposure they have been, we believe, almost entirely given up; but it is well to know that such tricks have existed, in order to be on our guard against their revival.

SUBSECT. V.—*Cultivation of the Cucumber in the open air.*

1082. *Cucumbers grown in the open air are commonly protected by hand or bell glasses.*—The seeds are sown some time about the middle of April in a cucumber or melon bed, and when they come up, they are potted out into small pots, two or three plants in each pot, and are kept properly watered, and stopped at the first or second joint. About the middle of May, a warm situation, where the mould is very rich, is pitched on, and a trench is dug out about two feet deep and three feet broad, and the length is proportioned according to the number of glasses it is intended for. The bottom of this trench is covered with prunings of bushes, or coarse vegetable rubbish of any kind, and it is then filled with good warm dung, and when the dung is come to its full heat, it is covered over with eight, ten, or twelve inches deep of

rich mould. The glasses are then set upon it about three feet distant from each other, and when the mould gets warm under them, the plants are turned out of the pots with their balls whole, and plunged in the mould under the glasses, and a little water given them to settle the mould about their roots, the glasses set over them, and after they have made roots, and begin to grow, in fine days they are raised a little on one side to let the plants have the free air; and as the weather gets warmer and warmer, air is given more plentifully, to harden the plants, so that they may be able to bear the open air, and run from under the glasses. When the plants begin to fill the glasses, they are trained out horizontally, and the glasses are set upon bricks or such like props, to bear them from the plants. After this the plants require nothing more but to be supplied with water when the summer showers are not sufficient, and to stop them when they become deficient of branches, and thin them of leaves or branches when they are likely to be overcrowded. In warm summers and in warm situations, by this mode of management, the plants will bear plentifully for about two months, provided they be not attacked by insects or weakened by diseases. If the situation should require shelter, a row of runner beans four feet from the bed at the north side and ends, and a row of some crop that will not grow more than three feet high, on the south side of the bed, and about the same distance from it, will attain this object. The surface of the ridge, for some time after it is made, should be covered with straw to shoot off the wet, and the leading branches must be pegged to the soil, but not stopped.—(Ayes.)

1083. *Increasing the atmospheric heat of the soil.*—When cucumbers are grown on the natural ground, as they are extensively at Sandy in Bedfordshire, a considerable portion of heat may be worked into it (see 956) by artificial means. Thus, when the bed has been marked out, let the soil be dug over in the evening of every sunny day, and then either raked perfectly smooth, or covered with mats or litter; in this way the radiation of accumulated heat being nightly intercepted, a sufficient quantity of heat will in a week or ten days be collected, to raise the temperature 8 or 10 degrees above that of the adjoining soil.—(Ayes's *Treatise*, p. 40.)

1084. *Cucumbers against a south wall.*—“Cucumbers will succeed beautifully, trained against a south wall, if planted in a little good soil to start them; afterwards they will flourish in the soil of the border, without further trouble, especially if the summer should be warm.”—(Duncan's *Cucumber Culture*, p. 83.) Warm coverings at night, so as to prevent the radiation of heat acquired through the day, would, in this case, and also in that of cucumbers grown in ridges, prove very beneficial.

1085. *Growing cucumbers on balconies, or in court-yards.*—“Those who have no garden ground, but have yards or balconies on a south, east, or west exposure, may plant them in very rich compost, in large pots, or boxes eighteen inches or two feet square, and train the plants to the wall. They will require precisely the same treatment in watering, stopping, &c., as directed for pots in the cucumber house. In this way those who have no garden may have the pleasure of growing their own cucumbers.”—(Ayes's *Treatise*, p. 41.)

1086. *Watering cucumbers in the open garden.*—During the time the plants are under the glasses, they may be watered in the same way as if they were under frames; but after the glasses are raised, and the plants

permitted to extend themselves over the bed, a very different process must be followed. Nothing is more common than to take a water-pot to a pump and fill it with water, the temperature of which does not in all probability exceed that of the mean temperature of the earth, viz. 48°, and directly proceed to sprinkle the cucumbers. Now the soil in the open garden, from May to September, will, if open and porous, seldom be below 60° in heat, and therefore to apply water at 48° will reduce it to 54°, or, according to Mr. Gregor Drummond (823-1) several degrees lower, and consequently check the plants; but if water is applied, the temperature of which is 70°, the heat of the soil will be raised to 65°, or, according to Mr. Gregor Drummond (*ibid.*), some degrees higher, and the plant will, as the cucumber requires bottom heat, be much accelerated in growth. Water, therefore, on a warm dull day, and as seldom as possible, but when it is done do it effectually; that is, saturate the ground to the depth of a foot at least, and with water which, either by admixture with warm water, or by exposure to the solar influence, has attained the same temperature as the soil in which the plants are growing (*ibid.* p. 40).

1087. *Cucumber and melon culture compared.*—Much of what has been advanced on the culture of the cucumber may be applied to the culture of the melon, but their treatment differs in the following particulars. The melon cannot be ripened in this country in the winter-time, and therefore the seeds need never be sown before February. The soil for the melon should be of a firm texture, loamy, and should lie solid in the bed rather than loose like that of the cucumber. It is often covered with gravel, pebbles, tiles, or slates (1047). When the fruit of the melon is advancing to maturity, water must be gradually withheld so as not to deteriorate the flavour; whereas in cucumber culture the supply of water must be uninterrupted. The melon, in hot, dry seasons, can be brought to a higher degree of perfection than the cucumber, because the atmosphere cannot in general be kept sufficiently moist for the latter fruit. In the highest state of cultivation, the cucumber requires as much heat as the melon; but it may be grown in a much lower temperature, more especially as compared with that required by the Persian varieties of the melon, for these require a greater heat than the Cantaloups.

SECTION IX.—*Culture of the Banana.*

1088. The banana (*Musa paradisiaca*, L.) is a scitamineous (50) herbaceous evergreen, a native of Asia, in forests, in soil formed of rich masses of vegetable matter, kept moist by the shade of trees. There are many varieties cultivated in India and other warm regions of the East, varying in height from three feet to twenty feet; but those which are in most esteem in British gardens are the *Musa p. Cavendishii*, from the Isle of France, and the *M. p. dácca*, from the East Indies, neither of which exceed the height of three feet or four feet. The culture of these plants for their fruit in British stoves is of very recent date, but as the fruit is excellent, and is produced great part of the year, it may probably become as general as that of the pine-apple. The culture of the banana for the dessert was first commenced by Mr. Paxton in 1836, who, after two years' trial at Chatsworth, said that we "might recommend it advantageously for a suburban garden;" and this, as will be afterwards seen, is confirmed by five years' experience.

(*G. M.* 1833, p. 104.) The *Musa p. dácca*, and some other varieties, have been fruited by Mr. M'Nab, in the stove of the Edinburgh Botanic Garden, who, in December 1836, sent a large box of it to the Lord Mayor of London, for the banquet given to the Queen at Guildhall.—(*G. M.* 1833, p. 106.) Some excellent varieties of banana have also been fruited in the gardens at Syon; and the Duke of Devonshire's variety, *M. p. Cavendishii*, is grown in abundance for the table of the King of the French, at Versailles and Meudon.—(See *G. M.* 1841, p. 387.) All the varieties of banana are propagated by suckers; they are grown in large pots or tubs, eighteen inches or two feet in diameter, in a mixture of leaf-mould, sand, and thoroughly rotten dung, and watered with liquid manure. The same temperature that suits the pine-apple will suit the banana. Suckers will fruit within the year, and they may be retarded or accelerated so as to ripen their fruit at almost every season. The following paragraph on this fruit was supplied to the *Gardener's Magazine*, in 1841, p. 430, by Mr. Paxton.

1089. *A Banana house*, 30 feet long, 15 feet wide, 12 feet high at the back and six feet high at the front, heated by flues or by hot water, will hold about ten full-grown or fruiting plants, with room between for different-sized successional ones, to be tubbed successively as the large plants ripen off their fruit, these being shaken out of their tubs as soon as the fruit is gathered, and potted, to produce suckers; by judicious management in tubbing and in administering water, a supply of fruit may be had the greater part of the year. I have had at one time ten fruiting plants nearly of the same size and age, being suckers produced the same spring, and receiving similar treatment; yet no two of them produced their spadix at the same time; and even if they were disposed to do so, it may be prevented, different treatment being given them. As their approach to fruiting is easily ascertained by their leaves decreasing in size, soon after which the embryo fruit-stalk may be detected by the sudden swelling of the lower part of the stem, if more than one should show these indications at one time, the one it is desired to fruit first must have abundance of water and the warmest situation, and the others be retarded by opposite treatment. The period between them may be still further lengthened a considerable time, if the whole spadix of fruit of one approaching too close upon another in ripening be cut off with a portion of the stem attached, when the upper tier of fruit is just ripening, and suspended in a dry and airy room, in the way that late grapes are often kept. I have cut excellent fruit from a spadix, two months after it had been separated from the plant; and they may be made to ripen fast or slow in this manner, according to the temperature to which they are exposed. The quicker the flower-stem is made to develop itself, the longer the spadix will be, and the greater quantity of fertile flowers it will produce; consequently the greater weight of fruit, which will vary from fifteen to thirty pounds, according to the plant's strength, the season, and other circumstances. I need hardly add that the soil can scarcely be too rich, and that it should be rather light than retentive, in order that abundance of water may be given, and readily pass off. In *Paxton's Magazine of Botany* for 1836, it is observed that "a pit 40 feet long, 15 feet broad, and 5 feet high, will produce several hundredweight of fruit in a year, with no other care or attention than that of giving plenty of manure to grow in, and a good supply of heat and water. The Banana will fruit at all seasons, and no doubt with easier culture than any kind of fruit grown under glass."—(*Ibid.* 1836, p. 316.)

SECT. X.—*Forcing the Strawberry.*

1090. *Data on which the forcing of the strawberry is founded.*—The strawberry (*Fragaria, L.*) is a genus of herbaceous perennials or biennials, of which some species are natives of Europe, and others of North and South America. They all grow in woods, and in soil more or less loamy and moist; but the kinds have been so changed by culture in British gardens, and this culture has been so successful both in the open garden and under glass, that we shall adopt it as a guide. Almost all the kinds of strawberry in cultivation will bear forcing; but the kinds preferred are chiefly the Old Scarlet or Virginian, for its high flavour and colour in confectionary, Keen's Seedling, and the Roseberry or Aberdeen Seedling, for their large size and abundant crops, and occasionally the Alpine, because it can be kept in a bearing state throughout great part of the winter. As the flavour of the Scarlet and Keen's seedling strawberries is seldom good when they are ripened before the middle or end of March, forcing is seldom commenced till the middle of January, and those excited about that time, and properly treated, will ripen fruit in about nine weeks. The plants should be previously well established in pots; though in default of this they may be taken up with balls, and potted, and at once placed in the forcing-house; or the balls may be set close together on the surface of a bed of fermenting material, or heated by a flue or hot-water pipes underneath. The crown of the plants, whether in pots or on a bed, should not be more than a foot from the glass. The temperature at first should not exceed 45° or 50°, with fire heat, and abundance of air should be given, even when the temperature is as low as 40°. After the fruit is set, the temperature may be raised from 55° to 60°, with fire heat, and 65 or 70° with sun heat, provided abundance of air is given. Strawberries may be forced with great advantage in the peach-house, or in the cherry-house, in pits, or in such houses as that shown in fig. 127, in p. 189. They may be also forced in the open garden by having pipes of hot water laid a foot under the surface of the soil, between the rows of the plants, and covering them with glass or with canvas during nights, and in stormy weather. In short nothing can be more easy than forcing this most delicious fruit.

1091. *Routine practice in forcing Keen's Seedling and the Old Scarlet or Virginian strawberries.*—As soon as the runners are fit for the purpose, lay a quantity, say two and three in a 32-pot, others one in a 60, in a good strong loam, with a portion of well-decayed manure. Place a stone on each runner, for the double purpose of keeping the plant in a fixed position and preserving moisture to the roots. The first runners are preferable, the sort Keen's seedling. As soon as the plants are well rooted, re-pot the sixties into thirty-twos, and the thirty-twos into twenty-fours—still using the same strong soil; then place them in the hottest part of the garden, fully exposed to the direct rays of the sun, but not under a wall. The best situation is the centre of a vine-border, first placing there a quantity of half-decayed manure, generally some old dung linings, to put round the pots, to prevent the sun acting too powerfully on the roots. Here they should be left exposed to the elements most conducive to bring them rapidly to a state of maturity: a free circulation of air, abundance of moisture, which they should be liberally supplied with, and a full share of solar heat. In this situation the plants grow freely, forming well-matured crowns, to send up fine stems of bloom in the forcing-

house, with strong and vigorous roots to support them. Those in twenty-fours remain; after a time examine the others, and those that have the strongest roots re-pot into twenty-fours, pursuing the same method as before; so that, out of 700 or 800 pots, half the number will be twenty-fours, with one, two, or three plants in a pot, and the remainder in thirty-twos, with one plant in a pot. One plant to either sized pot is preferable to a greater number; and if the above method is pursued, it will, from the rapidity of their growth, be found quite sufficient. If the autumnal rains are heavy, lay the pots on their sides, and about the middle of December place them in some frames, to keep the frost from injuring the roots, till they are placed in the forcing-house.

1092. *Thus grown and protected*, the strawberries may, any time between December and March, be brought into the forcing-pit, previously filled with tan, dung, or leaves, to about eighteen inches of the glass. On this bed the plants are set, and a gentle temperature of from 50° to 55° is maintained in the pit: if without fire-heat, so much the better. From this time, till the plants have perfected their fruits, a leaf should never be allowed to droop for want of water: yet the reverse is equally destructive, more especially before the flower-stems appear; as soon, however, as these are up, a liberal supply of water is necessary till the fruits get to their proper size; when it must again be supplied sparingly, only just enough to keep the leaves from flagging, till the strawberries are gathered. Whilst in flower, a temperature of from 60° to 65° , with a free circulation of air, is best. The fruit once set, the plants will do well in a stove where the minimum temperature is as high as 75° , provided abundance of air can be admitted. Plants treated in this manner, introduced into the forcing-house in the middle of December, will generally perfect their fruit about the middle of March. The fruit ought to be thinned out: all the deformed ones should be cut clean away, and the more promising ones should be pegged to the sunny side of the pot, and if there are too many leaves the footstalks of a number of them may be broken or twisted, so as to check the flow of sap and throw it into the fruit. Dry heat and free air are indispensable to their being well flavoured.

1093. *After forcing*, turn the plants out of the pots, and plunge them in rows, at moderate distances, in a piece of spare ground in the garden, well exposed to the sun and free circulation of air. From these a slight gathering will be obtained after the natural crops are over; and well-established plants for forcing may be obtained from their runners, the latter being so much earlier produced than they are from plants in the open ground. In the autumn take the plants up with good balls of earth, and plant them in rows in a melon-pit or cold frame, placing them rather thick, to economise the rows and press the mould firmly to their roots. The pit need have neither bottom-heat nor pipes, but be simply covered with mats. As soon as the frosts set in, place the lights on, but do not begin to cover up with mats before March. If warm showers come in April, take the lights off, and let the plants have the benefit of the showers (which is better than watering from a pot), to forward them. When the sun is shining hot in the afternoon, shut up close, and cover up directly with double mats. You will find the next morning a sensible difference in their appearance. These plants will bear abundantly, coming in at a very seasonable time, just before the outdoor strawberries, which are very often retarded by late frosts; when the

days being generally very hot, strawberries are in great demand, and, it being too hot for them in the houses, they are sometimes very scarce. After the fruit is gathered, the plants are dug up and thrown away, and the pit planted with melons. By following this simple routine, year after year, you will be able to supply a family, however large, with abundant crops of this beautiful fruit, and in the highest state of perfection, at a very trifling expense.—(*Gard. Mag.* xvii. p. 265.)

1094. *The Alpine strawberry* continues bearing in the open air till it is checked by frost, and if a month previously to this a number of plants have been planted in a bed of soil on heat, or potted and placed in a frame, pit, or strawberry-house, quite near the glass, and a temperature kept up of from 45° to 55° during night, and from 55° to 60° during day, the plants will continue bearing during winter; and they may be succeeded by other plants kept through the winter in cold frames, and put into heat about the middle of February. This mode is very successfully practised in the neighbourhood of Paris.—(*See Gordon, in Gard. Mag. for 1841, p. 269.*)

SECT. XI.—*Forcing the Asparagus, Sea-kale, Rhubarb, Chiccorry, and other fleshy roots.*

1095. These different vegetables may be forced where they stand in the open garden, by placing hot dung over them; or when they are planted in rows or beds, by digging out trenches between eighteen inches or two feet wide, and two feet deep, and filling up these trenches with hot dung. Or the plants may be taken up before the forcing season, with as many of the roots as possible, and planted close together in a house, frame, pit, or even cellar, on a bed of fermenting matter, or of soil heated artificially, at first to 40° or 50°, and gradually raised to 60°, 65°, or 70°. Nothing can be more simple or easy than this kind of forcing, since it is merely the excitement by heat and moisture, without or with but very little light and change of air, of the mass of vegetable nutriment laid up in the root-stalk.

1096. *Asparagus*.—In the beginning of winter, begin six weeks before it is proposed to have a crop; when the days are longer, five weeks, or but a calendar month before. Those who wish to have asparagus on the table at Christmas should prepare for forcing it in November. The temperature at night should never be under 50°. In the day-time, keep the maximum down to 62°. If by the heat of the bark or dung, and the use of mats or canvas covers at night, the thermometer stand as high as 50°, fire-heat will be unnecessary; but otherwise recourse must be had to the flues or hot-water pipes. A very moderate degree of fire-heat, however, will be sufficient; and a small fire made in the evening will generally answer the purpose. Sometimes in dull, hazy weather a fire may be necessary in the morning, in order to enable you to admit air more freely, and to dry off damp. Air must be freely admitted every day in some cases, to allow any steam to pass off, and for the sake of the colour and flavour of the plants. As the buds begin to appear, as large a portion of air must be daily admitted as the weather will permit. When the asparagus bed has, after planting, stood two or three days, and when the heat has begun to warm the roots, give the plants a sufficient watering. Pour it out of a pot, with the rose on it, to imitate a shower of rain; let the bed have enough to moisten the mould well, and to wash it in among the roots. Repeat such waterings now and then. By the time the buds have come up three inches above the surface,

they are fit to gather for use, as they will then be six or seven inches in length. In gathering them, draw aside a little of the mould, slip down the finger and thumb, and twist them off from the crown. This is a better method than to cut them; at least it is less dangerous to the rising buds, which come up in thick succession, and might be wounded by the knife, if cutting were practised. The roots, after they have furnished a crop, are considered useless for future culture, because no leaves having been allowed to develop themselves, of course no buds could be formed for the succeeding year. If the pit in which asparagus is forced be twenty-five feet to thirty feet long, it will be enough for the supply of an ordinary family to fill one-half at a time. If the second half be planted when the shoots in the first half are fit for use, and so on, a constant succession may be kept up in the same pit for any length of time required. In some gardens asparagus is grown in beds cased with pigeon-holed brickwork, with alleys between two feet wide and two feet deep, which are filled with hot dung, and frames are put over the beds. This, however, is an expensive mode, and we are not aware of any advantage which it has over Mr. Lindegaard's practice of merely deepening the alleys to about three and a half feet, and filling them up with hot dung, covering the beds with litter, over which hoops for supporting mats should be placed; or any other means of protection should be adopted that may best prevent the effects of cold at night, or of rain and sleet, or snow, either of which would rob the ground of much of its acquired warmth from the linings. Beds treated in this manner in December will produce a crop in four or five weeks, which will last for five or six weeks. After the crop is gathered, the dung is removed from the alleys, which are then filled to the brim with rich soil, for the roots to strike into. Asparagus plants forced in this manner are injured, but in three seasons they will be restored and may be forced again successfully. When asparagus is forced in this manner later in the season, much less dung is required, and the plants are proportionately less injured.—(*Hort. Trans.* vol. v. p. 509.)

1097. *Sea-kale* may be forced exactly in the manner above described for asparagus; but a less degree of heat is required, for the sea-kale naturally shoots up early in spring, while the buds of the asparagus are much later in appearing. The asparagus requires to be grown four years from the seed before it is fit to force, and hence Mr. Lindegaard's mode, by which the plants are not destroyed, is the best where practicable; but as the sea-kale can be forced at two years' growth, and the plants are consequently less valuable, there is less objection to taking them up, forcing them, and throwing them away. Mr. Errington plants a certain number of rows of sea-kale every spring, three feet apart, and the plants fifteen inches distant in the rows; the plants having been raised from seed the previous year in a drill. The roots are taken up for forcing as soon as the leaves are decaying, with much care; and as much as possible removed entire, as the root is of course a magazine of nourishment for the incipient bud. The main stock is then 'laid in by the heels,' and covered with litter until wanted. In the mushroom-house there is a pit or trench sunk below the level of the floor-line about four feet: this furnishes room in the length of the house for about four successive ages; and the second lot of roots is introduced the moment the first begins to bud, and so on with the rest. Fermenting matter, viz., dung and leaves mixed, is placed about two feet six inches deep, under the roots, taking care to have bottom-heat enough; as, if that becomes too hot, the heat can easily be reduced with

water; and the more water the sea-kale receives in this way, the more tender it becomes. The roots are placed in this fermenting matter as thick as they will stand, merely flooding in some fine old tan or old rich soil with water, to fill the crevices between the roots completely. The surface of the crowns, when so placed, is a foot, or nearly so, below the floor line; and, when planted, a row of trusses of straw is laid side by side over the whole, to shut in the steam, and keep it completely dark, which is one of the main points; and, with the straw and the shutters, this is completely effected. In the same house Mr. Errington produces a continual supply of chicory, rhubarb, and other articles, by the same system.—(*G. M.* 1841, p. 270.)

No vegetable is more easily or cheaply forced than sea-kale, whether in the open air in beds or drills, or by covering the plants with pots (fig. 58, in p. 143) or boxes to be surrounded by hot dung; or by taking up the plants and potting them, and placing them in cellars, frames, or pits, or on a bed of heated materials. A temperature of from 40 to 45 degrees will excite vegetation, after which it may be raised to 50 or 55 degrees. Great care must be taken never to exceed 55 degrees. Plants of sea-kale in the open ground may be forced every year; but much the cheapest mode is to take up the roots and force on beds heated artificially.

1098. *Rhubarb and Chicory*.—What has been said of sea-kale, in the preceding paragraph, will apply equally to rhubarb and chicory. They may both be forced in the open ground by trenches filled with hot dung, or by pots or boxes placed over them, and surrounded by that material; or, what is by far the most economical mode, the plants may be taken up and potted, and placed in a cellar; or, like the sea-kale, they may be planted close together on a bed of material heated artificially, or laid side by side in the floor of a vinery, or between the flue and wall, and covered with tan, peat, or leaf-mould. The rhubarb should be grown at least two years from the seed, in the same manner as the sea-kale, before being taken up for forcing; but the chicory may be sown the same year. The leaves of the chicory require to be blanched, and therefore it ought always to be forced in the dark; but as most people prefer the rhubarb only partially blanched, a certain degree of light may be admitted. In Belgium the roots of chicory are taken up on the approach of winter, and stacked in cellars in alternate layers of sand, so as to form ridges with the crowns of the plants on the surface of the ridge. Here, if the temperature is a few degrees above the freezing point, the crowns soon send out leaves in such abundance as to afford an ample supply of salad during the whole winter.—(See Lippold, in *G. M.* for 1836, p. 250.)

1099. *Forcing other roots*.—The common dandelion (*Leóntodon Taráxacum, L.*) affords a salad in all respects equal to that of the chicory, and may be similarly treated. Hamburg parsley, the common parsley, burnet, fennel, wild spinach (*Chenopódium Bónus Hénricus, L.*), wild beet, for the leaves as spinach, and the common turnip—for the leaves as greens, and various other plants having fleshy roots, and of which the foliage or leaf-stalks are used in salads or cookery, may be forced on the same principle as asparagus, sea-kale, &c.; the practice being founded on the physiological fact first explained to gardeners by Mr. Knight, viz., that “the root of every perennial herbaceous plant contains within itself, during winter, all the organisable matter which it expends in the spring in the formation of its first foliage and flower-stems; and that it requires neither food nor light to

enable it to protrude these, but simply heat and water; and if the root be removed entire, as soon as its leaves become lifeless, it will be found to vegetate, after being replanted, as strongly as it would have done if it had retained its first position."

SECT. XII.—*Forcing the common Potato, the sweet Potato, and other tubers.*

1100. *The common potato* (*Solanum tuberosum, L.*) is forced in a great variety of ways. The best varieties for this purpose are the ash-leaved kidney, the Rufford kidney, Fox's seedling, and Shaw's Early. (See OUR CATALOGUE OF CULINARY VEGETABLES). They may be forced in pots on shelves in a peach-house or vinery, or in frames or pits moderately heated, the plants in every case being kept quite near the glass, as few plants suffer more when placed at a distance from the glass than the potato. Abercrombie says, "for a fair crop of tubers, which shall be somewhat dry and floury, and of the size of a hen's egg, plant sets of the ash-leaved variety in single pots filled one-third part with light earth in January. Place them in a hothouse or hotbed, earth them up as they appear, and about the middle or end of February transplant them, with their balls entire, into a pit prepared as for asparagus. Distance, from plant to plant, one foot each way. Give water occasionally, and admit as much air as possible at all times. Potatoes so managed will produce a crop at the end of March or beginning of April." The general mode is to plant in frames or pits, on a bed of fermenting material, sufficient to produce a gentle heat, for the potato will not bear rapid forcing, a high temperature, or a dry atmosphere. They however, cannot have too much light, being natives of a high table-land, with a clear sky. Some gardeners plant them on old hotbeds and supply the heat by linings; and many plant them on beds unprotected by glass, but covered with hoops and mats during nights and very severe weather.

1101. *A substitute for new potatoes* is obtained by placing layers of potatoes alternately with sawdust in a box, and placing it in a moderate temperature in a room or cellar. The potatoes vegetate and produce tubers in December and January, about the size of walnuts, and sometimes larger, without any leaves having been protruded. This plan is most successful when potatoes of the growth of the season-before-last are used. By this treatment, no leaves will emerge above the soil, and, consequently, as no nutritive matter can be deposited by them, the new potatoes, which may be produced at any required period by burying the old potatoes three weeks before, are nothing more than a recomposition of the old tuber, in consequence of the application of heat and moisture. Few persons, however, will be satisfied with this kind of substitute for a new potato formed by the aid of light and foliage. Another mode of producing a substitute for new potatoes is, by retarding the tubers of early varieties, by keeping them in a cool dry cellar till June or July, and then planting them. Being early sorts, they produce, even when planted thus late, a crop of young potatoes which possess in a great degree the flavour peculiar to potatoes taken fresh from the stem. By covering the ground with litter, so as to exclude the frost, young potatoes may thus be obtained throughout the winter. (See *G. M.*, vol. viii., p. 56, and our CATALOGUE OF CULINARY VEGETABLES). In the mild climate of Cornwall, where the winters frequently pass with little or no frost, the planting of sets can be deferred till autumn; and with

a little protection, the plants, although pushed above ground, are preserved through the winter, and, in consequence, afford an early supply of genuine young potatoes.—(*G. M.*, ii., p. 464, and v., p. 107.)

1102. *The sweet potato* (*Convólulus Batátas, L.*), though but little cultivated in British gardens, is imported from Spain and sold in the fruit-shops. It is cultivated in the open air in the neighbourhood of New York (*G. M.* vol. v. p. 275) during their hot summers, and on dung-beds in the neighbourhood of Paris, where it is sold in the market and the fruit-shops, and much esteemed. The best crops that we saw in 1828 were in Admiral Tchitchigoff's garden at Sceaux. The tubers are planted in February, or earlier or later at pleasure, and in the pine-stove or in a small hotbed; and the shoots they produce are taken off and planted a foot apart every way, on dung-beds, covered with 15 inches of earth and protected by hoops and mats in the manner of ridged cucumbers. This may be done any time from April to June, and the shoots are not dibbled in, but laid down in drills about 3 inches deep, keeping 2 inches of the point of the shoot above the earth. In about two months after transplanting, some of the tubers will be fit to take off for use, and the plants will continue producing till they are destroyed by frost. To preserve the tubers through the winter the greatest care is required. In the King's forcing-gardens at Versailles, they are kept in a growing state all the winter in the pine-stoves. With the exception of this difficulty of preserving the tubers through the winter, the sweet potato is just as easily cultivated as the common potato. Though the shoots are naturally ascending and twining, like those of *Tâmus communis*, the plants are not sticked, and therefore the shoots cover the ground, and form over it a thick matting of dark green smooth foliage. In the early part of the season, the tubers are taken off as they attain the size of early kidney potatoes; later the whole crop is dug up. If the sweet potato were once fairly introduced into British gardens, we have no doubt it would form an article of regular culture there. (*G. M.* v. 276.)

1103. *The Oxalis Deppei*, which, it will be found from our CULINARY CATALOGUE, produces tubers, stems, and foliage, that are much esteemed; and the *Tropæolum tuberòsum*, which also produces eatable tubers, with the flavour of sea-kale or the richest asparagus, may be forced in the same manner as the potato.

SECT. XIII.—*Forcing Kidney-beans and Peas.*

1104. The kidney-bean (*Phaseòlus vulgàris, L.*), being a native of India, may be forced in the same heat as that required for the pine-apple; but although it will bear this extreme, it will succeed in a temperature very much lower. The varieties generally preferred are—the early speckled, early negro, and dun-coloured dwarf, the latter being thought the best. They are planted in equal parts of rotten dung reduced to a soil, and loam, in shallow 24-sized pots: place in the bottom of the pot one inch of crocks, and above them 1 inch of soil; then plant six beans, covering them with 1 inch more of soil. These pots may be stowed away in any corner of the stove till the plants appear above ground, when they must be brought near the glass, and thinned out to two or three of the best plants. As they advance, they must be earthed up; and the leader may be pinched off, to render them short and bushy. When they come into flower, air must be admitted, to set the fruit; and every pod must be gathered as soon as it is fit for the table, not to rob

the others that are forming. The plants may be grown in a house at any temperature above freezing, and below blood-heat; the medium, 60° to 65°, is preferable. They succeed well when planted out in a pit or frame, with or without bottom-heat, in rows 18 inches apart, and 3 inches in the row; and, as they advance, they are to be topped as above, and sticked. Planted at Christmas, they require about eight weeks to bring fruit fit for the table, in a temperature of 60° or 65°. To have kidney-beans all the year, the first sowing for forcing should be made in August, and sowings should be made every four or five weeks till April, after which the crop in the open air from plants which have been raised in heat will come into use. The aphid and thrips often attack the French bean when grown under glass, but these insects may be readily destroyed by fumigation, by tobacco-water, or by quassia-water.

1105. *The common garden pea* (*Pisum sativum, L.*), may be forced, but being a native of a colder climate (the South of Europe), not so successfully as the kidney-bean. The best early varieties are the early May, early Warwick, and early frame. It is necessary to begin at a low temperature, and not to exceed 50° or 60° with sun heat, and from 40° to 50° during the night, till the fruit is set. Afterwards the temperature may be increased, so as to vary during the day from 55° to 70°. The peas may be sown in pots or boxes, and either fruited in them, or transplanted into other pots or boxes, or a pit. In general the best mode is to grow them in pots or boxes, because these admit of being kept well ventilated and close to the glass. Without abundance of light and air it is in vain to attempt forcing the pea. For the earliest crop the seeds may be sown in October, and these will produce pods in February or March, from which time by successive sowing, peas may be obtained till they are produced in the open ground from plants which have been raised in heat, and transplanted into a warm sheltered situation. Whatever description of forcing is adopted, transplanting is found to check luxuriance, concentrate growth, and produce a greater amount of blossom in a limited space.

SECT. XIV.—*Forcing Salads, pot-herbs, sweet-herbs, and other culinary plants.*

1106. *Lettuce, chicory, radish, cress, mustard, rape, parsley, chervil, carrot, turnip, onion,* and similar plants, may be raised in pots or in beds, in a gentle heat, and quite near the glass. In general it will be of little use beginning to sow sooner than January; and indeed, with the exception of the carrot, parsley, and onion, February will be soon enough, on account of the light required. Young carrots being much used in soups, some families require a supply all the year, which is to be obtained by successive sowings in the open air and on heat. The first sowing on heat may be made in January, to succeed the autumnal sowing in the open garden; and the second may be made in February or March, to serve till the first crop in the open air comes into use.

1107. *Small salading*, such as cresses, mustard, rape, radish, chicory, lettuce, &c., to be cropped when in the seed leaf, or in the third or fourth leaf, may be sown in boxes or in beds, and kept in a warm, moist atmosphere, near the light. As the plants forming small salading are always cut beneath the seed-leaf, as soon as one portion of salading is gathered, the

soil may be stirred and a second crop sown. Where there is a constant demand for small salading, a sowing requires to be made every week.

1108. *Radish*.—To obtain the earliest spring radishes, Abercrombie directs to “sow on a hot-bed, of dung or leaves, some of the early dwarf short-top varieties in December, January, or the beginning of February. Having made a hot-bed two feet or two and a-half feet high of dung, place on the frame. Earth the bed at top six inches deep; sow on the surface, covering the seed with fine mould about half an inch thick; and put on the glasses. When the plants have come up, admit air every day in mild or tolerably good weather, by tilting the upper end of the lights, or sometimes the front, one, two, or three inches, that the radishes may not draw up weak and long-shanked. If they have risen very thick, thin them in young growth, moderately at first, to about one or two inches apart. Be careful to cover the glasses at night. Give gentle waterings about noon, on sunny days. If the heat of the bed declines much, apply a moderate lining of warm dung or stable litter to the sides, which, by gently renewing the heat, will forward the radishes for drawing in February and March. Remember, as they advance in growth, to give more copious admissions of air daily, either by tilting the lights in front several inches, or, in fine mild days, by drawing the glasses mostly off; but be careful to draw them on again in proper time. Small turnip-radishes of the white and red kinds may be forced in the same manner. For raising early radishes on ground not accommodated with frames, a hot-bed made in February may be arched over with hoop-bends or pliant rods, which should be covered with mats constantly at night, and during the day in very cold weather. In moderate days turn up the mats at the warmest side, and on a fine mild day take them wholly off.”

1109. *To produce full-grown cabbage-lettuces throughout the winter* is a desideratum in Holland, where the higher classes have cabbage-lettuces on their tables every day in the year. The seed is sown on the first of September, and when the plants have produced their fourth leaf they are transplanted into a melon-bed which has done bearing; and as soon as they have taken root, abundance of air is given night and day. In October, when the air grows cold, and the heads of the cabbage-lettuce begin to get close or hard, air is no longer given, and the lights are entirely closed; but the leaves must be prevented from touching the glass, as, if they do, the least unexpected frost will hurt their edges, and the consequence will be that the plants will rot. In this case the frame will have to be lifted every now and then. When the nightly frosts commence, generally in October, great attention must be paid to covering the beds with a single layer of bast mats, and adding slight linings; yet too much covering is to be avoided before the plants are grown to perfect heads. Watering is quite out of the question, and even very hurtful; care, indeed, should be taken to prevent moisture as much as possible. Cover more or less, according to the severity of the weather, and keep the lights uncovered in the day, whenever and as much as the weather will permit. In this way the Dutch gardeners produce cabbage-lettuce during the whole winter till April, when they are succeeded by the plants which have been early forced. In the Royal gardens in Denmark, this method was practised by M. Lindegaard for nearly half a century; by Mr. Rutger, at Longleat, for thirty years: for an equal period at Bulstrode, when that place was the residence of the Duke of Portland; and for a number of years at Hylands, when that property

belonged to P. C. Labouchere, Esq.—(See *G. M.* vi., p. 691 ; viii., p. 174, and iii. p. 388.)

1110. *Perennial pot and sweet herbs*, such as mint, sage, tarragon, savory, thyme, tansy, scurvy-grass, and such like plants, may be taken up from the open ground, potted, and transferred to the forcing-house, where they will soon produce abundance of foliage ; care being taken to let the heat with which forcing is commenced be low, in proportion to the coldness of the country of which the plant is a native, and that of the season at which it naturally expands its leaves. Thus, in forcing scurvy-grass, which is a native of Denmark, a much lower temperature ought to be commenced with than in forcing sage, which is a native of Greece ; and again, a plant which naturally springs up in April will bear commencing with a higher temperature than one which makes considerable progress in the previous colder months.

SECT. XV.—*Forcing the Mushroom.*

SUBJECT. I.—*Data on which the Culture and Forcing of the Mushroom is founded.*

1111. *The mushroom* (*Agáricus campéstris L.*) is indigenous to Britain, appearing “in the fields chiefly after Midsummer, in the months of July, August, and most abundantly in September. On a ten years’ average, the temperature of these months respectively in the neighbourhood of London has been found to be 64°, 62°, and 57° ; and in the same periods the temperature of the earth one foot below the surface is a few degrees higher ; but at the depth of two or three inches, where the vegetating spawn is situated, the temperature in hot sunny weather is frequently as high as 80°. Whilst such hot weather continues, mushrooms are rarely met with ; but when the atmosphere changes to a humid state, and when the earth becomes sufficiently moistened and lowered in temperature, in consequence of rain and absence of sun-heat, to be between 60° and 65°, mushrooms become plentiful. Hence it may be concluded that spawn will not be injured by a heat of 80° during what may be termed its underground state of progression. This is corroborated by the fact that spawn introduced into melon-frames when the beds are moulded, increases whilst the melons are grown in a heat of about 80° ; and when the melon crop is over, the frame cleared, and the heat of the bed naturally abated, a gentle watering, with shade, is all that is necessary to bring up an excellent crop of mushrooms from the spawn so deposited. It is evident, from what has been stated, that the spawn requires a high temperature for its diffusion ; but, when this has taken place, a declining temperature is requisite, till gradually the bottom-heat is lowered to 60° or 65°, and the temperature of the air limited between 55° and 65°, when the production first appears above the soil.

“With regard to moisture, it may be observed that a dry atmosphere is injurious, not only to artificial crops, but also to those in the fields ; for the latter, warm foggy mornings are most favourable, and these should be imitated as closely in cultivation as circumstances will permit. A gentle steam is more easily maintained in mushroom-houses than in structures adapted for other subjects of cultivation where light is an object of importance ; but mushrooms do not require its agency, and consequently a glass roof is unnecessary : on the contrary, the roof and walls where they are intended to be grown should be composed of such substances as will cause the least possible

condensation of the internal vapour, and which are in other respects eligible for the purpose.

“A thatched roof of a good thickness is very proper; a slated or tiled one is, on the contrary, objectionable, unless a ceiling be formed under it. If the cavity between the ceiling and the external covering were filled with dry moss, a more complete protection would be formed against any sudden vicissitudes of cold and heat, an object of importance towards success either in the cold winter months or during the greatest heat of summer.”—(*Penny Cyc.* vol. xvi. p. 19.)

SUBJECT. II.—*Forcing the Mushroom in British gardens.*

1112. *The ordinary form of a mushroom-house* is a lean-to shed, at the back of a south wall, or of a range of hothouses, about nine feet wide, eight feet or nine feet high at front, and twelve feet or fifteen feet at the back. Along the middle there is a path three feet wide over a flue, or hot water-pipes, or in some cases a trench of two feet wide, and the same depth for a bed of fermenting manure. Planks, in this latter case, are placed over the dung for the purpose of walking on. The space between the walls and the path is occupied by shelves of slate or flag-stone, three feet broad, eighteen inches or two feet apart in the height; each shelf having a slate or stone curb nine inches deep. The manner in which mushrooms are grown in such a house is as follows:—

1113. *The spawn* may be either made or purchased. Cake or brick spawn is the sort best worth making, and the best sort of materials to make it of are, equal portions of horse-droppings, cow-droppings, and loam, well mixed, and pounded or beaten, adding only as much water as will bring the materials to the consistency of brickmakers' moulding clay. Then let a circular mould without a bottom, nine inches in diameter and three inches deep, be placed on a table, with the wide end uppermost, and filled with this mortar and straked level; before it is turned out of the mould, let three holes be made in each cake, with an iron-shod dibber, one inch and a half deep: the mould must be shaped like the frustum of a cone, that the cakes may easily part with it. When the cakes are all but hand dry, let them be spawned, by putting a piece of spawn about the size of a pigeon's egg in each hole, inclosing it with a little of the original mortar. Then pile the cakes in pairs, with their spawned ends together, resembling a cask; and in this state let them be cased up in brick-shaped batches, and sweated and kept up to about 85°, by placing a layer of sweet dung all round and over the batch, varying it in quantity, to obtain the desired heat. The spawn must be examined as it runs in the cakes, and when one is broken and appears mouldy all through, and smells of mushroom, it is mushroom spawn in the highest state of perfection. It must not be allowed to run so far as to form a thread-like substance. To preserve it, it must be thoroughly dried in an airy loft, and kept dry for use. It will retain its properties for several years.

1114. *To grow the mushrooms.*—Collect a quantity of horse-droppings, dry them a little in an open shed, then lay a stratum of loamy turf, two inches or three inches deep, in the bottom of the bed, and over this three layers of droppings, each about two inches deep, rendered as compact as possible, by giving each layer a good pummeling with a hand-mallet. When the last layer is made up, thrust a few “watch sticks” into the bed, in order to ascertain when it begins to heat. When the heat is getting pretty strong,

let the bed be first beaten all over, then make holes with an iron-shod dibber, nine inches apart, and deep enough to reach the stratum of loam: these will soon cool the bed; and when the heat is declined to about 80° , the holes may be bored by a conical block of wood, to about two inches in diameter, at two inches deep, in order to receive the spawn. These holes must be filled up, to about three inches from the surface, with loam and horse-droppings mixed; then insert a bit of spawn, about the size of a hen's egg in each, and fill the holes up level with the surface, with the loam and droppings. The holes being closed, the heat will increase, and must be attended to: if violent, a few deep narrow holes may be made to let it escape; and, if too slight, it may be aided by a covering of dry hay, or a layer of warm dung; and when all danger of violent heat is gone by, and the spawn beginning to run, put on the upper stratum of loam, mixed with a little cut hay or dry horse-droppings to make a tough firm crust, about one inch deep. A temperature of from 55° to 60° is found best for the atmosphere in the house, and about 90° of bottom heat will set the spawn actively to work. The beds must not be allowed to get too dry—a layer of moist hay will prevent this; and, if too wet, a dry atmosphere can be got by gentle fires and open ventilators, which will aid them a little. But a bed once allowed to get thoroughly wet after spawning is hopeless, and should certainly be removed without loss of time.—(*G. M.* for 1839, p. 335.)

1115. *Growing the mushroom in a cellar* may be readily accomplished where the temperature does not fall below 45° , or rise above 70° . Take a quantity of fresh manure, with short litter intermixed, from a stable where the horses are fed on hay and corn, but not on green food. Spread the manure on the floor of the cellar about four inches deep, and beat it firmly down with a mallet. After a few days repeat this operation, and again do so at intervals, till the bed becomes about fourteen inches deep, and of such a breadth as may be most convenient. To ascertain the degree of heat, put two or three sharp pointed sticks into the bed, and when, upon being drawn out the next day, they feel about milk-warm, or between 80° or 90° , it is time to put in the mushroom spawn. Observe, however, that when this operation is performed, the heat should be rather on the decline than on the increase.

Having purchased, or otherwise procured the spawn, break it into pieces about the size of a hen's egg. Place the pieces all over the bed, about a foot apart, and two inches below the surface. Beat the whole down hard. Be careful not to let the heat increase above the degree mentioned above, otherwise the spawn will be destroyed, and the bed must be stocked again with fresh spawn. Indeed, for security's sake, it is always best to repeat the spawning when the heat is on the decline. After all danger of increased heat is passed, cover the bed with light soil about two inches deep, then beat it down hard. Mushrooms always do best in a firm hard soil: however hard, they will find their way through it. They have even been known to raise the pavement of a cellar floor.

1116. *Management of the bed*.—Examine the sticks which were originally placed in the bed, if they are lukewarm all is right. A few days afterwards cover the bed with hay or straw; but if it increases the heat, remove it for a time. If the place is warm and dark this covering may be dispensed with. In five or six weeks the mushrooms ought to appear. A gentle watering now and then will hasten their growth; but too much will cause the spawn

to rot, and then, of course, the bed will be unproductive, whereas it ought to produce for five or six weeks. The covering keeps the soil moist, especially when much exposed to the air.—(*J. Wighton, in G. M. for 1842.*)

1117. *Mushroom spawn*, planted in loam and dung, or in either, and screened from sun and rain in summer, will produce this vegetable in abundance; and the same materials will produce the same effect, under favourable circumstances, in winter; such as being placed in boxes or baskets in a stable or warm cellar. Mushrooms may be grown remarkably well on dung-beds, covered with frames, having thatched hurdles or boards instead of glass; the surface of the bed being covered with hay, litter, or dried shorn grass.

Half-dried droppings of highly fed horses, good spawn, and a gentle moist atmosphere, are the principal things to be attended to in cultivating the mushroom.

1118. *In gathering mushrooms* for present use, they may be cut; but, if they are to be kept a few days, they must be got with the stem entire, which is easily done by slipping it off with a gentle twist.

1119.—*The duration of a crop of mushrooms* varies from three to six months, so that it is always safe to make up a bed or a couple of shelves every three or four months. Very successful and economical modes of growing the mushroom will be found in *Callow's Improved Mode of Culture*, 1831, post 8vo., 7s. 6d.; and in *Smith, on Cucumbers and Melons*, 1839, 12mo., 4s.

CHAPTER IV.

CATALOGUE OF FRUITS.

1120. *The fruits usually cultivated in British Gardens* are, for the greater part, borne on trees and shrubs, but some are on herbaceous plants. They are mostly natives of temperate climates, and cultivated in the open garden, but a few are natives of warm or tropical countries, and require the protection of glass and artificial heat. The whole may be arranged, either systematically, or according to their natures; or geographically, or according to the climates in which they are indigenous; and this last arrangement will also indicate the classification which may be made with reference to their treatment in a state of culture.

1121. *Botanically*, the fruits usually cultivated in British gardens, are classed by the natural system, or according to their natures, as follows:—

Berberàcæa. Bérberis, the barberry.

Aurantiàcæa. Citrus, the orange, lemon, citron, lime, and shaddock.

Vitàcæa. Vitis, the grape.

Amýdalíneæa. Amýgdalus, the almond, peach, and nectarine; Armeniàcæa, the apricot; Prúnus, the plum, and Cérasus, the cherry.

Pomàcæa. Pýrus, the apple, the pear, and the service; Cydònia, the quince; Méspilus, the medlar; and Eriobótrya, the Japan quince.

Rosàcæa. Rùbus, the raspberry, and Fragària, the strawberry.

Granatàcæa. Pùnica, the pomegranate.

Myrtacæ. Psidium, the guava.

Cucurbitacæ. Cucumis, the cucumber and melon; Cucúrbita, the gourd, and pumpkin, and Cárica, the pawpaw.

Passifloracæ. Passiflora, the granadilla.

Cactacæ. Opúntia, the Indian fig.

Grossulacæ. Ribes, the gooseberry and currant.

Caprifoliacæ. Córnu, the cornel, and Sambucus, the elder.

Vaccinacæ. Vaccinium, the bilberry, and Oxycoccus, the cranberry.

Solanacæ. Physàlis, the winter cherry, and the Peruvian cherry; Cáp-sicum, the Cayenne pepper; Lycopérsicum, the love-apple, and Solànum, the egg-plant.

Æleagnacæ. Shephérdia, the buffalo berry.

Urticacæ. Ficus, the fig, and Mòrus, the mulberry.

Juglandacæ. Jùglans, the walnut, and Càrya, the hickory.

Corylaceæ. Castànea, the chestnut, and Córylus, the filbert.

Musacæ. Mùsa, the banana.

Bromeliacæ. Ananássa, the pine apple.

1122. *Geographically and Horticulturally*, these fruits may be arranged as belonging to:

1123. *Climates analogous to that of Britain*, and which can be grown in the open air in British gardens, including the barberry, plum, cherry, apple, pear, quince, medlar, raspberry, strawberry, gooseberry, currant, cornel, elder, bilberry, cranberry, winter cherry, buffalo-berry, mulberry, chestnut, filbert, walnut and hickory.

1124. *Climates analogous to that of the South of France*, and which can be grown against walls exposed to the South, or heated by flues in British gardens, including the vine, almond, peach, nectarine, apricot, pomegranate, and fig.

1125. *Climates sub-tropical, or tropical*, including the orange, lemon, lime, and shaddock, Japan quince, guava, cucumber, melon, gourd, pumpkin, pawpaw, granadilla, Peruvian cherry, Indian fig, Cayenne pepper, love-apple, egg-plant, banana, and pine-apple.

This last arrangement we shall adopt as the most suitable for horticultural purposes, and we shall therefore treat first of hardy, or orchard fruits, next of wall fruits, and lastly of house fruits. The cornel, buffalo berry, pomegranate, winter cherry, Peruvian cherry, guava, pawpaw, granadilla, and Indian fig, are but little cultivated in British gardens, yet as the possessor of a suburban garden may reasonably wish to taste all the fruits that can be grown in any British garden whatever, whether small or large; and as a single plant of each kind of fruit will afford this gratification, and occupy very little room in the garden, we thought it right to include them, though of each we shall treat but very slightly. See the notice of the fruits cultivated in our very limited garden at Bayswater, given in the *Suburban Gardener*, p. 341.

Those who wish for more extensive lists than we shall here give of the fruits in common cultivation, will consult the Horticultural Society's *Fruit Catalogue*, third edition; those who wish to see engravings, and peruse botanical descriptions, of the species of trees and shrubs from which the different varieties of cultivated kinds have been originated, may consult the *Encyclopædia of Trees and Shrubs*; and those who wish to know the

natural, horticultural, and domestic history of every species, in greater detail than they have ever elsewhere been given, will have recourse to the *Arboretum et Fruticetum Britannicum*.

SECT. I.—*Hardy or Orchard Fruits.*

1126. The hardy fruits include all those which arrive at maturity in the open garden, without the aid of glass or artificial heat. These are the apple, pear, quince, medlar, the true service, cherry, plum, gooseberry, currant, raspberry, strawberry, cranberry, bilberry, cornel, elder, barberry, winter cherry, buffalo berry, chestnut, filbert, walnut, hickory, and mulberry.

SUBSECT. I.—*The Apple.*

1127. *The Apple*, *Pyrus Mâlus L.* *Mâlus communis Dec.*, (Pommier, *Fr.*, Apfelbaum *Ger.*, Apfel, *Dutch*, Pero Melo, and Melo Pomo, *Ital.*, and Manzana, *Span.* *Eng. Bot.*, t. 179; *Arb. Brit.*, Vol. VI.; and *Encyc. of Trees and Shrubs*, p. 45,) is a deciduous tree, under the middle size, with spreading branches, which form in general an irregular head. In its wild or crab state, it is indigenous in most parts of Europe, and as a fruit-tree, it is cultivated in all civilised countries, more especially in those of temperate climates. It flowers in May, and ripens its fruit at various periods from July to November, and some sorts of apple may be kept throughout the year, or longer. The tree is naturally of considerable hardness and durability, but the cultivated varieties are comparatively delicate and short-lived. Trees of the more hardy varieties, however, have been known to endure for two or three centuries; but it is presumed that individual trees of such varieties as the Hawthornden, and the Ribston pippin, would scarcely live a century. The apple, like every other plant, accommodates itself more or less to the climate and soil in which it is placed, but still it attains a higher degree of perfection in one particular climate and soil, than in any other. The climate of England, and the north of France, and the loamy soils on lime-stone rock that are found in these countries, appear to bring the apple to the highest degree of perfection. Italy and Spain are much too warm, and the north of Germany and Sweden, too cold and sunless. Several kinds of apples were introduced into Britain by the Romans, who possessed, according to Pliny, twenty-two varieties; but, in all probability, these were lost in the interval between the Roman civil power in Britain, and the power of the Church, though many wildings might doubtless spring up, when the trees established by the Romans began to be neglected. Some of the varieties in existence, it may be reasonably supposed, were introduced by the Roman clergy, but the greater number of sorts which have not been raised in Britain have doubtless been introduced from Normandy, either when that country was subjected to England, or previously at the Norman conquest. The apple is not indigenous in North America, but nevertheless it flourishes in all the temperate parts of the United States, and the flavour of some varieties grown in America, for example the Newtown pippin, is thought by many to be superior to that of any kinds grown in the north of France, or England. The number of varieties now in cultivation has been greatly increased within the present century, partly from importations, but chiefly from seedlings raised in this country. In consequence, we have varieties suitable for different soils and

situations, from the warm moist climate of Devonshire and Cornwall, to the cloudy and stormy atmosphere of Orkney. There are varieties which ripen as early as July, and others which are not fit to eat till the following spring; and which, with proper care, will keep till apples come again, and even longer. No fruit tree is more prolific than the apple when in a suitable soil and situation, and no fruit is applied to a greater variety of useful purposes.

1128. *The uses of the apple* in pies, tarts, sauces, the dessert, or boiled or roasted, is familiar to every one. The expressed juice fermented forms cider,—that of the crab verjuice; and when both these liquids are mixed, and properly managed, a very good wine, it is said, may be produced. One-third of boiled apple pulp, baked with two-thirds of flour, and fermented for twelve hours, is said to make an excellent bread, very palatable and light. In confectionery the apple is used for comfits, compôtes, marmalades, jellies, pastes, tarts, fritters, and various other purposes. To form a jelly, the apples are “pared, quartered, and the core removed, and put in a closely-covered pot, without water, in an oven, or over a fire. When well stewed, the juice is squeezed through a cloth, a little white of an egg is added, and then sugar; and lastly it is skimmed, and by boiling reduced to a proper consistence.”—*Kenrick*. Medicinally, boiled or roasted apples are considered laxative and at the same time strengthening. In perfumery, the pulp of the apple beat up with lard forms pomatum; and by mixing apples with elder-flowers, in a close vessel, an odour of musk is said to be communicated to them. The juice of the apple concentrated by boiling will keep for several years, and may be used to form a liquor similar to cider, by adding a little to water as it is wanted for use. The apple-tree when in flower is very ornamental, particularly some varieties which have their petals tinged with pink, such as the Hawthornden; and the tree is still more beautiful when covered with fruit, especially with such as are highly-coloured, such as the red Astrachan, the tulip-apple, &c. The bark of the tree may be used for dyeing yellow; and the wood being fine-grained and very compact, is well adapted for turning and for staining, so as to be used as a substitute for ebony. We have dwelt long on the uses of the apple, because, with Speechly, we regard it as a fruit of more use and benefit to the mass of society than all the other fruits cultivated in Britain united.

1129. *Properties of a good apple*.—Apples for table are characterised by a firm juicy pulp, elevated, poignant flavour, regular form, and beautiful colouring; those for kitchen use by the property of falling, as it is technically termed, or forming in general a pulpy mass of equal consistency when baked or boiled, and by a large size. Some sorts of apples have the property of falling when green, as the Keswick, Carlisle, Hawthornden, and other codlins; and some only after being ripe, as the russet tribes. Those which have this property when green are particularly valuable for affording sauces to geese early in the season, and for succeeding the gooseberry in tarts. For cider an apple must possess a considerable degree of astringency, with or without firmness of pulp or sugariness of juice. The best kinds, Knight observes, are often tough, dry, and fibrous; and the Siberian Harvey, which he recommends as one of the very best cider apples, is unfit either for culinary purposes or the table. The same eminent pomologist has found that the specific gravity of the juice of any apple recently

expressed, indicates, with very considerable accuracy, the strength of the future cider.

1130. *Varieties*.—The varieties of apple in cultivation previous to the time of Henry VIII. do not appear to have been numerous; but Evelyn informs us, that Harris, the fruiterer to that monarch, introduced many sorts of apples and other fruits from Flanders, and distributed them in the neighbourhood of thirty towns in Kent only, to the great and universal improvement of the country. In the time of Charles I., Lord Scudamore introduced a number of cider apples from Normandy into Herefordshire. Hartlib, during the Commonwealth, in 1650, “believes there are nearly 500 sorts in this island.” Some were introduced from Holland in the time of William III., and the number would doubtless gradually increase till the commencement of the present century, when it has been greatly accelerated by the growing taste for gardening, and the great stimulus given by Mr. Knight to raising new fruits from seed. The Horticultural Society of London have collected varieties of fruit from every part of the world, and the number of sorts of apples, that have been proved in their gardens to be distinct, is believed to be nearly 1500; the number of names exceeding twice that amount, many varieties having more than one name. The great difficulty, where the choice is so ample, is to make a selection, and this, with the assistance of Mr. Thompson, we have been enabled to do, so as to present lists of unquestionable excellence.

1131. *Early dessert Apples.*

Early Red Margaret, syn. Red Juneating, middle size, conical, greenish yellow striped with red, tender and rich; ripe in August; a good bearer, and the fruit most abundant at the extremities of the branches.

Early Harvest, syn. Large Early, or Prince’s Harvest. Above the middle size, roundish, yellow, with crisp, juicy flesh, and brisk rich flavour; ripe in the beginning of August.

Oslin, syn. Arbroath pippin. Middle size, oblate, pale yellow, firm, rich, spicy, aromatic; ripe in August and lasting till September; a good bearer, and altogether one of the best summer apples. A Scotch variety.

Kerry Pippin. Middle size, oval, yellow and red, firm, sugary, and rich; September to October; a good bearer, a healthy tree, and altogether an excellent fruit. As the name implies, it is an Irish variety.

Summer Golden Pippin. Below the middle size, ovate, flattened at the eye, yellow, crisp, and rich; September; tree of medium size, and a tolerably good bearer.

1132. *Dessert Apples to succeed early kinds.*

Wormsley Pippin. Middle size, roundish, pale green, crisp, juicy, and rich; September to October; excellent for the dessert, and peculiarly rich when cooked; the tree a great bearer, healthy and vigorous.

King of the Pippins, syn. Hampshire yellow. Above the medium size, rather oblong, yellow and red, firm, juicy, and rich; October to January; a great bearer, and a vigorous, healthy tree.

Golden Reinette, syn. Wyke pippin. Middle size, flattish, yellow and red, sugary, rich, yellow flesh; October to January; a good bearer, the tree of the middle size, and the fruit very handsome.

Maclean's Favourite. Middle size, roundish, yellow, crisp, rich, with the flavour of the Newtown Pippin; November till February; tree moderately vigorous, a good bearer.

Claygate Pearmain. Middle size, pearmain shaped, greenish yellow and brownish red, rich, with a Ribston pippin flavour; November till March; tree hardy.

Ribston Pippin, syn. Glory of York. Above the middle size, roundish, greenish yellow and red, crisp, juicy, peculiarly rich and high flavoured; November to March; a good bearer, a spreading tree, deserving a wall, where it will not otherwise succeed.

Court of Wick, syn. Wood's Huntingdon. Below the medium size, ovate, yellow and some red, firm, juicy, and rich; a very excellent fruit; October to April; tree hardy, a good bearer.

Pearson's Plate. Under the middle size, oblate, yellow, green, and red, of first-rate quality; December to March; a good bearer, and remarkably handsome apple.

Golden Harvey, syn. Brandy apple. Small, roundish, yellowish russet, firm, exceedingly rich, and high flavoured; in this respect a fruit of the very highest excellence; December to May; the tree is slender, upright, and a moderate bearer.

Hughes's Golden Pippin. Small size, roundish, yellow, firm, juicy, rich; December to February; a good bearer, and a moderately vigorous tree.

Pitmaston Nonpareil. Middle size, roundish, pale green with slight russet, rich nonpareil flavour; December till February; a good bearer.

Braddick's Nonpareil. Nearly middle size, roundish, green, and bright brownish red, partakes of nonpareil flavour; January till April; tree a most abundant bearer.

Herefordshire Pearmain, syn. Old Pearmain. Above the middle size,

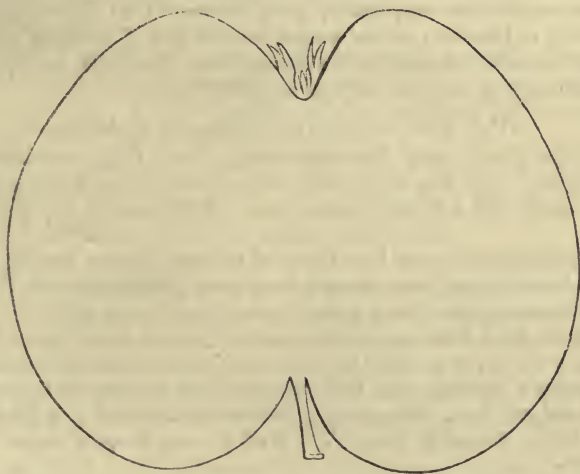

Fig. 359. *Pearmain-shape, exemplified in the Herefordshire Pearmain Apple.* The Pearmain shape is understood to be a truncated cone, with the base rounded, and projecting more towards the stalk on one side than the other.

pearmain-shaped (fig. 359), yellowish, green and red, rich, yellowish flesh ; November to March ; a good bearer, and a spreading, healthy tree.

Sturmer Pippin. Middle size, short, conical, yellowish green and brownish red, firm, brisk, rich ; February to June ; a good bearer and a healthy tree. The fruit retains its briskness till Midsummer.

Court Pendu-Plat, syn. Garnon's apple. Middle size, oblate, green and red, firm, rich, and sugary ; December to April ; a great bearer, a small tree, blossoming late, by which it escapes the spring frosts. A Dutch variety.

Reinette du Canada. Large, flattened, greenish yellow and brown, juicy, brisk, very rich, subacid ; November to April ; tree spreading, and a good bearer. Very common in France.

Old Nonpareil, syn. *Reinette Nonpareil*. Middle size, roundish, flattened, and broadest at the base, greenish yellow, firm, crisp, peculiarly rich, aromatic ; January to May ; a good bearer, a tree with slender shoots, rather upright than spreading, and the fruit excellent.

Scarlet Nonpareil. Middle size, roundish, greenish yellow and red, firm, crisp, sugary ; January to April ; a good bearer and a healthy tree.

Downton Nonpareil. Middle size or rather large, round, greenish russet, juicy, with sharp, brisk flavour ; December till April ; tree hardy, and an excellent bearer.

1133. *Early Kitchen Apples.*

Dutch Codlin. Very large, roundish, greenish yellow ; August to September ; a good bearer, and a vigorous tree.

Keswick Codlin. Above the middle size, conical, greenish yellow, juicy, subacid ; August to September ; a great bearer and a healthy tree.

Hawthornden. Large, roundish, oblate, pale green, firm, juicy, subacid ; October to December ; a great bearer, the tree coming soon into bearing.

Nonesuch. Middle size, round, green streaked with red, crisp, subacid ; September to October ; a good bearer, and the tree of medium size. The fruit of this variety is noted for its transparency when made into apple-jelly, for which purpose it is the best sort in cultivation.

1134. *Kitchen Apples for Winter and Spring use.*

Blenheim Pippin, syn. Blenheim orange. Very large, roundish, yellow and streaked with red, tender and rich ; November to February ; a moderate bearer, and a strong growing tree. This is also a very good dessert apple.

Tower of Glammis, syn. Late Carse of Gowrie. Large, conical, greenish yellow, brownish red next the sun, firm, juicy ; November till February ; tree vigorous, a good bearer ; a heavy, excellent kitchen apple.

Waltham Abbey Seedling. Large, roundish, yellow, firm, requires but little sugar in cooking ; September till February ; the tree an abundant bearer.

Dumelow's Seedling, syn. Wellington. Above the middle size, roundish, yellow and red, firm, crisp, juicy ; November to March ; a good bearer, and a hardy spreading tree. The fruit in long keeping retains well its briskness.

Bedfordshire Foundling, syn. Cambridge pippin. Large, roundish, greenish yellow, firm and rich ; November to March ; a good bearer, and a vigorous healthy tree.

Alfriston. Very large, roundish, greenish yellow, firm, juicy, subacid; November to April; a good bearer, and a healthy tree.

Gloria Mundi, syn. Monstrous pippin. Very large, roundish, yellow, tender, juicy; October to January; a moderate bearer; the fruit, from its size, is apt to be blown from the tree, unless it be grown on dwarfs. An American variety.

Royal Russet, syn. Leathercoat. Large, obtuse, conical, russet, somewhat rough and subacid in flavour, but excellent cooked; November to May; a good bearer, and a spreading tree.

Brabant Bellefleur. Large, roundish, yellow and red, firm, crisp, juicy; November to April; a good bearer, a spreading tree, and an excellent fruit.

Northern Greening. Middle size, oval, green, firm, crisp, juicy, subacid; November to April; a good bearer, and the fruit not liable to shrivel.

Norfolk Beaufin, syn. N. Beefin. Middle size, roundish, green and dark red, hard consistence; December to June; a good bearer, and the fruit excellent when dried as a sweetmeat.

Easter Pippin, syn. French Crab. Middle size, roundish, green and dull brown, and will keep above a year, firm, crisp, and subacid; December; a good bearer, and a hardy tree.

Gooseberry Pippin. Large, somewhat oblong, yellow, firm, subacid; February till August; named from its sauce being a substitute for, and resembling that of green gooseberries.

1135. *Cider Apples.*

Siberian Bitter Sweet. Small, roundish ovate, yellow, more sweet than bitter; September; a great bearer, and the tree free from insects and canker.

Foxley. Small, roundish ovate, orange yellow, specific gravity 1080; October and November; a great bearer, and a healthy vigorous tree.

Red Streak, syn. Old Red Streak, or Scudamore's Crab. Roundish, streaked, spec. grav. 1079; December to April; a good bearer, and the fruit produces cider of the first quality.

Fox Whelp. Middle size, ovate, dark red, spec. grav. 1078; December to January; a good bearer, and a healthy tree.

Golden Harvey. A dessert apple, already described, which produces excellent cider, spec. grav. 1085.

Hagloe Crab. Small, ovate, yellowish, spec. grav. 1081; October to February; a great bearer, and a healthy, hardy tree.

Cooper's Red Streak. Middle size, roundish, streaked; November to December; a great bearer, and a vigorous, healthy tree.

1136. *Dessert apples which may be used as kitchen apples.*—Sugarloaf Pippin, Wormsley Pippin, Autumn Pearmain, King of the Pippins, Fearn's Pippin, Ribston Pippin, Old Pomeroy, Herefordshire Pearmain, Reinette du Canada, Dutch Mignonne, Downton Nonpareil, Newtown Pippin, Boston Russet.

1137. *Kitchen apples which may be used as dessert apples.*—Gravenstein, Blenheim Pippin, Bedfordshire Foundling, London Pippin, Northern Greening, Rhode Island Greening.

1138. *Apples for cottage gardens, where the soil and situation are favourable, and which may be used either for the table or the kitchen.*—Where the space will admit of only one tree, the best is the Ribston Pippin; where two, the Ribston Pippin and the Blenheim Pippin; where three, or more,

add successively to those previously named, the Sturmer Pippin, King of the Pippins, Herefordshire Pearmain, Wormsley Pippin, Reinette du Canada, Bedfordshire Foundling, Downton Nonpareil, Waltham Abbey Seedling.

1139. *Apples for training against the walls or on the roofs of cottages, or on the walls of cottage gardens.* (See p. 471)—Ribston Pippin, Old Nonpareil; and if a large kitchen apple be required, the Bedfordshire Foundling.

1140. *Apples for cottage gardens in situations liable to spring frosts.*—The Court Pendu-plat, as expanding its blossoms later in the season than any other apple; and the Northern Greening.

1141. *Apples for a cottage garden in an unfavourable climate.*—The Claygate Pearmain and Sturmer Pippin are considerably hardier than the Ribston Pippin. The Northern Greening is a hardy and late kitchen apple; and the Keswick Codling is a hardy autumn kitchen apple. The Hawthornden comes earlier into bearing than any other variety generally cultivated; and it is to be preferred to the Keswick Codling, were it not that it is liable to canker in some soils.

1142. *Apples adapted for walls of different aspects* are enumerated in p. 422.

1143. *Apples adapted for espaliers, dwarfs, or conical standards,* are enumerated in p. 428.

1144. *Apples suitable for an orchard* are enumerated in p. 431.

1145. *Apples remarkable for the form of the tree, or the beauty of the blossoms or fruit.*—The red Astrachan has the fruit of a bright red, with a fine bloom like that of a plum. The white Astrachan, or transparent crab of Moscow, has the fruit of a wax colour, with a fine bloom, and it is almost transparent. The black crab has small fruit which is of no use, but it is so dark as almost to be black. The Lincolnshire Holland pippin is remarkable for the large size of its blossoms, and the fruit keeps till February. The tulip apple has fruit of a very bright red, and is a great bearer. The violet apple has fruit of a violet colour, covered with a bloom like that of the plum. The cherry crab is a spreading tree with drooping branches, and numerous fruit about the size and colour of a large cherry. The supreme crab is a more erect tree than the cherry crab, with larger fruit. Bigg's everlasting crab is a vigorous-growing, round-headed tree, the fruit and leaves of which remain on long after Christmas, in sheltered situations.

1146. *General principles of selecting varieties of the apple.*—The first requisite in forming a selection is to determine how far the climate, soil, and situation, differ from those of the central counties of England, which may be taken as those for which most of the selections above given are adapted. A number of varieties which may be grown as standards in the centre or the south of England, require a wall in various parts of the north of England and of Scotland. The winter and spring table apples may require a south wall in one district, while in another they may attain equal maturity as standards or espaliers. Where there is ample room, a selection of large sorts, as the Alexander and Blenheim pippin, or of such as are the most beautifully coloured, as the violet, Hollandbury, &c., may be made to gratify the eye; where room is wanting, useful sorts and great bearers are to be preferred,—such, indeed, as are enumerated in

the above selection, which has been made with a view to both quality and abundance of produce. In general, small-sized fruit are to be preferred for standards, as less likely to break down the branches of the trees, or be shaken down by winds; middling-sized and high flavoured sorts for walls; and the largest of all for espaliers. In respect to a soil liable to produce canker, sorts raised from cuttings may be desirable, as the Burknott and codling tribe; and where an occupier of a garden has only a short interest therein, such as come into immediate bearing, as the Burknotts and others from cuttings, and the Hawthornden and other short-lived dwarf sorts on Paradise or creeping stocks, may deserve the preference. On the contrary, where a plantation is made on freehold property, or with a view to posterity, new varieties on crab or free stocks should always be chosen, as, if for cider, the Grange, Ingestrie, Harvey, &c. Some excellent sorts will grow and produce crops everywhere, as the Hawthornden, codling, and Ribston pippin; the latter of which Nicol says, will grow at John o'Groat's House, and may be planted in Cornwall; others are shy bearers in cold situations, as the Newtown pippin of America, most of the newly-imported French sorts; and the Italian apple *Malo di Carlo*, which though exceedingly beautiful and delicious in the north of Italy, proves pale and insipid in England in our finest summers. Indeed, the apples of the south of Europe generally, when transplanted to England, prove worthless. See 387.

1147. *Propagation.*—The apple may be propagated by seeds, cuttings of the branches or roots, by layers, suckers, inarching, grafting, or budding, but the two last modes are most generally adopted for continuing varieties, and seeds are seldom resorted to, except when new varieties are the object. Only a few sorts, such as the Burknott, some of the codlings, and the creeping apple, can be increased readily by cuttings; but this mode is resorted to occasionally, when these kinds are wanted as stocks for grafting on. Suckers from a grafted tree can only be used as stocks; but from kinds of apple which are used chiefly as stocks, such as the paradise apple, suckers are not an uncommon mode of propagation. It thus appears that the first step in the propagation of the apple by grafting or budding, is the propagation of the stock. Crab stocks are raised from seeds of the wild crab, and are used when the object is strong and durable trees; wildings or seedling apple stocks, are used for strong trees in good soils, and are raised from seeds of apple trees, most commonly of free-growing seedlings, which have grown in hedges in cider counties, or from cider apples; dwarfing stocks, such as the paradise, doucin, creeping apple, and some codlings, are commonly raised from layers (625) and suckers. Seedlings, after one year's growth in the seed-bed, are transplanted in rows, three feet apart and eighteen inches distance in the row; and they are commonly grafted the third or fourth spring from the seed, when they are from half an inch to one inch in thickness. Both dwarfs and standards are commonly grafted within a few inches of the ground, and the standards are formed by encouraging the leading shoot, which is commonly cut over at the end of the second year at the height of five or six feet from the ground, and after it has grown another season in the nursery, the side-shoots being cut off about midsummer, it is fit for being transplanted to where it is finally to remain. If the tree should not be sold or transplanted the first year after the head is formed, the shoots are

shortened, technically "headed in," to one or two buds, and this operation is repeated every spring till the plant is sold or transplanted to where it is finally to remain. The same heading-in takes place with dwarfs, the reason in both cases being that it is desirable to have no more wood left on the tree than the root, after undergoing the mutilation consequent on transplanting, can readily support. Occasionally, both standards and dwarfs are trained in the nursery, either as standards or as dwarfs or espaliers, in which case, at the time they are to be removed, great care is requisite to take them up with as large a proportion of their roots as possible. The more frequently dwarf trees are transplanted in the nursery before being finally removed, the greater will be the number of their fibrous roots; and as these must necessarily be within a limited space, the quantity of nourishment they take up will be limited also. Hence by their number of fibrous roots, they will suffer little from removal, while by the concentration of these roots they will only absorb the nourishment obtained within a very limited space, and thus keep the tree dwarf, and throw it early into a fruit-bearing state; or at least prevent it from growing so vigorously as if it were furnished with a number of ramose roots, which by extending their fibres to a distance have a proportionately greater command of nourishment. Hence maiden plants one year grafted on free stocks that have not been transplanted, are to be preferred in every case where the object is large and vigorous trees; and when the object is dwarf trees, plants on dwarfing stocks that have been several times transplanted should be chosen.

1148. *Soil and Situation.*—The apple tree acquires the largest dimensions in a deep strong loam, or marly clay, on a rocky bottom, or on a subsoil that is not retentive of moisture, and in a situation which is neither very high nor very low. "It will grow tolerably well in any common soil, neither extremely sandy, gravelly, nor clayey, on a dry subsoil, and with a free exposure. On wet, hilly subsoil, it will do no good; but, after being planted a few years, will become cankered, and get covered with moss. Where fruit trees must be planted on such soils, they should first be rendered as dry as possible by under-draining; next, provision made for carrying off the rain-water by surface-gutters; and, lastly, the ground should not be trenched above a foot deep, and the trees planted rather in hillocks of earth, above the surface, than in pits dug into it. There is no point of more importance than shallow trenching and shallow planting in cold wet soils, in which deep pits and deep pulverisation only serve to aggravate their natural evils of moisture and cold."—*Sang.*

1149. *Mode of bearing, pruning, and training.*—The apple bears invariably on the old wood, often on that of the preceding year, and the blossoms continue being produced from terminal and lateral spurs, or short robust shoots, for a great number of years. These spurs require to be thinned out, when they become crowded, to be shortened when they become too long, and to be cut in when they become so old as to produce smaller fruit than is desirable.

The treatment of spurs is that part of the pruning of the apple when trained against walls or espaliers, on which the production of fruit chiefly depends, and it requires greater skill and care than any other part of pruning. For this reason, and as the spur pruning of the apple corresponds exactly with the spur pruning of the pear against walls or espaliers, and in a

great measure also with that of all other fruit trees that bear on spurs, we shall enter into it here at some length, as this will save repetition in treating of the pear, cherry, plum, apricot, mulberry, and even the gooseberry and currant. We shall commence with an apple tree one year grafted, just taken from a nursery and planted at the base of a wall or espalier rail. We shall give the winter and summer pruning for ten years, commencing every year with the beginning of the winter pruning, which should always be performed as early in the winter as possible. We have supposed the tree to be trained in the horizontal manner, but the mode of treating the spurs is equally applicable to every other kind of training, and to standard trees or bushes as well as to those against walls or espaliers. We quote this article verbatim from the *Gardener's Magazine*, Vol. III.

1150. *Spurring-in pruning. First year. Winter pruning.*—The tree is headed down before it begins to push; in doing which, the foot is placed upon the soil, and close to the bole, in order to prevent it from being drawn up by the force which is used in the operation. The cut is made in a sloping direction towards the wall, and about half an inch above the bud which is selected for the leading shoot. The tree is cut down so that seven buds remain.

Summer pruning. If all the buds push (which will generally be the case), they are all permitted to grow until they have attained three inches in length, when two of them are rubbed off; those rubbed off are the third and fourth buds, counting upwards from the origin of the tree. The uppermost shoot is trained straight up the wall for a leading stem, and the remaining four horizontally along the wall, two on each side the stem of the tree. These shoots are trained nine inches apart, for when they are much nearer than this they exclude the sun and air from operating upon the buds and wood, in such a manner as is required to keep the tree productive. When the leading upright shoot has attained about fifteen inches in length, the end is pinched off so as to leave it about eleven inches long. This causes shoots to be produced from the upper part of the leader thus stopped, three of which are trained in, the uppermost straight up the wall, and the others one on each side the stem of the leader. This stopping of the leading shoot is not performed later than the end of June or early in July; for, when it is done much later, those shoots which push afterwards in that season do not arrive at a sufficient degree of maturity to withstand the winter, and are frequently destroyed by frost. When it happens that a tree has not done well in the early part of the season, and the upright shoot is not of a suitable length or vigour at the proper period for stopping it, it is not meddled with afterwards until the winter pruning of the tree. When the tree grows either too weak or too vigorous, lower the branches or raise them as may be required. See 791, rule 2.

Second year.—Winter pruning. At the middle or end of November the tree is pruned. The upright leading shoot is now shortened down to ten inches from the place where it was last stopped. The tree will now be represented by the accompanying sketch (fig. 360). The side shoots (but which will hereafter be termed branches), are not shortened, but left their full length. If, during summer, the end of a branch should have been accidentally broken or damaged, the general consequence resulting from it is the production of several shoots or fruit buds. If shoots (which is very

generally the case) were produced, and were shortened during summer agreeably to directions for similar shoots in the treatment of the tree for the second year (see *Summer pruning*), they are now cut down to about half an inch in length (fig. 361). If, instead of shoots, natural fruit-buds should have been produced (these are short and stiff, from half an inch to an inch in length, and reddish at the ends), such are allowed to remain untouched, as it is on those that fruit are produced. The advantage of shortening back the upright shoot as much as is directed to be done is, that by it branches are certain to be produced at those places desired, so that no vacancy occurs. The leading upright shoot thus attended to will reach the top of a wall twelve feet high in seven years, which is as soon as the tree will be able to do, so as to support every part sufficiently. The tree is always loosened from the wall every winter pruning; the wall is swept and washed, recoloured with paint or coal-tar, if required; and the tree is anointed with soft soap, or some anti-insect composition, and fresh mulch laid to its roots.

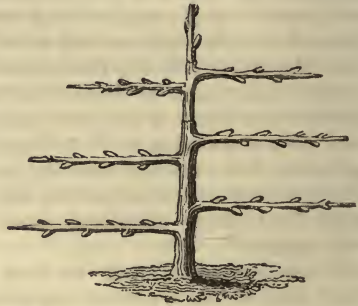

Fig. 360. *Horizontal Training, first year.*

Summer pruning.—When the buds upon that part of the leading stem which was produced last have pushed, they are all rubbed off to the three uppermost. The topmost is trained straight up the wall, for a lead to the main stem; and the two others, one on each side. The instructions given for stopping the leading shoot in summer, also shortening it back in winter pruning, &c., are attended to until the tree arrives at a few inches from the top of the wall. The side branches are allowed to grow without being shortened back at any time, until they have extended as far as can be permitted, when they are pruned in every winter, by cutting back each leading shoot to two buds from where it pushed the previous spring. Any shoots arising from the fore part of the main stem are taken clean away. The buds upon the wood made last year will this summer generally make fruitful ones. If, on the contrary (as is sometimes the case), shoots are produced instead of fruitful buds, they are allowed to grow ten or twelve inches long, until the wood attains a little hardness towards the bottom of it, when they are cut down to about two inches in length; and at the bottom part of what remains, one or two fruit-buds are formed, so as to be productive in most cases the next year, but in others not until the second year. Although such a shoot was shortened as directed, yet it will generally push a shoot or more the same season from the top part of it. After such have grown a suitable length (as before described), they are cut back to about two inches from where they pushed. If more than one shoot were produced after the first shortening, and a bud or two is well swelled at the origin of the shoot (as before described), all the shoots are left, and shortened as directed; but, if no such bud is produced, all the shoots are cut clean away, excepting one, which is treated in shortening as before directed. The latter practice will generally be found necessary, and also be more advantageous, as a greater

portion of sun and air is admitted to the buds, which will be considerably strengthened and forwarded to a mature state. If after such treatment fruit-buds are not produced from the origin of the shoot, nail the shoot to the wall, parallel with the branch, which is uniformly successful in producing them.

Third year.—Winter pruning. Such of the buds as produced wood shoots the last year, and were shortened during summer as described, are now shortened more. It frequently happens that a fruitful bud, or in some instances two, will have been formed at the lower part of the shoot, (fig. 361, *aa*); such shoots are now cut off about a quarter of an inch above the uppermost of the fruitful buds (*b*): but (as it is sometimes the case), if there have not been fruitful buds produced, there will be growing buds, and then the shoots are cut down so as to leave one bud (fig. 361, *c*). On some occasions the growing buds and fruitful buds will appear but very indistinctly, and in an embryo state; when this is the case the shoots are cut down so as to leave two of those embryo buds (*dd*). There are generally some natural fruit buds which did not push to shoots, all such are left entire (*e*). They are of a reddish colour, and are easily distinguished from growing buds, which are considerably less and all of a dark colour.

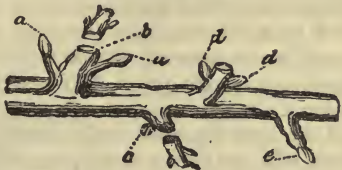

Fig. 361. Spur Pruning, third year.

Summer pruning. This summer the fruitful buds are productive. When the fruit has swelled a little, a shoot generally proceeds from the stem of the spur (which it may now be called), just underneath the fruit: such are allowed to grow eight or ten inches long, and are then shortened back to two inches, or so as to leave three eyes upon each (fig. 362, *A a*).

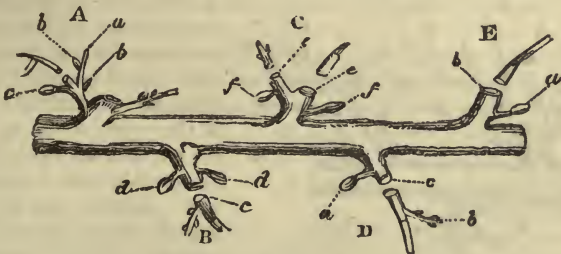

Fig. 362. Spur Pruning, fourth year.

By shortening the shoot, strength is thrown into the fruit, and, during summer, two or more fruit-buds are generally produced at the bottom of the shoot thus cut down (fig. 362, *bb*), or, otherwise, from the lower part of the spur (fig. 362, *c*). It sometimes occurs that when the tree is very vigorous, some of the buds (fig. 362, *bb*) will push into shoots, or occasionally into bloom, during the latter end of summer. If shoots, they are allowed to grow, and are then shortened, as described for similar shoots; but, when bloom is produced, it is immediately cut off close under the blossom.

The shoots (fig. 361, *c*) produced after the third year's winter pruning are

allowed to grow, and are then shortened, as already directed for similar shoots (see *Second year's summer pruning*). The shoots which were pruned as directed last winter, and had embryo buds (fig. 361, *dd*) during this summer generally have a fruit-bud, and in some cases two, formed at their bases. The treatment of all shoots produced upon any of the spurs in future, is agreeably to the previous instructions given.

Always thin the fruit, and where two are situated together, take one away; this is done when they begin to swell.

Fourth Year.—Winter Pruning. The spurs (fig. 362, *A B*) which were productive last summer, and upon which a shoot was made and shortened (fig. 362, *a*, spur *A*), are now regulated in the following manner:—If there be two good fruit-buds formed upon the stem of the spur (fig. 362, *d d*, spur *B*), all that part of it above such buds is cut away, about a quarter of an inch above the uppermost (as at *c*); but, if there is only one good fruit-bud upon the stem, and one upon the shoot which was cut in during summer (as at *a*, spur *A*), then it is pruned off (as at spur *c*, *ee*), so that two buds only remain (as at *ff*). When there is only one fruit-bud upon the stem of the spur (as spur *D*, *a*), and no fruitful buds at the shoot (*b*), then all the spur is pruned away (as at *c*). Sometimes those spurs that bear fruit will not have a shoot produced, but, instead of it, a fruitful bud (as spur *E*, *a*); it is then pruned off just above such bud (as at *b*).

Summer Pruning. All shoots are pruned, as already directed, in the second and third years.

Fifth Year.—Winter Pruning. All the spurs are allowed to retain three fruitful buds each; but as there are generally more than is required to keep, some of them are thinned away, retaining the best buds. The ripest buds are most plump and red at the ends. If such buds are situated near to the origin of the spur (as fig. 363, spur *A*, *a a a*), they are retained in preference to similar fruitful buds that are nigher the end of the spur (as *b b*); the spur is then cut off (as at *c c c*). When there are no fruitful buds near to the origin of the spur, those are left that are further off; but always take care to preserve the bud situated nearest to the branch which supports the spur, whether it be a growing or a fruitful one (as spur *B*, in which *a* is a fruitful bud, and *b* a growing one).

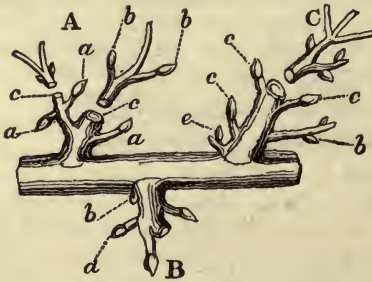

Fig. 363. *Spur Pruning fifth year.*

If there be a suitable supply of buds upon the old part of the spur (as *c, c c c*), they are retained in preference to those buds formed at the bases of shoots which have been pruned during summer (as *e b*); for when there is a proper supply on the old part of the spur, all such shoots are cut clean away, with the exception of one that is situated near to the origin of the spur (as *e*), when that bud and the two next are only left.

Summer Pruning is performed as before directed.

Sixth Year.—Winter Pruning. In order to convey a correct method of

the treatment of the spurs in future, it will be necessary to point them out by numbers, as 1, 2, and 3. The enumeration will proceed from the bole of the tree, along the branch. After three spurs are thus numbered, begin again, and proceed with No. 1, &c. (agreeably to fig. 364).

Every spur, No. 1, is now cut down to the lowest bud there is upon it, whether it be a fruitful bud (as *a*), or growing bud (as *b*). Every spur, No. 2, to have three fruit buds (as *ccc*), and every spur, No. 3, to have four fruit buds (as *d d d d*). When a spur, No. 1, is destitute of either a fruitful or a growing bud towards the lower part of it, such a spur is cut down so low as only to leave about one half inch remaining (as fig. 364, *A*). There is generally an eye or embryo of a bud situated near to the origin of the spur (as *a*, spur *A*); from this a shoot or a fruitful bud is produced the ensuing summer, and thus a supply is obtained for that cut away.

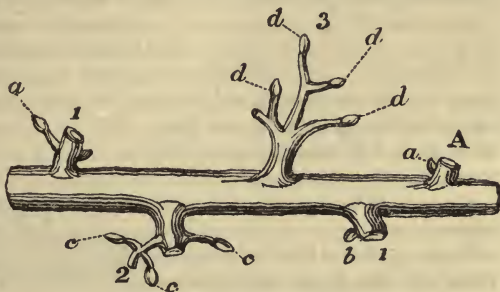

Fig. 364. Spur Pruning, sixth year.

Summer Pruning. All shoots are shortened during summer, as before directed. Particular care is paid to the spurs No. 1, as a shoot or a fruitful bud is generally produced nearer to the base of the spur than to the bud that was left at winter pruning, and most commonly at the opposite side of the spur to it. Either a shoot or a fruitful bud generally pushes from those spurs that were cut entirely down (as spur *A*, fig. 364); the shoots are cut down, as directed for others.

Seventh Year.—Winter Pruning. The spurs No. 1 now generally have two fruit-buds each; they are allowed to retain them (as fig. 365, *aa*). If, instead of a fruitful bud, a shoot pushed (as *b*), and a fruitful bud was

formed at the lower part of it; the shoot is then cut off just above it (as at *c*); but if there is not a fruitful bud formed, it is cut down, so as to leave it half an inch long (as at *d*). The spurs No. 2 have four fruit-buds left

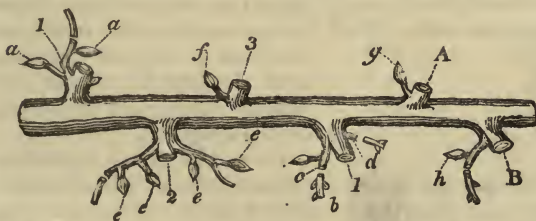

Fig. 365. Spur Pruning, seventh year.

upon each (as *eeee*); the spurs, No. 3, are now cut down, so that only one fruitful bud remains (as *f*).

If a fruit-bud has been produced from the spur cut entirely away (as spur *A*, fig. 364), it is left entire (as fig. 365, *g*); but if a shoot, instead of a fruitful bud, it is cut off just above the lowest bud, whether a fruitful or a growing bud (as at *h*, spur *B*). This treatment to such spurs cut entirely down, is always pursued to similar ones in future.

Summer Pruning.— This is attended to agreeably to the foregoing directions.

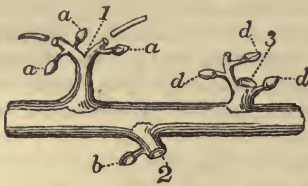

Fig. 366. Spur Pruning, eighth year.

spurs, No. 1, are allowed to have four fruit-buds each (as fig. 367, *a a a a*); the spurs, No. 2, to have two fruitful buds (as *b b*), and the spurs, No. 3, to have three (as *c c c*).

Summer Pruning. Performed as before.

Tenth year.— Winter Pruning. The spurs, No. 1, are now cut down again (as fig. 368, *a*, a fruitful bud, and *b*, a growing bud). The spurs, No. 2, are pruned to three fruit-buds (as *c c c*), and the spurs, No. 3, to four fruit-buds (as *d d d d*).

It will be observed that the spurs, No. 1, have now been cut down twice; the first time in the sixth year, and the second in the tenth. Thus, those spurs cut down to a fruitful bud (as fig. 364, *a*) have borne fruit four years; and those spurs cut entirely down, or to a growing bud (as *A, b*, fig. 364), would have only borne fruit three years. In these two cases, always leave the spurs with three fruit-buds each this winter, and cut them down the following winter, unless they have grown very vigorous and straggling.

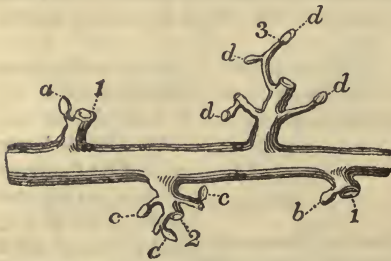

Fig. 368. Spur Pruning, tenth year.

The system already detailed, of cutting down and renewing the spurs, is practised with all others as here directed. Thus, the next year, the spurs No. 3 are cut down (as in fig. 365, *f*), and the second year from this time, the spurs No. 2. (as fig. 366, *b*), and in the fourth year from the present time, the spurs No. 1 cut down (as fig. 364, *a*, and fig. 368, *a*) require to be cut down again.

Conclusion—To some the above directions may appear tedious and intricate; but it became necessary to enter into minute details, in order to illustrate the principle of this system of spur pruning, the object of which is to obtain spurs always at a proper distance from each other, so that a suitable portion of sun and air may be admitted to them, and so that the spurs may always be kept supplied with young healthy wood and

Eighth Year.— Winter Pruning. The spurs, No. 1, are allowed to retain three fruit buds each (as fig. 366, *a a a*), and the spurs, No. 2, are now cut down (as *b*); the spurs, No. 3, are regulated as was done to spurs Nos. 1 and 2. See *Sixth and Seventh Year's Summer Pruning.*

Summer Pruning. This is performed as before directed.

Ninth Year.— Winter Pruning. The

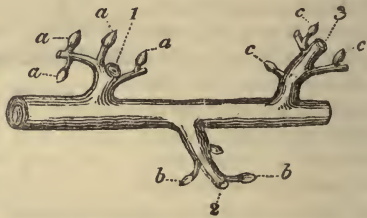

Fig. 367. Spur Pruning, ninth year.

fruitful buds. This renewal of spurs may be practised for a great many times, and thus those long injurious straggling spurs which are so generally seen on wall trees and espaliers may be avoided. (*G. M.* iii. p. 2—9.)

1151. *Pruning, with reference to the entire tree*, should have for its object to admit the light and air among the branches, to preserve the symmetry of the head by causing it to spread equally, and in the same form and manner on every side, and to eradicate branches which are diseased or decaying. In the case of espalier and wall trees it may frequently become necessary to shorten a portion of the roots in order to lessen the vigour of the branches, and throw them into a fruit-bearing state; and the same treatment may occasionally be required for dwarfs, and conical trees (794 and 798) on dwarfing stocks; but it can seldom or never be either necessary or desirable for standards, which require the aid of long ramosé roots to enable them to resist high winds; and their roots as well as their heads having abundant space for extension, a due equilibrium is preserved between them. (*G. M.* for 1842, p. 309.) Most trees and shrubs, whether fruit-bearing, ornamental, or merely useful, require a certain degree of pruning in summer, as well as in autumn or spring. The object of summer-pruning, in all standards and bushes, ought to be to stop or to thin out shoots of the current year, in order the better to admit the sun and air to mature, by means of the leaves, the shoots which remain. The shoots, so stopped or removed, may either be cut or stopped to one or two buds with a view to forming spurs, or cut close off, according as there may or may not be room for the spurs to be developed. In the case of trees on walls, espaliers, or trained as dwarfs, or cones, it is not desirable to add much strength to the root, and therefore most of the summer shoots should be shortened early in the season by pinching out their points with the finger and thumb, when they are only a few inches in length, repeating this operation when the shoot, thus shortened, has again developed its last or farthest bud, as in the case of summer pruning the vine (961). At the same time, wherever shoots are wanted to complete the form or dimensions of the tree, or when it is desirable to add strength to the stem or the root, there the branches should be left at their full length to be laid in, shortened, or cut out, at the autumnal or winter's pruning, as may be found most desirable. The apple against a wall or espalier is almost always trained in the horizontal manner, already described in detail (806): it is better adapted for dwarfs than any other fruit-tree, and the mode of training these, as well as of forming cones, has been given (792 to 799). Espalier-training has been exemplified (896), and also apple-training against walls (806). Apple-trees, when grown old and unfruitful, may frequently be headed in (762) with advantage, more especially if the surface of the soil is stirred and enriched with fresh soil and manure. They may also be regrafted (653).

1152. *Gathering and keeping*.—All apples, intended to be kept for some weeks or months, should be gathered by hand and carried to the fruit-room in baskets; but as it is difficult to prevent a number of fruit from dropping, or in exposed situations from being blown down by the wind, all that are bruised should be kept by themselves, in order to be used first. Table apples should be spread out singly on shelves, or packed in sand, fern, or kiln-dried straw, or in jars with any of these materials (858); but kitchen sorts may be laid in layers on shelves, or on a cool floor. The common mode of keeping, by those who grow apples in large quantities for the market, is to

lay them in heaps in cool dry cellars, and cover them with abundance of straw. In some parts of England they are preserved in ridges, the apples being laid on, and covered with, green turf or straw, and the ridge finished with a foot or more of soil to keep out the frost, in the same manner as is done in keeping potatoes in ridges or hods. By this mode they keep perfectly; but it is evidently better adapted for a market gardener who sells his produce in large quantities, than for a gentleman's gardener who has to furnish small portions of fruit daily. For him, shelves or the cellar-floor are to be preferred during the winter, and jars during the spring and summer months.

The French crab, the northern greening, and various other long keeping sorts, may be preserved in dry sand, on a large scale in cellars, or in ridges (or hods or pics, as they are called in some places), or on a small scale in jars kept in cellars, for two years or upwards. The French crab may also be kept on shelves in a garret for two years; but by this mode it is always more or less shrivelled. What is termed the sweating of apples, consists in covering them with short grass, aftermath hay, mats, or blankets, or any similar covering, so as to excite a degree of fermentation, the heat produced by which expands the water in the apple, and causes it to exude through the pores of the skin. This takes place sooner or later, according to the temperature of the atmosphere, but generally, in a fruit-cellar at 40°, in the course of a week or ten days, after which the apples are wiped, and being thus deprived of a portion of their moisture, it is thought they will keep better. This may be true where they are kept on shelves, exposed to a change of air; but the natural moisture of the apple is no impediment to its keeping in any situation where the air and the temperature are not, or but very slightly, changed.—(See 858 and 930.)

1153. *Diseases, Insects, Casualties, &c.*—No tree is more subject to the canker than the apple, and particularly some kinds, such as the Ribston pippin, Hawthornden, &c. Practically, the canker may be considered incurable; but it may always be prevented, or its appearance deferred, by procuring young trees which are free from it, and taking care not to plant them too deep, or to dig deep round them afterwards, so as to force the roots to penetrate into the subsoil. The canker is not only produced by too deep planting, by deep digging, in cultivating the ground round the tree, and by a wet or otherwise unfavourable subsoil, but by a late climate or a late season, in which the wood is not properly ripened. To facilitate the ripening of the wood in a bad climate, nothing is better than to prevent the tree from making much wood to ripen; and this may be effected by keeping the soil poor rather than rich, by planting on hillocks above the surface, and by never stirring the soil more than an inch or two in depth, for a space round the tree equal to, or rather more than, that covered by its branches. The woolly aphis, or American blight, is the most injurious insect that infests the apple tree, but it is also that which is most easily destroyed. This is effected by washing the parts with diluted sulphuric acid; which is formed by mixing $\frac{3}{4}$ oz. by measure of the sulphuric acid of the shops with $7\frac{1}{2}$ ozs. of water. It should be rubbed into the parts affected by means of a piece of rag tied to a stick, the operator taking care not to let it touch his clothes. The same mixture applied all over the bark of the tree will effectually destroy mosses and lichens. After the bark of a tree has been washed with this mixture, the first shower will re-dissolve it, and convey it into the most minute crevice, so as effectually to destroy any insects that may have escaped. (*G. M. vol. IX., p. 336.*)

There are several species of weevil which attack the young shoots of the apple tree, or bore into their blossom buds before they expand in spring. There are also several species of moth, some butterflies, and the aphid and chermes máli, but very little can be done either to prevent the attacks of these insects, or to destroy them after they have made their appearance. Smoke of any kind, such as from damp straw, if the heads of the trees can be enveloped in it, will bring down caterpillars, and by destroying these the number produced next season will be lessened. Tobacco water, thrown over the tree with an engine, will kill the aphid and chermes, but this remedy is too expensive for general use. Lime-water will destroy the caterpillars of all insects that live on the leaves of plants; but neither it nor tobacco-water can be readily brought in contact with the larva of beetles and other insects that live in the interior of the bud or shoot.—See our Chapter on Insects, and the different modes of destroying them, p. 93 to 123; and also that on the Diseases and Accidents to which Plants are liable, p. 123 to 126; and consult “Kollar’s Treatise on the Insects injurious to Gardeners, Foresters, and Farmers.”

SUBJECT. II. *The Pear.*

1154.—*The Pear*—*Pyrus communis*, L. (Poirier, *Fr.*; Birnbaum, *Ger.*; Peer, *Dutch*; Pero, *Ital.*; and Pera, *Span.*; E. B. 1784; *Arb. Brit.* vol. ii. p. 880; and *Encyc. of Trees and Shrubs*, p. 417), is a deciduous tree of a more upright and regular form than the apple-tree, and of greater duration. It is indigenous in the woods of most parts of Europe, and also in many parts of Asia; but it is not found in North America. The wild pear differs from the apple in growing on poorer soil, having a larger and more permanent tap root, and in a seedling state not coming so soon into bearing. The pear in its cultivated state is found in the gardens of all civilized countries, more especially in those of temperate climates. In Britain it forms a leading article in the dessert, from July to March, or later.

1155. *Uses.*—The fruit of the pear is more esteemed in the dessert than that of the apple, but the latter is much more valuable in the kitchen. The pear is used for baking, stewing, *compôtes*, and marmalades. Pared, and dried in the sun, the fruit will keep several years, either with or without sugar, and those sorts which are less esteemed for the table are found to answer best for this mode of drying and preserving. Perry is made from the expressed juice of the pear, fermented in the manner of cider, and when well made of the most suitable kinds of fruit, it is more highly prized than cider. The tree has not its white blossoms tinged with red, like those of the apple, but it grows to a greater height and assumes a more pyramidal shape; the leaves die off in autumn of a richer yellow or red; and the tree being of greater duration than the apple, it is from these properties better adapted for ornamental plantations. The wood is light, smooth, and compact, and much used in turnery, tool-making, for picture-frames, and for dyeing to imitate ebony. The leaves will dye yellow.

1156. *Properties of a good Pear.*—Dessert pears are characterised by a sugary aromatic juice, with the pulp soft, and sub-liquid or melting, as in the beurrés or butter-pears. Kitchen pears should be of large size, with the flesh firm, neither breaking, that is, firm and crisp, nor melting, and rather austere than sweet, as in the Wardens. Perry pears may be either large or small; but the more austere the taste, the better will be the iquor. Excellent

perry is made from the wild pear, which is altogether unfit either for the kitchen or the dessert.

1157. *The varieties* of pear cultivated by the Romans, Pliny informs us, were numerous; in France they have long been more so than the varieties of the apple; and hence the kinds in former cultivation in this country were obtained from France, and generally required the protection of walls. Since the peace of 1815, however, many new and hardy varieties of pear have been introduced from Belgium, where the cultivation and improvement of this fruit has, till lately, been more attended to than anywhere else. Some excellent and very hardy varieties have also been raised by the late Mr. Knight, so that the old French varieties, with the exception of some of superior excellence, such as the Jargonelle, are rapidly disappearing from our gardens. In 1842 more than 700 sorts had been proved, in the Horticultural Society's Gardens, to be distinct, as appears by the Society's Fruit Catalogue. The following selections from this large number have been made for us by Mr. Thompson.

1158. *Dessert Pears arranged in the order of their ripening and keeping.*

Citron des Carmes, syn. Madeleine. Middle size, obovate, yellowish green, tender, juicy; July; a good bearer, and an upright growing tree.

Jargonelle, syn. Epargne. Large, pyriform, greenish yellow, tender, juicy, rich, and melting; August; a good bearer. The tree generally requires a wall, for like the Colmar, Brown Beurré, and many old French varieties, its constitution is not adapted to withstand the vicissitudes to which standards are subjected; but as the fruit ripens in the hottest part of the season, it will succeed on any aspect, even facing the north.

Summer St. Germain. Middle size, obovate, pale green, tender and juicy; August and September; a good bearer as a standard, and a vigorous-growing tree.

Ambrosia, syn. Early Beurré. Middle size, roundish, greenish yellow, buttery and rich; September; a good bearer, and a strong growing tree.

Dunmore. Large oblong-obovate, greenish yellow, and smooth brown russet, buttery, melting and rich; September; a hardy vigorous tree, and bears abundantly as a standard.

Fondante d'Automne. Middle size, obovate, greenish brown, melting and rich; September and October; a good bearer, and a hardy tree.

White Doyenné, syn. White Beurré. Above the middle size, obovate, pale yellow, buttery, deliquescent; September and October; a great bearer, and producing fruit of the best flavour when grown as a standard.

Seckle, syn. New York Red Cheek. Small, obovate, brownish yellow and red, tender, juicy, high aroma; October; a good bearer as a standard.

Louise Bonne of Jersey. Large, pyriform, greenish brown and red, melting; October and November; a good bearer as a standard.

Marie Louise, syn. Braddick's Field Standard. Large, oblong, greenish yellow and brown, melting, buttery, delicious; October and November; a great bearer, and a hardy tree.

Beurré Bosc, syn. Calebasse Bosc. Large, pyriform, russeted, of a cinnamon colour, buttery and high flavoured; October and November; a moderate bearer, and best grown as a standard.

Gansel's Bergamot, syn. Bonne Rouge. Large, obovate, yellow russet brown, melting, buttery, high flavoured; October and November; a moderate bearer, and best adapted for being grown against a wall.

Duchesse d'Angoulême. Very large, obtusely obovate, yellow and russet, melting and juicy; October and November; a good bearer, especially against a wall; but the fruit is better flavoured from a standard.

Beurré Diel, syn. *Dorothée Royale.* Very large, obovate, or obtusely pyramidal, yellowish brown, buttery and rich; October and November; a great bearer, and a hardy vigorous tree.

Hacon's Incomparable, syn. *Downham Seedling.* Middle size, or rather large, roundish, brownish, or greenish yellow, slightly russeted, buttery, rich, and high flavoured; December and January; one of the hardiest and best of pears.

Nelis d'Hiver, syn. *Bonne de Malines.* Middle size, obovate, yellowish russet brown, buttery, melting, very rich; November to January; a good bearer as a standard, and deserving also a wall.

Althorp Crassane. Middle size, roundish, obovate, greenish brown, buttery, first-rate flavour; October and November; a good bearer, as a standard; being hardy it does not require a wall.

Winter Crassane. Large, turbinate, green, yellow, and brown, buttery, first-rate quality; January; a hardy tree, and a great bearer as a standard.

Napoleon, syn. *Médaille.* Large, obtusely pyramidal, pale green, melting, and extremely juicy; November and December; a good bearer, a vigorous tree, either on a wall or as a standard, and free from canker.

Thompson's. Middle size, obovate, brownish yellow, melting, buttery, and rich; November till January; bears as a standard.

Glout Morceau, syn. *Beurré d'Hardenpont.* Large, obtuse elliptic, pale green, buttery, melting, excellent; November to January; a great bearer; deserves a wall, but does not particularly require it; a hardy tree, and altogether one of the most valuable sorts of pears in cultivation.

Passe Colmar, syn. *Chapman's.* Middle size, obovate, greenish yellow russet, melting, juicy and sugary; December and January; a great bearer, either as a wall tree or standard, and free from canker.

Knight's Monarch. Middle size, obovate, yellowish brown, melting, and very rich; December and January; a good bearer, and a hardy tree.

Ne plus Meuris. Middle size, roundish and somewhat irregular in shape, brownish russet, buttery and rich; November to March; a great bearer, and the tree hardy.

Easter Beurré, syn. *Bergamotte de la Pentecôte.* Large, roundish oblong, yellowish green, russet, and brown, buttery and melting; January to March, and in jars among sand till June; a great bearer, and well deserving a wall.

Beurré de Ranz, syn. *Hardenpont du Printemps.* Large, obtusely pyramidal, brownish green, melting, juicy and rich; March to May, or in jars, among sand or kiln-dried straw, till July; a good bearer, and well deserving a wall. This and the two preceding varieties being the best keeping pears, ought to be planted in greater quantity than any other variety in private collections, so as to produce an abundant supply through the spring and, by careful keeping, till pears come again.

1159. *Kitchen Pears arranged in the order of their ripening and keeping.*

Bezi d'Heri, syn. *Französische Rumelbirne.* Middle size, roundish, yellow and reddish blush, tender, and with the flavour of anis; October to January; a great bearer, and succeeds well as a standard; excellent for stewing, and very free from grittiness.

Bequêne Musqué. Middle size, oblong, tapering, pale yellow, stews

tender; October to January; a great bearer, a hardy tree; and though the fruit in a raw state is disagreeable, yet it is excellent when stewed.

Spanish Bon Chrétien. Large, pyramidal, yellowish green and red, tender and very good; November and December; a moderate bearer, requiring a wall.

Double de Guerre, syn. *Double Krijgs.* Large, oblong, obovate, brownish-russet, and red, stews tender; November to February; a good bearer, and succeeds well as a standard.

Catillac, syn. *Katzenkopf,* or *Cats' Head.* Large, broadly turbinate, brownish-yellow, and red, stews a good colour; December to April; a good bearer, and succeeds well trained *en pyramide.*

Uvedale's St. Germain, syn. *Uvedale's Warden.* Very large, oblong, greenish-yellow, and brown, very good; December to April; a moderate bearer, requires a wall, on which the fruit has been grown to weigh upwards of three pounds, but it is not so productive as the preceding.

1160. *Perry Pears, arranged in the order of their merits.*

Oldfield. Below the middle size, turbinate, pale, russet-green, austere; a great bearer, a hardy tree, and the specific gravity of the juice 1067.

Barland. Small, obovate, greenish-russet, very austere; a great bearer, and the specific gravity of the juice 1070.

Longland. Middle size, oval, yellowish, austere; a great bearer, an upright tree, and the specific gravity of the juice 1063.

Teinton Squash. Middle size, roundish, greenish-russet, very austere; a moderate and rather uncertain bearer, but the perry very highly esteemed.

1161. *A list of pears adapted for walls of different aspects,* has been given in p. 422.

1162. *A list of pears for espaliers, dwarfs, or standards, trained conically or spurred in,* has been given in p. 428.

1163. *A list of pears adapted for an orchard or being grown as standards,* will be found in p. 432.

1164. *A selection of pears, where the space is very limited, or for cottage gardens.*—*Jargonelle,* *Dunmore,* *Marie Louise,* *Beurré de Capiaumont,* *Beurré Diel,* *Hacon's Incomparable,* *Glout-morceau,* *Easter Beurré,* and *Beurré de Ranz.* These are pears of first-rate excellence, and they will all succeed as standards in any climate where wheat can be brought to perfection, with the exception of the *jargonelle*, which, from the causes already mentioned (p. 546), requires a wall or espalier, even in the best climates. Where there is only room in a cottage garden for one pear tree, *Hacon's Incomparable*, which is one of the best, and almost a constant bearer, may have one branch or limb grafted with the *Marie Louise*, others with the *Easter Beurré,* *Glout-morceau,* and *Beurré de Ranz*, which would thus afford a succession of fruit of first-rate excellence from October till March. The three last-named pears may be advantageously trained against the walls of a cottage, or on a trellis raised about 6 inches above its roof (987). The *jargonelle* succeeds admirably against cottage walls, and on any aspect.

1165. *Pear trees of forms adapted for landscape scenery.*—*Glout-morceau,* a handsome pyramidal tree with spreading branches, hardy, a good bearer, and the fruit most excellent. *Swan's egg,* a handsome pyramidal tree, and an excellent bearer, but the fruit of only second-rate merit. The *Elcho,* a Scotch variety, with a fastigate head almost like that of a Lombardy poplar, but the fruit of little value; and the *Beurré Diel,* a handsome and somewhat fastigate tree, a great bearer, and the fruit excellent.

1166. *The propagation, nursery culture, and choice of plants*, are much the same for the pear as for the apple ; but the pear is never propagated by cuttings, which root with difficulty, and as it is oftener required for walls than the apple, it is more frequently flat trained for one, two, or three years in the nursery.—The pear is grafted or budded on stocks raised from seeds of the wild pear, or from any strong upright-growing kind, when the object is large and durable plants ; and when dwarfs or conical trees are to be produced, the stock used is the quince, which is propagated for that purpose by layers. The mountain ash, the medlar, the wild service, the white beam, the common thorn, and the crab apple, have also been used as stocks for the pear ; and hence, wherever there is a thorn hedge, or a wood or plantation containing white service trees, white beam trees, or the mountain ash, pear trees may be speedily grown in abundance. Grafting on the mountain ash is practised at Ems and in other parts of Nassau (*G. M.* 1842, p. 228.), and is said to retard the blossoming of the trees, and thus adapt them for a climate where there is danger from spring frosts ; while the flesh and flavour of the pear is said not to be affected. Grafting the pear on the thorn is known to bring it into very early bearing, and to produce thriving trees on a strong clayey soil, where neither stocks of the wild pear nor the quince would thrive. The thorn stock, however, is said to render the fruit smaller and harder. When the thorn is grafted either with the apple or pear, the scions or buds require to be inserted as near the root of the stock as possible, in order that the moisture of the soil may aid in the swelling of the stock, which, notwithstanding this care, generally remains of smaller diameter than the apple or pear grafted on it, and thus acts like the operation of ringing in increasing the fruitfulness of the tree. The quince, as it grows naturally in situations within the reach of water, is evidently the best stock for moist soils, and it is also thought the best for clayey and light soft soils ; while for chalky and silicious soils, and gravels of every kind, the pear stock is recommended. The pear does not unite very readily with the apple, and when it does so, is but of short duration. When grafted on a pear stock, the plants have fewer fibrous roots, in proportion to the bulk and age of the plant, than the apple on a crab stock ; and hence it requires more care in taking up for removal, and in the nursery requires to be more frequently transplanted than the apple. As quince stocks have more fibrous roots than pear stocks, the pear on them is transplanted without difficulty.

1167. *Soil, situation, and final planting*.—The pear grows naturally on a much poorer and drier soil than the apple, but to produce large crops of excellent fruit it requires like it a deep loamy soil on a dry subsoil. On a wet subsoil the pear will do no good, and the remarks made under this head (1148), in treating of the apple, are equally applicable to the pear. The distances at which the pear ought to be planted against a wall may be somewhat greater than that for the apple, or from 25 to 30 feet against a wall 12 feet high (890). The distance against espaliers, and as dwarfs or cones on dwarfing stocks, and in orchards, has been already given (902 and 908).

1168. *The mode of bearing, pruning, and training* the pear is much the same as for the apple, but in most of the varieties, the spurs are somewhat longer in being formed, being generally produced on two years' old wood, instead of the former year's wood. The branches of standard pears are a so less liable to cross each other than those of the apple, and hence pear tree in an orchard require, comparatively with the apple, little pruning.

In training the pear on walls or espaliers horizontally, the ordinary distance between the shoots is from 9 inches to 12 inches, the latter distance being adopted for large-leaved pears, such as the jargonelle; but for shy-bearing pears, which always are most prolific on young spurs, it has been proposed to have the main branches at double the distance, and to lay in

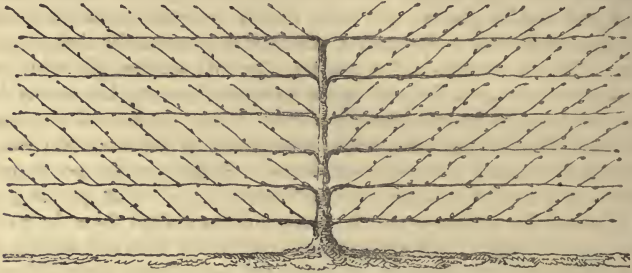

Fig. 369. A method of training shy-bearing Pears.

laterals from them at regular intervals, as in fig. 369. These laterals in two or three years will be covered with spurs and blossom-buds, and will be more certain of producing fruit than the spurs on the main branches. They can be renewed at pleasure, by cutting them off, having previously encouraged young shoots to supply their place. (See an elaborate article on this subject in *Gard. Mag.* vol. ii. p. 262.)

On walls or espaliers the pear is apt to produce a superfluity of young shoots, but this is chiefly owing to the borders being made *too* deep and rich, and to their being dug deeply and cropped, by which the roots are forced down to the subsoil, where they are supplied with more moisture than is beneficial for the fruitfulness of the tree, and which consequently expends itself in young shoots. The remedies are root pruning or disleafing (772), and mulching the border with litter instead of digging it. The summer shoots, which it is foreseen will not be wanted at the winter's pruning, should be stopped (768), as recommended for the apple.

Old standard pears may be cut in, and wall or espalier trees headed down to within a few inches of the graft; or the horizontal shoots may be cut off within a few inches of the upright stem, and a graft of a superior kind put on each. This has now become a very general mode of renovating old pear trees on walls or espaliers, that have been trained horizontally, and it affords an excellent opportunity of grafting a number of different kinds on one tree. On a wall 12 feet high there will be at least twelve horizontal branches on each side of the main stem, which will allow of grafting twenty-four different sorts on one tree, with a much better chance of an equilibrium of vigour being maintained among the kinds, than in grafting different sorts on a tree trained in the fan manner, or on a standard in the open garden, in which one or two robust sorts generally overcome all the rest.

Thinning the blossoms of pear-trees, and soaking the soil well with water at the same time, has been found to facilitate the setting of the fruit, and the practice might be worth adopting in a small suburban garden, not only with pear-trees but with fruit trees in general. The blossoms may be cut off with the averruncator or the flower-gatherer (418); but the most certain mode of benefiting by the practice of thinning the blossoms of any description of tree,

is to remove the blossom-buds the preceding autumn, or as early in spring as they can be distinguished from the leaf-buds. This will greatly strengthen the blossoms which remain, and go far to ensure the setting of the fruit.

1169. *Gathering and keeping*.—Dessert pears of the summer kinds, being softer and more tender than apples, require greater care in handling: they require to be kept but a short time before being used, and should therefore be placed in that division of the fruit-room which is devoted to summer fruits (856 and 931). Those which are intended to be kept for winter and spring use may be laid on open shelves, and the latest keeping kinds may be packed in jars, as recommended for apples (1152).

1170. *The diseases, insects, and casualties*, to which the pear is liable, are much the same as the apple; but the pear is less subject to canker, is seldom affected with the woolly aphis, and the tree being of more vertical growth is also less liable to be broken by winds.

SUBJECT. III.—*The Quince.*

1171. *The Quince*, *Pyrus Cydonia*, L.; *Cydonia vulgaris*, W.; (Coignassier, *Fr.*; Quittenbaum, *Ger.*; Kivepeer, *Dutch*; Cotogno, *Ital.*; and Membrillo, *Span.*—*Arb. Brit.* vol. iii. p. 830, and *Encyc. of Trees and Shrubs*, p. 450), is a low, much branched, crowded and distorted deciduous tree, a native of Austria and other parts of Europe, generally in moist soil or near water, and in a situation somewhat shady. It blossoms in May or June, and ripens its fruit in October and November. The tree has been grown for its fruit since the time of the Romans. The fruit is not eaten raw but stewed, or in pies or tarts, along with apples; it is much esteemed, and it makes excellent marmalade. When apples have become flat, or have lost their flavour, a quince, or even a part of one, in a pie or pudding, will add sharpness, and communicate a flavour by many preferred to that of apples alone. The fruit is large, and of a golden yellow when ripe, and its appearance on the tree bears a nearer resemblance to the orange than any other hardy fruit; and on this account, and also the beauty of its large pale-pink and white blossoms, the tree well deserves a place in ornamental landscape. On the borders of a pond it attains the highest degree of beauty, which is doubled by its reflection in the water. The use of the quince, as a stock for dwarfing the pear, has been already mentioned (1166).

1172. *Varieties*.—These are the oblong, or pear quince; the ovate, or apple quince; and the Portugal quince. The Portugal quince has broad cordate leaves, and an oblong fruit, which is more juicy and less harsh than that of the other varieties, and therefore the most valuable. It is rather a shy bearer, but is highly esteemed for marmalade, as the pulp has the property of assuming a fine purple tint in the course of being prepared. This is also the best sort upon which to work the pear-tree, its wood swelling more in conformity with that of the latter, than the harder wood of the other sorts.

1173. *Propagation, soil, and other points of culture and management*.—The quince is generally propagated by layers, but cuttings root without difficulty, and the Portugal quince is sometimes grafted on the pear quince, or the wild pear, or thorn. In propagating for stocks, no particular care is requisite in training the plants; but for fruit-bearing trees, it is necessary to train the stem to a rod, till it has attained four feet or five feet in height, and can support itself upright. The best standards, however, are produced

by grafting at the height of five feet or six feet on the pear, the thorn, or the mountain ash. The quince is generally planted in the orchard, in some part where the soil is good and somewhat moist: it bears on two-years old wood, and requires little pruning except thinning out crossing, crowded, or decaying branches. Trained against an espalier, it blossoms in May or the beginning of June, and the fruit in October or November makes a fine appearance. The fruit may be kept in the same manner as the apple, on shelves; or packed in sand, or kiln-dried straw.

SUBJECT IV.—*The Medlar.*

1174. *The Medlar*, *Méspilus germanica*, L. (*Neflier*, Fr.; *Mispelbaum*, Ger.; *Mispelboom*, Dutch; *Nespolo*, Ital.; and *Nespero*, Span.—*E. B.* 1523; *Arb. Brit.* vol. ii. p. 877; and *Encyc. of Trees and Shrubs*, p. 414), is a low deciduous tree, with crooked tortuous branches, a native of Europe and the west of Asia, in bushy places and woods, and said to be found wild in Kent, Sussex, and some other parts of England. It flowers in May and June, and the fruit is ripe in November. It is eaten raw, in a state of incipient decay, when it has a peculiar flavour and acidulous taste, relished by some but disliked by others.

1175. *Varieties.*—The Dutch medlar has the largest fruit; the Nottingham medlar has the fruit of a quicker and more poignant taste; the stoneless medlar has small obovate fruit, without stones or seeds; and the wild medlar has the leaves, flowers, and fruit smaller than in any of the other kinds except the stoneless. The first and second sorts are alone worth cultivating in small gardens, and as the fruit does not keep long, one tree of each kind will generally be found sufficient.

1176. *Propagation, soil, and other points of culture and management.*—Grafting on its own species is considered the best mode of propagation for the medlar as a fruit-tree; but it will root by layers, and, but with difficulty, by cuttings. The seeds, if sown as soon as the fruit is ripe, will come up the following spring, and make plants fit for grafting dwarfs in two years, and standards in three years. It requires a similar soil and situation to the quince, and the same treatment as that tree in every other respect, excepting that no attempt is made to keep the fruit longer than the period of its natural decay. It is laid on wheat straw spread on the shelves, in order that it may not be bruised, and is generally fit to eat about the end of November, and it lasts till the end of January.

SUBJECT V.—*The True Service.*

1177. *The True Service*, *Sórbus doméstica*, L.; *Pýrus Sórbus Gært.* and *Arb. Brit.*, (*Cornier*, Fr.; *Spierlingbaum*, Ger.; *Sorbenboem*, Dutch; *Sórho*, Ital.; and *Serbal*, Span.—*E. B.* 350; *Arb. Brit.* vol. ii., p. 921; and *Encyc. of Trees and Shrubs*, p. 442), is a middle-size deciduous tree, with a handsome regular head, a native of France and other parts of central Europe, and of Barbary, in the neighbourhood of Algiers; and a solitary tree of this species has been found in Wyre Forest, near Bewdley in Worcestershire. The leaves are pinnate, and closely resemble those of the mountain ash; but the fruit is much larger, and, when ripe, is of a rusty brown, tinged with yellow and red. It flowers in May, and the fruit is ripe in October. It is eaten like that of the medlar, but is deemed inferior. There is a pear-shaped variety, one apple-shaped, and a third berry-shaped; the latter

being the form of the fruit in the wild plant. The tree is rarely planted for its fruit in Britain, and is now neglected on the Continent. One may be introduced in an orchard or a shrubbery for the sake of variety. It is propagated by layers, or by grafting on the mountain ash, or any allied species. It requires a good soil in order to produce abundant and large fruit; but very little pruning is necessary, and we have never seen or heard of its being trained against an espalier; though we have no doubt it would be more prolific if grafted on the common thorn, and so treated. There are fruit-bearing trees in the arboretum of Messrs. Loddiges at Hackney, and in the Hort. Soc. Garden.

1178. *Pyrus torminalis* (*Arb. Brit.* vol. ii. p. 913; *Encyc. of Trees and Shrubs*, p. 436), the Gripping-fruited Service tree, is not cultivated in gardens, but it grows wild in Sussex, and the fruit is sent to Covent Garden market, and eaten in a state of incipient decay, like that of the True Service.

1179. *Pyrus A'ria*, var. *crética* (*Arb. Brit.* vol. ii. p. 910, and *Encyc. of Trees and Shrubs*, p. 403), the Cretan white beam tree, has a mealy, agreeably-tasted fruit, which is eaten when ripe, and before it has begun to decay. In our opinion this is as well worth cultivating as the True Service.

SUBSECT. VI.—*The Cherry.*

1180. *The Cherry* (*Cerasus sylvéstris* and *C. vulgáris*, *Arb. Brit.*; (*Cerisier*, *Fr.*; *Kirschenbaum*, *Ger.*; *Karseboom*, *Dutch*; *Ciriego*, *Ital.*; and *Cerezo*, *Span.*—*E. B.* 706; *Arb. Brit.* vol. ii. p. 693, and *Encyc. of Trees and Shrubs*, pp. 277, 278) is, in its wild state, a middle-sized deciduous tree, a native of most parts of Europe, and of part of Asia, and cultivated for its fruit from the time of the Romans. It is the first hardy fruit that ripens in the open air in Britain, and is grown extensively in Kent and Hertfordshire for the London market. It is also one of the earliest of forced fruits, being as we have seen (1026) ripened in March, and sometimes even in February (1028).

1181. *Use.*—The fruit, besides being highly valued for the dessert, is useful in pies, tarts, and other preparations in cookery and confectionery. Steeping cherries in brandy is said to improve its strength and flavour; a wine may be made from the pulp, and from the pulp and kernel bruised and fermented the German spirit *Kirschwasser* is distilled. The mode of preparing this spirit, and various other foreign or less common uses of the cherry, will be found given at length in the *Arboretum Britannicum*. The fruit of the Kentish cherry may be stoned, and dried, and used like raisins. The gum which exudes from the tree is said to have all the properties of gum arabic. The wood of the tree is hard and tough, and is used by the turner, flute-maker, and cabinet-maker: and the wild cherry, as a tree, is an excellent nurse for the oak on light soils, while its fruit is a great encourager of the thrush, blackbird, and other singing birds.

1182. *Varieties.*—The Romans had eight kinds of cherry, and in England in the time of Parkinson there were twenty-four sorts. In France and Germany the sorts were more numerous than in England before the collection made by the Horticultural Society of London. From that collection the following very select list has been made for us by Mr. Thompson.

1183. *Dessert cherries arranged in the order of their ripening.*

Early purple Guigne, syn. Early purple Griotte. Large, heart-shaped, dark purple, flesh purple, tender, rich; beginning to the middle of June; leaves with long petioles, the fruit very handsome.

May Duke, syn. *Royale Hâtive*, Fr.; *Doppelte Mai Kirsche*, Ger. Large, roundish, dark red, flesh tender, juicy, rich; end of June; a good bearer, and the tree with erect branches.

Knight's Early Black. Large, obtuse, heart-shaped, black, flesh purplish, rich; end of June; a good bearer, and a very handsome and excellent fruit.

Downton. Above the middle size, roundish, heart-shaped, pale yellow and red, flesh pale amber, juicy, rich; beginning to the middle of July; a good bearer.

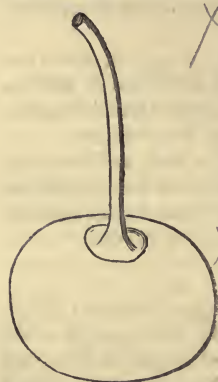

Fig 370. The term *oblate* exemplified in the *Royal Duke Cherry*.

Elton. Large, heart-shaped, pale yellow and red, flesh whitish, very rich and sweet; beginning to the middle of July; a good bearer, and esteemed the richest pale cherry.

Royal Duke, syn. *Royale tardive*. Large, oblate, (see fig. 370) dark red, flesh reddish, tender, juicy, rich; middle to the end of July; a good bearer, and the habit of the tree fastigiate, like that of the *May Duke*.

Bigarreau, syn. *Graffion*. Large, obtuse, heart-shaped, white and red, flesh whitish, firm, sweet; end of July and beginning of August; an abundant bearer, and a very handsome and much cultivated fruit, particularly for the London market.

Florence. Large, obtuse, heart-shaped, pale amber and red, flesh sweet and rich; August; a good bearer when the tree has attained a certain age, but not when it is young.

1184. *Cherries for preserving.*

Kentish, syn. *Montmorency à longue queue*. Middle size, oblate, bright red, flesh whitish, juicy, acid; middle to the end of July; a great bearer, the tree with drooping shoots. The fruit of this variety is much used for pies. It has also the peculiar property of the stalk adhering so firmly to the stone that the latter may be drawn out without breaking the skin, excepting at the base. In this state the fruit is dried in hair sieves in the sun, or placed in a gently heated oven, and the cherries so treated will keep a year, and when brought to table have the appearance of raisins.

Morello, syn. *Amarena*, Ital. Large, obtuse, heart-shaped, dark red, flesh purplish red, juicy, acid; August and September; an abundant bearer, and chiefly on the one year old wood; the fruit is excellent for preserving and for putting into brandy.

1185. *Cherries adapted for being trained against walls of different aspects.* See p. 422.

1186. *Cherries adapted for espaliers or dwarfs.* See p. 428.

1187. *Cherries adapted for being grown as standards.* See p. 433.

1188. *Cherries for a cottage garden.*—*May Duke*, *Late Duke*, *Kentish*, and *Morello*.

1189. *Cherries for the north of Scotland.*—*May Duke*, *Elton*, *Downton*, *Tilger's Redheart*, *Winter's Blackheart*, *Lundy Gean*, *Kentish*, *Morello*.

1190. *Propagation, nursery culture, and choice of plants.*—Budding is more frequently resorted to than grafting, because the wounds made by the latter operation are apt to gum. Stocks raised from stones of the wild cherry,

or the cultivated cherry, are used when free growing plants are required; the Morello, when the object is plants of moderate size; and the perfumed cherry (*Cerasus Mahaleb*), when very dwarf trees are wanted. Standard cherry trees are generally budded standard high, on free stocks of three years' growth from the seed, which have been one year transplanted. Cherry stones for stocks are sown in sandy soil in autumn, immediately after they have been taken from the fruit; or they are preserved in sand through the winter, the heap being two or three times turned over, and sown in spring. The plants come up the same season, and may be transplanted in autumn, in rows three feet apart, one foot distant in the row if for dwarfs, and eighteen inches if for standards. If for dwarfs, they may be budded the following summer; but if for standards, a third season's growth will be required. The dwarfs require no pruning the first year; but the second spring, if not sold, or transplanted to where they are finally to remain, they require to be cut down, and, if intended for a wall, the shoots should be flat trained by means of a row of three or four stakes to each tree. Whatever pruning is required for the cherry should be done a little before midsummer, which, while it is found to prevent gumming, is also favourable for the healing over of the wounds the same season. The best plants for removal are those which have been one or two years worked; but as the cherry produces abundance of fibrous roots, it may be transplanted after it has been three or four years trained, more especially if growing in a loamy soil.

1191. *Soil, situation, and final planting.*—The cherry grows naturally in dry sandy soils, and in situations rather elevated than low; but the cultivated tree requires a soil rather more loamy, which, however, must be on a dry bottom. Almost all the varieties may be grown as standards, and there is no great difference between them in regard to hardiness; but the earliest and largest fruit is produced against walls, by which the fruit is also improved in flavour, while the apple and pear grown against walls are apt to become mealy. The distances at which cherry-trees may be planted against walls, espaliers, as dwarfs, and in the orchard, are given 890, 902, and 908.

1192. *Mode of bearing, pruning, and training.*—The fruit is generally produced on small spurs or studs, from half an inch to two inches in length, which proceed from the sides and ends of the two-year, three-year, and occasionally from the older branches; and as the new spurs continue being produced from recently formed wood, bearing branches are never shortened back where there is room for their extension. The cherry is not very prolific in wood, and the shoots do not often cross one another, therefore very little pruning is required for standards. Against walls, or espaliers, the horizontal mode of training is generally adopted, excepting for the Morello, the Kentish, and other slender-wooded kinds, for which some of the modifications of the fan method (801 to 805) may be chosen. The Morello, as it bears on the wood of the last year, may be trained in Mr. Seymour's manner, figs. 291 to 295, or in the half-fan manner, figs. 313 and 318. In summer-pruning strong growing cherries, most of the laterals should be stopped when a few inches in length; but in the case of the Morello, a regular supply of young wood should be left all along the branches, as exhibited in Mr. Seymour's figures, p. 367, to succeed the shoots which are charged with fruit. The Morello produces a few fruit on spurs formed on two-year old wood, but scarcely ever on wood of the third year; therefore

the only mode of managing this tree, to ensure a crop of fruit, is to have a regular succession of laterals, the growth of the last year, all along the shoots. In many gardens these laterals are not laid in; and though the tree by this mode does not assume such a neat appearance, yet the crop of fruit we believe is greater. Disbudding early in spring is of as much use in setting the fruit of the cherry in the open garden as we have seen it to be in the forcing-house (1028). As in all young trees the blossoms are for a number of years comparatively weak, the number of blossom-buds removed from them in thinning should be great in proportion. Old or diseased cherry-trees may sometimes be renovated by cutting in or heading down, but in general the wounds necessarily made exude so much gum as to prevent their ever being entirely covered with bark, in consequence of which the stems and roots rot in the interior. To prevent this evil as much as possible the soil should always be renewed at the time of amputating.

1193. *Gathering and keeping.*—The fruit can only be gathered by hand, and care should be taken not to pull out with the foot-stalks of the fruit any of the buds which are to produce the blossoms of the succeeding year; unless, indeed, these buds should be so abundant that the lessening their number will be advantageous rather than otherwise. Where no buds can be spared, the stalks may be cut with scissors. For the dessert the cherry is never kept longer than a day or two. In gathering the fruit from standard trees, the orchardist's crook, fig. 335, will be found useful in bringing the branches within reach of the gatherer.

1194. *Diseases, insects, casualties, &c.*—The gum is almost the only disease to which cherry-trees are liable; the exudation when it has once commenced is not easily checked, but if the tree is healthy in other respects, and in a suitable soil and situation, the gum will not do much injury; in an unfavourable soil it commonly brings on canker. Against a wall the cherry is liable to the attacks of the red spider, aphides, and some other insects, which may be destroyed or kept under by the usual means. Syringing the trees with tobacco-water and soft-soap, before the blossoms have expanded, will destroy every insect to which the cherry is liable, and they may be washed with clear lime-water from the time the fruit is set till it has begun to colour. The greatest enemies to ripe cherries are birds, from which they are to be protected by netting, in the case of walls and espaliers, and by the use of the gun in the case of standards. Cats (370) may also be employed for this purpose, or some of the other modes described in pp. 119 and 120.

1195. *A Dutch cherry garden.*—In Holland, and other parts of the continent, it is a favourite practice with the possessors of gardens to eat the fruit direct from the trees or plants, and this was formerly more generally the case in Britain than it is at present. In the villas of the wealthy, a small garden, in some retired part of the grounds near the house, was set apart for this purpose, and planted with summer fruits, especially cherries, gooseberries, and strawberries; and in some cases this garden was entirely covered with a roof of netting. One of the most complete gardens of this kind, in the neighbourhood of London, existed, in 1828, at Hylands, near Chelmsford. It was in the form of a parallelogram, twice as long as broad, and contained a quarter of an acre. It was surrounded by a wire fence, ten feet high, the texture being such as to exclude small birds; that is, each mesh was two inches high by one inch broad. The principal standard

trees are cherries of the best early and late kinds, one or two early apples, one or two early pears, and one or two early plums. The trees are planted in quincunx, and their branches are trained in a horizontal position so as to be within reach of the hand, by being tied down to stakes. All round the margin are, first a bed of strawberries, and next a row of plants of gooseberry, currant, and raspberry. A gravel walk surrounds the whole, between the strawberry-bed and the row of fruit shrubs, and the space among the standard trees is simply left unstirred, so that when dry every part of it may be walked on. The manner in which the roof of netting is fixed over this garden is thus:—At regular diances, all through the area, wooden boxes, as sockets for posts, as at fig. 371, *b*, are fixed in the ground, and when the cherries begin to ripen,

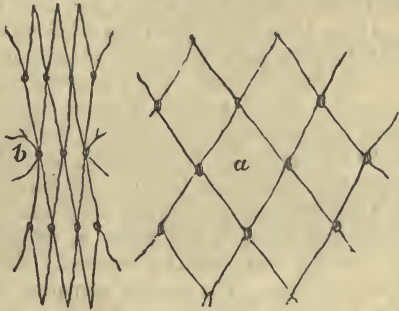

Fig. 371. Netting for covering a Cherry Garden.

a net of the kind used in pilchard fishing, and made at Bridport, in Dorsetshire, the meshes of which are two inches wide, is drawn over the whole parallelogram, fastened to the top of the wire fence by hooks which are fixed there, and supported above the trees by the props placed in the sockets. These props are fourteen feet high at the sides, and gradually rise to the middle of the garden, and they have blunt heads, in order not to injure the netting. The netting necessary for covering this space, which is eighty feet by two hundred and twenty feet, is in two pieces, each one hundred feet by one hundred and fifty feet; it is put on in the following manner:—One piece is spread out immediately within the wire fence, and a number of men with poles carry it over the tops of the trees and posts, after it is fastened to one side; then they fasten it on the other, and so on till the whole is completed. The separate divisions are then joined together, which thus form one entire netted roof, giving the garden a very singular and yet new and agreeable appearance. During rain, or dewy evenings, the net is tightened or stretched to its utmost extent (fig. 371, *a*), and forms a grand

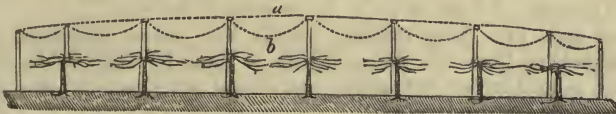

Fig. 372. Section through a Cherry Garden, showing the netting tightened by rain, (*a*) and slackened by drought (*b*).

vault over the whole cherry garden (fig. 371 *a*, and 372 *a*); during sunshine, or when the weather is dry, it is slackened (fig. 371, *b*), and forms a festooned vault, supported by posts (fig. 372, *b*). It is advisable to tan the net every year with oak bark, which adds greatly to its durability.

Were the object of this cherry garden merely to protect the fruit from birds, training the trees on espaliers and applying nets, as is done against walls, would be an easier and cheaper mode; but the cherry garden at Hylands is intended as a place of enjoyment where ladies and gentlemen

may wander about and help themselves from the trees and bushes. (*G. M.* iii. p. 397.)

Forcing the cherry. See p. 480.

SUBJECT. VII.—*The Plum.*

1196. *The plum* (*Prunus insititia*, *L.*; and *P. domestica*, *L.*; *Prunier*, *Fr.*; *Pflaumenbaum*, *Ger.*; *Pruinboom*, *Dutch.*; *Prugno*, *Ital.*; and *Ciruelo*, *Span.*: *E. B.* 1783, *Arb. Brit.* vol. ii. p. 687, and *Encyc. of Trees and Shrubs*, p. 272 and 273) is a low irregular deciduous tree, a native of most parts of Europe, and also of part of Asia and Africa, and it is either indigenous or naturalised in North America. Its culture in gardens is as universal as that of the cherry, and dates from the time of the Romans.

1197. *Use.*—The plum is a delicious dessert fruit, and it is also excellent in pies, tarts, conserves, sweetmeats, and in a dried state. A wine is made from the pulp, and a powerful spirit from the pulp and kernel fermented. *Raki* is made in Hungary by fermenting apples ground or crushed with bruised plums, and distilling the liquor. The spirit produced is said to be very agreeable to the taste, and, though not quite so strong, much more wholesome than brandy. In the south of France, an excellent spirit is obtained from the bruised pulp and kernels of plums, fermented with honey and flour, by distillation in the usual manner. Medicinally, plums are cooling and laxative, especially the dried fruit called *brignoles*, or French plums. The mode of preparing these plums is detailed at length in the *Arboretum Britannicum*, vol. ii. p. 689. The wood of the plum is used in turnery, cabinet-work, and in making musical instruments, and the tree is valued in ornamental landscape from its being one of the earliest which come into blossom.

1198. *Varieties.*—The Romans had a multiplicity of sorts of plums, and the varieties have long been very numerous in France and Italy. The following selections are, as usual, by Mr. Thompson.

1199. *Dessert plums arranged in the order of their ripening.*

Royale Hâtive. Middle size, roundish, purple, flesh parting from the stone, amber-coloured, very rich, August; shoots very downy.

Drap d'Or, syn. *Mirabelle grosse.* Small, round, yellowish, flesh separating from the stone, rich and excellent, middle of August; a good bearer, young shoots downy. A very excellent sort, which precedes the green gage in ripening, and resembles it in richness of flavour.

Green gage, syn. *Reine Claude.* Middle size, round, yellowish green, flesh separating from the stone, richest of plums; middle to the end of August; a good bearer, extensively known and cultivated, and most deservedly so. Young wood smooth.

Kirke's. Large, roundish, purple, flesh separating from the stone, very rich, beginning to the middle of September; a good bearer, the young shoots smooth. The fruit bears some resemblance to that of the *Reine Claude violette*.

Washington, syn. *Bolmer's Washington.* Large, roundish, yellow, flesh separating, excellent, September; downy shoots and tree very vigorous; a good bearer, succeeds well as a standard.

Reine Claude violette, syn. *Purple gage.* Middle size, roundish, purple, flesh separating, rich and sugary; September; a good bearer, the shoots smooth. The richest purple plum in cultivation.

Coe's golden drop, syn. *Coe's imperial*. Large, oval, yellow, flesh adhering, very rich, September and October; a good bearer, with smooth shoots. A most valuable late dessert fruit, as well as for preserving.

Ickworth Imperatrice. Middle size, obovate, purple, flesh adhering, rich, October; a good bearer, smooth shoots, the fruit hangs long on the tree, and remains longer fresh after being gathered than any other sort.

1200. *Kitchen Plums arranged in the order of their ripening.*

Orleans, syn. Red damask. Middle size, round, purple, flesh separating, middle to the end of August; a good and constant bearer, the tree hardy, with downy shoots.

Shropshire Damson, syn. Prune damson. Small, obovate, purple, flesh adhering, smart, juicy, middle of September; tree a great bearer, with downy shoots; the best of the damsons for preserving.

White Magnum Bonum, syn. White Mogul. Large oval, yellow, flesh adhering, September; a good bearer, with smooth shoots. The fruit excellent for sweetmeats.

St. Catherine. Middle-size, oval, yellow, flesh adhering, rich, middle to the end of September; a good bearer, with smooth shoots; excellent for preserving, and one of the kinds used for that purpose in Provence.

Quetsche, syn. German prune. Middle-size, oval, purple, flesh separating, September; a good bearer, and well adapted for drying, being the kind of which the German prunes of the shops are prepared, by slow and repeated drying in an oven.

Coe's Golden Drop, and the *Green Gage*, given as dessert plums, are also equally good for culinary purposes, and preserving.

1201. *A selection of plums for walls of different aspects*, is given in p. 422; for *espaliers and dwarfs*, in p. 428; and for *an orchard*, in p. 433.

1202. *Dessert and kitchen plums for a garden of limited extent*—*Royale Hâtive*, *Drap d'Or*, green *Gage*, *Kirke's*, *Washington*, *Reine Claude violette*, *Coe's golden drop*, *Ickworth Imperatrice*, *Coe's fine late red*, early *Orleans*, *Shropshire damson*, and *white Magnum Bonum*.

1203. *A selection of dessert plums for a very small garden*.—*Royale Hâtive*, green *Gage*, purple *Gage*, *Coe's golden drop*, and *Orleans*.

1204. *Dessert and kitchen plums for a cottage garden*.—*Royale Hâtive*, green *Gage*, *Coe's golden drop*, and *Reine Claude violette*; and for the kitchen, the *Shropshire damson*, *winesour*, and *white Magnum Bonum*.

1205. *Propagation, nursery culture, and choice of plants*.—The plum, like other stone-fruit, is mostly propagated by budding, and the stocks, when the object is large and permanent trees, are the muscle, *St. Julian*, *Magnum Bonum*, or any free-growing plum, either raised from seed, or, as is more commonly done, from layers, (625) or suckers. The dwarfing stock for the plum is the *Myrobolan*, or *Mirabelle*, of the French. The common baking-plums, such as the damson, bullace, &c., are generally propagated by suckers, without being either budded or grafted. The muscle and *St. Julian* plums are extensively propagated in the nurseries, as stocks for the peach, nectarine, apricot, and almond. The nursery culture of the plum, and the choice of grafted or trained plants, are the same as for the cherry.

1206. *Soil, situation, and final planting*.—The plum naturally does not grow in so light a soil as the cherry, nor in so clayey a soil as the apple; and in a state of culture, a medium soil, on a dry subsoil, is found to be the

best. Only the finer varieties are planted against walls, and none of them require a south aspect excepting in very cold exposed situations in the north, or when the object is to have an early crop. The distances adopted in final planting, are given in pp. 423, 429, and 431.

1207. *Mode of bearing, pruning, and training.*—All the varieties produce their blossoms on small spurs, which are protruded along the sides of the shoots of one, two, or three years' growth, generally in the course of the second and third year. These spurs, if duly thinned, and when necessary cut in, will continue bearing for five or six years, or longer, in the case of wall-trees and espaliers; and when the fruit becomes too small, it is easy to renew the branches, one at a time, by encouraging young shoots from the main stem. Standard trees require very little pruning, beyond that of occasionally thinning out the branches, and this should always be done before midsummer, to prevent the gum from appearing on the wounds. Plum trees against walls or espaliers are generally trained in the horizontal manner. Old trees may be renovated by heading in or cutting down.

1208. *Gathering, keeping, packing, &c.*—The fruit is generally gathered by hand, and, with the exceptions mentioned, it cannot be kept longer than three or four days without losing its flavour, or shrivelling. As the bloom of the plum is more easily rubbed off than that of any other fruit, great care is requisite in gathering it, and in packing, when the fruit is to be sent to a distance. Nettle leaves, on account of their roughness, are the best material in which to envelop the fruit, and it ought to be sent in suspended boxes (860). As the plums brought to market are very liable to have the bloom rubbed off, some fruiterers supply an artificial bloom, by putting the fruit in an atmosphere charged with finely calcined magnesia, as is done in giving an artificial bloom to the cucumber (1081). At first sight it may appear surprising that a white powder should be employed to give a bloom to the green surface of the cucumber, and the purple or yellow surface of the plum; but the colour of the fruit in these and all other cases, resides under the bloom in the skin, and the bloom is merely a number of semi-transparent colourless particles, secreted by nature for some useful purpose, which are very well imitated by any very fine colourless powder.

1209. *Insects, diseases, casualties, &c.*—The red spider is the common enemy of the plum against walls, and is to be kept under by frequent and abundant waterings with the syringe. The Gages and all very rich plums, when nearly ripe, are attacked by wasps, which may be lured away by vessels of honied water (357), or excluded by netting (353). The gum and canker are not unfrequent in the plum when it has been severely pruned, or when it has been planted too deep, or the roots subjected to vicissitudes of drought and wet (375 to 378).

1210. *The plum may be forced* by the same treatment as the peach, but with a temperature a few degrees lower. The sorts generally preferred for forcing, are the *précoce de Tours*, green gage, purple gage, white perdrigon, Orleans, early Orleans, and Morocco; all of which will force very well in pots, either in the peach-house or the cherry-house.

SUBJECT. VIII.—*The Gooseberry.*

1211. *The gooseberry*, *Ribes Grossularia, L.*, and *R. Uva crísipa, L.*; (*Groseille à maquereau, Fr.*; *Stachelbeerstrauch, Ger.*; *Kruisbes, Du.*; *Uva-spino, Ital.*; and *Grosella, Span., E. B.*, 1292—2057; *Arb. Brit.*

vol. ii., p. 972; and *Encyc. of Trees and Shrubs*, p. 473,) is a deciduous shrub, a native of Piedmont and other Alpine regions, and long cultivated in British gardens. The fruit is of little worth in a wild state, and the shrub does not appear to have been known to the Romans, nor to have been much cultivated in any part of the world except in Britain. With us it is esteemed for pies and tarts next in value to the apple; and as a luxury for the tables of the poor, it is even more valuable than that fruit, since it can be grown in less space, in more unfavourable circumstances, and brought sooner into a state of full bearing. At the tables of the wealthy it contributes to the dessert from the end of July to the end of September, and longer by matting up or otherwise covering the bushes.

1212. *Use*.—Before being ripe it is much used for tarts, pies, sauces, and creams, and when mature it is esteemed in the dessert. Unripe gooseberries are preserved in bottles, and the ripe fruit in sugar. Bruised and fermented, wines and brandies are made from the green fruit, and gooseberry Champagne is often substituted for that of the grape. In the *G. M.* for 1833, p. 180 to 182, and p. 551, will be found a variety of receipts for preparing gooseberry wines and spirits, with figures of the apparatus for crushing the fruit, fermenting and distilling the liquor, &c.

1213. *Varieties*.—Parkinson enumerates only eight sorts, but there are now some hundreds of kinds in British nurseries, most of them raised from seed in Lancashire and Cheshire, where the weight of the berry has been raised from ten pennyweights, the usual weight of the old sorts of red and green gooseberries, to thirty-two pennyweights and upwards, the weight of the largest modern kinds that have gained prizes. The following selections are by Mr. Thompson:—

1214. *A selection of gooseberries for a suburban garden*.—*Red gooseberries*: red Champagne; red Warrington; Keens' seedling; Warrington; rough red, used for preserving; red Turkey; Rob Roy; ironmonger. —

Yellow gooseberries: Yellow Champagne; early Sulphur; Rumbullion. The last much used for bottling.

Green gooseberries: Early green Hairy; Pitmaston Greengage; green Walnut; Parkinson's Laurel; Massey's Heart of Oak; Edwards's Jolly Tar.

White gooseberries: White Champagne; early White; Woodward's Whitesmith; Taylor's Bright Venus; Cook's White Eagle; White Honey.

A more extensive selection is given in p. 429.

1215. *The largest prize gooseberries* in cultivation by the growers in Lancashire, in 1840 and 1841, with their respective weights, were as follow: *Red*: Young Wonderful, 32 dwts. 16 grs.; London, 32 dwts.; Companion, 28 dwts. *Yellow*: Pilot, 27 dwts. 5 grs.; Leader, 27 dwts.; Teaser, 25 dwts. *Green*: Thumper, 28 dwts. 7 grs.; Peacock, 26 dwts. 10 grs.; Invincible, 26 dwts. 4 grs. *White*: a Seedling, 24 dwts. 12 grs.; Eagle, 24 dwts. 9 grs.; Miss Hammond, 24 dwts. 6 grs. These varieties are all great bearers and of good flavour; the flavour of Peacock is said to resemble that of the Green Gage Plum.—*M. S. G.*

1216. *Gooseberries for a cottage garden*.—Red Champagne and red Warrington; yellow Champagne and early Sulphur; Pitmaston Green Gage; Massey's Heart of Oak, and early green Hairy; Woodward's Whitesmith; Taylor's Bright Venus, and Crystal.

1217. *Large Lancashire Gooseberries adapted for a cottage garden.*—*Red*: * Prince Regent, Wonderful, * Top Sawyer, * Huntsman, Companion, Lion, Lancaster Lad. *Yellow*: * Rockwood, * Sovereign, * Smuggler. *Green*: * Niger, * Greenwood, * No Bribery, Peacock. *White*: * Wellington's Glory, * Whitesmith, * Queen Charlotte, Eagle, Fleur de lis.—(*A Townsman in Gard. Chron.* 1841, p. 84.)

The most valuable red gooseberry in cultivation is perhaps the red Champagne, generally called the Ironmonger in Scotland, the fruit of which is of superior flavour, is well adapted for all the purposes to which gooseberries are applied, and by matting it may be preserved on the bush till December. The branches of this variety grow more upright than those of any other gooseberry, and hence the plants occupy less space, and are in no danger of having the fruit soiled by being too near the ground. They are also particularly well adapted for training in the upright manner on espaliers. The fruit of the Pitmaston green gage will hang on the branches till it shrivels and almost candies. The red Warrington is an excellent gooseberry, either for the table or wine-making, but it is of pendulous growth, and part of the fruit is apt to be rotted in wet seasons. There is a general prejudice against the large Lancashire kinds, which, it is alleged, are deficient in flavour; but this is not the case with many of them; for example, those recommended (1217) for a cottage garden; and from our own experience we can assert that it is not the case with the sorts marked * in the above selection.

1218. *Propagation, nursery culture, and choice of plants.*—The common mode of propagation is by cuttings, which should be formed from shoots taken from healthy vigorous plants in autumn, as long and straight as they can be got. The point of the shoot should be shortened two or three inches, to where the wood is firm, and the buds mature; and the cutting, which should, if possible, be twelve or fifteen inches in length, should afterwards be treated as directed in p. 260. They should be planted in sandy loam, in a moist situation, shaded from the direct influence of the sun, but not covered or confined by the branches of large trees. Some of the Lancashire growers tie a little moss round the lower part of the cutting, which is said to cause it to strike stronger roots. In loamy moist soil they need not be planted above three inches deep, but in ordinary garden soil six inches will be safer; in either case the cutting must be made quite firm at its lower extremity. Cuttings of the growing wood will succeed under a hand-glass, but it can seldom be necessary to take so much trouble. Where there is only one plant of a rare kind, the most certain and rapid mode of propagation is by laying down the branches along the surface of the ground, as practised by the stock-growers in propagating plum and Paradise stocks (625). Suckers are occasionally resorted to, but as they generally contain a greater number of adventitious buds at the lower extremities than shoots from the branches, they are apt to throw up more suckers than them. Gooseberries seldom remain longer in the nursery than two years, being transplanted into rows two feet by one foot the autumn of the same season in which they are struck. No other pruning is requisite than removing suckers or shoots from the stem, so as to leave three, or at most four, divergent shoots to form the head.

1219.—*Soil, situation, and final planting.*—The best soil is a cool marly loam, warm, deep, well manured, and kept moderately moist; either by the

situation and subsoil, or by the surface being covered by the branches of the bushes, so as greatly to lessen evaporation. The situation should be open, and by no means shaded with standard fruit trees, the gooseberries grown under which are almost always bitter. In general gooseberries and all fruit shrubs should be cultivated in plantations by themselves (904); but in small gardens they may be placed in rows along the borders, either as dwarfs or espaliers: plants one, or at most two years' from the cutting, are most suitable, and the distances in both cases have been already given (904 and 906).

1220.—*Mode of bearing, pruning, and training.*—The fruit is produced on the shoots of the preceding year, and on spurs from shoots of three or more years' growth. The largest fruit is always produced on the wood of the preceding year, and as the spurs grow old, and increase in size, the fruit becomes smaller, though it increases in quantity; which, indeed, is the case with all fruit grown on spurs. The gooseberry requires to be pruned in early summer, because in general it produces more shoots than can be allowed to remain, without depriving the fruit-bearing branches of a due share of light and air. All superfluous shoots, therefore, should be stopped with the finger and thumb when they are between one inch and two inches in length, and again stopped at the second joint, when they have made a second growth. A common fault in gardens is to allow the shoots of gooseberries and currants to grow nearly their full length before they are thinned out, in consequence of which the fruit is deprived of its due share of nourishment, light, and air, and more strength is communicated to the root than is required for the due adjustment of the root and top. Hence, in almost all gardens, we find the gooseberry and currant bushes far too luxuriant. All the training the gooseberry, treated as a bush, requires, is to stop or prune it in such a manner as to keep the bush rather open in the centre, and the branches all radiating outwards from the stem, or from the main branches; crossing one another as little as possible, and when they do cross, never touching. On espaliers they should be trained in the perpendicular manner (808 and 906), or at an angle of 45°, or half that angle; and if only two upright shoots are trained from every plant, the trellis or espalier rail will be the sooner covered. Where plants are in abundance, which they may in many cases be by raising them from cuttings at home, only one upright shoot may be trained from each cutting, and these being planted at one foot apart, the trellis or rail, if not more than five feet high, will be completely covered in three years. If the champagne or ironmonger is planted, and the plants, when cuttings, allowed to make only one vertical shoot from the terminal bud, then after they have made two years' growth against the espalier rail, they will have reached its summit, and may be spurred in afterwards from within a foot of the ground to the top of the rail. If a double espalier rail, such as we figured in the *Suburban Landscape Gardener*, fig. 69, p. 232, is used, a very handsome gooseberry hedge will thus be formed, which will bear abundance of fruit of the best flavour, because freely exposed to the light and air, for twelve or fifteen years.

1221. *The growers of gooseberries for prizes* necessarily take much more pains in pruning and training than the gardeners of private gentlemen. The plants are raised from cuttings in the usual manner, and in the autumn of the first year they are transplanted to the soil and situation where they are to produce their fruit. This is, if possible, a deep warm, rich, marly loam,

moderately moist, at the bottom of such a slope as shall at once produce shelter from the highest winds of the locality, and ensure a certain degree of coolness, and supply of moisture, from what may be termed the insensible escape of the rain which has sunk into the soil in the upper part of the declivity. Being planted, the next step is to prepare for pruning and training, by procuring a few hooked sticks, (fig. 373) and forked sticks (fig. 374); the former to hold down the branches that are inclined to grow upwards, and the latter to support those which are inclined to grow downwards.

Fig. 373. *Hooked stick for training prize gooseberry bushes; length two feet.*

Fig. 374. *Forked stick for training prize gooseberry bushes; length two feet.*

These are applied to the plant in the manner shown in fig. 375, in which, also, the roots appear regularly spread out in every direction. In the autumn of the second year these three shoots will have produced a number of side-shoots, most of which may be shortened to one eye, and the others reduced to one-half of their length. No shoots should be left either at the origin or the extremities of the branches, but only at the sides; the fewer the number of shoots, and the younger the tree, the larger will be the fruit. Thus the plant, when pruned in the November of the second year, will consist of



Fig. 375. *A trained prize Gooseberry-bush, two years' growth from the cutting.*

three principal shoots, each bearing two young shoots, shortened to about seven inches of their length. These last, in the pruning of the third year, are to be left with two shoots only of new wood; these shoots being placed in such a manner as to preserve the symmetry of the plant, without crowding it in any part. The same system of pruning and thinning is continued in future years—cutting out the old wood occasionally, so as to preserve a moderate and constant supply of strong, healthy young shoots, from which alone large and fine fruit can be expected. Whenever the extremities of the branches grow more than from twenty inches to two feet from the main stem, they must be cut back; for large fruit will never be produced at the extremities of long branches. The roots of the plants must also be attended to, by cutting a trench round the plant at the distance to which the branches are limited, so as to shorten all the main roots to that length, smoothing their extremities with the knife, and filling up the trench with fresh marly loam, enriched with cow-dung. Some growers even carry the system of root-pruning so far as to lay bare the whole of the roots, and thin out and shorten the larger ones in the same manner as is done with the branches, re-covering the roots with fresh soil. The fruit after being set is thinned out, as well as the branches, and not more than one or two berries

are allowed to a branch when the object is prize fruit; we have, indeed, seen not more than two berries to an entire bush, the shoot being pegged down to within a few inches of the ground, and a saucer of water placed under each berry, in order, by its evaporation, to keep its surface moist and promote its swelling. The berries intended for prizes are protected from heavy rains by a cap of oiled paper, or by a bell-glass, or any other suitable contrivance; because should a slight shower fall on them at the time they are ripening, they are very apt to burst. These caps, however, must not be put on except when rain is expected, in order not to deprive the leaves of sun and air. Prize gooseberry bushes are thought to be at their best when five or six years old from seed, and four or five years from cuttings.

1222. *Gathering and keeping.*—Unripe gooseberries for tarts are in a fit state for that purpose by the end of April, and they may be thinned out from those that are to remain for ripening till the middle of July. If two-thirds of the produce of every plant is thinned out in a green state, it will add considerably to the size of those which remain. Ripe gooseberries should be gathered the day in which they are sent to table, but both these and unripe fruit may, when necessary, be kept a week or more, by being placed in the icehouse-room, or in the fruit-cellar. Gooseberries may be preserved on the trees, either by matting-up each bush separately; by covering with canvas, or matting both sides of an espalier or gooseberry-hedge; or by enclosing a square of bushes by pales or canvas frames six feet high; constructing the framework of a roof over this space, and covering it with canvas. This will exclude birds and insects, and also, in a great measure, light, by which the decay of the fruit will be retarded for several weeks; more especially if the covering has been put on a few days before the fruit is thoroughly ripe.

1223. *Insects, diseases, and casualties.*—No pest is more common in gardens than the gooseberry caterpillar, by which is meant the larva of several kinds of moths, saw-flies, and some butterflies. They are all hatched on the leaves, and the great art of preventing them from injuring the plants is to watch for the appearance of the eggs, and as soon as any are seen commence syringing the plants powerfully with lime-water, using an inverted rose on the syringe, so as to throw the water against the under-sides of the leaves, as it is there that the eggs are deposited. We feel confident that lime-water, when properly prepared (202) and applied, will destroy, at all events in its young state, the larva of every insect that lives on the leaves of plants; but to those who find it insufficient, we would recommend, first, to moisten the leaves by the syringe or watering-pot, and then to dust them, either with powdered quick-lime, coarse tobacco powder, or the powder of white hellebore (*Veratrum album*); or if either of the two last plants be used, the powder may be mixed with soapsuds, and the plants watered or syringed with it; but in this case the skin of the fruit will not escape, being covered with the liquor. Lime-water, therefore, is in our opinion the only unexceptionable application. Unfortunately in many gardens the caterpillars are not observed until they have attained a considerable size, and done great part of the mischief, when they are also more difficult to destroy. Hand picking is recommended in such cases, but the mischief being already done, this only prevents the insect from attaining maturity, which, no doubt, is an advantage, by lessening the number of females for producing future broods. See the section on insects, p. 99.

1224. *Forcing*.—The gooseberry may be forced in pots, and this is frequently done in the north of Germany and Russia, especially where there are Scotch gardeners. The temperature is never allowed to be high, and abundance of air is given during sunshine. Mr. Hay, at Bristol, plants gooseberries and currants in pots in November, removes them to the peach-house in January, and sends the plants to table, with ripe fruit on them, by the end of April. *Ribes divaricatum* and *R. niveum* (*E. of Tr. and Sh.*, pp. 470 and 471), produce rich perfumed fruit well adapted for tarts, and for improving, by cross fecundation, the common gooseberry.

SUBJECT. IX.—*The Red and White Currant.*

1225. *The Red and White Currant*—*Ribes rubrum*. L. and R. r. var. *album*, (*Groseiller commun*, *Fr.*; *Gemeine Johannisbeere*, *Ger.*; *Aalbessboom*, *Dutch*; *Ribes rosso*, *Ital.*; *Grosella*, *Span.*;—*E. B.* 1289, *Arb. Brit.*, vol. iii., p. 977; and *Encyc. of Trees and Shrubs*, p. 477)—are deciduous shrubs, the red variety indigenous in England and other parts of Europe, and the white variety produced from it by culture. The fruit in a wild state is small and very acid, but in gardens it has been increased in size and greatly improved in flavour. It contributes to the dessert from the beginning of July to September, and by matting up (1222) the fruit will hang on the trees till November or December.

1226. *Use*.—The appearance of large red currants at table is brilliant, and contrasts well with dishes of white currants, and with green fruit, such as apples, pears, and plums. The taste cannot be called rich, but it is agreeably subacid and cooling. The red currant is much used for jellies, jams, wines, to acidulate punch, and for tarts; and continues longer in season, both for the table and the kitchen, than any other summer fruit.

1227. *Varieties*.—The best are the White Dutch, red Dutch, Knight's Sweet red, which is less acid than the red Dutch, and Knight's large red. No selection can be better for a cottage garden, or for a garden in the coldest part of the country; but for display the Champagne currant may be added, which is large and of a very pale red.

1228. *The propagation and future treatment of the red and white currant* scarcely differs from that of the gooseberry. When the fruit is required to be large, only a limited number of bunches ought to be allowed to remain on the branches, and the greater part of the summer shoots ought to be stopt and stopt again in order to throw strength into the fruit; admit the sun and air to give it colour and flavour, and also to ripen the wood. Even in general cultivation, stopping the shoots in the end of June ought to be performed, as, by so doing, the buds at the base are enlarged. The currant is very frequently trained against a north wall, because there it ripens later, and is thought to hang longer on the tree; but its flavour in such a situation is inferior to what it is when grown in the open garden, either as a bush, or on an espalier. The fruit should be gathered in a dry state, and it should not be heaped up on a dish till it is about to be sent to table. Late in the season it is sometimes disfigured by cobwebs, dust, and particles of decayed leaves, in which case it should be washed and dried on a sieve, or by hanging up in the fruit-room before it is presented at the dessert. The currant, like the gooseberry, is attacked by the larvæ of moths, by a species of aphid, by a coccus, and when the fruit is ripe it is sometimes devoured by earwigs. The latter may be lured into bundles of bean-stalks

or reeds, and shaken out of them into hot water or lime-water; and the former may be destroyed by the usual means. See 1223 and 355. The red and white currant may be forced in the same manner as the gooseberry, and the fruit will ripen in the same period.

SUBJECT. X.—*The Black Currant.*

1229. The Black Currant, *Ribes nigrum*, *L.* (*Cassis* and *Poivrier*, *Fr.*; *schwartzte Johannisbeere*, *Ger.*; *Ribes nero*, *Ital.*;—*E. B.* 1821. *Arb. Brit.*, vol. ii., p. 983, and *Ency. of Trees and Shrubs*, p. 480), is a deciduous shrub, common in woods throughout great part of Russia and Siberia, and occasionally found apparently wild in Britain. It is sometimes brought to the dessert, but its use is more frequently to make jams, jellies, wines, and to flavour punch, or as a gargle for sore throats. In Scotland the berries are eaten in puddings and tarts; and in Russia, and also in Ireland, they are put into spirits, as cherries are in England. The Russians also ferment the juice with honey, and thus form a strong and agreeable liquor. The dry leaves form such an excellent substitute for green tea, that few persons can detect the difference. By far the best variety is the black Naples, which is easily known from the other varieties by coming earlier into leaf; and next the black grape. Cuttings strike readily, and other points of treatment are the same as for the red currant, excepting that the fruit of the black currant is produced chiefly on the shoots of the preceding year, though partly also from spurs or blossom-buds at the base of these shoots. The plant is less subject to insects than either the red currant or the gooseberry. It forces well, and in Russia this is practised for the sake of the young foliage. *Ribes aureum* has fruit resembling the black currant, and, with other species of the genus, might doubtless be made to contribute to the varieties, or improvement, of our gooseberries and currants.

SUBJECT. XI.—*The Raspberry.*

1230. The Raspberry, *Rubus Idæus*, *L.* (*Framboisier*, *Fr.*; *Himbeerestrauch*, *Ger.*; *Framboos*, *Dutch*; *Rova ideo*, *Ital.*; and *Frambueso*, *Span.*; *E. B.* 244, *Arb. Brit.*, vol. ii. p. 737, and *Encyc. of Trees and Shrubs*, p. 313), is a suffruticose deciduous plant, with biennial stems, a native of Britain and other parts of Europe in moist woods, and cultivated in gardens from an unknown period, though it is doubtful whether it was known to the Romans. Even in a wild state the fruit is grateful to most palates, and it has been enlarged in size and greatly improved in flavour by cultivation. The shoots which are produced from the stock during one summer produce fruit the next, and afterwards die. Technically the shoots are called canes, from the straight smooth cane-like appearance of the shoots of some of the varieties, more especially the *Barnet*. The fruit ranks in the dessert with the gooseberry and strawberry, but its principal uses are for jams, tarts, sauces, sweetmeats, and ices; and it is employed on a large scale in preparing cordial spirituous liquors, and cooling syrups. Raspberries are reckoned next in efficiency to the strawberry in dissolving the tartar of the teeth, and as like that fruit, and the fruit of the bramble, it does not undergo the acetous fermentation in the stomach, it is recommended to gouty and rheumatic patients.

1231. *Varieties.*—Above a dozen are in cultivation, but those the best worth cultivating are the following: the *Red Antwerp*, *Yellow Antwerp*, *Barnet*, which is the tallest growing kind, *Cornish*, and *Red Globe*. For a

small garden the red and yellow Antwerp and the twice-bearing red are recommended; and for a cold and late situation the early prolific, Barnet, red Antwerp and yellow Antwerp.

1232. *Propagation, soil, and other points of culture.*—The only mode of propagation is by suckers, except by seeds, which is only resorted to when new varieties are wanted. Seedlings carefully treated will produce fruit the second year. The suckers are separated in autumn, either by taking up the whole plant and dividing it, or by slipping them off from the sides and roots of the main stock. They may be planted at once where they are finally to remain in a compartment by themselves, in rows from north to south, four feet apart every way. They will grow in any good garden soil, and if on the lower part of a slope towards the north, east, or west, the soil will be kept moderately moist by its position, and the situation will not be so much exposed to light and heat as if it sloped to the south. The raspberry grows naturally in soft, peaty, or vegetable soil, shaded by woods, and always moist; but it is most prolific in fruit, and the fruit is better flavoured, in the more substantial and drier soil, and opener situation, of the garden. In making a plantation three or more suckers are allowed to each stool, and planted in a triangle at six inches apart. The plants will produce fruit the first year, but if this fruit, or even a third part of it, can be dispensed with, the suckers for the succeeding year will be greatly strengthened by cutting the stems of the newly-planted plants down to within six inches of the ground. The plantation being established, the future treatment consists in going over the stools every year early in May, and selecting six or seven of the strongest suckers from each stool for next year's bearing wood, and destroying all the rest, unless they are wanted for a new plantation. In autumn, as soon as the fruit is gathered, the stems which have borne it should be cut down to the ground to give light and air to the suckers; but as these are sometimes liable to be injured by frost, they should not be pruned till the following March. They may then be shortened to two-thirds or three-fourths of their length, by cutting off the weak wood at the extremities of the shoots. If large fruit is wanted, but few stems (canes) should be left to each stool, and these should be tied singly to stakes placed round the stool in a circle, at about a foot distance from it, so that the canes when tied to the stakes shall be bent outwards; which position at once facilitates the development of the buds all along the canes, exposes the fruit more freely to the sun and air, and allows room for the suckers to rise upright from the stool without shading the fruit-bearing canes. Sometimes, instead of a circle of stakes round each plant, a line of rails or of iron-wire, or long rods with the bark on, is placed between every alternate two rows of raspberries, supported at about three feet from the ground by stakes; and to these rails, wires, or rods, the canes from the adjoining plants are bent over and fastened by ties of matting or willow-twigs. In this way every alternate space between the rows is covered by the bearing canes which are bent over it, and the other spaces are left open for gathering the fruit. Where a large crop of fruit is wanted, without regard to the size of the berries, half the number of the canes on each plant may be bent over, so as to meet the half of those of the adjoining plant, and a foot or more of the points of the canes of each plant may be interwoven and made fast by matting. A row of raspberries thus treated will present a series of arches of fruit-bearing branches, alternately with columns of suckers; the bending

of the bearing canes will cause every bud to break, the fruit-bearing laterals will be exposed to the sun and air without being crowded by the suckers, and the latter have more room for their foliage, and hence grow stronger, and ripen their wood better. This being the easiest and most economical mode of training the canes, is that most generally adopted in gardens. Where very large fruit is required, the whole or the greater part of the suckers may be destroyed as fast as they appear, and the blossoms may be thinned; but this practice, by destroying the plant, requires a double plantation,—one for producing suckers, and another for producing fruit; and hence it should only be adopted in gardens where there is abundance of room. To obtain a successional crop late in the season, the canes of the red and yellow Antwerp, and of the twice-bearing varieties, may be cut down to the ground in spring, and the suckers, which will be produced with more than usual vigour, may be stopped in the beginning of June, which will cause the buds to break and produce fruit late in the season; generally, till it is destroyed by frost. The suckers of the twice-bearing raspberry naturally produce a second crop,—that is, they produce fruit the first year as well as the second. The ground between the rows should be manured and dug every year, but no attempt should be made to grow a crop between the rows after the first year. A new plantation may be made every six or seven years, or oftener, if the plants should show any symptoms of degeneracy; or if their travelling roots should grow out of bounds, which they are very apt to do from the outside suckers always being the strongest, and consequently selected for bearing in preference to the inside suckers. The doctrine of the excretions of the roots of plants (917), has also been alleged as a reason for renewing a plantation of raspberries more frequently than is done in the case of most other plants, (see *G. M.* vol. x. p. 14), but general experience does not appear to us to justify any treatment in respect to the raspberry not equally applicable to other plants with travelling roots, which remain several years on the same spot.

1233. *Gathering*.—The fruit begins to ripen in the end of June, and continues being produced till October. It should be gathered immediately after it becomes ripe, which is known by every part of it being equally high-coloured, and by the pulpy part separating readily from the conical receptacle. If allowed to remain ripe on the plant for two days, the eggs of a beetle, *Byturus tomentosus*, which had been deposited in it when in flower, become maggots, and render it unfit to be used. If gathered and kept two or three days, the same effect takes place; or the fruit becomes mouldy and unfit for use.

1234. *Forcing*.—The raspberry forces equally well with the gooseberry and currant, either in pots or planted in the free soil of a cherry-house; or it may be planted in pits, and trained under *the glass*, which is the practice in Holland.

1235. *The Cloudberry*, *Rubus Chamæmorus*, *L.*, the fruit of which is superior in flavour to that of the raspberry, grows on mountains in the Highlands of Scotland and Sweden, in moist, peaty places, but it is cultivated with great difficulty in gardens. The *crimson bramble*, *R. arcticus*, has also a high-flavoured fruit, and it may be grown even in the neighbourhood of London, in beds of moist peat. The *dewberry*, *R. cæsius*, the *stone bramble*, *R. saxatilis*, the *upright bramble*, *R. suberectus*, and the *common bramble*, *R. fruticosus*, may all be cultivated in gardens, by the amateur

of leisure, who by cross fecundation, with skill, care, and perseverance, might raise some new varieties worthy of a permanent place among cultivated fruits.

1236. *The Nootka Raspberry*, R. Nutkânus, *Arb. Brit.*, vol. ii., p. 745, and *Encyc. of Trees and Shrubs*, p. 318, produces large red fruit, which is found to make excellent tarts. If the same care were bestowed on this species which has been given to the raspberry, we have no doubt it would become one of our standard fruit shrubs. R. odoratus, a closely allied species, or perhaps, only a variety, with fragrant foliage, is said to produce yellow fruit of a large size, and a very fine flavour, (*ibid.*)

SUBJECT. XII.—*The Strawberry.*

1237. *The Strawberry*. Fragària, L. (Fraisier, *Fr.*; Erdbeerpflanze, *Ger.*; Aadbezie, *Dutch*; Pianta di fragola, *Ital.*; and Fresa, *Span.*;) is an herbaceous stoloniferous plant, of which there are several species, natives of Europe, the temperate parts of Asia, and North America. The fruit has received its name from the practice, more common in former times than at present, of laying straw or litter between the rows. The fruit of the European strawberry in a wild state, gathered from the woods, has long been esteemed by the rich as well as the poor, but little or no improvement took place in its culture till the introduction of the Virginian Strawberry or Scarlet, the Pine or Surinam Strawberry, and the Chili Strawberry, which are considered by botanists as distinct species. All these sorts will breed together indiscriminately, and thus have been produced some hundreds of sorts, many of very great excellence, and chiefly by British gardeners; for till within these few years, no other strawberry was cultivated on the Continent than the small sort common in the woods. What renders the strawberry of particular value in our eyes is, that like the gooseberry, it can be grown in as great perfection in the ground plot of the cottager, as in the finest walled garden of the extensive landed proprietor.

1238. *Use.*—The fruit is much valued in the dessert, of which, without the aid of glass, it may form a part from the beginning of June to November, and by the aid of the forcing-pit from March till May. It is of very general use in confectionery, and is recommended medicinally in cases where acid fruits are injurious. It dissolves the tartareous incrustations of the teeth, promotes perspiration, and has many other good qualities. In short, it is one of the most inoffensive fruits, even when eaten to excess.

1239. *Varieties.*—These have been classed by Mr. Thompson as under:

1. *Scarlet strawberries.*—Fruit mostly small, colour bright, and flavour acid, with slight perfume. 1. *The old scarlet*, syn. scarlet, Virginian, &c.; middle size, globular, of a uniform light scarlet; flesh firm, pale scarlet, and high flavoured. A great bearer, and from its colour and flavour the best of all strawberries for the confectioner. 2. *The Grove End scarlet*, syn. Atkinson's scarlet. Ripens after the preceding, and is a more abundant bearer. 3. *Roseberry*, syn. Rose, Scotch scarlet, Aberdeen seedling, and prolific pine: an excellent bearer, and well adapted for forcing. 4. *Garnstone scarlet*. 5. *Black roseberry*. 6. *American scarlet*; rich sugary flavour, and a good bearer, ripening late; and 7. *Coul late scarlet*.

2. *Black strawberries.*—Fruit conical, with a neck, flavour rich, and highly perfumed. 1. *Downton*, syn. Knight's seedling: a good bearer, ripening late; the fruit preserves well, and makes excellent sweetmeats.

The plants, when the fruit is setting and swelling, require to be liberally supplied with water. 2. *The Pitmaston black*; and 3. *The sweet cone*, are both very high-flavoured, but too delicate for general cultivation. 4. *Elton seedling*, syn. Elton. A great bearer, ripening late. X

3. *Pine strawberries*. Fruit large, varying from nearly white to almost purple; flavour sweet, and often perfumed. 1. *Keens' Seedling*, syn. Keens' Black Pine: a great bearer, ripening early in the season; the best strawberry for general purposes, and for forcing. 2. *Old Pine*, syn. Carolina, and twenty other-names. Fruit large, conical, with a neck; flesh, pale scarlet, firm and juicy, with a rich grateful flavour; a good bearer in strong loamy soil, in an open, airy situation, but not in a light soil, or when much sheltered or shaded. The leaves are of a darker green than those of any other strawberry. 3. *Myatt's Pine*; high flavoured, but a shy bearer. 4. *Myatt's British Queen*. A larger fruit than that of Keens' Seedling, and having more flavour; an abundant bearer, and a very free grower. 5. *Swainstone Seedling*; fruit large, bearing considerable resemblance to Keens' Seedling, but with a brisker flavour, and may be distinguished further by its scabrous leaf-stalks; a great bearer in the usual strawberry season, and it also produces an abundant late succession.

4. *Chile Strawberries*. Fruit large, seeds prominent, flesh more or less insipid. 1. *Wilmot's Superb*. Fruit very large, roundish, sometimes cock's-comb-shaped, pale scarlet, flavour indifferent; ripens rather late; attains a large size in strong, rich soil, but has no other recommendation.

5. *Hautbois strawberries*.—Scapes tall and strong, fruit middle-sized, pale greenish white, tinged with dull purple; flesh solid and musky. 1. *Prolific hautbois*, syn. Conical hautbois, double bearing, and various other names. Fruit large for this class, conical, dull purple; flesh greenish, firm, rich, and perfumed; ripening in the end of June or July; an abundant bearer. In plantations of this variety there are commonly a number of plants found sterile, from the abortion of the female organs, and sometimes of the stamens, for which reason runners ought to be taken only from those plants that are prolific. 2. *Large flat hautbois*. syn. white hautbois, Bath hautbois, &c. Fruit large, roundish, reddish next the sun; flesh greenish-white, firm, juicy, and musky; a great bearer, ripening rather later than the preceding sort, and, like it, subject to sterility. 3. *Black hautbois*; darker coloured and higher flavoured than the two preceding varieties, but not so prolific. X

6. *Green strawberries*, comprehending the *Fragaria collina* and *F. viridis* of botanists. 1. *Green strawberry*, syn. green pine, pine-apple, green alpine, &c. Fruit tolerably large, roundish, of a powdery green, tinged with brownish red next the sun; flesh solid, greenish, very juicy, with a somewhat pine-apple flavour: ripe in July, and an abundant bearer, at least in the Hort. Soc. Garden.

7. *Alpine and wood strawberries*, comprehending the *Fragaria semperflòrens*, and *F. véscà* of botanists. The alpine and the wood-strawberry differ chiefly in the form of the fruit, which in the alpine is conical, and in the wood varieties, roundish. 1. *Red alpine*, syn. scarlet alpine, Des Alpes à fruit rouge, Des Alpes de tous les mois à fruit rouge, Des Alpes de quatre saisons à fruit rouge. Fruit the largest of its class, conical, red; flesh rich, and high flavoured; bears abundantly in light, sandy, rich soils, especially when liberally supplied with water in dry hot weather, and continues producing from June to November: the only strawberry generally cultivated

in French gardens. 2. *White alpine*, syn. Des Alpes à fruit blanc, &c., only differs from the preceding sort in having the fruit white, and the flavour somewhat more delicate. 3. *Red wood*, syn. Rouge commun, Des bois à fruit rouge, &c., resembles the preceding in colour and flavour; but the fruit is smaller, and the plants do not bear so long in succession. 4. *White wood*, only differs from the preceding in having the fruit white.

1240. *Selection of strawberries from the above classes in the order of their ripening*.—1. Old Scarlet, first or second week in June; 2. Grove-end scarlet; 3. Keens' seedling; 4. Roseberry; 5. Swainstone Seedling; 6. Old pine; 7. Black roseberry; 8. Prolific, or conical hautbois; 9. Large flat hautbois; 10. Myatt's British Queen; 11. Downton; 12. American scarlet; 13. Elton seedling; 14. Coul late scarlet. To these are to be added, 15. The green strawberry; 16. The red alpine; and, 17. The white alpine, which commence bearing in July, and if properly treated produce fruit till they are destroyed by frost.

1241. *A selection for a small garden* may consist of—1. The Swainstone seedling; 2. Keens' seedling; 3. Old pine; 4. Prolific hautbois; 5. Downton; 6. Coul late scarlet; 7. Elton; and 8. Red alpine. To these the old scarlet may be added for confectionery.

1242. *A selection for a cottage garden*.—Swainstone Seedling, Keens' Seedling, and Red Alpine.

1243. *A selection for a confined, shady situation*, or for growing in an orchard shaded by standard fruit-trees. The alpinas, woods, and greens.

1244. *Propagation, soil, &c.*—All the sorts are propagated by runners, but the green strawberry and the alpinas are sometimes also increased by division and by seeds. The runner plants are taken off when their roots are two or three inches in length, which is generally the case in the last week of July, or early in August. By some they are planted where they are finally to remain, which is the best mode when there is abundance of ground, and a scarcity of hands; and by others they are planted in nursery beds, a foot apart every way, where they remain till the end of February or beginning of March following; and they should then be removed and planted with balls, by means of a hollow trowel (fig. 29 in. p. 135). When runner plants are to be transplanted without receiving any check, they are rooted in pots in the manner already described (1091). The soil for all the varieties, except the greens and alpinas, should be a strong loam, well enriched with stable-dung; and the best situation for all of them, is one which is open and fully exposed to the sun. For the greens and alpinas the soil should be lighter, and if the situation is a walled border facing the east, and hence somewhat shaded from the meridian and afternoon sun, the plants, by being kept cooler, will thrive with less watering. Nevertheless, alpinas will thrive remarkably well, and their fruit will have a higher flavour, in the most exposed and sunny situation, provided they are abundantly supplied with water. This is proved by the extensive plantations in the openest part of the royal kitchen-garden at Versailles, where, not being able to accomplish all the watering in the mornings and evenings, it is continued overhead, even during the hottest sunshine. (*G. M.*, p. 387.)

1245. *Culture*.—Though the strawberry, like most herbaceous perennials, excepting grasses, is found chiefly in woods and waste places not subjected to agriculture or the pasturage of domestic animals, yet in a state of culture it is found most productive of large high-flavoured fruit, when

grown in the open garden in plantations freely exposed to the sun and air. The place of the strawberry in a rotation of crops in the kitchen garden is given in 919—4. The plants are generally planted in rows, but sometimes in beds; and they are occasionally planted as edgings to gravel-walks. In this latter mode they bear well: the gravel of the walk retaining moisture and its surface reflecting heat, while nutriment is obtained from the border; but the fruit in this situation is apt to be soiled by the gravel after heavy rains. In whatever way the strawberry is grown it requires to be renewed every third, fourth, or, at the latest, fifth year. Instances, however, are given of the pine grown on a strong loamy soil, which has been top dressed every two or three years, and producing good crops for twelve or twenty years. In some of the sorts, such as Keens' seedling, the Swainstone, and hautbois, the scape which bears the fruit is strong and rises above the leaves and keeps it clean; but in others, as in the scarlets, the scapes are short and weak, and the fruit reclines on the ground; and with all this class of strawberries mulching is a desirable point of culture.

1246. *Culture in rows.*—In the ordinary mode of culture the runners are planted in rows varying in width with the kind of strawberry, and the time during which the plantation is wished to last. If that should be four or five years, the rows of the kinds belonging to the first four classes may be two feet six inches apart, and the plants placed at one foot six inches distant in the row. Next year a few good-sized early fruit will be produced from each plant; a good crop the year following, and a full crop during the third and fourth years; after which, owing to the large size which the stools will have attained, the fruit, though produced in abundance, will be smaller. As the ground will not be fully occupied the first year, a row of onions may be sown in the middle between every two rows of strawberries. A little manure may be dug in every year late in autumn, diminishing the quantity if the plants run much to leaf, and increasing it if the foliage appears deficient in vigour. Top dressings may also be applied in autumn or winter with great advantage; and such may consist of leaves, dung, any rich compost, or even loam alone, and their own decayed foliage may also be included; of the latter, therefore, the plants should not be deprived, by previously mowing and clearing off the leaves in autumn, as is often improperly done. The strawberry being a native of woods, is naturally covered with leaves every autumn, and hence, a top dressing that would smother many other kinds of plants, will prove beneficial to the strawberry. All the runners should be taken off, excepting such as are wanted for a new plantation, as soon as they appear, and more especially before the fruit has ripened.

1247. *Culture in beds.*—The large kinds are planted in rows two feet apart and eighteen inches distant in the row; each bed contains two rows, and an interval of three feet wide alternates with each bed, as an alley from which to water and gather the fruit, &c. The late Mr. Keens grew his strawberries in this manner. The runners were first planted in a nursery bed, where they remained from August till March; when they were removed to the fruiting beds. There they bore an excellent crop the first year, a very good crop the second, and a good crop the third; after which the plants were dug down. Another mode of growing strawberries in beds is as follows: a plot of ground is laid out in beds three feet wide, with alleys between fifteen inches wide; and each bed is filled with plants one foot apart

every way, early in August. Next year, after the plants have borne their crop, they are dug down, with or without manure, as may be deemed necessary, and replanted. In this way strawberries are grown on the same ground for a number of years, no plant ever producing more than one crop. A third mode of growing strawberries in beds consists in having every alternate bed, not of strawberries, but of some low-growing crop; and keeping it under low-growing crops for two, three, or more years. The beds are then prepared for the reception of strawberries, and they are filled simply by allowing the runners of the adjoining beds to take possession of them. This they will have done, in the most effectual manner, by the end of August, when the plants must be thinned out where too thick, and the parent beds all dug down and cropped with low-growing vegetables, such as turnips, carrots, onions, &c., for one, two, three, or four years, according as it may be desired to have large or small fruit. When the runners are only allowed to bear one crop, the fruit will be large and early, but if they are retained for three years, the fruit will be much smaller the third year than the first. This mode is attended with very little labour, and if the runners are only allowed to produce one crop it will be as abundant and large as by any mode of culture whatever. In some gardens formerly beds of runners, neither thinned or manured, were allowed to produce four or five crops, but the fruit, though abundant when the soil happened to be a strong loam, was so small that in the present day it would not be thought fit to send to table. Planting in rows and renewing the plantation every three or four years for scarlets, and five or six for pine sorts, or in the case of alpinés every second year, is evidently preferable to any mode of growing on beds.

1248. *Mulching and watering.* Mulching is useful both for keeping the fruit clean, and retaining moisture in the soil. If stable litter is used, and put on just before the leaves expand, it will serve also as manure; the animal matters which adhere to it will be washed in by the rains, and by the time the fruit is ripe the litter will be bleached as white as clean straw. Short grass may be used as a mulch, but it is too retentive of moisture, and the same may be said of leaves. Coarse gravel requires too much labour in laying down and taking off; but flat tiles form an excellent mulch, retaining moisture, and reflecting heat among the leaves and fruit. Some persons have had tiles made of a semicircular form, each with a small semicircle, about three inches in diameter, cut out of it, so that two of these tiles cover a circular space round the plant; but not only is this a needless refinement and waste, the tiles being unfit for anything else, but a portion of the ground is left unmulched; whereas, by using common drain tiles the ground can be more completely covered, no extra expense is incurred in their manufacture, and they are as fit for roofing, and variety of other purposes, as if they had never been used for mulching. Watering is essential to a good crop of strawberries in dry weather, and may be performed on a large scale by the watering barrel, fig. 325, in p. 384, or on ordinary occasions by the watering pot. The best time is the evening or early in the morning, because at these seasons least is lost by evaporation (826); and the water should always, if possible, be of a temperature somewhat higher than that of the soil. Some amateurs grow their strawberries in beds having small open brick channels as alleys, and these and the beds being formed on a perfect level, by filling the alleys with water, it penetrates

the soil of the beds on each side. Surface irrigation, however, appears preferable, because the soil being warmest there, the water will carry down heat to the interior of the soil.

1249. *Culture of particular kinds.* The strawberries from which it is most difficult to procure good crops are the Old Pine and Myatt's Pine. The *Old Pine* will not fruit at all unless the situation be open, and it succeeds best in strong loam, though the late Mr. Keens found it thrive best on a light soil. The plants should be kept from August to March in a nursery, at a foot apart every way, and after being planted out they will bear well for three years, but not longer, unless well supplied with top dressing. *Myatt's Pine* requires a rich loam, and the plants should be placed in rows, on a sloping surface to the S. or S.E., four feet apart, in order that the intervals may be trenched down as soon as the plants have fruited; the runners are permitted to establish themselves on the fresh ground, and remain there to fruit, while the preceding year's plants are destroyed. This process, like that of growing strawberries on annual beds, must be repeated every year. The *Scarlet Strawberry*, when only to be grown for three years, may be planted in rows twenty-one inches apart, and each plant eighteen inches distant in the row. The *Hautbois*, grows naturally on a clayey loam or chalk, but it also, like the pine, thrives in light soil, which may be well supplied with manure, which does not produce excess of foliage in this variety, as it does in the old pine and some others. The rows may be two feet apart, and the distance between the plants eighteen inches. In all plantations of this variety a number of sterile plants will be found, which as soon as they are discovered ought to be taken up and destroyed. Many gardeners suppose that it is necessary to retain a number of what are termed, improperly, male plants, that is, those in which the stamens are perfect, but the receptacle and pistils imperfect, yet as the rudiments of all the parts are evident, the plants cannot be said to be diœcious; but it is better to propagate only from hermaphrodite plants, for though some of the runners of these may prove sterile, yet the greater part will be prolific. This variety forces remarkably well and preserves its musky flavour. The *Alpine* strawberry may be raised from seed on a bed of light rich earth early in spring; the plants will be ready to plant out in beds, at a foot distance every way, in July, and they will come into bearing in two or three weeks afterwards. The plantation will last three years. A better mode than raising the *Alpine* strawberry from seed, is to select runners from stools which have borne the largest, handsomest, and best-flavoured fruit. This is the mode practised in the neighbourhood of Paris (*G. M.*, 1841, p. 266), where this strawberry is brought to a much higher degree of perfection than it is in England. Late in autumn all the runners and some of the lower leaves should be removed, to prevent the fruit from damping off. The white *Alpine* is generally considered as having a more delicate flavour than the red. Both varieties are much weakened by runners. Both force readily, and in France, two or three year old stools are used for this purpose, and they are taken up and potted the autumn previously to forcing them. The *Green* strawberry, and *Wood* strawberry, should be treated exactly like the *Alpine*.

1250. *Retarding a crop.*—This may be done to a certain extent by planting on the north side of an east and west wall, or in any situation shaded from the sun, or exposed to the north; but the most effective mode of pro-

curing a late crop is to remove all the blossoms that would have produced the first crop; and then, after allowing the plants to receive a check from the dry warm weather, which usually occurs in the latter end of June, to supply water abundantly. The water in this and in all other cases should have been sufficiently long exposed in a pond or basin to acquire the temperature of the atmosphere; or this temperature, and a few degrees more, may be given to it artificially by a portable heating apparatus. Strawberry plants which have been early forced, when turned out into the open garden generally produce some fruit late in the season (1093), and this quantity may be increased in number and size by judicious watering.

1251. *Accelerating a crop in the open garden.*—This may be done by planting a row close along the base of a wall having a south aspect. The best variety for this purpose is the Bishop's wick, which has small leaves and an early habit, and which, so treated by Mr. Williams of Pitmaston, ripened its fruit towards the end of May. Another mode consists in planting on the south side of an east and west ridge of soil. The ridge may be no larger than to admit of a single row, or it may be four feet or five feet high, so as to admit of three or four rows on the south side for accelerating a crop, and an equal quantity on the north side for retarding one. If the ground on the south side is covered with flat tiles, bricks, flints, or pebbles, they will retain moisture, conduct heat to the soil, and reflect it also among the plants. At East Combe, near Blackheath, a ridge of this kind, the sides of which form an angle of 45°, ripens fruit three weeks earlier than the flat surface of the same garden. The common calculation is a fortnight earlier for the south side, and eight or ten days later for the north side; so that by means of a ridge, the strawberry season in the open garden is extended at least three weeks. Sometimes these ridges are built of brick-work, in steps, and sometimes they are formed of stones, in the manner of a wall built without mortar, the plants being placed in the interstices. In whichever way the ridge is formed, there ought to be a gutter of three inches or four inches in width along the apex, as a channel for supplying warm water to the roots. It would be an improvement also to cover the south side of the ridge during nights by mats or canvas, supported on hoops or rods at nine inches or one foot above the plants, to check radiation. Ridges of this kind require to be taken down every year after the crop is gathered, and replanted with the earliest runners that can be got. The ordinary slope of the ridge is an angle of 45°, because loose soil will remain stationary at that angle; but where the ridge is to be faced with stone or brick, the slope may be nearly perpendicular, or at all events 70°. In the garden of a cottage which has been built on a platform, the sloping bank which supports the latter might be planted with strawberries, either with or without the addition of stones or tiles.

1252. *Gathering* the fruit should take place when it is quite dry, and they should be taken to table the same day. It should always be gathered with the calyx attached, though this used to be generally neglected in Scotland and on the Continent.

1253. *Forcing.*—See 1090.

SUBJECT. XIII.—*The Cranberry.*

1254. *The Cranberry*, *Oxycoccus*, *Pers.* (*Airelle*, *Fr.*; and *Heidelbeere*, *Ger.*—*Arb. Brit.*, p. 1028, and *Encyc. of Trees and Shrubs*, p. 616), is a

genus of low trailing shrubs; one, *O. palústris*, the English cranberry, a native of Britain and the north of Europe in moist bogs; and the other, *O. macrocárus*, the American cranberry, a native of swamps in the United States. The fruit of both has long been gathered from the native habitats of the plants, and used for tarts and other purposes; and it forms an article of exportation both from Sweden and North America. Both sorts may be cultivated in gardens in peat-soil, kept moist; and if it is enriched with thoroughly rotted dung, the vigour of the plants will be greatly increased, and the flavour of the fruit improved. The English cranberry requires a more constant supply of moisture than the American; but the fruit of both is better flavoured when grown with much less moisture than they experience in their native habitats. The American cranberry has even been grown in beds of dry peat-soil, and produced a plentiful crop of excellent fruit. The plants are readily propagated by layering the shoots, or by taking off their points and striking them in sand under a hand-glass. Both species may be grown on the margin of a pond, among moist rockwork.

1255. *The Scotch cranberry*, *Vaccínium Vitis idæa* L.; the whortleberry, *V. Myrtillus* L.; the great bilberry, *V. uliginòsum* L.; and various other species of *Vaccínium*, bearing edible and very agreeable cooling acid fruit, may all be grown in dry peat. They are all described in our *Arboretum*, pp. 1078 to 1167, and in the *Encyc. of Trees and Shrubs*, pp. 604 to 615. When a garden is situated in a part of the country where peat soil abounds, and perhaps forms part of the garden or adjoins it, it may be worth while to attempt growing these fruits; but not otherwise, as the only useful one, the cranberry, can be obtained from the grocers' shops in all large towns from December till March.

SUBSECT. XIV.—*The Mulberry.*

1256. *The black or garden Mulberry*, *Morus nigra*, L. (*Mûrier*, Fr.; *Maulbeerbaum*, Ger.; *Moerbessboom*, Dutch; *Moro*, Ital.; and *Morel*, Span. *Arb. Brit.* vol. iii. p. 1342, and *Encyc. of Trees and Shrubs*, p. 705), is a middle-sized deciduous tree, a native of Persia, and supposed to have been introduced into Europe by the Romans. It has been cultivated in England since the middle of the 16th century, for its highly aromatic fruit, which ripens in August, and, like that of the strawberry, does not undergo the acetous fermentation in the stomach. An agreeable wine is made from the juice, and a syrup from the unripe berries. It is readily propagated by cuttings or truncheons, and will thrive as a standard in any good garden soil in the central districts of England; but north of York, and in Scotland, it requires a south wall. As the fruit drops as soon as it is ripe, the tree is generally planted on a lawn or grass plot; but the fruit attains a larger size when the soil round the tree is kept slightly dug and well manured; and previously to its ripening the space under the branches may be sown thick with cress seed, which will form a close, soft carpet for the fruit to drop on. In a small garden the tree may be very conveniently grown as an espalier. The fruit is produced chiefly on short shoots of the same year, which are protruded from last year's wood, and on spurs from the two-year old wood; both laterals and spurs being produced mostly at the ends of the branches. The tree being of slow growth, very little pruning is required for either espaliers or standards; though no doubt thinning out the branches would strengthen those that remain. The fruit should be gathered just when

it is about to fall, and used the same day. The tree forces well in pots, and the plants for this purpose may be procured by planting entire branches, so as to form at once bushes two or three feet high (*G. M.*, 1842). The branches should be taken from the parent trees in autumn, after the leaves have dropped, and after being potted they may be plunged under a north wall till February, when they may be transferred to a pit or forcing-house, where they will produce fruit the same year early in June. The tree is remarkable for the great age which it attains, and its vitality; instances being common of trees growing after remaining out of the ground for a year, or being transplanted in full leaf, and after remaining a year dormant. One, or at most two, mulberry-trees are sufficient for a suburban garden, whether large or small.

SUBJECT. XV.—*The Walnut.*

1257. *The Walnut*, *Jùglans règia*, *L.* (*Noyer*, *Fr.*; *Walnussbaum*, *Ger.*; *Walnootboom*, *Dutch*; *Nocil*, *Ital.*; and *Nogal*, *Span.*; *Arb. Brit.*, vol. iii., p. 1420; and *Encyc. of Trees and Shrubs*, 732), is a deciduous tree, of large size, a native of Persia and Caucasus, which has been cultivated in England as a fruit and timber tree from the middle of the 16th century, or before. The ripe kernel is used in the dessert, and the fruit whole, in a green state, before the nut and its involucre, or husk, harden, forms an excellent pickle. The timber, being very light in proportion to its strength and elasticity, is much used for gun-stocks. The variety most esteemed for its fruit is the Thetford, but the large French and tender-shelled are also good sorts. They are propagated chiefly by budding on the common walnut, or by inarching; but as there is little demand for these trees, most of those which are sold in the nurseries are seedlings. The tree thrives best in a deep sandy loam, and it is generally planted in the north margin of the orchard, or on a lawn, or in a paddock. Seedlings will bear in from five to seven years from the seed, or sooner by ringing the branches. The fruit is produced, as in most amentaceous trees, from short shoots of the current year protruded from the extremities of the preceding year's shoots. It is gathered by hand for pickling, and too frequently beaten down with rods when ripe; but as it drops of itself just before the leaves, no beating down, or gathering from the branches, is requisite. The fruit is best kept in dry sand, or slightly covered with straw. Little or no pruning is ever given to this tree, though there can be no doubt that thinning out the branches would throw more strength into the fruit of those which remain.

1258. *The Pacane-nut Hickory*, *Càrya olivæfórmis*, *A. B.* iii. p. 1441, and *E. of Tr. and Sh.* p. 736, some varieties of which, Michaux says, produce fruit which is far superior to that of the European walnut, (and of which Washington is said to have been so fond that during the war of independence he had always his pockets full of them); and the *shell-bark hickory*, *C. álba*, *A. B.* iii. p. 1446, and *E. of Tr. and Sh.* p. 739, may be grafted on the walnut, and treated in all respects like that tree.

SUBJECT. XVI.—*The Sweet Chestnut.*

1259. *The Sweet Chestnut*, *Castànca vésca*, *W.* (*Châtaignier*, *Fr.*; *Castainenbaum*, *Ger.*; *Karstengeboom*, *Dutch*; *Castagno*, *Ital.*; and *Castano*, *Span.*; *E. B.*, 886; *Arb. Brit.*, vol. iii. p. 1716, and *Encyc. of Trees and Shrubs*, p. 911), is a large deciduous tree, a native of Spain and Italy, and

cultivated in the South of England, more especially in Devonshire, for its fruit, as well as its timber. The nut is brought to table roasted, and eaten with salt, or with salt fish, or stewed in cream. In Spain and Italy, it is used as an article of food, boiled, roasted, in puddings, cakes, and bread. In France and Italy there are a great many varieties in cultivation, and upwards of twenty have been grown in the Garden of the Horticultural Society, of which the Downton and Prolific are among the best. For a small garden, the Châtaigne exalade of the South of France deserves the preference, not only as producing the best fruit of all the varieties for the table, but on account of the tree being an abundant bearer, and of so small a size that it might be very well grown as an espalier. The varieties are propagated by grafting on the species. The fruit is produced in the same manner as that of the walnut, and every other particular respecting its culture is much the same as for that tree.

SUBSECT. XVII.—*The Filbert.*

1260. *The Filbert*, *Córylus Avellàna*, L. (Noisette, *Fr.*; Nussbaum, *Ger.*; Hazelnoot, *Dutch*; Avellano, *Ital. & Span.*; *E. B.* 723, *Arb. Brit.*, iii. p. 2017, and *Encyc. of Trees and Shrubs*, p. 921), in a wild state is the hazel-nut, common in woods in many parts of Europe, on loamy soils. Its use in the dessert is familiar to every one. By cultivation several varieties have been obtained, of which the best are the red and white filbert, and Cosford, which ought to be in every collection; the cob-nut, because its branches grow more upright than the other varieties; and the great cob-nut, the Downton large square nut, and the Spanish nut, on account of their large fruit. All these varieties are usually propagated by grafting on the common hazel-nut, or on the Spanish nut, which grows very fast, and differs from all the others in not sending up suckers. "The plants should be trained to a single stem, from a foot to two feet in height, and then be permitted to branch into a symmetrical head, rather open in the middle, and not of greater height than a man can conveniently reach from the ground to perform the necessary operations of pruning and gathering." (*Gard. Chron.*, 1841, p. 51.) The fruit is produced from the preceding year's wood, and in unpruned trees is always most abundant at the extremities of the branches, where the leaves of the preceding year have had abundance of light and air. Hence the importance of pruning so as to keep the bush open in the centre. The spring, at the time the male blossoms are shedding their pollen, is the best time for pruning, as by the shaking of the trees the pollen is diffused. The young shoots should be shortened to half their length, cutting to a female blossom, and removing all side suckers. If a plantation is to consist of a single row, the plants may be placed from eight feet to ten feet apart; but if there are to be several rows together, the intervals between them may be ten feet or twelve feet. The whole may be treated like a plantation of currants on a large scale. The usual situation for a plantation of filberts is the orchard, where single rows may be introduced, for a few years, between rows of standard fruit-trees. If a separate plantation of filberts is formed, currants or gooseberries may be introduced in the intervals between the plants for four or five years—care being taken to destroy them whenever their branches are within a foot or two of the filberts. A plantation of filberts will last twenty years, and if occasionally manured, it will produce from 20 cwt. to 30 cwt. of nuts per acre

annually. The nut weevil lays its eggs in the fruit in June, where it is hatched, and escapes in August. There is no practical preventive of this insect, and all that the gardener can do is to remove all the nuts that have been perforated by it. The fruit is gathered when the calyx turns brown, and at a time when it is quite dry, and it may be preserved through the winter with the husks, or in dry sand, or in air-tight vessels. Some put them into large garden-pots, sprinkling a little salt amongst them, which is said to preserve the husks from getting mouldy and rotting; the pots are turned bottom upwards on boards, and covered with earth or sand to exclude the air. The dealers subject them to the fumes of sulphur in close vessels, when newly gathered and dried, in order to improve the colour of the calyx.

SUBJECT. XVIII.—*The Berberry, Elderberry, Cornelian Cherry, Buffalo-berry, and Winter Cherry.*

1261. *The Berberry*, *Bérberis vulgàris*, L. (*Epine vinette*, Fr.; *Berberitzen*, Ger.; *Berberisse*, Dutch; *Berbero*, Ital., and *Berberis*, Span.; *E. B.* 49, *Arb. Brit.* i. p. 298, and *Encyc. of Trees and Shrubs*, p. 42), is a deciduous shrub, a native of Britain in woods and hedges on dry soil, and sometimes planted in gardens for its fruit; which is not eaten raw, but is excellent when preserved in sugar, in syrup, or candied. The berries are also made into jelly and rob, both of which are not only delicious to the taste but extremely wholesome, and they are pickled in vinegar when green as a substitute for capers. They are also used instead of lemon for flavouring punch, for garnishing dishes, and for various other purposes, independently of their medicinal properties. When the fruit is to be eaten, there is a variety in which it is larger and less acid, *B. vulgàris*, var. *dúlcis*, (*E. of Tr. and Sh.*, p. 43), of which there are plants in the Hort. Soc. Gardens, from which scions may be procured for budding or grafting on the common berberry. For all the other purposes the species may be taken, though for the curious there are varieties with yellow, white, purple, and black-coloured fruit; and there is one also without seeds, *B. v. aspérma*, of which the delicious *confitures d'épine vinette*, for which Rouen is so celebrated, are made.

1262. *The Magellan sweet Berberry*, *Bérberis dúlcis*, D. Don, syn. *B. buxifòlia*, *B. rotundifòlia*, has round black berries about the size of those of the black currant, which are produced in great abundance, and used in its native country, both green and ripe, as we use gooseberries, for pies, tarts, and preserves, for which it is said to be most excellent. (See *Arb. Brit.* i. p. 301, and *E. of Tr. & Sh.* p. 47.) The plant is evergreen, quite hardy, and very ornamental, flowering from March to June, and ripening its fruit in June and July. It has ripened fruit in the nursery of Mr. Cunningham, at Edinburgh, who says, it is as large as the Hamburgh grape, and equally good to eat.

1263. *The Nepal Berberry*, *B. aristàta*, Dec., syn. *B. Chíttria*, a native of Nepal, and *B. asiática*, Roxb., also from Nepal (*Arb. Brit.* i. pp. 306, 307, and *Encyc. of Trees and Shrubs*, p. 49), produce purple fruit covered with a fine bloom, which in Nepal and other parts of India are dried in the sun like raisins, and, like them, brought to table. The plants are quite hardy and fruit abundantly in English gardens, and the amateur of leisure might add them and the Magellan berberry to his collection of hardy fruits.

All the species of berberry throw up numerous suckers, and become crowded with shoots and branches, and hence when fruit is the object they should be trained to single stems, for one foot or two feet in height, and all suckers removed; and the branches should be kept moderately thin. All the species will succeed perfectly in any good soil, and in an open situation in the orchard.

1264. *The Elder-tree*, *Sambucus nigra*, *L.* (*Sureau*, *Fr.*; *Hollunderbaum*, *Ger.*; *Vlierboom*, *Dutch*; *Sambuco*, *Ital.*, and *Sanco*, *Span.*; *E. B.* 476, *Arb. Brit.* ii. p. 1027, and *Encyc. of Trees and Shrubs*, p. 513), is a low deciduous tree, a native of most parts of Europe, and chiefly found near human habitations. It is highly ornamental both when in flower and in fruit. An infusion of the flowers is used to flavour some articles of confectionery, and a wine is made from the fruit by boiling it with spices and sugar. Immense quantities of fruit are grown in Kent, and other places in the neighbourhood of London, and sent to market for making this wine, which is always taken hot, and commonly after supper. The tree requires a good soil and an open airy situation, and should be kept free from suckers.

1265. *The Cornelian Cherry*, *Cornus Más*, *L.*; *C. máscula*, *L'Hérit.* (*Cornouiller*, *Fr.*; *Kornel Kirsche*, *Ger.*; *Kornoelje*, *Dutch*; *Corgnolo*, *Ital.*; *Cornejo*, *Span.*; *Arb. Brit.* vol. ii. p. 1014, and *Encyc. of Trees and Shrubs*, p. 501), is a low deciduous tree, a native of the middle and south of Europe, in the margins of woods, and in soils more or less calcareous; and it has been cultivated in gardens, from the time of the Romans, for its fruit, which, however, was not much esteemed by that people. It was very general in ancient gardens; its fruit being very ornamental on the tree, and also found excellent in tarts, robs, and preserved in various ways. As seedling plants of this species of *Cornus* bear only male blossoms for twelve or fifteen years, and some continue to do so always, it is desirable to procure plants which have been grafted, or raised by layers from fruit-bearing trees, the flowers of which are always hermaphrodite. Du Hamel says that there are varieties of cornel in France and Germany with wax-coloured fruit, white fruit, and fleshy round fruit. The tree should be planted in a situation open to the south, but sheltered from high winds.

1266. *The Buffalo berry*, *Shephárdia argétea*, *Nutt.*; *Hippóphæ argétea*, *Pursh.* (*Rabbit berry*, *Amer.*, and *Graisse de Buffle*, *Fr.*; *Arb. Brit.* vol. iii., p. 1327, and *Encyc. of Trees and Shrubs*, p. 700), is a low tree, a native of the banks of the Missouri, where it flowers in April and May, and ripens its scarlet diaphanous berries in September. These are said to be about the size of the red currant, much richer to the taste, and they are produced in such abundance as to form one continued cluster on every branch and twig. The tree being diœcious, care should be taken to procure both sexes. There are plants in England, but, as far as we know, they have not yet ripened fruit. In an account of this fruit in the *Gardener's Magazine* for 1831, the writer considers it "one of the greatest acquisitions of the fruit-bearing kind that has recently been brought into notice in the United States."

1267. *The Winter Cherry*, *Phýsalis Alkekéngi*, *L.* (*Coqueret*, *Fr.*, and *Judenkirsche*, *Ger.*), is a herbaceous creeping rooted perennial, a native of the south of Europe, quite hardy, and growing freely, and producing fruit abundantly in common garden soil. The fruit is yellow, and about

the size of a cherry, with an agreeable sweetness; it ripens in September, and will hang on the plant, protected by its inflated calyx, through great part of the winter. It was well known to the ancients, and was cultivated in most gardens till late in the last century, since which it has been neglected. In the neighbourhood of New York the fruit is grown in large quantities, and dried, and used as a sweetmeat, in which state it is most excellent (*G. M.* 1842, p. 331). Several other hardy species, including *P. pubescens*, also produce edible fruit.

SECT. II.—*Half-hardy or Wall Fruits.*

1268. The wall-fruits of Britain include all those which in the central districts of England require the aid of a wall to bring them to perfection. These are the grape, peach, nectarine, almond, apricot, fig, pomegranate, love-apple, egg-plant, and Peruvian cherry.

SUBSECT. I.—*The Grape.*

1269. *The Grape Vine*, *Vitis vinifera*, *L.* (*Vigne*, *Fr.*; *Weintrauben*, *Ger.*; *Druif*, *Dutch*; *Vigna*, *Ital.*, and *Vina*, *Span.*; *Arb. Brit.* vol. i. p. 477, and *Encyc. of Trees and Shrubs*, p. 136), is a trailing or climbing deciduous shrub, a native of Syria and other parts of Asia, and though enduring our winters in the open garden, yet only ripening its fruit under glass or against a wall. It has been in cultivation since the time of the Romans, both as a wine and a table fruit. The grape abounds in tartaric acid, which in general agrees with delicate persons better than any other; and hence it is universally considered one of the most wholesome of fruits. Many varieties have been produced by different soils and situations on the Continent, in countries where the vine is grown for many years on the same spot for wine; and by seeds in Britain, where the fruit is grown solely for the dessert. All the best kinds of grapes have either been fruited in the Horticultural Society's Garden, or exhibited at their shows; and from these and other sources of knowledge, Mr. Thompson has prepared for us the following selections:—

1. *Grapes with round, dark, red, purple, or black berries.*

Early black July, syn. *Maurillon hâtif*, &c.—Bunches and berries small, flavour sugary; ripe against a wall in the end of August or beginning of September; the blossom easily injured by cold. This is the first grape which ripens on the open walls in the neighbourhood of Paris. In 1840 we found it in the shops in the last week in July.

Black Frontignan, syn. *Muscat noir de Frontignan*; *black Frontignan*; *black Constantia*, &c. Bunches and berries of medium size; flavour musky, rich; ripe in October. A very excellent grape.

2. *Grapes with oval, dark, red, purple, or black berries.*

Black Prince, syn. *Sir Abraham Pytche's black*.—Large long bunches, large berries, flavour sweet and pleasant; ripe in October; deserving a place in a vinery, and will also ripen on a wall.

Black Hamburgh, syn. *Frankendale*, &c.—Large bunches, very large berries, flavour sugary and rich; ripe in October; a good bearer, and deservedly one of the most generally cultivated of grapes, whether under glass or against a wall.

Black Morocco, syn. *Raisin d'Espagne*, &c.—Bunches large, berries very

large, flavour sweet and tolerably rich, ripening late. The blossoms require to be set with black Hamburgh, or some other hardy grape.

West's St. Peter's, syn. Raisin des Carmes.—Bunches middle size, berries large, flesh firm, flavour sugary and rich; late in ripening. A great bearer, and one of the very best winter grapes.

3. Grapes with round white berries.

Royal Muscadine, syn. Chasselas doré, &c.—Bunches large, berries above the middle size, flavour rich and sweet; ripe in September. A good bearer, and altogether an excellent grape.

Chasselas musqué, syn. Le Cour.—Bunches middle size, long, berries middle size, flavour rich, musky; ripe in September. An excellent grape, combining much of the flavour of the Muscat of Alexandria.

White Frontignan, syn. Muscat blanc.—Bunches and berries middle size; juice rich, with a highly musky flavour. A much-esteemed grape, which will ripen either against a hothouse or against a wall.

4. Grapes with oval white berries.

White Muscat of Alexandria, syn. Passe musqué blanc, &c.—Bunches and berries large, flesh firm, musky-flavoured and delicious; only ripens under glass. Generally esteemed the finest and richest grape in cultivation, and particularly adapted for the hothouse and pine-stove.

Cannon-hall Muscat.—Closely resembling the Muscat of Alexandria; but the flesh is firmer, and the skin yellower. The blossoms do not set well, unless fecundated artificially; which may be done with their own pollen, by means of a camel-hair pencil, or by the pollen of any other grape that may be in flower at the same time.

5. Grapes with red, rose-coloured, greyish, or striped berries.

Red Frontignan, syn. Muscat rouge.—Bunches and berries middle size, flavour rich, musky, and excellent. A grape of first-rate excellence.

Grizzly Frontignan, syn. Muscat gris.—The same qualities, and equally excellent as the preceding variety.

1270. *A selection of grapes for early forcing*.—Esperione, Black Prince, Cambridge Botanic Garden grape, White Muscadine, Royal Muscadine, White Sweetwater, White Frontignan, Grove End Sweetwater, Red Frontignan.

1271. *The selection of grapes grown at Hungerton-hall (973)*, so as to produce three crops in a year in the same house.—Black Frontignan, syn. Purple Constantia, White Frontignan, syn. White Constantia, Grizzly Frontignan, Muscat of Alexandria, Stillwell's Sweetwater, West's St. Peter's, Black Damascus, Black Tripoli, Black Hamburgh, White Portugal, Syrian.

1272. *A selection of grapes of various flavours and colours*, placed in the order of their ripening.—White and Red Muscadine, White and Red Muscats of Alexandria, White and Red Frontignan, Black Muscadine, White Raisin, White and Black Hamburgh, Black Prince, White Sweetwater, White Nice, and West's St. Peter's. These sorts are of fourteen different flavours; there are an equal number of whites and reds; some with large bunches and berries, as the Nice, and others with high-flavoured berries, as the Frontignan. The foliage in autumn will be alternately tinged with red and yellow; and, supposing the Muscadines to be placed next the end at which

the flue enters, they will ripen nearly a month earlier than any of the other kinds.

1273. *Grapes for a late crop in a vinery.*—Black Damascus, Black Frontignan, Black Hamburgh, Red Syracuse, Black Muscadel, syn. Black Raisin, and White Raisin, Black Prince, and West's St. Peter's.

1274. *Grapes for a house in which pines are grown.*—White Muscadine and Sweetwater, for early sorts; and for a succession, Black Muscadel, Hamburgh, and Damascus, White Frontignan, and Muscat of Alexandria. Half of the whole number of plants should be Muscats, and half of the remainder Hamburghs and Frontignans. One plant of each of the other sorts will be enough.

1275. *Grapes with small leaves, and hardy; adapted for the rafters of a green-house.*—White and Black Sweetwater, Black Cluster, syn. Black Morillon, Black Muscadine, Parsley-leaved Muscadine.

1276. *Grapes with small leaves, less hardy than the preceding selection, and fit for the rafters of a plant-stove.*—Chasselas Musqué, Blue Frontignan, Blue Tokay, Royal Muscadine, and Parsley-leaved grape.

1277. *Grapes with small bunches and berries adapted for being grown in pots or boxes.*—Black and White Corinth, Black Cluster, and Pitmaston White Cluster, Red and Grizzly Frontignan, White and Red Burgundy, &c.

1278. *Grapes for a cottage garden where the climate is not very favourable.*—White Muscadine, Black July, Large Black Muscadine, and Pitmaston White Cluster.

1279. *Grapes suitable for the open wall, or for cottages* in situations where the peach will ripen on the open wall—see Mr. Hoare's list in p. 472. If the peach requires a flued wall, so will the grapes in this list; and when they are planted against a house, it should only be on those walls which are decidedly warm, from facing the south and from a fire always being kept in the room within, or from the wall containing a chimney-flue to a fire in constant use.

1280. *Propagation*, see 606, 958, 968, and 981.

1281. *Culture, pruning, training, &c.*, see Sect. II., pp. 452 to 472.

1282. *Pruning.*—The shoots of the vine, the rose, and indeed of plants generally, have always on the lower part of the growing shoot two or three weak leaves, which soon drop off, and the buds in the axils of these leaves are generally so small as to be called by gardeners blind. They are never developed unless the shoot is cut down to them, and even then, if they push, they never produce blossoms. Hence, in shortening young wood of the vine in the open air, it should seldom or never be cut to one of these blind buds, but to a conspicuous plump bud, three, four, or five leaves from the origin of the shoot. The largest leaves and best buds on vines in the open garden will generally be found those produced between the middle of May and the middle of June; and such buds, if the vine is tolerably strong, will be certain of producing shoots with blossoms. These remarks are applicable in a particular manner to vines grown against walls and cottages, where no extraordinary attention is paid to the soil; but for vines under glass or against walls, with highly enriched borders, the young wood of the vine may be cut off nearly close to the old wood, and the shoot that will be produced from an embryo bud will contain blossoms, as already noticed under *spurring-in pruning* (963). It is necessary for the amateur vine-pruner to

bear these two facts constantly in mind, because otherwise he might go on pruning his vines for years, without ever having a single bunch of fruit. By pruning vines in the open garden a week or two before the fall of the leaf, they are put sooner to rest, and will burst their buds earlier the following spring.

1283.—*Thinning.* The bunches ought to be reduced in number, when more are produced than it would be judicious to allow the plant to mature; and some of the leaves ought to be removed, when they are so much crowded about the bunches as to prevent them from colouring. In thinning out the berries of bunches, the bunch ought never to be taken hold of by the fingers, as is too frequently done, but by a small piece of hooked wire, and the berries ought to be taken off with a pair of small scissors. Thinning grapes with hands covered with perspiration, or with fowl scissors, frequently produces the rust, an incurable disease, which greatly disfigures the berries.—(*Gard. Chron.* 1842, p. 289).

1284.—*Setting the blossom.* It sometimes happens, more especially in early forcing, that the incipient bunches twist and shrivel up just before coming into bloom; the cause appears to be the want of heat at the root, which may either arise from the roots being too deep, or from their being outside, and not properly protected by thatching, (0000) or warmed by hot dung. The permanent remedy for this evil is obvious; but as Mr. Fish judiciously observes, "it is frequently of as much, if not of more, importance, to know how to make the most of existing circumstances, though unfavourable, than to be conversant with the very circumstances and management that will ensure success." We will state Mr. Fish's remedy for this serious evil. To keep the bunches from shrivelling and twisting up, Mr. Fish suspended small pieces of lead, little stones, bits of clay, &c., with slight strings of matting to the points of his bunches, just when they were coming into bloom, sometimes attaching an additional small weight to the shoulder of the bunch (*Gard. Chron.*, 1842, p. 189). In this way the blossoms set, and the bunches came to maturity when every other means had failed, and this not merely in a solitary instance, or on a small scale, but in a house of great width in Mr. Tattersall's garden at Hyde Park Corner, and in several wide houses, in which the roots of the vines have got down into a moist clay, in the garden at Putteridgebury, the seat of Colonel Sowerby, near Luton. We had an opportunity of seeing these houses in March last, when the bunches in two of them were loaded; the one house with the berries set and swelling, and the other with the blossoms beginning to open. As soon as the berries have fairly begun to swell, the weights are removed. The rationale of this system we do not pretend to know, unless it be the same principle of pressure which seems to facilitate the rooting of a cutting, and the protrusion of spongioles from the root of a cabbage plant, when applied to their lower extremities.

1285. *Growing grapes in pots.*—The only utility of growing grapes in pots where there are plenty of hothouses, is to have a few to ripen in March and April. West's St. Peter's, or the sort cultivated by Mr. Oldaker and Mr. Paxton as such, (*G. M.*, vol. ii., p. 174, and vol. xiii., p. 96) if properly managed, will hang in good condition till the end of February, or, in some seasons, till March; in short, as Dr. Lindley observed, when commenting on some grapes of this variety, exhibited by Mr. Paxton, on January 17th, 1837, it is "decidedly the best winter grape known." Where there is

an early vinery, good grapes may be ripened in the beginning of May where the border is protected from frost and snow: so that a regular succession can be had all the year round. Mr. Tillery, the Duke of Portland's gardener, at Welbeck, has "put a dozen pots in on the 10th of October, and cut on the 2nd of March; another dozen in the beginning of November, and cut in April. Where grapes can be grown on the rafters, and proper attention paid to the borders," he observes, "it is so much time thrown away to attempt growing them in pots. To the amateur and gardener with, perhaps, only a hothouse or two, the case is different, for they are worthy of all his care and attention."—*Gard. Chron.*, 1841, p. 830.

1286. *General treatment of the vine.*—No tree or shrub will do with so little water, either at the root or over the leaves, as the vine, provided the border is sufficiently rich. Even in vineries watering may be totally dispensed with during the whole of a course of culture, though it will facilitate the breaking of the buds and the swelling of the fruit. Hence a vinery, if formed of a handsome shape, with the sides and roof of glass, might be covered inside with vines, with the floor matted or carpeted, so as to be used, during a part of the summer season at least, as a reading or working room. In this case the vines should be planted outside; or planted inside, close to the outside walls, so as, in either case, to allow of the floor being paved. The only drawback to vines so treated is the attacks which they, in common with all plants, are liable to from insects; and these can only be got rid of by the use of water or some liquid, or by fumigation. The vine, however, is less subject to insects or diseases than any other fruit-bearing tree or shrub.

1287. *Growing grapes for wine-making.*—Excellent wine may be made from unripe grapes, and these may be produced in abundance in the central and southern districts of England, in the open garden on espaliers. The plants may be trained on horizontal wires in the Thomery manner (905), in that of Mr. Hoare (984), or the wires of the trellis may be chiefly perpendicular and two feet apart, and at each a vine cutting may be planted and trained upright and spurred in, as recommended for the gooseberry and currant on an espalier (1220). After the lapse of three or four years to establish the plants, an immense quantity of fruit would be produced in this manner on a small space. The best varieties for wine-making, where the grape will ripen, are the Miller's Burgundy, known by its woolly leaves, and the Claret, known by its leaves dying off of a dark claret colour; the Black Cluster and the Muscadine will attain as great a degree of maturity as the kinds mentioned, and will answer both for wine making and eating. It is unnecessary to observe, that the walls and roofs of cottages (986) will bring the grapes nearer to maturity than an espalier in the same climate.

SUBJECT. II.—*The Peach and Nectarine.*

1288. *The Peach and Nectarine*, *Pérsica vulgàris* Dec.; and *P. lævis* Dec.; (*Pêcher*, *Fr.*; *Pfirschaum*, *Ger.*; *Persikkeboom*, *Dutch*; *Persico*, *Ital.*; and *Alberchigo*, *Span.*; *Arb. Brit.*, vol. ii. p. 680, and *Encyc. of Trees and Shrubs*, p. 266), is a deciduous tree under the middle size, a native of Persia, and cultivated in gardens for its fruit from the time of the Romans. The nectarine (*pêche lisse*, *Fr.*), is distinguished from the peach by having a smooth skin, while that of the peach is downy. The Almond is supposed

by many to be the peach in a wild state, but for convenience in treating of their culture we have kept them apart, both in the *Arboretum Britannicum*, and in this work. The peach has long been cultivated extensively in France, from whence our best varieties have been obtained; it is highly prized in India, and is common in the warmer parts of the United States as an orchard fruit.

1289. *Use*.—The peach and nectarine are dessert fruits, next in estimation to the grape and the pine-apple; they also make delicious preserves, and the peach, when gathered a little before it is ripe, most excellent tarts. In the Southern States of North America, and in some parts of France, the pulp is fermented, and brandy obtained from it by distillation. A few of the green leaves put into gin or whisky give these spirits the flavour of noyau. As both the leaves and the skin of the fruit contain prussic acid, the use of the former should not be carried to excess, and the skin of the latter should always be removed before the pulp is eaten.

1290. *Properties of a good peach or nectarine*.—Flesh firm; skin thin, of a deep or bright red colour next the sun, and of a yellowish green on the shady side; pulp yellowish, full of high-flavoured juice; the fleshy part thick, and the stone small.

1291. *Varieties*.—These are naturally arranged into two divisions, peaches and nectarines: and each of these again into freestones or melters (*pêches*, *fr.*, the peach, and *pêches lisses*, *fr.*, for the nectarine); and clingstones (*pavies*, *fr.* for the peach, and *brugnons*, *fr.* for the nectarine); the flesh of the former parting readily from the stone, and that of the latter adhering to it. There are upwards of fifty kinds of peach and nectarine in nursery catalogues, but the few of decided excellence are included in the following selection by Mr. Thompson. They are all free-stones or *melters*; few or no *clingstone* peaches or nectarines being thought worthy of cultivation in British gardens.

1292. *Select Peaches arranged in the order of their ripening*.

Grosse Mignonne, syn. French Mignonne, and above thirty other synonyms. Large, flatly globose, greenish yellow and deep purplish red, dotted, flesh melting, yellowish white, red at the stone; rich and vinous; middle of August to the beginning of September. A very good bearer, forces well, and is not subject to mildew.

Red Magdalen, syn. Madeleine de Courson, &c. Middle size, round, pale yellow and red, dotted, flesh melting, white, slightly tinged with red at the stone; rich and vinous; end of August to the beginning of September; the tree is a good bearer, but requires a favourable situation, whether on a south wall or a peach-house.

Royal George, syn. Madeleine à petites fleurs, &c. Middle size, round, flesh melting, whitish and dotted, deep red, rich and excellent; early in August and beginning of September. The tree is a good bearer, and forces well, but apt to mildew; in other respects this is one of the best of peaches.

Noblesse, syn. Vanguard, &c. Large, roundish, pale greenish yellow and red, clouded with darker red, flesh melting, greenish white to the stone; rich and excellent; end of August to the beginning of September. A good bearer and forces well.

Malta, syn. Belle de Paris. Large, roundish, or somewhat obovate, pale greenish yellow, clouded with red; flesh greenish white, rich; end of August or beginning of September; tree hardy, a good bearer; the fruit

bears carriage well, and will keep longer after being gathered than perhaps any other variety.

Barrington, syn. Buckingham Mignonne. Large, roundish; pale yellow and red, flesh white, rayed with red at the stone, melting and rich; middle of September; a good bearer.

Bellegarde, syn. Galande, &c. Large, round, deep red clouded with darker red, flesh melting, white, rayed with red at the stone; excellent; beginning to the middle of September. A very good bearer, forces well, and altogether a most excellent peach.

Late Admirable, syn. Royal, &c. Large, roundish, greenish yellow, clouded with red, flesh melting, white, red at the stone; excellent; middle to the end of September. A good bearer, and the best late peach.

1293. *Select Nectarines, arranged in the order of their ripening.*

Elruge, syn. Claremont, &c. Middle size, somewhat oval, pale green and deep violet; flesh melting, pale to the stone; tender and delicious; end of August to the beginning of September. A very good bearer, and one of the most valuable of nectarines.

Violette Hâtive, syn. Hampton Court, &c. Middle size, roundish ovate, pale green and dark violet, flesh melting, pale green rayed with red at the stone; of highly excellent flavour; end of August to the beginning of September. The tree a very good bearer. This and the preceding sort are the two best nectarines in general cultivation.

New White, syn. Flanders, &c. Large, roundish, white, tinged with red; flesh melting, white, tender, vinous; end of August to the beginning of September. A good bearer, but being rather tender it should be budded on some hardy peach or nectarine. A tree of this variety at Butleigh, in Devonshire, completely covers a wall twelve feet high to the extent of forty-four feet; it is trained in Mr. Callow's manner (803 and 1297), and its produce, when thinned to four feet per square foot, is from one hundred and fifty to one hundred and eighty dozen; a quantity not unusual for it to bear. (*G. M.*, vol. x., p. 38).

Pitmaston Orange.—Large, roundish ovate, orange yellow, and brownish red; flesh melting; orange-red close to the stone; rich and sweet; beginning of September. A very good bearer, and a vigorous tree.

1294. *Peaches and Nectarines for a wall to come in, in succession, from the beginning of August to the end of September, arranged in the order of their ripening.* *Peaches*:—Early Anne, † Gross mignonne, * Royal George, * Double montagne, * Noblesse, * Malta, * Royal Charlotte, † Bellegarde, Barrington, † Late Admirable. Of those marked *, two or three plants may be planted; and of those marked †, three or four, according to the extent of the wall devoted to this fruit. The best *Nectarines* for a wall are, the † Elruge and † Violette Hâtive. A more extended selection of *Peaches* and *Nectarines* for a wall has been already given (888).

1295. *Peaches for a cold late situation*.—Acton Scot, which ripens about London in the end of August, and is a very hardy tree; the Bellegarde, and the Malta, included in our first list (1292).

1296. *A selection of Peaches for forcing*.—Bellegarde, Noblesse, Grosse mignonne, Royal George, Royal Charlotte, and Barrington (see 992).

1297. *Propagation and nursery culture*.—Budding on plum stocks is the general practice; but some of the more delicate kinds are budded on the almond, strong growing seedling peaches, or on the apricot. On the peach

stock they grow very vigorously at first, but do not long continue to thrive. For general purposes the plum stock is by far the best, as from its abundance of roots it transplants readily; while the roots of the almond and peach, being few and very remote, they transplant with difficulty. The French gardeners use the almond stock for light chalky or sandy soils, and the plum stock for clayey or loamy soils. When the plants are not removed the first year to where they are finally to remain, they are cut down in the nursery to three or four eyes, and the shoots produced trained in the fan manner, already described at length (801). This may either be done in the open garden against a row of stakes, or the plants may be removed to a wall, which is the best mode for ripening the wood. To ensure this result the plants should in no case be placed in very rich moist soil. An expeditious mode of covering a wall with peach or nectarine trees, where the subsoil is dry, or the bottom of the border paved, or rendered impervious to the roots of the trees by other means, is thus described by a gardener who practised it in Essex. Kernels of peaches, nectarines, or apricots, are planted under the walls on the spots where the trees are finally to remain, in January; and the plants raised are either budded with the desired sorts in the August of the same year, or grafted in the splice manner already described (652) in the following March. When budding is employed, the point of the shoot produced by the bud is pinched off after it has grown six inches or eight inches in length, and only five buds are allowed to push; the five shoots produced by these buds are shortened with the finger and thumb to five inches or six inches in length, and these being disbudded, so as to admit of only two shoots from each, a complete fan-shaped tree is produced in one season. These trees bear the third year, and those which are grafted bear the second. (*G. M.*, vol. ii., p. 149.) A wall might be covered with equal expedition by stopping the shoots of seedlings in the same manner as the shoot produced by a bud; but in this case there is the risk of some, or perhaps most, of the sorts, not proving so good as some of the old established kinds. The quickest mode of proving the quality of peaches, or of the fruit of other trees raised from seed, is to take a bud from them, and insert it near the extremity of a lateral branch of a tree of the same species (645-2). Budded on the Moor-park apricot, the flavour of the peach is said to be greatly improved; on the mirabelle or mirabolan plum, the tree is somewhat dwarfed (1205).

1293. *Soil, situation, &c.*—A fresh loamy soil on a dry bottom answers best, and care should be taken not to enrich the soil so much by manure as to occasion the production of longer shoots than can be properly ripened. In few situations should the peach border be more than eighteen inches or two feet in depth, and it need not be more than ten feet or twelve feet in width, even when the walls are fifteen feet in height. (See 836.) The peach in Britain is almost always planted against a south wall, but in some sheltered situations it will succeed on a south-east or south-west aspect. Against a south-west wall the blossoms are more liable to be injured by the heavy rains from that quarter, and the shoots are apt to grow stronger, in which case they ought to be laid in more horizontally than in the case of a wall facing the south. Mr. Glendinning recommends all peach walls to be covered with horizontal copper wires, extended longitudinally at six inches or seven inches' distance, and fastened to cast-iron eyes driven into the wall. The advantage is, that a man can tie two trees to the wires with bast ligaments,

in the same time that he can nail one tree to the bricks. When nails and shreds are used, he prefers the latter of a dark colour, and narrower than are generally used, because they look neater, and they last long enough, as they are never applied a second time. Where the peach is grown only for tarts it may be tried as an espalier. Where there is a choice of plants from a nursery, trees three or four years trained, if grafted on plum stocks, may be chosen, and the trees, if carefully removed in October or November, will bear a few fruit next year. "In planting never dig a pit, because, by the sinking of the loose soil the tree will in two or three years be much too deep; spread the roots carefully out on the surface of the border, and cover them three inches with soil." This is Mr. Glendinning's mode with the peach, and it would be an immense advantage to adopt it in the case of all fruit trees and fruit shrubs whatever, which are planted on newly-trenched ground. Where a wall to be covered with peaches is upwards of twelve feet high, riders may be planted as before recommended (389), and these should always be trees which have been several years trained, the object being to cover the walls as soon as possible. Permanent dwarf trees may be planted at fourteen feet to twenty feet apart, according as the wall is twelve feet or fifteen feet in height. (See 890.)

1299. *Mode of bearing, pruning, &c.*—The blossom-buds in all the different varieties of peach, nectarine, and almond, are produced almost exclusively on the wood of the preceding year; and that wood seldom produces blossom a second time. There are, however, occasional small spurs produced on two-year-old wood, but these cannot be reckoned on. The great art in pruning the peach, therefore, is to produce an annual crop of young wood all over the tree, which can only be done by shortening back lateral shoots on every part of it. In the course of the spring and summer, all the shoots that are not wanted to bear the following year should be disbudded (771), that is, entirely removed as soon as the buds begin to expand; and in the course of the winter pruning following, all the shoots left ought to be shortened according to their strength and situation, the weakest cut to one or two buds, the less weak to one half or more of their length, and the strongest shortened one-fourth or one-third of their length. According to the common mode of fan-training (801), Callow's mode (803), and Hayward's mode (804), these shoots are left all over the tree, as equally as can be done by the eye, or as the shoots produced admit of; but, according to Seymour's mode of training (802), they are left at regular and fixed distances, and the buds being all removed between these fixed points, no laterals are produced anywhere else; so that the tree once fully formed on this system, nothing can be more regular than its future treatment. Notwithstanding these advantages, Seymour's system has not been adopted to such an extent as might have been expected; and the same remark is applicable to Mr. Callow's system, which we agree, with Mr. Glendinning (see an excellent article on the culture of the peach on open walls in the *G. M.* for 1841), appears a great improvement on the common fan mode of training.

1300. *Mr. Callow's mode of training.*—By the common fan manner of training, Mr. Callow found that the lower branches soon became weak, from having been laid in at a less angle than the others, which deprived them of their due proportion of sap. While striving to obviate this difficulty, he was struck with the form of the lower branches of some elms, which, though they projected ever so far horizontally, still had their extremities always

inclined upwards. Taking these branches for his guide, he altered his mode of training, and, by turning up the extremities of the branches, so as to give all an equal inclination and equal curvature, convex towards the horizontal line of the earth, he was enabled to maintain all parts of the tree in equal vigour. This mode of training, which he adopted about 1800, has continued to be his practice ever since, and under it the trees have grown to a large size, and have continued in a full state of health to a considerable age. By the adoption of this very simple and natural system of training, Mr. Glendinning, who adopted it extensively at Bicton in 1832, observes, various inexplicable failures will be avoided; such as premature decay, an unequal quantity of young wood in the centre of the tree, and the constant and grievous calamity of losing the entire under limbs, which completely disfigures the tree for ever. Hayward's mode of training is founded on the same principle as Mr. Callow's, viz. that the sap will always flow in the greatest quantity to the most vertical buds.

1301. *Shortening the young wood of the peach.*—This is practised by all the different modes of training that are or ever have been used in Britain. The effect of shortening the shoots of the peach is not merely to throw more sap into the fruit, but to add vigour to the tree generally, by increasing the power of the roots relatively to the branches. The peach being a short-lived tree, it has been justly remarked by Mr. Thompson, were it allowed to expend all the power of its accumulated sap every year, it would soon exhaust itself, and die of old age; as the standard peach trees do in a few years in the unpruned American orchards, and in those of Italy, and as the almond does in the neighbourhood of Lyons and Vienna. No tree is so apt, as the peach, to produce over-luxuriant shoots, technically water-shoots, or gourmands. These may always be known by the extraordinary vigour of their commencement, which is almost always from latent buds after the regular buds of the tree have been developed. These buds ought to be rubbed off immediately, and as fast as they appear, in order to throw the sap which would have been wasted by them into the other parts of the tree; or if the entire tree is too strong, the shoots may be left to grow, care being taken to disleaf them (772) as fast as they advance, in order that no new sap may be generated. Besides these over-luxuriant shoots, others will arise not suitably situated; as when they come on the main stem, or on the fronts of the branches, technically fore-right shoots; all of which ought to be rubbed off, retaining only such as are required to bear fruit the following year; such as may be wanted to supply the place of a branch which has been or is to be cut out; such as may be wanted for propagation, and such as are terminal, unless the tree has attained its utmost limits when the terminal shoots may be stopped at two or three joints. What is called the summer pruning of peach trees, commences as early in spring as the leaf-buds can be distinguished from the blossom-buds, when all that are not wanted of either should be rubbed off; and it continues till the fall of the leaf, immediately after which the winter pruning may be performed, but should not be deferred later than February. In winter pruning the rule, as in all similar cases, is to cut to a leaf-bud, and as this sometimes is situated between twin blossom-buds, care must be taken not to injure the latter, as it is in such situations that the fruit is produced with least expense of sap to the tree; the branch attracting sap to the fruit from the root, and also returning sap to it from the leaves. When there is only one blossom-

bud, a shoot is as necessary for it as if there had been two. In either case the shoot may be shortened to three or four leaves after the fruit is stoned, which will be quite sufficient to maintain a circulation of the sap in connection with the fruit.

1302. *In summer-pruning the peach* in cold, late situations, it is found that stopping the shoots, when they are an inch or two in length, facilitates the production of blossom-buds and the ripening of the wood. The French method of disbudding in spring and summer, and pinching off with the finger and thumb in the latter season, instead of leaving the young shoots to become woody, and afterwards using the knife, and also their mode of pinching off the blossom-buds, instead of allowing more blossoms than are wanted to set their fruit, and afterwards thinning it out, and of taking out all the leaf-buds not wanted as soon as they have swelled a little, so as to have very few shoots to remove, well deserves to be imitated by the British gardener. A French gardener seldom uses his knife to a peach-tree in the summer season; and, indeed, if he were to allow as much of the strength of the tree to run to waste in fruits to be thinned out, and shoots to be cut away in winter, his borders, which are narrow, shallow, and poor compared with those in British gardens, would be unable to support the tree.

1303. *Thinning the fruit* must be attended to when the blossoms have not been thinned, or not thinned sufficiently: it should commence when the fruit are about the size of large peas, and be continued till the stoning season is over. Healthy trees may be allowed to ripen four peaches to every square foot. The smaller the number and the larger the size, the less will the tree be exhausted in proportion to the weight of fruit produced; for, as we have already observed, a greater exhaustion is produced by the seed and stone than by their fleshy envelope. Ten dozen of peaches, weighing 12 lbs., will exhaust the tree nearly twice as much as five dozen amounting to the same weight.

1304. *Treatment of the peach border.*—The peach, as well as most other wall-fruit trees, Mr. Errington, Mr. Glendinning, and other scientific and experienced gardeners, observe, is most commonly planted in borders far too deep and too rich. If a good loamy soil from the surface of an old pasture-ground can be procured, and if the border is not cropped, it will require no manure for several years. If the soil is either poor at first, or becomes poor, bone manure may be applied, as decomposing slowly; or if the trees become weak, the surface may be annually mulched with stable dung. All fruit-tree borders, Mr. Glendinning observes, should be occasionally forked up; but no spade should ever be used for this purpose, not even among goose-berry bushes; for more injury is done by it than most people are aware of. No vegetables should ever be cultivated in fruit-tree borders, more especially none that require manure. Mr. Callow stirs his peach borders with the fork frequently during the summer months; digs them slightly with the spade in winter, laying the soil up in ridges; and he never sows or plants vegetables on peach borders, except a few lettuce or endive near the walk. Throughout the summer the peach border will require occasional watering, more especially when the fruit is approaching to maturity; but water ought to be withheld when it is stoning and when it is ripening; as in the former case it is found to cause the fruit to drop.

1305. *Over luxuriant peach trees* may be reduced by disleafing, root-pruning (776), or, what is perhaps the best mode, especially if the tree has been too

deep planted, or that effect has been produced by the sinking of the tree or the raising of the border, by taking up and replanting, bringing the roots within six inches of the surface. The operation may be performed in autumn immediately after the fall of the leaf; and during next summer the surface of the border should be well mulched to retain moisture and encourage the production of fibres.

1306. *Old decaying peach trees* may sometimes be renovated by cutting them down and renewing the soil, but in general it is far better to root them out and plant young trees.

1307. *Protecting peach trees during winter and spring.*—In cold elevated situations some gardeners protect the branches of their peach trees from severe frost by tucking in among them branches of broom, birch, or beech, which serve to check the radiation of heat from the wall. Others, when the branches are frozen, water them well before sunrise, which, when the vegetable tissue is not too far ruptured by frost, saves the branches from injury by thawing them more gradually than the sun would do, as well as by supplying moisture for evaporation. Mr. Barron, at Elvaston Castle, in Derbyshire, a low moist situation, found his peaches, apricots, and plums very subject to the gum, and to die off by whole branches at a time. Suspecting that this might be owing to the effect of the frost on the imperfectly ripened wood, he hung up netting made of hay ropes before the trees, and at about one foot distance from them, in the beginning of winter, leaving them on all spring, and has never since experienced these evils. The blossoms of peach trees are also protected by tucking in branches of spruce-fir, birch, or beech, which have been cut in summer, and dried and stacked on purpose, and which having been so treated retain their leaves; and also yew branches, the leaves of which do not drop off like those of the pine and fir tribe. The best protection of this kind, however, is afforded by the leaves of common fern, tucked in along the shoots as shown in fig. 376. The



Fig. 376. *Branch of a peach-tree, with the young wood protected by fern.*

stalk of the leaf is introduced into a shred at the base of the lateral shoot which is to bear the fruit, and the point of it is brought to the point of the lateral; it is there wound once or twice round the nail near the point of the shoot, taking care to reserve an inch or two of the point of the frond to be turned in between the point of the shoot and the wall, which is a sufficient fastening if properly done. As soon as the fruit is set the fern is removed.

The most efficient mode, however, of protecting the peach and all other wall-fruit trees, is by a thin canvas covering let down from a temporary wooden coping, as used in the Horticultural Society's Garden (463). Another very good mode is that which is described as adopted by Mr. Callow. Iron rods are attached horizontally to the temporary coping, from which bunt-

ing is suspended by rings; each piece of bunting is of the size of the tree; and in the day-time it is drawn from the sides to the middle, and fastened to the wall till near sunset, when it is spread out again. A very efficient mode is to cover the wall with double netting, and allow it to remain on till the fruit is fairly set. This mode dispenses with much daily labour, and, like the thin canvas, protects the blossoms from the frequently too powerful rays of the sun, which, striking against a south wall, is more than the peach, as a standard in its native country, has to bear at the blossoming period of the season.

1308. *Growing the peach on a flued wall.*—When this is the case, fire should not be applied till after the fruit has stoned, the object being not to force forward the blossoming of the trees in spring, but to accelerate the ripening of the fruit and wood in autumn. The maturation of the wood may, in some cases, require the border to be thatched to throw off heavy rains, and lessen the flow of moisture to the shoots.

1309. *The acceleration of the ripening of a crop of peaches* on a common wall has been effected by covering the border, to the width of five or six feet from the bottom of the wall, with tiles; the reflection of the heat from which has been found by Mr. Barron (*G. M.* 1840,) to ripen the fruit in the lower part of the wall, a fortnight before that on the upper part. The retardation of a crop may be effected on the same principle, by interposing a screen of canvas, or boards, or any other convenient medium between the trees and the sun. It should, however, be placed merely as a screen, and not as a preventive against the escape of radiant heat from the wall and ground, a principal object in spring covering; when retardation is required, the screen should be placed so as to intercept the sun's rays, leaving at the same time an opening at top for the escape of radiant heat.

1310. *Gathering* should take place a day or two before the fruit is to be used, and before it is dead ripe, and it should be laid on clean paper in the summer fruit-room. Peaches may be gathered in the heat of the day without any deterioration of flavour; in this respect they are very different from such northern fruits as the gooseberry, currant, and strawberry, which should be gathered in the morning. Provision for the dropping of ripe fruit should be made as already directed (998).

1311. *Diseases, Insects, &c.*—The peach and nectarine are liable to the honey-dew, mildew, gum, blister, and canker. The mildew may be destroyed by watering the leaves and dusting them with sulphur; but little can be done with the other diseases, excepting taking care that the regimen is suitable. The blister (*la cloque*, Fr.) is produced by cold when the leaves are just expanding, and it thickens and distorts them in such a manner, as to prevent the proper elaboration of the sap. Nothing can be done with them but taking them off, as soon as warmer weather favours the production of healthier foliage. Lifting the trees and replanting them in fresh soil, and taking care that the shoots are annually thoroughly ripened, will check incipient canker and gum, and enable trees tainted with these diseases to continue bearing for some years longer than they otherwise would have done. The red spider, the chermes, the black and green aphid, and the coccus, attack the peach. The last should be washed off by syringing with soft-soap and water, or with clear water, and a hard brush. The chermes is the cause of the leaves rising into unsightly red blister-like tubercles, and can only be destroyed by the use of tobacco-water, which, after it has taken effect, may be

washed off with clear water. The curled leaves, however, being better than no leaves at all, should not be taken off till the shoot has elongated and produced two or three perfect leaves. For the other insects mentioned, washing abundantly with lime-water, or even with common clear water, will in general keep them under. In order to destroy the eggs of insects which may be deposited on the branches, many gardeners wash them over after the spring pruning with a mixture of lime-water, so thick as to act like white-wash, and form an incrustation on the shoots, which prevents or retards the hatching of the eggs by the exclusion of air; others use a mixture of soft-soap, sulphur, lime, and soot, which destroys the eggs; and some use soft-soap and sulphur alone. In general, however, where the trees and soil are in a good state, and their treatment proper, the free use of clear water will answer the purpose of all other washes. Woodlice, earwigs, the large blue fly, and wasps, attack the fruit when it is ripening, and may be collected by means of bundles of bean-stalks or reeds, flower-pots partially stuffed with hay, and glasses or bottles of sugared water. See the Chapter on Insects.

1312. *The essential points of peach culture* are thus given by Mr. Callow, already mentioned:—"Use a strong loam for the border; never crop it; add no manure; keep the trees thin of wood by disbudding and the early removal of useless wood; shorten each shoot according to its strength, at the spring pruning; elevate the ends of the leading branches so that they may all form the same curvilinear inclination with the horizon; and, what is of the utmost importance in the culture of the peach, at all times keep the trees in a clean and healthy state."—(*Gard. Mag.* vol. x. p. 40.)

1313. *Forcing the peach and nectarine.*—See 989 to 1017.

SUBJECT. III.—*The Almond.*

1314. *The Almond*, *Amýgdalus L.* (*Amandier, Fr.*; *Mandelbaum, Ger.*; *Amandelboom, Dutch*; *Mandorlo, Ital.*; and *Almendro, Span.*; *Arb. Brit.* vol. ii. p. 674; and *Encyc. of Trees and Shrubs*, p. 263), is a deciduous tree, a native of Persia and other Eastern countries, closely resembling the peach, and supposed, as we have already observed (1286), to be that fruit in its unimproved state. There are two kinds—the common or sweet almond, (*A. communis, L.*), and the bitter almond (*A. c. amara, Dec.*) Though these sorts are kept nominally distinct, yet when either are raised from seed, both bitter and sweet almonds are frequently found on the same tree; and this is frequently the case even with grafted varieties. Of both the bitter and the sweet almond, the kernel of the stone is the only part used; that of the sweet almond is brought to the dessert in an imperfectly ripe, and also in a ripe, and in a dried state. Both kinds are cultivated in the south of Europe, and in the Levant. The kernels are much used in cookery, confectionery, perfumery, and medicine. The varieties best deserving culture are, the *tender-shelled*, the fruit of which is small; the *sweet*, which is larger; and the *Jordan*, which is also large and sweet. These and all the other varieties are propagated by budding on the plum, and sometimes on seedling almonds for dry situations. The trees are commonly grown as standards, and as such will ripen fruit in fine seasons as far north as York; but at Edinburgh they require a wall. In Britain, the tree is more valued for its blossoms than for its fruit; but nevertheless, in every suburban garden, where there is room, there ought to be a tree or two for the latter purpose, as well as several for the former.

SUBSECT. IV.—*The Apricot.*

1315. *The Apricot*, *Armeniaca vulgâris*, *Lam.* (*Abricotier*, *Fr.*; *Aprikenbaum*, *Ger.*; *Abrikoos*, *Dutch*; *Albicocco*, *Ital.*; and *Albarico-gueira*, *Span.*; *Arb. Brit.* vol. ii. p. 682; and *Encyc. of Trees and Shrubs*, p. 267), is a low deciduous tree, a native of Caucasus, very extensively distributed through the countries of the East, and cultivated in European gardens from the time of the Romans. In British gardens the apricot is the earliest wall-fruit, flowering with the sloe in March, ripening about the end of July, and supplying the dessert till the middle of September. Its uses are the same as the peach; in addition to which it makes excellent marmalades, jellies and preserves, and tarts even when gathered green, and of the smallest size. In the Oases of Upper Egypt the fruit of a particular variety called the *Musch-Musch*, is produced in great quantities and dried, so as to form an article of commerce.

1316.—*Varieties.* These are much less numerous than those of the peach. The following selection is by Mr. Thompson.

Large early, syn. *Abricot gros précoce*. Large, somewhat oblong, compressed, bright orange red next the sun, elsewhere pale orange; flesh juicy and rich; ripens about the middle of July. The earliest large sort of apricot.

Royal. Large, roundish oval, resembling the *Moorpark* in appearance and equalling it in richness of flavour, but differs in ripening about ten days earlier, and having no pervious channel along the edge from the base to the apex of the stone; ripens about the end of July or beginning of August; a valuable sort.

Moorpark, syn. *Abricot pêche*, &c. Large, roundish, brownish-orange, intermixed with ferruginous specks; flesh very rich and juicy; stone peculiarly perforated, so that a pin may be introduced from the base to the apex; ripens in the beginning or middle of August.

Breda, syn. *Abricot de Hollande*, &c. Rather small, roundish, or obtusely four-sided, deep brownish orange; flesh deep orange, juicy, rich, and high-flavoured. Ripens from the beginning to the middle of August, on walls, and as the tree will succeed as a standard the fruit may be obtained at a much later period of the season; the fruit from standards will, of course, be smaller, but it will be richer, and it is excellent for preserving. As the tree generally bears over-abundantly in the open ground, when the season is favourable for the fruit setting, it requires and deserves a little shortening and thinning of the shoots as a winter pruning.

1317.—*Apricots for walls of different aspects.* See p. 422.

Turkey, syn. *Large Turkey*. Large, roundish, deep yellow, with brownish orange-red spots; flesh pale yellow, juicy, and rich; ripens in end of August or beginning of September.

1318. *Apricots for the walls of a Cottage.* The best is the *Moorpark*, which in Lincolnshire, and other parts of England, bears well on the gable ends, and ripens early in consequence of the heat communicated to the wall by the flue. The fruit is thinned, and the thinnings are sent to market for tarts, and afterwards the ripe fruit, the whole producing twenty shillings or upwards. Next to the *Moorpark* the *Breda* may be taken as the hardiest, and the red *Masculine* as the earliest.

1319.—*Propagation, nursery culture, &c.* For dwarfs, the apricot is gene-

rally budded on the muscle plum, or on any other variety; but the Breda, when intended for a standard, is budded on the St. Julian plum, which produces a strong clean stem. The Moorpark is sometimes budded on an apricot stock; and when it is wanted to have very dwarf plants, some recommend budding one variety on another that has been previously budded on a mirabelle plum. As the apricot is a very early plant, budding may be commenced sooner than in the case of the peach. The nursery culture is the same as for that tree, and the plants remove equally well after being three or four years trained.

1820.—*Final planting, pruning, &c.* In the warmer parts of the country, an east or west aspect is preferred to the south, the heat of which brings forward the blossom too early, and renders the fruit mealy. Where the fruit is only wanted for tarts, it may be grown as a standard or as an espalier. It would well repay to give standards a winter pruning in order to regulate the branches, and moderately shorten the young shoots to prevent their becoming naked as they elongate, a tendency which both standard apricots and peaches have in this climate. The blossom is produced chiefly on the young shoots of the last year, but partly also upon spurs which rise on the two or three years old shoots. The fan method of training is generally preferred; or the horizontal manner, with the branches elevated so as to form an angle of $22\frac{1}{2}^{\circ}$ with the horizon. We mention $22\frac{1}{2}^{\circ}$ rather than 20° , because experience has taught us that the parts into which a right angle is divided, look best when they are halves, quarters, or thirds. The reason seems to be that the relation of these divisions to a right angle is more easily ascertained by the eye. In almost every other respect, what has been advanced respecting the pruning, training, and general management of the peach, will apply to the apricot. The chief point of difference in the treatment required for the two trees is founded on the precocity of the apricot, which has given rise to the following remarks, the scientific and experienced author of which will be readily recognised by our readers. "In consequence of the tree blossoming so early, its blossoms, particularly in the case of young trees, are extremely liable to drop off in setting. This is not to be wondered at, when it is considered that the ground is frequently at the time (March) in as cold a state as at any period of the whole season, neither the sun's heat nor the warm rains having reached so far below the surface as to warm the soil in contact with the roots; and thus whilst the latter are in a medium perhaps a little above freezing, the tops, exposed to a bright sun against a wall, are at that period of the season occasionally in a temperature as high as 90° or 100° Fahr. The injurious effects of this disparity must be sufficiently obvious to every one, and the only remedy to be adopted is to have a very complete drainage below the roots, and the whole soil of the border, not retentive, but of a pervious nature. If it could also be kept perfectly dry previous to the commencement of vegetation, and then only allowed to receive the rain when warm, avoiding the cooling effects of melting snow and hail, the tree would thus be placed under circumstances comparatively more natural." (*Penny Cyc.*, vol. x., p. 500.) Thatching the border, therefore, for the sake of the roots, and covering the branches with netting of hay ropes, may very properly be adopted with the apricot, in all low, cold, moist situations (838). Naked stems or branches of apricot trees trained against a wall are apt to be scorched to death in summer, and hence limbs or whole trees are sometimes lost. In order to prevent this, it is advisable to train shoots so as to

protect such naked parts from the direct rays of the sun ; and if some of these shoots should be at variance with the regular disposition of the branches, still the mind would find sufficient compensation for the slight breach of irregularity that might be apparent, in the discovery of design and utility. The fruit should be gathered before it is thoroughly ripe, otherwise it is apt to become mealy. The tree is much less subject to insects than the peach ; probably from the more coriaceous nature of its bark and leaves. It does not force well, but one or two plants of the red Masculine may be tried in the peach-house.

SUBJECT. V.—*The Fig.*

1321. *The Fig*, *Ficus Cárlica L.* (*Figuiet, Fr.*; *Feigenbaum, Ger.*; *Vigenboom, Dutch*; *Fico, Ital.*; and *Higuera, Span.*—*Arb. Brit.*, vol. iii., p. 1365, and *Encyc. of Trees and Shrubs*, p. 712), is a low, deciduous tree, a native of Asia and Barbary, in situations near the sea, and naturalised in Italy and the south of Europe, where it has been cultivated since the time of the Romans, as it has been in Greece and Egypt from the earliest ages. In British gardens the fig is chiefly cultivated under glass ; but it will arrive at maturity on the open wall in warm situations, and indeed wherever the grape will ripen. The fruit is of no use, except in a ripe state, when it is much prized for the dessert by many persons, while others prefer the dried figs of commerce. The fig is much cultivated in the south of France and Italy, where the varieties are numerous. Among the best of those grown in British gardens are the following :—

Brown Turkey, syn. *Brown Italian*. Fruit middle-sized, obovate ; skin brown ; pulp very delicious ; the plant equally desirable for growing against a wall or in pots.

Brunswick, syn. *Madonna*, &c. Fruit very large ; skin pale green on the shaded side, next the sun of a brownish-red ; flesh pinkish, extremely rich, sweet, and high-flavoured ; ripe the beginning and middle of August. The leaves deeply and more beautifully divided than in any other variety. "This," says Mr. Lindley (*Guide to the Orchard*, &c.), "is one of the most useful of the hardy figs. In a south-eastern corner, trained against a wall, it ripens by the middle of August in even unfavourable seasons. In an ordinary summer, in the neighbourhood of London, it begins to mature by the beginning of that month. It is, perhaps, the largest purple fig we have, and the most useful variety that can be selected for a small garden." At *Whiteknight's*, near Reading, it ripens as a standard.

Marseilles, syn. *Pocock*, &c. Fruit small ; the skin pale green ; flesh white, dry, sweet, and rich ; ripe in August ; succeeds well in the highest temperature of a pine-stove, in which it was for many years cultivated by the late Mr. Knight, of Downton Castle. On the open wall it is but an indifferent bearer.

Nerii. Fruit rather less than the *Marseilles*, and more long in shape ; skin pale greenish-yellow ; pulp similar in colour to that of a pomegranate ; much the richest fig known in Britain ; there is in its juice a slight degree of very delicate acid, which renders it peculiarly agreeable to most palates ; succeeds best under glass, in a low temperature.

Pregussata. Fruit large ; skin reddish-purple ; pulp deep red ; remarkably sweet and rich ; seeds unusually small ; ripe from August to October.

Small brown Ischia. Fruit small ; skin brown ; pulp purple, of a very

high flavour; leaves less divided than most other sorts; ripe late in September.

Yellow Ischia, syn. *Cyprus*. Fruit large; skin yellow; pulp purple and well-flavoured; leaves large, and not much divided; ripe in September; the tree grows luxuriantly, but does not produce much fruit in England.

1322. *Selections of the best figs for forcing* are enumerated, p. 486; those adapted for walls of different aspects, p. 422; the best for a cold, late situation are, the brown Turkey, the small green, and black Ischia: the first much the best.

1323. *Propagation, culture, &c.*—The fig roots readily from cuttings of the ripened wood, and it may be also budded or grafted, and trained in the nursery like any other fruit-tree. Young plants, however, of two or three years' growth are preferable for removal, as the fig is then very abundantly furnished with fibrous roots. It requires a south wall, and a light soil thoroughly drained, to which, however, water of the same temperature as the soil must be abundantly supplied as soon as the first leaves are expanded, when the fruit is setting; for if the roots are too dry at that time, the fruit will drop off. The fan mode of training is most suitable; and as the fruit in the open air is produced on the points of last year's shoots, a number of such shoots should be preserved all over the tree. See on this subject what has already been stated on the treatment of the fig under glass (1032). The ripening of the fig might be accelerated by planting it against a flued wall, and by protecting the wood by fern, spruce branches, or hay-rope netting, (1320). In some parts of the south of England the fig is grown on espaliers, and as a standard; and when the winters are mild, it bears abundantly when so treated. It succeeds remarkably well at Tarring and Lancing in a loamy soil on chalk; and in the gardens of Arundel Castle, in the same county, the standard fig-trees are as large as full grown apple-trees. Care should be taken in gathering the fruit not to destroy the bloom, nor to crush it by laying one above another. They will keep good only for two or three days.

The culture of the fig under glass, is given in p. 485.

SUBSECT. VI.—*The Pomegranate.*

1324. *The Pomegranate*, *Punica Granatum*, L. (*Grenadier*, *Fr.*; *Granaatenbaum*, *Ger.*; *Granaatboom*, *Dutch*; *Melagrano*, *Ital.*; and *Granado*, *Span.*—*Arb. Brit.*, vol. ii., p. 939, and *Encyc. of Trees and Shrubs*, p. 456) is a low, deciduous tree, in its form and mode of growth not unlike the common hawthorn. It is a native of the south of Europe and other warm countries; and has been long cultivated in the north of France as a greenhouse tree, in the same manner as the orange, for the beauty of its fruit. This also was formerly the case in England, but at present the pomegranate is with us entirely neglected. As it is a most ornamental fruit both on the tree and at table; and as it can be brought to maturity against a south wall in situations where the fig will ripen, we would recommend one plant to be tried wherever there is room. Plants of the cultivated pomegranate will be best obtained from Genoa, where it is propagated by layers and cuttings and by grafting on the common sort. It may be trained in the fan manner, taking care to leave a sufficient number of lateral spurs, on the points of the shoots proceeding from which the blossom is produced. The ripening of the fruit might be greatly accelerated by planting the tree against a flued wall,

and as the tree is greatly injured by such a winter as that of 1837-8, it might be advisable to protect the wood during winter by hay-rope netting.

SUBSECT. VII.—*The Peruvian Cherry.*

1325. *The Peruvian Cherry*, *Phýsalis peruviana*, is a biennial, a native of Buenos Ayres, Lima, and other parts of South America, where it grows from six feet to ten feet high. It is occasionally cultivated in British stoves and forcing-houses for its fruit, which is produced through the winter as well as during summer, and tastes exactly like that of the hardy species (1267). It is commonly trained against a trellis, on the back of an early forced vinery or peach-house; but, treated like the capsicum or love-apple, it will ripen its fruit in abundance, during summer, against a south wall.

SECT. III.—*Tropical or Sub-tropical Fruits.*

1326. The fruits which we include in this section are such as require to be grown entirely or chiefly under glass, viz.: the pine-apple, banana, the orange and lemon tribe, the melon and cucumber, and some fruits not in general cultivation, but which may be tried by the curious amateur.

SUBSECT. I.—*The Pine-apple.*

1327. *The Pine-apple*, *Ananássa sativa*, *Lindl.* (*Ananas*, *Fr.*; *Ger.*; and *Ital.*; *Pijn appel*, *Dutch*; and *Pina*, *Span.*), is a low evergreen shrub, a native of South America, the natural history of which having been given in p. 443, we have only here to describe the varieties best worth cultivating.

1328. *Pines cultivated chiefly for their high flavour.*

The Queen. One of the best varieties at present known for general cultivation. It grows freely, fruits early, and, being higher flavoured than many of the larger kinds, is still the most valuable for a small family. Exposed to a very high temperature in the months of June, July, and August, it is liable to become hollow near the core, but early or later in the season it is not subject to that defect. It is the sort generally grown by gardeners for the London market. The Ripley Queen, a slight variety of the common Queen, is probably the best; the leaves are greener and broader, and it does not throw up so many suckers.

The Moscow Queen. An excellent variety, but rather a slow grower; the fruit is about the same size as the common Queen, but superior to it in flavour.

The Black Jamaica. An excellent fruit at all seasons of the year, but particularly in the winter months, when pines rarely come to perfection; it cuts firm to the core, is highly flavoured, keeps some time after it is fully ripe, and bears carriage better than any other variety. It is, however, rather a slow grower, and the fruit seldom attains a large size.

The Brown Sugar-loaf. The best of the sugar-loaf kind; it is a large, handsome, and highly-flavoured fruit, swells freely in the winter months; its flesh is firm and juicy.

The Black Antigua. An excellent and highly flavoured pine if cut when it begins to turn from green to yellow, but if allowed to remain on the plant until it is quite ripe it loses all its richness.

1329. *Pines cultivated chiefly for their large size.*

The Enville. Deserving a place in collections as one of the handsomest

pinus in cultivation; although it is neither rich nor highly-flavoured. The crowns are often cock's-comb like.

The White Providence. May be grown to a large size, and the shape is very handsome, but the flavour inferior.

The Trinidad, syn. Pitch Lake Pine. Said to be grown in the island of Trinidad to the weight of 26 lbs. In England it has been grown to the weight of 5 lbs. or 6 lbs., and of that size the flavour is good.

1330. *Culture.* This is given at length in Sect. I., p. 443, and we shall here give a general summary. Plant in turfy, rich, but not adhesive loam, well enriched with rotten stable dung or old night soil; plunge the pots in tan or leaves, or some other medium that will produce, or at least retain heat. At no period, either of winter or summer, allow the temperature of the air of the house to fall lower than 70° , but in summer let it rise for the Queen varieties as high as 80° or 85° , and for the other sorts as high as 90° or 100° ; the bottom heat should never be under 70° , and it may rise as high as 90° when the atmosphere is at or above that temperature; in summer give air early in the morning, and shut up at three in the afternoon with a high temperature, syringing the plants overhead; grow the Queen pines by themselves; the Black pines by themselves, as they require a higher temperature; and the large pines also by themselves, as they require larger pots and more room than the other kinds. Treated in this manner pines will seldom be infested with insects; but if they should, the remedies have been already given (953). To cause a pine to show fruit give it a check by withholding water for a considerable time, till the leaves have become quite lax and almost flagging, and then supply water and heat liberally.

SUBJECT. II.—*The Banana.*

1331. *The Banana*, *Musa sapientum*, L. (Banancier, *Fr.*; and Pisang, *Ger.*), is a scitamineous plant, the natural history and culture of which has been already given, p. 512. Every plant throws up a single flower-stem, which flowers and fruits; after which the plant dies, and is succeeded by a sucker. The fruit of none of the varieties contains seed, and hence these suckers are the only means of propagation. There are several species or varieties, but those best worth cultivating in Britain are the *M. s. Cavendishii*, syn., *M. s. chinensis*, and the *M. s. dácca*, both already noticed, and the *M. s. St. Helenensis*, to be afterwards described. Several other kinds have been fruited in the Edinburgh Botanic garden, and in the stove of Sir George Thomas Staunton, at Leigh Park, Hampshire, but the above three sorts are best worth cultivating for their fruit. (See J. M'Nab and R. Carter, in *G. M.* 1842.)

Musa sapientum, var. *St. Helenensis*, the St. Helena Banana, grows to the height of fourteen feet. The usual weight of each bunch of fruit is from 60 lbs. to 80 lbs., being double the weight of the bunches produced by any of the other varieties that have fruited in Scotland. It was introduced from St. Helena to the Edinburgh Botanic Garden in 1830.—(J. M'Nab, in *G. M.*, 1842.)

M. s. var. *dácca*, the dácca Banana, is considered by Mr. M'Nab as next in value to the St. Helena variety. Its average height of stem, in the Edinburgh Botanic Garden, is seven feet, producing clusters from 10 lbs. to 20 lbs. weight. The fruit is smaller and drier than that of the St. Helena Banana, but perhaps rather higher flavoured. At Leigh Park, this variety,

when allowed plenty of room in a congenial climate, grows twenty feet high, with a stem measuring three feet in circumference at the base; leaves ten feet long and three feet broad; the bunch of fruit weighing above 50 lbs. The fruit is more pointed than that of *M. s. Cavendishii*, and of excellent quality.

M. s. var. Cavendishii, syn. *M. s. chinensis*, the Duke of Devonshire's Banana, is valuable on account of its fruiting at a small size, and within a year from the time the suckers are taken off. The fruit is not so plump as that of the two preceding varieties, and it has a great tendency to smother one half of each cluster in the folds of the leaves, unless very great heat be given just at the time it is developing its flower-spike.

1332. *Culture, &c.* Twenty plants of *Musa s. Cavendishii*, may be fruited within the year, in a pit thirty feet by fifteen feet, and the weight of fruit produced may be from 400 lbs. to 500 lbs. An equal weight of pine apples may be fruited in the same space in the same time; but much additional room would be required for bringing them forward, for six months at least, before they were put into the fruiting-house. The summer temperature for the Banana is 65° min., and 85° max., or more with sun heat. Winter temperature, 65° min., and 75° max. The Bananas that ripen in winter are but little inferior to the summer fruit. For other details see R. Carter, in *G. M.*, 1842.

SUBSECT. III.—*The Melon.*

1333. *The Melon*, *Cucumis Melo L.* (*Melon*, *Fr.*; *Melone*, *Ger.*; *Meleon*, *Dutch*; *Mellone*, *Ital.*; and *Melon*, *Span.*), is a trailing or climbing tendrilled annual, the history and culture of which will be found in p. 487, and the following are the best varieties at present in cultivation.

1334. *Melons with red flesh.*

Black rock, syn. *Rock Cantaloup*. Fruit very large, round, depressed at both extremities, covered with knobs, or carbuncles; weight, from 8lbs. to 14lbs. A large showy fruit, but of inferior flavour. The *Dutch rock cantaloup* is a smaller-fruited variety, weighing from 5lbs. to 8lbs.

Early Cantaloup. Fruit small, nearly round, ribbed, but not warted; flavour good; weight from 2lbs. to 4lbs. Valuable for its earliness and for being a great bearer.

Netted Cantaloup, syn. *White-seeded Cantaloup*. Fruit round, and rather small; skin pale green, closely reticulated; flesh dark reddish orange, with a rich sugary juice; weight, from 2lbs. to 5lbs.

1335. *Melons with green flesh.*

Franklyn's Green-flesh. Roundish, sometimes a little netted, skin greenish-yellow when ripe, flesh exceedingly tender and rich; weight from 3lbs. to 4lbs. One of the best melons for a general crop. *Bailey's Green-flesh* is an improved variety of this kind.

Improved Green-flesh. Roundish, not ribbed like most of the other kinds of green-flesh; slightly netted, skin thin, and pale yellow when ripe; flesh thick, green, and of exquisite flavour; weight, from 4lbs. to 5lbs. A good bearer, and one of the best of cantaloup melons.

Beechwood. Oval, greenish yellow, netted; flesh pale-green, rich and sugary; a good bearer, and one of the very best.

1336. *Persian Melons.*

Keising Melon. Egg-shaped, about eight inches long by five inches wide in the middle; colour, pale yellow, netted all over; flesh nearly white, high-flavoured, and texture like that of a ripe Beurré pear.

Large Germek Melon. Shaped like a depressed sphere; usually six inches deep, and varying from seven inches to nine inches in breadth; skin sea-green, and closely netted; flesh green, becoming paler toward the middle, firm, juicy, rich, and high-flavoured; weight from 5lbs. to 6lbs.; ripens early, and a good bearer.

Green Hoosainee Melon. Egg-shaped; five inches long by four inches broad; skin light-green, netted; flesh pale greenish-white, tender, full of pleasant, sweet juice. Hardy, and a great bearer.

Persian Pine-apple Melon. Ovate, netted; skin of a deep colour when ripe; flesh granulated, the juice not so luscious as in some other varieties; weight about 3lbs. A handsome variety.

Sweet Ispahan. Fruit ovate, from eight inches to twelve inches long; skin nearly smooth, of a deep sulphur colour; flesh white, extending about half way to its centre, crisp, sugary, and very rich; weight 5lbs. to 6lbs.

1337. *Winter Melons.*

Winter Melons are but little cultivated in England, but they are common in the south of France and Spain, and annually imported by the fruiterers in the autumn. They are oval or oblong, netted, with white flesh, and a sugary flavour. The two best varieties are the Dampsha, and the Green Valencia. Both sorts have the valuable property of keeping till the winter months, if hung up by the stalks, or in nets, in a dry room.

1338. *Water Melons.*

The *Water Melon* is the *Cucúrbita citrúllus*, *L.* (*Pasteque*, *Fr.*; *Wassermelone*, *Ger.*; *Water-meloen*, *Dutch*; *Cocomero*, *Ital.*; and *Arbusi*, *Russ.*) is a trailing annual, producing a large, round, smooth, dark-green fruit, with dark seeds. It is full of watery juice, which is refreshing, but almost without flavour. It is much cultivated in Italy and other parts of the south of Europe, but very rarely in England. The foliage is very ornamental, and the shoots extend to a great length. The time for ripening melons to a high degree of perfection in Britain extends from about the middle of June to the middle or latter end of September. Ripened before or after these periods the flavour is inferior, for want of sun.

SUBSECT. IV.—*The Cucumber.*

1339. *The Cucumber*, *Cúcumis satívus L.* (*Concombre*, *Fr.*; *Gurke*, *Ger.*; *Komkommer*, *Dutch*; *Citriuolo*, *Ital.*; and *Pepino*, or *Cohombro*, *Span.*) is a trailing or climbing tendrilled annual, of which we have already given the history and culture, p. 494. The varieties in cultivation are continually changing, but those considered the best, at the present time, are the following:—

Syon House. Skin of a smooth and shining green, with few or no spines; usual length between eight inches and nine inches. Hardy, and a great bearer, and, according both to Duncan and Ayres, the best of all cucumbers for pot culture.

Hort's Early Frame. Skin of a deep green, with black spines; length

from eight inches to ten inches. A very early cucumber, and well adapted for winter forcing.

Duncan's Victoria. Skin deep green, set thickly with black spines; length from twenty-four inches to twenty-eight inches. Mr. Duncan, who raised this variety, has had fruit four inches long previous to the expansion of the bloom, and twenty-four inches long in nine days from the setting! He considers it one of the finest varieties of cucumber in existence.

Weedon's Cucumber is an excellent kind for early forcing, and is a good bearer; but, according to Ayres, it is neither long nor finely formed. *Allen's Victory of Suffolk* Mr. Ayres considers a splendid variety; he has grown it to the length of twenty-four inches in the open garden, and to thirty inches in pots. *Snow's Horticultural Prize* approximates to Mr. Ayres' criterion of a perfect cucumber the nearest of any he has yet met with. The *Small Russian* cucumber is considered the best for pickling, and the large white *Bonneuil* for stewing.

SUBJECT. V.—*The Pumpkin and Gourd.*

1340. *The Pumpkin, or more properly Pompion, and Gourd, Cucúrbita L.* (Courge, *Fr.*; Kürbis, *Ger.*; Kauwoerde, *Dutch*; Zucca, *Ital.*; Calabaza, *Span.*; and Albobaro, *Port.*) are trailing or climbing tendrilled annuals, natives of tropical climates, and long in cultivation, both in the old and new world, for their fruit. This, in some varieties, is used in a ripe state, and in others before it is fully grown, in soups, stews, pies, tarts, boiled or fried, and as a substitute for greens or spinach. In Hungary, sugar has been obtained from the gourd at the rate of 100 lbs. to between 2000 lbs. and 3000 lbs. of pumpkins; and an excellent edible oil is obtained there from the seeds, at the rate of 1 lb. of oil to 5 lbs. of seeds. The tender points of the shoots may in many cases be substituted for the fruit, or used as greens or spinach. The kinds in cultivation are very numerous, but the leading sorts are as follow:—

The Pumpkin, or Pompion, C. Pèpo, L. (Potiron, *Fr.*; Pfebekürbis, *Ger.*) Large, roundish, smooth, green striped or blotched with white. The oldest variety in cultivation in England; tender and excellent in an unripe state as a substitute for greens, and mixed with apples in pies, but not near so good when fully ripe.

Spanish Pumpkin., C. Pèpo var. L.; Potiron d' Espagne, *Fr.*; Spanische Pfebekürbis, *Ger.* Middle size, somewhat flattened; skin green, smooth, hard; flesh firm, and of an excellent flavour. Said to be greatly preferable to the preceding variety.

The Vegetable Marrow, C. ovifera, var. L.; Courge à la moëlle, *Fr.*; Markige Melonen-kürbis, *Ger.*; Succada, *Ital.* Under the middle size, oval, five inches to eight inches long; pale yellow; flesh tender till the fruit is ripe, when it becomes stringy. One of the best gourds in cultivation when used in a young state, and before the seeds begin to be matured. The sweet gourd of Brazil closely resembles this variety both in form and properties.

The Mammoth Gourd, syn. American Gourd, C. máxima, Pèpo, Dec.; Potiron jaune, *Fr.*; and Melonen-kürbis, *Ger.* Very large, sometimes weighing 100 lbs., and one has been grown of the enormous weight of 245 lbs., at Luscombe, in Devonshire; round; skin yellow; flesh deep yellow, solid. Used as a substitute for turnips, carrots, &c., in soups and broths, and for potatoes and other vegetables, with meat. It is only used when ripe, and in that state will keep several months, even though a portion should be cut

off for use every day. The Harrison pumpkin is a new American variety of the Mammoth, supposed to be the most productive known.

The Squash-melon pumpkin, or bush gourd, C. Melópepo, L.; Cource melonée, *Fr.*; Melonen-kürbis, *Ger.* Middle size; round; skin yellow when ripe. Chiefly used in a green state when of the size of a hen's egg. Much cultivated in America as food, for men, cattle, and swine. The early orange squash is mentioned by Kenrick (*American Orchardist*, 1841. p. 370), as a new summer variety; very early, and of superior quality. The Canada crook-neck, he says, is, without doubt, superior to any and all others for a late or main crop: the fruit, in a dry and mild temperature, will keep till the following summer. The seeds of these two varieties, we believe, may be obtained of Mr. Charlwood.

The Turban pumpkin, or Turk's-cap, C. Pèpo, var. clypeàta, L.; Geramon turban, or Patisson, *Fr.*; Pastenkürbis, *Ger.*; and Zucca Gerusalemme, *Ital.*; the warted gourd, *C. verrucòsa, L.*; the orange gourd, *C. aurántia, L.*; the bottle gourd, or false calabash, *C. Lagenària, L.*, *Lagenària vulgàris, var. turbinàta, Ser.*; and various other sorts to be found in nursery-men's catalogues,—are cultivated chiefly as ornamental fruits. The fruit of the orange gourd is bitter; and that of the bottle gourd is said by Dr. Royle (*Botany of the Himalayas, &c.*, vol. i., p. 219) to be poisonous. The bottle gourd is at first long and cylindrical, like a cucumber, but as it ripens, it swells chiefly at the upper end, thus acquiring the form of a Venetian bottle. After being gathered, the end of the neck where it was attached to the plant is cut off, the pulp and seeds carefully taken out, and the interior repeatedly washed, so as to remove the bitter principle which constitutes the poison.

1341. *Culture.* All the sorts are propagated exclusively by seeds, which, being large, require to be covered with nearly an inch of soil. They may be sown in April, in a hotbed, under glass, or in a stove, to raise plants for transferring to the open garden, at the end of May, under a warm aspect; or for planting out in the middle of May, on a ridge of hot dung, under a hand-glass or half-shelter: otherwise sow, at the beginning of May, under a hand-glass, without bottom heat, for transplanting into a favourable situation; or sow three weeks later (after the 20th) at once in the open garden, under a south wall, for the plants to remain. The smaller-fruited kinds do best trained to an upright pole or trellis. From time to time earth up the stems of the plants. As the runners extend five feet or more, peg down at a joint, and they will take root. Water copiously whenever warm weather without showers makes the ground arid; and thin out the shoots where they are crowded. With those kinds the fruit of which is gathered green, by no means allow any to ripen, because that would stop the production of young fruit; and where the fruit is to be used ripe, or where it is allowed to ripen for the production of seed, do not allow more than one, if the kind is large, or two or three, if it is middle-sized or small, to ripen on a plant. Where the walks of a garden are covered with wire trellis-work, of the kind indicated in figs. 124 and 125 in p. 186, they may be covered with the smaller-fruited species, and even with cucumbers and water-melons during summer when shade is desirable for the walk; while, in winter, the trellis will be left naked to admit the sun and air to dry the gravel or flag-stone. Nine different modes of dressing the tops and fruit of gourds are given by an eminent French cook in *G. M.* vol. viii. p. 184.

SUBJECT. VI.—*The Tomato, the Egg-plant, and the Capsicum.*

1342. *The tomato*, or love-apple, *Lycopersicum esculéntum*, *Dunal*, (*Tomate*, *Fr.*; *Liebes Apfel*, *Ger.*; *Appeltjes der liefde*, *Dutch*; *Pomo d'oro*, *Ital.*; and *Tomates*, *Span.*), is a trailing annual, a native of South America, which, when raised in a hot-bed, and afterwards planted against a wall in the open air, will ripen its fruit in England. The fruit, which is an irregular red or yellow berry from one inch to four inches in diameter, is never eaten raw, but when ripe is used in soups and sauces, and for other purposes in confectionery and cookery; and in a green state it is pickled. The juice is made into a sauce, which is considered excellent both for meat and fish. Various recipes for making this sauce will be found in *G. M.* vol. i. p. 353; and vol. vii. p. 698. The best variety is the large red-fruited. The seeds may be sown in a hotbed in March, and transplanted once or twice into pots, so as to be ready to transfer to the base of a south wall, or any other situation where it will enjoy the full influence of reflected sun heat, about the middle or end of May, according to the situation and the season. The vacant space between fruit-trees will answer for this purpose; or a temporary wall of boards, five feet high, may be erected; or, in warm situations, they may be trained on a steep bank, raised artificially to an angle of 45°, and covered with flat tiles. The plants have a very beautiful effect on an espalier; but they only ripen their fruit there in the warmest summers. The fruit will be increased in size, and its maturity accelerated, by stopping every shoot after it has produced one cluster of fruit, and by judiciously thinning the leaves. The fruit ripens between August and October, and if hung up in a dry airy part of the summer fruit-room, it will continue fit for use till the end of November. One ripe fruit reserved for seed will contain enough for any garden whatever: cleanse the seeds from the pulp, dry them thoroughly, and preserve them in paper till next spring.

1343. *The Egg plant*, Mad Apple, or Jew's Apple, *Solanum Melongèna L.* (*Melongène*, *Fr.*; *Tollapfel*, *Ger.* and *Dutch*; and *Melanzana*, *Ital.*), is an erect branchy annual, a native of Africa, and cultivated in British gardens for its fruit, partly as an ornament, and partly for its uses in cookery. The plant grows about two feet high; the fruit is oval, and about the size of a hen's egg, or larger when cultivated with extraordinary care. There are two varieties, *S. m. ovigerum*, *Poule pondeuse*, ou *Plante aux œufs*, *Fr.* in which the leaves are without thorns; and *S. m. esculéntum*, in which there are prickles on the stem leaves and calyx. The fruit of the first variety is white and shining, and, though used in Spain and Italy, is not considered so wholesome as that of the other. Of it there are varieties with the fruit, large, small, round, oval, all of a dirty violet colour, which are used in great quantities in Paris. It is divided lengthways, and fried in oil with pepper, salt, and the crumbs of toasted bread, and in various other ways which are detailed at length in French cookery books. In the garden the plant receives the same treatment as the tomato, though it requires a greater degree of heat to ripen it, and should therefore always be trained against a south wall. The fruit hung up will keep through the winter, and therefore the seed need not be taken out till wanted for sowing.

1344. *The Capsicum*, or *Bird Pepper*, *Cápsicum L.* (*Piment*, *Fr.*; *Spanischer Pfeffer*, *Ger.*; *Spaanshe peper*, *Dutch*; and *Peberone*, *Ital.*)

There are three or more species in cultivation for their fruit, natives of tropical climates; the annual capsicum, the Spanish, or Guinea pepper, *C. ánnuum L.*, a native of South America, growing in our stoves about two feet high, and producing pods, long or short, round, long, or cherry-shaped, and red or yellow, in the autumn of the same year in which the seed is sown; the bell pepper, *C. gróssum, W.*, a biennial, a native of India, producing large red or yellow berries, which remain on through the winter; the bird pepper, *C. baccátum L.*, and the chilies or cayenne pepper, *C. frutésceus, L.* To these the French have lately added another variety, the tomato capsicum, Piment tomate, *Fr.*, the fruit of which is round, yellow, furrowed, twisted like the tomato, and in a green state so mild as to be eaten sliced in salad. This is also the case with the bullock's-heart variety of the common capsicum, the *C. cordifórme* of Miller. In the native countries of these plants there are numerous varieties which are cultivated for using green, and for pickling, and for making the well-known cayenne pepper, which is much employed in curries and other preparations. In Britain they are used chiefly for the two former purposes, and for putting into vinegar, which from the fruit being in some places called chilies, is called Chili vinegar. Medicinally, a small portion of the fruit put into a carious tooth is said to give instant relief, and Chili vinegar mixed with barley water forms an excellent gargle. It is also, from its pungent and digestive properties, the most suitable condiment to all kinds of fish. The ripe fruit ground into powder, as cayenne pepper, is in great request as a condiment in every part of the world, and more especially in hot countries: both in a green and ripe state, it is much used as seasoning, and in the preparation of pickles, and it also forms an excellent pickle of itself. Fresh gathered in a green state, pickled, ripe, or as cayenne pepper, taken during dinner, it prevents flatulency and assists digestion. When ripe, it may be preserved on the plant for several years by hanging it up in a dry and moderately warm room. In some families the green fruit is supplied daily throughout the year, from plants kept in the pine-stove.

1345. *Culture of the capsicum.*—The seeds should be sown in March on a hotbed, and transplanted from one pot into another till the middle of June, when in warm parts of the country, the annual sorts may be transferred to a warm situation in the open garden, where they will at least produce fruit fit for pickling; and if trained against a south wall, it will ripen in many situations when the summer proves warm. In less favourable circumstances the plants should be kept in pots and under glass, either in a frame or pit, or in a greenhouse. In this state they will ripen their fruit, which will remain on the annual plants great part of the winter; and that of the biennial and frutescent kinds may be kept in the greenhouse in a fruit-bearing state for two or three years. The market-gardeners about London, who raise immense quantities of capsicums for pickling, transplant first on heat, three inches or four inches apart, and in June plant out in rows, a foot apart and six inches distant in the row. The fruit is gathered and sent to the market as soon as it has attained the proper size; and not being then above half that of the ripe fruit, an immense quantity of pods is produced during August and September. A single ripe pod will produce enough of seed for a small garden, and it need not be separated from it till wanted for sowing.

SUBJECT. VII.—*The Orange Family.*

1346. *The Orange family*, Citrus, *L.*, includes the sweet orange, bitter orange, bergamot orange, lime, shaddock, sweet lemon, true lemon, and citron. It is very doubtful how far the orange was known to the Romans, though the citron is said to have been cultivated by Palladius in the second century; and it is generally thought that the golden apples of the Hesperides either were, or bore some allusion to this fruit. One or more of the varieties have been in cultivation as ornamental trees in the royal orangeries of France since the commencement of the fifteenth century, and in the open air in the warmest part of the south of Europe for its fruit, for at least three centuries. In Britain, at the present time, the different species and varieties are cultivated under glass chiefly as ornamental trees, but in part also for their fruit, which from some gardens is sent regularly to table throughout the greater part of the year. We shall arrange the different kinds after the *Histoire Naturelle des Orangers* of Messrs. Risso and Poiteau, as given by the latter author in the *Bon Jardinier* for 1842.

1347. *The common orange* is the *C. Aurantium*, *L.* Oranger, *Fr.*; Pomeranze, *Ger.*; Oranje appel, *Dutch*; Arancio, *Ital.*; and Naranja, *Span.* In the year 1500, there was only one orange-tree in France, which had been sown in 1421, at Pampeluna, then the capital of the kingdom of Navarre. After having been taken from Pampeluna to Chantilly, and from Chantilly to Fontainebleau, it was, in 1684, taken to the orangery at Versailles, where it still remains, holding the first rank among the numerous trees there for its shape and beauty, under the name of the Grand Bourbon, François I., &c. From the establishment of the orangery at Versailles, the taste for orange-trees spread extensively in France, till about the middle of the eighteenth century, when it began to give way to a taste for more rare exotics. The oldest orange-trees in England were planted at Beddington, in Surrey, about the end of the sixteenth century, and here as in France it was the most popular tree, till it was supplanted by a taste for plants of other countries, and more especially the plants of the Cape. At present the taste for the orange tribe is reviving, both in France and England. The uses of the fruit of the orange in the dessert, in confectionery, and in medicine, and its flowers in perfumery, are universally known. The more remarkable varieties of the orange are the following: the China, (*Arancino*, *Ital.*), pear-shaped, Nice, tiny-fruited, fingered, blood-red, ribbed, sweet-skinned, Mandarin, and St. Michael's. The last two are by far the best worth cultivating for their fruit. X The *Mandarin* orange, *C. nobilis*, *H. K.*, is small, oblate, with a thin rind, which separates of itself from the pulp, so much so, that when fully ripe the latter may be shaken about in the inside like the kernels of some nuts. It is originally from China, but is now cultivated in Malta. The flesh is of a deep orange colour, and its juice and flavour superior to those of most varieties. The *St. Michael's* orange is also small, but the skin instead of being of an orange colour like that of the Mandarin, is of a pale yellow; the fruit is generally without seed, the rind thin, and the pulp extremely sweet. It is the most delicious of all the oranges, and the tree is a great bearer. It is in general cultivation in the Azores, from which it is shipped in large quantities. The *Tangerine* orange is strongly recommended by some.

1348. *Bigarade*, *Seville*, or *bitter orange*, *C. Bigaradia*, *Poit.*, Bigara-

dier, *Fr.*; Melangolo, *Ital.*, has-elliptic leaves, with a winged stalk, very white flowers, and middle-sized, globose, deep-yellow fruit, the pulp bitter and acid. This is the hardiest variety of the orange, and that which has the largest and most fragrant flowers, which are produced in great abundance. The fruit is chiefly used in making marmalade. The tree is that chiefly grown by the French gardeners for its flowers, to gather for nosegays. The varieties are the horned, the female, the curled-leaved, the purple, the double flowered, the Seville, the myrtle-leaved, and the Bizarre. The *Curled-leaved Bigarade*, le Bouquetier, *Fr.*, Melangolo riccio, *Ital.* has small curled leaves, and thick clusters of flowers at the ends of the branches; the plant is very hardy, and it is that most generally cultivated in French gardens for its flowers, and in Italy and Spain, for both its flowers and its fruit. The *double-flowered Bigarade* is prized on account of its fragrant double flowers, which last longer than those which are single. The plant requires a very rich soil. The *Seville Bigarade*, or Seville orange of the shops, has round dark fruit, with an extremely bitter rind. It is imported from Spain, and used for marmalades, bitter tinctures, candied orange-peel, and for flavouring Curaçoa. The *myrtle-leaved Bigarade*, is said to be employed by the Chinese gardeners as an edging to flower beds, in the same way as box is in this country. The *Bizarre Bigarade* is a *lusus naturæ*, with deformed leaves, purplish or white flowers, and fruit half Bigarades, and half lemons, or citrons, some having the pulp sweet, and others having it acid and bitter.

1349. *The Bergamot orange*, *C. Bergàmia*, *Poit.*, has small flowers, and pear-shaped fruit, the whole plant having a peculiar fragrance, much valued by the perfumer, who obtains from the flowers and rind of the fruit his bergamot essences. The rind, first dried and then moistened, is pressed in moulds into small boxes for holding sweetmeats, to which they communicate a bergamot flavour. There are several varieties of this species in the Genoese nurseries.

1350. *The Lime*, *C. Limétta*, *Poit.* (*Limettier*, *Fr.*), has obovate leaves on a wingless stalk, small white flowers, and roundish pale-yellow fruit with a nipple-like termination. The leaves and general habit of the plant resemble those of the lemon; but the acid of the pulp of the fruit, instead of being sharp and powerful, is flat and slightly bitter. It is principally used in flavouring punch and in confectionery. Among the varieties are the Pomo d'Adamo, in which Adam is supposed to have left the marks of his teeth.

1351. *The Shaddock*, *C. decumàna*, *W.* (*Pampelmous*, *Fr.*; *Pumpelmuss*, *Ger.*; *Pumpelmoes*, *Dutch*; and *Arancio massimo*, *Ital.*) The leaves are large and winged, and the flowers and fruit very large and roundish; the skin of the fruit is yellow, and the rind white and spongy; the pulp is juicy and sweetish. The plant forms an excellent stock for grafting other kinds upon. The fruit makes a splendid show at table, and is found cooling and refreshing. It has been grown successfully on the open wall in some gardens in Devonshire, with the protection of glass and mats during the winter months, but without artificial heat. M. Poiteau considers the "forbidden fruit" of the shops to be a variety of this species, but others make it a variety of the lemon.

1352. *The sweet Lemon*, *C. Lùmia*, *Poit.* (*Lumie*, *Fr.*) The fruit has the leaves, the rind, and the flesh of a lemon, but with a sweet pulp. There are many varieties in Italy, but very few are cultivated either in France or

England. The flowers differ from those of the lime in being red externally.

1353. *The true Lemon*, *C. Limonium*, *Poit.* (*C. Médica*, var. *Limon*, *W.*; *Limonier* or *Citronnier*, *Fr.*; *Limonier*, *Ger.*; *Citroen*, *Dutch*; *Limone*, *Ital.*; and *Limon*, *Span.*) Leaves ovate-oblong, pale-green with a winged stalk, flowers red externally, fruit pale-yellow, with a juicy and very acid pulp. Unlike the other kinds of citrons, the lemon on the Continent is generally raised from seed, and hence the great difference in quality of the fruit obtained in the shops.

1354. *The Citron*, *C. Médica*, *L.* (*Cidratier*, *Fr.*; *Citronier*, *Ger.*; *Limoen*, *Dutch*; *Cedro* or *Cedrato*, *Ital.*; and *Limon*, *Span.*) Leaves oblong, flowers purple externally, and fruit yellow, large, warted, and furrowed; rind spongy and thick, very fragrant; pulp subacid. Supposed to be the Median or Persian apple of the Greeks. As an ornamental tree, it is one of the best of the genus *Citrus*. A delicate sweetmeat is prepared from the rind of the fruit, and the juice with sugar and water forms lemonade, and is used to flavour punch and negus, like that of the lemon. The Madras citron is the largest and best variety, and has been grown to an enormous size, both in England and Scotland.

1355. *Propagation and Culture*.—All the kinds will root by cuttings, either of the young wood partially ripened, planted in sand in spring, and covered with a bell-glass; or of ripe wood put in in autumn, kept cool through the winter, and placed on heat when they begin to grow in the spring. Grafting and budding, however, are the usual and the best modes of propagation, and the stocks may either be raised from seeds or cuttings: citron and shaddock stocks are esteemed the strongest, and those of the Seville orange the hardiest. For ornament the plants are generally grown in pots or boxes (see 423 and 424); but for fruit and also for ornament, when the luxuriance of the tree is an object, they will thrive best when planted in the free soil in a house devoted to them; or against a flued or conservative wall, to be covered with glass in the winter season. At Beddington they were planted against a wall, and protected by a temporary structure; and in the Duke of Argyle's garden at Whitton, where Miller informs us the citron was grown as large and as perfectly ripe as it is in Italy or Spain, the trees were trained against a south wall, flued, over which glass covers were put when the weather began to be cold. The finest oranges and lemons in Paris, some years ago, were grown by M. Fion against a wall like peach-trees; and in Devonshire, at Combe Royal, Luscombe, Butleigh, and other places, all the kinds are grown against the open garden walls, and protected during winter, not by glass, but by wooden shutters. In the south of Devonshire, at Luscombe, orange-trees have withstood the winter in the open air upwards of a hundred years, and produced fruit as large and fine as any from Portugal (see *G. M.* ii. p. 29, vi. p. 704, x. p. 36). All the kinds of *Citrus* require a loamy soil, richly manured, well drained at bottom, and rendered on the surface pervious to water, by the soil being unsifted and mixed with fragments of freestone. When grown in pots or boxes a richer soil, better drained, is required than when the trees are planted in a border. Being evergreens, and the sap in consequence circulating during the winter (718), the soil, even in mid-winter, ought never to be allowed to become so dry as might be the case were the trees deciduous. When any of the sorts are grown for their fruit for the table,

much the best mode is to grow them against a wall or trellis, either under glass throughout the year, or against a wall to which sashes can be fitted during the winter months. They may also be grown as standards in a span-roofed house placed in the direction of north and south; and if the situation is warm and sheltered, the roof and sides of such a house may be entirely removed in the summer season, and the ground turfed over, so as to give the trees the appearance of standing on a lawn. Tall standard trees for this purpose may be obtained from Genoa through the Italian warehouses. The standard winter temperature for the orange is 48° with fire heat; but as the season advances it may be 15° or 20° higher; and in summer it may vary between 60° and 80° . The roots should never be kept in a temperature so low as 40° ; at 45° a gentle circulation will be maintained, sufficient to prevent the roots from perishing, as they very frequently do when, internally, the juices of the plant are stagnant, and externally these are surrounded by stagnant water, the consequence of imperfect drainage. As all the Citrus tribe grow naturally in woods, and many of them in islands near the sea, a situation somewhat shaded is preferable to one fully exposed to the sun; and a very high temperature during summer is less essential than the continuation of a moderate degree of heat during winter. Orange-trees will bear exposure to the sun if previously in good health; but in all cases it would be advisable to place a thin canvas screen between them and the rays of the sun when the plants are first set out in summer, and especially when they are trained against a wall. With regard to such plants as are required to be brought into a flowering state, exposure to direct solar light will expedite such condition. In the management of orange-trees in large boxes and tubs, great care is requisite to ascertain that the water reaches the roots of the plants; for the balls of soil are generally so firm and compact that the water will not penetrate them, but passes off between the ball and the sides of the box. The compactness of the ball is owing to the system formerly practised by gardeners of sifting to a fine mould all the soil which they used in potting. By the present mode of using, in every case, comparatively rough, turfy soil, more or less mixed with fragments of stone, balls so compact as not to admit water poured on their surface can hardly occur. When orange-trees in boxes are placed in the open air in the summer season, the situation ought always to be thoroughly sheltered and partially shaded, more especially, as above observed, when the trees are first exposed, otherwise the leaves will soon lose their deep green. Hence it is that orange-trees thrive better in greenhouses with opaque roofs, even when not taken out in the summer time, as used to be the case at Cashiobury, than any other tree, not even excepting the camellia.

SUBJECT. VIII.—*The Guava, Lo-quat, Granadilla, and other fruits little known in British gardens.*

1356. *The Guava, Psidium L.*—There are several species, but that which has been found to succeed best in British stoves is Cattley's Guava, *P. Cattleyanum, Lindl.*, an evergreen shrub or low tree, a native of China, which produces abundance of fruit, about the size of gooseberries, of a purple colour, juicy, and flavoured somewhat like the strawberry. It fruits very well in a large pot in loamy soil, in a light airy situation, and the fruit ripens in autumn, or in the winter season. On the back of the conservatory at Worksop, it ripens two or three dishes weekly all through the winter, and

the fruit is preferred to any other for the dessert. When well ripened, the berries become as black as sloes, and are really delicious, resembling a strawberry in flavour.—*Proceedings of H. S.*, vol. i., p. 200.

1357. *The Lo-quat* or Japan Quince, *Eriobótrya japónica*, *Lindl.*, is an evergreen tree from Japan, of which there are some varieties that will stand the open air against a wall; but to ripen fruit they require the heat of the peach-house in summer, and of the green-house in winter. Independently of its fruit this is one of the handsomest trees for a conservative wall, on account of its fine large foliage.

1358. *The Granadilla*, *Passiflora L.* There are five species of this genus, the fruit of which may be eaten, viz.: the granadilla vine, *P. quadrangulàris L.*; the apple-fruited granadilla, or sweet calabash, *P. malifórmis L.*; the laurel-leaved granadilla, or water lemon, *P. laurifólia L.*; the flesh-coloured granadilla, *P. incarnàta L.*; and the purple granadilla, *P. édulis*. The latter will ripen its fruit in a green-house, but the others require a stove. They are all twining shrubs, natives of South America or the West Indies, and require abundance of room, and to be trained close to the glass in the stove, excepting the *P. édulis*, which may be trained under the rafter of a greenhouse.

1359. *The Indian Fig*, or prickly pear, *Opúntia vulgàris Haw.*, is a native of Barbary, naturalised in the South of Italy, and cultivated in Virginia. The fruit is of a purplish red, with an agreeable subacid flavour. It was cultivated by Justice, near Edinburgh, in 1750, and by Braddick in the open air, in the neighbourhood of London, in 1820. It requires a dry soil, and the protection of glass to ripen its fruit properly; but it would produce abundantly in a pit in a layer of soil on a bed of stones, which admitted of being occasionally heated by a flue.

1360. *The Pawpaw*, *Cárica Papàya, L.*, is a cucurbitaceous tree, a native of the East Indies, of rapid growth in our stoves, and soon producing a very showy fruit, larger than a lemon, and agreeable to the taste. It has been ripened and sent to table for several years at Ripley Castle (*G. M.* 1838, p. 432.)

All the above fruits, and some of those which follow, have been ripened under glass in Britain, and sent to table; more especially Cattley's Guava, which is cultivated in many gardens.

1361. *The Olive*, *Òlea europàea L.* is a branchy low evergreen tree which requires the protection of a greenhouse, and might be cultivated for the sake of its fruit for pickling.

1362. *Other exotic fruits* which might be cultivated by the amateur, or which may be included in a select collection of stove plants, are as follow: *The Great Indian Fig*, *Opúntia Tùna*; *the Barbadoes Gooseberry*, *Peréskia aculeàta*; *the Strawberry Pear*, *Cèrus triangulàris*; *the Akee Tree*, *Blìghia sápicà*; *the Alligator Pear*, or *Avocado Pear*, *Laúrus Pérsea*; *the Anchovy Pear*, *Griàs cauliflòra*; *the Durion*, *Dùrio zebethinus*; *the Jamrosade Apple*, or *rose-apple*, *Eugènia Jámbos*; *the Malay Apple*, *E. malaccénsis*; *the Bastard Guava*, *E. Pseudò-Psídium*; *the Cayenne Cherry*, *E. cotinifolia*; *the Cherimoyer*, *Anòna Cherimòlia*; *the Custard Apple*, *A. reticulàta*; *the Alligator Apple*, *A. palústris*; *the Sweetsop*, *A. squamòsa*; *the Soursoop*, *A. muricàta*; *the Mammee apple*, *Mammèa americàna*; *the Lee-chee*, *Euphòria Litchi*; *the Long-yen*, *E. Longàna*; *the Mango Tree*, *Mangífera índica*; *the Mangosteen*,—or *Mangustin*, *Garcínia Mangostàna*; *the Cocoa-nut*, *Còcos*

nucifera ; the *Bread-fruit*, *Artocarpus incisa* ; the *Chinese Lemon*, *Triphasia aurantiola* ; the *True Lotus*, *Zizyphus Lotus* ; the *Jujube Tree*, *Z. Jujuba* ; the *Kaki*, *Diospyros Kaki*. The last four will fruit in a greenhouse. To these various others might be added from the last edition of the *Encyclopædia of Gardening*, and from the 1st edition of the Horticultural Society's *Catalogue of Fruits*.

SUBJECT. IX.—*Remarks applicable to Fruit-trees, and Fruit-bearing Plants generally.*

1363. Standard fruit-trees occasion less trouble in managing, and are more certain in bearing, than either wall-trees or espaliers ; though there are some trees, as the peach, which are too tender for being grown as standards, and others, as the vine, which are unsuitable. In standard trees, the top will generally be adjusted to the root naturally, and hence in such trees very little pruning will become requisite beyond that of thinning out crossing or crowded branches ; but, in wall and espalier trees, as the top is disproportionately small to the roots, pruning, or disbudding, &c., as a substitute, becomes necessary during the whole period of their existence. The nearest approach which a wall-tree can be made to have to a standard, is when in the case of north and south walls, one half of the branches are trained on the east side of the wall, and the other half on the west side ; or when one tree is made to cover both sides of a double (899) espalier. Pruning may be rendered almost unnecessary by disbudding, disleafing, and stopping ; but this will not always be the best course to pursue. When the root of a wall-tree is to be strengthened, more shoots should be left than are required for being laid in at the winter pruning ; and when the root is to be weakened, all or a part of the shoots produced may be left, but they must be disleafed or stopped as fast as they advance in growth (772) ; or the stem may be ringed (770) ; or the young shoots twisted or broken down (774) ; or the roots pruned (776).

Keeping roots near the surface, and encouraging the production of surface roots, will have a tendency to moderate the production of wood ; and deep planting and stirring the surface to one foot or more in depth, will throw the roots down to a moister stratum, and encourage the production of wood, but of an inferior quality for the future production of fruit. Dry sandy soil, not rich, will produce moderate growth and precocity, both in the fruit and the ripening of the wood, and rich deep soil the contrary ; hence dry soil, comparatively poor, ought to be preferred for cold late situations, in which it is always desirable to ripen early both the fruit and the wood. By depriving a tree or a plant of its first crop of buds, a second crop will be produced the same season, but some weeks later ; and on this principle late crops of leaves may be produced on all plants, and of fruit on all such trees and plants as have the power of forming blossom-buds, and expanding them in the course of one season ; as, for example, the raspberry, strawberry, grape, and all annual and biennial fruit-bearing plants whatever. As all plants require a certain period of rest, by bringing on this period sooner in autumn, by disleafing and depriving the roots of moisture by thatching the ground over them, they will be predisposed to vegetate sooner in spring. Hence the advantage of pruning all trees, the young wood of which is not liable to be injured by frost, immediately after the fall of the leaf. All wood that is not thoroughly ripened should be protected during winter by branches, fern,

hay, netting (1320), or some other means ; but as this is only applicable to wall trees, the soil for all others should be so adjusted to the climate as to ensure their wood ripening in the open garden or orchard. As the most exhausting part of every fruit is the seed, and as the number of seeds in every fruit is limited by nature, it follows that a few fruit grown to a large size will be less injurious to a plant than the same weight of fruit produced in fruits of small size. As in plants in a state of seed-bearing, the chief energies of the plant are directed to the nourishment of the seed, so in those fruit-bearing plants in which the fruit is gathered green, such as cucumbers, gourds, capsicums, peas, beans, kidney-beans, &c. ; none of the fruit should be allowed to mature any seed, so long as any of it is gathered in an unripe state. Hence the immense importance of thinning out the blossom-buds of trees before they expand, and thinning out the fruit before the embryo of the seed begins to assume that stage which in berries and pomes is called setting, and in nuts and stone fruit, stoning. When a fruit is once set or stoned, if the embryo of the seed be destroyed by the deposition in it of the eggs of an insect, or the puncture of a needle, the fruit, if it does not fall off, will ripen earlier, but will be in most cases of inferior flavour. The same result will take place to a limited extent even with leaves, when they are punctured.

Any check given to the head of a tree, such as disleafing, the attacks of insects, disease, overbearing, &c., has a tendency to cause the plant to throw up suckers, if it is natural to the root or stock to do so. As the leaves produced at the base of a young shoot are small and generally soon drop off, so the buds in the axils of such leaves are never blossom-buds till they have become invigorated by at least another year's growth ; and hence when young wood is shortened, if blossom is the immediate object it ought not to be cut farther back than to the first large bud. This is particularly applicable in the case of vines, roses, &c. In shortening such wood on spur-bearing trees, such as the apple and pear, only one or two of the imperfect buds are left at the base of the shoot (see p. 539, *Winter Pruning*), and these the following year generally become blossom-buds, if the tree is neither too weak nor too luxuriant. In general, winter pruning a young tree retards the period of its fruit-bearing, but greatly increases the vigour of the tree ; hence delicate trees, such as the peach, require more pruning than very hardy trees, such as the apple and plum.

“Summer pruning effects various objects : it exposes the fruit, where it exists, and also the embryo fruit-buds, and leaves connected with them, to the beneficial influence of light, air, and dews. This is effected by removing those portions of shoots which as they advance would more and more shade the lower parts and prevent them in a great measure from deriving advantage from the above important agencies as regards vegetation ; these may be termed mechanical effects. Physiologically considered, the progress of the sap is limited by summer pruning, and is directed towards the leaves and buds on the lower parts of shoots, which are in consequence invigorated, more especially as their free exposure to light, &c., enables them better to elaborate this increased supply. But although the foliage so left to act is increased in size and efficiency, yet the agency of this portion in producing roots is notwithstanding less powerful than the whole mass would be if the shoots were allowed to grow wild throughout the summer ; for in proportion to the mass of healthy foliage so is the increase of roots. Hence

excessive vigour is moderated by summer pruning, and this in a greater or less degree according to the time and manner of performing the operation. The longer the operation is deferred, and the less the portion cut off from the shoots, the greater will be the strength which the roots will derive; and the earlier and shorter the shoots are cut, the less will be the quantity of foliage, and proportionally so the quantity of roots. Therefore, if a tree is too vigorous, summer pruning should commence by disbudding such shoots as they appear, as are not at all wanted to be retained for wood or spurs; and as soon as the shoots intended to produce fruit, spurs, or buds at their base have become furnished with five buds, the extremity may be pinched off. As many as five buds are mentioned, because fewer does not complete one turn of the spiral, which may be traced by following the arrangement of the buds on a shoot of such fruit-trees as are usually trained on walls. In the course of a fortnight the uppermost buds on the portion left will have commenced to push, and they must be allowed to go on for a longer or shorter time without stopping, according as there may be more or less danger of the buds at the base being also developed into shoots, instead of remaining in the character of a fruit-bud till next spring. If the roots, and, of course, the tree generally, require to be invigorated, the shoots will not be so numerous and may be allowed to extend till after Midsummer, and then only shortened for a little at first, in order that as much foliage as is consistent with the principles above explained may be left to act. It is a very prevalent but no less erroneous notion, that, in the case of an over-vigorous tree, as much wood should be retained, and as many shoots allowed to grow as is possible, in order that its vigour may be moderated by the expenditure. Those who hold this opinion may rest assured that the more a young tree grows, the more it is capable of growing; for growth is not a mere evolution of parts already formed, evolved by a determinate amount of expansive power. If ten buds give rise to a hundred others, these last have the power of originating, in the same ratio, one thousand, and so on, as long as force of sap towards new formations is undiminished." All shoots under half an inch in diameter, cut from the side of a stem before Midsummer, will generally heal over the same season. Terminal wounds made by shortening, will not heal over till a shoot has been produced, the base of which will cover the wound.

The fruit-bearing shoots of all trees, in a natural state, are chiefly such as are lateral, while the wood of the tree is chiefly increased by the vertical shoots; hence some modification of lateral training will, in almost every case, be found preferable to training vertically. Lateral roots are also those which contribute most to fruit-bearing wood; and tap or deep-growing roots to upright and barren wood. All restraint imposed on trees, whether by training, root-pruning, or ringing the branches, if not followed up by art, will speedily end in disfiguring the tree and rendering it unfruitful, till it has assumed its natural form and habit of growth; and if the tree should be of a species so tender as not to ripen fruit in its natural form as a standard, it will by assuming that form have become useless as a fruit tree. In the case of all trees in a state of culture, and more especially such as grow in soil the surface of which is heated more than that of the general surface of the locality, as is the case of a border exposed to the reverberation of the sun's rays in front of a south wall, artificial supplies of water are necessary at particular seasons, and water therefore must be considered as much an element of culture as manure. All the diseases of fruit

trees cannot be effectually prevented or cured by judicious culture, but most of them may; and all insects which live on the surface of trees, may be destroyed or subdued by abundant washings with clear water by the syringe or engine. All fruit-bearing plants (and indeed all others), grown in pots, ought to be potted in soil which has not been sifted, and which, if not sufficiently coarse to keep it so open as to receive water freely, should be mixed with fragments of wood, bones, and stone, for that purpose, for supplying manure, and for retaining moisture (749).

Most of the foregoing remarks were made when treating of particular trees, but we have thought it might be useful to the amateur and the young gardener here to recapitulate them.

CHAPTER V.

CATALOGUE OF CULINARY VEGETABLES.

1364. *The culinary vegetables usually cultivated in British gardens* are herbaceous plants, annuals, biennials, and perennials, with one or two suffruticose or shrubby plants. We shall first arrange them systematically, and next class them jointly according to their culture in the garden, and their uses in the kitchen. In the following arrangement, the names, which are in italics, indicate kinds which are not at all, or not much in cultivation at present, but which, for the greater part, have formerly been in use in England, and still continue to be so on the Continent, or in some other part of the world.

Ranunculàcæ. *Nigèlla sativa* L., the fennel-flower, formerly cultivated for its seeds as a substitute for pepper, and still grown for that purpose in France. There are very few plants in this order that are not poisonous.

Crucifera. *Nastúrtium* R. Br., the water cress; *Barbarèa* R. Br., the winter cress, and the American cress; *Cardámine* L., the meadow cress; *Peltària* L., the garlic cress; *Cochleària* Tou., the horse-radish, and the scurvy cress; *Thláspi* Dec., the penny cress and garlic cress; *Sisýmbrium* L., the hedge cress; *Alliària* Adan., the garlic cress; *Camelina barbarea-fòlia* Dec., the perennial cress; *Senebièra*, Poir., the wart cress; *Lepidium* L., the common cress; *Brássica* L., the cabbage, borecole, savoy, turnip, &c.; *Sinàpis* Tou., the mustard; *Moricándia* Dec., the cabbage mustard; *Erùca* Tou., the rocket cress; *Crámbe* Tou., the seakale; *Ráphanus* L., the radish; *Erucària* Gær., the Spanish mustard. The general properties of this order are, anti-scorbutic, stimulant and acrid, and there is scarcely any of the species the foliage of which may not be eaten; the seeds of all of them yield oil by expression.

Capparidàcæ. *Cápparis* L., the caper.

Caryophýlleæ. *Alsine* L., the chickweed, which in spring may be used as greens.

Malvàcæ. *Hibiscus esculéntus* L., the okro.

Tropæòleæ. *Tropæolum* L., the Indian cress, and the *Tropæolum* tuber. The plants of this order have the same properties as the *Crucifera*.

Oxalidàcæ. *Óxalis* L., the wood-sorrel, and *Óxalis Déppeï*, B. C.

the wood-sorrel tuber. The plants of this order are intensely acid: pure oxalic acid is found in *O. acetosélla*.

Rutàcææ. *Rùta Tou.*, the rue.

Leguminòsæ. *Melilòtus cærùlea L.*, the fragrant melilot for distillation; *Glycyrrhiza L.*, the liquorice; *Psoràlea L.*, the bread-root; *Cicer L.*, the chick-pea; *Fàba Dec.*, the bean; *Ervm L.*, the lentil; *Pisum L.*, the pea; *Làthyrys L.*, the Spanish lentil, and the tuberous *Lathyrus*; *Órobùs Tou.*, the tuberous bitter vetch; *Àpios Boer.*, the tuberous *Apios*; *Phasèolus L.*, the kidney-bean; *Sòja Moen.*, the soy-bean; *Dólìchos L.*, the Lubian bean; *Làblab Adan.*, the Lablab bean, and the Nankin bean; *Cajànus Dec.*, the pigeon pea; *Árachis L.*, the American earth-nut; *Cércis L.*, the Judas-tree. None of the leaves of any of the plants of this order are eaten by man; but the seeds of many of the species are farinaceous, the pods of some saccharine, as the sugar-pea, or nutritious as those of the kidney-bean; while the flowers of the Judas-tree have an agreeable acidity, and are used in salads. The seeds of a number of species, as of the laburnum, are poisonous.

Rosàcææ. *Sanguisórba L.*, the great burnet; *Potèrium L.*, the common burnet; *Potentilla anserina L.*, the silver weed.

Onagràcææ. *Ænothèra L.*, the tree-primrose, the roots of which are edible, abounding in mucilage, and the tops used in salads; *Epilòbium angustifòlium L.*, the willow herb, the tender shoots of which are eaten as asparagus, and the leaves as greens.

Hydrocharìdææ. *Tràpa L.*, the water chesnut.

Portulàcææ. *Portulàca L.*, the purslane; *Claytònia L.*, the American spinach.

Crassulàcææ. *Cotylèdon L.*, the navelwort spinach; *Sèdum àlbum L.*, the stone-crop salad.

Ficoìdææ. *Tetragònia L.*, the New Zealand spinach.

Umbellìferææ. *Àpium L.*, the celery; *Petroselinum Hofm.*, the parsley; *Càrum L.*, the caraway; *Bùnium L.*, the earth-nut; *Tràgium Spr.*, the anise; *Sium L.*, the skirret; *Ænánthe pimpinelloìdes Thuil.*, the tuberous-rooted dropwort; *Ligústicum L.*, the lovage; *Críthmum L.*, the samphire; *Angélica L.*, the angelica; *Anèthum L.*, the fennel; *Pastinàca L.*, the parsnep; *Cumìnum L.*, the cumin; *Daucus L.*, the carrot; *Chæròphýllum L.*, the chervil; *Mýrrhis L.*, the myrrh; *Smýrniùm L.*, Alexanders; *Coriàndrum L.*, the coriander. The leaves of most of the plants, with the exception of the parsley, samphire, the prangos, hay-plant, and perhaps a few others of this order, are unwholesome, and some of them are poisonous; but the seed or fruit is in no case dangerous. The stalks and stems of the celery, the roots of the skirret, the parsnip, and the tubers of *Ænánthe pimpinelloìdes*, are eatable; while the leaves and tubers of *Ænánthe crocàta* are poisonous.

Valerianàcææ. *Valerianèlla Dufr.*, Lamb's lettuce.

Compòsitææ. *Leóntodon L.*, the dandelion; *Picris L.*, the Ox-tongue; *Hypochàris L.*, the hawkweed; *Lactuca L.*, the lettuce; *Sónchus L.*, the sow-thistle; *Scorzònèra L.*, the scorzonera; *Picrídium Per.*, the salad Picridium; *Tragapògon L.*, the salsify; *Cichòrium L.*, the endive and succory; *Scòlymus L.*, the Scolymus root; *Àretium L.*, the Burdock; *Cýnara L.*, the artichoke and cardoon; *Cárthamus L.*, the saffron-flower; *Ínula L.*, the elecampane; *Tagètes L.*, the tarragon marigold; *Spilánthes L.*, the Para

cross, and the Brazil cress; *Heliánthus L.*, the Jerusalem artichoke; *Caléndula L.*, the pot marigold; *Balsamita Desf.*, the costmary; *Tanacétum L.*, the tansy; *Artemisia L.*, the tarragon, wormwood, &c.; *Ánthemis L.*, the chamomile; *Achillèa L.*, the tarragon milfoil. *Dáhlia Cav.*, the dahlia, for its petals to be used in salads. Most of the species of this order are wholesome, except some of the tribe *Cichoràcæ* in their wild state, such as *Lactuca viròsa L.*, which is narcotic, and which is cultivated about Edinburgh, for the production of opium.

Campanulàcæ. *Campanula L.*, and *Phyteuma L.*, the common, and the wild rampion.

Convolvulàcæ. *Ipomœa L.*, the sweet or Spanish potato.

Boragíneæ. *Borago L.*, the borage.

Solanàcæ. *Solanum L.*, the potato; and *Nicotiana L.*, the tobacco, which is grown by gardeners for the destruction of insects.

Labiàtæ. *Méntha L.*, the mint and peppermint; *Saturèja L.*, the savory; *Thýmus L.*, the thyme; *Origanum L.*, the marjoram; *Hyssòpus L.*, the hyssop; *Teucrium L.*, the germander; *Rosmarinus L.*, the rosemary; *Stachys L.*, the clown's allheal; *Marrubium L.*, the horehound; *Lavándula L.*, the lavender; *Melissa L.*, the balm; *Horminum L.*, the clary; *Melittis L.*, the bastard balm; *Sálvia L.*, the sage; *Ócymum L.*, the basil. All the plants of this order, without exception, are wholesome, and those used for culinary, confectionery, or perfumery purposes, are tonic, cordial, stomachic, or aromatic.

Plantagíneæ. *Plantago L.*, the star cress, formerly used in salad.

Amaranthàcæ. *Amarántus L.*, the Chinese spinach. The leaves of most of the species of this order may be used as pot-herbs.

Chenopodiàcæ. *Basélla L.*, the Malabar spinach; *Chenopodium L.*, the perennial spinach, the Quinoa, &c.; *Átriplex L.*, the garden orache, or French spinach; *Bèta L.*, the beet; *Spinacia L.*, the spinach; *Salicòrnia L.*, the marsh samphire. The leaves of many of the species may be used as pot-herbs, and the roots of the beet, and seed of the Quinoa are wholesome food, but the seed and fruit of some of the species are unwholesome.

Polygonàcæ. *Rùmex L.*, the common sorrel and Patience sorrel, *Rhèum L.*, the rhubarb. The leaves and shoots of the plants of this order are more or less acid. The leaf-stalks of the rhubarb are excellent in tarts; but the roots are nauseous and purgative, and the whole plant somewhat astringent.

Laurinæ. *Laúrus L.*, the Sweet Bay, for its leaves, which are used in flavouring confectionery.

Euphorbiàcæ. *Euphòrbia Láthyris L.*, the seeds of which are used as a substitute for capers.

Urticàcæ. *Hùmulus L.*, the hop; *Urtica L.*, the nettle.

Scitamíneæ. *Zíngiber L.*, the ginger.

Dioscoreàcæ. *Dioscòrea L.*, the yam; *Tàmus L.*, the black bryony.

Asphodèleæ. *Állium L.*, the onion, leek, garlic, shallot, &c.; *Aspáragus L.*, the asparagus; *Alstramèria pállida*, the Chili arrow-root.

Tulipàcæ. - *Lílium L.*, the Kamtschatka potato.

Melanthàcæ. *Veràtrum álbum L.*, the white hellebore. The powdered root is used for destroying insects.

Cyperàcæ. *Cypèrus L.*, the rush nut, a native of the South of Europe, and cultivated in the warmer parts of France, for the tubers, which are formed on its roots.

Gramineæ. *Zèa L.*, the Indian corn.

Fúngi. *Agáricus L.*, the mushroom; *Morchélla L.*, the morel; *Tùber L.*, the truffle.

It thus appears that the esculent vegetables which might be cultivated in British gardens belong to thirty-eight natural orders, and to above 140 genera; and the number might have been increased from *Gerard's Herbal*, and other old gardening or botanical books. All the species are either natives of Britain, or of analogous climates; or they admit of being brought to maturity, with only one or two exceptions, in the open garden, during the summer season. To know the natural order to which any culinary vegetable belongs, is useful in two points of view: first, it suggests the idea that all the other plants belonging to the same order are probably endowed more or less with the same properties, and may be treated in the same manner, and in cases of emergency used for the same purposes; and secondly, that as every plant draws from the soil, not only the nourishment common to plants in general, such as carbon, but some particular saline principle, such as phosphate of lime, &c., it suggests the propriety of not allowing plants of the same natural order to follow each other in the same rotation (917). For these reasons we might have adopted a botanical classification in treating of the different species and varieties; but for the amateur and the practical horticulturist, an arrangement founded jointly on the culture and uses of the plant, will, we think, be much more useful. At the end of each section, we shall enumerate, from the Natural Arrangement (1364), the plants which may be used as substitutes for those generally cultivated in gardens, and which are treated of at length.

1365. *Horticulturally and economically*, therefore, the culinary plants of British gardens may be thus arranged:

I. ESCULENTS.—*Plants used for their nutritious properties.*

Brassicaceous esculents, syn. cabbage tribe; comprehending the white and red cabbage, cabbage colewort, Savoy, Brussels sprouts, borecoles, cauliflower, broccoli, Kohl Rabbi, and Chinese cabbage.

Leguminaceous esculents; comprehending the pea, bean, and kidney-bean.

Radicaceous esculents, syn. esculent tubers, and roots; comprehending the potato, Jerusalem artichoke, turnip, carrot, parsnep, red beet, skirret, scorzonera, salsify, and radish.

Spinaceous esculents; comprehending the garden spinach, white beet, orache, perennial spinach, New Zealand spinach, sorrel, and herb-patience.

Alliaceous esculents; comprehending the onion, leek, chives, garlic, shallot, and rocambole.

Asparagaceous esculents; comprehending asparagus, seakale, artichoke, caudon, rampion, hop, &c.

Acetariaceous esculents, syn. salads; comprehending lettuce, endive, succory, celery, mustard, rape, corn-salad, garden-cress, American-cress, winter-cress, water-cress, burnet; and some of those included in other sections, as the sorrel, tarragon, Indian cress, &c.

Adornaceous esculents, syn. seasonings and garnishings; comprehending parsley, purslane, tarragon, fennel, dill, chervil, coriander, carraway, anise, horse-radish, Indian-cress, marigold, borage, and some others included in other sections.

Condimentaceous esculents, syn. plants used in tarts, and for preserving

and pickling; comprehending rhubarb, *Oxalis crenata*, angelica, elecampane, the samphire, caper; and the Indian-cress, radish, kidney-bean, onion, red cabbage, &c., included in other sections; and among fruits before given, the cucumber, love-apple, egg-plant, capsicum, &c.

Aromaceous esculents, syn. sweet herbs; comprehending thyme, sage, clary mint, marjoram, savory, basil, tansy, and some of those in other sections.

Fungaceous esculents; comprehending the mushroom, truffle, and morel.

II. HERBS; *plants used for their fragrance, for medicinal purposes, or as poisons for vermin.*

Odoraceous herbs, syn. fragrant herbs, plants used in domestic distillation; comprehending lavender, rosemary, peppermint, and others included in preceding sections.

Medicaceous herbs, syn. medicinal herbs, plants used in domestic medicine; comprehending chamomile, hyssop, wormwood, horehound, balm, rue, liquorice, blessed thistle, blue melilot, and some others.

Toxicaceous herbs, plants used in gardens for subduing or destroying insects; comprehending the tobacco, white hellebore, foxglove, &c.

1366. *Propagation and seed-saving*.—The greater number of culinary vegetables are annuals, or biennials, which are propagated by seeds; but a few are perennials or shrubby, and these are increased by division of the root, or by cuttings or layers. The seeds are for the most part purchased annually from the seedsman, whose business it is to procure from all quarters the best kinds, and have them grown for him by a particular class of cultivators known as seed-growers. The more select varieties are frequently grown by private gardeners for their own use; but this can only be done to a limited extent, on account of the liability of varieties of the same species or race, as of different kinds of cabbage or turnip, to become hybridised by proximity, and by their flowering at the same time. The care and labour, also, which are required for saving seeds on a small scale, is so disproportionate to the produce, that it would render the seeds much more expensive than if they were purchased; and hence the practice is seldom resorted to, except in the following cases:—to preserve a valuable variety, which could not with certainty be purchased true; and to grow a large quantity of only one or two kinds for the sake of selling to, or exchanging with, the seedsman, for small quantities of the different kinds which may be wanted.

1367. *The selection of varieties* is an important part of the gardener's care, and one of more difficulty than in the case of fruit trees; because in culinary vegetables the kinds are continually changing, from the influence of soil, culture, neglect, fashion, &c.; so that a sort of pea, onion, broccoli, or cabbage, which is esteemed the best at one time, may in the course of a few years be almost forgotten. The number of synonymes of varieties is also very great, and though these were settled in most cases by the Horticultural Society some years ago, yet from the frequent introduction of new sorts the task would require to be undertaken almost yearly. In general, dwarf-growing varieties come soonest to maturity, and, consequently, they remain less time on the ground; they also resist cold and drought better, from their leaves lying close on the surface of the ground; and, for these reasons, are preferable to tall-growing varieties. We shall, with the assistance of several good practical gardeners, give a selection of the best varieties in culture at the present time, recommending the amateur

and young gardener to deal only with the most respectable seedsmen, and to be guided by them in cases where he cannot profit from the information contained in books.

1368. *Whether a crop which is raised from seed ought to be sown where it is finally to remain, or sown in a seed-bed and transplanted*, is an important point for the gardener's consideration. His decision must be formed, partly on the nature of the plant, and partly on the extent of garden-ground which he can command. Some plants, such as the turnip, with the exception of the Swedish, parsnep, radish, &c., will not produce a crop when transplanted; and others, such as the beet and spinach, succeed but indifferently; while for the pea and bean, the labour, except in the case of the earliest crops, would be disproportionately great to the advantage gained. The carrot is sometimes transplanted on a prepared border for an early crop; and transplanting may be performed with tolerable success with the other sorts mentioned if done when the plants are very young, and with proper care; but certainly it is only advisable to be performed except in cases of emergency. All the cabbage tribe—lettuce, endive, &c. transplant freely, and there is a great saving of ground by sowing them in seed-beds, instead of sowing them where they are finally to remain. For example, if the lettuce or endive plants which occupy a few square yards of seed-bed for a month, were at once sown where they are finally to remain, they would occupy, perhaps, several rods of ground one month longer than they otherwise would do. Thus a crop of peas may be coming into flower, at the time when the endive or lettuce was sown on the seed-bed, and when the lettuce or endive plants were ready to transplant, the crop of peas will have been gathered, and the crop of endive will follow it; but had the crop of endive been sown where it was finally to remain, an additional piece of ground, equal to that occupied by the peas, would have been required. It is easy thus to see that by the transplanting system half the garden ground will suffice that is requisite for the sowing system; and as a proof of the economy of this system generally, it may be observed that it is the one followed by all the market-gardeners in the neighbourhood of London. Another advantage attendant on the transplanting system—more especially in the case of esculents, the leaves of which are the parts used—is, that the plants being deprived of part of their tap-root, throw out a greater number of lateral roots, in consequence of which the production of radical leaves is encouraged, and the tendency to run to flower is retarded, while a more succulent growth is induced, owing to the plants being placed in newly prepared soil. A corresponding effect, we have already seen (p. 615), takes place when the tap-roots of trees are shortened.

1369. *Soils*.—Though garden plants grow naturally in soils very different both in their chemical constituents, and mechanical properties, yet in a state of cultivation, there are few or none of them that will not thrive in the soil of a garden, which is neither extremely sandy, gravelly, clayey, chalky, nor peaty, provided it has been well pulverised and drained, and manured with stable-dung. Practically, almost the only changes that can be made in garden-soil are, to render it richer by stable-dung, or other animal manure; lighter, by the addition of leaf-mould; more compact, by the addition of clay in a natural state; more open by the addition of burnt clay or sand; more calcareous, by the addition of lime; and more sandy on the surface, for the purpose of raising seedlings to transplant, by working in a top-dressing

of sand. Of these different ingredients, animal manure, sand, and leaf-mould are alone universally in request in kitchen-gardens, for adding to their soils, whatever these may be.

1370. For the *proportion* of each crop which under ordinary circumstances require to be cultivated, the *quantity of seed, plants, or sets*, necessary for this purpose, the place of the crop in the *rotation*, the advantage of sowing or planting in rows, and various other points of general application, we must refer the reader back to the Chapter on the *Cropping and General Management of a Kitchen Garden* in p. 434.

SECT. I.—*Brassicaceous Esculents, or the Cabbage Tribe.*

1371. *The cabbage tribe* include the white and red cabbage, savoy, Brussels' sprouts, borecole, cauliflower, and broccoli. All these are considered to have sprung from *Brássica olerácea L.*, a cruciferous biennial, found on the sea-shore at Dover and a few other parts of Europe, on chalky or calcareous soil. At Dover the plant varies considerably in its foliage and general appearance, and in its wild state it is there used as a culinary vegetable, and found of excellent flavour, (*G. M.*, viii. p. 54.) Improved varieties have been cultivated in gardens since the time of the Romans, and probably long before. They occupy a large space among the rotation crops (923) of every kitchen-garden, because there is not a day in the year in which one or more of the kinds is not required at table. We shall first enumerate the varieties, and the best sub-varieties of each, and give what is peculiar in their culture; and conclude the section with the culture and management of the cabbage tribe generally.

1372. *The white cabbage*, *B. olerácea* var. *capitata Dec.* (*Chou pommé*, or *cabus blanc*, *Fr.*) is perhaps the most general vegetable in cultivation in temperate climates; it is in perfection from May to November, and the Scotch or field cabbage and the Vanack afford a supply through the winter; from the open air, when the winter is mild, and taken up and planted under cover when it is severe. The properties of a good cabbage are, a small, short stem, and a large, compact, well-formed head of succulent leaves, surrounded with but few loose leaves. The best sub-varieties are, the *early dwarf*, syn. *Battersea*, and the *early York*, for early and late crops, and the *Cornish* and *Vanack* for main crops. The Vanack cabbage is always in season; and as it sprouts freely from the stem after being cut, and the sprouts form heads as well as the summits of the plants, one plantation of this kind might serve the whole summer, and actually does so in some considerable gardens in the neighbourhood of London. The main plantation of cabbages, to come into use in May, is made about the end of October, and for this the seeds are sown in the last week of July or first week of August. Many of the London market-gardeners are so particular in this respect that they sow annually on the same day, viz.—July 25, or as near it as circumstances will permit. The seeds are sown in an open, airy situation, quite thin; and watered and shaded, if necessary. The ground for the plantation being prepared by deep digging and manuring, if it is not already rich, the early sorts, being small, are planted out in rows fifteen inches or eighteen inches apart, and about one foot distance in the row; the Vanack cabbage and Cornish at two feet distance, and eighteen inches in the row; and the Scotch cabbage, which, however, is but little cultivated in gardens, at three feet between the rows, and two feet in the row. For the Scotch cabbage to attain the largest size the seed should be sown

in cold, stiff soil, about the middle of August, and the plants transplanted in the May of the following year. They will form immense heads by the middle of November. The plants are commonly planted in drills, because that admits of earthing up the stems, which, by encouraging the production of surface-roots, adds to the vigour of the plants, and, it may be presumed, to the richness and flavour of the cabbage. The routine culture consists in pulling up any plants that run to flower, and supplying their places with others left in the seed-bed on purpose; hoeing up weeds; stirring the soil with a pronged spade or hoe, and watering when the weather is very dry. For a late summer and autumn crop, sow in the end of February or beginning of March, and transplant in May, June, or July. These two seasons of sowing and transplanting are enough for the largest garden as well as the smallest.

For a cottage garden the early York, Battersea, and Vanack are recommended by Mr. Thompson (*Gard. Chron.* 1841, p. 84); and the early York, Vanack, early Brompton, early Battersea, syn. nonpareil, by Mr. Paxton (*Ibid.* 1842, p. 93). With spring planted crops in cottage gardens a mazagan bean may be sown alternately with every cabbage plant in the same row.

1373. *The Couve Tronchuda*, syn. large-ribbed cabbage, *B. oleracea costata oblõnga Dec.* (*Chou vert à grosses côtes, Fr.*; *Tranxuda. Port.*), is a delicious vegetable, much more tender than the common cabbage. The plants may be sown in the first week in August, preserved through the winter in frames, and transplanted in spring about the same time as the cauliflower; or the seed may be sown on heat early in spring. The ribs of the outer and larger leaves, when divested of their green parts, and well boiled, make a good dish, somewhat resembling sea-kale. The heart or middle part of the plant is, however, the best for use; it is peculiarly delicate, tender, and agreeably flavoured, without any of the coarseness which often belongs to the cabbage-tribe. There is a dwarf variety known in Portugal by the name of *Murciana*, which is much earlier than the other, and unlike it, throws out numerous suckers from the lower part of the stem. This, when cooked, is much more delicate and tender than the other taller and coarser ribbed variety.

1374. *Cabbage coleworts*, are cabbages used before they have formed hearts, or become cabbaged. The seeds of any early variety are sown from the middle of June to the last week of July, and transplanted in August, September, and October, as ground becomes vacant by the removal of peas, beans, onions, &c. The plants are put in at from six inches to eight inches apart every way, according to the size which they are expected to attain before being gathered; and they are occasionally watered if the season is dry, so as to forward them as much as possible before winter. They are gathered (or pulled up to retain the sap in them if they are to be sent to a distance) as wanted, late in autumn, and throughout the whole of the winter, and will be found far superior to the cabbage sprouts which can be obtained at these seasons.

1375. *The Red Cabbage*, *B. oleracea var. capitata rubra, Dec.* (*Chou pommé rouge, Fr.*), is chiefly used for pickling, though sometimes for sauerkraut. The seed is sown in spring, and treated in all respects like the spring sown white cabbage. The dwarf red is esteemed the best sub-variety.

1376. *The savoy*, *B. oleracea var. bullata major, Dec.* (*Chou de Milan, ou pommé frisé, Fr.*), has wrinkled leaves, but in every other respect it

resembles the common cabbage, and may be cultivated in the same manner. As it is chiefly used during winter, and after it has been mellowed by frost, only one sowing is necessary in March, for planting out from June to August. The best varieties are the *large late green*, and the *yellow*, which, however, is not so hardy as the other.

1377. *Brussels sprouts*, *B. oleràcea bullàta gemmifera*, *Dec.* (*Chou de Bruxelles*, or *à jets*, *Fr.*), differs from the savoy in forming small green heads like miniature savoy cabbages along its stem, which often grows three feet or four feet high. These miniature cabbages are used as winter greens, or with a sauce composed of vinegar, butter, and nutmeg, poured upon them hot after they have been boiled. The top, or terminal cabbage, is very delicate when dressed, and quite different in flavour from the side cabbages. There is no particular variety, but as the plant is supposed to degenerate in Britain, seeds from Brussels are preferred. These are sown early in April, and the plants transplanted into rows, eighteen inches apart every way, in June. The side leaves are sometimes taken off as the plants advance in height, to throw more sap into the buds which form the sprouts, or side cabbages; these come into use after the first frost.

1378. *Borecole*, *B. oleràcea acéphala sabéllica*, *Dec.* (*Chou vert*, or non pommé, *Fr.*). Of this variety there are many sub-varieties, but the best are the *dwarf green Scotch kale*, *syns.* German greens, curlsies; and the *dwarf purple Scotch kale*, the latter being valued by cooks, on account of its boiling to a brighter green than the other. For very cold late situations there is the *Jerusalem kale*, *syn.* Ragged Jack, a dwarf sub-variety, with long serrated leaves, which, being produced close to the ground, the plants are less injured by the frost than those of the taller varieties. The *Buda*, *syn.* Russian kale, is so dwarf as scarcely to have any stem, and is very hardy. The sprouts of this kind may be blanched like sea-kale by turning a pot over the plant early in spring. As all the borecoles are only wanted during winter and spring to supply the place of cabbage, the seeds are sown in April, or later, and the plants put out, where they are finally to remain in June; or earlier or later, according to the situation, and the ground which may become vacant. The distance of the Scotch kale may be two feet between the rows, and eighteen inches in the row; those of the Buda and Jerusalem kale may be a few inches less.

1379. *Cauliflower*, *B. oleràcea Bótrytis cauliflòra*, *Dec.* (*Chou-fleur*, *Fr.*), is the most delicate production of the cabbage tribe, both with reference to the table, and to its culture. The head of embryo flowers is the part used, and it ought to be compact, round, not broken at the edges, convex on the upper surface, and succulent throughout. There are only two varieties, the *common*, and the *large Asiatic*, the latter newly introduced. In books an early and a late variety are mentioned, but in the seed-shops and gardens they are the same, the earliness or lateness depending on the time of sowing. As it is desirable to have cauliflower as many months in the year as possible, three sowings are made at different times, *viz.*: between the 18th and 24th of August, for plants to stand through the winter and produce the first crop next May and June; in the end of February or beginning of March, on a moderate hot-bed for transplanting in April, to produce the second crop in July and August; and in the beginning of April for transplanting in June to produce a crop from September till the first frosts; or later if the plants can be protected where they stand, or removed and planted in a shed or

cellar. Of these three crops the heads produced by the first, if properly managed, will be by far the largest, on account of the great quantity of prepared sap that will be accumulated in the plants, from the prolonged period of their growth.

The first crop.—When the plants have leaves one and a half inches broad, prick them out at three inches or four inches apart, either in the open garden, for transplanting in October, or under a wall, or in some other warm, sheltered situation, to remain through the winter, and be transplanted in spring. In most parts of Britain, cauliflower requires the protection of glass through the winter, and hence the first crop is almost always planted in patches of four or five plants, placed so as to be covered by a hand-glass or bell-glass (434, 435, 462). The glass remains over the plants throughout the winter, air being admitted every fine day, either by tilting up the glass with a brick or other prop; by taking it off altogether; or, if the cover of the glass forms a separate piece from the sides, taking it off, raising it, or changing its position (fig. 77, in p. 152), according to circumstances. The patches for being covered by hand-glasses are put out in rows, about three and a half feet or four feet apart, and about three feet patch from patch in the row; each patch being of the size of the bottom of the hand-glass, or about eighteen inches square. Put three or four plants under each glass, to allow for deaths during the winter, and for transplanting all, except two or three, into the open ground in the following April. In the last week of April or the first of May, the glasses may be removed, and put over the transplanted plants till they have taken root, and afterwards used for cucumbers, gourds, or other purposes. The soil all round the patches should now be stirred, and, if not already very rich, manure may be added, or the plants may be frequently watered with liquid manure. By keeping on some of the glasses as long as the plants can be contained under them, a part of the crop will come in earlier; and by frequently stirring the soil and supplying liquid manure, so as to retard the appearance of the flower and keep the plants long in a growing state, a portion of the crop will be later and larger. If some of the patches have been planted in sandy soil, not very rich, the plants will be smaller and forwarder than the others, and will admit of being covered by the glasses till the crop is fit to cut, which will give a very early supply. The same objects will be effected to a certain extent by giving a similar treatment to plants which have stood out through the winter at the base of a wall, or to plants which have been sown in spring. Thus Mr. Falla, in Northumberland, sows in January under a hand-glass, pricks out into a bed of soil mixed with sand; afterwards removes the plants, with balls, to soils similarly mixed, where they are finally to remain; and thus he attains as early a crop as if he had sown in August, and transplanted in October under hand-glasses in the usual way: with this difference, however, that the heads are much smaller, the plants by the sandy soil being brought prematurely into flower (*Gard. Chron.* 1842, p. 54, and *G. M.* 1842, p. 327).

The second crop.—Prick out the plants as soon as they admit of it into beds, six inches apart every way, so as to admit of their being taken up with balls, and planted in rows, four feet by three feet, in rich soil, in the end of April or the beginning of May.

The third crop.—Proceed in the same manner, and transplant into rows, three feet by two feet, about the middle of July.

A *winter crop* may be obtained by sowing in the middle of July, in a warm border, or on the south side of an east and west ridge, and allowing the plants to come to heads without transplanting, but taking care to thin them to twelve inches or fourteen inches apart every way. In the course of November, heads will be formed from three inches to nine inches or ten inches across, and the plants may then be removed with balls, and planted in a bed of soil, to be covered by a frame and sashes; or in a bed under an open shed, and farther protected by mats and dry hay. By this latter mode, which may be adopted where a frame cannot be had, Mr. Cockburn, in Sussex, has been able to send three dishes of cauliflower to table every week during the autumn and winter till February (*Hort. Trans.* vol. v., p. 281). Cauliflowers may also be preserved by burying them entirely in dry soil, and thatching the ridge to keep out rain and frost, or by burying in dry bog earth; in either case wrapping up the heads with the surrounding leaves to keep them clean. In gathering, cut off the head with some inches of the stalk and a circle of surrounding leaves; after which pull up the plant, as the stems do not produce sprouts, like almost all the other varieties of the cabbage tribe.

1380. *Broccoli*, *B. oleracea* *Bótrytis cymosa* *Dec.* (*Broccoli, Fr.*), differs from the cauliflower in being so much hardier as to produce a supply of heads during the winter. There are a number of excellent varieties, which may be arranged as:—

1. *Purple or green-headed*, of which the best variety is the *early purple Cape*, a dwarf sort, which should be sown the first and third week of May, and second week in June. The *late dwarf purple*, which should be sown the second or third week in May for a crop to stand the winter.

2. *Sulphur-headed*, of which the best variety is the *Portsmouth*, which, if sown about the second or third week in May, and transplanted in June, will produce a crop to come into use during March, April, and May following. The *late sulphur*, sown at the same time, will come into use during April and May.

3. *White-headed*, of which the best are *Grange's early cauliflower broccoli*, which, sown about the first and third weeks of May, will come into use when cauliflower begins to get scarce, from the end of September till Christmas; the *early white*, with smaller heads than the preceding, which, sown at the same time as Grange's early, will come into use from November till February, and is the kind generally grown for the London market; *Knight's protecting*, which is the hardiest of this class, and when sown about the third week in May, comes into use at the end of March following and lasts till May, when the cauliflower grown under hand-glasses is ready; and the *spring white*, syn. *late dwarf Tartarian*, approaches nearer to the cauliflower than any other variety. The heads are quite delicate, and very white; and the plants seldom grow higher than a foot, and are very hardy. The seed should be sown between the 1st and 10th of April, and the heads will be in perfection in the May of the next year. *Chappell's new cream-coloured broccoli*, is a large and excellent variety; for use from autumn till spring. Sow in April for the autumnal supply, and in May for the spring crop.

General culture.—Most of the sorts may be planted in rows $2\frac{1}{2}$ feet by 2 feet; but for the dwarf varieties, such as the *late dwarf purple*, and the *spring white*, 18 inches every way will be sufficient. The routine culture

consists of watering when the plants are newly planted, destroying the weeds by hoeing, stirring the soil with a fork, and earthing up the stems. The very dwarf sorts require no protection in ordinary winters; but the taller growing kinds are apt to be severely injured by frost, and should either be protected where they stand, or by removal to an open shed, as directed for cauliflower. A mulching of hay, straw, or leaves, or a number of branches with the leaves on, stuck in among the tall-stemmed sorts, is frequently found effective. In gathering the heads, they should be cut while they are compact, or as technically expressed before the curd becomes broken, with about six inches of the stalk to each head, and the stems may be left to produce sprouts.

1381. *The Turnip-cabbage*, or turnip borecole, *B. oleracea* Caúlo-ràpa communis Dec., (Chou-rave, *Fr.*, Kohl Rabbi, *Ger.*) is a dwarf-growing plant, with the stem swelled out so as to resemble a turnip above ground, but of a delicate green colour. It is much cultivated in Germany, and even forced for the sake of the stem or turnip, which, taken in a young state, is dressed whole and eaten with sauce, or as vegetables to meat, like turnips or potatoes. In England it is very little used. The seed is sown in early spring, and the plants treated like other borecoles; the stem or turnip part being gathered while it is quite succulent, and will boil tender. To procure a supply throughout the summer, two or three sowings would require to be made.

1382. *The Chinese Cabbage*., *B. chinensis* L. (Pe-tsai, *Chinese*; Chou Chinois, *Fr.*), is an annual, apparently intermediate between the cabbage and the turnip, but with much thinner leaves than the former. It is of much more rapid growth than any of the varieties of the European cabbage—so much so, that when sown at Midsummer it will ripen seed the same season. It has been cultivated and used as greens by M. Vilmorin and a few other persons in the neighbourhood of Paris; and there are specimens in the Hort. Soc. Garden, but it does not appear likely to become a general favourite. It requires an extremely rich, and rather moist soil.

1383. *General culture and management of the cabbage tribe*. In the choice of sub-varieties, it will be borne in mind that the dwarf kinds come soonest into use, and retain heat and moisture better, by the covering which their leaves afford to their stems, and to the soil, than the tall-growing kinds; but that owing to the shorter period at which, in most cases, they arrive at maturity, they require a richer soil; while the ramose roots of the tall kinds extend to a greater distance, and consequently are adapted for poorer soil; and in rich soils for producing larger plants. As all the varieties are biennials, the largest crops will be produced by autumnal plantations, by which longer time is given to the plants to lay up a stock of organisable matter. An ounce of seed of any of the varieties is the usual quantity ordered from seedsmen for small or middle-sized gardens, and half an ounce will be enough where several sub-varieties are sown; as, for example, of broccoli. The seed comes up in ten days or a fortnight, according to the season. In early spring, when it is desirable to advance the plants as rapidly as possible, the seed should be sown in light rich soil in a warm situation; but in autumn, when the great object is to produce plants of firm texture that will resist the winter, a poor, and rather stiff or clayey soil, is preferable. Where the plants are to be transplanted with the dibber, numerous fibrous roots are of little use after the plant is taken up, because they are

mostly withered and rendered useless before they are restored to the soil ; but where they are to be transplanted with balls the fibrous roots are preserved, and in order that these may be produced in abundance by the seedlings, the seed should be sown very thin in soil mixed with sand, or pricked out into such soil. As pricking out greatly strengthens the plants before their final removal, it should not be neglected where an abundant produce is the object. All the cabbage tribe that produce sprouts may be propagated readily by taking off these sprouts as cuttings ; and this mode is said to be generally adopted in Brazil, and it has been tried successfully in Suffolk. (*G. M.* vol. ix., p. 227.) The ends of the cuttings are exposed to the atmosphere for 20 or 30 hours to cauterise the wounds ; and this exposure is also found useful, on the same principle, to very vigorous seedlings, when the points of the tap-roots are taken off, and the plants are to be planted with the dibber. In transplanting, the great art to insure success, is to make sure that the earth is pressed moderately close to the lower extremity of the root, and afterwards giving a plentiful watering, which will have the effect of washing down the finer particles, and thereby filling up interstices better than could have been done by any other means, and without bruising the tender fibres of the root (701), because without this closing in of the soil the spongiole would not be renewed there ; and that being the growing point of the root, it is of more consequence that it should be renewed there than anywhere else, since it insures vitality and circulation to all above it. In making every plantation, there should be a small reserve of plants retained in the seed-bed, or pricked out in the general reserve-ground of the garden (p. 418), to supply any losses that may occur from deaths or running to flower ; or the plants may be placed thicker in the rows, and afterwards thinned out. As all the kinds have the property of rooting freely from the stems, the plants, excepting the few that are stemless, are strengthened by being earthed up ; and to increase the depth of this earthing, they are planted in drills two or three inches deep. All the varieties require an open, airy situation, for no one ever found the cabbage in a wild state in hedges or woods ; but it should be sheltered from high winds, as plants on the sea-shore, whether among cliffs or on the beach, generally are. The soil should be deep, well pulverised, and it can hardly be too rich ; unless the object be to hasten maturity, when it should be comparatively poor and sandy. It is highly probable that the plants would be benefited by a slight sprinkling of common sea-salt given once to each crop in an early stage of its progress. The soil should always be more or less calcareous ; not only as the plant grows naturally on limestone or chalky cliffs and shores, but because the finest-flavoured cabbages and broccolis in England are produced in gardens in Kent on the south bank of the Thames, made in old chalk-pits. As the leaves of all the kinds are naturally large and succulent, they present a large perspiring surface, and therefore, to maintain this succulency in long-continued droughts, the plants should be liberally supplied with water ; and as they are all gross feeders, they may all be watered with liquid manure. In all the sprouting varieties, when the stem is to be preserved for this purpose, the leaves should be taken off, that the sap may be thrown into the buds ; and when these do not break freely, it will be facilitated by slitting the stem from an inch or two below the top to within an inch or two of the bottom, keeping the slit open with a bit of stick or a small stone ; or the same object may be effected by cutting a notch above the buds (617). A

slit from the top downwards will also effect the same object, but it disfigures the top of the stem. The hearting or heading, and consequently the blanching of all the kinds, will be promoted by loosely tying up the leaves, as soon as the plants show an indication of hearting, with strands of matting; and this may be usefully practised with the earliest spring cabbages, and with the borecoles when it is wished to have the leaves blanched. To increase the size of the flower-heads of cauliflower and broccoli, as soon as the flower appears, break down, or twist, the footstalks of all the large leaves, in order to throw more of the organizable matter into the flower. Most of the varieties, but more especially the broccolis, are subject to the club in the root; an unnatural protuberance produced by the puncture of an insect, and the subsequent hatching of deposited eggs, and apparently producing a diseased habit, so that club roots are produced afterwards in the same plant without the intervention of an insect. When the club has once appeared on the roots of a plant, there is no remedy for it; but in soils and situations subject to this disease, the insect may be deterred from laying its eggs in the root by putting a little quicklime in the hole made by the dibber, before inserting the plant. Incorporating burnt clay with the soil has also been found to check clubbing, as well as to annoy worms and slugs; but the quantity necessary for these purposes, unless it was also required for the improvement of the soil (174), amounts almost to a prohibition of their use. As the leaves, more especially of the common cabbage in very dry weather, are subject to be covered by aphides, and to be eaten by the larvæ or caterpillars of butterflies (*Pontia* sp.), as soon as the former or the eggs of the latter are observed, the plants should be liberally watered with clear lime-water, and the operation repeated till every egg and caterpillar is destroyed. Even copious supplies of clear water, poured on the plants for several evenings in succession, will effectually destroy the caterpillar in every stage of its growth; and in no variety of the cabbage tribe, excepting the cauliflower when it is nearly mature, will water in the slightest degree injure the flavour. Where lime-water or water alone cannot be supplied in sufficient quantities, the eggs of the butterflies ought to be collected and destroyed; and indeed this may be done in connexion with watering. The eggs are deposited in small patches on the upper side of the leaf; and in very warm weather they will hatch in twenty or thirty hours, and soon spread over the whole surface of the leaf. Slugs and earth-worms may be effectually destroyed by lime-water; or as a convenient substitute, where quicklime is not at hand, potash and water, or a decoction of foxglove, henbane, white hellebore, or walnut leaves. In general, the routine culture of the cabbage tribe consists in destroying weeds as soon as they appear, stirring the soil as deep as the roots will admit with a fork, or a pronged hoe, and supplying water or liquid manure when the condition of the plants, or the soil, or the state of the weather, requires it. Where the stems are left to produce sprouts, deeply stirring the soil and manuring are of essential service. In gathering the crop, when sprouts are not wanted, the plants, after the head is cut off, should be pulled up by the roots and carried to the manure-heap; or, if the stems are to be left, they should be stripped of their leaves, and the whole of these removed to the dung-heap and mixed with other materials; for nothing among vegetables is more offensive than the decaying leaves of the cabbage tribe, and indeed of the *Cruciferae* generally. Coleworts are generally gathered by pulling them up by the root,

by which the sap is retained better than if the heads were cut off. If after gathering any of the varieties it should be suspected by the cook that the heads contain slugs, caterpillars, or earth-worms, by plunging them into salt and water for a minute or two the vermin will be driven from their hiding-places among the leaves and left in the water. All the kinds may be preserved in a growing state through the winter under an opaque roof, the sides being opened on the south side on fine days; and the heading kinds, by burying in the soil (1379). Being gathered, none of the kinds will keep fresh above two or three days; but chopped into small pieces, and put in a cask in layers, each layer sprinkled with salt, a liquor is formed, immersed in which the cabbage, turnip, and every other cruciferous plant, will keep through the winter, and thus is formed the sauerkraut of the Germans. To save seed of any variety, select the finest specimens, and take care that no other brassicaceous plant is in flower at the same time within a considerable distance of it (866 and 1366); and the more specimens there are planted together of any one variety for the purpose of seeding, the less liable they are to become adulterated. A solitary brassicaceous plant can never be depended on unless many miles indeed remote from any other; whereas a body of fifty or so will produce the sort generally true, even although not far from other varieties. The seed will keep four or five years; but as after a year it is liable, in common with other seeds, to the attacks of the weevil, *Curculio L.*, it ought to be exposed every winter during severe frost in a thin layer for an hour or two, which will completely destroy vitality both in the eggs and the insects. The place of the cabbage tribe, in a rotation of crops, may be after or before the leguminous tribe, or the Alliaceæ (924).

1384. *Substitutes* for the cabbage tribe are to be found in the Cruciferae generally, the tender leaves of almost all of which may be used as greens, and the embryo heads of flowers as substitutes for broccoli. Among the best substitutes are the leaves of the turnip when running to flower, the wild cabbage, and the garlic cress or sauce-alone, *Erýsimum Alliária L.* (*Alliária Adan.*) The spinaceous and acetariaceous esculents may also, in general, be used as greens. Nettles are a very common substitute, and an excellent one when gathered tender.

SECT. II.—*Leguminaceous Esculents.*

The leguminaceous esculents of British gardens are chiefly the pea, bean, and kidney-bean, all of which thrive best in a deep free soil. In every garden they occupy a larger space than any other rotation crop, but they do not occupy it long; the main crops arriving at maturity in from three to four months.

SUBJECT. I.—*The Pea.*

1385. *The pea*, *Pisum sativum L.* (*Pois, Fr.*), is a tendrilled climbing annual, a native of the South of Europe, but arriving at maturity in the course of the summer in British gardens. No vegetable is more highly prized than green peas, and few are more nourishing when nearly ripe, or ripe. The seeds alone are eaten in most kinds, and they are boiled with mint to correct a slight tendency which they have to flatulency; but the entire pod is eaten of the sugar pea, in the manner of that of the kidney-bean, the outside edges of the pods being stripped off previously to boiling.

The inner tough film which lines the pods is wanting in this variety, which renders it very distinct. Peas gathered when partially ripe, and dried, are used in soups and stews; but it is found that after they have been kept a year they do not break, or fall well in the soup: it is also understood among dealers in peas, that those which have been grown on stiff soil, or on sandy soil, that has been limed or marled, will not fall in boiling, whether new or old.

1386. *The varieties* are numerous, but the following are among the best: The *early frame*, height three feet, and *Charlton*, four feet, for the first crop; and the *Auvergne*, a very full-podded variety, (three to four feet), to follow; then *Knight's dwarf green marrow*, the *blue Prussian* (three to four feet), and *Groom's superb dwarf blue*, a very prolific variety, with peas like those of the blue Prussian, and so dwarf as to require no sticks. These will form a good selection of dwarf varieties. Among the numerous varieties of tall peas, none is equal in point of excellence to *Knight's tall marrow* (six to ten feet). The *Milford marrow* is, however, a distinct variety with very large green seeds; it is of medium height. For the purpose of the pods being cooked in the manner of kidney-beans, the *dwarf crooked sugar pea* is to be recommended.

In general only the small-sized peas, such as the frames and charltons, should be grown for the first crop, and all the other crops should be of large-seeded peas, such as the marrows, blue Prussians, &c. The seed is ordered by the pint; and of the frame and charlton, one pint will sow a row of twenty yards; and of the larger sorts, a row of thirty-three yards. The seed will come up in a week, ten days, or a fortnight, according to the season.

1387. *Culture*.—The pea, being a tendrilled climber, whenever it is to be cultivated to the greatest advantage, ought to be supported by pea sticks, which are branches of trees or shrubs well furnished with spray, and of lengths suited to the height to which the plants grow. These sticks are put in in two rows with the row of peas between them, the sticks or branches in one row being opposite the intervals of those in the other row. They are placed upright, but somewhat wider apart at top than at bottom, to allow room for the branching of the stems as they ascend, and for the larger space required for the top foliage, which is larger than that below, and for the pods. To facilitate the sticking, peas are always sown in rows. They are also always earthed up, principally for the sake of keeping the plants upright, as they do not produce roots freely above the collar, like the cabbage tribe. When sticking peas is inconvenient, or impracticable, from the extent of the crop, the rows are earthed up on one side only, so as to throw the haulm to the opposite side, by which means the ground between the rows is more readily kept clean, the crop more readily gathered, and the plants not so liable to be blown about by high winds. Rows of peas which are not to be stucked may be closer together than such as are to be stucked; because the tops of the plants of one row may extend to the lower parts of the plants of the row adjoining, without doing the plants of either row any injury. Hence when peas are not to be stucked, nor to be gathered green, the greatest amount of produce is obtained when they are sown broadcast; but by this mode the soil cannot be conveniently stirred or weeded. Peas are generally sown in single drills, at the same distance apart as the plants grow high, with intervening rows of spinach, or some such secondary crop (923) which is gathered before the peas are matured; but for all the taller growing kinds it

is better considerably to increase the distance, so as to allow abundance of light and air to the peas, by which they will be much more productive, and a crop of a more permanent kind than spinach, such as some of the cabbage tribe, or roots or tubers, obtained between. A much larger crop, and a great saving of ground, is by this means obtained. It is well known that the outsides of double rows bear much more abundantly than the insides; and if only two rows in one place, and two more in another, fifteen or twenty feet distant, were sown, there would be four outsides; whereas, if they were all sown together, there would be but two outsides. Two rows in one place occupy three feet six inches in width, and two rows in another the same, making together seven feet; but if four rows were sown together, they would take up eleven feet or twelve feet of ground. Here, therefore, is a saving of ground of nearly one half. (*G. M.*, vol. iv. p. 225.) In pea culture, there is not a greater error than that of sowing the seeds too thick in the row. We would recommend, in every case except in that of the crops sown to stand the winter, to deposit the peas singly in the same manner as beans are planted. We know some gardeners who practise this mode, and they have always a larger produce, larger pods, and larger peas in them, than those who sow thick, and do not thin out. Abercrombie, who is one of the safest of guides in matters of this kind, recommends for the early frame, three peas in the space of an inch; dwarf marrowfat, two in an inch; blue Prussian and similar sorts, three in two inches; for Knight's marrow and all similar dwarf sorts, a full inch apart; and for all the tall-growing sorts, an inch and a half or two inches apart. For the early sorts, the seeds of which are small, the drills may be an inch and a half deep; and for the larger sorts, they may be two inches deep. After covering the peas by putting back, with the hoe, the earth that came out of the drill, it should be trodden down, if the soil is in good condition as regards dryness; but if from situation, or the state of the weather, it should be otherwise, it is better only to chop the soil with the teeth of the rake, holding the handle nearly upright.

1388. *The earliest crops.*—In the neighbourhood of London, every gardener is expected to gather peas in the first week in June, if not before. To accomplish this, the early frame should be sown in a warm border, or along the south side of an east and west ridge in the open garden, in the first week of November. If the winter is mild the plants will appear above ground in January, or early in February, when they must be slightly earthed up, and during hard frosts protected by haulm, fern, litter or dried branches with the leaves on. Early in May they will have shown blossoms, and then every plant must be stopped at the first joint above the blossom, so as not to have more than two pods on a plant. The whole strength of the root being thus thrown into these pods, they will grow rapidly. If there is any spare space close along the bottom of a south wall, a row of peas may be planted there in December, protected by branches of yew, or spruce fir, during severe frosts, and during every night till they come into flower; and instead of being sticked, the plants may be kept close to the wall with twine or strands of matting, and stopped at the first joint above the first flowers. Thus treated, the pods will be fit to gather a fortnight before those in the open part of the warmest border; but if the wall is covered with the branches of fruit-trees to within a foot of the ground, these will be materially injured by the shade of the peas. A second sowing of the same variety on a warm border, or on the south side of a

drill, may be made after the first; and a third sowing, which may be of the early Charlton, may be made in March. This will suffice for the early crops. The plants of the last two sowings need not be stopped, nor will they require protection.

A very convenient mode of obtaining an early crop is to sow the peas in January in shallow pots, and protect them from frost by placing them close to the glass in the front of a greenhouse, or under a frame, hand-glasses, or hoops and mats; and about the middle of March to turn them out with balls into the open air in such situations as we have mentioned. Where pots are scarce, the peas may be sown in rows on pieces of turf, or even tiles, or pieces of boards covered with soil, brought forward on a slight hot-bed, and afterwards deposited in the open ground; or they may be raised in shallow pots, and afterwards separated and transplanted singly in rows. In short, there are numerous ways in which peas may be forwarded under cover, or in very gentle heat, in January and February, so as to be ready to transplant into the open ground about the middle or end of March. Peas may be



Fig. 377. Cover for Peas and other early crops.

protected in the open garden by portable covers such as fig. 377, which is thus formed:—Two long and two short poles of larch, fir, or other straight wood, form each side; the top piece is left longer, to form handles at each end, and the sides are attached to the top with hinges, and kept apart by two removable stretchers. The whole is then covered with sugar-mats, fastened on with laths. The covers are always kept on during nights, and mostly opened or taken off during the day.—(G. M. 1842, p. 187.)

1389. *Portable walls for early crops of peas, &c.* As a substitute for a brick wall a portable wall might be formed of very thick boards, or of double boards; the vacuity within to be filled up with charcoal, and protected from rain by a coping, and from dropping out by a fixed bottom. Such a wall need not be above three feet in height, and to render it portable, it may be made in lengths of six feet or eight feet, with stakes to serve as strengthening piers, and for readily fixing the wall to the ground. These hurdle walls, as they may be called, would be found useful for a variety of purposes beside forwarding peas; such as ripening tomatos, capsicums, melons, &c.

1390. *The summer and autumn crops.* The first sowing may be made in the middle of March, and where peas are in demand, which they are in almost every family, a sowing may be made every three weeks, till the 1st of August. Those sown in the latter period will not produce a crop unless the autumn is fine; but if this should be the case, peas may be gathered till December. In sowing during summer when the ground is very dry, after being dug and the drills drawn, the bottom of the drill ought to be thoroughly soaked with water before the peas are sown, and firmly rolled after they are covered; and throughout the whole summer, whenever there is a continuance of drought, water ought to be liberally supplied. All the late crops ought to be sown in the driest soil which the garden affords, in an open airy situation, and sticked; the last operation being essential to prevent the plants of the late crops from rotting; and as a preventive against this and mildew, the seeds should not be sown too thickly.

Gathering. The rows should be looked over daily and all those pods gathered that are sufficiently advanced; for if a single pod on a stem is

allowed to remain, so long as to begin to ripen, the production of young pods will, in a great measure, cease; whereas if they are gathered as fast as the peas are produced of an eatable size, the plants will continue to grow and to produce pods much longer than they otherwise would do. The same doctrine applies to cucumbers, (p. 614) kidney-beans, and all cases where fruit is gathered before it is ripe.

1391. *Diseases, vermin, &c.* The mildew may in general be prevented by abundant waterings, which indeed is a preventive to both diseases and insects. Birds attack peas when they appear above ground early in spring, eating out the growing point; and again when the pods are beginning to ripen, and may be scared by some of the usual means (370.) Mice are very apt to eat the peas when newly sown, to prevent which some sow chopped furze along with them; others rub the peas with powdered resin, and some cover the drills with a layer of clean sharp sand, which it is alleged drops into the ears of the mice, while they are burrowing underneath it; but in our opinion the best mode is to attempt the destruction of the mice, which is easily effected by a covered pit, or a covered vessel of water (372.) With respect to birds, they are so useful in gardens in keeping down insects and eating snails, worms, &c., as well as so agreeable by their song, that we would allow them a small share of such seeds and fruits as are of easy growth. The reader is recommended to peruse on this subject the articles on birds in Waterton's *Essays on Natural History*.

To save seed, allow a row or two, according to the quantity wanted, to ripen all their pods, previously pulling out any plants that appear to be of a different variety, or to have degenerated. Peas will grow the second year, but not often the third or fourth.

In a *rotation* of garden crops, the pea alternates well with the cabbage tribe, with root crops, or with perennial crops.

Forcing the pea. See 1105.

SUBSECT. II.—*The Bean.*

1392. *The garden bean*, *Vicia Faba L.* (*Fève de marais, Fr.*) is an erect annual, supposed to be a native of Egypt, and, like the pea, in cultivation from the remotest antiquity, for its seeds. These are used in soups, or dressed by themselves, and are considered very nourishing, though not of so delicate a flavour as the pea. The best *varieties* are, Marshall's *early dwarf prolific*, by far the best early variety; the *early mazagan*, so named from a place in Portugal, a later growing early variety, which comes in about a fortnight after Marshall's; the *early longpod*, a very prolific variety; the *broad Windsor*, with the largest seeds, and best-flavoured of all the beans, but not a good bearer, excepting in rich soils; and the *Dutch longpod*, the best variety for a late crop. The *seed* is ordered by the pint, and for the small beans a pint is required for every eighty feet of row, and for the larger kinds two quarts for every 240 feet of row. The bean comes up in a week, ten days, or a fortnight, according to the season. Not less than a quart of seed will be required to produce a single gathering occasionally. The times of *sowing*, and the situation in the garden, for the earliest crops, are the same as for the pea; but the plants do not require sticking, nor, as the seeds are longer of coming to maturity, is it usual to sow later for an autumnal crop than the beginning of June. Marshall's dwarf prolific bean may be planted in rows two feet apart, and at six inches distant in the row, and the other

sorts in rows two feet and a half to three feet apart; or, which will insure a larger crop, in rows eight feet or ten feet apart, with dwarf-growing crops between, as recommended for the pea (1337). The seeds may be deposited in drills an inch and a half or two inches deep, and covered and pressed down like the pea. Very early crops may be brought forward under cover, or by other means used in obtaining an early crop of peas. The bean transplants remarkably well, and many gardeners adopt this mode with their earliest crops.

1393. In *cottage gardens*, not only in Britain but in the North of Europe generally, it is customary to plant beans in the same rows with cabbages, and also with potatoes; a bean being planted alternately with every potato set, or cabbage plant. The rows of potatoes or cabbages are two feet and a half or three feet apart, according as they may be of small or large sorts; the distances in the rows are eighteen inches, and between each two plants a bean (the longpod is the best variety for this purpose) is deposited. If the beans are transplanted they get the start of the potatoes or cabbages, and as they come in early they will be gathered before they can do any injury to the cabbage or potato crops.

1394. All the *routine culture* required for a crop of beans is, destroying weeds, slightly earthing up the stems, stirring the soil, watering in very dry weather, and stopping the plants when the first opened blossoms are beginning to set. Stopping in the case of an early crop may take place as with the pea, at the joint above the first blossom as soon as it appears; but this is only when a very early crop is more desirable than an abundant one. A very late crop of beans may be obtained by cutting over a summer crop, a few inches above the ground, as soon as the plants have come into flower. New stems will spring from the stools in abundance, and continue bearing till they are destroyed by frost. Beans for the table should be gathered before they arrive at maturity, which is known by their being black-eyed, that is black at the hilum or point of attachment to the pod. When this has taken place, beans are tough and strong tasted, and much inferior for eating as a dish; though they are excellent in the soups of the cottager. The bean is sometimes attacked by the *black aphid*, which may be kept under by abundant syringing with lime-water. Seed of any variety may be saved by allowing a sufficient number of plants to bring their pods to maturity; it will keep a year, and sometimes two years.

The bean is rarely or never forced, not being held in sufficient estimation for this purpose by the wealthy classes of society.

SUBSECT. III.—*The Kidney-bean.*

1395. *The Kidney-bean*, *Phaseolus L.* (*Haricot, Fr.*), includes two species; the *common dwarf kidney-bean*, syn. French bean, *P. vulgaris L.* an annual, growing twelve or eighteen inches high, a native of India; and the *runner*, syn. climbing kidney-bean, *P. multiflorus W.*, a twining annual, attaining the height of ten or twelve feet, a native of South America. Though both sorts are too tender to endure our springs and autumns in the open air, yet so rapid is their growth during our summers, that they produce abundant crops of green pods in the open garden, from June to October, and, by forcing, these can be obtained all the year. The unripe pods both of the dwarf and twining kidney-beans, form the most delicate legume in cultivation; having no tendency to flatulency like the pea and bean, and producing

abundant crops in dry hot weather, when the pea, unless abundantly watered, is withered up. The green pods, also, make an excellent pickle; and the ripe seeds are much used in cookery, especially in what are called haricots, soups and stews. The scarlet runner, one of the twining varieties, is at once a highly ornamental plant, and eminently prolific in pods, from July till the plant is destroyed by frost; and as it is of the easiest culture, it forms one of the most valuable plants in the catalogue for the garden of the cottager.

1396. *Varieties*.—Those of the dwarf species (Haricot nain, or sans rames, *Fr.*), are very numerous; but the kinds considered best worth cultivating are the *early negro* for an early crop; *Fulmer's early*, a very prolific variety for a succession; and the *cream-coloured* for a main crop. The best variety of the twining species (Haricot à rames, *Fr.*), for cultivating for its pods to be used green, is the *scarlet runner*; though there is a large *white runner*, and also a *variegated-blossomed runner*, which produce equally good pods, but the blossoms are not so ornamental. The pods of the kidney-bean are smooth, and those of the scarlet-runners are rough outside. The roots of the scarlet runner, if taken up on the approach of frost and preserved through the winter, will grow again next spring, like the roots of the marvel of Peru, or the Dahlia; or like them they may be protected where they stand; but as nothing would be gained by this practice, it is never adopted. Half a pint of seed will sow a row eighty feet in length, the beans being placed from two inches and a half to three inches apart in the row; and this length of row will be required for gathering a single dish at a time. The seed comes up in a week or less.

1397. *Culture of the dwarf sorts*.—The first sowing in the open garden may be made in the beginning of April, if the situation is warm, and the soil dry. The second about the middle of the month, and subsequently sowings may be made every three or four weeks till the first week in August. The rows may be two feet asunder, and the beans deposited in drills from two inches to three inches apart, and covered to the depth of one inch, or one inch and a half. The routine culture consists in watering abundantly in very dry weather, and using lime-water, if, which is often the case, the plants are attacked by snails or slugs.

1398. *Culture of the twining sorts*.—These being rather more tender than the dwarfs, are not sown till towards the end of April or the beginning of May; a second sowing may be made about the middle of May; and a third and last in the first week of June. In cottage gardens, one sowing in the beginning of May will produce plants which, if the soil is in good condition, water judiciously applied, and the green pods gathered before the seeds formed in them begin to swell, will continue bearing, from the middle of June, till the plants are destroyed by the frosts. The rows, as in every similar case, should be in the direction of north and south, for reasons already given (723); they should be at least four feet apart, and the beans should be placed in shallow drills, three inches asunder, and covered about two inches with soil. Where the plants come above ground they may be slightly earthed up; and in another week when they begin to form runners, they should be staked with branches or rods, the former being preferable, of six or eight feet in length, a row being placed along each side of the plants, as in sticking peas; but instead of the stakes for runners being placed wider apart at their upper extremity, they may be made to meet there, as, contrary to the vegetation of the pea, the twining stems of the runner produce more leaves below than at their summits. In many cases, the scarlet runner may

be planted where it will not only produce excellent crops, but afford shelter or shade to a walk, a seat, a grassplot, a cucumber bed, or a temporary arbour. Where sticks or rods are scarce, wires or even twine may be substituted, and in this way the scarlet runner may be trained against wooden walls, pales, or other fences, or made to cover the walls of a cottage. The following mode of arranging pack thread, or hempen lines, for the support of scarlet runners, is practised in the neighbourhood of St. Petersburg. Take half-inch and two-inch wide rods or laths, join them at top as in fig. 378, *a*, so as to leave the ends a few inches beyond the junction; stick the lower ends into the ground, just within the lines of the plants. Connect these triangles by similar rods at the bottom, as at *b*, about three inches above the soil. Take a cord, fix it firmly to the lower bar; carry it over the upper bar, which is placed in the cross formed by the long ends left, as shown in the figure. Make a loop a yard long, carry the cord again over the

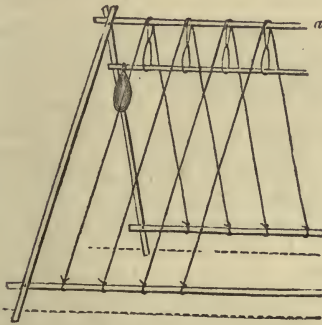

Fig. 378. Prop for Climbing Plants.

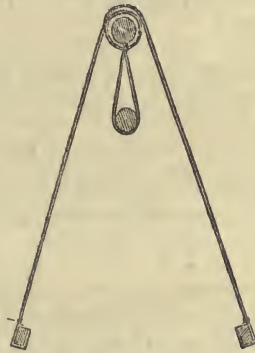

Fig. 379. Section of the Prop for Climbing Plants.

plank (that is, round it), and fix the other end to the lower rod on the other side. In like manner go on through the whole length, taking care to make the loops all of the same length. Through these loops suspend a long stick or bar, the section of which is shown in fig. 379; hang to this bar bags of sand, as many as may be wanted. Train the plants up the strings, and when they are well grown the whole will be covered, and when in flower the appearance will be very ornamental. By this method, the cords being fixed at the lower bars will not pull the plants out of the earth, the tension and contraction of the cords being counteracted by the bar suspended in the loops, which is raised or lowered by every change of atmospheric moisture; so much so, indeed, that it serves as an hygrometer. (*G. M.*, 1841, p. 211). In some market gardens in the neighbourhood of London, very abundant crops of the scarlet runner are obtained without staking, by merely stopping the plants after they begin to form pods. By this treatment they also continue longer in bearing, when the pods are to be gathered green; but when seed is to be ripened, it is found best to stake the plants.

1399. *Gathering*.—Care should be taken not to let any of the pods ripen, otherwise these will attract all the strength of the plant, and prevent in a great measure its future growth, for the production of young pods (p. 614). The kidney-bean is sometimes attacked by the aphides, but its greatest enemies in the open garden are the snails and slugs. A few plants should be

set aside for ripening seed early in the season, in order that they may be perfectly matured while the weather is fine. The seed cannot be depended on above a year.

Forcing the kidney-bean. See 1104.

1400. *The Lima bean*, *Dólíchos L.*, of which there are several species and numerous varieties, is cultivated in France and the South of Europe, but it is rather too tender for the open air in Britain. See the *Bon Jardinier* for 1842, p. 257.

1401. *The common lentil*, *Érvum Léns L.*; the *winter lentil*, *E. Ervilia L.*; the *Spanish lentil*, *Láthyros sativus L.*; and the chick pea, *Cicer arietinum L.*; and some other lentils, are annuals cultivated on the Continent as peas are in England, for their ripe seeds, which are put in soups or dressed as a dish in the same manner as haricots.

1402. *The white lupin*, *Lupinus álbis L.*, is cultivated in some parts of Spain and Italy for its ripe seeds, which are put in soups, or dressed like haricots.

1403. *Substitutes* for leguminaceous esculents are few, and chiefly the *field pea*, which is a variety of the garden pea, and the *sea pea*, *Pisum marítimum L.*, a perennial, a native of Britain, on the sea-shore.

SECT. III. *Radicaceous Esculents.*

1404. *The principal esculent roots cultivated in British gardens*, are the potato, Jerusalem artichoke, turnip, carrot, parsnep, red beet, skirret, scorzonera, salsify, and radish. All of these plants thrive best in deep sandy loam on a dry bottom, deeply trenched, and well manured, and with an atmosphere moist and moderately warm. The potato, turnip, and carrot occupy a considerable space in the garden, but not the others. In a rotation of crops they all answer well for succeeding leguminous or alliaceous plants, and some of them for following the cabbage tribe.

SUBSECT. I. *The Potato.*

1405. *The potato*, *Solànum tuberòsum L.* (*Pomme de Terre, Fr.*), is a solanaceous herbaceous perennial with tuber-bearing subterraneous stems, a native of the western coast of South America, and in cultivation in Europe, for its tubers, from the beginning of the sixteenth century. Its uses as a culinary vegetable and as a substitute for bread are known to every one. Potato starch, independently of its use in the laundry, when mixed with a small proportion of wheat flour makes a most excellent light bread; and it is also manufactured into a substitute for sago, arrow-root, and tapioca; and as starch is convertible into sugar by fermentation, both a wine and a spirit can be produced from it. The tender tops are eaten as spinach in Canada and Kamtschatka, in the same manner as those of the gourd; and the unripe berries have been pickled and preserved, and when ripe dressed like those of the tomato. As potatoes, like bread, are required at table every day in the year, if the whole supply is grown in the garden, a large breadth will be required for this purpose; but the winter supplies are chiefly obtained from the field or the public market, and indeed in most gardens only the early crops are grown. The crop is more exhausting than any other, except in cases where seed is ripened, as when a gardener grows his own turnip or onion seed. In the rotation it ought either to be accompanied with, or follow, a light crop which has been grown on soil in good heart. The uses of the

potato in the management of live stock, and its field culture, being foreign to this work, we shall confine ourselves to a brief notice of its culture in gardens.

1406. *Varieties*.—*Early sorts*: stems without flowers, and generally from one foot to eighteen inches in length. *Ash-leaved kidney*: very early, prolific, and well flavoured. *Fox's seedling* and *Early Manly*: not quite so early, but very prolific, and of excellent quality; the last, perhaps the most profitable early potato that can be grown. The *Rufford kidney*, syn. lady's finger; considered the earliest variety in Lancashire, and also the best flavoured, but not quite so prolific as the preceding kinds. *Shaw's early*: a large, comparatively coarse, sort, generally cultivated in fields for the London market; very prolific, but not very mealy or high-flavoured.

Late sorts.—Stems with flowers, those with pink, red, or purple tubers, blue, and of the white tubers, white; generally between two feet and three feet in length. The *bread-fruit*: roundish, white, mealy, prolific. The *purple eye*: large, round, and mealy. The *red-nosed kidney* and the white *Yorkshire kidney*: both mealy fine-flavoured sorts, and the latter will keep till June. *Kemp's seedling*, a very prolific variety, of excellent quality, much grown in Lancashire. The *late bright red*, syn. Devonshire red: round, mealy, and by frequent turning, and, as soon as they begin to sprout; picking out the eyes, will keep good till July. *Lancashire pink-eyed*: round, large, mealy, and an excellent keeper. *Purple*, syn. Scotch purple: small, round, mealy, and keeps later than any other variety. Those who require a greater number of kinds may consult Chatwin's *Catalogue of Potatoes*, published in 1842, in which, about one hundred and fifty varieties are described.

1407. *Culture*.—The potato is propagated by cuttings of the tuber, technically sets; and where new sorts are wanted by seed. A quarter of a peck of tubers will produce from 120 to 150 sets, according to the size of the tuber; and as these should be planted at from six inches to nine inches a part in the drill, according to the kind of potato, a calculation may readily be made of the quantity of any particular kind wanted for sets. (See 916.) The result of many experiments in the culture of the potato by sets, made by the late Mr. Knight, the Horticultural Society, Sir G. S. Mackenzie, and others, is thus given by Dr. Lindley in the *Gardener's Chronicle*:—

“ Good sets with single eyes, taken from partially ripe tubers, or small tubers undivided, furnish the best means of multiplying the potato. Large tubers have been recommended, but it has been proved experimentally that no advantage is derived from employing them, while there is a great disadvantage, in consequence of the large quantity required. It has been found, too, that if the tubers are over-ripe, that is to say, have acquired all the mealiness and solidity possible, they are apt to produce the curl. It is, therefore, the practice with some growers of potatoes to take up in the autumn what they want for ‘seed’ before the general crop is ripe, or to select for sets the worst-ripened potatoes they can pick out.

“ The period of planting should be as soon after the 1st of March as circumstances will permit. ‘I have uniformly found,’ says Mr. Knight, ‘that to obtain crops of potatoes of great weight and excellence, the period of planting should never be later than the beginning of March.’ This is in order to give the potato as long a summer as possible. From experiments made some years ago in the garden of the Horticultural Society, it appeared

that a crop planted in the first week of March exceeded that planted in the first week of April by about a ton and a quarter per acre. It must be obvious, however, that the propriety of planting thus early will depend upon the nature of the soil, and that it is too early for wet, heavy land, although it is the best season for light soils. In reality, land cannot be advantageously cropped with potatoes until all the superfluous moisture has drained away or evaporated.

“In all cases the plantation should be made in open places, fully exposed to light. The quality of the potato depends upon the quantity of starchy matter (mealiness) it contains. Now this starchy matter can only be formed abundantly by the action of light upon the leaves, which are the natural laboratory in which such secretions take place, and from which they are conducted by sure, though hidden, channels to the tubers where they are stored up. To plant potatoes, then, in plantations or orchards, or under the shade of trees, is to prevent the formation of the mealiness which renders this plant so nutritious, and to cause the tubers to be watery and worthless. This is probably one reason why field potatoes are usually better than those raised in gardens.

“But the potato may suffer by its own shade as much as by the shade of other plants. When its sets are planted too close, the branches shoot up and choke each other, the leaves of the one smothering the leaves of the other; so that the more sets are planted, the smaller will be the crop of this plant. Mr. Knight was the first to point out this common error, and to show that there is a certain distance at which the sets of each variety of potato should be planted so as to insure the greatest produce. By planting too close, the plants smother, and so injure each other; by planting at too great a distance, land is uselessly wasted. Practice and well-conducted experiments demonstrate what theory suggested, that the true distance at which potatoes should be set is to be determined by the average length of the haulm. One kind of potato is dwarf, and only grows six inches high; its rows should, therefore, be only six inches apart. Another kind grows three feet high, and its rows should be three feet asunder. The space from set to set in the rows appears to be immaterial; six or eight inches are sufficient for those which grow two feet high. An experiment formerly conducted by the writer of these observations showed that, when the Early Champion, a sort whose stems are on an average two feet long, was planted in rows two feet six inches apart, the produce was 15 tons 19 cwt. 82 lbs. net per acre; while, by reducing the distance between the rows to two feet, the produce was increased to 24 tons; but by diminishing it still further to one foot six inches, the produce was reduced to 22 tons 16 cwt. 102 lbs.; and where the rows were only six inches apart, the produce fell to 16 tons 17 cwt. 110 lbs. Such an experiment seems conclusive.

“The depth at which the potato should be planted is not ascertained with the same exactness, nor perhaps can it be; for much will depend upon the nature of the soil. In warm, dry land, we regard nine inches as not too deep,” provided the sets are large and strong; “in cold, stiff soil, four inches would be better. Six inches is a good depth for average land,” and, indeed, may be considered the best depth in most soils. Weak sets do not come up well at nine inches deep; but, on the contrary, four inches is too shallow, occasioning the tubers to be partially exposed to the light, and hence to become green. If, however, the land is so shallow as to admit of no

greater depth, then more space must be allowed between the rows for earthing up. "In one of the experiments above alluded to, different depths were also inquired into, when the rates of produce were nearly as follows:—Three inches deep gave 13 tons; four inches, 14 tons; six inches, $14\frac{1}{2}$ tons; and nine inches, 13 tons. At so great a depth as nine inches, sets are apt to perish, unless the soil is dry, light, and warm. The deeper, however, the sets can be safely inserted. the better, for the following reason:—Potatoes are formed on underground branches; the deeper the set, the more branches will be formed before the shoots emerge from the soil, and consequently the more ample will be the means possessed by the potato plant of forming tubers. The important practice of earthing up is to effect the same end, by compelling the potato stem to grow as much as possible under ground.

"The best method of increasing a crop of potatoes is to destroy all the flowers as they appear. The flowers and fruit of plants are formed at the expense of the secretions elaborated by the leaves; if of those secretions a part is consumed in the organisation of flowers and fruit, there is so much the less to accumulate in the tubers; but if no such consumption is permitted, the tubers will become the depositories of all the nutritious matter which the plant is capable of producing."—(*G. C.*, 1842, p. 155.)

A very common error in the garden culture of the potato is to plant them too thick, in consequence of which, for want of light to the foliage, the tubers never become mealy. A better mode would be to plant the rows at such distances as to allow room for a row of brocoli, Brussels sprouts, or borecole, between them, the stems of which would be sufficiently tall not to be injured by the foliage of the potato by the time it reached them in the autumn. We have seen a long-stemmed sort of potato grown on espaliers, and an immense crop produced.

1403. *For an early crop.*—The sets may be planted in the first week of October, in a sheltered dry situation, in light sandy soil, eight inches or nine inches deep, and the surface of the ground afterwards covered with long dry litter in such a manner as to exclude the frost and throw off rain. To facilitate the latter object, the sets are best planted in beds, the rain being conducted by the litter to the alleys; or three rows may be planted at a foot apart, leaving every third interval of the width of twelve feet. The plants will appear above ground in March, and with the usual routine culture, and nightly protection till all danger from frost is over, they will produce potatoes fit to gather in May, or early in June. Another mode is to forward the sets by laying them on dry straw in a warm loft, room, or cellar, or on the floor of a greenhouse in January, or the beginning of February; and when they have produced shoots of two inches or three inches in length, which will be the case about the middle or end of March, to plant them out in dry, warm, sheltered soil, covering them with litter at night, and exposing them to the sun during the day. Both these modes are practised in Lancashire and Cheshire, and by both young potatoes are brought to market by the first week of June, and sometimes earlier. By using whole potatoes as sets, burning out with a red-hot iron all the eyes except one, the abundant nutriment thus supplied increases the rapidity of the growth of the young shoots, and produces both an abundant and an early crop. Planting either sets, or sprouted sets, at the base of a south wall, and giving nightly protection, will produce potatoes fit to gather about the end of May; and sets

planted in pots forwarded on heat, and afterwards turned out into a warm border, will effect the same object. For ordinary early crops in the open garden the ash-leaved kidney may be planted in rows eighteen inches apart, and six to eight inches asunder in the row, from the middle of February to the middle of April.

1409. *The Lancashire practice*, in planting for an early crop, is as follows:—In the beginning of winter lay the ground up in narrow ridges, two feet and a-half centre from centre, fig. 380, *a*;

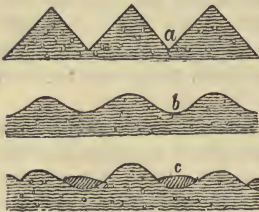

Fig. 380. *The Lancashire mode of planting potatoes.*

the ridges will be loose from the effects of frost, dry from its position, and warmed by its exposure to the sun to the depth of two inches or three inches; collect this dry mould in the bottom of the furrows, between the ridges, as at *b*; then lay on a little dung, and plant as at *c*; cover to the depth of two inches with dry warm mould from the top of the ridge, and when the plants begin to appear add two inches more, and again two inches when they appear a second time. (*G. M.*, 1, p. 407.) This is

also one of the best modes of planting a main late crop, whether in the garden or the field, as testified by W. Falla, in *Gard. Chron.*, 1842, p. 252.

1410. The first *gathering* of early potatoes may be made by taking one or two of the largest tubers from every plant by hand, previously removing a portion of the soil with a small three-pronged fork, fig. 33, *c*, in p. 135, and afterwards replacing the soil. This, especially if a good watering is given, will throw more strength into the tubers which remain; when the lower leaves begin to fade the crop may be taken up as wanted, by digging up the plants and collecting the tubers.

1411. *Messrs. Chapman's new spring potatoes*.—"The production of what may be termed late young potatoes, has been achieved extensively by the Messrs. Chapman, of Brentford. They employ principally for this purpose a white kidney, not a late one; but yet none of the earliest varieties. The tubers are taken up in spring, and spread thinly on a hard dry surface, in order to prevent their springing too far before the time they require to be planted. The greening thus induced is to be regarded as an unavoidable consequence of exposure to air and light rather than an essential condition; for forwardness could be otherwise easily promoted by a few days' earlier planting, at the warm season, at which it takes place, that is, the middle of July. They are then planted in the open ground in the usual way. The crop is taken up before frost and stored between layers of soil, whence the tubers, being delicately skinned, are taken only as required for use, forming, both as regards appearance and quality, a very fair substitute for forced new potatoes till the following spring. Any of the earlier varieties, such as the ash-leaved kidney, or early Manly, might be planted even later, and still be in time to produce tubers before frost; and they would prove equally delicate when first taken up, but would not retain the quality of new potatoes so long after as a variety which is less disposed to attain an early maturity." (*N. in G. M.* 1842.)

1412. *For a main or late crop*, sets, containing each a single eye, are preferable. In cutting sets, enter the knife a little above the eye, slanting

the section somewhat downwards: each eye will thus have a fair proportion of substance till the crown only is left of similar size to the other pieces; but here the eyes are generally too much crowded, and therefore all the eyes, except one or two, should be pared off. The sets should have been previously cut and exposed to the air for two or three days, to dry up the moisture of the wound. They should be planted in rows two feet, or two feet and a-half wide, and from six inches to eight inches apart in the row, according to the richness of the soil and the vigour of the sort; and about six inches deep. The best time in the climate of London is (1407) the first week of March, if the soil and the weather are suitable, or a week or more later, if they are otherwise. They may either be planted in the Lancashire manner (1409), in drills drawn six inches deep, or in holes made by the potato dibber (fig. 17, in p. 131). They require no further culture than stirring the soil between the rows, keeping it clear of weeds, and drawing the earth up to the stems to the height of three inches or four inches above the general surface; not, however, in a narrow ridge, as is sometimes done, but in a broad rounded ridge, thereby providing soil for covering the tubers that may be protruded into it from the stem; and pinching off the blossom buds as soon as they appear. The crop will be fit to gather when the leaves and the points of the shoots have begun to decay. They may either be wholly taken up and stored in a cellar, or in a ridge (1152), or left in the ground covered with litter, and taken up through the winter as wanted (857). For potatoes to be used before March this is an excellent mode; but at that season they generally begin to grow, and then recourse must be had to such as have been covered, so as to retard vegetation. (See 1416.)

1413. *Young potatoes during winter* are obtained by the following modes: In Cornwall the sets are planted in October; they spring up a few weeks afterwards, are ready before the autumnal frost stops their growth, and the soil being covered with litter, to exclude the frost, they are begun to be used about the end of December, and continue in use till May, when they are succeeded by the spring-planted crops. Of late years Covent-garden market has received supplies of early potatoes from Cornwall, treated in the above manner (*G. M.*, vols. ii. v. vi.) In various parts of the country young potatoes for the table during winter are thus produced:—Large potatoes are picked out from the winter stock of any early variety, and buried in dry soil to the depth of three feet. This depth, and the circumstance of treading the soil firmly over the potatoes, so far exclude both heat and air as to prevent vegetation. About the middle of July following, take the tubers out of the pit, and pick out all the buds except a good one in the middle of the potato. Plant these potatoes in a dry border sloping to the south, the soil being in good condition, but not manured. Place the eye or bud of each potatoe uppermost, and as their growth will be rapid at this season, earth them up carefully, to preserve their stems from the wind. About the end of October the young potatoes formed by the plants will average the size of pigeon's eggs, and all that is now required to be done is, to cover them well up with long litter, to preserve them from the frost. During winter they may be dug up as wanted, and their delicate waxy taste will resemble that of new potatoes (*G. M.*, vol. viii. p. 56). Mr. Knight procured a crop of young tubers by planting large ones in September; not a single shoot from these tubers appeared above the soil, but a portion of the matter of the old tuber was merely transformed into young ones, as frequently

happens when potatoes are laid between layers of earth in boxes. (*Ibid.* p. 315.) The same thing has been effected by R. Taplin, who selects the largest potatoes he can find in spring, continues rubbing off the sprouts as fast as they appear till the month of August, when he prepares a bed of light soil, about six inches thick, in a dry, warm shed. On this bed he places his potatoes whole, and nearly close to each other, covering them with light soil, four inches deep, giving it a moderate watering, and letting the bed remain in that state till it is time to cover it over, in order to protect it from frost. On examining the bed in December, he found an abundant crop of potatoes, without the least appearance of haulm or outward shoot from the parent root. (*Gard. Chron.* 1841, p. 182). See also 1101.

1414. *Selecting and preparing the sets.*—As the buds at the top end of the tuber, like those on the points of shoots of trees, always vegetate first, these are chosen for sets for an early crop, and they are found in the case of the Rufford kidney to produce a crop nearly a fortnight earlier than sets taken from the root end of the tuber, where the starch being more concentrated, requires a longer period to be converted into mucilage (552). For a main crop the point of the tuber should be rejected whenever it contains a number of small buds, because these produce an equal number of weak stems, which, as shown above (1306), are far inferior in productiveness to one good stem; and the root end ought to be rejected, because the buds there, especially when the potato is over-ripened, sometimes do not vegetate. Early potatoes intended for being cut into sets are found to keep better and sprout earlier when they are taken up before they are ripe, just when the outer skin peels off, and before the stalk or stem begins to wither, and exposed to the direct influence of the sun in any dry surface, till they become green. This will require a month or six weeks, when they become quite green and soft, as if frosted, and often much shrivelled. They are then put away in a cellar or pit, where they remain dry and cool till February, when they will be found sprouted and fit to cut into sets, and plant at once.

1415. *Greening potatoes for sets*, is practised as above (1414), stated with a view towards forwarding the crop; but “why it does so, appears to be imperfectly understood, even by those who practise it. It is well known that tubers are not solely formed on the underground part of the stem; they are also formed upon the stem above ground in many varieties, and these formations are of course green. Though formed at the same time as those below, or later, yet they sprout directly, in the same manner, even in the case of late varieties, the underground tubers of which do not vegetate till the following spring. When, however, an underground tuber is exposed to light, it becomes green, and thereby is assimilated to the nature of the tuber produced above ground, and like it disposed to sprout earlier than those not subjected to the influence of light. It is not, however, necessary to green the sets for a general crop, for if planted in time they come up early enough to be safe from spring frosts without previous exposure, for the purpose of greening; but in the case of early plantations (1408), with protection if necessary, greening may be of some advantage; and in the method of retarding the sets so as only to plant them in July for a late young crop, it is unavoidable, for the tubers would either grow too much or rot, if they were not spread out in a dry cool situation, and consequently one unfavourable for growth. Instead of greening the tubers when taken up, and

afterwards pitting them till spring, it would most probably answer better not to expose them to the process till more immediately before planting, in order that the excitement to growth might go on without an intermediate check.—(*N. in G. M.* 1842.)

1416. *Taking up and preserving a crop.*—The art of keeping potatoes, whether for culinary purposes or propagation by sets, is founded on the following principles:—“Potatoes may be viewed as tuberous stems, edible only when in a blanched state; for exposure to light is injurious to their nutritive qualities, more especially if vegetation is excited. The latter may be checked, it is true, by various means; but nothing can prevent the tubers from becoming green if long exposed to direct light. That this affects them even in winter, in some degree, there is no doubt; but as the heat of the season advances, the influence of light becomes much more evident; and when some time exposed to light, instead of being wholesome, they ultimately become, to a certain extent, poisonous. Potatoes ought, therefore, to be kept as much as possible in the dark. They ought not to be exposed to light a single day after they are dug up; they are even deteriorated in quality by spreading out to dry previously to storing up. The less they are dried the better, for drying injures the skin. If the skin, and perhaps a portion of the substance immediately below it, is made to part with its natural juices by drying, it is not at the same time rendered incapable of absorbing moisture if presented to it; but the natural juices, although watery, are yet not water; and, therefore, the latter substance being foreign, must, when introduced into the tuber, prove injurious to it. Fermentation is sometimes brought on by putting moist potatoes together in large masses in a warm situation, and of course changes the whole substance, and annihilates the vegetative principle. It should, therefore, be carefully guarded against, by not throwing the potatoes into too large heaps, but rather laying them up in long ridges, with divisions of earth at intervals corresponding with the quantity of potatoes that are intended to be taken out at once. If potatoes are dried unavoidably, they should not be again wetted till such time as they are about to be cooked. No good judge of the nature of potatoes would choose to purchase out of the washed heaps exposed in towns in preference to such as are unwashed. It is not well to use straw next potatoes, for it becomes decomposed by the moisture, and, by its decomposition, carburetted hydrogen is formed. The colour of the flesh of the white kidney potatoe has been known to be changed from white to yellow when boiled, in consequence of a straw covering having been placed next them in the ridge, and at the same time a bad flavour communicated. If the above observations are attended to, failures to any extent worth noticing in the vegetation of the sets will not occur. Potatoes have been known to have been taken up in a very wet state indeed, and buried in small quantities in moderately dry soil; but no failure in the sets resulted from such practice.” (*N. in G. M.*, 1842.) Potatoes intended for seed, as we have seen (1407), should be taken up before they are ripe; but those for keeping should be mature. The greatest care is necessary, in both cases, not to make the slightest wound on the rind of the tuber, which, if done, is certain of sooner or later bringing on decay. They may be preserved in cellars which are out of the reach of frosts, in pits in dry sandy soil, or in ridges above the surface, five feet wide, and of any convenient length, first covered with turf, if it can be had, placing the grassy side uppermost,

not next the potatoes; then with a coat of six inches or eight inches of soil, and, lastly, with such a thick coating of thatch as shall as effectually exclude both rain and heat, as if ice were to be kept instead of potatoes. If the potatoes are covered up in this manner, when they and the soil beneath them are of a temperature not much above the freezing point, they will keep without sprouting, for any required period; provided the same care be taken in opening and covering them, when any are wanted for use, as is done in taking ice from an ice-house. To lessen this care, as many as will serve a week may be taken at a time. As ice may be preserved from thawing in an underground cellar, so may potatoes be from sprouting. Whenever potatoes are preserved in a situation that admits of such a rise of temperature as to occasion their sprouting, they ought to be turned over as often as the sprouts have grown to half an inch in length; otherwise their quality will become greatly deteriorated by the increase of fibrous matter in the tuber, in consequence of the action of the sprouts. Indeed, the best mode is to scoop out the eyes with the point of a knife or gouge (418), or to sear those of the potatoes which are to be kept longest with a hot iron, or to scald or destroy vitality, by putting them for a short time in boiling water, or in a heated oven. Kiln-drying potatoes is a practice not uncommon in some parts of Scotland; but they should not be afterwards wetted till they are being prepared for use. Every one who knows the difference in the eating of the potato that has, and one that has not sprouted, will admit the importance of this subject.

1417. *Diseases, insects, &c.*—The potato is subject to the curl in the leaves, which, when it has once taken place, cannot be remedied, but which may, in general, be prevented by using healthy sets from the middle or top end of the tuber, and by good culture in well pulverised soil, dry at bottom. The heating and fermenting of sets, after they have been cut, often produces the curl and other diseases; and some particular soils and manures seem to be the cause of the scab in the tuber. These diseases, however, are more common in fields than in gardens. A change of variety, or of sets of the same variety from a different locality, is frequently resorted to, more especially in field culture, as a general preventive of disease in the potato.

Forcing the Potato, see 1100.

The sweet potato, *Convolvulus Batatas*, L., has already been treated of in the Chapter on Forcing (1102).

SUBJECT. II.—*The Jerusalem Artichoke.*

1418. *The Jerusalem Artichoke*, *Heliánthus tuberòsus* L. (*Poire de Terre*, Fr.) is a corymbiferous tuberous-rooted perennial, a native of Brazil, but sufficiently hardy to thrive in the open air in Britain. Before the potato was known, the tubers of this plant were much esteemed, but they are now comparatively neglected, though in our opinion the Jerusalem Artichoke is as deserving of culture as the common artichoke. The tubers are wholesome, nutritious, and in stews boiled and mashed with butter, or baked in pies with spices, they have an excellent flavour, resembling that of the common artichoke. Two or three rows of a few yards in length are sufficient to afford a small family an occasional dish through the autumn and winter. Propagation is effected by division of the tuber, or by small tubers planted in March: the soil ought to be light, sandy and rich, and the situation open. As the stems grow from four feet to eight feet in height, the rows may be three

feet or four feet apart, and the plants a foot distant in the row. The tubers may either be taken from the plants as wanted, or the crop dug up and housed in the manner of potatoes. No plant in the whole catalogue of culinary vegetables requires less care in its culture. It very seldom flowers, but by destroying the tubers as they appear, it might doubtless be made to produce seed, by means of which some improved varieties might possibly be obtained.

SUBJECT. III.—*The Turnip.*

1419. *The Turnip*, *Brássica Ràpa L.*, is a cruciferous biennial, a native of Britain, of no value in its wild state, but so greatly changed by culture as to become one of our most useful culinary and agricultural vegetables. It was cultivated by the Romans, but was little known about London till the beginning of the 17th century. The use of the root in broths, soups, stews, and entire or mashed, is general in all temperate climates, and also the use of the tender radical and stem leaves, and the points of the shoots, when the plant is coming into flower, as greens. The seedling plants, when the rough leaf is beginning to appear, like those of all others of the Brassica family, are used in small salading. The earliest crop of turnips comes into use about the end of May, or beginning of June, and a succession is kept up throughout the summer by subsequent sowings; and turnips may be had through the winter, partly from the open garden and partly from roots stored up, in the manner of potatoes. Hence a large portion of the kitchen-garden is devoted to this crop. A well-grown turnip has a large, smooth, symmetrical bulb, a small neck, and a small root or tail, with few fibres, except near its lower extremity. In the rotation the turnip follows the potato, the leguminous family, or any crop not cruciferous.

1420. *Varieties.*—The *early Dutch*, white, small, and if sown towards the end of March or the beginning of April, will be fit for use towards the end of May; the *Stone*, white, larger, and adapted for successional crops till winter. *Scotch yellow*, syn. garden yellow, excellent for winter use; the *Swedish*, syn. Rutabaga, greenish-yellow, of excellent flavour, but requires a great deal of boiling; it will keep either in the open garden till March, when its tops will make excellent greens, or in the root-cellar, or buried in a thatched ridge till turnips come again. This variety differs from all the other kinds of turnip in admitting of being transplanted, and yet bulbing nearly as well as if sown where it is finally to remain. The other varieties may be transplanted, provided the very extremity of the tap root is preserved uninjured, which is done by using a transplanter (fig. 32, in p. 135), or by having part of a row of plants sown over a layer of compact rotten dung. The point of the tap root stops at the dung, and branches into it, and the plant can thus be taken up along with the dung without injury. The *Maltese*, syns. yellow Maltese, golden Maltese, is a very good, small, yellow, much flattened, winter turnip. The *Teltow*, syn. French turnip; yellow, small, long-rooted like a large radish, but of most excellent flavour, always used with the rind on, in which the flavour resides; neither fit to be eaten boiled alone or raw; but two or three of them in seasoning will give a higher flavour than a dozen of other turnips. This variety is much cultivated on the Continent, though neglected in England; but in our opinion it ought to be in every suburban garden.

1421. *Culture.*—The turnip, with the exception of the Rutabaga, can only

be propagated by seed, and for a bed four and a half feet by twenty-four feet, the plants to remain being thinned to seven inches' distance every way, the quantity required is half an ounce. The seed comes up in ten days or a fortnight, according to the season. The soil should be in good heart, and well pulverised. If sown in raised drills, they do better than on level ground, more especially on soils inclined to be tenacious. Sown broadcast on such soils, they do no good. A sowing should be made once in March, and twice in April, for the earliest crops; and afterwards at intervals of four or five weeks, till the middle of August, for a winter crop or for plants to stand through the winter to shoot up and supply greens in February, March, and April. The main crops of white, yellow, and French turnips, should be sown in the latter end of June. All the sorts should be sown in drills, as admitting of stirring the soil among the plants with less labour. The earliest and latest crops should be of the early Dutch, as coming into use sooner in autumn, and sending up sprouts soonest in spring. They may be in rows a foot apart, and the plants thinned out to six inches' distance in the row, and this width will also answer for the French turnip; but the stone and the yellow may be sown in rows eighteen inches apart, and the Swedish at two feet; the distance in the rows being proportionately increased. The routine culture consists in weeding, thinning, stirring the soil, and supplying water abundantly in very dry weather, to prevent the roots from becoming tough and stringy; taking great care, when stirring the soil, not to earth up the roots, which will prevent their swelling.

1422. *In gathering* the root the entire plant is necessarily pulled up, and the tops and tails taken at once to the rot heap. Choose the largest, and take them from the most crowded parts of the rows, to make more room for the growth of those which remain. In gathering the tops in spring, the tenderest leaves only are taken, whether from the crown of plants that have not yet run, or from the flower-stems. Some also gather the points of the stems, which, however, are much less delicate than the leaves, but excellent to salt beef. The leaves and tops are equally good from all the varieties; but most acrid from the French turnip, and least so from the Swedish.

1423. *Preserving turnips through the winter.* In ordinary winters neither the yellow nor the Swedish turnip require to be covered; but as when left exposed they will begin to vegetate, in February a portion of the crop should be taken up, topped (but not tailed, which would favour the escape of sap), and preserved in sand or straw in the root-cellar, or in a ridge like potatoes (1416); and like them so thickly thatched as to exclude both heat and rain, and maintain a degree of coolness that will prevent vegetation. Or the rows as they stand on the ground may have the leaves cut off and covered with soil, so as to form them into ridges, and after the whole mass of the ridges has been cooled down to 32° by frost, it may then be thickly covered with litter, to exclude the heating influence of the sun. A third mode of preserving turnips through the winter, consists in cutting off the tops with a slice of the roots attached, so as to prevent them from ever vegetating again, and in this state, with or without the tails, burying them in moist sand in a cellar, or in a ridge in the open air like potatoes. As the turnip vegetates at a much lower temperature than the potato, much greater care is required to keep it in a dormant state.

1424. *To save seed.*—One kind only can be sowed in one garden in the

same year. The best formed roots, and those which have come earliest or latest into maturity according to the variety, should be selected and transplanted in autumn, or early in spring, into a spot by themselves, and the stems tied to stakes, if there should be any danger apprehended from high winds. The seed will keep four or five years, but should be acrated once every winter, during severe frost (1333).

1425. *Diseases, insects, &c.*—The turnip in very dry seasons is liable to the mildew, if it has not been liberally supplied with water; and also to excrescences on the root, produced by a species of cynips which deposits its eggs there. Lime, soap-boilers' waste, putrid urine, or the urine of cows, are said to render the soil offensive to the parent-fly; and when its attacks can be foreseen, this mode may be adopted, more especially as, if it fails, it will at all events manure the soil. On coming through the ground, the plants are liable to the attacks of a small jumping beetle, called the turnip-flea, *Háltica némorum*, besides five or six other insects of different kinds, the effects of which are very serious in field-culture; but in gardens they can generally be guarded against, or counteracted by watering, or by digging down and re-sowing.

1426. *Forcing the turnip* for the root is seldom attempted in British gardens, though in Russia and some parts of Germany it is sown on hotbeds, as radishes are in England. The roots, more especially those of the Swedish turnip, placed close together on heat in January, will produce an abundance of delicate sprouts through February and March.

SUBJECT. IV.—*The Carrot.*

1427. *The carrot*, *Daucus Caròta L.* (*Carotte, Fr.*), is an umbelliferous biennial, common in Britain and other parts of Europe, of no use in cookery in a wild state, but by culture rendered succulent, agreeable, and when young highly nutritive. It is excellent in a mature state as a dish, or in stews; and no vegetable is so much in demand for soups. For the latter purpose, it is required in some families throughout the year; several crops being forced, and the supply from May to October being furnished from the open garden. A considerable breadth is therefore required for this crop, which in the rotation may follow some of the cabbage tribe, or some crop that has been manured; for any manure, except what is in a liquid state, applied to the carrot, causes the roots to branch and their rind to become ulcerated.

1428. *Varieties.*—*Early horn*; orange, short, coming earlier to maturity than any other variety. *Early scarlet horn*; larger than the preceding, and better for a main crop. *Long orange*, syn. Altringham; orange-red, long, well-adapted for a main crop. *Long red Surrey*; red, long, excellent also for a main crop. *Long white*; white, very delicate flavoured, produces an immense crop, but does not keep well through the winter. *Violet*, syn. purple; violet, large, sweet, not much cultivated.

1429. *Culture.*—By seed is the only mode of propagation; and as the seeds have numerous forked hairs on their edges, by which they adhere together in clusters, they should be rubbed between the hands and mixed with dry sand, in order to separate them as much as possible before sowing. For a bed four and a half feet by thirty feet, the plants to be thinned out to six inches every way, or for 150 feet of drill, 1 oz. of seed will be requisite. The seed does not come up for four or five weeks in spring, and for

three or four in summer and autumn. The soil should be light and sandy, and deep and rich, in consequence of being well trenched and manured the preceding year. The first sowing of the early horn may be made in the middle of February, in a warm border; and if the family require a constant supply of young carrots, successional sowings may be made, as recommended, for a constant supply of turnips. From the middle of March to the first week in April is the best time for sowing the main crop for taking up and preserving through the winter; and a crop of small carrots, to stand through the winter and afford roots in February, March, and April, may be sown in the first week in August. The early scarlet horn is by some the only carrot grown, answering well both for an early and a main crop (*G. M.*, 1840, p. 207, and 1841, p. 27). All the crops that are to be drawn young may be sown in drills, six inches apart, and the plants thinned out to three inches, but those which are intended to produce carrots of full size should be sown in drills eighteen inches apart, and the plants thinned out to from eight inches to ten inches in the row. Carrots will grow in peat. Deep holes may be made with a large dibber, and filled with prepared rich sandy soil, and two or three seeds sown in each hole, to be afterwards thinned, so as to leave the best in each hole. They may be produced of large size in this way, even where the ground is too stiff to produce otherwise a good crop.

Routine culture as in the turnip (1421), with this difference that the soil between the rows should not be stirred deeper than is necessary to kill the weeds; for by so doing the lateral fibres will be encouraged to grow large and disfigure the main roots.

1430. *Gathering and keeping*.—Young carrots are drawn by hand, and full-grown ones dug up with the spade or two-pronged fork, a trench being made alongside one row after another, so as to admit of taking out the carrots without, in the slightest degree, injuring their rind. A portion of the main crop may be left in the ground, and covered with litter to be taken up as wanted; and the remainder may be preserved in cellars or in ridges by some of the modes recommended for preserving turnips. When the top is cut off along with a slice of the root, there is no difficulty in preserving carrots till carrots come again; indeed they have been so preserved for two years (*G. M.* vol. vii. p. 191); but we should prefer keeping on the tops and burying the carrots in an ice-cold thatched ridge.

1431. *Diseases and insects*.—The root is sometimes disfigured by ulcers, supposed to be the effect of recent manure, and they are often attacked by the grub of some dipterous insect, which in its perfect state may be prevented from depositing its eggs, by watering the soil after the plants have come up with some nauseous liquid manure, such as putrid urine or spirits of tar, at the rate of about one gallon to every sixty square yards (*C. M'Intosh, in Gard. Chron. for 1841, p. 53*). Grubs already in the soil cannot so readily be destroyed, unless the ground is so deep that they may be trenched down when the want of air will kill them; but some other crop may be grown on it which the insects will not attack.

1432. *Seed saving*.—Select some of the finest specimens and transplant them in autumn, growing only the seeds of one variety in one year in the same garden. The seed, if kept dry and adhering to the stalk, will keep three or four years; but if separated from the stalk, it will grow with difficulty the second year.

Forcing the carrot. See 1106.

SUBSECT. V.—*The Parsnep.*

1433. *The parsnep*, *Pastinaca sativa*, L. (Panais, *Fr.*), is an umbelliferous biennial, a native of Britain, on calcareous soils in open situations, and withstanding our severest winters. It has been as much changed by culture as the carrot, and like it its roots are highly valued both in horticulture and agriculture. With respect to culinary purposes, they are in season from October till March. They differ from the carrot in being only used in their mature state, and chiefly during winter; forming a dish to be eaten to meat or to salt fish; and they are used in soups, mashed, stewed, and fried. Beer and wine can be made from them, and also a powerful spirit. The parsnep is excellent food for cows, being highly nutritive, and giving to the milk a peculiarly rich and agreeable flavour, resembling that from cows that are fed on the richest old pasture. Hence it should be grown on a large scale by every cottager that has a cow. Only a moderate space is required for them in the gentleman's garden, and they come in in the rotation along with the carrot and the beet. The varieties are few; the *hollow-crowned* is best worth cultivating. The *Siam* variety has a small yellow root of a high flavour, and the turnip-rooted has a round root.

1434. *Propagation and culture.*—The seed required for a bed five feet by twenty feet, the plants to be thinned to eight inches' distance every way, is one ounce: and the same for a drill of one hundred and fifty feet; the seed comes up in eight or ten days. Seldom more than one crop is required, and this is sown in March, in rows eighteen inches apart, the plants being afterwards thinned out to eight inches' distance in the row. Routine culture as in the carrot. The roots are not liable to be injured by frost, and may therefore be left in the ground to be taken up as wanted till February, when they will begin to grow. If parsneps are required after this season, a quantity of roots must be taken up in winter, and stored like those of the carrot, taking care either to cut off the tops, with a slice of the root, or to bury in an ice-cold thatched ridge. The parsnep is seldom attacked by diseases, or by insects. Seed may be saved as in the carrot, and it generally retains its vitality only one year.

SUBSECT. VI. *The Red Beet.*

1435. *The Red Beet*, *Beta vulgaris* L. (Betterave, *Fr.*), is a chenopodiaceous fusiform-rooted biennial, a native of the South of Europe on the sea-coast, and cultivated in gardens for its root from the beginning of the seventeenth century, and probably long before. The roots are boiled and eaten cold, either to meat, especially mutton, by themselves, dressed as salad, or in mixture with other salad ingredients; they form a beautiful garnish, and a very desirable pickle. The thin slices dried in an oven are also used in confectionery, and the leaves may be used as spinach or greens. The roots must be washed and also boiled with all their lateral fibres, and, in short, without any part cut off except the leaves; because it is found that when the root is wounded in any part, the colour in boiling escapes through the wound. There are several varieties, but the best are the *common red beet*, the *Castelnaudari*, with a nutty flavour, and *White's gigantic dark*, a new variety of very great merit. The *turnip-rooted* is an early variety with the roots round, and the *Basano* beet has the skin of the root red, and the flesh veined with rose colour, but it is scarcely known in British gardens. The

common red and gigantic dark red are the best for a cottage garden. There are various kinds of white-rooted and yellow-rooted beet, but these, being grown chiefly for their leaves as spinach, will be noticed in the section on spinaceous plants. Seldom more than one crop of beet is required, and this is sown in the last week of March or the beginning of April. For a bed four feet and a half by twelve feet, or one hundred and fifty feet of drill, one ounce of seed is sufficient. The ground should be prepared as for the carrot, and the seed may be sown in drills at the same distances, and the same routine culture given, with this difference, that blanks when they occur may be filled up by transplanting when the plants are quite small. The plants come up in a month. The crop will be ready for use in September, and may be treated in all respects like a crop of carrots, and like them, if desirable, kept in pits from December till the September following. Seed may be saved as in the carrot, and it will keep nine or ten years.

SUBJECT. VII. *The Skirret, Scorzonera, Salsify, and Enothera.*

Though these plants are at present but little cultivated in British gardens, yet we think a small portion of each deserves a place for the sake of variety.

1436. *The skirret*, *Sium Sísarum*, *L.* (*Chervis, Fr.*) is an umbelliferous tuberous-rooted perennial, a native of China, and in cultivation in British gardens from the beginning of the sixteenth century. The part used is the root, which is composed of fleshy tubers, about the size of the little finger, and joined together at the collar of the plant in the manner of the tubers of the ranunculus. The tubers were formerly esteemed as "the sweetest, whitest, and most pleasant of roots," either boiled and served up with sauce, or fried in various ways. The root is in season during the same period as the parsnep. There are no varieties; but when the plant is cultivated, it is generally propagated by dividing the roots. Seed, however, may be obtained, and its culture and management is in all respects the same as that of the beet. The seed keeps four years.

1437. *The scorzonera*, or *Viper's grass*, *Scorzonèra hispánica*, *L.* (*Scorzonère, or Salsifis d'Espagne, Fr.*), is a chicoraceous fusiform-rooted biennial, a native of the South of Europe, in culture in British gardens since the middle of the sixteenth century. The root is straight, conical, and about the thickness of a middle-sized carrot, with a black rind. It is used boiled or stewed, in the manner of carrots or parsneps; it comes into use in August, and may be taken up in November, and preserved as long as may be thought desirable. Though a perennial, it is always propagated by seed, of which an ounce will be sufficient for one hundred and fifty feet of drill. The seed comes up in three or four weeks. The routine culture is the same as for the carrot and parsnep, and seed may be saved in the same manner; it keeps good two years.

1438. *The salsify*, or *purple Goat's beard*, *Tragopògon porrifòlius*, *L.* (*Salsifis, Fr.*), is a chicoraceous fusiform-rooted biennial, not unlike the scorzonera, to which, however, it is much to be preferred, but with much narrower leaves, at a distance resembling those of leeks, a native of England, formerly cultivated for its roots, which were used like carrots and parsneps. The seeds may be sown in March or April, and treated in all respects like those of the scorzonera. The seed keeps two years.

1439. *The Spanish salsify*, *Scólymus hispánicus*, *L.* (*Cardouille, Fr.*),

is a carduaceous biennial, a native of the south of France, where the roots of the wild plant are collected and dressed like those of salsify or scorzonera, which they closely resemble when dressed. (*Bon Jard.*, 1842.)

1440. *The tree-primrose*, *Oenothera biennis*, L., an onagrarioid fusiform-rooted biennial, a native of North America, is cultivated in some parts of Germany for the same purpose as the scorzonera, and the points of the shoots are used in salads. The roots of the other biennial species may doubtless be similarly applied. Seeds are readily procured from the seed-shops, and the plant grows freely in sandy soil.

SUBJECT. VIII.—*The Hamburgh Parsley.*

1441. *The Hamburgh parsley*, *Āpium Petroselinum tuberòsum* *Bon Jard.*, is a biennial, resembling the common parsley, but with much larger, less curled leaves, and with large fusiform roots of the same colour and texture as those of the parsnep. It is occasionally cultivated in Germany, to put in soups and stews, and also as a separate dish, like the parsnep or 'Teltow turnip. Its culture is in all respects the same as that of the parsnep.

SUBJECT. IX.—*The Radish.*

1442. *The radish*, *Ráphanus sativus* L. (*Radis* and *Rave*, *Fr.*), is a fusiform-rooted cruciferous annual, said to be a native of China, in cultivation in Britain from the earliest period of garden history, for the roots which are eaten raw as salad, or in mixture with other ingredients. The roots are also excellent when boiled and sent to table in the manner of asparagus. The young seedling leaves are sometimes used as small salading, and the seed-pods are frequently pickled, and used as a substitute for capers.

1443. *Varieties.*—These are arranged as spring and summer radishes, turnip radishes, autumn radishes, and winter radishes. The first class are delicately acrid, the second more powerfully so, and the last strong and coarsely pungent.

Spring and summer radishes.—*Scarlet*, syn. salmon-coloured: in most general cultivation. *Short-topped scarlet*: the earliest and best variety. *Semi-long scarlet*: a new sort, said to remain longer crisp than other spring and summer radishes; and the *semi-long rose coloured*, also of excellent quality. The short-topped scarlet is the best for a cottage garden.

Turnip radishes.—*White turnip*: root globular. *Rose-coloured turnip*. *Yellow short-topped turnip*: form cylindrical.

Autumn radishes.—*White Russian*: root large and long, white, tapering like a carrot, flavour nutty, like that of the rampion. *Yellow turnip*: root large, ovate, rough, yellow or dusky brown without, but white within. *Round brown*: root large, greenish brown; the first is the best for a cottage garden.

Winter radishes.—*White Spanish*: root large, outside greenish white, flesh hot, firm, solid, and white. *Black Spanish*: root large, rough, black, flesh white, hot, firm, solid; the hardiest of the winter radishes; the best for a cottage garden.

1444. *The soil* for all the kinds should be light, rich, and well pulverized to at least eighteen inches in depth, and the situation for an early crop sheltered and exposed to the sun. The seed should be sown in January and February for a crop to be drawn in March and April, and covered with

mats, straw or fern, nightly and during great part of the day in snowy or very cold windy weather. The seeds should be scattered so thin as not to come up thicker than one and a half inches or two inches apart. For a bed four feet six inches by twelve feet, two ounces of seed will be required. It will come up in eight or ten days. Successional sowings may be made every ten days or a fortnight, till the end of May; afterwards the autumn radishes may be sown till the end of July; and the winter radishes may be sown from the beginning of July till the end of August. The autumn and winter radishes are most conveniently cultivated in rows, and as they are allowed to attain a considerable size before being used, the distance between the rows may be nine inches or a foot, and the distance in the row six inches. The winter radishes come into use in October, and being very hardy, may either be left in the open ground through the winter, which is the practice in Russia where the ground is covered with snow, and taken up as wanted; or stored up in ridges or cellars in the manner of turnips or carrots. The tender green seed-pods used in pickling are taken from plants of the early sorts that have been allowed to run to seed for that purpose in July and August. The early radishes are so short a time on the ground that they are seldom troubled with insects; but in the case of seed-bearing plants, the sparrows are very fond of the newly-formed seeds. In saving seed only one kind ought to be grown in the same garden at the same time. The seed will keep two years.

For forcing the radish, the details have already been given at length (1108).

SUBSECT. X.—*Oxalis Déppeï*, *O. crenàta*, and *Tropæolum tuberòsum*.

1445. *Deppe's oxalis*, *O. Déppeï* B. C., is an oxalideous bulbous-rooted perennial, a native of Mexico, introduced in 1827, and strongly recommended for cultivation for its fusiform roots, which form a delicate vegetable dish; and for its stems, flowers, and leaves, for putting into salads. The roots, when the plant is properly cultivated, become nearly four inches in length, and above an inch in thickness, consisting of cellular matter without woody tissue or sap vessels, not unlike, in texture and nutritious properties, the tubers of the salep orchis, *O. mòrio*, L. "The roots are gently boiled with salt and water, after being washed and slightly peeled; they are eaten like asparagus, in the Flemish fashion, with melted butter and the yolk of eggs. They are also served up like scorzonera and endive, with white sauce. They form, in whatever way they are dressed, a tender succulent dish, easy to digest, agreeing with the most delicate stomach. The analogy of the root with salep indicates that its effect should be excellent upon all constitutions. The young leaves are dressed like sorrel, put in soup, or used as greens; they have a fresh and agreeable acid, especially in spring. The flowers are excellent in salad, alone, or mixed with corn salad, endive of both kinds, red cabbage, beet-root, and even with the petals of the dahlia, which are delicious when thus employed. When served at table, the flowers with their pink corolla, green calyx, yellow stripes, and little stamens, produce a very pretty effect."—(Professor *Morren in Gard. Chron.* 1841, p. 68.) Propagation may be effected by the little scaly bulbs, which are found in abundance round the collar of the plant. They require a light sandy soil, enriched with decayed vegetable matter, and frequent watering in very dry weather; and Prof. Morren waters with liquid cow-dung in May. The bulbs may

be planted about the middle or latter end of April, when all danger from frost is over, in drills seven inches asunder, the bulbs five inches apart in the row, and covered with an inch-deep of soil. The bulbs being exceedingly small, three or four of them are put down together, so as to form a group of plants. Vegetation continues till October, when the plants may be taken up, and the roots preserved through the winter in sand in a dry cellar, protected from frost. The bulbs are previously taken off the sides of the crown of the root, and preserved till the planting season, in the same manner. Prof. Morren has seen a single plant produce from forty-five to fifty bulbs.—(*Ibid.*, and *Annales des Sciences Physiques &c.*, de Lyon, tome viii., 1838.)

1446. *Oxalis crenata* Jacq., a tuberous-rooted oxalis from Lima, where it is used as an esculent, has been cultivated in this country since 1832, for the same purposes as *Oxalis Déppeii*; but it is said to be inferior to that species in the flavour of the tubers. The stalks and leaves, however, are used in tarts, alone or with other vegetables or fruits. The plant was much cultivated ten years ago, but is now out of repute, while *O. Déppeii* is coming into favour. There are several other bulbous or tuberous rooted species of *Oxalis* from South America, which might in all probability be used in the same manner as the species mentioned.

1447. *Tropæolum tuberosum* Maund., is a tropæolaceous tuberous-rooted climbing perennial, growing five feet or six feet high, introduced from Peru in 1837, which has also been added to the list of our esculent roots. The tubers, when well grown, are about the size of hens' eggs, and have the flavour of sea-kale or asparagus, joined to somewhat of the hot taste of garden cress. The plant is propagated either by cuttings taken from tubers placed in heat early in the season, and treated like cuttings of dahlias so obtained, or by cuttings of the tubers, leaving one good eye in each set. These may be brought forward on heat in separate pots, and when all danger from frost is over, turned out into a light, rich, sandy soil, three feet or four feet apart every way, and either left to cover the ground with their trailing stems, by which the soil will be kept moist, or sticked like peas. The latter is the best mode in a moist season or damp soil. In October, when the leaves are beginning to decay, the plants may be taken up, and the tubers placed in a dry cellar, or in a pit or ridge, out of the reach of frost and damp, in the manner of the tubers of oxalis, or those of the potato. This tropæolum was first successfully cultivated by Mr. Cameron, of the Birmingham Botanic Garden, who, from about a dozen tubers, raised twenty-five plants in April, turned them out in July, and dug up half a bushel of tubers from them in November. (*G. M.*, 1838, p. 254.) *T. édule*, of which there are plants in the Hort. Soc. Garden, and other species with tuberous roots, might doubtless be used as substitutes for the *Tropæolum tuberosum* *L.*

1448. *Substitutes for esculent roots* are to be found in the roots or tubers of *Psoralea esculenta* *Dec.*, a leguminous perennial, a native of Missouri, cultivated in North America; *Láthyrus tuberosus* *L.*, *Órobis tuberosus* *L.*, *Àpios tuberosus* *Boer.*, *Árachis hypogæa* *L.*, all well-known leguminous perennials; *Potentilla Anserina* *L.*; *Tràpa nàtans* *L.*; the common caraway, *Càrum Càrui* *L.*, a well-known umbelliferous biennial, a native of Britain in meadows, the roots of which were formerly eaten as parsneps are, the leaves used in garnishing, and the seeds, as they still are, in confectionery and distillation; *Campánula*, any of the fleshy rooted species; *Állium*, any species; *Lílium pomponium*; *Echinóphora spinòsa* *L.*, the prickly samphire,

the roots of which are eatable, with the flavour of parsneps, and the young leaves make a very wholesome and excellent pickle; *Cypèrus L.*, the rush nut, and some others.

SECT. IV.—*Spinaceous Esculents.*

1449. *The only spinaceous esculents* generally cultivated in British gardens are the common spinach, and the sorrel; but we have also French spinach, beet-spinach, perennial-spinach, New Zealand-spinach, and herb-patience. They are all very mild in quality, and may be used as greens by persons with whom the cabbage-tribe would disagree. In the rotation of crops, some of them, as the common spinach, are secondary; others, as the white beet, are annual; and some, as the sorrel, are stationary.

SUBJECT. I.—*The Common Spinach.*

1450. *The common spinach*, *Spinàcia oleràcea L.*, (*Epinaud Fr.*) is a chenopodiaceous, diœcious annual, a native of the north of Asia, in cultivation from the middle of the sixteenth century, or earlier, for its succulent leaves. It is a very hardy plant, the Flanders variety particularly, withstanding the severest frost. The leaves are used boiled and mashed up as a separate dish, and in soups or stews, with or without the addition of sorrel. The leaves may be obtained from the open ground from April to November, and also to a moderate extent through the winter, and spring. There are three varieties, the *round-seeded*, for sowing during summer; the *Flanders spinach*, which has also smooth seeds but larger, and very large leaves, for sowing in autumn for use in winter and spring; and the *prickly-seeded*, or common winter spinach. The quantity of seed required for a bed $4\frac{1}{2}$ feet by 30 feet is two ounces, or for 150 feet of drill, one ounce. The seed comes up in a fortnight or three weeks, according to the season. The best mode of sowing is in drills 8 inches apart for summer spinach, and 10 inches or 1 foot for Flanders-spinach; the plants in the former case to be thinned to 6 inches apart, and in the latter to 8 inches, as soon as they have shown a proper leaf. In order that the leaves may be succulent, and properly flavoured, the soil should be rich and the situation open and airy, more especially for the main crops. The summer crops are frequently sown alternately with rows of peas or beans; but, as the spinach is generally more or less shaded by these crops before it is fit to be gathered, it is never of so good a quality as that which is grown in the open garden. For summer spinach, the first sowing may be made in open weather in January, and sowings in succession every three or four weeks may be made till the end of July. For winter and spring use, a large sowing of the Flanders variety, and also some of the prickly-seeded, which some prefer, should be made in the first or second week of August, and a secondary one towards the end of that month. These sowings will come into use in November, and will continue to afford gatherings occasionally through the winter, and frequently in spring, till May or June. The routine culture of all the sowings consists in thinning, stirring the soil between the rows, and watering, in very dry weather. In gathering, the largest leaf only, or at most a few of the largest leaves, should be taken off one plant at a time: they may either be cut or pinched off. A portion of the winter crop may be protected by hoops and mats, when a heavy fall of snow is anticipated, to admit of its being more readily gathered. Seed may be saved by leaving a portion of

a row, containing both male and female plants. When the female blossoms are set, the male plants should be pulled up. The seed will keep four years.

SUBSECT. II.—*Orache, or French Spinach.*

1451. *The orache, or French spinach, Atriplex horténsis L.*, is a chenopodiaceous polygamous annual, growing to the height of three feet or four feet, a native of Tartary, and in cultivation as a spinach plant from the beginning of the sixteenth century. The leaves are used as in the common spinach, to mix with those of sorrel, and sometimes also the tender points of the shoots. There are three varieties, the *white*, syn. pale green-leaved, the *green-leaved*, and the *dark red-leaved*. An ounce of seed will sow a drill of one hundred feet in length; and it comes up in ten days or a fortnight. A dozen or two of plants placed two feet apart every way, in rich soil, in an open situation, kept moderately moist, will afford gatherings two or three times a week during the whole summer. The leaves ought to be taken while they are tender, and the blossoms pinched off as fast as they appear. The earliest crop may be sown in February, and for succession another sowing may be made in June. One plant will afford abundance of seed, which will keep two years.

SUBSECT. III.—*New Zealand Spinach.*

1452. *The New Zealand spinach, Tetragònia expánsa H. K.*, is a ficoidaceous trailing annual, a native of New Zealand, growing freely in the open garden during our summers, and suffering much less from drought than the common spinach. It has been more or less in culture as a spinach plant since the beginning of the present century; but it is of inferior quality to the common spinach, and even to the orache, or French spinach. The seed, of which $\frac{1}{4}$ oz. will be sufficient, may be sown on a gentle heat in March; it will come up in ten days, and the plants may be transplanted into small pots and kept in a cold frame till the middle of May, when they may be turned out into the open garden, allowing each plant at least a square yard for the extension of its trailing branches. Half a dozen plants are enough for an ordinary-sized garden. The rest is routine. Seed may be saved in fine seasons from plants in the open garden; and in cold wet summers by planting on dry rubbish, keeping a plant in a pot, or training one up a wall. It will keep two years.

SUBSECT. IV.—*Perennial Spinach.*

1453. *The perennial spinach, Chenopòdium Bónus Henricus L.* (*An-sérine, Fr.*) is a chenopodiaceous perennial, a native of Britain, in loamy soils, and formerly cultivated in gardens for its leaves, which, when grown in a rich soil on vigorous young plants, make a very succulent spinach. The plant is easily propagated by division, and it also ripens seeds. In Lincolnshire it is said to be cultivated in preference to the common spinach.

1454. *The leaves of many of the annual indigenous chenopodiums* may, doubtless, be used as spinach, when nothing better can be got; as may those of the *Quinò*, *Chenopòdium Quinò W.*, an annual, a native of Peru, and extensively cultivated there for its small white seeds. There are two varieties, the green and the red-leaved; they grow about the height of the orache, to which they bear a very close general resemblance.

SUBJECT. V.—*The Spinach Beet, and the Chard Beet.*

1455. *The spinach beet*, leaf beet, or white beet, *Bèta cìcla L.* (*Bette*, or *Poirée, Fr.*) is a chenopodiaceous biennial, a native of the sea-shores of Spain and Portugal, and in cultivation in British gardens from the middle of the sixteenth century, for the leaves, which are boiled as spinach, or put into soups, and used as greens.

1456. *The chard beet*, syn. Swiss chard, (*Poirée à cardes, Fr.*,) belongs to this species; it has leaves with strong white footstalks and ribs, and these, separated from the disk of the leaf and dressed like asparagus, are thought to be nearly as good as that vegetable. There are varieties with *white, yellow, and red* midribs.

The advantage of using the white beet as a spinach plant is, that it affords a succession of leaves during the whole summer; and hence it is recommended for the gardens of cottages. The same advantage also attends the use of the sea-beet, *Bèta marítima L.*, a biennial, or imperfect perennial, a native of our shores. Culture of both the leaf beet and the chard beet as in the red beet (1435); and a single plant will produce abundance of seed, which will keep five or six years.

SUBJECT. VI.—*Patience Spinach.*

1457. *Patience spinach*, Herb Patience, or Patience dock, *Rùmex Patiéntia L.* (*Rhubarbe des Moines, Oseille-épinards, and Epinards immortels, Fr.*), is a polygonaceous perennial, a native of Italy, formerly common in gardens as a spinach plant, but now much neglected. The leaves rise early in spring, and continue to be produced during great part of the summer; they should be gathered when quite tender, and boiled with about a fourth part of common sorrel. It may be raised from seeds, or increased by division like the perennial spinach (1453).

SUBJECT. VII.—*The Sorrel.*

1458. *The sorrel*, *Rùmex L.* (*Oscille, Fr.*), is a polygonaceous genus, of which two species have been long in cultivation for their leaves as sorrel. The *French sorrel*, syn. Roman sorrel, or round-leaved sorrel, *R. scutátus L.*, is a perennial, a native of France and Italy; and the *common garden sorrel*, *R. Acetòsa L.*, is an indigenous perennial, common in moist meadows. The leaves of both species are used in soups, sauces, and salads; and very generally by the French and Dutch as a spinach; in the latter way it is often used along with herb-patience, to which it gives an excellent flavour, as well as to orache, turnip-tops, nettle-tops, and those of Jack-by-the-hedge. There are several varieties of the common sorrel, but that most esteemed is the *large-leaved*, *l'oseille de Belleville, Fr.* The *mild-leaved*, *R. montànus H. P.* (*l'oseille vierge Fr.*), is a dioecious species, of which the leaves are smaller and less acid than those of *R. Acetòsa*. The male plant of this species is recommended in the *Bon Jardinier* for being planted as edgings in the kitchen-garden. All the kinds are propagated by division or by seeds, and they may be grown in rows eighteen inches apart, and a foot distant in the row; lifting a portion of the plantation every year after the flowering season, when the plants are in a comparatively dormant state, and dividing them, and replanting. If this is neglected for two or three years, the plants will become large and crowded, produce only small leaves, rot in

the centre, and ultimately die off. Wherever French cookery is in demand, a considerable breadth of sorrel will be required, and to produce the leaves in a succulent state the soil ought to be rich, loamy, and kept moist.

1459. *Substitutes* for spinaceous esculents are to be found in chenopodiaceous plants generally: in ficoideæ, portulacæ, amarantacæ, polygonacæ, crassulacæ, and oxalidacæ; to which we may add, *Symphytum officinale* L., in Boraginacæ. See these orders in pp. 617, 618.

SECT. V.—*Alliaceous Esculents.*

1460. *The alliaceous esculents* in cultivation in British gardens are chiefly the onion, leek, shallot, and garlic; but there are also the chiye and the rocambole. They are all asphodelaceous perennials belonging to the genus *Allium* L. They all require a rich, loamy soil and an open situation; the onion, shallot, and leek crops occupy a considerable proportion of every garden, and they may follow either the cabbage tribe or some of the leguminosæ; they are all more or less subject to the onion-fly, which is described under the subsection on the onion (1470).

SUBSECT. I.—*The Onion.*

1461. *The common onion*, *Allium Cèpa* L. (*Oignon*, *Fr.*), is an asphodelaceous bulbous perennial, the native country of which is unknown, but its culture is as old as the history of the human race, and as extensive as civilization. The common onion, though treated as an annual when grown for its bulb, and as a biennial when grown for seed, is yet as much a perennial as the garlic, and, like it, produces offsets the second year, though not in such abundance. The Welch onion, potato onion, and bulb-bearing onion, are different species, or very distinct varieties, also cultivated in British gardens, but not of such antiquity as the common onion. The onion is in universal use, when young, in salads; and when more advanced, or when mature, in soups, stews, or alone boiled or roasted.

1462. *Varieties and species.*—*The silver-skinned*; middle-sized, or small, chiefly used for pickling. *Nocera*; very small, roundish or oblate, with one or two small leaves, in colour resembling the silver-skinned; good for pickling. *Strasburgh*, syn. globe, Dutch, Deptford, Essex, and other names; large, oval, light-red tinged with green, strong flavour, perhaps the most generally cultivated. *James's Keeping*; large, pyramidal, and in other respects like the preceding. *Blood-red*, syn. Thomas's onion; middle-sized, flat, strong flavour, and very hardy; esteemed in the London market for its diuretic properties. *White Spanish*, syn. Reading, White Portugal; large, mild, good for a general crop, but not a long keeper. *Brown Portugal*; resembles the preceding, excepting in colour. *Tripoli*; the largest onion grown; oval, light-red, mild, but does not keep long after it is taken up. *The Welch onion*, or ciboule, *A. fistulosum* L., a native of Siberia, strongly flavoured, but does not bulb; very hardy, sown in autumn for drawing in spring. *The underground, or potato onion*, *A. Cèpa*, var. *aggregatum*, *G. Don*, multiplies by young bulbs on the parent root, which have all the properties of the common onion, and are equally productive, but do not keep longer than February. *The tree, or bulb-bearing onion*, syn. Egyptian onion, *A. Cèpa*, var. *viviparum*; the stem produces bulbs instead of flowers, and when these bulbs are planted they produce underground

onions of considerable size, and being much stronger flavoured than those of any other variety, they go farther in cookery.

1463. *Propagation and Culture.*—All the kinds, except the last two, are propagated by seeds, of which two ounces will be requisite for a bed 4 feet by 24 feet, to be drawn young; or one ounce for a bed 5 feet by 24 feet, to remain till they are full grown. The seed will come up in about a fortnight. The soil in which the onion succeeds best is a strong loam well enriched with manure, which may be of the strongest kind, such as bullocks' blood, night soil, powdered bones, &c. previously rotted. It should be well pulverised to a considerable depth. Where the soil is not apt to produce annual weeds, the best mode is to sow broadcast, because less labour is required in thinning; but in the case of soils abounding with the seeds of weeds, it is better to sow in drills, 9 inches apart for the smaller kinds, and a foot for such as are larger: the plants to be thinned out when 3 inches high to 4 inches, 6 inches or 8 inches, according to the kind, or whether onions of large or moderate size are wished for. To produce small onions for pickling, the silver-skinned variety, or the Nocera, should be sown thick, or very thick, according to the size wanted; and to produce very large onions, the Tripoli ought to be sown thin, and the soil stirred once or twice during the summer, care being taken, in this and in every other case of stirring the soil among



Fig. 381. The sickle-hoe. Fig. 382. The small-drill hoe.

onions, not to earth up the incipient bulb, that being found to impede its swelling. Liquid manure may be freely applied. The time for sowing a main crop, to produce bulbs for keeping through the winter, is the beginning or middle of March; and great care is requisite not to cover the seed more than an inch, and to press the soil on it firmly by treading or rolling. Thinning and hoeing-up weeds should be performed with a 2 inch hoe (394), and the soil may be stirred with the Spanish hoe, fig. 21, in p. 132; or, if the plants are very close, with the sickle hoe, fig. 381. When the seeds are to be sown in drills, these may be made either singly with the drill-hoe, fig. 382, or in three or four at a time, by the drill-rake, fig. 383. The teeth of



Fig. 383. The drill-rake.

this rake, like the head, are of wood; the latter being pierced with holes an inch apart, so that the teeth, which are to form the drills, may be fixed at any convenient distance. Market-gardeners sometimes, instead of distributing the seed along the drill, drop four or five seeds together at every six or eight inches distant, giving no thinning afterwards, but leaving the plants to press against and push aside one another. This saves the labour of thinning; and if the soil is kept well stirred between the rows, a considerable bulk of crop will be produced, though the onions will be very irregular in point of size.

1464. *An autumn and winter crop of onions*, for being drawn as wanted for salads and soups, is procured by sowing about the middle of August the Strasburgh, or globe. These will be fit for use by Michaelmas, and will afford supplies through the winter, and in early spring till the March-sown crop for drawing comes into use; or till thinnings can be obtained from the main crop. Formerly the Welch onion was sown to stand through the win-

ter for a spring crop, but as it does not bulb, and is rather stronger than the common onion, it is now but little cultivated: being much hardier, however, it answers well for cold late situations.

1465. *A transplanted crop* is, by many gardeners, preferred to a sown one. The seed is sown quite thick in the last week of August, or first week of September, and transplanted into rows, the ordinary kinds 9 inches wide, and 6 inches or 8 inches apart in the row, and the larger kinds at double these distances, in the following March; the greatest care being taken to keep the whole of the bulb above ground, and only to fix the fibres in the soil. Onions thus treated attain a large size, and produce a uniform crop, without the trouble of thinning, some weeks before a crop sown in March; the only drawback is that the plants sometimes run to flower. Some persons, instead of leaving the onions in the seed-bed through the winter, sow in June, or even in April, if the soil is very poor, quite thick, take up the bulbs in September, and dry them and hang them in bags till the April following; when they are transplanted, by pressing them down with the finger and thumb, at regular distances, in rows. As the object is to prevent the bulb from being earthed up, the ground should be previously trodden or rolled, at least along the line where the plants are to be placed. The shorter the time these onions have been in the ground the preceding year the less likely will they be to run to flower. Another mode of obtaining a transplanted crop, is by sowing in February on a slight hotbed, or merely under glass, and transplanting into rows in April.

1466. *The potato-onion* may be planted in February, in shallow drills 1 foot apart and 6 inches distant in the row, leaving the point of every bulb exposed, and pressing its lower end firmly to the soil. In Devonshire, where this onion is grown extensively, it is slightly earthed up during summer in the manner of potatoes. It is a common saying there, that it should be planted in the shortest day, and taken up in the longest; which being fully two months before the common onion is taken up, it is evident that the potato-onion cannot keep so long as that variety. It is an excellent onion for the cottager, as it produces both an early and a certain crop.

1467. *The bulb-bearing onion*.—The small bulbs are collected from the heads of the stems, and planted in shallow drills in September; or the stems, with the heads and bulbs attached, are hung up in a dry airy shed from October till February, and the bulbs are then planted rather closer together than those of the potato-onion. The crop will be fit to take up in July, or the beginning of August.

1468. *Treatment common to all the kinds*. When the leaves begin to decay at the points, or when any indication of running to flower appears, bend down the stem an inch or two above the bulb, in order to check the supply of sap thrown into the leaves, and thereby promote its accumulation in the bulb. This is commonly done by one person with the back of the rake, or by two, with the handle of a rake or hoe between them. If one bending has not the desired effect, repeat the operation, or bend the stem back again, or give it a twist and turn down at the same time. In very warm dry seasons, the bulbs come to maturity and the stems decay naturally with perhaps a few exceptions; but in cold wet seasons, the operation is useful, and is generally performed about the middle of August.

1469. *Diseases, insects, &c.* The onion in good soil is little subject to disease, but there are some insects which live on it in their grub or maggot

state. When a crop has been attacked by insects, but little can be done ; but when an attack is anticipated, it may be prevented by watering the ground with some fetid liquid, such as putrid urine, or thin putrid liquid manure, which by its offensive smell will deter the parent insect from depositing its eggs in the plant, and at the same time invigorate the plant, and prepare it to resist their attacks.

1470. *The onion fly*, *Anthomyia cepàrum Meigen*, a dipterous insect, not unlike the common house-fly, is the most common insect which attacks the onion, the leek, and the shallot, and as it frequently occasions very serious losses, the following details respecting it by Mr. Westwood may be useful. During the summer months, and especially in June and July, the cultivator of onions is annoyed by perceiving that, here and there, in various parts of his crops, the plants appear to be in a dying state, and the leaves fallen on the ground. At first, this is observed in plants which are only just above the surface of the soil, and which are not above the thickness of a straw. These soon die, and then others, of a larger size, are observed to decay in a similar manner ; this continues until the middle of July, and even until the onions are full-grown ; at which time they have occasionally sufficient strength to survive the injury, with the decay of a portion only of their outer layer or root, the centre part remaining sound. In this manner whole beds are destroyed ; and it seems to be of little use to sow again, as the fresh-sown plants fare no better. In light soils especially, the attacks of this insect are occasionally very annoying to the gardener. On stripping off the coats of the young onions which show evident signs of decay, it is at once perceived that it is owing to the attack of a small grub, destitute of legs, upon the vital parts of the bulb or stem of the plants, that its destruction is occasioned. On pulling up a very young onion, its interior is found to be completely devoured by a single grub at its very heart ; but, in plants of larger growth, at least half a dozen of these grubs have been counted, varying considerably in size. In the summer season, these grubs are about a fortnight in arriving at their full growth. They generally consume the entire of the interior of the onion, the outside skin of which is alone left dry and entire, serving as a place in which they undergo their transformations, without forming any cocoon. In about another fortnight the perfect fly makes its appearance, the time varying according to the season, from ten to twenty days. (*G. M.* 1837, p. 242.) To prevent the attacks of this insect, it has been recommended to sow after strawberries that have occupied the soil for four or five years, or to strew the surface of the soil with charcoal cinders, such as may be obtained from a wood where charcoal has been made ; or to transplant in preference to sowing, dipping the roots or the bulbs in a puddle consisting of three parts of earth, and one of soot. The most effective mode with a sown crop, we believe to be that first mentioned, viz., to water with any fetid liquid, such as stale soap-suds mixed with a little stale tobacco-water, from the middle of May till the beginning of July. (*G. M.* 1841, p. 88.)

1471. *Gathering the crop.* When the necks shrink and the leaves decay, pull or dig up the bulbs ; spread them on dry ground, in the full sun, to dry and harden completely, turning them every two or three days, and in a week or fortnight they will be ready to use. Clear off the grossest part of the leaves, stalks, and fibres ; then spread out the bulbs in an airy loft or cool dry cellar, in which they should be turned over occasionally, and those

that begin to decay picked out. Thus treated, onions will keep sound and good, all winter and spring, till May following, except the potato-onion, which with difficulty keeps beyond February. Onions are not injured by frost, unless they are moved when frozen, which, by bruising them, ruptures the tissue, and when a thaw takes place, the bruised part becomes a wound, and the bulbs begin to decay. Onions intended for market are tied by the neck round sticks, by strands of matting, or plaited into straw, and thus form what are called ropes of onions. Hanging up these ropes in an open airy shed is the best way of keeping them; but if they are spread out, or hung up in a close cellar, room, or loft, somewhat above 40° they will grow.

1472. *To save seed*, select some of the finest specimens and plant them in rich soil early in spring. The seed will ripen in August, when the heads should be cut off and laid in cloths exposed to the sun till they are perfectly dry, when the seed may be thrashed out, and again exposed to the sun for a few hours, previously to being put up in bags. It will keep two years, and sometimes three. It varies considerably in price, according to the crop in this country, and also in Holland, whence much onion seed is imported.

SUBJECT. II.—*The Leek.*

1473. *The Leek*, *Allium Pórrum L.* (Poireau, *Fr.*), is a perennial, a native of Switzerland, in cultivation in British gardens, from an unknown period. Its blanched stem is used in soups and stews, and in a dish by itself, served up on toasted bread with white sauce. The best variety is the *broad-leaved* or London leek, which is always raised from seed, though suckers may be obtained from old plants. For a seed-bed four feet wide by eight feet in length, one ounce of seed is sufficient, which may be sown about the middle of March, and will come up in a fortnight. The plants should be transplanted when three or four inches high, in May or June, if possible in showery weather; previously shortening a little the roots, and taking off the tips of the leaves. They require a very rich soil, and may either be planted along the bottom of drills, or on the surface in rows, ten or twelve inches apart, by six or eight inches in the row; inserting the sheathed stems nearly up to the leaves, or, in default of this mode of planting, earthing them up as they grow, in order that a greater portion of the plant may be blanched. In planting, press the soil to the fibres with the dibber, but leave the stem quite loose and free, and as it were standing in the centre of a hollow cylinder, two inches in diameter, and at least six inches deep. This cylinder will afterwards be filled up by the swelling of the stem, and as the leaves are so close together, it is a much better mode than attempting to earth the plants up. Some plant in hollow drills, and earth up as in celery culture, which produces very large stems. Some form holes with a large dibble, drop the plant in, followed by as much loose earth as will just cover its fibrous roots, and afterwards water once a day, till it has taken sufficient hold of the soil. If the soil is very rich to a considerable depth, and on a dry bottom, the size of the stem, by this mode of culture, becomes enormous. The leeks will be fit for use in September, and will continue in perfection till the following April or May, when they may be taken up and placed in a cool cellar to retard vegetation, which will admit of their being used till the middle or end of May; or much later, if growth is prevented by cutting off the plate from which the roots proceed. When severe frost is anticipated, a portion of the crop may be taken up in the beginning of winter, and

planted in sand, in an open shed ; or it may be protected where it stands. A few plants left will produce abundance of seed, which will ripen in September, and may be treated like that of the onion. The seed will keep two or three years.

SUBJECT. III.—*The Shallot.*

1474. *The Shallot*, *Állium ascalónicum L.* (*Echalotte, Fr.*), is a bulbous-rooted perennial, a native of Palestine, and long in cultivation for its bulbs, which separate into cloves. These are used like the bulbs of onions, in soups and stews, and in a raw state cut small, as sauce to steaks and chops ; and sometimes a clove or two is put into winter salads, more especially potato salad. The best variety is the *long-keeping*, which will remain good two years. Propagation is effected by dividing the bulb into its separate cloves, and planting and managing these in all respects like the potato onion (1466). The soil should be rich, and particular care taken to guard against the onion fly, by the means already indicated (1470). Mr. Knight planted on the surface of the ground, earthed up a little at first, and as soon as the roots had taken hold, removed the soil with the hoe, and by abundant watering, which he found a check to the ravages of the maggot. The bulbs, if planted in March, or, as is sometimes done, in the preceding November, will be ready for use towards the end of July, and the crop may be taken up in September, and spread in an airy loft, or tied up in ropes, like onions. A sufficient quantity of the smallest cloves ought to be selected for sets for the following year.

SUBJECT. IV.—*The Garlic.*

1475. *The Garlic*, *Állium sativum L.* (*Ail, Fr.*), is a bulbous-rooted perennial, a native of the South of Europe, long in cultivation for flavouring meats, and for various sauces and ragouts. In many parts of Europe, particularly in France and Spain, the peasantry rub garlic over the slices of their black bread as a seasoning, and find the bread so prepared delicious. The bulb divides into cloves like the shallot, and is cultivated exactly in the same manner. The leaves begin to wither in August, and the bulbs may be taken up in September, dried, and laid in an airy loft, or tied up in ropes.

SUBJECT. V.—*The Chive.*

1476. *The Chive*, *Állium Schœnóprasum L.* (*Civette or Ciboulette, Fr.*), is a bulbous perennial, a native of Britain, in meadows and pastures, but rare. It has been long in cultivation for its leaves, which are used in spring salads, in soups, omelets, and generally as a substitute for young onions. The bulbs are very small, and seldom applied to any culinary purpose. The plant flowers in May, and after the leaves have begun to decay in June, it may be taken up and divided, and replanted in rows, one foot by six inches ; but as the chive is little used except in cottage gardens, a very few plants are sufficient, and these may be planted in the herb-ground in the slip. If kept cut so as to prevent its flowering, it will succeed for several years in the same spot. No cottage garden ought to be without the chive, which may be planted as an edging to walks not much frequented.

SUBJECT. VI.—*The Rocambole.*

1477. *The Rocambole*, *Állium Scorodóprasum L.* (*Ail d'Espagne, Fr.*), is a bulbous perennial, a native of Denmark, formerly cultivated for the

same purposes as garlic, but now comparatively neglected. It differs from garlic in having the bulbs smaller, milder to the taste, and in producing bulbs on the joints of the stem, as well as at its base.

1478. *Substitutes for alliaceous plants* are to be found in the genus *Allium*, of which there are several indigenous species, and a number in gardens which are natives of other countries. Three cruciferous plants, by no means rare, also taste and smell of garlic, viz., *Peltària alliàcea L.*, a perennial from Austria; *Thláspi alliàceum L.*, a biennial from the South of Europe; and *Alliària officinàlis Andræ.* (Jack-by-the-hedge), a perennial, a native of Britain. The latter is used as greens or spinach in many parts of the country.

SECT. VI.—*Asparagaceous Esculents.*

1479. *The asparagaceous esculents* belong to various natural orders, but the principal are the asparagus, the sea-kale, and the artichoke; there are a few others of less note. They are all comparatively plants of luxury, though the asparagus and the sea-kale may with propriety be cultivated in the garden of the cottager, who if he does not use the produce, may sell it.

SUBSECT. I.—*The Asparagus.*

1480. *The asparagus*, *Aspàragus officinàlis L.*; (*Asperge Fr.*) is an asphodelaceous perennial, found in light sandy soils on the sea-shore in Britain and other parts of Europe; often where it is covered by drifting sand, and watered by salt-water during spring-tides. It is also found in abundance in sandy steppes in the interior of Russia. It has been in cultivation, for its stalks when they are just emerging from the ground, as a culinary esculent, from the time of the Greeks; coming into use in the open ground in May, and lasting till the middle of June, and procured by forcing during the winter and spring months. The shoots or buds, more or less blanched according to taste, are boiled and served on toasted bread with white sauce, and the smaller shoots, which are allowed to become green, are cut into pieces about the size of peas, and used as a substitute for that legume. There scarcely can be said to be any particular variety, though the preference is generally given to seed saved at Battersea, Gravesend, or Mortlake, places famous for the large size to which asparagus has been grown for the London market.

1481. *Soil, and sowing or planting the asparagus.*—Asparagus can only be grown large, and succulent, on a soil sandy, deep, light, more especially on the surface, from vegetable matter, and well enriched with animal manure. The toughness and stringyness of the London asparagus are owing to the surface soil through which it sprouts being too deep, and not sufficiently light. In consequence of this the woody fibre of the sprouts has time to strengthen and harden; whereas, were no other covering than leaves or even leaf-mould used, the sprouts would be quite tender throughout the greatest part of their length. From the asparagus being a sea-side plant, it may be inferred that salt water might be occasionally beneficial, and hence fresh stable-dung mixed with sea-weed has long been found the best manure for asparagus in Scotland; and night-soil the best at St. Sebastian, where the surface of the beds is only about three feet above high-water mark. (*G. C.* 1842, p. 187.) From this last circumstance, and from the nature of the asparagus grounds at Ulm and Augsburg on the Danube, and

in a small sandy island in the Oise in France, at which places the soil is a coarse sand, saturated with water at three feet beneath the surface, we are led to conclude, that if the subsoil at the depth of three feet is porous and kept moist in the growing season by the water of an adjoining river or lake, as the hyacinth gardens are in Holland, and the surface strewed over every spring with salt, there will be a union of the most favourable circumstances for growing asparagus to a large size. The soil ought to be trenched at least three feet deep, and a layer of animal manure of some kind, such as good stable-dung, or night-soil, put in the bottom of the trench, and mixed with the soil throughout in trenching; and if the ground is re-trenched immediately before planting, so much the better. For the convenience of management the plants may be grown in beds four feet wide, with alleys between them two feet wide. There may be three rows of plants in each bed, the outer rows nine inches from the edge of the bed, and the centre row fifteen inches from the outer rows. To afford the means of keeping the beds of a regular width, a strong oak stake may be driven down in each corner, which will be a guide in stretching the line, when the alleys are to be dug out in autumn, and filled in from the bed in spring. The seed may be sown in drills an inch deep in March, and the plants thinned out to the distance of one foot in the July following. A slight crop of radishes and onions may be sown broadcast over the beds the first year, but nothing the second, or in any future year. The fourth year the plants will afford stalks fit to cut. To save time, two year-old plants are sometimes used instead of seeds; these are either purchased from a nursery, or raised in a seed-bed, and for a bed four and a half feet wide, by six feet long, one quart of seed will be sufficient. If sown to remain, then for three rows in a bed fifty feet in length, half a pint of seed will be necessary. The seed will come up in three weeks. The quantity of plants required is easily calculated. They are planted in the trench manner (728), or in drills (726), in February or March, keeping the crowns of the roots two inches below the surface. The quantity of ground sown or planted, even in the smallest garden, should not be less than a rod, as it requires that extent of plantation to produce a single good dish. For a large family one-eighth of an acre will be requisite; but five poles, planted with 1600 plants, will yield from six to eight score heads daily for a month. A crop from seed will allow of one stalk from each plant being gathered the third spring; two stalks the fourth spring, and three or more the fifth; while a plantation of two-year-old plants transplanted, will allow of one stalk being cut from each plant the second spring, two the third, and so on.

1482. *Routine culture.*—About the middle of October, every year, cut down the decayed stalks of the plants close to the ground, and chop them to pieces in the alleys with the spade, after which stretch the line along the alleys from the stakes placed at the corners, and dig out as much soil, and chopped stalks, as will cover the bed to the depth of three or four inches; previously laying on a layer of stable dung. This is called the winter dressing. About the end of March, just before vegetation commences in the roots, the spring dressing is given, which consists in forking over the surface as deep as the crowns of the plants over the rows, and twice as deep between the rows. Then rake the surface of the beds even, drawing off nearly as much soil into the alleys as had been dug out of them for the winter's dressing; stretching the line as before, and finishing off the edges in a neat and

regular manner. If sea-weed has not been laid on along with the dung at the winter dressing, a sprinkling of salt, or of wood ashes, or of both, may be scattered on the surface of the beds; and over this a layer of tree leaves of the last year, half decomposed, or of dry litter, may be placed, in order to blanch the sprouts. In dry weather, water should be supplied abundantly, either by means of liquid manure in the alleys, or clear water poured over the beds. Nothing more is required till the asparagus is fit to gather, which in the climate of London is about the end of April, and it lasts till midsummer, when its place at the table is taken by green peas. In the neighbourhood of London, soil from the alleys is laid over the beds to a considerable thickness in spring; so that the shoots are obtained blanched to a great length; but there is very little tender at the top, in consequence of the shoots having to grow so long before they get through so great a thickness of soil, much woody fibre being, as before observed (1481), formed during its progress.

1483. *Gathering.*—To suit the taste of some persons, asparagus should be so far grown as to become green, but in general it is preferred more or less blanched, that is, when the shoot is three or four inches above the surface of the soil, with the terminal bud close and plump. In some parts of the Continent each particular stalk is blanched by putting a wooden or earthenware tube, eighteen inches long, and one inch in diameter within, over it; and at St. Sebastian the beds are covered, before cutting commences, to the depth of eight inches with dead leaves, which effects the same object, and keeps the soil moist. The last mode well deserves to be adopted in this country, as well as that of watering abundantly during the gathering season. In young plantations, gather only the largest stalks for two or three weeks, and then permit the whole of the others that may be produced to run to flower; but in plantations in full vigour, gather all the stems that appear, whether large or small, for a month or six weeks, or till the time fixed on for leaving off gathering. If, instead of gathering all the stems, some are allowed to run to flower while the gathering is going on, but few more stems will be sent up from the root, and these weak on account of the main force of the sap being spent in the flowering stem. To ensure large stalks, gathering should not be continued longer than the middle of June; or if continued till the end of the month, no cutting should take place the following year. It must be constantly borne in mind that the stalks of the coming year, culture and other circumstances alike, depend on the number of matured stalks with healthy leaves of the present year. In gathering, first scrape away a little earth from the shoot; then cut it off within the ground, with a narrow sharp-pointed knife, or small saw, nine inches long (fig. 41 in p. 138); thrusting the knife or saw down straight, close to the shoot, cutting it off slantingly, about three inches below the surface, and taking care not to wound the younger buds advancing below. The shoots are next sorted and tied in bundles of between two and three inches in diameter, and in that state sent to the kitchen, or to market.

1484. *Culture after gathering.*—The alleys, being no longer required for walking in to gather the asparagus, are now richly manured and planted with cauliflower, which, under ordinary circumstances, will be all gathered by the time the winter dressing commences. The beds require only to be kept clear of weeds, and the plants to be stripped of their blossoms, as these expand; excepting such as may be required for producing seed. Where the

plants are weak, they may be strengthened by two or three waterings with liquid manure.

1485. *The duration of an asparagus plantation* is never less than ten or twelve years; but in deep sandy soils, well enriched with manure, it will last twenty or thirty years. The plants are seldom attacked by insects, though the asparagus beetle (*Crioceris asparagi*, L.) sometimes makes its appearance in spring, and ought to be deterred from laying its eggs by watering with some fetid liquid in April, or gathering the insects, which are easily known from their bright lively colours, by hand. (*G. M.* 1837, p. 337).

1486. *To save seed*, allow the blossoms of some of the strongest stems to remain on; the fruit will ripen in October, and may either be thrashed out and kept in bags, in which state it will retain its vitality for four or five years; or it may be retained on the stems, and these being hung up in a dry place, the seed will grow at the end of fifteen or twenty years.

Forcing the asparagus in the open garden and under glass has been already treated of (1096).

SUBSECT. II.—*The Sea-Kale.*

1487. *The sea-kale*, *Crámbe marítima*, L. (*Chou marin*, Fr.), is a cruciferous perennial, with long strong deeply penetrating roots, a native of Britain, on the sea-coast in many places, and always most vigorous in a sandy soil, or a loamy subsoil, overflowed by spring tides. The young shoots and leaf-stalks, just as they come through the sand, and are blanched and tender, have been boiled and eaten by the inhabitants of the western shores of England from time immemorial; but the plant was not cultivated as a garden esculent till after the middle of the last century. It is now reckoned second in excellence to the asparagus, and to be found in every good garden, sometimes even in that of the cottager. It comes into use in the open garden in the beginning of March, and continues good till May; and by forcing it can be obtained from November throughout the whole of the winter and spring. No plant requires less care in its cultivation, or less heat to force.

1488. *Propagation and culture.*—By seed is the common mode, but it will also grow freely by cuttings of the roots. If sown to transplant, a seed-bed four feet by ten feet will require two ounces; if sown in drills to remain, the same quantity will sow one hundred and fifty feet of drill. The seed will come up in a month. It is generally grown in rows two feet apart, and the plants about the same distance in the row. Seeds, plants which have been one year in the seed-bed, or cuttings of the roots of old plants, may be used; in the latter case leaving two eyes to each cutting; or cuttings without eyes may be used, provided the upper part of the cutting be planted uppermost; or the cutting be laid on its side in a shallow drill. (*G. M.*, vol. ii. p. 365.) Sowing and planting may take place about the beginning of March. The best soil is a deep sandy loam, thoroughly enriched with manure, including sea-weed, if it can be got, or if not, a sprinkling of salt once a year. The most efficient mode of culture would be to follow that recommended for asparagus. The strongest plants are produced from seeds sown where the plants are to remain. Three rows may be marked out two feet apart, leaving an interval of three feet after every third row, the centre of which, to the width of eighteen inches, is to be treated as an alley for the convenience of gathering the crop. The seeds

may be dropped in patches of three or four along the drills, and the plants thinned out to one plant in a place, soon after they come up. The first winter's dressing may consist of some littersy stable-manure, sea-weed, and leaves, spread over the surface, which may be forked in early in the following spring. This may be repeated the second autumn, increasing the thickness, and the second spring a few stalks may be gathered. The third autumn the dressing may be repeated; or the rows may be covered with leaves alone, with sand, or with soil dug out of the alleys, to the depth of six inches. The third spring several stalks may be gathered from each plant; and the fourth spring the plantation will be in full bearing. Excepting in the first spring after sowing, no spring dressing is required till May, after the crop has been gathered. The London market-gardeners plant the sea-kale in rows from four to six feet apart, and every autumn after the leaves have died down to the surface, they dig a trench between the rows, and cover the plants with soil to the depth of a foot. As the crop is gathered, the ridges so formed are levelled down, and a crop planted between. By this mode the whole produce of the plant is gathered at once, every part of it being completely blanched and tender. (*G. M.*, vol. ix.)

1489. *Gathering*.—The points of the stems will appear above the leaves, or other matters with which the plants have been covered the preceding autumn, about the beginning or middle of March, according to the warmth of the situation, and of the season. Remove the covering round such of the young stems as are about three inches long, and cut them over half an inch above the collar, taking care not to injure any of the buds which remain on the plant, and which will immediately begin to swell. From four to six heads or stalks, according to the size, make a dish, and they are sent to the kitchen or the market tied together like asparagus. Three stout plants will afford five dishes in a season; and hence when the number of dishes required by any family are known, one third added to their number will give the amount of plants required for a plantation. A plantation will afford a succession of gatherings for six weeks, after which period the plants should be uncovered, and their leaves suffered to grow, in order to strengthen the roots for the succeeding year. If very large and succulent sea-kale is required, gathering should only be made every other year, and the plants should be manured with stable dung or nightsoil.

1490. *The culture after gathering*.—The leaves or dung with which the plants were covered may be partly forked in, and partly carried away; water supplied abundantly in very dry weather, including liquid manure if thought necessary, and the blossoms stripped from all the plants not required to produce seed. By the end of October the leaves and stems will be decayed, when the winter covering should be given as before directed.

1491. *Diseases and insects* give little trouble in cultivating the sea-kale, because the crop is generally gathered before the insect season. The expanded leaves, however, are sometimes attacked by the caterpillars of moths and butterflies, and by the turnip-fly, both of which may be subdued by abundant watering with lime-water.

1492. *The duration of a plantation of sea-kale* is in general six or eight years; but as the roots, when cut over below the collar, send up abundance of buds, even when the heart of the root is decayed, by a little care in procuring fresh sprouts from the roots, a plantation might be continued on the same ground for an indefinite period.

1493. *To save seed.* Leave the blossoms on a few of the strongest plants; the seed produced by which will ripen in August, and the stalks may be collected and thrashed like those of the common cabbage. The seeds will retain their vitality for four or five years.

1494. *Forcing.* Where a crop is to be forced in the open ground, the ordinary mode is to cover the plants in autumn with sea-kale pots (fig. 58, in p. 143), or with large garden pots, and to cover these and the whole surface of the ground with hot dung, or a mixture of hot dung and leaves. When this is done in October, kale may be gathered in November or December; and by successive applications of heat to other parts of the plantation, a supply may be obtained till it can be procured from the plants covered with soil, or leaves only. Other modes of forcing have been already noticed (1097).

SUBJECT. III.—*The Artichoke.*

1495. *The artichoke*, *Cýnara Scólumus L.* (*Artichaut, Fr.*), is a carduaceous perennial, a native of the South of Europe and North of Africa, in cultivation in British gardens from the middle of the sixteenth century. The plant is cultivated for the head of flowers, which is gathered before their expansion; and the common receptacle, and the base of the involucreal scales, are the parts eaten. These are boiled, sometimes fried in butter, and they are occasionally eaten raw in salads. The receptacles, or bottoms, as they are commonly called, after being blanched in boiling water, are sometimes dried and preserved for use during winter and spring. In the North of Spain the lesser flower-heads are cut soon after they appear, and the pith (? bottoms) is extracted, and forms a palatable ingredient in the puchera or olla, a favourite Spanish dish. Artichoke bottoms are also combined with capsicum in a sort of stew made of fowl. (*Captain Churchill, in Gard. Chron., 1842, p. 284.*) The first heads are ready in July, and by continuing to gather them before allowing any to expand their flowers, they will continue being produced till November; and by cutting off the heads at that season, with a foot or more of stalk attached, and inserting the stalks in moist sand, in an open shed secured from frost, they will keep fit for use till January or longer. The leaves of the artichoke may also be blanched like those of the cardoon. The varieties are, the *Globe*, with a globular purplish head, which is the best variety for a main crop; the *French*, with an oval green head, considered as having more flavour than the other, and being hardier. Both sorts are propagated by rooted suckers taken from the old plants in March and April, and planted in rows four feet asunder, and two feet distant in the row. The soil ought to be deep, sandy, and rich, and seaweed is said to be an excellent ingredient in the manure for this plant, being the manure used in the Orkney islands, where the artichoke grows stronger than anywhere else. The routine culture consists in keeping the plants clear of weeds, thinning out the shoots produced by the stools, stirring the soil, manuring once a year, in autumn or spring, and laying litter round the plants in autumn to protect the roots from frost during the winter. The plants will produce some heads the first year, and all that they produce may be gathered as soon as they attain the proper size, as the strength of the root depends on the leaves, and not on the flowers. The plantation will continue productive for six or seven years, or longer. In gathering, the heads are cut off within an inch or two of the stalk attached, and half-a-dozen heads are considered as making a dish.

1496. *Culture for producing the chard.*—This is only attempted when the artichoke plantation is to be renewed, and the old plants to be thrown away. After Midsummer, cut over the leaves within half a foot of the ground, and the stems as low as possible. Then, when the new crop of leaves, which will be produced in September or October, are about two feet high, tie them up close, first slightly with matting, and in a few days afterwards with hay or straw, and earth them up like celery; or lay litter round the stems. In a month or six weeks, the interior leaves will be found completely blanched, and fit for use. By digging up the plants before frost sets in, and planting them in sand in an open shed, they will keep till Christmas, or later.

The artichoke is seldom attacked by *insects*, and though generally propagated by division, slips, or suckers, yet it ripens seeds freely in September, which, sown the following spring, will produce heads in the second summer. The seed keeps three years.

SUBJECT. IV.—*The Cardoon.*

1497. *The cardoon*, or chardoon, *Cýnara Cardúnculus L.* (*Cardon, Fr.*), is a carduaceous perennial, a native of the South of Europe and the North of Africa, closely resembling the artichoke in appearance and properties. It has long been cultivated in gardens for the mid-rib of the leaf, which is rendered white and tender by blanching, and is used stewed, or in soups and salads during autumn and winter, much in the same manner as celery. The flavour is that of the artichoke. It is much more in request on the continent than in England. In France the corollas, both of the cardoon and the artichoke, as well as those of several thistles, are dried and used as a substitute for rennet, in curdling milk.

1498. *Cookery of the cardoon.*—“When a cardoon is to be cooked, its heart, and the solid, not piped, stalks of the leaves are to be cut into pieces, about six inches long, and boiled like any other vegetable, in pure water, not salt and water, till they are tender. They are then to be carefully deprived of the slime and strings which will be found to cover them; and having thus been thoroughly cleaned, are to be plunged in cold water, where they must remain till they are wanted for the table; they are then taken out and heated with white sauce, marrow, or any other of the adjuncts recommended in cookery books. The process just described is for the purpose of rendering them white, and depriving them of a bitterness which is peculiar to them; if neglected, the cardoons will be black, not white, as well as disagreeable.”—(*Gard. Chron.*, p. 143.)

1499. *Varieties, propagation, &c.*—There are several varieties, but the best are the *cardoon of Tours*, and the *Spanish cardoon*. The cardoon is always propagated by seed, which must not be sown too early, unless it is abundantly supplied with water in the dry season, otherwise it is apt to run to flower. In the climate of London, the end of April, or beginning of May, is found a proper time for a crop to come into use in November; but an earlier crop may be obtained by sowing in March. It may be sown and transplanted, but it is found best to raise the plants where they are finally to remain. Sow in patches of three or four seeds. Prepare shallow trenches a foot wide, and four feet apart centre from centre, manuring the soil in the bottom of the trench. Sow the seed in patches in the centre of the trench twenty inches, or two feet apart, and as soon as the plants come up, one only should be left in each patch. Two ounces of seed will be sufficient for

fifty patches. With the usual routine culture, the leaves will be three feet or four feet long by the middle of October, when they should be first slightly tied up with pieces of matting for a few days, and afterwards closely wrapped round with hay-bands, so as completely to exclude the light from the root to about two-thirds of the length of the leaves. In three weeks the interior leaves will be fit for use. On the approach of winter, they may be earthed up like celery, as high as the hay-bands, to protect them from the frost; or they may be covered with litter and thatched hurdles, for that purpose; or taken up with balls, and placed close together in an open airy shed.

In taking the plants for use, remove the hay-bands and the outer leaves, and shorten those which are tender and blanched to the length of eighteen inches or two feet, cutting off the root. One or two plants will make a dish. Seed may be saved by protecting some plants, the leaves of which have not been blanched, through the winter, in the spot where they have grown; they will flower in the following July, and ripen seed in August, which will keep five or six years.

SUBJECT. V.—*The Rampion.*

1500. *The Rampion*, *Campánula Rapúnculus L.* (*Raiponce, Fr.*), is a campanulaceous fusiform-rooted biennial, a native of England in gravelly soil, and formerly much cultivated in gardens for its roots as well as its leaves. The latter are excellent, eaten raw as a salad, or boiled as spinach; and the root, which has the flavour of walnuts, is also eaten raw like a radish, or mixed with salads, either raw or boiled and cold. It is always propagated by seed, which is so exceedingly small, that a sixteenth part of an ounce is sufficient for any garden. It will come up in a fortnight. As in the case of other biennials, if sown too soon, the plants will run to flower the same season. The end of May, or beginning of June, is considered the best time for a main crop; but a crop to come in early may be sown in March. The seeds may either be sown broadcast or in drills six inches apart, and from a quarter to half an inch in depth; in either case covering the seed with not more than an eighth of an inch of soil. The plants may be thinned out to three or four inches apart, and the soil among them should not be deeply stirred, lest the roots should be encouraged to branch, which they are very apt to do, and are then unfit to be sent to table. The principal point in the culture of the rampion, is to sow it in a deep sandy light rich soil, which can be penetrated by the roots without difficulty; and to supply water abundantly in very dry weather. The roots may be taken up as wanted from November till April, when the plants will begin to run; but by burying the roots out of the reach of surface heat, in the manner of potatoes (1416), they may be kept through the summer. A few plants allowed to stand the second year will produce abundance of seeds, which will keep two years.

SUBJECT. VI.—*Substitutes for Asparagaceous Esculents.*

1501. *Substitutes for asparagaceous esculents* are to be found in the following plants:—*The Hop*, *Hùmulus Lúpulus L.*, the young shoots of which, when they have risen three or four inches from the root, are boiled in the hop districts, and eaten like asparagus, to which they are considered little inferior. *The Bladder Campion*, *Silène inflàta H. K.*, a perennial common on sea-shores, the tender shoots of which, when not above two inches long, have

a flavour which, according to Bryant, is surpassed by few garden vegetables; and it will continue producing these shoots for two months. In our opinion, it well deserves cultivation. *The Virginian Poke*, *Phytolacca decandra L.*, a perennial from Virginia, where the points of the young shoots are used as asparagus. *The Willow-herb*, *Epilobium angustifolium L.*, the young and tender shoots are eaten as asparagus, and the leaves as greens. *Solomon's seal*, *Polygonatum vulgare Dec.*, the young shoots are boiled and eaten as asparagus, and the roots said to be dried, ground, and made into bread. *The common Comfrey*, *Symphytum officinale L.*, the blanched stalks form an agreeable asparagus. *The Black Bryony*, *Tamus communis L.*, the blanched tops are eaten as asparagus. *The Burdock*, *Arctium Lappa L.*, the tender stalks are eaten as asparagus. *Stachys palustris L.*, the underground stems of which, when grown in rich moist soil, are white, crisp, and agreeable to the taste. *The Milk-thistle*, *Carduus Marianus L.*, is a biennial, a native of Britain, on rich soils. The young stalks, peeled and soaked in water to extract a part of their bitterness, and then boiled, are said to be an excellent substitute for asparagus. When very young the leaves are used as a spring salad; and the large leaves, blanched in autumn like those of the cardoon, form a good substitute for that vegetable, and they are also used as greens. Early in the spring of the second year, the root is prepared like skirret or salsify (1436 and 1438), and in the summer of the second year, the receptacle of the heads of flowers gathered before they expand, is pulpy, and eats like that of the artichoke. *The Cotton-thistle*, *Onopordum Acanthium L.*, is an indigenous biennial, the leaves of which were formerly blanched and used like those of the cardoon; the tender blanched stalks, peeled and boiled like asparagus, and the receptacle of the flower treated like that of the artichoke. *The Carlina-thistle*, *Carlina acanthifolia All.*, a perennial, a native of Carniola, and the common species *C. vulgaris L.*, a biennial, a native of Britain, produce large heads of flowers, the receptacle of which may be used like that of the artichoke; and in all probability the flowers and leaves of most carduaceous plants might be used like those of the artichoke and cardoon. *The pyramidal Campanula*, *Campanula pyramidalis L.*, and various other species of campanula, producing fusiform, or fleshy, roots, might doubtless be used as substitutes for the rampion, as are those of the campanulaceous plants, *Phyteuma spicatum L.*, in Sussex, and *Canarina Campanula L.*, in the Canary Islands. *Ruscus aculeatus L.*, for its tender young shoots in spring; *Ornithogalum pyrenaicum L.*, the Bath asparagus, the flower-stems of which are brought to market at Bath, where the flowers are in a close head like an asparagus bud; the mays, *Zea Mays L.*, the sweet or sugar variety of which, when the seed is immature, is much used in America, roasted, fried, or boiled.

SECT. VII.—*Acetariaceous Esculents.*

1502. *The acetariaceous esculents*, or salads, in cultivation in gardens are numerous, but those of most importance are the lettuce, endive, and celery. They are all articles of luxury, unless we except the lettuce, which is a useful vegetable in every cottage-garden.

SUBSECT. I.—*The Lettuce.*

1503. *The lettuce*, *Lactuca sativa L.* (*Laituc, Fr.*), is a cichoraceous plant, annual or biennial, according to the time in which it is sown; con-

sidered by some as the *Lactuca viròsa* in a cultivated state, and by others as a different species, of Eastern origin. It has been cultivated in British gardens from the time of Elizabeth, and by suitable management may be had all the year. Lettuce is in universal esteem in a raw state, as a cooling and agreeable salad, and it is also used in soups and stews.

1504. *Varieties*.—The varieties are very numerous, and are included under two divisions.

1. *Cos lettuces*, of which the best are the *black-seeded green*, a very hardy kind, which does not run readily to seed; the *Bath cos*, which is the best for standing the winter in the open ground; the *brown cos*, and the *whit Paris cove cos*.

2. *Cabbage lettuces*, the best of which are: the *brown Dutch*, hardy and of good quality; the *grand admirable*, a very fine lettuce, which continues a long time without running to seed; the *Hammersmith hardy green*, the best for standing through the winter; the *Marseilles*, a large excellent summer lettuce; the *Malta*, excellent in the early part of summer; and the *Dutch forcing*, the best kind for growing through the winter under glass.

1505. *Propagation and culture*.—All the sorts are raised from seed, which being small and light, for a seed-bed four feet by ten feet $\frac{1}{4}$ oz. is sufficient, and will produce four hundred plants. It comes up in ten days or a fortnight. To grow large succulent lettuces, it is essential that the soil be deep, light, sandy, and rich, on a dry subsoil; and that it be abundantly supplied with water during the hot season. In Spain, recent night-soil is used as a manure for the lettuce; being buried in a trench between every two rows of plants. To produce a supply of lettuce throughout the year, the first sowings may be made in the beginning of February, on a warm border, or on the south side of an east and west ridge, either broadcast or in drills, and of the kinds preferred by the family. Some persons dislike the cabbage lettuce from its softness, while others prefer it for that reason. As soon as the plants have shown the third leaf, they should be thinned with a two-inch hoe, so as not to stand nearer together than six inches; or in the case of the large-growing varieties, such as the *Marseilles* and *Malta*, a foot. From this time till the beginning of August a sowing may be made every fortnight or three weeks, choosing a north border, or screening the ground from the sun, by wickerwork hurdles, in the hottest part of the season. The crop sown in the first week of August will last till it is destroyed by frost, or till October; from which time recourse must be had to the lettuces grown under glass in the manner before described (1109). Independently of the forced crop, a sowing may be made in the third week in August, which, if the winter should be mild, will afford some plants for use during the winter; and a sowing in the last fortnight of September, under the shelter of a south wall, in poor, dry, sandy soil—or in the same soil, covered by a frame and sashes—or by hoops and mats, to be taken off every fine day, will produce plants for transplanting early in spring. These, if put into light rich soil, in a warm situation, at one foot apart every way, will produce plants fit for use about the end of April, when the forcing of lettuces may be given up; and this spring-transplanted crop will be in perfection during great part of the month of May. In this way lettuces are obtained throughout the year both in private and public gardens; but the market-gardeners about London, instead of sowing the crops where they are to remain,

sow in seed-beds and transplant (1368). The plants to stand through the winter for spring-transplanting are sown in a cold frame about the middle of September, and planted out in February or the beginning of March. The first spring sowing for transplanting is made on heat, and the subsequent sowings in the open garden; always on comparatively sandy, poor soil, that the plants may form abundance of roots and comparatively rigid foliage, so as not to suffer so much from transplanting, as if they had been grown on rich soil, and consequently had tender succulent leaves and roots. The routine culture consists of little more than weeding and watering; each crop being but a short time on the ground. In the beginning of summer the Cos varieties are sometimes slightly tied up with matting, to hasten their blanching. In gathering, pull up the plant, and take the outside leaves and roots at once to the rot-heap.

1506. *Lettuces as small salad* are produced by sowing the seed in drills, and cutting over the plants when they are in the third and fourth leaf, as is done with mustard and cress.

1507. *To save seed*, a few plants which have stood through the winter and been transplanted into rich soil in spring, or some spring-sown plants, may be allowed to run, and the seed will be ripe in August, and will keep three years; but as it is very precarious to save lettuce seed in wet seasons, it is an excellent method to grow a few plants in pots in good soil, one in each pot, and place them in front of a south wall, moving them under glass shelter to ripen off, if the weather render it necessary. Birds are very fond of lettuce seed; and the lettuce-fly, *Anthomyia Lactucæ Bouché* (see *Kollar*, p. 160), lays its eggs in the flower, the larvæ produced by which live on the seed.

Forcing.—See 1109.

SUBJECT. II.—*The Endive.*

1508. *The endive*, *Cichorium Endivia L.* (*Chicorée des Jardins, Fr.*), is a cichoraceous fusiform-rooted biennial, said to be a native of China and Japan, but long cultivated in European gardens for its leaves as salad. These are blanched to diminish the bitter taste, and they are used chiefly in autumn, winter, and spring. There are two principal varieties:—*The Batavian*, syn. broad-leaved (*Chicorée scarole, Fr.*); and *the curl-leaved* (*Chicorée frisée, Fr.*); of each of which there are a number of sub-varieties. As the season for endive is from August till March or April, the first sowing is made about the middle of June; the second about the end of that month; the third in July; and the fourth in the beginning of August. The plants are seldom raised where they are finally to remain (though in very dry weather they succeed best by that mode), but generally in seed-beds; and for one four feet wide by ten feet in length, $\frac{1}{2}$ oz. of seed is sufficient. The advantage of sowing in seed-beds, and afterwards transplanting, in this and similar cases, has been already noticed (1368). When the plants attain three or four leaves, they should be transplanted into rich soil, at one foot apart every way; and, as they are generally earthed up, to facilitate this process, they may be planted in drills. The two latest crops for use during winter and spring should be planted in a dry, warm border, or on the south side of an east and west ridge.

1509. *Blanching*.—As the summer and autumn crops advance to maturity, a portion should have the leaves tied up every ten days or fortnight, to cause the hearts to blanch and become tender, crisp, and mild-tasted; but this

ought not to be done till the plant is almost fully grown, for blanched leaves can no longer add any strength to the root. This operation ought only to be performed in dry days, and when the leaves are quite dry; and in winter, when the weather is dry without frost. The mode of performance is as follows:—When the plants are well filled up in the heart, and apparently nearly fully grown, put your fingers under the leaves which rest upon the ground, and gather the whole plant up in your hands into a conical form; then tie it round with strands of matting, loose during summer, but tighter late in autumn and in winter, when the plant grows slower; arranging the leaves so as to terminate in a point at the top, in order to prevent rain from falling into the heart of the plant. The curled endive, if carefully earthed up, will blanch tolerably well without being tied; but the broad-leaved variety, from its looser growth, hearts and blanches much better when bandaged. The blanching, when the weather is hot and dry, will sometimes be completed in a week; but late in autumn and during winter it will require a fortnight or a month. As soon as it is properly blanched, it should be taken up for use, as it will rot afterwards in a week or less, more especially if much rain fall. Sometimes blanching is effected by laying a flat tile on the plants; setting tiles or boards on each side of them, and bringing them together at top in the form of a ridge, so as to confine their growth and exclude the light; or covering them with garden-pots or blanching-pots, in the manner of sea-kale. In the north of Spain the blanching of endive is generally effected by covering the heart of the plant with a fragment of tile; “over this a light covering of earth is sifted. The fringed edges of the exterior leaves are carefully freed from earth, and exposed to light; having small bits of tile laid over that portion of the soil from which they protrude, to render the blanching perfect, and produce what the gardeners particularly pride themselves on, viz.: a plant of endive white all over, excepting the edges of the outer leaves, which should show about two inches of green.”—(*Churchill in Gard. Chron.*, 1842, p. 452.)

1510. *A crop may be preserved through the winter*, either by covering it where it stands by thatched hurdles raised on props (fig. 329 in p. 401); by hoops and mats; by removing it with balls to an open airy shed; by covering it with dry litter, taking it off every fine day; or, what is best of all, covering it where it stands with frames and sashes, taking the latter off every fine day. During the period that the endive is covered, tying up for blanching must go regularly on with every plant about ten days or a fortnight before it is to be gathered.

The endive is little troubled with *insects*; but snails and slugs attack it, as they do the lettuce, in every stage, and require to be kept under by frequent waterings with lime-water.

Seed may be saved as in the lettuce, and it will keep good four or five years.

SUBJECT. III.—*The Succory.*

1511. *The succory*, chiccory, or wild endive, *Cichorium Íntybus L.* (*Chicorée sauvage, Fr.*), is a cichoraceous fusiform-rooted perennial, a native of England, in chalky soils, in open situations. It is much cultivated on the Continent for its roots, which are cut in slices, kiln-dried, and ground as a substitute for coffee; and for its leaves, which are blanched and used like those of the endive. It is also sown thick, and when quite young cut as small salad (1506). In Flanders the roots are scraped and boiled, and eaten

along with meat, or with a sauce of butter and vinegar. In British gardens it is only cultivated as a winter salad. It is sown in the end of June or beginning of July, and treated like the endive, except that it is not blanched. Instead of this process, the leaves are cut off the plants, but so as not to destroy their hearts, about the beginning of October; the roots are then dug up, shortened, and planted in pots, or portable boxes, with the dibber, very close together in rich soil, watered, and afterwards protected from the frost by a light covering of litter, taken off in the daytime, or by any other convenient means. In a week or two the plants will be established, and the pots or boxes are then removed, as the produce is wanted, into the mushroom-house, or into a cellar, or any other dark warm place where the light will be completely excluded; or into any light warm place, and covered over so as to force the production of leaves and the blanching of them at the same time. In a few days the roots will push forth leaves which will be completely blanched, and each leaf, when fully expanded, may be gathered separately till the plants cease to produce any. These leaves in Belgium, and in the North of Germany and Russia, are considered as forming the most agreeable of all winter salads; and by a sufficient number of roots, it may be had in perfection from November till May. It is not even necessary to plant the roots in pots or boxes: they may be left in the soil covered with litter, and taken up to be forced as the salad is wanted; or they may be taken up and preserved in sand; or they may be pitted in the manner of potatoes; portions being regularly taken up, potted, and forced as wanted. The roots being established in the pots before forcing is a matter of very little consequence, as the leaves are supplied, not from the soil by means of the spongioles of the fibres, but from the nutriment laid up in the roots. The temperature of the mushroom-house, or other place in which the chiccory is forced, should be between 55° and 60°; but the roots will send up leaves if the temperature is a few degrees above the freezing point. (See 1098.) No blanched production is more beautiful than succory, as the leaves become of a pure white with most delicate pencillings of crimson, when grown as above recommended in a mushroom house. Aboard ship the roots of the succory are packed into casks of sand, with their heads protruding through numerous holes pierced in the sides of the cask, by which means a maximum of produce is procured from a minimum of space.

1512. *An excellent substitute for the succory*, both as a salad and a coffee plant, may be found in the common dandelion, *Leóntodon Taráxacum L.*, which is by many persons, and by us among the number, considered not inferior to it for both purposes.

SUBSECT. IV.—*The Celery.*

1513. *The celery*, *Àpium gravéolens L.* (*Celcri, Fr.*), is an umbelliferous biennial, a native of Britain, by the sides of wet ditches, and in marshy places, especially near the sea; and though poisonous in a wild state (when it is called smallage), yet by long cultivation it has become one of our most agreeable salads. The part used is the blanched leafstalks, and in the case of one variety the roots. Both stalks and roots are used raw in salads from August till March, and also in soups and stewed. In Italy, the points of the unblanched leaves are used to flavour soups; and in Britain, when neither stalks, leaves, nor roots can be had, the bruised seeds form a good substitute.

1514. *Varieties*.—Those at present considered the best are, the *Italian*, a dwarf-growing variety, the best for an early crop; the *red solid*, syn. Manchester-hardy, which grows to a large size, single plants having measured four feet six inches in height, and weighed nine pounds; *Seymour's solid*, very solid, and fine-flavoured; *Seymour's superb white*, very solid, large size, good flavour, and well adapted for early crops; the *turnip-rooted*, syn. celeriac (Celeri-rave, *Fr.*, and Knoll-sellerie, *Ger.*), has rough irregular shaped roots, about the size of the fist; it is generally cultivated in Germany, but in England is considered coarser than the kinds of which the blanched stalks are used. Upright or stalked celery, when well grown, has the stalks solid, and not hollow or piped, as is frequently the case—thoroughly blanched, crisp, tender, and of a delicate flavour. The roots of the celeriac should be solid, tender, and delicate. To attain these qualities both sorts require to be grown with rapidity, in very rich soil, kept very moist at the root, but dry about the leaves.

1515. *Propagation and culture*.—The celery, like other culinary biennials, is only propagated by seed, and half an ounce is sufficient for a seed-bed four and a half feet by ten feet, of the stalked or upright sorts; but for celeriac, as it is a spreading plant, half the quantity of seed will suffice for the same space. The seed is long in coming up, often a month; and this is one reason why the first sowing is generally made on heat. As the celery grows naturally in marshy soil, and as such soils are always rich in vegetable matter, and when near the sea must be slightly saline, these circumstances afford a guide for its culture in the garden; in which it can never be brought to a large size, without constant and abundant supplies of water during the whole period of its growth. The flavour, however, is better when it is grown of smaller size, and with less water. In general, three crops are enough even for a large family: the first should be sown in the end of February, to transplant in June, and to come into use in August; the second is sown in the end of March, to be transplanted in July, and to come into use in September; and the third is sown about the middle of April, to be transplanted in the first week of August, and to come into use in October or November, and last till March. The plants raised by every sowing, when about two inches high, should be pricked out into rich soil two inches or three inches apart every way, and again transplanted into a nursery plantation, also in rich soil, about six inches apart every way. Those for the earliest crop may be pricked out in a small hotbed, and transplanted into a warm border; but those for the others do not necessarily require artificial heat. As the earlier crops of celery are very apt to run to flower, and as this tendency in herbaceous plants, and especially annuals and biennials, is known to be checked and retarded by destroying the tap-root, and encouraging the production of fibrous roots (699 and 1368); some excellent growers of celery adopt the following process with their plants:—The seed-bed, whether for an early or a late crop, is formed of fresh, dark, loamy soil, mixed with old rotten dung, half and half, and placed on a hotbed. The nursery or transplanting bed is formed with old hotbed dung, very well broken, laid six inches or seven inches thick, on a piece of ground which has lain some time undisturbed, or which has been made hard by compression. The situation should be sunny. The plants are set six inches apart in the dung, without soil, and covered with hand-glasses. They are watered well when planted, and frequently afterwards. By hardening the soil under the dung

in which the plants are set, the root is formed into a brush of fibres ; and by thus preventing the pushing of a tap-root, the plant never runs to seed before the following spring.—(*Caled. Hort. Mem.* vol. ii.)

1516. *Transplanting into trenches.*—Where the object is to have very large celery, only one row ought to be planted in a trench ; but where a moderate size is preferred, there may be two rows ; or the trenches may be made four feet or six feet wide, and the celery planted in rows across the trench, at the distance of a foot from one another, and six inches apart in the row. Single trenches, when the object is to grow celery alone, may be made in the direction of north and south, three feet or four feet apart, centre from centre, and eight inches or ten inches deep ; the soil dug out being formed into a ridge between the trenches. As every trench is opened, dig into the bottom a coating of five or six inches in thickness of thoroughly-rotted dung, and along the centre of the trench insert the plants with a trowel, at six inches apart. When the plants are being removed, previously to planting, all side slips should be carefully taken off. Where celery is to be grown with other crops, as in simultaneous rotations (921), the trenches may be made six feet or eight feet apart centre from centre, and a row of peas for sticking, or some other crop of short duration, should be grown between every two rows of celery. Where celery is to be planted in rows across broad trenches, whatever may be the width of the trench, a similar width must be allowed between them for containing the soil dug out ; and these trenches should be made in the direction of east and west, for the same reason that trenches for single or double rows are made in the direction of north and south. To save ground, the plants before they are planted in the trenches should be kept in the nursery till they are ten inches or twelve inches high, taken up with balls, any descending roots shortened, any suckers that may have appeared removed, and the points of the leaves cut off, so as to throw the whole strength of the plant into the central bud, or growing point.

1517. *Blanching.*—It has been already observed (1509), with respect to blanching generally, that it weakens the plant by lessening the power of the leaves to elaborate nourishment, and return it to the root ; and hence, celery which is intended to grow of large size should be nearly full-grown before it is earthed up at all. Mr. Stewart grew celery which averaged from 9 lbs. to 12 lbs. weight, which had not been finally earthed up more than three weeks before it was gathered, and which had only one slight earthing-up previously to the final one, which was in September. On the other hand, when celery is wished to be of small size, and tender, it ought to be earthed up in an early stage of its growth, and the process continued as it advances in height. If the plants have been liberally supplied with water when first put into the trenches, and daily afterwards, excepting during rains, they will be ready to receive the first earthing-up in three or four weeks. This is done by paring down a little soil on each side of the trench with the spade, drawing it against the plants, and taking care that none of it gets into their hearts. To prevent this, each plant may be first slightly wrapped round with a strand of matting ; and to do this on a large scale, a strand is procured of great length, or is added to as it is applied ; and one end being tied round and fastened to the first plant in the row, it is passed on to the next plant, giving it one twist round the leaves, and so on till the other end of the row is reached, when it is there fastened to the last plant. The moulding-up may now proceed with rapidity, and when finished the strand should be removed,

and applied to the row in the next trench. It is scarcely necessary to observe, that where there are two rows in a trench, both must be tied up at the same time; or that when the rows are made across a broad trench, three ought to be tied, to prevent all risk of soil getting into the heart of the third row, while the first is being earthed up. The height of the soil applied may be three, four, or five inches, according to the height of the plants; and the earthings up may take place at intervals of ten days or a fortnight, till, by degrees, the stalks are covered to the height of twelve inches for the earliest crop, and eighteen inches, or two feet, or more, for the later crops; always taking care to perform the operation when the plants are quite dry, and to keep the heart open and free; except in the last earthing before winter, when the summits of the plants may be nearly closed to exclude rain. The longer celery is allowed to grow before applying the soil, the longer time does it require to blanch; but, in general, three weeks or a month will effect this, more especially in the early part of the season. Red celery requires a longer time to blanch than white celery, and never entirely loses its red colour. The latest crop of celery which is to be in use through the winter will require to be protected by dry litter, or thatched hurdles, during severe frosts; or it may be taken up and preserved in sand or soil, in a shed or cellar. When celery is frozen, it begins to rot immediately after the first thaw; and therefore to prolong a crop in the open garden, protection of some sort is essential on the approach of severe frosts.

1518. *Late spring celery.*—As celery is in great demand for soups in most families, especially during winter and spring, when other delicate vegetables are scarce, a crop may be procured till the beginning of June by the following means: Sow on a seed-bed about the middle of May; prick out, when the plants are six weeks old, into rows six inches apart, and allow the plants to remain in this nursery till September or October; then transplant them into trenches; earth them up slightly, and protect them by litter or thatched hurdles during winter; and in February or March earth them up finally. The stalks thus produced will not always be fit to use in salads, but they will be valuable for soups and stews. No celery crop that has been blanched in autumn will keep sound longer than the end of March; but green celery which has been only slightly earthed up will stand through an ordinary winter with little or no protection.

1519. *Taking the crop.*—The plants should be dug up without being bruised, beginning at one end of a row; and afterwards, the roots and green points of the leaves being cut off, and the loose outer leaves removed, the heart of the plant in a compact state is fit for being sent to the kitchen; but if intended for market, or to be sent to a distance, the outer leaves should be kept on, and also all the root excepting the fibrous part.

1520. *Celeriac* is cultivated with greater ease, and at less expense of ground and manure, than the common celery; and it may be used in the kitchen for seven or eight months in succession. The times of sowing are the same as for the other sorts, and the plants should be pricked out in a similar manner. They should be divested of all side-slips, not only before transplanting, but also during their after growth. Early in June they may be finally transplanted in rows fifteen inches apart every way, into flat beds of very rich light or sandy soil, with two-foot alleys between, to admit of watering the plants. The routine culture here consists chiefly in liberal waterings, and in slightly earthing up the roots after they have swelled to their full size

in order to blanch them. The celeriac has a continual tendency to revert from the knob-rooted form to that which is natural to it; and hence, like the turnip and similar plants of culture, it will not attain any large size if much earthed up. Still, the celeriac, to be eatable, requires to be blanched, and therefore must be earthed up to a certain extent, but the less the better.—(*G. M.* vols. ii. p. 415, and v. p. 364.) The roots of the celeriac may be taken up on the approach of frost, and preserved in sand or soil out of the reach of surface-heat, like potatoes (1416), for an indefinite period. The London market used formerly to be supplied with this root from Hamburg.

1521. *Diseases, insects, &c.*—The celery is liable to the canker in some soils, and also to be eaten by the maggot of the celery-fly, *Tephritis Onopordinis Fab.*, which is hatched in the leaves, and may be destroyed as soon as these have a blistered appearance, by cutting them off, and bruising or burning them; or fœtid substances may be frequently sprinkled near the plants, as a preventive.

1522. *To save seed.*—Select the finest specimens of the variety to be propagated, in February or March; and either remove a part of the soil with which they have been earthed up, and allow them to flower where they stand, or transplant them to a more convenient situation. The seed will ripen in September, and will keep ten years.

1523. *The alisanders, or alexanders, Smýrnum Olusàtrum L., and S. perfoliatum L.* (*Maceron, Fr.*), two umbelliferous biennials, the first a native of Britain, and the other of Spain, were formerly cultivated, and the leaf-stalks blanched like those of the celery; and their leaves were also used as pot-herbs and in salads. The flavour of the leaves being very much like that of celery, they may be useful in spring for putting into soups.

1524. *The Naples parsley, syn. celery parsley (Persil-celeri, Fr.)*, appears to be a hybrid between the common broad-leaved parsley and the celery. We have never seen it in England; but about Paris and in Italy it appears to be cultivated and used in the same manner as celery.

SUBJECT. V.—*The Lamb's Lettuce, Burnet, the Garden Cress, Winter Cress, American Cress, and Water Cress.*

1525. *The Lamb's lettuce, or corn-salad, Valerianélla olitòria Dec.* (*Mâche, Fr.*), is a valerianaceous indigenous annual, very hardy, and which requires no other culture than sowing in August, September, and February, and thinning the plants to three inches apart. The leaves should be gathered singly, like those of spinach, when of full size; except when the plant is grown as small salading, when the leaves and stems may be cut over, as in gathering the common cress or mustard. They are considered as forming, when used raw, a delicate salad; and when boiled, a good spinach.

1526. *The burnet, Potèrium Sanguisórba L., and Sanguisórba officinàlis L.*, are rosaceous perennials, the leaves of which, especially those of the second species, are put into salads, and sometimes into soups; and so much are they esteemed in Italy, that the Italians have a proverb, quoted by Evelyn, signifying that a salad without burnet is good for nothing.

1527. *The garden cress, Lepídium sativum L.* (*Cresson Alénois, Fr.*), is a cruciferous annual, long in cultivation for its young leaves, which have a peculiarly warm and grateful relish, either alone, or with other salading. There are several varieties; the best of which are the *common Curled-leaved*, the *Normandy curled*, and the *Broad-leaved*. The Normandy curled is the

hardest and most useful variety, supplying a beautiful garnish to dishes throughout the winter. The seed, which comes up in three days, may be sown in September and October for winter and spring supply; and in March, April, and May, for summer use. These five sowings will afford a constant supply throughout the year of leaves to be gathered singly, whether for garnishings or salads; but as the cress is also used as a small salad (1107), and for that purpose gathered in the seed-leaf, where it is in demand in that state, it should be sown three or four times every month—during winter and spring under glass, and in summer and autumn in a shaded situation, the soil being kept moist by watering, or by covering with hand-glasses or mats. The soil should always be rich, the great object being rapid growth, so as to ensure succulence and delicacy. A few plants allowed to run to flower will produce abundance of seed, which will keep two years. Half a pound of seed at least will be required where the cress is in constant demand as small salading.

1528. *The winter cress*, *Barbarèa vulgàris H. K.*, and the American cress, *B. præcox Dec.*, are cruciferous perennials, natives of Britain in watery places, and by careful culture in gardens they can be made to produce their leaves throughout the year. Sow in August, or the beginning of September, in rows a foot apart, for a crop to stand through the winter, and thin the plants out to six inches in the row. If the leaves are gathered singly, and the plants protected from frost by glass, or nightly coverings, they will afford a regular supply till next June. The plants will then run to flower, and produce seed in abundance.

1529. *The water cress*, *Nastúrtium officinàle H. K.* (*Cresson de Fontaine, Fr.*), is a cruciferous amphibious creeping perennial, held in general estimation in this and in other countries as an antiscorbutic plant, and brought to market in immense quantities from its natural habitation in running water, or artificial plantations made there. The most favourable description of water is a clear stream, not more than an inch and a half deep, running over sand or gravel; the least favourable, deep still water on a muddy bottom. It is evident, therefore, that there are few private gardens in which the water cress can be cultivated in running water; but fortunately it will grow luxuriantly in rich sandy soil, if watered overhead every evening and morning during the growing season; and the cresses thus produced are undoubtedly of a richer taste than those grown in clear running water. The plants may be raised from seed, or obtained by division of old plants; and they may be planted early in spring, a foot apart every way. In gathering, only the points of the shoots should be taken, as the lower leaves are not only coarser, but apt to be infested by the larva of insects if growing in water, and by snails and slugs if on land.

For a small garden, the Normandy cress and the water cress are the only plants of the cress kind worth cultivating.

SUBSECT. VI.—*Small Salads.*

1530. *Small salads* are understood to be very young plants of the salad kind, sown thick, and gathered, some, as the cress, mustard, rape, radish, and some other cruciferous plants, in the seed-leaf; and others, as the lettuce, endive, succory, Lamb's lettuce, and various others, when in the third or fourth leaf. In general, all rapid-growing salad plants are fit for being used as small salads, and are so used on the continent; but the principal small salads in England are the cress, mustard, rape, and radish, which are sown

weekly all the year round on fine rich soil kept warm, moist, and shaded, and cut in the seed-leaf, generally in about a week after they are sown. Of the small salads which are allowed to advance beyond the seed-leaf before they are cut, by far the best is the common cos lettuce. There are two kinds of mustard which may be grown as small salading, *Sinàpis álba L.*, and *S. nìgra L.*; but the former alone is grown as salading, the latter being the kind grown in fields for its seeds to be ground into the flour-of-mustard of the shops. It is, therefore, seldom seen in gardens. The rape, *Brássica Nàpus*, var. *oleifèra Dec.*, is only grown in gardens as a small salad, and as in the case of other small salads, when much in demand, one pound of seed of each kind at least will be required.

1531. *Substitutes for mustard* are to be found in the wild radish, *Ráphanus Raphanístрум L.*; the sea-radish, *R. marítimus Sm.*; in the wild mustard, *Sinàpis arvènsis L.*; the fine-leaved mustard, *S. tenuifòlia L.*; in all the species of *Brassica*, &c.; and, in short, in all the annual and biennial species of *Cruciferae*, not excepting the wall-flower and stock gillyflower, though these and various others are not worth growing as salad-plants.

SUBSECT. VII.—*Substitutes for Acetariaceous Esculents.*

1532.—*Substitutes for acetariaceous esculents are found in the following plants.*—*The Brooklime*, *Verónica Beccabúnga L.*, a scrophularinous perennial common in rivulets and wet ditches, and used like the water-cress. *The Garden Rocket*, *Erùca satìva Dec.*, a cruciferous annual, used like the common cress and mustard. *Scurvy Grass*, *Cochleària officinàlis L.*, a cruciferous biennial found on our sea-shores, the leaves of which are used like the water cress. *Wood Sorrel*, *Oxalis Acetosèlla L.*, an oxalidaceous perennial, the leaves of which form a very grateful addition to salading, and communicate an agreeable relish to dishes of mashed greens: this may also be said of the leaves of all the other species of *Oxalis*. To these may be added the young leaves of all the cruciferous plants mentioned in p. 616; the leaves and flowers of *Tropæolum màjus L.*; the flowers of *Cércis siliquástrum L.*; the petals of the *Dahlia*; the points of the shoots of *Ænothèra biennis L.*; the leaves of *Sèdum álbum L.*; of *Crithmum marítimum L.*; of *Salicòrnia herbàcea L.*; of *Hypochæris maculàta L.*; of *Picrídium vulgàre L.*; of *Spilánthes oleràcea L.*, and of *S. fúsca Hort. Par.* (see *Bon Jard.* 1842, p. 317); of *Balsamita vulgàris Desf.* the costmary, a leaf or two of which is sometimes used to add to the flavour of mixed salads; of *Achillèa Millefòlium L.*; of *Ínula crithmifòlia L.*; of *Cochleària Coronòpus L.*; of *Plantàgo Coronòpus L.*, and various others.

SECT. VIII.—*Adornaceous Esculents.*

1533. *Adornaceous esculents*, under which term we include chiefly the plants used as garnishes, such as the parsley, chervil, fennel, horse-radish, &c., include a great variety of plants belonging to different natural orders, and some of which, such as the Indian cress, might even have been included under acetariaceous esculents. The culture of all the plants of this section is very simple, and with the exception of the horse-radish, a dry calcareous soil, poor rather than rich, is to be preferred; because such a soil is found to be most favourable for the preservation of their aromatic properties. With the exception of the horse-radish, they are generally grown in a compartment, commonly a border, in the outer garden or slip, by themselves.

SUBJECT. I.—*The Parsley.*

1534. *The parsley*, *Apium Petroselinum L.* (*Persil, Fr.*), is an umbelliferous biennial, a native of Sardinia, long in cultivation as a seasoning, and also as a garnish. Eaten along with any dish strongly seasoned with onions, it takes off their smell, and prevents their after-taste; no herb is more valuable as communicating flavour to soups and stews. There are two varieties, the *plain-leaved*, and the *curled-leaved*, but the latter alone should be cultivated, because the former is apt to be confounded with a poisonous plant, the fool's parsley, *Æthusa Cynapium L.*, an indigenous annual, common as a weed in most gardens, but which can never for a moment be mistaken for the curled-leaved parsley. Parsley-seed, of which an ounce will sow a drill 150 feet in length, requires to be sown every year in February, either broadcast or in rows, but not as an edging or walks as is commonly done; because in that situation the leaves get soiled or injured. The seed will remain in the ground from forty to fifty days before it vegetates, being a longer period than is required for any other garden-seed; and, contrary to what is general, parsley-seed that has been kept several years comes up sooner than new seed; unless, indeed, the new seed has been taken from the plant before it was fully ripe, and sown immediately. The plants should be thinned out to six inches' distance in the row; and also all those plants that have not the leaves beautifully curled should be pulled up, an operation technically called roguing (864); because one of the principal uses of parsley is as a garnish, and the curled leaves are incomparably more ornamental than the plain ones. They should be gathered leaf by leaf; and when there is a want of young tender leaves, the plant should be cut over by the surface of the ground, when a new set of leaves will be sent up. In order that there may be a supply in the winter season, a sowing should be made about May, to be covered in October with a frame and sashes, or with hoop sand mats, or propped hurdles. The parsley leaf may be preserved in a state fit for being used in soups and stews, by drying it in a Dutch oven, or in a tin roasting-screen (or hastener), and when it becomes brittle, rubbing it into a fine powder, and putting it into glass bottles till wanted for use. Seed may be saved by selecting a few plants with the most beautifully-curled leaves, and allowing them to run to flowers. The seed will ripen in July, and will keep six or eight years.

1535. *The Hamburgh parsley*, the roots of which are eaten like those of the parsley, has been noticed under esculent roots (1441); and the *Naples parsley*, the footstalks of the leaves of which are used like celery, was noticed when treating of that vegetable (1524).

SUBJECT. II.—*The Chervil, the Coriander, Dill, Fennel, Tarragon, and Purslane.*

1536. *The chervil*, *Chærophýllum sativum Pers.* (*Cerfeuil Fr.*), is an umbelliferous annual, a native of the South of Europe, and cultivated for the same purposes as the parsley; but as it runs rapidly to seed, several sowings require to be made in the course of the growing season. Sow in shallow drills six inches apart, and thin out the plants; and when gathering, take the leaves singly. They may be dried and preserved in the same manner as those of parsley. A few plants allowed to run will bear abundance of seed, which will keep six or eight years.

1537. *The coriander*, *Coriándrum sativum L.*, an umbelliferous annual, a native of the south of Europe, is sometimes cultivated in gardens for the same purposes as the chervil; but more frequently, especially on the Continent, for its seeds, which are sold by the confectioners encrusted in sugar.

1538. *The anise*, *Tràgium sativum Spr.*, is an annual, a native of Egypt, sometimes cultivated in gardens for the same purposes as the coriander.

1539. *The dill*, *Anèthum gravèolens L. (L'Anet Fr.)*, is an umbelliferous biennial, a native of Spain, the leaves of which are occasionally used in soups and sauces, and to put along with pickles, especially cucumbers. Two or three plants will be enough for any family. It is easily propagated by division, or by seeds.

1540. *The fennel*, *Anèthum Fœniculum L. (L'Anet Fr.)*, is an umbelliferous perennial, resembling the dill, but considerably larger, a native of the south of Europe, and very generally cultivated in gardens for the stalks and leaves. The leaves, boiled, enter into many fish-sauces, and, raw, form a beautiful garnish; the tender stalks are used raw in salads; and the blanched stalks of the variety called *finocchio* are eaten with oil, vinegar, and pepper, as a cold salad; and they are likewise put into soups. Three or four plants of the common fennel are sufficient for any garden. The finocchio may be grown in rows in light, rich soil, and earthed up to the height of five inches or six inches, to blanch the stalks. This blanching will be effected in ten days or a fortnight; and by cutting down a few plants at a time during summer, a succession of young shoots will be produced, which, being blanched, will afford a supply from June till December. The soil ought to be calcareous, dry, and rich, and watered in very dry weather.

1541. *The tarragon*, *Artemisia Dracúnculus L. (L'Estragon Fr.)*, is an anthemideous perennial, a native of Siberia, cultivated for its leaves and the points of its shoots as an ingredient in salads, soups, stews, pickles, and other compositions. By infusion, the stalks and leaves make tarragon vinegar, which is considered one of the best condiments for fish. Tarragon is propagated by division or by seed, and grown in rows eighteen inches apart and six inches distant in the row. The soil in which it is grown should be dry and calcareous; otherwise the plants will be comparatively without flavour, and be apt to perish in a severe winter. It is easily forced by transferring a few plants to the hotbed or hothouse (1110); and the stems may be gathered just before they are coming into flower, dried, compressed into small packets, and put up in paper as already described (857).

1542. *Substitutes* for the tarragon are to be found in the *Achillèa serràta E. B.*, and the *Tagètes lùcida Cav.*; in the latter plant more especially. The former is much used in Nottinghamshire, under the name of sweet mace. *Achillèa nana L.*, and several dwarf species of *Artemisia*, are used for the same purpose in the Alps.

1543. *The purslane*, *Portulàca oleràcea L.*, and *P. sativa Haw. (Pourpier Fr.)*, is a portulacaceous annual, with succulent leaves and procumbent stems, a native of South America, and cultivated for its young shoots and succulent leaves as ingredients in spring and summer salads, and as pot-herbs and pickles. There are two sorts, considered as distinct species, the *green* and the *golden*; the latter is more showy as a garnish, but the former is more succulent as a salad. Where a constant supply is required, the first sowing should be made on heat in February, and the others monthly, on a warm border till August. The shoots are gathered for use when they are

from two inches to five inches in height, and well furnished with leaves; and if they are cut off close to the collar of the plant, it will sprout out again, and afford a second supply. A few plants will produce abundance of seed, which will keep good two years.

SUBJECT. III.—*The Indian Cress, Borage, and Marigold.*

These plants are annuals, and only a very few of each are required for any garden.

1544. *The Indian cress, or nasturtium*, *Tropæolum majus* L. (Capucine, *Fr.*), is a tropæolaceous trailing or climbing annual, a native of Peru, but growing vigorously in the open air in the climate of Britain. The flowers make a beautiful garnish alone, or along with those of the borage, the marigold, oxalis, dahlia, &c.; and both the flowers and the young leaves and tender shoots are eaten in salads, having a warm taste like the common cress, whence the name Indian cress. The fruit is gathered green, and pickled like capers, for which they form so excellent a substitute that they are preferred to the true caper by many persons. The two sorts best worth cultivating are *the common large*, with an orange flower, and *the blood-red flowered*. The seed may either be sown on heat in March, and transplanted in May, or sown in May where it is finally to remain; and in order to keep the flowers and fruit quite clean, it is advisable to stick the plants in the manner of peas. The leaves, points of the shoots, and flowers, should be gathered only a few hours before using; and the fruit for pickling, while green, plump, and tender. One or two plants will ripen abundance of seed, which will keep two years.

1545. *The borage*, *Borago officinalis* L. (*Bourrache Fr.*), is a boraginaceous annual, indigenous or naturalised in Britain, and generally cultivated among other plants used in garnishing for its beautiful blue flowers. The tender leaves and points of the shoots are used in salads and as pot-herbs, more especially on the Continent. The flowers and upper leaves are sometimes put in a cool tankard, which is a beverage composed of wine, water, lemon juice, and sugar. The seed keeps four years.

1546. *The marigold*, or pot-marigold, *Caléndula officinalis* L. (*Souci des Jardins, Fr.*), is a helianthemideous annual, the double-flowered varieties of which have been long cultivated in gardens as ornamental plants, for their flowers as garnishes, and for their petals, which are occasionally used in broths and soups. A few plants are enough for any garden, and they may be raised from seed sown in February or March. The petals may be gathered, dried in the sun, and put up in paper for winter use.

SUBJECT. IV.—*The Horse-radish.*

1547. *The horse-radish*, *Cochleària Armoræa* L. (Cranon, or Le Grand Raifort, *Fr.*), is a cruciferous perennial, a native of England in marshy places, long cultivated for its roots or underground stems. These are scraped into shreds, as a garnish and a condiment to roast-beef, and also as an ingredient in winter salads and sauces; and by some persons it is eaten raw, with bread and butter. It is propagated by cuttings of the root, either of the crown, with one or two inches of the root attached, or of the root, without any visible buds, about the same length, and planted with the upper end uppermost, as in sea-kale (1483). These cuttings may either be dropped into holes, made by a dibber, fifteen or eighteen inches in

depth, and about the same distance apart every way, the upper part of the hole being filled in with light soil or wood ashes; or they may be planted while the ground is being trenched, covering it to the depth of eighteen inches. March is the season for planting, and the soil should be rich, free, moist, and at least two feet deep. The roots, that is the part produced between the top of the cutting and the surface of the ground, and which may be called a blanched stem, will be fit for use at the end of the first autumn, when the leaves have decayed; but they will be much stronger at the end of the second autumn. They ought never to be allowed to remain longer than three years, nor to ripen seed, otherwise the roots become tough and disagreeable to use. A portion ought to be planted every year, to come in in succession. In taking the crop, begin at one end of a row, and dig down as far as the roots have penetrated, so as to take up every particle of root, for the least fragment left will send up leaves the following year. For this reason many gardeners grow their horse-radish always on the same spot of ground; trenching up one-half every winter; and selecting the larger roots, and laying them up in sand, or earthing them up in a shady border, for use, and leaving the smaller roots in the bottom of the trench for next year's crop. In whichever way horse-radish is grown, the soil ought to be deep, rich, and moist, in order that the growth may be rapid and the root succulent; the flower-stems should be cut off as soon as they appear, because they deprive the root of nourishment which would otherwise be sent down to it; and the crop should not be allowed to stand more than two years, or at most three, otherwise the roots will become filled with woody fibre, sticky, and unfit for use.

1548. *Lepidium latifolium* L., a cruciferous annual, a native of Britain on the sea-coast, has roots resembling those of the horse-radish, which may vrey well be used as a substitute; the leaves are excellent as greens, and not bad in salads.

SECT. IX.—*Condimentaceous Esculents.*

1549. *Condimentaceous esculents* are such as in cookery are always used with pastry in the form of tarts, pies, puddings, &c.; or preserved in sugar, or pickled in vinegar. Though fruits are chiefly employed in these preparations, yet we have as substitutes the rhubarb and the *Oxalis crenata* for tarts, pies and puddings, and the angelica for preserving in sugar, and the samphire for pickling. The principal plant belonging to this section, however, is the rhubarb, which, though scarcely known as a tart plant in the commencement of the present century, is now become generally cultivated for that purpose, even in the garden of the cottager. The other plants of this section occupy but a very small space in the herb-ground.

SUBSECT. I.—*The Rhubarb.*

1550. *The Rhubarb*, *Rhèum* L. (*Rhubarbe* Fr.), is a polygonaceous perennial, a native of Tartary, and other countries of the East, of which there are several species, hybrids and varieties, in culture for the petioles of the radical leaves. These are peeled, cut into small pieces, and put into tarts and pies, in the manner of gooseberries and apples, or, like them, baked whole in a dish. A wine is also made from them, and they are also pickled and preserved. There are a great many different kinds in cultivation, and every year produces some new sort; but those considered the best at the

present time are : the *Elford*, with scarlet stalks, for an early crop ; *Myatt's Victoria*, for a main crop, and it is also the best for forcing ; and Rhèum australe *D. Don.*, syn. *R. Emòdi Wal.*, for a late crop. The latter has an excellent flavour, somewhat resembling that of apples. To ensure the flavour in pies and puddings, a portion of the stalks should always be put in without being peeled.

1551. *Propagation and culture.*—By seed is the best mode when the soil is rich and deep, because the tap-root penetrates at once to a great depth, and the plant is less likely afterwards to suffer from drought ; but it will grow quite well by division, which is the most certain mode of continuing particular varieties. The soil being deeply trenched and richly manured, a few seeds may be deposited in drills two feet apart for the *Elford*, and three feet for the other sorts ; and nearly the same distance may be allowed in the rows. When the plants come up, reduce the patches to single plants, and, with the usual routine culture, one or two leaves from each plant may be gathered the second year, three or more the third, and several every year for a number of years afterwards ; though as the number of buds on the crowns of the roots increase, the leaves will be smaller. The flower-stems should be cut down as soon as they appear, unless seed is wanted. Some persons prefer the leaves partially blanched, and for this purpose place a sea-kale pot over each plant, but without the cover ; others have grown it in chimney-pots for the same purpose, and find also an increased produce from the greater length of stalk. The progress of the *Elford*, or any other early variety, may be greatly accelerated in spring by covering each plant with a common hand-glass, or with the substitute (figs. 111—113, in p. 172) invented by Mr. Forsyth. In gathering the leaves, remove a little soil, bend them down, and slip them off, without injuring the buds at their base, and without bruising the stalks or knife. The stalk is fit to use when the disk of the leaf is half expanded ; but a larger produce and a fuller flavour are obtained by waiting till the leaf is fully grown. One plant allowed to run will produce abundance of seed, which ripens in August, and will keep a year.

Forcing the rhubarb. See 1098.

1552. *Substitutes* for the tart rhubarb may be found in every other species of the genus, not even excepting the supposed medicinal species, *R. palmatum* ; in the stalks of the *oxalis crenata* (1446), of the sorrel (1458), and of the different species of dock, which, according to Cobbett, are sent to market for that purpose in America.

SUBJECT. II.—*The Angelica, Elecampane, Samphire, and Caper.*

1553. *The Angelica*, *Angélica Archangélica L.*, is an umbelliferous biennial, a native of England, in moist situations in good soil, but rare, and cultivated in gardens for their leaves, and the tender flower-stalks, which were formerly blanched like celery. They are now chiefly candied with sugar by the confectioners ; and in Sweden and Norway, the leaves and stalks are eaten raw, or boiled with meat and fish ; and the seeds are used to flavour ardent spirits. The time for gathering the stalks is May, and if the plant be then cut down, a second crop will be produced ; and if the flower-stems be cut off as fast as they appear, the plant, though a biennial, will last several years. Seed is produced in abundance, and will keep three or four years.

1554. *Substitutes* for the angelica are to be found in the alisanders (1523),

and the lovage, *Ligústicum scóticum L.*, an umbelliferous perennial, eaten raw in the Highlands of Scotland.

1555. *The elecampane*, *Ínula Helènum L.*, is a carduaceous perennial, a native of the South of England in moist pastures. The root is fusiform, thick, and aromatic, and is candied like the stalks of the angelica, and much admired in France and Germany. The plant ought to be taken up yearly, and divided and replanted, in order that the roots may be obtained succulent and tender, and for the same reason the plant ought never to be allowed to come into flower.

1556. *The samphire*, *Crithmum marítimum L.*, is an umbelliferous perennial, a native of England, on rocky cliffs by the sea, and cultivated in gardens for its seed-pods, which make a warm aromatic pickle, and its leaves, which are used in salads. It is propagated by division, or by sowing the seed in April; but in either way it is rather difficult of cultivation. It succeeds best in a gravelly soil, kept moist, and sprinkled in spring with a little powdered barilla, or common sea-salt. During winter it requires to be protected by a little dry litter. By this treatment it has produced an ample supply of shoots, which may be cut twice in a season. Seed may be saved, or plants procured from their native habitats on the sea-coast, as for example at Dover, Salcombe, and on the coast of Galloway and Haddington shires.

1557. *Substitutes* for the samphire are to be found in some other plants which grow within salt-water mark; for example, the golden samphire, *Inula crithmifolia L.*, a perennial, not uncommon in salt marshes; and *Salicórnia herbàcea L.*, a chenopodiaceous annual, found on muddy sea-shores throughout Europe; in *Echinóphora spinosa L.*, an umbelliferous plant, a native of sandy shores in Lancashire and Kent; the young leaves of which make a wholesome and excellent pickle.

1558. *The caper*, *Cápparis spinosa L.*, is a capparidaceous trailing shrub, a native of the South of Europe, on rocks and dry stony or gravelly places, and cultivated about Marseilles, and other parts of France, for its flower-buds, when about half the size which they attain before expanding. It might be cultivated in the South of England in the open garden, and in other parts against a conservative wall; or if it were thought necessary a few plants under glass would supply all that would suffice for an ordinary family. It would thrive on the rocky shores of the south of Devon, more especially about Salcombe, where the *Agave* stands through the winter without protection; and it will also succeed in Somersetshire, as Sir John Trevelyan has proved, by planting it on the sides of an old stone quarry.

1559. *Excellent substitutes* for the caper are found in the unripe fruit of the Indian cress, and of the *Euphórbia Láthyris L.*

1560. *The ginger*, *Zíngiber officinále L.*, a scitamincous perennial from the East Indies, is sometimes cultivated in our stoves for the roots, or creeping underground stems, to be taken when succulent, and pickled and preserved. The plants are divided when in a dormant state, and planted in rich light soil, and in a year afterwards the roots are fit to gather. (*G. M.*, vol. vii., p. 578.)

1561. *The flowers of Magnòlia grandiflora L.*, are pickled in some parts of Devonshire, and considered exquisite in flavour; and we have no doubt that the flower-buds of the other species, and the leaf-buds when bursting, of all the species, and also of the tulip tree, might be used for the same purpose.

SECT. X.—*Aromaceous Esculents.*

1562. *The esculent aromatic plants*, or sweet herbs, in common use, are about a dozen in number, but they all grow in a very limited space in the herb garden. The soil for all of them may be dry and calcareous, with the single exception of the mint family. They are used to give flavour to soups, stews, and other dishes; and in sauces and various stuffings. The leaves and stalks of all these plants may be gathered when they are coming into flower, dried, and compressed in a shallow box by a screw press, so as to form packets about the size of a small octavo volume, which, being put up in paper, will retain their fragrance for two or three years. Nothing can be worse than the former mode of keeping herbs, by hanging them up loose, in the back sheds, or in the seed-room, where they soon became covered with dust, and deprived of their aroma.

1563. *The common thyme*, *Thymus vulgaris L.*, is a labiaceous evergreen undershrub, a native of Spain and Italy. The young leaves and tops are used either green or dried in soups, stuffings, stews, and sauces. It is readily increased by seeds, cuttings, or by division, and the plants should be renewed by one or other of these modes every year in spring.

1564. *The lemon thyme* is the *T. citriodorus Pers.*, a trailing evergreen, used for the same purposes as the preceding species; but being less pungent it is more grateful, and therefore used as a seasoning for veal, instead of lemon peel.

1565. *The sage*, *Sálvia officinális L.*, is a labiaceous evergreen undershrub, a native of the South of Europe. The leaves and tender tops are used in stuffings and sauces, for many kinds of luscious and strong meats; as well as to improve the flavour of various articles of cookery. There are several varieties: *the common, red, or purple leaved; the narrow-leaved green; and the broad-leaved green*, all of equal merit. They are propagated by seeds or cuttings, and like the thyme, the plantation ought to be renewed every two or three years, otherwise it is very apt to be destroyed by the winter.

1566. *The clary*, *S. Sclàrea L.*, is a biennial, a native of Italy, sometimes used as a substitute for the sage.

1567. *The common mint*, or spear mint, is the *Méntha víridis L.*, a labiaceous creeping stemmed perennial, a native of England, in marshy places; the young leaves and tops of which are used in spring salads, and form an ingredient in soups; they are also employed to give flavour to certain dishes, as peas, &c.; being boiled for a time, and then withdrawn. Mint is much in demand about London as an ingredient in a sauce for lamb. It is propagated by division of the roots before they begin to grow in spring, which are buried in shallow drills; or by the young shoots slipped off when they are three inches or four inches in length, and planted in beds a few inches apart. To produce tender stalks and leaves the plants require to be liberally supplied with water. When mint is to be dried the stalks should be cut when they are just coming into flower, dried in a shady place, compressed in packets, and papered; to be laid up in a drawer or herb case till wanted for use. One packet may be sent to the kitchen at a time. No plant is easier to force, and this ought always to be done in time for new lamb. (See 1110.)

1568. *The pennyroyal mint*, *M. Pulègium L.*, is a low creeping perennial, a native of England, in wet commons, and on the margins of brooks. It is used in cookery like the common mint, and for distilling pennyroyal water.

1569. *The pot marjoram*, *Origanum Onites L.*, is a labiaceous under-shrub, a native of Sicily, but hardy enough to stand through our winters. The leaves and tender tops, green or dried, are used in soups as a substitute for those of the sweet or knotted marjoram. It is readily propagated by division of the roots, or by seeds.

1570. *The sweet marjoram*, or knotted marjoram, *O. Majorana L.*, is a biennial, a native of the South of Europe, and long cultivated in British gardens as a seasoning for soups, and for other culinary purposes. This species being somewhat tender, is commonly sown on a slight hot-bed towards the end of March, or on a warm border about the middle of April; in the former case transplanting it into rows one foot apart, and the plants six inches distant in the row; and in the latter case thinning them out without transplanting. The green tops may be gathered as wanted; but those to be preserved in packets will have most flavour, if gathered when just coming into blossom. The seed, of which a quarter of an ounce is sufficient for any garden, is commonly imported, and will keep four years.

1571. *The winter marjoram*, *O. heracleoticum L.*, is a perennial, a native of the South of Europe, with leaves resembling those of the knotted marjoram, but with the flowers in spikes instead of whorls. It is used like the other marjorams, and propagated by division.

1572. *The winter savory*, *Satureja montana L.*, is a labiaceous under-shrub, a native of the South of Europe, and cultivated for its tender tops as a seasoning for soups and made dishes, and for boiling with peas, beans, &c. It is propagated by seed, cuttings, or division, like thyme, but most frequently by the latter mode.

1573. *The summer savory*, *S. hortensis L.*, is an annual, a native of Italy, with larger leaves and a more agreeable fragrance than the winter savory, to which it is generally preferred. It is sown in drills, one foot apart, in the open garden, in March or April.

1574. *The sweet basil*, or larger basil, *Ócymum Basilicum L.*, is a labiaceous annual, a native of the East Indies, cultivated for its highly aromatic properties. The leaves and bracteæ, or leafy tops, are the parts gathered; and, on account of their strong flavour of cloves, they are often used in highly-seasoned dishes, as well as in soups, stews, and sauces; and a leaf or two leaves are sometimes introduced into salads. Sow on a hot-bed in the end of March, and plant out in a warm border when all danger from frost is over, allowing the plants at least a square foot of space for each. Seed is generally imported from Italy, and it keeps two years.

1575. *The bush basil*, or least basil, *O. minimum L.*, an annual, also from the East Indies, is a much smaller plant than the former, but being equally aromatic, and rather more hardy, is frequently substituted for it.

1576. *The tansy*, *Tanacetum vulgare L.*, is an anthemideous perennial, a native of Britain on the sandy banks of rivers, and cultivated in gardens for the young leaves, which are shredded down, and employed to flavour puddings, omelets, and cakes. There is a variety with the leaves doubly curled, which is generally preferred. No plant is more easily propagated or cultivated, and it also forces freely.

SECT. XI.—*Fungaceous Esculents.*

The only fungaceous vegetable cultivated in Britain is the common mushroom, though attempts have been made to bring under subjection the truffle and the morel.

1577. *The garden mushroom*, *Agáricus campéstris L.*, is a hymenomycetaceous fungus, a native of Britain and most parts of Europe, appearing in pastures in August and September, and readily distinguished from other fungi by its fine pink or flesh-coloured gills, and pleasant smell. As the natural history of the mushroom was given when treating of the mode of forcing it (1111), and as there are no varieties to be described, we have only to notice a practice sometimes adopted of growing the mushroom, in imitation of nature, in grass-lawns and pastures. The attempt will not succeed in every soil and situation, but it has done so in a great many instances. Take mushroom spawn—the mode of procuring which has been already given (1113)—and in the beginning of July inoculate a lawn or pasture with it by simply raising one piece of turf, three inches thick, with the spade, in every square yard, inserting a small fragment of spawn beneath it, and pressing it firmly down again with the back of the spade or the foot. This will not interfere with the mowing of the lawn, and in all probability a crop will be produced during the latter end of August and the beginning of September; and mushrooms will appear of themselves in the same ground for a number of years afterwards. Mushroom spawn has also been planted among potatoes and other crops in the open garden, and has produced mushrooms, but no mode yet discovered is so certain as those in which artificial heat and a bed of stable-dung is employed (*G. M.*, vol. ix., p. 223). The mushroom, when cultivated in houses, is liable to the attacks of various insects, slugs, and worms, all of which may be collected by baits, or devoured by a toad or two kept on purpose.

1578. *The truffle*, *Tüber cibárium Sibth.*, is a gasteromycetaceous fungus, a native of Britain, and growing naturally some inches below the surface. It is very common in the downs of Wiltshire, Hampshire, and Kent, where dogs are trained to scent it out, and where also it is sought out and devoured by pigs;—which on the Continent are used to discover the localities of this fungus, as dogs are in England. It is sent to the London market from different parts of England in a green state, and imported from the Continent sliced and dried; the most celebrated truffles are those from the oak forests of Perigord. Various attempts have been made, both in Britain and on the Continent, to cultivate the truffle, but hitherto without success (*G. M. I.*, VIII., and XIII.); but it would appear that Dr. Klotzsch, of Berlin, has ascertained that the best course is to take truffles which are no longer good for the table, being over-ripe, and nearly in a state of decomposition, diffusing a disagreeable odour; to break them into pieces, and place them two inches or three inches deep in the earth, in rather raised flat places, under copse or underwood, protected from the north and east winds. Truffles in the state in which they are eaten are never ripe, and therefore unfit for propagation.—(*Gard. Chron.* 1842, p. 287.)

1579. *The morel*, *Morchélla esculénta Pers.*, belongs to the same division of fungi as the truffle. It is a native of Britain in wet banks, in woods, and in moist pastures, and is in perfection in May and June. When gathered dry it will keep several months. It is used for the same purpose as the truffle, but like it has not as yet been subjected to cultivation.

1580. *Substitutes* for these fungi may be found in a number of species of the same genera, more especially of *Agáricus*, but as a great number of fungi are considered poisonous, it would be dangerous for any one to collect them for edible purposes from mere description without figures. We refer therefore to *Soverby's English Fungi*, in which coloured plates are given of

all the indigenous species, and those which are edible, and those which are poisonous, particularly pointed out. See also *Descrizione dei Funghi Mangerecci più comuni dell' Italia e de velenosi che possono c' omedesimi confondersi, del Dottor Carlo Vittadini. Milano, 1835.*

SECT. XII.—*Odoraceous Herbs.*

1581. *The odoraceous herbs*, or perfumery herbs, cultivated in British gardens in the present day, are, with the exception of lavender and peppermint, applied to very little use.

1582. *The lavender*, *Lavándula spica L.*, is a labiaceous under-shrub, a native of the South of Europe, a few plants of which are cultivated in every garden for their powerfully aromatic flowers. These are gathered with a portion of the stalk attached, and tied up in little bundles, dried, and placed among linen to perfume them and to deter the moth. They are also used for scenting rooms, wardrobes, and for a variety of similar purposes, and for affording by distillation lavender-water. It is propagated by seeds or cuttings, and thrives best on dry calcareous soils, in which it will last five or six years. *L. latifolia Ehrh.*, and *L. viridis Herit.*, are cultivated in some gardens instead of the common sort, or along with it.

1583. *The rosemary*, *Rosmarinus officinális L.*, is a labiaceous evergreen under-shrub, a native of the south of Europe, and like the lavender highly aromatic. The flowers are used like those of the lavender, and for distilling Hungary-water; and the sprigs are sometimes used as a garnish. It is readily propagated by seeds or cuttings in dry calcareous soil, and a plant will last six or seven years.

1584. *The peppermint*.—*Méntha piperita L.*, is a labiaceous creeping-stemmed perennial, a native of England in watery places. Its only use is for distilling peppermint-water, for which purpose it may be propagated like the mint (1567), and planted in a soft, rich soil, moist either naturally or by art. The stalks are gathered when they are in full flower, and taken at once to distil. The plantation, from its travelling-roots, requires to be renewed every four or five years.

SECT. XIII.—*Medicaceous Herbs.*

1585. *The medicinal herbs* enumerated in this section, are still found in a number of gardens, though very little use is made of them.

1586. *The medicinal rhubarb*, *Rhèum palmatum L.*, may be cultivated like the tart rhubarb, and after standing three or four years, the plants may be taken up and their larger roots dried for use. After taking up and cleaning the roots and cutting off the lateral fibres, cut them into sections an inch or more in thickness, make holes in them, and string them, and hang them up to dry in an airy loft, laundry, or kitchen, gradually, till they are fit for being bruised into a powder, or cut into pieces about the size of peas, to be taken as pills. Till about the commencement of the present century, it was customary for almost every gardener in Scotland to grow enough of rhubarb, and of chamomile, for his own family; and also, if he had children, a certain quantity of wormwood and rue as anthelmintics.

1587. *The chamomile*, *Ánthemis nóbilis L.*, is an anthemideous creeping perennial, a native of England in gravelly pastures, and cultivated for its flowers, which are bitter and stomachic, and much used as chamomile tea.

1588. *The wormwood*, *Artemisia Absinthium L.*, is an anthemideous

perennial, a native of Britain in calcareous pastures, and formerly cultivated as a vermifuge, and for other purposes in domestic medicine. It is found beneficial to poultry, and should be planted in poultry grounds; and it is also used as a substitute for hops in beer. It is easily propagated by cuttings or division.

1589. *The rue*, *Ruta graveolens L.*, is a rutaceous evergreen under-shrub, a native of the south of Europe, the leaves of which are sometimes eaten with bread and butter, and frequently given to poultry for the croup. They also make a beautiful garnish.

1590. *The horehound*, *Marrubium vulgare L.*, is a labiaceous perennial, a native of Britain on dry chalky or gravelly soil, and was formerly in demand as a cure for coughs and asthmas, for which candied horehound is still a popular remedy.

1591. *The hyssop*, *Hyssopus officinalis L.*, is a labiaceous evergreen under-shrub, a native of the South of Europe, the leafy tops and flowers of which are gathered and dried for making hyssop tea and other purposes.

1592. *The balm*, *Melissa officinalis L.*, is a labiaceous perennial, a native of Switzerland, of which balm tea and balm wine used to be made.

1593. *The blessed thistle*, *Centaurea benedicta L.*, is a cardueaceous annual, a native of the South of Europe, an infusion of the leaves of which is considered as stomachic.

1594. *The liquorice*, *Glycyrrhiza glabra L.*, is a leguminous deep-rooting perennial, cultivated in fields more frequently than in gardens for its saccharine juice, which is used as an emollient in colds, fevers, &c.

1595. *The blue melilot*, *Melilotus cærulea L.* (*Baume du Perou, Fr.*), is a leguminous annual, a native of Switzerland, Bohemia, &c., remarkable for its powerful fragrance, which is used in Switzerland to aromatise the Schabziger cheese, and there and in other countries to perfume clothes, and afford, by distillation, a fragrant water. In a dried state, the perfume is more powerful, and it is retained for upwards of half a century.—(*Bou Jard.* 1842.)

SECT. XIV.—*Toxicaceous Herbs.*

1596. *The poisonous plants* cultivated in gardens for the purpose of destroying insects or vermin are few, and indeed the tobacco is almost the only one.

1597. *The tobaccó*, *Nicotiana Tabacum L.*, is a solanaceous annual, a native of South America; and cultivated to a limited extent in gardens for horticultural purposes: "It is used to fumigate hot-houses; large infusions of it are put into most washes that are prepared for extirpating insects; and by drying and grinding it into the form of snuff, it is found very efficacious in destroying the green-fly on peach and rose trees out of doors." The best variety is the *large-leaved Virginian*.

1598. *Propagation and culture.*—The practice in the Hort. Soc. gardens is as follows:—"The seeds were sown about the middle of March, covered very lightly with fine loam, and placed upon a moderate hot-bed. When the plants were come up, and had acquired sufficient strength, they were pricked into shallow pans, about two inches apart; they were then gradually inured to the open air on good days, and finally planted out in the middle of May, at three feet apart, in rich ground. They were shaded with flower-pots, and occasionally watered, till they had taken root and begun to grow. No more attention

was bestowed, except keeping the ground clean, until their lateral shoots began to show themselves, which were constantly kept pinched off as they appeared: these, if suffered to remain, would have had the effect of very much reducing the supply of sap from the useful leaves of the plants. They were topped at sixteen or eighteen leaves, according to their strength. The tobacco was ripe in the beginning of September, as was indicated by the leaves becoming mottled with yellow spots, those at the bottom more so than at the top of the plant; they were also more glossy and shining than before."

1599. *After management.*—"In most gardens the leaves are stripped off the plants in a green state, and thrown together in a heap to ferment; while, little or no attention being paid to the degree of temperature which such fermentation should reach, the usual consequence is burning or rotting the leaves. Tobacco so treated has neither the taste, the smell, nor the efficacy of tobacco, and when burnt in hothouses is by no means effective in killing insects, without a great proportion of regularly cured and manufactured tobacco being burnt along with it. Hothouses also smell very disagreeably for eight or ten days after being fumigated with it."

1600. *Curing.*—"The mushroom-house being at this time disengaged, was thought an eligible place for the curing process. The plants were taken up quite dry, with a few of their roots; but no particular attention was paid to saving many of the latter, as the object was only to avoid breaking the bottom leaves (which might have been the case by cutting the stems). The plants were carried immediately to the house, and hung on nails in the walls, and on ropes in the middle of it. When all had been brought into the house, it was shut up quite close, the fire lighted, and the temperature kept to 70°; until the leaves got completely yellow, which they did in four or five days. The heat was then raised to 75°; and in about a week the leaves, with the exception of the midribs, were cured, and of a fine brown colour. The heat was then increased to between 80° and 90°; and in five days the midribs were so completely killed, that the thick ends of them would have broken immediately on attempting to bend them. The leaves were now very much curled, and dry as fire could make them, and if subjected to any pressure would have crumbled to snuff. Fire was discontinued, and the floor of the house well watered. This was repeated as it evaporated, and in twenty-four hours the leaves were as soft and pliable as could be desired: they could now be handled without breaking or wasting them. When stripped off the stalks, they were stretched out singly, and laid above one another, smoothing them gently with the hands. When all were laid out neatly, they were well pressed, to give them form and keep them smooth; they were then tied in hands, of about half a dozen leaves in each, and packed into a tub, being well pressed as they were put in. In this way they remained a fortnight, when they began to mould slightly at the midribs, in consequence of the weather being moist and warm. They were then rehung in the house, and very gradually dried by fire-heat; were afterwards brought to a moist state in the manner above described, and finally were repacked in the tub, where they now remain, well pressed, and in a good keeping state. The tobacco continues to improve in smell and appearance with its age.

"The important points in the above mode of curing are, to carry the plants to the house whenever they are taken up; for if the sun be bright, the leaves would sunburn in a short time. The leaves require to be yellow

before the heat is increased, otherwise the tobacco would cure too light-coloured; and the midribs must be completely killed before the leaves are taken off the stalks; for if not once made very dry, they would never keep.

“The power which the leaves possess of absorbing moisture in a damp atmosphere is immense, and very curious: a person unacquainted with it would not believe, on seeing a leaf in its driest state, that it could ever be brought back so as to be again pliable.

“The number of leaves that each plant ought to be allowed to produce should be determined by the quality of the ground, the earliness or lateness of the season, &c.: when these combine to the advantage of the plants, they are able to perfect proportionally more leaves. By a timely and careful attention to such circumstances, and by pinching off the lateral shoots, the climate of England, or that of Ireland, is in every respect sufficient to the full perfection of tobacco. Four months are not fully required to bring it to maturity.

“In the case of large plantations being made, shading with flower-pots would be attended with considerable expense: it is not, however, of absolute necessity; for, when tobacco plants are pricked out some time previous to planting, they make good roots, which are of greater benefit to them, after they are planted, than shading is. Shading with pots, however, is certainly useful; but it is by no means an essentially necessary part of the management of tobacco. The leaves flag under a hot sun; but, if the ground is moist, quickly recover.”—(*Gard. Mag.* vol. x. p. 503.)

1601. *The white hellebore*, *Veràtrum álbum L.*, is a melanthaceous tuberculous-rooted perennial, a native of Denmark, and formerly in much repute as a powerful medicine. The part employed is the root dried and powdered; and as it has lately been found more efficacious than tobacco powder (1223) in destroying the caterpillar on the gooseberry, it might be worth while to cultivate it in gardens for that purpose. The plant is not rare, and is easily propagated by seeds or by division. At two years from the seed the roots may be fit for use, and may be taken up, dried on a hothouse flue, and beat into powder, first on a stone with the cast-iron rammer (fig. 37 *c*, in p. 136), and afterwards, if thought necessary, to a finer powder, in a mortar. A decoction of the leaves and stems might probably also be effective; or they might be treated like those of the tobacco, and afterwards used in fumigation or as snuff.

1602. *The foxglove*, *Digitális purpúrea L.*, is a scrophularinaceous biennial, a native of Britain, and common in copse-woods and hedge-wastes. The whole plant is poisonous, and may be used for the same purpose, and in the same manner, as the tobacco.

1603. *The henbane*, *Hyoscýamus níger L.*, and the thorn-apple, *Datúra Stramónium L.*, are well known indigenous annuals, of highly narcotic properties, which, if treated like the tobacco, would probably be equally efficacious in the destruction of insects.

1604. *Walnut leaves*, in strong decoction, are found to destroy worms; and the leaves of the sweet bay, *Laúrus nóbilis L.*, which are used in very small quantities to flavour tarts, have been also put into frames and pine-stoves to destroy the red spider, by the evaporation of the prussic acid with which they abound.

APPENDIX.

9, *in p.* 4.—In comparing plants with animals, the leaves can only be compared to lungs; and, similarly to lungs, it is true, they aerate the sap, and imbibe oxygen, as the lungs do to the blood: but, when we carry the comparison further, we find that not only do the leaves imbibe oxygen, but they also, by imbibing the chemical power of the light, decompose carbonic acid, absorbing the carbon, and setting the oxygen free. This is a power which has never been ascribed to lungs; and, as the chemical power absorbed probably acts in other ways on the sap presented (see 124), though it is difficult to discriminate between organic secretion of particular organs and the chemical power of light, it has been by many eminent physiologists called digestion. Comparative physiology is valuable as assisting us to understand more readily what we are ignorant of, by comparing it with what we are already acquainted with. It is necessary to know the functions which the different organs perform before we can estimate their value, or know the necessity of supplying them with proper food; and the more we can simplify the subject, by classifying one organ in one organised being with one destined to a similar purpose in another, we the more readily arrive at a general knowledge of the whole. There are many difficulties, however, in comparative physiology; and the proper class of organs to which leaves may belong seems one of the principal stumbling-blocks.

103, *in p.* 26.—It may be questioned whether the roots of *Rosacæ*, &c., abound in adventitious buds. It is more likely these buds are called into existence by an effort of the vitality of the plant. In such as the *Rhús*, *Papàver*, &c., which abound in a thick viscid sap, the very smallest pieces, in which it is scarcely possible buds could be formed, are found to produce them, if they have only fibres to collect nourishment. The buds are generally formed at the edges of the cut, where the leaf is extravasated, showing they are formed from the extravasated sap, and did not previously exist in the state of buds. The edge of the cut is sometimes so crowded with buds, that they cannot be supposed to have had pre-existence in such large quantities. The buds noticed at 121 may be more properly called axillary than adventitious.

128, *in p.* 34.—It has been customary to call the cause of fruiting an accumulation of nutritive matter. Were this the case, we would add to the fruitfulness of a tree by augmenting the quantity of its food or nutritive matter. The reverse of this, however, more often takes place, as in ringing and taking away roots, impoverishing the soil, &c., all which diminish the quantity of nutritive matter, and yet generally add to fruitfulness. It is not that impoverishing is itself the cause: were we able to increase the light and heat as we can increase food, there would be less cause for impoverishing. The supply of food, however, is most at our command; the others, especially the light (the most needful), we have but little power over, and must, therefore, curtail the food to suit our limited means. A certain highly

elaborated state of the food is necessary before fruit-buds can be formed : experience teaches us this, as we see that fruit-buds are always most plentifully formed in seasons when the accumulation of the chemical power of the light from an unclouded sky has added most to the power of the leaves. Chemistry has not yet been able to unravel the changes required to bring the sap into a proper condition for producing fruit-buds ; but that it is the quality, more than the quantity, experience abundantly points out.

128, *in p.* 34.—It has been pointed out that a large quantity of crude sap is not conducive to fruitfulness, but the contrary ; and that, therefore, a smaller quantity duly elaborated is to be preferred. It may, however, be observed, that in order that the fruit may be large and abundant, an abundant supply of nourishment is absolutely necessary ; and therefore efforts should be made, by the employment of every means in our power, towards the elaboration of the largest possible quantity of sap, rather than adopt the prompt system of partial starvation, by means of which the fruit, if produced in abundance, must necessarily be small. A full crop of fruit cannot be obtained, unless from buds and branches previously well nourished. If a vigorous branch is ringed so as to throw it into a bearing state, the fruit will be larger than from a weak branch either so treated or left untouched. *N.*

157, *in p.* 48.—Magnesia, in its caustic state, is much longer in returning to the mild state, by regaining its carbonic acid from the air, than lime, especially if lime is present, as it generally is with magnesia. In this caustic state, it may be dangerous in excess ; but, being more sparingly soluble than caustic lime, excess is not so apt to occur.

158, *in p.* 48.—The sulphate of iron being the most soluble of any of the salts of iron, is most hurtful. Turning up the soil, and exposure to the air, change the sulphate into an insoluble peroxide ; and quicklime decomposes the sulphate, so will also mild lime or chalk, but not so powerfully, the sulphuric acid of the iron replacing the carbonic of the lime.

188, *in p.* 59.—There is a good deal of loss in mixing quicklime with substances putrefying rapidly. The lime seizes on the carbonic acid of the substances, forming an insoluble carbonate of lime ; and the extraction of the carbonic acid hastens decomposition. Ammonia, being expelled in greater quantity, is always the result of the application of quicklime, as may be detected by the smell. It may be useful, in a commercial way, to sustain a great loss for the purpose of making the article negotiable ; but, where convenience will admit, rapidly putrefying substances are most economically prepared by mixing with earth or compost, and keeping cool by turning. Where they have to be carried far, sulphuric acid (vitriol), where cheap, will disinfect most economically ; or, if cheaper, sulphate of lime (gypsum) ; or sulphate of iron (copperas), if very cheap. Quicklime is most useful with substances that decay slowly ; its avidity for carbonic acid causes it to be extracted from the slowly decomposing substances it is mixed with, as couch-grass, roots, weeds, &c., and hastens their decomposition. (See 195).

188, *in p.* 59.—Earth is undoubtedly the best substance for mixing with nauseous manures. In many cases the extra expense of carriage, occasioned by greater bulk in consequence of admixture with soil, will be fully compensated by the benefit arising from the addition of soil of a different nature to that on which the compost is laid ; thus a quantity of maiden loam would improve permanently a piece of worn-out ground to an extent that would more than pay for carriage from a con-

siderable distance ; and therefore the intrinsic value of the soil, as a dressing, ought to be allowed for as a deduction from expense of carriage in the case of using it in the way of compost. It is very doubtful whether night soil, disinfected by sulphuric acid, or sulphate of iron, &c., would form a manure half as good as if it had been mixed with a sufficient quantity of earth in compost. *N.*

189, *in p.* 59.—When there are not sufficient of the phosphates in the soil for bones, their application will have a more powerful effect at first, than after long continuance has caused the soil to abound in these.

193, *in p.* 60.—Inorganic substances, though not found in great quantity in vegetables (from 1 to 10 per cent. only), are yet essential. Though great part of their action is as solvents, to introduce other substances, yet the plant will not thrive without them. It is found, for instance, in peaty soils, that there is a great deficiency of silicates and phosphates ; and that wheat and oats thrive much better on these soils, when bones, containing phosphates, and when wood ashes, decomposed straw, &c., containing silica, are added. The structure of the plant cannot be built up without all the requisites ; and, though not needed in such quantities as the organic substances, and more generally found mixed in the soil, they (the inorganic) are yet essential, as the straw will not stand without its proportion of flint or silica ; and the lime, phosphorus, soda, and potash found in all parts of the plant are indispensable. (See 208). Soda is a constituent to a small extent in beans, clover, &c., and even in wheat.

214, *in p.* 66.—A great many mineral manures may be most cheaply sown with the hand, dry, in the state of powder ; but are more safely distributed well re divided, will do more good, but may be more

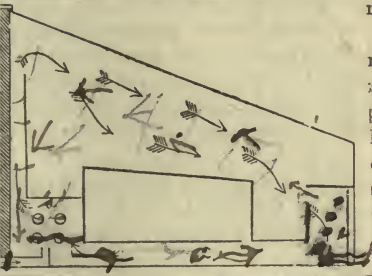

nures can be applied in the bulk, they will always be, which are useful only as a saving of expense. It improves in the soil, improves its mechanical texture, and, in soils such as peat soils, silicate of potash and phosphate of lime can be added cheaply, it may give these also the same effect as if they were used before, as both of these are found in manure), and permanently improved in its texture. Farming the inorganic substances needed, improves the soil, and is most permanently beneficial ; but where

this cannot be got sufficiently cheap, or where peculiar deficiencies or excesses occur in the soil, recourse may be had, with a great degree of profit, to inorganic manures in small compass.

268, *in p.* 85.—The motion of air or wind is caused by colder air replacing warmer ; this may cause the cooling effect of breezes in summer. Why the effects of still cold air are not so great as those of air in motion is, because, when in motion, the cold air is constantly replacing that partially heated by the human body. Why motion of heated air should, when uniformly heated, give relief, is not so plain. Why moisture gives relief is connected with electricity. In dry air the electricity of the body accumulates, because dry air is a bad conductor. Moist air, being a good conductor, draws off the excess of electricity, which, when present, was causing a pricking, uneasy sensation ; and, when removed, the body gets more elastic and exhilarated. Motion is undoubtedly of benefit to leaves and stems of plants.

281, *in p.* 90.—Plants suffer most at a distance from light, when the light is only from the top, or one-sided. This has been called the attraction of light, but is no explanation. In the one-sided light it may be the greater solidifying of the

side next the light which draws. In the top-light of frames, the want of direct light at the sides may cause partly the greater elongation of the top; but plants elongate below glass, even though surrounded by light. The want of motion is a great cause of this: plants uniformly elongate more in a sheltered than an exposed field. If there is any such thing as attraction between light and plants, as roots follow their food (which is partly hygroscopical in the latter case), it will be, like the attraction of gravitation, more easily perceivable in its effects than capable of explanation. Refraction will disperse the light: it is difficult to understand how it should weaken what does pass through. The chemical power of light, however, is so much connected with electricity, that it may be weakened in a way we cannot account for. The chemical power of light is greatest in the least luminous part of the rays; and yet, as the quantity of light is equal, that of the equator must have most power. There is a connexion between heat, light, and electricity, not yet explained; the optical qualities of light have been much more attended to than the chemical. The red rays have more momentum than the blue; thus causing the red of the rising and setting sun, and the azure blue of the sky. Perhaps more of the blue or chemical portion of the sun's rays may thus be lost in refraction.

454, *in p.* 167.—I have found the leather wallet much improved by having the two sides nailed to two pieces of wood about an inch and a half wide; and also one piece down the middle, so as to form a parting; one of which does for nails and the other for shreds.—*H. O.*

463, *in p.* 173.—I should think any protection from frost would be much more effectual if drawn up or removed during a mild day; the plant would be hardier also and healthier, and the extremes between heat and cold not so great. In Scotland, woollen nets are most used; from the coldness of the climate they are most beneficial; and those who keep them constantly standing find they do harm; the foliage is not so healthy, and insects collect. There is seldom so much heat there as to require shading for the blossom. Dry, cold east winds do most harm.

474, *in p.* 181.—White walls will heat the air around the leaves most through the day from reflection, as these are seldom close to the wall; and the extreme of cold will not be so great at night, which is most dangerous. Black-coloured walls, though they absorb heat during the day, will not retain it to give off at night, as it will be conducted through the wall in great part during the day, and any little retained be speedily radiated off in the early part of the night.

501, *in p.* 205.—The temperature of the blood is 94° to 98° , and the heated air is not likely to be much below the temperature of the skin; to that extent, however, it will undoubtedly increase the effect; and, in motion, will give motion to the leaves and stems of plants, and will not stagnate and corrupt.

504, *in p.* 208.—Subsequent improvements have been made on Rogers's conical boiler by Mr. Shewen, and modifications of it have been adopted by Mr. Stephenson and various persons. Messrs. Garton and Jarvis, of Exeter, have invented and put up at various places a boiler on the same general principle as that of Mr. Rogers's, viz. having the fire in the centre of the water—but totally different in mechanical construction. This boiler will be figured in the *Gardeners' Magazine*. The boiler most generally in use for heating horticultural structures at present, is unquestionably that of Mr. Rogers as improved by Mr. Shewen. Two of these are now (Oct. 1842) putting up in the Hort. Soc. Garden.

524, *in p.* 225.—A small building on the *north* side of a larger one is in a lower

temperature throughout the year than if it stood in the open sun ; consequently it will always act as a condenser of moisture in the atmosphere that is in contact with it. Thus, if a portion of wall is of the same temperature as the air, supposing the latter to be within say 1° of saturation, the wall, with regard to the moisture it may contain, will remain in nearly the same state ; increase the heat of the wall, and it will give out moisture, and will ultimately become dry ; but render the wall several degrees colder than the surrounding atmosphere, or lower than its dew point, and, like the dew on the cooled bulb of Daniell's hygrometer, previously explained, a deposition of moisture will immediately take place. This fact ought to be borne in mind where dwelling-houses are to be erected in the proximity of thick and lofty trees, or where trees of such description of growth are planted near houses ; for if a row of trees are growing on the north sides of houses, the latter are not in consequence affected by damp ; but if the houses are at the north side of the trees, nothing but strong fires, equal to the discrepancy of temperature occasioned by a northern exposure, will render the houses equally dry ; and even in this case, as the fire-heat cannot be made to pervade every part of the building, it is probable a habitation in a northern exposure will not prove so healthy under any circumstances as one otherwise situated.—N.

564, *in p.* 245.—Substances yielding oxygen should be of most use in germination to oily seeds, which have a deficiency of oxygen in themselves.

571, *in p.* 248.—According to Liebig, ammonia hastens and strengthens germination ; and, according to the same authority, charcoal and snow absorb ammonia from the atmosphere ; this may be great part of the benefit.

575, *in p.* 251.—The plexus of vessels at the heel of the shoot or insertion of the branch in the stem, causes a peculiar activity of life there ; and both buds and roots are much more easily formed and in greater quantity there than in any other place of the shoot. The insertion of the branch resembles in this respect the collar of the stem (577). If the heel of the gooseberry or currant-cutting is taken out completely by breaking off, not cutting, it is better than taking off a piece of the old wood.

578, *in p.* 252.—Cuttings of growing succulent wood have vitality most active, and strike root most quickly ; but, from the unripened state of the wood, are most apt to die, and require to be kept more close and moist. There is danger in both extremes, and both must be guarded against in such as are difficult to strike.

580, *in p.* 253.—When the season is hot and warm, and little time to attend to keeping moist, succulent cuttings, such as pinks, are most certain to strike, by paring close below the uppermost joint, and cutting off above close to the joint, leaving none of the leaves uncut, except those beginning to develop. Such a cutting is a mere joint in a vital, active, not ripened state, and will stand a great deal of heat ; if covered with a hand-glass in sunny weather, or in a hotbed frame in cold weather, they seldom or never fail. Excitement of heat, not preservation, is all that is wanted.

581, *in p.* 254.—When cuttings are tardy to strike, and have callosities formed, heat has a powerful effect in causing them to root. Those that have stood months, without appearance of rooting, will strike in a few days in a strong heat.

601 *in p.* 262.—The best mark for such as strike most readily by pieces of the root is an abundance of thick viscid juice, as in the genera *Rhús*, *Papàver*, *Ailántus*, *Gymnócladus*, &c., which strike more freely than *Cydònia*, roses, thorns, &c., which have less.

614, in p. 269.—Mr. Barnes, gardener to Lady Rolle, at Bicton, mixes charcoal with the soil in which he grows every kind of plant, from the cabbage and the onion to heaths, pine-apples, and orchidæ, and with extraordinary success. The charcoal is generally broken into small pieces, say an inch or more in length, and seldom thicker than a quill; but he also uses it of a larger size, along with drainage materials, and, when sown along with seeds, in a state of powder. See the history and details of this practice in *Gard. Mag.* for 1842. We were not aware of Mr. Barnes's discovery till after the last sheet of this work was printed, otherwise we should have introduced a notice of it in its proper place. See p. 706.

650 in p. 287.—It is of great consequence that the graft and stock should be pressed closely together, in order that the first emission of cambium from the stock should come in contact immediately with the inner bark and albumen of the graft. When grafts are taken off, and tied on in a growing state, the wood of the graft clings and dries; having no roots to feed it, it shrinks from the stock, leaving an empty space, and before it is filled up, unless the stock is very vigorous, the graft dies. This might be obviated by grafting before the sap rises, but grafts will not succeed till the flow of sap has begun to rise briskly; late grafting always succeeds best; and, hence, the grafts when taken off before growth commences, and kept moist till the stock begins to grow, always succeed best, as they experience no checks. Much of the success of grafting, however, depends on the state of the weather; if the heat prevails so as to keep the sap flowing, every healthy graft, well fitted, will succeed; if not, they may perish before the sap rises.

669 in p. 297.—A species of grafting I think you have not noticed may be denominated bud-grafting, and is the best for most evergreens, as daphnes, &c. When the stock has begun to grow vigorously cut the head off, and, making an incision in the bark a few inches down, open it on both sides, the same as for budding; prepare the graft without a tongue, and insert the lower part as you would a bud, leaving the herbaceous growing top green above. Soft succulent evergreens in which the bark opens freely will do better in this way than any other.

696 in p. 308.—Much of the success of budding depends on the stock and bud growing vigorously, to supply the juices or cambium causing the union to take place; and allowing the bark to separate easily from the wood, so as to prevent laceration and bruising of the vessels in separating them. If the bark does not fly up freely from the stock, when the handle of the knife is inserted, it is not likely the bud will succeed; and the same if the shield of the bud does not part freely from its wood; if either of them has commenced ripening, or if the sap has not begun to run or flow, the labour will be in vain. In order to insure the cut being smooth, and no laceration of the bark of the shield taking place, the best of all methods (especially for such barks as the cherry and plum, which will not bear handling, and are very apt to spoil) is to mark the size of the shield intended, all round the bud with the point of the knife, cutting into the wood, and then introducing the thumb at the side of the bud, and raising it off with a gentle squeeze. If the shoot is growing vigorously, it will spring out, without any difficulty, so clean and smooth on the edges, as greatly to facilitate the success of the operation. By the common method, if the bark is much handled, the shield of the bud is apt to be spoiled at the edges before insertion.

703 in p. 311.—In transplanting deciduous trees before the leaves are fallen, it is found in practice that the shoots are not ripened, and die back often to a considerable distance, in the same manner as if the leaves had been destroyed by early frost. The young fibres, also, will protrude spongioles more quickly in the spring

from the fibre that has been well ripened, than from that lifted before ripened. It can only be when the distance of removal is very short, and the plants very small, and lifted with the earth adhering to the roots, that the transplanting of deciduous plants in autumn, before ripe, can be attended with any advantage. In the nurseries, we have great experience of lifting and shouging immense quantities of deciduous plants, and experience must say on this head, that any process of growth which may be going on in the interior of the plant during winter has very little if any outward appearance. Unless the winter is more than ordinarily mild, the spongioses are never seen to protrude, nor the buds to swell, till the spring begins to advance. Such as gooseberries, cherries, thorns, birch, larch, &c., may begin in February or March; beech, oaks, apples, &c., are later, and seldom begin to show much before April or May. Even the mezereon, which often flowers in February, is seldom found to protrude new roots before that period. Of course the period will vary as to localities; some soils and situations are more than a month earlier than others, within very short distances. Autumn planting is preferable where the soil is dry, as it washes the soil closer to the root; where the soil is clayey, and the weather soft at planting time, it gets into a state of puddle and rots the roots in winter; and, unless the weather is dry at planting time in autumn, such soils had better be deferred till spring. Quarters of young trees planted in autumn will stand all winter without the appearance of failure; and yet, when the spring drought sets in, will fail nearly as much as spring-planted ones, showing that very little has been done by the plant towards establishing itself in the ground during winter. (Autumn is considered decidedly best in the climate of London.)

717, in p. 321.—According to a table made out by Mr. Robert Thompson, and published in *Lindley's Theory of Horticulture*, the atmospheric moisture for the different months of the year 1831, is as under:—

	Mean Temp.	WIND.							Mean Moisture.	
		North	N. East.	East.	S. East.	South	S. West.	N. West.		
January . . .	31·6	882	893	989	1000	982	1000	983	1000	966
February . . .	39·0	815	657	992	1000	963	874	804	1000	888
March . . .	39·0	815	688	752	1000	913	846	846	1000	857
April . . .	53·2	747	778	870	775	711	846	752	902	797
May . . .	60·0	718	687	574	767	798	1000	752	651	743
June . . .	57·5	721	572	574	767	798	664	707	673	684
July . . .	57·5	721	703	662	767	798	750	684	599	710
August . . .	64·8	773	836	690	767	776	724	666	826	757
September . . .	56·6	907	1000	723	767	813	853	761	905	841
October . . .	56·6	907	1000	1000	904	885	862	939	905	925
November . . .	56·6	907	1000	1000	1000	980	938	940	938	962
December . . .	39·0	971	920	1000	1000	980	939	986	1000	974

N.

724 in p. 325.—In order to make sure that the lowest extremity, or root, of the plant should be most pressed, as you very judiciously request, (technically, it is called in the nurseries fastened,) it is necessary that the point of the dibber should be so introduced into the ground, as that it will be nearer the plant at the root than at the surface, the line of its direction inclining at a slight angle towards the plant. When the line of direction of the dibber points from the plant, they are fastened only at the surface, and the roots are not at all fixed in the soil. This is a very material matter to attend to, where much dibbing is practised. It is easier for the operators to push the dibber from the plant, and they require to be watched. The

plants dibbed in the wrong way may be easily detected by giving them a slight pull, when they will be found to draw up easily, while those properly fastened at the roots retain their hold. If dry weather succeed the operation, almost all of those fastened at the surface only will die. Trees planted with the dibber are best for planting out again, as the roots are found spread out equally on both sides, while those trench-planted with the spade are found to have the roots all on one side, from the manner they are laid in, and the ground being beat back with the spade in the act of cutting the trench; they are generally also bent in the root, when the trench is sloped to make the plants lie, which facilitates the work but hurts the plant.

730, *in p.* 326.—Shaking a tree up at the time of being planted, to settle the soil about the roots, is a very bad practice; it draws the roots from their proper position, and, when the tree is again let down in its proper place, they are bent in an unnatural manner, and the throwing up of suckers is the consequence.—*H. C. O.*

735, *in p.* 328.—In watering box edgings, &c., newly planted in dry weather, it is of great moment when the earth is trod firmly to the roots, and before levelling on the remainder of the earth, to saturate the soil completely, all round the roots, with water, with an unsparing hand, and then finish by spreading the dry soil above. When water is poured on the surface of the soil in dry weather, the deluge of water runs the surface of the soil into a paste, which again hardens by the sun into a cake, obstructing thus the free entrance of the atmosphere into the soil, without which no plant will thrive. When straw or moss, or any of the other articles you mention, is spread on the surface, it obviates this fault. Where this cannot be done, it is better to open holes in the soil, or pare up a portion of the surface, saturating the soil below, and then adding the dry soil when the moisture begins to subside. One such watering will be better than ten surface waterings, which often do more harm than good. Where none of these plans can be adopted, the direct beams of the sun should be kept from the surface, by a covering open at the ends for shade.

740, *in p.* 330.—Such bare-rooted plants as white-broom, double-flowering whins, some pines and oaks, &c., which are very difficult to transplant and remove, are found to succeed better by being nursed in pots; but the roots have acquired such a tendency of matting together, and twining round one another, that it is a long time after planting before they shoot away freely again into the soil; and till this is done the growth will not be vigorous. The fibres may be parted again, but the roots have got a tendency to matting they do not recover for some time; and parting the ball destroys in some measure the capability of being easily transplanted. It should only be resorted to with scarce and valuable plants or shrubs, not trees.

752 *in p.* 336.—One of the specific principles of pruning is also the stimulus given to vitality. When the leading branch of a small tree, which, perhaps, has not been growing well, but has got the roots fully established, is cut back to one bud, not only is the rush of sap which should have supplied the whole buds diverted into the one, and the shoot made thus more vigorous, but the vitality of the tree has acquired an impetus that it did not formerly possess. From a lazy slow-growing plant it has been converted into one of a quick, healthy, vigorous growth, a stimulus is given to the roots also to increase, and the tree is entirely renovated. The benefit is lasting, not temporary, and will continue, if circumstances are favourable, and no check of bad soil or bad weather ensues to counteract its vigour. It is thus that the forester cuts back his oak plants in the forest, after

being a few years planted, and trains a single shoot from the bottom, knowing well that the vigour of this one shoot will be lasting; that the impetus given to the growth of the tree will continue; and that, in a few years, the cut over tree will be many times larger than those allowed to stand uncut. It is thus that nursery-men increase the vigour of their young plants by pruning; and that gardeners, when pruning for wood, cut farther back than when pruning for fruit.

758 in p. 338 & 768 in p. 341.—If the tops of the shoots of forest trees are pinched off in time, and proper attention paid to the plantation from its commencement, the contending large arms being converted into small side shoots, there will be little need for pruning at all, and skill will be of more consequence than labour. It is shortening-in, or fore-shortening, done in a much better and much easier way.

761, in p. 339.—The laying-in of small shoots, in place of cutting back to naked branches and spurs, should be more encouraged. More distance than usual should be left between the leading branches, and plenty of young wood nailed in after the manner of peach trees. It diminishes the quantity of breast-wood, which is an evident practical anomaly, and serves no good purpose, being annually renewed and annually cut out. The growth should be much better spent in producing young wood and fruit, which will not require so much slashing of wood.

767, in p. 341.—The thin layer of alburnum is the consequence of stunting rather than the cause. A tree may be renovated though not cut back to the collar, and part of the old stem with its thin alburnum left. The vigour of the new growth will give a thicker coating of alburnum; though old hardened bark will not swell up so quickly as the new bark on a young shoot.

769, in p. 342.—I have seen very fruitful trees covered every year with blossoms so thickly that the greater part had to be brushed off, and the trees very vigorous, where the *outer bark* had been renewed a few years before. The situations, however were sheltered; the practice has not been much adopted yet, and it is doubtful if it would suit exposed situations; but for sheltered places it appears to be very effectual in renovating the vigour of old trees. It should be more often tried than it is.

770, in p. 342.—It has been generally said that ringing of trees contributes to fruitfulness by *accumulating* sap; but it is not explained how this is done. The wood being of more specific gravity above the ring is no proof of this, because it is denser from not having swelled out so much in bulk, rather than from accumulation of sap. The ring prevents, to a certain extent, the ascent as well as descent of the sap; and it more probably acts by furnishing a smaller quantity of sap, which is more easily brought into a highly elaborated or organised condition than the ordinary larger quantity would have been. The ring does not in the first instance prevent the ascent of the sap, the alburnum, its principal channel, not being interfered with.

771, in p. 343.—Extent should be given to the wall-tree to exhaust itself by growth, and so bring on maturity. If the border is not too rich, this should be better than tearing off a great mass of breast-wood. More young shoots should be laid in, and they should be left longer at pruning-time in the strongest-growing sorts. In weak-growing sorts, apt to fruit, they should be encouraged with manure, or we may have dry mealy, in place of large succulent fruit.

772, in p. 343.—It is not clear how disleafing will assist a tree to throw off superabundant sap. Disleafing should rather prevent elaboration of the sap, and keep the tree fuller of crude juices. It will, however, by lessening evaporation, stop the

rapidity of ascent, and cause less food to be absorbed by the roots, not more to be thrown off by the tree. In luxuriant trees it may be apt to occasion disease, from too much crude sap. The safest plan, I should think, to overcome superabundant growth, would be to give little food, by making the border poor and dry, giving plenty of room to extend, and leaving the young wood long. If all these will not do, the next best thing would be to curtail the roots.

774, *in p.* 344.—The summer pruning of pear-trees has lately been the subject of discussion in *Gard. Chron.* between Mr. Ayres and others. I do not approve of the breaking-down system if it could be avoided. I have seen it practised more than twenty years ago; but it is unsightly, and greatly tends to obstruct the light from benefiting the buds at the base of the shoot, and on spurs, &c. At the same time, I admit there is something in it which renders it not entirely objectionable; for below the breakage, fruit-buds form more readily than if the shoots were at once cut off. Instead, therefore, of breaking down the summer shoots of pear-trees, and leaving them hanging in front during a great part of summer, it would certainly be better to nail them between the branches—at least, all that could be bent to that position; one nail would be sufficient for each shoot. After being thus secured, where they will occasion least shade in regard to the more permanent portions, the shoots could be cut half-way through with a knife about two or three inches from their bases. Those shoots that cannot be so trained from their being right in front may be treated agreeably to the principles (1363 *in p.* 613) and the ample directions for the management of the apple-tree in 1150, p. 537 to p. 543. *N.*

776, *in p.* 345.—Root-pruning, by curtailing a few of the largest roots, lessens the quantity of spongioles for a few years, and so curtails the quantity of absorbed and ascending sap. This being more easily elaborated and brought into the highly organised condition required for fruitfulness, causes the production of blossoms and fruit. It is the tendency, however, of cutting roots to increase roots; and in a few years the greater number of small roots and the increased quantity of spongioles should, especially if heavy dressings of rotted manure are added, as recommended by some, and which should make up for the want of extension of the roots in quest of food, aggravate in place of remedying the luxuriance of growth. Pruning back all the roots of a fruit-tree may bring the plant to something of the nature of a paradise stock, which abounds in roots, yet these being matted close round the stem, and not extending in quest of food, die off, and stint the growth from the spongioles not falling in with nutriment. If the root-pruning is renewed at short periods, it may render this state more permanent; but if great doses of manure are given, it will lessen the effect; and if the trees are neglected to be cut back periodically, they will ultimately get much more luxuriant than under the ordinary process of management. To keep the borders poor but healthy, sweet, and well pulverised, and dry, by draining and elevating the plants on hillocks where necessary, is best. A moderate degree of extension will suffice for the plants coming to a fruitful condition, and there will be less need to resort to root-pruning.

794, *in p.* 334; and 1363 *in p.* 613 to p. 616.—“All fruit-bearing plants (and indeed all others) grown in pots, ought to be potted in soil which has not been sifted, and which, if not sufficiently coarse to keep it so open as to receive water freely, should be mixed with fragments of wood, bones, and stones, for that purpose, for supplying manure, and for retaining moisture.” (P. 616.) Since the above was printed and published, we have been in Devonshire, and seen at Bicton, the seat of Lady Rolle, coarse, rooty, unsifted soil, mixed with fragments of stone, pebbles, and also with fragments of charcoal, used in every description of pot cul-

ture, by Mr. James Barnes, and with a degree of success which, if equalled, has never been surpassed. Mr. Barnes has been in the habit of using rough, rooty, unsifted soil for upwards of twenty years, and of introducing a portion of charcoal among such soil for more than twelve years. He was led to use charcoal from observing, in a wood where charcoal had been burned, the great luxuriance of the weeds around the margins of the places where the charcoal heaps had been, and where a thin sprinkling of charcoal dust had got amongst the weeds. He got a basketful of this dust, and tried it first among cucumber soil. He found it improved the plants in strength and colour, and then began trying it with other soft-growing plants; and he has continued trying it ever since with thousands of plants under pot culture, and with most kitchen-garden crops. Mr. Barnes finds the following a good plan to make a rough sort of charcoal for use in the kitchen-garden:—When made, it must be kept dry; and when seed is sown in the open garden, the charcoal must be put into the drills along with it, at the rate of three or four pints of powdered charcoal to a drill of 100 feet in length. Collect a quantity of rubbish together, such as trimmings of bushes, cabbage and broccoli stalks, old pine-apple stems, and such other parts of plants as will not readily rot; put these together, laying some straw beneath them, and set the straw on fire. The straw must be so laid, as that the fire can run into the middle of the heap. When the heap is completed, cover it over with short, close, moist rubbish, such as short grass, weeds, and earth, from the rubbish-heap, in order to keep the flame from flaring through at any one place for any length of time. As soon as the fire breaks through in a blaze, throw on more short rubbish, so as to check the flames. It is necessary to thrust a stake or broom-handle into the heap in different places, in order to encourage the fire to burn regularly through it; but as soon as the flames burst through these holes, stop them up, and make others where you think the heap is not burning. When it is all burned, collect the whole of the charred rubbish, ashes, &c., sift it through different-sized sieves, and put the sizes separately into old casks or boxes, keeping these boxes constantly in a dry place. In Mr. Barnes's potting-shed, we observed four different sizes of charcoal (considering charcoal dust as one size) sods of heath-soil; different kinds of loam; leaf-mould; pots filled with four different sizes of pebbles, from the size of a grain of wheat to that of the palm of the hand; four different sizes of broken freestone; four different sorts of sand; two sizes of bone—one of half-inch pieces, and the other of bone-dust; four different sizes of broken pots for draining; different sizes of shards for putting over the holes of pots, previously to laying on the drainage; a basket of live moss, a box of soot, and one of rotten cow-dung.—*See Mr. Barnes in Gard. Mag. for November, 1842.*

832, *in p.* 388.—Much of the benefit of stirring ground depends on its being stirred in proper weather. Dry weather, when the soil is between the wet and dry, and this weather likely to continue a day or two, is the best time; and the mechanical texture of the soil should be such as to allow it to break pretty freely into small pieces, and retain that form when dried, so as not to fall down too easily into a powdery mass.

833, *in p.* 389.—Liquid manures and top-dressings should be applied in showery weather. It is a loss to have them on the surface, but they do most good, especially the volatile kinds, to growing crops; when they are applied before the crop is put in, they should be pointed in with the spade or rake, or harrowed in to the soil in the fields.

859, *in p.* 402.—The eggs of insects which are deposited on seeds may be

destroyed by exposing the seeds in thin layers in the open air during severe frosts ; a practice common among seedsmen with all seeds which are above a year old.

863, *in p.* 405.—When it is wished to see the fruit of young seedlings, without waiting till the plant comes to maturity, it may be effected by inserting a bud near the extremity of one of the branches of a wall-tree of the same species, in full bearing, and clearing away most of the other blossoms around to give it a fair trial.

868 *in p.* 407.—The common single daisy, when brought from the fields, and planted in a rich soil in the garden, becomes double. I have seen even the diminutive *Sagina procumbens* become double by cultivation. The improvement on single dahlias from cultivation in rich soil is of recent date. When any of these is neglected, as when the double-daisy edging is allowed to stand long and exhaust the soil, it gets single ; and the want of cultivation causing double dahlias and other flowers to assume the single state may be seen every season. An old root of a dahlia allowed to stand on the same piece of ground, without manuring, and to accumulate a number of stems, seldom produces full flowers. Mr. Munro's is an instance in point ; but it is not two kinds of sap, but a more highly organised state, and a crude unelaborated state, of the same sap. When the quantity of sap is great, as in young and vigorous plants, flowers are seldom at all produced, till the process of growing, by extending the system of leaves and branches, has produced the proper balance. The plant, which formerly had more sap than its chemical and vital powers could elaborate into the highly organised state required for producing fruit, having now acquired more strength, becomes fruitful ; and, exhausted by its fruit-bearing, generally continues fertile, unless deluged again with too much food, in the shape of manure. Such plants as fruit-trees in which the fruiting state, or state of maturity, is brought about with difficulty, at a lengthened period of years, are seldom found to produce double flowers. In those plants, however, in which the flowering state is produced annually, double flowers are more frequent. The different parts of the flower also differ as to the state of organisation in the food required to feed them. Calyx, corolla, stamens, and pistils, are only more highly organised states of leaves, or what would have been leaves ; and each, in the order they are mentioned, continues to be more highly organised than the preceding. In the ordinary mature state of the plant, with a sufficiency of properly organised food, the germs of these parts of the flower will be produced in the normal manner ; but if an over-supply of food, or of water to carry the food to the absorbent vessels of the root, should ensue, the condition of the food may be altered ; from a highly organised condition it may be lowered nearer to the comparatively crude state required for leaves. In this state it is obvious that the germs which would have started in the form of pistils and stamens may be lowered, for want of proper food, to the inferior condition of petals, or even of leaves. When the branch is highly gorged with unelaborated sap, the pistil may even again assume the state of a terminal bud, and lead away a young shoot from the centre of the flower, as is often seen to be the case in roses and other flowers. The above appears to be the theory of double flowers most consonant to experience, it matters not whose it may be ; and it agrees with all observation, that a luxuriant supply of food is the cause of this monstrosity. It is also apparent, that, the farther we reduce the supply of food, it will be the more easy again to gorge the plant which has been starved, and produce monstrosity. If the seed has an extra vigour of itself, it may produce so large an absorbent system of roots as may enable it, in a rich state of the soil, to gorge the flower and produce monstrosity, from an ordi-

nary state of the plant. It will be found, however, more easy in practice to gorge a stunted plant than to luxuriate the ordinary state of one ; and hence the most successful cultivators of double stocks are those who grow them first in a starved condition, and then luxuriate them in a very rich soil ; or stint the plant by keeping the seed for some years, provided it is only strong enough to grow. I have seen seed kept till it was thought to be too old for growing, produce almost every plant with double flowers ; while the very same seed, a few years before, had rarely a double flower among the lot. This will be found a more easy method than to produce the same effect by extra-vigorous seeds, and is that most adopted in practice.

869, *in p.* 408.—In beds of ranunculus flowers, it is easy to pick out the varieties recently raised from seed, from the older varieties, by the greater vigour of the plant. The older varieties of the dahlia, whether from neglect or decay, are not so vigorous as they were at coming out. It is the case with newly raised seedling carnations, and flowers in general. The Lancashire gooseberries are never found to maintain the weights they had originally, when a few years from seed and the plant at maturity. Seedling potatoes have the leaves much more pulpy and vigorous than the old varieties. It is evident that circumstances will affect these, and that sometimes, from better soil, shelter, manure, &c., the case may be changed, and the older varieties may sometimes be most vigorous ; but in general it will be found the rule holds good, that the newest raised seedlings possess most vigour.

911, *in p.* 433.—Whatever mode of stirring the surface be adopted, every facility should be given to the admission of atmospheric air, heat, and moisture, and the bottom made as dry as possible by draining. The great quantities of manure given to border crops of vegetables furnish perhaps the most fruitful source of sponginess in the wood.

914, *in p.* 434.—The land in gardens is generally too rich for potatoes to be well ripened and dry ; more tubers are produced of a large size, than the leaves and light are able to ripen and fill with starch.

954, *in p.* 452.—I believe the assumption is correct that the vine when forced is not calculated to sustain uninjured a temperature much below 40°. I have had vines under my care greatly injured by being exposed to the rigours of winter, and I have known several instances of its happening to others.—*H. C. O.*

958, *in p.* 454.—It is most vexatious to find a fruit tree has been planted untrue to name, but in the case of the vine it is easily remedied, by grafting the sort required upon it ; this will save several years, as a vine, if grafted on a good strong stock, should be in full bearing the third year.—*H. C. O.*

959, *in p.* 454, and 1283, *in p.* 585.—I cannot subscribe to the practice of depriving a vine of a portion of its leaves when the fruit is ripening ; if the roots are not at fault a deficiency of colour in the grape more frequently arises from a deficiency of air, or by the plant being too heavily cropped, than by being shaded. I have seen grapes attain the darkest colour densely shaded by leaves ; and, on the contrary, I have seen them attain only a grisly red colour when light and the sun's rays were admitted to the utmost extent possible.—*H. C. O.*

990, *in p.* 473.—It is there said—"The roots should be well supplied with water before the fruit begins to ripen off." I think both the peach and cherry tree oftentimes lose their fruit by injudicious watering ; both at the time of the setting and stoning of the fruit, water should be administered very sparingly ; this I consider a very material point to be attended to.—*H. C. O.*

1032, *in p.* 486.—The principal point to be attended to, in order to keep the old branches furnished with young shoots, is, occasionally ringing or notching them ; and keeping the whole of the young shoots which the shoots so treated throw out stopped at every third or fourth joint throughout the summer.—*H. C. O.*

1115, *in p.* 525.—In Russia and the North of Germany mushrooms are frequently grown in shelves in a cowhouse or stable, in which also other articles are forced.—(*G. M.* vol. vii. p. 653).

1153, *in p.* 544.—Canker in fruit trees, like the cancer in the human body, appears to be owing to a diseased state of the sap or blood, producing morbid concretions, of an inferior degree of organisation to the tissue by which they are surrounded, which they live on, and destroy, like parasites, till vitality is arrested. Plants being a congeries of separate distinct beings, which have each an independent existence of themselves, may be more easily renovated by amputation and removal of the exciting causes ; but in these, also, the sap is affected, as it breaks out in ulcerous morbid sores often, when to all appearance removed. Willdenow characterises it as produced by an acrid corroding gum, caused by the acid fermentation of excess of sap from low-lying damp gardens. Others have thought it to be of a fungoid nature, propagating itself as above stated, and living on the healthy tissue, which it disorders and destroys. It is evidently aggravated, if not produced, by a bad climate, and removed by a good one ; as trees that are very apt to canker in the open ground are generally free of it on good walls. It is also produced by a too rich damp state of the soil, as it is often removed by remedying this, and laying the ground dry and sweet about the roots. It is also constitutional ; as some sorts are liable to be hurt, while others, in the same circumstances, appear not susceptible. Climate, and food, and constitution will, therefore, all require to be attended to in guarding against this pernicious evil. Amputation, and cutting away all the diseased portion, should be resorted to on its first appearance ; a neglected wound may even bring on this morbid condition of the tissue. Vitality requires to be kept continually in action, especially during the active period of growth ; if a stagnation is brought about by cold weather, it may form a favourable state for the development and growth of the parasitical morbid cancerous state of the tissue. If food is in excess, or any particular portion of the food, it may thus become deleterious (most minerals found in the soil are needed in smaller or larger quantities, it is only excess that renders them deleterious), and the vitality of the tree may not be able to correct it, till, by accumulation, it forms a diseased cancerous state of the tissue : the more weak and languid the constitution, the more apt it will be to succumb, and the more necessary will be the stimulus of heat to enable it to overcome. The exudation of gum in stone fruit is unattended, to the same extent, with the cancerous morbid state of parts exhibited by the apple and pear ; but the disease appears to exist also in the sap, and to be ramified through the branches, in the same way as canker, as may be often seen on cutting in to arrive at its source. The small unripened shoots appear most liable, as being most tender. The bark and alburnum appear first to be infected in these young shoots, especially in the peach ; the young wood of which, being delicate from want of ripening, appears unable to stand the severity of spring, gets discoloured in blotches, and gum begins to exude. It would appear here that the disease arises from imperfectly-ripened tissue getting injured by severity of the weather, and affording a nidus for it. In other cases, however, the gum begins to exude from parts to all appearance sound and perfect, as if caused by a plethoric diseased state of the sap. It is probable that, as in the cancer in the human body, which may be brought on

from a wound neglected or a diseased state of the blood or constitution, so likewise, in plants, the same disease may be brought about by different causes ; as in the analogous fungoid disease of mildew on the leaves, which, it appears, may be brought on by excess of moisture or excess of drought, producing a diseased state of the stomata of the leaf, and a nidus for the fungus.

1168, *in p.* 549.—If the system of training noticed in this section, or something like it, were more generally practised, there would be less need to complain of breast-wood. On standard trees there is no occasion to go through forms of pruning to produce spurs ; and, if the side branches were more encouraged in wall-trees, we should have shorter shoots and natural spurs, and the tree would be kept full of young wood to the centre, from the abundance of young shoots to renew any that were getting naked. There should be greater distance between the leading shoots, and abundance of side shoots laid in to fill the wall ; though they might not all be got mathematically arranged, the system of leaves and roots would be better balanced, the continual excitement to produce which causes the great abundance of breast-wood. If the greater part of this were nailed in, the tendency to produce fresh breast-wood next year would be checked, and the tree become fruitful on the small branches ; better fruit would be produced ; and the tree being full of young wood, any part of it could be renovated at pleasure.

1214, *in p.* 561.—The Glenton Green, Manchester Red, Hedgehog, and Honey varieties, are worth adding to this section.

1217, *in p.* 562.—Lancashire Lad is the best bearer and best flavoured here—better with us than the most of them you name, and deserves a star. Shakspeare, Sir Francis Burdett, Triumphant, Foxhunter, Grand Turk, and Tarragon, among the reds ; Rattlesnake, Sally Gunner, Scorpion, Prince of Orange, China Orange, and Yellow Lion, among the yellows ; Favourite, Bang Europe, Lord Crewe, and Troubler, among the greens ; Lily of the Valley, Bonny Lass, White Lion, Sheba Queen, and Sally Miller, among the whites, and not in your lists, have been all proven here of great value both for bearing and eating. Some with higher pretensions, which have come out later, are not proven yet.

1223, *in p.* 565.—Having been much troubled with caterpillars on our gooseberry stools in the nursery, we have tried lime, soda, potash, salt, soap-suds, and tobacco. The tobacco infusion will kill them, but is very apt to injure the foliage ; the salt has the same fault, but we could not perceive that it or any of the others had much effect ; when the lime was put on, however, they crowded away, twisted together like a cable-rope, down the stem, as fast as they could, and took the direction for the nearest bush, at an angle, as they were planted in the quincunx form, and as straight as if they had been guided by a line. The hellebore powder we found the most deadly of any, and it does no injury to the leaves. When it is long kept, or has got damp, it is apt to lose its pungency, and will do no good ; but if in the pungent, acrid state of fresh-ground powder, which may be known by its effect on the nostrils, it will not fail to kill all the caterpillars it reaches. They are on the under side of the leaf, and the applications tell best when thrown upwards. We prefer to throw it upwards in the state of dry powder, by the finger and thumb : a small quantity, like a pinch of snuff, if dry, flies off like vapour from the fingers, and may thus be directed where any are seen, the shoots being held up to expose the back of the leaf ; there is least waste of powder in this way when the caterpillars are not very plenty. Others throw it up with a puff-bellows, the mouth round, like a dredge-box ; and others dust it on from above with a

dredge-box. This takes less trouble, though it requires more of the powder; and the leaves should be damped, to retain what does not fall on the insects till they reach it. If some are in the state of eggs and others of larvæ, the application may require to be repeated; but will not fail if the hellebore is fresh ground and pungent, and reaches the insects. The powder insinuates itself between the hairs of the insect, and reaches the tender skin more readily than water; it should be well toasted, if damp weather, to allow of its dividing well.

1234, *in p.* 569.—The raspberry is well adapted for forcing, and is worthy of more general cultivation in forcing-houses; a few old stools taken up and planted against the back wall of a peach-house, at the time of commencing to force, will, with moderate care, furnish many dishes of fruit.—*H. C. O.*

1267, *in p.* 581, and 1342 *in p.* 606.—In the neighbourhood of New York the cherry tomato is cultivated and preserved as a sweetmeat. At first this sweetmeat was supposed to be made of the winter cherry, as stated in 1267; but it has since been found to be a small round tomato.

1379, *in p.* 624.—Mr. Barnes informs us that there is a late variety of cauliflower in cultivation by some market-gardeners quite distinct from the early variety, though it is seldom to be met with in the seed-shops. Mr. Barnes was formerly in practice in some of the principal market-gardens about London; an immense advantage with reference to the management of the kitchen-garden of a private gentleman.

1462, *in p.* 659.—Some here are in the habit of planting Strasburgh and other common onions, early in spring, in the same way as they do potato onions. When any flower-stem appears, they pinch out the centre, and find the roots of the common onion, treated in this way, to offset and produce an aggregation of bulbs nearly, if not equally, as well as the potato variety, which resembles the globe, but appears to have acquired the habit of not running to seed.

1463, *in p.* 660.—In deep alluvial loam, the onion plants grow most luxuriantly, but are more apt, especially in wet seasons, to produce what are called scullions; the foliage being strong and thick at the neck, but the root made soft and ill-ripened, and will not keep. It has been found advantageous sometimes to roll or tread well such land; but in the general run of seasons here, when the climate is moist, soil of a rather clayey nature is found to suit best, and to produce the foliage small at the neck, and the bulb round, protuberated, and well ripened. A thin crop also is more apt to produce most scullions, and it is safer to have the crop rather to the thick side, as they are found to increase less in foliage and more in root, and though the onions are not so large, the weight of the crop is more, and keeps better. Much of the tendency to produce thick necks flows, as in turnips, from not picking the roots well in saving the seed. The plants that have small foliage, and handsome well swelled-out roots, are most likely to produce their like again from seed, and much depends on the carefulness of the person who saves the seed. Here, where great breadths of onions are annually sown, the seed imported from Holland from careful agents there is allowed to give the best crops. Soil that can be broken small to a fine surface requires less seed. † Clayey ground intended for onions should be thrown up rough in January or February to get the frost, which allows of its forming a fine covering for the seed, and thus ensures a better braird. On light dry soils, near the coast, the practice of sowing in autumn is found to succeed best, as the onions fail in the drought of summer when spring-sown. The autumn-sown ones did but live also last season, being too dry for small

crops. The broadcast is the most prevalent practice here, though some who have drilled them in light land approve most of that way. Nitrate of soda has been very beneficial to the onions here this dry season, partly, perhaps, from its deliquescent nature. We have often seen soot produce a powerful effect on onion crops.

1463, *in p.* 660.—Mr. Barnes (see note to par. 749) thins and hoes all his seedling crops with short-handed goose-necked hoes, with square-edged blades of different sizes, but chiefly of two inches in width. He uses two hoes at a time, one in each hand. He never has weeds pulled up among seedling crops, but always attacks them in the seed-leaf state with these hoes.

1470, *in p.* 662.—The maggot has been more than usually destructive among onions this season. Perhaps the drought, producing a sickly state of the roots, attracts the fly to lay its eggs, as other maggots do on substances commencing to putrify. Their instinct is strong, and may lead them to detect this state of the root before perceptible above ground. Some carrots we observed this year, at the time they commenced to droop, we found that in those much hurt in the roots the maggots abounded; in those less hurt, fewer maggots; some of them sticking to the outside, and commencing to enter; while in the roots, on which a few brown spots here and there were all the symptoms of disease, we find many destitute of maggots altogether, and in whole sound roots found none. The thinning of carrots very often induces maggots, if done in dry weather. We observed this season beds dressed with nitrate of soda, and growing healthy, alongside of others not dressed and unhealthy; and the fly, if not guided by instinct, might have spoiled the healthy as well as unhealthy roots, which it did not. That the fibres first fail in the onion, and that the maggot enters from the bottom of the onion at the fibres, and eats upwards, is the opinion of all here; no trace of entering from the neck of the stem can be perceived, and its course upwards appears visible in the eaten-away decayed appearance of the root there. The maggots are perhaps more the effect than the cause of bad growth.

1481, *in p.* 665.—As corroborative of your ideas on asparagus, I have often seen it produced strongest where pieces of the garden were imperfectly drained, and rather marshy. Mr. Cuthill says, "I believe it has been proved that asparagus likes as much moisture as can well be given it. The best asparagus I have ever seen was at Mr. Bird's, a market-gardener at Ipswich, where the beds were under water nearly all the winter, and he always cut asparagus sooner than his neighbours." (*G. M.* vol. xii. p. 597.)

1363, *in p.* 613.—If the theory that ten buds give rise to a hundred, and these last to one thousand, and so on as long as sap towards new formations is undiminished, be taken in connexion with the sentence before, that the more a young tree grows the more it is capable of growing, it would seem to give the idea that the growth of trees, if properly fed, is unlimited, which, I think, is not intended. If a tree is disleafed and disbudded when young, it will undoubtedly disable and retard growth, and precocity may thus be induced, and perhaps disease also. If the young shoots are allowed to ripen, and are cut back, the tree will push again more strongly next season, the vital force being stimulated by the effort of the tree to re-place; an activity is communicated to growth, which continues for some time, which if annually renewed and properly fed at the roots is apt to produce immense quantities of young wood without fruit. The pruning of the young roots has a tendency to increase them also. The production of one hundred buds from ten, and of one hundred from one thousand, will only continue, however, so long as *the force of sap to new forma-*

tions is undiminished. There is a period in all trees when this force is so diminished, that small short shoots only are produced, and this is the period of maturity or fruitfulness. This period may no doubt be hastened by disbudding and disleafing, but is apt to engender disease; it is like taking away a part of the stomach and lungs, to hinder the development of absorbent lacteals, and is dangerous. A safer way is to cramp the development of the whole, by limiting the food, by making the soil poor. The allowing the border to lie unstirred has partly the same effect. The action between the heat, moisture, and gases of the atmosphere on the roots is diminished, and in vigorous growing varieties, and rich borders, is beneficial by impoverishing. The best way of all, however, is to allow the tree to come to maturity, by laying in as much young wood, and giving as much extent as requisite; and the period will arrive sooner or later, according to the inherent vigour of the variety, the richness of the soil, and warmth and light of the climate, when short shoots only will be produced, and these fruitful. That giving extent will moderate vigour cannot certainly be doubted, otherwise there would be no limit to the size of trees. Though, perhaps, not a mere evolution of parts already formed, which is an obscure subject, and one which will perhaps never be in our power to resolve, yet there is certainly a limit to expansive power. It may be, and undoubtedly is, greater in favourable than unfavourable situations, but has always yet been limited, as a certain extent can be named which trees have not yet been found to exceed; whether from an inherent limit in the power itself, or the circumstances in which it is placed, is likely to be for ever incapable of determination.

1384, *in p.* 630.—In dry sandy poor soils, the cabbage-plants are found to club at the roots, fully as readily as in good loamy soils. Where there is not a sufficiency of plants without club at the roots, it has been found beneficial to cut out the protuberance, and destroy the insect. A sifting of soot and coal ashes on the surface has been generally found to aid in preventing the attacks of these insects, and also of the turnip beetle.

1406, *in p.* 639.—In this quarter of the country great failures in the crop of potatoes have occurred, to guard against which the best method is to plant the ground as moist as possible, and use well-rotted manure and vigorous unripe sets; drought in planting-time long continued in spring having been found most prejudicial. See R. Symburn, "On the Culture and Preservation of Potatoes," in *Gard. Mag.* vol. xvi. p. 20.

1411, *in p.* 642.—The old everlasting potato (a small round sort) introduced by the Messrs. Falla, of Newcastle, and the later introduced small white kidney, called Fairy, have both the same properties as the above, of Messrs. Chapmans, producing great swarms of small thin-skinned waxy potatoes which, being covered with haulm, afford a dish of young potatoes through the whole winter.

1415, *in p.* 644.—Potatoes that are greened possess more inherent vigour in the sets; the potato is a bud, or collection of buds, on an under-ground stem; and a greened one has as much more vigour as the stem of an unblanched plant would possess over that of a blanched one. The young shoot will rise stronger, and the greened skin will not be so easily affected by weather.

A MONTHLY CALENDAR OF OPERATIONS.

The paragraphs are referred to ; not the pages.

THE nature of this work precludes the necessity of giving a very copious calendar of operations ; still it would be incomplete without one : we shall therefore briefly state what should be done in each month, and in most cases refer to the paragraphs in the body of the work for the practical details.

JANUARY.

VEGETABLE DEPARTMENT.

Artichokes : secure from frost, if not yet done (1495). *Asparagus* : plant on a hotbed twice in the month, to keep up a succession (1096). *Carrot* : sow on a slight hotbed (1106). *Cauliflower* : sow in a box, and place in a forcing-house, if the autumn-sowing failed (1379). *Celery* : protect during severe weather (1518). *Cucumbers* : prepare a seed-bed for sowing next month ; renew the linings of the fruiting-beds ; keep them made up above the surface of the soil in the frame (1061). *French Beans* : sow in pots for forcing (1104). *Mint* and other *herbs* : take up and plant in pots or boxes, and place in a forcing-house (1110). *Potatoes* : plant on a slight hotbed (1100). *Radishes* : sow on a slight hotbed, or in the same frame with potatoes (1108). *Rhubarb* : take up old roots, and plant in boxes or pots ; place them in a forcing or mushroom house (1098).

FRUIT DEPARTMENT.

Pinery : maintain a temperature in the fruiting-house of from 75° to 85° by day, and from 68° to 72° by night (946) ; succession-house, from 5° to 8° lower ; nursing pits about 60°. *Vinery* : commence forcing for fruit in June ; begin with a temperature of 50° (969) ; gradually increase it the first month to 60° min. (971). *Peach-house* : commence forcing for fruit in May ; begin with a temperature of 50° (998). *Cherry-house* : commence forcing with a temperature of 45° min. by night (1021). *Figs* : plants in pots may now be placed in a vinery (1034). *Strawberries* : take plants in pots into a forcing-house or pit twice in the month (1090). *Prune* the Apple (1149), Pear (1168), Plum (1207), Cherry (1192), Gooseberry (1220), Currant (1228), and Raspberry (1232), if the weather is not severe. Nail and tie wall and espalier trees (786).

FEBRUARY.

VEGETABLE DEPARTMENT.

Beans : plant in boxes for turning out next month, also sow in the open ground (1392). *Cabbage* : sow on a warm border (1372). *Carrots* : sow on a warm border (1429). *Cauliflowers* : prick out those sown in boxes last month on a slight hotbed (1379) ; sow on a sheltered border (1379). *Celery* : sow in boxes, and place in a forcing-house for first crop (1515). *Cucumbers* : plant from the seed-bed, and afterwards keep the heat by night 70° to 75°, and by day 75° to 85°. *French Beans* : earth up former sowings, and sow again (1104). *Lettuce* : sow on a warm border (1505). *Mushrooms* : make beds and spawn at 80° (1114). *Onions* : sow in boxes, and place in a forcing-house, for planting out in April. *Peas* : sow in boxes, and in the open ground (1388). *Potatoes* : plant on a slight

hotbed and on a warm border (1408). *Radishes*: sow on a warm border (1444). *Sea-kale*: cover up (1097). *Spinach*: sow 1450. *Turnips*: sow (1420).

FRUIT DEPARTMENT.

Pinery (946): give air in mild weather, slightly sprinkle the plants on fine mornings. *Vinery* (971): increase the heat as there stated for the preceding month. *Peach-house*: cease syringing when the trees are in flower (998). *Cherry-house* (1021): give air at every favourable opportunity. *Fig-house*: commence forcing where the trees are planted in the borders (1033). *Melons*: sow seed for early crop (1037). *Strawberries*: take into the forcing-house for succession (1092). *Fruit-trees* of all sorts may be planted if the weather is open (1363). *Prune* and *nail* fruit-trees (786). *Dig* fruit quarters (928).

MARCH.

VEGETABLE DEPARTMENT.

Artichokes: make new plantations (1495). *Asparagus*: make new beds (1481); top-dress the latter end of the month (1482). *Basil*: sow (1574). *Beans*: plant twice in the month (1392). *Beet*: sow (1435). *Cabbage*: fill up vacancies in the autumn plantations. *Capsicums*: sow seed (1345). *Carrots*: sow the main crop (1429). *Herbs*: make new beds. *Horse Radish*: make new plantations (1547). *Jerusalem Artichokes*: plant early in the month (1418). Sow *Leek* (1473). *Lettuce*: prick out on a slight hotbed those sown last month in boxes. *Mushrooms*: make beds for summer use (1114). *Onions*: sow the main crops (1463). *Parsley*: sow, if neglected last month (1534). *Parsneps*: sow the main crop (1434). *Peas*: sow twice; earth up early crops. *Potatoes*: plant main crop (1408). *Radishes*: sow twice (1444). Sow *Salsify* (1438). *Savoys*: sow beginning and end (1376). *Scorzonera*: sow (1437). *Shallots* and *Garlic*: plant the beginning of the month (1474, 1475). Sow *Spinach* (1450). *Turnips*: sow on a sheltered border (1420).

FRUIT DEPARTMENT.

Pinery: pot succession plants (944); top-dress fruiting plants. *Vinery*: see *Diary* (971). *Peach-house*: remove all foreright shoots from the trees (995); when the fruit is set, syringe them (1011). *Cherry-house*: increase the heat after the bloom is set and stoned (1024). *Fig-house*: water freely, both at the root and over-head (1033). *Melons*: plant out from last month's sowing (1042). *Strawberries*: give air freely while in flower (1092). *Prune* and *nail* Peaches and Nectarines, and afterwards protect them with nets or other covering (1307). Finish *planting* fruit-trees. *Graft* fruit-trees (650).

APRIL.

VEGETABLE DEPARTMENT.

Beans: plant twice, and earth up the early crop (1392). Sow *Borecole* (1378). *Broccoli*: sow the winter varieties (1380). *Brussels Sprouts*: sow, beginning of the month (1377). *Cabbage*: prick out the February sowing (1372). *Cardoons*: sow for early crop (1499). *Cauliflowers*: plant out those wintered in frames (1379). *Celery*: prick out the early-sown on a slight hotbed (1515). *Cucumbers*: sow to plant out on ridges (1082). *French Beans*: sow, the beginning of the month (1397). *Lettuce*: fill up the autumn plantations (1505). *Onions*: transplant the autumn sowing (1465); and also those sown in boxes in February. *Peas*: sow twice in the month; earth up and stick early crops (1390). *Radishes*: sow twice in the month. Sow *Spinach* first and third week. *Turnips*: thin, and sow the latter end (1421). *Vegetable Marrow*: sow, the middle of the month (1341).

FRUIT DEPARTMENT.

Pinery: add fresh tan between the pots of fruiting plants, and sprinkle them

over-head frequently (946); pot suckers that have been wintered in dung beds (933). *Vinery*: when the grapes are set, keep a very moist atmosphere (971), and commence thinning them immediately (1283). *Peach-house*: partially thin the fruit before stoning, afterwards thin to the quantity required to ripen off (996); syringe the trees daily in fine weather, and smoke them occasionally, to keep down insects (999). *Cherry-house*: after the fruit is stoned, give the trees a good root-watering (1024), which will probably be sufficient till the fruit is gathered; watch narrowly for insects (1023). *Fig-house*: when the shoots have made three or four joints, stop them to cause them to produce fruit in the autumn (1032). *Melons*: allow several of the main shoots to reach the sides of the frame before being stopped (1037). *Prune* and nail figs (1232). *Disbud* peaches and nectarines (1301).

MAY.

VEGETABLE DEPARTMENT.

Basil: plant on a rich sheltered border (1574). *Beans*: top the early crops (1394); plant twice in the month. *Beet*: thin to 15 inches apart. *Borecole*: prick out of the seed-bed. *Broccoli*: prick out those sown last month, and make another sowing of the winter kinds; also Cape and Granges the last week (1380). *Cabbage*: plant out the February sowing (1372). *Cauliflower*: earth up and water with liquid manure; take off the hand-glasses (1379). *Cucumbers*: prepare ridges for out-door crops (1082). *French Beans*: make sowings the first and last weeks (1397). Transplant *Leeks* (1473). *Lettuce*: transplant early sowings; sow twice in the month (1505). *Onions*: thin them to nine inches apart (1463). *Peas*: make two sowings. *Potatoes*: earth up the early crops (1412). *Radishes*: make two sowings. *Spinach*: sow, the middle of the month (1450); thin former sowings. *Scarlet Runner*: sow, beginning and middle of the month (1398). *Turnips*: make a sowing, if not done the end of last month (1421).

FRUIT DEPARTMENT.

Pinery: Give the plants manure-water occasionally, if fruit of a large size is required (952); keep up a high temperature during the day (945). *Vinery*: keep the laterals stopped to one joint (961); take away all useless shoots. *Peach-house*: When the fruit begins to ripen, withhold water both at the roots and over-head (1015); at the same time admit air freely (1011). *Cherry-house*: raise the temperature to 70° when the fruit is swelling off (1024). *Fig-house*: as the first crop approaches maturity, only sufficient water should be given to prevent the second crop of fruit falling off. *Melons*: regulate the Vines at an early stage of their growth; after the fruit is set, put pieces of slate beneath it (1037). Continue to *disbud* wall-trees (1301); remove their coverings when danger from frost is over (1307); and *wash* the trees with soap-suds when the fruit is set (1311). *Thin* the fruit of the Apricot.

JUNE.

VEGETABLE DEPARTMENT.

Asparagus: discontinue cutting (1483). *Beans*, put in the last crop (1392); top and earth up former crops (1394). *Broccoli*: sow Cape and Granges (1380). *Cabbage*: sow seed for Coleworts (1374). *Capsicums*: plant out on a warm border (1345). *Carrots*: thin to two inches apart (1429). *Celery*: transplant into trenches for an early crop (1516). *Cucumbers*: plant under hand-glasses (1082). *Endive*: sow for an early crop (1508). *French Beans*: make a sowing the middle of the month (1397). Transplant *Leeks* (1473). Transplant *Lettuce*. *Peas*: complete the sowing of the marrow varieties (1390). *Potatoes*: earth up (1412). *Radishes*: sow as in last month. *Savoys*: transplant for an early crop (1376). *Scarlet Run-*

ners: make the last sowing (1398). *Spinach*: sow twice. *Tomatos*: turn out against walls (1342). *Vegetable Marrow*: plant under hand-glasses (1341).

FRUIT DEPARTMENT.

Pinery: pot the succession plants and suckers (949); plunge in a brisk bottom heat, and shade (941). *Vinery*: as the fruit approaches maturity keep a dry atmosphere (971); a few leaves may be taken off or tied on one side where they shade the fruit (959). *Peach-house*: suspend nets or mats beneath the trees, and place in them some soft material to catch the falling fruit (998). *Cherry-house*: when the fruit is gathered, give the trees several good washings to destroy insects; the house should also be smoked (1023). *Figs*: in pots must be duly supplied with water (1034). *Melons*: ridge out late crops, give air freely to ripening fruit (1037). Summer prune *Vines* against walls (984). Finally thin *Apricots*. Set traps for Wasps (357). Net *Cherry-trees* (1195).

JULY.

VEGETABLE DEPARTMENT.

Borecole: transplant (1378). Transplant *Broccoli* (1380). Transplant *Brussels Sprouts* (1377). *Cauliflower*: transplant from the April sowing (1378). *Cabbage*: sow in the last week for a crop to come in in May (1372). *Celery*: transplant into trenches (1516). *Endive*: make a second sowing (1508). *French Beans*: earth up, and make the last sowing the latter end of the month (1397). *Lettuce*: make a sowing the first and last week (1505). *Peas*: make two last sowings of early sorts (1390). *Radishes*: sow on a cool border (1444).

FRUIT DEPARTMENT.

Pinery: discontinue watering those plants which are ripening their fruit (946); keep a moist atmosphere in the succession house. *Vinery*: carefully avoid raising a dust when the fruit is ripe (971); give air freely. *Peach-house*: when the fruit is all gathered, give the trees several good washings over-head; give abundance of air till the leaves begin to decay, when the lights may be removed (1008). *Cherry-trees* in pots should now be placed in a shady situation (1025). *Fig-house*: when the first crop is gathered, water the trees liberally to bring forward the second crop. *Melons*: pay proper attention to the plants in the open air (1045). Finally thin wall-fruit (1303). Prune and tie espalier trees (1150). Bud fruit trees (676). Pot *Strawberry* runners for forcing (1091). Mat *Currants* and *Gooseberries* to preserve them (1222). Stop the shoots of *Vines against walls* two joints above the fruit.

AUGUST.

VEGETABLE DEPARTMENT.

American Cress: sow to stand the winter (1528). Transplant the main crops of *Borecole* (1378); and *Broccoli* (1380). *Cabbage*: sow for main spring crop (1372); transplant for Coleworts (1374). *Carrots*: sow to stand the winter (1429). *Cauliflowers*: transplant to come in during the autumn (1379); sow for the main spring crop (1379). *Celery*: transplant into trenches (1516); and earth up for blanching (1517). *Endive*: make the last sowing (1508); and transplant from former sowings. *Lettuce*: sow for standing through the winter (1505); transplant from former sowings. *Onions*: sow for standing through the winter (1464). *Radishes*: sow the winter varieties (1444). *Savoys*: transplant the main crop (1376). *Scarlet Runners*: earth up and stick (1398). *Spinach*: sow the main winter crop (1450). *Turnip*: sow the winter crop (1421).

FRUIT DEPARTMENT.

Pinery: pot the succession plants into their fruiting-pots (945); plunge into a good heat, and shade till they begin to grow again (941). *Vinery*: syringe the

Vines, and give them a root-watering after the fruit is cut, to prevent the leaves decaying prematurely (971). *Peach-house*: the light may be taken off the early house, and used for the purpose of forwarding Grapes against walls. *Fig-house*: syringe the trees frequently to keep down insects (1033). Make new plantations of *Strawberries* (1244). Cut down the old canes of *Raspberries* when the fruit is gathered (1232). Keep the shoots of *wall-trees* nailed in; displace all laterals. Stop the laterals of *Vines* to one joint. Continue to bud *fruit-trees* as in last month.

SEPTEMBER.

VEGETABLE DEPARTMENT.

Cabbage: prick out from last month's sowing (1372). *Celery*: earth up for blanching (1517). *Chervil*: sow for winter use (1536). *Curled Cress*: sow for winter use (1527). *Endive*: transplant (1508); and tie up for blanching (1509). *Mushrooms*: Make beds for winter use (1114). *Onions*: pull up and house them when dry (1471). *Parsley*: cut down a portion of the spring sowing (1534). *Potatoes*: take up the early sorts (1416). *Purslane*: sow for winter use (1543). *Shallots* (1474) and *Garlic* (1475) should now be taken up. *Dig* up vacant ground (531).

FRUIT DEPARTMENT.

Pinery: pot suckers that have been taken off fruiting-plants; disroot and replot the old stumps (944); prepare the fruiting-house for the fruiting-plants. *Vinery*: the lights of the early forced-house should now be left open night and day (971); or they may be taken off if repairs are required. *Peach-house*: if any vacancies are to be filled up, take out the old soil and replace it with fresh (1001) ready for planting next month. Protect out-door Grapes from wasps by bagging the bunches. Gather fruit as it ripens (930). Expose wall-fruit to the sun and air to give it flavour and colour. Continue to make new Strawberry plantations as in last month.

OCTOBER.

VEGETABLE DEPARTMENT.

Artichokes: tie up the leaves for producing the chard (1496). *Asparagus*: cut down and winter-dress (1482). *Beet*: dig up and lay in sand (1435). *Cabbage*: plant out for the main crop (1372). *Cardoons*: tie up the leaves for blanching (1499). *Carrots*: take up the main crop (1430). *Cauliflower*: prick out under hand-glasses, and into frames (1379). *Cucumbers*: make beds, and sow seed for early crops (1054). *Lettuce*: plant out for the main spring crop (1505). *Parsneps*: take up and preserve in sand (1434). *Potatoes*: take up the main crops (1416). *Tomatoes*: gather the unripe fruit and lay in a forcing-house. *Dig* and *trench* ground during dry weather, 533, 534.

FRUIT DEPARTMENT.

Pinery: the plants intended for fruiting next season should now be got into the fruiting-house, if they were not put in when potted; only partially plug the pots at first (946); plant all the remaining suckers in spent tan or a dung-bed (941). *Vinery*: As soon as the leaves have fallen from the Vines, prune them (962, 963); take off the loose rough bark, and wash them (971). *Peach-house*: fill vacancies with trees from the walls in the open garden (1003); take up and plant carefully (737). Pot cherry-trees for forcing (1020). Withhold water from fig-trees when the fruit is gathered. *Melons*: keep up the heat of the beds, to forward the ripening of the late fruit. Gather any remaining fruit (931). *Plant* fruit-trees of all sorts (737, 893). *Prune* Currants (1228) and Gooseberries (1220).

NOVEMBER.

VEGETABLE DEPARTMENT.

Artichokes: cover the roots with litter (1495). *Beans*: sow first crop (1392). *Cauliflowers*: protect those which have formed heads from frost (1379). *Celery*:

take every favourable opportunity to earth it up (1517). *Cucumbers*: ridge out the plants in the fruiting-beds (1057). *Endive*: preserve from frost (1510). *Horse Radish*: dig up for winter use (1547). *Jerusalem Artichokes*: take up for winter use (1418). *Peas*: sow for an early crop (1388). *Salsify*: dig up for winter use (1438). *Scorzonera*: dig up for winter use (1437). *Sea-kale*: clear away the decayed stems and leaves (1490). *Preserve* culinary vegetables from frost (857).

FRUIT DEPARTMENT.

Pinery: water the plant cautiously at this season; those planted on a dung-bed will require none: admit air at every favourable opportunity (943). *Vinery*: protect the border where the Vines of the early forcing-house are growing outside (956). *Peach-house*: prune (994) and dress the trees (1010) as soon as the leaves have fallen. *Cherry-house*: if the lights have been taken off, they should now be replaced, but left open night and day, unless the weather is severe. The trees should now be pruned. *Pot Fig-trees* for forcing (1034). Continue to plant all sorts of fruit-trees, as in last month. Protect Fig-trees (1323). *Prune* the Apple (1149), Pear (1168), Plum (1207), Cherry (1192), Filbert (1260), and Gooseberry and Currant, as in last month; also nail and tie those against walls and espaliers. Look over the fruit in the fruit-room (931). Muleh newly-planted fruit-trees, to protect them from frost.

DECEMBER.

VEGETABLE DEPARTMENT.

Asparagus: take up roots for forcing (1096). *Celery*: protect during severe frosts (1517). *Cucumbers*: attend to the linings of the beds (1061). *French Beans*: plant in pots for forcing (1104). *Mushrooms*: keep a moist and steady temperature in the house (1111). *Radishes*: sow on a hotbed for early use (1108). *Rhubarb*: take up roots, and pot for forcing (1098). *Sea-kale*: take up roots carefully, for forcing (1097). *Small Salad*: keep a succession, by sowing once a week (1107). Prepare materials for hotbeds (842).

FRUIT DEPARTMENT.

Pinery: Slightly increase the temperature of the fruiting-house (946); if there is a great declination of bottom-heat, add a little fresh tan between the pots. *Vinery*: Put on the lights, if they have been removed, so as to protect the Vines from severe frost (969). *Peach-house*: after the trees are tied to the trellis, take away a little of the loose, dry top-soil; slightly dig the border (1010), so as not to injure the roots, and add some fresh soil (997). *Cherry-house*: Fix the trees to the trellis, and make preparations for forcing next month. *Fig-house*: the frost should be kept out (1035); and if the trees need any pruning, it should now be done. Continue to prune and nail in mild weather. Partially unnailed the shoots of Peach and Nectarine trees. Protect Strawberries in pots (1091), and all fruit-trees intended for forcing. Dig fruit quarters where pruning is completed (928).

NOVEMBER, DECEMBER, AND JANUARY.

The young gardener will have leisure during the long evenings of these three months to improve himself by reading, to which he should add writing and drawing, including of course arithmetic and mensuration. In these days, when the employers of gardeners are readers of gardening books, and often possess a considerable knowledge of vegetable physiology, the young man who does not occupy every moment of his spare time in improving himself, has no chance whatever of getting a good situation as head gardener.

GENERAL INDEX.

*** The pages are referred to ; not the paragraphs.*

- ACETARIACEOUS esculents, substitutes for, 683
Acrogens, orders belonging to, 16.
Air and ventilation necessary to plants in a growing state, 88 ; mode of heating and ventilating on Mr. Penn's principle, 85
Alisanders, culture of, 680
Alliaceoous plants, substitutes for, 665
Almond, its use, &c., 595
Amphibious animals, their uses in gardens, 114
Angelica, its use and culture, 688
Annular budding, how performed, 308
Apple, history of, 528 ; uses of and properties of a good one, 529 ; number of varieties of, and a selection of early and late dessert sorts, 530 ; a selection of early and late kitchen sorts, 532 ; list of dessert and kitchen, for espaliers, dwarfs, or trained standards, 428 ; a select list for an orchard, 431 ; selection of sorts for making cider, and valuable sort for cottage gardens, 533 ; principles to be observed in selecting varieties, 534 ; modes of propagation, 535 ; soil and situation best adapted for, and mode of bearing, pruning, and training, 536 ; summer and winter pruning of dwarfs, espaliers, and those against walls for the first ten years of their growth exemplified, 537 ; gathering and keeping, 543 ; diseases, insects, &c. to which the trees are liable, with modes of eradication, 544
Apricot, a selection of the best sorts, and the propagation of the trees, 596 ; planting, pruning, and general management of, 597 ; a few remarks on forcing the, 487
Artichoke, culture of, 670 ; culture of, for producing the chard, 671
A'rum maculatum, a native plant, the roots of which are sometimes used as a substitute for arrow-root, 656
Asparagus, soil suitable for, and mode of sowing or planting, 665 ; general culture of, 666 ; particulars of the mode of forcing, 516 ; thrives best in wet-bottomed soil, 713
Asparagaceous esculents, substitutes for, 672
Asphalte roofing, its use in affording protection to glass roofs, 161
Atmosphere considered with reference to the culture of plants, 67 ; its constituent parts, 67 ; agitation of, promotes the vigour of plants, 83
Atmospheric moisture, much not necessary in greenhouses, 87 ; moisture always present, 76 ; to measure the degree of, 76 ; necessary to plants, 77 ; at perfect command in hothouses, 79 ; condensation of, on the glass of hothouses, 80 ; moisture necessary in plant structures, 215 ; method of procuring, 216. See Table in p. 703.
Balm, its use, &c., 694
Banana, history of, 512 ; construction of a house for, and mode of cultivation, 513 ; list of varieties of, 601
Basil, culture of, 691
Baskets, method of making, 148 ; uses of, 151
Bean, a selection of varieties and their culture, 634
Beet, the Red, selection of varieties and their culture, 651 ; culture of the Spinach and Chard, 658
Bell glasses, 152
Bellows, fumigating, 156 ; powdering, 157
Berberry, use of, and mode of cultivation, 580

- Birds, their nature, and the orders to which they belong, 115 ; modes of deterring, 119 ; to destroy, 120
- Blanching, vegetables which require it, and means by which it is effected, 389
- Blight, by what produced, 126
- Boiler, size of, for heating by hot water, 207
- Borage, its use and culture, 686
- Borecole, culture of, 624
- Botanic stoves described, and their uses, 223
- Boxes for plants, 145
- Broccoli, varieties of, and their culture, 626
- Brussels Sprouts, culture of, 624
- Budding, uses and principles of, 300 ; mode of performing, 302 ; shield, 303 ; flute, 307 ; annular, 308 ; bud-grafting, 702
- Buds, the development of, explained, 22
- Bulbs, described, 30
- Burnet, use of, 681
- Cabbage, varieties of, and mode of culture, 622 ; culture of the Chinese, 627 ; tribe, general culture and management of, 627, and 714 ; substitutes for the, 630
- Calycifloræ, orders belonging to, 12
- Canker, 123 ; its preventive and cure, 124. See note in p. 710.
- Cap to prevent worms from entering pots, 96
- Caper, culture of the, 689
- Caps, mode of making oiled paper, for protecting flowers, 162
- Capsicum, use and culture of, 607
- Cardoon, use, culture, and cookery of, 671
- Carnations, mode of layering, 276
- Carrot, selection of varieties, and their culture, 649
- Caterpillars on gooseberry bushes, to destroy, 711
- Cauliflower, culture of, 624 ; a late variety quite distinct from the early variety, 713
- Celeriac, culture of, 680
- Celery, selection of varieties, and culture of, 677
- Chamomile, its native locality, &c., 693
- Chapman's new spring potatoes, 642
- Charcoal, its use in striking cuttings, 263 ; in the culture of plants generally, more especially in pot-culture as practised by Mr. Barnes, 702, 706
- Cherry, history and general treatment of, in a forcing-house, 480 ; construction of a house for forcing, 480 ; kinds best adapted for forcing, and time of commencing to force, 481 ; insects to which the trees are subject, with the means of eradicating or destroying them, 481 ; treatment of plants in pots, 482 ; forcing by a temporary structure, and the German practice of forcing, 483 ; use of, and a selection of the best sort for dessert, arranged in the order of their ripening, 553 ; sorts for preserving ; a selection of sorts for a small garden, and for the north of Scotland, 554 ; mode of propagating, and general management of, 554 ; a Dutch Cherry garden described and figured, 556
- Cherries, for espaliers, dwarfs, or standards, 428 ; for an orchard, 433
- Chervil, culture of, 684
- Chesnut, use of, and management of the trees, 578
- Chicory, mode of forcing, 518
- Chive, culture of, 664
- Citron, see Orange
- Cleft-grafting, how performed, 291
- Climbing plants, wire frame-work for, 355
- Clipping, its object, and mode of performance, 236
- Cold, in buildings with a northern exposure, 701
- Coniferæ, propagation by cuttings of the order, 261
- Conservatory described, and its use, 223
- Coriander, culture of, 685
- Corn salad, culture of, 681
- Corollifloræ, orders belonging to, 14
- Cranberry, culture of, 576
- Cress, selection of varieties, and culture of, 681
- Cucumber, history of, mode of culture in British gardens, and a list of the best

- early varieties, 494 ; particulars of their culture on a dung-bed, 496 ; management of the linings of dung-beds, 500 ; particulars of their culture in pits heated by linings, flues, or hot water, with the mode of constructing a pit to be heated by flues, 503 ; construction of Corbett's pit, to be heated by hot water, 505 ; culture in pots in forcing-houses, 506 ; construction of Ayres's cucumber-house, 507 ; treatment of the plant in Ayres's house, 509 ; treatment necessary for the production of fine fruit for prize exhibitions, 510 ; particulars of their culture in the open air, 510 ; a selection of the best varieties of, 603
- Currant, a selection of sorts of red and white, and their culture, 566 ; uses of and culture of the black, 567 ; select list of, 430
- Cutting plants, mode of performance, 235
- Cuttings, principles of propagation by, 249 ; the plant and shoot to be selected for, 250 ; time of taking off, 252 ; preparation of, 253 ; the number of leaves to be left on, 253 ; manner of taking off, 254 ; treatment of till they are planted ; 255 ; the best soil for, and depth to plant, 256 ; distance to plant, 257 ; after-treatment of, 258 ; glasses for covering, 258 ; watering, 258 ; temperature most suitable for, 259 ; striking in water, 263 ; striking in powdered charcoal, 263 ; different modes of forming plants from, 270 ; to induce plants to produce shoots for, 271. See the Notes in p. 701.
- Digging, how to be performed, 229
- Dill, use and culture, 685
- Disbudding and disleafing. See Pruning, and the note in p. 713.
- Division, propagation by, 280
- Draining, alters the condition of soils, 51
- Earthworm, natural history of the, 94 ; natural uses of, 95 ; injury done by the, 96 ; to destroy, 96 ; cap to prevent their entrance into pots, 96
- Egg-plant, use and culture of, 606
- Elderberry, its use, &c., 581
- Elecampane, culture of, 689
- Endive, culture of, 675
- Endogens, orders belonging to, 15 ; described, 21
- Engines, Read's patent, 154
- Esculents, substitutes for leguminaceous, 638
- Espalier rails described, 184 ; rail of cast iron, 426 ; strained wire, 427
- Evergreens, best season for transplanting, 320 ; mode of transplanting, and conditions to be observed, 322 ; machines and implements necessary for transplanting large ones, 323 ; mode of packing, 324
- Exogens, grand divisions of, 10 ; described, 21
- Fennel, its use and culture, 685
- Fermenting materials for supplying heat to pits and frames, 196
- Fig, history, and general particulars of culture under glass, 485 ; varieties best adapted for forcing, and practice of forcing in pots, 486 ; winter treatment under glass, 487 ; a selection of sorts, 598 ; propagation and culture, 599
- Filberts, selection of sorts, and management of the trees, 579
- Flowers, parts of described, 34 ; to cause plants to produce them, 34 ; fertilization of, 35 ; the supposed cause of double, 408. See Note in p. 708.
- Flued walls, mode of constructing, 182
- Flues, various modes of heating plant structures by, 197
- Flute-budding, different modes of, and how performed, 307
- Forcing-houses, their uses, 224
- Fox-glove, a substitute for tobacco, 696
- Frame, a description of the common hot-bed, 176
- Frames, mode of making oiled-paper, 161 ; mode of fastening mats or other covering on, 394
- Frozen plants are recovered by early watering, 75
- Fruit, its excellence depends chiefly on the developement of the leaves, and their exposure to light, 35 ; gathering and preserving, 401, 440 ; packing, 403 ; exotics which may be cultivated for their fruit, 612 ; trees, &c., which may be cultivated for their fruit, 581
- Fruit-trees, distribution of, in a kitchen-garden, 420 ; select list of, for walls, 422 ; the distance from each other at which they should be planted against walls, 423 ;

- mode of planting, 424 ; selection of, for espaliers and dwarfs, 424 ; construction of a common espalier-rail for, 425 ; cast and wrought iron espalier-rails for, 426 ; the object of training, 357 ; different modes of training in the open garden and against walls, 358—375 ; beneficial effect of pruning, 337 ; method of causing them to produce blossom-buds, 345 ; distance from plant to plant at which espaliers and dwarfs are to be planted, 329 ; select list of, for an orchard, 431
- Fruit tree borders, management of, 439
- Fruit-trees, and fruit-bearing plants, general remarks on their culture, 613
- Fruit-room, its construction, 225 ; management of, 441
- Fruits cultivated in British gardens, and their classification according to the natural system of Botany, 526 ; arranged according to the climate they inhabit, 527
- Furnace, best mode of constructing, for heating by hot water, 207
- Gardeners, house described, 224 ; wages of different grades of, 414
- Garden pots, sizes of, 142 ; ornamental, 143
- Gardens, order and keeping of, in what it consists, 409 ; rules to be observed in, 410 ; general management of, 412
- Garlic, culture of, 664
- Guava, culture of, 611
- Ginger, culture of, 689
- Glass, law of the reflexion of light from, 192
- Glazing, best modes of, 219
- Gooseberries, select list of, and distance they are to be planted from each other, 429 ; uses of, and a selection of the best sorts, 561 ; propagation and general management, 562 ; insects and diseases to which the trees are liable, with modes of eradication, 565 and 711 ; additional sorts enumerated, 711.
- Gourd, use and culture of, 604
- Granadilla, culture of, 612
- Grafting, various modes of, 287. See Notes in p. 702.
- Grapes, a selection of sorts, arranged according to the form and colour of the berries, 582 ; selection of sorts of various flavours, 583 ; a selection of sorts for various purposes 584 ; general management of the Vines, 584 ; on growing them in pots, 585 ; on growing them for making wine, 586 ; to produce two or three crops in one house in a season, 463
- Grape-vine, history of, and general particulars relating to the culture of, under glass, 452 ; form of house for the culture of, 454 ; propagation of, 454 ; mode of pruning and training against walls, 455, 468 ; mode of culture under glass at Oakhill Gardens, 457 ; a diary of the course of culture at Oakhill Gardens, 459 ; mode of culture on walls and against cottages, 464 ; pruning and training of, on Mr. Hoare's system, 468 ; kinds most suitable for open walls, or for cottages, 472 ; insects and diseases of, with modes of prevention and cure, 472.
- Greenhouse described, and its use, 222 ; plants, propagation by cuttings of, 261
- Gum in fruit-trees, its causes, 125
- Hand-glasses, 152 ; description of a substitute for, 172
- Heat, conduction of, 67 ; radiation of, 68 ; soil a bad radiator and conductor of, 70 ; means of counteracting the radiation of, 71 ; on retaining it by coverings, 215
- Hellebore, white, its use and culture, 696
- Henbane, its probable use in the destruction of insects, 696
- Herbaceous grafting, how performed, 293, 296
- Herbaceous plants, distinguishing character of, 18 ; propagation by cuttings of hardy and half-hardy, 261
- Herbs, mode of forcing, 523
- Hoeing, its object, and mode of performance, 232 ; with a hoe in each hand, 713
- Honey-dew, its supposed causes, 126
- Horehound, its use, &c., 694
- Horse Radish, culture of, 686
- Hotbeds, materials used for, 391 ; preparation of materials for, 392 ; M'Phail's principle for, and formation of common, 393 ; management of, 394
- Hothouses, their use and situation, 187 ; most perfect form of, 188 ; form of for winter forcing, 189 ; advantages and disadvantages of curvilinear roofs to, 189 ; advantages of ridge and furrow roofs to, 190 ; materials used for, 192 ; contraction and expansion of iron roofs, 193 ; modes of supplying heat to, 195 ; mode of heating them on Mr. Penn's principle, 85 ; uniform degree of moisture produced by it, 86 ; difference of the heat of the glass internally and externally, 82 ;

- advantages of maintaining a high temperature in hot houses during the day, and a low one during the night, 397; mode of fixing canvas shades to, 175; on supplying water to plants in, 220.
- Hot water, various modes of heating plant structures by, 201; on the size and best form of pipes, 204; the situation the pipes should be placed in, 205; size of boiler, 207; rain-water should be used for heating by, 213; open gutters for circulating, 214
- Hybrid plants, the number of useful and beautiful ones in cultivation, 7
- Hyssop, its use, &c., 694
- Implements of horticulture, 127; the principles on which they are constructed, 128
- Inarching, uses and principles of, 297; mode of performing side and terminal, 298
- Indian Fig, culture of, 612
- Insects, their nature and classification, 99; transformation of, 101; food of, 102; distribution and habits of, 104; uses of, 105; means contrived by nature to limit the multiplication of, 105; enemies of, 106; means of destroying them, 108; articles required for destroying, 170
- Instruments used in horticulture—knives, 137; asparagus knife, hedge bills, 138; saws, pruning chisels, shears, 139; axe, verge and grass shears, scythes, 140; various others, 141
- Iron, in the form of an hydrate, injurious to vegetation, 48; roofs, contraction and expansion of, 193
- Jerusalem Artichoke, culture of, 646
- Kidney-bean, selection of varieties of the dwarf species, and their culture, 636; culture of the twining sorts, 636; particulars of the mode of forcing, 520
- Kitchen-garden, its situation, arrangement, extent, and soil, 416; should be well drained, trenched, and levelled, 417; accompaniments to a, 418; plans of two, 419, 421; systems of cropping the, 435; general proportion of crops for one, 434; general management of, 434; seed required for a garden of $1\frac{1}{4}$ acres, 435
- Ladder, description of a folding one for hothouses, 168
- Lamb's Lettuce, see Corn Salad
- Lavender, culture of, 693
- Layering, operation of, 272; soil necessary for, 277
- Layers, the principles of propagation by, 272; the time they require to produce roots, 277
- Leaves, the development of explained, 22; of endogenous plants should be preserved uninjured during their period of growth, 10; necessary to the existence of the plant, 32; principles of propagation by, 266; conditions required for the rooting of, 267; plants usually raised by, 268; propagation of bulbs by, 268; of plants rooted in charcoal, 269
- Leek, culture of, 663
- Lemon, see Orange
- Lettuce, mode of obtaining full-grown Cabbage Lettuce throughout the winter, 522; selection of varieties, and culture of, 674
- Level, its use, 169
- Light, influence of, on the distribution of plants, 41; the effect of its absence on plants, 89; follows the same laws as heat, 90; radiation and transmission of, 90; refraction of, 91; the importance to plants of perpendicular, 91; means of increasing the efficiency of, 92; heat should be in proportion to, 92; absence of, occasionally necessary to some plants, 93; light and motion, 699, 700
- Lime, its constituent parts and uses, 48; action of on vegetable substances, 62; uses of, 63; compost, 63
- Lime, see the Orange family, 608
- Liquorice, its use, &c., 694
- Loam, varieties of, 49
- Lodge for under-gardeners described, 225
- Loquat, culture of, 612
- Love-apple, see Tomato
- Machines used in horticulture:—wheelbarrow, 153; garden syringe, pneumatic hand-engine, 154; barrow-engine, 155; fumigating bellows, iron fumigating pot, 156; powdering bellows, mowing-machine, and various others used in gardens, 157

- Manures:—organic, or animal and vegetable, 56; leaf-mould, 56; green crops, seaweed, malt-dust, rape-cake, haulm, rotten tan, peat soil, 57; urine, 58; hair, wool, feathers, leather, horn, rags, dead animals, night-soil, sugar-bakers' scum, bones, dung of animals, 59; saving and collecting of, 60; liquid, 389 and 707
—inorganic, or mineral, 60; quicklime, mild lime, chalk, 61; marl, gypsum, sea-shells, 62; saltpetre, salt, 63
- Manures, mixed:—coal-ashes, vegetable ashes, 64; soot, street-sweepings, liquid, 65; application of, 66
- Marjoram, culture of the, 691
- Marigold, culture of the, 686
- Mats, mode of making straw, and their usefulness, 159
- Medlar, general particulars of its culture and management, 552
- Melon, history of, 487; summary of culture for the Cantaloup Melon, 488; practice of Melon culture in British gardens, 490; culture in the open air, 492; insects and diseases which the plants are subject to, with the mode of treatment to be adopted for their eradication, 493; a selection of the best varieties of, 602
- Mice, mode of catching them, 121
- Mildew, its causes and cure, 125
- Mint, culture of, 690
- Moisture, its influence on the distribution of plants, 41; the capacity of air for, 80
- Monochlamydeæ, orders belonging to, 14
- Morel, its locality, 692
- Mowing, its object and mode of performance, 238
- Mulberry, use of, and management of the trees, 577
- Mushroom, general particulars of its culture, 523; form of house for, and mode of culture, 524; mode of culture in a cellar, 525; mode of growing it in lawns and pastures, 692; in cow-houses and stables, 710
- Nasturtium, culture of, 686
- Nectarine, see Peach
- Offsets, propagation by, 279
- Onion, selection of varieties, 659; culture of, 660; culture of the Potato, and bulb-bearing sorts, 661. See Notes in p. 712 and 713
- Operations:—digging, 229; trenching, 230; hoeing, 232; raking, 233; rolling, 234; sawing, 235; clipping, 236; sowing, 243; layering, 272; grafting, 280; inarching, 298; budding, 302; transplanting and planting, 309; potting, 329; pruning, 335; thinning, 349; training, 351; weeding, 378; watering, 382; blanching, 389
- Orache, culture of, 657
- Orange, the use and varieties of, 608; propagation and culture of the Orange family, 610
- Orangery described, and its use, 223
- Organic matter in soils, necessary to fertility, 49
- Orchard, its formation and its situation, 430; select list of fruit-trees for, and the distance apart at which they are to be planted, 431; culture of the soil in the, 433.
- Oxalis Déppeï, culture of, 654
——— crenata, culture of, 655
- Parsley, culture of, 684; use and culture of the Hamburgh, 653
- Parsnep, culture of, 651
- Peach and Nectarine, history of, and general particulars relating to the management of, under glass, 472; construction of the house for, and kinds best adapted for forcing, 474; mode of training and pruning, 475; general treatment of from the commencing of forcing, 476; insects and diseases to which the trees are liable, with modes of prevention and cure, 476; on their culture in pots, 477; course of culture for two years at Stow Hall Gardens, 477; use of, and select list of Peaches arranged in the order of their ripening, 587; select list of Nectarines arranged in the order of their ripening, 588; propagation of, and culture of the young trees, 588; soil and situation best adapted for the trees, 589; mode of pruning and training, 590; management of the borders in which the trees are growing, 592; modes of protecting the trees during winter and spring, 593; diseases and insects to which the trees are liable, with modes of eradication, 594; essential points of Peach culture, 595

- Peach-trees, mode of protecting by canvas coverings, 173
- Pears, uses of, and properties of a good one, 545 ; number of varieties of, and a selection of dessert sorts, arranged in the order of their ripening and keeping, 546 ; a selection of kitchen sorts arranged in the order of their ripening and keeping, 547 ; a selection of sorts for perry, and a selection of the best sorts for small gardens, 548 ; mode of propagation, soil and situation best adapted for, and method of pruning and training the trees, 549 ; select list of, for espaliers, dwarfs, or thinned standards, 428 ; select list of for an orchard, 432 ; beneficial effects of thinning the blossom-buds, 550 ; gathering and keeping the fruit, 551
- Peas, a selection of varieties, and their culture, 631 ; mode of protecting early crops, 633 ; means of destroying vermin by which they are attacked, 634 ; mode of forcing, 521
- Pennyroyal, culture of, 690
- Peppermint, its use and culture, 693
- Peruvian Cherry, culture of, 600
- Pine-apple, history of, and general particulars of its culture, 443 ; mode of culture at Oakhill Gardens, 444 ; construction of pits for the culture of, 445—448 ; sizes of pots used at Oakhill Gardens, 448 ; their growth in beds of soil, 450 ; to cause them to grow to a large size, 451 ; insects which sometimes infest the plants, and modes of destroying them, 452 ; selection of best sorts, 600 ; summary of culture, 601
- Pine-stove described, 223
- Pine and Fir tribe, mode of grafting the, 294
- Piping, in what manner performed, 261
- Pits, their construction and use, 220 ; their usefulness for plant structures, 224
- Plant structures, modes of ventilating, and the necessity of it, 217
- Plantations, object of thinning ornamental, 350
- Planting with the trowel, and in drills, 325 ; temporary mode of, 325 ; different modes of, 326, 327 ; general rules for, 329. See Notes in p. 703 and 704
- Plants, food of, must be reduced into a pulpy mass before being absorbed by them, 3 ; injured by being cut close to the ground in a young state, 3 ; leaves necessary to the growth of, 4 ; require rest, 5 ; means by which they are multiplied, 6 ; light necessary to the growth of, 6 ; classification of, 8 ; the grand classes of the Natural System explained, 9 ; number of genera, species, and varieties of, 10 ; distinguished as evergreen, sub-evergreen, persistent-leaved, deciduous-leaved, ligneous, suffruticose, 17 ; nomenclature of, 19 ; structure of, 20 ; sexes of, 23 ; fruit of, 24 ; functions of, 24 ; growth of described, 26 ; motion of sap in, 31 ; absorb and liberate gases, 33 ; the vigour of seedlings depends on the age of the seed, 37 ; geographical distribution of, 37 ; the important influence of temperature on the distribution of, 38 ; the influence of light on the distribution of, 41 ; the influence of moisture on the distribution of, 41 ; influence of soil on the distribution of, 43 ; stations of, 43 ; habitations of, 45 ; exhalation from the leaves of, 81 ; diseases of, 123 ; props for climbing, 163 ; wicker-work protector for, 171 ; garden labours with, 235 ; leaves of, rooted in powdered charcoal, 269 ; watering, mulching, and staking newly-planted, 328 ; object of growing them in pots, 330 ; drainage necessary to those in pots, 332 ; care of newly-shifted, 333 ; management of hair-rooted kinds, 334 ; modes resorted to for the annual resting of, 399 ; the advantages of resting of, 400 ; packing and transporting, 402 ; the process of cross-breeding for raising new varieties from seed, 406 ; precautions to be observed to prevent the promiscuous fecundation of, 406 ; modes of perpetuating, 407 ; duration of, 408
- Plants and animals, analogy between, 2
- Plum, its use, and a selection of dessert sorts arranged in the order of their ripening, 558 ; selection of sorts for a small garden, and the general management of the trees, 559 ; gathering, keeping, and packing the fruit, 560 ; select list of for espaliers, dwarfs, or trained standards, 428 ; select list of for an orchard, 433 ; a few remarks on forcing the, 487
- Pomegranate, culture of, 599
- Potato, selection of varieties, and their culture, 639 ; Lancashire practice of planting, 642 ; modes of obtaining young ones during the winter, 643 ; taking up and preserving the crop, 645 ; particulars of the mode of forcing, 519. See Notes in p. 714
- Potting, its object and mode of performance, 330, 331 ; time and season for, 334 ; importance of using rough turfy soil mixed with stones, &c. 616 and 706
- Propagation, principles of, 239 ; by seed, 240 ; by cuttings, 249 ; by joints and

- nodules, 264 ; by bulbs, tubers, and tubercles, 266 ; by bulb-bearing leaves, 266 ; by leaves, 266 ; by cuttings, 270 ; by layers, 272 ; by suckers, 277 ; by slips, 278 ; by runners, 279 ; by offsets, 279 ; by division of the root, 280 ; by grafting, 280 ; by inarching, 297 ; by budding, 300
 Props for climbing-plants, 163 ; to increase the durability of wooden, 164
 Protection, articles for, 158 ; materials used for, 390
 Pruning, principles and use of, 336 ; close pruning explained, 338 ; shortening-in, fore-shortening, spurring-in, 339 ; heading-in, close-lopping, lopping, snag-lopping, lopping-in, 340 ; cutting down, stopping the shoots, 341 ; disbarking, ringing, 342 ; disbudding, disleafing, 343 ; clipping, root-pruning, 345 ; seasons for, 348. See Notes in p. 704—706.
 Pumpkin, or Pompion, use and varieties of, 604 ; culture of, 605
 Purslane, culture of, 685
 Quadrupeds, a notice of the smaller, injurious to gardens, 120 ; means of destroying and deterring them, 121
 Quince, general particulars of its culture and management, 551
 Radish, selection of varieties and their culture, 653 ; mode of forcing, 522
 Raking, its object and mode of performance, 233
 Rampion, culture of, 672
 Raspberries, select list of, 430
 Raspberry, uses of, and a select list of sorts, 567 ; propagation and culture of, 568
 Reed walls, mode of constructing, 183
 Rhubarb, propagation and culture of, and a selection of the best varieties, 688 ; particulars of the mode of forcing, 518 ; medicinal, mode of preparing, 693
 Ringing, its effects on fruit-trees, 342
 Rocamboles, culture of, 664
 Rogers's conical boiler and hot-water apparatus described, 208 ; best fuel for, 211 ; subsequent improvements in, 700
 Rolling, its object, 234
 Roots, propagation by cuttings of, 262 ; root-grafting, how performed, 293—295 ; pruning, its beneficial effects in checking luxuriant growth, 345
 Roots, substitutes for esculent, 655
 Rosemary, culture of, 693
 Rubus, various species which may be cultivated for their fruit, 569
 Rue, its use, &c., 694
 Runners, propagation by, 279
 Sage, culture of, 690
 Salads, mode of forcing, 521
 Salsify, culture of, 652
 Samphire, its use and culture, 689
 Sap, motion of in plants, 31
 Savory, culture of, 691
 Savoy, culture of, 623
 Sawing, mode of performance of, 235
 Scorzonera, culture of, 652
 Sea-kale, particulars of the mode of forcing, 517 ; its propagation and culture, 668
 Seedling plants, time and method of transplanting, 310
 Seed, what is necessary to the germination of, 25 ; process of germination in, 240 ; to cause them to germinate quickly, 241 ; the period necessary for the germination of various sorts of, 242 ; the quantity of moisture most favourable to the germination of, 242 ; depth to which it should be buried to cause it to germinate, 243 ; degree of heat most favourable to the germination of, 243 ; atmospheric air necessary to the germination of, 244 ; to accelerate the germination of, 244 ; vitality of, 246 ; season for sowing, 247 ; process of sowing, 248 ; quantity required for a kitchen-garden of one and a quarter acre, 435
 Seeds, what they consist of, and their vitality, 36 ; packing and transporting, 402
 Seed-room, its construction, 225
 Service, its culture and management, 552
 Shaddock, see Orange
 Shading, the object of, and materials used for, 390

- Shallot, culture of, 664
 Sheds, their use for various purposes, 226
 Shelter, the means to produce, 84
 Shield-budding, different modes of, and how performed, 303
 Shrubs, distinguishing character of, 18
 Side-grafting, how performed, 292
 Skirret, use and culture of, 652
 Slips, propagation by, 278
 Slugs and snails, natural history of, 96; to destroy them, 98
 Small salads, plants used for, 682
 Soil, the influence of, on the distribution of plants, 42; peat, 49, 57; object of labours on the, 227; necessity of pulverizing, during dry weather, 228; the advantage of frequently stirring it, 388. See Notes in p. 707 and 709.
 Soils, considered with reference to horticulture, 45; origin and kinds of, 46; sandy, 46; gravelly, clay, 47; on the inclination of the surface of, 50; varieties of, indicated by the plants which grow on them, 50; improvement of, 51; altering the texture and composition of, 51; burning of, as a means of improving, 53; pulverizing of, necessary to their improvement, 54
 Sorrel, culture of, 658
 Spinach, culture of the common, 656; culture of the New Zealand and perennial, 657; culture of the Patience, 658
 Splice or whip-grafting, how performed, 288
 Strawberry, history of, and the practice of forcing it, with a list of the sorts best adapted for the purpose, 514; time of beginning to force, and treatment of the plants after forcing, 515; culture of the Alpine, 516; use of, and a selection of the best sorts, 570; a selection of sorts in the order of their ripening, and one for a small garden, with their propagation and culture, 572; culture of particular kinds, 575; methods of accelerating a crop of fruit in the open garden, 576
 Structures, portable, 171
 Subsoils, importance of good, 50
 Succory, culture of, 676
 Suckers, propagation by, 277
 Syringe, Read's garden, 154
 Scythes and sharp-edged implements, to keep from rusting, 129

 Tallies and labels, different forms of, 164; best method of painting and lettering, 167
 Tansy, culture of, 691
 Tarragon, its use and culture, 685
 Temperature, its important influence on the distribution of plants, 38
 Thalamifidæ, orders belonging to, 11
 Thermometers, their uses explained, 169
 Thyme, culture of, 690
 Timber-trees, girdling and felling, 347; machine for girdling, 347
 Toads, their usefulness in destroying insects injurious to gardens, 94
 Tobacco, its propagation and culture, 694; mode of curing for garden purposes, 695
 Tomato, use and culture of, 606
 Tools used in horticulture, 129; common lever, crowbar, perforators, 130; dibbers, picks, draw-hoes, 131; Spanish hoes, lawn-scraper, thrust-hoes, spades, 132; turf-spades, verge-cutters, trowels, and spud, 134; daisy-weeder, transplanters, dung and tan forks, digging-forks, 135; rakes, besoms, beetles, and rammers, 136; mallet, hammer, garden pincers, 137; and instruments, chests of, where procured, 141
 Tool-house described, 226
 Training, the principles and operation of, 352; instruments required for, 376; comparative view of the different modes of, 376. See note in p. 711
 Transplanting, uses and theory of, 309; mode of preparing trees for, 312. See p. 702.
 Trees, injured by being planted deeply, 4; distinguishing character of, 17
 — and shrubs, propagation by cuttings of deciduous, 260; propagation by cuttings of evergreen, 260; mode of layering, 273; the time to transplant deciduous, 311; different modes of transplanting, 312; on transporting and replanting, 314; on the treatment of, after transplanting, 317; on supporting and protecting newly-planted, 318
 Trellises and lattice-work for fruit-trees and climbers, 186
 Trenching, its object and mode of performance, 230

- Tropæolum tuberosum*, culture of, 655
 Truffle, where to be found, and by what means, 692
 Turnip, selection of varieties, and their culture, 647
 ——— Cabbage, culture of, 627
- Utensils used in horticulture: garden-pots, 142; blanching-pot, 143; water-saucers, 144; plant-boxes, 145; watering-pot, 146; sieves, 147; pot-carriers, baskets, 148; bell-glasses, hand-glasses, 152; powdering-boxes, 153; various others, 153.
- Varieties, duration of, 408; new varieties of herbaceous plants, 409. See Notes in p. 709
 Vegetable culture, what necessary in, 5
 Vegetables, improvement of by cultivation, 404
 ——— culinary:—systematically arranged according to their natural orders, 616; number of genera of, which may be cultivated in British gardens, 619; horticulturally arranged, 619; propagation, and seed, saving of, 620; general remarks on their culture, and soils best adapted for, 621; times of sowing and planting culinary, 438; gathering and preserving, 401
 Vegetable marrow, see Gourd
 Vegetation, stimulants to, 245; modes of accelerating, 391; modes of retarding, 395
 Vermin, necessity of destroying those injurious to gardens, 93
 Vines, propagation of by joints, 265; objections to depriving a vine of a portion of its leaves when the fruit is ripening, 709; causes of a deficiency of colour in the fruit, 709; the vine when forced not calculated to sustain uninjured a temperature below 40°, 709 *See Grape & Vine.*
- Walls, their use in gardens, 176; direction and best materials for, 177; height of, 178; copings of, mode of fixing temporary rafters to, 179; construction of, 180; trellised, colouring the surface of, flued, 181; conservatory, 183; reed as a substitute for brick, 183
 Wall-trees, to protect, 74; articles required for training, 167
 Walnut, use of, and management of the trees, 578; leaves, useful for destroying worms, 696
 Wasp and fly traps, 111
 Water, the presence of, increases the tendency to spring and autumn frosts, 75; its importance in cultivation, 382; comparative effects of spring and pond, 383; application of to plants, 385. See Notes in p. 703, 704
 Watering-barrow for strawberries, 384
 — pots, 146
 Water-cress, culture of, 682
 Wedge-grafting, how performed, 292
 Weeding, and implements for, 238, 381
 Wicker-work hurdles for sheltering plants, 163
 Wormwood, its use, &c., 694
- Young gardeners, advice with reference to their improvement by reading, writing, drawing, &c., during the long winter evenings, 720.

THE END.

LONDON:

BRADBURY AND EVANS, PRINTERS, WHITEFRIARS.

The following ERRATA occur in only a Part of the Impression.

- Page 1, line 17, from the top, for "The two last," read "The last two."
— 14, — 25, for "Bignonicææ," read "Bignoniaceæ," and for "Cobæacææ," read "Cobæaceæ."
— 15, — 33, for "uniform," read "ensiform."
— 15, — 45, for "seldom if ever branched," read "very seldom branched."
— 16, — 5, for "Alisimacææ," read "Alismacææ."
— 16, — 44, for "plants," read "plant."
— 16, — 45, for "species or orders," read "species, or orders."
— 55, — 42, for "Pulveriziæg," read "Pulverising."
— 61, — 13, for "(200)," read "(201)."
— 66, — 20, for "over-croppings," read "over-cropping."
— 67, — 9, for "the latter two," read "the two latter."
— 76, — 13, for "those clouds," read "clouds formed."
— 77, — 8, for "between then ; it is," read "between them. It is."
— 98, — 22, for "weazel being their natural enemies," read "weazels, being their natural enemies."
— 107 — 18 for "great flocks," read "large flocks."
— 128, heading, for "construction and use," read "construction and uses."
— 145, line 3, for "by a common saucer," read "for a common saucer."
— 165, — 41, for "paint," read "part."
— 167, — 4, for "boiling," read "boiled."
— 169, — 18, for "plants," read "planks."
— 174, — 19, for "hoops," read "hooks."
— 178, — 31, for "south and north," read "east and west."
— 179, — 20, for "or row," read "a row."
— 192, — 14, for "vol. xx," read vol. xv."
— 193, — 24, for "greater," read "heavier."
— 221, — 12, for "may be served," read "may be preserved."
— 224, — 47, for "be forced," read "are forced."
— 225, — 41, for "beach," read "beech."
— 234, — 1, for "whence," read "which."
— 235, — 40, for "the operation," read "this result."
— 241, — 33, for "caryopsi," read "caryopses."
— 255, — 27, for "(D. diòica, formòsa and umbellàta)," read "(D. diòica, formosa, and umbellata)."
— 289, — 34, for "b," read "a."
— 289, — 35, for "c," read "b."
— 293, — 28, for "peas," read "pears."
— 327, — 48, for "requiring," read "acquiring."
— 353, — 16, for "backs," read "bricks."
— 369, — 21, for "proved," read "approved."
— 369, — 47, for "left-hand," read "right-hand."
— 369, — 50, for "right-hand," read "left-hand."
— 395, — 33, for "are preserved," read "is prolonged."
— 396, — 4, for "coal-cellar," read "cold cellar."
— 396, — 26, for "lower," read "low."

- Page 404, — 4, for "its reach," read "his reach."
 — 405, — 3, for "were placed," read "was placed."
 — 413, — 18, for "are wanted," read "is wanted."
 — 422, — 35, first column, for "Beurré Rance," read "Beurré de Ranz."
 — 423, — 3, — — for "Grisley Frontignac," read "Grizzly Frontignan."
 — 432, — 47, — — for "Alfriston," read "Alfreton."
 — 432, — 30, second column, for "Beurré Rance," read "Beurré de Ranz."
 — 433, — 5, — — for "Jackworth Impératrice," read "Ickworth Impératrice."
 — 433, — 10, — — for "Drapée Rouge," read "Diaprée Rouge."
 — 443, — 27, for "lowest," read "coldest."
 — 446, — 2, for "three," read "twenty."
 — 460, — 45, for "Cease," read "Ceased."
 — 463, — 41, for "Grisley Frontignan," read "Grizzly Frontignan."
 — 470, — 46, for "shoot," read "arm."
 — 486, — 48, for "curb," read "kerb."
 — 487, — 41, for "Cucumis," read "Cùcumis."
 — 512, — 36, for "paradisàca," read "sapiéntum."
 — 512, — 41, for "Mùsa p. Cavendishii," read "Mùsa s. Cavendishii."
 — 512, — 42, for "M. p. dácca," read "M. s. dácca."
 — 513, — 1, for "Mùsa p. dácca," read "Mùsa s. dácca."
 — 513, — 6, for "M. p. Cavendishii," read "M. s. Cavendishii."
 — 527, — 2, for "Cucumis," read "Cùcumis."
 — 557, — 10, for "diances," read "distances."
 — 582, — 5, for "fruit," read "tomato."
 — 585, — 20, for "(0000)" read "(956)."
 — 589, — 35, for "mirabolan," read "myrobalan."
 — 626, — 41, for "Tartarian, approaches," read "Tartarian, which approaches."
 — 656, — 3, for "rush nut, and some others," read "rush nut, 'Arum maculatum, and some others."
 — 684, — 38, for "parsley," read "parsnep."

The following Notes ought to have appeared in p. 699 and 706.

268 in p. 85. "Why motion of heated air should, when uniformly heated with the body, give relief, is not so plain." p. 85. Evaporation goes on more rapidly when the air is in brisk motion than is the case when it is still; and evaporation produces cold: hence, although a still, and a brisk air may be of the same temperature, yet they produce a very different effect, as indicated by the sensations; a brisk motion causing rapid evaporation, and occasioning a proportionably greater degree of cold on the surface, than is the case when evaporation goes on slowly in a still atmosphere.—N.

859 in p. 402. The eggs of insects, and seeds of weeds, in soil which is to be used for potting plants, are effectually destroyed by kiln-drying; which is more especially necessary when the surface of pasture or meadow land is used. Turf from a loamy soil, kiln-dried, chopped up and mixed with thoroughly rotted dung, with the addition of a few stones, smaller or larger according to the size of the pots to be used, will grow well almost every kind of plant, except some of the more delicate of the hair-rooted kinds.—R.

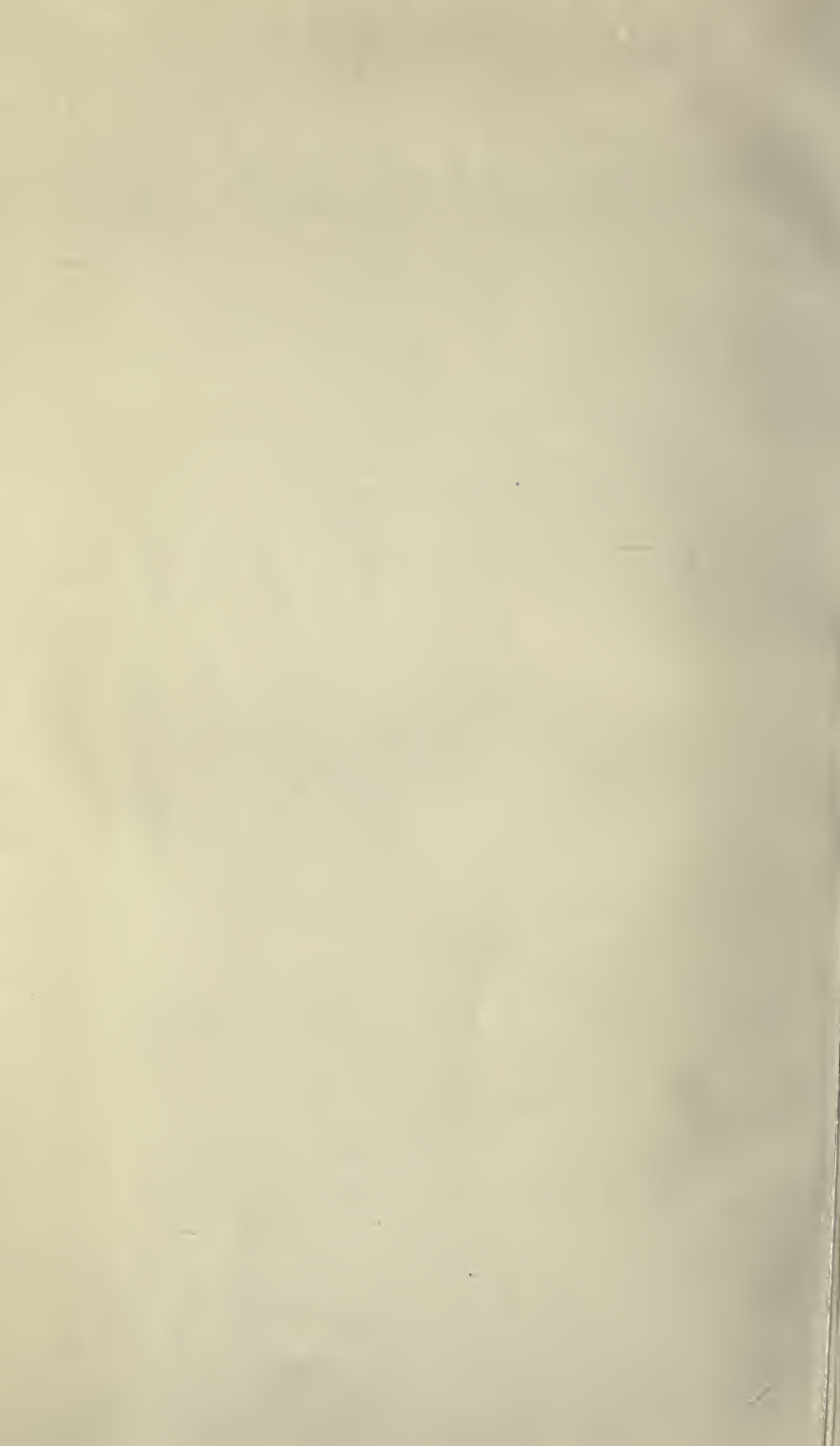

L6

J. C. Loudon

Suburban Horticulturist

5898
L6

4289

~~LIBRARY BRANCH OF THE COLLEGE OF AGRICULTURE~~

