



營造法式

卷二十九

總例圖樣

園方方園圖

壕寨制度圖樣

景表版等第一

水平真尺第二

卷二十九

宋 李誠 撰

石作制度圖樣

柱礎角石等第一

踏道螭首第二

殿內闕八第三

鉤闌門砧第四

流盃渠第五

圓方圖

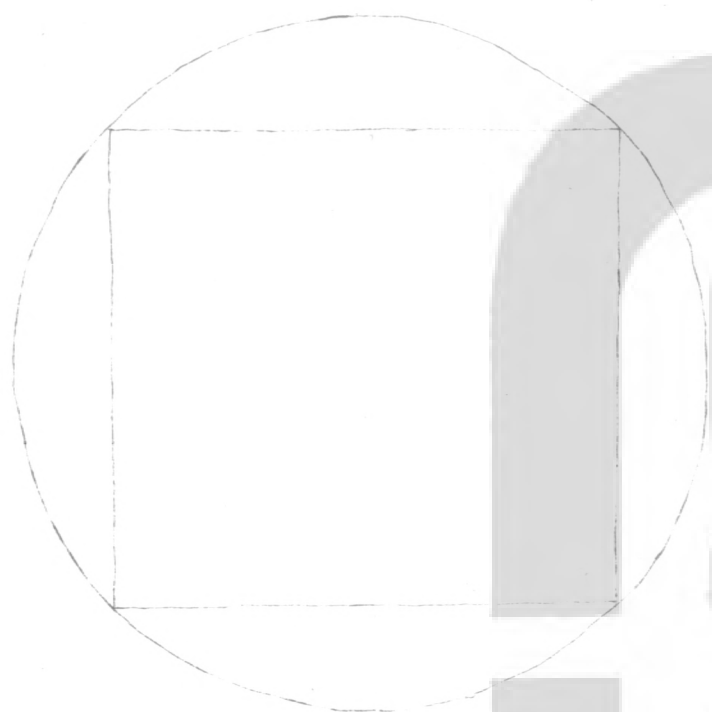

方圓圖

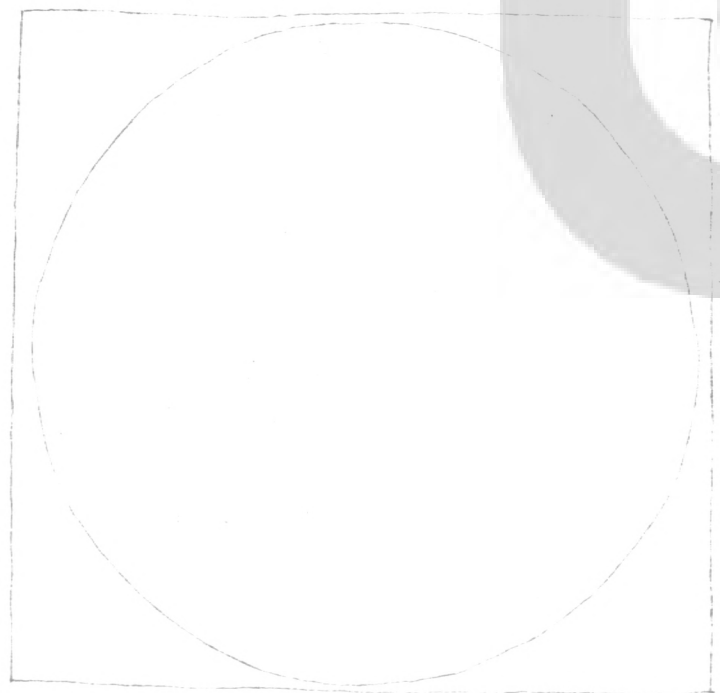

水池景表

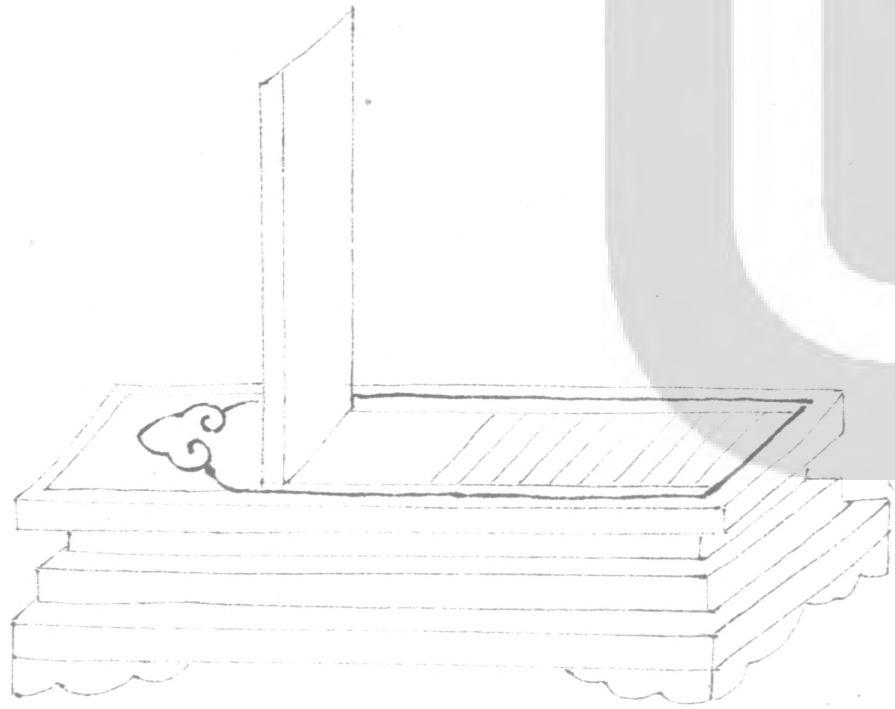

景表版

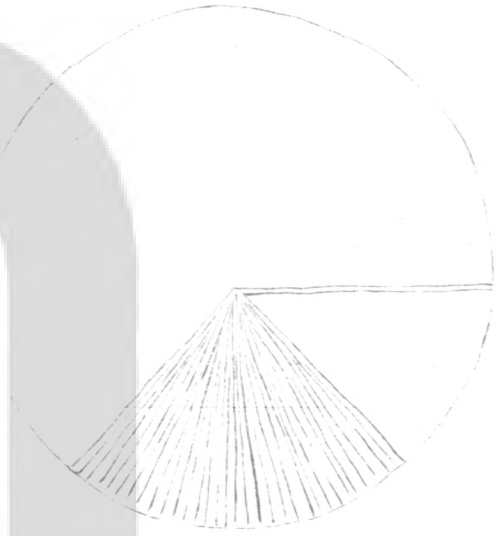

望筒

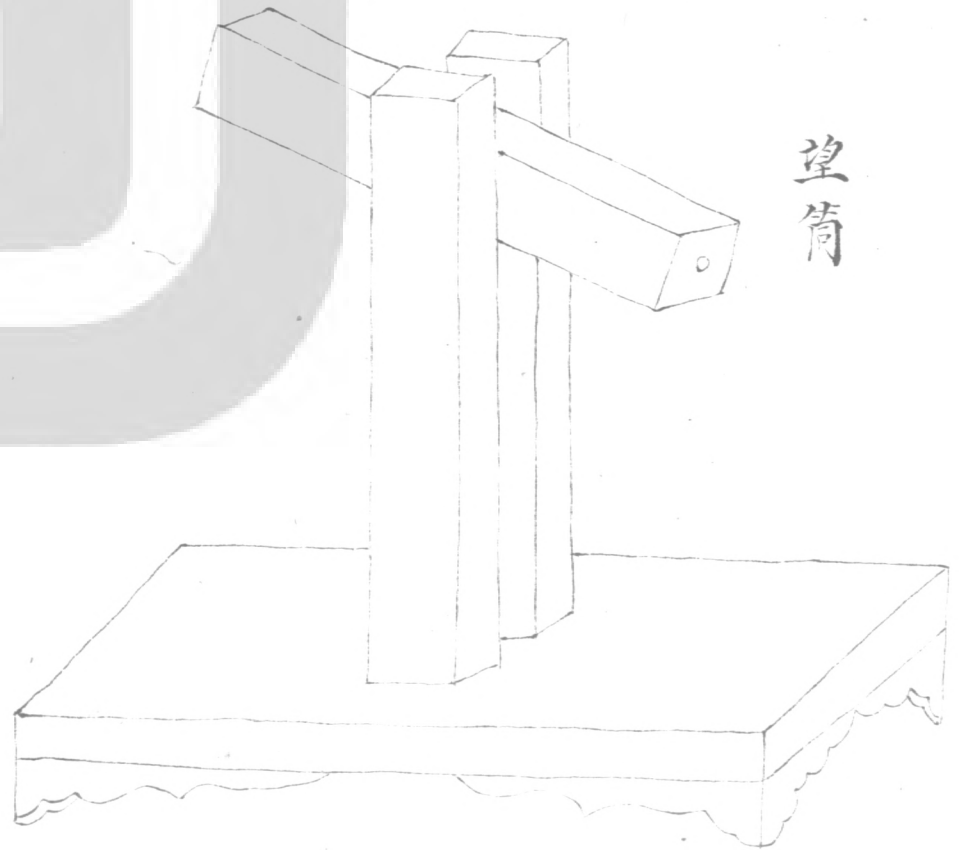

真尺

水平

卷二十九

四

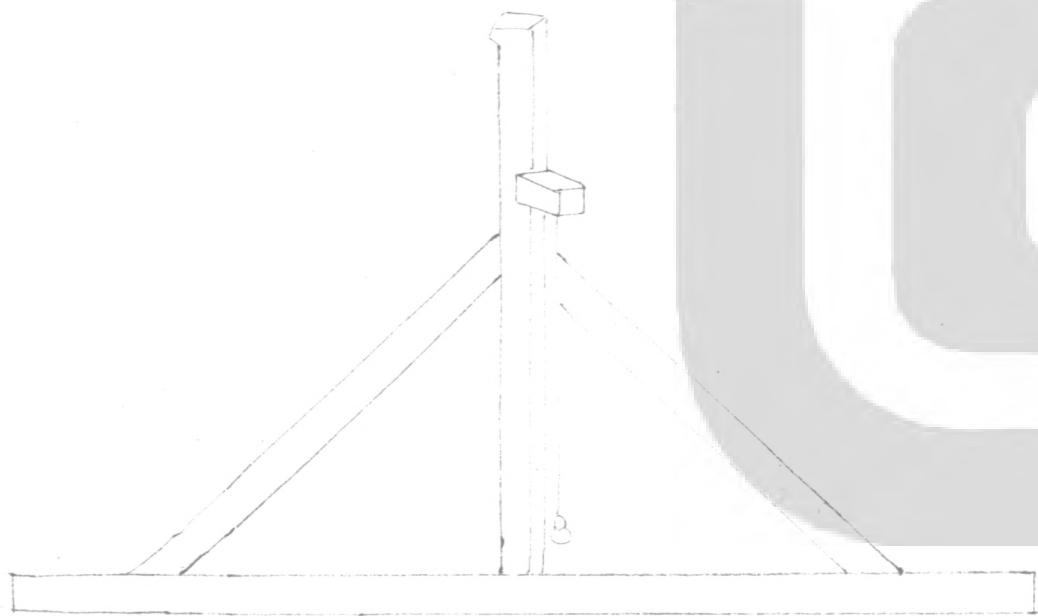

柱礎

別地  
起  
海石榴華

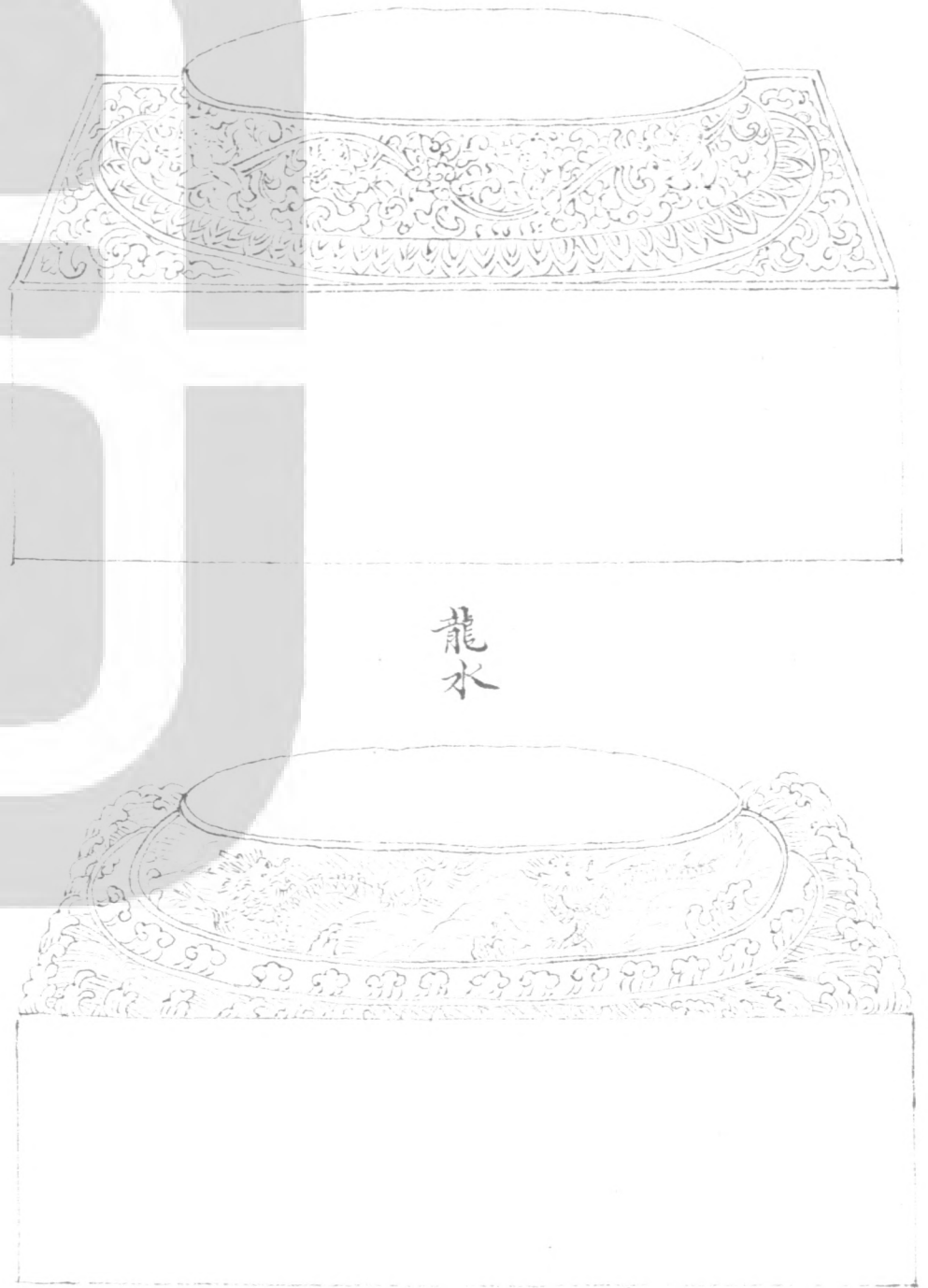

壓地  
隱起  
牡丹華

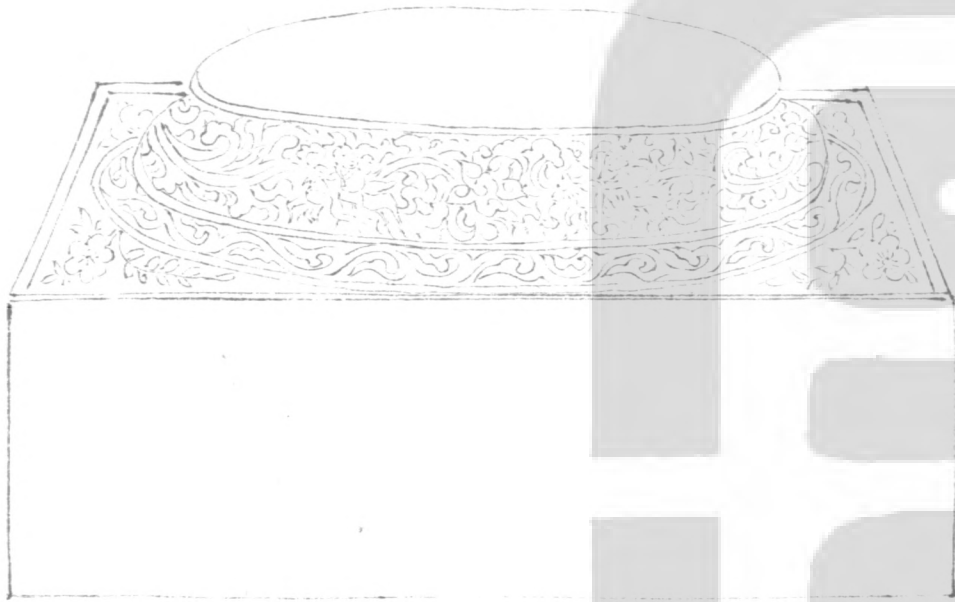

寶相華

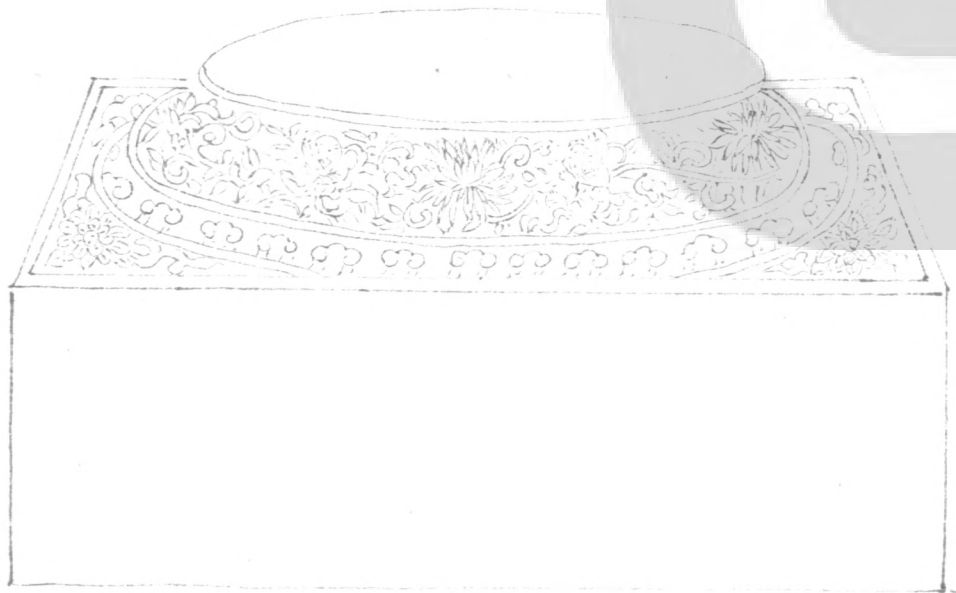

龍水

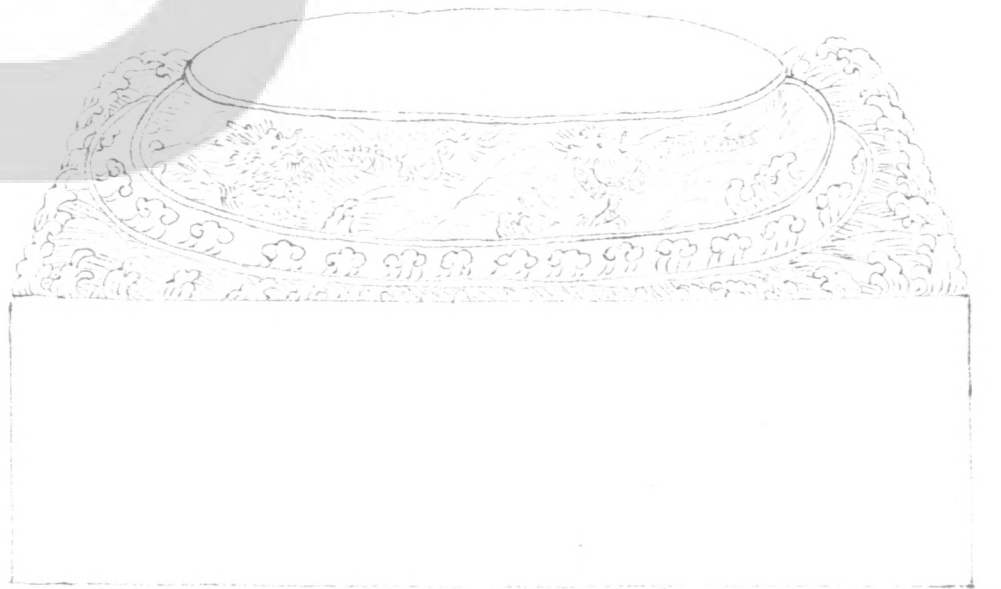

鋪地蓮華

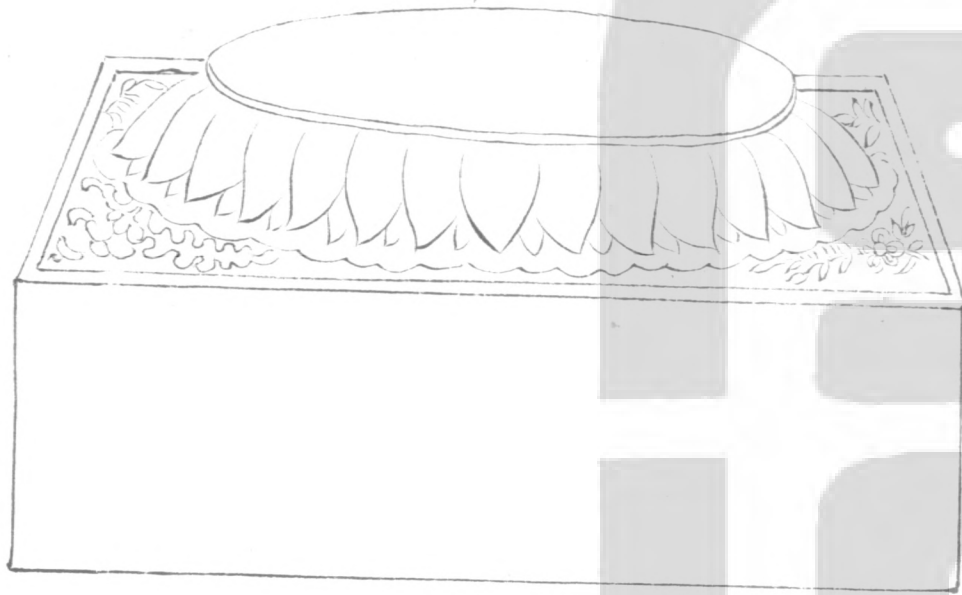

仰覆蓮華

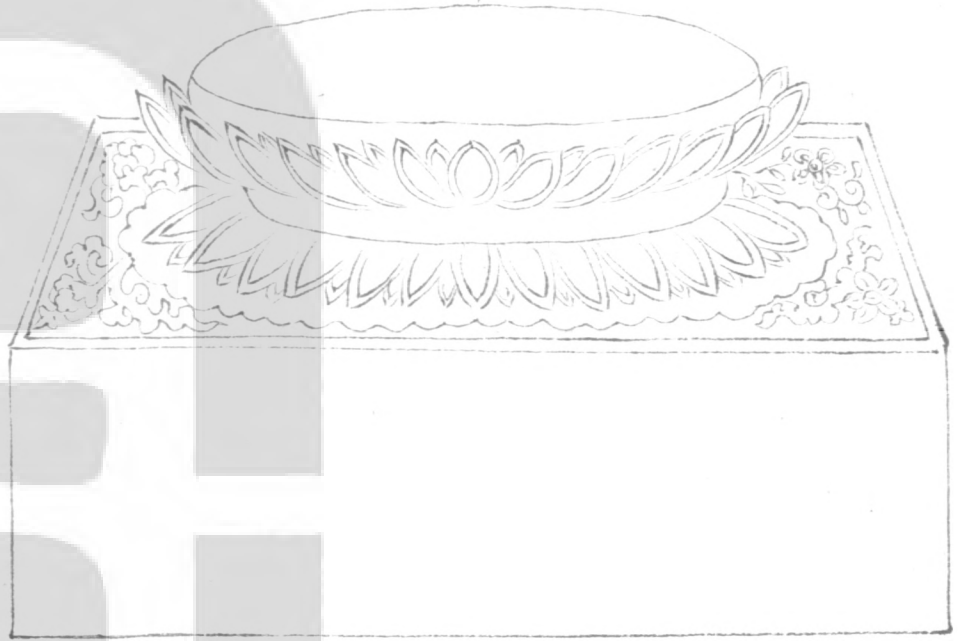

減地平銀華

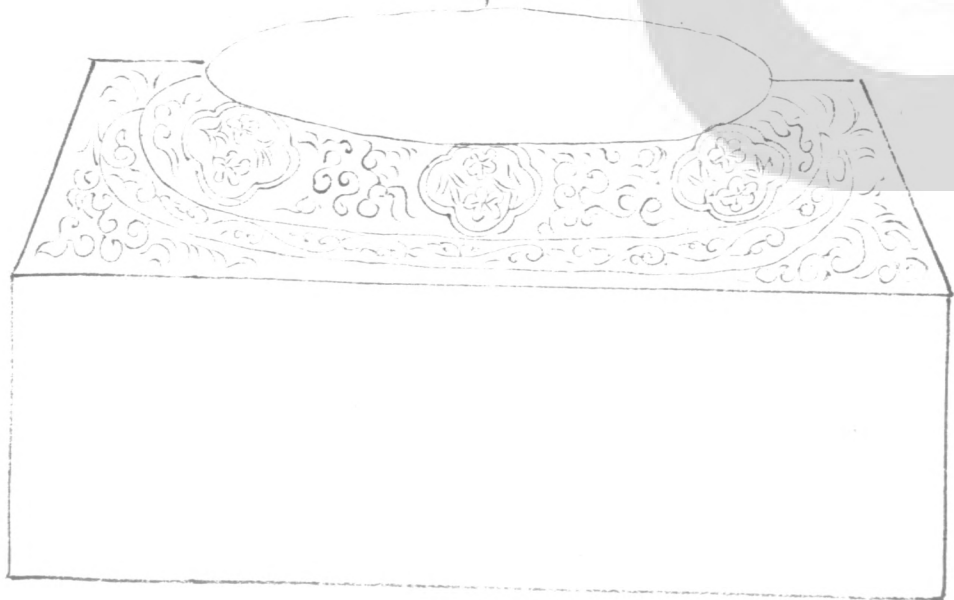

寶蓮華

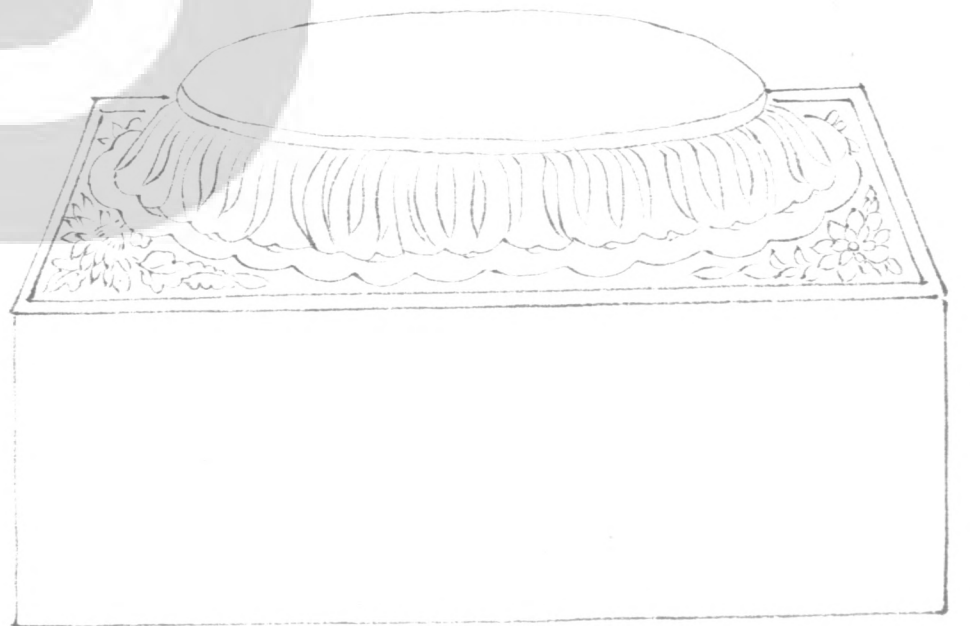

角石

剔地起突雲龍

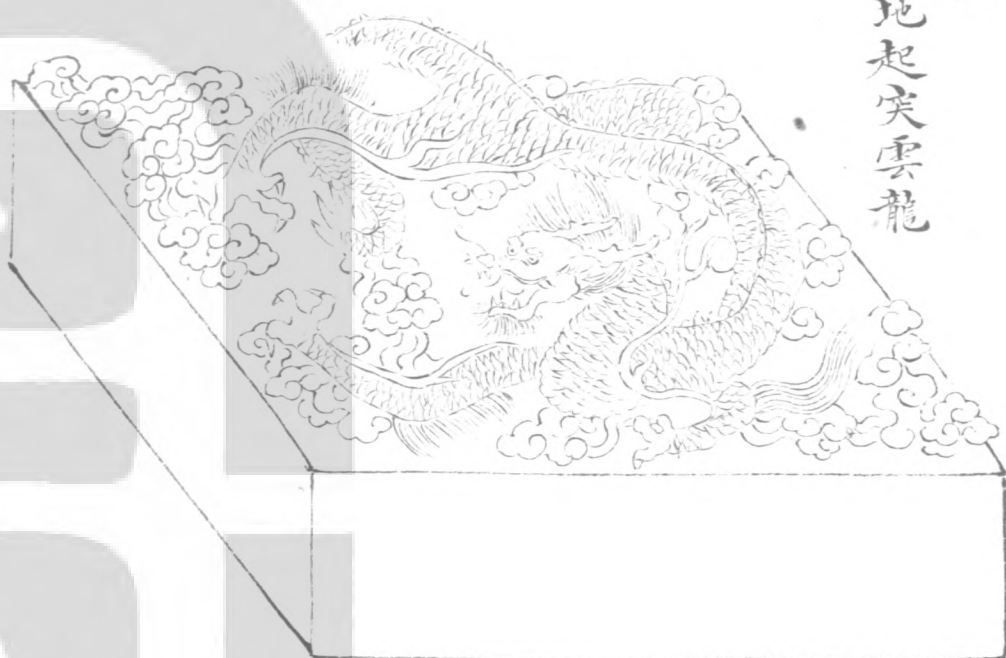

盤鳳

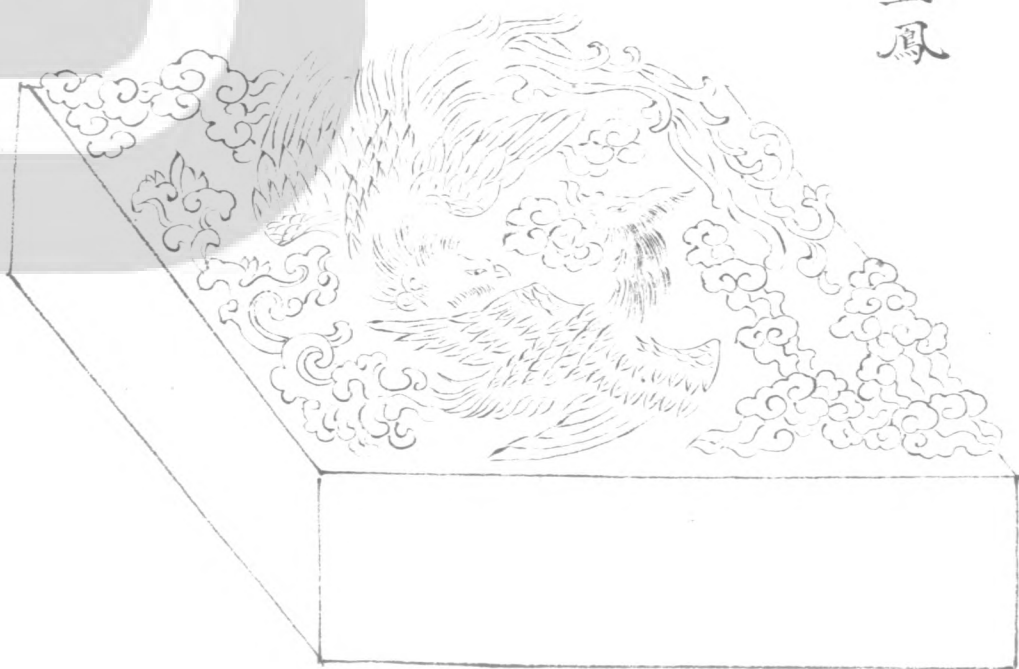

剔地起突獅子

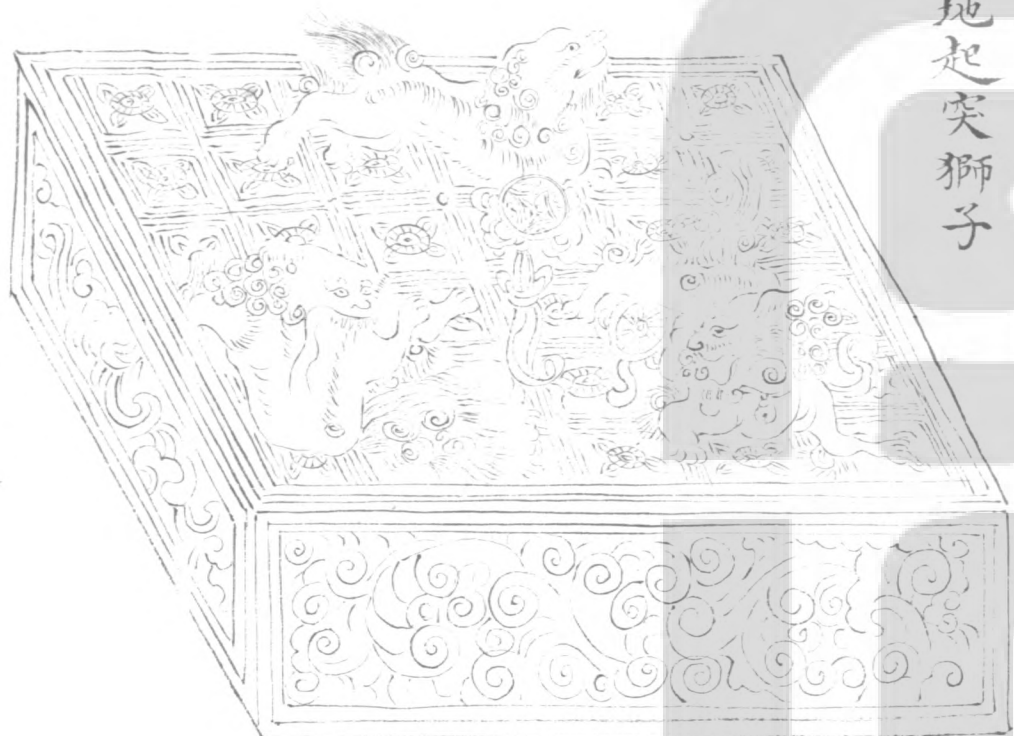

壓地隱起海石榴華

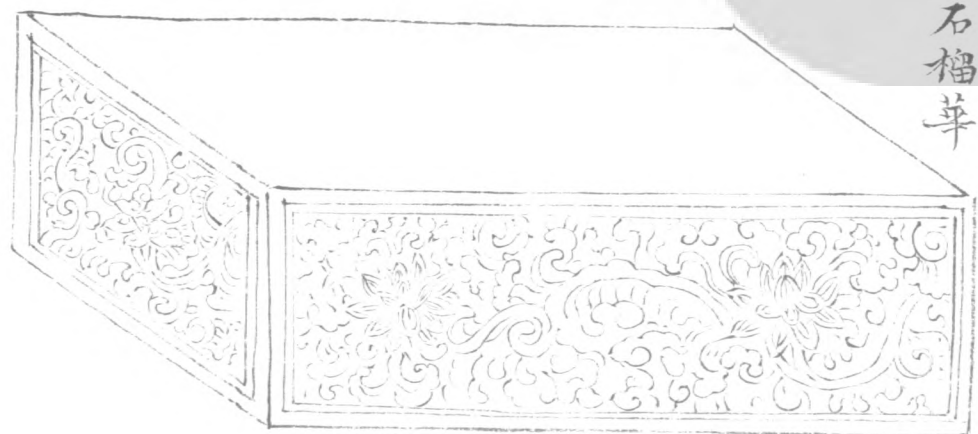



階基疊澁坐角柱

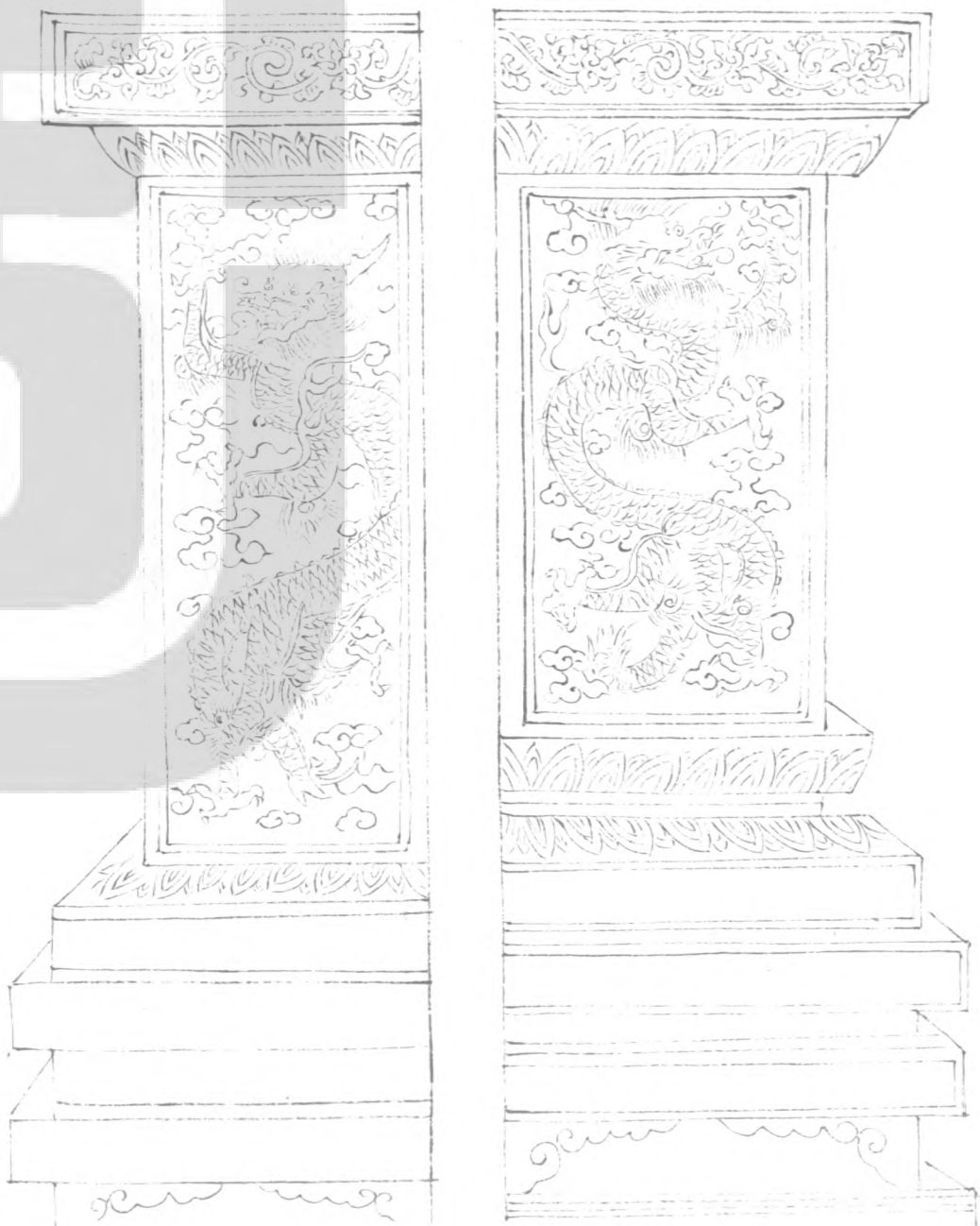

角柱

引地起突雲龍

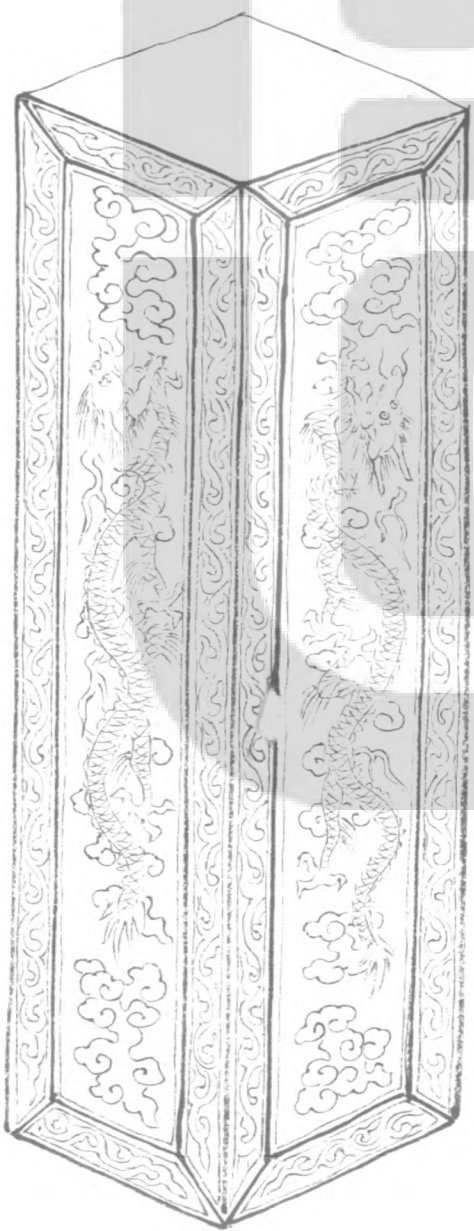

壓地隱起華



壓闌石

剔地起突華



壓地隱起華



踏道

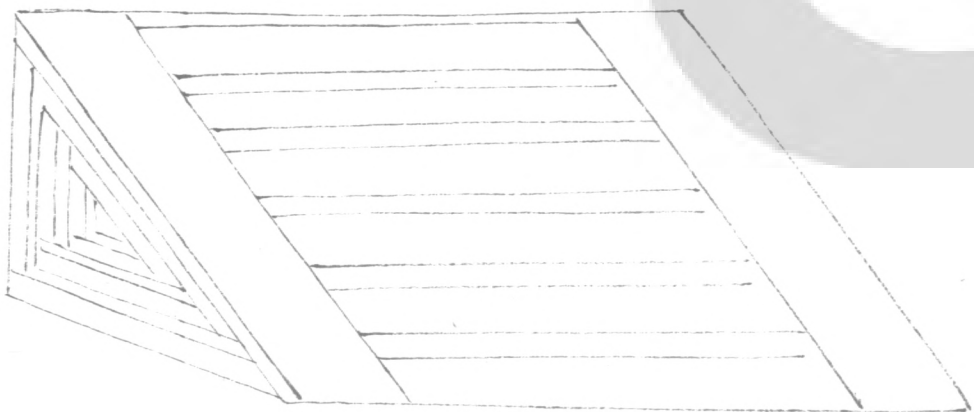

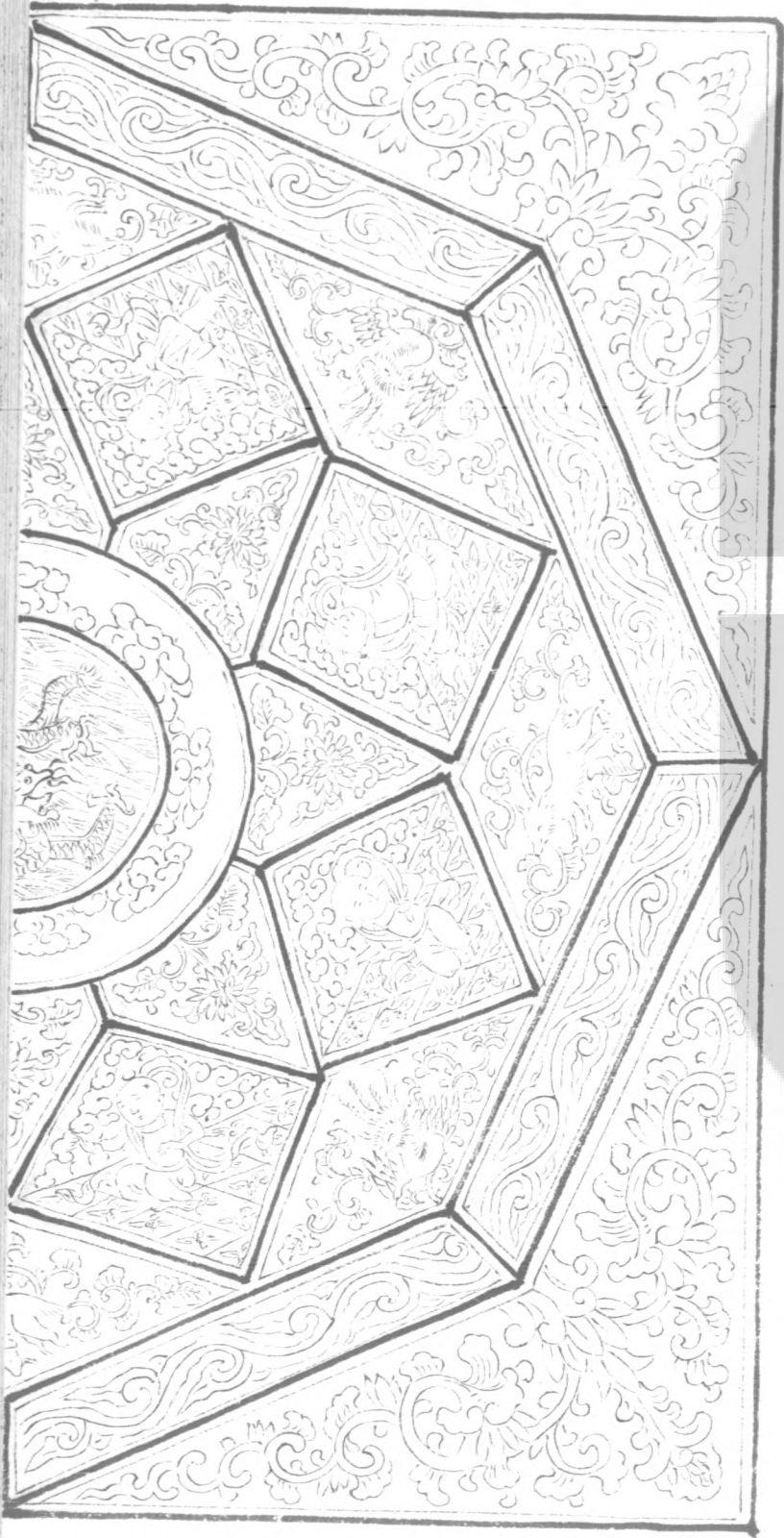

殿堂內地面心圖八

螭首



重臺鉤欄

卷二十九

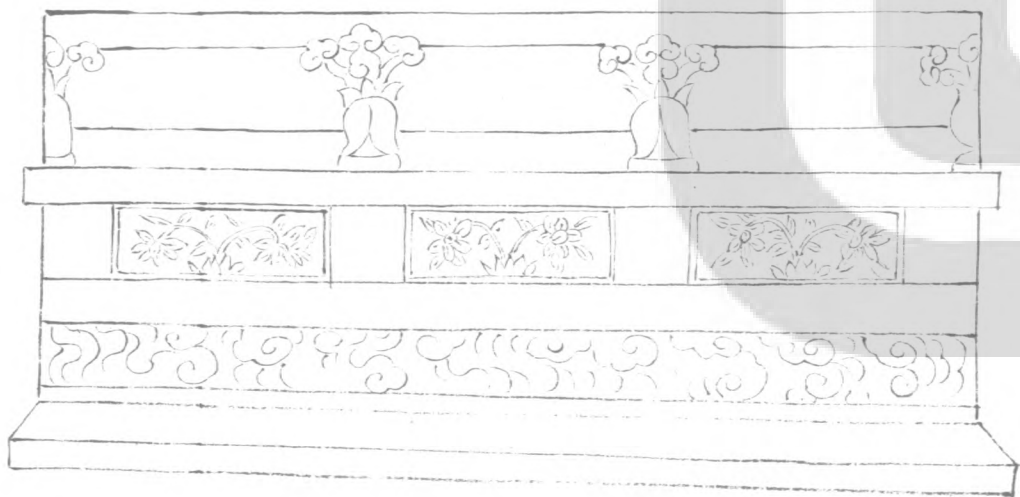

上

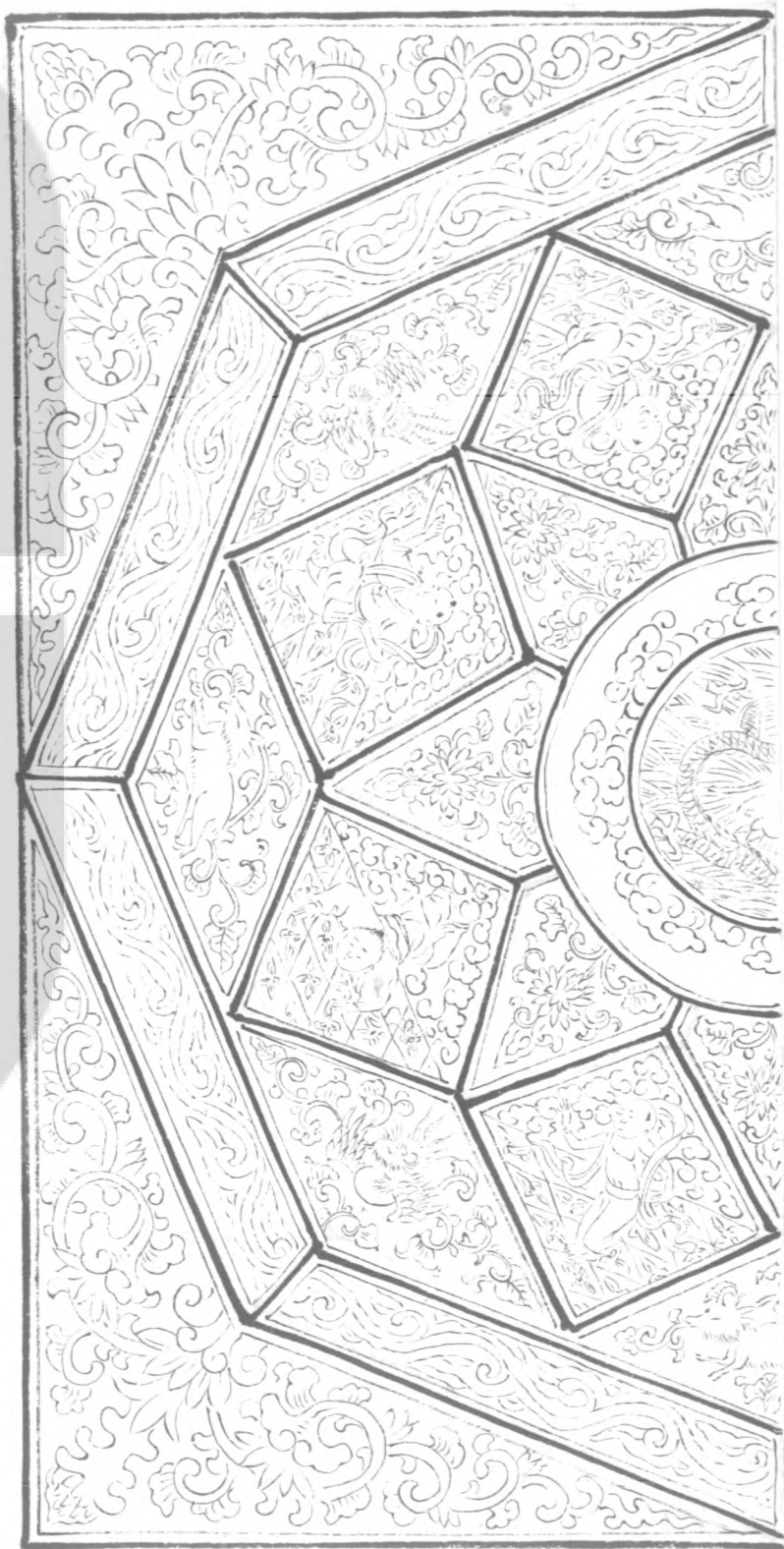

單鉤闌

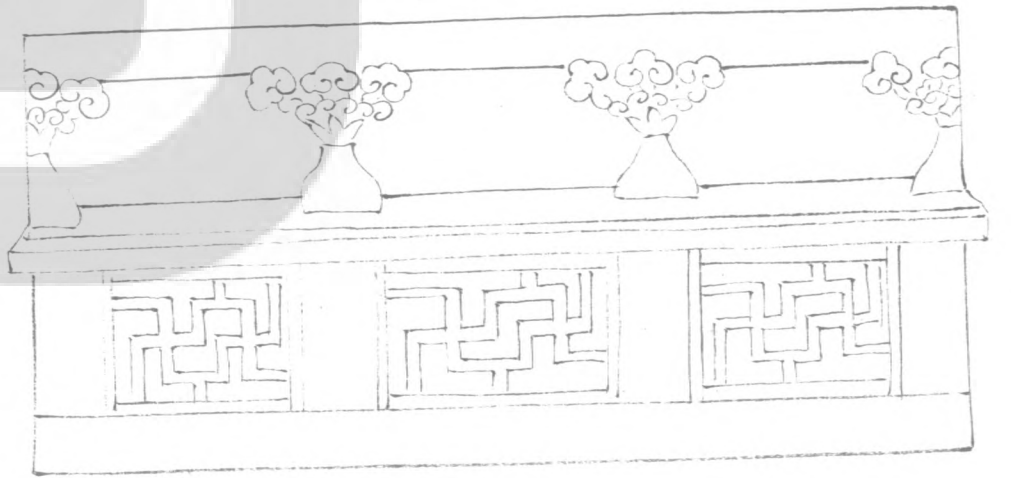

望柱

減地平銀華



別地起突  
纏柱雲龍



壓地隱起華



門  
砧

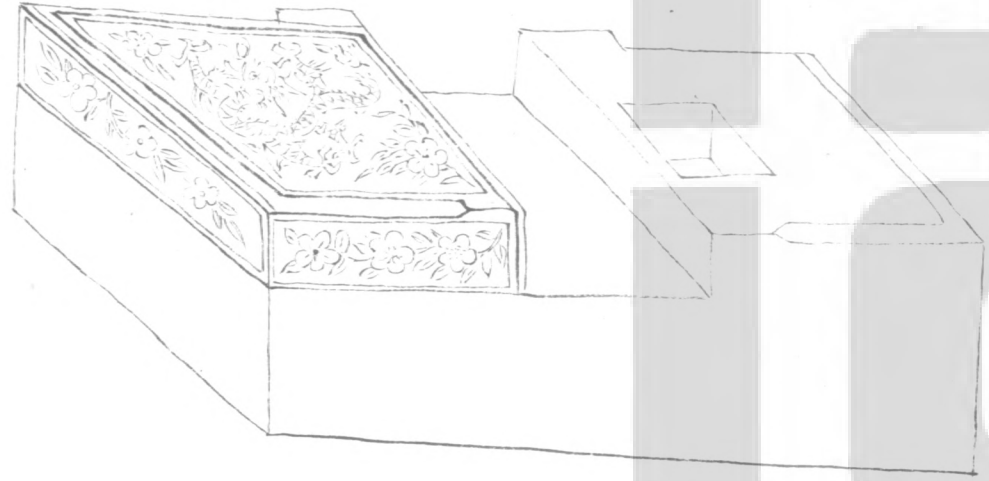

望  
柱  
頭  
獅  
子



卷  
二  
十  
九

十  
三

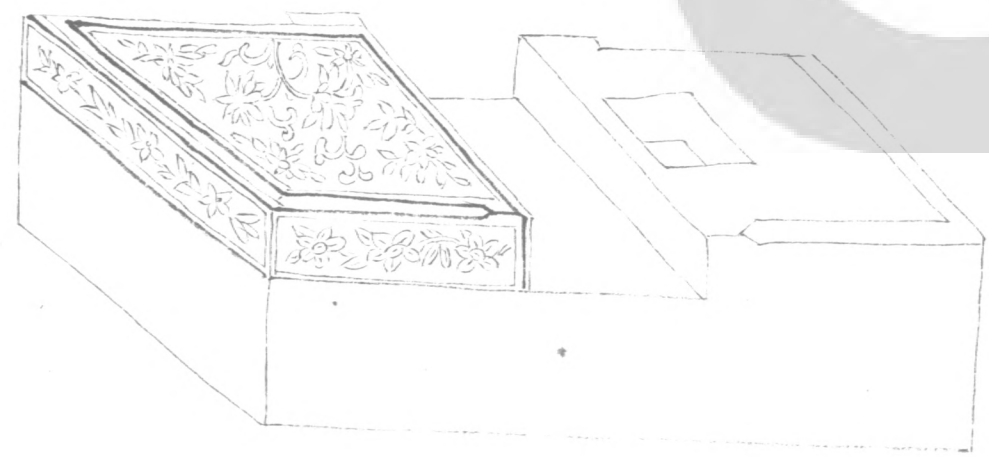

望  
柱  
下  
座

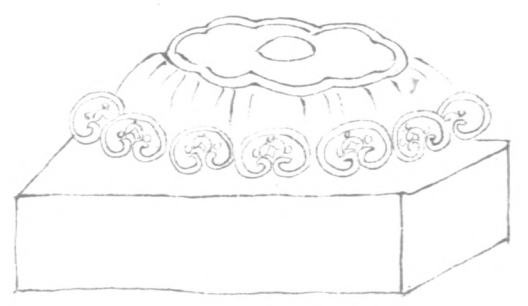
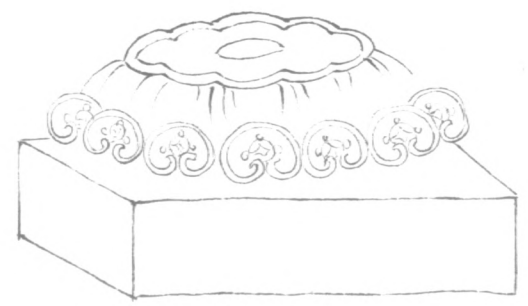

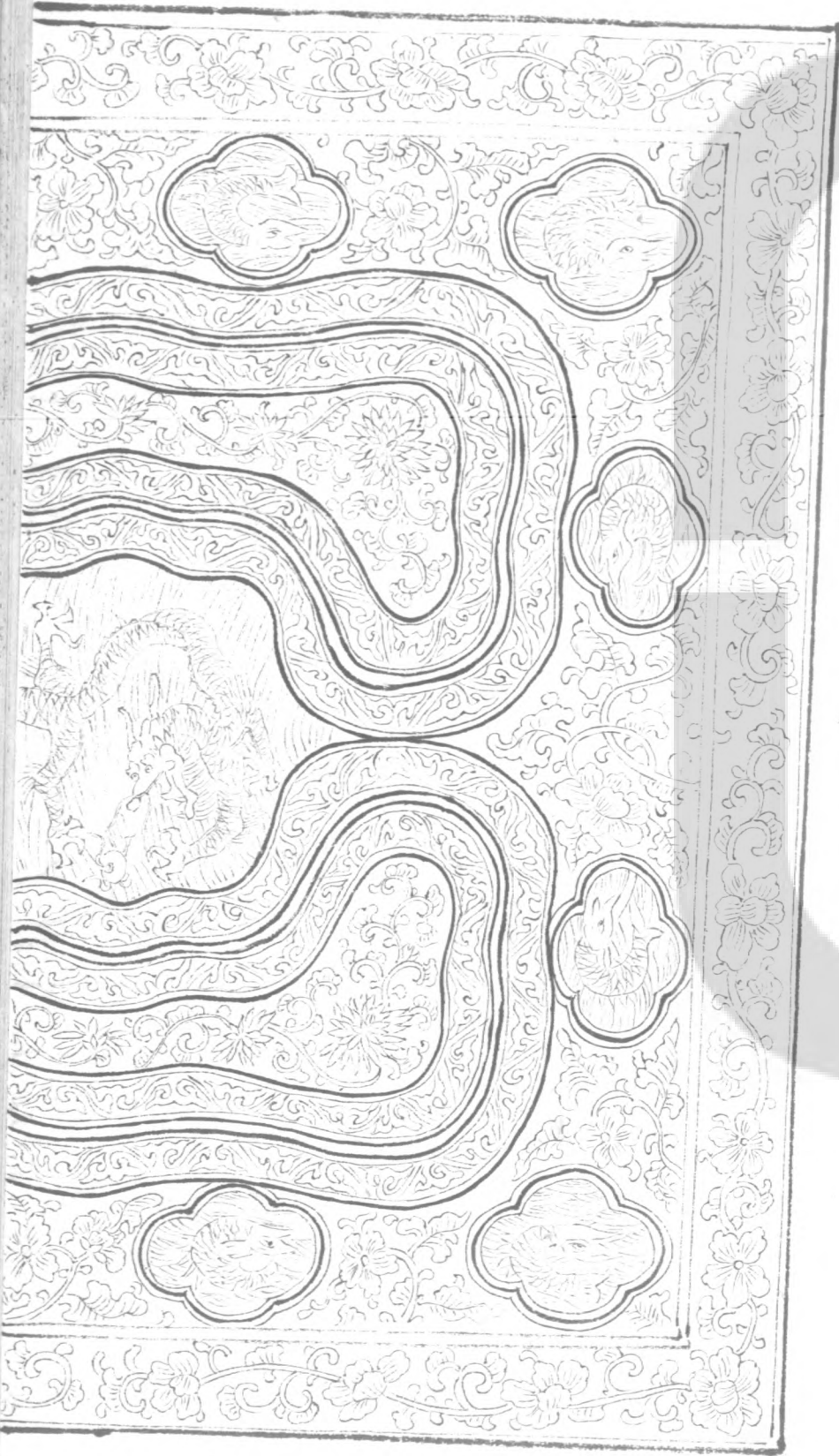

國字流盃渠

地袱

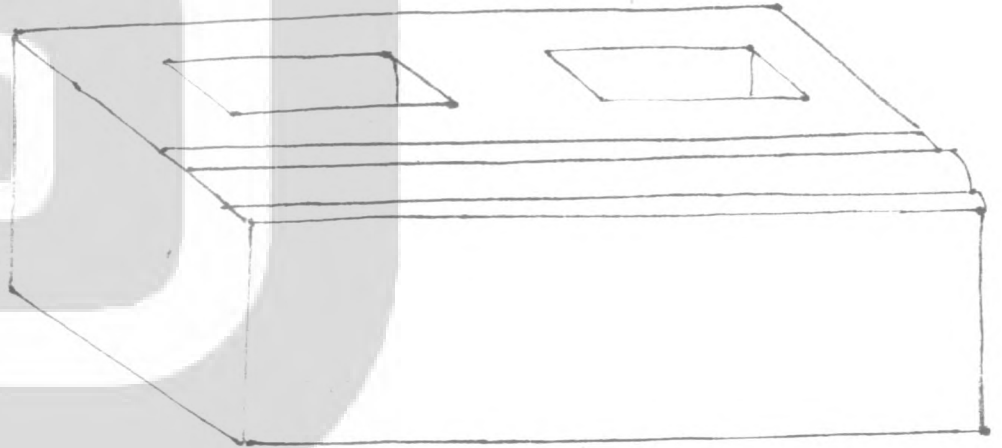

風字流孟渠

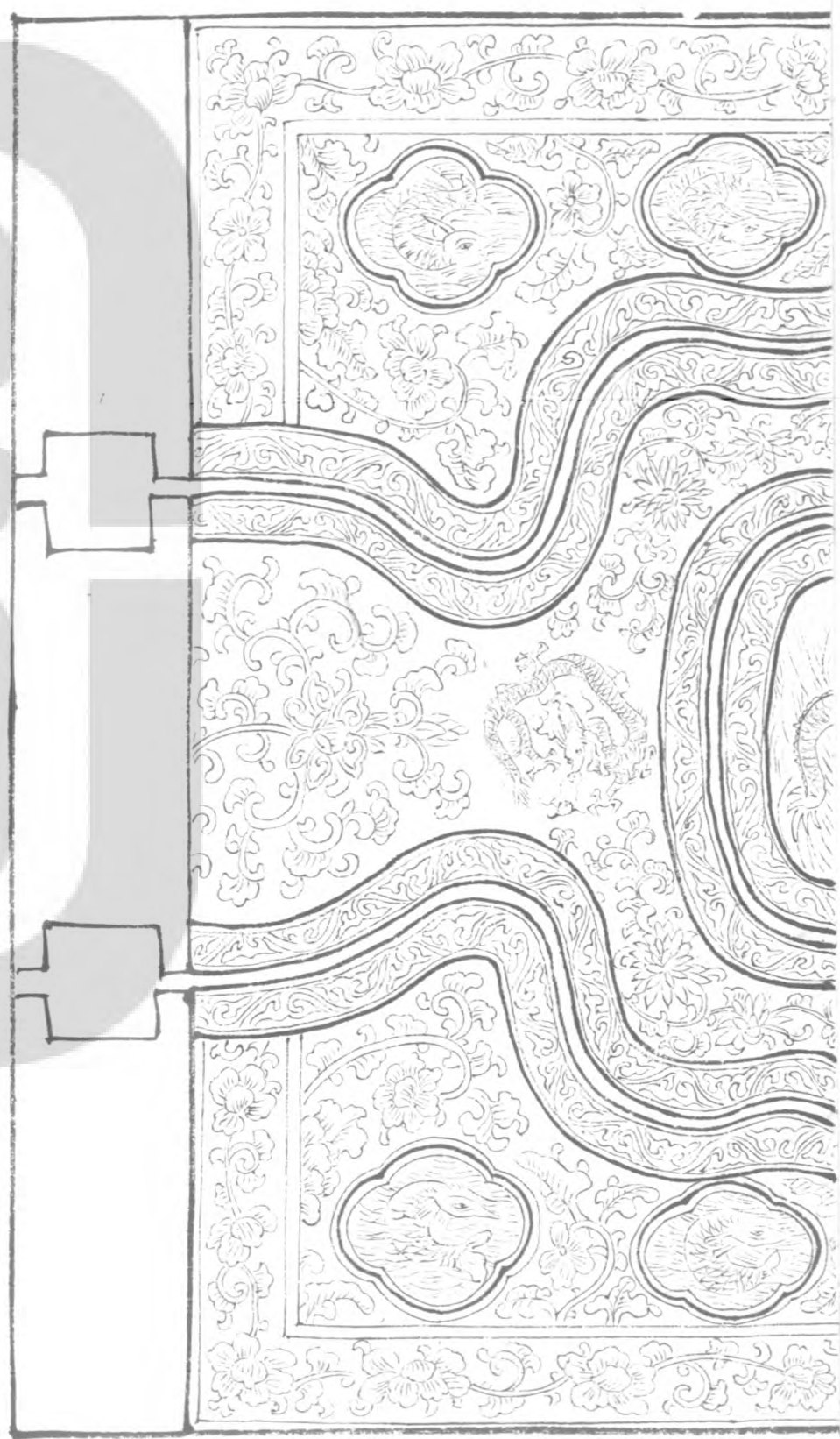
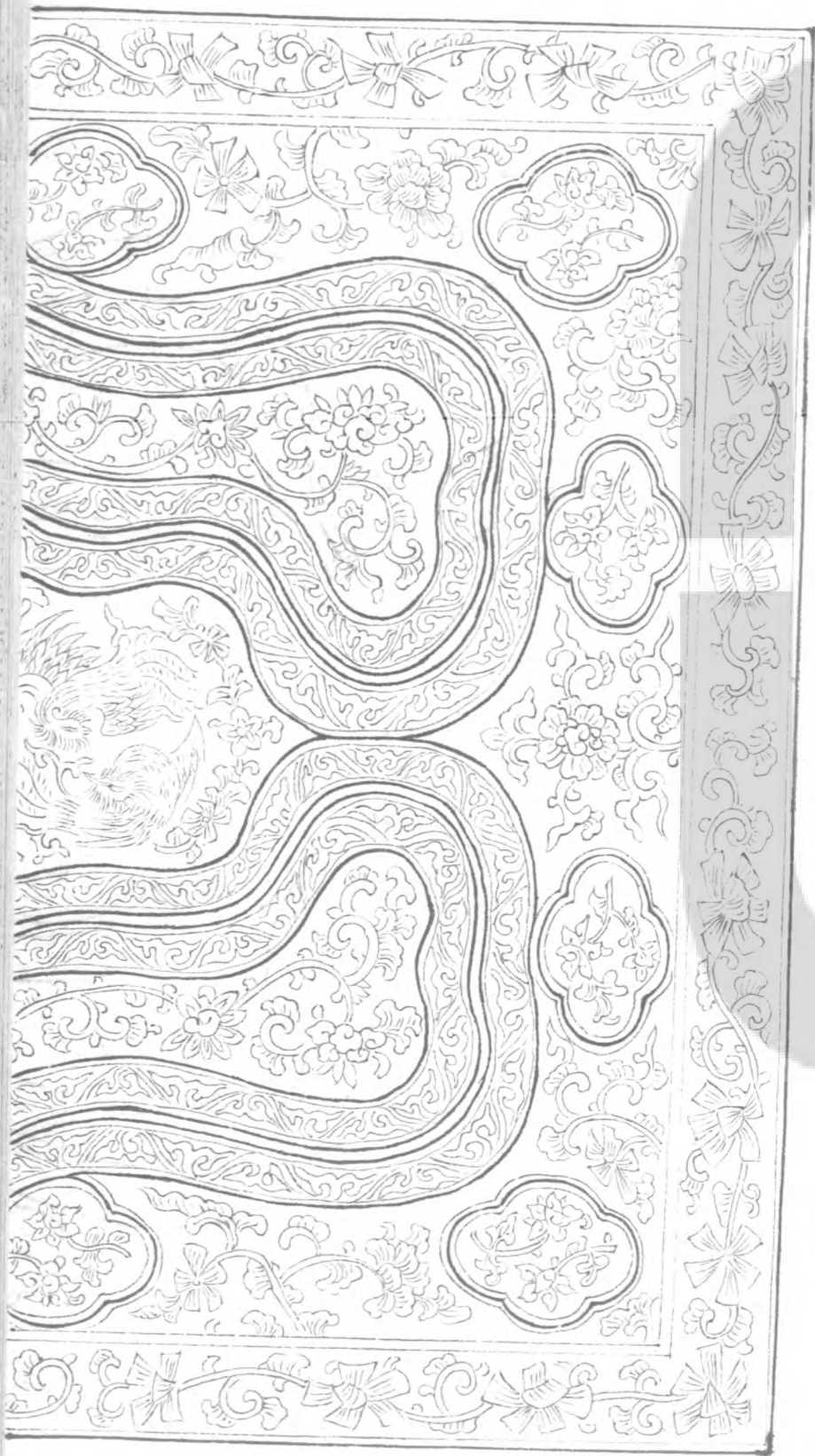



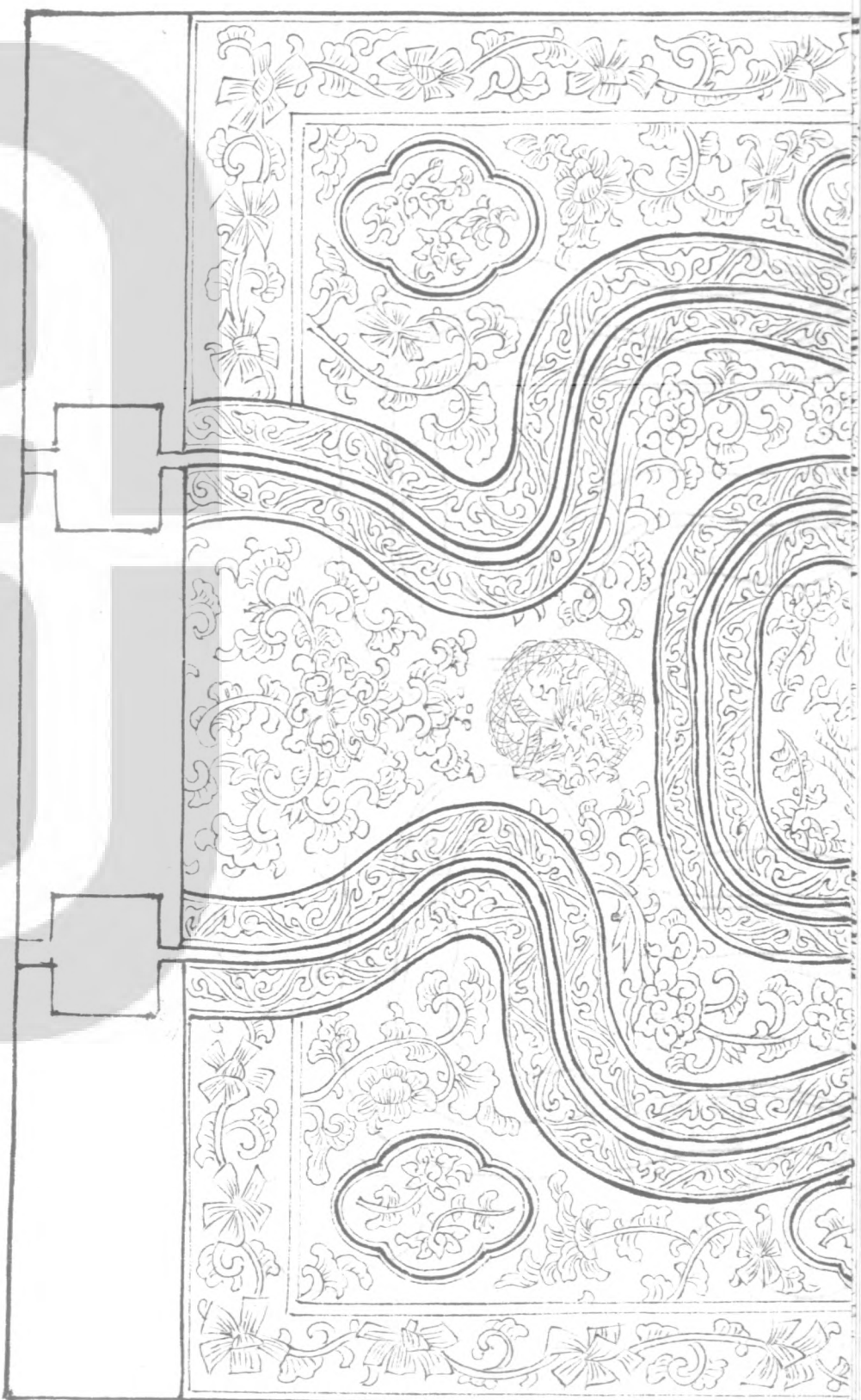

營造法式卷二十九

營造法式

卷三十

大木作制度圖樣上

栱料等卷殺第一

梁柱等卷殺第二

下昂上昂出跳分數第三

舉折屋舍分舍數第四

宋 李誠 撰

紋割鋪作拱昂科等所用卯口第五

梁額等卯口第六

合柱鼓卯第七

搏縫櫺間第八

鋪作轉角正樣第九

拱科等卷殺第一

華拱

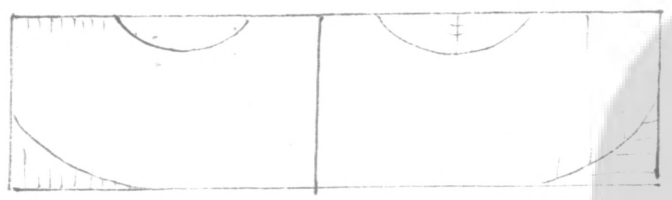

泥道拱

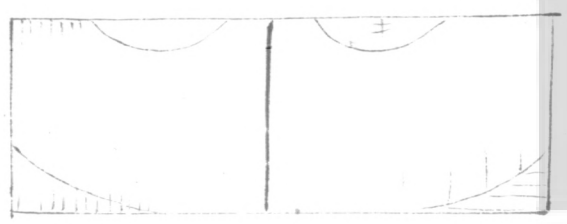

拱

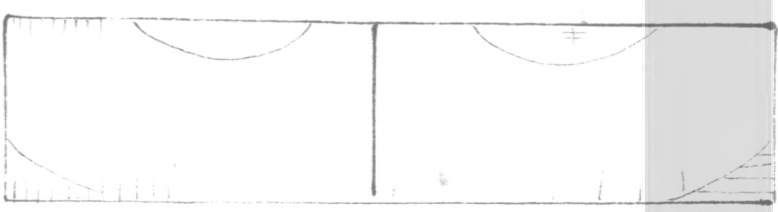

瓜子拱

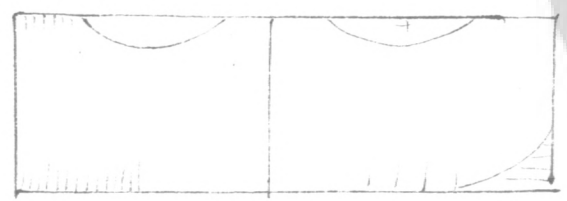

令拱

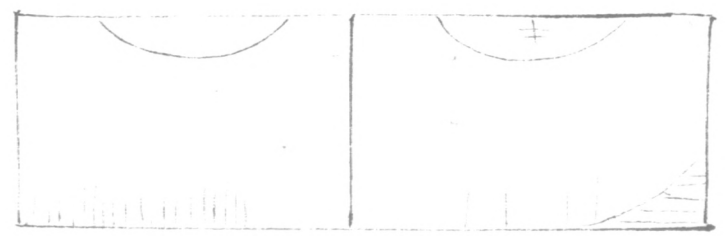

月梁

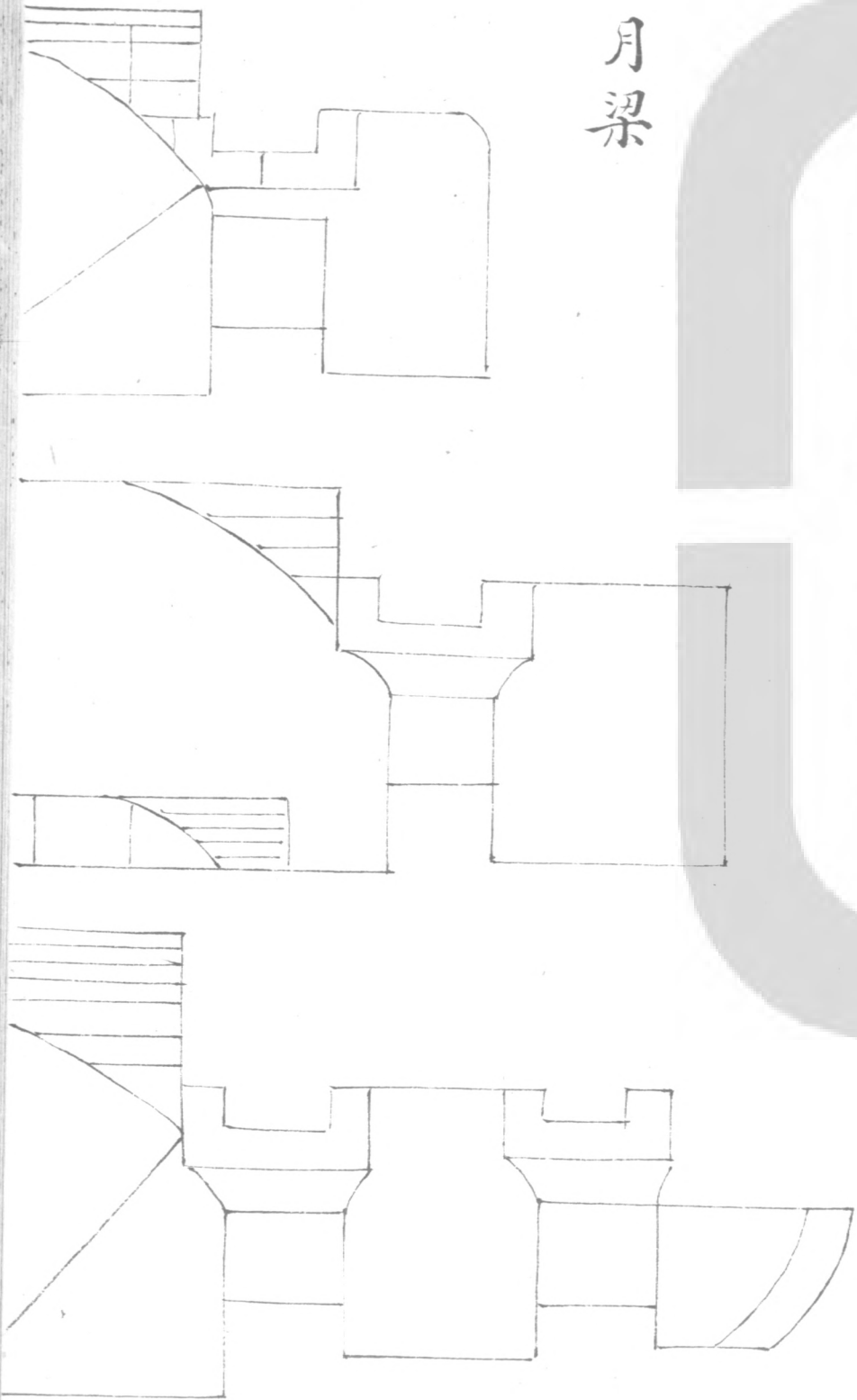

梁柱等卷殺第二

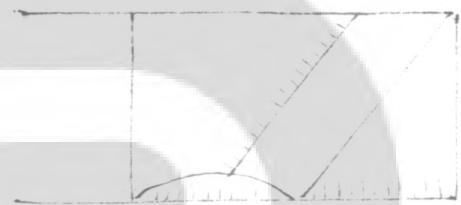

要頭

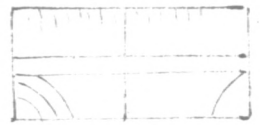

交五科

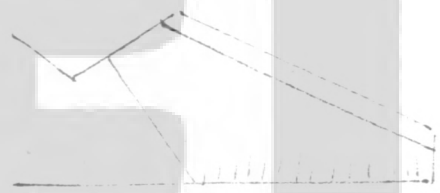

下昂尖

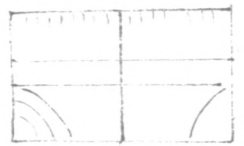

齊心科

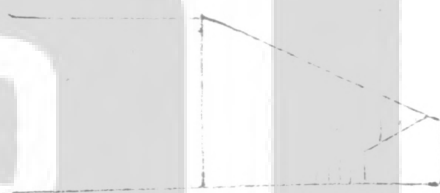

華頭子

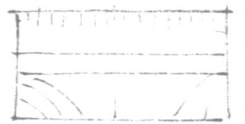

散科



替木頭



櫃科

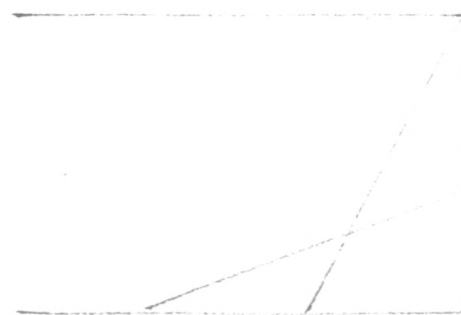

梁抹頭

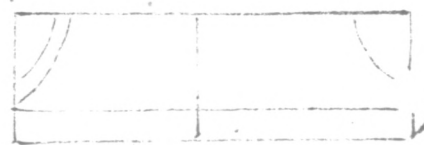

柱磧

額肚并柱樣  
下檐額肚

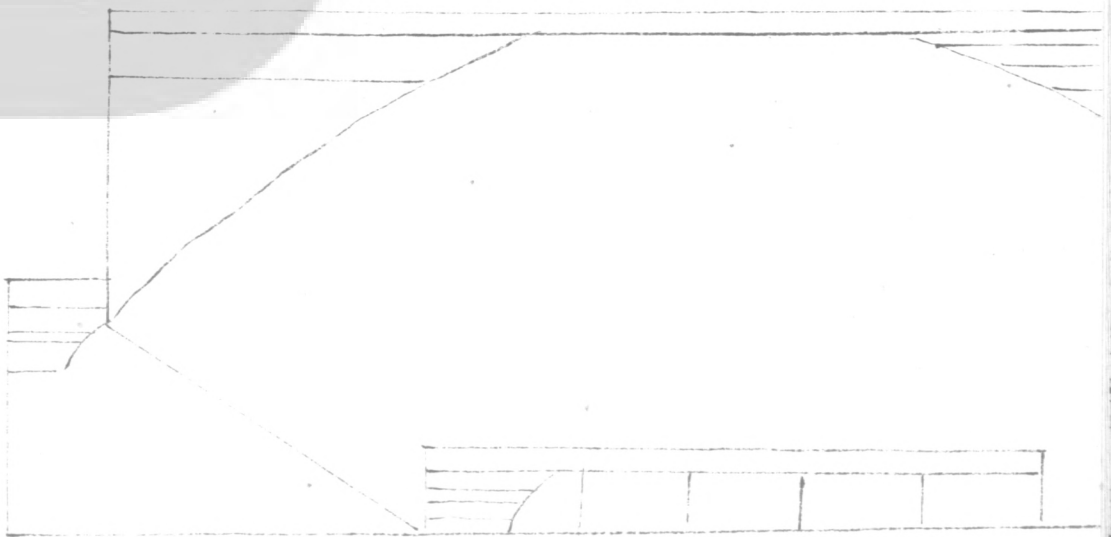
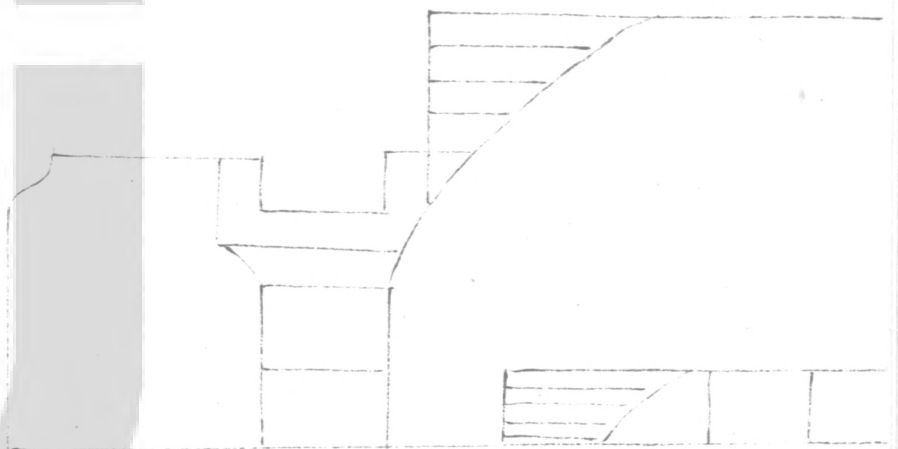
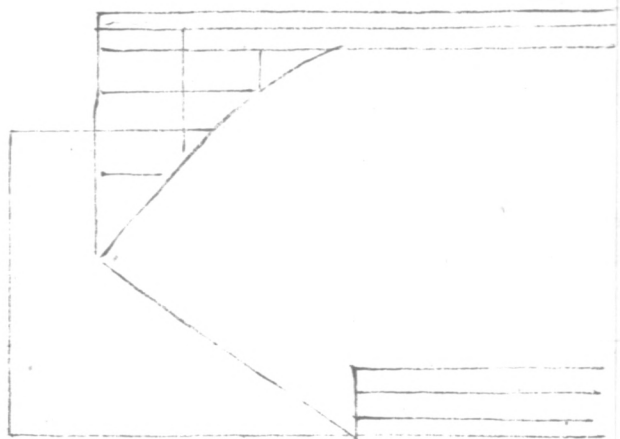
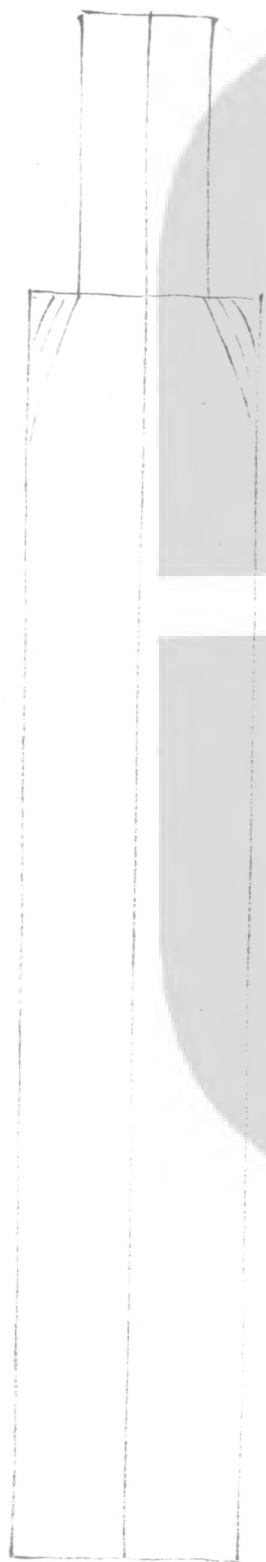

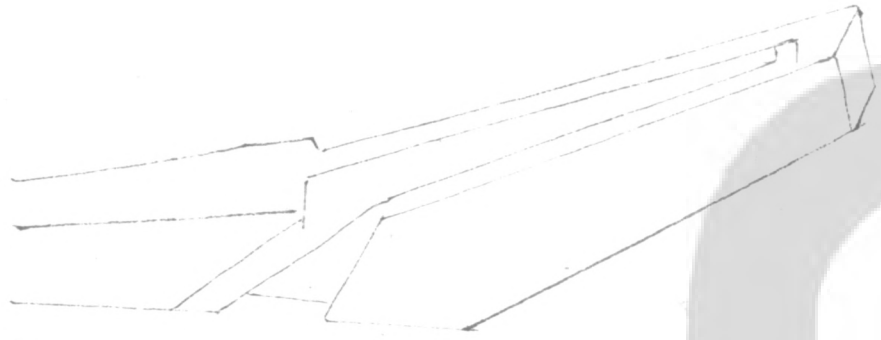

子角梁

大角梁

三瓣頭或  
只作搭頭

措頭綽幕

蟬肚綽幕

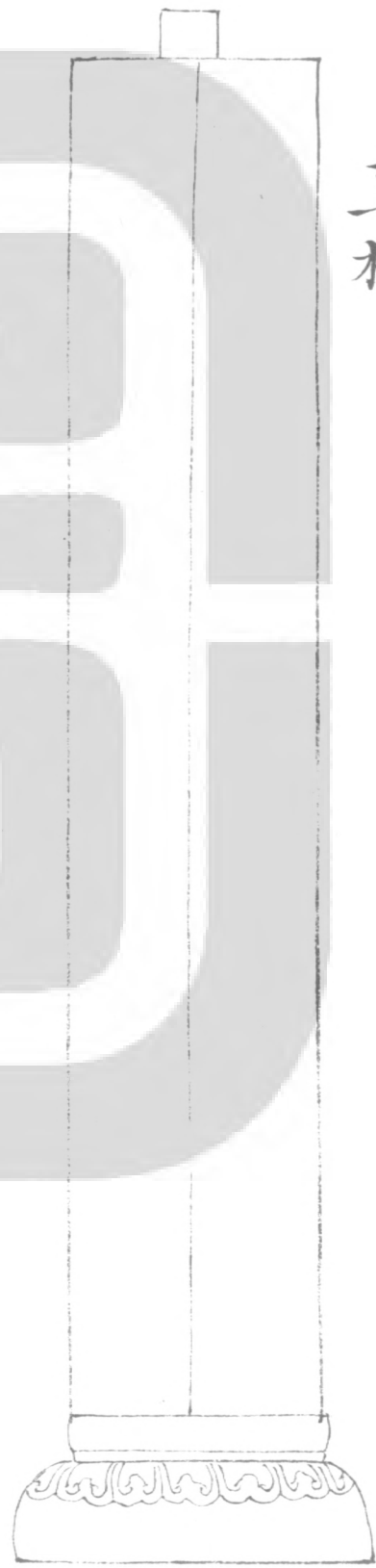
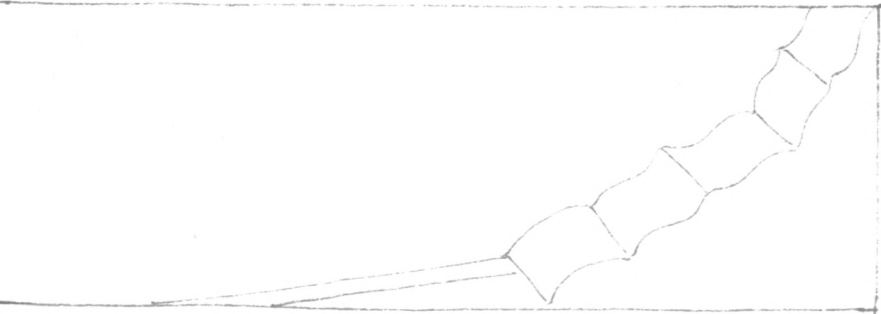
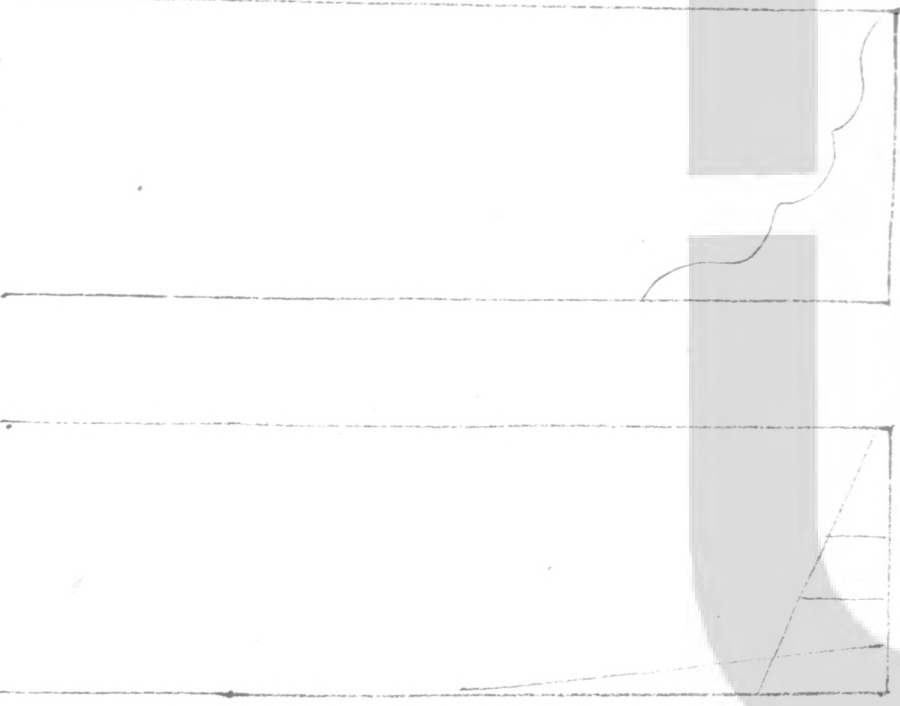

直柱

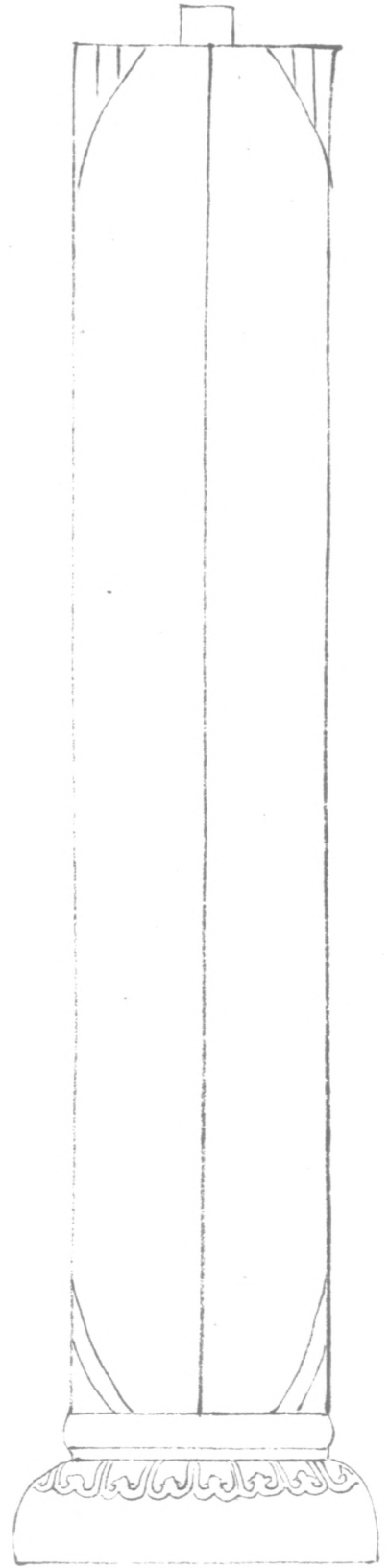

梭柱

鷹嘴駝峯三瓣

兩瓣駝峯

招瓣駝峯

檀笠駝峯

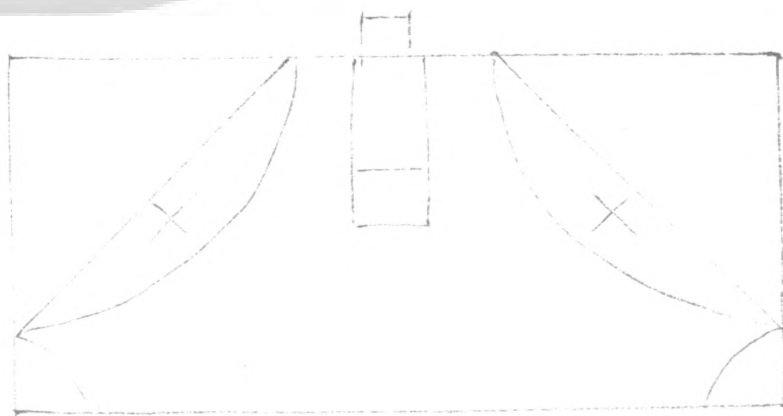
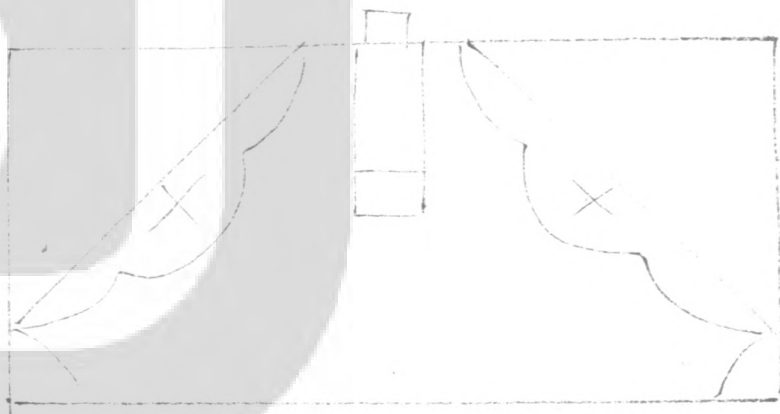
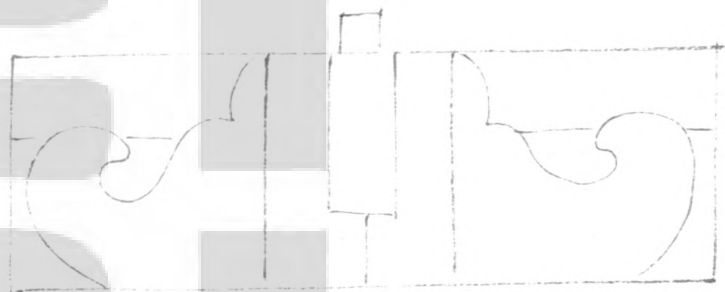
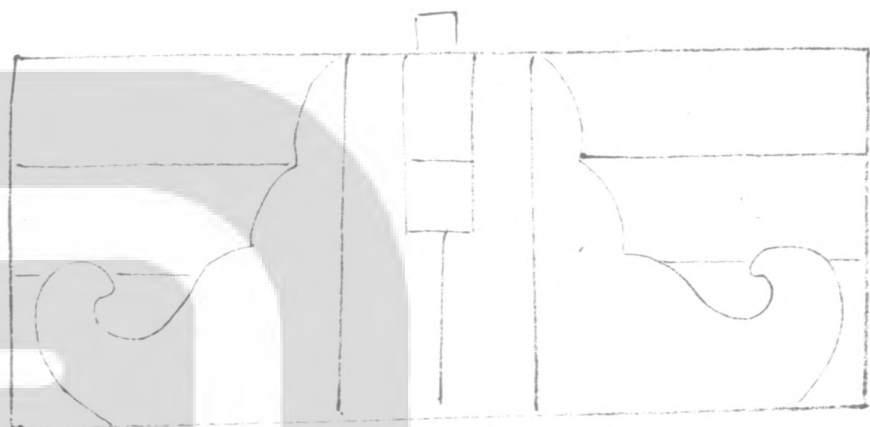

下昂側樣

四鋪作裡外並一抄  
卷頭壁內重拱

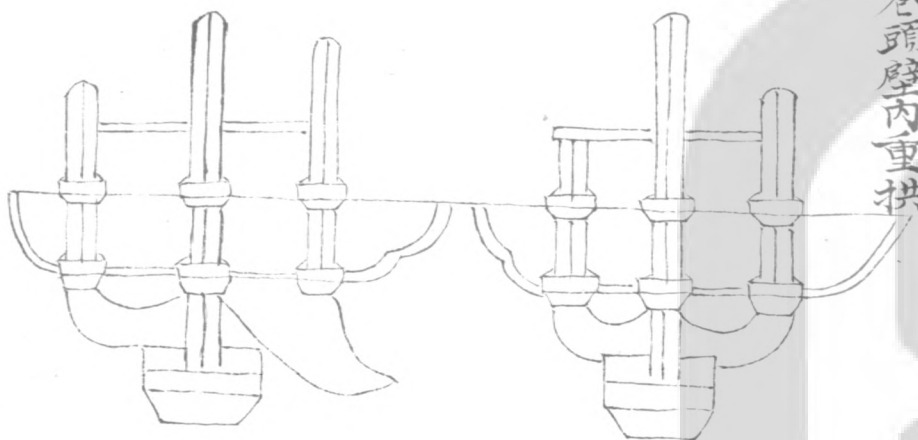

下昂上昂出跳分數第三

五鋪作重拱出單抄單下昂裡  
轉五鋪作重拱出兩抄並計心

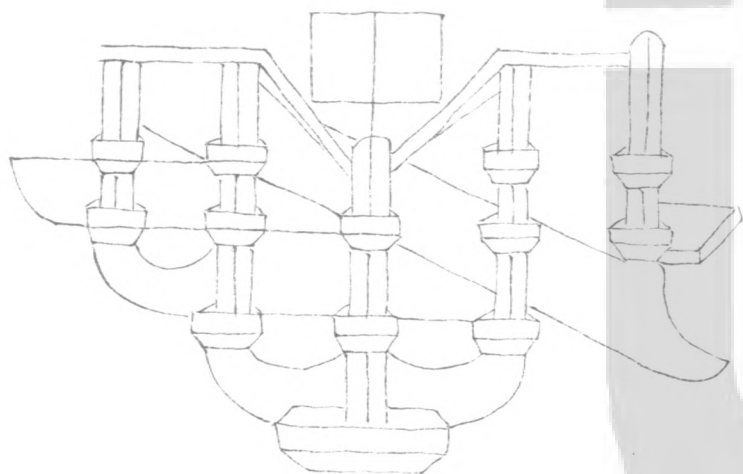

六鋪作重拱出單抄雙下昂裡  
轉五鋪作重拱兩抄並計心

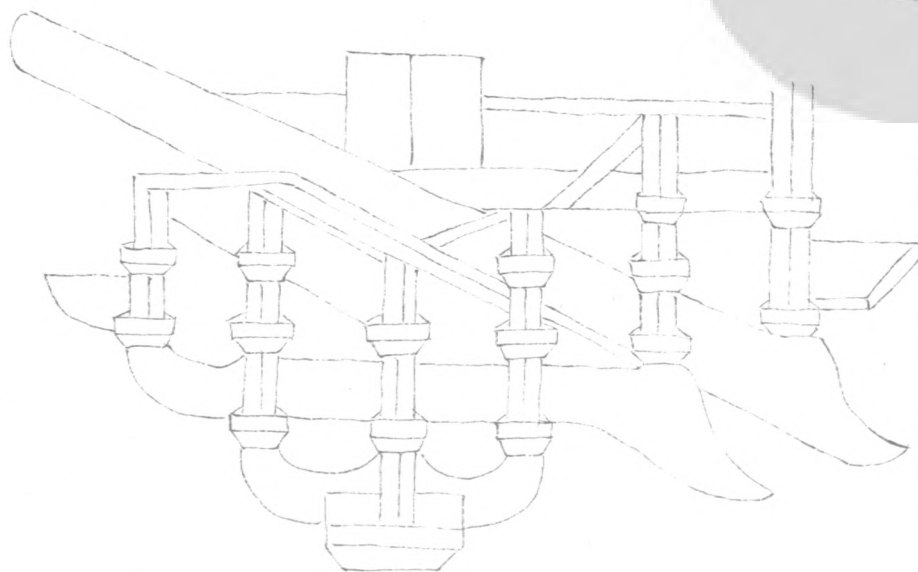

七鋪作重拱出雙抄雙下昂裡  
轉六鋪作重拱出三抄並計心

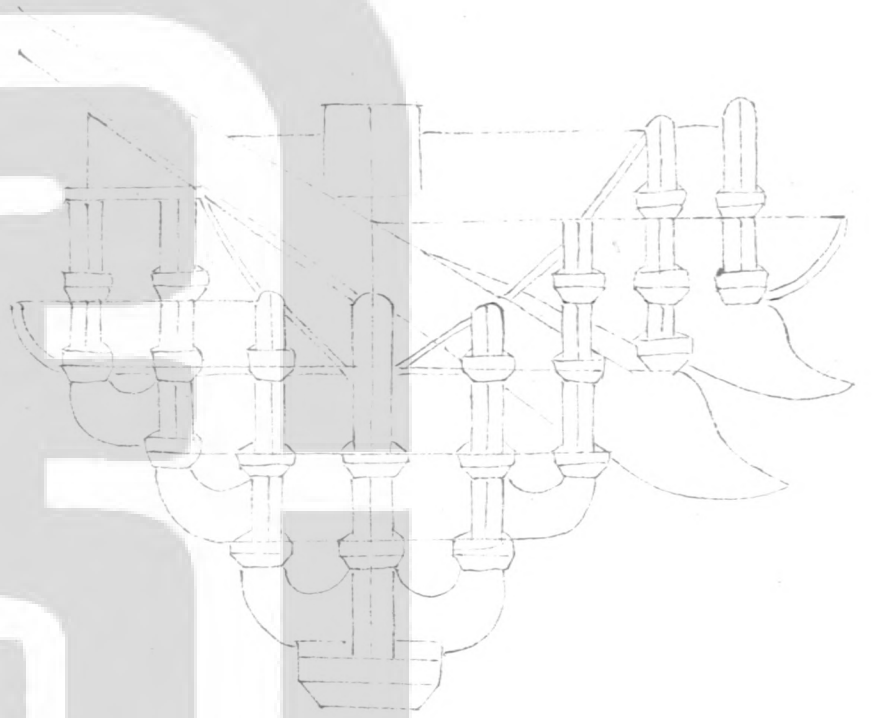

八鋪作重拱出雙抄三下昂裡  
轉六鋪作重拱出三抄並計心

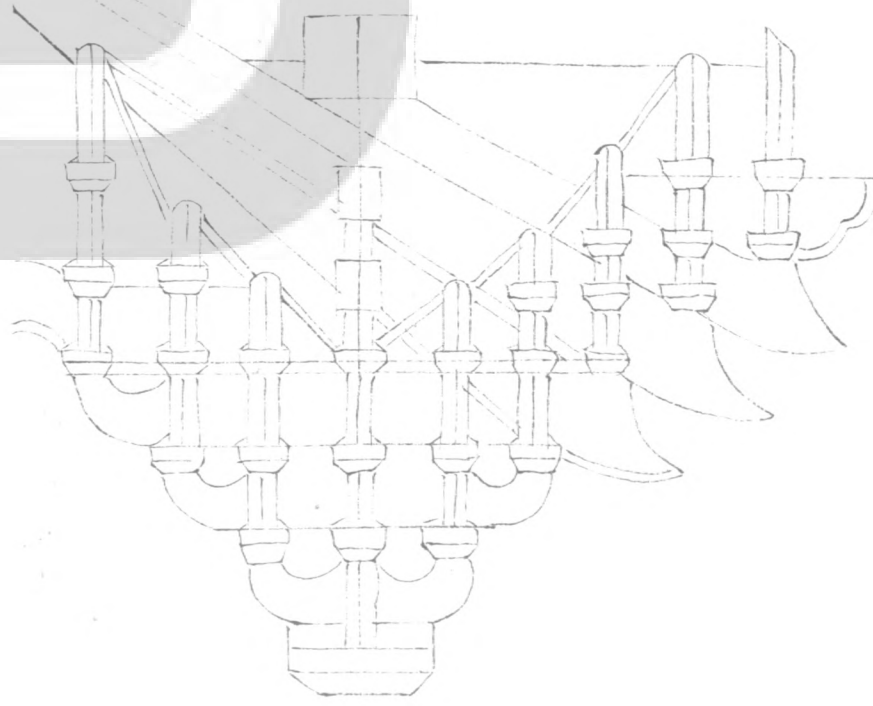

上昂側樣

五鋪作重拱出  
上昂並計心

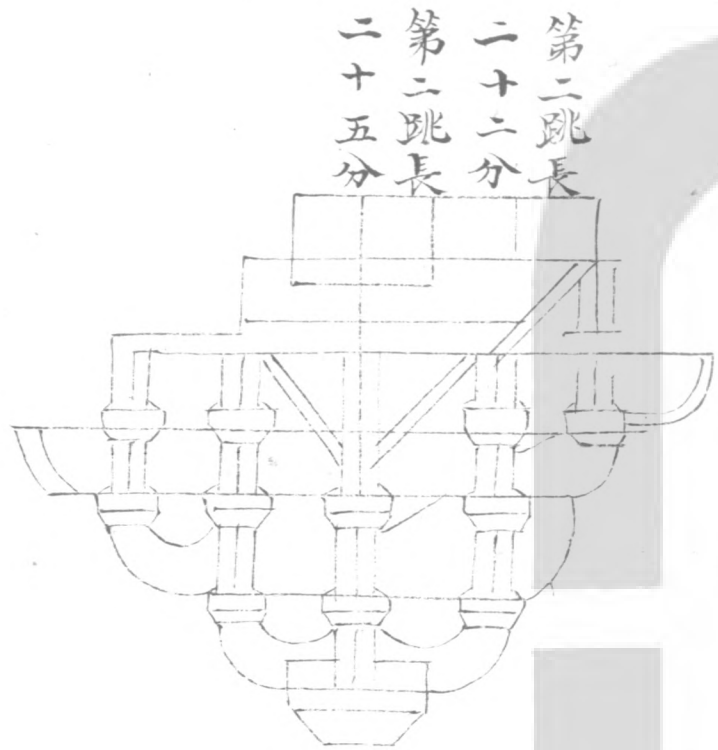

第二跳長  
二十二分  
第二跳長  
二十五分

六鋪作重拱出上昂偷  
心跳內當中施騎科料

第二第三  
跳共長二  
十八分  
第一跳長  
二十七分

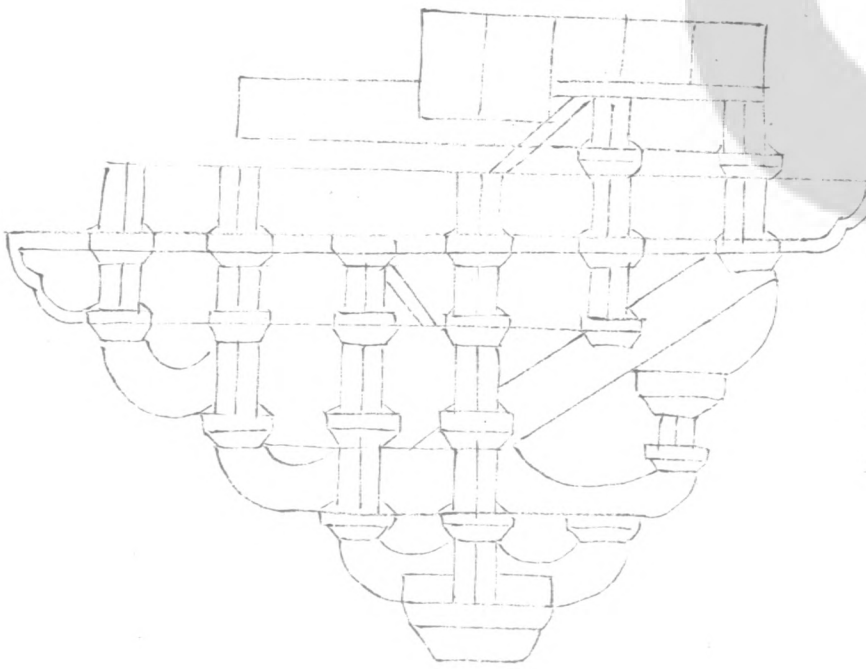



七鋪作重拱出上昂偷  
心跳內當中施馳科拱

第三第四  
跳共長三  
十五分  
第二跳長  
一十五分  
第一跳長  
二十三分



八鋪作重拱出上昂偷  
心跳內當中施馳科拱

第四第五  
跳共長二  
十六分  
第三跳同  
第二跳  
第二跳  
長十六分  
第一跳長  
二十六分

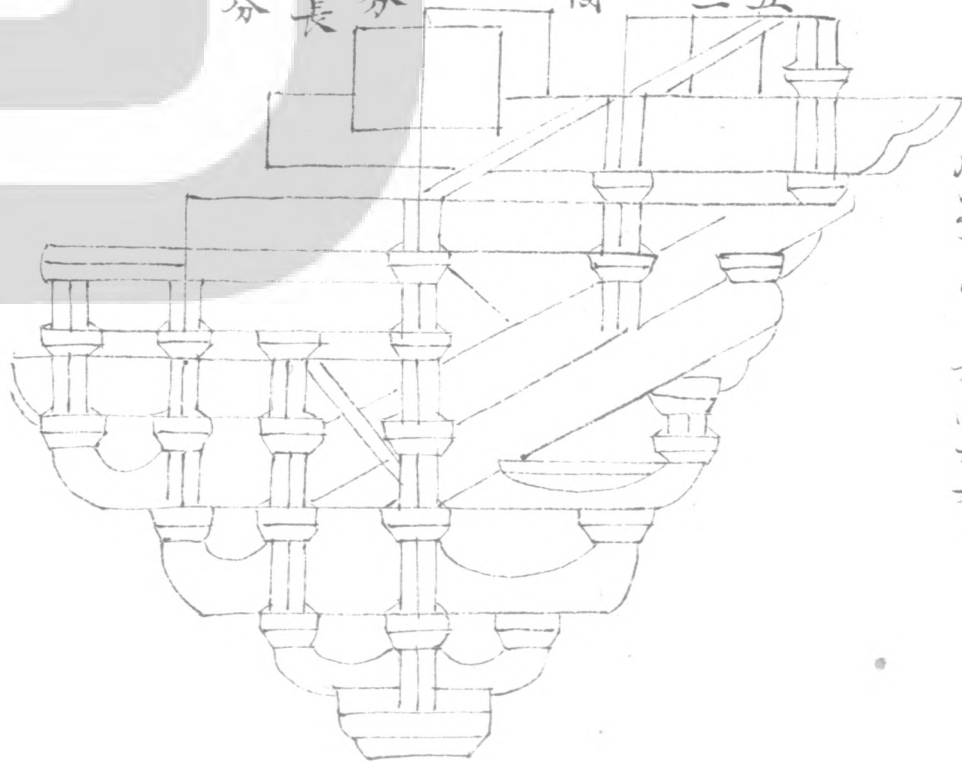

舉折屋舍分數第四

未弦為第一折  
青絃為第二折  
黃絃為第三折

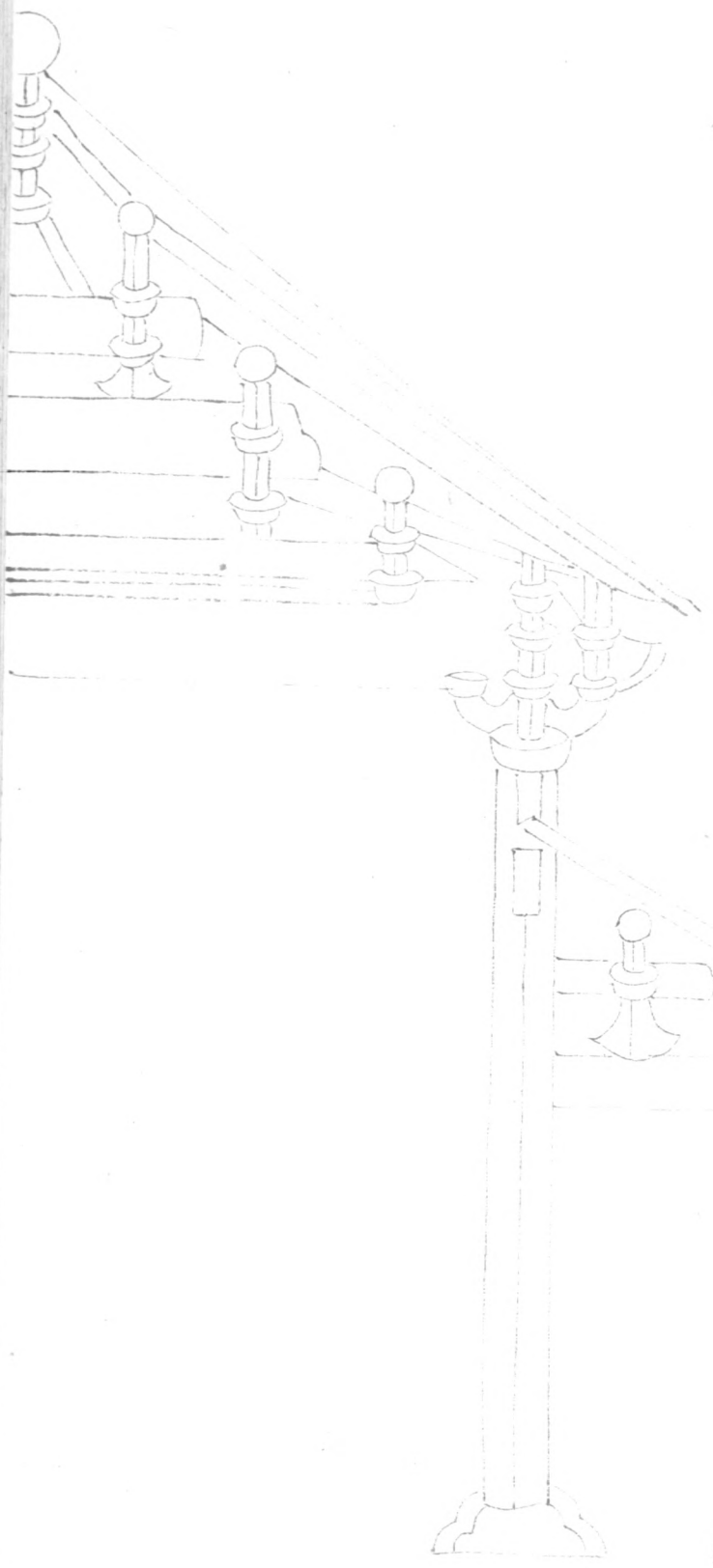

亭榭闢尖用甌瓦舉折

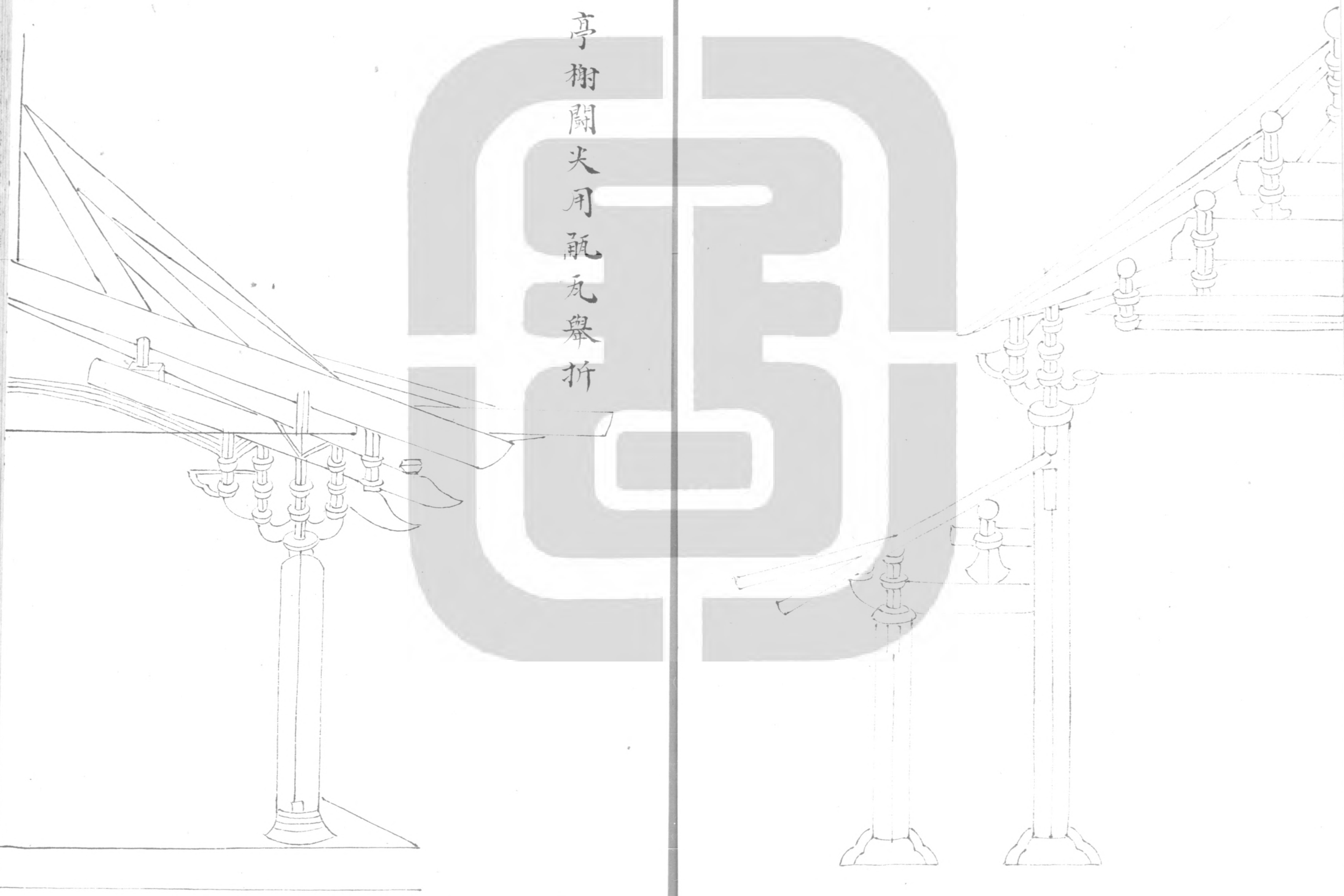

亭榭闢火用瓦舉折

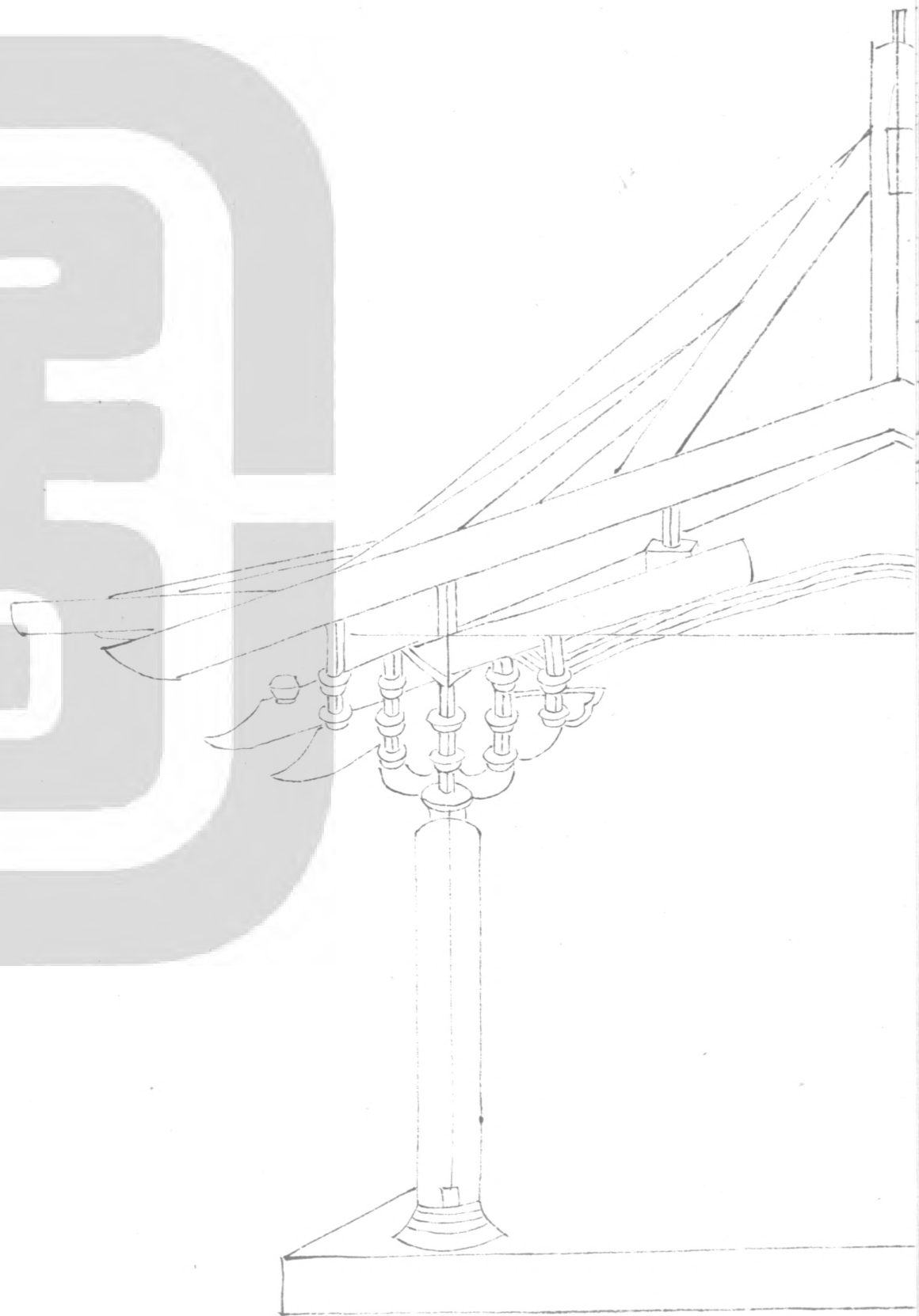
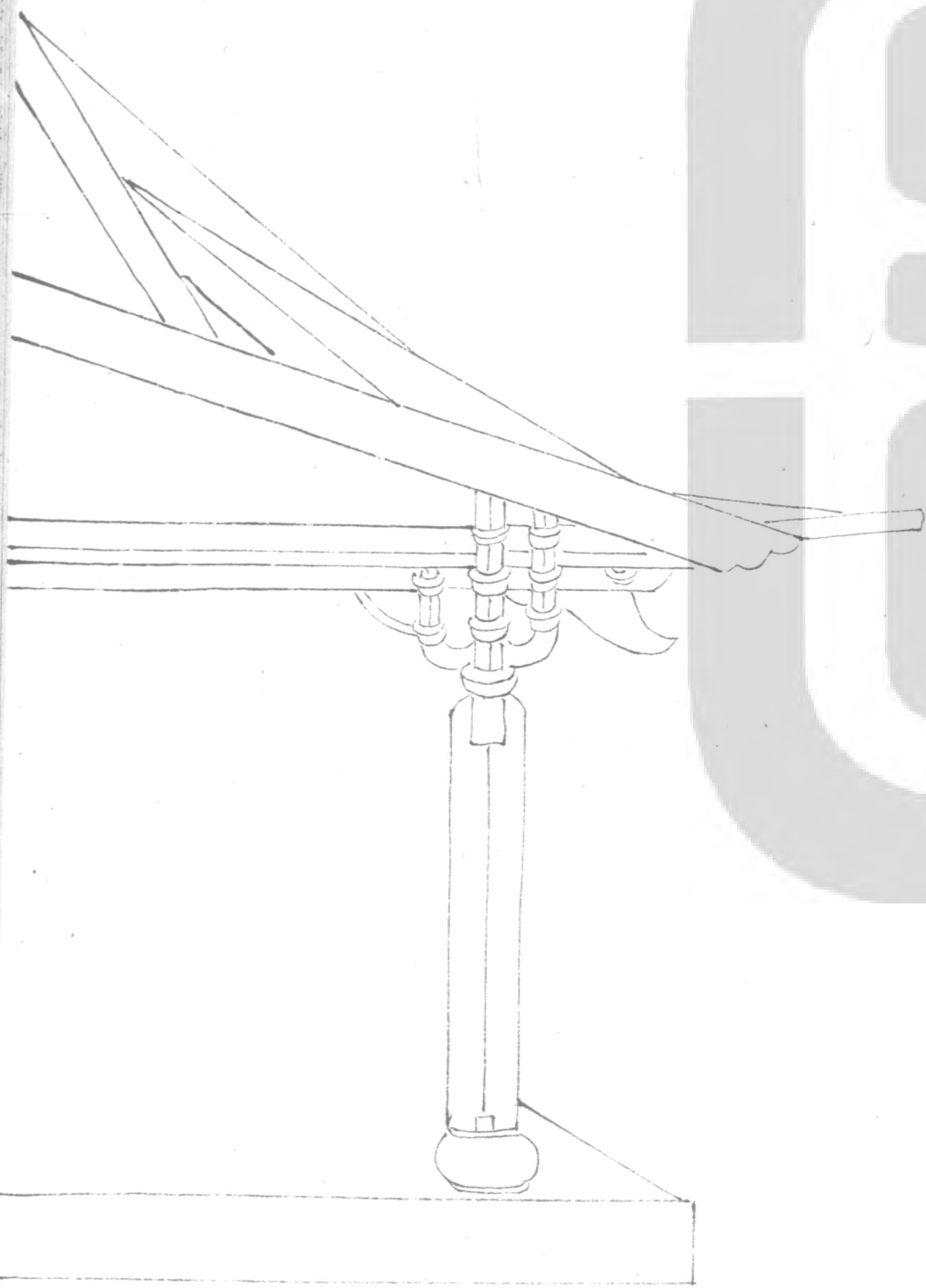

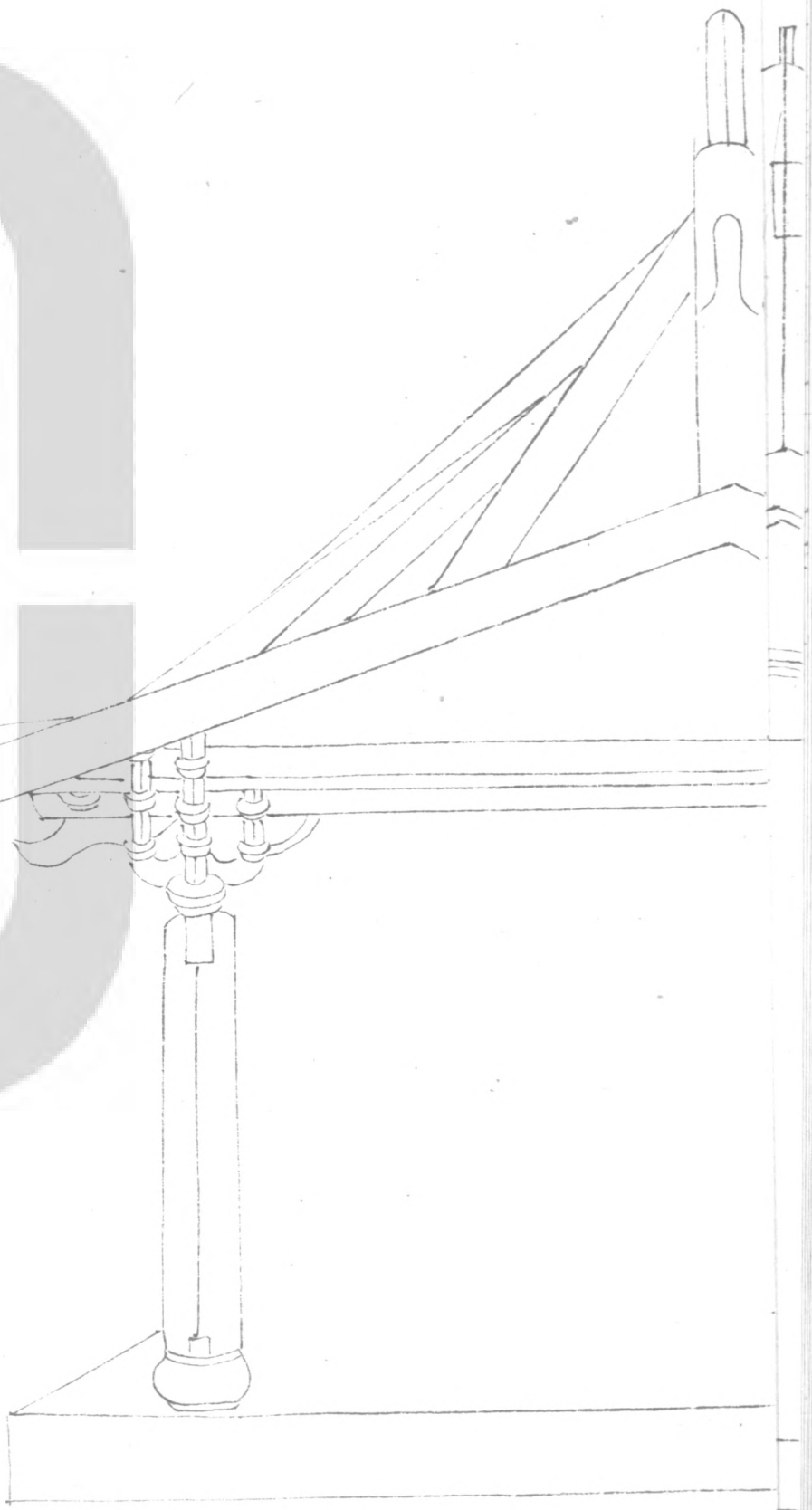

絞割鋪作拱昂科等所用卯口第五

華拱  
足材

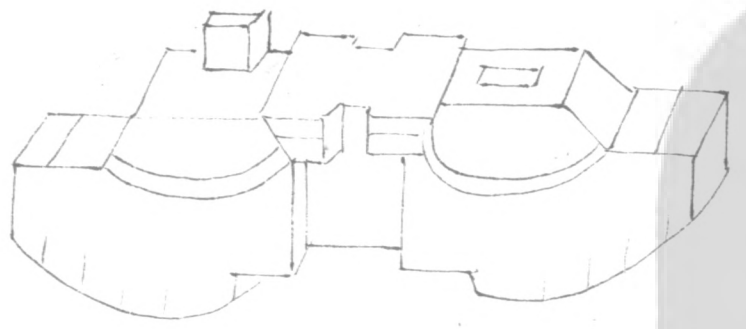

華拱  
單材

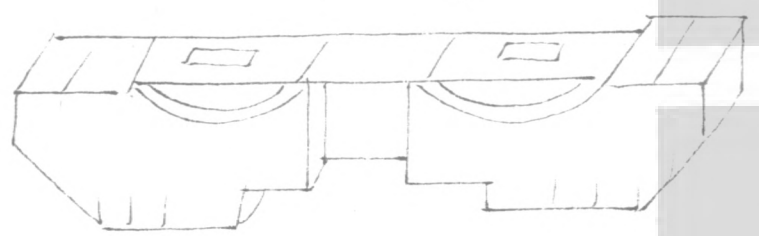

華拱第二跳

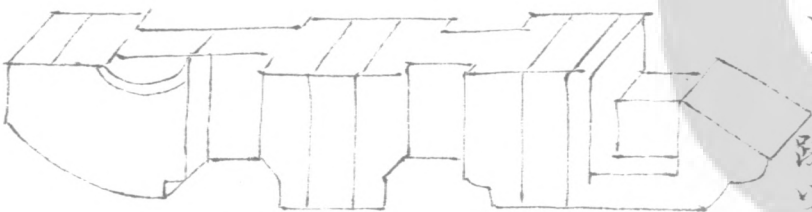

外作華頭子如第三跳以上隨跳加長

以五鋪作名件卯口為法其六鋪作以上並隨跳加長

闇楔

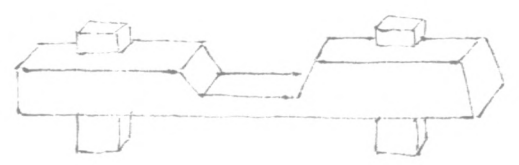

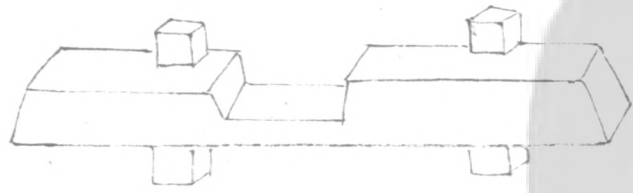

慢拱  
施閣契  
壁內用上

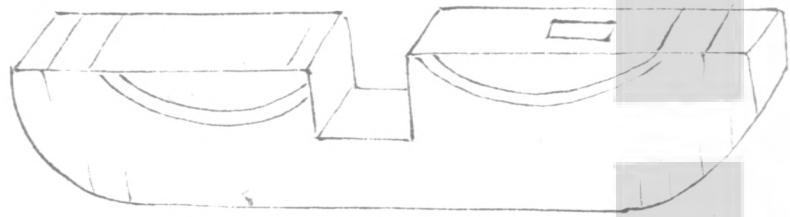

慢拱  
吊用  
外跳騎

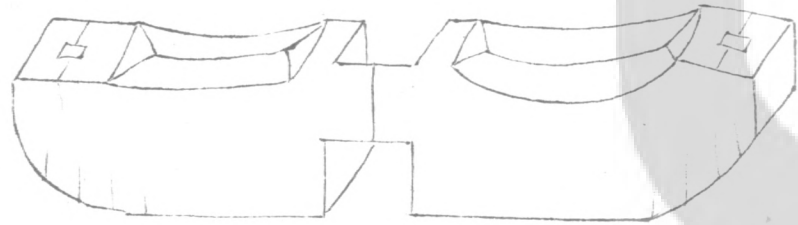

慢拱  
用  
裡跳

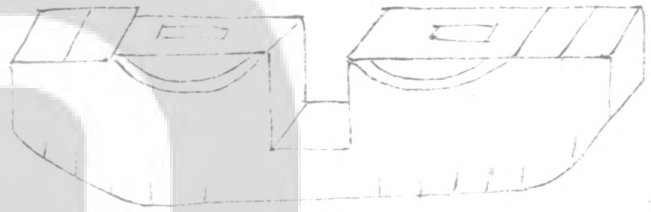
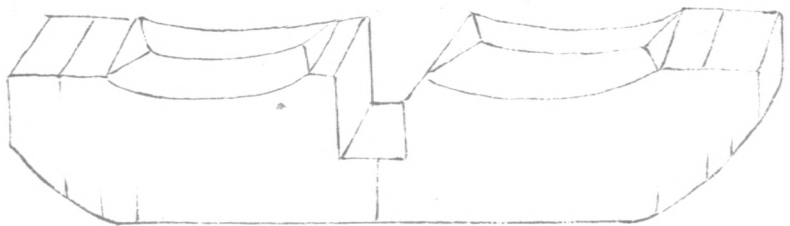

泥道拱  
閣契  
上施

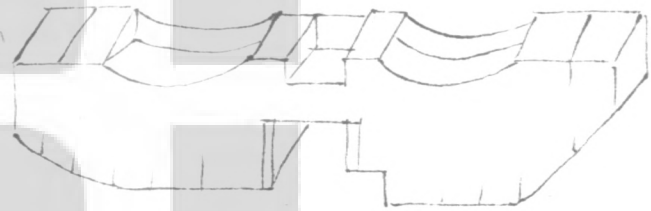

瓜子拱  
用  
外跳

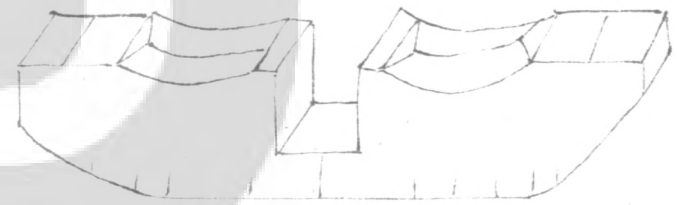

瓜子拱  
用  
裡跳

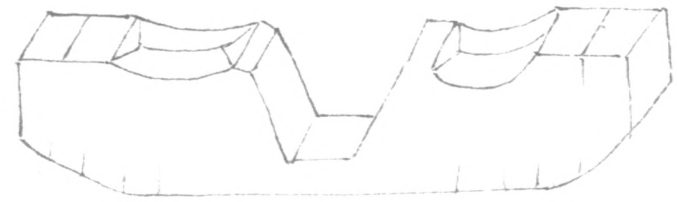

瓜子拱  
用  
絞拱

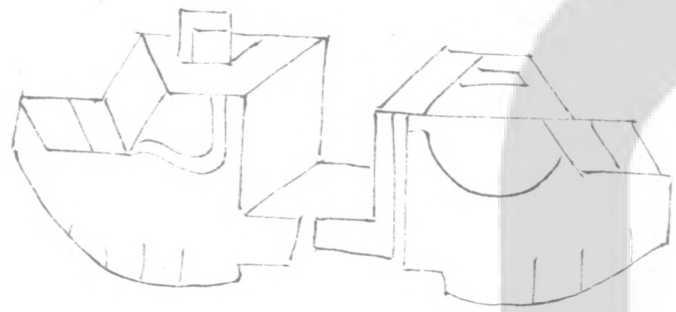

華拱與泥道拱相列  
外跳用

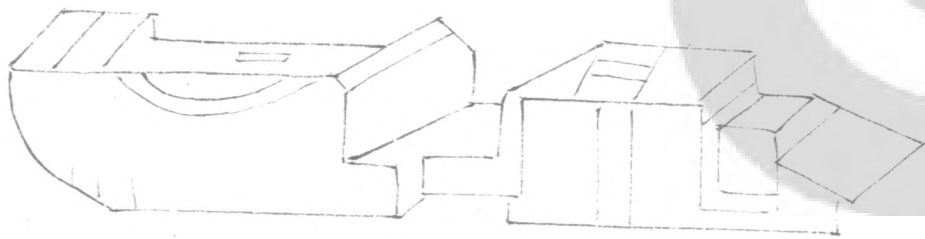
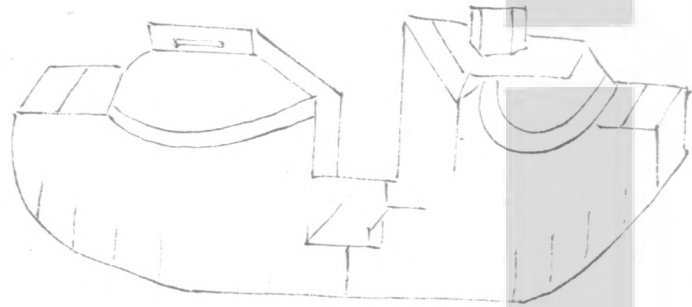

慢拱與華頭子相列  
外跳用七鋪作  
以上隨跳加長

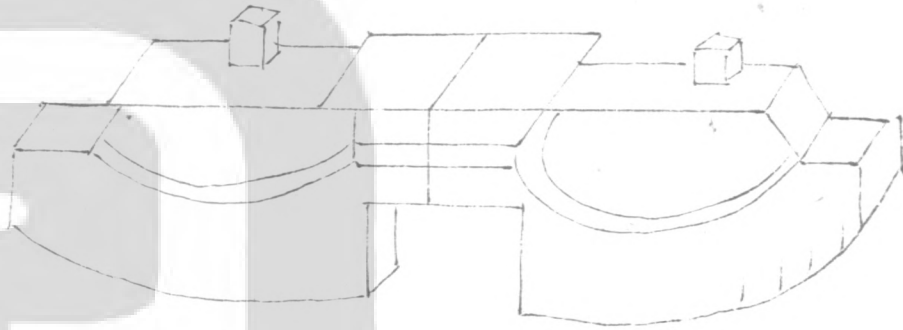
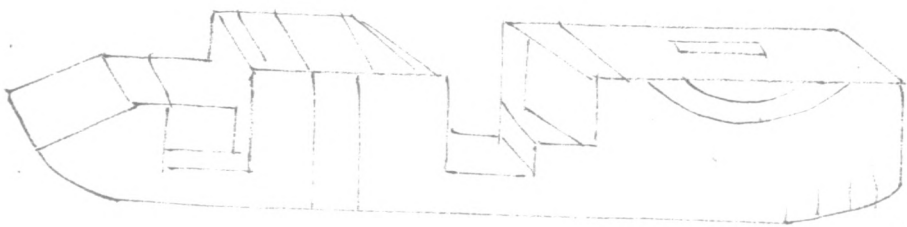

慢拱  
足材騎  
拱用

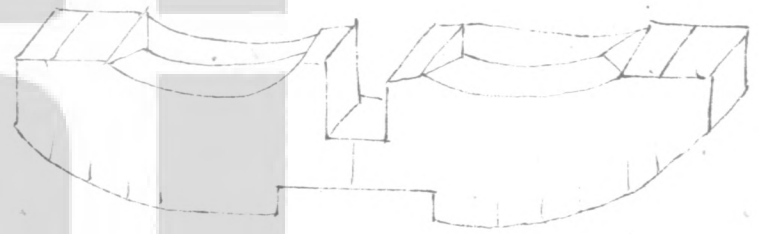

令拱  
外跳用

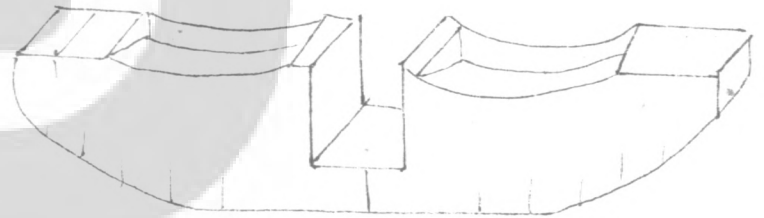

令拱  
裡跳  
用

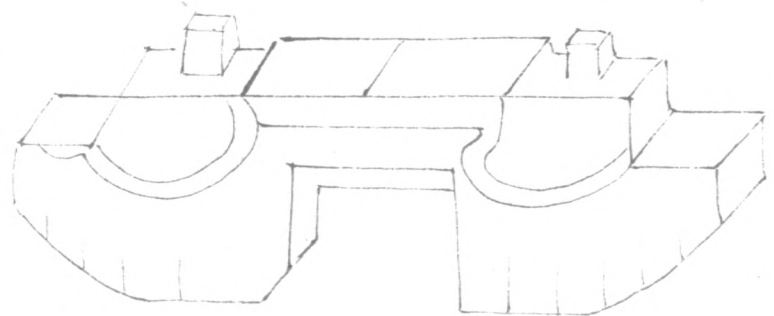

令拱  
足材騎  
拱用

瓜子拱與小拱頭相列用外跳

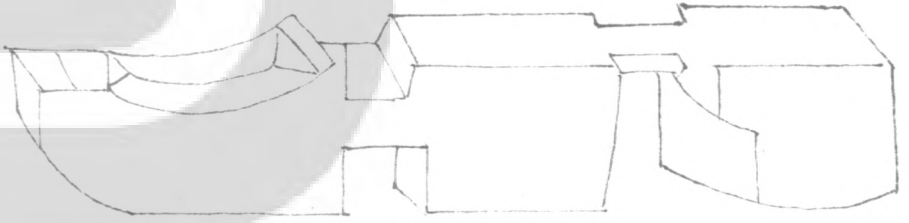
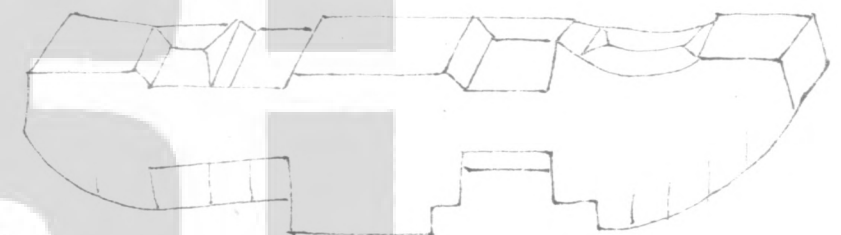

慢拱與切几頭相列用外跳

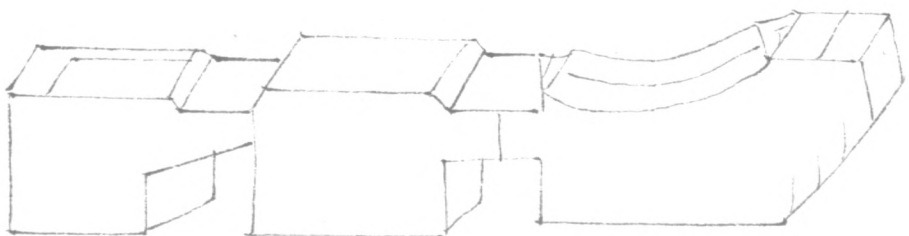

瓜子拱與令拱相列

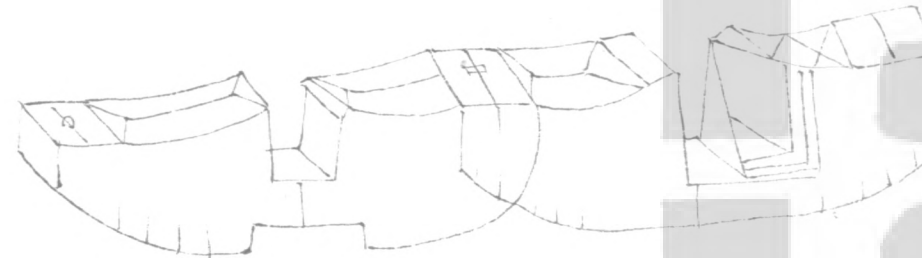

外跳駕為交首拱也  
六鋪作以上並用瓜子拱

慢拱與切几頭相列

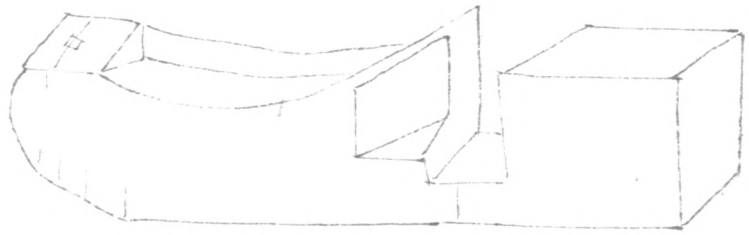
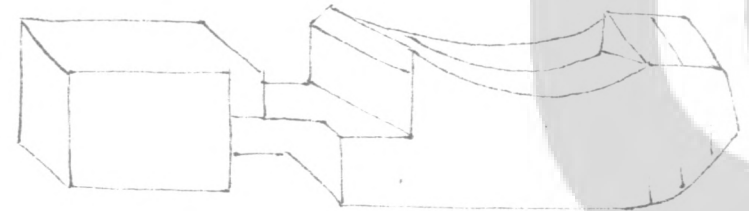

用裡跳

瓜子拱與小拱頭相列  
用裡跳

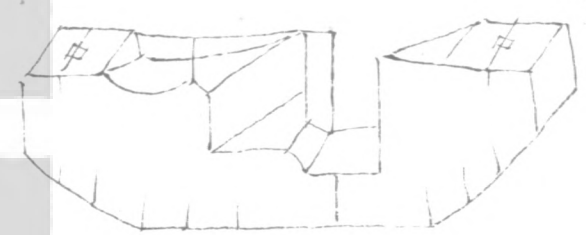
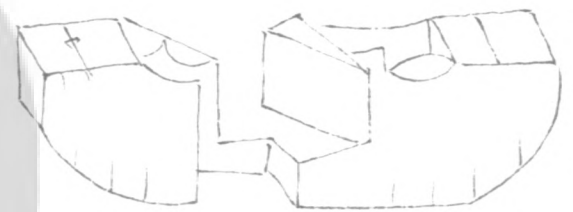

令拱與小拱頭相列  
用裡跳

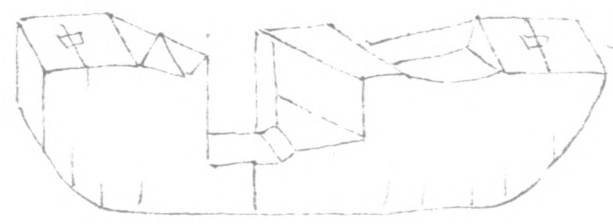
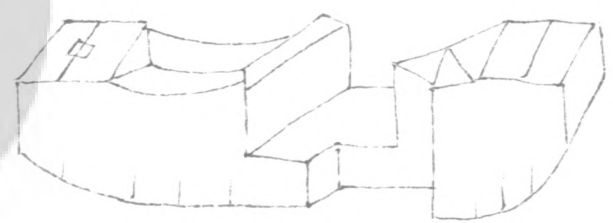

柱頭或補間鋪作內第二跳下昂  
第三跳以上  
隨跳加長



合角下昂  
角內用六鋪作  
以上隨跳加長

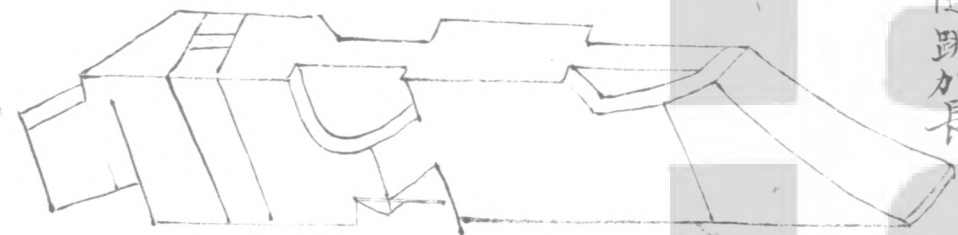
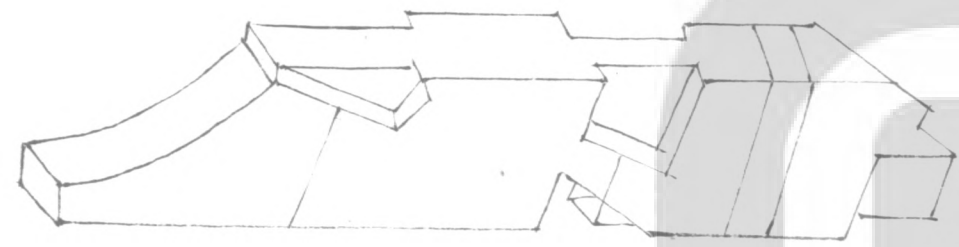

耍頭  
外跳昂  
上用

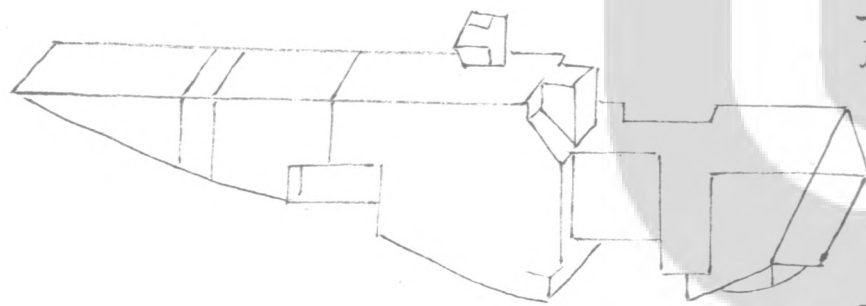

耍頭  
裡跳上用七鋪作  
以上隨跳加長

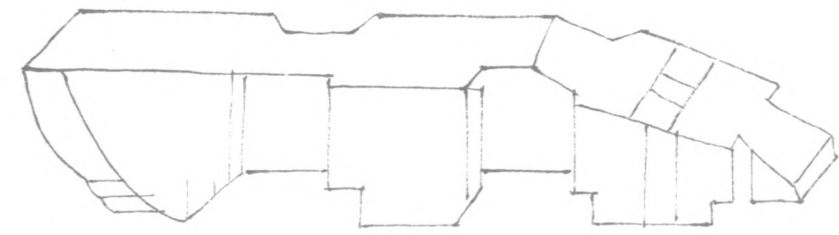



視方頭

華拱  
角內第一跳用

華拱  
角內第二跳用  
七鋪作以上隨跳加長

耍頭  
角內用七鋪作  
以上隨跳加長

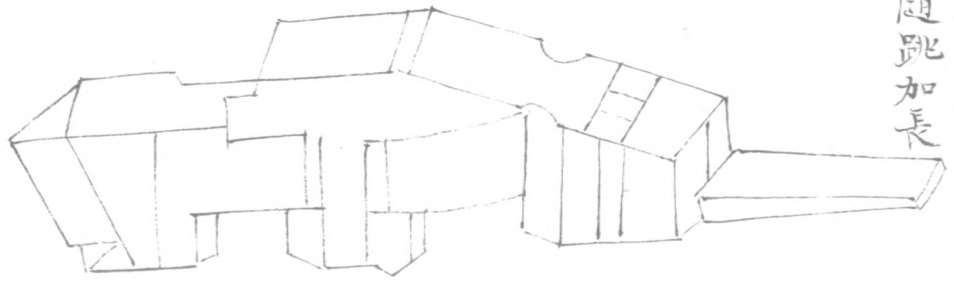
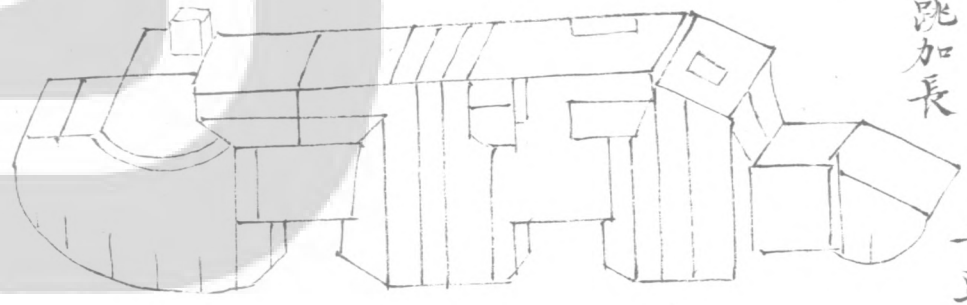
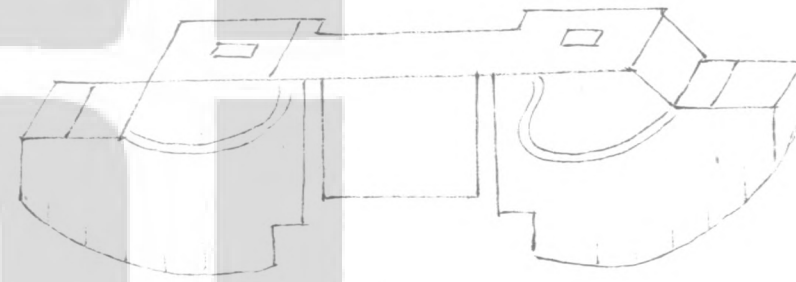
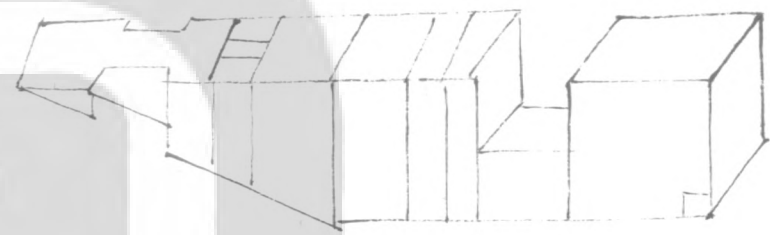

由昂  
角內用六鋪作  
以上隨跳加長

方櫃料  
角內用

方櫃料  
柱頭或  
補間用

圓櫃料  
角內用

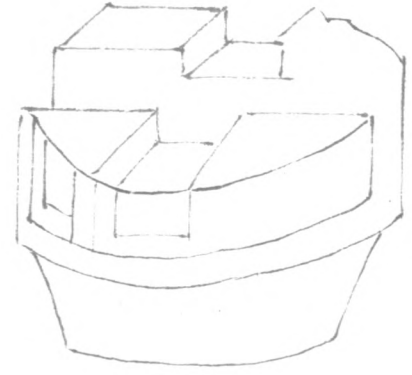
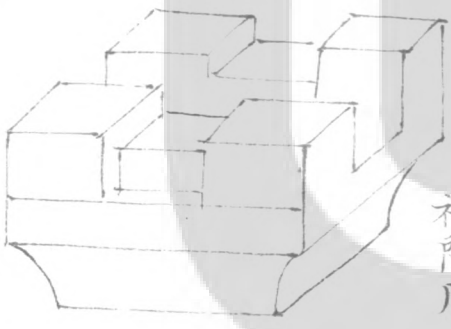
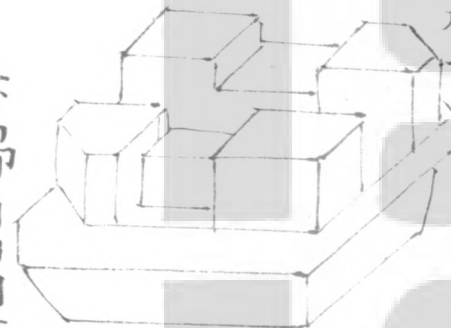
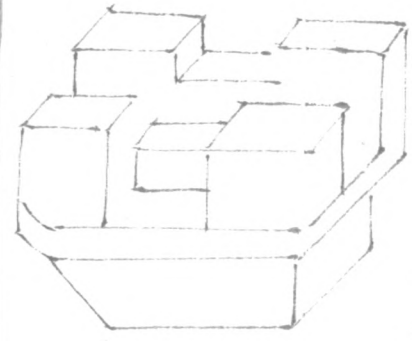
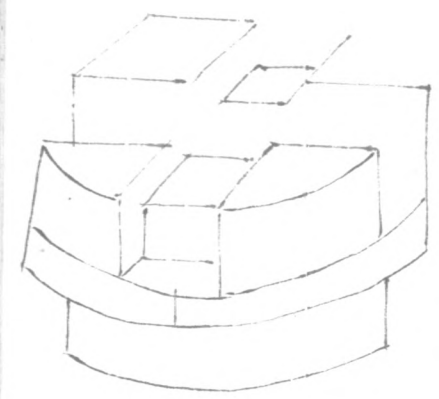
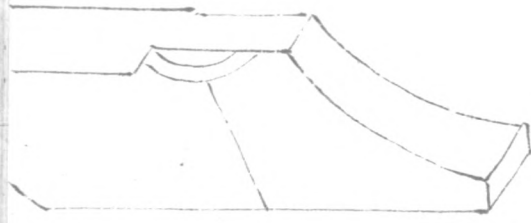
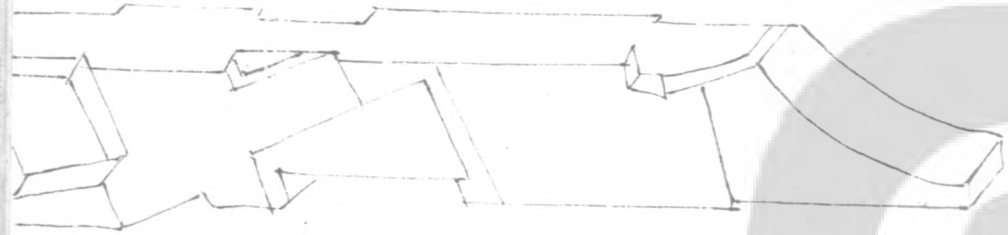

下昂  
角內用六鋪作  
以上同由昂

圓櫃料  
柱頭用

訛角箱料  
補間  
內用

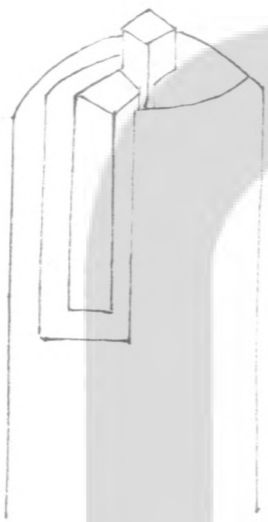
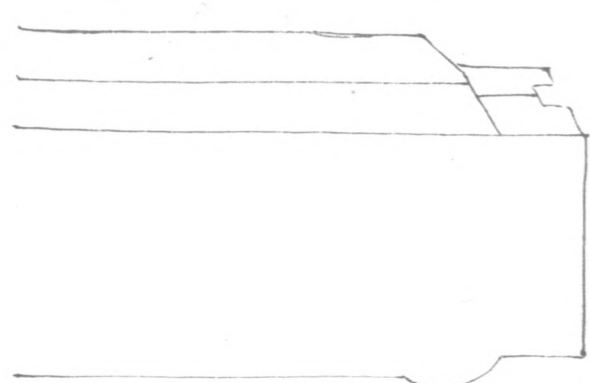

梁柱 鑄口  
梁額等外口 第六

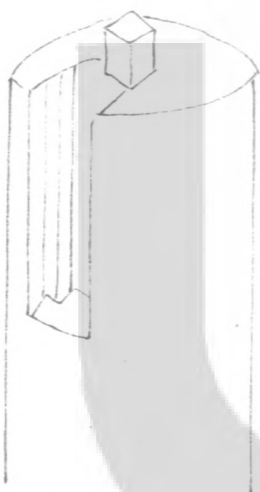
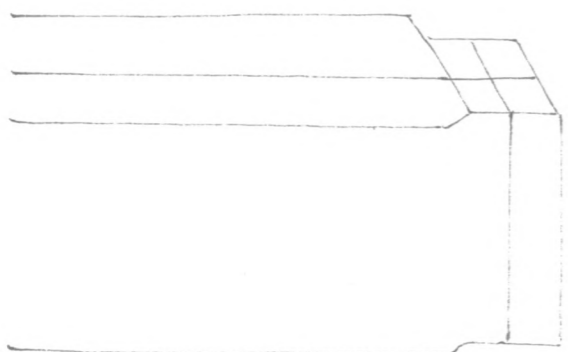

梁柱 鼓外

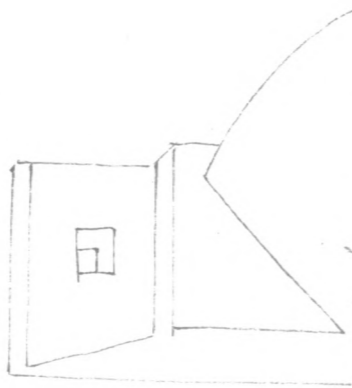
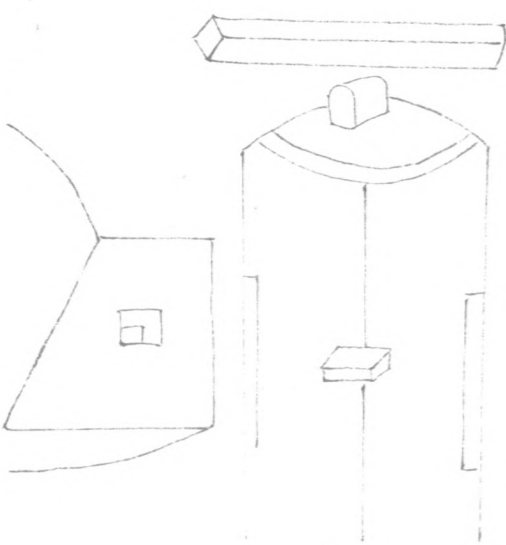

梁柱對外 藕批塔掌  
蕭眼穿串

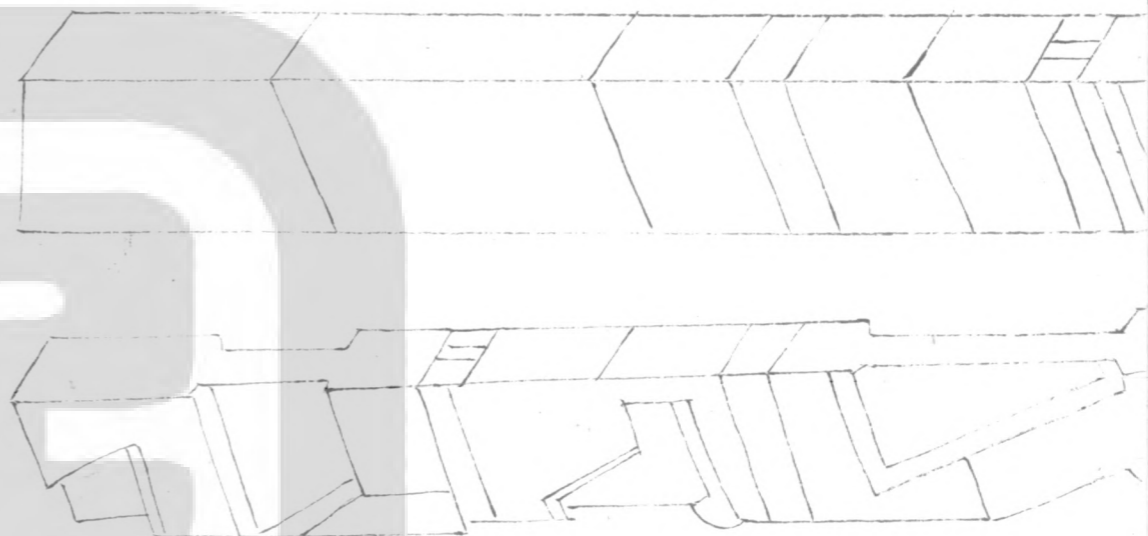

平盤料 華拱  
上用

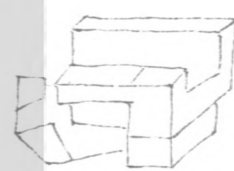

齊心料 令拱  
上用

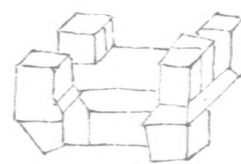

交互料 橫包

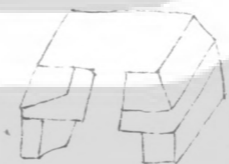

散料 泥道拱  
上用

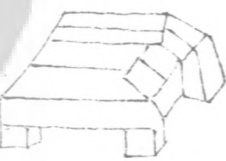

齊心料 泥道拱  
上用

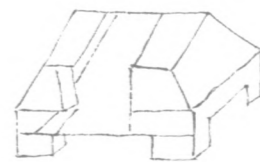

交互料 昂上

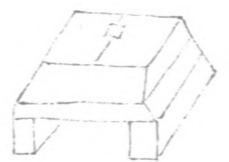

散料 外跳  
上用



平盤料 昂上  
用

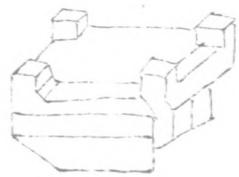

齊心料 泥道拱  
上用

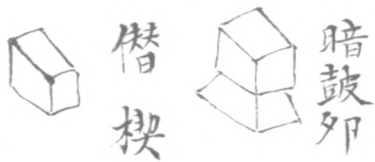

暗鼓卯



替楔

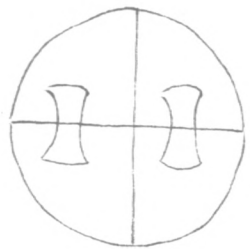

正樣



蓋鞠明



鞠

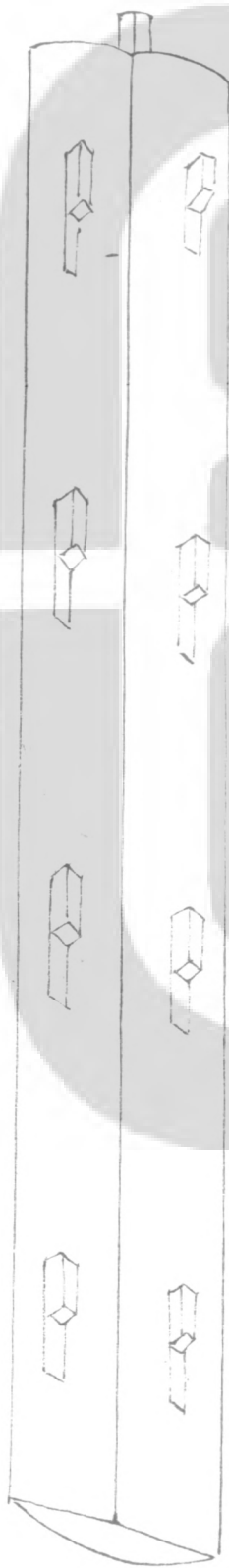
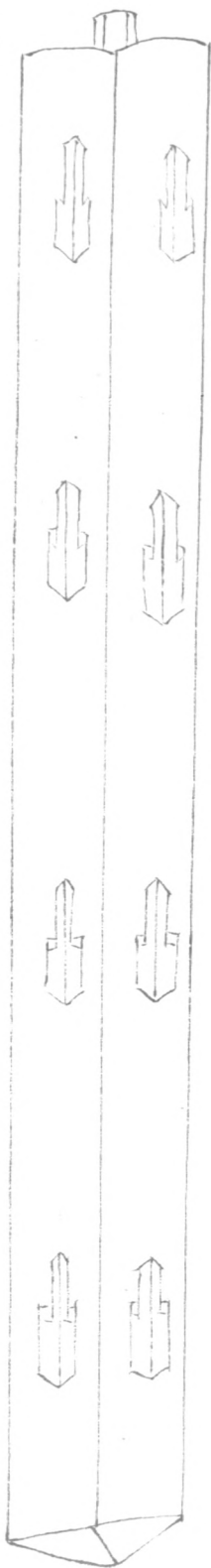

兩段合

合柱鼓卯第七

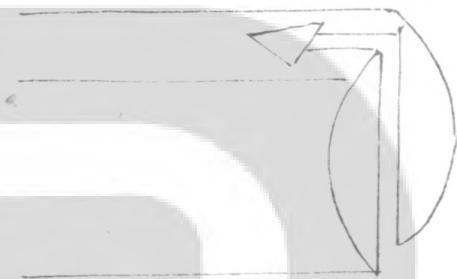

搏間縫  
煙根  
頭口

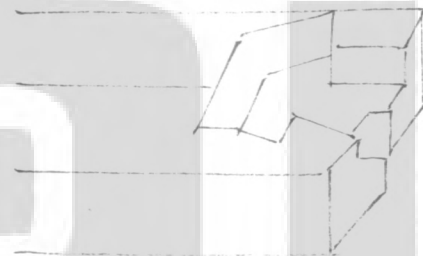
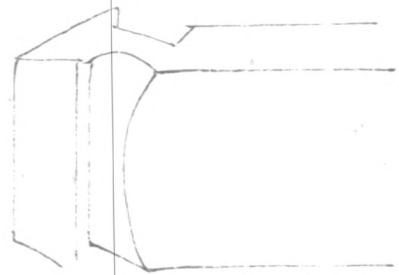

普拍方間縫  
煙根  
頭口

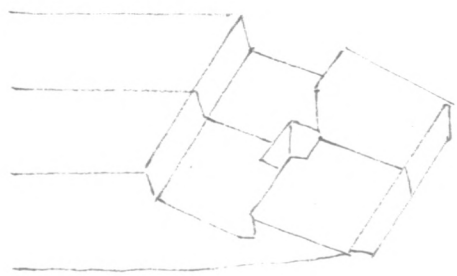

普拍方間縫  
勾頭  
搭掌

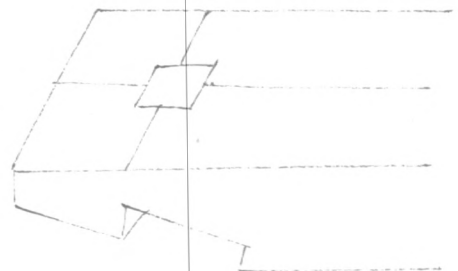

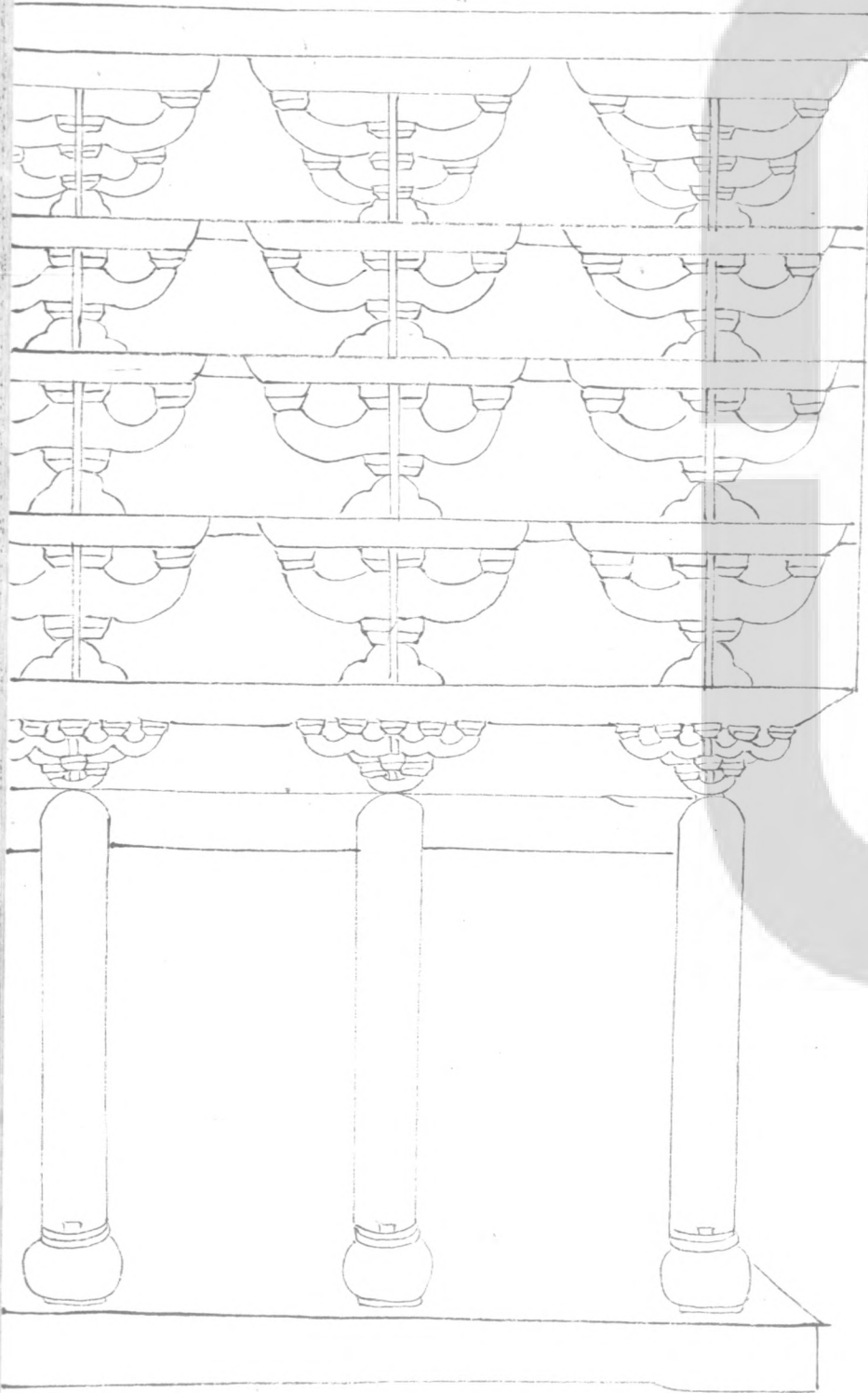

兩材 搏  
 間 縫  
 單材 襷  
 間 間  
 今 拵  
 拱 節  
 實栢 第  
 襷 八  
 間 栢



三段合  
 同 四段

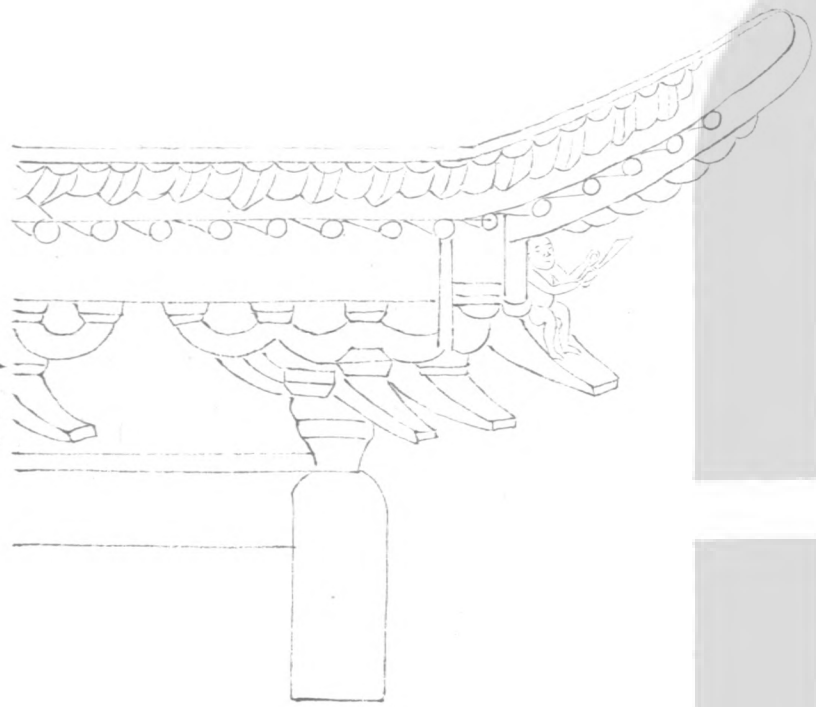

鋪作轉角正樣第九  
殿閣亭榭等轉角正樣四  
鋪作壁內重拱插下昂

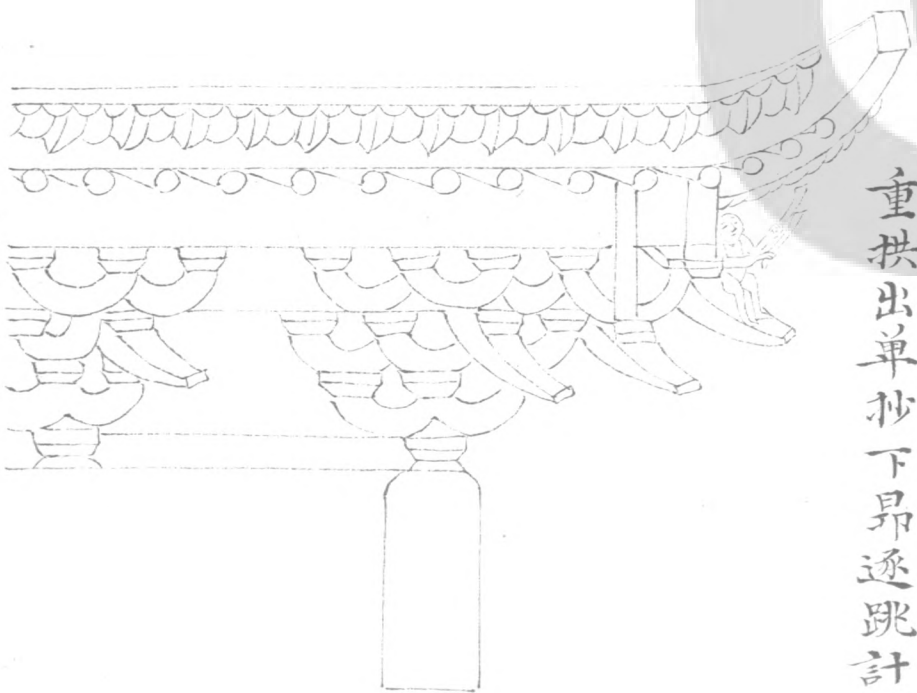

殿閣亭榭等轉角正樣五鋪作  
重拱出單抄下昂逐跳計心

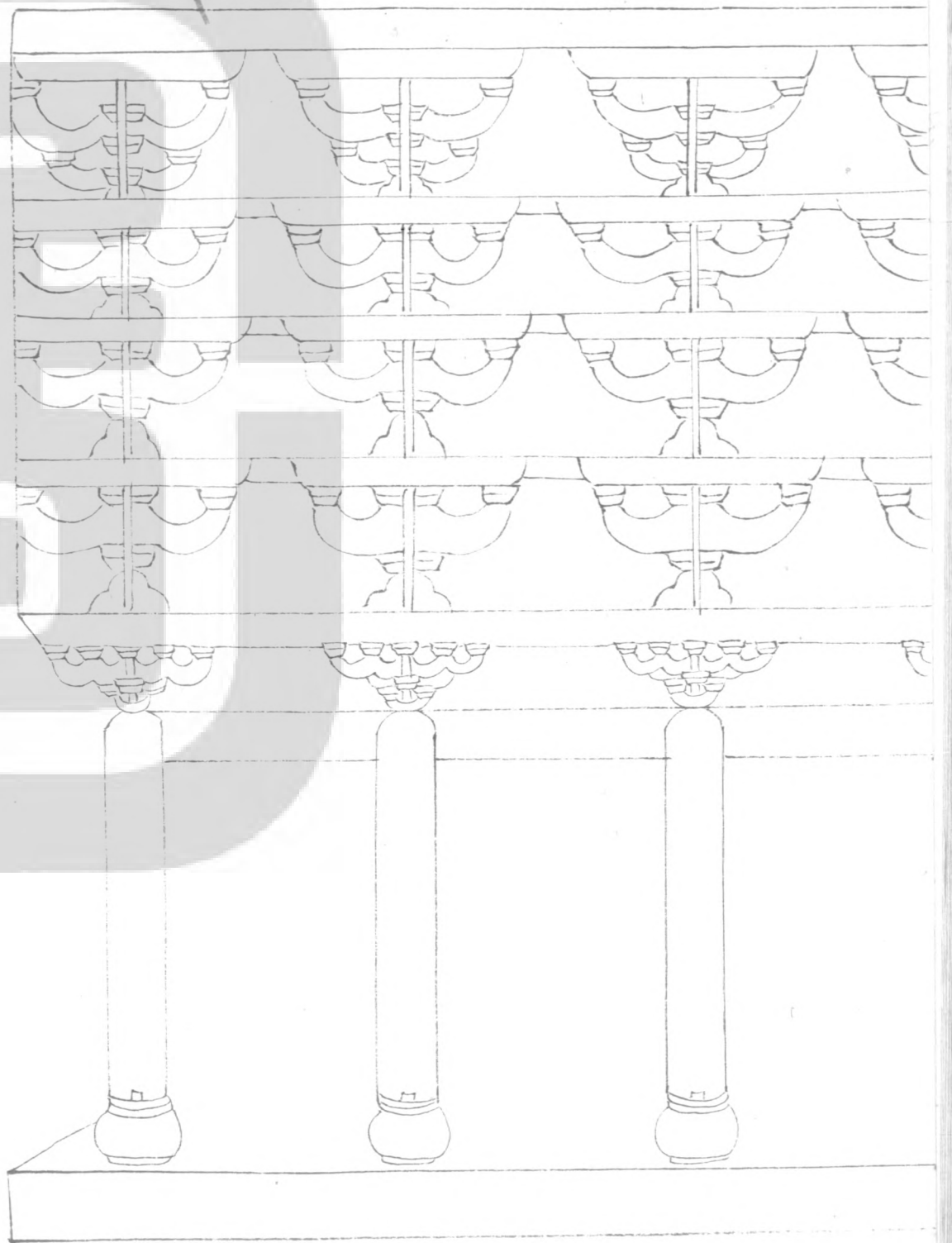

殿閣亭榭等轉角正樣六鋪作  
重拱出單抄兩下昂逐跳計心



殿閣亭榭等轉角正樣七鋪作  
重拱出雙抄兩下昂逐跳計心

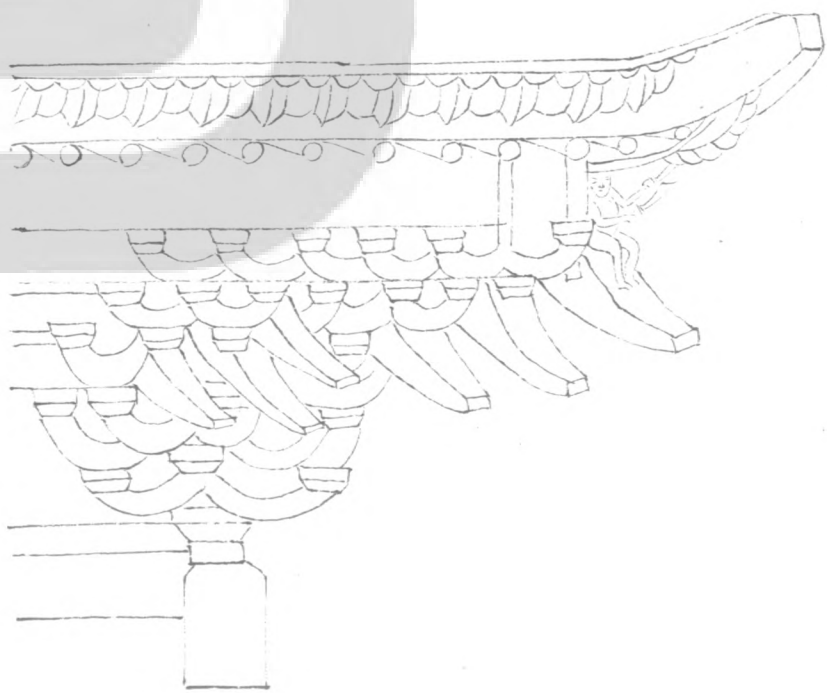

樓閣平坐轉角正樣六鋪  
作重拱出卷頭並計心

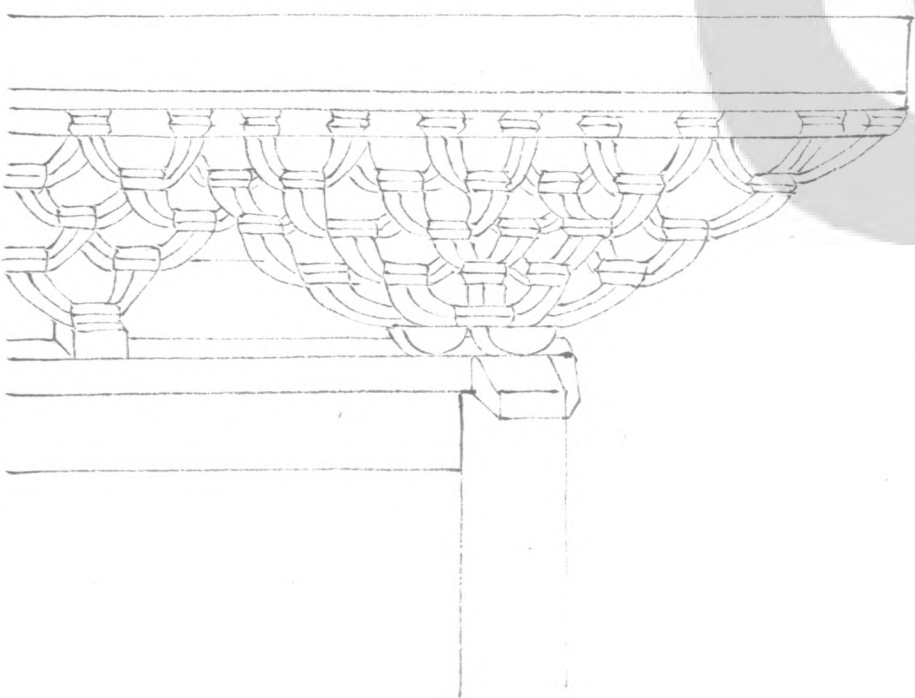
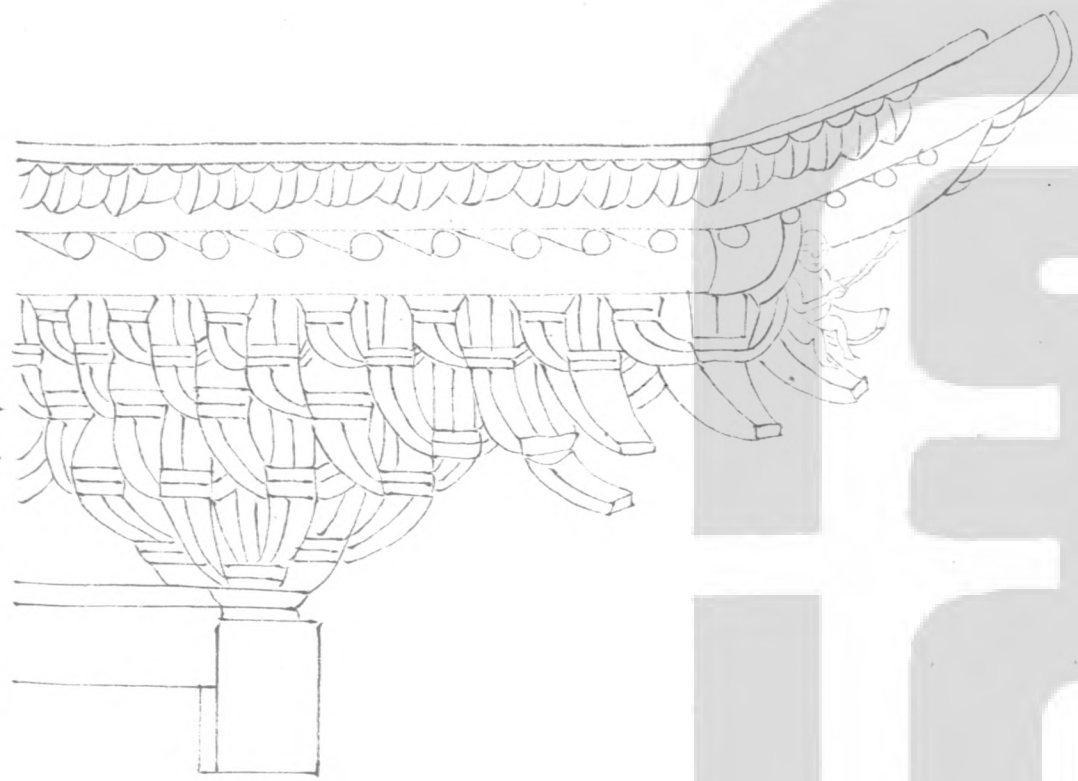

樓閣並坐轉角正樣七鋪  
作重拱出卷頭並計心

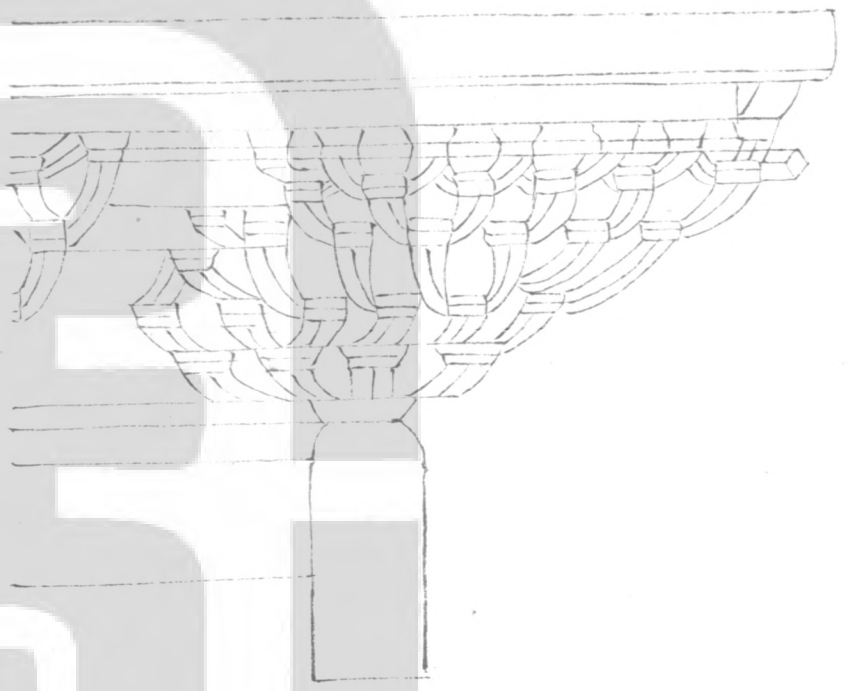

樓閣平坐轉角正樣七鋪作重拱  
出上昂偷心跳內當中施騎科拱

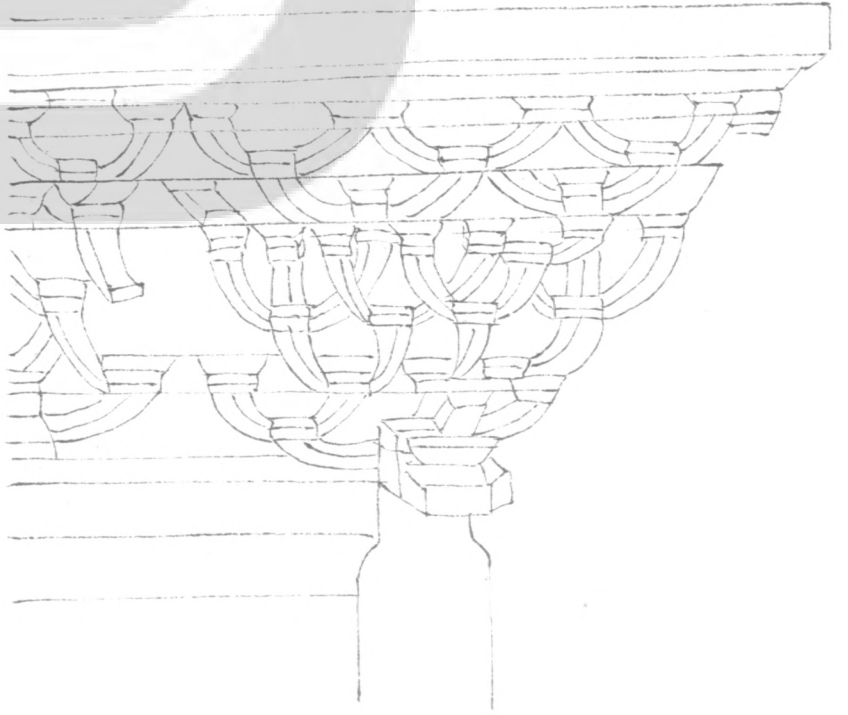

營造法式卷三十

營造法式

卷三十一

大木作制度圖樣下

殿閣地盤分槽第十

殿堂等八鋪作副階六鋪作雙槽斗底槽準此草架側樣第十一

殿堂等七鋪作副階五鋪作雙槽草架側樣第十

宋李誡撰



二

殿堂等五鋪作

副階四鋪作

單槽草架側樣第十

三

殿堂等六鋪作分心槽草架側樣第十四

廳堂等自十架椽至四架椽間縫內用梁柱第十五

殿閣地身盤九間  
身內分心斗底槽

殿閣地盤殿身七間副階周市  
各兩架椽身內金箱斗底槽

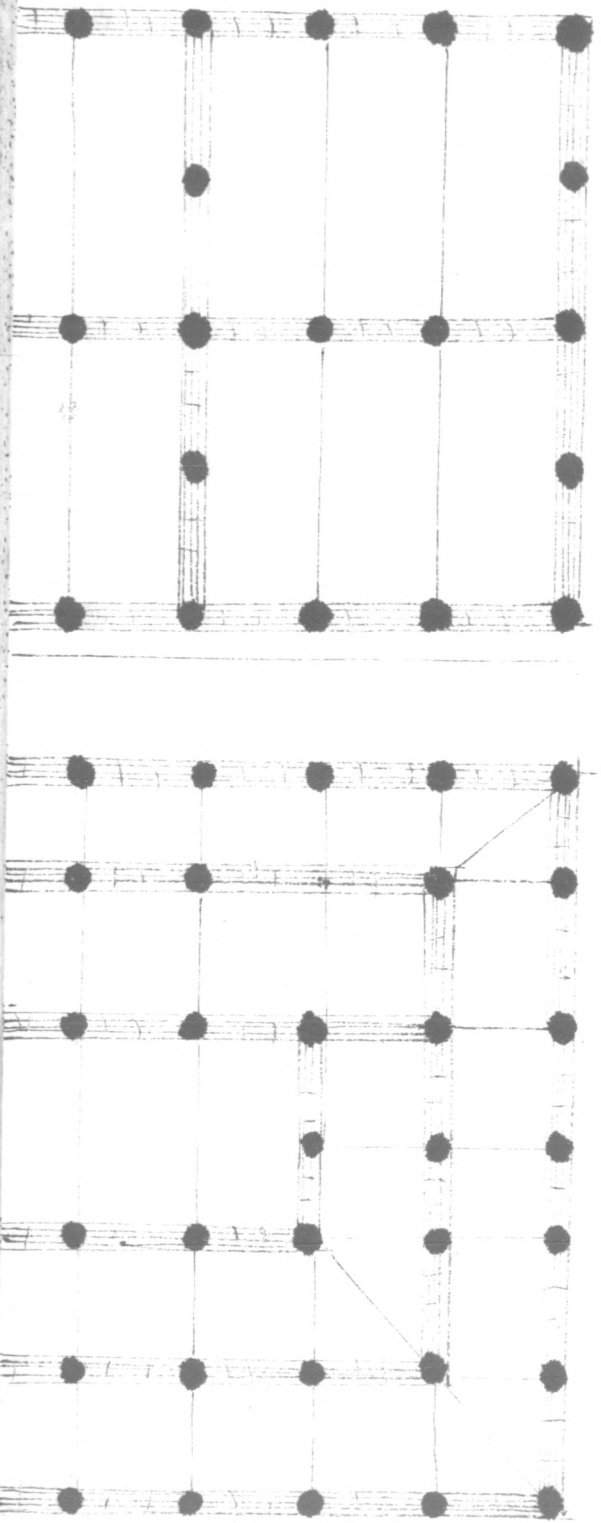

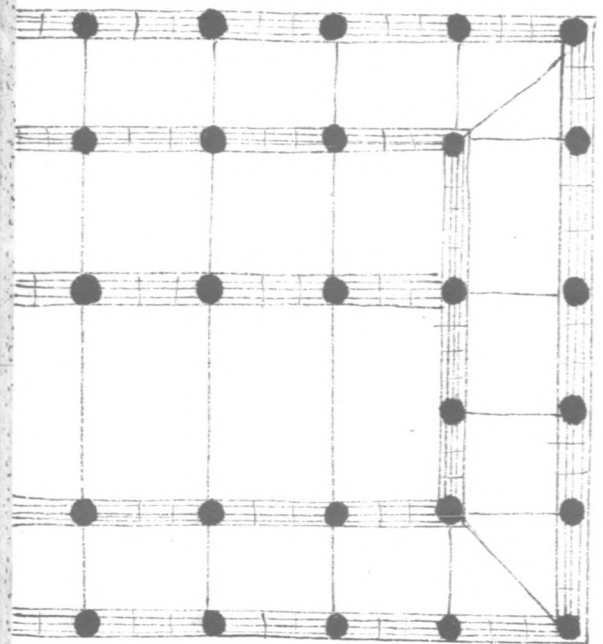

殿閣地盤殿身七間副階  
周市各兩架椽身內單槽

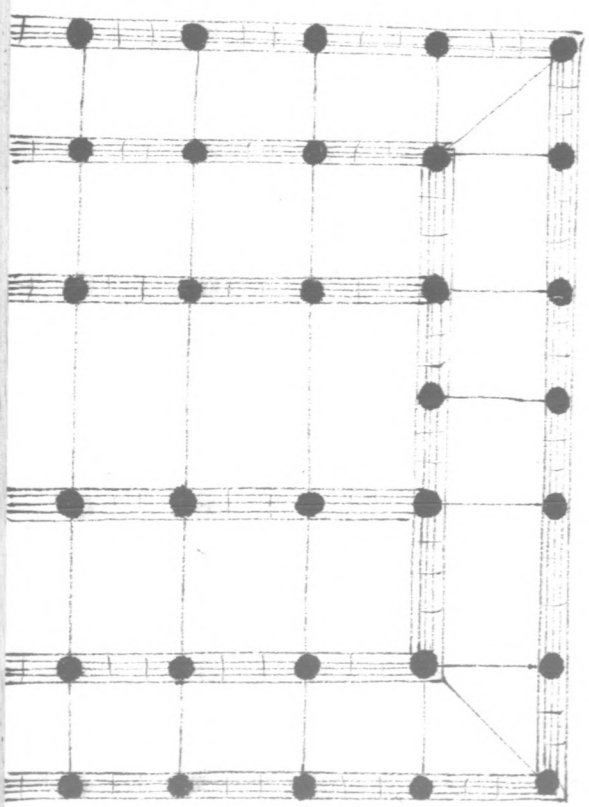

殿閣地盤殿身七間副階  
周市各兩椽身內雙槽

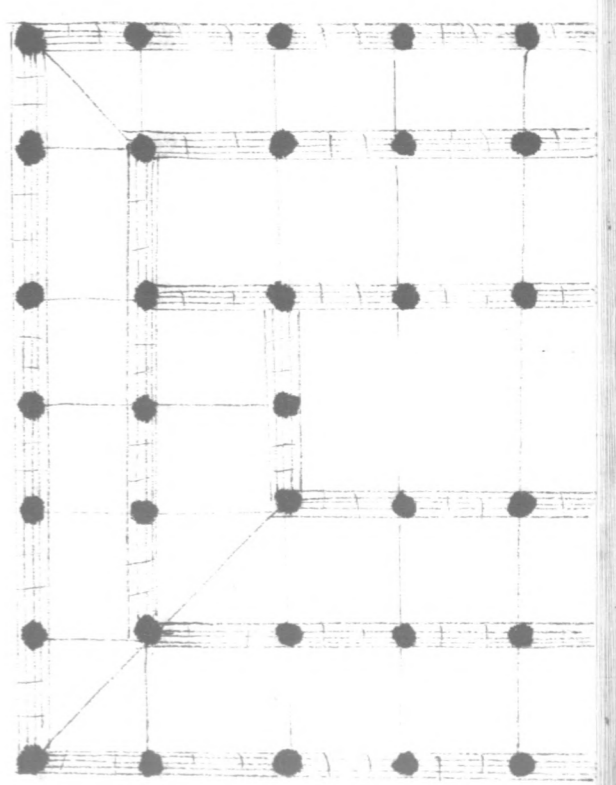
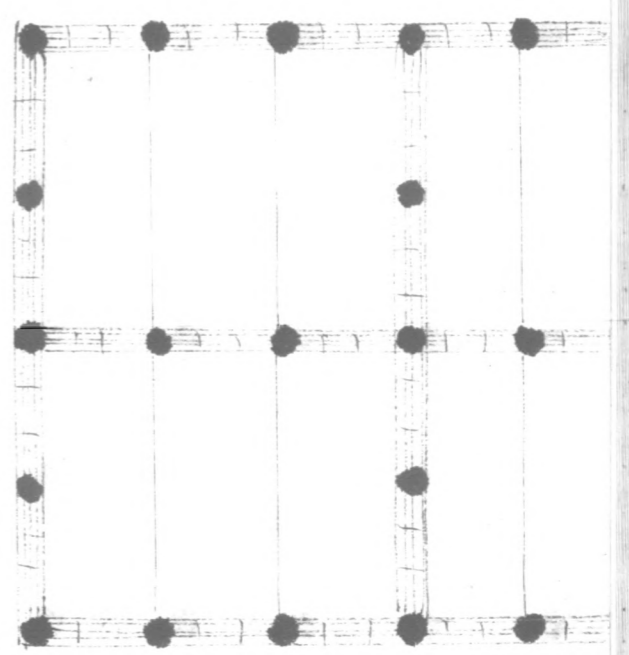

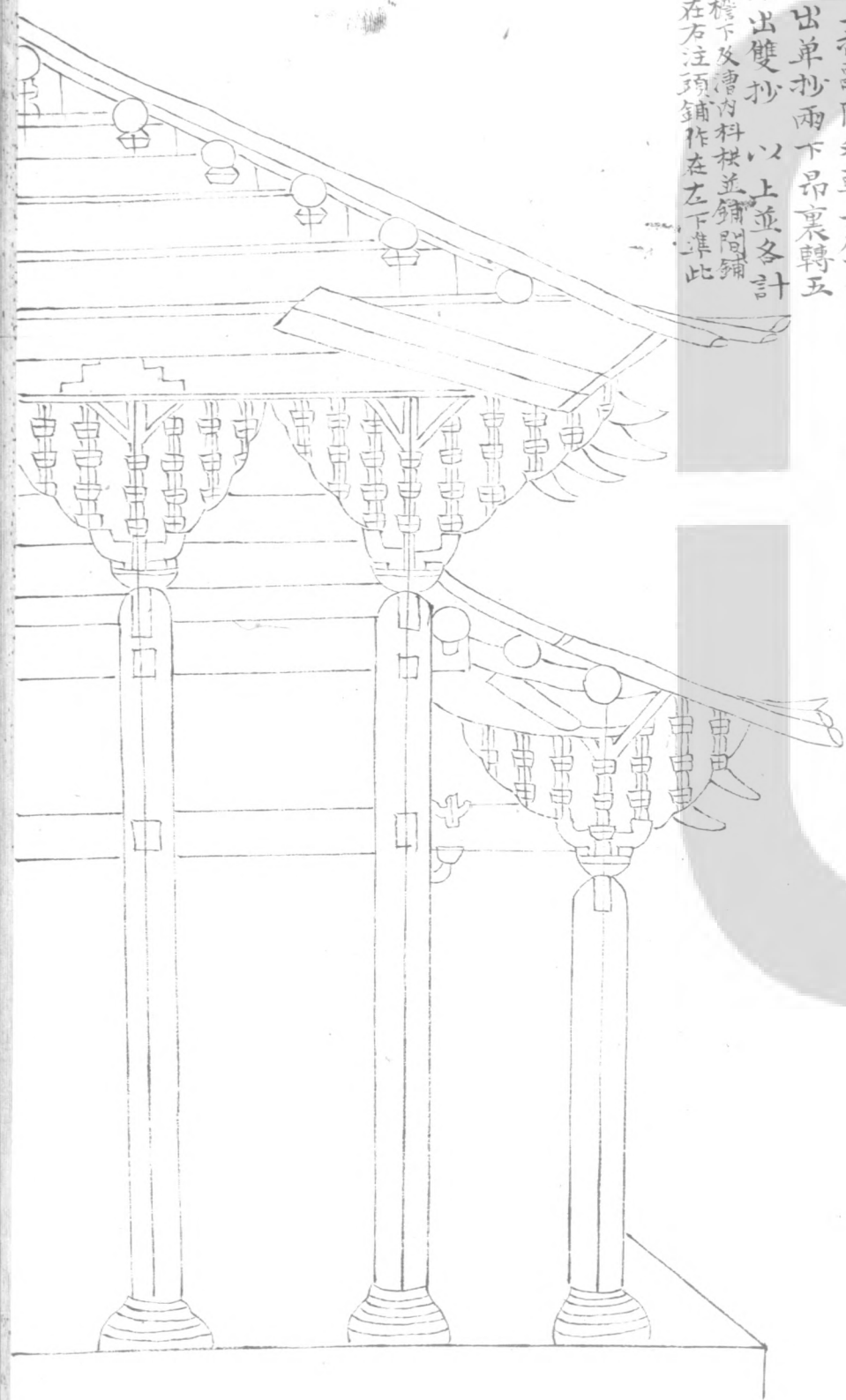

殿側樣十架椽身內雙槽  
 殿身外轉八鋪作重拱出  
 雙抄三下昂裏轉六鋪作重  
 拱出三抄副階外轉六鋪作  
 重拱出單抄兩下昂裏轉五  
 鋪作出雙抄以上並各計  
 心其檼下及槽內科枋並鋪間鋪  
 心作在右頭鋪作在左下準此

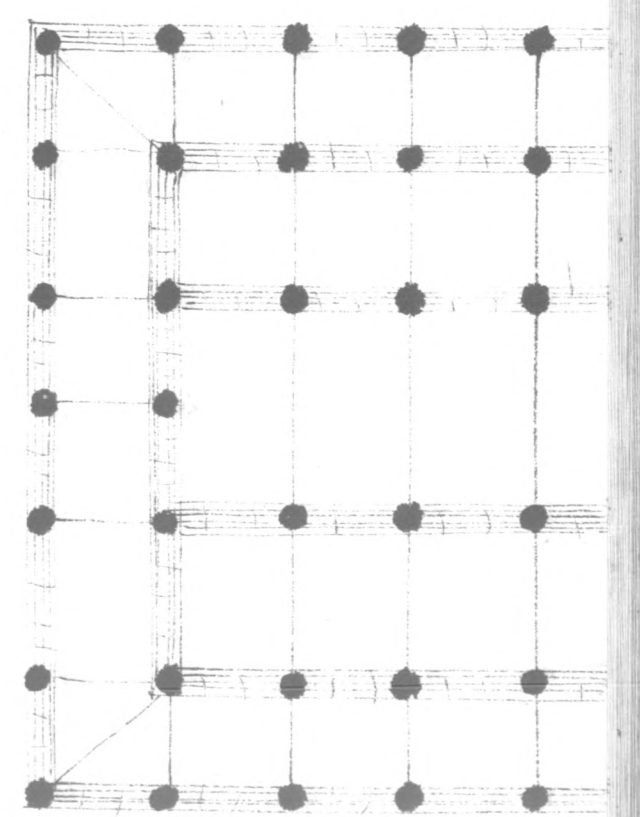
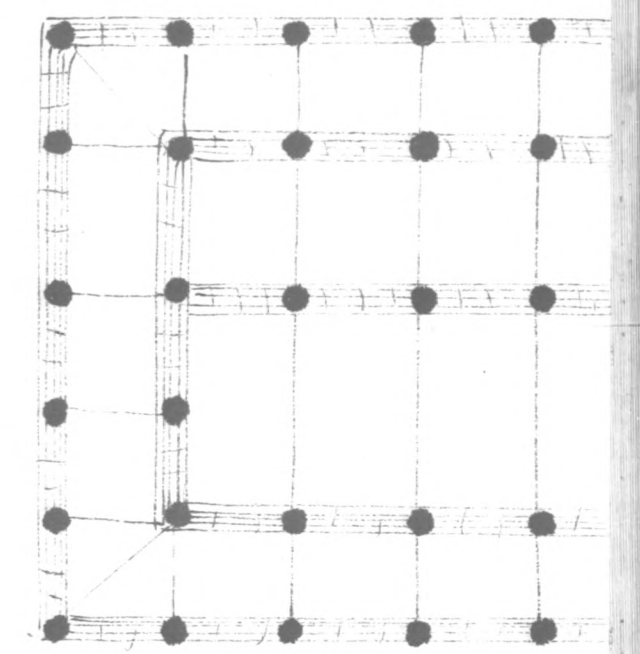

殿側樣十架椽身內雙槽殿  
身外轉七鋪作重拱出雙抄  
兩下昂裏轉六鋪作重拱出  
三抄副階外轉五鋪作重拱  
出單抄單昂裏轉五鋪作出  
雙抄以上並各計心



殿側樣十架椽身內單槽殿  
身外轉五鋪作重拱出單抄  
單下昂裏轉五鋪作重拱出  
雙抄副階外轉四出插昂裏  
轉出一跳以上並各計心

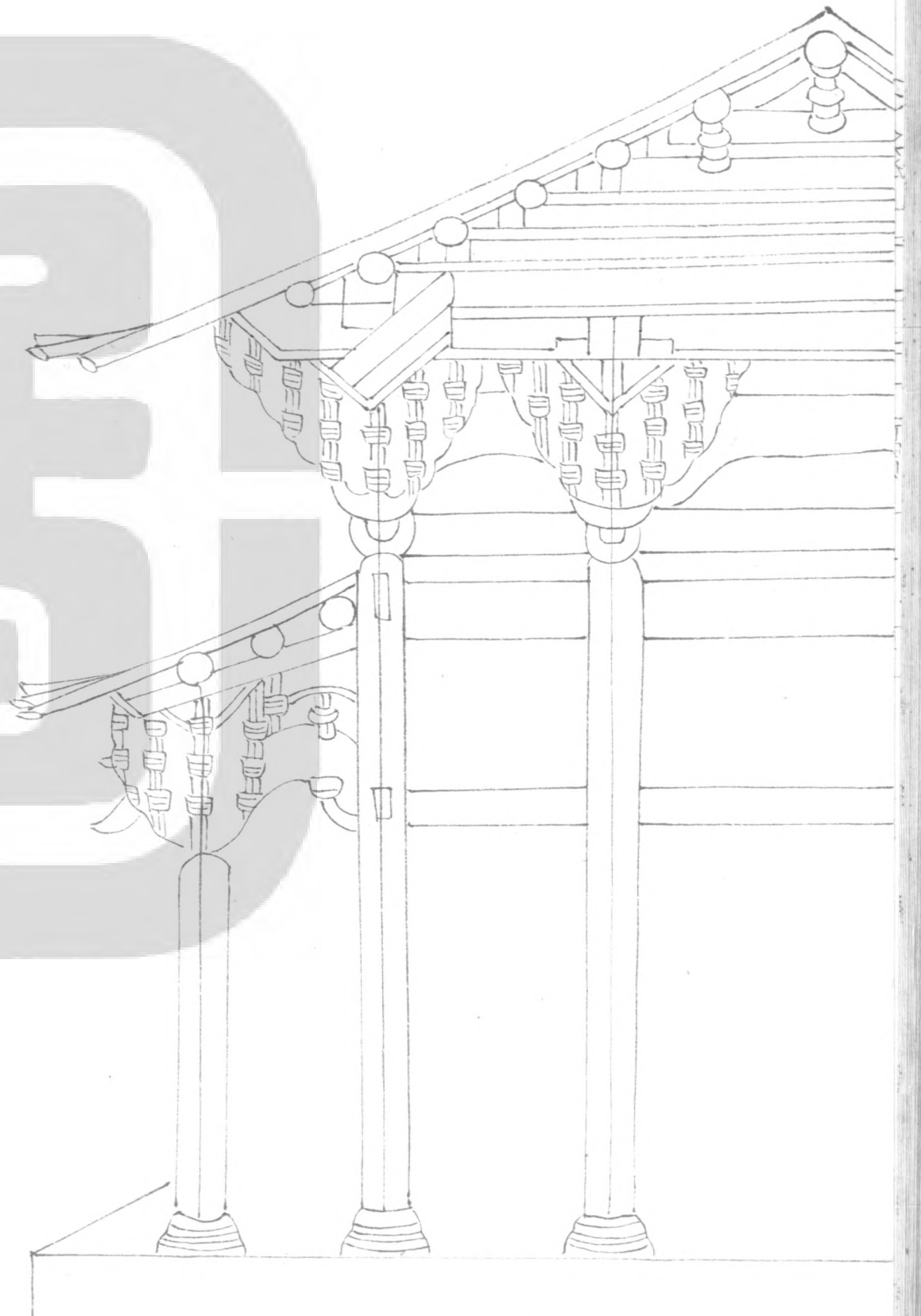
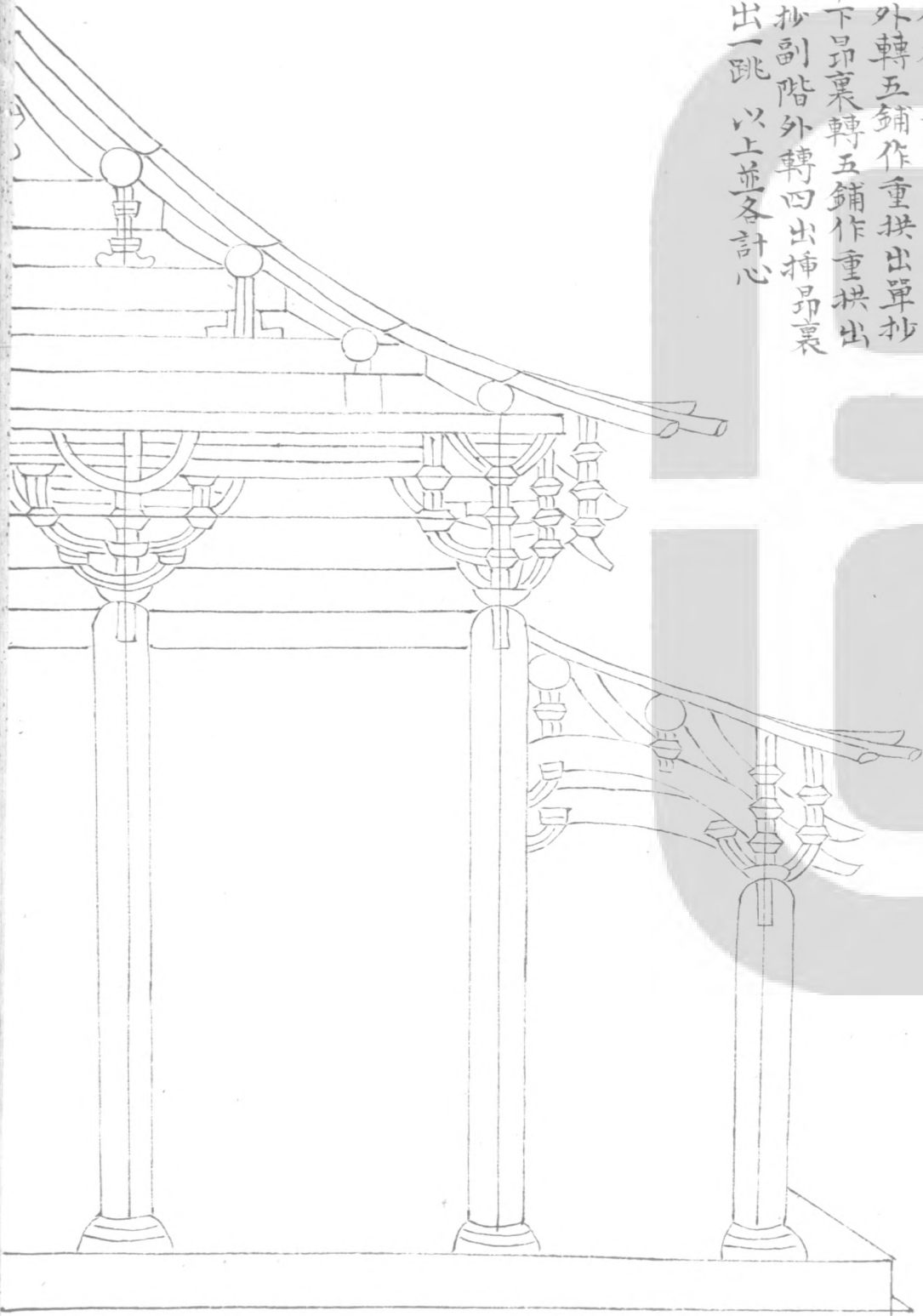

殿側樣十架椽身內單  
槽外轉六鋪作重拱出  
單抄兩下昂裏轉五鋪  
作重拱出兩抄以上並  
各計心

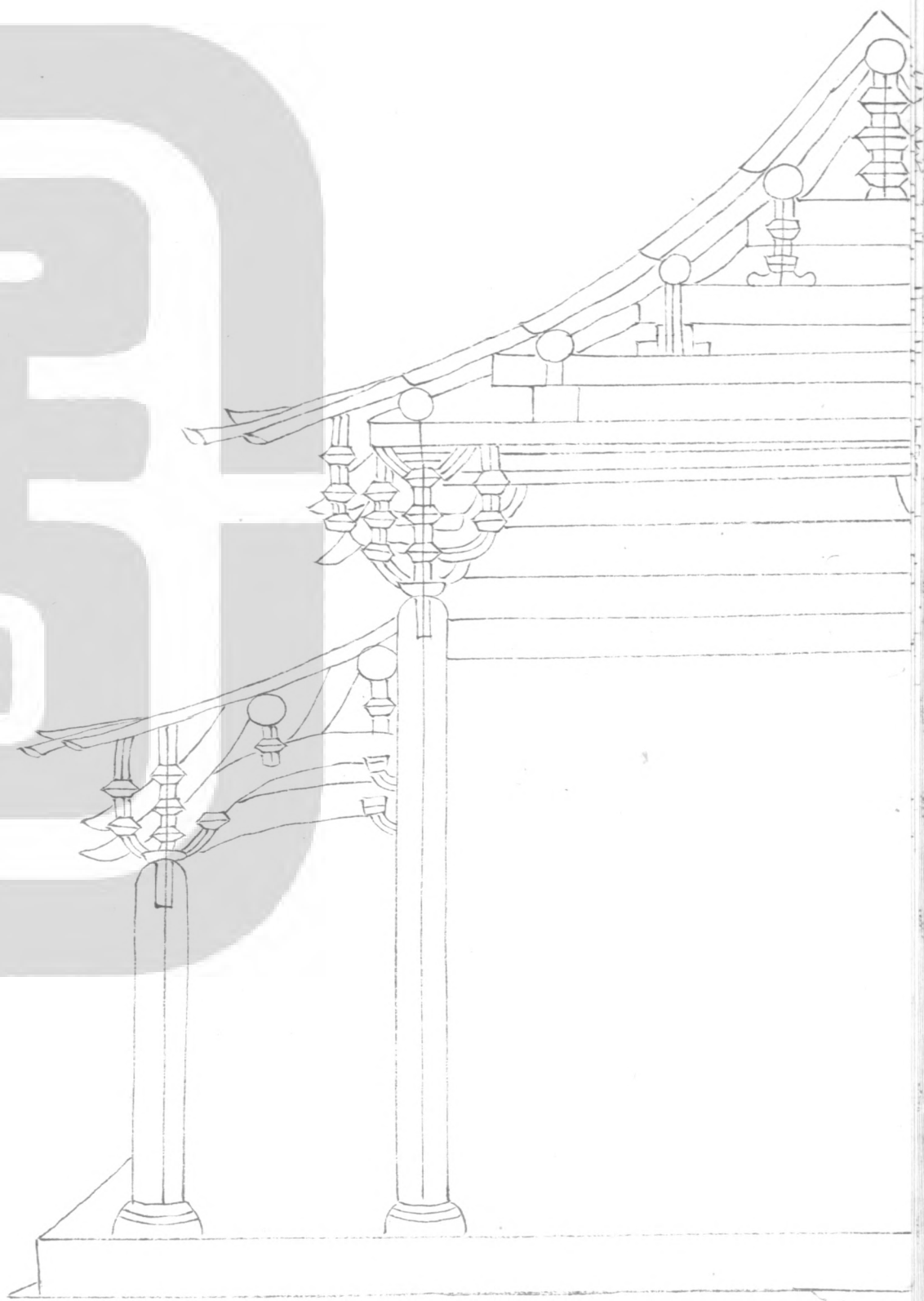
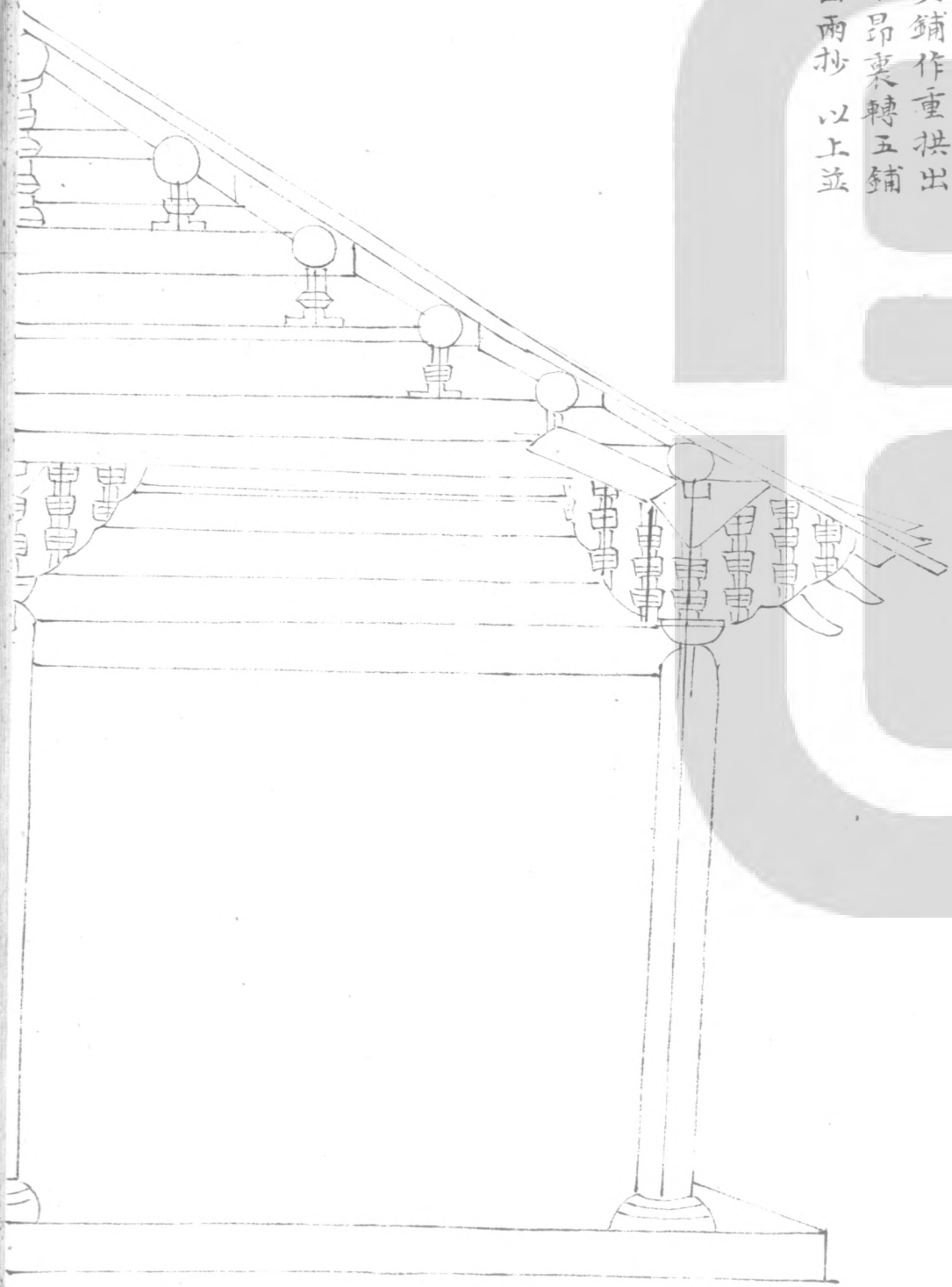

十架椽屋分心三柱

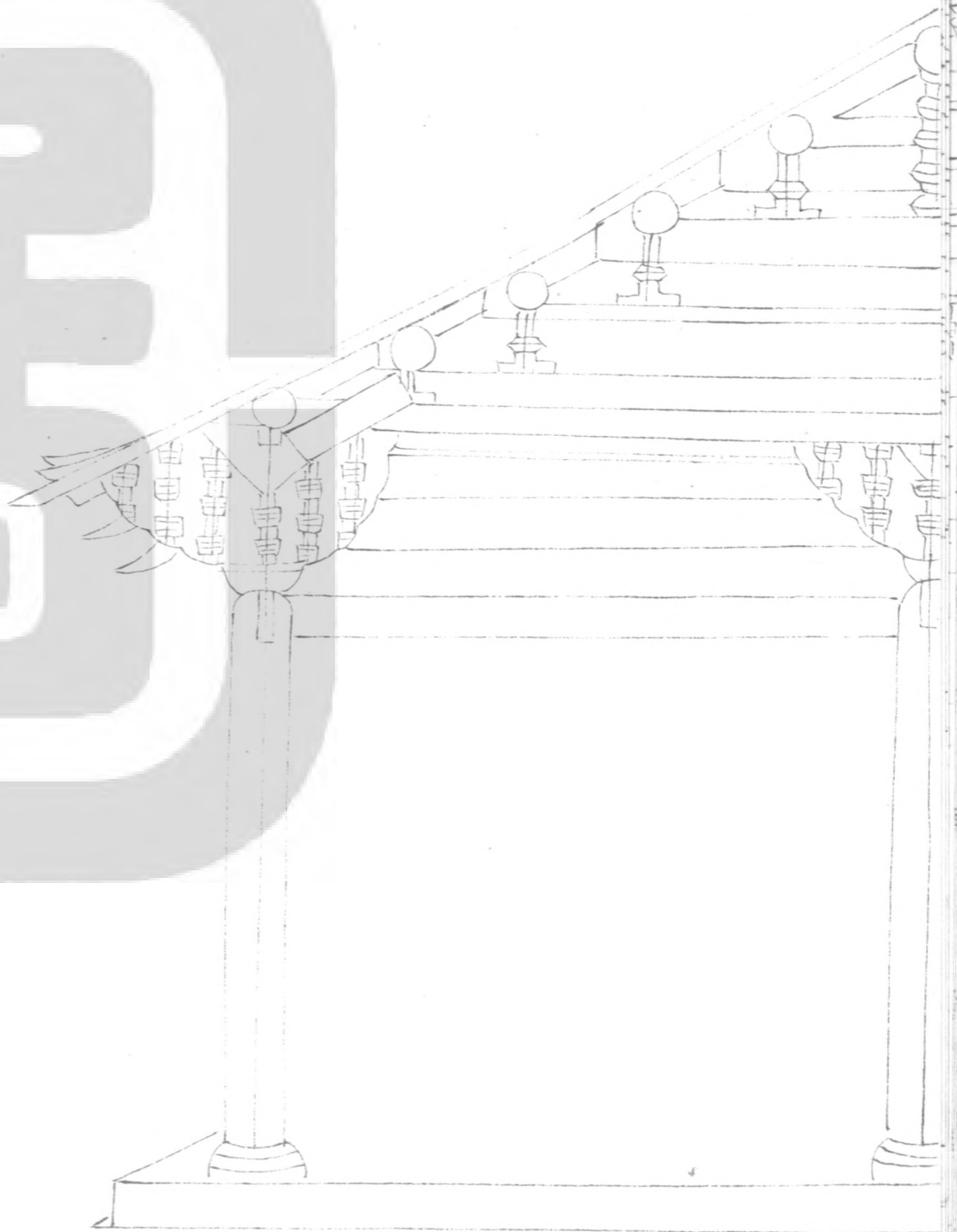
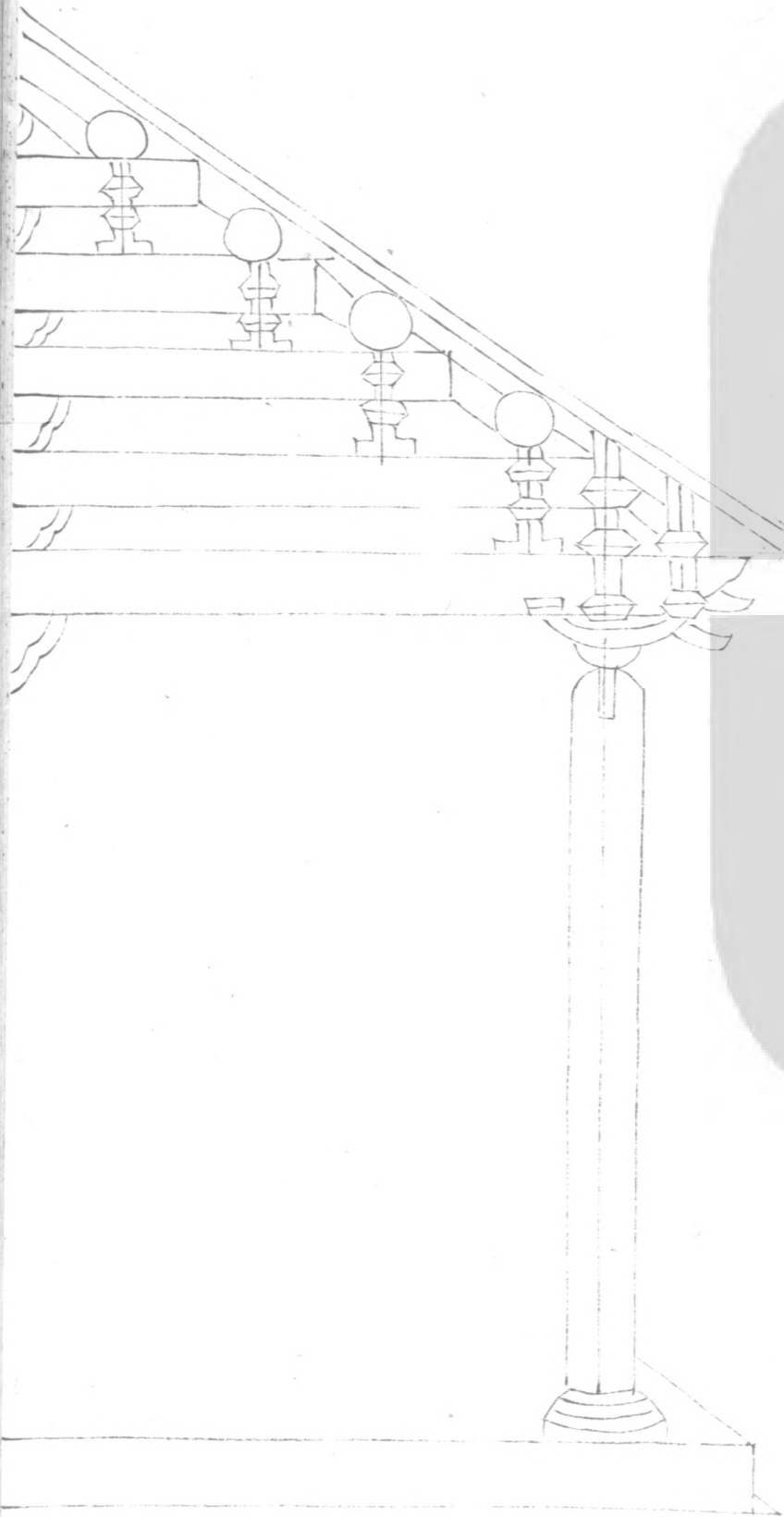

十架椽屋前後三椽楸用四柱

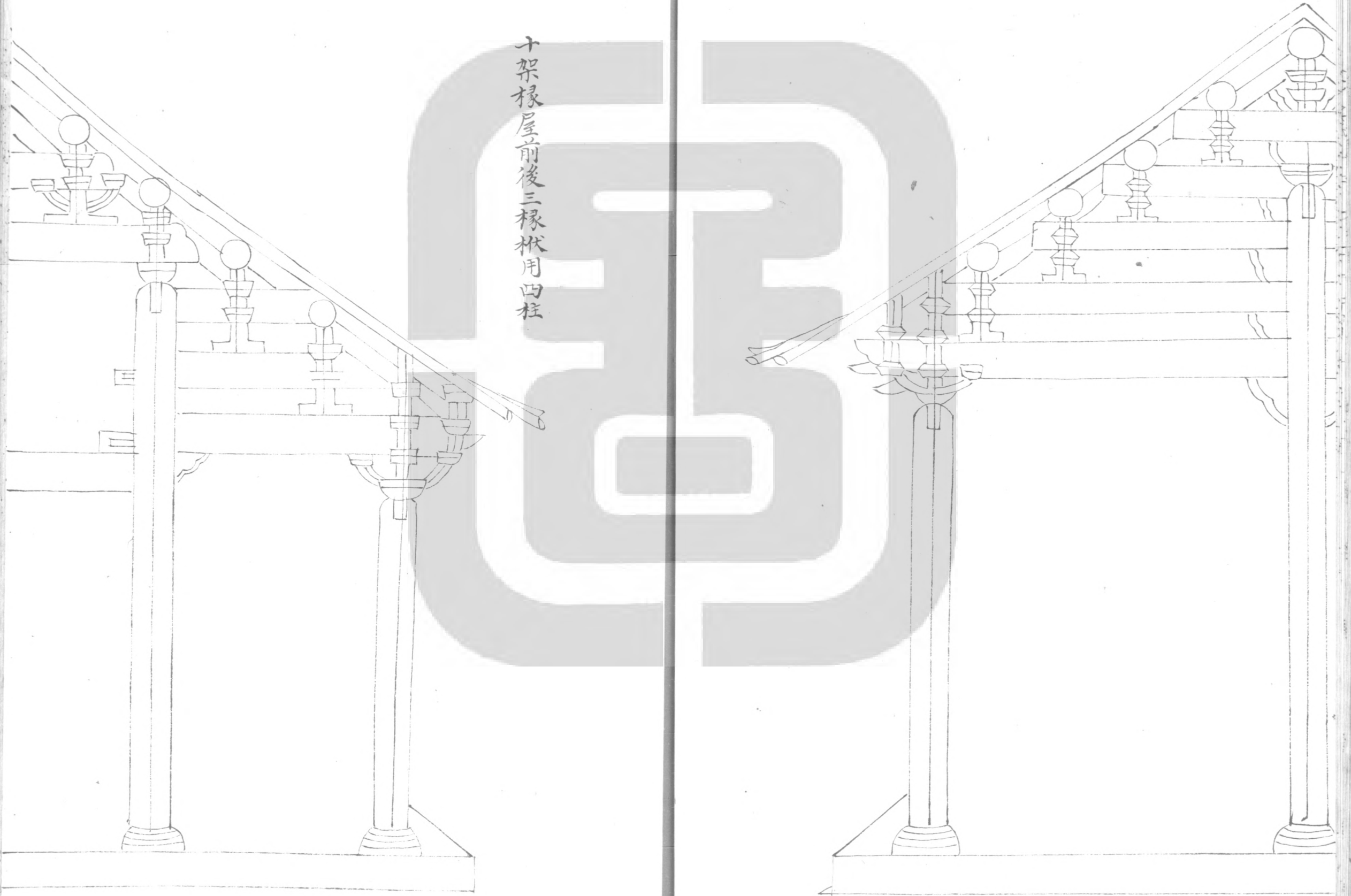



十架椽屋分心前後乳楸用五柱

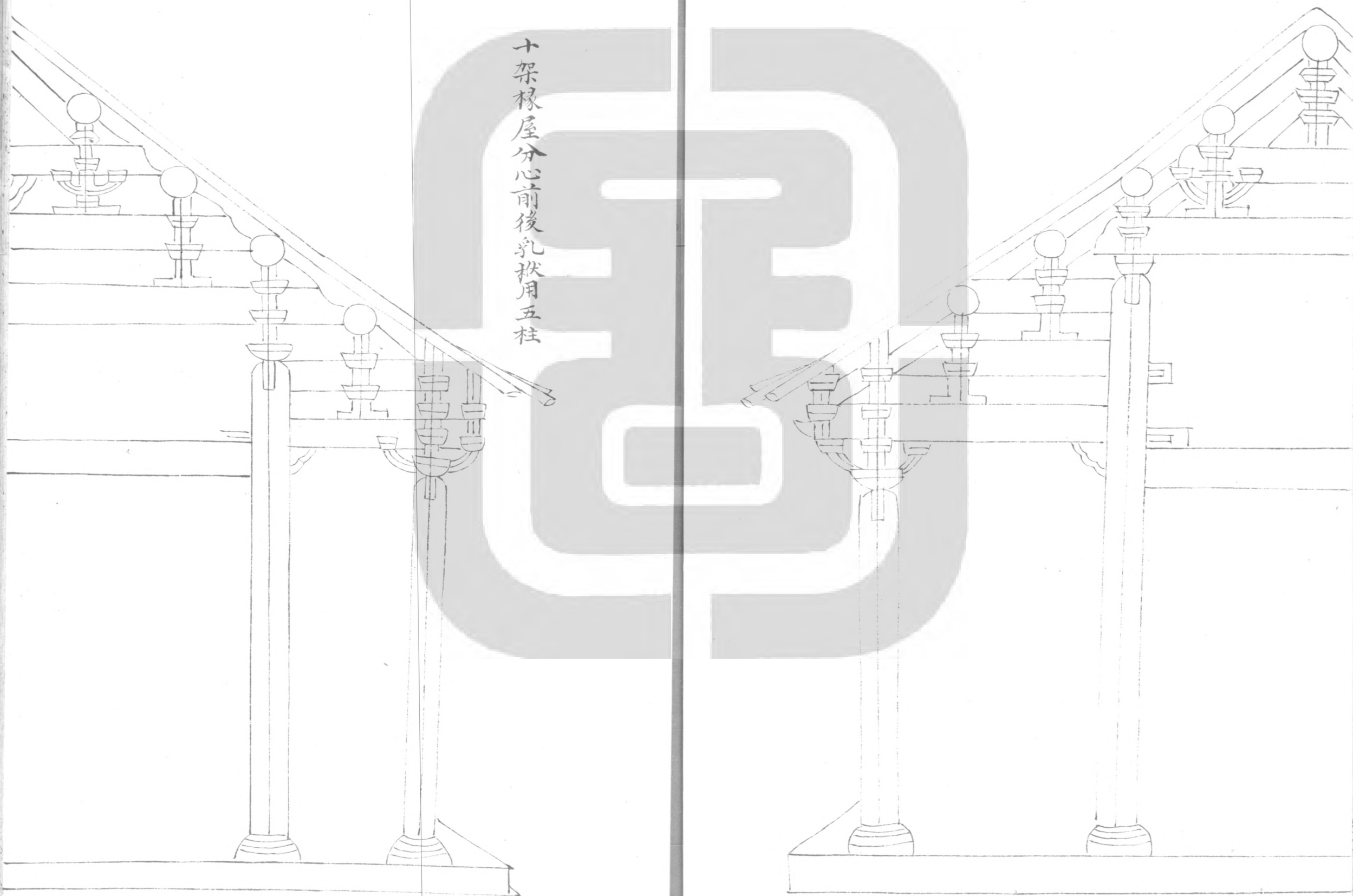

十架椽屋前後並乳楸用六柱

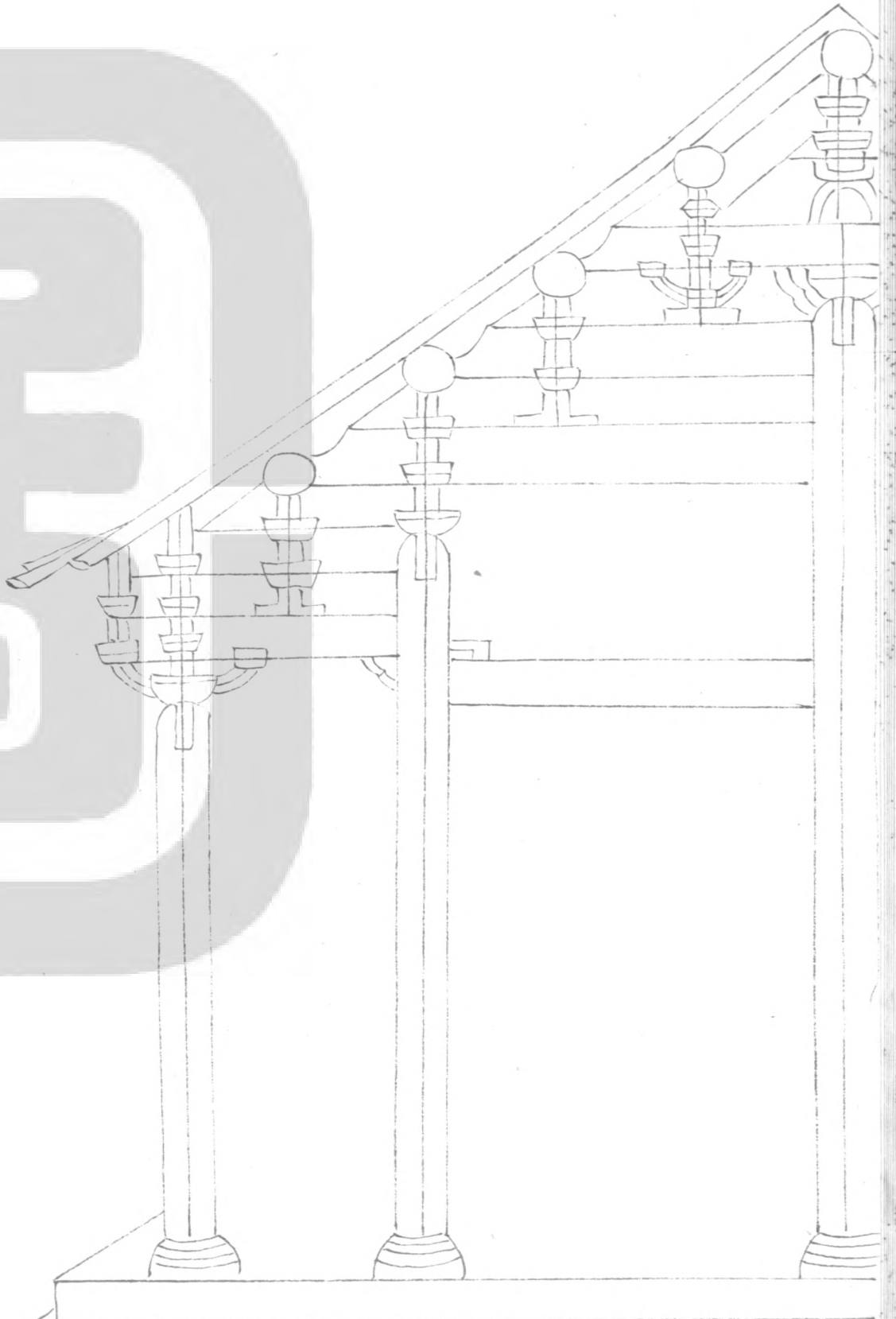
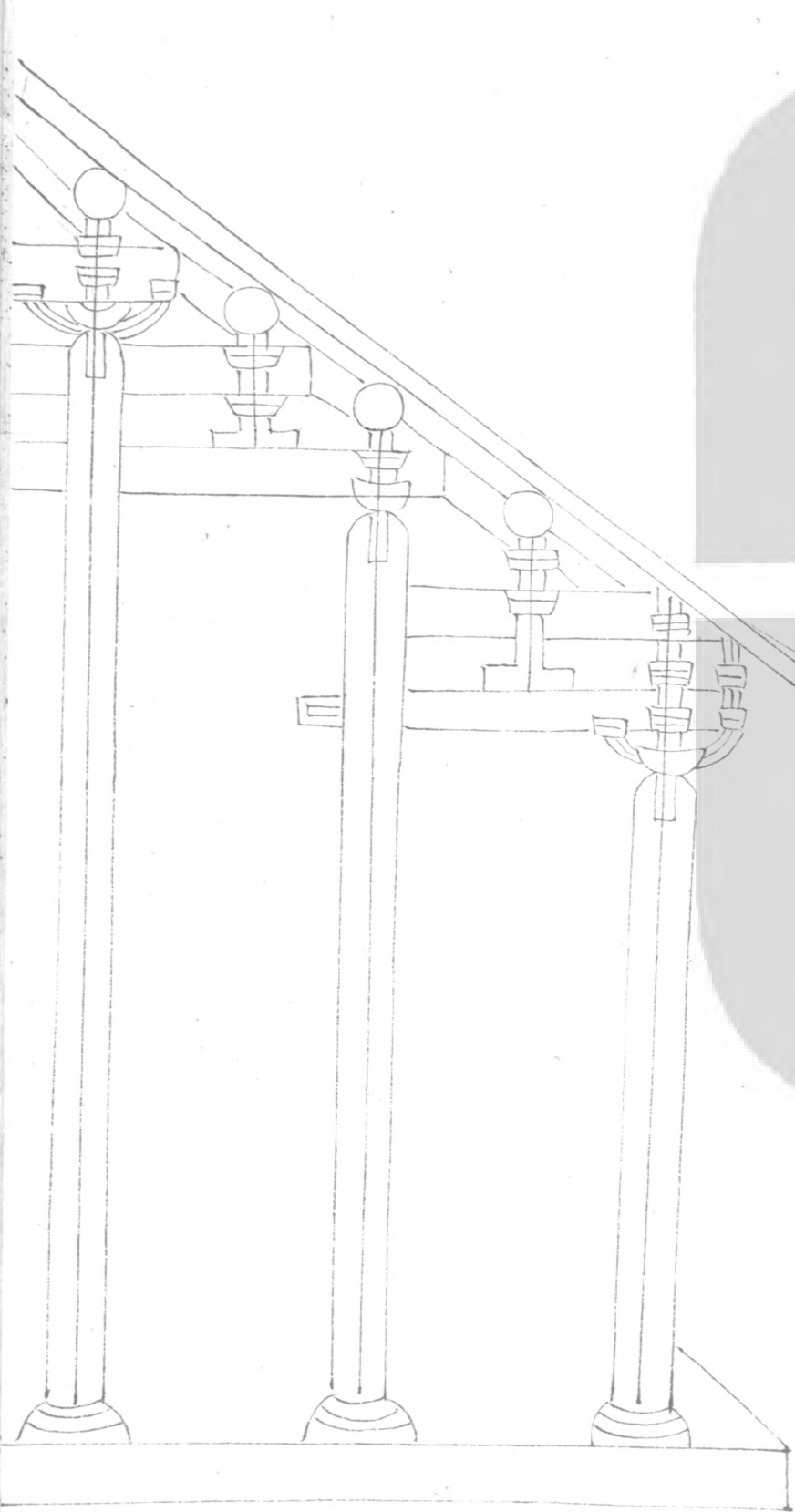

十架椽屋前後各割牽乳楸用六柱

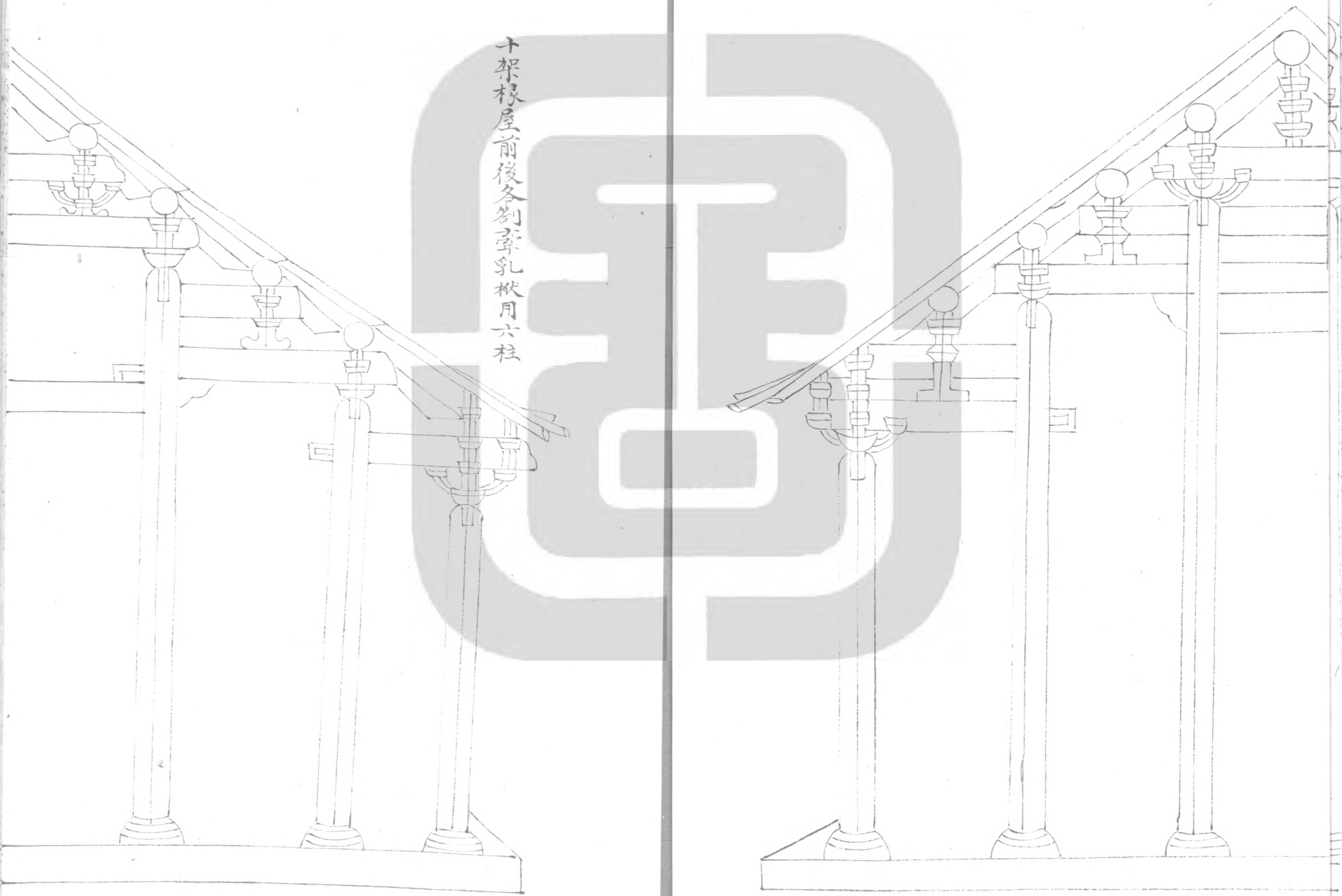

八架椽屋分心用三柱

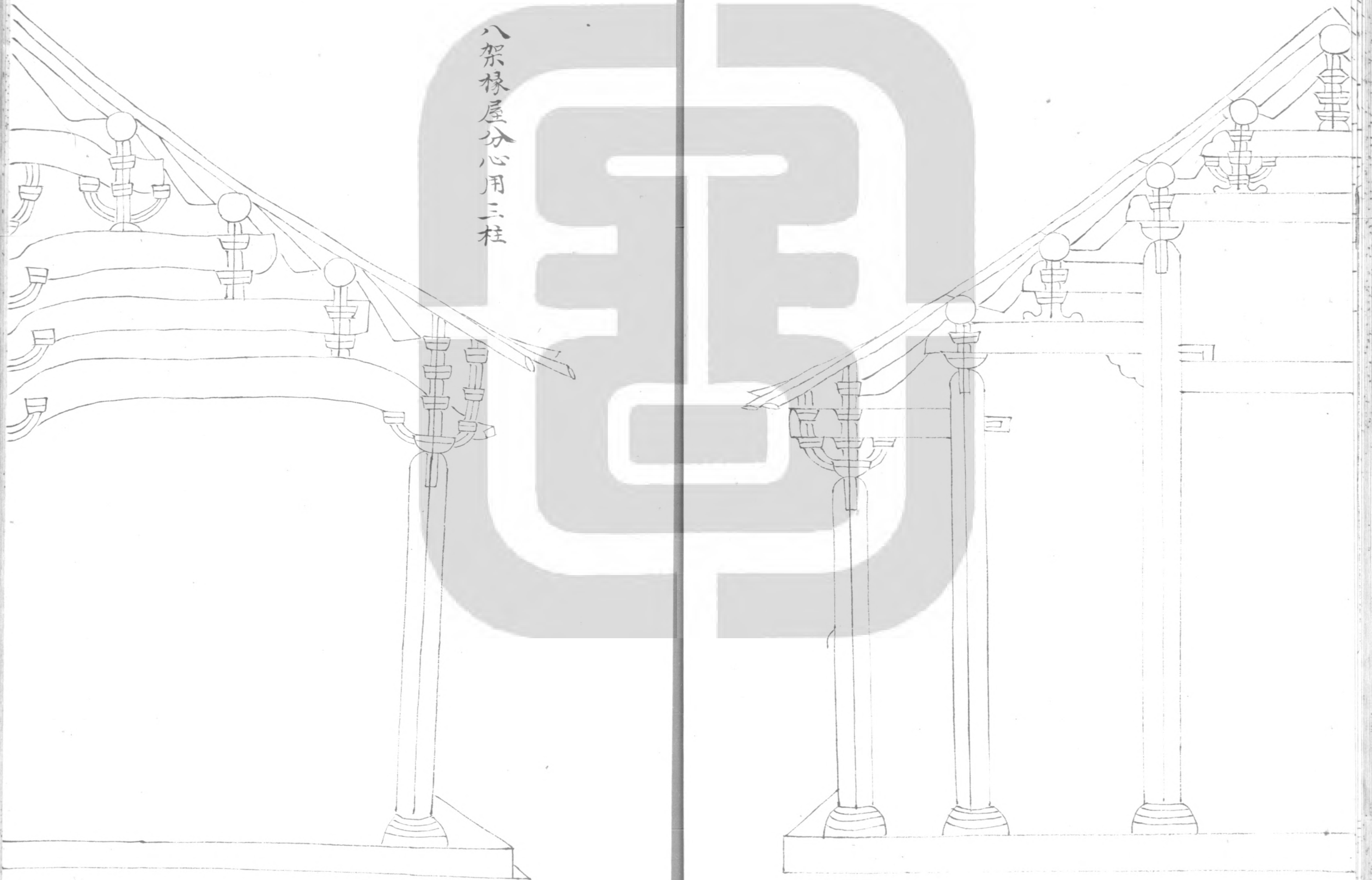

八架椽屋乳栿對六椽栿用三柱

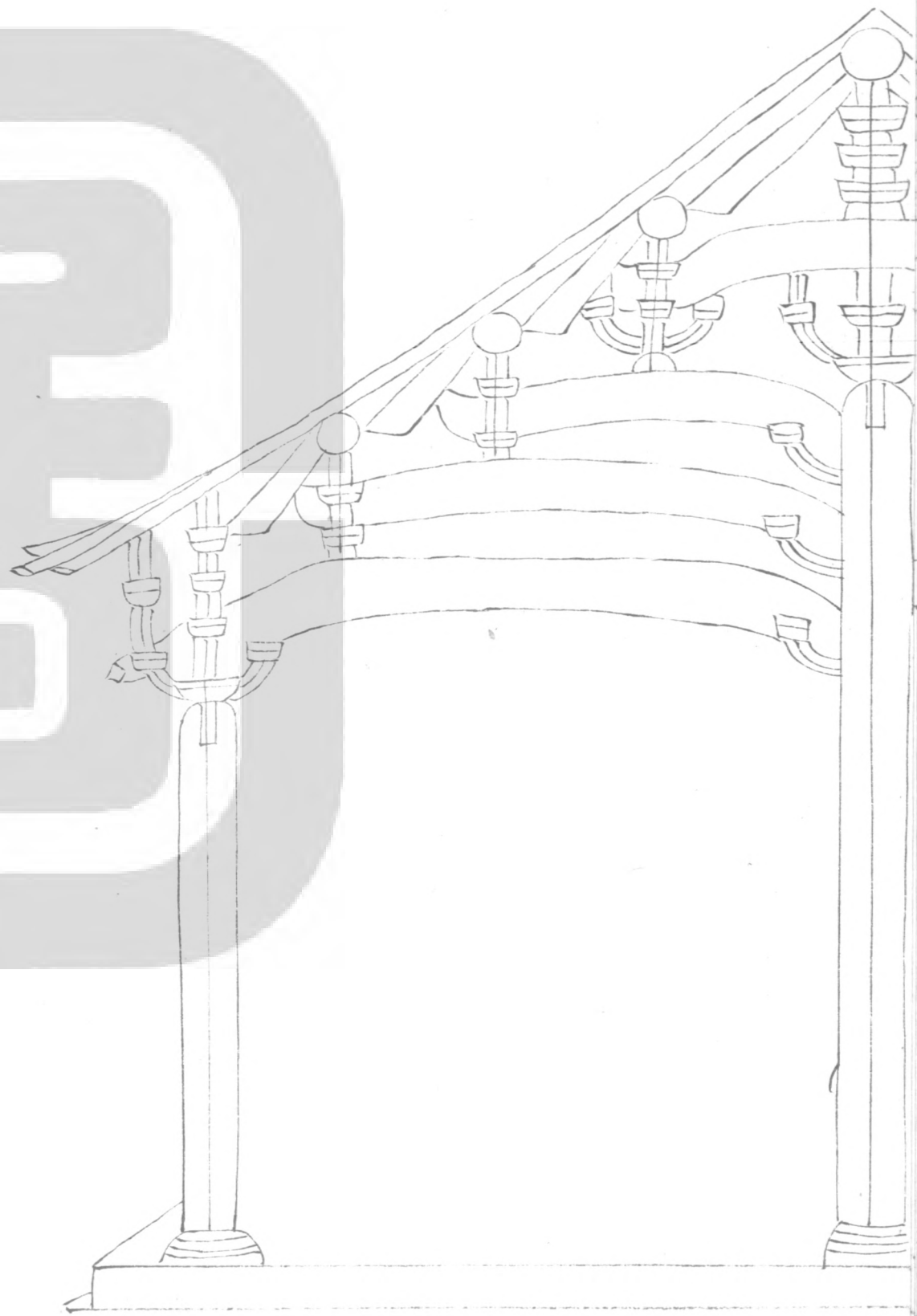
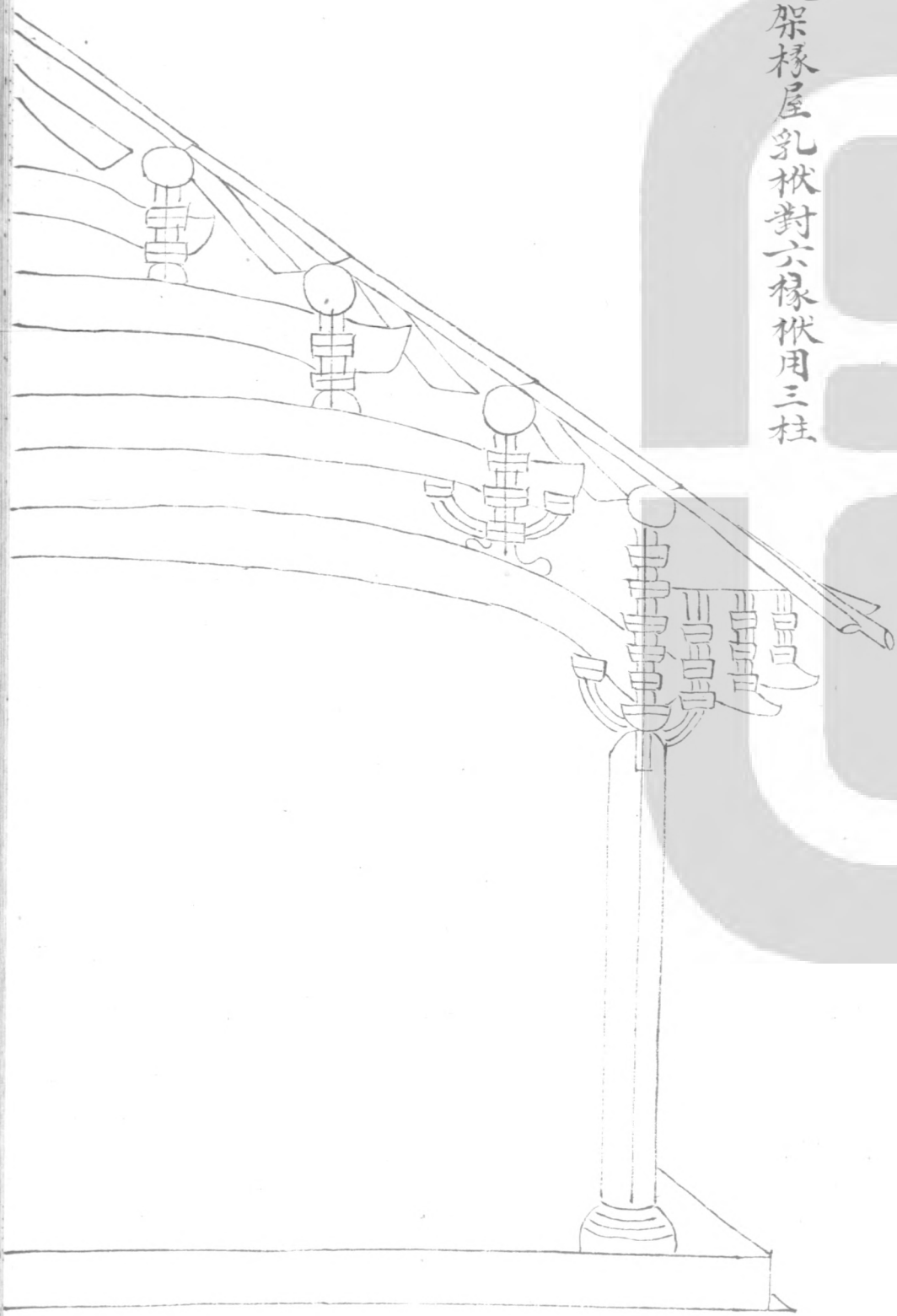

架椽屋前後乳栿用四柱

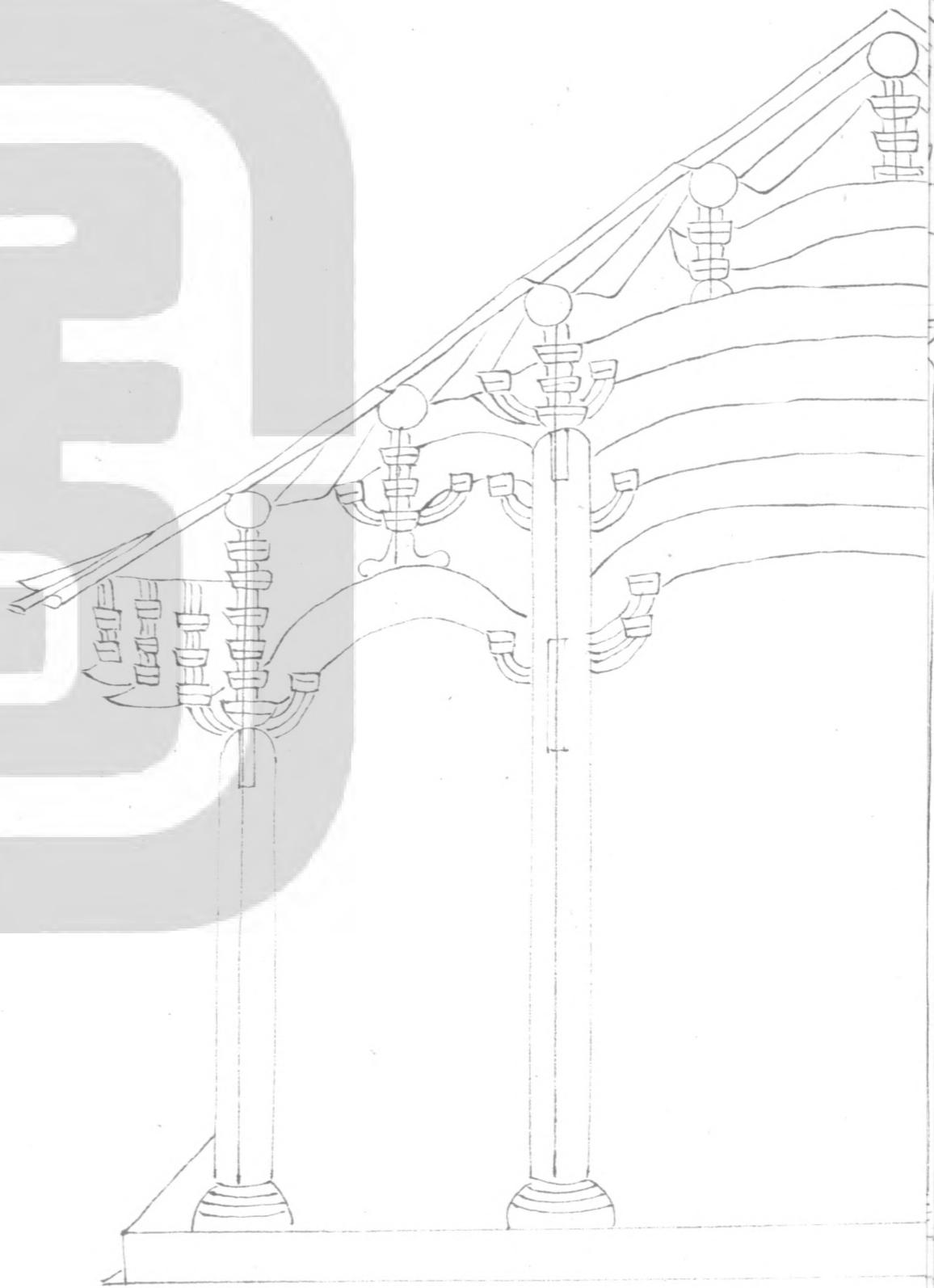
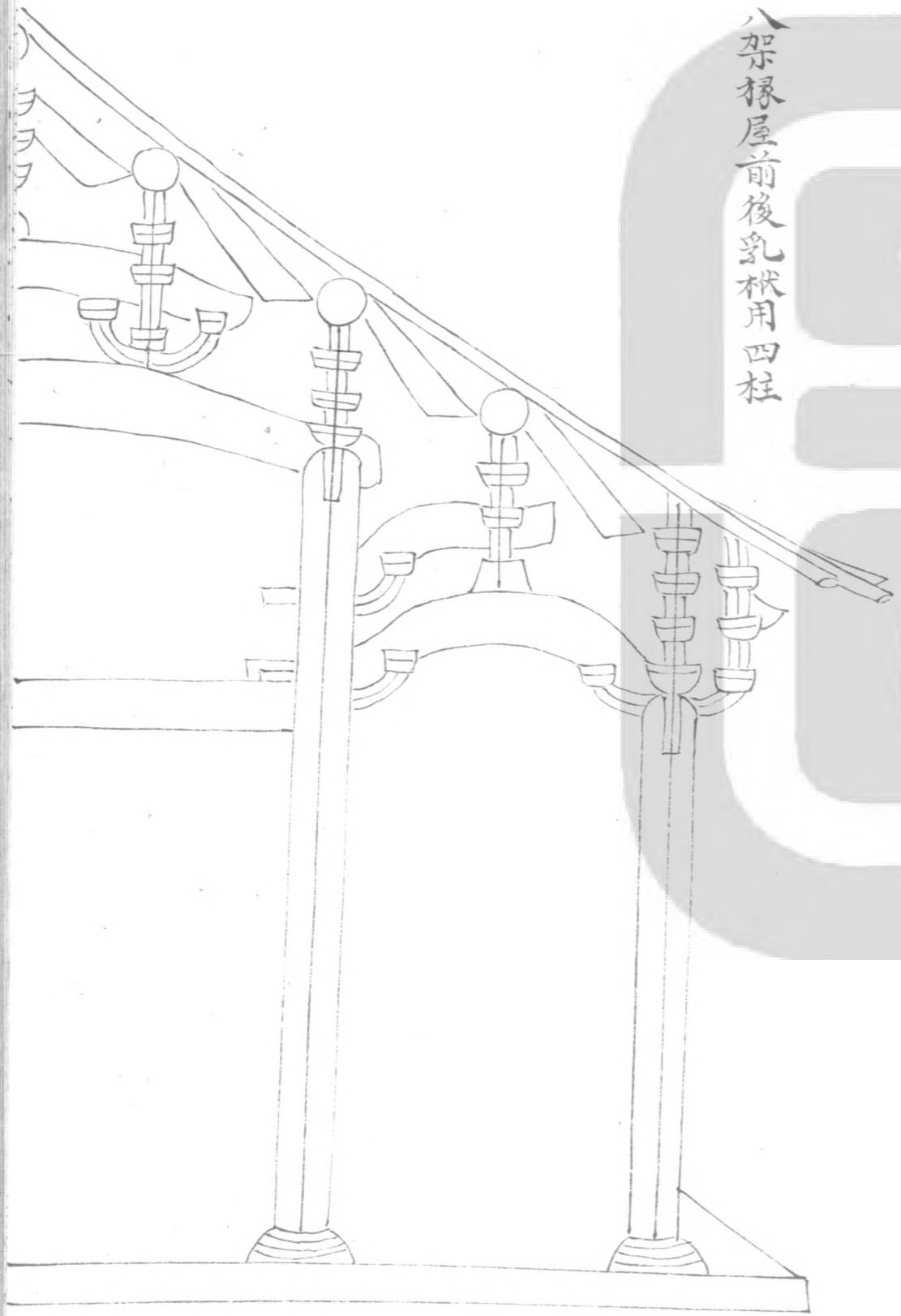

八架椽屋前後三椽楸用四柱

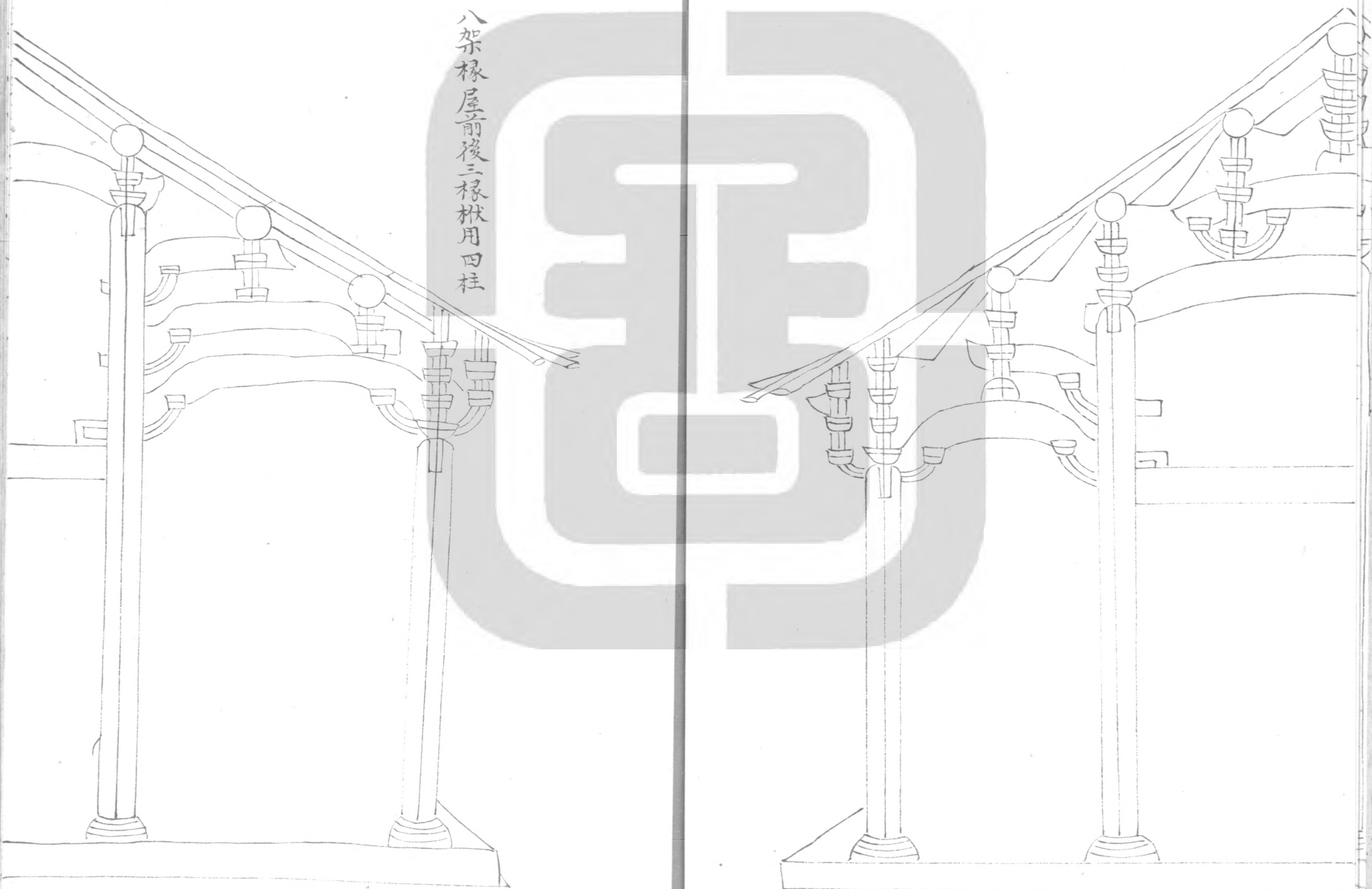

八椽屋分心乳楹用五柱

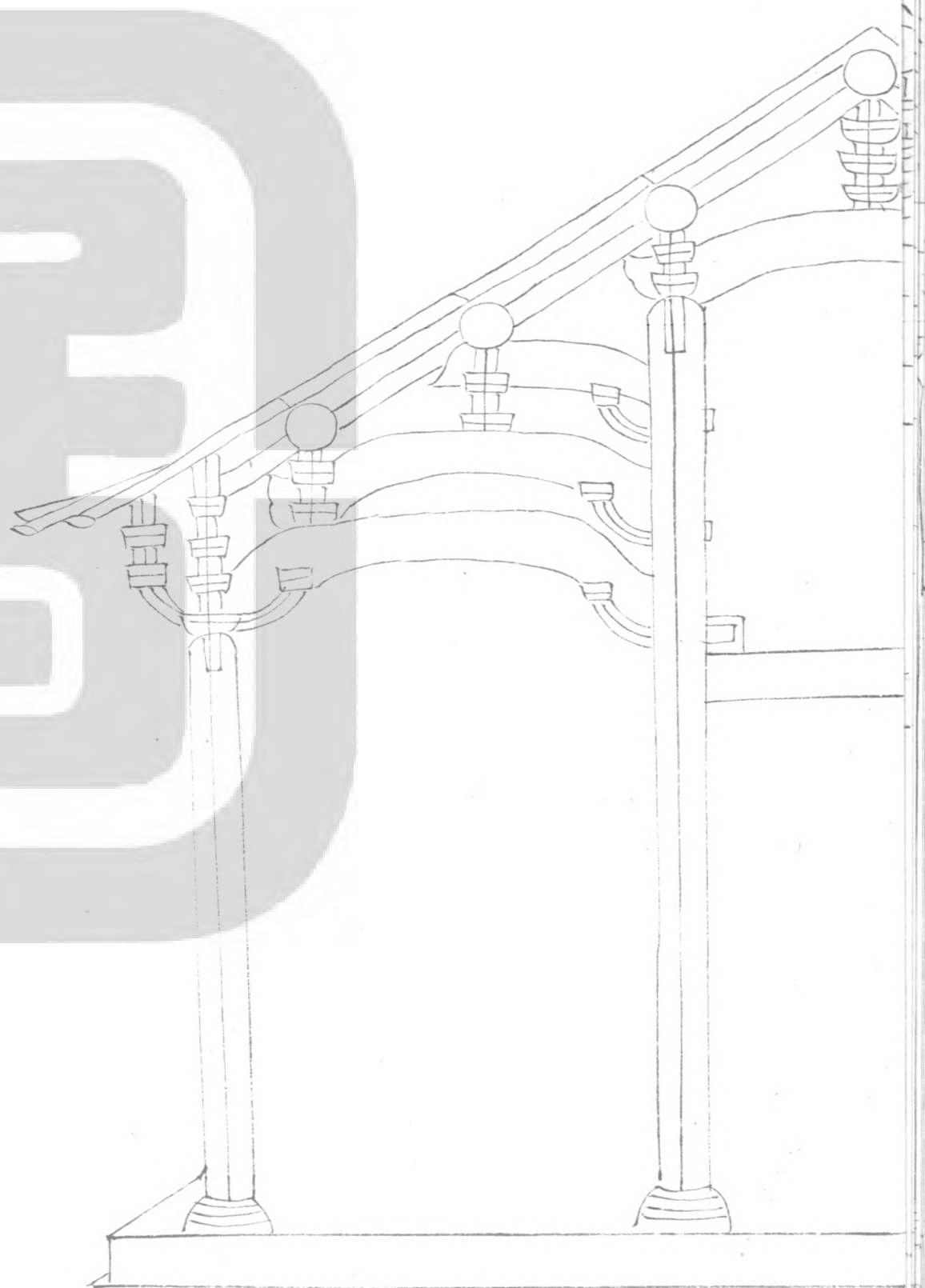
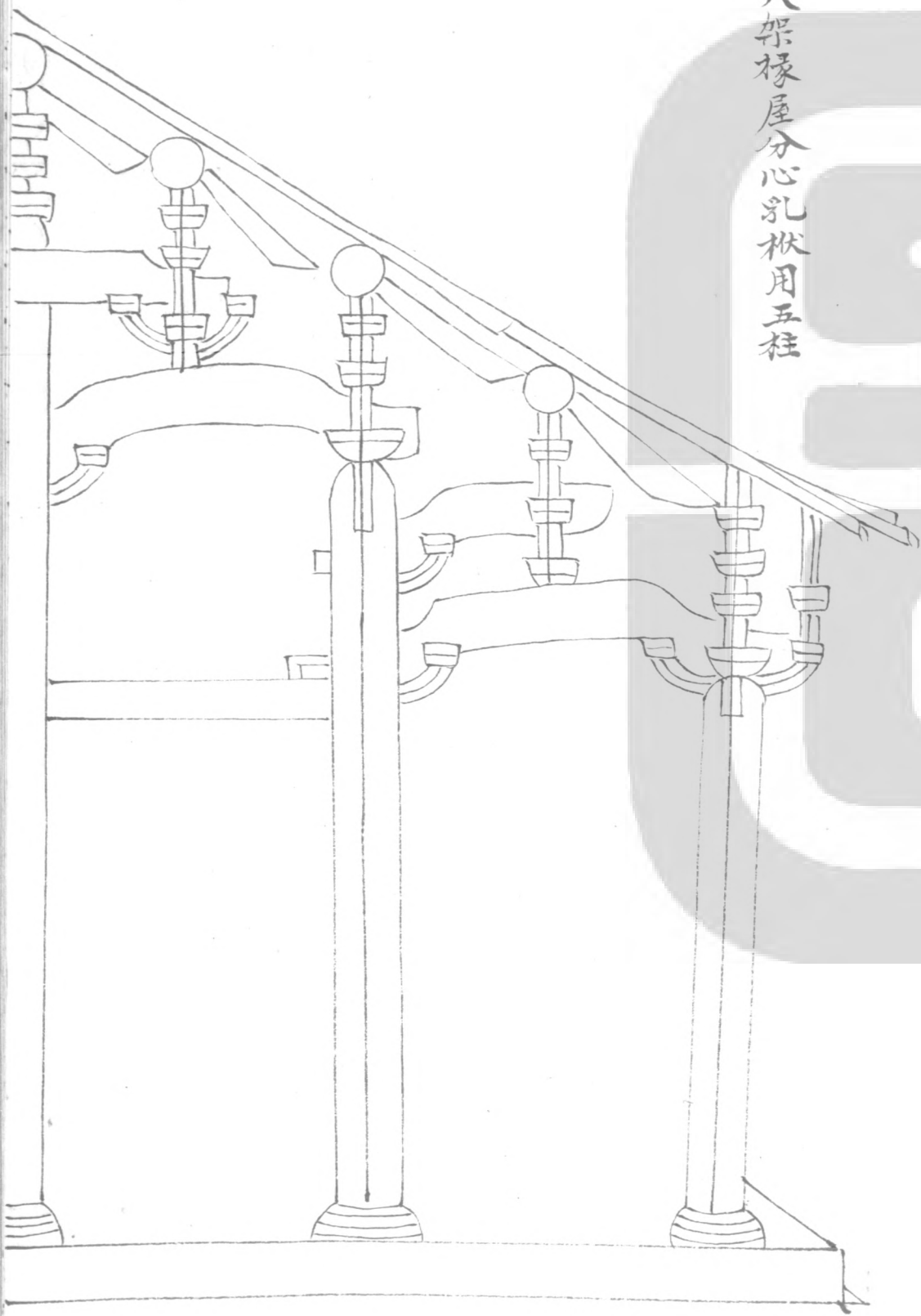



八椽屋前後剝牽用六柱

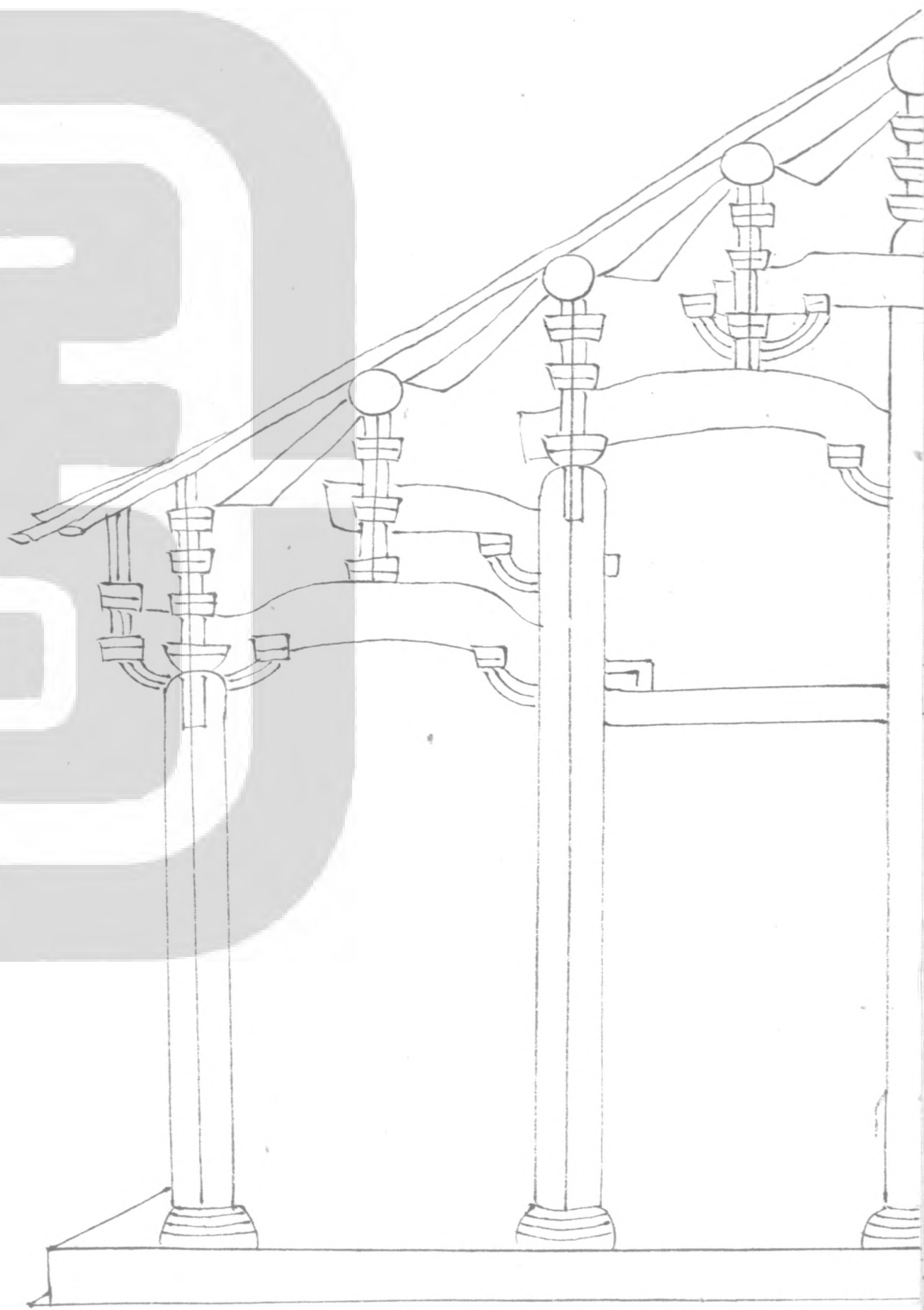
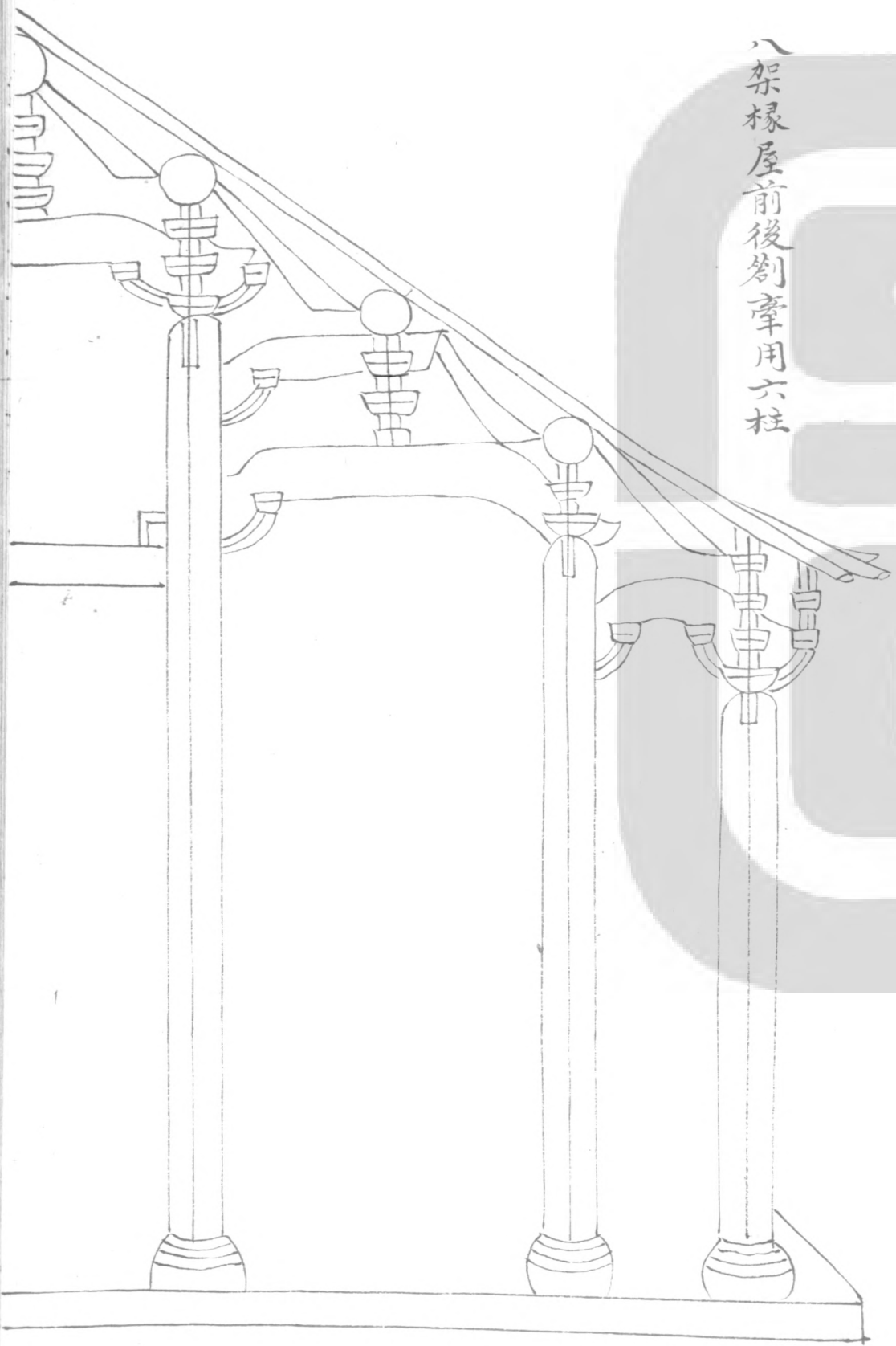

六架椽屋分心用三柱

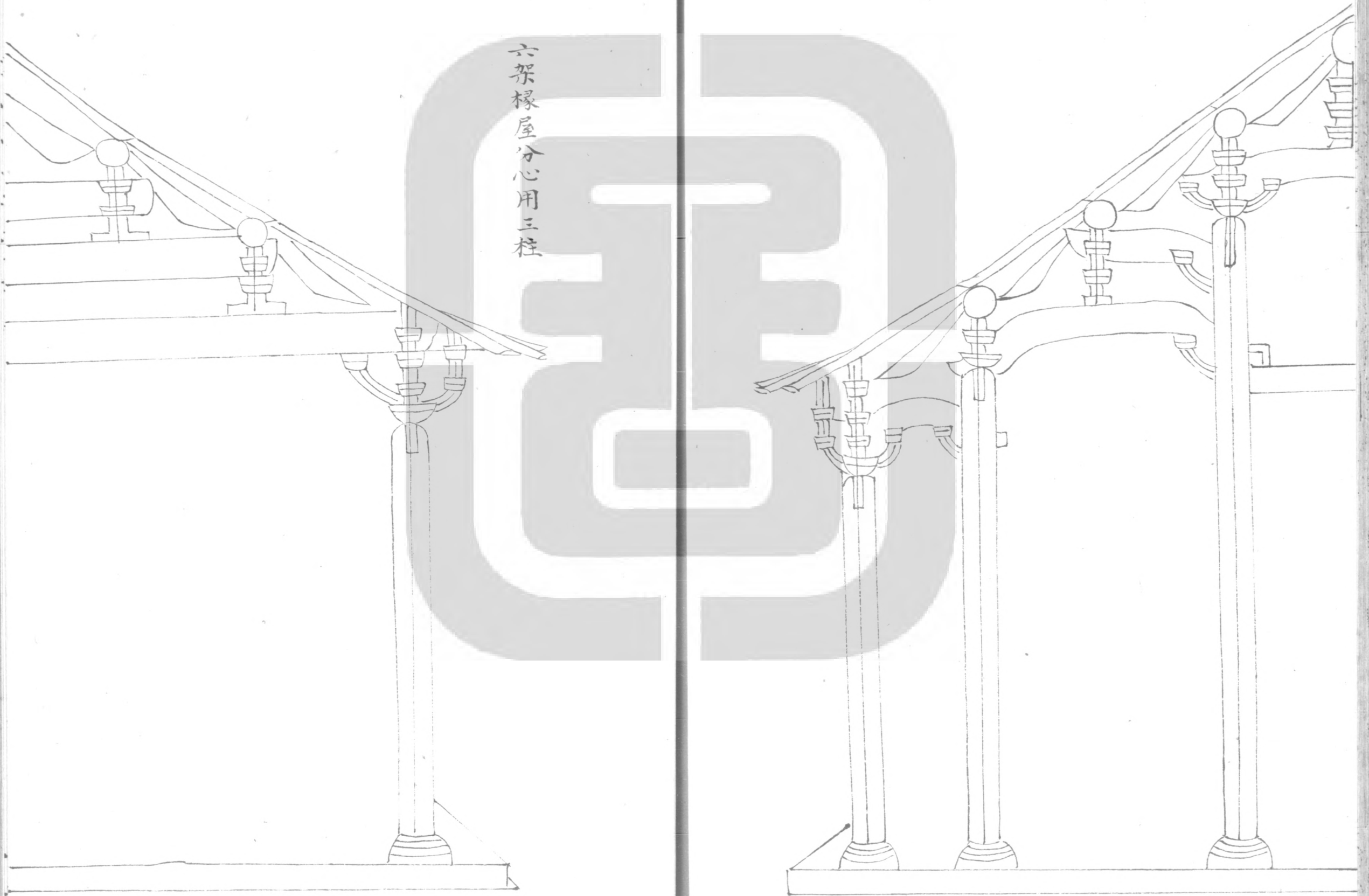

六椽屋乳袱對四椽用三柱

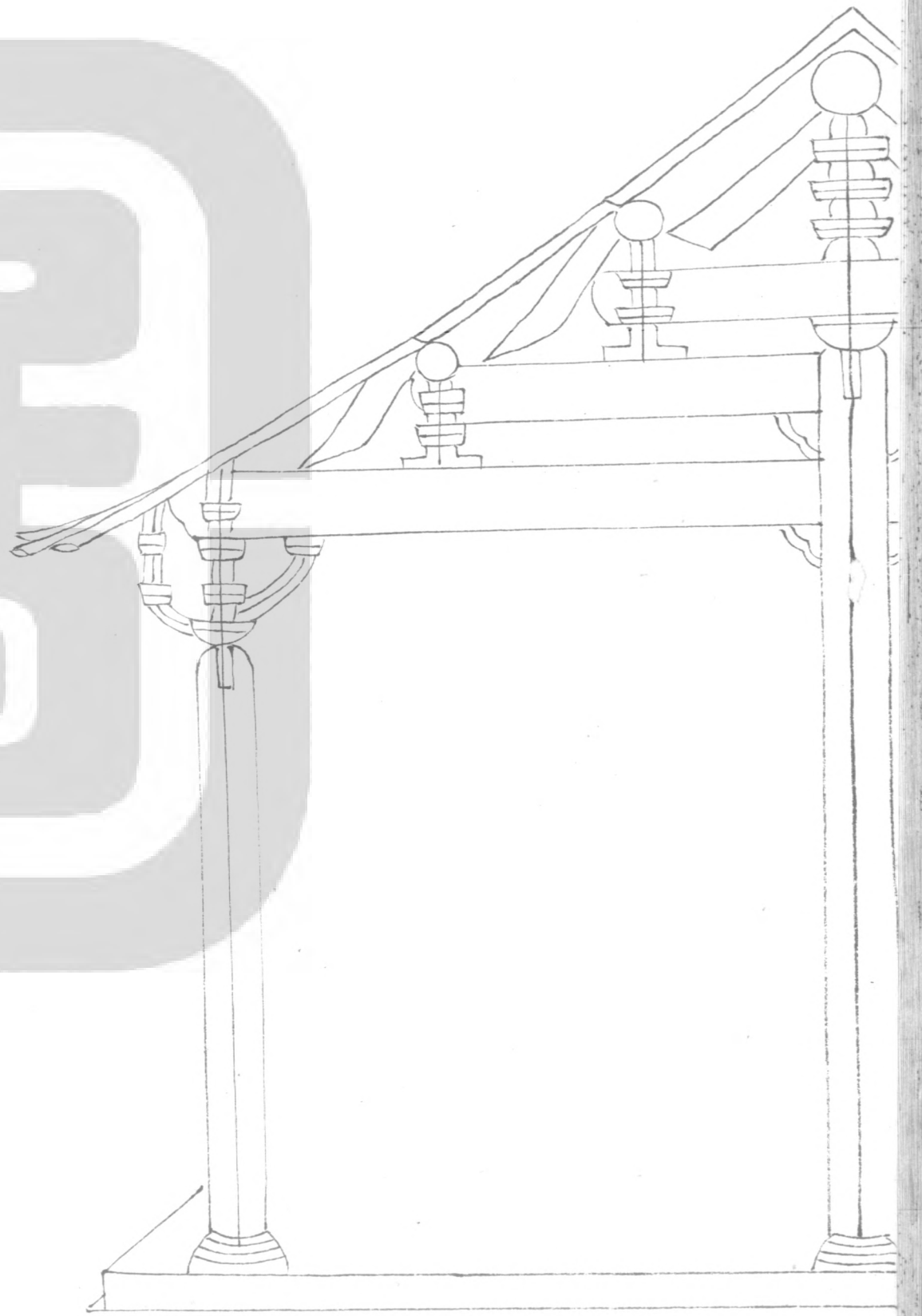
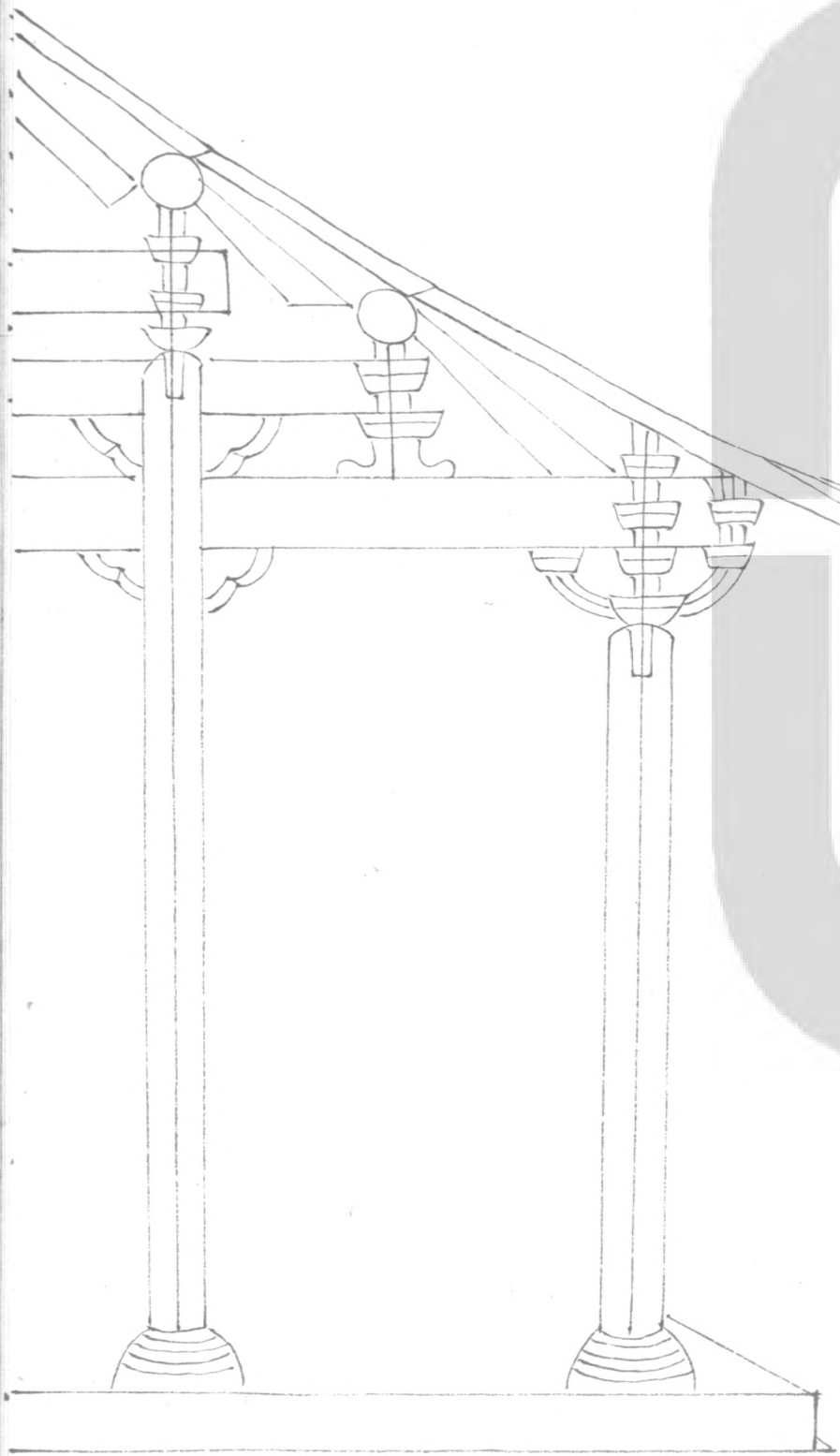

六架椽屋前後乳枋剝牽用四柱

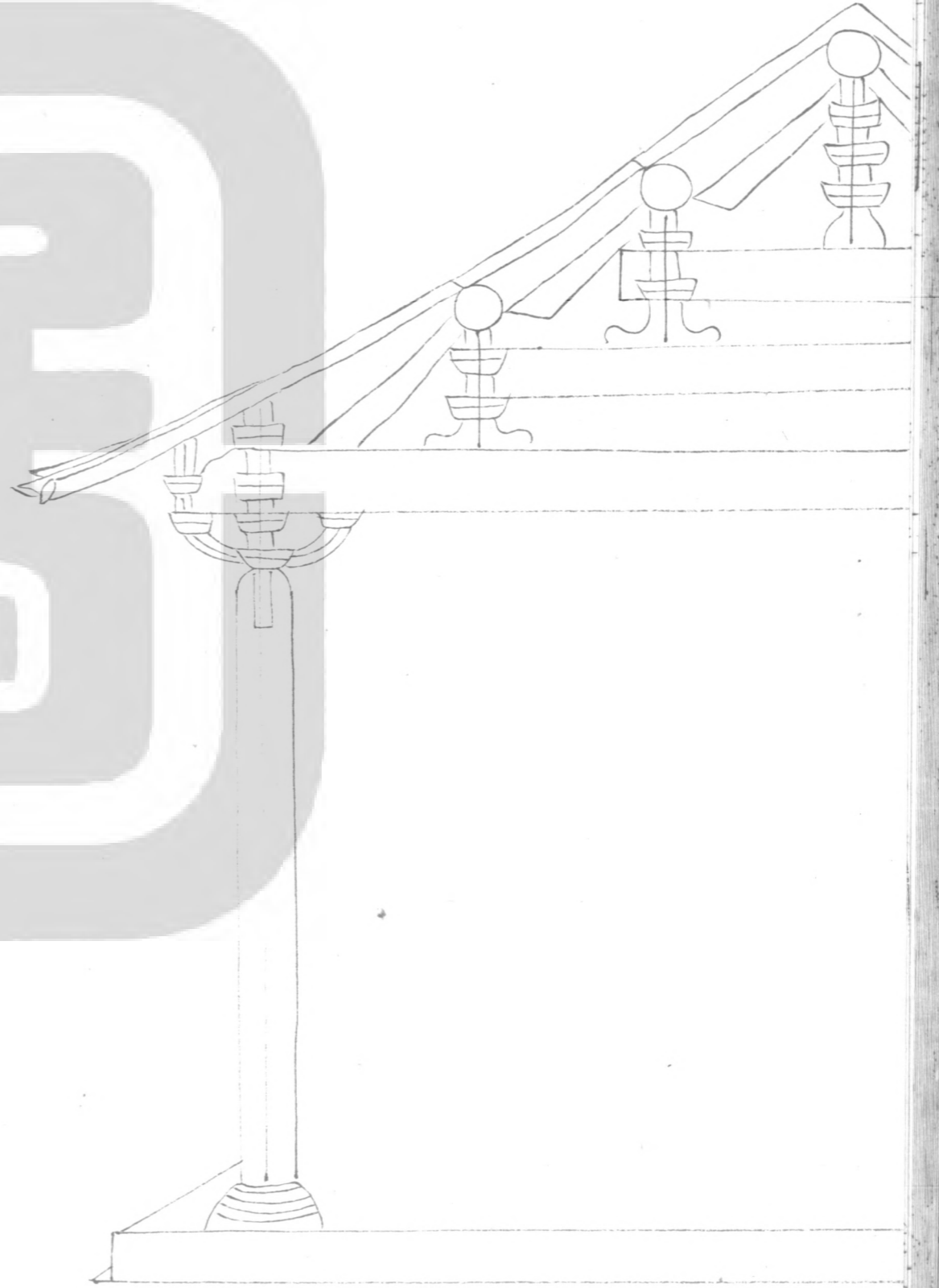
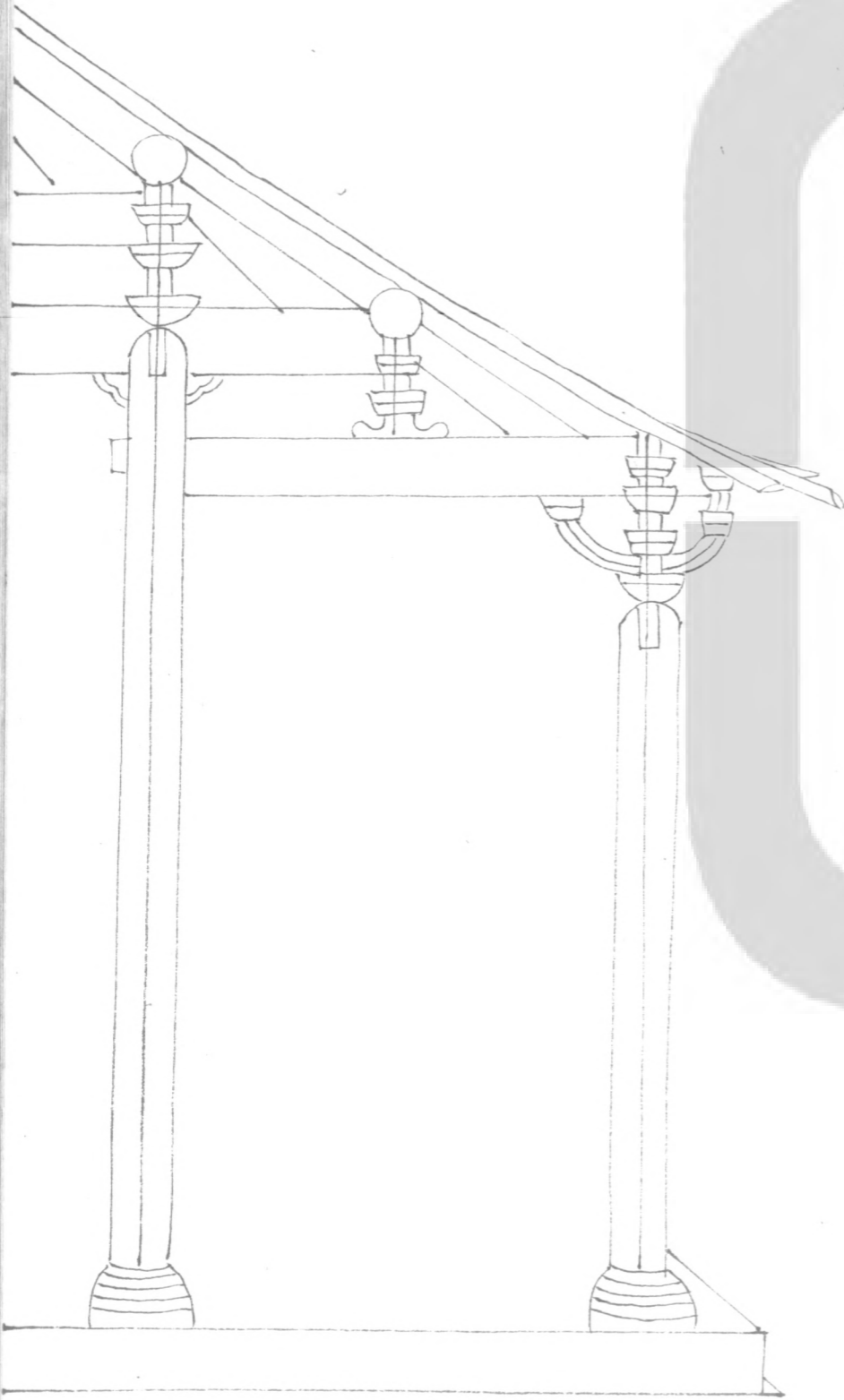

四架椽屋分心用三柱

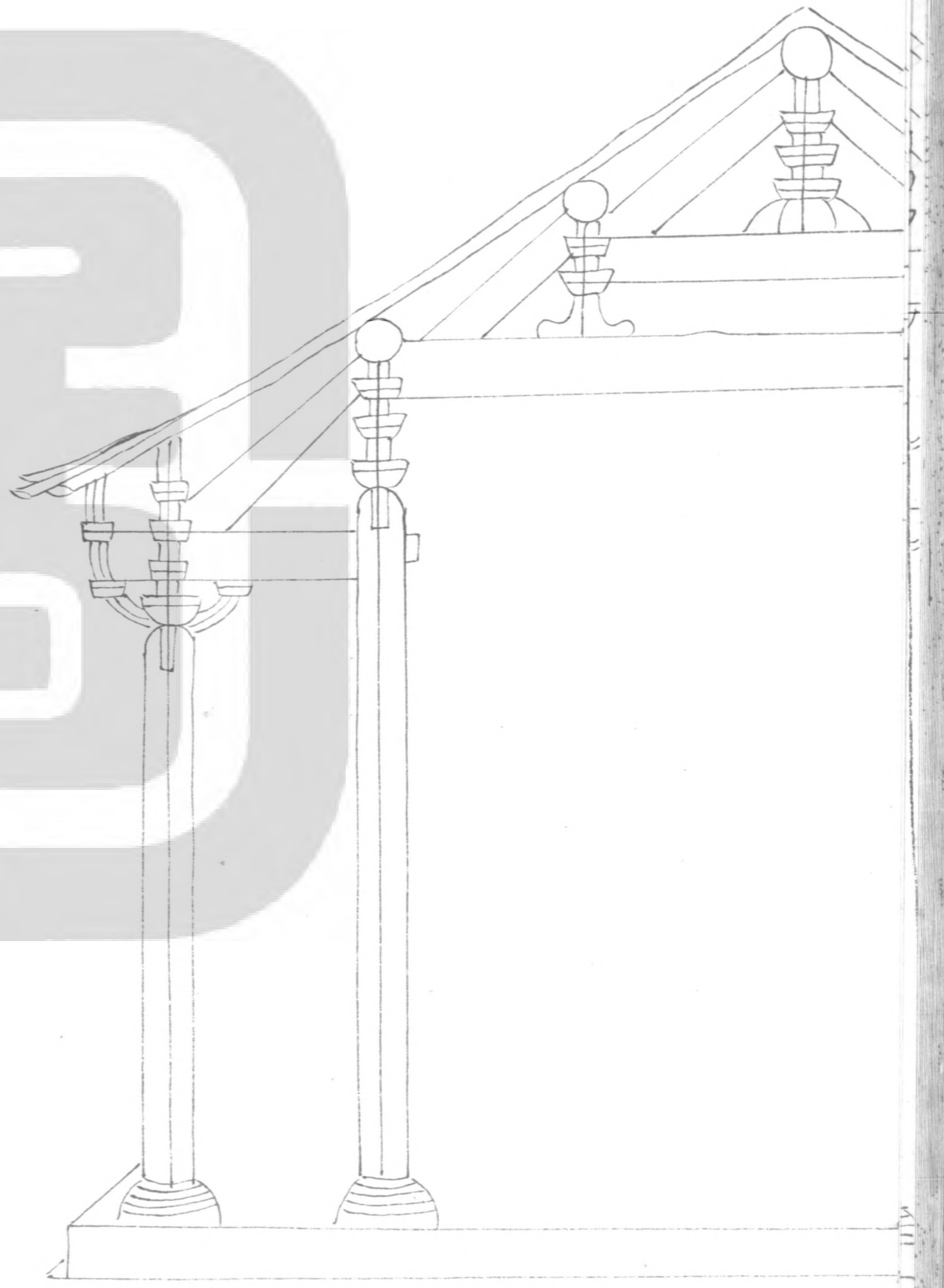
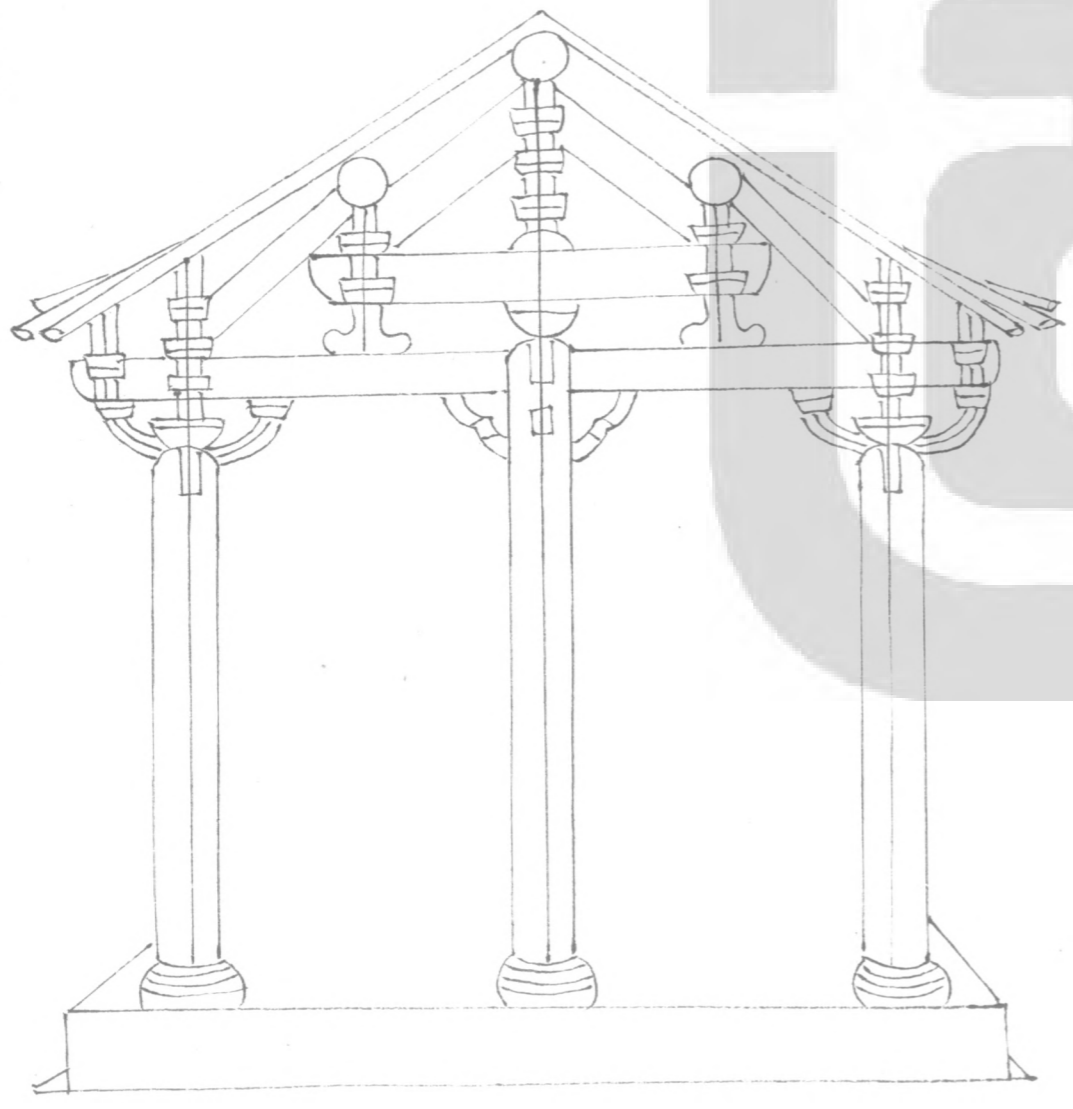

四架椽屋劄亭二椽用三柱

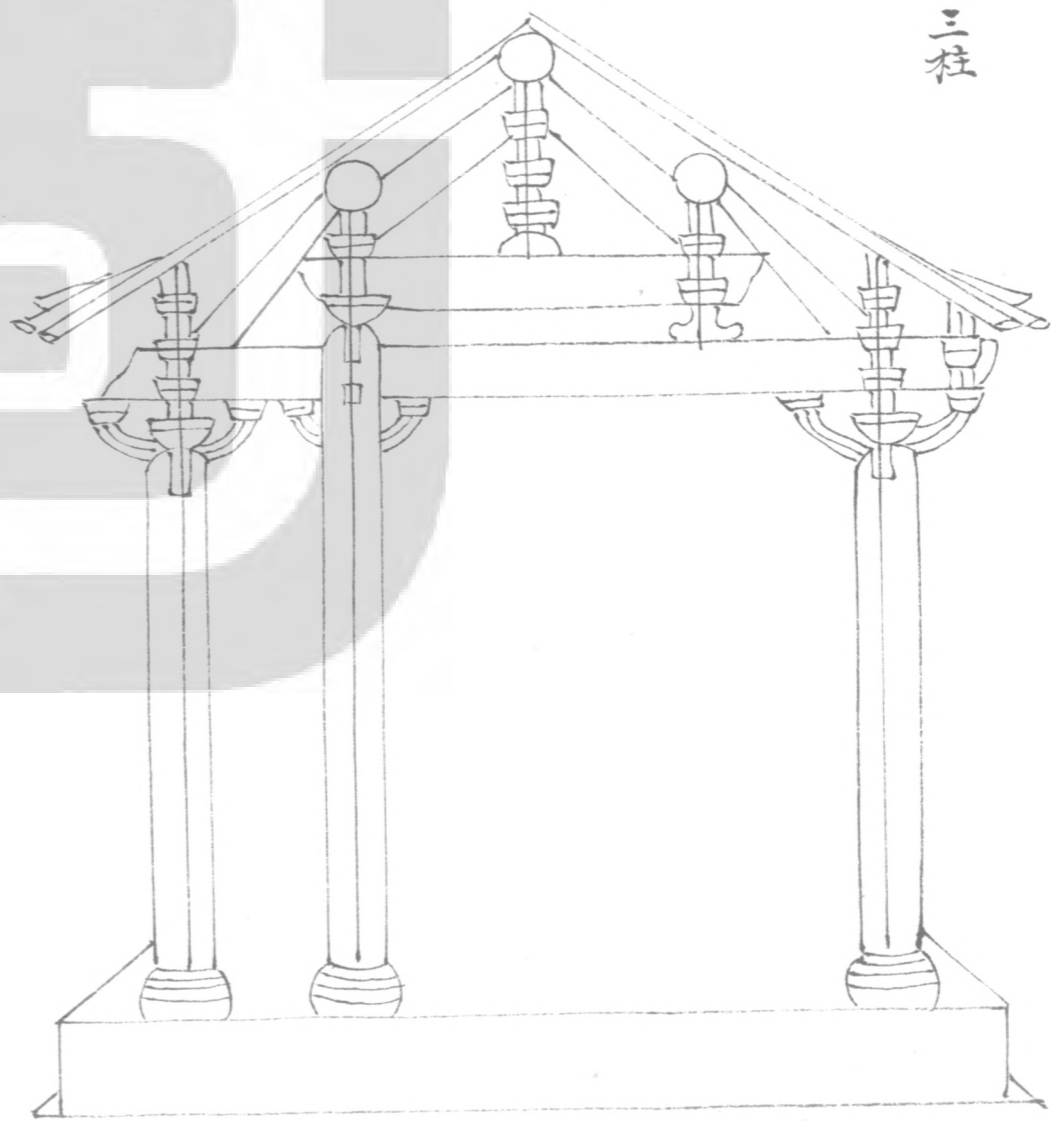

營造法式卷三十一

營造法式

卷三十二

小木作制度圖樣

門窓格子門等第一

垂魚  
附

平棊鈎闌等第二

殿閣門亭等牌第三

佛道帳經藏第四

宋 李誥 撰



彫木作制度圖樣

混作第一

拱眼內彫棟第二

格子門等腰華版第三

平棊華盤第四

雲拱等雜樣第五

版門

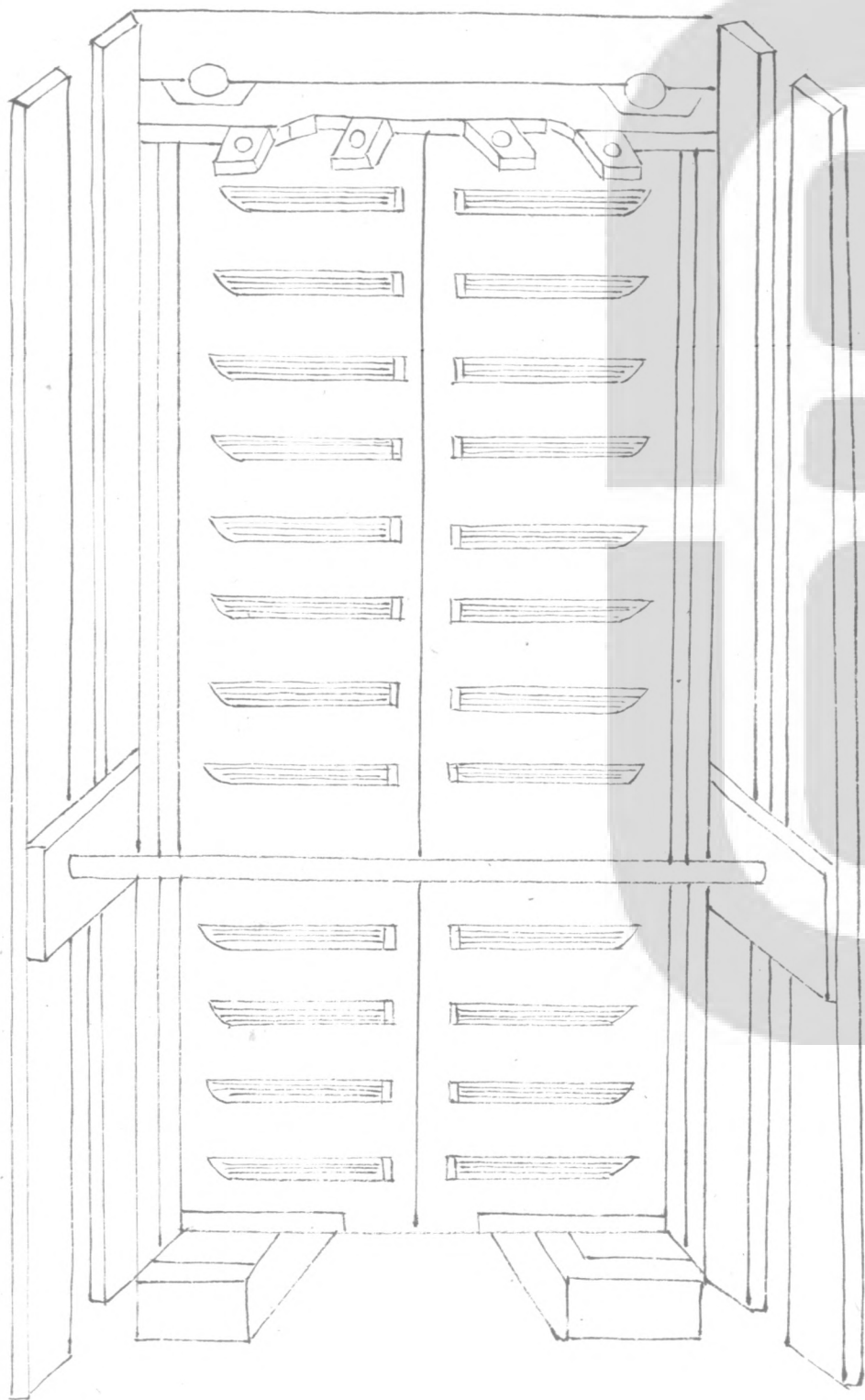



牙頭護縫軟門

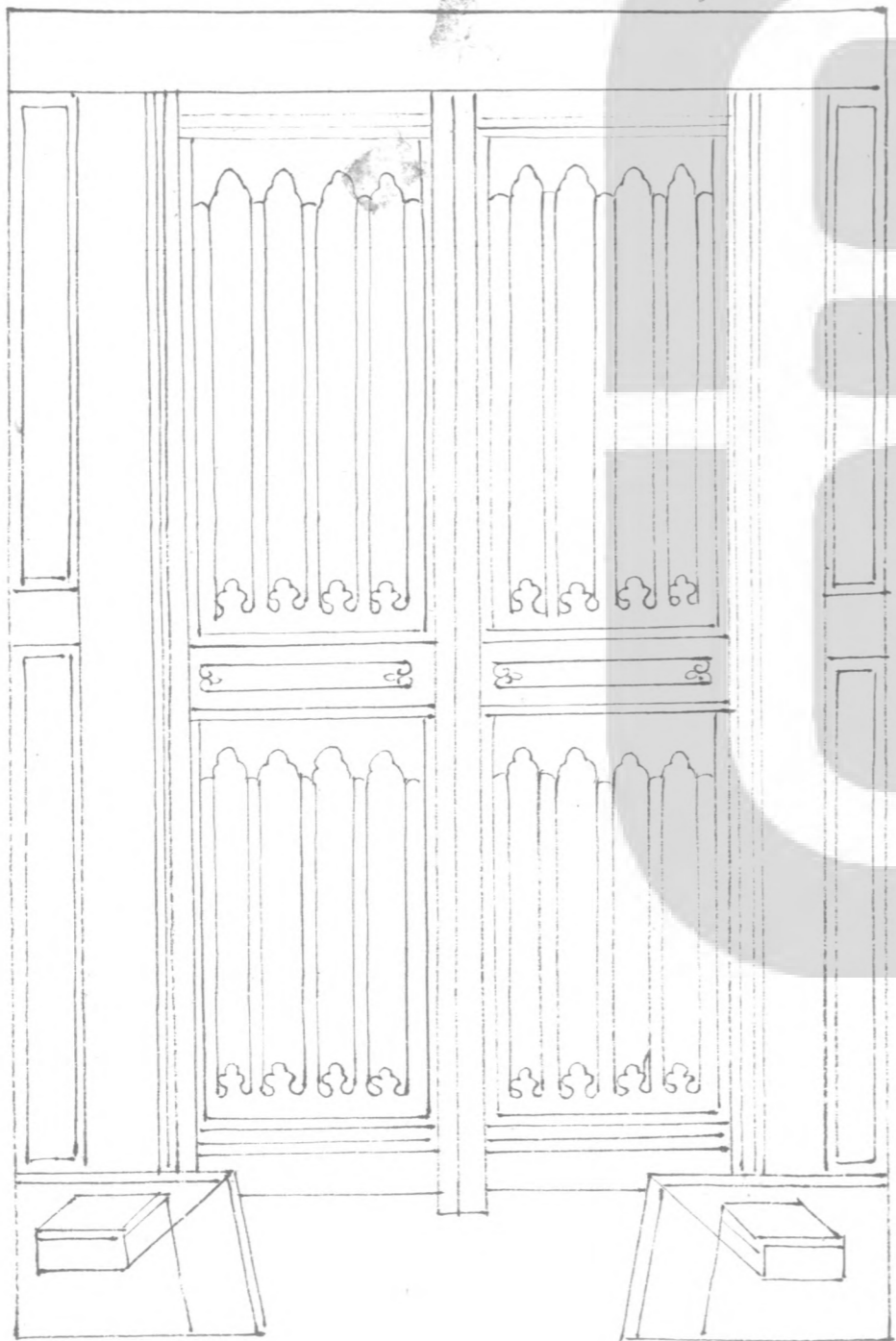

烏頭門

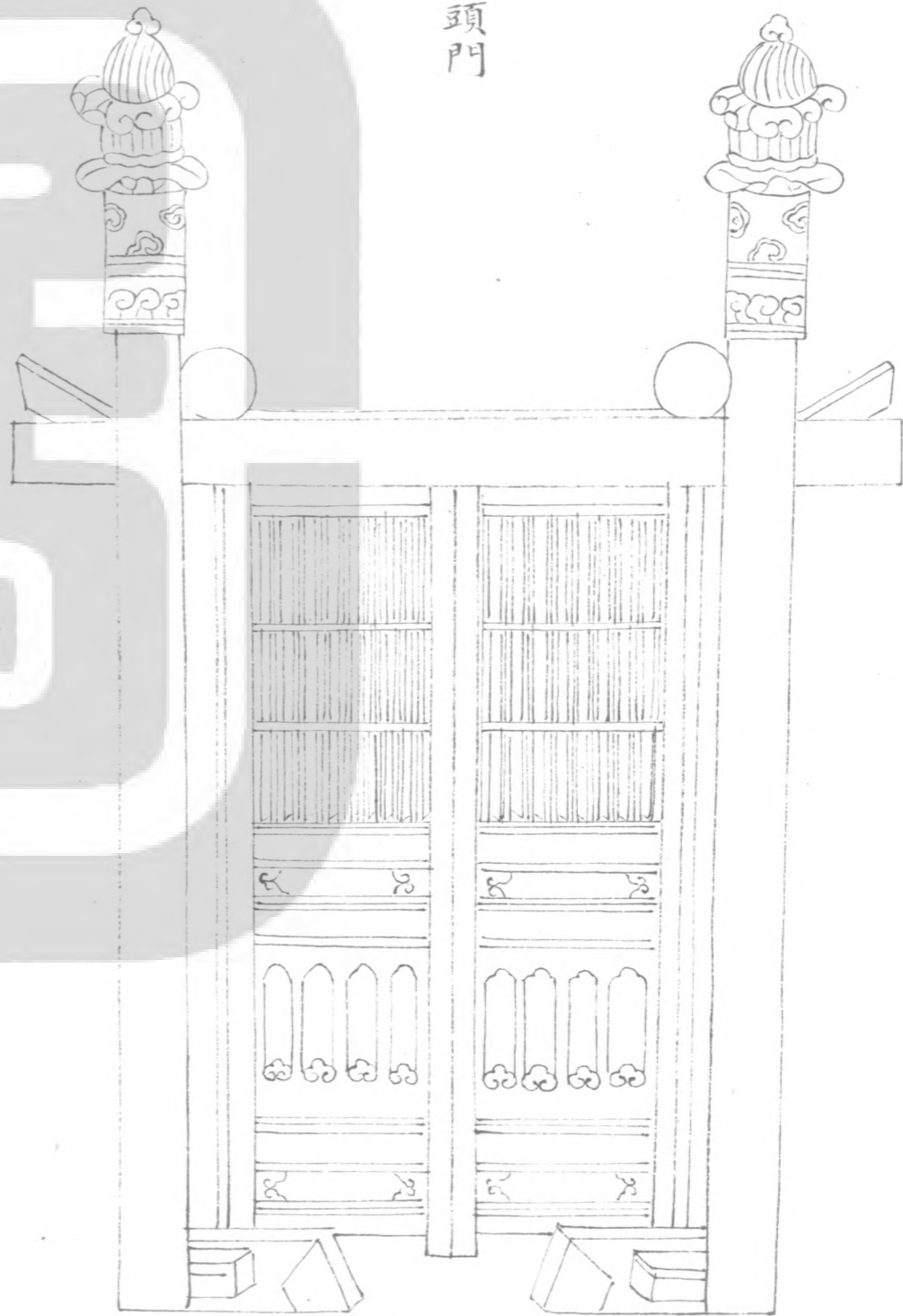

合版軟門

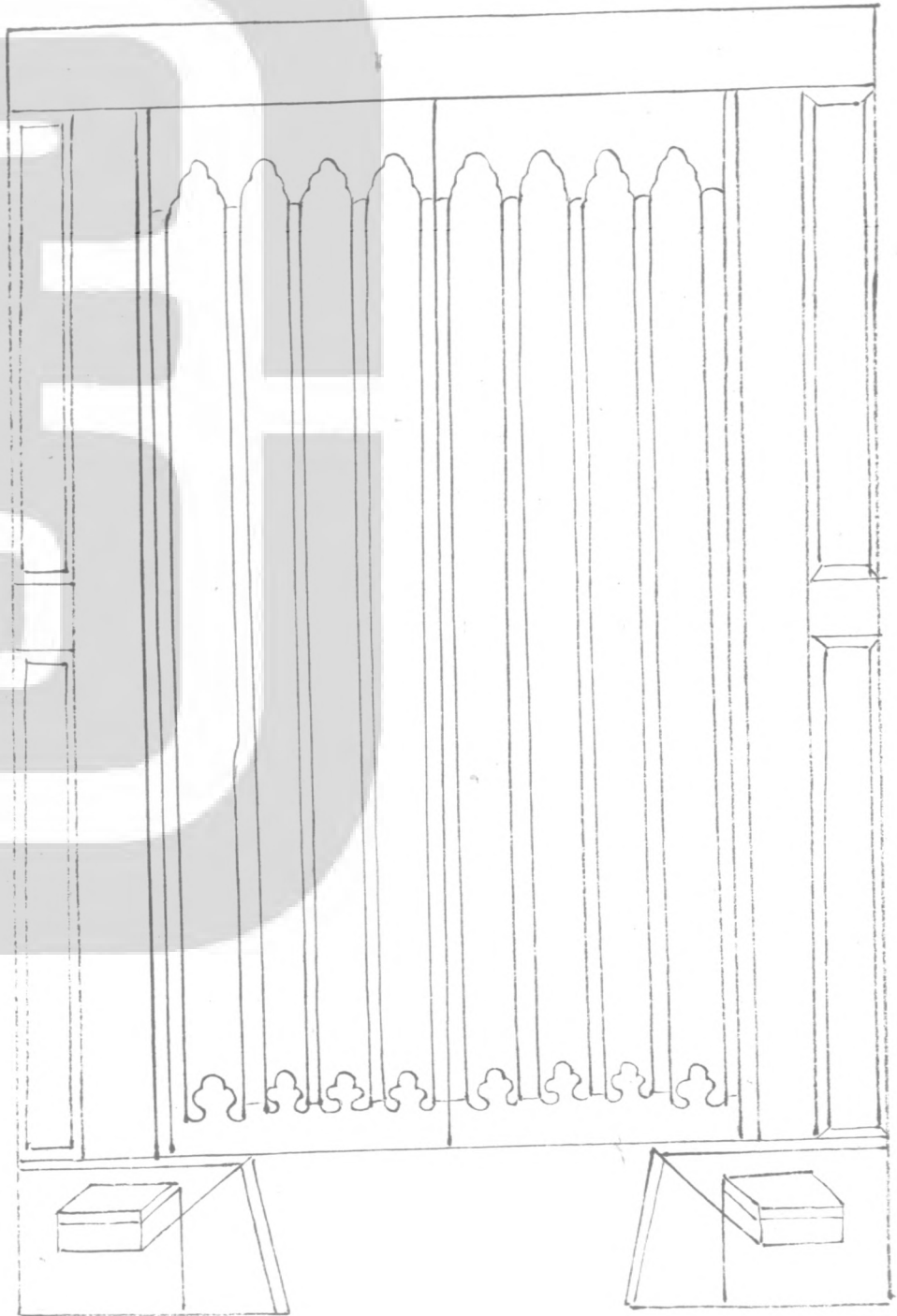

搥鑲柱

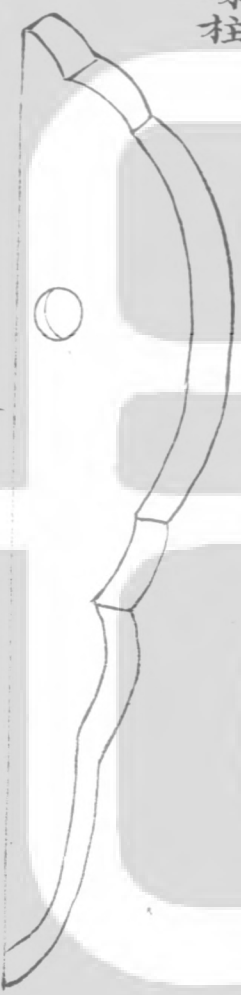

排又福

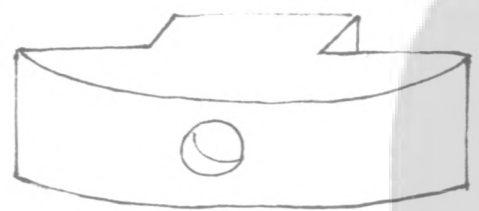

伏兔手拴

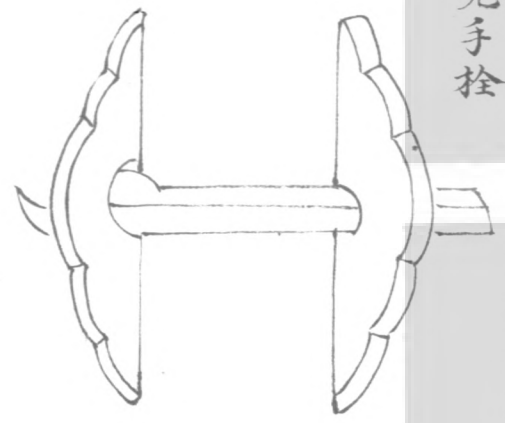

伏兔



承枋福



門砧

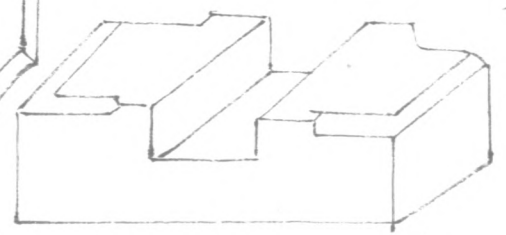

雞栖木

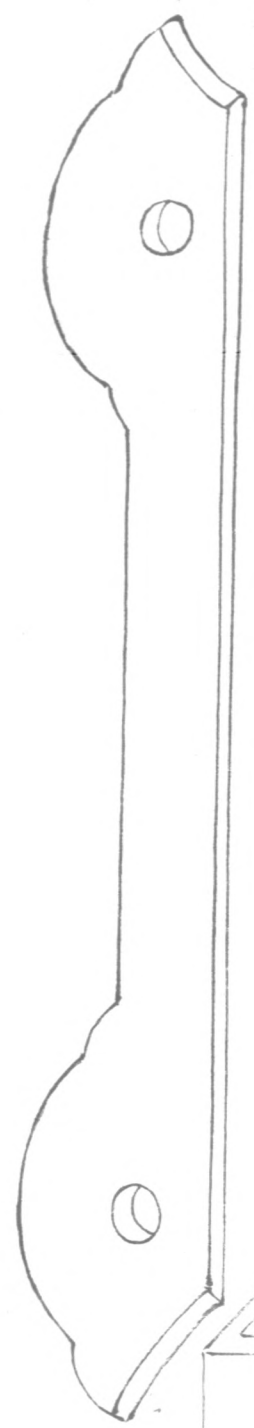

駁雷窓

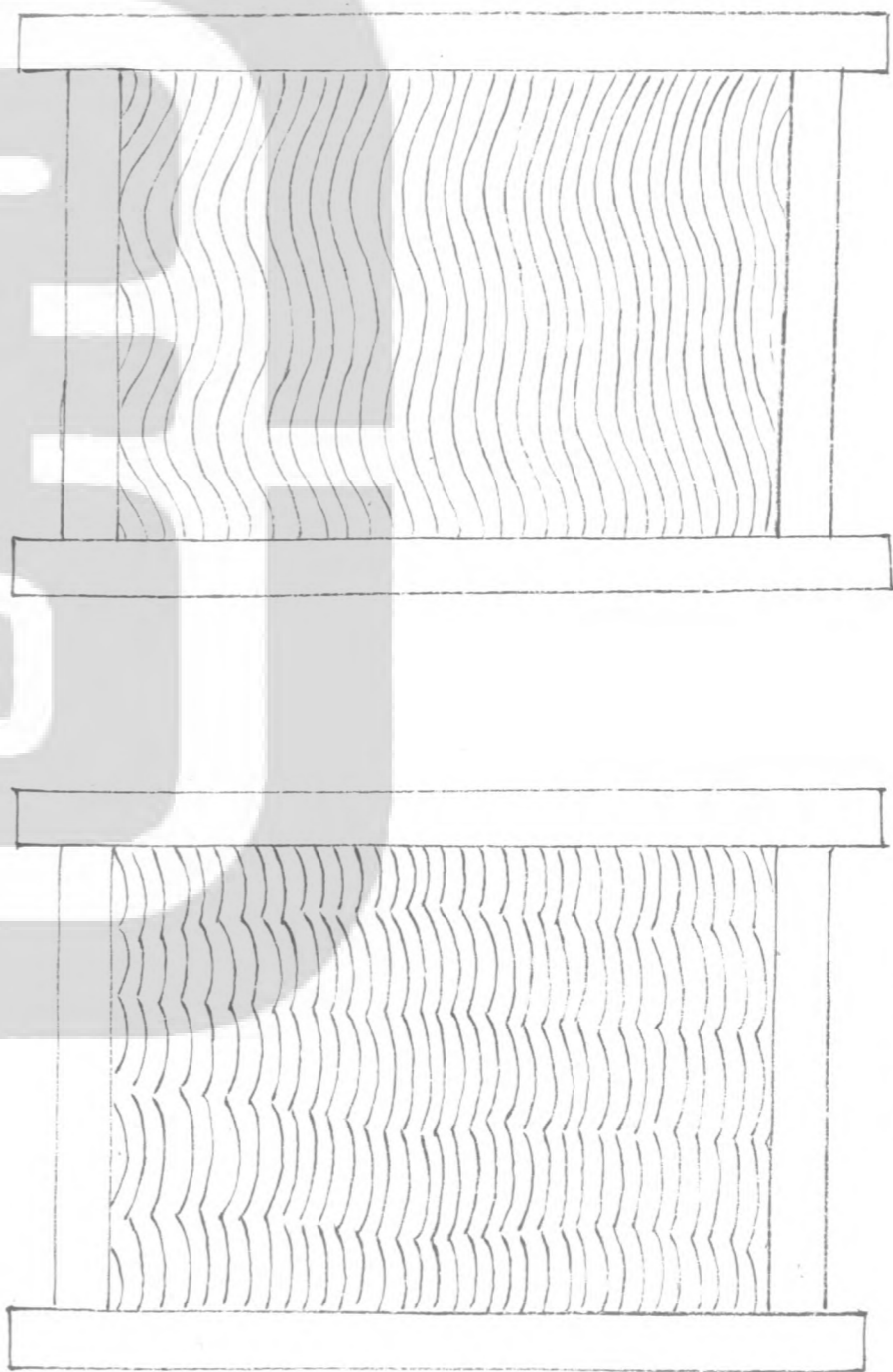

水文窓

挑白毬文格眼

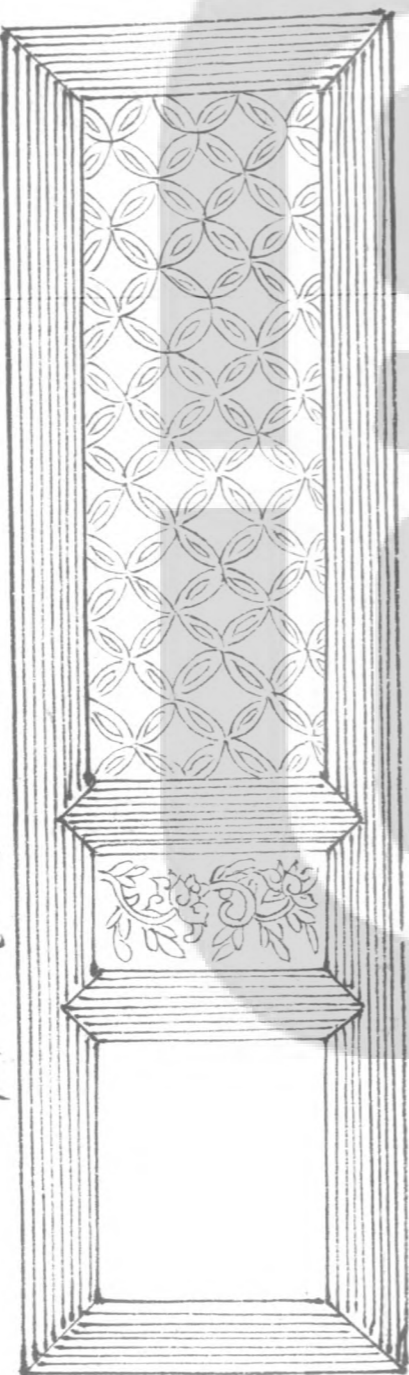

四混四程中心出雙線入混內出單線

四斜毬文上出條椗重格眼

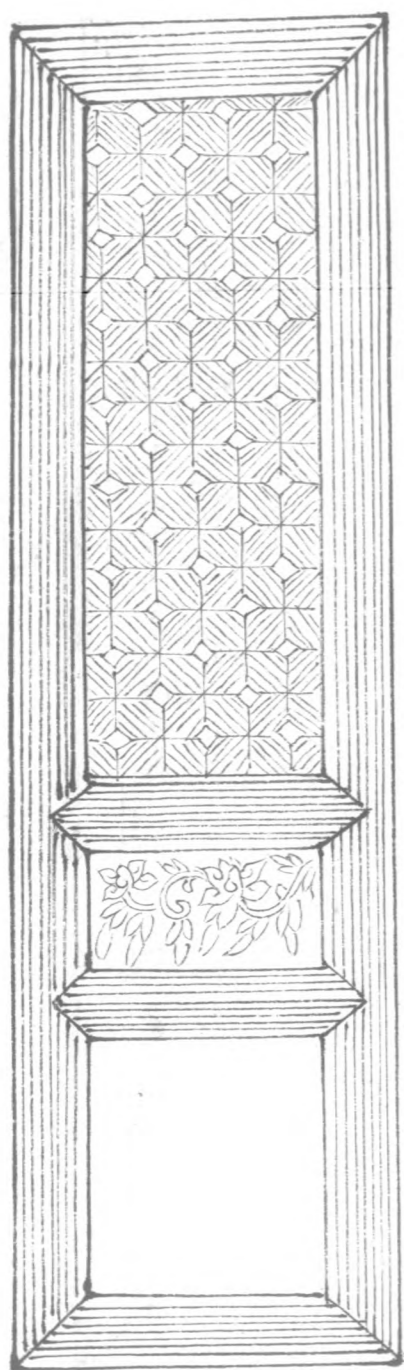

四程破瓣雙混平地出雙線

四直毬文上出條徑重格眼

四程四棍出單線

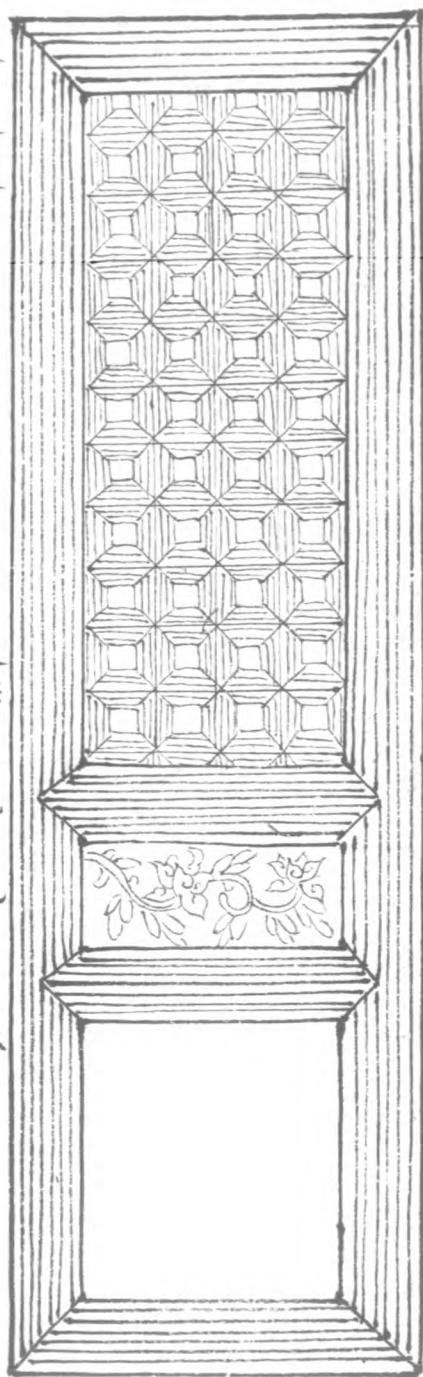

四混出雙線方格眼

四程破瓣單混平地出單線

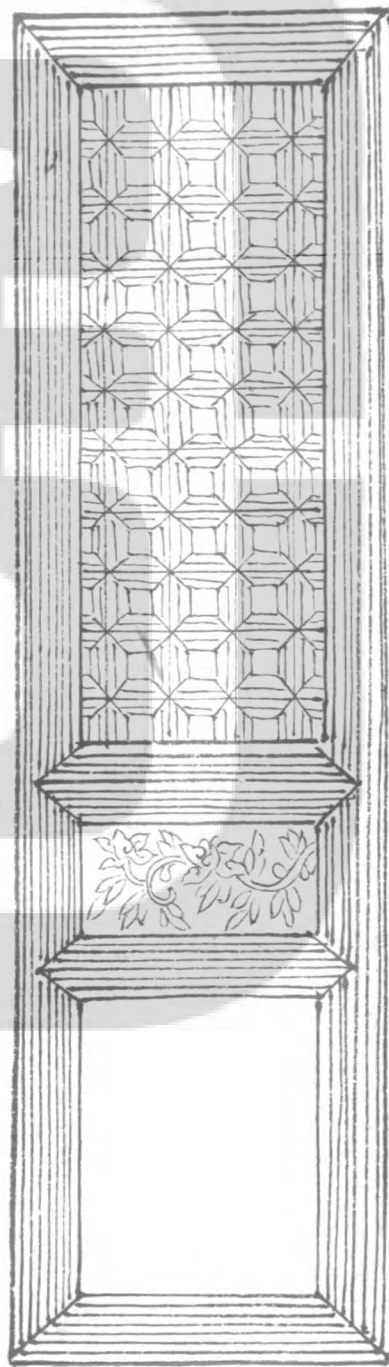

麗口紋瓣雙混方格眼

四程通混出雙線

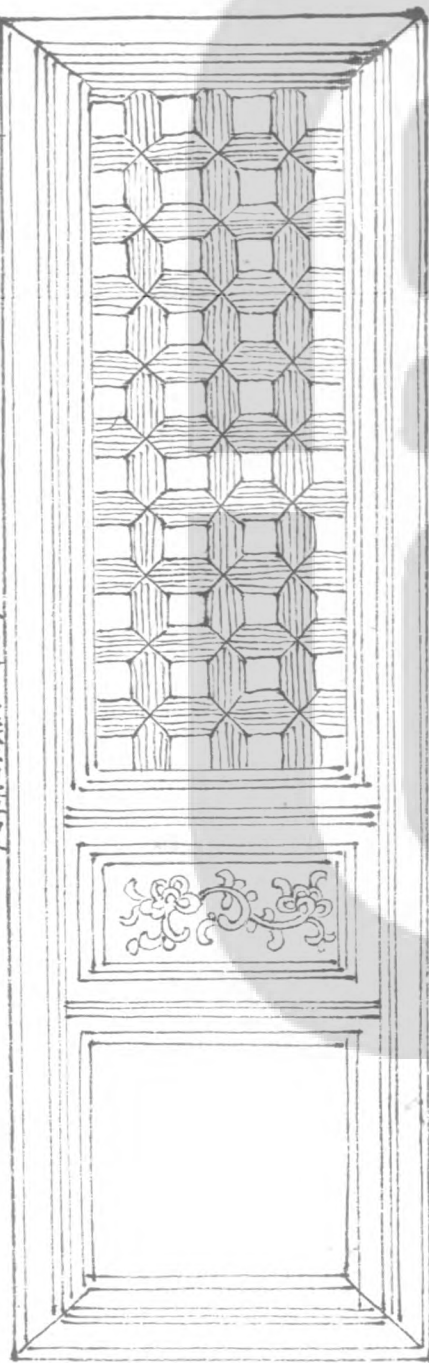

通混出雙線方格眼

四程通混壓邊線

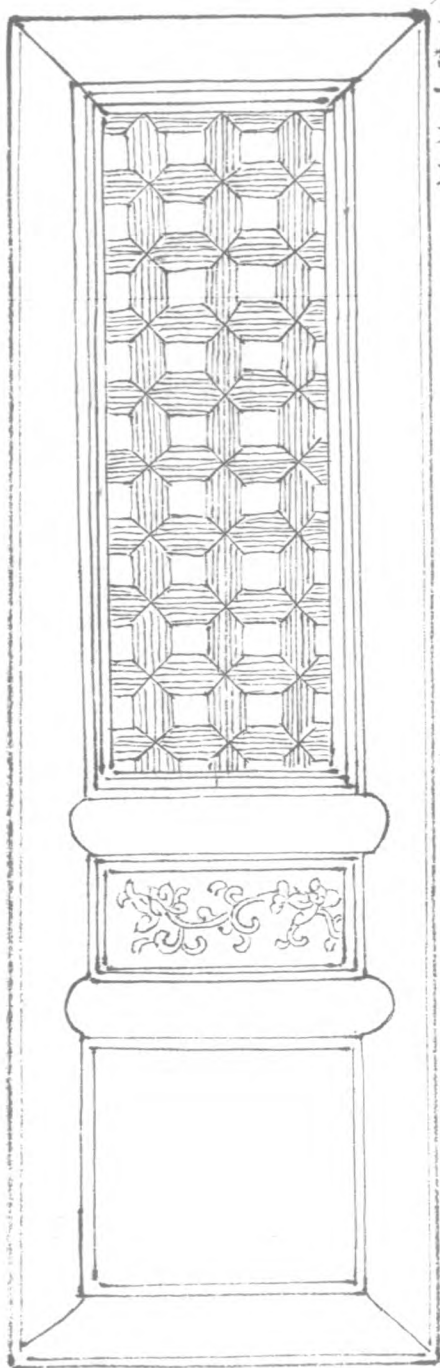

通混壓邊線四攏尖方格眼

四程素通混

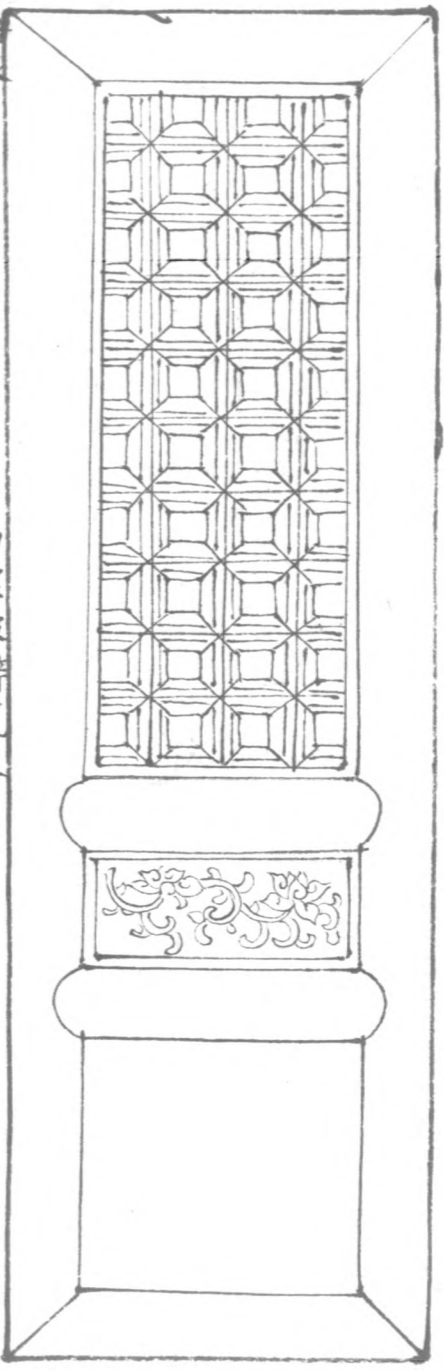

平出線方格眼

四程破瓣攏尖

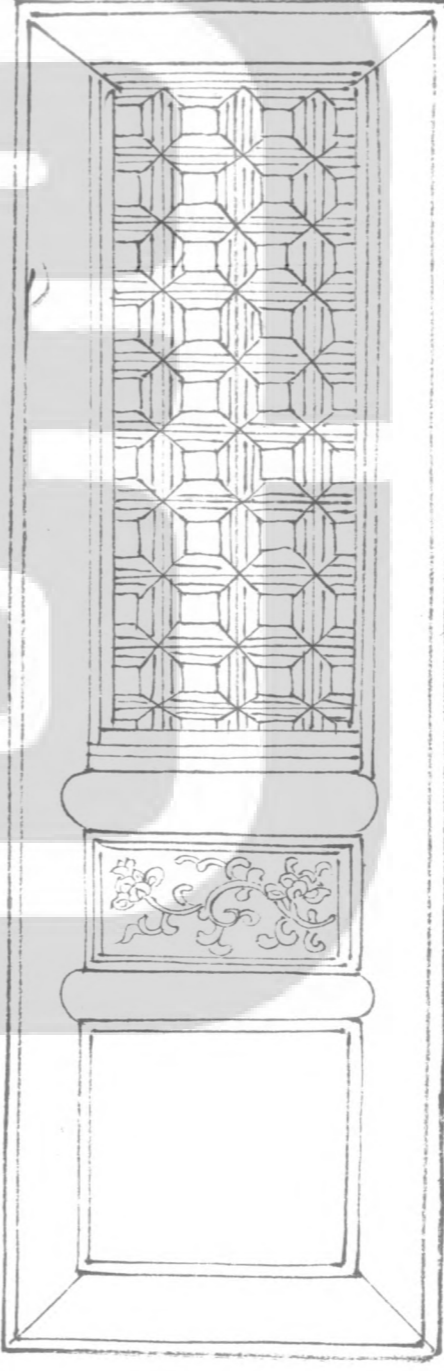

格子門額限

麗卯挿栓

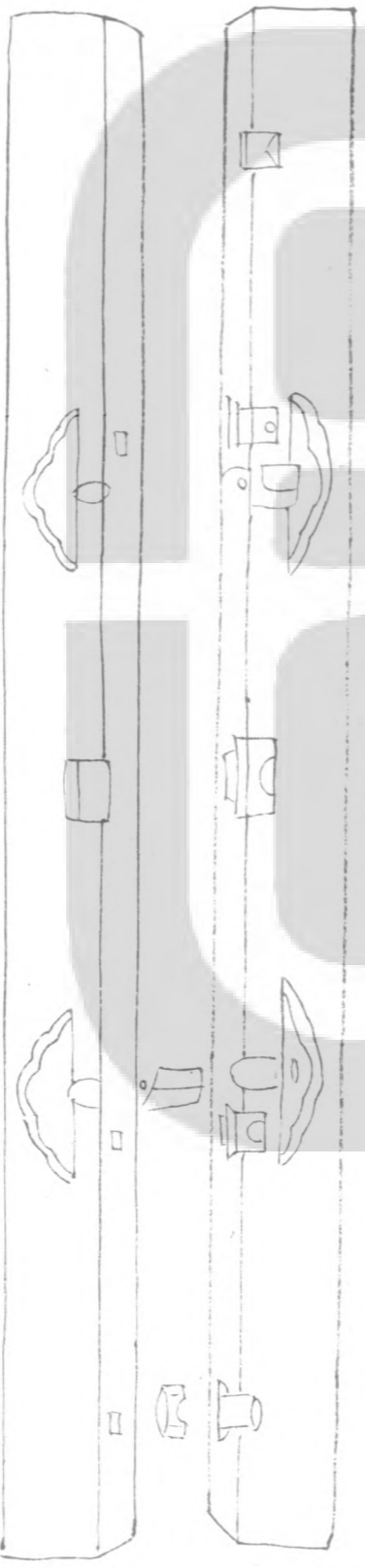

直卯撥捺

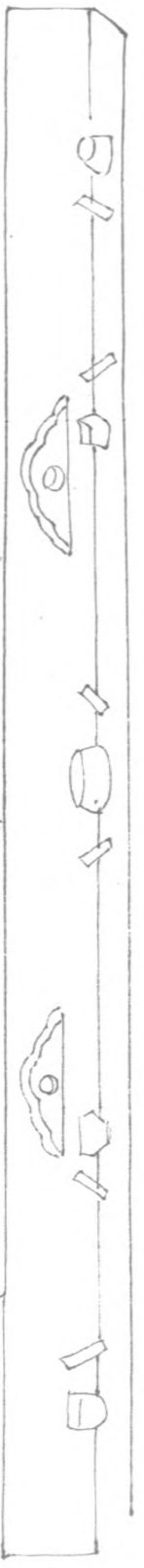
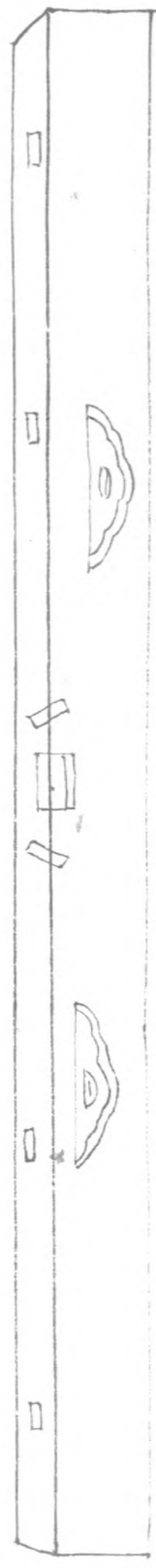

立捺



截間格子

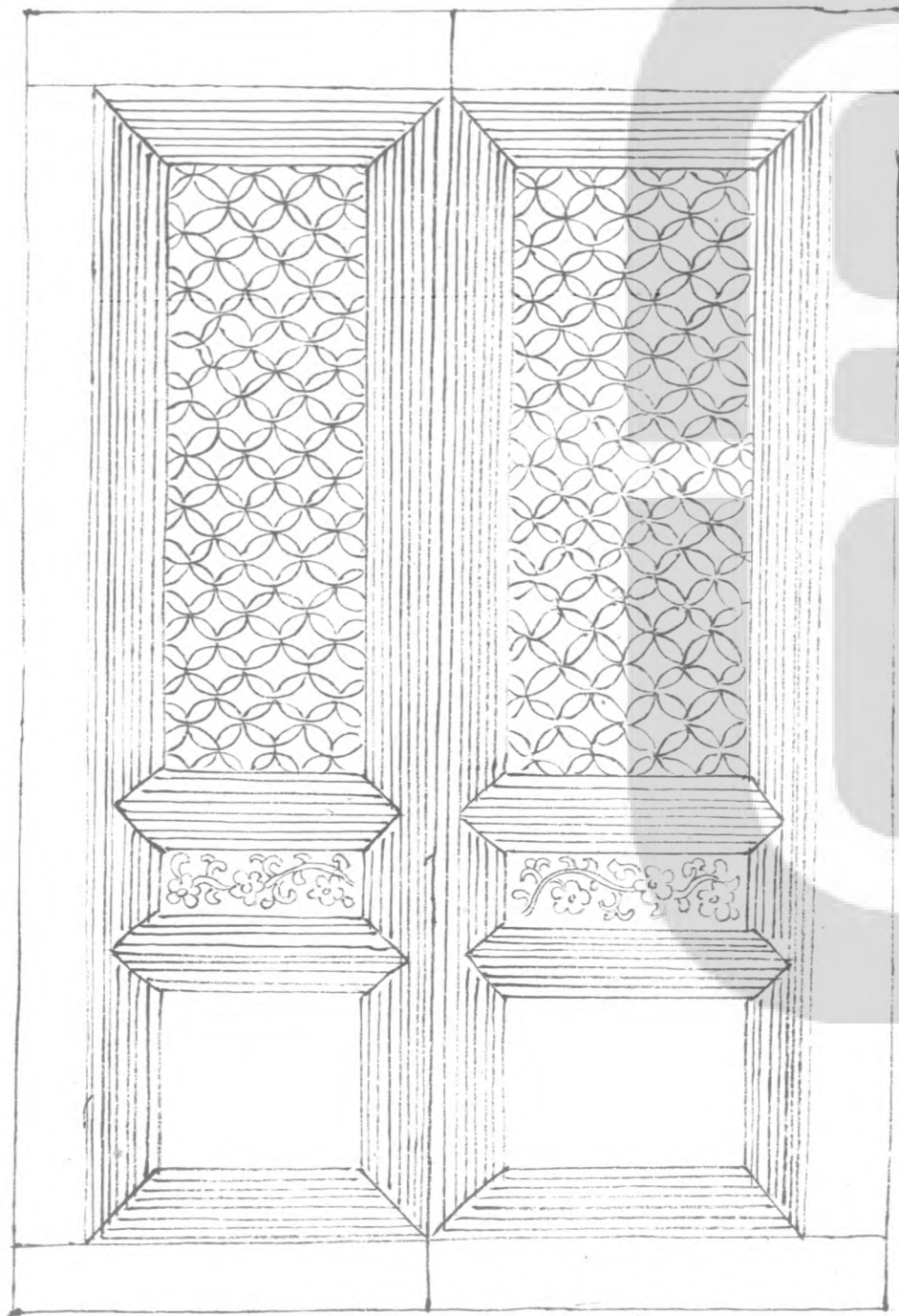

四程破瓣雙混平地出單線

關檻鈎窓

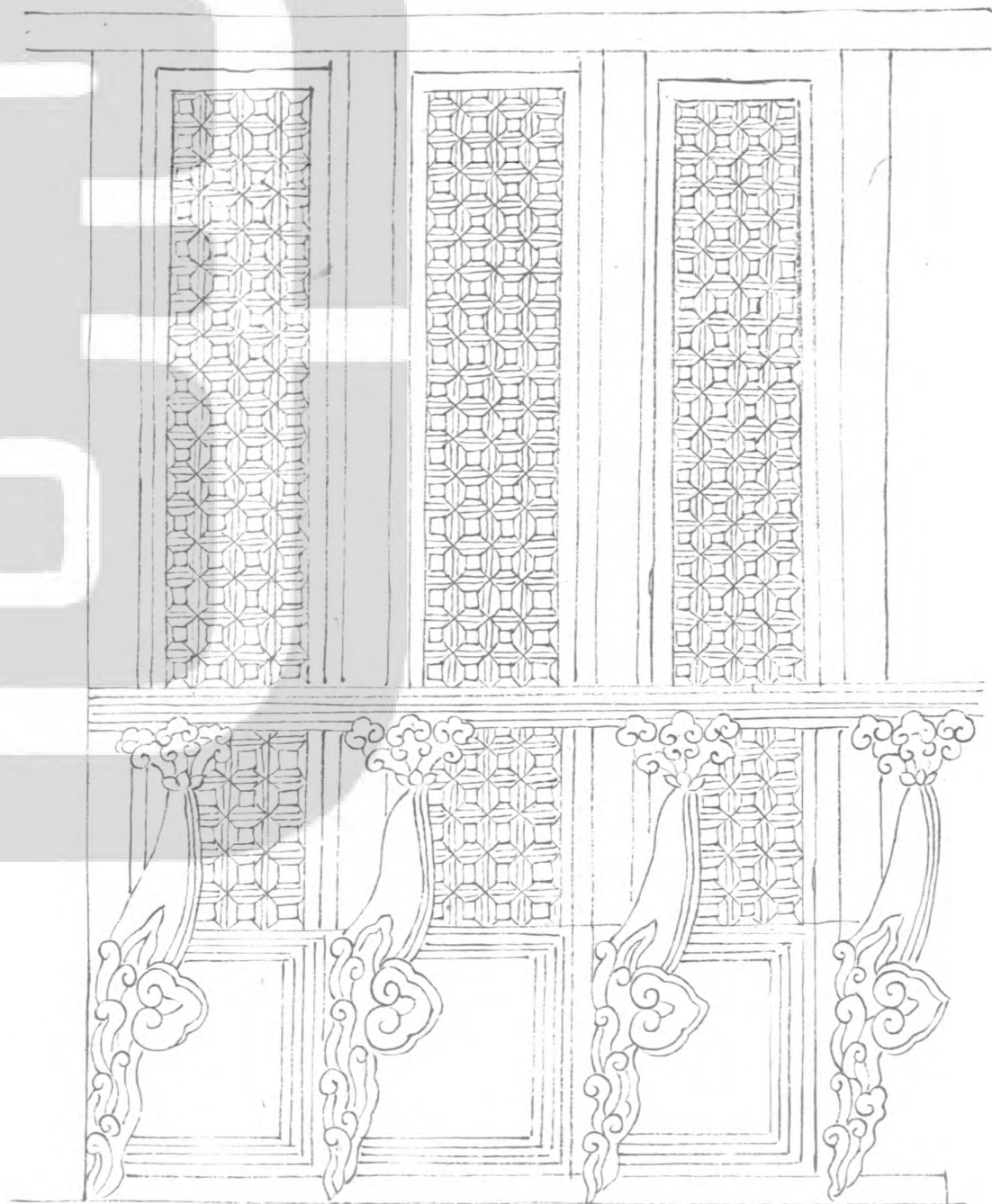

截間帶門格子

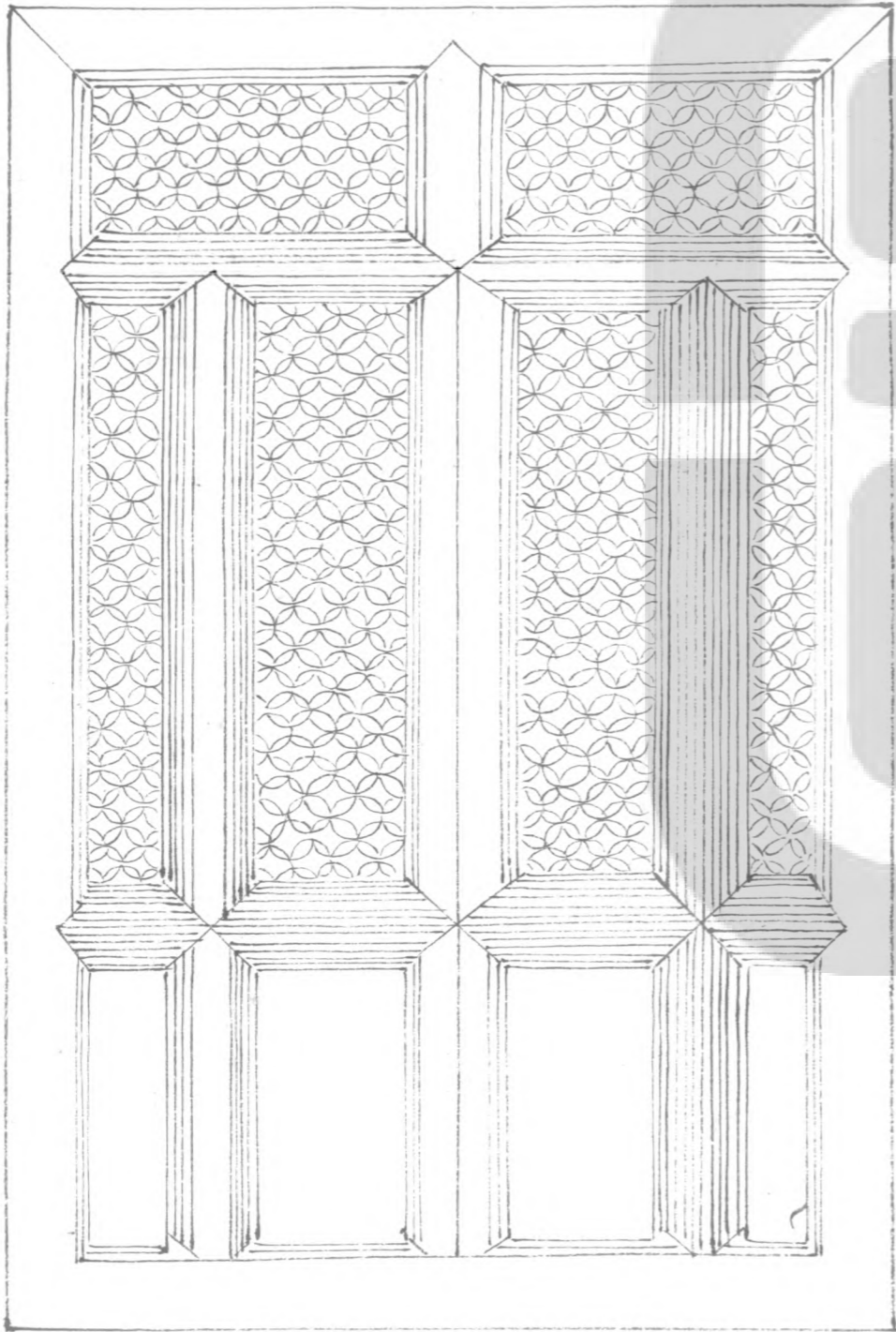

四程破瓣單混壓邊線

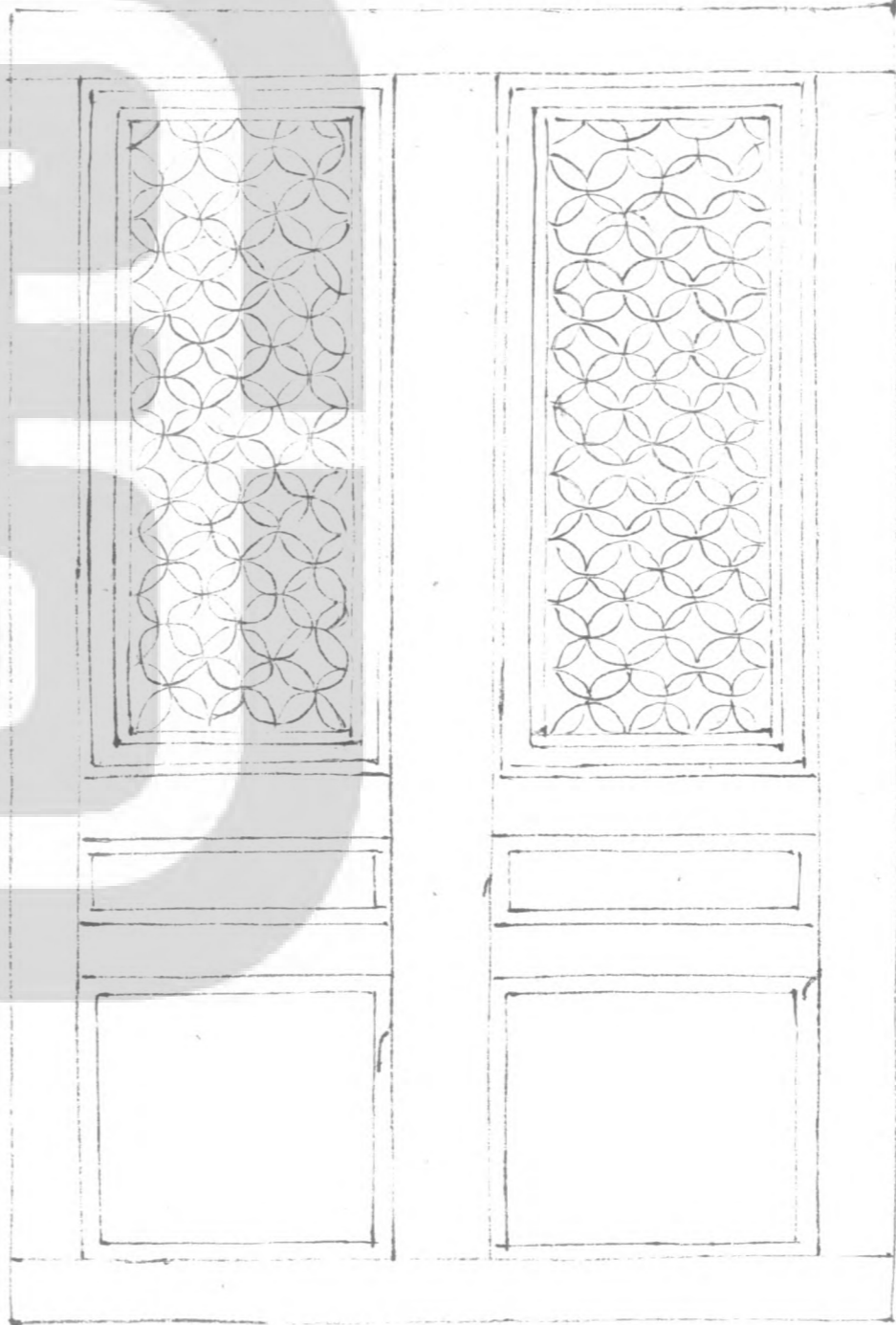

四程方直破瓣

又瓣入卯

彫雲垂魚

素垂魚



菴草

菴草

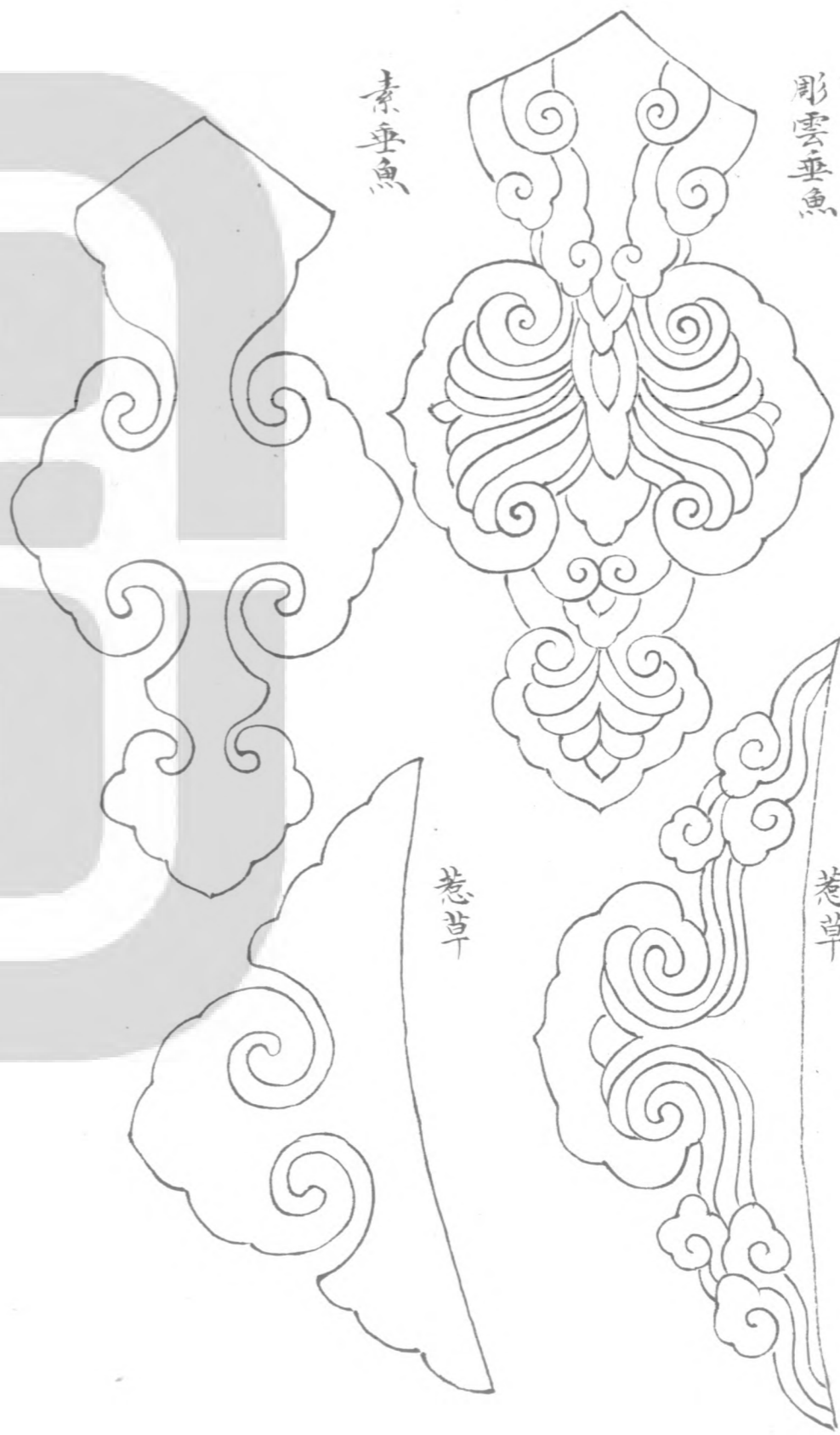

盤毬

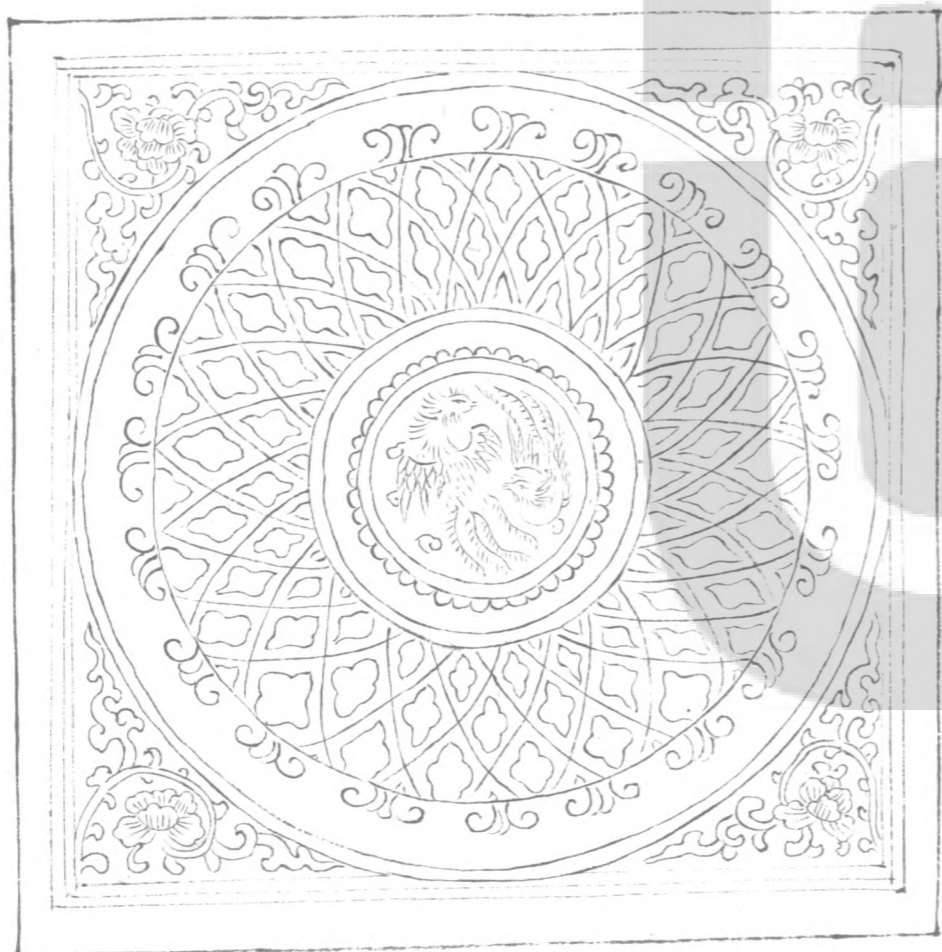



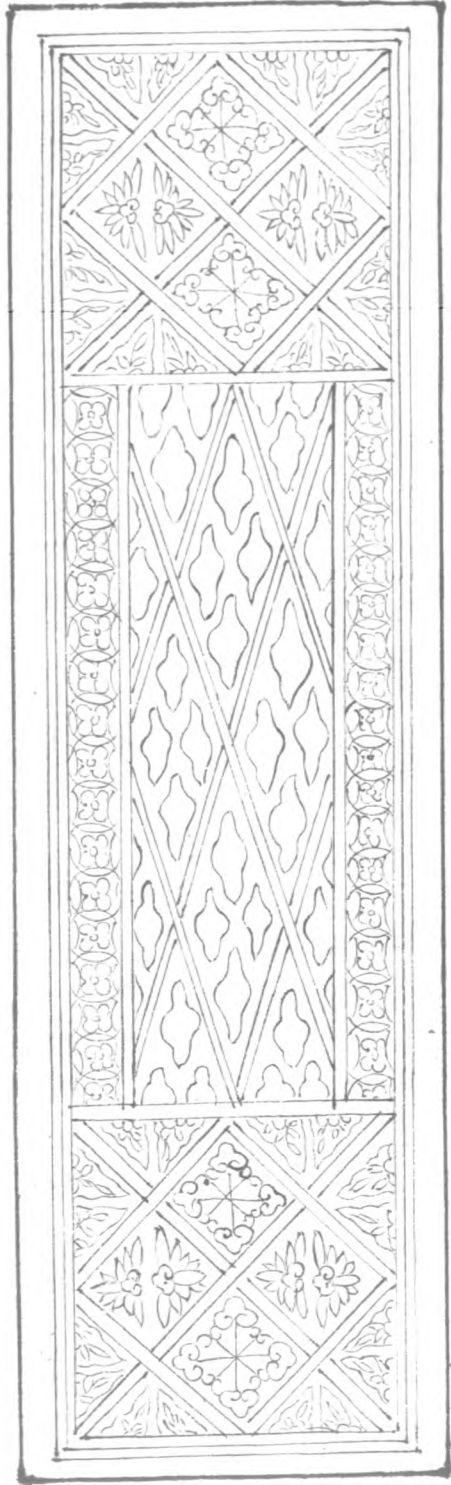

疊勝

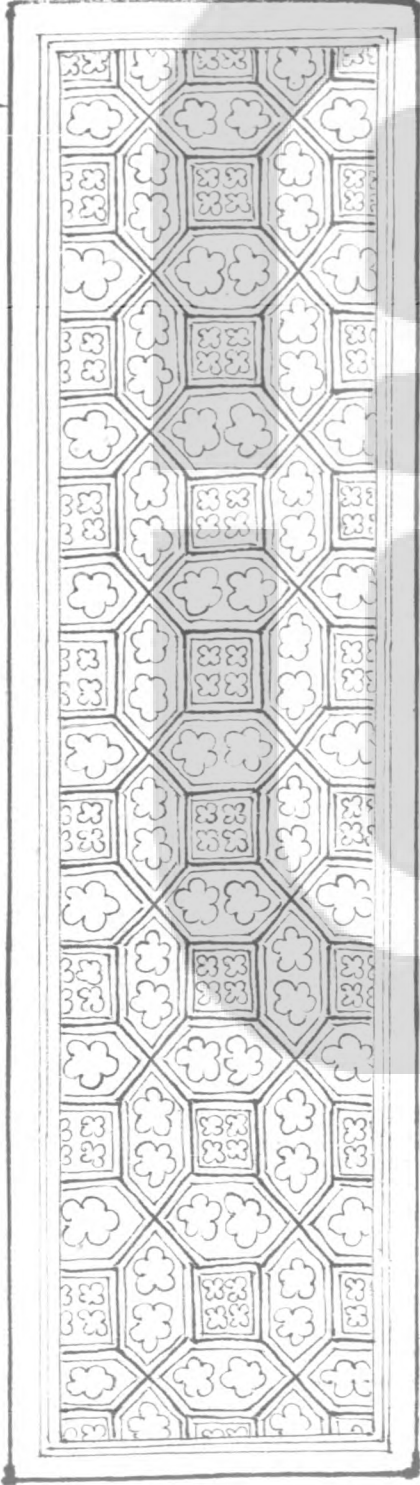

穿心關

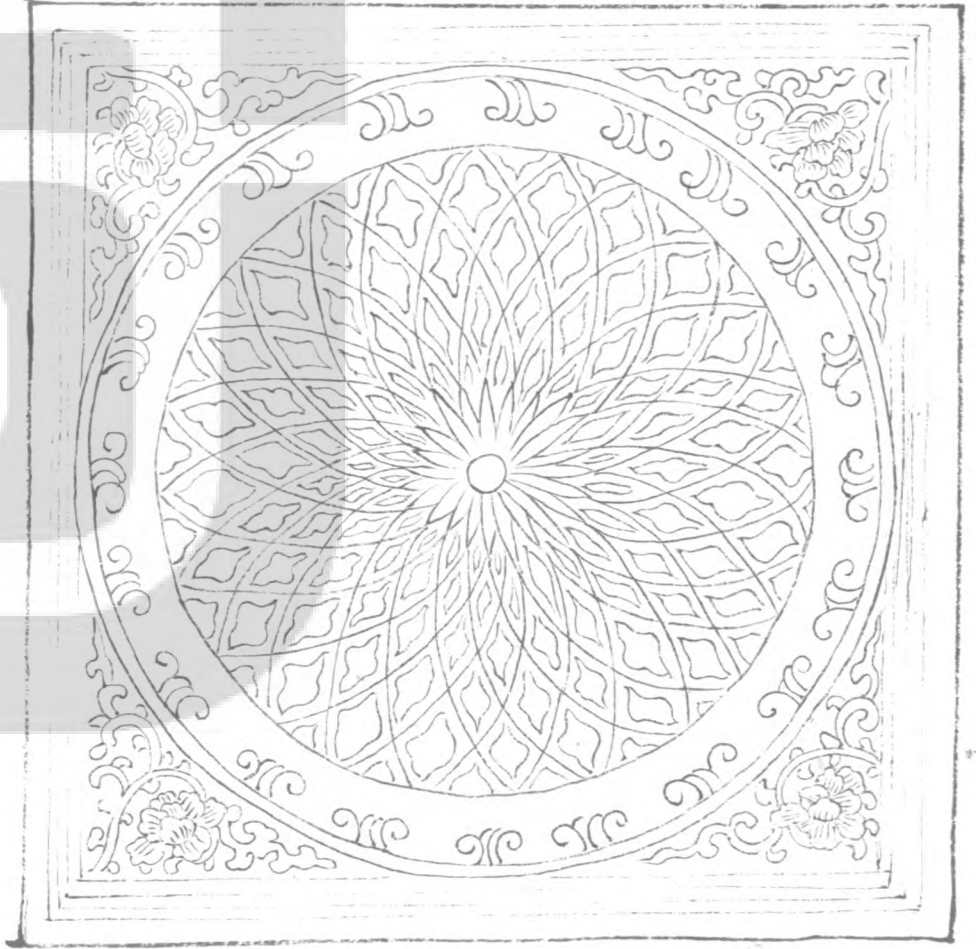

瑣子

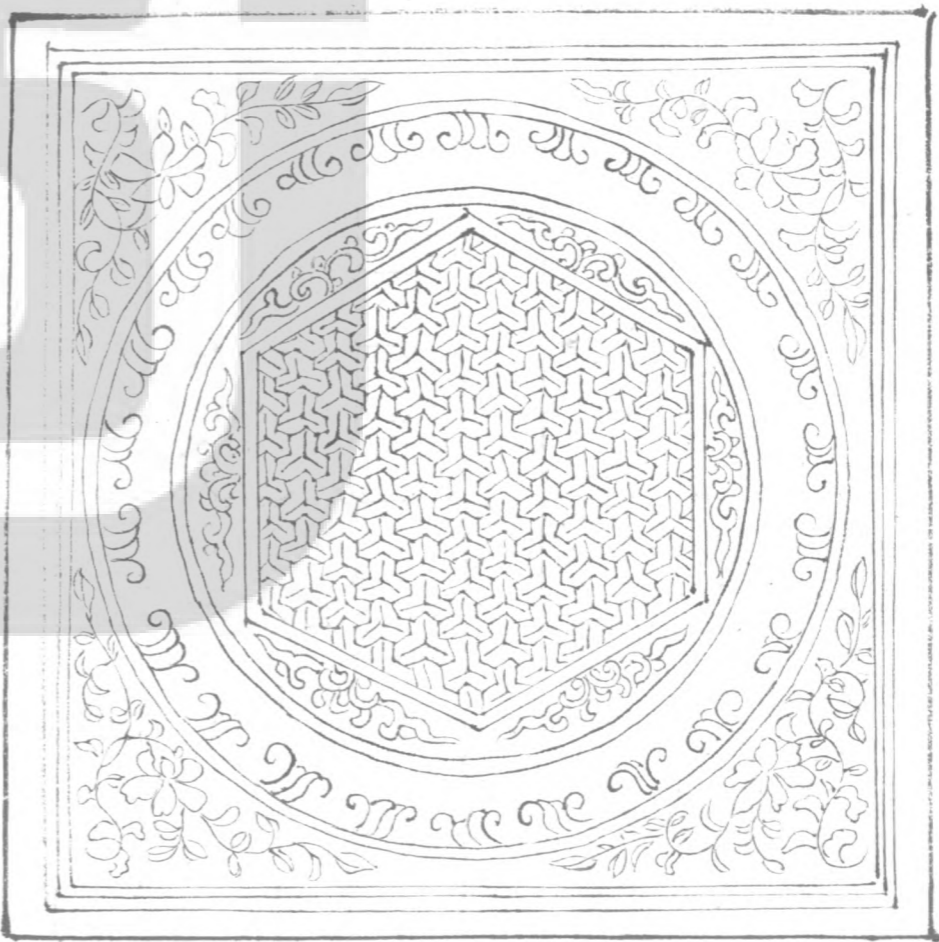

簇六毬文

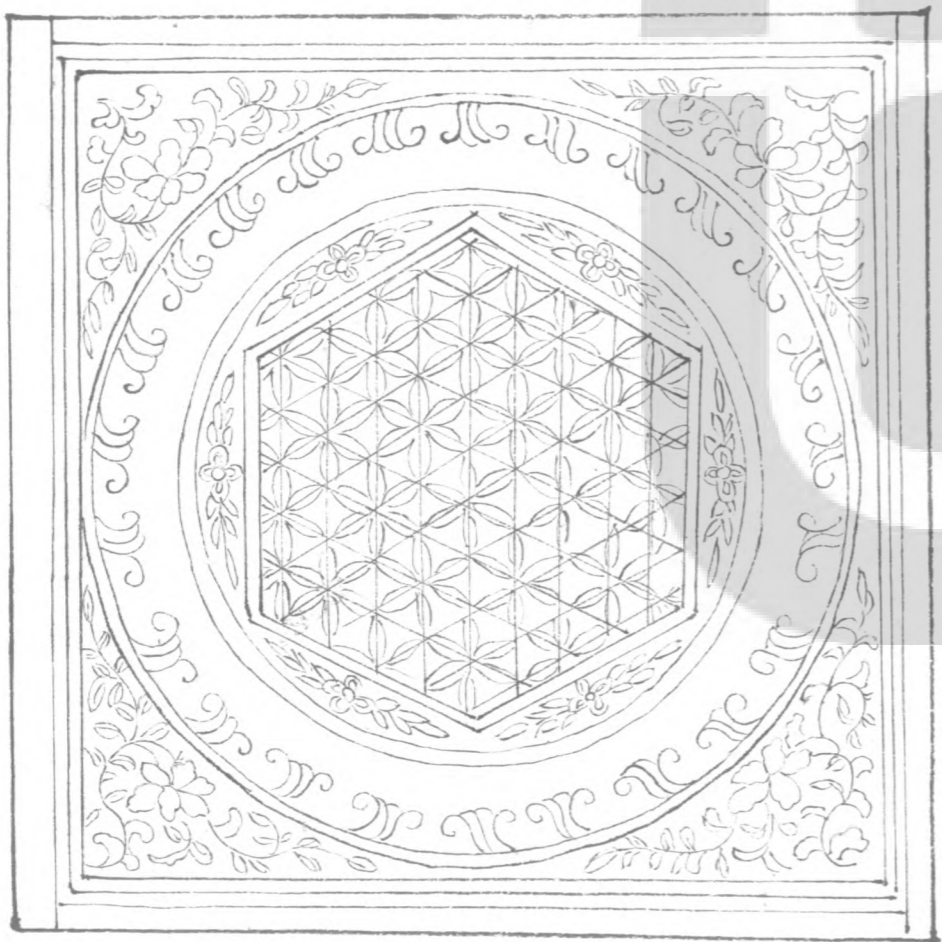

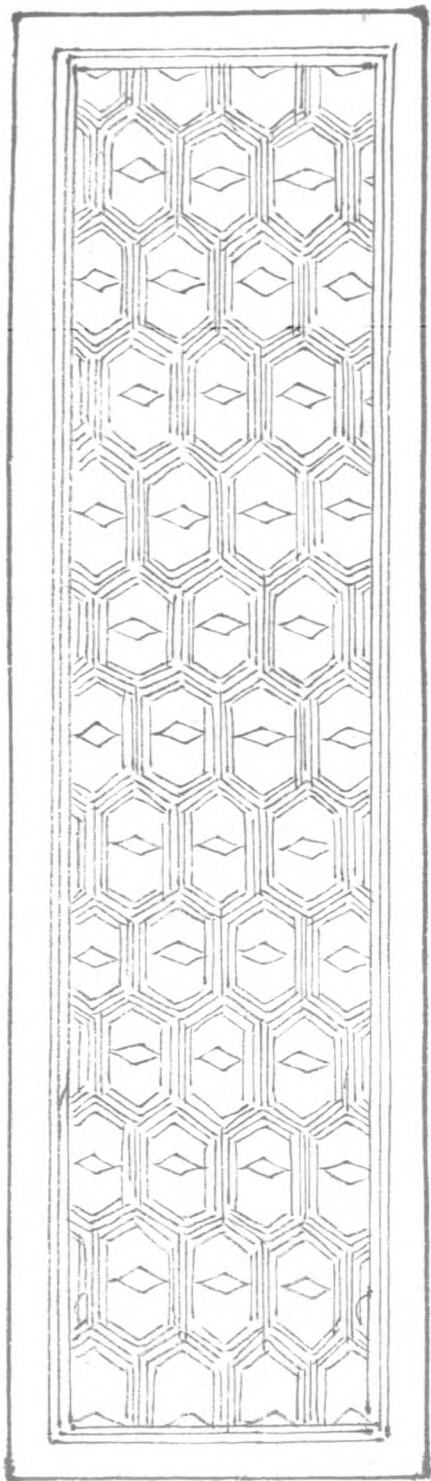

龜背

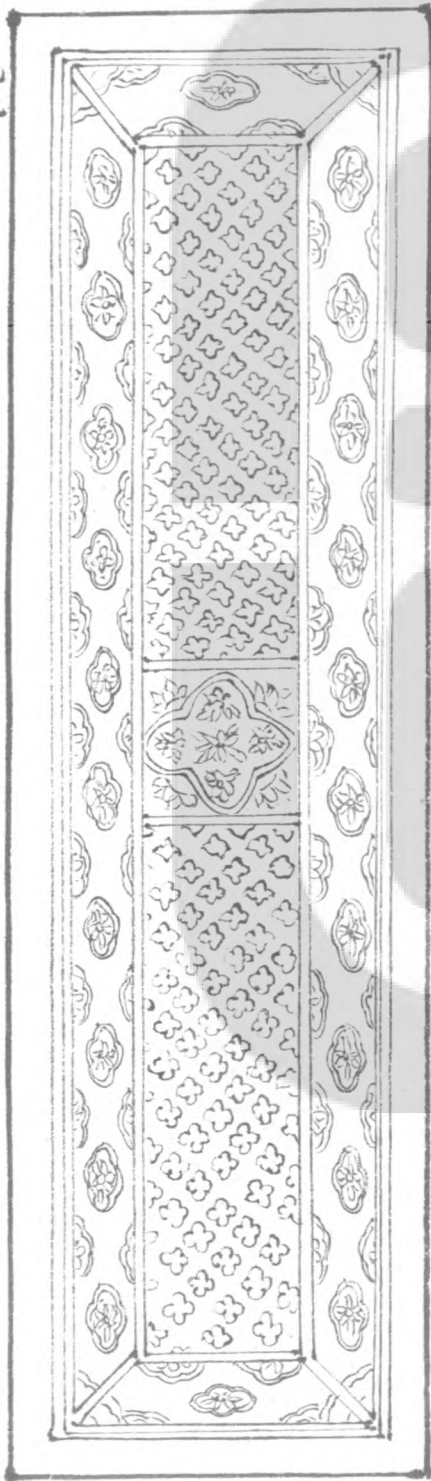

柿帶

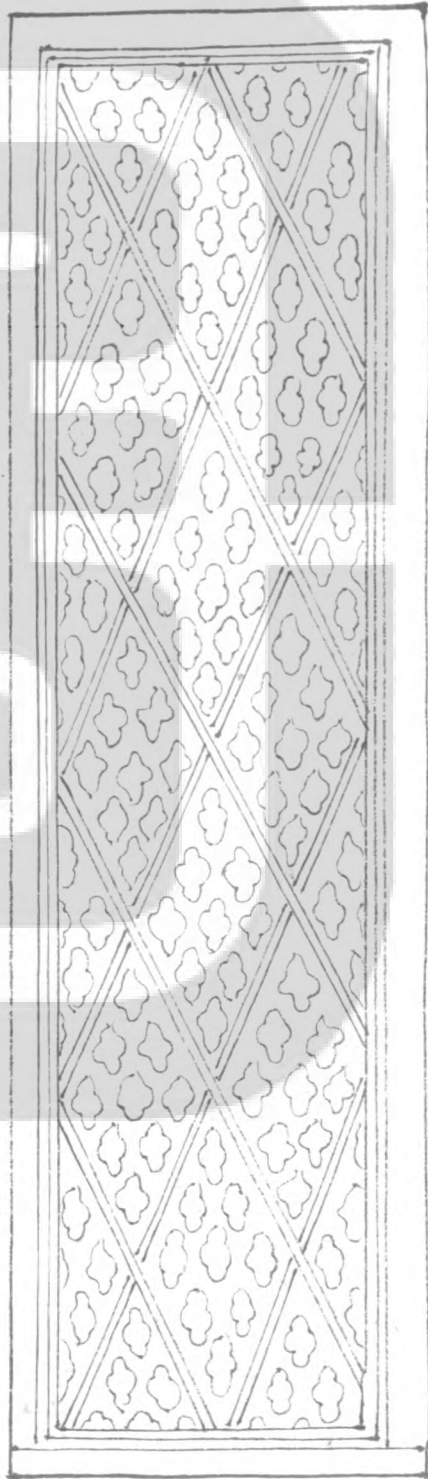

羅文疊勝

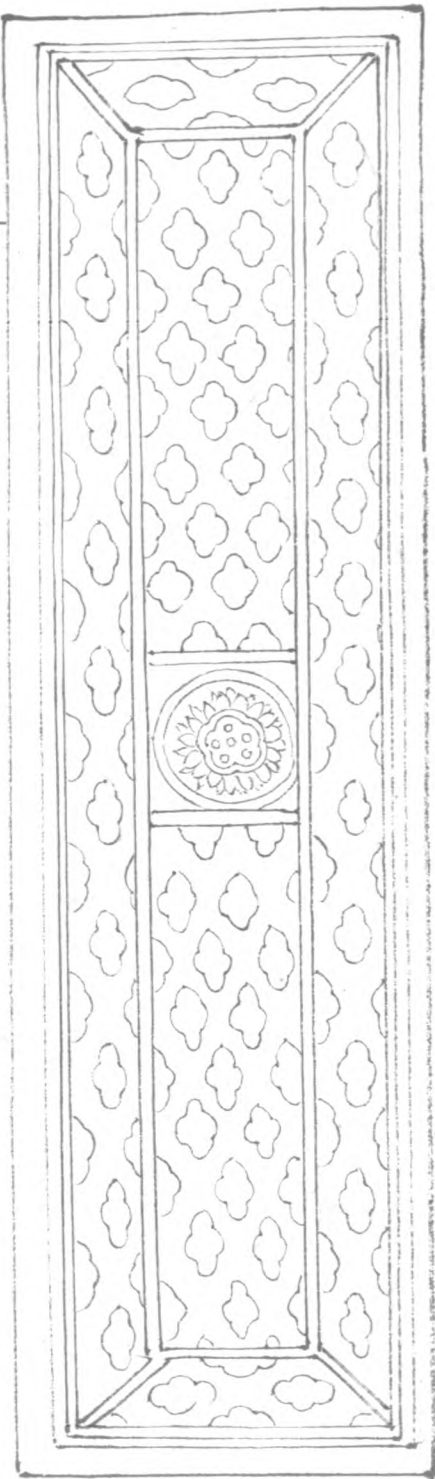

羅文



簇六填華毬文



簇六重毬文

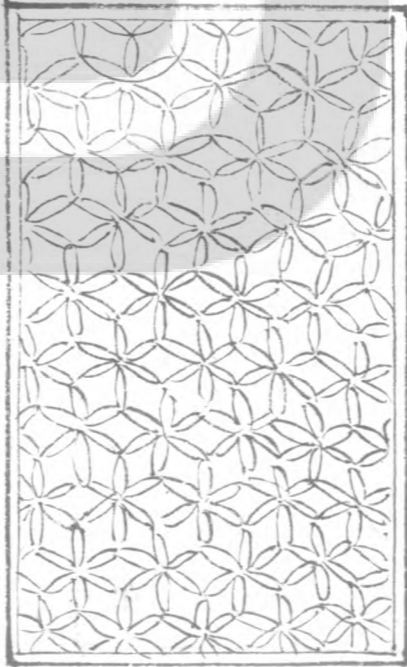
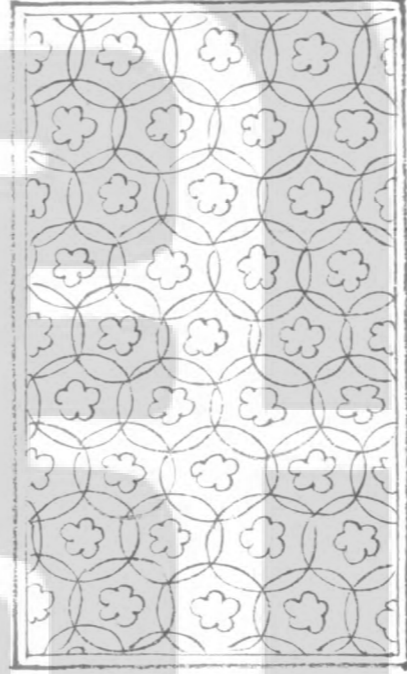

簇六雪華

交圓華

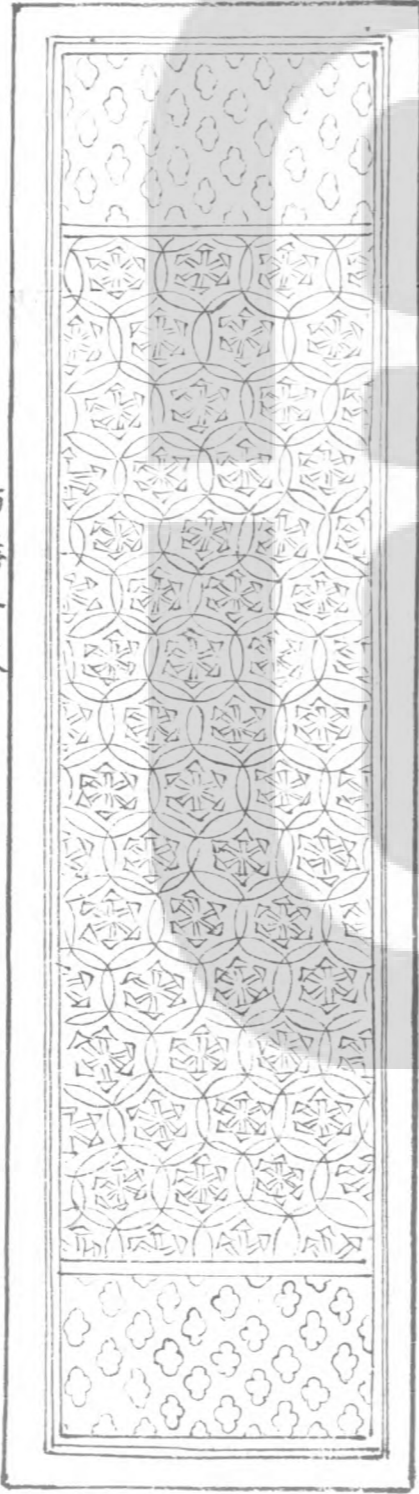

柿蒂方勝

平釧毬文

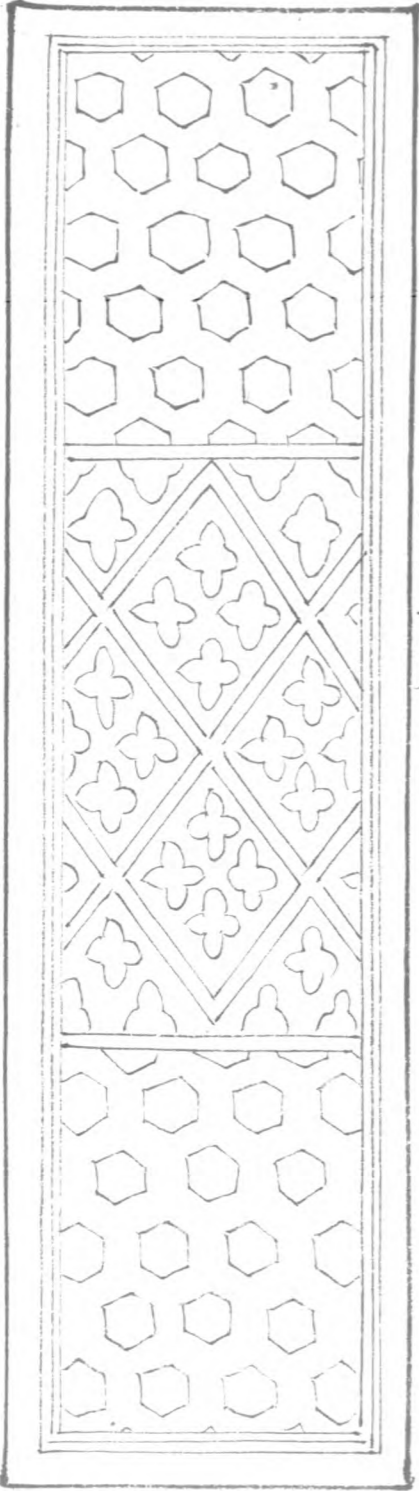

裏槽外轉角平棊

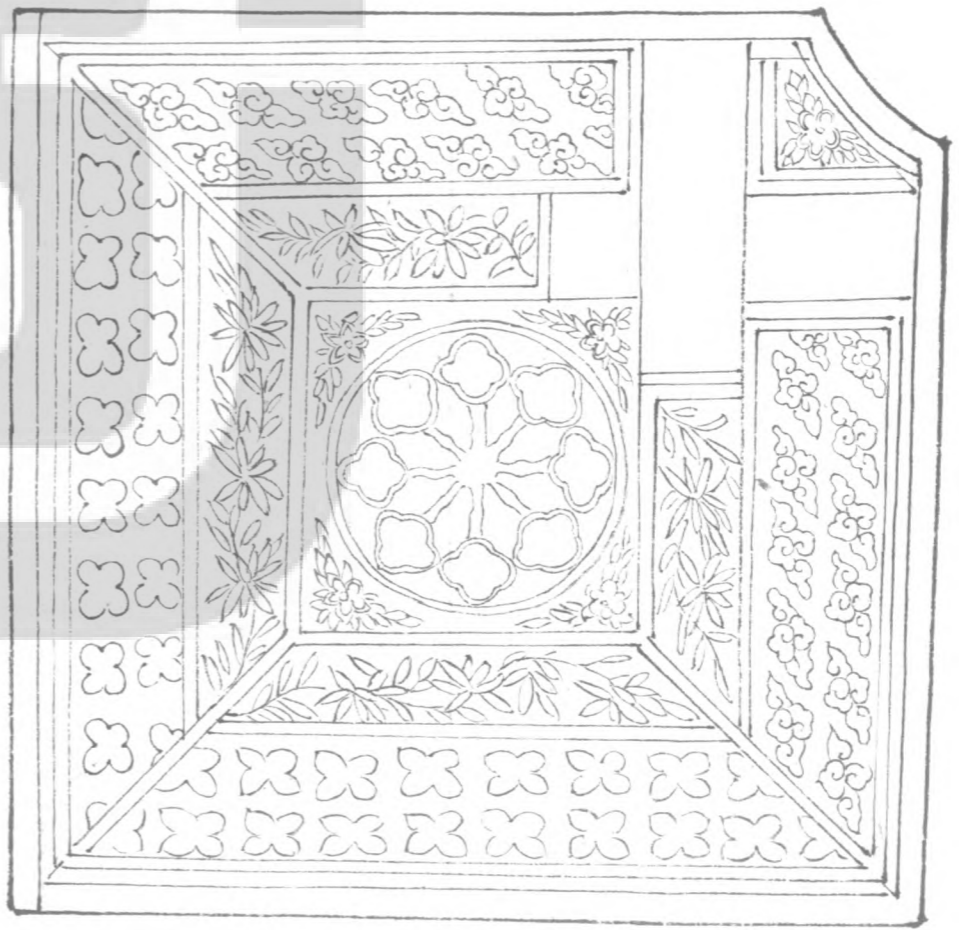

簇六球文轉道

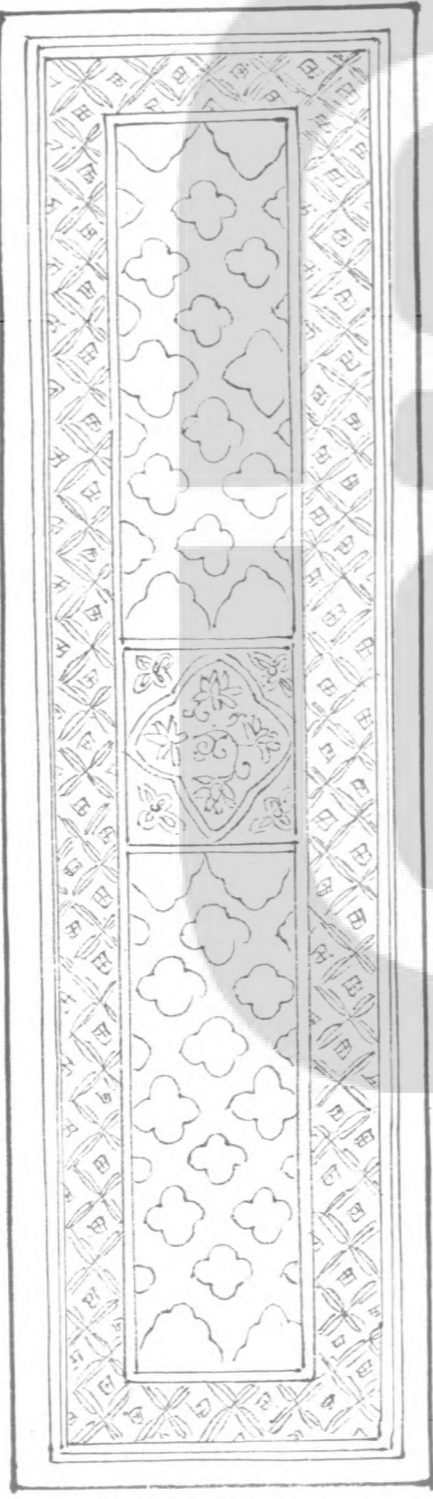

内方園栴蒂相間

栴蒂轉道

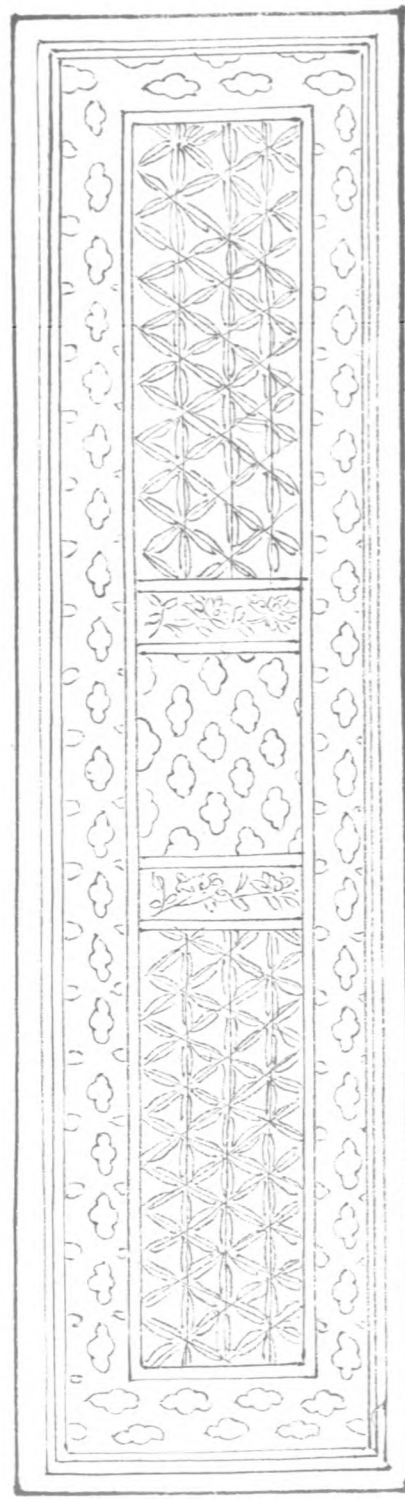

重臺瘦項鈎閑



填辮車鈎毬文

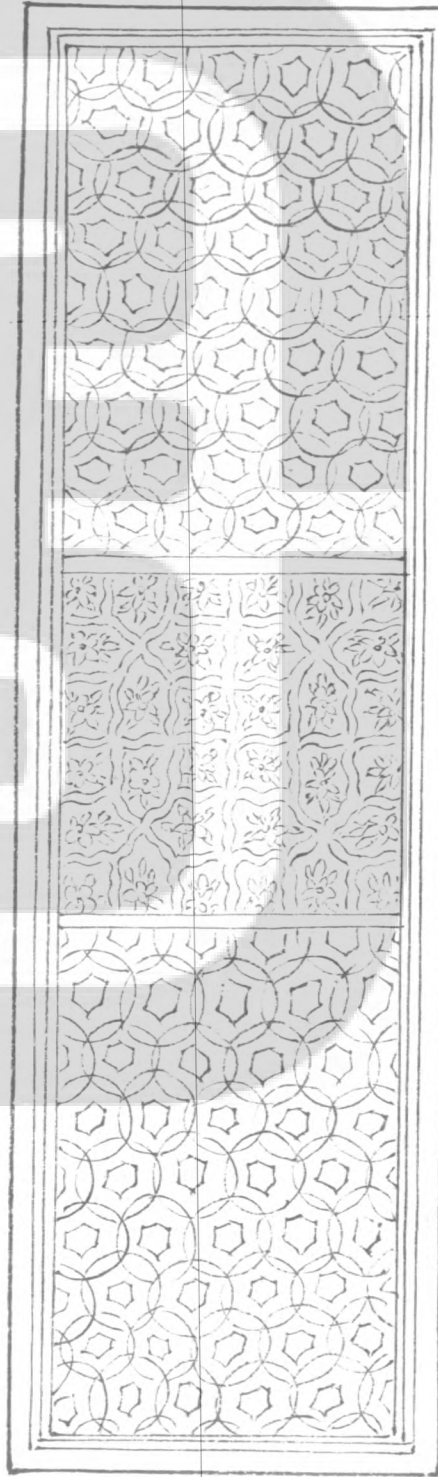

開十二

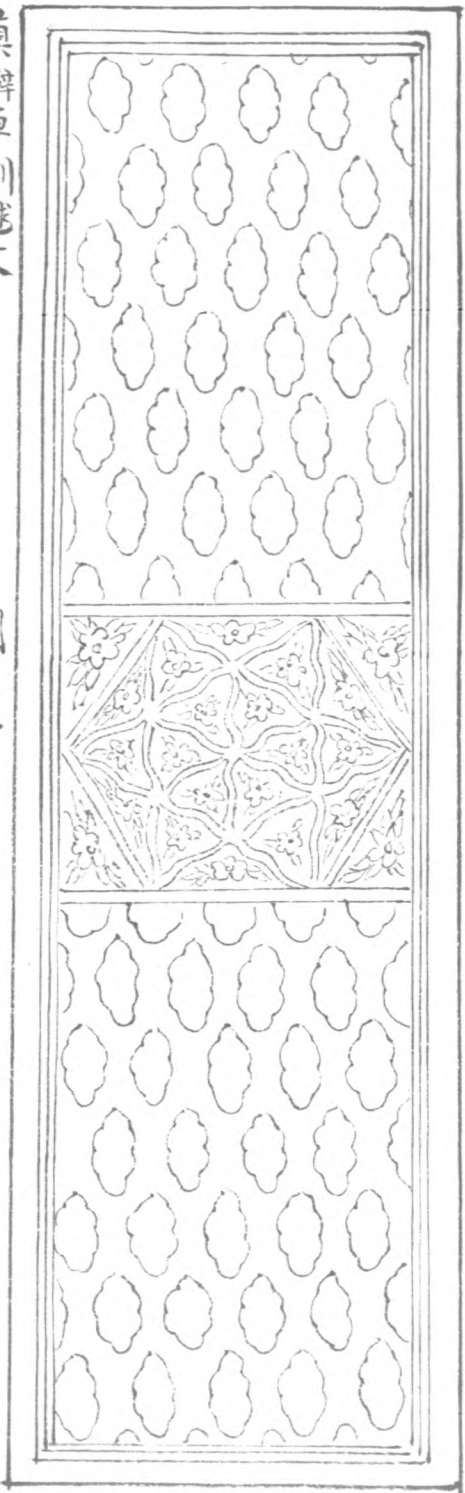

單撮項鈎闌

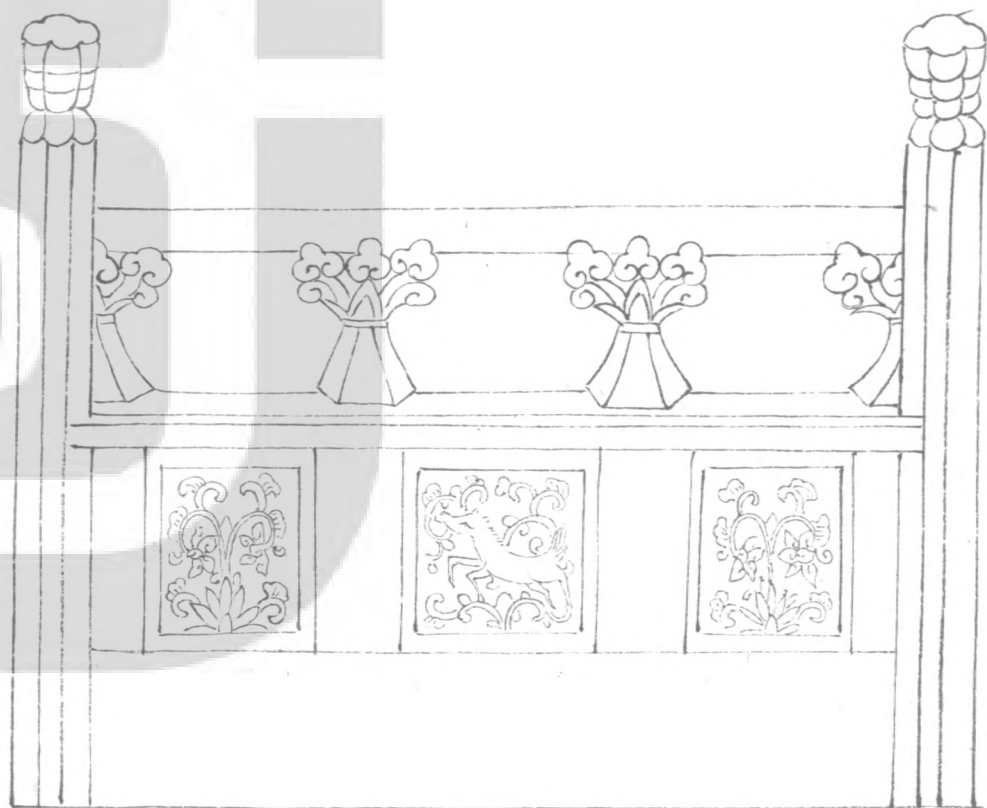

望柱海石榴頭

上下串破瓣出單線

銀脚地袱

標子雲頭身  
內一混心出  
單線壓雙線

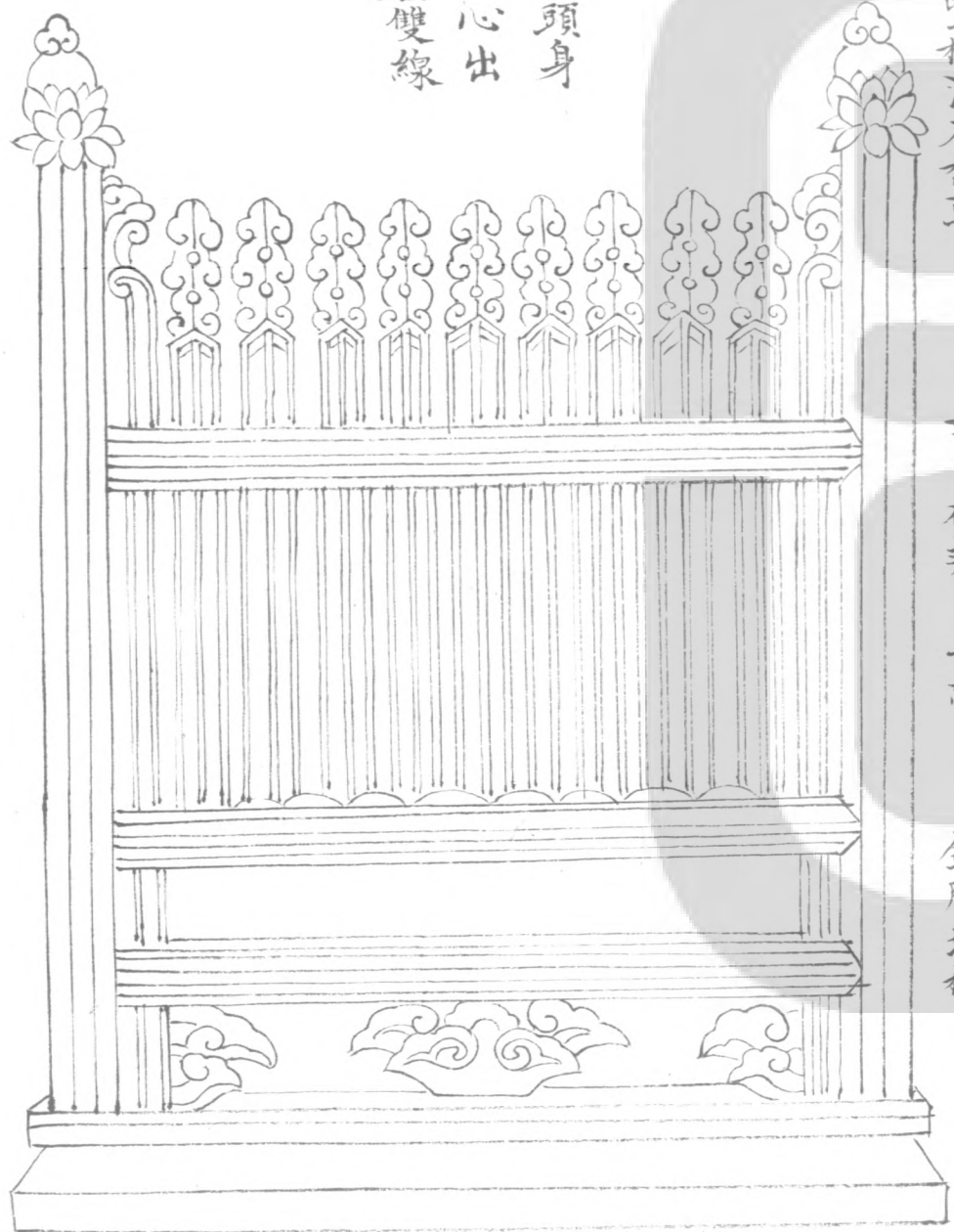

華帶牌

櫛子海石榴  
頭身内同上



上下串破辦壓白出單線

地震



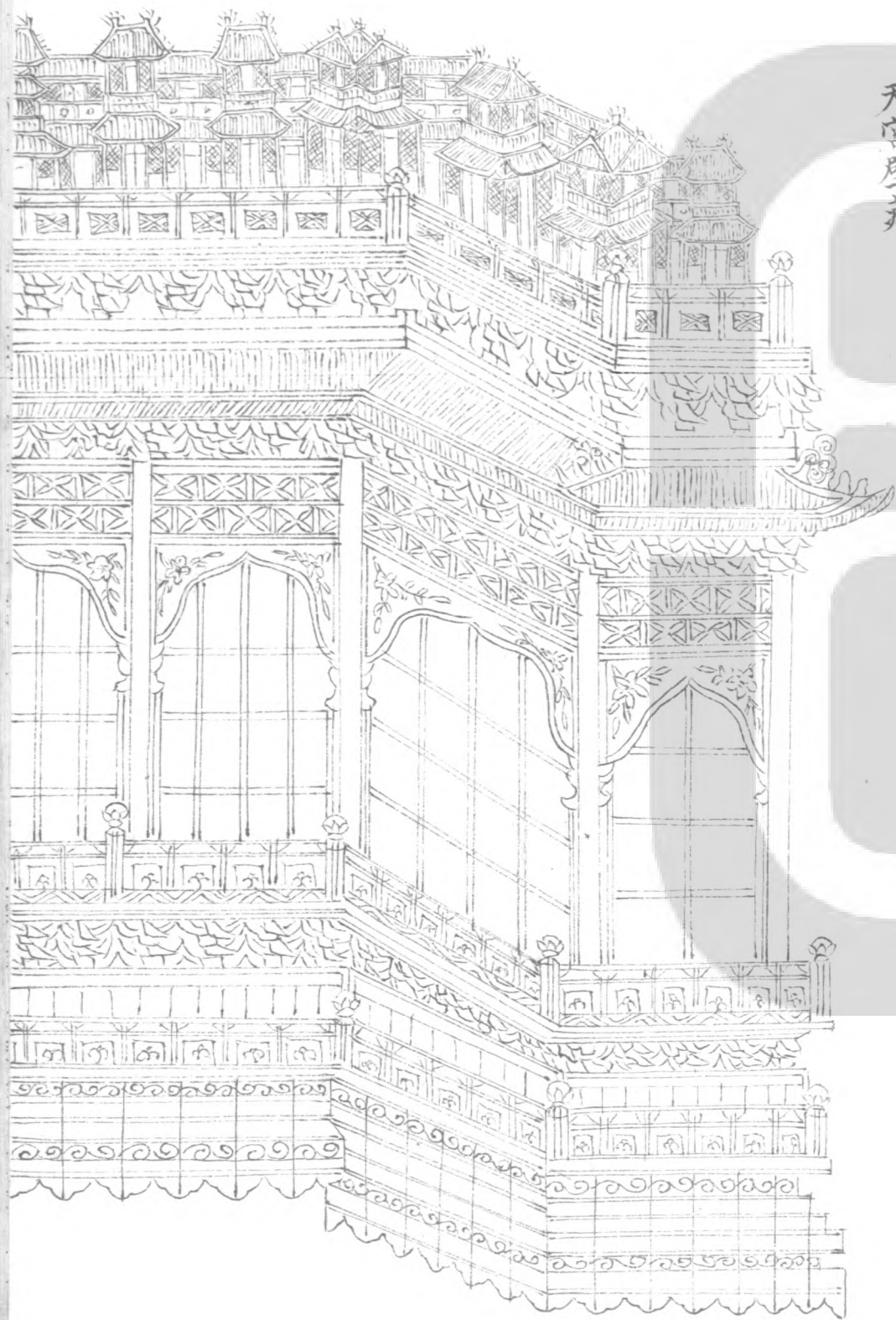

天宮壁藏

風字牌

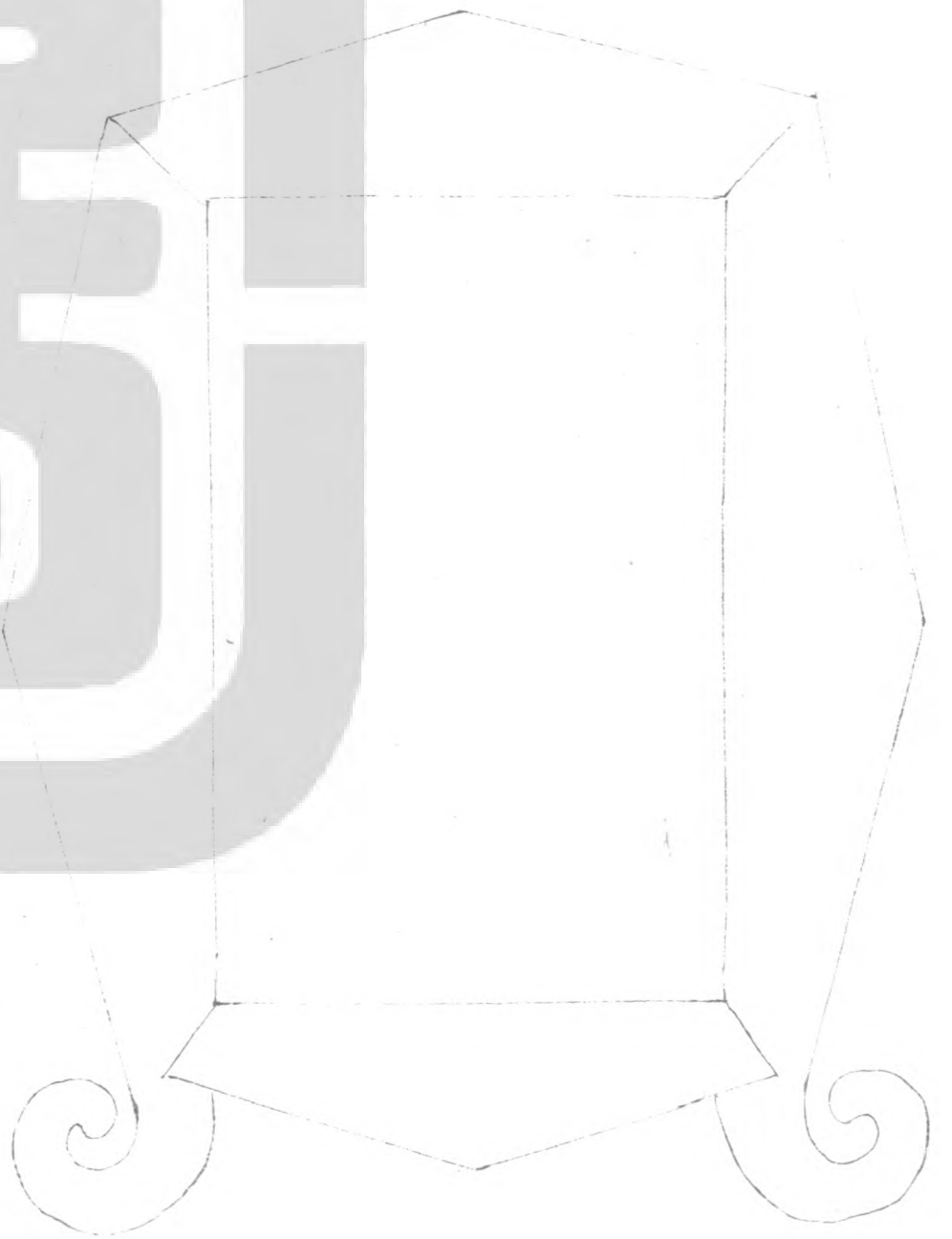

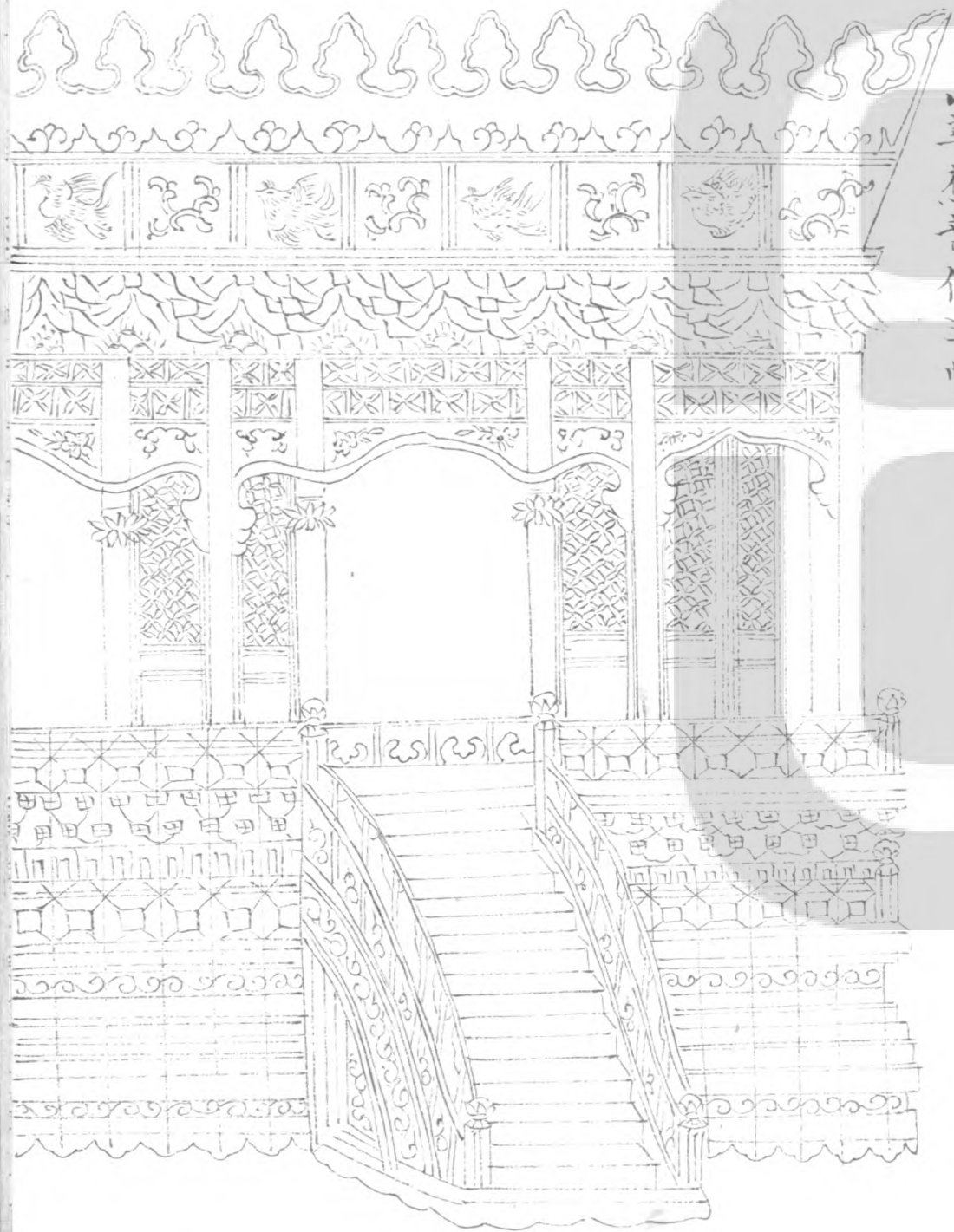

山萃蕉葉佛道帳

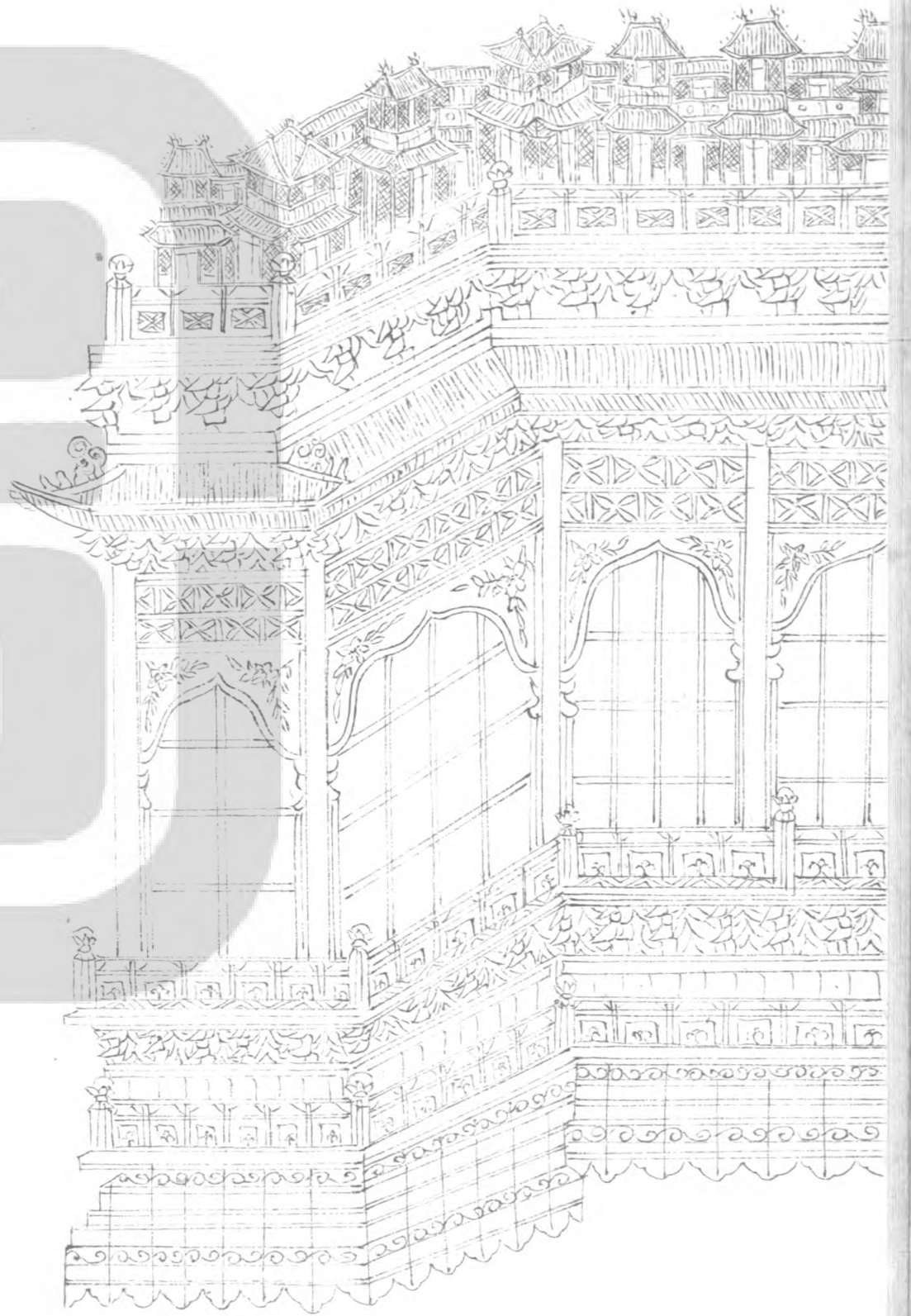

九脊牙脚小帳

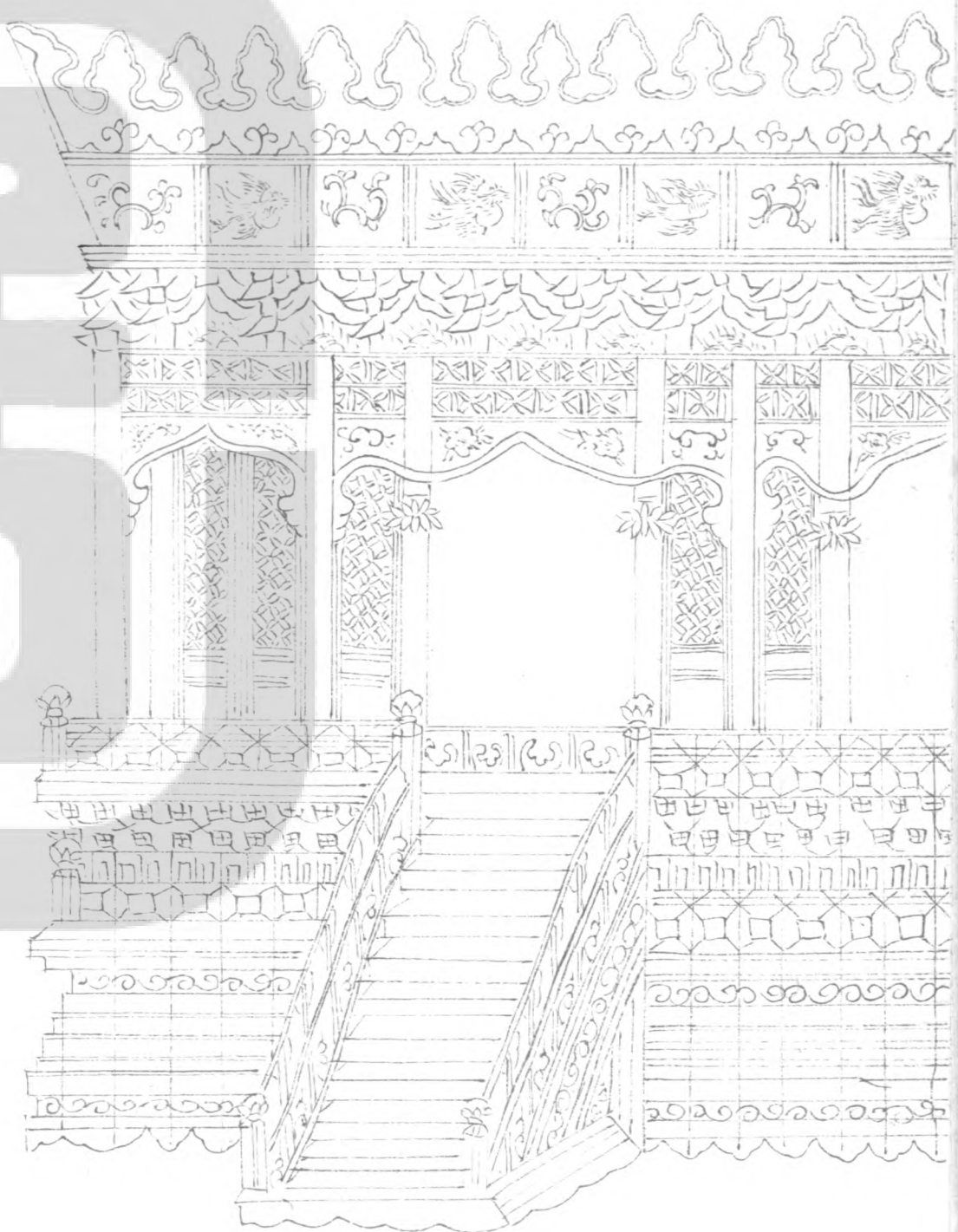
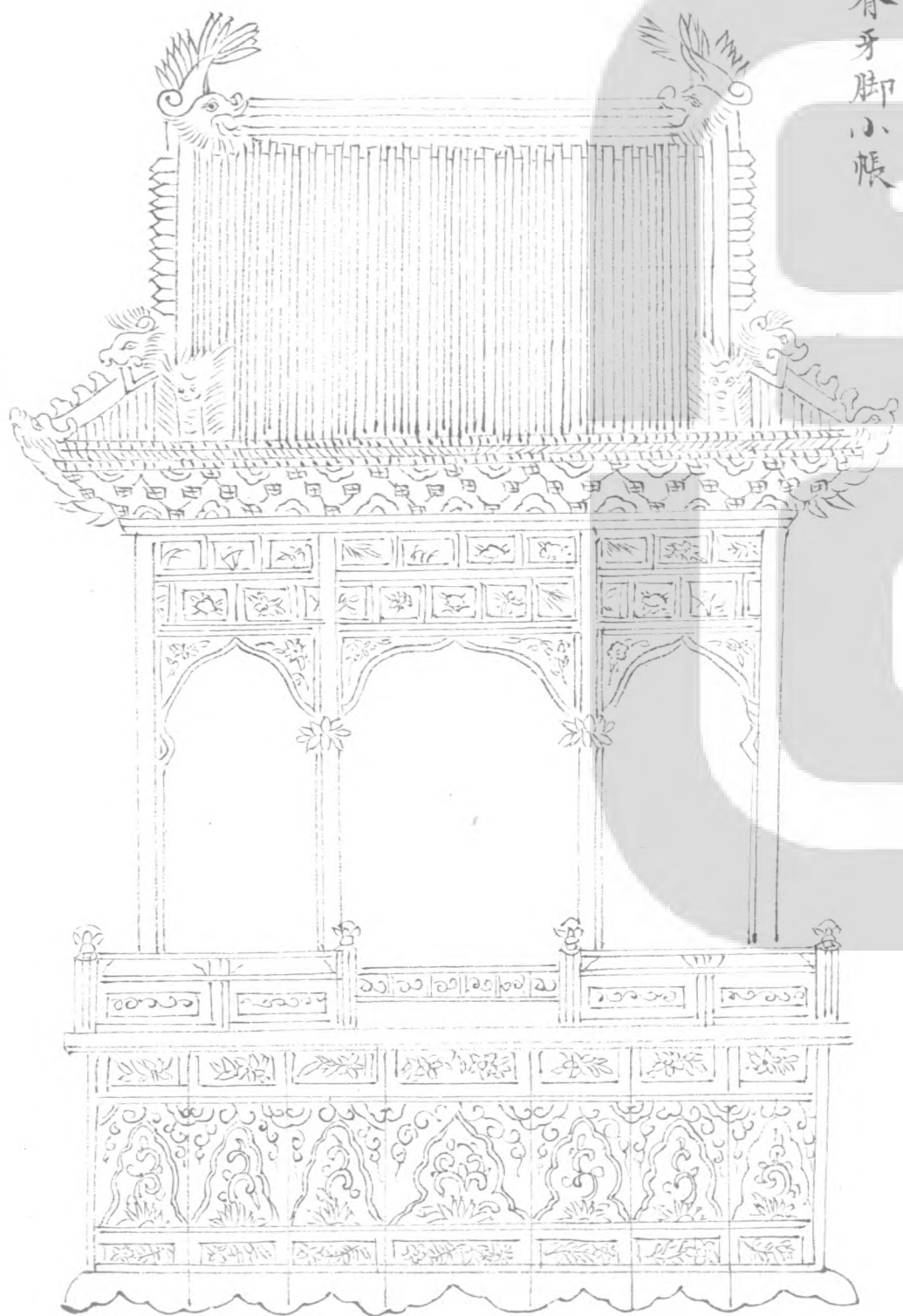

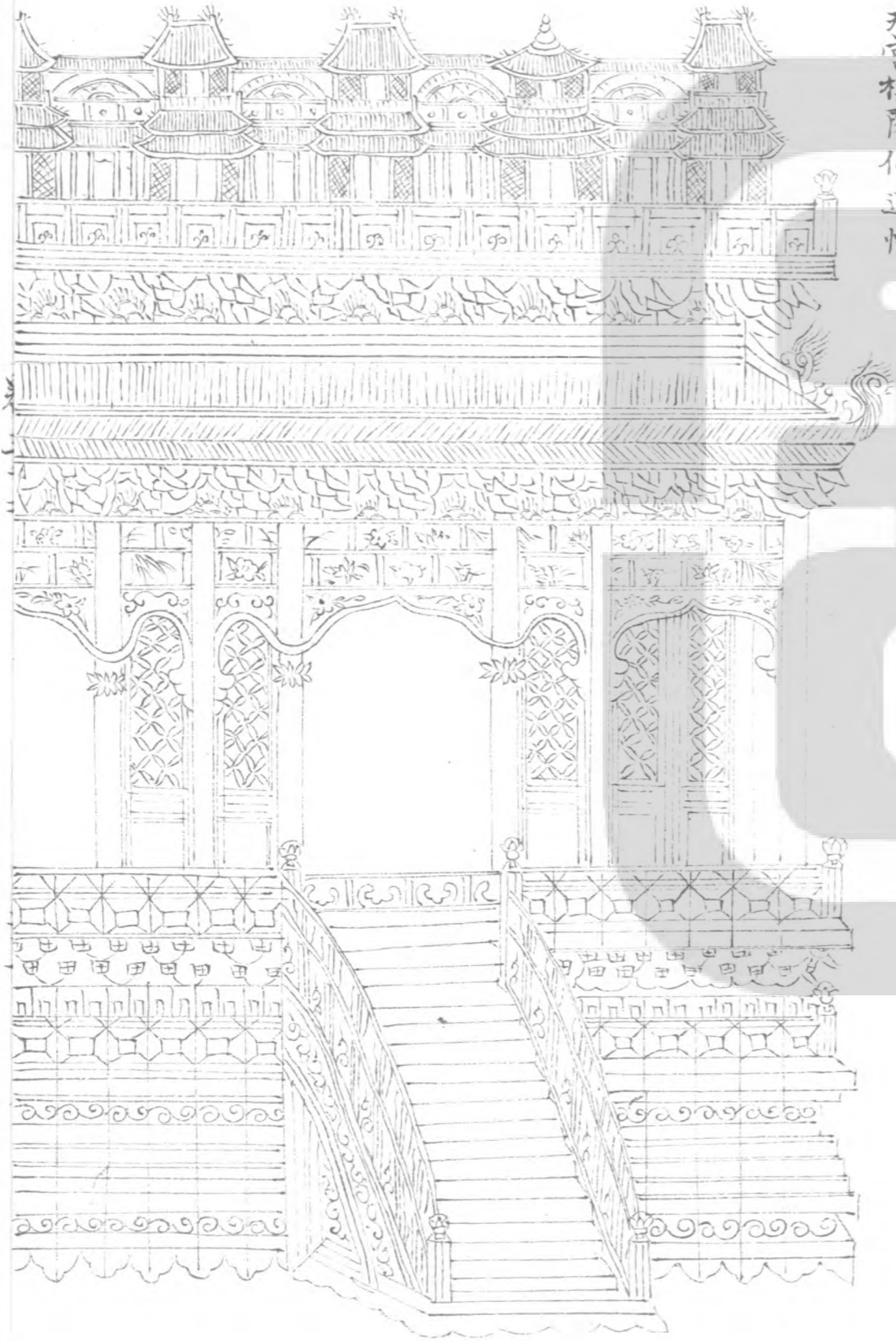

天宮樓閣佛道帳

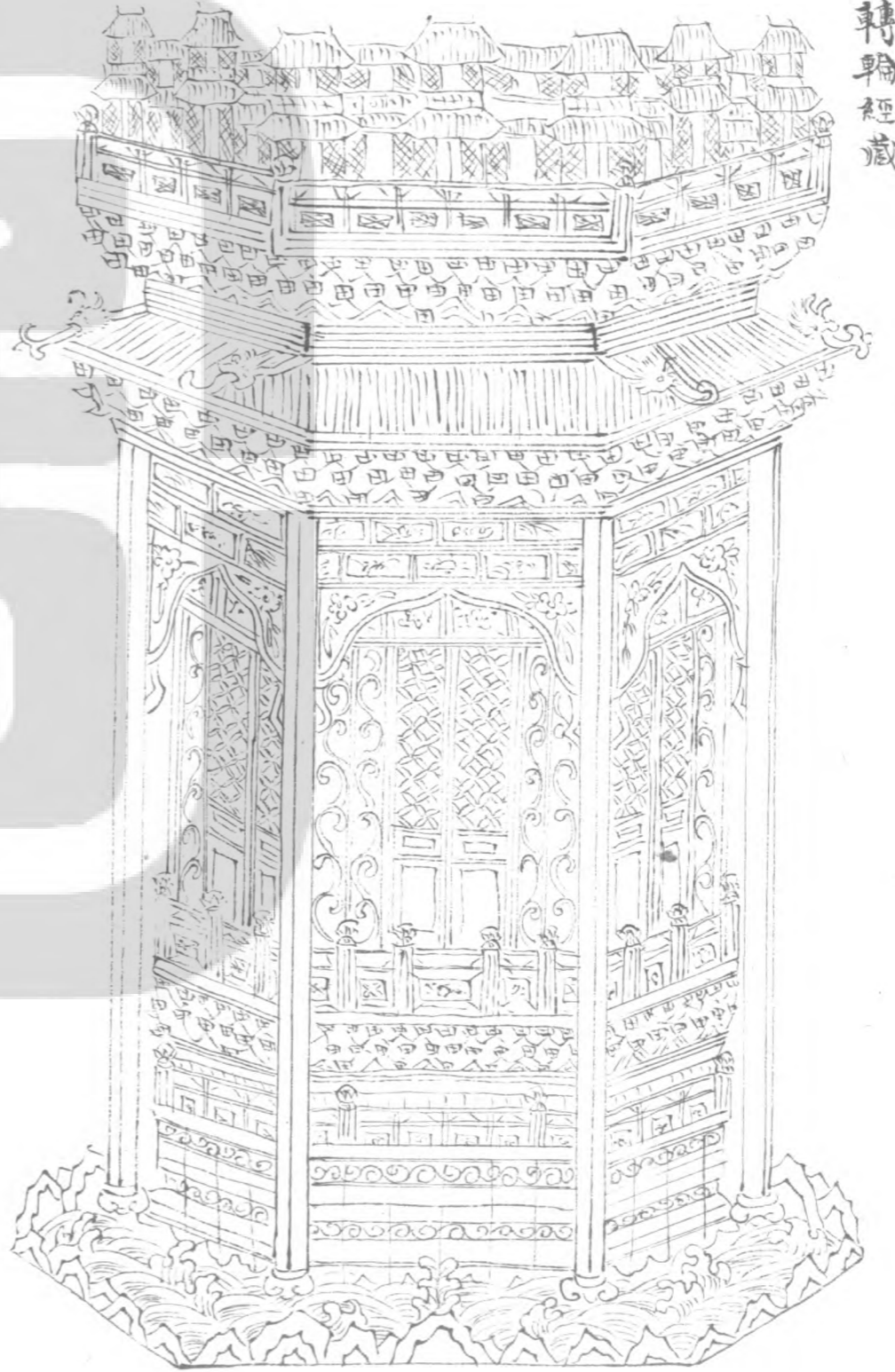

轉輪經藏



菩薩



化生



玉女



坐龍



托支



佛孫



獅子



鸞



鳳

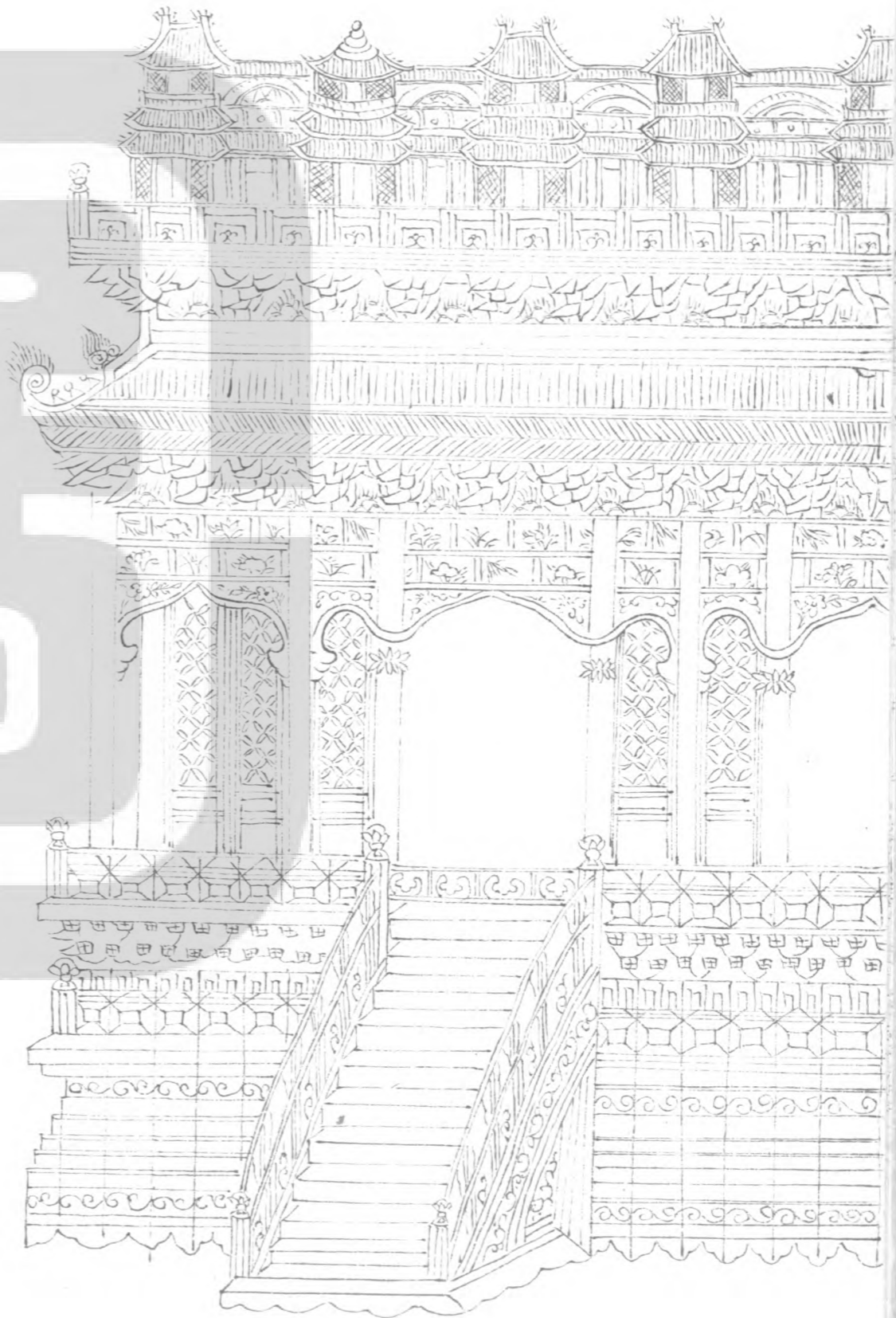

重拱眼壁内華盆

牡丹



單拱眼壁内華盆

拒霜華  
等雜華



別地突起三卷葉



兩卷葉

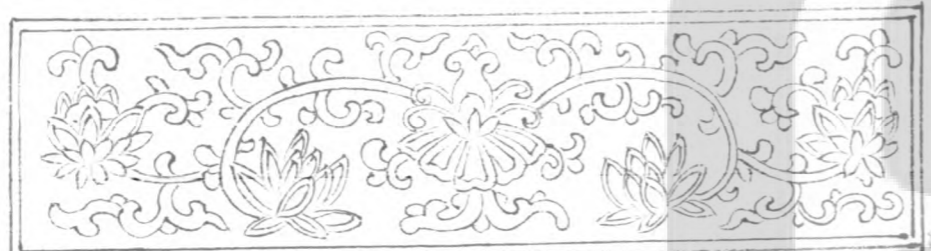

一卷葉

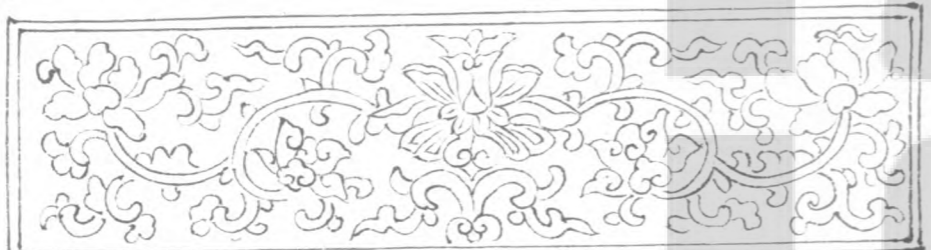

別地字葉



平卷葉

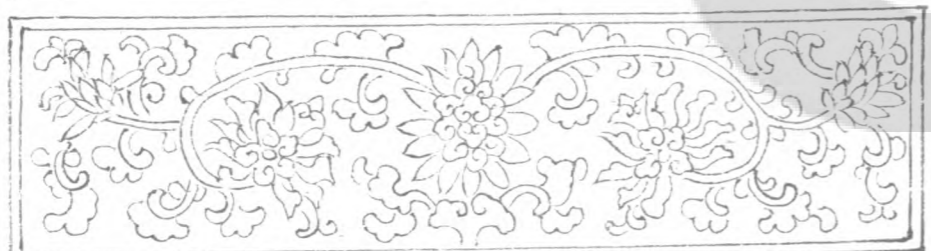

透空平卷葉



雙雲  
頭拱



海石榴華雲拱



單地霞



像生蓮荷  
華地霞



單雲  
頭拱



像生華雲拱

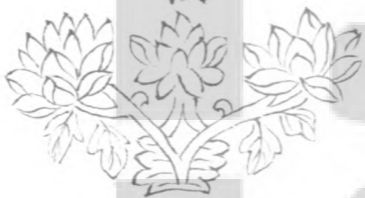

重臺地霞



像生牡丹  
華地霞

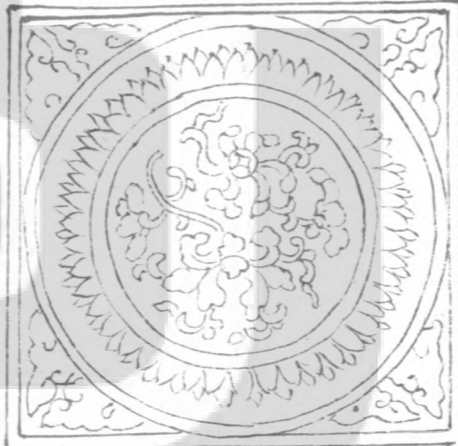

平棊華盤

混作纏柱龍



鈎蘭華版

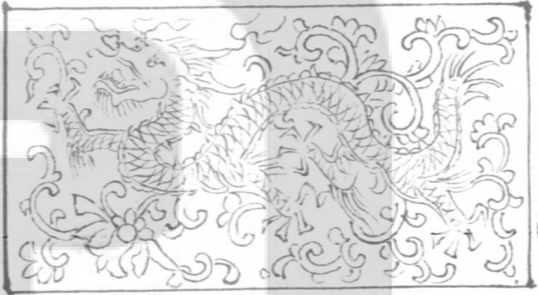

椽頭盤子





營造法式卷三十二

營造法式

卷三十三

彩畫作制度圖樣上

五彩雜華第一

五彩瓊文第二

飛仙及飛走等第三

騎跨仙真第四

宋 李誠 撰

五彩額柱第五

五彩平棊第六

碾玉雜華第七

碾玉瑣文第八

碾玉額柱第九

碾玉平棊第十

海石榴華

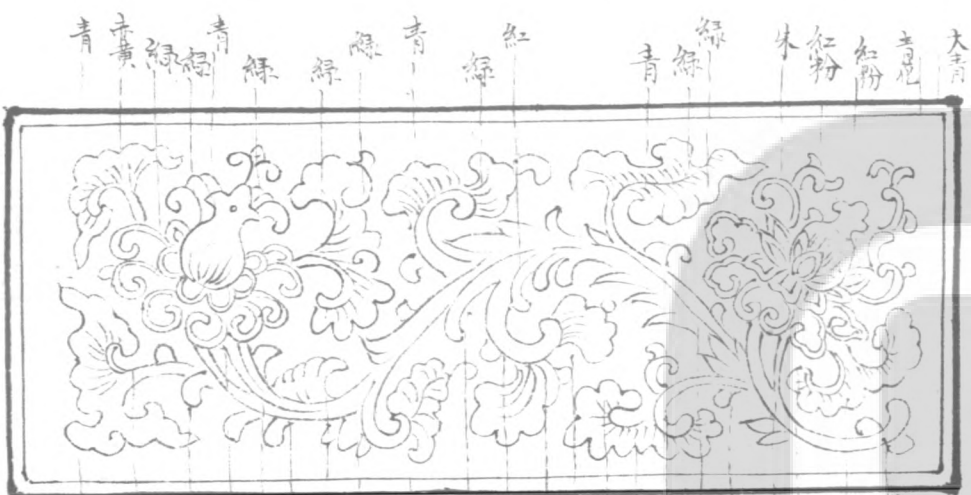

寶牙華

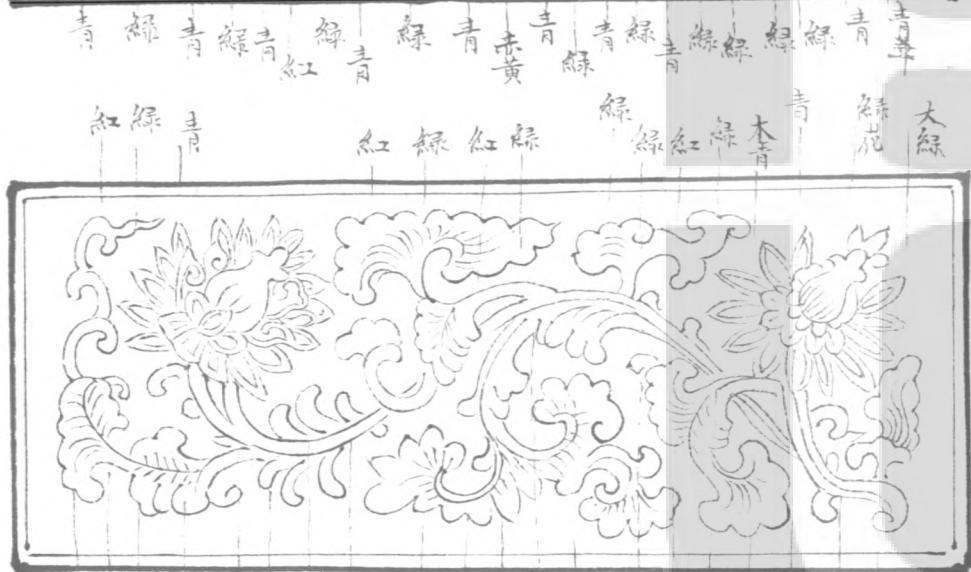

太平華

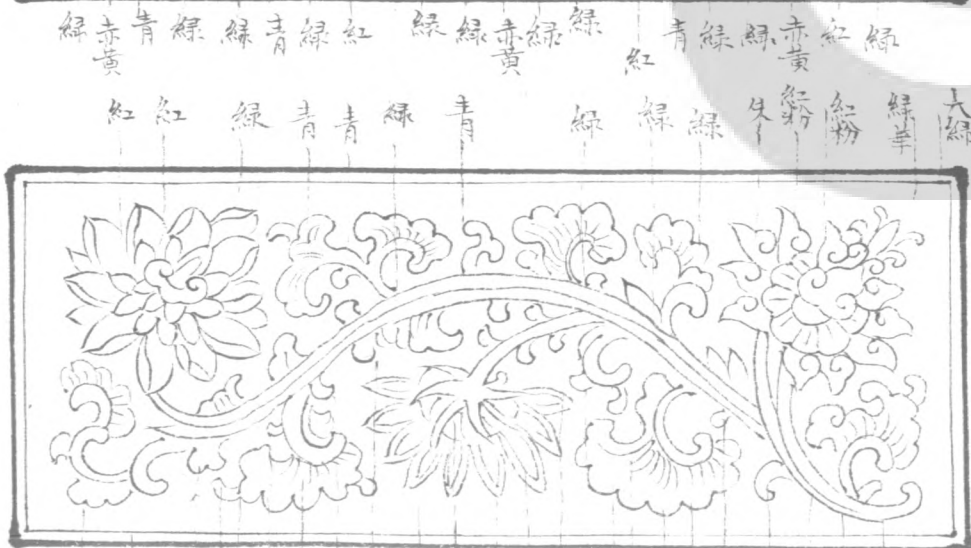

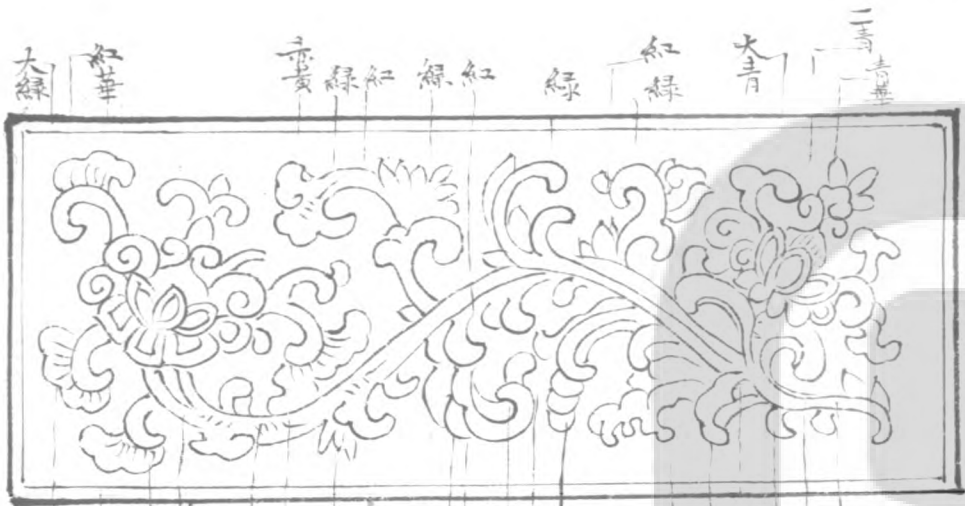

海石榴華 枝條卷成

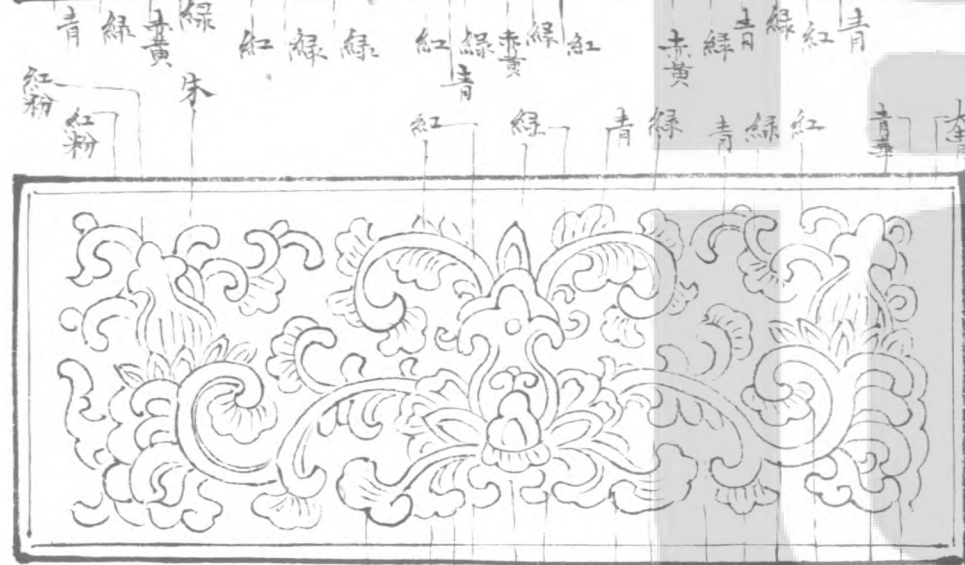

海石榴華 鋪地卷成



牡丹華 高生

用葉 用華  
綠並 紅頭

紅 綠 綠 紅 青 綠 青 青 紅 紅 赤 黃 大青 綠 青華 大青

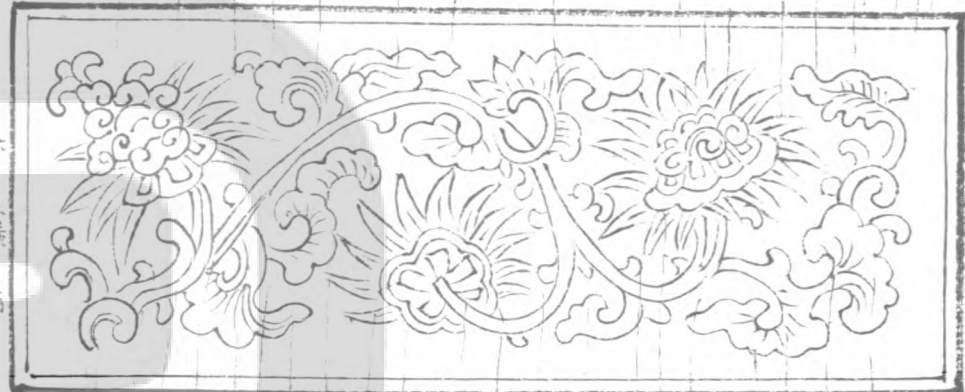

寶相華

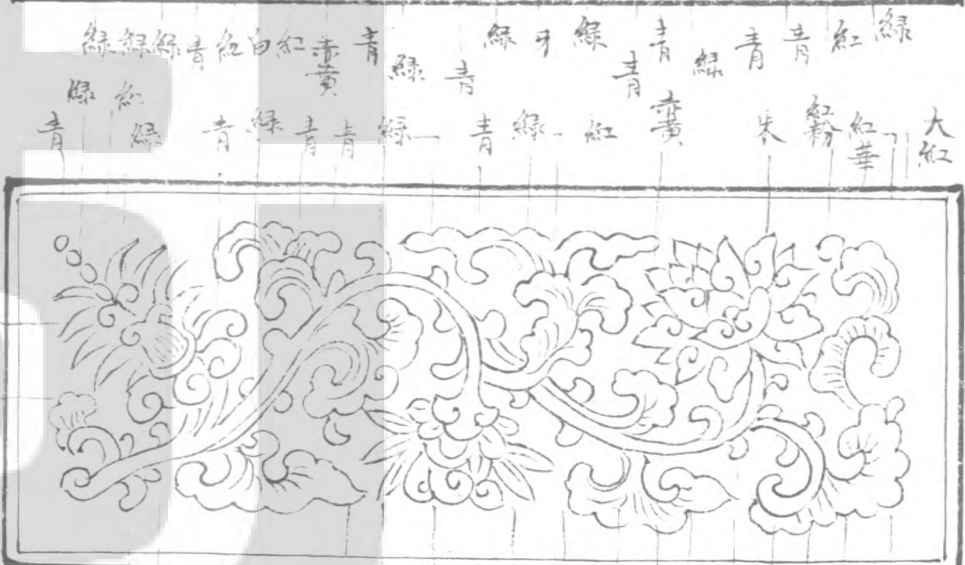

牡丹華

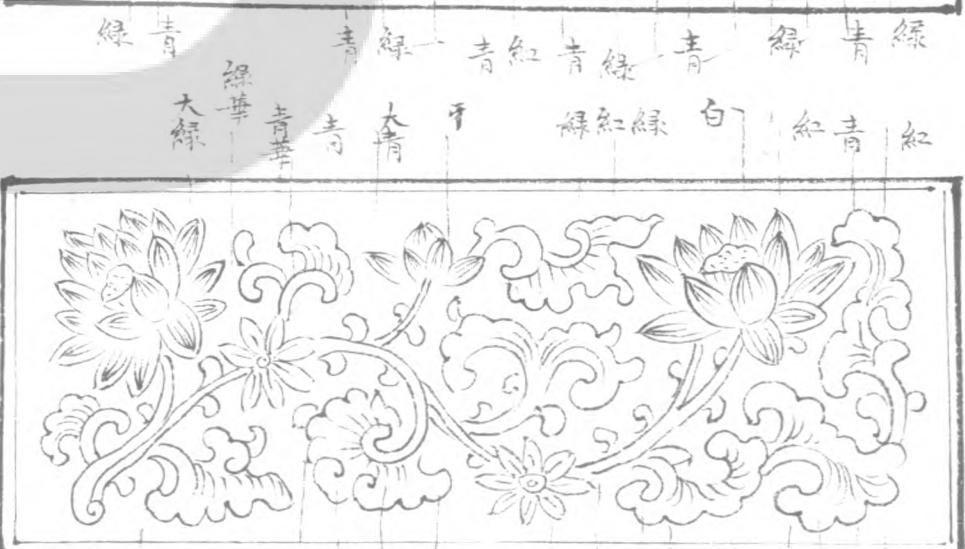

蓮荷華

牙 紅 綠 豆 綠 華 綠 紅 一 綠 綠 紅 青 綠

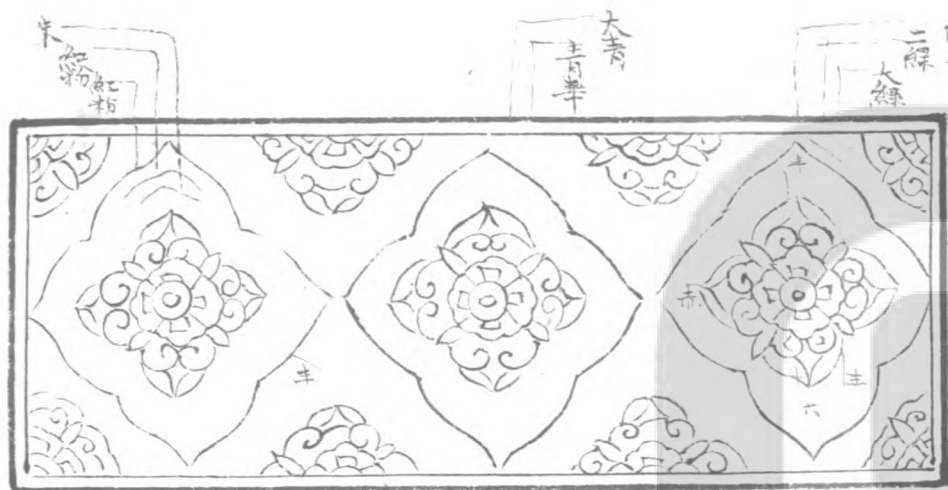

方勝合羅

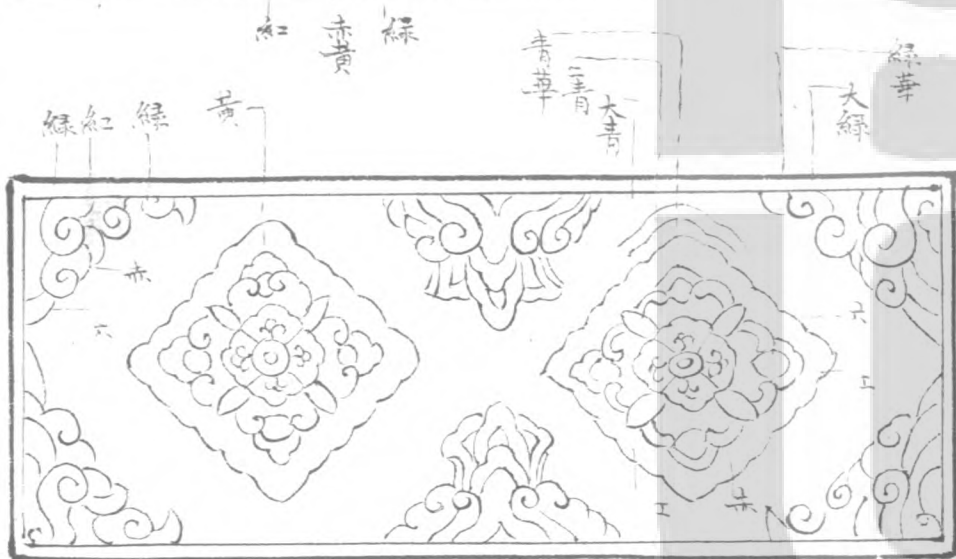

圈頭合子

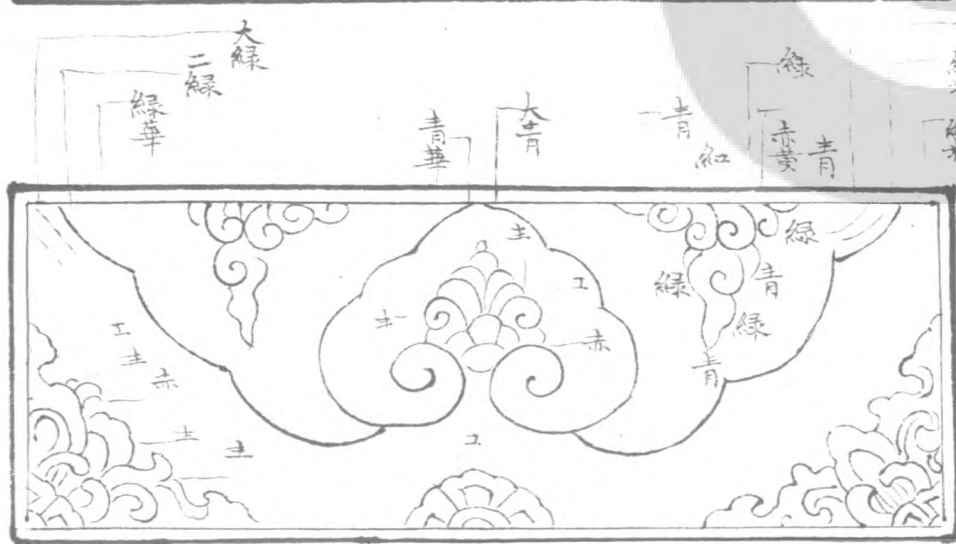

豹脚合暈



蓮荷華 寫生

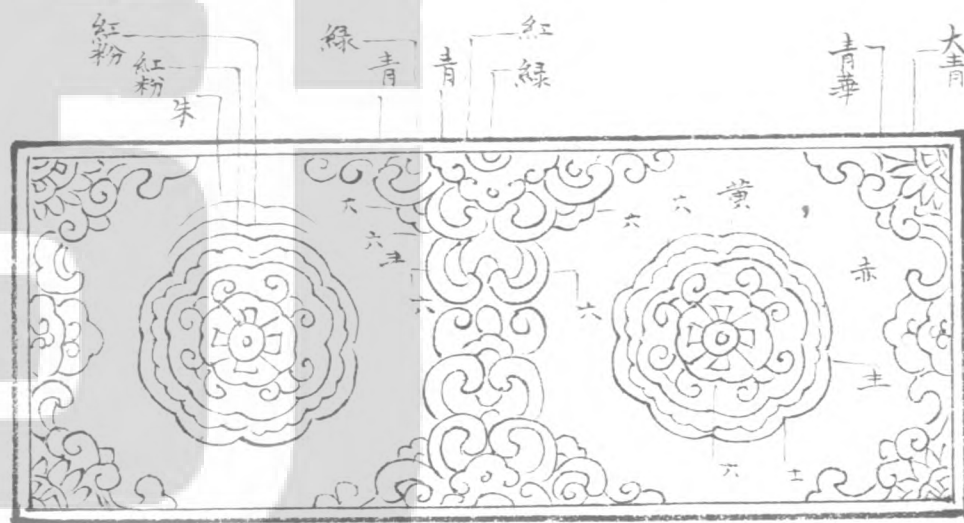

團料寶照

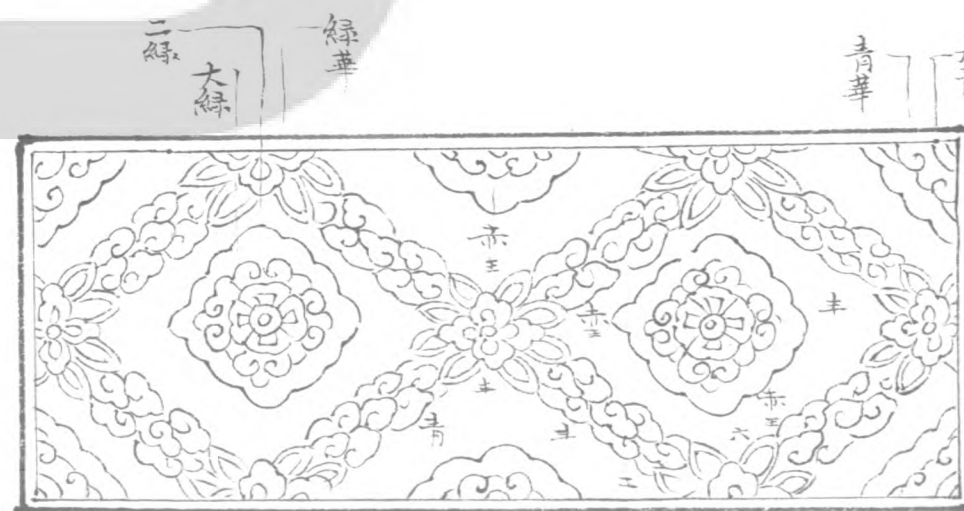

團料柿蒂

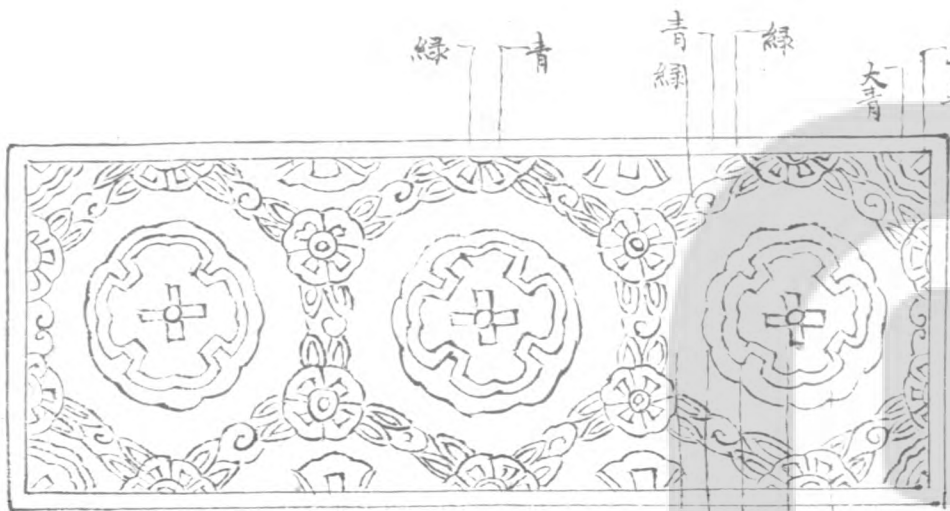

瑪瑙地

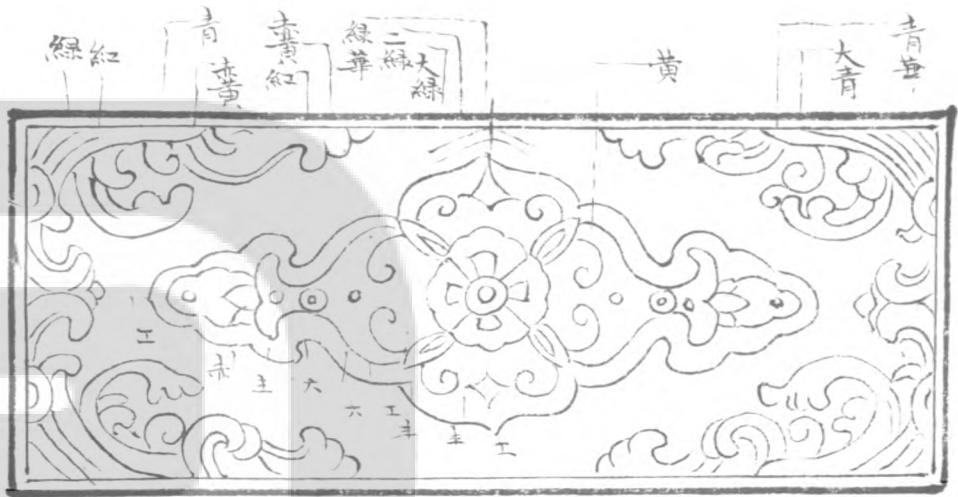

梭身合暈

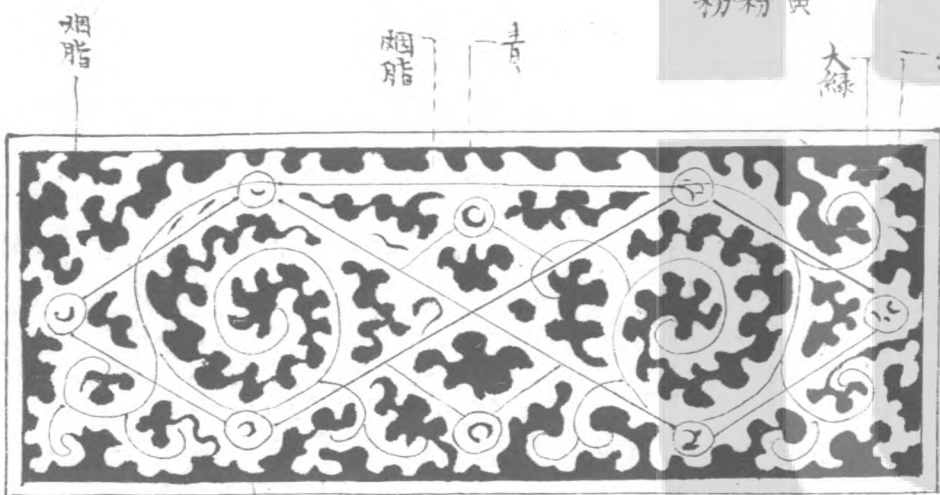

玻璃地

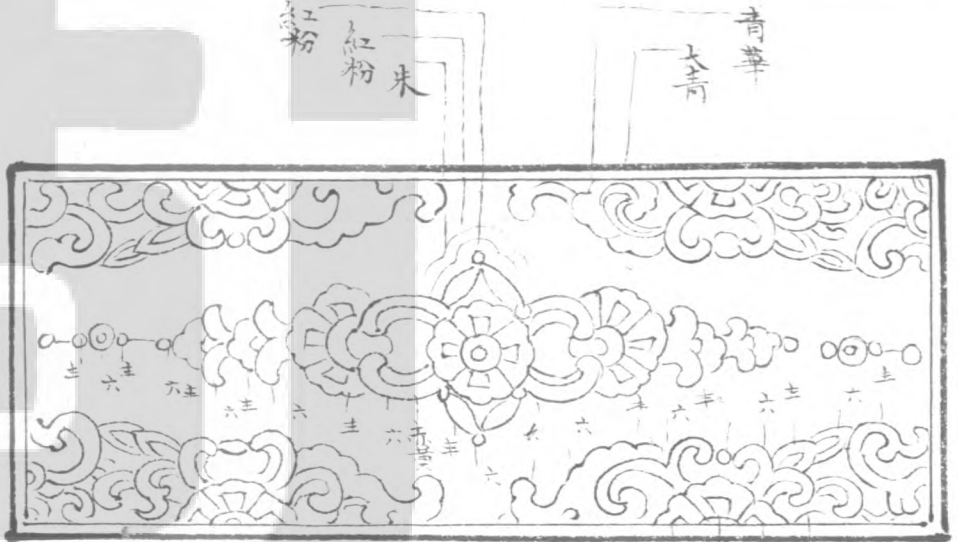

連珠合暈

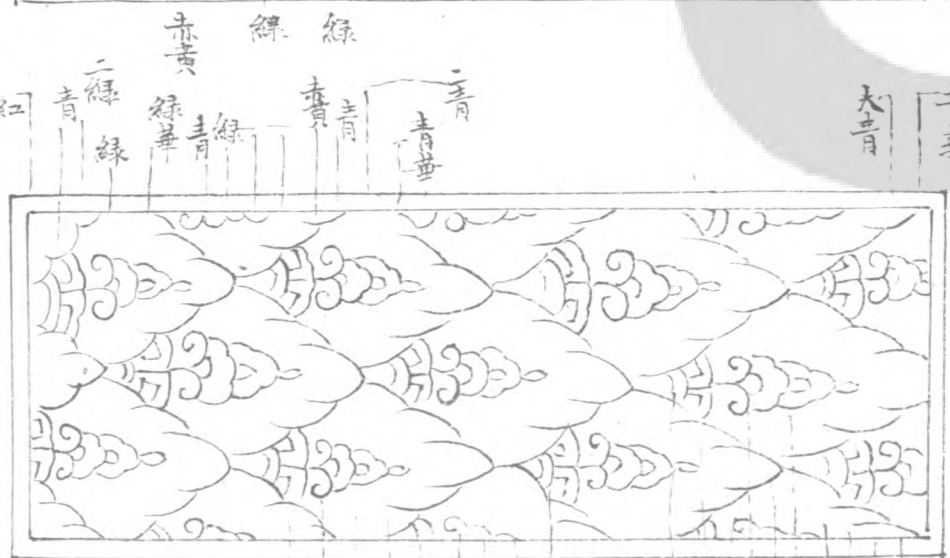

魚鱗旗脚

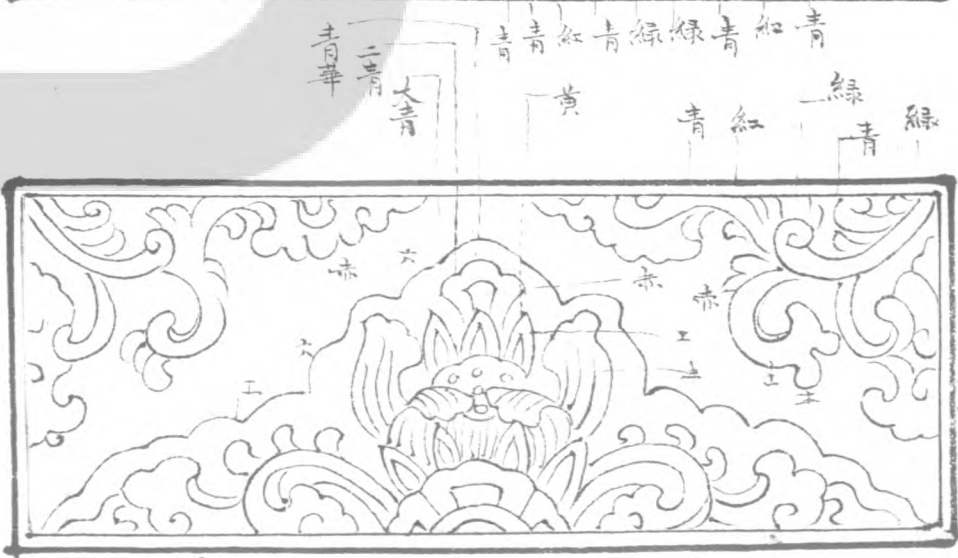

偏暈

紅青綠青綠青朱身黃 紅青綠青綠青朱紅粉

紅綠赤綠 綠赤青紅赤青

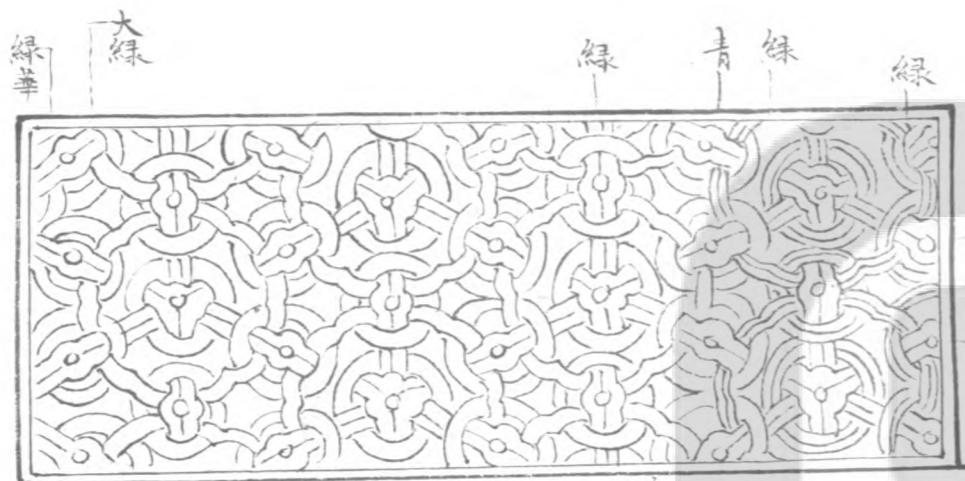

聯環  
紅  
綠  
綠

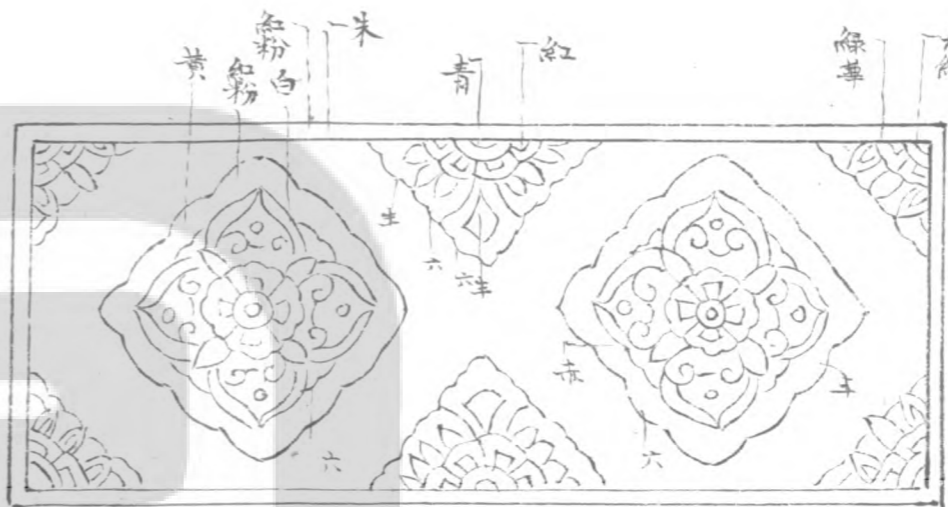

圖頭柿蒂

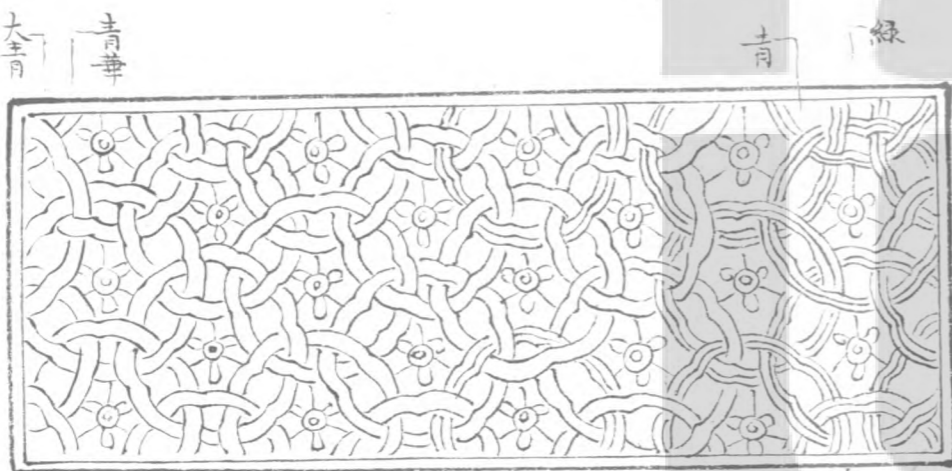

瑪瑙

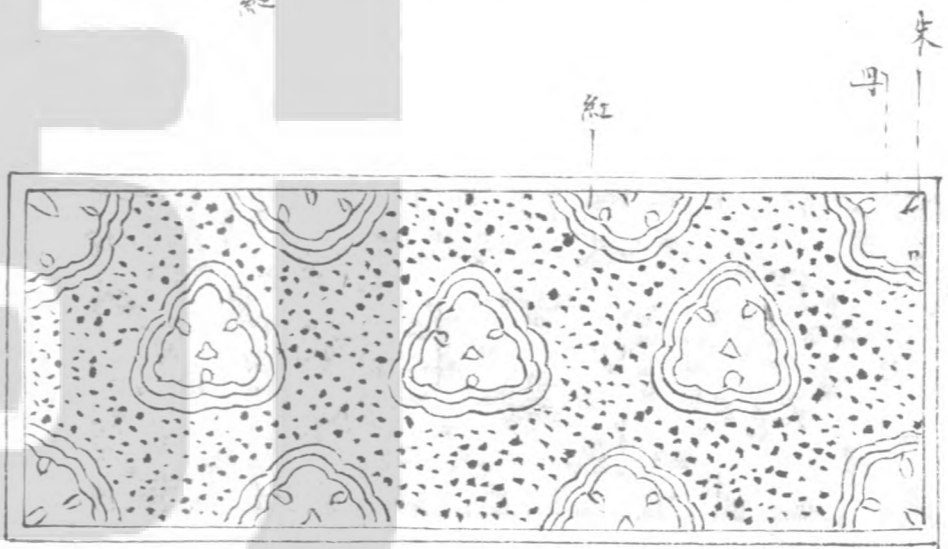

胡瑪瑙

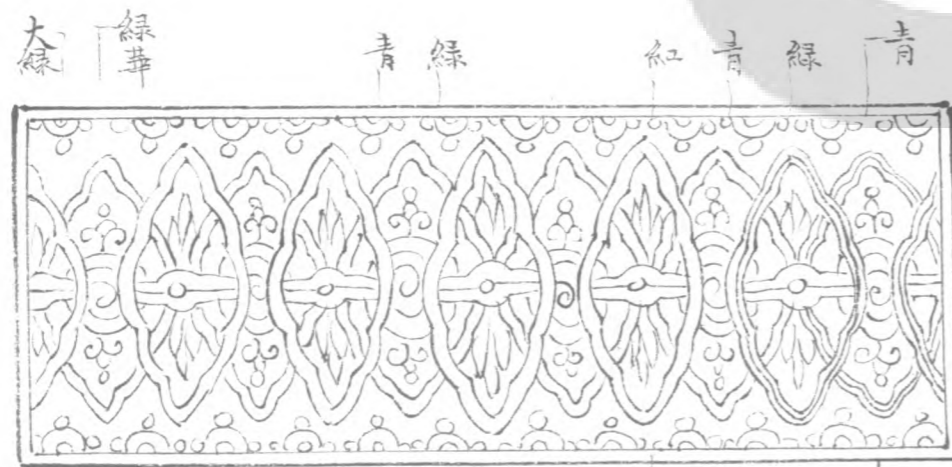

疊環

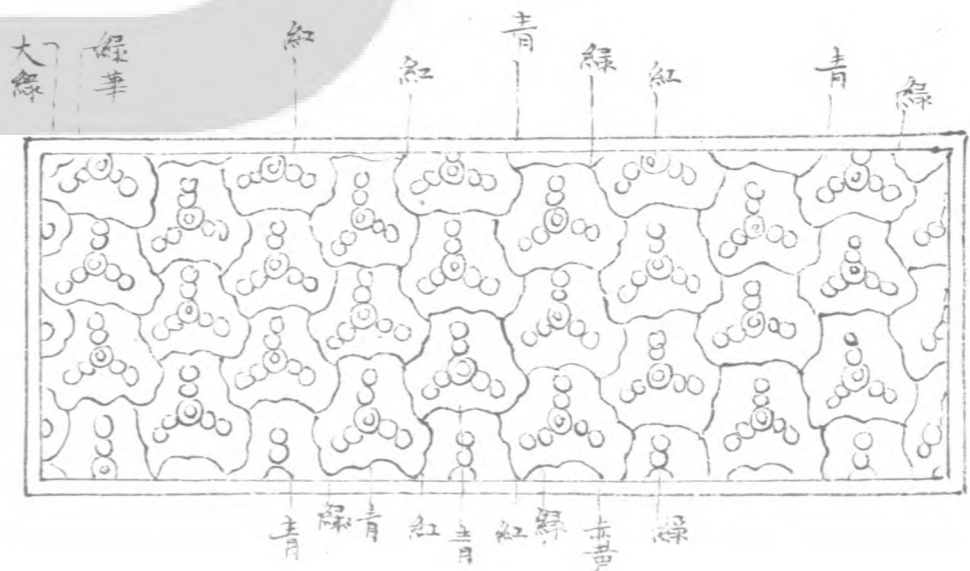

瓊子

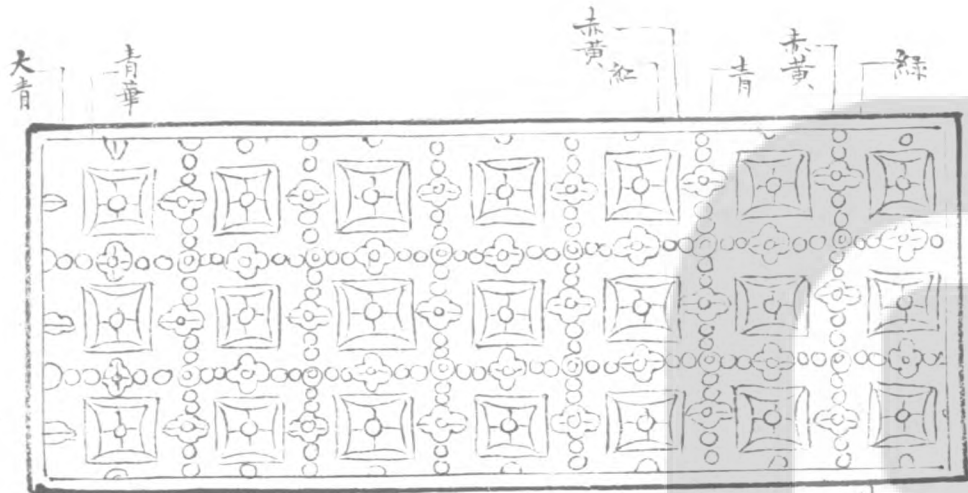

方環

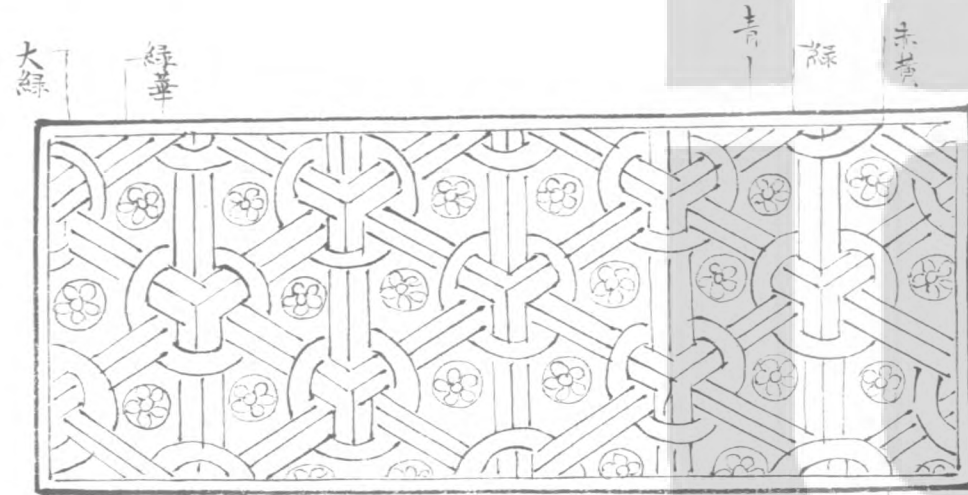

羅地龜文

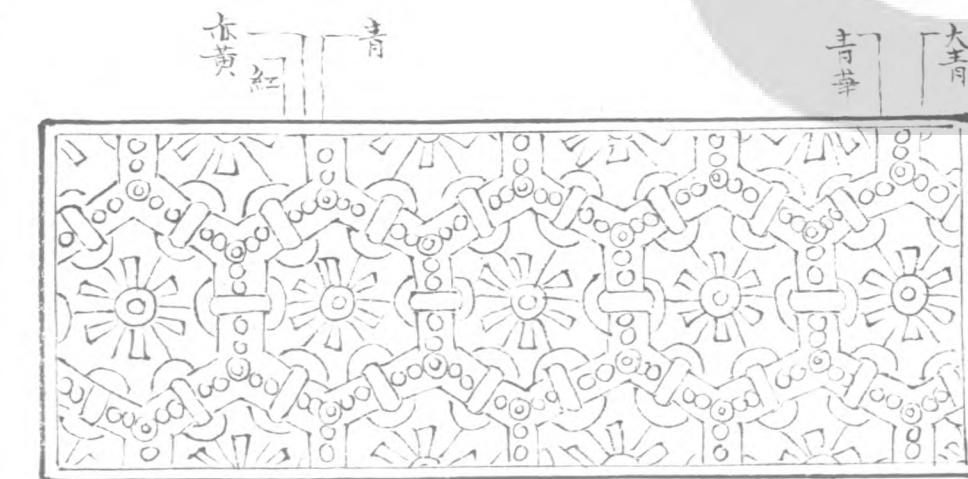

六出龜文

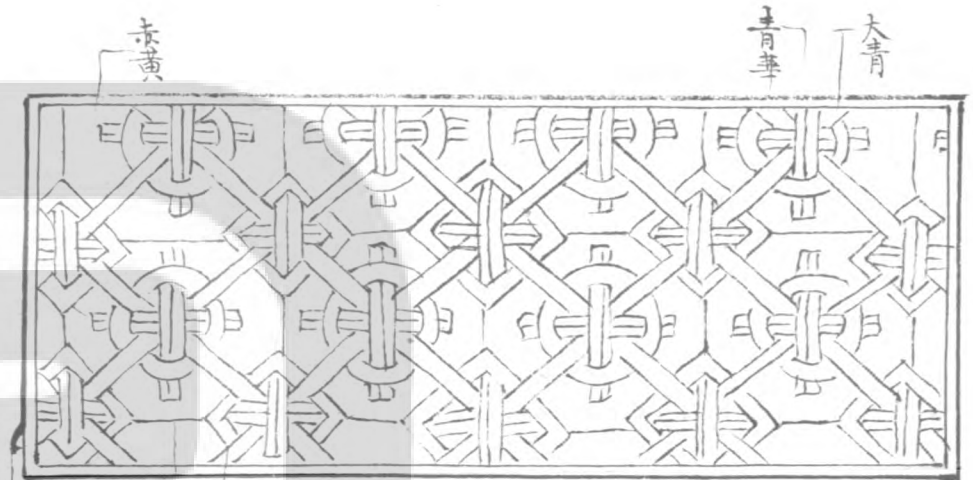

篋文

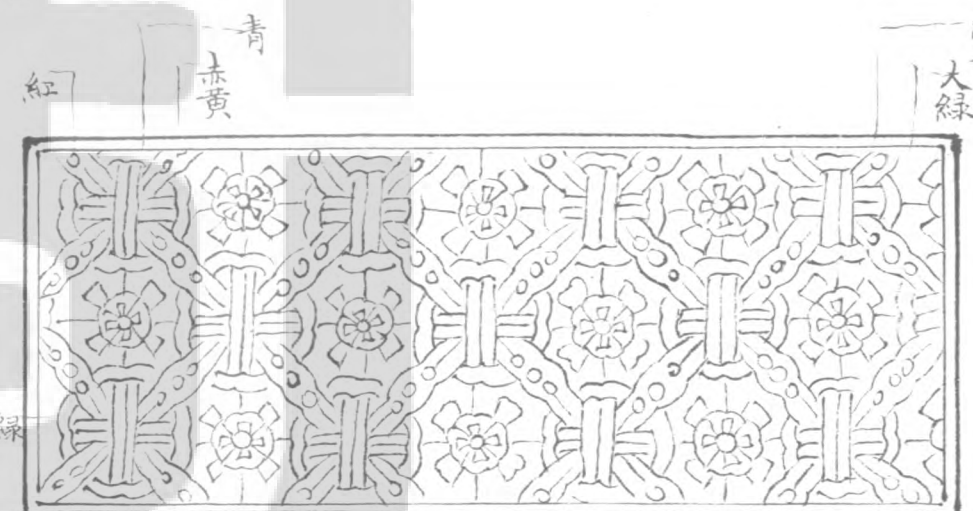

金鈺

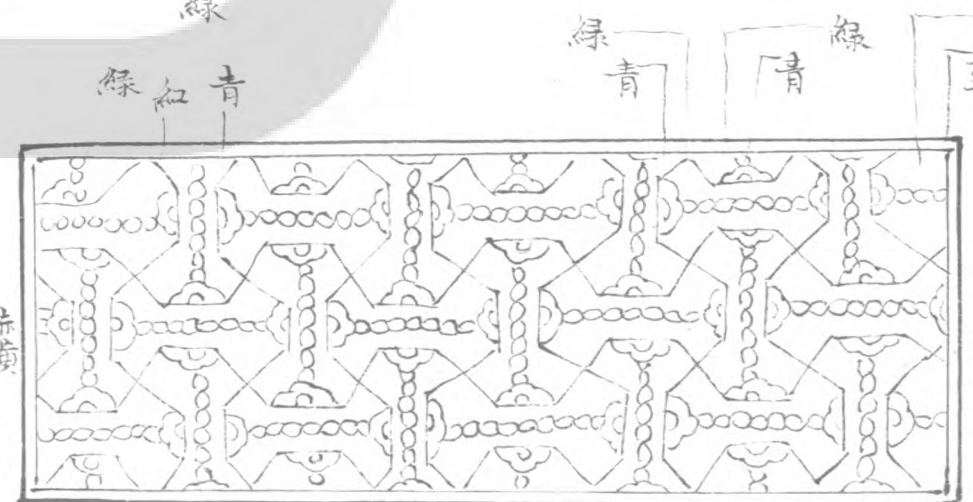

銀鈺

大青 青華 赤黃 紅 青 赤黃 紅

赤黃 青華 大青 青 紅 赤黃 紅

大青 綠華 青 紅 赤黃 紅

紅 赤黃 大青 綠華 大青 綠華 大青

赤黃 紅 青 赤黃 大青 青 赤黃 紅

赤黃 綠 紅 青 綠 青 大青 赤黃

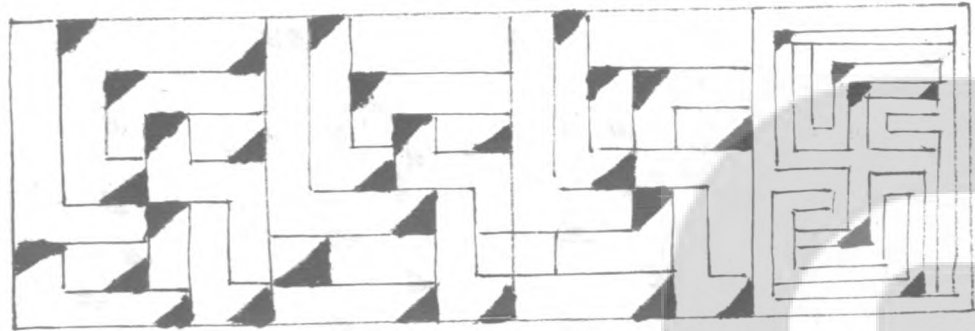

方字

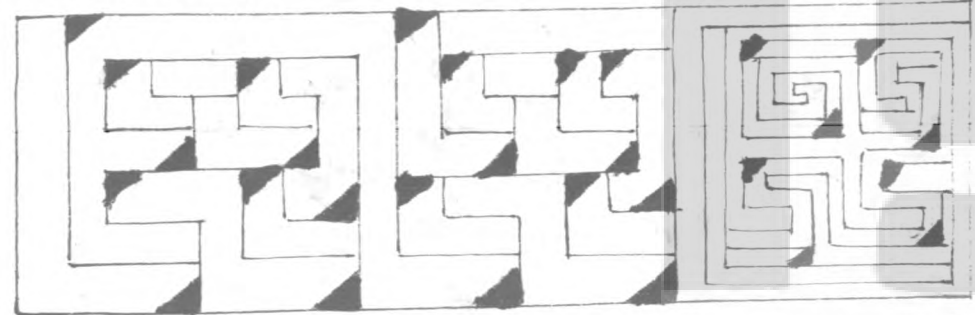

四斗底

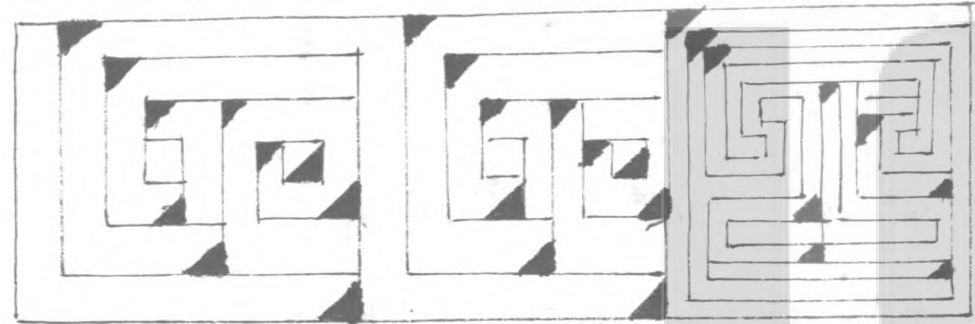

雙鑰匙頭

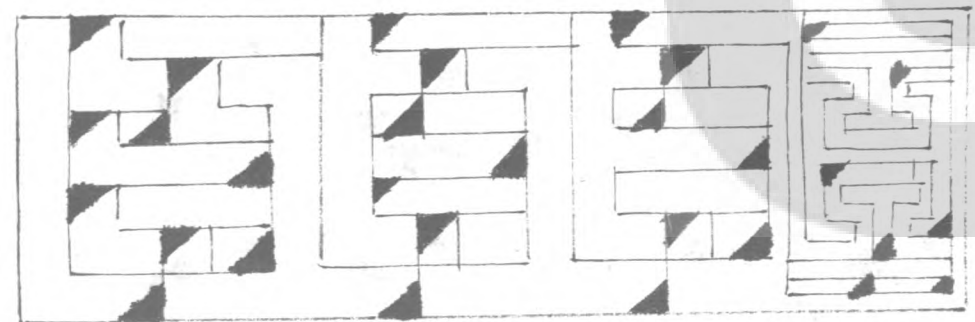

丁字

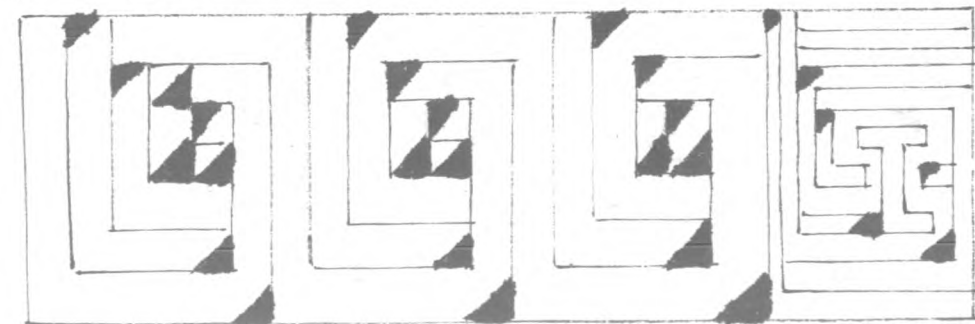

單鑰匙頭

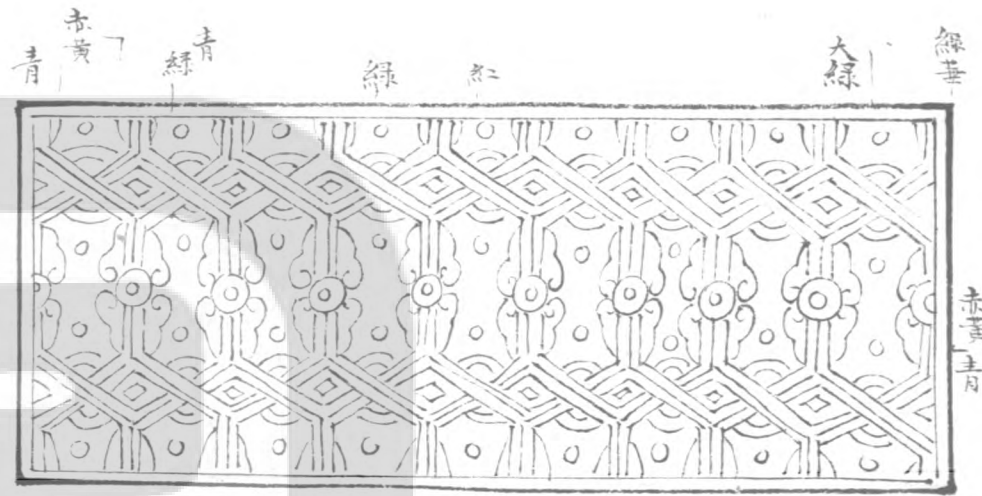

交脚龜文

赤黃  
青

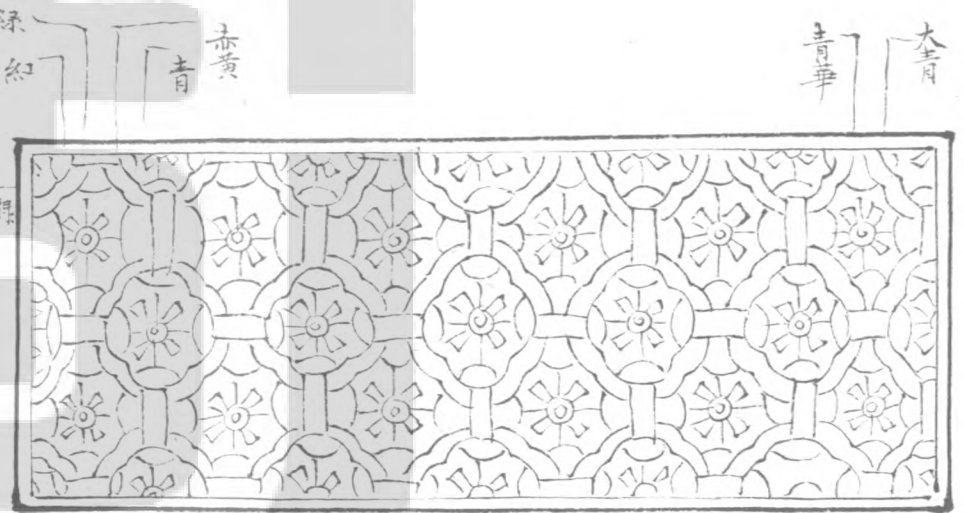

四出

赤黃  
青  
綠  
紅

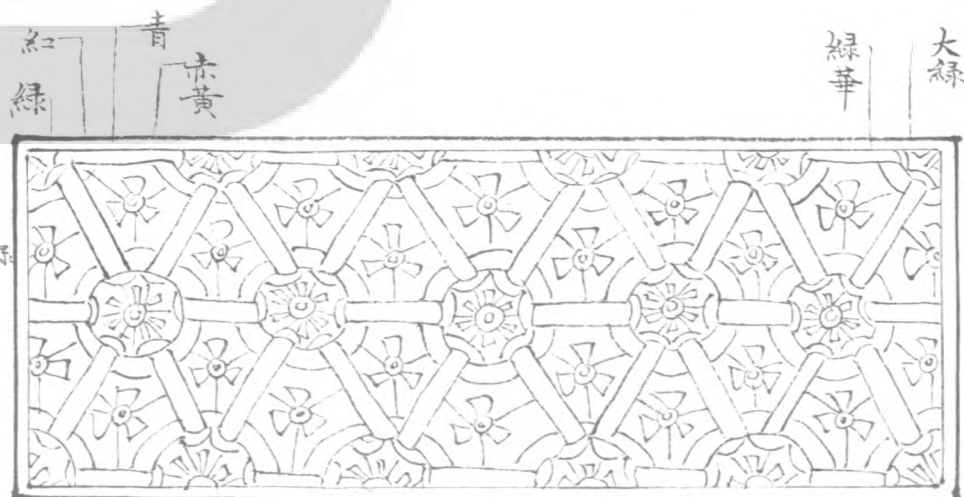

六出

赤黃  
青  
綠  
紅  
大綠  
青華

青





飛仙

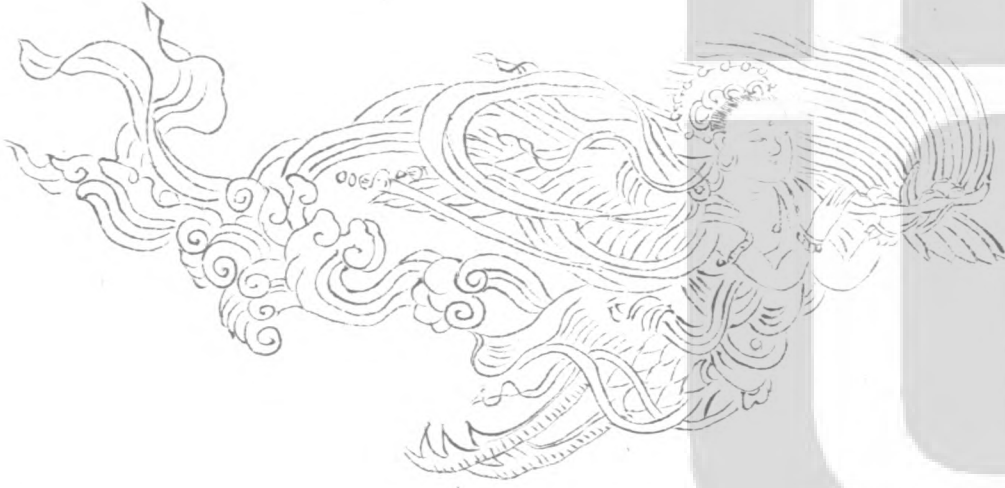

嬪伽



共命鳥

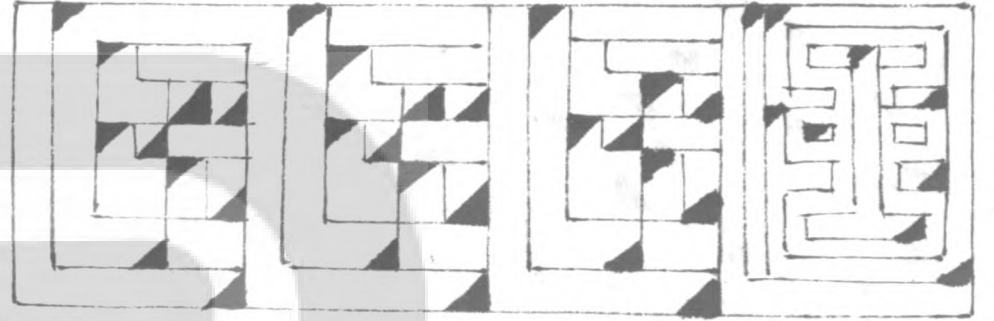

王字

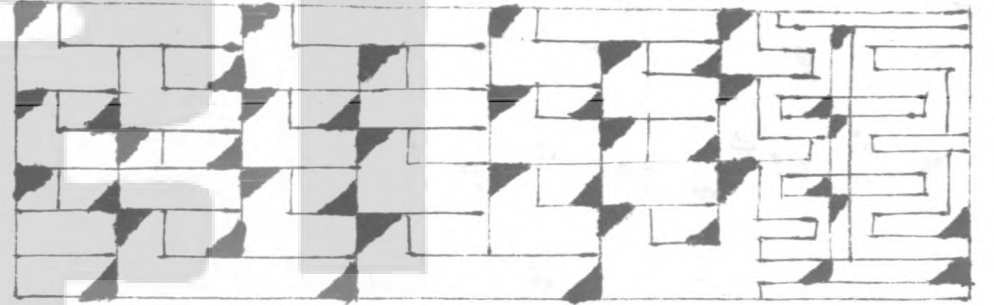

同上

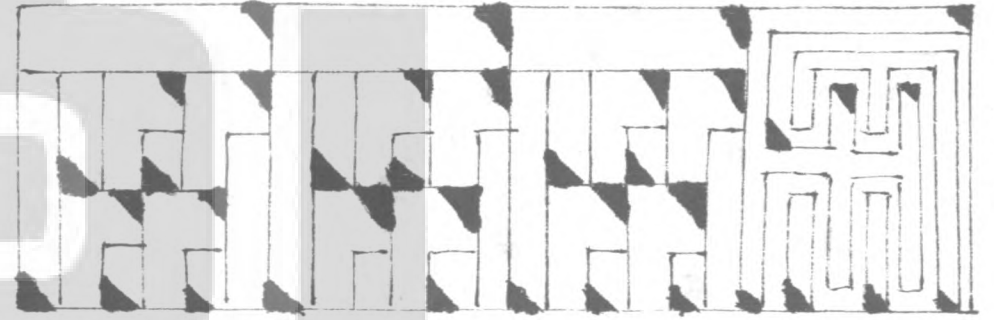

同上

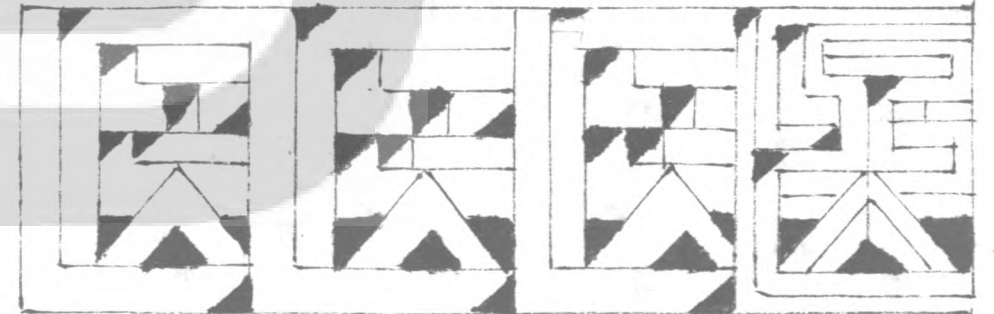

天字

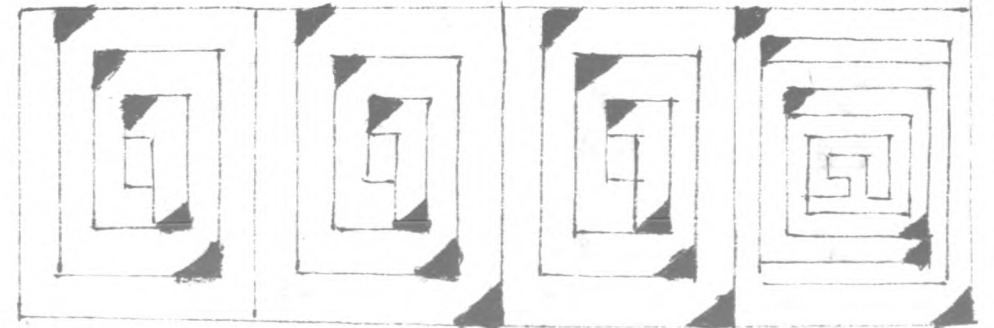

香印



鳳凰

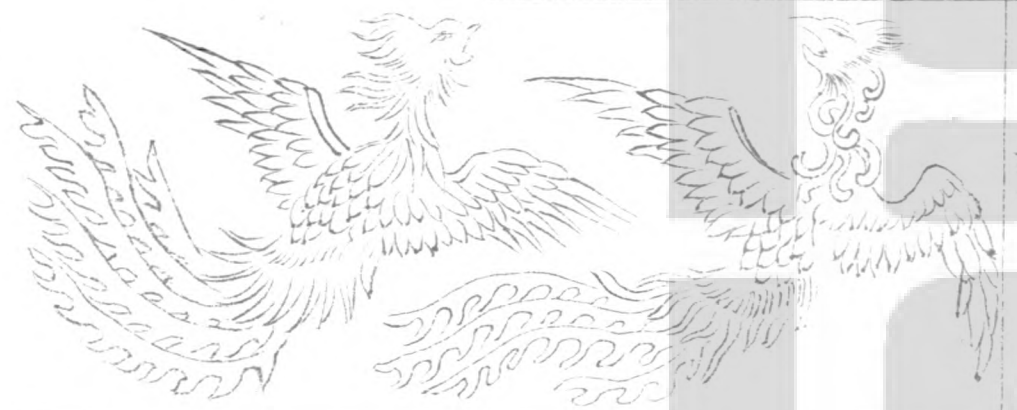

鷹



孔雀



仙鶴





谿鵠

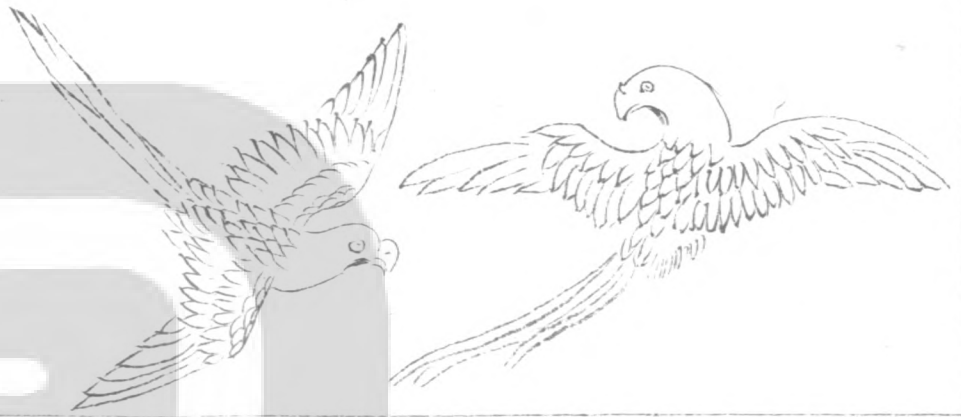

鸚鵡



賀鵠



山鵠

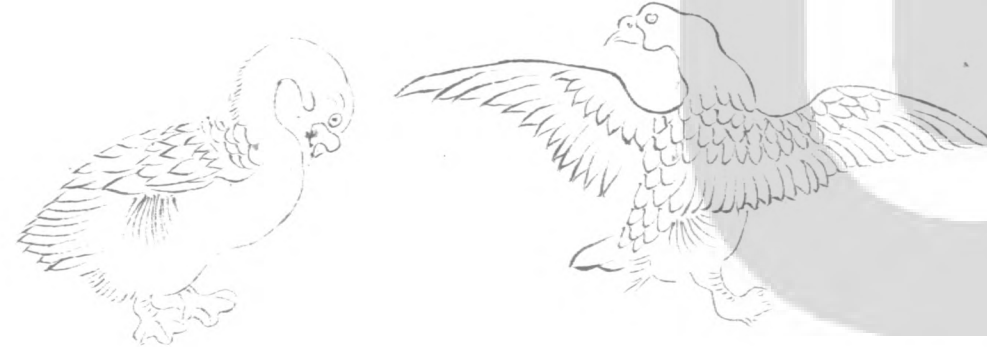

鵠



練鵠



華鵠



山雞



天馬



卷三十三



海馬

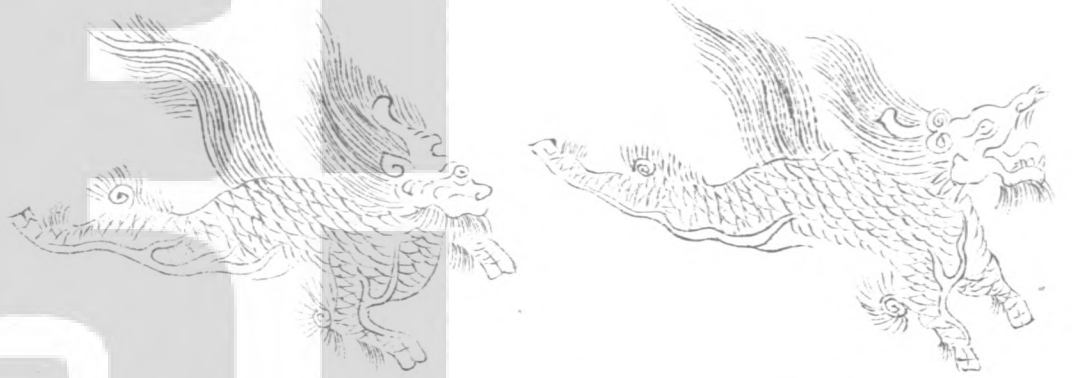

仙鹿

十二

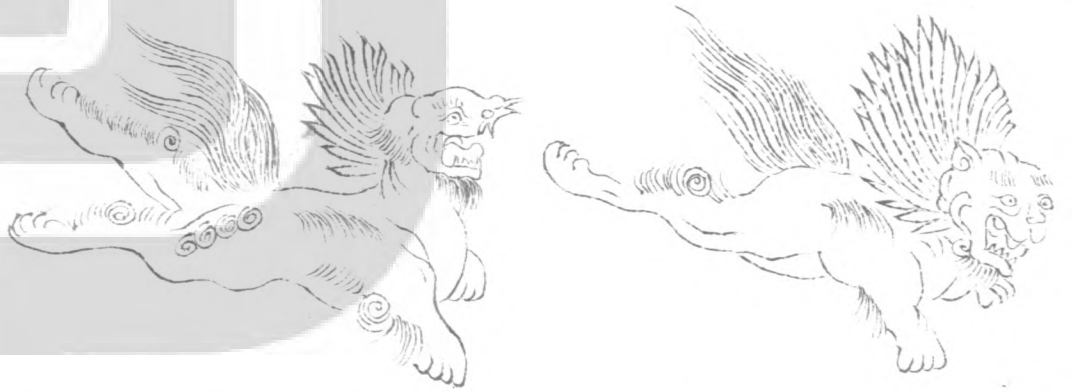

羚羊





真人



山羊

卷三十三



女真



象

十三



金童



犀牛



玉女



熊

化生



真人



女真



玉女



拂霖



僚蠻

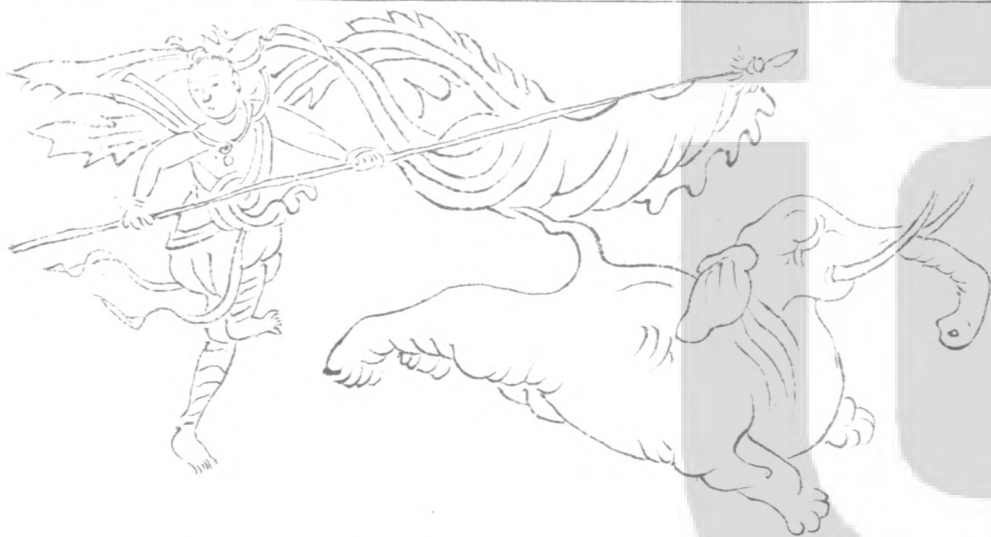

化生



青華  
二青  
大青  
二綠  
大綠  
細華



豹脚

紅粉  
紅粉  
末  
二綠  
大綠  
細華  
大綠  
細華



合蟬鸞尾

青華  
二青  
大青  
二綠  
大綠  
細華  
大青  
青華



馬回車



大青 青華 二青 大青 二青 大青 二青 大青 二青



三卷如意頭

青華 大青 赤黃 丹 朱



單卷如意頭

大綠 綠華 大青 青華 紅粉 朱 紅粉 朱

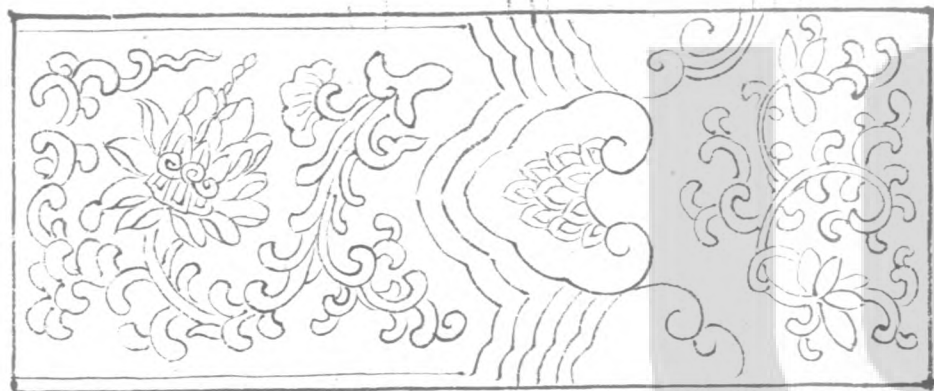

簇三

大綠 綠華 青華 二青 大青

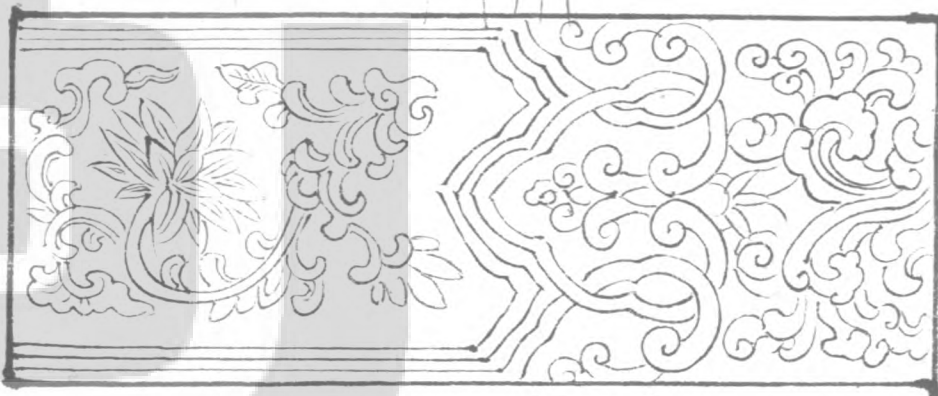

劍環

大青 青華 朱 紅粉 二綠 綠華 大綠



牙脚

大青 大綠 綠華 紅粉 朱 紅粉

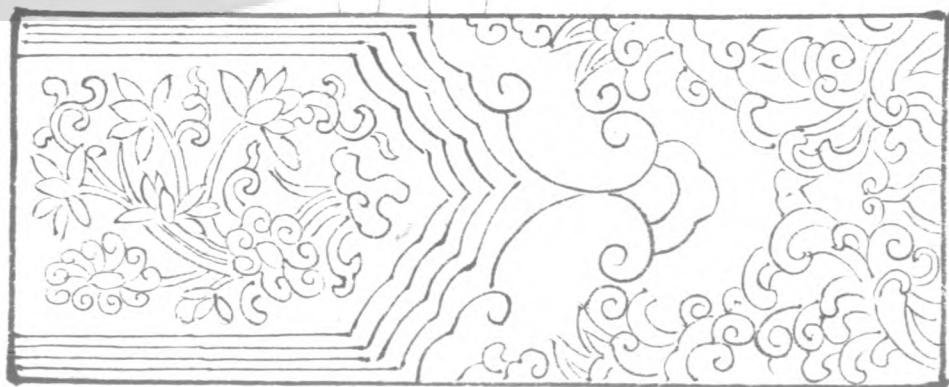

雲頭



海石榴華內間六入圍華科



青  
青華  
大綠  
綠華

寶牙華內間柿蒂科



紅粉華  
朱  
粉  
粉華  
青華  
大青

枝條卷成海石榴華內間四入圍華科

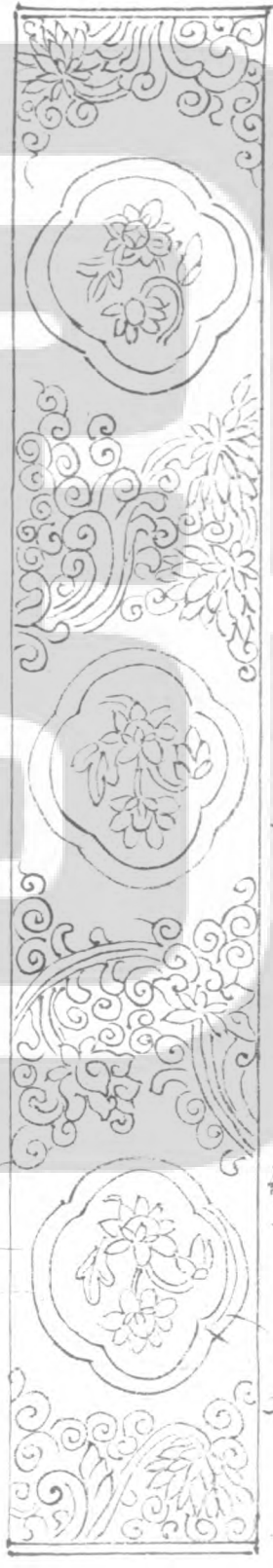

上青  
二青  
大青

五彩平棊第六  
吳華子童心思者係青量外綠者係綠理黑  
首條紅並條環五共不量運者係五彩裝造

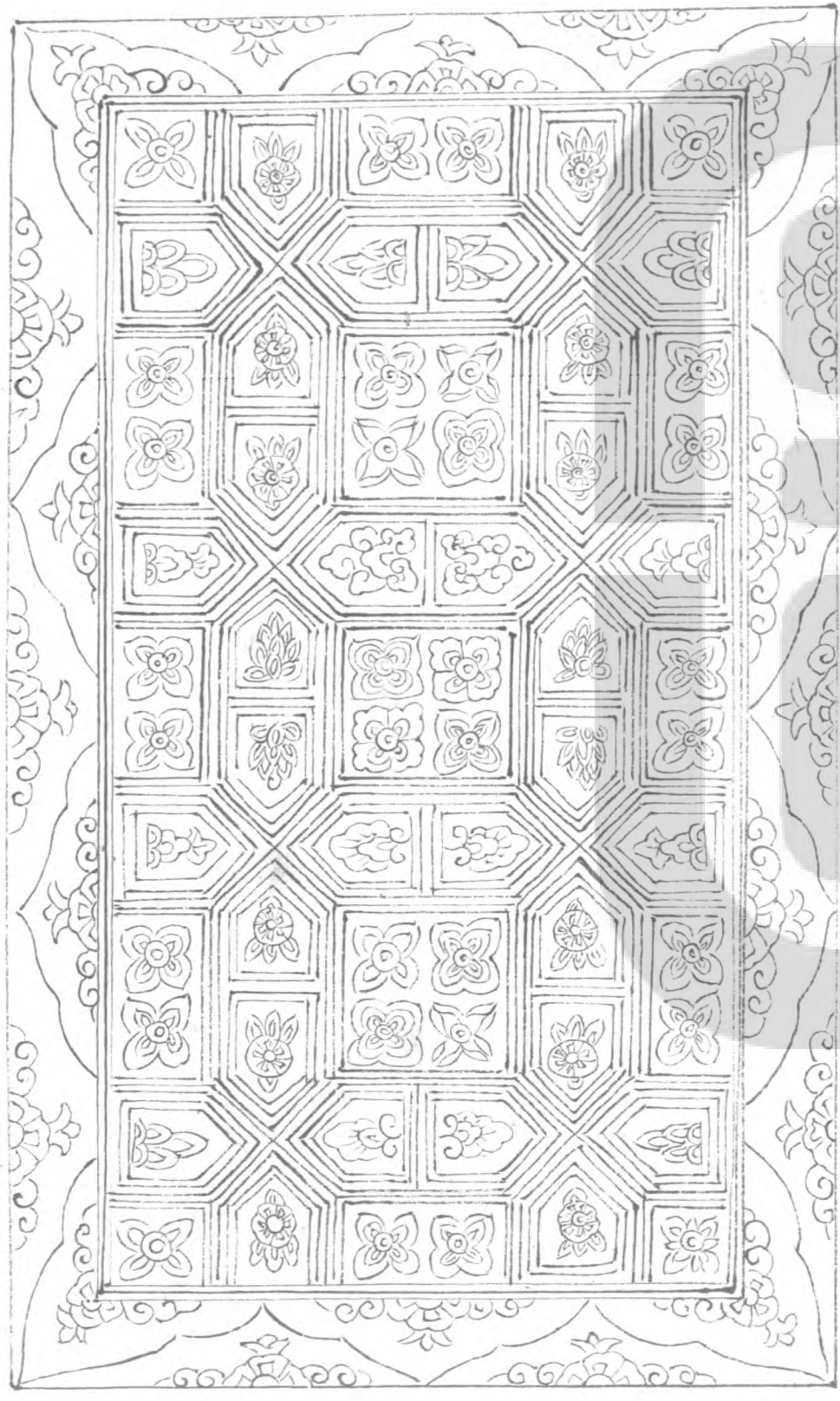

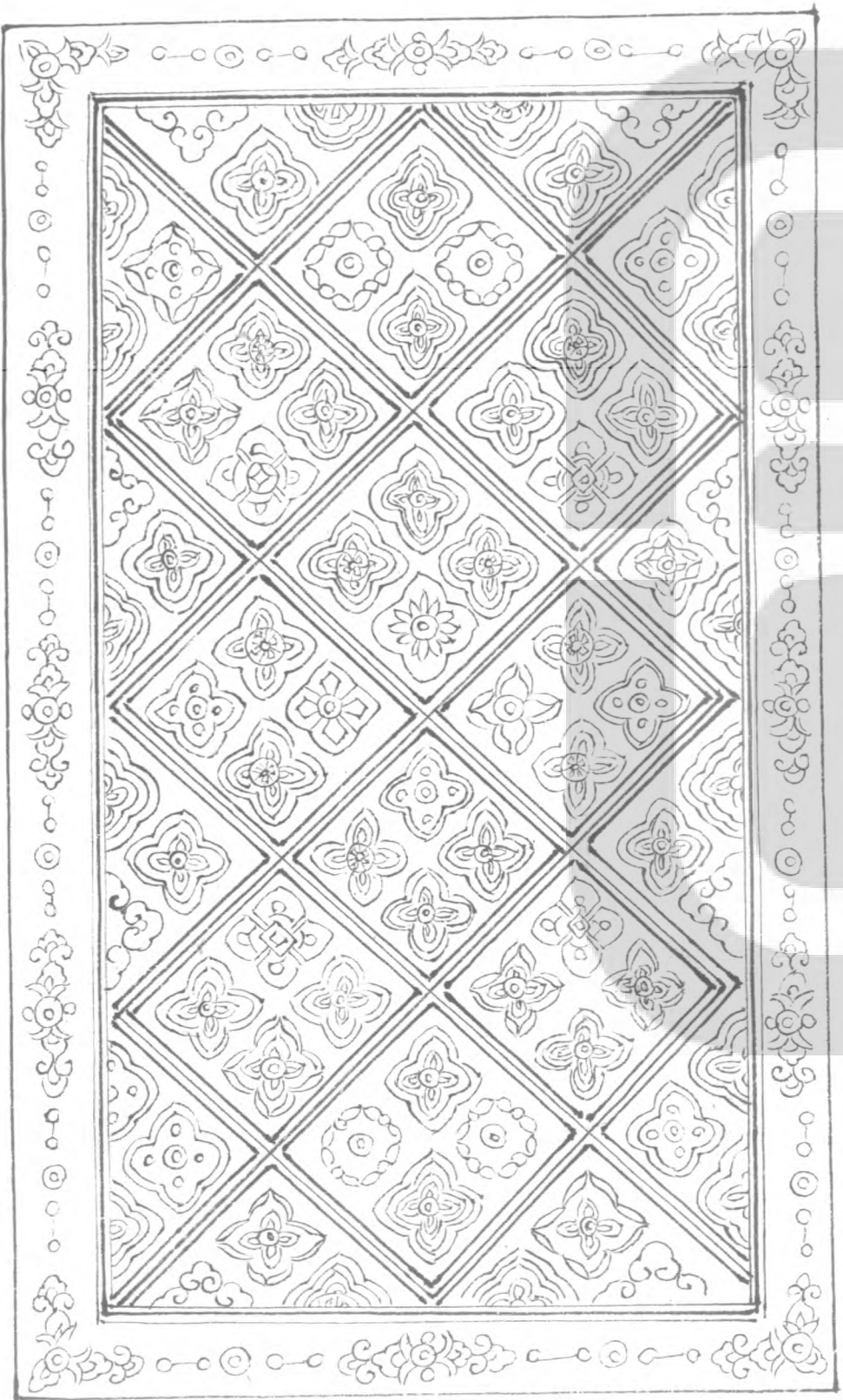

線

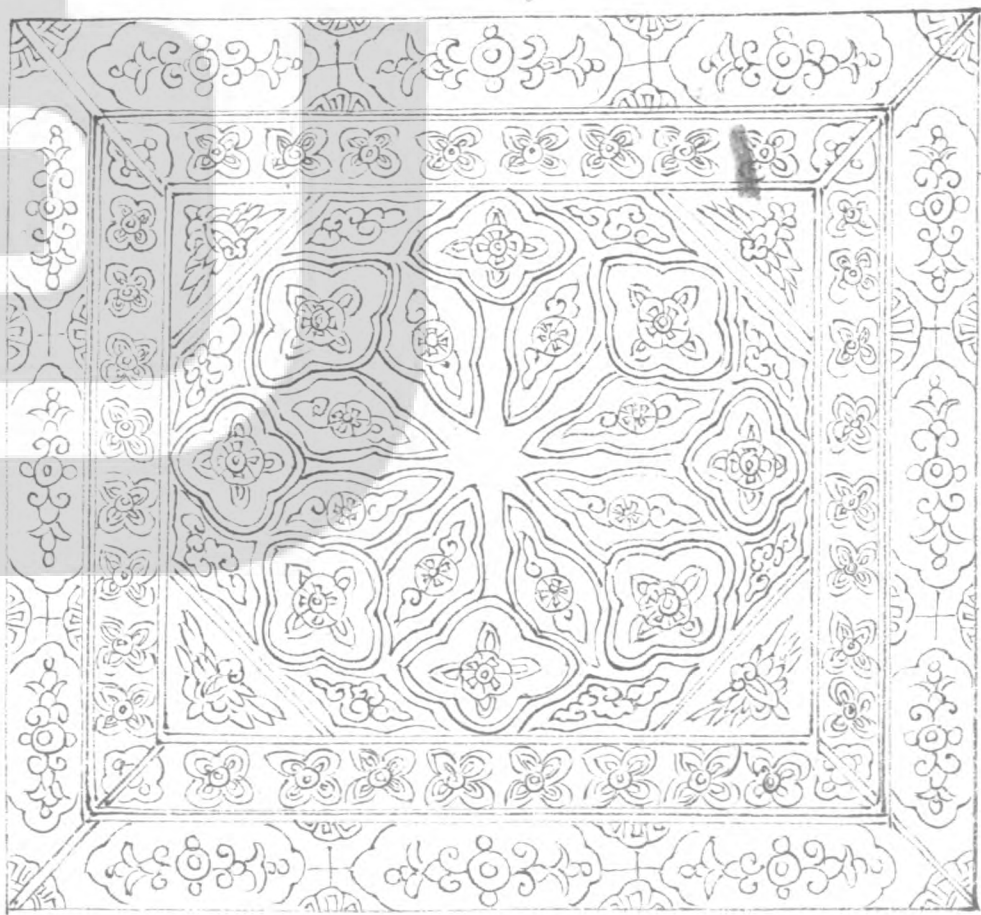

大  
小  
二  
種

大青 青華 白 大綠 綠華

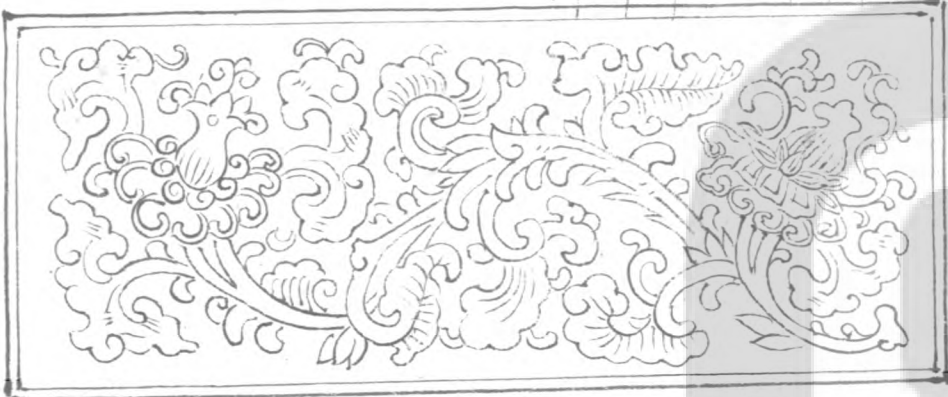

海石榴華

大青 青華 白 綠華 大綠 青



寶牙華

大青 青華 白 綠華 大綠



太平華

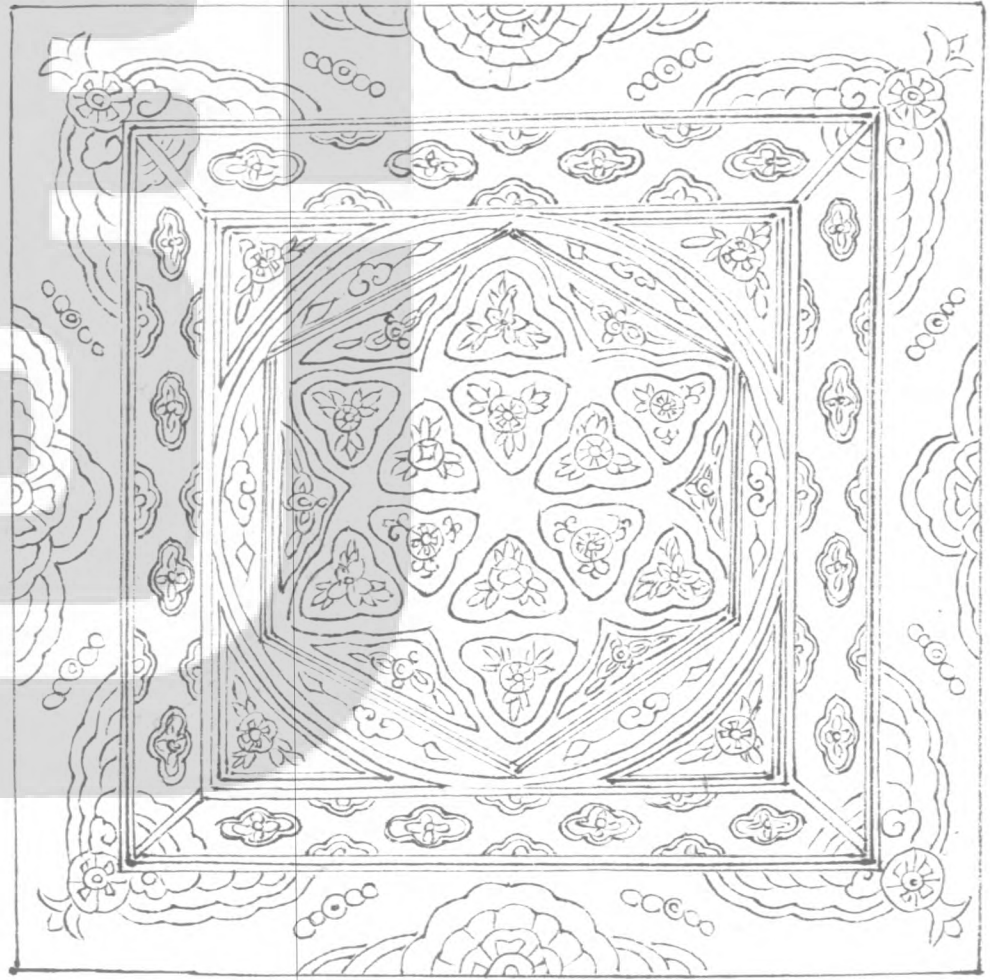

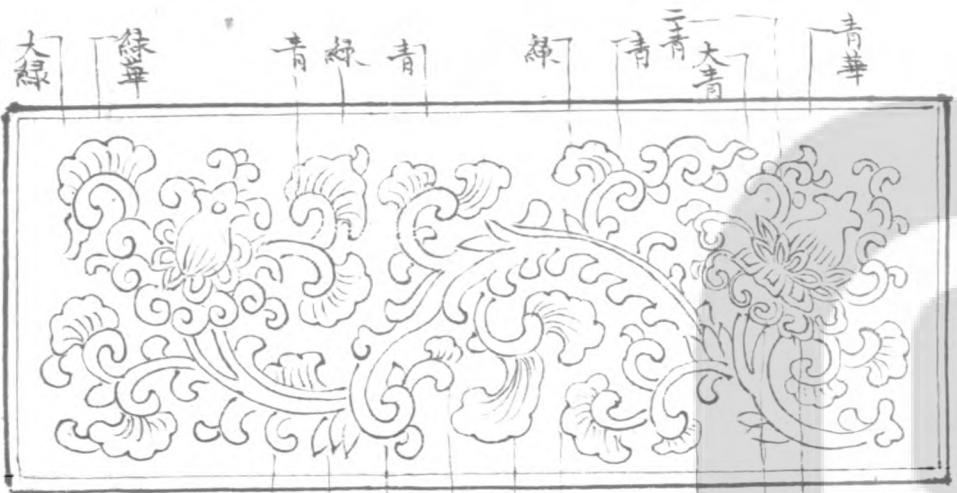

海石榴華  
卷成 枝條

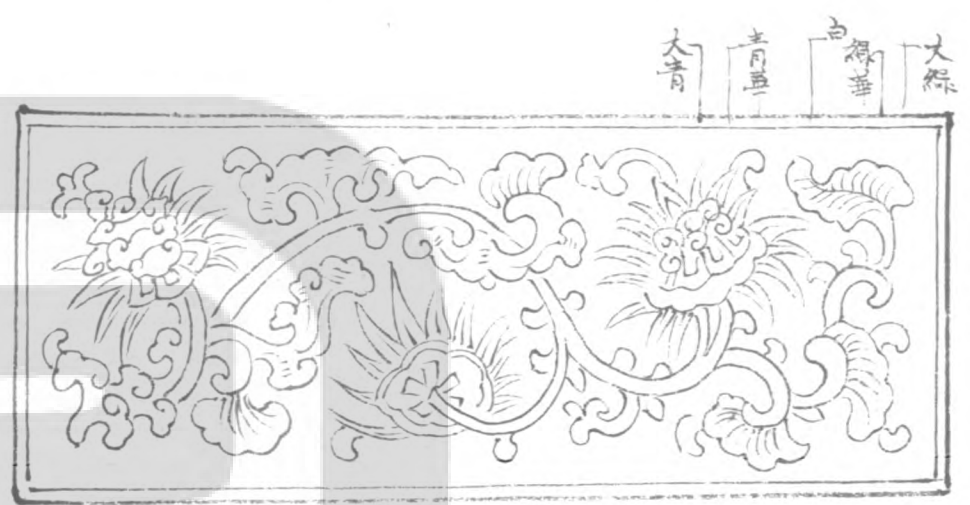

寶相華

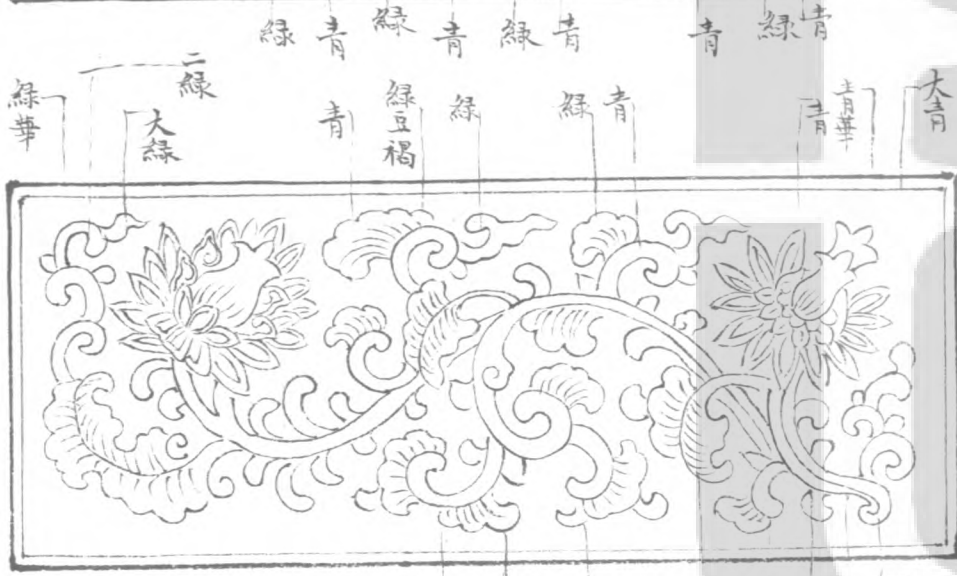

海石榴華  
卷成 鋪地

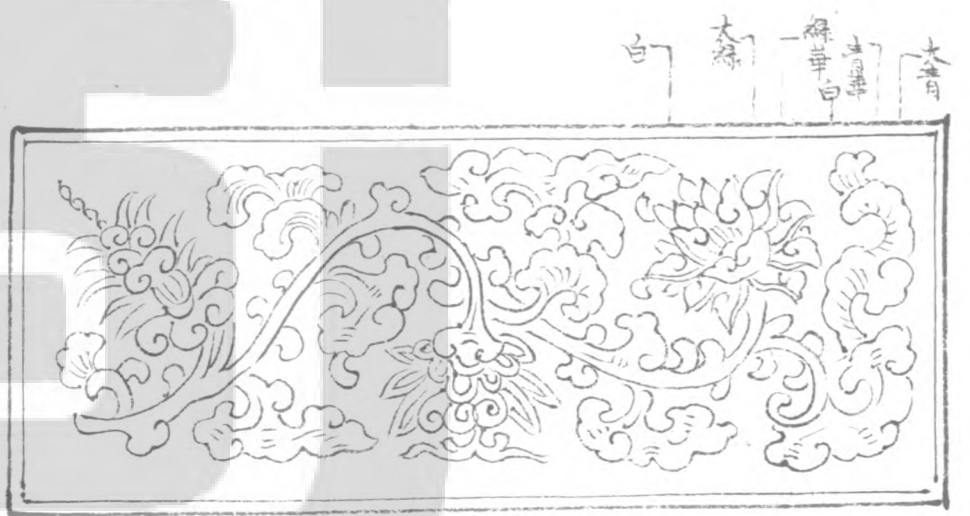

牡丹華

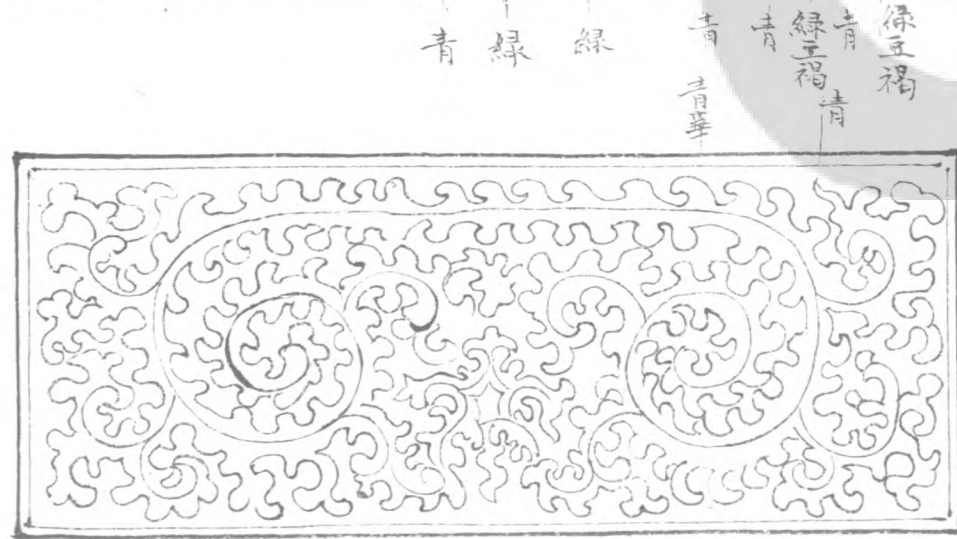

龍牙蕙草



蓮荷葉

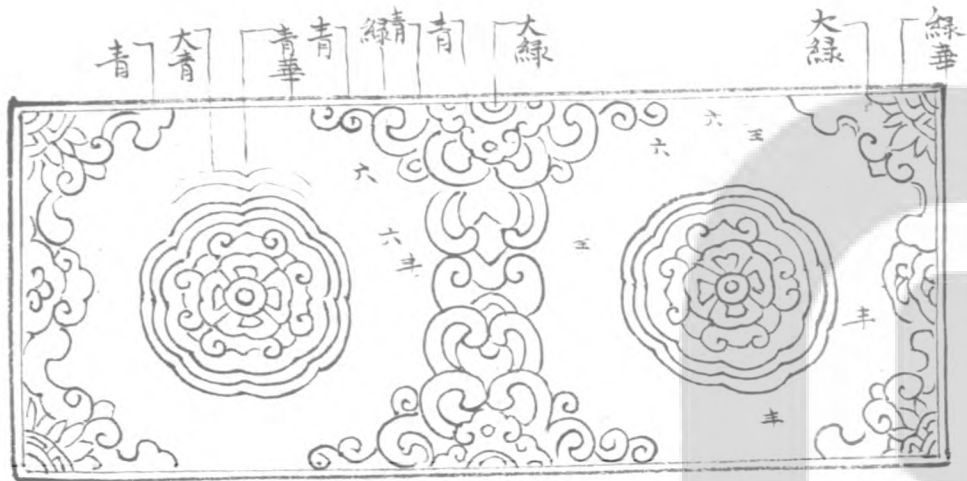

團科寶照

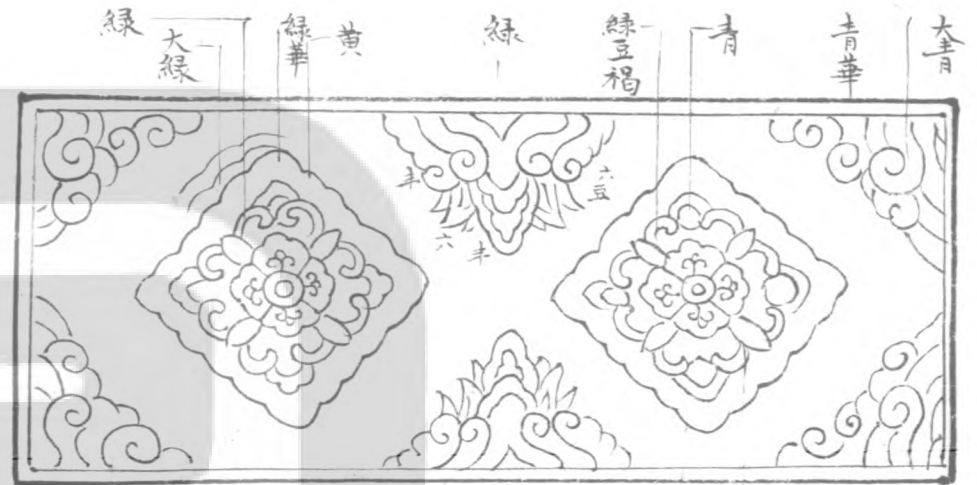

團頭合子

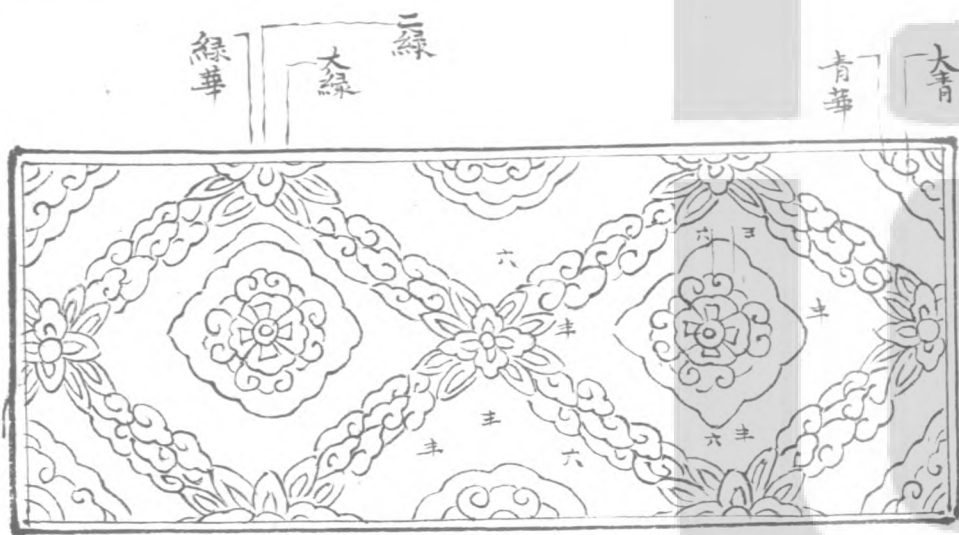

團科柿蒂

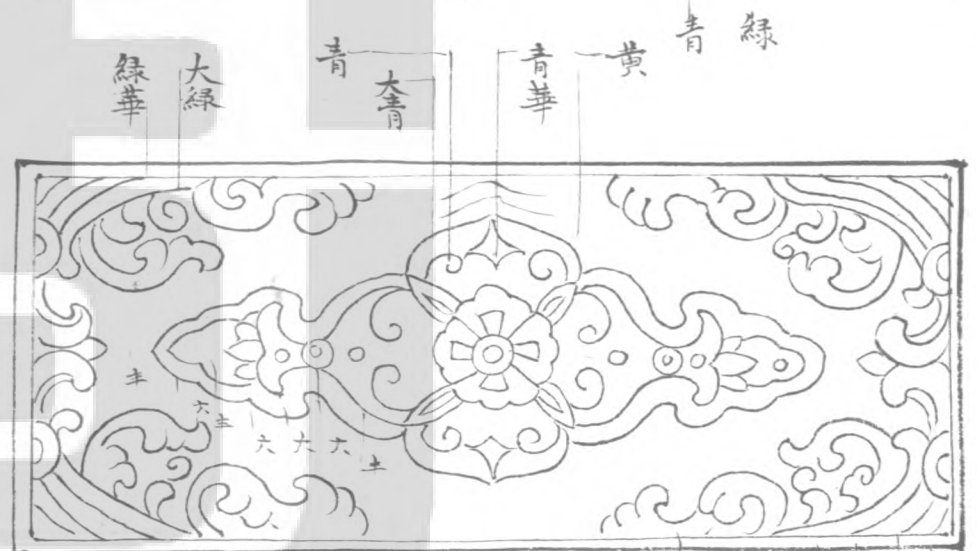

梭身合暈

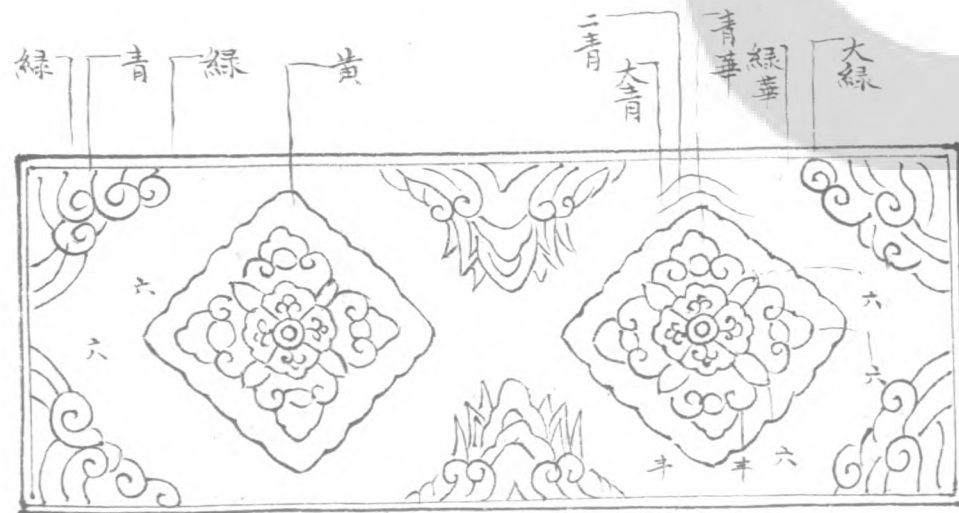

團頭柿蒂

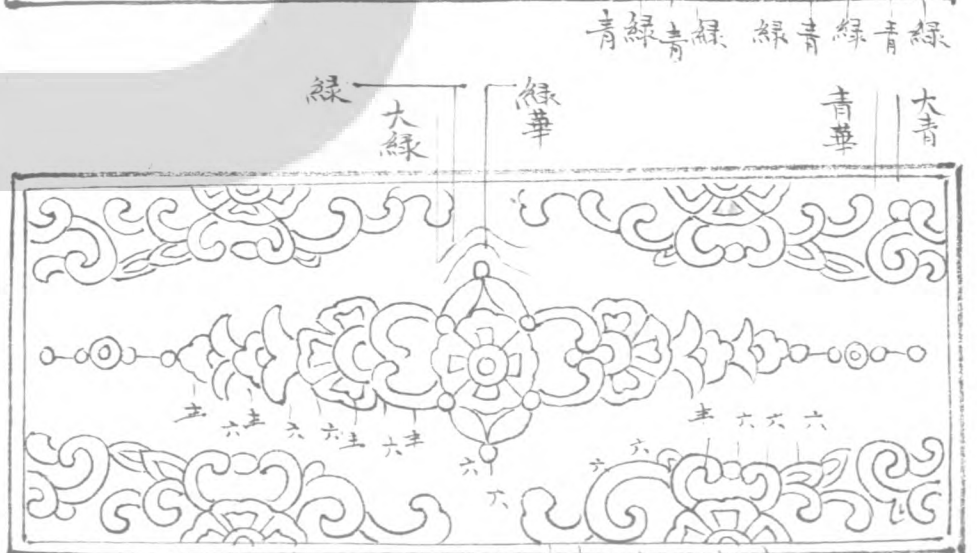

連珠合暈

綠綠青 綠青綠青 綠

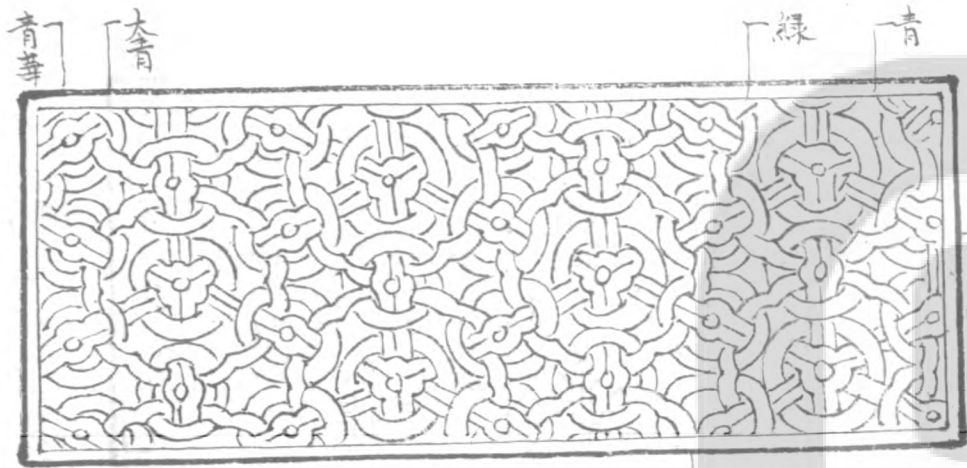

聯環  
青綠

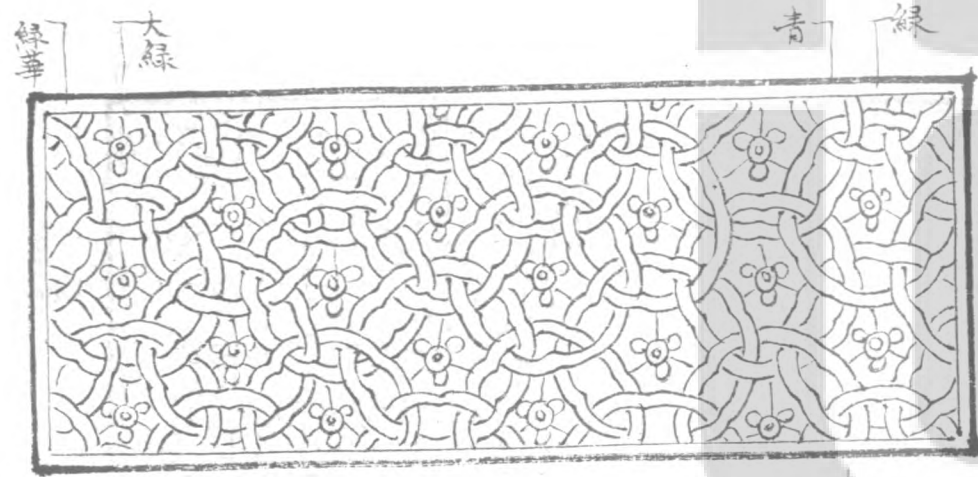

瑪瑙  
綠

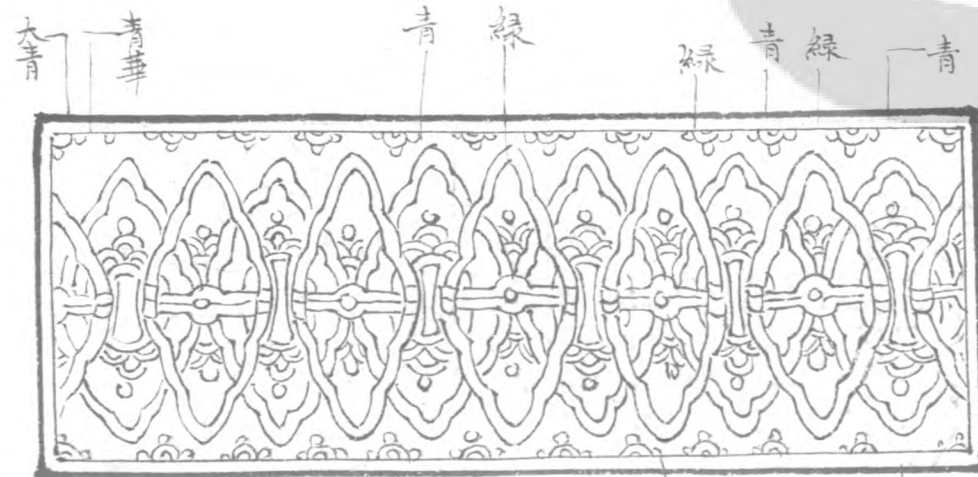

疊環  
綠

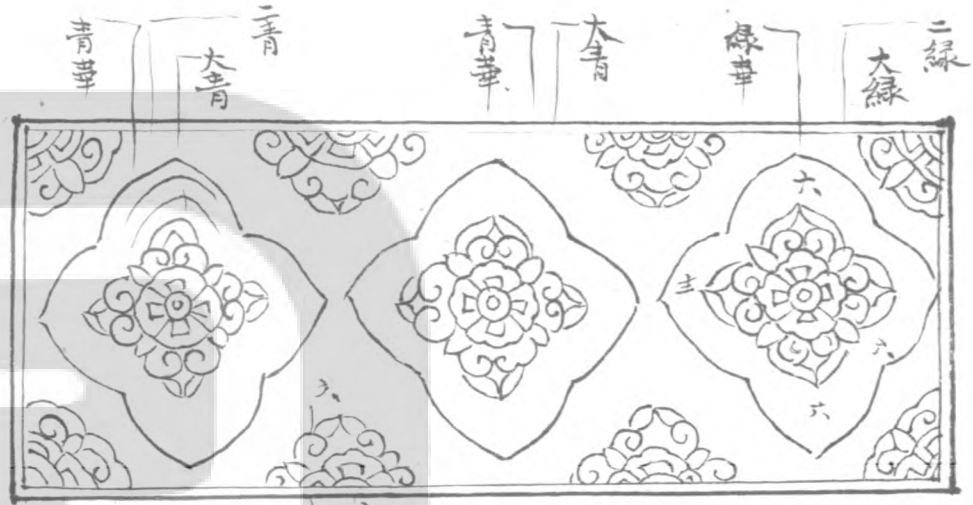

方勝合羅

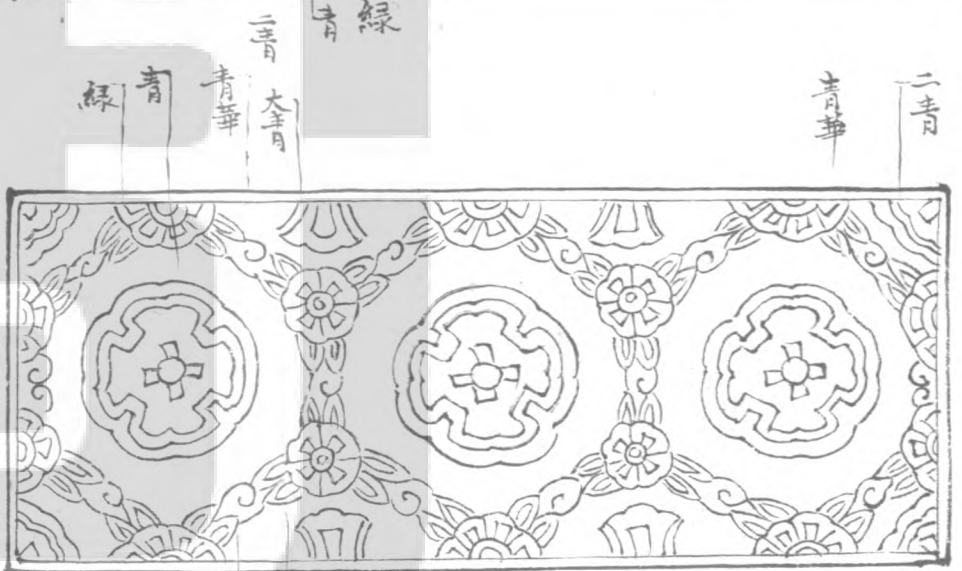

瑪瑙地

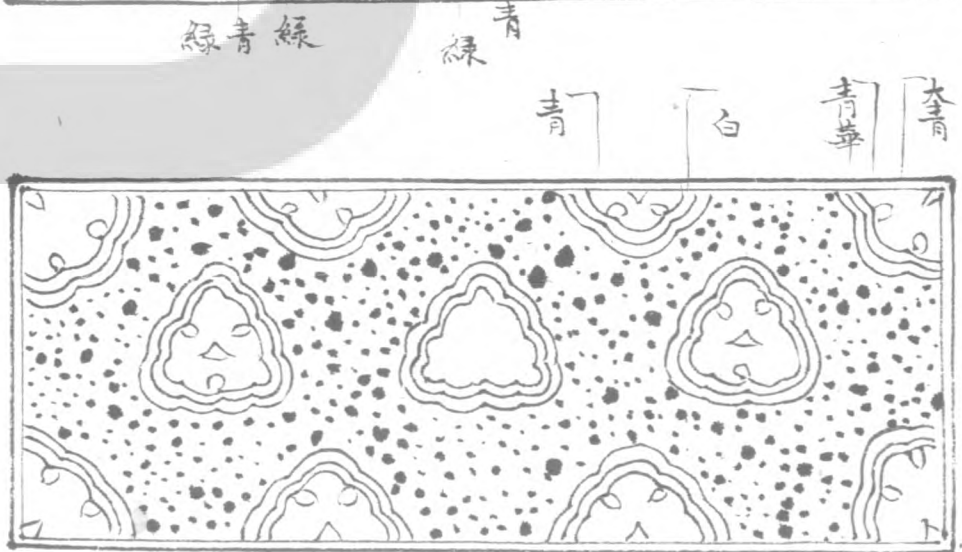

胡瑪瑙

青華 大青

綠 青

青華 大青 二青 青華 大青 二綠

綠華 大綠

青 綠

綠 青 青華 大青 青華 二青

大青 青華

青 綠 綠 青 綠 青

青 白 青華 大青

大綠 綠華 青綠 綠青 綠

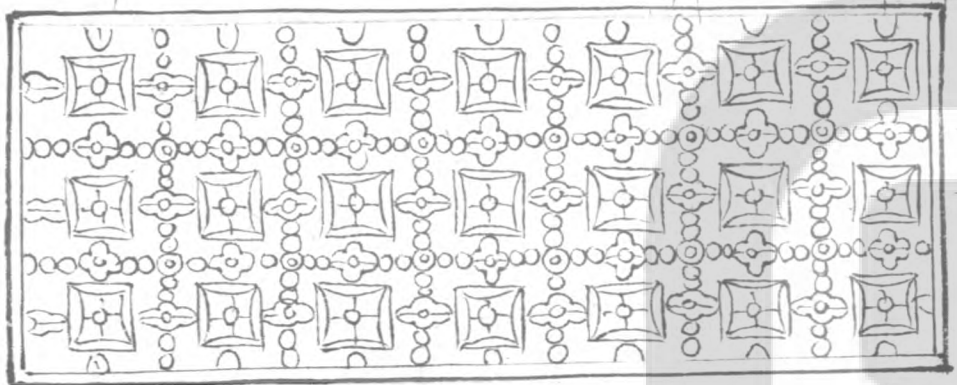

方環

綠豆福 綠華 大綠

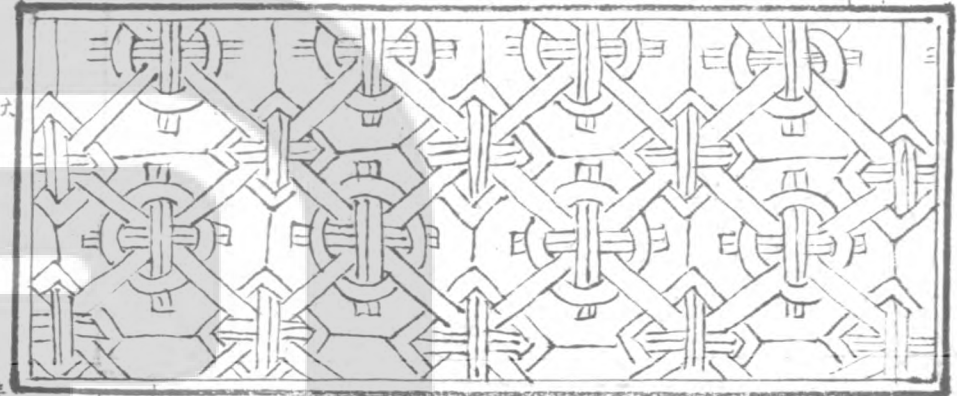

篋文

大青 青華 青 綠 綠豆福

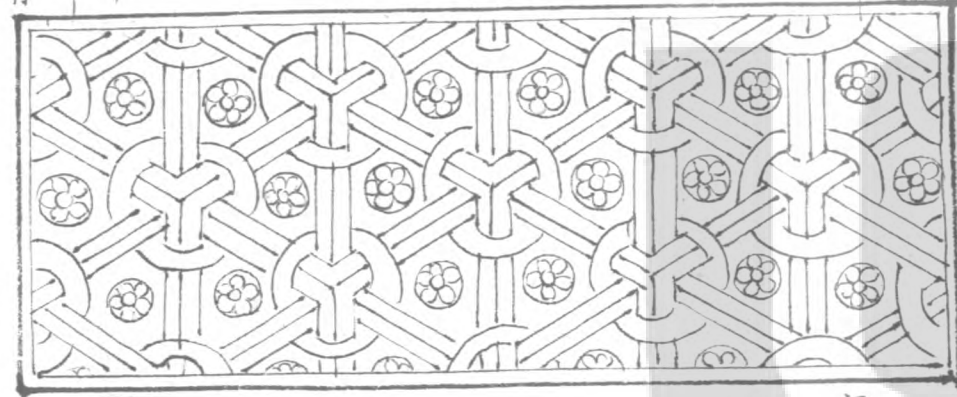

羅地龜文

青華 大青 青 綠福 青

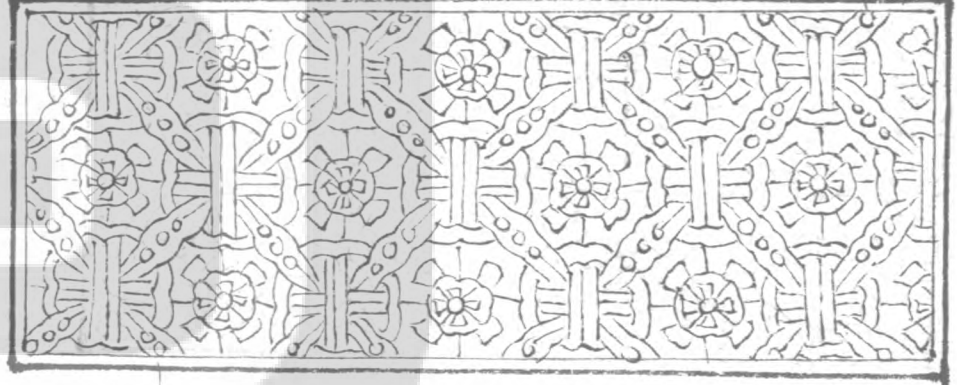

金銀

綠青 青 綠 大綠

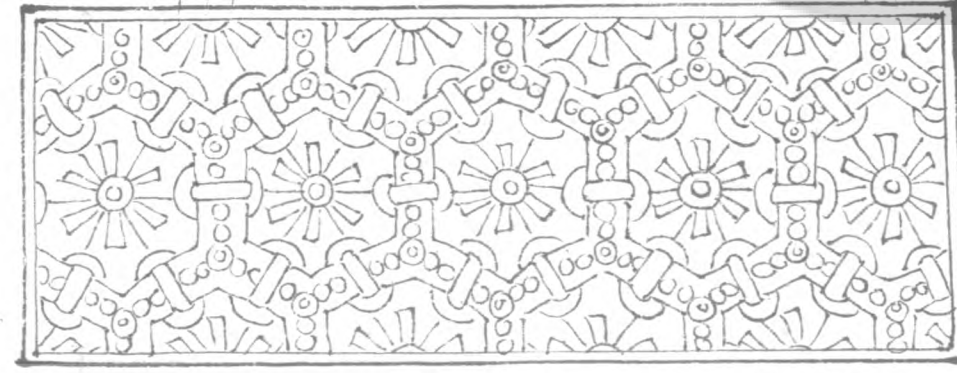

六出龜文

綠青 青 青 青 綠華 大綠

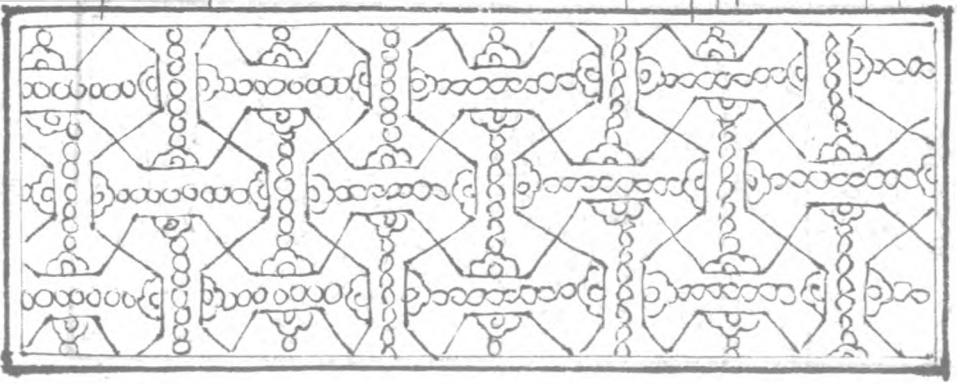

銀鏡

卷三十三

二十三

青綠

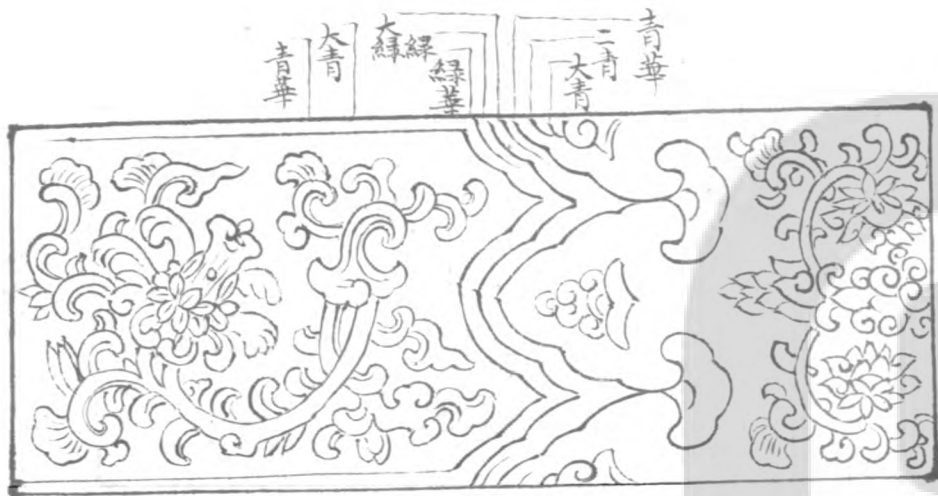

豹脚

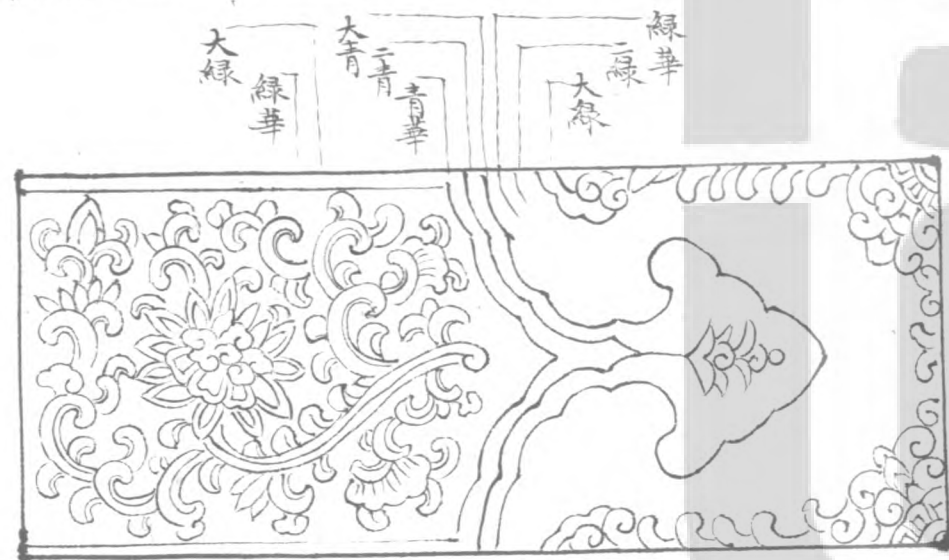

合蟬鷺尾

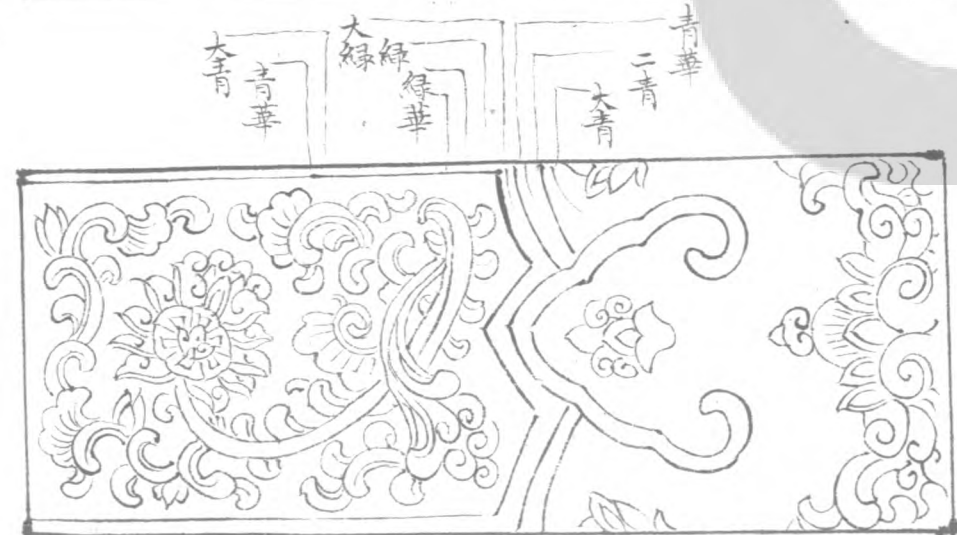

疊置

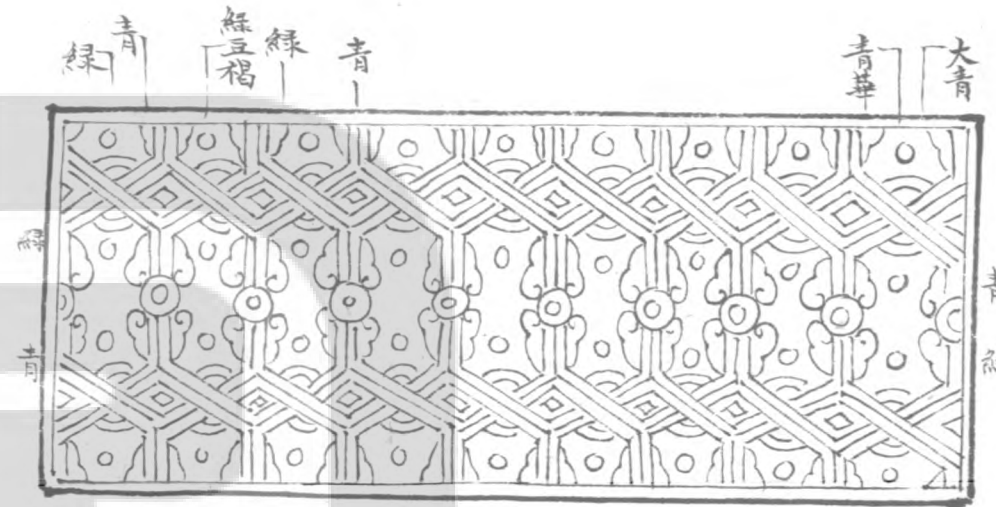

交脚龜文

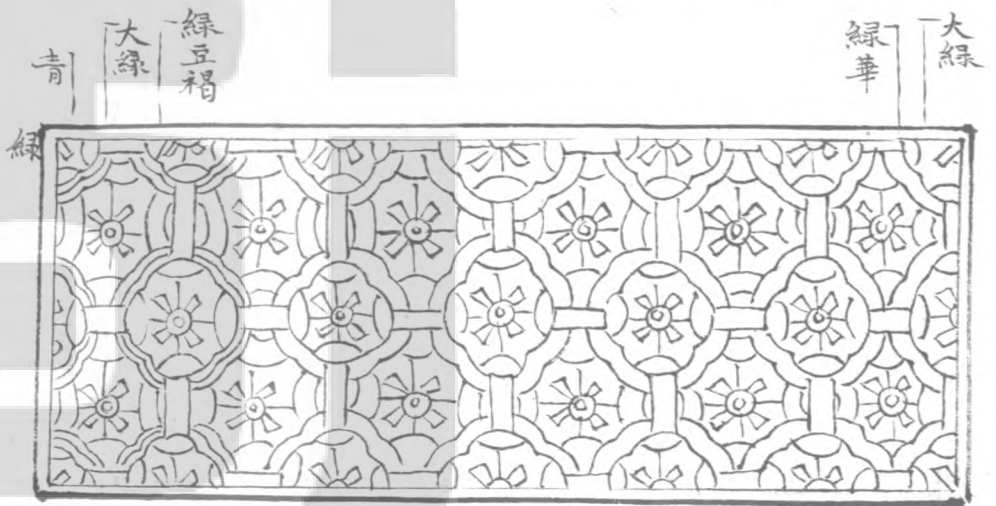

四出

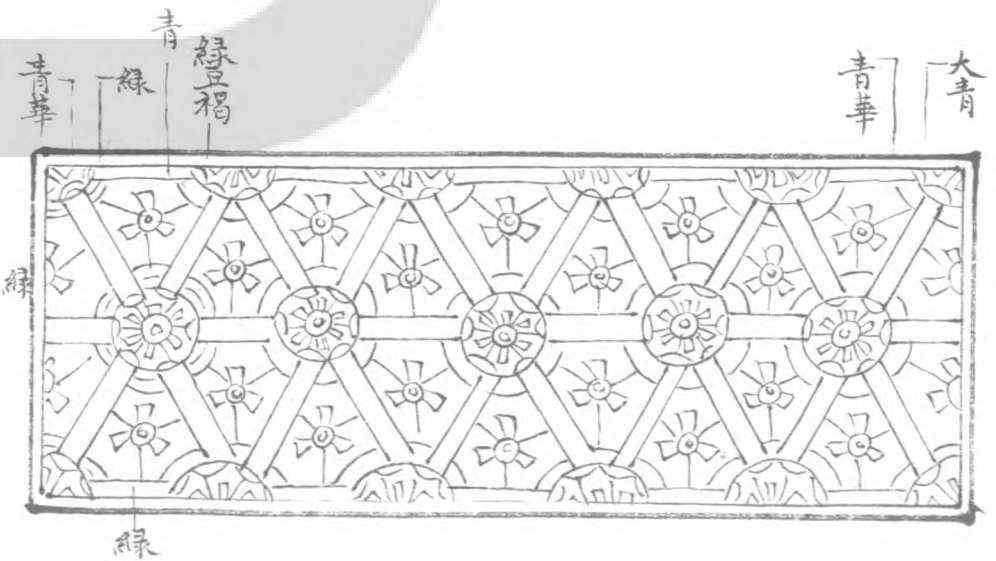

六出



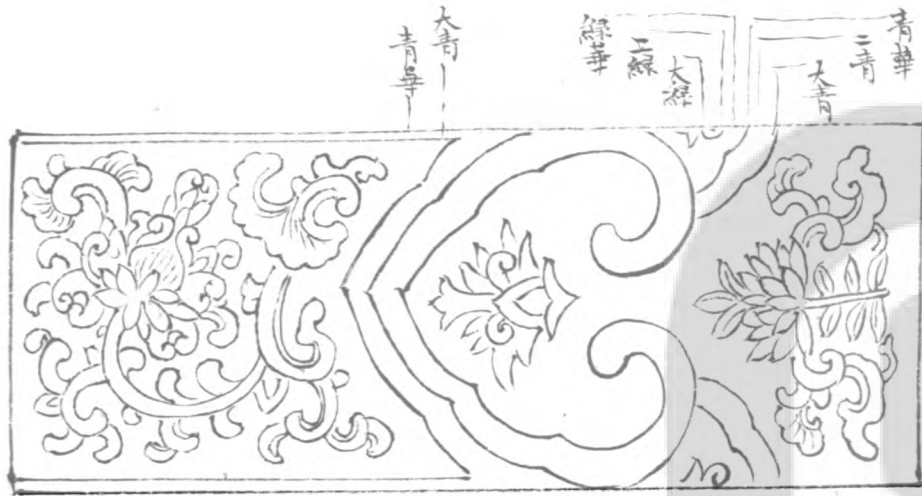

三卷如意頭

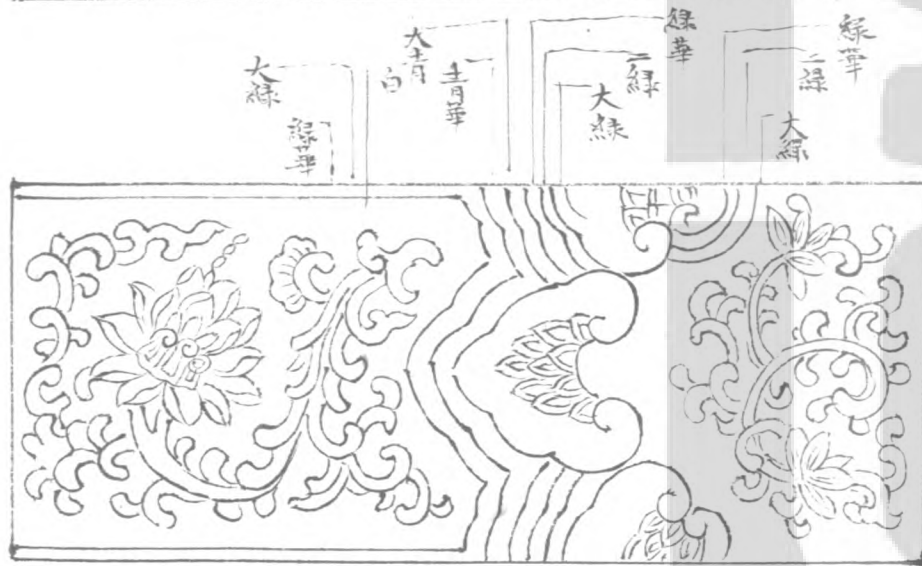

簇三

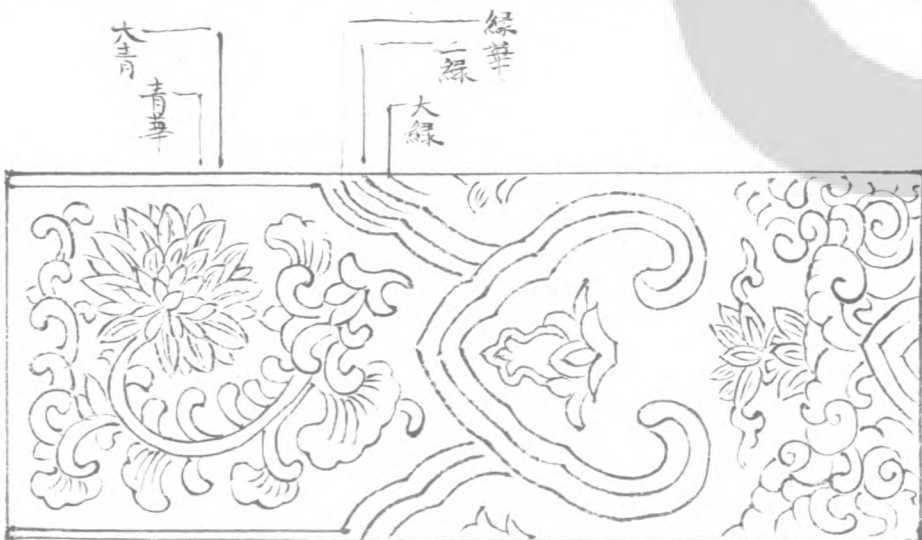

牙脚

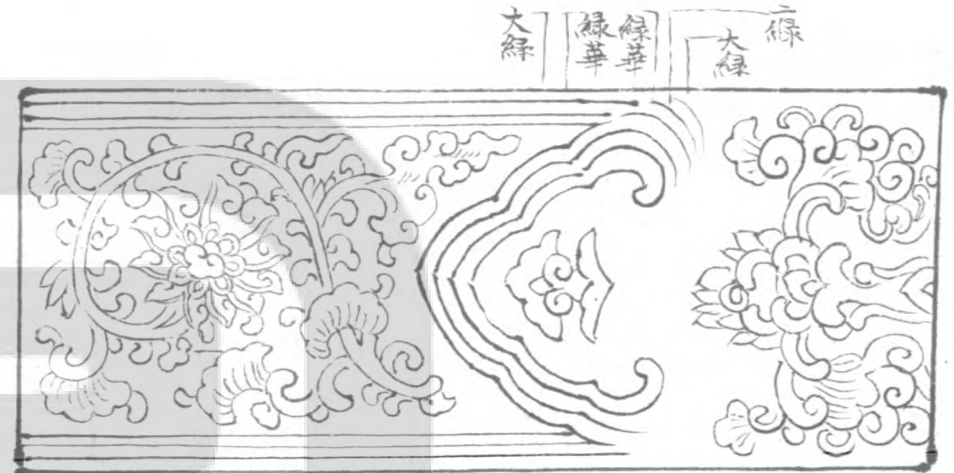

單卷如意頭

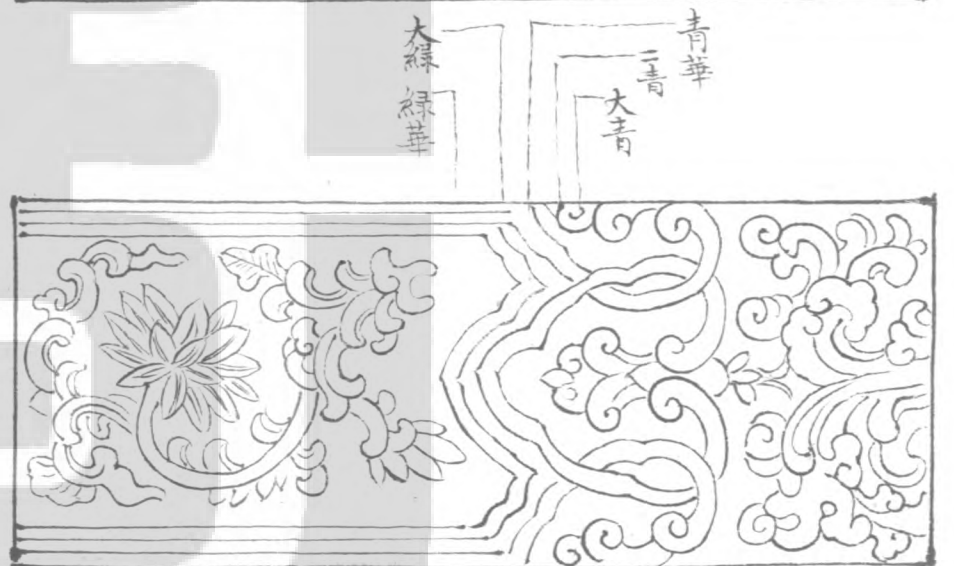

劍環

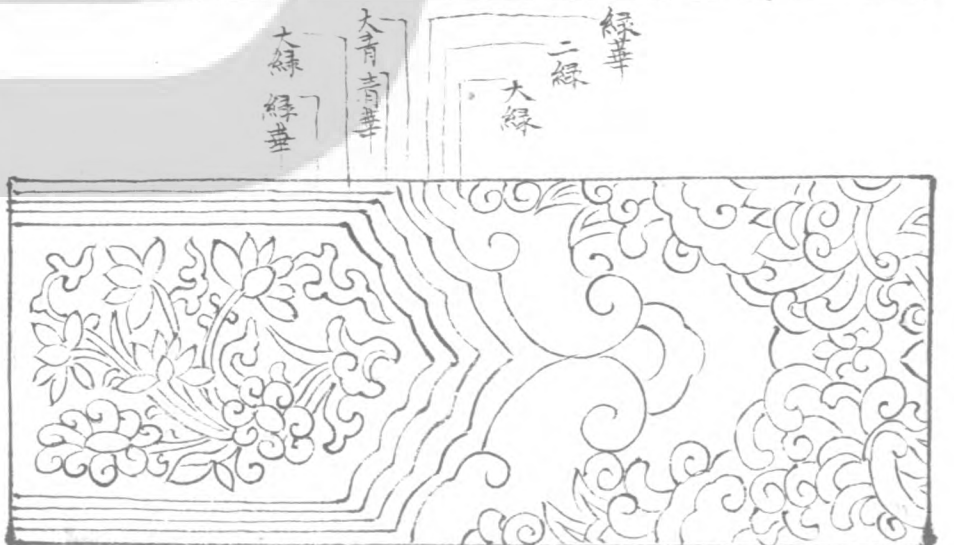

雲頭

海石榴華內間六入園華科



大綠二綠  
綠華 無豆福

寶牙華內間柿葉科



大青  
大青  
綠豆福

枝條卷成海石榴華內間四入園華科

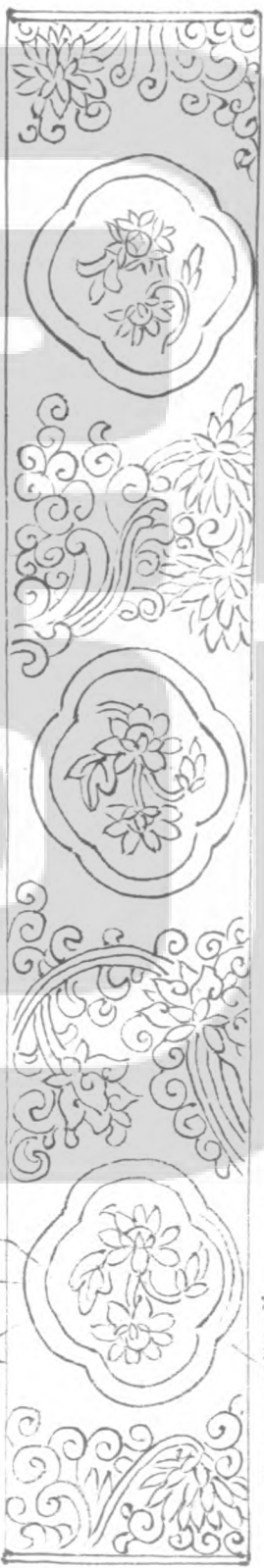

綠華  
綠豆福  
大綠

青  
青  
大青

碾玉平基第十  
其羔子筆心畫者條青單外綠者條綠出  
條碾玉裝其不單者白上極和畫青

青

綠

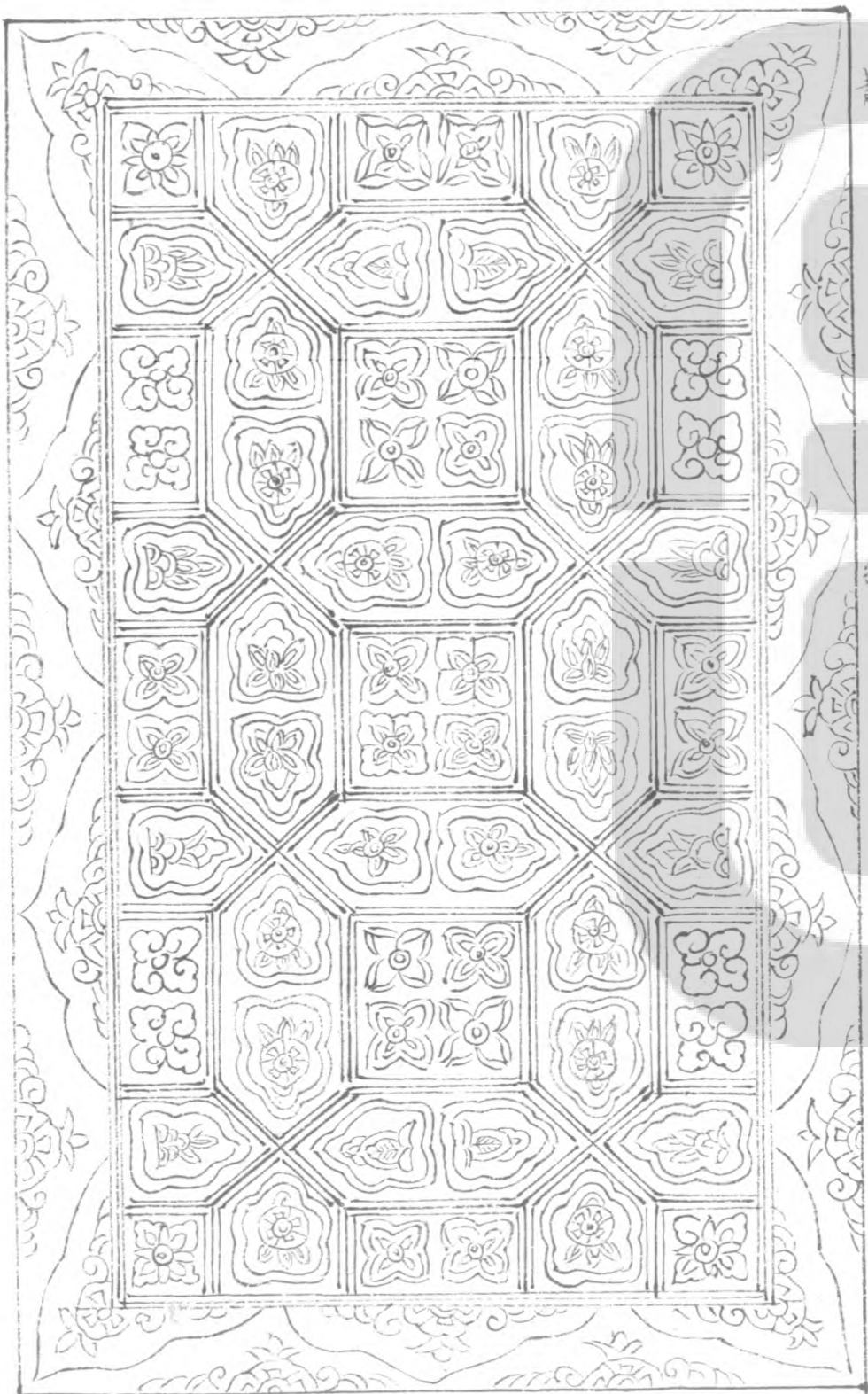

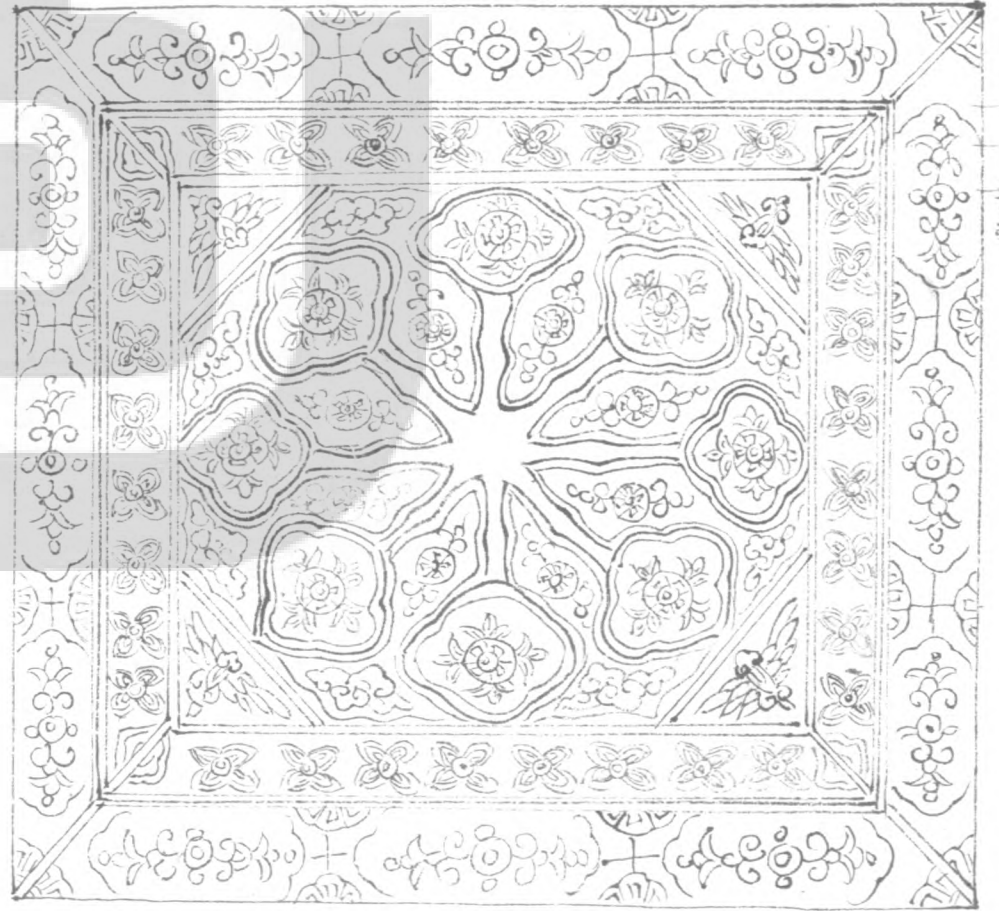
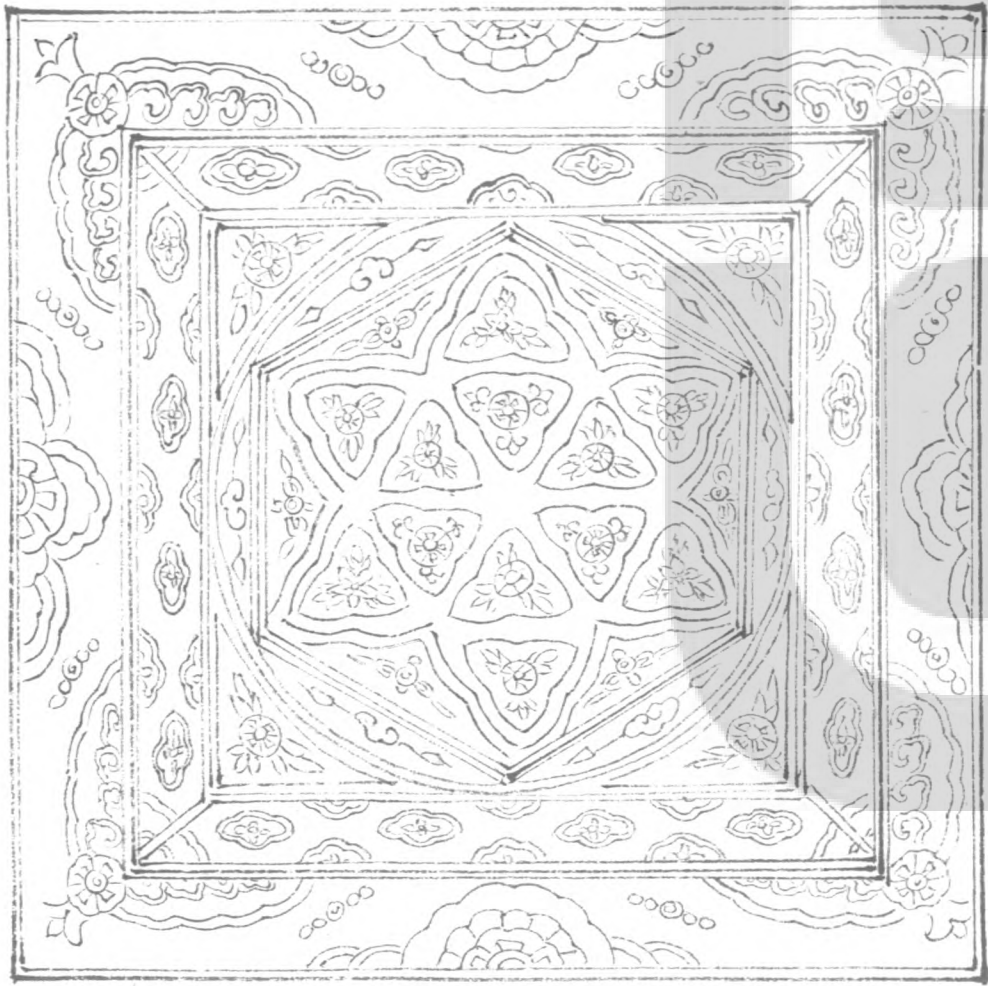

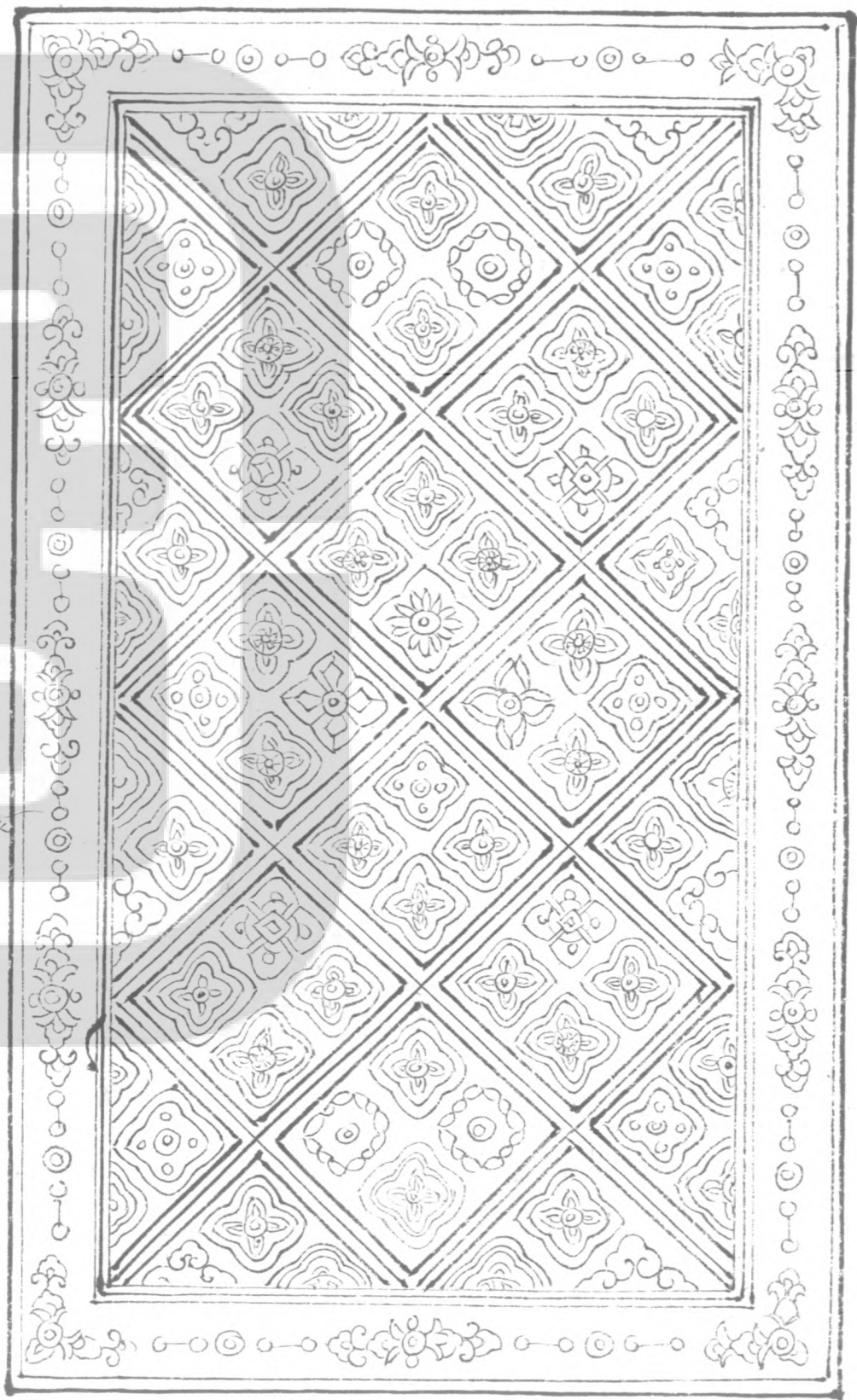

營造法式卷三十三

營造法式

卷三十四

彩畫作制度圖樣下

五彩遍裝名件第十一

碾玉裝名件第十二

青綠疊暈棧間裝名件第十三

三暈帶紅棧間裝名件第十四

宋 李誠 撰

兩暈椽間內畫松文裝名件第十五

解綠結華裝名件第十六  
解綠  
裝附

刷飾制度圖樣

丹粉刷飾名件第一

黃土刷飾名件第二

彩畫作制度圖樣下

五彩過裝名件第十一

五鋪作料拱

四鋪作料拱

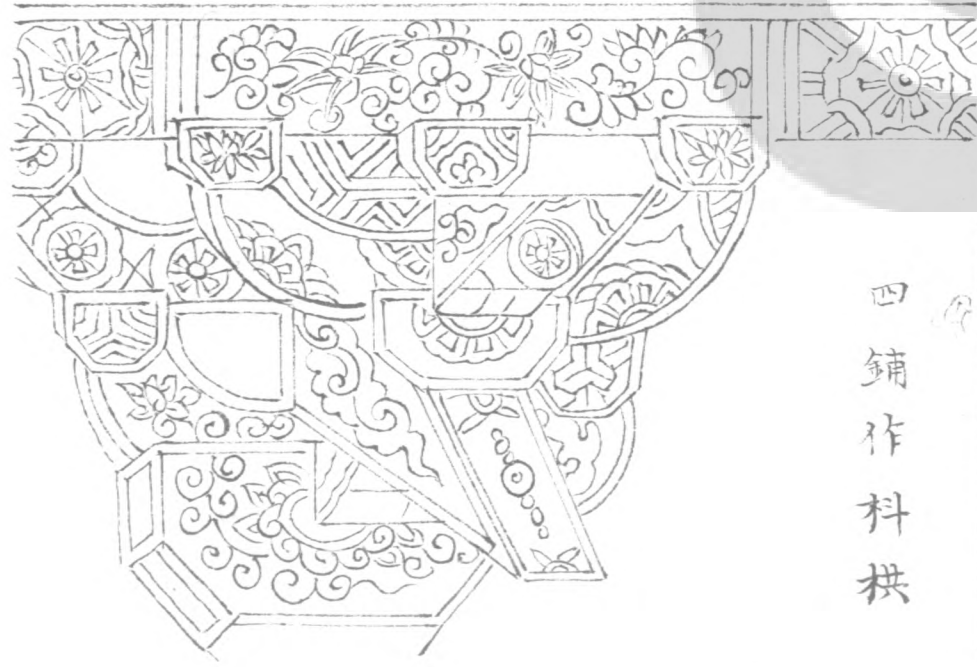
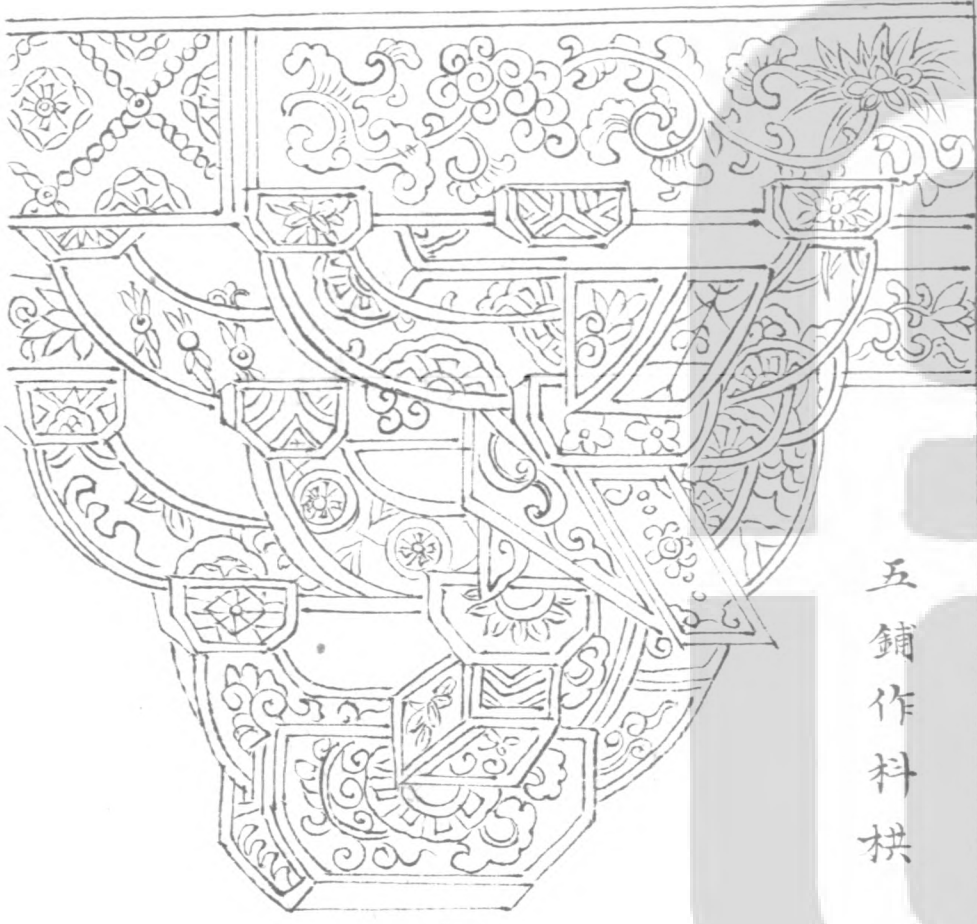

卷三十四

二

五彩裝淨地錦

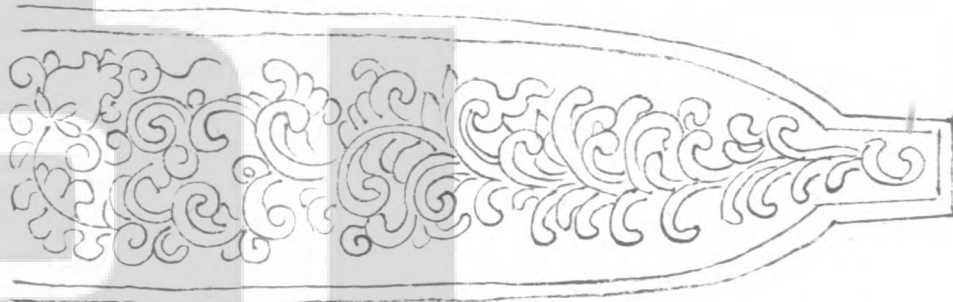
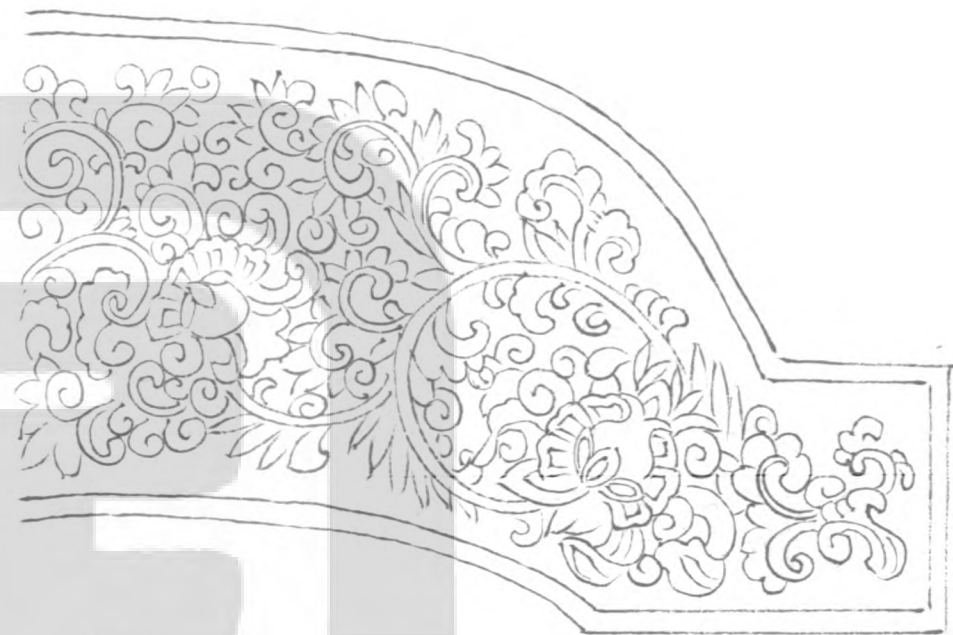
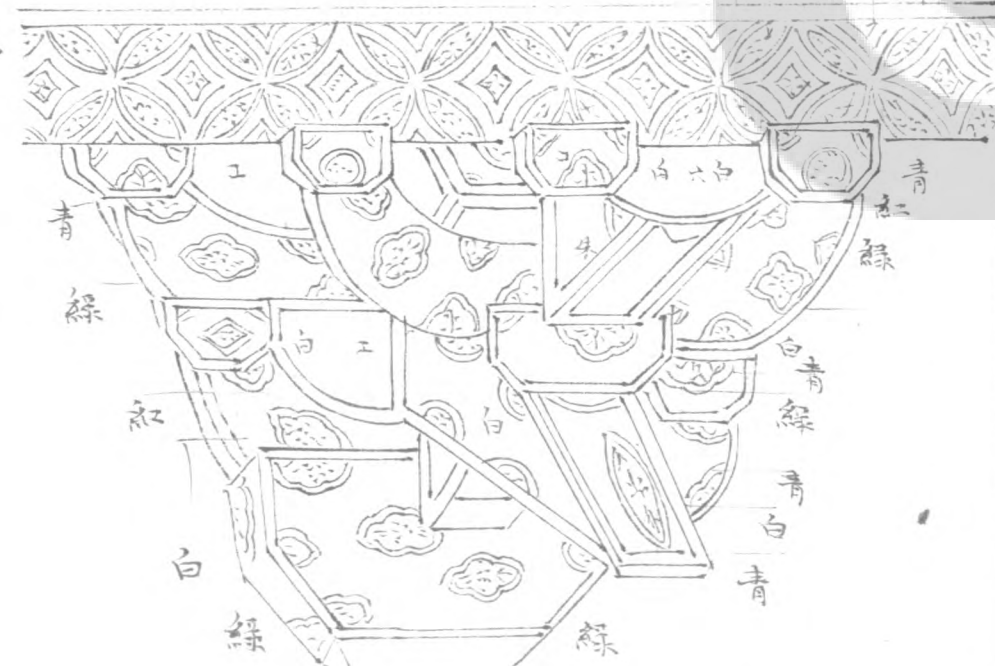
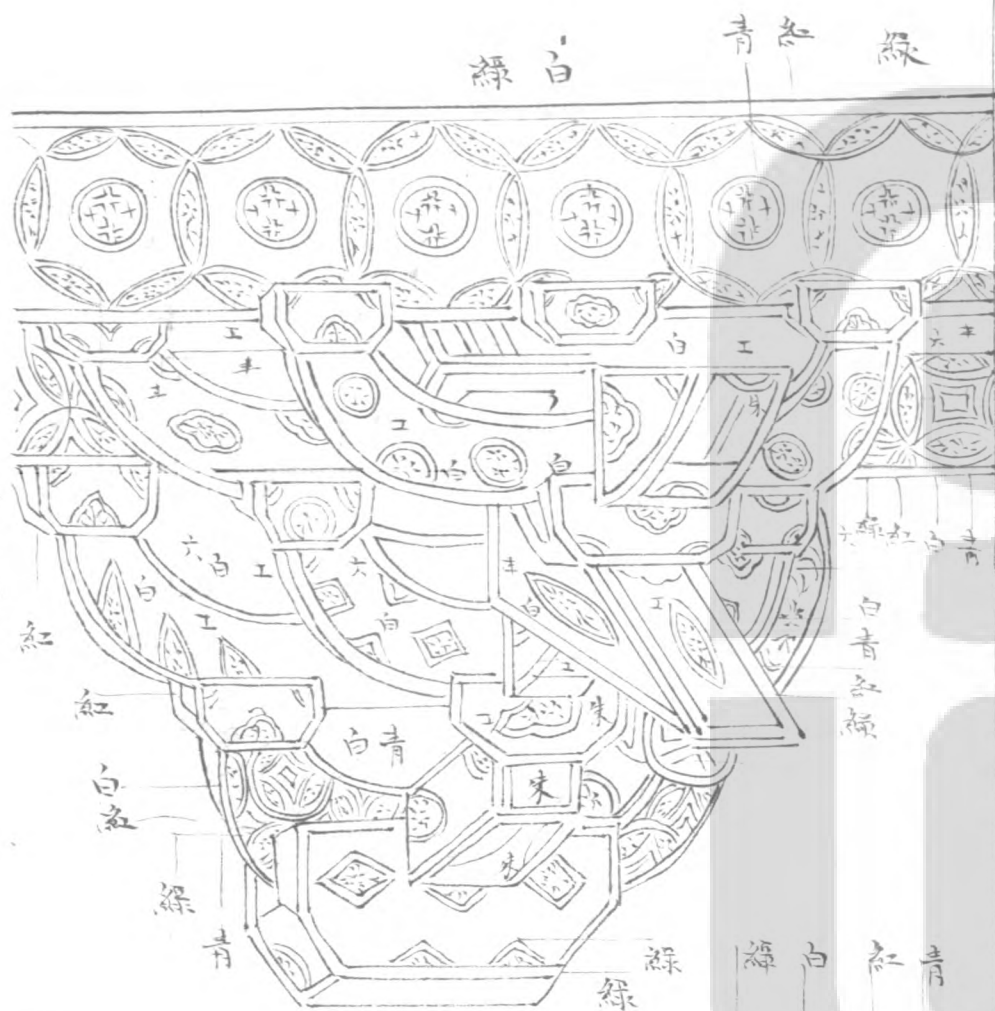

梁椽 飛子

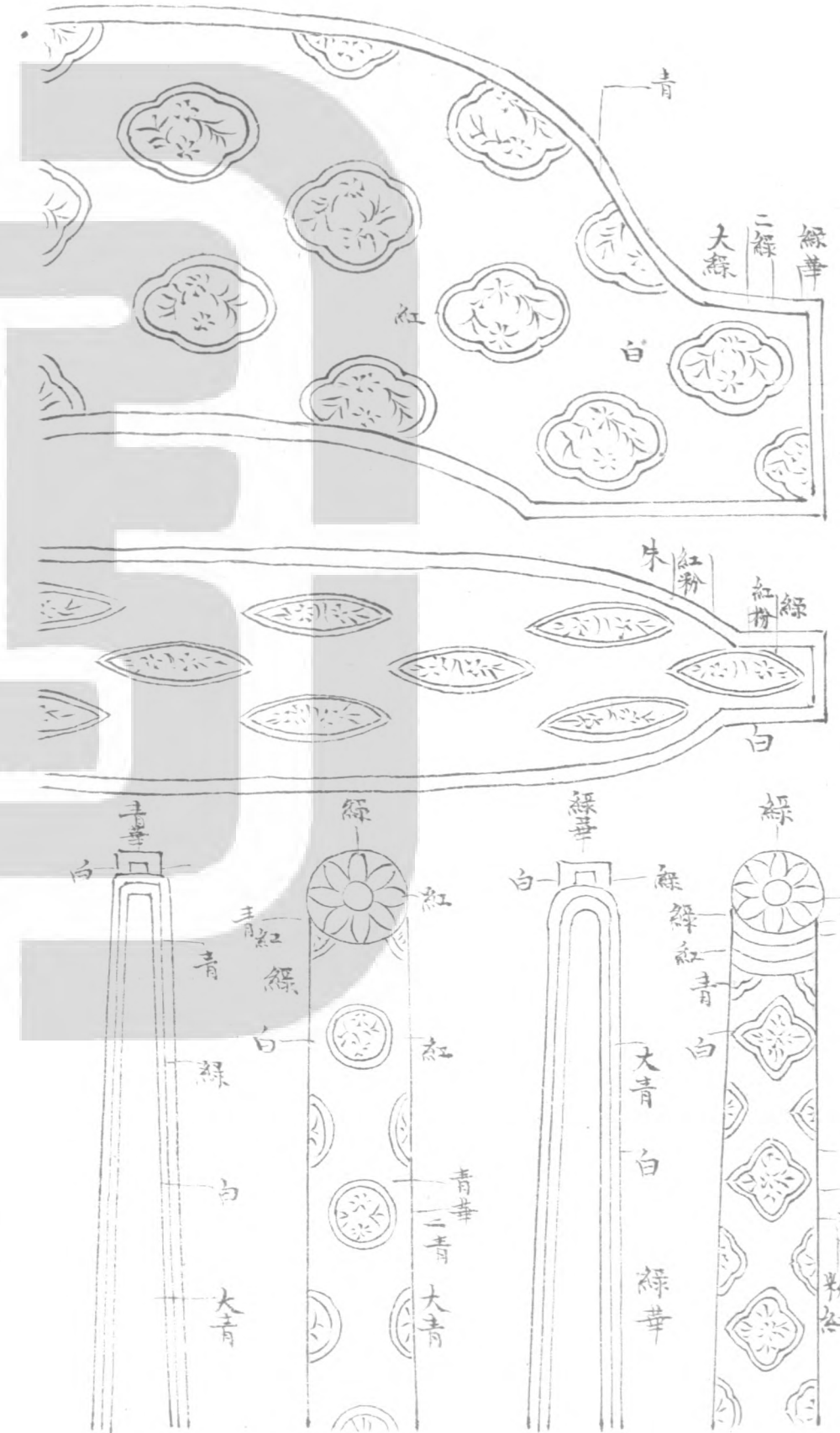

五彩裝拱眼壁  
重拱內



單拱內

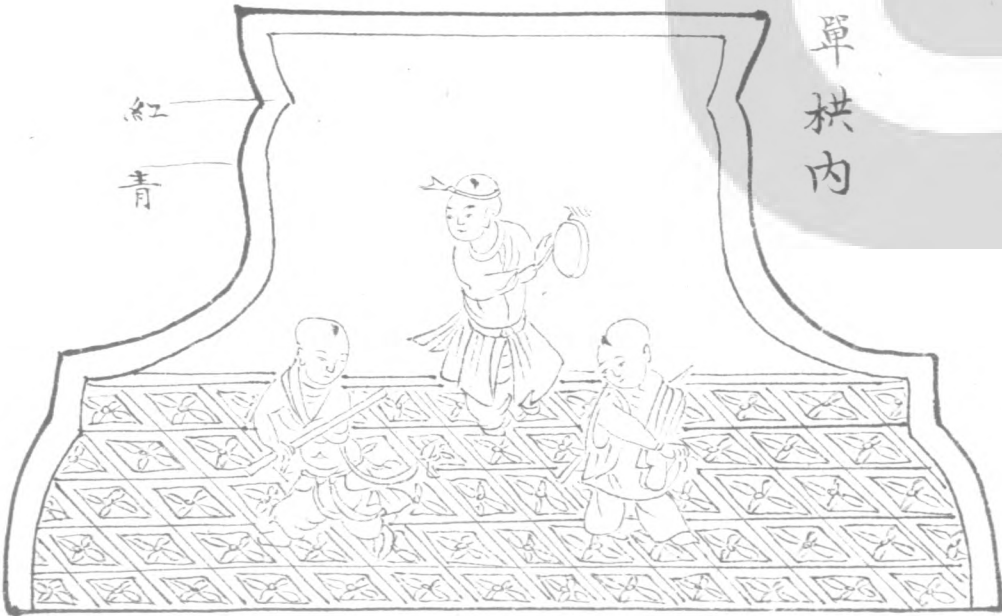



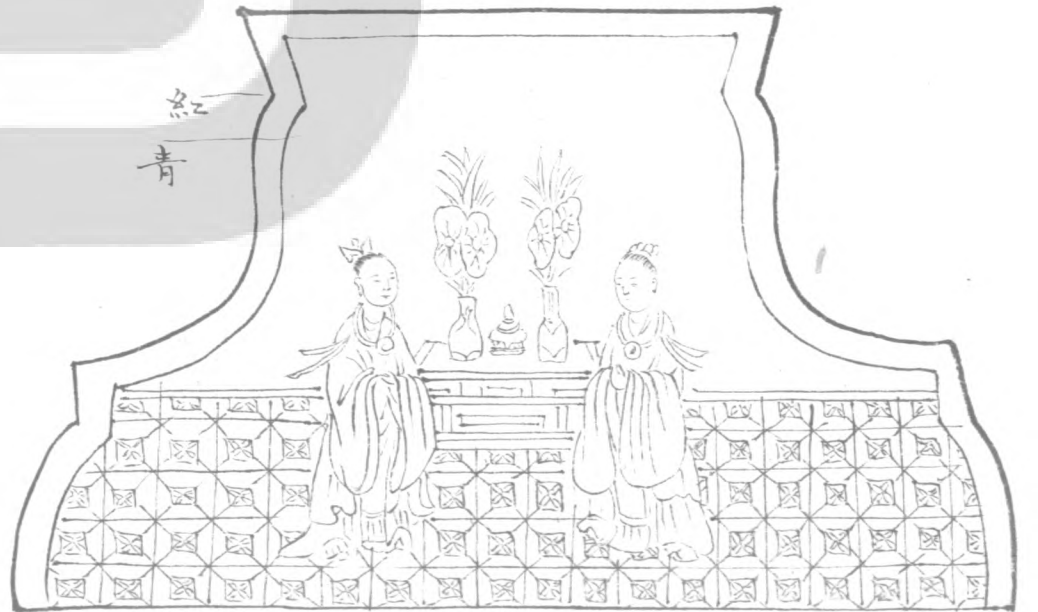

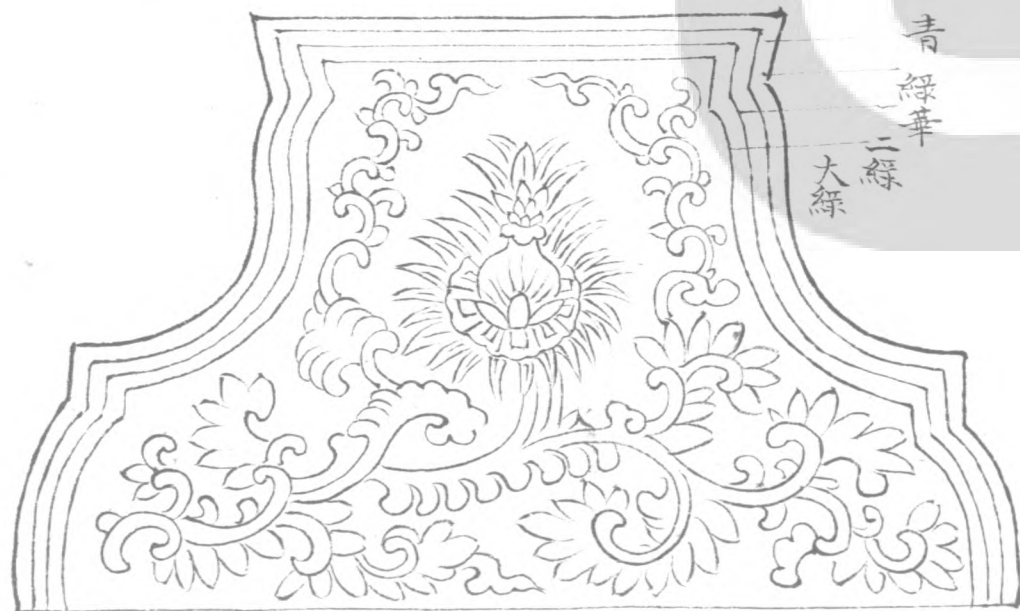
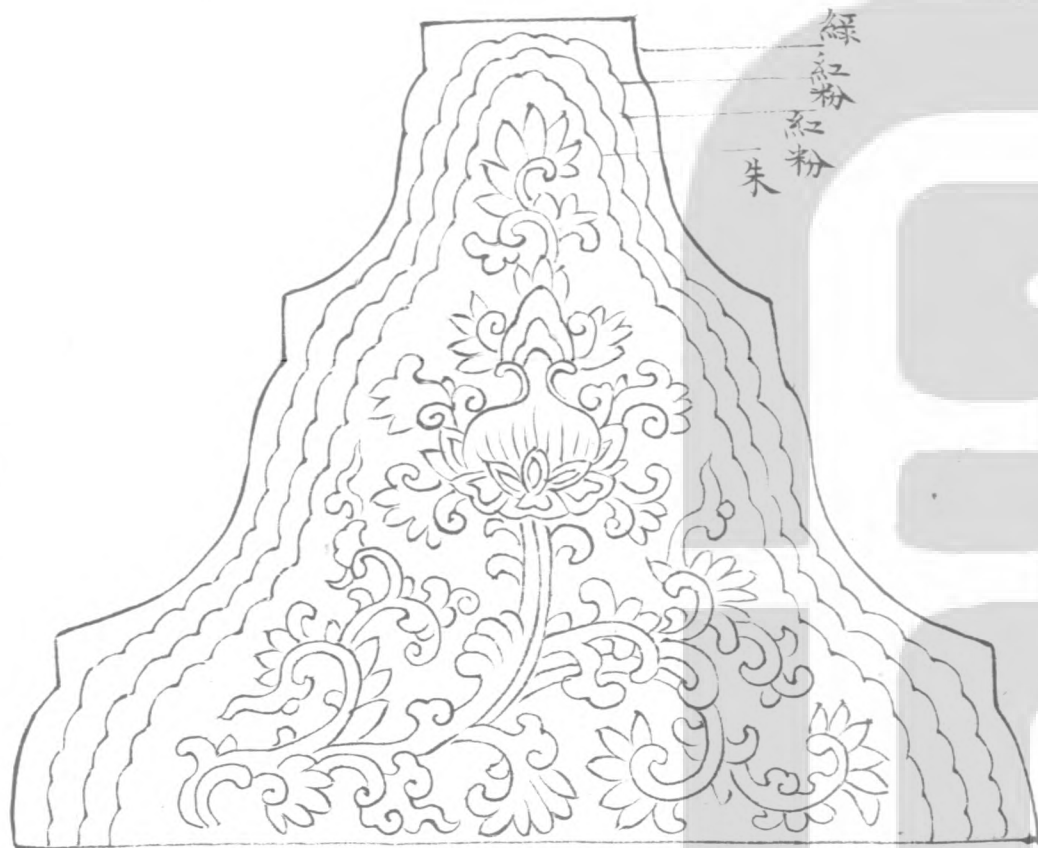

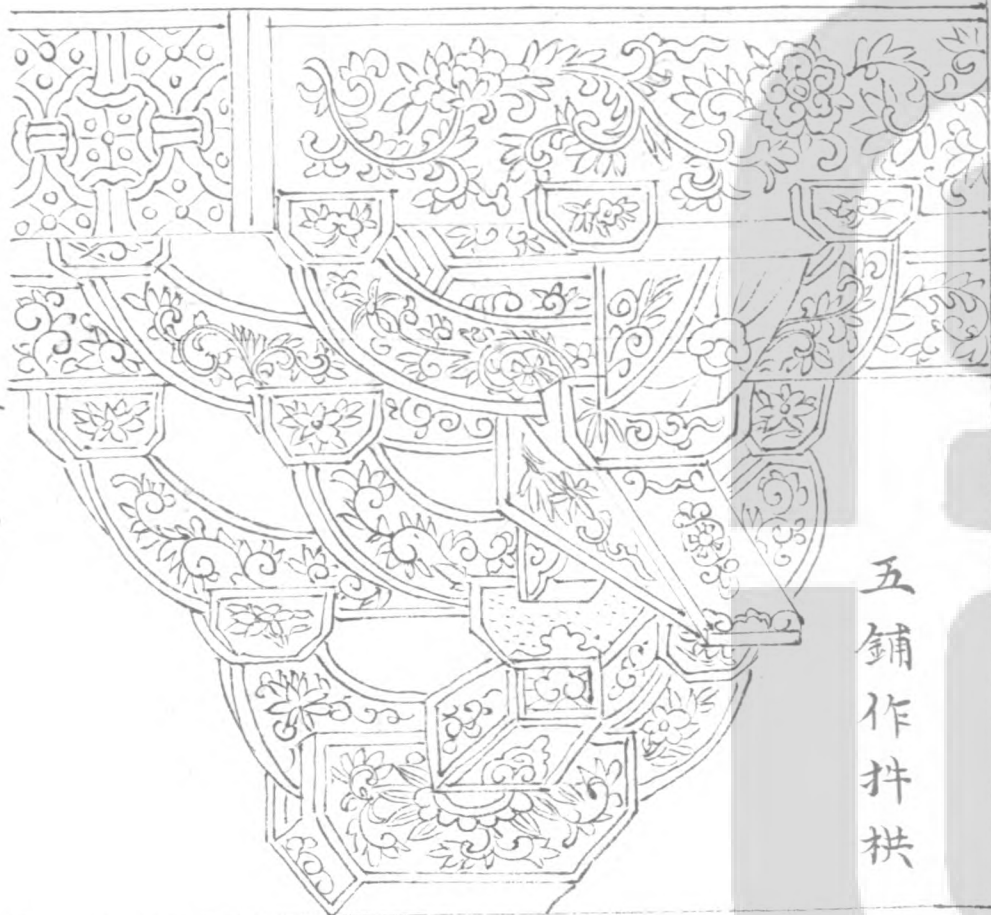

五鋪作拱

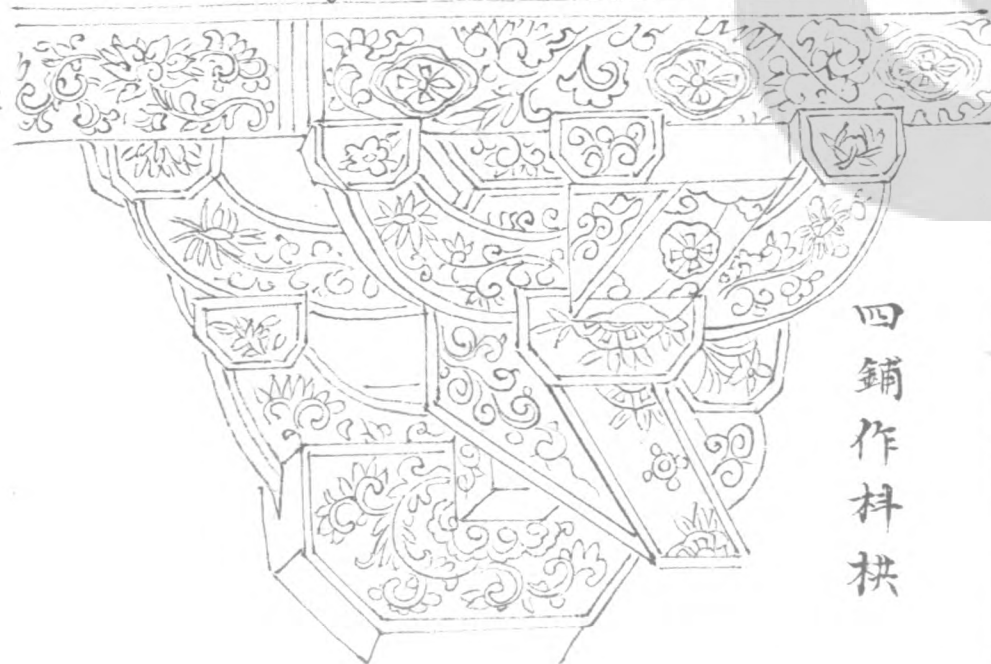

四鋪作拱

碾玉裝名件第十二

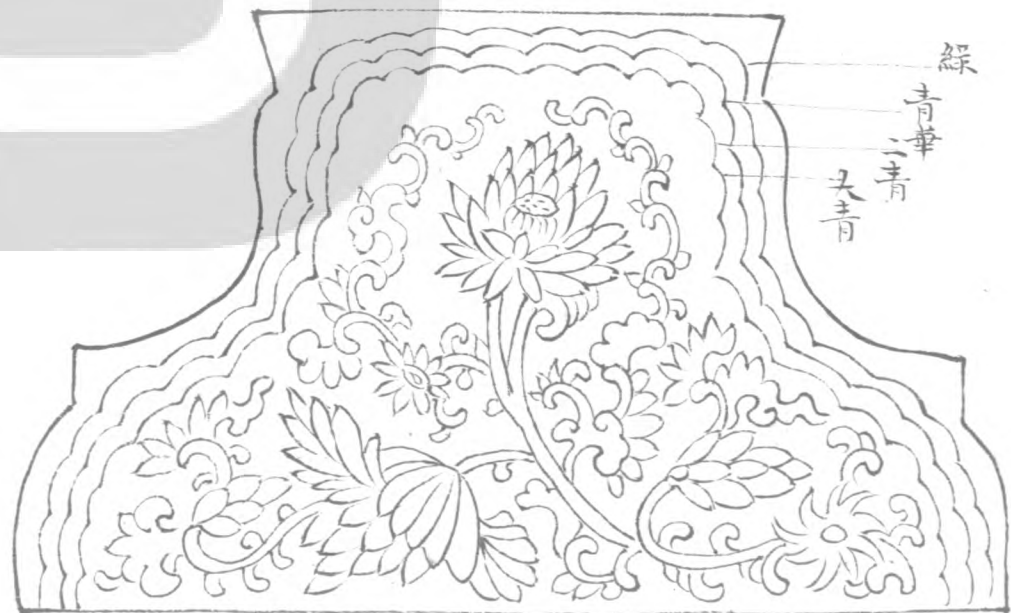
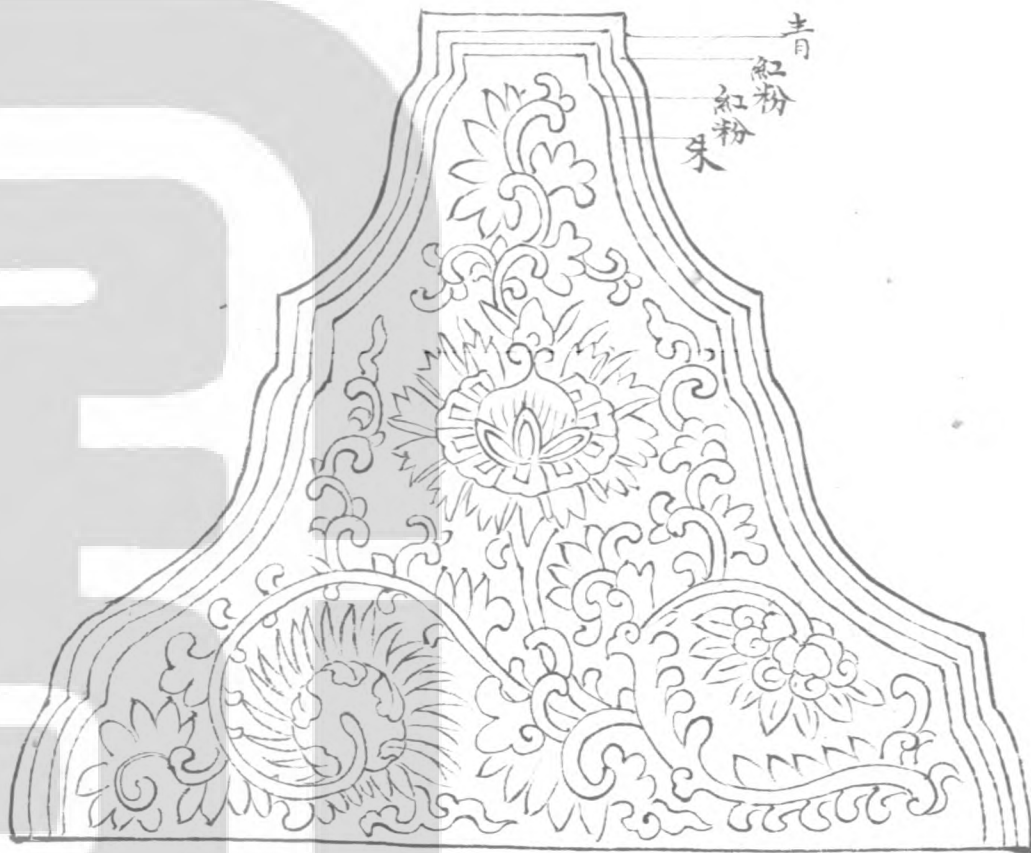

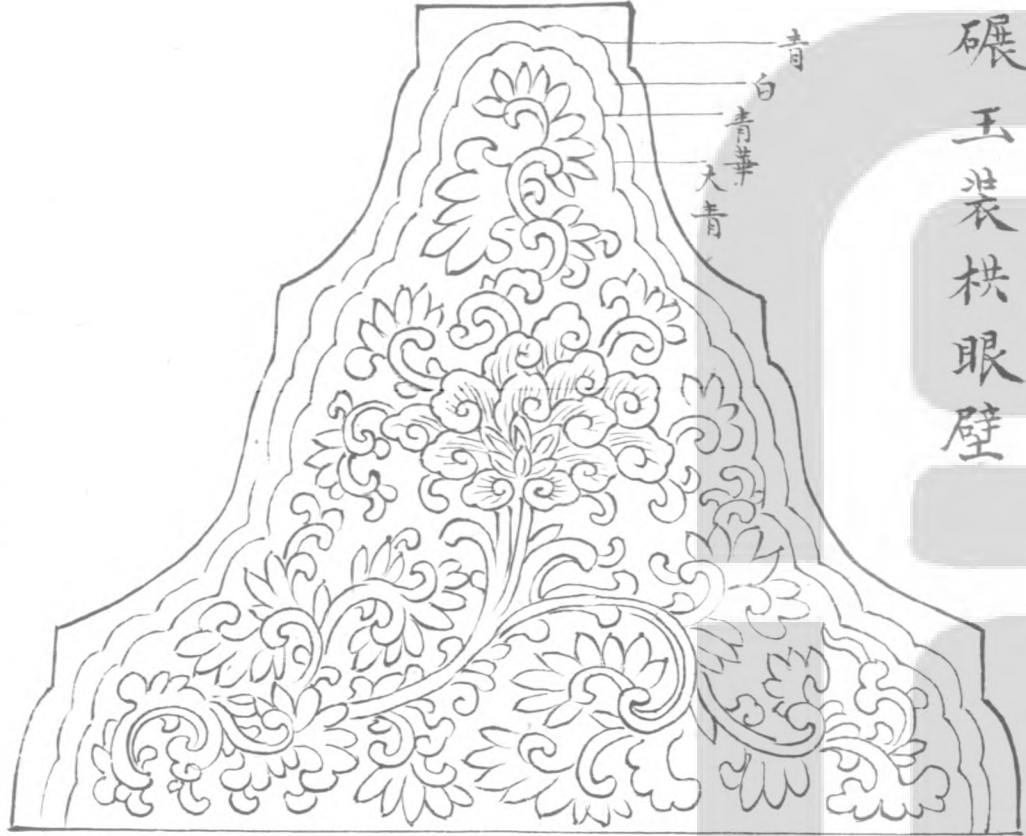

碾玉裝拱眼壁

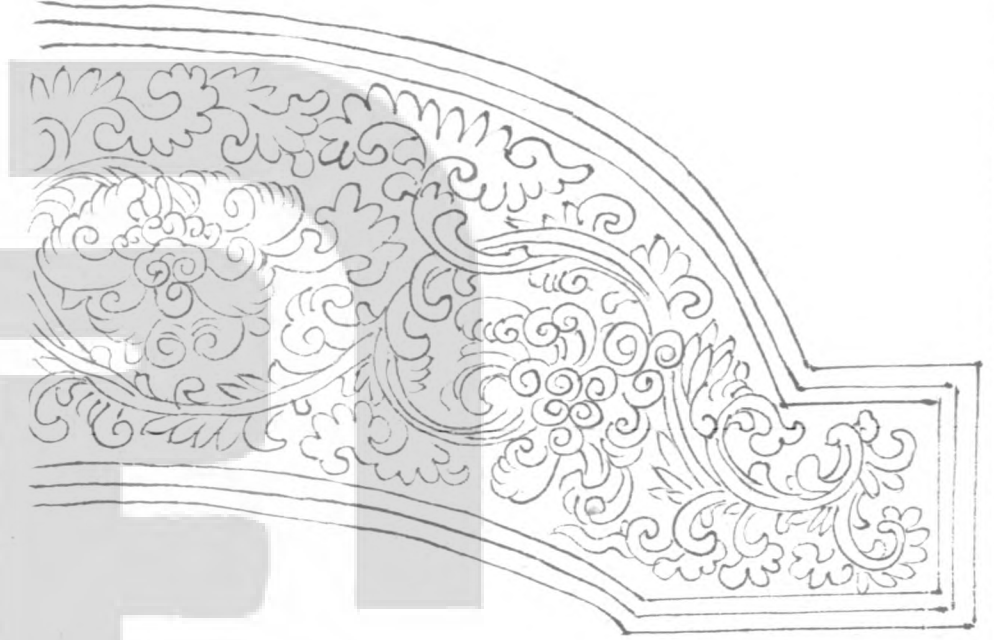
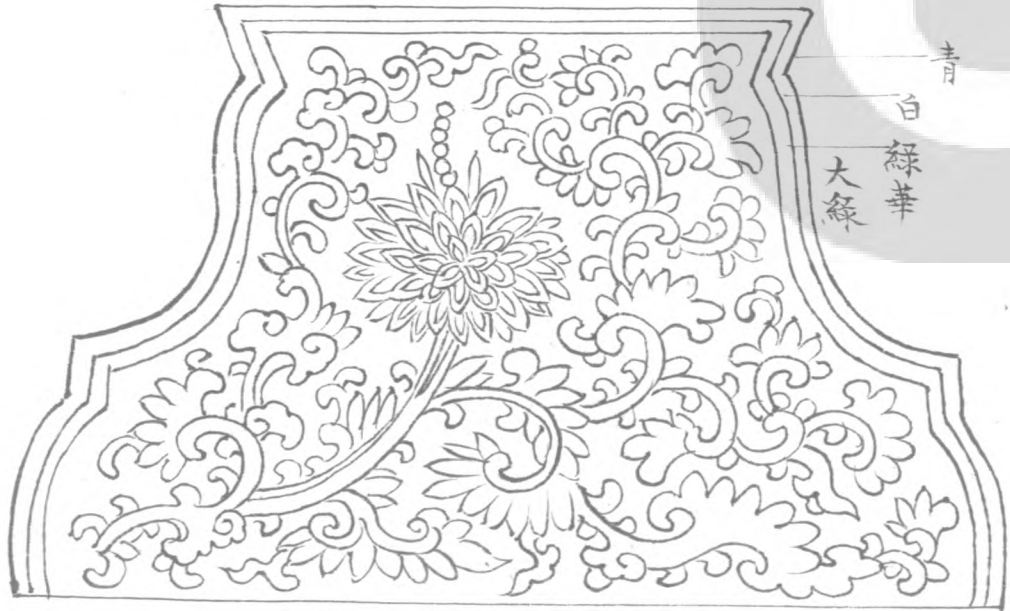

梁椽飛子

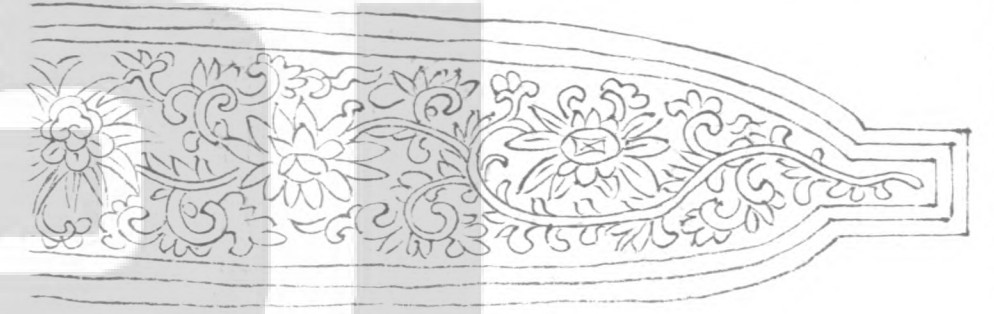

青 綠

青 綠 青 綠

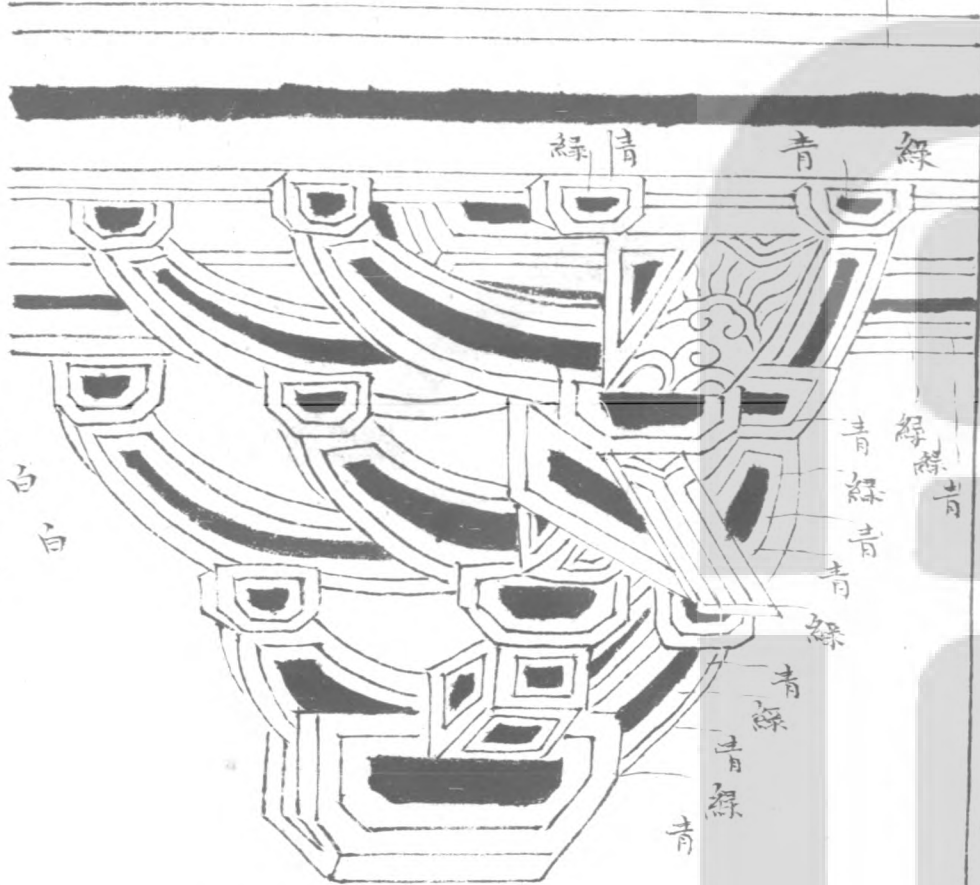

青綠疊暈椽間裝名件第十三

青 綠

青 綠

青 綠

青 綠

青 綠

青

卷三十四

九

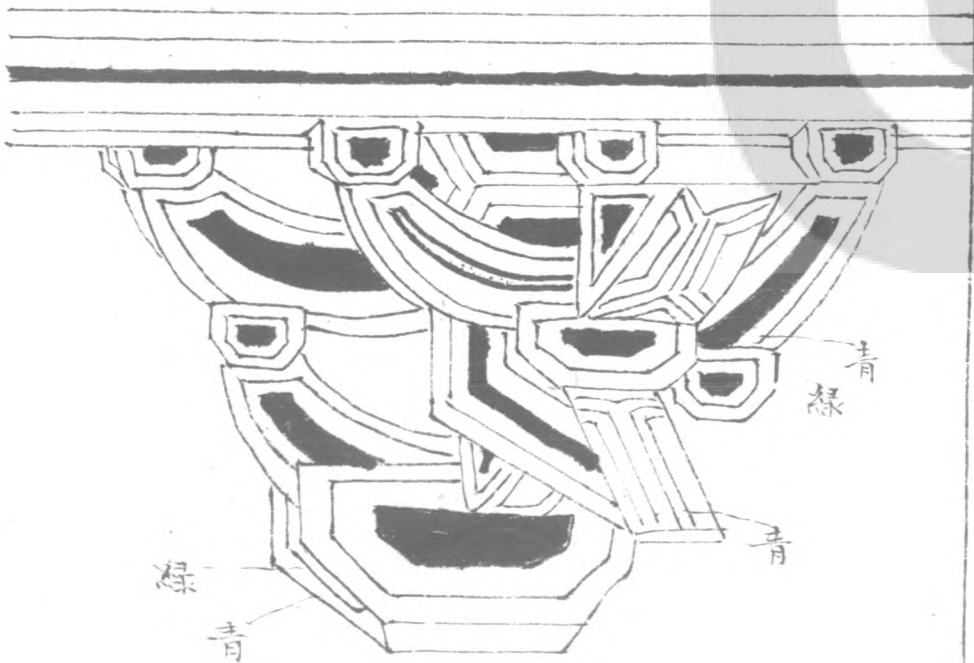

青

綠

青

綠

青

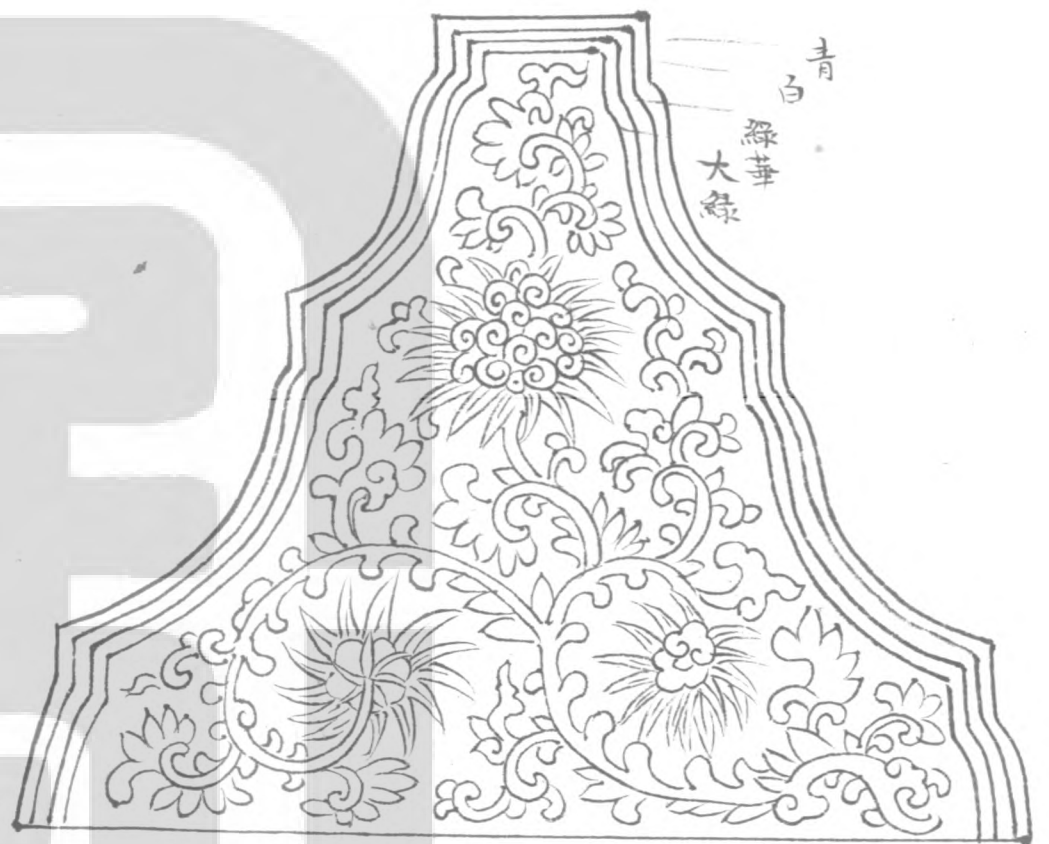

青

白

綠華

大綠

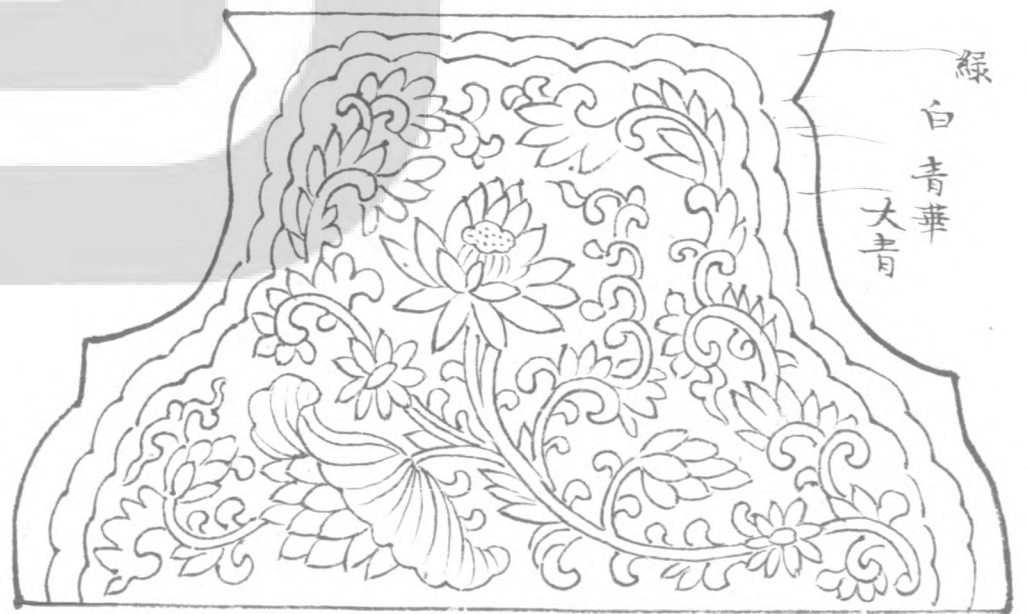

綠

白

青華

大青

梁椽飛子

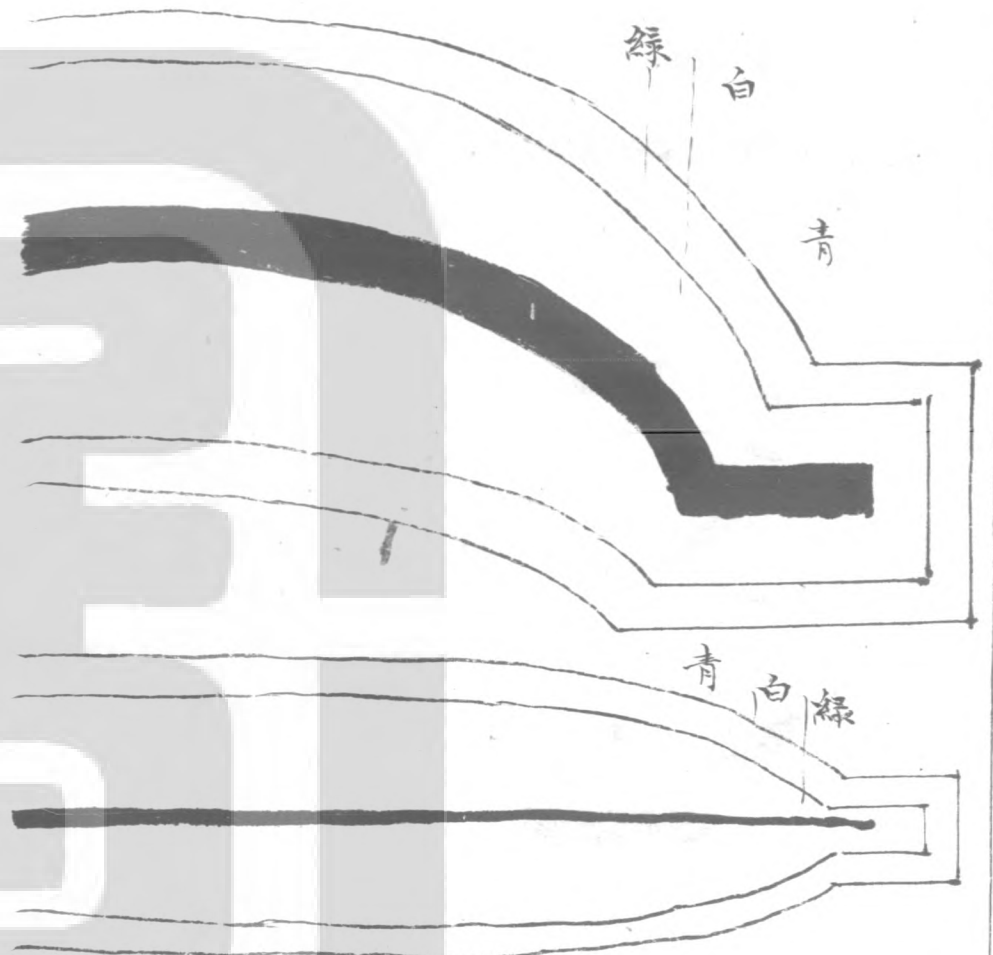

青綠疊暈玉暈椽間裝

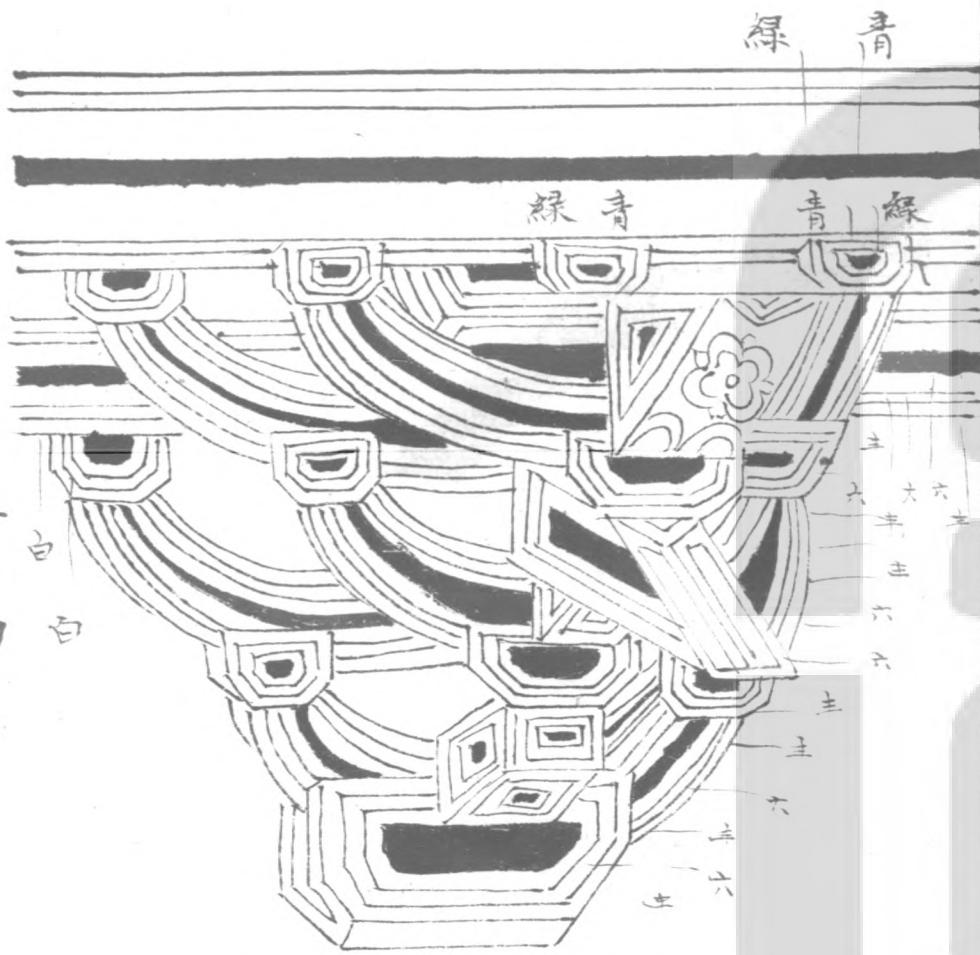

卷三十四

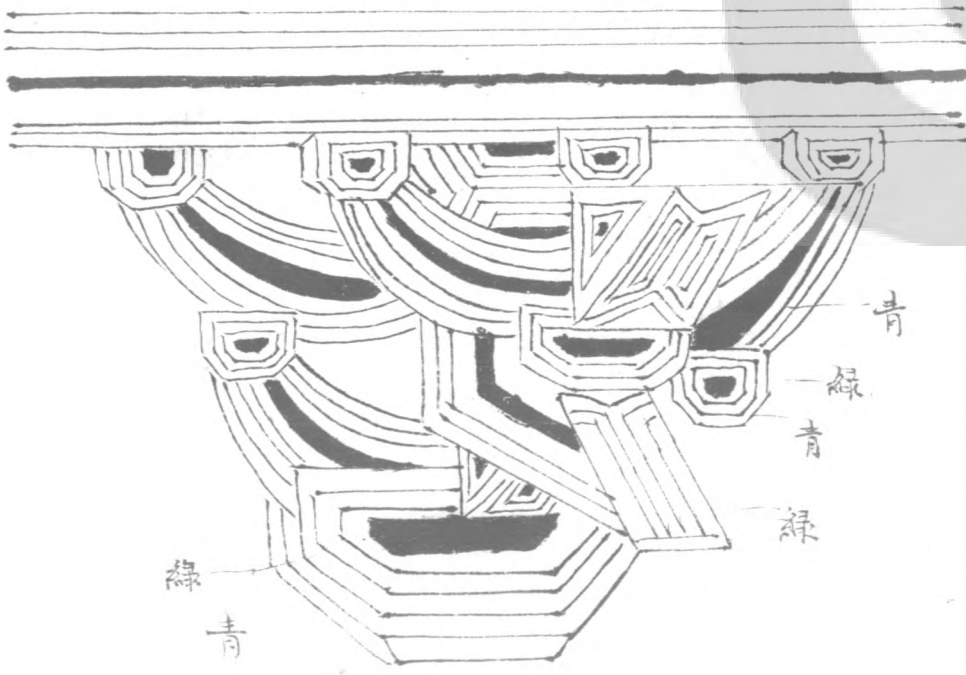

十

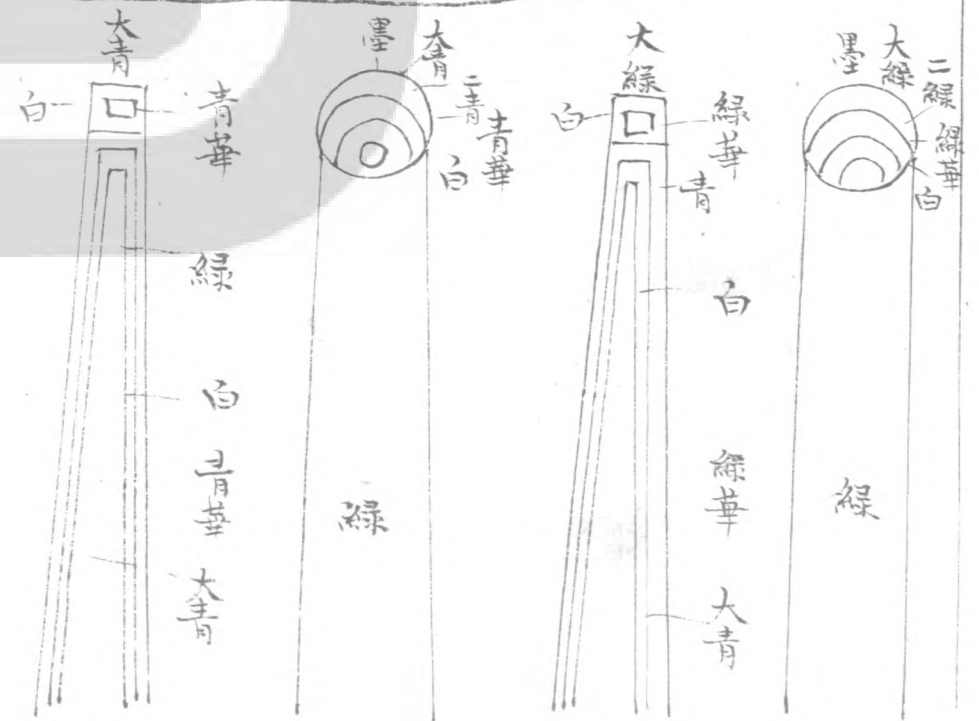

梁椽飛子

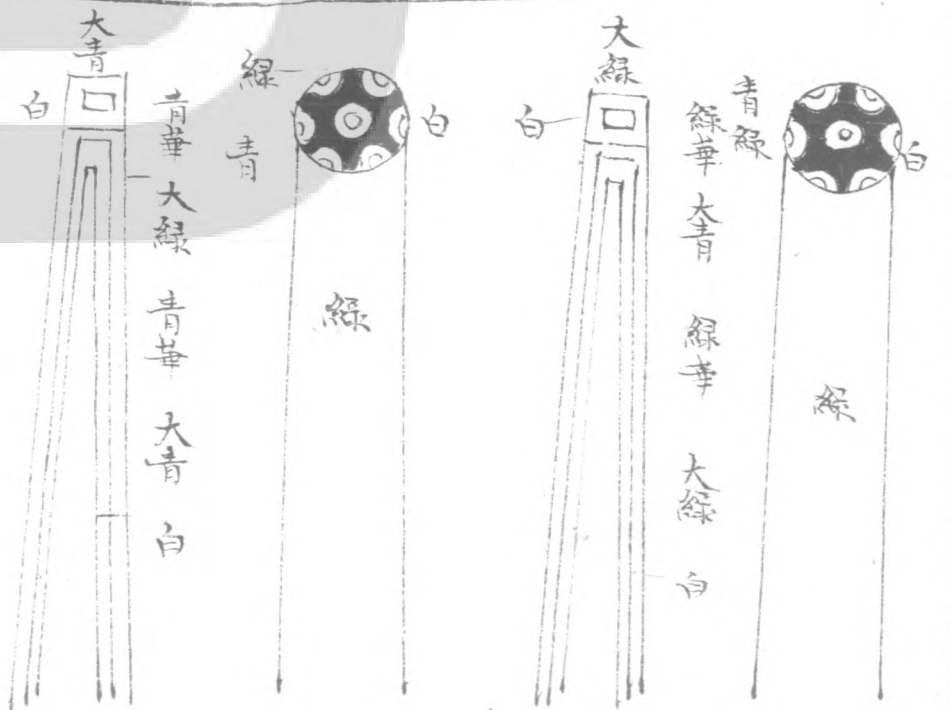
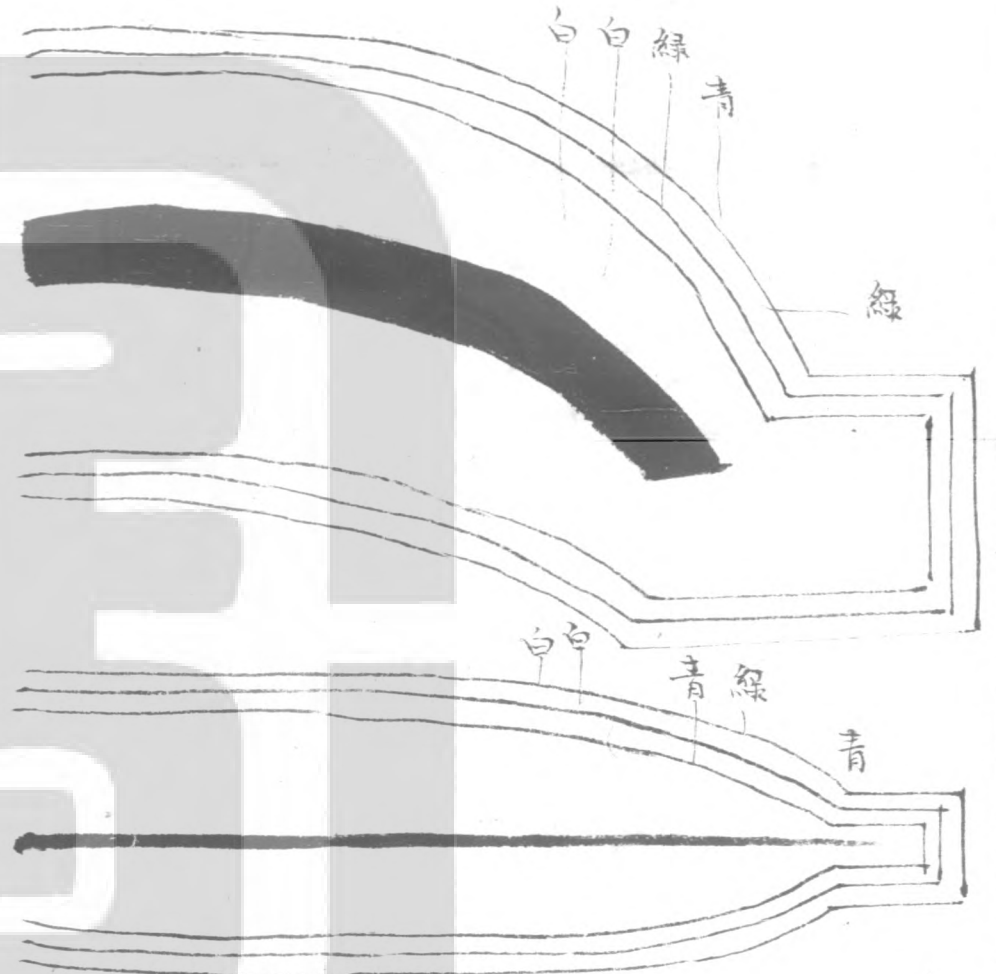

三暈帶紅椽間裝名件第十四

綠 青

綠 青 青 綠

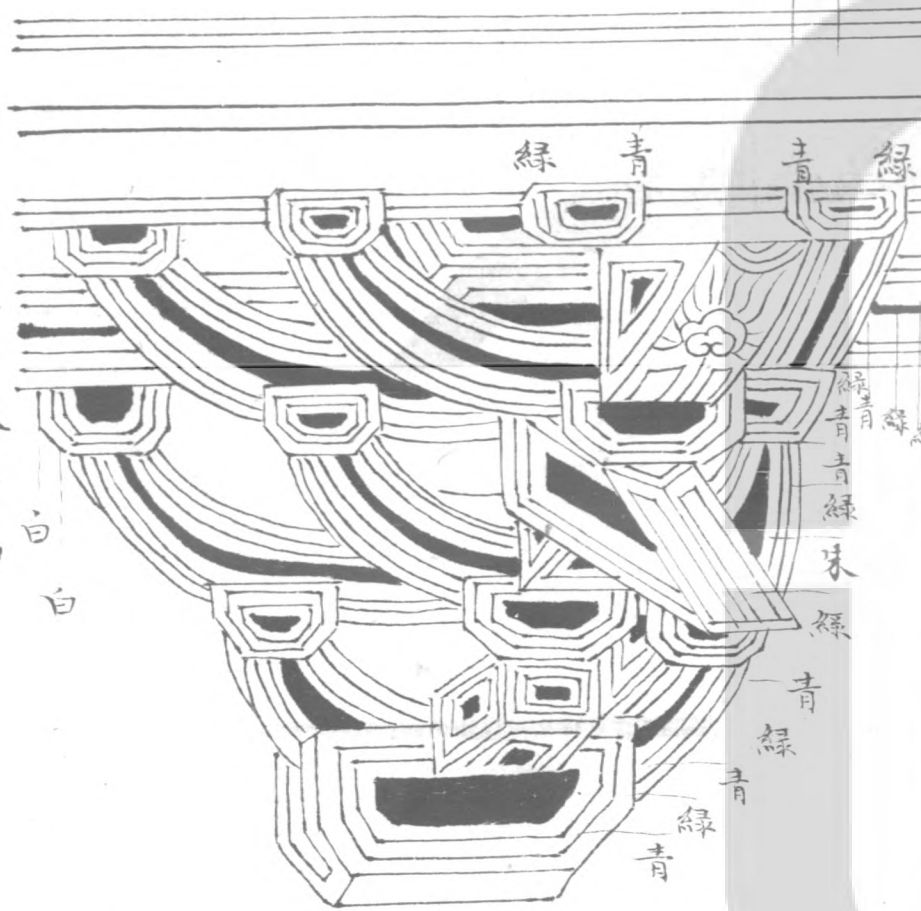

卷三十四

白 白

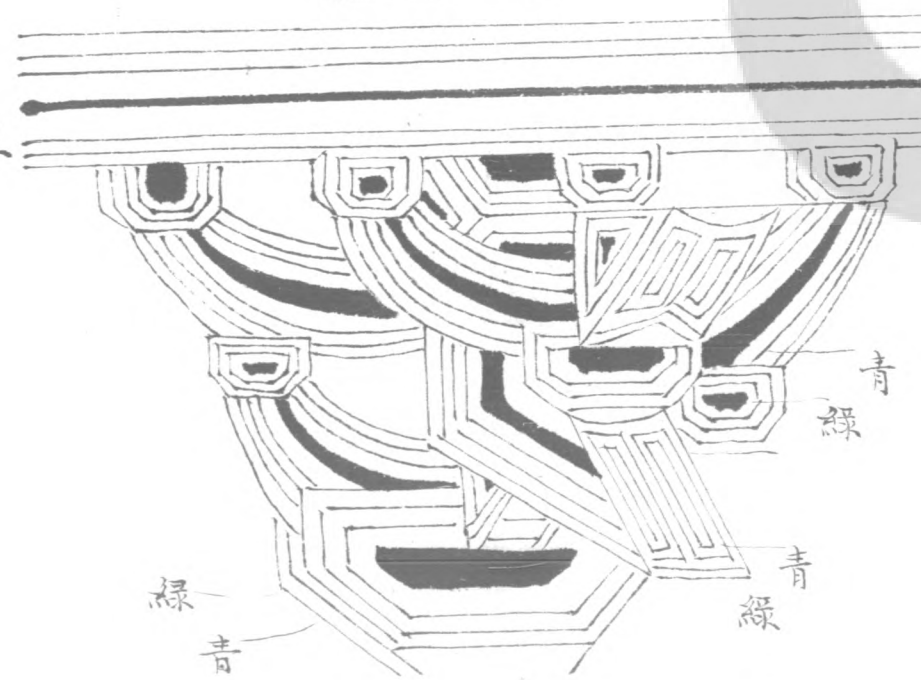

十一

綠 青

青 綠

梁椽飛子

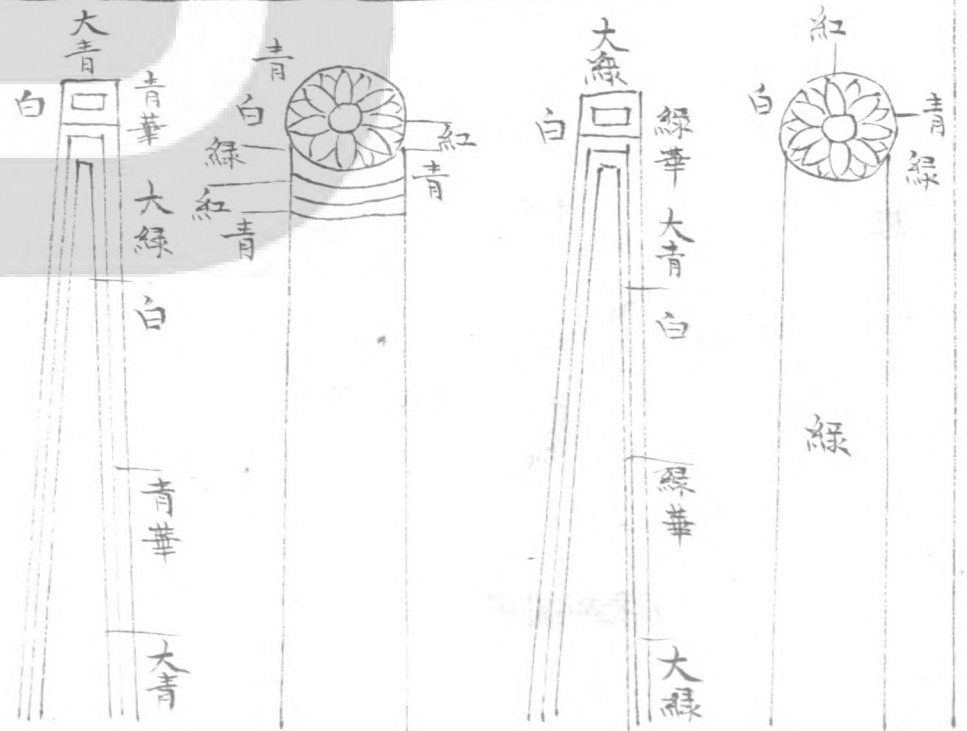
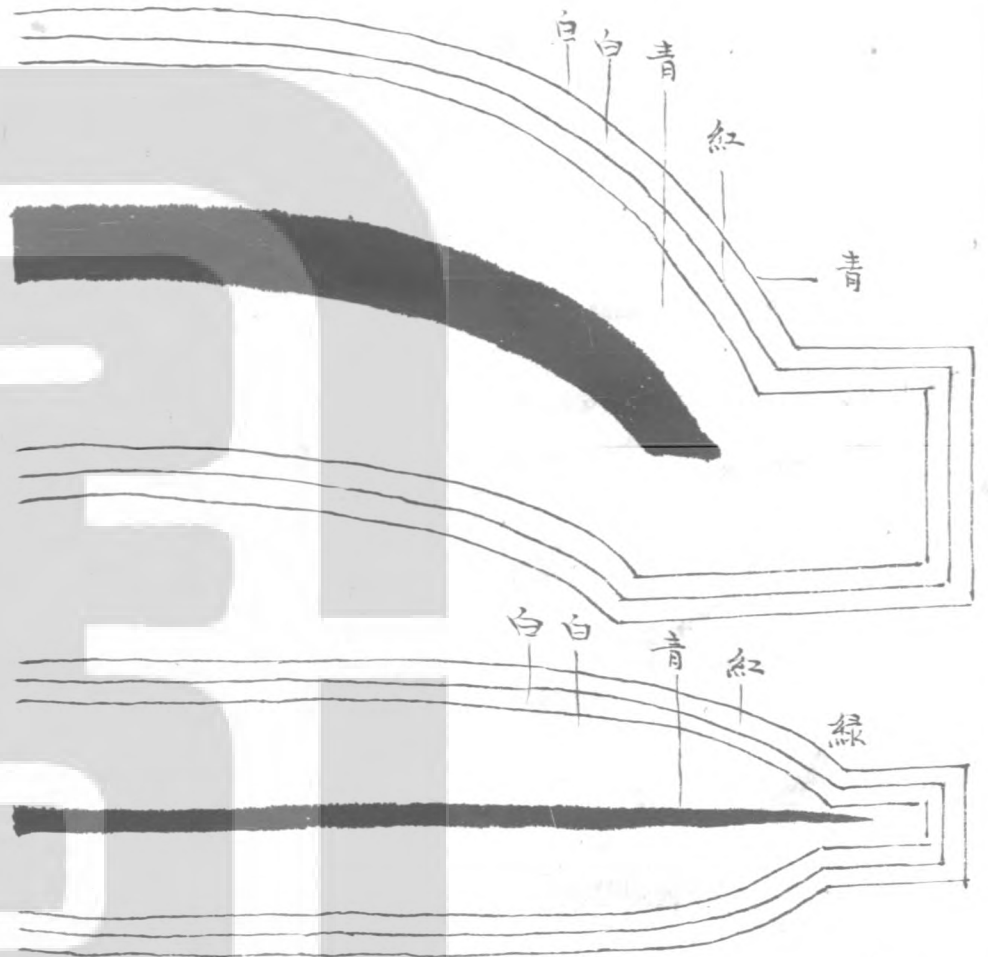

兩暈椽間內畫松文裝名件第十五

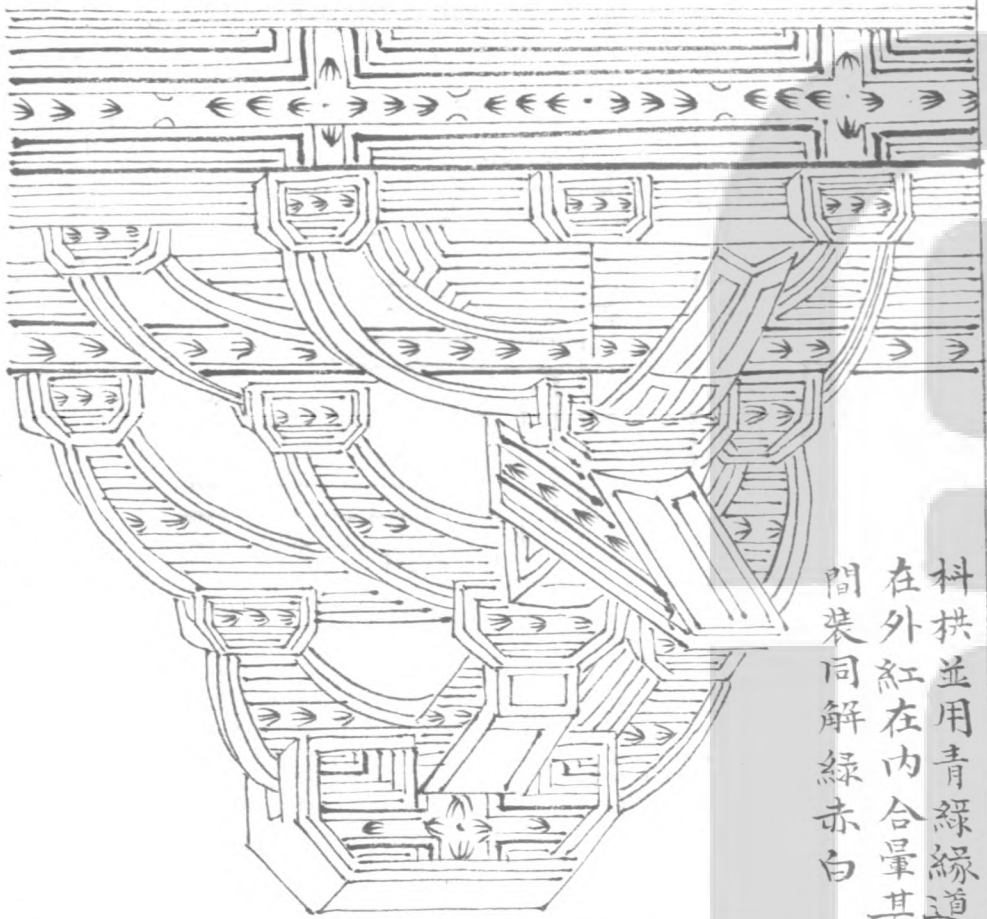

料拱並用青綠緣道  
在外紅在內合暈其  
間裝同解綠赤白

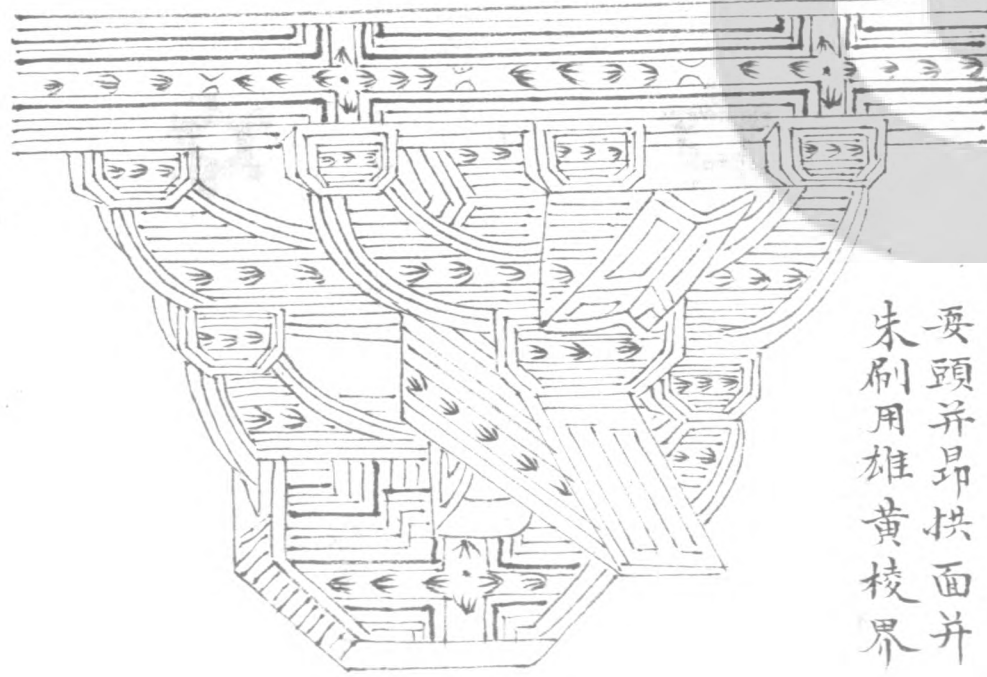

要頭并昂拱面并  
朱刷用雄黃椽界



梁椽飛子

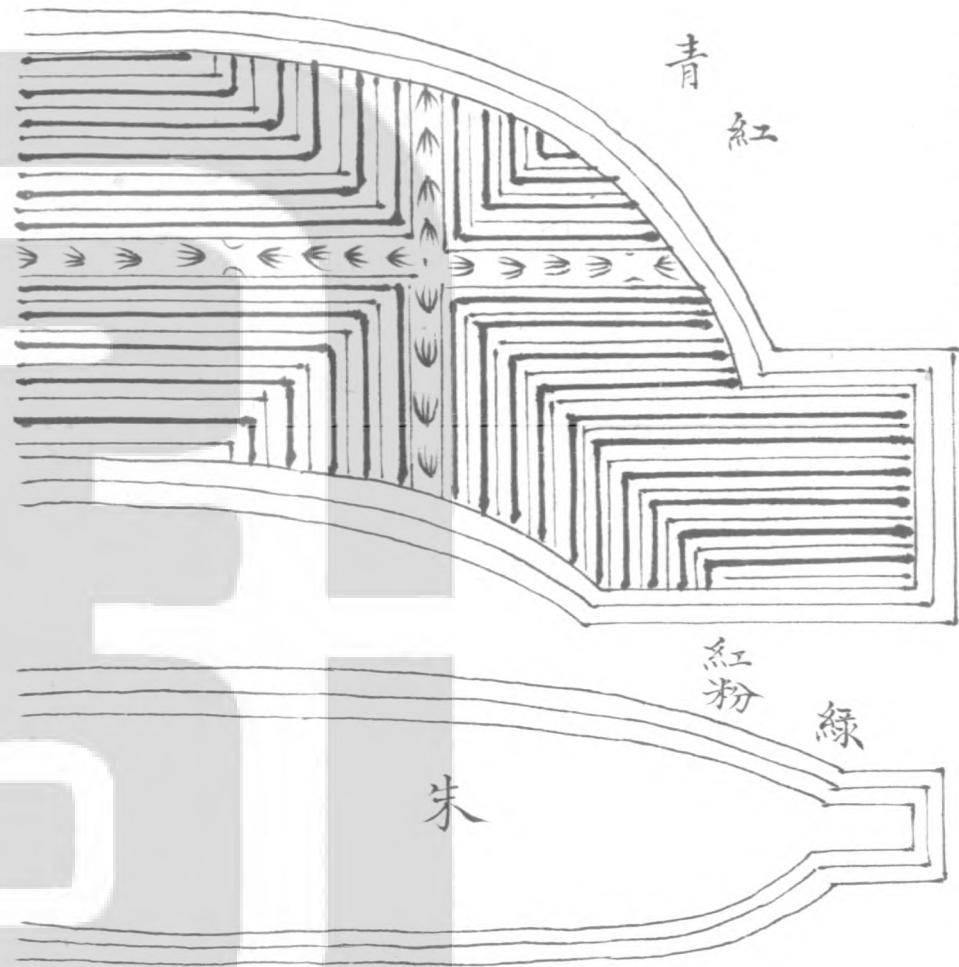

朱

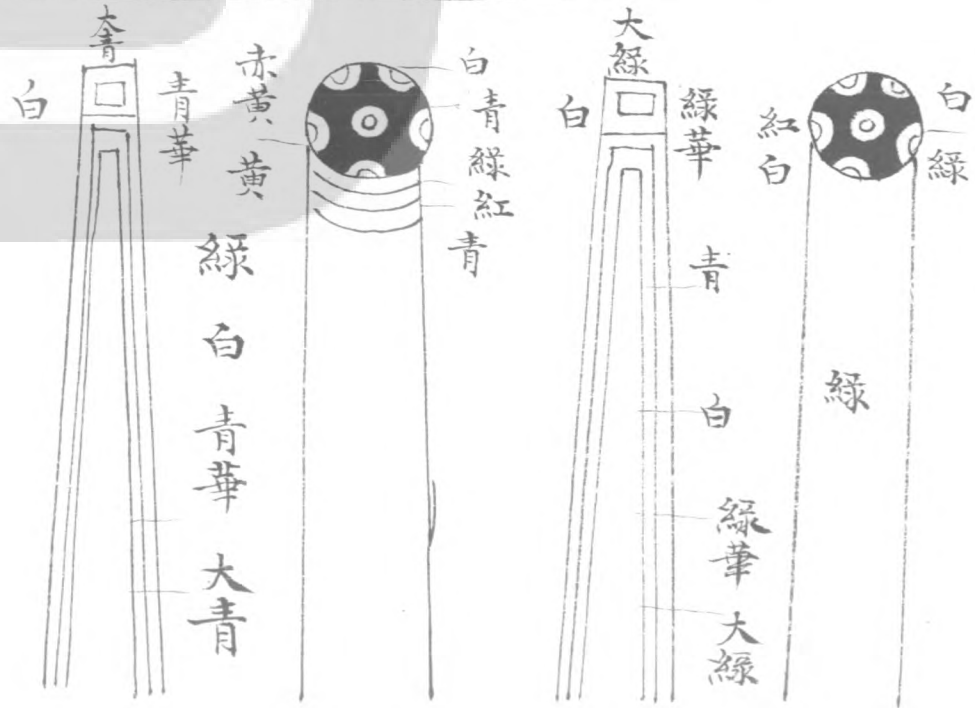

解線結華裝名件第十六裝解附綠

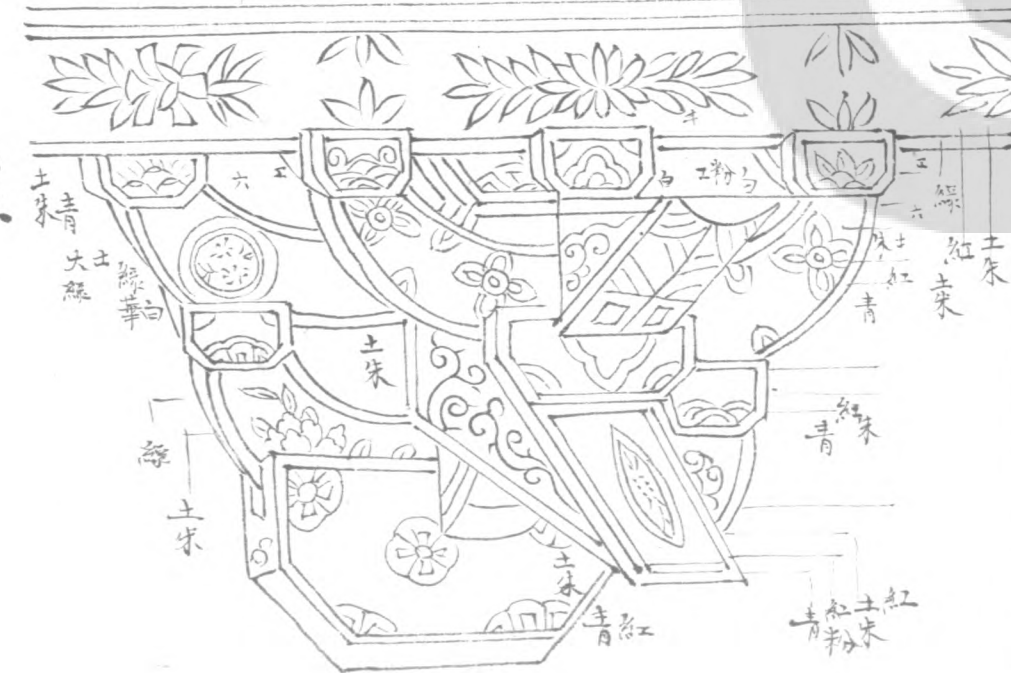
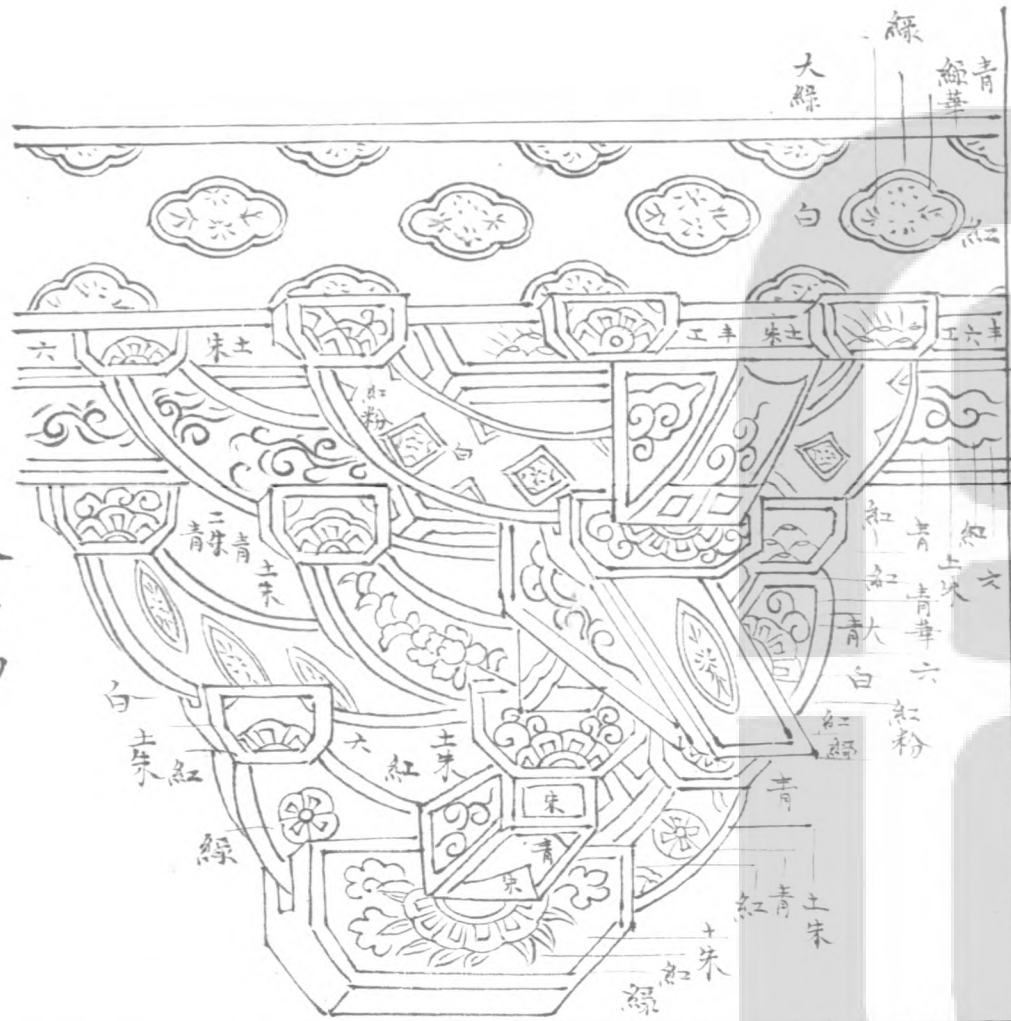

梁椽飛子

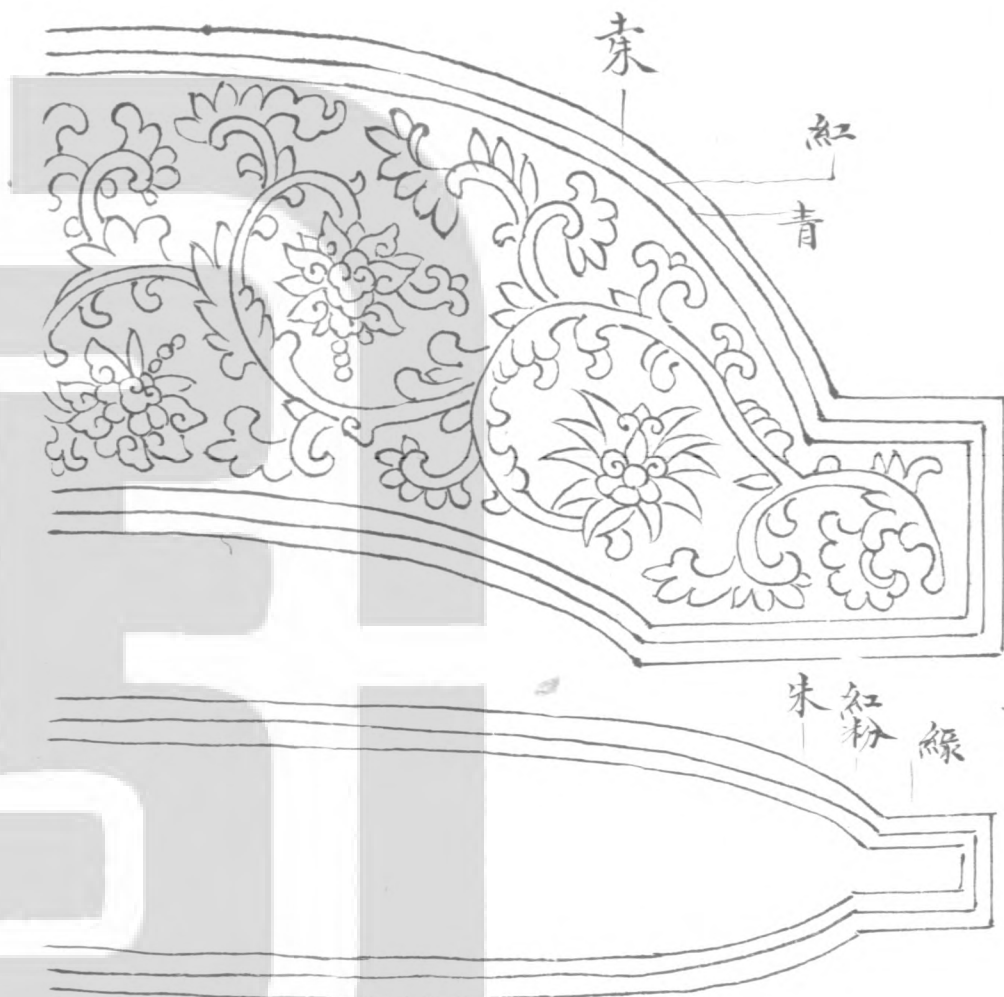

朱 紅 粉 綠

解綠裝名件

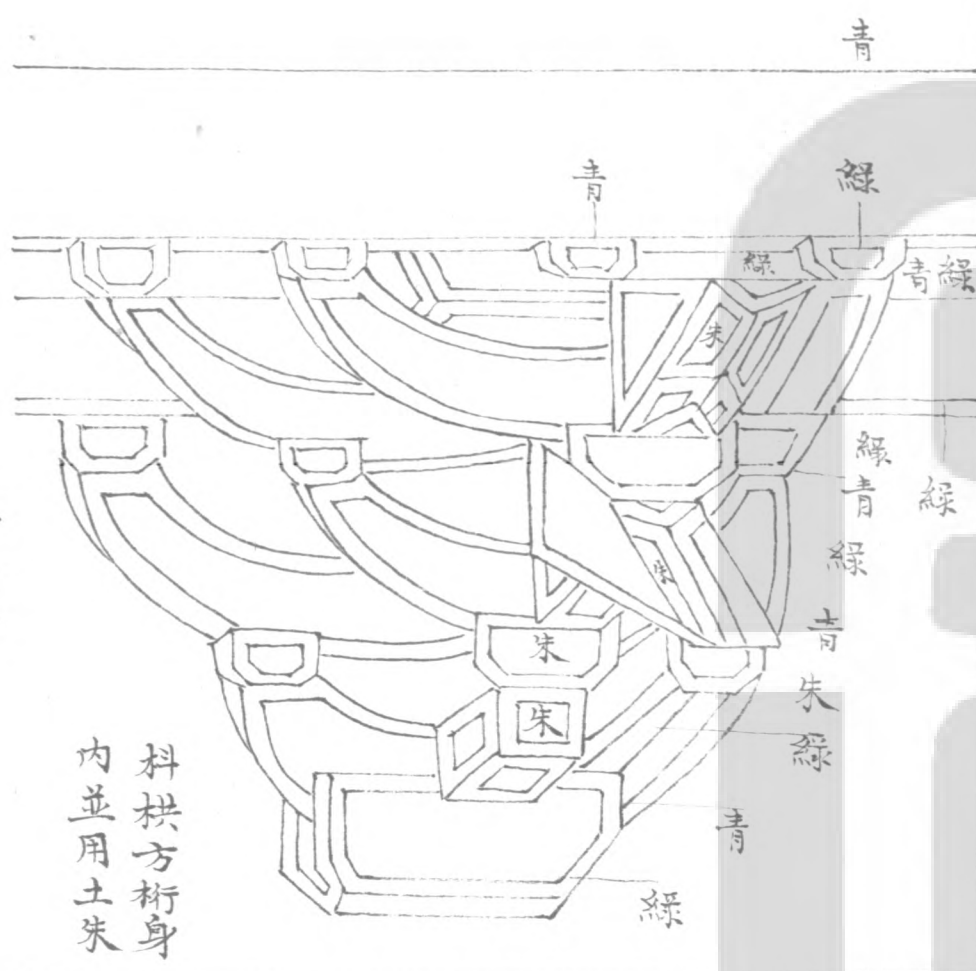

料拱方榫身  
內並用土朱

凡青綠並大青在外青華在中粉線在內  
凡綠綠並大綠在外綠華在中粉線在內

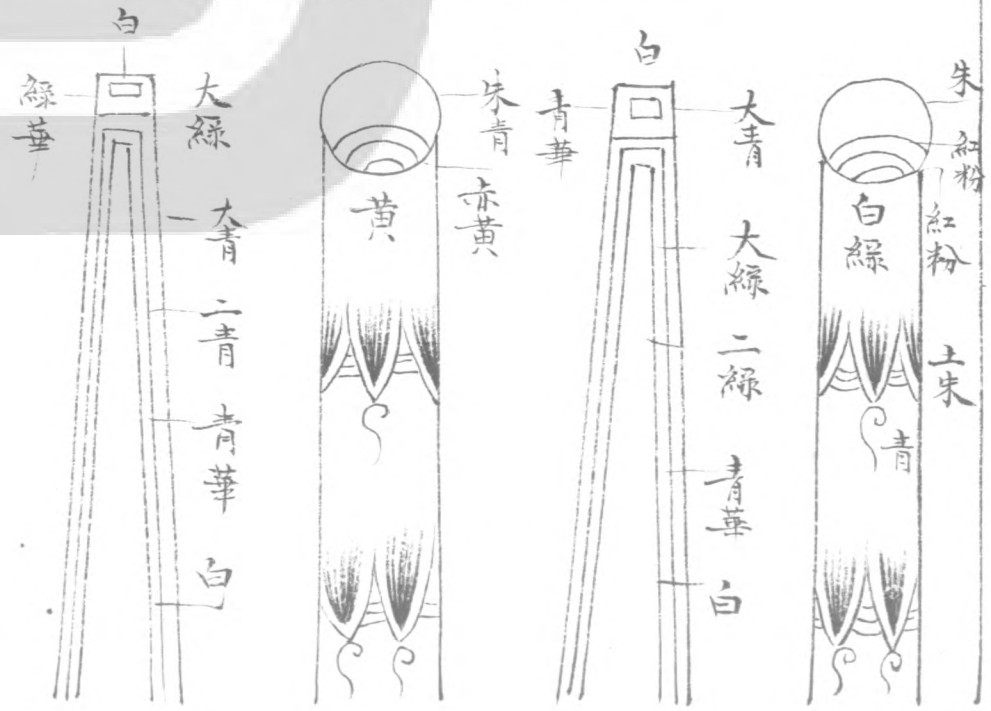
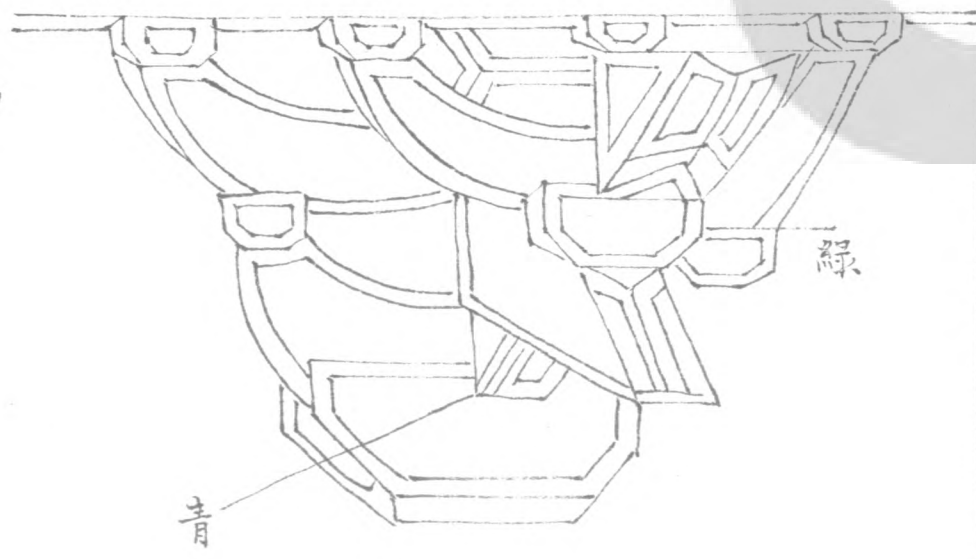

梁椽飛子

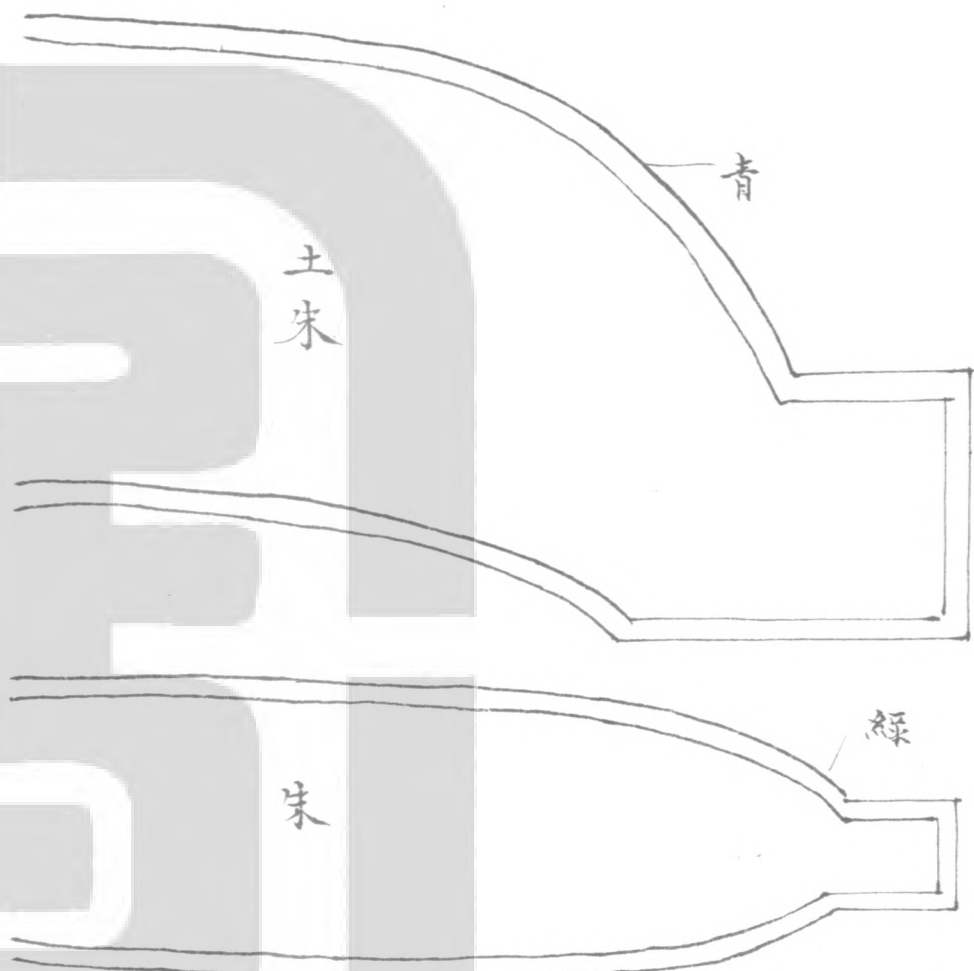

青

土朱

朱

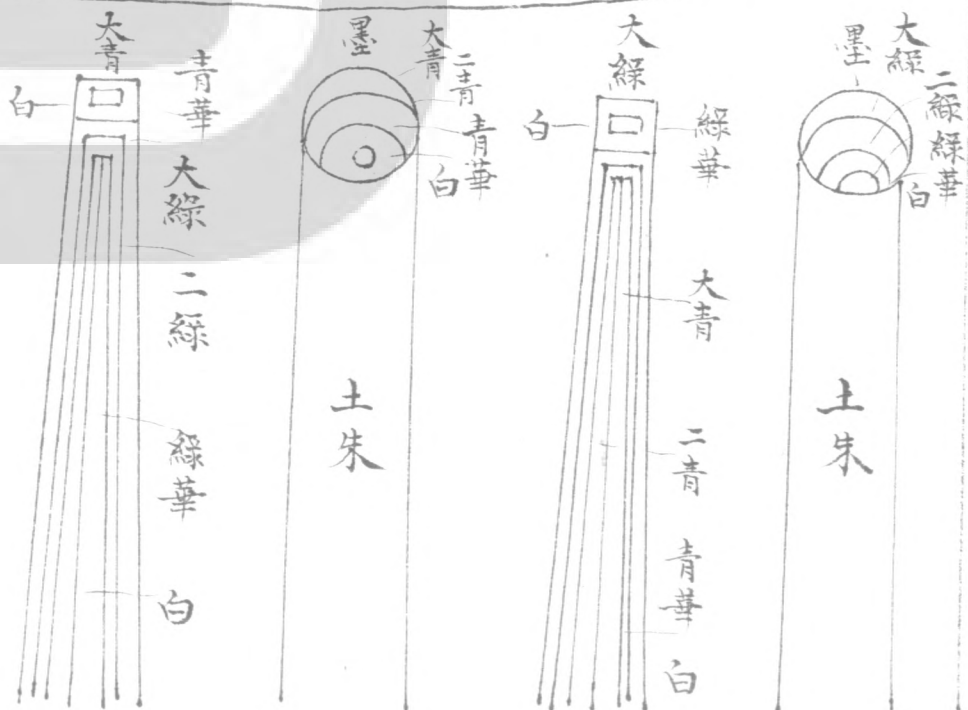

大青  
青華  
大綠  
二綠  
綠華  
白

大青  
二青  
青華  
白

大綠  
二綠  
綠華  
大青  
二青  
青華  
白

土朱

土朱

刷飾制度圖樣

丹粉刷飾名件第一

料拱方桁綠道並用  
白身內地並用土朱

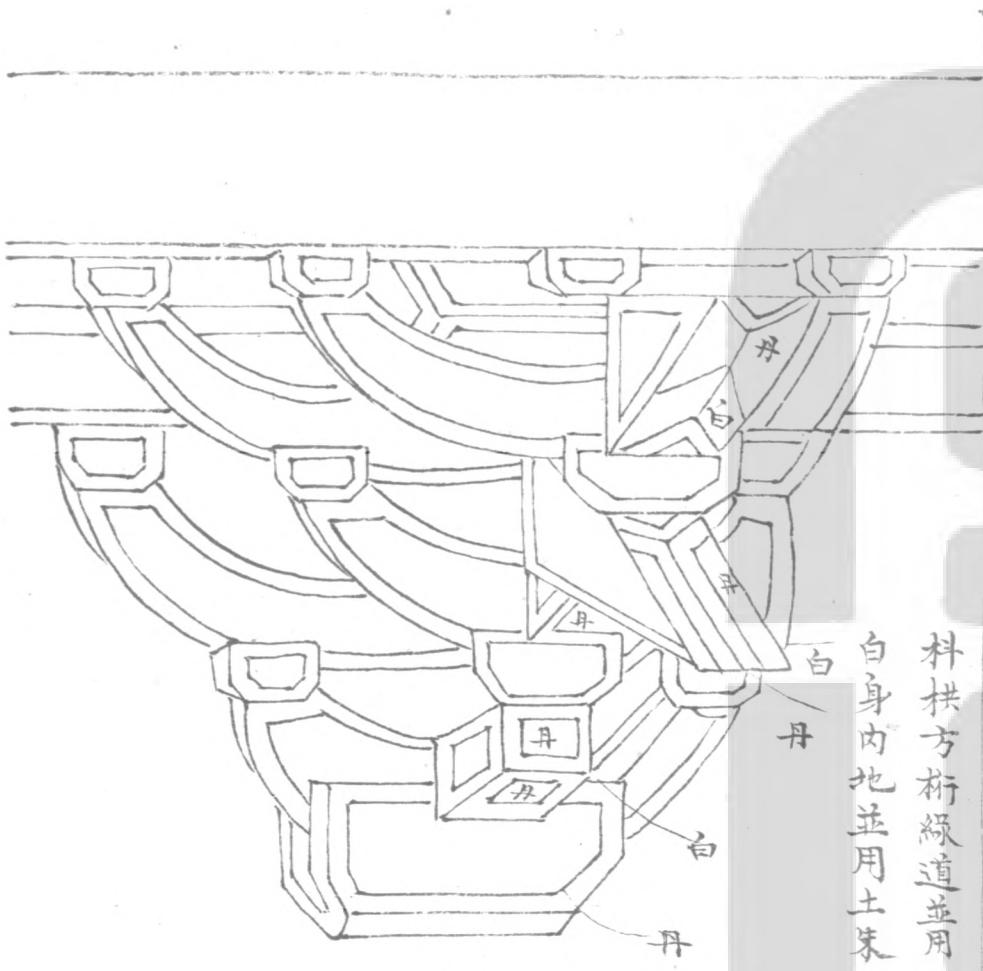

丹  
白  
丹  
白  
丹  
白

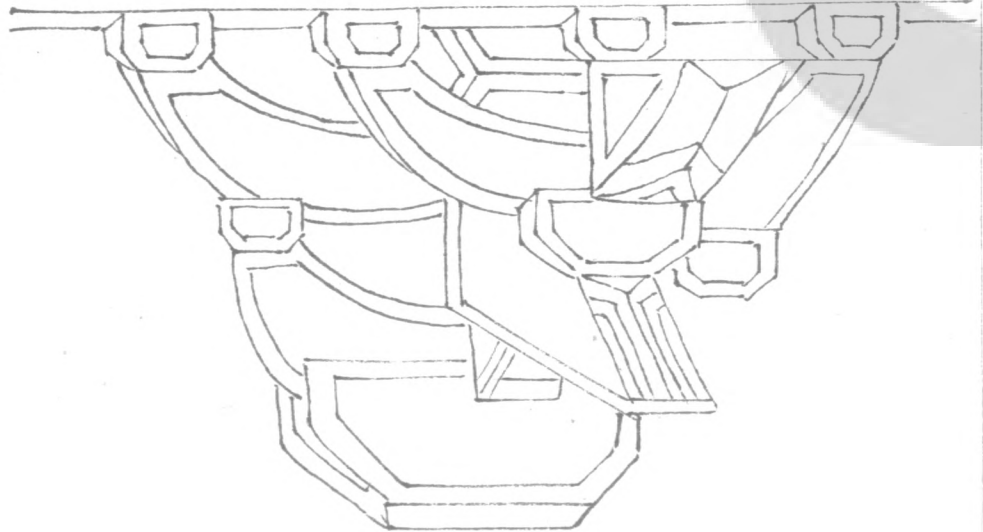

梁椽飛子

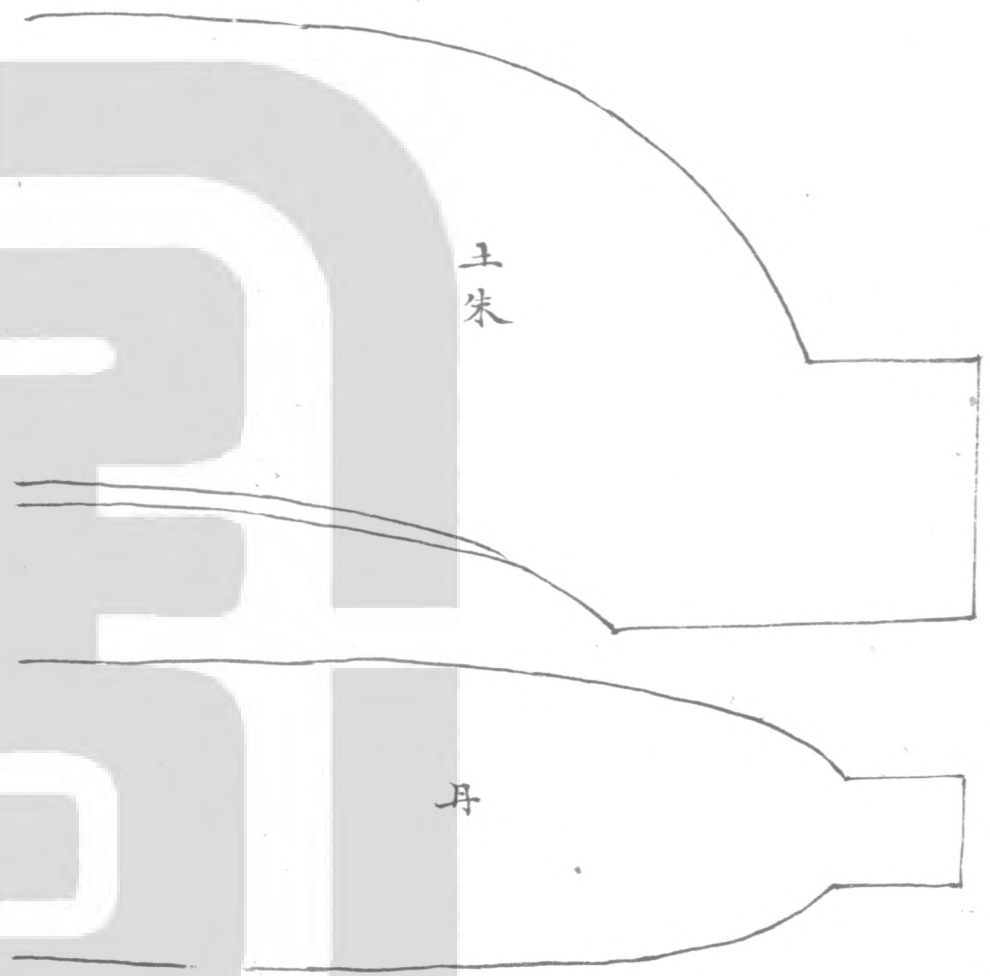

土朱

丹

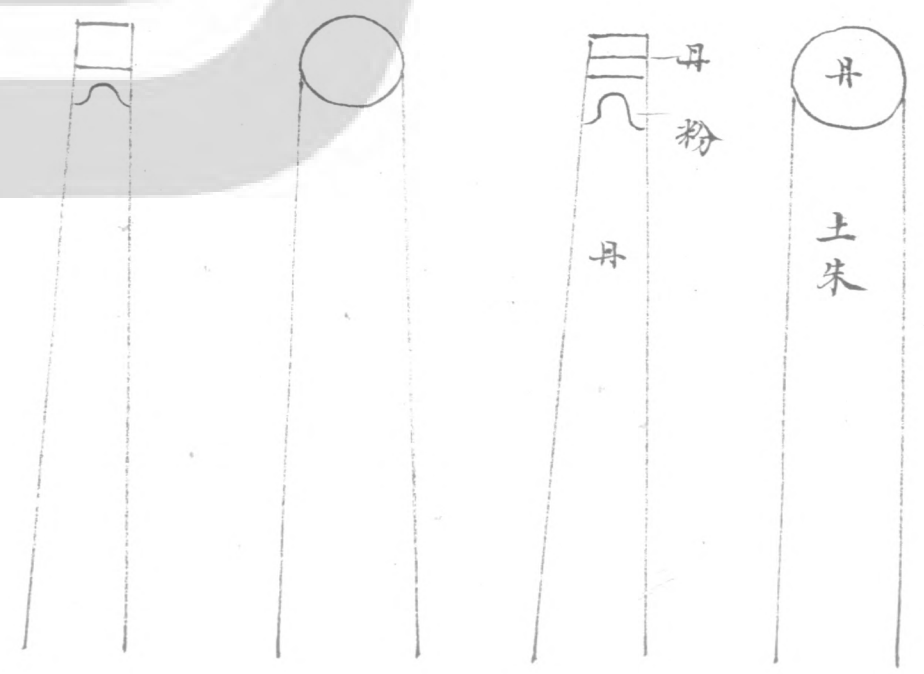

丹粉

丹

土朱

黄土刷飾名件第二

料拱方術緣道並用  
白身內地並用黃土

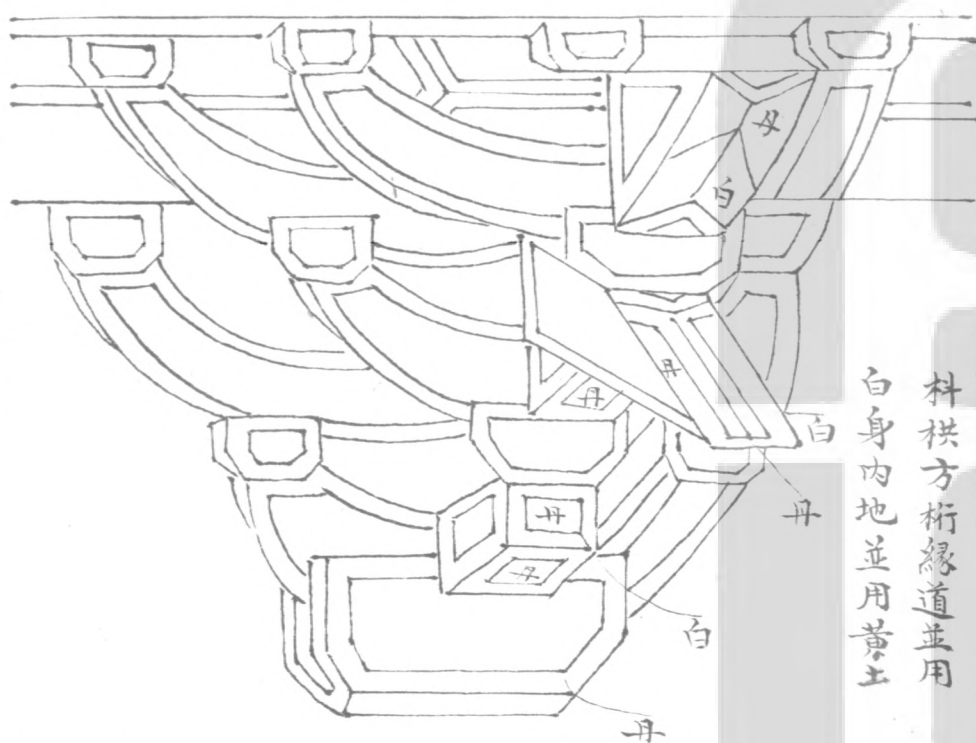

丹

白

丹

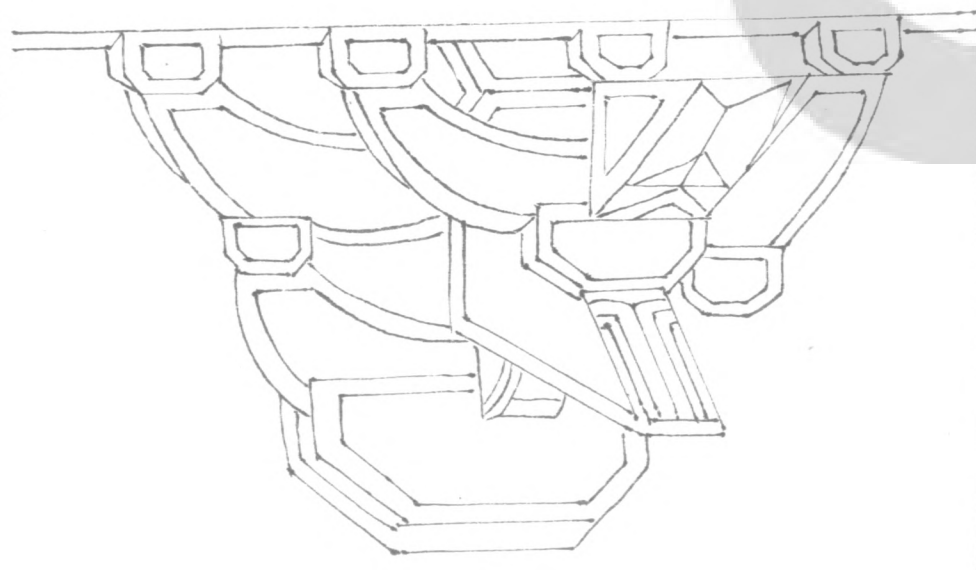

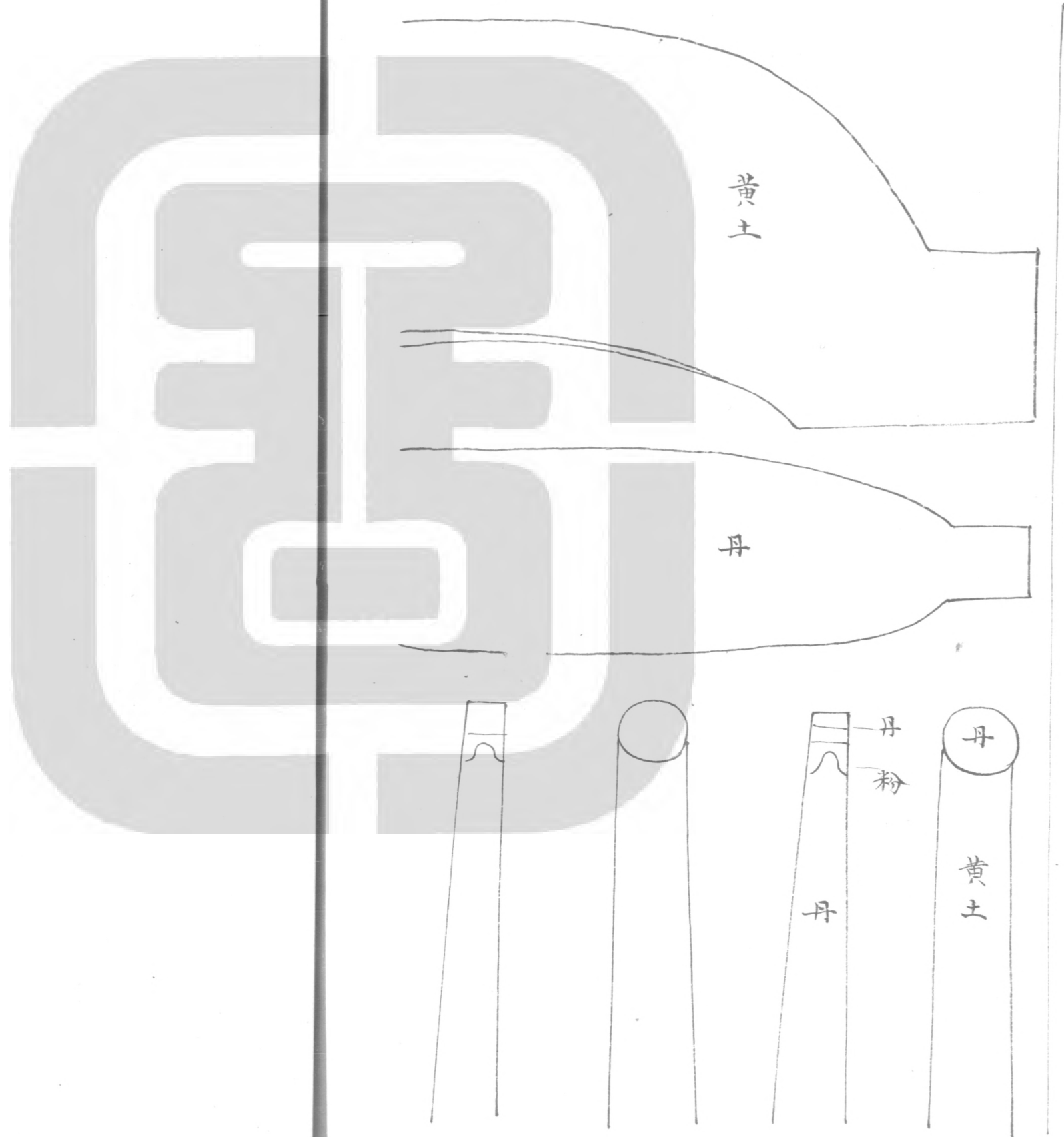

營造法式第三十四



