

I. *An Extract from the Minutes of the Royal Society, March 16, 1731, containing an uncommon Case of a Distempered Skin, by John Machin, Sec. R. S. & Prof. Astr. Gresh.*

A Country Labourer, living not far from *Euston-Hall* in *Suffolk*, shewed a Boy (his Son) about Fourteen Years of Age, having a cuticular Distemper, of a different Kind from any hitherto mentioned in the Histories of Diseases.

His Skin (if it might be so called) seemed rather like a dusky coloured thick Case, exactly fitting every Part of his Body, made of a rugged Bark, or Hide, with Bristles in some Places, which Case covering the whole excepting the Face, the Palms of the Hands, and the Soles of the Feet, caused an Appearance as if those Parts alone were naked, and the rest clothed. It did not bleed when cut or scarified, being callous and insensible. It was said he sheds it once every Year, about Autumn, at which Time it usually grows to the Thickness of three Quarters of an Inch, and then is thrust off by the new Skin which is coming up underneath.

It was not easy to think of any Sort of Skin, or natural Integument, that exactly resembled it. Some compared it to the Bark of a Tree; others thought it looked like Seal-Skin; others like the Hide of the Elephant, or the Skin about the Legs of the Rhinoceros; and some took it to be like a great Wart, or Number of Warts uniting and overspreading the whole Body. The bristly Parts, which were chiefly about the Belly and Flanks, looked and rustled like the Bristles, or

R r

Quills,

Quills, of an Hedge-Hog, shorn off within an Inch of the Skin.

His Face was well featured, and of a good Complexion, if not rather too ruddy; and the Palms of his Hands were not harder, or in worse Condition than is usual for Workmen or Labourers. His Size was proper for his Age; his Body and Limbs straight, and, excepting as to this Deformity, well shapen.

This rugged Covering gave him no Pain or Uneasiness, unless that sometimes after hard Work, it was apt to start and cleave, and cause a Bleeding. And notwithstanding the unusual Disposition of his Humours to form so strange an Integument, his natural Excretions were said to be in the ordinary Course and Manner, without any thing remarkable attending them.

The Father knew of no Accident to account for this distempered Habit; but said that his Skin was clear at his Birth as in other Children, and so continued for about seven or eight Weeks; after which, without his being sick, it began to turn yellow, as if he had had the Jaundice; from which by degrees it changed black, and in a little time afterwards thickned, and grew into that State it appeared in at present. That he has been in Health from his Birth, and hath no Sickness at the Season when he sheds it. He further said, that his Mother had received no Fright, to his Knowledge, whilst she was with Child; and hath born him many other Children, none of which have ever had this, or any other unusual Distemper or Deformity.

TAB. I. Fig. 1. *Represents the Back of the Boy's Hand.*

Fig. 2. *Represents a Portion of this extraordinary Epi-*

Epidermis, *which was probably a Prolongation of the Nervous Papillæ grown to about the Size of common Twine Packthread; and these standing as close together as the Bristles in a Brush, seemed, like them, to be all shorn off even, and of the same Length, viz. about half an Inch above the Skin.*

Fig. 3. *Shews some of these Bristles, or Stumps, magnified; where it is visible that some of them are flat at Top, others concave; some pointed like a Cone, and others very irregular.*

II. *Conjectures upon the Nature of Intermittent and Reciprocating Springs.* By Mr. Joseph Atwell, F. R. S.

BEFORE I offer the following Thoughts to the Consideration of the *Society*, I beg leave to premise something upon the Nature of Philosophical Conjectures in general, and the Sense in which I would be understood to propose these in particular.

A just and satisfactory Account of any one Phænomenon in Nature, cannot be expected without a true and perfect History of the Fact. This is seldom to be met with: Those who live nearest the Place of any natural Curiosity, and have the best Opportunity of making proper Observations upon it, seldom regard what Time and Use have rendered familiar. On the other hand, Strangers and Travellers, inclined to make a better Enquiry into Things of this Kind, are too often, if not always, in want of Time,

TAB. I.

Philos

Fig. 3.

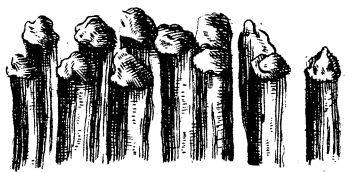

Fig. 1.

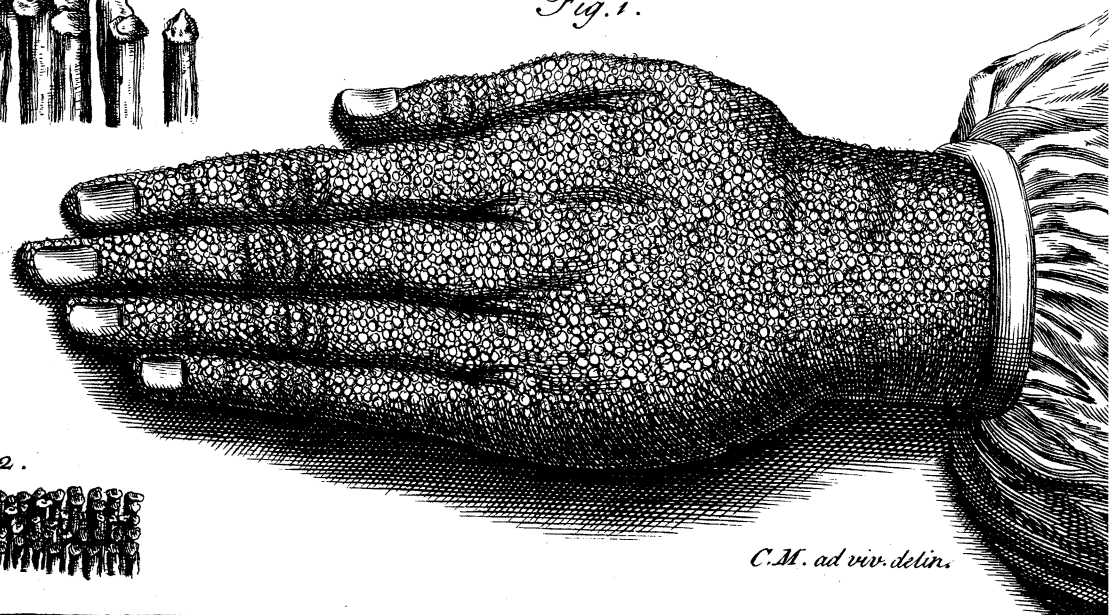

Fig. 2.



C.M. ad viv. delin.

TAB. II.

Fig. 1.

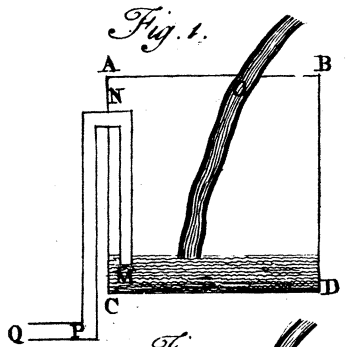

Fig. 2.

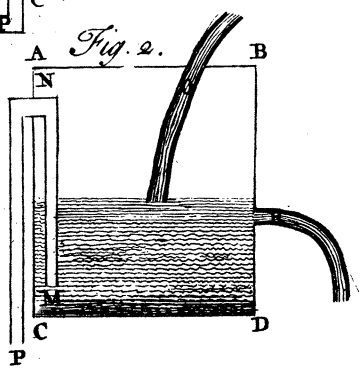

Fig. 3.

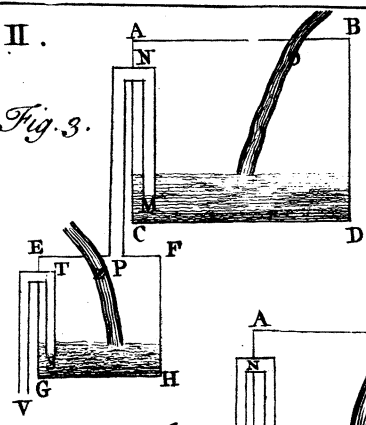

Fig. 4.

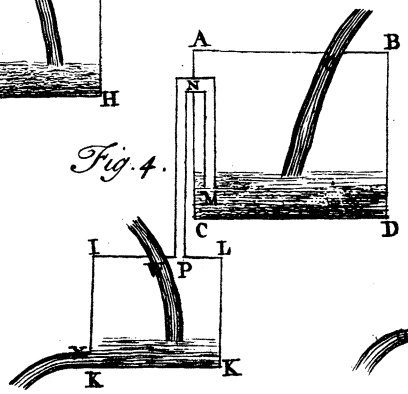
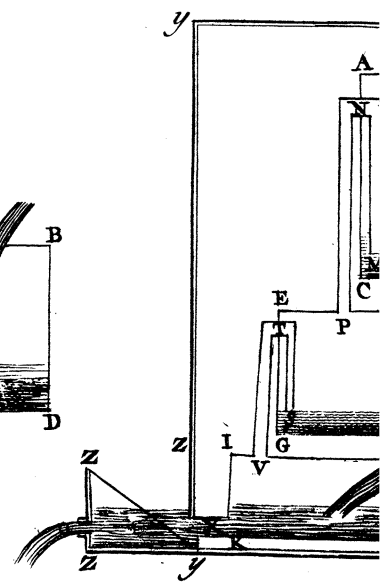
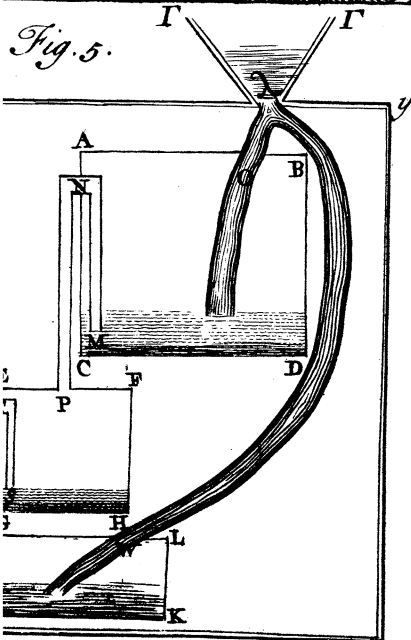
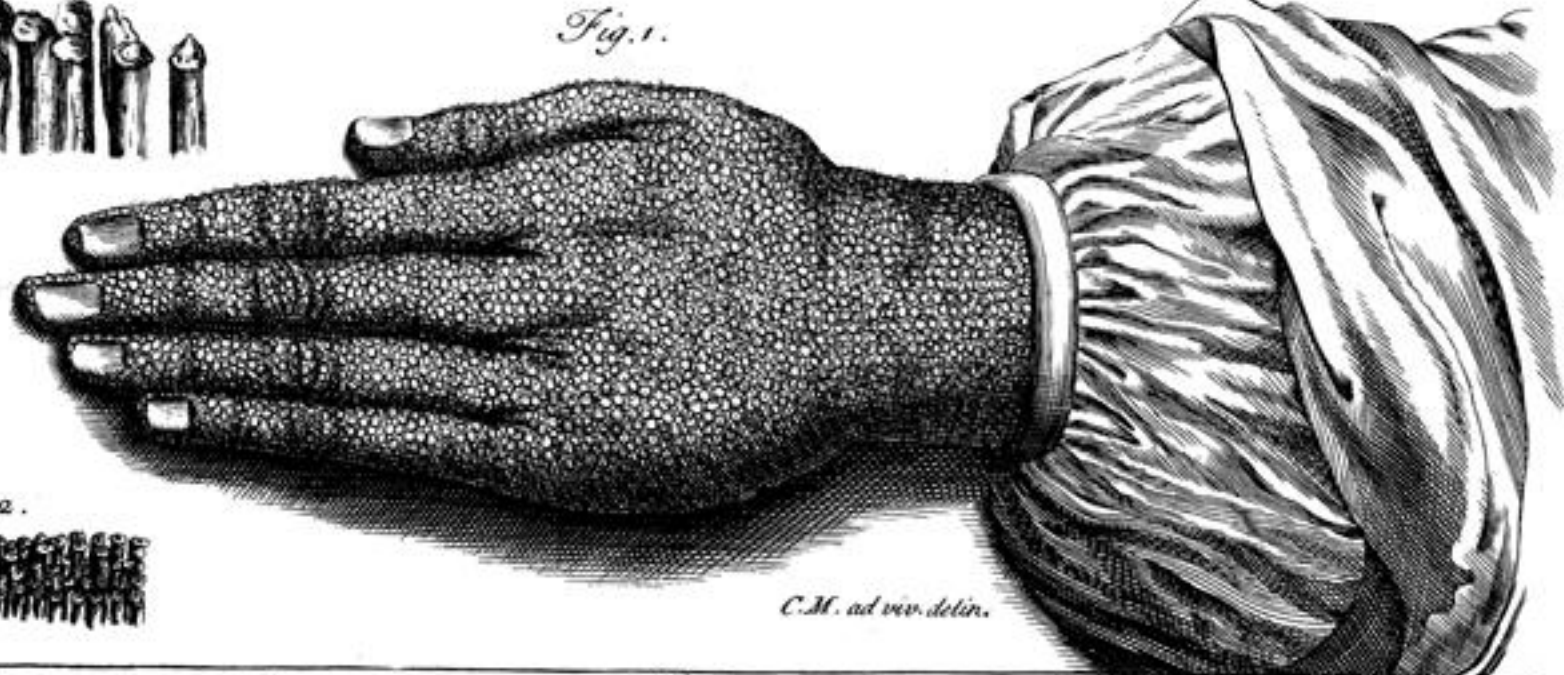

Fig. 5.





J. Mynde sc. J



C.M. ad viv. delin.



TAB. II.

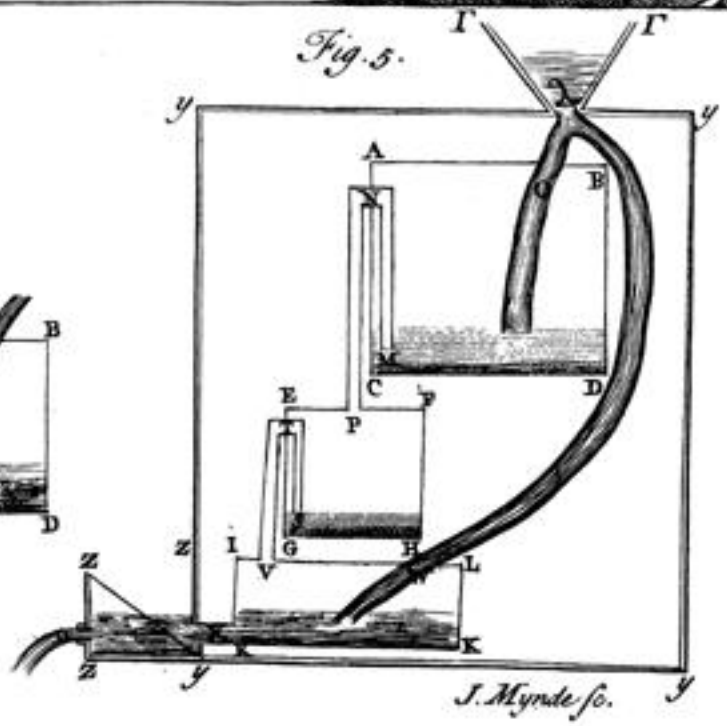
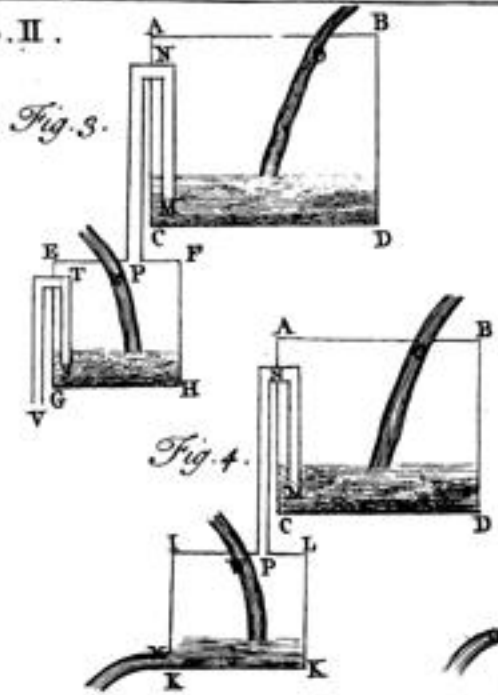
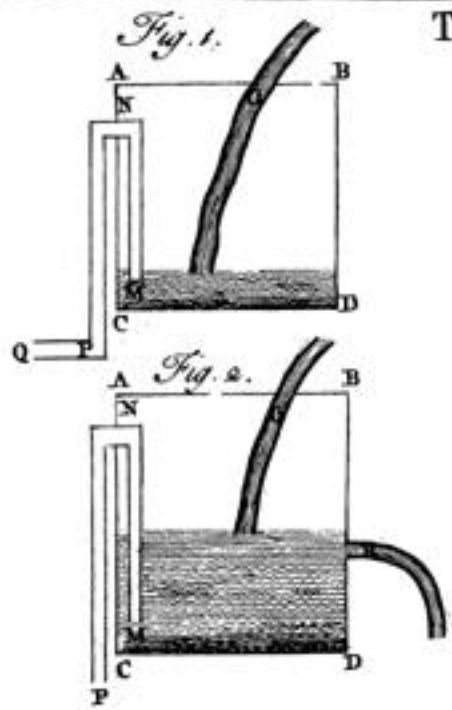

J. Mynde sc.