

TE
662
.A3
no.
FHWA-
RD-
79-45
c.3

Report No. FHWA-RD-79-45

A PEDESTRIAN PLANNING PROCEDURES MANUAL

Vol. I. Overview
November 1978
Final Report

DEPARTMENT OF
TRANSPORTATION
SEP 22 1987



Document is available to the public through
the National Technical Information Service,
Springfield, Virginia 22161



Prepared for
FEDERAL HIGHWAY ADMINISTRATION
Offices of Research & Development
Environmental Design & Control Division
Washington, D.C. 20590

FOREWORD

This manual identifies the significant data, procedures and criteria that should be considered in the planning, selection and evaluation of both comprehensive pedestrian systems and individual facilities.

Research in pedestrian safety is included in the Federally Coordinated Program of Highway Research and Development as Task 1 of Project 1E, "Safety of Pedestrians and Abutting Property Occupants." Mr. John C. Fegan is the Project Manager from the Office of Research and Mr. Richard Richter is the Implementation Manager from the Office of Development.

Sufficient copies of Volume I are being distributed to provide a minimum of three copies to each regional office, five copies to each division office and ten copies for each State highway agency. Two copies each of Volume II and Volume III are being sent to the regional and division offices and five copies of each to the State highway agency. Direct distribution is being made to the division offices.

Charles F. Scheffey
Director, Office of Research
Federal Highway Administration

NOTICE

This document is disseminated under the sponsorship of the Department of Transportation in the interest of information exchange. The United States Government assumes no liability for its contents or use thereof. The contents of this report reflect the views of the contractor, who is responsible for the accuracy of the data presented herein. The contents do not necessarily reflect the official views or policy of the Department of Transportation. This report does not constitute a standard, specification, or regulation.

The United States Government does not endorse products or manufacturers. Trade or manufacturers' names appear herein only because they are considered essential to the object of this document.

662
 .A3
 10.
 FHWA-
 RD-
 79-45
 C-3

DEPARTMENT OF
 TRANSPORTATION
 SEP 22 1987

1. Report No. <p style="text-align: center;">FHWA-RD-79-45</p>	2. Government Accession No. <p style="text-align: center;">DTIC</p>	3. Recipient's Catalog No.										
4. Title and Subtitle <p style="text-align: center;">A Pedestrian Planning Procedures Manual Vol. I. Overview</p>		5. Report Date <p style="text-align: center;">November 1978</p>	6. Performing Organization Code									
		8. Performing Organization Report No.										
7. Author(s) <p style="text-align: center;">L.S. Kagan, W.G. Scott, U.P. Avin</p>		10. Work Unit No. (TRAIS) <p style="text-align: center;">FCP 31E042</p>										
9. Performing Organization Name and Address RTKL Associates Inc. Kilkeary, Scott and The Village Square Associates, Inc. Village of Cross Keys 509 Powell Drive Baltimore, Md. 21210 Annapolis, Md. 21401		11. Contract or Grant No. <p style="text-align: center;">DOT-FH-11-8816</p>										
		13. Type of Report and Period Covered <p style="text-align: center;">Final Report June 1975-November 1978</p>										
12. Sponsoring Agency Name and Address Office of Research Federal Highway Administration Department of Transportation Washington, D. C. 20590		14. Sponsoring Agency Code										
15. Supplementary Notes <p style="text-align: center;">FHWA Contract Manager: John C. Fegan, HRS-41</p>												
16. Abstract <p>The Manual identifies the significant data, procedures and criteria that should be considered in the <u>planning</u> and <u>evaluation</u> of both comprehensive pedestrian systems and individual facilities.</p> <p>This volume provides a general background and introduction to pedestrian planning and to the technical procedures of Volume II. The major topic areas covered in this volume include:</p> <ol style="list-style-type: none">1. The Pedestrian Planning Context2. The need for a Pedestrian Planning Process3. Overview of the Pedestrian Planning Process4. Application of the Pedestrian Planning Process. <p>Other volumes in this series are:</p> <table style="margin-left: auto; margin-right: auto; border: none;"> <thead> <tr> <th style="text-align: left;"><u>Vol. No.</u></th> <th style="text-align: left;"><u>Report No.</u></th> <th style="text-align: left;"><u>Short Title</u></th> </tr> </thead> <tbody> <tr> <td>II</td> <td>79-46</td> <td>Procedures</td> </tr> <tr> <td>III</td> <td>79-47</td> <td>Technical Supplement</td> </tr> </tbody> </table>				<u>Vol. No.</u>	<u>Report No.</u>	<u>Short Title</u>	II	79-46	Procedures	III	79-47	Technical Supplement
<u>Vol. No.</u>	<u>Report No.</u>	<u>Short Title</u>										
II	79-46	Procedures										
III	79-47	Technical Supplement										
17. Key Words <p style="text-align: center;">Pedestrian Planning Accommodations Safety</p>		18. Distribution Statement <p>No restrictions. This document is available to the public through the National Technical Information Service, Springfield, Virginia 22161</p>										
19. Security Classif. (of this report) <p style="text-align: center;">Unclassified</p>	20. Security Classif. (of this page) <p style="text-align: center;">Unclassified</p>	21. No. of Pages <p style="text-align: center;">117</p>	22. Price									

PREFACE

The Pedestrian Planning Process is presented in three separate volumes.

VOLUME ONE

Volume One, the Overview, provides a general background and introduction to pedestrian planning and to the technical procedures of Volume Two. The major topic areas covered in this volume include:

The pedestrian planning context

- background
- the need for pedestrianization
- objectives of pedestrian planning
- relationship to land use/transportation planning

The need for a pedestrian planning process

- state of the art
- rationale for the process (utilization, benefits and impacts, pathway choice)

Overview of the Pedestrian Planning Process (PPP)

- major PPP phases (the demand modelling phase, the design and evaluation phase)
- description of the PPP tasks (brief overview of each task)

Application of the Pedestrian Planning Process

- objectives of the process
- using the procedures
- determining procedure(s) applicability

VOLUME TWO

Volume Two, the Procedures, is operational and sequential in nature. Each procedure within the Manual sets forth all the fundamental requirements for successfully conducting that specific aspect of pedestrian facilities planning, design and evaluation in terms of:

- Approach
- Data provided or required
- Specific methods of analysis or evaluation to be used
- Use and interpretation of output to aid in the decision-making process
- Relationship of specific procedures to the overall PPP

VOLUME THREE

Volume Three, the Technical Supplements, explains the derivation of the data provided in Volume Two and presents considerably more detailed data and methodologies for various tasks as well as worked examples. This material is supplemental to the Procedures Volume and is to be used in conjunction with it. This volume also provides the user with a fundamental understanding of the research underlying the development of the Process, allows him to examine its assumptions, and modify data to suit his specific conditions.

METRIC CONVERSION FACTORS

Approximate Conversions to Metric Measures

Symbol	When You Know	Multiply by	To Find	Symbol
LENGTH				
in	inches	2.5	centimeters	cm
ft	feet	30	centimeters	cm
yd	yards	0.9	meters	m
mi	miles	1.6	kilometers	km
AREA				
in ²	square inches	6.5	square centimeters	cm ²
ft ²	square feet	0.09	square meters	m ²
yd ²	square yards	0.8	square meters	m ²
mi ²	square miles	2.6	square kilometers	km ²
	acres	0.4	hectares	ha
MASS (weight)				
oz	ounces	28	grams	g
lb	pounds	0.45	kilograms	kg
	short tons (2000 lb)	0.9	tonnes	t
VOLUME				
tsp	teaspoons	5	milliliters	ml
Tbsp	tablespoons	15	milliliters	ml
fl oz	fluid ounces	30	milliliters	ml
c	cups	0.24	liters	l
pt	pints	0.47	liters	l
qt	quarts	0.95	liters	l
gal	gallons	3.0	liters	l
ft ³	cubic feet	0.03	cubic meters	m ³
yd ³	cubic yards	0.76	cubic meters	m ³
TEMPERATURE (exact)				
°F	Fahrenheit temperature	5/9 (after subtracting 32)	Celsius temperature	°C

Approximate Conversions from Metric Measures

When You Know	Multiply by	To Find	Symbol	
LENGTH				
millimeters	0.04	inches	in	
centimeters	0.4	inches	in	
meters	3.3	feet	ft	
kilometers	1.1	yards	yd	
	0.6	miles	mi	
AREA				
square centimeters	0.16	square inches	in ²	
square meters	1.2	square yards	yd ²	
square kilometers	0.4	square miles	mi ²	
hectares (10,000 m ²)	2.5	acres		
MASS (weight)				
grams	0.035	ounces	oz	
kilograms	2.2	pounds	lb	
tonnes (1000 kg)	1.1	short tons		
VOLUME				
milliliters	0.03	fluid ounces	fl oz	
liters	2.1	pints	pt	
	1.06	quarts	qt	
liters	0.26	gallons	gal	
cubic meters	35	cubic feet	ft ³	
cubic meters	1.3	cubic yards	yd ³	
TEMPERATURE (exact)				
°C	Celsius temperature	9/5 (then add 32)	Fahrenheit temperature	°F

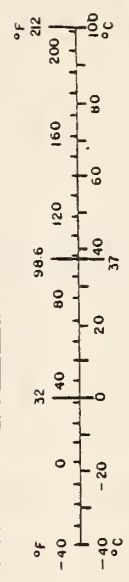
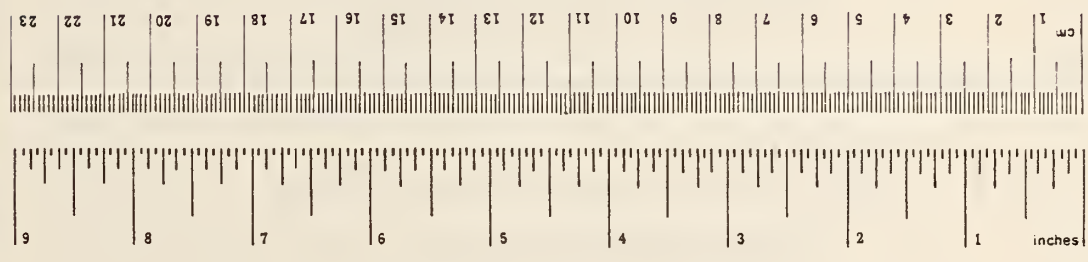

* 1 in = 2.54 (exact). For other exact conversions and more detailed tables, see NBS Misc. Publ. 236, Units of Weights and Measures, Price \$2.25. SD Catalog No. C13.10.286.

TABLE OF CONTENTS

	<u>Page</u>
I. The Pedestrian Planning Context	
A. Background	1
B. The Need For Pedestrianization	1
C. Pedestrian Planning	3
D. Relationship To Land Use/Transportation Planning	3
II. The Need For A Pedestrian Planning Process	
A. State Of The Art	9
B. Rationale For The Process	9
1. The Concept Of Utilization	10
2. System Benefits And Impacts	10
3. Utilization And Pathway Choice	12
III. Overview Of Pedestrian Planning Process (P.P.P.)	
A. Introduction	20
B. Major Pedestrian Planning Process Phases	22
1. The Demand Modelling Phase	26
2. The Design And Evaluation Phase	28
C. Summary and Description Of P.P.P. Tasks	32
IV. Application Of Pedestrian Planning Process	103
A. Introduction	103
B. Objectives Of The Process	103
C. Using The Procedures	103
D. Determining Procedure(s) Applicability	106

LIST OF FIGURES

Number	Title	Page
1	Modal Travel Time Comparison	4
2	Classification Of Pedestrian Facilities	5
3	Potential Benefits Of Implementing Pedestrian Facilities	7
4	Conceptual Model Of Pathway Utilization	13
5	Pathway Attributes Affecting Tripmaking Behavior	16
6	Relationship Between Pathway Impedance And Tripmaking	17
7	Tripmaking On Pathways With Different Impedances	18
8	Major Issues Addressed Within The PPP	21
9A	Simplified Flowchart Of The PPP Tasks	23
9B	Flowchart Of Task Interrelationships Within The PPP	24, 25
10	Intercentroid Separation And Friction Factors	29
11	Relationship Of Model Elements	31
12	Initial Site Analysis	33
13	Data Inputs To PPP Tasks 1-13	34
14	Data Inputs To PPP Tasks 13-27	35
15	Pototypical Pedestrian Survey	37
16	Pedestrian Survey Inputs To The PPP	44
17	Major Survey Probe Areas	45
18	Typical Temporal Pattern Of Pedestrian Volumes	47
19	Density Of Tripmaking	49
20	Average Land Use Generation Rates	51
21	Pedestrian Volume Counts On A Retail Street	52
22	Pedestrian Generation - Specialty Shops	52

LIST OF FIGURES (CONT'D)

<u>Number</u>	<u>Title</u>	<u>Page</u>
23	Pedestrian Volume Counts On Office Streets - 4 Cities	53
24	Pedestrian Generation - Office Buildings	53
25	Sample Mapping Of Pedestrian Generation In Study Area	55
26	Nominal And Effective Separation	58
27	Base Map With Overlay Of Generation Cells	59
28	Development Of Preliminary Network	60
29	Consolidated Network	61
30	Network Coded For Noon Office To Retail Exchange	62
31	Potential Corridor Utilization Map	65
32	Assessment Of Pedestrian Network Impacts On Planning Policy	68
33	Mapping Of Selected Pedestrian Network Requirements	72
34	Interface Of Multimodal Requirements	75
35	Evaluation Of Network Feasibility	76
36	Determination Of Initial Implementation Feasibility	78
37	The Development Of Alternative Movement Strategies	79
38	Network Facilities Plan	87
39	Relationship Between Program Elements And Design Treatments	88
40	Pedestrian Systems Interface Elements	90
41	Factor Influencing Design Treatments	92
42	Facilities Cost Approach	95
43	Alternative Approaches Provided To Facilities Cost Analysis	96
44	Possible Outcomes Of Level Of Effectiveness Assessment	97

LIST OF FIGURES (CONT'D)

<u>Number</u>	<u>Title</u>	<u>Page</u>
45	Design Plan Documentation - Widened Sidewalks	99
46	Design Plan Documentation - Plaza Treatment	100
47	Design Plan Documentation - Sections	101
48	Design Plan Documentation - Design Details	102
49	Limited - Context Application Of The PPP	105
50	Guidelines On The Application Of The PPP	108

LIST OF TABLES

Number	Title	Page
1	Elements Influencing Pedestrian Movement (And Pathway Utilization)	11
2	Important - Pathway Attributes	14
3	Evaluation Within The PPP	94

I. THE PEDESTRIAN PLANNING CONTEXT

A. BACKGROUND

Planning is a process that considers the total dynamic range of social, economic and physical forces acting upon and influencing the future growth and development of the environment.

By definition, planning involves the continuous study of the environment as it is affected and influenced by growth and shifts in population, changes in the economic structure, and modification of the function and distribution of activity systems. It is through the examination of activity systems that the factors responsible for generating change and influencing growth and development can be identified. Negative factors of growth and change are not in evitable. They can be altered by conscious and collective decision-making policies. Hence, a central issue in planning, given that growth and change will obviously occur, is to forecast and influence the form that will result.

Most cities are continually addressing the question of growth and change within the process of reshaping their downtown areas through reurbanization and redevelopment.

Typically, the central business district (CBD) or urban core of a city will be composed of functional districts -- each serving a specific purpose, as characterized by specific activities such as retailing, offices, parking, transit, housing and restaurants. The intense concentration of activities in the core area are dependent on interpersonal contacts. This contact, in turn, depends on the extent to which these centers are accessible -- from outside the core, and within and between each district. Therefore, transportation planning, covering all modes providing for the required movement between activities, must be a necessary part of urban policy planning.

A major component of this movement, the pedestrian and walking trip, have often been ignored in transportation planning within the urban core. The next two sections address this issue.

B. THE NEED FOR PEDESTRIANIZATION

In the distant past, urbanization patterns and land use distributions were largely influenced by the mode of walking. This personal form of mobility is an essential component of most social and economic activities, and the urban environment within cities was characterized by amenities scaled to pedestrians. The subsequent advent of mechanized forms of transportation, however, characteristically changed the urban structure.

The antiquated street systems, predicated upon patterns of past land use activities, now serve a much larger population and a very different magnitude and distribution of land uses resulting from environmental growth. This, coupled with an increase in the amount of space devoted to vehicular movement, has forced pedestrians into an unbalanced competition for available urban transportation space.

To the motorist, pedestrians represent delays, barriers to turning movements, and the source of potentially dangerous attention conflicts. To the pedestrian, the motor vehicle also represents barriers to movement, a threat to their personal safety, and the source of undesirable noise and air pollution.

The pedestrian-vehicular conflict is one of the most significant conflicts that every U.S. city is experiencing. Nationally, 20% of all fatalities involving a motor vehicle are pedestrians, and 65% of these accident fatalities occur in urbanized areas. However, the impact of this conflict is not limited to any one particular segment of the urban environment, but has innumerable implications for the economic, social, and physical forces acting upon our metropolitan areas.

The automobile may have made pedestrian movement obsolete in low density environments, but in concentrated urbanized areas, no motorized mode of movement offers the combination of capacity, accessibility and flexibility that walking allows within a limited geographic area. As a result, even in a highly mechanized society such as ours, downtowns continue to be places where pedestrians are in a majority. These factors have been measured statistically. However, a paradox exists. In cities such as Chicago, Philadelphia, New York, and many others, a range of 70% to 80% of all intra-CBD trips made daily are non-motorized --walking trips. In addition, a significant percentage of the total trip length of all remaining motorized trips is also by walking. Yet, approximately 50% to 70% of the CBD area is devoted to vehicles.

In response to a growing concern for the problems associated with pedestrian/vehicular conflict, an increased awareness of the problems of energy and the environment, and the intense focus on downtown revitalization and improvement, numerous cities have introduced, or are considering the introduction of, facilities for pedestrians (pedestrianization). According to a recent study, over 70% of those U.S. cities whose downtowns are experiencing an upswing in economic vitality have implemented major pedestrian facilities, including shopping malls, transitways, skywalks or auto-free zones. Large-scale facilities in cities such as Minneapolis, Cincinnati, Montreal, Toronto and London serve as outstanding examples of the potential of pedestrianization. It should be noted that while the introduction of pedestrian facilities has not been the cause of economic growth but has rather responded to it, it has the potential in a healthy economic climate for catalysing, organizing and focusing further growth.

C. PEDESTRIAN PLANNING

Pedestrian planning addresses issues relative to the accommodation of pedestrian movement within an urban area. Paramount emphasis is placed upon the physical and functional linkage between new planned areas and existing activities. The planning output should represent the feasible and necessary elements for creating this unified linkage. At the same time, pedestrian planning serves as a basis for making modifications to future land use development patterns throughout the downtown.

The objective of pedestrian planning is the development of a network plan which provides facilities and accommodations to ensure and foster effective exchange for pedestrian trip-making between and within planned and existing activity centers. The plan is concerned principally with accommodation of short trips -- nominally 10 minutes or less -- that occur throughout the day within the urban core.

For the purpose of comparison the relationship between the pedestrian trip making component and travel time for other modes is illustrated in Figure 1. As indicated in this figure pedestrian trips up to one-half a mile (or approximately 10 minutes) are competitive with the travel time of motor vehicles.

A Pedestrian Network Plan is developed within the context of a broad range of coordinated pedestrian accommodations and facilities (such as street malls, second-level walkways, pedestrian movement systems, arcades, street crossings, and other forms of pedestrianization - see Figure 2) that will be required to link major existing and future planned activity centers within the city.

Through a comprehensive evaluation of existing and forecasted pedestrian travel patterns, as well as pedestrian movement requirements, pedestrian utilization of a downtown can be increased. Implicit is the recognition that pedestrian mobility and amenity have an impact upon the economic and social wellbeing of an urbanized area, and that the extent of this impact is a direct function of the way in which pedestrian facilities are used.

D. RELATIONSHIP TO LAND USE/TRANSPORTATION PLANNING

The pedestrian and the walking trip are the primary interface between the urban land use activities including other modes of transportation, and as such, constitutes an important component of the Land Use/Transportation Process. Unfortunately, this aspect has been largely ignored. The subjugation of the pedestrian component to the more dominant vehicular considerations of the urban transportation planning process has been principally due to the lack of adequate data and technical procedures related to the planning, design, implementation and evaluation of pedestrian systems. Furthermore, criteria and standards did not exist for defining data and

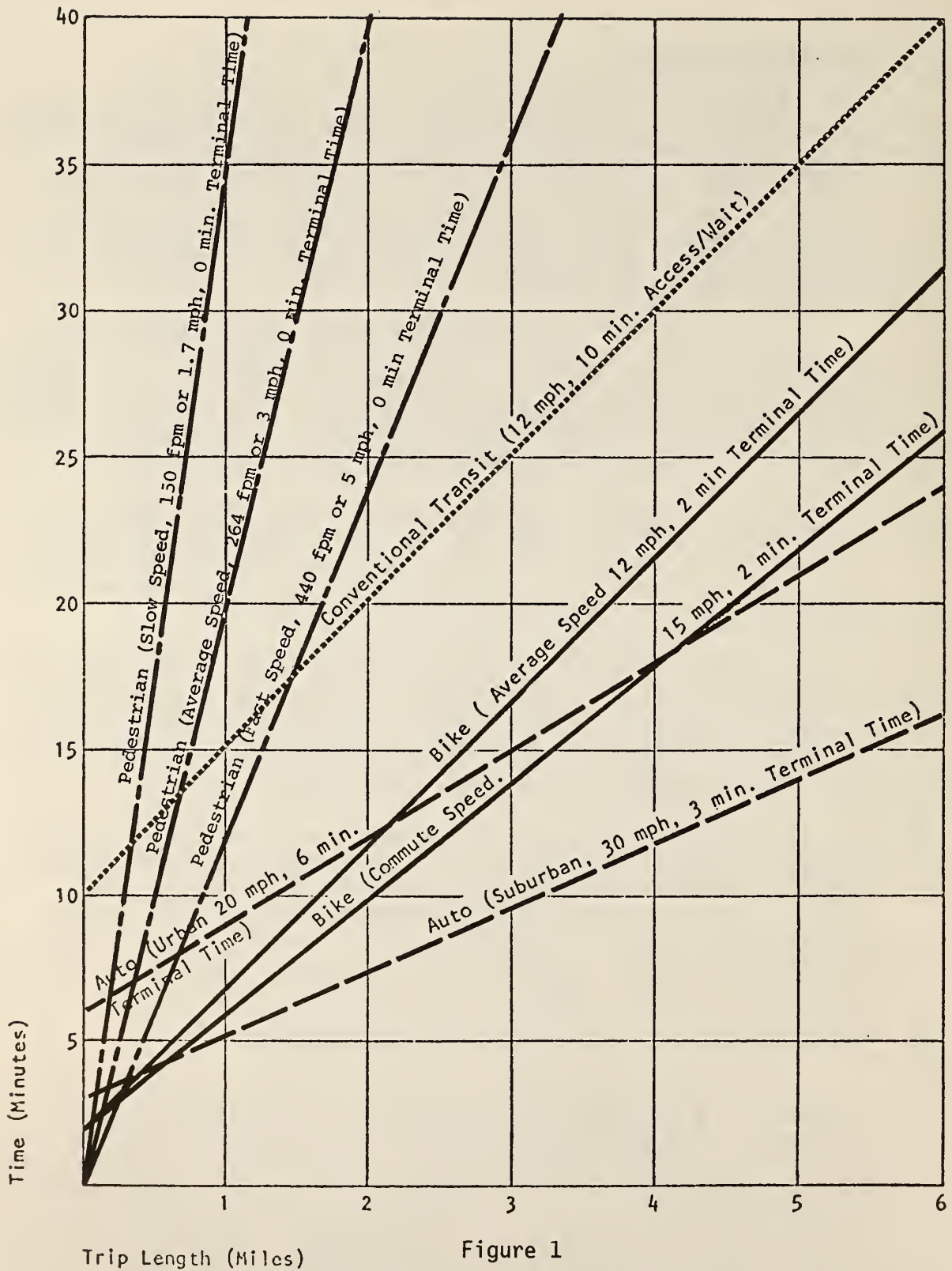

Trip Length (Miles)

Figure 1

Modal Travel Time Comparison

WHAT ARE PEDESTRIAN MOVEMENT SYSTEMS ?

THESE ARE CIRCULATION SYSTEMS WHICH ACCOMMODATE SHORT TRIPS MADE AS

- * WALKING TRIPS ONLY
- * THE WALKING TRIP PORTION OF VEHICULAR/TRANSIT TRIPS

THESE SYSTEMS ARE COMPOSED OF PEDESTRIAN FACILITIES WHICH CAN BE CLASSIFIED IN TERMS OF THREE BASIC TYPES OF SEPARATION

* HORIZONTAL

- PARALLEL - WIDENED SIDEWALKS,
- DISPLACED - [ALLEYWAYS
FULL MALLS
PART. MALLS

* VERTICAL

- BELOW GRADE - [SUBWAYS
UNDERPASSES
- ABOVE GRADE - SKYWAYS

* TIME

- CROSSWALKS
- STREET CLOSINGS

Figure 2

Classification Of Pedestrian Facilities

procedural requirements relative to the establishment of a comprehensive pedestrian planning process.

However, pedestrian planning is a vital component of the Land Use/Transportation Planning Process. It can no longer be considered ex post facto. It is an integral part of the Planning Process. Underlying this attitude is the recognition that pedestrian mobility, as well as other transportation considerations, has a broad range of impacts upon the social and economic structure of an urbanized area. Figure 3 depicts the most significant of these impacts. Furthermore, significant cost savings can be achieved if new environments are preplanned to accommodate pedestrian movement. When the pedestrian component is not considered concomitant with other aspects of the Planning Process, the result is high cost and negative economic feasibility.

Previous studies of the costs and impacts of pedestrian facilities cite, numerous examples of systems that were developed with no clear understanding of pedestrian behavior and movement, or systems that were planned using invalid traffic engineering methods of analysis. This lack of understanding of the pedestrian or use of invalid planning bases for pedestrian systems has resulted in facilities that are obviously unsuccessful.

The pedestrian network is a primary component of the total transportation network. Uniform accessibility is the conceptual approach to transportation planning in new community developments where much of the population live within walking distance of major community activity centers, and pedestrian-ways take on a special importance in the initial circulation and land use planning phase of development.

Incompatible modes of circulation are often separated (either horizontally or vertically) to increase both the efficiency and safety of movement. The circulation network is composed of a hierarchy of street types, depending upon their intended utilization. These network elements range from those which are totally vehicular-dominant to those which are exclusively pedestrian-oriented. Between these two extremes are streets and network elements which serve parking, buses and transit. The degree of separation between these various modes is a function of their compatibility and interface.

Modally balanced movement systems are often advocated as a goal for urban areas. While desirable, this is not practical through transportation only. Some areas will be more accessible than others. In the past, we have tended to think of accessibility only in terms of mechanized movement (auto, bus, transit). However, each of these trips begins and ends with a pedestrian walking trip. Almost all of a person's average daily interactions take place within small centers that are less than a ten or fifteen minute walk from their place of work. The proximity of activities, services, and amenities

WHY PED SYSTEMS ?

POTENTIAL BENEFIT :



ECONOMIC VITALITY

- Increase Retail Sales
- Increase Property Values
- Increase Tax Base
- Increase Land Utilization/Intensity
- Increase Investment Opportunity



TRAFFIC MANAGEMENT

- Improve Accessibility
- Reduce Modal Conflict
- Improve Capacity
- Reduce Energy Dependence



ENVIRONMENTAL IMAGE

- Improve Environmental Quality
- Improve Environmental Appearance
- Provide a Sense of "Place"



SOCIAL BENEFIT

- Provide Amenity/Comfort
- Provide Open Space for Community Activity
- Increase Safety/Security
- Increase Community Pride
- Improve Mobility

Figure 3

Potential Benefits Of Implementing Pedestrian Facilities

within walking distance from a place of work is partly a function of their accessibility.

Acceptable walking distances are the determinant of urban macro-forms in terms of defining the location and design of service areas, relative density, and activity distribution. This concept is particularly relevant in an age of reduced energy consumption. Now is the time that transportation and land use planning criteria must be modified and reapplied for pedestrian usage. Previous criteria and guidelines should be set aside. There is the need for a process exhibiting a clear understanding of pedestrian travel behavior, the factors which impact pedestrian movement, and the relationships between facilities planning/design and facilities utilization and impact. The process must also take into account the broad range of economic, environmental, physical, and social community-wide impacts. Perhaps, more importantly, the process must consider a pedestrian network in context with other available travel modes. In doing so, the individual requirement of each travel mode must be taken into consideration as well as issues of modal interface.

These factors underscore the requirement for the development of a comprehensive Pedestrian Planning Process which takes into consideration the total spectrum of circulation needs required to develop an efficient and modally integrated transportation system. In addition to the specific requirements relative to pedestrian travel, consideration must be given to vehicular and transit flow and accessibility, parking, and other trip-making components. The pedestrian network must be developed within the context of these other trip-making components, because it will have a substantial impact upon each of them.

II. THE NEED FOR A PEDESTRIAN PLANNING PROCESS

A. STATE OF THE ART

Capital expenditures, of substantial magnitude are continually being made to implement pedestrian facilities, yet there exists virtually no basis for effective decision-making. Little is known about the factors that contribute to the success or failure of a facility. No consistent data base exists to guide decisions. Planning tools are not available. Without a basis for decision, pedestrian planning has been largely based on intuition. Attempts are often made to duplicate existing successful systems, but since a comprehensive understanding of relevant factors is missing, the copies often fail.

In recent years, research and published material addressing pedestrians and related topics has been increasing, although it is still extremely sparse. The subject of pedestrian pathway capacities has been treated in detail. Pedestrian walking speeds and distances has received considerable attention, and limited data on the land use generation of walking trips, trip-making behavior and exchange are available. Several studies have presented models that forecast pedestrian trip exchange. Topics related to pedestrian safety have been covered extensively and considerable data have been published. The costs and benefits of pedestrian accommodations has also been given extensive treatment. To date, however, nothing has been available to guide the actual planning, design and evaluation of pedestrian systems. Although some of the documented experiences of other researchers is helpful, the planner has lacked the procedures needed to guide the entire pedestrian planning process.

The remainder of this Manual is devoted to the presentation of a process that synthesizes and unifies a vast amount of primary and secondary material into a unified approach to the planning, design and evaluation of pedestrian systems.

B. RATIONALE FOR THE PROCESS

The pedestrian planning process (PPP) described in subsequent sections has been based upon several fundamental concepts:

- That pedestrian facilities are implemented to provide a wide range of benefit to both users and non-users, and
- The extent to which these benefits are realized is directly affected by the degree of utilization of the facility by pedestrians.

1. The Concept of Utilization.

The concept of utilization is central to the process, and consequently, many steps of the process are directed toward increasing the probability that a facility will be used as planned. The process enumerates all the factors and impacts that should be taken into account in establishing the need for a facility, as well as determining the location, extent and nature of pedestrian network components.

Utilization is the key to assessing the potential effectiveness of a given or proposed system -- for without utilization, no benefit can be derived. Utilization, on the other hand, is dependent on the functional design characteristics of the facility, as well as the pedestrian's perception of the personal benefit to be realized by using the facility. This circular notion of benefit and utilization was a fundamental basis for the PPP.

New pedestrian facilities, therefore, must be planned and designed to maximize their propensity to be utilized. The extent to which they are utilized is dependent on two factors:

- Facilities must serve significant points of pedestrian trip production and attraction (location and extent); and
- Facilities must provide the pedestrian with net benefits -- both real and perceived -- which exceed those found on alternative pathways (nature of the facility).

Thus, if the pedestrian system operates on pedestrian desire lines and provides advantages over alternative, competing pathways, the system will be utilized and overall benefit will accrue.

Evaluating the potential for pedestrian utilization of an existing or planned accommodation requires the identification of those factors which influence pedestrian movement. Pedestrian movement and pathway utilization are directly influenced by those elements listed in Table 1. The degree to which each of these factors influences pedestrian trip-making varies from location to location.

2. System Benefits and Impacts

System benefits can be viewed at three levels:

FACTORS	EFFECT UPON PEDESTRIAN MOVEMENT
I. <u>LOCATION OF PEDESTRIAN TRIP GENERATORS</u>	
- Distribution and density of land use mix	- Location of major routes
- Origins - Destination patterns	- Level of accessibility
- Patterns of trip exchange	- Degree of trip-making
	- Linkage requirements
II. <u>CHARACTERISTICS OF TRIP-MAKING</u>	
- Trip-maker	- Propensity of trip-making
- Trip purpose	- Perception of crime and safety
- Trip length (time/distance factors)	- Needs and preferences
- Trip frequency	- Attitudes towards trip-making
III. <u>PEDESTRIAN MOVEMENT BEHAVIOR</u>	
- Existing travel patterns and analysis of major routes	- Degree of utilization
- Forecasted travel patterns and analysis of major routes	- Degree of pathway activity
- Existing pedestrian volumes	- Provision of pathway attributes
- Forecasted pedestrian volumes	
IV. <u>PATHWAY CHOICE VARIABLES</u>	
- Level of Accessibility	- Degree of utilization
- Availability of alternate travel modes	- Viability of pedestrian mode as competing alternative
- Traffic volumes	- Degree of pedestrian mobility
- Impedance factors	- Potential for pedestrian-vehicular conflict (impact upon pedestrian safety)
- Pathway attributes (interest, level of activity, directness, continuity, orientation, provisions of shelter, capacity, etc.	- Impedance to pedestrian movement (capacity)
- Shortest route - degree of time savings and convenience	- Choice of alternative routes
- Attitudes and perceptions	- Propensity for trip-making

Table 1.

Factors Influencing Pedestrian Movement And Pathway Utilization

- First Order - direct benefits to the pedestrian;
- Second Order - benefits to motorists and abutting property occupants; and
- Third Order - higher order benefits such as those that accrue to the locality.

First order benefits accrue directly to the pedestrian as a function of facility (or pathway) attributes. These impacts, then, are related to the facility location, extent and nature. Examples include:

- Reduction of pedestrian delays -- resulting from vehicular conflicts, etc.
- Pedestrian time savings and convenience
- Increased safety -- accident reduction
- Pedestrian comfort related to climate protection
- Increased security -- reduction of crime
- Increased orientation and perceptual factors

Second order benefits are those that accrue to non-users as a function of pedestrian utilization of the facility. They are related to facility location, extent and nature, but to a lesser degree than first order benefits. Examples include:

- Reduction of vehicular delays and traffic congestion
- Increase in land utilization and densities
- Increases in property values and property rental rates
- Increases in gross retail sales
- Increases in reinvestment of capital related to area improvements
- Increases in occupancy rates

Lastly, third order benefits include all other, usually indirect, impacts of the facility. Examples include:

- Increases in municipal tax revenues
- Improved air quality and noise reduction
- Reduction in crime rate
- Increases in social "community" activity due primarily to the provision of an urban open space system

3. Utilization and Pathway Choice

In the above discussion, the interrelation between utilization and benefit was presented. An integral part of this interrelationship is the notion that pedestrians will use pathways which provide them the greatest real and/or

perceived net benefit. This idea is fundamental to the PPP. In general, the process addresses ways in which pedestrian movement objectives can be forecasted, and the pedestrian's pathway choice influenced by enhancing positive pathway attributes, while reducing negative impedances. The following discussion expands upon this interrelationship.

A conceptual model of pedestrian pathway utilization is shown in Figure 4.

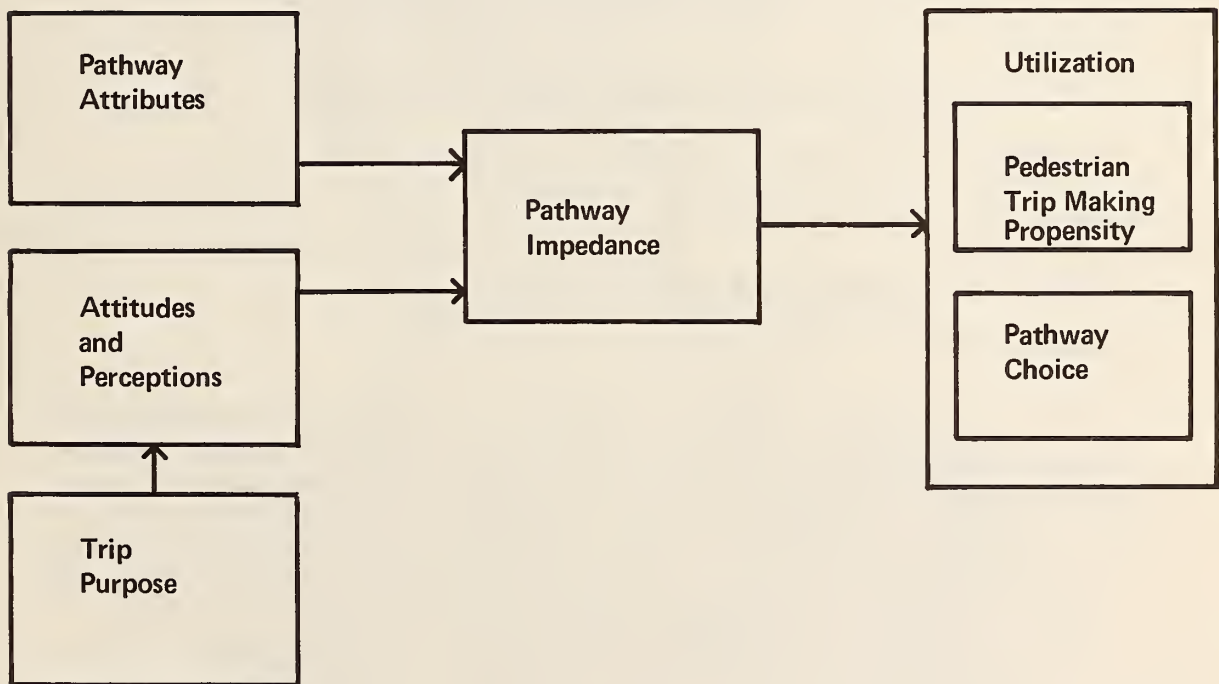

Figure 4

Conceptual Model Of Pedestrian Utilization

Pathway attributes are those characteristics of pedestrian system elements that encourage, or discourage, pedestrian activity and use of the links. These attributes are closely associated with the notion of pathway impedance that is discussed in the next section. As shown in Table 2, the attributes can basically be classified into three different groups, each of which is discussed below.

Movement Attributes

- Directness
- Continuity
- Capacity

Physical Comfort Attributes

- Environmental Protection
- Safety
- Amenity

Psychological Comfort Attributes

- Attractiveness
- Coherence
- Security

Table 2

Important Pathway Attributes

Pathway impedances are those elements of the pedestrian experience that influence the real and/or perceived separation between two points. In general, this notion of impedance, or separation, is a function of the pedestrian trip-making environment -- that is, the attributes of the pathway between the two points, and the attitudes and perceptions of the individual(s) making the trip, in terms of how they relate to the pathway. The latter will usually vary as a function of trip purpose; a shopper is apt to react to a given pathway in a manner that is substantially different from that of a commuting pedestrian.

Impedances can be classified into three generic groups, as follows:

Impedances Affecting Movement

- Irregular pathway configuration - indirect routing, turning movements, hills, inadequate access to pathway
- Vehicular/pedestrian conflicts - delays due to vehicular traffic
- Pedestrian/pedestrian conflicts - crowding, queues, crossing interference, lack of pathway capacity

- Vertical change elements - stairs, ramps, inoperable escalators, delays at elevators
- Physical barriers - obstructions such as improperly placed street furniture and fixtures, pathway discontinuities
- Maintenance - inadequate maintenance or enforcement of municipal ordinances

Impedances Affecting Physical Comfort

- Environmental - inclement weather, noise, air pollution, wind
- Vehicular/pedestrian conflicts - risk to safety due to vehicular traffic
- Amenity - inadequate provision of benches, shade, water fountains

Impedances Affecting Psychological Comfort

- Unattractive elements - "deadwalls," inactive areas, abandoned buildings
- Disorientation - lack of directional information, signing, visual cues
- Poor security - real or perceived crime, undesirable elements (gangs, skid rows)
- Maintenance - inadequate maintenance or enforcement of municipal ordinances

For any given pathway, the impedances affecting movement generally give rise to a physical separation between two points that can be expressed directly in physical units such as time, distance or energy. Hence, these impedances represent an invariant physical condition of separation which will be termed nominal separation. Physical comfort and psychological comfort impedances, on the other hand, represent factors that add to the perceived separation between two points. That is, an unfavorable condition, such as heavy vehicular traffic, may represent a perceived risk to the pedestrian; this risk represents an obstacle in much the same way that a stair, for example, represents an obstacle. Hence, the perceived risk would contribute to the real, or nominal, separation. The combination of nominal separation with other perceptual factors results in an effective separation of two points. Figure 5 illustrates this concept. Effective separation is analogous to the generic term impedance.

In general, the pedestrian synthesizes two types of information regarding a desired trip:

- Pathway attributes, or characteristics of the walking environment likely to be encountered during the proposed trip, and

PATHWAY ATTRIBUTES AFFECTING TRIP MAKING BEHAVIOR

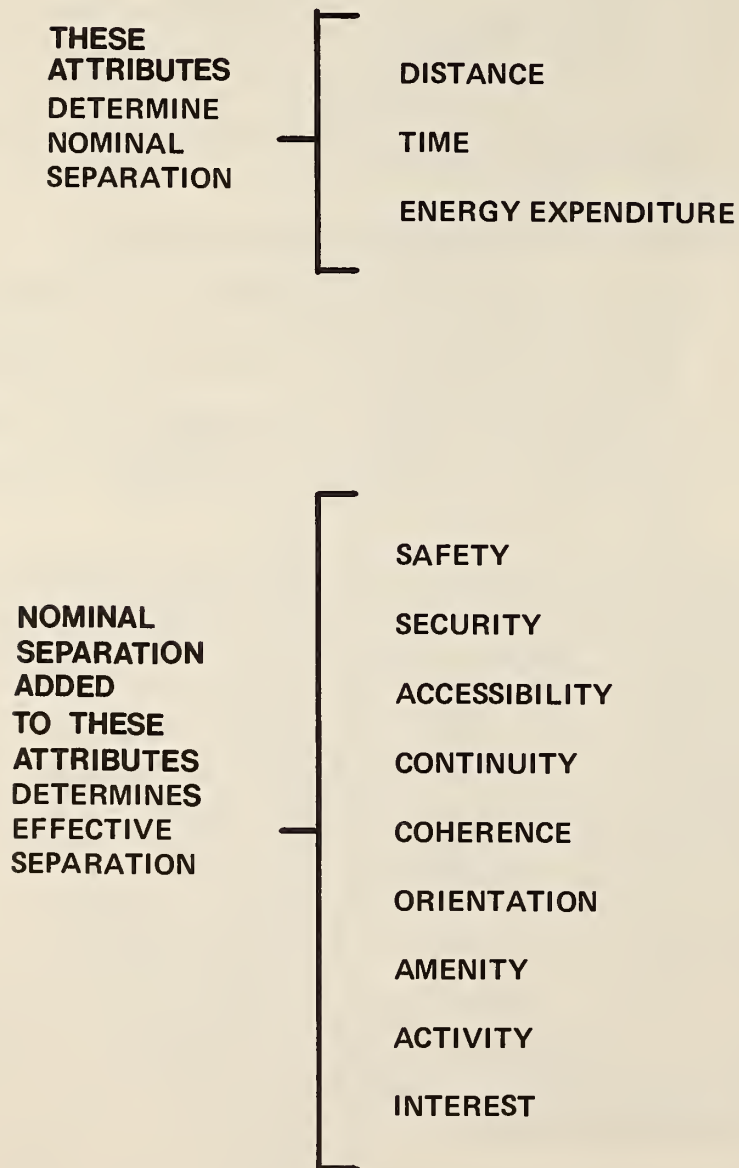

Figure 5

Pathway Attributes Affecting Tripmaking Behavior

Individual attitudes and perceptions regarding the pedestrian experience, depending on the purpose or objective of the proposed trip.

From this synthesis, a notion of impedance is developed which is translated through pedestrian behavior into an effect on network utilization and pathway choice.

Basically, given the individual's desire to go from point A to point B, the question is: What is his propensity to make the trip as a pedestrian, as opposed to making it via another mode, or not make it at all? Experience has shown that this pedestrian trip-making propensity is attenuated as a function of the effort required to make the trip on foot. The effort required will be proportional to the impedance characteristics of the pathway connecting the two points, where an impedance is any characteristic of the pathway that affects the time, distance and/or energy -- both real and perceived -- needed to make the pedestrian trip. Hence, a relationship between pedestrian trip propensity and impedance similar to that shown in Figure 6 exists.

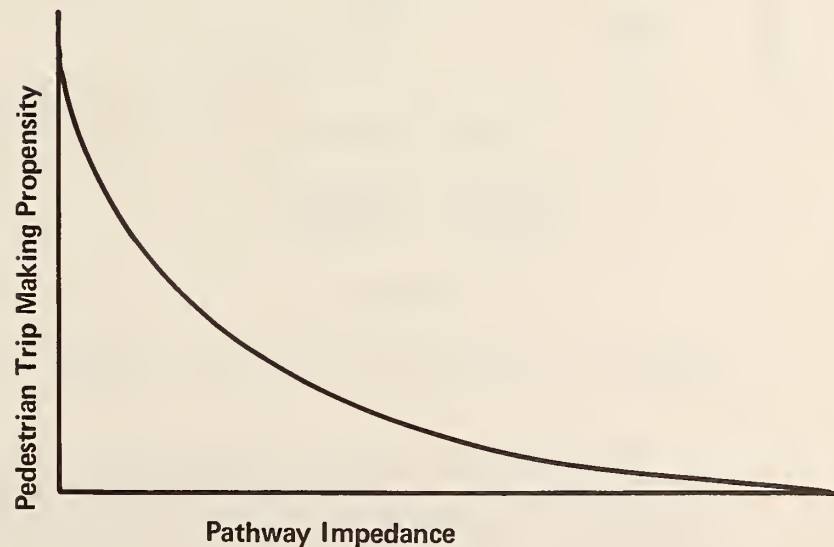

Figure 6

Relationship between pathway Impedance and Tripmaking

When impedance is small, there is a great propensity to make pedestrian trips and utilization is increased; but as impedance increases, this propensity reduces to the point where a pedestrian trip is no longer feasible and no pathway utilization occurs.

Therefore, the amount of impedance found, in general, within a pedestrian system will have an impact on pedestrian trip-making propensity, and the extent to which the system is utilized.

Another aspect of the utilization notion deals with pathway choice. That is, how does the existence of alternative pathways between two given points affect pedestrian behavior. In Figure 7, two pathways with different impedances are indicated.

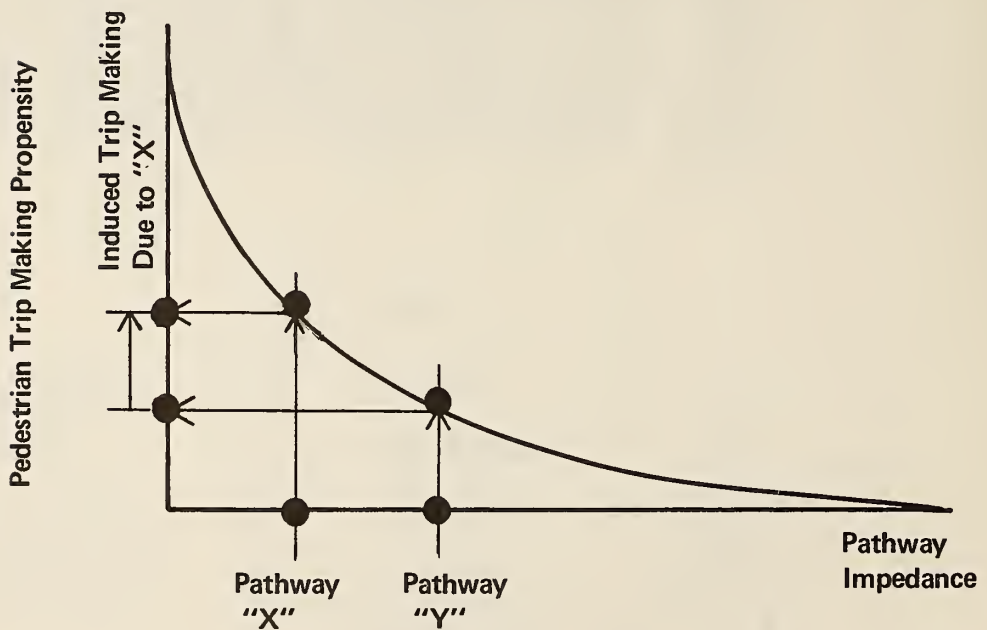

Figure 7

Tripmaking On Pathways With Different Impedances

Since pathway "X" is characterized by less impedance than pathway "Y", it should be utilized by a greater percentage of all pedestrians making the trip. Furthermore, it should induce some pedestrian trips to be made that would not have been if "Y" were the only route.

Experience has shown also that pathway "X" would probably be utilized by nearly all pedestrians, especially for those trips where a "shortest route" syndrome would apply.

Hence, the reduction of pathway impedance, in the case of alternative pathways, would greatly affect pathway choice and could also induce increased utilization of the overall system.

A basic objective in pedestrian planning and design is to reduce effective separation, or impedance, by controlling pathway attributes.

III. OVERVIEW OF THE PEDESTRIAN PLANNING PROCESS (PPP)

A. INTRODUCTION

The purpose of this overview is to provide a brief synopsis of the pedestrian planning process, and to familiarize potential users with the PPP components and their interrelationships. While the description of the process is largely non-technical it will provide a basis for the user's developing a general work plan for any given study. Guidelines for applying the process are provided in Section IV of the Overview.

Pedestrian planning heretofore has most often been based on subjective judgement rather than on technical, analytical, objective procedure. This has resulted, in many cases, in the apparent failure of pedestrian facilities that may have been well designed, but ill conceived or misplaced. Pedestrian facilities do not necessarily attract pedestrian users. In order to be utilized, they must be designed to accommodate desired movement more adequately than alternative paths. The PPP is designed to accomplish this end.

In brief, the PPP identifies the significant procedures and criteria that should be considered in the planning, design, evaluation and implementation of pedestrian systems. Applicable system components include street closings; street conversions (to full or partial malls); street improvements such as widened sidewalks; skyways, overcrossings and second-level walkways; subways; vertical change elements such as stairs and ramps; mechanical systems; and various other facilities dedicated to the accommodation of pedestrian movement. The process also integrates a broad range of environmental, economic, social-behavioral, and operational factors that should be considered by urban designer and traffic engineers using the Process. In addition to the technical procedures and operational criteria, methods have been incorporated for examining and evaluating both system effectiveness (in terms of feasibility) and potential impacts (social, economic, physical and behavioral). Figure 8 summarizes the major issues addressed within the process.

Additionally, the process has the following characteristics:

- Can be applied to both large-scale (extended pedestrian systems) or small-scale (single facility or component) projects;
- Deals with short trip-making (usually less than 15 minutes) -- walking only trips as well as the walking trip component of other more extended trips;

ISSUES ADDRESSED WITHIN THE PROCESS

*** DEMAND**

- Trip forecasting
- Trip generation
- Trip exchange

*** BEHAVIOR**

- Perceptual factors influencing pathway choice as well as trip making propensities

*** TRAFFIC MANAGEMENT**

- Modification of traffic and transit network to accommodate pedestrian circulation while maintaining or improving operational efficiency for all modes.
- Provision of a modally integrated and balanced circulation system

*** IMPACT**

- Measurement of potential environmental, social, economic and physical consequences resulting from systems implementation and operation (feasibility determination).

Figure 8

Major Issues Addressed Within The P.P.P.

- Is sensitive to pedestrian behavior in terms of real and perceived factors that influence movement;
- Allows the user flexibility in data collection, procedure application, and level of analytical detail; and
- Operates primarily as a responsive rather than generative tool.

The last point requires explanation. The PPP is most appropriate when applied to those situations where major land use and urban transportation policies have been determined. The process then responds to these policies to determine the appropriate location, linkage, access, extent and nature of pedestrian accommodations. Conversely, the model is not appropriate as a predictor of land use growth and distribution, for example; that is, it does not generate a basis for major urban policy. However, in some cases, the PPP may impact on policy. For example, the process may provide a basis for the strategic location of major generators such as a subway station or a convention center.

B. Major Pedestrian Planning Process Phases

In section III C, the PPP overview will be discussed in terms of individual process tasks. In this section the PPP is presented in terms of its two major phases. The phases, illustrated on a simplified flow chart of the PPP tasks in Figure 9, are as follows:

- A demand modelling phase, including Tasks 1 through 13, during which the present and/or future movement of pedestrians is examined using a gravity model approach to produce a network plan showing the distribution and assignment of pedestrian volumes; and
- A network design and evaluation phase, including Tasks 13 through 27, during which the first phase output is utilized, together with additional analyses, to develop a network plan addressing the specific planning and design of network segments including pathway links, nodes and modal interface requirements.

Each of these major phases is discussed in more detail below.

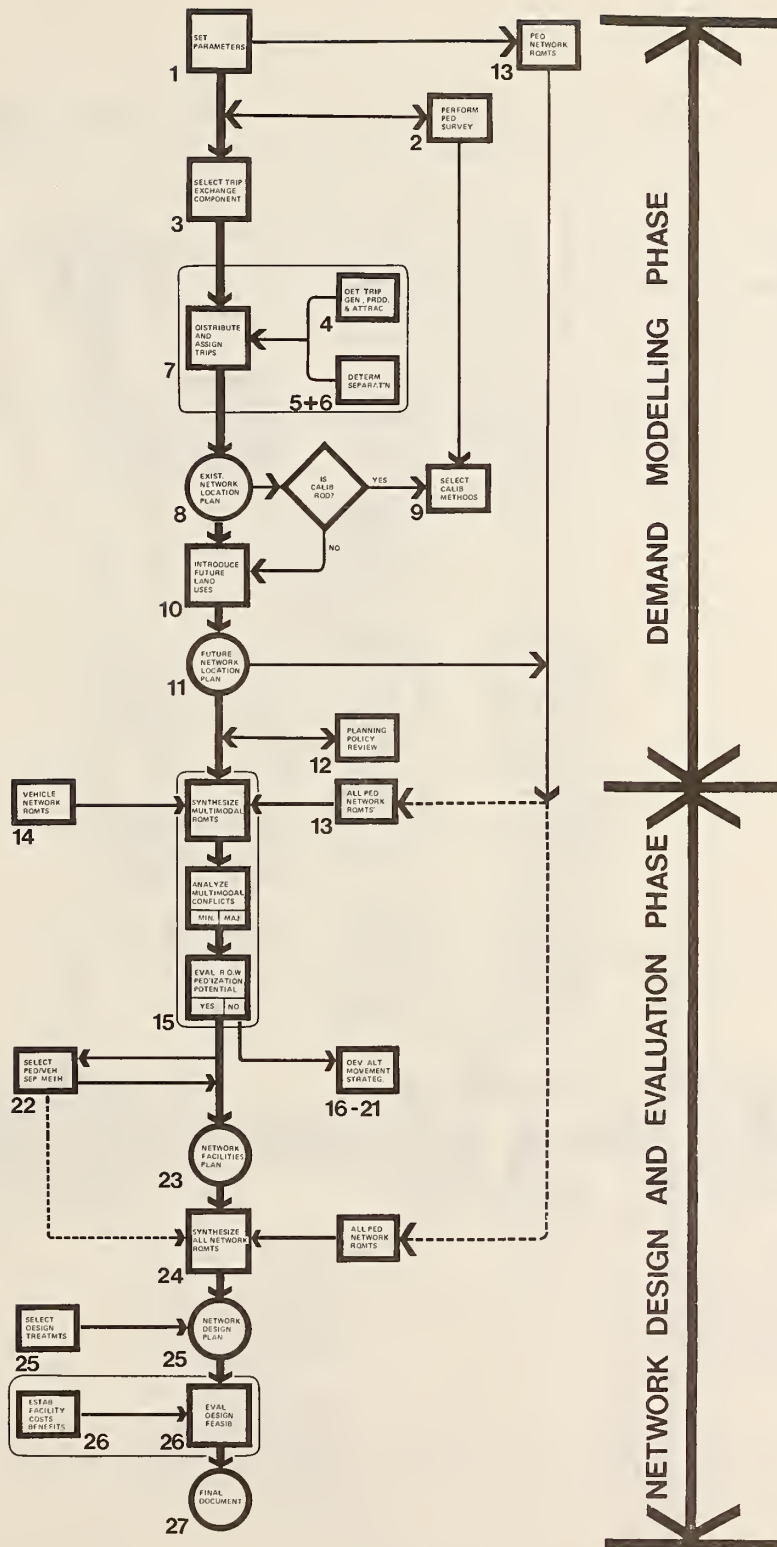
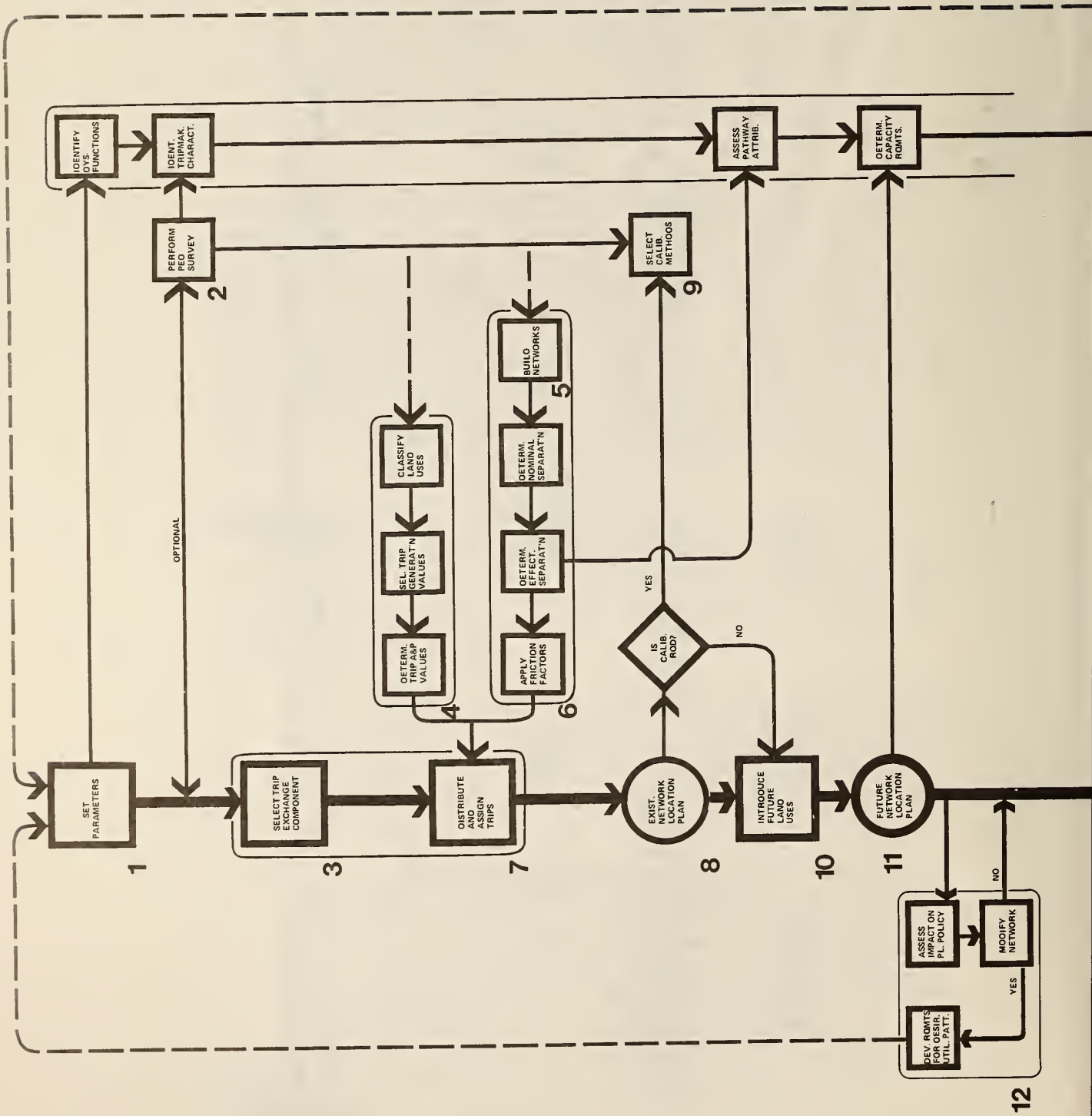

Figure 9A

Simplified Flow Chart Of The P.P.P. Tasks



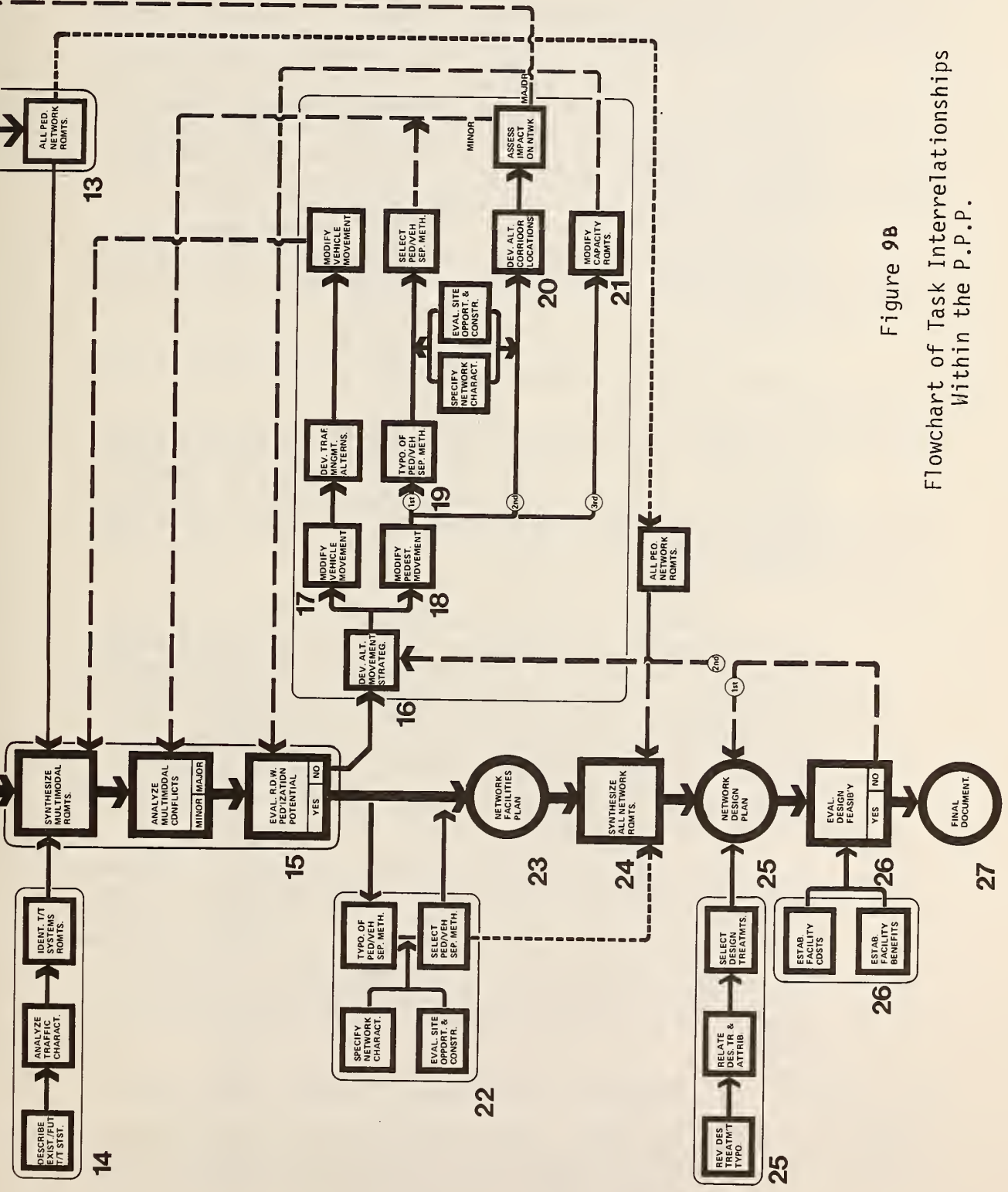

Figure 9B
Flowchart of Task Interrelationships
Within the P.P.P.

1. The Demand Modelling Phase

This section deals with the Task 1 through 13 leading to the development of a network plan showing the distribution and assignment of pedestrian trip making within the study area. Primary components of this phase include examination of: (1) the present and future pedestrian trip generation characteristics of various land use activities (also called centroids); (2) the trip making propensity between land use activities as a function of connecting pathway attributes; (3) the trip exchange patterns resulting from (1) and (2); and (4) the assignment of these trips to alternative network pathways. This collection of tasks, together with numerous supporting functions, comprises the demand modelling phase.

The gravity model approach used in this phase is discussed further on page 63 under Task 7.

The importance of the modelling tasks, relative to the remainder of the process, should not be exaggerated since they are simply a means to an end rather than an end in themselves. However, the model embodies several concepts that may be unfamiliar to urban designers and traffic engineers; therefore, a special discussion of its characteristics is in order.

The objective of the modelling effort is to forecast future movement of pedestrians given that extensive modification to the existing urban environment will be accomplished. Indeed, in the absence of extensive change (addition of new land uses, modification of the traffic network, etc.), it may be more efficient to simply conduct surveys or counts to define movement. However, where the impact of urban change on pedestrian movement is not clear, it may be advantageous to conduct the modelling.

The primary output of the modelling phase is a network plan which shows the distribution and assignment of future pedestrian volumes. Distribution is the process in which centroid to centroid travel volumes are estimated. Assignment refers to the process of determining route or routes of travel and allocating centroid to centroid trips to these routes. This output is obtained through the following steps:

- (1) A specific trip purpose is chosen for analysis;
- (2) For each existing pedestrian centroid (activity/center) that produces and/or attracts trips related to the trip purpose being examined, a trip generation rate is determined;

- (3) The existing centroids are then described in terms of a network showing existing interconnecting routes, and each route is assigned a measure of separation between centroids in terms of perceived time;
- (4) The trip generation measures and inter-centroid separation measures, converted to measures of trip-making propensity (friction factors) are then manipulated mathematically (using a gravity model approach) to distribute and assign the trips;
- (5) The trip volumes are then arrayed on the network plan and compared to the extent possible with similar statistics obtained through surveys, counts or other means;
- (6) As appropriate, trip generation rates and the friction factor curves are adjusted until the user is confident that the gravity model is adequately simulating reality;
- (7) Finally, future land uses and future pathway links are introduced into the network and operated upon by the calibrated model to obtain the primary model output -- the distribution and assignment of forecasted pedestrian volumes.

The output of (7) above forms the basis for the remainder of the process. At this point, however, it is important to caution that the process cited above is performed only to the extent that it is necessary to obtain a basis for the remaining effort. The modelling output is not an end in itself; it is simply a means to an end -- the pedestrian design plan. In some cases, simple counts or gross estimates may suffice, provided the user is comfortable that an appropriate degree of accuracy exists. Furthermore, the user should belabor the modelling effort only as necessary to obtain the basis for proceeding with the process.

Trip generation rates express the rate at which trips are generated (produced and attracted) for a given trip purpose. These rates usually indicate the peak hour, directional trips per unit of centroid site. For example, an office building may produce 10 trips out per 1000 gross square feet for employee lunch trips leaving during the peak hour of 11:45 AM to 12:45 PM. Similarly, a peak 15-minute rate might be 5 trips out per 1000 gross square feet between noon and 12:15 PM, with the other 5 trips (on the average) spread over the other 3/4 of the peak hour.

Intercentroid separation is a measure of the trip time (or distance) between two centroids. Briefly, a nominal measure based on distance, time and energy is developed, with all units converted to time. This nominal measure will include the actual walking time, delays due to waiting, crowding and similar impedances, and time-equivalent penalties associated with stairs, etc. An effective measure of separation is then obtained by adjusting the nominal separation to account for pedestrian behavior and perception of the pathway. For example, a 10-minute trip might seem like (be perceived as) an 8-minute trip if the pathway is attractive and comfortable; but might seem like a 12-minute trip if the pathway is dreary. The resulting measure of effective separation is then converted to a measure of trip propensity (the relative probability that the pedestrian will make the trip on foot). This measure is called the friction factor and is developed based on known characteristics of pedestrian behavior as a function of trip purpose. The above concepts are illustrated in Figure 10.

In the figure, the nominal separation, S_1 , is reduced, as a result of favorable pathway attributes, to S_2 - the effective separation. This perceived separation reduction increases the pedestrian's propensity to make the trip, as measured in terms of friction factors, from F_1 to F_2 . Negative pathway attributes would have tended to reduce the friction factor.

The trip distribution and assignment is accomplished in two interrelated steps. First, a gravity model approach is made to distribute trips produced by each centroid among all attraction centroids as a function of intercentroid separation and strength of attraction. This determines how many trips produced at each production centroid go to each attraction centroid. Trips can then be assigned to specific routes (series of pathway links) using an appropriate rationale. A simple rule is to assign all trips to the route characterized by the minimum separation and none to competing routes (all-or-nothing assignment); trips can also be split based on their relative friction factors or other scheme (generically known as stochastic assignment). Following this step, the user has a "loaded" network showing pedestrian volumes for each network link.

2. The Design And Evaluation Phase

The second major phase consists of Task 13 through 27, and leads to the development of a network design plan and its supporting documentation. The network plan provides specific planning and design detail for network segments including pathway links, land use activities and network nodes, and transportation modal interfaces.

Primary components of the PPP included in this Phase are: (1) interface with the traffic and transit network; (2) resolution of multimodal conflicts; (3) development of specific pedestrian network planning and design requirements; (4) network design treatments; and (5) systems evaluation.

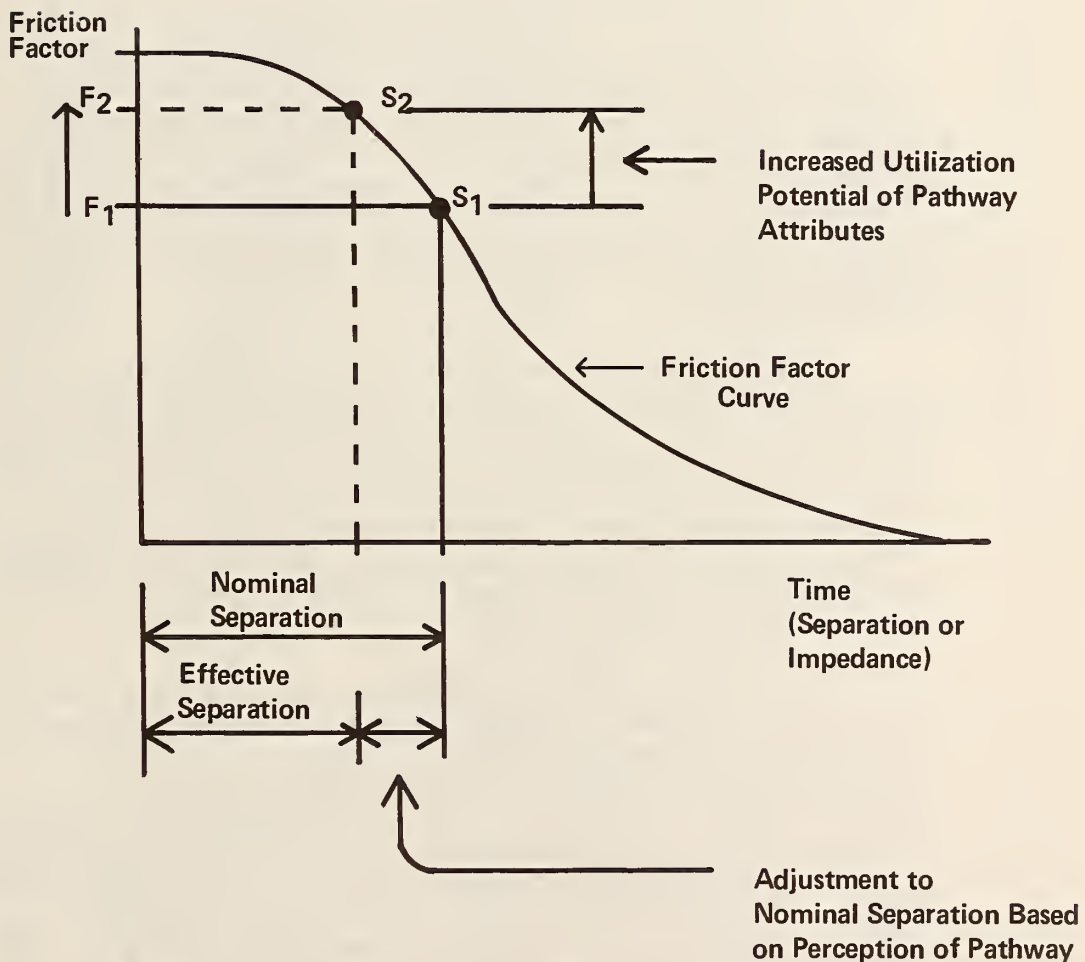

Figure 10

Intercentroid Separation And Friction Factors

In the first PPP Phase, the locations of major network corridors based upon their utilization potential, were identified. Since the implementation of a pedestrian system may have a substantial impact upon the existing vehicle access network in terms of capacity, accessibility, etc., an important aspect of this phase will be to apply a set of procedures for evaluating the impact of pedestrian decisions upon the vehicle network. The design process will thus identify the specific potential for pedestrianization through a consideration of multi-modal requirements and alternative movement strategies. This component will address the definitive nature and extent of each network segment and each pathway element.

The resolution of multimodal conflicts, through the use of pedestrian-vehicular separation, modification to the traffic network through improved traffic management techniques, and/or development of alternative pedestrian movement corridors, will result in a more refined set of requirements for the pedestrian network and its various components. These requirements are then synthesized using input from the entire process to form the basis for the network design.

Evaluation procedures have been included within each of the respective methodologies and technical procedures at several critical steps within the Pedestrian Planning Process, since the performance as well as the outcome of these procedures required that a specific assessment be made within that procedure. However, comprehensive evaluation procedures addressing the cost and benefit of the completed network design have also been included to provide a final assessment of the PPP output.

A generalized representation of the interrelationship that exists between primary elements of the two phases, in terms of the network elements, is shown in Figure 11. Trip Generation (volumes produced and/or attracted) is a network node, or centroid, element which depends primarily on the land use characteristics of pedestrian activity centers. Inter-Centroid Separation is a concept associated with centroid pairs, and their interconnecting pathway links; it embodies the effects of physical separation (time, distance and energy), and pathway characteristics and their influence upon pedestrian behavior and perception. Trip Distribution is an element that reflects the aggregation of trip generation and intercentroid separation in terms of how trips produced are exchanged between competing attraction centroids; Finally, Network Design And Evaluation elements relate to the way in which the trip volumes can be accommodated within a network, and also addresses cost/benefit and impact issues.

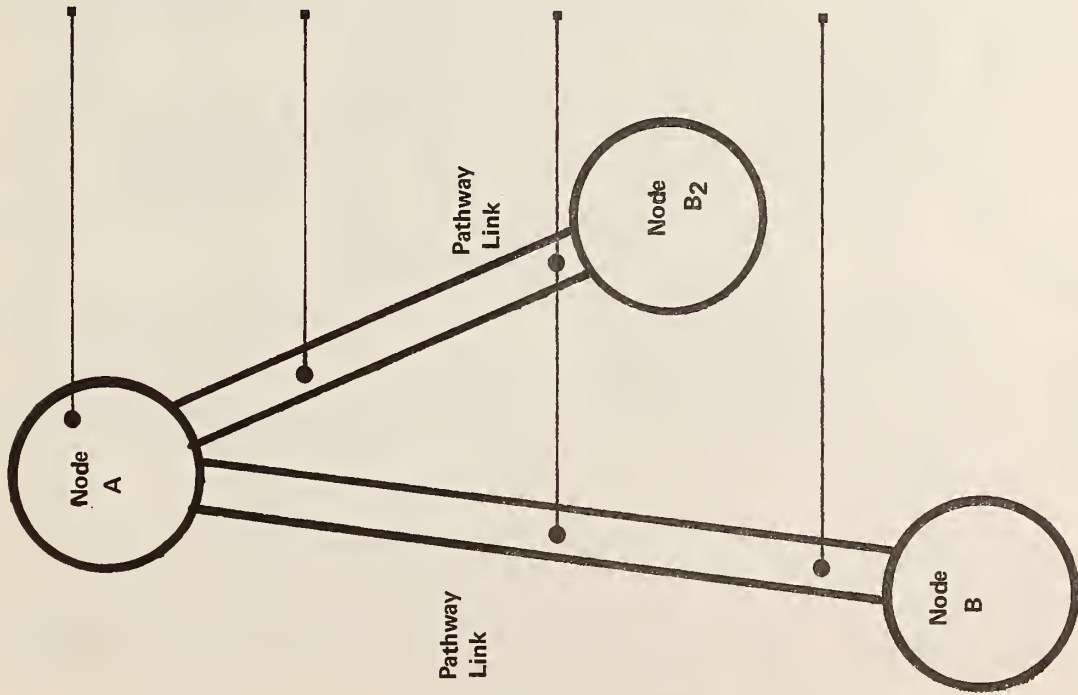

TRIP GENERATION:

Deals with the production and attraction potential of land use activity nodes.

INTER-CENTROID SEPARATION

Deals with the effect of physical separation and pathway characteristics upon pedestrian trip-making behavior.

TRIP DISTRIBUTION (EXCHANGE)

Deals with the potential volume of trips being exchanged along specific links between various activity nodes.

NETWORK DESIGN/EVALUATION

Deals with the following:

- modal interface requirements
- methods of ped/veh separation
- design treatments
- cost/benefit issues
- impacts

Figure 11
Relationship Of Modal Elements

The individual tasks which comprise the PPP are discussed in more detail in the next section.

C. Description Of PPP Tasks

In this section, an overview of each PPP Task is provided. The interrelationship between the tasks described below is shown in Figure 9B. It should be noted that a comprehensive flow through the process would be conducted sequentially from Task 1 to Task 27, with the exception of Task 13 which is initiated together with Task 1. However, the actual application of the process will depend on site-specific needs and emphasis, and upon the need for conducting reassessment of preceding tasks as indicated by the feedback loops shown on Figure 9B. Guidelines relative to the PPP application are provided in Section IV. The PPP Tasks are now detailed.

TASK 1

SET STUDY PARAMETERS

Before initiating subsequent tasks, the user must examine the problems and issues that produce the need to apply the Pedestrian Planning Process, and based upon this examination, set objectives and specific parameters to guide the remainder of the study. The purpose of this task is to define the extent to which each procedure will be invoked.

The assessment will involve the following:

- Explicit definition of the problems and issues to be addressed, and establishment of clearly defined study objectives;
- Analysis, in sketch terms, of the study area and issues associated with its size and configuration;
- Review of data availability and requirements based on the above; and
- Resolution of the approach and relative allocation of effort to individual study phases and procedures.

In situations where the study will be performed as a team effort, the above assessment is of particular importance so that all participants -- representing in most cases, different points of view -- have a clear understanding of the process application and its objectives. A work plan reflecting these discussions should be developed and reviewed periodically throughout the course of the study.

At a lower level of detail, the following questions are typical of those that influence the extent and allocation of study effort:

- The size and configuration of the cordon area of the study;
- The length of the planning horizon (long range vs. short range, for example);
- The location, extent and probability of realization for future land uses;

- The need for conducting a pedestrian survey, and other data-related issues; and
- The manner in which the study will be responsive, both in terms of its initial objectives and related to modification, if necessary, during its course, to the inputs, participation and review by participants from the public and/or private sectors.

A prerequisite for this task is a familiarity with the concepts contained in the Overview, in particular Section IV, and with Supplement 1, "Definitions of Concepts and Terms used in Pedestrian Planning." Figure 12 illustrates an initial graphic analysis of major land use zones and noon movements within a study area. Figures 13 and 14 depict data requirements for the major PPP Tasks.

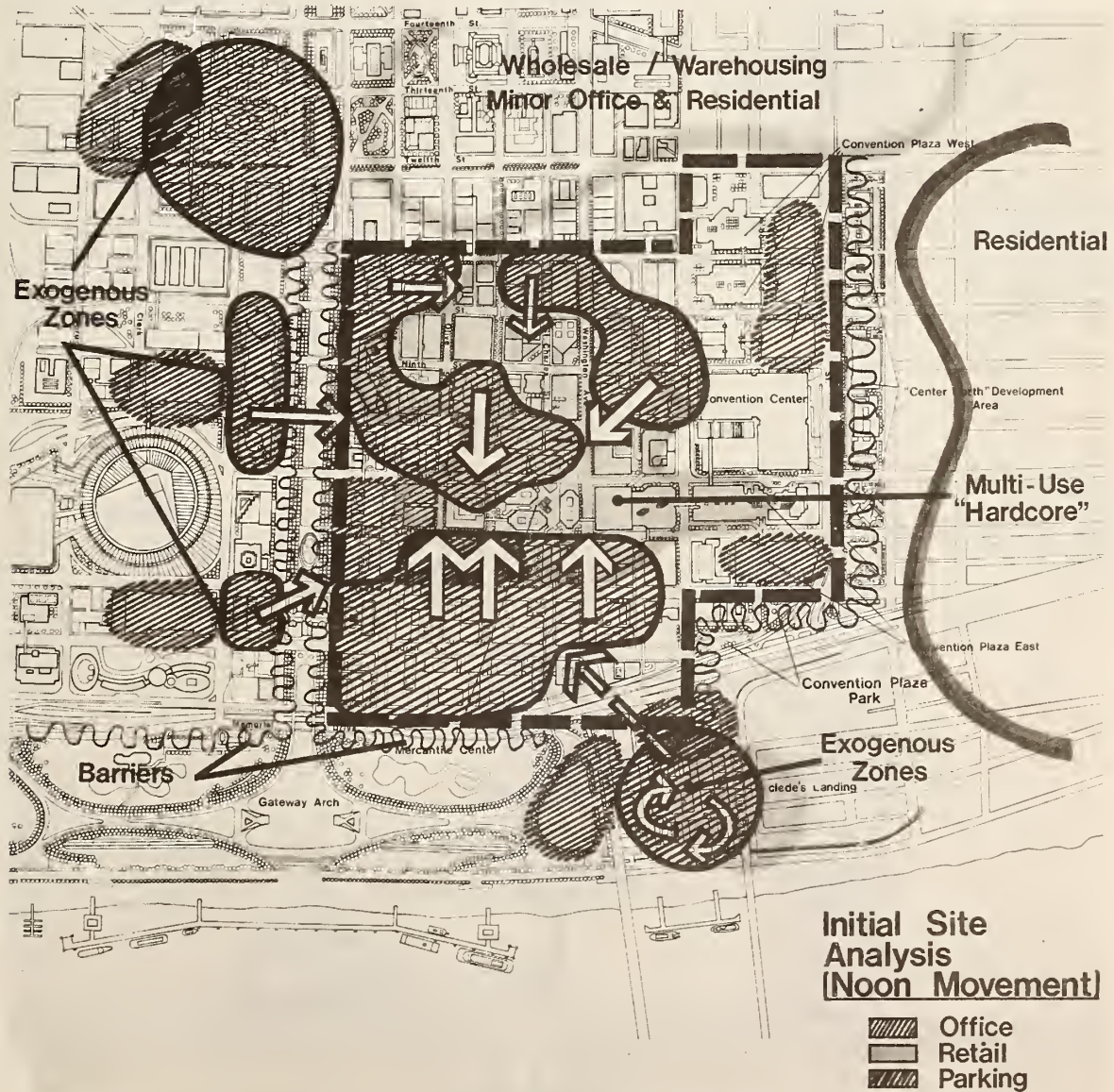

Figure 12

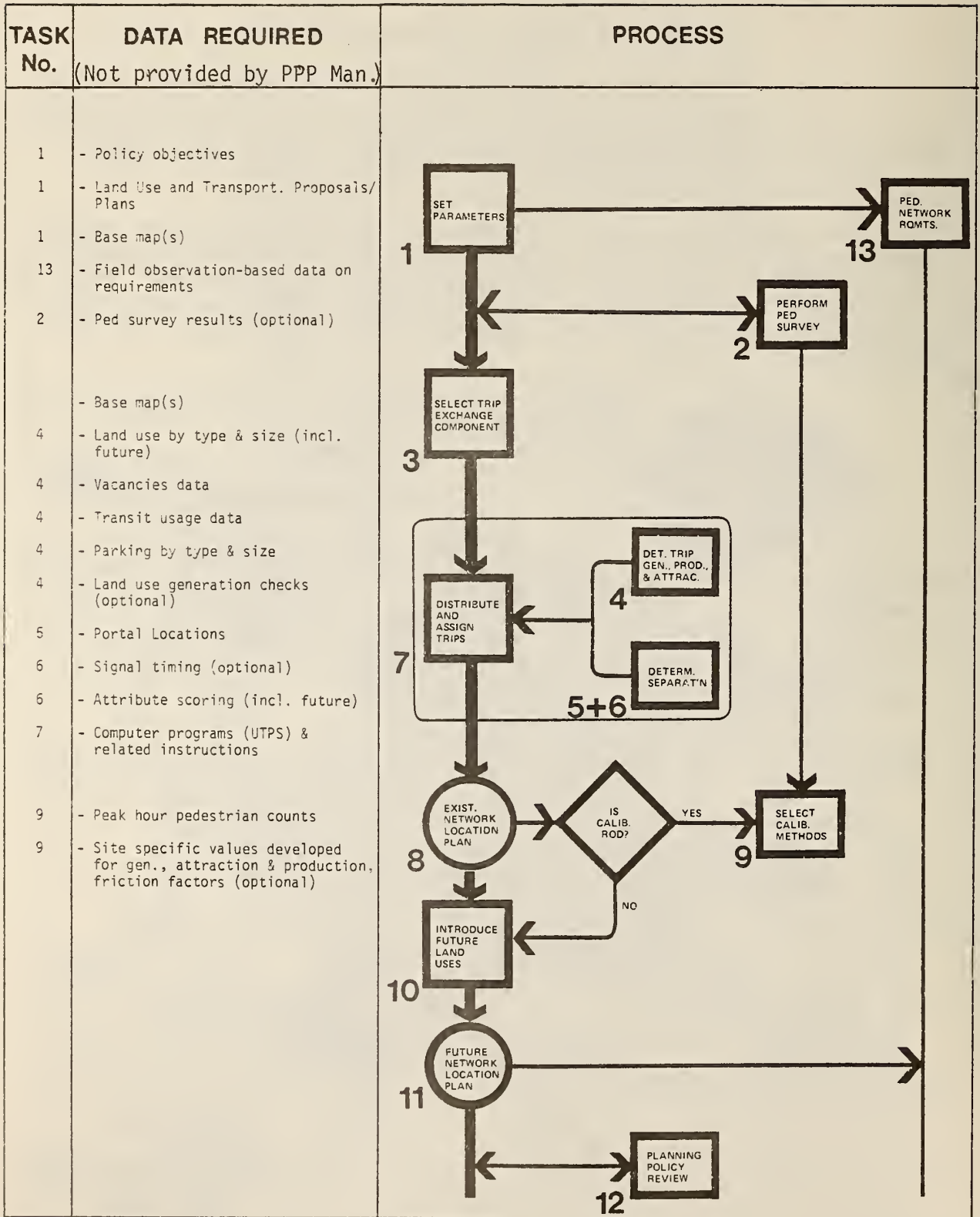

Figure 13

Data Inputs To PPP Tasks 1-13

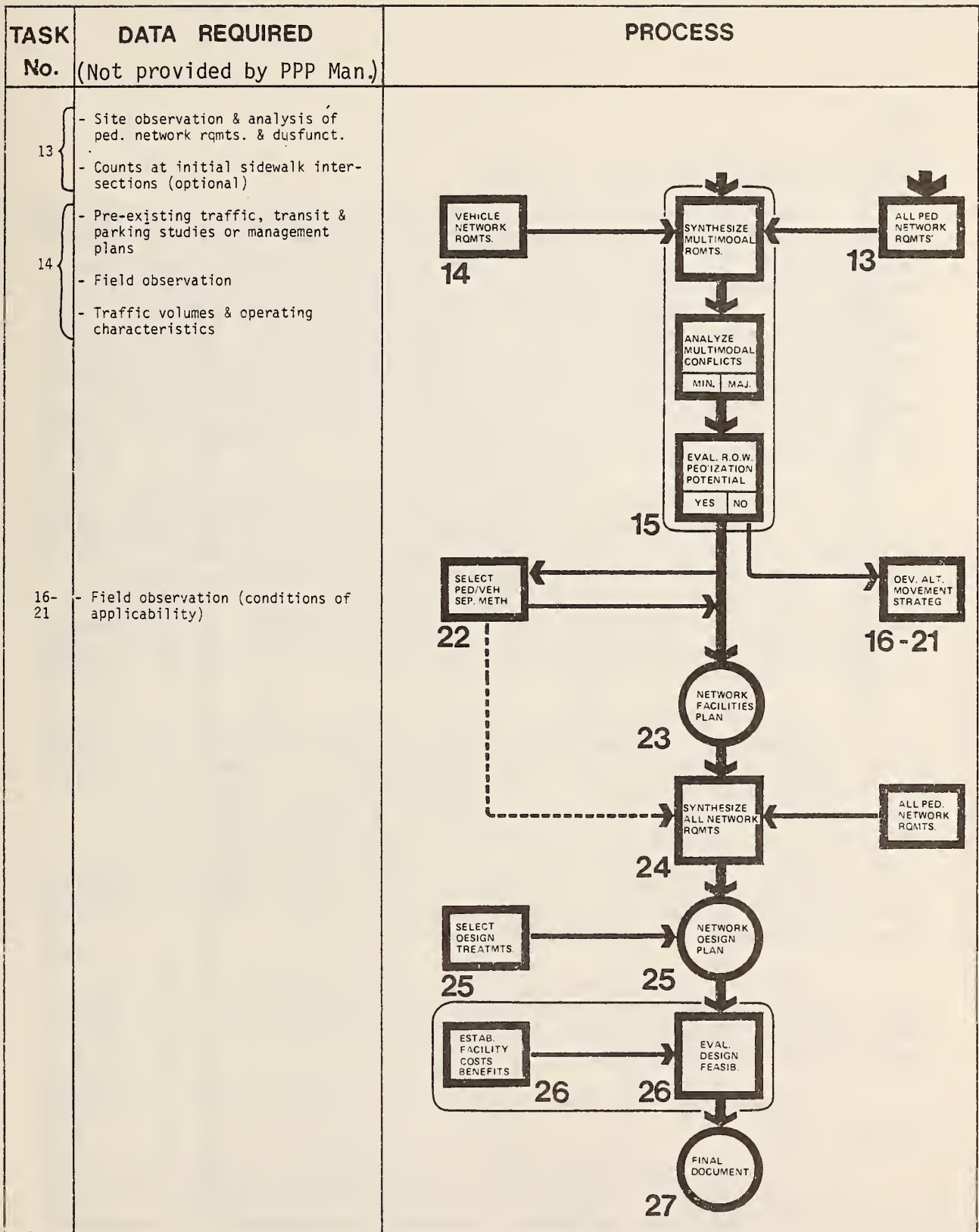

Figure 14
Data Inputs To PPP Tasks 13-27

TASK 2

PERFORM A PEDESTRIAN SURVEY (OPTIONAL)

The Pedestrian Planning Process has been designed to minimize the need to collect and analyze site specific data. However, the user must recognize that if the data input to them are general, as the aggregated data presented within the process are, the results will be less site-specific than if locally unique information had been used. Therefore, where greater accuracy is desired, throughout the process, site specific data should be collected and used. A secondary benefit of this effort is that it provides better, and sometimes unexpected, insights into local pedestrian behavior, and greater confidence in the process outputs. It also provides the planner greater flexibility to modify and tailor individual procedures to suit the given situation.

Although many data elements concerning pedestrian movement can be obtained by unobtrusive methods such as counting, photography, and tracking, other data can only be obtained using more direct methods. The method that provides the most reliable and useful data, within reasonable bounds on cost, is a pedestrian survey. Accordingly then, the planner has the option to conduct a pedestrian survey. However, manpower, time schedule and budget issues must be considered so that any surveying efforts can be tailored to these or other constraints.

All illustrative example (Figure 15) of a fairly comprehensive survey instrument is included for guidance in the Procedures. This sample survey has been designed to provide a large amount of relevant input to many tasks in the PPP (see Fig. 16). Major probe areas identified by the survey are illustrated in Fig. 17. However, the survey instrument is offered as a guideline only. Certain probe areas may require modification in order that they be responsive to site specific conditions and issues under study or a different survey approach (eg. street interviews) might be elected. Prior to undertaking any surveying, the sample survey prototype should be evaluated in a cost/benefit sense.

To assist the planner in approaching and executing the survey task, the sample survey has been broken down, as shown in Fig. 16, into those question clusters and the related analysis that constitute various inputs to the modelling tasks.

In general, the survey provides for the collection of two kinds of data:

- Data that is perceptual and attitudinal and provides the planner with insights and interpretive abilities
- Data that is factual and provides site-specific technical inputs to the modelling tasks.

While these two categories often overlap and the same data can either be analyzed rapidly to provide a sense of pedestrian behavior, or

STREETS FOR PEOPLE

THE CITY OF NEEDS YOUR OPINION ON HOW TO MAKE DOWNTOWN A BETTER PLACE

_____ is continually striving to meet the needs of all people who use the Downtown Area. One of the ways the City is working to meet these needs is by creating a better walking environment. The City would like your participation in the creation of this environment. This survey is intended to take into account your walking experience and your needs as a pedestrian.

GENERAL INFORMATION:

1. Please Print.
2. Read and answer all questions carefully.
3. Please mail within 5 days - No postage necessary.

PART A

The following set of general questions are to be completed by all downtown users.

1

During a normal week how many days do you come to the downtown?

<input type="checkbox"/> 5 or more days	<input type="checkbox"/> Once
<input type="checkbox"/> 2 - 4 days	<input type="checkbox"/> Less Than Once

2

In general where is your point of arrival and departure located? (such as bus stop or parking space)

Arrival: _____

Departure: _____

3

What is the main purpose for your trips?

- | |
|---|
| <input type="checkbox"/> Downtown Employee (if checked, please complete Part B) |
| <input type="checkbox"/> Shopping (if checked, please complete Part C) |
| <input type="checkbox"/> Personal Business |
| <input type="checkbox"/> Other _____ (please specify) |

4

By what means do you arrive in the downtown?

- | | |
|-------------------------------|---|
| <input type="checkbox"/> Bus | <input type="checkbox"/> Car - As Driver |
| <input type="checkbox"/> Taxi | <input type="checkbox"/> Car - As Passenger |
| <input type="checkbox"/> Walk | <input type="checkbox"/> Other _____ |
- (Please Specify)

5

If you travel by auto, do you have difficulty finding a parking space?

- | |
|---------------------------------------|
| <input type="checkbox"/> Never |
| <input type="checkbox"/> Occasionally |
| <input type="checkbox"/> Always |

THANK YOU FOR PARTICIPATING

Figure 15
Prototypical Pedestrian Survey

PART B

The following set of questions are to be completed only by employees who work downtown. The questions refer to your trips to and from your place of work.

6

Where is your place of work? (building name or location)

7

Within 15 minutes, when do you normally:

Arrive in the Downtown _____ AM _____ PM

Depart the Downtown _____ AM _____ PM

8

After arrival in the downtown, how many blocks do you have to walk to get to work and how many minutes does it generally take?

_____ Blocks To Work _____ Minutes Required

8a

Please mark the path(s) that you take during this walking trip on the attached street map by drawing and arrow from start to end. (An example is shown on the attached map.)

The following questions refer to your lunchtime trips.

9

On average, how many days a week do you leave your place of work at lunch time?

_____ Days A Week

10

How many of these trips are for: (write the number of trips in the appropriate box/s)

- Eating Only
- Shopping Only (other than eating)
- Recreation and Exercise Only
- Eating and Shopping
- Eating and Other (_____ Please Specify)
- Shopping and Other (_____ Please Specify)
- Other Only (_____ Please Specify)

11

Within 15 minutes when do you generally go out and return from your lunch time trips?

Go Out: _____ Return: _____

12

Please identify (by name or location) three places that you are most likely to visit during lunchtime. (In sequence)

Place _____ Visits Per Week

1. _____
2. _____
3. _____

12a

Please mark the path(s) that you take during this walking trip on the attached street map by drawing and arrow from start to end. (An example is shown on the attached map.)

Figure 15 (continued)

EXAMPLE

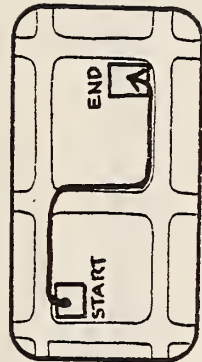

Please mark the path that you take during your walking trip in the downtown area by drawing an arrow from start to end on the street map below. An example is shown at the right of the page. Be as accurate as possible and show short cuts, where you cross streets, etc.

Please use the following line types to indicate the nature of your walking trip(s).

- Work Trip
- Lunch Trip
- Shopping Trip

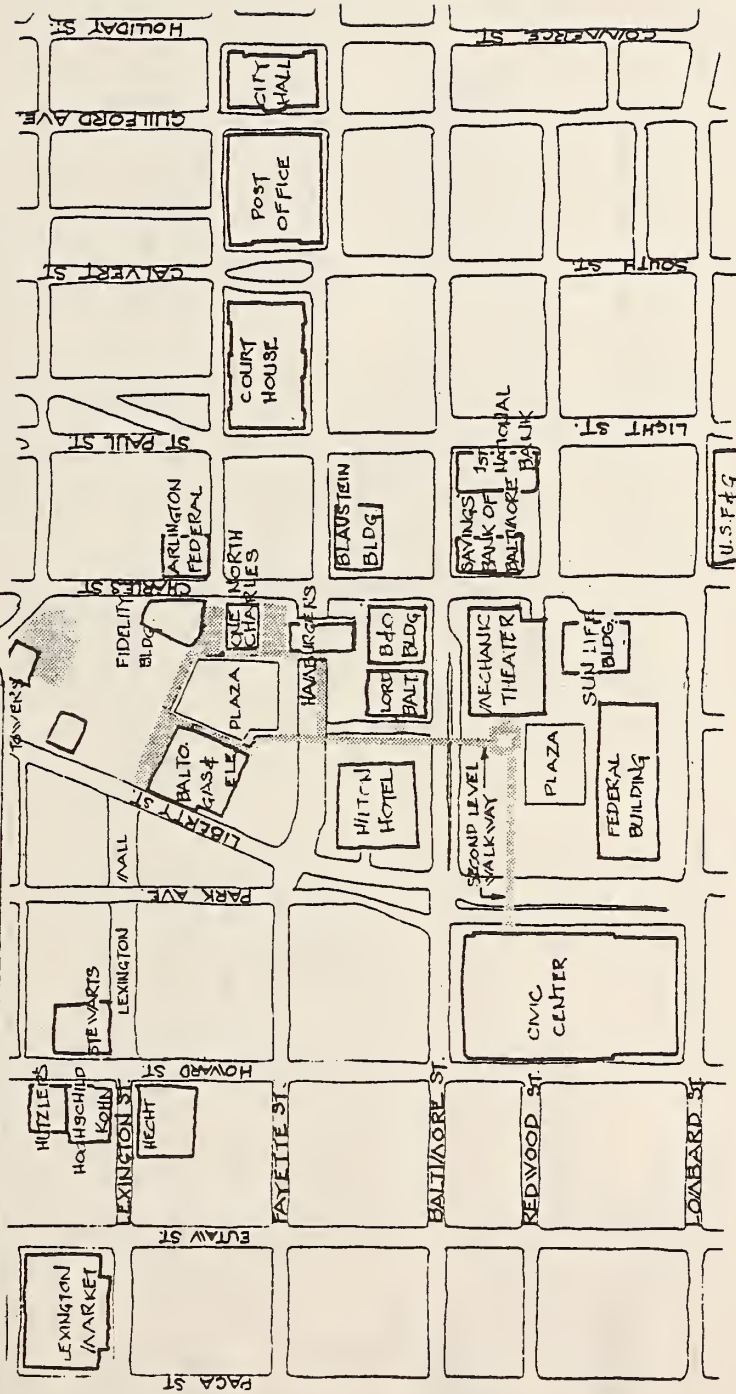

Figure 15 (continued)

PART C

The following set of questions are to be completed only by shoppers (other than employees).

13

When do you generally arrive and depart from the downtown?

Arrive	<input type="checkbox"/>	Before 11:30 AM	<input type="checkbox"/>
	<input type="checkbox"/>	11:30 - 1:30 PM	<input type="checkbox"/>
	<input type="checkbox"/>	1:30 - 4:00 PM	<input type="checkbox"/>
	<input type="checkbox"/>	4:00 - 6:00 PM	<input type="checkbox"/>
	<input type="checkbox"/>	After 6:00 PM	<input type="checkbox"/>
Depart			

14

If you arrive by auto, how far must you park from your primary destination?

Less Than 1 Block
 2 - 4 Blocks
 More Than 5 Blocks

15

How many stops do you generally make during your shopping trip?

_____ Stops

16

Please list the three places that you are most likely to visit during your shopping trips. (In sequence)

1. _____
 2. _____
 3. _____

17

Do you generally have lunch downtown during your shopping trip?

No
 Yes (Please specify name and location)

17a

Please mark the path(s) that you take during this walking trip on the attached street map by drawing and arrow from start to end. (An example is shown on the attached map.)

PART D

The following set of questions are to be completed by all respondents. The questions refer to leisure time trips (entertainment/recreation).

18

Do you spend any of your leisure time in the downtown area?

None
 About Once A Week
 More Than Twice A Week
 Weekends Only

19

If you come downtown for leisure activities, how do you spend your time?

Strolling, Sightseeing,
 Window Shopping
 Theater
 Restaurants
 Special Events
 Culture
 Other

20

Where in the downtown do you spend the majority of your leisure time? (Please specify name and location.)

Name _____ Location _____

Figure 15 (continued)

PART E

The following set of questions are to be completed by all respondents. The intent of the questions is to find out what your attitudes and opinions are regarding the nature of the downtown walking environment.

21

Why do you choose the particular path(s) that you do for your walking trip(s)? (Please indicate which of the reasons listed below are the 3 most significant by using a "1" for your first choice, "2" for your second choice, and "3" for your third choice.)

- Less Problem With Traffic
- Shortest in Time
- Shortest in Distance
- Most Interesting and Attractive
- Most Familiar
- Comfortable to Walk
- Has More People and Activity
- Safe from Crime
- Less Exposed to Weather
- Has Stores and Shops
- Less Air Pollution and Noise
- No Special Reason
- Other

22

Do you generally need directions to make walking trips in the downtown?

- No
- Yes (if yes, please indicate below how you find your way)

- Used Map
- Asked Someone
- Used Street Names and/or Numbers
- Landmarks/Familiar Buildings
- Guessed My Way
- Other (Please Specify)

23

In general, which areas and streets within the downtown would you avoid walking due to your feelings of safety from criminal acts? Indicate locations:

_____ Street between _____ and _____
 _____ Street between _____ and _____
 _____ Street between _____ and _____
 _____ Street between _____ and _____

24

What problems and inconveniences do you associate with walking in the downtown? (Please indicate which of the problems listed below are the 3 most significant by using a "1" for your first choice, "2" for your second choice, and "3" for your third choice.)

- Too Many Steps
- Danger from Traffic
- Long Waits for Traffic or Signals
- No Place to Rest
- Unsafe from Crime
- Air Pollution, Exhaust
- Requires More Time
- Longer in Walking Distance
- Too Steep
- No Protection from Bad Weather
- Easy to Get Lost, Confusing
- No Sun, Too Shady
- Dirty, Bad Appearance
- Too Many Obstacles/Barriers
- Too Crowded
- Unfamiliar
- Too Noisy
- No Shops or Stores
- Uninteresting
- No Shade, Too Sunny
- Other _____

25

Are there places or areas within the downtown that are located inconveniently for walking trips?

Name _____ Location _____

Figure 15 (continued)

26

What can be done to improve the walking environment if to encourage greater use? (Please indicate which of the Improvements listed below are the 3 most significant by using a "1" for your first choice, "2" for your second choice, and "3" for your third choice.)

- Provide shelter from weather
- Provide more places to sit and rest
- Provide more stores, shops and restaurants
- Provide better directional signs
- Provide more escalators
- Provide better access to activities
- Provide better lighting
- Provide more landscaping
- Provide more activities and events
- Provide more interest (fountains/sculpture)
- Provide better police protection
- Provide Greater Safety from Vehicles
- Provide street malls
- Other (please fill in below)

THANK YOU FOR YOUR COOPERATION

PLEASE

FOLD - SEAL & MAIL

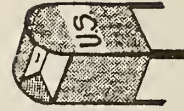

Figure 15 (continued)

POSTAGE WILL
BE PAID BY
ADDRESSEE

BUSINESS REPLY MAIL
FIRST CLASS PERMIT NO.

**STREETS FOR PEOPLE
THE CITY OF
P.O. BOX**

NO POSTAGE
STAMP NECESSARY
IF MAILED IN THE
UNITED STATES



Figure 15 (concluded)

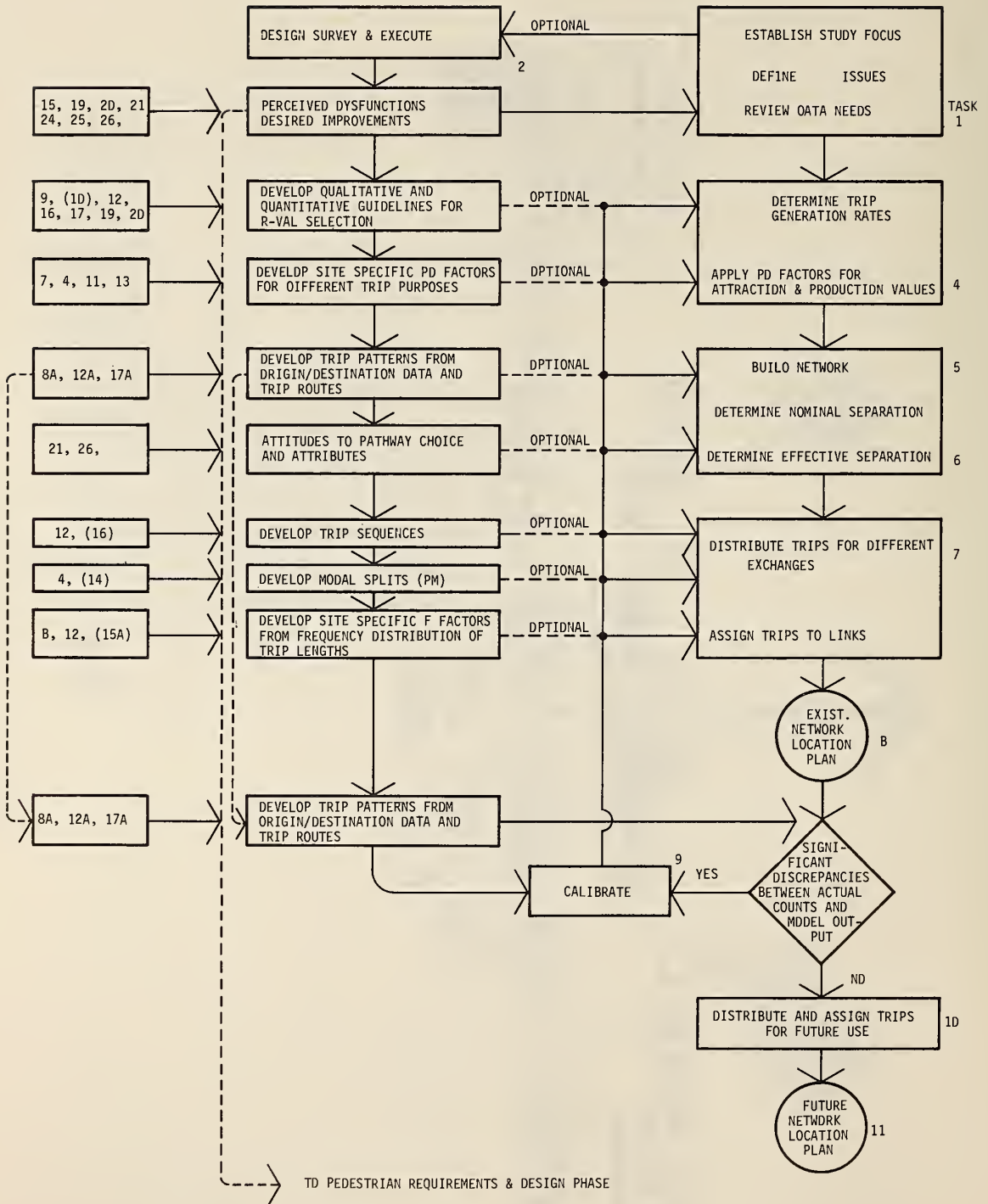

Figure 16

Pedestrian Survey Inputs To The PPP

TARGET DATA AREAS FOR PEDESTRIAN SURVEY

* EMPLOYEE WORK TRIPS

- Time of arrival/departure
- Mode of Arrival
- Trip routes

* EMPLOYEE LUNCH TRIPS

- Trip purposes
- Trip routes
- Origin/destination data
- Temporal data
- Trip lengths

* SHOPPING TRIPS

- Origin/destination data
- Trip lengths
- Temporal data

* ENTERTAINMENT/RECREATIONAL TRIPS

- Frequency
- Trip purpose
- Destination data

* ATTITUDES AND PERCEPTIONS

- Pathway choice criteria
- Perceptions of the pedestrian environment
- Perceived dysfunctions
- Desired improvements

Figure 17

Major Survey Probe Areas

more rigorously, to yield numerical parameters for the same behavior, the two kinds of data have their specific and timely contributions. From this point of view, it is clear from Fig. 16 that if a survey is to be performed, the earlier it is implemented and analyzed, the more useful will it be for reviewing the decisions made during Task 1.

After the first analytical input is completed, the planner has the choice, as the diagram indicates, of developing his own site-specific technical data through further survey analysis for use in the modelling tasks or using the Manual's generic technical data and deferring until the calibration task to see if any further selective analysis of survey data is required for calibration purposes. The latter option will probably be less time-consuming while the former will likely produce more accurate output.

TASK 3 SELECT MOVEMENT COMPONENT(S) FOR EXAMINATION

Task 3 is the first of a series of interrelated tasks leading to development of pedestrian network location plan which forms the basis for subsequent tasks. The task sequence beginning with this task is as follows:

- Task 3 - one or more major components of pedestrian movement within the urban core are selected for examination, and each component is then examined in Tasks 4 through 11;
- Task 4 - centroids of pedestrian trip production and attraction are identified, average hourly measures of two-way trip generation (R-values) are developed, and these values are converted to production and attraction volumes for each movement component;
- Task 5 - for each movement component, a graphic pedestrian network composed of centroids and interconnecting pathways is developed;
- Task 6 - for each movement component, measures of inter-centroid travel time (separation) are computed, and are converted to trip-making probabilities (friction factors);
- Task 7 - based on existing land uses only, each movement component is examined using a gravity demand model approach to distribute and assign pedestrian trips within each network;
- Task 8 - trip distribution and assignment volumes are collected, as appropriate, across all movement components to obtain a network location plan for existing land uses, which shows the relative utilization of network pathways;
- Task 9 - the network location plan, for existing land uses developed in Task 8 is compared for consistency with independent data, for example, pedestrian counts, and if deemed necessary, steps 4 through 8 are repeated until a satisfactory location plan is obtained,

- Task 10 - future land uses are introduced and step 7 repeated to obtain movement component distributions and assignments reflecting future, as well as existing uses; and
- Task 11 - a network location plan, including future uses, is developed in a manner similar to that employed in Task 9.

In Task 3, which initiates the above sequence of tasks, one or more major components of daily movement within the urban core are selected. Figure 18 illustrates a typical daily temporal pattern. The rationale for this approach is discussed below.

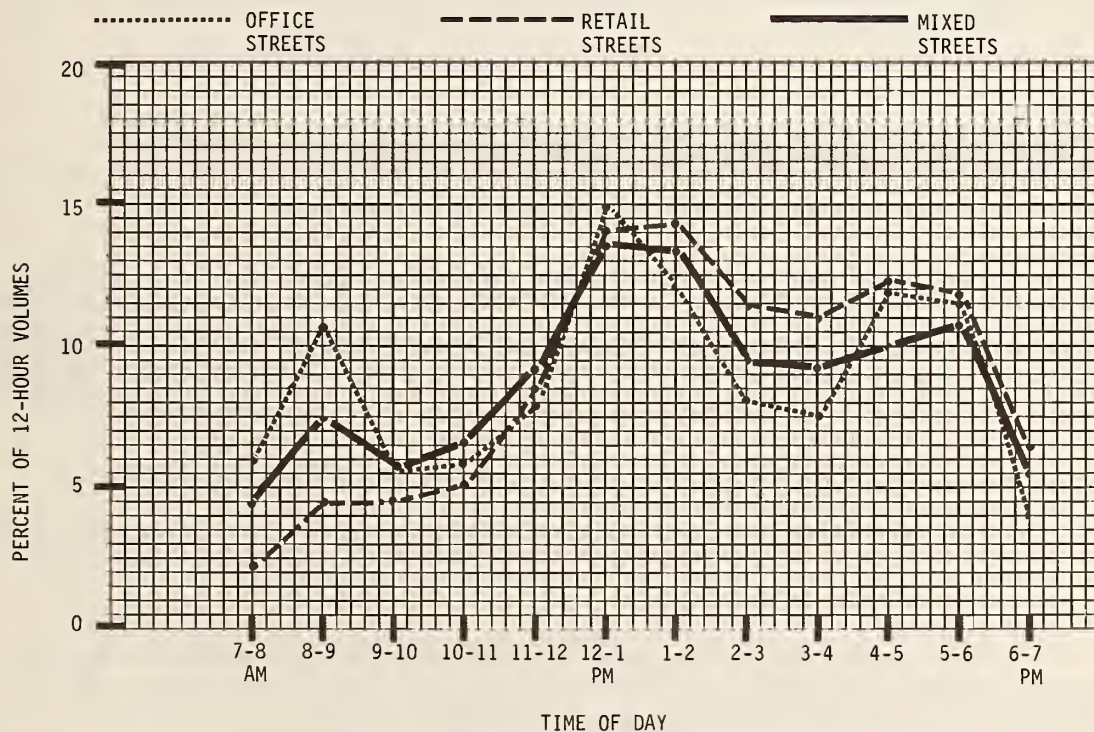

Figure 18

Typical Temporal Pattern Of Pedestrian Volumes

The trip distribution and assignment model utilized in Task 7 is only applicable to short, peak period analysis where trips are single-purpose and unidirectional (from the viewpoint of the individual pedestrian). The model is not capable of simulating the dynamics of trip making involving multiple stops, direction reversals, meandering and similar complexities of pedestrian behavior. For this reason, the analysis of pedestrian trip exchange is treated as one or more "snapshots" made at

appropriate peak periods. Typically, this would include the following movement components:

- Noon office to retailing trip exchanges;
- Noon retailing to retailing trip exchanges;
- PM employee to terminal trip exchanges;
- PM shopper to terminal trip exchanges; and
- Other trip exchanges.

This list is not intended to be exhaustive and the user is encouraged to assess the site-specific need for each type of analysis. The "other trip exchanges" category refers to any specific component of pedestrian movement deemed worthy of examination. Additional guidance is provided in the procedures.

TASK 4

DEVELOP CENTROID PRODUCTION AND ATTRACTION VALUES

In Task 4, the following steps are conducted;

- Land uses are classified, and characterized by a measure of size;
- Using data provided in the procedures which reflects national, aggregated experience or similar data obtained by making use of site-specific sources, a set of generation factors (R-values) by land use type are selected; and
- multiplied by the land use size parameter to produce a generation value which is
- modified through multiplication with a peak directional (PD) factor associated with a specified peak period and pedestrian trip purpose

The production or attraction values generated by this last step are used as input to Task 7, at which time the trips are analytically distributed throughout the pedestrian system.

The classification of land uses for the purpose of estimating pedestrian generation has been designed to include those uses responsible for the majority of pedestrian trip making in the urban core. Analysis of downtown Baltimore has shown, for example, that 95% of all pedestrian trips made occur within 50% of the land area as indicated in Fig. 19.

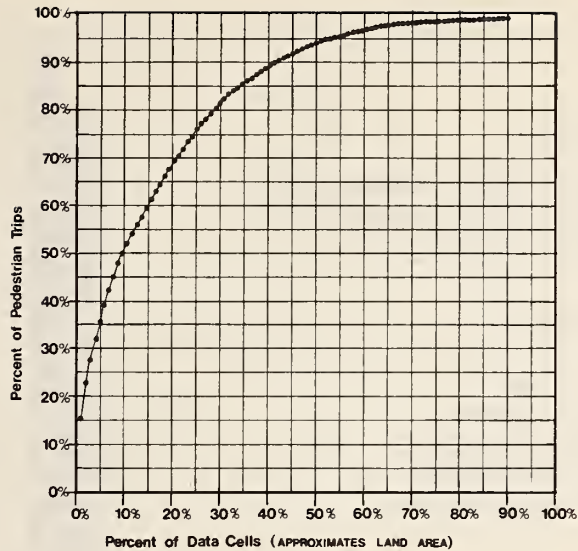

Figure 19

Density Of Tripmaking

Some land uses such as wholesaling or warehousing have been purposely omitted since they generate minimal pedestrian traffic in most central areas. Exceptional land uses such as tourist attractions and convention facilities defy generalization and can only be estimated using site-specific input. The classification used in the Procedure includes:

Office

- Local use buildings
- Headquarters buildings
- Mixed use buildings

Retail (excluding food related)

- Specialty retailing
- General merchandising store

Retail (including food related)

- Fast food carry out
- Fast food with service
- Full service

Parking

- Parking lot
- Parking garage

Residential

- Single family dwelling
- Apartment dwellings
- Hotels and motels

Modal Transfer

- Bus stops
- Taxi stands
- Subway stations
- Bus terminals
- Railway stations

Other

- Tourist attractions
- Parks
- Stadia
- Convention halls, etc.

Following classification, the land uses are characterized by an appropriate measure of their size. Typical dimension include net square feet for office and retailing, number of seats for restaurants, number of occupied rooms for hotels, and so on.

Data are provided in the Procedures for estimating average land use generation rates for offices, retailing, restaurants, parking and residential. These data were derived from extensive analysis of trip generation counts, and are based on national coverage over a representative range of cities.

The data generally reflect average, moderate weather conditions with no precipitation. The user is encouraged to compare these data with site-specific information where possible. Figure 20 uses average generation rates to illustrate differences in the generation potential of various land use types. Figures 21, 22, 23 and 24 show daily temporal trip generation derived from typical data samples for individual buildings and streets. The data generally reflect average, moderate weather conditions with no precipitation. The user is encouraged to compare these data with site-specific information where possible in either this task, or, if appropriate, in Task 9, Calibration.

Generation (the R-factor) is estimated in trips produced and attracted (two-way trips) during an average hour measured from 7:00 AM to 7:00 PM on a weekday. Ranges are provided and the user will be required to use judgement to account for variation caused by site-specific factors such as the following:

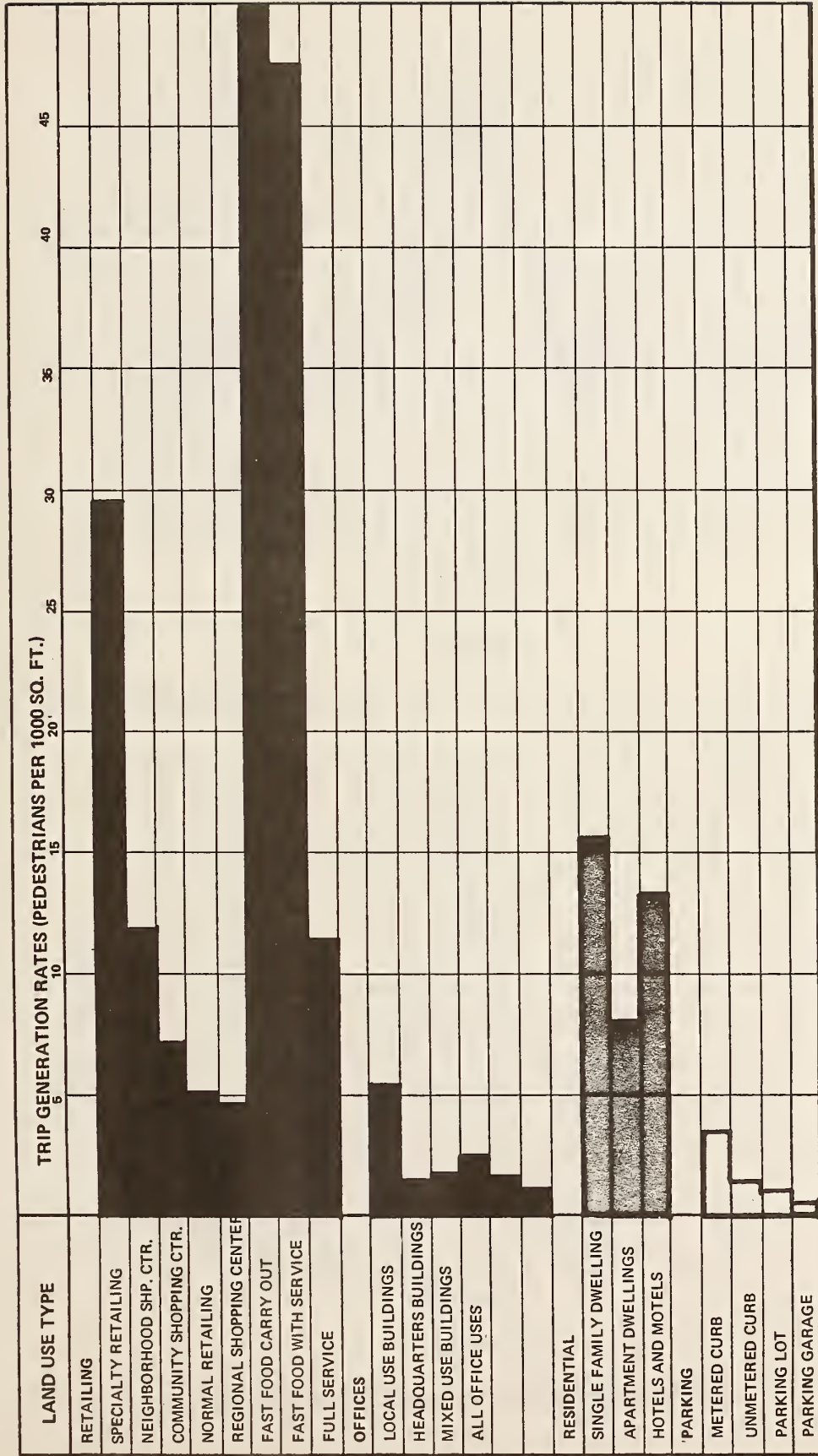

TRIP GENERATION IS A FUNCTION OF TYPE AND SIZE OF LAND USE

Figure 20
Average Land Use Generation Rates

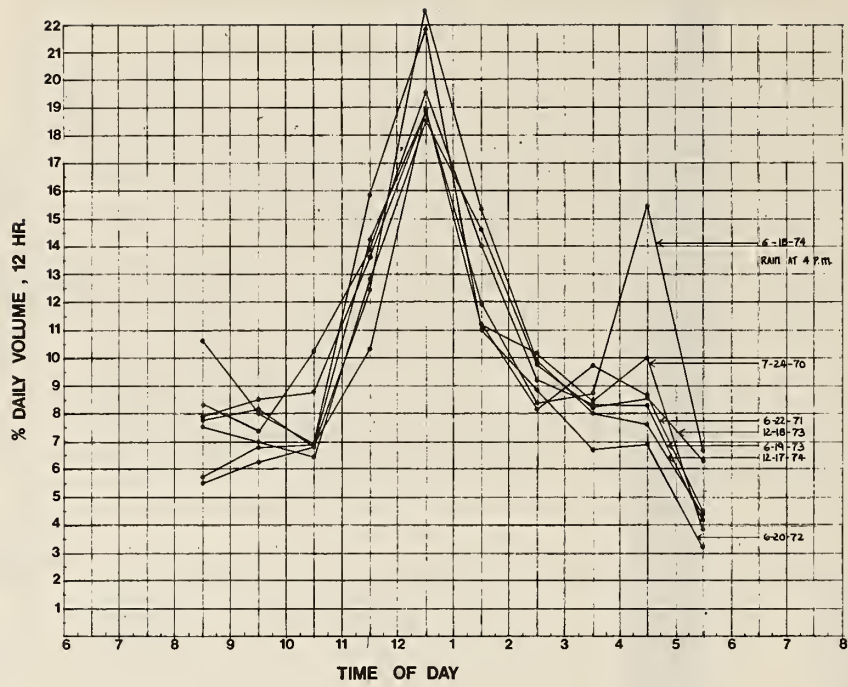

Figure 21

Pedestrian Volume Counts On A Retail Street - Summers and Winters

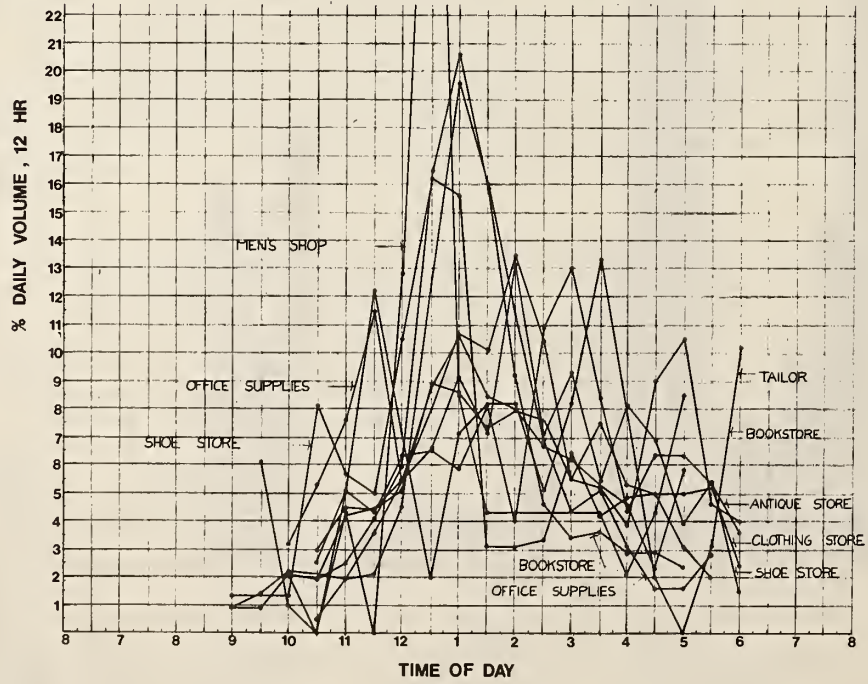

Figure 22

Pedestrian Generation - Specialty Shops

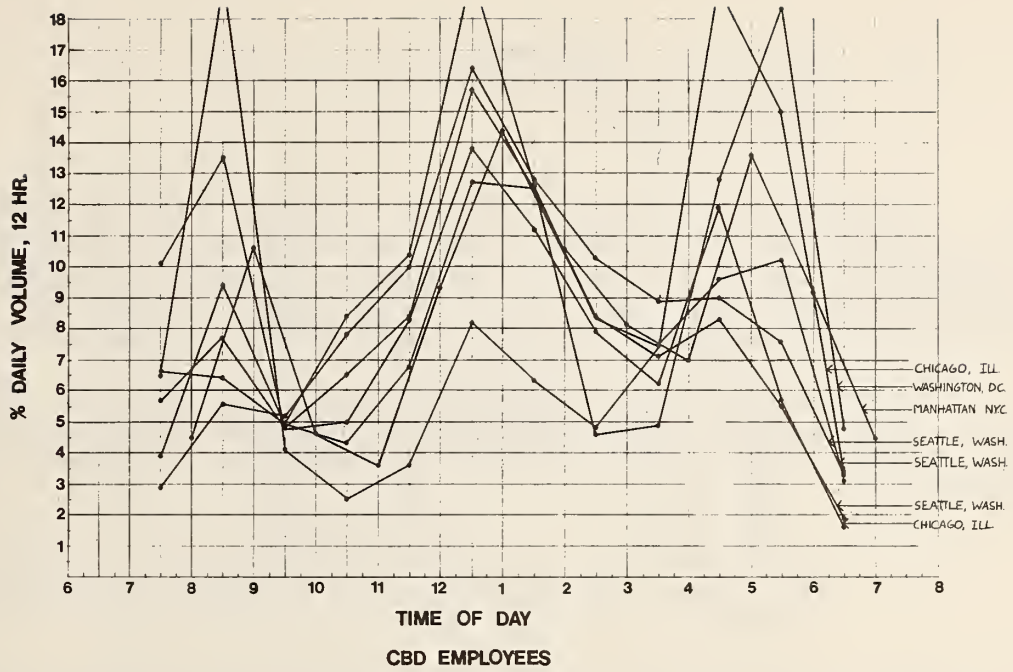

Figure 23

Pedestrian Volume Counts On Office Streets - 4 Cities

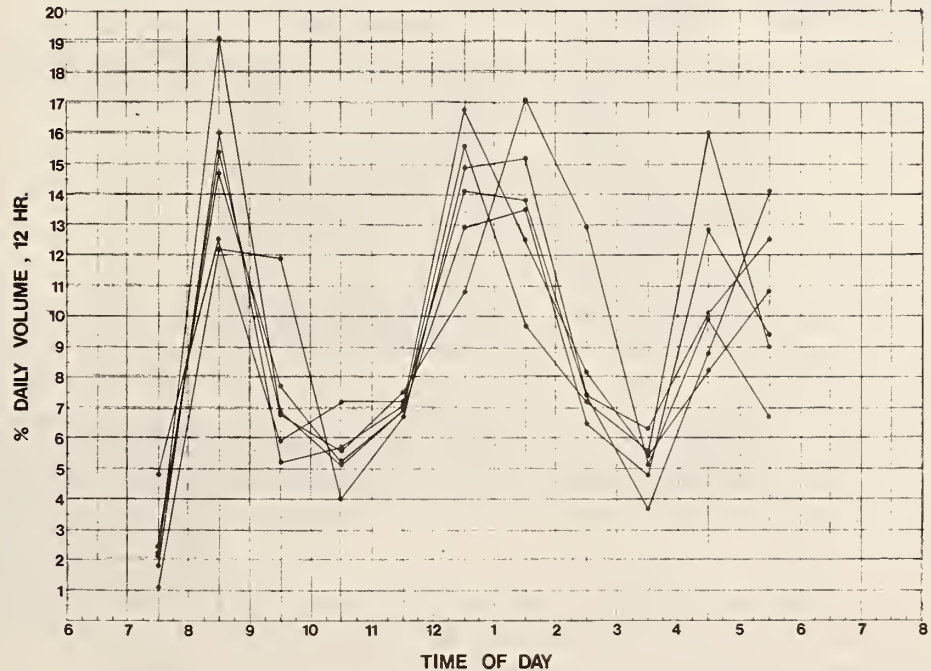

Figure 24

Pedestrian Generation - Office Buildings

- The quality of generators
- Availability of accessible opportunities
- Unique land uses
- Vacancy rates

R-factors are determined for each centroid -- both existing and future -- and multiplied by the centroid's size parameter to produce its trip generation. Since this factor represents average hourly generation, accounting for all trip purposes, it is independent of the movement component analysis; and therefore, is only computed once for each centroid.

Once a movement component has been chosen for analysis, the average trip generation for each centroid is converted by multiplication with factors provided in the Procedures to reflect three movement-specific conditions:

1. The increased two-way volumes associated with the peak period under consideration (as a multiple of average hourly volumes);
2. The percentage of trips out to reflect production, or trips in to reflect attraction, associated with the peak period under consideration; and
3. The fractions of an hour represented by the peak period under consideration.

The resultant production and attraction volumes are input to the model in Task 7.

TASK 5

BUILD NETWORKS

Following classification of land uses and determination of trip generation rates for all major centroids, a graphic pedestrian network is developed for each trip purpose (movement component) being examined. The network consists of circles denoting pedestrian activity centers or centroids, connected by line that represent the pathways between these centers. The inter-centroid pathways can, if necessary for more adequate definition, be subdivided into a series of pathway links. (See Fig. 29 for an example).

The mapping of generation values (see Fig. 25 for an example) over a base map of the study area can provide a basis for delimiting the extent of network. It may also provide insight into probable trip exchange patterns and routings.

In developing a pedestrian network, the level of detail incorporated, that is, the extent to which centroids and pathways are defined

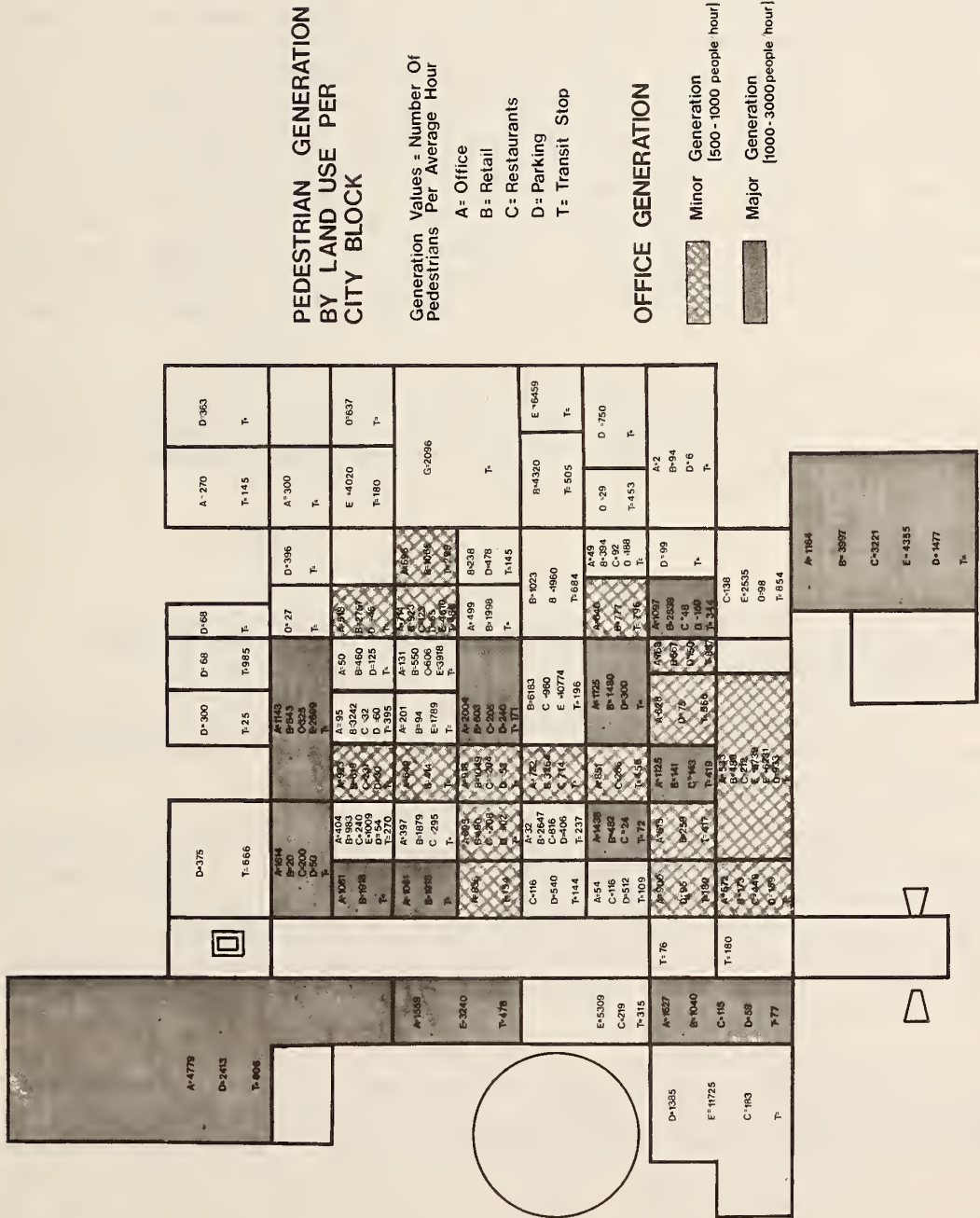

Figure 25
Sample Mapping Of Pedestrian Generation In Study Area

and differentiated, will be a decision made by the user. However, numerous factors will affect this decision.

Basically, there is a trade-off between the considerable effort required to examine a more detailed network in order to develop refined pedestrian movement data, and the less intense effort required to examine a less detailed network which will yield a more aggregated movement data. The network is simply a tool to facilitate the analysis and can be tailored to situations ranging from a macro analysis of large urban areas to the microscale of a single pathway facility. Hence, to a large extent, the intended application of the network will determine the level of detail that is required. However, since the computational effort described in subsequent tasks increases geometrically as the level of detail increases, the user should insure that the detail included is minimized, consistent with the requirements of the analysis. Examination of even moderately complex networks will require the application of appropriate computer programs.

The pedestrian networks produced in this task will form the basis for recording the centroid generation rates computed in Task 4, the separation values and friction factors developed in Tasks 5 and 6, and subsequently the pedestrian trip distribution and assignment values produced by the model in Tasks 7 and 10.

TASK 6

DETERMINE NOMINAL AND EFFECTIVE INTER-CENTROID SEPARATION MEASURES, AND FRICTION FACTORS

Using the networks developed in Task 5, travel time along their pathways and pathway links must be determined for use in the distribution and assignment modelling tasks.

The extent to which pedestrian trips are made between centroids will depend, in part, on the "distance" between them. The real or perceived "distance" between centroids, or more generically, their separation, is a function of walking distance, trip time, pathway impedances, and various perceptual factors that influence the propensity of a pedestrian to make the trip. In this task, methods are presented for developing separation measures between centroids.

In addition to spatial separation (walking distance) and temporal separation (trip time) considerations, typical pathway elements that contribute to the real or perceived pedestrian separation of a centroid pair are:

Vertical Displacement

- stairs
- ramps
- escalators
- elevators

Horizontal Displacement

- turning movements
- directness
- impedances

Delays

- crowding
- queues
- waits

Psychological and Physiological Factors

- comfort and amenities
- security
- safety
- interest and attractiveness
- orientation

The term effective separation will be used to describe the distance between two points as perceived by pedestrians as a function of time, distance and the other influencing elements cited above.

Distance, time and energy (under average conditions) represent invariant measures of separation associated with a given pathway. These measures are used to establish a nominal separation that will be modified by behavioral or perceptual factors to obtain the effective separation. For example, 1000 feet of pathway, characterized by numerous points of interest, may be perceptually shorter than 1000 feet to a pedestrian on a recreational trip; but may still appear as 1000 feet to a commuter going from a bus stop to a place of employment.

Nominal separation measures are expressed in terms of time, usually as minutes. Distance and energy are converted to time using pedestrian movement on level, unimpeded pathways as the normative condition. To convert the nominal travel times to effective travel times, the planner must conduct a field survey of existing streets and rate specific aspects, or attributes, of the street environment. These site specific ratings are combined with generic ratings based on research findings for the same attributes so as to provide a final trip-purpose-contingent weighting. Fig. 26 illustrates these concepts. Work sheets integrating the planner's rating with precalculated weights are provided.

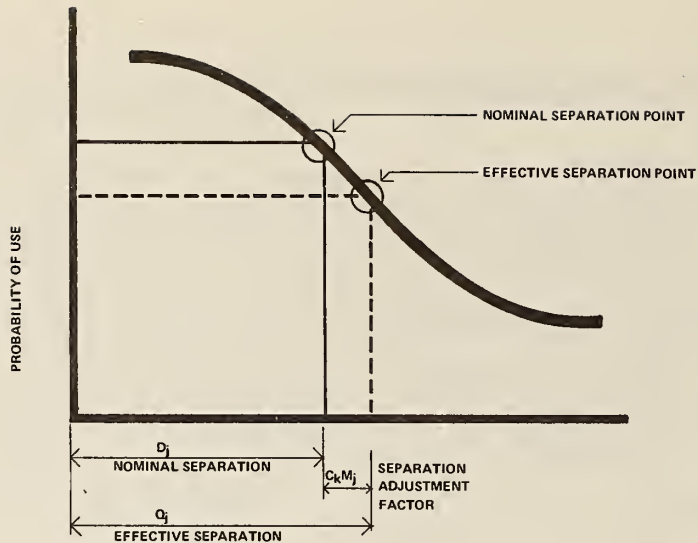

$$Q_j = D_j [C_k M_j]$$

where

C_k = CONSTANT VALUE (NORMALIZING)

M_j = TOTAL DISTANCE MOVED FROM NOMINAL TO THE INFLUENCE OF ALL ATTRIBUTES WITH RESPECT TO TRIP PURPOSE

$$= \left[\frac{r_j - 5}{10} \right] [G_i] \text{ OR } \left[\begin{array}{c} \text{FIELD SURVEY} \\ \text{RATING} \end{array} \right] \left[\begin{array}{c} \text{ASSIGNED} \\ \text{WEIGHT} \end{array} \right]$$

PATHWAY ANALYSIS INTEGRATING PERCEPTUAL VARIABLES AND INTERCENTROID SEPARATION

Figure 26

Nominal And Effective Separation

The effective separation measures represent the perceived pedestrian travel times between centroid pairs. The probability that a pedestrian will choose to make a trip, or the trip propensity, is related to the magnitude of the perceived travel time. As the perceived travel time increases, the propensity to make the trip is reduced, or attenuated. By examining the marginal probabilities on trip attenuation curves developed from experience data, it is possible to obtain estimates of the probability that a pedestrian trip, requiring a given travel time, will be made. These probabilities, known as friction factors, or travel time factors, are developed in this task and provided as input to the gravity model where they influence the trip distribution within the network.

Figures 27 through 30 present a sequence of sample graphics as a visual summary of key products from Tasks 5 and 6.

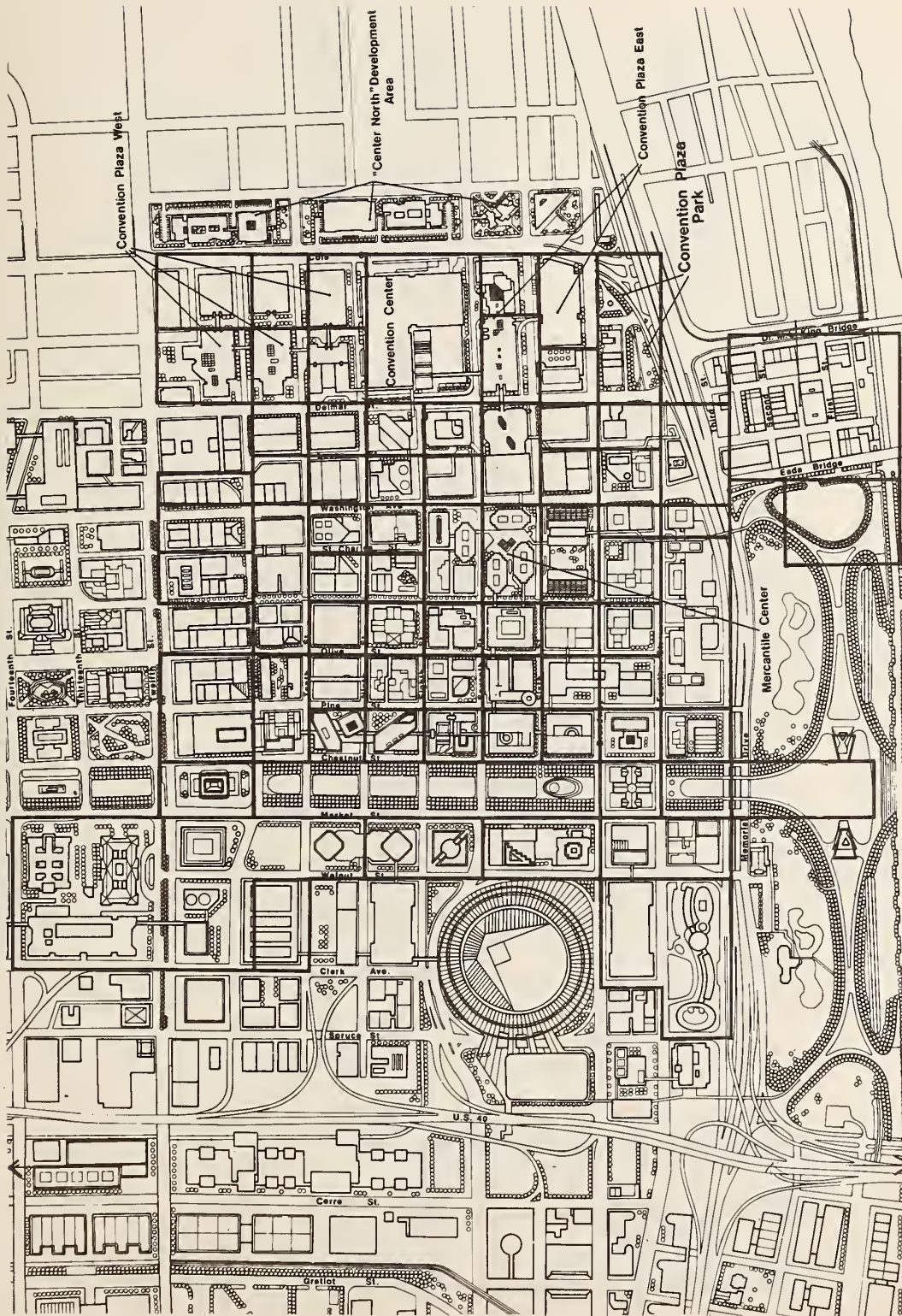

Figure 27

Base Map With Overlay Of Generation Cells

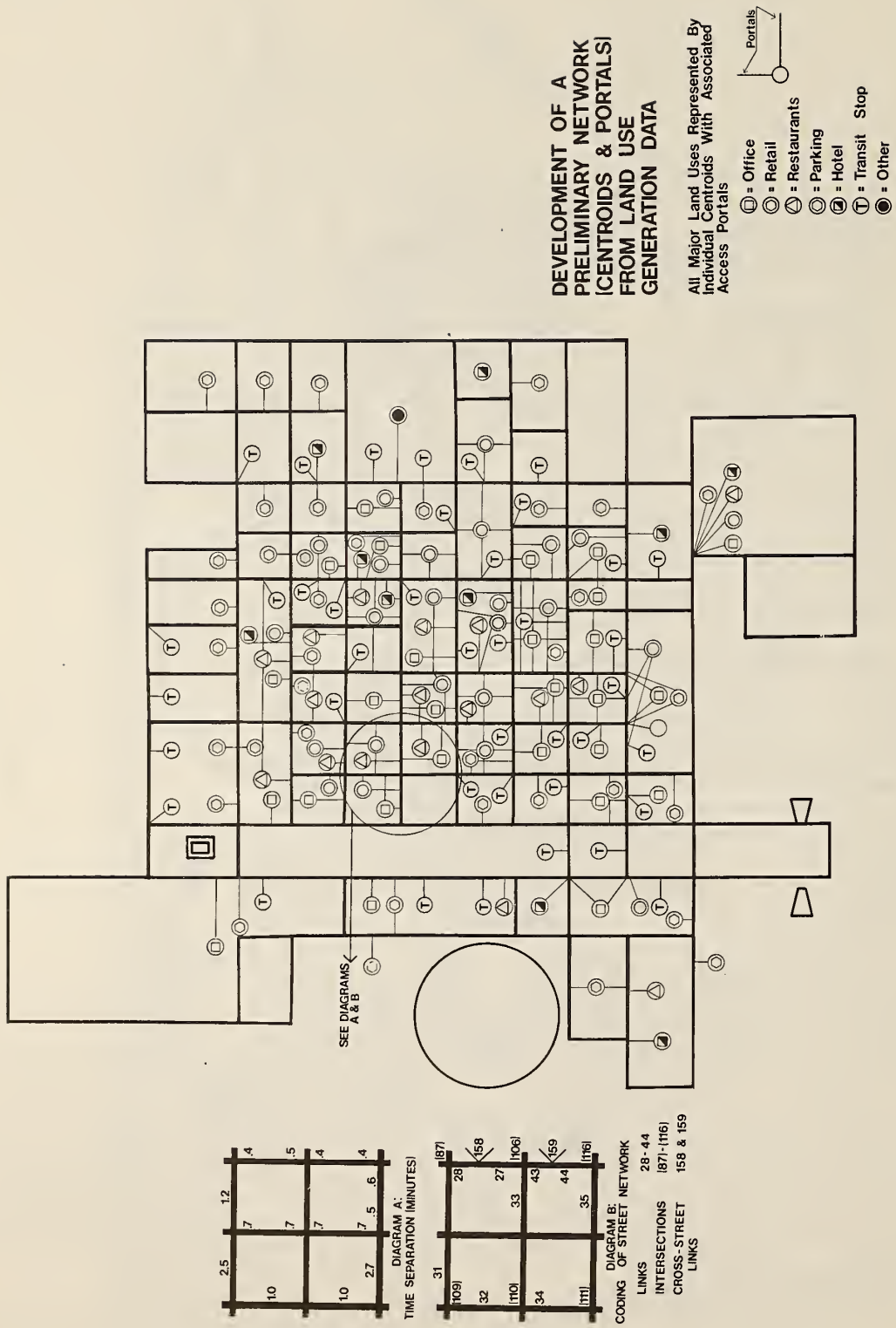
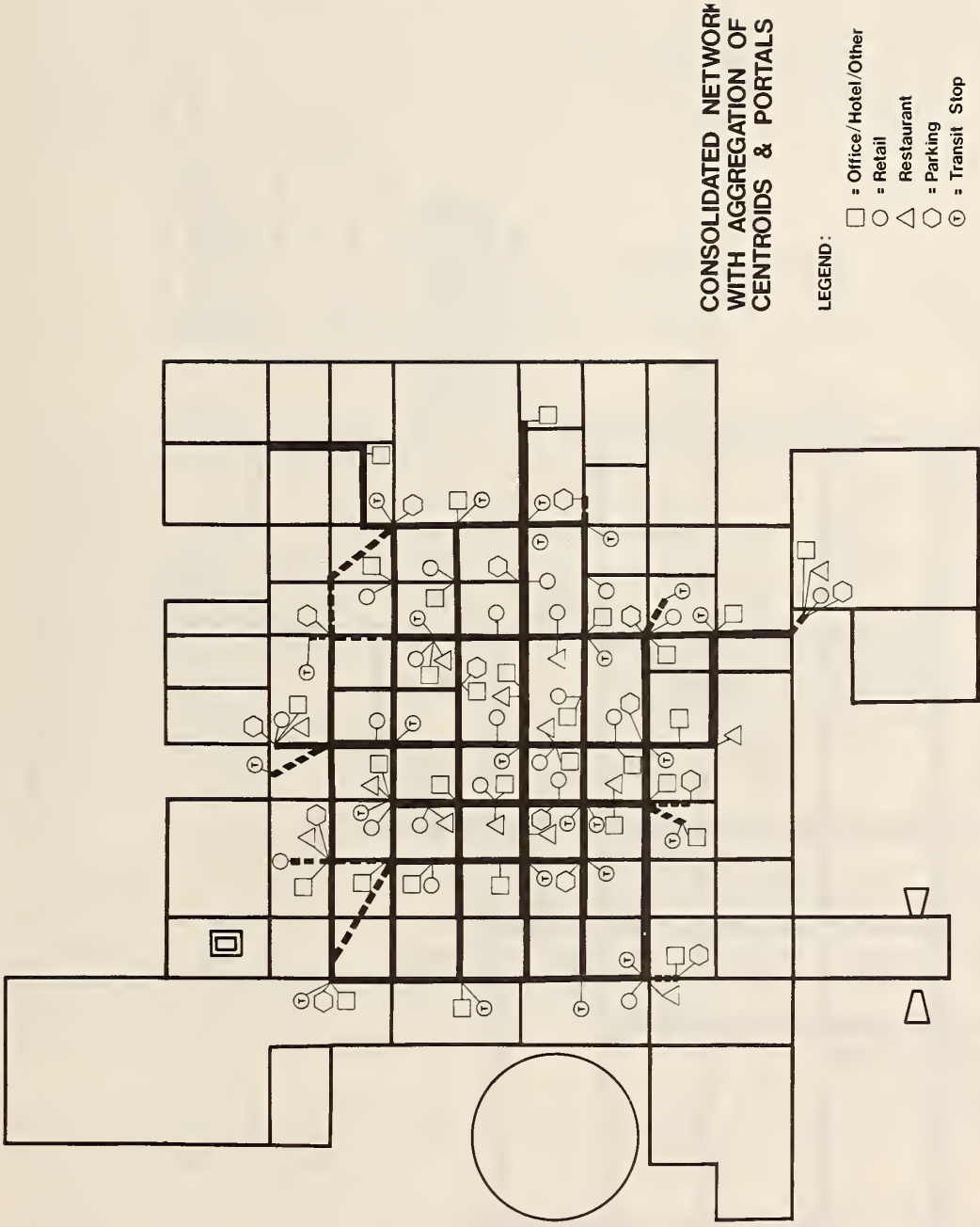

Figure 28
Development Of Preliminary Network



**CONSOLIDATED NETWORK
WITH AGGREGATION OF
CENTROIDS & PORTALS**

- LEGEND:**
- = Office/Hotel/Other
 - = Retail
 - △ = Restaurant
 - ⬡ = Parking
 - ⊙ = Transit Stop

Figure 29
Consolidated Network

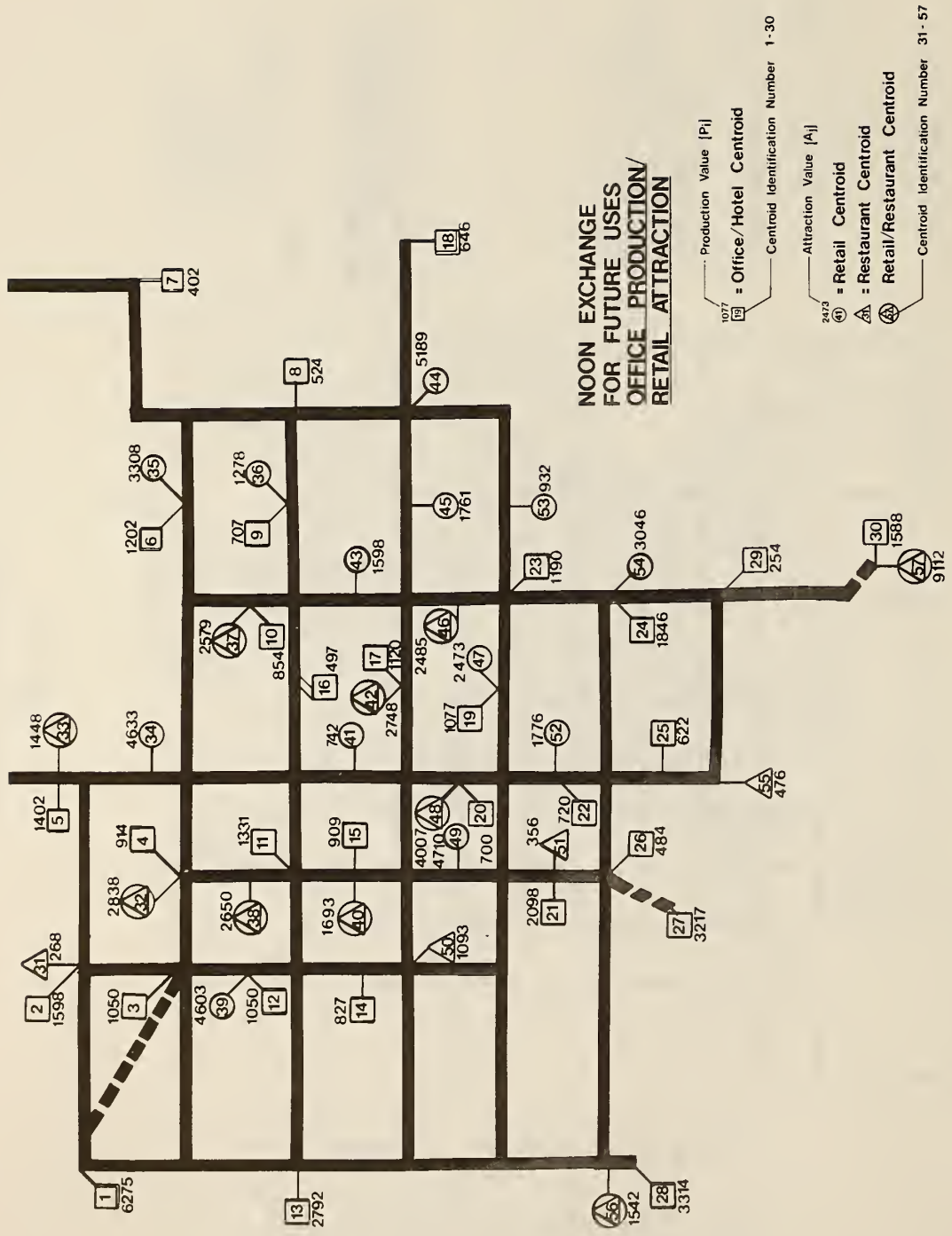

Figure 30
Network Coded For Noon Office To Retail Exchange

TASK 7

DISTRIBUTE AND ASSIGN TRIPS

In this task, existing pedestrian movement associated with the peak period trip exchange category being examined is simulated using a gravity model approach similar to that employed in the analysis of vehicular demand requirements. Each exchange category is analyzed separately and the results aggregated, as appropriate in Task 8.

This task has two major steps:

- Distribution of trips produced to centroids that attract these trips using the gravity model; and
- Assignment of this trip exchange to network pathways and links.

The gravity model input consists of the pathway friction factors, and pedestrian volumes produced and attracted at each centroid. The model consists of an iterative procedure that balances the trip attraction strength of network centroids against trip propensities (friction factors) representing their distances from centroids of trip production. After several interactions, the model achieves a stable, balanced distribution of trips (equilibrium) within the network. When this condition results, the model produces output that shows the number of trips produced at each centroid and attracted to each centroid. For example, if 100 trips are produced at centroid A, the model will show that 75 are attracted by B, and 25 are attracted by C. This distribution will be influenced by the relative attractiveness of B and C, their travel time as measured from A, and the complex interaction of all other centroids.

Once the inter-centroid distribution of trips is known, the trips can then be assigned to one or more competing pathways connecting the centroids. The least complex method of assigning trips is to assign all trips (between A and B) to that pathway with the minimal travel time; this is known as an "all-or-nothing" assignment. However, the user has the option, given adequate resources and need, to assign trips using more complex methods such as a stochastic assignment based on the relative travel times on competing paths.

The above steps are repeated for each exchange category. The results are aggregated in Task 7, and if necessary, reexamined using methods suggested in Task 8.

TASK 8

PRODUCE EXISTING NETWORK LOCATION PLAN

By transferring data on link volumes, from Task 7, to the pedestrian network graphic or to the base map, utilization maps are produced which may be used for several purposes:

Trip exchange components, consisting of different trip purpose during different temporal periods (peaks), can be computed and aggregated to obtain a profile of daily pedestrian volumes. Since it would be impractical to attempt to model all components of daily movement, the aggregated profile would not include all trips. However, it would provide a profile on the relative magnitude of utilization for each network link.

This data can be further analyzed and simplified by developing a high, medium and low discrimination of the daily (or specific peak component) network utilization. In subsequent tasks, the focus of attention will be that network composed of links exhibiting the highest utilization.

The links or corridors of high utilization represent existing situations with potential for pedestrianization of one form or another, provided that the requirements of other movement modes in the same corridor can also be accommodated.

Fig. 31 illustrates a potential corridor utilization map. This kind of map will be a primary input for examining considerations in subsequent tasks.

Also, a composite of movement components that coincide during a peak hour can be developed to form the basis for identification and examination of potential short-term capacity problems and similar aspects of design. Depending on the peak period that yields the maximum volume, potential requirements for pedestrian treatment will be defined; for example, if the maximum utilization is associated with employee terminal trips, then requirements for directness and other attributes that minimize trip time become important.

This composite will also be useful for comparison with pedestrian count data in Task 9.

TASK 9

CALIBRATE THE TRIP DISTRIBUTION AND ASSIGNMENT MODEL

The pedestrian trips distributed and assigned to the network in the previous task should be checked for consistency with actually measured pedestrian peak hour volumes.

The purpose of this exercise is to allow the planner to develop a reasonable level of confidence in the model's proportional replication of actual existing trips on those links with high potential utilization. Since exact numerical correspondence between modelled and observed volumes across the whole network is not being sought but rather a degree of proportional consistency on significant links, calibration within the PPP is not viewed as a major exercise.

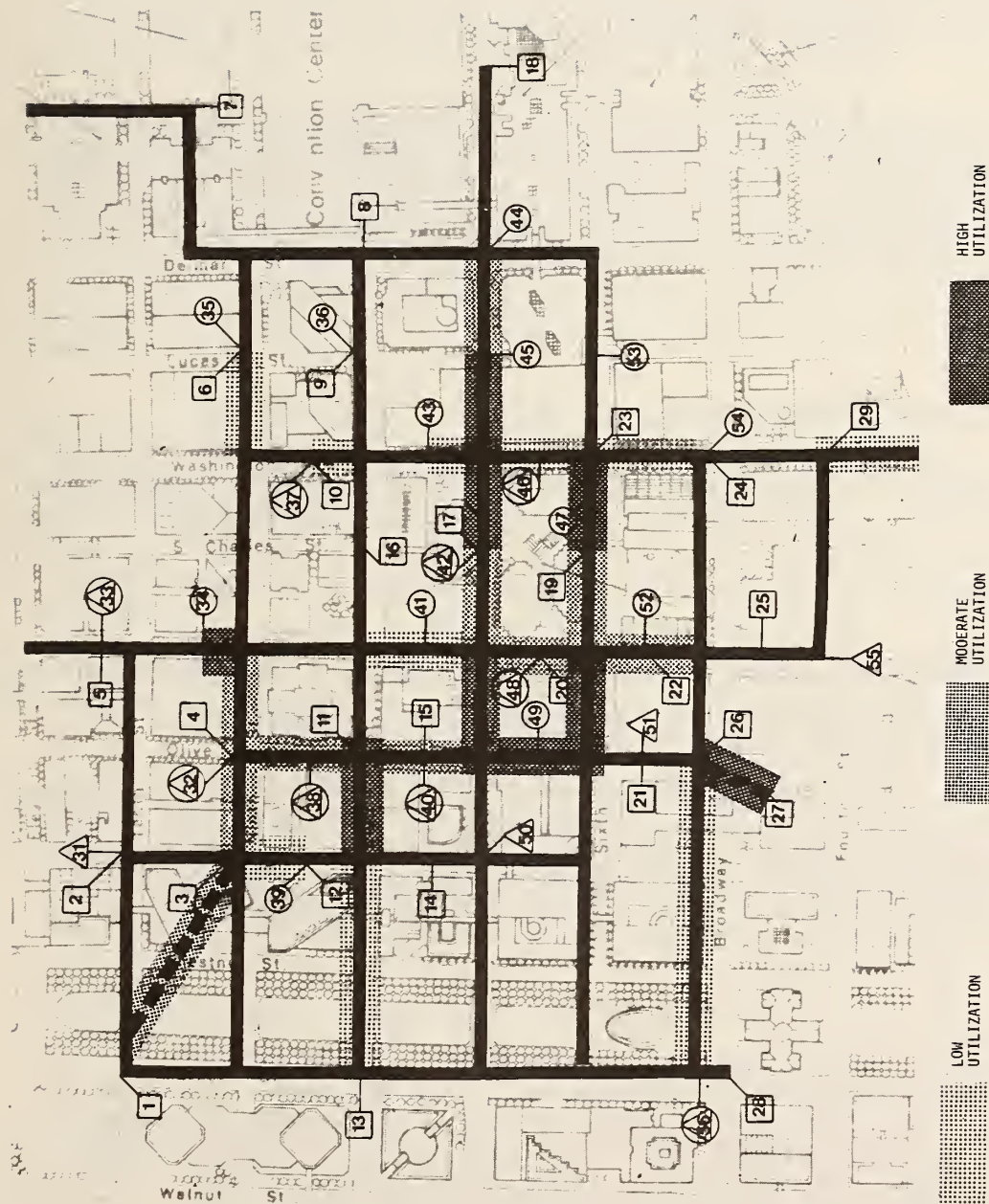

Figure 31
Potential Corridor Utilization Map

If discrepancies are such that calibration is deemed necessary, the planner can then manipulate any or several of the following model inputs:

- generation values
- network construction
- peak directional factors
- friction factors
- exchange components
- trip assignment process

If the pedestrian survey has been performed, an analysis of the relevant questions will provide invaluable guidelines and data for the calibration exercise. If not, selective site-specific tests might be required to generate calibration data. Generic guidelines are provided in reference material to aid in the calibration.

TASK 10

INTRODUCE FUTURE LAND USES

Through Task 9, the process has primarily addressed existing land use generation. In this task, however, the data associated with future land uses is introduced into the calibrated model that produced the satisfactory network location plan in Task 9. Centroid production and attraction values for future uses were developed in Task 4 and appropriate friction factors in Task 6.

These inputs are now used to cycle through the gravity distribution and assignment process to yield modified patterns of forecasted utilization resulting from future conditions.

In this task, and depending on the user's resources, the impact on trip making of different land use configurations and time horizons can be investigated. Similarly, the validity of any preconceived pedestrian facilities or policies can be tested by modelling a "before and after" condition, each with its appropriate separation times and routings.

TASK 11

PRODUCE FUTURE NETWORK LOCATION PLAN

This task duplicates Task 8, except that a future condition is being represented by the network. This product will probably not be a network in the strict sense of a continuous pattern of links. There will in all likelihood be points or areas of discontinuity.

There is a specific utility in knowing about discontinuities of the above kind. These areas of discontinuity are the result of various

site specific conditions which do not support pedestrian trip making (e.g., high crime, topography, physical barriers, pathway indirectness, impedance and high degree of pedestrian/vehicle conflict. In later steps, travel patterns will be examined and a determination made as to whether increased exchange between two areas is required (assuming that no exchange or minimal exchange presently exists). In order to support trip-making between these areas significant provisions regarding pedestrian generators, attractors pathway primary attributes and pedestrian countermeasures will need to be provided, as described in Task 12.

If, however, the examination of travel patterns illustrates that other viable alternative routes are currently used in exchange between the two areas under consideration, then the provision of connectivity may not be viable. In this case, effort should be made to reinforce and consolidate trip-making along one or more of the alternative pathways under review where such consideration is consistent with general planning policy. In this case, countermeasures may be applied to pathway routes where movement is to be reconstituted for the purpose of reducing utilization in these areas.

The corridors with high utilization potential will in subsequent Tasks be examined to determine the degree to which they warrant some form of pedestrianization for the purpose of accommodating and fostering aggregate trip-making.

TASK 12

ASSESS AND RESOLVE POTENTIAL NETWORK IMPLICATIONS FOR PLANNING POLICY

The future development or redevelopment of downtown urban land is guided and controlled by planning policy. Such policy is usually embodied in and reflected through master plans, various ordinances, budgeting, taxing systems and so on. The impact of future development or redevelopment on pedestrian trip-making patterns and the implications of these patterns in terms of available rights-of-way, adjacent land use impacts, etc., is generally not examined as part of planning policy decision making. The trip-making impacts of future land use decisions, while initially unknown or unforeseen, may nevertheless be significant. For example, a general policy to revitalize a deteriorating retail street may be unknowingly negated through the displacement of existing and future pedestrian traffic along that street to another route as the result of the location of a major new pedestrian attractor; or the creation of an intermediate attractor or a more accessible attractor may reduce the utilization by pedestrians of a future or less accessible attractor.

This step in the Pedestrian Planning Process allows the impacts of the potential utilization network on planning policy to be assessed and, if desired, permits the recreation of an alternative potential network more consistent with policy intentions.

This step in the procedures is thus a significant point of interface between the city as "client" and the planning team undertaking the Pedestrian Planning Process.

Figure 32 illustrates the sequence of procedures that follows:

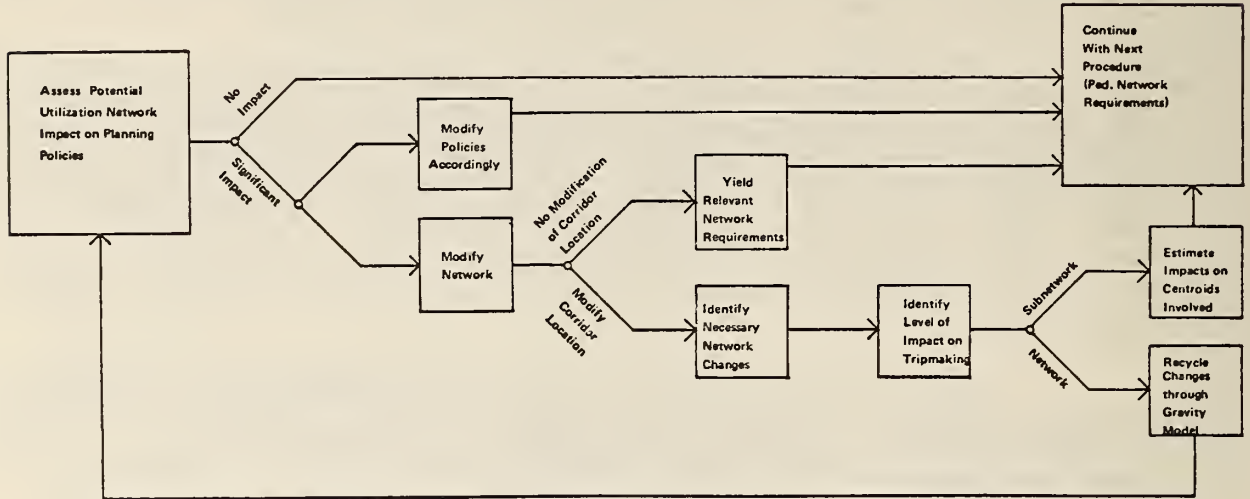

Figure 32

Overview Of Pedestrian Network Impacts On Planning Policy

TASK 13

DEVELOP PEDESTRIAN NETWORK REQUIREMENTS

The application of the distribution and assignment models in Task 3 through 12 have allowed the planner to isolate those pathways or corridors with high potential utilization. In the procedure tasks that now follow, these selected corridors will be the focus of detailed attention in the development of a requirements program for the walking environment.

Elements of this program will have already been developed (as indicated in the process diagram, Fig. 9B) as a result of:

- the preliminary analysis of problems of issues in Task 1,
- the pedestrian survey, if performed, in Task 2 and
- the rating of pathway attributes in Task 6.

This task expands the requirements program and provides appropriate recording formats.

The network location plan merely indicates those paths along which pedestrians would tend to move given the distribution of land uses and the existing pathway attributes. Whether or not these preferred pathways do or can, in fact, accommodate their potential utilization is an issue that is faced in the procedures under the "Examination of Capacity Requirements".

The PPP, however, goes beyond the capacity - availability question. Its orientation is towards the improvement of the pedestrian environment, where demand may warrant it. An issue to be faced thus, is whether the existing pedestrian environment can be further improved along those corridors of high potential. Such improvements would be in response to existing functions or dysfunctions of the network. The development of such requirements for pathway modification constitutes in fact a program of network requirements. Guidelines for the creation of this requirements programs are provided in the procedures.

These requirements derive from the following considerations:

- A. Network functions which are identified through an examination of trip-making characteristics
- B. Network dysfunctions which are specified through an examination of the following:
 - Users' perceptions of needs and desires
 - Existing negative social, economic and environmental impacts
 - Non-functional space
- C. Dimensional requirements for pathways (spatial parameters) which result from applying a level of service standard to pedestrian movements

These considerations provide a basis for network planning and design at various levels or scales:

1. Network (overall)
2. Sub-networks (elements or subcomponents of the overall network)

The specific nature of the considerations identified above will determine the degree to which they influence the planning, design and operation of either the network or various sub-networks of which the overall network is composed. Therefore, these considerations can be expressed as requirements for overall network planning and design, or sub-network planning and design, or both.

The nature of the above considerations for yielding the network requirements is further described in the following three sections.

(1) Trip Making Characteristics

The intent is to specify those factors which influence pedestrian movement and pathway utilization. These factors are one set of considerations in specifying pedestrian network planning and design requirements.

The relevant trip making characteristics to be specified can be classified as follows:

1. Tripmakers
 - attitudes and perceptions
2. Tripmaking
 - trip volume
 - trip patterns
 - trip length
3. Pathway characteristics
 - pathway impedances
 - availability of alternative modes

Each characteristic will be dealt with independently in terms of data collection, analysis and recording format.

(2) Dysfunctions

Pedestrian networks are often planned and implemented in response to a number of perceived or real dysfunctions. The identification of dysfunctions provides a wide range of issues which must be taken into account within the context of an overall planning strategy.

Dysfunctions where they relate to trip making can produce requirements for the pedestrian network such as a reduction in pedestrian/vehicular conflict or improved access to abutting activities, etc.

In a larger sense, the pedestrian network itself can be used as an instrument contributing to the reduction of dysfunctions in the achievement of broader planning strategies such as downtown revitalization, improved vehicular flow, enhanced civic image, etc.

Dysfunctions relevant to the pedestrian network can be described in terms of the following:

1. The user's perception of needs and desires

Needs and desires are articulated in response to perceived problems or dysfunctions. Such needs or desires can cover a wide range of issues. Examples might be a need for open space, a desire to connect two functionally interdependent land uses, a need for interaction, etc.

2. Existing negative social, economic and environmental (physical) impacts.

a. Negative social impacts to be reduced include crime, pedestrian/vehicular accidents, insufficient privacy to residential land uses.

b. Negative economic impacts is to be addressed include lack of access to pedestrian-dependent land uses, lack of visibility or poor orientation to land uses, impedances which increase travel time and other costs.

3. Non-functional space is defined as any one of the following conditions:

a. An existing vehicular right-of-way that is unnecessary to the functioning of the vehicular circulation network.

b. A vehicular right-of-way that is considerably underutilized in terms of its available right-of-way.

c. Vacant sites.

d. Functionally obsolete land uses or structures.

Non-functional space is considered a dysfunction in that it constitutes an unexploited resource.

Figure 33 is an example of a graphic analysis of selected pedestrian network requirements and dysfunctions based on the above considerations and field observation.

(3) Network Capacity Requirements

An important aspect of designing the pedestrian network is the proper sizing of pedestrian facilities. These facilities should be sized to provide adequate capacity to handle their projected peak volume of use in a comfortable, convenient and economical manner. Care must be taken in designing

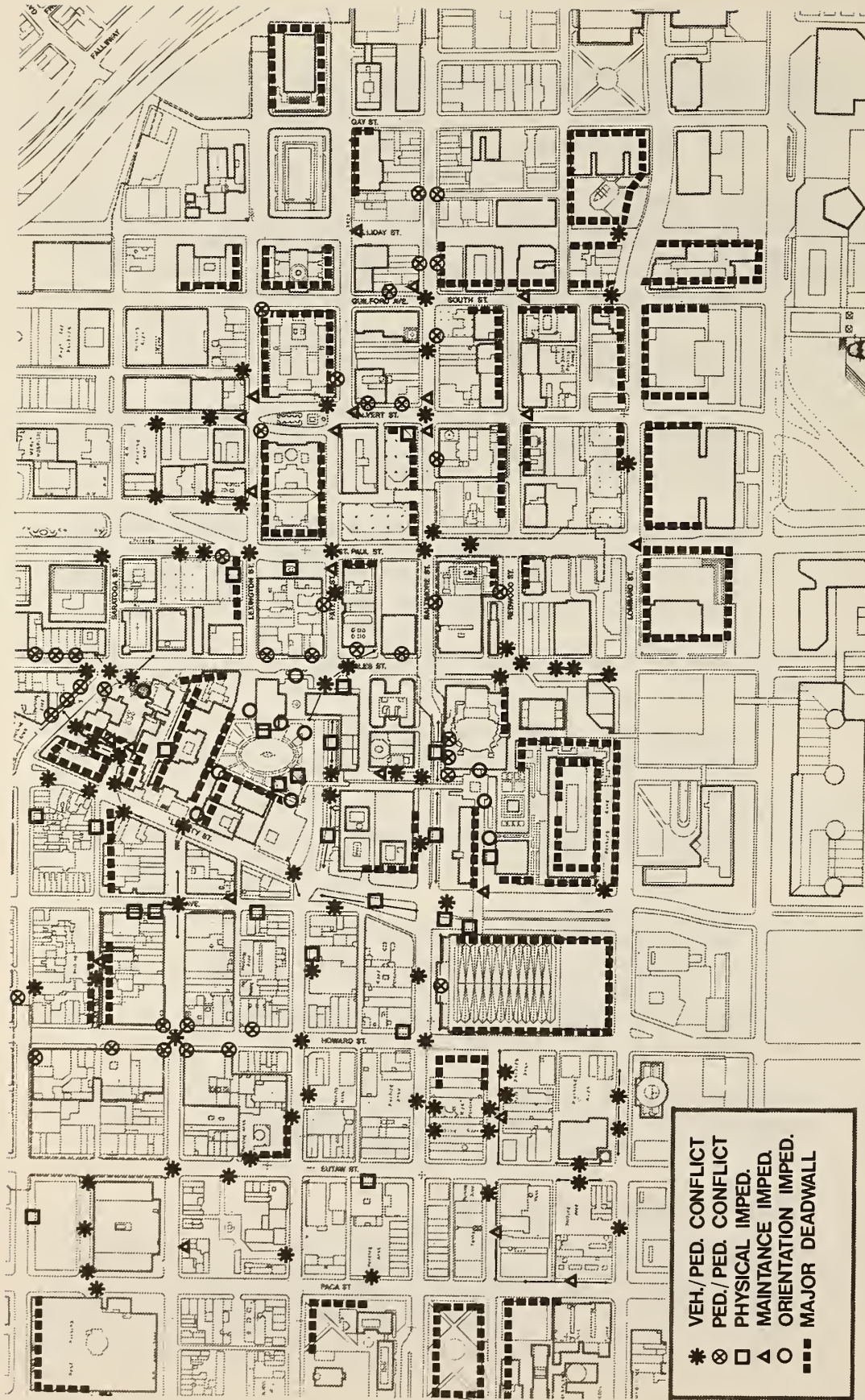

Figure 33
Mapping Of Selected Pedestrian Network Requirements

these facilities to avoid both underdesigned capacity which could lead to excessive congestion and oversizing that would lead to uneconomical solutions.

The process of establishing spatial requirements of the pedestrian network in response to capacity requirements entails the application of certain design standards to the projected peak volume of pedestrian traffic using a particular facility of the network. Design standards developed for this manual are based upon a "level-of-service" concept similar to that employed in vehicular traffic planning. Level-of-service standards measure the quality of pedestrian movement at different levels of spaciousness. They reflect the fact that as the density of pedestrian traffic increases, a pedestrian's freedom of movement, in terms of speed and maneuverability, becomes more constrained. The interrelationships of pedestrian walking speed, spacing and probabilities of conflict has provided basis for establishing various levels of service.

The pedestrian network plan is composed of a number of components or facilities, including walkways, stairways, street crossings, bus stops, etc. These facilities accommodate pedestrians not only in locomotion but also in queuing situations. Generally, the most concentrated area of pedestrian traffic occurs at street intersection points where two sidewalk corridors intersect and flow along one of these corridors is interrupted by the traffic signal phasing that regulates street crossing. These intersection areas within the pedestrian network plan can be generally characterized as the "weakest link of the chain."

Procedures and design standards have been developed for the following prototypical conditions commonly found within a pedestrian network plan:

- 1) walkway width requirements
- 2) sidewalk intersection area requirements at signalized intersections
- 3) stairway width requirements
- 4) escalator design capacity requirements
- 5) other queuing area requirements (bus stops, interface areas of pathway segments with different flow capacities, etc.)

TASK 14

DEVELOP TRAFFIC AND TRANSIT NETWORK REQUIREMENTS

Since the pedestrian network will for the most part utilize the available street rights-of-way, implementation in terms of the specific

degree to which any particular network segment can be pedestrianized is a function of the specific R.O.W. requirements for accommodating other travel modes as well as pedestrian trip making.

Therefore, a comparison between pedestrian network requirements and other modal requirements will have to be made (Task 15). Various aspects or characteristics of the vehicular access network, service/delivery and transit systems must thus initially be examined. These include identifying

- operating characteristics
- areas of surplus capacity/deficiency
- systems dysfunctions
- the range of physical and functional constraints related to vehicular or transit usage and modal interface.

The above characteristics are examined specifically for the purpose of determining the amount of existing street right-of-way which can be used to accommodate pedestrian circulation.

Figure 34 summarizes the concerns and relationship of Tasks 13 and 14.

TASK 15

SYNTHESIZE MULTI-MODAL REQUIREMENTS

The analysis of traffic/transit systems characteristics was conducted without reference to the pedestrian network requirements. These characteristics must now be examined within the context of pedestrian network requirements. Therefore, the specific objective of this step will be to assess the pedestrian network requirements for each street segment within the context of other modal requirements for the purpose of evaluating the potential for network implementation. This evaluation is two-fold:

- A. To identify areas of conflict where implementation of the pedestrian network will result in negative impacts upon other travel modes, and
- B. To evaluate the degree to which any specific street segment can be pedestrianized.

Figure 35 further describes this evaluation of network feasibility.

The outcome of this synthesis is the identification of those conditions which affect the determination of initial feasibility. Conditions for feasibility are as follows:

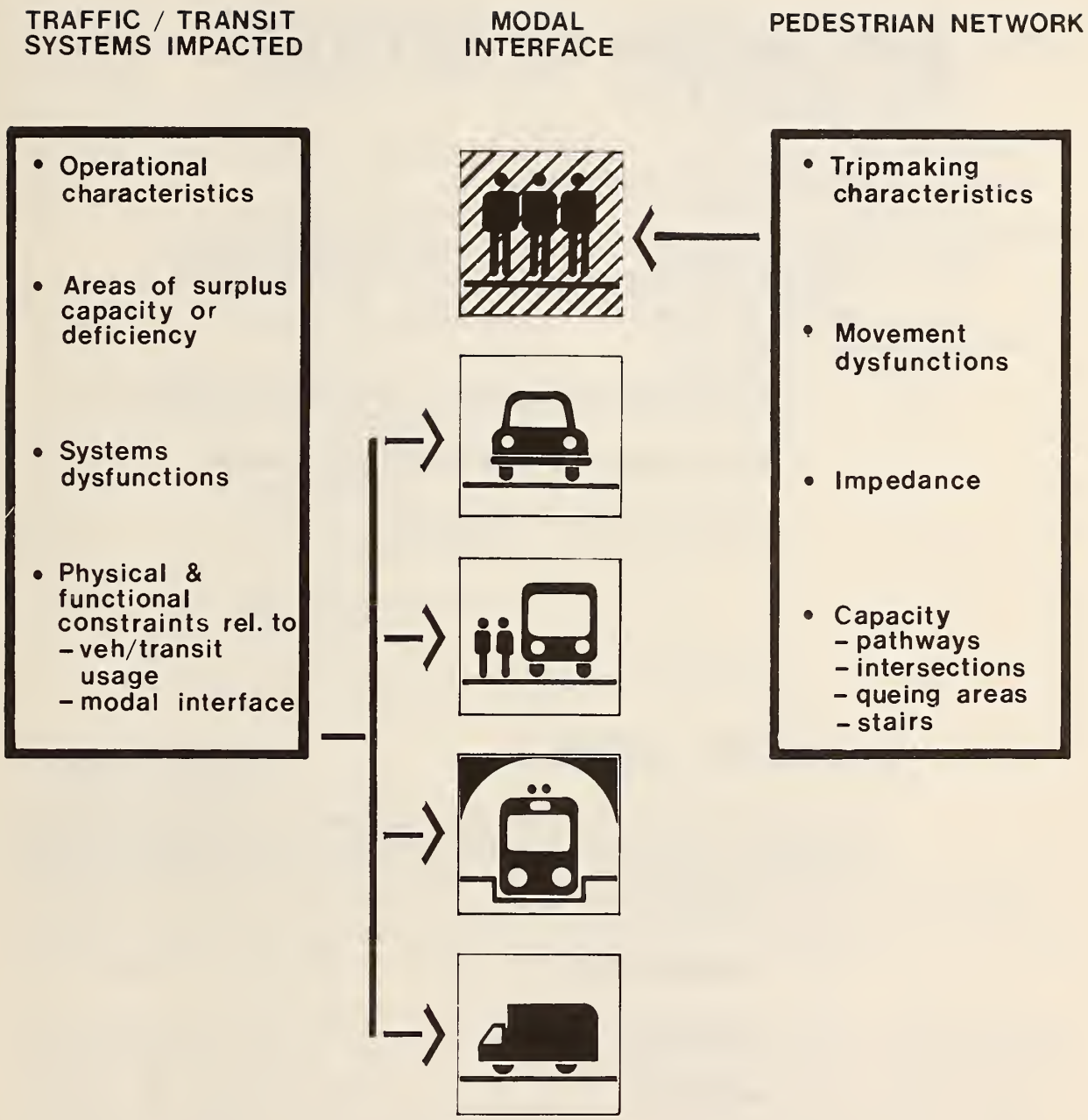

Figure 34
Interface Of Multimodal Requirements

EVALUATION OF NETWORK FEASIBILITY

CONFLICT ISSUES

**WILL NEGATIVE IMPACTS UPON OTHER TRAVEL MODES
RESULT FROM IMPLEMENTATION OF THE PEDESTRIAN
NETWORK IN TERMS OF:**

- * SYSTEMS DISPLACEMENT (INCLUDING PARKING)**
- * SYSTEMS OPERATING DYSFUNCTIONS AND**
- * MODAL INCOMPATIBILITIES**

CAPACITY ISSUES

**IS ADEQUATE SPACE AVAILABLE TO ACCOMMODATE ALL MOVEMENT
MODES WHILE MAINTAINING APPROPRIATE LEVELS OF SERVICE FOR:**

- * VEHICLES**
- * PEDESTRIANS**
- * PARKING**
- * SERVICE**

Figure 35

Evaluation Of Network Feasibility

<u>Initial Feasibility Outcome</u>	<u>Conditions Affecting Initial Feasibility (necessary & sufficient)</u>	<u>Required Resolution Dependent upon both the nature and magnitude of impact</u>
Yes	Space is available	Resolution through urban design treatments - proceed to assessing methods of pedestrian/vehicle separation and to design treatments
Yes	Degree of potential impact minor	
No	Space not available	Resolution requires the development and evaluation of alternate movement strategies
No	Degree of potential impact major	" " " " "
No	Space not available	" " " " "
	Degree of potential impact major	" " " " "

Figure 36 illustrates the above conditions.

TASKS 16 THROUGH 22

DEVELOP ALTERNATIVE MOVEMENT STRATEGIES

Examination of the existing pedestrian, traffic and transit network characteristics and requirements will result, as pointed out above, in the identification of several pertinent conditions of feasibility which address the impact of implementing segments of the pedestrian network.

Where the conditions do not indicate initial feasibility i.e., where the potential multi-modal conflicts (which include lack of available space and major requirements impacts) are such that the desired pedestrianization cannot be realized within the existing situation such resolution will be achieved through the development of alternate movement strategies whose purpose will be to provide for the required pedestrian space and to reduce major negative multi-modal impacts. Figure 37, which duplicates a portion of the overall process flowchart (fig. 9B), illustrates the alternative movement strategies.

There are two basic strategies for the resolution of potential conflicts:

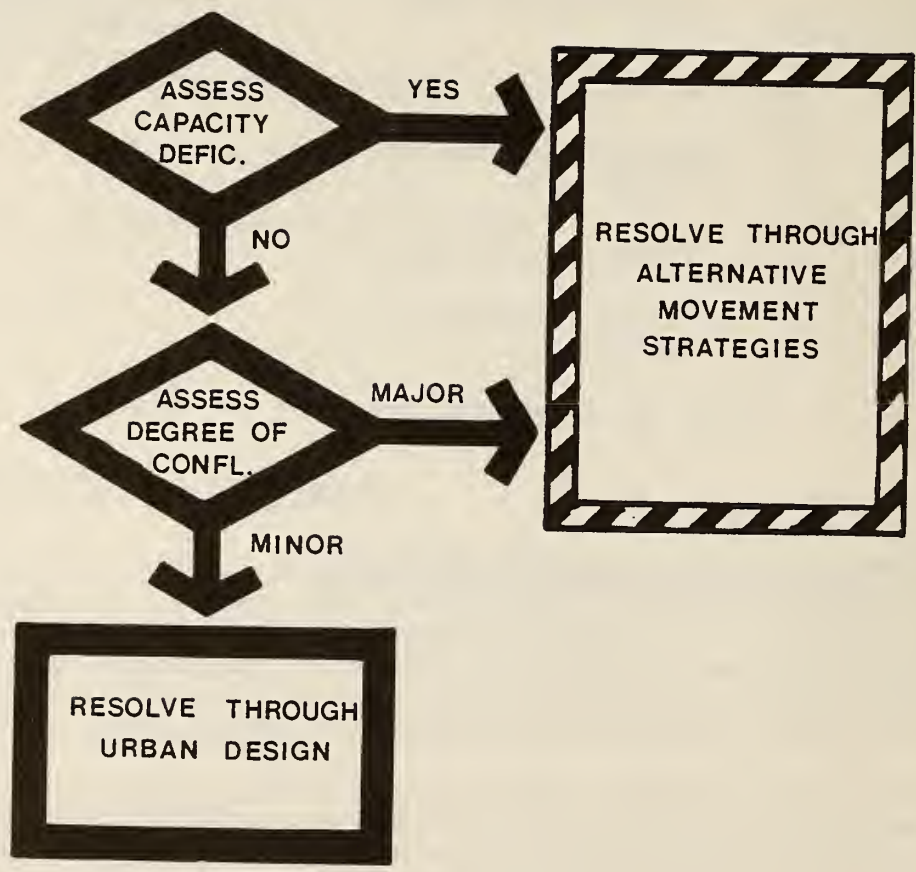
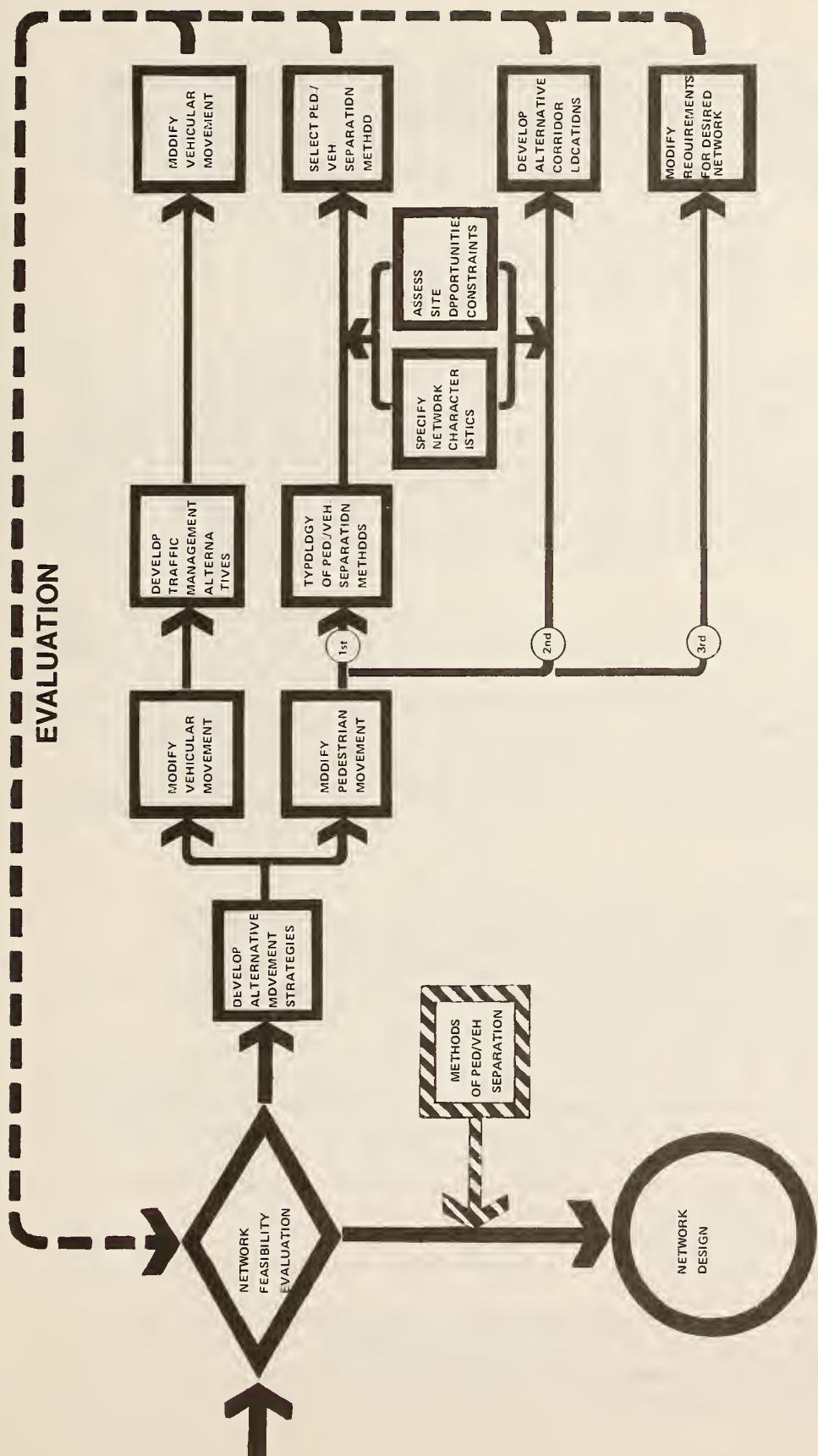

Figure 36

Determination of Initial Implementation Feasibility



DEVELOPMENT OF ALTERNATIVE MOVEMENT STRATEGIES

Figure 37
The Development Of Alternative Movement Strategies

1. Modification of the existing traffic and transit network through traffic management planning. Traffic management planning is for the most part oriented to satisfying very specific traffic operations and control objectives such as:

- improved safety
- reduction in vehicular volume
- reduction of vehicular speed
- mode shifting
- others

In this instance alternative traffic management plans will focus primarily upon modifications to the traffic and transit networks which will allow the implementation of horizontal methods of pedestrian/vehicle separation (widened sidewalks, partial malls, transitways) in the pedestrian facilities network. These alternatives for the redistribution and rerouting of traffic and transit will ultimately determine the specific degree to which specific street rights-of-way can be pedestrianized.

The objectives relative to the reuse of existing available street rights-of-way for pedestrian circulation are accomplished through the redistribution of traffic volumes as well as the modification of both the direction and flow of vehicular and transit traffic. The alternatives for traffic and transit redistribution must be coordinated so as to insure an equitable traffic operation for all modes affected. This means that changes and alterations to the traffic and transit system should not result in

- reduction in overall mobility
- reduction of accessibility (to all modes impacted)
- reduction in traffic handling capacity
- increase in vehicular delay time
- reduction in parking inventory through the removal or redistribution of on-street parking.

The net impact of changes and alterations to the existing traffic and transit networks required in order to accommodate the proposed pedestrian circulation plan should, however, result in

- increased safety through a reduction in pedestrian/vehicular conflict
- increased mobility
- increased levels of accessibility through a reduction in modal conflict
- increased capacity which will reduce vehicle delay time
- amelioration of negative environmental impacts (noise, pollution), and
- others (add objectives)

The alternative traffic and transit plans must be developed and tested against specific traffic and transit operational standards to insure that implementation of the pedestrian circulation system will not produce negative impacts.

2. Modification of the pedestrian network in terms of three alternatives:

a. The employment of various methods of pedestrian/vehicular separation

The selection of any particular method of separation of pedestrian/vehicular movement is dependent upon the following:

- assessing network characteristics
- assessing existing site opportunities and constraints

Taken together these are called the Conditions of Applicability.

b. The development of alternative locations for specific corridors of the network.

Should these earlier avenues of investigation prove unsuccessful -- that is to say, if based upon the technical demands in terms of pedestrian circulation requirements and other modal requirements, the network segment cannot be accommodated or implemented within the parameters of the existing street rights-of-way -- then alternative pedestrian corridor locations must be examined.

The objective of such a reexamination is to determine whether or not the specific network links affected can be accommodated in other areas adjacent to or in the vicinity of the initial corridor location without jeopardizing the intent of the overall circulation plan in terms of utilization. This reexamination may take into consideration:

- (1) The use of parallel alleys.
- (2) The use of horizontally displaced pathways which are mid-block or penetrate through interior or exterior public space of adjacent development parcels and other alternatives which foster linkage between major building generators.
- (3) The use of alternative street rights-of-way.

Since, however, the initial corridor locations were based upon a comprehensive set of pedestrian trip making

factors, they indicate the most direct and desirable routes. Alteration of these routes through relocation may result in a less desirable location and in many cases locations which are not feasible as they are less direct and will therefore be less utilized. In other cases, due to the location of existing land use activities and due to the lack of opportunity to create alternative parallel pedestrian rights-of-way, corridor relocation will not be feasible.

The potential utilization of the modified or relocated pathways is contingent upon the ability to modify pedestrian movement behavior, that is, to change and redirect movement to the provided pathway. In certain instances this is possible, specific conditions however, are required in order to provide benefits to the user (the pedestrian) thus achieving behavior modification and insuring a high degree of utilization.

These conditions are based upon the following criteria:

- (1) Activities which have the ability to generate pedestrian trips
 - (2) Activities which have the ability to attract pedestrian trips
 - (3) Provision of pathway attributes which induce increased utilization and maximum perceived benefits to trip makers
 - (4) Introduction of pedestrian countermeasures which will reduce the utilization of alternative pathways.
- c. The modification (reduction) of pedestrian level of service standards

Pedestrian network capacity requirements are predicated upon prescribed level of service standards as well as other initially established pedestrian trip making criteria. Therefore, a less drastic method of accommodating pedestrian movement (should previous alternatives prove unsuccessful) is to modify the level of service standards which were initially employed to determine pedestrian network capacity requirement (effective width) on various network links.

Reduction of the level of service standards will directly affect the amount of R.O.W. needed for the pedestrian pathway and thereby reduce the impact of the pedestrian network plan upon the available street R.O.W. This, of course, requires the acceptance of less than optimal criteria for the movement of pedestrians in terms of capacity,

walking speeds and queuing levels. In some cases it may not be feasible to reduce level of service standards for pedestrian volumes relative to available pathway width and volumes may approach levels of "congestion", thereby making the link deficient. As the link itself becomes an impedance to the flow of pedestrian traffic, utilization is reduced and consequently potential benefits are impaired.

It is likely that several of these strategies and tactics will be applied to different parts of the network either separately or in combination.

Their employment will modify some of the earlier data inputs and results that have been generated in previous steps.

The decision to investigate vehicle movement modification before pedestrian movement modification or vice versa for the resolution of a conflict will depend, of course, on the nature and magnitude of the given conflict and on the resultant judgement as to which strategy is likely to be the most relevant or effective in dealing with it.

Where there has been some prior policy-related determination of an intended pedestrian facility, such as the creation of a partial mall on a particular segment, then the movement strategy options to test the feasibility and implementing of the facility would be narrowed to an investigation of traffic and transit management planning.

Generally traffic and transit management strategies are likely to be less costly to implement than the pedestrian movement strategies of vertical separation or corridor relocation. The third pedestrian movement alternative of reducing the level of service standards involves no implementation costs at all since it is merely a computational method for accepting reduced standards for pedestrians. Following this option will result in increased levels of congestion and thus decreased pathway amenity on pathway segments where levels of service are reduced -- an outcome clearly at odds with the overall objective of the Pedestrian Planning Process, namely, the facilitation of pedestrian movement. This particular strategy, then, must be viewed and used as a last resort in the resolution of spatial and other multi-modal conflicts.

If none of the other movement strategy options can resolve conflicts and if this last resort would yield an unacceptable level of pedestrian congestion then the resolution of conflict or the required pedestrianization might be unattainable unless tradeoffs are considered.

Following development of an alternative, it will be necessary to reexamine the effect that the proposed approach has upon earlier steps in the planning process. The specific conduct of this reexamination will depend on the extent and nature of the proposed alternative, and will be determined by the user to suit the objectives of a particular analysis. This judgement will be made within the consideration of several broad guidelines:

- All alternatives should be assessed against multi-modal requirements to ensure compliance, reduce conflicts and impacts, and achieve basic objectives
- Alternatives involving modification to vehicular/transit network elements only will require reexamination of multi-modal requirements at the points of critical pedestrian/vehicular interface affected by the changes
- Alternatives involving modification to pedestrian network elements only will usually require reexamination within the context of the potential utilization network and its associated gravity model analysis
- Alternatives comprised of modifications to both the vehicular and pedestrian networks will require a more comprehensive reexamination, possibly involving at a minimum a brief review of all prior steps in the planning process.

Regarding the reexamination of changes to the pedestrian network, the amount of effort expended to determine the impact of modifications should be kept to a minimum, and should require only a fraction of that dedicated to the initial analysis. In most cases, the modifications will be localized, and will affect a small subset of the original network elements. The impact of these local network changes on outlying network elements will be small, due to the attenuation of pedestrian trip propensity with time or distance. The converse is also true -- that is, outlying network elements will not greatly affect movement within a local area. Hence, in the reexamination of movement impacts of local modifications, the majority of the effect can be determined by looking at only a subnetwork area.

TASK 22

SELECT METHOD OF PEDESTRIAN/VEHICULAR SEPARATION

If the outcome of the evaluation of multimodal requirements was such that:

1. pedestrianization potential (in terms of R.O.W. availability) is sufficient and
2. multimodal conflicts and impacts are minimal,

then the investigation of alternative movement strategies would not be undertaken. Even under such circumstances, however, the creation of specialized pedestrian facilities might be undertaken. For example, in a given situation existing sidewalks, while adequate, may be used at their maximum capacity during peak hours. Vehicular traffic alongside might underutilize its r.o.w. Under such circumstances and depending upon the adjacent land uses and planning policy intentions, it may be desirable to widen the sidewalks and install various landscaping amenities. Alternatively, while no problems may result from the sidewalk capacity analysis and other network requirements, significant opportunities might exist to develop pedestrian facilities (e.g., extensive redevelopment, hilly topography). Irrespective of the results of the multimodal evaluation, then, an assessment of methods of pedestrian/vehicle separation must be made so that the nature of the pedestrian corridors can be specified.

The procedural outline for selection of methods of pedestrian/vehicle separation is as follows:

Introductory Steps 22.1 through 22.3 parallel Steps 19.1 through 19.3.

- | | |
|-------------|---|
| Step 22.4.1 | Identify factors which influence the selection of Methods of Pedestrian/Vehicular Separation (As in 19.4.1). |
| Step 22.4.2 | Identification Interdependencies Between Conditions of Applicability and Methods of Ped/Vehicular Separation (As in 19.4.2) |
| Step 22.5.1 | Identify Data Sources (As in 19.5.1) |
| Step 22.5.2 | Synthesize Prevailing Conditions (As in 19.5.2) |
| Step 22.5.3 | Evaluate the Applicability of Alternative Methods of P/V Separation (As in 19.5.3) |
| Step 22.5.4 | Selection of Method of P/V Separation (As in 19.5.4) |
| Step 22.5.5 | Identify Specific Physical and Functional Requirements of the Selected Method of Ped/Veh Separation (As in 19.5.5). |

It should be noted that those procedures which refer to the assessment of the separation method's impact on available r.o.w. and conflict resolution (as in Step 19.4) are omitted in the latter parts of the

above sequence. Any new physical or functional requirements which result from the selection of a method of separation will be resolved in the selection of design treatments.

TASK 23

PRODUCE NETWORK FACILITIES PLAN

If the outcome of the evaluation of multi-modal requirements was such that:

1. Pedestrianization potential (in terms of R.O.W. availability) is sufficient and
2. Multi-modal conflicts and impacts are minimal,

then the investigation of alternative movement strategies would not be undertaken. In this case, the First Network Plan would remain unchanged. Prior, however, to commencing the Design Phase, an assessment and determination of the methods of pedestrian/vehicle separation must be made as the selection of specific design treatments will be related to the various methods of separation selected.

The selection of specific methods of pedestrian/vehicle separation determines the final disposition of each segment of the network. The Network Facilities Plan graphic should include the following information:

1. The nature of network segments in terms of methods of pedestrian/vehicle separation
2. The location of vertical corridors.

Figure 38 is an example of a network facilities plan.

TASK 24

ORGANIZE ALL SUBNETWORK REQUIREMENTS FOR DESIGN PROGRAM

By this phase, all issues having implications that are network-wide have been resolved. The general disposition of the network is now a given. Design treatments will affect discrete network segments and, at most, localized subnetworks.

The design program consists of all the requirements or performance specifications that will govern the selection and application of design treatments. Figure 39 indicates diagrammatically the relation between the program elements and the design treatments selection phase which follows.

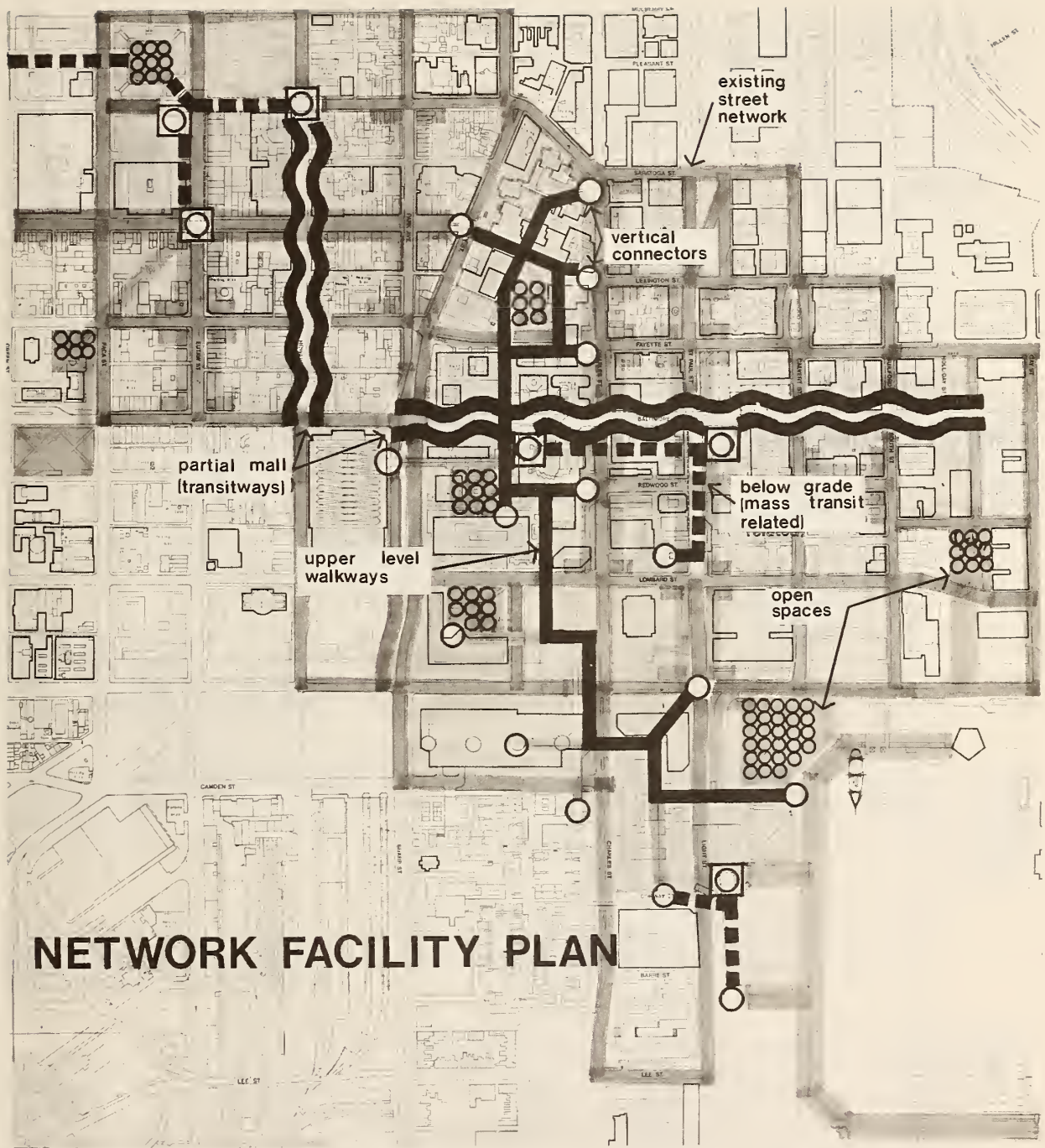

Figure 38

Network Facilities Plan

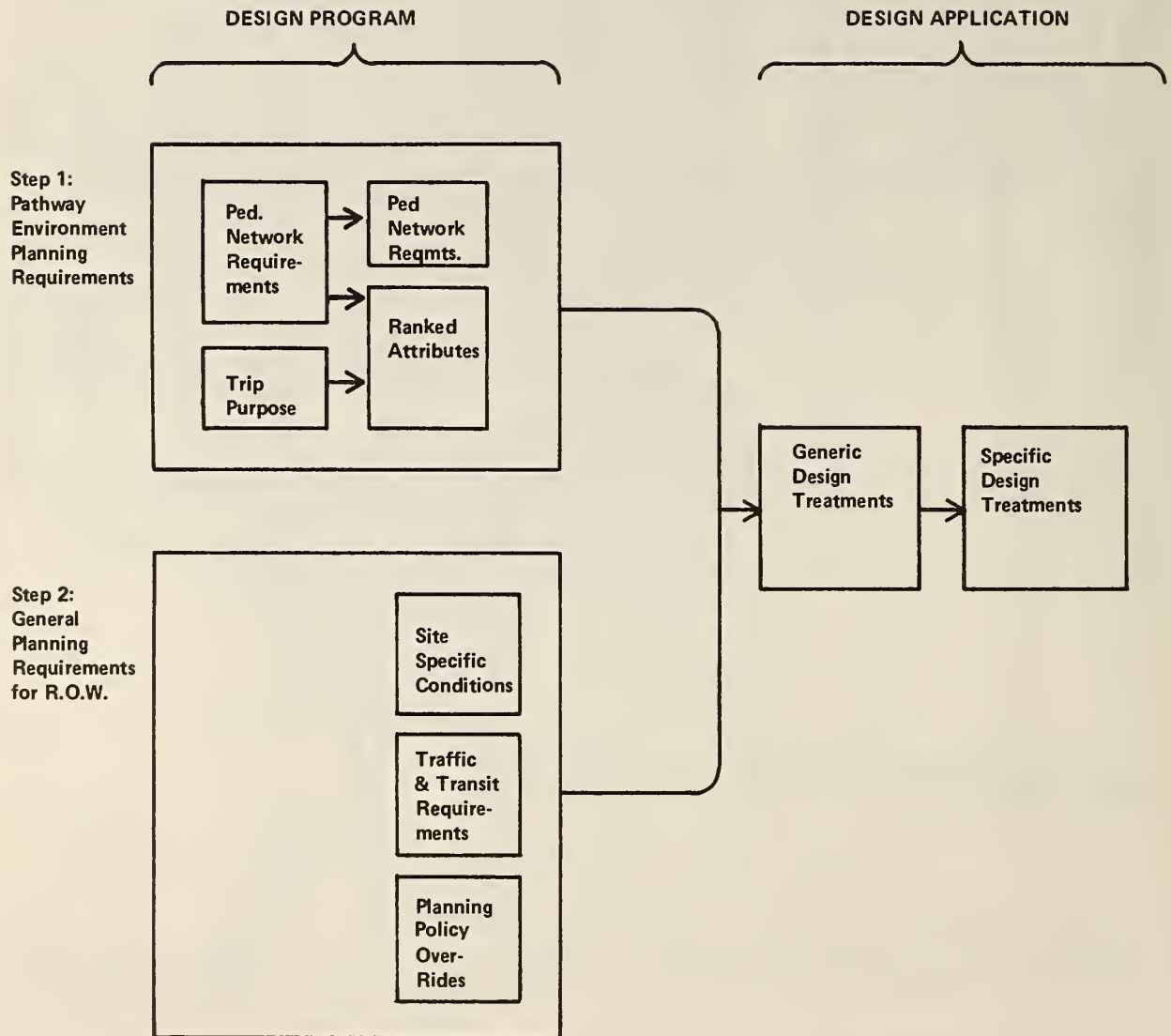

Figure 39

Relationship Between Program Elements And Design Treatments

The program is organized into two categories which correspond with a classification of the street environment into two zones as portrayed in Figure 40. The requirements of one zone, that of the pathway environment itself, was analyzed in Step 13.0, where special attention was paid to the need for various attributes. The other refers to more general planning requirements that relate to the overall R.O.W. and its interface with the pathway environment. These requirements as a listing of these categories indicates, have been accumulated at various points in the procedures.

1. Physical and functional pedestrian network requirements (Task 13)
2. Requirements related to traffic and transit systems characteristics (Task 14)
3. Requirements related to methods of pedestrian/vehicular separation (Task 19)
4. Requirements related to general planning policy (Task 12)
5. Requirements related to site specific conditions (Task 1 and 13)
6. Requirements deriving from survey responses (Task 2)

Taken together, the requirements related to the two zones constitute a comprehensive program for design.

TASK 25

SELECT DESIGN TREATMENTS

The selection and application of design treatments is the last of the planning and design phases of the Pedestrian Planning Process prior to the evaluation of the plan. As such, this phase synthesizes all the data generated to date that are relevant to design treatment decisions.

By this phase, all issues having implications that are network-wide have been resolved. The general disposition of the network is a given. Design treatments will affect discrete network segments and, at most, localized subnetworks.

The intent of the procedures in this phase is to provide guidelines for the selection of appropriate generic types of design treatments and the avoidance of inappropriate ones. No attempt will be made to specify the great variety of available design treatments nor the infinite number of site-specific conditions or combinations of conditions which might suggest a particular treatment as the solution. This is the domain of the designer where sensibility and judgement come into play. These procedures seek only to usefully structure for the designer the necessary diagrammatic information and selection criteria. In addition, while the special needs of handicapped pedestrians are not highlighted in the guidelines, the importance of these provisions is not to be overlooked by the designer.

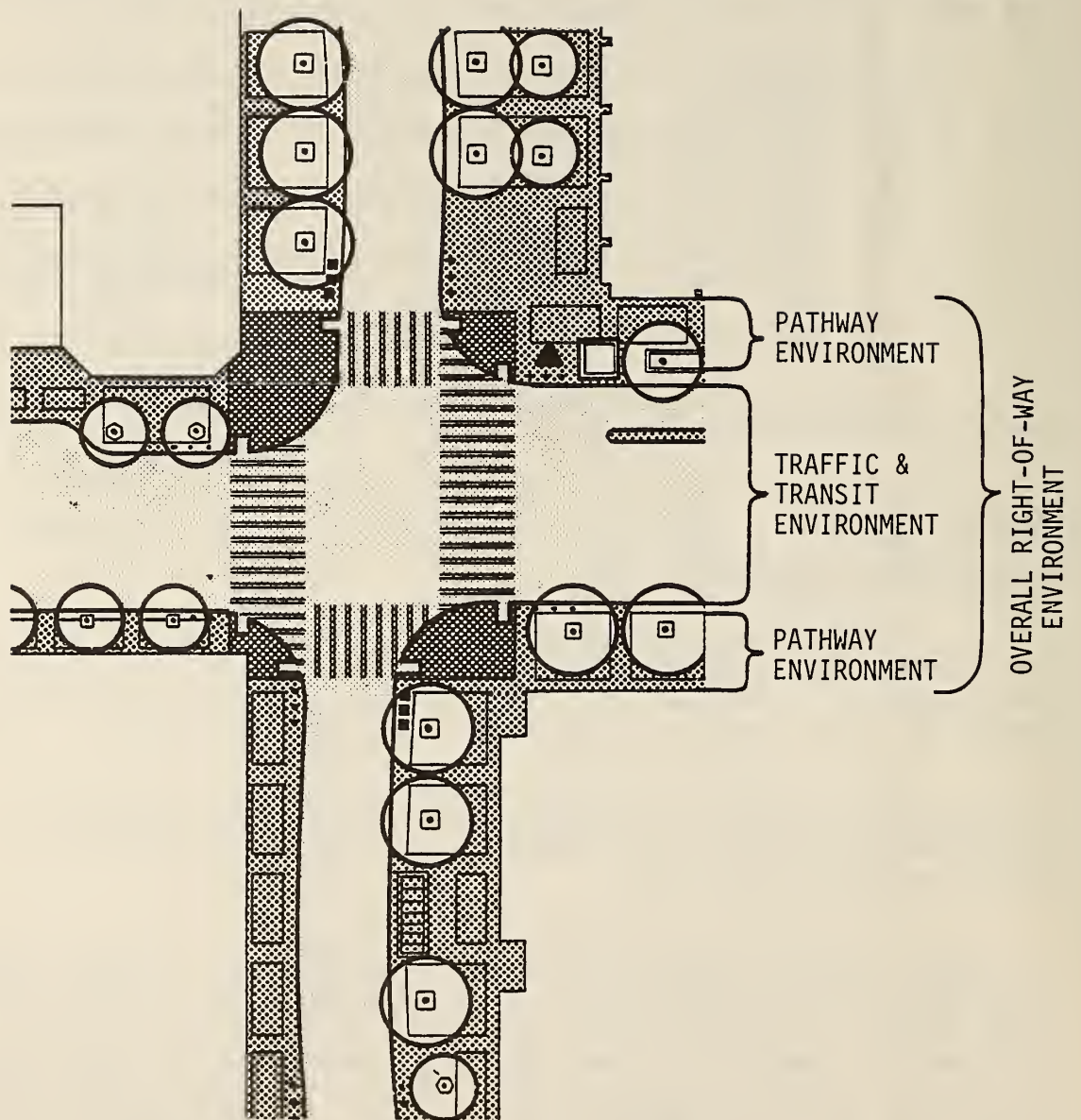

Figure 40
 Pedestrian Systems Interface Elements

The programmatic information or requirements and the selection criteria will be interfaced with a typology of generic design treatments including the following:

- traffic control devices
- pedestrian countermeasures
- vertical connectors
- signage
- lighting
- street furniture
- landscaping

The subnetwork requirements that were synthesized in the earlier steps are associated with those pathway attributes which they support and these attributes are related to the design treatments. Over and above these attributes that are suggested by the subnetwork requirements, the attributes that are associated with the segment's primary trip purpose are also extracted and related to design treatments so that an overall ambiance or setting consistent with trip purpose may be established.

The relationship between the above data and the design treatments is depicted in Figure 41.

In some cases, the type and location of a design element will be wholly determined by the nature of the requirement itself (e.g., a pedestrian activated crosswalk signal); in others, there will be a wide freedom in choosing between elements and in locating them on the pathway.

Where some latitude exists, the location of elements must be related to the physical/functional characteristics of pathways.

Pathways under use can be subdivided in terms of the following physical/ functional characteristics:

1. Circulation areas - those parts of the pathway used for continuous movement by trip makers (the effective width)
2. Ancillary areas - those parts of the pathway not used for continuous movement by trip makers but adjacent to or associated with the pathway
3. Specialized conditions or functions

In certain cases, the configuration of the pathway or the nature of abutting land uses will determine which part of the pathway will be used as the circulation area and which will become ancillary. In other cases the designer, through the placement of design elements, will indicate the pathway's differentiation into circulation or ancillary areas. The need for such differentiation is contingent upon trip purposes along the pathway. Schematic guidelines are provided for the positioning of elements which take into account trip purpose and other relevant conditions affecting placement.

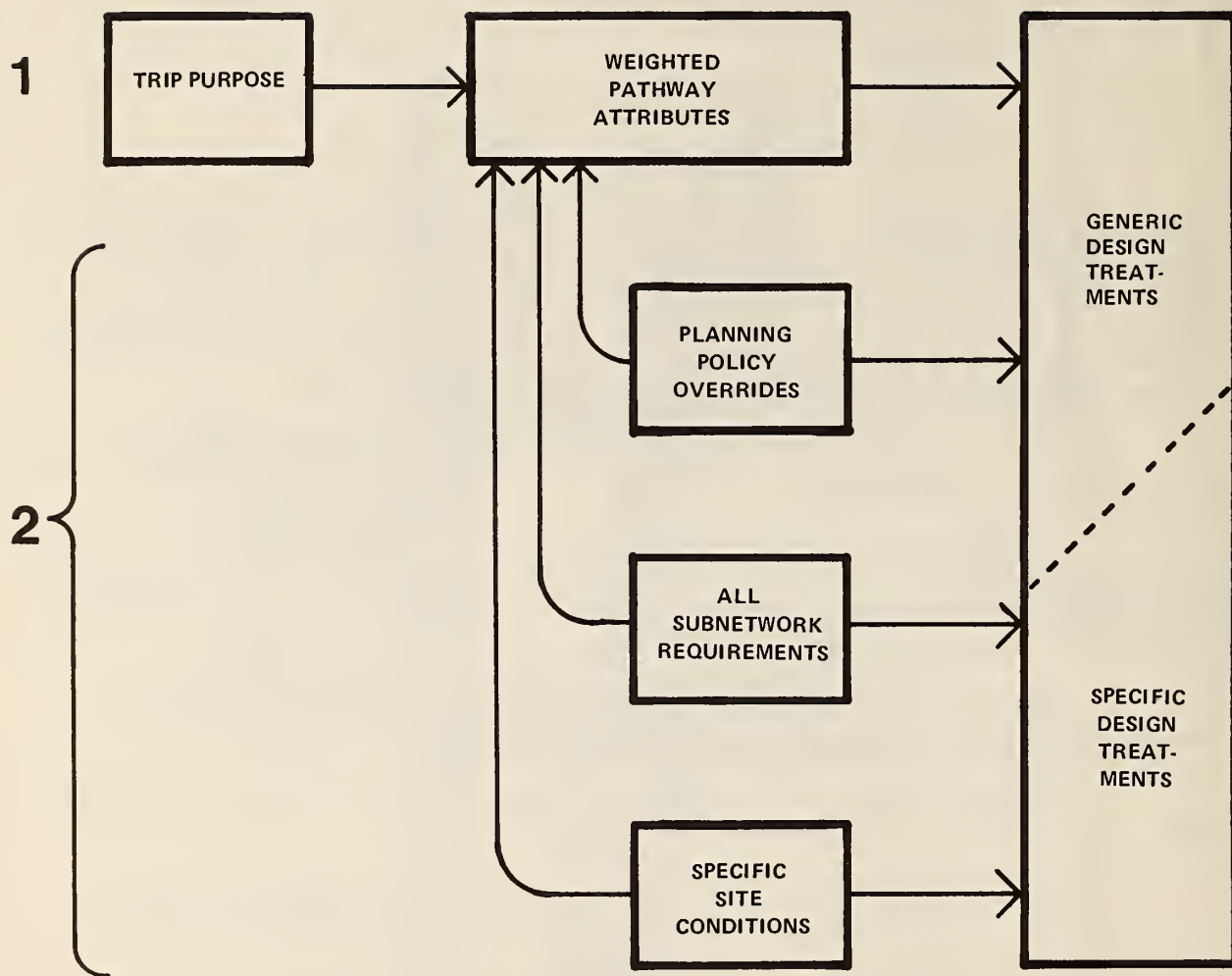

Figure 41

Factors Influencing The Selection And Placement Of Design Treatments

TASK 26
PERFORM NETWORK IMPACT ASSESSMENT

Evaluation procedures have been developed within the respective methodologies and technical procedures of several critical steps within the Pedestrian Planning Process since the performance as well as the outcome of these procedures required that a specific assessment be made within that procedure.

Evaluation procedures which are "built-into" the Planning Process can be identified in the following Table:

Task	Item	Description of Evaluation
4.	Trip Generation	Assessment of generic trip generation against actual counts.
6.	Intercentroid Separation	Assessment of forecasted exchange patterns against actual travel patterns. (Relative distribution or proportion not actual quantification)
7.	Trip Exchange	Assessment of actual attitudes and perceptions of trip makers against generic data.
9.	Calibration	Assessment of modelled volume assignments against actual counts
12.	Planning Policy	Assessment of the impact of potential network upon current planning policy decisions
13.	Identification of Pedestrian Network Requirements	Assessment of current deficiencies and impacts relative to the walking environment
15.	Identification of Impacts and Conflicts	Assessment of pedestrian network requirements against multi-modal requirements. (Implementation feasibility)
15.	Evaluation of R.O.W. Potential For Pedestrianization	Assessment of pedestrian network requirements (spatial) against available street R.O.W. (implementation feasibility)
17.	Traffic/Transit Characteristics	Assessment of existing traffic/transit systems deficiencies and dysfunctions

16-21.	Development of Alternative Movement Strategies:	
-	Traffic Management	Assessment of traffic/transit alternatives against current traffic/transit systems operational efficiency
-	Selection of Methods of P/V Separation	Assessment of various separation methods against network characteristics, site opportunities, constraints and cost
-	Relocation of Movement Corridors	Assessment of impact of corridor relocation upon network utilization in terms of trip making and trip exchange
-	Modification of Level of Service Standards	Assessment of impact upon network utilization in terms of trip making
23.	Development of Network Facilities Plan	Assessment of plan refinements in terms of separation methods with municipality
25.	Pathway Attributes	Assessment of the impact of pathway attributes related to trip making by specific trip purpose.
25.	Design Treatments	Assessment of the relationship between pathway attributes and design treatment categories

Table 3

Evaluation Within The PPP

For the most part, the evaluation procedures identified above deal specifically with issues related to network planning in terms of corridor location and disposition (e.g. separation methods).

Prior to finalizing the design, the Network Design Plan (which is the result of Task 25.0) must be evaluated. This evaluation includes consideration of the following:

- (1) Degree to which the Design Plan satisfies all subnetwork requirements (synthesized in Task 24.0)
- (2) Implementation feasibility based upon financial resources, approval and consensus of implementing bodies, etc.

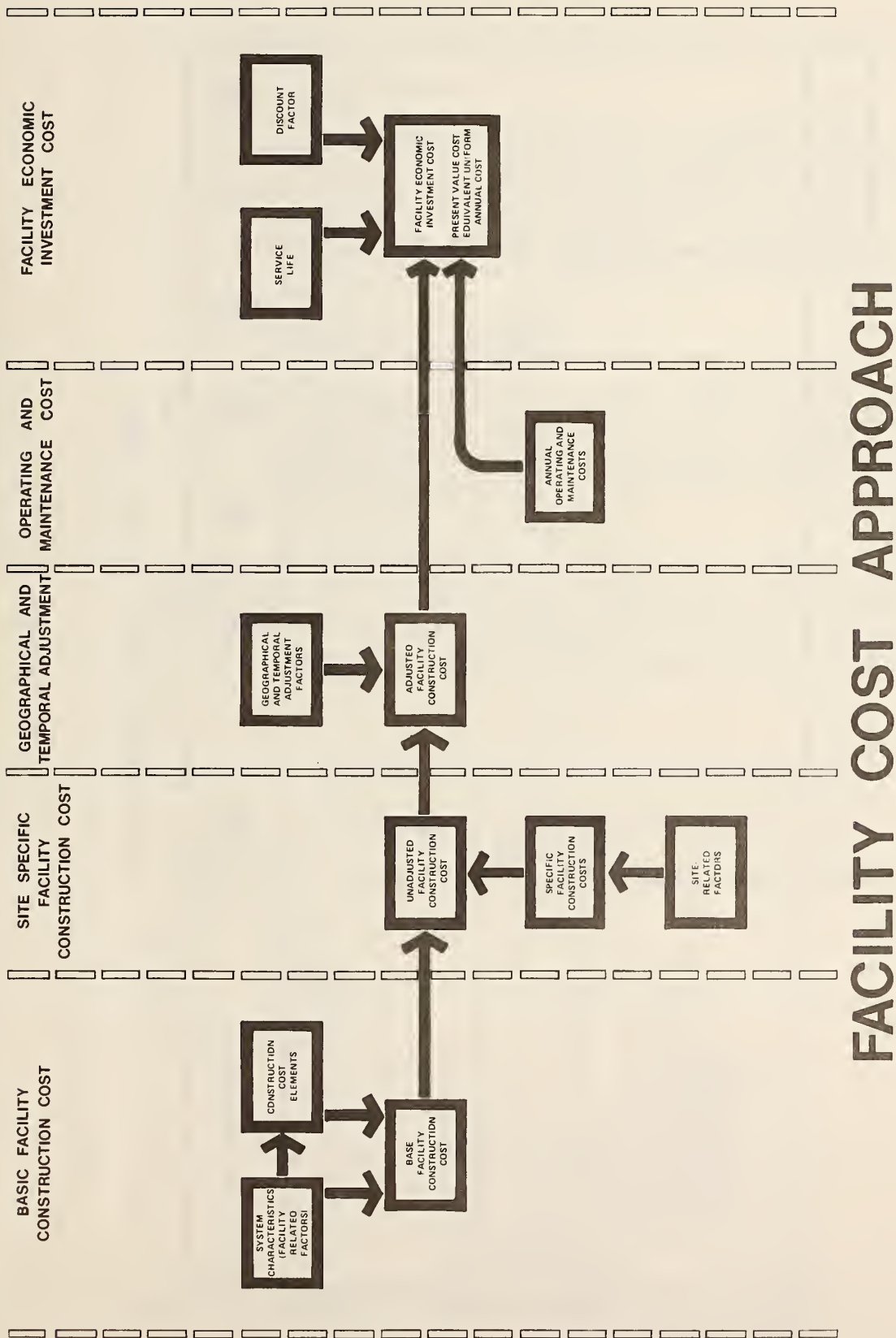

FACILITY COST APPROACH

Figure 42

Facility Cost Approach

	UNIT COST APPROACH				COST ESTIMATING APPROACH (BASED UPON EXISTING FACILITIES)					
	UNIT COST	QUANTITY	TOTAL COST	MALL	PART. MALL	TRANSITWAY	SKYWALKS	SUBWAYS		
1	SYSTEMS CHARACTERISTICS <ul style="list-style-type: none"> ▪ DIMENSIONAL PROPERTIES ▪ STRUCTURAL PROPERTIES ▪ MATERIAL AND CONSTRUCTION METHOD ▪ TERMINAL CONNECTIONS REQUIRED ▪ ENCLOSURE SYSTEM ▪ MECHANICAL SYSTEMS 									
2	SITE PREPARATION									
3	LANDSCAPING									
4	STREET FURNITURE									
5	SIGNING/LIGHTING									
6	SITE RELATED IMPACTS <ul style="list-style-type: none"> ▪ UTILITIES ▪ FOUNDATION CONDITIONS ▪ TRAFFIC DELAYS 									
7	OPERATION AND MAINTENANCE COSTS									
8	ECONOMIC LIFE CYCLE INVESTMENT COST									
	\$		\$	\$	\$	\$	\$	\$	\$	\$

FACILITIES COST ANALYSIS

Figure 43

Alterations Approaches Provided To Facilities Cost Analysis

(3) Assessment of systems cost/effectiveness

- Systems Costs

The approach for examining the facility costs in the Procedure is based upon the development of a basic cost estimating structure (summarized in Fig. 42) and a procedure for computing costs at various levels (illustrated by Fig. 43) for the purpose of comparison between preliminary cost estimates of specific proposed facilities.

- Systems Effectiveness

The assessment of the level of effectiveness that will be achieved through network facility implementation invokes the interrelated concepts of systems benefits and systems utilization. The level of effectiveness is a function of both the benefits to be derived as well as the utilization attained.

The level of effectiveness will be measured in terms of the net change in benefit as well as utilization between the proposed facility and the existing environment. The possible results of such an assessment are illustrated in Figure 44.

		BENEFIT	
		Proposed Greater Than Existing	Proposed Less than or Equal To Existing
UTILIZATION	Proposed Greater Than or Equal to Existing	Select Proposed 1	Existing Preferable 2
	Proposed Less Than Existing	Requires Further Analysis 4	Existing Preferable 3

Figure 44

Possible Outcomes Of Level Of Effectiveness Assessment

A sequence of steps that may be used in assessing level of effectiveness is provided in the Procedures.

As a result of this evaluation process, the Design Plan may be modified through:

- a. Reconsideration of design treatment or, if necessary,
- b. Through reconsideration of the alternative movement strategies selection.

TASK 27

PRODUCE NETWORK DESIGN PLAN

Once any revisions to the design based on impact assessment are completed, final graphic presentations are prepared. Figures 45, 46, 47 and 48 are typical products of this final task.

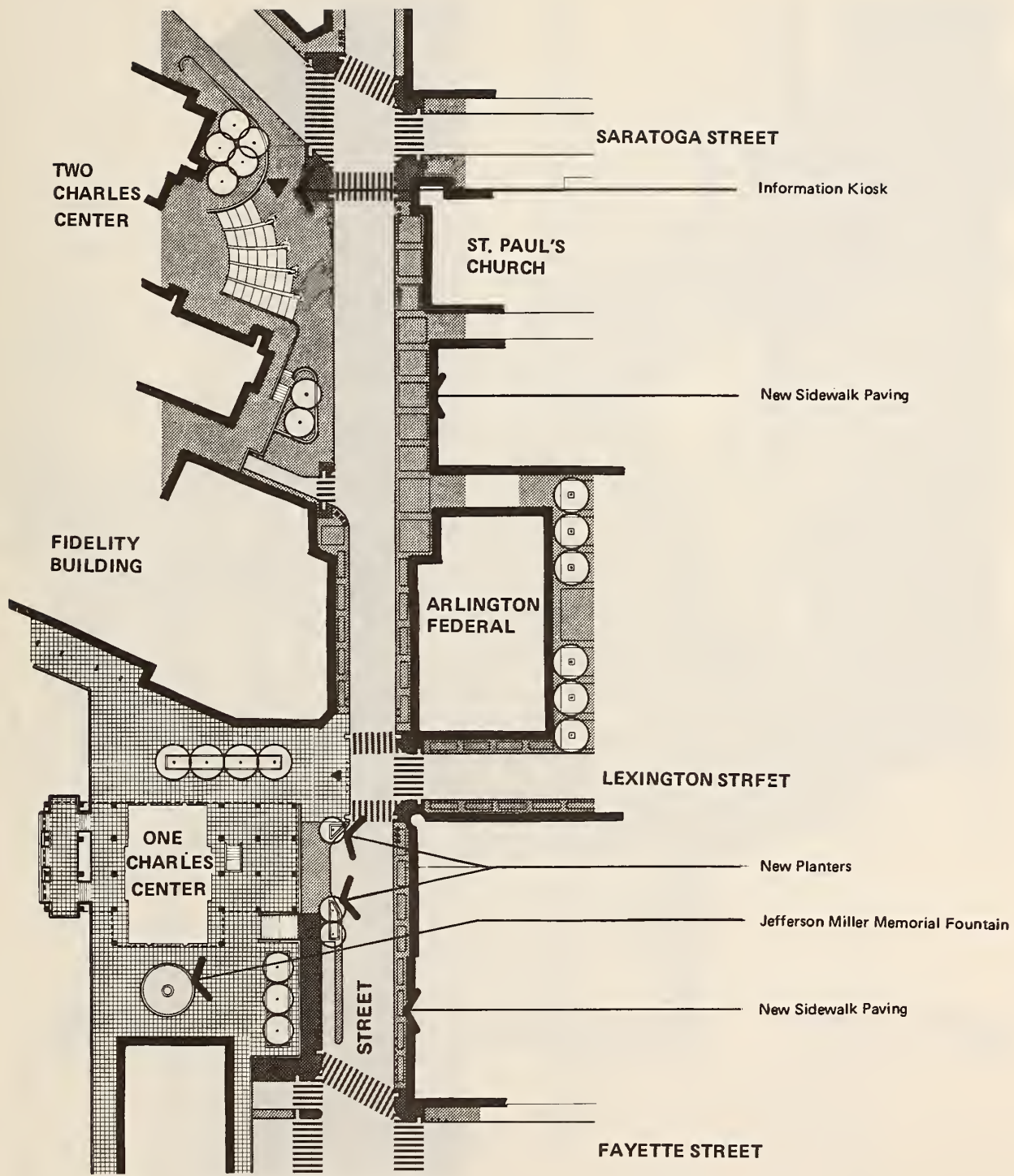

Figure 45

Design Plan Documentation - Widened Sidewalks

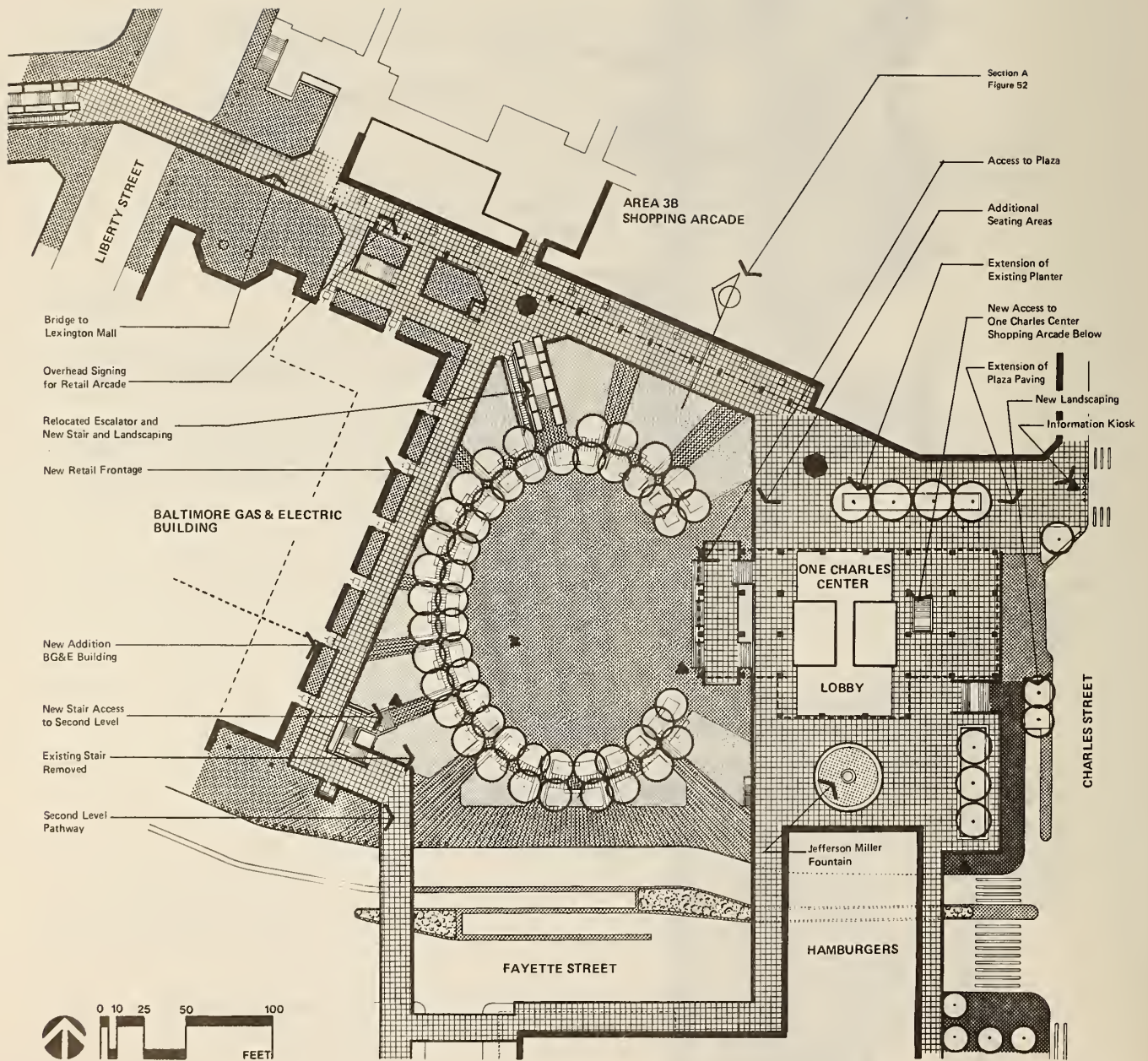

Figure 46

Design Plan Documentation - Plaza Treatment

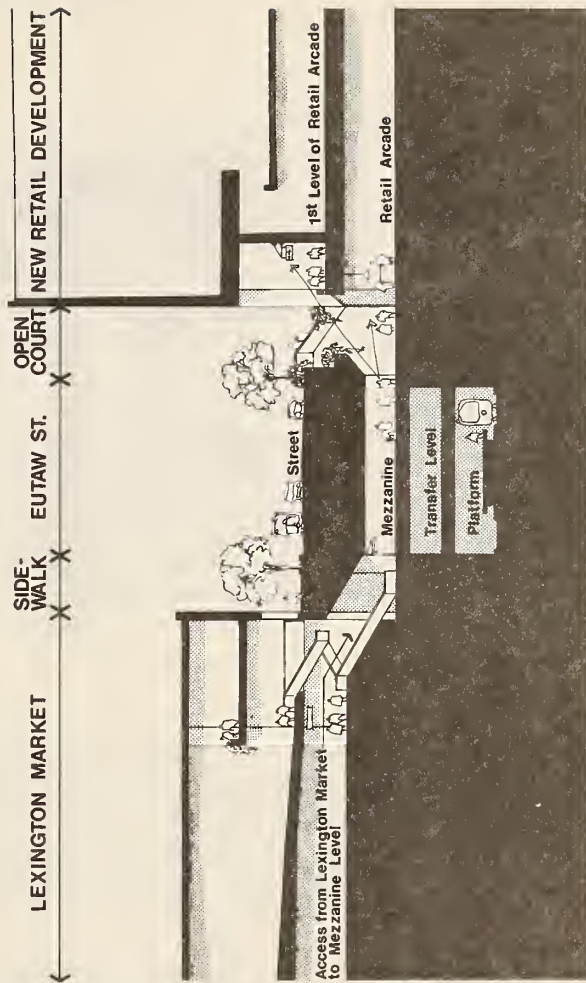
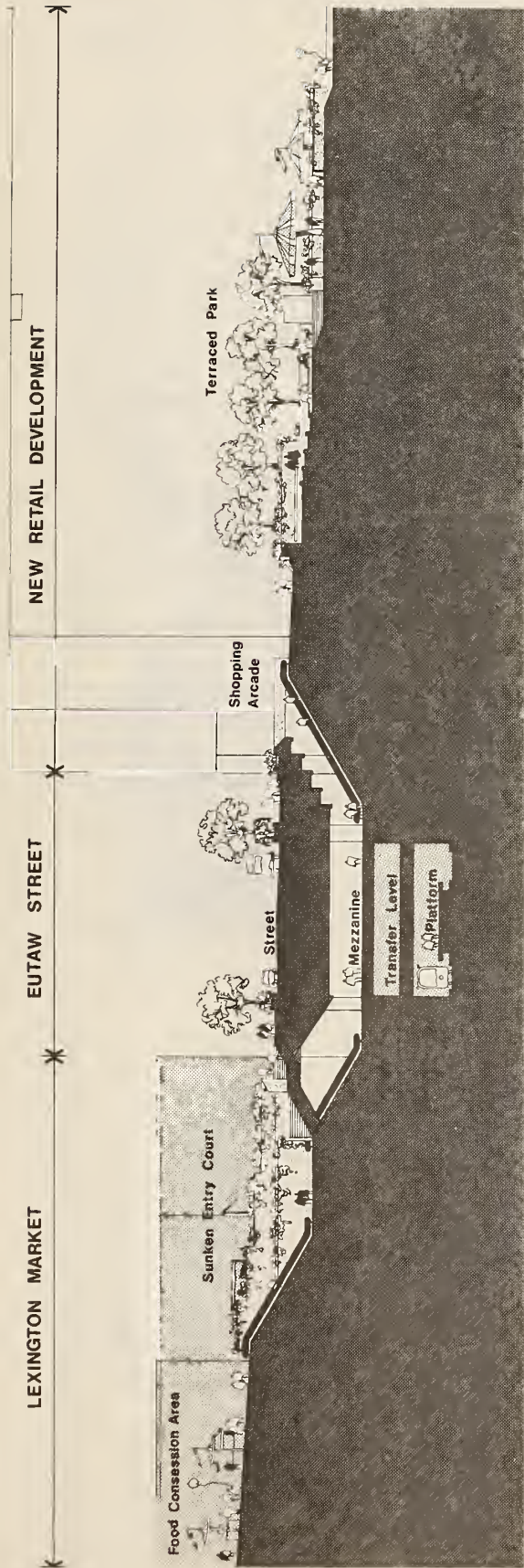
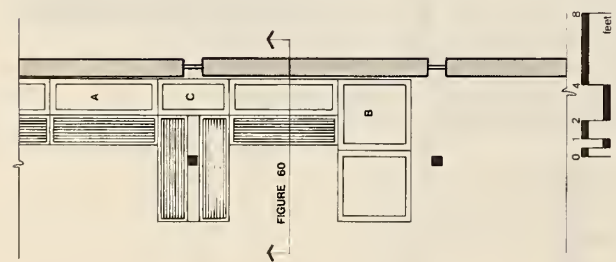
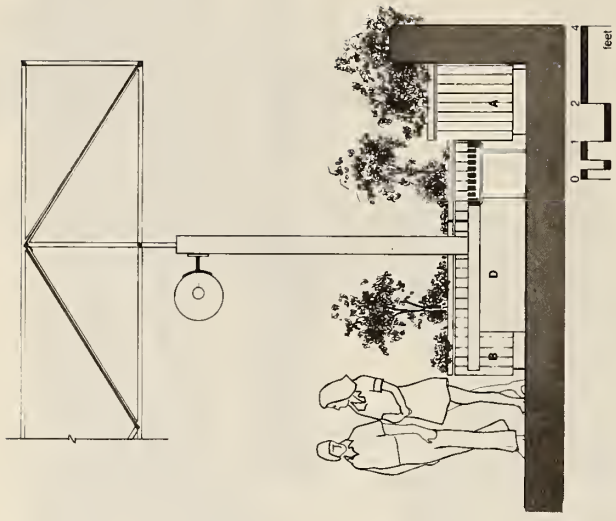

Figure 47

Design Plan Documentation - Sections



- A: PLANTER 24.6' x 30" H
- B: PLANTER 24.4' x 30" H
- C: PLANTER 24.4' x 30" H
- D: BENCH 20" x 6 x 17" H

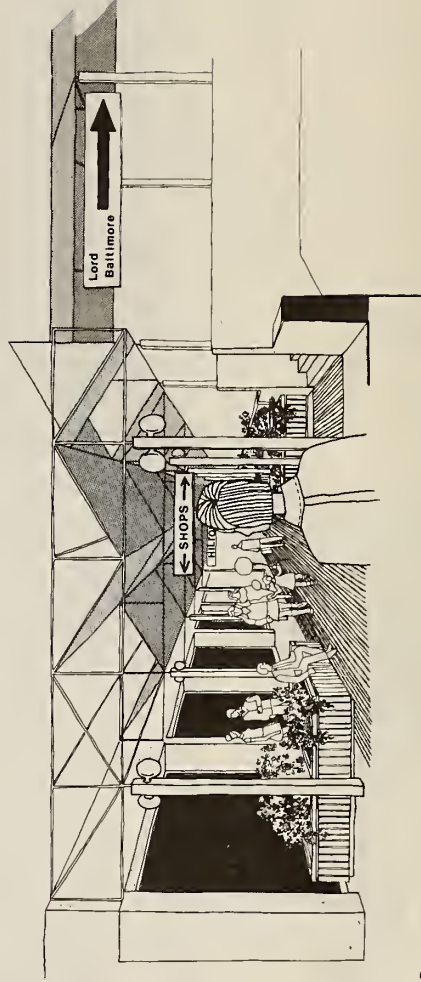
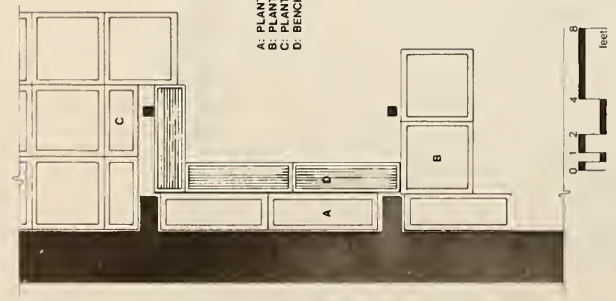

Figure 48
Design Plan Documentation - Design Details

IV. APPLICATION OF THE PEDESTRIAN PLANNING PROCESS

A. INTRODUCTION

The Pedestrian Planning Process consists of a comprehensive set of interrelated procedures. Although the procedures represent a series of progressive steps leading to the development of a pedestrian design plan (including feedback where appropriate), their application to any given situation will probably require some tailoring. In practice, emphasis may shift among procedures; some steps may be omitted; or the process may be terminated prior to the design plan. Indeed, the first task in the process consists of an assessment of how subsequent procedures will be applied as a function of specific, site-dependent requirements. In this section, the subject of process application is discussed in a generalized way in order to provide guidelines for use of the PPP. These guidelines are directed at all interested participants -- managerial, operational, active or passive -- so that appropriate decisions can be made. In this way, such things as study timing and level of detail, expected outputs, and similar elements can be dealt with, in general terms, prior to initiation of the detailed process.

B. OBJECTIVES OF THE PROCESS

The purpose of the PPP is to provide a basis for planning, designing, evaluating and implementing pedestrian systems and facilities. Emphasis is on the development of a rationale for planning both network systems or individual facilities, as well as on the specification of criteria or physical requirements related to the location, extent and nature of individual components.

Specifically, the procedures can be applied for the purpose of determining the following:

- The need for a facility (level of demand)
- The locational feasibility (site selection) of pathways and network components in terms of the degree to which these will be utilized in trip making.
- Both the physical and functional specifications relative to the design of movement systems and specific systems elements in terms of the extent, nature and configuration of systems components.
- The potential (physical, economical, social and environmental) impacts as well as the benefits associated with systems implementation (feasibility of implementation).

C. USING THE PROCEDURES

The PPP has been developed to operate at two levels:

- Application leading to the design of a total pedestrian movement system; or

- Application leading to the design of an individual pedestrian facility.

The first level of application would include consideration of an extended urban area having the potential for comprehensive pedestrian treatment. The second level of application would include consideration of a much more limited area with attention given, in most cases, to a single facility such as a street closing, widened sidewalk, or skyway component. Figure 49 illustrates the context and elements of a problem of this kind involving selection between the location, nature and extent of alternative pedestrian routes. The use of the PPP will depend on the level of application, which in turn will be dependent upon specific issues and objectives.

In many cases, the objectives underlying the need for pedestrian planning are stimulated by forces related to traffic or economic considerations. Prior research has shown that most often large-scale pedestrian systems are implemented as a by-product of concern for issues such as the following:

- Improving vehicular traffic flow.
- Economic revitalization of commercial activity (through improvements to shopper access and the addition of shopper conveniences).
- Improving appearance and environmental image.
- Reduction of adverse traffic impact.
- Provision of open space.

Hence, although the stimulation came from non-pedestrian considerations, the response has often taken the form of a pedestrian treatment, including establishment of full pedestrian systems, auto-restricted zones and similar extended facilities.

The development of an overall plan for pedestrian trip-making will usually require full utilization of the planning procedures set forth by the Manual. Most often, this level of effort will be required when local issues have a systems orientation, and relate strongly to one or more of the following areas of concern:

- Improvement to overall traffic flow and levels of accessibility through the employment of various traffic-management techniques.
- Desire to create a modally-balanced and integrated circulation system.
- Desire to achieve "modal shifts".
- Improvement of modal interface resulting from the inclusion of bus or rapid transit and people-mover systems.
- Reduction of overall traffic delays and conflicts resulting from pedestrian movement and modal incompatibility.
- Incidence of major new redevelopment areas which will result in a reconstitution of the vehicular and pedestrian access network.

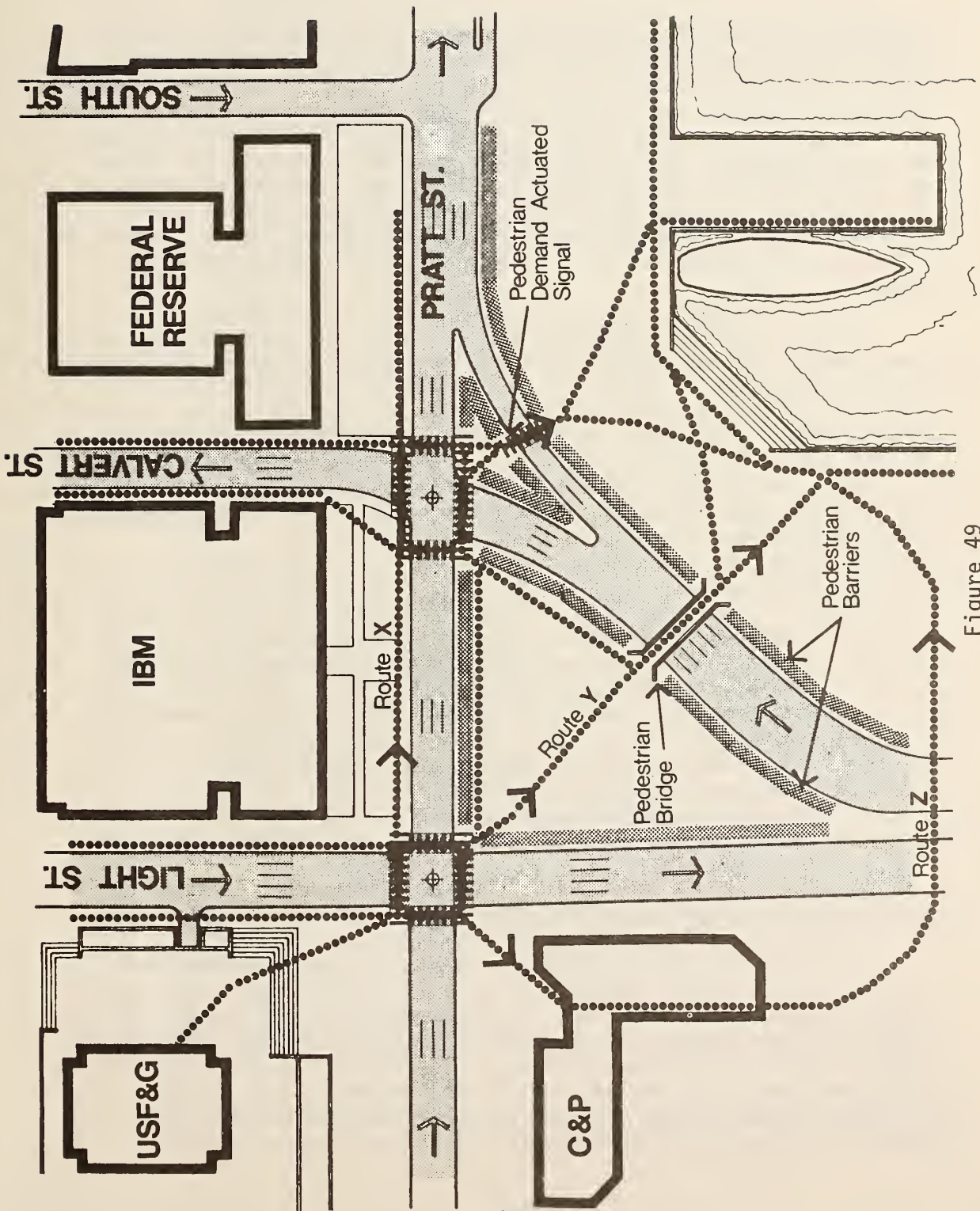

Figure 49

Limited - Context Application Of The PPP

- Major economic revitalization which will result in changes in land use activity and accessibility.
- Issues related to climate and/or topographic conditions.

Regarding the development of an individual pedestrian facility, studies indicate that a majority of currently operational pedestrian facilities have not been implemented as part of an overall comprehensive pedestrian network plan. Over a period of years many of these isolated facilities have been expanded to constitute an overall network for pedestrian trip making. This process has for the most part not been predicated upon a pedestrian planning rationale but rather, has responded to specific revitalization plans or localized areas of new development or redevelopment. The predominant factors which influence the implementation of such individual facilities are for the most part site-specific and are responsive to localized planning issues.

However, specific localized problems may only represent a part of a much wider set of issues which will require focusing upon a broader area for resolution. Therefore, the specific nature and impact of such issues must be fully identified prior to addressing the issue of the "systems" versus the "single facilities" approach.

There are, however, certain contextual issues which would invoke the selective use of various Manual procedures relative to examining a single pedestrian facility.

These include:

- Reduction of pedestrian/vehicular conflicts.
- Improvement of accessibility and convenience levels to shopper in commercial areas.
- Reduction of negative economic, social and environmental impacts.
- Improvement of environmental image and amenity.
- Provision of open space (auto free).
- Negotiation of unique topographic or climatic conditions.
- Evaluation of a single pedestrian facility or a pedestrian movement system.

D. DETERMINING PROCEDURE(S) APPLICABILITY

The selection and use of the entire process or of individual procedures within the process will be controlled by the issues associated with any given situation. It is essential that these issues be clearly identified and articulated prior to commencement of Procedural Tasks. Examination of the issues will determine which tasks need to be performed, and will provide a basis for how much effort should be allocated to each task. The process itself will provide the order in which the tasks are to be performed.

In determining Procedure applicability, the following points should be considered:

1. Determination of a level of applicability (full network or individual facility);
2. Identification and articulation of problems and issues relative to the pedestrian trip environment, in terms of --
 - Community needs;
 - Traffic management;
 - Multi-modal systems planning;
 - Major new development/economic revitalization or changes in land use activities; and
 - Economic, social and environmental impacts and dysfunctions.
3. Determination of the study area boundaries.
4. Selection of procedures to resolve problems and address the issues identified.

Points 1, 2 and 3 are iterative and dependent. For example, a decision to enlarge, or reduce, the study area will influence the level at which the procedures are applicable and/or the nature of the problem/issue set.

Setting the study area boundaries is worthy of additional comment. The temptation exists to enlarge the study area so as to capture all the possible effects of outlying areas or zones. This will, however, have a substantial effect on the level of effort that will be required to implement the procedures. It is advised that the study area should be as limited as possible, recognizing that some effects at or near the boundary will be lost. Since most movement in an urban center is confined to a small part of the entire area (for example, 60% of all trips being made in 20% of a CBD is typical), the boundary effects are not likely to influence major planning decisions. An alternative approach might be to examine a large area at a gross level of detail initially to identify areas to be studied in more detail.

Once a framework of issues and problems has been identified and organized in accordance with the major procedural components of the PPP Manual, a determination can be made as to which procedures are to be emphasized in the execution of the process.

Figure 50, which relates major PPP Task areas to generic problems and issues, is provided as guidance in making this determination.

Individual procedures should be selected, or emphasized within the process, based upon their ability to resolve specific problems or

		PEDESTRIAN PLANNING ISSUES													
		1	2	3	4	5	6	7	8	9	10	11	12	13	
MAJOR TASKS IN THE PEDESTRIAN PLANNING PROCESS	I	PEDESTRIAN SURVEY													
	II	NETWORK MODELLING													
	III	PEDESTRIAN NETWORK REQUIREMENTS													
	IV	MULTIMODAL REQUIREMENTS (CONFLICTS/CAPACITY)													
	V	DEVELOPMENT OF ALTERNATIVE MOVEMENT STRATEGIES													
	VI	SELECTION OF METHOD/S OF PED./VEH SEPARATION													
	VII	COST/BENEFIT EVALUATION													
	VIII	FACILITY DESIGN													
	IX	IMPLEMENTATION (PHASING & EXECUTION)													
			SELECTION OF OPTIMAL LOCATION FOR PEDESTRIAN FACILITY												
			DECISION ON FACILITY TYPE AND DESIGN												
			TRAFFIC MANAGEMENT												
			REDUCTION OF ADVERSE TRAFFIC IMPACTS												
		MULTI-MODAL BALANCE													
		MAJOR REDEVELOPMENT PLANS OR OPPORTUNITIES													
		MODIFICATION OF ENVIRONMENTAL IMAGE AND APPEARANCE													
		ECONOMIC REVITALIZATION													
		COMMUNITY NEEDS													
		PROVISION OF OPEN SPACE AND AMENITY													
		ACCESSIBILITY BETWEEN LAND USES													
		EVALUATION OF PROPOSED PEO. NETWORK PLAN													
		EVALUATION OF PROPOSED SPECIFIC FACILITY													

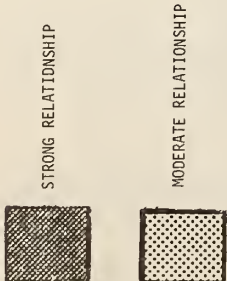

Figure 50
 Guidelines On The Application Of The PPP To Pedestrian Planning Issues

issues. The user should seek to set priorities based on site-specific conditions.

Each procedure within Volume Two of the manual sets forth all the fundamental requirements for successfully conducting that specific aspect of pedestrian facilities planning, design and evaluation in terms of:

- Approach
- Data provided or required
- Specific methods of analysis or evaluation to be used
- Use and interpretation of output to aid in the decision-making process
- Relationship of specific procedures to the overall PPP.

The user is referred to Volume Two for a continuation of the manual and an understanding of its technical application.

PHONE	DATE
785-742-777	8/16/68
2380-9776	8/16/68

FEDERALLY COORDINATED PROGRAM OF HIGHWAY RESEARCH AND DEVELOPMENT (FCP)

The Offices of Research and Development of the Federal Highway Administration are responsible for a broad program of research with resources including its own staff, contract programs, and a Federal-Aid program which is conducted by or through the State highway departments and which also finances the National Cooperative Highway Research Program managed by the Transportation Research Board. The Federally Coordinated Program of Highway Research and Development (FCP) is a carefully selected group of projects aimed at urgent, national problems, which concentrates these resources on these problems to obtain timely solutions. Virtually all of the available funds and staff resources are a part of the FCP, together with as much of the Federal-aid research funds of the States and the NCHRP resources as the States agree to devote to these projects.*

FCP Category Descriptions

1. Improved Highway Design and Operation for Safety

Safety R&D addresses problems connected with the responsibilities of the Federal Highway Administration under the Highway Safety Act and includes investigation of appropriate design standards, roadside hardware, signing, and physical and scientific data for the formulation of improved safety regulations.

2. Reduction of Traffic Congestion and Improved Operational Efficiency

Traffic R&D is concerned with increasing the operational efficiency of existing highways by advancing technology, by improving designs for existing as well as new facilities, and by keeping the demand-capacity relationship in better balance through traffic management techniques such as bus and carpool preferential treatment, motorist information, and rerouting of traffic.

3. Environmental Considerations in Highway Design, Location, Construction, and Operation

Environmental R&D is directed toward identifying and evaluating highway elements which affect the quality of the human environment. The ultimate goals are reduction of adverse highway and traffic impacts, and protection and enhancement of the environment.

4. Improved Materials Utilization and Durability

Materials R&D is concerned with expanding the knowledge of materials properties and technology to fully utilize available naturally occurring materials, to develop extender or substitute materials for materials in short supply, and to devise procedures for converting industrial and other wastes into useful highway products. These activities are all directed toward the common goals of lowering the cost of highway construction and extending the period of maintenance-free operation.

5. Improved Design to Reduce Costs, Extend Life Expectancy, and Insure Structural Safety

Structural R&D is concerned with furthering the latest technological advances in structural designs, fabrication processes, and construction techniques, to provide safe, efficient highways at reasonable cost.

6. Prototype Development and Implementation of Research

This category is concerned with developing and transferring research and technology into practice, or, as it has been commonly identified, "technology transfer."

7. Improved Technology for Highway Maintenance

Maintenance R&D objectives include the development and application of new technology to improve management, to augment the utilization of resources, and to increase operational efficiency and safety in the maintenance of highway facilities.

* The complete 7-volume official statement of the FCP is available from the National Technical Information Service (NTIS), Springfield, Virginia 22161 (Order No. PB 242057, price \$45 postpaid). Single copies of the introductory volume are obtainable without charge from Program Analysis (HRD-2), Offices of Research and Development, Federal Highway Administration, Washington, D.C. 20590.

DOT LIBRARY



00178003

