

IMAGERY ANALYSIS REPORT

THE EVENTS AT WACO

TEXAS

19 APRIL 1993

PREPARED FOR

THE US DISTRICT COURT FOR THE
WESTERN DISTRICT OF TEXAS

AND

THE OFFICE OF SPECIAL COUNSEL

BY



**IMAGERY ANALYSIS REPORT
THE EVENTS AT WACO TEXAS
19 APRIL 1993**

Table of Contents

1	EXECUTIVE SUMMARY	3
1.1	BACKGROUND.....	3
1.2	GUNFIRE	4
1.3	TIME OF THE FIRE	4
1.4	PERSONNEL.....	4
2	BACKGROUND	5
2.1	REPORT COMPILATION	5
2.2	SYNOPSIS	5
2.3	INSTRUCTIONS	5
2.4	DISCLOSURE OF INTERESTS	5
2.5	THE EXAMINATION OF EVIDENCE.....	5
2.6	DETAILED METHODOLOGY	6
2.7	TECHNICAL EQUIPMENT.....	6
2.7.1	<i>To View The Enclosed CD-ROM Interactive Video Clips</i>	7
2.7.2	<i>To View Each Video Clip As A Continuous Loop</i>	7
2.7.3	<i>To View Each Video Clip Frame By Frame</i>	7
2.8	REFERENCE MATERIAL	7
3	THE MT. CARMEL COMPOUND	8
4	FLIR IMAGERY INTERPRETABILITY	10
4.1	FLIR TAPE 1	10
4.2	FLIR TAPE 2.....	11
4.3	FLIR TAPE 3.....	11
4.4	FLIR TAPE 4.....	12
5	TERMINOLOGY	13
6	PASSIVE SPECULAR SOLAR REFLECTIONS (PSSR)	14
6.1	FLIR TRIAL RESULTS	14
6.2	PSSRs AT THE SWIMMING POOL.....	14
6.3	PSSRs AT THE STORAGE TANK.....	15
7	ACTIVE THERMAL RESPONSES (ATR)	17
7.1	FLIR TRIAL RESULTS	17
7.2	ATR EXAMPLE FROM 19 APR 93.....	17
8	MASTER EVENT LIST AND VDS (UK) ANALYSIS	18
9	ALLEGED BRANCH DAVIDIAN GUNFIRE	23
9.1	WHITE SIDE	23
9.2	RED SIDE	30
9.2.1	<i>Damaged Corner (B2 Window)</i>	30
9.3	EVENTS AT RED SIDE ON CHAPEL ROOF.....	31

9.4	BLACK SIDE.....	34
9.4.1	CAFETERIA ROOF.....	34
9.4.2	RESIDENTIAL TOWER.....	37
10	ALLEGED GOVERNMENT GUNFIRE.....	39
10.1	CRITERIA FOR GUNFIRE	39
10.1.1	MUZZLE FLASH FLIR SIGNATURES DERIVED FROM FLIR TRIAL.....	39
10.1.2	COMPARISON OF IDENTIFIED EVENTS WITH CRITERIA FOR MUZZLE FLASH FLIR SIGNATURE.....	39
10.2	GREEN SIDE	40
10.3	BLACK SIDE	45
10.4	ALLEGED GUNFIRE FROM GOVERNMENT HELICOPTER	54
11	ANALYSIS OF THE TIME OF THE START OF THE FIRE	56
11.1	RED / WHITE CORNER.....	57
11.2	CAFETERIA	58
11.3	COLLAPSED WALKWAY.....	59
12	SIGHTING OF PERSONNEL.....	60
13	CONCLUSIONS.....	63
13.1	BACKGROUND.....	63
13.2	VDS (UK) TASK.....	63
13.3	IMAGERY EXAMINED BY VDS (UK)	63
13.4	MASTER EVENT LIST.....	63
13.5	ANALYSIS.....	63
13.6	ALLEGED GOVERNMENT GUNFIRE	64
13.7	TIME OF THE FIRE.....	64
13.8	PERSONNEL.....	64
13.9	AUTHENTICATION.....	65
13.10	REPORT DISTRIBUTION.....	65

ATTACHMENT 1: RESUMES OF NICK M. EVANS, PETER AYRES AND DANIEL DAVID OXLEE

ATTACHMENT 2: IMAGERY ANALYSIS REPORT FLIR TRIAL

ATTACHMENT 3: LOG OF DOCUMENTS RECEIVED

ATTACHMENT 4: MENSURATION REPORT FOR THE ANALYSIS OF MOUNT CARMEL COMPOUND

ATTACHMENT 5: IMAGERY INTERPRETABILITY RATING SCALES (IIRS)

1 EXECUTIVE SUMMARY

1.1 Background

On 9 September 1999, the Attorney General of the United States of America appointed Senator John C. Danforth to investigate certain events that occurred at the Mt. Carmel Compound in Waco, Texas on 19 April 1993. Immediately after his appointment, Senator Danforth established the Office of Special Counsel (OSC) to carry out this investigation.

On 2 Dec 99, VDS (UK) was engaged by the OSC and the US District Court for the Western District of Texas to review FLIR imagery taken by an FBI Night Stalker aircraft flying over the Mount Carmel compound on 19 April 1993.

VDS (UK) was tasked to determine:

- Whether Government forces fired weapons
- Whether the start time of the fire could be identified on the FLIR
- Whether personnel could be seen on the ground

To address these points VDS (UK) has:

- Examined all FLIR tapes from the FBI Night Stalker
- Examined hand-held air-to-ground imagery taken by the FBI relevant to the task
- Examined hand-held ground imagery relevant to the task
- Taken into account the results of the FLIR trial staged by VDS (UK) at Fort Hood in March 2000

VDS (UK) received a report¹, originated by the Davidian experts' study of the FLIR imagery, alleging:

- 15 instances of Government gunfire
- 3 Flashbang detonations
- 1 sighting of a person on the ground
- 18 instances of Davidian gunfire

In addition to these 37 reported instances, VDS (UK) then identified a further 20 instances of similar anomalous thermal activity.

Our following report provides an analysis of these 57 events.

Detailed exploitation of the FLIR imagery, together with comparative analysis of the collateral imagery, and of muzzle flash and debris reflection identified during the FLIR trial, leads us to the following conclusions.

¹ Caddell & Chapman – Indications of Gunfire or Heat Flashes on FLIR Tape 3 - 20 Oct 99 supplemented by Edward Allard – Analysis of the April 19, 1993 WACO FLIR Videotapes, March 1, 2000.

1.2 Gunfire

From the information available to VDS (UK), we have concluded that the 57 thermal events, including the alleged sighting of a person, are all caused by Passive Specular Solar Reflection, Active Thermal Reflection or movement of debris.

Our report provides illustrations identifying the causes of these thermal events.

1.3 Time Of The Fire

Our determination of the first outbreak of fire **indicated on the FLIR imagery** is at 12:07:43 on the second floor of the Red/White corner. A near-simultaneous outbreak occurs at 12:08:26 at the cafeteria / kitchen entrance.

Our report provides illustrations of the outbreaks of fire.

1.4 Personnel

Our conclusion is that throughout the morning of 19 April 1993, no persons are seen on imagery until 12:10:50; thereafter numerous personnel (assumed to be Government personnel by their actions) attend the fire.

2 BACKGROUND

2.1 Report Compilation

This report was compiled by staff of Vector Data Systems (UK) Ltd (VDS(UK)).

VDS (UK) is a UK-registered, majority-owned subsidiary of Vector Data Systems Inc (VDS Inc) and is located in Peterborough, England from where it operates primarily in support of UK Ministry of Defence requirements.

The company specialises in providing imagery exploitation ground stations, imagery software and imagery training and consultancy services. The operational and executive control of all VDS (UK) activities is vested in the UK staff, all of whom are UK nationals. VDS (UK) has not previously been under a direct contract to the US government. In 1997 VDS Inc, Alexandria, VA, was acquired by the Anteon Corporation.

The lead VDS (UK) analyst for this report was Daniel David Oxlee, supported by Nick Evans and Peter Ayres. Biographies for these members of staff are at Attachment 1.

2.2 Synopsis

On 9th September 1999, the Attorney General of the United States appointed Senator John C. Danforth to investigate certain events that occurred at the Mount Carmel compound in Waco, Texas on 19th April 1993. Immediately after his appointment Senator Danforth established the OSC to carry out this investigation.

2.3 Instructions

On 2nd December 1999, VDS (UK) was retained by the OSC to analyse and interpret airborne Forward Looking Infrared (FLIR) imaged by the FBI using a Night Stalker aircraft flying an orbit above the Mount Carmel compound on 19 April 1993.

2.4 Disclosure of interests

No member of staff at VDS (UK) has any connection with any of the parties, witnesses or advisers involved in this case.

2.5 The Examination Of Evidence

The examination of imagery evidence took place at VDS (UK) premises at Newark Road, Peterborough, England from 4 January 2000 until 5 May 2000.

2.6 Detailed Methodology

We viewed the FLIR videos using a video recorder with a frame-by-frame viewing capability. This procedure allowed us to observe individual frames at length and to familiarise ourselves fully with the events that took place. We also digitised the FLIR tapes to enable us to use a variety of digital techniques to view, analyse and compare data using the software tools detailed at Para 2.7.

We selected the most appropriate FLIR images of each event in order to determine significant features regarding the Shape, Size, Shadow and Associated Features of the object and its background. Most importantly, we studied the Tonal Ranges of both object and background in terms of ground resolution and thermal discrimination.

Having identified 57 specific instances of potential thermal activity requiring detailed examination, we then undertook a comparative assessment (one event with another) where those events looked similar with regard to sun angle/sensor aspect.

It is important to note that we used all of the available FLIR imagery in making this comparison and not only the frames that have been selected for illustrations in this report.

We then reviewed all the available collateral imagery (ground & air) and conducted comparative analysis with the FLIR, using a variety of softcopy exploitation techniques, in order to reach an interim assessment. Where possible, we used imagery of similar scale and viewpoint.

Finally, and following the FLIR Trial held under our direction at Fort Hood on 19th March 2000 (Attachment 2), we compared results from that FLIR trial with our interim assessment to reach the final conclusions stated in this report.

2.7 Technical Equipment

The imagery was exploited on our Desktop Imagery Exploitation Workstation (DIEWS) which includes the following commercially available software packages:

- Falcon View™
- Digital Imagery Exploitation Production System™ (DIEPS)
- Remote View™
- Raindrop™
- Adobe Photoshop™
- Adobe Premiere™

Additionally, we utilised a SUN Ultra 2 workstation mounting DIEPS™ software and CrystalEyes™ stereo viewing equipment to view individual frames in stereo, together with an Apple Mac workstation with MiniCAD 7™ software to generate 3D drawings and support our mensuration.

Report generation and desktop publishing was achieved using a suite of PCs using Microsoft™, Paintshop Pro™ and Adobe™ software.

The accompanying interactive CD-ROM supporting illustrations were generated using General Dynamics Digital Video Analyser.

2.7.1 To View The Enclosed CD-ROM Interactive Video Clips

- You will need a PC equipped with CD-ROM drive and web browser / media player
- Insert the CD into your CD player
- Select *Run* from your *Start* menu
- Double click the *VDS (UK) Report* folder to open the folder
- Double click the *Index* icon to open the Index
- When the Analysis Package Index opens, click [VDS](#)
- When the Video Package window opens, click [VDS](#)
- To play the video clips, click [Play Video Clip](#) as required
- To view any attached images click [Attached Files](#) as required

2.7.2 To View Each Video Clip As A Continuous Loop

- Your *Media Player* may be configurable for *Auto Repeat / Continuous Play*

2.7.3 To View Each Video Clip Frame By Frame

- Your *Media Player* may be configurable for frame by frame play

2.8 Reference Material

All material used in the compilation of this report is itemised at Attachment 3. The information cut-off date was 10 April 2000.

3 THE MT. CARMEL COMPOUND

Figure 1 illustrates the compound and is colour coded in accordance with the reporting colour codes allocated in 1993 by the FBI. For ease of reference we have used these FBI colour codes to avoid confusion and for ease of cross-reference with reporting by other agencies.



Figure 1

Side elevations of the compound are illustrated at Figure 2. Detailed dimensions may be found in our photogrammetry report at Attachment 4.

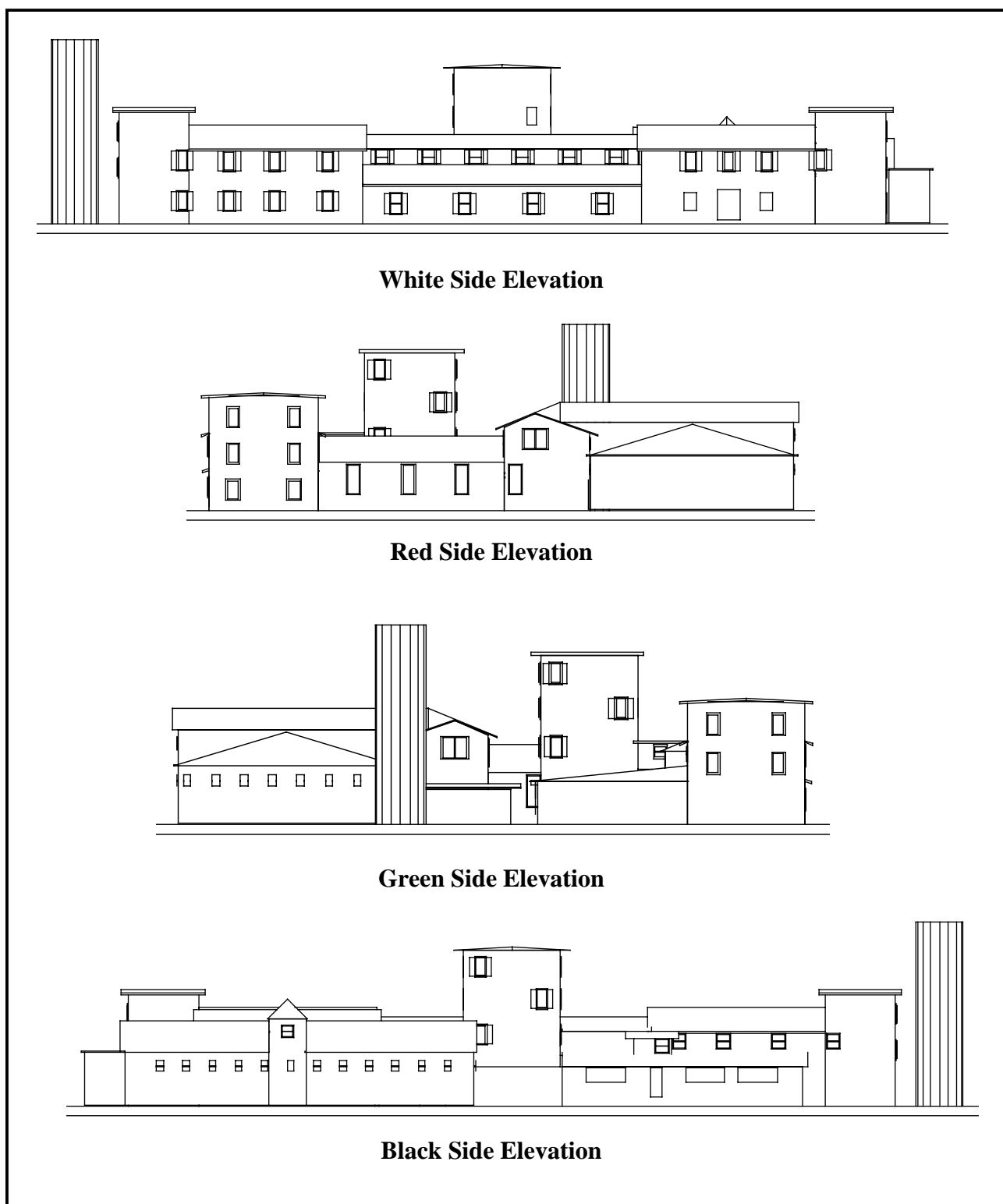

Figure 2

4 FLIR IMAGERY INTERPRETABILITY

Four Night Stalker FLIR tapes covering the events at Mt Carmel on 19th April 1999 were viewed and assessed for interpretative quality using the Infrared Imagery Interpretation Rating Scale (IIRS), adopted as a standard by NATO, and included as Attachment 5.

FLIR TAPE	START	END	IIRS RATING	COMMENT
1	05:58	08:00	0 - 1	-
2	07:57	09:30	2	Night Stalker off task 09:30 to 10:41.
3	10:41	12:41	6 - 7	Sensor switched off 10:47:16 to 10:52:58. Reason unknown.
4	12:41	14:01	5	Degraded by fire causing FLIR system saturation.

4.1 FLIR Tape 1

FLIR Tape 1 covered the acknowledged timespan when Government agents first attempted to displace Davidian personnel present within the compound. Although the tape was viewed throughout, obscuring cloud cover during virtually the whole of this imaging period reduced the overall IIRS rating of FLIR Tape 1 to IIRS 0-1.

The FLIR operator had selected “black-hot” for most of the tape.

An example of the best imagery from FLIR Tape 1 is at Figure 3.

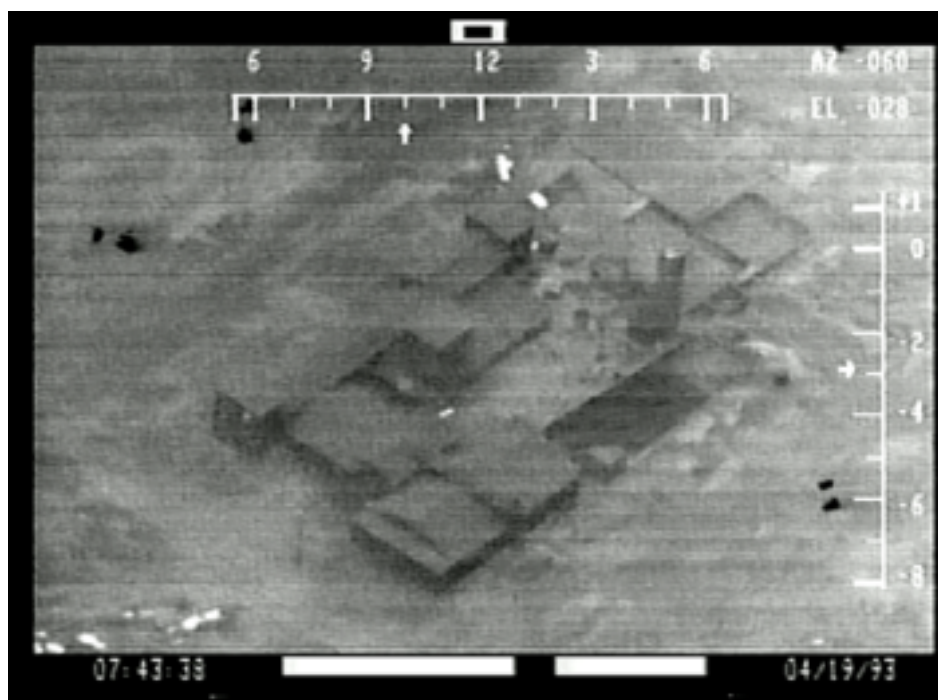

Figure 3

4.2 FLIR Tape 2

FLIR Tape 2 is rated overall at IIRS 2, and again the operator had selected “black-hot”.

This imagery was better than on FLIR Tape 1, due to improving weather conditions. Even so, the imagery lacked the potential to observe gunfire, although some military-type vehicle movement was visible. An example is the building penetration on the White side by CEV-1 that occurred at 09.11 hrs, depicted at Figure 4.



Figure 4

4.3 FLIR Tape 3

FLIR Tape 3 is rated at IIRS 6-7, notwithstanding the prolonged time interval since April 1993 and the numerous viewing of this analogue tape by the various parties prior to its despatch to VDS (UK) in January 2000.

FLIR Tape 3 is of an overall resolution sufficient to allow detailed analysis of some 15 instances of alleged² Government gunfire, 3 alleged Flashbang detonations, 1 sighting of a person on the ground together with 18 instances of alleged Davidian gunfire.

² Caddell & Chapman – Indications of Gunfire or Heat Flashes on FLIR Tape 3 - 20 Oct 99 supplemented by Edward Allard – Analysis of the April 19, 1993 WACO FLIR Videotapes, March 1, 2000.

In addition to these 37 reported instances, VDS (UK) has identified a further 20 instances of similar anomalous thermal activity.

4.4 FLIR Tape 4

This “white-hot” tape shows the Compound as the fires rapidly spread. As a consequence, the radiant energy threshold is such that the automatic gain control could not (apparently) produce a meaningful image for much of the time.

5 TERMINOLOGY

Some terminology used in this report is, of necessity, specialist in nature and subject to national variation.

However, in this report the term **Passive** refers to a return on the FLIR imagery that is the result of *solar action*, whilst the term **Active** indicates that the source of the emission stems from *mankind* (for example a running engine).

Although **Temperature** is the dominant factor in determining the strength of a thermal return on FLIR, other factors such as the of type of **Material**, the **Surface Texture**, the **Slant Range** from a target, and the **Imaging Aspect** must be considered during detailed imagery analysis.

The majority of commonplace materials have the property to absorb and to subsequently re-emit radiant energy to varying degrees in the long-wave infrared part of the electromagnetic spectrum; however, items such as glass and polished metals tend to act very poorly in this respect and display low **Emissivity** with consequent high **Reflectivity**.

In the **passive** sense some glass / polished metals have the ability to reflect more than one-third of the thermal energy incident upon them. Thus, with the right imaging aspect a considerable amount of energy can be reflected back to the sensor system, if the sensor system is moving relative to the Sun angle. The **passive** effect is here termed **Passive Specular Solar Reflection (PSSR)**.

In the **active** sense, the same materials can reflect mankind-derived energy to the sensor system, again given the right imaging aspect. The **active** effect is here termed **Active Thermal Reflection (ATR)**.

There is a correlation between the location of the sensor, the sun angle and the recording of PSSR returns on the FLIR. As the aircraft orbits the Mt Carmel compound, certain PSSRs are imaged only when the sensor viewing aspect, sun and reflecting debris are in a specific correlation – we term this sensor viewing aspect the **Sensor Zone of Regard**.

6 PASSIVE SPECULAR SOLAR REFLECTIONS (PSSR)

6.1 FLIR Trial Results

The FLIR trial results (Attachment 2) clearly identify PSSRs collected by the Lynx FLIR in the 8-14 micron part of the electromagnetic spectrum. The following two events, recorded by the Night Stalker FLIR on 19 April 93, act as an empirical example of PSSR, as described in the FLIR Trial report.

6.2 PSSRs At The Swimming Pool

Master Event List VDS Serial 1.

A number of flashes can be observed on the water at the deep end of the pool. The swimming pool flashes are the result of wave motion on the water in reflective line-of-sight with both the sun and the FLIR sensor, and are identified as PSSRs.

There is a very bright return from an unidentified object at the edge of the pool that is assessed also to be a PSSR.

These flashes were not included within the Davidian allegations of weapon discharge, and yet they display very similar characteristics to the other series of flashes claimed to be gunfire, see Figure 5.

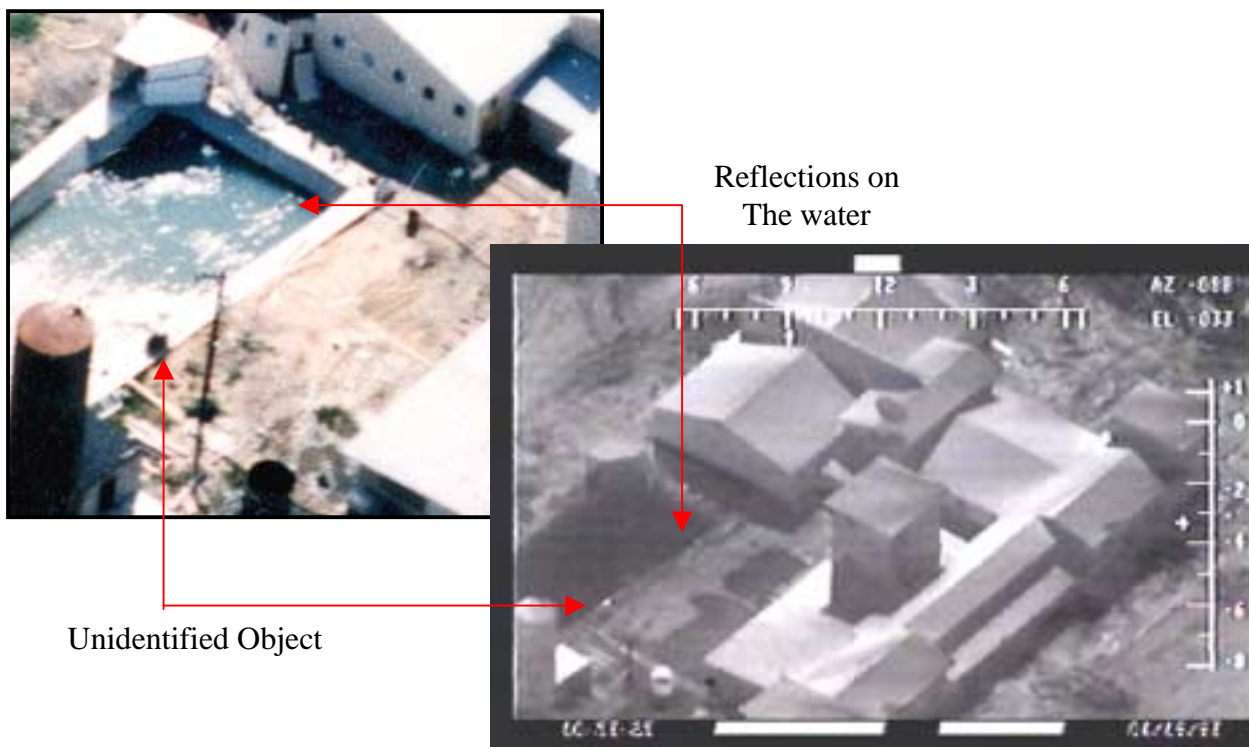

Figure 5 - See CD ROM Video Clip # 1

6.3 PSSRs At The Storage Tank

Master Event List VDS Serial 3.

Two flashes can be seen on the FLIR (Figure 6) that are similar in all respects to the majority of those alleged to be gunfire elsewhere on FLIR Tape 3. These two flashes from the same spot result from what is believed to be a smooth metal plate (Figure 7, imaged prior to 19th April 1993) lying on the ground in reflective line-of-sight with both the sun and the FLIR sensor, and are therefore identified as PSSRs.



Figure 6 - See CD ROM Video Clip # 2



Figure 7

These flashes are not observed at other times since the sun shadow, angularity, and the gap between nearby building and the storage tank are not replicated exactly elsewhere on the FLIR

coverage.

These flashes were not included within the Davidian allegations of weapon discharge, and yet they display very similar characteristics to the other series of flashes claimed by the Davidians to be gunfire.

7 ACTIVE THERMAL RESPONSES (ATR)

7.1 FLIR Trial Results

The FLIR trial results (Attachment 2) clearly identify ATRs collected by the Night Stalker FLIR in the 8-14 micron part of the electromagnetic spectrum. Figure 8, recorded by the Night Stalker FLIR during the 19 Mar 00 FLIR Trial illustrates an empirical example of ATR, as described in the FLIR Trial report.



Figure 8 - See CD ROM Video Clip # 3

7.2 ATR Example From 19 Apr 93

Figure 9 illustrates an ATR caused by the heat of the CEV engine reflected from debris on the ground during CEV operations at Mt Carmel.



Figure 9 - See CD ROM Video Clip # 4

8 MASTER EVENT LIST AND VDS (UK) ANALYSIS

VDS (UK) Serial	Time	Event	Alleged Gunfire VDS (UK) Analysis and Flash Durations (seconds)	Report Figure Number
1	10: 53: 24 to 10: 53: 25	Black SideFlashes in water at deep end of pool	PSSRs from water	5
2	10: 54: 21	Red sideFlash at damaged structure (below window B2)	PSSRs from debris amongst damage (³ 0.13, 0.20)	17, 52
3	11: 05: 50 to 11 : 05 :52	Green / White sideFlashes near a dome-roofed water storage tank	PSSRs from very low emmissivity material on the ground (1.00, 0.87)	6, 7
4	11: 14: 10	Red sideFlash at damaged structure (below window B2)	PSSRs from debris (0.03,0.07,0.03)	18
5	11: 18: 21 to 11: 18: 23	Black sideFlash from left rear hull of CEV- 2	⁴ Alleged Government Gunfire PSSRs from debris on CEV (0.90)	37
6	11: 18: 48	Black sideFlash at demolished corner of Gym	Side panelling pushed out by CEV- 2. Top edge movement of resultant debris depicted (0.53)	38
7	11: 23:25	Black sideFlash near left rear of CEV- 2, close to Gym	Alleged Government Gunfire ATR from debris on ground (0.20)	39
8	11: 24: 30 to 11:24:32	Black sideFlashes directly to the rear of CEV-2	Alleged Government Gunfire ATR from debris on ground, CEV passes directly over it (0.30)	40
9	11: 24: 50 to 11 :24: 51	Black sideFlashes from window B3 or B4 overlooking Cafeteria roof	Alleged Davidian Gunfire from window PSSRs from debris on roof (0.13, 0.20)	24
10	11: 25: 02	Red sideFlash on Chapel roof	Alleged Davidian Gunfire or Government Flash Bang PSSRs from debris on roof (0.13, 0.03, 0.07, 0.03)	20
11	11: 25: 04	Red sideFlash on Chapel roof	Alleged Davidian Gunfire PSSRs from debris on roof (0.10)	21
12	11: 26: 27	Black sideFlashes near rear right drive sprocket of CEV 2	Alleged Government Gunfire ATR from debris on ground (0.03, 0.03)	41

³ USA National Television Standards Committee (NTSC) video framing rate is 30 frames per second, 2 fields per frame

⁴ Caddell & Chapman – Indications of Gunfire or Heat Flashes on FLIR Tape 3 - 20 Oct 99.

VDS (UK) Serial	Time	Event	Alleged Gunfire VDS (UK) Analysis and Flash Durations (seconds)	Report Figure Number
13	a. 11: 28: 04 to 11: 28: 07 b. 11: 28: 13 to 11: 28: 14	Green sideFlashes in Courtyard in front of Residential Tower	Alleged Government Gunfire PSSRs from falling debris as CEV-2 penetrates Gym (a. image fault, 0.03, 0.07, 0.10, b. 0.70)	31
14	a. 11: 28: 18 b. 11: 28: 21	Black sideFlashes from window B4 overlooking Cafeteria roof. Also on roof	Alleged Davidian Gunfire from window PSSRs from debris on roof in all cases (a. 0.10, b. 0.27)	24
15	11: 28: 22	Black side Flashes on Cafeteria roof	PSSRs from debris on roof (0.27)	24
16	a. 11: 30: 08 b. 11: 30: 14	Green sideFlashes (weak) in Courtyard in front of Residential Tower	PSSRs from fallen Gym debris (a. multiple 0.03, b. multiple 0.03)	31
17	11: 30: 26	Black sideFlashes on Cafeteria roof. Also from window B3 overlooking Cafeteria roof	Alleged Davidian Gunfire from window PSSRs from debris on roof in all cases (0.40, 0.30)	25
18	11: 34: 32	Green sideFlash in Courtyard in front of Residential Tower	Alleged Government Gunfire PSSRs from fallen Gym debris (0.27)	31
19	11: 34: 32	Green sideAlleged man running from destroyed NE corner of Gym to diving platform at corner of Swimming Pool	Alleged Government Agent Wind blown debris material from damaged Gym	32
20	11: 34: 33	Black side Flashes on Cafeteria roof	PSSRs from debris on roof (0.10)	26
21	11: 34: 45	Red sideFlash on Chapel roof	Alleged Davidian Gunfire PSSRs from debris on roof (0.40, 0.30)	21
22	11: 38: 31	Black sideFlash 15 feet in front of CEV-2	Alleged Government Gunfire PSSRs from fallen Gym debris (0.37)	43
23	11: 38: 45	Black sideFlash at black spot at innermost penetration by CEV- 2 into Gym	Alleged Government Gunfire PSSRs from fallen Gym debris (0.73)	42
24	11: 42: 00 to 11: 42: 01	Red sideFlash at damaged structure (below window B2)	PSSRs from debris amongst damage (0.07, 0.07, 0.07)	18

VDS (UK) Serial	Time	Event	Alleged Gunfire VDS (UK) Analysis and Flash Durations (seconds)	Report Figure Number
25	11: 43: 33	<i>White side</i>Flash on single-storey Quarters roof	<i>Alleged Davidian Gunfire</i> PSSRs from debris on roof (0.27)	10
26	11: 43: 35 to 11: 43: 38	<i>White side</i>Flashes from window B5 overlooking single-storey Quarters roof	<i>Alleged Davidian Gunfire from window</i> PSSRs from very low emmissivity material (0.30, 0.37, 0.47, 0.23)	10
27	11: 44: 48	<i>Black side</i> Flash on Cafeteria roof	<i>Alleged Davidian Gunfire towards CEV- 2 or Courtyard</i> PSSRs from debris on roof (0.17)	26
28	11: 44: 52 to 11:44: 53	<i>Black side</i>Flash on Cafeteria roof - then flash from Residential Tower window C3 followed by multiple flashes on roof	<i>Alleged Davidian Gunfire towards CEV- 2 or Courtyard</i> PSSRs from debris at base of Tower and on roof of Cafeteria (0.17, 0.17, 0.17, 0.03)	26, 29
29	11: 45: 15 to 11: 45: 24	<i>White side</i>Flashes on single-storey Quarters roof (at flag pole end)	<i>Alleged Davidian Gunfire towards CEV- 1</i> PSSRs from debris on roof (0.13, 0.27, 0.30)	10
30	11: 46: 32 to 11: 46: 33	<i>Black side</i>Flash on ground at base of Residential Tower. Also on Cafeteria roof twice	PSSRs from debris at base of Tower and on roof of Cafeteria (0.13, 0.10)	27, 29
31	11: 46: 34	<i>Green side</i>Flash in Courtyard	<i>Alleged Government Gunfire</i> PSSRs from fallen Gym debris (0.23)	33
32	11: 46: 36	<i>Black side</i>Flash from window B4 overlooking Cafeteria roof	PSSRs from debris on roof (0.03)	26
33	11: 46: 43	<i>Black side</i>Flash from Residential Tower window C1	<i>Alleged Davidian Gunfire towards CEV-2</i> PSSRs from debris at base of Tower (0.13)	29
34	11: 47: 05	<i>White side</i>Flash from window B5 overlooking single-storey Quarters roof	<i>Alleged Davidian Gunfire towards CEV-1</i> PSSRs from debris on roof (0.23)	11
35	11: 48: 14	<i>Black side</i>Flash from window B4 or from Cafeteria roof	PSSRs from debris on roof (0.23)	28
36	11: 49: 01 to 11:49: 07	<i>White side</i>Flashes from window B5/B6 overlooking single-storey Quarters roof	<i>Alleged Davidian Gunfire towards CEV-1</i> PSSRs from debris on roof (0.43, 0.17, 0.33, 0.20, 0.33)	11, 12
37	11: 50: 17	<i>Black side</i>Flash in Courtyard - near base of Residential Tower	PSSRs from debris on ground (0.23)	29

VDS (UK) Serial	Time	Event	Alleged Gunfire VDS (UK) Analysis and Flash Durations (seconds)	Report Figure Number
38	11: 50: 27	Black sideFlash from Residential Tower window C1	<i>Alleged Davidian Gunfire</i> PSSRs from debris on roof (0.37)	30
39	11: 50: 59 to 11: 51: 04	White sideFlashes from window B5 overlooking single-storey Quarters roof. Also on roof near flag pole	<i>Alleged Davidian Gunfire towards CEV-1</i> PSSRs from debris on roof (0.40, 0.27, 0.27)	12, 13
40	11: 55: 46 to 11:55:47	White sideFlashes from windows B5 and also B6 overlooking single-storey Quarters roof	<i>Alleged Davidian Gunfire</i> PSSRs from debris on roof (0.33, 0.37, 0.33, 0.50)	13
41	11: 57:26 to 11:57:28	White sideFlashes from window B5 overlooking single-storey Quarters roof. Also on roof	<i>Alleged Davidian Gunfire towards CEV-1</i> PSSRs from debris on roof (0.20, 0.33, 0.33)	14
42	11: 58: 04	White side"Flash" from damaged window B11 as CEV- 1 withdraws from main door	Movement of debris out of shadow (0.47)	16
43	11: 59: 03	White sideFlashes on single-storey Quarters roof. Also on roof near damaged area	<i>Alleged Government Flashbang Alternatively, alleged Davidian Gunfire</i> PSSRs from very low emmissivity material (0.40, 0.23)	14
44	12: 00: 40	Black sideFlash from several yards behind CEV-2	<i>Alleged Government Gunfire</i> PSSR from fallen Gym debris (0.47)	44
45	12: 01: 06	Red sideFlashes on ground in front of Chapel	PSSRs from debris on ground (0.20)	22
46	12: 05: 13 to 12: 05: 16	White sideFlashes from windows B5 and also B6 overlooking single-storey Quarters roof	<i>Alleged Davidian Gunfire towards an M2 Bradley MICV</i> PSSRs from debris on roof (8, 0.33, 0.13, 0.33, 0.57)	15
47	12:07:43	White Side ... second floor window at tower end.	Active Thermal Signature emanating from inside building.	51
48	12: 07: 51 to 12: 07: 56	Red sideAlleged heat source at second floor window B1 at White corner	Active Thermal Signature emanating from inside building - seen through damaged window.	52
49	12: 08: 26	Black sideFirst 'hot' return from cafeteria/kitchen entrance	Probable seat of a fire - separate from that at Red/White corner (Serial 48)	53
50	12: 08: 31	Black sideLong duration flashes from within Gym	<i>Alleged Government Weapon Discharge</i> PSSRs from Walkway window which has dropped onto Gym debris (0.80)	45

VDS (UK) Serial	Time	Event	Alleged Gunfire VDS (UK) Analysis and Flash Durations (seconds)	Report Figure Number
51	12: 08: 50	Green side ...Flash near corner of damaged Gym (closest to Tower)	Alleged Government Gunfire PSSRs from fallen Gym debris (0.80)	34
52	12: 08: 51	Black sideFlashes next to CEV-2 at Gym	Alleged Government Gunfire PSSR from debris on ground (0.17, 0.10)	46
53	12: 09: 00	Green sideFlash on Lean-to roof at side of Chapel	Alleged Government Gunfire PSSRs from fallen window glass (the window under the Satellite Dish) Possibly blown out as a result of the fire (0.23)	47
54	12: 09: 23	Green sideFlash from Inner-Courtyard to right of Residential Tower	Alleged Government Gunfire ATR (as a result of the fire)from debris on ground (0.13)	36
55	12: 10: 21	Black side'Hot' return from rear of collapsed Walkway at Gym	Probably resulting from the spread of fire on Red side	54
56	12: 10: 50	White sidePerson lying on single-storey Quarters roof (near flag pole)	Can be discriminated due to strong object/background tonal variances	55
57	12:11: 00 to 12:11:23	Green sideMultiple flashes in debris in Courtyard	Alleged Government Gunfire ATR (as a result of the fire) from debris on ground	35

9 ALLEGED BRANCH DAVIDIAN GUNFIRE

VDS (UK) was **not tasked** to identify possible Davidian gunfire, but we have included the following analysis for completeness and comparative purposes and to **establish the efficacy of the reflective infrared phenomena on 19 April 1993.**

Alleged Davidian gunfire was reported as emanating from three main areas - at or near rooftops at the White, Red, and Black sides.

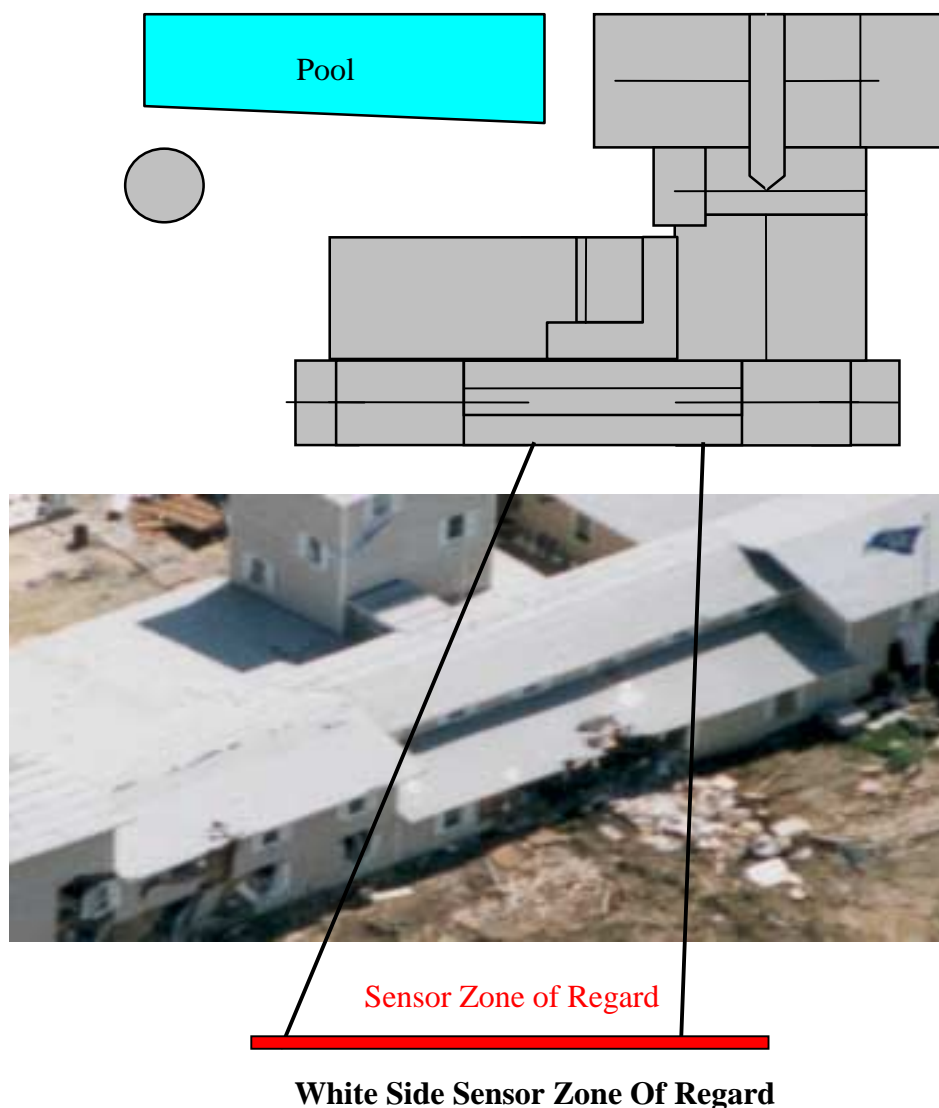

9.1 White Side

Master Event Serials 25,26,29,34,36,39,40,41,42,43 & 46

These thermal events are only apparent when the aircraft is imaging within the nominated Sensor Zone of Regard, when line-of-sight reflectivity is fleetingly met.

Thus, on Tape 3, no alleged Davidian gunfire is observed from (or near) this roof at any other time, even though the roof has been imaged from different angles.

At least one flash occurs on 23 differently timed occasions. These 23 flashes span some 26 minutes in time and occur only when the sensor is in the same position with regard to the sun and to the roof in question.

It is also noteworthy that this roof provides a consistent tonal background on which to observe a thermal return. Moreover, there is a clear correlation between debris on the roof and the thermal flashes, illustrated in the following series of FLIR images, Figures 10-15, compared with the optical colour images.

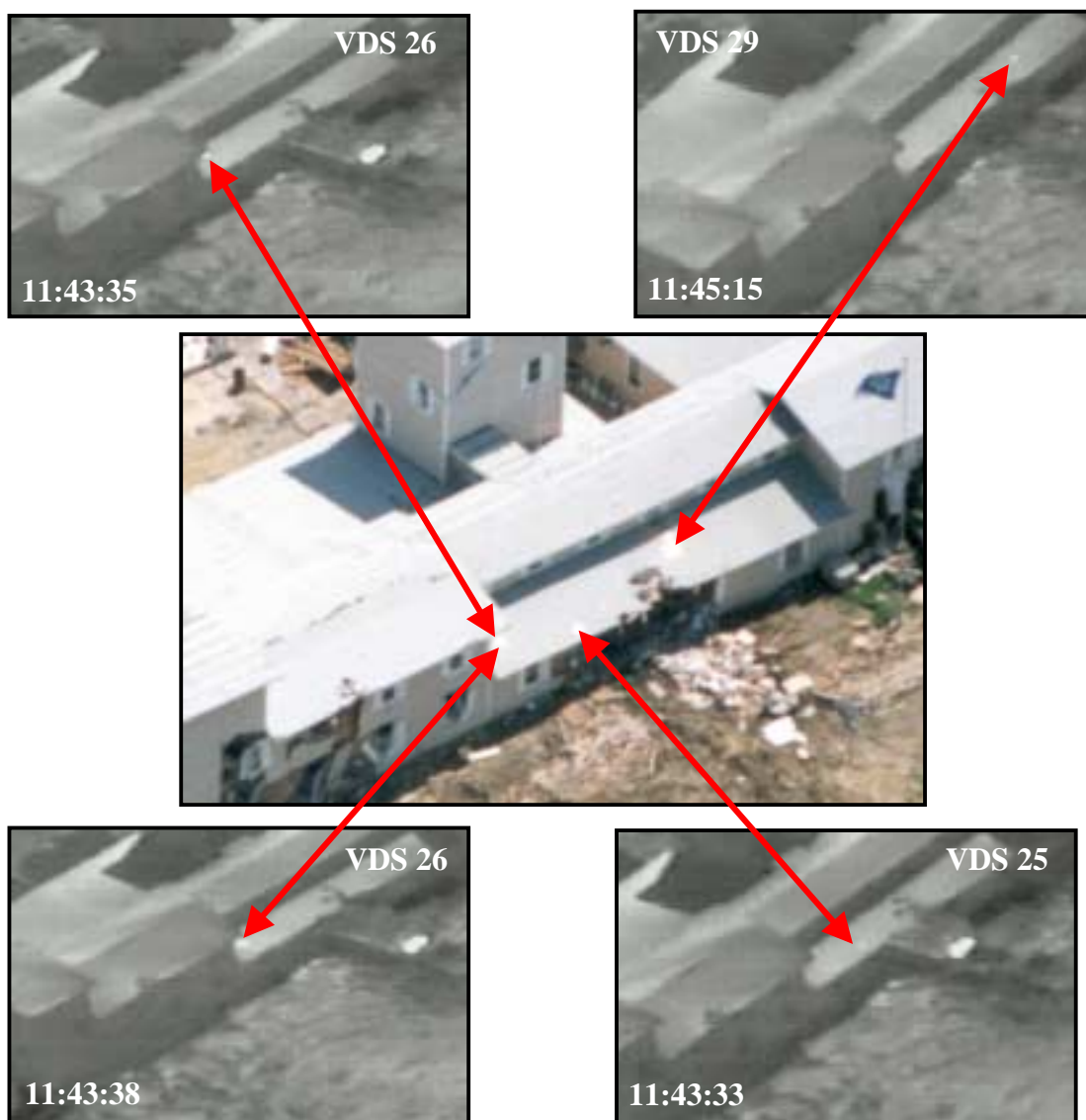

Figure 10- See CD ROM Video Clip # 5 and Attached File

As in Figure 10, there is a clear correlation between glint from the optical image and from the PSSRs on the FLIR imagery at the diverse times illustrated. Yet again, debris on the ground also falls into the Sensor Zone of Regard and therefore the PSSRs are recorded.



Figure 11

Figure 12 illustrates that the point of origin of the flashes is on the roof in all cases, and not from a nearby window, as alleged.

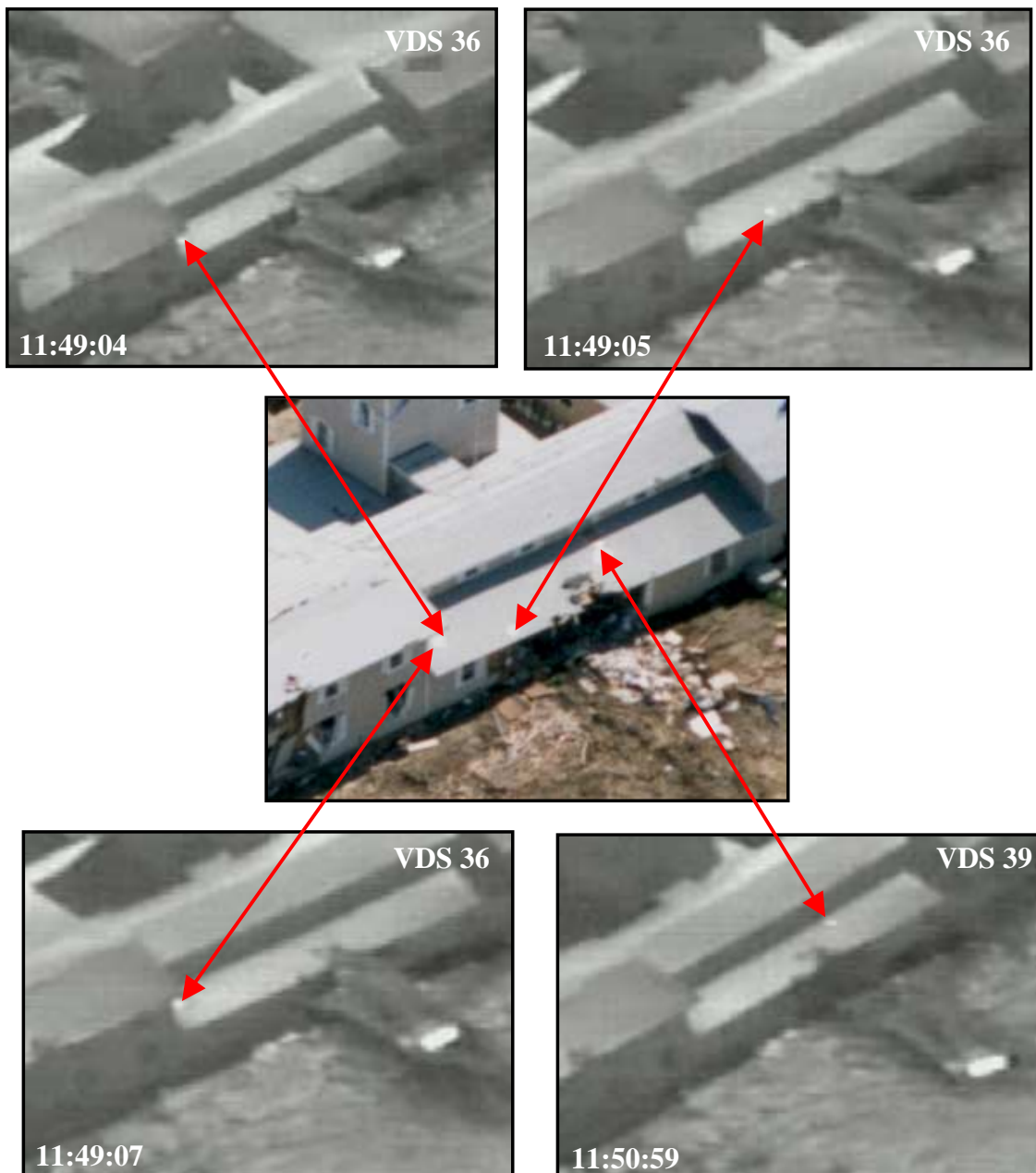

Figure 12

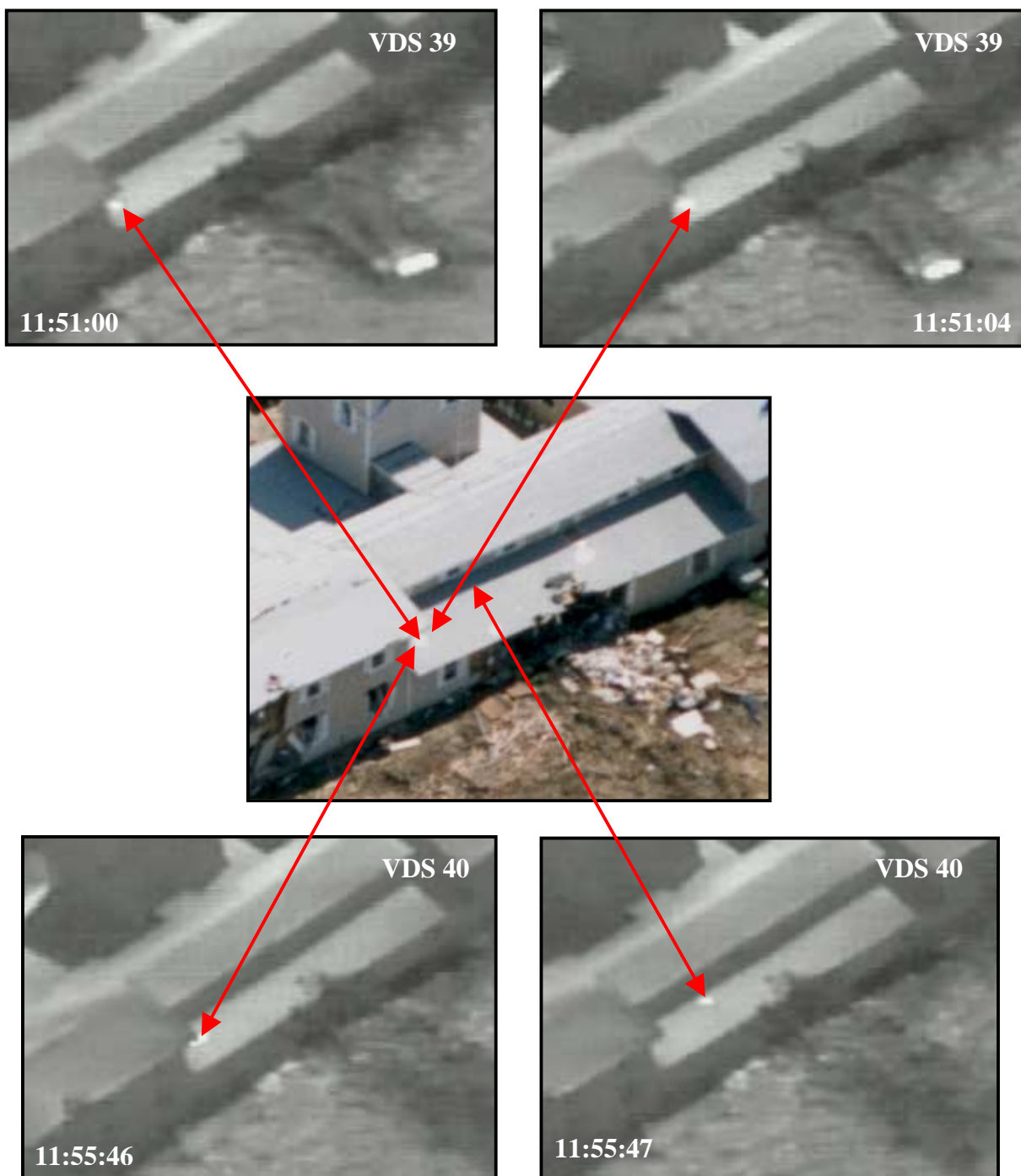

Figure 13

The developing shape of each flash is consistent with a PSSR and is without the directional properties associated with gunfire. Moreover, the duration of the flashes is excessive for gunfire.

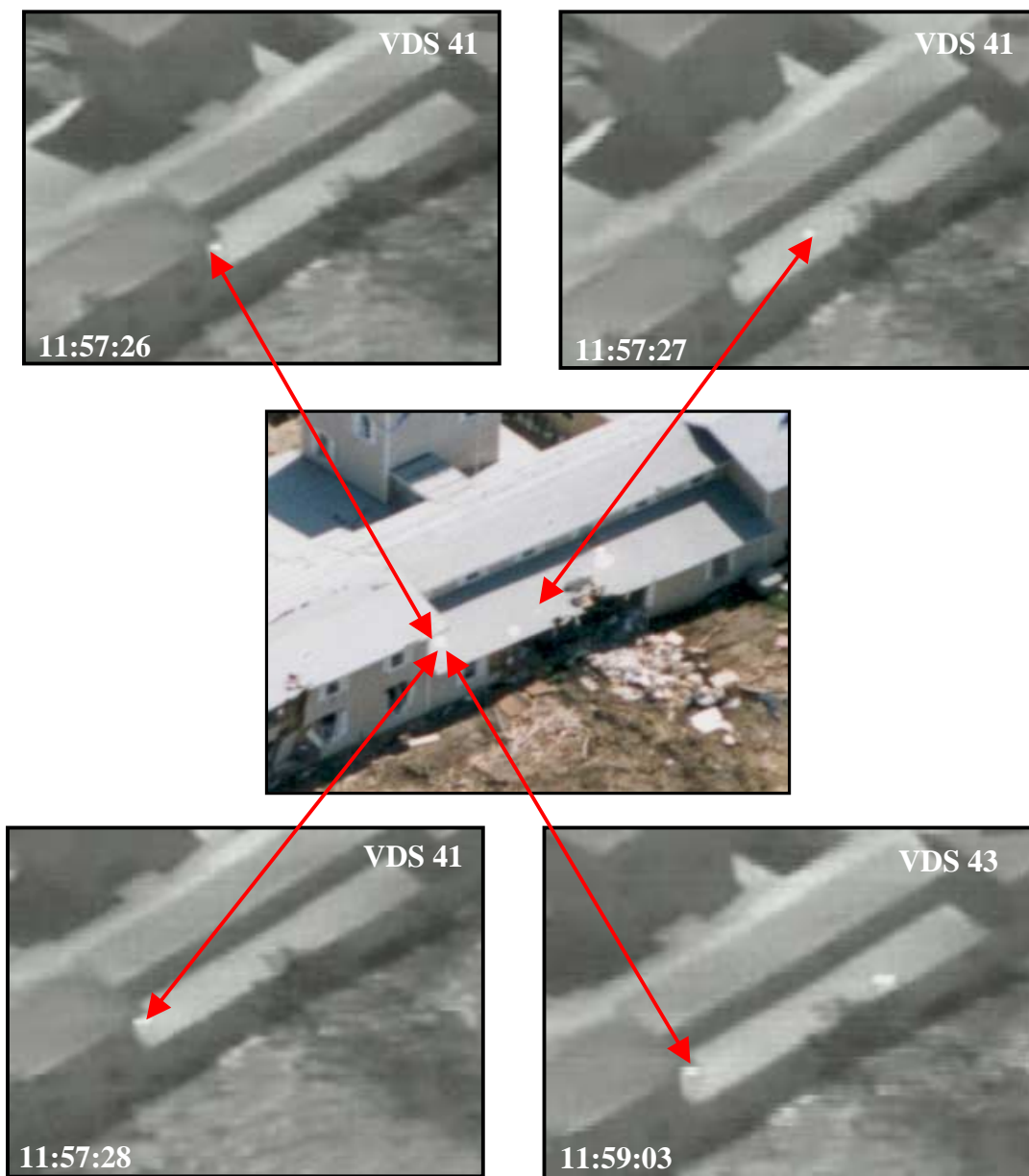

Figure 14

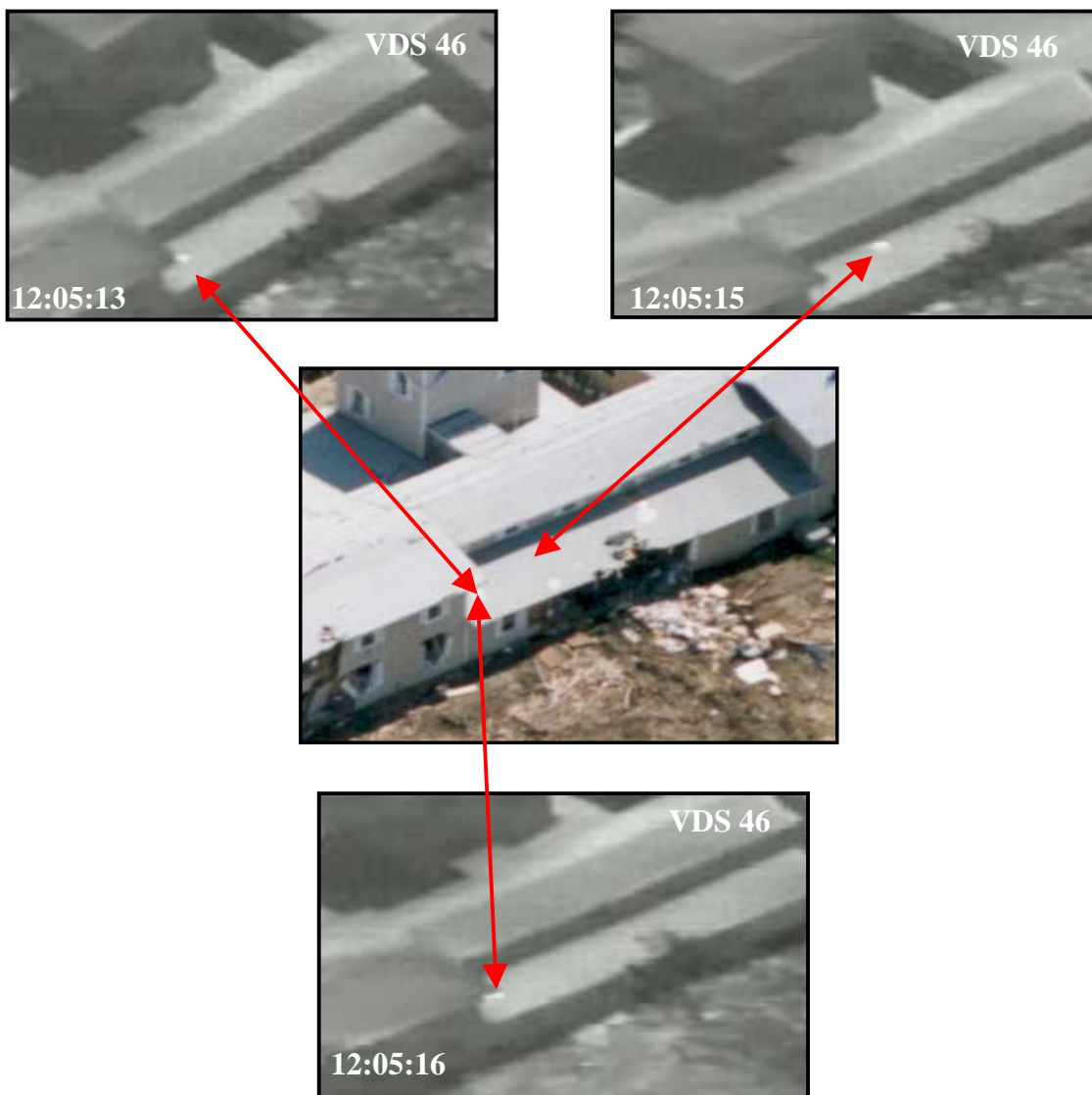

Figure 15

Figure 16 illustrates the remaining event on White side (VDS 42), which is the “flash” that occurs when the CEV penetrates the Main Door. As the CEV withdraws, it pulls out some debris that produces a PSSR.



Figure 16 - See CD ROM Video Clip # 6

9.2 Red Side

This group of events is described under two sub headings. The first concerns damage to a window and its surrounding wall, and the second part the alleged gunfire from the Chapel roof.

9.2.1 Damaged Corner (B2 Window)

Master Event Serials 2, 4 & 24

Three observable flashes occur from within the damaged area on different occasions. These flashes span some 48 minutes in time overall. The colour illustration at Figure 37 depicts reflecting material within the debris.

As with the White side events, these flashes are only apparent when the sensor is at the same approximate position to the Sun. However, in this case, the Sun is behind the sensor each time. The FLIR images at Figures 17 and 18 illustrate a PSSR from the same material at the same point (red arrow).

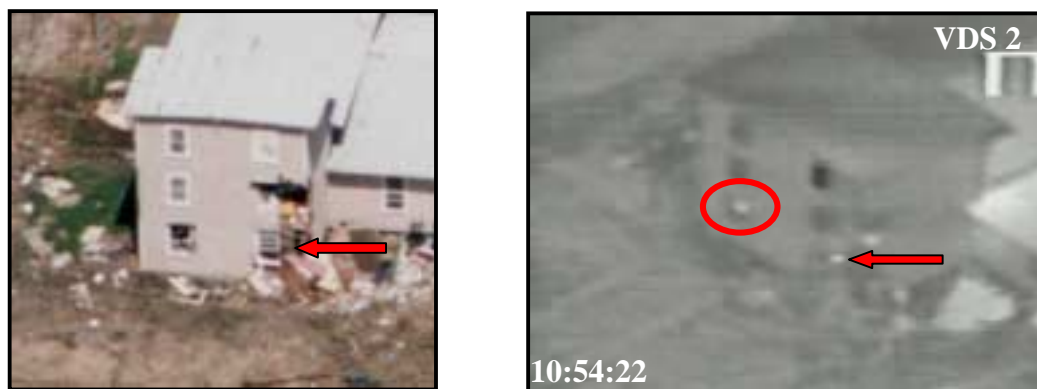

Figure 17

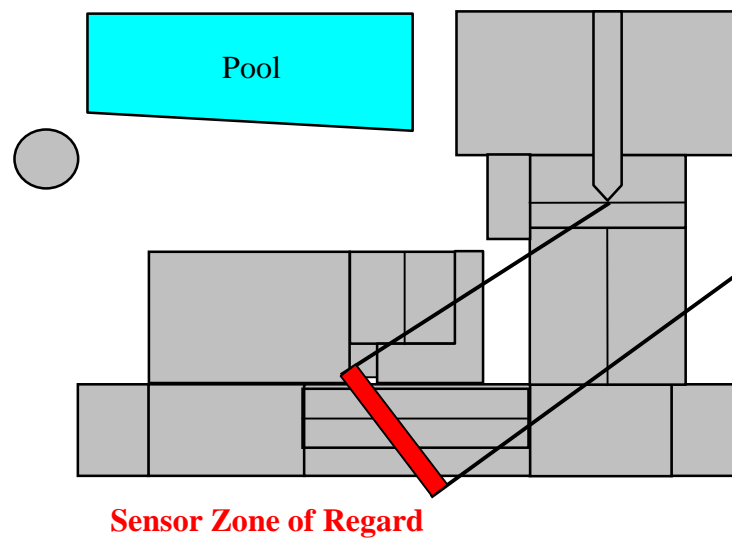

Figure 18

Note also the consistently cold return from one of the upper windows, which is believed to feature a metal blind. More importantly, there is also an ATR from within the room at the lower left (red oval). **This room is in the vicinity of the subsequent fire**, which is discussed in Section 11.

9.3 Events At Red Side On Chapel Roof

Master Event Serials 10, 11, 21 & 45



Red Side Chapel Roof Sensor Zone Of Regard

At least three thermal flashes occur from this location, each time when the sensor is in the appropriate Zone of Regard. As with the White side roof, there is correlation with glass debris on the roof (Figure 19).

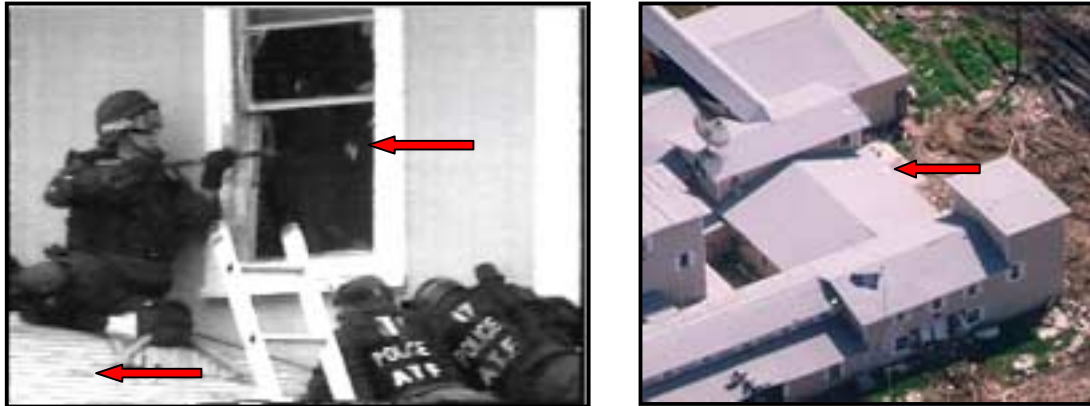

Figure 19

Analysis of all available imagery illustrates a correlation between shards of window glass deposited on the Chapel roof during the original ATF raid and the PSSRs on the FLIR. Moreover, the following sequence of four FLIR images at Figure 20 (VDS 10) illustrates the PSSR expanding and contracting between consecutive video frames.

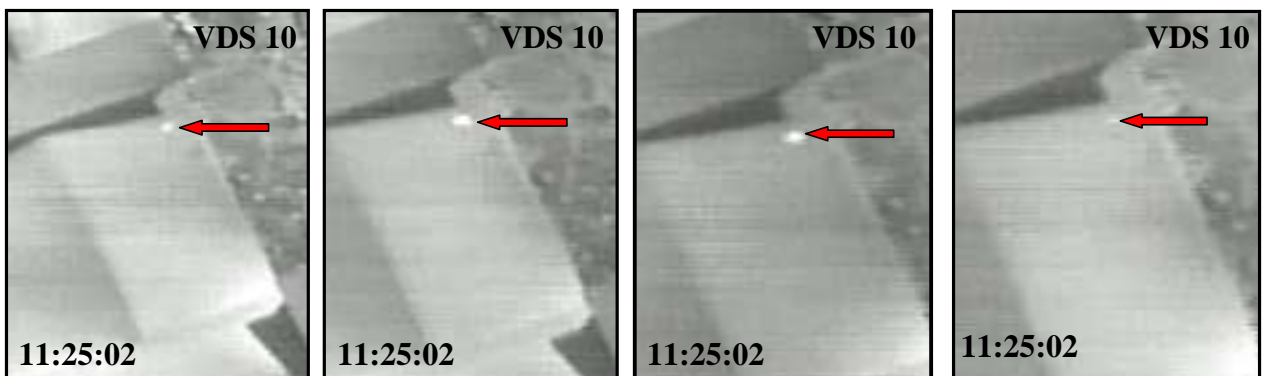

Figure 20 - See CD ROM Video Clip #7

Figure 21 illustrates a similar correlation elsewhere on the roof, two seconds after VDS 10 at 11:25:04 (VDS 11) and also at 11:34:45 (VDS 21).

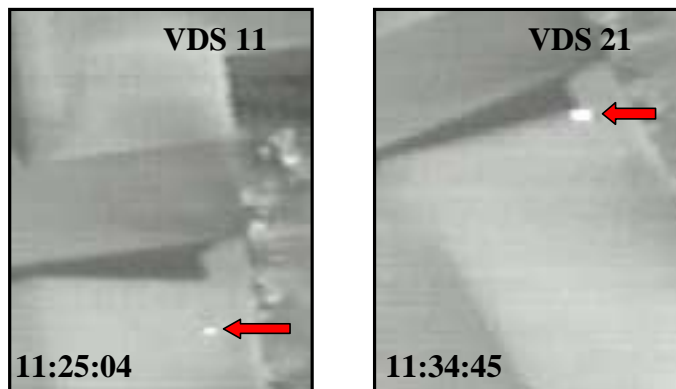

Figure 21

Figure 22 illustrates the return from amongst debris on the ground at 12:01:06 (VDS 45).

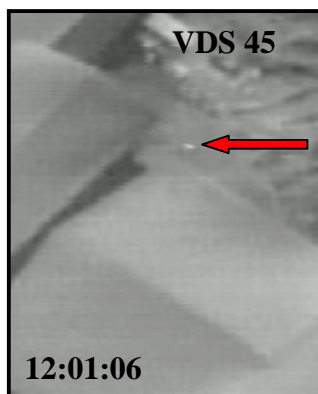
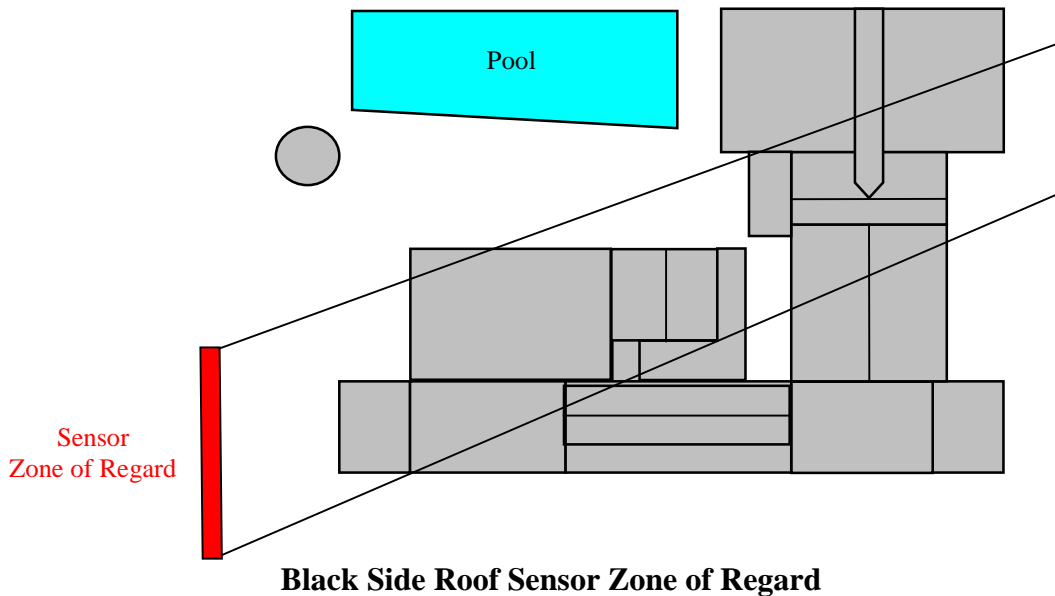

Figure 22

9.4 Black Side

9.4.1 Cafeteria Roof

Master Event Serials 9,14,15,17,20,27,28,30,32,33, 35, 37 & 38.



Returns from this debris-strewn roof show the greatest number of flashes on FLIR Tape 3 at any particular location, and cover a 26-minute period in time. Again, there is discernible correlation between debris and PSSR flashes. Of significance, our analysis indicates that the flashes are *not emanating from the windows* as alleged in some instances, rather from debris strewn on the roof – see Figures 23 and 24.

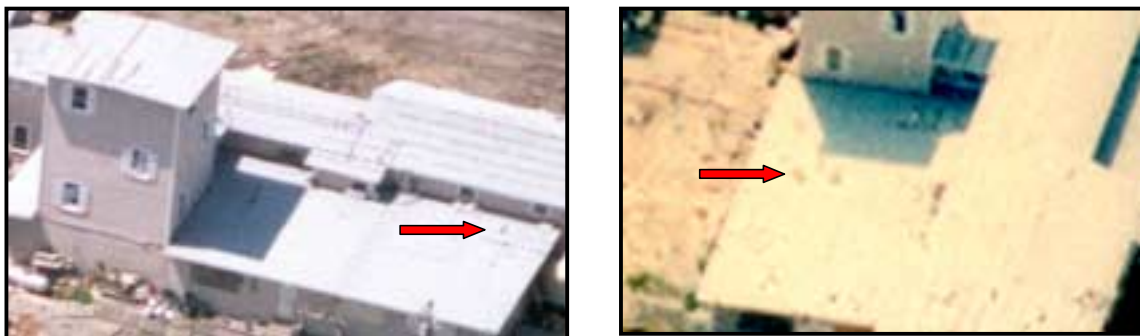

Figure 23 See Attached Files On CD-ROM - Clip 8



Figure 24

The following sequence also serves to refute the Davidian “*gun wad*” claim, since it can be seen from the following three sequential images that the supposed “*gun wad*” (Figure 25, red arrow) precedes the alleged *gun flash* (Figure 25, yellow arrow). It is also apparent, through the use of stereoscopic techniques, that the alleged *gun flash*, emanated from PSSR from the roof and not from the window.



Figure 25 - See CD ROM Video Clip # 8

As with all of the sightings on the Cafeteria roof, Figures 26 and 27 reinforce random flash dispersal from PSSRs that match with debris distribution. Once again, the shape, size, distribution, and the flash duration are commensurate with PSSRs from random debris.

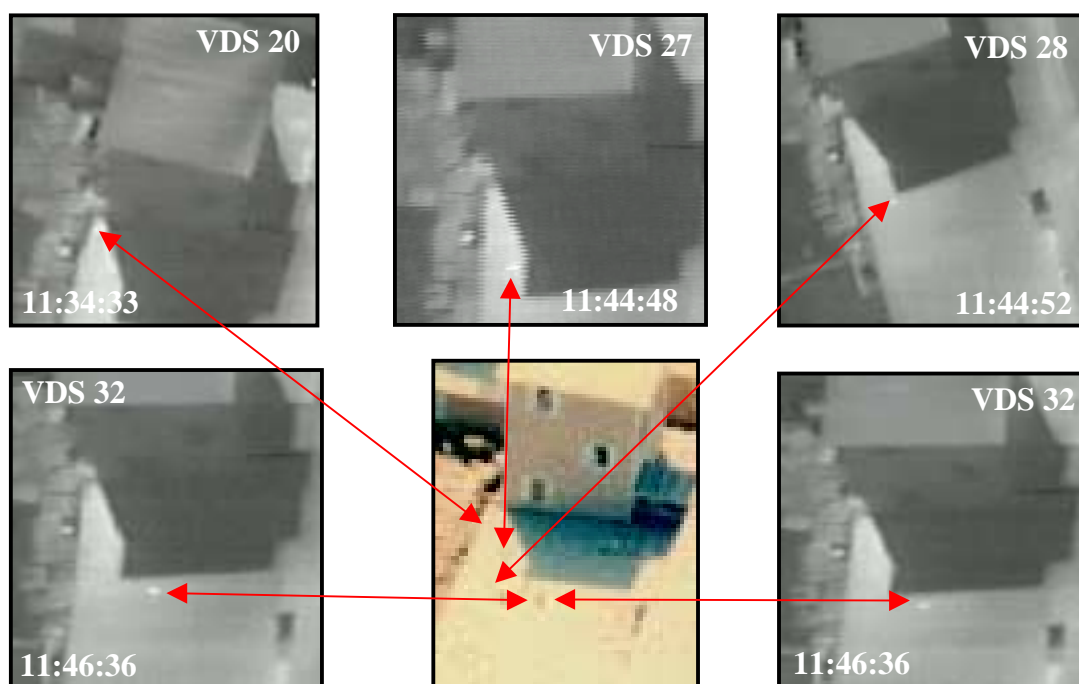

Figure 26

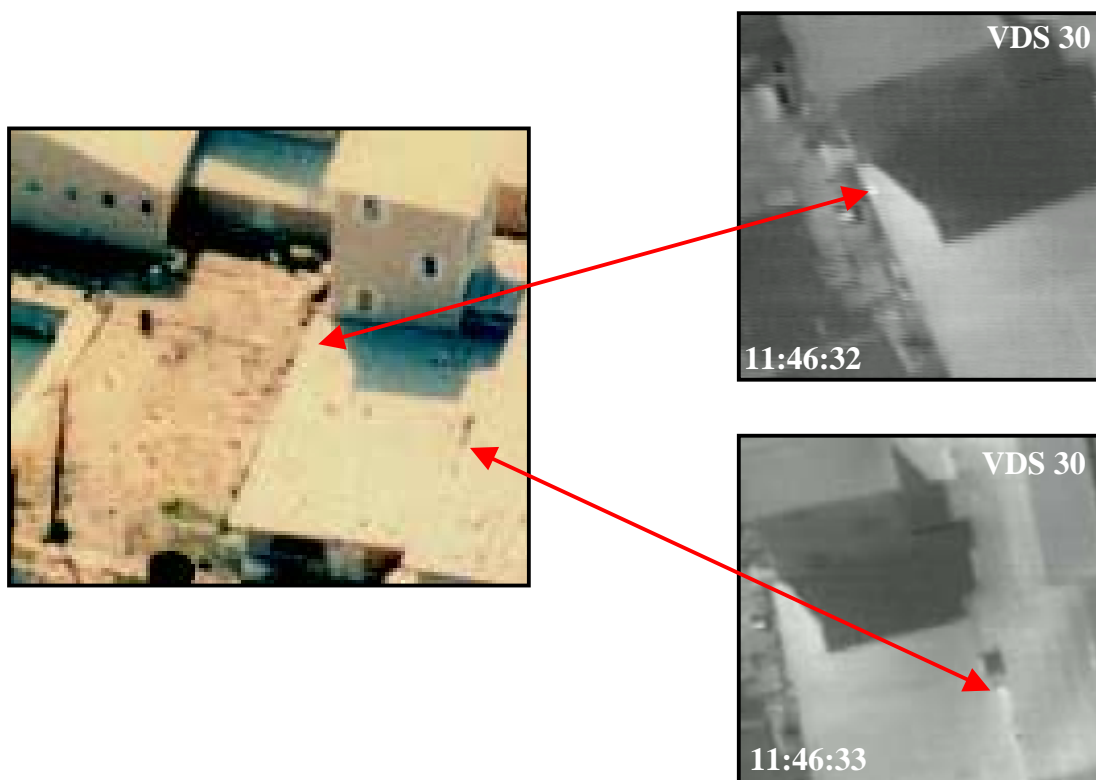

Figure 27

The three FLIR images at Figure 28 demonstrate the pulsating, non-directional nature of the flashes.

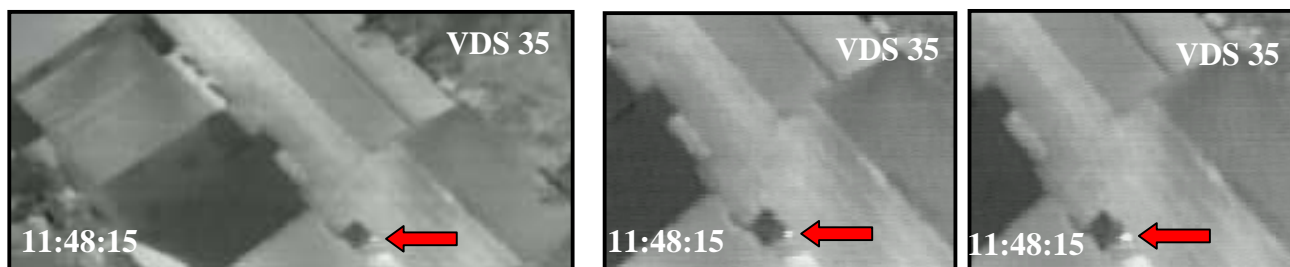

Figure 28

9.4.2 Residential Tower

Master Event Serials 28,30,33,37 & 38

On at least five occasions there is evidence of a flash from the vicinity of the Residential Tower. These flashes were alleged to be gunfire from within the Tower, directed out through the windows. However, Figures 29 and 30 clearly show that the flashes emanate from debris on the ground at the base of the Tower.

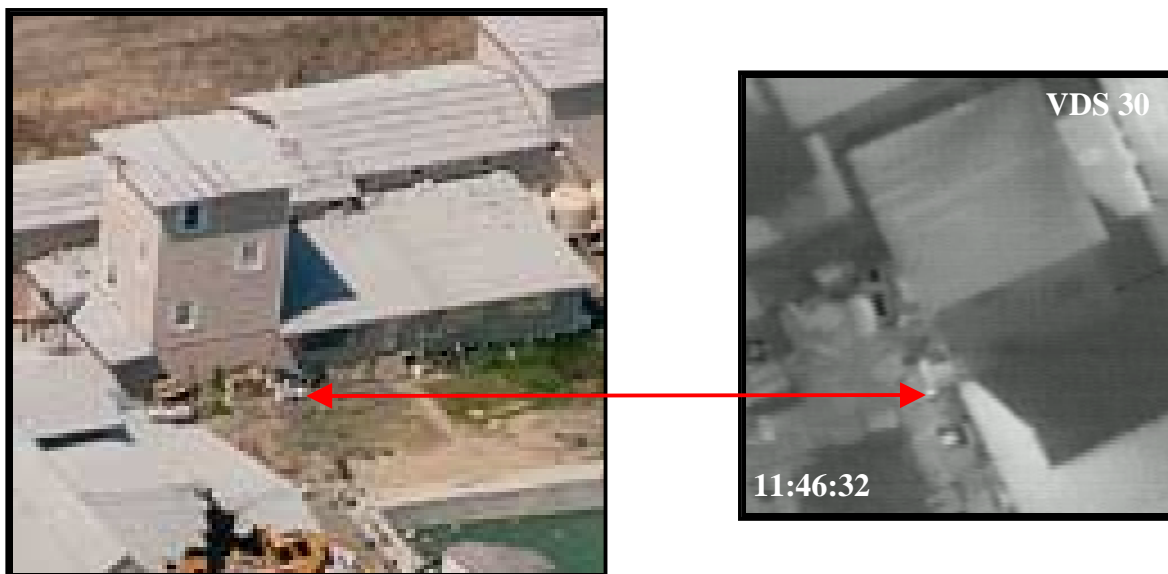

Figure 29

Figure 30 (VDS 38) also illustrates how the PSSR duration is too excessive to be gunfire.

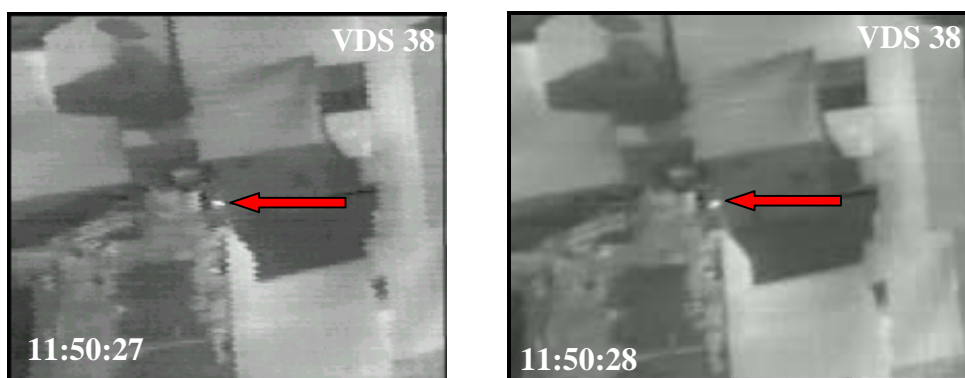

Figure 30

10 ALLEGED GOVERNMENT GUNFIRE































10.1 Criteria For Gunfire

10.1.1 Muzzle Flash FLIR Signatures Derived From FLIR Trial

Shape	Linear, aligned with muzzle elevation and azimuth
Size	Small, extending some 2-3 feet from muzzle area
Shadow / Stereo	Flash may be seen above ground level, with a shooter's thermal return
Tone	Bright light-toned flash
Associated Features	Always associated with shooter firing position
Duration	Very short duration flash, visible on FLIR for as little as 0.02 second

10.1.2 Comparison Of Identified Events With Criteria For Muzzle Flash FLIR Signature

Red  = Does not meet criteria **Green**  = Does meet criteria

Event (VDS(UK) Serial No)	Essential Criteria For A Muzzle Flash FLIR Signature					
	Shape	Size	Shadow / Stereo	Tone	Associated Features	Duration
5						
7						
8						
10						
12						
13						
18						
22						
23						
31						
43						
44						
50						
51						
52						
53						
54						
57						

10.2 Green Side

Master Event Serials 13,16,18,19, 31,51,54 & 57.

Some of these events were alleged to be Government gunfire in the Courtyard at the Green side. However, the flashes evident in this Courtyard are the result of PSSRs from debris that has fallen into the yard as the Gymnasium is damaged by CEV-2. Significantly, **no flashes are seen on any FLIR tapes of this Courtyard prior to the demolition.** Moreover, the object/background thermal discrimination is such that the Government Agents alleged to be firing weapons from these particularly exposed positions would be identifiable on the FLIR tape as the flashes occur. **No personnel are seen in this Courtyard, either on the FLIR tapes or the Colour photographs (Figure 31).**

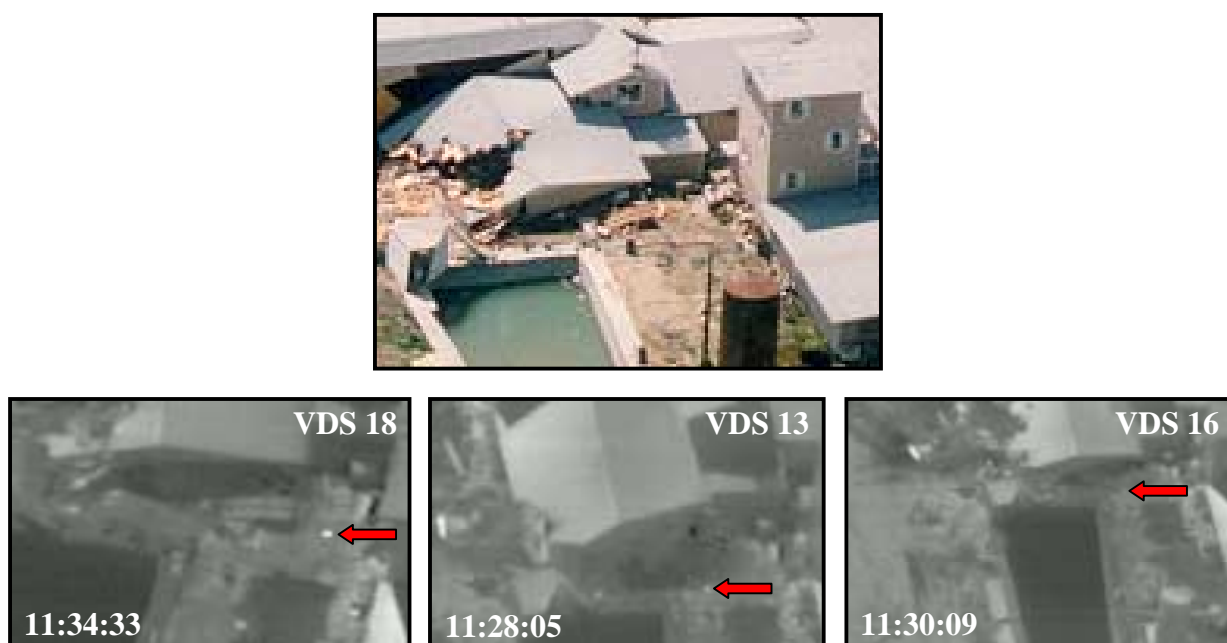

Figure 31

In some instances, the images were subjected to stereoscopic and flicker viewing techniques to enhance perception of where a shooter might be; the 11:34:33 image is a good example of PSSR.



Figure 32 - See CD ROM Video Clip # 9

The sequence illustrated at Figure 32 was alleged to show a “man” running from the destroyed NE corner of the Gym to the Swimming Pool diving platform. Image enhancement reveals that the event is caused by wind blown debris.

In order to illustrate the pulsating nature of PSSR flashes seen at VDS 31, Figure 33 is as sequential as possible and shows the flash commencing as a point source, then expanding and contracting.

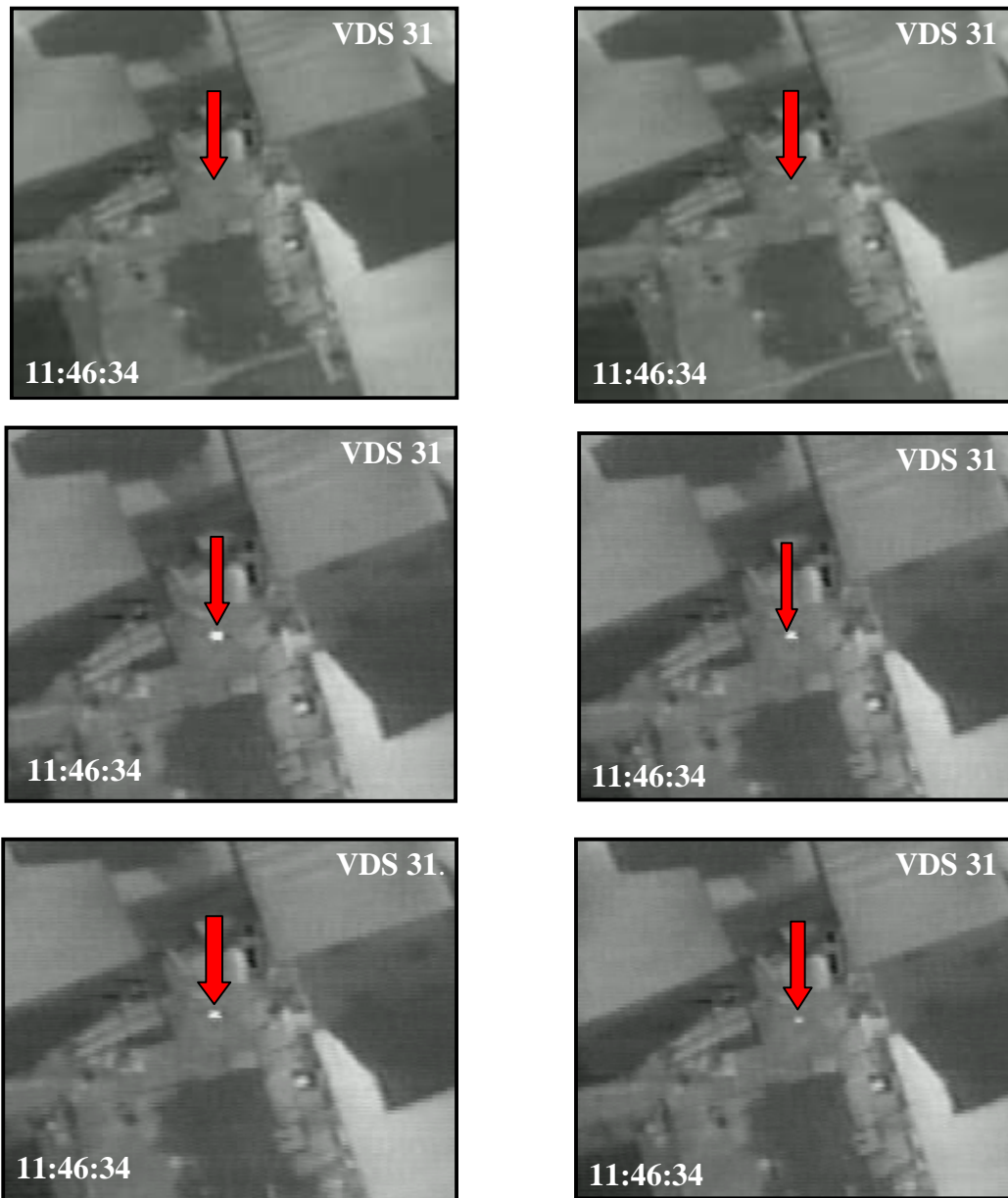

Figure 33 - See CD ROM Video Clip # 10

Figure 34 illustrates VDS 51, caused by PSSR from other debris at a later sun angle.



Figure 34

Once the fire is established, the FLIR shows a number of ATRs from burning materials (arrowed), together with thermal reflections from low-emissivity materials. A number of these ATRs are illustrated below at Figure 35.



Figure 35 - See CD ROM Video Clip # 11

The series of flashes in the Outer Courtyard have been correlated with previous PSSR events. However, this time (VDS 54) in the Inner Courtyard, the debris is producing an ATR from the Cafeteria – Figure 36.

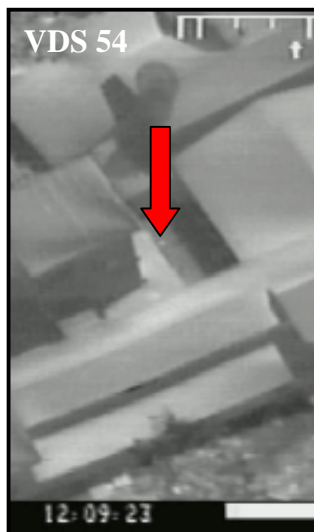
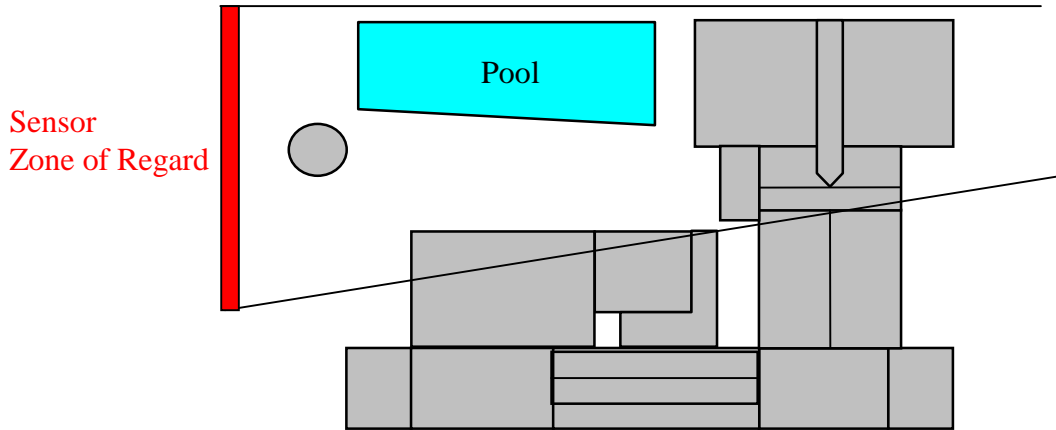

Figure 36

10.3 Black Side

Master Event Serials 5,6,7,8,12,22,23,44, 50, 52, & 53



Black Side Gymnasium, Courtyard & Lean-to Roof Sensor Zone of Regard



Figure 37 - See CD ROM Video Clip # 12

One of the more difficult events to resolve is VDS Serial 5. A flash is emitted from the left-rear of CEV-1 as it passes the right-hand end of the Gymnasium (Figure 37).

It is alleged that the flash was caused by one of two options; either a weapon such as an M79 grenade launcher or, alternatively, that an agent astride the rear of the CEV fired a shot.

On the first option, analysis reveals that the flash originates from just forward of a box left of the engine that houses the gearing mechanism. The box is a standard item on all CEVs of this type. There is no firing port of any description in this vicinity.

The turret was rotated to the trail position throughout the FLIR coverage, and the turret-mounted fixed smoke dischargers are thus facing rearward. It is not possible to fire either a gun or an M79 through fixed smoke dischargers.

As to the second option, that an agent was astride the rear of the CEV in order to fire into the Gymnasium, this theory is not practicable. Examination of a CEV during the FLIR trial and subsequent detailed imagery analysis refutes the theory that a person would lie or crouch in such proximity to the very hot CEV engine. Our analysis of the FLIR shows that there is no person on the exterior of the vehicle as it starts its journey to the Gymnasium; furthermore, no one climbs aboard during transit.

Stereoscopic viewing indicates that the flash is omni-directional, unlike that of linear muzzle flash.

On the imagery evidence, we conclude that the flash is the result of a PSSR from debris lodged near the box from a previous CEV intrusion into the buildings. The CEV is in the appropriate sensor Zone of Regard at the time of the flash.

Figure 38 (VDS 6) illustrates the effect of falling debris as the CEV penetrates the Gym.



Figure 38



Figure 39

Figure 39 is the first of a series that well illustrate the phenomena of an ATR, with the heat of the CEV engine reflected from debris material nearby when the CEV penetrates the Gymnasium. As with PSSRs, provided the essential angularity between object and sensor is present, then an ATR will be recorded.

This phenomenon is the cause of the events illustrated at Figure 40, where the very hot engine of the moving CEV is reflected in the debris and imaged by the sensor as it obtains the requisite angularity.

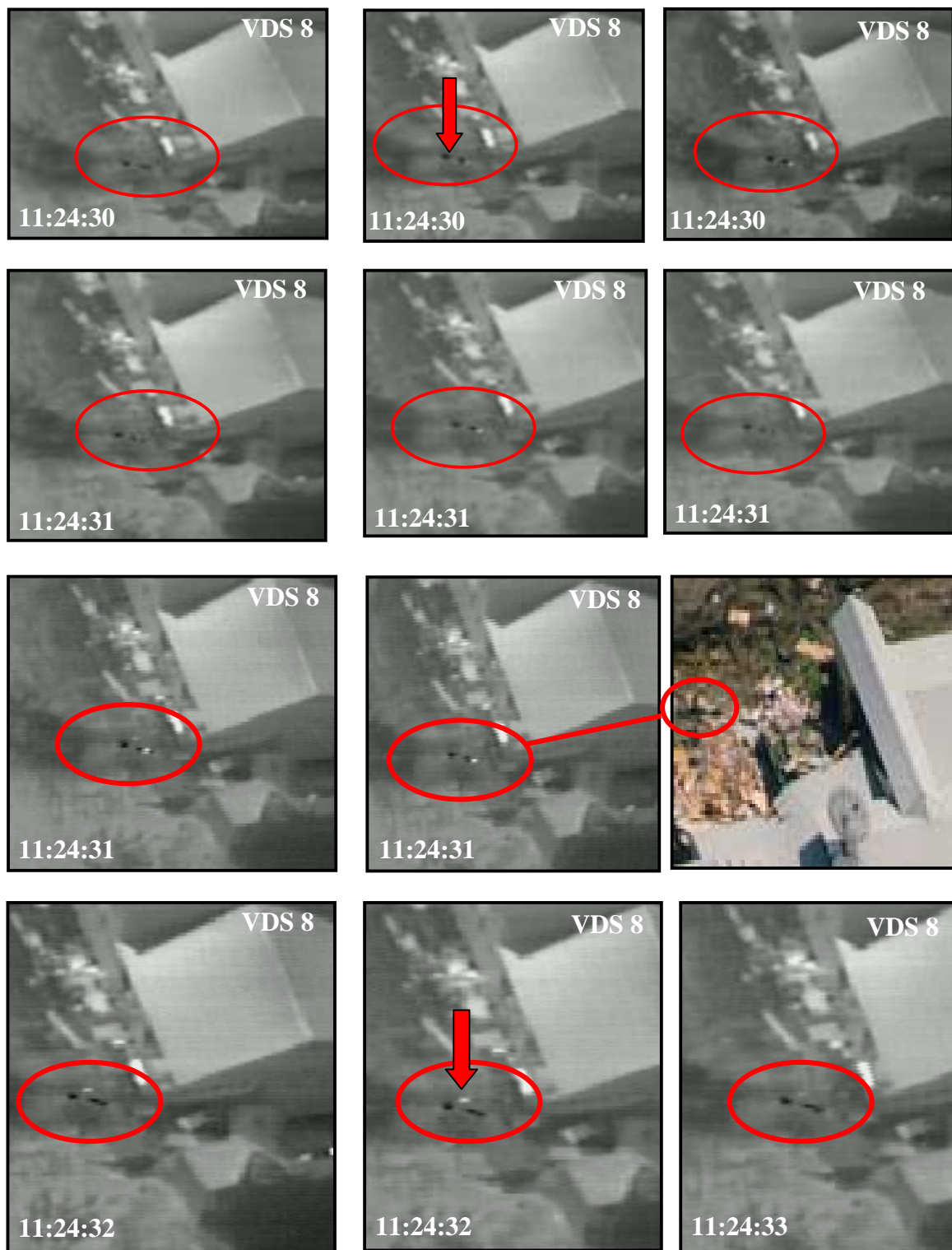

Figure 40

The ATR effect was well demonstrated at the FLIR trial, and is readily apparent here when the CEV is travelling to, and also from, the Gymnasium (Figure 41).

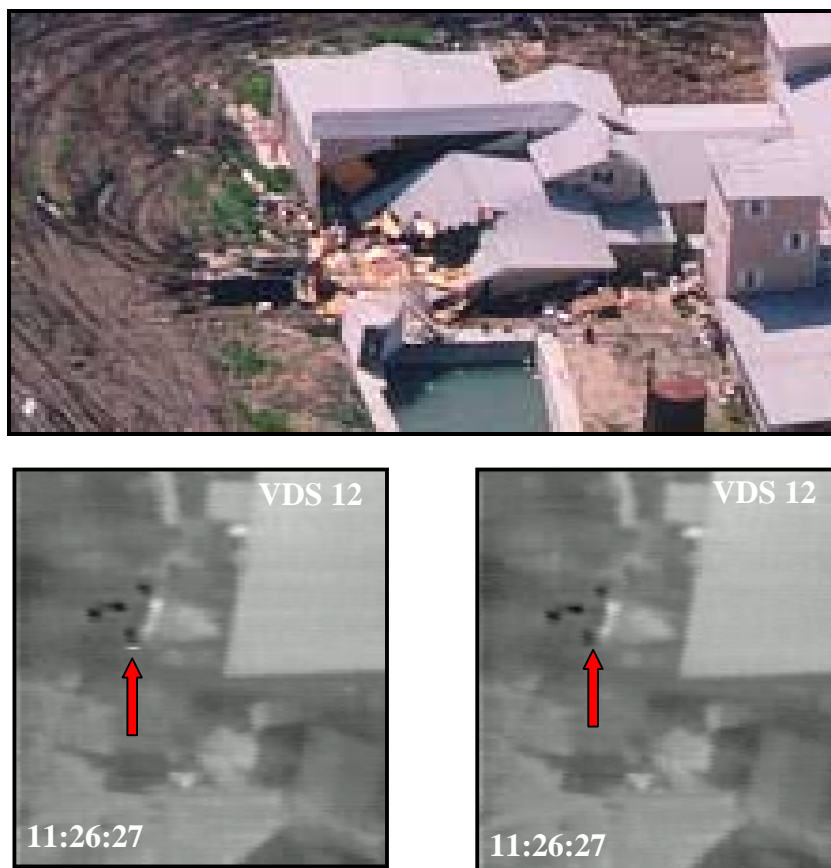

Figure 41

Figure 42 (VDS 23) is a good example of a PSSR that becomes more obvious when viewed stereoscopically when it can be seen that the dark toned material is debris.



Figure 42

The flash illustrated at Figure 43 (VDS 22) is a further PSSR return and takes place within the nominated Sensor Zone of Regard.



Figure 43

Figure 44 illustrates a further PSSR response from debris (VDS 44)

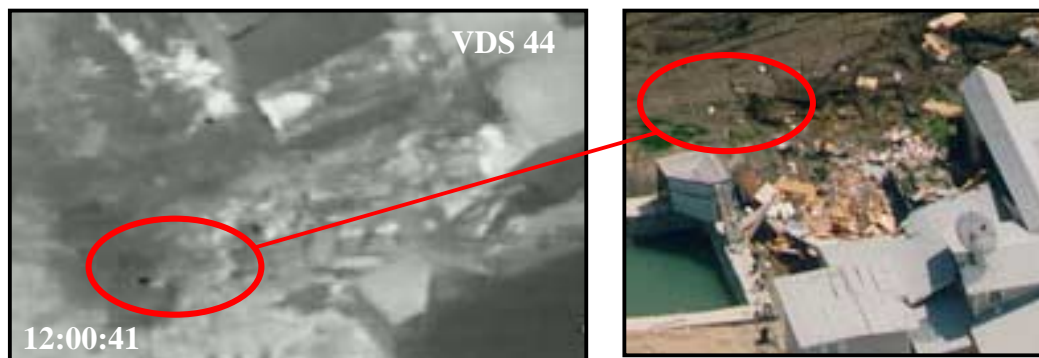

Figure 44

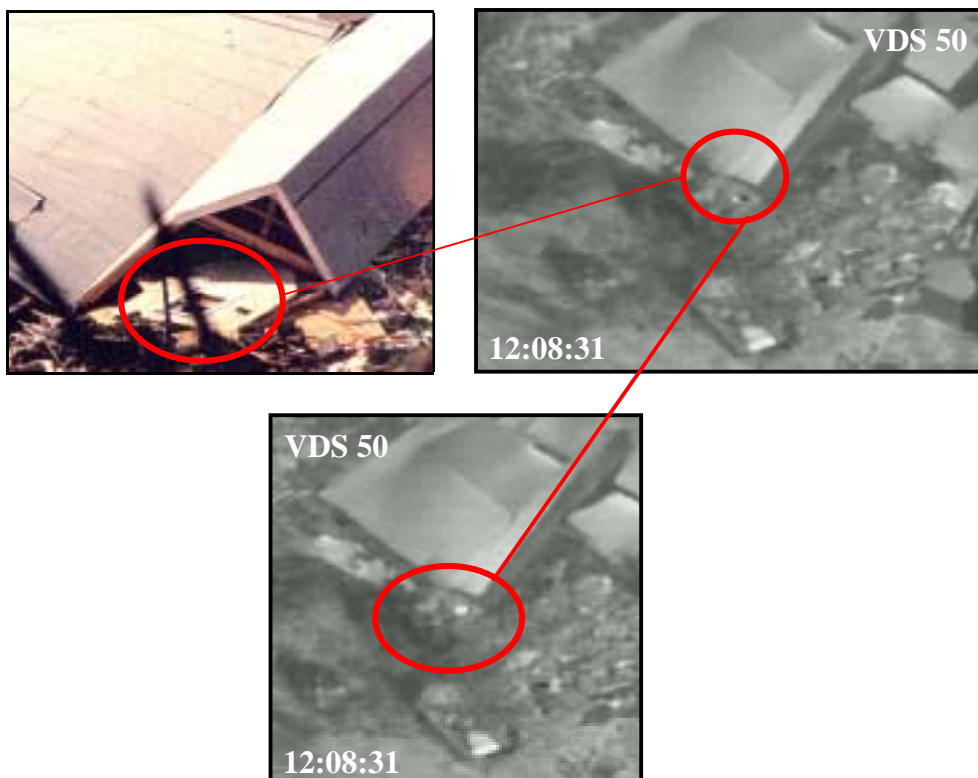

Figure 45 - See CD ROM Video Clip # 13

Event VDS 50 was alleged to be a Government weapon discharge of long duration. From examination of comparative imagery together with the FLIR trial results, it is apparent that the effect is a PSSR from the fallen window illustrated at Figure 45.

VDS (UK) Proprietary

The thermal event that takes place to the left of CEV-2 outside of the Gymnasium and illustrated at Figure 46 is a PSSR. In this instance the duration of the flash is also excessive for muzzle flash.

It has also been alleged that the forward hatch of the CEV was opened at 12:08:12 and that a person emerged to take position and fire from the ground at 12:08:51 (VDS 52); this event is illustrated in sequence below.

As the CEV reverses from the gymnasium, the forward deck is in fact covered in debris, and it is this debris blowing in the wind that gives the appearance of a hatch opening.

However, if the CEV is viewed on the FLIR until 12:10:36, it pauses next to the boat-trailer. The colour image clearly illustrates (large red arrow) the debris still in place over the forward deck of the CEV.

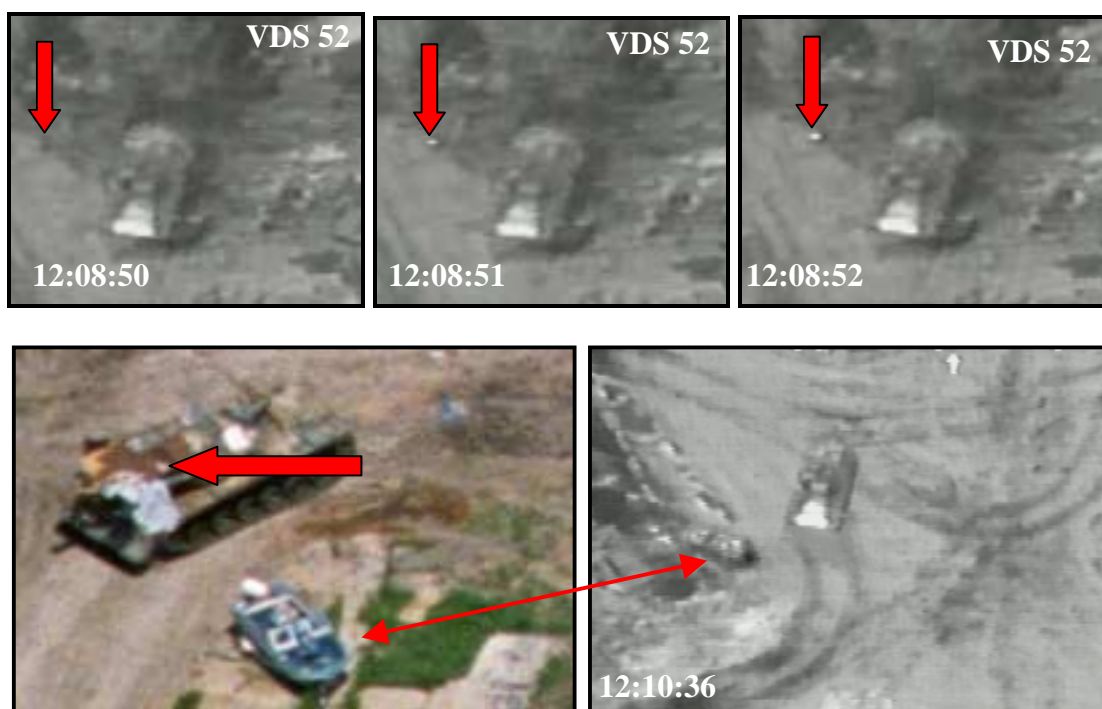

Figure 46 - See CD ROM Video Clips # 14,15

The PSSR flash (Figure 47) evident on the Lean-to Roof (VDS 53) is the result of glass having fallen from the nearby window. The glass may have been blown out as a result of the fire.



Figure 47

10.4 Alleged Gunfire From Government Helicopter

As an adjunct to our work in analysing the FLIR imagery, VDS (UK) was also tasked to comment upon flashes, alleged to be gunfire, seen on two video films of a Government UH-1 helicopter and taken from a ground-based video camera.

At Figure 48 we illustrate 2 un-timed optical video images, taken from a ground video camera, of a UH-1 helicopter in a near hover but beginning to lift and rotate to the left. A flash is seen emanating from the left cockpit side-screen area.

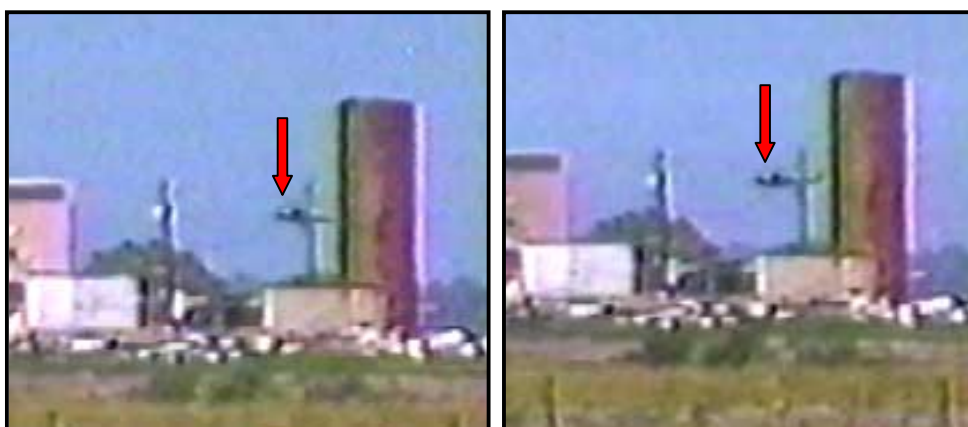

Figure 48- See CD ROM Video Clip # 16

Figure 49 illustrates a helicopter of similar type flying slowly from left to right, without time data available to VDS (UK). Again, on this poor quality image, a flash emanates from the right cockpit side-screen area. This image was taken during the damping down operations after the main fire.

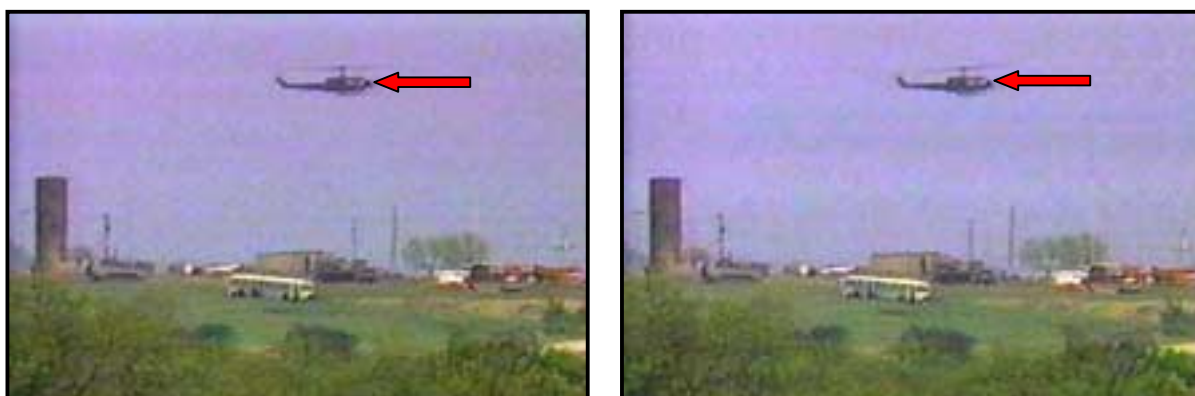

Figure 49 - See CD ROM video Clip 17



Figure 50

Figure 50 illustrates a similar helicopter with rear crew compartment doors open, with weapon(s) mounted in the rear crew compartment, as used by US military forces. The weapons are fired from the open door positions.

The helicopters at Figures 48 and 49 both have the rear crew compartment door closed and the flashes seen are emanating from the forward left quarter and forward right quarter of the cockpit canopy respectively, and not from the area of the rear crew compartment.

We therefore conclude that these flashes are further examples of solar reflection, this time in the visual waveband, and caused by sunlight instantaneously reflected at the video camera from the helicopter canopy side-screens.

11 ANALYSIS OF THE TIME OF THE START OF THE FIRE

Master Event Serials 47,48,49 & 55

VDS (UK) was tasked to report at what time the fire was first evident on FLIR Tape 3.

The outbreak of the fire on the FLIR is illustrated below. The FLIR was recorded by a circling aircraft, which did not provide continuous coverage of the whole compound all the time. Additionally, the FLIR would be unlikely to record smoke unless the smoke contained hot particulate.

On the FLIR imagery there appears to be two separate, yet closely timed, outbreaks of fire. One occurred at the Red/White corner, and the other at the Cafeteria, illustrated in the diagram below. Our analysis is overleaf

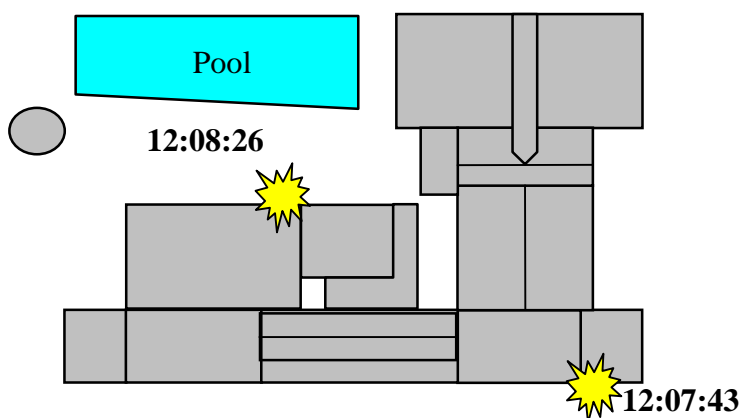

Locations Of The Outbreaks Of Fire Seen On FLIR

11.1 Red / White Corner

Figure 51 illustrates the first FLIR sighting assessed (VDS 47) as 12:07:43, when an ATR return is apparent through the White side window. By 12:09:23 the fire is well under way and obvious from the same window.

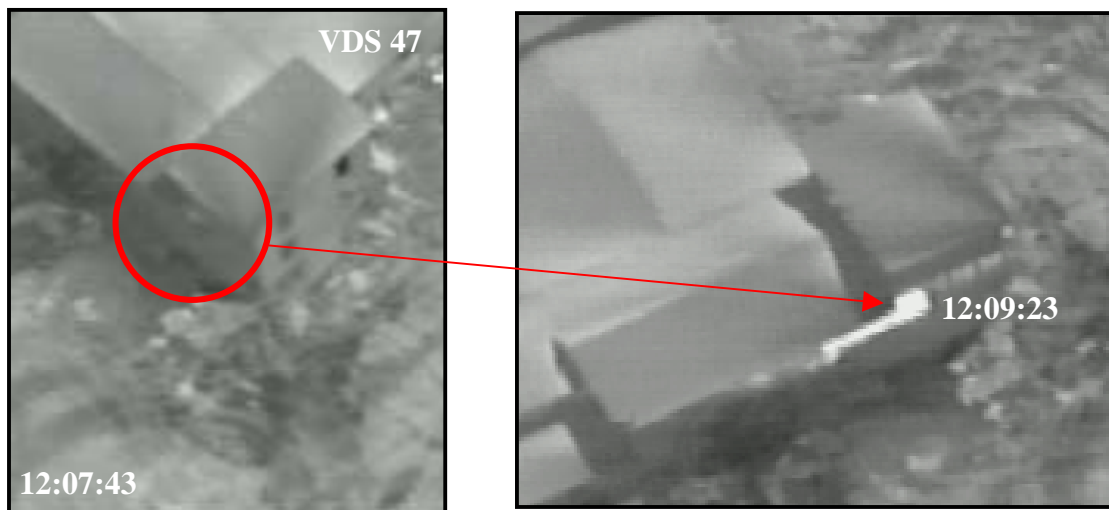

Figure 51 - See CD ROM Video Clip # 18

The thermal return (VDS 48) on Figure 52 is the first indication of the presence of an ATR source within that room on the second floor. The illustration used for VDS 2 (VDS 2 was caused by a PSSR from debris at corner of building) is also included below to provide evidence of a similar return from the room underneath as early as 10:54:22.



Figure 52

11.2 Cafeteria

Figure 53 illustrates a strong ATR at the Cafeteria (VDS 49) at 12:08:26. From the strength of the return, we consider it probable that this thermal signature would have been identified some time earlier, had the FLIR imaged that part of the building earlier.



Figure 53

11.3 Collapsed Walkway

The first thermal evidence of fire in the collapsed Walkway area (VDS 55) is illustrated at Figure 54, starting at 12:10:21 with a rapid build of thermal activity.



Figure 54 - See CD ROM Video Clip # 19

12 SIGHTING OF PERSONNEL

The first sighting of personnel on any FLIR tape (Figure 55) occurs at 12:10:50 (VDS 56) when a person is observed prone on the White side roof. However, on the colour photograph which was probably taken at a slightly different time, he appears crouched on the roof.



Figure 55 - See CD ROM Video Clip # 20



Figure 56

Figure 56 is produced in response to the charge that the Bradley MICV discharged gunfire towards the fire. Neither the direction of the flash (arrowed), nor its duration, supports this allegation. The flash is actually an ATR of the fire. Note how personnel (circled) are clearly visible in the contrasting object/background scenario.



Figure 57 - See CD ROM Video Clip 21

Figure 57 provides a further example of personnel, in this instance standing on the tornado shelter. At this time, the object to background discrimination of the shelter roof enabled one

person (red arrow) to be easily seen on the FLIR. The contrast is less obvious for other personnel (yellow arrow) standing at the edge of the shelter at that time.



Figure 58

The FLIR trial report (Figure 58) provides ample evidence of the ability of FLIR to discriminate people in a variety of combat clothing at lower ambient temperatures of 61°F – 67°F, and for cold thermal shadows to remain on the ground after those personnel had moved. However, the ambient temperature on 19 Apr 93 was by now around 80° F, and yet personnel are still readily apparent on the FLIR.

Their visibility on the FLIR imagery militates against any hypothesis that humans are less easy to see on FLIR in higher ambient temperatures, when body temperature and the ambient temperature are similar.

On the other hand, there may be occasions of radiometric crossover when humans, and other objects, have the same radiant flux as their background. As a consequence, the sensor system is unable to distinguish between the two and the object disappears. However, it is important to recognise that this is a brief phenomenon. Comparative analysis before, during and after the radiometric crossover event negates the effect of this phenomenon.

Therefore, had people been active on the ground earlier on 19 April 1993, when the ambient temperature was lower, they should have been apparent on the FLIR.

13 CONCLUSIONS

13.1 Background

On 9 September 1999, the Attorney General of the United States of America appointed Senator John C. Danforth to investigate certain events that occurred at the Mt. Carmel Compound in Waco, Texas on 19 April 1993. Immediately after his appointment, Senator Danforth established the Office of Special Counsel (OSC) to carry out this investigation. On 2 December 1999, VDS (UK) was engaged by the OSC and the US District Court for the Western District of Texas to review FLIR imagery taken by an FBI Night Stalker aircraft flying over the Mount Carmel compound on 19 April 1993.

13.2 VDS (UK) Task

VDS (UK) was tasked to determine:

- Whether Government forces fired weapons
- Whether the start time of the fire could be identified on the FLIR
- Whether personnel could be seen on the ground

13.3 Imagery Examined by VDS (UK)

- Examined 4 FLIR tapes and 3 duplicate tapes from the FBI Night Stalker
- Examined hand-held air-to-ground imagery taken by the FBI and relevant to the task
- Examined ground imagery and press coverage and relevant to the task
- Took into account the results of the FLIR trial held at Fort Hood on 19 March 2000

13.4 Master Event List

In addition to 37 instances reported as gunfire-related incidents by the Davidians' experts, VDS (UK) identified a further 20 instances of similar, but unreported, anomalous thermal activity on the FLIR tapes. These 57 incidents were tabulated and each incident was assessed individually. A review of ground video imagery of a Government helicopter in flight was also conducted.

Although tasked only to determine whether Government forces fired weapons, we included a full analysis of possible Davidian gunfire for both completeness and comparative purposes.

Detailed exploitation of the FLIR imagery, together with comparative analysis of the collateral imagery, and of muzzle flash and debris reflection identified during the FLIR trial, was undertaken at our facility in Peterborough, England over the period 4 January to 5 May 2000.

13.5 Analysis

The FLIR videos were viewed to observe individual frames and determine significant features

of each thermal event, the fire and for sightings of personnel. A comparative assessment was undertaken and all of the available FLIR imagery was used, not only the frames finally selected for illustrations to this report.

Collateral imagery (ground & air) was utilised in comparative analysis with the FLIR, using a variety of software and imagery exploitation techniques. Following the FLIR Trial at Fort Hood, we compared the results from that with our assessments in order to reach final conclusions.

13.6 Alleged Government Gunfire

We were unable to identify any gunfire, either from Government forces or from Davidians, from either the FLIR or other collateral imagery available to us.

We concluded that the thermal events and the alleged sighting of a person detailed in the Master Event List were all caused by either Passive Solar Specular Reflection, or by Active Thermal Reflection; with the remainder due to falling and/or wind-blown debris.

Each thermal event was described and attributed in the Master Event List and we provided our analysis of individual events together with illustrations to explain the causes of these thermal events.

The supposed gunfire emanating from the helicopter was assessed to be visible light energy reflection from the helicopter cockpit canopy.

13.7 Time Of The Fire

Our determination of the first outbreak of fire indicated on the FLIR imagery was at 12:07:43 on the second floor of the Red/White corner. A further fire outbreak occurred at 12:08:26 at the cafeteria /kitchen entrance and we provided our analysis and illustrations of the outbreak of fire.

13.8 Personnel

We concluded that throughout the morning of 19 April 1993, no persons were seen, on imagery available to us, until 12:10:50. After 12:10:50, numerous personnel (assumed to be Government personnel by their actions) attended the fire and were clearly visible on the FLIR, despite the relatively high ambient temperature. These personnel were also seen on collateral imagery. We provided our analysis and illustrations to support the analysis.

13.9 Authentication

D D Oxlee
Peterborough
5 May 2000

N M EVANS
Peterborough
5 May 2000

P AYRES
Peterborough
5 May 2000

13.10 Report Distribution

Copies: Qty 1

The Honorable Judge W S Smith
United States District Court for the Western District of Texas
Waco Division
PO Box 608
Waco
Texas 76703-0608
United States of America

Copies: Qty 5 plus 1 for further reproduction, as required

Attn: Mr Brad Swenson
Office of Special Counsel
200, North Broadway
St Louis
Missouri 63102
United States of America

Copies: Qty 1

Vector Data Systems (UK) Ltd

NICK M EVANS

VDS (UK) DIRECTOR OPERATIONS

SUMMARY

Prior to joining VDS (UK) in 1996, Nick Evans had 27 years of policy, management and technical experience in strategic and tactical imagery intelligence operations, having served extensively within the Defence Intelligence Staff at senior level, and most recently as the Command Intelligence Officer (CIO) at HQ Strike Command, an appointment triple-hatted with his Joint Warfare post as JHQ ACOS J2 and NATO position as Assistance Chief of Staff Intelligence, HQ AIRNW. As ACOS J2 he was responsible for intelligence support to all UK out-of-area joint operations including the Gulf and FRY. As CIO he sat on the Project Management Board and was responsible for the co-ordination of all user requirements for the RAF's LYCHGATE C4I system.

As Director Operations, Nick is responsible for the overall program management of all current VDS (UK) programmes, for bid proposals and corporate development.

QUALIFICATIONS

Educated at Barnstaple Grammar School (Devon) and Llandeilo Grammar School (Dyfed), he joined the RAF on a Direct Entry Commission. A Graduate of the Joint School of Photographic Interpretation and the Defence Intelligence and Security School, he has undertaken a full range of Command and Staff training courses appropriate to his rank in the RAF. Has successfully completed courses in advanced sensor interpretation, targeting and tactical questioning techniques.

EXPERIENCE

Vector Data Systems (UK) Ltd

(1996 - Present) Director Operations. Responsible for overall program management of VDS (UK) programmes, bid proposals and corporate development. Recent responsibilities include the RAPTOR programme for DLGS design, integration and maintenance, the GIEF Upgrade program and provision of electronic classrooms to the Defence Intelligence & Security Centre. Acts as senior advisor on all operational and imagery intelligence matters.

Royal Air Force (1969-1996)

(1993-1996) Group Captain, Command Intelligence Officer HQ Strike Command, Assistant Chief of Staff HQ UKAIR/AIRNW, Assistant Chief of Staff J2. Senior Intelligence specialist in the RAF, responsible for staffwork, targeting and intelligence support to all UK operational air forces and out-of-area operations. Liaison with all UK and US intelligence agencies and member of the MOD Defence Intelligence Steering Group. Senior User on the management board of the LYCHGATE project. Managed an operational staff of 95.

(1991-1993) Commanded Operations Wing, JARIC. Management of 225 imagery analysts and support staff. Daily operation of the UK National Imagery Exploitation Programme and production of UK target materials. IMINT support to the Government, Defence Intelligence Staff, UK Intelligence Community and Operational Commanders. Liaison with counter terrorism and counter narcotics organisations, as well as planning support to Special Forces. Reorganised exploitation operations to meet the requirement for improving timeliness and developed softcopy imagery working practices and visualisation products.

(1989-1991) DIS senior Staff Officer responsible for policy for the collection, exploitation, dissemination and archiving of all national intelligence and survey imagery. Formulation of the UK National Imagery Exploitation Programme and provision of IMINT support to operational commanders. Chaired the National Exploitation Sub Committee of the Joint Air Reconnaissance Intelligence Board, for which he acted as executive secretary. Controlled the provision of IMINT and IMINT based products to support UK operations in the build-up to and throughout OP GRANBY.

(1987-1988) DIS senior Staff Officer responsible for recruiting and training policy for the Intelligence Branch and Photographic Interpreter trade group, policy for tactical reconnaissance units, manpower forecasting, LTCs, budget and finance, as well as special security accreditation implementation at sensitive sites.

(1984-1987) Commanded the Harrier Force Reconnaissance Intelligence Centre at RAF Gutersloh, Germany. Responsible for a staff of 105 supporting field-deployed Harrier tactical recce operations. Also responsible for supporting NATO cross-tasked aircraft and a permanent member of the NATO TACEVAL team.

(1982-1984) Commanded a squadron of 40+ imagery analysts at JARIC working upon strategic intelligence imagery; specialised in the missiles and space target environment, including BMD and laser weapons technology. Supported the national imagery exploitation programme.

(1982) Detached as sole intelligence officer to support all UK flying operations based on Ascension Island during Op CORPORATE. Provided intelligence assessments, assisted in planning, and briefed all long range bombing, ARM, ASW and tanker sorties flown throughout Falkland Islands campaign.

(1981-1982) Commanded a small team of strategic intelligence imagery analysts at JARIC working on airfield studies. Supported the national imagery exploitation programme.

(1978-1982) Unit Intelligence Officer supporting all Harrier and Support Helicopter Force operations at RAF Gutersloh, Germany.

(1976-1978) Commanded the Recognition Materials cell at JARIC, producing innovative reference materials for aircrew, intelligence and imagery analyst staffs of all 3 services.

(1973-1976) Imagery analyst supporting F4 and Jaguar tactical recce operations at RAF Laarbruch, Germany. Provided conversion training for aircrews. Specialist in optical, IR and SLAR interpretation and responsible for all operational SLAR exploitation.

(1970-1973) Imagery analyst support to conversion of first Hunter aircrews onto Harrier, and initial deployments of the embryo Harrier force.

(1969-1970) Commissioned into RAF as Direct Entrant from school. Initial and professional training.

PETER AYRES

VDS (UK) IMAGERY INTERPRETATION SPECIALIST

SUMMARY

Peter Ayres served in the Royal Air Force as a Photographic Interpreter for 29 years, retiring as the senior Warrant Officer in his trade. He is widely experienced in the practice of both strategic and tactical imagery exploitation and has worked closely with the NATO Committees for air reconnaissance standards. He is a qualified RAF training instructor.

QUALIFICATIONS

Enlisted in the RAF in 1967 since when he graduated from the RAF Photographic Interpretation Course, JSPI; the Remote Sensing and Land Applications of Commercial Satellites Course, Silsoe College; the TADMS Radar Groundstation Operator's Course and the LOCE Intelligence System User's Course. He is also a graduate of the RAF Ground Instruction Technique Course and the RAF Management of Training Course.

EXPERIENCE Royal Air Force (1968 - 1996)

(1988 - 96) Trials Officer in the Reconnaissance Support and Development Cell (RSDC) at JARIC. Evaluated proposed new equipments and compiled detailed reports for MOD. Amended NATO Publications for MOD and represented the UK at the NATO Air Reconnaissance Working Party (ARWP) at NATO HQ, Brussels. Exploited video imagery of aircraft accidents and incidents to support RAF Boards of Enquiry. Developed and operated computer-based, imagery manipulation reference models of systems designed for the exploitation of radar and Tornado infra-red imagery. Evaluated software for imagery exploitation and imagery transmission. Temporary deployed to Incirlik, Turkey as OC the Reconnaissance Intelligence Centre (RIC) supporting Harrier GR7 air reconnaissance operations over northern Iraq.

(1985 - 1988) Operations Officer on II (AC) Squadron RIC, RAF Laarbruch, Germany, controlling 5 PIs and 10 PI(Assistants) employed in tactical optical and infra-red imagery interpretation of imagery collected by the Squadron's Jaguar aircraft

(1984 - 1985) Task Progress Officer in JARIC advising military and civilian personnel on air reconnaissance services and products.

(1980 - 1984) Instructor at the Joint School of Photographic Interpretation, RAF Wyton. Responsible for compiling the training syllabi and the training of PI(A)s. Instructed on the Basic, Tactical and Radar PI Courses.

(1979 - 1980) Operations Officer on 41 Squadron RIC controlling PIs and PI(A)s employed in tactical optical and infra-red imagery interpretation of film flown by the Squadron's Jaguar aircraft.

(1977 - 1979) PI on 4 (AC) Squadron RIC, RAF Gutersloh, Germany, employed in the exploitation of tactical optical imagery collected by the Squadron's Harrier aircraft.

(1973 - 1977) Strategic PI employed at JARIC, RAF Brampton.

(1972 - 1973) PI on 13 Squadron, RAF Akrotiri, Cyprus employed on in the exploitation of tactical optical imagery collected by the Squadron's Canberra aircraft, and later at JARIC (NE) , RAF Episkopi, Cyprus, employed on strategic PI duties.

(1968 - 1972) Employed at JARIC as a Plotter Air Photography and later as a Strategic PI.

DANIEL DAVID OXLEE

VDS (UK) IMAGERY ANALYSIS CONSULTANT

SUMMARY

Daniel David Oxlee commenced as an imagery analyst (IA) with the Royal Air Force in 1954. He subsequently saw service during a number of conflicts starting with Suez and including Malaya, Cyprus, and the Falklands, as well as The Gulf War. Whilst with the military he worked for a number of years on strategic detailed imagery analysis at the Joint Air Reconnaissance Intelligence Centre (JARIC (UK)). Additionally, he has worked with RAF tactical reconnaissance squadrons using the Hunter, Canberra, Phantom, Jaguar and the Harrier during which time he was on the NATO Tactical Evaluation Team. Earlier he was appointed Chief Imagery Analysis Judge on the series of international NATO air reconnaissance competitions. He served on a number of imagery related staff appointments at the Ministry Of Defence. He was awarded the Military OBE in 1983 for his services to intelligence. On retiring from the RAF he joined the Civil Service (CS) as an IA, becoming the Senior Intelligence Officer at the joint School of Photographic interpretation (JSPI) as part of the UK Defence Intelligence & Security Centre, until his retirement from the CS last year. Each year he chairs London based Intelligence, Surveillance, Targeting and Reconnaissance (ISTAR) Conferences involving major air reconnaissance industrial companies. At present he is under contract to lecture on Infrared Imagery Analysis for the MOD, and he is a regular IA lecturer at the Universities of Cambridge, Keele, and the UCI.

As an imagery analysis consultant Daniel is part of the VDS training and analysis team.

QUALIFICATIONS

Educated at South East London Technical College he qualified as a mechanical engineering design draughtsman before being drafted into the RAF as a National Serviceman. A graduate (distinction) of the UK Joint School of Photographic Interpretation, and of the Defence Intelligence and Security School, he attended the appropriate Command and Staff training courses. He qualified as a Class A instructor on advanced multi-sensor and military industrial subjects imagery analysis.

EXPERIENCE

(1999 to present) Specialist IA consultant with Vector Data Systems (UK) Ltd.
Senior IA with Kalagate in Forensic Imagery Analysis. Chairman Police Forensic Search Advisory Group. Principle Lecturer with Sira Technology on Thermal IR Analysis

(1987 to 1999) Senior Intelligence Officer at the JSPI at RAF Wyton and latterly at the Defence Intelligence Centre. Responsible for the advanced imagery analysis course at JARIC to include thermal infrared. Also lecturer to UK Police Forces on thermal infrared imagery analysis. Acted as industrial & infrared specialist at JARIC during the Gulf War.

(1986 to 1987) Investigating Officer with the UK Home Office Department.

(1984 to 1986) Commanded Operations Wing, JARIC. Management of around 200 imagery analysts. Daily operation of the UK National Imagery Exploitation Programme and production of UK target materials. IMINT support to the Government, Defence Intelligence Staff, UK Intelligence Community and Operational Commanders. Liaison with counter terrorism and counter narcotics organizations, as well as planning support to Special Forces. First commander of a combined wing to embrace analysis and targeting to meet the requirement for rapid exploitation.

(1982 to 1984) Commanded Imagery Support Wing, JARIC. Management of around 250 imagery technologists in direct and exclusive support of the operational staff.

(1980 to 1982) Commanded the Reconnaissance Support & Development Cell, JARIC (UK). Management of 30 advanced imagery specialists in research for MOD procurement and trials of potential imagery exploitation equipment. Executive member of the Technical & Operational Policy Committee, JARIC. Acted as JARIC's senior IA advisor to MOD staffs during the Falklands War.

(1979 to 1980) Commanded the Joint School of Photographic Interpretation. Management of 30 staff and responsible for the effective training of around 350 officers and tradesmen from the UK military, Foreign and Commonwealth, Civil Service and the Reserve Forces, to include operational command of the Naval and Airforce imagery analyst reserve formations.

(1977 to 1979) Defence Intelligence Staff Officer at the MOD. Responsible for the tasking of all national imagery collection assets through the Chairmanship of the Air Reconnaissance Sub Committee. UK representative on the NATO Imagery Reconnaissance & Intelligence Working Party. UK representative on the CANUKUS Air Reconnaissance Working Party.

(1976 to 1977) Commanded the Joint Air Reconnaissance Intelligence Centre (Near East), Cyprus. Management of around 300 imagery analysts and imagery technologists in support of middle eastern intelligence priorities concerning the rapid exploitation of all air breathing assets.

(1974 to 1976) Commanded the Harrier Force Reconnaissance Intelligence Centre at two locations in RAF Germany. Responsible for a staff of around 100 supporting field-deployed Harrier tactical recce operations. Also responsible for supporting NATO cross-tasked aircraft and a permanent member of the NATO TACEVAL team.

(1973 to 1974) Commanded the Canberra and the Nimrod Reconnaissance Intelligence Centre in Malta. Responsible for a staff of around 75 supporting survey

and operationally deployed aircraft as well as maritime operations. Detached operations in Maseira and in Iran.

(1972 to 1973) Detached duty with the Malaysian Airforce. Acted as specialist adviser on the setting up of an anti terrorist/counter narcotics air reconnaissance squadron using state-of-the-art thermal infrared and optical recording systems. Responsible for creating a viable operational procedure and a sustainable aircrew & analyst training system.

(1970 to 1972) Instructor at JSPI. Headed the syndicate covering multi-sensor subjects, including thermal infrared, together with military industrial subjects.

(1967 to 1970) Commanded a small team of strategic intelligence imagery analysts at JARIC working on military industrial studies. Supported the national imagery exploitation programme.

(1965 to 1967) Imagery analyst supporting the Hunter tactical recce operations at RAF Gutersloh, Germany. Provided visual report training for aircrews.

(1957 to 1965) Imagery analyst working in a number of sections in JARIC on the strategic exploitation of all-source imagery. Also part of a no-notice team deployed on first phase tactical detachments from RAF Wyton.

(1954 to 1957) Assistant photographic interpreter employed at JAPIC, RAF Nuneham Park and at JARIC, RAF Brampton in support of the imagery analysts. Qualified as an IA at JSPI in 1955.

**IMAGERY ANALYSIS REPORT
FLIR TRIAL
FORT HOOD, TEXAS
19 MARCH 2000**

PREPARED FOR

**THE US DISTRICT COURT FOR THE
WESTERN DISTRICT OF TEXAS**

AND

THE OFFICE OF SPECIAL COUNSEL

BY



TABLE OF CONTENTS

1	BACKGROUND	2
2	EXECUTION OF THE FLIR TRIAL	3
2.1	REFERENCE DATA.....	3
2.2	ENVIRONMENT.....	4
2.3	IMAGERY - GENERAL.....	4
2.4	LYNX FLIR IMAGERY.....	4
2.5	NIGHT STALKER FLIR IMAGERY	5
2.6	TRIAL SITE AREA.....	6
2.7	FIREARMS AND COMBAT DRESS	7
2.8	FIRING LINE ALLOCATION	7
2.9	CONTROL AND COMMUNICATIONS.....	8
2.10	REPORT TERMINOLOGY.....	8
2.11	TO VIEW THE ENCLOSED CD-ROM INTERACTIVE VIDEO CLIPS	8
2.12	TO VIEW EACH VIDEO CLIP AS A CONTINUOUS LOOP	9
3	TRIAL IMAGERY RESULTS	10
3.1	IMAGERY DUPLICATION.....	10
3.2	IMAGERY EXPLOITATION	10
3.3	THE TACTICAL MOVEMENT OF PERSONNEL.....	10
3.3.1	<i>Lynx Helicopter Series 1, Sequence 1, Round 1</i>	11
3.4	THE DISCHARGE OF A SELECTION OF TACTICAL FIREARMS.....	12
3.4.1	<i>Lynx Helicopter Series 1, Sequence 2, Round 1</i>	12
3.4.2	<i>Lynx Helicopter Series 1, Sequence 2, Round 2</i>	12
3.4.3	<i>Lynx Helicopter Series 1, Sequence 3, Round 1</i>	13
3.4.4	<i>Lynx Helicopter Series 1, Sequence 3, Round 1</i>	13
3.4.5	<i>Lynx Helicopter Series 1 Sequence 3, Round 1</i>	14
3.4.6	<i>Lynx Helicopter Series 1 Sequence 3, Round 3</i>	14
3.4.7	<i>Lynx Helicopter Series 1 Sequence 3, Round 3</i>	15
3.4.8	<i>Lynx Helicopter Series 2, Sequence 3, Round 1</i>	15
3.4.9	<i>Lynx Helicopter Series 2, Sequence 3, Round 1</i>	16
3.4.10	<i>Lynx Helicopter Series 2, Sequence 3, Round 3</i>	16
3.4.11	<i>Lynx Helicopter Series 2, Sequence 3, Round 3</i>	17
3.4.12	<i>Lynx Helicopter Series 2, Sequence 3, Round 3</i>	17
3.4.13	<i>Lynx Helicopter Series 2, Sequence 4</i>	18
3.5	THERMAL SIGNATURES (REFLECTED AND EMITTED) OF DEBRIS	19
3.5.1	<i>Lynx Helicopter</i>	20
3.5.2	<i>Lynx Helicopter</i>	20
3.5.3	<i>Lynx Helicopter</i>	21
3.5.4	<i>Lynx Helicopter</i>	21
3.5.5	<i>Night Stalker</i>	22
3.5.6	<i>Night Stalker</i>	22
3.6	COMPARISON BETWEEN FLIR SIGNATURES OF MUZZLE FLASH AND DEBRIS.....	23
3.6.1	<i>Muzzle Flash</i>	23
3.6.2	<i>Debris</i>	23
4	CONCLUSIONS	24
5	REPORT DISTRIBUTION	25

ATTACHMENT A: Surface Weather Observations

ATTACHMENT B: FLIR Trial Activity

1 BACKGROUND

On 9 September 1999, the Attorney General of the United States of America appointed Senator John C. Danforth to investigate certain events that occurred at the Mt. Carmel Compound in Waco, Texas on 19 April 1993. Immediately after his appointment, Senator Danforth established the Office of Special Counsel (OSC) to carry out this investigation.

In January 2000, VDS (UK) was engaged by the OSC and the U.S District Court for the Western District of Texas to prepare a conditional Protocol for conducting a test of the FLIR technology utilised on 19 April 1993.

VDS (UK) is a UK-registered, majority-owned subsidiary of Vector Data Systems Inc (VDS Inc) and is located in Peterborough, England from where it operates primarily in support of UK Ministry of Defence requirements. The company specialises in providing imagery exploitation ground stations, imagery software and imagery training and consultancy services. The operational and executive control of all VDS (UK) activities is vested in the UK staff, all of whom are UK nationals. VDS (UK) has not previously been under a direct contract to the US government. In 1997 VDS Inc, Alexandria, VA, was acquired by the Anteon Corporation.

VDS (UK) prepared the Protocol and all parties to the civil litigation agreed to the Protocol on 16 February 2000. The Protocol directed that VDS (UK), as the Court's experts, should verify to the U.S. District Court for the Western District of Texas whether the conditions for the Protocol were met satisfactorily during the trial. On 19 March 2000 VDS (UK) certified to the Court that:

- The FLIR trial was conducted under the conditions of the Protocol at Fort Hood, Texas.
- The trial imagery obtained from the Royal Navy Sea Lynx helicopter Sea Owl FLIR was assessed as having an overall IIRS rating of 7 at 4,000 ft Above Ground Level (AGL) and thus met fully the objectives set forth in the Protocol. As anticipated, the imagery was rated at only IIRS 5 for the 6,000 ft AGL element of the trial.
- Following upgrades to its FLIR system since 1993, the imagery obtained from the FBI Nightstalker FLIR was assessed as having an overall IIRS rating of 8 at both 4,000 ft AGL and 6,000 ft AGL.
- All conditions contained within the Protocol were met to VDS (UK) satisfaction.

REPORT ON THE FORT HOOD FLIR TRIAL - 19 MAR 2000

2 EXECUTION OF THE FLIR TRIAL

2.1 Reference Data

The FLIR trial was staged at Fort Hood Texas on 19 Mar 2000 using the **Lone Star** range.

Location:	UTM Grid 14R PV 234682
Map Sheet:	1: 50,000 Fort Hood MIM DMA Series V782S Edition 6

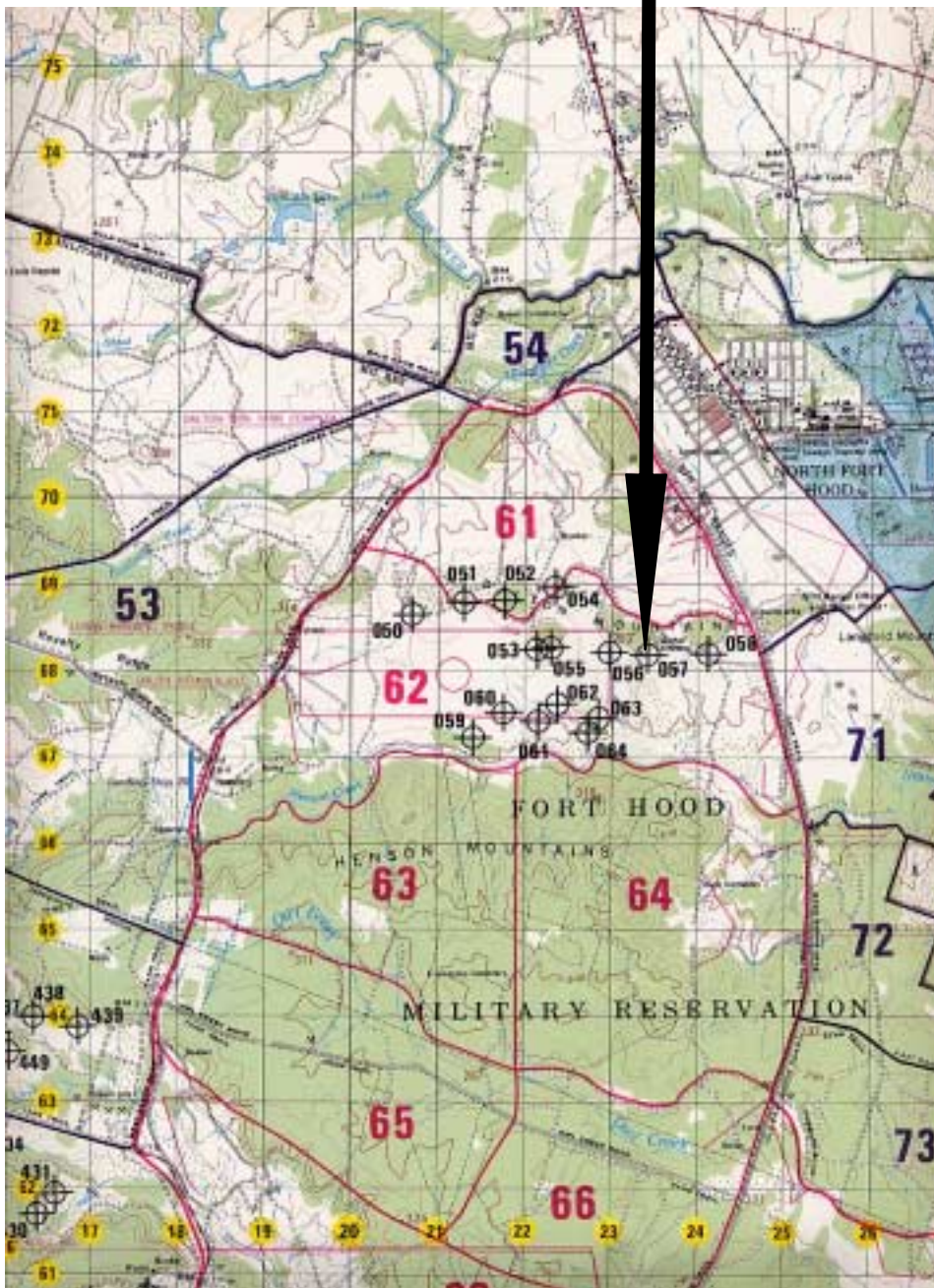

REPORT ON THE FORT HOOD FLIR TRIAL - 19 MAR 2000

2.2 Environment

The trial site was prepared as detailed in Annex A to the Protocol.

Surface weather was acceptable to meet the aims of the Protocol, although flying was delayed from a planned 1030 hrs start to 1100 hrs to allow the surface air temperature to more closely resemble the conditions at Waco of 19 April 1993.

The surface weather observation log is at Attachment A.

2.3 Imagery - General

The imagery requirements detailed at Annex C to the Protocol were met fully.

Details of the trial ground activity and shooting sequences are at Attachment B.

Trial imagery results are at Section 3 and were assessed on the ability of airborne FLIR to capture:

- The tactical movement of personnel under conditions meeting the requirements of the Protocol
- The discharge of a selection of tactical firearms under conditions meeting the requirements of the Protocol
- Thermal signatures (reflected and emitted) of debris likely to have been present on 19 Apr 93, where conditions for recording of reflection or representative sources are met

Extracts from the trial FLIR imagery illustrating these results are included on the accompanying CD-ROM (See Para 2.11 **To View The Enclosed Interactive Video Clips**).

2.4 Lynx FLIR Imagery

The FLIR installed in the Lynx is the same generic sensor type as used in the Night Stalker flown at Waco in April 1993, but with a different installation fit. However, in its normal role as a target acquisition sensor, the Lynx FLIR is displayed in real time to the helicopter crew and not recorded.

To support the occasional requirement to record and replay FLIR imagery, the Lynx can be fitted with a Hi-8 video recorder operating in PAL format at 625 lines. This is the recorder used during the FLIR trial.

Field of view in maximum zoom mode is 2° and the maximum depression angle for the Lynx FLIR is 30°. To acquire IIRS 6 –7 FLIR imagery, representative of the original April 1993 imagery, the Lynx flew at 4,000 ft AGL in a 20° right hand banked attitude. In this attitude, sensor to target slant range was computed as 5,561 ft, at a composite depression angle of 45°.

As mandated in the Protocol, automatic gain control was used, with some resulting degradation to the acquired imagery due to occasional system saturation.

REPORT ON THE FORT HOOD FLIR TRIAL - 19 MAR 2000

The 4,000 ft AGL Lynx trial imagery was assessed as meeting the required IIRS rating, achieving a rating of IIRS 7 overall. Imagery acquired from 6,000 ft AGL was rated at IIRS 5 overall, as predicted.

2.5 Night Stalker FLIR Imagery

The current FLIR installed in the Night Stalker is a modified version of that used at WACO in April 1993. Modifications relate to improved sensor cooling (with commensurately improved thermal discrimination) and the use of digital assemblies.

Imagery is recorded on NTSC format VHS tapes at 525 lines.

Field of view is 1.7° at maximum zoom and the maximum depression angle for the Night Stalker FLIR is 60° . When compared to the Lynx, this enables the Night Stalker to position itself closer to overhead the target without dramatically increasing the angle of bank. In turn, this leads to a reduced sensor to target slant range and the ability to image in a more vertical mode, thereby providing an improved radiant flux; conversely thermal discrimination reduces as oblique slant range increases. Moreover, the narrower field of view provides slightly larger scale imagery than that from the Sea Owl FLIR.

As mandated in the Protocol, automatic gain control was used, with some resultant degradation to the acquired imagery due to occasional system saturation.

The 4,000 ft AGL Night Stalker trial imagery was assessed as easily meeting the required IIRS rating, achieving a rating of IIRS 8 overall. Imagery acquired from 6,000 ft AGL was also rated at IIRS 8 overall.

Both the Lynx and Night Stalker aircraft imaged a full sequence of fire from 4,000 ft AGL and 6,000 ft AGL.

2.6 Trial Site Area

The trial site area was prepared as detailed at Annex D to the Protocol. The trial site area is detailed at Figure 1.



Figure 1 Trial Site Area

REPORT ON THE FORT HOOD FLIR TRIAL - 19 MAR 2000

2.7 Firearms and Combat Dress

The firearms and combat dress for the firing sequences proposed in Annex E to the Protocol were all available and utilised as detailed below.

FIRING LANE	WEAPON	COMBAT DRESS
A	Heckler & Koch 9mm MP5 (suppressed)	Green Nomex flight suits, camouflage webbing utilities, body armour with plate, ballistic helmets.
B	Remington Automatic shotgun M870 12g	Green Nomex flight suits, camouflage webbing utilities, body armour with plate, ballistic helmets.
C	Heckler & Koch 9mm MP5	Green Nomex flight suits, camouflage webbing utilities, body armour with plate, ballistic helmets.
D	Rifle M16 .223 w/M203	Black raid gear without NVGs
E	CAR-15	Full Sniper ghillie suit, face paint and appropriate vegetation adornment
F	Browning 88 9mm pistol	Camouflaged fatigues and special rain suit
G	M 60	Camouflaged fatigues and standard issue webbing utilities
H	Mk-19	Camouflaged fatigues and standard issue webbing utilities
Shooter from the Bradley	M-79 launcher	Camouflaged fatigues and standard issue webbing utilities

2.8 Firing Lane Allocation

The trial shooters were allocated firing lanes as detailed in the Protocol. An example of lane allocation is shown at Figure 2.

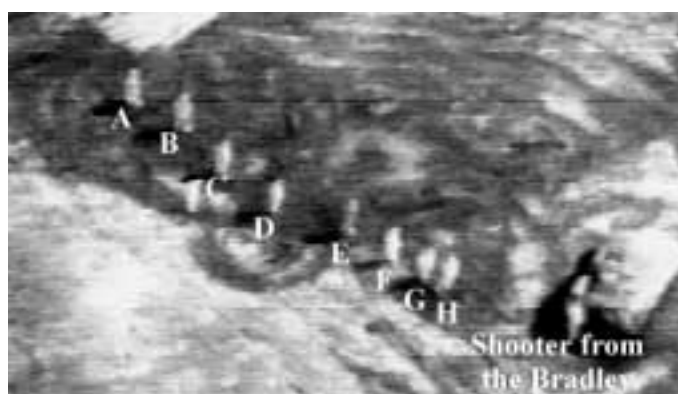

Figure 2 Firing Lane Allocation

2.9 Control and Communications

Operational control of all aspects of the trial was undertaken by VDS (UK). Tactical control of aircraft was exercised through an Air Boss, tactical control of shooters was exercised through a Range Controller.

Voice communications to support the FLIR trial were established as follows:

- Air Boss to Lynx (call sign Navy 319)
- Air Boss to Night Stalker (call sign Marla 01)
- Range Controller to shooters
- Range Controller to Lynx and Night Stalker

All voice communications were recorded on the aircraft FLIR tapes, as well as the three ground-based video cameras.

2.10 Report Terminology

Some terminology used in this report is, of necessity, specialist in nature and subject to national variation.

However, in this report the term **Passive** refers to a return on the FLIR imagery that is the result of *solar action*, whilst the term **Active** indicates that the source of the emission stems from *mankind* (for example a running engine).

Although **Temperature** is the dominant factor in determining the strength of a thermal return on FLIR, other factors such as the of type of **Material**, the **Surface Texture**, the **Slant Range** from a target, and the **Imaging Aspect** must be considered during detailed imagery analysis.

It is important to note that, although the majority of commonplace materials have the property to absorb and to subsequently re-emit radiant energy to varying degrees in the long-wave part of the electromagnetic spectrum, items such as glass and polished metals are very poor emitters in this respect.

In the **passive** sense some glass / polished metals have the ability to reflect more than one-third of the thermal energy incident upon them. Thus, with the right imaging aspect, a considerable amount of energy can be reflected back to the sensor system, if the sensor system is moving relative to the Sun angle. The **passive** effect is here termed **Passive Solar Specular Reflection**.

In the **active** sense, the same materials can reflect mankind-derived energy to the sensor system, given the right imaging aspect. The **active** effect is here termed **Active Thermal Reflection**.

2.11 To View The Enclosed CD-ROM Interactive Video Clips

- You will need a PC equipped with CD-ROM drive and web browser / media player
- Insert the CD into your CD player
- Select *Run* from your *Start* menu
- Double click the *FLIR Trial* folder to open the folder

- Double click the *Index* icon to open the Index
- When the Analysis Package Index opens, click [VDS](#)
- When the Video Package window opens, click [VDS](#)
- To play the video clips, click [Play Video Clip](#) as required, and [Attached Files](#) as required

2.12 To View Each Video Clip As A Continuous Loop

- Select your *Media Player* whilst viewing a video clip
- Select the *Edit* pull down menu
- Click *Options*
- Select *Auto Repeat / Continuous Play*
- Click *OK*

3 TRIAL IMAGERY RESULTS

3.1 Imagery Duplication

The original trial FLIR Hi 8 tape from the Lynx was assessed as meeting the requirements of the Protocol at IIRS 7 by VDS (UK) personnel at Fort Hood.

Subsequently, the OSC generated and distributed a digital copy of the FLIR filed on a 20Gb hard drive; this digital copy enabled repetitious viewing of the video without degradation of the original tape due to multiple replays, but showed some loss of detail.

An OSC-generated NTSC format VHS tape of the Lynx FLIR was used by VDS (UK) to extract short video sequences and to conduct frame-by-frame exploitation as necessary.

Copies of the Night Stalker FLIR were similarly generated by OSC in digital format, supported by an NTSC format VHS tape.

3.2 Imagery Exploitation

The trial FLIR imagery was exploited on our Desktop Imagery Exploitation Workstation (DIEWS) which includes the following commercially available software packages:

- Falcon View
- Digital Imagery Exploitation Production System
- Remote View
- Raindrop
- Adobe Photoshop
- Adobe Premiere

Video-based supporting illustrations were generated using National Technology Alliance Digital Video Analyser Version 4.0.4.

The trial imagery was used to establish the ability of IIRS 6 / 7 FLIR imagery to identify the following:

- The tactical movement of personnel
- The discharge of a selection of tactical firearms
- Thermal signatures (reflected and emitted) of debris

Illustrations from the Lynx FLIR trial imagery are included in the following paragraphs. Where it has been helpful to illustrate a particular point, illustrations from the Night Stalker FLIR have also been included.

3.3 The Tactical Movement Of Personnel

On the Lynx FLIR imagery the shooter personnel were visible at all times. There were times when the shooters were less clearly visible, due to the imaging aspect and the thermal response from the surrounding ground features. However, using various softcopy imagery exploitation packages, VDS (UK) was able to confirm the presence of all the shooters on the imagery, at all times.

3.3.1 Lynx Helicopter Series 1, Sequence 1, Round 1

Figure 3 timed at 11:01:57.54 illustrates the shooters in the prone position, behind the armoured vehicles.



Figure 3 Shooters In Prone Position

See CD ROM Video Clip # 1

Figure 4 timed at 11:02:01.76 illustrates the shooters moving forward to the firing positions. Cold thermal shadows are clearly seen where the shooters were previously in the prone position.



Figure 4 Shooters Moving Forward

See CD ROM Video Clip # 2

REPORT ON THE FORT HOOD FLIR TRIAL - 19 MAR 2000

3.4 The Discharge Of A Selection Of Tactical Firearms

Where weapon muzzle flashes are observed, they are detailed by time, shooter number, lane allocation and the weapons used.

3.4.1 Lynx Helicopter Series 1, Sequence 2, Round 1

Figure 5 timed at 11:09:27.46 illustrates a weapon muzzle flash from Shooter 5 in firing lane E (CAR-15).



Figure 5 Muzzle Flash – Car-15
See CD ROM Video Clip # 3

3.4.2 Lynx Helicopter Series 1, Sequence 2, Round 2

Figure 6 timed at 11:09:53.60 illustrates a weapon muzzle flash from Shooter 2 in firing lane B (Shotgun).



Figure 6 Muzzle Flash – Shotgun
See CD ROM Video Clip # 4

3.4.3 Lynx Helicopter Series 1, Sequence 3, Round 1

Figure 7 timed at 11:15:56.94 illustrates a weapon muzzle flash from Shooter 7 in firing lane G (M-60).



Figure 7 Muzzle Flash – M-60
See CD ROM Video Clip # 5

3.4.4 Lynx Helicopter Series 1, Sequence 3, Round 1

Figure 8 timed at 11:16:19.22 illustrates a weapon muzzle flash from Shooter 8 in firing lane H (Mk-19). A further flash is observed at 11:16:19.56



Figure 8 Muzzle Flash – Mk-19
See CD ROM Video Clip # 6

3.4.5 Lynx Helicopter Series 1 Sequence 3, Round 1

Figure 9 timed at 11:16:59.40 illustrates a weapon muzzle flash from Shooter 5 in firing lane E (CAR-15).



Figure 9 Muzzle Flash - CAR-15
See CD ROM Video Clip # 7

3.4.6 Lynx Helicopter Series 1 Sequence 3, Round 3

Figure 10 timed at 11:18:01.04 illustrates a weapon muzzle flash from Shooter 5 in firing lane E (CAR-15). A further muzzle flash is observed at 11:18:01.12.



Figure 10 Muzzle Flash – Car-15
See CD ROM Video Clip # 8

REPORT ON THE FORT HOOD FLIR TRIAL - 19 MAR 2000

3.4.7 Lynx Helicopter Series 1 Sequence 3, Round 3

Figure 11 timed at 11:18:30.74 illustrates a weapon muzzle flash from Shooter 8 in firing lane H (Mk-19). A further muzzle flash is observed at 11:18:30.92.



Figure 11 Muzzle Flash – Mk-19

See CD ROM Video Clip # 9

3.4.8 Lynx Helicopter Series 2, Sequence 3, Round 1

Figure 12 timed at 11:54:16.60 illustrates a weapon muzzle flash from Shooter 5 in firing lane E (CAR-15).



Figure 12 Muzzle Flash CAR-15

See CD ROM Video Clip # 10

REPORT ON THE FORT HOOD FLIR TRIAL - 19 MAR 2000

3.4.9 Lynx Helicopter Series 2, Sequence 3, Round 1

Figure 13 timed at 11:55:40.26 illustrates a weapon muzzle flash from Shooter 8 in firing lane H (Mk-19).



Figure 13 Muzzle Flash – Mk-19
See CD ROM Video Clip # 11

3.4.10 Lynx Helicopter Series 2, Sequence 3, Round 3

Figure 14 timed at 12:03:23.06 illustrates a weapon muzzle flash from Shooter 5 in firing lane E (CAR-15). A further flash is observed at 12:03:23.58.



Figure 14 Muzzle Flash – CAR-15
See CD ROM Video Clip # 12

REPORT ON THE FORT HOOD FLIR TRIAL - 19 MAR 2000

3.4.11 Lynx Helicopter Series 2, Sequence 3, Round 3

Figure 15 timed at 12:03:40.78 illustrates the airborne detonation of a flashbang round fired by Shooter 4 in firing lane D (M-16).



Figure 15 Detonation of Flashbang

See CD ROM Video Clip # 13

3.4.12 Lynx Helicopter Series 2, Sequence 3, Round 3

Figure 16 timed at 12:23:23.00 illustrates the airborne detonation of a flashbang round fired by Shooter 9 outside the Bradley. A similar detonation is seen at 12:23:44.96.



Figure 16 Detonation of Flashbang

See CD ROM Video Clip # 14

REPORT ON THE FORT HOOD FLIR TRIAL - 19 MAR 2000

3.4.13 Lynx Helicopter Series 2, Sequence 4

Figure 17 timed at 12:22:21.16 illustrates a weapon muzzle flash (Ferret Round) from the shooter outside of the Bradley (M-79 Launcher). The flash is aligned with the muzzle which is elevated at approximately 45° to the horizontal. A similar flash is seen at 12:22:33.60.



Figure 17 Muzzle Flash M-79
See CD ROM Video Clip # 15

3.5 Thermal Signatures (Reflected And Emitted) Of Debris

The trial debris area was constructed in accordance with Annex D of the Protocol. Ground imagery of the debris area layout is shown at Figure 18.



Figure 18 Trial Debris Layout

REPORT ON THE FORT HOOD FLIR TRIAL - 19 MAR 2000

3.5.1 Lynx Helicopter

Figure 19 timed at 11:04:54.26 illustrates a Passive Solar Specular Reflection from the trial debris area.



Figure 19 Passive Solar Specular Reflection From Debris
See CD ROM Video Clip # 16

3.5.2 Lynx Helicopter

Figure 20 timed at 11:55:55.50 illustrates a Passive Solar Specular Reflection from the debris area.



Figure 20 Passive Solar Specular Reflection From Debris
See CD ROM Video Clip # 17

3.5.3 Lynx Helicopter

Figure 21 timed at 11:56:06.20 illustrates a Passive Solar Specular Reflection from the debris area.



Figure 21 Passive Solar Specular Reflection From Debris
See CD ROM Video Clip # 18

3.5.4 Lynx Helicopter

Figure 22 timed at 11:56:00.32 illustrates a Passive Solar Specular Reflection from the debris area.



Figure 22 Passive Solar Specular Reflection From Debris
See CD ROM Video Clip # 19

3.5.5 Night Stalker

Figure 23 timed at 13:20:03 illustrates an Active Thermal Reflection from the debris located under the CEV, created by heat from the engine bay area being reflected from the debris.



Figure 23 Active Thermal Reflection

See CD ROM Video Clip # 20

3.5.6 Night Stalker

Figure 24 timed at 13:49:51 illustrates an Active Thermal Reflection from the debris located under the CEV, created by heat from the engine bay area being reflected from the debris.



Figure 24 Active Thermal Reflection

See CD ROM Video Clip # 21

3.6 Comparison Between FLIR Signatures Of Muzzle Flash and Debris

3.6.1 Muzzle Flash

- Shape – linear, aligned with muzzle elevation and azimuth
- Size – small, extending some 2 – 3 feet from muzzle area
- Shadow – does not apply, but when viewed in stereo is seen elevated above ground level
- Tone – bright light toned flash
- Associated features – always associated with shooter firing weapon
- Duration – very short duration flash visible on FLIR for 0.02 seconds or less

3.6.2 Debris

- Shape – not always linear, may be associated with shape of reflecting object
- Size – associated with size of reflecting object
- Shadow – does not apply
- Tone – bright flash, intensity varies according to reflectivity of debris
- Associated features – collateral imagery will reveal nature of debris / material generating the specific thermal response
- Duration – much longer duration than muzzle flash, visible for varying times, but can be 0.40 seconds or longer

4 CONCLUSIONS

VDS (UK) was engaged by the OSC and the U.S District Court for the Western District of Texas to conduct a test of the FLIR technology utilised by the FBI on 19 April 1993.

The FLIR trial was conducted under the conditions of the agreed Protocol at Fort Hood, Texas on 19 March 2000.

All conditions contained within the Protocol were met to VDS (UK) satisfaction.

The FLIR trial collected Lynx IIRS 7 FLIR imagery from 4,000 feet AGL; IIRS 5 FLIR imagery from 6,000 feet AGL was also collected from the Lynx and IIRS 8 imagery from both 4,000 and 6,000 feet AGL by the Night Stalker. Ground activity imaged included the tactical movement of personnel, the discharge of a selection of tactical firearms and thermal signatures (both reflected and emitted) of debris likely to have been present at Waco on 19 Apr 93.

Our analysis of the Lynx IIRS 7 FLIR imagery indicates the following:

- Personnel can be seen throughout the duration of the trial, even when dressed in a wide variety of combat clothing.
- Muzzle flashes from the tactical firearms employed in this trial are identifiable from a variety of sensor aspects, heights and from IIRS 7 (and IIRS 5) ratings. These muzzle flashes can be discriminated from the reflected and emitted thermal signatures of debris using imagery analysis techniques.
- Reflected and emitted thermal signatures of debris are identifiable from a variety of sensor aspects, heights and from IIRS 7 (and IIRS 5) ratings. Reflected and emitted thermal signatures can be discriminated from the muzzle flashes of the tactical firearms employed in this trial using imagery analysis techniques.

5 REPORT DISTRIBUTION

Copy #1

The Honorable Judge W S Smith
United States District Court for the Western District of Texas
Waco Division
PO Box 608
Waco
Texas 76703-0608
United States of America

Copy #2

Senator J C Danforth
Office of Special Counsel
200 North Broadway
St Louis
Missouri 63102
United States of America

Copy #3

Vector Data Systems (UK) Ltd
Anteon House
Newark Road
Peterborough PE1 5FL
England

ATTACHMENT A TO FLIR TRIAL REPORT
VDS/392/4

SURFACE WEATHER OBSERVATIONS

SURFACE WEATHER OBSERVATIONS (METAR/SPECI)										LATITUDE	LONGITUDE	STATION ELEVATION	TIME CONVERSION	MAG to TRUE	DAY	MONTH	YEAR	STATION (or grid coord) & STATE or COUNTRY	
										CLAS	CLAS	+918 Foot (MSL)	ILST to UTC 06 Hr. 06 Hr.	0 10 Deg. Deg.	19	MAR	2000	K014, TX	
SYNOPTIC DATA					SUMMARY OF THE DAY					ACTIVE RWNY AND EQUIP CHANGE		(90) REMARKS, NOTES, AND MISCELLANEOUS PHENOMENA (all times UTC)							
TIME (UTC)	TIME (LST)	NO	PRECIP (water equiv.)	SNOW FALL	SNOW DEPTH	24-HR MAX TEMP (°C)	PRECIP. (water equiv.)	SNOW FALL	SNOW DEPTH	TIME	RWNY No.	ALL TIMES IN ZULU SUMMARY OF THE DAY DATA TAKEN BETWEEN 1355-1955							
Mid (LST) to:	Mid (LST) to:	(43)	(44)	(45)	(46)	(47)	(48)	(49)	(50)	(51)	(52)								
1150	0550	(1)	-	-	-	21	0	0	0	-	-								
1750	1150	(2)	0	0	0	24-HR MIN TEMP (°C)	SPEED (knots)	DRCTN (true)	TIME (UTC)										
0550	2350	(4)	-	-	-	09	18	35	1525										
Mid (LST)	Mid (LST)																		
TYPE	TIME (UTC)	DRCTN (true)	SPEED (knots)	MAX WIND (knots)	VARIABILITY (true)	VISIBILITY			WEATHER AND OBSTRUCTIONS TO VISION	SKY CONDITION	TEMP (°C)	DEW POINT (°C)	ALSTG (inches)	STA PRES-SURE (inches)	TOTAL SLEET (inches)	OBS INIT			
						SLUGS	MILES	RUNWAY VISUAL RANGE LOCAL											
(1)	(2)	(3A)	(10)	(11)	(8)	(4A)	(4B)	(4C)	(5)	(7)	(8)	(12)	(17)	(21)	(18)				
SA	1355	320	10				7					09	05	3023		1 BH			
(13) RMK	SLPNO	ESTMD	ALSTG	8/100	9/100	FIRST													
L	1425	340	14				7					10	04	3022		BH			
(13) RMK	ESTMD	ALSTG					7					11	03	3022	E29.235	1 BH			
SA	1455	360	15				7					12	05	3022		BH			
(13) RMK	SLPNO	ESTMD	ALSTG	8/100	9/100	5/111						12	05	3022		BH			
L	1525	350	14	18			7					13	06	3022		BH			
(13) RMK	ESTMD	ALSTG					7					13	06	3022		1 BH			
SA	1555	340	10	16			7					14	04	3022		BH			
(13) RMK	SLPNO	ESTMD	ALSTG	8/100	9/100							14	04	3022		BH			
L	1625	330	10	15			7					15	05	3022		1 BH			
(13) RMK	ESTMD	ALSTG					7					15	05	3022		1 BH			
SA	1655	320	12				7					16	02	3021		BH			
(13) RMK	SLPNO	ESTMD	ALSTG	8/100	9/100							16	02	3021		BH			
L	1725	340	15				7					18	05	3020	E29.210	1 BH			
(13) RMK	ESTMD	ALSTG					7					18	05	3020	E29.210	1 BH			
SA	1755	320	10				7					19	02	3018		BH			
(13) RMK	SLPNO	ESTMD	ALSTG	8/100	9/100	58008						19	02	3018		BH			
L	1825	010	09				7					19	01	3016		1 BH			
(13) RMK	ESTMD	ALSTG					7					19	01	3016		1 BH			
SA	1855	360	10				7					19	05	3014		BH			
(13) RMK	SLPNO	ESTMD	ALSTG	8/100	9/100							21	04	3014		1 BH			
L	1925	330	08				7					21	04	3014		1 BH			
(13) RMK	ESTMD	ALSTG					7					21	04	3014		1 BH			
SA	1955	310	10				7					21	04	3014		1 BH			
(13) RMK	SLPNO	ESTMD	ALSTG	8/100	9/100							21	04	3014		1 BH			

LYNX - SERIES 1 - HEIGHT 4000 FT AGL 19-Mar-00

PLANNED START TIME	1100	ACTUAL START TIME	1101
PLANNED STOP TIME	1130	ACTUAL STOP TIME	1129

SEQUENCE 1: 5 ROUNDS SINGLE SHOT

ACTUAL START TIME	1101
ACTUAL STOP TIME	1108

SHOOTER	WEAPON	MOVE TO POSITION	ROUND 1	ROUND 2	ROUND 3	ROUND 4	ROUND 5	COMMENTS
A	H&K MP-5 SUPPRESSED							
B	870 SHOTGUN							Stoppage round 4, restart 1106
C	H&K MP-5							
D	M-16							
E	CAR-15							
F	9MM BROWNING							
G	M-60							
H	MK-19							
I	M-79							

SEQUENCE 2: 3 ROUNDS OF 3 SHOT BURSTS

ACTUAL START TIME	1109
ACTUAL STOP TIME	1114

SHOOTER	WEAPON	MOVE TO POSITION	ROUND 1	ROUND 2	ROUND 3	ROUND 4	ROUND 5	COMMENTS
A	H&K MP-5 SUPPRESSED							
B	870 SHOTGUN							
C	H&K MP-5							Stoppage round 2, restart 1112
D	M-16							
E	CAR-15							
F	9MM BROWNING							
G	M-60							
H	MK-19							
I	M-79							

SEQUENCE 3: 3 ROUNDS OF FULL AUTOMATIC OR FLASHBANG

ACTUAL START TIME	1115
ACTUAL STOP TIME	1118

SHOOTER	WEAPON	MOVE TO POSITION	ROUND 1	ROUND 2	ROUND 3			COMMENTS
A	H&K MP-5 SUPPRESSED							
B	870 SHOTGUN							
C	H&K MP-5							
D	M-16							
E	CAR-15							
F	9MM BROWNING							
G	M-60							
H	MK-19							
I	M-79							

SEQUENCE 4: M-79 FERRET / M651 / FLASHBANG

ACTUAL START TIME	1119
ACTUAL STOP TIME	1124

SHOOTER	WEAPON	MOVE TO POSITION	FERRET 1	FERRET 2	M651 1	M651 2	FLASH BANG 1	FLASH BANG 2	COMMENTS
A	H&K MP-5 SUPPRESSED								
B	870 SHOTGUN								
C	H&K MP-5								
D	M-16								
E	CAR-15								
F	9MM BROWNING								
G	M-60								
H	MK-19								
I	M-79								

SEQUENCE 5: CEV UNCOVERS DEBRIS UNDER CHASSIS

ACTUAL START TIME	1128
ACTUAL STOP TIME	1129

VEHICLE	MOVE FORWARD	EXPOSE DEBRIS	MOVE BACK	COMMENTS
CEV				

LYNX - SERIES 2 - HEIGHT 6000 FT AGL

PLANNED START TIME	1136	ACTUAL START TIME	1137
PLANNED STOP TIME		ACTUAL STOP TIME	1224

SEQUENCE 1: 5 ROUNDS SINGLE SHOT

ACTUAL START TIME	1137
ACTUAL STOP TIME	1140

SHOOTER	WEAPON	MOVE TO POSITION	ROUND 1	ROUND 2	ROUND 3	ROUND 4	ROUND 5	COMMENTS
A	H&K MP-5 SUPPRESSED							
B	870 SHOTGUN							
C	H&K MP-5							
D	M-16							
E	CAR-15							
F	9MM BROWNING							
G	M-60							
H	MK-19							
I	M-79							

SEQUENCE 2: 3 ROUNDS OF 3 SHOT BURSTS

ACTUAL START TIME	1144
ACTUAL STOP TIME	1147

SHOOTER	WEAPON	MOVE TO POSITION	ROUND 1	ROUND 2	ROUND 3			COMMENTS
A	H&K MP-5 SUPPRESSED							
B	870 SHOTGUN							
C	H&K MP-5							
D	M-16							
E	CAR-15							
F	9MM BROWNING							
G	M-60							
H	MK-19							
I	M-79							

SEQUENCE 3: 3 ROUNDS OF FULL AUTOMATIC OR FLASHBANG

ACTUAL START TIME Stoppage 1157 sensor problem
 ACTUAL STOP TIME

SHOOTER	WEAPON	MOVE TO POSITION	ROUND 1	ROUND 2	ROUND 3		COMMENTS
A	H&K MP-5 SUPPRESSED						
B	870 SHOTGUN						
C	H&K MP-5						
D	M-16						
E	CAR-15						Stoppage round 1 to 1153
F	9MM BROWNING						
G	M-60						
H	MK-19						
I	M-79						

SEQUENCE 4: M-79 FERRET / M651 / FLASHBANG

ACTUAL START TIME RESTART Sequence aborted due to weapon malfunction, restarted after sequence 5 at 1221
 ACTUAL STOP TIME STOP

SHOOTER	WEAPON	MOVE TO POSITION	FERRET 1	FERRET 2	M651 1	M651 2	FLASH BANG 1	FLASH BANG 2	COMMENTS
A	H&K MP-5 SUPPRESSED								
B	870 SHOTGUN								
C	H&K MP-5								
D	M-16								
E	CAR-15								
F	9MM BROWNING								
G	M-60								
H	MK-19								
I	M-79								Aborted and restarted 1221

SEQUENCE 5: CEV UNCOVERS DEBRIS UNDER CHASSIS

ACTUAL START TIME
 ACTUAL STOP TIME

VEHICLE	MOVE FORWARD	EXPOSE DEBRIS	MOVE BACK	COMMENTS
CEV				

NIGHT STALKER - SERIES 1 - HEIGHT 4000 FT AGL

PLANNED START TIME	1215	ACTUAL START TIME	1305
PLANNED STOP TIME		ACTUAL STOP TIME	1302

Temperature on site 67F

SEQUENCE 1: 5 ROUNDS SINGLE SHOT

ACTUAL START TIME	1305
ACTUAL STOP TIME	1308

SHOOTER	WEAPON	MOVE TO POSITION	ROUND 1	ROUND 2	ROUND 3	ROUND 4	ROUND 5	COMMENTS
A	H&K MP-5 SUPPRESSED							
B	870 SHOTGUN							
C	H&K MP-5							
D	M-16							
E	CAR-15							
F	9MM BROWNING							
G	M-60							
H	MK-19							
I	M-79							

SEQUENCE 2: 3 ROUNDS OF 3 SHOT BURSTS

ACTUAL START TIME	1309
ACTUAL STOP TIME	1311

SHOOTER	WEAPON	MOVE TO POSITION	ROUND 1	ROUND 2	ROUND 3			COMMENTS
A	H&K MP-5 SUPPRESSED							
B	870 SHOTGUN							
C	H&K MP-5							
D	M-16							
E	CAR-15							
F	9MM BROWNING							
G	M-60							
H	MK-19							
I	M-79							

SEQUENCE 3: 3 ROUNDS OF FULL AUTOMATIC OR FLASHBANG

ACTUAL START TIME

1312

 ACTUAL STOP TIME

1317

SHOOTER	WEAPON	MOVE TO POSITION	ROUND 1	ROUND 2	ROUND 3		COMMENTS
A	H&K MP-5 SUPPRESSED						
B	870 SHOTGUN						
C	H&K MP-5						
D	M-16						
E	CAR-15						
F	9MM BROWNING						
G	M-60						Jammed rounds 2 & 3
H	MK-19						
I	M-79						

SEQUENCE 4: M-79 FERRET / M651 / FLASHBANG

ACTUAL START TIME

1318

 ACTUAL STOP TIME

1319

SHOOTER	WEAPON	MOVE TO POSITION	FERRET 1	FERRET 2	M651 1	M651 2	FLASH BANG 1	FLASH BANG 2	COMMENTS
A	H&K MP-5 SUPPRESSED								
B	870 SHOTGUN								
C	H&K MP-5								
D	M-16								
E	CAR-15								
F	9MM BROWNING								
G	M-60								
H	MK-19								
I	M-79								

SEQUENCE 5: CEV UNCOVERS DEBRIS UNDER CHASSIS

ACTUAL START TIME

1319

 ACTUAL STOP TIME

1320

VEHICLE	MOVE FORWARD	EXPOSE DEBRIS	MOVE BACK	COMMENTS
CEV				

NIGHT STALKER - SERIES 2 - HEIGHT 6000 FT AGL

PLANNED START TIME ACTUAL START TIME
 PLANNED STOP TIME ACTUAL STOP TIME

Temperature on site 67F
 Test fire M60 1325 & 1326

SEQUENCE 1: 5 ROUNDS SINGLE SHOT

ACTUAL START TIME
 ACTUAL STOP TIME

SHOOTER	WEAPON	MOVE TO POSITION	ROUND 1	ROUND 2	ROUND 3	ROUND 4	ROUND 5	COMMENTS
A	H&K MP-5 SUPPRESSED							
B	870 SHOTGUN							
C	H&K MP-5							
D	M-16							
E	CAR-15							
F	9MM BROWNING							
G	M-60							
H	MK-19							
I	M-79							

SEQUENCE 2: 3 ROUNDS OF 3 SHOT BURSTS

ACTUAL START TIME
 ACTUAL STOP TIME

SHOOTER	WEAPON	MOVE TO POSITION	ROUND 1	ROUND 2	ROUND 3			COMMENTS
A	H&K MP-5 SUPPRESSED							
B	870 SHOTGUN							
C	H&K MP-5							
D	M-16							
E	CAR-15							
F	9MM BROWNING							Aborted round 1 jam on CAR-15
G	M-60							
H	MK-19							
I	M-79							

SEQUENCE 3: 3 ROUNDS OF FULL AUTOMATIC OR FLASHBANG

ACTUAL START TIME

1342

 ACTUAL STOP TIME

1346

SHOOTER	WEAPON	MOVE TO POSITION	ROUND 1	ROUND 2	ROUND 3			COMMENTS
A	H&K MP-5 SUPPRESSED							
B	870 SHOTGUN							
C	H&K MP-5							
D	M-16							
E	CAR-15							
F	9MM BROWNING							
G	M-60							
H	MK-19							
I	M-79							

SEQUENCE 4: M-79 FERRET / M651 / FLASHBANG

ACTUAL START TIME

1348

 ACTUAL STOP TIME

1349

SHOOTER	WEAPON	MOVE TO POSITION	FERRET 1	FERRET 2	M651 1	M651 2	FLASH BANG 1	FLASH BANG 2	COMMENTS
A	H&K MP-5 SUPPRESSED								
B	870 SHOTGUN								
C	H&K MP-5								
D	M-16								
E	CAR-15								
F	9MM BROWNING								
G	M-60								
H	MK-19								
I	M-79								

SEQUENCE 5: CEV UNCOVERS DEBRIS UNDER CHASSIS

ACTUAL START TIME

1349

 ACTUAL STOP TIME

1350

VEHICLE	MOVE FORWARD	EXPOSE DEBRIS	MOVE BACK	COMMENTS
CEV				

OFFICE OF SPECIAL COUNSEL INVESTIGATION

VDS (UK) LOG OF DOCUMENTS RECEIVED

SERIAL	DATE RECEIVED	ITEM	QTY	OSC REF NO
1	19/12/99	DRAWINGS	2	Gp I, Pkt C, side views, all floors Gp I, Pkt D, first and second floor plans
2	19/12/99	DRAWINGS	2	Gp I, Pkt C, side views, all floors
3	19/12/99	DRAWINGS	2	FLIR 26/3/93
4	04/01/00	VIDEO TAPE	1	FLIR 19/4/93 VHS Qc1
5	04/01/00	VIDEO TAPE	1	FLIR 19/4/93 VHS Qc2
6	04/01/00	VIDEO TAPE	1	FLIR 19/4/93 VHS Qc3
7	04/01/00	VIDEO TAPE	1	FLIR 19/4/93 VHS Qc4
8	04/01/00	VIDEO TAPE	1	FLIR 19/4/93 NTSC Qc1
9	04/01/00	VIDEO TAPE	1	FLIR 19/4/93 NTSC Qc2
10	04/01/00	VIDEO TAPE	1	FLIR 19/4/93 NTSC Qc3
11	04/01/00	VIDEO TAPE	1	FLIR 19/4/93 NTSC Qc4
12	04/01/00	VIDEO TAPE	1	Col photos of 19/4/93
13	17/01/00	CD ROM	1	DVD Clone of FLIR Footage. Ref FVI WTX S/N1335 date 07/01/00
14	17/01/00	DVD	1	Memo from Mike Hesse - Timeline for 19/04/93 - draft transcript
15	17/01/00	Draft transcript	1	Dept of Justice FLIR capabilities report of 29/04/97
16	17/01/00	Report	1	Major network News Footage
17	27-Jan-00	VIDEO TAPE1	1	Gunfire Footage
18	27-Jan-00	VIDEO TAPE2	1	Fire Footage
19	27-Jan-00	VIDEO TAPE3	1	Gas Footage
20	27-Jan-00	VIDEO TAPE4	1	FLIR Footage
21	27-Jan-00	VIDEO TAPE5	1	FLIR Footage
22	27-Jan-00	VIDEO TAPE6	1	FLIR Footage
23	27-Jan-00	VIDEO TAPE7	1	FLIR Footage
24	27-Jan-00	CD ROM	1	"Photographs" Fire
25	27-Jan-00	CD ROM	1	"Photographs" Tactical
26	27-Jan-00	ZIP DRIVE	1	"Photographs" Fire
27	27-Jan-00	ZIP DRIVE	1	"Photographs" Tactical
28	11-Feb-00	Tech reports	3	OSC294-001 to 0100 "Brad files - 39 items" Colour ground shots
29	18-Feb-00	CD ROM	2	Protocol US issued format
30	18-Feb-00	21 Page Text - hardcopy	1	Enlargements of WACO Area Vertical images. (Nat Guard)
31	18-Feb-00	Colour Prints	3	77 images at high res. FBI clour
32	01-Mar-00	CD-ROM	1	Edward Allard final report
33	10-Mar-00	report	1	System Engineering report
34	10-Mar-00	report	1	Jack Zimmerman report
35	10-Mar-00	report	1	Ferdinand Zegel final report
36	10-Mar-00	report	1	Maurice Cox report
37	10-Mar-00	report	1	CTL (DOJ) report
38	10-Mar-00	report	1	MADL Flash Analysis Report
39	10-Mar-00	report	1	MADL IR Video Review - fire development
40	10-Mar-00	Video	1	MADL Solar spec reflections
41	10-Mar-00	report	1	MADL Solar spec refl - Far IR
42	10-Mar-00	Video	1	Final rept Irving W Ginsberg
43	10-Mar-00	Report	1	MADL Muzzle flash detection
44	10-Mar-00	Report	1	Mensuration images Bitmap 1200 dpi ROMs 2-8 incl.
45	13-Mar-00	CD ROM	7	FBI - Glint Dallas Apr 97
46	13-Mar-00	Video	1	FBI - Lab Horseshoe Bay Texas
47	13-Mar-00	Video	1	FBI Nightstalker FLIR examples
48	13-Mar-00	Video	1	

OFFICE OF SPECIAL COUNSEL INVESTIGATION**VDS (UK) LOG OF DOCUMENTS RECEIVED**

SERIAL	DATE RECEIVED	ITEM	QTY	OSC REF NO
49	14-Mar-00	CD ROM	2	1200 dpi scans (9 images)
50	16-Mar-00	CD-ROM	12	150 - 1200 dpi scans
51	16-Mar-00	Floppy (damaged)	1	FLIR presentation
52	24-Mar-00	Computer Hard Drive	1	Trial Imagery
53	27-Mar-00	MET Reports	2	MET Reports for 18-19 Mar 00
54	03-Apr-00	Photo List	13	Large Photos
55	03-Apr-00	Photo List	855	Photos (Colour and B/W)
56	03-Apr-00	CD ROM dated 3/29/00	1	VDS Photos
57	03-Apr-00	Hi-8 Video Tape Lynx 1	1	FLIR Trial Video
58	03-Apr-00	Hi-8 Video Tape Lynx 2	1	FLIR Trial Video
59	03-Apr-00	NTSC Video Tape Lynx 1	1	FLIR Trial Video
60	03-Apr-00	NTSC Video Tape Lynx 2	1	FLIR Trial Video
61	03-Apr-00	NTSC Video Tape NS-1	1	FLIR Trial Video
62	04-Apr-00	Photographs of Trial Debris field	71	
63	06-Apr-00	Ground video of FLIR Trial	1	989-1298777 Lab No AV 9689
64	06-Apr-00	Ground video of FLIR Trial	1	989-1298777 Lab No AV 9689
65	06-Apr-00	Ground video of FLIR Trial	1	989-1298777 Lab No AV 9689
66	06-Apr-00	Ground video of FLIR Trial	1	989-1298777 Lab No AV 9689
67	06-Apr-00	Ground video of FLIR Trial	1	989-1298777 Lab No AV 9689
68	06-Apr-00	Ground video of FLIR Trial	1	989-1298777 Lab No AV 9689
69	08-Apr-00	CD ROM	1	Thermacam images of FLIR Trial
70	10-Apr-00	35mm slides	3	FBI slides 19/4/93 - 1030-1230
71	10-Apr-00	colour computer printout	10	FBI colour images 19/4/93
72	10-Apr-00	Colour Prints	1	FBI colour images 19/4/94

Mensuration Report for the Analysis of Mount Carmel Compound

- i. Vector Data Systems (UK) Ltd were requested by the Office of Special Counsel to produce a comprehensive set of measurements of the Mount Carmel compound in order to support their work to investigate the events that occurred there on 19th April 1993. VDS were provided the imagery necessary for the task, the main aim of which was to produce as precise a model of the compound as possible, from the collateral supplied. The work involved measuring not only the size of the component building structures but also the size and positions of the window apertures. In order to visually check the resultant dimensions, a three-dimensional Computer Aided Design model was produced. This model was then compared with many other views of the compound, some of which would not necessarily be directly suitable for the mensuration task.*
1. The optical collateral used for the purpose of mensuration was of reasonable quality, being high-resolution (typically 1200-dpi) scan digitised imagery. The majority of the imagery was low-oblique, long slant range, hand held photography. Supplemental to this imagery was close range, hand held photography taken from various vantagepoints on the ground.
 2. Further supplementary collateral was captured from the thermal infrared video imagery. Whilst neither the geometry of the imagery capture, nor the proportionality of the recorded image is not known precisely, imagery pixels were assumed to be able to be linearly calibrated in screen-X or screen-Y directions where near-vertical imagery was observed. This further imagery was required at the time the mensuration task was performed since much of the high quality imagery, subsequently available, was not initially provided.
 3. The origins of the imagery are unknown. Nothing is known about the camera system used to capture the imagery. The original negatives were unavailable. Since no interior or exterior orientation could be performed, the methods of classical photogrammetry were not possible for this task.
 4. Since these images were all taken from a reasonably long standoff position, it can be assumed long focal length lenses were used. This would have the effect of reducing radial distortion toward the edges of the frames.
 5. The method used for mensuration was by direct comparison of unknown dimensions with dimensions of known objects – namely the various military vehicles, which were observed in the frames of imagery, or previously measured aspects of the compound. The dimensions of the objects used were as follows:

Vehicle	Length (m)	Width (m)
M-728 Combat Engineer Vehicle	6.976	3.631
M-88 Armoured Recovery Vehicle	8.255	3.429
M-2 Infantry Fighting Vehicle (Bradley)	6.55	3.61

6. Complications arose from the obliquity of the aerial imagery, which results in a scale change throughout the images. This problem was overcome to some degree for horizontal distances by the availability of imagery from many angles around the compound and the piecemeal movement of the calibration objects – the military vehicles – throughout the period that the imagery was captured. Wherever such imagery was available, vehicles were measured whilst in the same object plane as the dimension to be measured, but this was not possible in all cases.
7. Observations were noted in a spreadsheet which recorded the x and y pixel positions of the observed points. A ‘pixel-distance’ was calculated using Pythagoras and a ‘pixel-gradient’ was calculated to keep a check on alignments of calibration objects and the distances to be measured. This is an important factor, since in the best case, calibration objects should not only lie in the same plane as the object to be measured, but the calibration dimension should be near parallel to the object dimension also.
8. No height information was gained directly from the oblique imagery since no calibration dimensions could be observed. Although the heights of the military vehicles are known, the obliquity of the aerial imagery made direct comparisons impossible.
9. Heighting of the compound and its component fabric was initially carried out by reference to the outside door at the back of the dining area. In this part of the compound, the walls are faced with horizontal ‘shiplap’ type panelling. It was possible to calibrate the height of these panels and then to count the number of panels making up the major parts of the compound structure. Windows that were not measurable in this way were sized by proportional reference to the previously calculated overall height of the building structure in which they were mounted.
10. The error statement is drawn from comparison of multiple measurements of a common object from all types of collateral and from different frames of the optical imagery. On the oblique imagery, both walls and roofs could be measured. Only the roof dimensions could be compared with the near-vertical capture, however. Error tolerances are not quoted for each individual dimension since in many cases they could only be measured once, but clearly the absolute error will be larger for greater dimensions. It is assumed that the systematic error introduced by the imaging process – capture angles, photographic equipment, photographic materials, photographic reproduction, and scanning - will be greater than the random error introduced by observing pixels on the screen. This assumption is supported in that, whether measuring small objects such as windows or large objects such as building facades, consistently repeatable observations could be made. The object distance represented by one image pixel was therefore very much less than the overall error quoted. A general error of $\pm 0.2\text{m}$ (± 8 inches) is quoted to give an impression of the overall accuracy of the dimensions given. Although some observed dimensions fall out of this error bound, it is considered that a weighted error should be applied to the calculated dimensions with emphasis given to those that best fit the plane and alignment of the calibration objects.
11. A total of 19 images were used collectively for mensuration of the Mount Carmel compound.

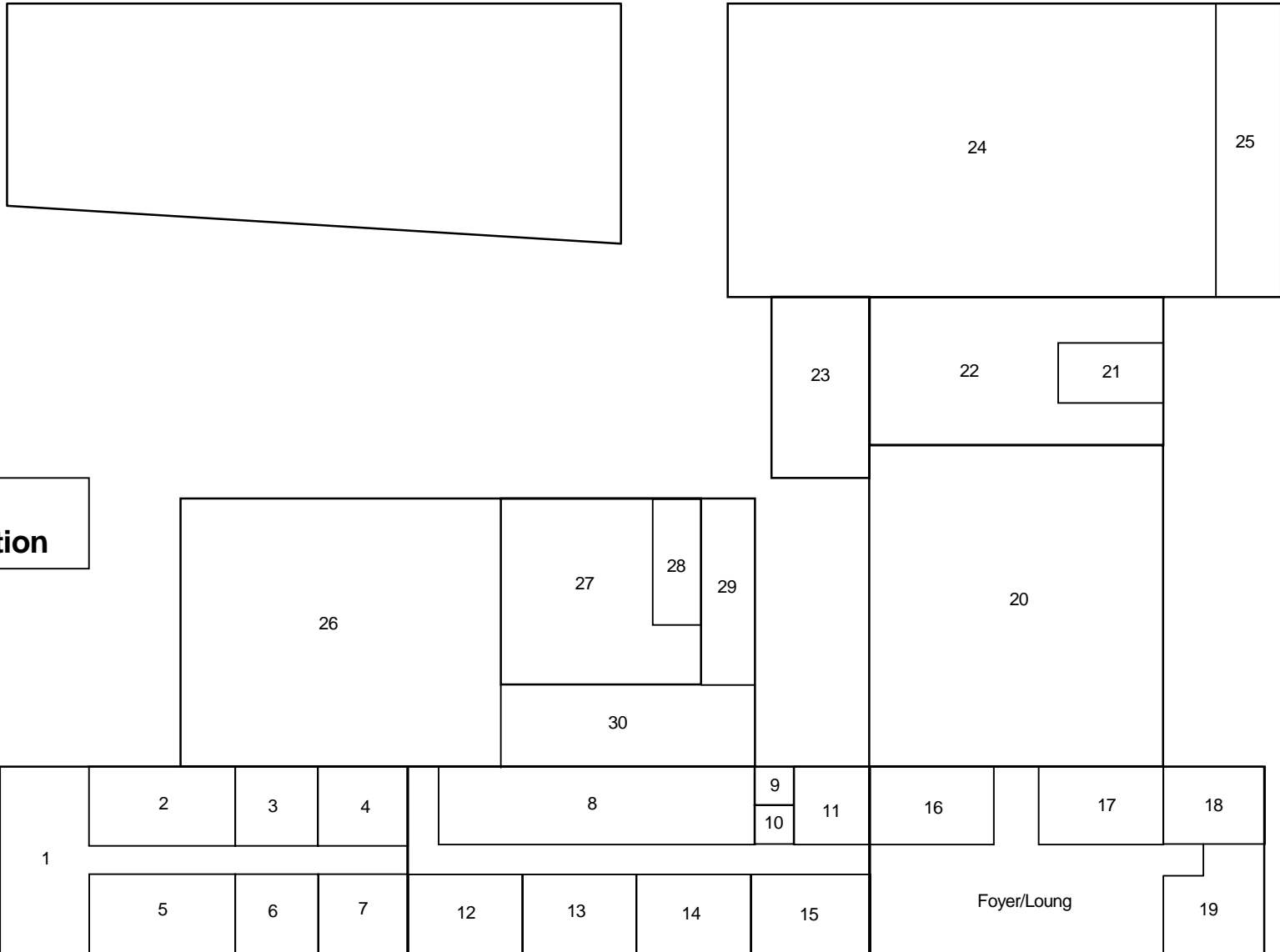

**First Floor
Room Identification**

Not to Scale

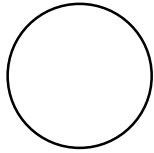
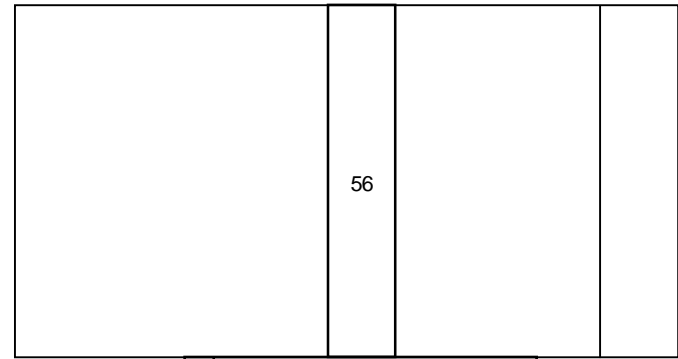
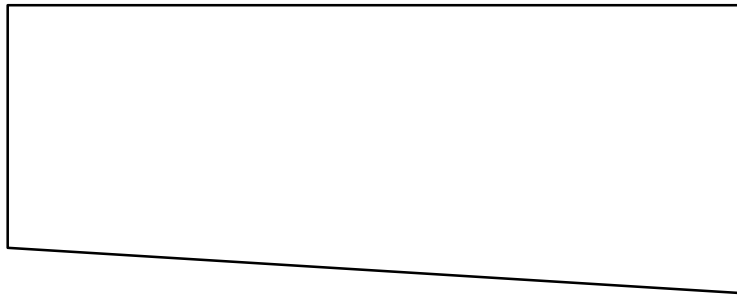

**Second Floor
Room Identification**

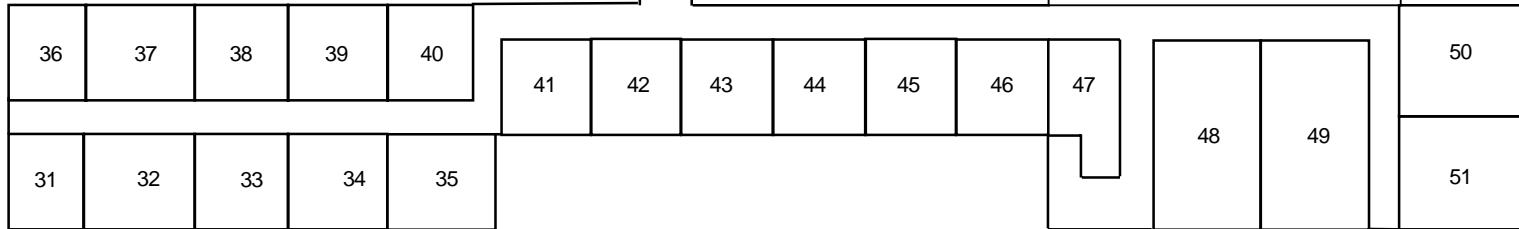
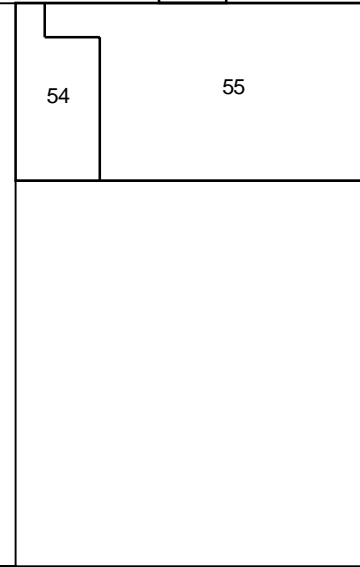
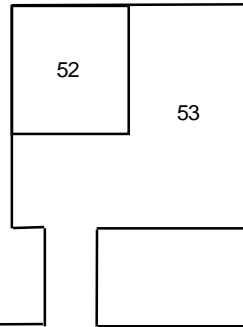

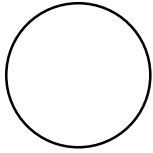
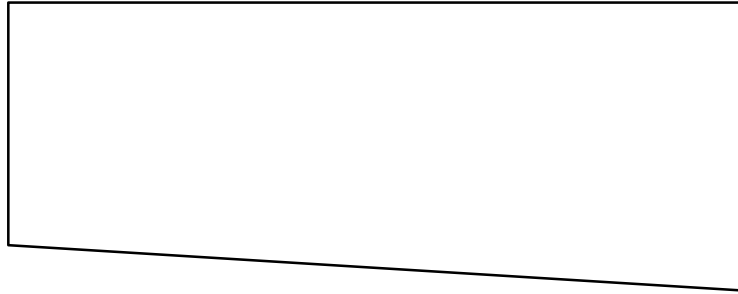

**Third Floor
Room Identification**

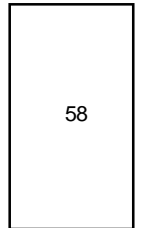
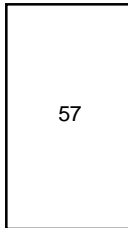
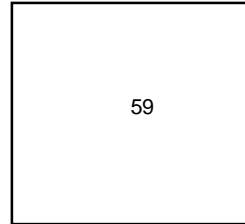

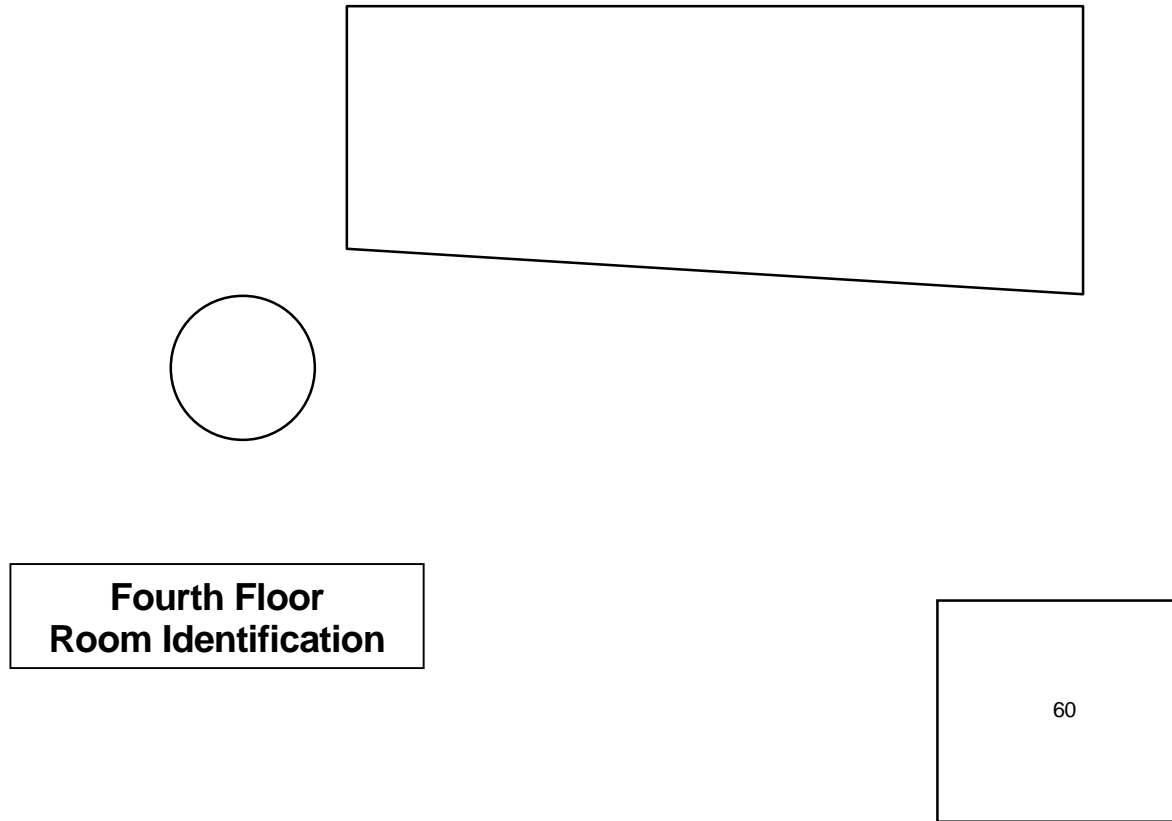

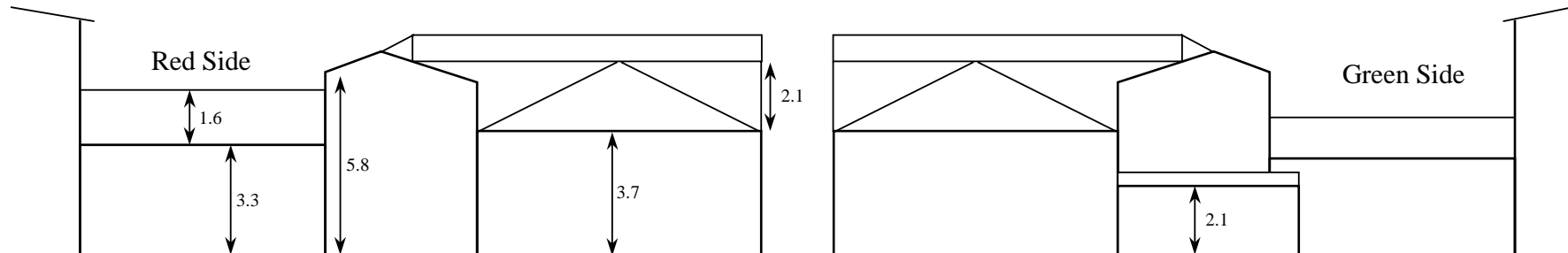
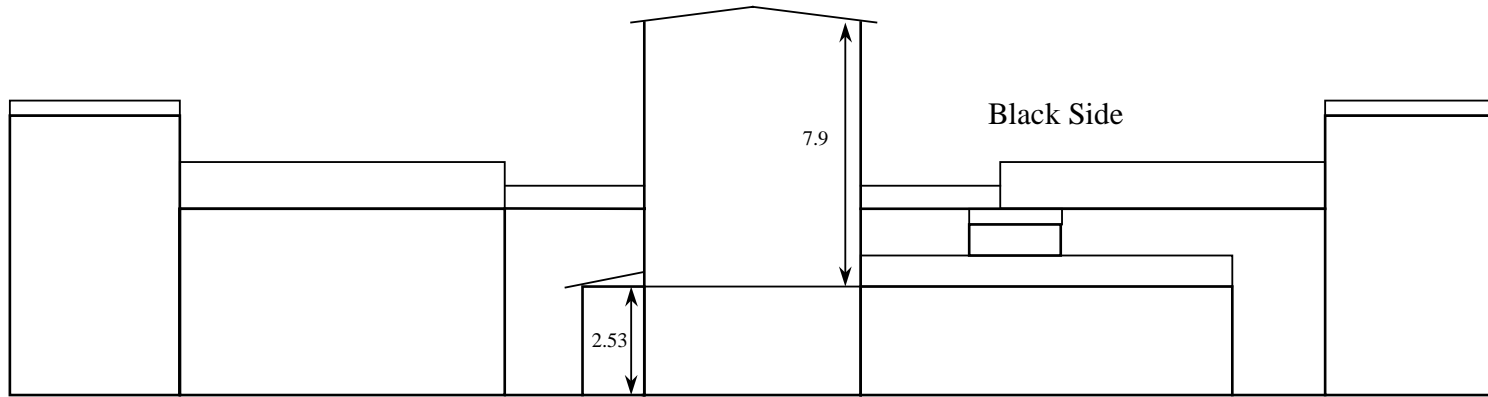
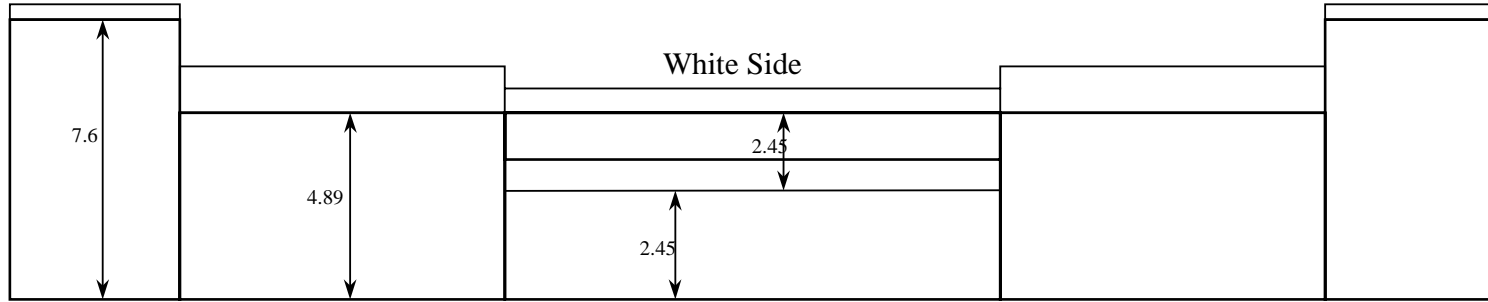

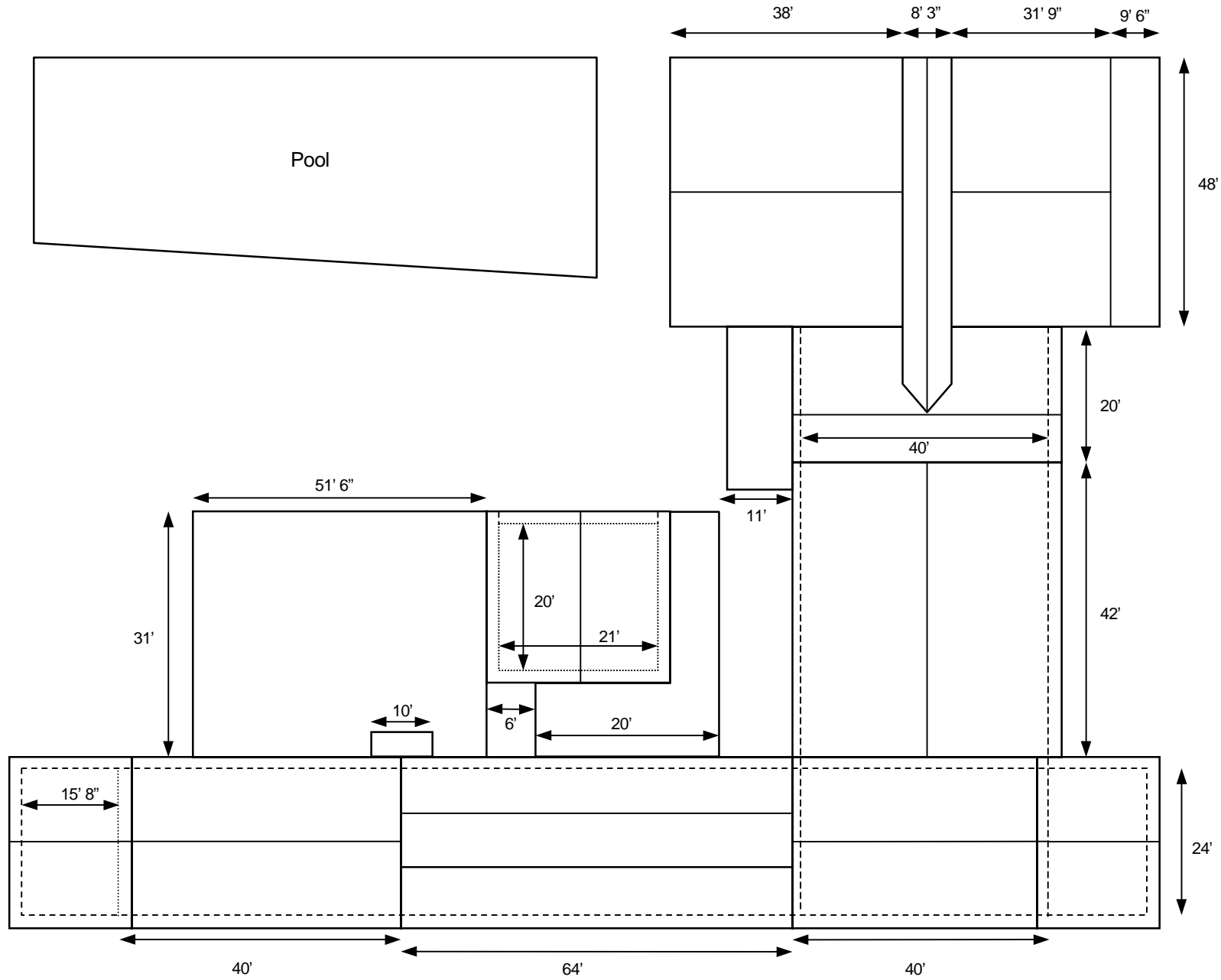
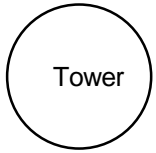

Not to Scale

All Dimensions ± 8"

MOUNT CARMEL COMPOUND

VDS (UK) Proprietary

Image Number 6-21

Calibration Object	Pixel Count	x1	y1	x2	y2	Pixel Distance	Calibration Distance (m)	Object Distance (m)	Pixel Gradient (deg)	Object Distance (ft)
CEV Width		3267	2623	3481	2644	215.028	3.631	0.0168862	-5.605	
Building Side										
White										
Centre		1986	2315	3134	2370	1149.317		19.41	-2.743	63.7
Block R		3130	2255	3851	2283	721.543		12.18	-2.224	40.0
Tower R		3851	2283	4140	2294	289.209		4.88	-2.180	16.0
Frontage		972	2363	4141	2503	3172.091		53.56	-2.530	175.7

Image Number 6-26

Calibration Object	Pixel Count	x1	y1	x2	y2	Pixel Distance	Calibration Distance (m)	Object Distance (m)	Pixel Gradient (deg)	Object Distance (ft)
CEV Length (Gym)		5211	2760	5599	2793	389.401	6.976	0.0179147	-4.861	
CEV Length		1964	2525	2315	2588	356.609	6.976	0.019562	-10.176	
Bradley Width		952	2706	1124	2706	172.000	3.61	0.0209884	0.000	
Building Side										
Red										
Tower		2773	2744	3191	2775	419.148		7.51	-4.241	24.6
Chapel		3246	2753	3963	2806	718.956		12.88	-4.228	42.3
Block		3963	2806	4310	2816	347.144		6.22	-1.651	20.4
Gym		4243	3064	5089	3128	848.417		15.20	-4.326	49.9
Walkway		4235	2541	5190	2608	957.347		17.15	-4.013	56.3

Image Number 6-15

Calibration Object	Pixel Count	x1	y1	x2	y2	Pixel Distance	Calibration Distance (m)	Object Distance (m)	Pixel Gradient (deg)	Object Distance (ft)
CEV Length		1242	3210	1647	3126	413.619	6.976	0.0168657	11.717	
Building Side										
Red										
Red Tower		2349	3663	2796	3615	449.570		7.58	6.129	24.9
Chapel										Not measurable
Block		3530	3460	3899	3430	370.218		6.24	4.648	20.5
Gym		3979	3723	4870	3656	893.516		15.07	4.300	49.4
Main Tower		2805	2934	3165	2907	361.011		6.09	4.289	20.0
Green Tower		1979	2023	2403	1986	425.611		7.18	4.987	23.6
										Corrected 6.08 19.9
										Corrected 14.67 48.1
										In plane of CEV
										Corrected 7.38 24.2

MOUNT CARMEL COMPOUND

VDS (UK) Proprietary

Image Number 6-1

Calibration Object	Pixel Count	x1	y1	x2	y2	Pixel Distance	Calibration Distance (m)	Object Distance (m)	Pixel Gradient (deg)	Object Distance (ft)
CEV Width		3339	2628	3517	2649	179.234	3.631	0.0202584	-6.729	
Gym Flat Section		2333	2224	2476	2235	143.422		2.91	-4.399	9.5
Building Side		2476	2235	2953	2277	478.845		9.70	-5.032	31.8
Black		2964	2166	3090	2183	127.142		2.58	-7.684	8.5
Walkway		2809	1844	3399	1882	591.222		11.98	-3.685	39.3
Chapel Width		3771	1722	4083	1754	313.637		6.35	-5.856	20.8
Main Tower		3683	1752	3767	1751	84.006		1.70	0.682	5.6
Cooler		4083	1785	4856	1854	776.073		15.72	-5.101	51.6
Café		4334	1539	4480	1554	146.769		2.97	-5.866	9.8
Café Roof Stairwell		5018	1498	5247	1526	230.705		4.67	-6.971	15.3
Tower Red										

Image Number 5-25

Medium Oblique

Calibration Object	Pixel Count	x1	y1	x2	y2	Pixel Distance	Calibration Distance (m)	Object Distance (m)	Pixel Gradient (deg)	Object Distance (ft)
CEV Width		4012	3343	4240	3361	228.709	3.631	0.015876	-4.514	
Building Side		2470	3007	2764	3014	294.083		4.67	-1.364	15.3
White		2764	3072	3546	3104	782.654		12.43	-2.343	40.8
Block L		3552	3227	4793	3297	1242.973		19.73	-3.228	64.7
Centre		4793	3177	5582	3214	789.867		12.54	-2.685	41.1
Block R		5581	3156	5899	3170	318.308		5.05	-2.521	16.6
Tower R		4017	2664	4427	2693	411.024		6.53	-4.046	21.4
Main Tower (top)		4922	2442	5697	2466	775.372		12.31	-1.774	40.4
Chapel (length)		2470	3263	5901	3452	3436.202		54.55	-3.153	179.0
Frontage										
Cross Check (sum of parts)										54.42

Image Number FBI0650080

Low oblique

Calibration Object	Pixel Count	x1	y1	x2	y2	Pixel Distance	Calibration Distance (m)	Object Distance (m)	Pixel Gradient (deg)	Notes	Object Distance (ft)
Tower		114	1802	666	1804	552.004	7.38	0.0133695	-0.208		24.2
Main Tower		922	1264	1365	1259	443.028	6.09	0.0137463	0.647		20.0
Building Side		662	1678	1632	1667	970.062		12.97	0.650		42.4
Red		1634	1547	2093	1585	460.570		6.16	-4.733		
Block		2103	2052	3220	2061	1117.036		14.93	-0.462		48.8
Gym											
Walkway to Tower		670	1070	924	1069	254.002		3.49	0.226		
Café Depth		669	1362	1364	1371	695.058		9.55	-0.742		

MOUNT CARMEL COMPOUND

Image Number	FBI0650078	Low oblique				Pixel	Calibration	Object	Pixel	Object	Object
Calibration Object	Pixel Count	x1	y1	x2	y2	Distance	Distance	Distance	Gradient	Notes	Distance
Walkway		1213	1535	1432	1532	219.021	(m)	(m)	(deg)		(ft)
Building Side	Gym 'Flat'	150	1748	391	1747	241.002		2.75	0.238		9.0
Black	Gym Left	391	1747	1224	1744	833.005		9.51	0.206		31.2
	Gym Right	1428	1742	2462	1731	1034.059		11.80	0.610		38.7
Gymnasium Windows	Window Width 1	557	1851	606	1853	49.041		0.56	-2.337		1.8
	Window Spacing 1	606	1853	707	1850	101.045		1.15	1.701		3.8
	Window Width 1	707	1850	763	1850	56.000		0.64	0.000		2.1
	Window Spacing 2	763	1850	865	1848	102.020		1.16	1.123		3.8
	Window Width 2	865	1848	917	1847	52.010		0.59	1.102		1.9
	Window Spacing 3	917	1847	1019	1846	102.005		1.16	0.562		3.8
	Window Width 3	1019	1846	1071	1847	52.010		0.59	-1.102		1.9
	Window Spacing 4	1071	1847	1172	1846	101.005		1.15	0.567		3.8
	Window Width 4	1172	1846	1226	1845	54.009		0.62	1.061		2.0
	Window Spacing 5	1226	1845	1329	1844	103.005		1.18	0.556		3.9
	Window Width 5	1329	1844	1381	1844	52.000		0.59	0.000		1.9
	Window Spacing 6	1381	1844	1483	1843	102.005		1.16	0.562		3.8
	Window Width 6	1483	1843	1533	1845	50.040		0.57	-2.291		1.9
	Window Spacing 7	1533	1845	1639	1845	106.000		1.21	0.000		4.0
	Window Width 7	1639	1845	1689	1846	50.010		0.57	-1.146		1.9
	Window Spacing 8	1691	1846	1792	1843	101.045		1.15	1.701		3.8
	Window Width 8	1792	1843	1842	1843	50.000		0.57	0.000		1.9
	Window Spacing 9	1842	1843	1946	1842	104.005		1.19	0.551		3.9
	Window Width 9	1946	1842	1997	1841	51.010		0.58	1.123		1.9
	Window Spacing 10	1997	1841	2101	1843	104.019		1.19	-1.102		3.9
	Window Width 10	2101	1843	2151	1838	50.249		0.57	5.711		1.9
	Window Spacing 11	2151	1838	2253	1837	102.005		1.16	0.562		3.8
	Window Width 11	2253	1837	2302	1837	49.000		0.56	0.000		1.8
	Walkway Window	1293	1620	1360	1620	67.000		0.76	0.000		2.5

MOUNT CARMEL COMPOUND

VDS (UK) Proprietary

Image Number		Low oblique					Calibration	Object	Pixel		Object
Calibration Object	Pixel Count	x1	y1	x2	y2	Pixel Distance	Distance (m)	Distance (m)	Gradient (deg)	Notes	Distance (ft)
White Frontage		547	949	4809	918	4262.113	53.56	0.0125665	0.417		175.7
Building Side	Upper Window 1	2087	992	2141	995	54.083		0.68	-3.180		2.2
Black	Lower Window 1	2087	1153	2143	1151	56.036		0.70	2.045		2.3
	Lean-to	3475	1034	3534	1034	59.000		0.74	0.000		2.4
	Window 2	3627	982	3679	983	52.010		0.65	-1.102		2.1
	Window Spacing	3679	983	3869	979	190.042		2.39	1.206		7.8
	Window 3	3869	979	3924	981	55.036		0.69	-2.083		2.3
	Window Spacing	3924	981	4161	980	237.002		2.98	0.242		9.8
	Window 4	4161	980	4213	980	52.000		0.65	0.000		2.1
	Window Spacing	4213	980	4450	955	238.315		2.99	6.022		9.8
	Window 5	4450	955	4506	955	56.000		0.70	0.000		2.3
Image Number		Low oblique					Calibration	Object	Pixel		Object
Calibration Object	Pixel Count	x1	y1	x2	y2	Pixel Distance	Distance (m)	Distance (m)	Gradient (deg)	Notes	Distance (ft)
Red Tower		113	1801	666	1804	553.008	7.38	0.0133452	-0.311		24.2
Main Tower (bottom)		925	1141	1368	1143	443.005	6.09	0.013747	-0.259		20.0
Main Tower (top)		925	762	1373	762	448.000	6.09	0.0135938	0.000		20.0
Building Side	Upper Window 1	220	1531	267	1531	47.000		0.63	0.000		2.1
Red	Middle Window 1	217	1708	266	1710	49.041		0.65	-2.337		2.1
	Lower Window 1	213	1851	269	1855	56.143		0.75	-4.086		2.5
	Upper Window Spacing	267	1531	509	1534	242.019		3.23	-0.710		10.6
	Upper Window 2	509	1534	556	1533	47.011		0.63	1.219		2.1
	Middle Window Spacing	266	1710	508	1667	245.791		3.28	10.075		10.8
	Middle Window 2	508	1667	555	1668	47.011		0.63	-1.219		2.1
	Lower Window Spacing	269	1855	504	1858	235.019		3.14	-0.731		10.3
	Lower Window 2	504	1858	561	1856	57.035		0.76	2.010		2.5
	Chapel Window 1	860	1737	917	1737	57.000		0.76	0.000		2.5
	Window Spacing	917	1737	1135	1735	218.009		2.91	0.526		9.5
	Chapel Window 2	1135	1735	1191	1713	60.166		0.80	21.448		2.6
	Window Spacing	1191	1735	1408	1735	217.000		2.90	0.000		9.5
	Chapel Window 3	1408	1712	1465	1714	57.035		0.76	-2.010		2.5
	Window Spacing	1465	1714	1678	1721	213.115		2.84	-1.882		9.3
	Lower Window	1678	1721	1741	1723	63.032		0.84	-1.818		2.8
	Double Window L	1747	1567	1807	1569	60.033		0.80	-1.909		2.6
	Double Window R	1822	1568	1880	1569	58.009		0.77	-0.988		2.5
	Upper Tower Window	1014	835	1064	839	50.160		0.68	-4.574		2.2
	Middle Tower Window	1231	1007	1279	1008	48.010		0.66	-1.193		2.2
	Lower Tower Window	1014	1191	1062	1189	48.042		0.66	2.386		2.2

HEIGHTING

VDS (UK) Proprietary

Image Number **4476 + Various**

Calibration Object	Pixel Count	x1	y1	x2	y2	Pixel Distance	Calibration Distance (m)	Object Distance (m)	Pixel Gradient (deg)
Block R Width	76	95	523	91	447.018	12	0.026845		0.513
Building Side White	Block R Height	372	270	375	79	191.024		5.13	89.100
	Central Block Base	76	269	79	168	101.045		2.71	88.299
	Central Block Upper storey	79	168	76	76	92.049		2.47	-88.132

Image Number **4358**

Calibration Object	Pixel Count	Number of Planks	Pixel Distance	Calibration Distance (m)	Object Distance (m)	Object Distance (ft)	Pixel Gradient (deg)	Notes
Using Shiplap Planks	Panelled Door on Café Shiplap Panel		0.000	1.98				Assumed to be a 6' 6" door 11 panels to height of door
				0.18094				
	Café Frontage	14			2.53	8.31		Height above Bunker
	Main Tower	44			7.96	26.12		
	Outhouse	13			2.35	7.72		
	Café Roof	4			0.72	2.37		
	Passage to Tower	14			2.53	8.31		
	Extension over Café	7			1.27	4.16		
	Accom Block	27			4.89	16.03		
	Red Tower	42			7.60	24.93		

Image Number **4358**

Calibration Object	Pixel Count	x1	y1	x2	y2	Pixel Distance	Calibration Distance (m)	Object Distance (m)	Pixel Gradient (deg)	Notes
Block R Height	156	224	159	103	121.037	5.13	0.042367		88.580	
Building Side White	Red Tower	268	225	267	43	182.003		7.71		

ROOM VOLUMES

All linear dimensions in FEET.

All dimensions are exterior

Wall thicknesses have been neglected

1st Floor

Men's quarters

Room	1	2	3	4	5	6	7	8	9	10	11	12	13	14	15
Breadth (ft)	55.77			48			3			9.5			16		
Depth (ft)	24			9			4.5			9			9		
Area (sq ft)	1338.48			432			13.5			85.5			144		
Height (ft)	8			8			8			8			8		
Volume (cubic feet)	10707.84			3456			108			684			1152		

Room	16	17	18	19	20	21	22	23	24	25	26	27	28	29	30	Foyer/Lounge/Corridor
Breadth (ft)	17	17	16	16	40	10	40	26	48	9.5	51.5	20	14	20	21	40
Depth (ft)	9	9	9	14.9	42	6	20	10	78	48	31	21	6	6	11	15
Area (sq ft)	153	153	144	298.4	1680	60	740	260	3744	456	1596.5	336	84	120	231	1137
Height (ft)	8	8	8	8	10.8	8.8	8.8	6.7	12	8	8	8	8	8	8	8
Volume (cubic feet)	1224	1224	1152	2387.2	18144	528	6512	1742	44928	3648	12772	2688	672	960	1848	9096

Total Volume 19671.84 cubic feet 728.5867 cubic yards

2nd Floor

Women's Quarters

Room	31	32	33	34	35	36	37	38	39	40	41	42	43	44	45
Breadth (ft)	9.77	11.5	11.5	11.5	11.5	9.77	11.5	11.5	11.5	7.5	10.5	10.5	10.5	10.5	10.5
Depth (ft)	9	9	9	9	9	9	9	9	9	9	8	8	8	8	8
Area (sq ft)	87.93	103.5	103.5	103.5	103.5	87.93	103.5	103.5	103.5	67.5	84	84	84	84	84
Height (ft)	8	8	8	8	8	8	8	8	8	8	8	8	8	8	8
Volume (cubic feet)	703.44	828	828	828	828	703.44	828	828	828	540	672	672	672	672	672

Room	46	47	48	49	50	51	52	53	54	55	56	Corridors
Breadth (ft)	10.5	9	20	20	12	12	10	20	16	20	48	178
Depth (ft)	8	8	12	12	16	16	10	21	10	30	8.25	5
Area (sq ft)	104	72	240	240	192	192	100	320	176	600	396	890
Height (ft)	8	8	8	8	8	8	8	8	8	8	8.5	8
Volume (cubic feet)	832	576	1920	1920	1536	1536	800	2560	1408	4800	3366	7120

Total Volume 11102.88 cubic feet 411.2178 cubic yards

3rd Floor

Women's Quarters

Room	57	58	59
Breadth (ft)	20	24	24
Depth (ft)	21	15.75	15.75
Height (ft)	8	8	8
Volume (cubic feet)	3360	3024	3024

Total Volume 9408 cubic feet 348.4444 cubic yards

4th Floor

David Koresh's Quarters

Room	60
Breadth (ft)	20
Depth (ft)	21
Height (ft)	8
Volume (cubic feet)	3360

Total Volume 3360 cubic feet 124.4444 cubic yards

Total Volume 43543 cubic feet 1612.7 cubic yards

- Notes
1. These areas/volumes are estimated using the floorplan laid out by previous testament and are not supplied solely by VDS (UK) Ltd
 2. The room volumes are calculated without roofspace.
 3. Not all voids and stairwells have been included.

HEIGHTING

VDS (UK) Proprietary

Image Number 650077

Calibration Object	Pixel Count	x1	y1	x2	y2	Pixel Distance	Calibration Distance (m)	Object Distance (m)	Pixel Gradient (deg)	Notes
Building Side	Red Tower Height	486	783	485	698	85.006	7.71	0.09071	-89.326	
Red	Chapel Height	706	766	705	730	36.014		3.27		
	Block R	706	766	705	702	64.008		5.81		
	Gym Height	935	790	934	749	41.012		3.72		

Image Number 650078

Calibration Object	Pixel Count	x1	y1	x2	y2	Pixel Distance	Calibration Distance (m)	Object Distance (m)	Pixel Gradient (deg)	Notes
Building Side	Gym Height	335	642	334	601	41.012	3.72	0.09071	-1.546	
Red	Walkway Height	334	601	334	578	23.000		2.09		
	Main Tower	552	575	551	469	106.005		9.62		For comparison
	Red Tower	251	550	249	473	77.026		6.99		
	Walkway Roof Pitch	347	577	347	565	12.000		1.09		

Image Number 4476

Calibration Object	Pixel Count	x1	y1	x2	y2	Pixel Distance	Calibration Distance (m)	Object Distance (m)	Pixel Gradient (deg)	Notes
Building Side	Block R Width	73	95	521	92	448.010	12	0.026785	0.384	
White	Kitchen Roof	73	166	74	131	35.014		0.94	88.363	
	Kitchen Upper Roof	74	81	73	53	28.018		0.75	-87.955	
	Block R Roof	521	75	520	31	44.011		1.18	-88.698	
Tower	10 Shiplap Planks	333	21			333.6615		1.8094		
		810	41			811.037		4.398141		
		477	27			477.7635		2.53316		
								1.69757		

WINDOWS

VDS (UK) Proprietary

Image Number **FBI-OSC-00002801**

Calibration Object	Pixel Count	x1	y1	x2	y2	Pixel Distance	Calibration Distance (ft)	Object Distance (ft)	Notes
	Tower Height	1179	2814	1122	1226	1589.023	26.1	0.01643	
Building Side Black	Tower Base Window	310	2661	301	2410	251.161		4.13	4' 1"
	Height from Base	310	2837					2.89	2' 11"
Main Tower	Tower Middle Window	886	2105	875	1854	251.241		4.13	4' 1"
	Height from Base							11.65	11' 8"
	Tower Upper Window	264	1579	259	1329	250.050		4.11	4' 1"
	Height from Base	310	2837					20.66	20' 8"
Accommodation Block	Stairwell	3215	2587	3204	2438	149.405		2.45	2' 5"
	Bridge to Tower	1782	2570	1778	2426	144.056		2.37	2' 4"
	Accommodation Corridor Left	3616	2513	3616	2364	149.000		2.45	2' 5"
	Accommodation Corridor Middle	4162	2497	4156	2348	149.121		2.45	2' 5"
	Accommodation Corridor Right	4832	2486	4828	2335	151.053		2.48	2' 5"

Image Number **FBI0650080**

Calibration Object	Pixel Count	x1	y1	x2	y2	Pixel Distance	Calibration Distance (ft)	Object Distance (ft)	Notes
	Tower Height	439	2306	442	1730	576.008	26.1	0.04531	
Building Side Red	Tower Lower Left Window	555	2227	556	2138	89.006		4.03	
	Tower Lower Right Window	833	2223	834	2134	89.006		4.03	
White/Red Tower	Base Height							3.76	3' 9" Height of base of window
	Tower Middle Left Window	550	2041	556	1951	90.200		4.09	
	Tower Middle Right Window	847	2037	847	1946	91.000		4.12	
	Base Height							12.19	12' 2" Height of base of window
	Tower Upper Left Window	549	1862	554	1773	89.140		4.04	
	Tower Upper Right Window	845	1857	844	1769	88.006		3.99	
	Base Height							20.12	20' 1" Height of base of window
	Average height							4.05	4'

Note. Due to the scale of the image, all windows can be assumed to be of equal height.

WINDOWS

Calibration Object	Pixel Count	x1	y1	x2	y2	Pixel Distance	Calibration Distance (ft)	Object Distance (ft)
	Stage/Gunroom	2018	2190	2018	1761	429.000	19	0.04429
Building Side								
Red	Chapel Window	2026	2109	2023	1971	138.033		6.11 6' 1"
	Height from Base							3.59 3' 7"
Chapel	Upper Window	2093	1873	2084	1784	89.454		3.96 4'
	Height from Base							14.04 14'
Image Number	FBI1050792							

Calibration Object	Pixel Count	x1	y1	x2	y2	Pixel Distance	Calibration Distance (ft)	Object Distance (ft)
	Right Block	1148	575	1150	143	432.005	24.9	0.05764
Building Side								
White	Middle Left Upper Window	819	388	819	321	67.000		3.86 3' 10"
	Height from Base	819	570					10.49 10' 6"
	Left Upper Window	657	386	657	319	67.000		3.86 3' 10"
Right Block	Middle Right Upper	984	388	984	321	67.000		3.86 3' 10"
	Right Upper	1183	388	1183	320	68.000		3.92 3' 11"
	Left Lower	653	523	653	457	66.000		3.80 3' 10"
	Height from Base	651	567					2.54 2' 6"
	Right Lower	982	526	982	460	66.000		3.80 3' 10"
	Height from Base							
Central Section	Middle Right Lower Window	89	518	91	451	67.030		3.86 3' 10"
	Height from Base	90	564					2.65 2' 8"
	Right Lower Window	344	522	346	455	67.030		3.86 3' 10"
	Height from Base	342	566					2.54 2' 6"
	Right Upper Window	441	368	440	332	36.014		2.08 2' 1"
	2nd Right	281	368	282	332	36.014		2.08 2' 1"

Calibration Object	Pixel Count	x1	y1	x2	y2	Pixel Distance	Calibration Distance (ft)	Object Distance (ft)
	Gym Height	1124	800	1116	475	325.098	12.1	0.03722
Building Side								
Black	Leftmost Window	469	605	467	544	61.033		2.27 2' 3"
	Height from Base	471	804					7.41 7' 5"
	5th from left Window	1085	598	1086	539	59.008		2.20 2' 2"
Gym	Height from Base	1085	800			1348.045		7.52 7' 6"
	Rightmost Window	2167	590	2163	529	61.131		2.28 2' 3"
	Height from Base	2163	792			2303.439		7.52 7' 6"
	Walkway Window	1213	373	1211	308	65.031		2.42 2' 5"
	Height from Base	1213	800			1453.055		15.89 15' 11"

BUILDING VOLUMES

Calculated Volume

	Width (ft)	Depth (ft)	Height (ft)	Volume (cubic feet)
Mainspace				
Main Tower	20	21	26.1	10962.0
Tower L	15.75	24	24.9	9412.2
Block L	40	24	16	15360.0
Accommodation Lower Floor	64	24	8	12288.0
Accommodation Upper Floor	64	16	8	8192.0
Block R	40	24	16	15360.0
Tower R	15.75	24	24.9	9412.2
Chapel	42	40	10.8	18144.0
Bedroom/Gunroom	20	40	19	15200.0
Lean-to	25	11	6.9	1897.5
Gym	86.3	48	12.1	50123.0
Walkway	8.2	48	2.1	826.6
Café and Tower Base	77.5	31	8.2	19700.5
Passage to Tower	11	9.8	8	862.4
Stairwell over Café	9.8	6	4.2	247.0
			Volume	187987.4

Error Calculation
Maximum Volume

	Width (ft)	Depth (ft)	Height (ft)	Volume (cubic feet)
	20.5	21.5	26.6	11724.0
	16.25	24.5	25.4	10112.4
	40.5	24.5	16.5	16372.1
	64.5	24.5	8.5	13432.1
	64.5	16.5	8.5	9046.1
	40.5	24.5	16.5	16372.1
	16.25	24.5	25.4	10112.4
	42.5	40.5	11.3	19450.1
	20.5	40.5	19.5	16189.9
	25.5	11.5	7.4	2170.1
	86.8	48.5	12.6	53043.5
	8.7	48.5	2.6	1097.1
	78	31.5	8.7	21375.9
	11.5	10.3	8.5	1006.8
	10.3	6.5	4.7	314.7
			Max Volume	201819.2

Minimum Volume

	Width (ft)	Depth (ft)	Height (ft)	Volume (cubic feet)
	19.5	20.5	25.6	10233.6
	15.25	23.5	24.4	8744.4
	39.5	23.5	15.5	14387.9
	63.5	23.5	7.5	11191.9
	63.5	15.5	7.5	7381.9
	39.5	23.5	15.5	14387.9
	15.25	23.5	24.4	8744.4
	41.5	39.5	10.3	16884.3
	19.5	39.5	18.5	14249.6
	24.5	10.5	6.4	1646.4
	85.8	47.5	11.6	47275.8
	7.7	47.5	1.6	585.2
	77	30.5	7.7	18083.5
	10.5	9.3	7.5	732.4
	9.3	5.5	3.7	189.3
			Min Volume	174718.2

	Width (ft)	Depth (ft)	Height (ft)	Volume (cubic feet)
Roofspace				
Main Tower	20	21	1	210.0
Tower L	15.75	24	1	189.0
Block L	40	24	1	480.0
Accommodation Lower Floor	64	24	3.3	2534.4
Accommodation Upper Floor	64	16	3	1536.0
Block R	40	24	4	1920.0
Tower R	15.75	24	1	189.0
Chapel	42	40	5.3	4452.0
Stage/Bedroom	20	40	3.3	1320.0
Lean-to	25	11	1.6	220.0
Gym R	31.8	48	6.9	5266.1
Gym L	38	48	6.9	6292.8
Walkway	8.2	48	3.3	649.4
Café	51.5	31	2.3	1836.0
Passage to Tower	Assumed Flat			
Stairwell over Café	9.8	6	0.7	20.6
			Roof Volume	27115.3

	Width (ft)	Depth (ft)	Height (ft)	Volume (cubic feet)
	20.5	21.5	1.5	330.6
	16.25	24.5	1.5	298.6
	40.5	24.5	1.5	744.2
	64.5	24.5	3.8	3002.5
	64.5	16.5	3.5	1862.4
	40.5	24.5	4.5	2232.6
	16.25	24.5	1.5	298.6
	42.5	40.5	5.8	4991.6
	20.5	40.5	3.8	1577.5
	25.5	11.5	2.1	307.9
	32.3	48.5	7.4	5796.2
	38.5	48.5	7.4	6908.8
	8.7	48.5	3.8	801.7
	52	31.5	2.8	2293.2
	10.3	6.5	1.2	40.2
			Max Roof Volume	31486.6

	Width (ft)	Depth (ft)	Height (ft)	Volume (cubic feet)
	19.5	20.5	0.5	99.9
	15.25	23.5	0.5	89.6
	39.5	23.5	0.5	232.1
	63.5	23.5	2.8	2089.2
	63.5	15.5	2.5	1230.3
	39.5	23.5	3.5	1624.4
	15.25	23.5	0.5	89.6
	41.5	39.5	4.8	3934.2
	19.5	39.5	2.8	1078.4
	24.5	10.5	1.1	141.5
	31.3	47.5	6.4	4757.6
	37.5	47.5	6.4	5700.0
	7.7	47.5	2.8	512.1
	51	30.5	1.8	1400.0
	9.3	5.5	0.2	5.1
			Min Roof Volume	22983.8

Total Volume	215102.6
Max Volume	233305.8
Min Volume	197702.0

Building Volume	187987.4	+/-	13550.505	Cubic Metres
Roof Volume	27115.3	+/-	4251.36	Cubic Metres

Total Volume: 215103 +/- 17802 Cubic Feet

7967 +/- 659 Cubic Yards

Notes

1. This is the original volume of the un-damaged building.
2. This calculation does not allow for lost space due to the fabric of the building
3. Some assumptions have been made about internal layout
4. In order to calculate internal volume, some knowledge of the inner fabric would be required.

BUILDING VOLUMES

**Error Calculation
Maximum Volume**

Minimum Volume

Calculated Volume

	Width (ft)	Depth (ft)	Height (ft)	Volume (cubic feet)
Mainspace				
Main Tower	20	21	26.1	10962.0
Tower L	15.75	24	24.9	9412.2
Block L	40	24	16	15360.0
Accommodation Lower Floor	64	24	8	12288.0
Accommodation Upper Floor	64	16	8	8192.0
Block R	40	24	16	15360.0
Tower R	15.75	24	24.9	9412.2
Chapel	42	40	10.8	18144.0
Bedroom/Gunroom	20	40	19	15200.0
Lean-to	25	11	6.9	1897.5
Gym	86.3	48	12.1	50123.0
Walkway	8.2	48	2.1	826.6
Café and Tower Base	77.5	31	8.2	19700.5
Passage to Tower	11	9.8	8	862.4
Stairwell over Café	9.8	6	4.2	247.0
Volume				187987.4

	Width (ft)	Depth (ft)	Height (ft)	Volume (cubic feet)
	20.5	21.5	26.6	11724.0
	16.25	24.5	25.4	10112.4
	40.5	24.5	16.5	16372.1
	64.5	24.5	8.5	13432.1
	64.5	16.5	8.5	9046.1
	40.5	24.5	16.5	16372.1
	16.25	24.5	25.4	10112.4
	42.5	40.5	11.3	19450.1
	20.5	40.5	19.5	16189.9
	25.5	11.5	7.4	2170.1
	86.8	48.5	12.6	53043.5
	8.7	48.5	2.6	1097.1
	78	31.5	8.7	21375.9
	11.5	10.3	8.5	1006.8
	10.3	6.5	4.7	314.7
Max Volume				201819.2

	Width (ft)	Depth (ft)	Height (ft)	Volume (cubic feet)
	19.5	20.5	25.6	10233.6
	15.25	23.5	24.4	8744.4
	39.5	23.5	15.5	14387.9
	63.5	23.5	7.5	11191.9
	63.5	15.5	7.5	7381.9
	39.5	23.5	15.5	14387.9
	15.25	23.5	24.4	8744.4
	41.5	39.5	10.3	16884.3
	19.5	39.5	18.5	14249.6
	24.5	10.5	6.4	1646.4
	85.8	47.5	11.6	47275.8
	7.7	47.5	1.6	585.2
	77	30.5	7.7	18083.5
	10.5	9.3	7.5	732.4
	9.3	5.5	3.7	189.3
Min Volume				174718.2

	Width (ft)	Depth (ft)	Height (ft)	Volume (cubic feet)
Roofspace				
Main Tower	20	21	1	210.0
Tower L	15.75	24	1	189.0
Block L	40	24	1	480.0
Accommodation Lower Floor	64	24	3.3	2534.4
Accommodation Upper Floor	64	16	3	1536.0
Block R	40	24	4	1920.0
Tower R	15.75	24	1	189.0
Chapel	42	40	5.3	4452.0
Stage/Bedroom	20	40	3.3	1320.0
Lean-to	25	11	1.6	220.0
Gym R	31.8	48	6.9	5266.1
Gym L	38	48	6.9	6292.8
Walkway	8.2	48	3.3	649.4
Café	51.5	31	2.3	1836.0
Passage to Tower	Assumed Flat			
Stairwell over Café	9.8	6	0.7	20.6
Roof Volume				27115.3

	Width (ft)	Depth (ft)	Height (ft)	Volume (cubic feet)
	20.5	21.5	1.5	330.6
	16.25	24.5	1.5	298.6
	40.5	24.5	1.5	744.2
	64.5	24.5	3.8	3002.5
	64.5	16.5	3.5	1862.4
	40.5	24.5	4.5	2232.6
	16.25	24.5	1.5	298.6
	42.5	40.5	5.8	4991.6
	20.5	40.5	3.8	1577.5
	25.5	11.5	2.1	307.9
	32.3	48.5	7.4	5796.2
	38.5	48.5	7.4	6908.8
	8.7	48.5	3.8	801.7
	52	31.5	2.8	2293.2
	10.3	6.5	1.2	40.2
Max Roof Volume				31486.6

	Width (ft)	Depth (ft)	Height (ft)	Volume (cubic feet)
	19.5	20.5	0.5	99.9
	15.25	23.5	0.5	89.6
	39.5	23.5	0.5	232.1
	63.5	23.5	2.8	2089.2
	63.5	15.5	2.5	1230.3
	39.5	23.5	3.5	1624.4
	15.25	23.5	0.5	89.6
	41.5	39.5	4.8	3934.2
	19.5	39.5	2.8	1078.4
	24.5	10.5	1.1	141.5
	31.3	47.5	6.4	4757.6
	37.5	47.5	6.4	5700.0
	7.7	47.5	2.8	512.1
	51	30.5	1.8	1400.0
	9.3	5.5	0.2	5.1
Min Roof Volume				22983.8

Total Volume	215102.6
Max Volume	233305.8
Min Volume	197702.0

Building Volume	187987.4	+/-	13550.505	Cubic Metres
Roof Volume	27115.3	+/-	4251.36	Cubic Metres

Total Volume: 215103 +/- 17802 Cubic Feet

7967 +/- 659 Cubic Yards

Notes

1. This is the original volume of the un-damaged building.
2. This calculation does not allow for lost space due to the fabric of the building
3. Some assumptions have been made about internal layout
4. In order to calculate internal volume, some knowledge of the inner fabric would be required.

IMAGERY INTERPRETABILITY RATING SCALES (IIRS)

An imagery interpretability scale is a tool used by people to make and communicate quantitative judgments about the potential interpretability of an image. The aerial imaging community utilizes the Imagery Interpretability Rating Scale (IIRS) to define and measure the quality of images and performance of imaging systems. Through a process referred to as "rating" an image, the IIRS is used by imagery analysts to assign a number, which indicates the interpretability of a given image.

The IIRS concept provides a means to directly relate the quality of an image to the interpretation tasks for which it may be used. Although the IIRS has been primarily applied in the evaluation of aerial imagery, it provides a systematic approach to measuring the quality of photographic or digital imagery, the performance of image capture devices, and the effects of image processing algorithms.

Background and Objective

The need to measure the quality or usefulness of an image is fundamental to the design and operation of imaging systems. A scale was designed to overcome the drawbacks of resolution. The IIRS is used by imagery analysts to assign a numerical rating to quantify the interpretability of an image. Interpretability is defined as a measure of how useful an image is for analysis or exploitation purposes. The IIRS provides a common scale, which can be used with different imaging systems. Studies and experience have shown that IIRS ratings by trained imagery analysts are accurate and precise. These ratings are made using typical scene content where no special test targets are required.

The IIRS provides a unique tool to objectively measure the subjective quantity of image interpretability. It is used for a variety of purposes within the aerial imaging community; however, its application outside that community has been limited.

IIRS Definition

The IIRS is composed of 10 rating levels, from 0 to 9, the higher the IIRS rating, the higher the imagery interpretability. To define the interpretability at a specific IIRS level, textual descriptors, referred to as IIRS criteria, are used. IIRS criteria are descriptions of common interpretation tasks that can be performed by an imagery analyst. In total, 55 criteria comprise the 10 IIRS levels; six criteria each at levels 1 through 9 and a single criterion at IIRS 0. The use of multiple criteria at each IIRS level is in part due to specialties by which imagery analysts have traditionally been organized, for example by air, electronics, ground, missile and naval categories. By having several criteria, an individual familiar with a particular criterion has other references to help understand the intended interpretability of that IIRS level. Because the IIRS criteria fall into categories related to military equipment, an airfield image, for example, is not likely to have examples of naval criteria present. To improve the possibility of specific IIRS criteria being present in an image, a cultural or non-military IIRS category provides examples of civilian equipment which may be seen in imagery more frequently than specific military content.

Rating an Image with the IIRS

The IIRS criteria are used as a reference to quantify, or rate, the interpretability of an image. To rate an image as a IIRS 5, for example, an imagery analyst must be able to accomplish all the IIRS 4 criteria and at least one IIRS 5 criterion. Conceptually, the

analyst must judge that the physical attributes or quality of the image are such that each of the IIRS 4 and one IIRS 5 criteria could be exploited. It is not a requirement to have the IIRS criteria present in an image to be rated. Experienced imagery analysts can successfully make IIRS judgments even if the specific criteria content is not present.

A certification process is used to qualify analysts to give IIRS ratings. Imagery that has been rated by a large number of analysts is used for both training and certification. Analysts are instructed in the IIRS procedure and given imagery examples at each IIRS level for familiarisation. A certification test must be passed in which an imagery analyst correctly rates a set of imagery within an acceptable error bound. In practice, imagery analysts often rate imagery without direct reference to the criteria listings. With experience, analysts establish an internal sense of the IIRS and can provide ratings consistent with their peers.

Image-Based IIRS

IIRS is defined by the 55 criteria, which comprise the scale. However, imagery examples which have been previously rated can also provide a means to rate imagery. Calibrated images spaced at uniform IIRS increment function as a visual reference to which test imagery may be compared. An observer judges the relative position where a test image falls between two calibrated images. A rating for the test image is derived by interpolation using the IIRS values for the calibrated images. Having all images in view facilitates the relative placement of each individual image. Observers are able to make multiple comparisons among images to judge correct placement. Imagery can be scaled on a softcopy display.

IIRS has been used to account for all factors that affect image interpretability. Image scale, measured as photographic scale (film system) or Ground Sample Distance (GSD in an electro-optical system), has a significant impact on the measured interpretability. Scale or GSD alone does not determine the IIRS of an image as sharpness, noise, and contrast also impact the NIIRS. These effects may be due to system characteristics (e.g. optical quality, focal plane performance), acquisition parameters (e.g., sun angle, atmospheric transmission, atmospheric haze), and exploitation conditions (e.g., film duplication, softcopy monitor quality). It is also possible to relate collection and exploitation system characteristics to the IIRS.

By design, the IIRS is independent of any particular imaging system and provides an unbiased measure of image interpretability. Although principally applied to complex aerial imaging systems, the IIRS concept, development methodology, and measurement tools provide developers and users of other imaging systems a statistical process to define and measure performance as it relates to the ultimate use of a system.

Infrared National Imagery Interpretability Rating Scale (NIIRS) –April 1996

RATING LEVEL 0

Interpretability of the imagery is precluded by obscuration, degradation, or very poor resolution.

RATING LEVEL 1

Distinguish between runways and taxiways on the basis of size, configuration or pattern at a large airfield. Detect a large (e.g., greater than 1 square kilometer) cleared area in dense forest. Detect large ocean-going vessels (e.g., aircraft carrier, supertanker, KIROV) in open water. Detect large areas (e.g., greater than 1 square kilometer) of arsh/swamp.

RATING LEVEL 2

Detect large aircraft (e.g., C-141, 707, BEAR, CANDID, CLASSIC). Detect individual large buildings (e.g., hospitals, factories) in an urban area. Distinguish between densely wooded, sparsely wooded and open fields. Identify an SS-25 base by the pattern of buildings and roads. Distinguish between naval and commercial port facilities based on type and configuration of large functional areas.

RATING LEVEL 3

Distinguish between large (e.g., C-141, 707, BEAR, A-300 AIRBUS) and small aircraft (e.g., A-4, FISHBED and L-39). Identify individual thermally active flues between the boiler hall and smoke stacks at a thermal power plant. Detect a large air warning radar site based on the presence of mounds, revetments and security fencing. Detect a driver-training track at a ground forces garrison. Identify individual functional areas (e.g., launch sites, electronics areas, support areas, missile handling area) of a SA-5 launch complex. Distinguish between large (e.g., greater than 200 meter) freighters and tankers.

RATING LEVEL 4

Identify the wing configuration of small fighter aircraft (e.g., FROGFOOT, F-16, FISHBED). Detect a small (e.g., 50 meter square) electrical transformer yard in an urban area. Detect large (e.g., greater than 10-meter diameter) environmental domes at an electronics facility. Detect individual thermally active vehicles in garrison. Detect thermally active SS-25 MSVs in garrison. Identify individual closed cargo hold hatches on large merchant ships.

RATING LEVEL 5

Distinguish between single-tail (e.g., FLOGGER, F-16, TORNADO) and twin-tailed (e.g., F-15, FLANKER, FOXBAT) fighters.

Identify outdoor tennis courts.

Detect armoured vehicles in revetments

Detect a deployed TET (transportable electronics tower) at An SAM site.

Identify the stack shape (e.g., square, round, oval) on large (e.g., greater than 200 meter) merchant ships.

RATING LEVEL 6

Detect wing-mounted stores (i.e., ASM, bombs) protruding from the wings of large bombers (e.g., B-52, BEAR, BADGER). Identify individual THERMALLY active engine vents atop diesel locomotives. Distinguish between a FIX FOUR and FIX SIX site based on antenna pattern and spacing. Distinguish between THERMALLY active tanks and APCS. Distinguish between a 2-rail and 4-rail SA-3 launcher. Identify missile tube Icicles on submarines.

RATING LEVEL 7

Distinguish between round attack and interceptor versions the MIG-23 FLOGGER based on the shape of the nose. Identify automobiles as sedans or- station wagons. Identify antenna dishes (less than 3 meters in diameter.) or/a radio relay tower. Identify the missile transfer crane on a SA-6 transloader. Distinguish between an SA-2/CSA-1 and a SCUD-B missile transporter when missile are not loaded Detect mooring cleats or bollards on piers.

RATING LEVEL 8

Identify the RAM airscoop on the dorsal spine of FISHBED J/K/L. Identify limbs (e.g., arms, legs) on an individual. Identify individual horizontal and vertical ribs on a radar antenna. Detect closed hatches on a [auk turret. Distinguish between fuel and oxidizer Multi-System propellant Transporters based on twin or single fitments on the front of the semi-trailer. Identify individual posts and rails on deck edge life rails.

RATING LEVEL 9

Identify access panels on fighter aircraft. Identify cargo (e.g., shovels, rakes, and ladders) in an open-bed, light-duty truck. Distinguish between BIRDS EYE and BELL LACE antennas based on the presence or absence of small dipole elements. Identify turret hatch hinges on armoured vehicles. Identify individual command guidance strip antennas on an SA-2/CSA-1 missile. Identify individual rungs on bulkhead mounted ladders.