

106328

THE ICE BOOK.

THE
I C E B O O K:
BEING
A COMPENDIOUS & CONCISE HISTORY
OF
EVERYTHING CONNECTED WITH ICE

FROM ITS FIRST INTRODUCTION INTO EUROPE AS AN ARTICLE
OF LUXURY TO THE PRESENT TIME;

WITH AN ACCOUNT OF THE

Artificial Manner of Producing Pure & Solid Ice,

AND

A VALUABLE COLLECTION OF THE MOST APPROVED RECIPES FOR
MAKING SUPERIOR WATER ICES AND ICE CREAMS
AT A FEW MINUTES' NOTICE

BY THOMAS MASTERS.

'Tut! tut! thou art all *ice*,
Thy kindness *freezes*.'

RICHARD III.—*Act IV. Scene 2.*

LONDON:
SIMPKIN, MARSHALL, & CO., STATIONERS' HALL COURT,
LUDGATE STREET.

1844.

CONTENTS.

	PAGE
PREFACE	ix
CHAPTER I.	
Introductory	1
CHAPTER II.	
Ice	13
CHAPTER III.	
Mode of Preserving Ice, &c.	49
CHAPTER IV.	
Freezing Apparatus	67
The Double-motion Machine	72
The Ice Preserver	82

CHAPTER V.

RECIPES.	PAGE
Nesselrode, or Frozen Pudding	85
Custard Ice Cream	86
Strawberry Ice Cream	87
Raspberry Ice Cream	88
Currant Ice Cream	88
Mille-fruit Ice Cream	89
Italian Ice Cream	89
Ratafia Ice Cream	89
Pine-apple Ice Cream	90
Ginger Ice Cream	91
Apricot Ice Cream	91
Lemon Ice Cream	92
Orange Ice Cream	92
Vanilla Ice Cream	92
Brown-bread Ice Cream	93
Plain Ice Cream	94
Pistachio Ice Cream	94
Biscuit Ice Cream	94
Maraschino Ice Cream	95
Noyeau Ice Cream	95
Cinnamon Ice Cream	95
Coffee Ice Cream	96
Howqua's-tea Ice Cream	96
Chocolate Ice Cream	97

RECIPES— <i>continued.</i>	PAGE
Colour	97
Wine Ices	98
Punch Ice	98, 99, 100
Punch à la Romaine	99
Nectar Ice	99
Punch à la Victoria	100
Water Ices	101
Lemon Water Ice	101
Orange Water Ice	102
Grape Water Ice	103
Pine-apple Water Ice	103
Cherry Water Ice	104
Currant Water Ice	104
Vanilla Water Ice	105
Peach Water Ice	105
Strawberry Water Ice	106
Raspberry Water Ice	106
Mille-fruit Water Ice	106
Melon Water Ice	107
Barberry Water Ice	107
Barberry Syrup	107
Apricot Water Ice	108
Apple Water Ice	108
Ginger Water Ice	108
To Clarify Sugar	109

CHAPTER VI.

	PAGE
On Freezing Mixtures	110
Freezing Mixtures with Ice or Snow	120
Freezing Mixtures without Ice	122

APPENDIX.

Raining Ice	132
Ice Market	133
Congelation by the Air-pump	135
Ice in Bengal : Effect of Dew	139
Substitute for Ice	141
Colour of Ice	142
To make a cheap Ice-house or Well	151
Another Ice Well	154
CONCLUSION	159
Certificate from Dr. Ryan	185
Letter from Dr. Radley	187
DESCRIPTION OF THE PLATES	191

P R E F A C E.

A NEW book, like a new acquaintance, requires an introduction before anything like respect can be paid to either one or the other. The present is no exception to the general rule, and a few words may therefore be prefixed, that the immediate design and tendency of our volume may be the better understood. First, as to its being the medium of bringing a novel invention before the public ; and, secondly, as to the valuable and exclusive information connected with a

much practised, but little known, branch of the confectioner's art—the manufacture of ices. With reference to the former, it may be stated that the apparatus is already in general request,—that its value is daily becoming more known and better appreciated in circles to which these peculiar inventions seldom gain access; and with reference to the latter,—that a book of this description has been long required. The preparation of one of the most delectable refectious known to this advanced era of modern culinary civilization, has been hitherto left to the experienced confectioner, on whose skill, not always within reach, depended the supply. By attending to the instructions contained in the following pages, ices may now be procured from the machine within

five minutes. The operation is so simple, that it can be performed by the most unpractised person ; and to families residing at a distance from town, it may with certainty be predicated that no modern invention comes recommended with more claims on their notice than the one of which ample explanatory details are here given. Equally adapted, as an article of utility, to the kitchen, and, as an article of ornament, to the dining-room, no mansion can be henceforward complete without it ; and it is not too much to anticipate, that this apparatus will speedily become an indispensable appurtenance to every house, in every clime, where the health and comfort of the inmates are matters of consideration.

The recipes for making water-ices and

ice-creams are carefully arranged from the most approved sources, and a variety of valuable and original recipes appended, which cannot fail to enhance the domestic utility of the work. In short, whatever was deemed necessary to render the book complete, has been procured, without regard to labour or expense; and it is hoped that the reader will derive as much pleasure from the perusal, as the writer anticipates will result from a trial of the machine therein recommended.

THE ICE-BOOK.

CHAPTER I.

INTRODUCTORY.

“Durata et alte concreta glacies.”

IF any age were justly entitled to the ambitious epithet of “the age of inventions,” it will be at once conceded by every impartial observer, that the present has most unquestionably established its claim to that title. No employment however trivial, no undertaking however great, is without the advantage of machinery in economizing the time

and accelerating the labour bestowed upon bringing its object to perfection. We have, by the aid of art, cities brought within the compass of a few hours that were formerly beyond a day's journey ; and even the floating shadows of the atmosphere, that scarcely start into being ere they again subside, can be daguerreotyped on the easel of the artist, and thus the fleeting vision of the moment may be perpetuated through all time.

Art has, however, not rested content with providing the luxuries and preparing the necessaries of humanity—it has dared to imitate nature in the production of its most wonderful phenomena, and *ice*, once the sole produce of her mighty laboratory, has been made by the skill and enterprise of her subject—man. In the midst of summer, on

the boundary of the equator, and beneath the zenith itself, can be now produced this wonderful substance, from which, in a few minutes, can be made the most delicious beverages that the world numbers amidst its luxuries. The ice, too, thus manufactured is crystal in its clearness, and wholesome in its purity ; no particle of an injurious or deleterious kind can enter into its composition, and it is, in fact, spring water in its best and healthiest form. To expatiate on the advantages of an expeditious production of ice would be here superfluous, so well known and so generally admitted is its utility to man. The facility, however, now for the first time afforded to the denizen of a warm climate must not be passed over without comment. By the aid

of this new machine can be obtained a constant supply of ice on board vessels bound to the East Indies or elsewhere, where the value and advantages of this commodity will be appreciated by all who have once experienced the enervating effects of an increased temperature, without having the means within reach to counteract its injurious influences. Another, and not the least of its recommendations, will be found to consist in the portability of its construction and the celerity with which the operation is performed, without, as in previous machines for this purpose, rendering it necessary to have a store of snow or ice to effect the freezing of the water. The merit of this ingenious invention is due to **Mr. Thomas Masters**, of Charlotte street,

Fitzroy square, who, after much experimental toil, and an expenditure commensurate with the importance of the object to be gained, has at last succeeded in accomplishing the work of his ambition, and now, by the researches of his art, has at once triumphed over the difficulty and imitated the chemistry of nature. Feeling constantly the want of some artificial mode of producing ice, and finding that there were no effectual means hitherto adopted, Mr. Masters at once undertook the task, and how well he has succeeded the reader has now the opportunity of judging. The transformations narrated in the "Arabian Nights," those gorgeous repositories of Eastern legendary lore, are not more marvellous or more speedy than the change of a liquid

body to a block of solid ice, which is effected by this process ; and when we consider how the cumbrous machinery of the ice-well is here superseded by an elegant and portable machine, so simple in construction that it can be put into operation even by a child, the progress of improvement may indeed be described as having reached its climax.

That an article in such general request, so extensively used in medicine and so indispensable to the delicacies of the table, should not have been before made by artificial methods, may truly excite surprise ; but whilst every other branch of chemical science has received the most profound attention, this particular department has been overlooked, and we shall find by our historical summary, that but little has been

attempted in the art through a wide range of years, though its necessity has never been for one moment questioned.

The several gradations in bringing this greatest luxury of warm climates and modern times to perfection, were probably the following :—First, preserving snow in pits, which was probably practised in very early ages, and mixing it with the beverage ; next, boiling the water, and placing it in a vessel in the midst of snow, which is mentioned—at least, the principle is recognised—by Aristotle and Galen ; then, the aid of evaporation was called in, by which artificial ice is procured throughout Hindostan ; and, lastly, nitre was employed to refrigerate the water containing the liquor to be used. This last discovery was claimed by Villa Franca, a Spaniard, in

1550, but we think it more probable that the Portuguese found it in their Indian possessions. From that time to the present— if we except a few trials, which proved intricate, expensive, and ineffectual— nothing was done in the way of congealing water by a simple and efficacious process, until the era of this last invention, by Mr. Masters, who having justly secured the advantages of his skill by patent, may be regarded as the first to bring the science of refrigeration to perfection. Throughout China, and the colonics, British and foreign, this machine has already been a theme of wonder and admiration, and it is for the English now to *appreciate fully* and participate in the advantages resulting from so serviceable a discovery.

The use of ice as a luxury and a medicine is very ancient. Hippocrates, a celebrated physician, a native of the island of Cos, in the Ægean Sea, (now the Archipelago,) who lived four hundred and sixty years before Christ, says, in his fifty-first aphorism of the second section, that “It is dangerous to heat, cool, or make a commotion all of a sudden in the body, let it be done which way it may, because everything that is excessive is an enemy to nature. Why should any one run the hazard in the heat of summer of drinking of *iced waters*, which are excessively cold, and suddenly throwing the body into a different state than it was before, producing thereby many ill effects? But, for all this, people will not take warning, and most men would rather run the hazard of their

lives or health than be deprived of the pleasure of drinking out of ice.”

There is an account of one of the Ptolemies having given an entertainment at the island of Elephantine to his nobles, served in double vessels, lined with ice obtained from the mountains in the neighbourhood.

That the Romans, during the empire, regarded ice and snow as essential to both luxury and health, may be seen from the expression, “*nivatæ potiones*,” which shews that cool drinks were in great esteem, and Martial also makes use of the phrase, “*nivarum colum*,” or snow-strainer.

Spain has long been celebrated for ice; in fact, the nature of the climate almost requires such a necessary, on account of

the heat and the languor thereby occasioned. The body, after having endured fourteen or fifteen hours' sun, requires some stimulant, or rather, cooler, to prepare it to undergo the fatigues of the following day.

The Italians, also, use quantities of ice. Pisanellus states, that before the use of ice was introduced into Sicily, the natives, living in a very hot air, were every year liable to malignant fevers, which swept away numbers of people, and we are assured that these fevers ceased upon the use of ice being introduced amongst them, after which there died a thousand people less every year than before in the town of Messina; and this gave occasion, even to the common people, to lay up every year their store of ice, that

they might be kept from those diseases they were subject to before, as much as they did bread and wine. In the next chapter we shall advert to ice itself.

CHAPTER II.

ICE.

ICE may be described as a brittle substance, commonly transparent, formed from fluids by the abstraction of their caloric or combined heat. The specific gravity of ice is found to vary according to the nature and circumstances of the water, the temperature of the atmosphere, &c. Dr. Irving, who accompanied Captain Phipps in his voyage towards the North Pole, found that a lump of the densest ice he could procure was about

a fourteenth part lighter than water. The expansion which water undergoes during its congelation is a phenomenon that has given philosophers a considerable degree of trouble to account for ; the fact is, however, unquestionable. M. Huygens, by means of the expansive force of ice, burst an iron tube of half an inch in thickness ; and the Academicians del Cimento, in the course of their experiments on this subject, filled bomb-shells, and vessels the strongest they could procure, with water : this on its congelation burst the shells and vessels to pieces. We are also told that those employed in iron works, when they want to burst old bomb-shells, find that the easiest method is, to fill them with water, stop the vent, and then expose them to the frost. The effects

of this expansive force are observable in numerous instances: trees are bent and rocks riven, walnut, ash, and oak trees are cleft asunder by frost, with a noise resembling the explosion of confined gunpowder. When a thick crust of ice covers the ground, and other ice continues to be formed underneath it, where there is not sufficient room for its expansion, as is often the case among the glaciers of Switzerland, it will sometimes expand with such force as to rend the superior strata asunder with violent explosions; and in the frozen regions towards the Pole, as we are told by travellers, explosions of this kind, frequently as loud as cannon, are very common. The increase of bulk which water undergoes in the state of congelation is attributed by

M. De Mairon, in his dissertation on ice, chiefly to a new arrangement of its parts, which takes place during the process. He observed that the icy skin on water is composed of filaments, which constantly and uniformly join at an angle of sixty degrees, under which angular disposition they must evidently occupy more space than if they were parallel. He found also, that ice, after it is formed, still continues to expand by cold ; for having obtained a lump of ice which was only one fourteenth part lighter than water, he exposed it for some days to the frost, and found by this exposure it had become one twelfth part lighter ; that is, it had expanded one eighty-fourth part in that time. M. De Mairon is of opinion, that this fact will sufficiently account for the break-

ing of ice in ponds during the time of their freezing. According to the experiments of Dr. Black, ice assumes 147 degrees of heat to reduce it to a fluid. Water, all crystallizable solutions, and the metals bismuth and antimony, expand in volume at the instant of solidification. The greatest obstacles cannot resist the action of this expansive force. This beneficial operation is exemplified in the comminution or loosening the texture of dense clay soils by the winter's frost, whereby the delicate fibres of plants can easily penetrate them.

Mankind soon conceived the idea of cooling water without snow or ice, from having remarked that it became cold more speedily when it had been previously boiled, or at least warmed, and then put in a vessel

among snow, or in a place much exposed to the air. Pliny seems to give this as an invention of Nero, and a jocular expression in Suetonius makes it, at any rate, probable that he was fond of water cooled by this method; but it appears to be much older. It seems to have been known even to Hippocrates—at least Galen believes so,—and Aristotle was undoubtedly acquainted with it, for he says that some were accustomed, when they wished water to become soon cold, to place it first in the sun and suffer it to grow warm. He relates also, that the fishermen near the Black Sea poured boiling water over the reeds which they used in fishing on the ice to cause them to freeze sooner. Galen, on this subject, is still more precise. He informs us, that the above was

not so much used in Italy and Greece, where snow could be procured, as in Egypt and other warm countries, where neither snow nor cold springs were to be found. The water, after it had been boiled, was put into earthen vessels or jars, and exposed in the evening, on the upper part of the house, to the night air. In the morning, these vessels were put into the earth, (perhaps in a pit,) moistened on the outside with water, and then bound round with fresh or green plants, by which means the water could be preserved cool throughout the whole day.

Athenæus, who gives a like account from a book of Protagorides, remarks, that the pitchers filled with water, which had become warm by standing all day long in the sun, were kept continually wet during the

night by servants destined to that office, and in the morning were bound round with straw. In the island of Cimolus, water which had become warm in the daytime was put into earthen jars and deposited in a cool cellar, where it grew as cool as snow. It was generally believed, therefore, that water which had been warmed or boiled was soonest cooled, as well as acquired a greater degree of refrigeration, and on this account boiled water is mentioned so often in the works of the ancients.

The experiments of modern philosophers have, however, proved very different in the result. When one, indeed, places boiling and cold water—other circumstances being equal—in frosty air, the latter will become ice before the former has cooled; but when

one exposes to the cold, water that has been boiled, and unboiled water, of equal degrees of heat, it may then be expected that the former will be converted into ice somewhat sooner.

Water, by being boiled, loses a considerable portion of its air, while that of unboiled water must be disengaged before it can freeze, and by this its particles are kept in continual motion, which may retard its congelation. Boiled water, however, in cooling imbibes air again, but for that purpose seven or eight days are necessary, according to the observations of Mariotte.

The experiments, however, made by Mariotte, Perrault, the Academy del Cimento, Marion, and others, shewed no perceptible difference in the time of freezing between

boiled and unboiled water ; but the former produced ice harder and clearer ; the latter, ice more full of bubbles. In later times, Dr. Black, of Edinburgh, has, from his experiments, asserted the contrary. Boiled water, he says, becomes ice sooner than unboiled, if the latter be left at perfect rest ; but if the latter be stirred sometimes with a chocolate stick, it is converted into ice as soon as the former. This difference he explains in the following manner :—Some motion promotes congelation ; this arises in the boiled water through its re-imbibing air, and therefore it must necessarily freeze before the unboiled, provided the latter be kept at perfect rest. Fahrenheit had before remarked that water not moved would manifest a temperature some degrees

below the freezing point without becoming ice.

M. Lichtenburgh, says Beckman, with whom I conversed on these contrary results, assured me that he was not surprised at this difference in the experiments. The time of congelation is regulated by circumstances with which philosophers are not yet sufficiently acquainted. A certain, but not every degree of stirring, hastens it ; so that every icy particle with which it is formed on the side of the vessel, or which falls from the atmosphere, may convert the water sufficiently cooled into ice instantaneously, and such unavoidable accidents must, where all other circumstances are equal, cause a great difference in the period of freezing ; a variation, therefore, in the time may be well

expected, both because the boiling of river water expels the aerial acid, and because it produces also a kind of inspissation, and because, by both these effects being produced, the water must undergo some change.

It is probable that the cooling of water in ancient times, of which we have before spoken, is not to be ascribed so much to the boiling as to the jars being kept continually wet, and to the air to which it was exposed. A false opinion seems, therefore, to have prevailed respecting the cause ; and because it was considered to be the boiling, many have not mentioned the real cause, which appeared to them only to afford a trifling assistance, though it has been remarked both by Galen and Athenæus. We know at present that the heat decreases by

evaporation, or that coolness is produced. A thermometer kept wet, in the open air, falls as long as evaporation continues ; with ether or vitriol, and still better with that of nitre, which evaporates very rapidly, one can, in this manner, bring water, even in the middle of summer, to freeze ; and Cavallo saw in summer a Fahrenheit's thermometer, which stood at 64° , fall, in two minutes, by means of ether, to $+ 3$, that is, to 29° below the freezing point.

On this principle depends the art of making artificial ice at Calcutta and other parts of India, between $25^{\circ} 30'$ and $23^{\circ} 30'$ of north latitude, where natural ice is never seen

Another method of cooling water seems to have been known to Plutarch. It con-

sisted in throwing into water small pebbles or plates of lead. The author refers to the testimony of Aristotle ; but this circumstance cannot be found in the works of that philosopher which have been preserved. It seems to be too unintelligible to admit of any opinion being formed upon it, and the explanation given by Plutarch conveys still less information than the proposition itself. This is the case in general with all the propositions of the ancients. We indeed learn from the questions that they were acquainted with many phenomena, but the answers scarcely ever repay the trouble which one must employ in order to understand them. They seldom contain any farther illustration, and never a true explanation.

It appears that the practice of cooling

liquors at the tables of the great was not usual in any country besides Italy and the neighbouring states before the end of the sixteenth century. In the middle of that century there were no ice-cellars in France; for when Ballou relates, in the account of his travels in 1553, how snow and ice were preserved at Constantinople, throughout the whole summer, for the purpose of cooling sherbet, he assures us that the like method might be adopted by his countrymen; because he had found ice-cellars in countries warmer than France. The word *glacière*, also, is not to be met with in the oldest dictionaries, and it does not occur even in that of Monet, printed in 1635. Champier, the physician who attended Francis the First, when he had a conference with the Em-

peror Charles the Fifth and Pope Paul the Third at Nice, saw the Spaniards and Italians put snow, which they caused to be brought from the neighbouring mountains, into their wine, in order to cool it. That practice, which excited his astonishment, he declared to be unhealthful; and this proves that in his time it had not been introduced at the French court.

Grand d'Aussy quotes an anecdote related by Brantome, from which he forms the same conclusion. The Dauphin, son of Francis the First, being accustomed to drink a great deal of water at table, even when he was overheated, Donna Agnes Beatrix Pacheco, one of the ladies of the court, by way of precaution, sent to Portugal for earthen vessels, which would render the water

cooler and more healthful, and from which all the water used at the court of Portugal was drank.

As these vessels are still used in Spain and Portugal, where the wine is cooled also with snow, both methods might have been followed in France. There are to be seen, in several collections of curiosities, fragments of these Portuguese vessels. They are made of red bole, not glazed, though they are smooth and have a faint gloss on the surface, like the Etruscan vases. They are so little burnt, that one can easily break them with the teeth, and the bits readily dissolve in the mouth. If water be poured into such vessels, it penetrates their substance, so that, when in the least stirred, many air-bubbles are produced, and it at

length oozes entirely through them. The water which has stood in them acquires a taste which many consider agreeable ; it is probable that it proceeds from the bark of the fir-trees, with which, as we read, they are burnt. When the vessels are new they perform their service better, and they must then have a more pleasant smell. If they really render water cold, or retain it cool, that effect, in the opinion of those who have seen them, is to be ascribed to the evaporation. Their similarity to those in which the Indians make ice is very apparent.

Towards the end of the sixteenth century, under the reign of Henry the Third, the use of snow must have been well known at the French court, though it appears that it was considered by the people as a mark of ex-

cessive and effeminate luxury. In the witty and severe satire on the voluptuous life of that sovereign and his favourites, known under the title of *L'Isle des Hermaphrodites*, a work highly worthy of notice, but which is exceedingly scarce, we find an order of the Hermaphrodites, that large quantities of ice and snow should everywhere be preserved, in order that people might cool their liquors with them, even though they might cause extraordinary maladies, which, it seems, were then apprehended. In the description of an entertainment, we are told that snow and ice were placed upon the table before the king, and that he threw some of them into his wine ; for the art of cooling it without weakening it was not then known. The same method was prac-

tised even during the whole first quarter of the seventeenth century.

Towards the end of the above century this luxury must have been very common in France. At that period there were a great many who dealt in snow and ice ; and this was a free trade which every person might carry on. Government, however, which could never extort from the people money enough to supply the wants of an extravagant court, farmed out, towards the end of the century, a monopoly of these cooling wares. The farmers therefore raised the price from time to time, but the consumption and the revenue decreased so much that it was not thought worth while to continue the restriction, and the trade was again rendered free. The price immediately fell, and

was never raised afterwards but by mild winters or hot summers. The method of cooling liquors by placing them in water in which saltpetre has been dissolved, could not be known to the ancients, because they were unacquainted with that salt. They might, however, have produced the same coolness by other salts which they knew, and which would have had a better effect ; but this, as far as we have been able to learn, they never attempted. The above property of saltpetre was first discovered in the first half of the sixteenth century, and it was not remarked till a long period afterwards that it belonged to other salts also.

The Italians, at any rate, were the first people by whom it was employed ; and about the year 1550, all the water as well as the

wine drunk at the tables of the great and rich families at Rome was cooled in this manner. Blasius Villafranca, a Spaniard, who practised physic in that capital, and attended many of the nobility, published in the before-mentioned year an account of it, in which he asserts more than once that he was the first person who had made the discovery publicly known. In his opinion, it was occasioned by the remark that salt water in summer was always cooler than fresh water. According to his directions, which are illustrated by a figure, the liquor must be put into a bottle or globular vessel, with a long neck, that it may be held with more convenience, and this vessel must be immersed in another wide one filled with cold water. Saltpetre must then be thrown

gradually into the water, and while it is dissolving, the bottle must be driven round with a quick motion on its axis in one direction. Villafranca thinks that the quantity of saltpetre should be equal to a fourth or fifth part of the water, and he assures us that, when again crystallized, it may be employed several times for the same use, though this, before that period, had by many been denied. Whether other salts would not produce the like effect, the author did not think of trying ; but he attempts to explain this of saltpetre, from the principles of Aristotle, and he tells his noble patrons what rules they should observe for the preservation of their health, in regard to their cooling liquors.

Towards the end of the sixteenth century,

this method of cooling liquors was well known, though no mention is made of it by Scappi, in his book on Cookery. Marcus Antonius Zimmara, however, speaks of it in his problems, though at what time this Apulian physician lived is doubtful. In a list of the professors of Padua, his name is to be found, under the year 1525, as Explicator Philosophiæ Ordinariæ ; and as another is named under the year 1532, we have reason to conjecture that he died about that time. But in that case, the physician Villafranca would probably have been acquainted with the problemata of Zimmara, and would not have said that, as one had spoken of this use of saltpetre before him.

Levinus Lemnius also mentions the art of cooling wine by this method, so much that

the teeth can scarcely endure it. We are informed by Bayle, that the earliest edition of his work, which has often been reprinted, was published at Antwerp, in the year 1559, in octavo. It contains only the first two books, but as the above account occurs in the second book, it must be found in this edition.

Nicolaus Monardes, a Spanish physician, who died about the year 1578, mentions this use of saltpetre likewise. It was invented, as he says, by the galley slaves ; but he condemns it, as prejudicial to health. From some expressions he uses, I am inclined to think that he was not sufficiently acquainted with it, and that he imagined that the salt itself was put into the liquor. At a later period, we find some account of it in various

books of receipts, such as that written by Mezalders, in 1556, and which was printed, for the first time, the year following.

In the Mineralogy of Aldrovaldi, first printed in 1648, this process is described after Villafranca ; but where the editor, Bartholomeus Ambrosianus, speaks of common salt, he relates that it was usual in countries where fresh water was scarce to make deep pits in the earth, to throw rock salt into them, and to place in them vessels filled with water, in order that it might be cooled. This remark proves that the latter salt was then employed for the same purpose, but it has led the editor into a very gross error. He thinks he can conclude from it, that the intention of potters, when they mix common salt with their clay, is

not only to render the vessel more compact, but also to make it more cooling for liquors. But the former is only true. The addition of salt produces in clay, otherwise difficult to be melted, the faintest commencement of vitrification ; a cohesion by which the vessel becomes so solid that it can contain fluids, even when unglazed ; but for this very reason it would be most improper for cooling, which is promoted by the evaporation of the water that oozes through.

The Jesuit Cabtus, who wrote a voluminous commentary on the *Meteorologica* of Aristotle, which was ready for the press in the year 1644, assures us, that with thirty-five pounds of saltpetre one can not only cool a hundred pounds of water, by quickly stirring it, but convert it into solid ice ; and for the

truth of this assertion, he refers to an experiment which he made. Bartholin says, that for the above account he can give him full credit; but the truth of it is denied by Duhamel, who suspects that this Jesuit took the shooting crystals of the salt to be ice. As far as we have been able to learn, no one in latter times has succeeded in congealing water by saltpetre alone, without the help of snow or ice. The powder which a Duke of Mantua had in the middle of the last century, and by which, as the story goes, water, even in summer, could be instantaneously converted into ice, may, without doubt, have been only saltpetre. Was this salt, therefore, considered formerly as the cause of the cold in the north-eastern and other countries, because it was used for cooling liquors?

Even at present many farmers will say, that such a field is cold because it abounds with saltpetre.

Who first conceived the idea of mixing snow or ice with saltpetre and other salts, which increases the cold so much that a vessel filled with water placed in that mixture is congealed into a solid mass of ice that may be used on the table, cannot with certainty be determined ; but we may mention the earliest account of it is that of Latinus Tancredus, a physician and professor at Naples, whose book " De Famâ et Siti," published in 1607, speaks of this experiment, and assures us that the cold was so much strengthened by saltpetre, that a glass filled with water, when quickly moved in the above mixture, became solid ice.

In the year 1626, the well known commentary on the works of Avicenna, by Sanctorius, was published at Venice, in folio. The author of this work relates that, in the presence of many spectators, he had converted wine into ice, not by a mixture of snow and saltpetre, but of snow and common salt. When the salt was equal to a third part of the snow, the cold was three times as strong as when snow was used alone.

Lord Bacon, who died in 1626, says that a new method had been found out of bringing snow and ice to such a degree of cold, by means of saltpetre, as to make water freeze. This, he tells us, can be done also with common salt, by which it is probable he meant unpurified rock salt ; and

he adds, that in warm countries, where snow was not to be found, people made ice with saltpetre alone, but that he himself had never tried the experiment. Mr. Boyle, who died in 1691, made experiments with various kinds of salts, and he describes how, by means of salt, a piece of ice may be frozen to another solid body. Descartes says, that in his time, this was a well known phenomenon, but highly worthy of attention.

Since that period, the art of making ice has been spoken of in the writings of all philosophers, when they treated on heat and cold, and, with many other experiments, has been introduced into various books of receipts. It was then employed merely for amusement, and no one suspected that it would ever be applied to an important pur-

pose in luxury. In the like manner Fagger's first bills of exchange were said to be useful only for gambling, and gunpowder was called a trifling discovery.

In the beginning of the last century, drinking cups made of ice and iced fruit were first brought to table ; but towards the end of that century, it appears that the French began to congeal, in this manner, all kinds of well-tasted juices, which were served up as refreshments at the tables of the wealthy. This was a grand invention for the art of cookery, which became common among the German cooks, both male and female, and since that time our confectioners sell single glasses of iced articles to the ladies at our balls and in the theatres.

We are acquainted with no older inform-

ation respecting this invention than what is contained in Barclay's "Argenis," which is indeed a romance ; but the author's account makes the probability of its being used so clear, that we may certainly conclude it was then employed, and especially mentions it several times. Arsidas finds, in the middle of summer, at the table of Juba, fresh apples, one half of which were encrusted with transparent ice. A basin made also of ice, and filled with wine, was handed to him ; and he was informed, that to prepare all these things in summer was a new art. Snow was preserved the whole year through in pits lined with snow. Two cups made of copper were placed the one within the other, so as to have a small space between them, which was filled with water ; the cups

were then put into a pail, amidst a mixture of snow and unpurified salt, coarsely pounded, and the water, in three hours, was converted into a cup of solid ice, as well formed as if it had come from the hands of a pewterer. In like manner, apples just pulled from the trees were covered with a coat of ice.

About the year 1660, Procope Conteaux, an Italian of Florence, conceived the happy idea, soon after the invention of lemonade, of converting that liquor into ice, by a process which had before been employed by jugglers. The ready sale which he found for his invention induced others to make articles of the like kind. His example, therefore, was followed by Le Fevre and Foi; and the three, for some years, enjoyed

a monopoly of this new-fashioned commodity. About the year 1676, liquors cooled by or changed into ice must, however, have been the principal things sold by the *limonadiers*, for being then formed into a company, the following delicacies were mentioned in the patent which they received on that occasion:—“ *Eaux de gelée et glaces de fruits et de fleurs, d’anis et de canelle, franchipanne d’aigre de cetre du sorbée,*” &c. There were at that time in Paris two hundred and fifty masters in this employment. In 1690, when De la Quintiny wrote, iced liquors were extremely common. In the year 1750, Dubuisson, successor to the celebrated Procope, began to keep ready prepared, daily, the whole year through, ices of every kind, for the use of those who were

fond of them. At first they were little called for, except in the dog-days; but some physicians recommended them in certain disorders. Dubuisson himself performed two cures, chiefly by means of ices, and after that, the more discerning part of the public made use of them in every season of the year. That this part of the public might never lose their conceit, the vendors of liqueurs always employed their thoughts upon new inventions: among the latest was that of iced butter. It was first known at the Parisian Coffee-house, (le Caveau,) in 1774. The Duke de Chartres often went thither to enjoy a glass of iced liquor, and the landlord, to his great satisfaction and surprise, having one day presented him with his arms formed of eatable ice, articles of a similar kind became the *mode*.

CHAPTER III.

MODE OF PRESERVING ICE, &c.

ICE may be preserved in a dry place under ground, by covering it well with chaff, straw, or reeds. Great use is made of chaff in some parts of Italy to preserve ice. The ice-house for this purpose need only be a deep hole dug in the ground on the side of a hill, from the bottom of which a drain can be easily carried out, for the escape of the water which is separated from the ice, that it may not melt and spoil the rest. If the

ground is tolerably dry, the ice preservers do not line the sides with anything, but leave them naked, and only make a covering of thatch over the top of the hole. This pit they fill either with pure snow, or with ice taken from the purest and clearest water ; because they use it, not as we do in England, to set the bottles in, but to mix with the wine. They first cover the bottom of the hole with chaff, and then lay in the ice, not letting it anywhere touch the sides, but forcing a large bed of chaff between ; they thus carry on the filling to the top, and then cover the surface with chaff. Ice packed in this manner will keep as long as they please. When they take it out for use, they wrap up the lump in chaff, and it may then be carried to any distant place without waste.

The ancients, from the earliest ages, were acquainted with the manner of preserving snow, for the purpose of cooling liquor in summer. This practice is mentioned by Solomon, and proofs of it are so numerous in the works of the Greeks and Romans, that it is unnecessary to quote them, especially as they have been collected by others. How the repositories for keeping it were constructed, we are not expressly told, but it is probable that snow was preserved in pits or trenches. When Alexander the Great besieged the city of Petra, he caused thirty trenches to be dug and filled with snow; these were covered with oak branches, and the snow kept in that manner for a long time. Plutarch says, that a covering of chaff and coarse cloth is sufficient; and at pre-

sent, a like method is pursued in Portugal, where the snow has been collected in a deep gulf, some grass, or green sods, covered with ordure from the sheep-pens, is thrown over it, and under these it is so well preserved that, the whole summer through, it is sent to the distance of sixty Spanish (nearly 180 English) miles, to Lisbon. When the ancients, therefore, wished to have cooling liquors, they either drank the melted snow, or put some of it in their wine, or they placed jars filled with wine in the snow, and suffered it to cool there as long as they thought proper. That ice was preserved for the like purpose, is probable from the testimony of various authors, but it appears not to have been used so much in warm countries as in the north. Even

at present, snow is employed in Italy, Spain, and Portugal, but in Persia, ice. There is no account to be found anywhere of Grecian or Roman ice-houses. By the writers on agriculture they are not mentioned, and there is reason to suppose that they were not in use.

We have now to speak of the formation of ice by evaporation, which is a natural process, by means of which heat is powerfully abstracted by the exhalation of moisture, while the latter assumes a gaseous constitution, in the act of combining with dry air. The fact seems to have been known in the warm regions of the East, at a very early period of society, suggested probably by the familiar use of a rude unglazed pottery for all culinary purposes.

The Egyptians and other inhabitants of the sultry shores of the Levant have, from the remotest ages, cooled the water for drinking in these porous jars. Athenæus reports, from a history of Protagorides, that King Antiochus had always a provision for his table, prepared in that way. The water having been carefully decanted from its sediment into earthen pitchers, these were transported to the highest part of his palace, and exposed to the keen and clear atmosphere, two boys being appointed to watch them the whole night, and keep constantly wetting their sides. This labour of sprinkling the surface of the jars seemed to have afterwards been spared, in consequence, probably, of the adoption of a more porous kind of earthenware. Galen, in his

“ Commentary on Hippocrates,” relates that he witnessed the mode of cooling water which was practised in his time, not only at Alexandria, but over all Egypt. The water, having been previously boiled, was poured at sunset into shallow pans, which were then carried to the house-tops, and there exposed during the whole night to the wind ; and to preserve the cold thus acquired, the pans were removed at day-break, and placed on the shaded ground, surrounded by leaves of trees, prunings of vines, lettuce, or other slow conducting substances.

The bottles or bags called alcarrazzas, made of goat-skins, in which the wandering Arabs are wont to carry their scanty provision of water, allowing a small portion of

the liquid to transude and exhale, render it by consequence, comparatively cool, and better fitted to allay the intolerable thirst created in journeys across the sandy deserts. In Guinea, it is customary to fill gourds or calabashes with water, and suspend them all night from the outer branches of trees. The Moors introduced into Spain a kind of earthen jug, named *bucaros*, which, being filled with water, present to the atmosphere a surface constantly humid, and furnish, by evaporation, during the dry and hot weather, a refreshing beverage. The same practice has been adopted by degrees in various parts of the south of Europe. In India, during certain months, the apartments are kept comparatively cool, by dashing water against the matting of reed or

bamboo, which line the doors and outside of the walls. Even the more luxurious mariners, in their voyages between the tropics, are accustomed to cool their wines by wrapping the bottle with wet flannel, and suspending it from the yard or under the cabin windows. In all such cases, the effect is accelerated, though not augmented, by the swiftness of the current of air. What have been called *Egyptian coolers*, and are now produced by our potters, are less perfect in their operation. Being very thick, they require only to be soaked in water, and the evaporation from the surface cools the adjacent air. On the inside, however, where the bottle is placed, the action, in consequence of the confined humidity, must be enfeebled. In damp

weather, these vessels, it is evident, are entirely useless.

The natives of India are likewise enabled, by directing a skilful process of evaporation, to procure for themselves a supply of ice during their short winter. In the upper country, not far, however, from Calcutta, a large open plain being selected, three or four excavations are made in it about thirty feet square and two feet deep, and the bottom covered, to the thickness of nearly a foot, with sugar-canes or dried stalks of Indian corn. On this bed are placed rows of small unglazed earthen pans, about an inch and a quarter deep, and extremely porous. In the dusk of the evening, during the months of December, January, and February, these are filled with soft water,

previously boiled, and suffered to cool; when the water is very fine and clear, a great part of the water becomes frozen during the night. The pans are regularly visited at sunrise, and their contents poured into baskets, which retain the ice. These are then carried to a conservatory, which is made by sinking a pit fourteen or fifteen feet deep, lined with straw, and covered by a layer of coarse blanketing. The small sheets of ice are thrown down into the cavity, and rammed into a solid mass; the mouth of the pit is then closed up with straw and blankets, and sheltered by a thatched roof.

Many experiments have been made on the subject of freezing mixtures by the Society of Petersburg, and by Mr. Walker,

of Cambridge. Salts are the solids most commonly used, and they are in general either mixed with snow or with acids. Thus, if we mix common salt and snow together, the temperature falls to 0° Fahrenheit; if we pour two ounces of nitric acid, diluted with an equal quantity of water, on three ounces of sulphate of soda, the temperature sinks below the beginning of Fahrenheit's scale. Equal parts of strong muriatic acid and of snow will produce a cold of -30° Fahrenheit; and the same proportions of diluted sulphuric acid and snow, if previously cooled down to -20° will cause the freezing of mercury, reducing the temperature to -60° . Dry muriate of lime and dry powdery snow, in the proportion of two of the former to one of the latter, if

previously cooled by immersion in salt and snow, will sink the temperature to -60° ; and three parts of muriate of lime and two of snow, similarly treated, will reduce the temperature to -73° . In all these experiments, it is the sudden conversion of sensible into latent heat that lowers the temperature of the mixtures; the substances assume the liquid form, their capacity for heat is increased, and the disappearance of the sensible heat manifested by the sinking of the thermometer. By particular management, a liquid may be frozen even by its own evaporation. This is the principle of Wollaston's philosophical toy, called *Cryophorus*; and it was ingeniously applied to an important practical purpose by the late Sir John Leslie,—viz., the production of

ice at a cheap rate in all climates. The apparatus employed by this philosopher is a powerful air-pump, which can at once exhaust from three to six flat receivers about twelve inches in diameter. These are fitted to different plates, each connected with the pump, and each provided with its stop-cock. A shallow glass dish, nearly the width of the receiver, intended to hold a thin stratum of sulphuric acid, is introduced under each receiver, and a cup of porous earthenware, supported on a glass tripod, about an inch above the surface of the acid, is under each receiver. Water is poured into this cup, which is then placed on its tripod, and the whole covered by the receiver. By working the air-pump, each receiver may be exhausted in succession.

The withdrawing of the atmospheric pressure causes the rapid evaporation of the water, the vapour of which is immediately absorbed by the sulphuric acid, and thus the vacuum is sustained. The latent heat necessary for the conversion of the water into steam or vapour by the acid, as quickly as it is formed, keeps up the vacuum, and speedily reduces the whole water to the freezing point, when it soon forms a cake of ice. By a full-sized machine of this kind, about a quarter-of-an-hour's labour will set the process in full operation ; and within the period of an hour afterwards, six pounds of solid ice may be obtained. During this process, the water loses only about one-fiftieth of its bulk, and the acid will be sufficiently strong for repeated operations of the same kind.

To shew that ice may be employed ornamentally, we may mention that there was a palace of ice built by the Empress Anne, of Russia, on the banks of the Neva, in 1740, which, when illuminated, had a beautiful and magnificent effect: another ice palace was built at Moscow during the last century. But although the moderns have devoted considerable attention to this subject, it is evident that the ancients were altogether unacquainted with artificial congelation, and with any cold, indeed, below that of freezing. The application of nitre to the cooling of water seems, before the close of the sixteenth century, to have suggested to the Italians the experiment of mixing it with snow. A very intense degree of cold was thus generated, capable of

converting speedily into solid ice a body of water contained in a smaller vessel immersed in the dissolving mixture. Sanctorio, who may be regarded as the father of modern physics, mentions in his "Commentary on Avicenna," that he produced the same effect by employing common salt instead of nitre, in the proportion of one-third part of snow, and had repeatedly performed the experiment in the presence of numerous spectators. From Italy, this discovery was gradually disseminated over the rest of Europe. In the course of the *seventeenth* century, iced creams, fruits, and various confitures, were first produced on the tables of the luxurious.

The famous coffee-house, *Procope*, was founded at Paris, in 1660, by a Florentine

of that name, a vendor of lemonade, who was very successful in the art of procuring rich ices. Thirty years afterwards, the use of such artificial delicacies in that city had become quite common.

Ice is used externally in many diseases where the application of intense cold is necessary, particularly in some affections of the brain. It is, as is well known, employed extensively in confectionary, for freezing creams &c., and for giving coldness to Champagne and other wines. In some cases of chronic indigestion, ice is also taken internally, by swallowing it in small pieces.

CHAPTER IV.

FREEZING APPARATUS.

ALTHOUGH ices have been so long and abundantly used, previously to the invention of this machine there has been no successful application of machinery to their formation: there have been attempts to apply mechanical agency in combination with chemical processes to produce rough ice, and, in some rare instances, in icing creams.

These plans have one and all failed in

becoming, practically useful, which has arisen either from the inefficiency of the machinery, the great expense of the materials used, or the difficulty attending the operations, none of which objections can be raised against the process about to be described, and which has already been conducted with so much success.

Before giving a detailed description of the machine and its various modifications used in this patent process, a few of the prominent advantages it possesses, and of which all former plans have been entirely destitute, and unattempted, may be mentioned.

Every person who is at all conversant with the manufacture of ice-creams or water ices, knows that the peculiar delicacy

of these confections, so far as regards the icing part of their preparation, consists in the degree of fineness or smoothness with which they are beaten up during the time of congelation, for unless the beating-up, as it is termed, be continued almost without interruption during the whole time the creams &c. are undergoing that process, the poorer and more aqueous parts of the preparation will separate from the rest. In this separate state they become solidified, and it is then necessary to mix them properly; so that it often happens, that although the substances used may be of the most delicate and choice sort, yet they are completely spoiled during the freezing, from want of proper beating-up, a process which never can be accomplished by the hand in

any degree equal to that effected by the machine. Indeed, it would be contrary to all experience to expect such could be the case; for machinery, as applied in all the various departments of the arts, supplies a more uniform and better product than that made by the hand, unassisted by such helps. From this it will be seen, that one great advantage of the machine is in the delicate fineness of the article which is produced, its texture being thoroughly smooth and homogeneous, and very different from that made by hand.

Another great recommendation of this plan is, that any person, however inexperienced, may commence at once, with a few directive remarks, such as are contained in these pages, and rest assured of success,

accomplishing that which heretofore could only be attained by considerable experience ; all that is necessary to be done in the beating-up part of the operation, being merely the turning of a wheel or crank handle, which a child with a little exertion can perform.

The icing machine is equally applicable as a churn, and to shew the variety of uses to which it can be applied, it may be mentioned, that one has been employed in freezing caoutchouc used in the manufacture of elastic fabrics. It will also be seen from the description, that the machines are superbly fitted up as ornamental pieces of furniture, having all the conveniences for preserving rough ice, cooling water, wine, liqueurs, &c.

THE DOUBLE-MOTION MACHINE.

The Plate No. 1 is the representation of a double-motion machine. It has two wooden pails fitted into the top part of the box, A ; this box contains the wheels, which cause the freezers to revolve ; the freezer is made of Britannia metal, and stands upon the end of an upright shaft, passing up through the bottom wooden pail, being made water-tight at that place by very simple means which it is not necessary to describe. When the handle on the outside of the machine is turned round, the freezer is made to rotate by means of the wheel-work. On the outside of the freezer there is a considerable space all round, which is to be filled with one or other of the freezing mix-

tures which are given at the end of this work. On the inside of the wooden pail there is placed a hollow metal case, which serves to protect the outer pail from the intensity of action of the freezing mixtures, and also to prevent the absorption of heat from without, and thereby economize the effects produced by the freezing mixtures. On referring to Figure 1, Plate 5, the positions of these various parts will be readily understood. C C is the freezer, H H the space occupied by the freezing mixture, and G G the inner metallic case, which it is advisable to fill with water. The inventor of these machines has been in the habit of filling it with pure spring water; and as the case is made so that the block of ice which is formed in it shall be of an

ornamental shape,—somewhat resembling a castle turret, when it is turned out of the case,—it may be used as an ornament upon the table or sideboard ; at the same time it will give an agreeable coolness to the room, when crowded, or during the warm season of the year. By a very little attention and trouble these blocks of ice can be beautifully decorated with fruits or flowers : for this purpose it is necessary that the fruit, flowers, or whatever ornament is to be frozen into the block should be put in at the commencement of the freezing, with a very small portion of water, and when this has become ice, introduce more of the ornaments, and another quantity of water, and so on until the case is completely filled. Were this plan not adopted, and the whole quantity of

ornaments and water put in at once, the ornaments would not be equally diffused throughout the block of ice, but would be either found at the upper or lower part, according as they sunk or floated in the water. The forms of the generality of substances will be retained almost entire and uninjured in the ice, such as fish, fruit, flowers, &c. When the block has to be taken out, the vessel must be immersed in water slightly heated, by which the ice is loosened from the sides, and easily slips out.

The inhabitants of very warm countries, but more especially the Parisians, are in the habit of cooling wines and other drinks, by merely throwing a small piece of ice into the glass or other vessel containing them :

the ice which is formed in these cases being made of pure spring water, is well calculated for such purposes, or the bottles containing the wines &c. may be put in the inside of the block when turned out, by which they will be speedily cooled. For this purpose such a vessel as is represented in Figures 6 and 8, Plate 6, will be found to be very efficient, being at the same time ornamental. In Figure 6, the block of ice is represented as having bottles inside. Sometimes, wine-coolers, as shewn in Figure 7, are used, where there is a space all round for containing water, by which a given quantity of ice is susceptible of cooling a greater quantity of wine than when used otherwise.

In using the machine above described, the

metallic case is filled with pure spring water, covered over, and put in its place. The freezer is then put upon the end of the spindle, (with the cover on,) which causes it to revolve ; the freezing mixture is then put into the space between the freezer and case before described, and must be well rammed down all round, and a few turns given to the wheel, which will cause the mixture to sink, when more must be added, until it is equal in height to the water or cream you intend to freeze, still pressing it down as close as possible. The next operation, after placing the freezing mixture in its proper position, is to pour the prepared materials for the cream or water ices into the interval and revolving chamber, or freezer. The spatula is now to be inserted

in the freezer, the false top put on, and the mahogany cover placed on the pail. The brass wire must now be passed through one lug of the pail, the stem or handle of the spatula, and screwed into the other lug, by which the spatula becomes and remains stationary, while the freezer is made to revolve by turning the handle, M. The revolving motion thus given to the freezer causes the freezing mixture to more quickly act upon it, and that which it contains, while the instant it is frozen upon the sides, it is removed by the spatula, Figure 1, Plate 5, in fine flakes, the residue of the creams &c. being all the time in a complete state of agitation, so that the different ingredients are prevented from separating from each other. The effects thus produced, as affect-

ing the quality of the ices, are such as could hardly have been expected.

The machine which has just been described as having two pails, might have (in all respects similar) had three, four, six, or any number, according to the quantity of ices required. Club-houses, hotels, or public gardens may find it requisite to have some one or other of these numbers of pails in their machines, but private families in general will find the one above described as sufficient, or even such an one as is represented in Plate 4, which has only a single pail and freezer, although it might have two, as this, which could be managed by withdrawing one and replacing it with the other, drawing off the water, and re-charging it with the freezing mixture; the working parts, and

indeed all the parts relating to the freezing, are precisely the same as Plate 1. It is provided, however, below with drawers, for the purpose of holding such articles as require to be kept cool, and a cellaret for cooling wine in bottles or decanters.

Plate 3, is a drawing representing a simpler sort of icing machine. The effects produced by the use of it are nearly similar to those of the machines which have been described; the manner of using it, however, is somewhat different. The crank handle fixed to the stem of the spatula, turns either the freezer, in the freezing mixture with which it is surrounded, whereby the freezing process is quickened, or by withdrawing the small screw in the top of the freezer, and putting the bolt which is on the top of

the pail into the hole made in the side of the freezer for that purpose, and then turning the crank handle, the spatula alone is made to rotate and beat up the creams &c. being iced. The process of freezing and beating-up, are carried on at one and the same time, by the machines first described, but by this they are two separate operations, and cannot be conducted together.

When any of the before-mentioned machines are used for churning, the spatula, represented in Figures 2 and 3, Plate 5, is put into the freezer, instead of that generally used for beating up ices. The churning spatula has three blades, or leaves, whereas the other is single; and instead of using freezing mixtures, as in icing, a quantity of

warm water (if necessary) may be put into the space for holding the freezing mixture : of course, the cream to be churned is put into the freezer.

THE ICE PRESERVER

Is found to be a great acquisition to those who are in the practice of using ice, either in small or large quantities, for cooling spring water, beer, or other fluids, and for the preservation of fish and other articles of food. The outer case is made of wood, and lined on the inside with the patent substance known by the name of oropholithe ; within this there is another wooden case lined with lead ; the wood, and especially the oropholithe, are bad conductors of heat, so that ice can be kept in these preservers for

months, by continually adding a small quantity of ice every second day. By those who are in the habit of using ice, this may be employed to great advantage, as they would, by having a preserver, require to open the ice-house but seldom. A small ice-preserver would be of great advantage to those who wish to cool beer or other drinks, by making the pipe which conveys the beer &c. from the cask to the engine or tap, pass through the ice contained in the preserver ; the pipe, being in contact with the ice, will always be kept in a very cold state, by which the beer &c. will be completely cooled as they pass along, and will require no extra ice, or prevent the preserver being used for any other purposes. Figure 4, Plate 6, is a drawing of one of these ice-preservers ; the central

portion is for holding the ice ; the two upper divisions on each end are for holding either beer, water, &c., to be cooled ; the lower compartments are drawers lined with lead, for preserving fish &c. Figure 5, Plate 6, is an end view of the same. Figures 1 and 2, Plate 6, represent a four-blade spatula, such as may be used in the churn, Figure 3, Plate 6. Figure 4, Plate 5, shews the bottom of the freezer resting upon the spindle, passing through the stuffing-box, as in Plates 1 and 4.

CHAPTER V.

RECIPES.

NESSELRODE, OR FROZEN PUDDING.

TAKE one pint of cream, half a pint of milk, the yolks of four eggs, one ounce of sweet almonds pounded, and half a pound of sugar ; put them in a stewpan on a gentle fire, set it as thin as custard ; when cold, add two wine-glasses of brandy and two wine-glasses of nectar, (a delicious beverage, prepared only by the author.) Freeze, and

when sufficiently congealed, add one pound of preserved fruits, with a few currants ; cut the fruit small, and mix well with the ice, and put it into moulds, and immerse them in a freezing mixture, such as ice and salt, &c., until required for table.

CUSTARD ICE CREAM.

To a pint of fresh cream add the yolks of six new-laid eggs ; stir them up well with a whisk ; add a thin slice of lemon-peel, as for custard ; put the pan on a gentle fire, or in hot water, stirring it until the cream appears to be setting ; remove it from the fire, and add pulverized sugar to palate ; place it in a vessel of cold water, continue stirring it a few minutes to prevent its curdling ; give it any flavour you

please ; strain it through a sieve, put in the freezer, and proceed as before directed. One quart.

STRAWBERRY ICE CREAM.

Pick some strawberries (the scarlets are considered the best) into a basin or pan, add sugar in powder, with a quantity of strawberry jam equal to the fruit, the juice of a lemon or two according to palate, a small quantity of new milk, and a pint of fresh cream ; mix and add a little colour, (the recipe for which is given in page 97;) freeze. One quart.

Or,

When fresh strawberries cannot be procured, take one pound of strawberry jam, the juice of one or two lemons, one pint of

cream, a little milk ; colour ; freeze. One quart.*

RASPBERRY ICE CREAM.

To one pound of raspberry jam, add the juice of one or two lemons, one pint of cream, a little milk ; colour ; freeze. One quart.

If raspberries are in season, it may be made with equal portions of raspberries and jam, and a small quantity of sugar.

CURRENT ICE CREAM.

The same as strawberry, only that a few raspberries or strawberries may be added to give it a zest.

* Should the cream be found not to freeze so quickly as you wish, add a little more new milk ; this applies to all cream ices.

MILLE-FRUIT ICE CREAM.

Take the juice of two lemons, one pint of cream, half a pound of sugar, one glass of wine, one glass of grape syrup ; mix ; freeze ; cut one quarter of a pound of preserved fruits, as for Nesselrode ; mix them well with the ice, and place it in a mould. One quart.

ITALIAN ICE CREAM.

Rasp two lemons on some sugar, express the juice of the lemons, to which add one pint of cream, one glass of brandy, one glass of nectar, half a pound of sugar ; freeze. One quart.

RATIFIA ICE CREAM.

Take one pint of cream, a little milk, half a pound of sugar, the yolks of two

eggs, two ounces of ratafias ; put them in a stewpan over a gentle fire, set as thin as custard, and the juice of half a lemon, when cold ; freeze ; take two ounces more ratafias, rub them through a sieve, and add, when the former is frozen, together with one glass of noyau or marischino. One quart.

PINE-APPLE ICE CREAM.

To half a pound of preserved pine-apple, or a raw pine-apple pounded with sugar, add sugar and lemon-juice to palate, one pint of cream, and a little new milk. Mix ; freeze. One quart.

Or,

Take a pine-apple weighing about half a pound, cut it in pieces, bruise it in a mortar, add half a pound of sugar, the juice of one

lemon ; rub them well together in the mortar ; pass through a hair sieve ; freeze ; a few slices of preserved pine-apple may be added, when frozen. One quart.

GINGER ICE CREAM.

Bruise six ounces of the best preserved ginger in a mortar ; add the juice of one lemon, half a pound of sugar, one pint of cream. Mix well ; strain through a hair sieve ; freeze. One quart.

APRICOT ICE CREAM.

To half a pound of apricot jam, add one pint of cream, the juice of one lemon, six bitter almonds pounded, one glass of noyau. Mix in a mortar ; rub through a hair sieve ; freeze. One quart.

LEMON ICE CREAM.

Take one pint of cream ; rasp two lemons on sugar ; scrape off into the vessel you are about to mix in ; squeeze them, and add the juice ; half a pound of sugar. Mix ; freeze. One quart.

ORANGE ICE CREAM.

Rasp two oranges slightly, lest the cream become bitter ; squeeze them, with the juice of one lemon, one pint of cream, half a pound of sugar. Pass through a sieve, and freeze. One quart.

VANILLA ICE CREAM.

Pound two sticks of vanilla, or sufficient to flavour it to palate, in a mortar with half

a pound of sugar ; pass through a sieve. Put it into a stewpan, with half a pint of milk ; boil over a slow fire, with the yolks of two eggs, stirring all the time, the same as custard ; add one pint of cream, and the juice of one lemon. Freeze. One quart.

BROWN-BREAD ICE CREAM.

Take a slice of bread, browned in the oven, half a pound of sugar, half a pint of milk, two sponge biscuits, one pint of cream ; put in a stewpan ; stir over a gentle fire, like custard ; pass through a sieve ; brown two slices of bread in the oven ; crumble them, and sift them, as for bread crumbs. When the mixture is frozen, add the bread crumbs, with a glass of maraschino. One quart.

PLAIN ICE CREAM.

To one pint of cream, add the juice of one lemon, half a pound of sugar, a little nutmeg. Mix ; freeze. If too rich, add a little new milk.

PISTACHIO ICE CREAM.

Take one quarter of a pound of pistachios, and the same quantity of Jordan almonds ; blanch, and pound in a mortar till fine ; add the juice of one lemon, half a pound of sugar, one pint of cream. Pass through a sieve ; freeze. One quart.

BISCUIT ICE CREAM.

To one pint of cream, add a little milk, two ounces of Naples or Victoria biscuits,

the yolks of two eggs, half a pound of sugar ; stir gently over a slow fire, the same as custard. Pass through a sieve ; freeze. When frozen, add a glass of nectar, and put in a mould. One quart.

MARASCHINO ICE CREAM.

One pint of cream, the juice of one lemon, half a pound of sugar, two glasses of maraschino. Mix ; freeze. One quart.

NOYEAU ICE CREAM.

One pint of cream, the juice of one lemon, half a pound of sugar, two glasses of noyEAU. Mix ; freeze. One quart.

CINNAMON ICE CREAM

Is prepared in the same manner as vanilla.

COFFEE ICE CREAM.

Take six ounces of the best Turkey coffee berries, well roasted ; put them on a tin, and place them in an oven for five minutes ; boil one pint of cream and half a pint of milk together, and put them into a can ; take the berries from the oven, and put them with the scalding cream ; cover till cold. Strain, and add one ounce of arrow-root ; boil, like custard, and add half a pound of sugar. Freeze. One quart.

HOWQUA'S-TEA ICE CREAM.

One pint of cream, half a pound of sugar, one ounce of tea, or a sufficient quantity to make one cup. Mix with the cream ; freeze. One quart.

CHOCOLATE ICE CREAM.

Infuse four or six ounces of chocolate, mix it well with a pint of cream, a little new milk, and half a pound of sugar Strain ; freeze. One quart.

COLOUR.

One ounce of cochineal, one ounce of salts of wormwood, one pint of water ; boil for five minutes over a slow fire , three ounces of cream of tartar and one ounce of roche alum. Take it off the fire before you add the last two ingredients, which must be put in very slowly, or the mixture will overflow. If for keeping, use clarified sugar instead of water.

WINE ICES.

Take a pint of any kind of wine ; rasp four lemons and an orange on a lump of sugar, which scrape into the vessel in which the composition is about to be mixed ; extract the juice of the lemons and orange ; add the wine, with a small quantity of water and half a pint of clarified sugar. Freeze. One quart.

A recipe for clarifying sugar will be given at page 109.

PUNCH ICE.

Take one pint and a half of lemon ice, (for which see page 101,) and add one glass of nectar, one of champagne, and one of rum, and the juice of two oranges. Freeze. One quart. This may be made

PUNCH À LA ROMAINE,

by well whisking the whites of four eggs, and mixing half a pound of powdered sugar gently with the whites. The ice must be well frozen before the eggs and sugar are added.

NECTAR ICE.

One pint of water and one pint of nectar. Mix and freeze. One quart.

PUNCH ICE.

To one pint and a half of lemon water ice add one glass of white rum, one of champagne, one of pale brandy, and half a glass of warm jelly, or the rum and wine may be omitted, and replaced by two glasses of nectar. Freeze. One quart.

PUNCH ICE.

Rasp two lemons, take the juice of six lemons, the juice of two oranges, half a pint of water, one pint of clarified sugar. Mix ; add one glass of rum, one glass of brandy, one glass of nectar ; freeze. One quart.

PUNCH À LA VICTORIA.

Rasp two lemons, take the juice of six, the juice of two oranges, half a pint of water, one pint of clarified sugar. Mix , strain ; freeze hard. Add one glass of rum, one of brandy, one of nectar ; charge the ice again, as the spirit will bring it down. Beat up the whites of three eggs quite *firm*, put one quarter of a pound o

sugar with the whites ; stir it gently in, put it to the ice, and mix slowly. One quart.

WATER ICES

Are essentially different from cream ices, both as regards amalgamation and taste ; the one having the richness of cream, the other only the purest water, flavoured by fruit. The superior manner in which ices are produced and beaten up by the apparatus herein described, renders them exceedingly delicious.

LEMON WATER ICE.

Take three lemons and rasp them on sugar, the juice of six, the juice of one orange, one pint of clarified sugar, half a

pint of water. Mix ; strain through a fine hair or lawn sieve ; freeze. One quart.

Or,

Take a sufficient quantity of lemons, six or eight to one quart ; rasp three or four of them on a lump of sugar, and scrape it into the vessel you are about to mix in ; squeeze the lemons, and add the juice of two oranges, half a pint of water, and one pint of clarified sugar. Strain ; freeze.

ORANGE WATER ICE.

The raspings of three oranges, the juice of four, half a pint of water, the juice of two or three lemons, one pint of clarified sugar. Mix ; strain ; freeze. One quart.

Or,

Take any number of oranges in the same

proportion as lemons for lemon water ice, and proceed as in the lemon water ice, only rasping one-half of the oranges ; but be careful not to rub the oranges too hard, or the ice will be bitter ; a table-spoonful of warm jelly may be added at pleasure. Strain ; freeze.

GRAPE WATER ICE.

The juice of four lemons, the raspings of one orange, half a pint of water, one pint of clarified sugar ; two glasses of grape syrup, one glass of sherry. Strain ; freeze. One quart.

PINE-APPLE WATER ICE.

Take half a pound of fresh pine-apple, bruised fine in a mortar ; add the juice of

one lemon, half a pint of water, one pint of clarified sugar. Pass through a sieve; freeze. One quart. Pine-apple may be added, as described in the recipe for pine-apple cream, page 90.

CHERRY WATER ICE.

One pound of Kentish cherries, bruised in a mortar with the stones; add the juice of two lemons, half a pint of water, one pint of clarified sugar, one glass of noycau, a little colour. Strain, freeze. One quart

CURRANT WATER ICE.

One pint of red currants, the juice of two lemons, half a pint of water, one pint of clarified sugar, a little colour. Strain; freeze. One quart. A few raspberries may be added to heighten the flavour

VANILLA WATER ICE.

Pound two sticks of vanilla (or so much as may be deemed sufficient to give a proper flavour) in a mortar ; put half a pint of water in the mortar, so as to get all out ; put it into a stew-pan, with one pound of sugar. Boil together ; strain through a fine sieve , add the juice of one or two lemons ; freeze. One quart.

PEACH WATER ICE.

Take six fine peaches, the juice of two lemons, one pint of clarified sugar, half a pint of water. Rub through a sieve ; freeze. One quart.

STRAWBERRY WATER ICE.

One pottle of scarlet strawberries, the juice of two lemons, half a pint of water, one pint of clarified sugar, a little colour. Freeze. One quart.

RASPBERRY WATER ICE.

One pottle of raspberries, the juice of two lemons, half a pint of water, one pint of clarified sugar. Colour; freeze. One quart.

MILLE-FRUIT WATER ICE.

Rasp two lemons, the juice of six lemons, the juice of one orange, half a pint of water, one pint of clarified sugar, two glasses of grape syrup, one glass of sherry, one quarter of a pound of the best preserved fruit, cut fine. When the ice is frozen, add the fruit.

MELON WATER ICE.

Half a pound of ripe melon, pounded in a mortar, the juice of two lemons, half a pint of water, one pint of clarified sugar. Strain ; freeze. One quart.

BARBERRY WATER ICE.

Take a sufficient quantity of syrup from the barberries, the juice of four lemons, half a pint of water, one pint of clarified sugar. Colour ; strain ; freeze. One quart.

Or,

Add barberry syrup to lemon water ice, to flavour it.

BARBERRY SYRUP.

Choose the finest and ripest barberries ; boil them in clarified sugar for about ten minutes ; when cold, bottle it for use.

APRICOT WATER ICE.

Take six ripe apricots ; rub them through a lawn sieve, with the juice of two lemons, the kernels pounded fine, one pint of clarified sugar, and half a pint of water. Strain ; freeze. One quart.

APPLE WATER ICE.

Quarter some fine apples, take out the cores, put them in a stew-pan ; boil them till they become of a proper consistency ; rub them through a sieve ; add lemon water ice to palate. Freeze.

GINGER WATER ICE.

Take six ounces of the best preserved ginger ; pound two-thirds of it in a mortar, and cut the rest into very thin slices ;

a sufficient quantity of lemon water ice, (about a quart ;) put the ginger in. Mix ; freeze.

TO CLARIFY SUGAR.

Take twelve pounds of sugar, twelve pints of water, half the white of one egg, well beaten up, and add it to the water. Boil ten minutes. This is used in all water ices.

CHAPTER VI.

ON FREEZING MIXTURES.

THE intensity of cold produced by mixtures is in proportion to the rapidity with which the various ingredients dissolve in water, and this disposition to dissolve is proportionate to the quantity of water each can take up to form a solution. When a liquid is cooled to its freezing point, *latent* or combined heat is made sensible or free heat, and flies off.

When a liquid is cooled beyond the

freezing point, it still parts with insensible heat, called the heat of fluidity, to accommodate the diminution of its specific capacity for heat, because all fluids and liquids have a greater capacity for heat than the solids &c. which produced them. Thus, water at 50° Fahrenheit, being cooled to zero, loses

18° to the freezing point ;

140° its heat of fluidity ;

32° between the freezing point and zero.

Therefore, a pound of freezing mixture absorbs 158° from one pound of water to be frozen, ere it is reduced from 50° to ice at 32°, or just as much heat is lost by the water to be frozen as would raise an equal weight of water from 50° to 208°.

Hence it will be seen, that all frigorific

mixtures, by rendering sensible or free heat insensible or latent, are from this cause in a condition to receive or take a large quantity of heat from any substance with which they are in contact.

It will be seen, also, that those salts are most useful to this effect which have the most powerful attraction for water. Thus, in mixtures of powdered snow or powdered ice with chloride of calcium, pure potash, or alcohol, respectively, a larger quantity of water is taken up by these substances than by any others, and consequently a more intense degree of cold is produced than with any other substance. Where ice or snow is not available, mixtures of different salts are used, such being preferred which not only exert no chemical action upon each other,

but which have a great attraction for water, and melt rapidly in it. In the few instances where chemical combination does take place in the freezing mixture, advantage is intended to be taken of the peculiar quality of water called its solvent power.

Thus, *ten pounds*, or one gallon, of water will dissolve *four pounds* of sea-salt, or one pound and a half of nitre, or *two pounds and a half* of phosphate of soda, or *five pounds* of sulphate of soda, or *ten pounds* of carbonate of potash, or, lastly, twenty pounds of chloride of calcium.

But water, after it has dissolved its own weight of chloride of calcium, will still dissolve a little of each of the other substances, and in this way increase the energy of a simple mixture, provided no diminution

of volume takes place, for it is a universal law in natural philosophy, that a *diminution of volume* is invariably attended with *evolution of heat*, and *increase of volume* by the *production of cold*, in consequence of an absorption of heat.

The freezing mixtures are instances of the latter ; and a mixture of sulphuric acid with one-fourth its weight of water, the temperature of which instantly rises to 300° Fahrenheit, is an example of the former.

The proportion of the *water of crystallization*, contained in the salts employed in these mixtures, augments or diminishes considerably their freezing power, for where any salt has not the proportion of water in its composition which is natural to it, a loss of cold-producing energy is the invariable

consequence, from an absorption of water, which assuming the solid state, renders latent heat sensible, in accordance with the physical law, "that whenever a vapour becomes liquid, or a liquid assumes the solid form, heat is given off, and *vice versâ*."

Thus, when water passes into steam or vapour, heat is absorbed, or taken up, by the water, either from the furnace, or from the stock of latent heat contained within its own substance; and when steam or vapour again becomes water, heat is given off to all surrounding objects, or, the demand for latent heat produces an absorption of heat from anything with which the vapour happens to be in contact.

Thus, when dry chloride of calcium and snow are intimately mixed in proper pro-

portion, the thermometer sinks from $+ 50^{\circ}$ to $- 40^{\circ}$, producing a freezing energy of 90° , or the capability to absorb as much heat as would cool an equal weight of water from 140° down to 50° .

But when the same weight of chloride of calcium, containing its natural water of crystallization, is similarly mixed with a like quantity of snow, the thermometer sinks from $+ 50^{\circ}$ to $- 50^{\circ}$, possessing an energy to freeze just 10° more than before, making a difference of 20° of cold lost to the operation in the former, but gained in the latter case. The same may be said of sulphate of soda, or hydrochlorate of ammonia, nitrate of ammonia, &c. &c.

The power of producing cold possessed by these mixtures depends greatly on the

state of division in which they are mixed together ; for if three pounds of chloride of calcium, in one or two pieces, were put beside five pounds of ice in a similar state, they would melt so slowly, as that, although the same quantity of heat would be absorbed by the two substances conjointly to enable them to become liquid, yet, in consequence of the rapid supply of heat from external objects conjointly with the substance to be frozen, little or no useful effect would take place.

But if five pounds of ice in *fine powder* be intimately mixed with three pounds of chloride of calcium, also in fine powder, so intense a degree of cold will be produced, as to freeze thirty-nine pounds of quicksilver, or sixty pounds of water, equal to six gallons.

From which it will be seen, that the more rapidly the salts in the mixtures melt, the greater the freezing power will be ; and the finer the state of division in which they exist previous to admixture, the more surface will be in contact and the more rapidly will they melt.

Löwitz found, by experiments, that the freezing powers of snow and sea salt may be represented by 100 ;

Snow, sea salt, and sal ammoniac, by	- -	200
Snow, nitre, sea salt, and sal ammoniac, by		300
Snow, sea salt, and nitrate of ammonia, by		500
Snow and chloride of calcium, by	- - -	1500
Snow and alcohol, by	- - - - -	2000

In other words, that an equal weight of each of the foregoing mixtures, in proper proportion, would freeze as follows :—

Snow and alcohol, twenty times as much as snow
and sea salt.

Snow and chloride of calcium, fifteen times as much.

Snow, sea salt, and nitrate of ammonia, five times
as much.

Snow, nitre, sea salt, and sal ammoniac, three times
as much.

Snow, sea salt, and sal ammoniac, twice as much.

FREEZING MIXTURES WITH ICE OR SNOW.

<i>Mixtures.</i>	<i>Parts.</i>	<i>Thermometer sinks</i>	<i>Degree of cold produced.</i>
Pounded Ice or Snow - 3	} 1	From any Temperature	32°
Common Salt - - - 1			
Pounded Ice or Snow - 3	} 1		32°
Soda - - - - - 1			
Snow or Pounded Ice - 2	} 1		5°
Muriate of Soda - - 1			
Snow or Pounded Ice - 5	} 2		12°
Muriate of Soda - - 2			
Muriate of Ammonia - 1			
Snow or Pounded Ice - 24	} 5		18°
Muriate of Soda - - 10			
Muriate of Ammonia - 5			
Nitrate of Potash - - 5			
Snow or Pounded Ice - 12	} 5	25°	
Muriate of Ammonia - 5			
Muriate of Soda - - 5			
Snow - - - - - 3	} 2	From + 32° to - 25° = 55	
Diluted Sulphuric Acid			
Snow - - - - - 8	} 5	From + 32° to - 27° = 59°	
Muriatic Acid - - - 5			
Snow - - - - - 7	} 4	From + 32° to - 30° = 62°	
Diluted Nitric Acid - 4			
Snow - - - - - 4	} 5	From + 32° to - 40° = 72°	
Muriate of Lime - - 5			

FREEZING MIXTURES WITH ICE OR SNOW—*continued.*

<i>Mixtures.</i>	<i>Parts.</i>	<i>Thermometer sinks.</i>	<i>Degree of cold produced.</i>
{ Snow - - - - -	2	} From + 32° to - 50° = 82°	
{ Cryst. Muriate of Lime	3		
{ Snow - - - - -	3	} From + 32° to - 51° = 83°	
{ Potash - - - - -	4		
{ Snow - - - - -	3	} From 0° to - 46° = 46°	
{ Diluted Nitric Acid	2		
{ Snow - - - - -	8	} From - 10° to - 56° = 46°	
{ Diluted Sulphuric Acid	3		
{ Diluted Nitric Acid	3		
{ Snow - - - - -	1	} From - 20° to - 60° = 40°	
{ Diluted Sulphuric Acid	1		
{ Snow - - - - -	3	} From + 20° to - 43° = 63°	
{ Muriate of Lime - -	4		
{ Snow - - - - -	3	} From - 10° to - 54° = 64°	
{ Muriate of Lime - -	4		
{ Snow - - - - -	2	} From - 15° to - 68° = 53°	
{ Muriate of Lime - -	3		
{ Snow - - - - -	1	} From 0° to - 66° = 66°	
{ Cryst. Muriate of Lime	2		
{ Snow - - - - -	1	} From - 40° to - 73° = 33°	
{ Cryst. Muriate of Lime	3		
{ Snow - - - - -	8	} From - 68° to - 91° = 23°	
{ Diluted Sulphuric Acid	10		

FREEZING MIXTURES WITHOUT ICE.

<i>Mixtures.</i>	<i>Parts.</i>	<i>Thermometer sinks.</i>	<i>Degree of cold produced.</i>
{ Muriate of Ammonia - 5		From + 50° to + 10° = 40°	
{ Nitrate of Potash - - 5			
{ Water- - - - - 16			
{ Muriate of Ammonia - 5		From + 50° to + 4° = 46°	
{ Nitrate of Potash - - 5			
{ Sulphate of Soda - - 8			
{ Water - - - - - 16			
{ Nitrate of Ammonia - 1		From + 50° to - 7° = 57°	
{ Carbonate of Soda - - 1			
{ Water - - - - - 1			
{ Water - - - - - 1		From + 50° to + 4° = 46°	
{ Nitrate of Ammonia - 1			
{ Sulphate of Soda - - 3		From + 50° to - 3° = 53°	
{ Diluted Nitric Acid - 2			
{ Sulphate of Soda - - 6		From + 50° to - 10° = 60°	
{ Muriate of Ammonia - 4			
{ Nitrate of Potash - - 2			
{ Diluted Nitric Acid - 4			
{ Sulphate of Soda - - 6		From + 50° to - 14° = 64°	
{ Nitrate of Ammonia - 5			
{ Diluted Nitric Acid - 4			
{ Phosphate of Soda - - 9		From + 50° to - 12° = 62°	
{ Diluted Nitric Acid - 4			

FREEZING MIXTURES WITHOUT ICE—*continued.*

<i>Mixtures.</i>	<i>Parts.</i>	<i>Thermometer sinks.</i>	<i>Degree of cold produced.</i>
{ Phosphate of Soda - - 9	}	From + 50° to - 21° = 71°	
{ Nitrate of Ammonia - - 6			
{ Diluted Nitric Acid - - 4			
{ Sulphate of Soda - - 8	}	From + 50° to - 0° = 50°	
{ Muriatic Acid - - - 5			
{ Sulphate of Soda - - 5	}	From + 50° to + 3° = 47°	
{ Diluted Sulphuric Acid 4			
{ Pulverized Hydrochlo- rate of Ammonia - - 5	}	From + 50° to - 10° = 60°	
{ Nitrate of Potash - - 5			
{ Water - - - - - 16			
{ Sulphate of Soda - - 5	}	From + 50° to + 3° = 47°	
{ Diluted Sulphuric Acid 4			
{ Sulphate of Soda - - 6	}	From + 50° to - 10° = 60°	
{ Hydrochl. of Ammonia 4			
{ Nitrate of Potash - - 2			
{ Diluted Nitric Acid - - 4			
{ Phosphate of Soda - - 3	}		
{ Pulverized Sal Ammonia 2			
{ Saltpetre - - - - - 1			
{ Diluted Aquafortis - - 2			
{ Water - - - - - 1			

Upon the mixtures with ice and snow no remarks need be made ; but upon those without ice it will be needful to say a few words. In mixtures without ice, although acids are very available, yet the author would not recommend the use of them, on account of their importability and burning quality, whereas the mixtures 1, 2, 3, and 4, may be packed in paper or jars, and sent to any part of the world without inconvenience, and they are the mixtures he would advise to be used. No. 4 may be used a hundred times over, by simmering the liquid slowly, or placing it in an earthen vessel in an oven until the water has evaporated, when the nitrate of ammonia will be left at the bottom, and will be of equal strength as at first, and losing nearly three-eighths of its

bulk. No. 3 is cheaper than No. 4, but cannot be used the second time so well, as the carbonate of soda will not separate easily from the nitrate of ammonia.

In all cases where diluted sulphuric or nitric acids are to be employed, the dilution must take place some hours before, as, upon the addition of water, heat is given off to a considerable amount. No. 9 is a very good mixture ; but, as acid is to be used, it is requisite to have a false top in a water-joint on the machine, to keep out any unpleasant smell which may arise therefrom. During the operation of freezing without ice, the machine will be required to be charged two or three times. The first charge must remain in it about fifteen minutes, and then drawn off, by means of the tap or screw,

into the vessel below, in which the wine to be iced is placed ; put in the second mixture, let it remain about twenty minutes, draw off as before, put in the third ; in ten or twelve minutes a block of ice will be produced, weighing from ten to twelve pounds, from three pints to two quarts of cream or water ice, and a dozen of wine cooled, if required.

It ought to be observed, that many objections exist against the use of mixtures, one of whose constituents is an acid ; primarily, on account of their destructive effects on the garments of servants and others not sufficiently observant of the cautions necessary to their use, and secondly, on account of the great nuisance arising from the disengagement of hydro-

chlorate acid gas in the one case, and of nitrous acid gas in the other, unless the frigorific recipient be immediately covered, and kept so.

With respect to the difference of expense, it must be admitted, that the acid mixtures are somewhat cheaper than those without ; their freezing action is a little more intense in effect, but less so in duration. Thus, a mixture of sulphate of soda and muriatic acid freezes during eight minutes, and produces a cold of 50° , whereas nitrate of ammonia and water have a powerful effect during fifteen minutes, but its energy is less intense in degrees of cold.

If the production of ice by acid mixtures be desired, it must be scrupulously observed that the salts must be put in

first, and the acid after. Fill the inner metallic vessel with the freezing mixture up to the mark inside, having previously inserted the freezer with the agitator attached; put on the top, and turn rather briskly; but if you freeze with ice or snow, there is no necessity for the agitator—indeed, it is much better without. In using acids, the action of the first charge only keeps up its freezing power during six minutes. After the lapse of that time, the charge must be drawn off, as before stated, and a second charge introduced, which continues the action for eight minutes longer; after which, a third mixture may be used, which will prolong the action ten minutes more, and produce the necessary effect for the formation of a block of ice,

refrigerating wines and liqueurs, and the freezing of creams, &c. But if a further continuation of the freezing action be required in order to preserve during some time the effect of the first three mixtures, a fourth may be introduced, and removed into the wine cooler after a lapse of twelve minutes, which may be followed by a fifth, or, applied in a similar manner, after a duration of action, two minutes longer with each succeeding mixture.

Water may be congealed in the freezer or central vessel usually set apart for creams &c., and the block of ice removed by dipping the exterior of the vessel in cold or lukewarm water.

APPENDIX.

ICE is only a re-establishment of the parts of water in their natural state. Galileo was the first that observed ice to be lighter than the water which composed it, and hence it happens that ice floats upon water, its specific gravity being to that of water as eight to nine. This rarefaction of ice seems to be owing to the air-bubbles produced in water by freezing, and which being considerably larger in proportion to the water frozen, render the body so much

specifically lighter ; these air - bubbles, during their production, acquire a great expansive power, so as to burst the containing vessels, though ever so strong.

RAINING ICE.—In December, 1672, there fell, in the west of England, a rain that, as soon as it touched any thing above ground, as a bough, or the like, immediately settled into ice, and by multiplying and enlarging the icicles, it broke all down with its weight. The rain that fell on the snow immediately froze into ice without sinking in the snow at all. It made an incredible destruction of trees beyond anything in all history, (Edin. Philos. Transac.) “ Had it concluded with a gust of wind,” says some gentleman on the spot, “ it might have been of terrible consequence.” The sprig of an

ash, of just three-quarters of a pound, being weighed, the ice thereon weighed sixteen pounds. Some were frightened with the noise in the air, till they discerned it was the clatter of the ice among the boughs dashed against each other. This icy rain was followed by glowing heats, and a wonderful forwardness of vegetation.

ICE MARKET.—At St. Petersburg, there is a place for the sale of provisions in a state of congelation. Here the astonished spectator is arrested by the sight of a vast open space or square, containing the bodies of many thousand animals in a state of congelation, and piled in pyramidal heaps ; cows, hogs, sheep, fowl, butter, fish—all stiffened into stony rigidity. The fish are exceedingly beautiful, and possess the vivid-

ness of their living colour with the transparent clearness of wax imitations. The beasts present a far less pleasing spectacle ; groups of many hundreds are seen piled up on their hind legs against one another, as if each were making an effort to climb over the back of its neighbour. The motionless apparent animation of their seemingly struggling attitudes, as if suddenly seized in moving and petrified by frost, gives a horrid life to this dead scene. Had an enchanter's wand been instantaneously waved over this forest of animals during their different actions, they could not have been fixed more picturesquely. Their hardness, too, is so great, that the natives chop them up for the purchasers like wood, and the chips of their carcasses fly off in the

same way as splinters do from masses of timber and coals, (Encyclop. Londinensis.)

CONGELATION BY THE AIR-PUMP.—The very ingenious Dr. Cullen seems to have been the first who applied the vacuum of an air-pump to quicken the evaporation of liquids, with a view to the abstraction of heat, or artificial congelation. In the year 1775, he plunged a full phial of ether into a tumbler of water, and in placing it under the receiver and exhausting the air, the ether boiled, while the surrounding water froze. In the year 1777, Mr. Edward Nairne, a very eminent London optician, published, in the Transactions of the Royal Society, “An Account of some Experiments made with an Air-Pump.” After stating that, at a certain

point of rarefaction, the moisture about the pump furnished an atmosphere of vapour, which affected his comparative results with the mercurial gauge and pear or syphon gauge, he says, "I now put some sulphuric acid into the receiver, as a means of trying to make the remaining contents of the receiver, when exhausted as much as possible, to consist of permanent air only, *unadulterated with vapour.*" He was thus enabled, by this artificial dryness, to exhibit certain electrical phenomena to great advantage. The next step which Mr. Nairne took was to produce artificial cold by the air-pump. "Having lately received from my friend Dr. Lind," he says, "some ether, prepared by the ingenious Mr. Wolfe, I was very desirous to try whether I could produce

any considerable degree of cold by the evaporation of ether under a receiver whilst exhausting." Accordingly, he succeeded in sinking a thermometer, whose bulb was from time to time dipped into the ether *in vacuo* 103° below 56° , the temperature of the apartment. Mr. Nairne made no attempt to condense the vapour *in vacuo* by chemical means, and thus to favour its renewed formation from the liquid surface. After Nairne's removing the vapour of water by sulphuric acid to produce artificial dryness, there was indeed but a slight step to the production of artificial cold by the very same arrangement ; but this step does not appear to have been attempted by any person from the years 1777 to 1810, when Professor Leslie was naturally led to make

it by the train of his researches on evaporation and hygrometry. In the month of June, 1810, Professor Leslie having introduced a surface of sulphuric acid under the receiver of an air-pump, and also a watch-glass filled with water, he found that, after a few strokes of the pump, the water was converted into a solid cake of ice, which being left in the rarefied medium, continued to evaporate, and after the interval of about an hour, totally disappeared. When the air has been rarefied two hundred and fifty times, the utmost that under such circumstances can perhaps be effected, the surface of evaporation is cooled down 120° Fahrenheit in winter, and would probably, from more copious evaporation and condensation, sink near 200° in summer. If the air be

rarefied only fifty times, a depression of 80° or even 100° will be produced. We are thus enabled, by this elegant combination, to freeze a mass of water in the hottest weather, and to keep it frozen till it gradually wastes away by a continued but invisible process of evaporation.

ICE IN BENGAL: EFFECT OF DEW.—From the rapid emission of heat from the surface of the ground, we can now explain the formation of ice during the night in Bengal while the temperature of the air is above 32°. The nights most favourable for this effect are those which are the calmest and most serene, and in which the air is so dry as to deposit little dew after midnight. Clouds and frequent changes of the wind are certain preventives of congelation.

water at intervals from the well. When articles of food are required to be kept some time longer than the heat of the weather will allow, they may be placed in a basket at the end of a rope, and let down into the well until they come within a foot or two of the water. For the like purposes, pretty deep pits, caves, or grottoes may be used.

COLOUR OF ICE.—Not only the water, but also the ice of different rivers has a peculiar colour, and this appears to depend not on accidental causes, as conjectured by Davy, because, if so, it could not be the same every year. “I have,” says Ritter von Wurzer, in Karsten’s Archives, b. 18, p. 103, “often observed this in the ice of the Rhine, which is always *bluish*, while,

on the other hand, the ice of the Moselle is always *greenish*. The ice of the small rivers that pour into the Lower Rhine—for example, the Ruhe &c.—is either white or only *pale greenish*. More than seventy years ago Liedenfrost first remarked this circumstance. This difference of colour is so striking, that the boatmen guide themselves by it, and know whether it is Rhine or Moselle ice they have to do with. That decaying vegetable matter is the cause of the green colour is by no means evident, for the clear and transparent ice of the Rhine is *sky-blue*—the clear and transparent ice of the Moselle is *green*. And why is this appearance the same year after year? Why are the streams of water in woods in general not green? Why is the sea water

green, even in places hundreds of miles from the land? I am not of opinion that iodine and bromine give to sea water its colour, for those sea plants which by their decomposition afford these substances, do not contain them in an uncombined state. The truth is, we have not discovered the cause of the colour of ice and water."

It may not be uninteresting to some of our readers to give a fuller account of the ice palace, built at St. Petersburg, on the banks of the Neva, at which in a former part of this work we have slightly glanced.

The palace was intended to have been erected on the River Neva itself, in order that it might be as near as possible to the source from which the ice was to be procured. It was accordingly begun upon

that river towards the end of the year 1739 ; but, says the author from whom this is quoted, “ the ice which sustains the weight of many thousand armed men, which supports great cannons and mortars frequently discharged, which did not break under the weight of a fortress of ice and snow, attacked and defended according to all the rules of war, and taken at last sword in hand, (which was performed seven years ago before the empress, that is, in 1732,)—this ice,” says the same author, “ began to give way under the walls of the palace as soon as they were raised to a considerable height, whence it was easily concluded that it could not support the weight of the whole when completed. In consequence of this failure, it was resolved to erect a palace on land : a

site having been chosen for that purpose, the building was recommenced, with the experience in ice-building gained by the attempt on the river.”

The manner, we are told, was very simple : “The purest and most transparent ice was selected ; it was cut from the Neva in large blocks, which were squared with rule and compass, and carved out with architectural ornaments. When each block was ready, it was raised to its destined place by cranes and pulleys, and an instant before letting it down upon the block which was to support it, a little water was thrown between the two, the upper block was immediately lowered, and the two became literally one ; so that the whole building in fact appeared to be, and really was, one

single piece, producing, without contradiction, an effect infinitely more beautiful than if it had been built of the most costly marble, its transparency and bluish tint giving it the appearance of a precious stone.

“ The dimensions of the building were— length, fifty-six feet ; depth, eighteen feet ; and height, including the roof, twenty-one feet. This was only the body of the house. The palisading was eighty-seven feet in length, and thirty-six in width ; and the actual length of the front view, including the pyramids at the corners, was one hundred and fourteen feet. The façade was plain, being divided into compartments by pilasters. In each division there was a window, the framework of which was

painted to represent green marble. It was remarked at the time that the ice, at the low temperature which prevailed, took the paint perfectly well. (Fahrenheit's thermometer, according to the observations of Delille, stood, on the 5th of February, at 30° below zero.) The panes were formed of slabs of ice as transparent and as smooth as plate glass: at night, these windows were generally lighted up; and frequently grotesque transparencies, painted on canvases, were placed in the windows. The effect of the illumination is represented to have been peculiarly fine, the whole palace being filled with a delicate pearly light. In the several apartments were tables, chairs, and all kinds of household furniture, of ice. In front of the palace, besides pyramids

and statues, stood six cannons, carrying balls of six pounds weight, and two mortars of ice. As a trial, balls of iron were fired from these cannons without bursting them. The experiment was tried in the presence of the court, and the ball pierced a strong plank, two inches thick, at the distance of sixty paces. The mortars were the size of those which carry a shell of eighty pounds ; when fired, the charge of powder was the same as that for the cannons." The same author says, that " the ice was not altogether useless in its destruction, for the large blocks of the walls were taken to fill the ice cellars of the imperial palace ;" consequently we find that, even in Russia, so far back as 1740, ice was considered as a necessary article in the *confectionnaire* of a Russian empress.

In the Peak of Teneriffe, there is a cavern where ice is preserved all the year round by natural causes. This subterranean glacier is below the limit of perpetual snow, and in a region where the mean temperature is probably not under 37° Fahrenheit. Neither is it, like the glaciers on the Alps, fed by snow water from the summit of the mountain. It appears that the ice is preserved in consequence of the cave in winter being filled with a great body of ice and snow, while in summer the rays of the sun do not penetrate the mouth of the cave, so that their influence is not sufficient to melt the whole mass.

TO MAKE A CHEAP ICE-HOUSE OR WELL.

Select a situation near to a pond, where drainage can be easily effected; if shaded by trees, the better; and the closer to the water, the less expense will arise in removing the ice from the surface of the water, as it will be only necessary to throw the ice from the bank into the well. Dig out the soil about five or six feet deep, and from eighteen to twenty-four in diameter. It will be requisite to line it with boards, or four-and-a-half-inch brickwork; if chalk, sawdust, or any non-conductor be at hand, it would be well to place some between the soil and the brickwork or boards. Make a centre, similar to those which bricklayers use for turning arches, and which must be very

strong ; cover it with grout, composed of a small quantity of lime mixed with sand, or any other binding substance, to make it airtight ; spread it over with clay, to the thickness of a foot ; thatch it with straw or stubble, or anything of that kind, down to the ground,—the thicker the better. Should it be a sandy soil, it will require no drainage ; but if clay, take an old cask and knock out the head, insert the cask in the centre of the bottom of the well to within about four inches of the top of the cask ; board or brick the bottom of the well in a sloping direction towards the centre, that the water may drain to the cask ; place a board with holes in it over the cask ; insert a pipe in the side of the cask, which should have communication with the pond, cesspool, or

any other convenient receptacle, to which the water in the cask may run. If a chalky or sandy soil, such precaution may not be necessary ; but in any situation it is always useful, for by that means you are secure of keeping the ice, and the well rendered airtight, provided the pipe on the outside be inserted in the water of the pond, receptacle, &c. There must be a small porch or lobby affixed to the side of the well, with two doors, and sufficient space between them to admit of a person entering and shutting the outer door before opening the inner one. It is almost unnecessary to say that you must have a ladder to descend into the well, and also take a light with you. The porch, if possible, should face the north. When the bottom of the well is covered

about six or seven inches with ice, mix half a hundred weight of common salt with that ice, and fill up the well, continually ramming the ice down, that it may lay close together ; but no more salt must be added, or the ice will dissolve. The small quantity of salt thrown on the ice at the bottom will cause a large portion of the cold air to ascend through the ice above, and keep it in a freezing state, and be the means of its becoming a solid mass ; should ice be found to recede from the sides of the well, it will be requisite to shovel some ice from the top into the apertures round the sides.

ANOTHER ICE WELL.

This is more expensive than the preceding.

Dig out the soil as before, about twenty-four feet in diameter, and from fourteen to twenty feet deep, as you think will best suit your purpose ; but, as in the preceding, choose a good situation,—for instance, a mound close to a pond would be the best ; erect a strong brickwork set in cement, at a distance of six inches from the outside, the space between which and the brickwork should be filled with chalk, well rammed down, so that no damp may penetrate through the brickwork, for the *more dry* ice can be kept the better. The well should be domed over with a nine-inch brickwork in cement, leaving a round orifice in the centre, from eighteen inches to twenty-four in diameter, by which the ice may be admitted, raising upon the orifice a kind of round chimney

about three feet in height, so that it may be upon a level with the clay or mould by which the dome is to be covered. On the top, a gutter or groove should be formed of brickwork, filled with sand or water, into which a lid of wood or stone may fit, in the same manner as an air-tight water joint, and the whole secured by a stone on the top. The dome should then be covered with clay and mould to the level of the mouth of the orifice, and may be planted with shrubs and creeping plants, which would serve as an ornament to the grounds, and protect the well from the sun's rays, provided the situation be such that a thatched top would be offensive to the eye. A thatched top is by far the best, because straw throws off the sun's rays, and anything dark absorbs them,

and causes a rarefaction of the air contained in the well, and contributes to the dissolving of the ice. The porch should be constructed as in the last description, and, if possible, face the north. The intermediate space between the doors may be filled with ice, to be used when wanted, and obviating the necessity of opening the well for some time, after which it should be filled with straw, stubble, or anything of the like nature, so as, before mentioned, to prevent the exit of the cold air out of the well. The roof of the porch or lobby must be covered over or thatched, the same as the well. With respect to the bottom of the well, lay the bricks in a sloping direction, in order that the water which drains from the ice may more easily run towards the centre, into the

cesspool, that the ice may be kept dry. A pump may be attached, if the cesspool and drain will not answer, but it is much better to have no pump, and, as before stated, the well ought to be sunk in a mound: even if a pump is attached, it may be neglected, and the water get to the ice and dissolve it. The bottom of the pipe of the pump, where it is necessary to use one, must be constantly immersed in water, and the same precaution must be taken with respect to the pipe or drain by which the water is carried from the well, that the mouth of it may be immersed in the water of the receptacle into which it flows. The cesspool at the bottom of the well must be covered with perforated boards, and salt used, as mentioned in the preceding article.

CONCLUSION.

WE have thus given a brief but comprehensive account of all the various modes hitherto adopted for making ice, as well as the disadvantages resulting from the ice thus made : it now remains for us to direct the attention of the reader to the value and importance of the apparatus which has been in the previous pages explained and illustrated. There is no necessity to expatiate on the refreshing qualities of ice itself,—that is already beyond the power of

controversy,—but on the apparatus which produces it a few words may still be said. For the expeditious production, and the perfect assimilation of its particles when the ice is beaten up, (to borrow a confectioner's phrase,) no machine has hitherto been constructed with such power as this. The freezing vessels may be removed and others substituted with ten times the celerity of any previously known method, and from the construction of the spatulas, and the firmness which they retain during the rotary motion, it is obvious that the cream or water ice must be rendered so smooth to the palate that not one particle can differ from another. Nor are these the only advantages possessed by the machine, for it also supplies the place of a churn, and

any lady or gentleman having the same apparatus in their breakfast-room in the morning, may have butter for their own breakfast, with only a little beneficial exercise being required for its production; this is merely effected by changing the spatula to one of a different shape, and altering the motion of the machine, which is done instantaneously, and thus, instead of ice, butter of the finest description is immediately obtained.

There are many in this age of science who would not believe that the very snow they sweep from their doors might become a source of employment for the poor, and made subservient to the palates of all who delight in cooling refreshments; yet the snow swept from the doors and

collected in the streets of this vast metropolis can be appropriated to the production of ice, and by very simple means.

Some time ago a patent was taken out for packing ice in square blocks, cut from the river St. Lawrence, which were placed edgeways, in such a manner as to prevent their uniting to become one solid mass. We will now shew how, without infringing a patent, solid ice may be procured by any one, in any quantity, at any time.

By having a wooden box, of any dimensions, which can be varied according to fancy or use, (we should in general recommend one about six feet in length, two in width, and eighteen to twenty-four inches deep,) and zinc or patent galvanized iron moulds, (the latter being the strongest and

most suitable for the purpose,) about three inches thick, and from sixteen to twenty-two inches deep, and twenty inches in length, twelve blocks of solid ice may be produced. These moulds, when filled with water, being immersed in the freezing mixture, of whatsoever kind it be, will, in a very reasonable time, congeal the water contained in the moulds ; but care must be taken to have the moulds a trifle less at the bottom than at the top, or the ice will not slip out.

The method generally employed in extricating the ice from the mould is to immerse it in lukewarm water for a quarter of a minute, when it is easily detached ; but be careful lest the water be too warm, for if so, the ice will crack ; or it may be dipped

into cold water above the ice frozen in the mould, leaving it about a minute, and it will then turn out, and may be placed in the ice preserver, setting it upon its edge. When snow and salt or pounded ice and salt are used, it must be rammed down so that there can be an equal action on each side and end of every mould ; it will not congeal the water above its own level ; consequently, the closer the mixture is pressed together, the quicker the freezing operation is accomplished. A tap ought to be fixed within two inches or two and a half inches of the bottom of the box, to draw off the water contained in it between the moulds, about every half or three-quarters of an hour, and then re-charged with the mixture.

The only means required for freezing

these blocks of ice, is snow, or pounded ice, and common salt, well mixed, in the proportion of three or four of snow or ice to one of salt, and that which has been used by ham-factors is quite as good as that which has not been used, and may be obtained at a trifling expense. Hence the ice-wells of noblemen and gentlemen might be filled with the purest ice, without the trouble of skimming ponds. How easily might hundreds, nay thousands, who are unemployed during the inclement season of winter, be supplied with the means of subsistence, by some collecting snow, others filling the moulds and attending to the congelation within the boxes, and in turning out the blocks. By employing a few men, quantities of snow might be obtained for the

purpose above mentioned, and the roads opposite the doors of the nobility and tradesmen would be cleared, and made conducive to filling the wells and ice preservers.

Hotel-keepers and others would eagerly seek after ice produced from pure spring water, when it could be purchased at an equally cheap rate as that collected from ponds, rivers, &c., because they would be well aware of its purity. And one thing should never be forgotten : it is a general remark among professional men of the present day, that if people were to plunge a lump of pure ice into any liquid they were about to drink, they would not be subject to those diseases which generally arise from the frequent use of distilled or fermented liquors.

Although full directions have been given as to the mode of using the machine, we still think it necessary to impress upon our readers how much depends upon the charging of it: if that is not effectually done, in nine cases out of ten, the operation must partially fail.

The mixture, therefore, as before stated, must be rammed down, so as to press as closely as possible to the freezer and metallic case, not forgetting to give a few turns to the fly-wheel, that an equal portion of frost may be diffused throughout the whole, or much blame may be attached to the machine, when in reality the fault may rest entirely in the charging up. When the cream or water ice is sufficiently frozen, it may be removed, leaving the metallic

case containing the spring water for about half or three-quarters of an hour, by which time it will have become solid without turning the wheel, although a slight agitation accelerates the congelation. The method of turning out these blocks has already been shewn.

We would here recommend the machine to be always kept perfectly clean, (*always leaving water at the bottom of the pail, which will be seen by the taps being raised a little from the bottom,*) whether in use or out of use, not only on account of appearance, but for its preservation, with the exception of those composed of metal, which must be always kept dry.

We do not think it irrelevant to our subject, to quote the following from the "Me-

chanics' Magazine" of Saturday, Feb. 10, 1844 :—

“ Considering how long we have been familiar with various means of artificial congelation—for half a century at least—and how eagerly in this country every discovery of science is turned to practical account, it is surprising that no one should before now have succeeded in adding to our multitudinous list of useful processes, one of so attractive a character and of such lucrative promise *as the manufacture of ice*. It is exactly twenty years since we published in our journal (No. 20, Jan. 10, 1824) a description of an ice-making apparatus, then some six or seven years old, invented by Professor Leslie, by which that eminent philosopher confidently

predicted we should be able 'to produce ice on a large scale, at all seasons, and in the hottest climates of the globe.' His agents were but a peck or so of parched oatmeal, and a good-sized air-pump! But notwithstanding the sanguine anticipations of Mr. Leslie, his apparatus never came into use: confectioners, restaurateurs, and others, still supply themselves, as of old, with ice of Nature's own making; and in countries where the thermometer never, or rarely, descends to the freezing point, the inhabitants are content to import their supplies, at a vast expense, from the (in this respect) more *favoured* regions of the North.

“The cadger providers of our Gunters and Verreys continue, as in the days of Pepys, to lay every suburban pond, 'from

Stratford Marshes to Wilsden Bottom,' under contribution; Rotterdam exports to Naples, New York to Calcutta and Hong-Kong. The ice trade between North America and the East Indies employs, of itself, several ships; and the Patent Office at Washington is seldom without some application before it, for some new mode of transporting the commodity. We have heard of the neglect of Leslie's ingenious scheme for saving all this vast trouble and cost accounted for, on the ground that there was nothing to be saved by it; and it is not improbable that the fact was found to be so; for air-pumps of a capacity adequate to the manufacture of ice 'on a large scale' are dear articles, difficult to keep in order, and, at best, of very slow operation. The

apparatus which we have now to present to the notice of our readers, is destined, if we mistake not, to experience a very different fate. We anticipate nothing less from it than the speedy and entire abandonment of the present traffic in natural ice. It is on a different principle from Leslie's, of cheap and simple construction, easy to work, not at all liable to get out of order, and wondrously rapid and efficient in operation. You may either have it of a large size, to produce in the shortest time possible a large quantity of ice; or you may, with one of small size, produce the same quantity by repeated operations so rapidly as to make the difference in time a matter of no moment. We have ourselves seen two quarts and a half of ice cream manufac-

tured by one of Mr. Masters' machines, little bigger than an ordinary tea-pot, in less than four minutes. In an hour it would have produced full thirty quarts, (allowing for the time taken up in emptying and re-filling,) which is more than enough for the largest private party. We saw also a circular tub, or pail of ice, of about an inch thick, and ten pounds in weight, intended to serve as a wine-cooler, produced on the same occasion within half-an-hour.

“ Mr. Masters' apparatus may be described in general terms, as being simply a rotary churn, applied to the purpose of refrigeration. It does, in fact, churn as well as freeze ; and herein, so far as the making of dessert ices is concerned, consists one of the most valuable features of the invention.

The solutions required to be converted—whether into ice creams or water ices—are whipped, beaten up, or churned, while in the act of freezing. The solutions are placed in vessels surrounded by frigorific mixtures, and caused to rotate with great rapidity; while certain spatulas, which are kept stationary within the rotating vessels, effect the churning or beating-up part of the process. The inventor mentions a great number of frigorific mixtures as suitable for the purpose,—as muriate of ammonia, snow, and common salt; nitrate of potash, snow, and common salt; crystallized chloride of calcium and snow, fused potash and snow, &c., but he lays no claim to particular ingredients. Where cold is not required to be of great intensity, a little natural ice

broken up into pieces, or new fallen snow, will probably answer as well as anything else ;” and the article concludes thus :—
“ It should be added, that when the machine is used as a butter-churn merely, the frigorific mixtures are dispensed with, and their place supplied with warm water if necessary.

“ The larger machine may be also occasionally used as a butter-churn, in the same way, or one division of it may be so employed, and the other appropriated to the making of ice.”

The editor, in his description of the machine, taken from the specifications, in which it states, a circular hollow block of ice can be produced in from one and a half to two hours, has a note to this effect :—
“ Sic in specification, but as before stated,

we saw one of these blocks actually produced in half-an-hour."—ED. M. M.

Various speculations have been started to account for the remarkable difference subsisting between the appearance of the ice produced by this apparatus, and that produced by the action of natural frost. The bare inspection of this artificial ice, and its comparison with the idea of ice which the mind has been accustomed to entertain, will enable the reader to discover the semi-opaque and marble-like appearance of the one and the crystalline transparency of the other; and in order to form a correct notion of the difference, it will be necessary to deviate from the subject, in order to notice similar

effects produced in like circumstances, and thus by analogy trace out the physical relations of the two specimens. Many substances occur in a natural state, which present under different circumstances, in relation to each other, precisely the same appearances. Thus, we observe silex under two forms, the quartz and rock crystal; diamond, in the milky and transparent states. The earth called alumina occurs frequently as an opaque, strong mass, and more rarely it is found in a transparent state, as in the ruby and sapphire. Carbonate of lime is found in a similar opaque condition, as in Carrara marble, or beautifully transparent in Iceland spar. Here we have instances of analogy sufficient, in which all the opaque substances are in an

amorphous or uncrystallized state, but when crystalline in their atomic arrangement, are exceedingly transparent. In order that the regular atomic arrangement of the particles composing any substance may take place, it is necessary that the change from the fluid to the solid state be *slow* and gradual ; and that the fluid or solution during this change should repose without disturbance or agitation. An instance in which the rapid solidification of an aqueous solution entirely disappoints the transparency of the mass, although crystalline, may be observed in sulphate of soda :—Fill a Florence oil flask with sulphate of soda, and after adding as much cold water as will cover the salt in the flask up to the bottom of the neck, set the whole in a saucepan half full of cold water over the

fire, until the whole is boiling hot, and the salt completely dissolved ; then, immediately on taking out the flask, cork it close with a soft cork, and tie a piece of wetted bladder over the cork and neck of the flask. When quite cold, the bladder and cork may be removed, when, instantly, the liquid contained in the flask will become solid, the flask warm, and if performed in the dark, a flash of electric light will be seen at the moment of solidification. The mass, instead of being transparent, will be opaque, and present much the same appearance as our artificial ice. Disturbance during the act of solidification is a fertile source of opacity, the most remarkable instance of which is to be found in the formation of marble, by continual deposition from running streams ;

and that of stalactites from the roofs of grottoes and caverns, both of which, although crystalline, are opaque. Hence we trace the cause of the marbled opacity of artificial ice to the rapid solidification of the water, disappointing its crystalline structure, and to the shaking of the apparatus during the process of freezing, neither of which causes of irregularity are present during the formation of ice on the surface of a pond, except in cases where, during frosty weather, violent winds ripple the surface of the water, when the ice presents the same appearance of milkiness or opacity. Another reason for the opacity of the ice is, that it being less exposed to the action of the atmospheric air, it cannot polarize, or it would be as transparent as that frozen by nature.

In reference to the utility and application of artificial ice, it may be augured that, in a therapeutic point of view alone, so beneficial will its application be in diseases of various kinds, that, independent of its domestic or culinary utility, the apparatus, as a medium of the rapid, convenient, and easy production of ice in any shape, will become an invaluable desideratum to the hospital as well as to every establishment of distinction or importance. As a refrigerant in febrile and inflammatory diseases, acidulated and aromatic beverages, formulas for making and icing which will be found in this work, may be administered with singular advantage and utility. The late Dr. Reid, in his work on cold ablution in the hot stage of fever, says, that in numberless cases where extreme

thirst, prostration of strength, restlessness, total want of sleep, and raving delirium prevailed, the application of ice-cooled water to the whole body by a sponge, slaked the thirst, roused the strength, calmed the patient, dispelled the delirium, and induced sleep, from which the sick awoke refreshed and comfortable ; and that all this train of symptoms of excessive excitement could always be anticipated and prevented by giving to the patient plenty of ice-cold ptisans, whenever he felt inclined to take them.

Do we wish for powerful local antiphlogistics or sedatives, we shall find them in disks or caps of ice, and when sufficient cold is produced so as to freeze mercury, ice at the same temperature, or disks of this metal, may be used as vesicatories, or counter-

irritants ; and for destroying the poison in the bites of rabid animals, it promises much.

In hemorrhage, no remedy has ever been used of half so much importance ; the application of a cold key or wet cold towel to the nape of the neck, in epistaxis or bleeding from the nose, is a remedy generally resorted to ; and in uterine hemorrhage, this is altogether a panacea. Where has the physician a remedy, which, by the touch of the wizard's wand, is either stimulant or debilitant, like cold water or ice?—or where can he find so near an approach to an universal medicine as warm and cold water—ice at 32°, and ice at 40° below zero ? This substance, in its varied phases, is at once stimulant and sedative, diaphoretic,

sudorific, and diuretic, ~~excitant~~ and refrigerant, emollient and roborant, astringent and relaxant? In hepatic and visceral obstructions, kept up by excitement, the highest encomiums of the sanative virtue of this remedial agent would be less than it deserves. In short, life itself may be roused or curtailed by its action ; and all the intermediate effects so desirable in therapeutic agents, the physician may find in this. These hints and observations are respectfully thrown out by a physician to his professional brethren, from a firm conviction that this invention and its ulterior applications are highly deserving of their most serious attention.

The author is proud to acknowledge the receipt of the following letters and certificate, bearing testimony to the utility of his invention :—

Certificate

FROM JOHN RYAN, M.D., LL.D, M.R.C.S.E.

LECTURER ON MATERIA MEDICA AT THE CHARLOTTE-STREET SCHOOL OF MEDICINE, BLOOMSBURY; AND PROFESSOR OF CHEMISTRY TO THE ROYAL POLYTECHNIC INSTITUTION, AND THE ROYAL NAVAL COLLEGE, PORTSMOUTH.

28, Somerset-place, Portman-square,
Sept. 28th, 1844.

MY DEAR SIR,—Having had several opportunities of observing your method of making artificial ices and ice-creams by your patented machinery, I cannot avoid the expression of my delight at the rapidity and perfect success of the whole process.

In many instances, without any previous

preparation, you formed for me cherry, ginger, lemon, and vanilla ices, in the course of two minutes ; and in an incredibly short space of time, produced in the same machine, and by the same process, an immense block of ornamental ice, in which you had imbedded leaves and various fruits, giving the whole a most beautiful and unique appearance. In fact, I could scarcely believe at first that you had employed merely pure water ; and it was only after careful examination and analysis that I became convinced.

You have certainly conferred upon society a great obligation in thus enabling us to form in our own dining-rooms this healthful delicacy ; and this, too, in so small a space of time, and by means of such portable and elegant machinery.

To the medical profession you may confidently look for approbation ; for you now enable them at all seasons, whether in the crowded fever wards of the hospital, or in private practice, to obtain for the patient a necessary adjunct to medical treatment.

Believe me, yours truly,

JOHN RYAN, M.D., LL.D.

To Mr. Masters.

London, Sept. 30, 1844.

SIR,—The rapid and easy production of ice, in its simple state, as well as in the form of iced creams, liqueurs, &c., by your patent freezing apparatus, created in me feelings of the most intense admiration and

astonishment. Acquainted previously with the **chemical details** of the production of ice, by the **rapid** solution of saline substances, with and without the use of ice, I was prepared to expect a result which falls far short of what you are capable of performing by your machine.

The production of four different iced liqueurs within the short space of two minutes, absolutely astounded me ; nor can I account for the **difference** of power betwixt your improved mode and the common method of freezing, than by the supposition that the **superior efficacy** depends mainly on the **large amount** of freezing surface available, from the use of your patent spatula.

To the **prospective eye** of the medical **philosopher**, your simple invention opens

many new and important views, in its application to the healing art, and I doubt not that it will ere long be the means of becoming an extensively useful local remedy for banishing from our pharmacopœia a great mass of the useless lumber which clogs our medical practice, and tends to associate us with the class of empirics.

To the hospital, to the surgery, to the hotel, this unique machine will, in its products, fail not to become an absolute desideratum, and be esteemed second to none of the most useful domestic or culinary utensils which time, utility, and custom have made absolutely necessary.

Under the firm impression that your invention deserves well of the public, I wish you the most complete success, whilst I

tender to you this small testimony of my
satisfaction and approbation, and remain,

Dear Sir,

Your most obedient servant,

WM. RADLEY, L.A.C.

D.M.P., M.D. Lugd. Bat.,

LECTURER ON TECHNOLOGICAL CHEMISTRY

TO MANY POPULAR INSTITUTIONS.

To Mr. Masters, 56, Upper Charlotte-street,
Fitzroy-square.

T. MASTERS' PATENT FREEZING APPARATUS.

Elevation.

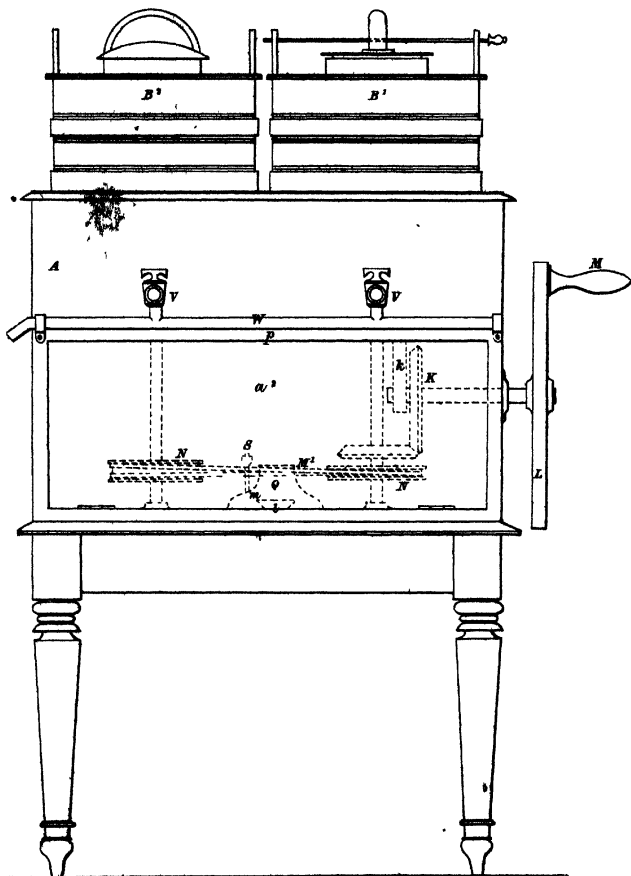

DESCRIPTION OF THE PLATES.

PLATE 1 is an elevation of a double-motion machine. A and a^2 is a box, into the upper part of which the pails, B¹ and B², are inserted, the lower part, a^2 , containing the machinery. V V are taps to draw off the water from the pails into the wine-cooler, some being inside and some out. P is a flap-door, which lets down, for the purpose of getting to the machinery to oil or cleanse it. M is a handle, by which the fly-wheel, L,

is turned, driving the machinery. Some are also made with a drawer underneath, which serves as a wine-cooler and various other purposes, as represented in Plate No. 4.

Plate 2 is an elevation of a single-motion machine, the freezer of which is made to rotate by turning a crank handle at the top, containing a drawer for keeping fish, game, butter, &c., and a wine-cooler or cellaret underneath, and into which the iced water from the pails can be drawn by means of the tap, F^o, to cool or ice the wine contained in it.

Plate 3 is an elevation of a machine similar to that described in Plate 2, with this difference, that it has a pedestal stand instead of a drawer and cellaret; it has a

T. MASTERS' PATENT FREEZING APPARATUS.

Elevation.

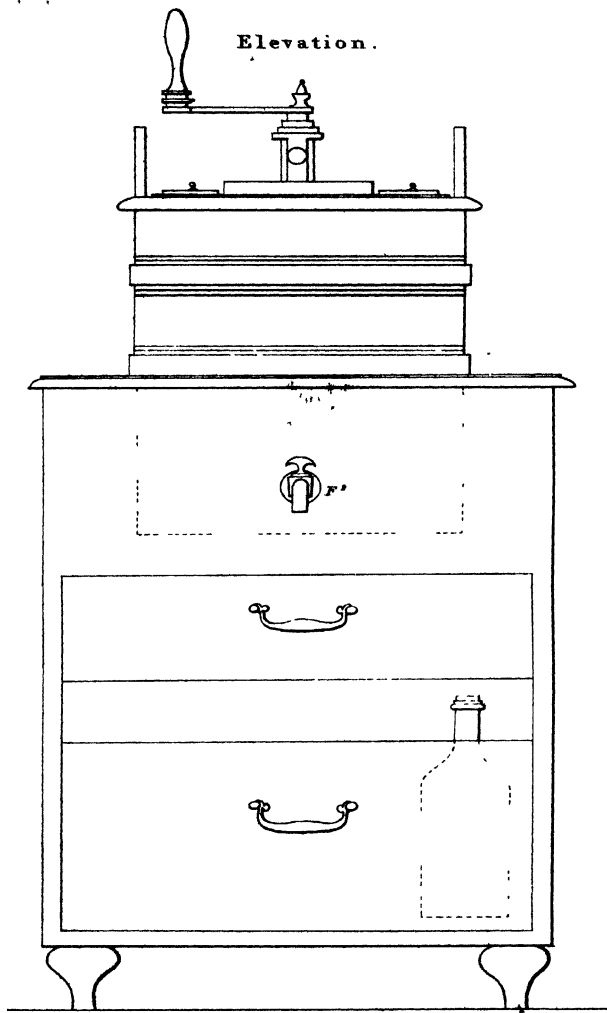

T. MASTERS' PATENT FREEZING APPARATUS.

Elevation.

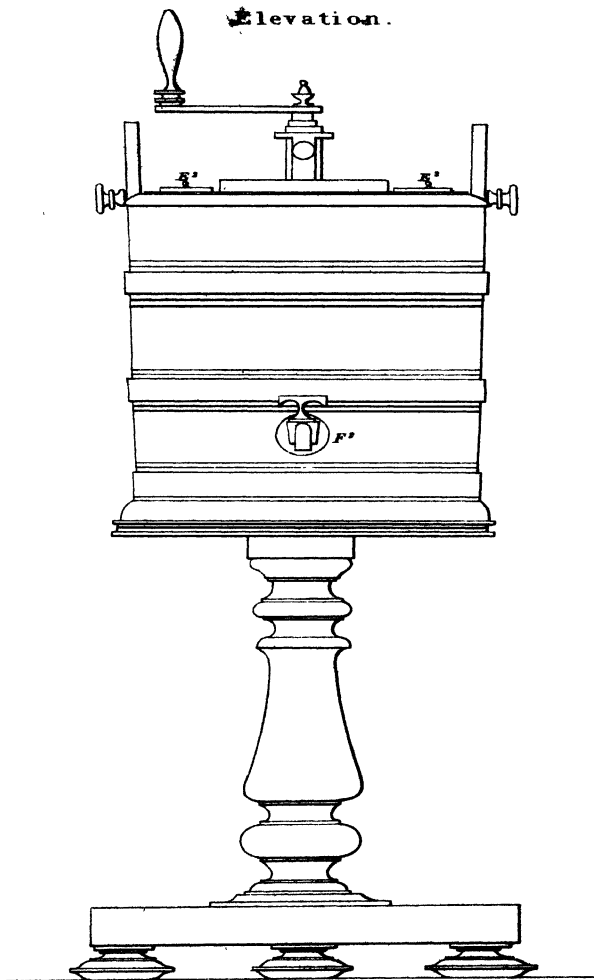

tap, F^2 , to draw off the water, the same as in the preceding. E^2 is a bolt, which stops the rotation of the freezer when the action of beating-up is required.

Plate 4 is a representation of a machine similar to the one described in Plate 2, with the exception of the machinery being propelled by means of a fly-wheel.

Plate 5, Fig. 1, is a section of the wooden pail, freezer, and metallic case, with spatula, E , inserted in the freezer, $C C$, which contains the cream or water ices. $G G$ is the metallic case, for holding the spring water to produce the block of ice. $H H$ is a chamber between the freezer and the metallic vessel, into which the frigorific mixtures are introduced, for the purpose of freezing the contents of those vessels. F is a false

cover to the freezer, to allow the handle of the spatula to obtrude ; and F^2 is a brass rod, passing through the lugs of the pail, ff , and the handle of the spatula, which causes it to remain stationary while the freezer revolves, and thereby beating up its contents ; d is a cap, attached to the bottom of the freezer, into which the upright shaft or spindle passes, by which the rotary motion is given.

Fig. 2, Plate 5, is a representation of a three-bladed spatula, as used for churning, the bottom of which is shewn in Fig. 3.

Plate 4, Fig. 5, is the bottom of a freezer enlarged, with the shaft passing into the before-mentioned cap and through the stuffing-box.

Plate 6, Fig. 1, is a drawing of a four-

T. MASTERS' PATENT FREEZING APPARATUS.

Elevation

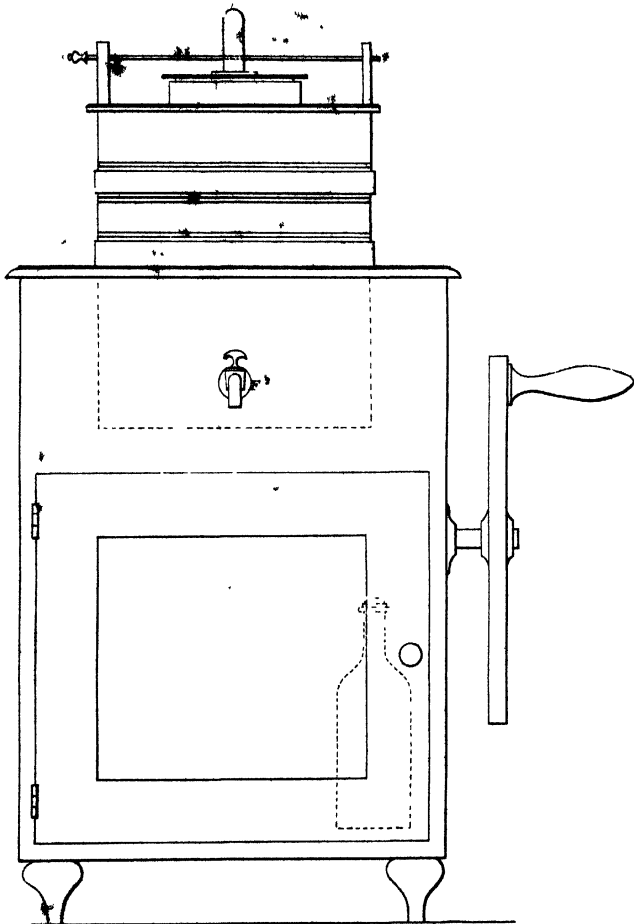

Fig. 1.

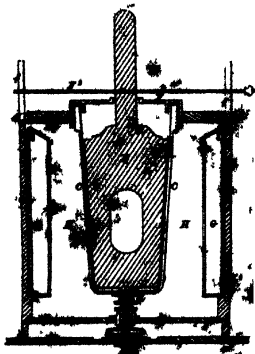

Fig. 3.



Fig. 4.

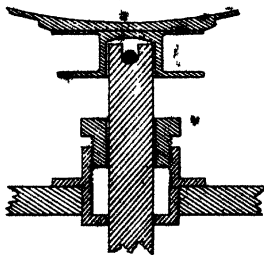

Fig.



bladed spatula for churning, the bottom of which, and the churn, is shewn in Fig. 2.

Fig. 3, Plate 6, is a section of a different kind of churn, with its spatula.

Fig. 4, Plate 6, is a section of an ice preserver, shewing the ice-well, K^s. L^s is a cistern, with a filter, containing water, which passes from it, through the coiled pipe, b^s, made of galvanized iron or lead, (the former is the best), and is drawn off at the tap in front, completely iced, from its having gone the circuit of the ice-well. M is a wine-cooler, for which purpose also O^s may be used. N^s is a drawer, which may be used for any cooling purpose, by placing a little ice at the bottom and laying the articles required to be cooled on the perforated shelves.

Fig. 5, Plate 6, is a representation of the end of the above.

Fig. 6, Plate 6, is a wine-cooler, with a block of ice turned out of the metallic vessel contained in the machine, into which bottles of wine may be placed, in order to be cooled.

Fig. 7, Plate 6, is a different kind of wine-cooler, or cellaret, which has a case all round, filled with filtered water, which, when ice or any freezing mixture is put into the bottom, becomes exceedingly cold, and is drawn off by a tap for table, cooling the wine much quicker than if there were only one case. Both this and the ice preserver contain perforated shelves, for keeping game, fish, butter, &c.

Fig. 8, Plate 6, is a shelf for Figs. 6 and 7,

T MASTER'S PATENT FREEZING APPARATUS.

Fig 1.

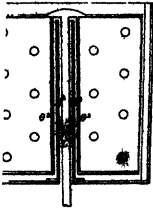

Fig 2.

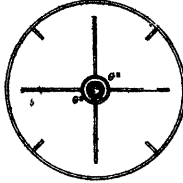

Fig 3.

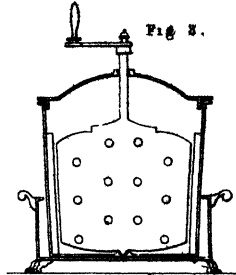

Fig 4

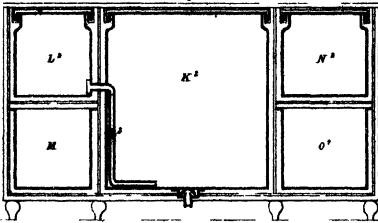

Fig 5

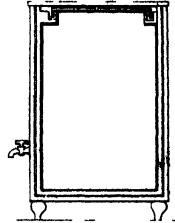

Fig 6

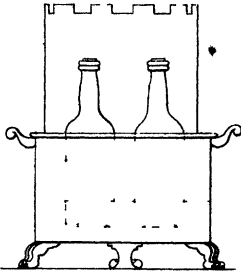

Fig 7.

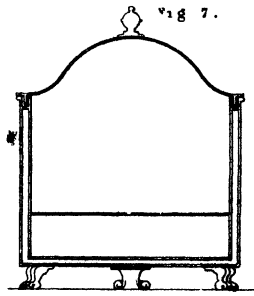
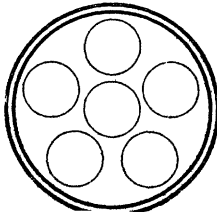

Fig 8



with holes in it to admit the bottles, and resting upon a ledge about four or five inches from the bottom.

We have been thus brief in this explanation, as the plates have been adverted to elsewhere.

There is also a spanner, or wrench, to unscrew the stuffing-box in the bottom of the pails belonging to the machines worked by the fly-wheel, which may sometimes require to be taken off, and the box re-stuffed, which is done by saturating some tow in hot lard, and after having taken out the tow previously placed in the box, re-fill it with fresh tow, making it tight all round the spindle, and again screwing on the top: this may be necessary once in three months, if used often.

There is also a small spatula sent with each machine, to take the ice off the sides of the freezer, and the larger spatula; and also a rammer, to ram the ice down in the pail.

* * The Galvanized Iron Machines are exactly the same as the Pedestal Machines, as shewn in Plate 3, with the exception of the wine-cooler underneath, into which the mixture from the pail above is let off by means of the plug or tap.

Should it be found that there is any difficulty in detaching the inner pail from the bottom of the machine, it will be necessary to wash the plug underneath with a cloth dipped in warm water, to make the ice slip off the more easily, and also to wash the inside of the inner pail with lukewarm water, to detach the block altogether.

A great advantage in these machines is, that the outside, being a double case, may be filled with water to be cooled for the table, unless, as in some cases, a solid non-conductor is introduced; but the air being a non-heat-conductor, you may freeze better without water, unless it is particularly wanted.

I C E S.

THE following PORTABLE ICES are prepared and sold only by THOMAS MASTERS, of No. 56, Upper Charlotte-street, Fitzroy-square, Patentee of the Freezing Apparatus—viz.,

NECTAR ICE, CHERRY ICE,
LEMON ICE, PINE-APPLE ICE,
AND VANILLA ICE,

to either of which it is only requisite to add half-a-pint of water to each pint of ice, and freeze, the operation of which may be performed in three or four minutes, by Masters' Patent Freezing Apparatus. Ample directions are given on each bottle and wrapper.

It may be advisable, however, to state that Lemon-water Ice may be converted into Ginger Ice, by merely adding bruised or sliced ginger, with its syrup, to the Lemon Ice when frozen, giving two or three turns to the wheel to mix it. In like manner, the flavour of Pine-apple Ice may be heightened by the addition of a small quantity of Pine-apple Marmalade.

Each of these Portable Ices is capable of making a superior cooling drink, by putting a wine-glass of the ice into half-a-

ICES.

pint of iced water, or as much as will suit the taste. The Lemon and Nectar are most excellent additions to Punch and Negus, imparting to them a rich and racy flavour, rarely to be produced by any other means.

Half-pints, 1*s.* 6*d.* each, or £0 16 0 per dozen.

Pints. . 2*s.* 6*d.* each, or 1 5 0 per dozen.

Quarts . 5*s.* 0*d.* each, or 2 8 0 per dozen.

MASTERS' PATENT

FREEZING, COOLING, ICE-PRESERVING,

AND

Churning Apparatus.

THIS apparatus may be considered as one of the most useful inventions of the present day, to say nothing of its ornamentality, it being not only a desirable appendage to the kitchen, but a real acquisition to the dining-room. It is so constructed, that ices may be frozen, butter churned, wine cooled, and rough ice produced and preserved, at one and the same time.

To confectioners and hotel-keepers it is invaluable, both from its economy and the rapidity with which it freezes, not consuming more than one-half the rough ice as when frozen by the hand or any other means, the whole process being completed in a few minutes; and also, from the peculiar construction of the spatulas, the ice is beaten up much finer and smoother than can possibly be done by any other method. The operation of freezing, with or without ice, is so simple, that the most inexperienced person can perform it.

The Wine-cooler, when detached from the freezing apparatus, may be removed with the greatest ease to any part of the house, and placed in any situation required, becoming at

FREEZING APPARATUS.

the same time an ornamental piece of furniture, from which the wine may be taken at pleasure. The apparatus may, if ordered, be made to fit to any place, with marble or other tops, and ornamented according to the purchaser's directions.

To fishmongers, hotel-keepers, and others, the Ice Preserver will be a great advantage, for it will preserve ice, fish, game, meat, butter, &c., far better than anything of the kind ever invented, and, at the same time, ice spring-water for the table.

The advantages of the Machine to freeze without Ice, to gentlemen in the East or West Indies, or any other place where ice cannot be procured, is incalculable, inasmuch as a block of ice can be obtained at the same time the cream or water ices are frozen for the table, wine &c., cooled; but if cream or water ices be not required, water may be substituted in the freezer, without the spatula, and a block will also be produced in the freezer. At the bottom of the pail in this machine, you will perceive a plug, by unscrewing of which, the mixture contained in the pail is let off into the cooler below, and must be replaced before you re-charge with the mixture; the contents of the cooler would then render several bottles of wine, soda-water, &c., as cold as ice itself. Should it be found that there is any difficulty in detaching the inner pail from the bottom of the machine, it will be necessary to wash the plug underneath with a cloth dipped in warm water, to make the ice slip off the more easily, and also to wash the inside of the inner pail with lukewarm water, to detach the block altogether. Another great advantage in these machines

FREEZING APPARATUS.

is, that the outside, being a double case, may be filled with water to be cooled for the table, unless, as in some cases, a solid non-conductor is introduced; but the air being a non-heat conductor, you may freeze better without water, unless it is particularly wanted. Many eminent medical men have stated to the inventor, that by producing blocks of ice he has conferred a great benefit on society in general, and have cited numerous cases wherein they may be used as a preservative of human life.

The apparatus may be seen at the Royal Polytechnic Institution, Regent-street; the Zoological Gardens, Regent's Park; the Botanic Gardens, Inner Circle, Regent's Park; at T. Masters', Inventor and Patentee, 56, Upper Charlotte-street, Fitzroy-square; and at J. S. Sweeting's, Fish and Oyster Establishment, 159, Cheapside, adjoining the Post Office, sole Agent.

The following is a general List of the Prices of the Apparatus:—

Pedestal Machine	£6	6	0
Metal Machine, with Wine-cooler	7	7	0
Single-motion, in deal, with Cooler	10	10	0
Single ditto, in mahogany or oak	11	11	0
Double-motion Machine, with Stand, in deal	13	13	0
Ditto, with Wine-cooler	15	15	0
Ditto, in oak or mahogany	16	16	0

WINE-COOLERS,

Such as Fig. 6, Plate 6, ornamented, from 30*s.* and upwards; such as Fig. 7, Plate 6, from 50*s.* and upwards.

FREEZING APPARATUS.

ICE-PRESERVERS,

For keeping Ice, cooling Wines, &c., with Trays, from seven guineas and upwards.

All of which are composed of the very best materials that can be procured for the purpose, and made by the most experienced workmen. The Freezers belonging to the Machines to freeze without Ice are not so stout as those made to freeze with Ice, on account of there being a greater friction when ice and salt are used than with any of the other mixtures.

THE

PATENT ROTARY KNIFE-CLEANER,

POLISHER, &c.

THE immense advantages to be derived from the use of the "Rotary Knife Machine," in establishments requiring the use of it, will render the cost of little or no importance. Amongst other benefits to be derived from its use, is the saving in the knives. A set of knives cleaned by this process will outwear three sets cleaned on a knife-board; an established fact, which has been amply tested during the last two years in the greater number of taverns, chop and coffee houses, in the United States of America, and New York in particular. In the next place, the knives will retain their original shape to the very last, being worn equally all over. The beauty of ivory and other handles is retained much longer, for there is no necessity for putting them into hot water, nor will they get discoloured from the heat of the hand of the cleaner, which it evidently does, and injures the beauty of them in once cleaning more than in eating with them forty times.

Again—the saving of time is immense: as many knives as each machine will hold at one time can be cleaned every half minute. What other plan at present known can equal this, or at all approach it? One man could, with the aid of the large machine, do the work of four or five—or, in other words, he could do as much work with it in one hour, as without it

[TURN OVER TO BACK OF NEXT LEAF.

THE PATENT
ROTARY KNIFE - CLEANER

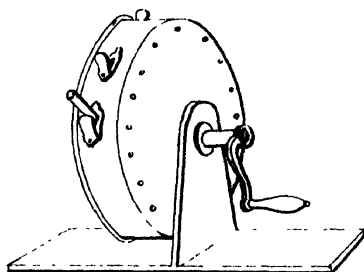

FOR SMALL ESTABLISHMENTS.

THE PATENT

ROTARY KNIFE - CLEANER

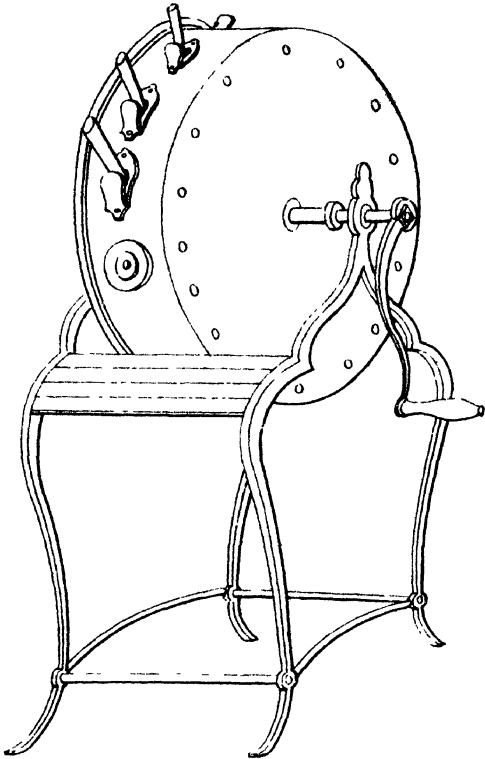

FOR LARGE ESTABLISHMENTS.

THE PATENT ROTARY KNIFE-CLEANER.

he could effect in four or five hours; and each of those four or five hours would be as laborious as the one hour with the machine: thus it gives him three or four hours to be devoted to some other employment. But this is not all; for this machine can be constructed so as to clean and polish all kinds of cutlery, armory-gun-barrels, bayonets, &c., as it gives a most delicate polish to all articles inserted in it, without noise or dust. It is scarcely necessary to remark that the machine for cleaning armory-gun-barrels, bayonets, &c., must be larger than those for cleaning knives and forks, and the insertions be placed horizontally, instead of vertically. It is, therefore, of inestimable value to cutlers and tool-makers, inasmuch as it will keep their goods continually polished, with but little labour.

The size of the machine is varied, so as to suit the largest as well as the smallest establishments.

The operation for cleaning, as before stated, takes about half a minute; the cost of the machines is from 25s. to £12.

The machine is so simply constructed, that it prevents the liability of getting out of order; the brushes will last for very many years, and when required to be renewed, can be done at a very trifling expense, as the backs will remain uninjured.

The attention of proprietors of hotels, club-houses, boarding-houses, steam-boats, packet-ships, colleges, academies, &c., as well as of housekeepers in general, is requested to the above valuable invention.

* * * The Machines may be seen at the Manufactories, 56, Upper Charlotte Street, Fitzroy Square, and at 14, Constitution Row, Gray's Inn Road.

Turn out quinas and upwards.

Also the Registered Hob Cleaning Apparatus;

*by which Tur. Tools may be cleaned and polished in a superior
manner at once*

Price Six Shillings and upwards

THESE MACHINES MAY BE SEEN IN ACTION AT THE MANUFACTORY,
56, UPPER CHARLOTTE STREET, FITZROY SQUARE,

AND AT THE

PATENTEE'S DEPÔTS, 150, NEW BOND STREET AND 7 MANSION HOUSE ST. CITY, OPPOSITE THE MANSION HOUSE.

W. C. C. 1871. "H. E. A. D. 1871"