

其四
樹木類

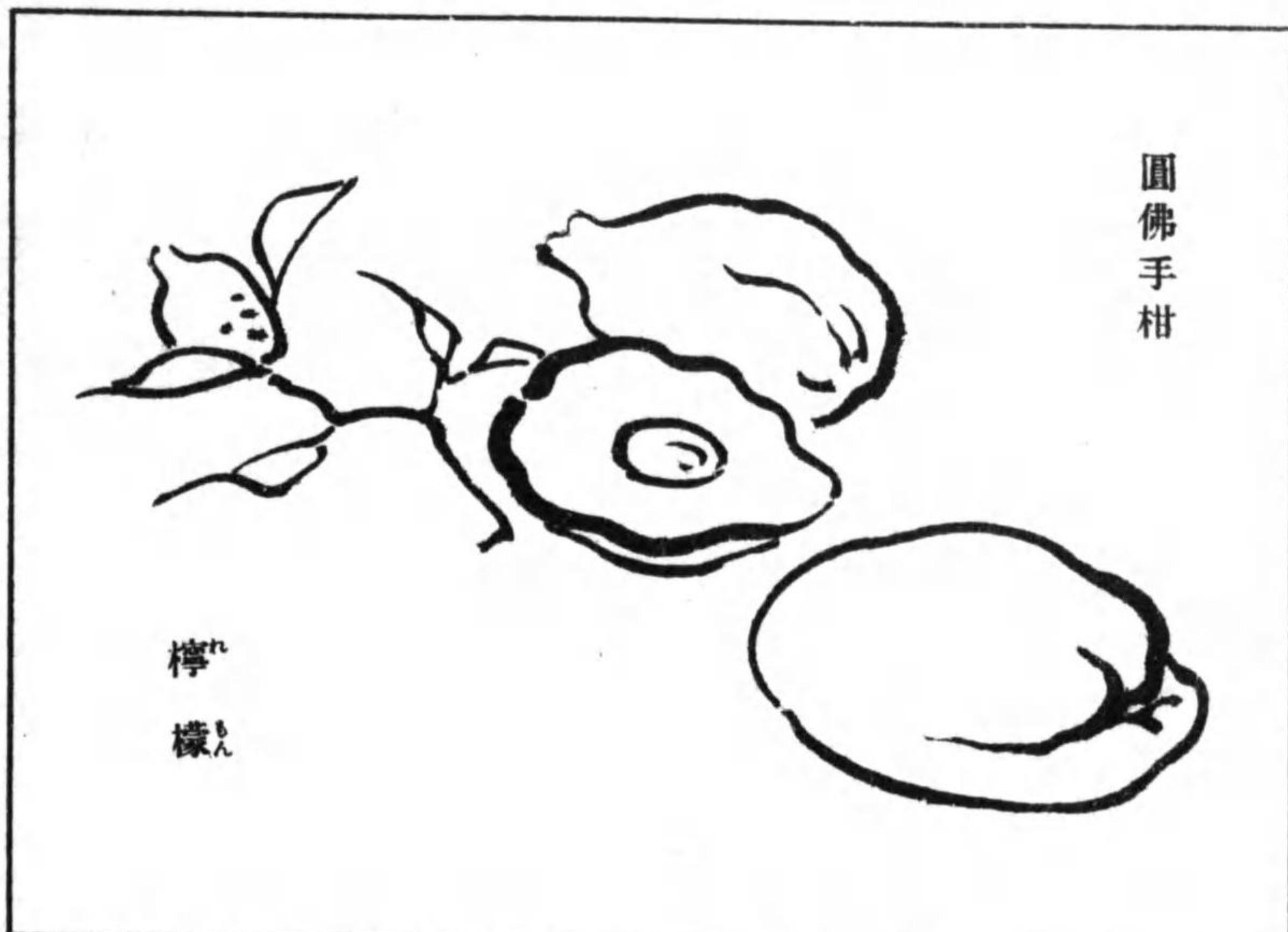

圓佛手柑

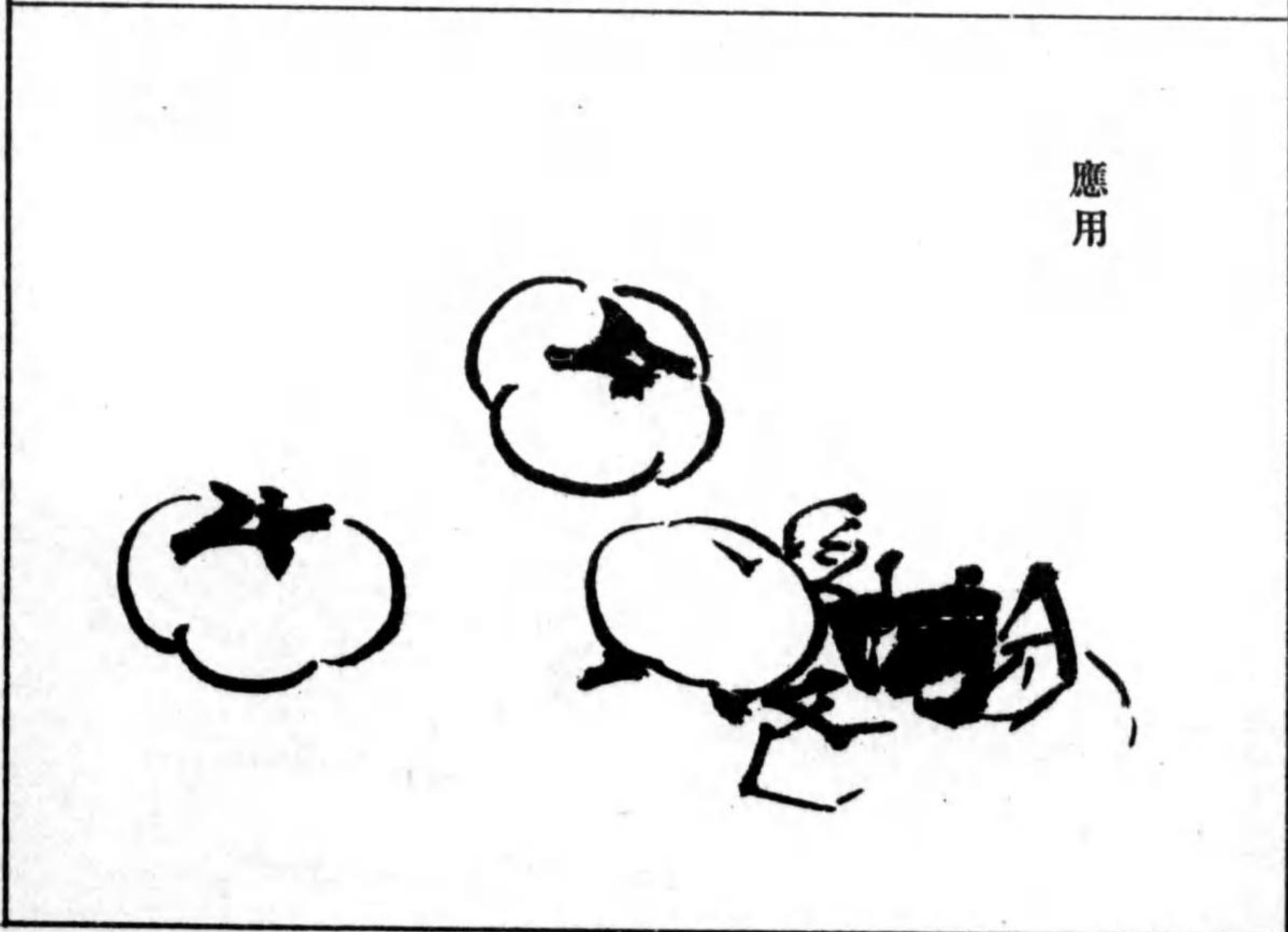

其四樹木等

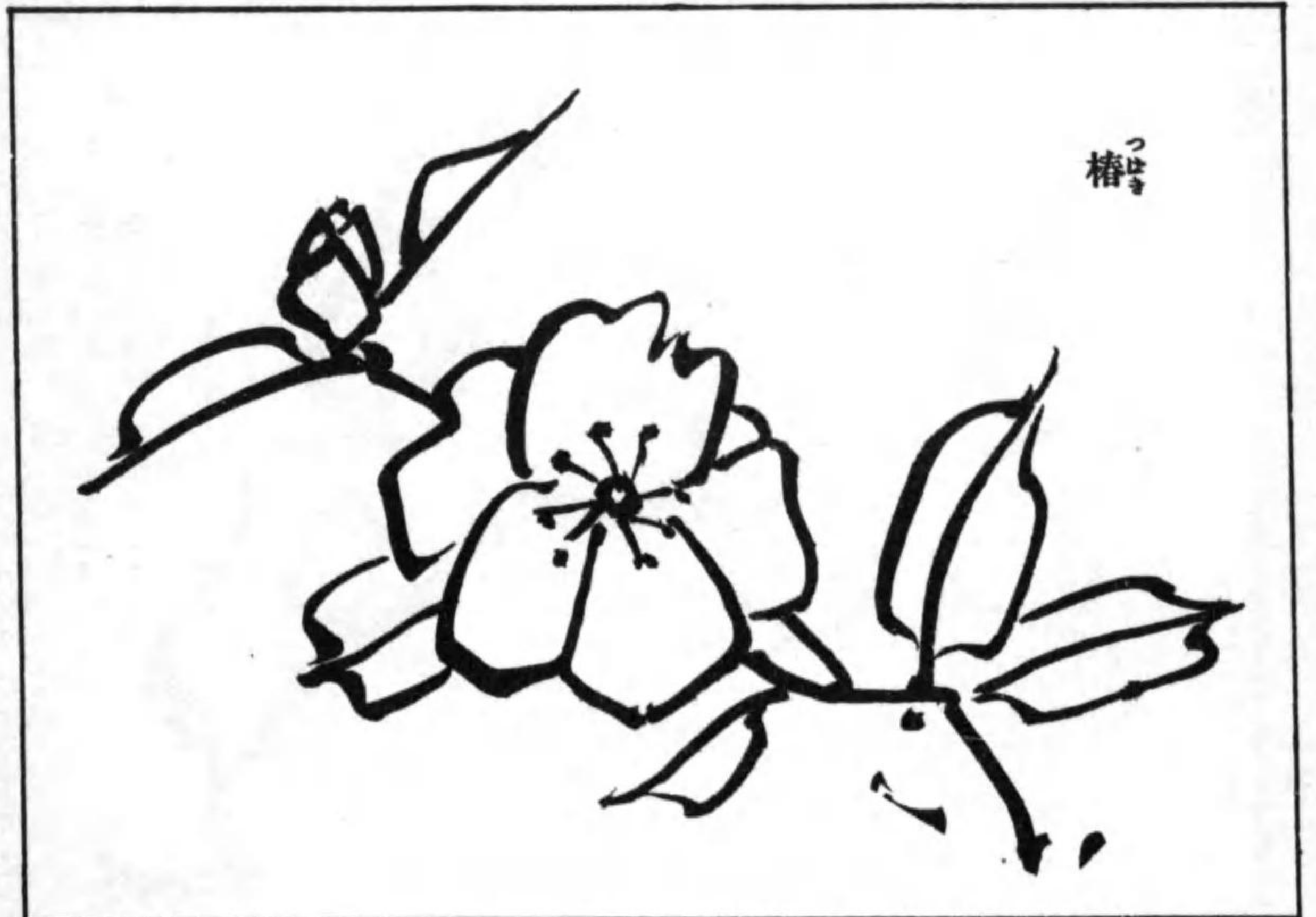

椿つばき

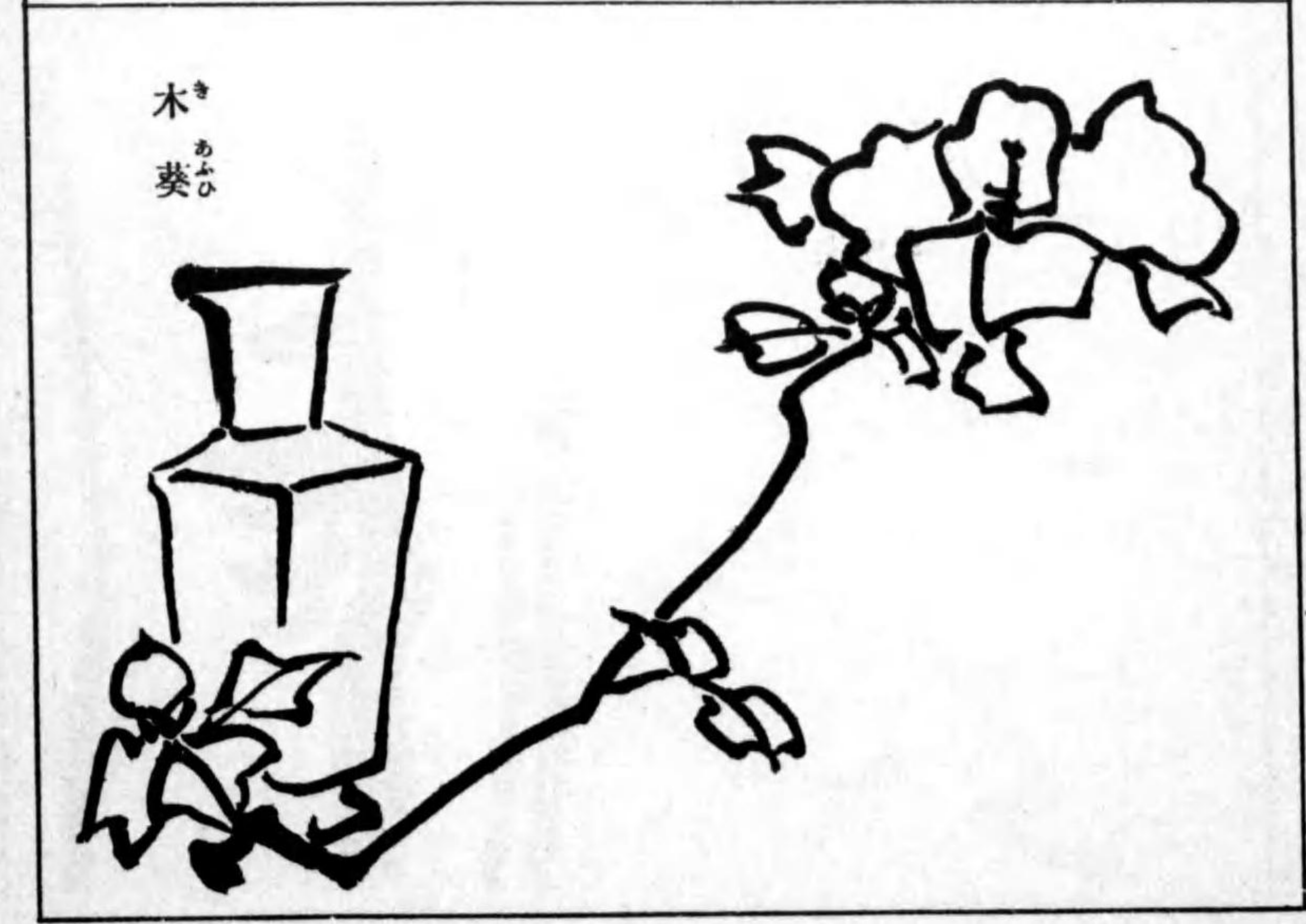

木き
葵あひひ

三十五

木蓮

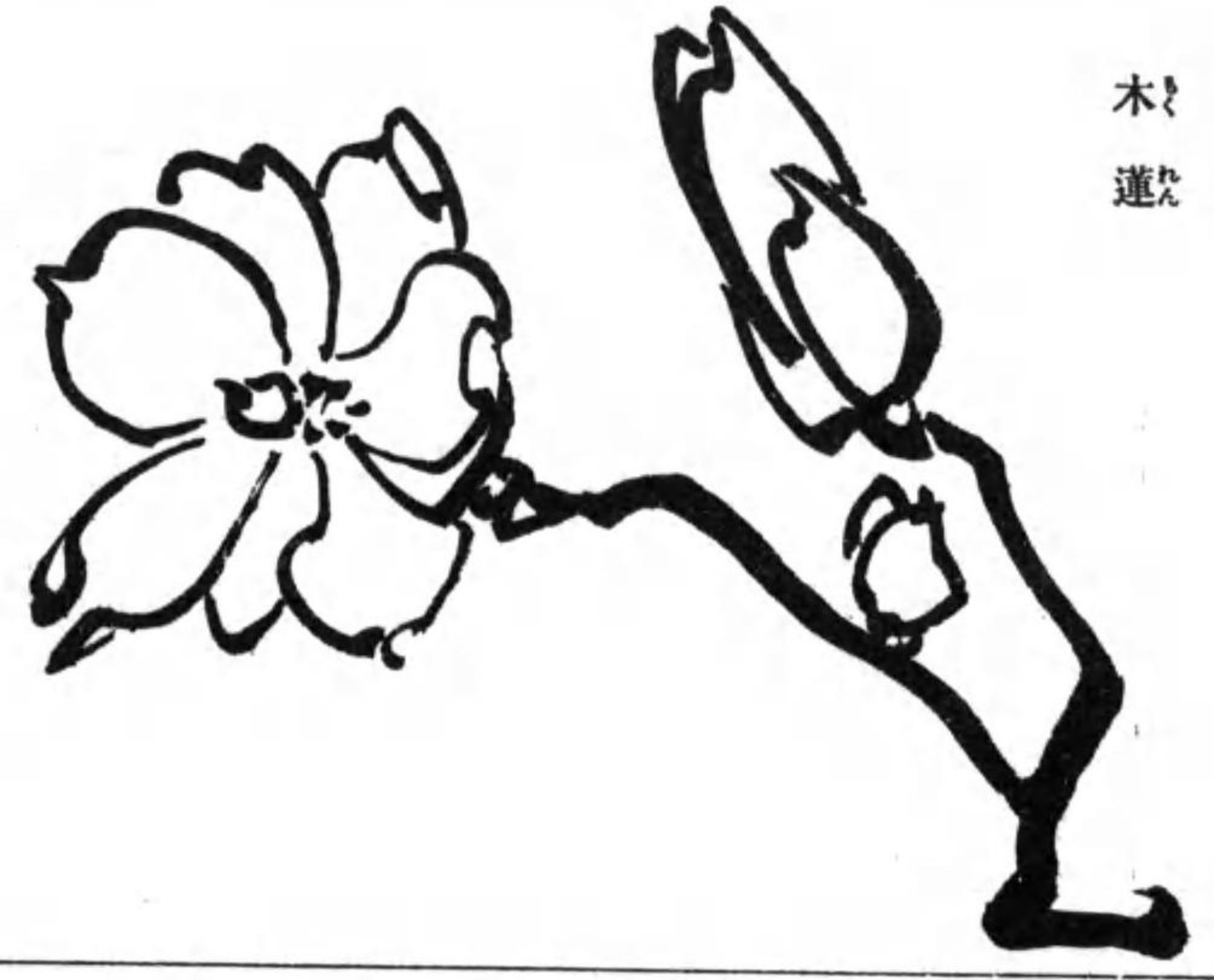

桐



石南華

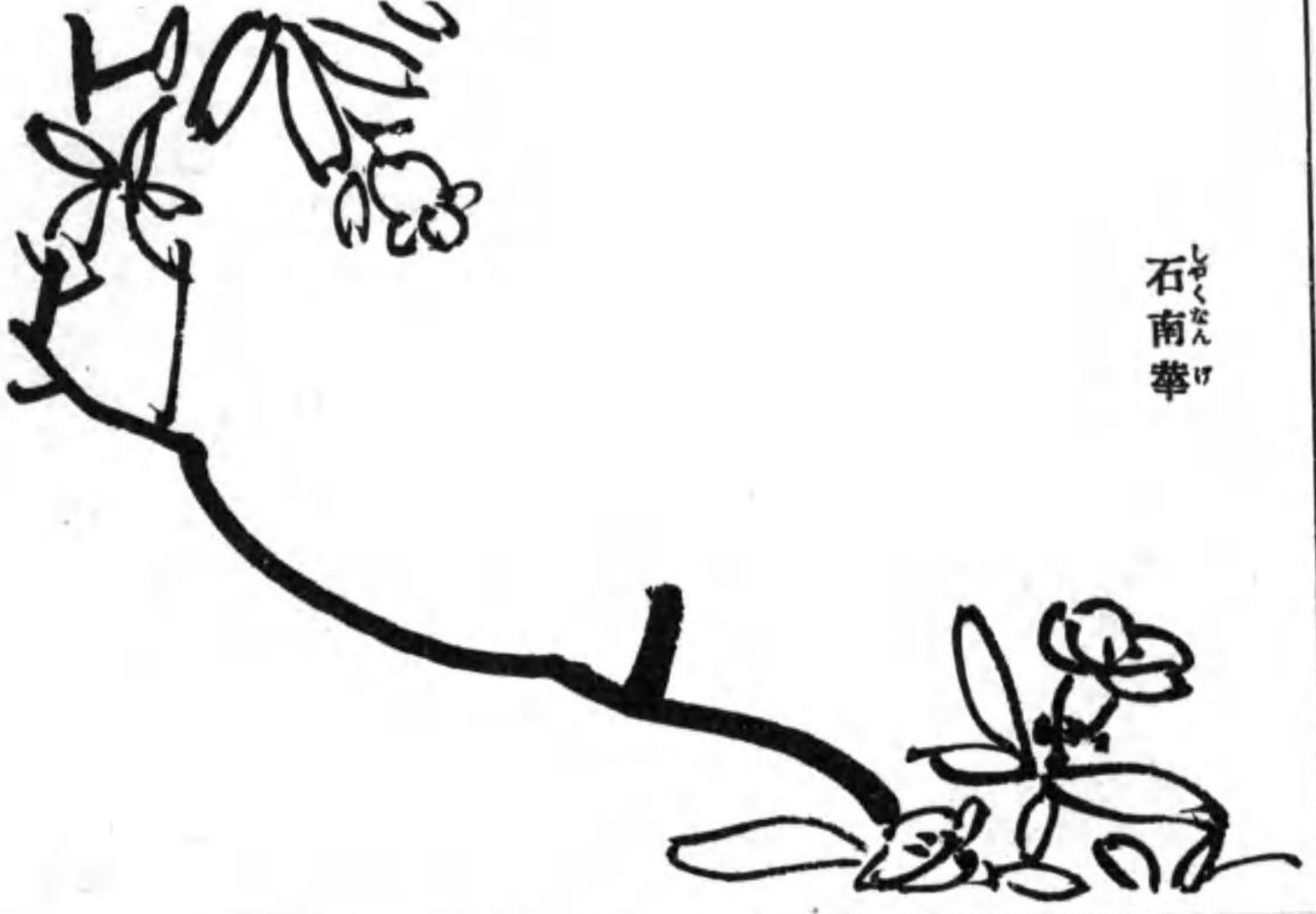

桑

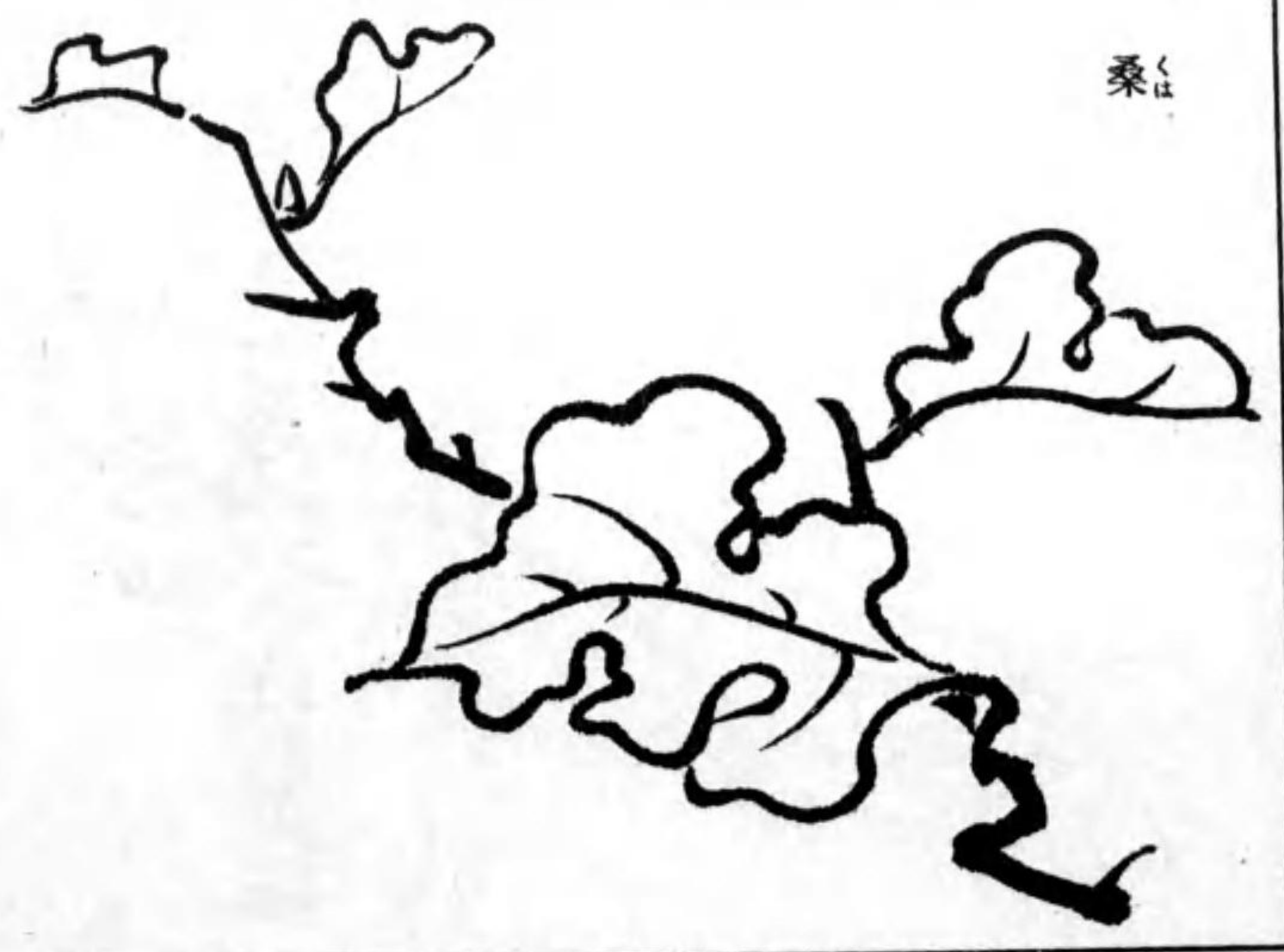

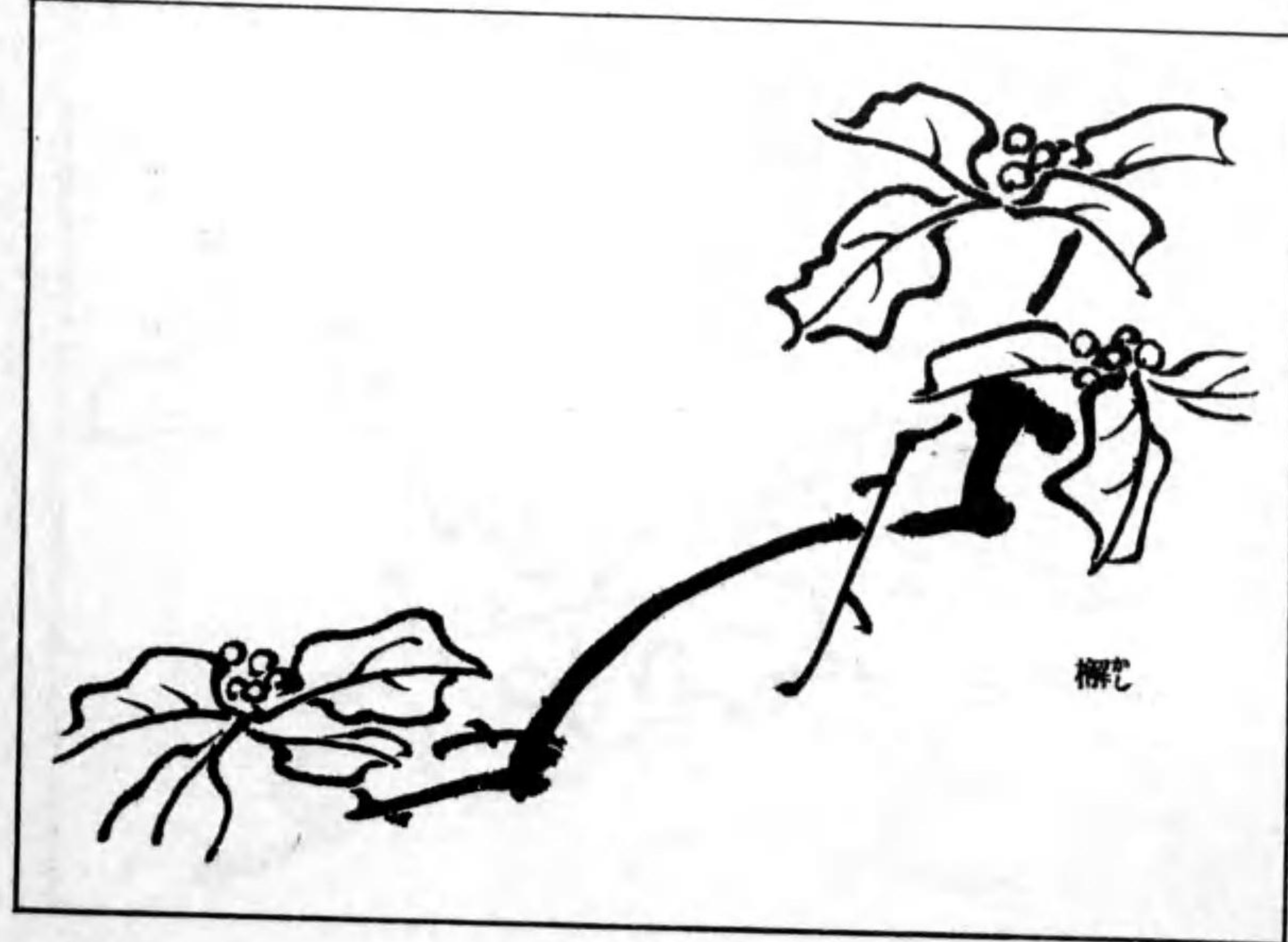
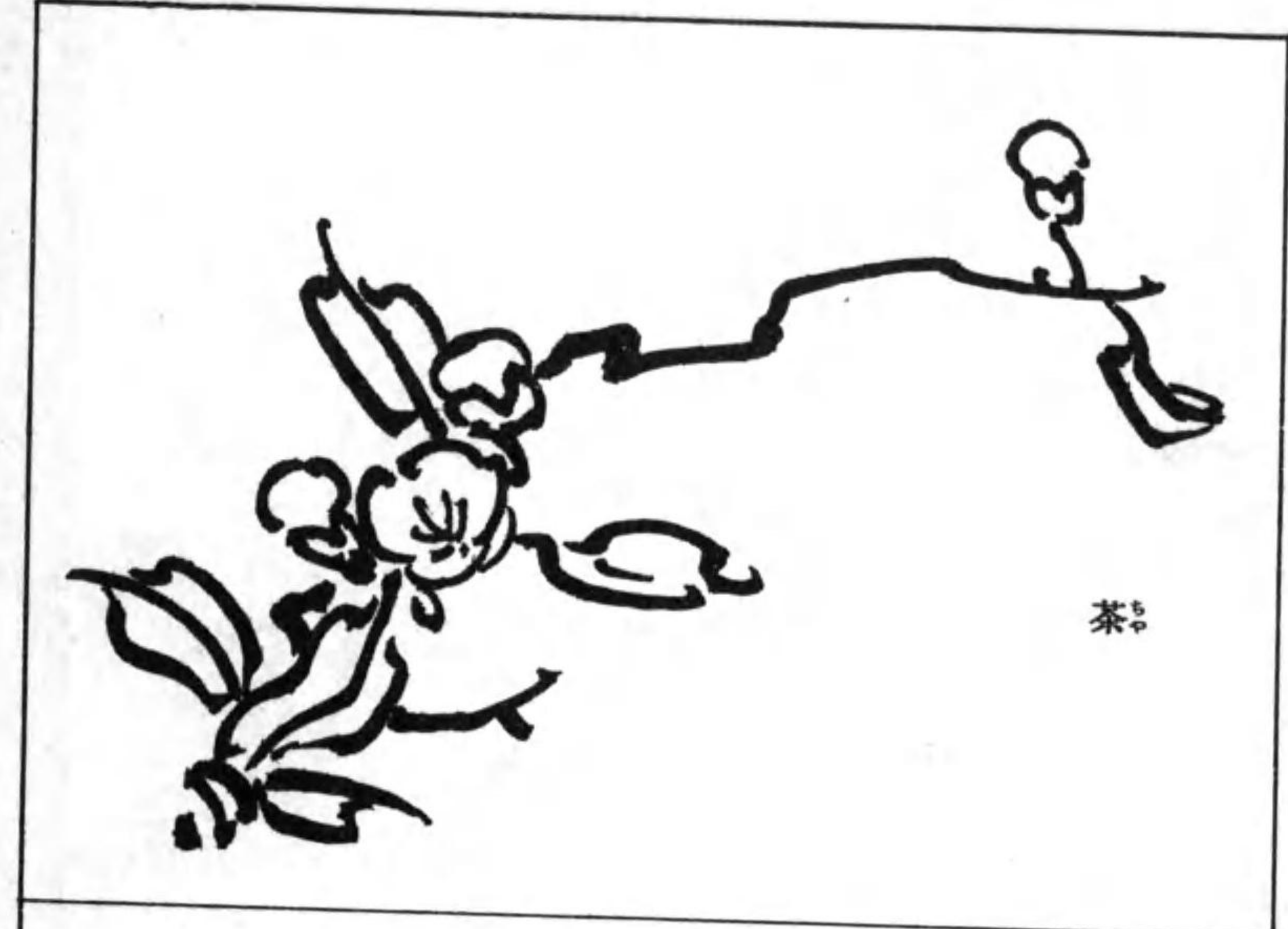

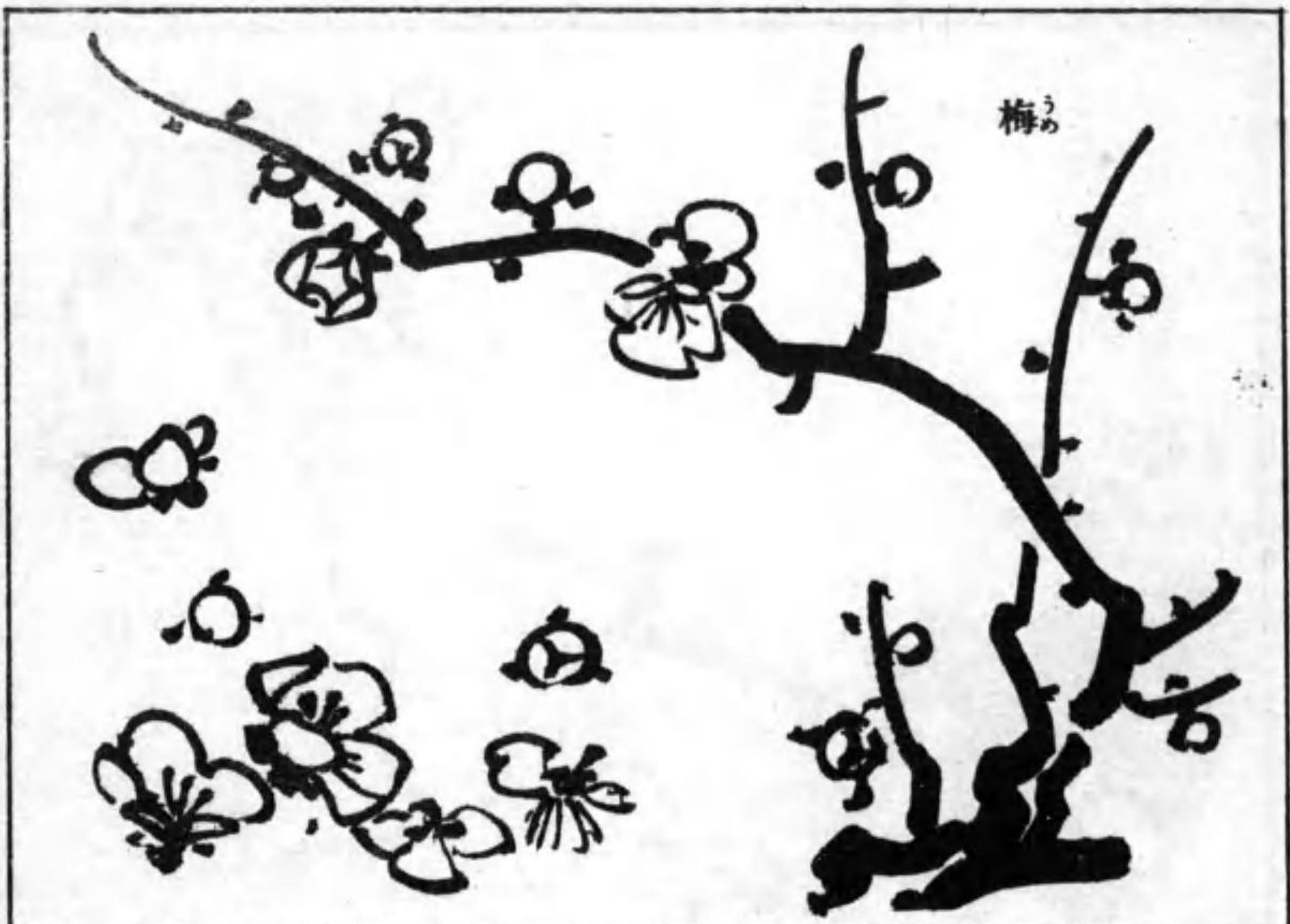

梅

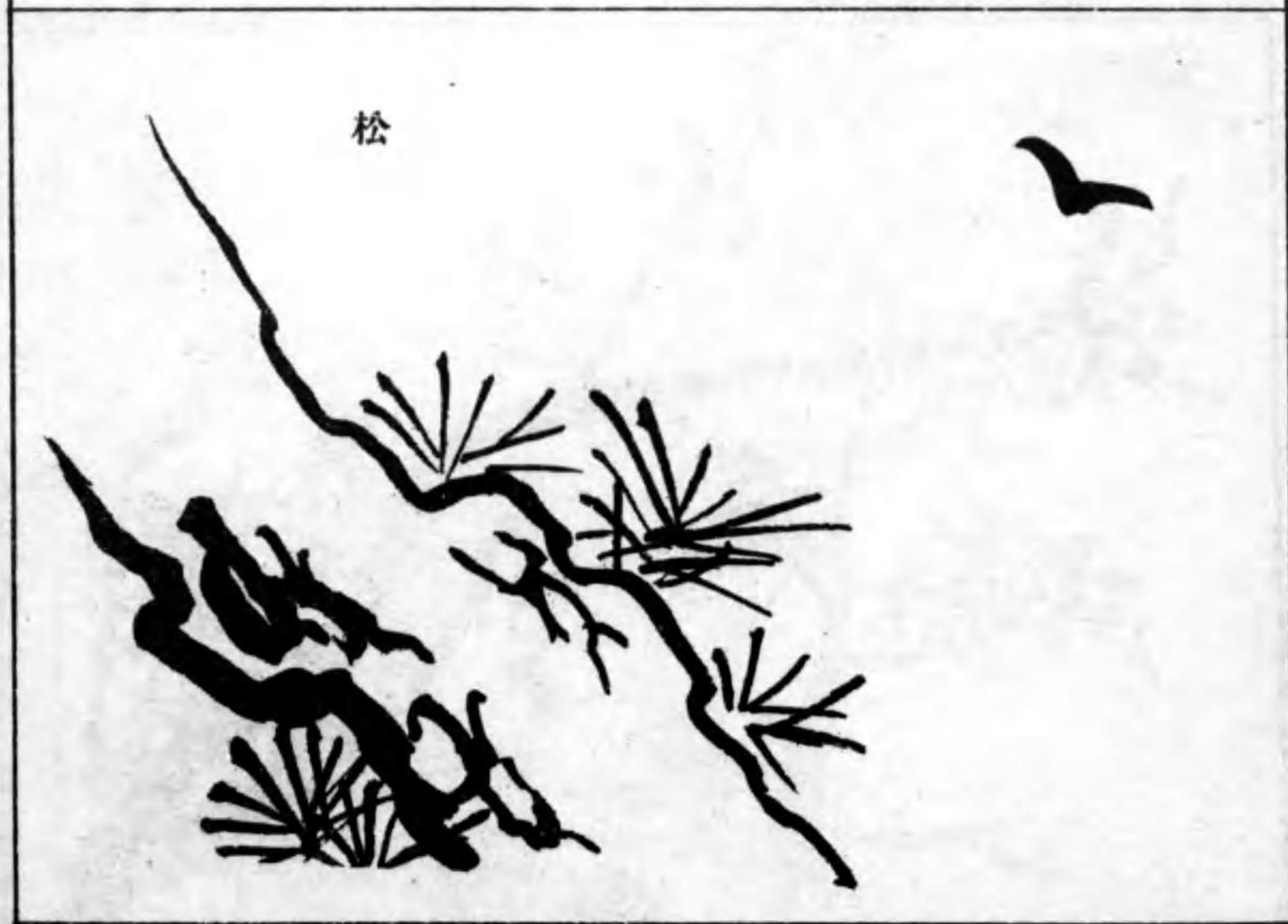

松

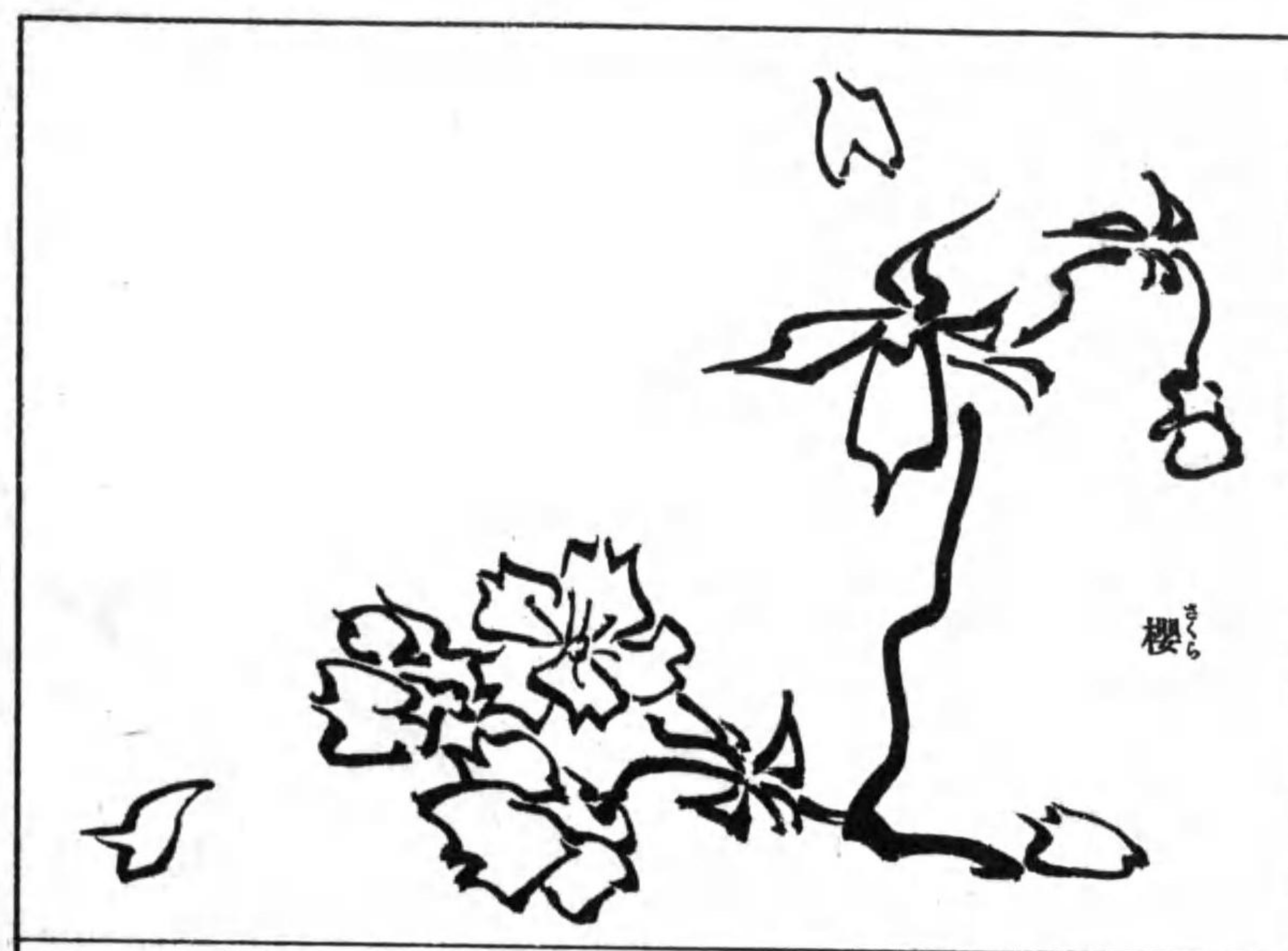

櫻

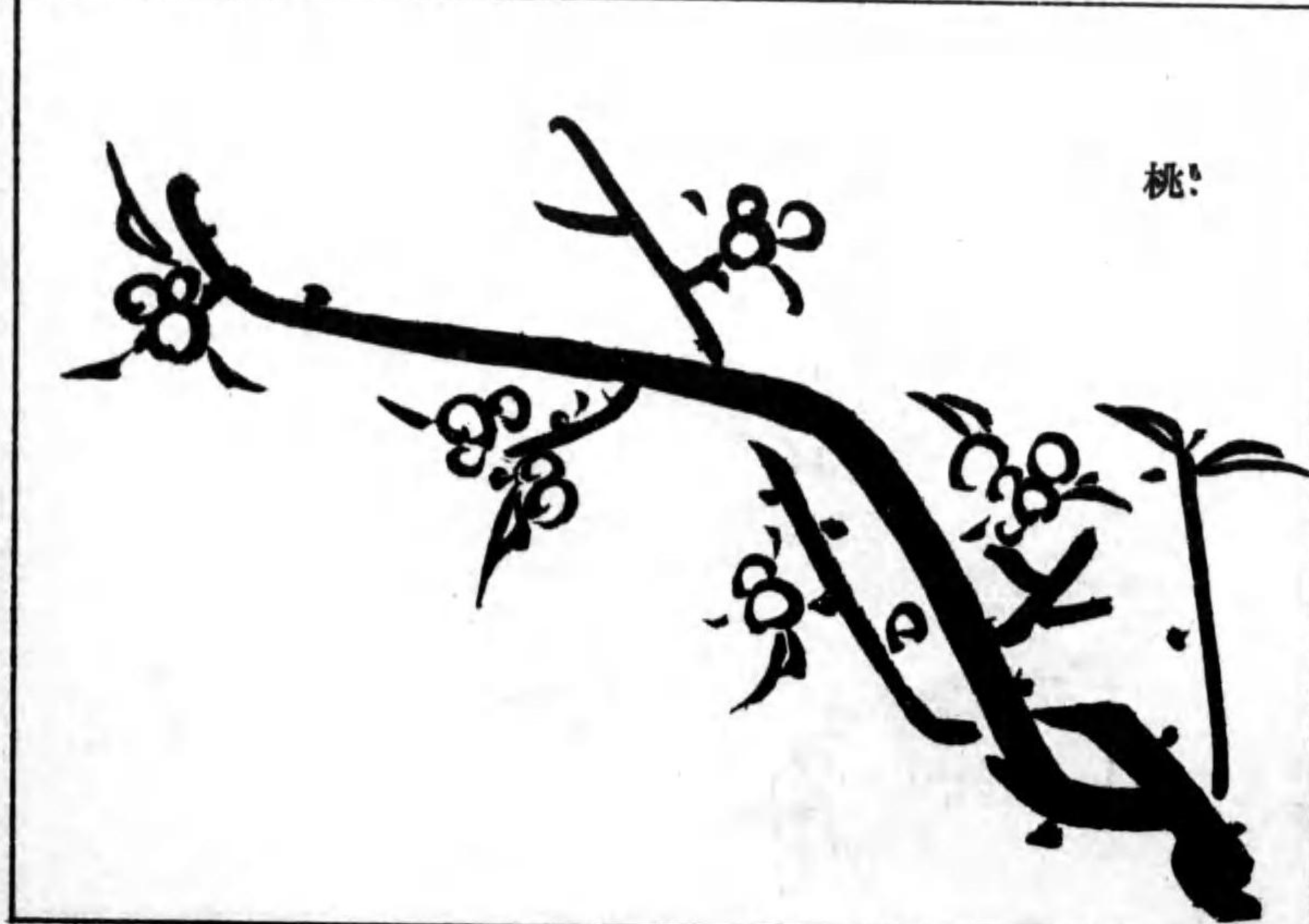

桃



枯林

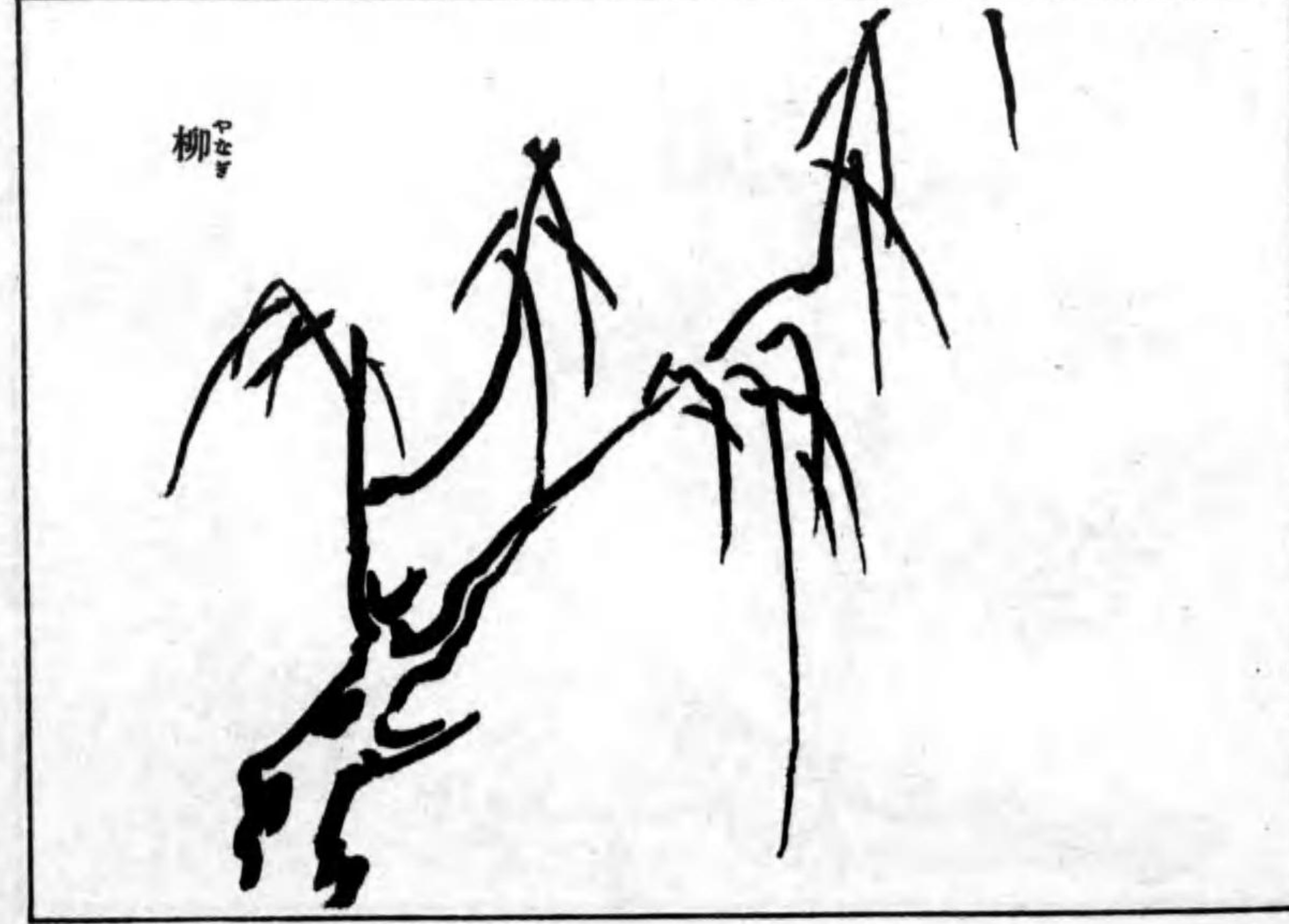

柳

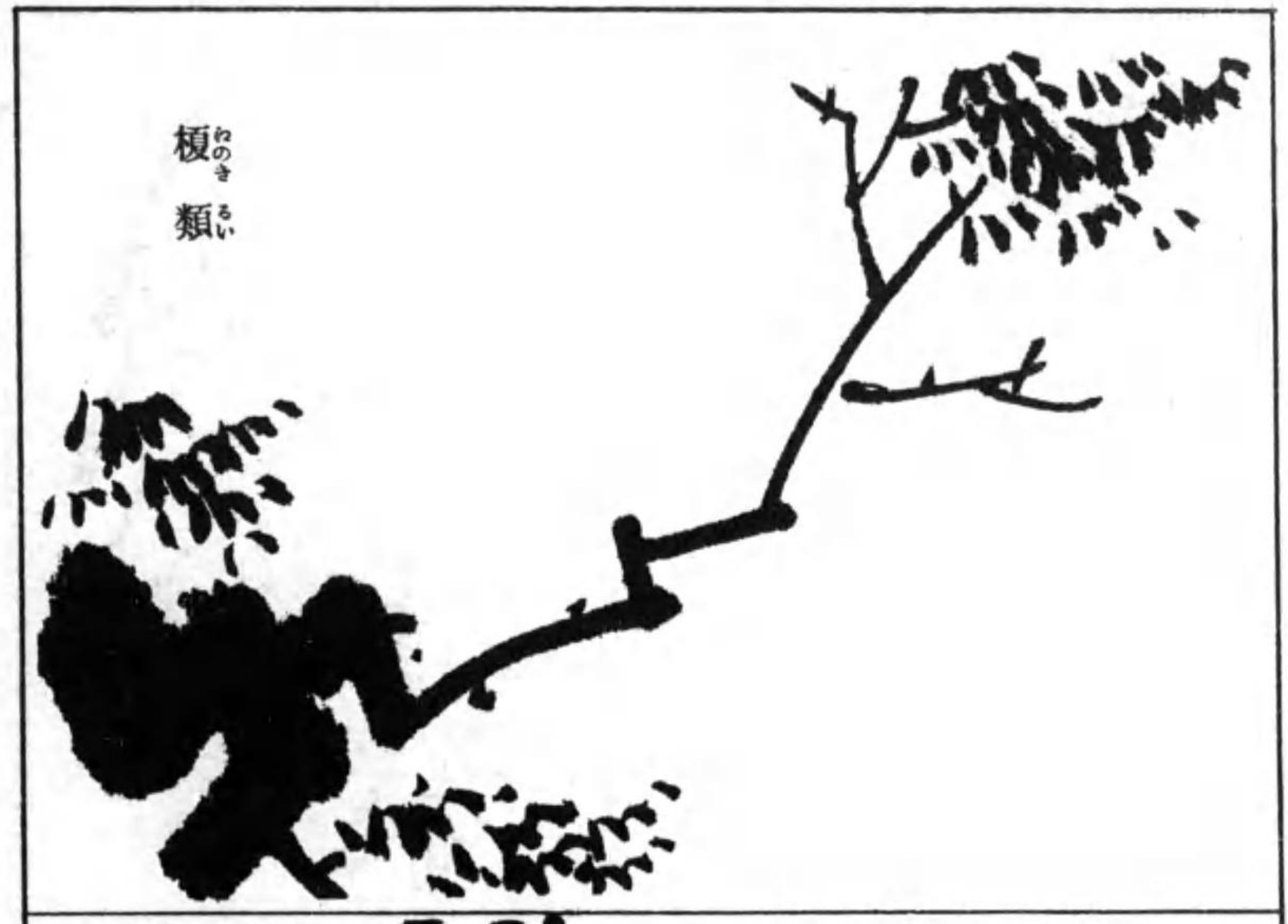

榎類

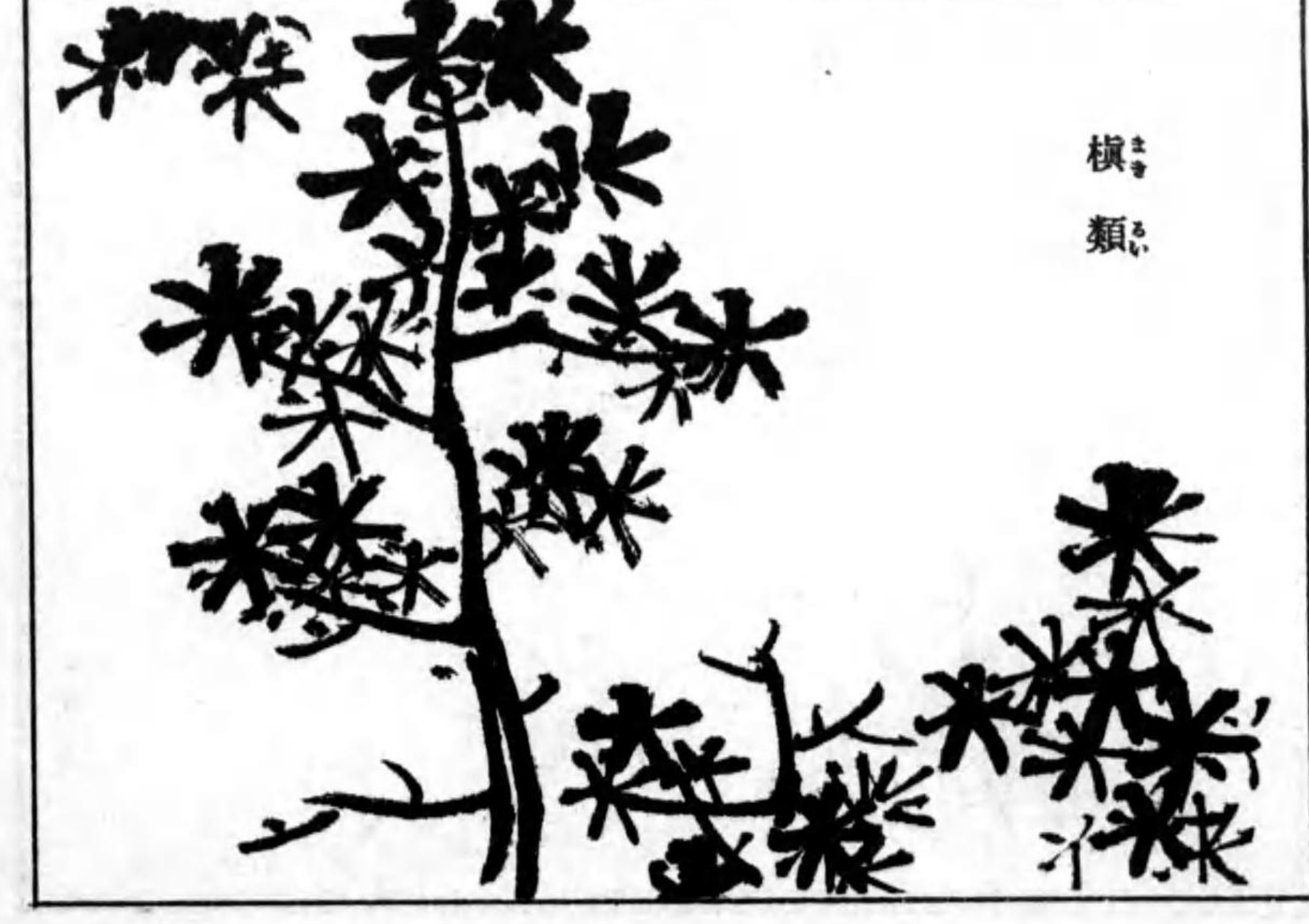

槲類

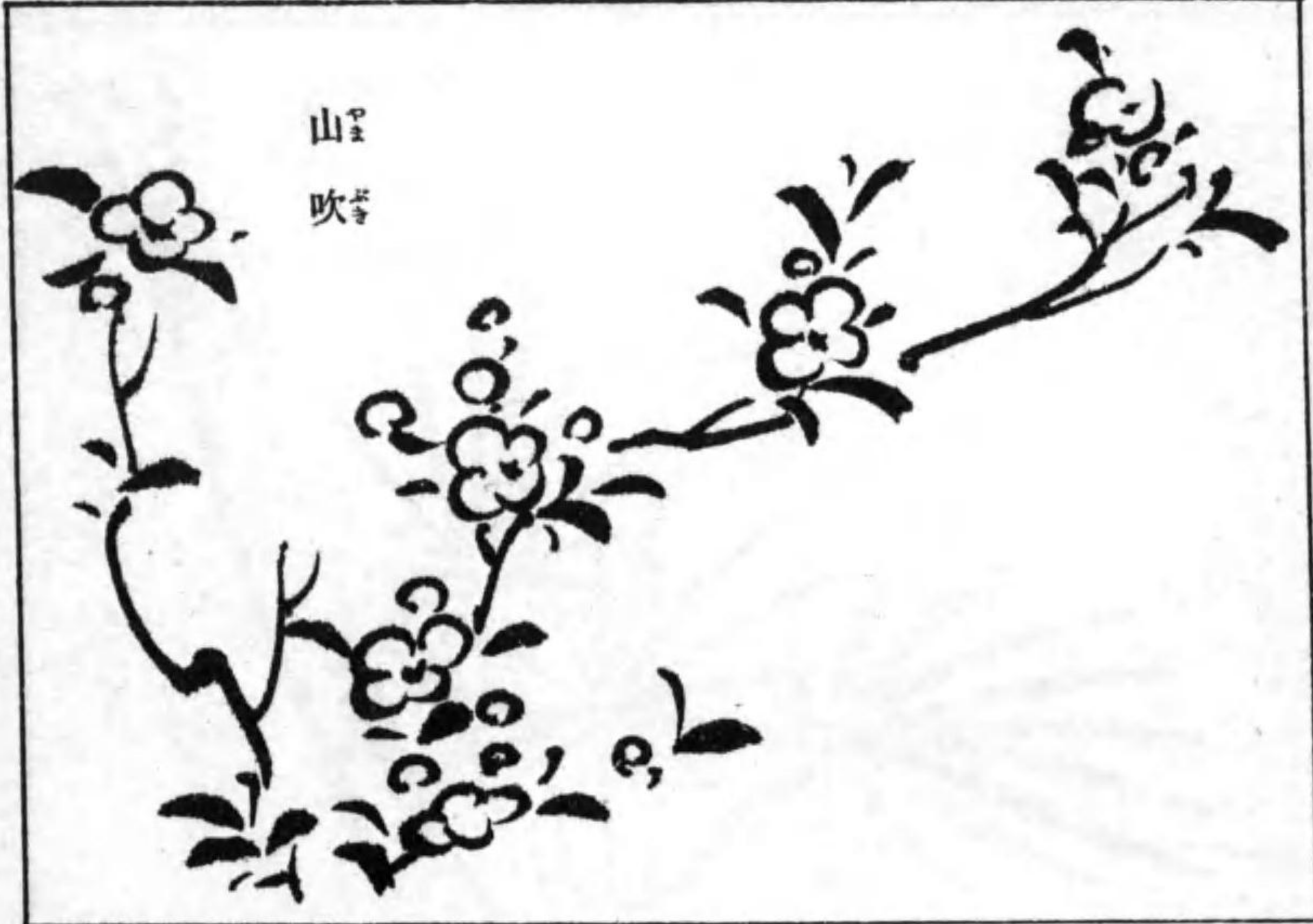

山
吹



椰
子

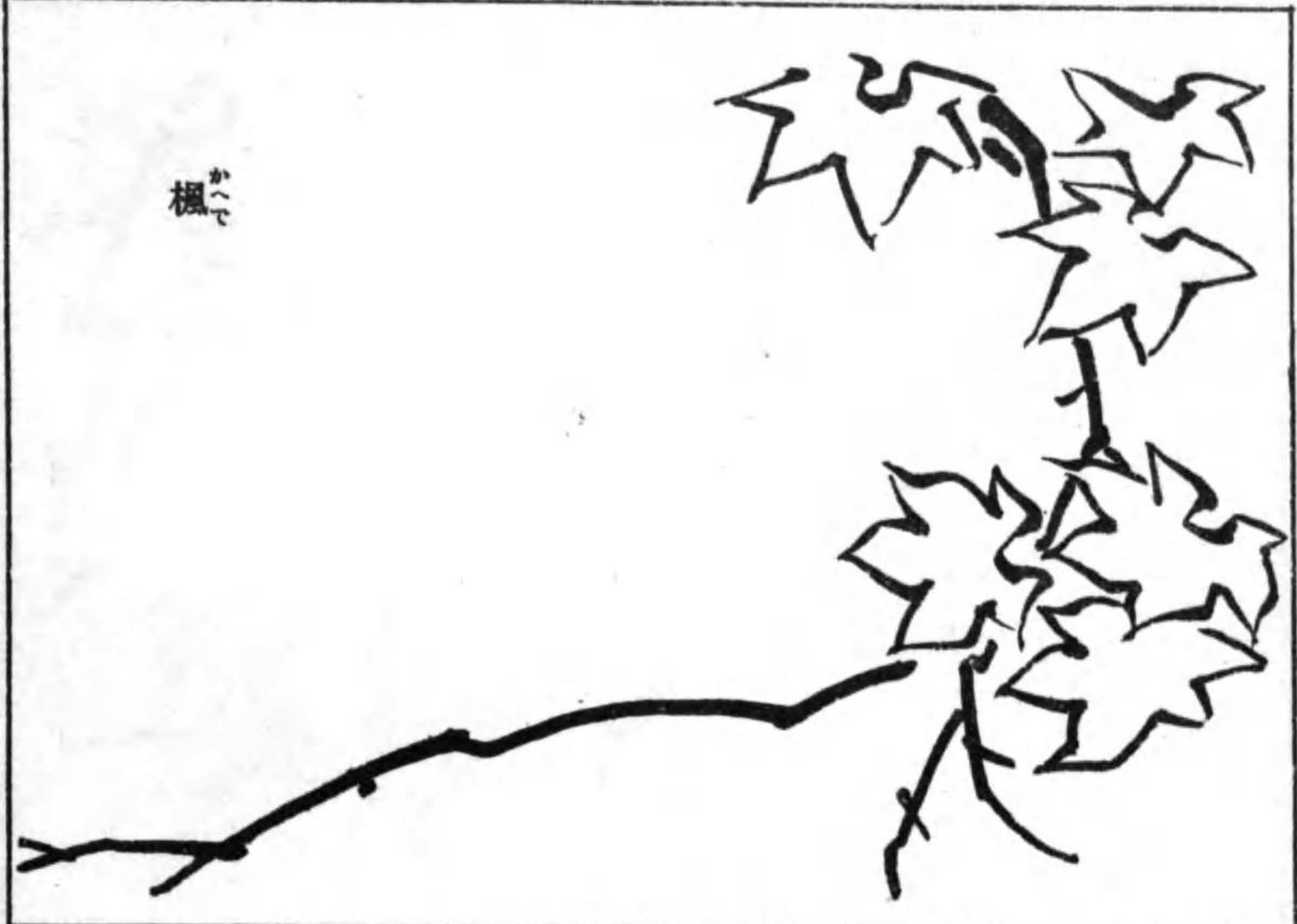

楓

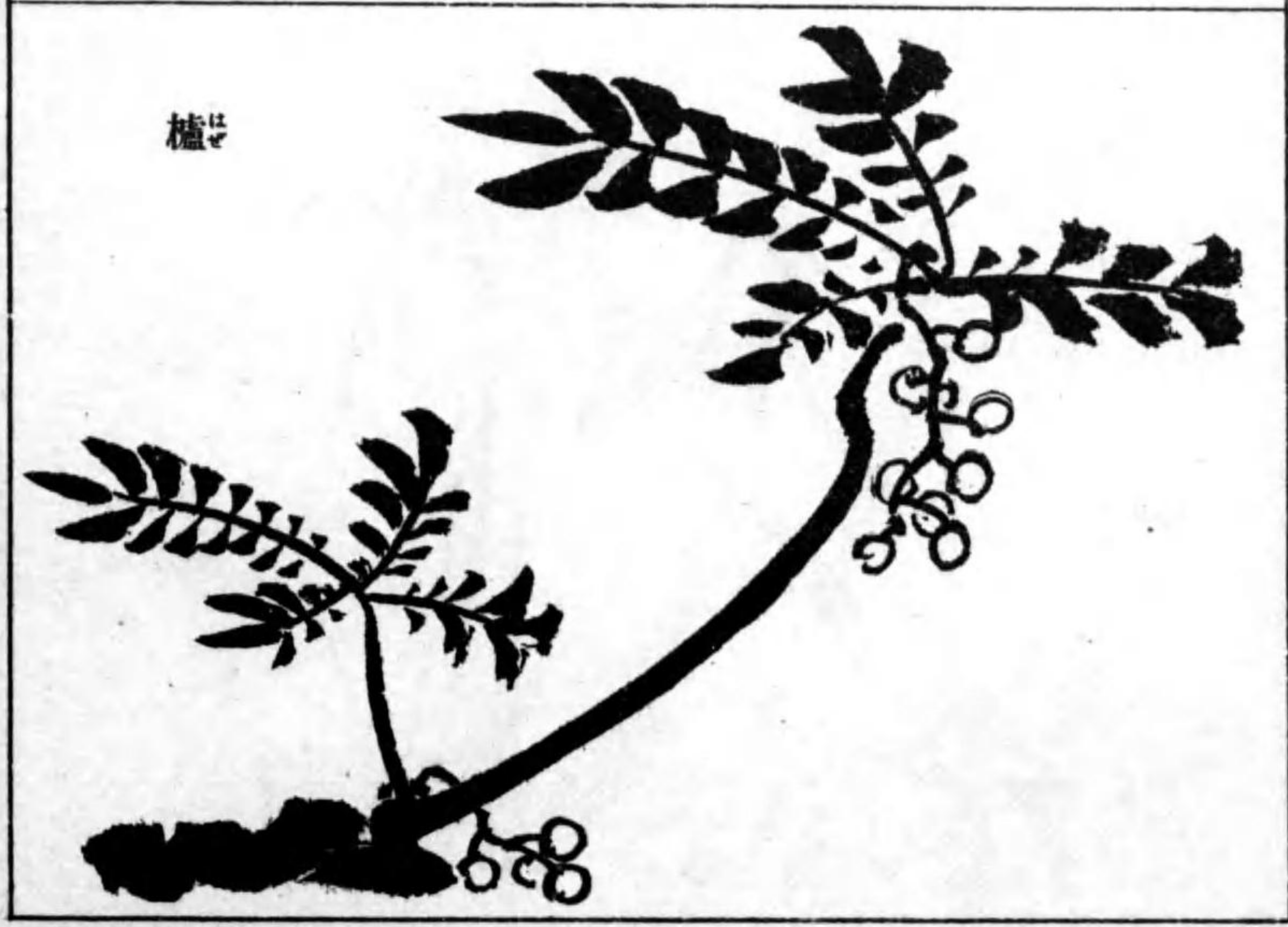

楮

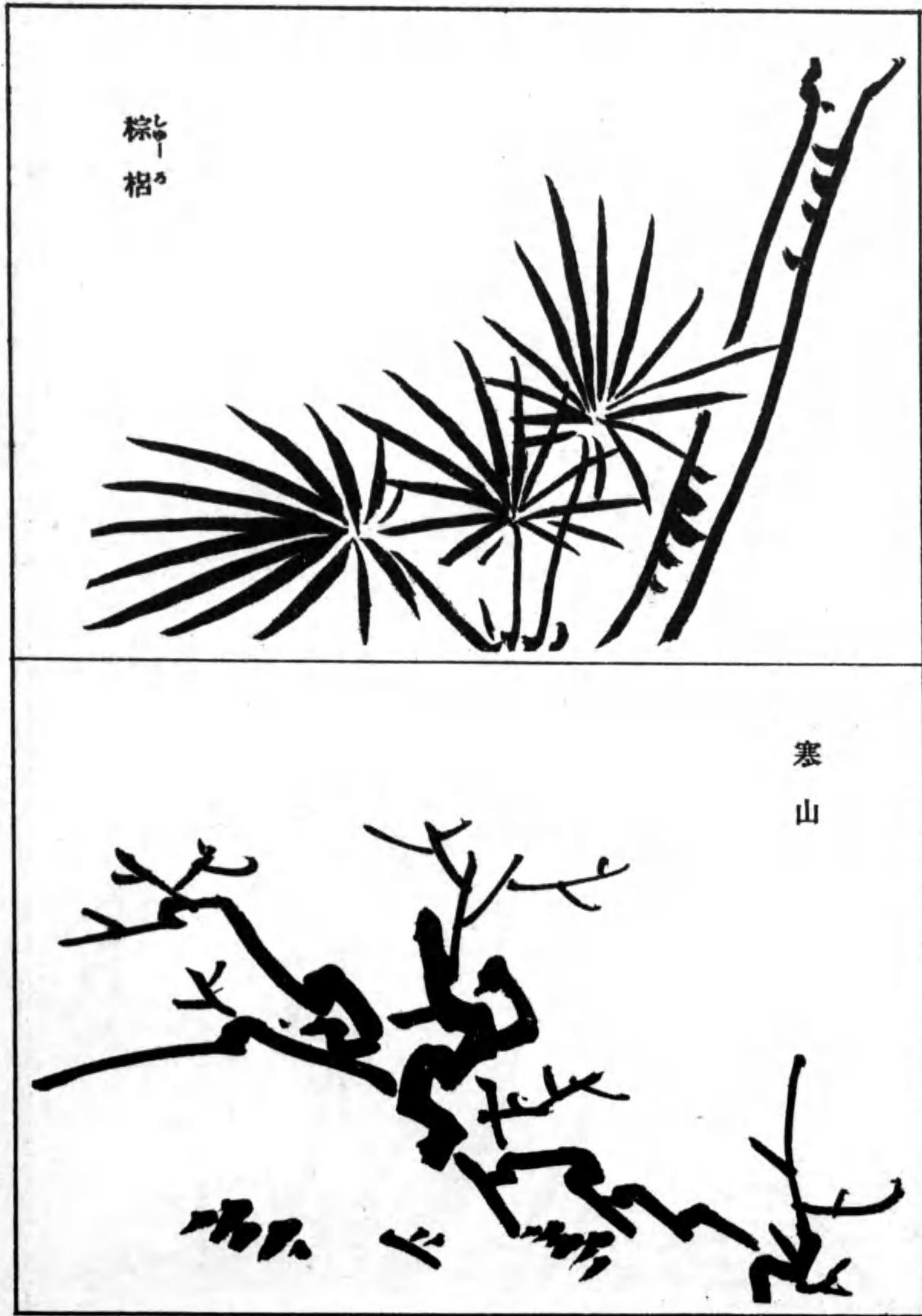
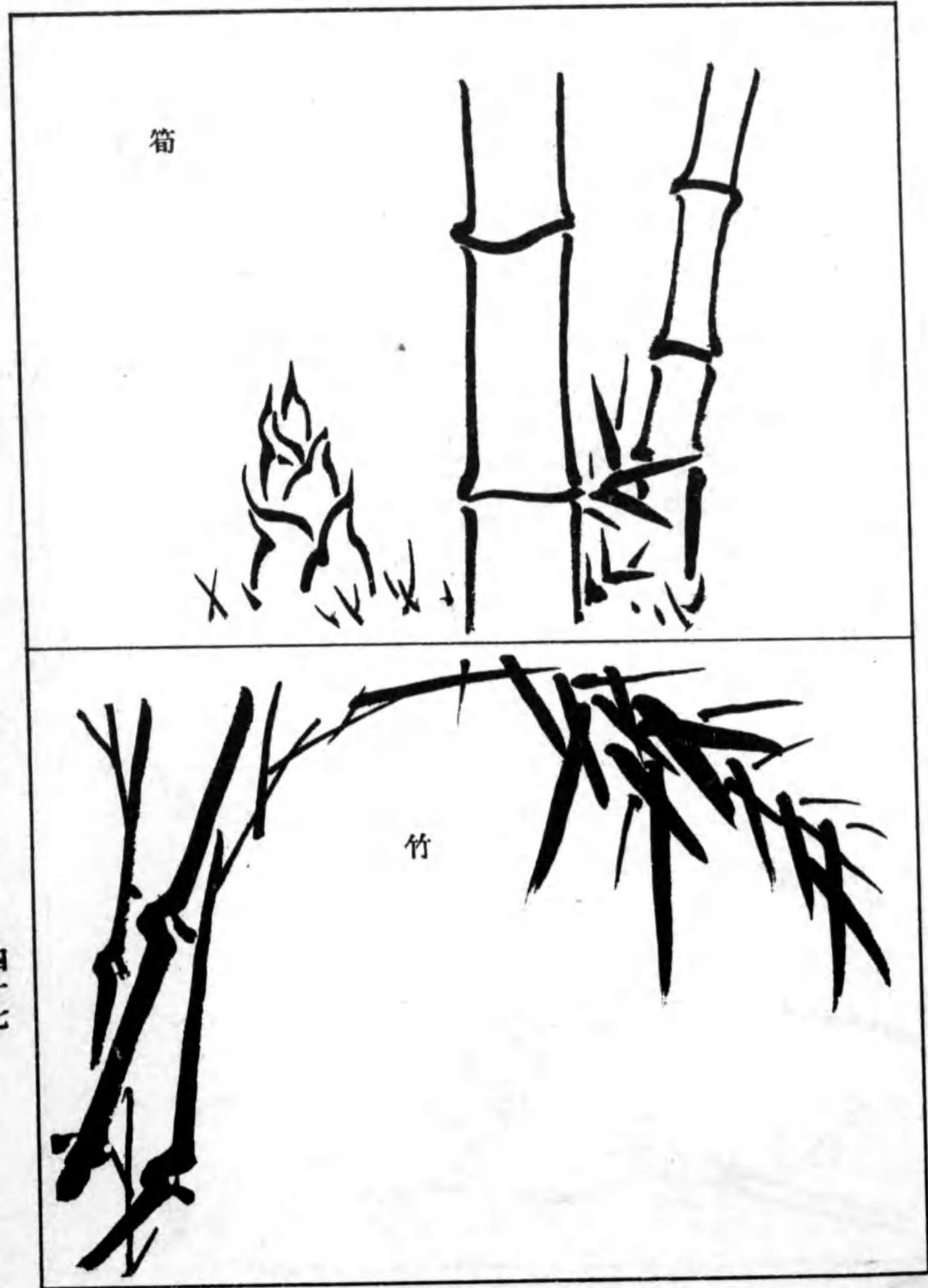

其五
器械器具玩具裝飾品類

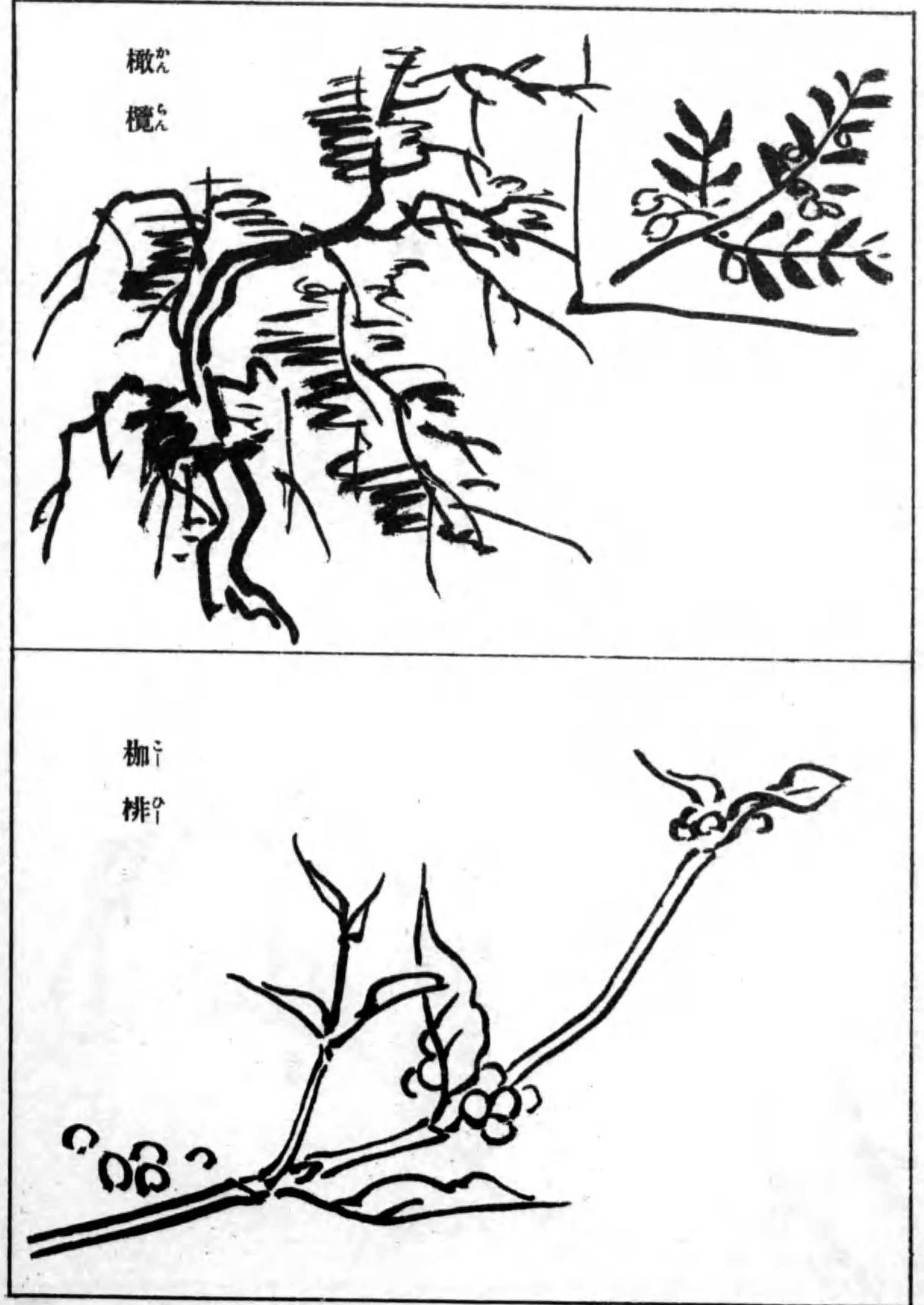

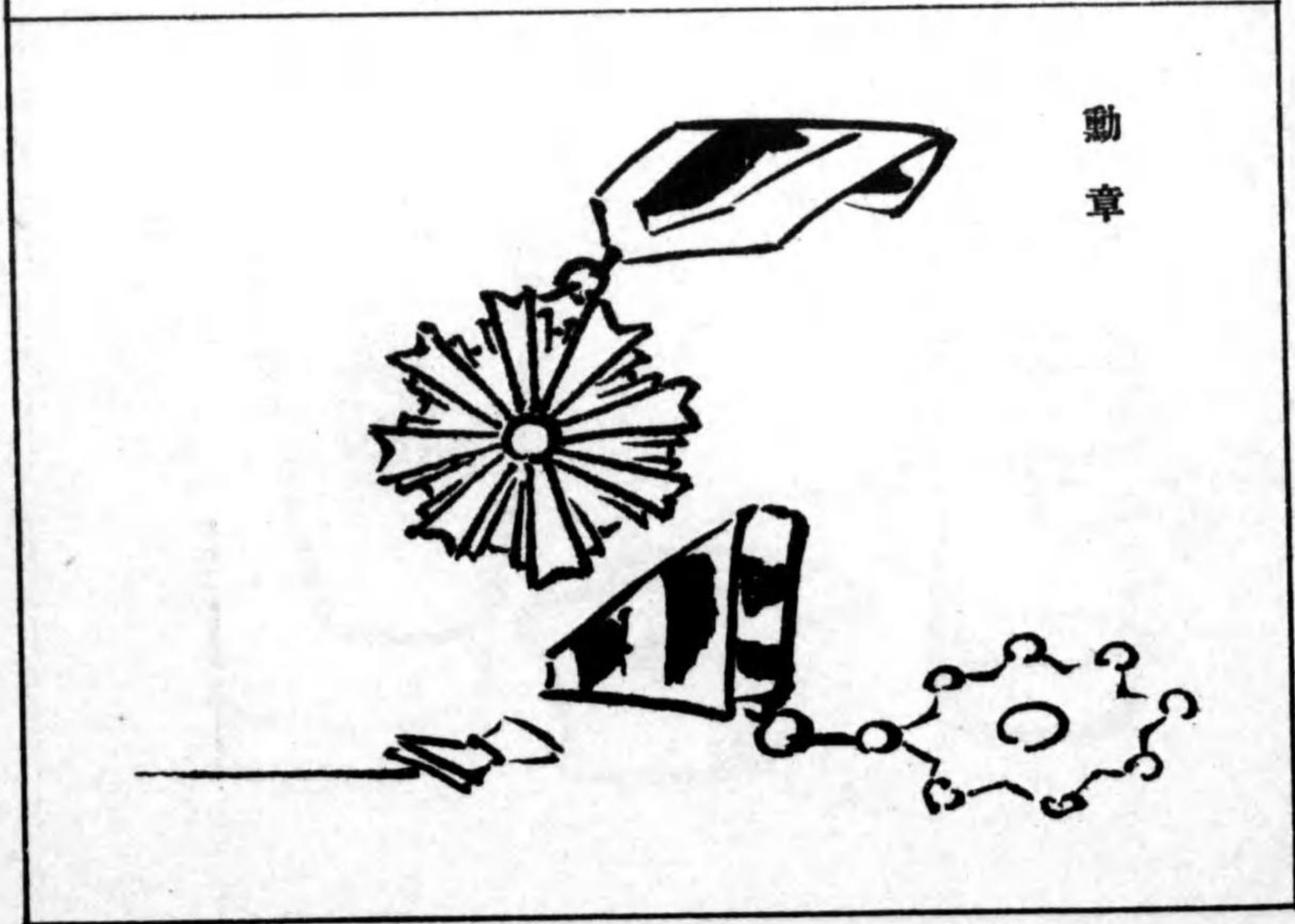
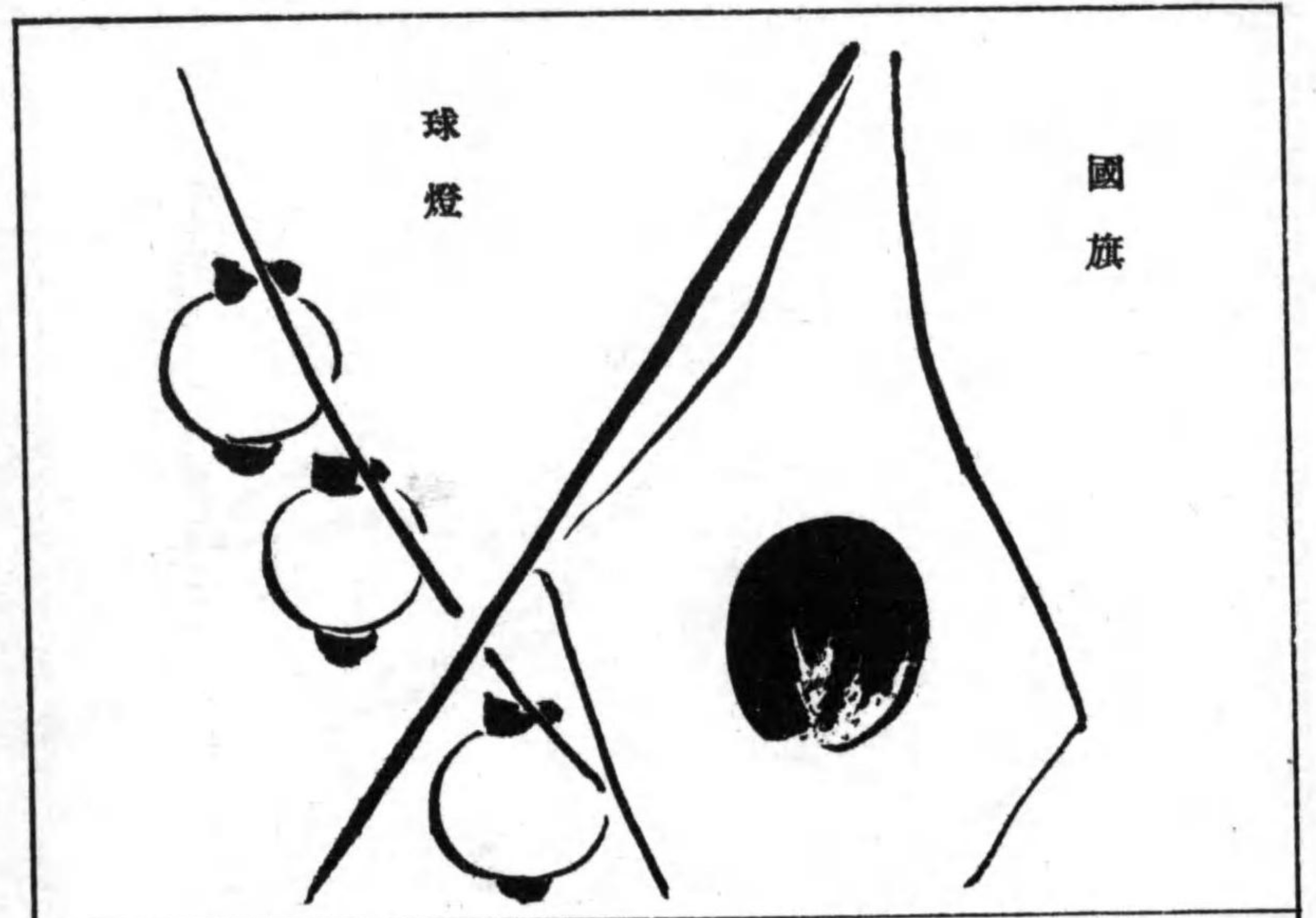

火鉢



香盒



銀



バケツ



露如

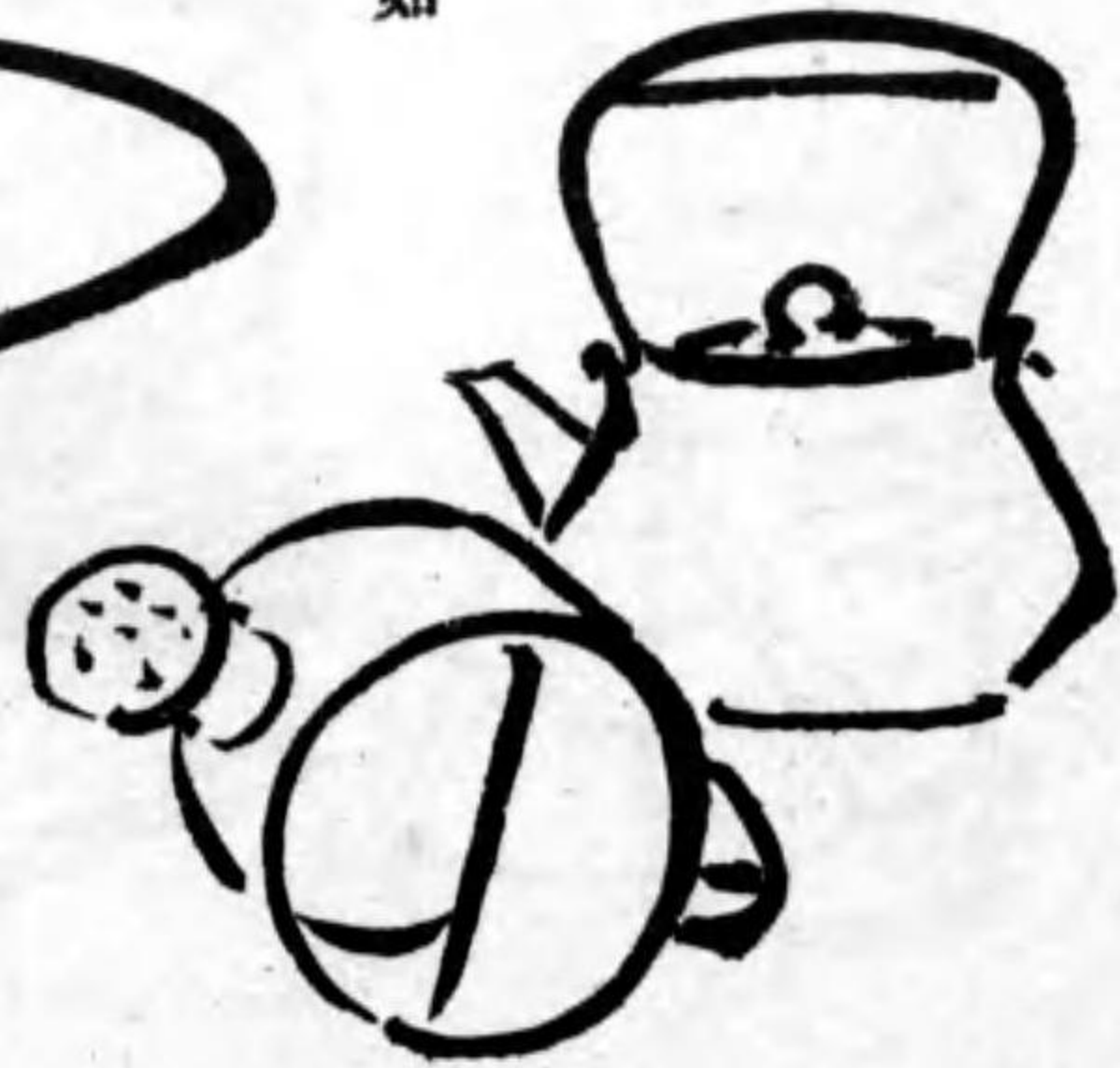

茶瓶

神寶

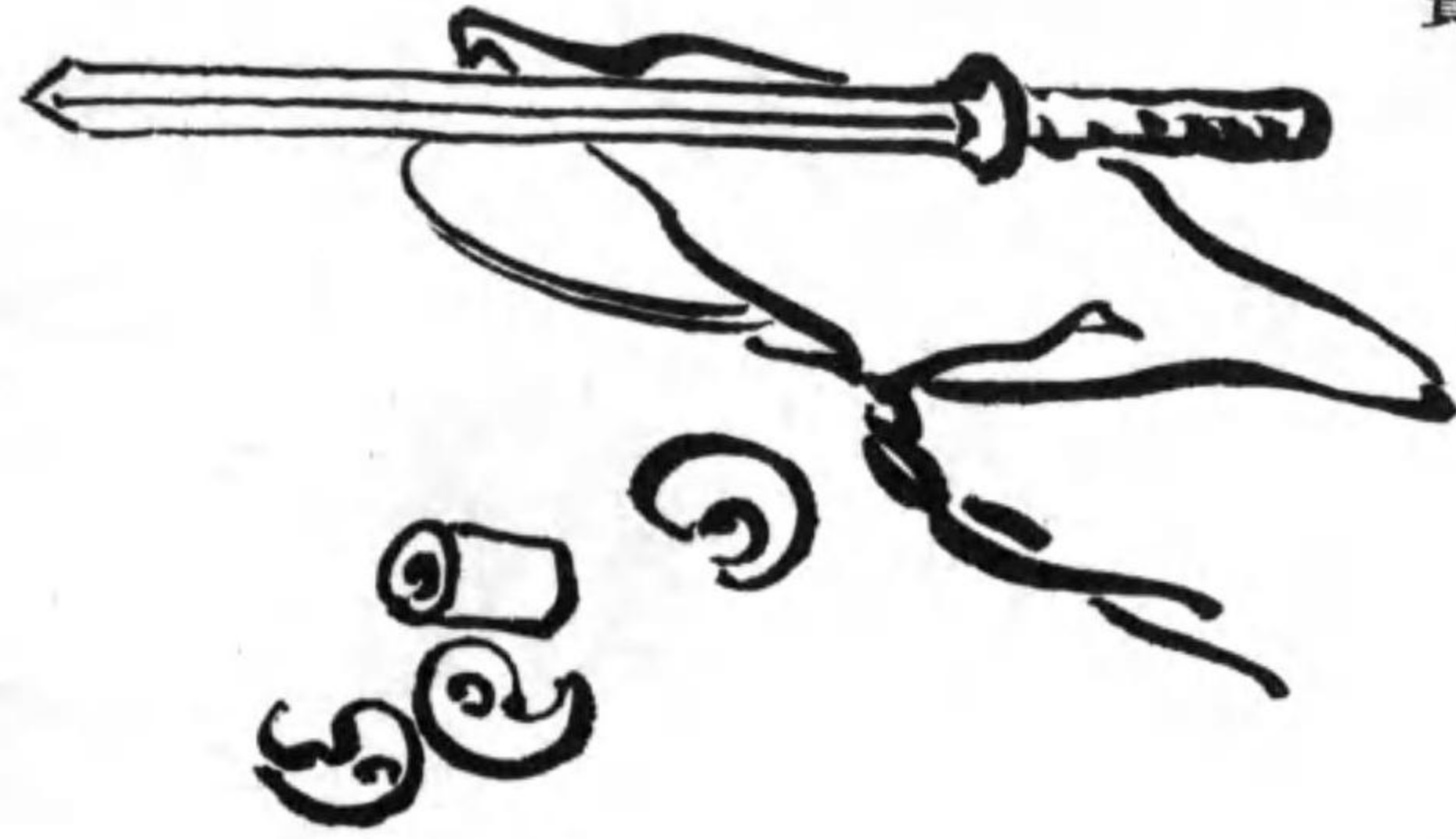

花瓶

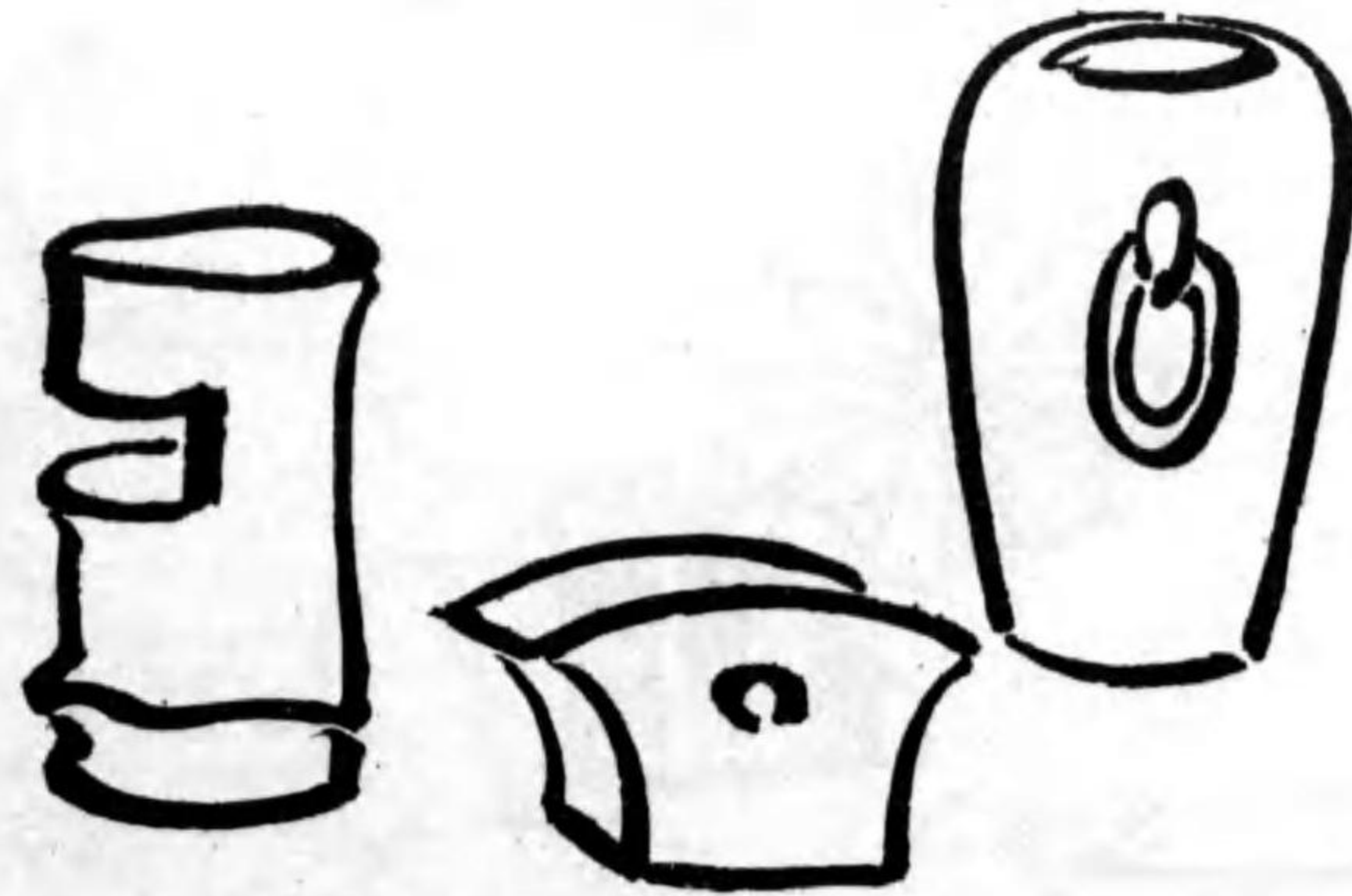

枕

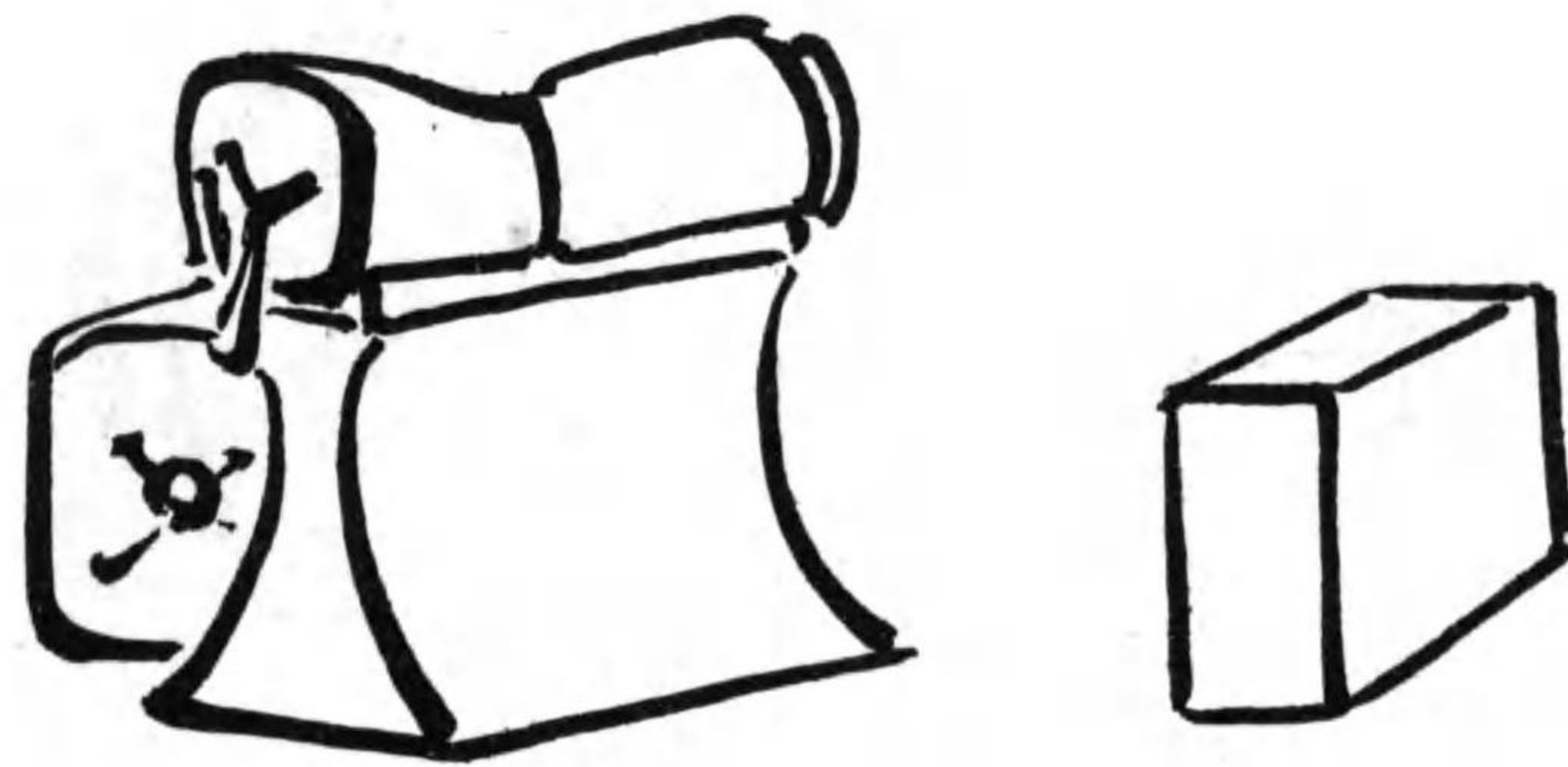

炭取

團扇

涼爐



茶碗

コップ

水差



帽子

洋筆

墨壺

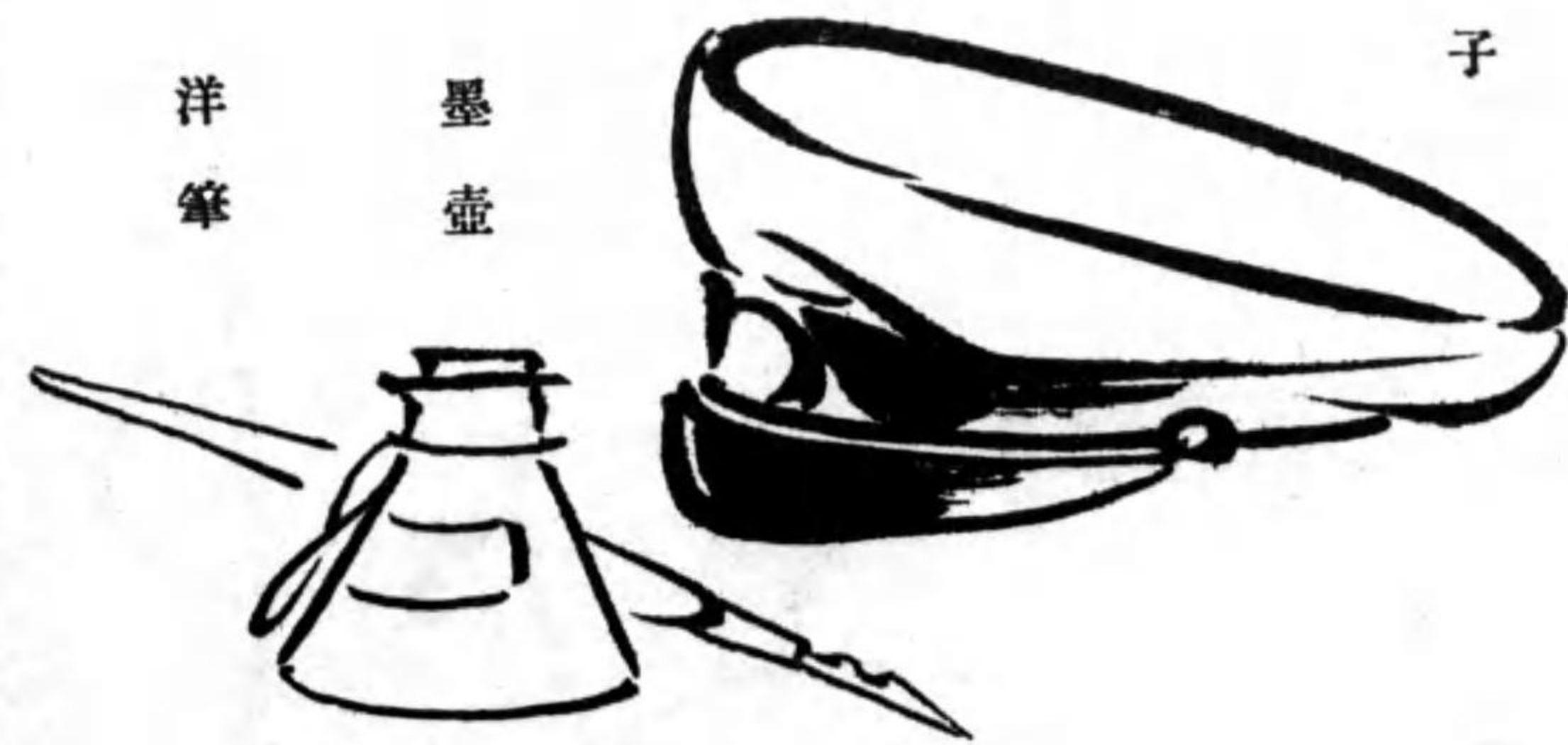

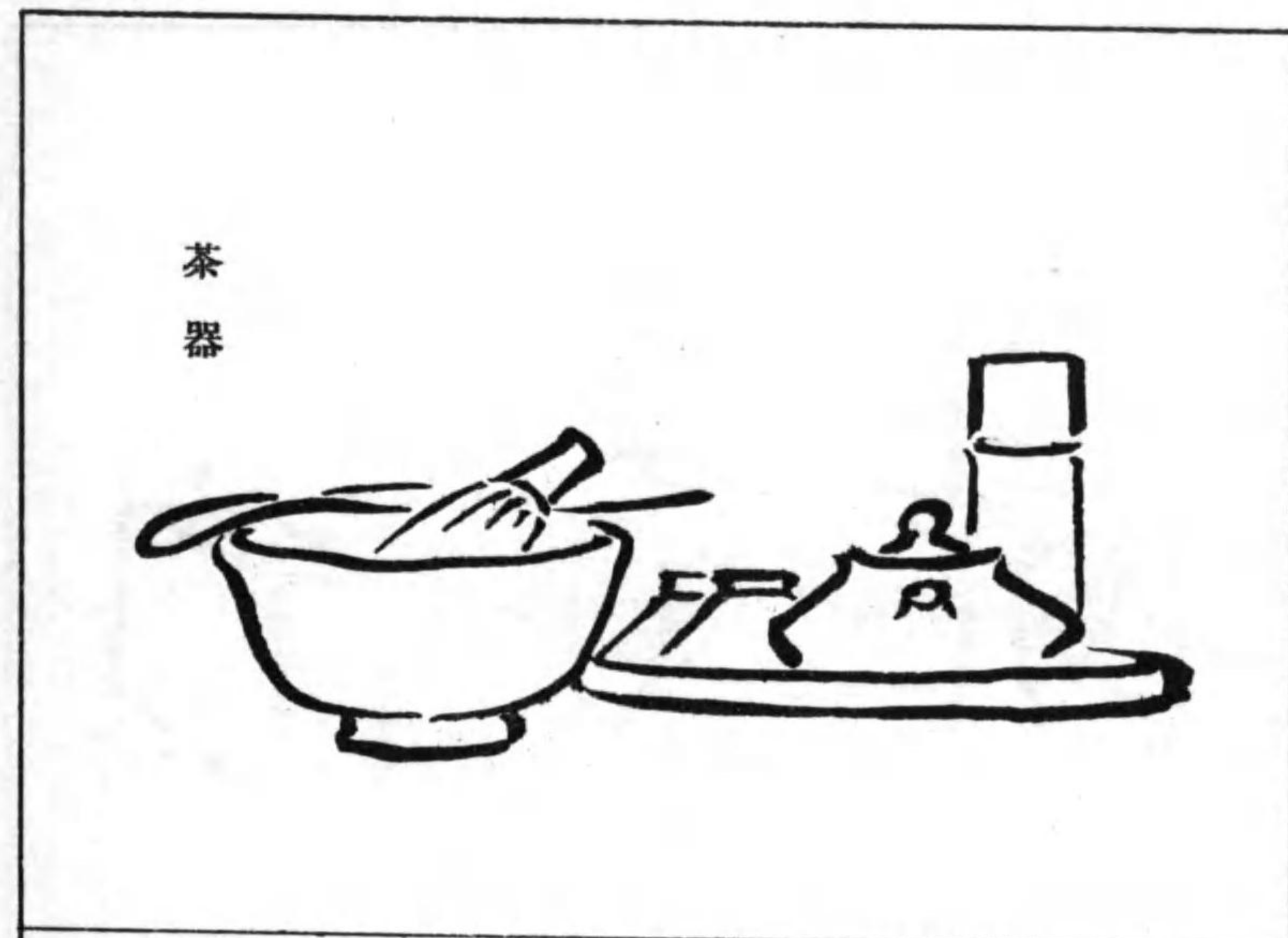
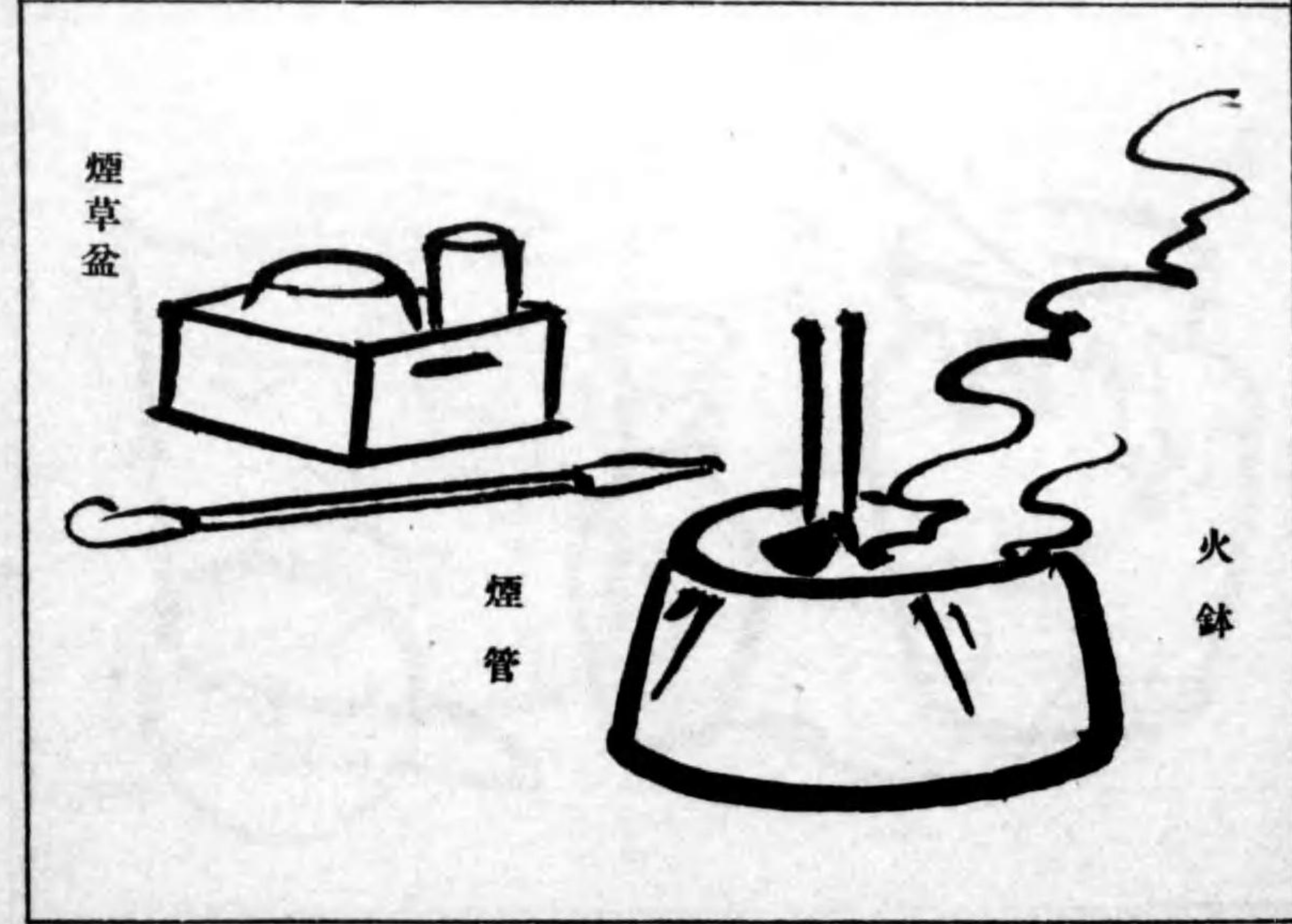
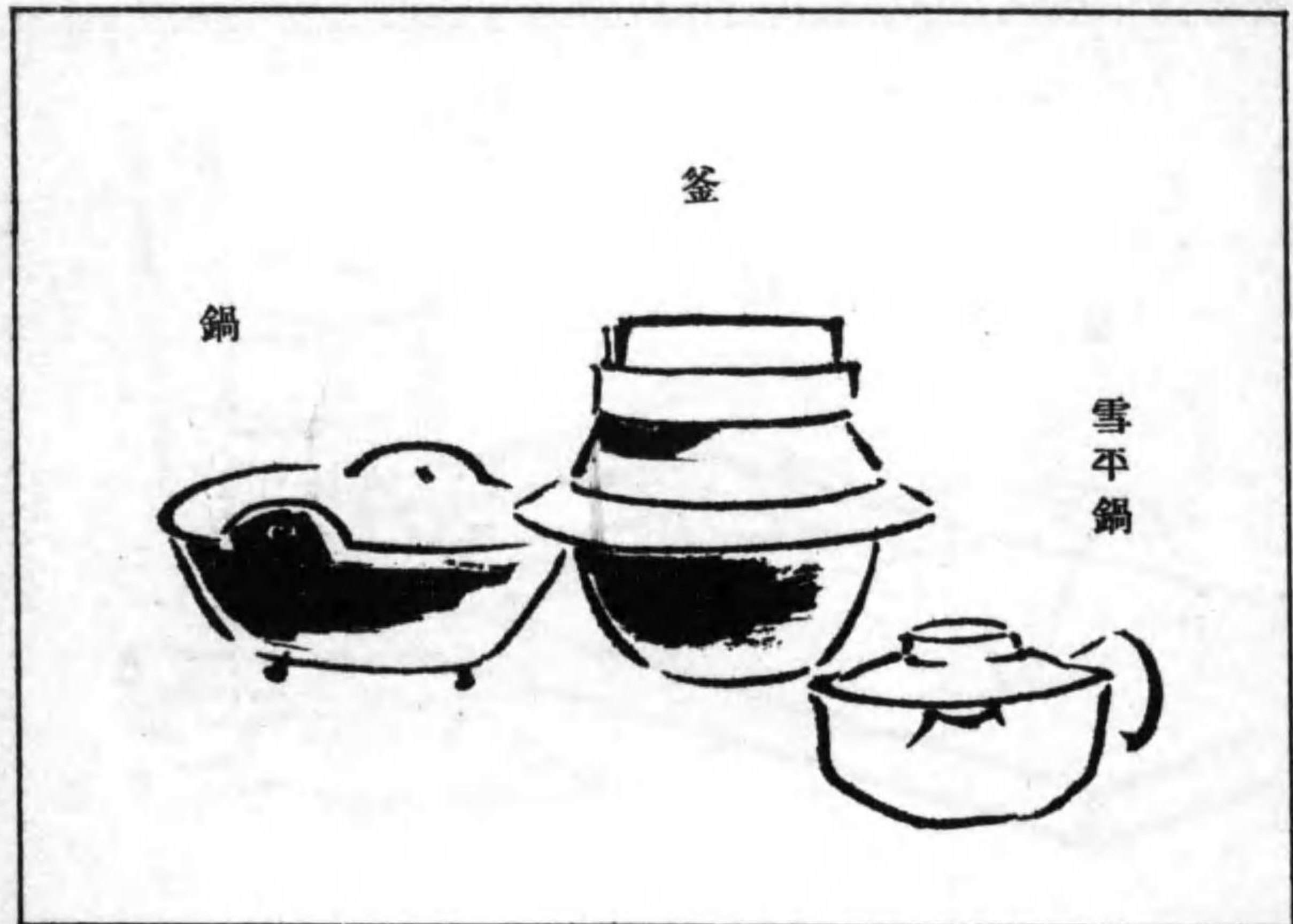

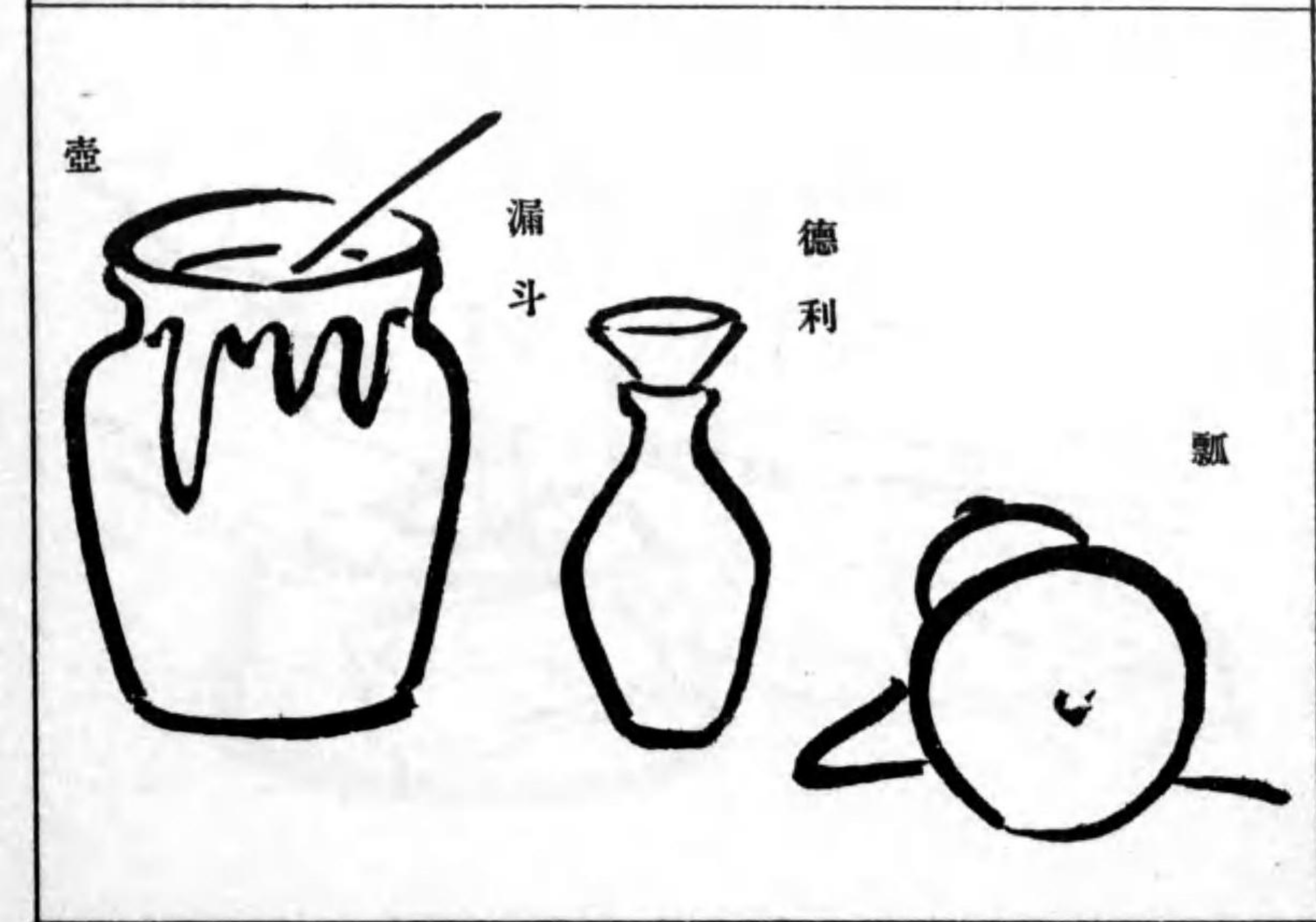
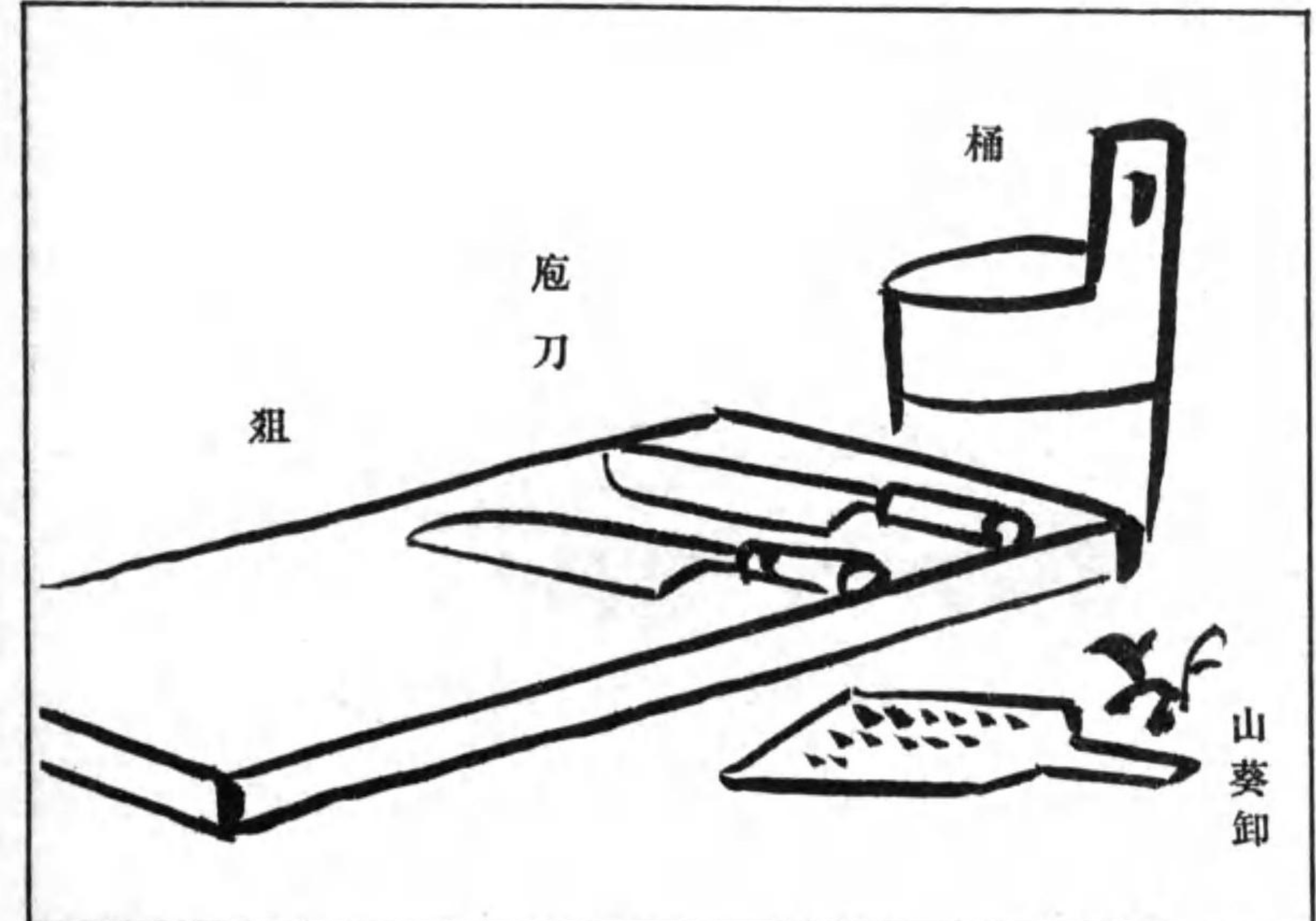
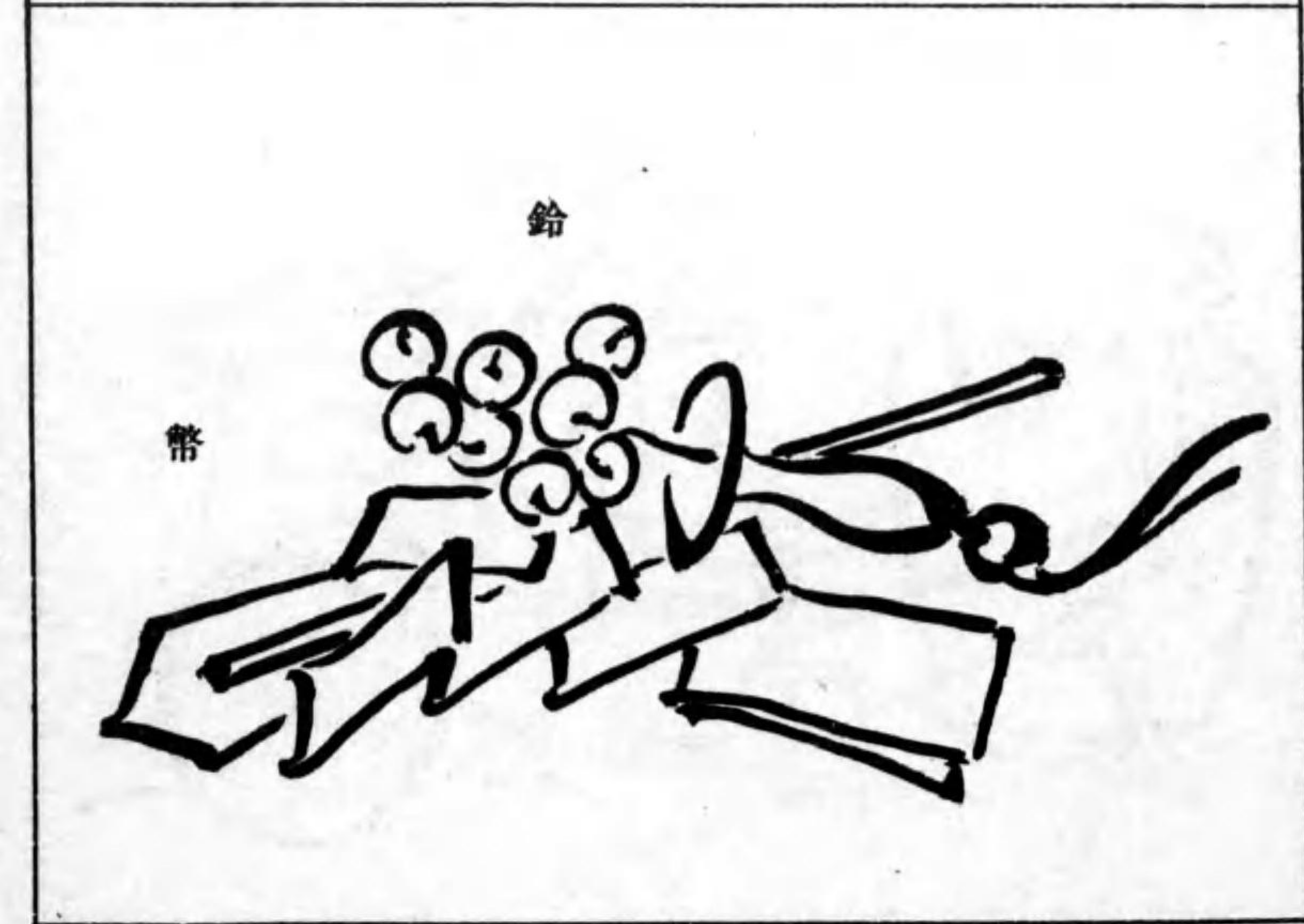
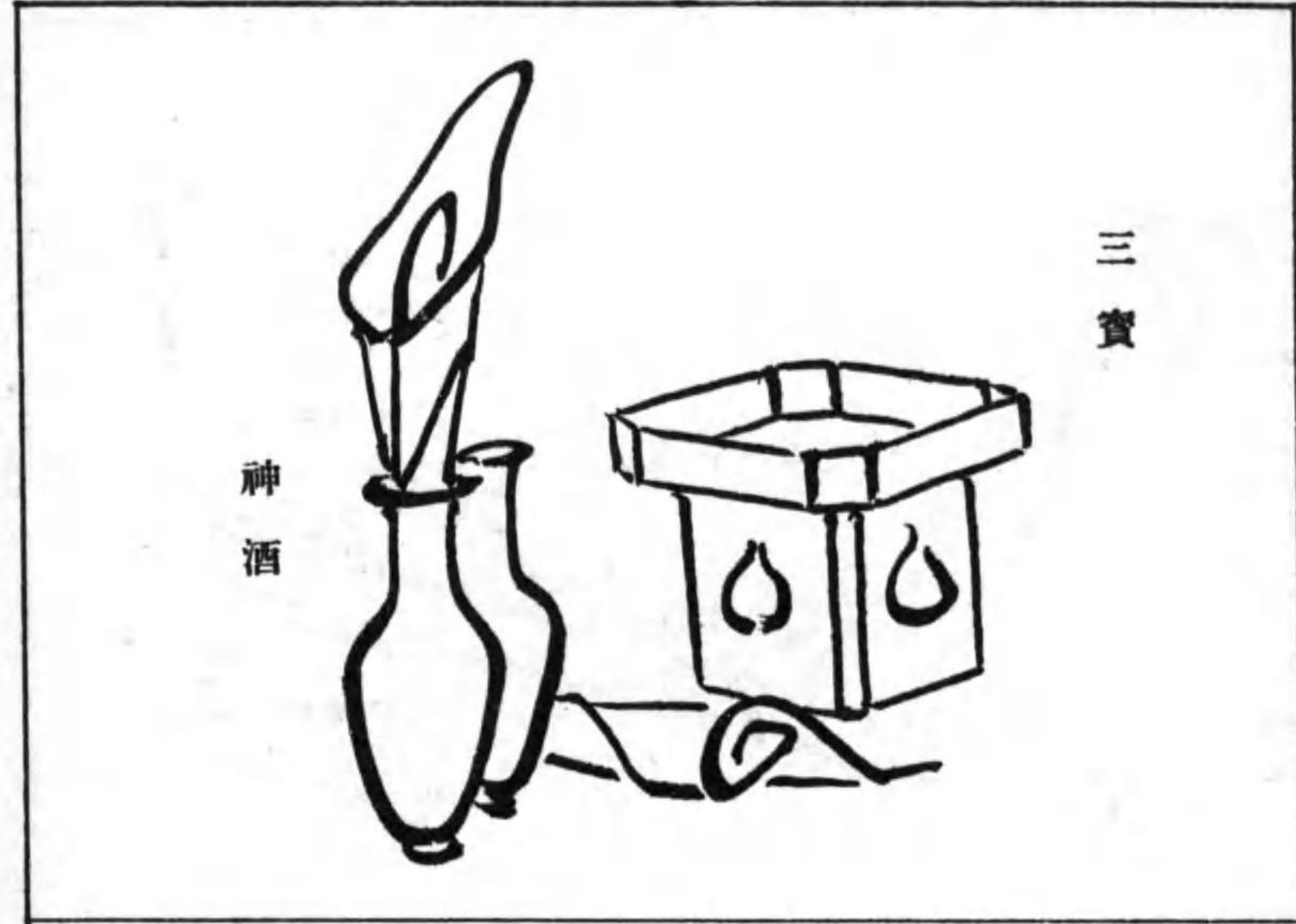

膳

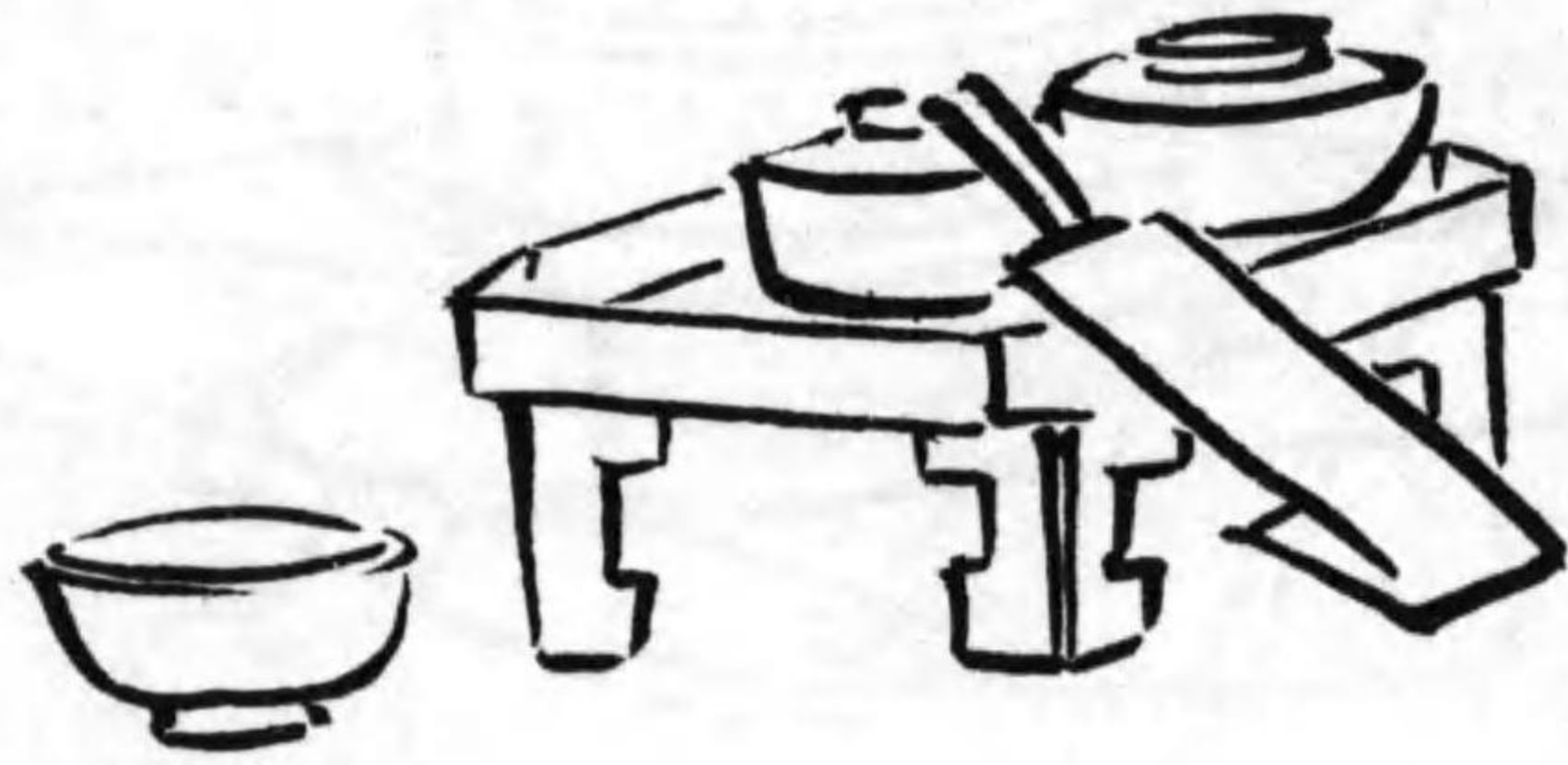

爐邊

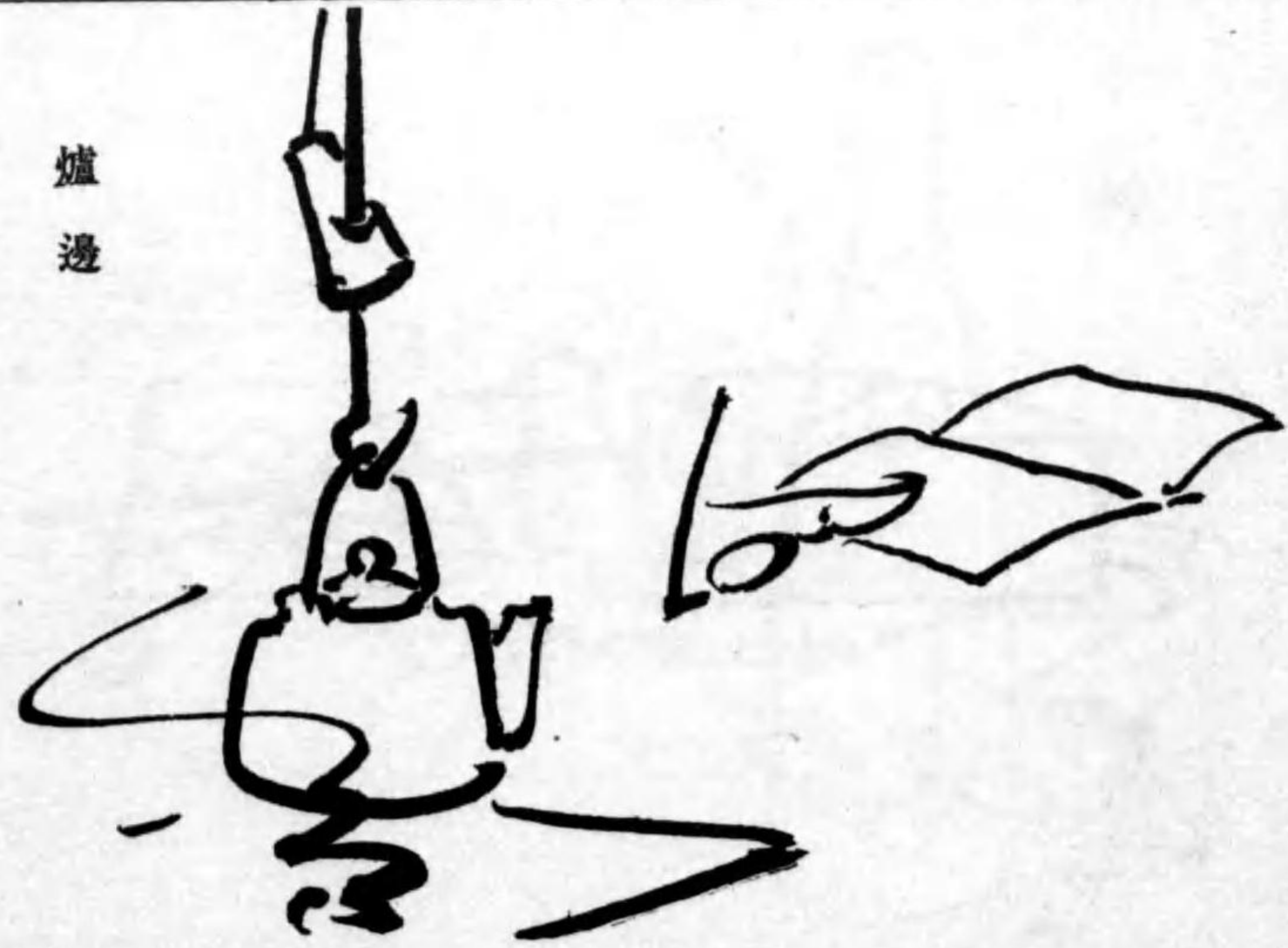

鏡餅



七五三飾

銚子

水引
奉書

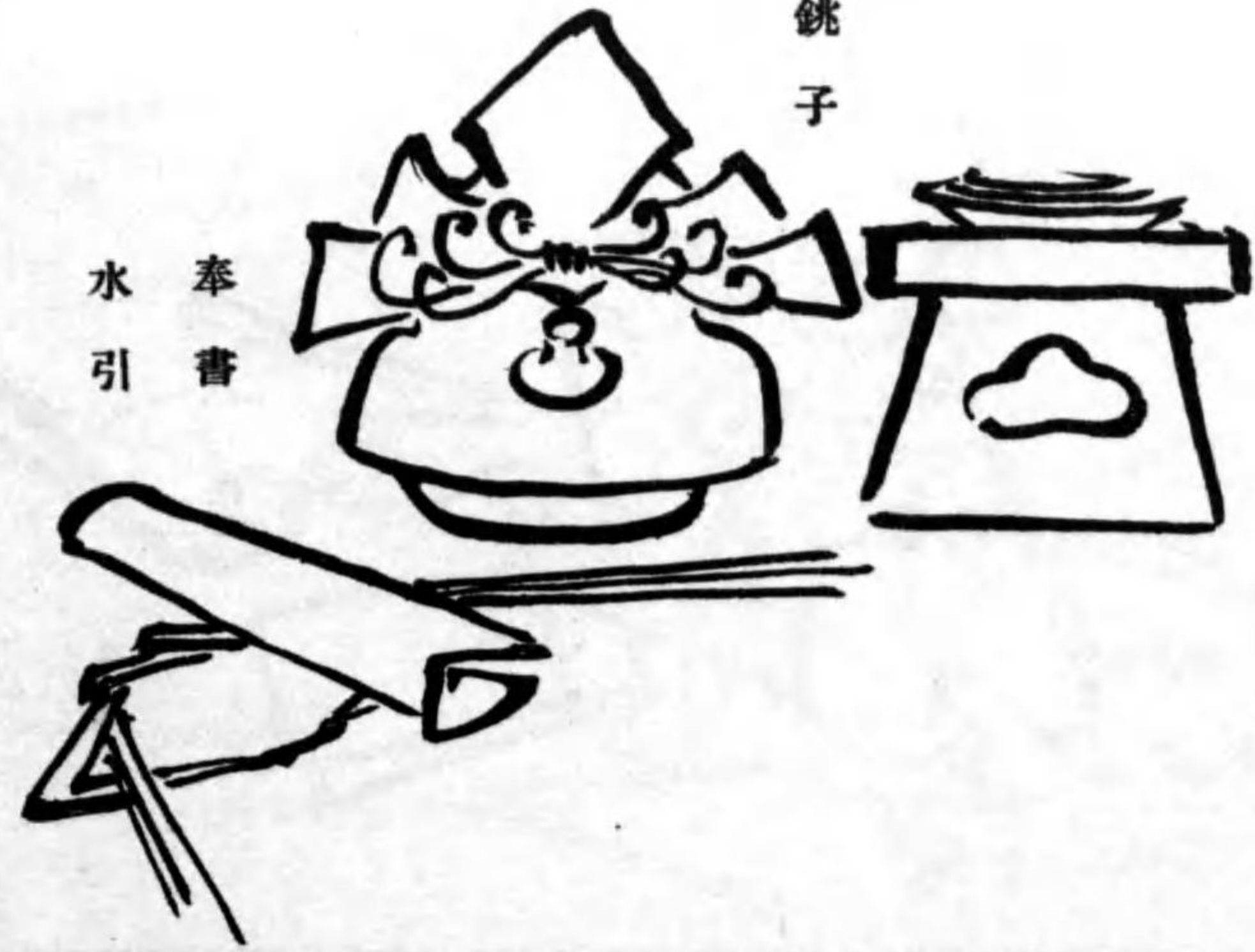

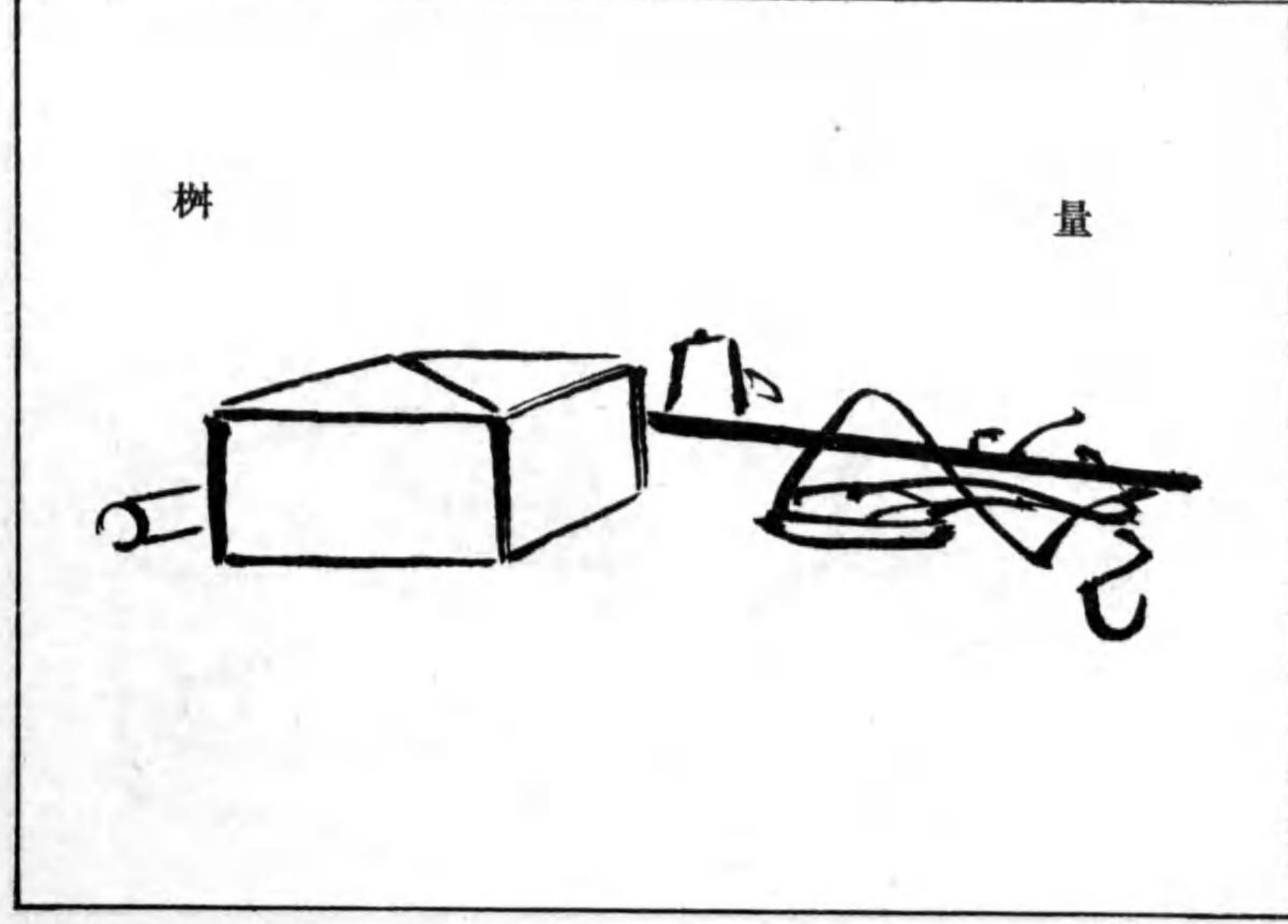
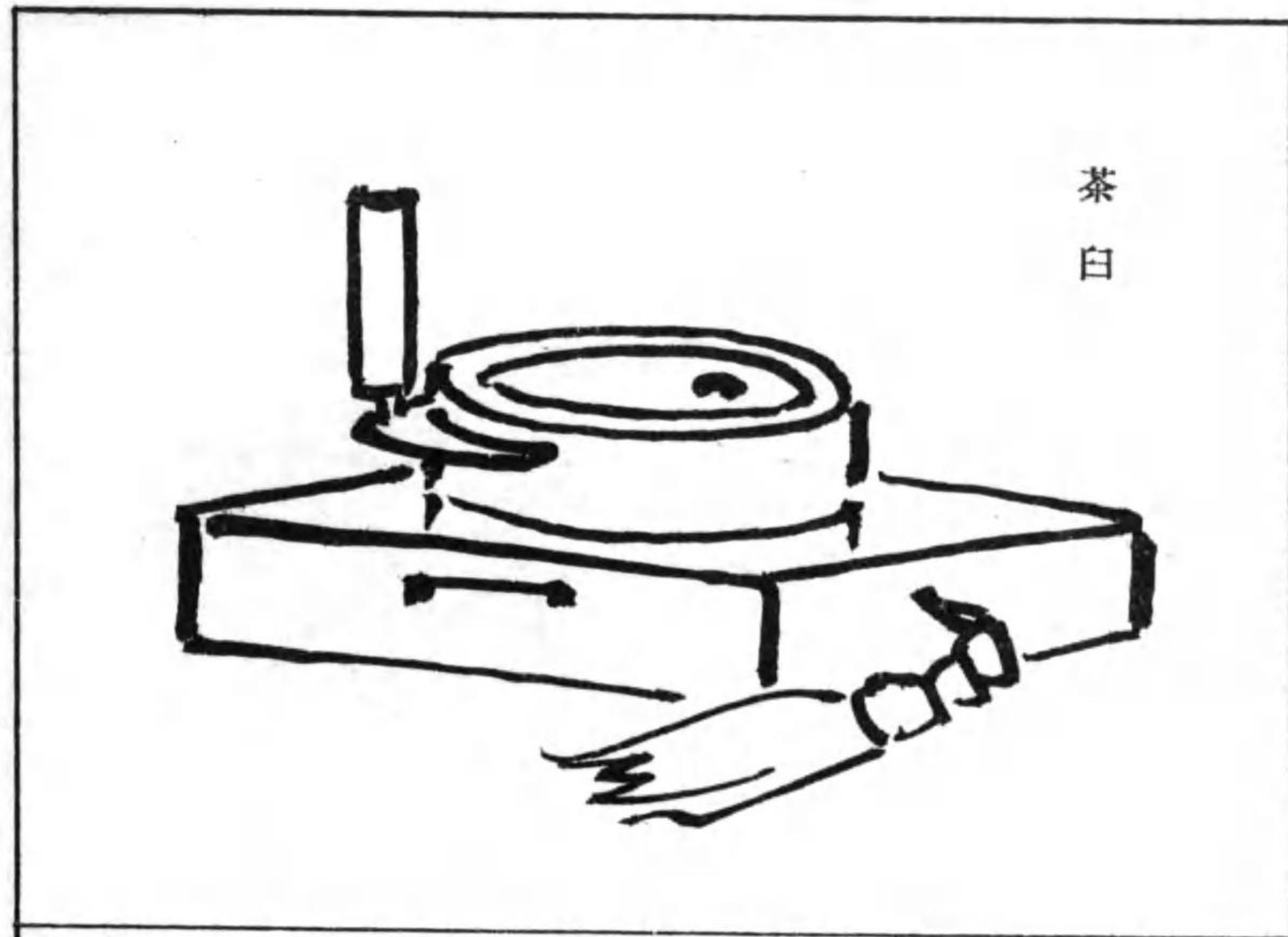
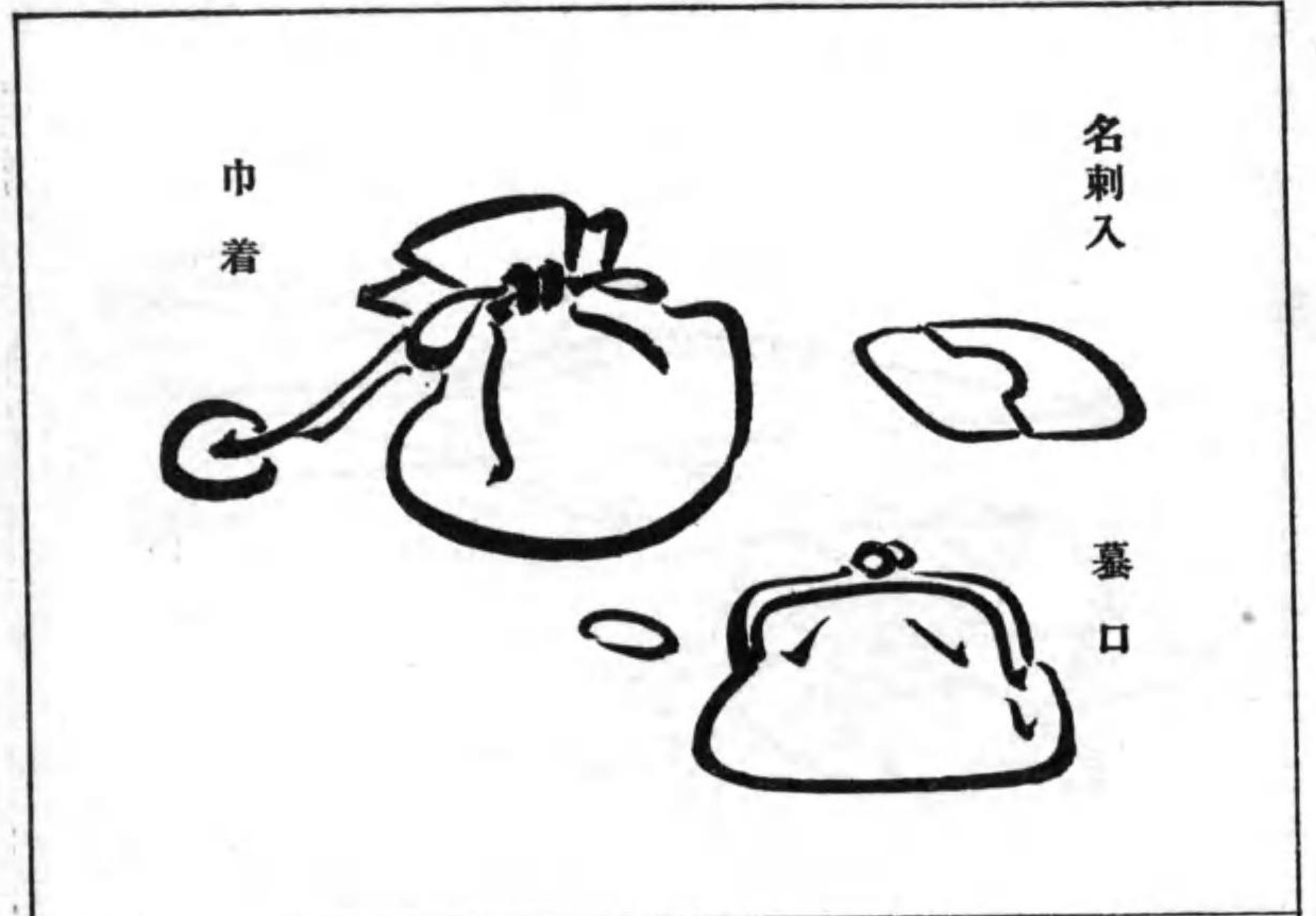

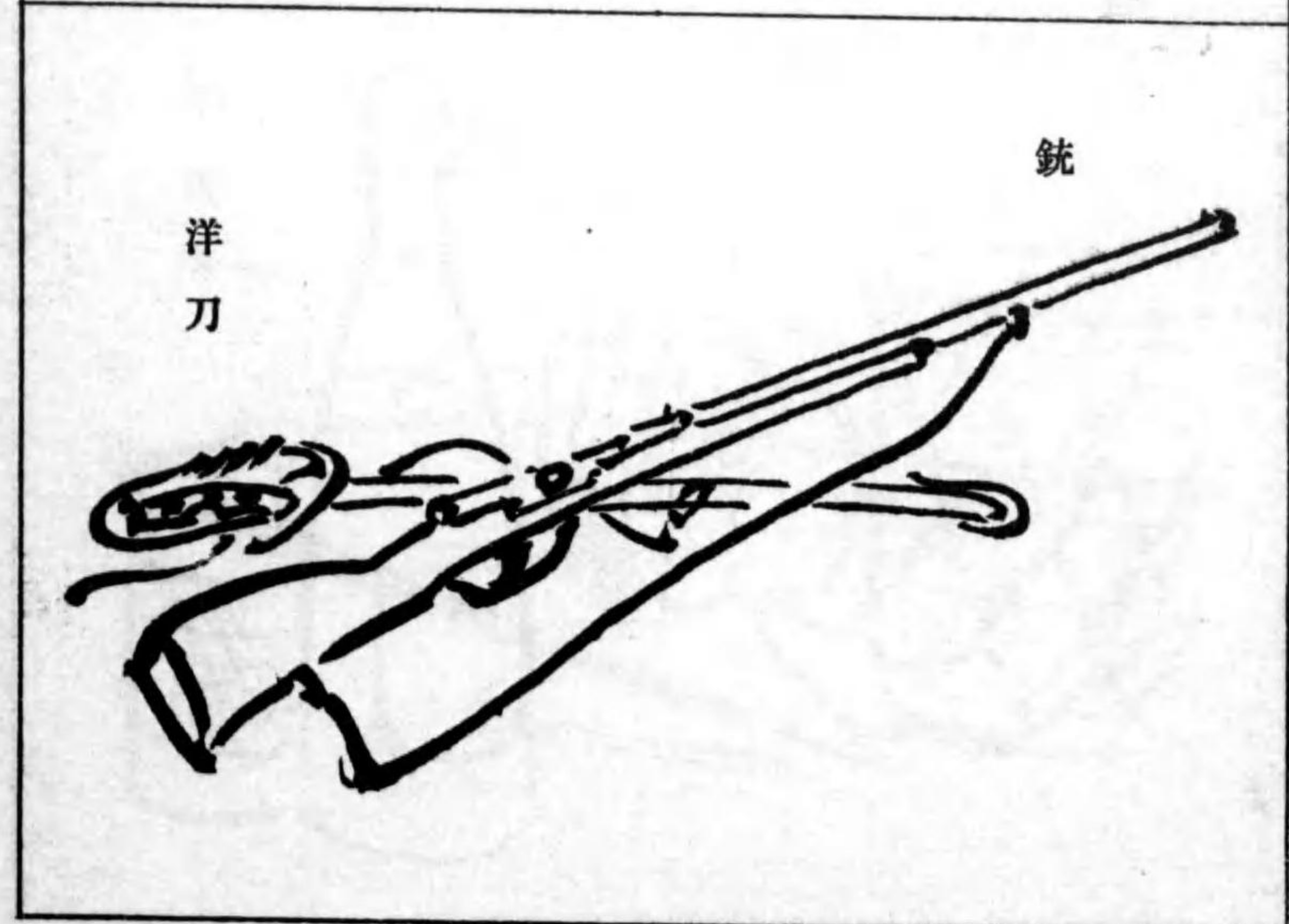
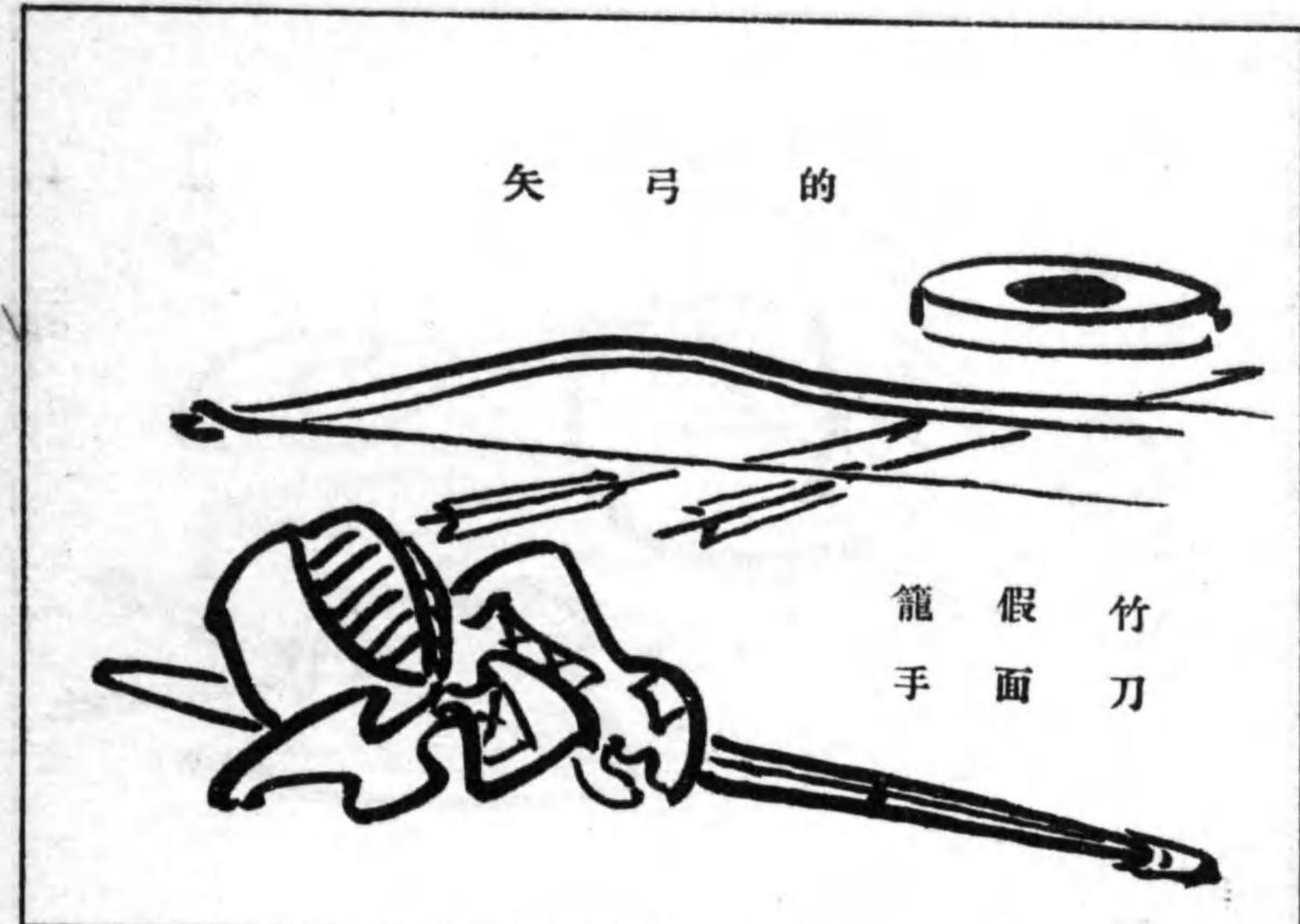
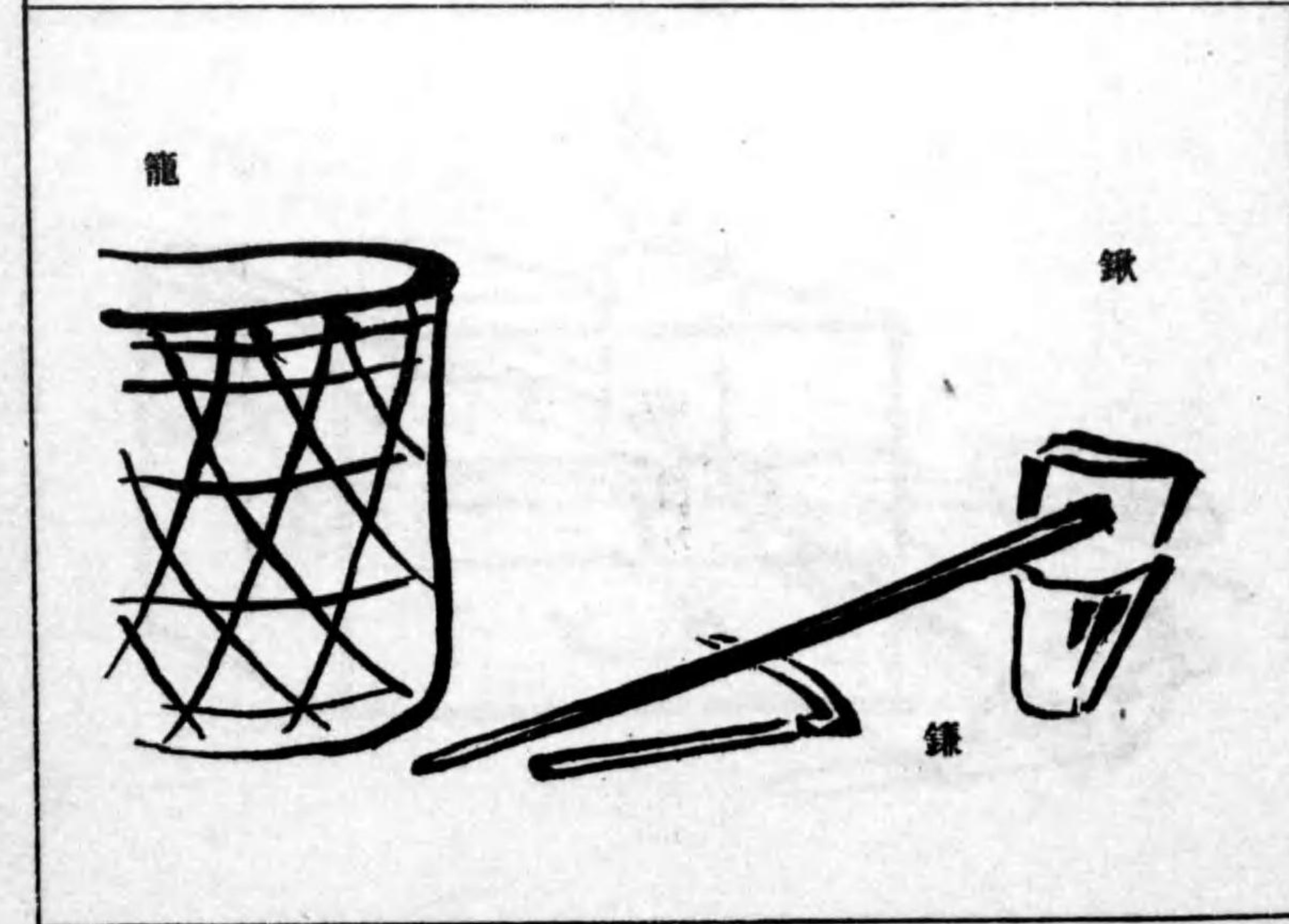
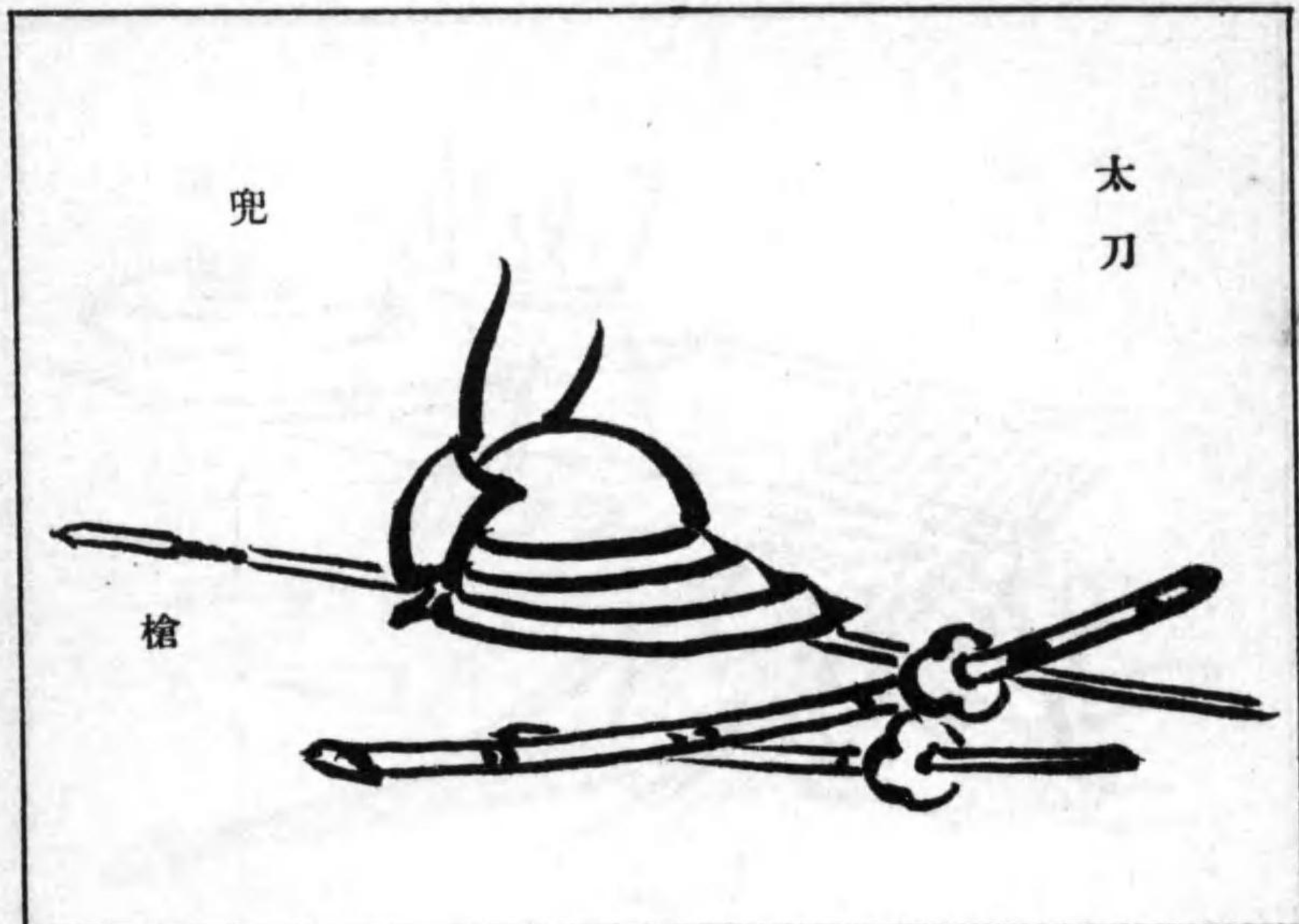

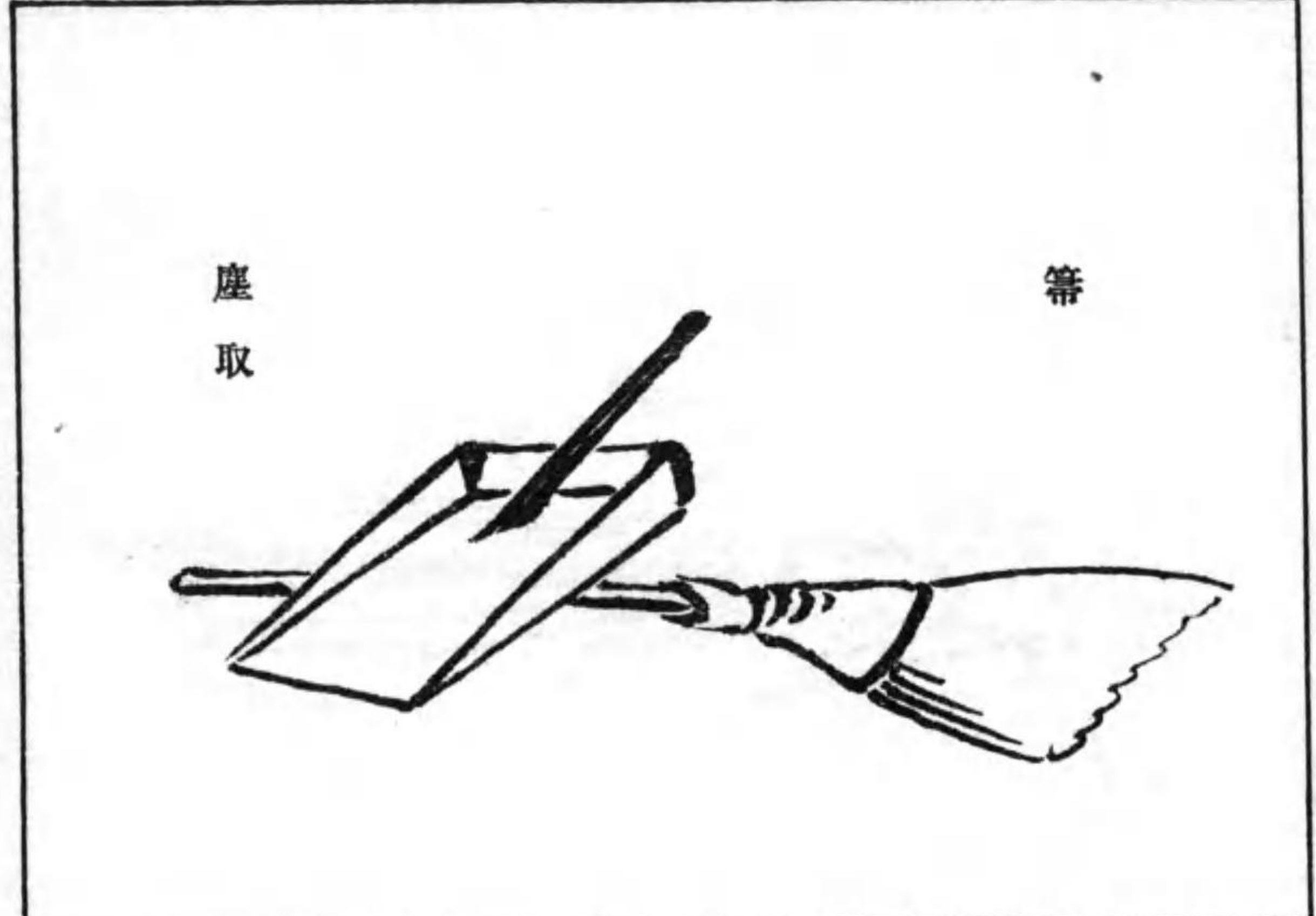

塵取

箒

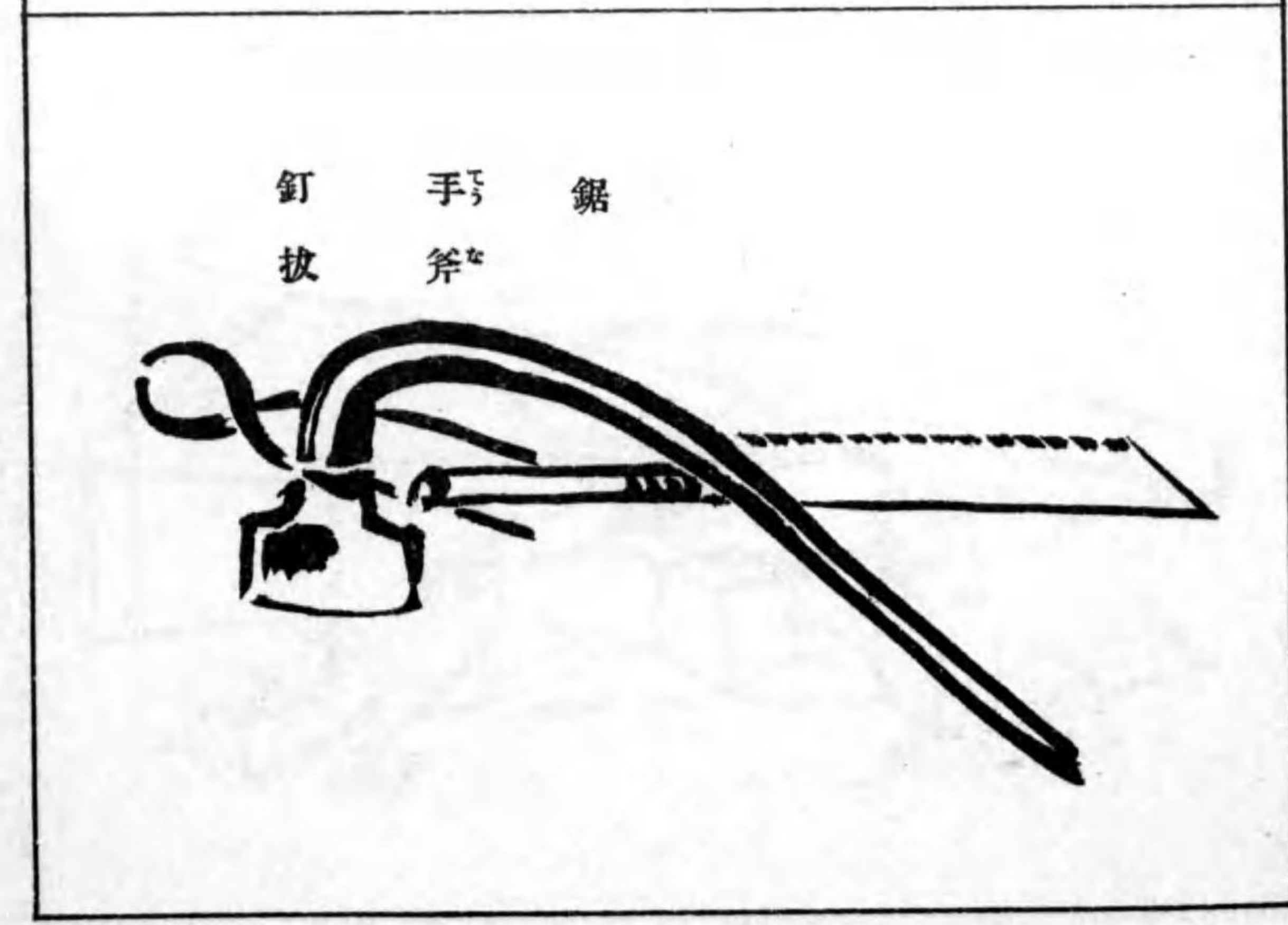

釘拔
手鋸
斧

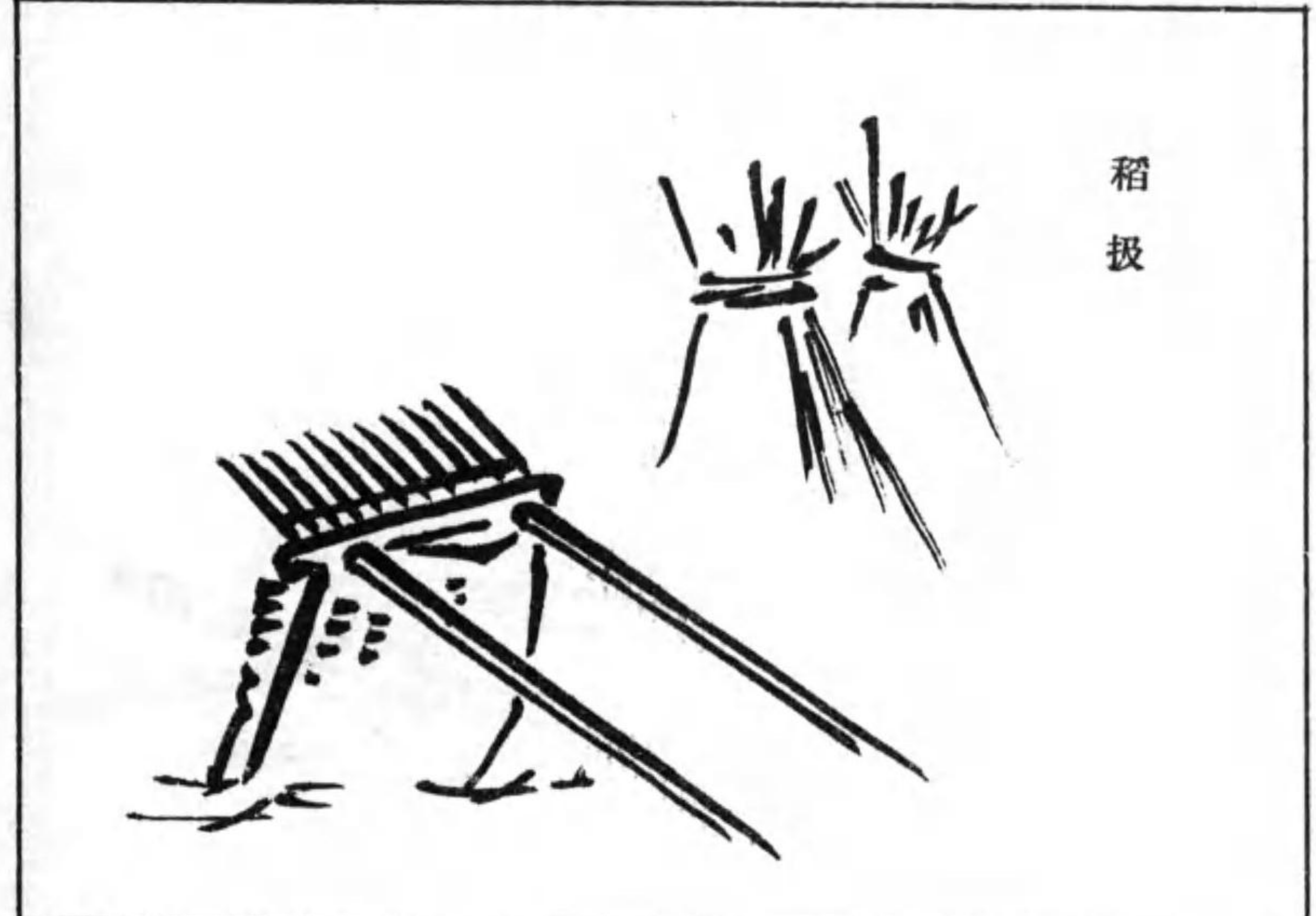

稻扱

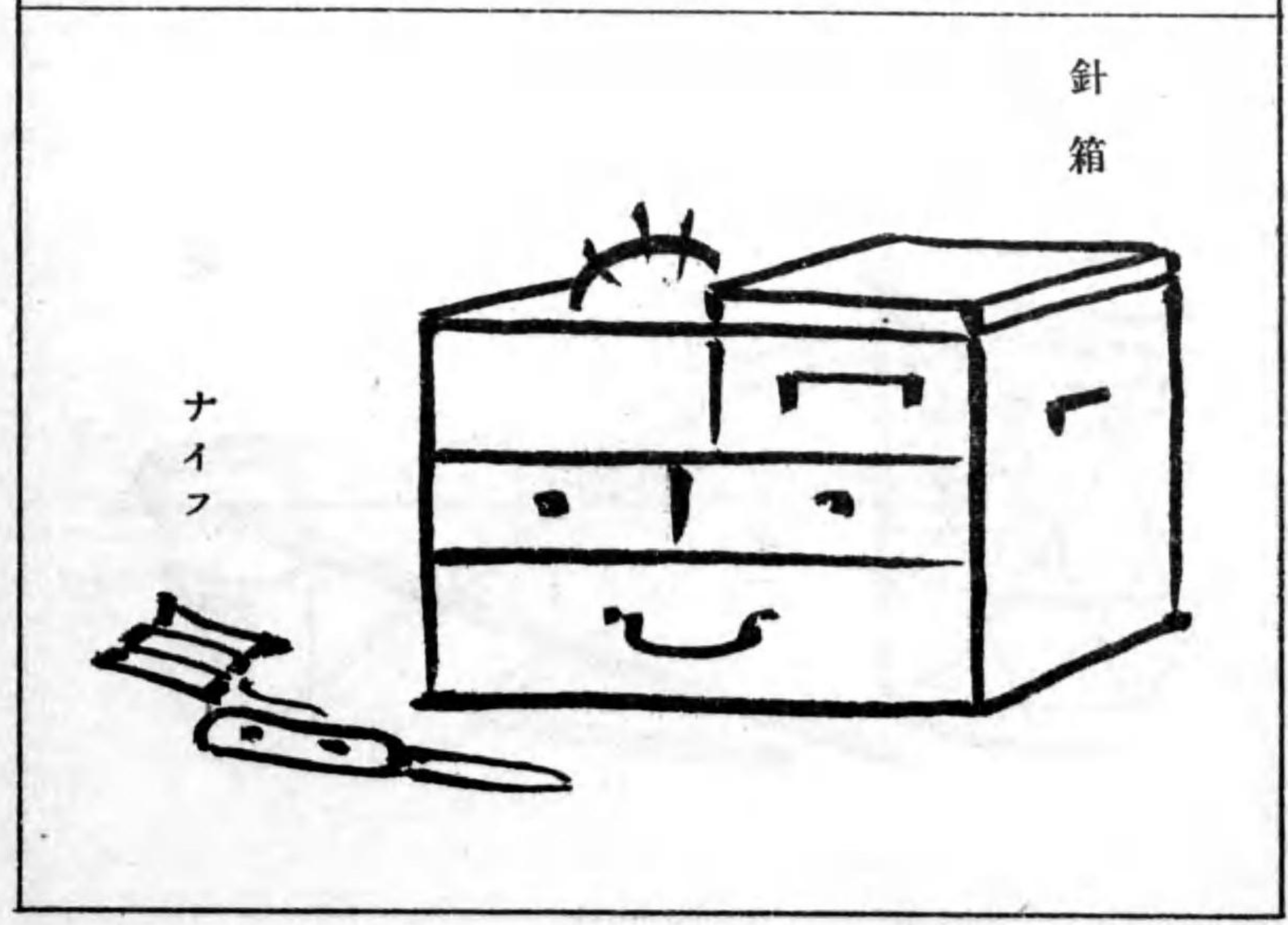

針箱

ナイフ

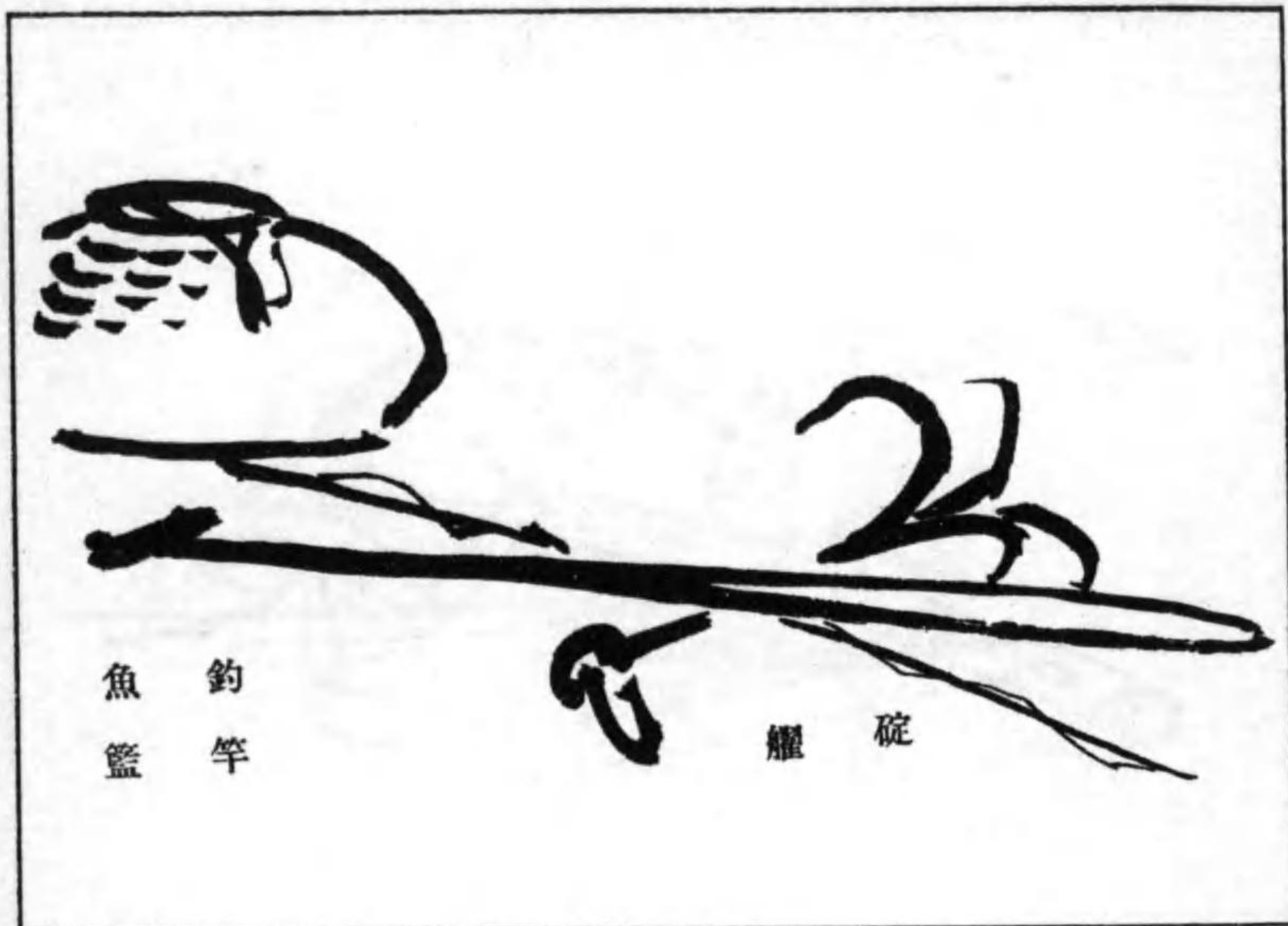

魚籃 釣竿

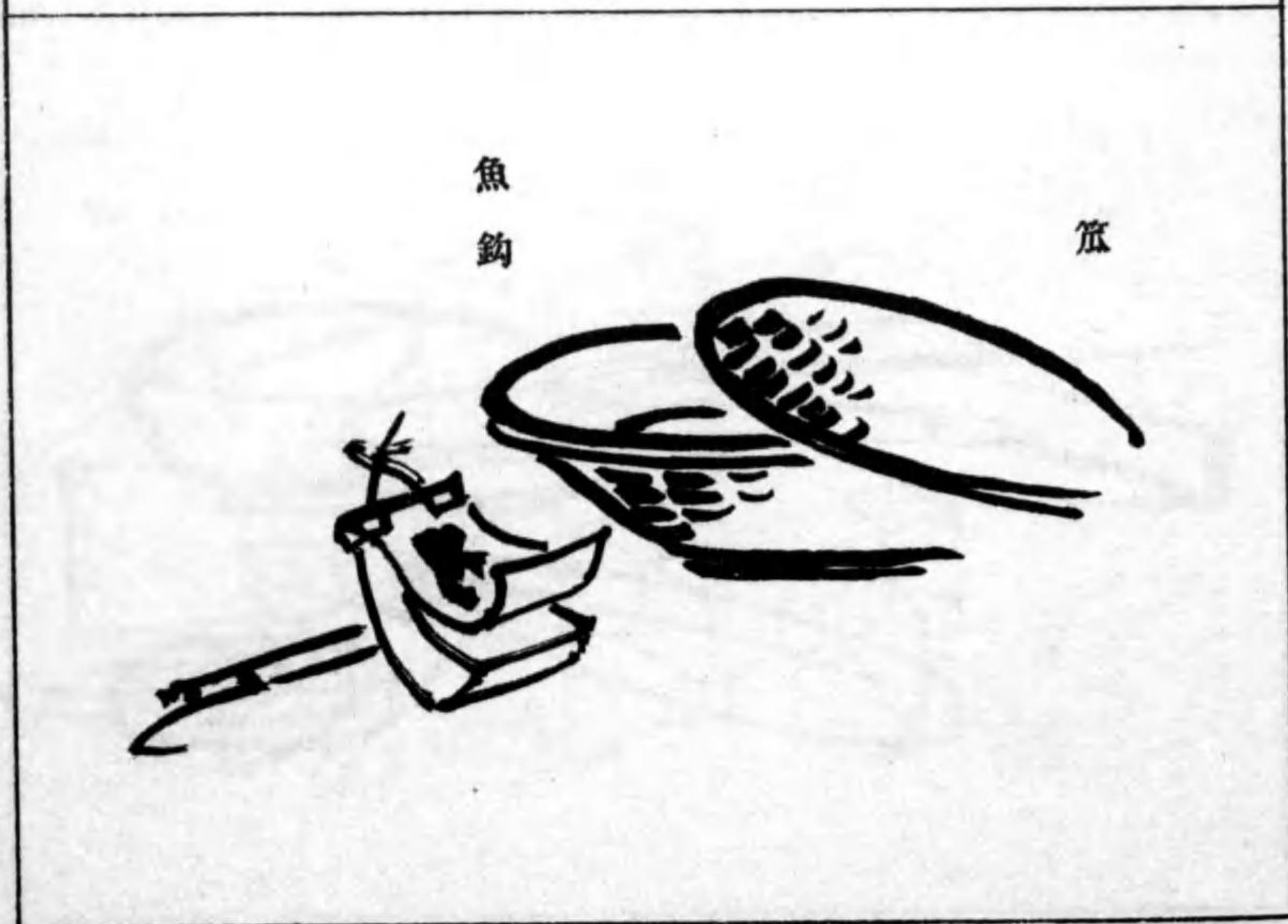

魚鈎 魚簍

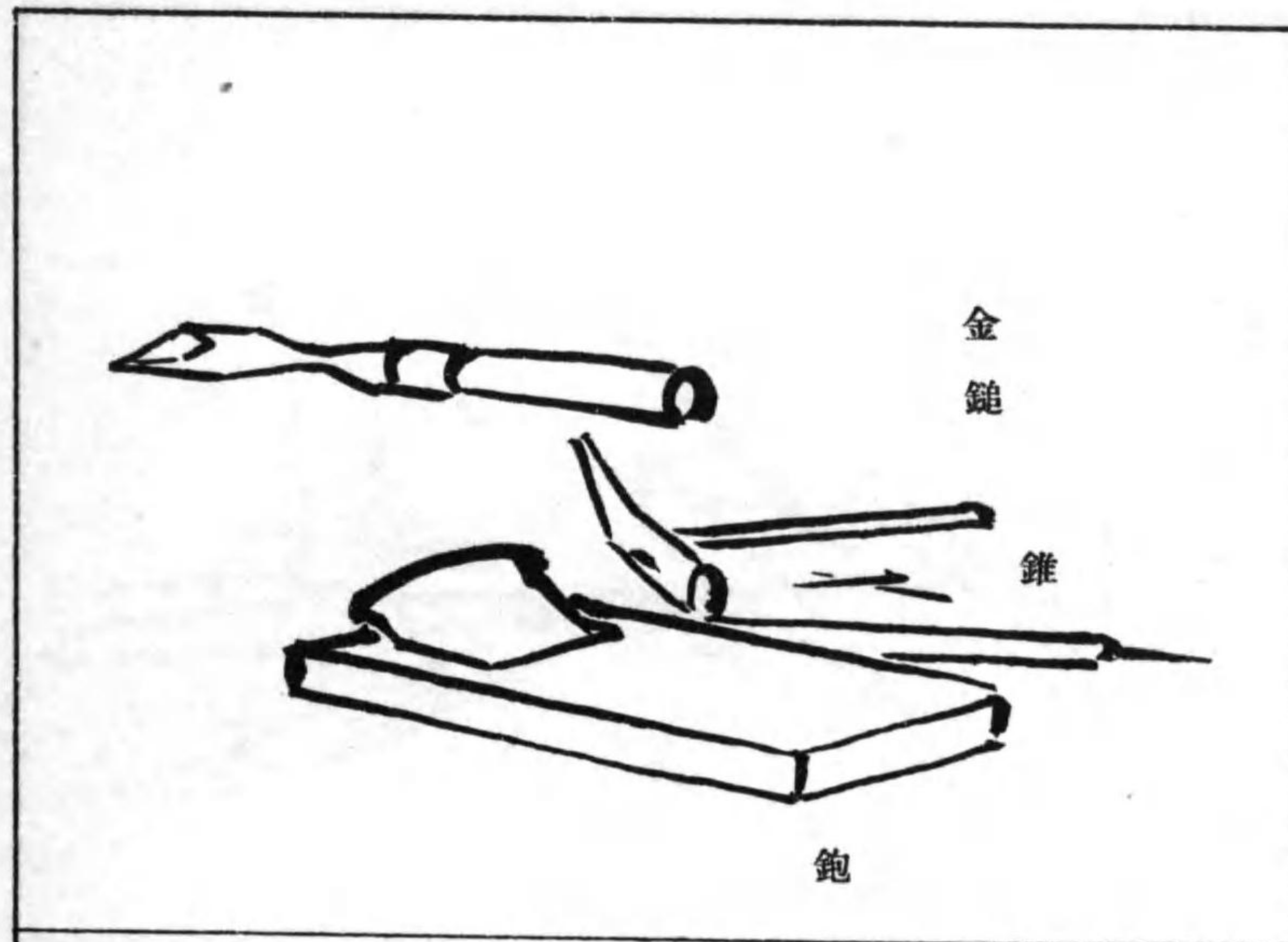

金鏈

錐

鉋

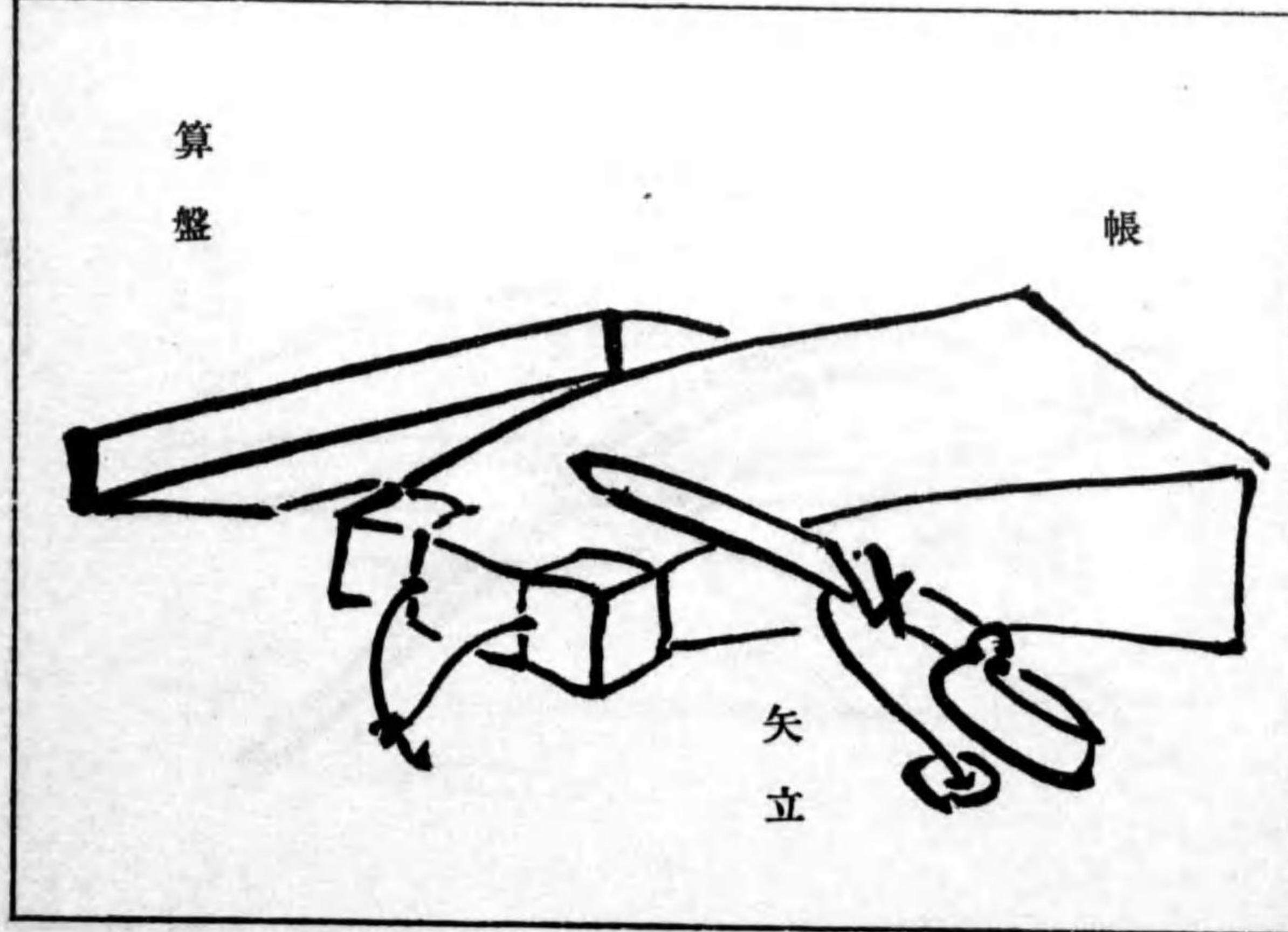

算盤

帳

矢立

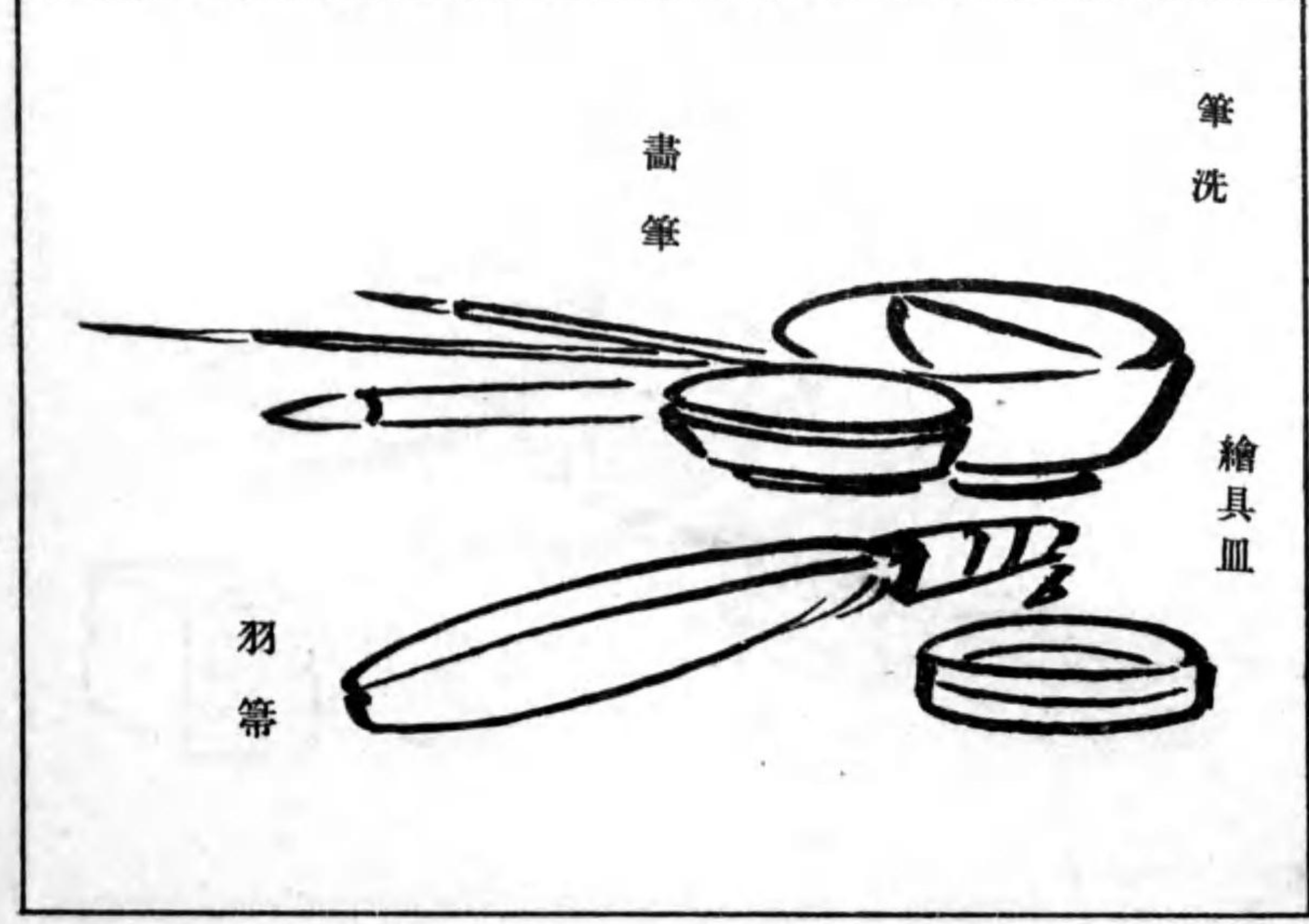
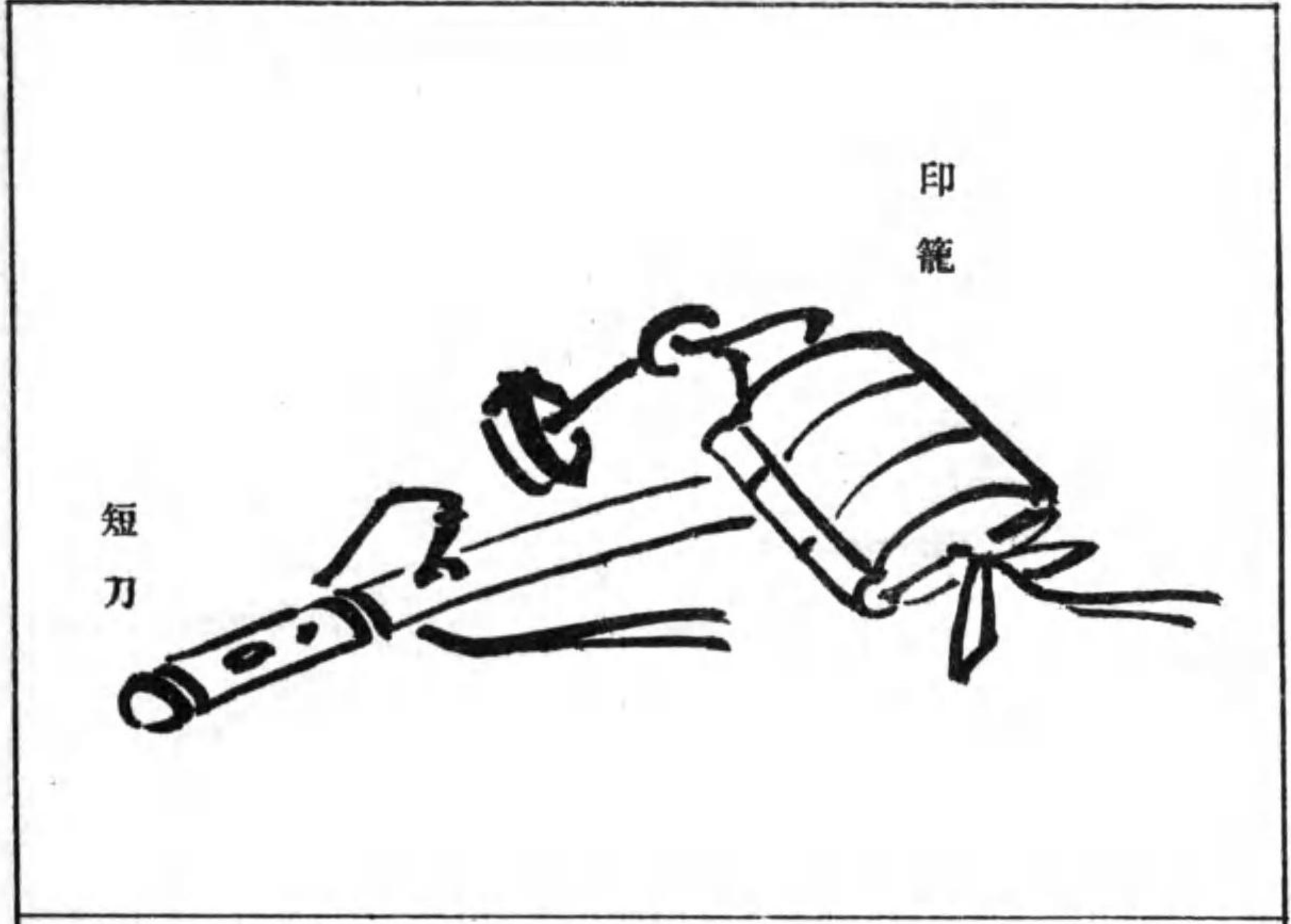
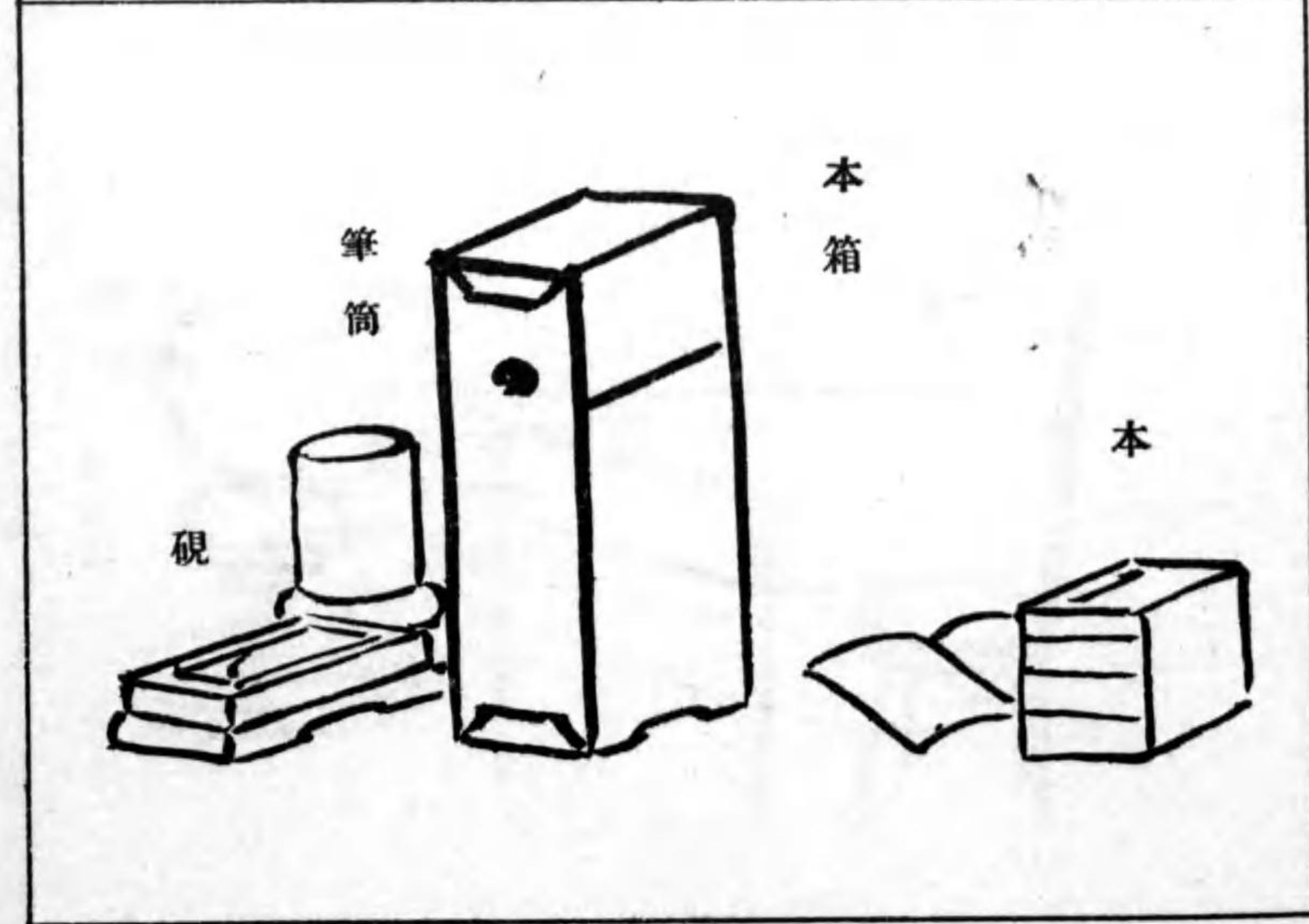
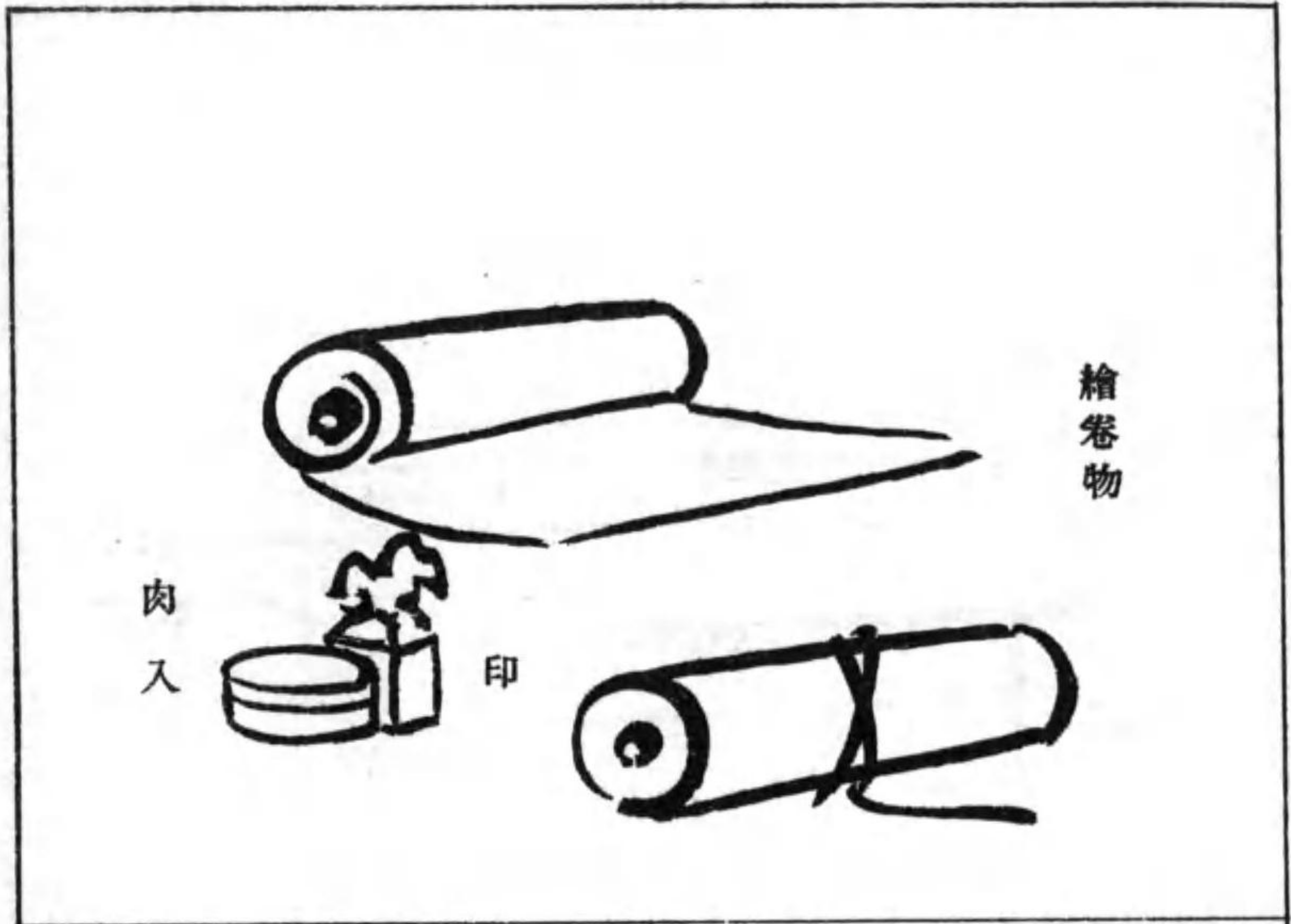

寒暖計



時計

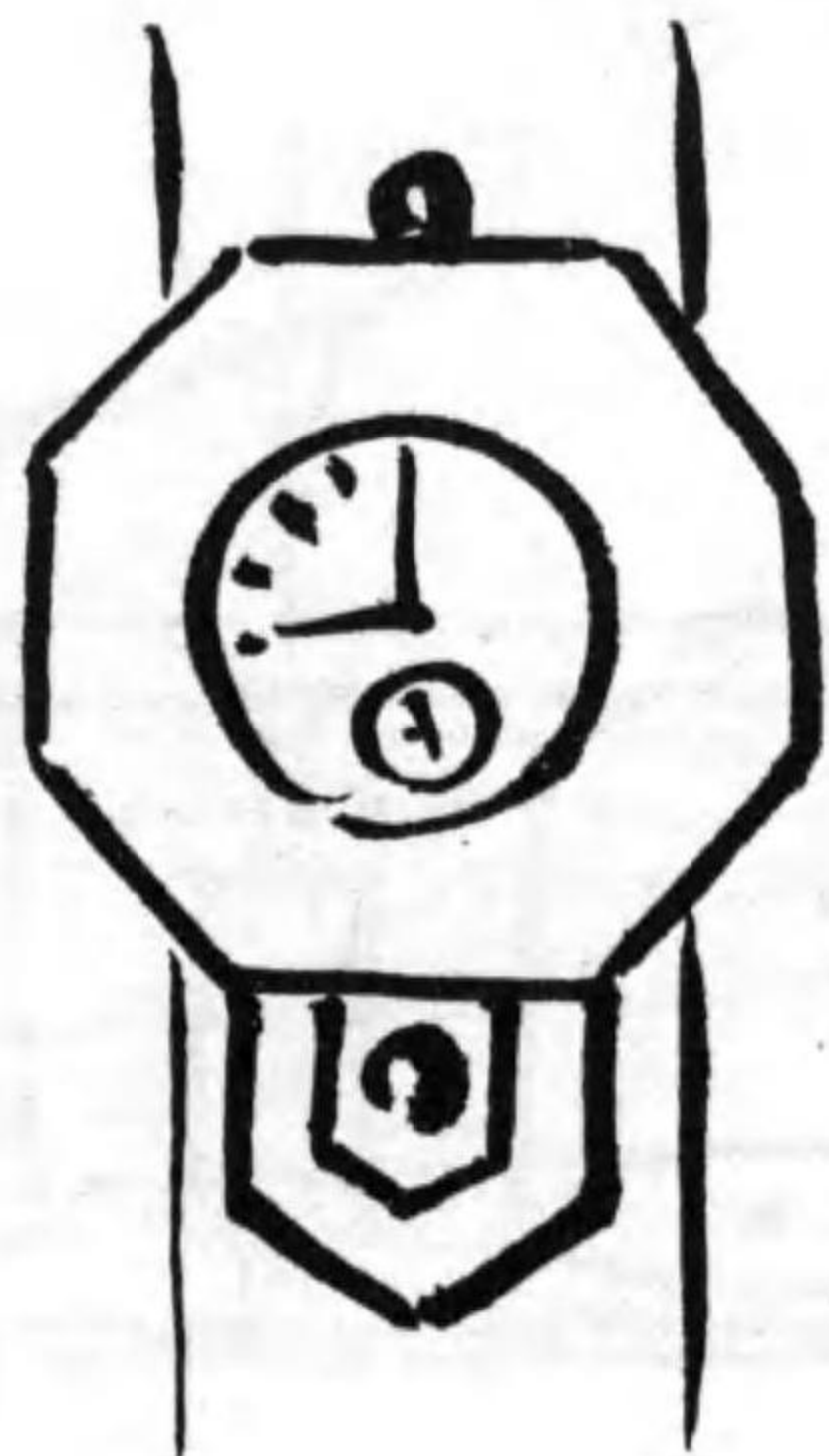

目覺時計

懷中時計

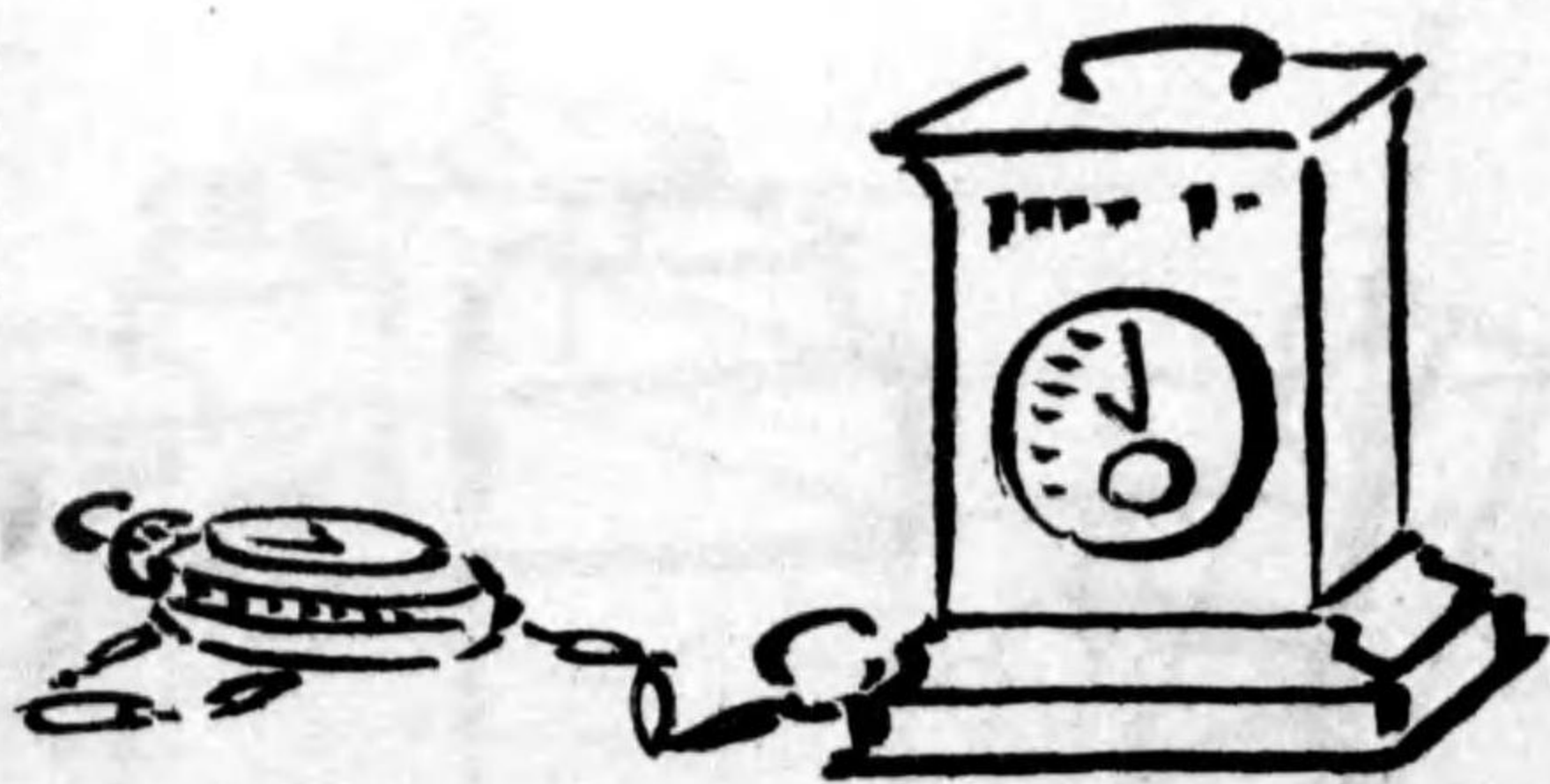

机

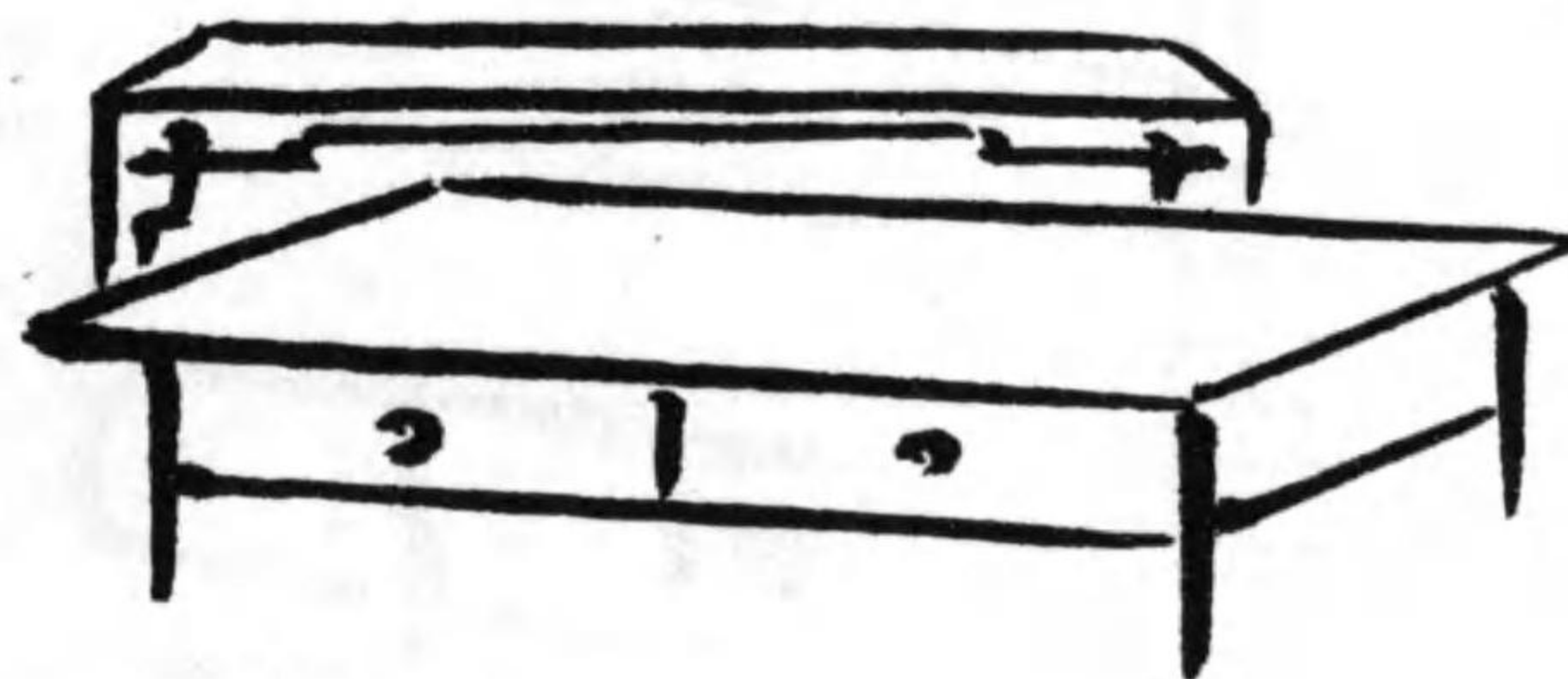

椅子
卓

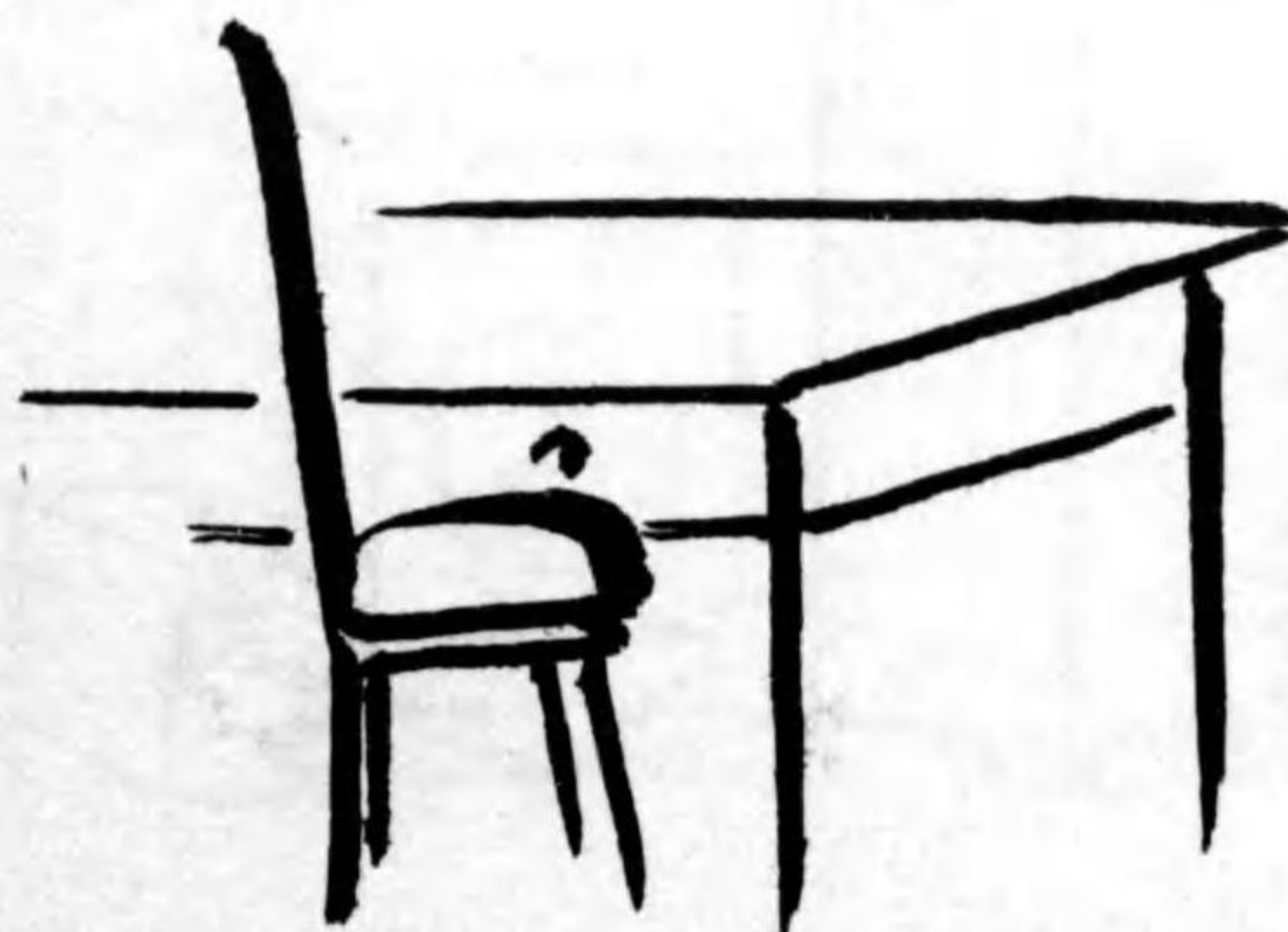

腰掛



膝寫盤

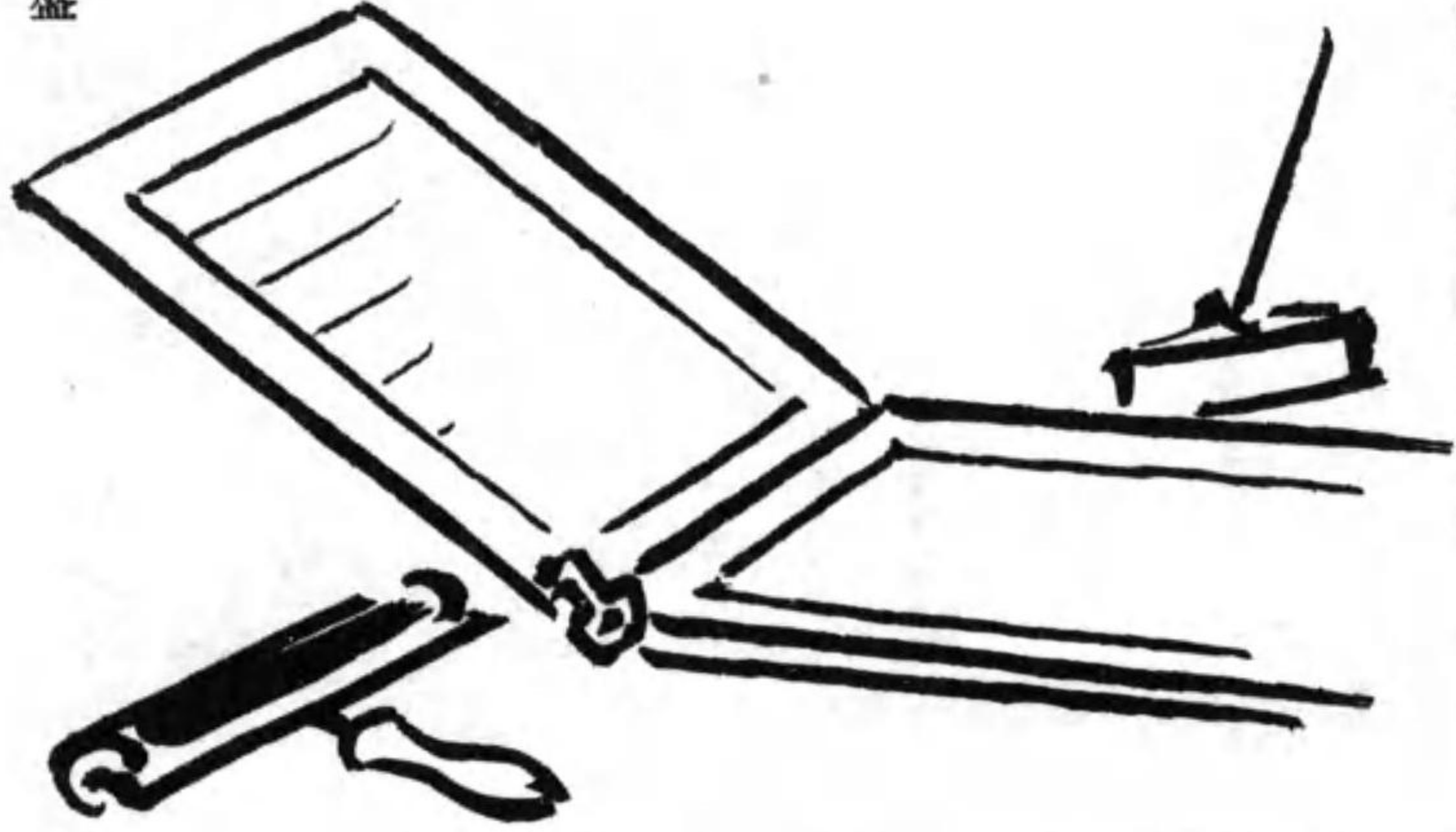

顯微鏡

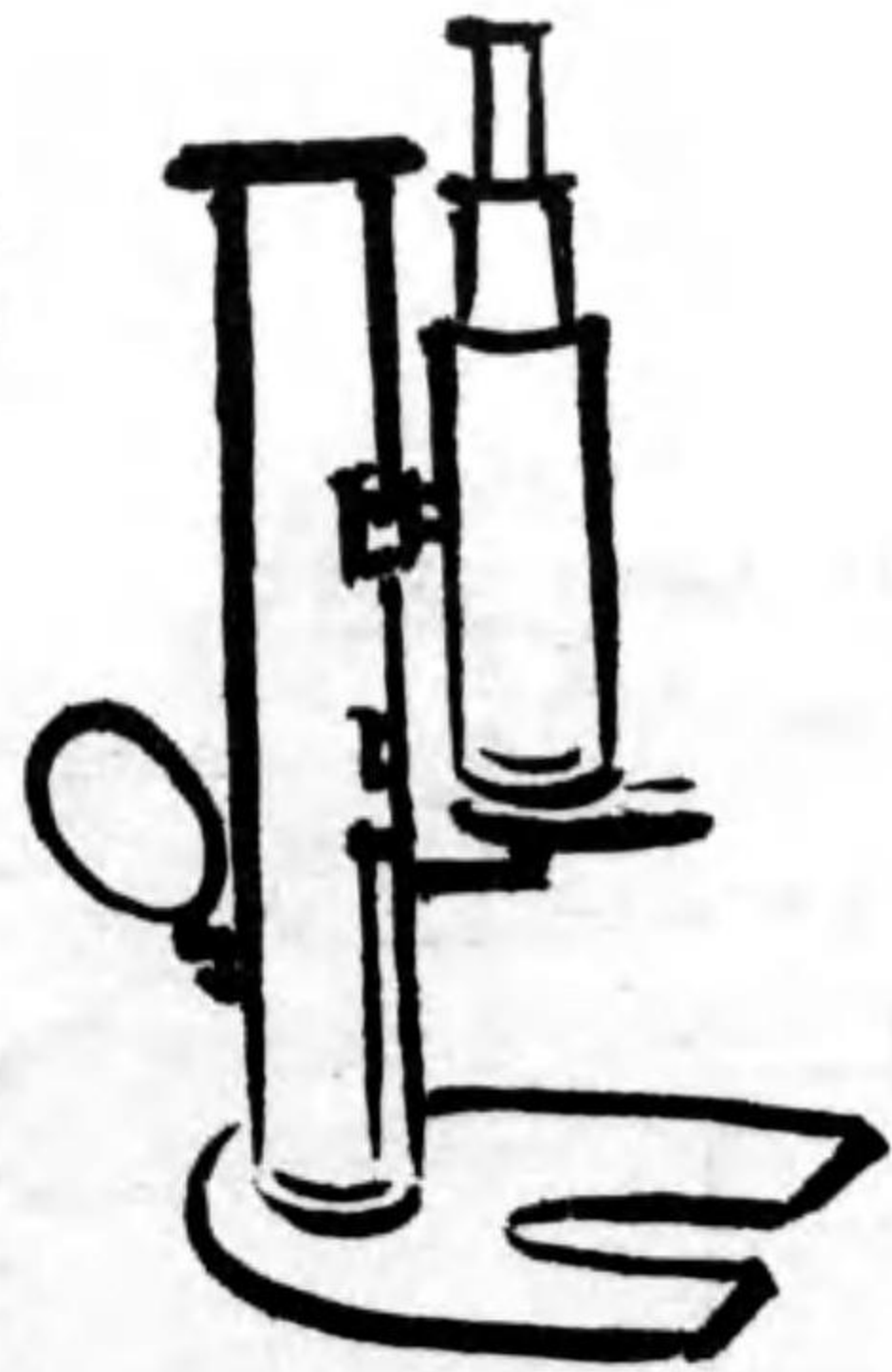

雙眼鏡



排氣機

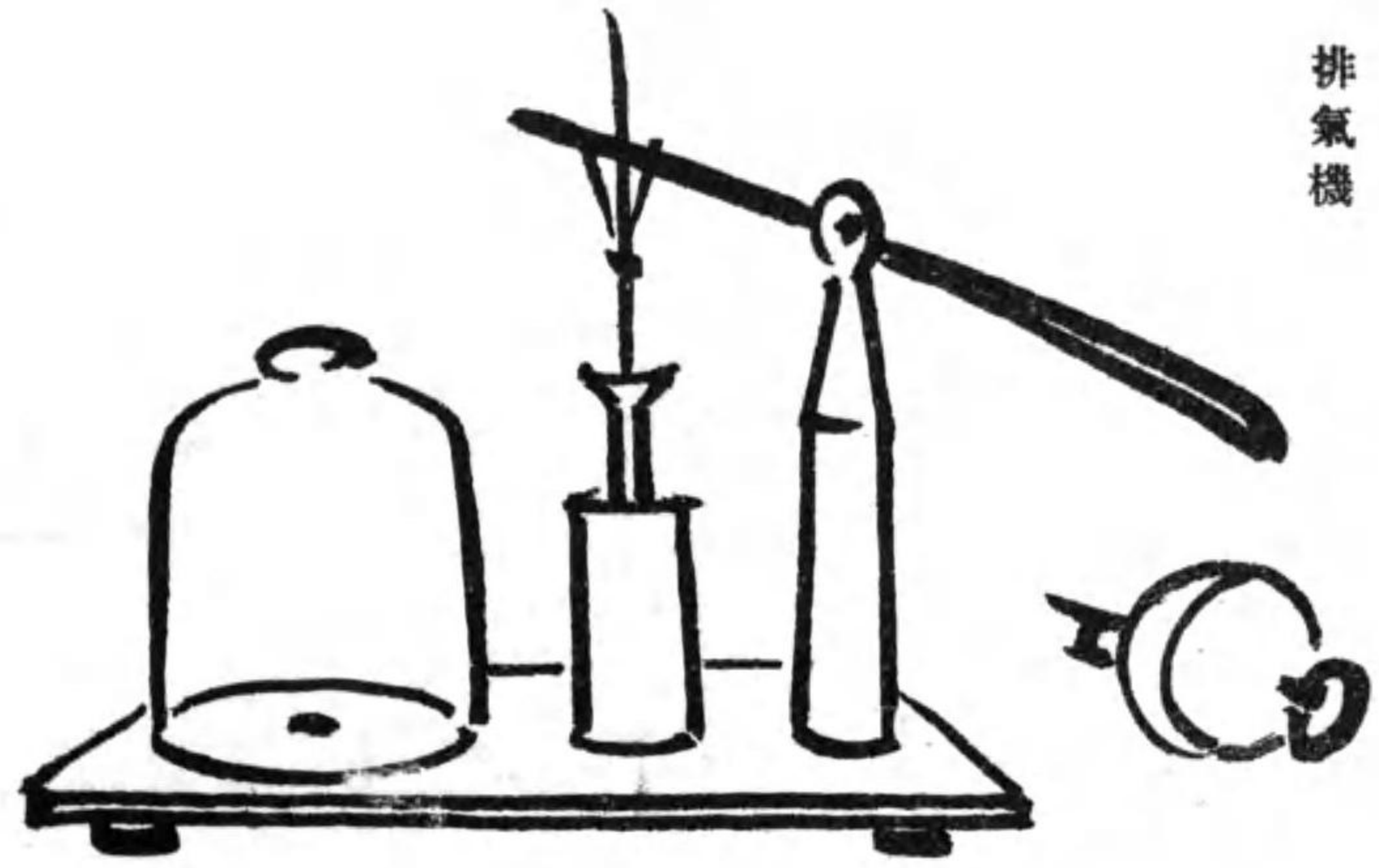

電池

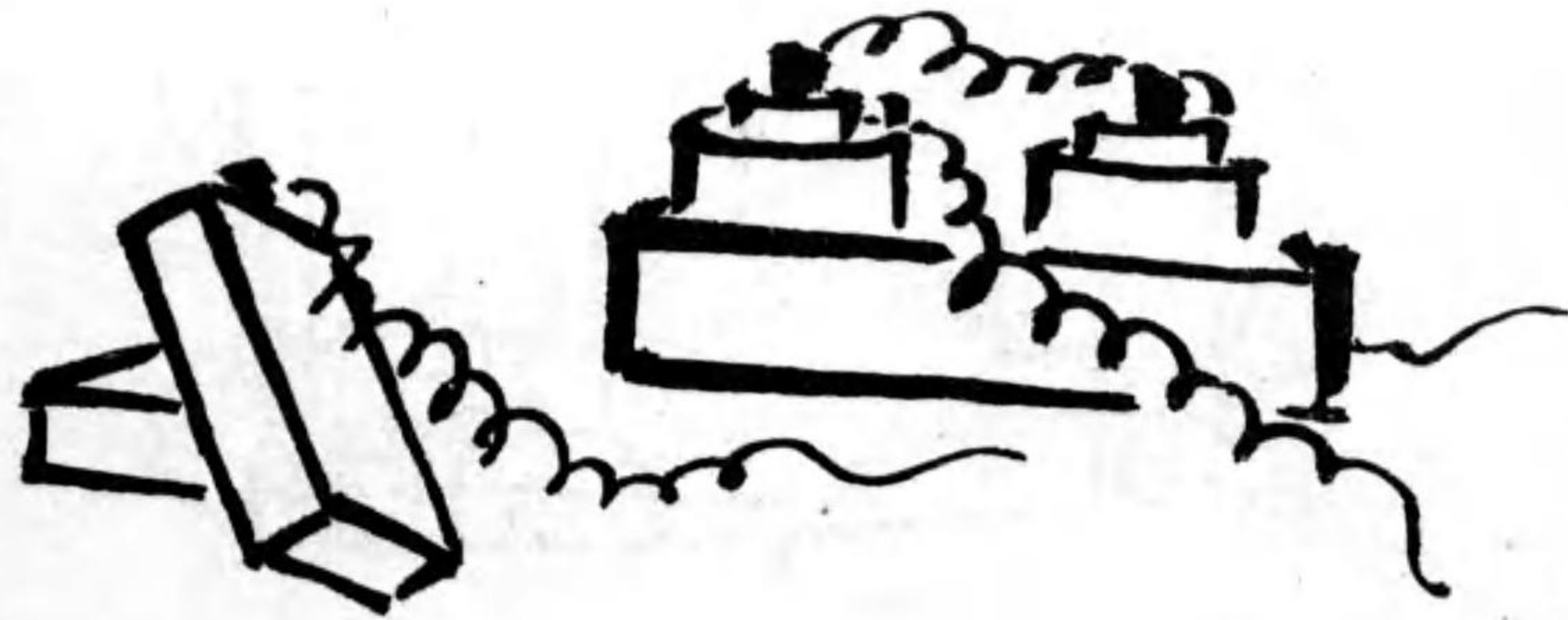

月琴



八雲琴

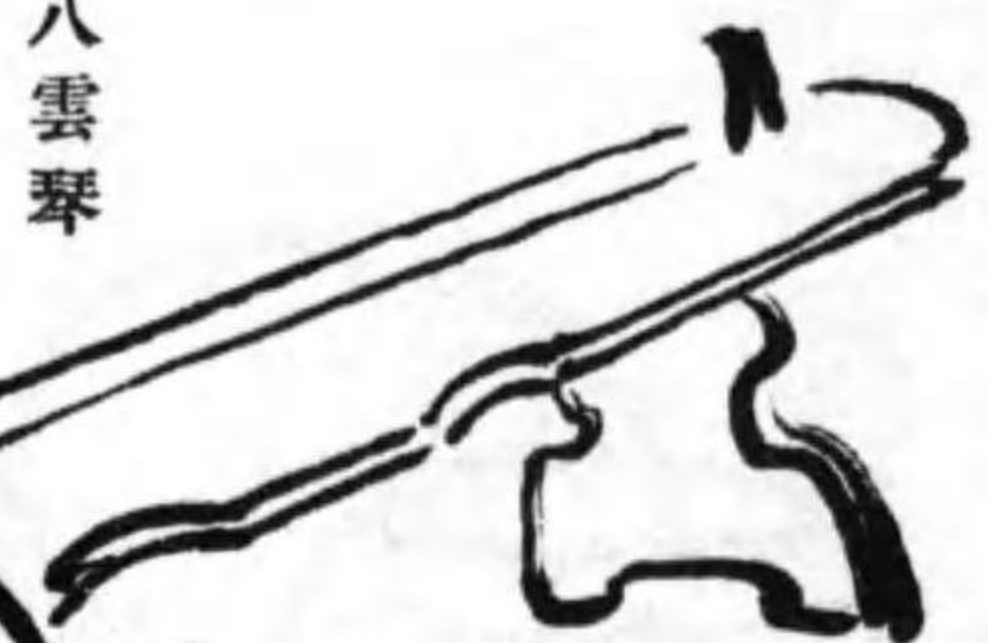

明笛



鼓



太鼓



地球儀



酒精燈



理髮鉸



剃刀



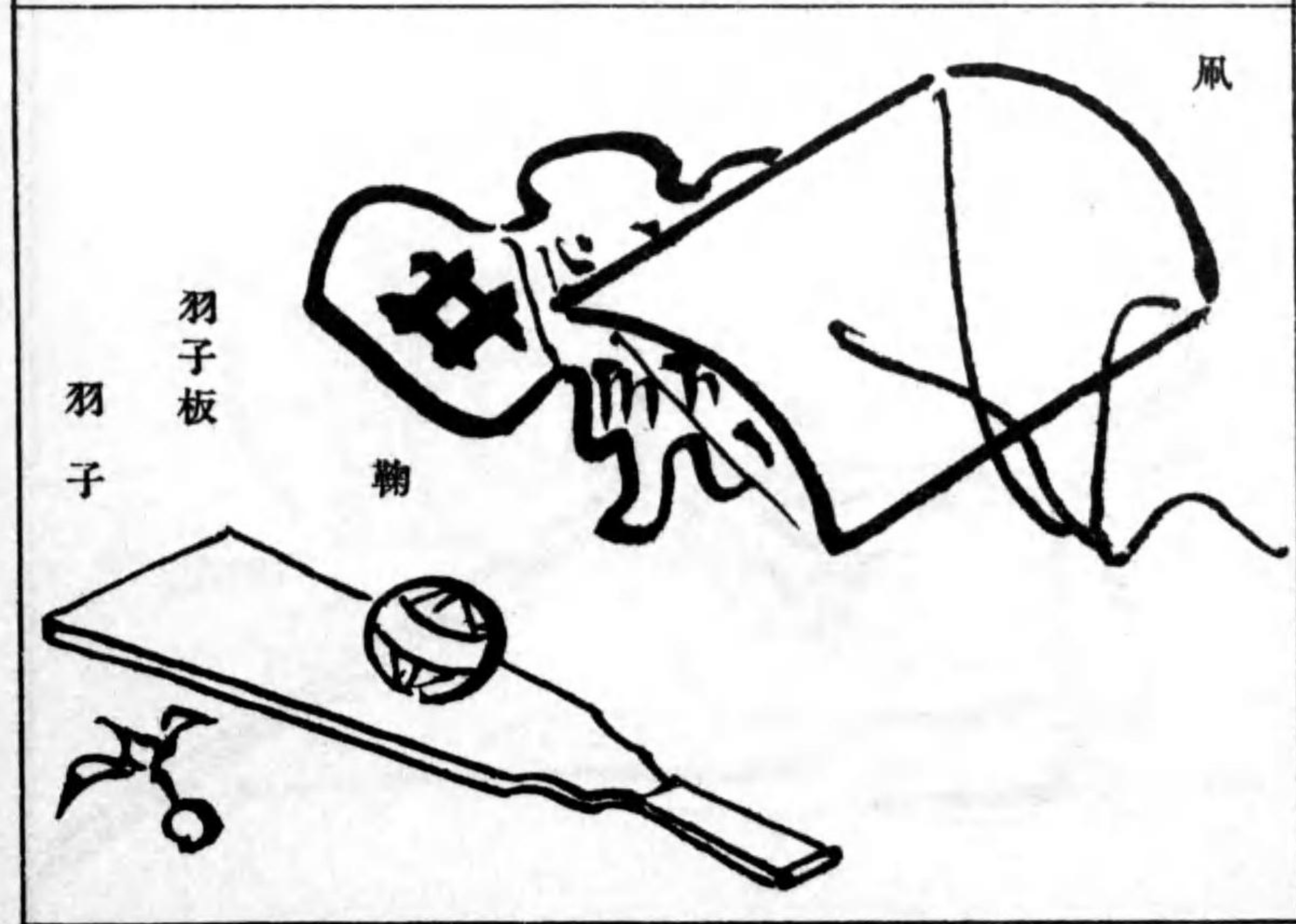
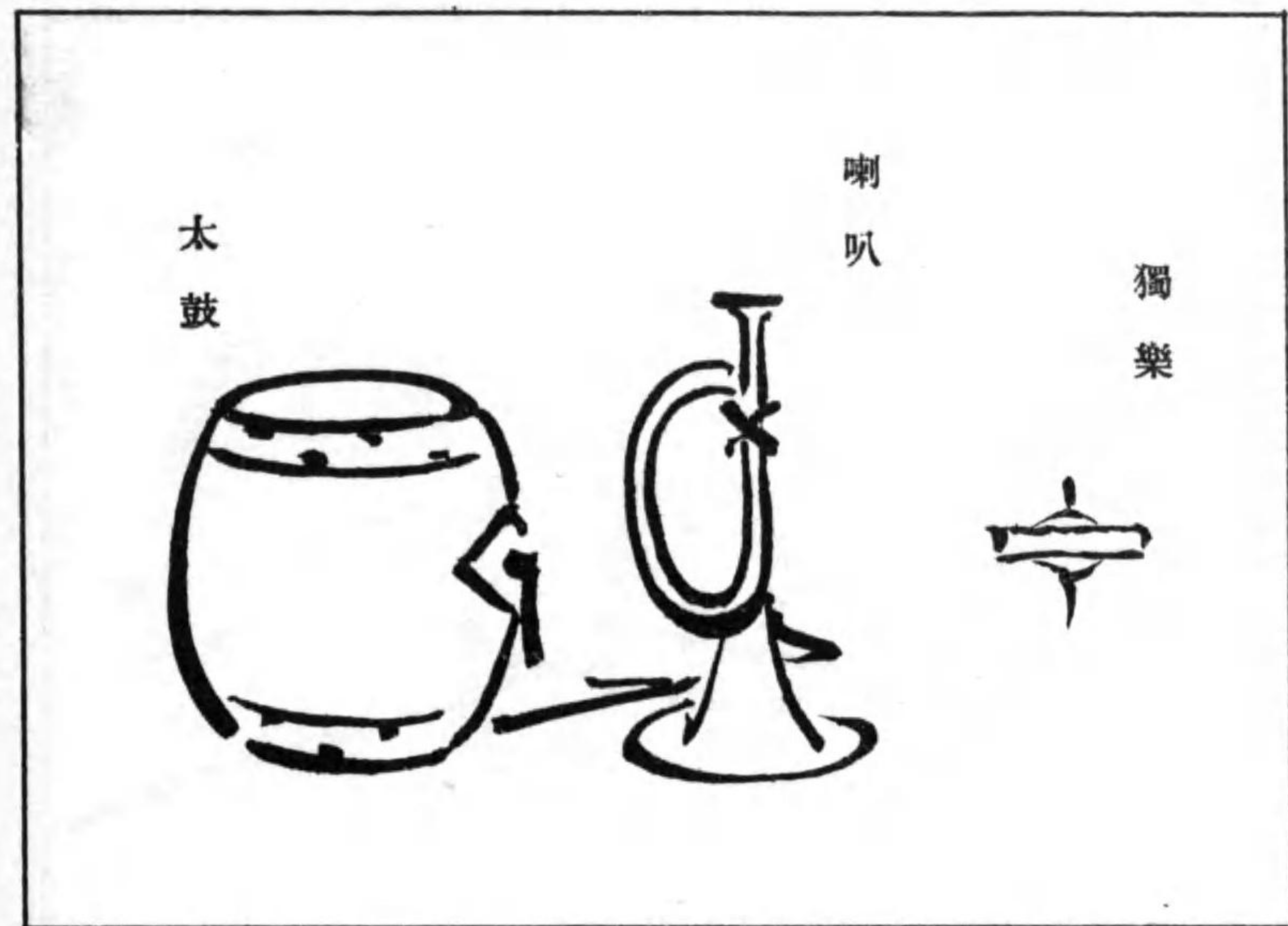
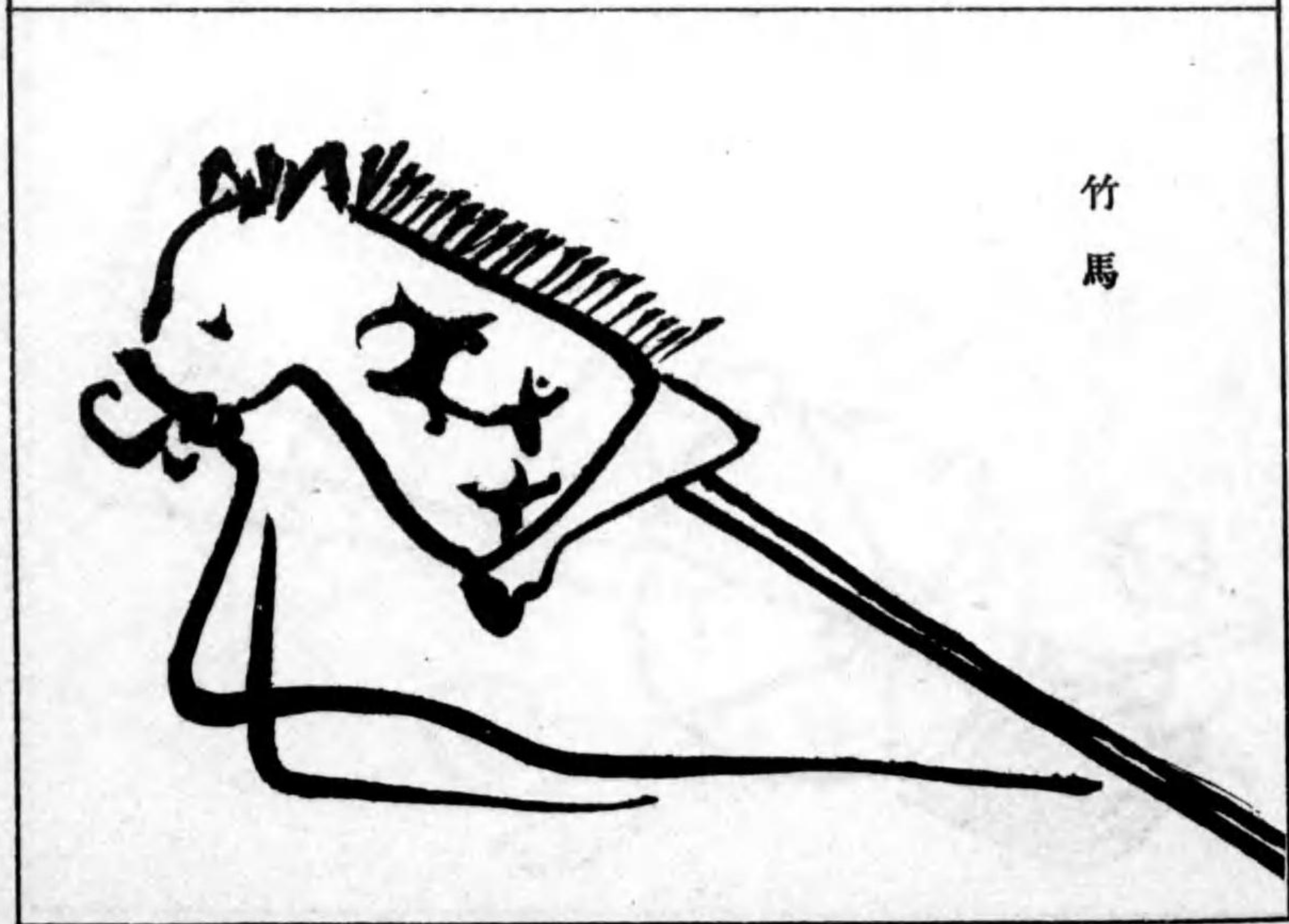
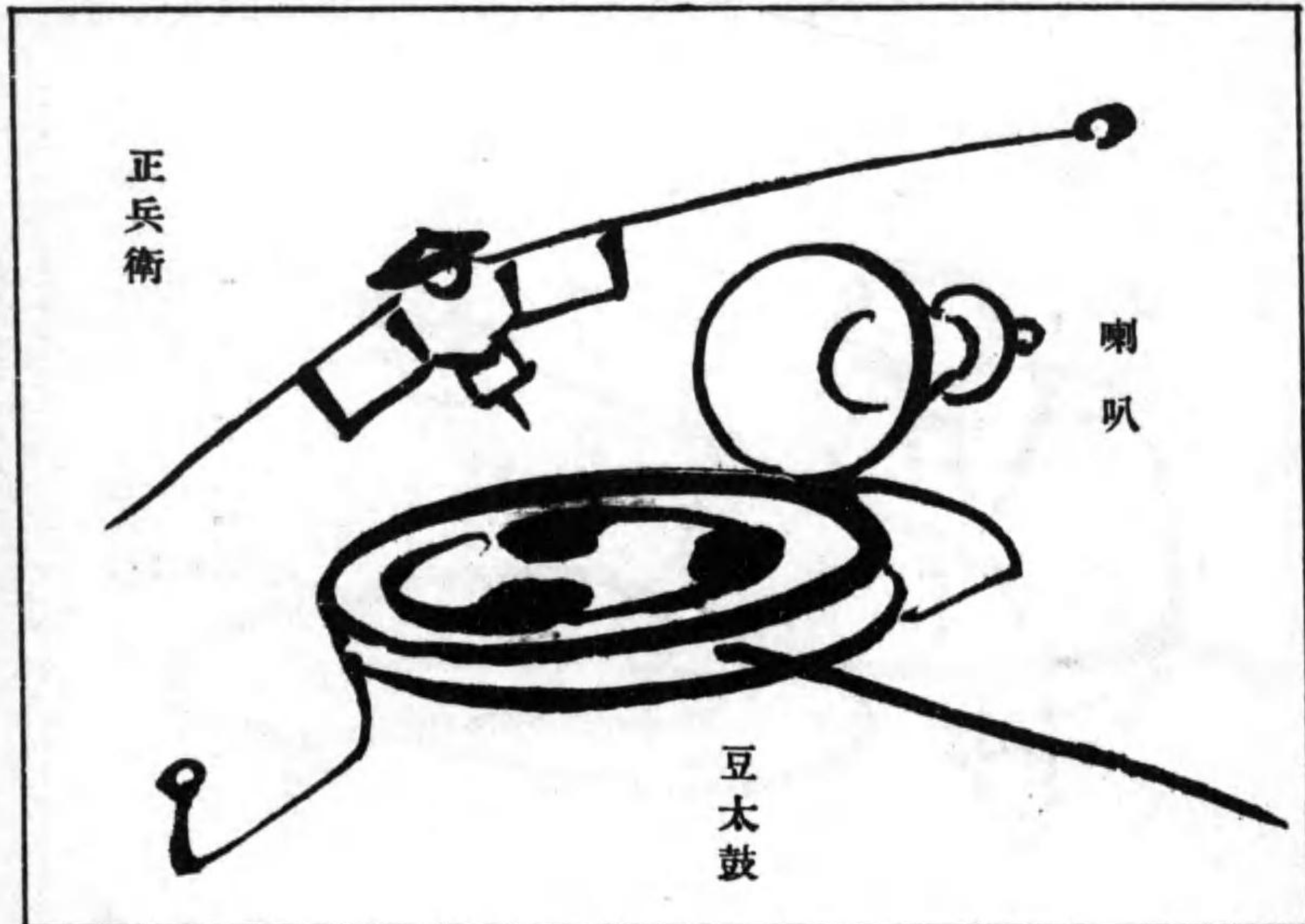

木 球 棍
環 竿 棒

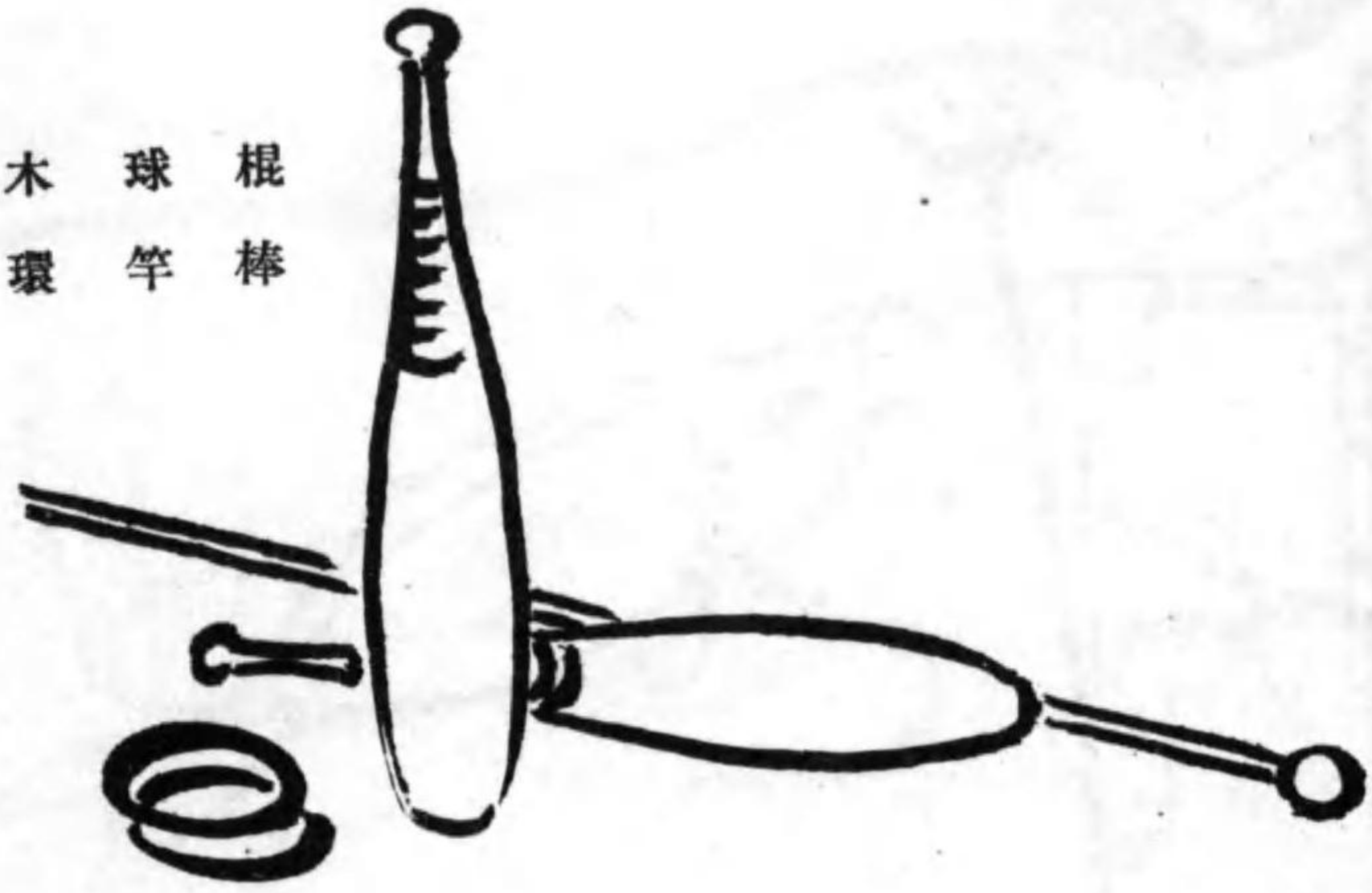

採 集 函
採 集 網

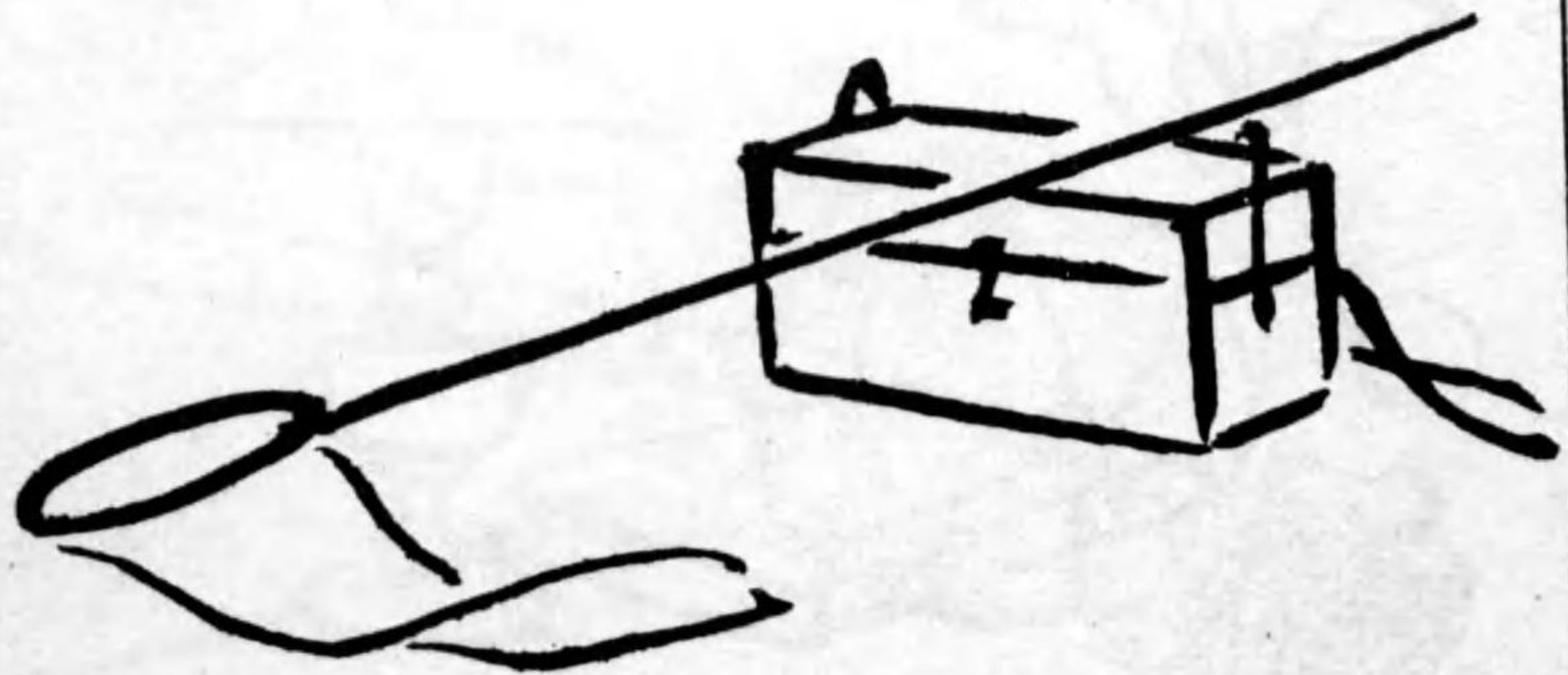

笛

彈 猿

鏡 鉢

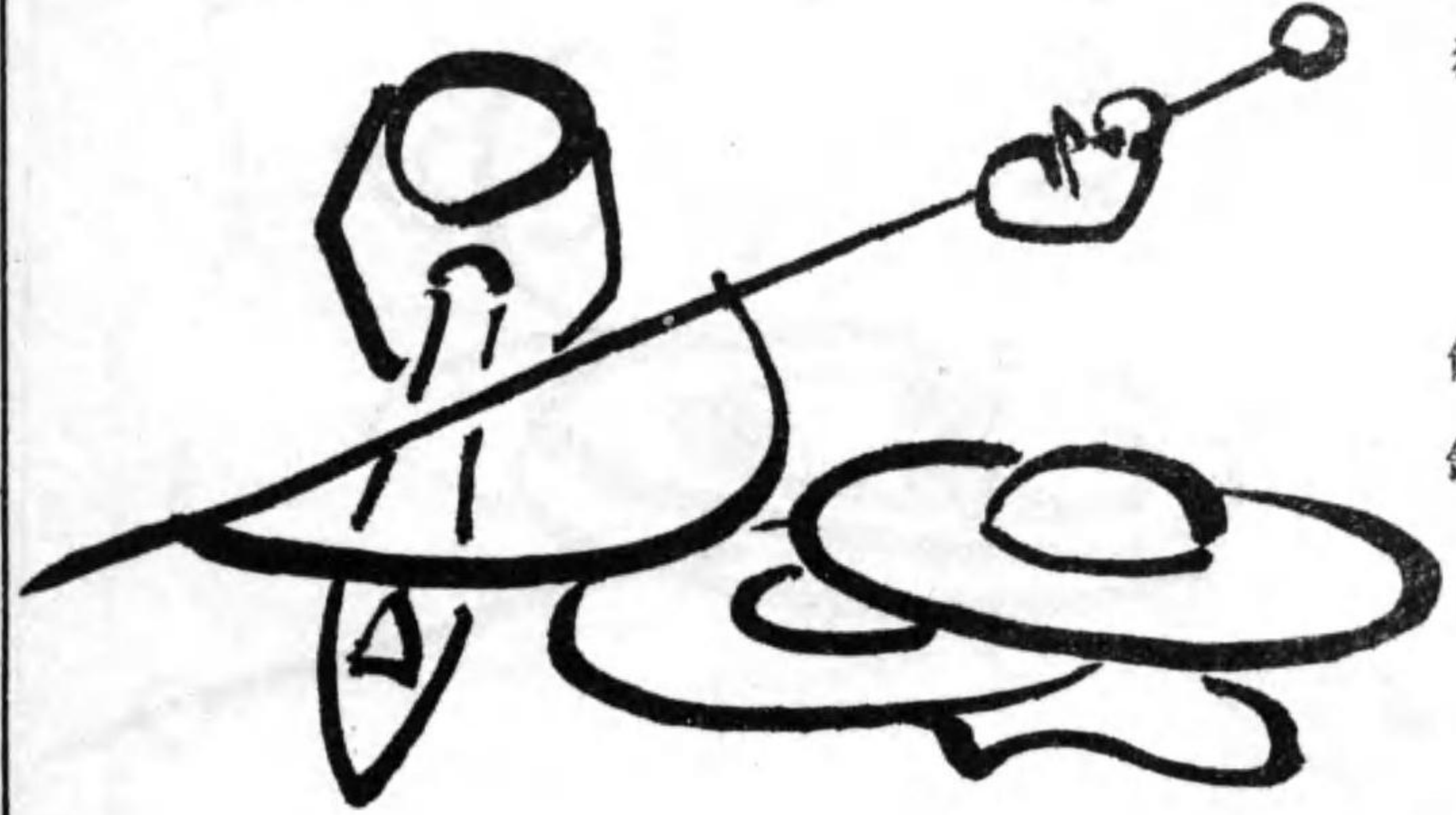

フットボール
バット
ボール
ラケット

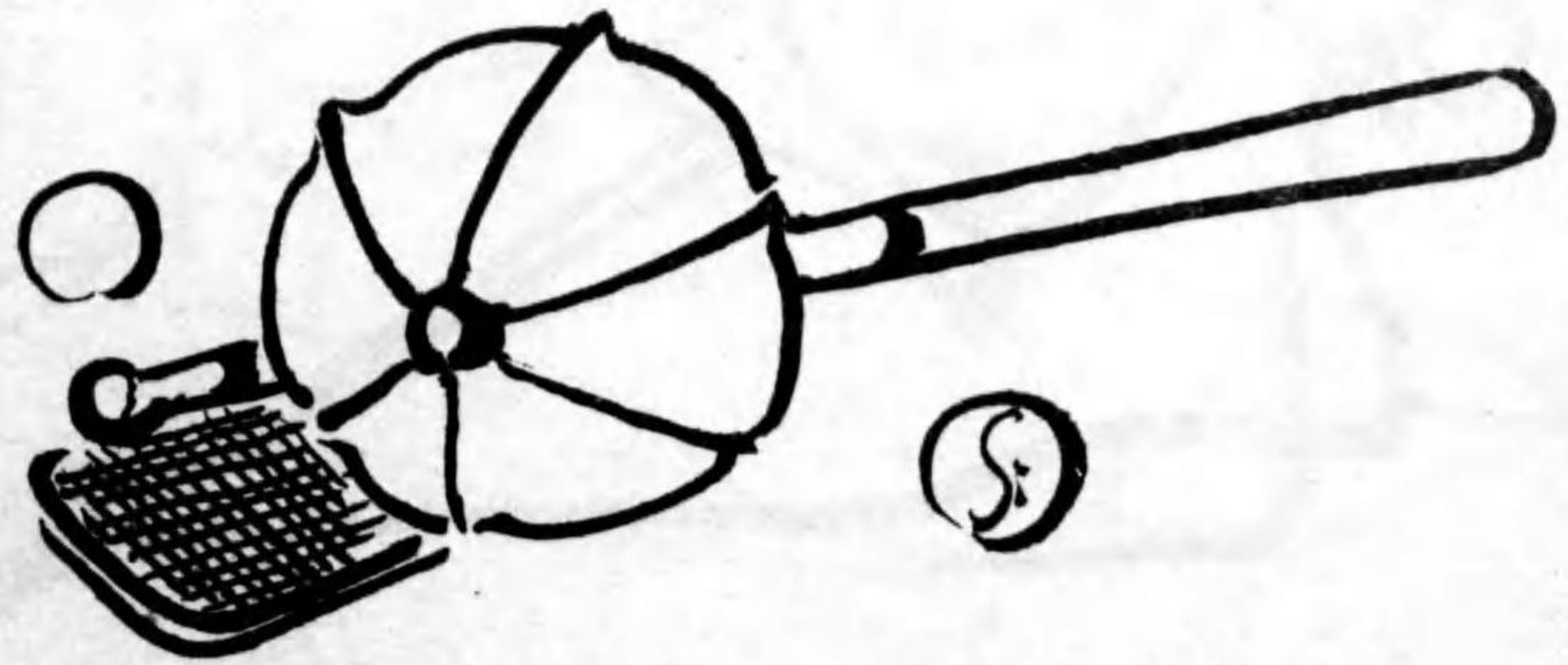

五月幟

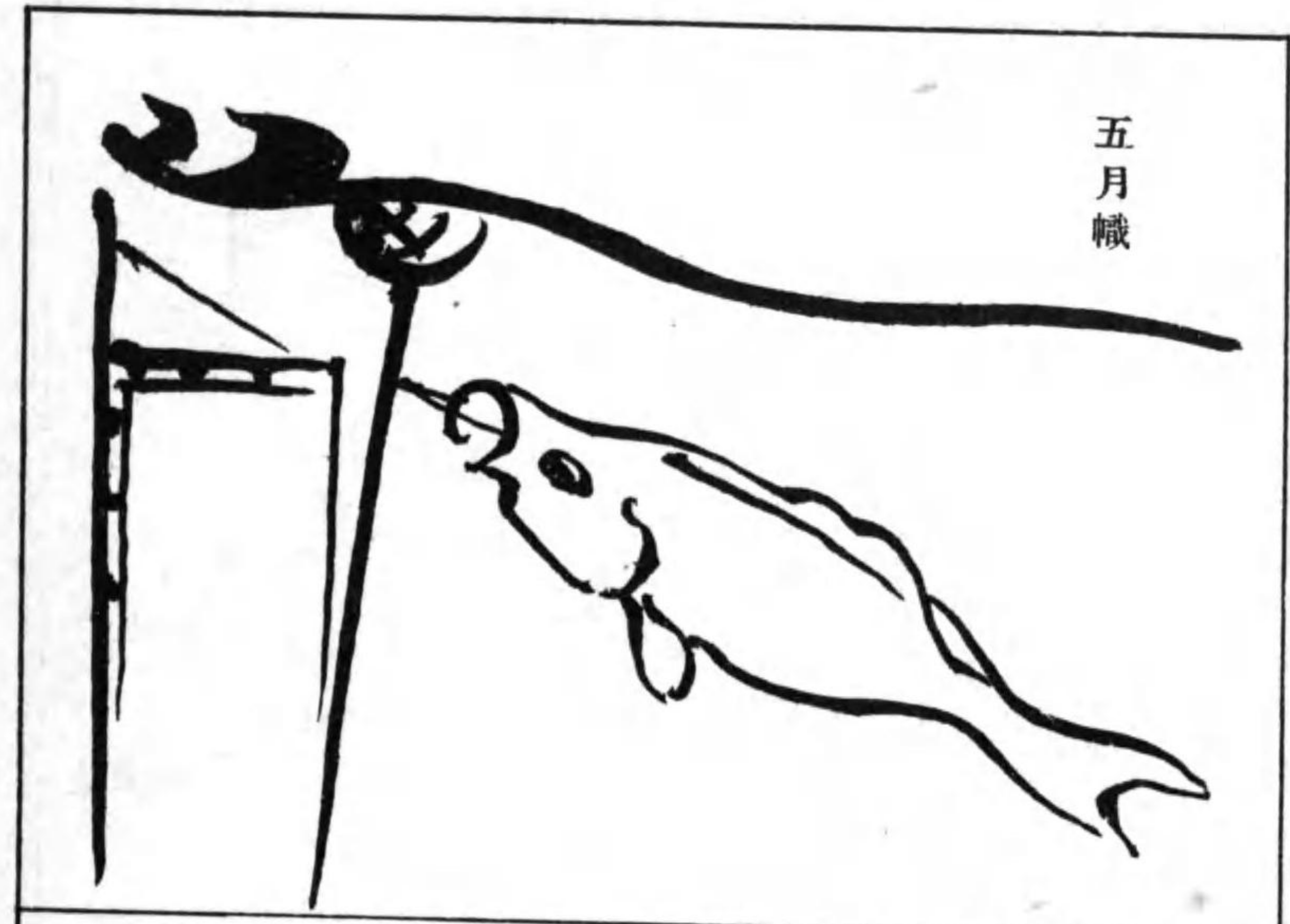

洋燈

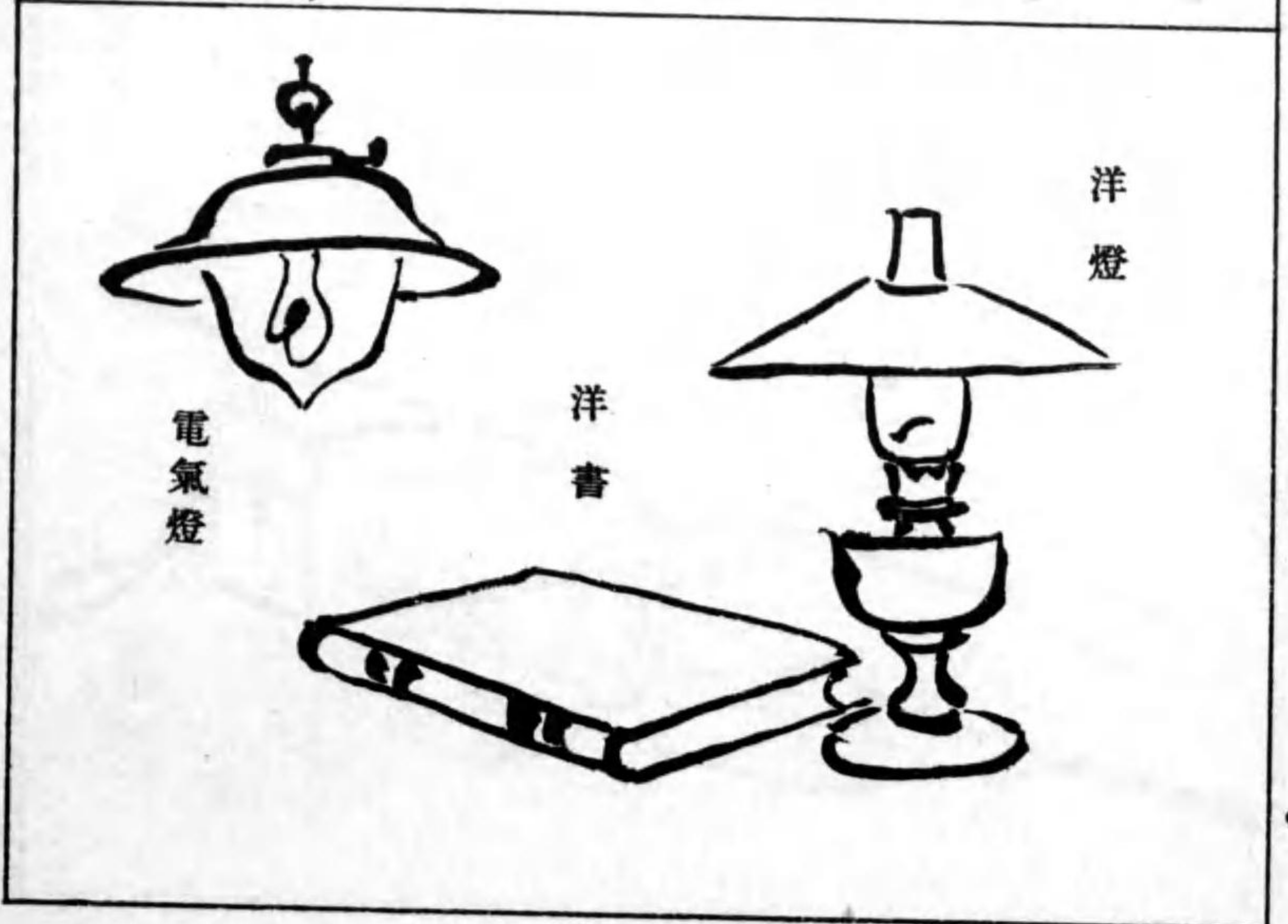

走馬燈
蠟燭
手燭
マツチ

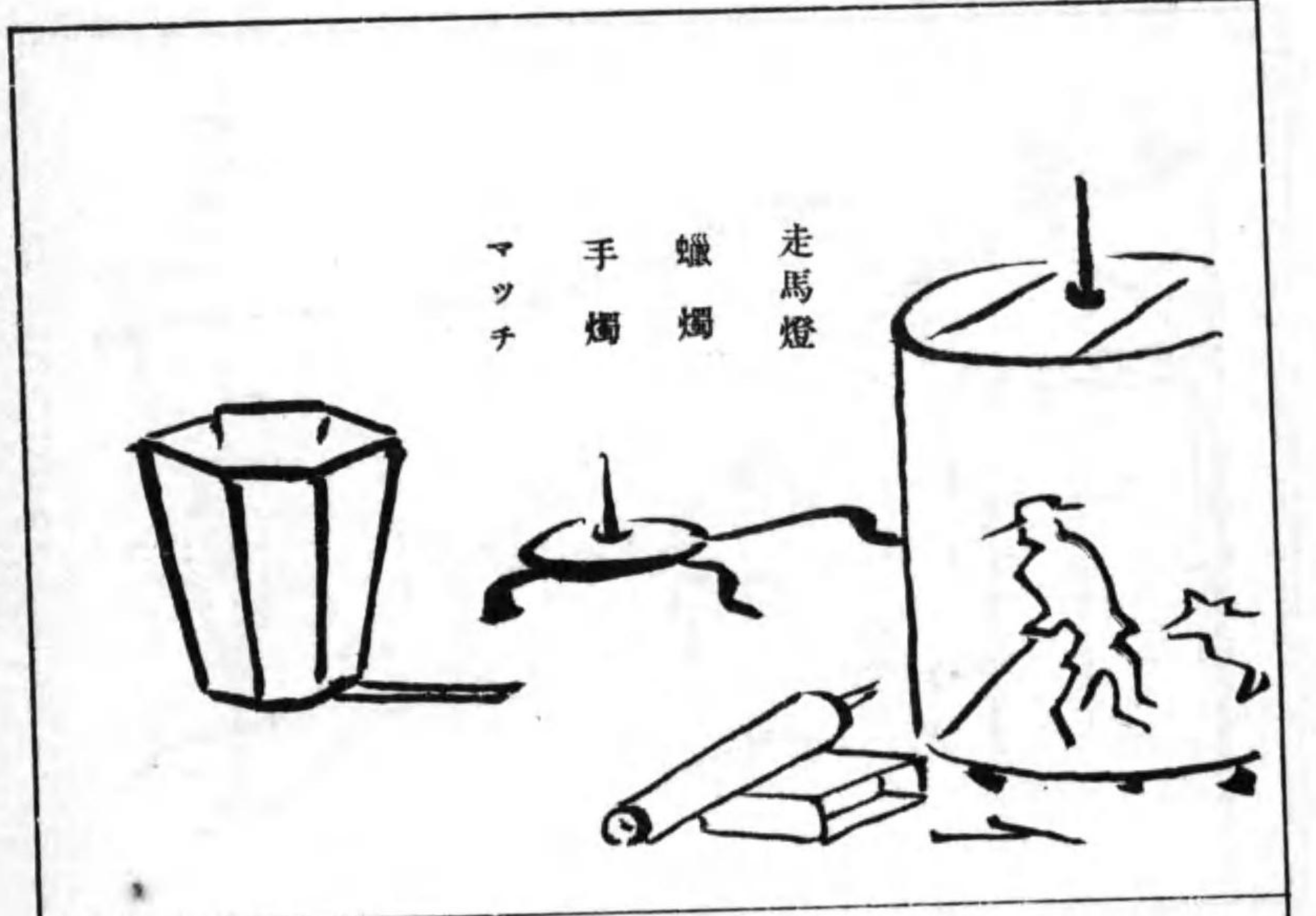

手水鉢

風鈴

水盆

玻璃球

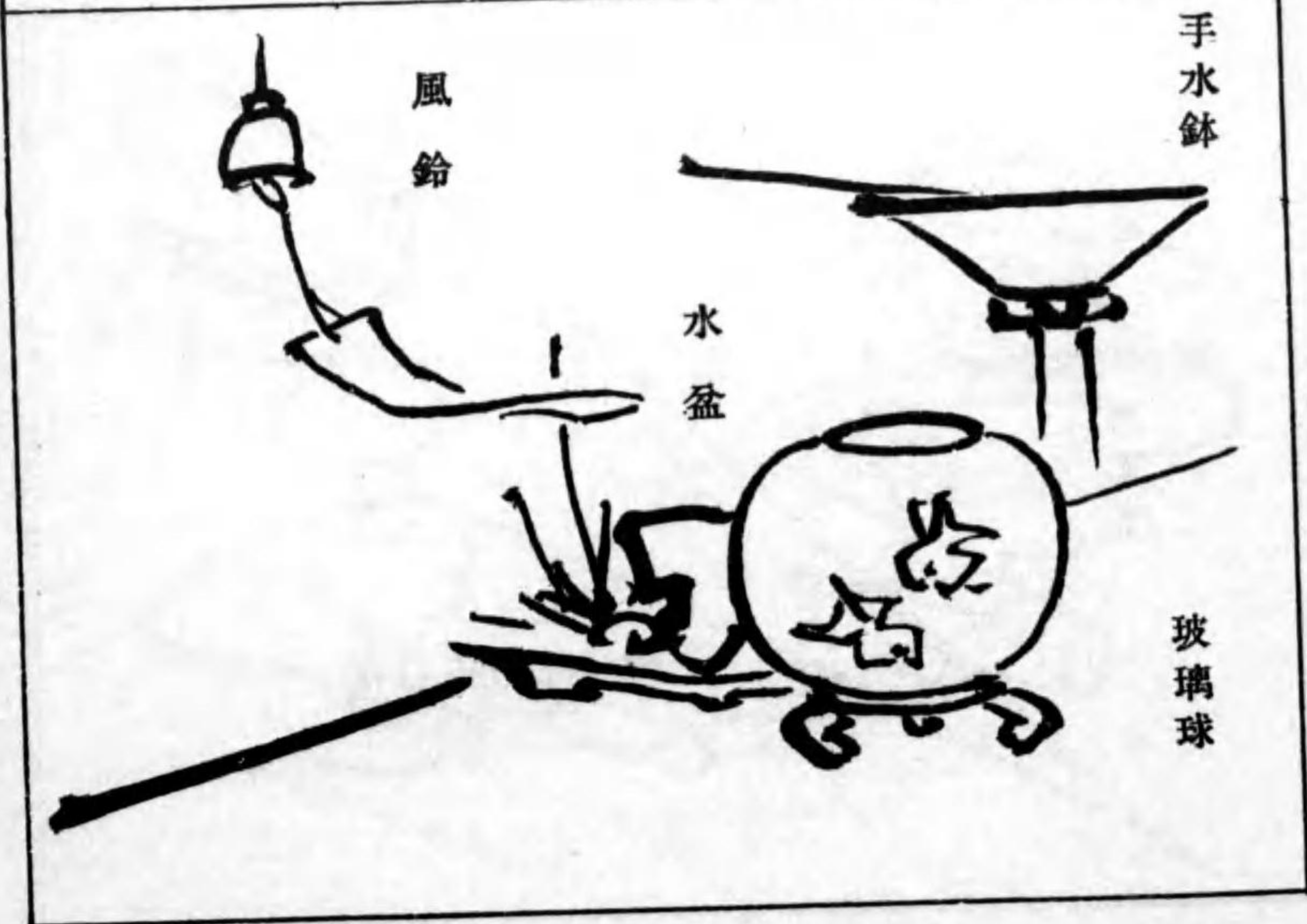

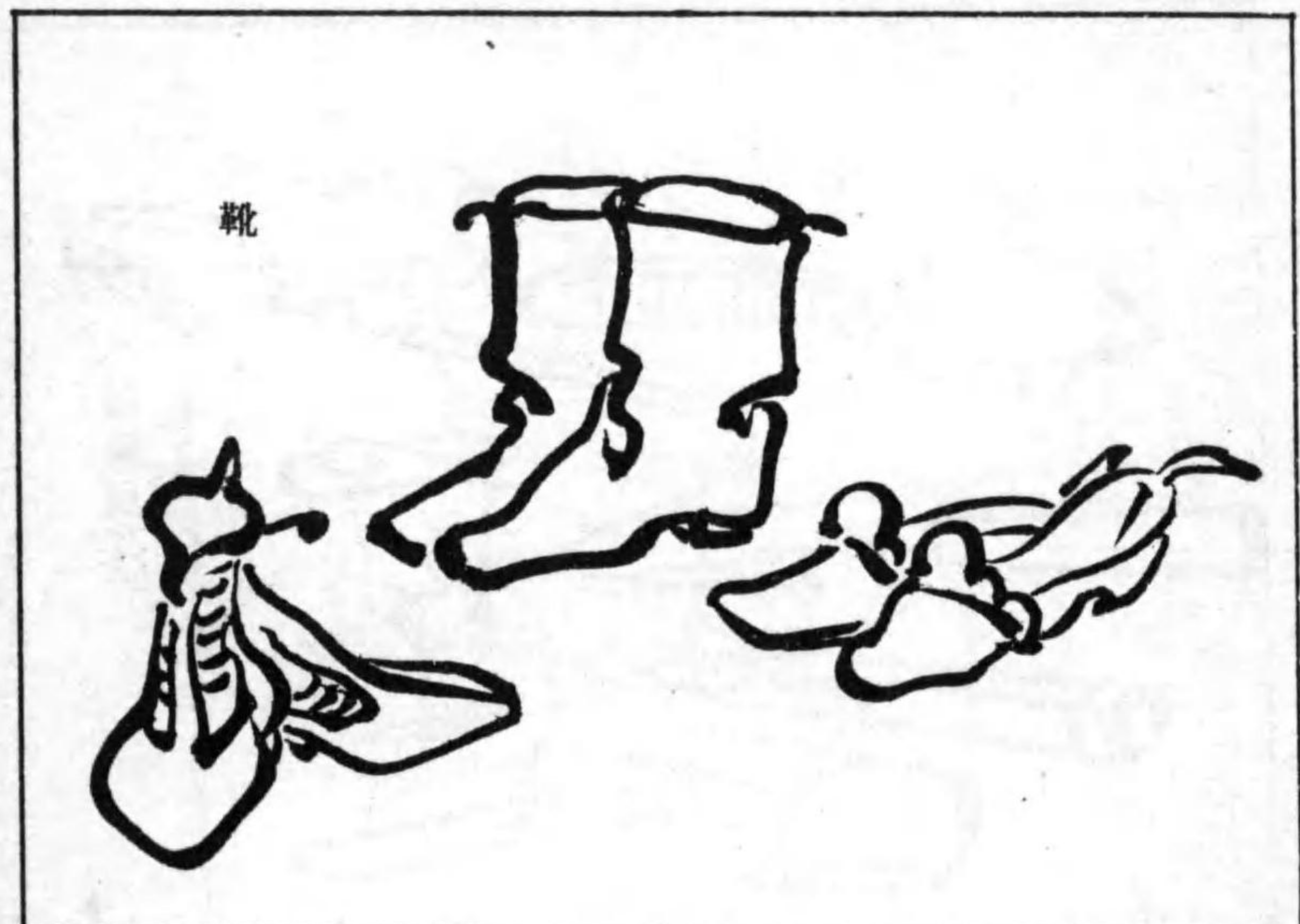

靴

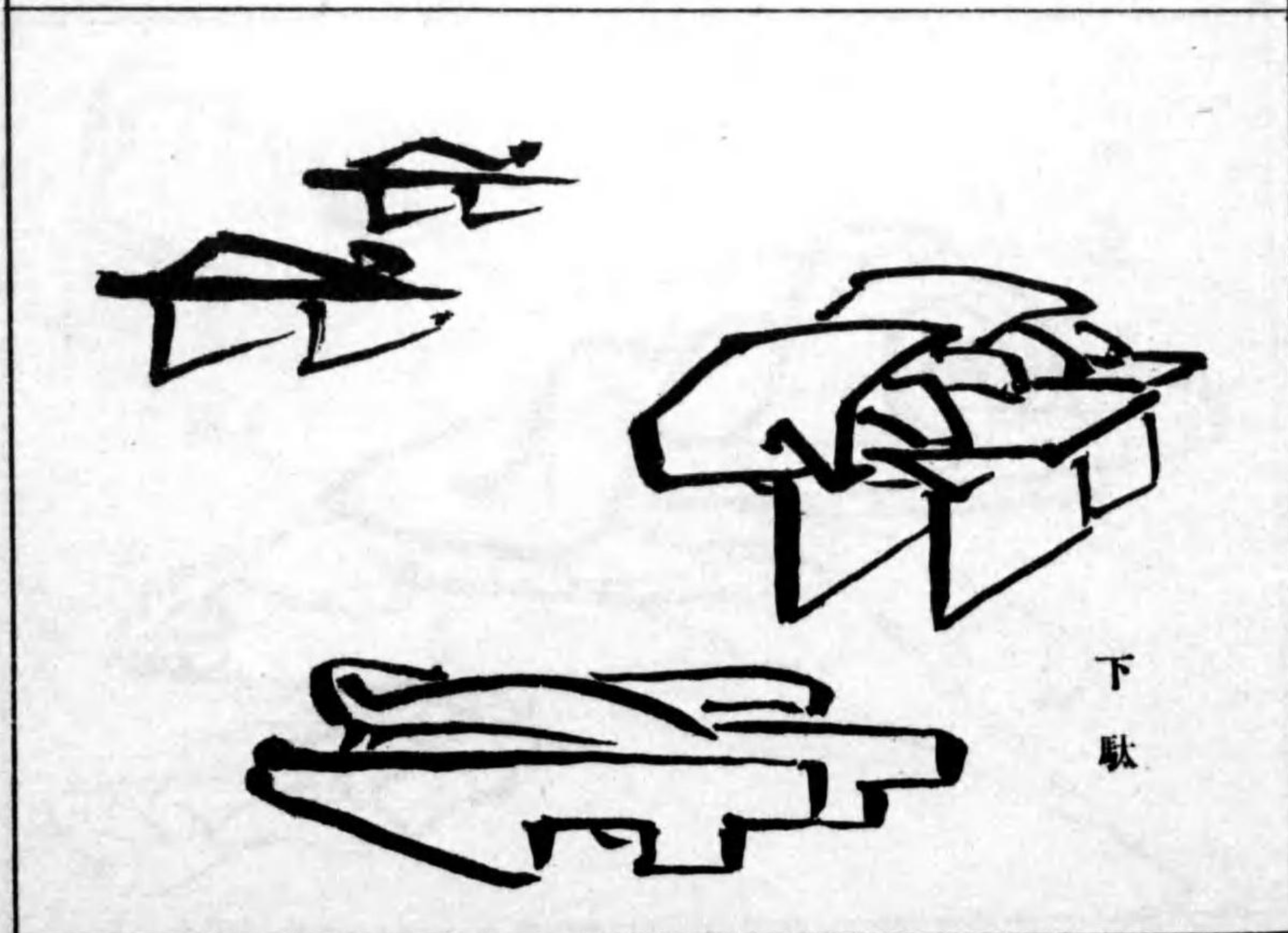

下
駄

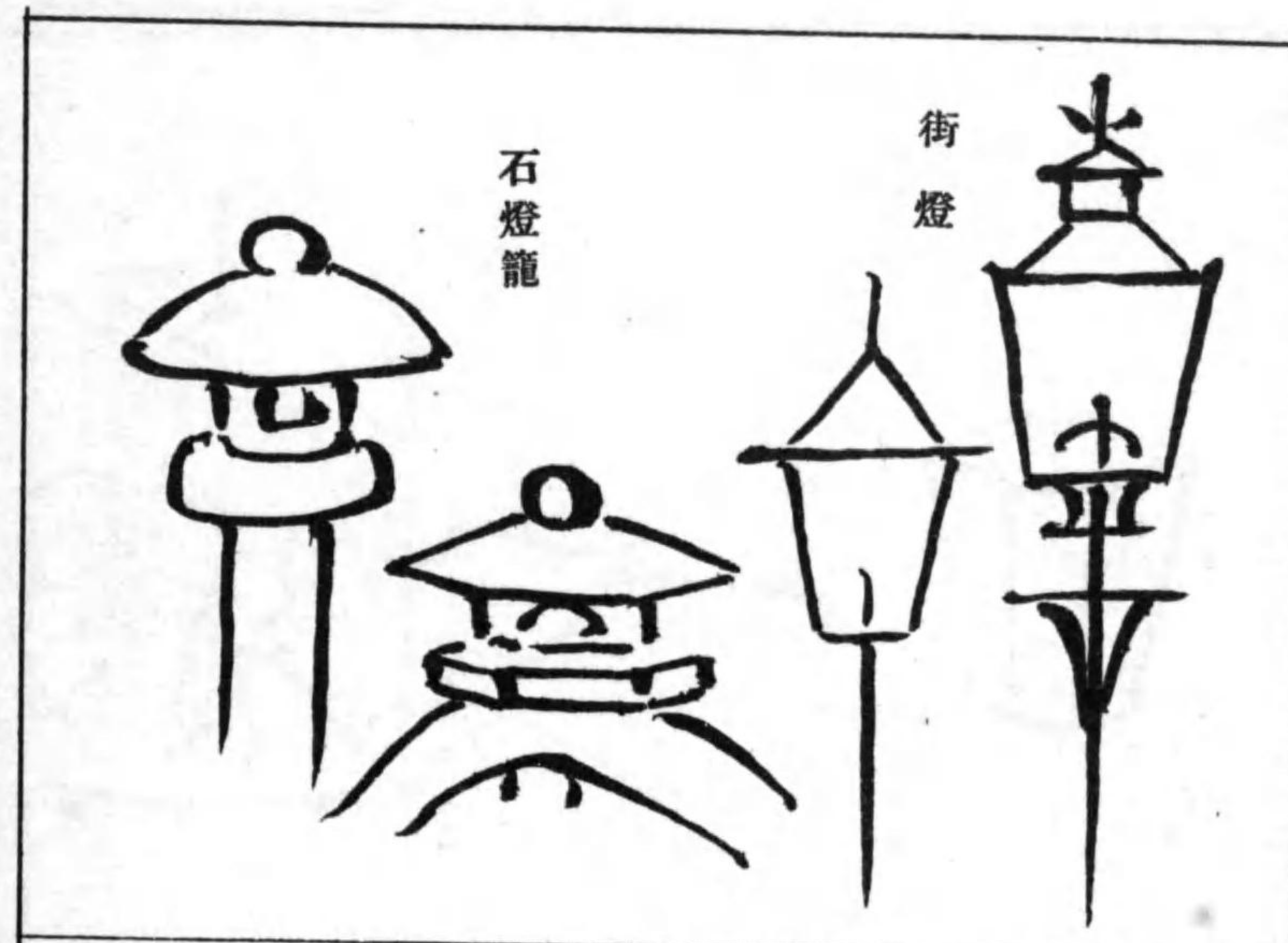

石
燈
籠

街
燈

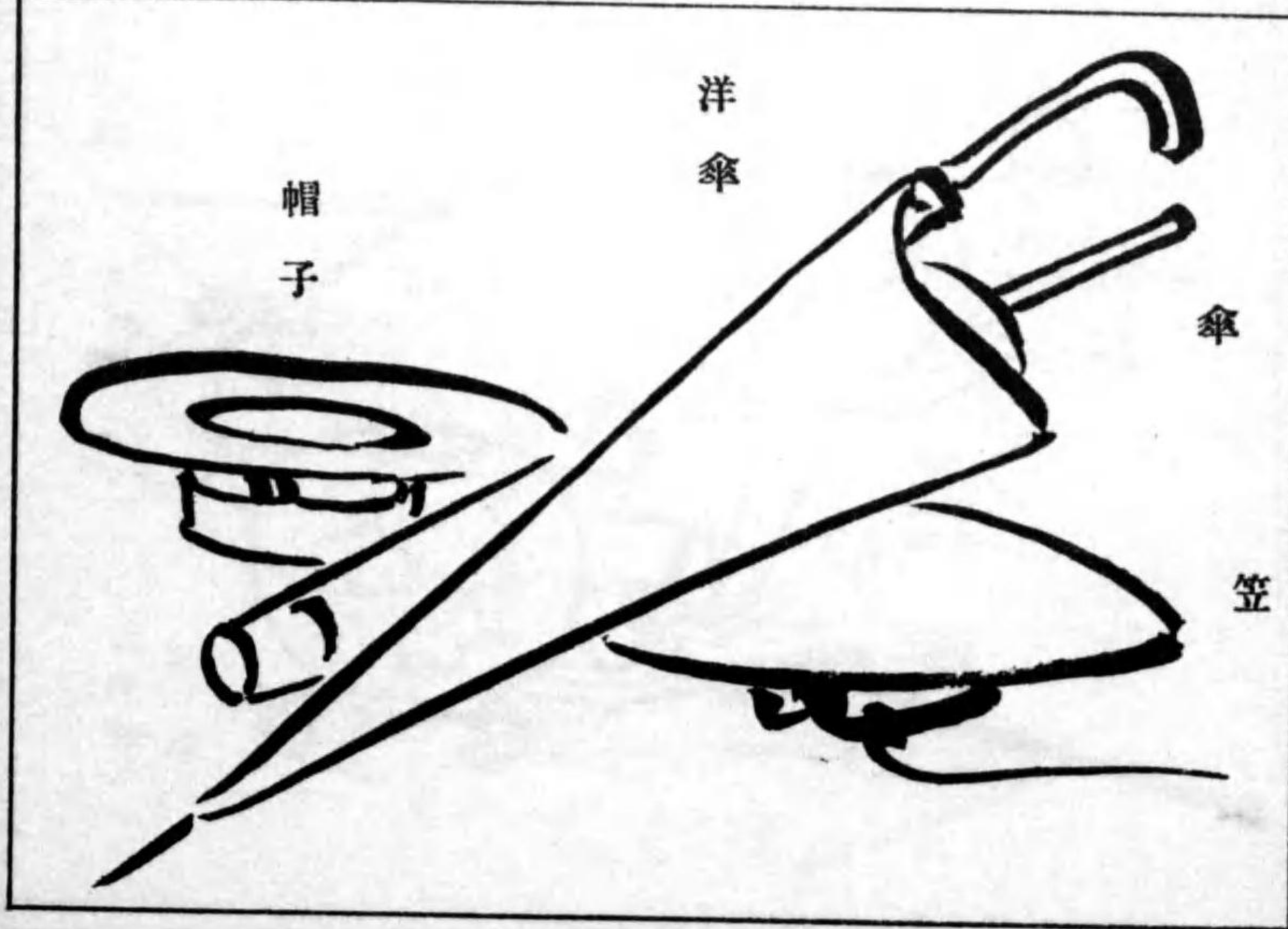

帽
子

洋
傘

傘

笠

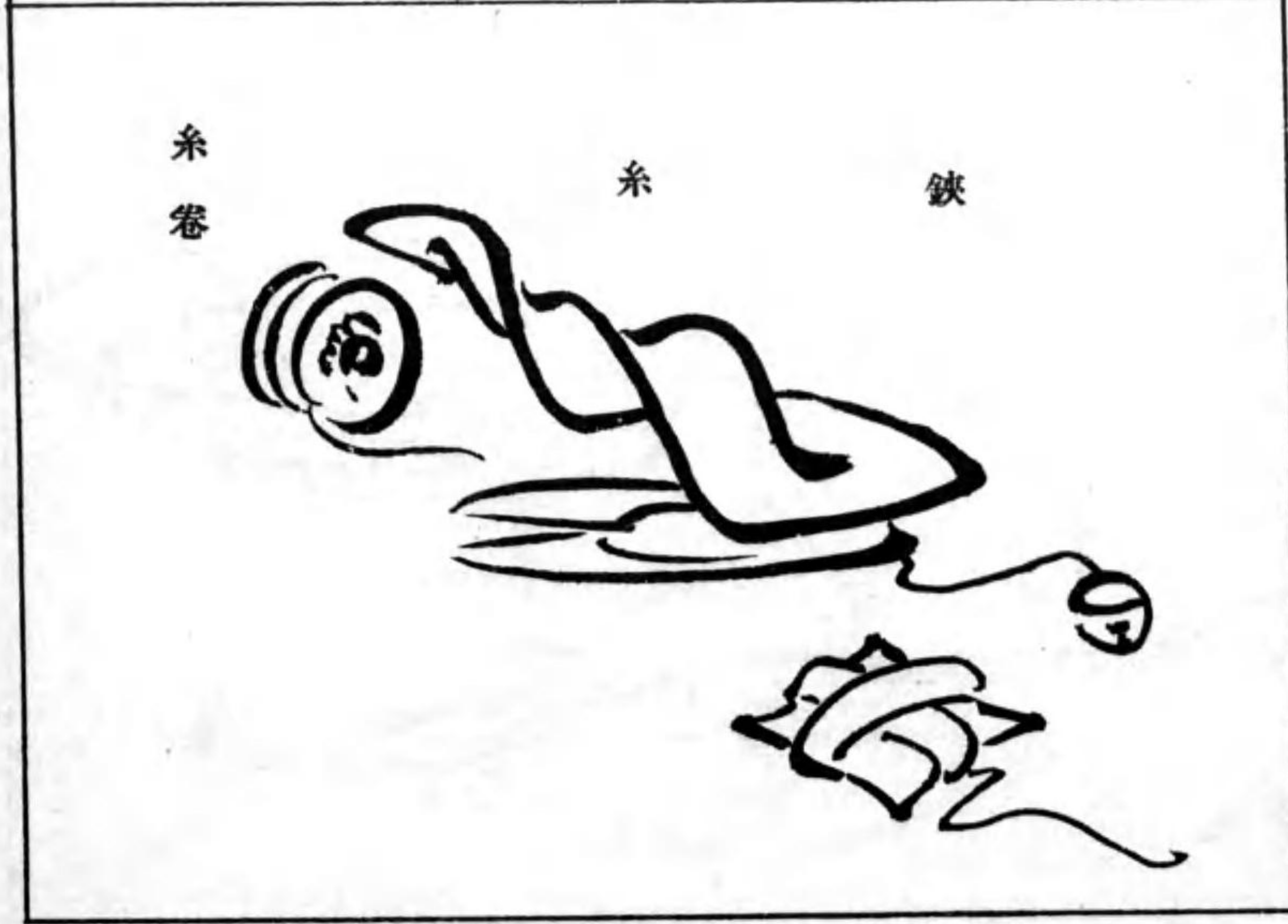
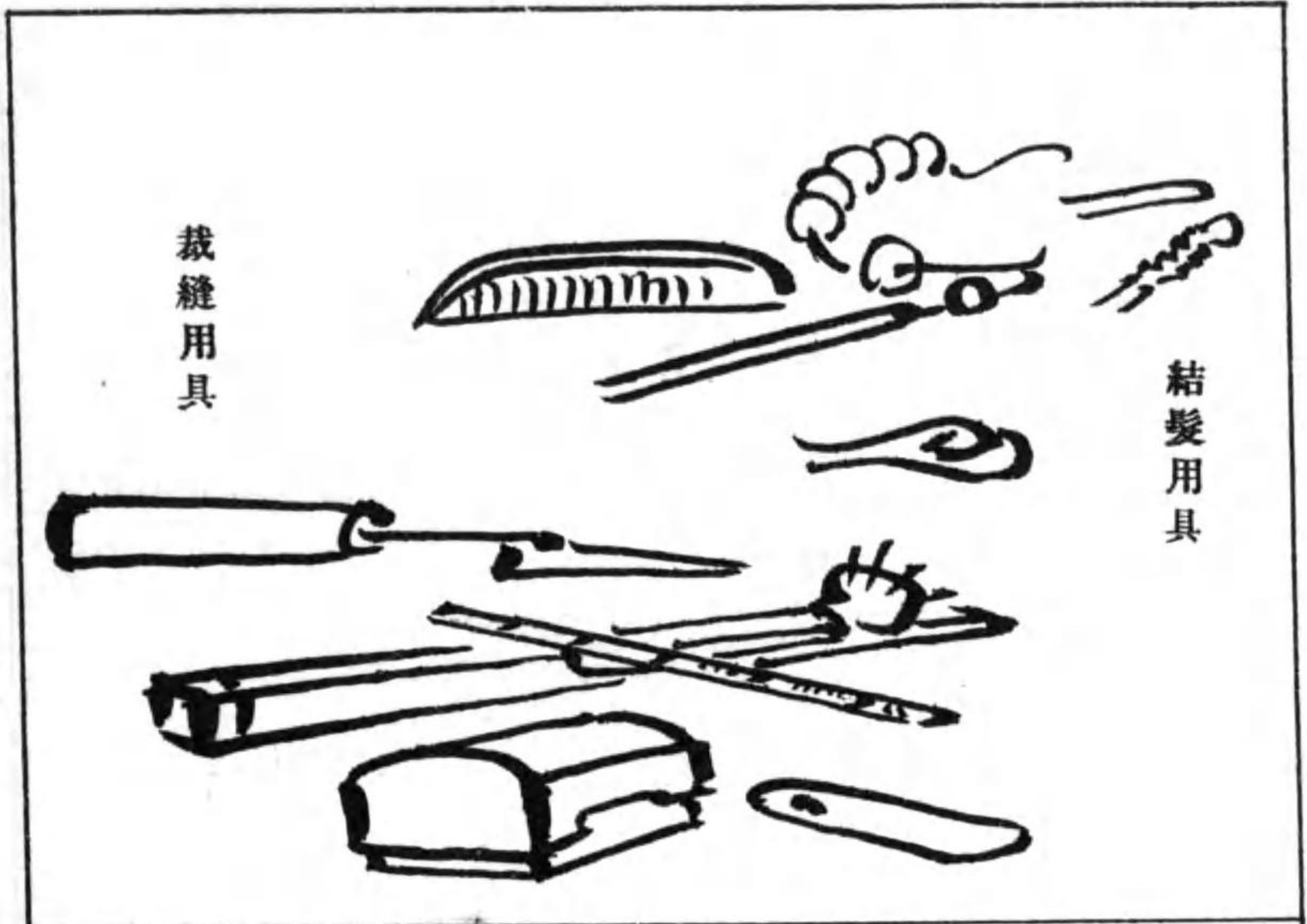
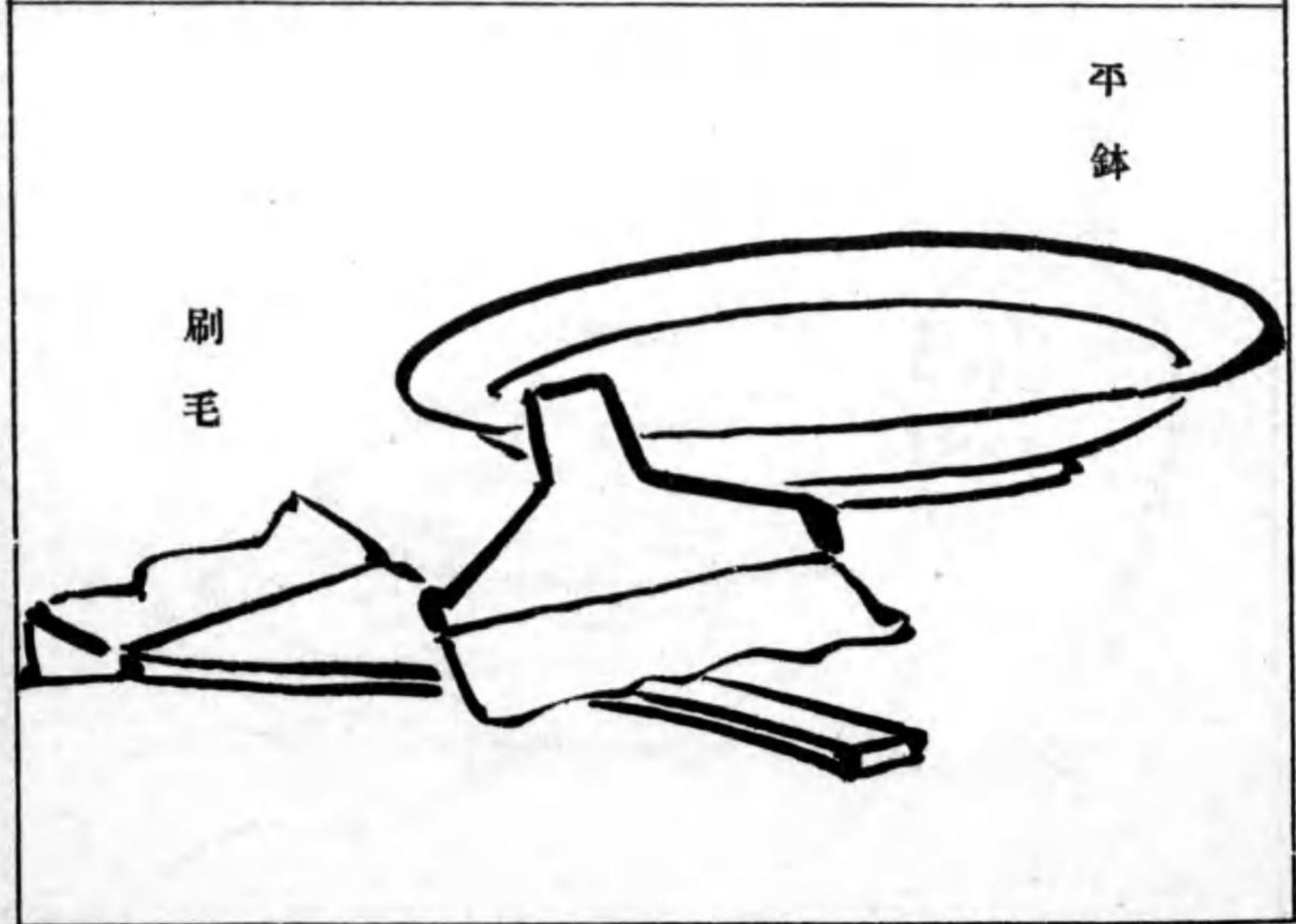
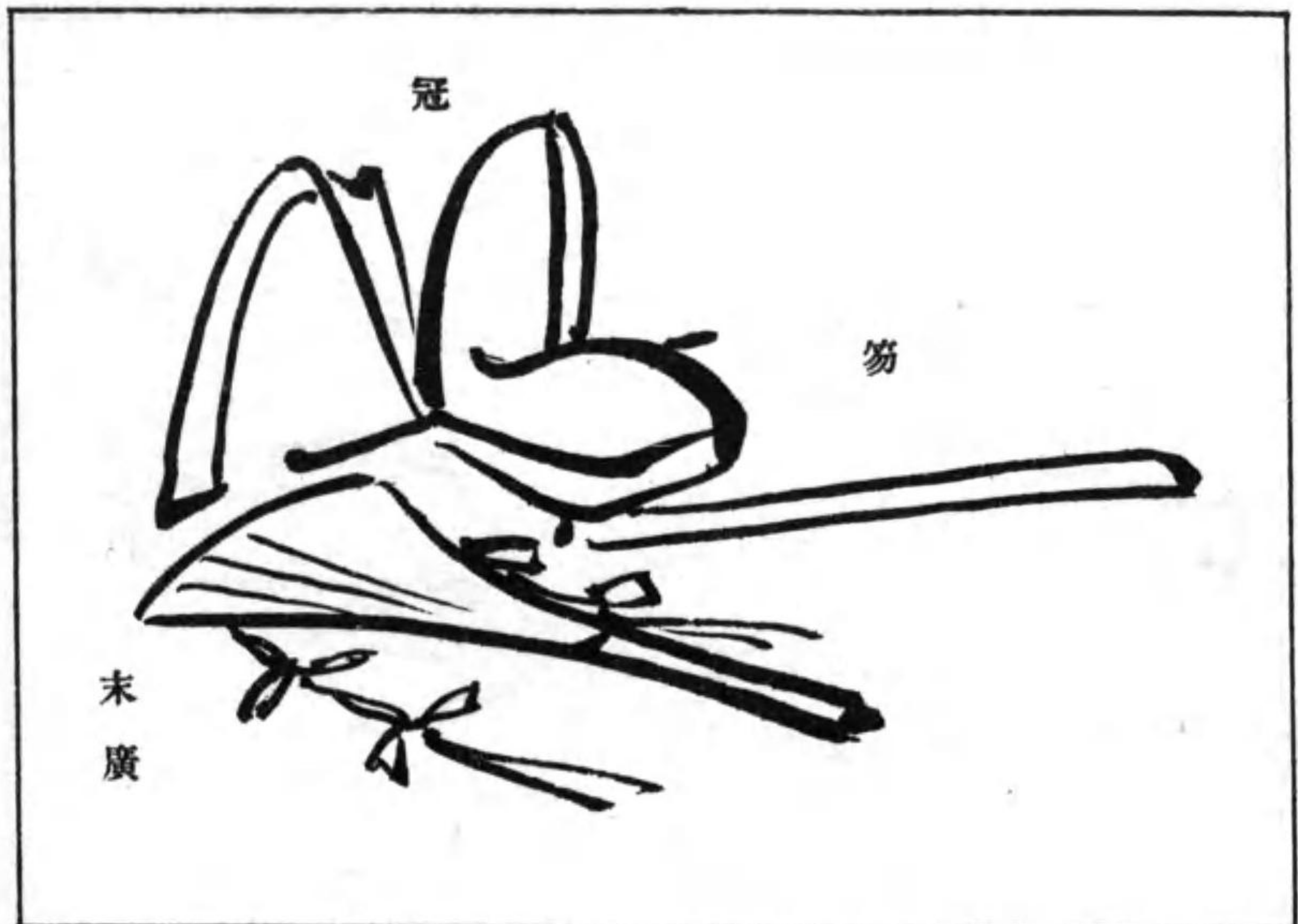



紙雜

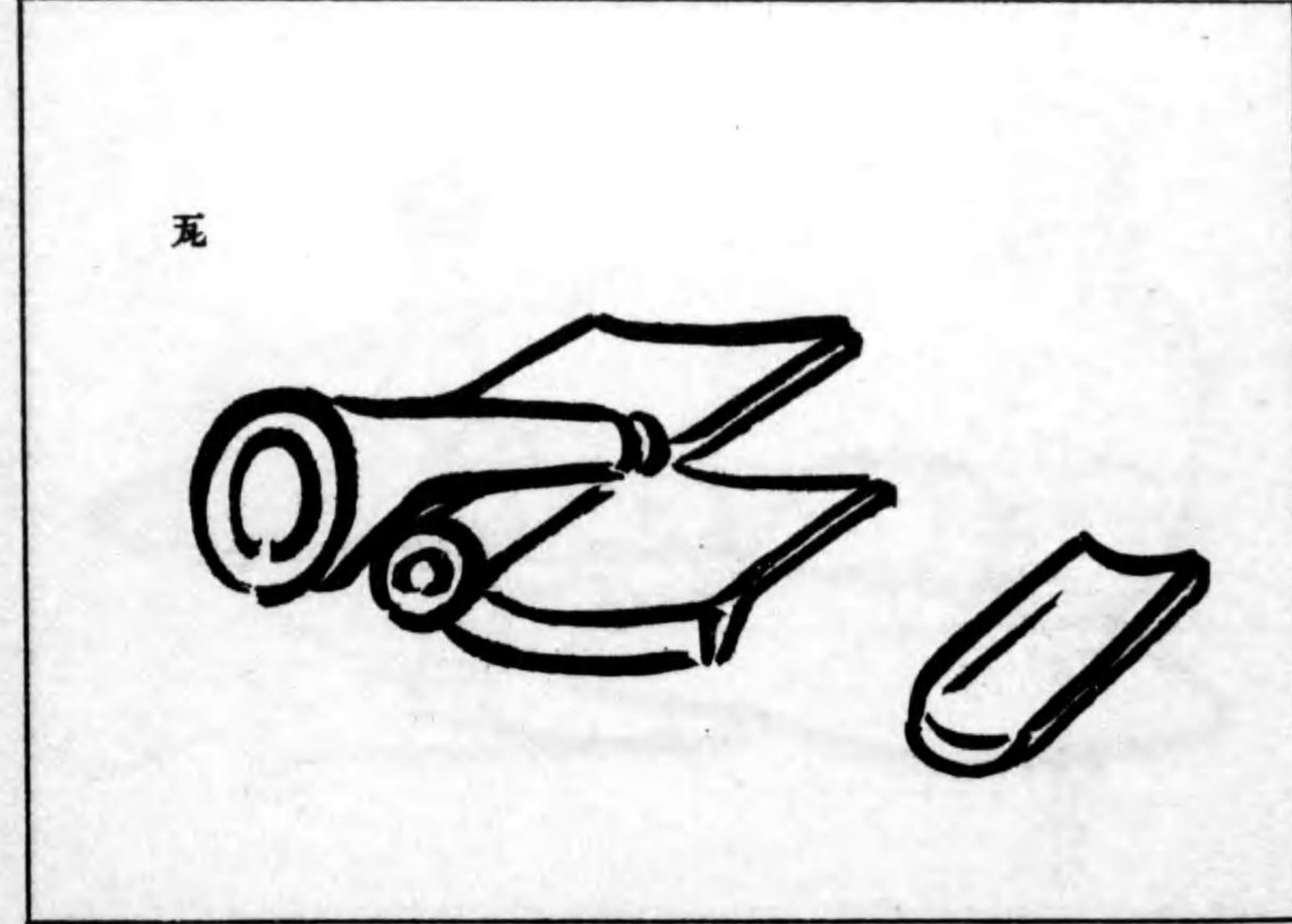

瓦

化粧道具

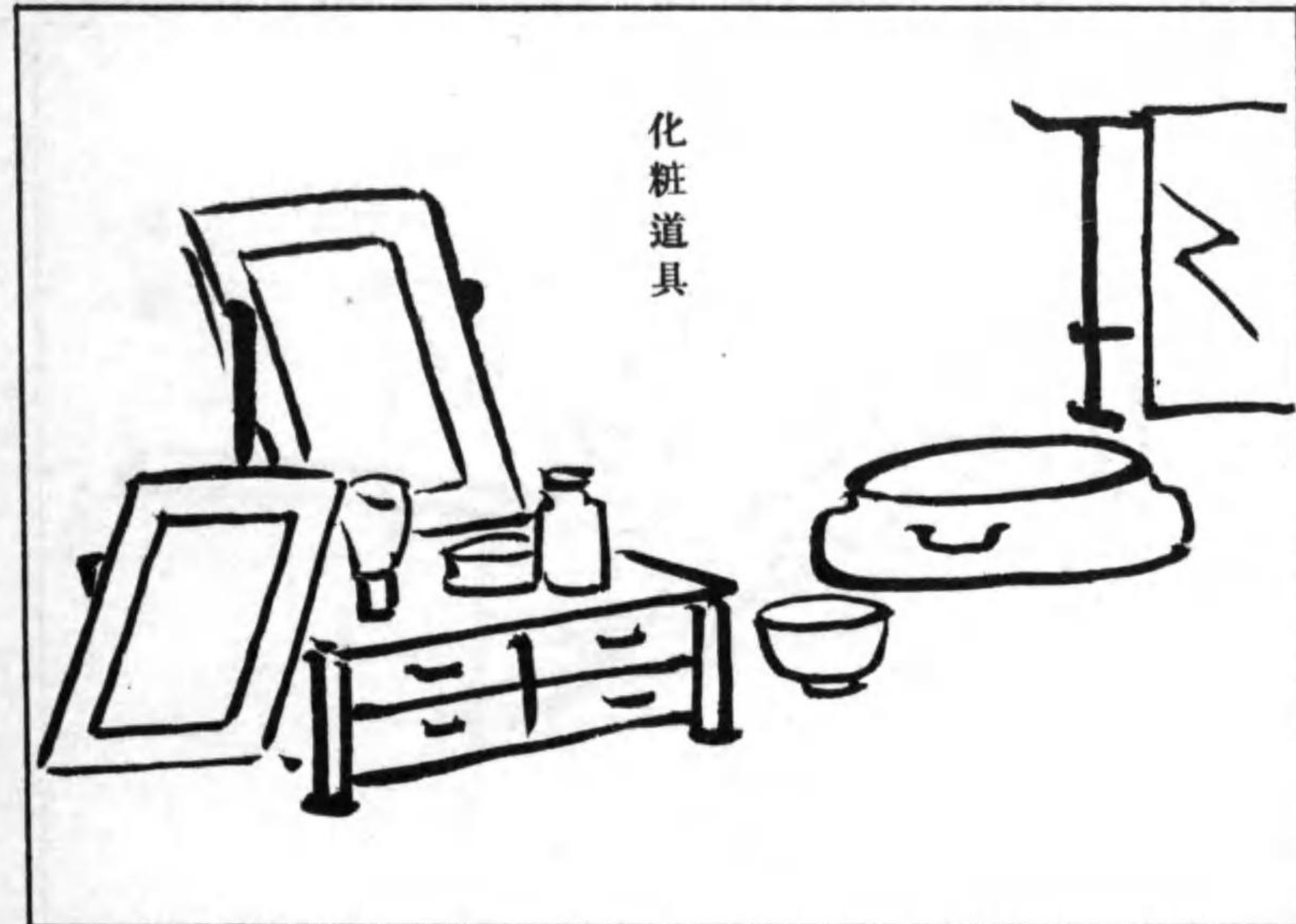

黑板畫法

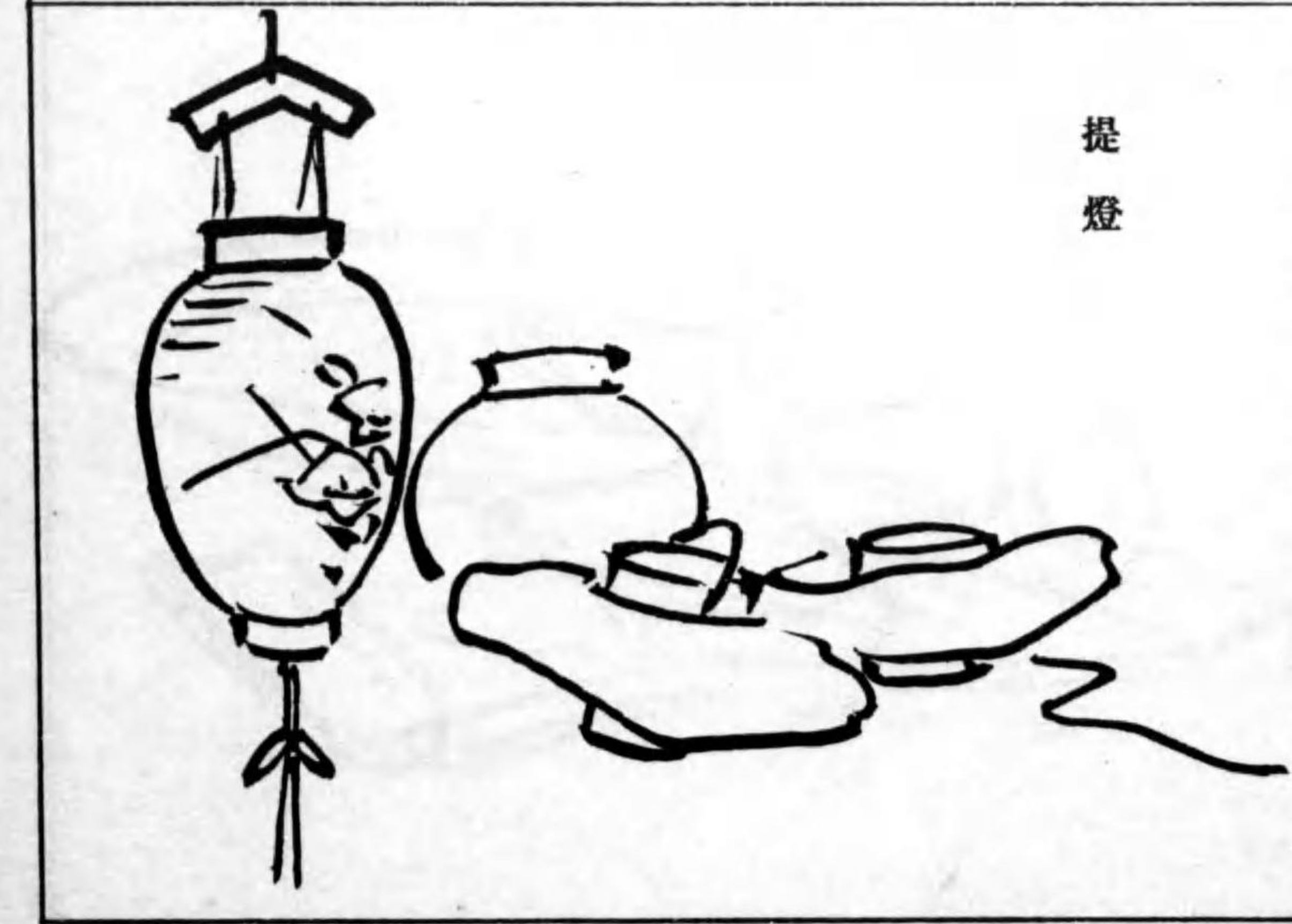

提燈

井

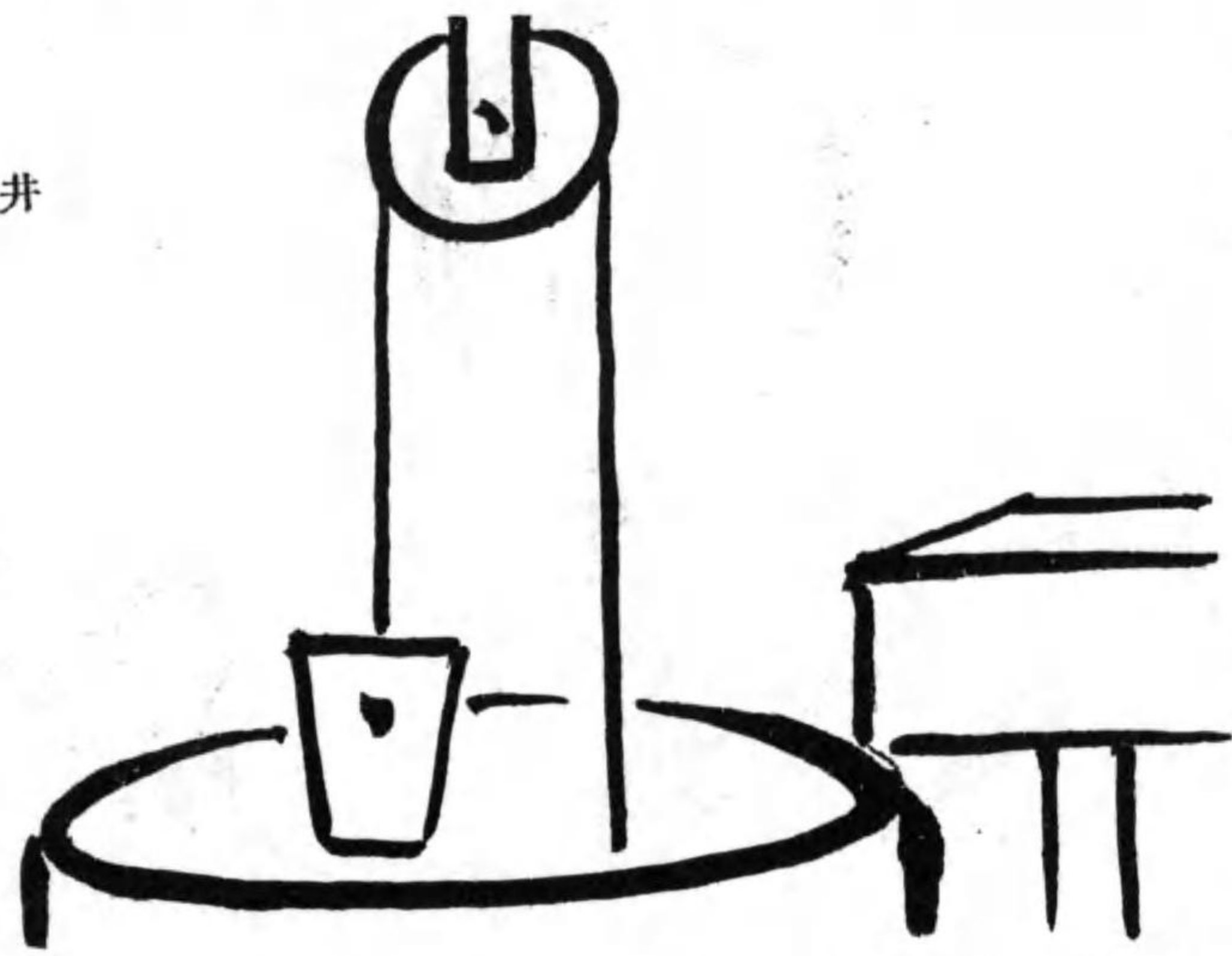

汽車

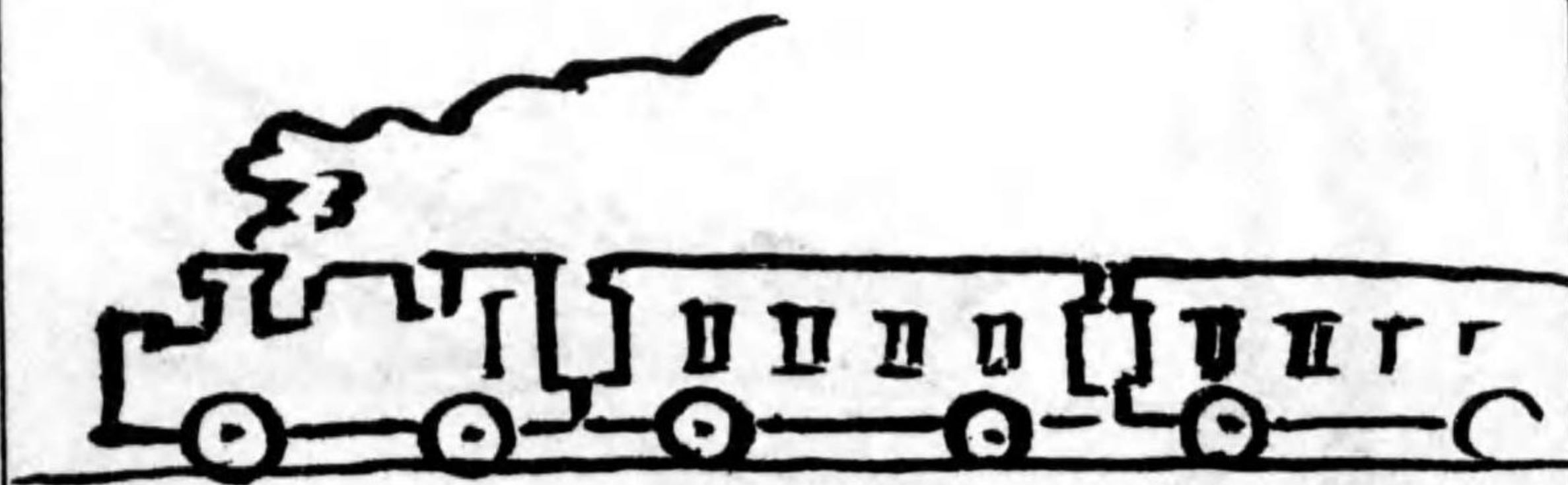

龍燈提燈

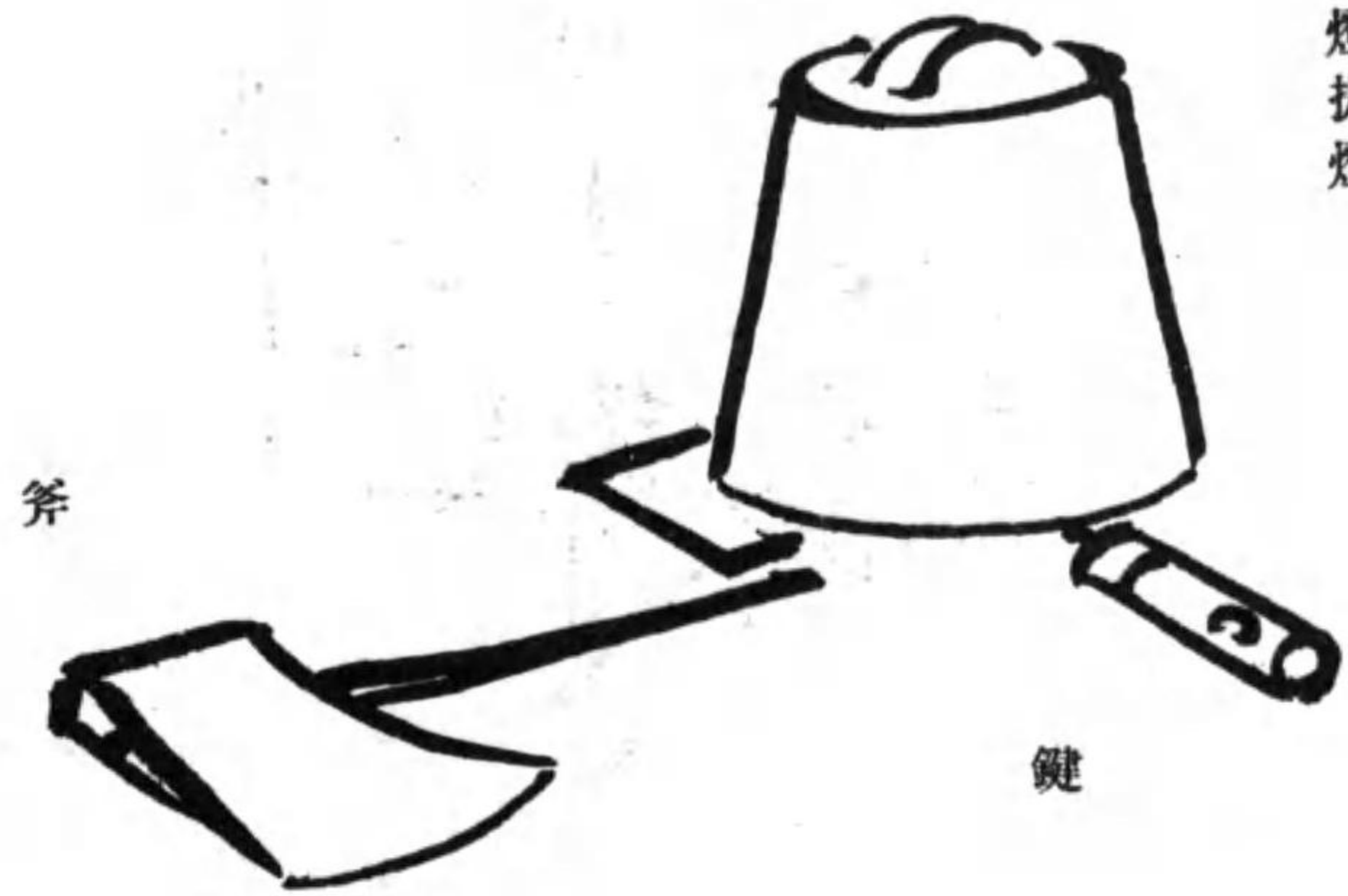

斧

鍵

笠

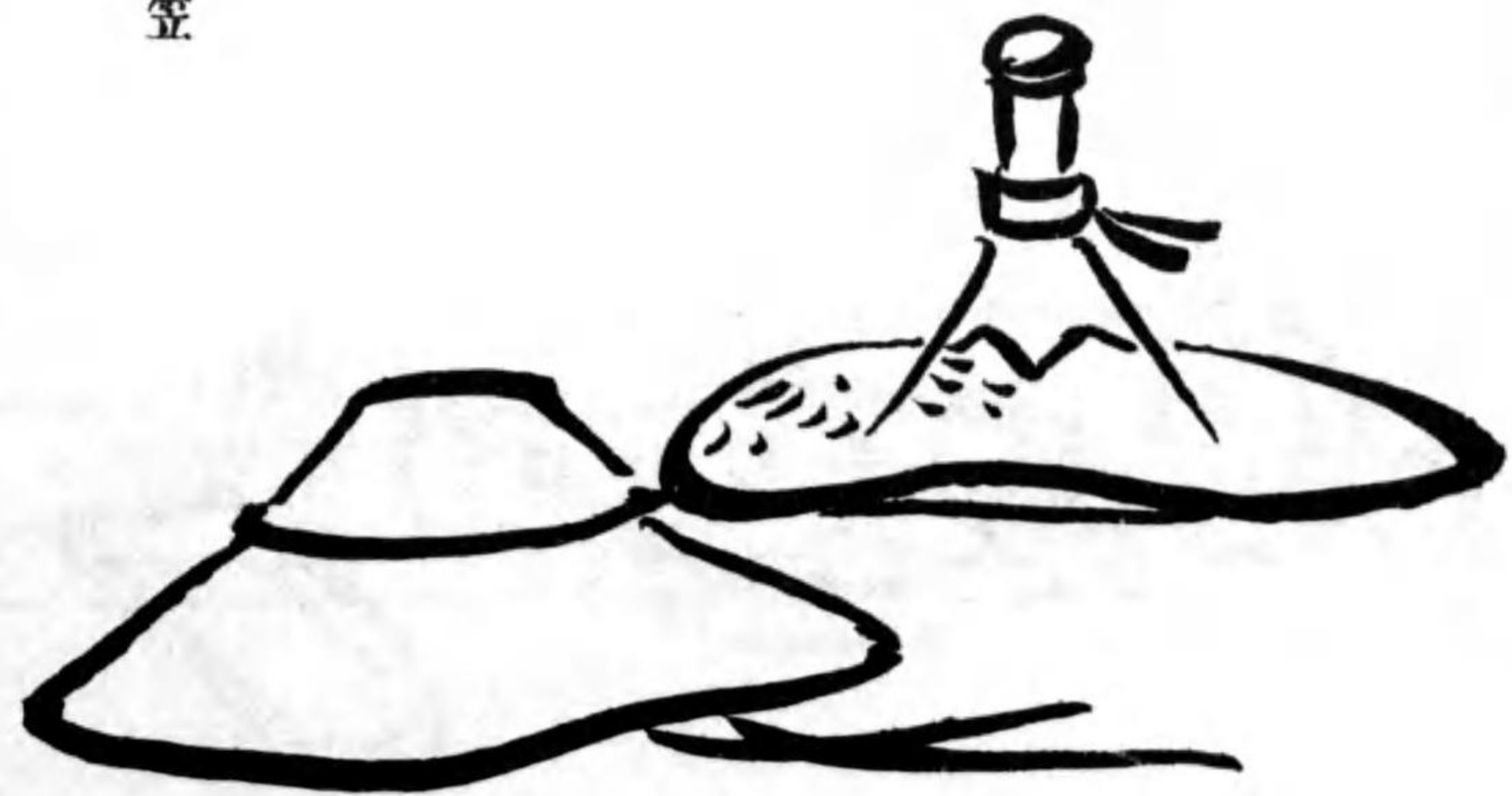

其六
船
舶
類

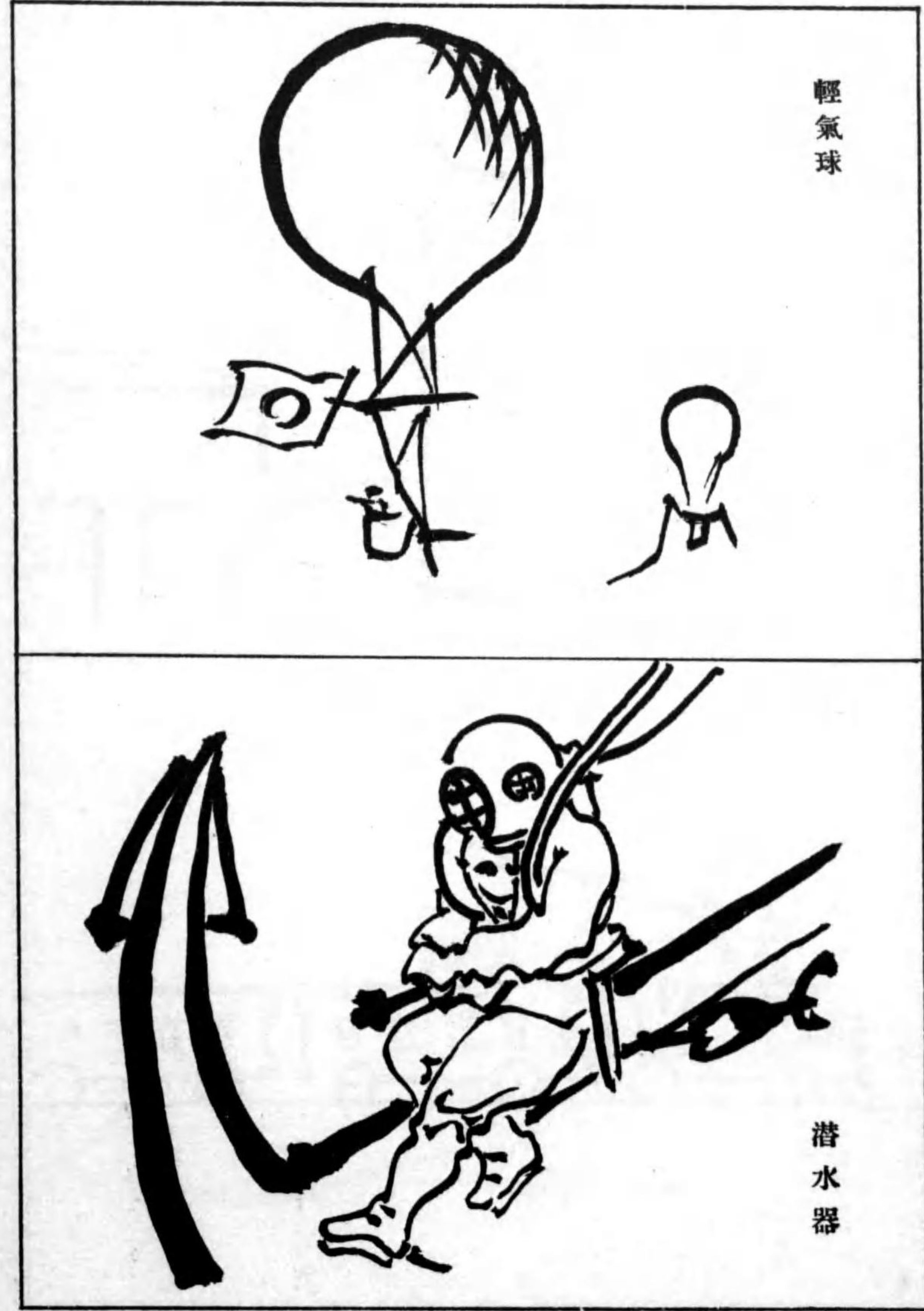

輕氣球

潛水器

帆船

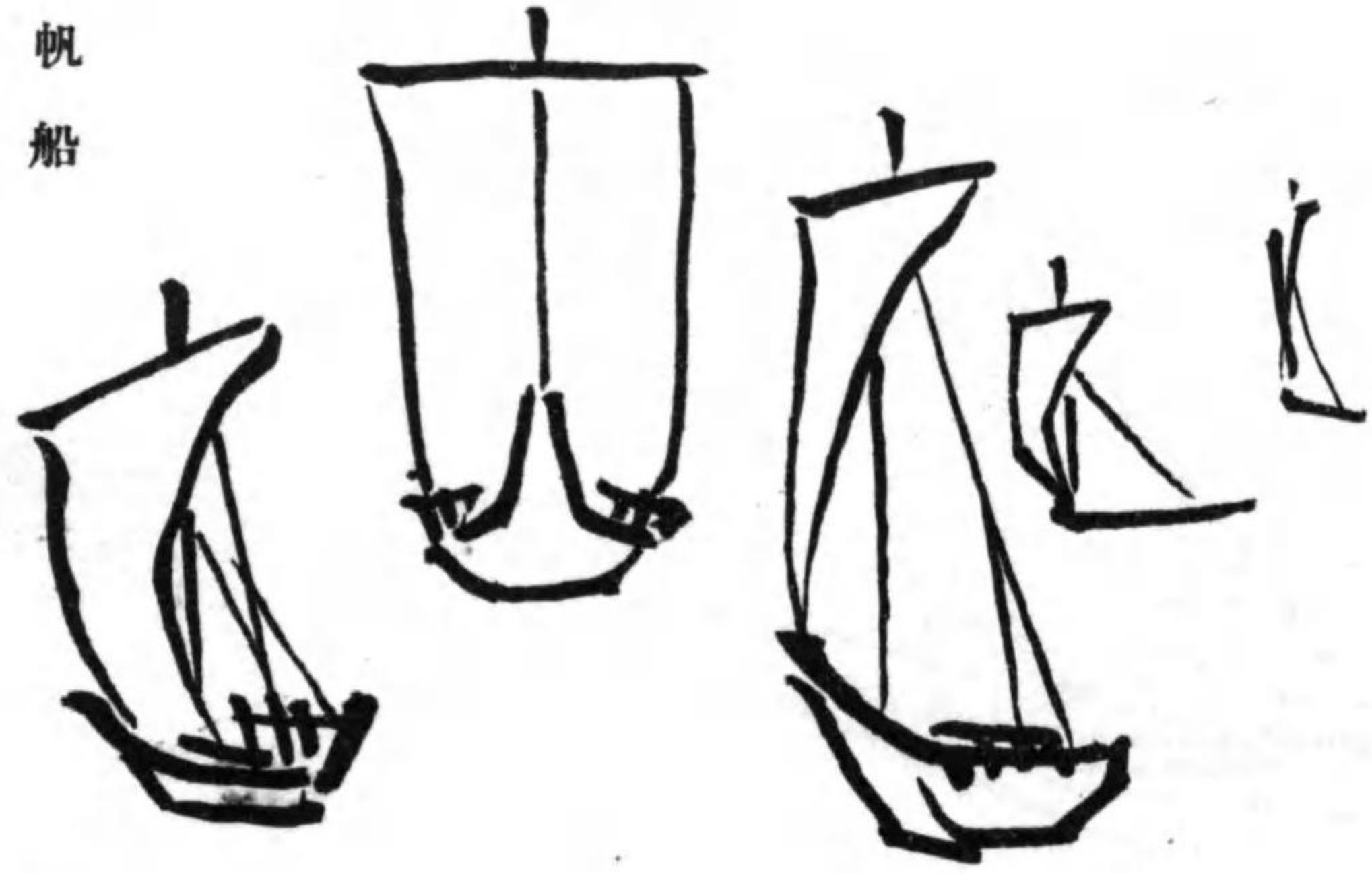

釣舟

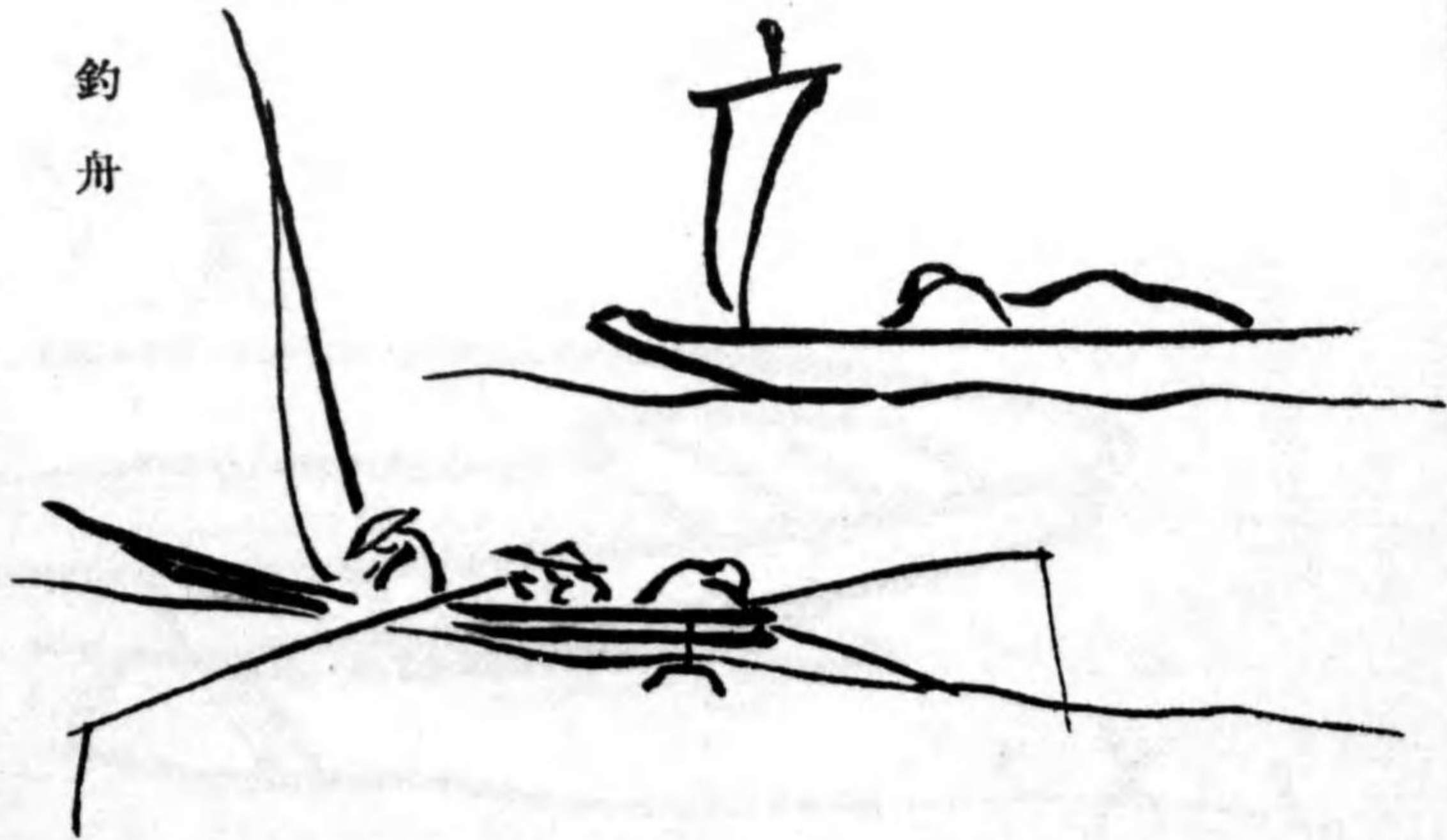

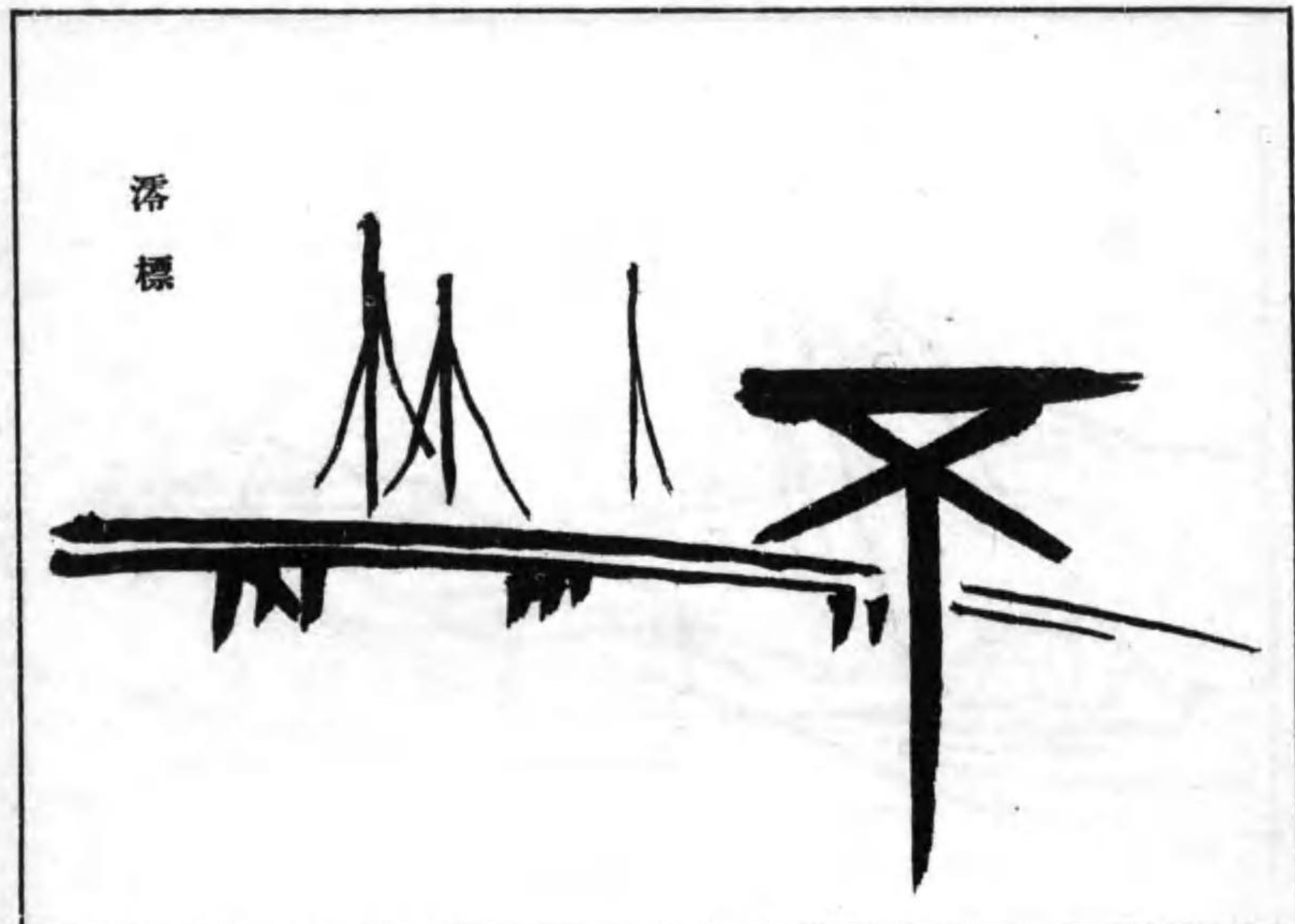

落標

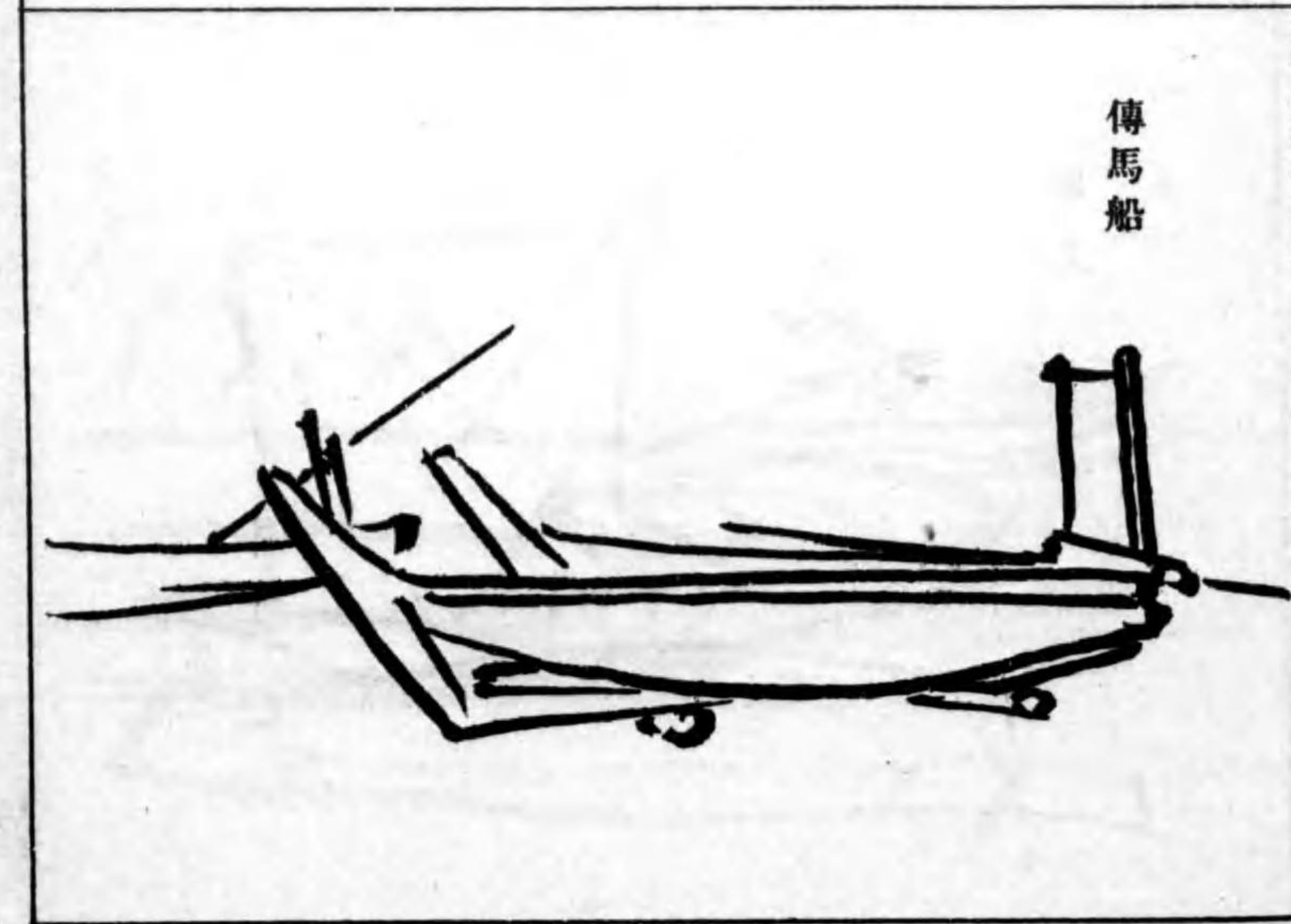

傳馬船

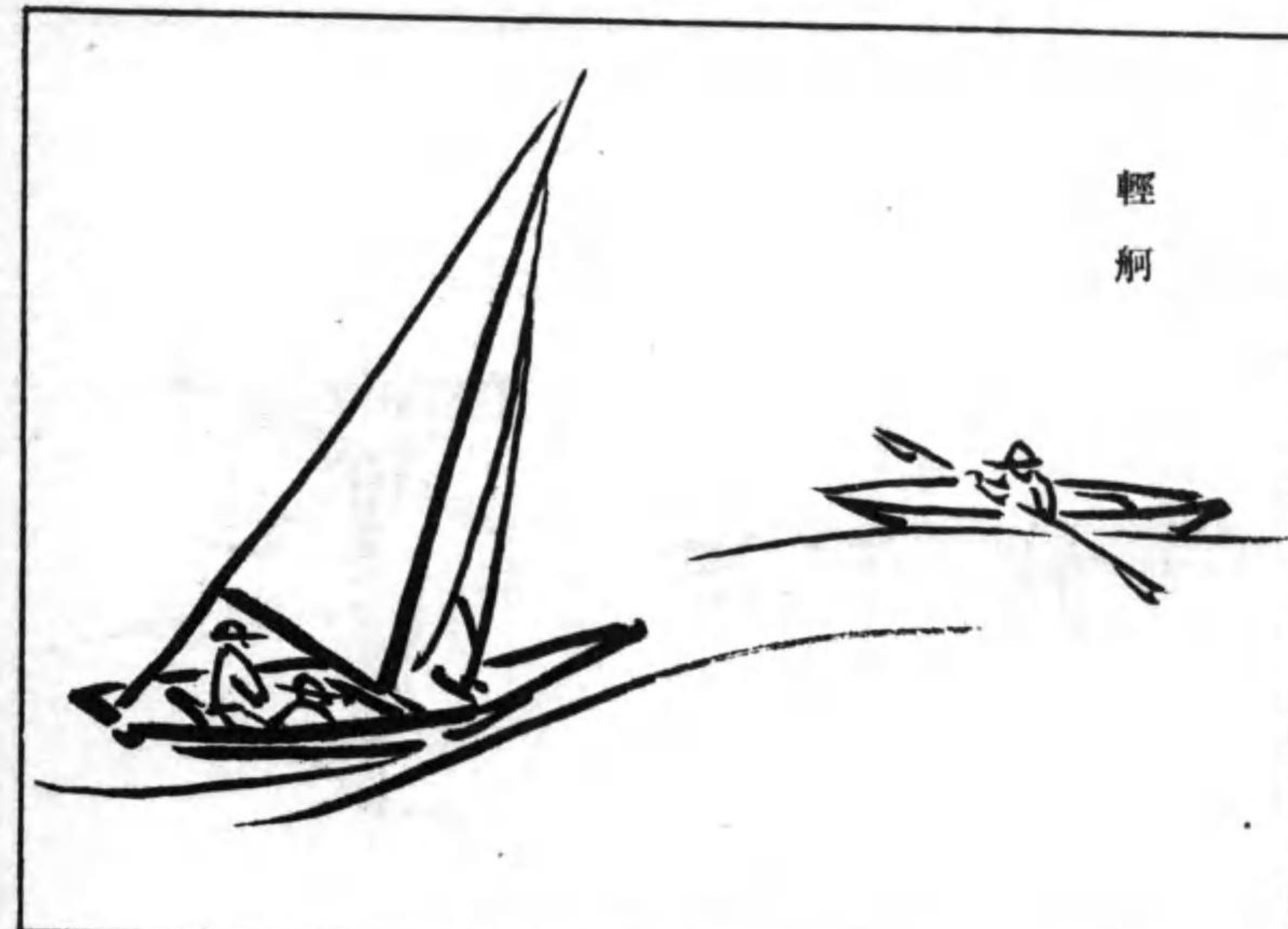

輕舸

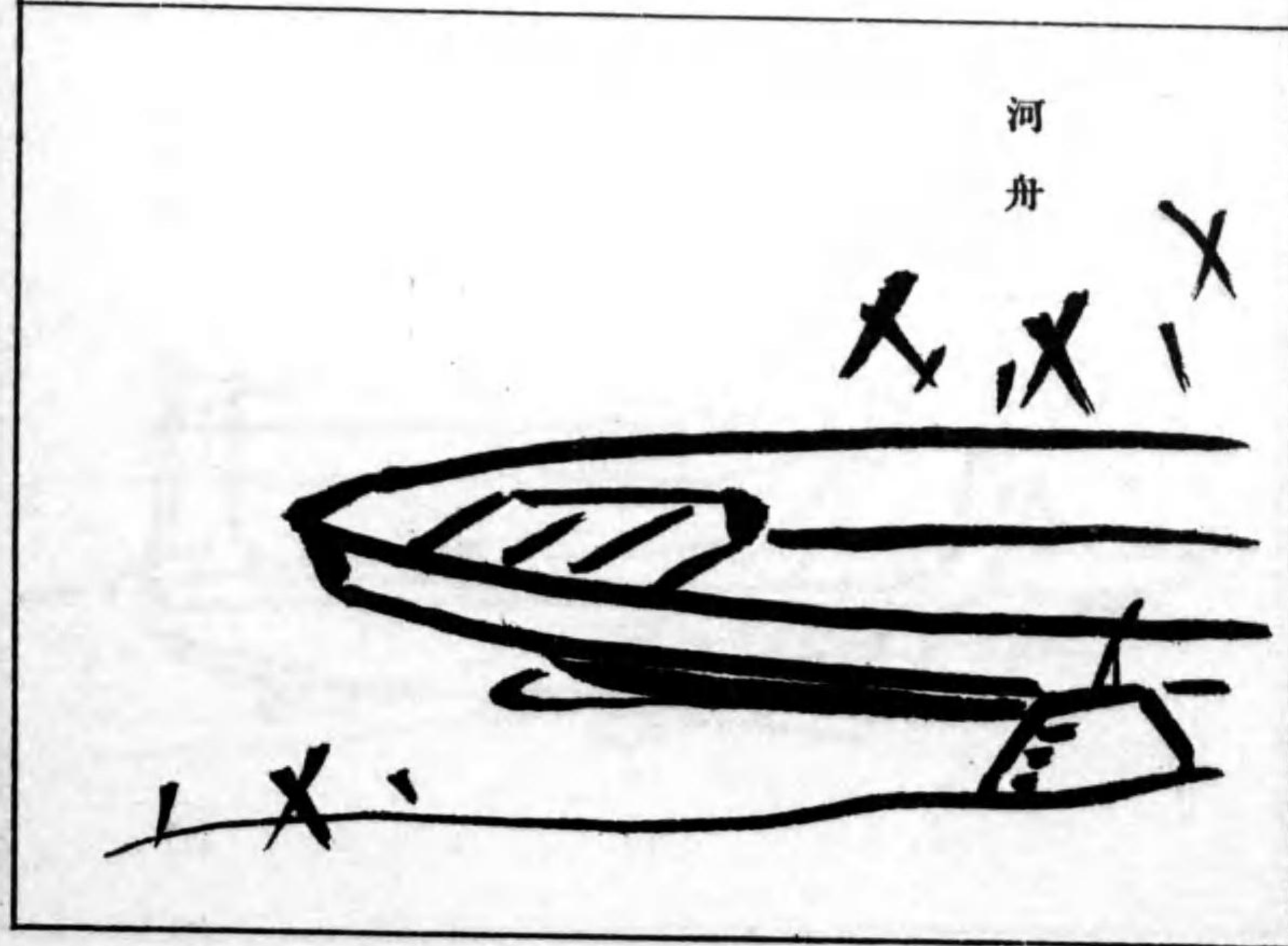

河舟

汽船

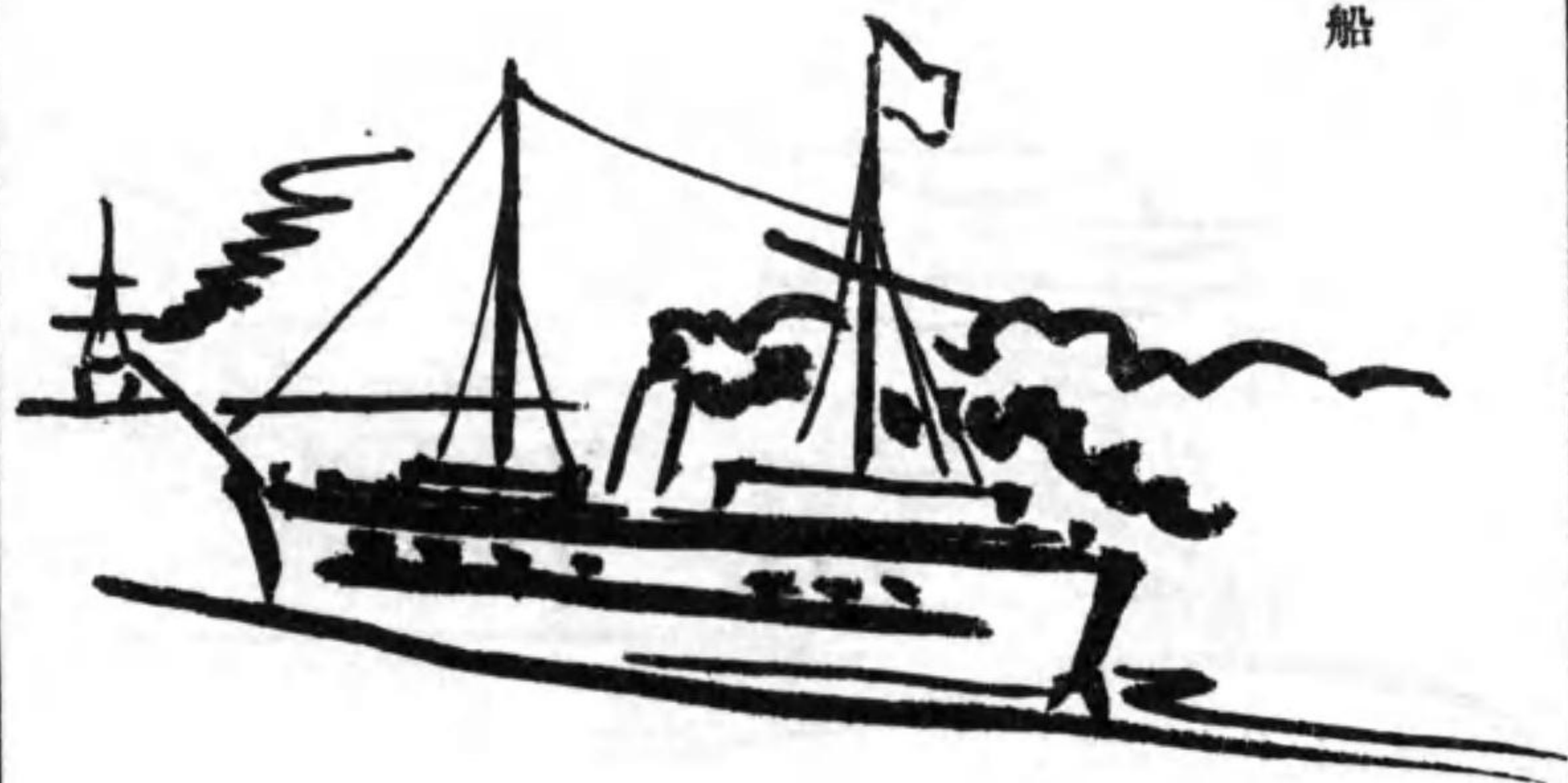

軍艦



園池

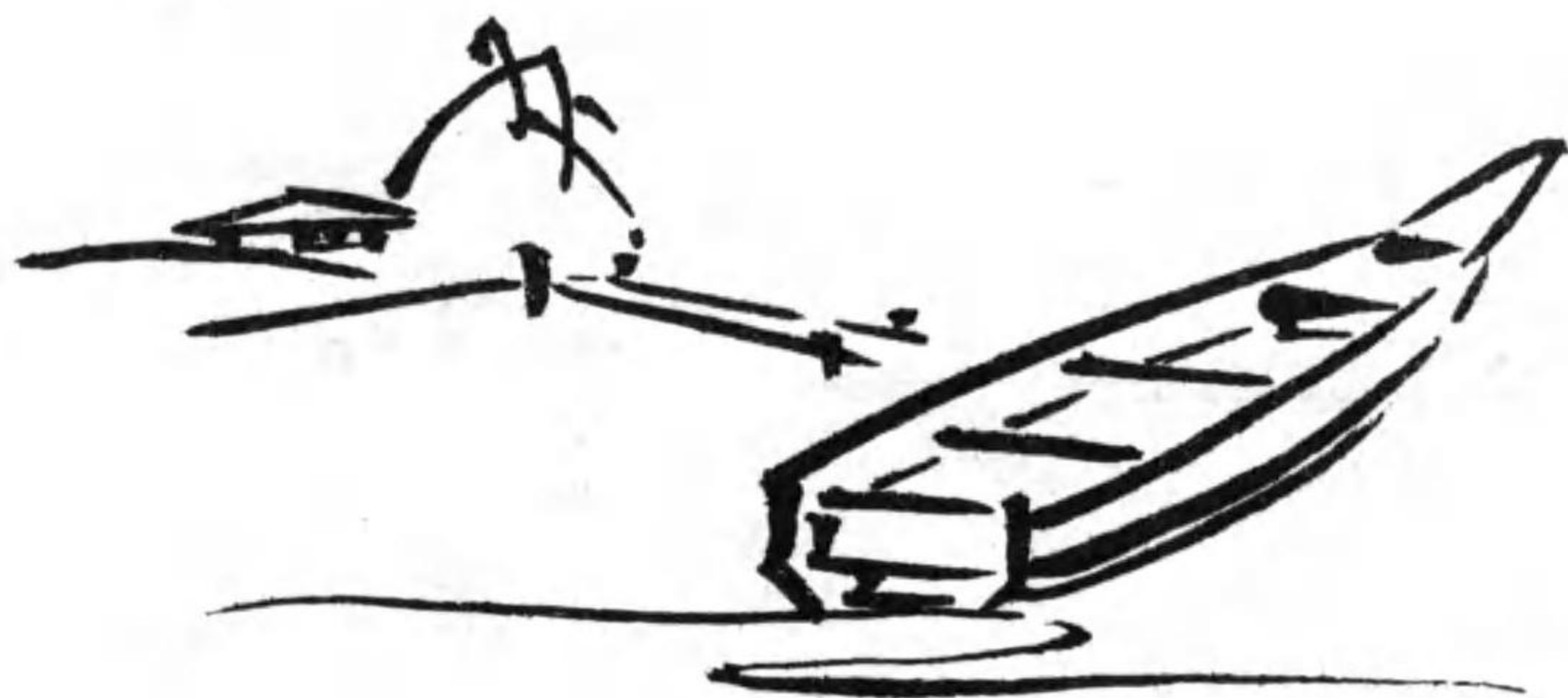

湖上

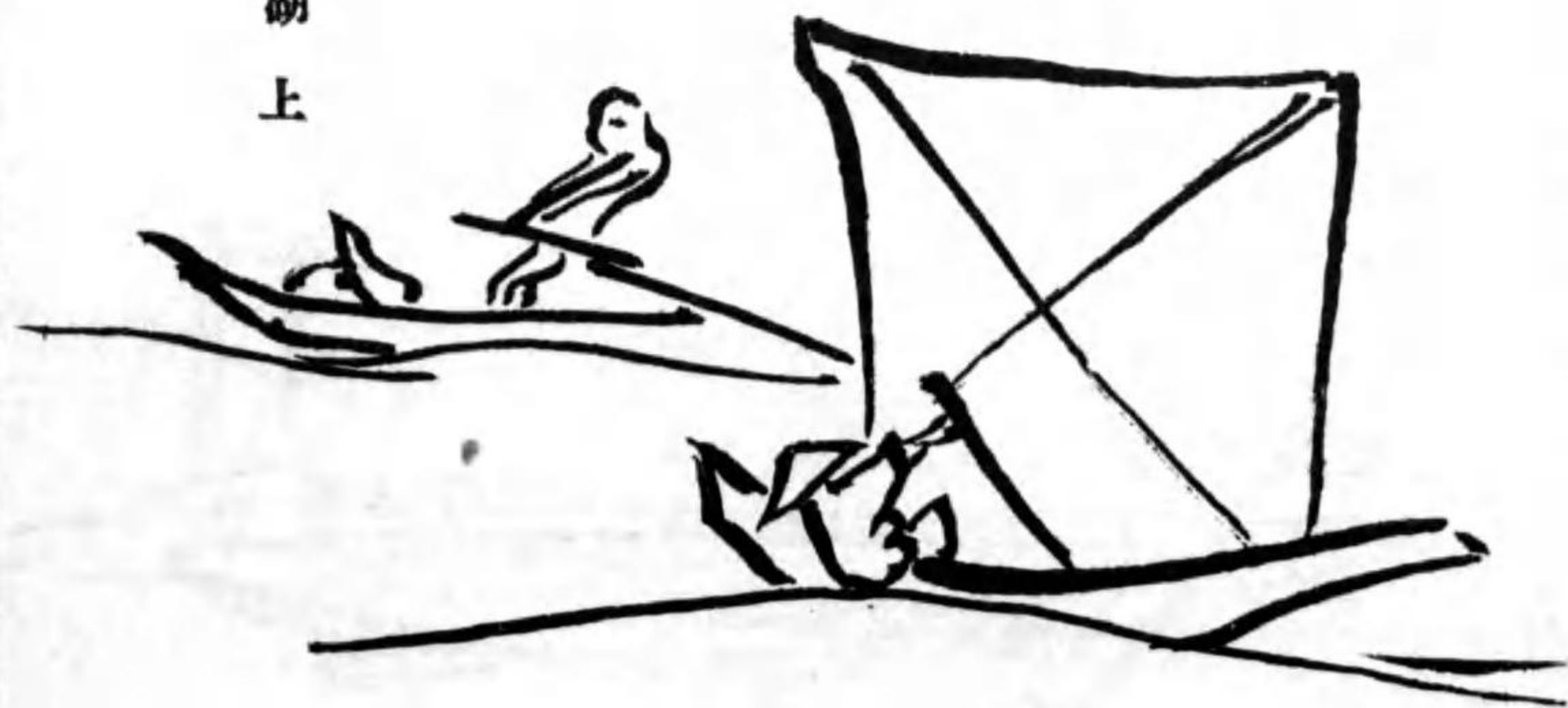

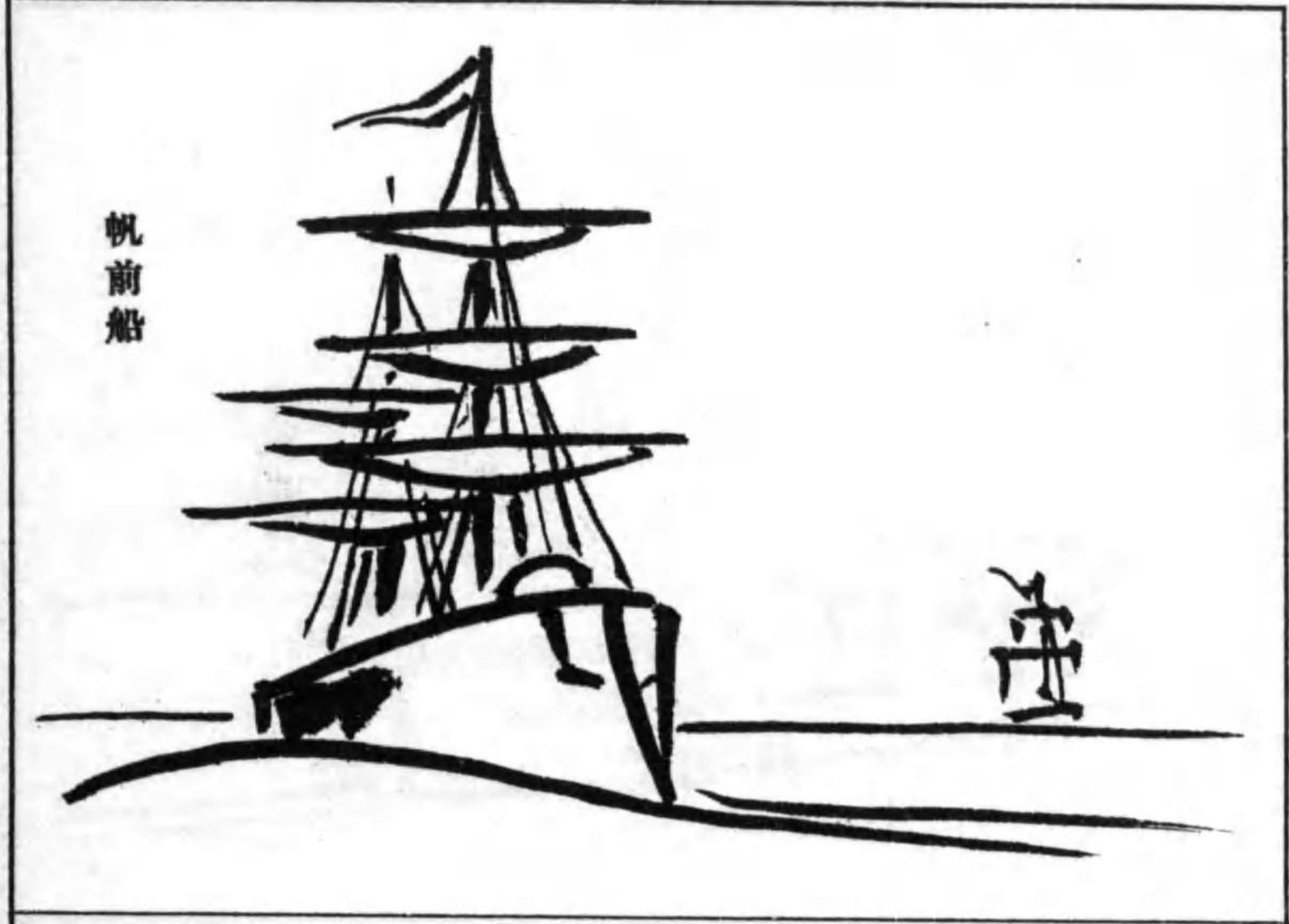

帆前船

西洋形小釣舟

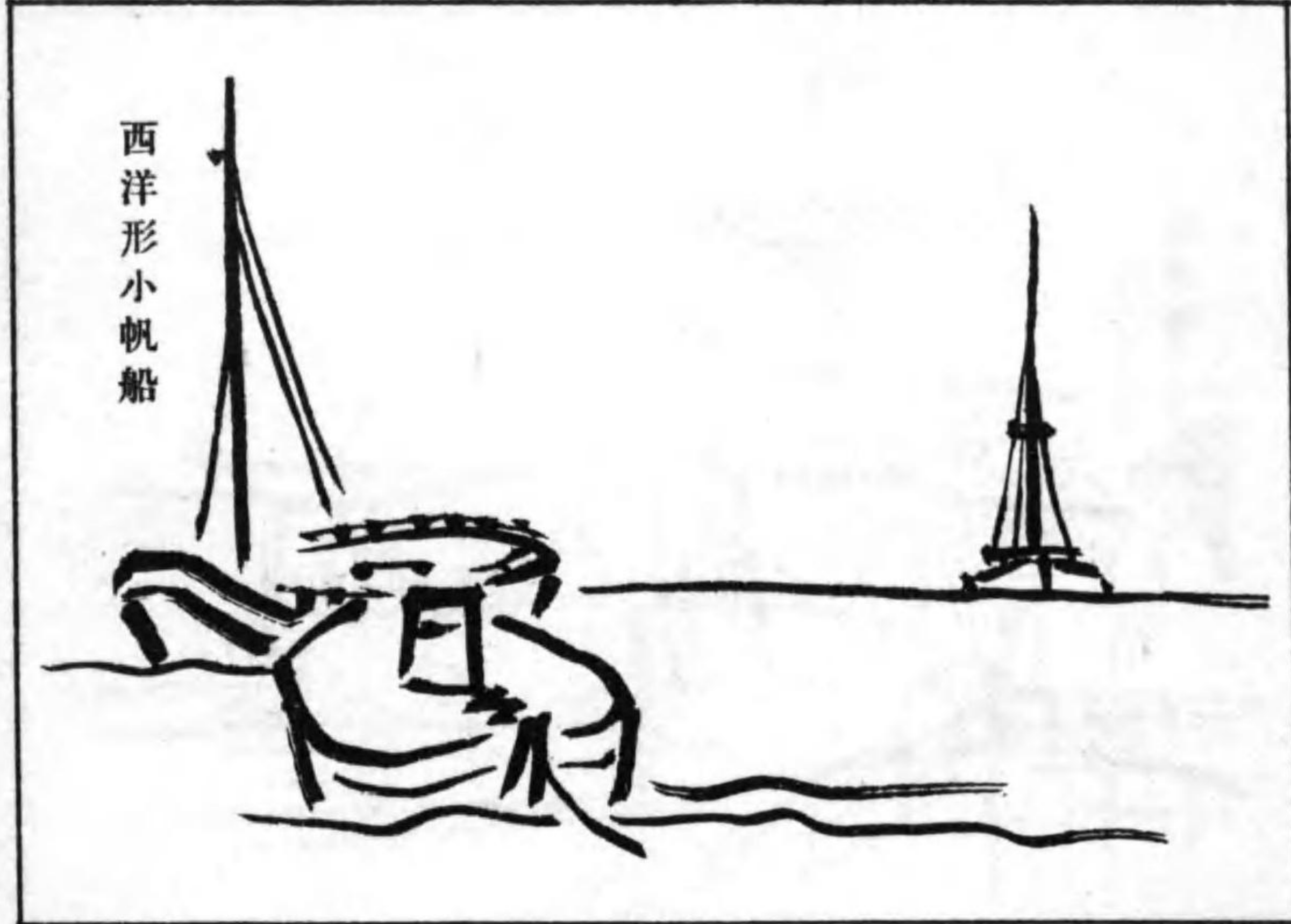
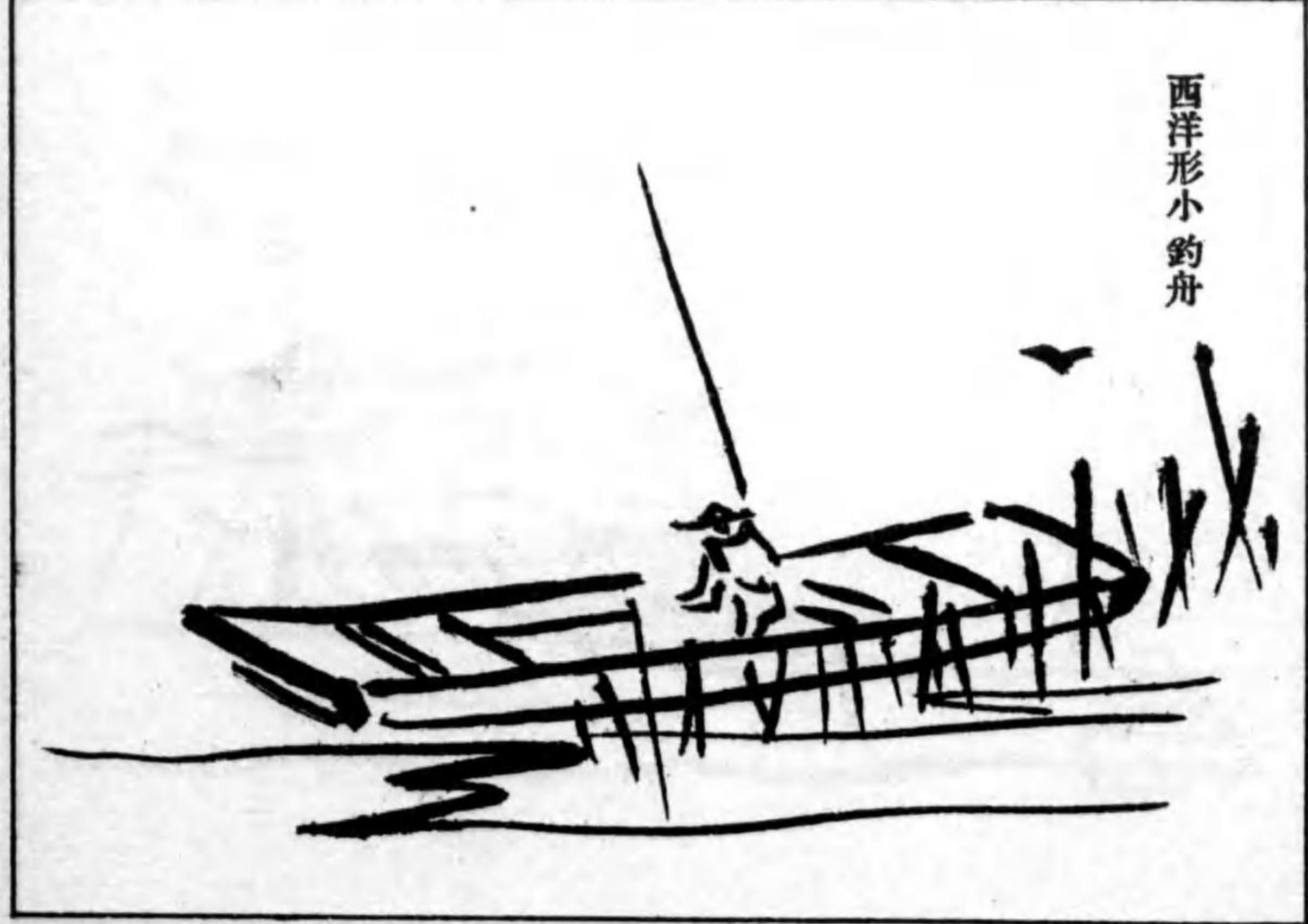

西洋形小帆船

泊船

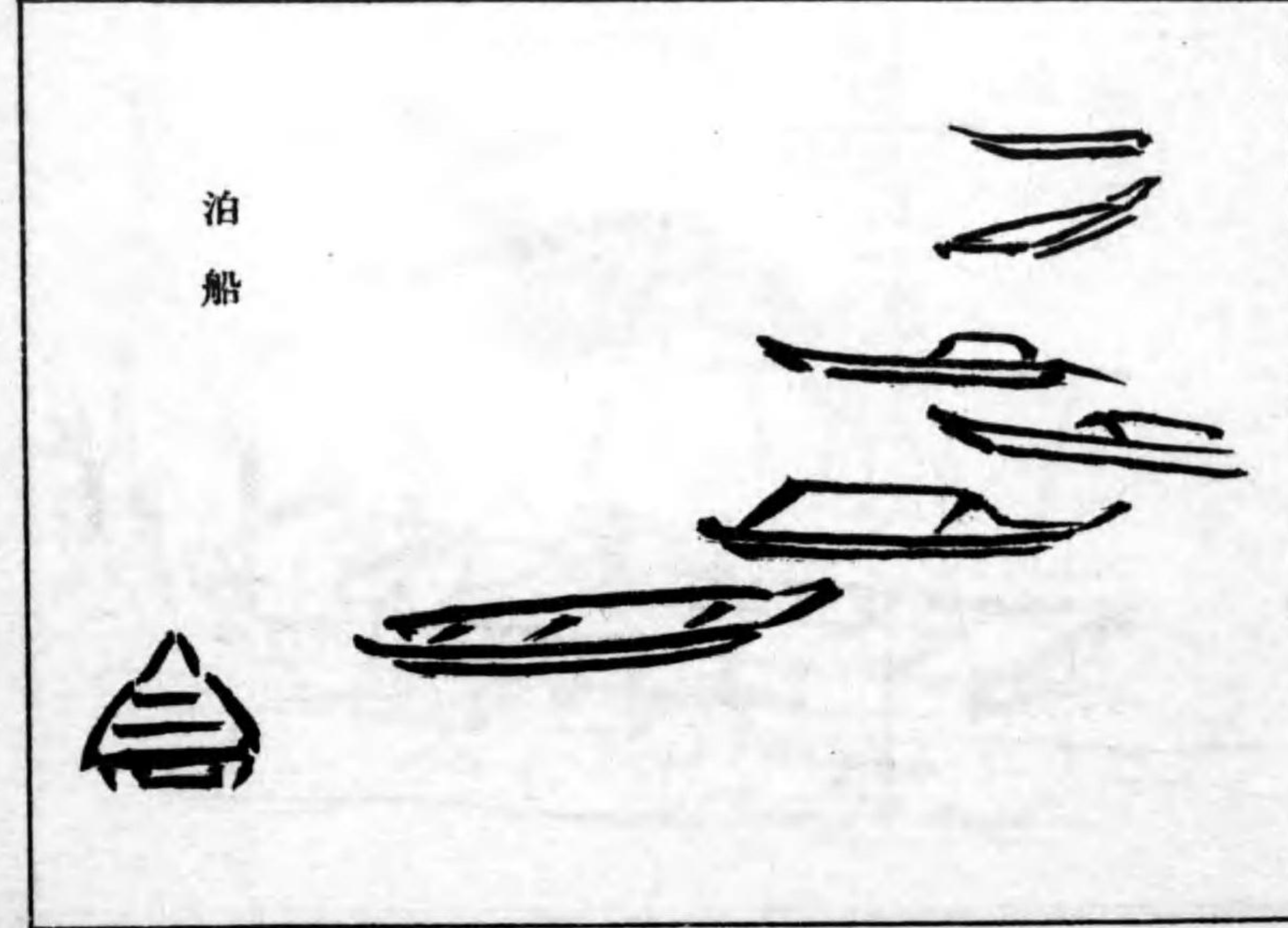

其七
橋梁家屋類

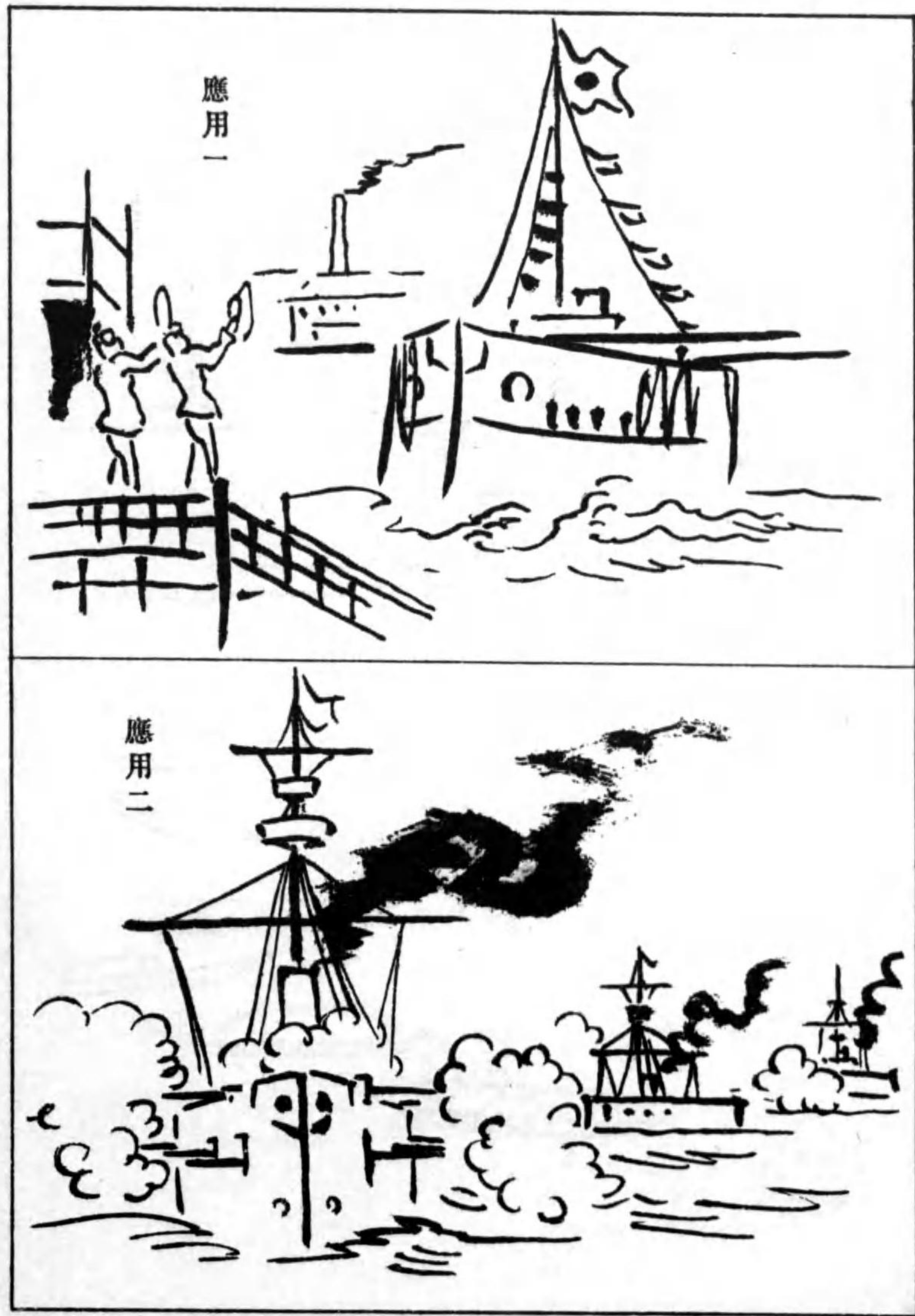

算盤橋

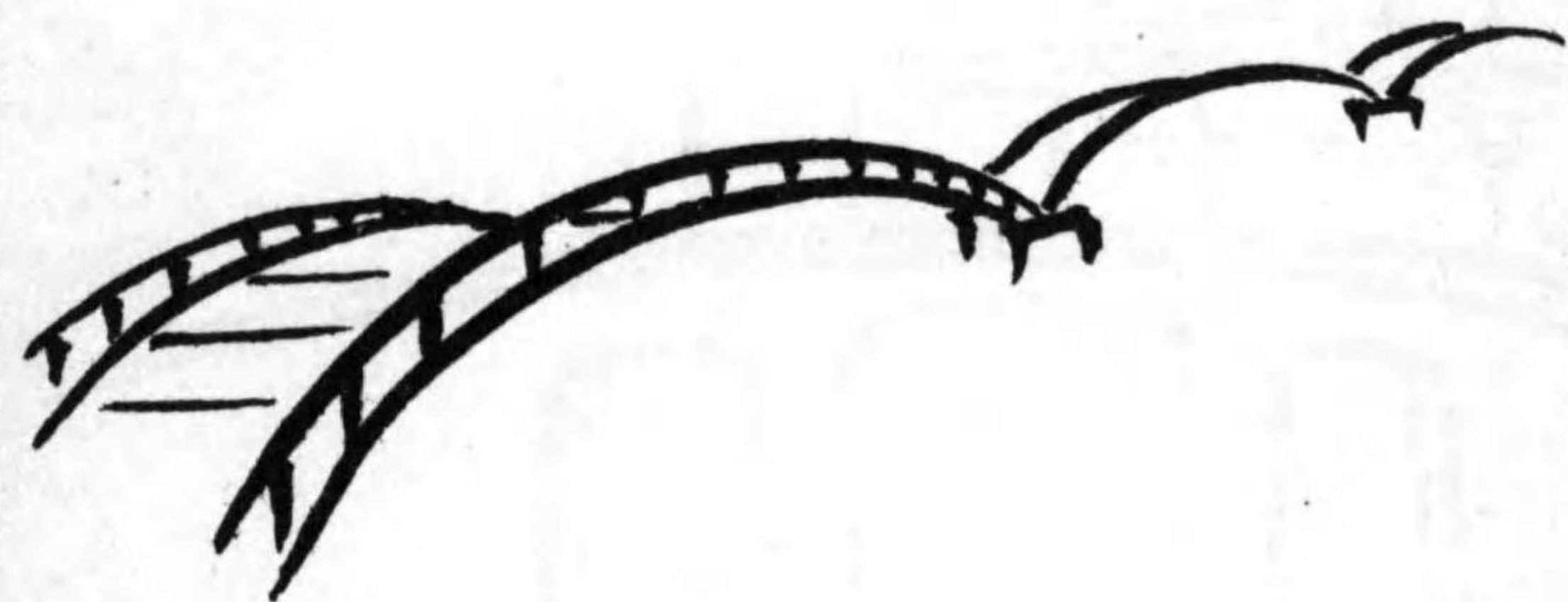

石橋一



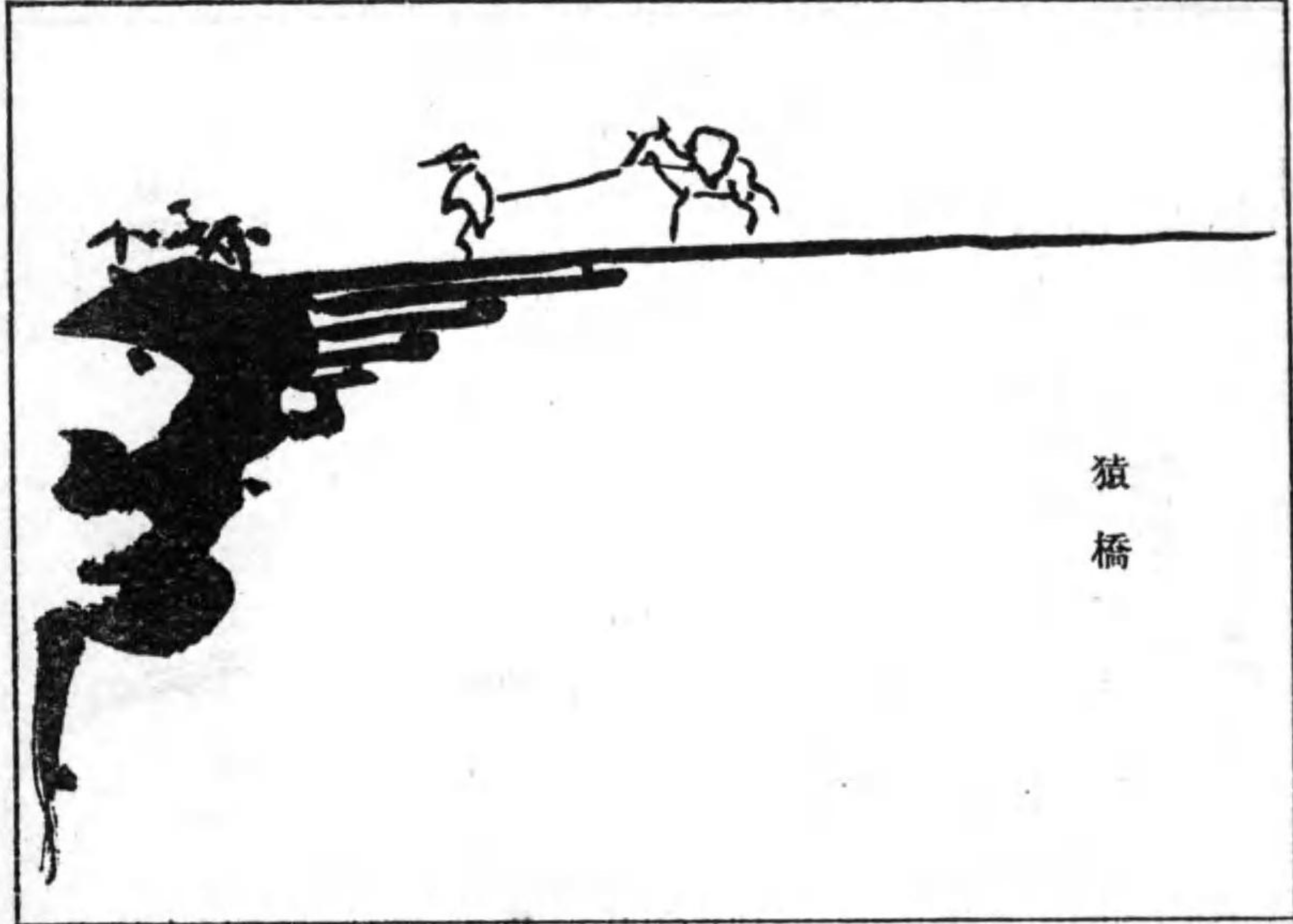

猿橋

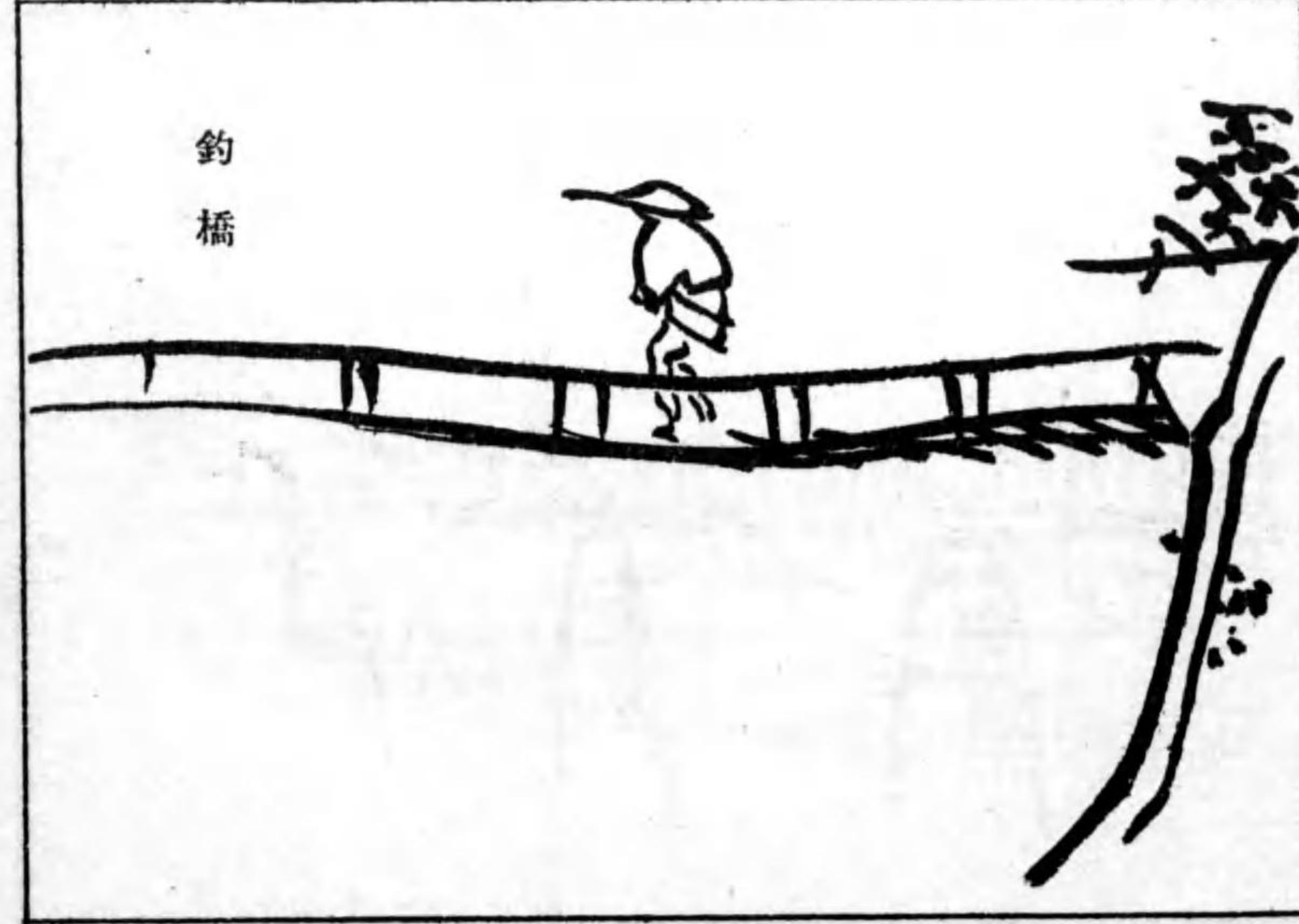

釣橋

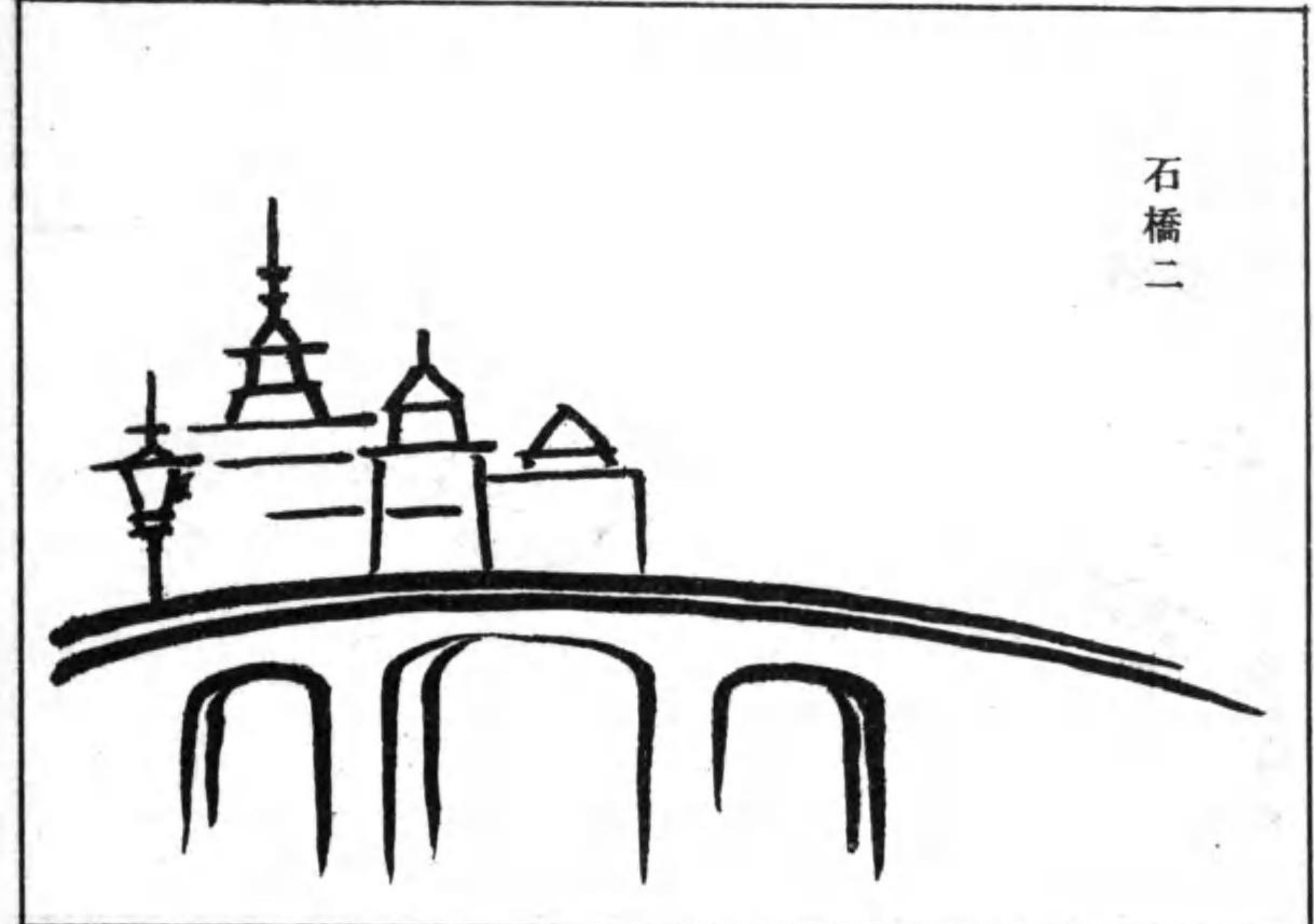

石橋二

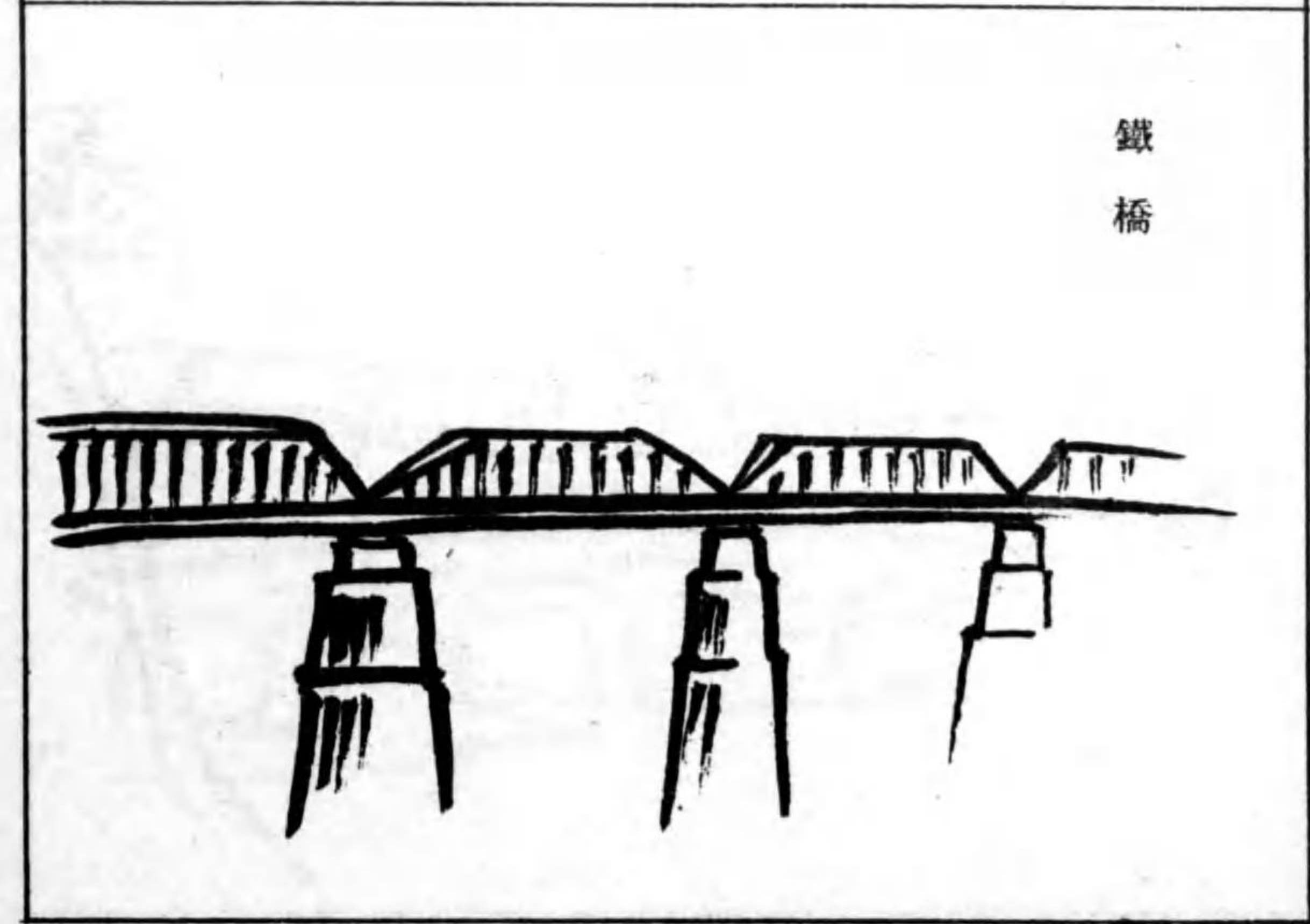

鐵橋

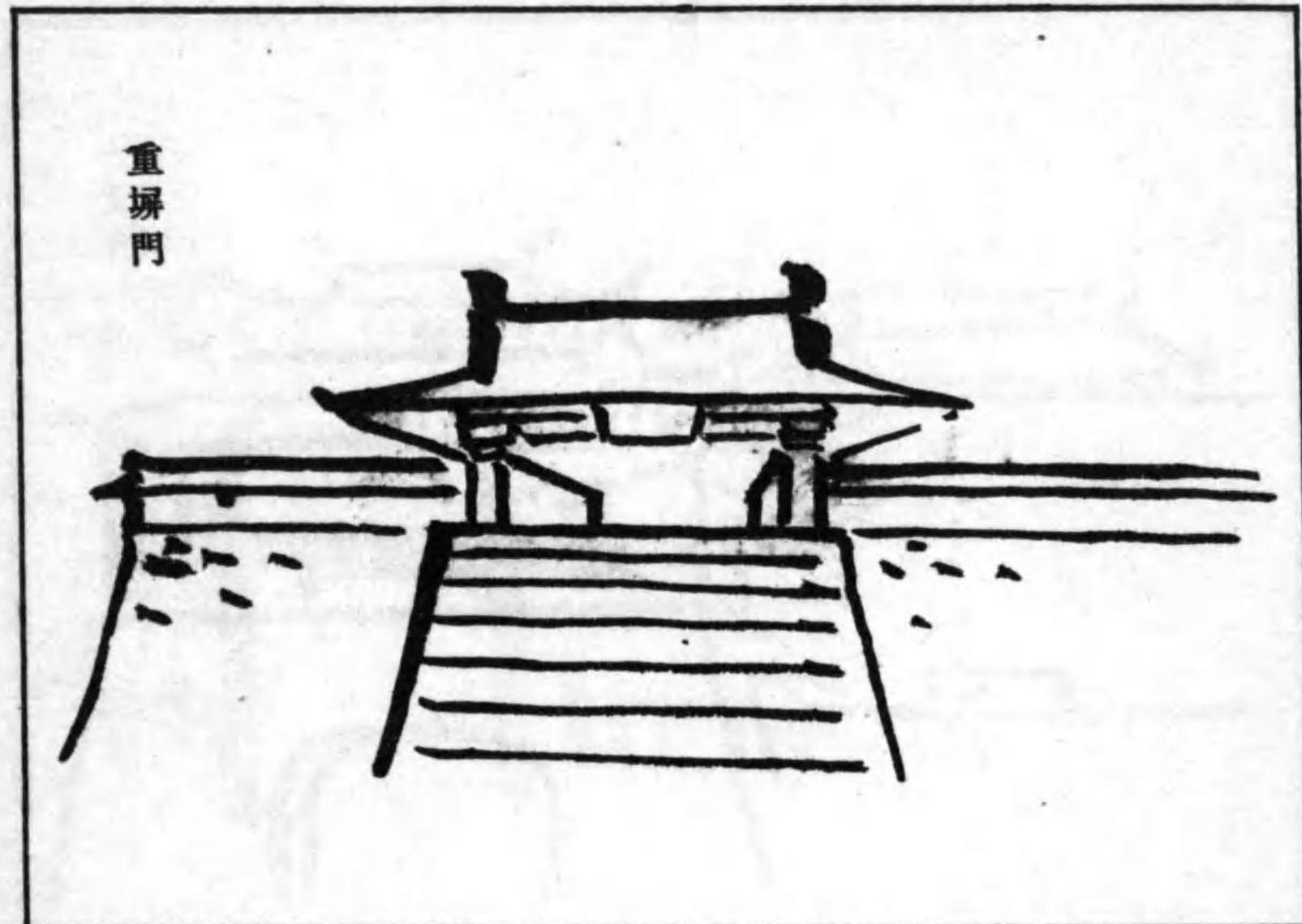

重塀門

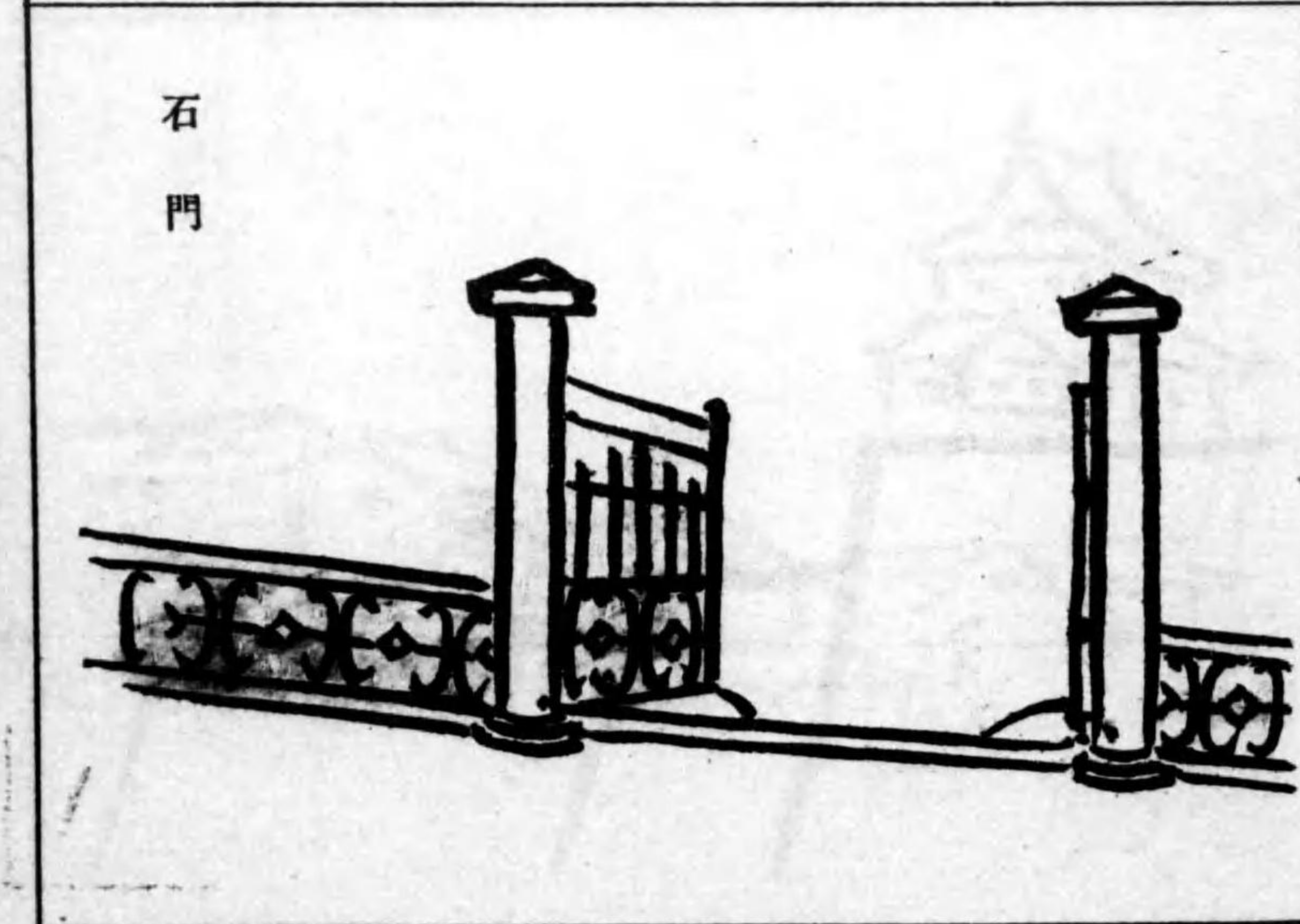

石門

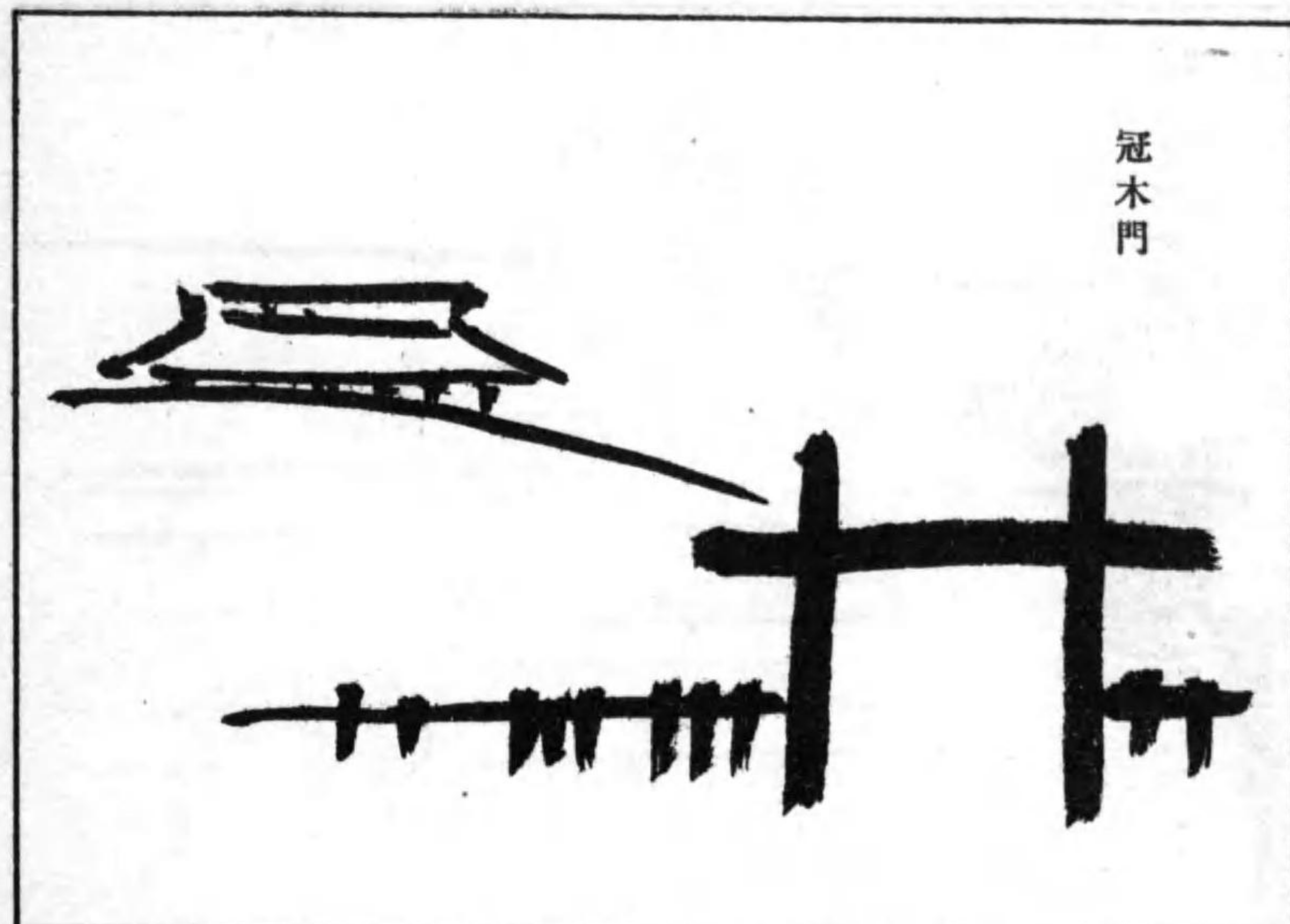

冠木門

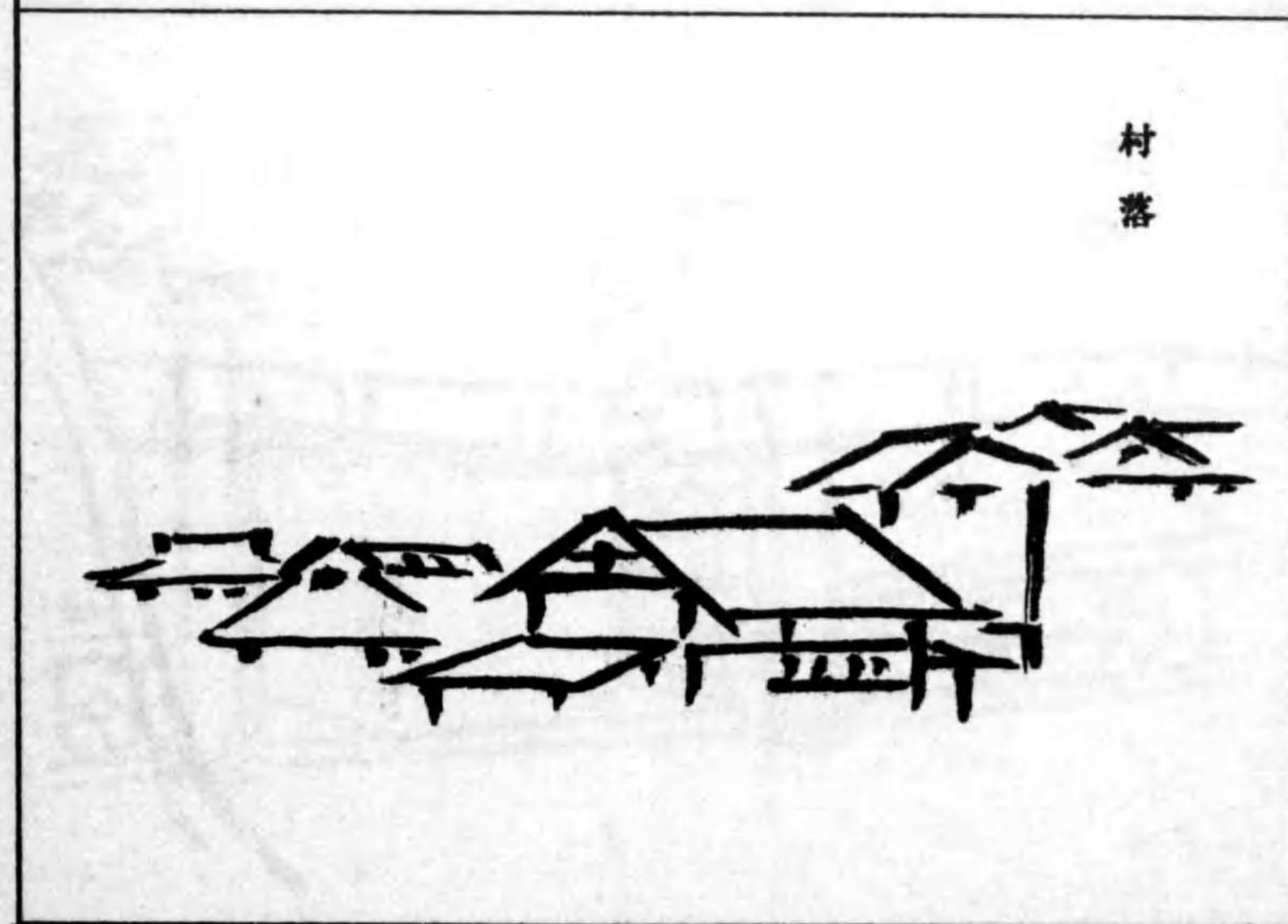

村落

支那城門

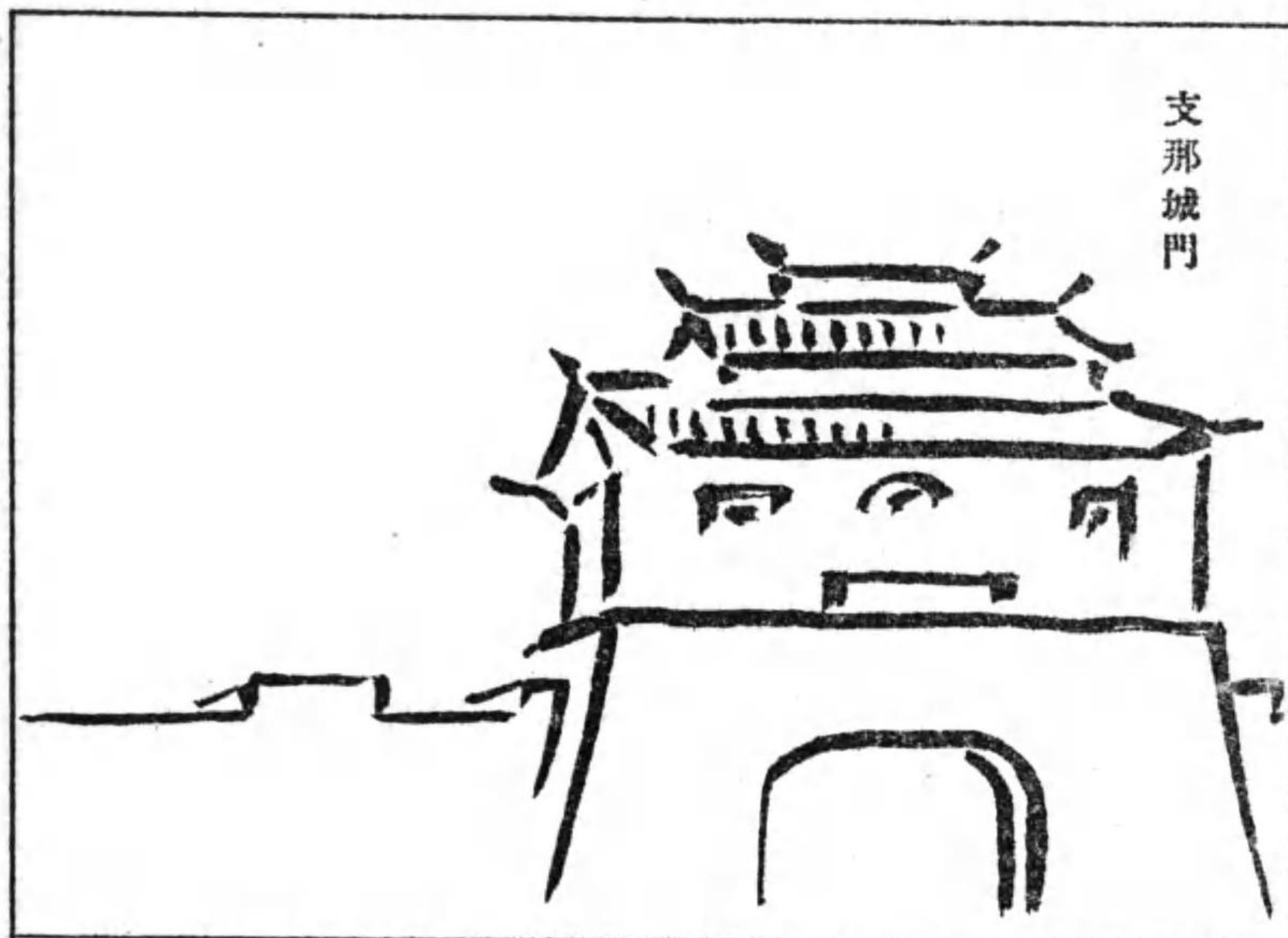

城一

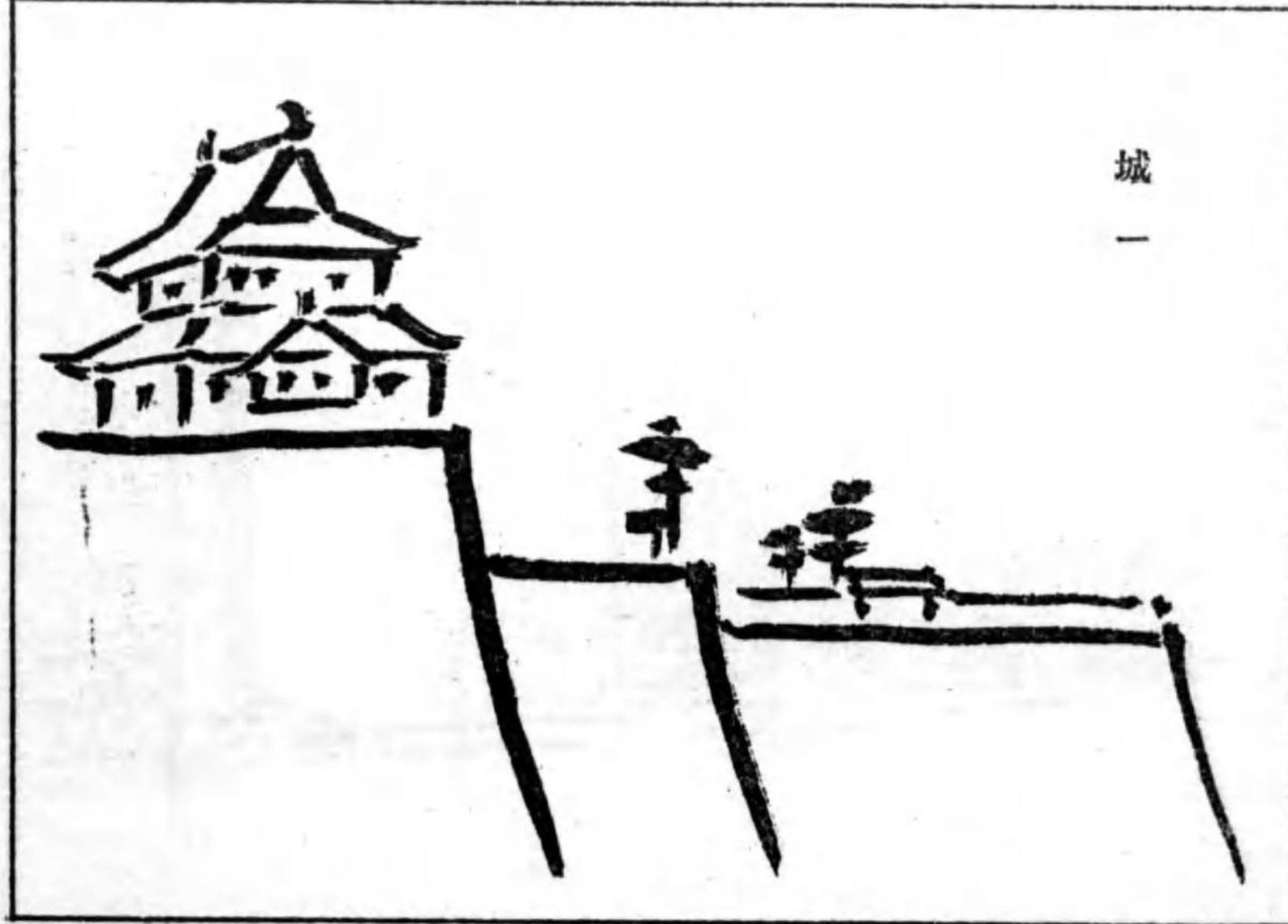

城二

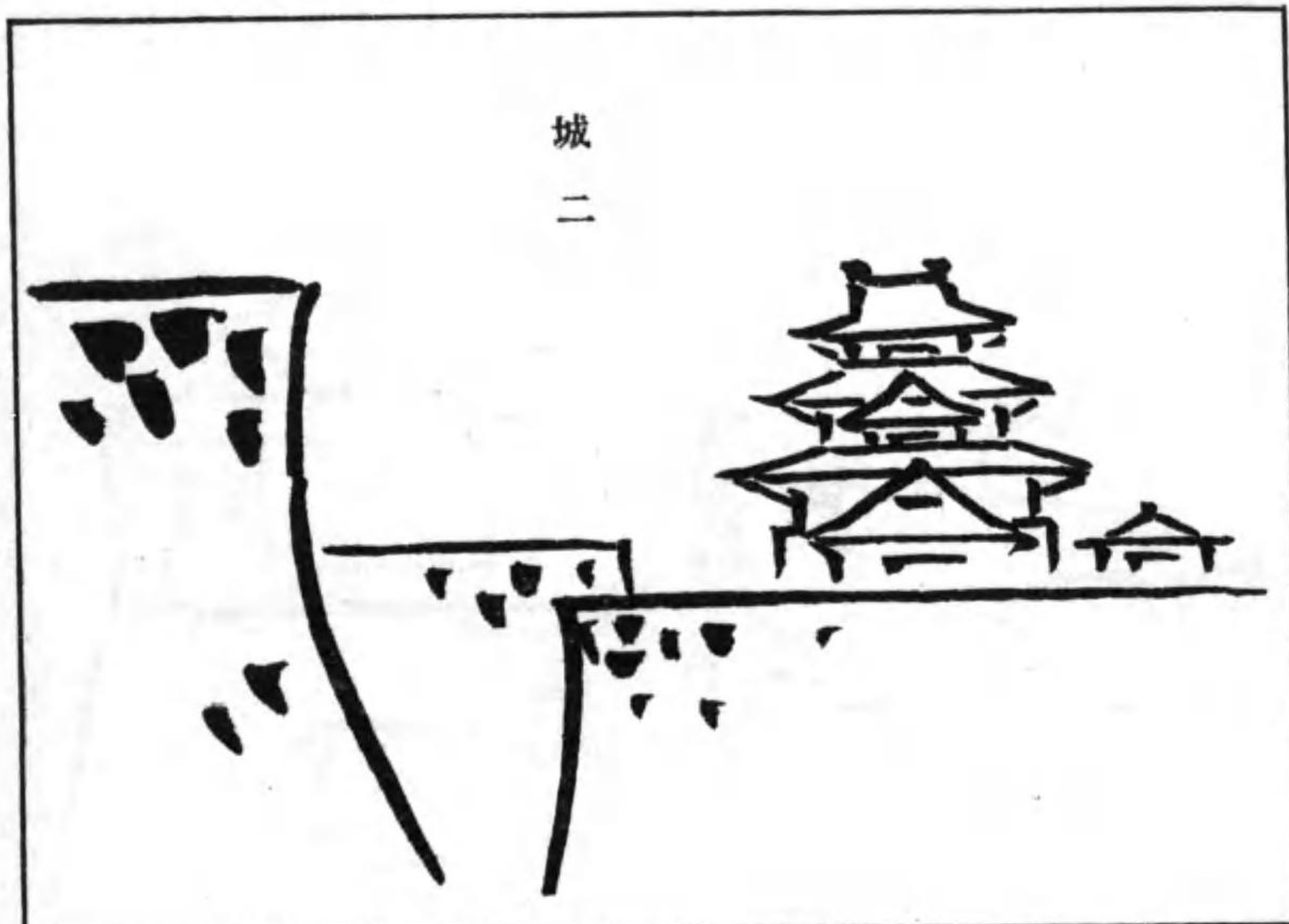

砲臺

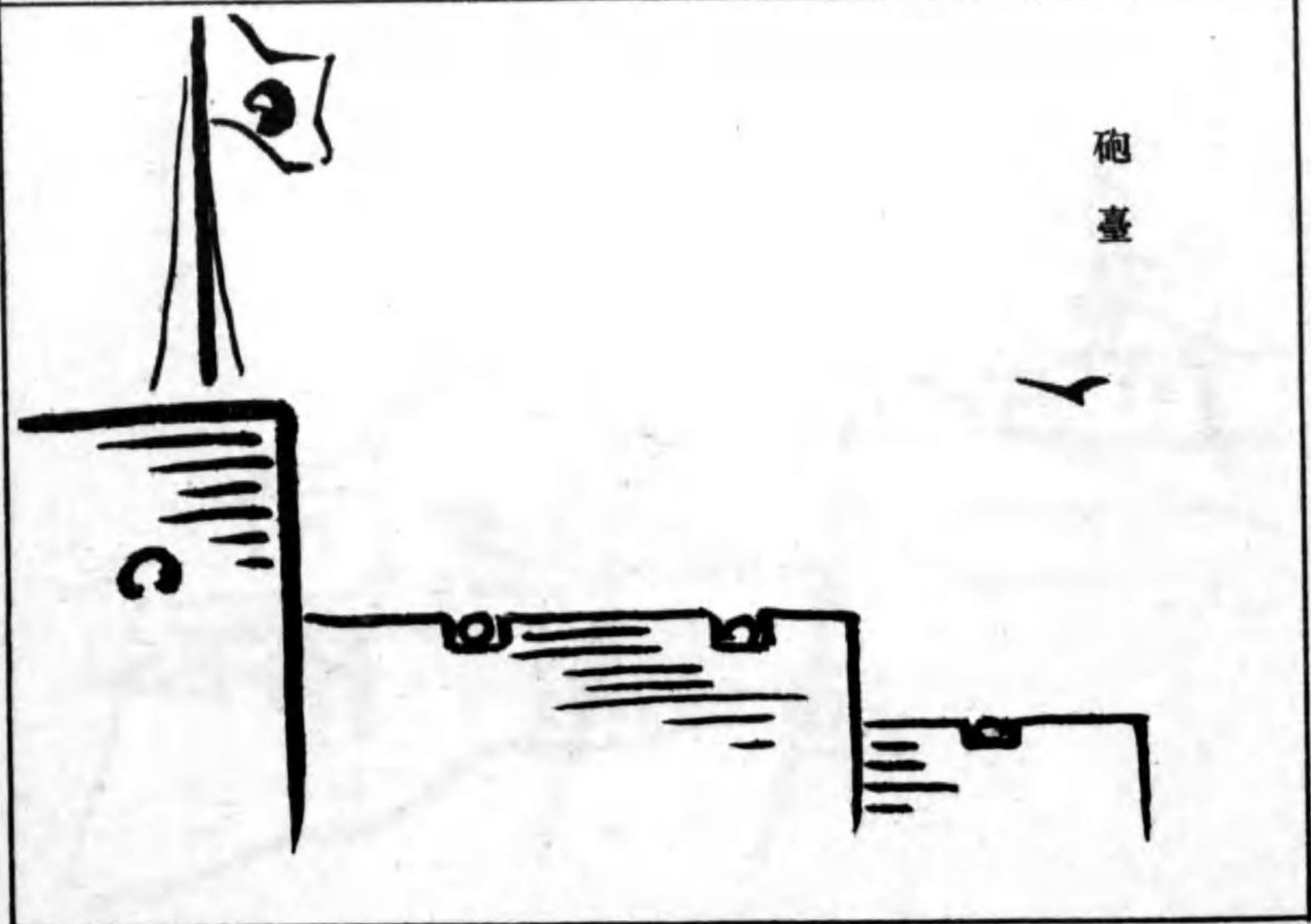

官省

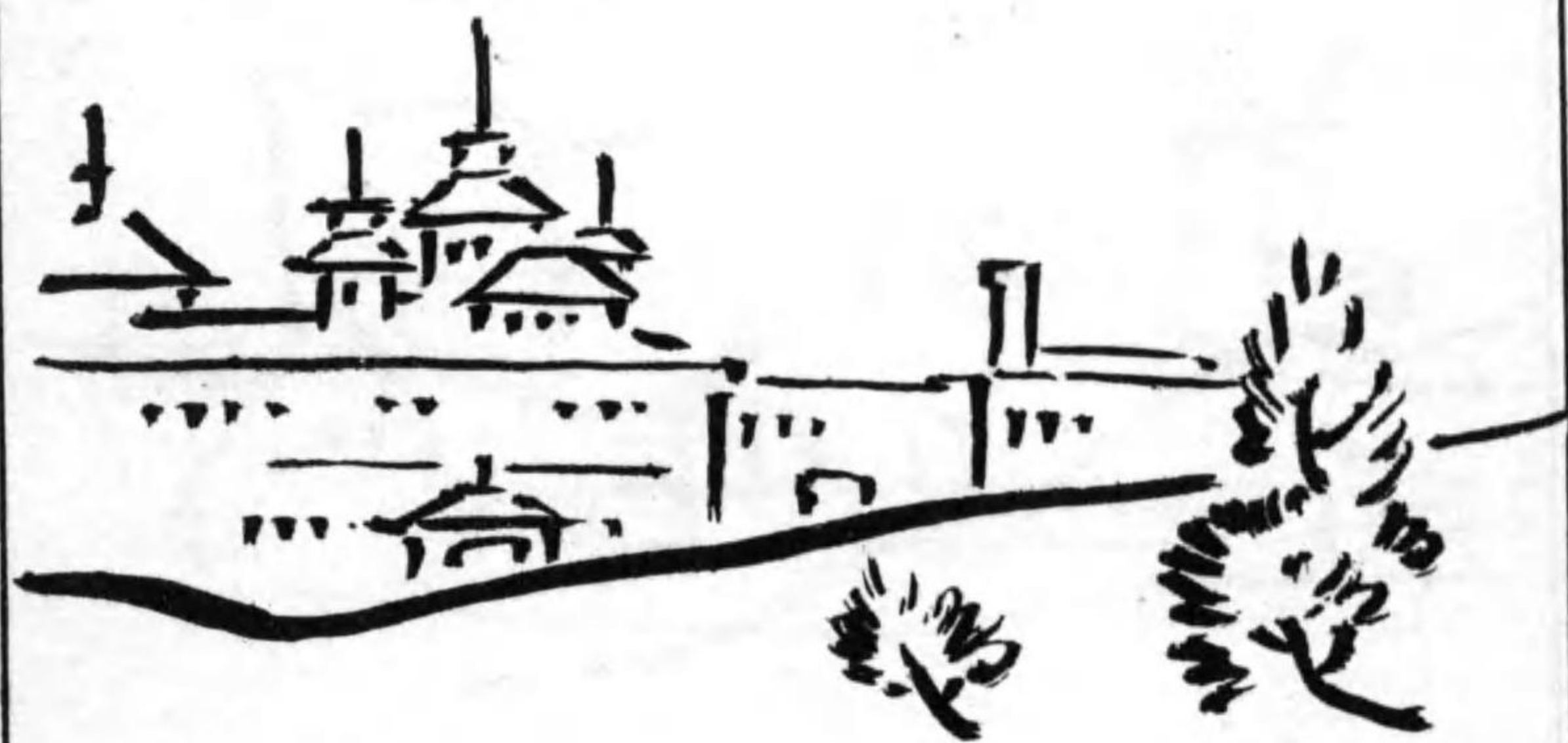

社
祠



羅馬城趾

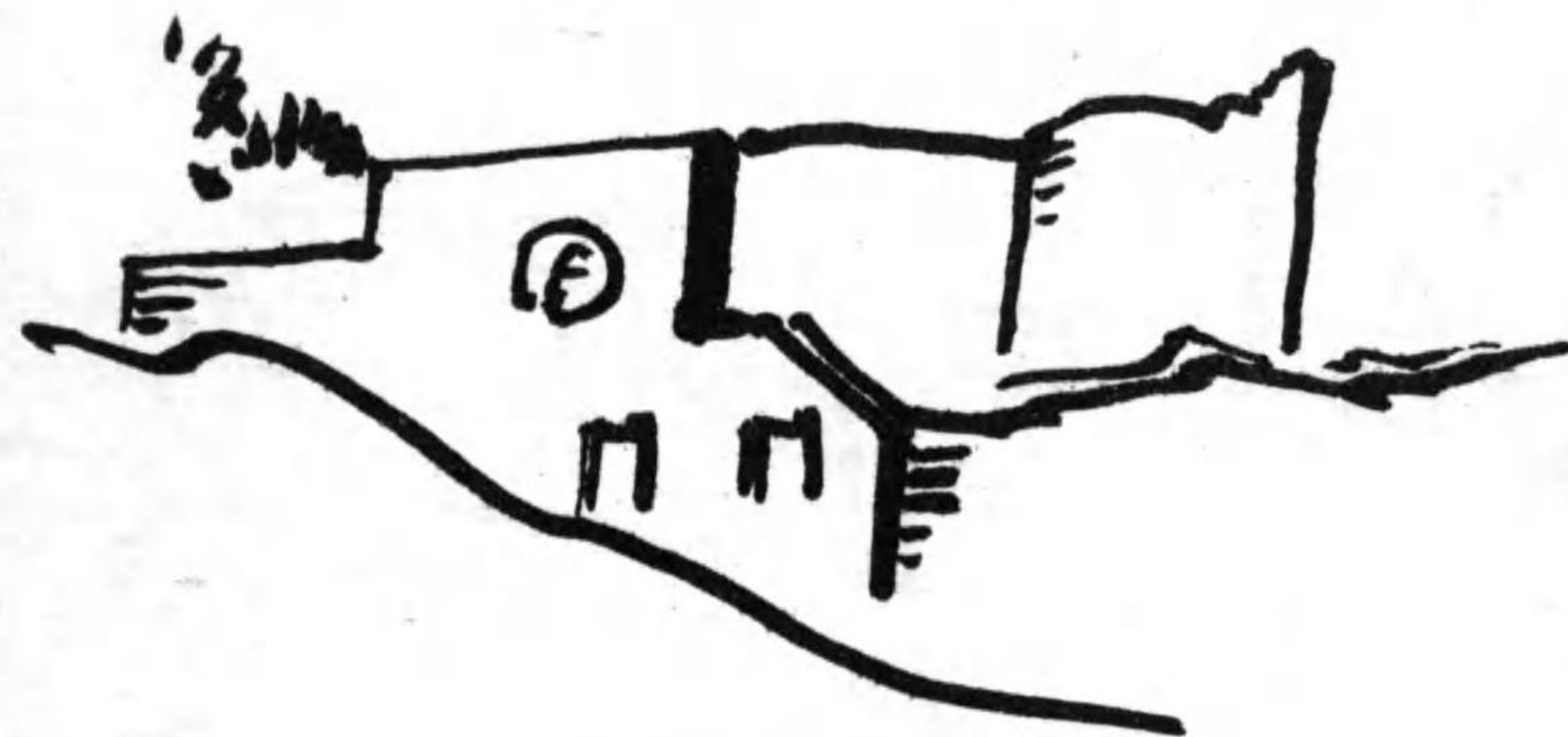

西洋田家



其八
山水風景類

黑板畫法

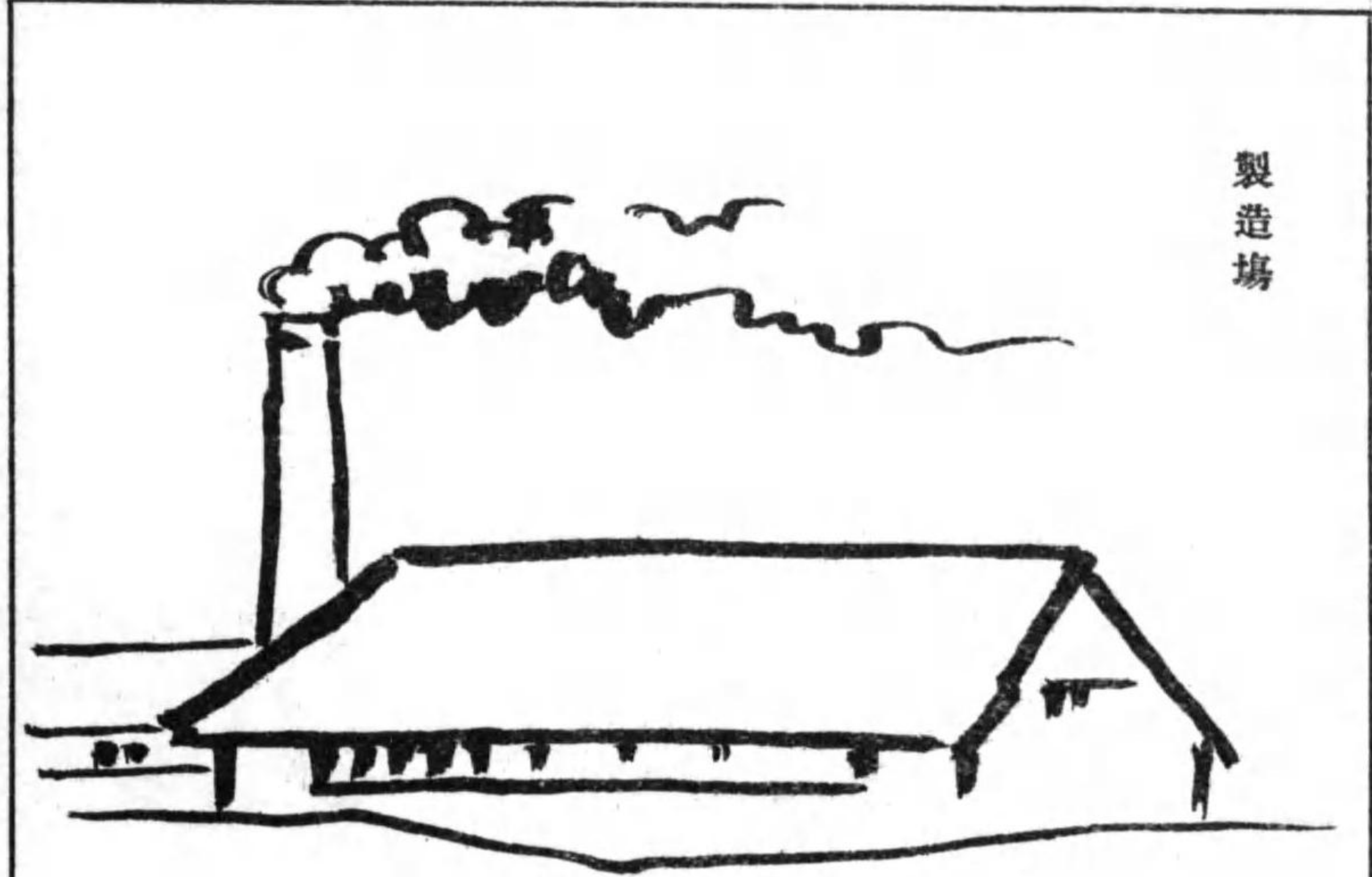

製造場

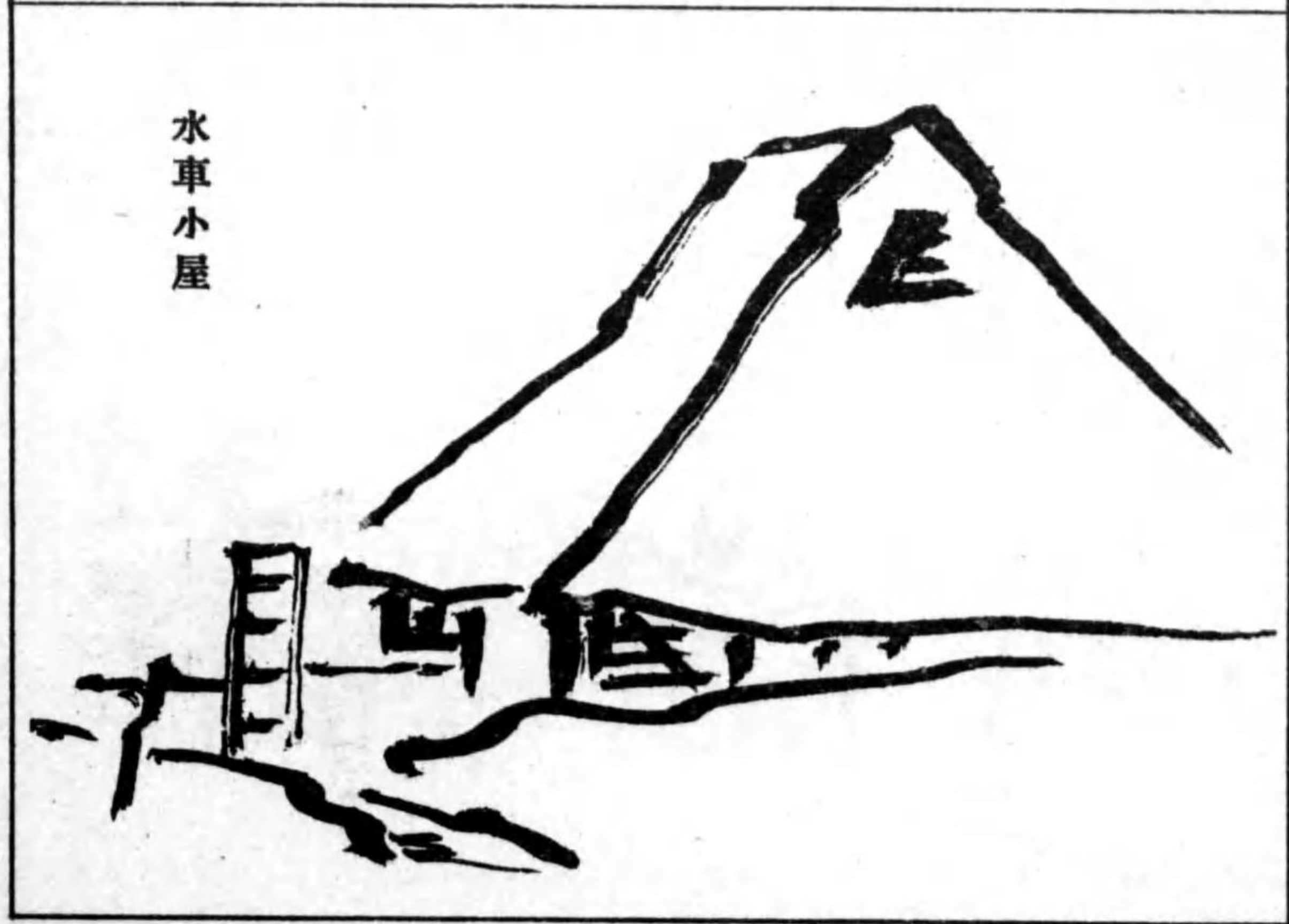

水車小屋

百八

月前梅

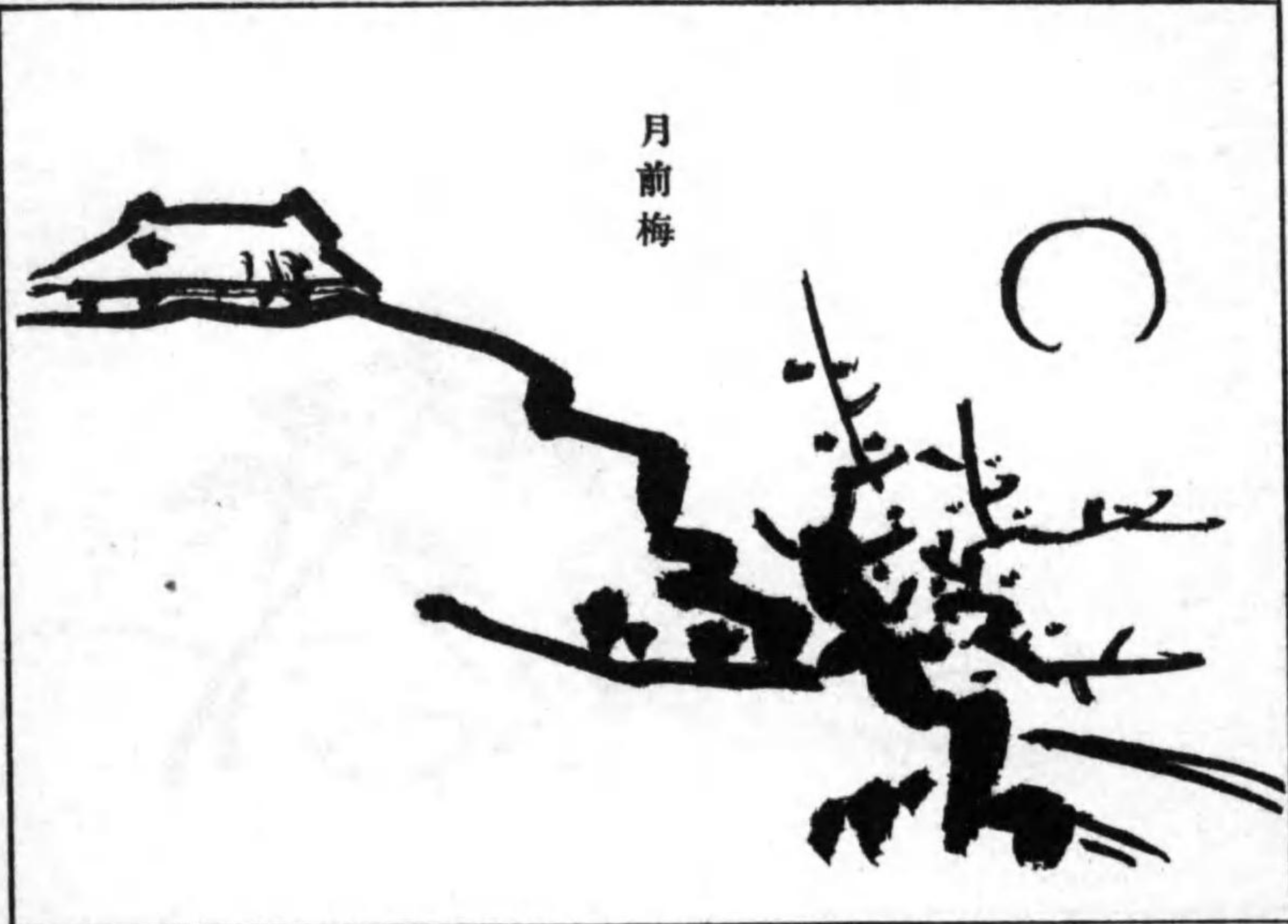

納涼



貿易港



大洋

ㄅ ㄅ



鹽濱



燈臺



夜櫻



橋の霜

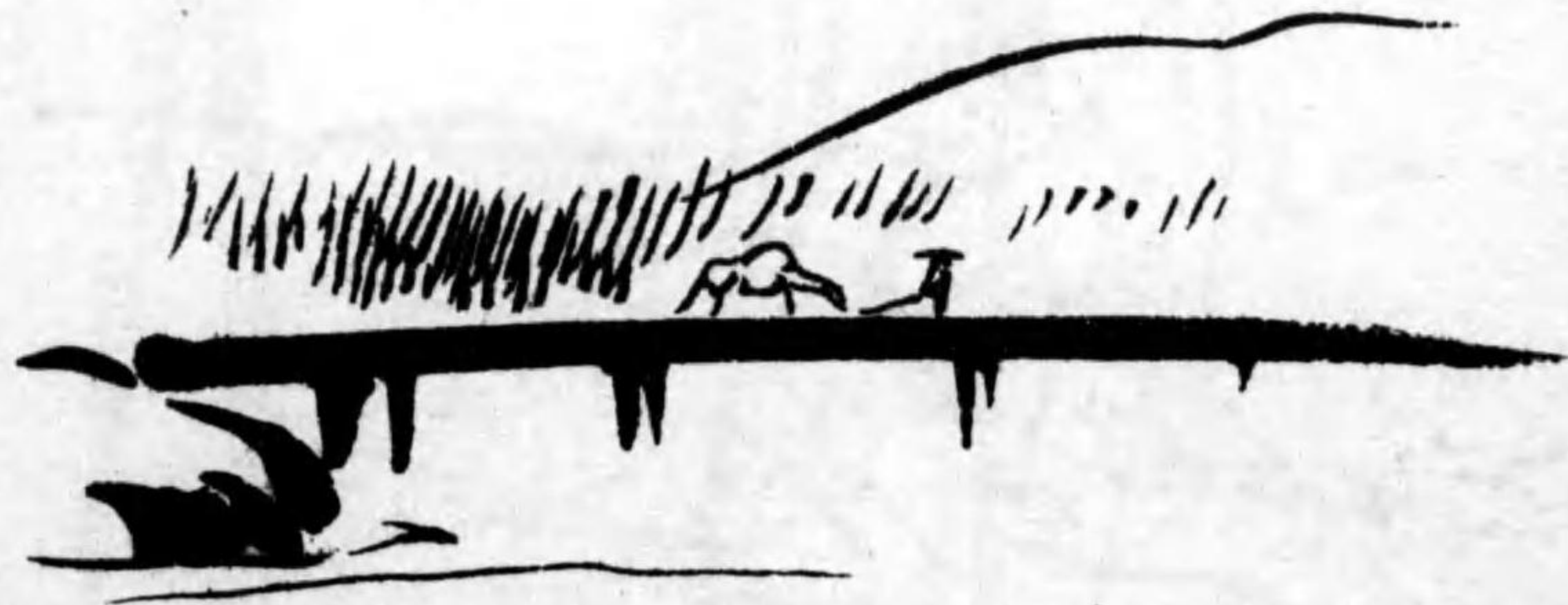

内海

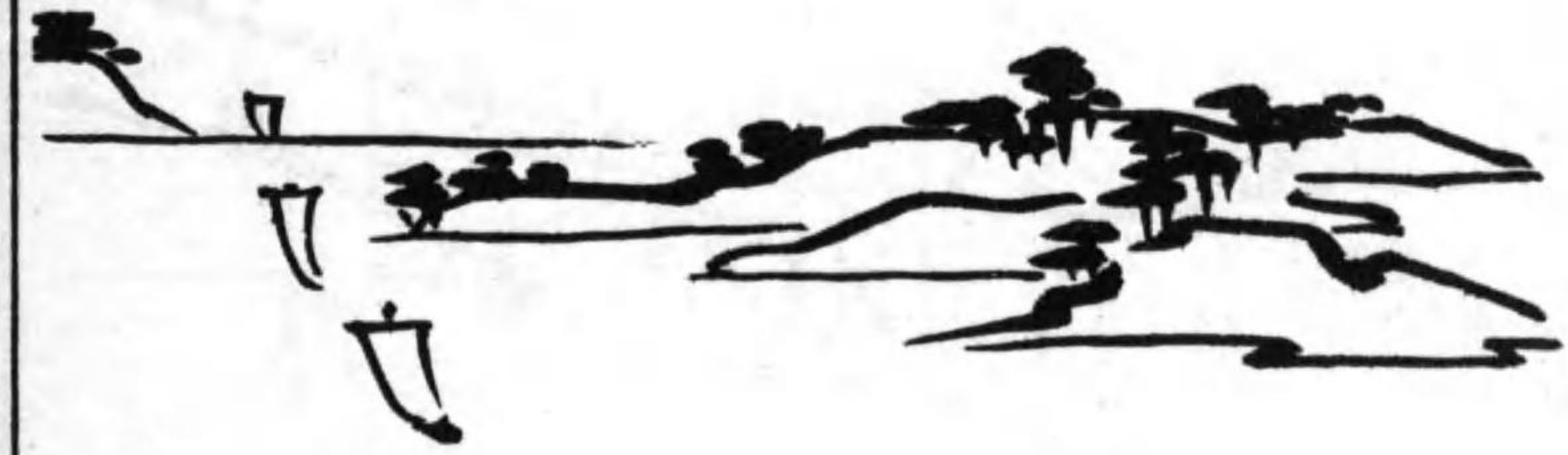

渡守



樵歌



火山



湖邊の春



日暮





沙漠

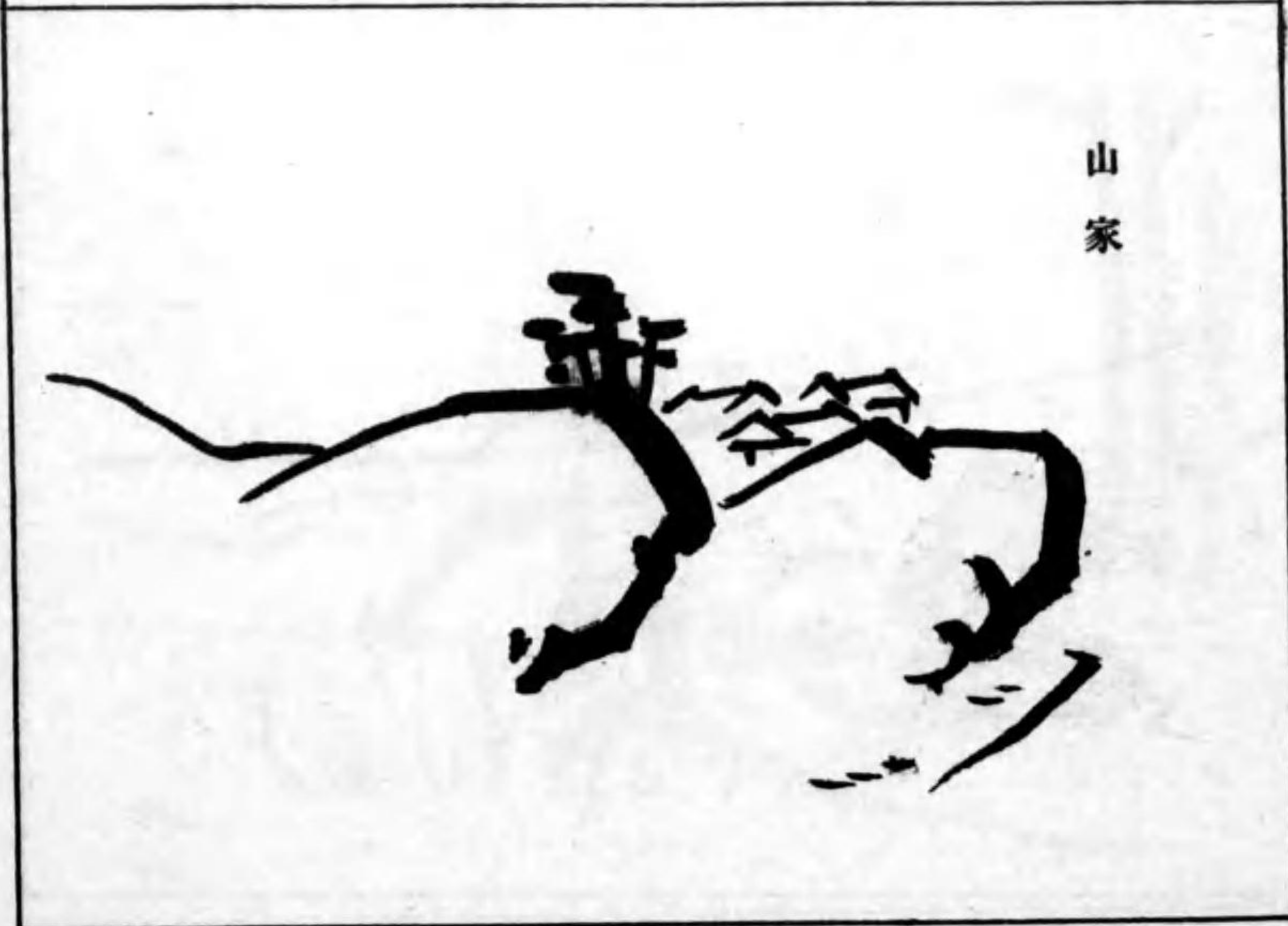

山家

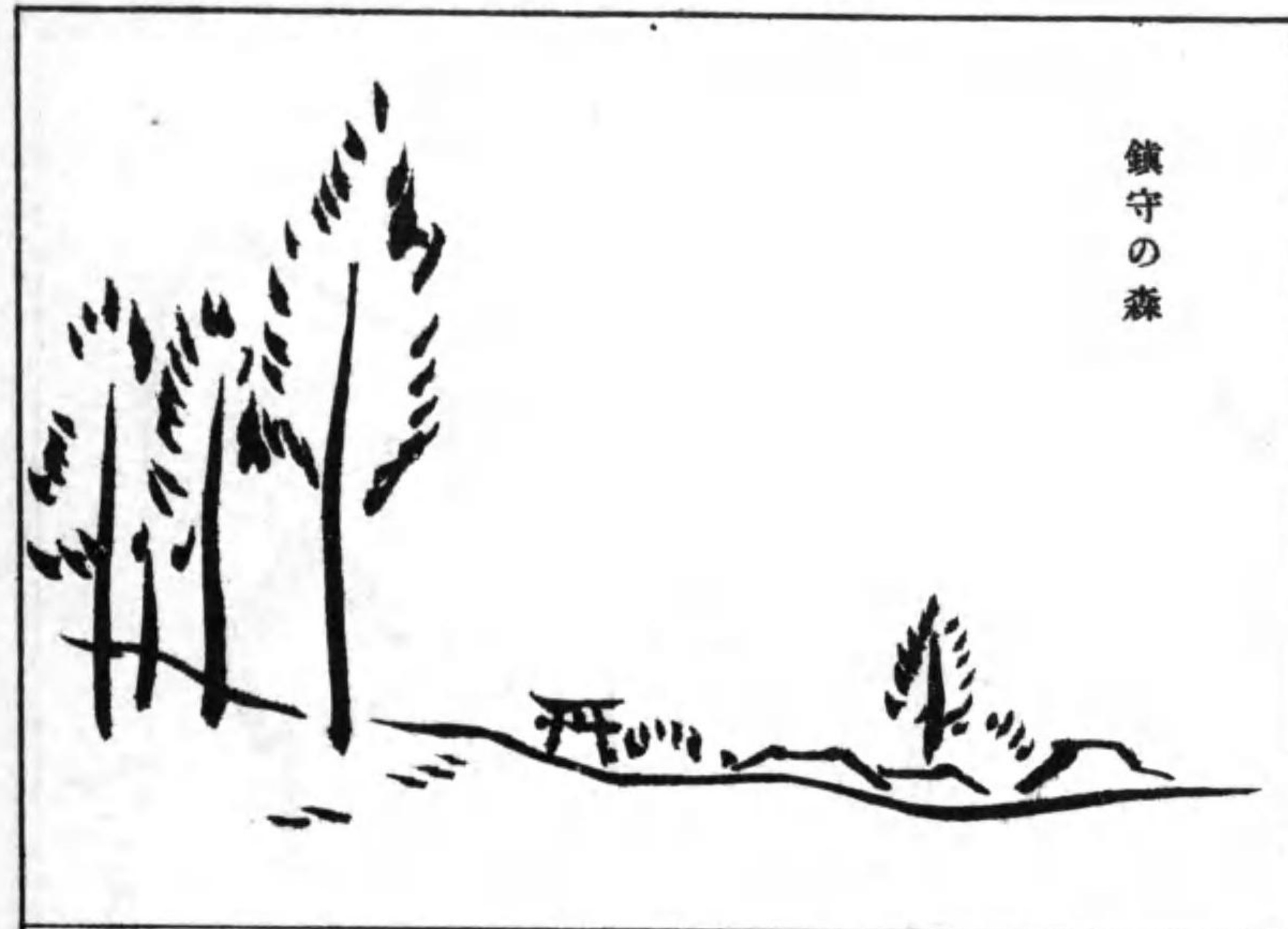

鎮守の森

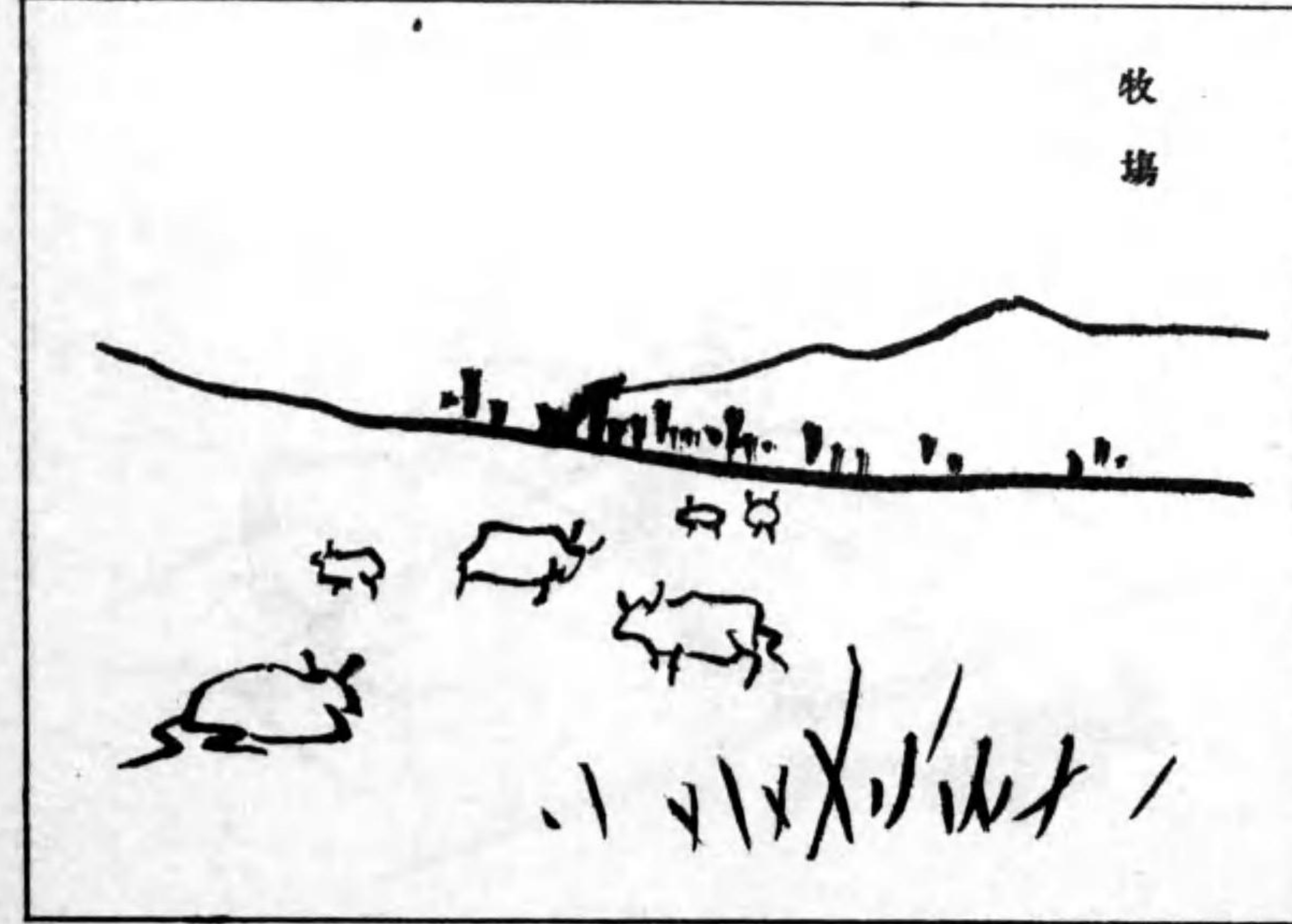

牧場



瀑布



晚秋



晚鴉

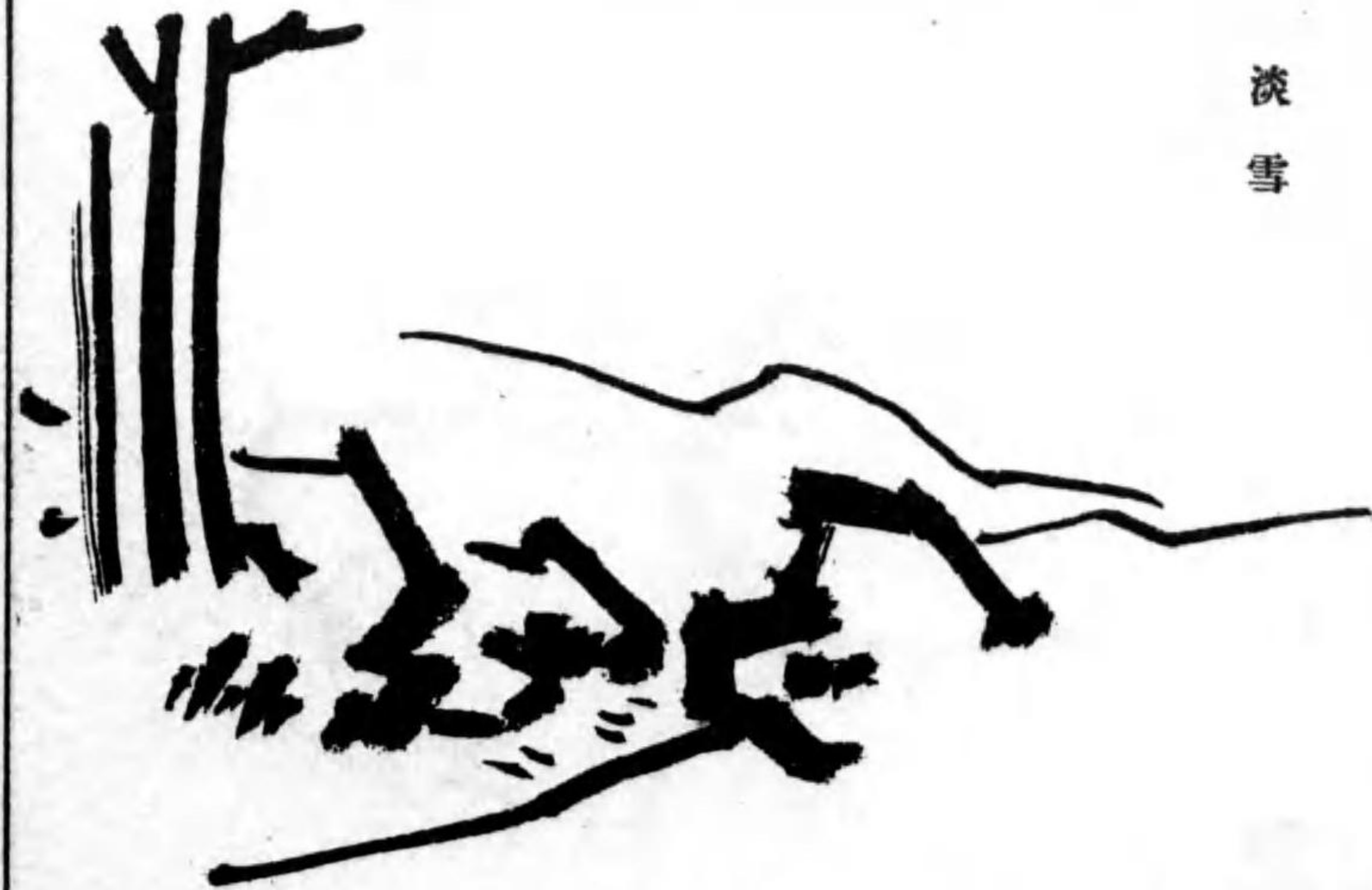

淡雪

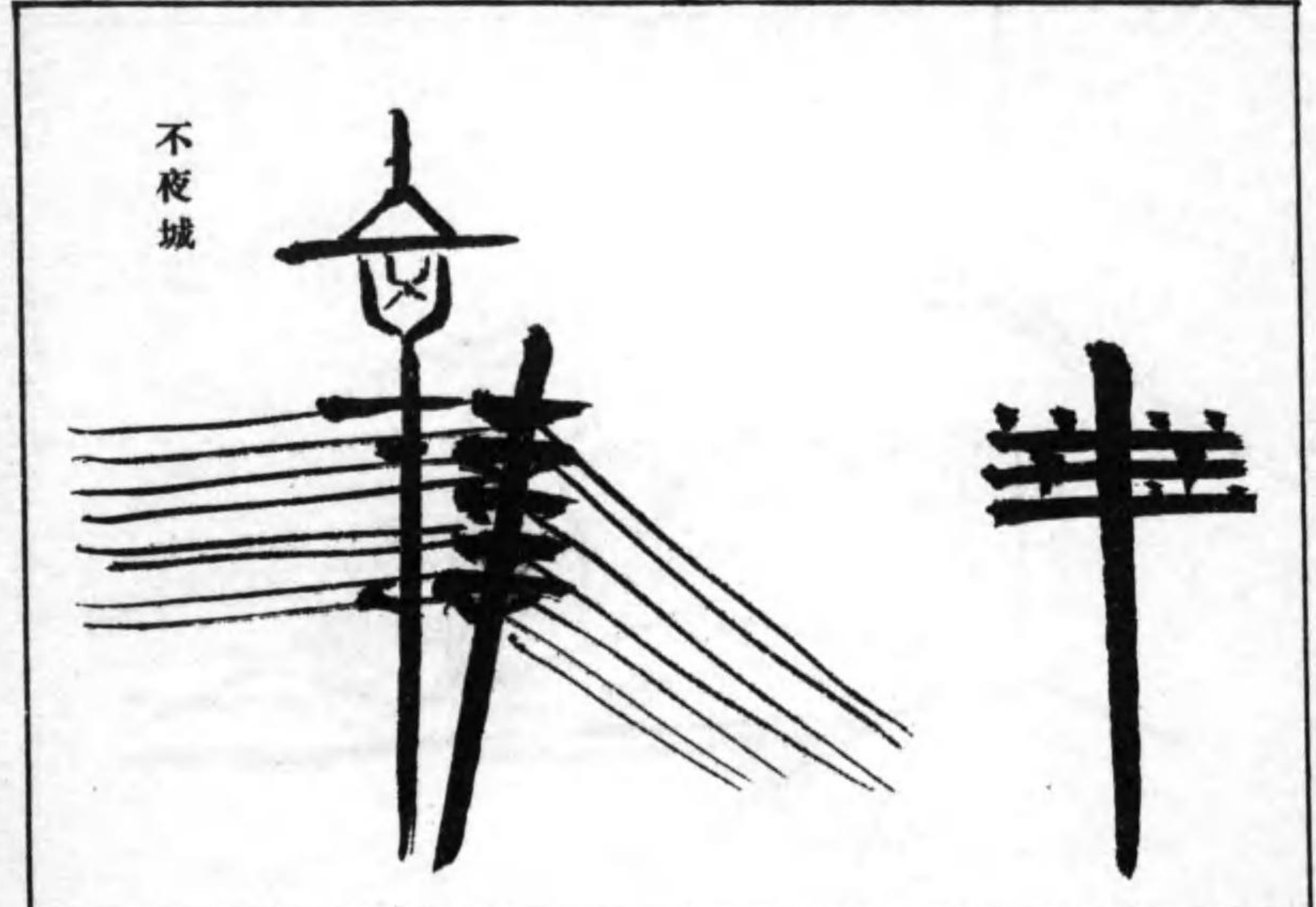

不夜城

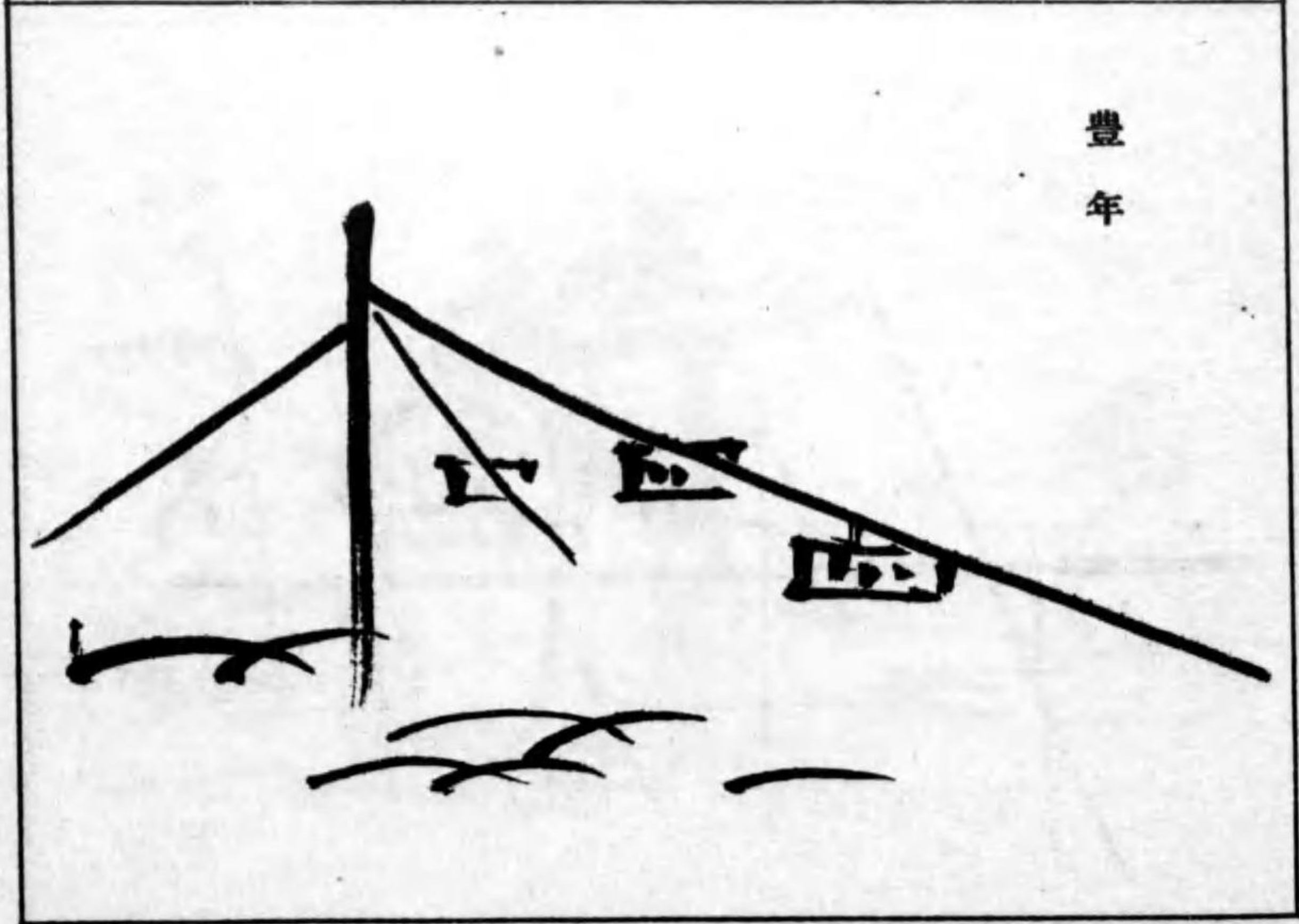

豐年

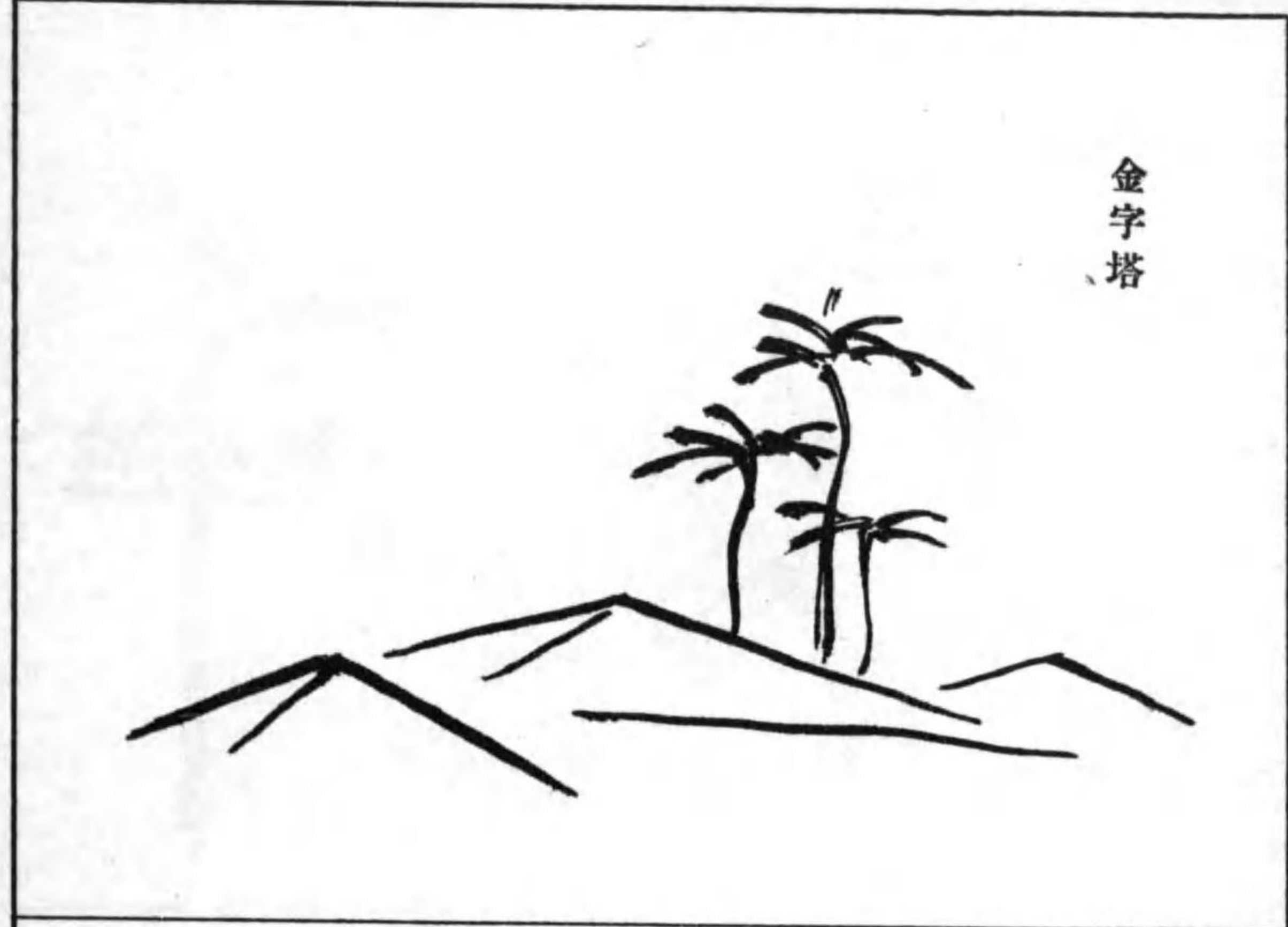

金字塔

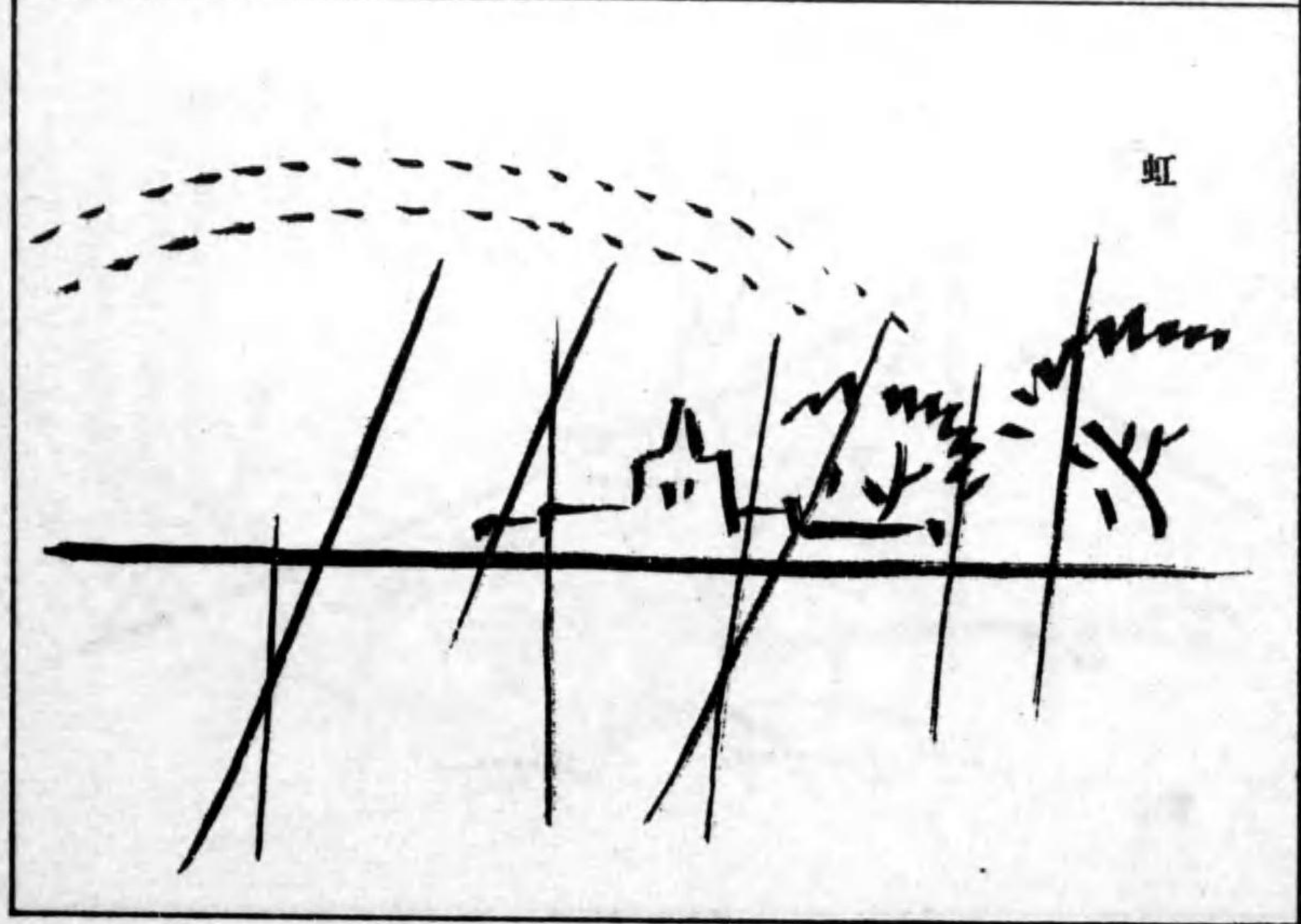

虹

橋立



嚴島



富嶽



松島



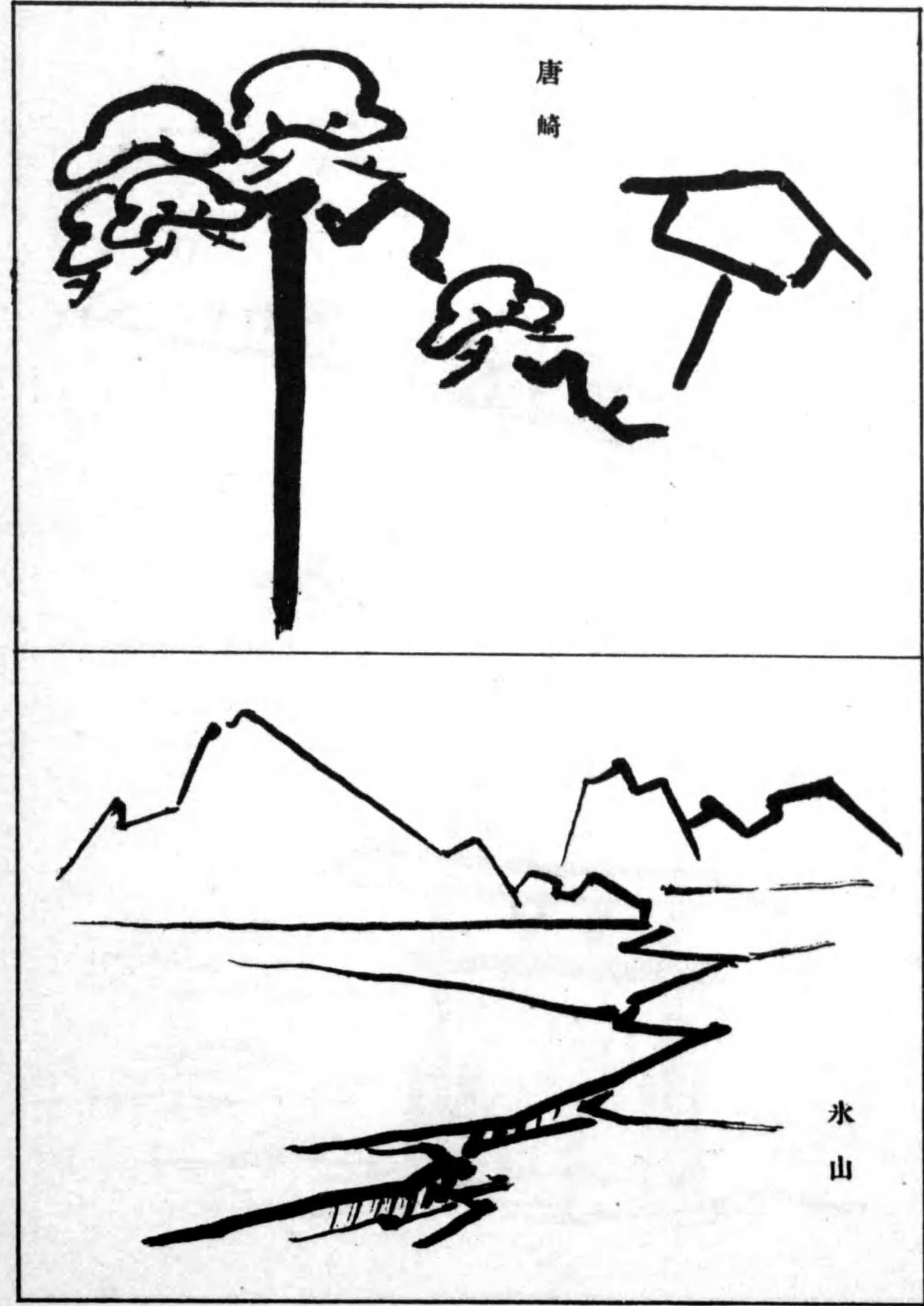

唐崎

氷山

其九

獸

類

犬



栗鼠

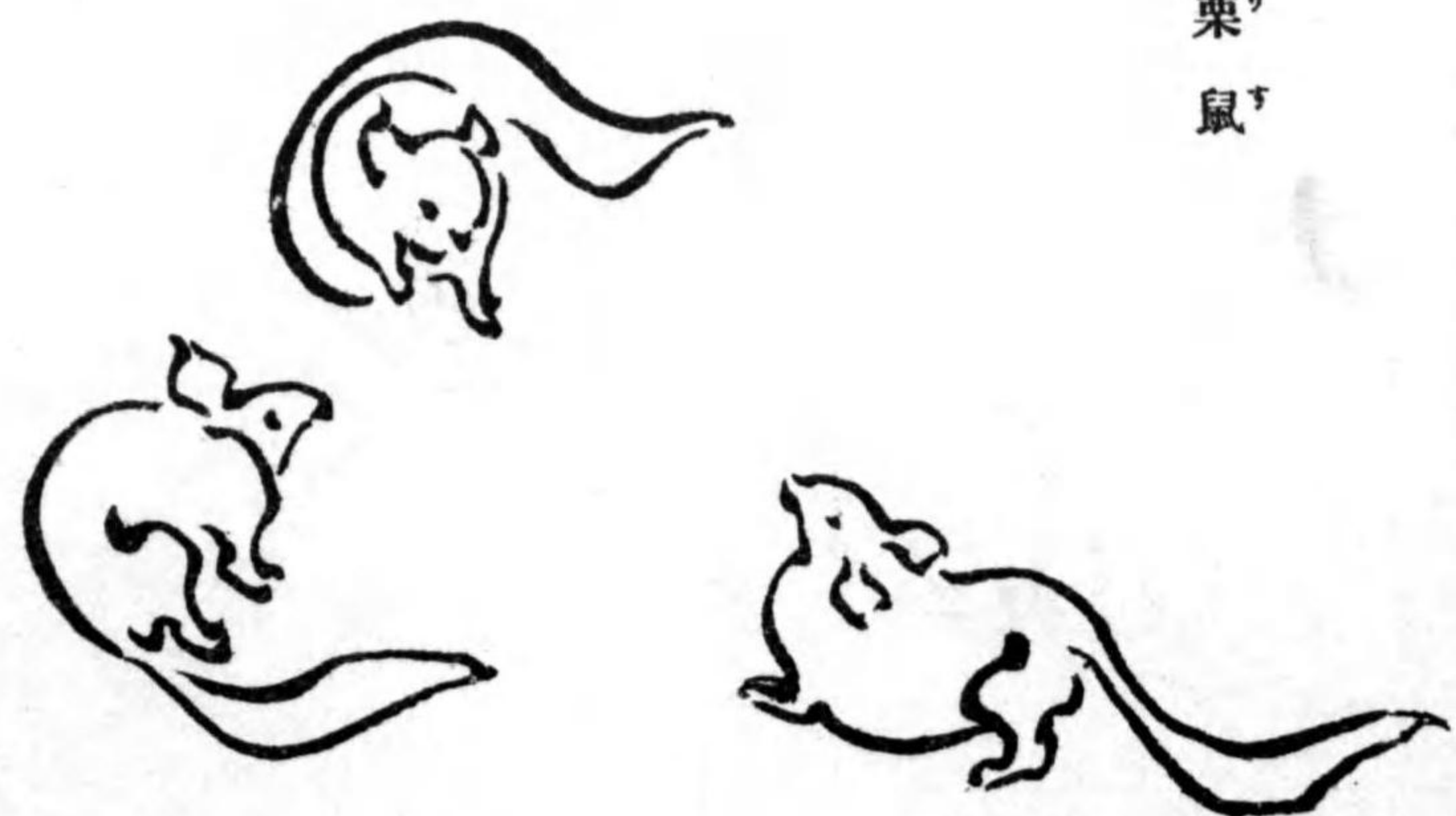

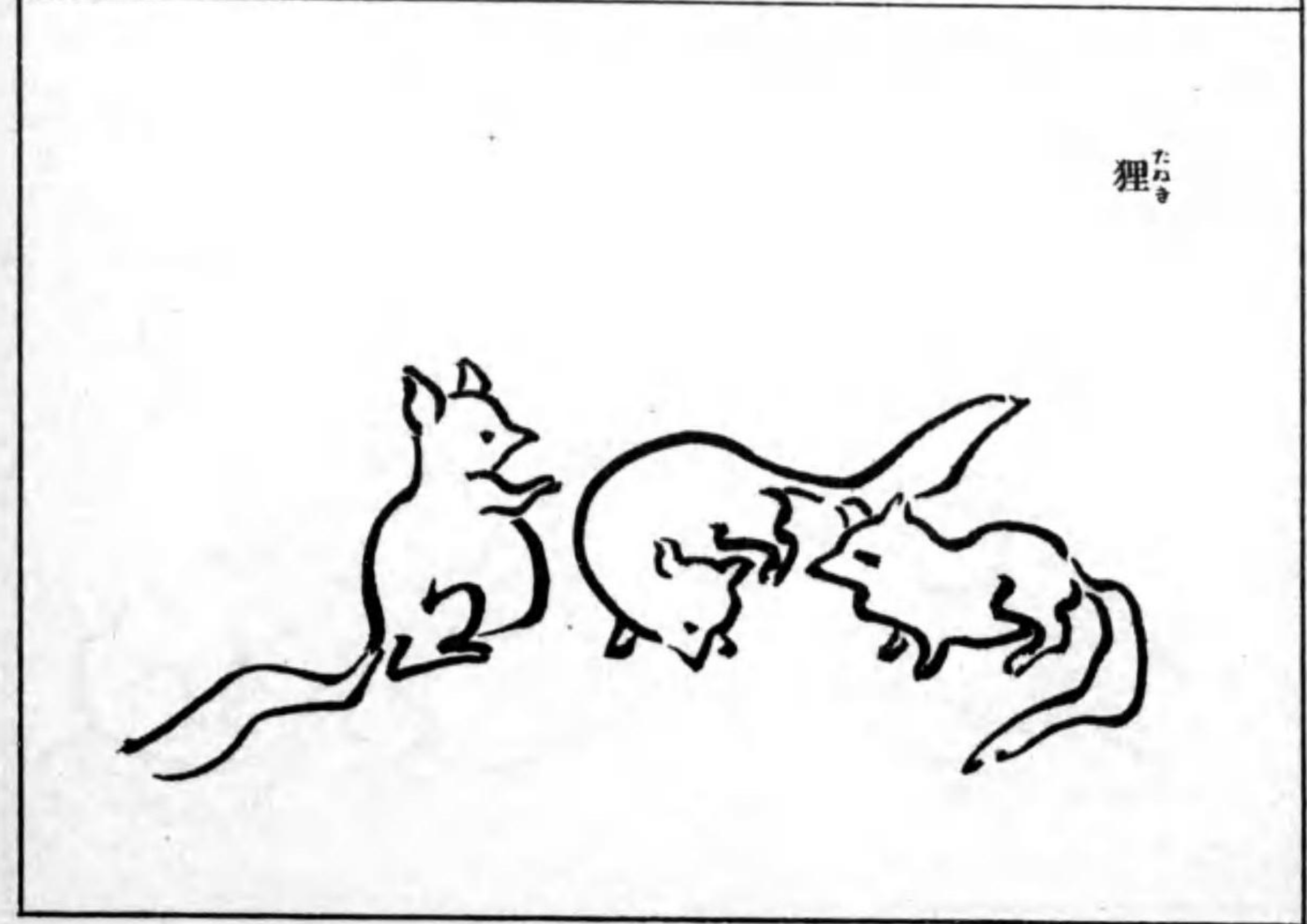
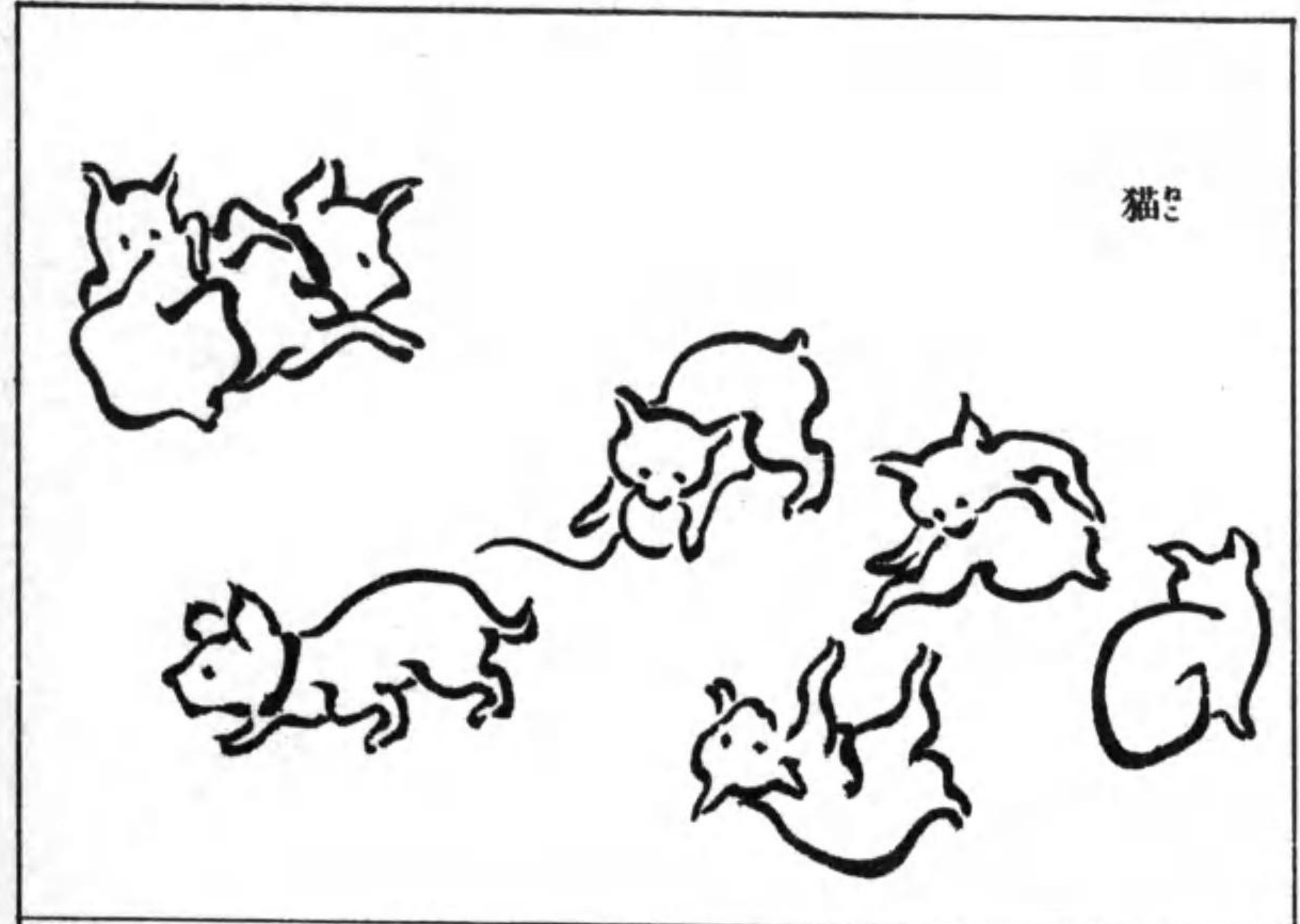
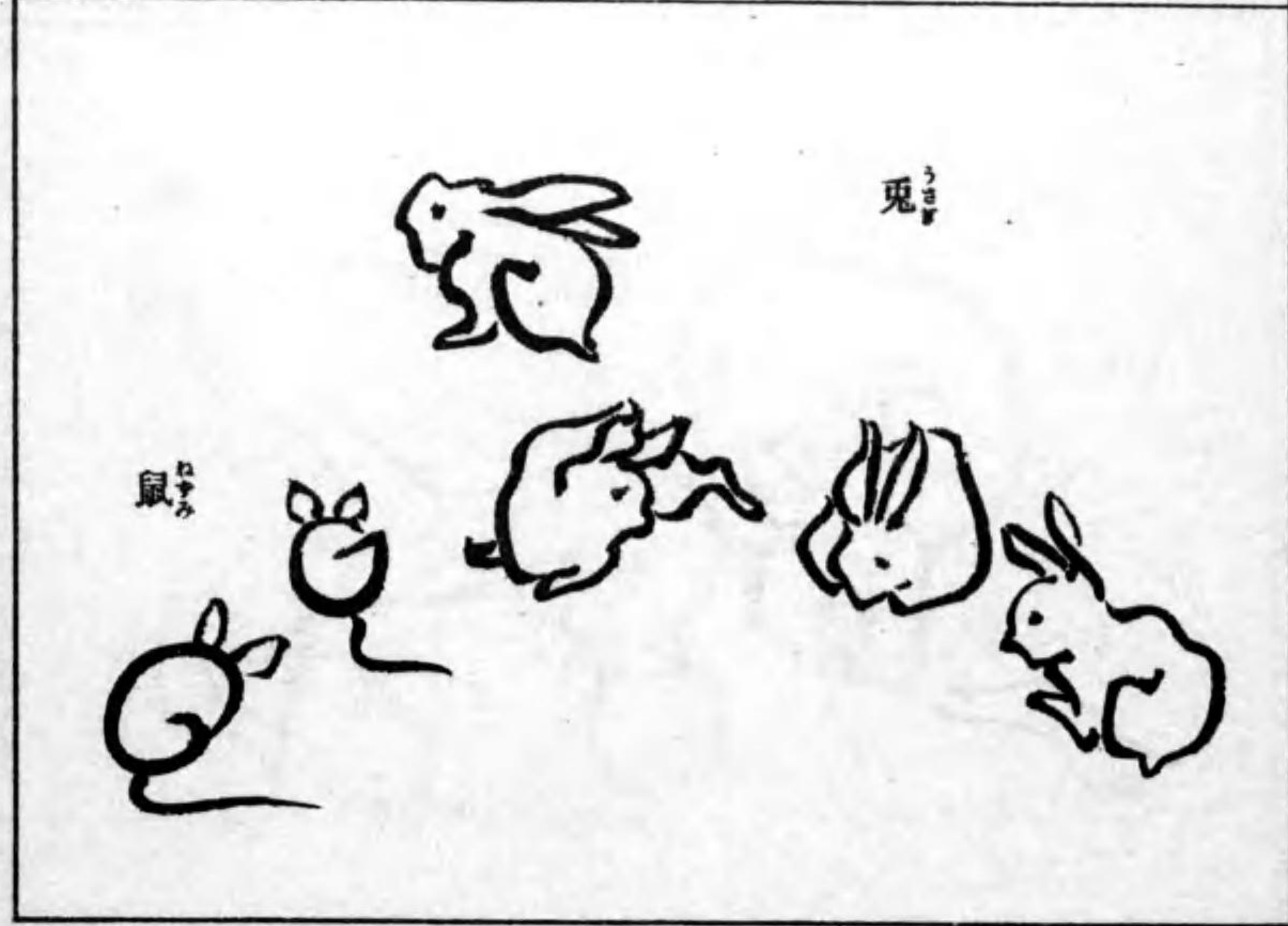
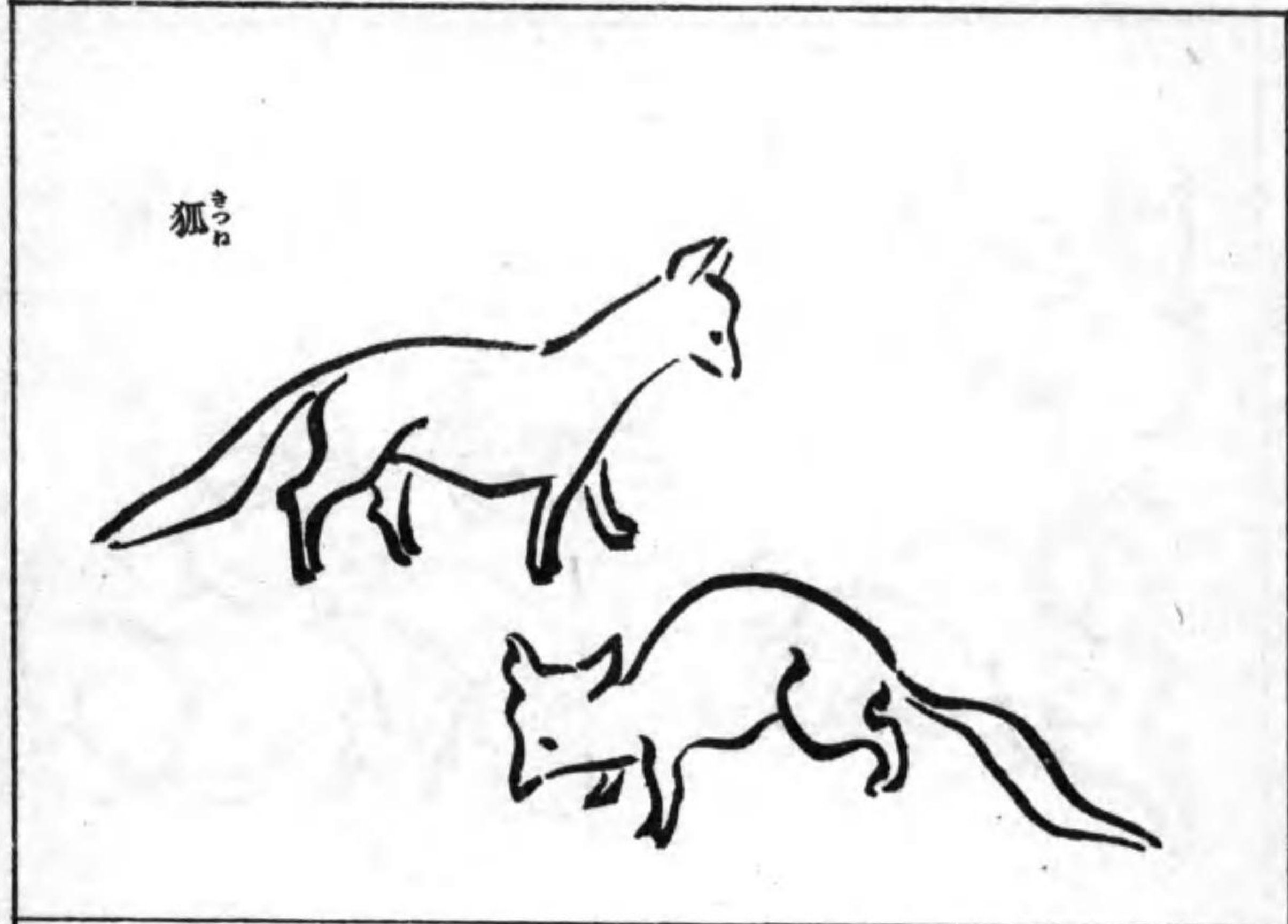

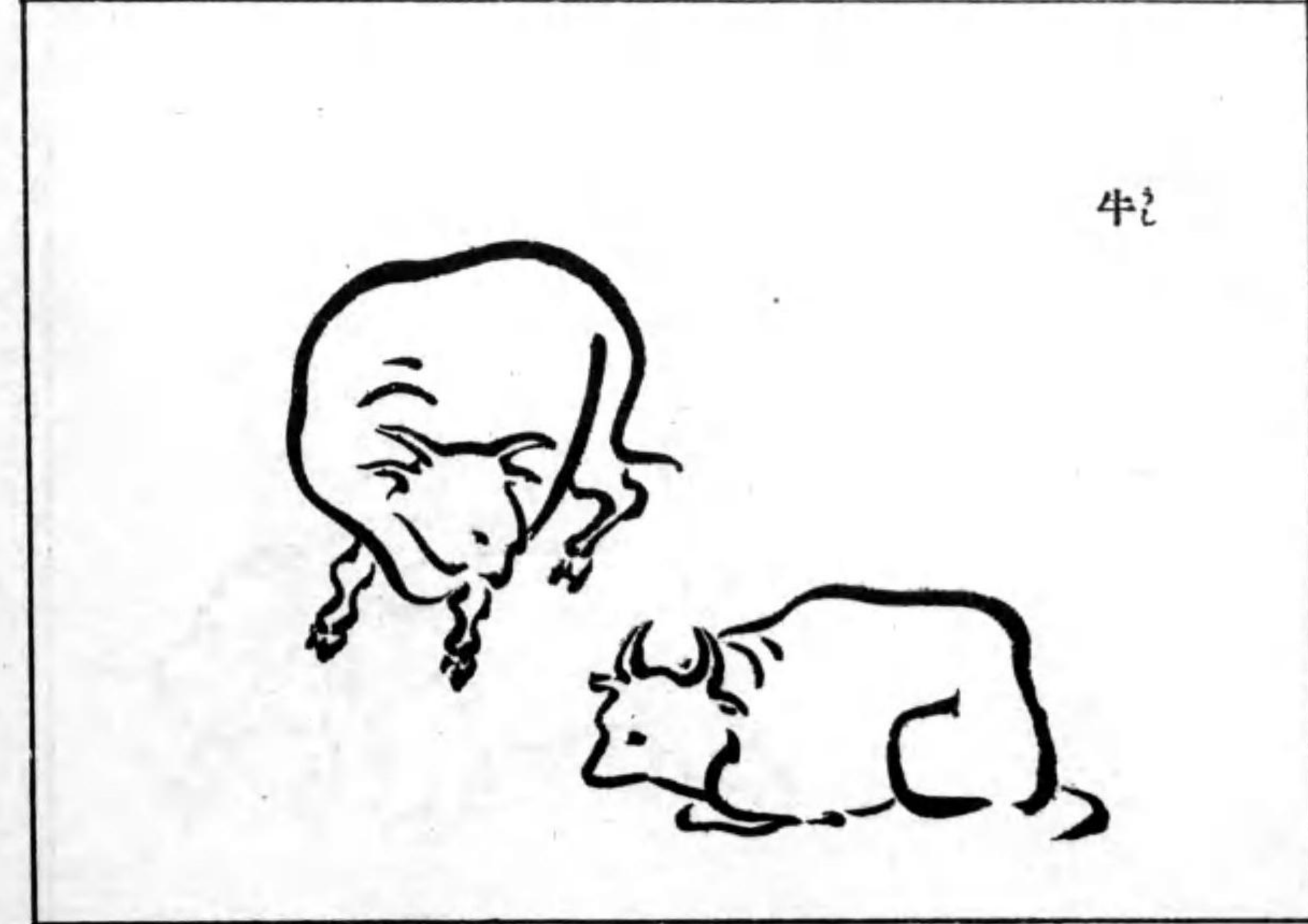
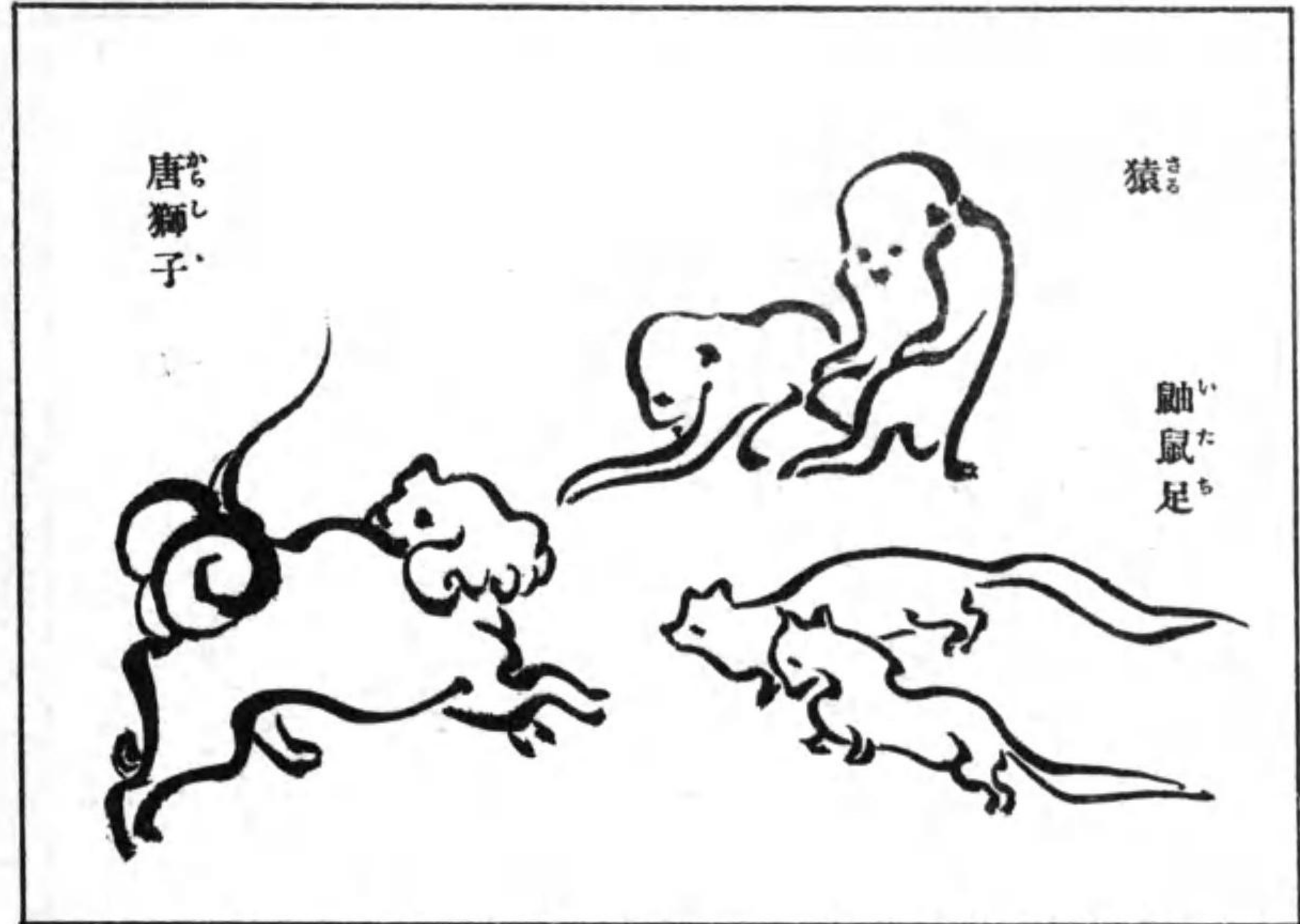
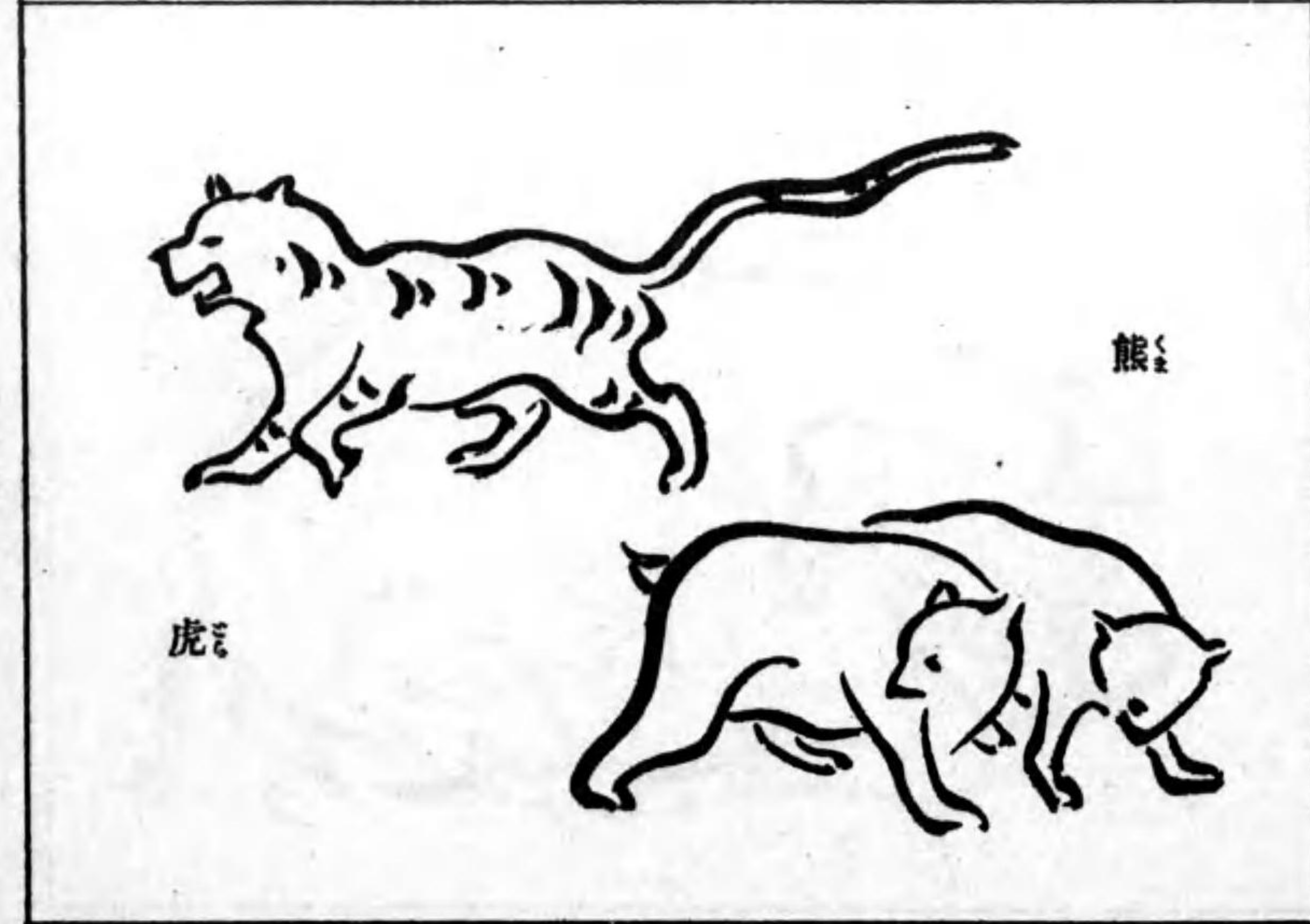
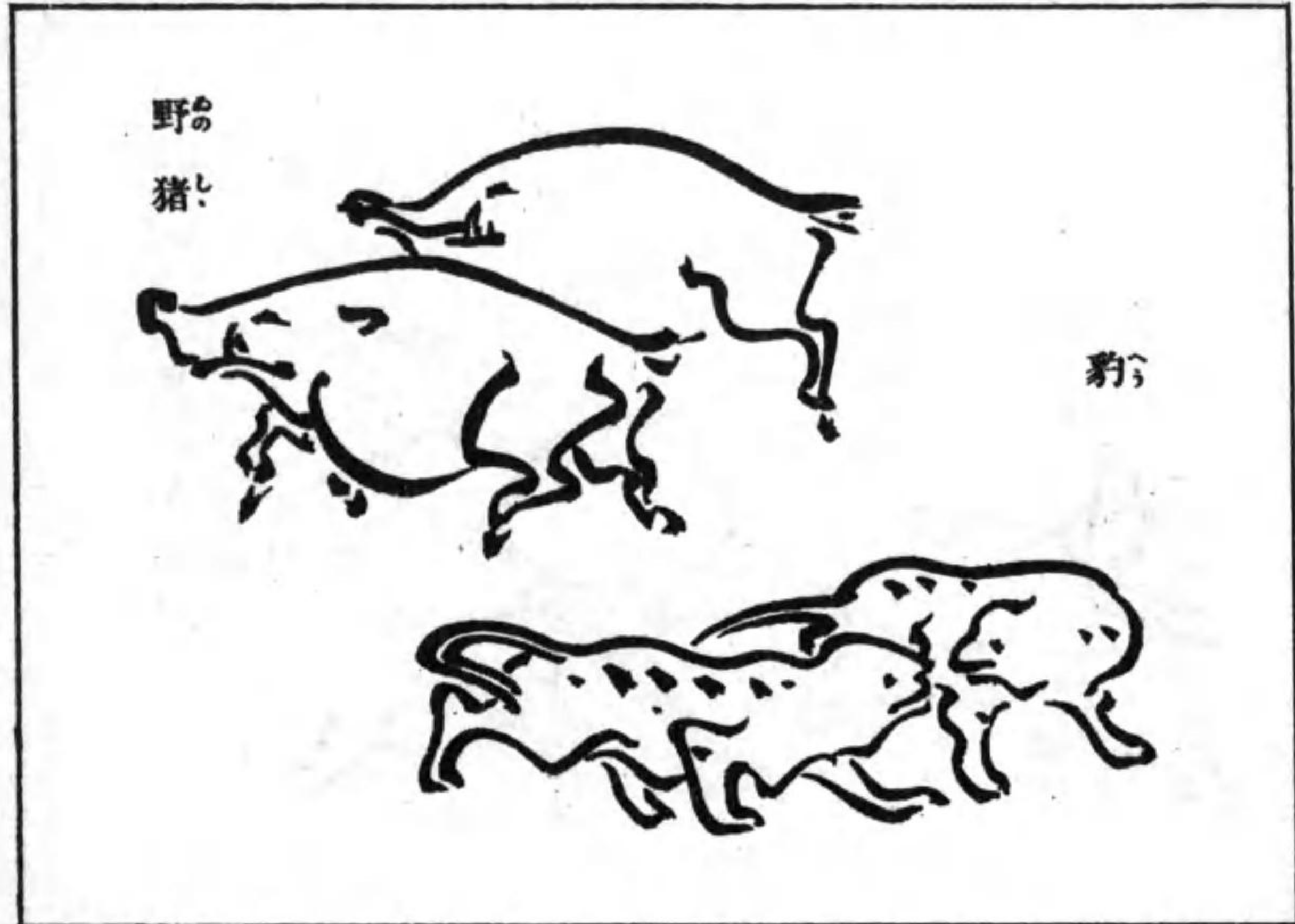

鼯鼠ウツクサ



鼯ウツクサ



豚ブタ



獅子シシ

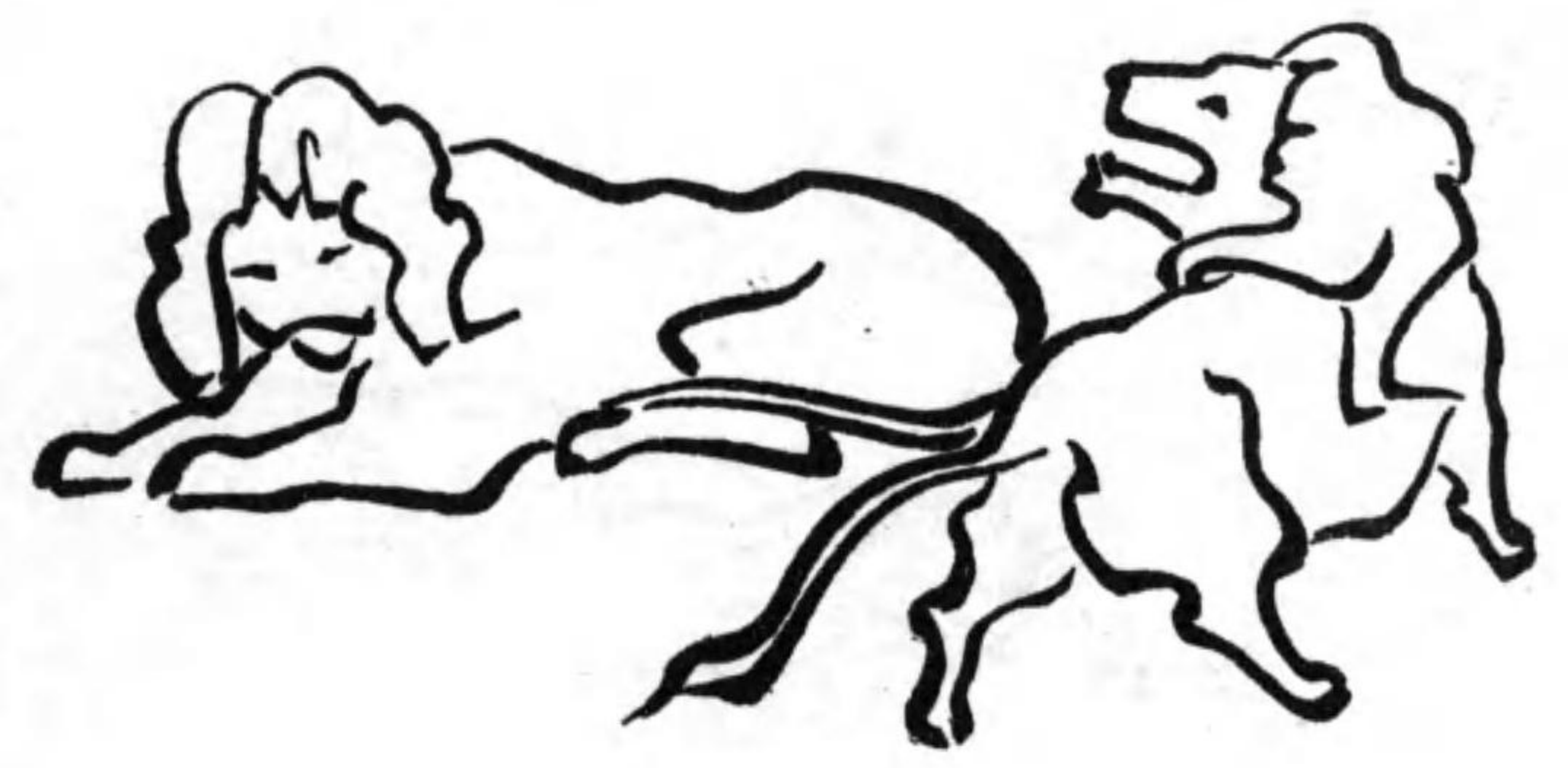

象ゾウ

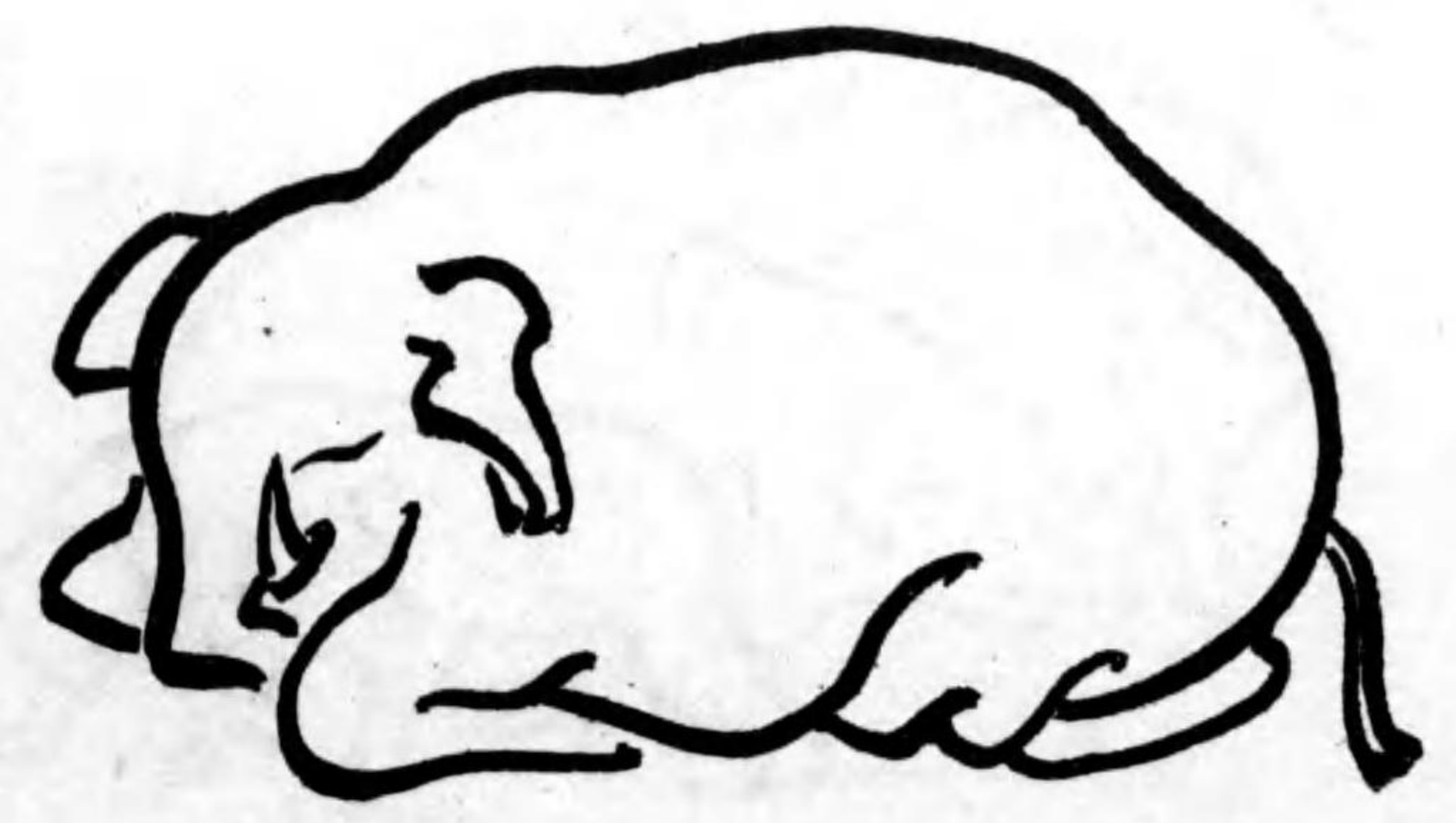

羊

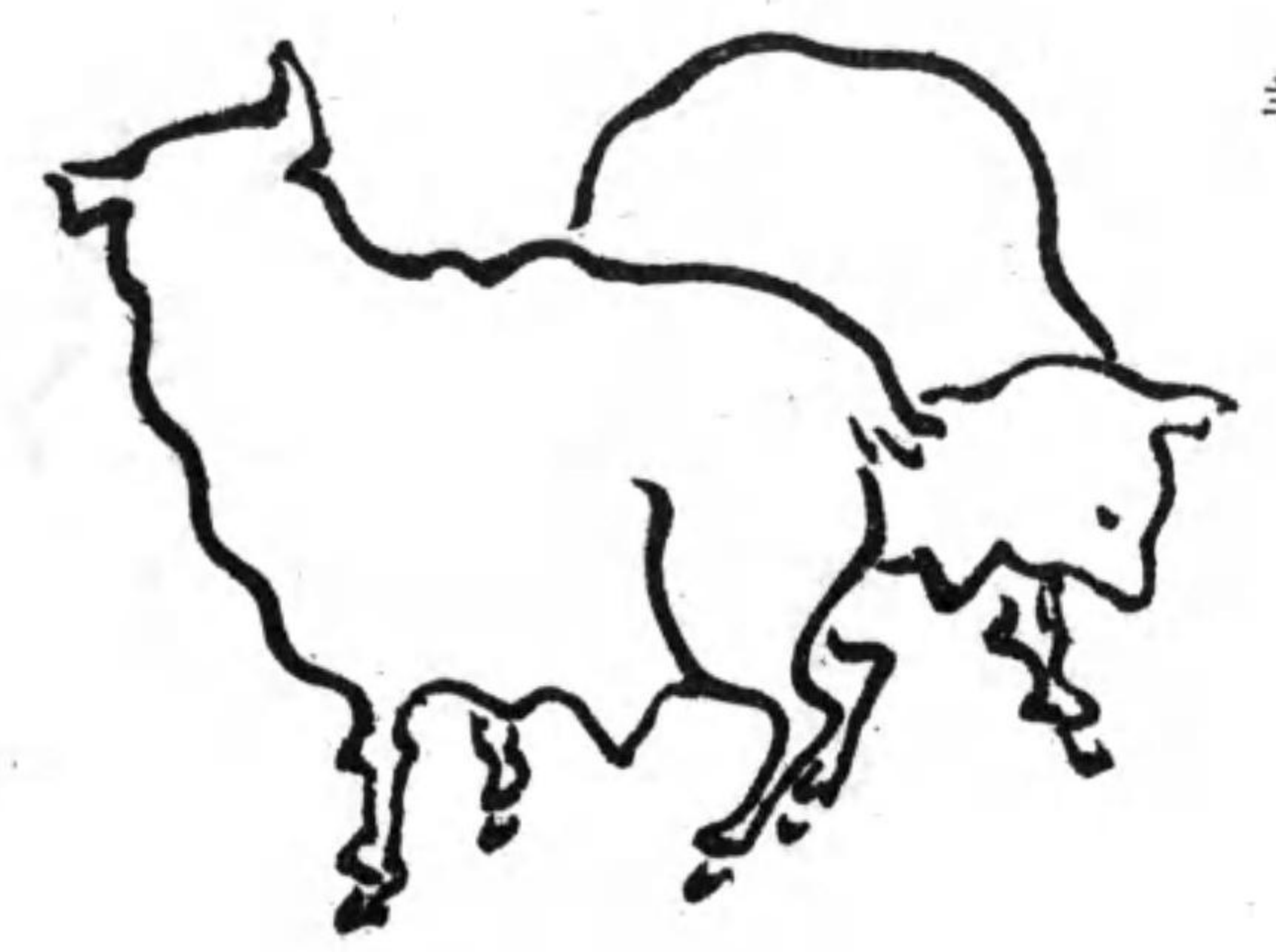

山羊

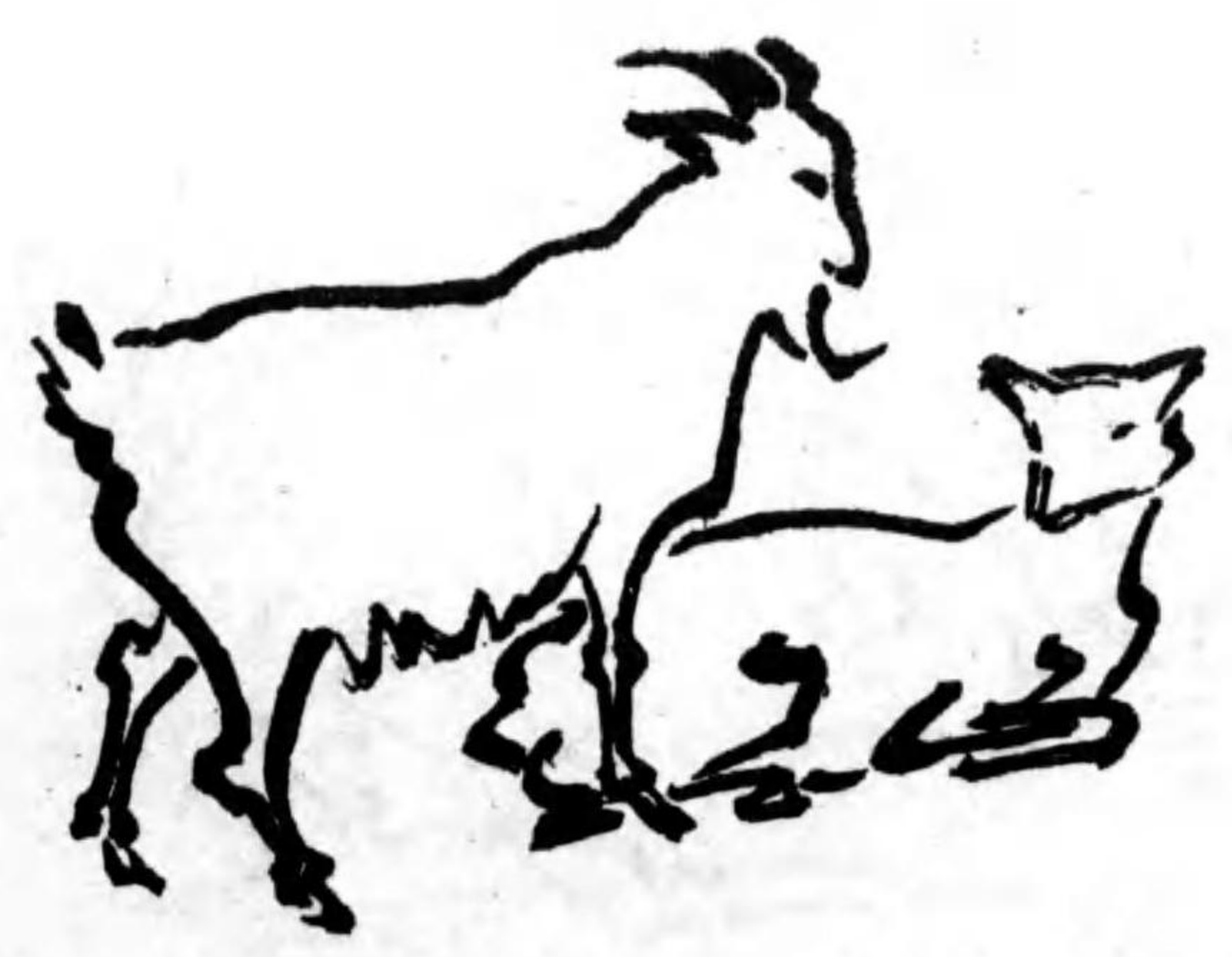

駱駝



袋鼠



蝙蝠かぶつ



鯨くじら



狼おほかみ



猿さる

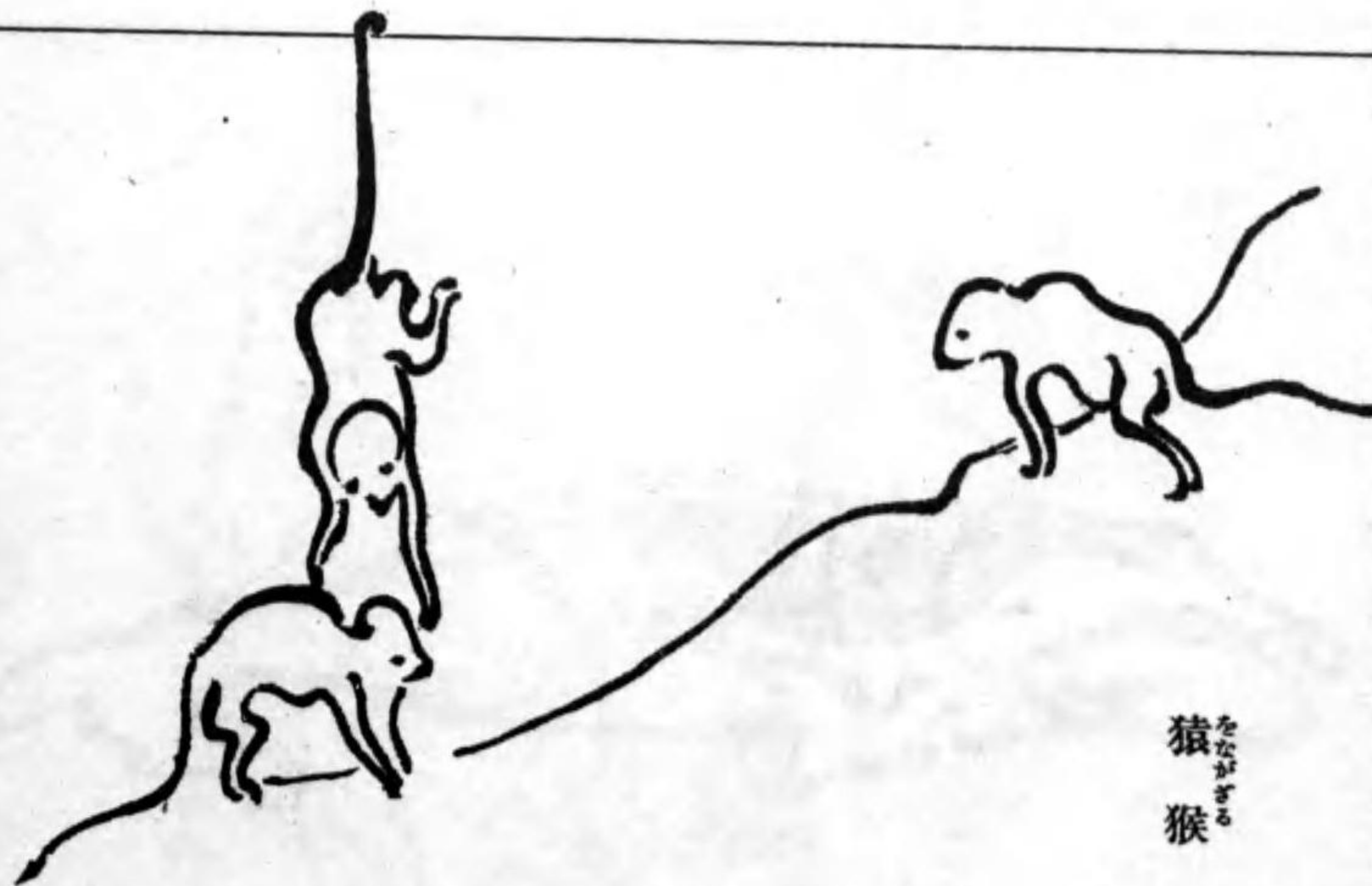

海豹ウシクジ



犀ウシ

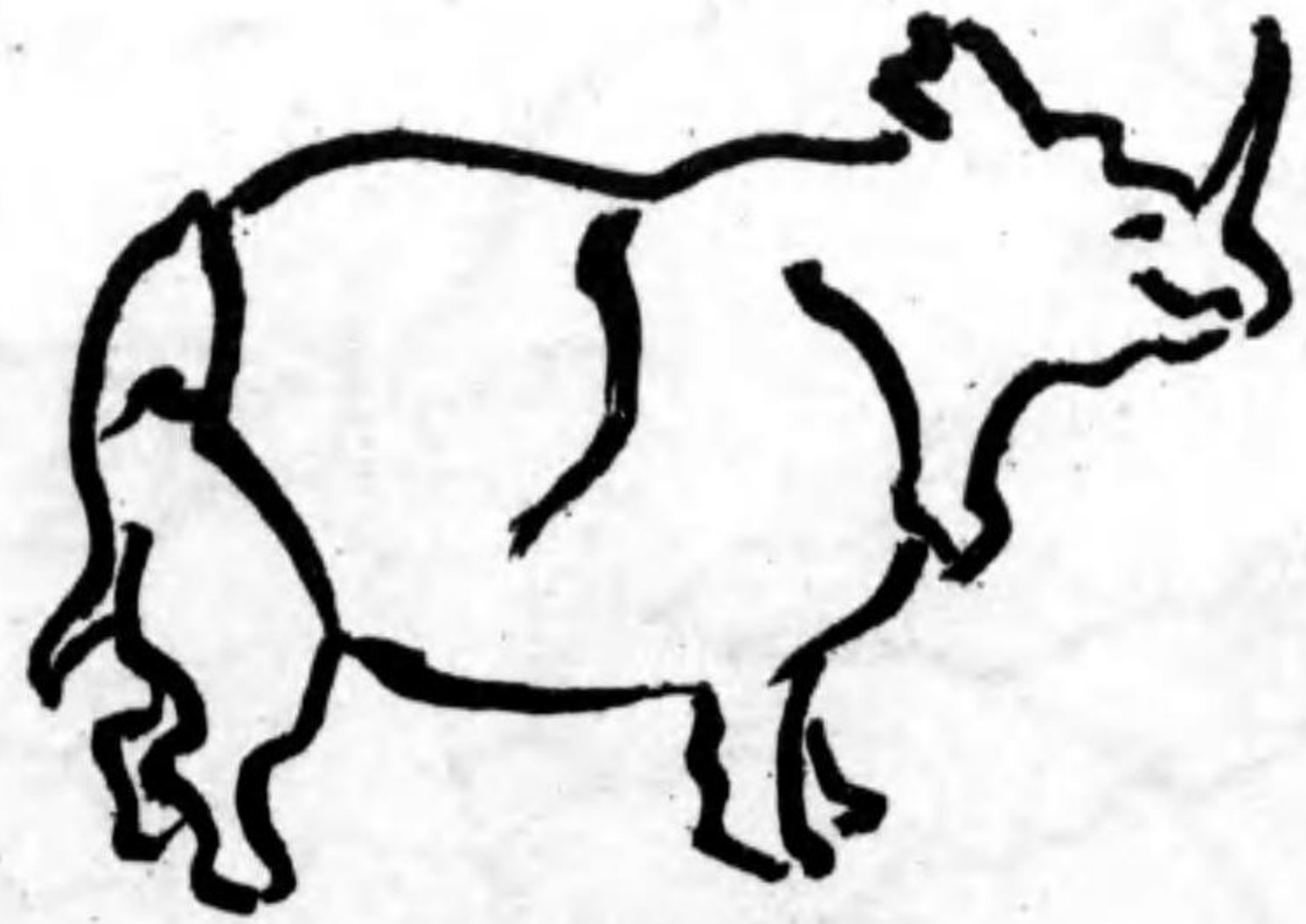

海鹿ウシクジ



犀豚ウシクジ

犀虎ウシクジ

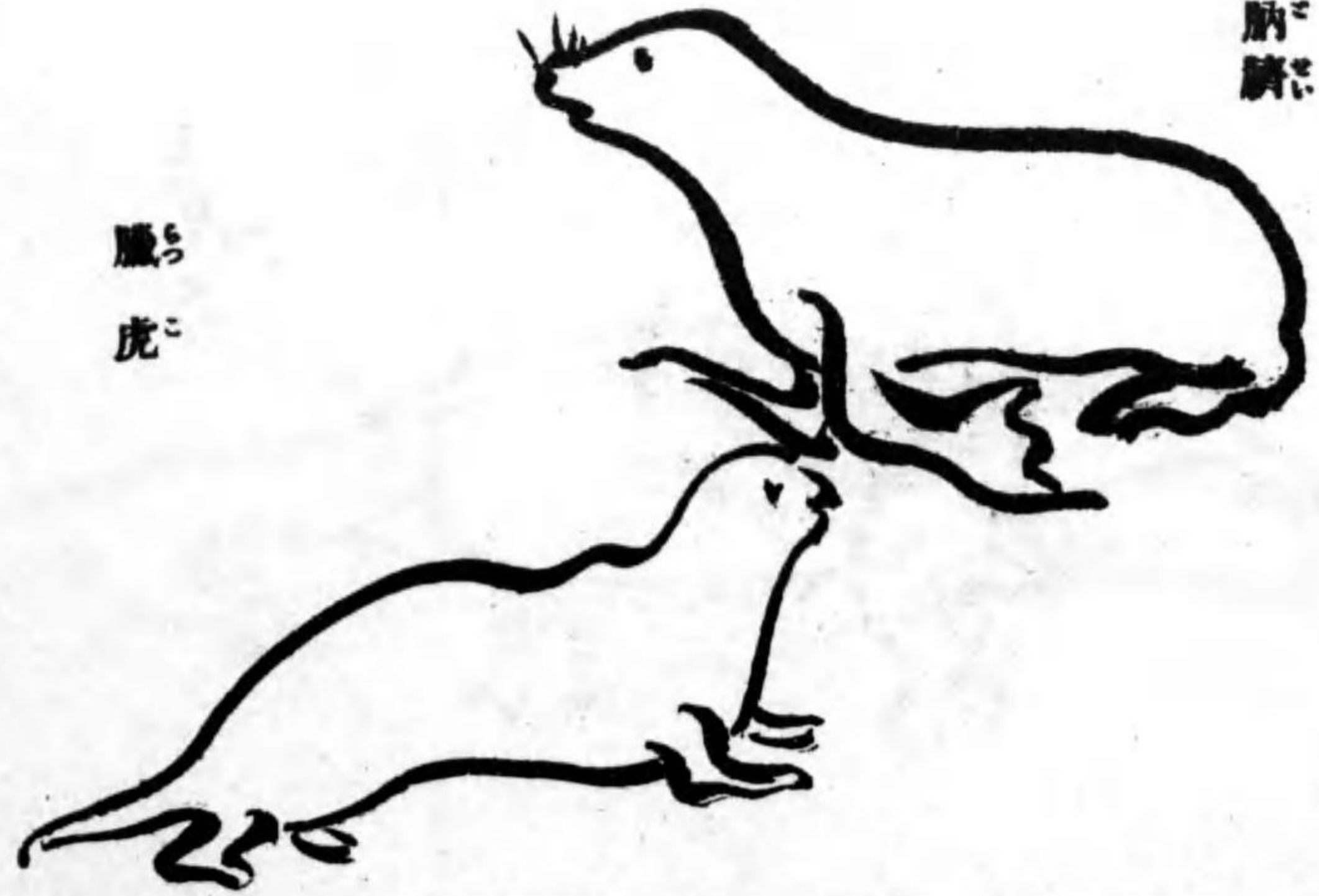

馬二

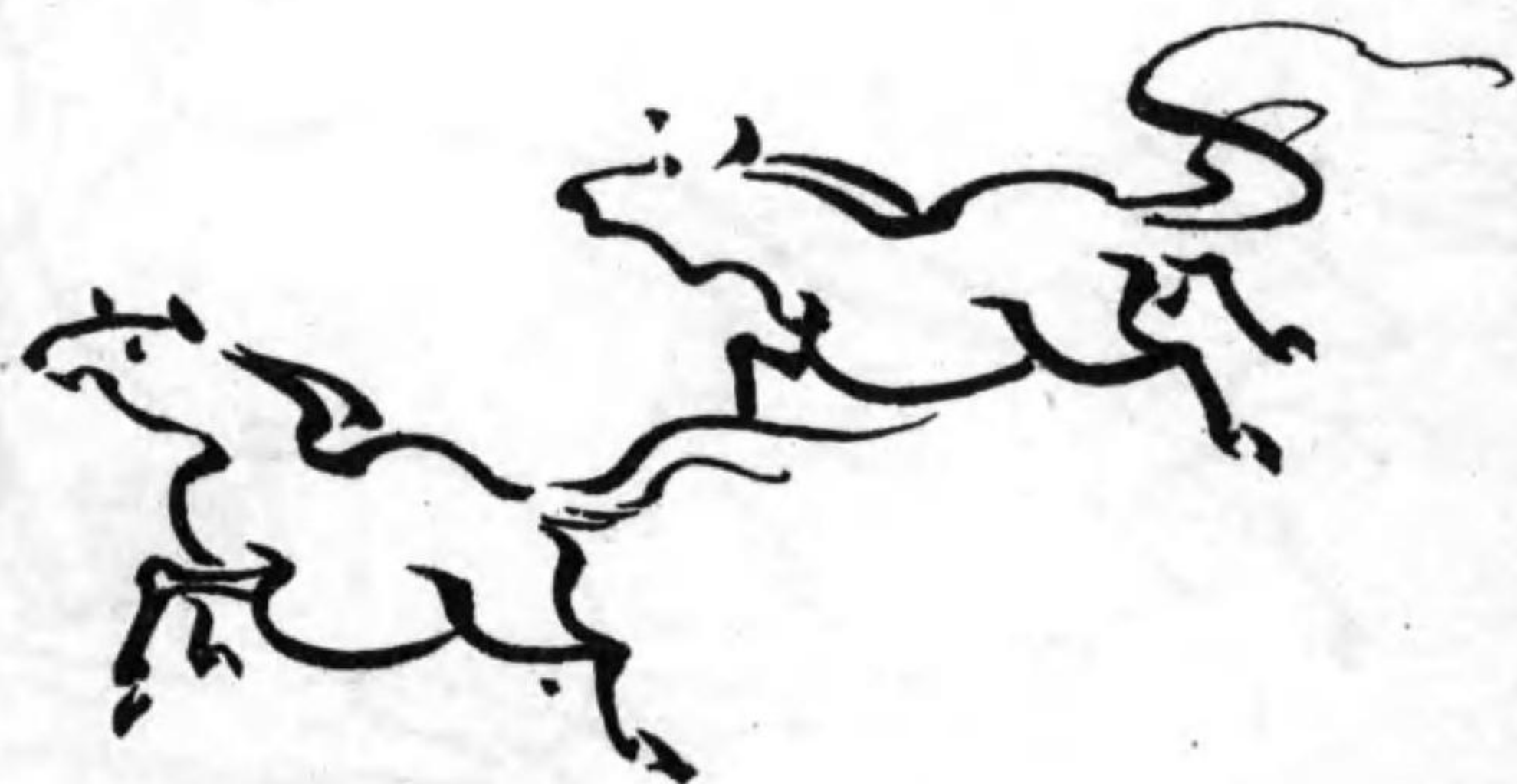

鹿

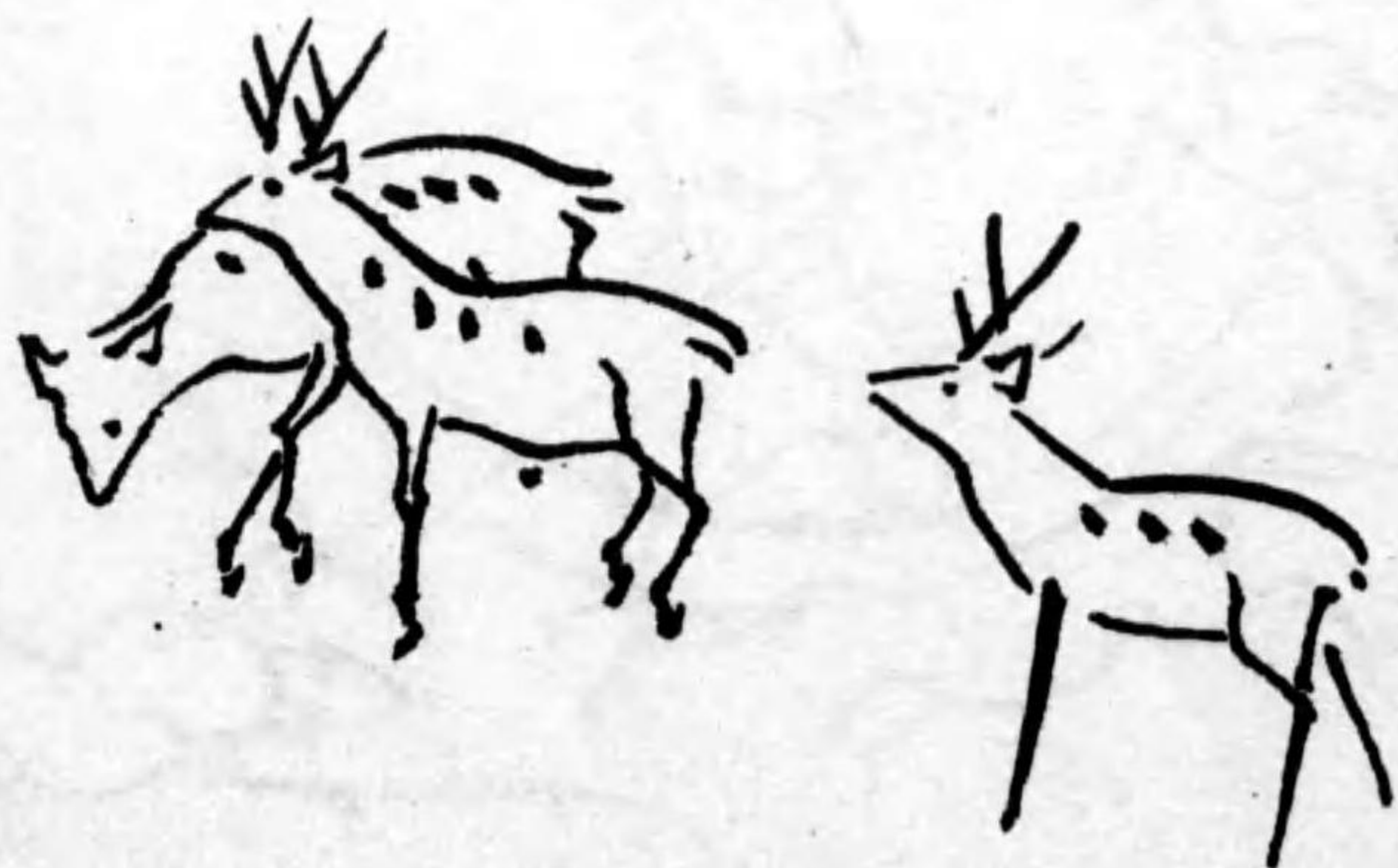

馴鹿

麒麟



馬一

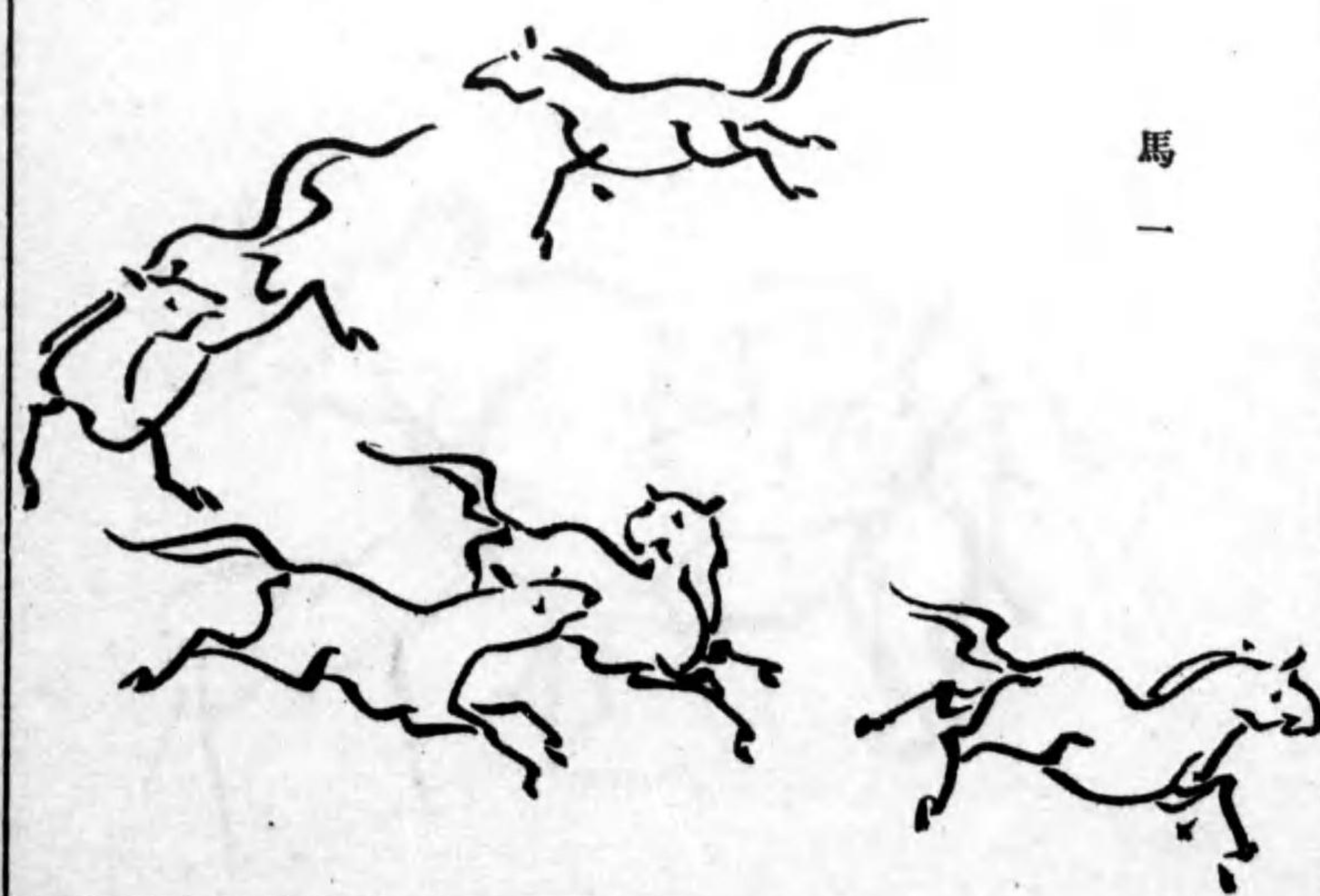

其十
鳥類

應用一



應用二



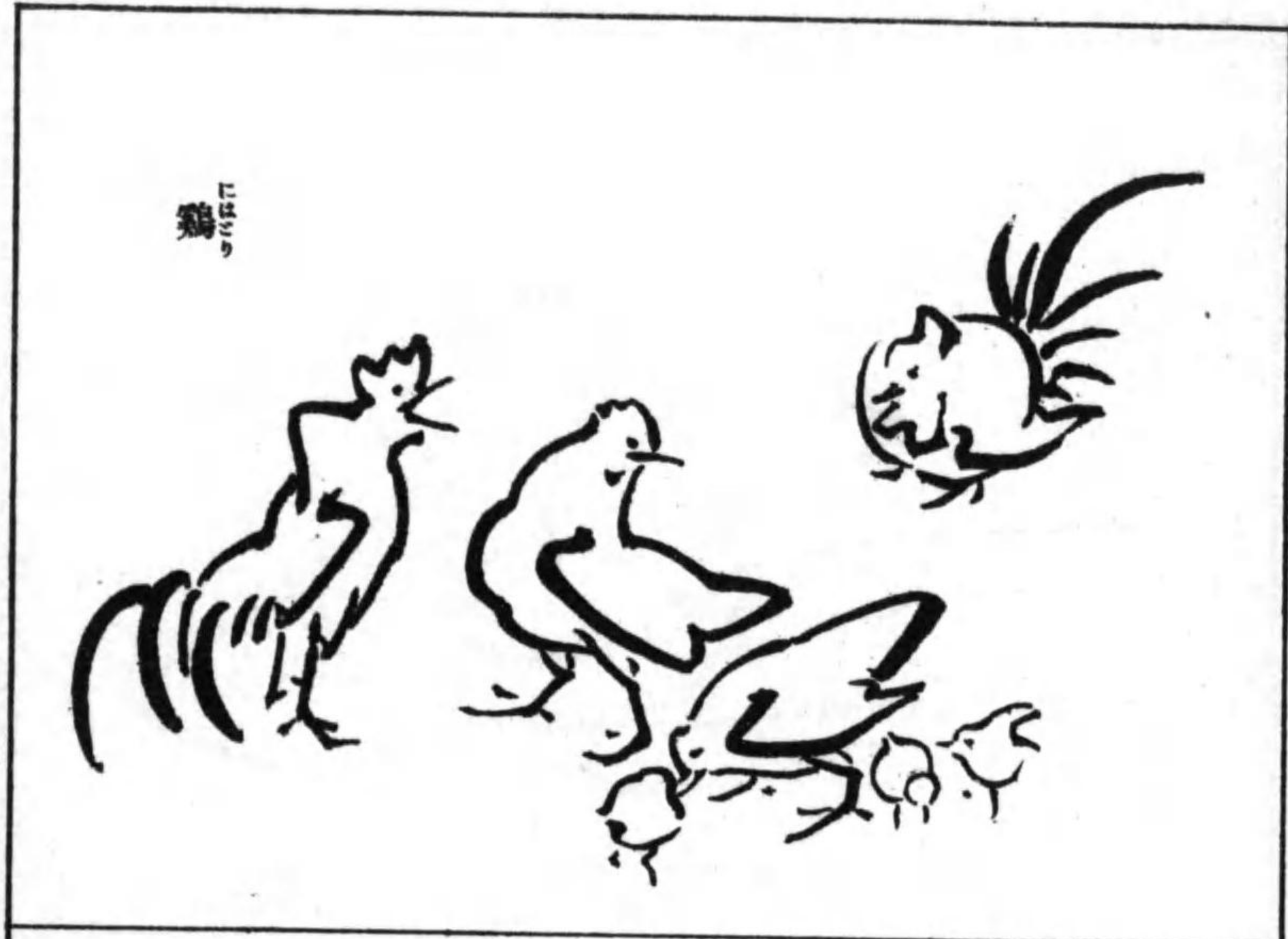

雞

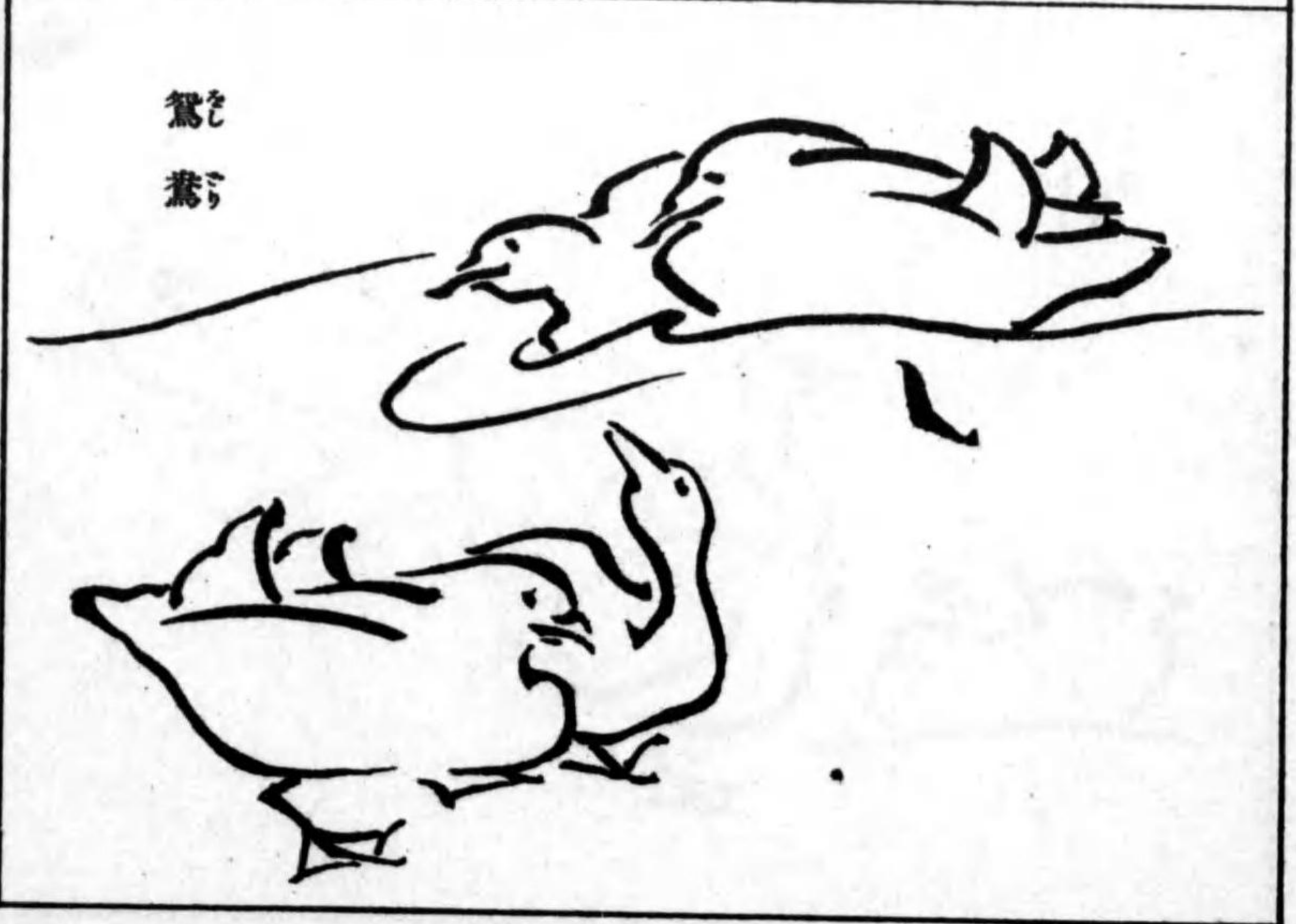

鴨
鵞

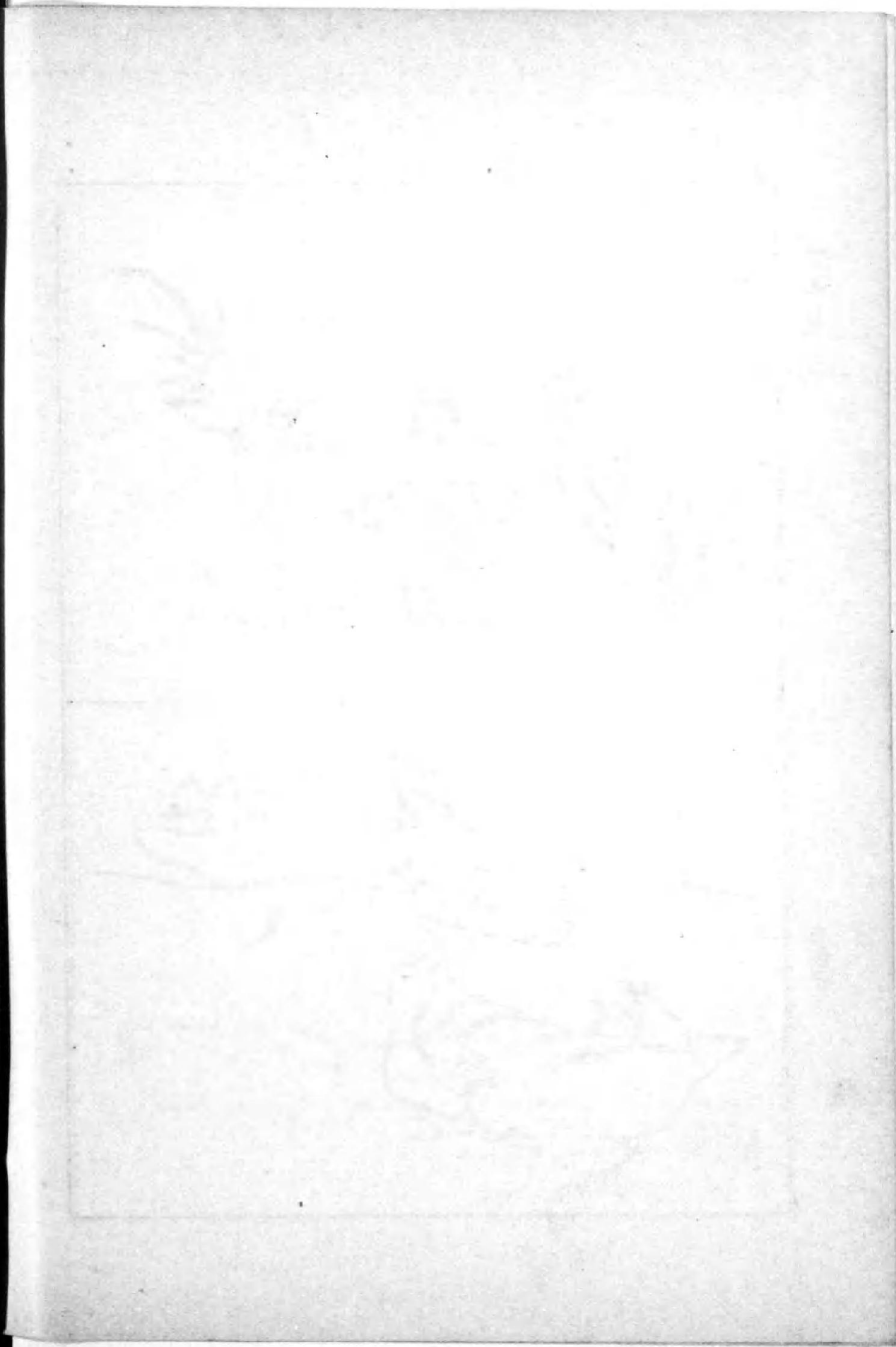

鴨

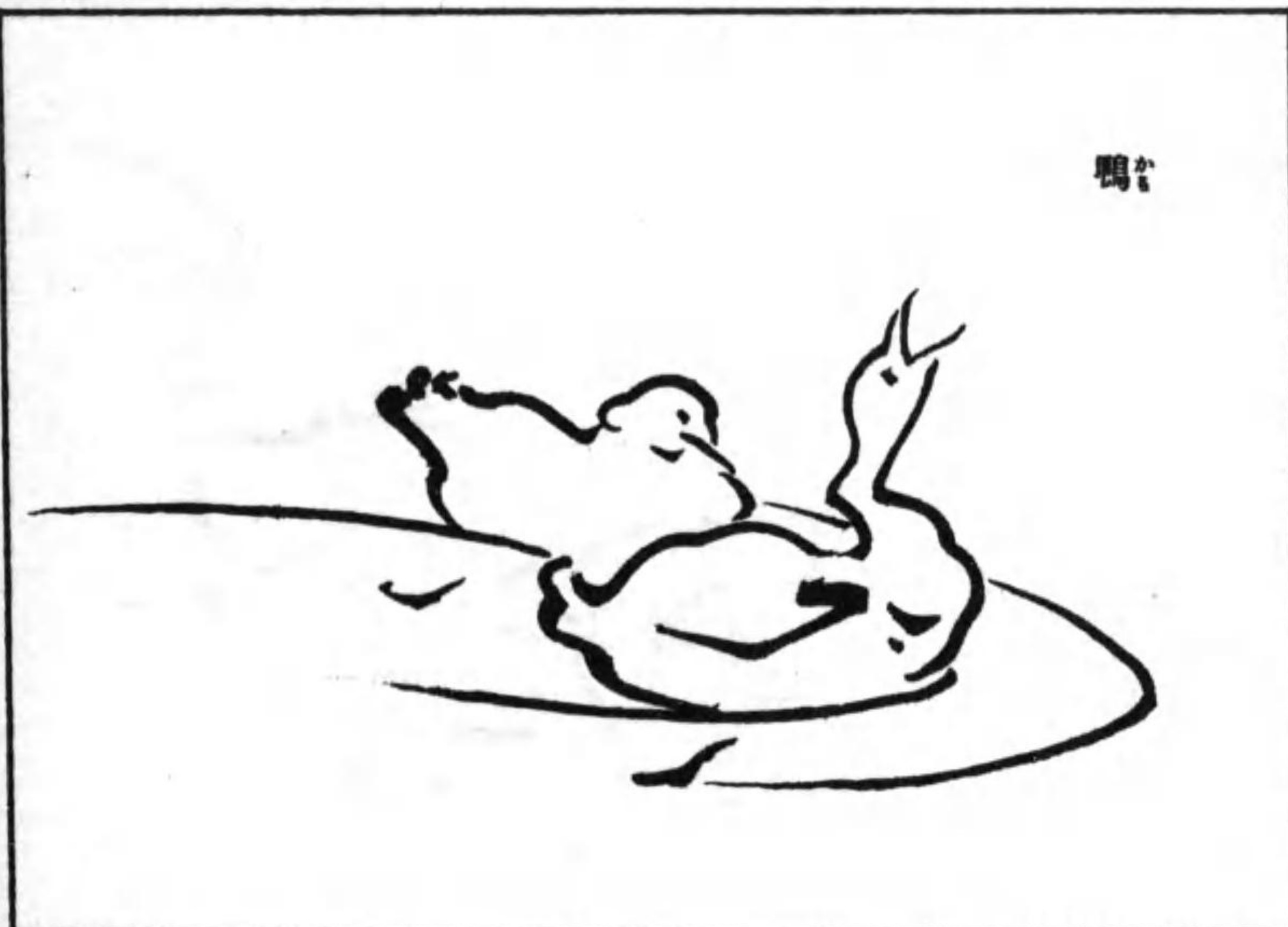

鴨

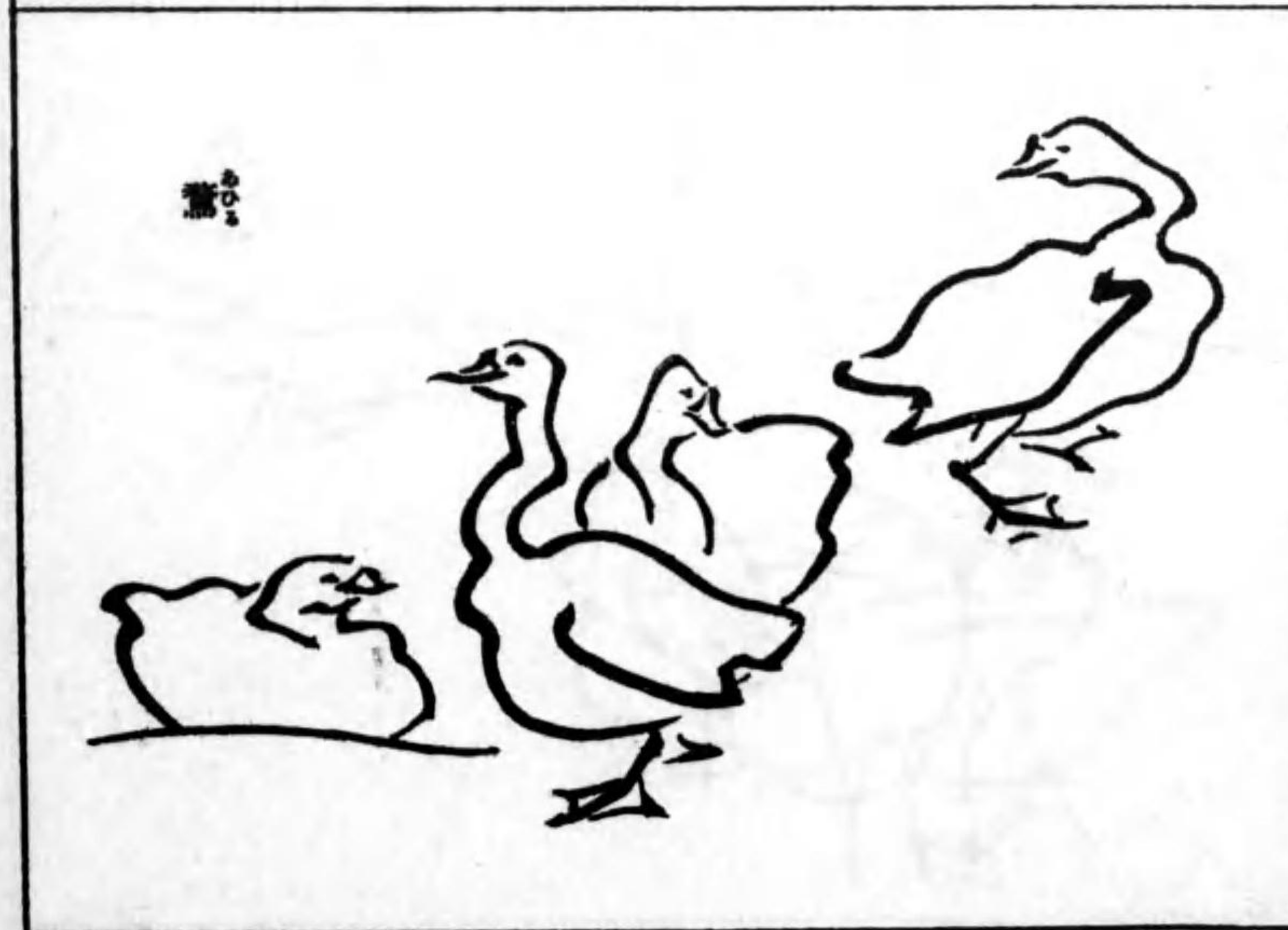

鴨
鳥

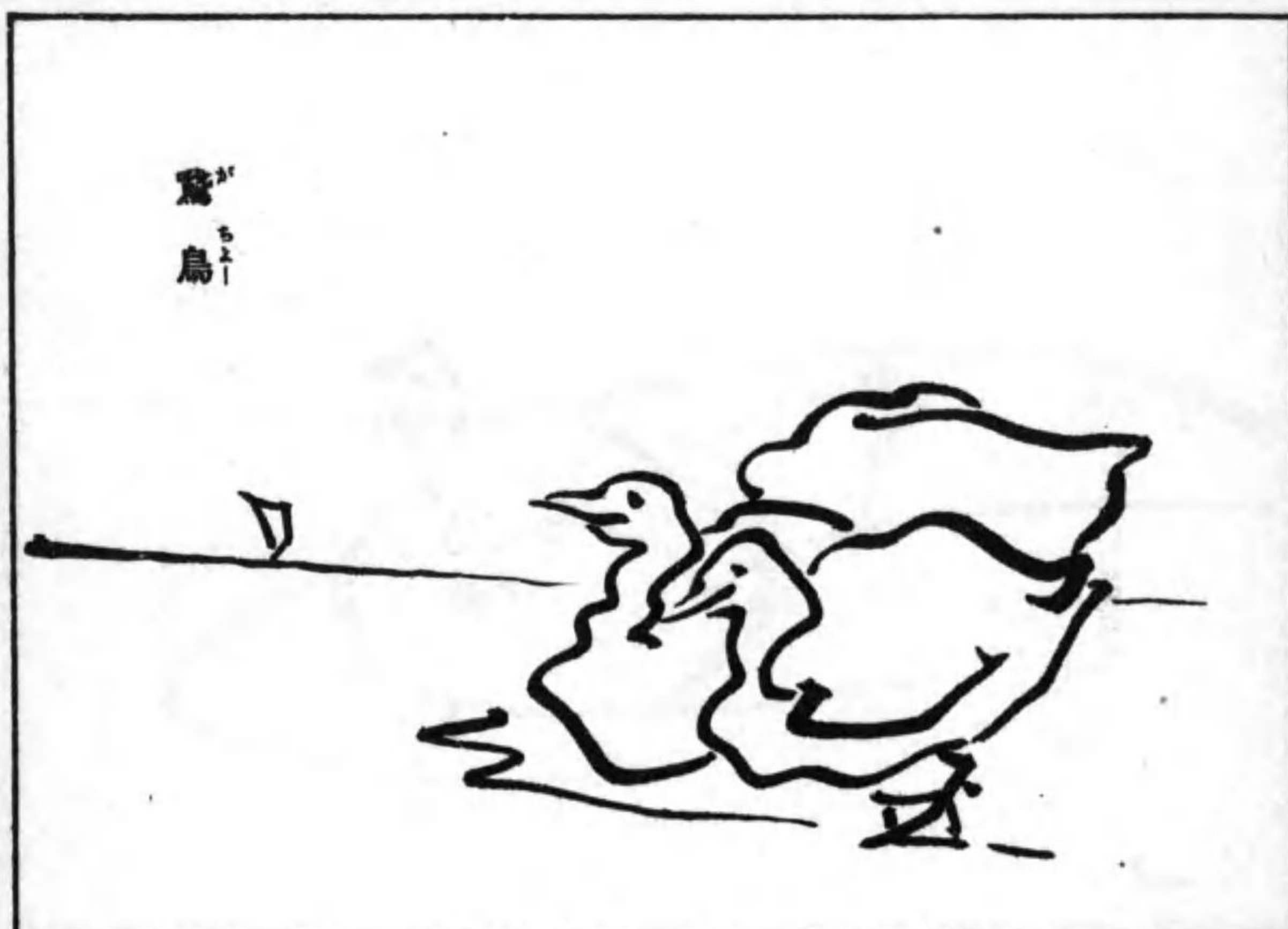

鴨

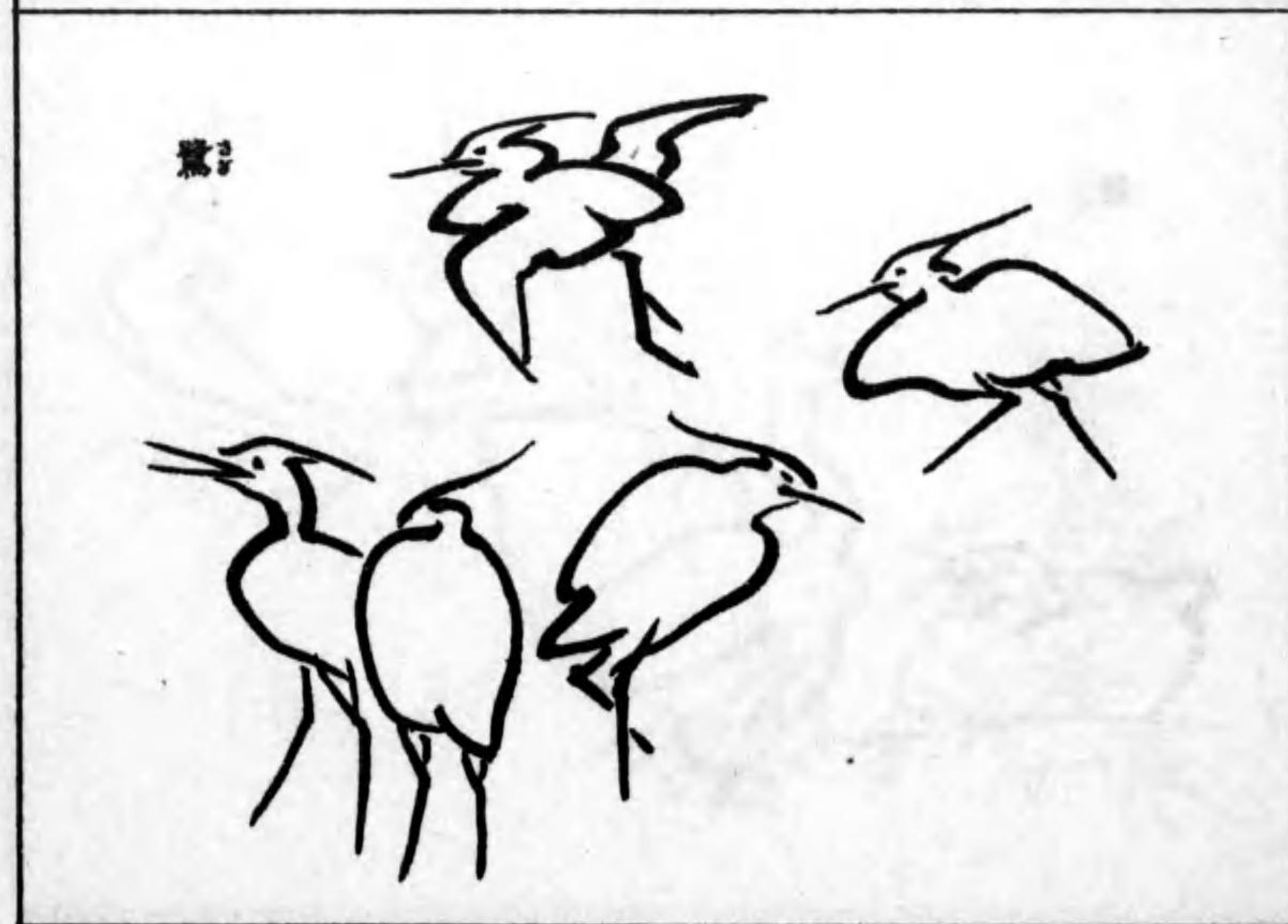

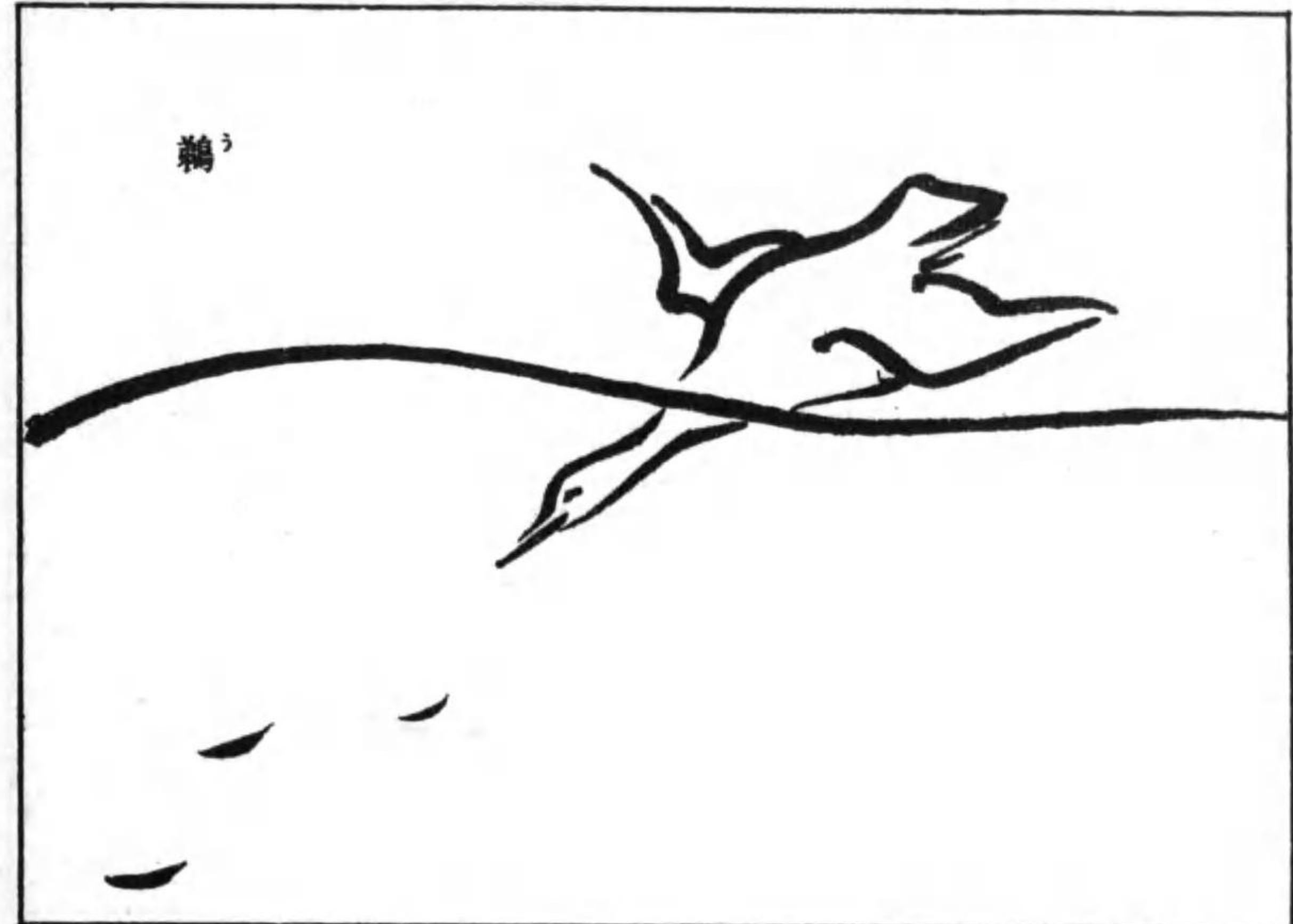
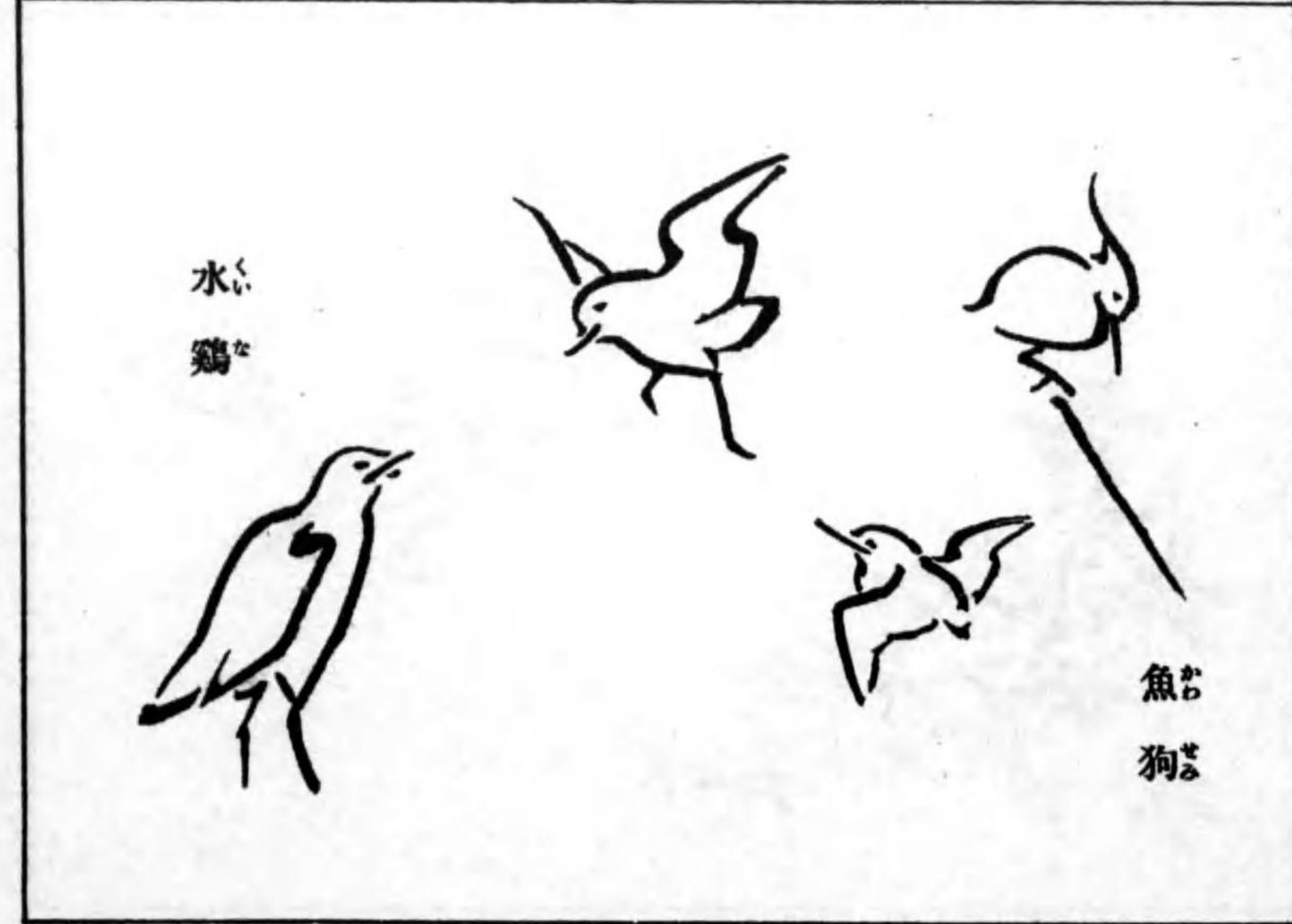
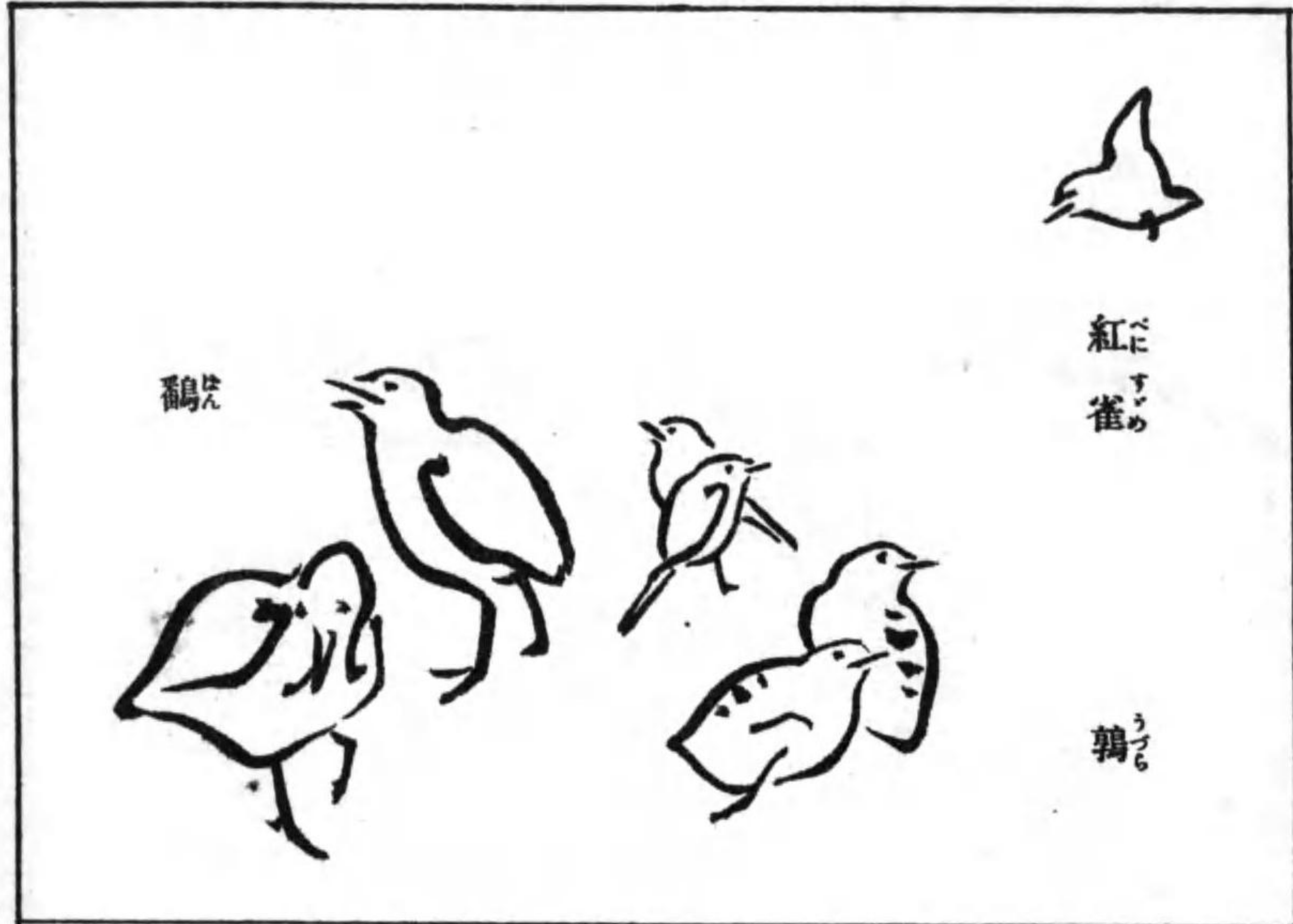

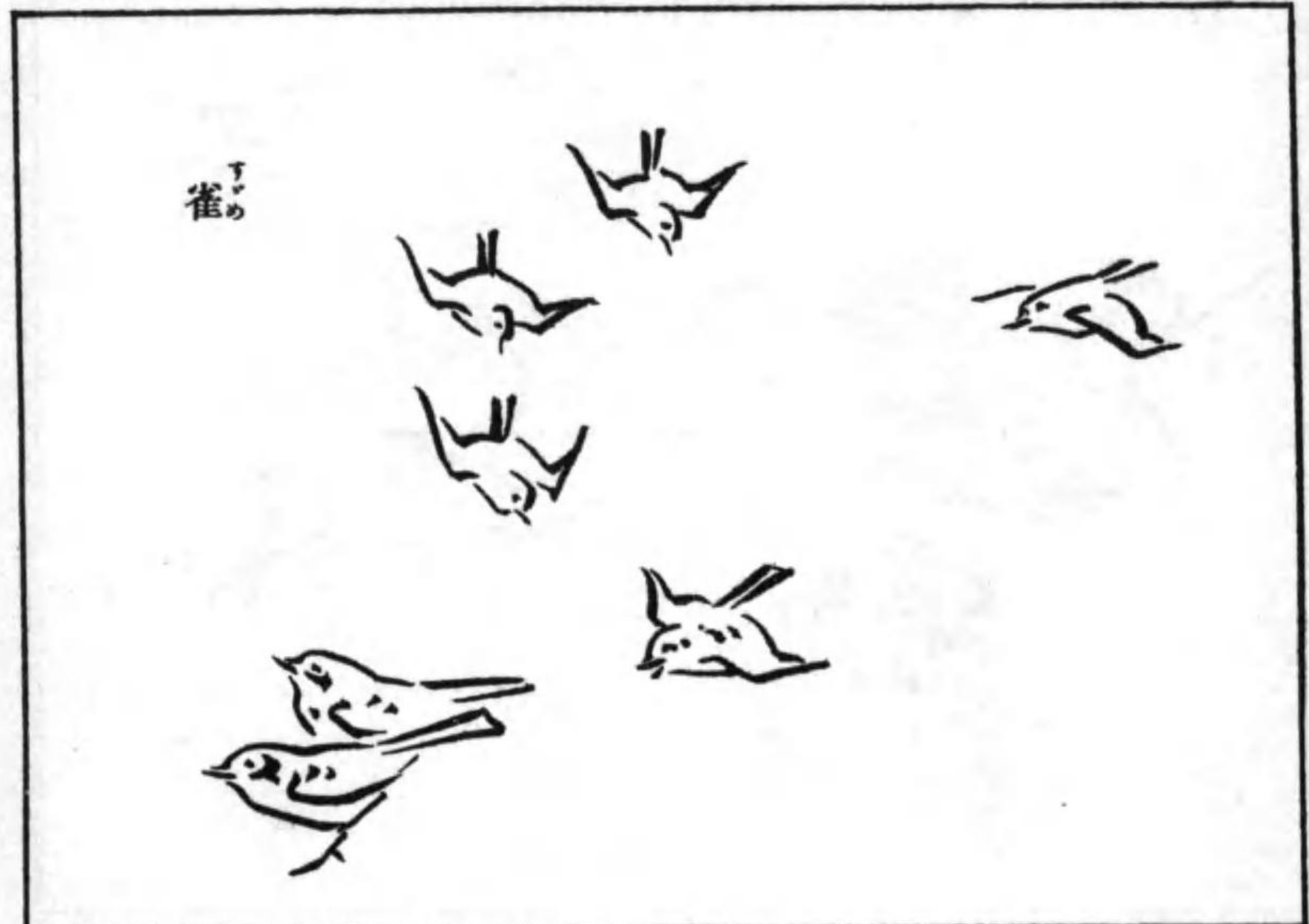

雀

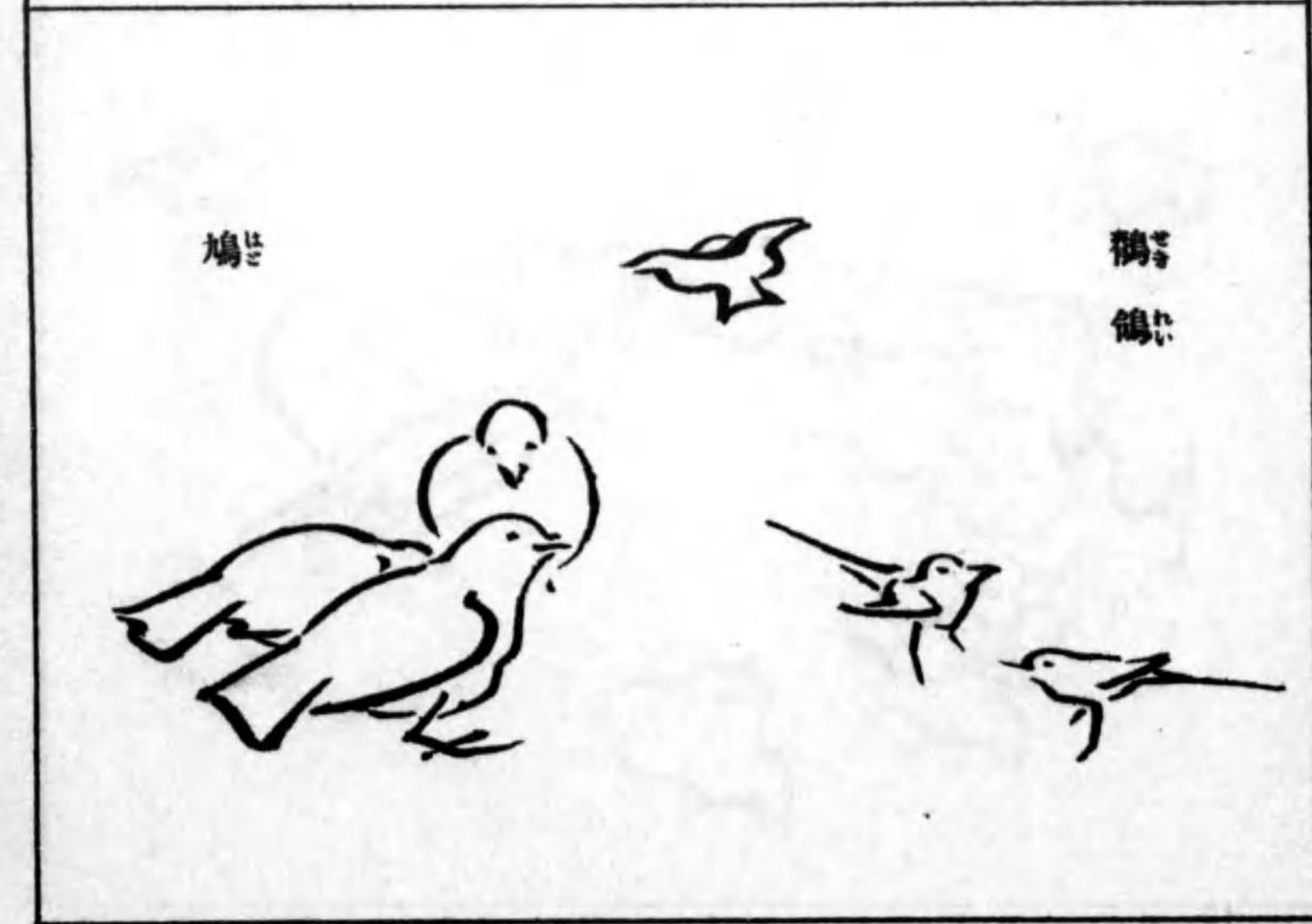

鳩

鴿

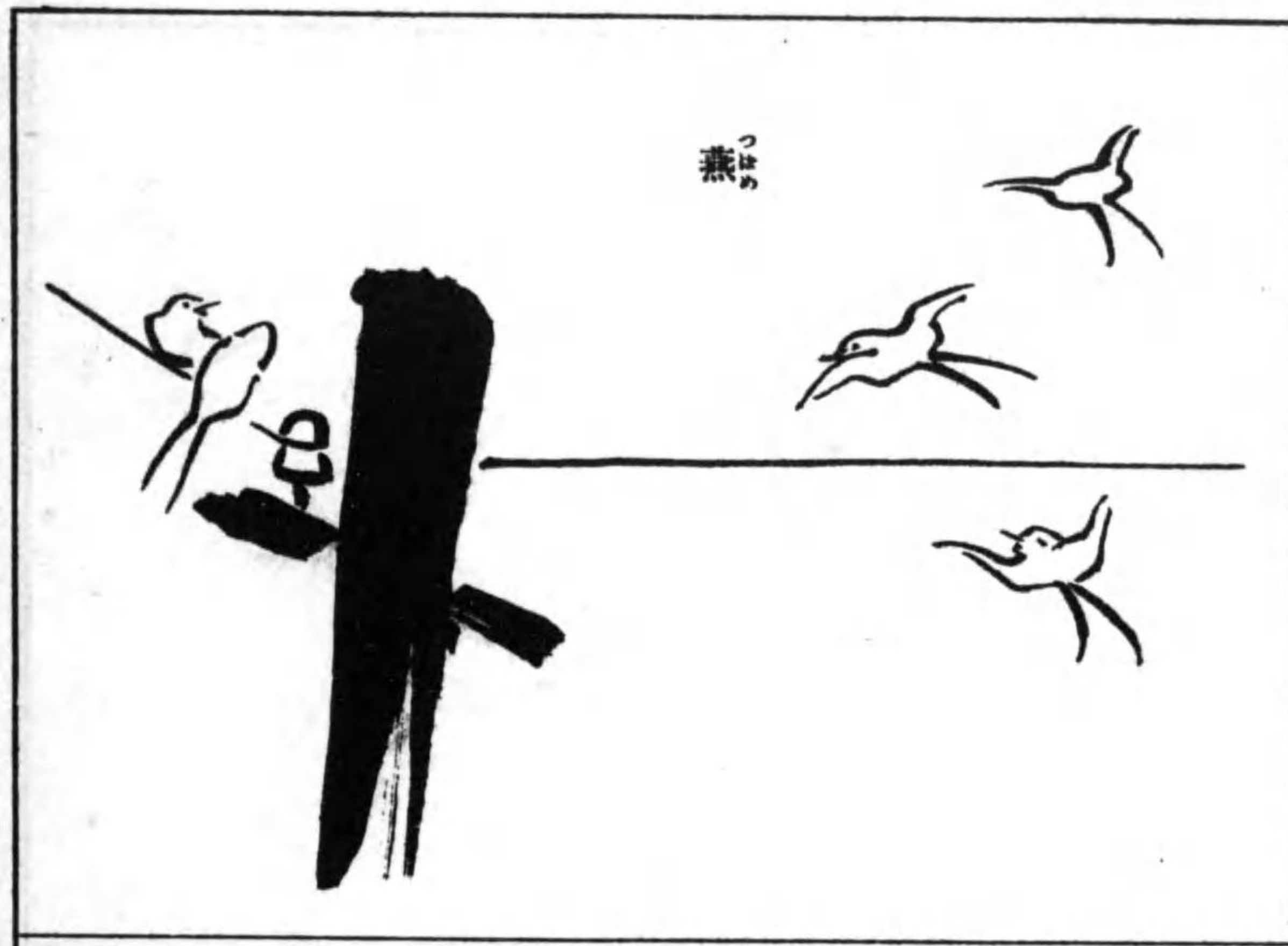

燕

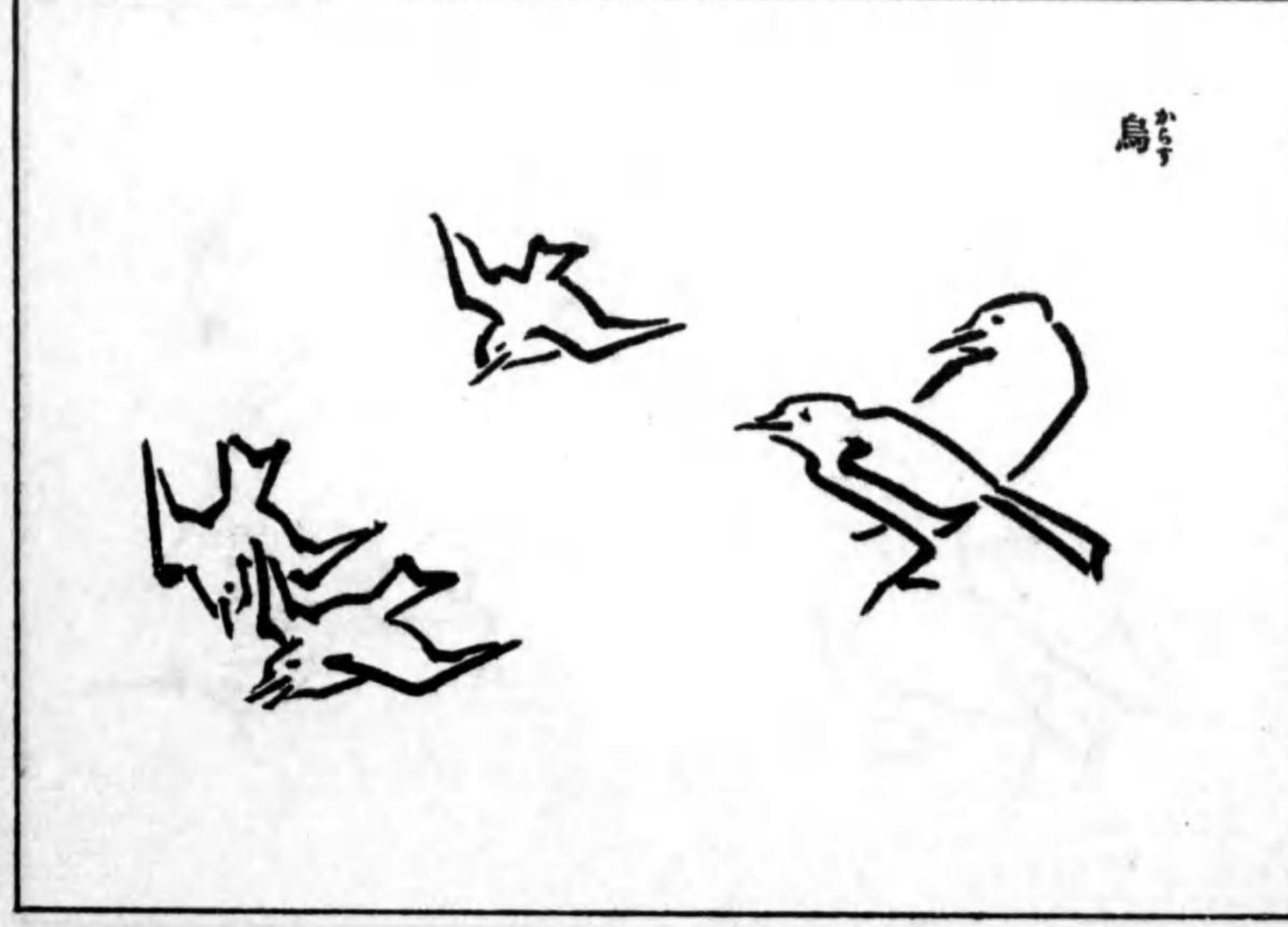

鳥

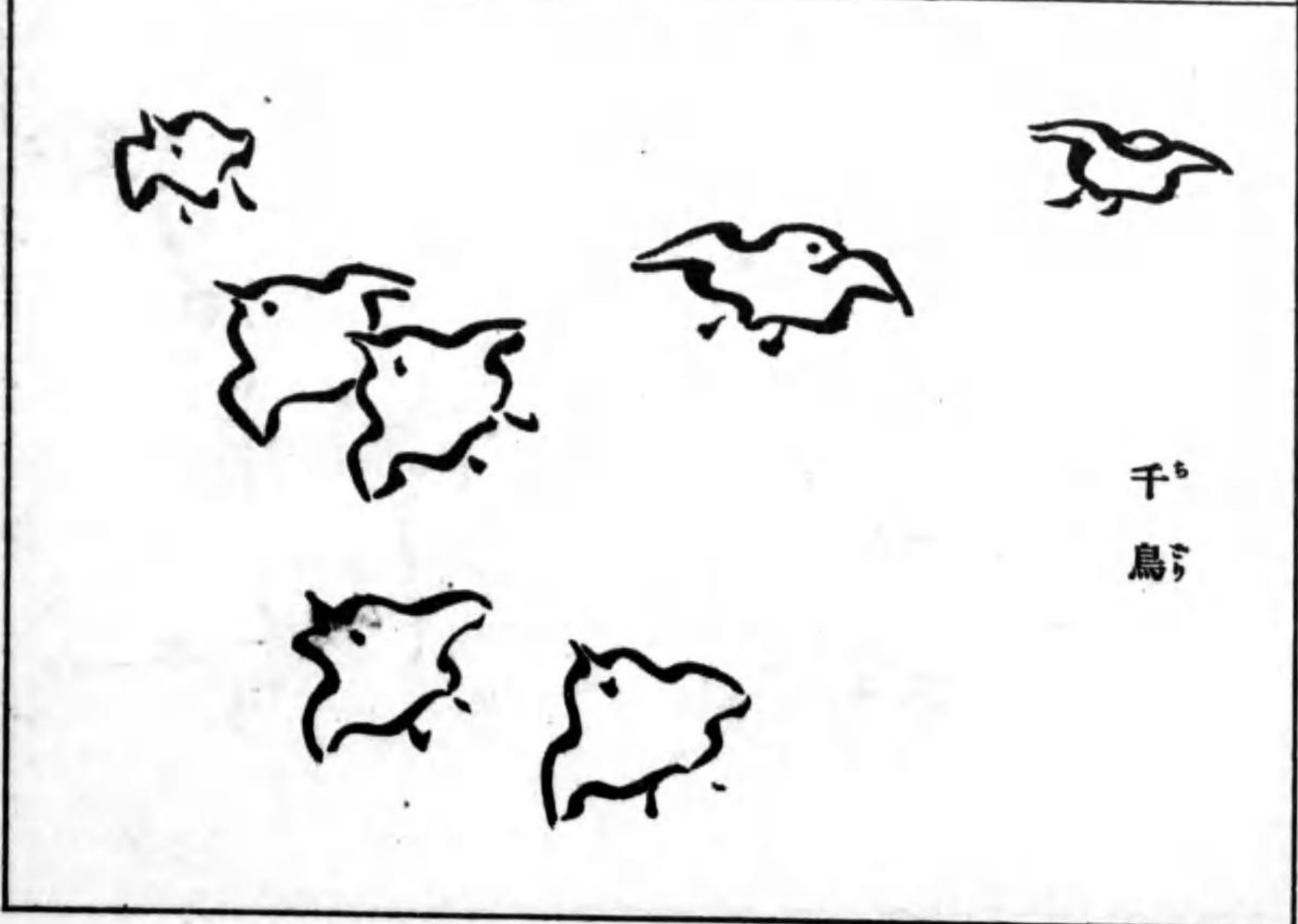
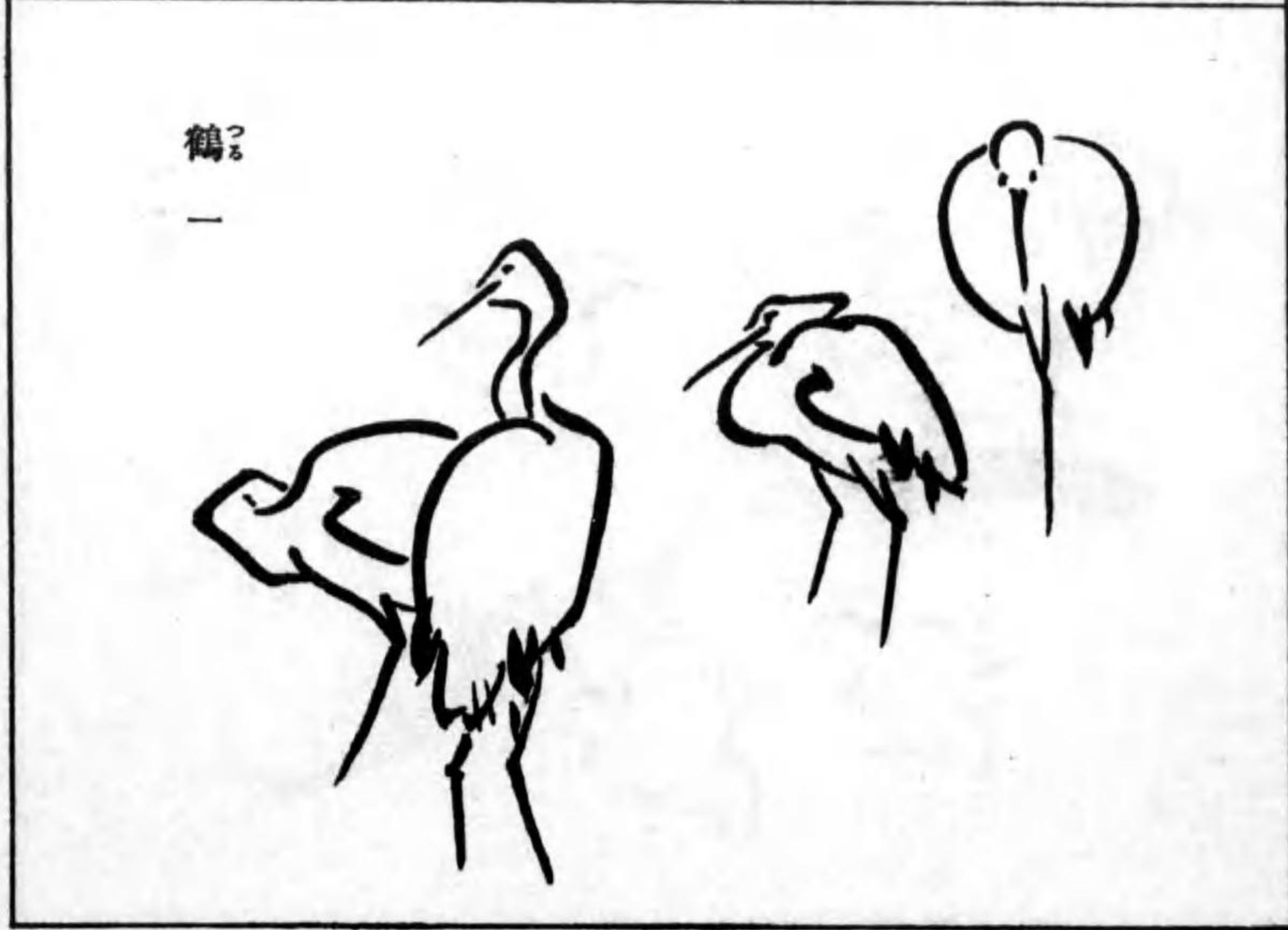
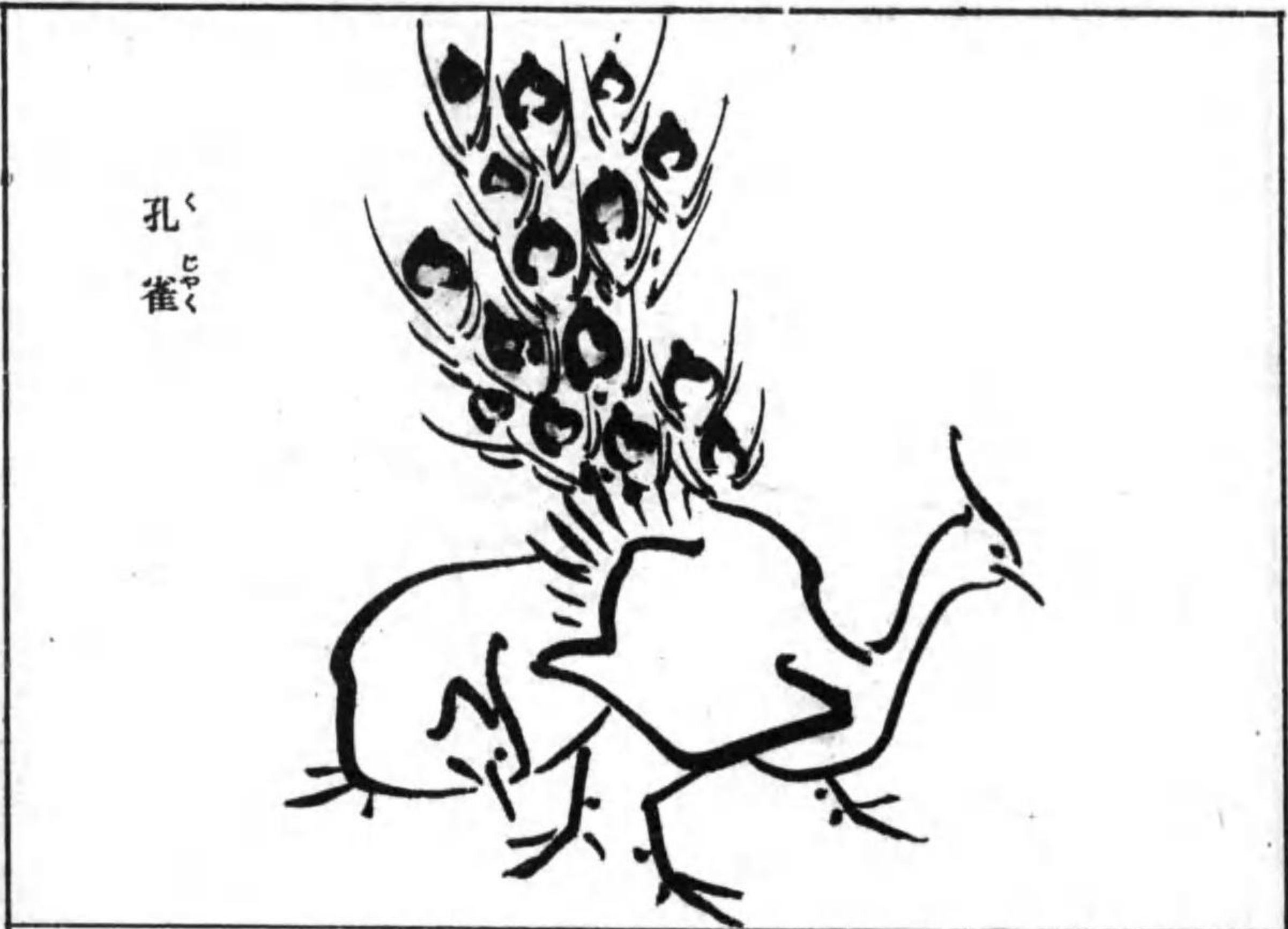

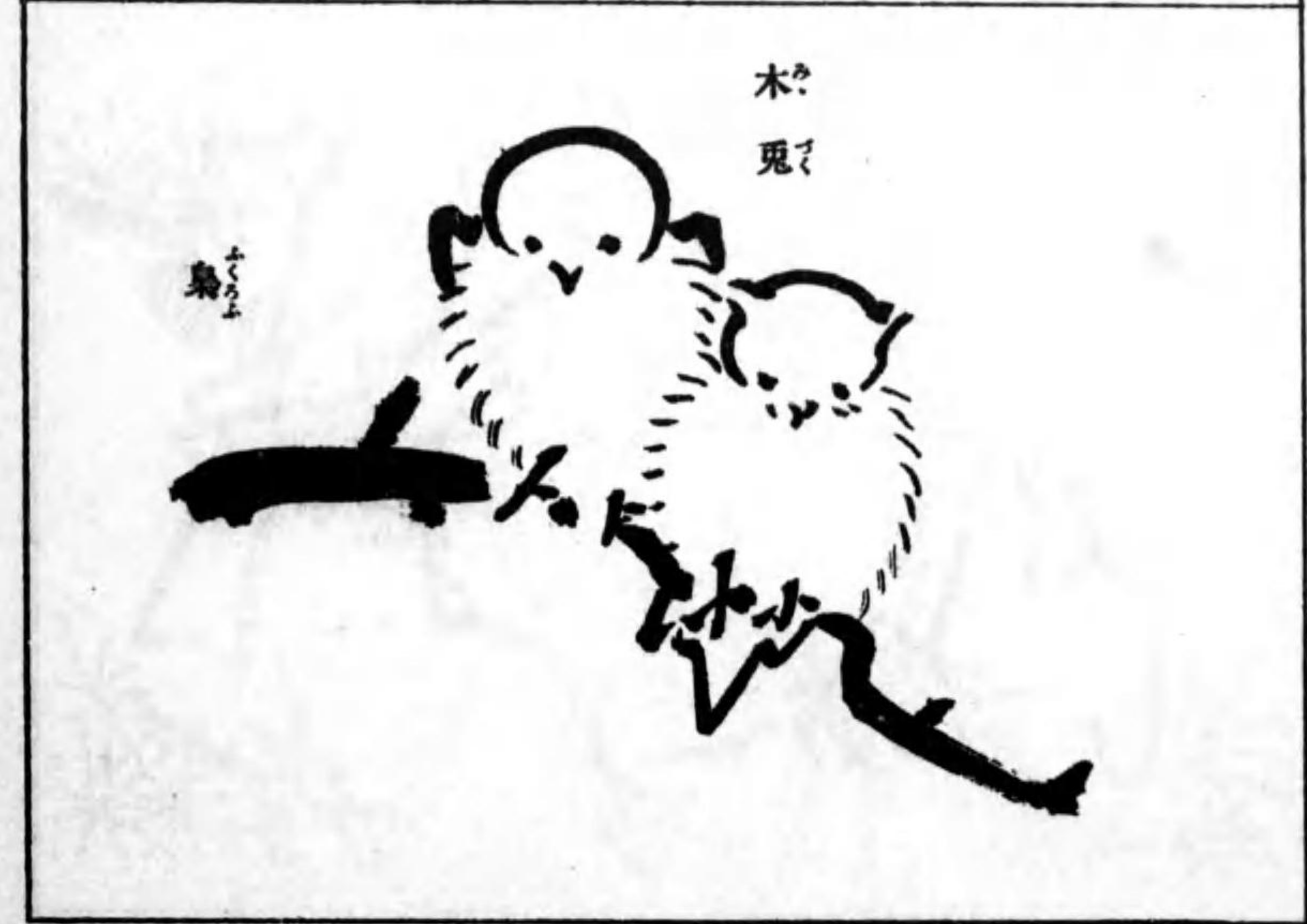
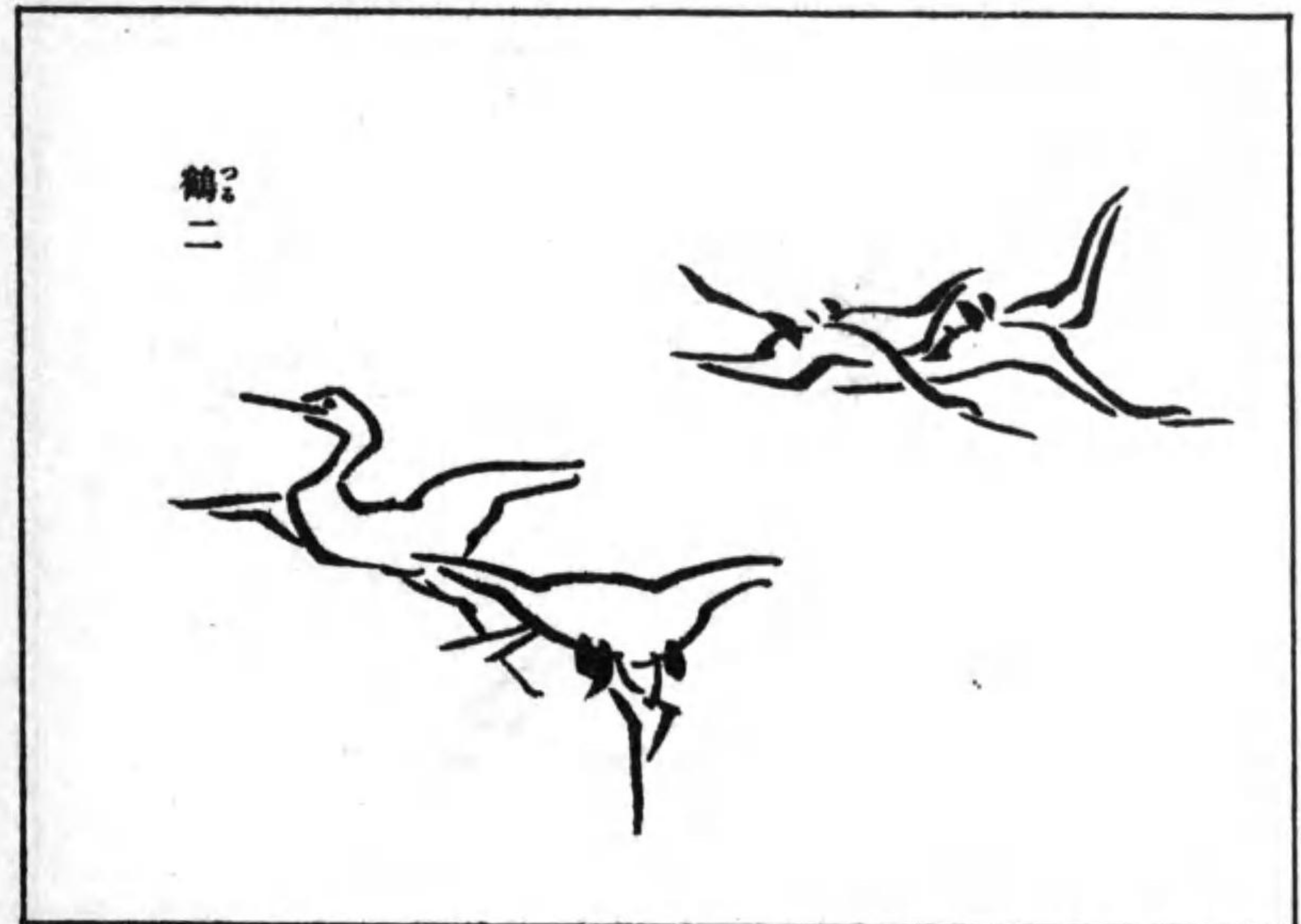
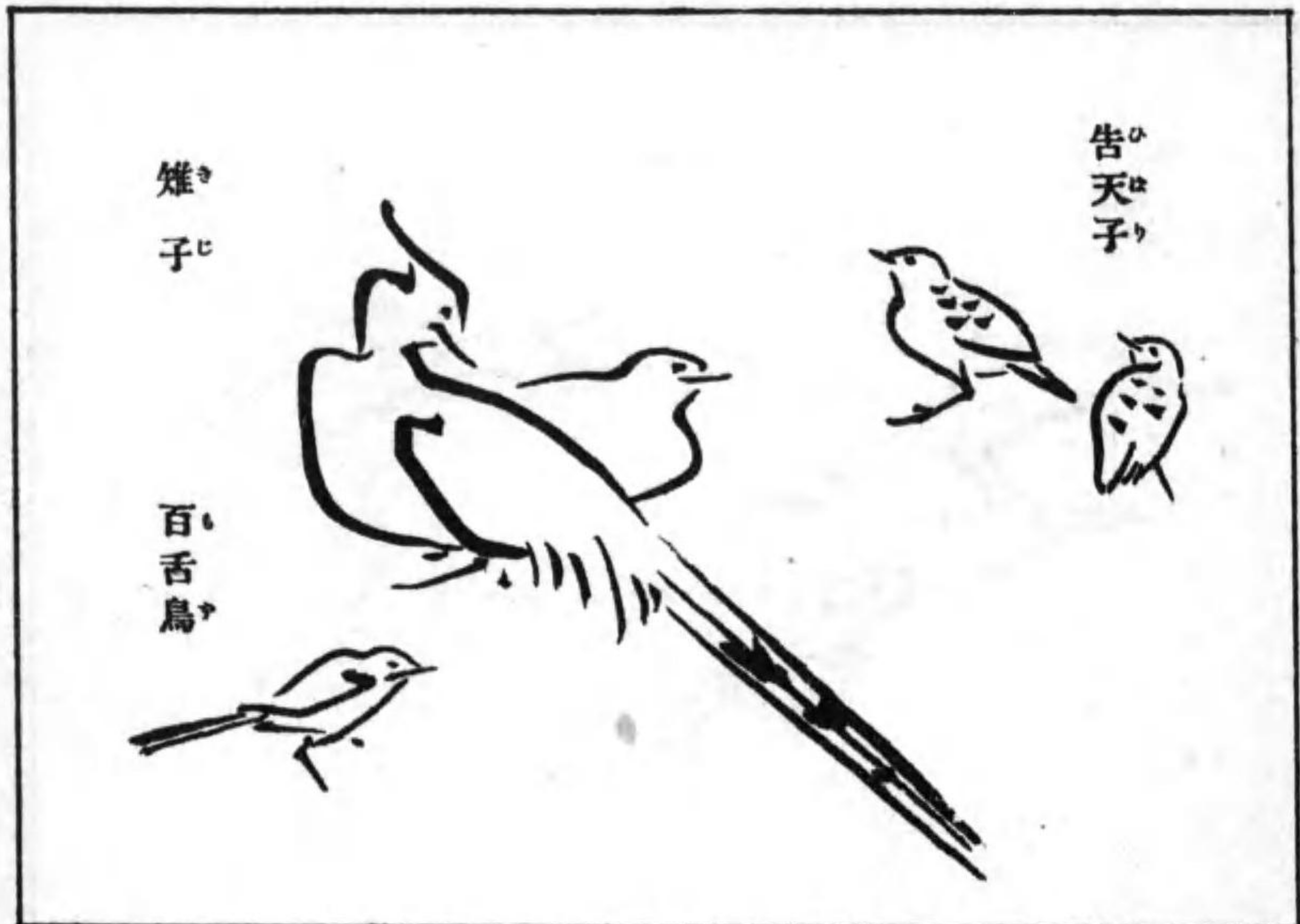

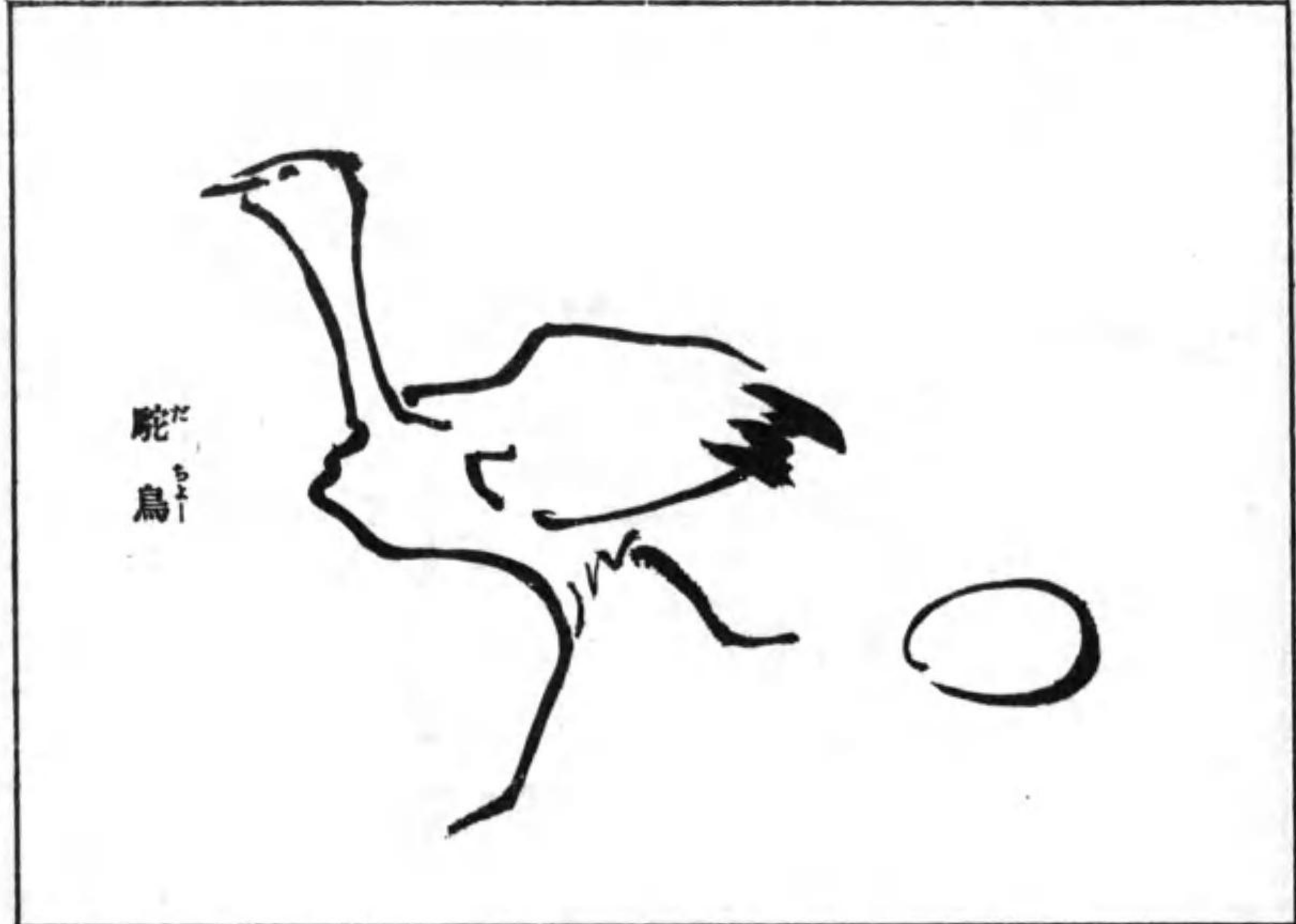

鸵鳥

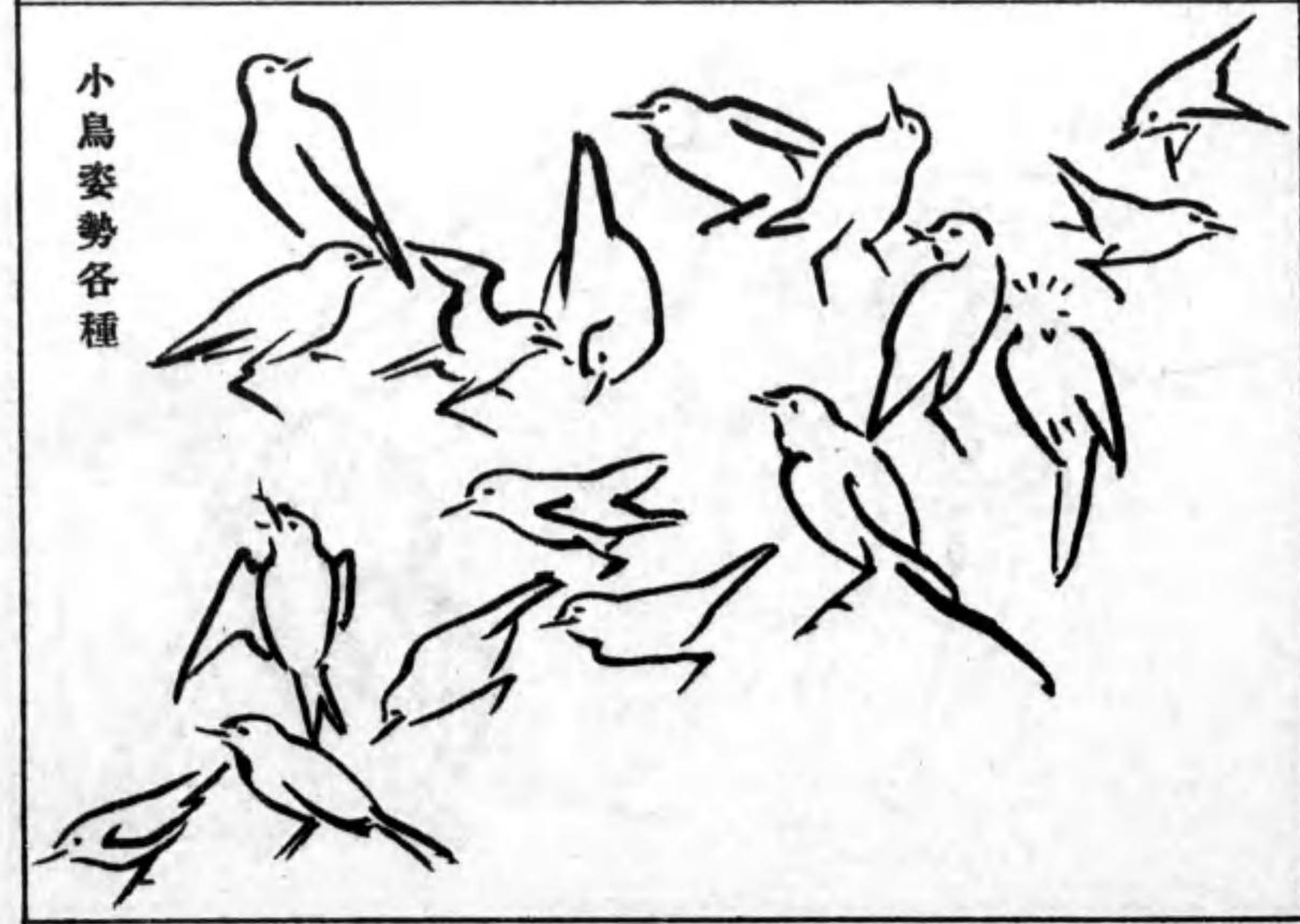

小鳥姿勢各種

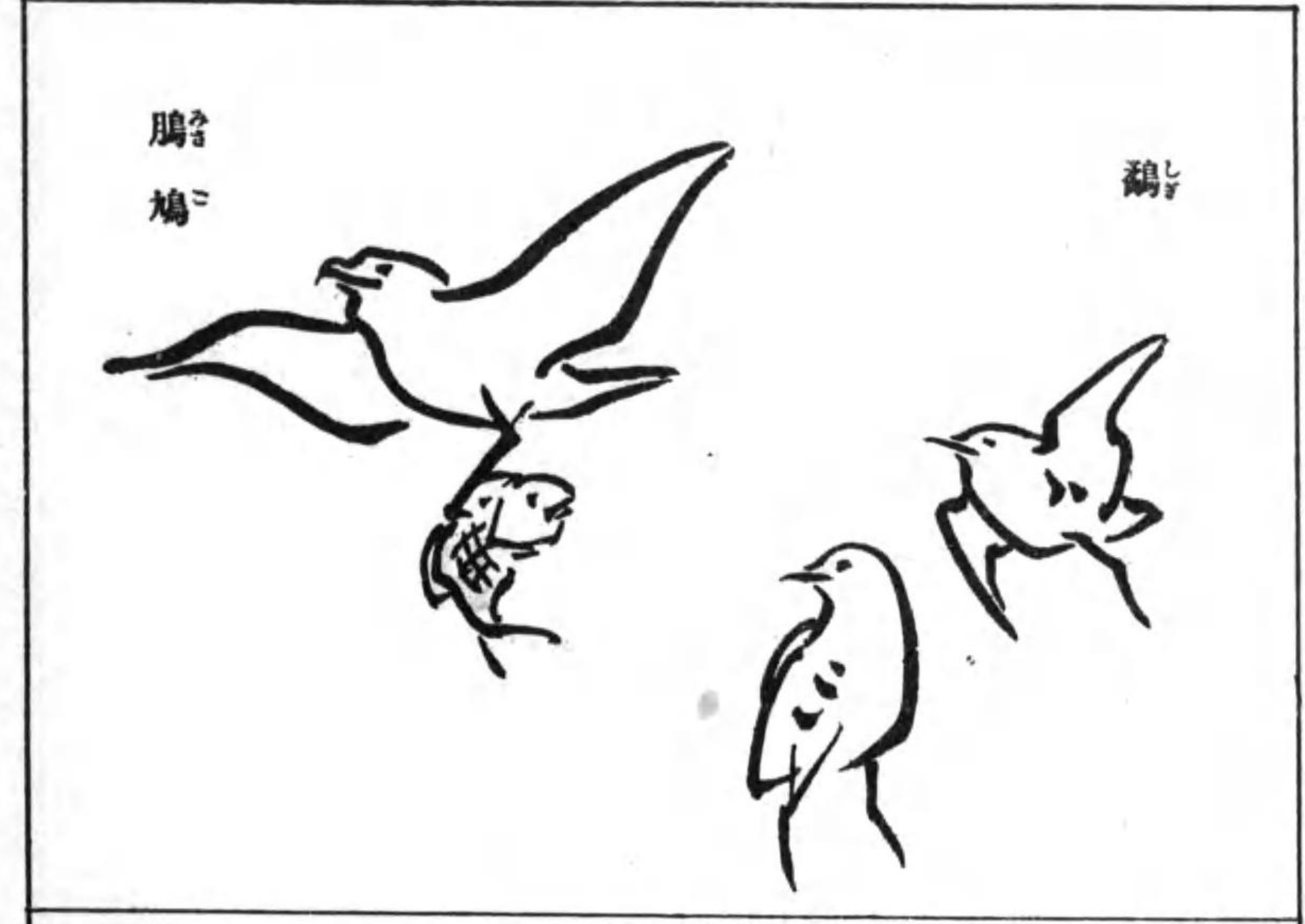

鵬鳩

鷓鴣



鷓鴣

鷓鴣

山鳥

應用一

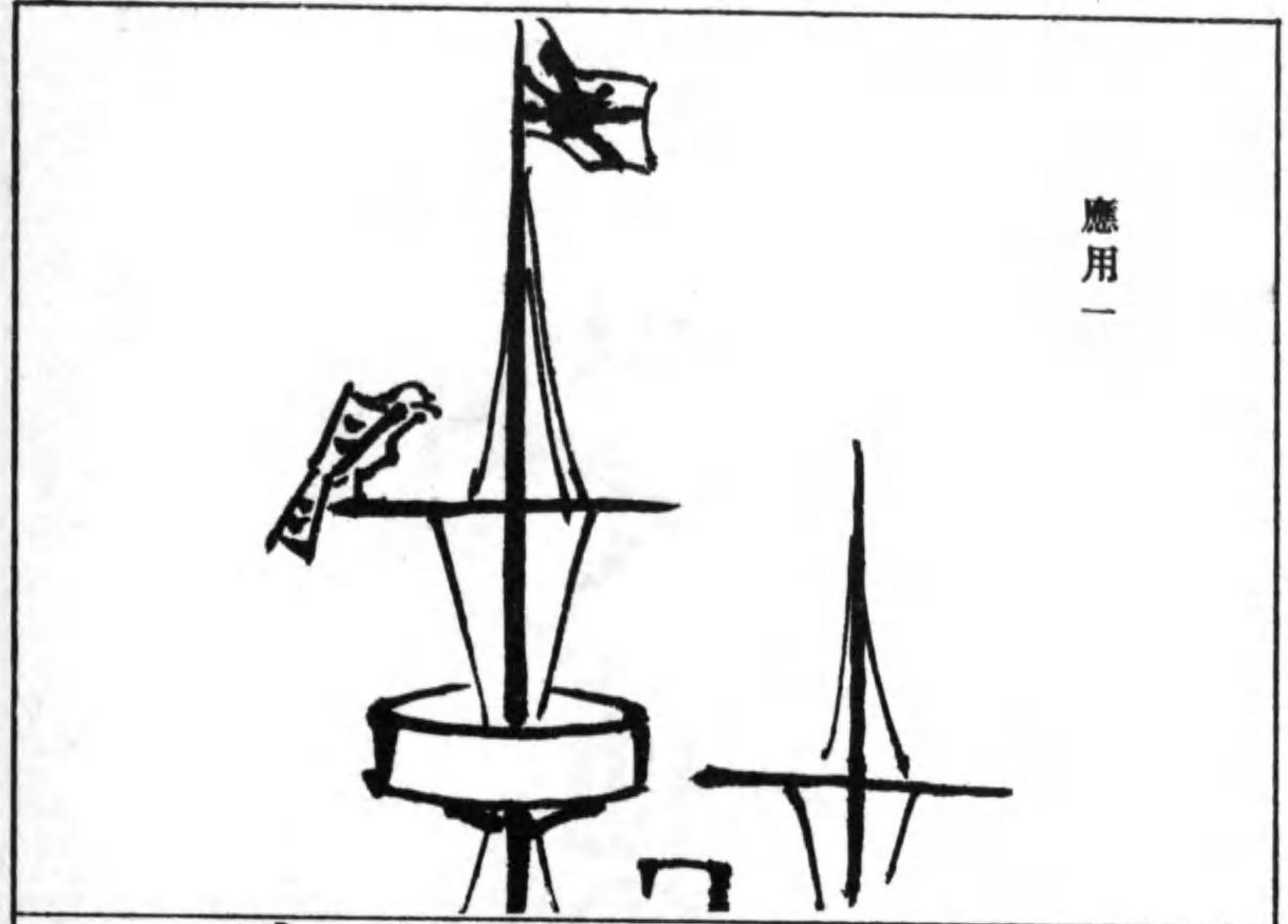

應用二

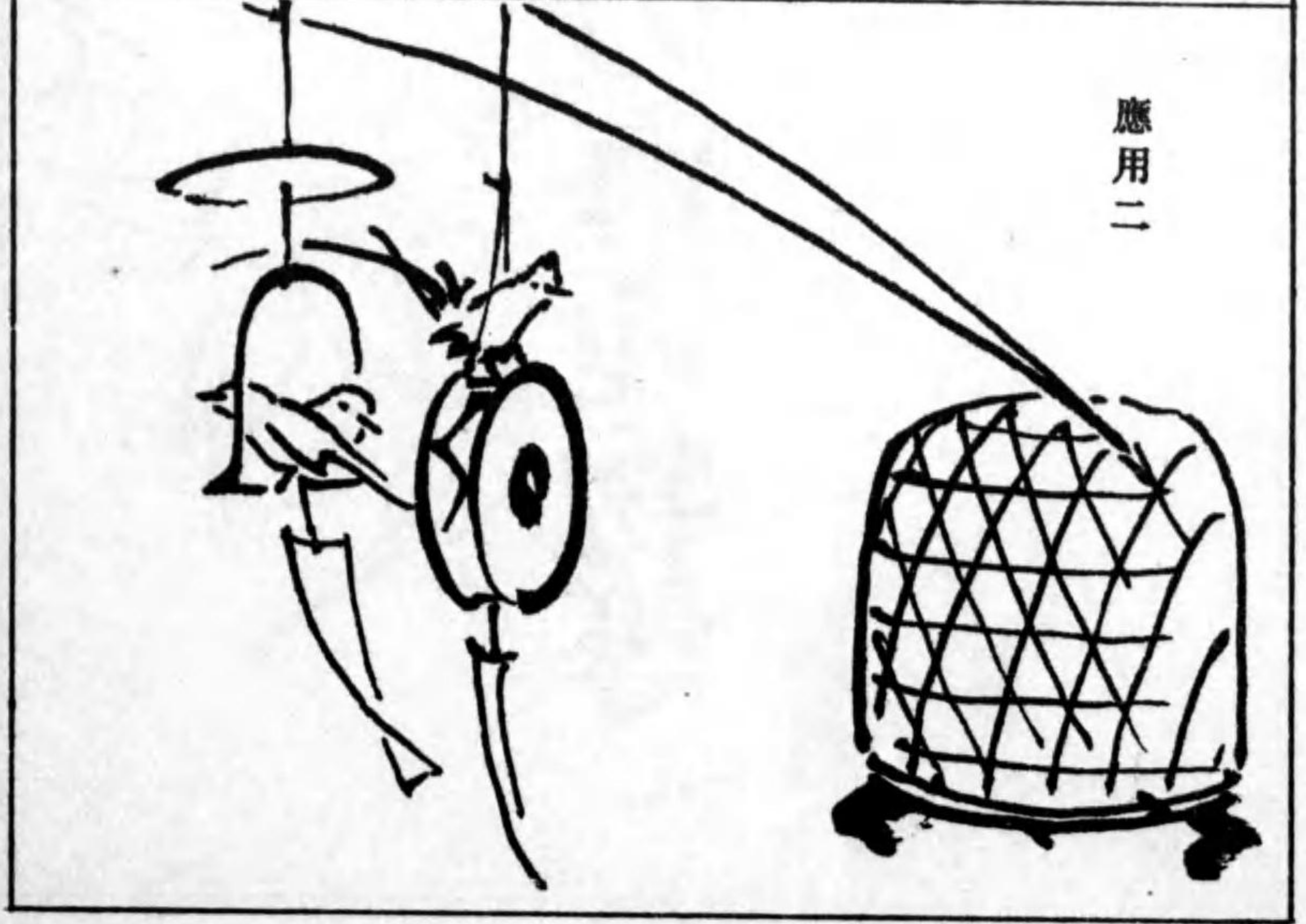

其十一
魚介其他の海産物等

鯉

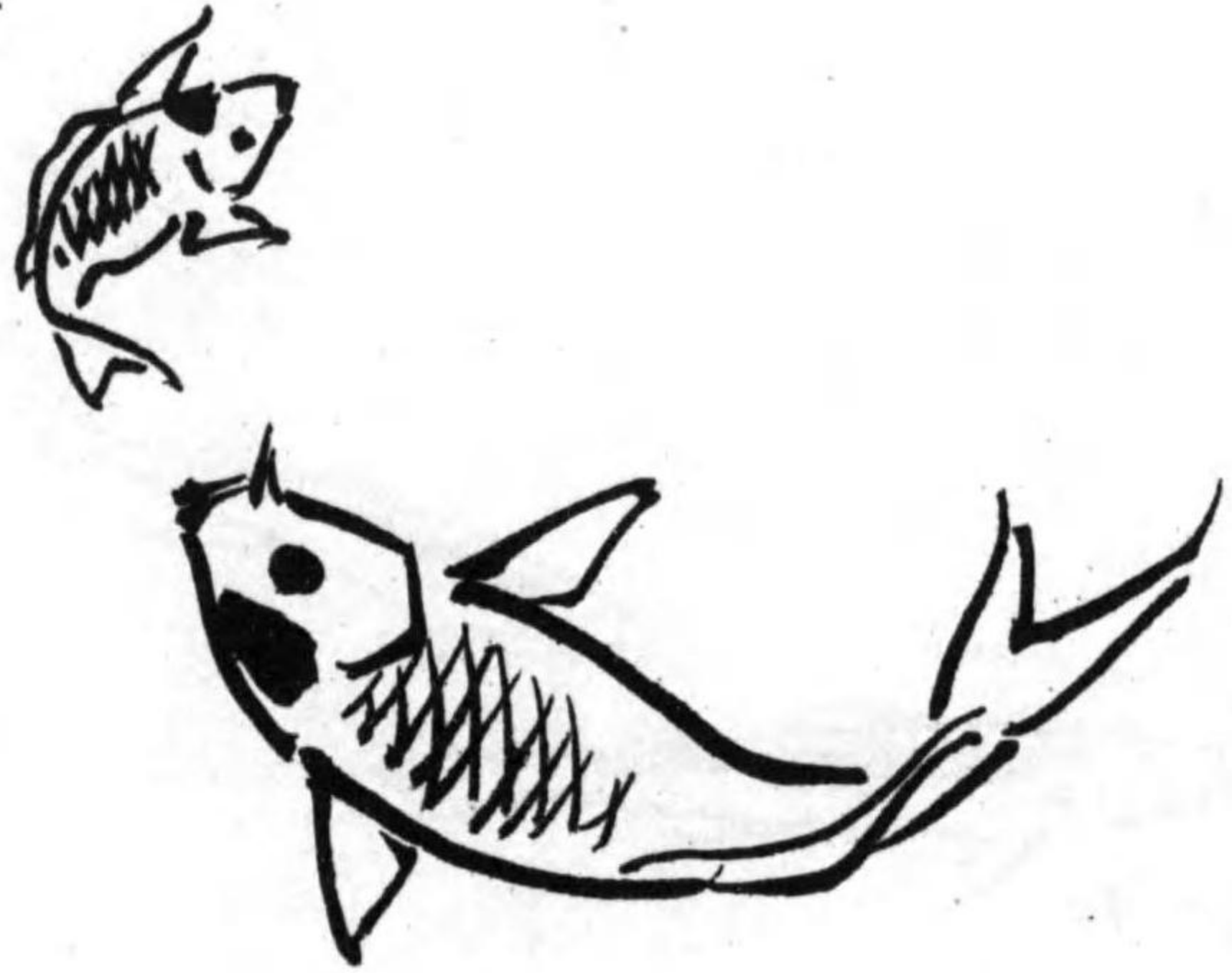

金魚

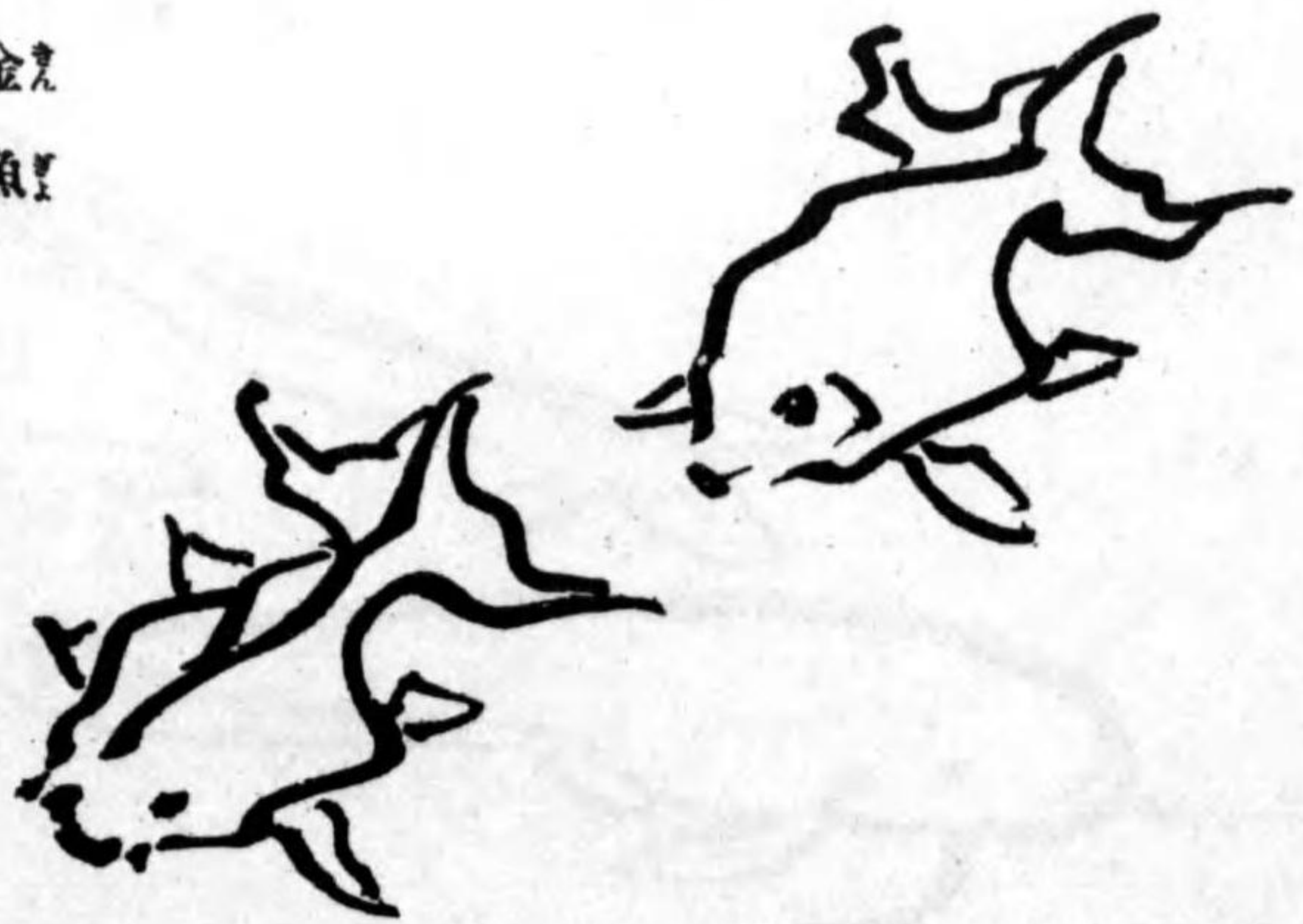

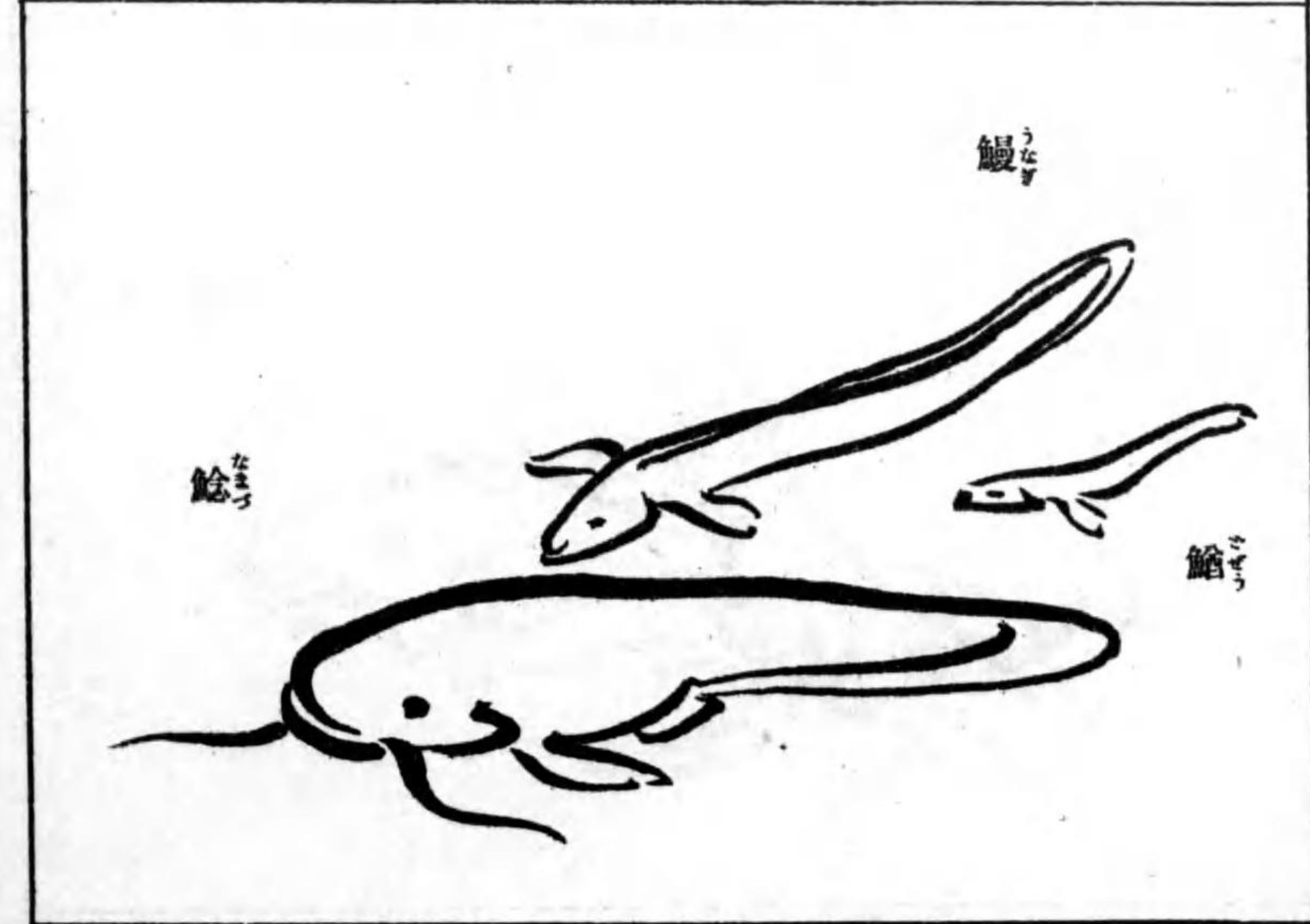
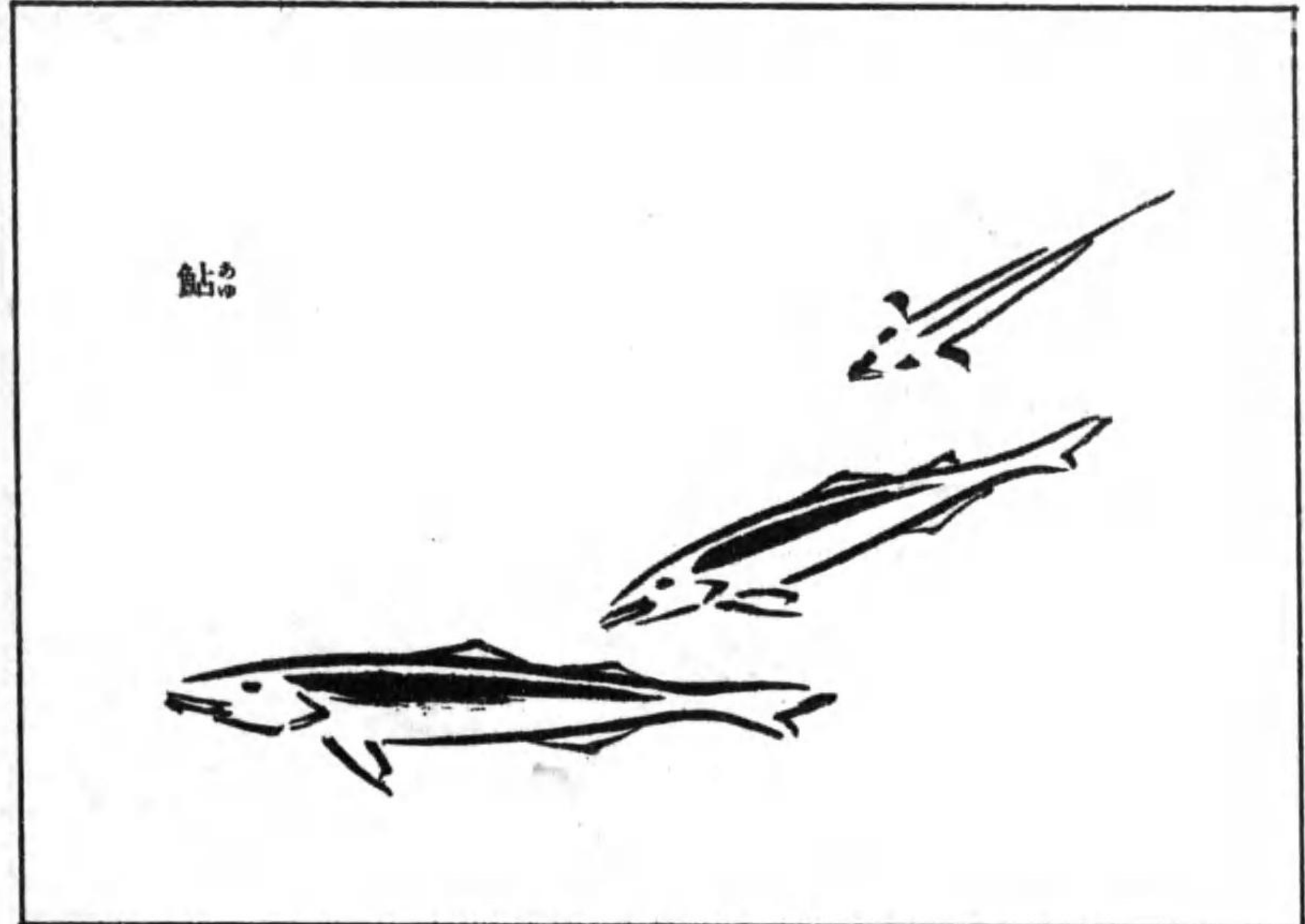
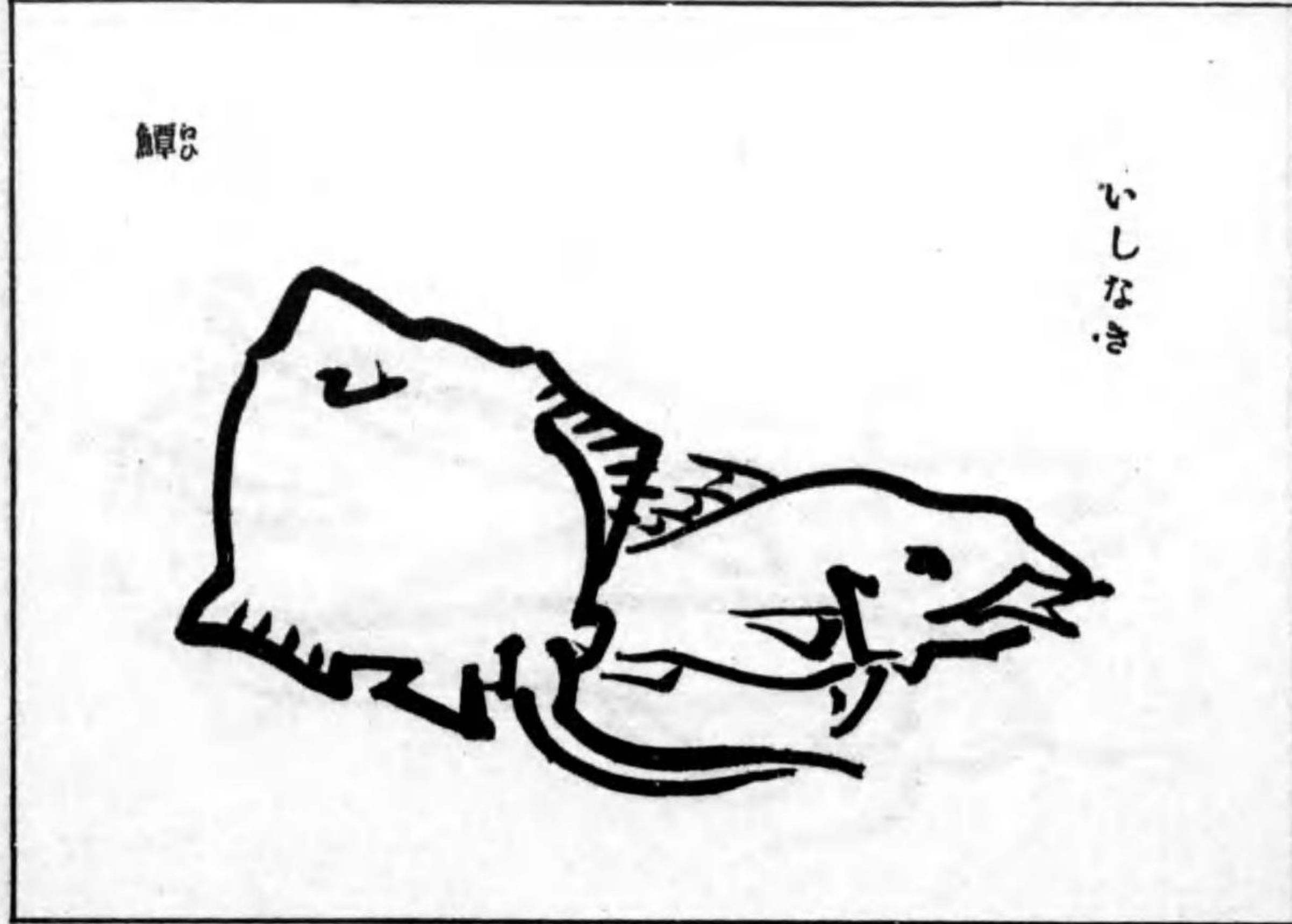
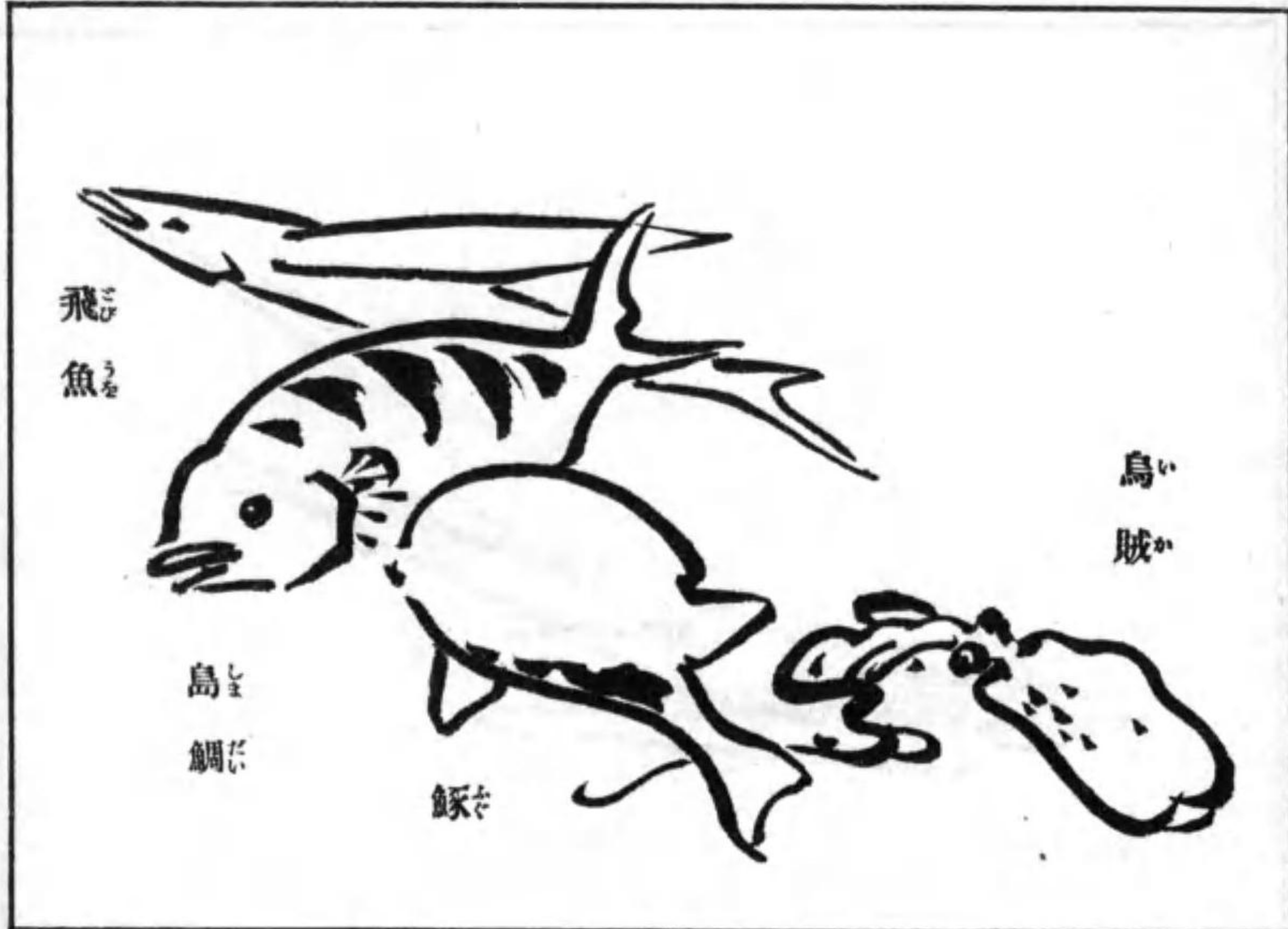

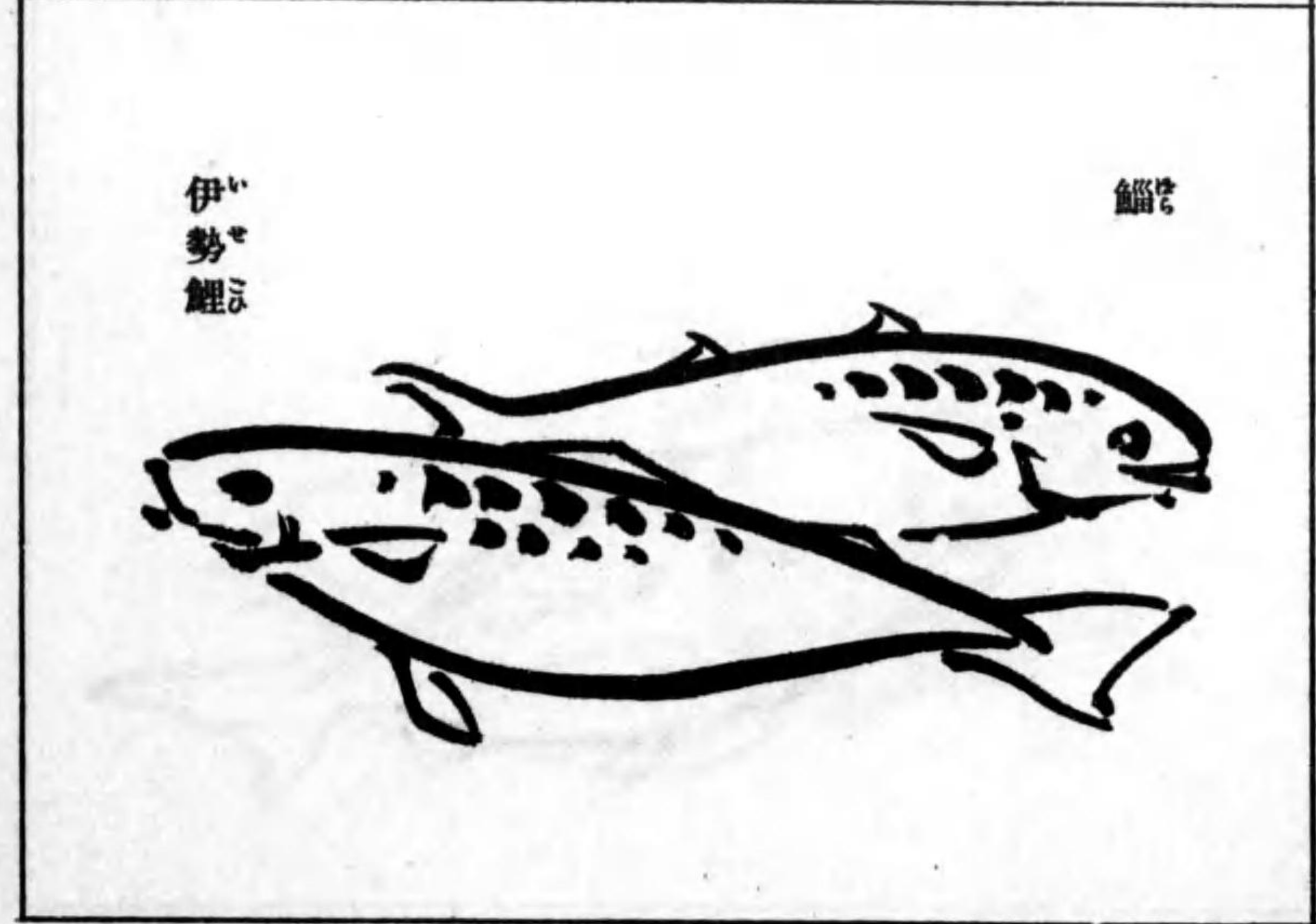
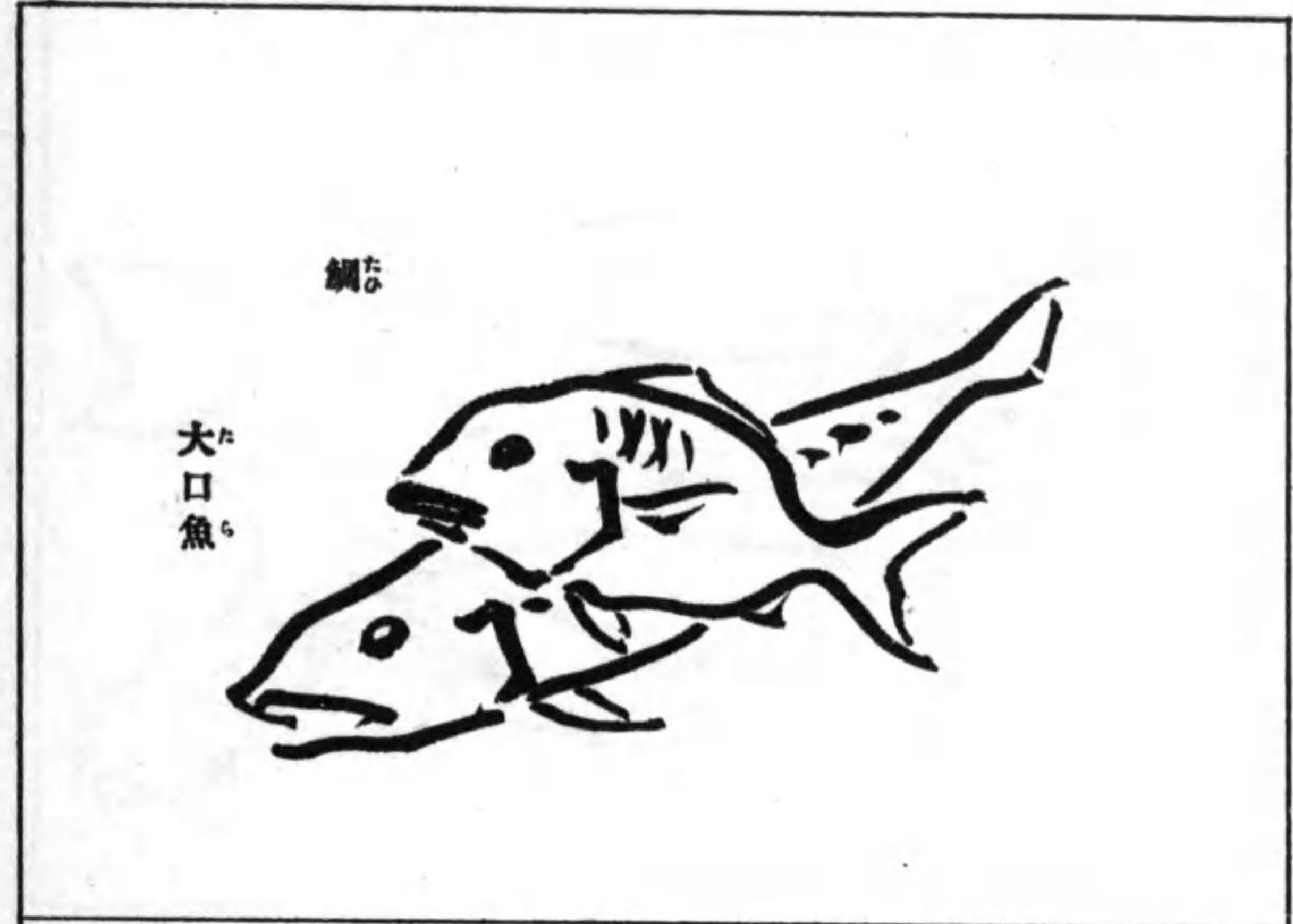
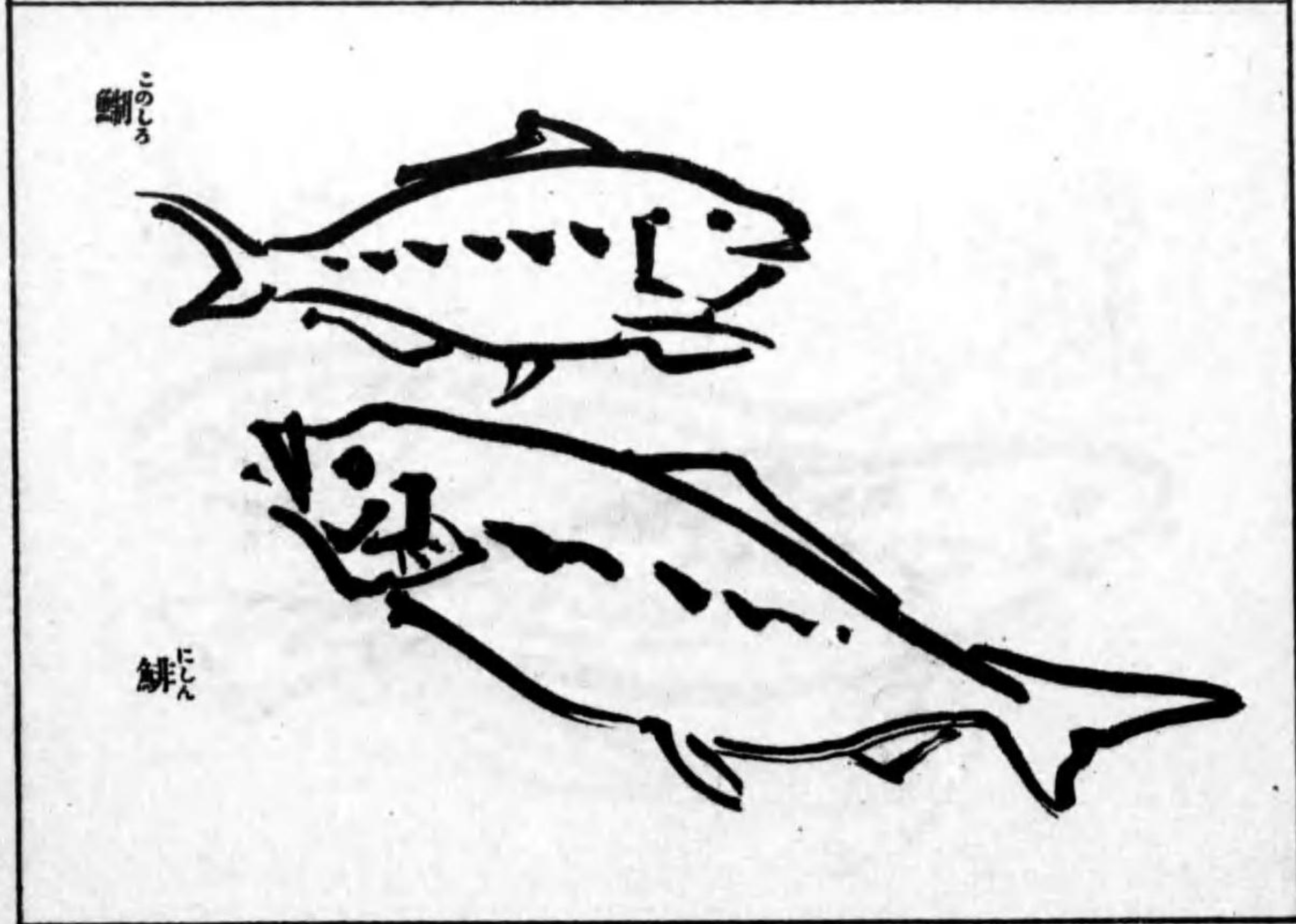
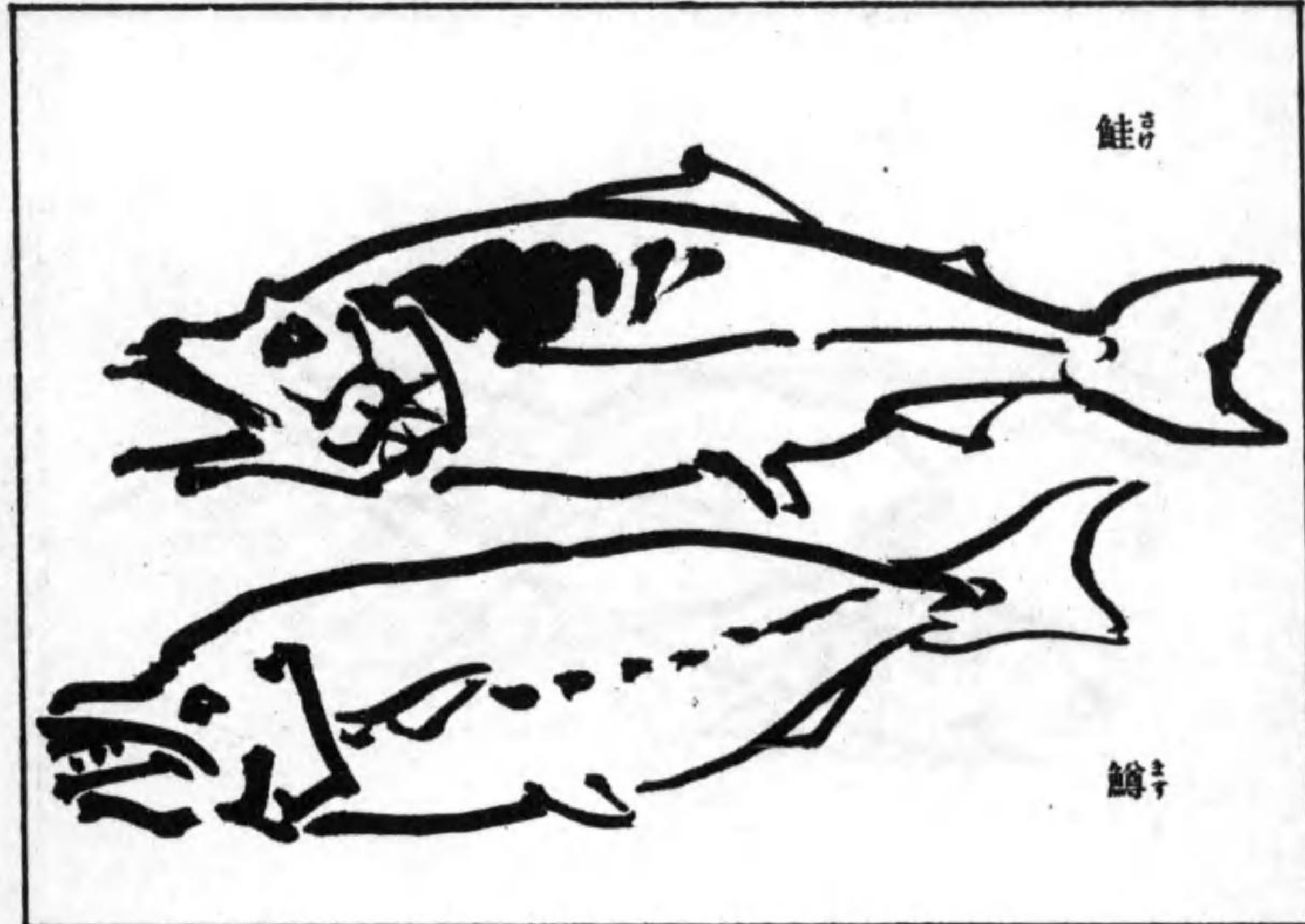

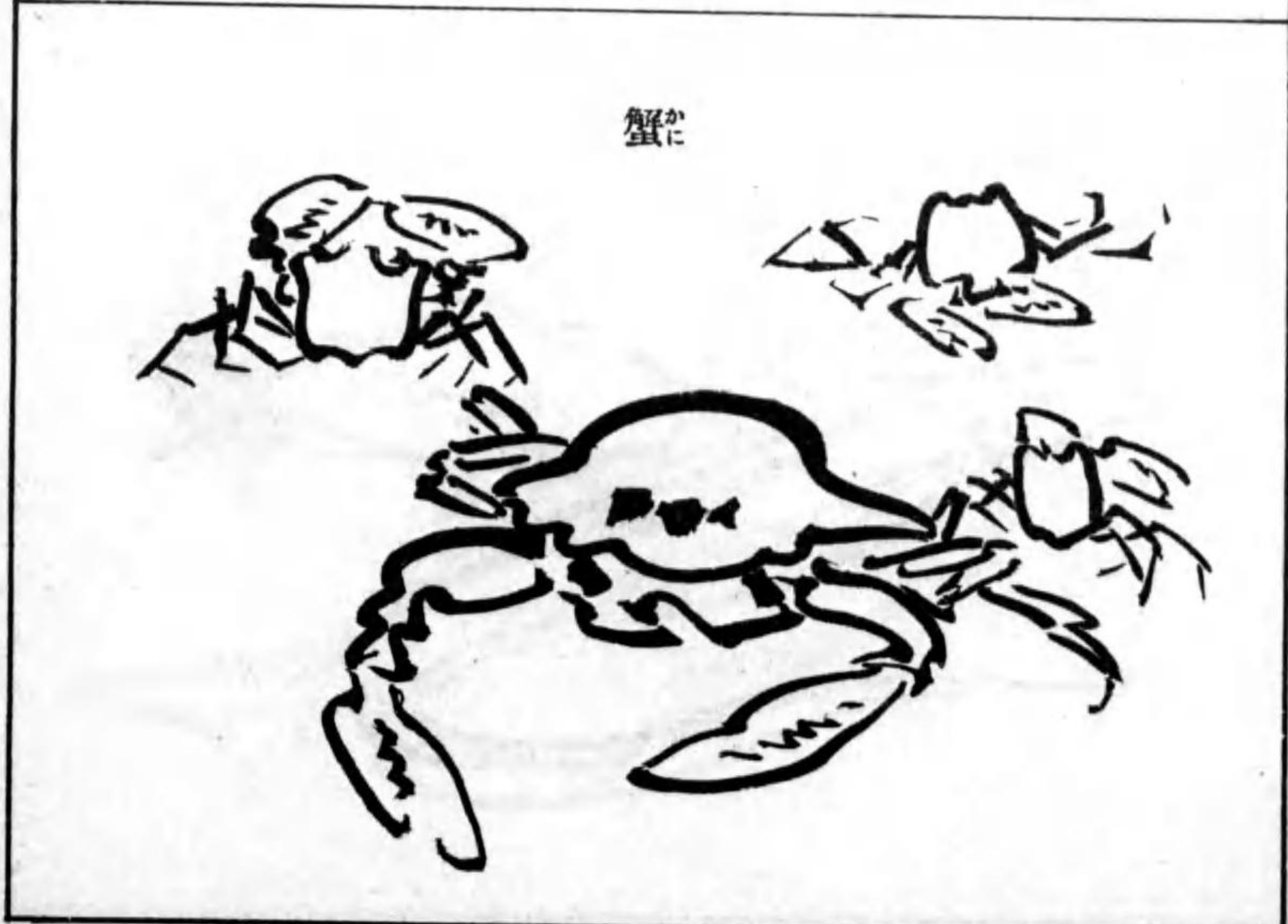
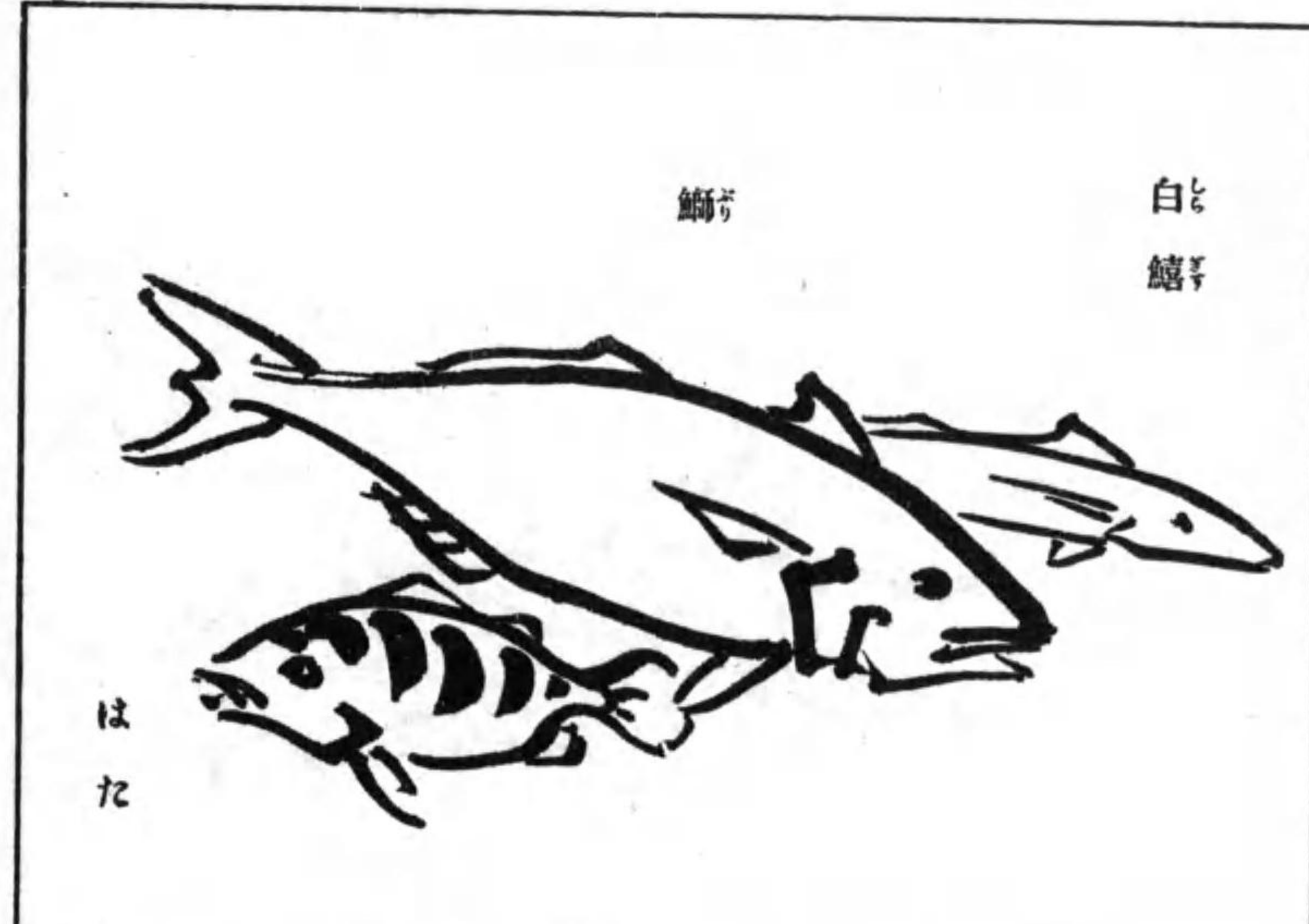
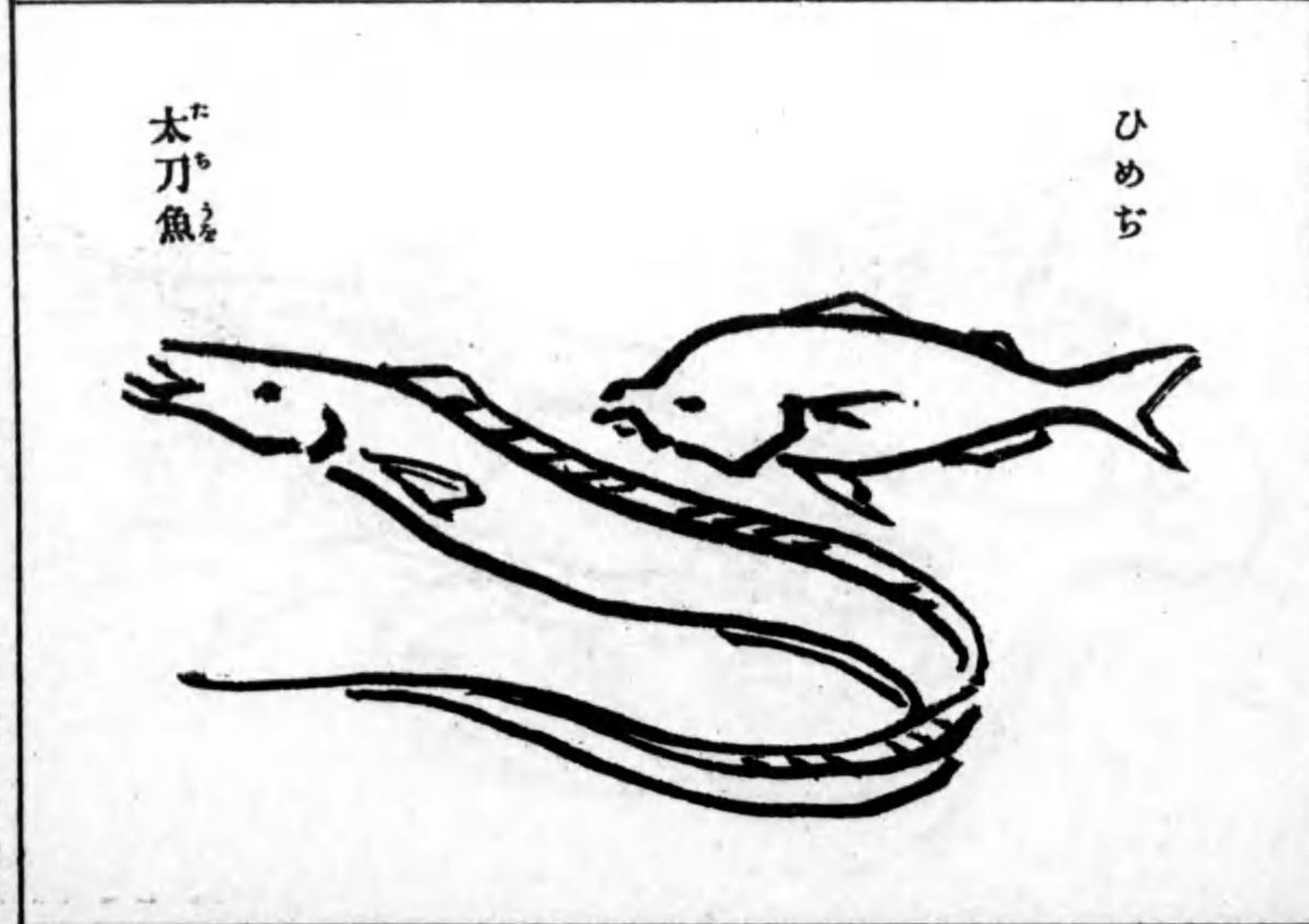
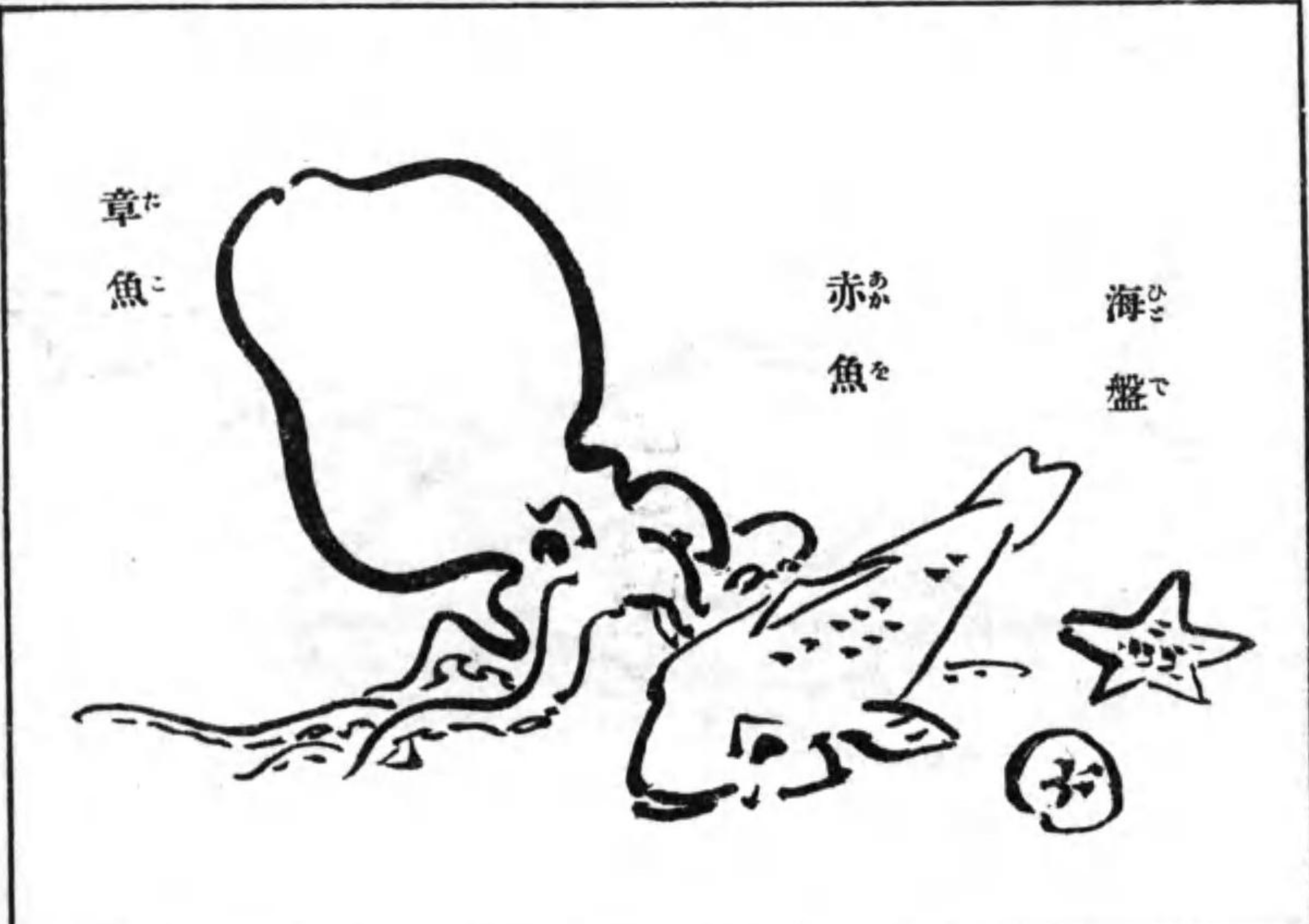

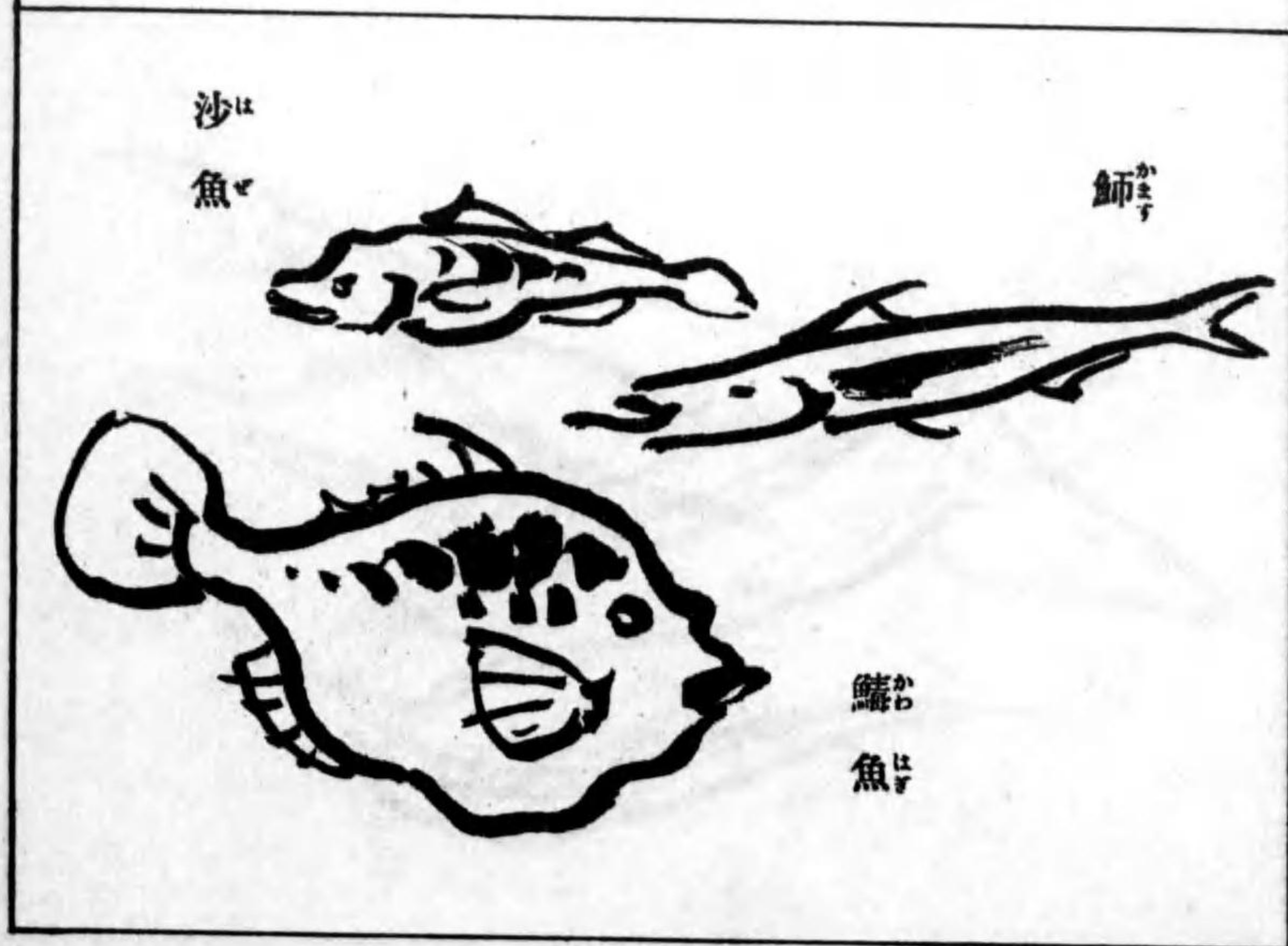
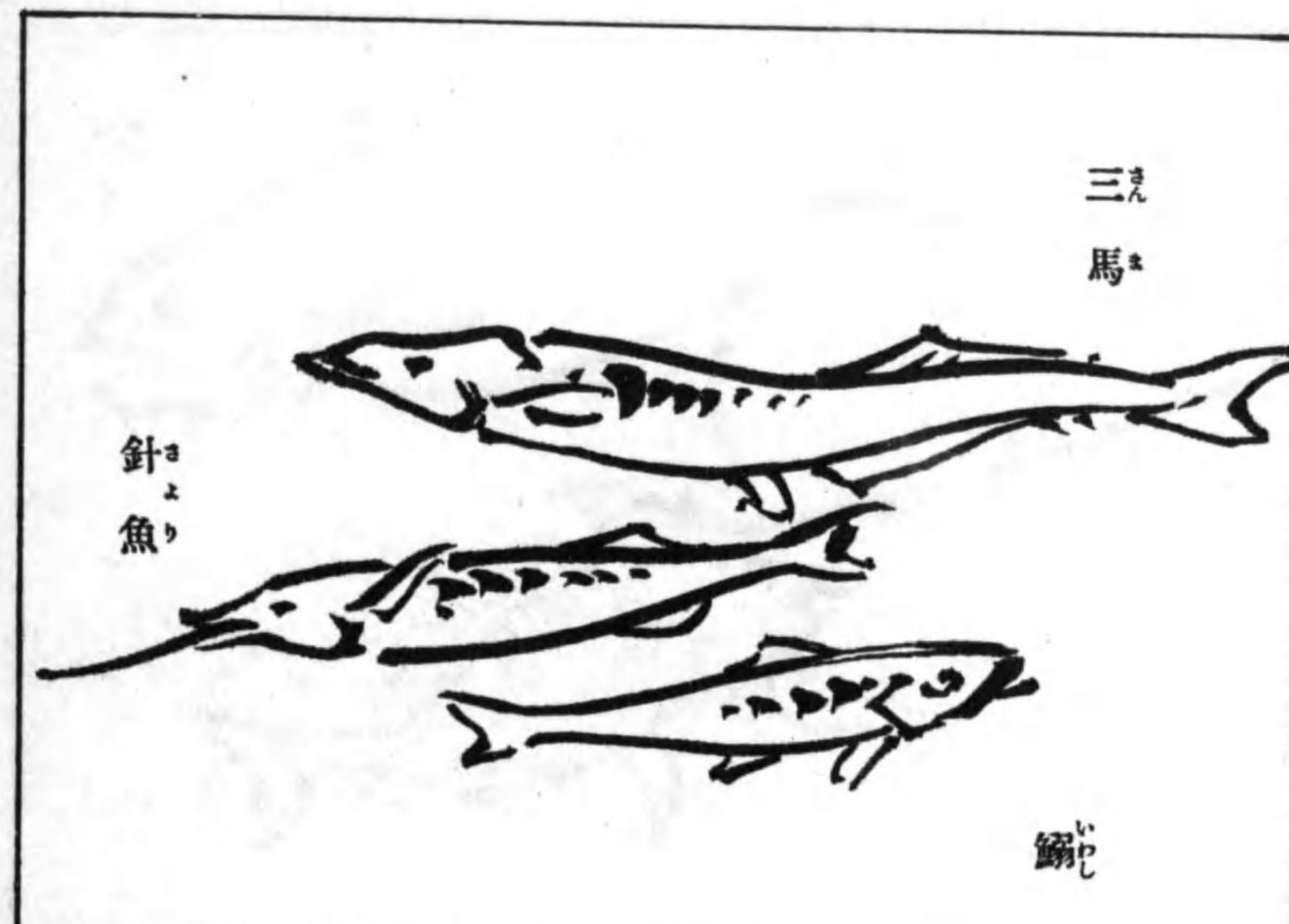
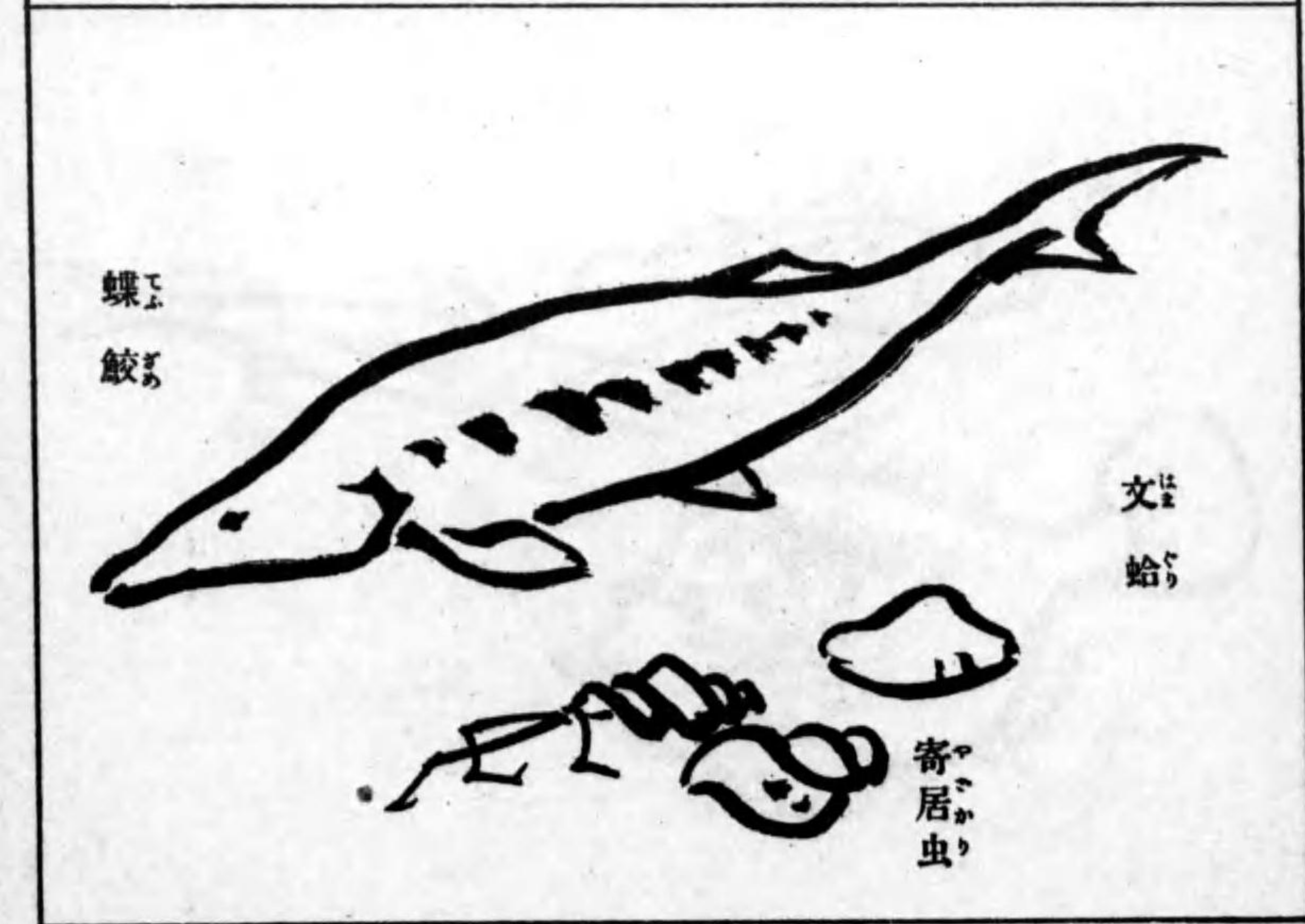
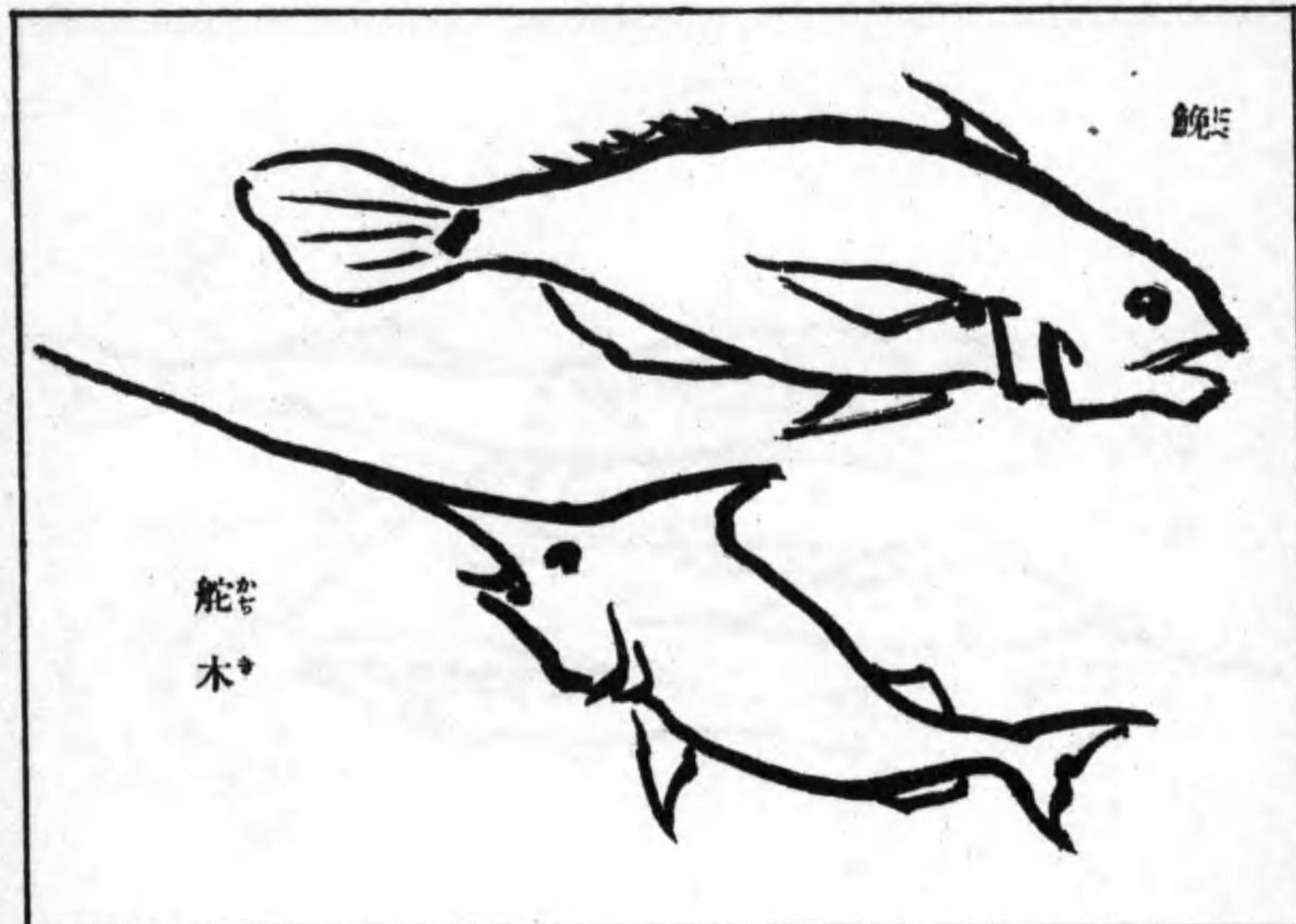

種木鮫

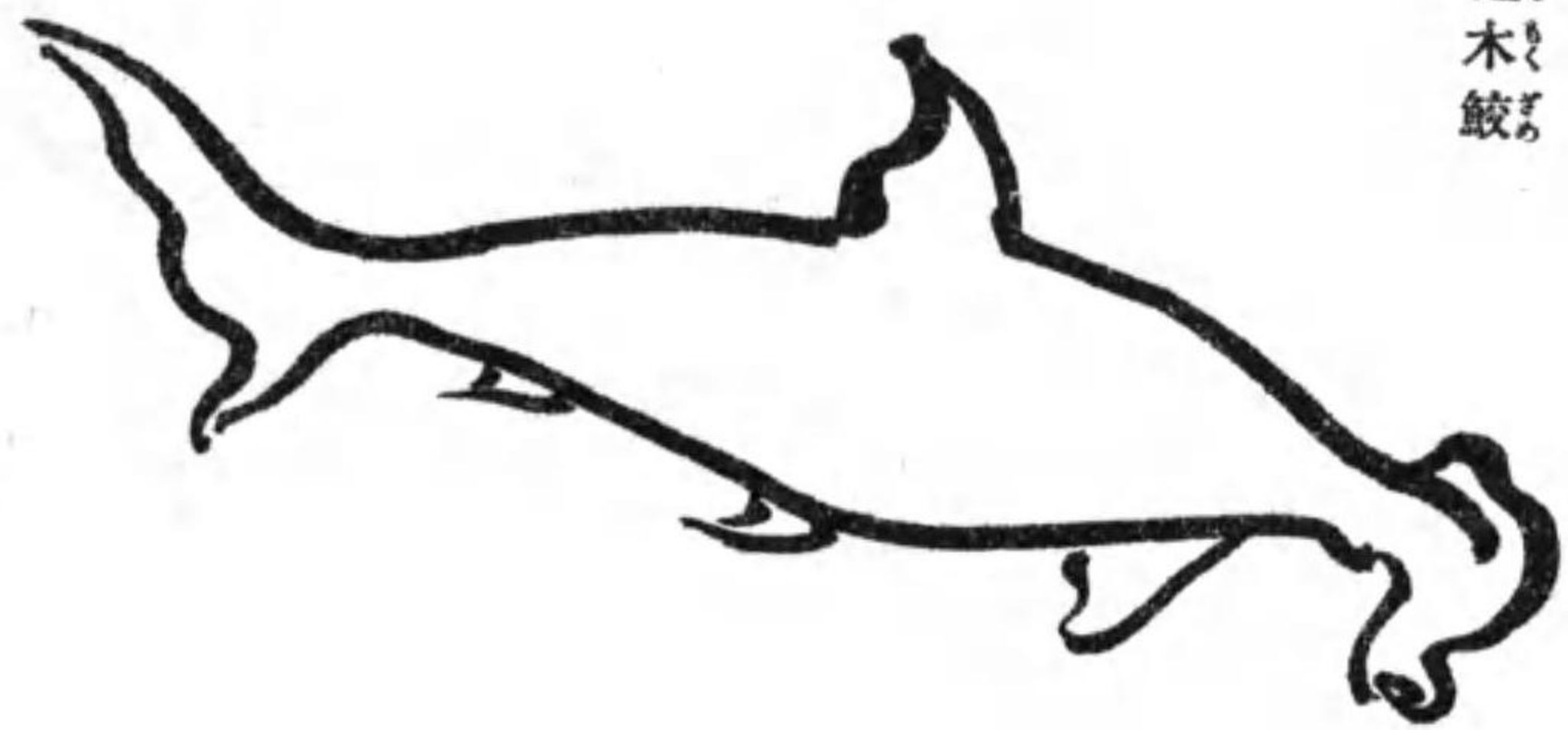

鰻

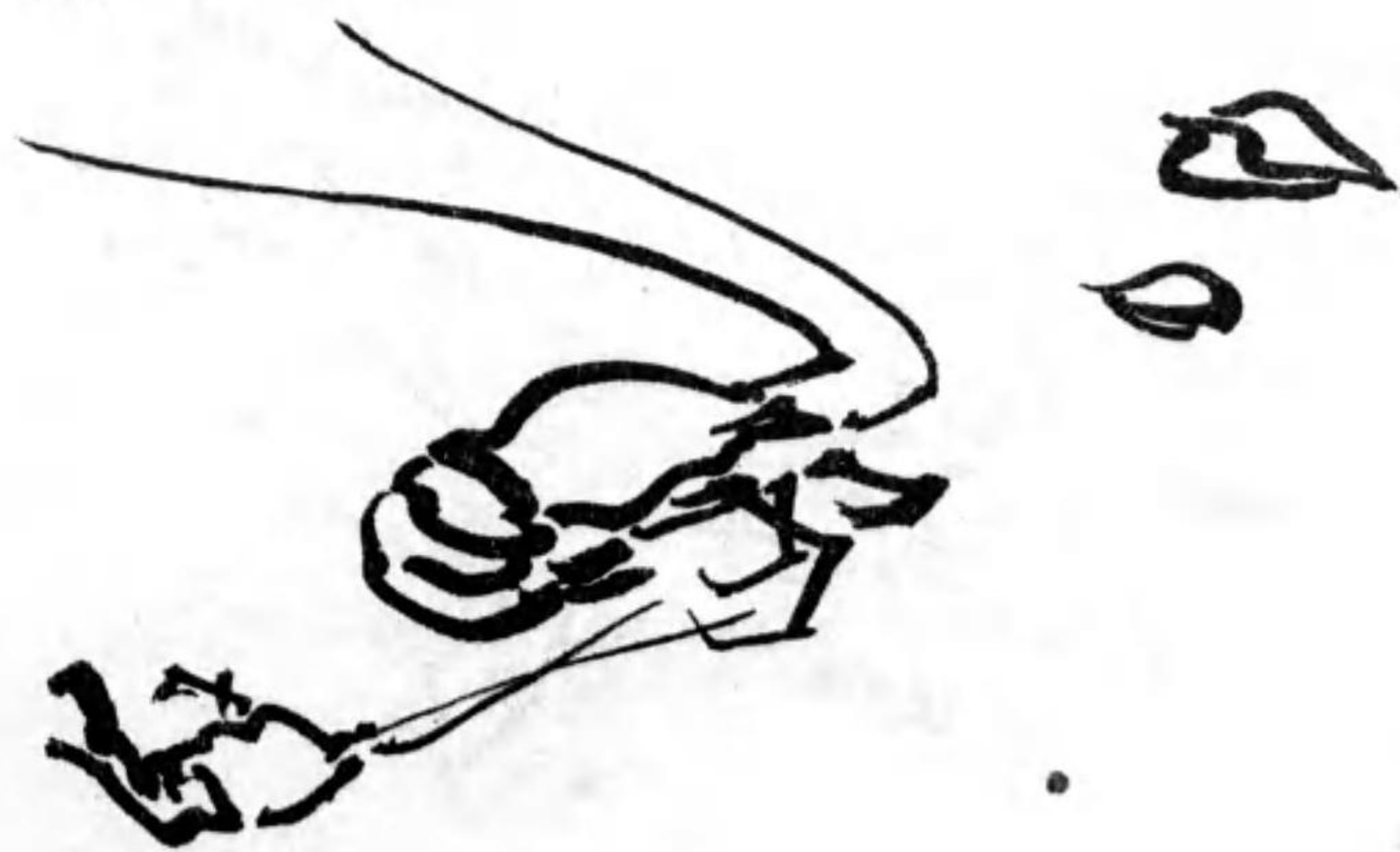

錫烏賊

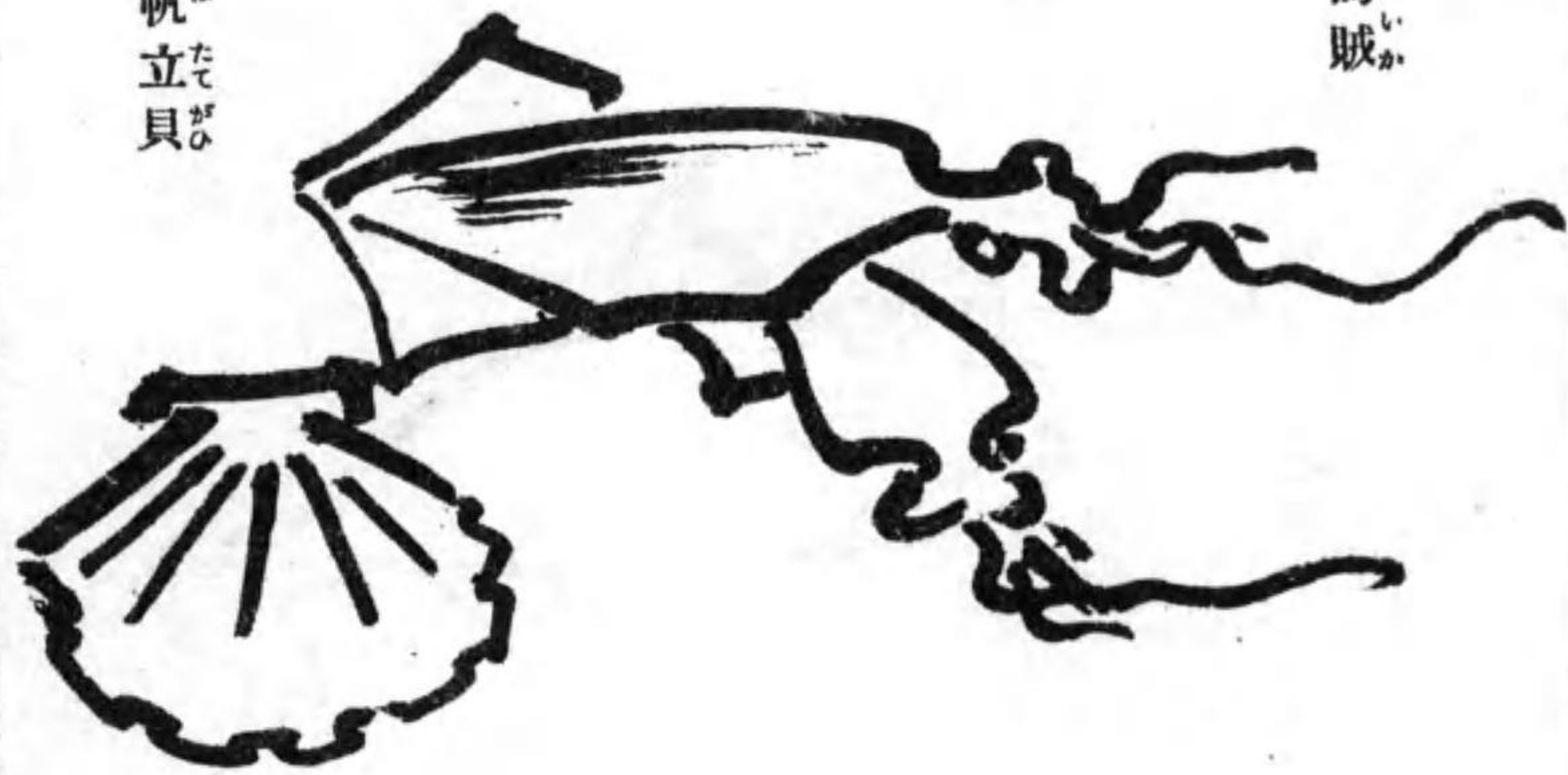

帆立貝



榮螺子

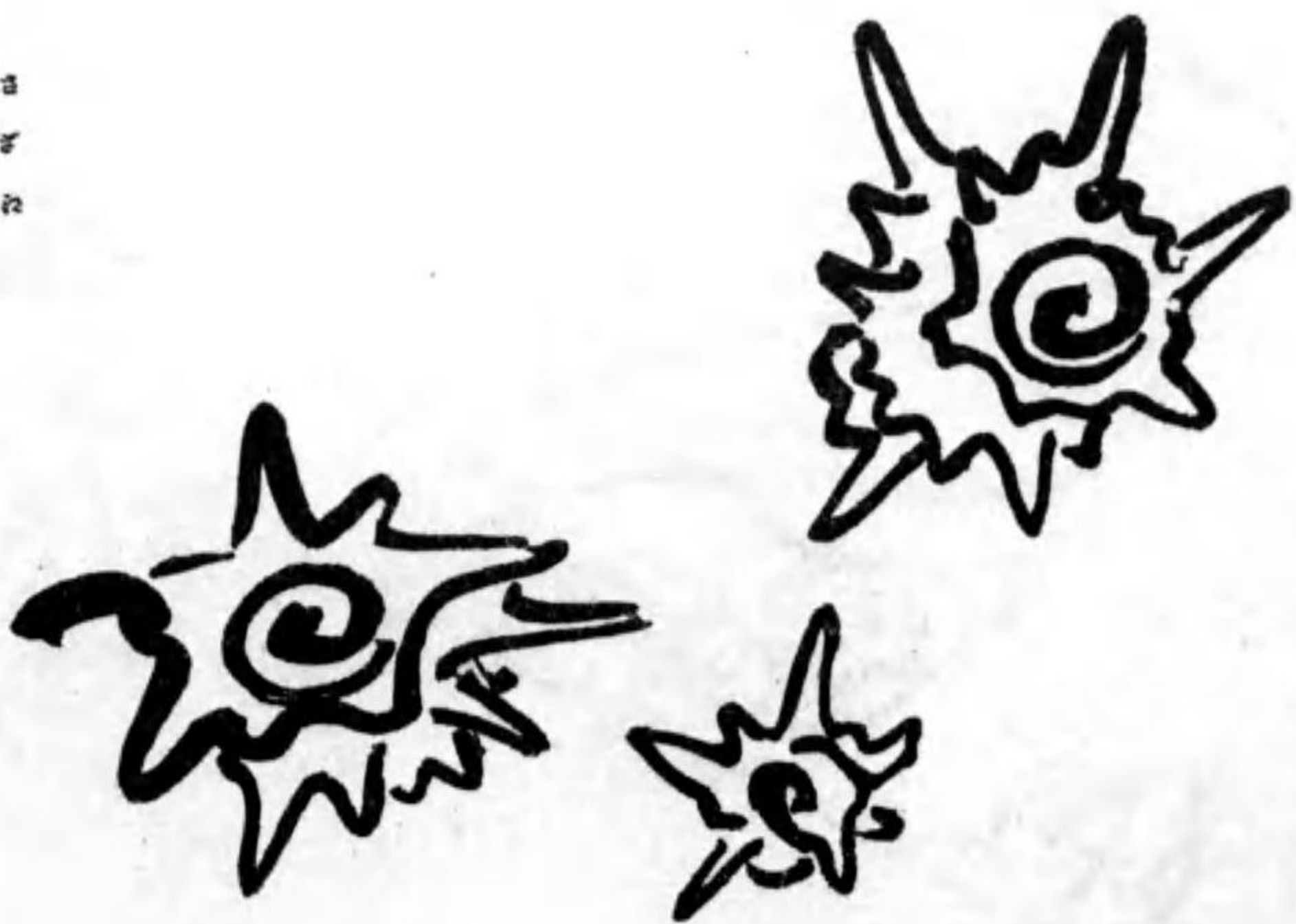

石
龜



玳
瑁

海
龜



雲
丹

烏
貝

蛸



煙

海
酸
漿

鮑

長
螺

田
螺

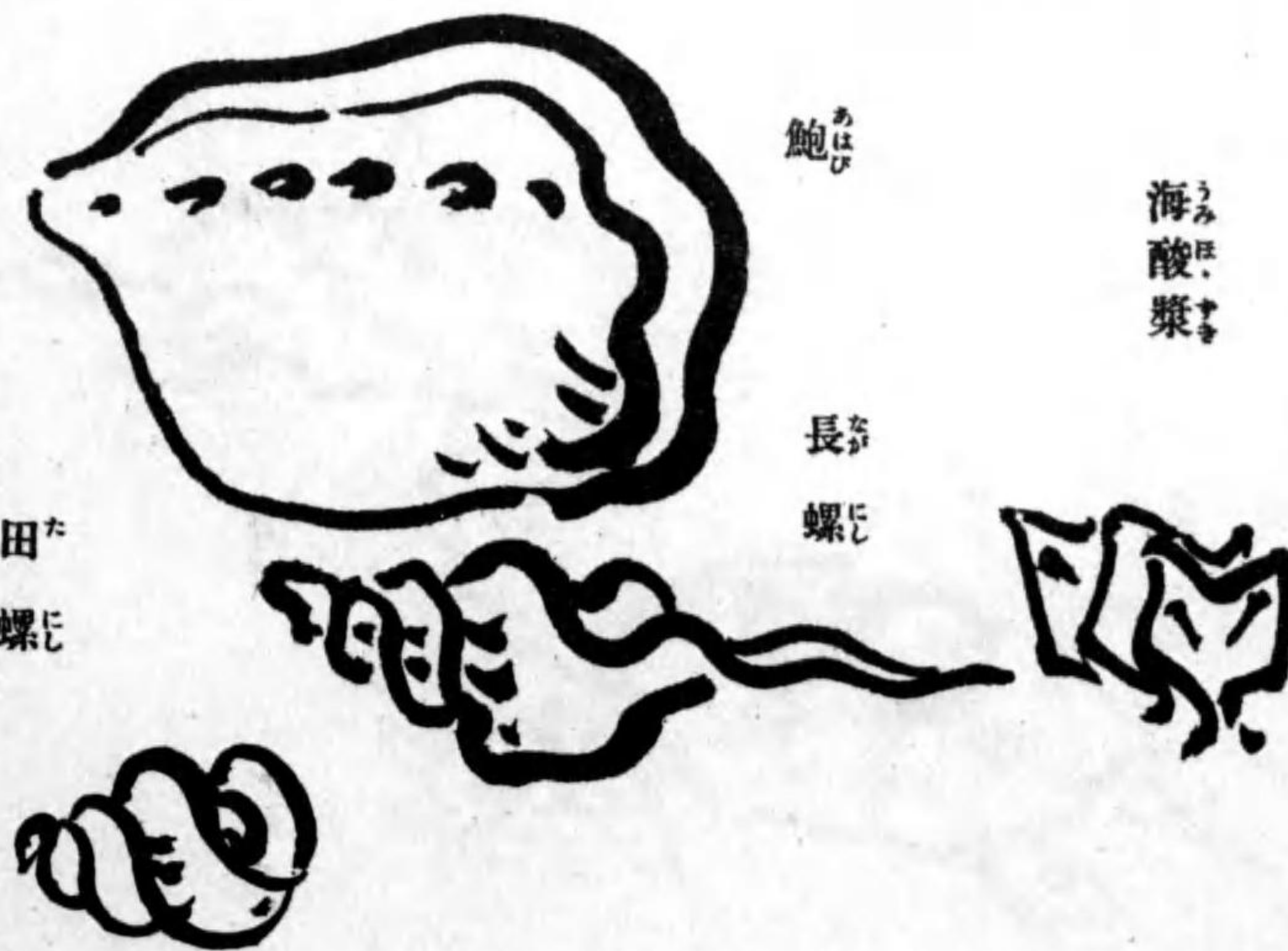

虫 類
其十二

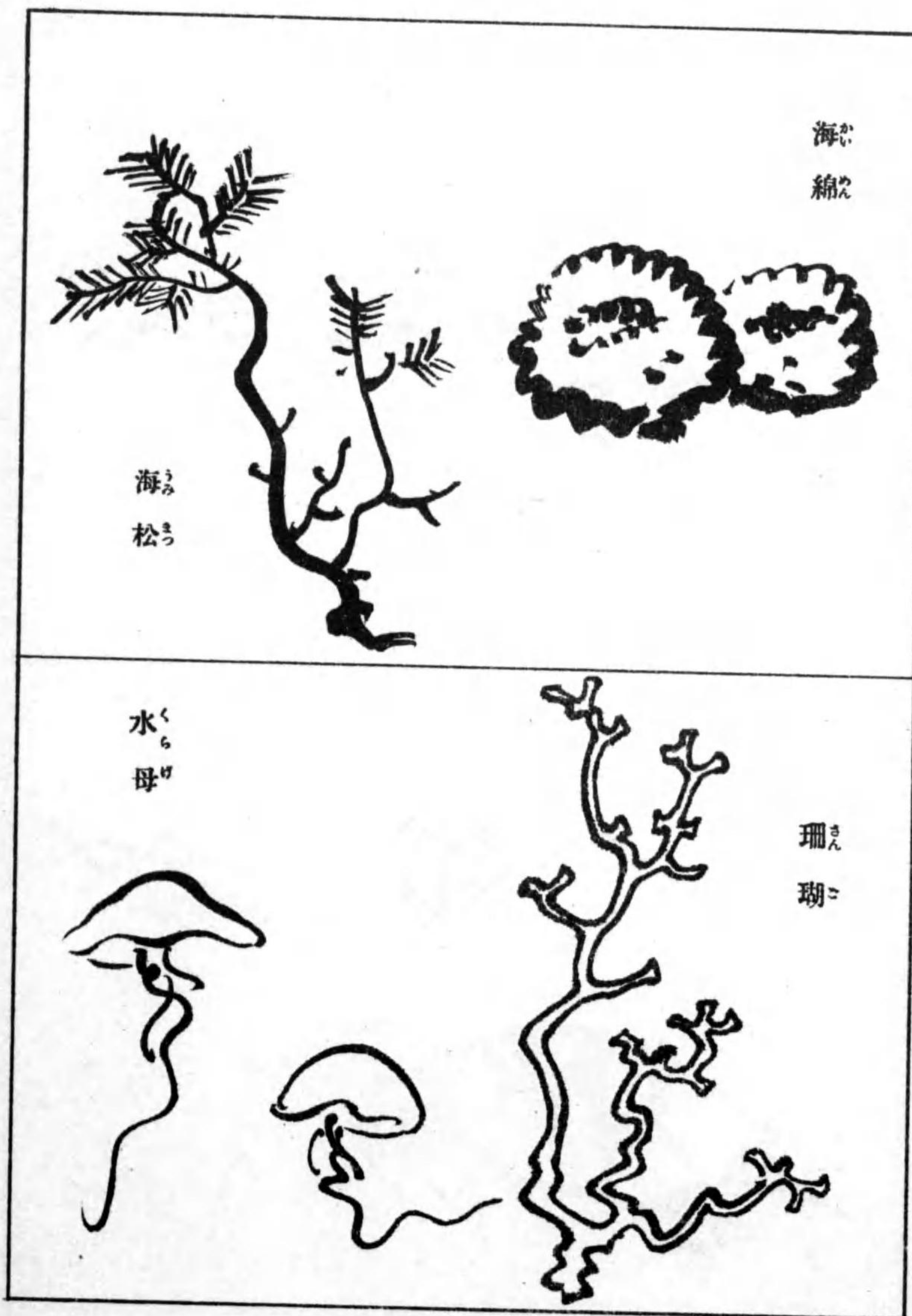

黑板畫法

百六十八

蜻蛉



蛾

繭



蠶

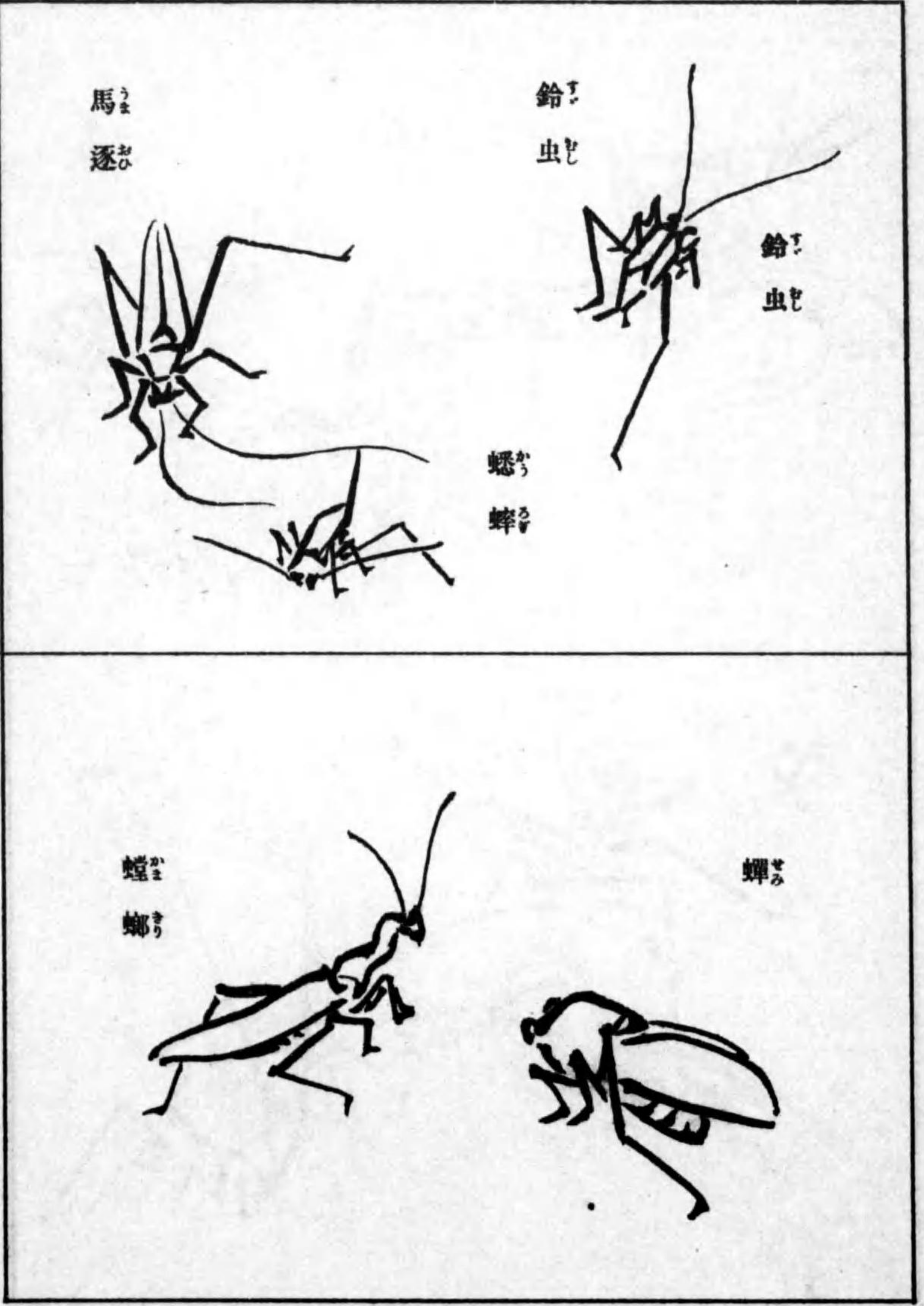
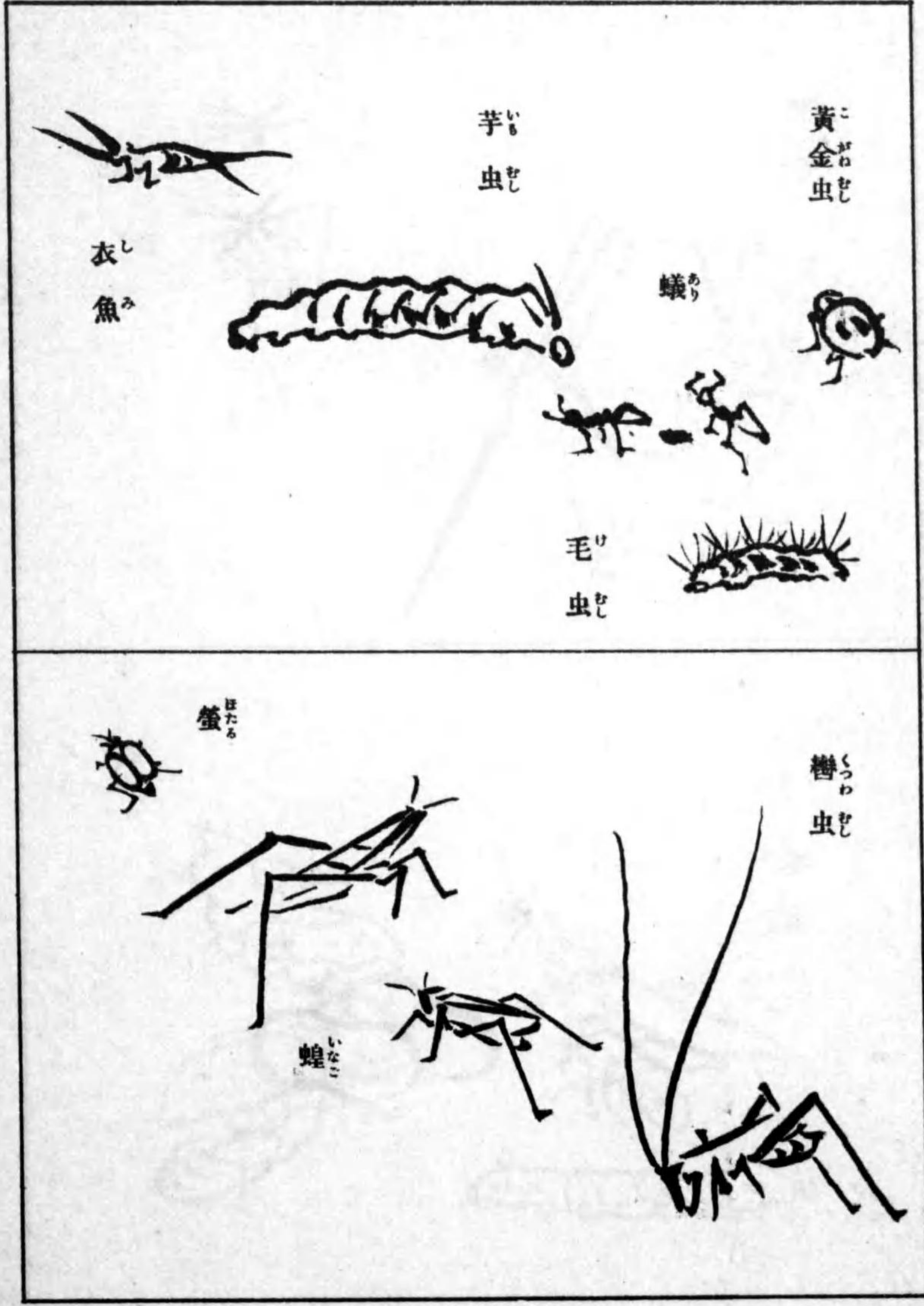

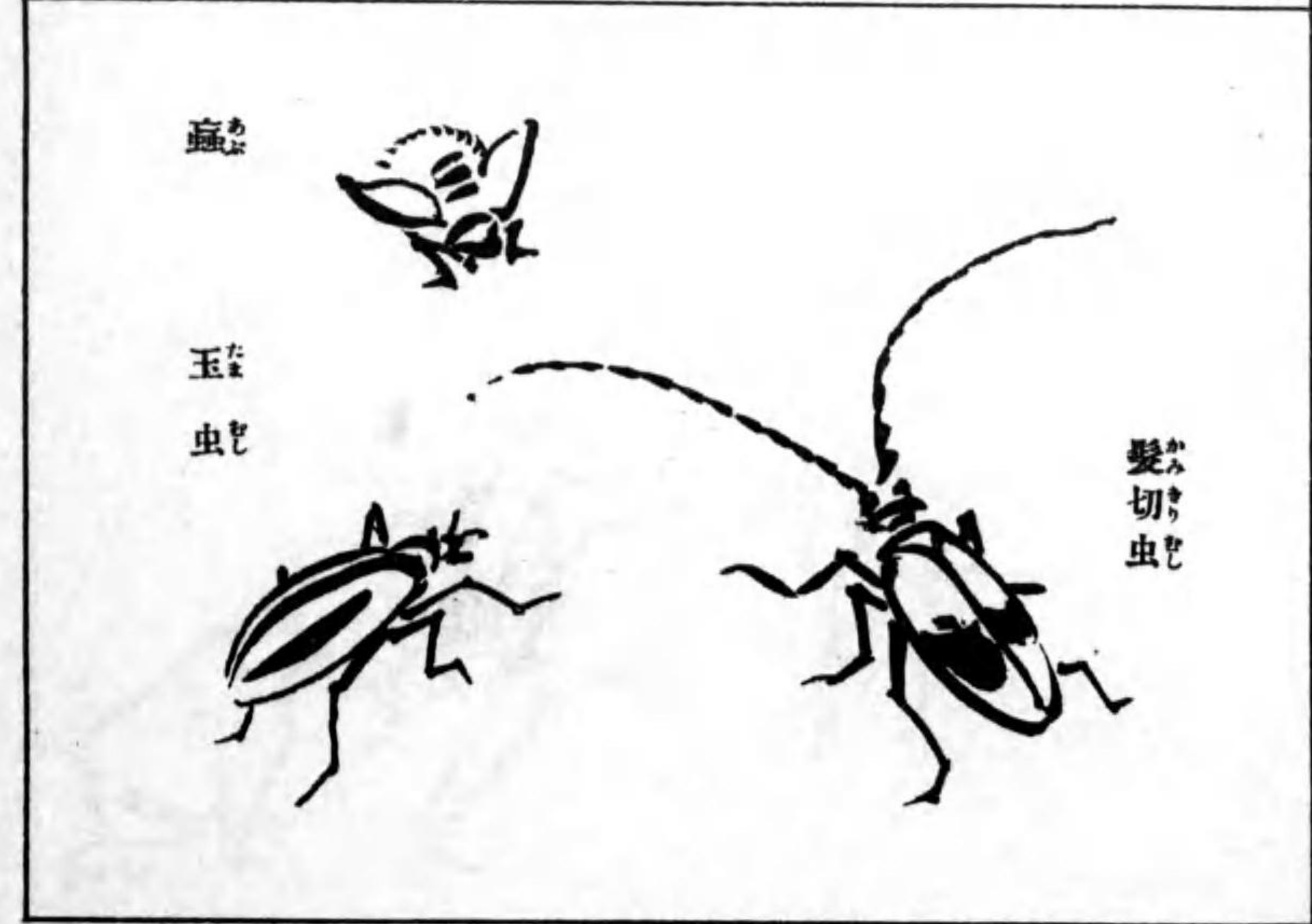
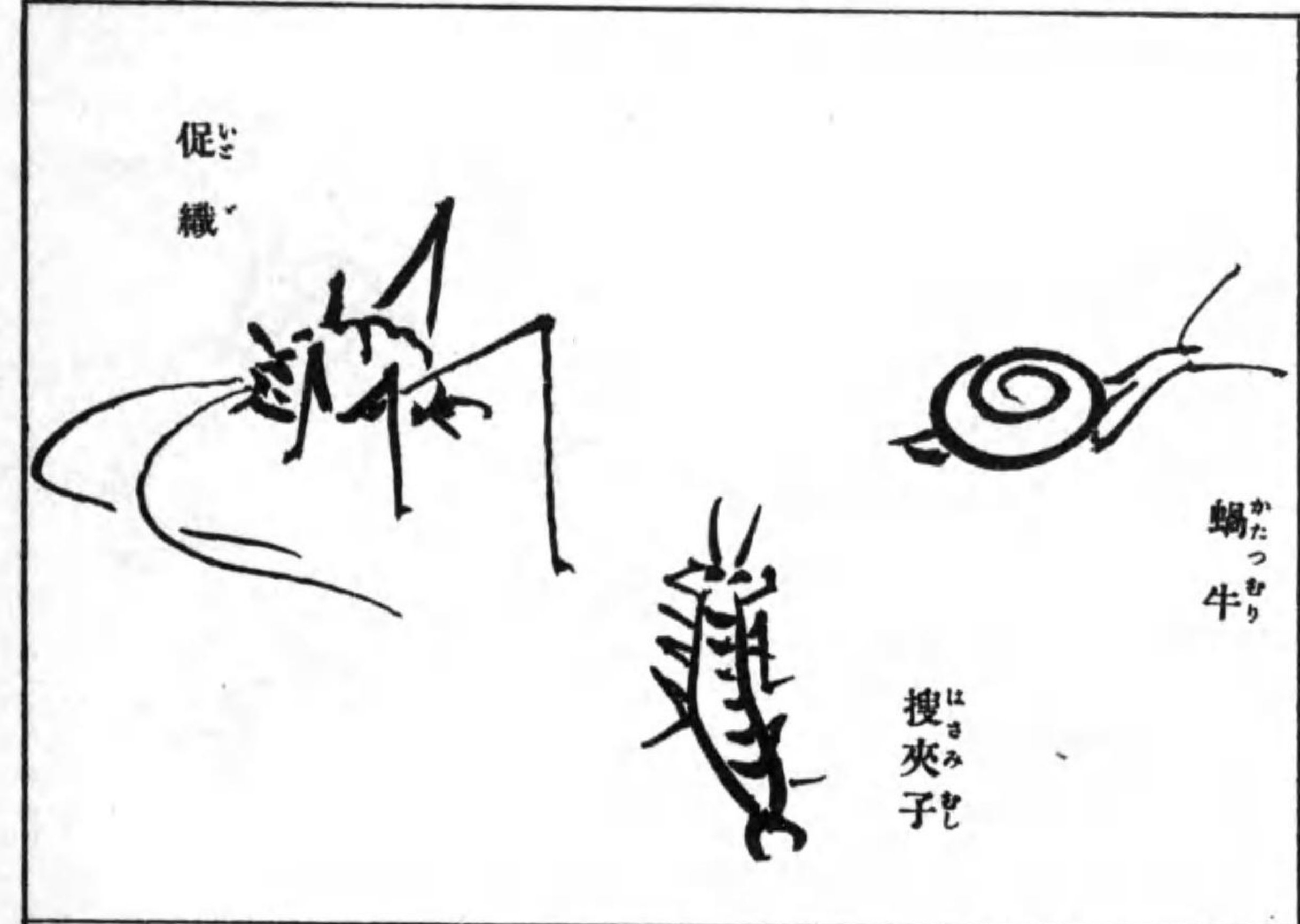
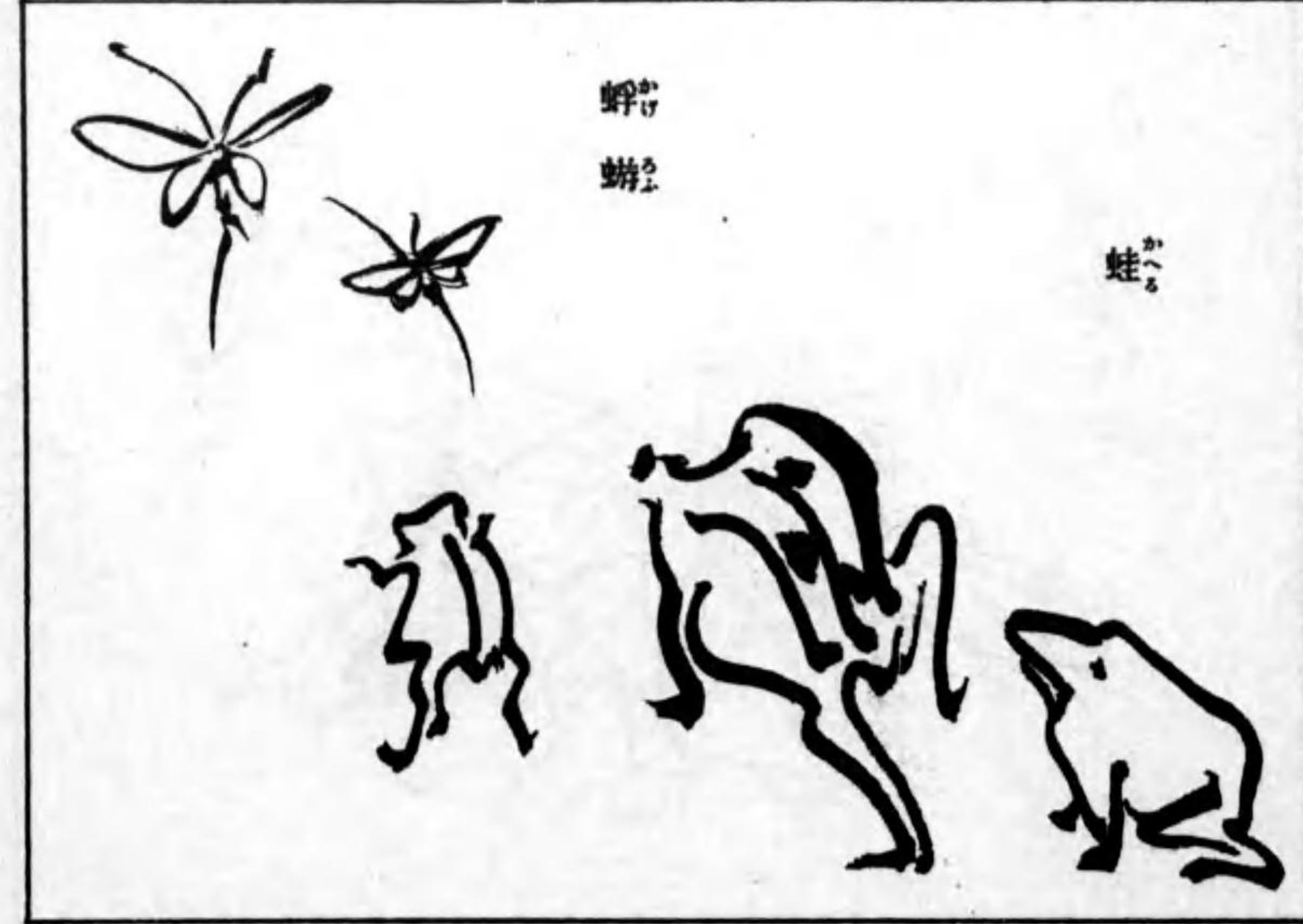
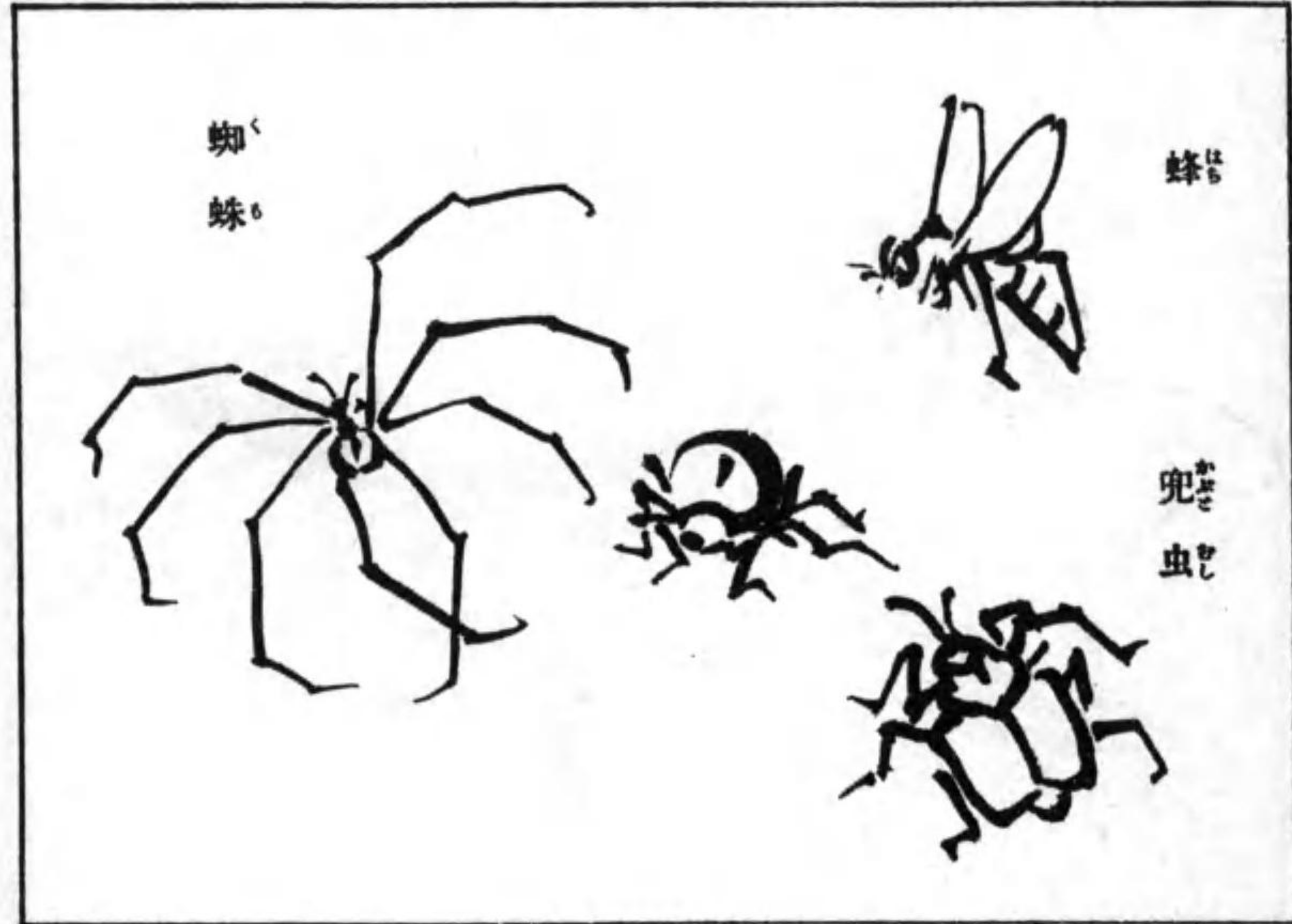

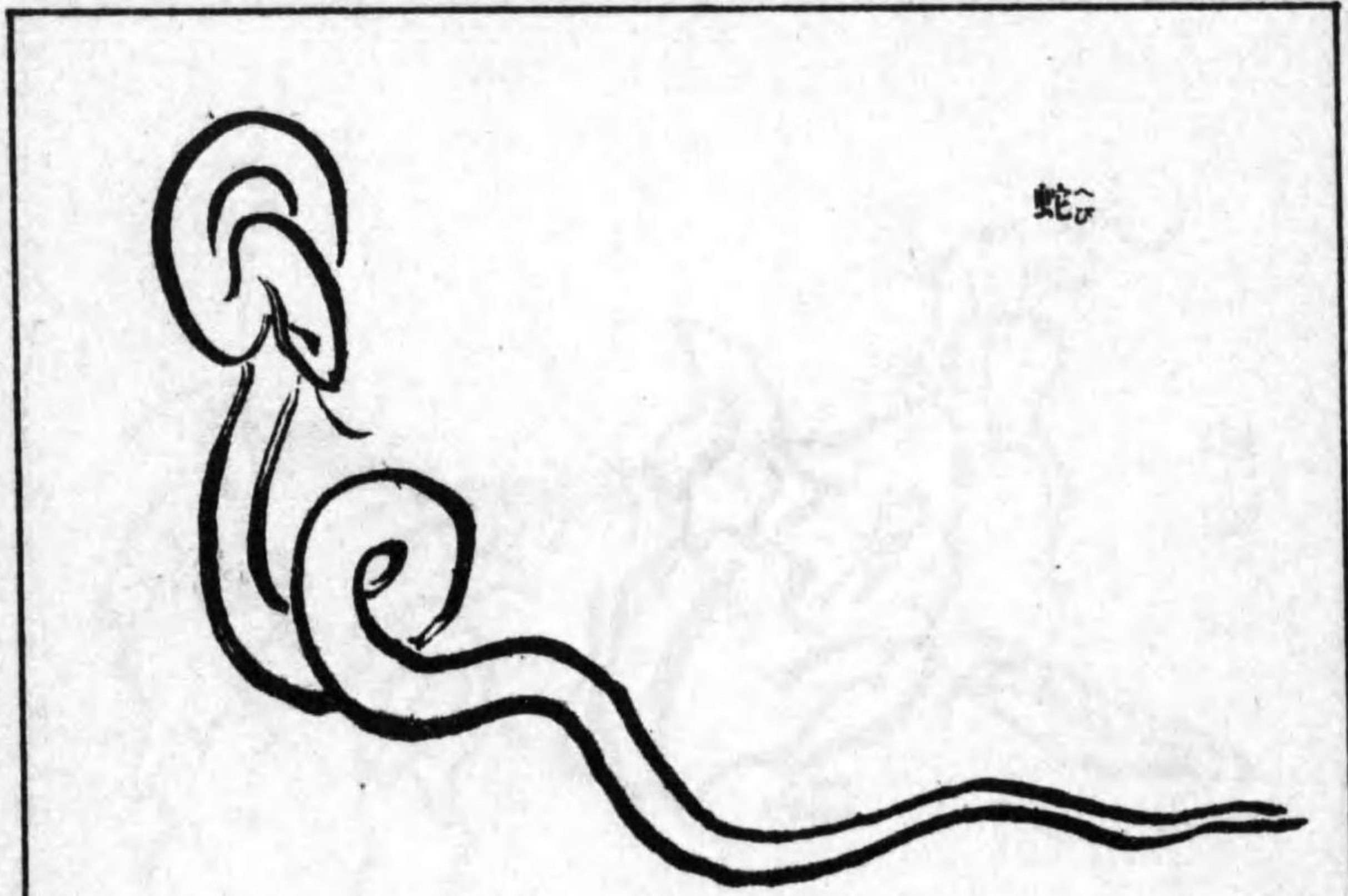

蛇ヘビ

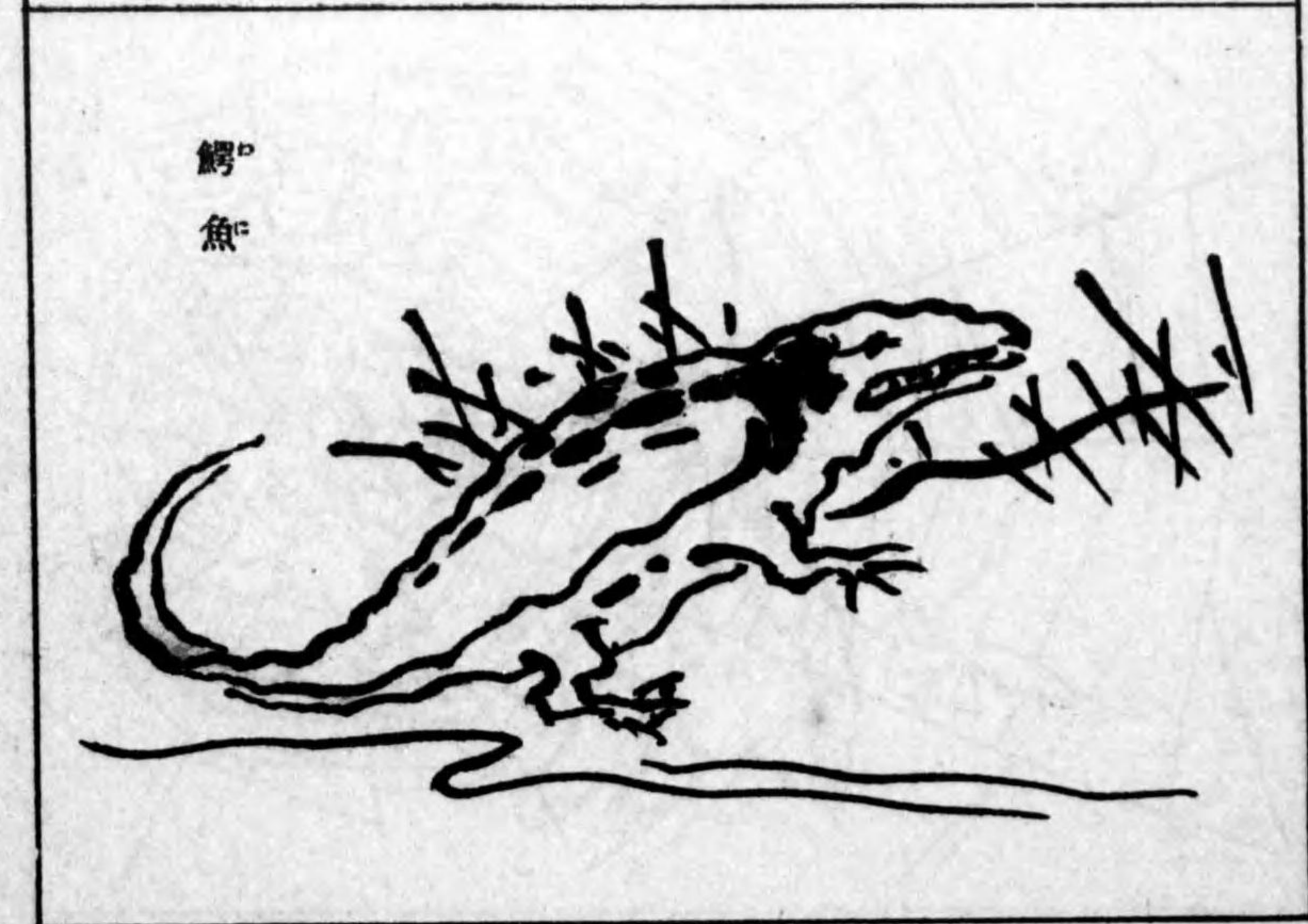

鱷カメ
魚イサ

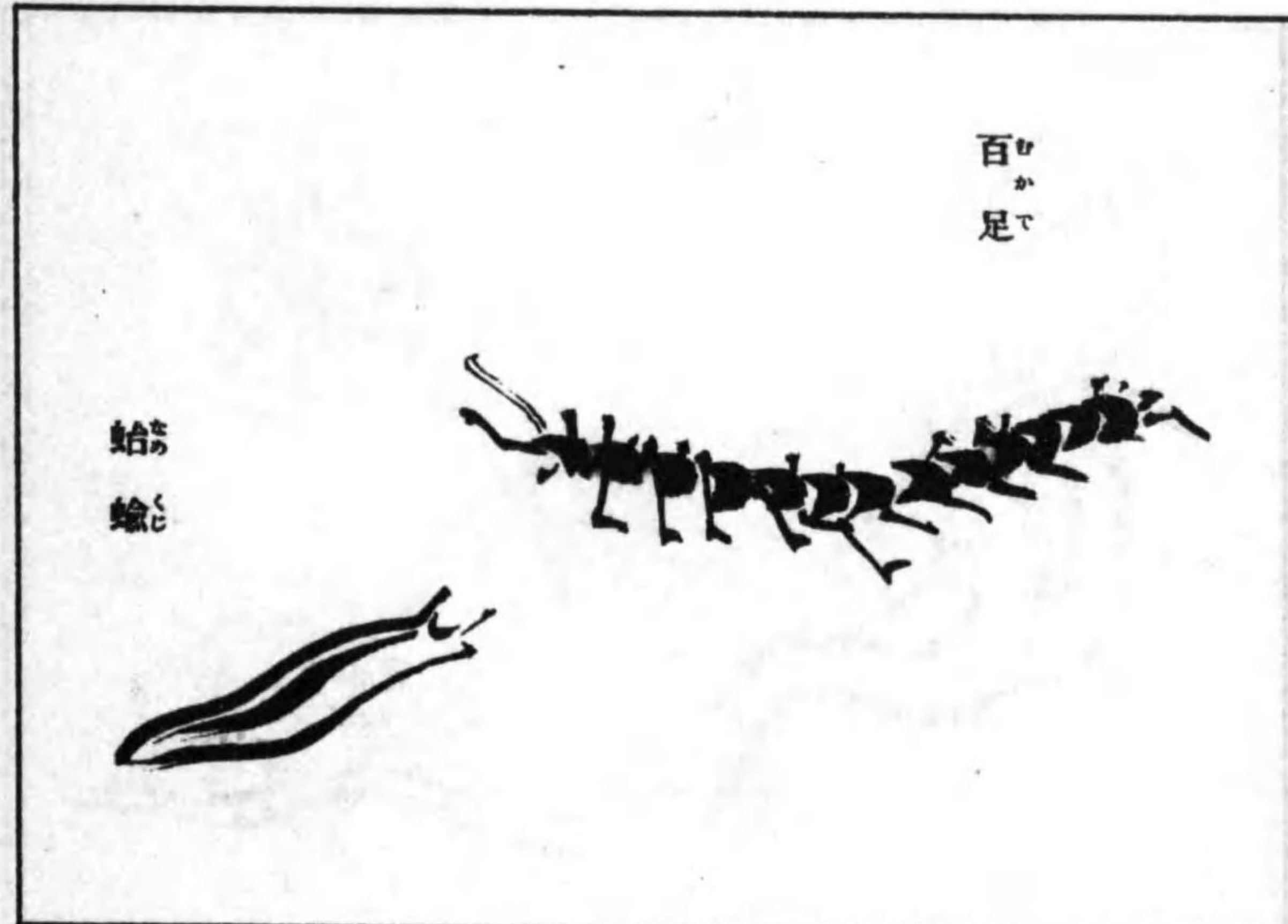

百ヒ
か
足ア

始ヒ
蟻アリ

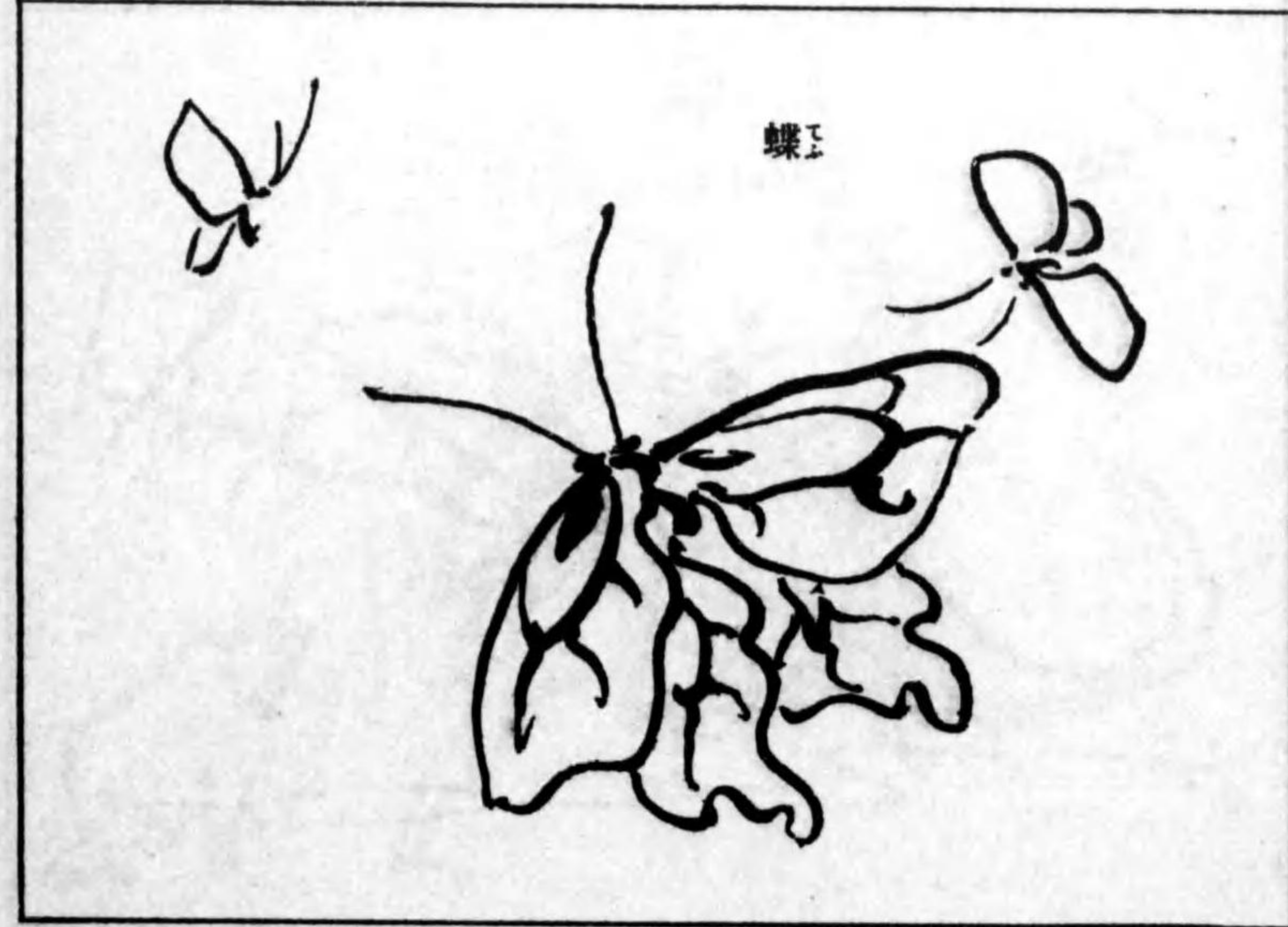

蝶チョウ

其十三
人

物

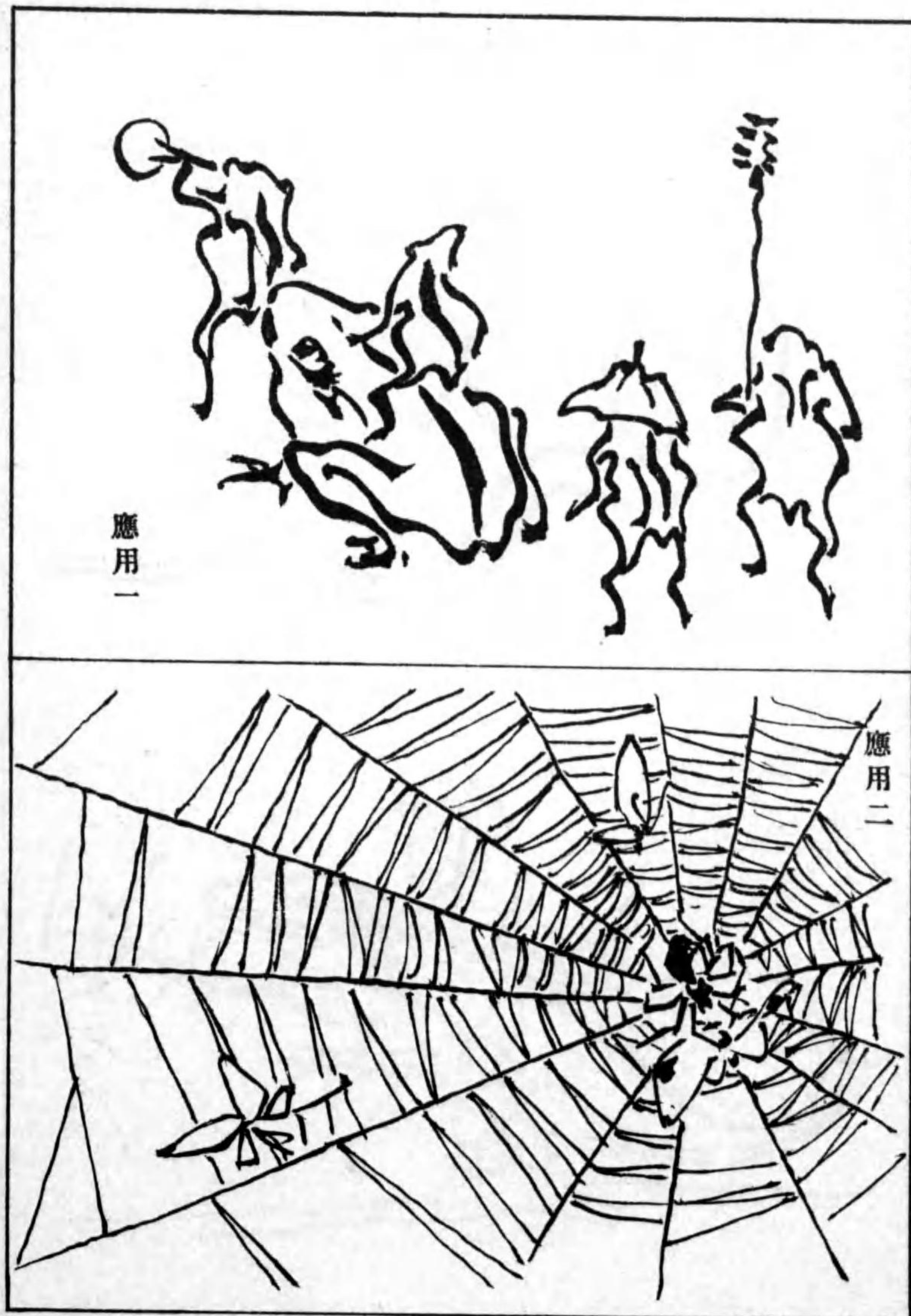

相撲

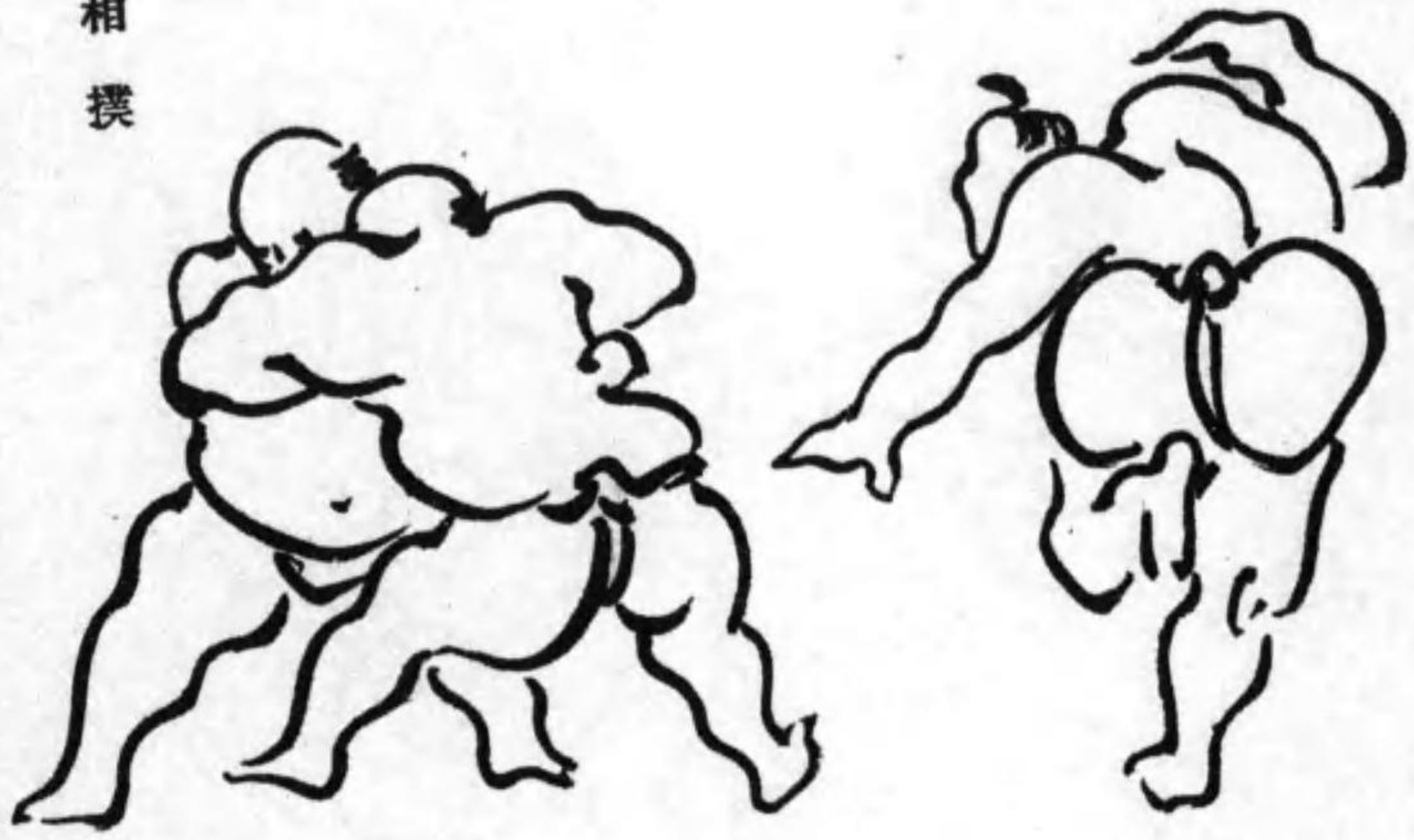

力競べ

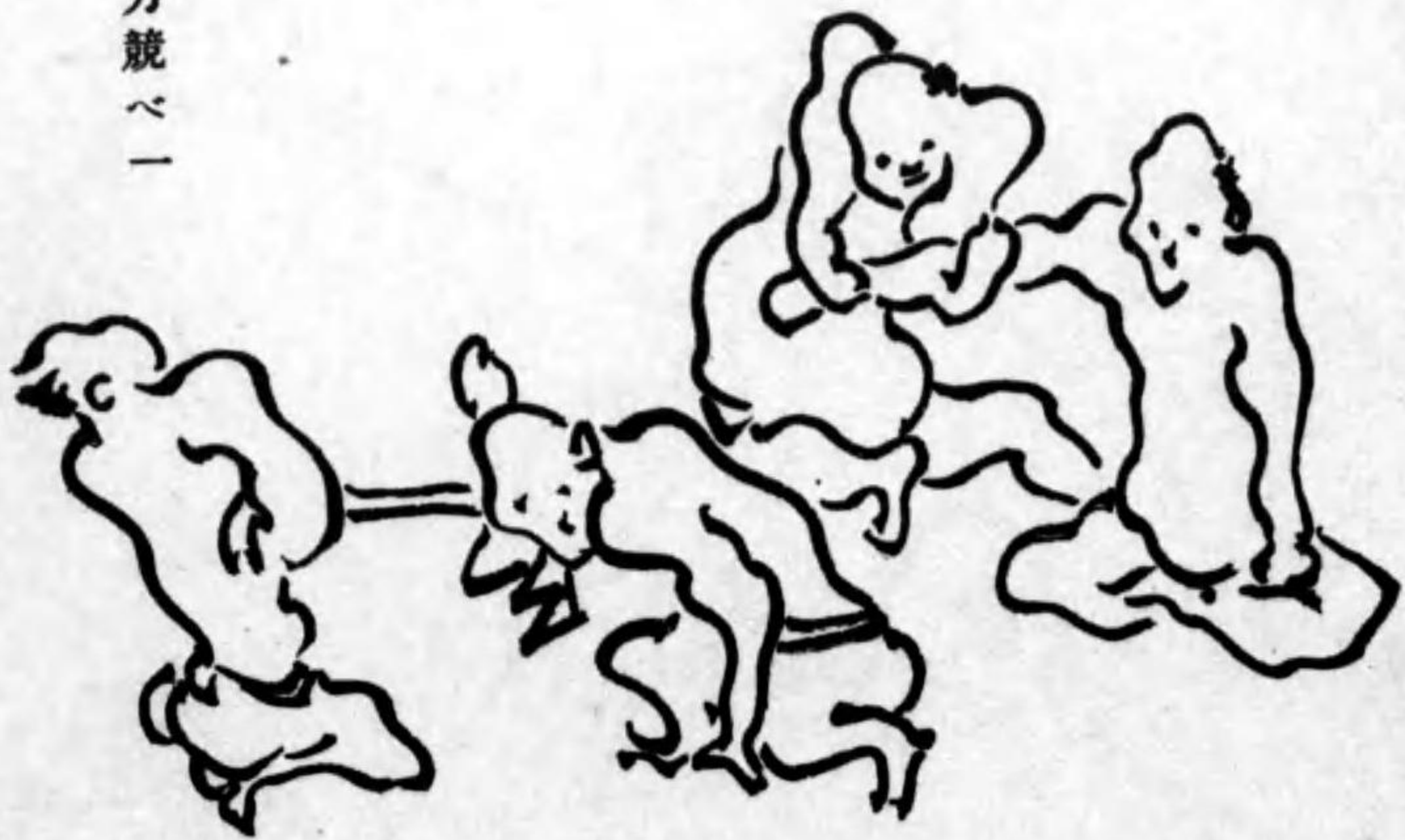

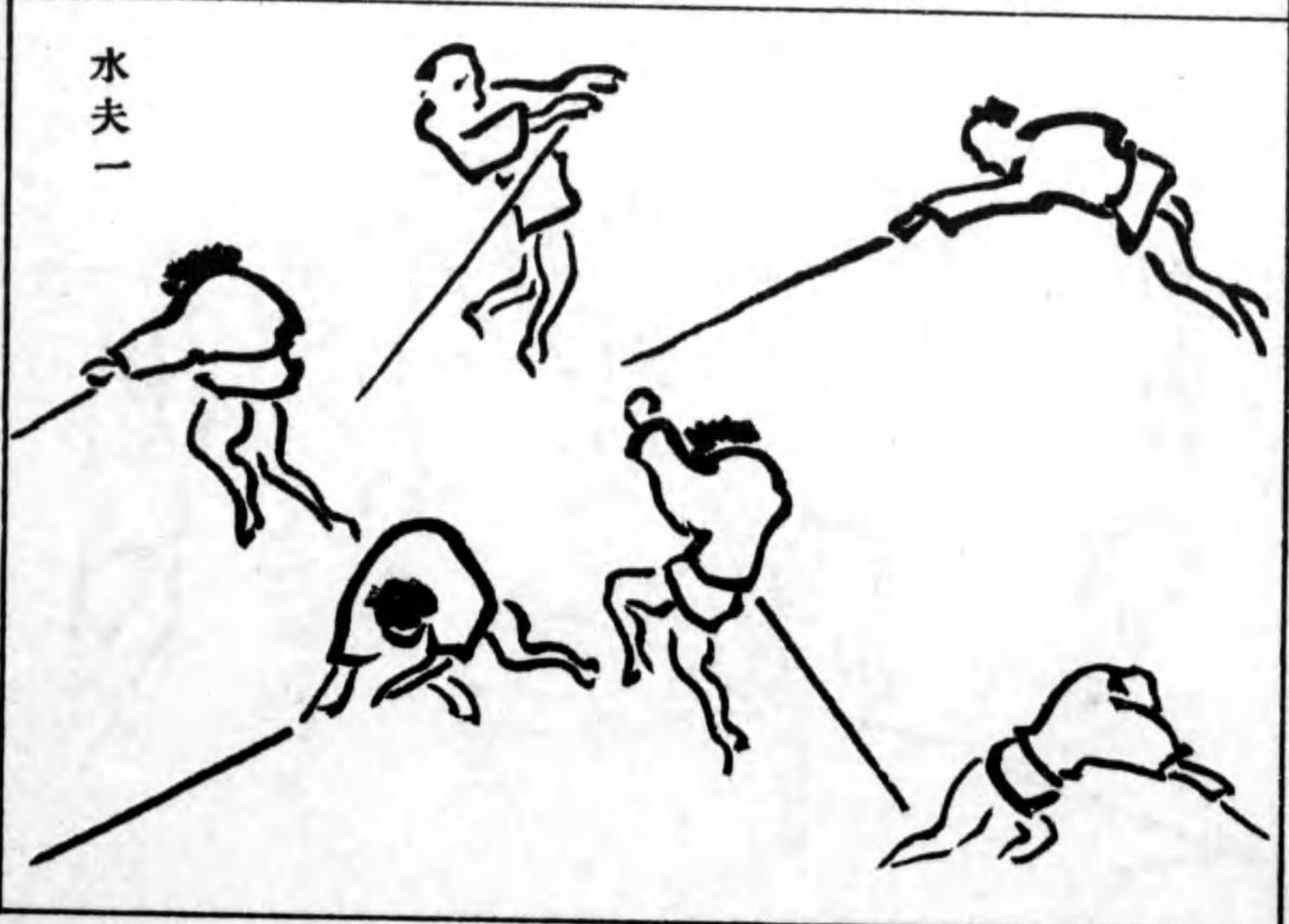
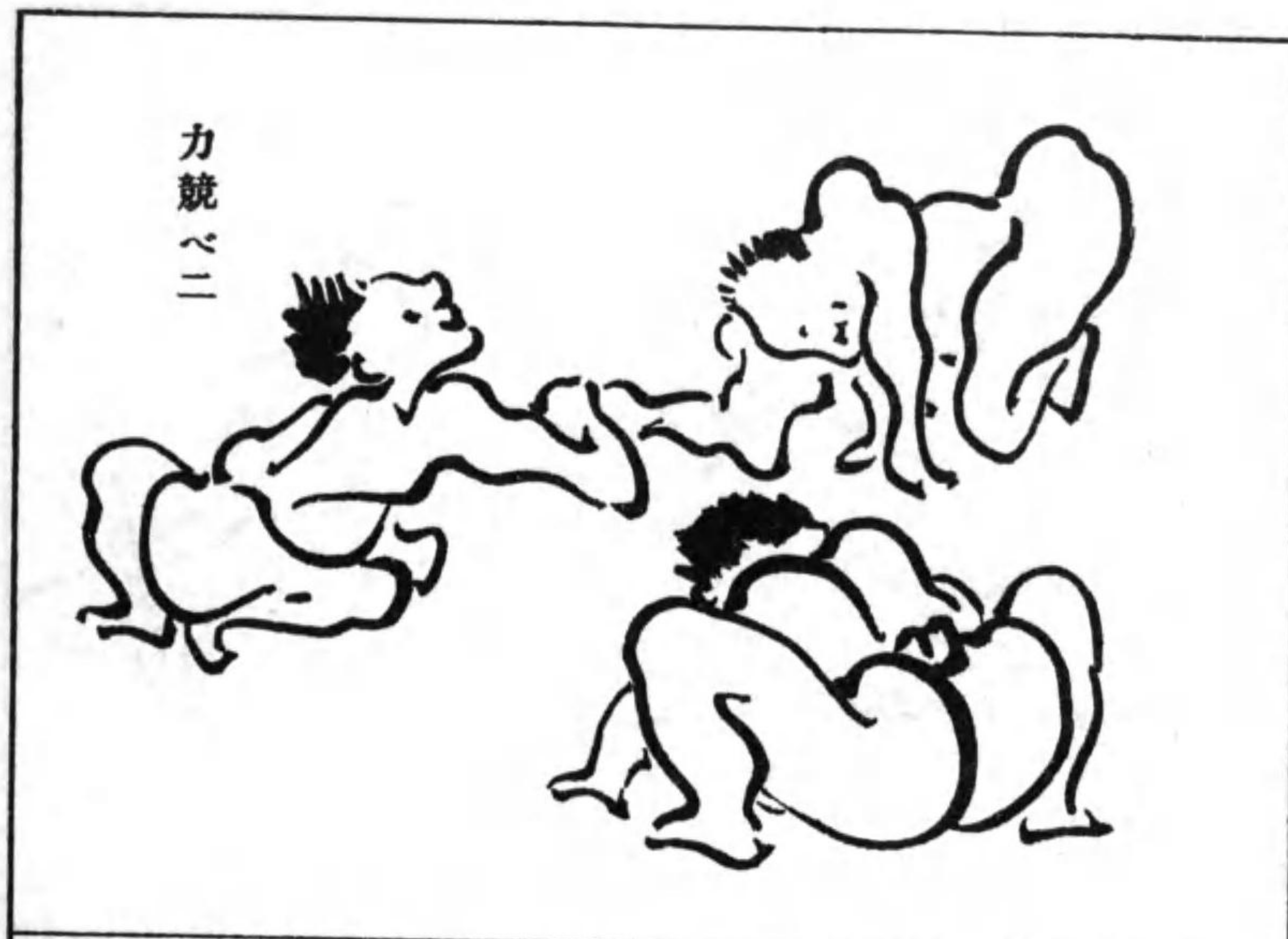
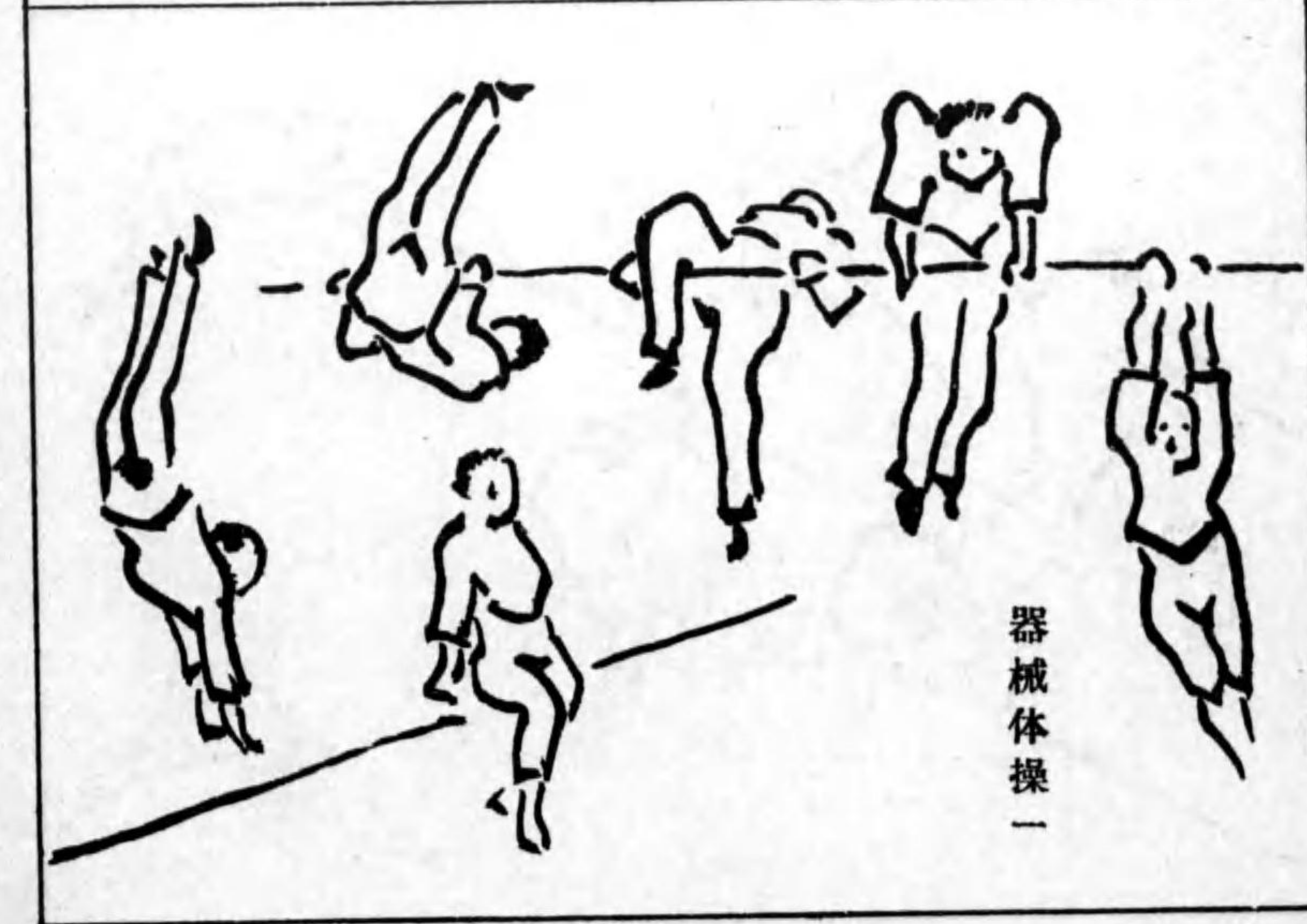
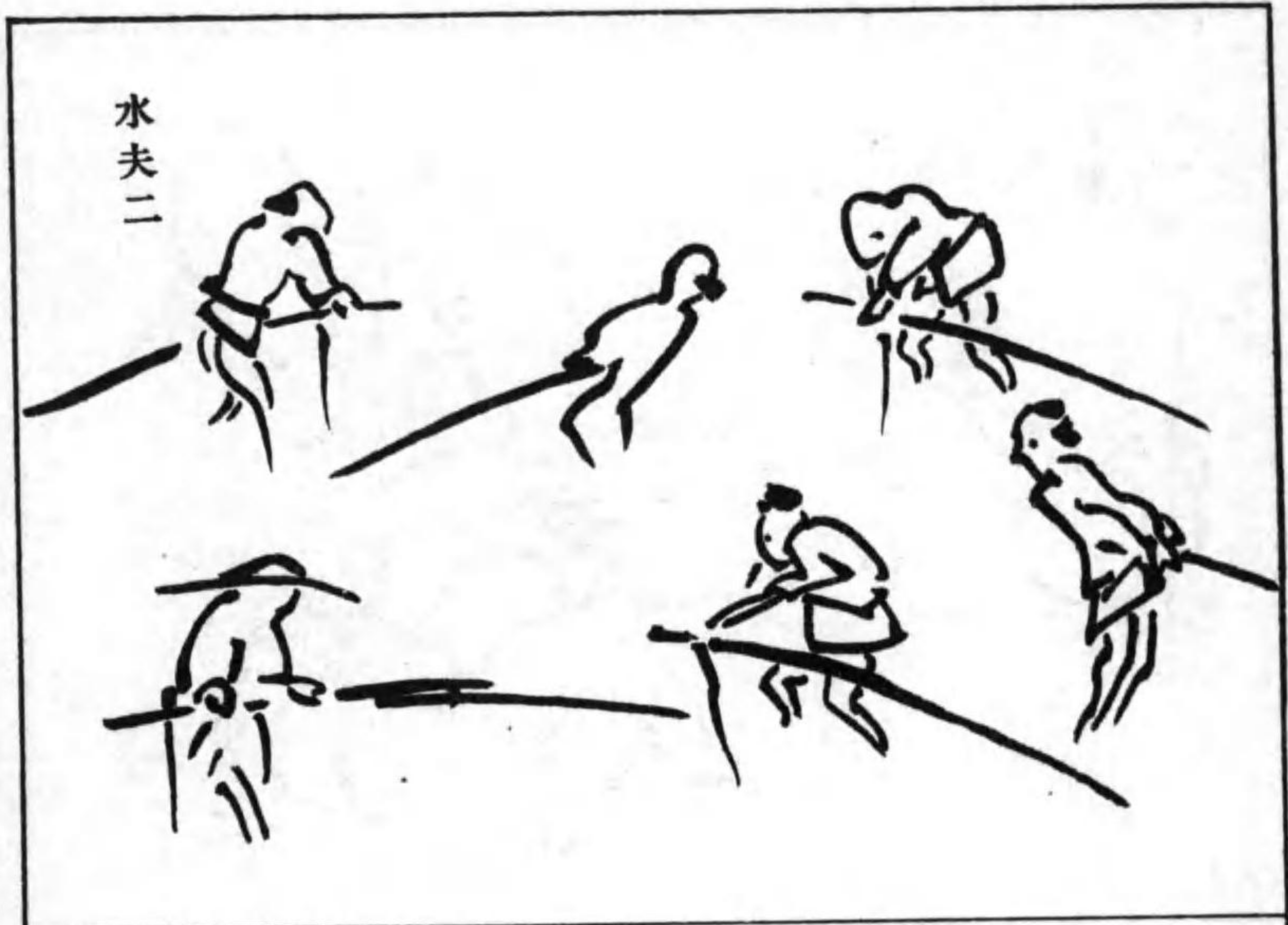

器械体操二

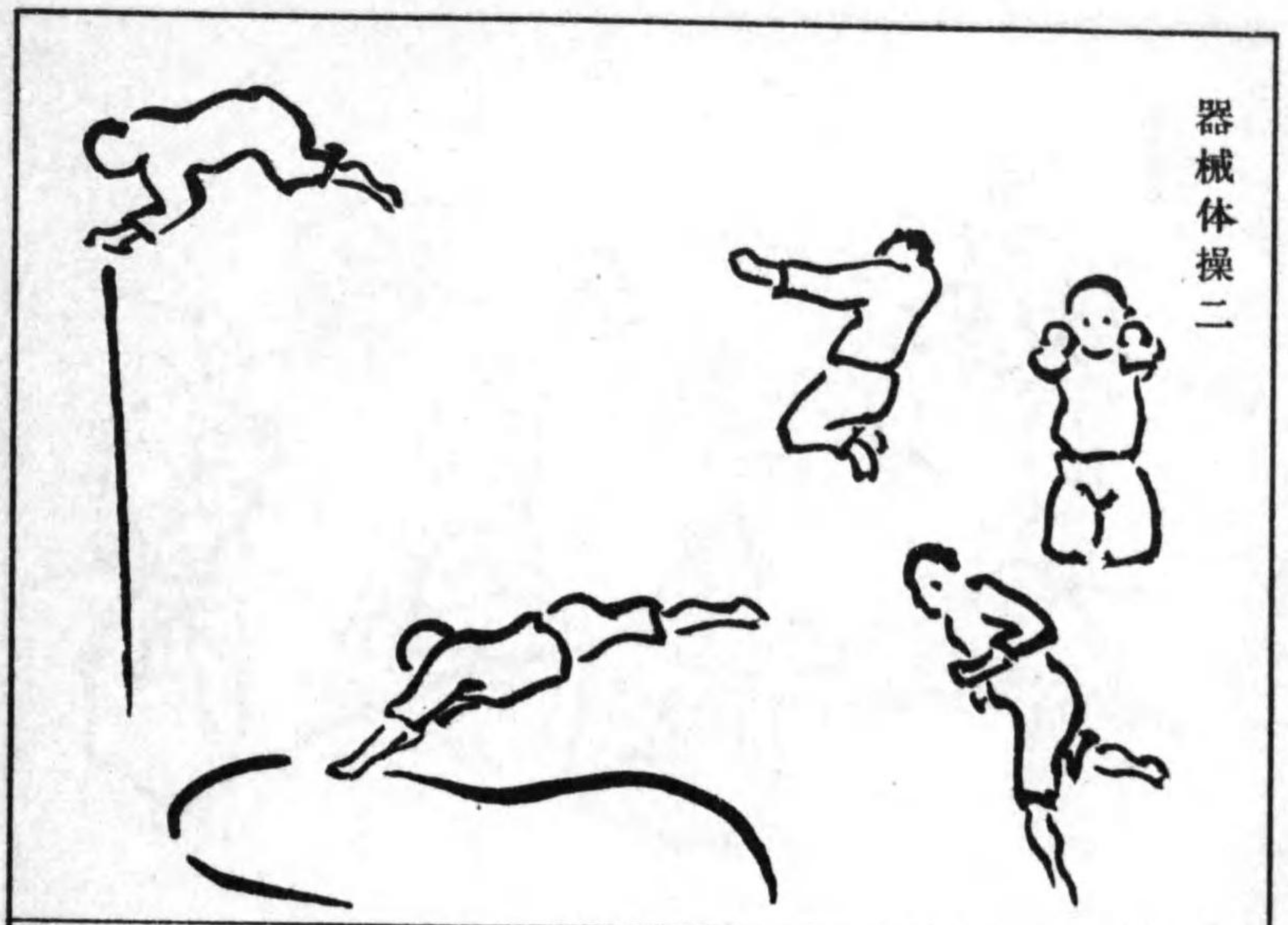

遊戲一

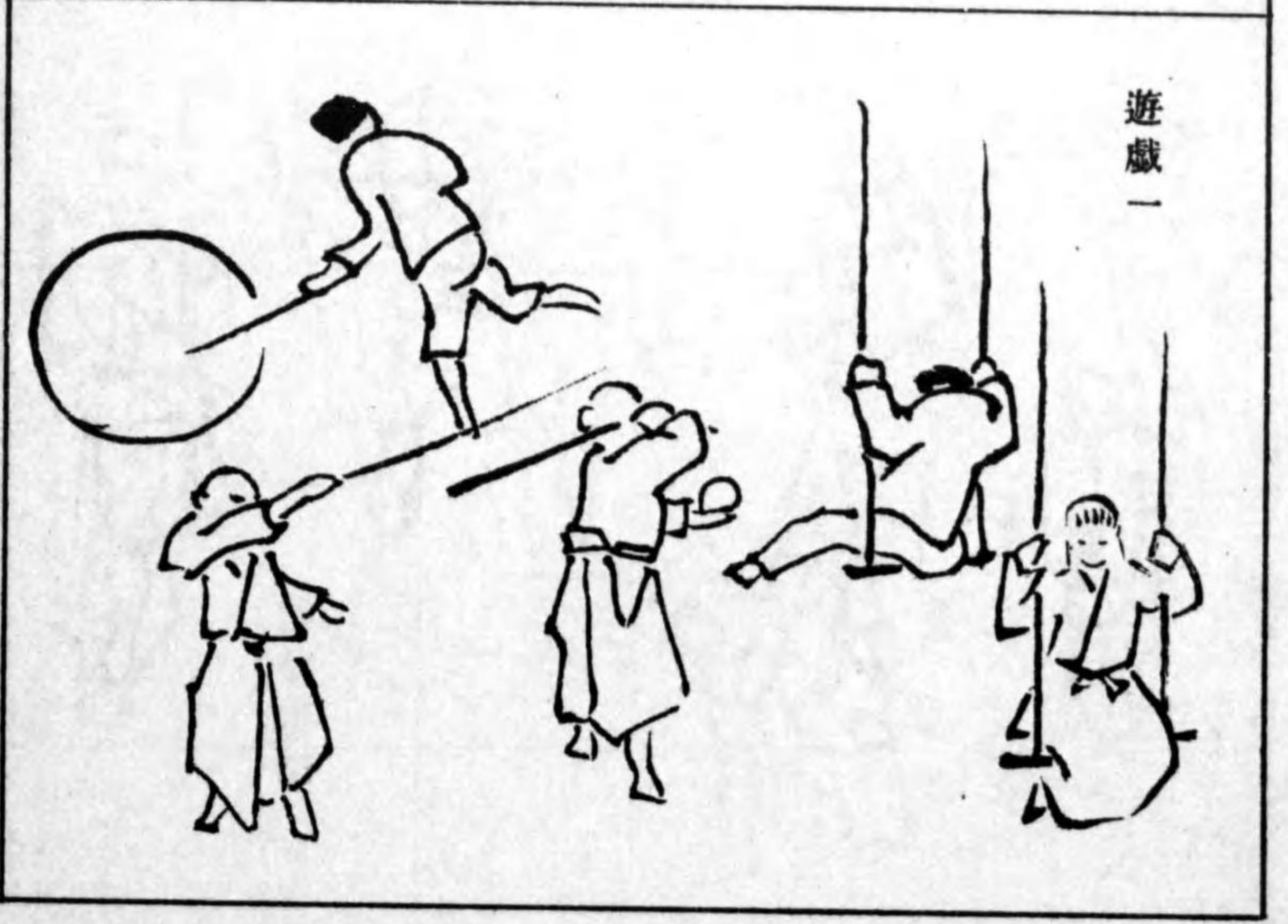

遊戲二



操銃

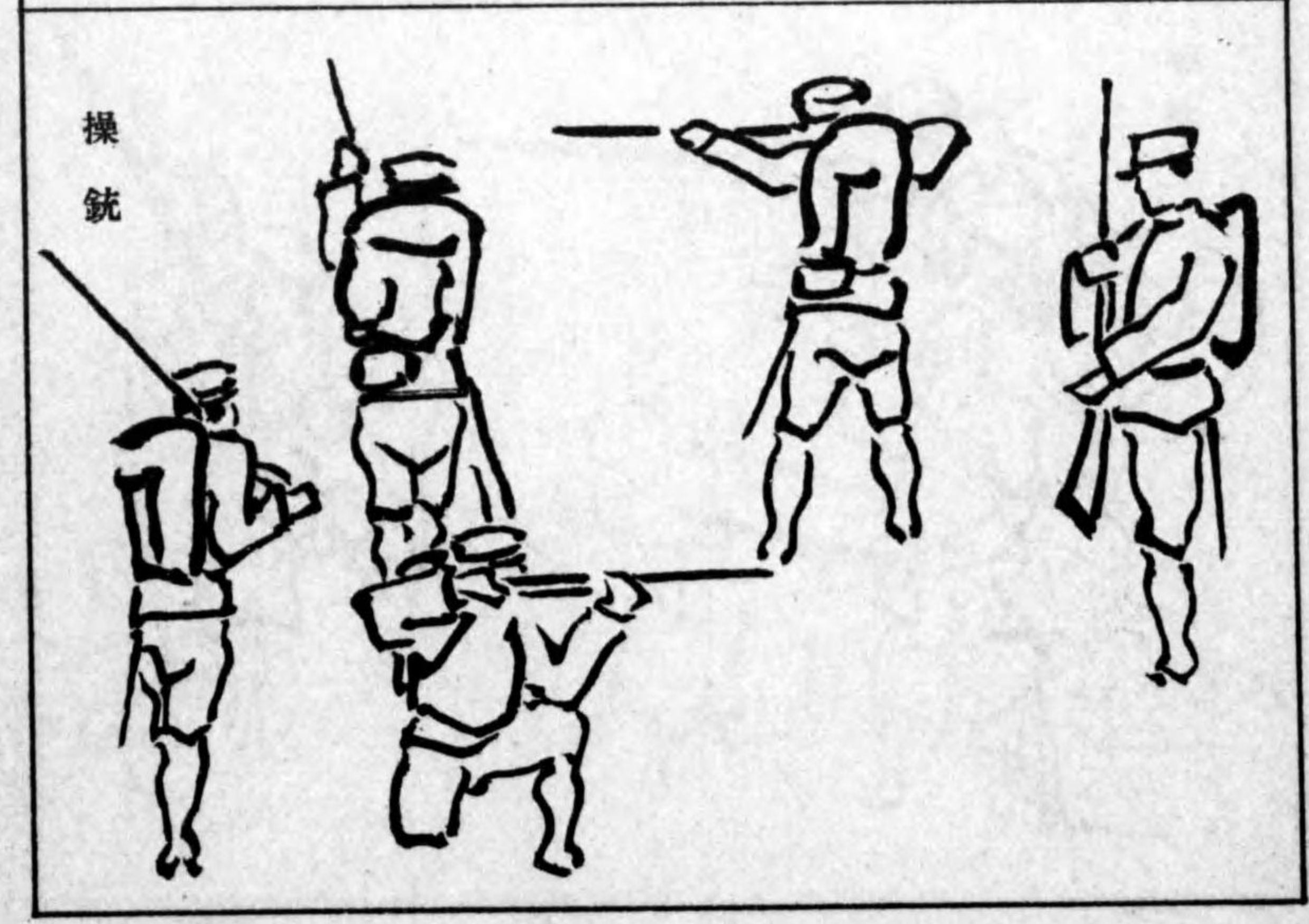

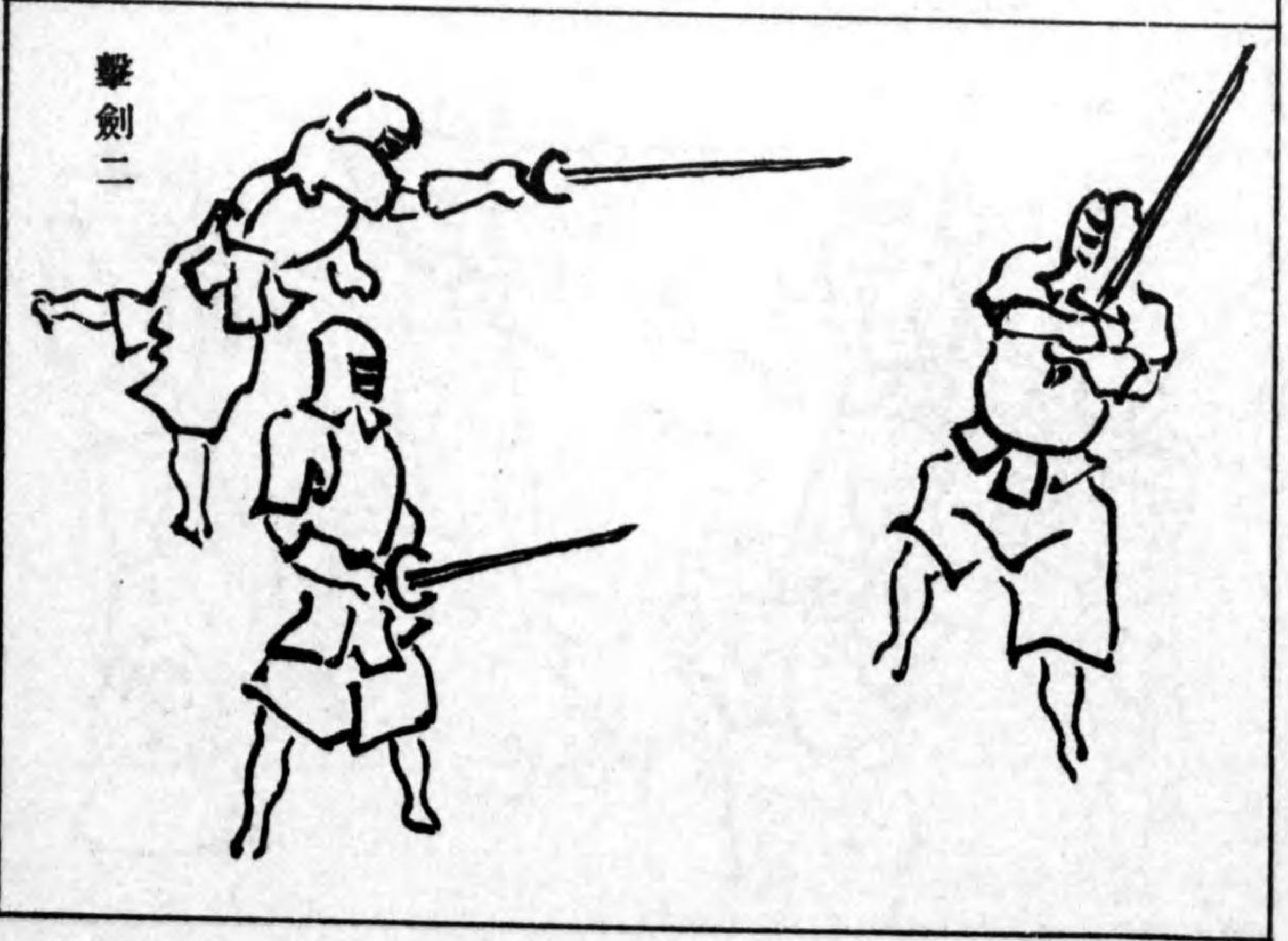
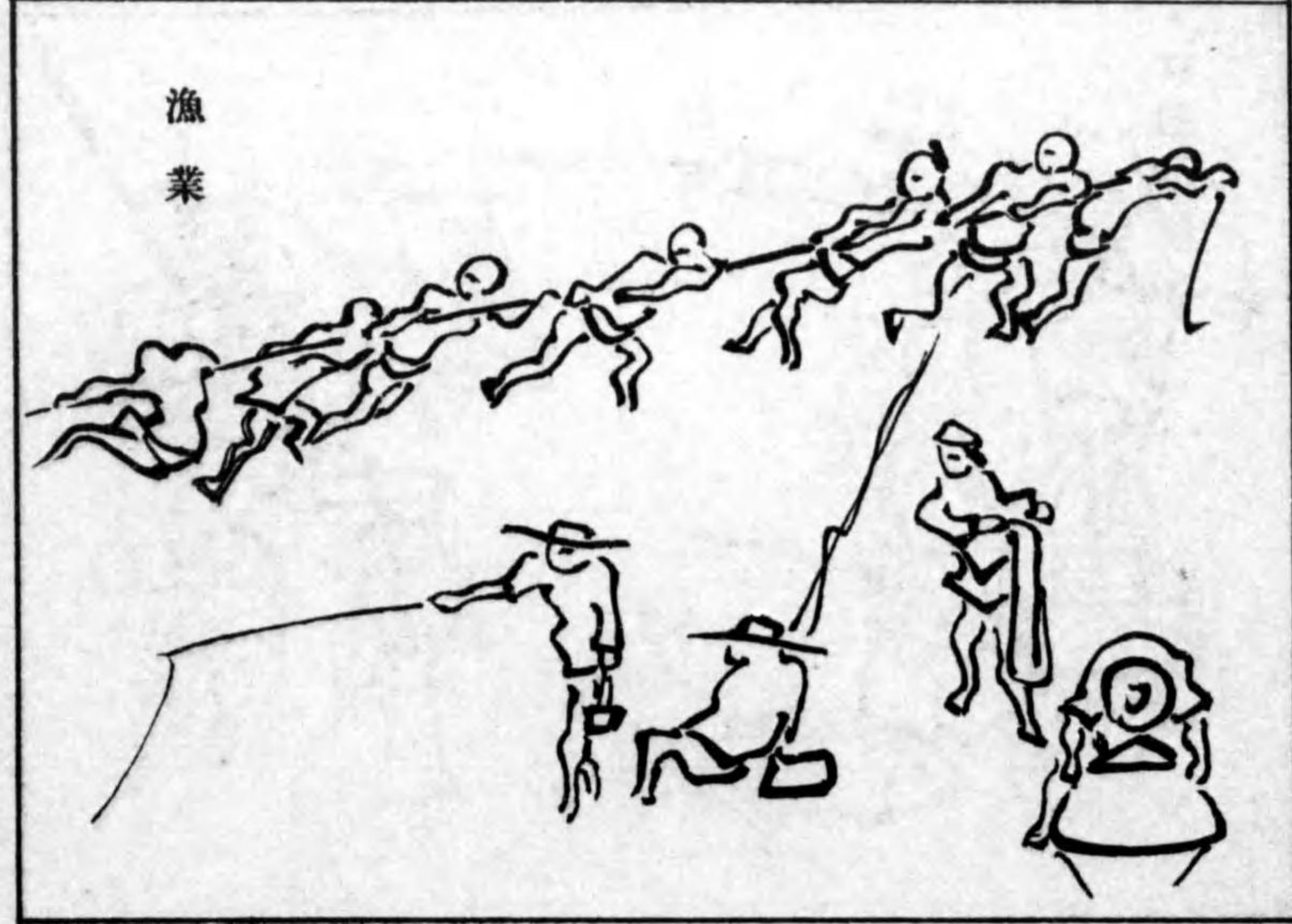
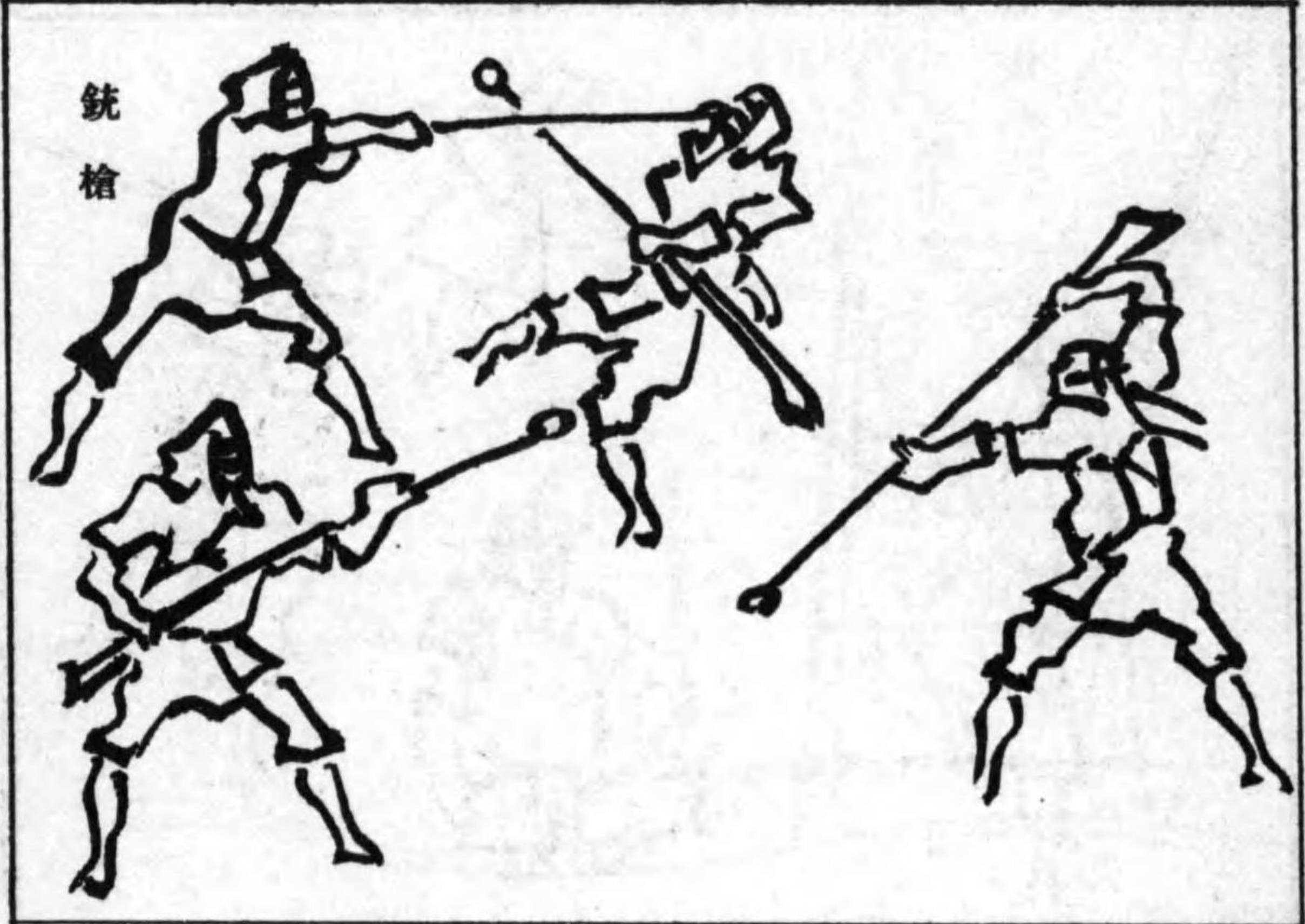

游泳

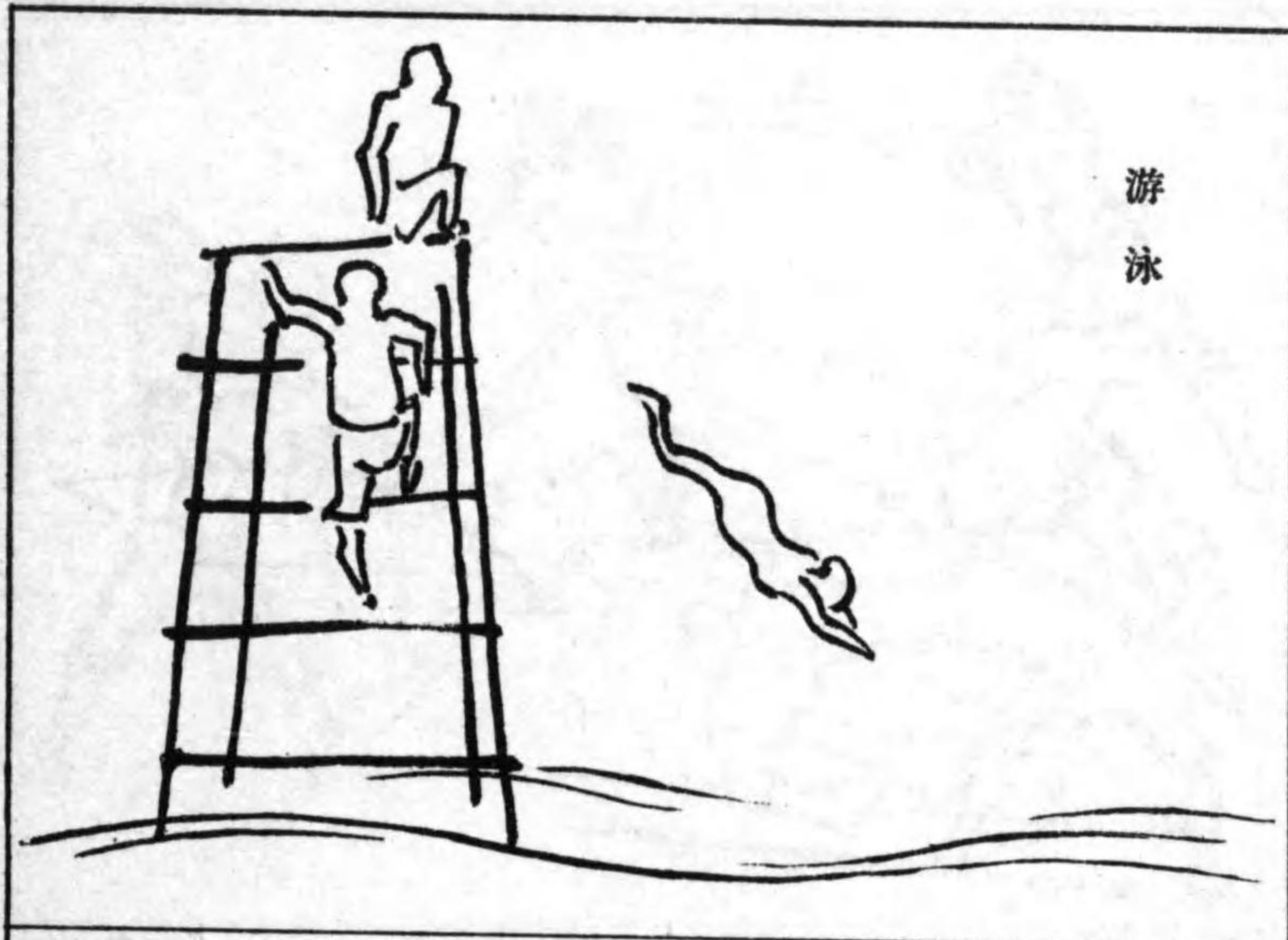

行商



大工



左官

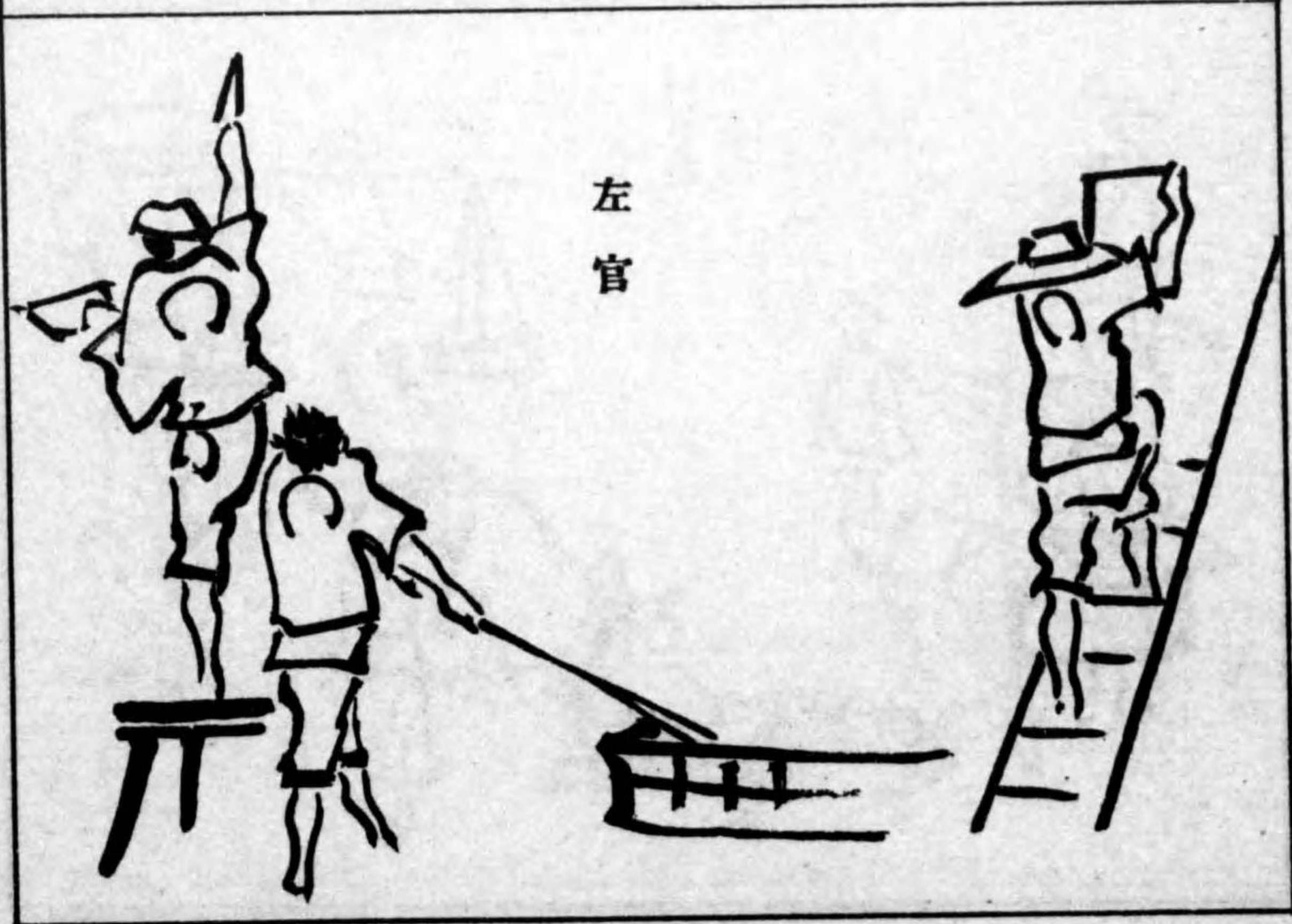

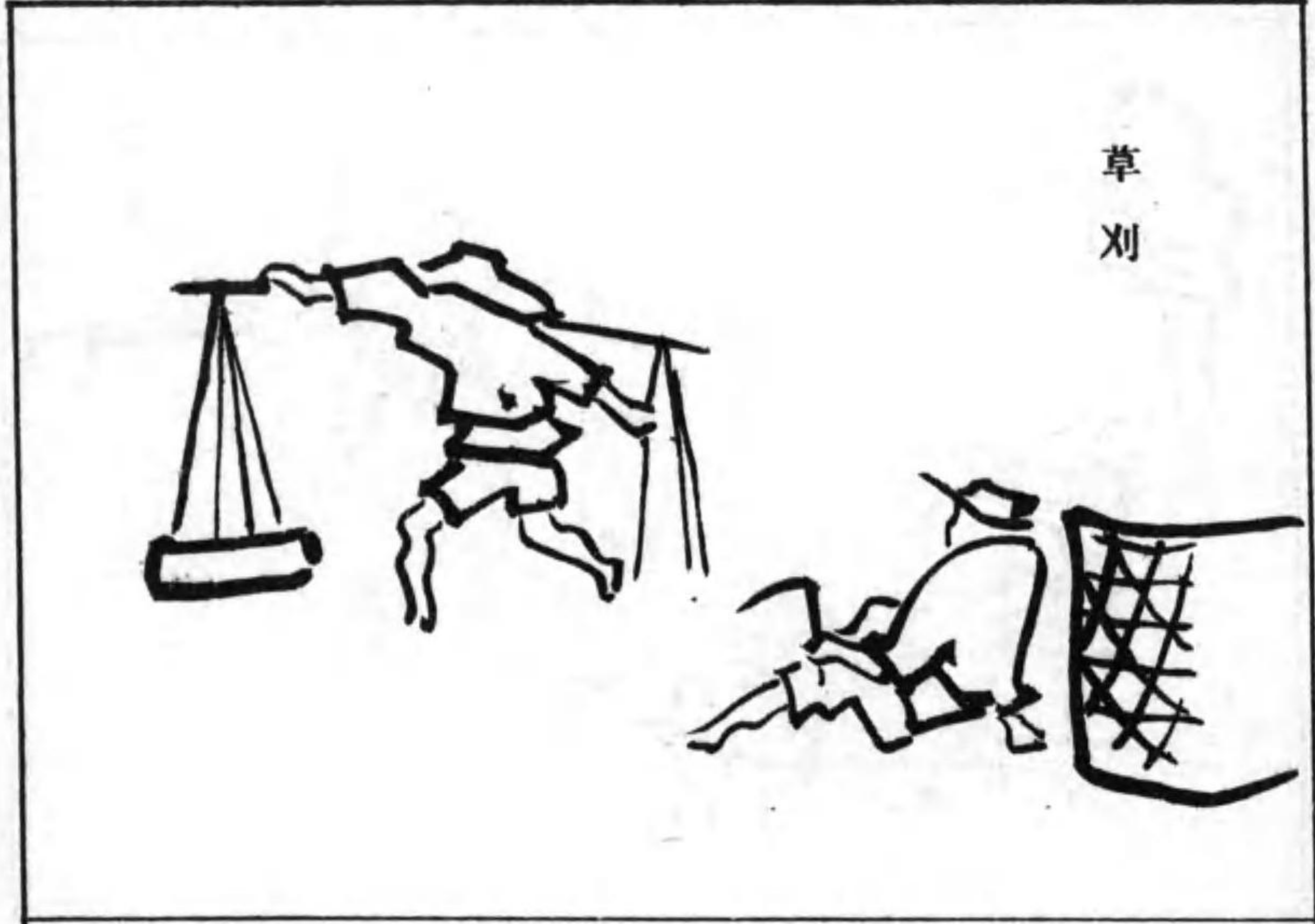

草刈

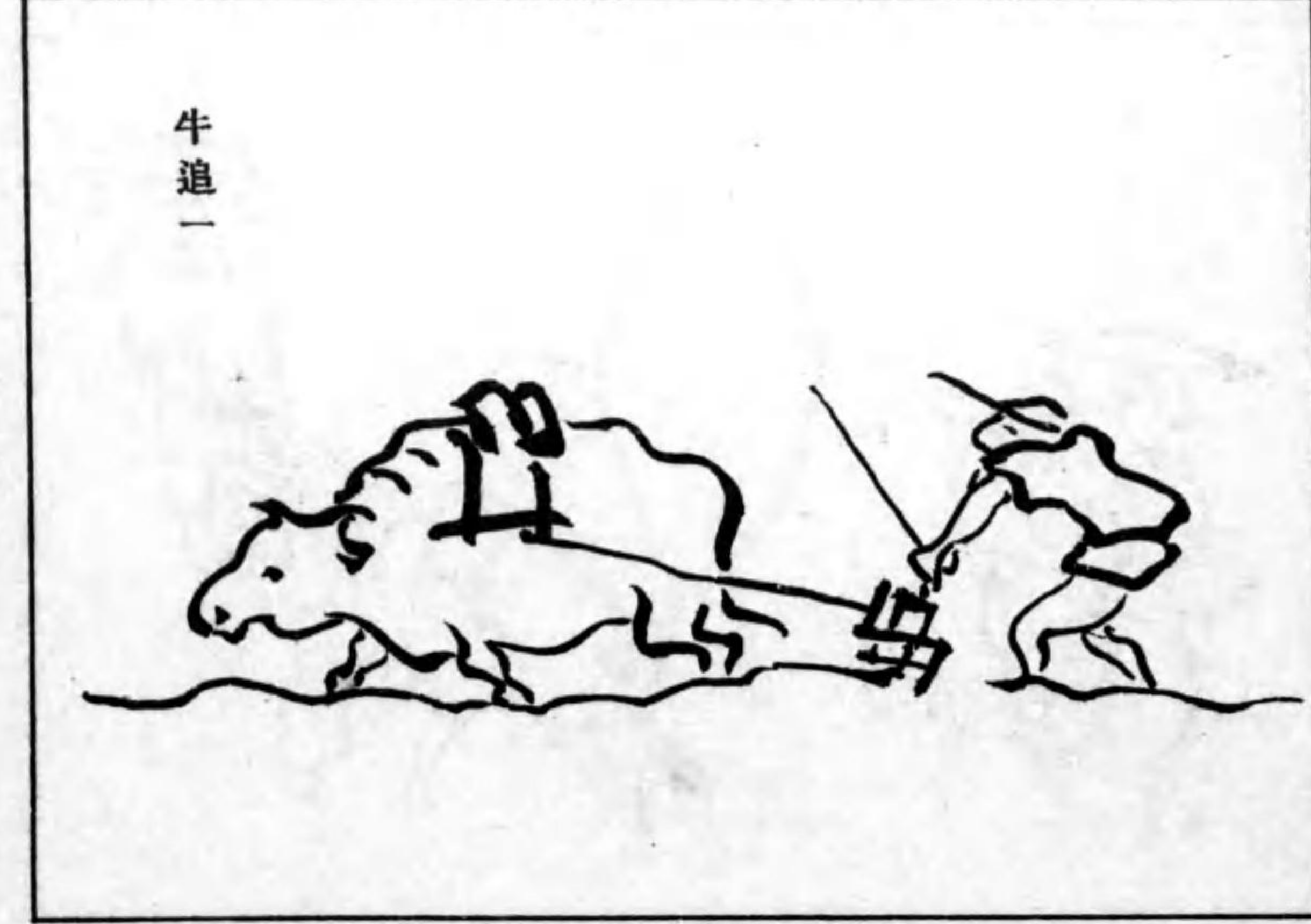

牛追一

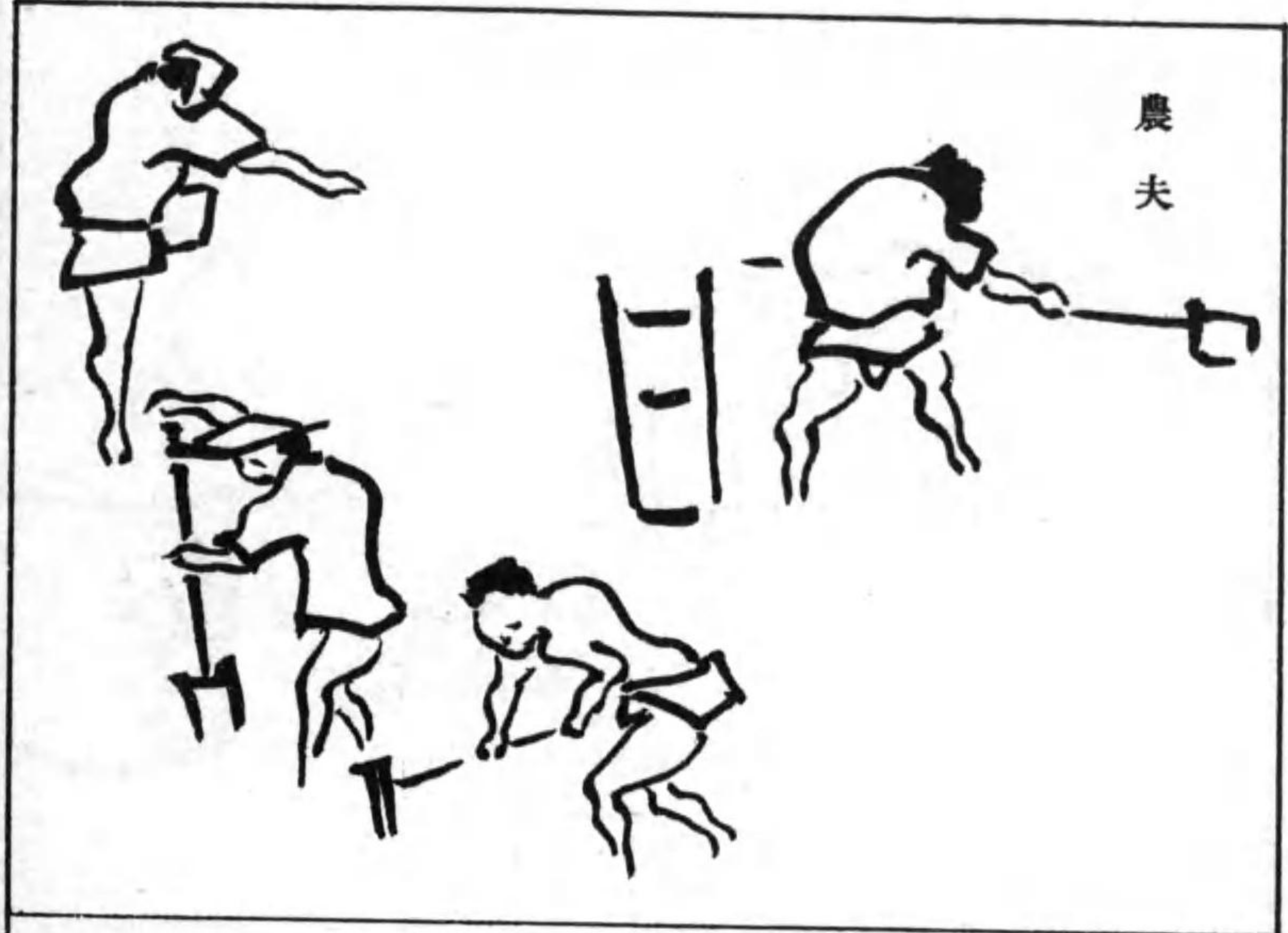

農夫

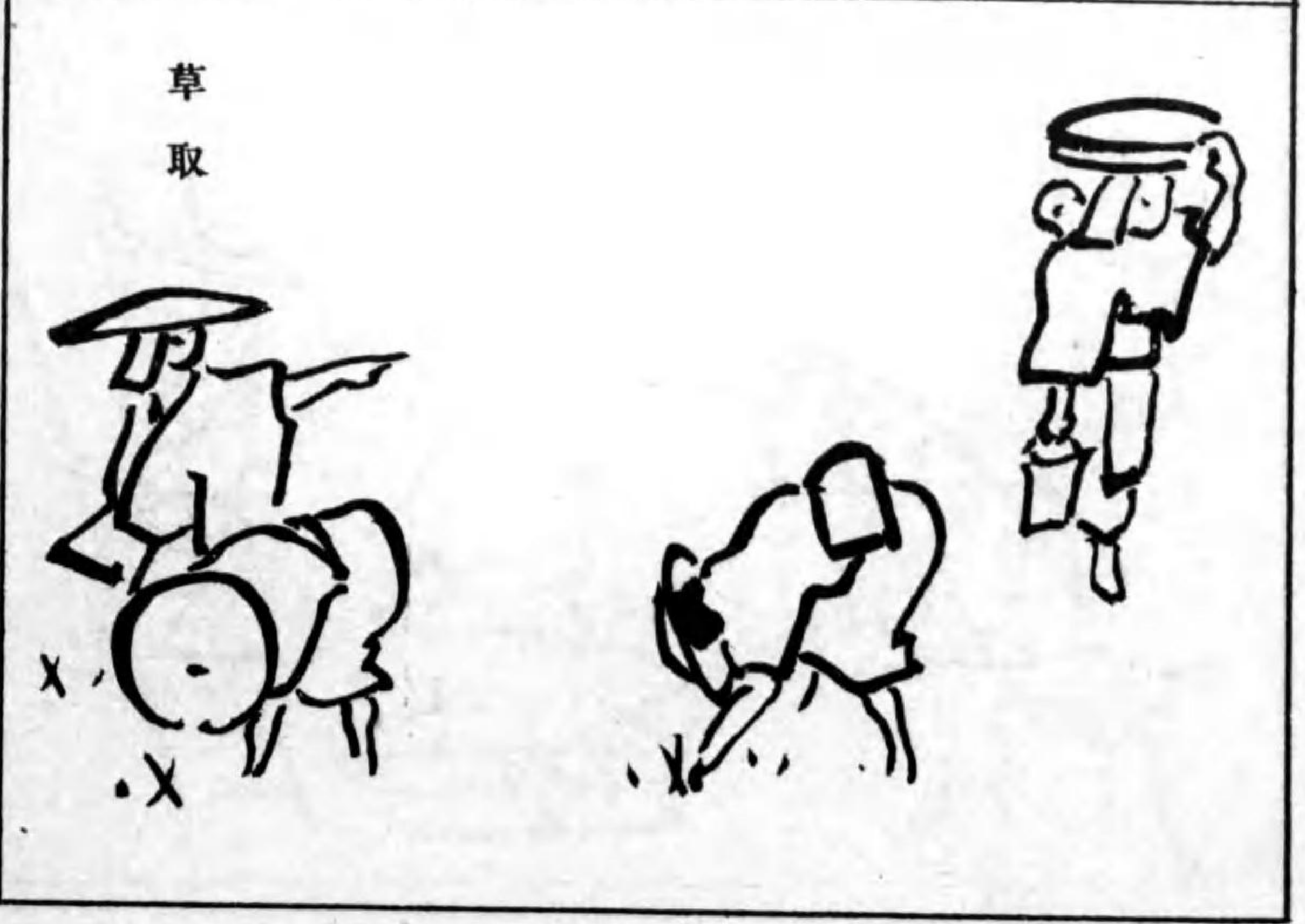

草取

牛追二

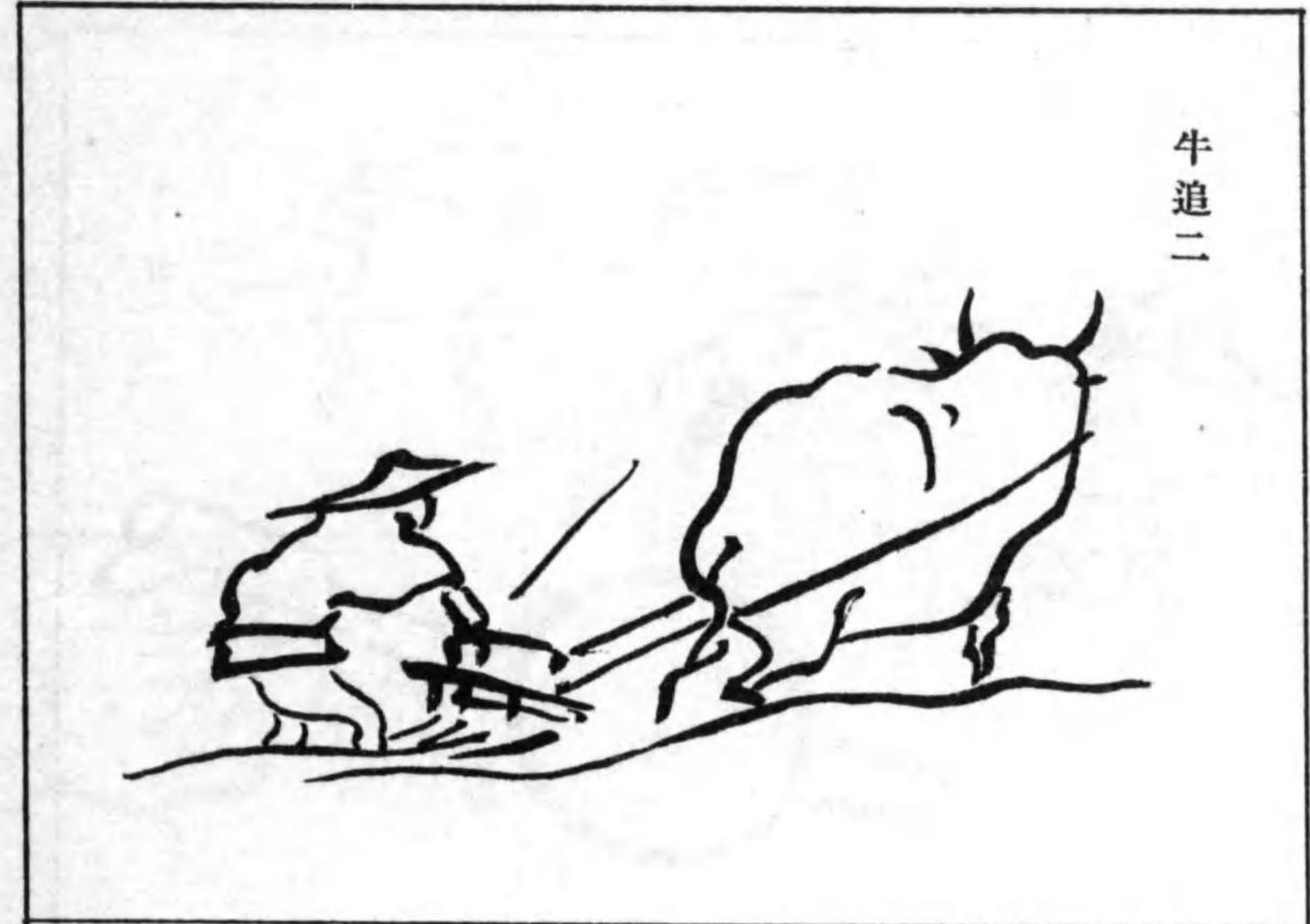

農家

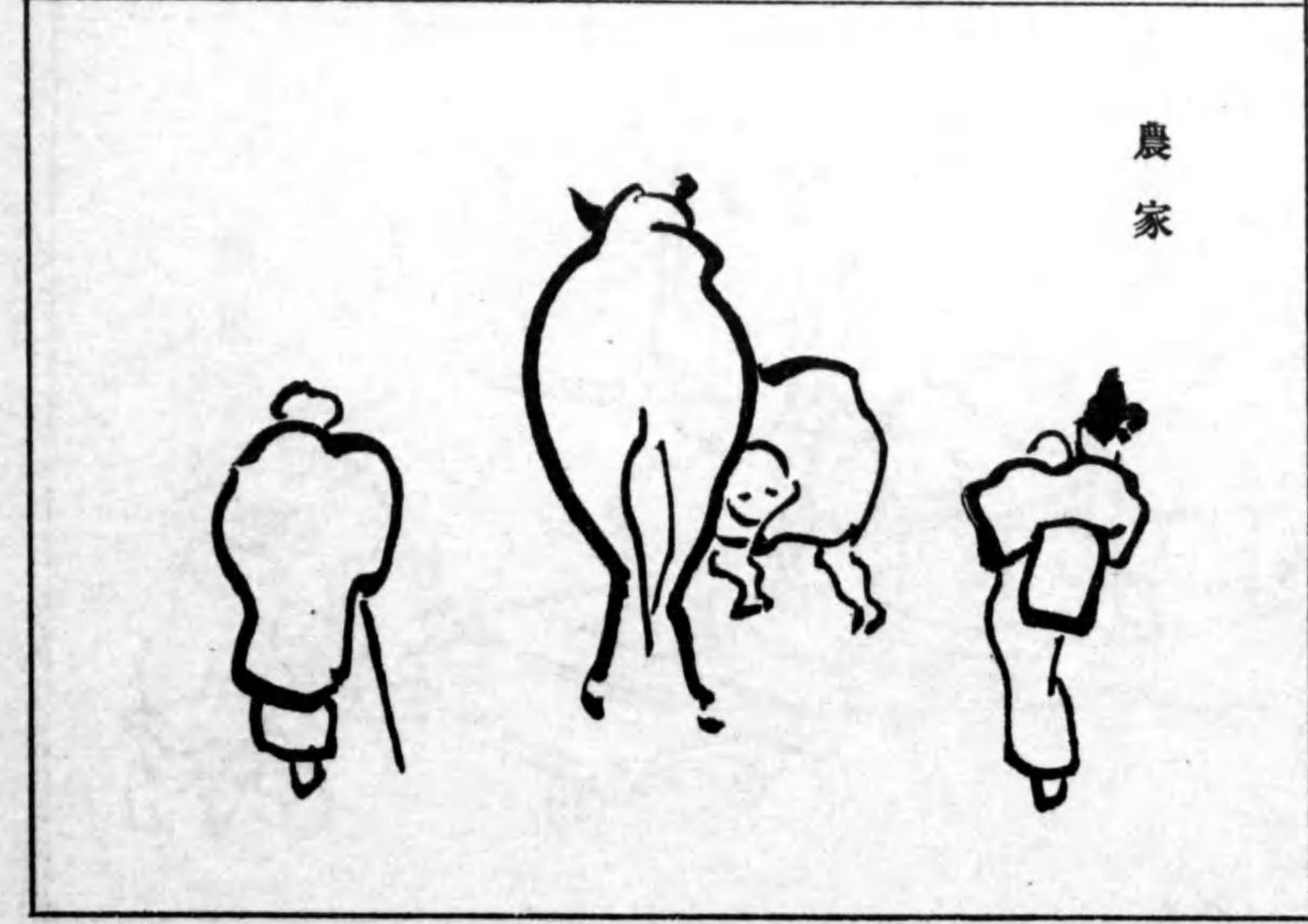

荷車

荷馬

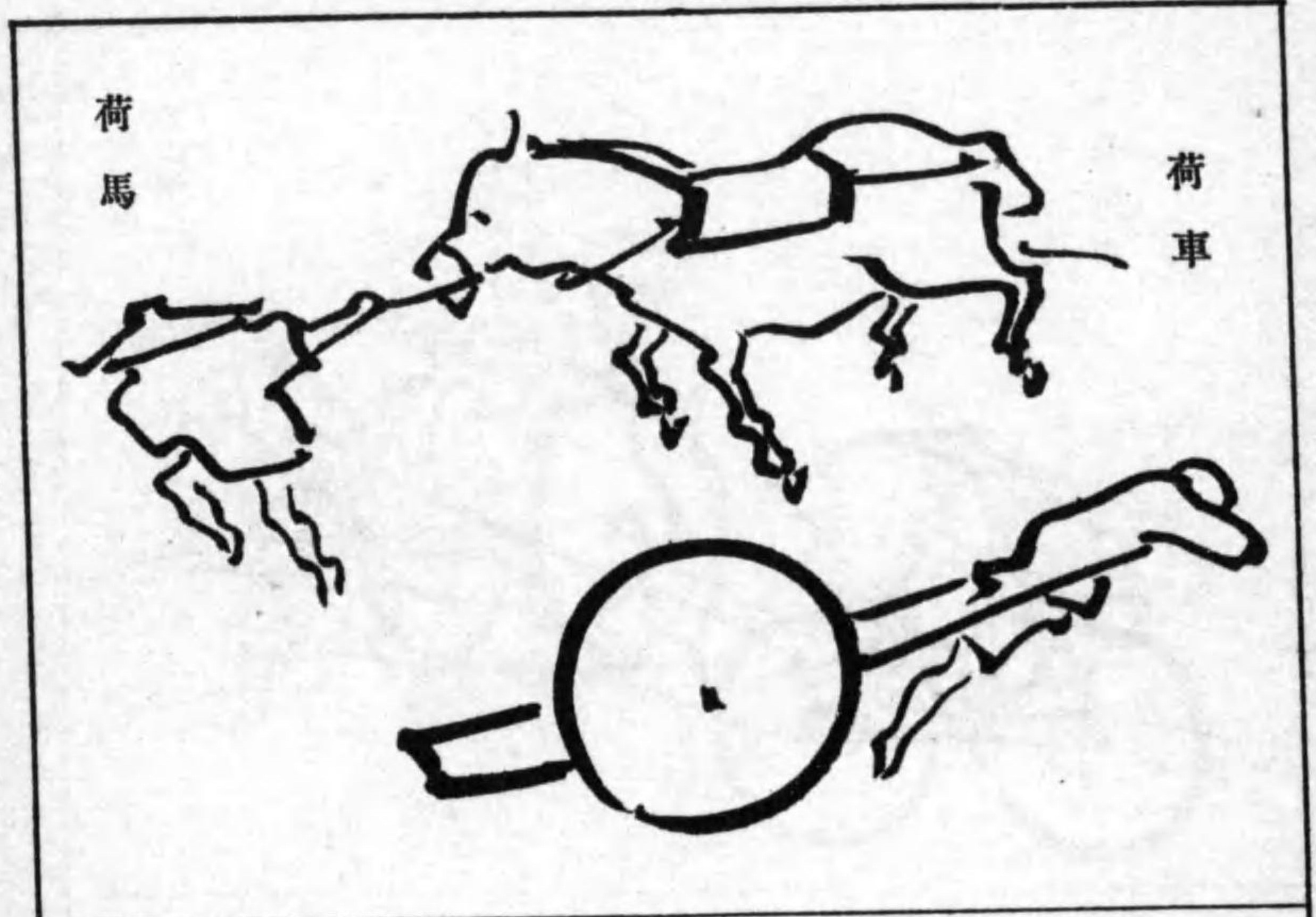

疊屋

豆腐屋

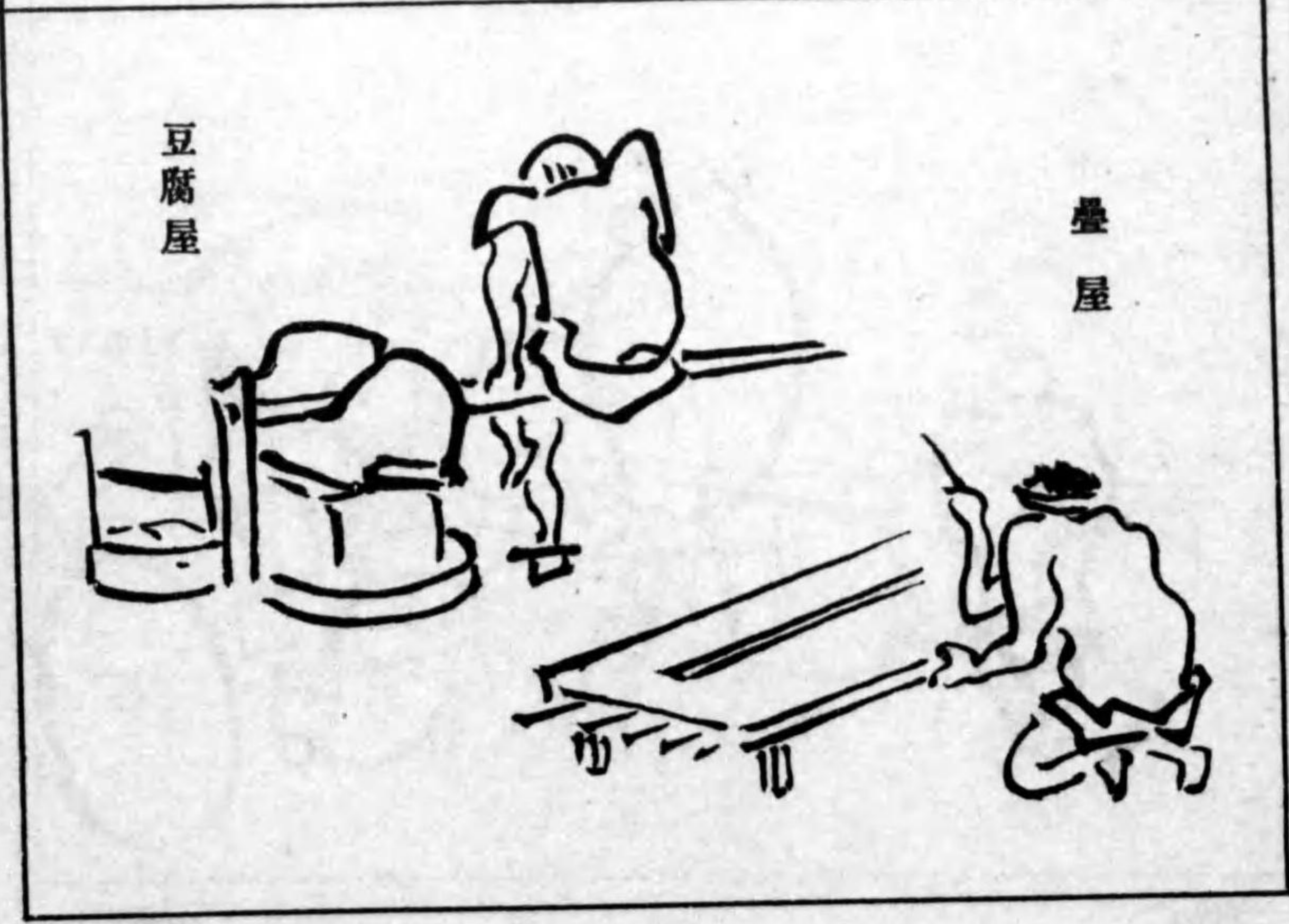

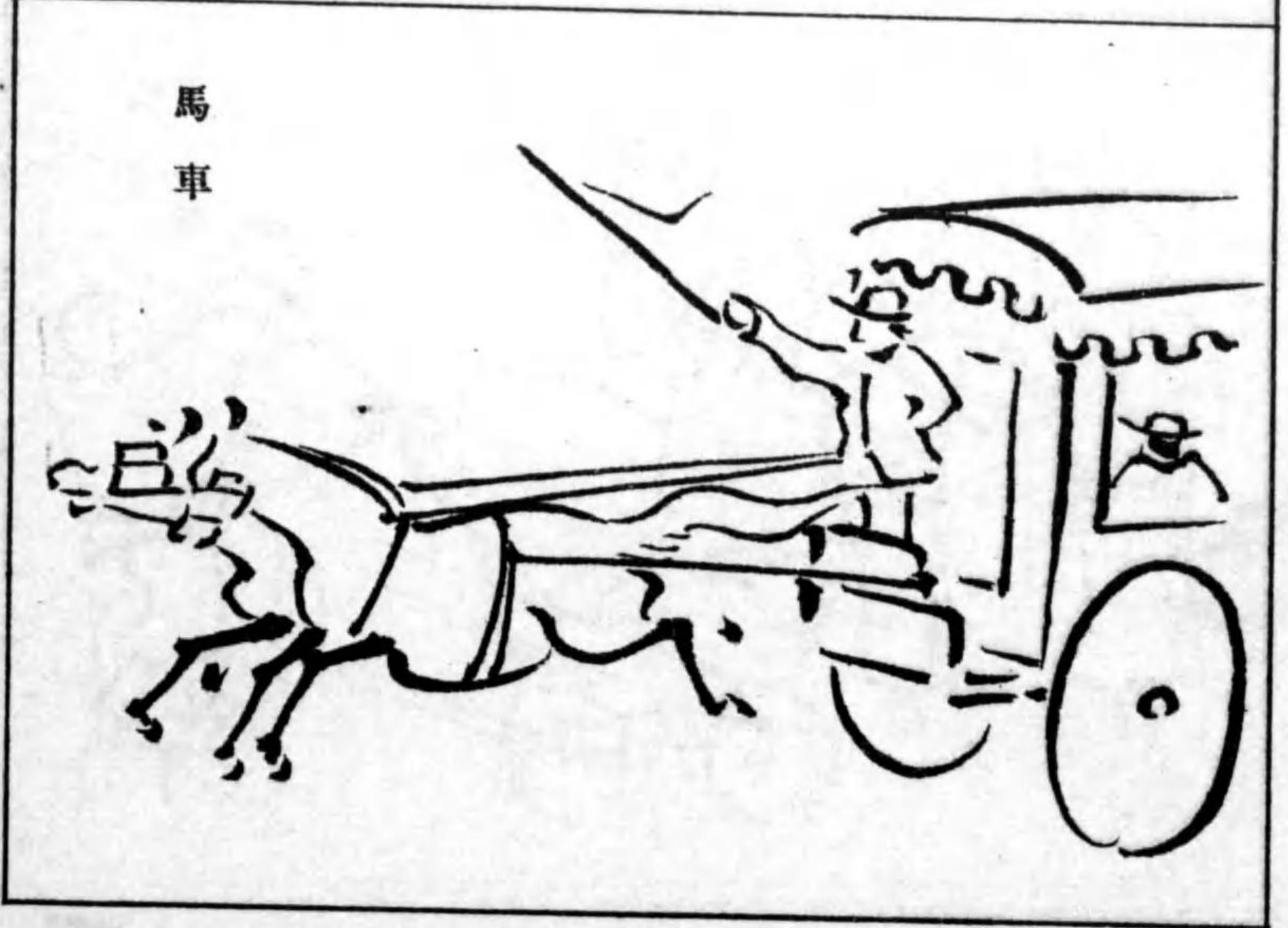
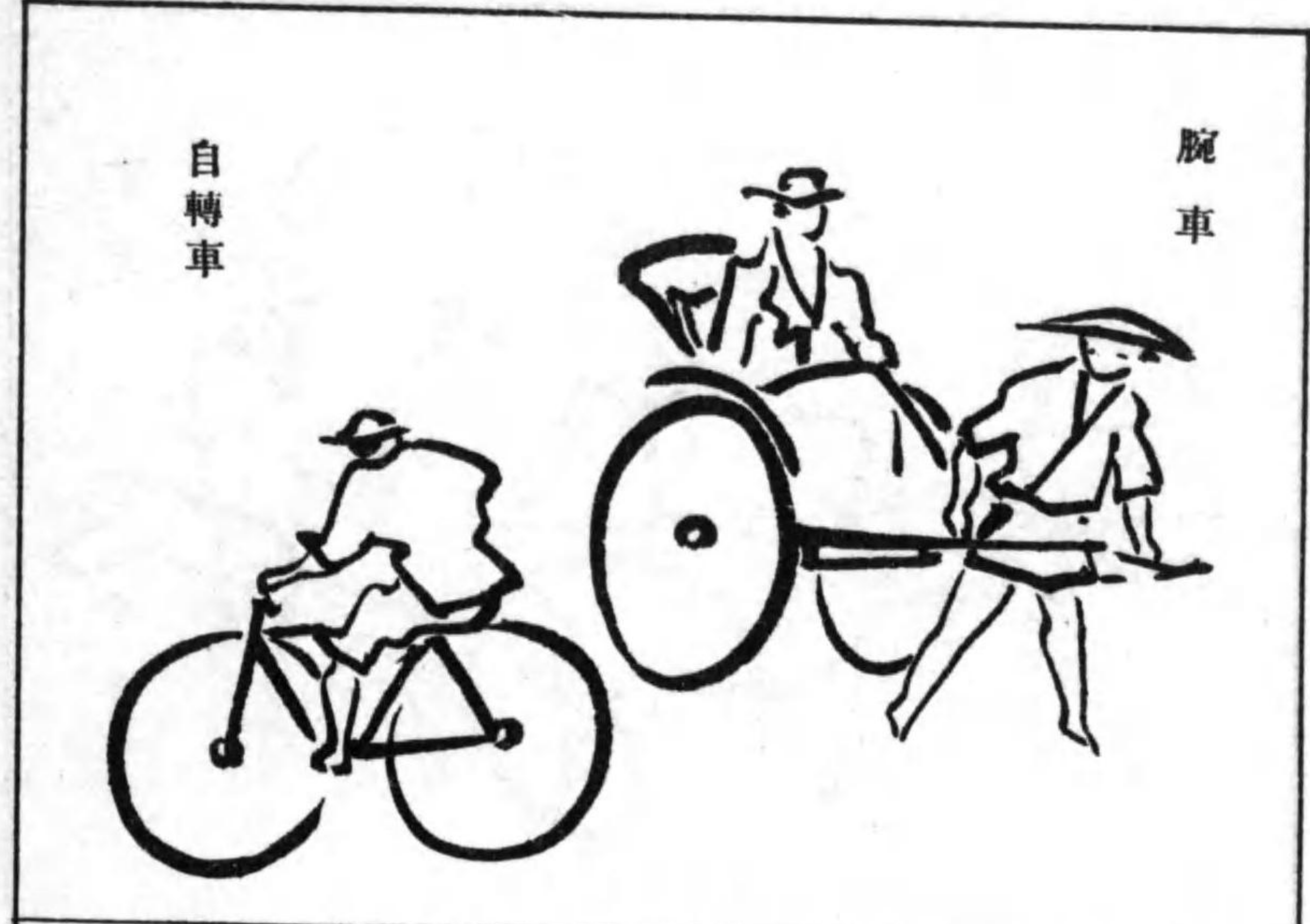
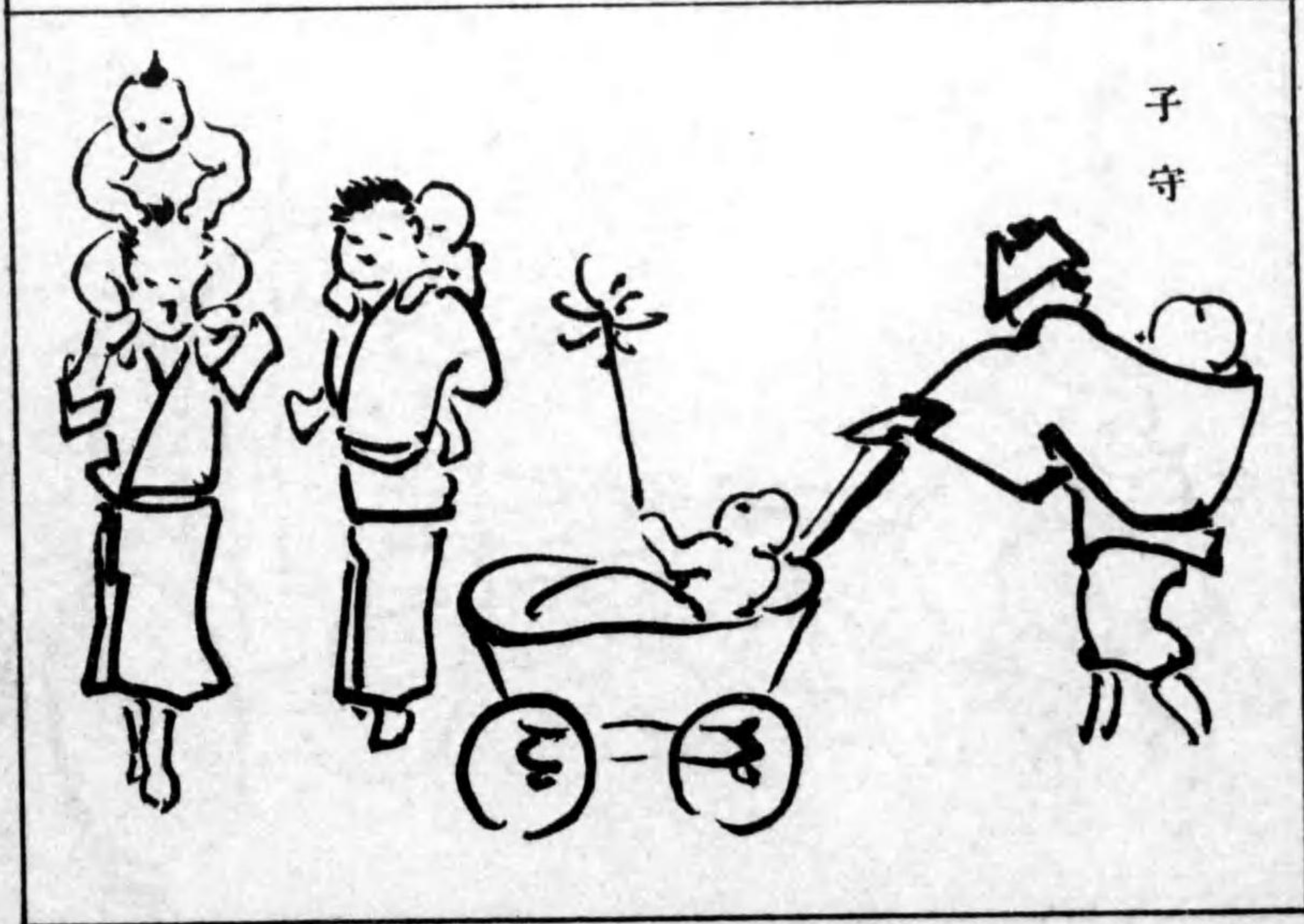
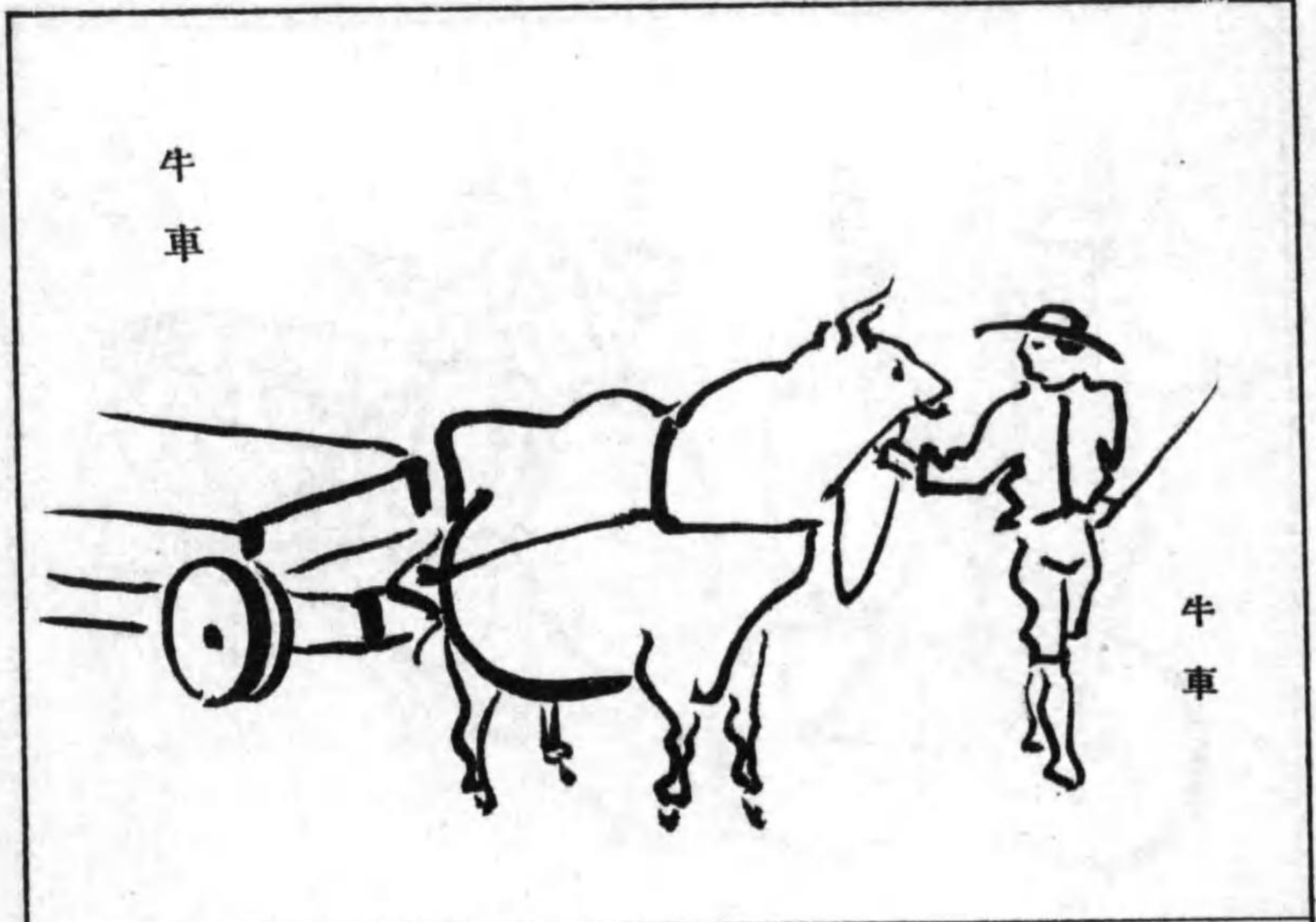



小學兒童

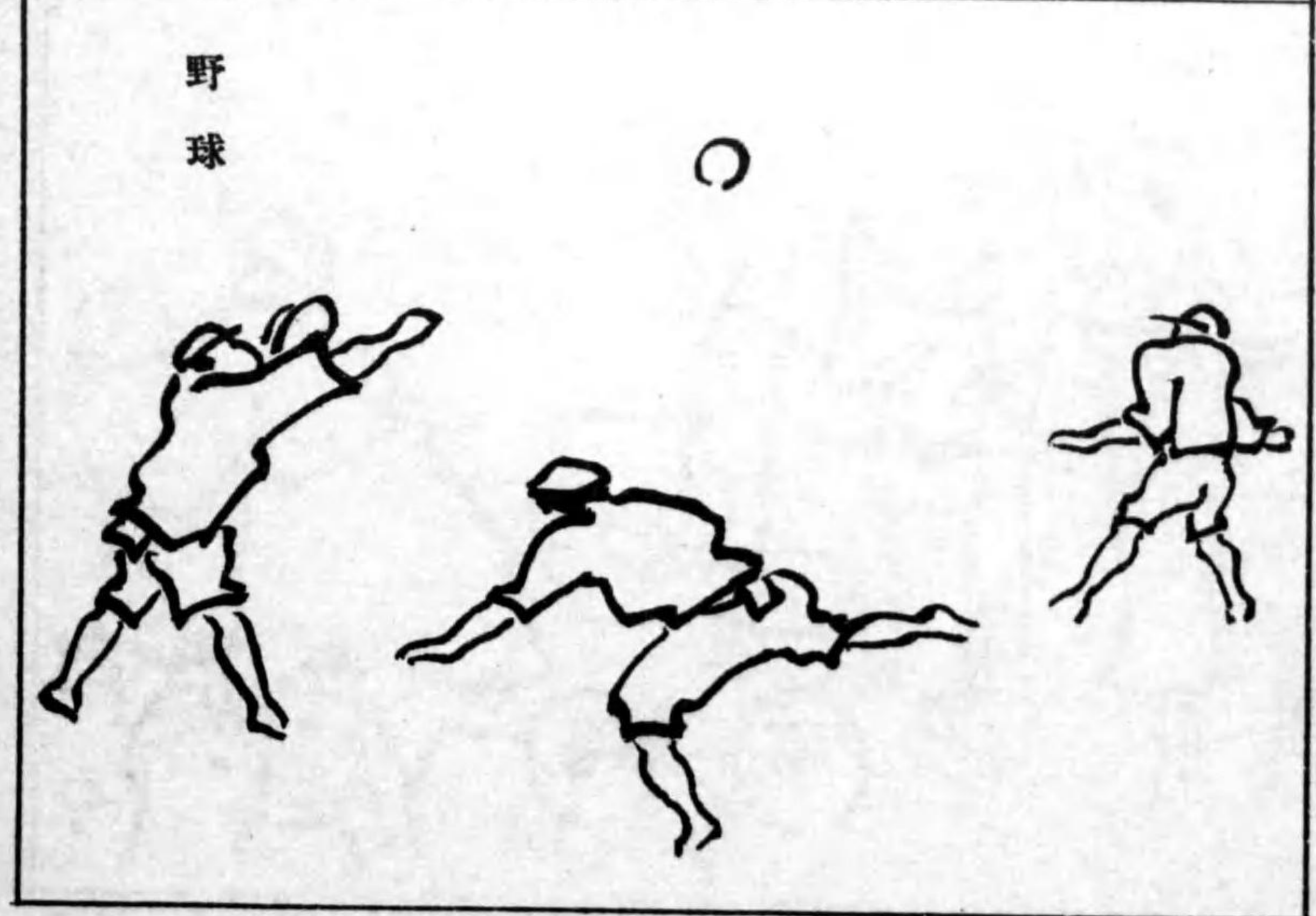

野球

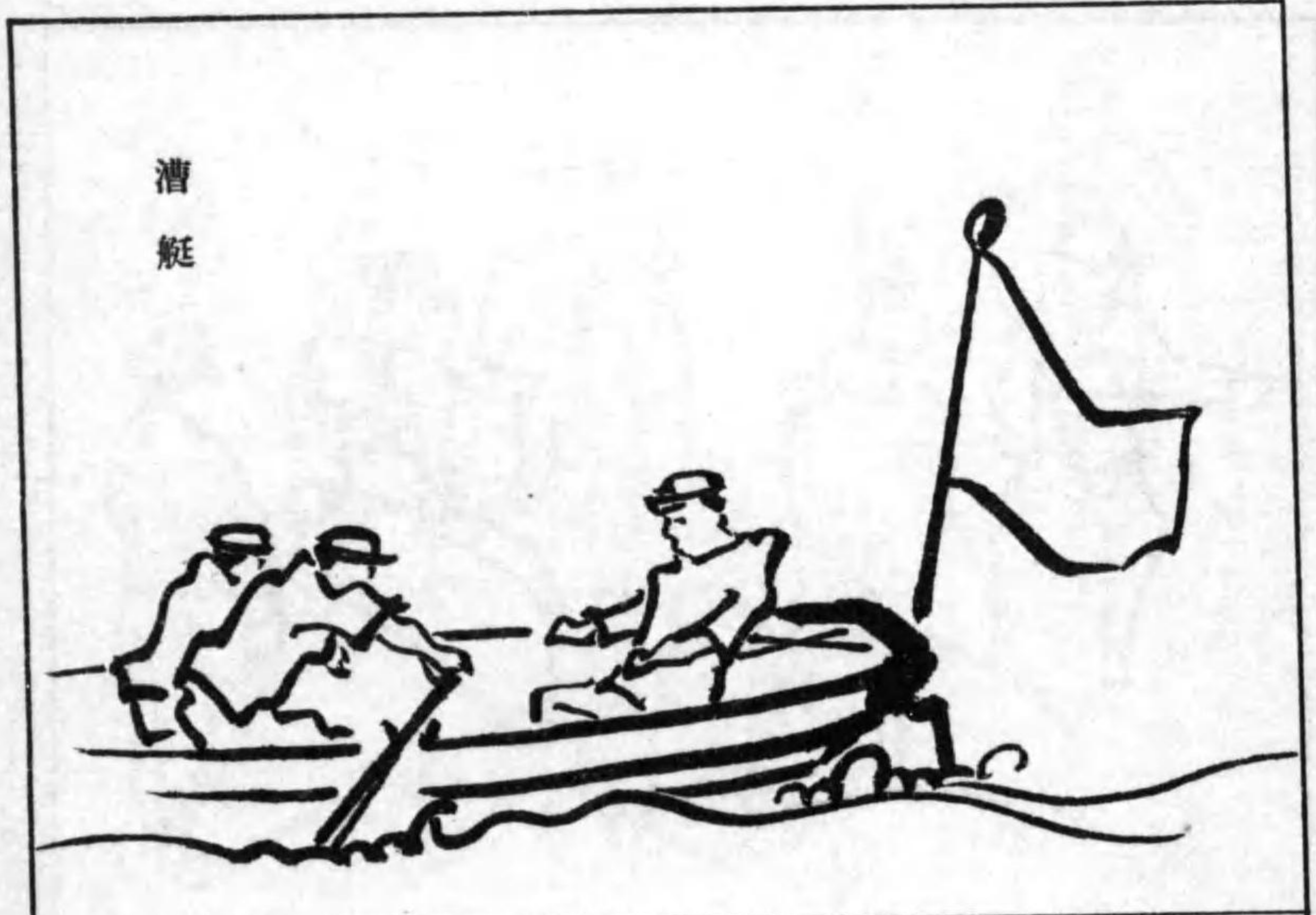

漕艇

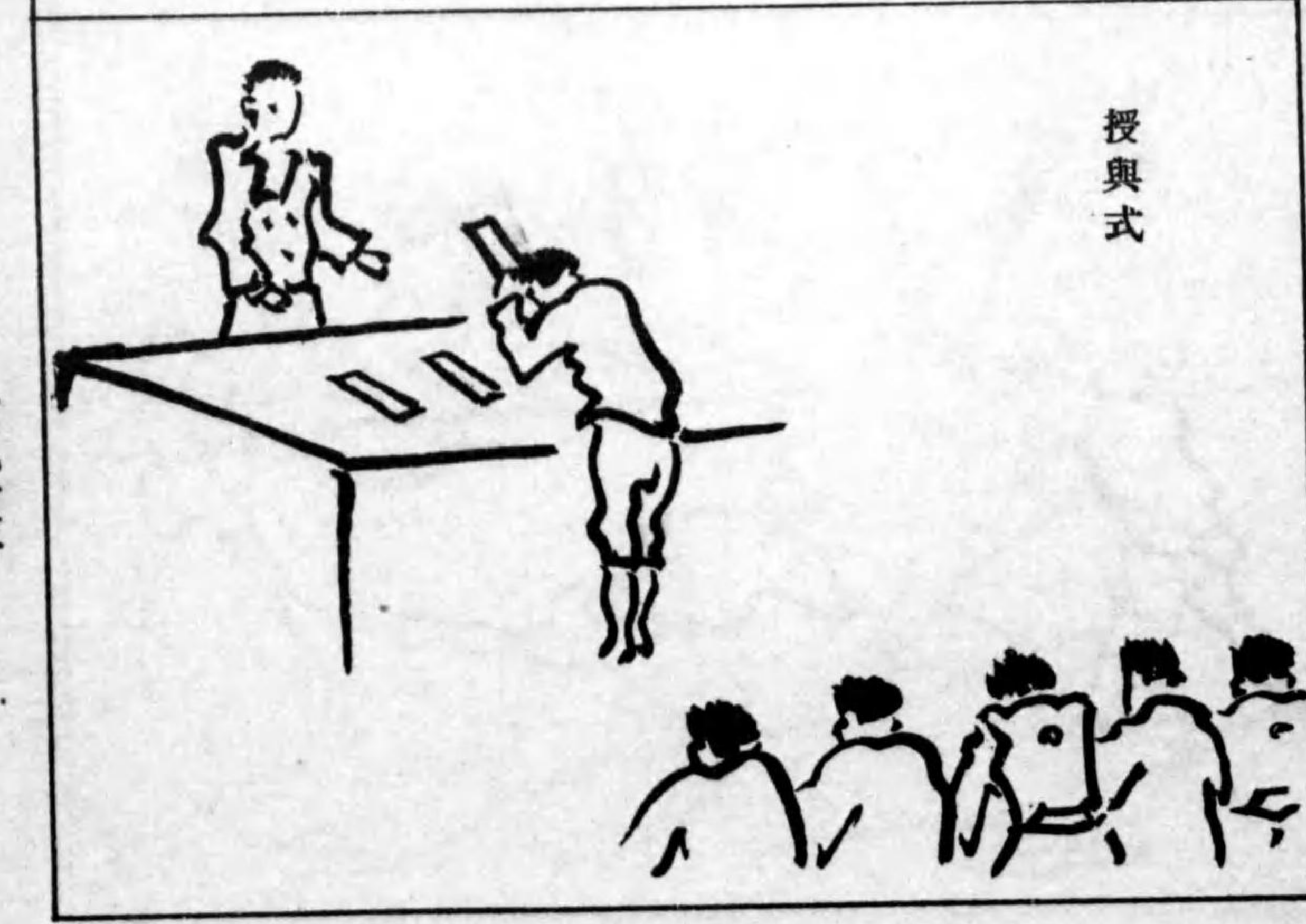

授與式

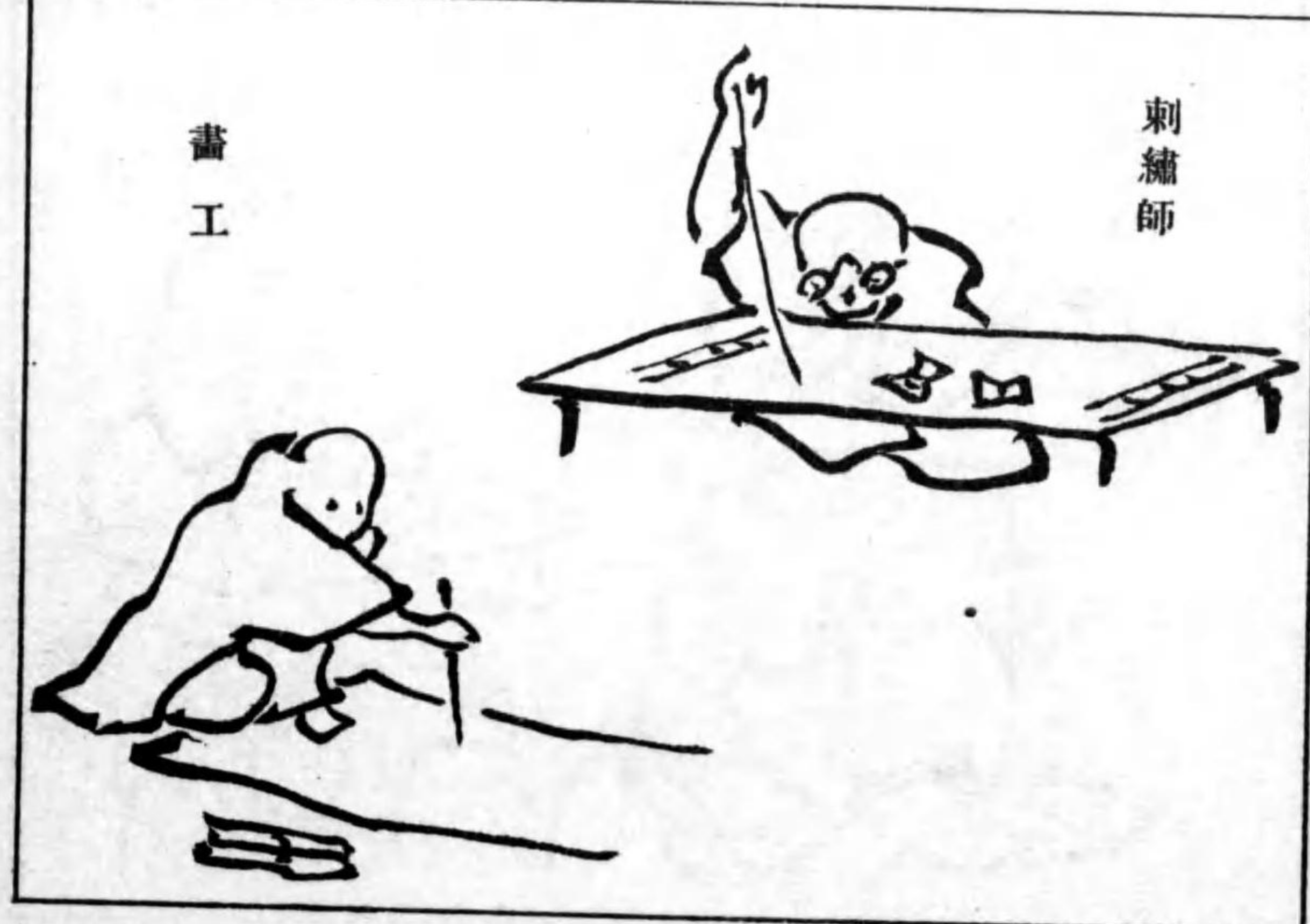
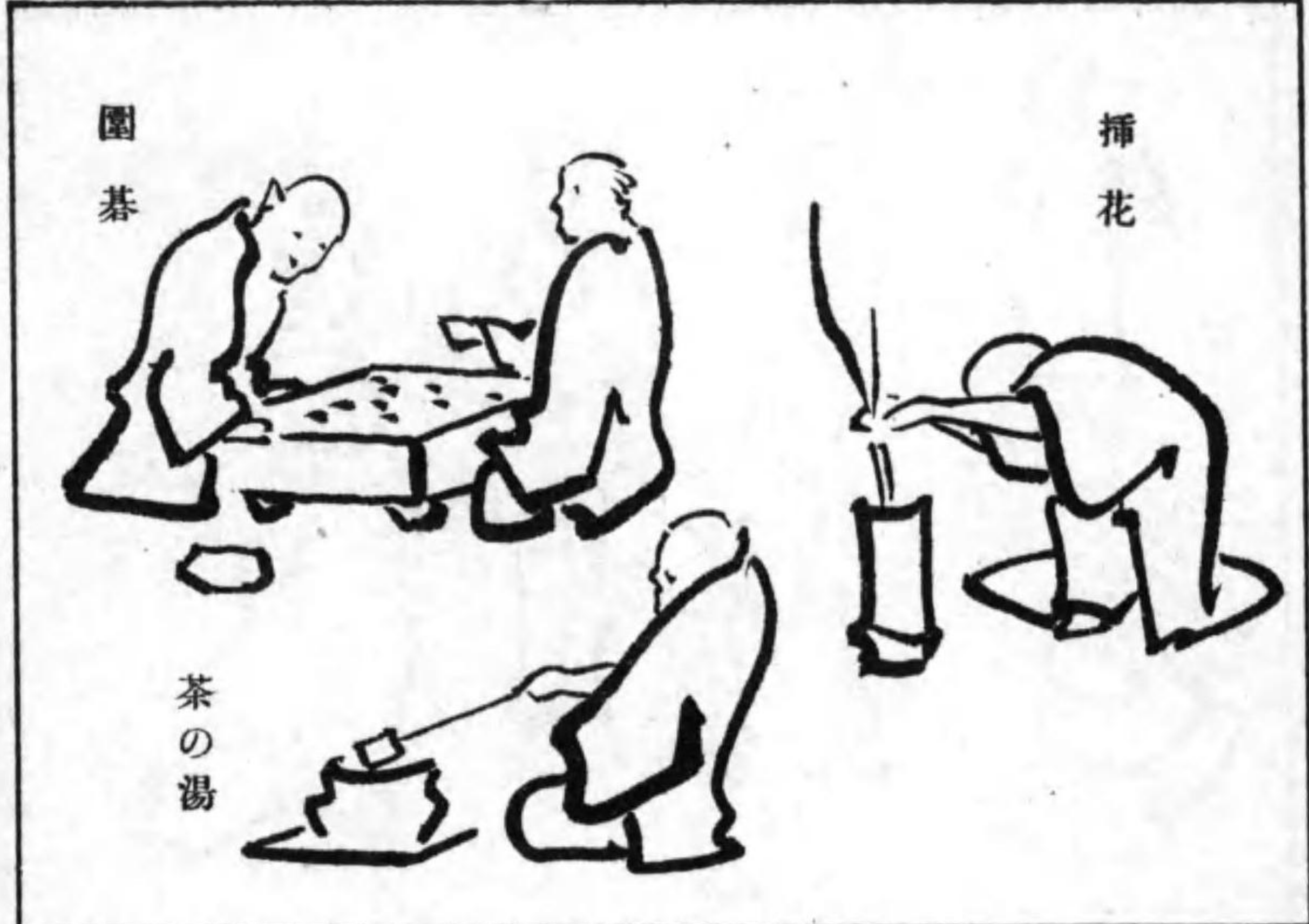

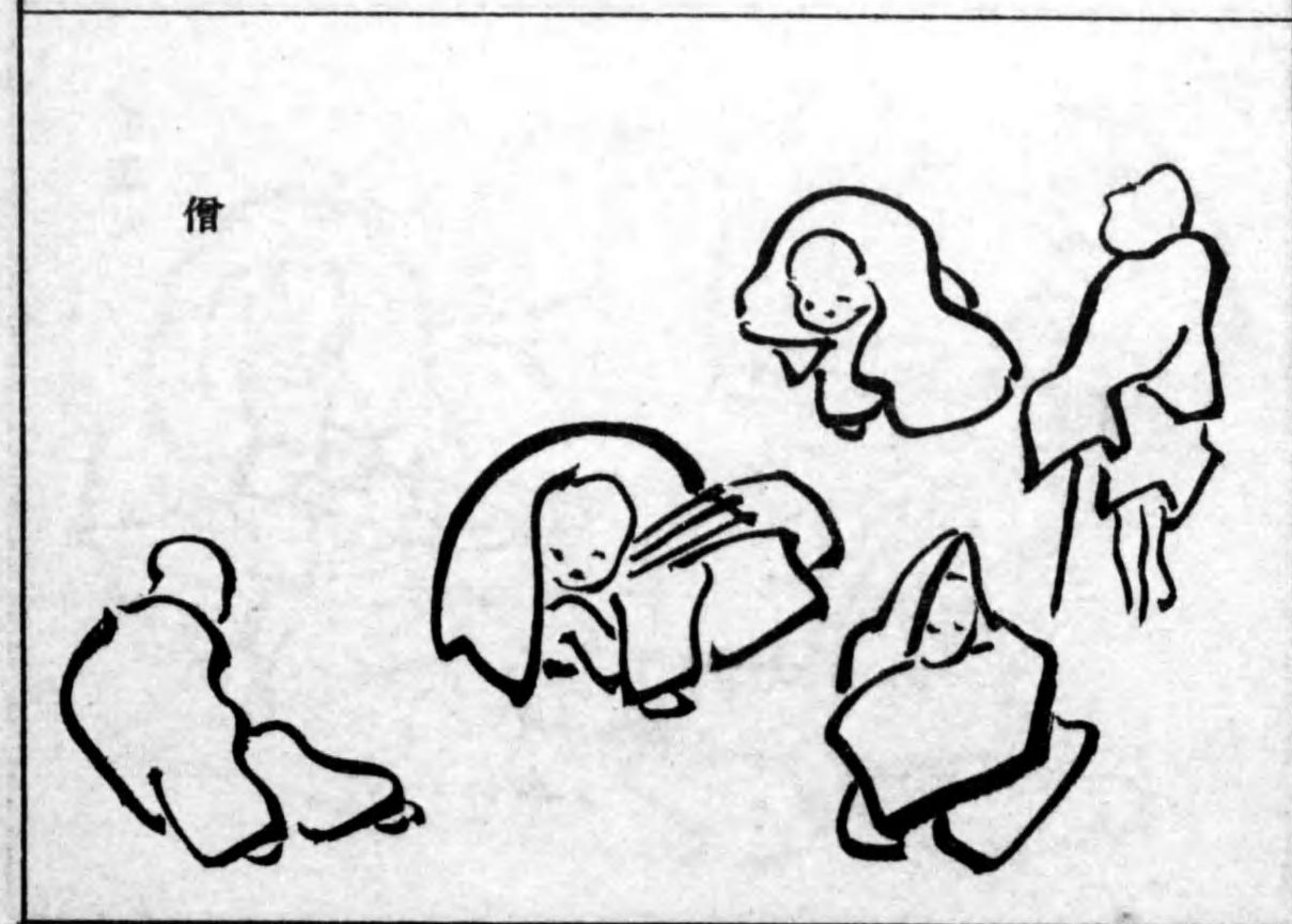
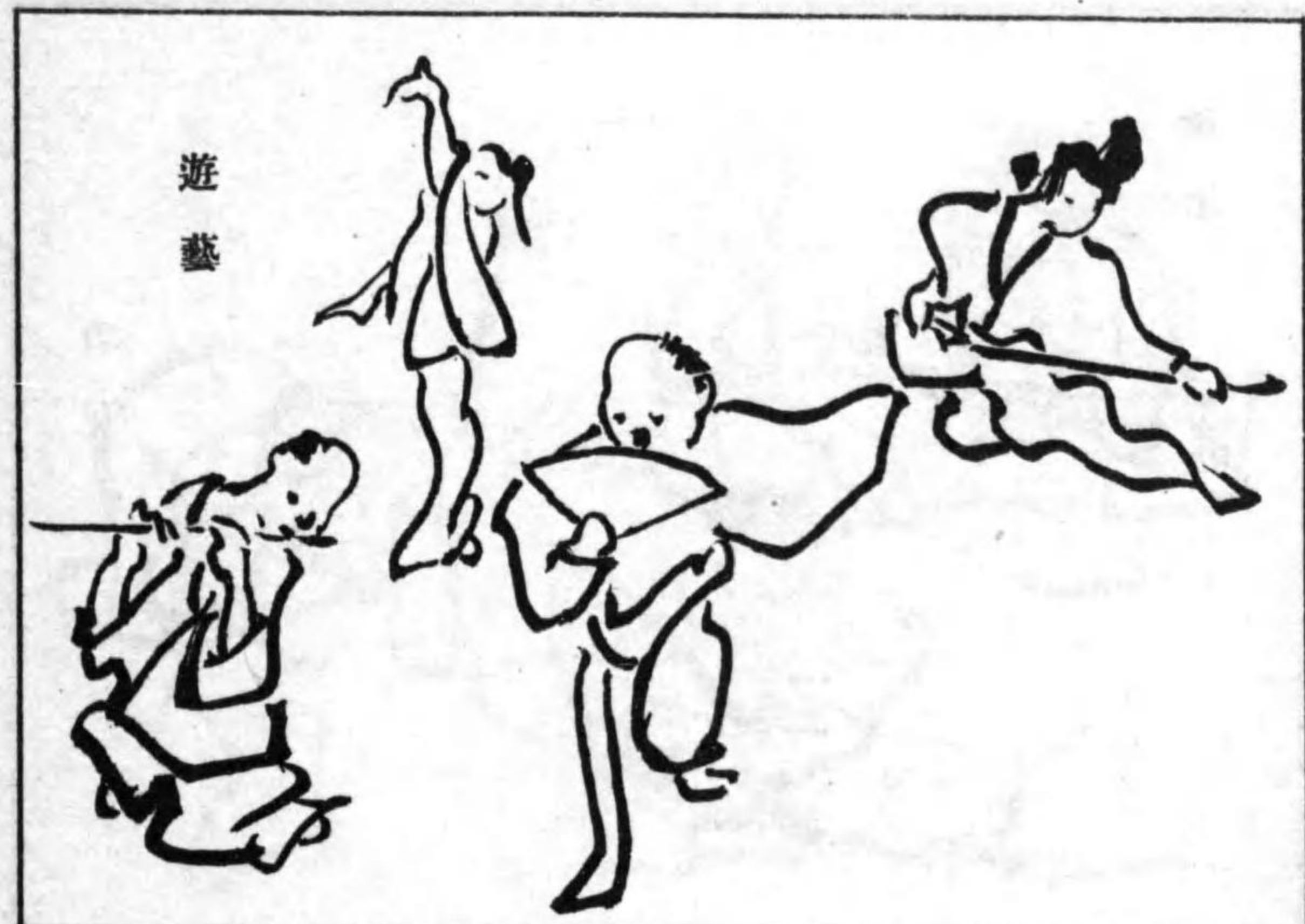
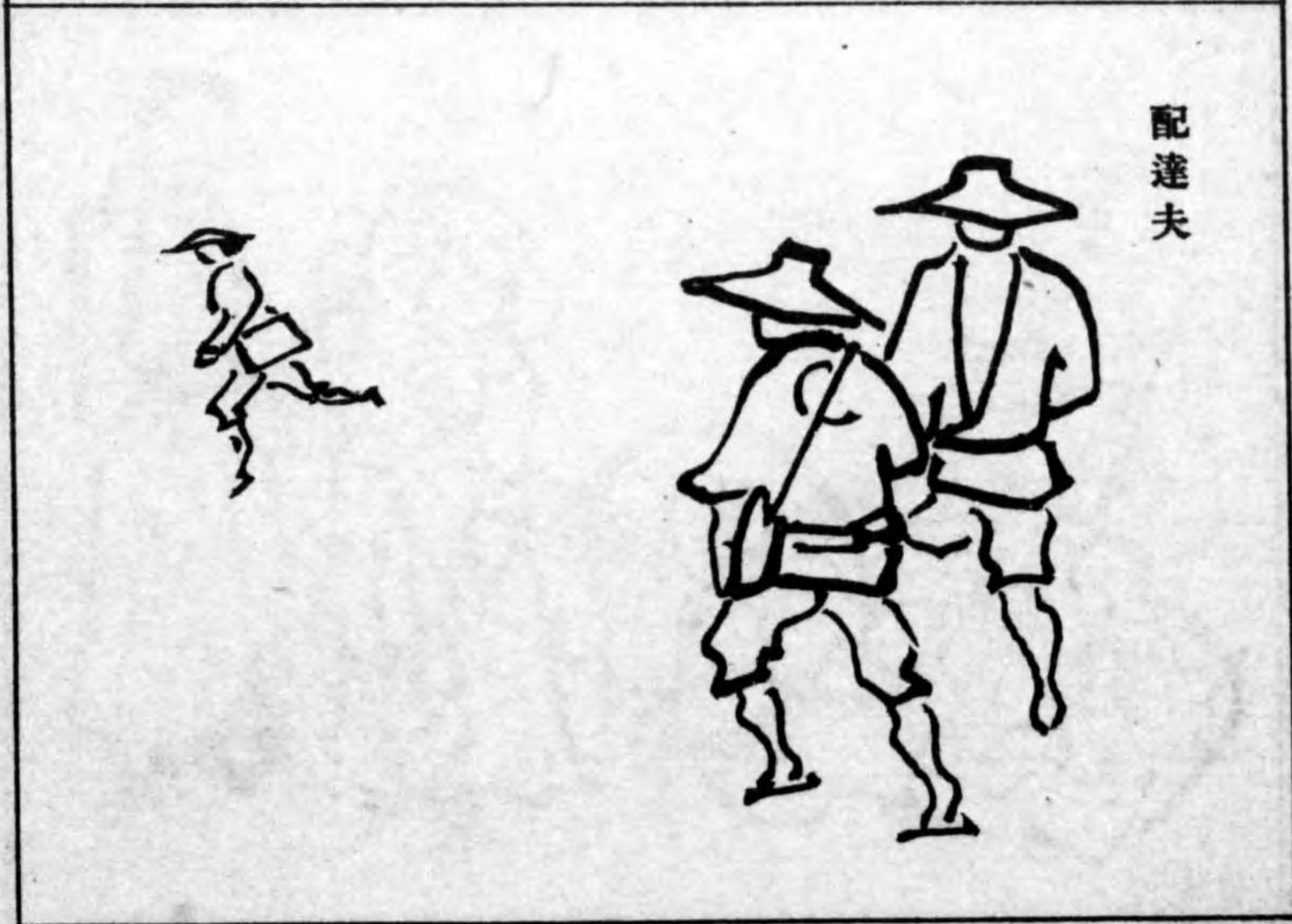

接待



江戸時代風俗



海水浴



病院



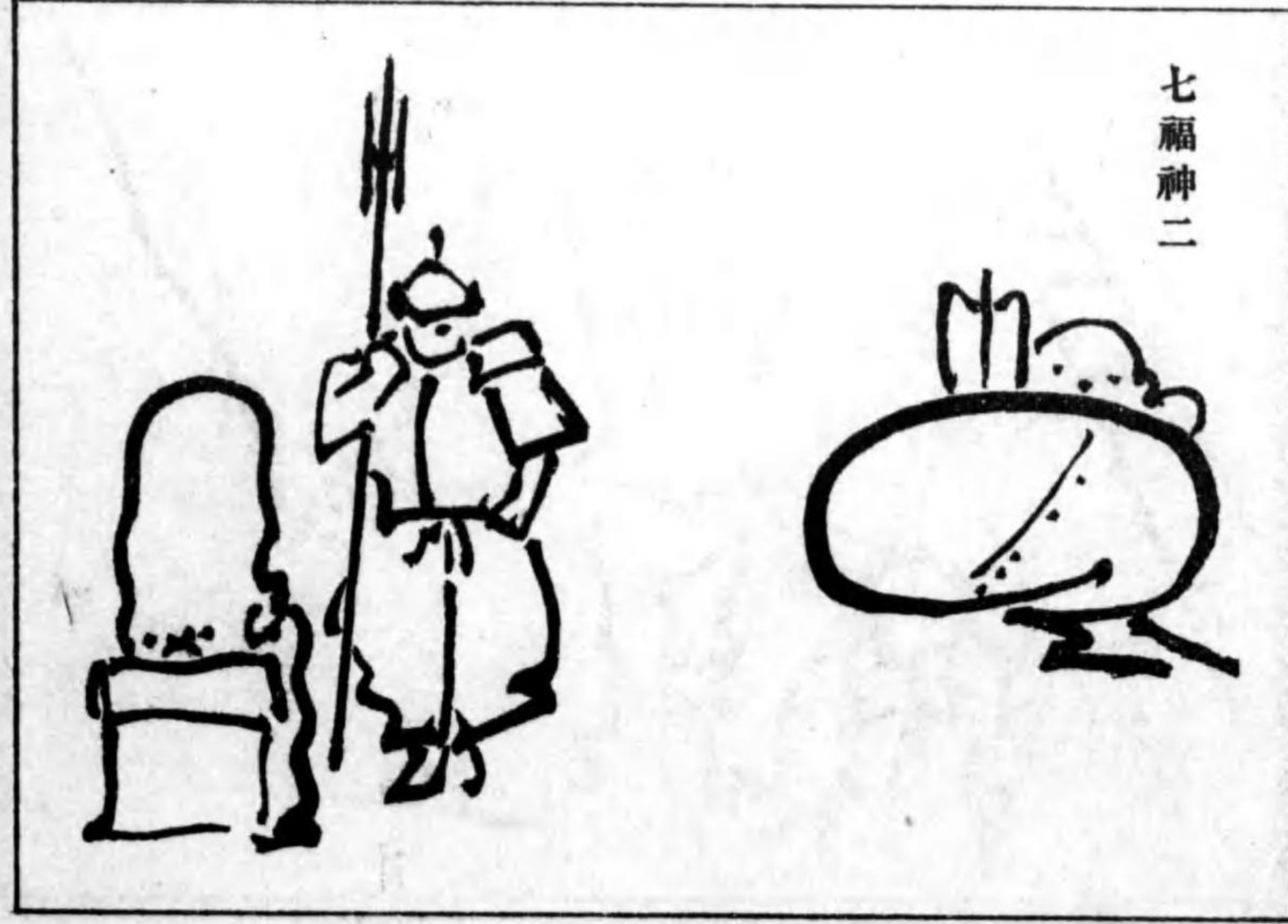
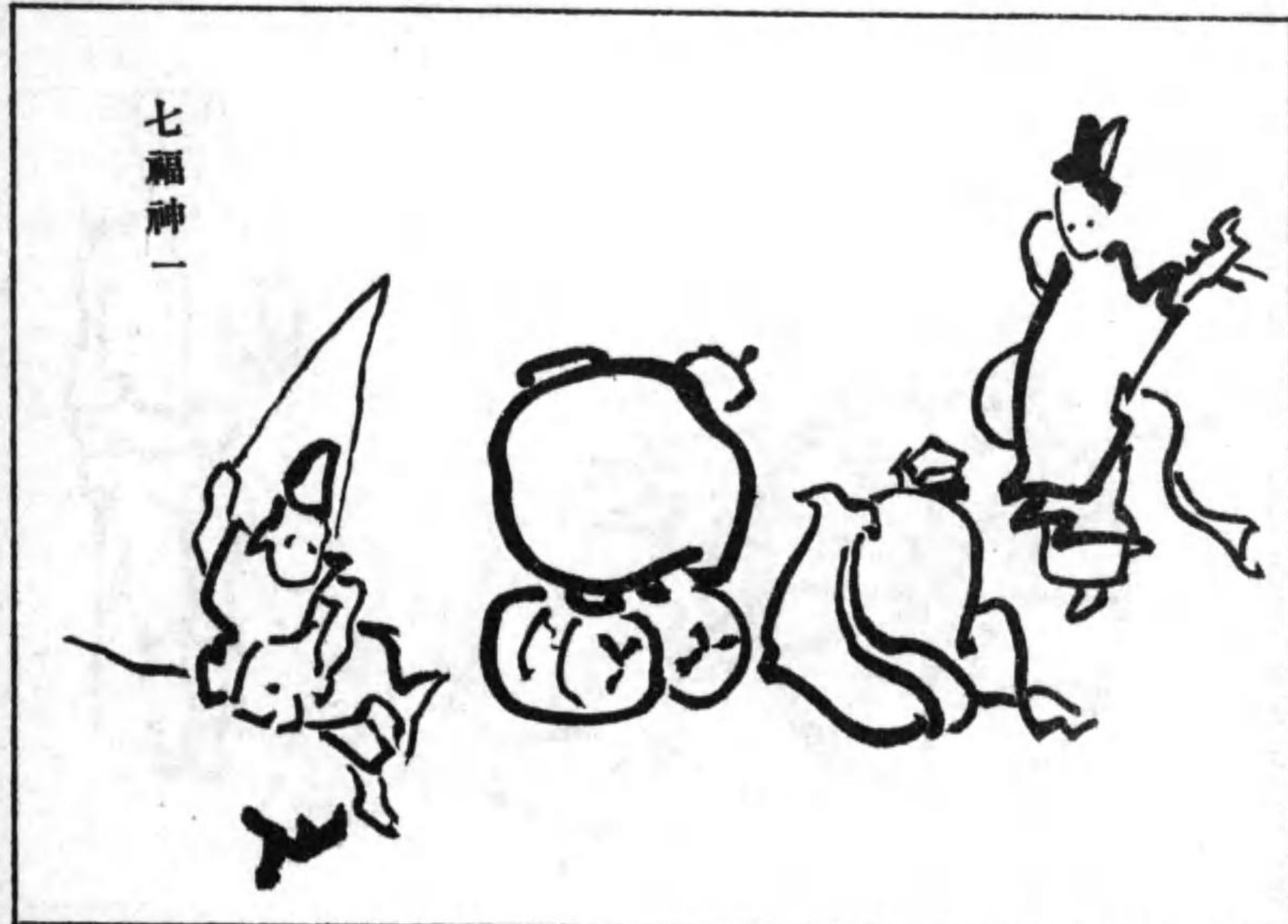
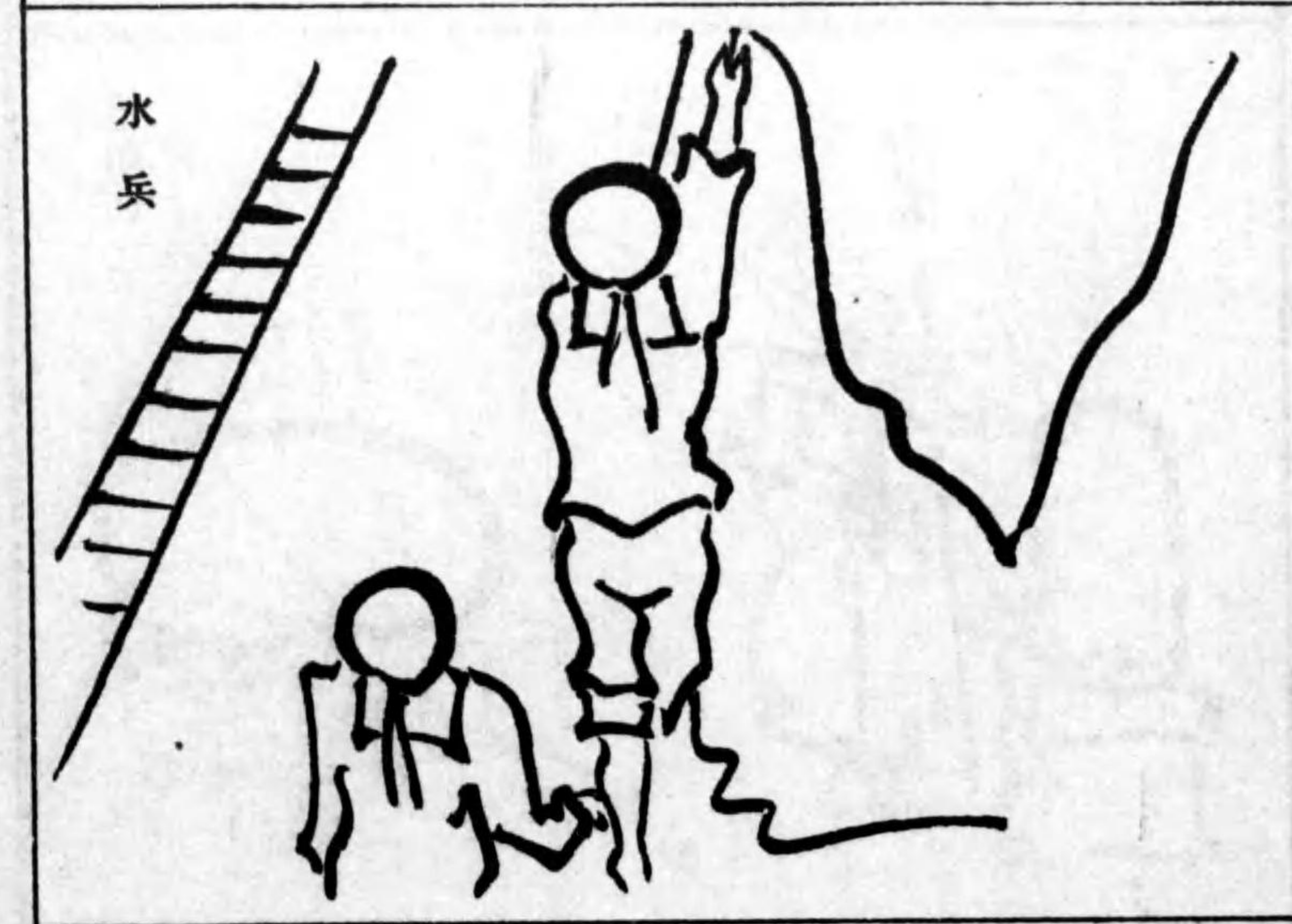
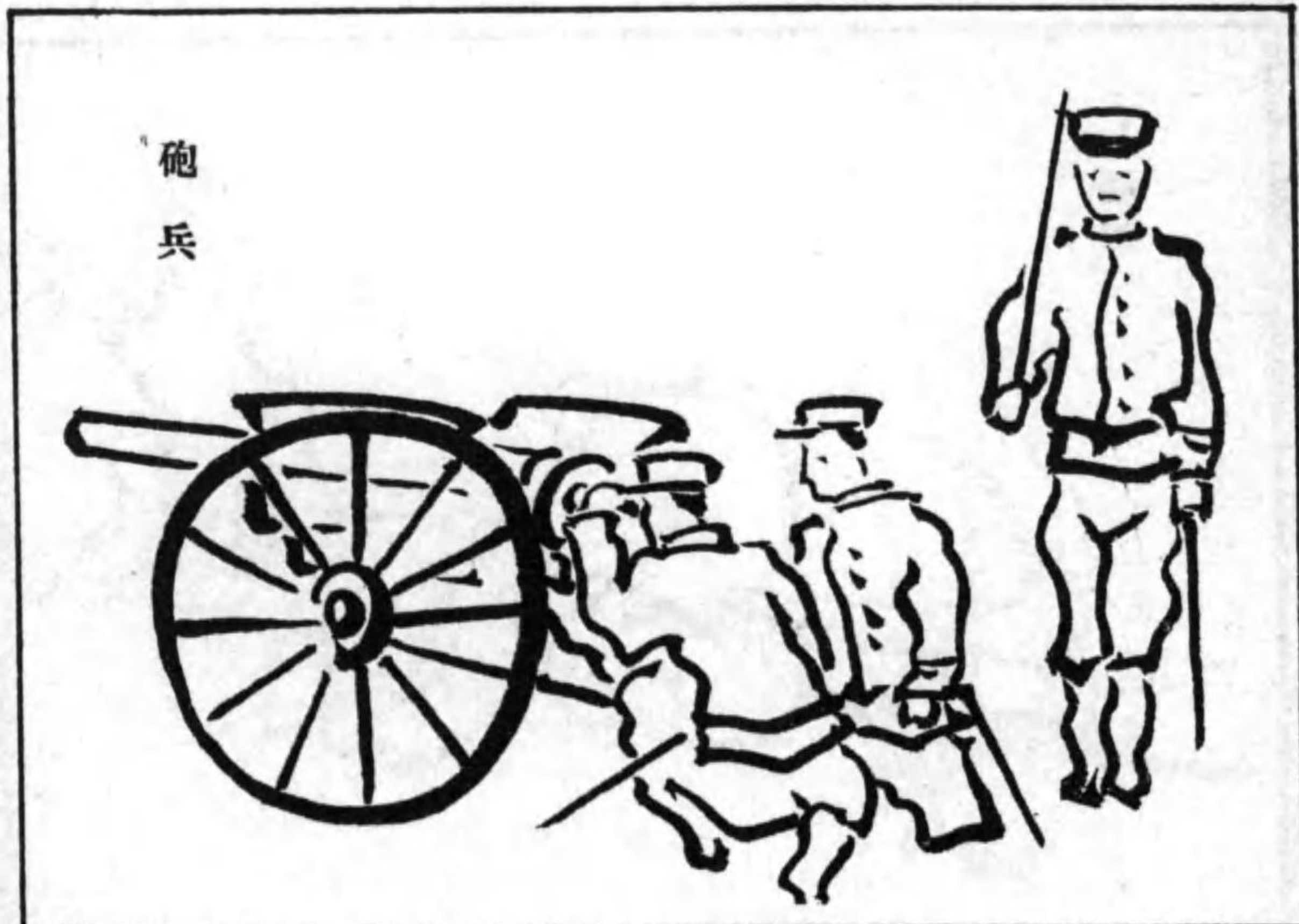

桃太郎



武者

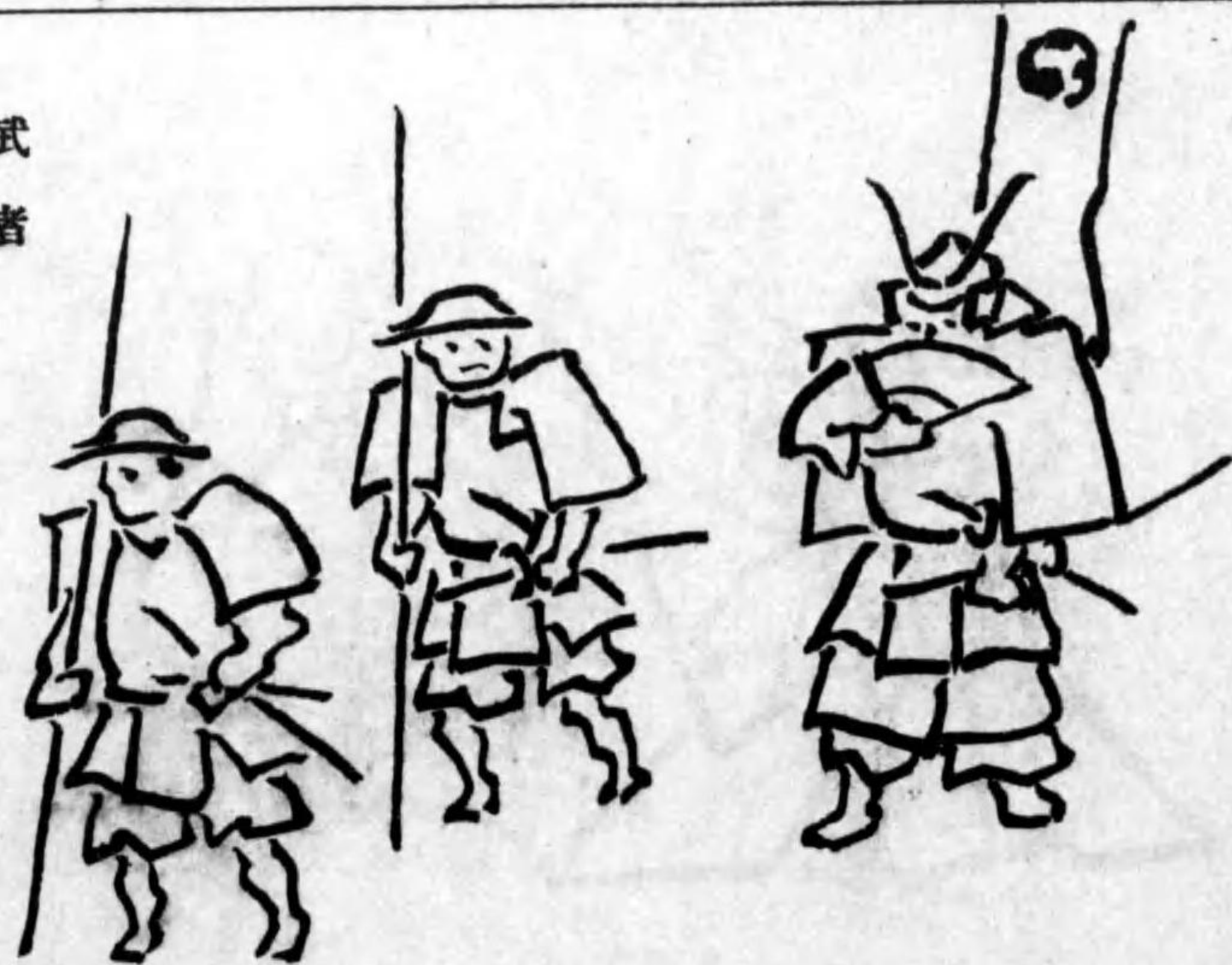

步兵



騎兵



金時



重盛

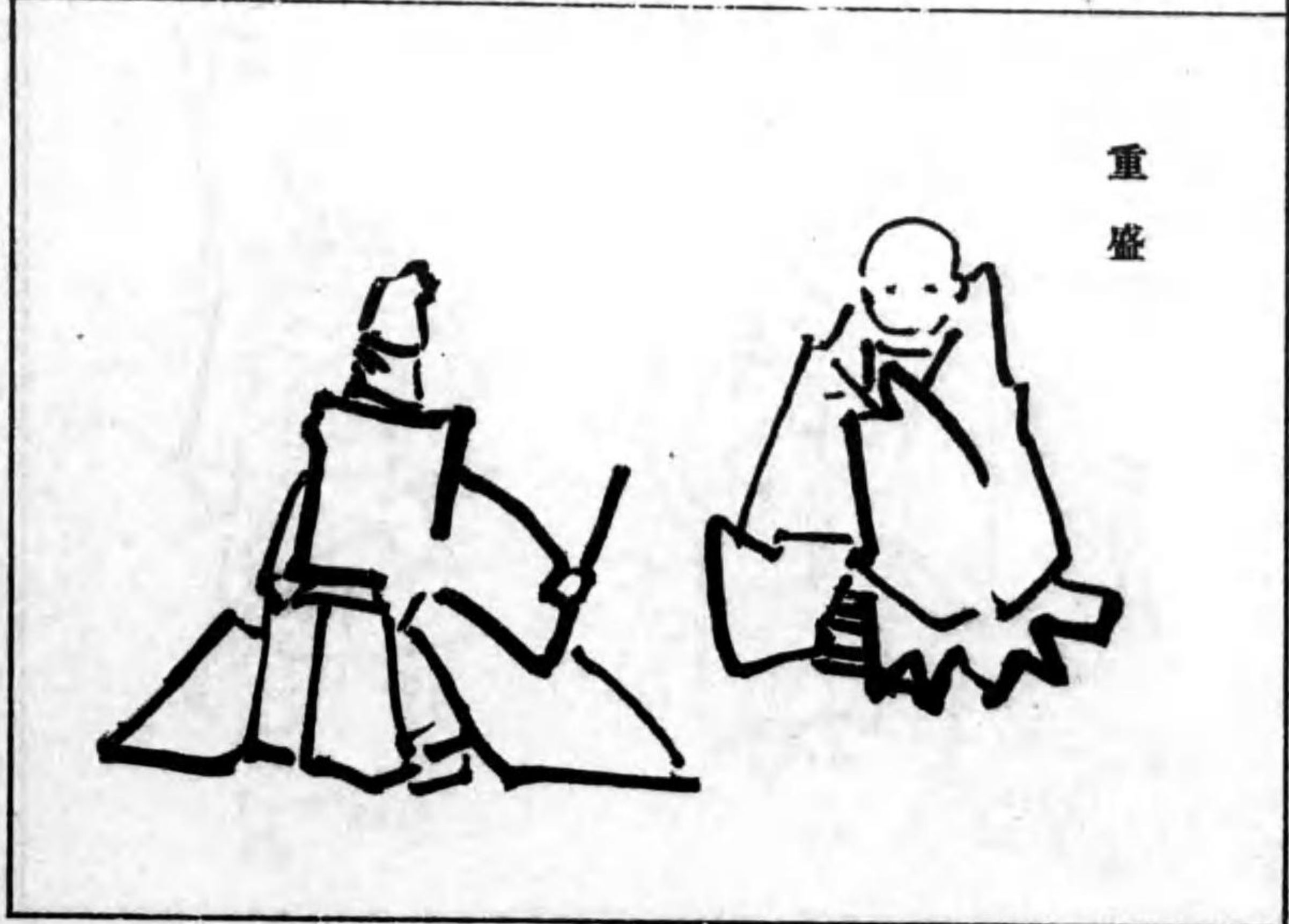

神世



支那人



朝鮮人





製茶

収穫一

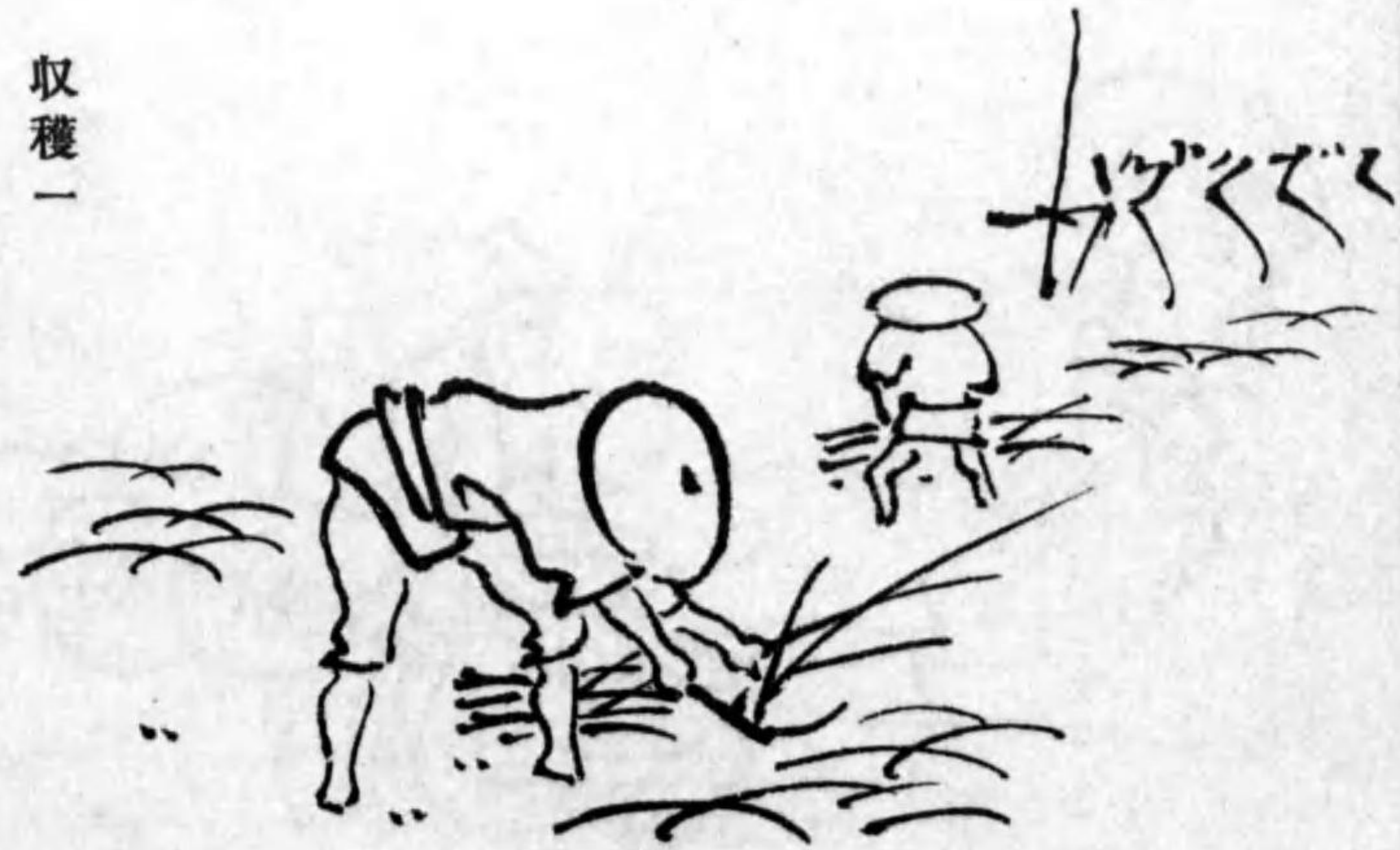

登校前

製鹽



舌切雀一



舌切雀二



收穫二



收穫三



舌切雀三



舌切雀四



舌切雀五

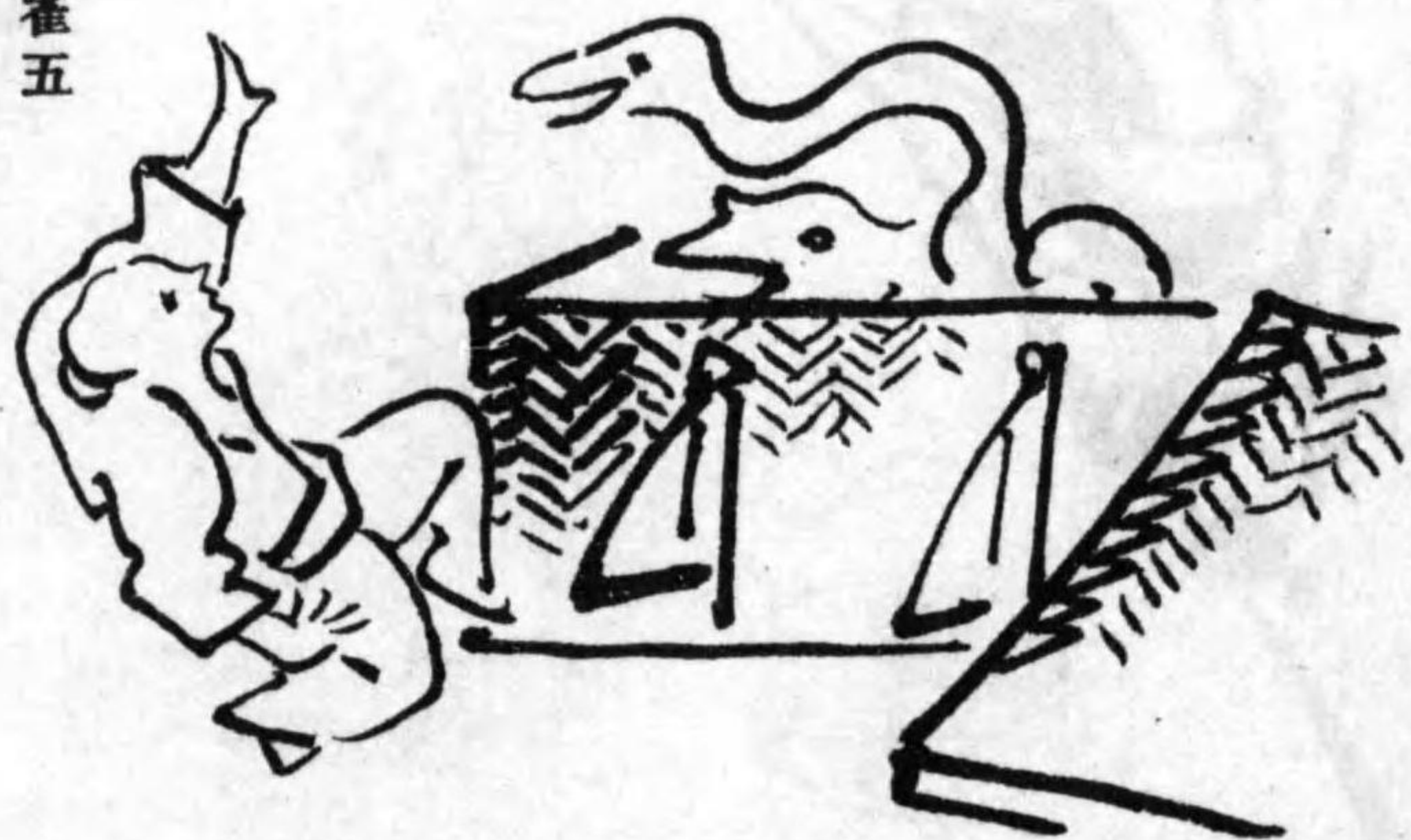

正直翁一

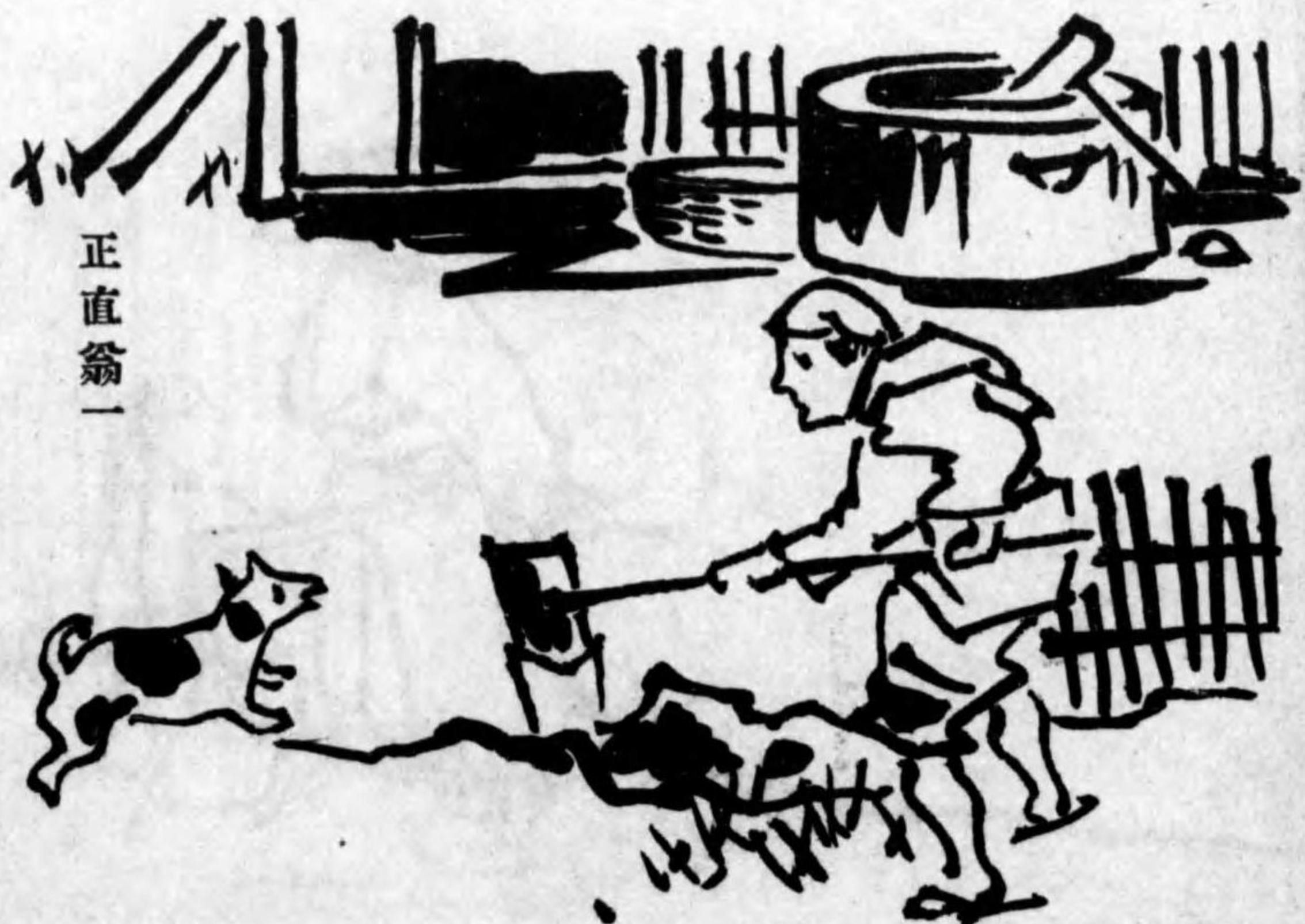

雜沓

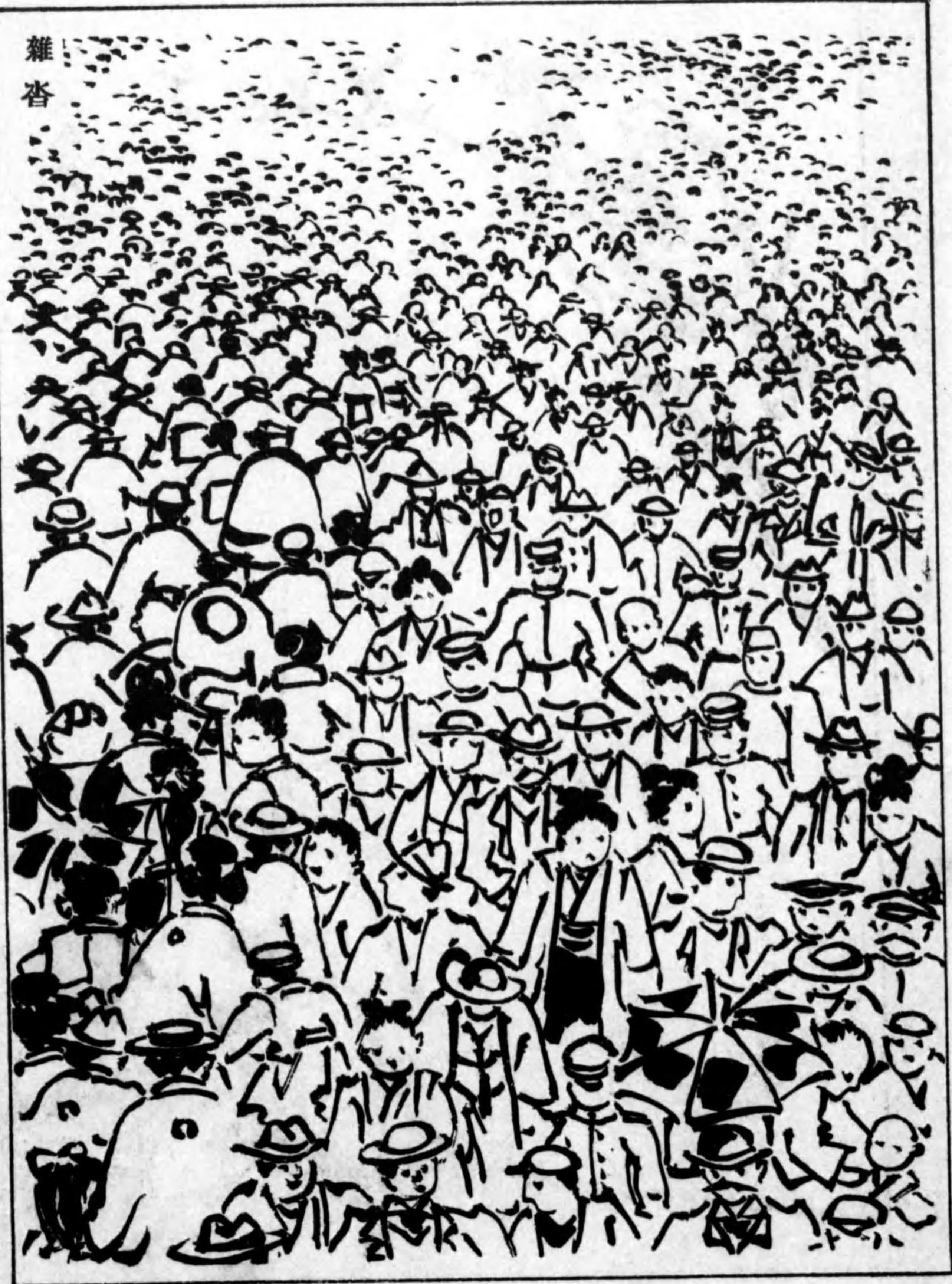

正直翁二



黑板畫法