

JAN 18 1923
DEPARTMENT OF COMMERCE

CIRCULAR

OF THE

BUREAU OF STANDARDS

S. W. STRATTON, DIRECTOR

No. 133

DESCRIPTION AND OPERATION OF AN
ELECTRON-TUBE DETECTOR UNIT FOR
SIMPLE RADIO RECEIVING OUTFITS

NOVEMBER 10, 1922



PRICE, 10 CENTS

Sold only by the Superintendent of Documents, Government Printing Office
Washington, D. C.

WASHINGTON
GOVERNMENT PRINTING OFFICE

1922

DESCRIPTION AND OPERATION OF AN ELECTRON-TUBE DETECTOR UNIT FOR SIMPLE RADIO RECEIVING OUTFITS.¹

ABSTRACT.

The apparatus now in use for radio reception, except the most simple types, uses electron tubes. Electron tubes are used for reception in many different kinds of circuits. One of the most elementary uses is as a simple detector. It is also possible to use electron tubes in reception in circuits using various kinds of amplification, or regeneration, beat reception, or other methods. A simple electron-tube detector set will not serve to receive signals transmitted by continuous-wave radio telegraphy. This circular describes a simple electron-tube detector unit and gives a method of operating it. The set with electron-tube detector is more sensitive than a set employing a crystal detector and may be expected to give more satisfactory results.

An antenna, lightning switch, ground connection, and telephone receivers which can be used in this set have been described in Circular No. 120. Tuning devices for use with this electron-tube detector set may be the tuning coil described in Bureau of Standards Circular No. 120 or the two-circuit coupler and variable air condenser described in Bureau of Standards Circular No. 121.

For an electron-tube detector unit it is necessary to have an electron tube, socket for the tube, filament rheostat, grid leak, grid condenser, by-pass condenser, binding posts, and other minor accessories. It is also necessary to have a 6-volt storage battery and a "B" dry battery of 22½ to 45 volts. Most of these parts should be purchased, although some can be made at home if desired. The cost of the complete electron-tube detector unit, including the tube and batteries, may be expected to be from \$23 to \$37. The principal part of this expense is the 6-volt storage battery. This estimate is exclusive of the cost of tuning device and telephone receivers described in Circulars Nos. 120 and 121, which may be from about \$10 to \$20. No estimate is made of the cost of equipment for charging storage batteries.

The electron tube, socket, condensers, filament rheostat, grid leak, and other parts of the detector unit are mounted on a wooden base and panel. The wood for the base and panel should be thoroughly dry and should preferably be protected by a coat of good electrical insulating varnish.

A complete description of the method of assembling and wiring the detector unit is given.

Illustrations are given showing the arrangement of the various parts and the complete assembled detector unit. The method of operating the set is also given.

CONTENTS.

	Page.
1. Introduction	4
2. Essential parts of complete radio receiving station	5
3. Description of parts	7
4. Assembly and wiring	11
5. Directions for operating	17
6. Notes on soldering	20
7. Approximate cost of parts	21

¹ This is one of a series of circulars describing radio receiving equipments of very simple type. The previous circulars of the series are Nos. 120 and 121. See Circular No. 120 for statement of the origin and purpose of this series. Each of these publications is obtainable from the Superintendent of Documents, Washington, D. C., at 5 cents per copy.

1. INTRODUCTION.

Electron tubes are now used in most radio receiving sets, except the more simple types. Crystal detectors may be used in very simple receiving sets, as described in Bureau of Standards Circulars Nos. 120 and 121. Electron tubes are used for reception in many different kinds of circuits. The simple detector circuit is one of the most elementary. It is also possible to use electron tubes in reception in circuits using various kinds of amplification, or regeneration, beat reception, or other methods. For descriptions of various kinds of tube receiving circuits reference may be made to the book *The Principles Underlying Radio Communication*, or to one of various other books now available, of which a list may be found in Bureau of Standards Circular No. 122, *Sources of Elementary Radio Information*.

This circular describes an electron-tube detector unit which may be used with the single-circuit radio receiving set described in Bureau of Standards Circular No. 120,² with the two-circuit radio receiving set described in Bureau of Standards Circular No. 121,³ or with any other tuning device.

The electron-tube detector unit may be substituted for the crystal detector; that is, its function is the same as the crystal detector, which is to make the signals from the radio transmitting station audible in the telephone receivers when the radio receiving set is tuned to the proper wave frequency (wave length). The use of an electron-tube detector will increase the receiving radius of the receiving set, so that it will be possible to hear high-power transmitting stations at a distance of about 75 miles, provided the transmitting station uses wave frequencies between 500 and 1,500 kilocycles per second (wave lengths between 600 and 200 m.). Under good atmospheric conditions signals from greater distances may be heard, especially at night.

The electron-tube detector unit described in this circular is one step forward in the understanding of more sensitive and complex apparatus. A later circular of this series describing audio frequency amplifiers is in preparation. *The simple electron-tube detector circuit will not make "continuous wave"*⁴ *signals audible.*

² Construction and Operation of a Simple Homemade Radio Receiving Outfit, obtainable from the Superintendent of Documents, Government Printing Office, Washington, D. C., price, 5 cents in cash.

³ Construction and Operation of a Two-Circuit Radio Receiving Equipment with Crystal Detector, obtainable from the Superintendent of Documents, Government Printing Office, Washington, D. C., price, 5 cents in cash.

⁴ See pages 431 and 501 of the book, *The Principles Underlying Radio Communication* (Signal Corps Radio Communication Pamphlet No. 40). This is a bound volume of over 600 pages, and is obtainable from the Superintendent of Documents, Government Printing Office, Washington, D. C., price, \$1.

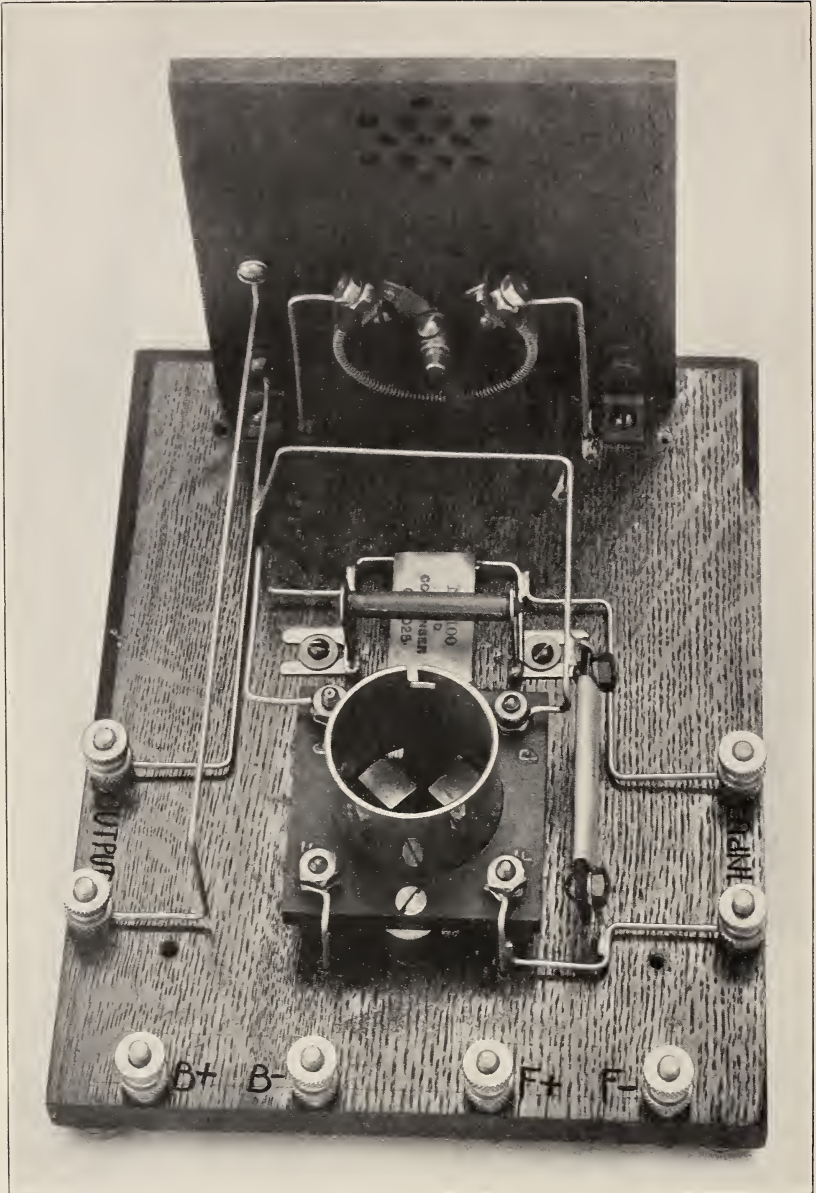

FIG. 2.—Assembled electron-tube detector unit

The cost of an electron-tube detector unit, complete with the necessary batteries, is between \$23 and \$37. The principal part of this expense is a 6-volt storage battery. No estimate is included of the cost of equipment for charging the storage battery.

Additional electron-tube amplifiers (described in subsequent publications), which will greatly increase the sensitivity⁵ and hence the receiving range of the receiving set, will not require additional storage batteries. This will make the added cost of the amplifiers comparatively small.

The cost of the tuning equipment and telephone receivers to be used with this detector unit, as described in Bureau of Standards Circulars Nos. 120 and 121, may be from \$10 to \$20.

This publication describes simple apparatus of satisfactory performance without reference to the possible existence of any patents which might cover parts of the apparatus. Apparatus in general similar to that described can be purchased from responsible manufacturers whose announcements can be found in current radio periodicals.

2. ESSENTIAL PARTS OF COMPLETE RADIO RECEIVING STATION.

A complete radio receiving station comprises:

ANTENNA, LIGHTNING SWITCH, GROUND CONNECTIONS, AND TELEPHONE RECEIVERS.—These are completely described in Bureau of Standards Circular No. 120.

TUNING DEVICE.—This may be the tuning coil described in Bureau of Standards Circular No. 120, or it may be the two-circuit coupler and variable air condenser described in Bureau of Standards Circular No. 121. While the two-circuit tuning device will be somewhat more selective⁶ than the single-circuit tuner, as stated in Circular No. 121, its use is not absolutely essential.

ELECTRON-TUBE DETECTOR UNIT (FIGS. 1, 2, AND 7).—The electron-tube detector unit is composed of a baseboard *B* and an upright panel *A*. On the baseboard *B* is mounted an electron tube *E* (shown only in Fig. 7), an electron-tube socket *S*, a resistor (grid leak) *R*, a grid condenser *C*, a by-pass condenser *C'*, and eight binding posts. On the upright panel *A* is mounted a filament rheostat *R'* (the adjusting knob *J* is shown in fig. 7), and two telephone-receiver binding posts *L* and *M*. The parts *S*, *R*, *C*, and *C'* are also shown in Figure 3. This circular tells how the various parts are assembled on the baseboard and the panel. No

⁵ The Principles Underlying Radio Communication, p. 448.

⁶ The Principles Underlying Radio Communication, p. 378.

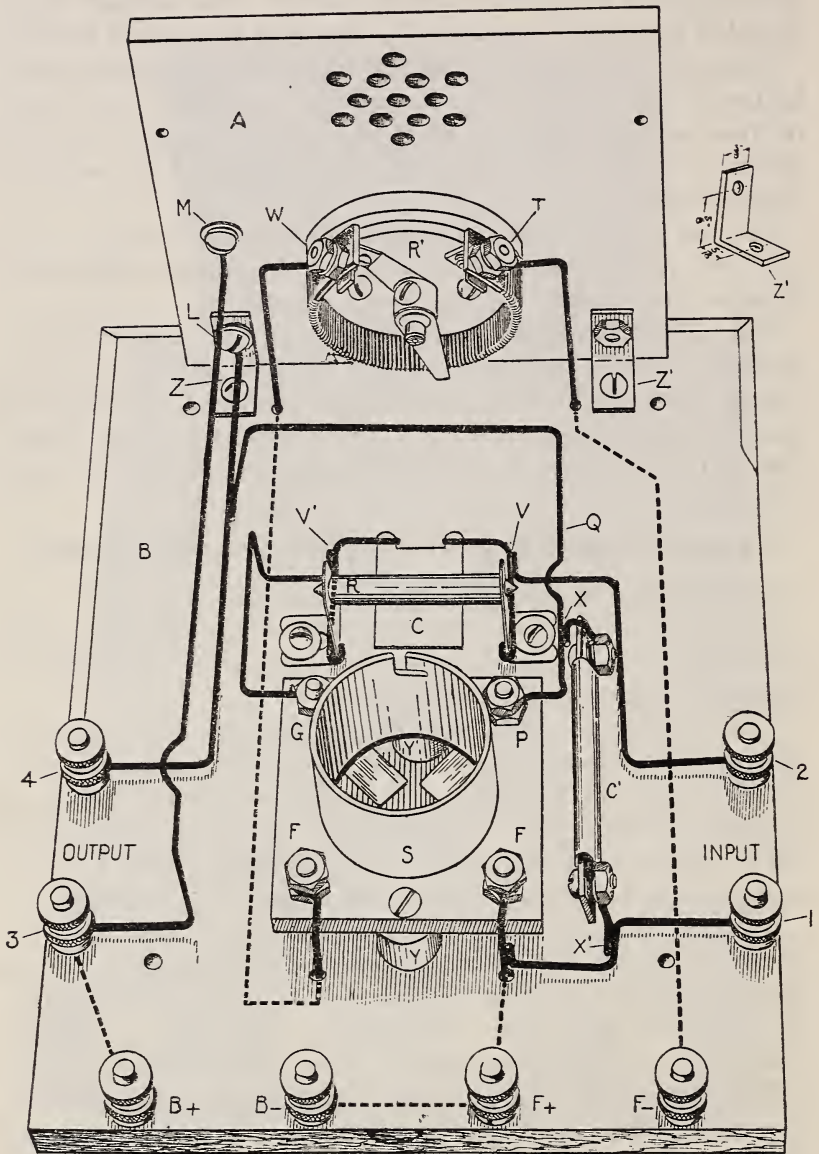

FIG. 1.—Diagram showing location of parts and wiring of electron-tube detector unit.

description is given of how the parts E , S , and R' are made, because they are rather difficult to construct. It is, of course, possible for one to make parts such as the electron-tube socket S and the filament rheostat R' .

ACCESSORIES.—Under the heading of accessories may be listed a 6-volt battery, used for lighting the filament, often called the "A" battery, having a capacity of about 60 ampere-hours, a $22\frac{1}{2}$ to 45 volt dry battery ("B" battery), binding posts, stiff copper wire, wood boards for the baseboard and upright panel, two brass angle braces for supporting the panel, and miscellaneous screws. The "A" and "B" batteries are shown in Figure 7. The "A" battery will usually be placed on the floor beneath the table upon which the other parts of the equipment are arranged. An insulating material panel may be substituted for the wood if desired. The electron-tube detector may also be entirely inclosed in a wood cabinet with a hinged cover, if desired.

3. DESCRIPTION OF PARTS.

BASEBOARD (B , FIGS. 1 AND 3).—The baseboard B is any kind of dry wood about $6\frac{1}{4}$ inches by $8\frac{1}{4}$ inches by $\frac{1}{2}$ inch thick. Eight holes are drilled through the base in which the binding posts are fastened. Spacing of these holes is shown in Figure 3. The baseboard is arranged so that the three remaining sides and a hinged cover may be added without changing the relative positions of the binding posts. Under each of the four corners of the baseboard B rubber or wood feet (risers) are fastened in order that the binding-post heads and wiring will be protected on the underside.

UPRIGHT PANEL (A , FIGS. 1 AND 4).—The panel A is any suitable dry seasoned wood about $4\frac{1}{2}$ by 5 inches by $\frac{3}{8}$ inch thick. In Figure 4 a back view of the panel is shown which brings the two holes for the telephone-receiver binding posts in the lower left-hand corner. If the panel is viewed from the front, these two holes will be at the lower right-hand corner. It is quite desirable that this panel present a good appearance, it being the front panel. Four holes are drilled in the panel A , one for the bolt which fastens the panel to the brace (see Z' , Fig. 1), two for the telephone-receiver binding posts L and M (Figs. 1 and 7), and one for the shaft of the filament rheostat R' (see Fig. 1). The exact location of the hole for the rheostat shaft is determined from the rheostat itself. It is drilled so that the rheostat will

occupy as low a position as possible, allowing room enough to do the necessary wiring.

ELECTRON TUBE (*E*, FIG. 7).—The electron-detector tube is a commercially available type. The several parts of an electron tube (sometimes called a vacuum tube) are described in *The Principles Underlying Radio Communication*, Chapter 6.

ELECTRON TUBE SOCKET (*S*, FIGS. 1, 2, AND 7).—The electron-tube socket may be any one of various commercially available types. There are many types available, and the majority of them are found satisfactory for this purpose.

GRID LEAK AND GRID CONDENSER (*R* and *C*, FIGS. 1, 2, AND 7).—The grid leak and grid condenser are sometimes sold as a unit and sometimes are sold separately, or they may be constructed. If a detector type of electron tube (sometimes called “soft” or “gas” tube) is used, it is better that these two parts be purchased with the tube, care being taken to select the proper values of resistance and capacity for the grid leak and the grid condenser, as specified by the manufacturer of the tube purchased. The resistance of the grid leak will usually be between 1 and 5 megohms (1,000,000 and 5,000,000 ohms) and the capacity of the grid condenser will be about 0.0003 μ f (300 μ f). If an amplifier type of electron tube (sometimes called a “hard” tube) is used, the resistance of the grid leak may generally be anywhere within the resistance limits suggested above and the same size of grid condenser used as mentioned above. Small mica condensers of suitable capacity can be purchased cheaply.

Experimental grid leaks may be made for such electron-tube detectors. This is only suggested for its educational feature. If a two-stage audio-frequency amplifier is used also, it will be quite difficult to make a grid leak that will work satisfactorily. Such an experimental grid leak may be made from a piece of fiber about $\frac{3}{8}$ inch wide, $1\frac{1}{2}$ inches long, and from $\frac{1}{32}$ to $\frac{1}{8}$ inch thick. Two $\frac{1}{8}$ -inch holes are drilled along the center line of the piece about 1 inch apart. A line is drawn between the two holes, using india or drawing ink. Contact with the ink line may be made by the use of two brass (6-32 or 8-32) machine screws about $\frac{1}{2}$ inch long and each equipped with one nut and two washers. The machine screws are put through the holes in the ends of the fiber strip with one washer on each side of the fiber strip. A small

piece of tin foil may be rolled up and wound around each machine screw between the fiber and the washer, so that the tin-foil pad will make contact with the ink line. When the nuts are tightened down, the tin-foil pads will flatten out and form a contact between the brass washers and the ends of the ink line. Since the ink line makes a partial electrical conductor of high resistance, the thickness and width of the ink line will determine the resistance of the grid leak to a great extent. The value of resistance may be decreased by inking the line over several times until the electron-tube detector works best. A suitable grid condenser may be made from tin foil and paraffined paper in the manner described in "Auxiliary Condensers and Loading Coil used with Simple Homemade Radio Receiving Outfits," a circular of the Bureau of Standards now in preparation, the total effective area of the condenser plates being reduced to about 6 square inches. This may be accomplished by using six tin-foil strips $\frac{3}{8}$ inch wide by 7 inches long instead of those described in the circular mentioned above. The width of the cap and base pieces and the paraffined paper insulating sheets may also be correspondingly reduced to better meet the space requirements of the electron-tube detector set.

BY-PASS CONDENSER (C' , FIGS. 1, 2, AND 7).—This is any small-sized fixed condenser having a capacity of from 0.0003 to 0.0015 μ f (300 to 1,500 μ f) which may be purchased or made according to the description given in the circular mentioned above. While this condenser is not absolutely necessary, its use is advisable.

BINDING POSTS (FIGS. 1 AND 2).—The binding posts used on the baseboard may be 6-32 or 8-32 brass machine screws each equipped with two nuts and two washers if regular binding posts are not available. The telephone-receiver binding posts L and M (figs. 1 and 7) are of the set-screw type to admit the tips of the telephone-receiver cords.

FILAMENT RHEOSTAT (R' , FIG. 1).—As has been previously stated, the filament rheostat may be constructed, but no suggestions regarding its construction are given here. If the rheostat is purchased, it is desirable to select one designed for panel mounting as well as one having a neat appearing knob and pointer. The rheostat should have a resistance of about 7 ohms and a current-carrying capacity of about $1\frac{1}{2}$ amperes.

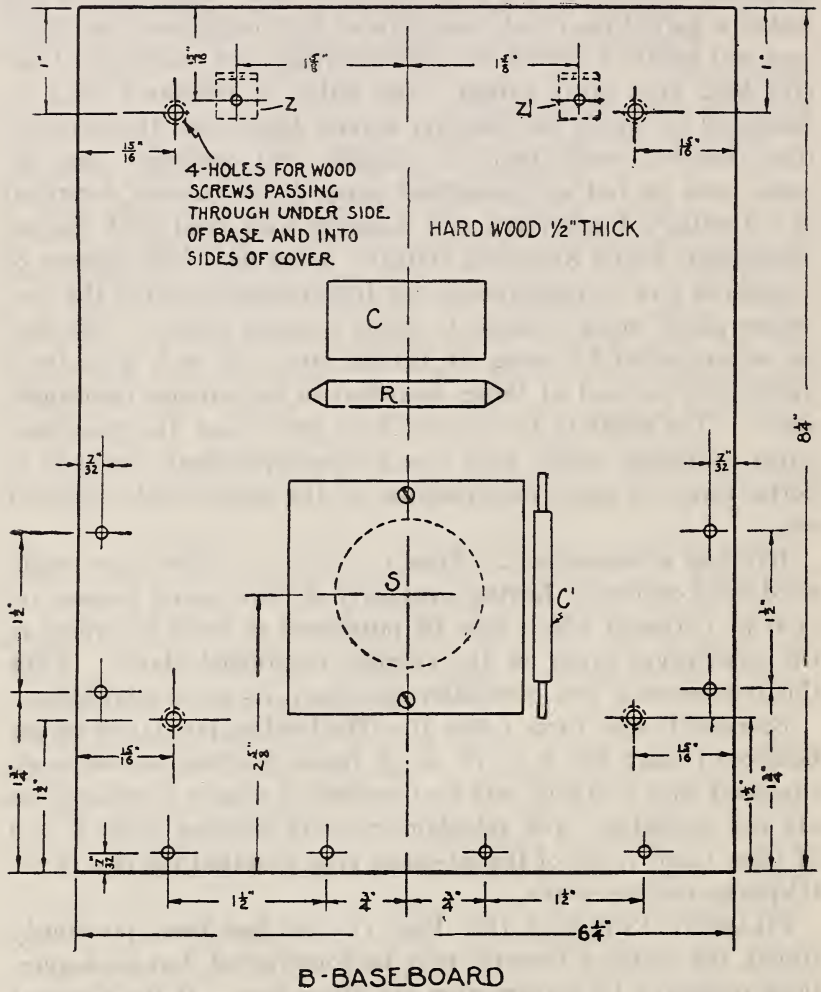

FIG. 3.—Baseboard.

ACCESSORIES.—The accessory batteries are commercial articles. The purchaser of a storage battery for lighting the filaments should get full instructions from the dealer for testing and recharging the battery. The dry battery ("B" battery) usually used for the plate circuit can not be recharged. The normal life of a dry battery of reliable manufacture is about six months. Storage batteries for use as "B" batteries are available. Their first cost is greater than that of dry batteries, but they may be recharged.

4. ASSEMBLY AND WIRING.

WOOD FINISH.—It is essential in electron-tube sets that the wood be protected from moisture. While the wood base and panel may be treated with paraffin, as suggested in Bureau of Standards Circular No. 120, it is more satisfactory to first dry the wood and then stain and varnish it, using a good varnish, preferably insulating varnish. Shellac is not used. It is rather difficult to give definite suggestions concerning drying and staining of wood. Wood may be put in a warm oven for an hour or so to insure more or less complete drying. A lampblack or carbon pigment stain is not used ordinarily on such radio parts, and it would be well to avoid the use of such stains. The stain and varnish are thoroughly dried before the apparatus is mounted on the wood baseboard and panel.

BASEBOARD (*B*, FIGS. 1 AND 7).—The eight brass machine screws or binding posts are put in the holes already drilled in the baseboard. If machine screws are used, the heads are put on the underside of the baseboard, with a brass washer between the head and the baseboard. A brass washer and two nuts are then fastened to each screw, on the upper side of the baseboard, with the washer next to the baseboard. The tube socket *S*, the grid condenser *C*, the grid leak *R*, and the by-pass condenser *C'* are next screwed to the baseboard. (Certain types of condensers will be held in position by the wiring only.) The exact location of these parts can not be stated, because the several types of parts commercially available will vary somewhat in dimensions. One can get a very good idea of the relative positions of the several parts from Figures 1, 2, and 7. The tube socket *S* is mounted so that the two terminals marked *G* and *P* (Fig. 1) are nearest the upright panel. Blocks *Y* and *Y'* are put under the socket *S* so that the four terminals of the socket do not touch the wood baseboard. This is done by cutting off two round wood blocks just long enough to raise the socket terminals clear of the base and mounting them so

that the screws which hold the socket to the baseboard will pass through holes in the centers of the blocks.

After the socket *S*, grid condenser *C*, grid leak *R*, and by-pass condenser *C'* are mounted the parts are wired up. No. 14 bare tinned copper wire is used in wiring. This makes the connections stiff and self-supporting. This wire is ordinarily furnished in rolls. The wire is straightened before it is used. It can be straightened by clamping or otherwise fastening one end solidly and pulling on the other end just hard enough to stretch the wire slightly. (It is also a good plan in wiring such sets to have all wires run as directly as possible, neatly, and all bends made at right angles.) When a wire is attached to a binding post, a loop or eye is formed on the end of the wire and the wire at the eye flattened with a hammer. This gives more contact surface. Special lugs may also be soldered to the ends of the wire before the connection is made.

A small hole is drilled through the baseboard just back of each of the tube-socket terminals marked *F* (see Fig. 1). A short piece of wire is fastened to the right-hand socket terminal marked *F*, and is then led through the small hole in the baseboard to the underside of the baseboard. The same wire is led to the binding post *F+* and fastened between the machine-screw head and washer underneath the baseboard. The same wire is further led to the binding post marked *B-* and fastened between the machine-screw head and washer underneath the baseboard. All wires which are run on the underside of the baseboard are shown in Figure 1 by dotted lines. A short piece of wire is soldered to the wire leading from the right-hand socket terminal marked *F* just above the baseboard and led to the "input" binding post No. 1 and fastened between the washer and the first nut. This wire is shown as a solid line, which means it is on the upper side of the baseboard. The wires do not touch the wood boards except at the terminals and where the wires pass through holes in the baseboard. The wires may be raised more or less to accomplish this.

The two terminals of the grid condenser *C* are connected to the two terminals of the grid leak *R*, as shown in Figure 1. A wire is soldered at *V* and led to the input binding post No. 2. This wire is kept quite close to the baseboard. Another wire is soldered at *V'* and led to the tube-socket terminal marked *G*. The remainder of the wiring is left until the upright panel is assembled and fastened to the baseboard. Suggestions regarding soldering are given later.

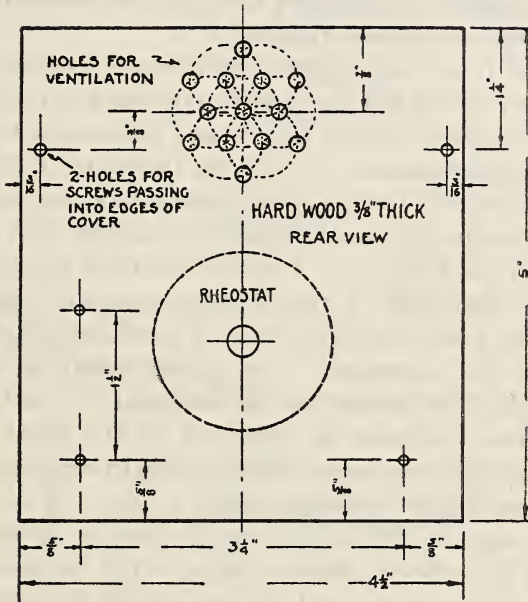

A-UPRIGHT PANEL

- 2-BOARDS FOR SIDES $7\frac{1}{4} \times 5 \times \frac{1}{2}$ "
- 1-BOARD FOR BACK $5 \times 3\frac{3}{4} \times \frac{1}{2}$ "
- 1-BOARD FOR TOP $7\frac{3}{4} \times 5\frac{1}{4} \times \frac{1}{2}$ "
- 2-HINGES BUTT $\frac{3}{4}$ "

FIG. 4.—Upright Panel.

UPRIGHT PANEL (*A*, FIGS. 1, 2, AND 7).—The filament rheostat *R'* is mounted on the upright panel *A*, so that the two terminals will be in a convenient position for wiring. Two binding posts of the set-screw type *L* and *M* (Figs. 1 and 7) are inserted in their proper holes and the upright panel mounted in position by bolting it to the two brass angle pieces (*Z* and *Z'*) shown in Figures 1, 2, and 3. One of the telephone receiver binding posts *L* serves as a bolt. Two small holes are drilled through the baseboard near the two terminals of the filament rheostat *R'*.

A wire is run from the "output" binding post marked 4 (Fig. 1) along the upper side of the baseboard to the back of the telephone-receiver binding post marked *L*. A wire is fastened to the tube-socket binding post marked *P* and from thence led to the back of the telephone-receiver binding post marked *L* or else soldered to a convenient place on the wire leading from binding post *L*. These wires are shown in Figure 1. A wire is run from the binding post marked 3 to the back of the telephone-receiver binding post marked *M*, and a wire is also run from *B +* to binding post marked 3, underneath the baseboard. One of the terminals of the bypass condenser *C'* is connected at the point *X*, and the other terminal of the condenser is connected to the point *X'*. The method of making these connections depends to some extent on the particular type of fixed condenser which is used. If the condenser be provided with flexible leads, one of them is soldered at the point *X* and the other is likewise connected at the point *X'*. If the condenser is provided with lugs, connections are made by bending the wires into the proper shape and soldering thereto.

A wire is run from a filament rheostat binding post marked *T* through the hole in the baseboard and thence along the underside of the baseboard to the binding post marked *F -*. Most of this wire is shown in Figure 1 by a dotted line. Likewise a wire is run from the rheostat binding post *W* underneath the baseboard and up through the left-hand hole in the baseboard at the rear of the electron tube socket *S* and connected to the left-hand binding post marked *F*. This completes the assembling and wiring of the electron-tube detector unit.

SPECIAL BINDING POSTS.—By the addition of two more binding posts properly connected this detector may be used in a "regenerative" circuit when the binding posts are externally connected to a "tickler" coil coupled to the tuner. These binding posts are added to the detector baseboard *B* in line with the "input" binding posts Nos. 1 and 2 (see fig. 1). They are $\frac{7}{32}$ of an inch from

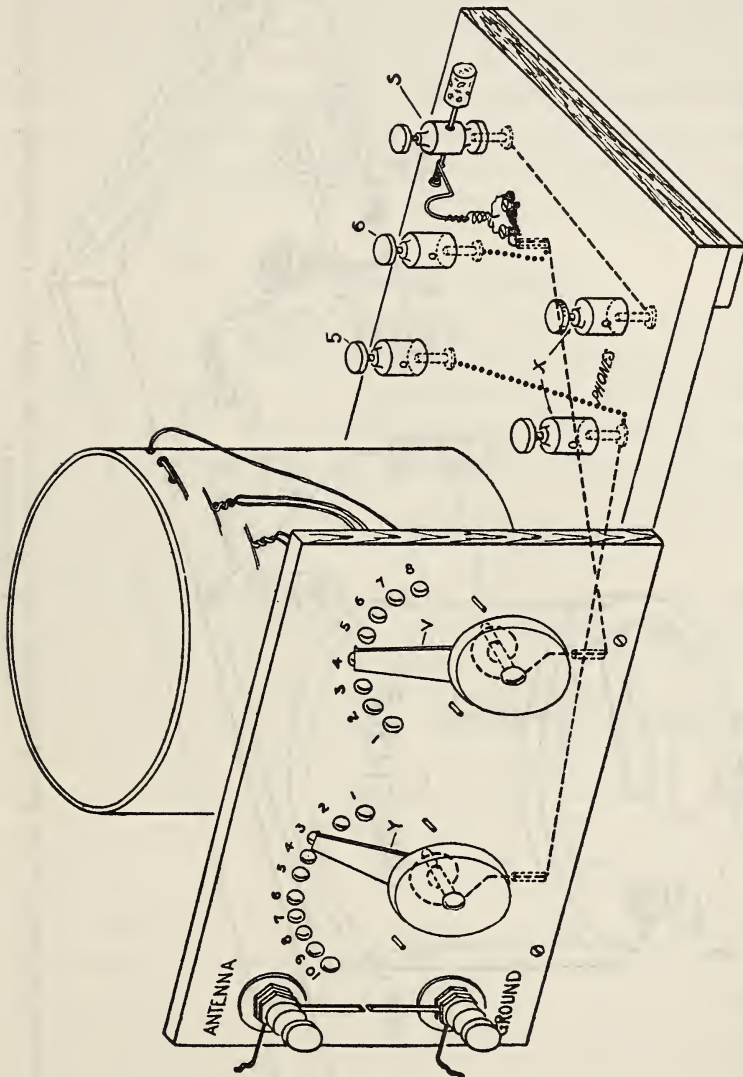

FIG. 5.—Single-circuit radio receiving set described in Circular No. 120, with wiring changes for use with electron-tube detector unit.

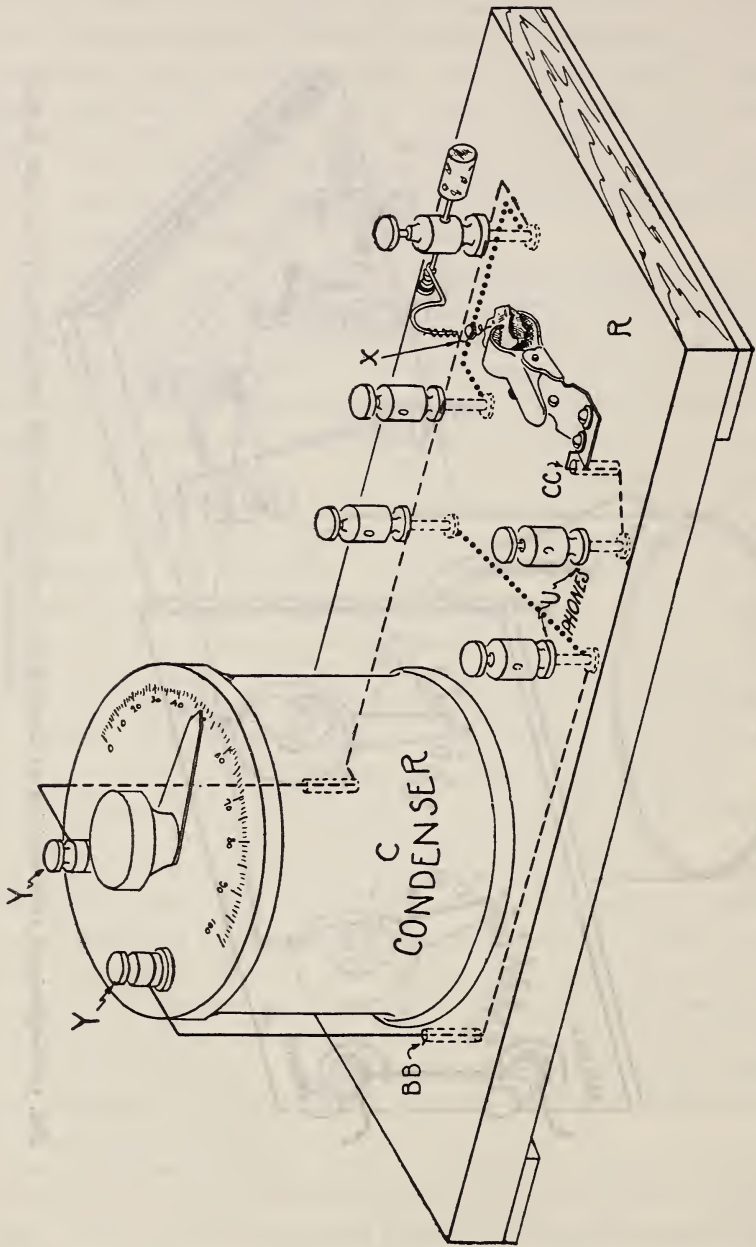

FIG. 6.—Condenser and crystal detector unit of two-circuit receiving set described in Circular No. 121, with wiring changes for use with electron-tube detector unit.

the edge of the baseboard, and the four binding posts are arranged in such a manner that they are equally spaced, $1\frac{1}{2}$ inches between centers. Referring to Figure 1, the wire which leads from the terminal *P* of the electron-tube socket is cut at some convenient place *Q*, and the two ends thus formed are connected to the extra binding posts. The connection *X*, from one terminal of the condenser *C'*, is also removed and a longer wire connected from this terminal to the other side of the point *Q* where the wire was cut. The method followed in making these connections does, of course, correspond with the style of wiring used in the complete electron-tube detector unit.

5. DIRECTIONS FOR OPERATING.

CONNECTIONS.—It has already been stated that better results are obtained if the two-circuit tuning device described in Bureau of Standards Circular No. 121 is used with the electron-tube detector. However, the single-circuit tuner described in Circular No. 120 may be used, or the electron-tube detector may be connected to any tuner not already supplied with an electron-tube detector. An advantage of the single-circuit receiving set is that it is simpler to adjust.

If the single-circuit tuner is used with this electron-tube detector, the several parts are arranged somewhat as shown in Figure 7. The single-circuit tuner (shown at extreme left) is fully described in Bureau of Standards Circular No. 120. Two more binding posts are added in the back right-hand corner and wired as shown in Figure 5. The greater portion of the wiring is beneath the baseboard. The wires shown as dashes (— — — —) are those already described in Circular No. 120. The wires shown as dots (.) are the new wires added. Such wiring will not disturb the set for use as a crystal detector receiving set. The second unit to the right is the electron-tube detector described in this circular. Accessory parts, such as telephone receivers, "B" battery, and "A" storage battery, are also shown in Figure 7. As previously mentioned, the "A" battery is shown here reduced in size, and it is usually placed under the table upon which the rest of the apparatus is arranged.

If the two-circuit tuning device is used with this electron-tube detector, the arrangements of the parts is similar to that shown in Figure 7, except that the two units, consisting of the coupler and the variable condenser with crystal detector, replace the single-circuit receiving set shown at the left. Connections between the secon-

dary of the coupler and the terminals of the variable condenser are the same as described in Bureau of Standards Circular No. 121. Two more binding posts are added at the rear edge of the baseboard supporting the variable condenser and crystal detector (see Fig. 6). The dotted lines indicate the new wiring connections as described for the single-circuit receiving set.

The antenna and ground wires are connected as described in Bureau of Standards Circular No. 120 and as shown in Figure 7. Binding post No. 5 (Fig. 7) is connected to binding post No. 1, and binding post No. 6 is connected to binding post No. 2. The telephone receivers are connected to the binding posts *L* and *M*, as shown in Figure 7. The red (positive +) wire of the "B" battery is attached to the electron-tube detector binding post marked *B* + and the black (negative -) wire to the binding post marked *B* -. An insulated flexible copper wire is run from the red (positive +) terminal of the 6-volt "A" storage battery to binding post marked *F* + (Fig. 7) and a similar wire from the black (negative -) terminal of the "A" battery to the binding post marked *F* -.

OPERATION.—The filament rheostat knob *J* (Fig. 7) is turned to the extreme left, and the electron-tube *E* inserted in the electron-tube socket *S*. The filament rheostat knob is then turned to the right until the electron-tube filament becomes lighted, the brilliancy depending upon the type of electron tube used. When one of the telephone-receiver terminals is removed from its binding post and again touched to the post, a sharp "click" in the telephone receivers will be an approximate indication that the circuit is in working condition. If the test buzzer as described in Bureau of Standard Circular No. 120 is available, it may be attached (as described in that circular) to the tuner binding post marked "ground" and then the rheostat adjusted until the sound in the telephone receivers is the loudest. The electron-tube detector unit is merely substituted for the crystal detector, and the tuning of the receiving circuit is the same as described in Circulars Nos. 120 or 121. When the signals from a desired transmitting station are heard as loud as possible by tuning, the intensity may sometimes be improved by adjusting the knob on the filament rheostat so as to increase or decrease the filament current (current from the "A" battery). The knob is kept in the position of minimum filament current without reducing the strength of the incoming signals.

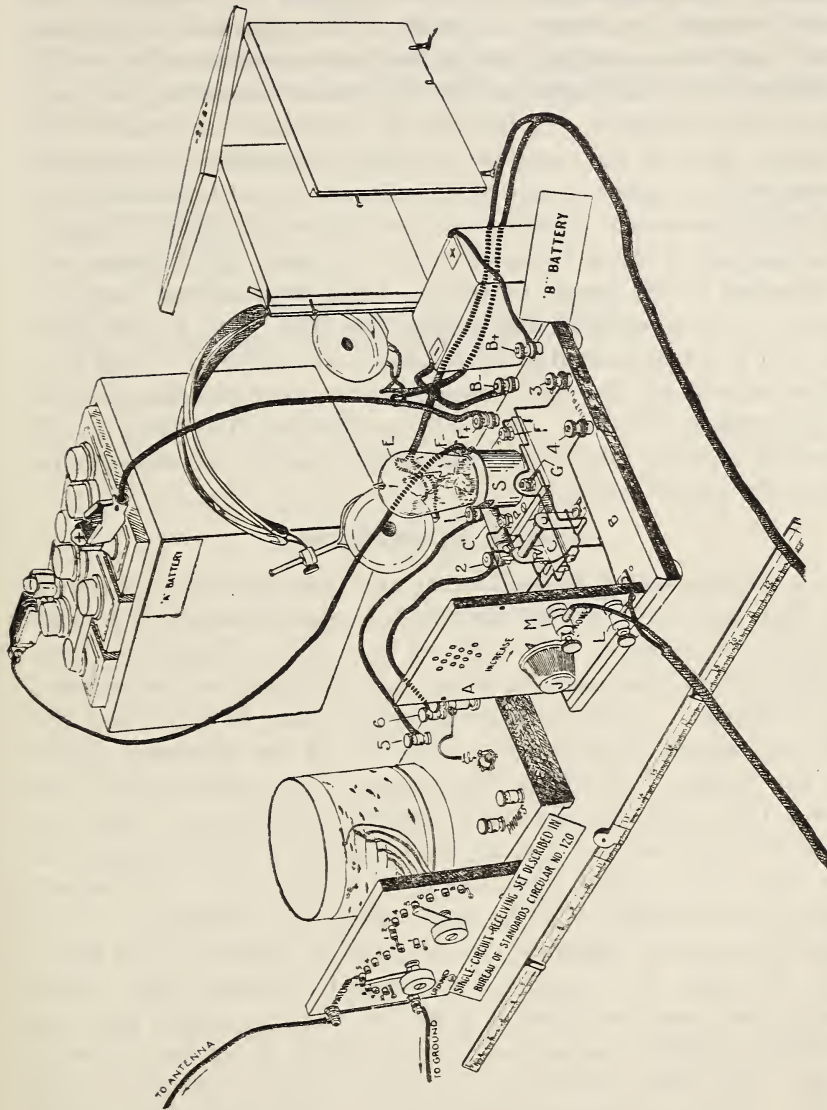

FIG. 7.—Method of connecting simple single-circuit radio receiving set, filament battery, plate battery, and telephone receivers, to the electron-tube detector unit, ready for use.

If a detector type of electron tube be used, the voltage of the "B" battery is changed until the greatest signal intensity is obtained. This necessitates the use of a tapped "B" battery. The operator must not expect too much of the apparatus at the first trial, and even assuming that he has had experience with crystal detectors, some difficulty may be experienced in getting the electron tube to operate. In this case he should first ascertain if the various parts of the complete receiving equipment are properly connected; or, again, it may be found that some of the connections to the electron-tube detector unit are improperly made. Special care should be taken to see that the "A" and "B" batteries are connected to the proper terminals of the electron-tube detector unit. It is especially important to see that the "B" or plate battery is *not* connected to the binding posts marked $F+$ and $F-$. This battery has too high voltage for the electron-tube filament and would burn it out. After a little experience the operator will find the electron tube to be much more positive in adjustments than the crystal detector.

6. NOTES ON SOLDERING.

It has been stated above that certain connections were soldered. In fact, one could well advise that all connections about a radio circuit be soldered, but soldered correctly. There are some general hints that may be given, but judgment and experience are essential. (1) The soldering copper must be clean and the tip well coated with solder. If the tip of the soldering copper is not bright, it should be filed clean. It is then heated, care being taken that the tip is not directly in the flame. After the copper is hot, not red hot, the tip is dipped in the soldering flux or paste and coated with solder. (2) The wires are cleaned where the soldering is to be done, using fine sandpaper, then a small amount of soldering flux or paste is applied at the joint, and the wires to be soldered are tinned or coated with solder before the wires are joined. After the wires are tinned they are soldered together, using just enough solder to make the joint solid. The joint should not be jarred while the solder is still soft. To do so weakens the joint and gives the solder a dull appearance. A good soldered joint will be smooth and bright. (3) All excess soldering flux or paste should be cleaned off. Gasolene or alcohol will assist in cleaning off the paste. This last point is sometimes overlooked, and the excess flux often causes the copper wires to corrode.

7. APPROXIMATE COST OF PARTS.

The following list includes the cost of parts of the electron-tube detector unit and the "A" and "B" batteries. It does not include the cost of the telephone receivers or of any of the other equipment used to make up the complete receiving outfit, since this has been given in Bureau of Standards Circulars Nos. 120 and 121.

Electron-tube detector unit:

Electron tube.....	\$5.00 to \$6.50
Electron-tube socket.....	.75 to 2.00
Filament rheostat.....	1.00 to 2.50
Grid leak and grid condenser.....	.50 to 1.50
By-pass condenser, about.....	.35 to .35
Ten feet No. 14 bare tinned copper wire, about.....	.10 to .10
Miscellaneous binding posts and screws, about.....	.75 to .75

Batteries:

"A" storage battery, 6-volt, 60-ampere-hour.....	15.00 to 20.00
"B" battery, 22½ to 45 volts.....	1.00 to 3.00

Total..... 24.45 to 36.70

WASHINGTON, August 16, 1922.





