

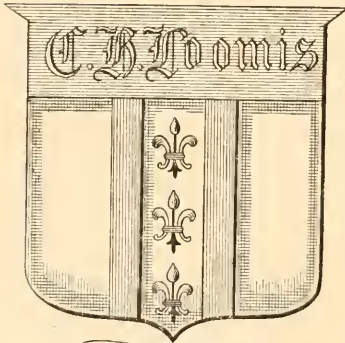

*SCIENCE*  
*GOSSIP.*









HARDWICKE'S  
SCIENCE-GOSSIP:  
1887.



HARDWICKE'S

# Science-Gossip:

AN ILLUSTRATED MEDIUM OF INTERCHANGE AND GOSSIP

FOR STUDENTS AND

LOVERS OF NATURE.

EDITED BY

DR. J. E. TAYLOR, F.L.S., F.G.S., F.R.G.S.I.,

HON. MEMBER OF THE MANCHESTER LITERARY CLUB, OF THE NORWICH GEOLOGICAL SOCIETY, OF THE  
MARYPORT SCIENTIFIC SOCIETY, OF THE ROTHERHAM LITERARY AND SCIENTIFIC SOCIETY,  
OF THE NORWICH SCIENCE-GOSSIP CLUB, OF THE GEOLOGICAL SOCIETY OF  
AUSTRALASIA, OF THE VICTORIAN FIELD NATURALISTS' CLUB,  
ETC. ETC.

VOLUME XXIII



London:

CHATTO AND WINDUS, PICCADILLY.

1887.

LONDON :  
PRINTED BY WILLIAM CLOWES AND SONS, LIMITED,  
STAMFORD STREET AND CHARING CROSS.

10603





## P R E F A C E .

THE necessity for saying something by way of Preface for the Twenty-Third time renders the formality increasingly difficult with every added year. Fortunately, we do not regard the ceremony as a "formal" one, but as a sort of annual hand-shaking between the Editor and his wide-spread staff of contributors, and still wider and immenser crowd of readers. Twenty-three years is a fair period in which to test the right of such a magazine as SCIENCE-GOSSIP to a literary existence. A good many able competitors and co-adjutors have come and gone; others are still coming and going. There is ample room and verge enough, for a "Struggle for Existence," and a "Survival of the Fittest" among popular scientific journals as well as among other and lower organisms.

This has been a Year of Reviews. The history of almost every notable undertaking—scientific, artistic, and literary—has been retrospectively surveyed for fifty years past. The Queen's Jubilee has been the opportunity of casting up our national intellectual accounts. In no department of progress has faster running been made than in Natural Science, not only in discovery, but in the revelations of new laws, and the growth of a new philosophy. Still more important is the fact, that scientific study and research have now become the *recreation* and "hobby" of thousands of men engaged in monotonous businesses and hard manual labour, to whom they come to add blessed sweetness to their lives, and make them worth living for. It is with no small satisfaction we find that SCIENCE-GOSSIP has been the means for nearly a quarter of a century of inter-communication between such men. Their number is increasing, and consequently the function of this journal is more necessary at the close of the present year than heretofore.

## PREFACE.

---

Entertaining this idea, we have endeavoured to widen the boundaries of the subjects under discussion. Natural Science has a very extensive cast-net, and we want to get as many fishes under as it can hold. If there is any particular group of new fishes it is desirable to catch, we shall always be glad if our readers would put us on their track.

Our *clientèle* is large, and our desire to please and profit every student is larger. Our magazine is small and *monthly*. What can it do among so many? But it is delightful to find that SCIENCE-GOSSIP is spoken of, generously and even thankfully, all over the world; and we venture to think there is no Encyclopædia of Popular Natural Science extant which comes up to our Twenty-Three Annual Volumes! That they are valued may be seen in any number of the "Publishers' Circular," where back volumes of SCIENCE-GOSSIP in the "original blue cloth," are constantly sought after among the "Books Wanted."

The New Year opens well, and promises brightly for our magazine. Hitherto we have been generously helped by every reader. The moment an Englishman likes anything, he wants somebody else to like the same thing too, and he acts as a missionary to induce him to like it. We want a few thousands of such ardent missionary readers to go forth and compel other readers to come in. Then our hands will be strengthened to do all that Editor and Publisher would delight to do.

# LIST OF ILLUSTRATIONS.

- Aphrosylus raptor*, Teeth of, 108  
Axolótl, the, 269
- BABOON, MANUS OF A, 80  
Belemnites, 132  
Bifurcation of the Third Digit of a Horse, 125  
Book-mite, A, 224
- Ceratinostoma oceanum*, 153  
*Chatopterus Valenciinii*, 201  
*Chelidonium majus*, 148  
Chickweed Winter Green, 77  
Club-shaped Canal, 105  
Converging Beams of Light, 13  
*Cordylura pubera*, 28  
*Cordylura pubera*, Teeth of, 29  
Crest Tit, The, 36
- Dentaria pinnata*, 156  
*Dentaria bulbifera*, 157  
*Dentaria digitata*, 157  
Development of Frog-Spawn, 32  
Diagram of *Vitreous foraminifera*, 84
- DIVERGING BEAMS OF LIGHT, 12  
Double Hollyhock, 172
- END OF POISON-BAG OF WASP, 62  
Eyes of Water Flea, 128
- FROG-SPAWN, DEVELOPMENT OF, 32  
Front View of Two Teeth of Lancet of Wasp, 62
- Gagea arvensis*, 272
- Gagea minima*, 273  
*Gagea Liottardi*, 273  
*Gagea lutea*, 272
- HALF PLAN OF QUERN, 152  
Half Vertebrata from the Spine of a Man, 81
- KINNI-KINNIC, AND INDIAN PIPES, 252
- LANCET WITH DUCT RUNNING THROUGH TUBE, 62  
Lancet of Sting of Humble Bee, 61  
Lancet of Wasp Sting, 61  
Leaf and Fruit of *Mangifera Indica*, 8
- Mangifera Indica*, Leaf and Fruit of, 8  
Manus of a Baboon, 80  
Manus of a Horse, 101  
Manus of Hipparion, 101  
Manus of the Modern Horse, 101  
Marine Hemipterous Insect, 4  
*Mastigocerca bicristata*, 173
- NEST OF THE PROCESSIONARY MOTH, 37  
*Notholca spinifera*, 249  
*Notholca scapha*, 267
- ODD PAGE IN NATURE'S BOOK, 198
- PARALLEL BEAMS OF LIGHT, 12  
Plant, Pressing and Drying Apparatus, 245  
Polish Fowl, Head of a, 124  
Proposed Tropical Insect Vivarium, 109  
Pygidium of the Flea, 129
- Rhus toxicodendron*, 9
- Schonomyza litorella*, Teeth of, 246  
Section at Côte St. Pierre, 84  
Section of an Ovary of a Human Fœtus at the Ninth Month, 100  
Section of *Nummulina levigata*, 84  
Section of Part of Calcarina, 84  
Shell-money, American, 177  
Side View of Two Teeth of Lancet of Wasps, 62  
Specimen from Grenville after King and Rowney, 104  
Sting, Lancets, and Poison-Bag of Wasps, 61  
Sting, Poison-Bag, and Poison-Gland of Humble Bee, 60  
Storm Clouds, Some Types of, 204, 221  
Supposed Stolen Passage from Grenville, 104  
*Synchata gyryna*, 149  
*Synchata longipes*, 220  
System of Canals in Calcite, 105
- TEETH OF *Cordylura pubera*, 29  
Transverse Section of Canals, 105  
Two Mirrors, 52, 76
- UNDER SURFACE OF *A. Bonnairi*, 5
- VISIT TO THE RED CRAG AND CHALK PITS OF SUFFOLK, 180
- WASP, END OF POISON-BAG OF, 62





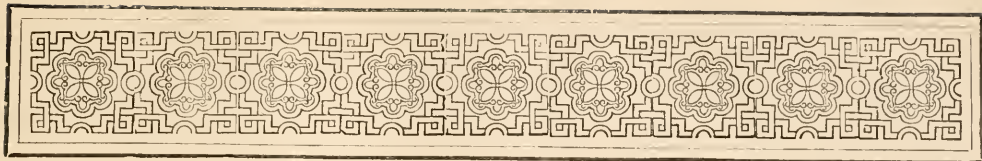

## THE MINERALS AND FLOWERS OF THE ENGLISH LAKE DISTRICT.

BY DR. P. Q. KEEGAN.



**A**N area some fifty miles in length and breadth, almost every inch of which is either wildly grand, or richly beautiful. Where on earth can be found such varied scenic beauty compressed in so limited a compass? Where can be found such a practical compendium, as it were, of all that is poetically impressive, entrancing, affecting?

Where can be seen such an infinite assortment of rock, fell, hill, dale, moorland, lake, cascade, and waterfall?

On the eastern portion of the district, huge mounds and hills appear, grass-green, and with smooth, sloping sides, rarely studded with rock or stone, or flanked by craggy precipice. Prolonged banks of elevated land, marshalled in parallel tiers, with intervening valleys watered by streams, that dash here and there in chequered cascades down the stony declivities. But the mountain tops here are comparatively smooth and rounded, level and plateau-like. Even the valley-walls, the escarpments of the adjacent hills are, for the most part, smooth and grassy, and descend in gentle slopes terraced with earth. Here and there a huge tumulus, emerald-green to the summit, and sometimes zoned with wood, rises sheer from the plain, or appears as a shoulder to some narrow ridge of hills. At some places a valley,

encompassed by groups of hills hewn into infinite shapes, slopes away into serrated edges, guarding narrow ravines lost in the long-drawn vista of obscurity. There are few tarns here, and these are generally low-lying, without much beauty of form, or impressiveness of situation. Charming lakes, mostly long and river-like, and guarded by wooded hills, and knolls, rich-clad in verdure, nestle in the deep-scooped hollow of the vales, with open freshness of the air, and sweet breathing on the surface aspect of the scene. Amid scenery such as this the atmosphere is usually bright, cheery, and serene, and the mountain tops are clear and unswathed by cloud, and free of vapour-depositing winds. The forms are soft, and harmoniously blended; the colouring is magnificently green, or of a dull brown, but occasionally a pale blue, and more rarely deep or shadowy purple and grey. Here is there no predominance or obtrusiveness of beetling cliffs, wild riven rocks, rugged ravines, or hollow combs, rents and fissures in the walls; nor any lavish effusion of strange chaotic blocks and boulders of stone, indicative of convulsion or disruption. Here Nature deals kindly with her visitant. Through long lonely valleys, by way of ascents gentle and gradual, over by-paths, smooth, soft, and sometimes marshy, she leads the wooer of her charms to scenes toned down from savage sublimity to exquisite soul-entrancing beauty and loveliness.

In the western portion of the district, a rugged, irclaimable wildness and barrenness, a more chastened and stronger beauty, an unequivocal stamp of the weird power of nature are the characteristics. A wild chaos of huge hill-tops, radiating as it were from a fixed centre, spreads out into rugged ridges. Wild, stony hills, cleft by deep, steep ravines are thrown into an infinity of fantastic shapes, as if rough-fashioned by potent subterranean forces, and lavishly strewn and sifted over, as it were, with countless blocks of bare unhewn stone. The gorges and ravines are more profound, the valley-walls pre-

sending a rugged facing, fluted and gashed by wind and weather. Here, among the high recesses, in situations impressively lonely and romantic, the mountain tarn nestles amid the grim wilds, rarely trodden by man. Here, too, the lakes are stern and desolate, encompassed by grisly rocks, wild and savage, that impress a solemn reflection upon the steel-like livery of their waters. The convulsed character of Nature's forces here may be gleaned from the general aspect of the mountain ridges. Hurlled into infinite shapes of rugged grandeur and irregular, save where some fair-shaped cone cleaves the air, their forms are exceedingly picturesque and impressive. Peaks, points, pillars, rocks, ridges, edges, and niches are presented in infinite assortment, and of potent picturesqueness.

These external characteristics are related to a physiognomy. They are especially and peculiarly facile, plastic, and, as it were, capricious: here they are eminently potent as vehicles of expression, i.e., they afford abundant scope to a spirit that aspires to, as it were, humanise material nature. The mountain-sides have broken surfaces, whence arises a play of colour ever mixed, and ever changing. Processions of yellow, vapoury clouds, fling off in volumes down the vales, or scudding athwart the hills, vary at times the shapes of the rocks on the summit of the ridges. Turbidity of the air, and turbulence of the elements are succeeded by clearness, calmness, and peace. Then, ascending to a table-land, we greet the company of mountains with a sympathy and a pleasure unalloyed; for therein we recognise nature subjected to tremendous force, internal or external, tossed and hurlled, wrought and fashioned into shapes beautiful, sublime, and picturesque, which the light and air decorate and embellish with exquisite sprinklings of trees and flowers, ferns and grasses. At times there is a heart-touching peace—"a sleep among the lonely hills;" and the valley, contemplated from a ridge on a quiet summer's evening, bodies forth tokens of complete rest and contentment. Occasionally we encounter a grisly screen of rock, rent and gashed, black and dismal; or a colossal pyramid of green bank projects singly from the plain, how or why we know not. In the higher valleys that branch away precipitously from the region of the loftier eminences, the streams tumble down from tier to tier of stone, singing now with merry music, now with hollow harmony, or whispering sweetly the secret of their blithe and merry turmoil. Afar off we hearken to its voice murmuring from out the heart of the mountain, a bleating sylph-like sweetness of sound, congenial to a quiet, pensive mood. Then, advancing upwards, we come upon the tarn, silent and calm, engirt with savage precipices—the mirror of grim shadow, the haunt of austere sound, the circumvented image of peace and rest eternal.

The deep-embosomed lake, clear and calm, resting in shadow, imparts a fairy charm to rocks, trees, and

clouds reflected in its clear depths; the transparent lustre of the flood, imparting to them a soul-like nonentity, an unsubstantiality akin to mind, a penetrability into the heart of nature. The lonely valley unenlivened by man, free and wild, without a trace of homestead or of cultivation, allows of nature to speak unreservedly, unbiassedly to us. Here nature is serious, and pregnant with meaning; here wildlings flourish, straggling and careless, but replete with life potency; here the more beautiful wild animals (the falcon, the heron, the hawk) scared from the haunts of men, resort, and fling their attractions unheeded to the air; here the waters sing and murmur in a free, unartificial way, consonant to the well-tuned soul; here, in short, Nature's panoply of heart-touching influences is most potent and unstinted. Yet pray do not despise the tract of wild heathery moorland, the deep dark waste, with its terribly brooding desolation. It is Nature herself that impresses us here. We observe, we contemplate, and absorb; and afterwards, when it has passed into the region of memory, we love its chastened image; for it is pregnant with a serious sobered spirit.

We shall now furnish a catalogue, with brief remarks, of the principal minerals that are found in this fascinating region:—

**THE MINERALS OF THE LAKE DISTRICT.**—There are some eighty-six varieties of minerals found in Cumberland and Westmoreland. Of these, fluorspar is one of the most beautiful and abundant, exquisite forms of a deep blue, lilac, green, and amber colour being found in the Alston Moor district. Calcite occurs beautifully crystallised at Greenside Mine, Dulton Fell Bowder Stone, etc. in hexagonal prisms, projecting clearly to some inches at various angles from the surface of the specimen. Barytocalcite and alstonite, formerly common, are now scarce. Dolomite appears in white, curved rhombs at Greenside, etc. Barytes is very common in every mine, especially at Force Crag, where I have seen it well crystallised in flat tables; the cock's-comb variety is also very interesting. Gypsum occurs as clear colourless crystals at Alston Moor, etc. Apatite is found in the granite of Threlkeld Quarry. Quartz is extremely abundant in the rocks, and as the matrix of galena, hematite and blende; eight varieties of it are found in the fells at various places. Garnet is found in many of the rocks round Keswick, St. John's Vale, etc.; also Epidote, fibrous and crystallised. Fine large crystals of Felspar, of a red tint, occur in the granite of Shap, and Carrock Fells. There is not very much Mica about; Chiastolite is embedded in rectangular spots in the slates about Skiddaw. Hypersthene occurs massive in the rocks of Carrock Fells, etc. Chlorite glistens in the green slates, with Nacrite and Talc. Tourmaline and Corundum are around Skiddaw Forest. The metallic minerals are well represented, some of them, such as Galena, Chalcopyrite, Hæmatite, and Blende being abundant



and of exquisite form and colour. The other iron ores, such as siderite, marcasite, ilmenite, are pretty common. Manganite is beautifully crystallised at Force Crag mine. Wad occurs in the recesses of Skiddaw. Erythrine and Smaltine are rather rare. Splendid specimens of Malachite and Chrysocolla have been found at Dale Head. Molybdenum ore, massive and disseminated in granite, appears at Coldbeck Fells, etc. Wolfram and Scheelite occur in the same locality, along with Bismuthine, and Tetradymite. Cerussite and Anglesite, crystallised and acicular, occur at Greenside, etc. Pyromorphite, of a rich golden yellow colour, is found at Brundholme mine. Johnstonite has been lately found at Greenside. Calamine, in reniform and botryoidal form, appears at Alston Moor. Smithsonite occurs in crystalline mammillary crusts, of a magnificent sky-blue colour, at Roughtengill.

As Patterdale and the adjacent glens are about the most prolific wild flower gardens in the Lake District, a description of Ullswater Lake may fitly precede our catalogue of their contents.

ROUND ULLSWATER LAKE.—In a hollow betwixt wild craggy precipices, and stretching away to meander through gently undulated meads and pasture lands, Ullswater, the nonpareil of English lakes, appears. Viewed from various standpoints—from the water's edge, from the adjacent fells, from the more remote peaks of the lofty mountains, a series of pictures and vistas can be commanded, which are unsurpassed in rich lavish beauty, and diversified grace. The steel-like mirror of the water is at times unruffled, and faithfully reflects the innumerable tints and hues, outlines and physiognomic expression of cloudland, and of the adjacent banks and precipices. How severe, dark, and stern is its aspect, when the bold front of Place Fell is buried deep in shadow! Then, deep and serene, calm as death, shrouded in gloom, mark what an infinite profundity and volume of expression—or shall we say feeling?—seems bodied forth from the liquid expanse. Or again, the sun streams out, the air flashes with light; then the lake seems aglow, with all her little islets bosomed soft, and all her rocks brightened round her.

Mount the craggy fell, and view the lake from the uplands at a moderate altitude. Then you observe the lavish effluence of greenery which its soft, moist exhalations serve to engender. A forest-crowned promontory, studded with a vigorous evolution of vegetable life, juts into the lake, the trees exquisitely embowered in a soft green flowing drapery, each tree-growth developed to the full, and prominent every zone, with shoots and branches decorated with green pendent tresses, shaken out in the dewy air. What an area of massy verdurous bloom richly clothing all the rugged hillside, and imparting such admirable beauty to the lakeland scene! Then, too, at other points, behold the profuse dottings, and scatterings,

and sprinklings of tree and shrub! Some are tiny and slender, others large, shadowy, and vigorously expanded—here in clumps and knolls, there dotted sparsely o'er the fell-side, even to the yellow margin of the water.

Then come round, and stand where the steep and shaggy fell-side reaches downward to the lake, to the point where its extreme height and craggy majesty of outline may be fully appreciated. Here the attractions of form, sublime and huge, are superadded—mighty curves, gigantic outlines traced by the towering hills, with sloping breasts and abrupt acclivities, perched as it were upon, and culminating in, the calm horizontal bosom of the water. Advance yet further now, and contemplate a fairy vista of the lake, with a background of huge, abrupt, diversified, towering mountains, softened away beneath the light and shade, and in the midst of that enchantment, and embossed on the calm floor of the water, an islet most picturesquely perched, and decked with an outgrowth of a few green trees. How exquisite the sense of beauty here! What a sweet and telling combination! Here, indeed, are the elements of an impressive picture. A sweet calm silvery lake of everlasting beauty, fair emblem of a lowly serenity: a tiny islet charmingly set, fit seat of the palm-crowned glories of an Indian isle, and withal, a background framing of hills rugged and severe, the fierce arena of cloudland gloom, and of terrific aerial effects and impressions.

Ascend some of the lofty mountains that encompass the southern reach of the lake, and scan it from their lofty altitudes. Ha! how the distance lends enchantment to the view! Sometimes only a narrow strip, or an oval patch peeps from among the thronging vista of hills. Sometimes the upper reach, or the middle reach, or both conjoined, are visible, stretched meanderingly through a low-lying tract. But the lower reach is the most beautiful one. Here, from this hill-top point of vantage, how bright and gleaming it seems amid the dark hill-screens that frown upon its shore. Clear and lustrous, as 'twere a mirror, the silvery mirror of Nature, what a contrast it is to the rugged diversity of sombre-shadowed hill and dale! How the islets seem to float as 'twere on the calm bosom of the water, like things of light in a fairy realm! It is, forsooth, an impressive centre of attraction. A physical aspect deliciously soft and soothing to the retina and ocular organs; an aspect pre-eminently calculated to render the mind cognizant of a mental quality perceived as existing in the object, cognizant of it as the very image of rest and placidity, and of clear, unsubstantial lustrousness amid a rugged, disrupted, unequivocally solid, and passionless environment.

WILD FLOWERS OF THE ULLSWATER DISTRICT.—In addition to the more common and familiarly known spring flowers, there may be seen here, in the meadows and woodland pastures, profuse forests of the yellow and red rattle, eyebright, dog's mercury, milkwort,

heath bedstraw (*Galium saxatile*), ragged robin (*Lychnis flos-cuculi*), together with any amount of "soft beds of thyme-bespinkled turf." On the mountains, are observed conspicuous and vigorous tufts of lady's-mantle (*Alchemilla alpina*), bilberry (*Vaccinium myrtillus*), juniper (*Juniperus communis*), club moss (*Lycopodium selago*); and occasionally we find butterwort (*Pinguicula vulgaris*), sheep's bit (*Fasione montana*), harebell (*Campanula rotundifolia*), saxifrage (*Saxifraga stellaris* and *aizoides*), heath (*Erica tetralix*), crowberry (*Empetrum nigrum*), sundew (*Drosera rotundifolia*), bog pimpernel (*Anagallis tenella*), cotton grass (*Eriophorum vaginatum*), scurvy-grass (*Cochlearia alpina*), madder (*Sherardia arvensis*), purging flax (*Linum catharticum*), grass of Parnassus (*Parnassia palustris*), marsh pennywort (*Hydrocotyle vulgaris*), cranberry (*Vaccinium oxycoccus*), bogbean (*Menyanthes trifoliata*), speedwell (*Veronica montana*), moss campion (*Silene acaulis*), willow herb (*Epilobium alsinifolium*); more rarely and inconspicuously, may be found roseroot (*Sedum rhodiola*), meadow rue (*Thalictrum alpinum*), mountain saxifrage (*Saxifraga oppositifolia*), sheep's sorrel (*Rumex acetosella*), sedge (*Carex rigida*); *Chrysosplenium oppositifolium*, etc. Rather more rarely may be seen, in the valleys and low-lying tracts, beautiful specimens of the purple and the yellow loosestrife (*Lysimachia vulgaris*), water ranunculus (*R. hederaceus* and *aquatilis*), figwort (*Scrophularia vernalis*), mint (*Mentha hirsuta*), meadow-sweet (*Spiraea ulmaria*), water avens (*Geum rivale*), brooklime; marsh cinquefoil (*Potentilla comarum*), whitlow grass (*Draba verna*), mossy saxifrage (*S. hypnoides*), woundwort (*Stachys sylvatica* and *ambigua*), water-lily (*Nymphaea alba*), lady's-smock (*Cardamine pratensis*), meadow and shining crane's-bill (*Geranium pratense* and *lucidum*), milfoil (*Myriophyllum verticillatum*), orpine (*Sedum telephium*), valerian (*Valeriana officinalis*), nipplewort (*Lapsana communis*), ox-eye daisy (*Chrysanthemum leucanthemum*), foxglove (*Digitalis purpurea*), yellow and ivy-leaved toadflax (*Linaria vulgaris* and *hederacea*), bugle (*Ajuga reptans*), white and red dead-nettles (*Lamium album* and *purpureum*), hemp-nettle (*Galeopsis ladanum*), snakeweed (*Polygonium bistorta*), water-iris (*Iris pseudacorus*), ramsons (*Allium ursinum*), bog asphodel (*Narthecium ossifragum*), hearts-case (*Viola odorata* and *lutea*) enchanter's nightshade, bittersweet, burnet, butterfly orchis, etc., woodsage, betony, cowheat, vetches, allgood, agrimony (*A. eupatoria*), bartsia, red and white campion, etc.

### AËPOPHILUS BONNAIREI, A SUB-MARINE INSECT.

By E. D. MARQUARD.

IN SCIENCE-GOSSIP for March last Mr. Joseph Sinel announced the discovery of this remarkable submarine hemipteron on the coast of Jersey, and gave a figure of the insect, together with some interesting notes respecting it. As I have recently had the good fortune to capture specimens on the coast of West Cornwall, a few additional remarks on the subject may be of interest to entomological readers.

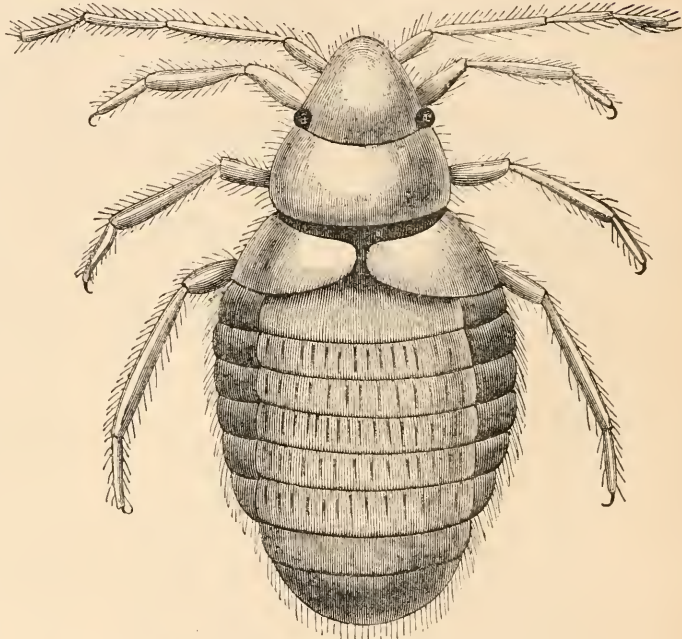

Fig. 1.—Marine Hemipterous Insect (*Aëpophilus Bonnairei*). × 16.

From the opening paragraph of the paper referred to, it is clear the author was not aware that *Aëpophilus Bonnairei* had already been recorded as British. In the "Entomological Monthly Magazine," vol. xviii. p. 145, it will be seen that the late Mr. Frederick Smith had in his collection specimens from Polperro, in East Cornwall, though they appear to have been identified only after his death, so that it is uncertain whether they were captured by him or not. From that date (1881) to the present time, I am not aware that any one has recorded the species from any part of the United Kingdom: for I presume that zoologically the Island of Jersey belongs to France.

About two years ago, on the rocks at Mousehole, near Penzance, I found two specimens of a curious hemipteron which interested me greatly, as I was at the time working specially at that order of insects;



but, unfortunately, I lost them before they were identified; and repeated search in the same locality failed to produce any more specimens until last November. Being again at Mousehole, hunting chiefly for polyzoa, at the verge of low-water mark, I happened to turn over a remarkably fine specimen of the large starfish (*Uraster glacialis*), and on the under side found a small family of these bugs, of which I secured three mature examples and a small larva. There were more larvæ, but they escaped. Immediately on my return home, I forwarded a living specimen to Mr. Edward Saunders, who at once pronounced it *A. Bonnairei*. Why this little colony should have selected this particular uraster to locate themselves upon is a puzzle, because I have examined dozens at various seasons of the year in the

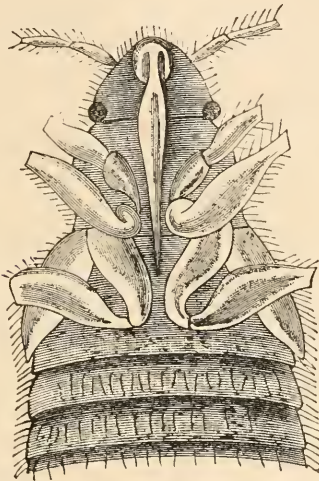

Fig. 2.—Under surface of *A. Bonnairei*.  $\times 16$ .

same spot, without even seeing an insect upon any. Those I found two years ago were under a small stone among seaweeds.

It is worthy of note that the original specimens discovered by Signoret in the Ile de Ré, as well as the Jersey ones, occurred under stones deeply imbedded in mud or loose gravel, whereas mine were found where there is neither one nor the other, but simply rocks and stones at the extreme point of low-water mark. At this moment of writing I have two specimens, an imago and a larva, which, with a fragment of ulva, have been confined in a closely-corked homœopathic tube of the diameter of an ordinary lead pencil, for eighteen days, and they are still lively.

The figure in SCIENCE-GOSSIP will serve to give a general idea of the insect, but it is inaccurate in one or two details: the abdomen is proportionally too wide, the thorax should be more square in front, the elytra should join the thorax and be attenuated posteriorly at the sides; the eyes are much more

prominent, and the claws double, not single, as represented.

I ought perhaps to mention, that the Mousehole rocks are situated about a couple of miles from Penzance, and quite fifty miles west of Polperro.

*Alphington, Exeter.*

## GOSSIP ON CURRENT TOPICS.

By W. MATTIEU WILLIAMS, F.R.A.S., F.C.S.

**I**CEBERG WARNINGS.—On turning back for reference to "Nature" of last year, I find (August 13) a valuable suggestion made by Mr. Lawton, of Hull, that appears to have been neglected. As everybody knows, many tall ships annually disappear very mysteriously, and there is little doubt that one of the most frequent causes of such calamities is collision with icebergs. The evidence of this is supplied by the narrow escapes which almost every sailor of much transoceanic experience has encountered. In many cases a sudden cooling of the air on a dark and misty night has given warning, but such warning only comes when the danger is much too close, when escape is only possible if the course of the ship is not directly head-on to the berg.

Mr. Lawton's suggestion is that the echoes produced by icebergs should be specially studied, in order that on dark nights in iceberg regions the steam whistle, ship's bell, guns, etc., should be used for feeling the approach of such danger. I have had some curious experiences of night echoes, and have observed the phenomena with some curiosity. Applying them to this case, my belief is that a steam whistle sounded in short sudden screams, as explosively as possible, will, with a little practice, enable the mariner to estimate roughly, not only the direction, but the distance of any such object as an iceberg; the distance being of course determined by the interval between the call and the answer. In steamships, which are the most subject to this danger the whistle is always available.

**A CARNIVOROUS PITCHER PLANT.**—The experiments made a few years ago by Mrs. Mary Treat, an American naturalist, on the *Sarracenia variolaris* are very interesting. At sunrise the cup is filled with a sweetish liquid, about half of which evaporates in the course of the day while the lid is open. Ants, flies, and insects generally, take the liquid with avidity, become stupid, unsteady on their feet, and tumble over when they attempt to clear their wings by brushing them with their legs. In plain English, they get very drunk. If removed from the bottle they return to it immediately they are released, and walk down its mouth never to return. Even large insects are guilty of similar disreputable proceedings. Mrs. Treat describes as follows the fate of a large

cockroach which was liquoring up on the threshold of a fresh cup that had caught but little or no prey. "After feeding a short time the insect went down the tube so *tight* (the expression is Mrs. Treat's, the italics are mine) that I could not dislodge it, even when turning the leaf upside down and knocking it quite hard. It was late in the evening when I observed it enter. The next morning I cut the tube open, the cockroach was still alive, but it was covered with a secretion produced from the inner surface of the tube, and its legs fell off as I extracted it. From all appearance the terrible *Sarracenia* was eating its victim alive. And yet perhaps I should not say terrible, for the plant seems to supply its victims with a Lethe-like draught before devouring them." When a large number of insects have been thus enticed and devoured a most offensive odour is perceptible, but the putrid matter does not appear to injure the plant, it absorbs it all and is nourished thereby. Pieces of fresh raw beef and mutton are similarly covered with the digestive secretion and the blood extracted from them, but they must be fresh, and are not so completely absorbed as the live game. At the end of three or four days all the remains of flies, beetles, cockroaches, &c., are absorbed, excepting their wings and other hard parts.

**TRIUMPHANT SIMPLICITY.**—That most powerful engine of modern research, the spectroscope, depends upon dispersion, *i.e.* the varying refrangibility of the different rays of light and their consequent outspread when passed through a prism of refracting material. Glass is generally used, but the dispersive power of glass is far exceeded by that dense, though volatile liquid, bisulphide of carbon. One prism-shaped glass trough filled with this liquid, will do the dispersion work of a train of five solid glass prisms, and allows much more light to pass through. Then why make any more spectroscopes of solid glass? is a natural question. The reason is that inequality of temperature produces convection currents in the liquid, and these currents produce striae that spoil the delicate definition of the spectral lines.

The "American Journal of Science," vol. 29, p. 269, tells us that the defect has been overcome by H. Draper, by two of the simplest devices conceivable. As the convection currents are caused by inequality of temperature, he regulates the temperature, and further prevents inequalities of density of the liquid by keeping it stirred by means of a small propellor wheel, driven by a nominal amount of power obtainable by watchwork or a small electro-motor.

**IMPERMEABILITY OF GLASS TO GASES.**—Many of my readers will remember the celebrated Florentine experiment, which was formerly supposed to demonstrate the general porosity of matter. A hollow sphere of gold was filled with water and then squeezed

in a screw press, so as to diminish its internal capacity. As the experiment proceeded, the water was seen to ooze through the solid metal, and bedew the outer surface of the flattened ball. Gases pass through metals upon much smaller provocation, as may be very unpleasantly proved by using a small unlined iron stove for heating a room, and allowing the sides of the stove to become red-hot. Carbonic oxide passes through the iron of its own accord, and makes its presence known by poisoning the atmosphere. This carbonic oxide, resulting from the semi-combustion of the coal, is an active acrid poison. It must not be confounded with carbonic acid, which results from complete combustion, and is only unbreathable, but not actively poisonous.

A. Bartoli has made a number of experiments of excessive severity for testing the possibility of forcing mechanically, or coaxing chemically, various gases through glass, and finds it absolutely impermeable. At a pressure of 126 atmospheres (1890 lbs. on the square inch) not even infinitesimal quantities passed through. Electrical devices were equally ineffectual.

**BLIND FISHES IN ARTESIAN WELLS.**—In last year's "Journal of Science," page 567, I find it stated on the authority of "The American Naturalist," that J. D. Caton has discovered a species of blind fishes in an Artesian well in California, the depth of which is 170 feet, and that Artesian wells in the Eastern States have already yielded eighteen species of sightless fishes.

Can this be true? If so, it is very wonderful indeed. How did the fishes get there? How long have the wells existed? The United States are not palæozoic, nor does the date of the invention of Artesian wells carry us far back in geological time. If so great an organic change can be so extensively evolved during the short life of these artificial sinkings, Darwin and his disciples must be wrong in demanding such long periods of time for other evolutions, and we may hope to demonstrate the origin of species in zoological stations and physiological laboratories sufficiently endowed to be inherited by our grandchildren. That is "if."

**CHARRING TIMBER.**—It appears that the practice of charring the lower part of posts that are to be driven into the ground has not the preservative effect generally attributed to it. "Iron" tells us that, "numerous trials have shown that charring leads to premature decay;" that if two posts are split from the same log, and one be charred and the other not, the charred post will perish before the other. It is quite true that the charring does protect the *surface* so far as it goes, and if the post could be charred throughout, without weakening it, the protection would be perfect; but the superficial charring only weakens the material in proportion to the depth to which it extends—the charcoal, being porous, admits



moisture to the substance of the wood, which commences its course of decay so much below the original surface, instead of at the surface. Had it commenced at the surface, all the time occupied in decaying down to the depth of the charring would be gained, supposing that the decay commences at the surface, and proceeds gradually inwards. The subject is one of considerable practical interest, and worthy of careful investigation.

**ANOTHER SOURCE OF ALCOHOL.**—During 1884, 1826 pipes of alcohol, having a value of £40,518, was made from the sweet potato in the Azores, and exported to Lisbon for fortifying wine. Subsequently, the production has increased, and is still increasing. The West India Islands being specially suitable for the cultivation of the sweet potato, the development of a new industry is anticipated there. A French chemist connected with Martinique has taken up the subject, but finds that the storage of alcohol in hot climates, and its carriage in large quantities through the tropics, is very dangerous. At 95° Fahr. it gives off vapour so rapidly, as to be practically an explosive.

He therefore proposes to desiccate the flour of this potato, and export it in that state to Europe. He says, referring to what has been already done at the Azores, "The alcohol, of which we have specimens, is superior in quality to the best marks of France. The distillery obtains 12 per cent., i.e. 12 litres of alcohol per 100° kilog. of sweet potato." Also that he has experimented on the sweet potato of Algeria, which gives 13·4 per cent.; that of Martinique and Brazil, 15 per cent., while ordinary potatoes only yield 3 per cent. Barley of 20 francs' value produces 25 litres, while an equal value of sweet-potato flour yields 39. 714 lbs. of maize are required to produce 22 gallons, while this quantity is obtainable from 519 lbs. of sweet-potato flour. Alcohol made from maize costs 10 francs per hectolitre (22 gallons) more, and sells for 8 to 10 francs less than the same quantity of sweet-potato spirit. It is anticipated that the sugar planters of Jamaica will take up the enterprise, the sugar bounties of our Continental neighbours having severely depressed their original industry. If so, a curious retaliation will fall upon France by the extinction of its cognac, and other so-called brandy trade. Once upon a time, eau-de-vie and cognac were synonymous. Now, it is very different. Fortunately for us, our beverage interest in alcohol is steadily diminishing; but, concurrent with this, is a continually increasing demand for alcohol in chemical manufactures.

**PREHISTORIC ART.**—The paper read on 22 Nov., by M. Albert Gaudry, before the Academy of Sciences of Paris, on the Montgaudier Cave (in the Charente district), is interesting on account of the artistic fragments it has brought to light. Pieces of ivory,

embellished with carvings of aurochs and other animals, are described as having been thus ornamented at a period when the cave-dwellers were still struggling for existence with the mammoth, the cave-bear, cave-lion, large hyena, and rhinoceros. Patriotic Frenchmen may claim that this is evidence of the artistic superiority of their prehistoric ancestors, and also of the dominant force of heredity. It also indicates a certain amount of progress already made by these people, sufficient to carry them far beyond "the missing link." But we must not forget that savages generally are artists—(please to understand, gentle reader, that I do not predicate the converse)—that clubs, paddles, and other weapons and implements are carved even by the rudest of existing human beings—some of them very elegantly.

When buying some spoons made of reindeer-horn from the Lapps of the Trömsdal, I found on the bowl of one of them a well-executed drawing of a reindeer, all the peculiarities of the animal more correctly delineated than in some of our book illustrations. On inquiry, I learned that it was the work of a lad of twelve or thirteen years of age, who was the proprietor of a lead pencil, and had consequently become an artist.

#### THE ECONOMICAL PRODUCTS OF PLANTS.

**THE POISON OAK, POISON IVY, OR POISON SUMACH.**—These are the various aliases applied to *Rhus toxicodendron*, Linn. (Fig. 4) which is a native of North America, having, according to some authorities, been introduced into this country as early as 1640, and it was well known to the older botanists; while other authorities state that it was first brought into notice in this country in 1793 by Dr. Alderson, of Hull, when he was following up the experiments of Du Fresnoy, made at Valenciennes; but I should say it was introduced much earlier than the latter date, although at present I have found no well-authenticated account of its introduction, and there is a large amount of difficulty experienced in tracing the history of introduced plants, owing to the scantiness of reliable records.

It is a small shrub, only a few feet in height. Leaves on long petioles, trifoliate; leaflets broadly ovate or rhomboidal, acute, slightly pubescent, entire or irregularly toothed or lobed (the illustration shows the entire form of leaflet); it is one of the most variable species in this respect. Flowers very small, produced in axillary racemes, greenish-white, dioecious; male flowers with fine stamens, and a rudimentary style; female flowers with fine abortive stamens, and a globose ovary; fruit roundish, pale green, of no value commercially. The tree throughout possesses excessively varied and narcotic properties; even its gaseous emanations produces very

deleterious effects upon some persons. It was formerly officinal, and admitted in the London Pharmacopœia, but has recently been excluded owing to its dangerous character under manipulation. It is still employed in America, the leaves being principally used in the form of a tincture or extract in cases of paralysis, chronic rheumatism, cutaneous disorders, &c. They possess a peculiar acrid principle, similar in its action upon the nervous system to strychnia.

The effect upon some persons caused by contact with the plant, is very remarkable; and the same effects are produced in such persons by its exhalations, if they are in contiguity to the plant. The same results are noticed in the case of the poison ash (*Rhus venenata*). A well-authenticated example of the injurious disposition of the latter is recorded by Dr. Bromfiel. He says: "The Rev. Dr. Bachman, of Charlestown, being once on a botanical excursion with some friends in the neighbourhood of the city, they came upon a specimen of the poison ash (*Rhus venenata*), and felt desirous of gathering specimens for examination. This they proceeded to do, though warned of the consequences likely to accrue from handling it. The doctor stood aloof from a danger which he knew to be inevitable in his own person, on near approach or contact. The result was some of the party suffered severely, the inflammatory action reaching up the arm to the trunk in one; in another, only as high as the elbow; while, in a third, the effects were confined to the hands, which, as is usual in these cases, became swollen, inflamed, and finally ulcerated; the rest mostly escaped the poison. On his return home, Dr. B. found a branch of the shrub in the vasculum, which had been put there by some sceptical joker amongst the company, who affected disbelief in poisonous properties of the plant. This he requested his daughter, who was not susceptible of the poison, to take out of the box and destroy, but, at her suggestion, permitted it to be dried for his herbarium. The next day symptoms of poisoning came on, intumescence of the entire body and lower extremities, attended with intolerable pain and irritation, confined him to bed for several days; nor was it till after many weeks that he was able to resume his duties. For several years after, he was subject to a periodical recurrence of the erysipelatous inflammation, which marks this particular poison." ("Lond. Journ. Bot." 7, 160.) On the other hand, many persons handle the shrub with impunity.

THE MANGO-FRUIT (Fig. 3).—This most valuable tropical fruit is produced by *Mangifera Indica*, Linn., the generic name being taken from "Manglio," the native name of the fruit. It was originally a native of India, but is now widely distributed and cultivated throughout that country, into the Malay Archipelago, Mauritius, and other parts of the eastern hemisphere; also occurring in many of the tropical parts of the western, being especially abundant in the West

Indian Islands. It forms a large tree; leaves alternate, oblong-lanceolate, stalked, entire; subcoriaceous in texture; flowers in freely-branched erect panicles, white, with spreading petals and fine stamens, four of which are abortive; fruit drupaceous, smooth, when ripe, of a deep yellow colour, very variable in size, form, and flavour; usually oval, or half pear-shaped, four inches or more long, and nearly as wide.

There is in the mango, like all cultivated plants, a great amount of variation, which is the inevitable result of such an extended period of cultivation, by the selection of the finer varieties and inter-breeding, which has evidently been done and effected. Some kinds are much superior in every way to others, and

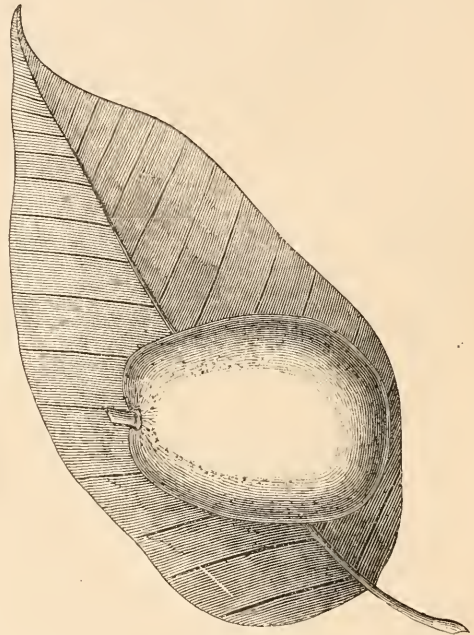

Fig. 3.—Leaf and Fruit of *Mangifera Indica*, Linn. (reduced).

this is a desideratum, as some of the inferior varieties are unappreciated by Europeans. Certain travellers have described their flavour as comparable to a mixture of tow and turpentine, while others are regarded as among the most delicious and grateful of tropical fruits, the consumption of which is enormous in a ripe state. But if eaten to excess they are strongly purgative, and in those unaccustomed to their use, boils are produced, the effect of which is beneficial. The fruit of the finest varieties possesses a strong and agreeable perfume, with a sugary-acid flavour. They contain a limited quantity of gallic acid, as is evidenced by the blue stain which is produced on the blade of a knife when cut; citric acid and gum are also present. The unripe fruits are largely employed in India as conserves for making tarts and pickles; and



in the latter form they are often imported into this country. The bitter aromatic root of the tree is used medicinally, as well as the bark, in the treatment of fevers, &c. A reddish-brown green resin exudes from the bark in very limited quantities naturally, but freely if the tree is wounded, which is also used medicinally in India, externally for certain cutaneous disorders, and internally for the cure of diarrhœa and dysentery. The young leaves possess pectoral properties, and the old leaves and stalks are used for cleansing the teeth and hardening the gums. The wood is held in great veneration by the Hindoo population, as it is burned together with sandal-wood in their obsequies. It is soft and porous in a young state, but that from old trees is very hard and durable.

for feeding pigs. *S. dulcis* is cultivated in the Friendly and Society Islands for its very refreshing and wholesome fruit, which is said to resemble pineapple in flavour. *S. birrea*, a native of Senegambia, produces a fleshy edible kernel, and the pulp of the fruit is employed by the negroes in the manufacture of an alcoholic liquor. The gum which exudes from the trunk of *Odina Odier*, a true native of India, is used as a plaster for sprains and bruises. The celebrated black varnish of Burmah and Martaban is yielded by a large Indian tree known as *Melanorrhœa usitatissima*; it occurs in the forests from Tenasserim and Pagu, quite to Manipur in Sylnet, and is called "Theat-see" in the former, and "Khan" in the latter country. The varnish is obtained by tapping; short joints of bamboo closed at the bottom are



Fig. 4.—*Rhus toxicodendron*.

The seed of the mango is particularly interesting in deviating from the normal type of development, as they frequently produce more than one embryo; and such seeds, when in a germinating state, exhibit curious differentiations from the usual type of germinating seeds. A good paper on these subjects was published in the "Journal" of the Linnean Society for 1861.

Amongst other plants of economical interest in the Anacardiaceæ, but which are of insufficient importance to describe in detail, are the hog plums, produced by various species of the genus *Spondias*. In the West Indian Islands the fruit of *S. purpurca* is known as the Spanish plum, and has a sub-acid, agreeable flavour, and is largely consumed. Also in the same islands and Brazil, *S. lutea*, *S. Mombia*, *S. tuberosa*, and other species of the fruit are consumed in limited quantities by the natives, but chiefly used

thrust into the holes made in the trunk, and left for about two days, when they are filled with a whitish juice, which turns black upon exposure to the air, and requires to be kept under water in order to preserve it. It is employed for lacquering all kinds of domestic utensils and furniture. The wood of this tree is very hard, and so heavy that anchors are made of it for the native boats. Another large Indian tree, which is named *Holigarna longifolia*, yields from the root and stem a similar black varnish, and in the Malaccas it is collected and employed for the same purposes. *Durua dependens* is a small Chilean tree, yielding drupaceous fruits, from which an intoxicating drink is prepared. *Schinus molle*, a tropical American tree, known commonly as false pepper, produces agreeable, edible, drupes; it also yields a kind of gum-mastic, with a peppery flavour, with purgative properties, which is also employed to harden the

gums. The root is also used medicinally; there is another species named *S. ariva*, which is said to cause swellings to those who sleep under its shade. The leaves of this and other species are filled with a resinous fluid, so that the least degree of unusual repletion of the tissues causes it to be discharged. Thus some of them fill the air with fragrance after rain; and *S. molle* expels the resin of its leaves with such violence when immersed in water, that they move in jerks, so as to have the appearance of spontaneous movement. ("Botanical Register" t. 1580.) This I have observed in *S. molle*, *S. ariva*, and one other species.

J. T. RICHES.

### OUR BRITISH SLUGS.

IN answer to Mr. Cockerell's strictures, I must say, firstly, that he gave me the list of British species; secondly, that he read over the manuscript previous to its publication during a lecture, and pronounced it "good;" and thirdly, that the additions he gives to our fauna were described as such since the writing of the article, and as such exempt my article from the criticism in that respect.

Mr. Brockton Tomlin I must thank for giving the original description of *T. haliotidea* var. *Campanyonii*, Drap. I could not lay hold of Campanyo's "Hist. Nat. des Pyrénées Orientales," and consequently my description was taken from the work of Moquin-Tandon.

To my paper, I wish, however, to supplement several additions. They are as follows:—

*Limax arborum*, B.Ch.: (1) *v. rosea*, Boeck. 1870; rosea, dorso brunneo-rufescente, carina pallide rosea, fasciis nigris, clypeo sub lente maculis ovalibus dense ornato. Belgian; (2) *v. colorata*, Boeck. 1870; aquosa, subpellucida, carina alba subnigro-marginata, clypeo ut in a fasciate abdomine utrinque brunneo-fasciato. Also Belgian; (3) *v. tigrina*, Weindl.; pallide virescenti-flavida, clypeo maculis nigris in seriebus 5 ornatis, corpore utrinque fasciis duobus abruptis. Wurtembergian; (4) *v. flavæ*, Weindl.; viridiflava, unicolor. Also Wurtembergian; (5) *v. heynemanni*, Beliz.; alba, clypeo picto, dorso maculis parvis nigris, rugis majoribus et carina alta notato.

*Limax cinereo-niger*: (1) *v. nigripes*; stabile, sole black-edged; (2) *v. ornata*, Less.; "mero carena e zona dorsale e 2 serie dei macchie bianche;" (3) *v. strobili*; "aut cinerea, nigro-maculata."

*Limax levis v. mucronata*, West.: luteo-brunneus, lateribus pallidis solea alba, clypeo processu conico; long. 10 mm. Ronneby in Sweden.

*Limax maximus, v. calosoma*, Eis and Stuxb.; obscure olivaceus, maculis pallidioribus clypeo atro, marginibus pallidis.

*Limax tenellus*: (1) *v. xanthia*, Bourg.; animal uniformiter luteolo-vel subviridulo-aurantiacum, rugis

dorsalibus argutis, elongatis, dorso convexo, ad caudam acute carinato, clypeo valde, anteriori, maximo, eleganter striatulo; long. 45 mm. German; (2) *v. squammatina*, Morel; aureo-virescens, lateribus cærulescentibus, tentaculis nigris, quadro-fasciatus, lineis lateralibus parallelis dorsalibus in unum convergentibus. Lusitanian.

*Arion ater*: (1) *v. melanocephala*, F. Big. (*L. flavus*, Müll. (?), Nilss.; *A. flavus*, Fér., Lehm.); albido-virescens *v. pallide thalassinus*, capite et tentaculis atris; (2) *v. gaudefroyi*, Mab. 1870; dorso griseo-rufescens *v. flavidus*, solea medio pallida, limbo griseo atro-lineato; (3) *v. brunnea*, Lehm. 1862; caffeatu *v. ferrugineus*, dorso obscuriore. German; (4) *v. olivacea*, Sehm. 1856; olivaceo-brunneus, obscurius fasciatus, subtus cinereus sudore luteo. German; (5) *v. sulcata*, Morel, 1845; omnino niger, margine radiato, castaneo; long. 15-16 cm. Lusitanian; (6) *v. servainiana*, Mab. 1870; corpus rufum, postice attenuatum obtusum, squamis vix elevatis, corpore contracto rectangularibus apud exempl. in spiritu conservata omnino deplanatis. French.

I may just mention here that Seibert (Malak. Blätt. 1873, p. 198 *et seq.*), from a long study, says that *A. flavus* is but a variety of *Arion ater*, and that the *v. melanocephala* of the latter is but its young of a greenish-white colour. This, however, in passing.

*Arion hortensis*: (1) *v. pectophila*, Mab. 1870; ater, fasciis lateribus obscurioribus, limbo rufo. French; (2) *v. anthracia*, Bourg. 1866; gracilis, minor (long. c. 30 mm.) uniformiter aterrimus, limbo paullo pallidiori. Meridional France; (3) *v. distincta*, Mab. 1868; minor, griseo-flavidus. French; (4) *v. oresiaca*, Mab. 1870; flavescens, tentaculis nigris. French.

*Geomalcus maculosus*, Allm.: (1) *v. allemanni*, Heyn.; ater vel obscure brunneus, albo-maculatus; (2) *v. typica*, Heyn.; ater maculis flavidis; (3) *v. verkrüzeni*, Heyn. (not *verkrareni*, as printed on p. 202 of last volume of SCIENCE-GOSSIP); griseus, albo-maculatus. There is a good figure of this species in Mal. Bl. xxi. t. 1, f. 1-6, to which the reader may advantageously refer. I stated at the top of the first column of p. 203 in this journal, last year, that Forbes and Hanley surmised this slug would eventually prove to be Asturian; I find that Westerlund, in his now publishing "Fauna Europæa"—a work of which by-the-way I advise every Science-Gossiper who can afford it to avail himself—that it is so.

I have said nothing of the varieties that Mr. Cockerell speaks of in his note in the November number, as he alone must be responsible for his own amendments. I give simply those he has left out.

J. W. WILLIAMS, D.Sc.

FROM Mr. Fred Enoch we have received No. 6 of the "Entomological Sketches," which accompany his well-known slides, and give full details of structure of the object mounted.

## ON COLLECTING DIPTERA.

By E. BRUNETTI.

I N recommending all collectors of insects, especially beginners, to take up the study of Diptera, I am aware that I am endeavouring to persuade them to attack one of the least known orders of the whole class, and it is for this very reason that I so strongly urge on all the necessity of rescuing the Diptera from the chaotic state into which it has gradually fallen, owing first to the small number of entomologists actively working at this order, and secondly, to the want of union between them.

Union is one of the first and most important rules to be observed in studying an obsolete group. If each worker took up one or two families, or part of a family, according to the number of species comprised, and assiduously confined himself to his special group, the task would be considerably facilitated, more especially so if the life histories were also investigated.

It is much to be feared that less is known of this order than any other, I mean, of course respecting the British species. All the other orders are at least fairly well known, it being almost unnecessary to remark how much has been done in the Lepidoptera by Messrs. Stainton, Morris, and Newman; in the Coleoptera by Dr. Sharp, Messrs. Waterhouse and Cox; in the Hymenoptera by Sir J. Lubbock and Dr. Fitch; in the Hemiptera by Mrs. Douglas, Scott and Edwards; in the Neuroptera by Messrs. McLachlan and Dale, and also in the Orthoptera.

But when we come to the Diptera we find a most lamentable absence of hard-working entomologists. I believe the number is actually limited to four, Messrs. Newall, Meade, Dale, and Cooke, of whom at least one has restricted his observations almost to a single family.

Though beginners may do little beyond the mere capture and netting of specimens, they may, in this manner, become of invaluable assistance to those possessing fairly representative collections and more advanced knowledge of the order.

I will mention an imaginary instance, to illustrate more fully my meaning.

Suppose the possessor of a good collection of these insects is in correspondence with ten beginners; suppose also that none of these beginners care anything about Diptera, but, to oblige their friend, they capture a few flies when on each country excursion. Considering the comparative abundance of individuals of this order, and the ease with which they may be obtained everywhere on any warm day, it is not unreasonable to assume each to catch ten specimens during each day's outing, which, on returning home, I suppose them to set (this being a rather important consideration).

Most collectors manage to obtain at least ten days' insect-hunting during the whole season, so that during

that time each would obtain one hundred specimens of Diptera in fair condition, which the young entomologist would forward to his friend, who, on receiving an equal number (approximately) from each of his ten correspondents, would find himself possessed of a thousand fresh specimens at the termination of each season.

This amount of material placed at his disposal would undoubtedly be of very great value, it being not at all improbable that some species new to the British fauna would by these means be added every year.

I think this imaginary example should be sufficient to show how much beginners may do by combining to assist those more advanced than themselves; they also would gain by the transactions by having their specimens named, besides the many advantages of a more experienced correspondent. Should a series of one species be sent, it would be advisable to return some of the flies, but the owner of the larger collection should be allowed the unconditional pick of the specimens; in return, naming all those he does not require, and returning them to the sender.

And now, in mentioning the return, which I, at least, am willing to make to those who will furnish me with specimens, I am aware of expressing an opinion that will meet with some disfavour from many entomologists.

I consider it would be a perfectly fair equivalent to pay in money for the specimens forwarded, taking them all round at so much a dozen, limiting, of course, the number of specimens of each species sent.

It appears to me easy to refute the imputation of degenerating the science to a pecuniary consideration by the following argument.

Exchange is by all admitted one of the fairest and most generally approved methods of increasing one's collection.

Now, if in return for, say, one hundred specimens of Diptera forwarded me by a lepidopterist, I offered him two or three dozen moths, he would undoubtedly accept them, and each would probably be satisfied with his bargain.

Suppose, then, he gave me a list of his desiderata, and, after sending me the Diptera, I bought several of the species he required and forwarded them to him, that also would be a fair transaction, I presume.

What matters it then, whether he is, or I am, the actual purchaser of the insects? that is to say, there is no difference between buying the insects myself and then posting them to him, or sending him so much in money to enable him to purchase them himself.

So far as I am concerned, I shall be most happy to pay a fair value for any consignments of Diptera forwarded to me, should they be of species of which I have not a sufficiently large series.

I know that there are many collectors who would forward me Diptera without asking for any return (I could mention several amongst my own corre-



spondents who are continually doing so), but I am appealing now to the large majority of collectors, to all collectors; and it is certain that to most it is more inducement to collect species of an order in which one takes no interest, if, by so doing, the means is obtained of enlarging one's collection of the favoured group.

I have also great hopes that, by inducing collectors to take Diptera, they may eventually gain some partiality for the order on its own merits.

By collecting all orders, a rule I have observed ever since embracing the study of entomology, the total number of species in my cabinets has nearly doubled, which would never have been the case had I confined myself to one single order.

Not to be mistaken as to my meaning in these last remarks, I may repeat that I do not advise the beginner to study all orders, but only to collect them; so that, by the exchange of specimens, those studying the various orders may reap mutual benefit.

Considering the comparative abundance of individuals of Diptera during the whole of spring, summer and autumn, and the ease with which the majority of them may be captured, I should count threepence a dozen a fair price to pay for Diptera, if set, and the number of specimens of each species to be sent I am inclined to limit to twenty.

My object in writing the present paper is merely to draw the attention of entomologists, especially beginners, to the Diptera, and to induce them to collect this order, if not for its own sake, out of friendship for those who would make good use of the specimens thus collected for them.

(To be continued.)

### THE MAGIC MIRROR OF JAPAN.

THE mirror in Japan is a most important feature everywhere. In the temples it takes the place of the cross of Roman Catholic countries; it is found among the regalia in the Imperial Palace; at a wedding it is a portion of the bride's trousseau. It constitutes, in short, a part of the national religion, and the "Great Divine Palaces" at Tsé have attained much renown from being the depository of the first mirror, and are to the Japanese much as the Holy Sepulchre is to the Greeks and the Armenians, as Mecca is to the Mahometans.

A Japanese myth tells how the Sun-queen once, being very angry, shut herself up in a cave, and thus, by her withdrawal, there came darkness over the earth. The gods tried by various artifices to entice her forth, but in vain. At length the first magical mirror was made, and the Sun-queen, seeing her face reflected in it, excited by curiosity and jealousy, came forth.

At the creation of the Japanese empire, the Sun-

queen presented it (along with two other treasures—presents of the gods) to her grandson, telling him to look upon the mirror as her spirit, and to keep it in the same house, and on the same floor, as himself, and to worship it as if he were worshipping her actual presence.

Ever since, this mirror, and the two other presents before-mentioned, have been a part of the regalia of the emperor, the mirror ranking even before the emperor himself.

Thus mirror-worship came into practice, and soon

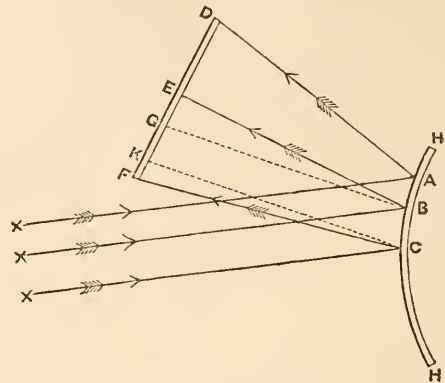

Fig. 5.—Parallel beams of Light.

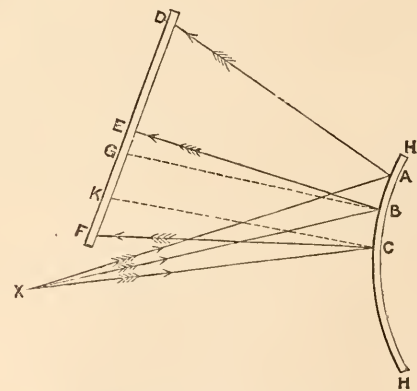

Fig. 6.—Diverging beams of Light.

spread among high and low in Japan. However poor and simple the furniture may be, the mirror is an indispensable portion of it—a sort of household god.

Professor Ayrton, when in Japan, tried to purchase a magic mirror; but he could not meet with one in the shops, though Europeans supposed them to be some standard Japanese trick; and he found the Japanese themselves unable to explain how they acquired their magic property; but this was readily interpreted to be by reason of the workman keeping it a secret, as people paid ten or twenty times the price for a magic mirror.

The Chinese, at a very early age, knew of magic mirrors, and Chin-Kouo, a Chinese writer of the eleventh century, speaks admiringly of them.

They were introduced from China and Japan into Calcutta, and interested the inhabitants much ;

that the witches of the Middle Ages had mirrors of Eastern manufacture, with imps and secret signs on the back. Probably also Chinese priestcraft, Greek and Etruscan oracles, made use of them. In the temple Kenchoji, situated in the ancient capital of

the Shogun, there is a wonderful old mirror, which if looked at a little obliquely reveals the face of a Buddhist god. Various faces of saints have thus been depicted in mirrors, but this is done by altogether another process than that of the magic mirror at present under discussion.

The mirror is circular in form, and is generally from three to twelve inches in diameter. The metal of which it is usually made is a composition of copper and tin, something like the specula of reflecting telescopes.

Round it is a rim of about  $\frac{1}{4}$  to  $\frac{1}{2}$  of an inch in breadth ; this rim is thicker than the inner part of the mirror which contains the figures or designs. The reflecting surface is more or less convex and polished with

mercury amalgam. On the back are raised designs, birds, flowers, dragons, geometrical patterns or Japanese scenes and myths. Occasionally mottoes or Chinese characters expressive of good wishes, long life, happiness, hope, are seen. The accompanying sketch gives some idea of the back of a Japanese mirror.

The handle is made of the same metal as the rest of the mirror, but usually covered with bamboo. Its magic property consists in this ; when the rays of the sun are reflected from its polished face, on the wall or screen, the figures and the design on the back of the mirror are distinctly seen in bright lines on a dark ground, though the back of the mirror is quite hidden from the light. Various explanations of this magic power have been given :

(1) The Chinese designated them "mirrors that let the light pass through them."

(2) Ou-tseu-ling (1260-1341) explains their magic property to arise from the employment of two kinds of copper of unequal density, the brighter reflexions being produced by the purer copper.

(3) Sir Charles Wheatstone and Sir David Brewster, both thought that the magic power was produced by some clever trick on the part of the maker, who drew on the face exactly similar figures as those on the back and carefully concealed them by polish, so that in an ordinary light they were not visible.

(4) Messrs. Arago and Biot accounted for it by

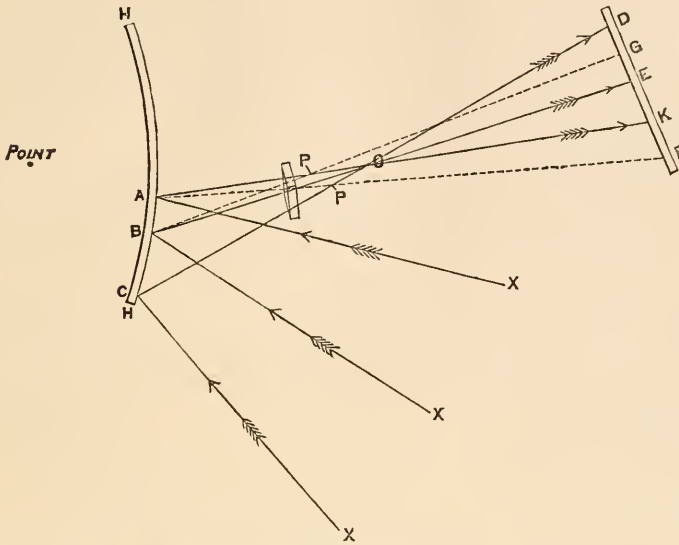

Fig. 7.—Converging beams of Light.



Fig. 8.

philosophers conjecturing how their magic property (which is only possessed by a few of those which come from the east) could arise.

From their great antiquity it has been suggested

stating that "the curvature of the surface is altered by the greater or less rigidity of the figures, and thus the foci of these parts are thrown at a greater or less distance from the mirror."

(5) Professors Ayrton and Perry also account for it as arising from inequality of curvature, and at the Royal Society, and Royal Institution, gave admirable explanations of it.

Struck by the fact (discovered by Professor Atkinson) that a small scratch made by a nail on the back (of one of these mirrors) was reflected as a bright patch on the screen, Professor Ayrton examined several mirrors to ascertain, if possible, the cause. He found that all those possessing the magic property were thin, and slightly convex. He next inspected their manufacture, and found that the surface of each half of the mould in which they were cast was flat. How did they become convex? He found that this arose partly from the tool with which the makers worked, and partly from the process of polishing.

The rough mirror was first made smooth with a hand-scraping tool; then the metal was worked with the megebo ("distorting-rod"), which makes the mirror really concave at the surface; but it receives a kind of "buckle," and springs back again, the surface becoming convex on the removal of the pressure of the distorting-rod. The thinner parts under the operation have a tendency to become more convex than the thicker. Hence it occurred to Professors Ayrton and Perry that the employment of different beams of light (convergent, divergent, parallel) would give the solution to the mystery. For if the magic power was caused by the molecular differences of the surface, the varied beams of light would make no practical difference; but, if it resulted from inequality of the curvature of the surface, then a converging beam of light would invert the phenomenon. This experiment proved to be the case.

The following summary will give some notion of the methods of Professors Ayrton and Perry's reasoning.

Let HH (Fig. 5) = Japanese convex mirrors.

Let XA, XB, XC = rays of a parallel beam of light.

Let AD, AE, CF = reflected rays on the screen.

Let DF = screen.

Let AB, BC = each other, then the amount of light falling on each will be equal.

If a portion (BC) of the mirror be flatter than the remainder, then the reflected light will only illuminate a smaller area, GK; but, as this smaller area has received the same amount of light as the larger, DE, therefore it will be brighter than the larger, but the intervening spaces (GE, KF) will be relatively dark.

The same reasoning applies to Fig. 6 = diverging beam of light.

Fig. 7 shows us the result of a converging beam of light.

Let XXX = rays of a beam of light converging to a point behind the convex surface of the mirror (nearer to the surface than half the radius of the mirror); after being reflected, the light converges to a point O in front of the mirror, its rays crossing, spread themselves out in an inverted position on the screen DF.

If AB is flatter than the rest of the surface of the mirror (say BC), it casts a paler and a larger reflection of light on the screen (placed at a distance) than BC does (see Fig. 7). If the screen be moved nearer the mirror, as P (see Fig. 7), the reflection from AB is not larger, etc., than the reflection from BC.

When the screen is placed very near the mirror, the reflections of the figures will be invisible, from the fact that "rays of light making very small angles with each other do not separate perceptibly until they have gone some distance."

Professors Ayrton and Perry tested magic mirrors by these rules, and found their phenomena in every way to agree with these laws, and by the application of lenses to intensify the results, fully established their views on the subject.

A. TOMLINSON.

#### TAMENESS OF A ROBIN.

AMONGST the many instances of tameness in wild birds coming within the ken of almost every country resident, none recorded, have, I imagine, surpassed the following.

One day, during the past summer, I entered my dining room to find, perched upon a book-shelf, a friendly redbreast, who, now and again, favoured me with a visit. Undisturbed by my entrance, from his standpoint upon the Book of books, he contemplated, with great apparent interest, my proceedings. Reflecting that books were not the most suitable perches for birds, I opened wide the door, and intimated that, at that moment, his room was preferable to his company. The hint was taken—instead, however, of making his exit through the open garden door—as I expected—flitting gaily across the hall, he entered the drawing-room. Here making himself quite at home, upon a chiffonniere, my friendly visitor disported himself, perkily, meanwhile, surveying his host, and making minute examination of my knick-knacks.

But, lo! suddenly all is changed, for, in the plate-glass back he discovers, reflected, his robinship's image, and in a very frenzy of rage precipitates himself upon it, wildly beating the glass with his wings, in his futile efforts to reach his supposed adversary. A greater regard for my treasures even than for his pugnacious birdship led me to interpose, and chase him from the room. He was not, however, to be thus summarily dismissed, for, alighting upon the top of the open garden door, he eyed me knowingly, utterly regardless of my ssh-ssh-sshs.



"Obstinate little fellow!" I mentally exclaim, as, taking from its stand my walking stick, I approach it close to his small person. "All right, I'm not a bit afraid—you won't hurt me, I know," one could well imagine was his soliloquy, as he cocked his head jauntily on one side, to catch a better view of the stick point. "No, thanks," one could further imagine his saying, "I'm right enough, and don't require a walking stick." Fearless bird! he allowed me to touch his wings with my stick—then to smooth his ruffled feathers—simply closing his bright little eyes, and remaining motionless, as if the operation were grateful to him. I presently summoned my wife and son from the garden, to witness the trust of my small feathered friend, and, in their presence, I again and again, repeated the operation, each time with the same result. Suddenly he darted into the garden, where from a shrub hard by the door, he poured forth his cheerful song, as if to thank his friends for kindness oft received, and then set forth in search of new adventure.

EDWARD H. ROBERTSON.

## SCIENCE-GOSSIP.

AT a recent meeting of the Philadelphia Academy of Sciences, Dr. Benjamin Sharp reported that he had discovered, that in poisonous snakes the pupils of the eyes are elliptical, whilst in the harmless species they are circular.

THE beautiful little fresh-water crustacean, *Leptodora hyalina*, has been found in Chatangua Lake, and also in a lake near Chicago, America.

THE annual exhibition of the South London Nat. Hist. Society was held on the 25th November, at the Bridge House Hotel, London Bridge. The exhibits consisted of entomological, ornithological and botanical specimens. The exhibition was the most successful ever held by this society, and, during the two hours in which it was open, it was visited by twelve hundred visitors.

THE Howietoun Fishery records the successful exportation of two hundred thousand salmon ova to New Zealand in the ss. "Ionic," and one hundred thousand Loch Leven trout ova to Newfoundland in the ss. "Siberian," during the last season.

A CORRESPONDENT (B. B.) writes:—In illustration of the allusion to the transference of print to plain paper, at p. 272 of the December SCIENCE-GOSSIP, I may mention that I possess a water-colour copy of an Italian picture which hangs behind a green silk curtain. Some little time after it was given me I had occasion to take the picture out of the frame, when I found on the glass which covered it the apparent semblance of a faint photographic negative. This was readily wiped off.

I should like just to correct a statement with regard to Dr. Johnson, on p. 271, last vol. It was the footman at Madame Du Bocage's who took the sugar in his fingers and threw it into Dr. Johnson's coffee. He adds, "I was going to put it aside; but hearing it was made on purpose for me, I e'en tasted Tom's fingers." It is an instance of the consideration for others which lay under a rugged exterior in that great and good man. See Croker's "Boswell," vol. vi. p. 22, ed. 1835.

WE note the death, at Settle, of Mr. Joseph Jackson, the original discoverer of the famous Victoria Cave near that town.

DURING December, Dr. J. E. Taylor, F.G.S., lectured on "A Lump of Coal," before the Sutton Coldfield Institute; on "The Great Ice Age," at Beccles; "Earthquakes and Volcanoes," at Manningtree; "Fruits," at Hadleigh; "Australia," at Harleston; and gave five lectures on "Mountain Scenery and Mountain Sculpture," in connection with the Ipswich Museum.

## MICROSCOPY.

COLE'S "STUDIES IN MICROSCOPICAL SCIENCE."—Sections 1, 2, 3, and 4, of No. 4 vol. are to hand, dealing with the following subjects:—"Vegetable Physiology," as illustrated by a fragment of one of the submerged leaves of *Salvinia*; "Animal Histology," (the generative organs); "Pathological Histology" (the normal kidney); and "Popular Studies" (illustrated by a marine alga). The plate of the latter is simply charming. Each "study" is accompanied by one of Mr. Cole's excellent slides, showing the object treated upon.

ASTIGMATISM IN MICROSCOPICAL OBSERVERS.—At one of the meetings of the Richmond Microscopical Society, Virginia, Mr. Christian exhibited an interesting slide (his own preparation), ingeniously mounted, with a view to discover any astigmatism of the eye. If the observer can see simultaneously all the lines of objects in the field well-defined and resolved, then his eye is practically without astigmatic defect. The object of the important test-slide is very obvious, as incomplete perceptions are often erroneously attributed to the inferiority of the objective used, when in fact they are the result of an astigmatic defect in the observer's eye. Results of observations among microscopists often differ because the operators of instruments are frequently not aware of the astigmatic condition of their eyes.

NEW SLIDES.—We have received an admirably mounted and most interesting slide from Mr. Ernest Hinton, 12, Vorley Road, Upper Holloway, of a

desmid (*Botryococcus Braunii*), in conjugation. Mr. Fred. Enock, 11, Parolles Road, Upper Holloway, has forwarded the latest of his instructive entomological slides, containing the "Scissor Bug" (*Heterotonia merioptera*) mounted complete, with extended wings, feet, and antennæ. From Mr. W. S. Anderson, Granby Street, Ilkeston, we have received a box of neatly mounted, and highly interesting slides of the following objects: Dung beetle (*Philonthus marginatus*), active pupa of Water Boatman (*N. glauca*), larva of Puss moth (*Dicranura vinula*), Frog-hopper (*Aphrophora spumaria*), Honey-bee (*Apis mellifera*), and ground spider (*Agelca elegans*). It can hardly be said there is no "Royal road to knowledge," when students are catered for in this instructive manner.

THE ROYAL MICROSCOPICAL SOCIETY.—The December "Journal" contains the following papers, besides the usual useful and thoroughly exhaustive "Summary of Research"—"Flagellated Protozoa in the Blood of Diseased and Apparently Healthy Animals," by Dr. Edgar M. Crookshank; and "On Trichodina as an Endoparasite," by T. B. Rosseter. Both papers are illustrated by plates. Dr. Crookshank's paper is highly important and not a little suggestive.

## ZOOLOGY.

SLUG VARIATION.—The notes I sent you on Mr. Williams's papers having been written before the appearance of the last of these in the September number, I now subjoin such few further corrections as seem desirable in relation to this. Page 202: (1) add vars. *nigripes*, Stabile, and *malacologorum*, Colb., as well as several very peculiar varieties described and figured by Pini in 1876; (2) var. *luctuosa* has been found in Yorkshire, at Shipley Glen; (3) to *L. arborum* add vars. *heynemanni*, Blz., *albomaculata*, Krage., *carpatica*, Hazay (a marbled or obscurely mottled form, with dark side-bands and a pale keel), *tigrina*, Weinel, *flava*, Weinel. (1876), *obscura*, Esmark, and *diana*, Heyn., and to the British forms add *rupicola* (found by Mr. Delap in Waterford, at 2,300 feet above sea level), *nemorosa* (recorded from Ireland and Hampshire), *maculata*, and *decepiens* (both Irish); (4) three forms of *L. lævis*, *nucronata*, *maculata*, and (monst.) *intenticulata* have been described, as also three, *xanthina*, *squammatina*, and *grisea*, of *L. tenellus*; (5) *Testacella maugei*, var. *viridans*, Morelet, is bronzy-green, with an orange sole; it has been found in South Ireland and in Portugal; (6) Heynemann has described three colour-varieties of *Geomalacus maculosus* from Ireland, which he calls *typica*, *allmani*, and *verkruzeni*, and gives a very excellent coloured figure of *allmani*. Mabilie has called the white form with black spots var. *andrewsi*. It seems

probable that some changes in nomenclature will be necessary before our British slug-list is brought into harmony with the ideas of Continental conchologists and the laws of priority. *Limax flavus*, of Linné, will have to be called by Draparnaud's name, *variegatus*, and *L. maximus*, Linné, will be called *L. cinereus* of Müller, the description given by Linné being in either case insufficient for identification, some authors (as, for instance, Miss Esmark, in the "Journal of Conchology") identifying Linné's *maximus* with what we know as *cinereo-niger*. *Limax tenellus* must be credited to Nilsson, Müller's description being too vague, and apparently of some other species. *Arion bourguignati*, Mabilie (misprinted "*Bouginatti*") is recorded by Mr. Hudson, on p. 259, from Middlesborough district, and is also reported in the "Naturalist" from another Yorkshire locality, and in the "Journal of Conchology" from Sussex, so it will be as well, for the information of conchologists, to give some account of its peculiarities. According to Mabilie (Rev. Zool. 1868), it is whitish-grey, blackish on the back, with lateral bands; there is a dorsal keel, which is prominent in young individuals, but scarcely observable in adults, appearing only as a pale line; the foot is whitish; length about 40 mil. This species is more nearly allied to *A. hortensis* than any other of our British forms, but it is now generally regarded on the Continent as distinct.—T. D. A. Cockerell, Bedford Park, Chiswick.

PLANORBIS LINEATUS, WALKER.—I have lately collected some half-dozen specimens of this shell, of an abnormal size. Their breadth is exactly  $7\frac{1}{2}$  mm. while Moquin gives 6 mm. as maximum and Jeffreys 5 mm. They occurred in a small pond near Cambridge, about 6 yds. square, associated with *Pal. cincta*, *Bythinia Leachii*, *Planorbis nitidus*, *corneus*, *vortex*, *complanatus*, *carinatus*, *Valvata cristata* and others.—Brockton Tomlin.

LIMAX AGRESTIS, VAR. ALBA.—I have recently taken a pure white example of this species at Bedford Park, Chiswick, living amongst *Carduus arvensis*, together with the usual form of the species. This variety is an albino, whereas the var. *albida*, Picard, as described by Moquin-Tandon, seems only to have been a very pale form of the type, or allied thereto.—T. D. A. Cockerell, Bedford Park.

PISIDIUM ROSEUM IN SURREY.—Mr. Taylor has identified as *Pisidium roseum* some *Pisidia* which I have lately found in a ditch on the banks of the Thames at Putney. This is the first locality in Surrey that has been recorded for the species, though it has been found in considerable numbers on the opposite side of the river, in the moat surrounding Fulham Palace.—F. G. Fem, Bedford Park.

"THE ROTIFERA." By C. F. Hudson, LL.D., and P. H. Gosse, F.R.S. (London: Longmans).—

The sixth and last part of this magnificent work is now published; and we shall not be surprised now to see it going up in price. The plates of the present part are of equal artistic merit to the rest of the series. We heartily congratulate the authors upon the high success of their work, and the way in which it has been received by the scientific public.

ENTOMOLOGY AND GEOLOGY.—At the last meeting of the Entomological Society of London, Mr. Howard Vaughan exhibited a long series of *Gnophos abscurata*, comprising specimens from various parts of Ireland, North Wales, Yorkshire, Berwick-on-Tweed, the New Forest, Folkestone, Lewes, and the Surrey Hills. The object of the exhibition was to show the variation of the species in connection with the geological formations of the various localities from which the specimens were obtained.

THE HESSIAN FLY.—To the same meeting, Miss E. A. Ormerod communicated a paper "On the occurrence of the Hessian Fly (*Cecidomyia destructor*) in Great Britain." It appears that there could be no longer any doubt as to the occurrence of the insect in this country, specimens obtained in Hertfordshire having been submitted to, and identified by, Professor Westwood, and by Mr. W. Saunders, of London, Ontario. Professor Westwood said the specimens agreed exactly with Austrian specimens in his possession, sent to him some years ago by Mons. Lésèbre, who had received them from the late Dr. Hammerschmidt, of Vienna.

## ANIMAL PSYCHOLOGY.

ABOUT CROWS.—Two years last August, when passing through the meadows here to my work about a quarter to six in the morning, I observed a crow pecking in a small pool formed in the walk by the previous night's rain. Being curious to know what he was so vigorously engaged with, I came cautiously forward, and saw it was a crust of bread which he was apparently softening in the water. On my approach, he flew away, and lighted on the grass some twenty yards off, and then commenced to peck away with seeming pertinacity. I passed on for a short distance, still keeping my eyes on him, when he started again for the pool, tossed in the crust, and turned it over two or three times in the water, at the same time testing, as I think, the softness of the crust. While thus engaged, another man coming up disturbed the crow at his breakfast, whereupon he lifted the crust, flew to some distance on the grass, laid down the crust, opened up a tuft of grass with his bill, put in the crust, and carefully drew the grass over it again, and when concealed to his satisfaction, immediately flew away. Now his purpose in steeping the crust and hiding it in the tuft of grass I can

understand, as I have no doubt he intended coming back for his meal, when it would be in a condition better suited for mastication; but the question comes, how was he to find out this particular tuft of grass among thousands around it? He took no note of the locality, so far as I could observe.—*J. W., Edinburgh.*

## BOTANY.

ALBINO VARIETIES.—Mr. J. Taylor's remarks on this subject are so interesting that I venture to add a little thereto, in the hope that others may be provoked to give the benefit of their learning or experience. I noticed last year, not far from Simmons' Yat, in the Severn Valley, a large patch of *Ajuga reptans*. The whole of the plants bore white flowers. There was no trace of the blue flower whatever. I have observed *Polygala vulgaris* within four miles of this city (Bath) bearing red, blue, and white flowers. The plants bearing blue flowers, and those bearing pink flowers, were growing on the same bank within a few yards of each other. I found last year specimens of *Orchis morio* presenting almost every shade of colour, from the normal one to white. There seems to have been so little written by English authors on the subject of colour in flowers that I am induced to quote verbatim two or three paragraphs on the subject from the excellent new edition of Dr. Goodall's "Physiological Botany" (Gray's Botanical Text Book, vol. ii. New York and Chicago, 1885). "The colours of petals and other coloured parts of the flower," observes Dr. Goodall, "are dependent either on the presence of corpuscles (the coloured plastids) or of matters dissolved in the cell-sap. The following account of the colouring matters in the very common *Viola tricolor* is condensed from Strasburger. A vertical section through a petal exhibits the epidermis of the upper side as consisting of elongated papillæ, while that of the lower side has only slightly rounded ones. Just below the epidermis of the upper side there is a layer of compact cells, under which are several rows of smaller cells with conspicuous intercellular spaces. The cells of the epidermis of both sides contain violet sap and yellow granules; the layer of compact cells under the epidermis of the upper side contains only yellow granules. The striking diversities in colour presented by different parts of a given petal depend wholly upon combinations of those two elements of colour: namely, violet sap and yellow granules. In some places, which are devoid of either of these elements, there are white spots: at these places the light is refracted and reflected by the intercellular spaces which contain air. If the air is removed by pressure, the spots will become transparent. The cell-sap in the parts of the flower may have almost any colour, especially shades



of red and blue; from this sap the colouring matter sometimes crystallises in the form of short and slender needles, for instance, in the *Delphinium consolida*. Dr. Goodall in another part of his admirable book adds, "Of all colours of flowers, white, pale yellow, and yellow are the most common."—*W. J. Wheatcraft*.

THE SYNTHESIS OF LICHENS.—Mr. Bonnier has read a paper before the French Academy, on "Experimental Researches on the Synthesis of the Lichens, in a medium destitute of germs." The researches, carried out by the author since 1882, have resulted in the complete reproduction by synthesis of a certain number of species of lichens under conditions fully confirming the views generally held regarding the complex nature of these vegetable organisms. The results clearly show, that a lichen is formed by the association of an alga and a fungus.

SEASONAL VARIATION IN THE OCCURRENCE OF ORCHIDS.—I see by reference to SCIENCE-GOSSIP of 1881, that in the year 1879, the spikes of *Ophrys apifera* (bee orchis) were very plentiful, and that in the following year, in the same place, there were none, or at least so few as to be hardly noticed. I do not know whether this question has been threshed out. From what I have read in SCIENCE-GOSSIP, a very lucid explanation does not seem to have been arrived at. In the year 1884, spikes of this plant were abundant in Fairford Park. Many of the blooms were very fine, several spikes having as many as six. During 1885, "Apifera" was even more abundant, especially in a meadow which gradually slopes to the river Coln. On the opposite side of the water to where I first observed the plant in the autumn of the same year, there were numbers of young plants showing their glaucous green leaves, and which I watched from time to time, until March of the following year (1886). When time for flowering drew nigh, I looked for my plants, but not one was to be seen, and I have not found one this year at all in this place. What seemed most strange was the disappearance of the plants, so that no traces were left behind. Do cattle in any way interfere with this plant, as the field was stocked with oxen for several months in the year?—*John Taylor*.

"A DICTIONARY OF PLANT NAMES." By James Britten, F.L.S., and Robert Holland (London: Trübner & Co.). Part III. of this excellent book has been published, concluding the volume. It is by far the completest and most exhaustive work we have on the subject. It has doubtless been a labour of love to its authors; but it has been a labour for all that, and, from a commercial point of view, by no means a remunerated one. The work has been brought out under the auspices of the Early English Text Society, in three parts, at ten shillings each. The last part ranges from "Paddic Stool" to

"Yellow-Cups," and, besides a very copious and useful index, it also contains a Bibliography, or list of works, more or less treating on the subject of Plant-names. There is also an "Introduction," or preliminary Essay on the subject, by the authors. We heartily congratulate Messrs. Britten and Holland upon the successful completion of their most useful and valuable work.

SISYRINCHIUM BERMUDIANUM.—In Bentham's "British Flora" this plant is said to be found "near Woodford, co. Galway, Ireland," and he mentions it as being very common throughout North America. He says nothing about its being found on the Continent of Europe, and indeed speaks of the genus as "almost exclusively American." I don't find the plant mentioned in Withering at all. Bentham speaks of two varieties, *auceps*, with broad stem wings and the outer bract longer than the flowers, and *mucronatum*, with narrow stem-wings, and outer bract shorter than the flowers. I found the former of these two forms at Baveno, in 1882, growing in the grassplot, in the garden of the Hôtel Beau Rivage. To all appearance it was wild; at any rate, I gathered and pressed three specimens, believing them to be wild. The flower is so small and inconspicuous that it does not seem at all likely it would ever be cultivated as an ornamental plant in gardens, though it might have been an escape from the flower border.—"P."

## GEOLOGY, &c.

THE DESCENT OF MAN.—The distinguished American naturalist, Professor Cope, has been engaged in working out the meaning of certain structures in the teeth of mankind. The structures occur generally in the second and third upper molars, where there are only three tubercles. In the anthropoid apes the same teeth have four tubercles; whereas in the lemur the number is the same as in man. He therefore regards this dental structure as a case of "Lemurine reversion"; and he finds it most abundantly represented among the Esquimaux (the lowest race of mankind); next among the Slavs, French, and European-Americans; and least marked of all among the Greeks, Italians, and Germans. So that the evidence is accumulating which points to a Lemurine ancestry of the human race, instead of the monkey, which has hitherto done duty in the mind of scoffers.

THE GEOLOGICAL ASSOCIATION.—The last number of the "Proceedings" of this society, contains the following papers:—"On some Trilobites from the Skiddaw Slates," by J. Postlethwaite, F.G.S., and J. G. Goodchild, H.M. Geological Survey, F.G.S., F.Z.S. (with plates). "Observations upon the Stratigraphical Relations of the Skiddaw Slates,"

by J. G. Goodchild, H.M. Geological Survey, F.G.S., F.Z.S. "On the connection in time of changes in Fossil Floras with those of Faunas," by Professor G.S. Boulger, F.L.S., F.G.S., &c. "A list of Genera and Species of Bivalved Entomostraca found in the Carboniferous Formations of Great Britain and Ireland, with Notes on the Genera and their distribution," by Professor T. Rupert Jones, F.R.S., F.G.S., and James W. Kirkby, Esq. (Illustrated).

"BRITISH PETROGRAPHY." By J. J. Harris Teall, M.A., F.G.S. (Birmingham: Messrs. Watson Bros. and Douglas). Part 10 of this splendid work has been issued. The Igneous rocks are continuously described as to their microscopical mineral characters. The Pyroxene and Pyroxene-Hornblende rocks are dealt with, and the exquisite coloured plates help the student amazingly. We wish Mr. Teall would reconstruct the horrible terminology of British Petrography.

## NOTES AND QUERIES.

THE RED-BACKED SHRIKE (*Lanius collurio*) IN NORTHUMBERLAND.—In June, last year (1885), at Harnham, near Belsay, Northumberland, I had the pleasure of seeing and making a few notes on the appearance and habits of this rare visitant to this country. According to Mr. John Hancock, in his "Catalogue of the Birds of Northumberland and Durham" (1874), this species is "a rare casual visitant. Two specimens were killed, near Kenton, on the Newcastle Town Moor, in the summer of 1829. These are mentioned in Mr. Selby's Catalogue, and are now in my collection. Another example, also in my collection, was shot at Horsley, Northumberland, May, 1834." These are all the instances of its occurrence mentioned. The individual bird seen by me was a male, and was first observed on the evening of June 10th, in a thick hedge along the bottom of a moist meadow. On the following day I again saw it, when it again admitted of a near approach without exhibiting any signs of alarm. Perched first on a bare projecting branch in the hedge, and afterwards on a young ash, the shrike sang softly and very sweetly. I thought the bird imitated the song of the skylark and the sedge warbler, as well as having other sweet notes of its own. On this latter occasion I was directed to the point in the hedge at which the shrike was located, by the continuous chiding notes of a sedge warbler, which obviously looked upon the large strange bird as an intruder upon its domains, and possibly knew it to be an enemy. On the former occasion, too, a sedge warbler, or a common white-throat, kept up an incessant stream of harsh chiding notes so long as the shrike was in its neighbourhood. Almost every day, for some weeks subsequently, I rambled along by this hedge, and others near by, but never again saw the shrike, which I was at first in hopes might be accompanied by a mate, and that their nest would be built in the neighbourhood.—*Charles Robson, Elswick, Newcastle-on-Tyne.*

DYTISCUS MARGINALIS IN A DRAPER'S SHOP.—Many are the disappointments of the most careful

collectors, and many are their "finds" under the most unpromising conditions. For some years, whilst collecting in the neighbourhood of Hull, it has been my custom to try every pond that lies in my path for *Dytiscus marginalis*, and with singularly disappointing results. Some eight or ten years ago two specimens fell to my net, and since then I have captured two or three larvæ, otherwise my search has been unavailing. Two specimens have, however, come into my possession in a rather curious manner. A few years ago my little daughter noticed a beetle near the water-tap in the yard, and of course brought me the news with the usual childish excitement. The stranger was a fine male specimen of *Dytiscus marginalis*. Last night (Sept. 1st) I heard some little stir in the shop. "It is a bat—a bee—a bee—a moth!" All the guesses were, however, incorrect, for when I was called in to capture the intruder, I found it to be a very fine male specimen of *Dytiscus marginalis*. It had flown through the doorway with considerable noise, and settled on a lady's apron. On being removed, it gnawed viciously at my fingers with its strong mandibles, and I deposited it in a large bell-glass, the quarters of five sticklebacks, vainly imagining that they would elude its attacks during the night, and intending to remove it in the morning. When morning dawned, however, I found that my hungry visitor had devoured three of the sticklebacks, the only remains of the defunct being the clean-picked spines of the individuals. The beetle must have travelled some distance, as I am not aware of any habitation in the immediate neighbourhood of my residence.—*E. Lamplough, Hull.*

HORNET AND WASP.—In some ivy on a wall to-day (Sept. 20th) I heard a loud buzzing, and, on looking to see the cause, I found a wasp in the grip of a hornet. I could not see that either used their stings; but the hornet held the wasp in such a position that probably he could not sting him. Two pairs of the hornet's legs were wound firmly round the wasp's body: the back of the wasp's body and head being held tightly against the hornet's body, the tail of the wasp being in the air. Having got his victim thus "in chancery," the hornet sawed away with his mandibles at the thin part of the wasp, where the tail is united with the body. After about one minute of this sawing the tail of the wasp dropped off, and in about another minute the hornet had devoured the head and body of the wasp, and flew away.—*W. Downes, Combe Raleigh Rectory, Honiton.*

RAT'S TEETH.—What Mr. Lee notes in last SCIENCE-GOSSIP (p. 214), relative to the curving inwards of the upper incisors of the rat, is not an uncommon occurrence. I have noticed this in several animals, but notably in the case of one rabbit, where the animal succumbed an emaciated victim to the curving upwards of its two anterior upper incisors in the bony substance of the maxilla. Perhaps it would not be an uninteresting matter to say here that Mr. Sutton, in his recent lectures to the Royal College of Surgeons on "Pathology and its Relation to Evolution," promulgated, as in his opinion, that the singular curving in the vertical direction, and then backwards and downwards of the canine teeth existing normally in Porcus as a distinctive specific character, and from which it has received its native name, which signifies "deer-hog," in reality started as a pathological occurrence, as in the case of Mr. Lee's rat, and became slowly and gradually developed during the long lapse of the ages first as a singularity, then as a common spec-



tacle, but still abnormal; and, lastly, as a generality, a normality, as a categorical and specific distinction. What Mr. Sutton's theory is worth integrally I know not, but it is worth hearing, if even only for its ingenuity.—*J. W. Williams, D.Sc.*

**DANCING BEARS.**—I wish to call attention to the spectacle generally known—but known, I had thought, only as a remembrance of the degraded past—by the name of “dancing bears,” a feature again becoming revived as a money-mongering pursuit among some brutish, travelling—shall we call them human?—men, who exhibit in our country towns. The other week I rode through Kidderminster on my way to a hamlet, in its environs, called Churchill. There in Worcester Street I saw two of these bears, each dragged by a rope attached to an iron ring of quite a couple of inches in diameter, and which ran through the upper lip on the right side. Is this torture to be permitted in humane England? I hope not. There was an inhuman, a cruel meaning attached to those iron rings; there was enough in them to make the heartstrings of any fond lover of the creation shiver in pitying sadness. What a cruel torture, too, must these poor brutes have suffered in order to bring them to teaching; and what they do suffer now from the hands of their savage tamers! Dumb they are, else their voices would be re-echoed against Christendom from the very stones. There is no piece of visionary *badinerie* here. My nature cannot, and I do not know what human nature could, stand such cruelties as these. “*Hinc illæ lachrymæ.*”—*J. W. Williams, D.Sc.*

**TUSSILAGO PETASITES.**—At Buxton, in the month of June, I noticed the flower stems of what I took to be this plant quite two to three feet high, and appearing well above the foliage, whilst in this county (Cumberland) I have never seen it more than a foot high. Can this be the same plant, or is the difference due to the climates? *Minulus luteus* is found on the banks of many of our mountain streams and rivers. I have found it growing by the roadside on Hartside Fell in the Pennine Range, nearly 2000 feet above the sea level.—*J. C. S., Penrith.*

**MOLE'S EYES.**—I think Miss Layard ought to give special allowance to such men as Carlyle and Matthew Arnold, who no doubt had hardly handled a scalpel in their lifetime; at any rate, for a scientific purpose. As for Aristotle, we must think, excuse, and say little of the scientific imperfections of his day; but, as again for Drummond, we must remember that his “Natural Law” is a popular treatise, and, as such, worthy its place on our bookshelves and our study table. But *Talpa Europæa* has a little jet black eye, and a pretty dear organ it is, set into a miniature orbit. Cuvier knew this, and he mentions it in his “*Règne Animal*,” and all naturalists know it. *Talpa cæca*, Sav., which Mr. Layard mentions, in effect as blind, Cuvier says is not blind, “for the eyelids have an opening, though smaller than in the common mole,” and the illustrious Baron also mentions, that he can demonstrate its optic nerve throughout its course (“*Règne Animal*”). But it may be noted that in the mole-rat (*Spalax*) the eyes are covered by a skin (Bell, “*Comp. Anat.*” p. 456). There is one thing certain, Mr. Layard, and that is, that we must take and taste the scientific wanderings of literary men, as a whole, *cum grano salis*.—*J. W. Williams, D.Sc.*

**BITTER-SWEET.**—It may interest the several correspondents who have written to SCIENCE-GOSSIP concerning the poisonous character of *Solanum dul-*

*camara* to know, that Duval gave 180 berries and four ounces of the extract to dogs without any ensuing effect, and that he also records a case in the human subject where four ounces of the extract were taken in two doses without any bad consequences. On the other hand, Chevallier tells us of a case where sleep was produced in a man who carried a bundle of it on his head (*Dict. des Drog.* t. ii. p. 228). Frank has given the decoction (*Handb. d. Toxicol.* S. 61, 1803), and Fages the extract and fruit in large doses (*Orfila, Toxicol. En.*) to human beings without any effects. Most evidently, then, these conflicting facts must be explicable on the ground of the varying activities of the plant, in its production of the solanine and picroglycine at varying seasons of the year.—*J. W. Williams, D.Sc.*

**DUMBLEDORES.**—With reference to my note on “Dumbledores” in the issue for July, I saw, a few days after writing, a humble-bee, a little larger and stouter than a honey-bee, force its way into the mouth of an *Antirrhinum corolla*, which, entirely closing after it, effectually resisted all efforts of the insect to regain its liberty. It was curious to watch the continuous opening and closing of the lower division of the flower, consequent on the struggle going on within, now a mere working of the lips, now an opening and snapping together again of the jaws, just affording a glimpse of the labouring insect within. After endeavouring in vain to escape until its strength was well-nigh exhausted, I set the little captive free. After this I observed other humble-bees similarly enter, and quit without difficulty certain of these flowers; but into some the insects were unable to gain admittance, the mouth being too firmly closed. No disposition to attack the corolla base was observed at this time. Watching, soon after this, by some broad beans, I noted the mode of procedure of several honey-bees, which was to go at once to the base of the bean-flower and pierce both calyx and corolla to reach the underlying sweets. Examining the flowers, I saw that, in many, large orifices existed on their bases as though eaten or worn away; in others, smaller and more recent punctures were discernible. A smaller dumbledore presenting itself, I directed my attention to it, and found that, unlike the honey-bee, it invariably addressed itself to the mouth of the flower; even unopened blossoms did not escape, for skilfully and quickly separating the wedge-like junction of the upper petal edges, this workmanlike dumbledore entered, trod down the lower petals, and reached the coveted prize. I offer my observations with much diffidence, for, being but a mere tyro in the science of natural history, albeit an ardent lover of nature, I fear my remarks may appear but crude beside the more enlightened notes of others.—*G. A. Newman, M.S.C.*

**BEEES AND FLOWERS.**—Flowers bitten through by bees were by no means uncommon last summer. The earliest examples were the common yellow crocus and the Arctic poppy (*Papaver nudicaule*), whose flowers have been frequently found bitten through early in the day. In the case of the poppy there seems to have been a lack of patience exhibited, as the corolla so soon expands after the sepals have fallen off. The pollen was evidently the object of the bees' visits, as both plants are destitute of honey. The columbines (*Aquilegia*) received a large share of attention from humble-bees. In this genus, which is melliferous, the honey is secreted in spurs, differing in shape and length in the different species; in the varieties of *A. vulgaris* the spur is rather short,

consequently the honey is easily obtainable. In such species as *Chrysanthia carulea*, *Sibirica* and *Olympica*, the spurs are longer and more difficult for the bees to get at. To get over this difficulty, the bees have torn open the spurs low down enough to extract the honey, a process interesting to the lover of bees, but rather annoying to a gardener. One species, *A. Californica*, having short thick red spurs, was left untouched, due, I believe, to the thickness of the spur.—*J. W. Odell, Pinner.*

QUERY AS TO PLANT.—There is a plant the name of which I would like to know. Perhaps one of our Gossips will help me. It is largely grown in some Indian gardens for its red fleshy calyx, which is acidulous and much esteemed for puddings, jams, etc. As near as I can recollect, the plant is an annual, and grows about three feet in height; flowers, malvaceous, and, I think, yellow, with dark centre; stems, red. The popular name for it in India is "Rozelle." I have thought that it may be a species of *Hibiscus*; and have been wondering whether, if cultivated somewhat as the tomato is, it would be practicable to introduce the plant into English gardens for culinary purposes. No doubt, if the experiment proved successful, the beautiful crimson fruit (*peccavi*, O ye botanists!) would be a welcome addition to our tables.—*G. A. Newman, M.S.C.*

SYCAMORE.—If Mr. William Jeffrey will cut open the seed of the morning glory (*Ipomoea purpurea*), he will find a coincidence to what he has spoken of the samaras of the sycamore in the September number.—*J. W. Williams, D.Sc.*

ARRAXAS GROSSULARIATA AND ITS FOOD PLANTS.—The original food of this insect appears to have been the hazel (*C. avellana*), for it is found abundantly in lanes feeding on this tree in the Highlands as well as in other parts of England. The imagines of the caterpillars which have fed on hazel are, on the average, much smaller and darker than those found in gardens which have fed on currant and gooseberry.—*W. Harcourt Bath, Birmingham.*

SIREX GIGAS AND *S. JUVENCUS*.—I possess a female of each of these species, taken at Elswick, Newcastle-on-Tyne; the former on July 27th, 1872, and the latter on Sept. 4th, 1869. Both insects are (or rather were) very fine and perfect specimens. *S. gigas* was knocked down with a book by myself as it flew heavily about in our backyard, in which were a window-sill fernery, and another small detached fernery, the greenery in which had possibly attracted it. It measures from the forehead to the tip of the ovipositor fully 19 lines, the ovipositor projecting beyond the tip of the caudal appendage a little over 2 lines only. *S. juvencus* was caught in the Ordnance Department of the Elswick Works, and was sent to me by a gentleman who knew I was interested in natural history. It measures  $12\frac{1}{2}$  lines to the tip of the ovipositor, which projects beyond the tip of the caudal appendage  $1\frac{1}{2}$  line.—*Charles Robson, Elswick, Newcastle-on-Tyne.*

SCARCITY OF WASPS.—Very few wasps were seen in this neighbourhood during the past season. Can this be accounted for by the severity of the weather in the early part of the season, which was so destructive to the swallows? In the first week in May, I killed fourteen queen wasps in three days. The next week the weather was very cold, and perhaps it may have destroyed the queen wasps, who had ventured in such large numbers out of their winter hiding places.—*C. H. Waddell, Kendal.*

POISONOUS NATURE OF THE YEW.—I must apologise for once more troubling you on this subject. Can any of your readers tell me whether there is any foundation for the belief, common to both upper and lower classes in these parts, that the leaf of the yew is poisonous only when cut from the tree and withered? As an example of this, farmers have no fear of letting horses feed in yew-fenced parks, except just after clipping them.—*Gresham F. Gillett.*

A SWARM OF APHODII.—When a great swarm of these insects appears, it is not always a sign of nuisances or sanitary neglect. Passing some years ago over Skircoat Moor, near Halifax, which was then free from houses, sewers, manure-heaps, etc., I noticed that the ground itself, the heather and the rocks were, so to speak, all alive with *Aphodius sphaecelatus*, so that it was scarcely possible to step without crushing some of them. There was certainly nowhere about any excrementitious matter by which they could have been attracted.—*J. W. Slater, 36 Wray Crescent, London.*

NORWEGIAN SUPERSTITION CONCERNING EELS.—Certain rivers in Norway swarm with eels, to such an extent, that the water-wheels of the saw-mills are occasionally clogged up and brought to a stand. The country people as a rule, however, neglect to catch these fishes, either for home consumption, or even for exportation. A superstitious notion still prevails, that eels are too intimate with the Trolls, and their fat is said to be employed by witches and sorcerers in the preparation of magic salves. What is the reason that in some parts of Scotland eels are unpopular as food?—*J. W. Slater.*

AN ADDER SWALLOWING HER YOUNG.—A fine specimen of the above reptile was seen to do so on the morning of the 10th of September last, a little way off the roadside between the village of St. Arvans and Midcliff, near Chepstow. After the act she was struck with a large stone, and when dead was opened, and thirteen young ones was found inside, nine of which were alive and four dead, but the latter with the mother were so much mutilated as to be useless for preservation; the nine are preserved in spirits, and in my possession.—*J. H. M.*

GREY WAGTAILS.—Since the middle of October one grey wagtail, sometimes with a companion, has made it a practice to tap, tap, at a south landing window of my house, taking short flights from the roof to the window pane and back again. The tapping commences with great regularity about 7 o'clock every morning, and continues till 9 or 9.30 A.M., then the tapping ceases, but occasionally may be again heard at intervals during the day. Johns, in his "History of British Birds," notices this peculiarity of the grey wagtail, and suggests that it might be well called "window-bird." Can any reader offer an explanation of this curious behaviour? There is no appearance of insects, which by the transparency of the glass might easily be detected as the object of search. During many years this curious behaviour has not been noticed till the present autumn and now. (Nov. 4.) The little bird is still continuing to pay us his morning visits.—*Svarraton Rectory, Hants.*

GOSSAMER IN SPRING.—Gossamer is not an exclusively autumnal phenomenon. One fine morning in March, 1879, a large tract of country to the west and north-west of Aylesbury, was covered with the well-known threads, which garnished every fence, bush and tuft and grass. There was a dead calm, and the barometer was high.—*J. W. Slater.*



**TOADS IN ROCKS.**—I should have thought that any one with any knowledge of natural history would have known that the old story about 'the live toad in the solid rock is exploded, but I am astonished that so well informed a writer should treat the matter as Dr. Keegan has done. It has been proved to demonstration that the thing is an impossibility, "dear old Gilbert White," and Dr. Keegan, notwithstanding. It is, as the Rev. J. G. Wood says, however slowly the flame of life may burn, combustion must cease and life fail some time, and this some time he proved by experiment in the case of imprisoned frogs to be at most twelve to thirteen months. I should like to know where the emphatic "abundant and irrefutable evidence" is to be obtained, or of any single case where the imprisoned live frog has been found by one whose testimony would be accepted as unimpeachable on such a point, by one of the leading scientists of the day, say, for instance, Sir John Lubbock. How is it that the stone or coal which is invariably reported to retain "the exact impression of the little creature" can never be produced when the matter comes to be investigated? That the frog has been found in the coal pit is probable enough, but it does not follow that he came out of the coal, any more than it does that the mice and beetles seen there do. I saw a butterfly in a coal pit at Ashton some years ago. What would Dr. Keegan have thought of me if I had declared it came out of the solid coal? These things are carried down in the pit cages, generally in the hay and straw which is taken down for the ponies employed below. To compare a three months' fasting "flat pattern live timekeeper," as O. W. Holmes calls him, to a 400 century fasting coal-imprisoned frog is absurd; one might just as well compare a thimble with the pyramid of Cheops. Let us have light on every subject, but leave the silly old toad story alone.—*Mark L. Sykes, Winton, Manchester.*

**QUERY AS TO MOSS.**—In reply to G. C. Goody's query, the moss described is probably *Fissidens adiantoides*. If he sends me a bit of it, I shall be glad to name it for him.—*Rev. C. H. Waddell, Kendal.*

**PLAGUE OF FLIES.**—Doubtless most persons observed what a nuisance the flies were during the last two months of summer, and how very scarce wasps have been last season. No doubt the absence of the latter accounts for the unusual number of the former. The same thing occurred in 1811 (see Kirby and Spence, p. 157).—*J. Bohns, Tonbridge.*

**THE DEVELOPMENT OF THE TADPOLE.**—Dr. J. W. Williams, in his note (p. 259) on my observation of Ciliated Cells in the Epidermis of the Young Tadpole, remarks that it ought to receive confirmation with a higher power of the microscope. One difficulty will be to bring a higher power than  $\frac{1}{3}$  in. to bear on the sides of a living tadpole. The presence of cilia, however, at the stage of growth mentioned, is undoubted. I have seen them repeatedly, and shown them to others; and they are further evidenced by the very strong currents in the water close to the body. I have no doubt that any one will be able to see them distinctly, if looked for at the proper time and in the proper way. According to my experience, minute cilia in general, on algæ, infusoria, planarian worms, etc., can be seen much more distinctly with a  $\frac{2}{3}$  or  $\frac{1}{2}$  in. objective and good dark ground illumination, than with  $\frac{1}{3}$  or  $\frac{1}{4}$  in. objective and transmitted light. I will, however, endeavour to make stained sections of the tadpole's skin next spring, and see if the cilia can be demonstrated in this way in a permanent slide.—*Charles Rousselet.*

**A NEW READER OF SCIENCE-GOSSIP.**—In the October number of SCIENCE-GOSSIP received to-day, I found the silken web of a small (book) worm, with the tenant quite well advanced in pupation. My paper-knife rather rudely disturbed—indeed, indefinitely postponed the operation. How did he get there?—*H. E. Valentine, Boston, Mass., U.S.A.*

**ADDERS AND THEIR YOUNG.**—The question of the adder swallowing its young, to shelter them from danger, is one which has troubled the minds of many generations of naturalists; but no one appears to have been able to bring forward such evidence, either for or against, as would suffice to convince the scientific world one way or the other. For instance, if we take up a work on Natural History, we find that the authors are, as a rule, unable to write definitely on the subject. Even such close observers of the ins and outs of nature as Gilbert White, Jesse, and the Rev. J. G. Wood of our own day, are only able to write from what they have been told by casual observers in favour of the swallowing doctrine, and therefore they leave it an open question. I know of several people—three being personal friends of mine, but entire strangers to one another—not naturalists, but just casual observers, who either write, or tell me they have seen the occurrence, and, in two cases after killing the older reptile, have extracted the young; but then, on the other hand, one is met by the assertion that such a thing cannot be, owing to the structure of the reptile. If any of our scientists are so circumstanced as to be able to take the matter up, and investigate it so thoroughly as to enable them to bring forward convincing proof on either side, they would remove a bone of contention, and earn the thanks of their brother students in the by-ways of Nature. If time and other matters will allow, I hope to study the subject myself next year, if I can get a supply of the reptiles to breed from, and watch closely.—*J. Herbert Allchin, Sutton Valence, Kent.*

**INSTINCT (?) OF SPIDER.**—A few days ago, I witnessed an act on the part of a spider which evidenced so strongly the possession of a mechanical instinct, or reasoning—it is impossible to say which—that I think our readers will be glad to have an account of it. I was sitting by a window, working, when I saw that a common house-fly had become entangled in two or three loose threads which hung from what had apparently been a perfect web, but which was then very much dilapidated; the fly, when I first observed it, was hanging almost to the bottom of a pane of glass, the web being in the upper left-hand corner. I did not take particular notice of it at first, but on looking again, after a lapse of five or ten minutes, I saw that the fly was not only dead, but that it appeared to have been raised higher. So I watched more carefully, and then saw that a small spider was busily at work, trying to raise its victim up to the remains of its web; it left the fly, went a short distance up the thread of web, and then tried to haul the fly up; but finding that, owing to some reason or other, it could not do so, it ran up to the woodwork at the top of the glass, fixed to it a new thread, which it brought down, wrapped it round the fly, ran up again a little way, and then succeeded in hauling the fly up about an inch, when it repeated the whole performance again, and several times afterwards, until it had drawn the fly almost to the top, when it seemed to be satisfied, and settled down to its well-earned feast. During the operation, and when it had raised the fly about one-third of the distance, it found its work hindered by a thread which was attached to the side framework of the glass, and so kept the fly down; but the spider just

ran round its prey, and appeared to sever the thread, for the fly was at once loosed, and swung freely. I looked a day or two afterwards, hoping to renew our acquaintance, but the housemaid's brush had rudely swept spider, fly, and web away.—*J. Herbert Allchin, Sutton Valence, Kent.*

NOTE OF THE CUCKOO.—The cuckoo commonly utters the three notes "cuck-coo-coo" mentioned by Mrs. Taylor. I believe it is generally when flying. Possibly the movement through the air with the beak open causes this.—*H. Lamb, Beaver Street, Maidstone.*

LUNAR RAINBOW.—At Staplehurst, Kent, on November 13th, at 7 P.M., I noticed a rainbow (which, I believe, is rarely to be seen at night) arising from the refraction and dispersion of the coloured rays of the moon in the drops of rain—for it was raining lightly at the time. Although faint, a little more than half the bow was distinctly visible for about three minutes, and then gradually disappeared.—*R. F., Dover.*

"ELECTRICAL ABSURDITIES."—I was rather surprised to see a paragraph under this side-heading in your paper. There is nothing new in the fact of electricity being employed to propagate plants, shrubs, or flowers. An interesting account of such experiments are given in Dr. Priestley's "History of Electricity," published 1794, in which it states that a Mr. Mainsbury, of Edinburgh, in 1746, made continuous experiments, applying electricity to develop vegetation. From this account it appears that myrtles so treated showed an earlier growth than those which were out; also, that flowers bloomed earlier. It might be curious, however, to know why these experiments were discontinued if they were successful. Was it found that the application of electricity exhausted prematurely the natural productive resources of the plant? This very pertinent question was asked at our recent "Science-Gossip Club," where we had a paper read on the "History of the Early Researches in Electricity"; but no information could be afforded at the time. A bibliographical and technical history of this new science would, no doubt, find numerous readers.—*W. Alex. Sothorn, Norwich.*

WHITE SPARROWS IN LONDON.—It may interest some of your ornithological readers to know, that yesterday I saw a white sparrow in London. It was feeding in the road with several others of the ordinary colour, and, so far as I could judge, seemed to be rather over the average size. It was not perfectly white; in fact, it is extremely doubtful whether any London bird could attain more than a dirty cream colour; but it possessed very few feathers of the normal hue. There was a dark patch at the top of the head, near the beak, and a ring of brown passed almost round the throat. The lower portion of the abdomen near the tail was, perhaps, the darkest part of the body, with the exception of a few brown feathers in each wing, which were most conspicuous when the bird was flying. The tip of the tail was also brown.—*W. C. Flood.*

THE EXTIRPATION OF LEPIDOPTERA.—I decidedly concur with Mr. Slater's averment, that fearful and unwarrantable destruction of insect-life is perpetrated annually by "mere collectors"; but the "mere collectors" do not by any means consist solely of boys; I believe that quite as many of these unthinking people are members of natural history and entomological societies. I am acquainted with not

a few, and do not forget, when an opportunity presents itself, to express my mind to these so-called entomologists. They are not justified in taking the lives of beautiful butterflies and moths for the sake of belonging to an entomological society. I am convinced that this is the sole ambition of many. They imagine themselves clever in being able to rattle-off, parrot-like, a number of scientific names; they know nothing of the principles on which classification is founded, nothing more of the insects than their names; they collect butterflies and moths as a school-boy does postage stamps. It is a great pity; but, if their own conscience does not condemn them, I am afraid any censure from me or any one else will not meet with aught but contempt.—*F. A. A. Skuse, Beech Cottage, Bow, E.*

ANOTHER USE OF BEE STINGS.—Under this heading, Mr. T. Winder, writing in your issue for December last, seems to have fallen into a considerable mistake with regard to the sting of bees and wasps, when he describes the wasp's sting as barbed, and the bees like a fine cambric needle. It seems pretty evident that Mr. W. has lived in a very happy state, never to have found out by experience another use for bees' stings, for, if he had, he would most surely have discovered that the sting of the bee is barbed, and therefore is torn from the insect and left in the wound, while that of the wasp, being like the needle, is withdrawn at once; his remarks regarding the sting tearing the cap of the honey cell are therefore so erroneous, that I feel compelled to correct them, in the interest of the many young readers of your most interesting paper.—*W. E. Harper, Maidenhead.*

ROCK SECTIONS.—If any reader of SCIENCE-GOSSIP has any of the following rock sections in his possession, I shall be obliged if he will send them to me to photograph. I will, in return, give him a photograph of each section, gratis. Muscovite granite, Hornblende granite, Granite, Biotite granite, Graphite granite, Gneiss, Luxullianite, Quartz felsite, Rhyolite, Pitchstone, Perlitic Pitchstone, Syenite, Trachyte, Diorite, Quartz Diorite, Quartz andesite, Hornblende andesite, Augite andesite, Enstatite andesite, Porphyrite, Nepheline phonolite, Lucite phonolite, Noseau and Haiyne phonolite, Gabbro, Leucite Basalt, Augite Basalt, Chialstolite slate, Mica schist, Hornblende schist, Chlorite schist, Red Gneiss, Grey Gneiss, Quartzite, Coals, etc.; also other rare or interesting rocks. The slides will be returned as soon as possible, in good condition.—*R. St. Stephens, A.R.S.M.*

THE AUSTRALIAN FRINGED LIZARD.—I should be obliged if some reader of SCIENCE-GOSSIP would kindly give me some information of this lizard (recently discovered, I believe), also where could I get a drawing of the same? Any information will be specially welcome.—*Fred Challis.*

CAN FREED CAGE-BIRDS SURVIVE?—Is it reasonable to suppose that British birds that have been reared by hand and kept in cages would, if turned at liberty in a proper locality and season, be likely to survive it? I put this question before two of your contemporaries, recently, and got for reply "Yes" and "No" respectively. I think Bechstein supports the latter theory, adding (if I remember rightly) "if they manage to live through the summer, they are almost sure to die the following winter!" Other authors I have perused do not touch the subject at all. I should be very glad of information, on this very (to me) interesting point, from a practical source.—*J. Wadsworth.*



## NOTICES TO CORRESPONDENTS.

TO CORRESPONDENTS AND EXCHANGERS.—As we now publish SCIENCE-GOSSIP earlier than formerly, we cannot undertake to insert in the following number any communications which reach us later than the 8th of the previous month.

TO ANONYMOUS QUEBRISTS.—We must adhere to our rule of not noticing queries which do not bear the writers' names.

TO DEALERS AND OTHERS.—We are always glad to treat dealers in natural history objects on the same fair and general ground as amateurs, in so far as the "exchanges" offered are fair exchanges. But it is evident that, when their offers are simply disguised advertisements, for the purpose of evading the cost of advertising, an advantage is taken of our gratuitous insertion of "exchanges" which cannot be tolerated.

We request that all exchanges may be signed with name (or initials) and full address at the end.

W. A. CLARKE.—The occurrence of the two distinct colours and varieties of chrysanthemum on the same stalk is very curious and uncommon.

B. PROSSER.—We suspect that the reference to the "scales" on the wings of insects other than butterflies and moths is erroneous. It may refer to the scales on the bodies of such insects as the *Thysanuridae*.

P. H. R.—See article in SCIENCE-GOSSIP, vol. xii. p. 263, on "How to Manage a Formicary."

W. J. HORN.—From your sketch, we judge the creature to be a species of Planula.

D. W.—The "nuts" are the seed of the Chilean pine (*Araucaria imbricata*).

M. T. DENNE.—Your specimens are: No. 1, *Plumularia pinnata*; 2, *Flustra chartacea*; 3, *Diphasia rosacea*; and 4, *Sertularia filiculata*.

J. B.—In purchasing a microscope for the first time, we think it would be better to get one with rack and pinion, and get used to working it. The objectives could be purchased as you needed them.

W. DUNCAN.—The specimen appears to be a variety of *Alcyonidium parasiticum*. No. 1 is not a Lepralia, but perhaps a species of Cellaria or Hippothoa—not indistinct to identify. No. 2 is a species of Microporella encrusting *Flustra foliacea*. No. 3, *Lepralia coccinea*.

## EXCHANGES.

DUPLICATES: Urania, Fulgens, Sloanus, Papilio, Glaucus, Thyodamus, Diphilus, Eucharis, Salmacis, Volina, Lassinassa, Philodice, Mariamme, Dananoides, etc. Desiderata: Urania, Rhyphæus, Morphos, etc. Send lists to—W. H. Scott, 14 Prospect Hill, Leicester.

WANTED, any illustrated books on British grasses and mosses.—T. J. Porter, Perranarworthal, Cornwall.

Fossil land and freshwater shells wanted, also recent forms of fossil genera, British and foreign.—Chas. Musson, 23 Mapperley Hill, Nottingham.

"KNOWLEDGE" for 1883-4, SCIENCE-GOSSIP 1884-5 to exchange; also a few well-blown eggs for others. Wanted, Morriss's "Nests and Eggs of British Birds."—H. F. Medley, Romsey, Hampshire.

KIRBY'S "European Butterflies and Moths," fine volume, quite new, 61 coloured plates, cost 37s. 6d., to exchange for telescope, album, crustacea, or other objects.—James Ellison, Steeton, Leeds.

WANTED, Nos. 160, 161, 167, 168 of "Quarterly Journal Geol. Society," also any odd number of "Geological Magazine."—George E. East, jun., 10 Basinhall Street, London, E.C.

WHAT offers for Captain Brown's "Fossil Conchology," 10 parts, complete, with 37 coloured plates, also 20 additional plates in cloth; Mantell's "Geology of the Isle of Wight," also "Wonders of Geology," and Buckland's "Geology and Mineralogy"?—George E. East, jun., 241 Evering Road, Upper Clapton, E.

DUPLICATES: *P. lineatus*, *A. fluviatilis*, *H. Cartusiana*, *H. caperata* var. *major* and *ornata*, *P. secale*, *B. perversa*, *C. Rolfii*, and *A. acicula*. Desiderata: British land and freshwater shells.—C. H. Morris, School Hill, Lewes, Sussex.

WING-CASES and foot pads of male *Dytiscus* for good unmounted material.—C. F. Cross, 56 Werneth Hall Road, Oldham.

FORTY species of British marine shells (over 100 shells), named and localised, good specimens, many rare.—C. S., Maplewell, Loughborough.

WANTED, British ferns, mosses, horse-tails, and grasses, in exchange for fossils of the Silurian, Devonian, and Carboniferous ages.—J. W. Baylis, 56 Vine Street, Liverpool.

WANTED, *Plumularia setacea*, *Sert. gracilis*, *Bugula turbinata*, *Notania bursaria*, etc. Good exchange in north-eastern species will be given.—W. Duncan, 1 India Street, Montrose.

WILL exchange Cassell's "Technical Educator" (unused) and Woodfall's "Letters of Junius" (Bohn's edition) for good fossils or shells.—R. Cairns, The Grove, Currier Lane, Ashton-under-Lyne.

BIRDS'-SKINS; owner has several Zululand birds'-skins, of various sorts and sizes, which he shot in South Africa; also an iguana-skin and a fruit-bat. Will exchange some for a microscope suitable for histological work; or open to offers.—Staff-Sergeant Fred. Smith, Medical Staff Corps, Royal Infirmary, Dublin.

To Irish botanists: Would be glad to exchange botanical specimens.—W. S. Harrison, 15 Park Place East, Sunderland.

COLLECTION of Ceylonese shells, including several rare species of *Helix*, *Bulinus*, *Cyclophorus*, *Cataulus*, etc. Offers solicited in good shells or fossils from various localities.—Miss Linter, Arragon Close, Twickenham.

WANTED: SCIENCE-GOSSIP for 1871-2-3, complete, bound or unbound.—F. R. Brokenshire, 24 Oxford Terrace, Exeter.

VOLS. ii. and v. of the "Intellectual Observer," and vol. i. and 22 parts unbound of the "Popular Science Review," all in good condition. What offers?—F. R. Brokenshire, 24 Oxford Terrace, Exeter.

WANTED, Morriss's "British Moths," and will exchange a number of well-set *V. urtica* for a larva collecting-box.—A. E. Large, 122 Sunny Hill Road, Streatham.

Would any one assist in stocking a museum at the new pupil teachers' school about to be opened in William Street, Hammersmith? Physiological, natural history, or geological specimens would be very thankfully received and acknowledged by W. Jacobs, 12 Selwyn Villas, Munster Road, Fulham, S.W.

To conchologists: British Unionidæ (freshwater mussels). Collectors having in their possession peculiar forms or varieties—especially if they be local or rare—would greatly oblige by lending them for examination; the writer undertaking to pay expenses of transit both ways, and to take great care of all shells entrusted to him. Duplicates will be gladly exchanged.—G. Sherriff Tye, 10 Richmond Road, Soho Park, Handsworth, Birmingham.

To conchologists: continental Unionidæ (freshwater mussels). The writer desires to exchange British or foreign land and freshwater shells for the above *Unio batavicus* not required.—G. S. Tye, 10 Richmond Road, Soho Park, Handsworth, Birmingham.

WOOD sections, many single and double stained, for exchange.—W. Stott, Lostock, Bolton.

HISTORICAL and other slides for exchange; hand and foot of Egyptian mummy from Thebes, 2000 years old; what offer in micro mounts or requisites? Robe of Soudanese dervish for exchange.—R. St. Stephens, A.R.S.M., 25 Fordingley Road, West Hampstead, London, N.W.

OFFERED, about 100 British wild plants, well pressed and neatly mounted on good paper, about 16 in. x 10 in., in exchange for any correctly-named microscopical slides.—T. J. Porter, Perranarworthal, Cornwall.

WANTED, a secondhand copy either of Lang's or Kirby's "European Butterflies."—R. Postans, Midhurst, Springfield Road, St. Leonards-on-Sea.

BRITISH wild plants: offered, well-dried specimens in exchange for well-dried specimens. Desiderata numerous; lists exchanged. Nos. 166, 212, 303, 376, 550, 551, 566, 608, 641, 646, 705, 726, 803, 1024, 1066, 1131, and many others.—Mr. Taylor, Certificated Botanist, Free Museum, Paisley, N.B.

## BOOKS, ETC., RECEIVED.

"Animal Anecdotes," by H. A. Page (London: Chatto & Windus).—"Lunar Science," by the Rev. T. Harley (London: Swan Sonnenschein & Co.).—"The Young Collector—Crustacea and Spiders," by F. A. A. Skuse (London: Swan Sonnenschein & Co.).—"The Animal World" (vol. for 1886).—"The Band of Mercy" for 1886.—"The Rotifera," by P. H. Gosse and Dr. Hudson, part 6 (London: Longmans).—"British Petrography," by J. H. Teall, part 10.—"Proceedings of the Camera Club."—Cole's "Studies in Microscopical Science."—"Journal of Royal Microscopical Society."—"Proceedings of American Academy."—"The Amateur Photographer."—"The Camera."—"The Scientific Enquirer."—"The Garner."—"The Naturalist."—"The Botanical Gazette."—"Journal of the New York Microscopical Society."—"Belgravia."—"The Gentleman's Magazine."—"Le Monde de la Science."—"American Monthly Microscopical Journal."—"The Midland Naturalist."—"Feuille des Jeunes Naturalistes."—"The American Naturalist."—"Proceedings of Geologists' Association."—"Proceedings Folkestone Nat. Hist. Soc."—"Proceedings Davenport Acad. Nat. Sciences," vol. iv.—"L'Ingénieur Electricien."—"Bulletins U. S. Geol. Survey," Nos. 28 and 29.—&c. &c.

COMMUNICATIONS RECEIVED UP TO THE 13TH ULT. FROM: T. J. P.—R. F. D.—P. H. R.—R. G.—G. S. D.—W. H. S.—W. P. H.—G. E. W.—H. H.—E. D. M.—J. W.—C. H. M.—C. S.—B. T.—T. W.—B. T.—C. G. E., jun.—B. P.—J. E.—H. F. M.—F. C.—F. W. E.—R. St. S.—W. E. H.—C. F. C.—H. A. C.—J. W. B.—R. D. P.—M. A.—R. B.—C. A. B. S.—F. A. A. S.—A. B. G.—C. M.—W. D.—W. A. C.—J. T.—W. G. W.—F. R. B.—E. H.—J. E. L.—S. W.—R. J. W.—R. E. L.—F. G. F.—T. D. A. C.—M. T. D.—R. C.—W. J.—F. S.—W. S. H.—N. F. L.—J. W. G.—J. W. W.—J. B.—W. A. C.—H. W. B.—W. W. W.—F. E. C.—B. W.—E. L.—R. St. S.—T. J. P.—R. P. M.—J. M. E. T.—&c. &c.



## THE TWO MIRRORS.

By W. J. N.

No. IV.



To complete the solution of the problem proposed in the last article, we have still to determine the position of the bull's-eye condenser, with which we are to form the pencil of parallel rays. Accuracy in this particular is an important condition of success. If the rays of the lamp be not rendered truly parallel, the focal distance already

assigned to the mirror will be incorrect.

The two "principal" foci of the bull's-eye, that is, its foci for parallel rays falling either upon its convex or its plane surface, must first be ascertained.

Place the lamp at some distance from a wall of the room. Near the wall-paper set the bull's-eye, on a level with the lamp-flame, and having its plane side turned towards the wall. Move it from and towards the wall, until a small spot of light is seen in sharpest focus on the wall paper, surrounded by a broad margin of weak light. Measure the distance between the plane side and the wall, and note it down as the principal focal distance of the lens when the parallel rays fall upon its convex surface.

Next, turn the plane surface towards the lamp, and repeat the experiment. The focal distance is now increased, and the bull's-eye has to be set a little further from the wall than before. The spot of light formed at the focus is not so bright, but the margin of diffused light has almost disappeared. Measure the distance between convex surface and wall, and

note it down in the "principal focus," when the parallel rays are received upon its plane surface.

Now let us suppose the conditions of these experiments to be reversed; a luminous body, of the same size as the focal spot of light, being placed at the same distance from the same surface of the bull's-eye as that measured in each of the two cases. The divergent rays emanating from that body will be rendered parallel by the bull's-eye. It appears, therefore, that when we employ the bull's-eye to reduce divergent rays to parallelism, either of its two surfaces may be turned towards the light; but that there is a difference of focal distance in the two cases, which must be remembered and attended to.

When brilliancy of illumination is the first consideration—as when using the spot lens—there will be an advantage gained by placing the bull's-eye in the nearer of the two positions, that is, with its plane surface turned towards the light. In all other cases, it is better to use the reversed position, the light obtained being somewhat more pure, although a little less powerful.

In connection with this use of the bull's-eye, there are two difficulties to be overcome. Firstly, the lens has a natural infirmity, called spherical aberration. Parallel rays passing near the margin are refracted differently from those passing near the centre, and come to a focus at a different distance. This caused the border of weak light surrounding the image on the wall-paper, above referred to. Marginal rays had come to a focus between the wall and bull's-eye, and then, crossing, had spread out so as to form the illuminated border. This effect of spherical aberration, it will be remembered, was much less noticeable when the convex side of the bull's-eye was turned towards the wall. Conversely, when diverging rays from a spot of light fall on the bull's-eye at the distance of its principal focus, the marginal rays instead of being rendered parallel, like the rest, are rendered convergent.

The second difficulty arises from the fact, that a



lamp-flame is not a small spot of light like the focal image formed on the wall, but a group of spots massed together. Only one small portion of the flame, therefore, can at one time represent the focal image, and emit rays which will all (apart from the effects of aberration) be rendered parallel by the bull's-eye.

We may, to a great extent, overcome these difficulties thus:—Turn down the lamp-wick, until the whole flame is very small indeed, and let one end of this small flame face the mirror. This will do much towards obtaining the small spot of brilliant white light desired. Then, to get rid of such admixture of convergent and divergent rays with the parallel pencil, as is still unavoidable from both the causes named, move the lamp, if possible, to a considerable distance from the mirror without altering its angular position. Many of the non-parallel rays will then pass outside the mirror, and the intensity of the others will be so reduced as to render them comparatively harmless.

But it may be objected, that it would not be possible to get sufficient light from so small a flame, placed at a distance from the microscope. I reply, that for most purposes (always excluding dark ground) the illumination lamp-wick may be turned down until the top of the flame is only just level with the top of the brass burner, and the lamp may, in addition, be placed at a distance of (say) two feet from the mirror—and yet the light will be ample for the one-eighth inch object-glass, plus the B eye-piece (say for a power of 600 diameters), and will be of the coolest, purest, kind—very agreeable to the eyes, and admirably fitted to secure the perfect working of the object-glass. I have found it possible to get a middling view of diatoms under the  $\frac{1}{4}$ -inch, by the light of a composite candle; and since writing the above paragraph I have examined many diatoms under the one-eighth, with the light of a lamp that was turned down as described above; so that, in fact, it appeared to be almost “out.”

Let the bull's-eye then be placed at the distance of one of its principal foci from the nearest part of the lamp-flame, the said distance depending, as we have seen, on which of its two surfaces faces the lamp. Adjust its height carefully to that of the flame, so that the rays may be received from the brightest portion of the same, and that the centre of the pencil may be thrown on to the centre of the mirror. If a line be supposed to pass from the edge of the flame to the centre of the mirror, that line should pass through the centre of the bull's-eye at right angles to its plane surface. (A piece of paper laid on the mirror may assist the novice to direct the rays thereto.)

In getting the microscope and its accessories ready for work, it is well to follow some regular method. To the beginner, I will venture to suggest the following:

1. Decide what kind of illumination will best suit the objects you propose to examine.

2. Set the mirror at the proper distance from the stage for the kind of illumination which you have selected.

3. Place the microscope on its platform, and by means of the thread and buttons, set the tube at the proper angle of slope.

4. If eye-piece or object-glass be present, remove it.

5. Place the mirror in the axis of the microscope.

To do this, first glance down the outside of the tube, and see that the movable stem on which the mirror slides is in line with the tube itself. Then look down the empty tube, and, without moving the stem, turn up the brass hoop which holds the mirrors, edgewise towards the eye, so that the mirrors face right and left and are hidden from view. If the hoop is not seen exactly in the centre of the field, turn the clip round upon the stem till the centering is accurate.

6. Slide the instrument, forward or backward, until the centre of the mirror is directly over the spot marked on the tray.

7. Place the lamp alongside the mirror, and raise it on its pillar (if necessary) until the top of the wick is just below the centre of the mirror; then remove it to its proper place on the tray, which place must correspond with the focal distance already assigned to the mirror.

8. Place the bull's-eye in position.

9. Look down the empty tube of the microscope, and, without altering any adjustment already made, turn up the plane mirror till you can see in it the illuminated bull's-eye. If the latter be in correct position, the centre and an elliptical space around it, but not the margin, will be brilliantly illuminated by a whitish-yellow (not red) light, without any appearance of dark spots. If the light be dim, or red, the bull's-eye is wrongly adjusted in height. If the shape of the illuminated surface be not symmetrical, the bull's-eye is not truly facing the mirror. If the illuminated surface have dark spots on it, or extend to the margin of the lens, the incident rays are not all parallel, the lens being too near the lamp. If the illuminated surface be small, the distance from the lamp is too great. No pains must be spared to get the correct pencil. Failing here, you fail entirely.

10. If the diaphragm is to be made use of, now slip its holder into position.

11. Gently turn over the mirrors in their Y-holder, that the concave mirror may be substituted for the plane one. (For low powers the plane mirror is better.)

12. Place a trial-slip on the stage, and see whether the light thrown upon it from the mirror is well-focused and good. If not, some mistake has been made, and must be corrected.

13. Attach object-glass and eye-piece.

14. Replace the trial-slip by the object, and rotate the diaphragm till the pleasantest amount of light is obtained.

That which has taken thus long to describe, is in practice very quickly accomplished: a few minutes sufficing to put everything in readiness for work.

To some microscopists it may seem unnecessary to be so exact in the details of illumination; but if the reader will give a fair trial to the system I am endeavouring to describe, I have full confidence, founded on my own success, that he will find himself a great gainer every way; obtaining better results, with more certainty, increased pleasure, relief to the eyesight, and great economy in the consumption of lamp-oil.

(To be continued.)

## MY DRAWING-ROOM PETS.

BY CLARA KINGSFORD.

### PART II.

I HAVE read that the lizard has a most rapacious appetite; mine I considered rather small and slow feeders, sometimes waiting quite half-an-hour between each capture, if the insect or spider was unusually large. They only fed quickly when very small flies or gnats were provided, which were caught at once in the mouth and swallowed instantaneously, and in quick succession.

It is popularly supposed that the lizard's bifid and very extensile tongue is used in catching its prey. I have never seen it so used; but how far it is used to assist in holding its prey when once caught I am not prepared to say. However, this poor, little, harmless tongue, source of so much fear to the uninitiated, and simply because it is bifid, is very useful for the purpose of drinking. Soon after noon my pet Tommy refused food, even if he had previously been very hungry and unsatisfied, for I was not always able to procure in the morning that which he required. For the rest of the day he would lie coiled up on the highest part of the grass, and always nearest the light, and watch my movements. When the shades of evening were closing o'er us, he would retire for the night. His habits were so regular that he was a perfect chronometer; and his being very sensitive to cold (as all lizards are), made him an exact indicator of the state of the temperature; even during the summer-time, if the weather was cold or only dull, his motions were slow and drowsy, and he would not eat—would remain with his eyes closed, only opening them partially to look at me when I spoke to him. But on a bright, warm day he was all activity—his bright eye was on the alert, his ear quickly turned at the slightest noise, and his agile figure was constantly to be seen gliding about, which at every turn fell into graceful curves; he would raise his head every now and then, and put out his tongue, and by dumb motions make his wants known, but he never uttered a sound, neither did any of his confrères in captivity. But I have at this

present time a French lizard (*Lacerta viridis*), which does emit a sound, something like "chup" or "chip," sharply and quickly pronounced. This lizard measures eleven inches, and is of a beautiful metallic green-and-black, and is a most docile and tractable individual, loving to be nursed and petted, and most patient under suffering.

When I first received Chups, for that is its pet name, its right eye was injured, which caused it much pain, and myself much anxiety. Upon one occasion whilst I was holding my newly-acquired pet in my hand, it rubbed its injured eye on it. I took the hint, and rubbed and bathed with hot water the injured organ, but without any favourable result—the sealed lids would not part. At last, by advice of my medical man, I applied oil; it was most touching to see the poor creature when I took it up turn its eye round to me in anticipation of having it dressed, and I could tell by the quivering of its body, that I sometimes pained it, yet it never attempted to bite or leave my hand. In a short time the oil softened the lids, and they came nearly off; and when my medical man severed the piece of flesh by which they hung, our patient gave a start, but never attempted to bite either of us. Most cruelly maligned are these reptiles when they are accused of stinging and biting.

Our two true British lizards, *Z. vivipara* and *Lacerta agilis*, hibernate, and when the autumn has far advanced, they betake themselves to their burrows, not to reappear until the early spring. I believe it is not yet ascertained whether their torpidity is very profound, and one must not judge by the actions of a creature kept in captivity, as my little pet was, in a warm room, where I had not the convenience to give him sufficient depth of sand to burrow in. However, like a contented and clever little fellow as he was, he made the best of his position by retiring early in October under the grass or saucer of water, to reappear at intervals of about three weeks' duration. About the middle of February, he was again to be seen all life and activity on bright, sunny days, and even at this abnormally early date he would have taken food, had I had any to offer him; and when March had fairly set in his appetite became very alarming, as was fully demonstrated by his actions. On one particularly hot day my poor pet was nearly wild, and I believe that he tried his hardest to express his wants verbally. I had not any insect food to offer him: I was in despair; when a kind young friend came in, who hunted up a dead and dried-up fly, which she threw to him; he caught it in his mouth, and swallowed it instantaneously. Nothing more could be found; we were at our wits' end; when I happily thought of offering him a small piece of raw beef, which he ate greedily, and a second and a third piece was accepted, and so on, until his appetite was appeased. *Necessitas non habet leges.*

Tommy would eat either raw beef, mutton, or lamb; small pieces of any one of these I presented



to him between the points of a pair of scissors. He evidently esteemed the first named as a veritable *bonne bouche*, and showed his preference and thorough appreciation of it by vulgarly, but very demonstratively, licking his wide mouth (furnished with two rows of teeth) well after each piece.

Feeding him in the above-mentioned manner tried my patience sorely, for, as I have before stated, he was a slow feeder; but I was stimulated into perseverance by the hope that providing living insect food for him would not again be necessary. But my pet was a knowing little fellow, always on the alert, and the instant he heard the buzz of a fly and saw it on the wing, he persistently refused the proffered meat, and there was nothing for it but to box flies and other small insects alive, and tumble the box, which opened as it fell, near him, and let free the poor victims. At first Tommy was startled, and would run and hide when a box rolled near him; but he soon learned to know what it contained, and would eye quite expectantly any person approaching him, box in hand, and would be ready to seize his prey the instant it escaped.

Tommy never took much water during the summer, or when he was in good condition. It was only on the occasion of his reappearing in the winter, as I have previously mentioned, when his body was attenuated, and his skin dry and hanging in folds around him, that water appeared useful and grateful to him. Weak, and scarcely able to drag himself along, yet he would immediately make for it; at first stand with his anterior limbs in it, and drink by slow but continued lapping for quite half-an-hour, after which he would wade into it, and remain for some time with the posterior portion of his body resting in it. This appeared a strange proceeding, considering how sensitive the lizard is to cold; but after mature consideration, I judged it must have been for the purpose of cleansing the pores, a row of which runs down the inside of each thigh of the *Z. vivipara*.

(To be continued.)

## TEETH OF FLIES.

By W. H. HARRIS.

No. 12.—*CORDYLURA PUBERA*.

THE fly whose dental organs are represented in the present illustration belongs to the Acalypterate division of the Muscidae; it is by no means rare if sought for in its usual habitat; it frequents marshy places, banks of rivers, and sluggish streams.

In size and shape it approaches very nearly the common dung-fly, but there are points of difference which distinguish it very clearly from *Scatophaga stercoraria*.

The following description is taken from Walker's 'Insecta Britannica.' "Head and thorax with

white tomentum; palpi tawny, with darker tips; antennae not near reaching the epistoma; third joint longer than the second. Thorax with two broad black stripes. Wings grey, tinged with yellow in front, tips brown, a slight incision at the tip of the præbrachial vein; discal transverse vein parted by much more than its length from the præbrachial transverse vein, and by much less than its length from the border, haltiers, tibiae, and tarsi tawny; abdomen slightly tinged with grey. Male: front very broad, frontalia deep black. Female: front moderately broad, frontalia red, abdomen compressed at tip."

The proboscis of this fly is of the ordinary type possessed by the Muscidae, each lobe contains seven teeth of universal form, they are simple stiletto-shaped organs, long, and moderately stout, hard and

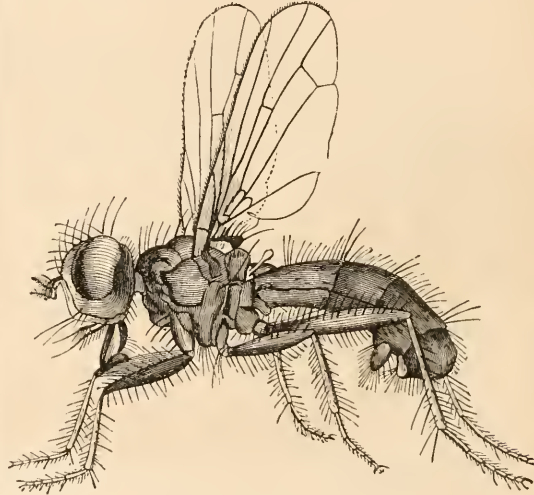

Fig. 9.—*Cordylura pubera*.

brittle, breaking with a clean fracture if unduly pressed, they are deep amber in colour, and collectively occupy a large portion of the oral aperture.

This appears to be the most primitive form of tooth, they are met with in many species of the Muscidae, in varying size and number, rarely, however, do they attain any great size, but range from hair-like processes to short blunted rods; it is in this fly the greatest development has been found, and hence it is made the type. The various forms of teeth appear to be produced by a simple process of evolution. Attention has been directed from time to time to the folding of the membrane which forms the foundation for the chitinous deposit, sometimes this folding commences at the base and terminates before reaching the free end, at others this order is reversed; occasionally the membrane is considerably more convoluted; it is to the modification of this process we must look for the origin of form, by the diminution or

entire suppression of one or more parts and by the multiplication or enlargement of others it is easy to produce the most divergent forms met with.

This fact, however, only establishes itself in the mind after much investigation, but I venture to think that a well-selected set of slides of the "teeth of flies" would form as good an illustration of the development of an organ as it is possible to find within the scope of animal economy.

Although not immediately connected with the main subject of these notes, there are one or two ideas which have been suggested during the investigation which I venture to add.

At first sight the Diptera would appear to offer little opportunity for studying traits of character, yet I dare affirm if anyone will give the requisite attention to the matter he will not be long before he dis-

cover pollen of plants can be conveyed in an unbroken condition to the stomach; I have a slide before me as I write, showing the stomach of one of these flies quite distended with grains in all stages of decomposition. The bulk of these flies are doubtless nectar-loving creatures in their perfect state, and in all their stages may be looked upon as friends to the gardener, the larvæ feeding upon aphides, while the fly aids the fertilization of the plant.

The phenomenon of sleep may be frequently witnessed in this family of flies. I have often seen a fly alight upon a leaf, and in the space of a few seconds become perfectly motionless, and in a few more seconds lose all consciousness of external objects; the hand could then be approached, or a feather, or any other object, could be waved about within a tenth of an inch of its large eyes, but it would remain perfectly oblivious of any danger. Repose of this kind rarely exceeds a few minutes at a time during the day-time. In the higher animals sleep is supposed to be the result of a torpid condition of the brain, during which its volume is somewhat diminished in consequence of a less active state of the blood passing through the vessels of the brain; exercise or mental occupation produces sleep, provided they are judiciously indulged in; as these flies are almost constantly on the wing, hovering hawk-like over plants, their attention apparently riveted upon the object they are seeking, there must be a large expenditure of muscular force and (if they think) the mental energy which requires frequent recruiting by short periods of repose.

Occasionally accounts appear in the newspapers of deaths having occurred from the bite of a fly. At first sight one is almost tempted to be incredulous

as to this being the true cause of such fatal results.

During the investigations necessary for compiling the series of notes on the teeth of flies, I have made some thousands of dissections of the mouth organs of various creatures of this large order. It is not at all an unusual occurrence to find the oral aperture literally teeming with Bacteria. Is it possible that in certain conditions of the blood, the bite of a fly, so infected, may be followed by a fatal result? If so, surely it is not too much to inquire if medical science cannot speedily find an antidote.

There may be nothing novel in this information, but at any rate, so long as death may be attributed to such an apparently simple cause, nothing bearing on the question ought to be considered unworthy of investigation, and it is with this object I am placing on record the experience gained over a number of years of close attention bestowed upon these insects.

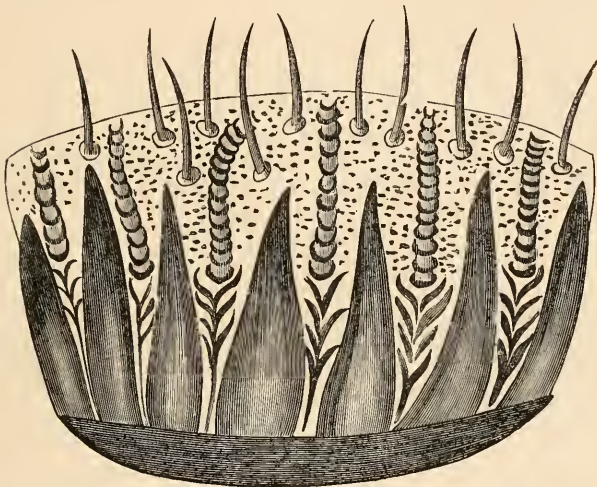

Scale of 1000<sup>th</sup> of an inch

Fig. 10.—Teeth of *Cordylura pubera*.

covers peculiarities of which he had little prior conception. There are social flies, and solitary flies; flies which show an innate smartness in their movements, and others sluggish and indolent in their avocations; timid flies, persistent flies, pugnacious flies, cunning flies, patient flies; in brief, whether these habits are ascribed to instinct or reason, taking into account the services they perform they are as well provided for their proper discharge as any other class of animals occupying a higher position in the scale of the great scheme of nature, and their recognition adds another point of interest for those who take up the study of the Diptera.

Among the Syrphidæ, which are truly flower-loving flies, no trace of dental organs can be discovered, the development of pseudo-tracheæ, however, reaches its maximum proportions in both size and number, so large, indeed, are the canals formed by them that



## ON COLLECTING DIPTERA.

By E. BRUNETTI.—NO. II.

*[Continued from p. 12.]*

SO far as the actual collecting of specimens goes, to which I wish to confine myself here, the rules to be observed are few and easily fulfilled.

Diptera may be caught with the ordinary gauze butterfly net—one that is rather shorter than usual will be found most useful, as many flies persistently hover above bushes and the small recesses in the lower branches of overhanging trees, and a long net is liable to get entangled in the brambles or other prickly vegetable growths, that is often met with in such situations.

Most of the Diptera inhabiting these situations are partial to a short flight, or to running about the sunny foliage, and when disturbed often return to the spot again, or retreat to the interior of the wood. Such are many of the Syrphidæ, the Dexiidæ, Tachinidæ, Asilidæ, and many of the Tipulidæ.

I must here diverge for a moment to remark, that many families or groups have a special manner of taking flight, and the sooner the collector becomes acquainted with the peculiarity of each, the more successful will he be, for a second stroke of the net is rarely afforded one in the case of flies, owing to their swift flight.

Bushy banks, especially those on which various wild flowers grow, are good hunting grounds for Diptera, and the species in these situations will all be found to take rapid flight, seldom returning to their resting place, unless they belong to the Syrphidæ, a family noted for hovering over flowers, especially during sunshine.

As a rule, the species preferring hot and sunshiny days for flight are more richly coloured and are more rapid on the wing than those which are to be found at all times in greater or less abundance.

The Syrphidæ, a few genera of the Stratiomyidæ, are the groups principally affected by the heat, and most likely to disappear with the sunshine.

Some species frequent fields where cattle graze, and the neighbouring woods, such as the Tabanidæ, Oestridæ, any many genera of blood-sucking Muscidæ; for these groups it is almost useless to search beyond the favoured localities.

One family, the Tipulidæ proper, is most plentiful on the borders of pools, marshy banks, and bushes growing, so to speak, in detached patches on large open spaces, though these latter should be sheltered in some manner, either by isolated groups of trees, the borders of a wood, or by being situated in a natural depression of the ground. After an evening shower this family is often abundant in such localities; I have often taken dozens on such occasions, where during the daytime it was difficult to beat a specimen from the bushes.

Many species are only to be found on dung, though in comparative abundance there; most of these thus taken will prove to be acalyptrate Muscidæ, the chief genera being *Drosophila*, *Pula*, *Limosura*, *Borbores*, *Tetanocera* and *Scatophaga* (two species of the last genus are abundant everywhere).

One brilliantly coloured genus of the higher Muscidæ, *Lucilia*, is often attracted by the odour of excrementitious matter, and I have occasionally taken *Asilidæ* on it.

The *Limnobiæ* and some other genera of *Tipulidæ*, the *Culicidæ* and *Chironomidæ*, chiefly frequent the banks of ditches or ponds, owing to the larva being aquatic, many species of these families are abundant on summer evenings, often unpleasantly so, usually collecting in small swarms and hovering over the waterside or beneath the lower branches of trees. Such are *Culex*, *Limnobia*, *Trichocera*, *Chironomus*, &c.

On reeds and the plants on the banks of ditches may be taken the pretty genus of *Tipulidæ*, *Ptychopteryx*.

Human habitations form the habit of no inconsiderable number of species, chiefly belonging to the *Anthomyiidæ*, a large sub-family of *Muscidæ*, over two hundred species of which are known to be British.

The *Phoridæ*, a small family following the acalyptrate *Muscidæ*, are, I believe, more often taken in houses than elsewhere.

I could probably compile a list of over fifty species taken myself in London houses, and Mr. Verrall, I believe, can increase this number to over seventy, but, in his case, though living in a country town, a more extensive range of species might naturally be expected.

Sweeping is a most excellent means of obtaining the smaller species of Diptera, and should be extensively employed, whilst beating is equally productive; both these methods should be practised at every opportunity.

I think I have now given a sufficient number of hints respecting the nature of localities likely to produce Diptera, and will conclude this part of the subject, by saying that, as a general, universal rule, Diptera are to be found everywhere and at all times.

Respecting setting, I must now make a few remarks, though the rules observed in the other orders of insects are applicable to the Diptera also.

It is better to pin all the specimens, but should any be earded, it is advisable to invert one or more of them, after subjecting them to a close examination, even to the minutest detail, so that no doubt can possibly exist of being the same species.

My experience teaches me, however, that in all cases, carding is better avoided, and the delicate pins now manufactured abolish the necessity of this questionable method of preserving Diptera.

When these extremely fine pins are employed, they



should be stuck into a small cube of white pith which is then gummed upon the end of a card, a stronger pin passing through the other end of the card, and the card raised up the pin to a convenient height. One of my objections to carding is the lack of uniformity of appearance noticeable in collections, owing to some entomologists pinning and others carding the same species.

(To be continued.)

## NATURAL HISTORY RAMBLES.

By H. WALLIS KEW, F.E.S.

No. I.—IN THE WOODS.

MANY afternoons have I spent in rambling about in Burwell Wood, which lies along the eastern foot of the Lincolnshire chalk wolds, not far from the little market town of Louth; on each occasion, however, some new point of interest presents itself—very often an insect, a shell, or a flower, not before taken there, is brought home.

Burwell Wood is mentioned by the celebrated Dr. Martin Lister in his "Historiæ Animalium Angliæ," dated 1678, where he records the taking of the pretty land-shell *Cyclostoma elegans*, which is still to be found in the locality. On page 123 of the old work mentioned above, the author, speaking of *Zonites fulvus*, says:—"I have found it more than once in moss at the roots of large trees in Burwell Woods, in Lincolnshire, yet the creature is very scarce." I have searched for this little shell, but am unable to find it now.

On the afternoon of the 4th of September, 1886, I had taken train to Authorpe Station for the purpose of walking home viâ Burwell Wood, and while going down the road, soon after leaving the railway station, a large wheel-shaped spider's web, such as are constructed by members of the family Epeirides, was observed hung from the foliage over the ditch by the hedge side. By beating the herbage and holding the net beneath the web, a fine female example of the extremely beautiful *Epeira scalaris* was obtained. As the prejudice against spiders, which have been much neglected by the general run of natural history observers, is so strong, it may be well to give a brief description of the colours of the species mentioned above, which is a large spider, females sometimes measuring eight lines. The abdomen of the female is very large, of a beautiful yellow colour, with a broad, clearly defined, rich brown band, with undulating edges, on the hind half of the upper side, which becomes narrower as it runs backwards. Along the same hedge another orbicular snare was noticed, this time with a garden spider (*Epeira diademata*) at rest in the centre.

Leaving the road and crossing over some fields, a pond was passed in which *Bythia tentaculata* appeared to be the most plentiful fresh-water shell; shortly after this Burwell Wood was reached, one or two notes being made on the way, viz. :—

A common blue butterfly (*Lycæna icarus*) seen on the yellow flowers of fleabane.

A sting-fly (*Heematopota pluvialis*, L.) seen, but fortunately not felt!

The celadine (*Chelidonium majus*) in flower by the hedge side in the village of Muckton. It was probably an escape from the cottage gardens.

*Zilla atrica* (= *Epeira calophylla*, Blackwall) abundant on holly and furze-bushes.

As soon as I had entered Burwell Wood a fine plant of the musk-mallow (*Malva moschata*) in full flower was found. My object was to cross the entire wood so as to arrive at Grisel Bottom, a very beautiful valley on the opposite side, one bank of which is wooded and the other grassy. While crossing the wood two specimens of the spider, *Epeira quadrata*, which is said to be the handsomest as well as one of the largest of British spiders, were obtained, together with another specimen of *Epeira scalaris*. The red berries of the woodbine were very conspicuous in the wood.

I now arrived at Grisel Bottom, and while going down its steep wooded side found dead shells of *Cyclostoma elegans*; the banks of this valley may have been the very place in which Dr. Lister found the shell in 1678. On flowers of Agrimony (*Agrimonia eupatoria*) here a ruby tail (*Chrysis ignita*) was observed, and curiously it was being preyed upon by a crab-spider (*Xysticus cristatus*).

On a thistle near, numbers of the peculiar larvæ of a tortoise beetle (*Cassida viridis* I believe) were noticed. In a moist place in the bottom of this valley, large brownish slugs (the variety *rufa* of *Arion ater*) were very plentiful amongst lesser spearwort (*Ranunculus flammula*), *Mentha aquatica*, and prostrate rushes. The money-wort (*Lysimachia nummularia*) was in flower here.

After leaving Grisel Bottom and while walking homewards round the border of the wood, a number of the common mouse-moths (*Amphipyra tragopogonis*), perhaps fifteen or twenty specimens, were found under the loose and partly decayed bark of an ash-tree. A specimen of the slug *Limax maximus*, var. *fasciata*, was also obtained under the same bark.

Louth, Lincolnshire.

WE are deeply grieved to have to record the death of an old friend, and an eminently able man, at a comparatively early age, Mr. H. M. Jenkins, F.G.S., the Secretary of the Royal Agricultural Society. In the earlier part of his life he was Secretary to the Geological Society.

## DEVELOPMENT OF FROG-SPAWN.

IN reference to an article which appeared in the June number of SCIENCE-GOSSIP on the development of the tadpoles of the common frog (*Rana temporaria*), I forward the following notes from my pocket-book, which may be interesting as comparing dates of development.

I took frog-spawn from a pond at Ashleigh, in

bottle was as lively as ever, though the water was perfectly warm.

In my pocket-book is a memorial inscription, "To the memory of ten tadpoles who died at the age of one month and a day. They lived a short and merry life, and died honourably, martyrs to the cause of science."

Not to be daunted, however, in my pursuit of tadpole-lore, I obtained some new specimens in exactly



Fig. 11.—Tuesday, March 23, 1886.  
Frog-spawn.



Fig. 12.—Saturday, March 26. First  
change noticed.



Fig. 13.—Sunday morning, March 27.  
Very occasional movement.



Fig. 14.—Sunday evening, March 27.  
Heads and tails brought together,  
terrific struggle after freedom.



Fig. 15.—Monday, March 28.  
Several free, but quiet and  
stupid. Entirely black.



Fig. 17.—Monday, May 3. Eyes visible from  
under side of tadpole.

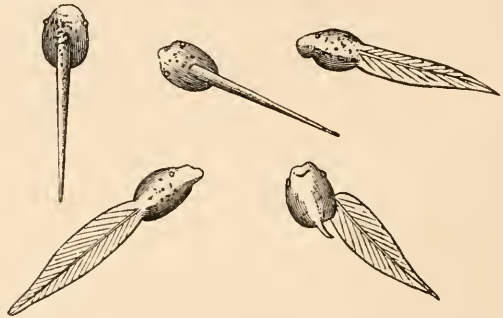

Fig. 16.—Friday, April 23. Very lively. Black, spotted with gold.

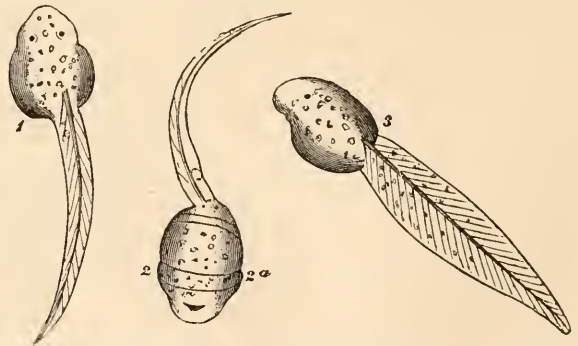

Fig. 18.—Thursday, June 3. Beautifully splashed with gold, eyes not  
visible from under side. 1. Upper side. 2. Under side. 2a. Blood-red  
band. 3. Side view.

Wiltshire, on March 23rd of last year. The following sketches, life-size, denote the changes as I observed them, the spawn being placed in a large glass preserve-bottle.

There occurs a break in my notes, occasioned by the untimely death of my tadpoles. Thinking that they would enjoy the sun, I placed the bottle on a sunny window-sill with the deplorable result, that the tadpoles were cooked.

A *Lymnaea minuta* which had occupied the same

the same stage of development as my late lamented protégés. They were much wilder and more active than the others (alas! perhaps in better health) and I had great difficulty in drawing them with any accuracy.

Since the accident I kept the tadpoles out of doors in the shade, only feeding them by changing the water every other day. As their development was slow, I did not again sketch them for a month.

They were then in size as drawn at Fig. 18.

On Friday, June 4th, for the first time, I gave them a meat diet, consisting of raw liver of fowl, which they appeared to relish, and clung to in the way described by your correspondent. This was in the evening. Some raw mutton given them next morning (the 5th) they almost left alone.

I awaited with impatience the wonderful transformation into the full-blown frog.

Did those gigantic Batrachians of old, such as *Cheirotherium labyrinthodon*, go through similar progressive stages! If so, one trembles to think of their tadpoles!

NINA F. LAYARD.

ASTRONOMY AND METEOROLOGY.

By JOHN BROWNING, F.R.A.S.

AT the meeting of the Royal Astronomical Society, held on November 12, Mr. Knobel drew attention to a photograph of the ring nebula in Lyra, in which it appears as elliptical in outline, with a marked decrease in intensity at the extremity at the major axis. A paper was read by Father Perry, written by Mr. A. Cortis, of Stonyhurst, on bands observed at the red end of the spectrum of sun spots.

Mr. J. Roberts read a paper on stellar photography which he illustrated by a number of photographs enlarged from the original negatives. Amongst them were some of a portion of Cygnus. The negatives were taken with a reflecting telescope twenty inches aperture. The enlargements contain an average of ninety-one stars to the square inch. Mr. Roberts photographed the Pleiades group, giving an exposure of three hours, and found the stars, Maia, Alcyone, Electra, and Merope, all surrounded with a nebulous haze, and that the space between these stars and others of the group is filled with nebulous light in streamers or fleecy masses.

Mr. Maunder gave some account of his observations of the recent solar eclipse in the West Indies. Dr. Schuster obtained two spectroscopic photographs, one with the slit radial, and one tangential, and he also obtained five photographs of the corona. Mr. Maunder obtained seven photographs of the corona. It becomes increasingly evident that the future of astronomy lies with photography. In this connection a most important proposal has been made by Dr. Gill to Admiral Mouchez, that an International Congress of Astronomers shall be held in the spring of 1887, in order to arrange a scheme for making a photographic survey of the whole heavens. This proposal has met with general adherence, and a date for the meeting of the congress will shortly be named. The scheme is of the most extensive character, as it is proposed to photograph all the stars visible in telescopes of very large aperture. These will probably form an atlas of fifteen hundred to sixteen hundred maps.

Mr. J. E. Gore has been making further observations of a reddish star of about the sixth magnitude near  $\chi^1$  (54) Orionis, and finds from an examination of its spectrum that it is probably a remarkable variable star. Later observations have clearly established that it is a regular variable star with a period of about a year. In July the magnitude had diminished below the twelfth, while on the 14th of September, it had considerably increased in brightness again. The magnitude was then nearly the ninth, and by the end of October, it had become about 8½. It was still increasing, and probably attained its maximum in December. This star should be carefully watched during the winter months, to establish its exact period.

In February, Mercury will be an evening star in the latter half of the month.

Venus will be an evening star throughout the month.

Mars will be an evening star, and will be near and Venus.

Jupiter will be nearly stationary between Virgo and Libra.

There will be no occultations or other celestial phenomenon of interest visible at Greenwich during the month.

*Rising, Southing, and Setting of the Principal Planets at intervals of Seven Days.*

	D.	Rises. h. m.	Souths. h. m.	Sets. h. m.
MERCURY ☿ . . . . .	5	7 46M	0 13A	4 40A
	12	7 43M	0 35A	5 27A
	19	7 34M	0 55A	6 16A
	26	7 20M	1 11A	7 2A
VENUS ♀ . . . . .	5	8 15M	1 16A	6 17A
	12	8 3M	1 21A	6 39A
	19	7 52M	1 26A	7 0A
	26	7 36M	1 30A	7 24A
MARS ♂ . . . . .	5	8 17M	1 24A	6 31A
	12	7 58M	1 17A	6 36A
	19	7 41M	1 10A	6 39A
	26	7 22M	1 2A	6 42A
JUPITER ♃ . . . . .	5	0 14M	5 15M	10 16M
	12	11 43A	4 48M	9 49M
	19	11 16A	4 21M	9 22M
	26	10 48A	3 53M	8 54M
SATURN ♄ . . . . .	5	2 1A	10 10A	6 24M
	12	1 32A	9 41A	5 54M
	19	1 3A	9 12A	5 25M
	26	0 33A	8 43A	4 57M

*Meteorology.*—Serious illness prevented me from writing my usual paper on Astronomy and Meteorology for the December number of this journal. In the present I have given all of interest or importance that has been done in the astronomical world, but the meteorology of November would now possess but little interest. The meteorology of December was,



however, so exceptional that I must refer to that as briefly as I can, and then give an abstract of the meteorology of 1886.

At the Royal Observatory, Greenwich, the mean reading of the barometer for the week ending December 4, was 29.74 in. The mean temperature of the air was 37.3 deg., and 4.3 deg. below the average in the corresponding weeks of the 20 years ending 1868. The general direction of the wind was south-west, and the horizontal movement of the air averaged 13.1 miles per hour, which was 0.6 above the average in the corresponding weeks of 16 years. Rain fell on two days of the week to the aggregate amount of 0.30 of an inch.

The mean reading of the barometer for the week ending December 11, was 29.13 in. The mean temperature of the air was 42.6 deg., and 0.1 deg. below the average in the corresponding weeks of the 20 years ending 1868. The general direction of the wind was south-west, and the horizontal movement of the air averaged 23.6 miles per hour, which was 10.9 above the average in the corresponding weeks of 16 years. Rain fell on six days of the week, to the aggregate amount of 0.84 of an inch.

The mean reading of the barometer for the week ending December 18, was 29.32 in. The mean temperature of the air was 38.3 deg., and 2.8 deg. below the average in the corresponding weeks of the 20 years ending 1868. The direction of the wind was variable, and the horizontal movement of the air averaged 14.5 miles per hour, which was 1.6 above the average in the corresponding weeks of 16 years. Rain fell on five days of the week, to the aggregate amount of 0.67 of an inch.

The mean reading of the barometer for the week ending December 25, was 29.72 in. The mean temperature of the air was 32.2 deg., and 7.3 deg. below the average in the corresponding weeks of the 20 years ending 1868. The general direction of the wind was south-west, and the horizontal movement of the air averaged 11.5 miles per hour, which was 1.2 below the average in the corresponding weeks of 16 years. Rain fell on two days of the week, to the aggregate amount of 0.34 of an inch.

For the week ending January 1, 1887, the mean reading of the barometer was 29.89 in. The mean temperature of the air was 32.7 deg., and 5.9 deg. below the average in the corresponding weeks of the 20 years ending 1868. The direction of the wind was variable, and the horizontal movement of the air averaged 11.6 miles per hour, which was 1.1 below the average in the corresponding weeks of 16 years. Rain or melted snow was measured on four days of the week, to the aggregate amount of 1.47 of an inch.

The weather of last year possessed little interest in the first few months. We had a long dreary winter and a cold cheerless spring. Summer also was cold and backward, but as it advanced there were short fitful bursts of intense heat until the beginning of October.

The early part of autumn was mild, but December brought us most exceptional weather. Storms, frosts, and floods showed us something of the good old-fashioned winter which unthinking people often sigh for. On the 26th of December we had a snowstorm of almost unexampled severity, more general and destructive than any we have experienced since the 18th of January, 1881.

The following Table is compiled from the observations published in the Daily Weather Report of the Meteorological Office.

Months.	TEMPERATURE.				RAINFALL.			
	Highest Observed.	Lowest Observed.	Mean for the Month.	Difference from the Average.	Rainy Days.		Total Fall.	
					Number of Rainy Days.	Difference from the Average.	Total Fall.	Difference from the Average.
	Deg.	Deg.	Deg.	Deg.			In.	p.ct.
January..	53	18	36.6	-1.9	22	+6	3.52	+60
February.	49	22	34.5	-6.7	9	-7	0.54	-71
March...	64	21	40.6	-2.3	13	+1	1.14	-20
April.....	70	34	48.1	-1.6	14	+1	1.37	-26
May.....	76	29	53.5	-0.6	19	+7	4.42	+155
June.....	78	42	58.9	-2.0	9	-4	0.82	-61
July.....	86	45	63.1	+0.9	12	-2	2.50	+15
August....	87	46	63.4	+0.1	12	-1	0.79	-64
Sept.....	85	40	60.3	+1.6	10	-5	1.74	-33
October...	80	39	54.2	+3.1	17	+1	1.85	-32
November	60	28	44.3	+1.8	15	-2	2.96	+38
December	54	19	37.3	-2.2	20	+6	4.72	+22
Values for the Entire Year.	87	18	49.6	-9	172	+1	26.37	+5

From this table it will be seen that the thermometer reached a maximum of 87° in August, and a minimum of 18° in January. This is the lowest minimum recorded since 1881. The aggregate rainfall for the year was 5 per cent. above the average. The number of very cool days was much larger than any year since 1879. This caused a considerable increase in the number of deaths due to diseases of the respiratory organs, which were more numerous than in either of the three previous years. The winter, instead of commencing in December and ending in February, commenced in September and continued till March. The observations of bright sunshine made at Greenwich show that the winter season was more cloudy than any since 1879. The mean temperature of the spring was below the average in all parts of the kingdom. During the week ending the 10th of July there was a short spell of tropical heat. The amount of bright sunshine registered at Greenwich during the summer was, with the exception of 1885, greater than in any year since 1877. Thunderstorms were very frequent; those of the 19th of July and the 13th of August being the most severe. The mean temperature of the autumn months was much above the average; a maximum of 80° was registered in London on the 4th of October. The rainfall in the

autumn was below the average, while the duration of bright sunshine was considerably above the average. The winter season which we are now experiencing is exceptionally tempestuous and was due to a deep barometrical depression, which in the centre reached 27.4 inches. In London the minimum reaching 28.3 is the lowest recorded since 1843.

#### RECENT ARTICLES AND PAPERS WORTH READING.

**D**R. CROOKSHANK'S "Flagellated Protozoa in the Blood of Diseased and Apparently Healthy Animals" (December No. "Journal Royal Microscop. Society").—"Fresh-water Invertebrates of the North America Jurassic," by Charles A. White ("Bulletin U.S. Geological Survey," No. 29).—"De l'Histoire des Lampes à Incandescence" ("L'Ingénieur Électricien," December 9th).—"Ancient Pottery of the Mississippi Valley," by W. H. Holme ("Proceed. Davenport Acad. Nat. Sciences").—"On Hydrophobia," by Dr. Tyson ("Proceed. Folkestone Nat. Hist. Soc.").—"The Connection in Time of Changes of Fossil Floras with those of Faunas," by Professor Boulger ("Proceed. Geologists' Assoc.," vol. ix. no. 7).—"Report on the Necessity of Preserving and Planting Forests," by R. W. Phipps (Pub. by Government of Ontario).—"On the Structure and Organisms in Carboniferous Limestone," by Ed. Wethered ("Geo. Mag." December).—"Strasburger on Foreign Pollination," by Thos. Hick ("The Naturalist," Dec.).—"On some Further Evidence of Glaciation in the Australian Alps," by Jas. Stirling ("Nature," December 23).—"The Sympathetic Nervous System," Lecture by Dr. W. H. Gastall ("Nature," December 23).—"Siliceous Pig Iron" ("Engineering," December 24).—"The Ruby Mines of Burmah" ("Times," December 31).—"The Future of Photographic Printing," by George Mansfield ("Amateur Photographer," January 7).—"De la Conservation des Vertébrés," by M. Gaston Buchet ("Feuille des Jeunes Naturalistes," January 1).—"On Noctiluca Miliaris," by Alfred W. Griffin ("Journal of Microscopy," January).—"On Some Spined Myriapods from the Carboniferous Series of England," by Dr. Henry Woodland ("Geological Magazine," Jan.).—"The River Tees, its Marshes and their Fauna," by R. Lofthouse ("The Naturalist," January).—"A B C, an Alphabetical Research," by J. Eyre, M.A. ("The Garner," December).—"Sun-Spot Observations in Hungary," by A. M. Clarke ("Nature," January 6).—"Progress of Electric Motors" ("English Mechanic," January 7).—"Notes on the Genus *Lycæna*," with coloured plate, by Richard South ("The Entomologist," January).—"On Some Darwinistic Heresies," by Professor Carl Vogt ("Annals of Natural History," January).

#### A WINTER'S DAY RAMBLE.

MONTREUX, CANTON VAUD.

**T**HE following notes from the lake-basin of Geneva may interest some readers of SCIENCE GOSSIP, made chiefly in the sheltered woods at the more mountainous end of the lake, and in the depth of winter.

The magnificent peaks of the Valais and Vaudois Alps have long since received their covering of pure snow. Deep drifts have accumulated in the accustomed places—under the abrupt precipices of the Tour D'ai, for example—there, in a gully partially exposed to driving winds, enormous masses of snow remain through winter. All the winds of heaven contend furiously round the peaks above, but in the sheltered woods, ravines, and silent gorges of the lower mountain barriers the air is perfectly still. Sharp frosts seal the ground, while overhead the sky is intensely blue and the mid-day sun shines with uninterrupted power. The dead leaves, twigs and branches are dry as bone (the elevation is 1200–1500 feet above the sea), affording a marked contrast to English woods at the same season, reeking with moisture and damp mould.

Here, in the bright, clear sunshine, it is worth while, standing in perfect stillness for a quarter-of-an-hour to observe the variety of birds actively flitting from tree to tree, busily in search of food and wellnigh careless of the approach of man: the most remarkable of the merry songsters is, perhaps, the crested tit (*Parus cristatus*), commonly distributed over Central Europe, but a rare visitor, I believe, in England. A dozen may here be seen hopping about in the thick brambles, for all the world like miniature owls with wise little faces; the feathers of the crest turn backwards over the head, and are black tinged with white—the back and wings are brown, the throat and chest pale brown or fawn, rings of dark and light feathers surround the eyes, which, with the speckled head, give a very singular appearance to the bird. Besides this species, the coalit (*Parus ater*), the titmouse (*P. cæruleus*), the great tit (*P. major*), and the long-tailed tit (*P. caudatus*), all frequent these same woods. *P. ater* runs round the trunks and branches silently and actively; like the tree-creeper, he habitually contrives to place the thickness of the trees between himself and inquisitive gazers.

Fairly common also is the nut-hatch (*Sitta Europæa*), which by the uninitiated may easily be mistaken for a small woodpecker. The slate-blue of the back and wings, with dull red breast, and whitish throat and patches of black behind each eye, however, render the plumage quite distinct. The shape of the bird is peculiar, well adapted to tree-climbing in search of insects—apparently an incessant occupation and chief vocation in life.



In times of exceptional cold certain finches hunt in droves, rendered daring by scarcity of food. I have thus met with a score of rich coloured bull-finches, gold-finches, and the mountain-finches, in separate flocks restlessly flitting across open spaces. The great green woodpecker (*Geococcyx viridis*) is a regular denizen of the woods, to be recognised by his peculiar cry even when invisible to the eye. The black woodpecker and small spotted (*Picus minor*) are more rarely seen. "Tap, tap," one hears on the bark often enough, but the birds hide themselves.

I have a passing acquaintance with a most audacious magpie in this neighbourhood. Each spring during the last four years the same pair have re-occupied the same nest, built at the extreme top of a cypress tree. The one bird I do not know

beeches. I am not acquainted with the specific name of the insect, which doubtless belongs to the Cynipidæ or gall-making tribe. Opening a perfect specimen of gall I found in it a single white maggot—the cherished morsel of the cole-tit. A microscopic section of the shell appears to show that the growth on the leaf retains the cell-structure of the plant.

Infesting the Austrian pines, and frequently stunting the branches, are found the curiously constructed webs of the processional moth (*Cnethocampa processionea*). The oval structure, perhaps five inches across the longest diameter, is cunningly made from a tangled mass of spun glass-like threads, secreted by the caterpillar. It is artistically fitted on at the axil of branch and stem, interwoven with the leaf-spines. A circular opening is left for the egress of the larvæ

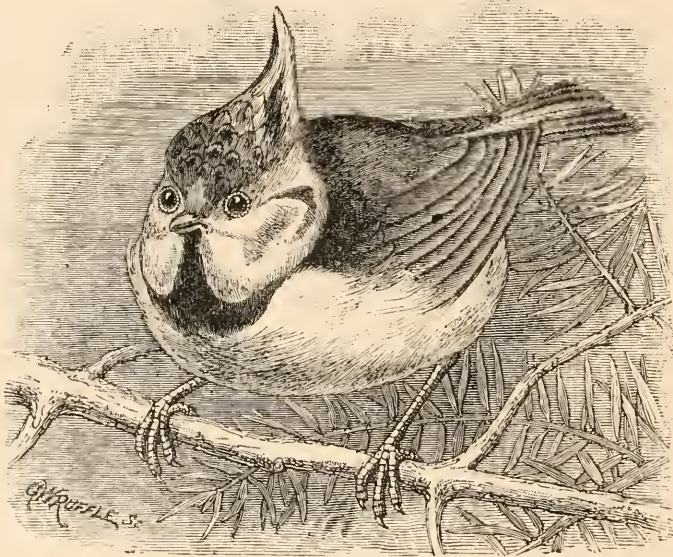

Fig. 19.—The Crested Tit (*Parus cristatus*),

much about; he always flies off when disturbed. The other is far more sociable, blinks its eyes, talks volubly and hops about at a circumspect distance. In an imperfect manner I have learned its jargon and often keep up a running conversation across the wall. Magpies and jays are very common; there are no destroying keepers on the watch. The water-ouzel, or dipper, may always be encountered on the shore of the lake below. He dodges among the loose stones, takes freely to the water, diving instantaneously at the approach of giants or uncouth monsters such as men.

The *Parus ater* attracted my attention by its diligent search among the beech-trees. Some hard substance was detached to be at once split in half by the sharp bill. Beneath the trees lay the empty cases, the remains of a conical gall growing on the

in their own peculiar manner, in the forthcoming spring or summer. Great numbers inhabit a single web. At the appointed season they wish to view the world. By means of a suspended thread the whole family reach the ground, at once starting in solemn procession, which nothing short of extermination will arrest. You may meet a regular line on the march and fail in every attempt to interrupt their progress. Sever the thread and a repair is at once effected. Place them on your hat, and the steady course is pursued in an endless circle, apparently in all content. The hairy glands secrete an irritant poison, causing inflammation to human flesh, almost dangerous with regard to children, and to be avoided by all. Although the caterpillars are common in Switzerland, it is a mystery what becomes of them all. They meander off and vanish; few of the pupæ seem to



attain full development, and the moth is exceedingly rare. A noted Swiss collector has informed me he could never himself catch a specimen, and had only obtained them for his great collection by exchange. Considering the quantity of eggs which must be deposited, this is singular. There are two species of the genus. The caterpillars of the one (*vide* figure)

finding this reptile in the torpid condition. I live in hopes of digging him out some day, to study his surroundings and degree of insensibility.

The common little brown lizard (*L. muralis*) is also now asleep. One warm day in late autumn I caught a baby specimen, barely two inches long. At home, on severing the spinal cord, the blood corpuscles,



Fig. 20.—Nest of the Processionary Moth (*Cnethocampa processionea*).

march in single, double, or triple line; the other species march in pyramid form.

I know a spot where the handsome green lizard (*Lacerta viridis*) has arranged his winter quarters, to hibernate until the return of the warm spring. Under a heap of stones and burrowed beneath the very foundations of a solid wall he lies snugly hidden away, tolerably secure from invasion. As far as I am aware, naturalists have not yet succeeded in

oval and large in comparison with my own, afforded a fine object for the microscope. Sections of the spinal-column, the nerves in the forked tongue, and the brilliant plates covering the skull all form attractive slides; the plates or scales appear five or six-sided, dovetailing one into the other very beautifully. The opal-like iris, under a low power properly illuminated, is a magnificent object, and the crystalline lens very perfect. If violently agitated through fear, the

little fellow quickly sheds his tail, which retains muscular action for an hour or more. The full-grown ones I do not believe can develop a fresh appendage, but the very young specimens I am not so sure about; in fact I think they may grow again. In support of this view, scores of full-grown lizards are seen minus the tail; a young one—never. Yet they must often cast them.

The small brown lizard is susceptible to sound and influenced by a fixed stare. To prove this:—On one occasion I forced one to remain fully a quarter-of-an-hour, lying on a wall, to be sketched. This was simply by whistling in a low key and steadily rivetting his eye. Directly I removed the fixed gaze and stopped whistling, the lizard disappeared over the wall. It would have been perfectly easy to hold him stationary for another equal period.

I cannot leave the woods without a reference to the beauty of autumn berries hanging well on into the winter. The clusters belonging to the guelder rose (*Viburnum opulus*) retain the cymes of transparent crimson fruit. The orange-scarlet calyces of the winter cherry (*Physalis alkekengi*) are still creeping on the ground, some decayed to a network showing the orange berry within. The spindle (*Euonymus europæus*) capsules of coral-pink have expanded, to show the contrast in colour with the berry inside. (In gardens below, the *E. japonica* is in fruit, nearly like that of the common spindle.) Bryony, tamus, privet, with splendid branches of butcher's broom (*Ruscus aculeatus*), covered with large crimson berries, still remain. Higher up in the woods, where limestone crags form a sheltering, perpendicular barrier, the crevices are clothed with numberless fronds of the lacy fern (*Asplenium fontanum*), now extinct, I fear, in Britain. *A. viride* is also found, a remarkable intermediate variety; also appears, *A. fontanum minus*; this, I think, is a hybrid between the other two species.

A tiny spring trickles forth from the rocks. In the midst of this, clinging in thick tufts to the face of the cliff, great masses of moss luxuriate. The species (*Ilypnium commutatum*) is of large growth, and otherwise worth inspection. Instead of being soft and yielding to the touch, the framework of each frond and branchlet is gritty and rigid; the cryptogam has absorbed the calcareous particles from the water. The *Marchantia polymorpha* also grows in great perfection, coating the moist stones. But one observer cannot describe the hundredth part of the organic life revealed so lavishly on every side. Fungi, land mollusca, colcoptera, larvæ, representatives of classes and orders seem abundant.

Christmas, 1886.

F. G. S.

P.S.—Since writing the above, a full-grown brown lizard has been shown to me, having a knotted joint in the middle of the tail. It is evidently a new growth from the joint; whether re-developed when the animal was young or not, I cannot say.

## GOSSIP ON CURRENT TOPICS.

By W. MATTIEU WILLIAMS, F.R.A.S., F.C.S.

**PRESERVATION OF TIMBER BY WATER.**  
—Builders and all others who are interested in the preservation of timber should understand the particulars of a discovery recently made by Professor Poleck, viz., that timber which has been long immersed in water is thereby rendered free from ordinary liability to dry rot. The water slowly dissolves out the nutritious albumen and salts of the wood, and thus deprives the fungus of its necessary food. In most of the mountainous timber-growing countries this immersion is obtained by the ordinary mode of transport which is that of felling the trees, then sliding them down the mountain slope into a torrent below, which tumbles them forward to a wider tributary, and this again carries them to a main river where they are collected and made into rafts, which slowly float with the aid of a little steering until they reach the estuary or depôts on the river side, where they are collected and shipped, or otherwise carried, to their final destination.

In the greatest timber district of Norway the mode of transport is simpler even than this. Trees and deals and planks, the latter sawn by water power near their place of growth, are pitched into torrents, lakes and tributaries, and thence float into the broad Drams Elv down which they slowly drift to the timber metropolis, Drammen; a longer town than the "lang town o' Kirkaldy," as it consists of little more than one street, a double row of houses three or four miles long with the broad river running down the middle. Each piece of wood is marked with the owner's brand, travels "on its own hook," independent of rafter, till it reaches this long street where it is shipped. I have seen parts of the river above Drammen about as wide as the Thames at Woolwich, so completely paved with floating timber that one might walk across it. Men are employed all along the banks to push stranded erratics back into the river. The result of this slow floating, especially to sawn deals, is a complete washing out of the fungus food above named.

Those who doubt the preservative action of water may try a simple experiment. Take two portions of sawdust from freshly cut timber, bury one in damp earth at once, but let the other be soaked for a week or two in an abundant quantity of fresh water; then bury this. The first example will rot away in a few years, the second will suffer no other change than a darkening of colour.

**NEW USES FOR SOLID CARBONIC ACID.**—The discovery of the possibility of solidifying carbonic acid is sufficiently recent to come within the reach of my recollection. I well remember the famous popular lecturer, Mr. Addams ("double d Addams," as he was called by way of distinction), promising to show



us, his audience, the snow-like solid at his next lecture, and how he fulfilled his promise by appearing in miserable plight with bandaged head and face, due to the explosion of a Thilorier cylinder he had used. He narrated the accident, attributing it to insufficient thickness of the cylinder, but he had now another stouter cylinder similarly charged in front of the lecture table which he hoped would resist the pressure. The front benches of the theatre were cleared forthwith, in spite of his hope.

It has remained merely a scientific curiosity nearly ever since, but now promises to become very useful. Messrs. Raydt and Kunheim produce it in Germany commercially, and hope to profit by its applications to the charging of beer in the cask, to the manufacture of aerated waters of all kinds, by simply introducing the necessary quantity of the snow which expands, and at once produces the required aeration. It is a most efficient fire extinguisher. A suitable vessel containing it and flung into the fire explodes when heated, and diffuses all around an atmosphere of carbonic acid gas in which no combustion can occur. For various purposes, where great compression is demanded, it may be used with very simple appliances. The Krupps find that a heat of  $360^{\circ}$  applied to it gives the enormous pressure of 1200 atmospheres. It may be used instead of compressed air for the raising of sunken ships.

CONDENSATION OF GASES.—Until nine years ago the old descriptive distinction between permanent gases and condensible vapours still remained, but on the 24th December, 1877 its lingering existence was finally extinguished by the announcement to the French Academy of Science that oxygen gas had been liquefied by two independent experimenters, M. Cailletet a French ironmaster, and Raoul Pictet a Swiss manufacturer of ice machines. The other gases, which up to this date had resisted all attempts to condense them, were speedily overcome, and now we may say every element may be a solid, a liquid, or a gas, according to the temperature and pressure to which it is subjected. The chief agent in obtaining these successes is ethylene, a liquid that boils at a temperature of  $-238^{\circ}$  F., i.e. 270 degrees below freezing. In the act of boiling it absorbs much heat, robs all its surroundings and cools them down as water cools the surface of our boilers by its evaporation. When thus cooled down to  $184^{\circ}$  below freezing, chlorine forms orange coloured crystals; at  $232^{\circ}$  below freezing, ether solidifies; at  $234^{\circ}$  absolute alcohol is a solid; at  $331^{\circ}$  liquid oxygen boils; at  $344^{\circ}$  air is liquid, and it boils in vacuo at 369 degrees below freezing. The lowest temperature yet obtained is  $-373$  F., or  $395^{\circ}$  below freezing. The absolute zero is supposed to be  $-459^{\circ}$  F. I say "is supposed," not that I suppose, my own supposition being that we know nothing about absolute temperature, or absolute anything else.

SEA AIR.—Professor F. S. Dennis, of New York, states that in the course of a trip across the Atlantic he made some experiments on the air about 1000 miles distant from land. He exposed capsules of sterilized gelatine for 15 minutes. No. 1 in the State Room upon the main deck of the steamer; No. 2 and 3 in a cabin on the promenade deck where the circulation was free; and No. 4 over the bow of the ship. Within 18 hours 500 points of infection had developed in No. 1; only five and six in Nos. 2 and 3 after ten days; and none at all in No. 4. By "points of infection" he means of course, bacteria, bacilli, or some kind of microbia, that may or may not be poisonous. The absence of such possibly mischievous forms of life over the sea, and as Tyndall has shown over the higher ground of the Alps, is very interesting, but we should not overrate its importance. The simple fact that an hour or two after most vigorous tooth brushing anybody may scrape myriads of microbia from his teeth, and tongue and palate—and most of these "comma-shaped"—should teach us not to be panic-stricken by the rapid generation of large numbers in experimental gelatine. A single whiff of the breath of the experimenter himself is sufficient for the establishment of a flourishing colony. If Professor Dennis had stood for 15 minutes at the bow of the ship with one capsule 2 or 3 feet forward of his face, and another behind his head he would probably have found a great difference between them, due to his own exhalations.

SUCCESSFUL OYSTER CULTURE.—The report of Mr. Saville Kent, Superintendent and Inspector of Fisheries to the Tasmanian Government, is very satisfactory. The success of the oyster beds is complete, and this success appears to be due to the fact, that the Tasmanian Government has put the right man in the right place. Everybody who knew Mr. Kent when in England knows that he is a devoted student of the subject in which he is now officially engaged. His report shows that oysters may be sown and reaped as reliably as potatoes, i.e. with only rare occasional failure. But to obtain such success the sower must understand his business, must select suitable places for the beds, where there is moving water containing sufficient food, and where proper arrangements are made for catching the spat in such wise that it shall not be smothered with sedimentary mud. The spat collectors used by Mr. Kent are cheap wooden frames that may be rocked or lifted to shake away the sediment. They are fully described in the report.

The present oyster famine in the British Isles is a national disaster and disgrace. The ancient Romans sent to Britain for their oysters and now we cannot supply ourselves, but are dependent on Portugal, Holland, and the United States. In a few years hence we shall probably import tinned oysters from



Tasmania. I remember when the retail price in London was sixpence per dozen for the best natives, and fourpence for large common oysters. Large profits were made at these prices. The present price of natives is 3s. 6d. per dozen. We have tens of thousands of acres of fine oyster ground on the coasts of England, Scotland, Wales, and Ireland, where millions of bushels might be annually raised, if proper means were adopted. All this would be newly created wealth for the nation, in the production of which many thousands would be most healthily employed. Nothing but ignorance and lack of enterprise stands in the way of the development of this most desirable industry.

THE CANALS OF MARS.—No astronomer has yet succeeded in supplying a satisfactory, or even a plausible explanation of these curious features of this planet. They appear as nearly straight lines, apparently cuttings with perfectly parallel borders stretching across the continents of the planet and reaching from sea to sea. They are about 15 miles wide. We have nothing like them on the earth, nor does the moon present any such phenomena. They were first observed by Schiaparelli, whose observations have since been confirmed by M. Perrotin with the great equatorial of the Nice observatory, and further verified by MM. Trepied and Thillon.

CLEAN AND DIRTY PIGS.—The American Consul at Copenhagen has been studying pigs, and has reported some of the results of his investigations. One of these is that their powers of mastication are small, so small that if fed with whole corn not more than half of it is available as food, the other half passing away in an undigested form. Therefore all such food for pigs should be boiled or steamed; or ground or bruised, and well soaked. Roots should be sliced. Peas should be allowed to sprout and be then bruised. A number of other instructions are given which the reader who is practically interested in the subject may find specified in the *Journal of the Society of Arts* of August 27th, 1866. The following is very interesting. Six pigs of equal weight were fed for seven weeks on a uniform diet. Three of them were daily cleaned with a comb and brush, the other three left in an unclean state. The three clean pigs gained 30lbs more weight than their dirty brethren. In another farm in Denmark, where the pigs were washed daily, there was not a single case of hog disease during three years, although it was very prevalent in the neighbourhood. The Danes are doing well in the pig business. When Jesse Collings's millennium is attained in this country, when every rustic shall have a minimum freehold of three acres and a cow, we shall be independent of Chicago and all other foreign sources of pork and bacon supply, for it is the cottager's pig that enjoys in the highest degree those blessings of civilisation which

adds 20 per cent. to his final result in bacon-value. I have seen and smelled wholesale pig farms in the suburbs of London that are spectacles of filthy horror, have admired the pigsties of Welsh and Irish cottagers, and have caressed their sleek inhabitants, after witnessing the tubbing and scrubbing so diligently administered to them by the mother of all the family, biped and quadruped. I can now purchase in London, Chicago hams at 6d. to 7d. per lb. retail, but must pay 9d. to 10d. for Irish hams, or about one shilling for York hams. All these dearer hams (and they are fully worth the difference of price) are derived from cottagers' pigs, pigs that dwell in clean comfortable homes and live in a condition of personal cleanliness.

---

#### OUR SCIENTIFIC DIRECTORY.

*Alton Microscopical Society*: President, Rev. F. Howlett; Hon. Sec. and Treasurer, Rev. J. Vaughan.

*Chorley Microscopical and Natural History Society*: President, J. A. Harris, Esq., M.D., Chorley; Hon. Sec., Richard Gill.

*Harrogate and District Naturalist and Scientific Society*: Patron, The Right Hon. Lord Walsingham, M.A., F.L.S., F.E.S., F.Z.S., M.B.O.U., etc. (Ex. Pres. Yorkshire Nat. Union); President, Mr. Wm. Storer; Hon. Sec. and Treasurer, Mr. F. R. Fitzgerald, F.S.Sc., etc., Clifford House, Harrogate.

*Lancashire and Cheshire Entomological Society*. [Meets last Monday in each month in the class-room of the Free Public Library, Liverpool.] President, S. J. Capper, F.L.S.; Hon. Secretary, John W. Ellis, L.R.C.P., F.E.S., 3 Brougham Terrace, Liverpool.

---

#### SCIENCE-GOSSIP.

WE understand that Mr. S. H. Vines is entirely recasting and almost entirely rewriting his edition of Professor Prantl's "Elementary Text Book of Botany," and that his new work may be expected from Messrs. Swan Sonnenschein & Co. in the course of this year. In the meantime the publishers are reissuing the existing book without alteration.

THE churches are rousing themselves to the value of scientific knowledge. A Society has been formed for the purpose of promoting intercourse among Wesleyan students of science. The basis and objects of the Society are not denominational, its intention being purely to bring into association with one another those members of the Wesleyan Church who are interested in scientific studies; hence it will be worked mainly by those who are attached to that church. The chief objects of the Society will be

the encouragement of practical scientific work among amateurs, the guidance of beginners in the study of natural history, the interchange of opinions upon scientific questions, and the collection and circulation of useful facts and observations bearing upon the sciences in general. It would be shown, too, that scientific tastes are not the exclusive possession of the religiously indifferent or the agnostic. The Journal is to be under the joint editorship of the Rev. Dr. Dallinger and Rev. Hilderic Friend.

WE are pleased to notice that a Microscopical Society has been formed at Alton, Hampshire, the Rev. F. Howlett being president.

MR. J. W. CHAMBERS, of the Board Schools, Ponton Road, Nine Elms, asks our readers to send him for his School Museum any natural history duplicates. We should be glad to see a Natural History Museum in every Board School in the country, and we are sure our readers will be only too glad to help to stock them.

WE are sorry to have to record the death of Mr. J. A. Phillips, F.R.S., the well-known chemical geologist, at the age of 64.

AN Australasian Association for the Advancement of Science has just been founded in Sydney. It will hold its first meeting next September—the 100th anniversary of the founding of the colony of New South Wales.

WE have received No. 79 of Mr. Wesley's useful "Natural History Scientific Book Circular."

THE "Sheffield Daily Telegraph" of January 4th has a paragraph about a man being killed at Little Lever, by the fall of an immense stone on the roof of a colliery, supposed to be a meteorite. This is too important a matter to be allowed to die the ordinary natural death of a "fill-up par." Can any of our correspondents about Little Lever send us a bit of this "immense stone" for diagnosis?

WE are very pleased to observe that Lord Salisbury has placed Mr. Thos. Bolton, the well-known and laborious caterer in microscopic natural history, on the Civil List Pension of £50 a year.

DURING January, Dr. J. E. Taylor, editor of SCIENCE-GOSSIP, lectured on behalf of the Chelmsford Museum, on "Australian Animals and Plants;" at Saxmundham, on "The Story of a Flint Pebble;" at the Windsor Institute, on "The World before Man;" and at Manningtree, on "The Deep Sea and its Inhabitants."

A "METEOROLOGICAL SOCIETY OF AUSTRALASIA" has been successfully founded at Adelaide.

OUR American brethren have started a "Journal of Morphology," and Mr. W. P. Collins, 157 Great Portland Street, is agent for England.

MR. THOMAS MOORE, the well-known botanist and horticulturalist, whose books on ferns have delighted more than one generation, has just died, aged sixty-seven.

WE are pleased to notice that Mr. Clement Wragge, who did such splendid work at the Ben Nevis Observatory, has been appointed Government Meteorologist for Queensland.

MR. L. UPCOTT GILL has completed the issue of his useful sevenpenny numbers on "Fancy Pigeons" and "British Cage Birds."

## MICROSCOPY.

A PHENOMENON IN ANILINE STAINING.—In the summer of 1884 I mounted several slides of desmids, *Spirogyra*, and other Algae from our Sutton Park and other places, the mounting substance being the article commonly known as "French Polish," being coloured with the addition of a little aniline-green and well mixed together. The said slides were spun in the usual manner on the turn-table, the cells being finally finished off with a last touching-up with the aforesaid "French Polish." About six months after, I thought I would look at them to see how this "French Polish" stood, and whether there were any signs of running in. When I came to look at them through my microscope, I was as much astonished as delighted, for the specimens one and all had become stained a beautiful and vivid green, of course rather too vivid, but nevertheless quite a surprise to me. I mentioned it to my friend Dr. Anthony, at whose advice I have made this public, as he said he thought it was quite new. The specimens stained were *Spirogyra inflata*, *S. Weberii*, *S. quinina*, *Stauraspermum gracile* and *St. viride*. The Desmids so treated were the *Closterium rostratum* in conjugation, and *Clos. Leiblorii*, &c.—*E. H. Wagstaff, Edgbaston, Birmingham.*

EXTRACT OF LOGWOOD.—Will some one kindly give me instructions in SCIENCE-GOSSIP how to prepare stain for microscopical purposes from extract of Logwood, and oblige *M. Hafsn, Pirville Terrace, Ditton-Widnuss, Lancashire.*

COLE'S "STUDIES."—These admirably written and succinct "Studies in Microscopical Science" issue with marvellous punctuality, "slides" as well as "studies." Indeed, of the two, we generally get the illustrative slides first. The last four parts to hand are as follows: 1. "Studies in Vegetable Physiology, Storage Cells, and Reserve Food Material" (illustrated by a section of the cotyledonary leaf of a pea). 2. "Animal Histology: the Uterus" (illustrated by section of uterus of rabbit). 3. "Pathological Histology: Congestion of Kidney." 4. "The Se

Fans." In the January issue, the 1st Study is in Vegetable Physiology, "The Protoplasmic Continuity;" the 2nd in Animal Histology, "Mammary Glands;" the 3rd in Pathology, a continuation of the paper on "Congestion of Kidney;" and the 4th in Marine Algæ. All the parts are illustrated by exquisitely drawn and coloured plates.

NEW SLIDES.—We have received from Mr. Fred Enock an exquisitely beautiful and well-mounted object—the "Fairy Fly" (*Litus cynipiscus*), forming No. 7 of his capital "Entomological Sketches." Mr. W. S. Anderson, Ilkeston, has sent us a box containing the following interesting subjects, all well mounted: water scorpion, cardinal beetle, brown ant, sun beetle, larva of dragon-fly, and the nymph-stage of the water-bug.

SECTIONS OF SPONGE.—Will some of your readers give me advice as to cutting sections of freshwater-sponge? I mean, so as to preserve them whole as they come from the microtome (the one I use is made after the directions given by a medical gentleman in your issue, Jan. 83, I think it was). Directly I dissolve out the paraffine and wax, the section goes to fragments. What I want to find is some transparent medium by which I can fasten the section in the slide—keep it so, while the imbedding mixture is dissolved and cleared away. The microtome has answered admirably for other things. I have some slides of sea-sponges, cut in this microtome which are very thin and well done.—*Joseph Clark.*

PRESERVING POLYZOA.—A new method of preserving polyzoa and other low forms of life has been discovered by Dr. A. Föttinger. Crystals of chloral hydrate are dropped into the vessel of water in which polypes have been placed, and in a short time the creatures become insensible, when they can be placed in alcohol. The advantage claimed for this method is that the polypes will remain expanded, and can therefore be preserved when exhibiting all their beauty of structure. The chloral acts, it would seem, in much the same manner as it affects higher organisms—that is, as a narcotic.

## ANIMAL PSYCHOLOGY.

ANECDOTE OF A SPIDER.—Some time since, when in Torquay, I saw an interesting sight which I here record. A friend was requested to water some ferns in a house during the absence, for a few weeks, of the occupier. The ferns were in a box in a window of one of the rooms of the house. A lead pipe, pierced with small holes, was so arranged that on turning a tap small jets of water were thrown up so as to fall over the box of plants. A very large spider had taken up its position at one end of the box in the window, and had constructed a web of about four

inches in diameter. Two of the jets of water rose near the web and wetted it. When the tap was turned, and the water flowing, the spider ran to one of the jets and began to work vigorously with its legs as if trying to climb up the rising stream of water; it would go back to its den and come out again, and repeat the performance two or three times, now at one jet, then at the other. This was done on each morning for some time. The question I wish to ask is this: Why did the spider do this? My friend who called my attention to it thought it came to drink, as it returned each time to its den with a drop of water on its body. My own impression was, that as the jet of water ran through a part of the web, the spider came to resist the interference, and was trying to oppose the flow of the stream.—*Ignoro.*

THE CROW.—Two possible explanations occur to me with respect to J. W.'s query. (i.) That the crow only flew to a short distance, and therefore never once took his eye off the tuft of grass. (ii.) That the general locality was well known to the crow, who only had to use his sense of smell to discover under which tuft he had previously concealed the crust of bread.—*F. C. D. B.*

MIGRATION OF BIRDS.—How do the British birds which migrate annually to far-off countries find their way back? Some people say that we must remember that a bird *en route* flies sufficiently high in the air to take what is commonly known as a "bird's-eye" view of the country over which, on their journey south, they traverse; and that consequently it is only the salient features that impress their memory. Well, no doubt, like Darwin's theory, this is a very plausible explanation, but it is not quite convincing. I believe I am not misinformed when I say that there exist records of birds returning to the same tree, nest, or thatched roof, year after year. Now, our said friends can scarcely maintain that such an insignificant thing as a thatched roof or a microscopic (comparatively speaking) nest is sufficiently prominent to impress a bird with a retentive knowledge of its locality. It is a well-known thing that if we vibrate a certain string in our memories, the result is a thoroughly connected train of thought. And further I believe it is agreed that migratory birds rest at certain points of their journey; and therefore, why should not each of these resting-points, when arrived at, bring a connective idea to the bird of what will guide him to his next resting-place? Here, I suppose, it will be objected that there is nothing to direct the birds between the intervening spaces. Granted; but it should be remembered that the young birds generally keep company with their seniors during their first migrations, thereby obtaining their knowledge of the course by a certain sort of apprenticeship—quite sufficient (in my opinion) to give them a comprehensive impression for these, to them, comparatively



short intervening spaces. I await criticisms with explanations annexed to them; it is so easy to cut a theory to pieces, but so difficult to build one.—*F. C. D. B.*

## ZOOLOGY.

**MOLLUSCA IN THE EALING DISTRICT.**—This neighbourhood is certainly one of the richest near London in land and freshwater shells, and will well repay a visit. As a proof of this, I append a list of forty species taken in the course of a single walk on April 26.—*Sphaerium corneum*, *Planorbis corneus*, *P. contortus*, *Physa fontinalis*, *Limnaea peregra*, *v. ovata* and *L. palustris*: in the pond, "To be let for building purposes" on the main road between Acton and Ealing. All the molluscan inhabitants of this pond, owing to favourable circumstances, reach an unusual size. In the canal, on the contrary, everything is more or less dwarfed and depauperated. *L. peregra v. acuminata*; in a pond near Ealing Common.—*Sph. corneum*, *Anodonta anatina*, *Unio pictorum*, *Paludina vivipara*, *Bythinia tentaculata*, *B. Leachii*, *Planorbis albus*, *P. vortex*, *P. carinatus*, *P. corneus*, *Physa fontinalis*, *Lim. peregra*, *L. stagnalis*, and *L. palustris*: in the Paddington Canal at Twyford—*Dreissena polymorpha* and *Sph. vivicola*: single valves in the Brent—*Pisidium fontinale*, *Planorbis nitidus*, *P. nautileus*, *P. vortex*, *P. corneus*, *Limnaea stagnalis*, *L. peregra v. ovata*, *Ancylus lacustris*: associated in a large pond near the canal at Twyford—*Arion ater*, *A. hortensis*, *Limax lewis*, *L. agrestis*, *Succinea elegans*, *Zonites cellarius*, *Z. nitidulus*, *Z. nitidus*, *Z. crystallinus*, *H. aspersa*, *H. nemoralis*, *H. hortensis*, *H. Cantiana*, *H. hispida*, *H. concinna*, *H. rufescens*, *H. rotundata*, *Cochlicopa lubrica*, *Clausilia rugosa*, and *Carychium minimum*. Twyford and Ealing—One specimen of *Physa fontinalis* had the lip tinged with pink, and two others exhibited well-marked spinal bands, the first having a single band near the periphery on the greater part of the body whorl, and the second a similar, but broader band at the periphery, and four distinct lines close together in the place of the fourth band in *H. nemoralis*.—*Sydney G. Cockerell*, 51 Woodstock Road, Bedford Park, W.

**ROTIFER INFESTED WITH TRICHODINA.**—Mr. F. B. Rosseter's paper in the December number of the Royal Microscopical Society's Journal on Trichodina induces me to record having found the same Infusoria on two occasions on a rotifer *Synchaeta pectinata*. On the last occasion I carefully watched for some time a *Synchaeta* infested with two Trichodinae which were running in all directions over the body and cilia of the Rotifer, and were not shaken off by the sudden and violent contractions characteristic of this species. The Trichodina on close

examination could not be distinguished from *T. pediculus*, parasitic on Hydra, as figured by Saville Kent. The Rotifer seemed not to suffer in any way, and as vigorous as the others free from Trichodina. *Synchaeta's* size is  $\frac{1}{16}$ th inch, and Trichodina is  $\frac{1}{300}$ th inch in diameter, or about one-sixth the size of the former, so that they were rather large parasites for the little Rotifer to carry about with him.—*Charles Roussellet*.

**GREAT BLACK-BACKED GULL.**—On January 4th one of these birds, probably driven inland by stress of weather, settled on the vane at the top of the spire of St. Marie's Church in the centre of this town, and remained there from 10.30 A.M. until noon. It was identified with the aid of a powerful telescope by Mr. J. T. Webster, of the Museum Hotel. As this spire is about 200 feet high, and the church stands over 250 feet above sea level, the gull could not have had a very warm perch. This is supposed to be the first appearance of the great black-backed gull in Sheffield.—*Thomas Winder, Sheffield*.

**OCCURRENCE OF LIMAX CINEREO-NIGER IN SUSSEX.**—Last August I obtained three specimens of this slug at Up Park, near Harting, in the extreme north-west corner of the county. Two were sent for identification to the Conchological Society, Leeds, and one of these turned out to be the variety *Ornati*. I have also lately met with the following slugs in West Sussex, which have not hitherto been mentioned in the local lists, viz. *Arion subfuscus*, *Arion bourguignati*, and *Limax lewis*.—*William Jeffery*.

**THE LITTLE BUSTARD IN WEST SUSSEX.**—I have just seen a specimen of this bird which was killed by Mr. Coote, of Clymping (Arundel district), towards the end of last year. A little bustard was killed some years ago at Bosham (Chichester district), by Mr. A. Cheesman. This was just prior to the publication of Knox's "Ornithological Rambles" in 1855, and is there noted.—*William Jeffery*.

**AXINUS CROULINENSIS.**—At the last meeting of the Glasgow Natural History Society, Mr. A. Somerville, B.Sc., F.L.S., exhibited specimens of *Axinus Croulinensis*, one of the smallest and most interesting of British marine bivalve shells. This mollusc was discovered forty years ago by Dr. Jeffreys off the island of Croulin, and has been taken by Canon Norman in Shetland waters, and in various of the Norwegian fiords. But since its discovery by Jeffreys, it is not known to have been taken in what may properly be termed British waters, until dredged by Mr. Somerville last August in about thirty fathoms water in Gairloch, Ross-shire, and also in Loch Broom. Specimens of the other two British species of the genus *Axinus* were shown for comparison, also an enlarged diagram illustrating the minute characteristics by which the species are distinguished.

THE DEVELOPMENT OF THE TADPOLE.—Having seen Mr. C. Rousselet's note in the last number of SCIENCE-GOSSIP, I am happy to be able to confirm his observations on the existence of the ciliated epidermal cells of the young tadpole. I have been aware of the existence of the cilia in question for three or four years, and had no idea that the fact was unknown to biologists. I first noticed the currents produced by the cilia while watching the circulation of the blood with a  $\frac{1}{2}$ -in. objective. With this glass the cilia are not easily seen, but the currents produced by them are very distinct. In order to see the cilia well, the tail should be gently scraped and the free cells examined in a little water, with a  $\frac{1}{2}$ -in. objective; the cilia are then plainly visible. A very weak solution of osmic acid brings them still better into view, but quickly destroys the vitality of the cell; the cilia become stationary, and after a short time seem to be attracted to the body of the cell and are lost to view. I fear Mr. Rousselet will meet with no success in his attempt to preserve stained sections, owing to this capillarity between the cilia and the cell, which comes into play as soon as the protoplasm of the cell ceases to live.—*P. E. Wallis, East Grinstead.*

OUR BRITISH SLUGS.—Will the readers of my communication with this heading in the January number kindly make the few following emendations? Line 28, "Beliz" should be "Bielz"; and "stabile," "Stabile" on line 30. There is a very good figure of *Limax arborum*, B. Ch., in Göteb. Handl. 1868, to which reference can be made. It is interesting to note that of *Geomalcus* there have been six new species described by several French authors, Normand, Baudon, Letourneaux, and Mabile, as *G. intermedius*, N.; *G. bourguignati*, M.; *G. paladilhiannus*, M.; *G. moitessierianus*, M.; *G. mabilli*, B.; *G. vandeanus*, L.; all of which Heynemann in Malac. Blätt. xxi. has clearly shown to have been created from the examination of young Arions. In this lies an evident moral to all those who would name slugs, but from an extensive and close acquaintanceship with slug-lore and with slug-life.—*J. W. Williams, D.Sc.*

## BOTANY.

TOLYPELLA INTRICATA, IRREGULAR APPEARANCE OF.—This rare species of the British Characeæ has been remarkable, in that it "does not appear to have been found for two successive years in any locality," vide a review of British Characeæ, by Messrs. Groves, p. 16. In the year 1883, when botanising on a bleak day in March, and feeling depressed with the barrenness of the day's search, this plant was detected in a small pool between two woods in S. Beds where it flourished luxuriantly during that spring. The pool is only about nine feet long and six feet wide, but the plant was developed in such

perfection, that, in May, Mr. H. Groves came down to gather some, in company with the writer. During the ensuing summer the water all evaporated, and the chara disappeared. During the following year, 1884, when the pool was pretty well filled with water, no trace of the plant could be detected, although it was carefully examined at intervals of a few weeks, during the whole of the spring and summer. The next year, 1885, it re-appeared in fair quantity, but not so luxuriantly as in 1883, and it was left almost untouched, so that its fruits might be matured. Again, in the spring of 1886, the pool was carefully examined, when the plant was found in small quantities, this being, it is believed, the first instance in which it has been detected in the same station for two successive seasons, that is, in 1885 and 1886. This irregularity of appearance seems equally well marked in the Characeæ, as in some of the orchids. As examples may be mentioned, *Chara hispida*, has grown for several years in a pool at Totternhol, whereas, at Simbury, it has only grown in one season; *Chara vulgaris* almost filled a pond at Brumtingham one season, and was entirely absent the next; *Nitella mucronata*, abundant in a pool near Bedford in 1882, but has not re-appeared there, although it has been detected in the adjoining river. *Nitella opaca*, in one pool at Snodan; it grew in 1882, but has been absent since, whereas, at another station about a mile distant, the same species has appeared several years in succession. The year 1886 was remarkable for the scarcity of Characeæ in this district, which have been less abundant than in any year since 1882. The foregoing remarks are given in the hope, that they may stimulate observation on the hitherto unexplained causes of the irregularity in appearance of some of our native plants, a true solution of which would probably only be obtained by a series of data extending over a succession of years.—*J. Saunders, Luton.*

AMPHIPLEURA PELLUCIDA.—On p. 258, Mr. W. E. Simmonds asks how this diatom is to be resolved by Scibert's  $\frac{1}{16}$ th water immersion, and confesses to having wasted many hours in attempting to see the striæ; now Siebert's glass having, or professing to have, a numerical aperture of a little over 0.99, it would be possible theoretically to resolve striæ of 104.0.0 to the inch with the aid of monochromatic light, the ordinary amphipleura has striæ about as fine as 93.000 to 96.000 to the inch. I do not think the margin is sufficient, as in practice these cheap glasses never work up to theory. If Mr. Simmonds is anxious to see amphipleura, I would advise him either to get an easy frustule of the Peruvian variety, with striæ about 60.000 to the inch, or to possess himself of a Homogeneous oil immersion objective. He will then be able to gratify himself with a sight of the "bars" on amphipleura.—*P. E. Wallis, East Grinstead.*

BEES AND FLOWERS.—On Saturday morning, August 14th, 1886, while watching the bees in the garden, I saw a bee fly from a flower of the tea-tree (*Lycium barbatum*), to a bed of flowers consisting mostly of *Antirrhinum majus*. The most remarkable fact was that, after opening the flower, the bee at once turned over upon its back, so that the abdomen came in contact with the anthers. This insect was evidently collecting pollen, having called at the tea-tree for a sip on the way. This was an admirable method for collecting pollen, the only drawback being the difficulty experienced when the bee wished to come out. However, this did not prevent the bee carrying out its plan. It visited a number of flowers in this way until a friend, whose curiosity was so greatly excited, made the bee aware that it was being narrowly watched. Although I have spent many mornings watching the bees, it was only on this occasion that I saw the flowers visited in this way.—*R. Paulson.*

MIMULUS LUTEUS.—In preparing some transverse sections of *Mimulus* for microscopic examination, I observed a difference in structure from the ordinary form of annular plant-stems. Usually they have the fibro-vascular bundles separated by the intervening cellular tissue of the plant-stem; but in the *Mimulus* stem the fibro-vascular bundles give place to a complete ring of wood. The plants were in bloom, and in fine condition. Could any reader say if this is an uncommon form of stem?—*P. Kilgour.*

ALBINO VARIETIES.—In response to Mr. Wheatcraft's appeal in SCIENCE-GOSSIP for January (p. 17), I beg to say that in June, 1880, I saw large patches of *Gentiana verna*, the flowers of which were white. Many were quite pure, others, however, were slightly tinged with blue. To the best of my recollection, there were no plants with flowers of the usual colour near. The white-flowered variety occurred on the grassy border of the road which leads from Nanders to Finstermünz, but only, if my memory serves me, on the right-hand side. There were a great many plants, and I found them in patches along an extent of probably two hundred yards or more. I once found on the Axenstrasse, above Brunnen, a plant of that very elegant little campanula, so common on the Alps (I forget the name of the species) which had pure white flowers. This plant grew in the midst of a number of others whose flowers were of the usual colour. I am not sure, but I think that whenever *Crocus vernus* occurs on the Continent, the flowers will always be found to vary in colour between white and purple. I have seen this state of things in three localities at least. One was on the heights above Castellamare in February. Another was on a mountain at the back of Cadenabbia in May, and a third was on an alp near the Dreizüinen in the Dolomite country, this was early in July. It may be worth mentioning

that within ten days of seeing those last I gathered blossoms of *Colchicum autumnale* at Berchtesgaden, so that these two plants, one of which in England flowers in March and the other in September, must have been in flower in the two last-mentioned localities at the same time, spring and autumn, so shaking hands.—*P.*

BEE ORCHIS, IRREGULAR APPEARANCE OF.—In reference to note by J. T., in current number of SCIENCE-GOSSIP, the writer's opinion is that the subject is far from being exhausted, and appears to remain one of the unsolved problems of plant history. The erratic appearance of *Ophrys apifera* referred to in 1879, still characterises the species in this district, but with one remarkable exception. There is a station for it about half a mile south of Luton, on a hillside, through which has been made a deep cutting for the Midland. In this place a few plants have been found in blossom every year from 1882 inclusive. In the search for them, assistance has been rendered by my friend Mr. Catt, so that between us, we have been enabled to investigate the matter at the proper flowering season. It certainly is curious, and suggestive of great caution in scientific deduction, that just as one was being confirmed in belief from numerous observations, that bee orchis might never be expected to re-appear in the same station for two or three consecutive seasons, a small group of plants should persist in blossoming for five seasons in succession, that is from 1882 to 1886. There is nothing remarkable in the station, which is green-sward on a hillside, with a north-west aspect, or calcareous soil, just such as finds its repetition in many neighbouring localities where this plant is essentially erratic in its appearance. The remark with reference to the interference of cattle with them, is suggestive of a valid reason, as the writer has often seen flowering spikes, on the basis of which were leaves that had been cropped by animals. So that it is quite possible the energies of the plant might be temporarily crippled to the destruction of its "starch"-producing foliage, without which it could not of course produce a supply of reserve material to nourish the flower-spike of the following season. Another orchid, noteworthy for its irregular appearance, is *Spiranthes autumnalis*, which in one station did not blossom between 1879 and 1883.—*J. Saunders, Luton.*

THUNDERSTORMS AND FROSTS.—I have noticed for the last three years that the frequency of thunderstorms has been on the decrease in summer months, whilst frosts have increased in severity. Perhaps some other reader of SCIENCE-GOSSIP has noticed the same and would be able to offer an explanation. Does the electrical condition of the atmosphere have anything to do with this phenomenon?—*H. J. Frederick.*



## GEOLOGY, &amp;c.

A PALEOLITHIC WORKSHOP.—Mr. J. Allen Brown, F.G.S., F.R.G.S., recently read a paper before the Antiquarian Society, on his discovery of a Paleolithic workshop floor of the Drift period, near Ealing. In West Middlesex such old floors or former land surfaces are often discernible, and such habitable spots have been preserved in different parts of the Thames Valley, though they have frequently been disturbed, removed, and re-deposited in other places by the changing course, and curves of the wider river of the past, and by floods and other conditions of the severer climate which then prevailed. The paleolithic workshop floor is about one hundred feet above the present bed of the Thames, and about two miles distant from it, is situated near the junction between the Creffield Road and Mason's Green Road, Acton. The floor is here about six feet from the surface, with a steeper slope to the river than the present surface. It is covered to this extent with sand, brickearth, and trail deposits. At this site, on an area of about forty feet square, were found nearly 600 unabraded worked flints, including long spear or javelin heads, from five to six inches long, neatly trimmed to a point, and of the same form as those of obsidian, &c., now employed by the natives of New Caledonia, the Admiralty Islands, and Australia, for insertion into the shafts of their spears, to which they were fixed by lashings, &c. There were also shorter ones, not only wrought along the sides to the point where the flake required trimming, but also neatly chipped at the butts into rough rudimentary tangs. Such spear-heads have not only been described by Messrs. Lartet and Christy from the cave of Le Moustier, in the Dordogne, but have been met with in the alluvial deposits of the Somme at Abbeville, the Seine, and other French rivers, as well as by Dr. J. Evans, from Mildenhall, &c. Roughly wrought hatchets, axes, or choppers formed from flakes chipped on one or both faces to a cutting edge were also found rather abundantly on the floor. They are probably some of the earliest rude celt forms. Large numbers of knives formed from flakes, often neatly worked on the edge with fine secondary work and also saws chipped with a distinctly serrated edge, were exhibited from this site, with other tools apparently intended to be used as chisels, &c. Large numbers of waste flakes as well as blocks of flint which had been worked upon, were also found at this spot; and in Ealing, about two miles distant, in a deposit of about the same age, a large boulder of metamorphic rock, concave on both faces and roughened and scored in the hollow from use, was met with; it is  $7\frac{1}{2}$  inches long; and a quartzite boulder which fits the hollow, was found near it, in fine gravel. They are the first pounding-stones discovered in the drift deposits.

## NOTES AND QUERIES.

A WASP'S NEST.—I have read this article by L'Aigle in a recent number of SCIENCE-GOSSIP, with considerable interest, but would suggest that some further particulars would greatly enhance its value. I am endeavouring to collect authentic information concerning our social wasps. Can your correspondent name this species? In what part of the country does he live? What was the length of life of his wasps, (1) as eggs, (2) as larvæ, (3) as pupæ? About what date was the nest abandoned? for, I suppose, if a British nest, it is deserted now. L'Aigle says the paper was made from decayed wood. Did he actually see this particular wasp gathering decayed wood? and did he see it gathering materials from any other source? He also says that the wasp worked day and night; does this mean that it worked all through the night, as hornets are said to do, or only, as is usually the case with *Vespa Germanica* and *V. vulgaris*, until about an hour after sunset? I presume that the illustrations accompanying the article were taken from the particular nest alluded to. I may take this opportunity of pointing out the importance in many cases of affixing the name of the place where the observations were made. And again, remarks upon the earliness and lateness of flowering, etc., are of little value when they are evidently inserted long after they have been written, and when the printer omits the date.—*F. W. Elliot.*

BEES' STINGS.—If bees' stings are smooth, and wasps' so barbed, how is it that hive bees leave the sting behind so much oftener than wasps do?—*F. W. Elliot.*

MALE WASPS.—I should be glad to be informed where and when the males of the common wasps are to be found, and how they may be outwardly distinguished from the queens?—*Reginald W. Christy.*

BEES AND WASPS' STINGS.—I am amused at your correspondent, W. E. Harper, correcting T. Winder about the barbs on sting of wasp, and advise him to look again more carefully. Years ago I dissected and mounted dozens, but never found one without the barbs. Their visibility may perhaps depend on the position the sting is in. All I can say is that, unless the stings of bees and wasps are different to what they used to be, both are barbed.—*E. G. Matlock.*

CURIOUS PHENOMENON ON ICE.—I should feel obliged if some of your correspondents could give a satisfactory solution of the following occurrence. A friend of mine, Mr. John Stirling, of Fairburn, in Ross-shire, on the border of Inverness-shire, made a new curling-pond last summer about 150 yards  $\times$  80 yards, and 3 feet deep, in a place where there was a good deal of peat, and an artificial bank was made at the low end puddled with peat. On the other sides there are natural banks, mostly peat, and a lead was made from the River Orrin to supply the pond. On the 13th of December the ice was strong enough to skate on, when a number of white spots were observed on it as though there was air underneath, and the ice was weak on these spots. They were mostly on the south or river side of the pond. On the 14th we curled on the pond (our rink), but only where there were no white spots, as where they were the ice would not stand curling—therefore a large portion of the pond was useless for curling. One of the party thought it would be a good thing to let out

this air and made a hole in one of these white spots when there was a rush of "gas," then the water came up, and the ice looked the same as the rest of the pond. Another of the party said, "Let us put a lighted match to it and see if it will burn." A large spot was selected, a hole made and a lighted match applied. At once there was a jet of bluish flame about three feet high, which burnt about two or three minutes and which singed our friend's beard. It was just getting dark. We all got to work with a box of matches and a sharp pointed stick, or anything that would make a hole in the ice, which was about three inches thick, and in a short time there were a dozen or more of these jets of gas in full blaze coming from the ice; the effect was most curious and weird. What was this, gas? Was it sulphuretted hydrogen, or petroleum fumes from the peat? I noticed when the pond was being made that many of the puddles had an oily kind of stuff like paraffin floating on them; but I did not observe any smell from the gas escaping from the ice.—*W. C. P.*

**THE EFFECTS OF THE LATE SEVERE WEATHER UPON MICE.**—On the evening of the 6th ult., while walking on the main road between two neighbouring towns, I was surprised to see five or six small creatures start up from the fresh horse-droppings and make for the adjacent hedgebanks—what could they be? not frogs, as they did not jump but ran nimbly in a zigzag direction. But while walking and wondering what they could be, the same thing occurred again, and this time I was quick enough to observe that they were mice, and during the passage of the next two miles, some twenty or thirty were sent scampering into cover at the sound of my approach. For the next mile none appeared, and it occurred to me, that, as there were three stacks near the roadside in that distance, that the mice there, were better provided for than their brethren. I tried to catch one to discover its species, but was not successful. Several people that have been asked if they had seen the like in other directions, have replied in the affirmative.—*Edwin E. Turner, Coggeshall, Essex.*

**EXPLOSION OF EGGS.**—Enclosed is a cutting from the "New York Tribune" for November 21st, respecting the explosion of an ostrich egg. I have known the eggs of a domestic fowl explode with a report as loud as a toy cannon.—*C. F. Cross.*

**FRIGHTFUL EXPLOSION OF AN OSTRICH EGG.**—Dr. George Blair, of Yale College, was knocked insensible and nearly killed by the explosion of an ostrich egg in Peabody Museum on November 20th. Such an occurrence was never heard of before, according to the scientists of the city. The egg came from South Africa, and weighed  $3\frac{1}{2}$  pounds.

**AQUARIUM NOTES.**—A correspondent in SCIENCE-GOSSIP of December last, writes under this heading, concerning the destruction of water-plants by minnows. I have kept specimens of this fish for a long time in an aquarium supplied with the common anacharis (which if H. D. O. F. has not tried, I should certainly recommend him to do, as it is very easily obtainable, and grows luxuriantly) and I have never found them eat or destroy it. If care be taken to feed them with a moderate quantity of animal and vegetable food, their destructive habits will probably disappear. With regard to the Dytisci, they should on no account be placed in an aquarium with fish, as I have often known them to kill fish some three or four inches long; but the great hydrophilus (one of

the largest of our British aquatic Coleoptera) may safely be kept with fish and other inhabitants of the aquarium.—*H. A. Crossfield, South Hackney.*

**ROSELLE**, of which the scientific name was asked in our January number, is the *Hibiscus sabdariffa*, Linn. It is grown in all the gardens of India, particularly in the Bombay provinces, and the calyces are made into tarts or jelly, the latter not inferior to that of the red currant. The "Cyclopaedia of India" says there are five varieties cultivated, that its leaves are used as greens, and that in the French West Indian Islands a kind of cider is prepared from it. It is often grown in flower beds. The stem, if cut when in flower, and the bark scraped off, steeped immediately, displays a mass of fibres of a fine silky nature.

**ROZELLE.**—The plant so called and cultivated in India is *Hibiscus sabdariffa*, DC. Prod. It is not indigenous, but a native, to the best of my recollection, of the West Indies. It makes a capital jelly—a good substitute for that obtained from red currants and very like it in appearance.

**CUCKOO WITH FALSE NOTES.**—I have more than once observed in SCIENCE-GOSSIP notices of cuckoos uttering false notes. We had one here some years ago, for several consecutive years, singing in Torachilly, Ross-shire, which always sang cuck-coo-coo, cuck-coo-coo, from the very first of its arrival about the 1st May. I have not heard it now for these last two seasons. I notice eagles (golden) are getting more plentiful here. I saw no less than four large ones a few days ago from my dining-room window while at breakfast, soaring over the hill. While on the subject of Ross-shire, let me recommend to your readers a very interesting and instructive book which has just come out: "Gairloch, in North-West Ross-shire: Its Records, Traditions, Inhabitants and Natural History," by John H. Dixon, F.S.A. Scot. (Co-operative Printing Co. Ltd., Edinburgh).—*W. C. P.*

**ARE GROWING LEAVES OF THE YEW-TREE POISONOUS?**—I was conversing with a farmer on the above subject a short time ago, and he assured me that two of his cows had died from the bad effects produced by eating the leaves of the yew-tree. There cannot possibly be any truth in the assertion that the leaves are poisonous only when dried.—*J. Lea.*

## NOTICES TO CORRESPONDENTS.

**TO CORRESPONDENTS AND EXCHANGERS.**—As we now publish SCIENCE-GOSSIP earlier than formerly, we cannot undertake to insert in the following number any communications which reach us later than the 8th of the previous month.

**TO ANONYMOUS QUERISTS.**—We must adhere to our rule of not noticing queries which do not bear the writers' names.

**TO DEALERS AND OTHERS.**—We are always glad to treat dealers in natural history objects on the same fair and general ground as amateurs, in so far as the "exchanges" offered are fair exchanges. But it is evident that, when their offers are simply disguised advertisements, for the purpose of evading the cost of advertising, an advantage is taken of our *gratuitous* insertion of "exchanges" which cannot be tolerated.

We request that all exchanges may be signed with name (or initials) and full address at the end.

**J. S. GALIZIA.**—You may get any or all of the scientific magazines referred to in our list, of Mr. W. P. Collins, 157 Great Portland Street, London.



M. JOHNSTON.—The books on British spiders, bees, beetles, etc., by Staveland, Shuckard, Rye, and others, are fairly exhaustive for students. You could hardly procure better general textbooks to work by.

J. M.—Mr. R. St. Stephens', A.R.S.M., address is as follows: 25 Pondwych Road, West Hampstead, London, N.W.

### EXCHANGES.

OFFERED, thirty-six varieties of downs from British birds, correct and clean, for two good slides or prepared anatomical sections, or other material.—W. Sim, Gourdas, Fyvie, N.B.

VOL. V. of "Records of Buckinghamshire," unbound and perfectly clean, published at 19s., by Bucks. "Archæological Society," in exchange for books on natural history, or offers. Rejected offers not answered.—F. H. Parrott, 35 Doughty Street, London, W.C.

LEGAL.—A collection of statutes now in use, with notes in the margin, together with an abridgment of the residue which are expired, altered and worn out of use. With statutes made in the reigns of Charles I. and II., by Thomas Manby, A.D. 1670. Quite perfect. What offers?—E. M. O., 7 Cavendish Terrace, Eltham, Torquay.

OFFERED, SCIENCE-GOSSIP for 1833, clean, unbound; also newly bound, in one volume, 1865-1867. Wanted, books or magazines on botany.—E. Hogben, 2 Royal Terrace, Bexhill, near Hastings.

TEN years' SCIENCE-GOSSIP and other scientific papers offered in exchange for the figured volume of "British Marine Shells," by G. Jeffreys, or for tropical shells.—Miss F. Hele, Fairlight, Elm Grove Road, Cotham, Bristol.

WANTED, Carpenter's "Revelations of the Microscope" and works on Infusoria and pond-life, or micro slides or apparatus. A few fossils and books in exchange.—C. L. Lord, 34 Burlington Crescent, Goolse.

WANTED, SCIENCE-GOSSIP, Nos. 1-57, 59, 60, 68-70, 80, 94-120, 122, 126-129, and 131. Can offer SCIENCE-GOSSIP, 1876-1882.—F. C. King, 2 Clarendon Street, Preston, Lancashire.

WANTED, *Pisidium roseum*, *Zonites nitidus*, *Z. glaber*, *Test. haliotidea*, *Succinea oblonga*, *Helix fusca*, *H. pygmaea*, *Pupa ringens*, and *Ameba lineata*. Send desiderata. British land and freshwater shells offered in exchange.—John R. B. Masefield, Roehill, Cheddar, Staffordshire.

NAMED rocks wanted from Cheviots and south of Scotland. Rocks, fossils, shells, etc., offered in exchange.—J. Havell, Ingleby Greenhow Vicarage, Northallerton.

WANTED, accessories, reagents, etc., for histological works. Apply, stating requirements, to—F. R. Rowley, 60 Lower Hastings Street, Southfields, Leicester.

WANTED, collections of rare foreign stamps, coins, and medals. Offered, natural history specimens.—W. K. Mann, Wellington Terrace, Clifton, Bristol.

OFFERED, many continental dried plants; send list for exchange to—C. Copineau, Juge au Tribunal civil de Doullens (Somme), France.

A SWIFT'S microtome, in good condition, cost £5. Will exchange for standard books.—C. Morley, 21 Eccleston Road, Ealing, W.

WANTED, complete volumes of SCIENCE-GOSSIP; thirty-six different micro slides, neatly mounted, for exchange.—Fred. Beddow, Derby.

"NATURE," from 1st January, 1885, till now, or the end of current volume. What offers? Wanted, Braithwaite's "Mosses," in parts, or natural history books.—J. W., 3 Norfolk Terrace, Dumfries.

CLEAN copies of SCIENCE-GOSSIP, complete for the year 1884, and 1885, omitting Jan. and four numbers of 1885 (Jan., Oct., Nov., Dec.), all good, clean copies; also vol. v. of the Postal Microscopical Society ("Journal of Microscopy and Natural Science"), and Oct. part of vol. iv., in first-class condition; also microscopic lamp and turntable for mounting, the latter nearly new. Particulars on application.—W. W. Ranson, The Cottage, Priory Road, Anfield, Liverpool.

WANTED, a specimen of *Rubus suberectus*; midland plants or a book in exchange.—R. Garner, Stoke-upon-Trent, Staffordshire.

WANTED, eocene fossils, named and localised, in exchange for others; also, what offers for first ten parts of Brown's "Fossil Conchology," with 37 plates, some coloured, containing about 1200 figures, published at 30s.—George E. East, jun., 241 Evering Road, Upper Clapton, E.

CASSELL'S "The Sea," "Countries of the World," "Familiar Wild Flowers," "Illustrated Readings," and "Technical Educator," also SCIENCE-GOSSIP for 1884-86, with coloured plates complete; all unbound and in the very best condition. What offers in micro apparatus, first-class slides, or slide cabinets?—W. Mathie, 42 McKinlay Street, Glasgow.

WANTED, nests with eggs of British and foreign birds; rare eggs offered in exchange.—J. T. T. Reed, Ryhope, Durham.

MICRO SLIDES.—What offers in first-class slides only, for Louis' series of 12 slides selected diatoms in groups, also for Watson's type slide of 50 diatoms from Campeachy Bay? A large number of miscellaneous slides for exchange. Offers not entertained not answered.—W. Mathie, 42 McKinlay Street, Glasgow.

BOTANICAL preparation; offered for loan of "Microscope in Botany."—W. White, Litcham, Swaffham.

HERBARIUM, British and foreign, what offers?—J. Harbord Lewis, F.L.S., 145 Windsor Street, Liverpool.

EXOTIC butterflies: many fresh duplicates, including *Orn. Brookiana*, *arrivansus*; *Morpho cypris*, *Adonis*; *Urania rhyphus*, etc. Also wings of brilliant species for microscopic purposes.—Hudson, Railway Terrace, Cross Lane, nr Manchester.

WANTED, "Conchologia Iconica," vols. xviii.-xx.; also "Monographs on Mollusca" (Palæontographical Society). State requirements.—Miss Linter, Arragon Close, Twickenham.

WANTED, Kirby & Spence's "Entomology" and SCIENCE-GOSSIP for 1885 and 1836, bound or unbound; will give in exchange "The Amateur Photographer" for 1886 or 1885, unbound or otherwise.—C. Gregory, c/o Mrs. Sharp, 4 Bateman Terrace, West Kensington Park, W.

WANTED, "Quarterly Journal of the Geological Society," Nos. 132 (November 1877), 134 (May 1878), and 143 (August 1880), any or all.—W. G. Spencer, Stanton House, The Fosse, Leicester.

WHAT offers for the "Abridgment of the Gardener's Dictionary," by Philip Miller?—H. M., Townfield Street, Chelmsford.

THE "Stamp Collector's Handbook," by E. L. Pemberton; "Violin-Making," by E. H. Allen; some good fishing-tackle and a rod, never used. Wanted in exchange, back volumes of SCIENCE-GOSSIP before 1836 (bound or unbound), micro apparatus of any kind, zoological or physiological slides.—Miles Johnston, Oban House, Balham Park Road, Balham.

WELL-MOUNTED Polyzoons for exchange; also *Batrachospermum moniliforme* and other algae.—W. Stott, Lostock, Bolton.

"NATURE," vol. i.; "Intellectual Observer," vols. ii. and v.; "English Mechanic," vols. xxx.-xxxiii.; all well bound; exchange.—Linden, New Brompton, Kent.

WANTED, supplements to Wood's "Index Testaceologicus," also back numbers (1832 and previous years) of the "Journal of Conchology."—C. L. S., 8 Trinity Street, Hastings.

*P. vivipara*, *H. arbutorum*, *H. ericetorum*, *D. polymorpha*, *C. laminata*, *C. tridens*, *A. anatina*, and good micro slides in exchange for other land and freshwater shells.—J. C. Blackshaw, 4 Ranelagh Road, Wolverhampton.

### BOOKS, ETC., RECEIVED.

"Mountains and Mountain-Making," by T. M. Reade, F.G.S. (London: Taylor and Francis).—"The Greyhound," by Hugh Dalzell (London: L. Upcott Gill).—"Handbook of Practical Botany," by E. Strasburger (London: Swan Sonnenschein & Co.).—"Text-book of British Fungi," by W. Delisse Hay (London: Swan Sonnenschein & Co.).—"Sonnets on Nature and Science," by S. Jefferson (London: T. Fisher Unwin).—"British Petrography," by J. H. Teall, part 10.—"Proceedings of the Camera Club."—"Cole's "Studies in Microscopical Science."—"The Amateur Photographer."—"The Camera."—"The Scientific Enquirer."—"The Garner" (vol. for 1886).—"The Naturalist."—"The Botanical Gazette."—"Journal of the New York Microscopical Society."—"Belgravia."—"The Gentleman's Magazine."—"Le Monde de la Science."—"American Monthly Microscopical Journal."—"The Midland Naturalist."—"Feuille des Jeunes Naturalistes."—"The American Naturalist."—"Journal of Microscopy."—"Journal of Quekett Microscopical Club."—&c. &c.

COMMUNICATIONS RECEIVED UP TO THE 13TH ULT. FROM: R. G.—C. P.—G. F. H.—M. G.—C. C.—W. C. P.—C. M.—C. W.—W. K. M.—H. T. M. R.—G. O. H.—C. I.—S. S. L.—T. R. F. G.—E. P. P.—E. H. W.—F. B.—H. I. F.—A. T.—F. R. W.—I. G.—J. R. B. M.—J. W. B.—W. I. N.—F. C. K.—M. H.—C. W. D.—R. H. N. B.—F. H.—C. L. L.—R. W. C.—J. M.—C. W. H.—E. H.—J. H.—E. G.—M. J.—C. R.—W. S.—F. H. P.—I. F. H.—E. C.—A. H. B.—F. L.—W. J. N.—T. W.—W. M.—G. H.—G. E.—J. T. T. R.—J. W. C.—I. B.—J. L.—W. M. R.—J. S. W.—I. W.—W. E. C. N.—E. A.—T. D. A. C.—H. C. B.—R. G.—J. C. B.—J. W. W.—F. L.—F. B. W.—F. D. B.—F. E.—H.—M. R.—W. W.—W. G. S.—E. E. T.—M. J.—H. M.—G. S. P.—R. B. P.—C. G.—S. S.—J. C.—J. H.—L.—P. E. W.—H. N. W.—J. J. B.—A. O.—W. J.—H. H. R.—J. L.—C. L. S.—Dr. M.—J. B.—W. S.—J. S. G.—H. U. J.—J. G.—R.—D. P.—F. G.—H. M.—C. P.—H. W. L.—H. F. H.—J. R. C.—&c. &c.





## CHAPTERS ON FOSSIL INSECTS.

By ROBERT B. COOK.

No. II.



IN our last article we very briefly traced the geological history of the orders Neuroptera, Orthoptera, Hemiptera, and Coleoptera, representatives of all which orders have been found in the Palæozoic rocks; it now remains for us in like manner to notice those orders which apparently appeared later in geological time.

### 1. *Euplexoptera*.

—This small order, composed of the earwigs, which insects have been ranked by some naturalists as Coleoptera, and by others as Orthoptera, but are now generally placed in a small separate order—is first represented in the Lower Lias marls of Schambelen, Switzerland, by one species very different from any living form, being, according to Professor Heer, more transitional between Orthoptera and Coleoptera; this insect itself affording as much difficulty to correctly name, as the earwigs generally have afforded in their classification. Fossil earwigs have also been found in the Solenhofen slate of Bavaria, the Eocene formations of Monte Bolca near Verona, and of Aix in Provence, and the Miocene deposits of Oeningen in Switzerland.

2. *Diptera*.—Some very fragmentary specimens, thought by Professor Westwood to belong to this order, have been discovered in the Lower Lias formations of the west of England; but the oldest undoubted remains come from the Purbecks of England and the Solenhofen slate of Bavaria (both

formations of Upper Oolitic age), and include the genera *Bibio*, *Tipula*, *Cecidomya*, *Musca*, and *Culex*. In all the Tertiary insect-bearing strata the Diptera occur in great abundance, most of the existing genera being represented by species more or less allied to the present forms.

3. *Trichoptera*.—This order, which comprises the caddis flies, and which, according to Westwood, “forms the connecting link between the Neuroptera and Lepidoptera,” appears for the first time in the Purbeck beds of Dorsetshire, and occurs subsequently in the Eocene beds of the Isle of Wight and of Aix in Provence, while the Miocene freshwater formations of Auvergne are composed in great part of what is known as “Indusial limestone,” so called from the rock being formed entirely of the “*indusiæ*” or larval cases of the caddis worms cemented together by calcareous or siliceous matter; and it is most interesting to note, that the larva of the caddis fly seems to have possessed the same habit then as now of sticking small shells to its case, for the caddis cases found in the dried-up lakes of Auvergne are very often covered with the shells of a small species of *Paludina*, thus resembling in a great measure the common English species of caddis worm, which is so fond of attaching to its case the small shells of *Planorbis nautilus*, and other species. Fossil caddis cases have also been found at Oeningen, Locle, and elsewhere.

4. *Hymenoptera*.—A small fragment of a wing found in the Lower Lias marls of Schambelen, Switzerland, has been assigned by Professor Heer, with much hesitation and doubt, to the order Hymenoptera; but the occurrence of this solitary and doubtful specimen, unconfirmed by any other Hymenopterous remains from formations of the same age, is scarcely sufficient to establish so high an antiquity for the order. However, in the Solenhofen slate, an Upper Oolitic formation already several times referred to, veritable Hymenoptera occur, which have been assigned to the family *Apidæ*. In the Tertiary

formations fossil remains of Hymenoptera have been procured from the Middle Eocene leaf beds of Bournemouth, and the Upper Eocene limestone of the Isle of Wight, those from the latter formation consisting chiefly of ants belonging to the genera *Myrmica* and *Formica*. On the Continent the Upper Eocene formations of Aix have yielded fossil sawflies, the parasitic Ichneumons, and Chalcididae, together with various species of wasps and ants. Remains of Hymenoptera have also been found, although only sparsely, in the Lower Miocene formations of Switzerland and Germany: but in the Middle and Upper Miocene divisions represented respectively by the marls of Radoboj in Croatia, and the lacustrine deposit of Oeningen, already noticed so often, they occur in great plenty, comprising chiefly ants, ichneumons, bees, wasps, and Sphegidae.

5. *Lepidoptera*.—This order, the most well-known of our insect relations, is also the most recent of the important orders to appear in geological time. It is true indeed that a fossil wing found in the Stonesfield slate of England some years ago has been described by Mr. Butler as that of a butterfly, which he has named *Palaontina oolitica*; but this classification is not recognised by Mr. Scudder and other entomologists, who do not consider the wing to be lepidopterous at all, and as there is no sufficient evidence of the existence of flowers—upon which butterflies depend—contemporaneous with this species, it is very probable that the insect has been incorrectly named. Some very fragmentary remains from the Upper Purbeck beds of England have also been assigned to the Lepidoptera; but these, owing to their very imperfect condition, cannot with certainty be referred to any one order specially. Thus, if the foregoing doubtful specimens be excepted, Professor Heer's dictum, "Lepidoptera make their first appearance at Solenhofen," remains a true statement of what is at present known concerning the antiquity of the order. From that well-known slate formation two interesting lepidopterous insects have been discovered, *Sphinx Snelleni*, a large hawk-moth somewhat similar to the existing *S. convolvuli*, and *Bombyx antiqua*, a nocturnal or night-flying moth. Another species from the same formation, *Pseudosirex Darwini*, would appear by its name to have some affinity with the genus *Sirex* of the Hymenoptera; but not having seen a description or figure of this species, I cannot speak as to its relationship. It is, however, in the Tertiary strata that remains of Lepidoptera first become anything like general. The Upper Eocene Bembridge beds of the Isle of Wight have yielded two specimens belonging to the genus *Lithosia*; while those of Aix in Provence have supplied us with seven species:—five butterflies belonging to the families Papilionide, Nymphalide, and Hesperide, and two moths, *Noctuides desperditus* and *Pyralites obscurus*, together with the fossil larva of a butterfly belonging to the Satyridæ. An interesting fact

connected with these fossil lepidoptera from Aix is that in almost every case remains of the plants which in all probability served the larvæ for food have been found in the same beds from which the insects were obtained. A beautiful and well-preserved fossil butterfly (*Pendryas persephone*) figured and described by Dr. Dawson, comes to us from the extensive Tertiary deposits of Colorado, U.S., and forms one of the most remarkable examples of fossil insects yet discovered, both on account of the excellent state of its preservation and the divergence it exhibits from living types. It is a valuable contribution of the New World to the geological history of the Lepidoptera. Returning to Europe, the Lower Miocene lignites or Brown Coal formations of Germany have yielded a fossil butterfly, *Vanessa vetula*, and a small moth belonging to the Tineina, *Nepticula fossilis*; the Middle Miocene marls of Radoboj give us three butterflies and five moths, the latter comprising two Noctuidæ, two Geometridæ, and one *Pyralis*; while the Upper Miocene deposit of Oeningen supplies us with fragments of wings and bodies of a moth of the family Bombycidæ, a well-preserved larva of the same family, and a larva sac of *Psyche pinula* curiously made of pine leaves. These remains complete the list of our fossil Lepidoptera.

6. *Thysanoptera*.—This small order, consisting of the Linnæan genus *Thrips*, is composed of minute insects well known to gardeners from their habit of visiting flowers. A very beautiful fossil specimen, discovered in the Tertiary formations of America, is so exquisitely preserved that the minute fringes of its wings are clearly visible under the microscope. When we consider how rare it must be that all the conditions necessary for the preservation of such minute and fragile insects are present together, we must feel how wonderful it is that any remains of them have been preserved at all, much more so, when a specimen has been preserved in such a perfect manner as this delicate little *Thrips*.

Summarising the results already gathered from the discoveries we have so briefly passed in review, we find the oldest orders to be the Neuroptera and Orthoptera, whose larvæ in so many cases live under the water; then follow the hardy Coleoptera and aquatic Hemiptera, all of which date back to Palæozoic times. In the Secondary rocks earwigs, two-winged flies, and caddis flies begin to occur, and high up in the Oolitic formations the more highly and specially developed Hymenoptera and Lepidoptera make their first appearance, the latter order, composed wholly of species purely suctorial in their mode of life, only becoming of general occurrence in Tertiary times, when the flowers they visit and fertilise begin to appear also.

Before concluding I must acknowledge my indebtedness for the information contained in this and the preceding paper to the admirable works of Professor Heer, Dr. Dawson, and Mr. Scudder; also



to some excellent papers from the pen of Mr. Herbert Goss, F.L.S., which appeared in the "Entomologists' Monthly Magazine" some few years ago. Finally, the study of fossil entomology is one which is worthy of attention not merely on account of the direct evidence it affords of the age of the several insect orders and their representatives, but also on account of the light it incidentally throws on the existence of other forms of life. For wherever an insect is found we know that its food must have existed too, and so certain beetles indicate the presence of fungi, mosses, and animals; certain aquatic insects and larvæ the presence of other water insects; and certain flies, moths, bees, etc., the existence of the flowers upon which they depend for subsistence; while these flowers in their turn indicate the existence of the insects by which they are fertilised. So we notice the several members of the great family of Life each dependent on one another, and therein we may see an image of the narrower human family—everyone dependent in some measure for life and support upon his fellow men.

#### VARIATIONS IN PLANTS.

IT would be a good work for some disciple of Darwin to write a monograph of the genus *Brassica*, as illustrating the inherent tendency of plants to vary, and the possibility of fixing their varieties by selection so as to form races which may be taken for true species. It is believed by many persons that cabbages may be crossed with swede turnips, if they are allowed to flower in the neighbourhood of such plants happening to blossom at the same time; in which case, we may reasonably ask whether the swedes commonly referred to, *Brassica campestris*, are specifically distinct from *Brassica oleracea*? It would be difficult indeed to classify and describe the varieties of cabbage, borecole, cauliflower, broccoli, coleworts, and savoy, with anything like scientific precision, especially as much of the information required for such a work would have to be derived from catalogues in which cauliflowers are put between carrots and cucumbers; an arrangement not very intelligible to botanists. The usefulness of such a work would, however, be so great as to make it worth while to face and overcome its difficulty. Notwithstanding all that has been said by botanical philosophers, and done by practical gardeners to prove the capacity of plants for spontaneous variation, whenever we speak of an actual difference between a seedling plant and the plant from which the seed was taken, we are immediately met by the suggestion that bees, or some winged insects, are responsible for the change, or that the unhappy parent of the wayward plant had been, by some means, crossed in love. This is often quite erroneous. It is

by no means likely that savoy were the offspring of a cross between the common cabbage and Scotch kale, and it is inconceivable that the plant from which those three varieties were derived, could have become the progenitor of broccoli and cauliflowers in any other way than by variation, originating spontaneously in the only sense in which that word has any meaning; that is, independently of any known external influence. When a tendency to vary manifests itself in any plant, it often has an aptitude to run in different directions, and the effect of selection, whether natural or artificial, is to determine the direction such a movement shall take. Twelve years ago a gentleman gave me seeds of Portugal cabbage, from which I raised plants, the heads and hearts of which having been cut and eaten, I allowed some of the branches to flower and bear seed. I laid no obligation on them to be true to the traditions of their family or race, but rather encouraged any vagaries which it might suit them to take, except that I set my face against yellow flowers, destroying any plant where such a colour appeared. This was to preclude suspicion of crossing, as I do not know of any other sort of cabbage with white flowers. My plants ran in the direction of borecole, which is perhaps no great wonder, for in Sweet's "Hortus Britannicus," I find the variety *Costata* described as having white flowers in a list of varieties under the word Borecole, printed in large letters. In Sutton's "Spring Catalogue" for 1874, Portugal cabbage is called *Brassica costata oblonga*, so that I have no need for doubt as to the proper name and affinities of my plants. From the seed of one plant saved last year, I have now plants of kale, purplish-green cabbages, with smooth leaves tending to form a head, or it may be a heart as pure and tender as my own, and one at least showing some resemblance to the red cabbages commonly used for pickling. If I had a garden as large as that of the Royal Horticultural Society, I would put these plants in several places, with a view to obtain from them as many races. As it is, I can only choose that which I like best to perpetuate. This is a sort of variegated kale, which, as it will have white flowers, will, I suppose, be sufficiently distinct for me to boast of having raised it in a few years by selection from the seeds of Portugal cabbage without hybridisation or crossing.

JOHN GIBBS.

WE are pleased to welcome a new friend and neighbour in the "Essex Naturalist," which henceforth will appear as the "Journal" and "Transactions" of the Essex Field Club, under the editorship of Mr. William Cole, the Hon. Sec. We know of no other field club which has so rapidly come to the front as the "Essex." This first number of the "Essex Naturalist" is eminently readable.



## THE TWO MIRRORS.

By W. J. N.

No. V.

IN the preceding articles, the incident pencil has been supposed to consist of parallel rays. Such are the rays of a beam of daylight, naturally and in perfection, since they emanate from a source which is infinitely distant. Such too, in good degree, are the rays of the artificial pencil which we have learned to derive from the diverging rays of a minute lamp-flame, by placing the bull's-eye before the lamp at the distance of its principal focus. We have not had occasion to study the relations of conjugate foci, for in connection with a parallel pencil no conjugate focus has existed. No reason has, therefore, appeared for keeping the lamp at some exact point of distance, in order to preserve integrity of focus in the reflected rays. Nor has the brightness of the illumination depended on the nearness of the lamp. It is one of the advantages of a parallel pencil, that

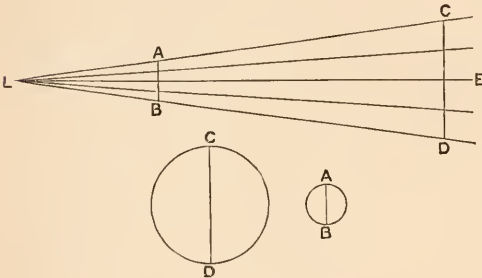

Fig. 21.

it retains its illuminating power for long distances; and reasons have been given why the artificial pencil should become more pure—without being materially less brilliant—as the distance between the lamp and the mirror is reasonably increased. The two points which have principally claimed our attention hitherto, have been—how to render the incident rays of lamp-light truly parallel, and how afterwards to compel them to form certain desired angles with the principal axis of the concave mirror.

Passing from that part of our subject, we enter upon another, which is somewhat more difficult, the nature and management of a DIVERGENT PENCIL.

By angles of incidence must now be understood the angles formed with the principal axis of the concave mirror by a single ray of the pencil—namely, its central ray or axis. Their importance, and the method by which their magnitudes are to be determined, will be the same as in the case of the parallel pencil. (See vol. for 1886, pp. 251 and 267.)

The properties of *conjugate foci* will come before us in connection with a new relationship found to exist between the lamp, the concave mirror and the

object; and the brightness of the illumination, instead of being independent of the distance of the lamp, will be found to depend mainly upon it.

There are two forms of divergent pencil. Let us call them, the *simple* and the *compound*. A simple pencil consists of rays which pass in straight lines from the flame to the mirror. The compound pencil consists of rays whose first lines of direction have been altered by passing them through the bull's-eye

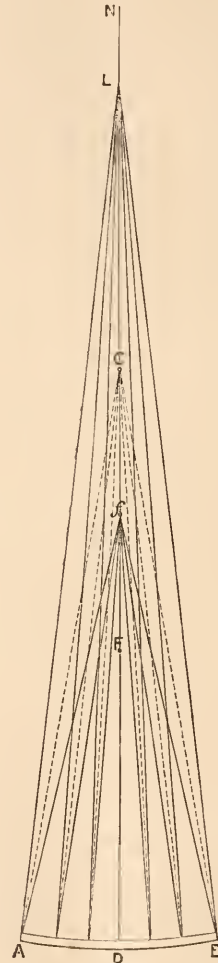

Fig. 22.

condenser. The amount of divergence is thus reduced. The bull's-eye, when used for this purpose, is placed at a distance from the lamp slightly less than that which would parallelise the rays; less, that is, than the distance of its principal focus. The divergence of a pencil may thus be reduced to any desired extent, the object being to crowd upon the mirror a larger number of the constituent rays.

Fig. 21 represents the section of a simple divergent pencil, LCD, made lengthways through the central

ray LE. Such a pencil has the form of a cone, of which the luminous point L is the vertex, and LE the axis. The peculiarity about it which we have first to notice is, that *the intensity of the illumination on a given surface, varies inversely as the square of the slant distance from the source of light.*

If a cross-section of the cone-shaped pencil were made at any point B, in a plane at right angles to the axis, that section would evidently be a circle having AB for its diameter. Take LD equal to three times LB, and at D suppose another cross-section to be made. It will again be a circle, with the diameter CD; and because LD has been taken equal to three times LB, CD (as may be geometrically proved) will be equal to thrice AB. Also, because the areas of circles are to one another as the squares

If the point L be supposed to move along ND towards N, *f* will move in the opposite direction towards F; and when L has become infinitely distant, *f* will coincide with F, the incident rays having become parallel (compare Fig. 158, Nov. 1886, p. 249). Again, if L be supposed to move along ND towards C, *f* will advance towards L, and at C they will meet. If L continue to move towards F, *f* will leave C and move away in the opposite direction towards N. The points L and *f* will, in fact, have changed places, *f* occupying the first position of L, when L reaches the first position of *f*. When L comes to the principal focus F, there will be no point *f*, the reflected rays having become parallel. If L passes F towards D, the reflected rays will be divergent.

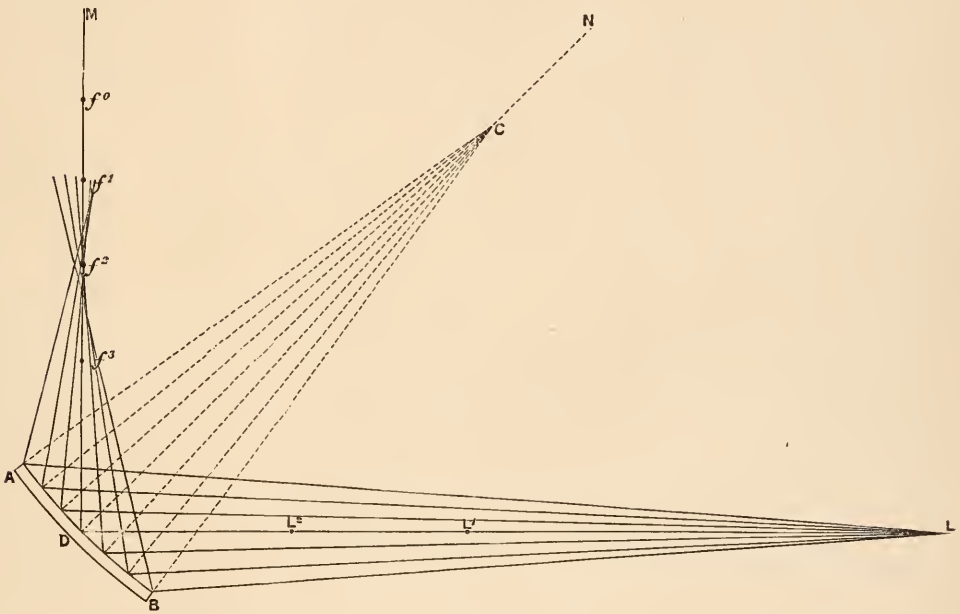

Fig. 23.

of their diameters, the area of the section at B is to that of the section at D as  $1^2$  is to  $3^2$ , or as 1 to 9. That is to say, the rays have so spread themselves by divergence, as to cover at CD nine times the space which they covered at AB; and the intensity of the illumination on any given portion of the section at D is therefore, only  $\frac{1}{9}$ th of that on the same extent of surface at B.

In Fig. 22 we have a section of the small concave mirror previously represented, whose centre of curvature is C, and principal focus F. Let L be a luminous point, beyond C, in ND the principal axis of the mirror; and LAB be a simple divergent pencil emanating from L and falling upon the mirror AB. The rays will be reflected with a fair amount of exactness to *f*, a point in the principal axis between F and C.

Any change therefore in the position of L, involves a corresponding change in the position of *f*, and this relation between the two points is expressed by calling them *conjugate foci* of the mirror. The number of conjugate foci is infinite.

On page 250 of the vol. for 1886, it was explained why the principal focus F cannot be employed by the microscopist. The focus *f*, in any of its positions on ND, the principal axis of the mirror, is equally unavailable, and for the same reasons. He cannot place his lamp in line with the principal axis of the mirror, so as to represent the point L in the figure. The incidence of the pencil must necessarily be oblique.

It would be convenient now to show by several figures, as was done for parallel rays (vol. for 1886, p. 250), the alterations made in the distance of the

mean focus from D, by different degrees of obliquity given to the incident pencil. But in order to save space, I will take a single case, and explain in what respects it differs from others which might have been presented.

In Fig. 23 the axis LD of a simple divergent pencil forms an angle of  $90^\circ$  with MD, the axis of the microscope, and of  $45^\circ$  with ND the principal axis of the concave mirror. The distance of L from D is the same as in the last figure. The distance of the mean focus from D is not the same, but is reduced from 2.25 inches to 1.4 inch only; it is at the point  $f^2$  instead of at  $f^\circ$ . The accuracy of the focus has also suffered by the obliquity of the incident pencil. It will be well to compare this figure with the corresponding one for parallel rays (Fig. 160, vol. for 1886, p. 250). The important point to be noticed is, that while the parallel rays in Fig. 160 may come either from a lamp at the distance of 2 feet, or from a white cloud at the distance of a mile, without altering the position of the mean focus  $F^2$ , the divergent rays in Fig. 23, on the contrary, cannot be focused fairly at the point  $f^2$  unless they emanate from the point L. The position of the mean focus  $f^2$  depends, therefore, partly upon the angle of incidence and partly upon the distance of L from D, the centre of the mirror; whereas in the case of the parallel pencil, it depended upon the angle of incidence alone.

If the angle of incidence were  $30^\circ$  instead of  $45^\circ$ , and the distance of L from D remained the same, the mean focus would be at the point  $f^1$ , the focal distance being 1.82 inches; and were the angle of incidence  $60^\circ$ , the mean focus would be at the point  $f^3$ , the focal distance being .9 inch. In the former case the focus would be much more satisfactory than in the latter.

For each of these angles of incidence the distance between L and D could be largely varied, and every variation would alter the distance of the conjugate focus. For instance, if L in the figure were moved towards D,  $f^2$  would retreat towards M and would reach  $f^\circ$  by the time that L had reached L<sup>1</sup>. When L arrived at L<sup>2</sup>, there would be no conjugate focus at all, the reflected rays having become parallel. If L were moved away from D,  $f^2$  would approach D until it coincided with the position of  $F^2$  in Fig. 160 (vol. for 1886, p. 250), L having by that time become so distant as to render the incident rays parallel.

(To be continued.)

CAGE BIRDS SURVIVING THE WINTER.—There seems no reason why they should not if the season is mild, and plenty of suitable food. I possessed a canary that escaped and lived. It was seen a year after, and being a hen, it may have mated with a wild species. Tropical birds certainly would not survive.

## HOOKER'S STUDENT'S FLORA AND THE LONDON CATALOGUE.

I WAS much pleased with the genial tone and kindly spirit of Mr. Wheatcroft's letter in the November issue of SCIENCE-GOSSIP; but I must ask the privilege of making a few comments upon it.

If I erred in placing too much reliance upon the accuracy of knowledge and soundness of judgment of Sir J. D. Hooker, I think Mr. Wheatcroft equally and similarly errs in regard to Dr. Asa Gray. The principle of nomenclature laid down by Dr. Gray is undoubtedly good; and if its application could rest with a man possessed of an infallible and omniscient mind, I would at once chant "Amen" to it. But it is obvious that such condition can never be obtained, the most eminent is fallible, and hence a rigid application of Dr. Gray's principle is inadmissible. It excludes all hope of revision, no matter how grave may have been the error in the first instance, and, as I conceive it, this exclusion of revision defeats at least one of the fundamental principles of science, viz. the correction and elimination of error, and the substitution for it of a nearer approximation to truth.

It is unfortunate that Mr. Wheatcroft did not consult Sir J. D. Hooker's "Student's Flora," before fixing upon its author, even by implication, the presumptive blame for the change of name cited as an example. As a matter of fact, Sir J. D. Hooker has *not* changed the name *Chlora perfoliata* to *Blackstonia perfoliata*, unless he has done so since the publication of the third edition of his "Student's Flora," for in that book the old name is retained. Why it has been changed in the "London Catalogue" I do not pretend to know, perhaps the editor will let us into the secret, not of this only, but also of others; one thing is certain, that however slight a change be made, it is sure to clash with custom at some point, and thus affect the convenience of a greater or smaller number of individuals; and the "London Catalogue" seems to have been altered and made unintelligible to those accustomed to the old edition, as much, if not more, by the re-numbering of the species and introduction into the body of the work of many of those excluded species and aliens which in former editions were put at the end, as it has been by changes of names.

Mr. Wheatcroft disclaims any but the purest motive for his writing on this subject; I have no wish to question his sincerity nor to impute to him other than the motive he has suggested.

In the hope of helping such of my botanical brethren as do not possess the new edition of the "Student's Flora," I append a list of the changes of names, and some alterations of classification which appear in it as compared with the first edition. It will be observed that in nearly every case where a change has been made, the old name is retained as



a synonym. I have endeavoured to make the list perfect, but it is possible there may be omitted from it one or two of the minor varietal changes, but these omissions are few and not of great importance.

Name in First Edition.	Name in Third Edition.	Synonym, if any.
<i>Ranunculus aquatilis</i>	<i>R. heterophyllus</i>	<i>R. aquatilis.</i>
<i>R. aquatilis</i> , var. <i>Symeii</i> (Hook. and Arn.)	<i>R. marinus</i>	<i>R. aquatilis</i> , var. <i>Symeii.</i>
<i>R. pantothrix</i> (sub-sp.)	<i>R. trichophyllus</i>	<i>R. pantothrix.</i>
<i>R. circinatus</i> (sub-sp.)	<i>R. circinatus</i> (sp.)	<i>R. divaricatus.</i>
<i>Papaver Lamotteii</i> (sub-sp.)	<i>P. dubium</i> , proper	<i>P. Lamotteii.</i>
<i>Fumaria pallidiflora</i> (sub-sp.)	<i>F. capreolata</i> , proper.	<i>F. pallidiflora.</i>
<i>Brassica sinapistrum</i>	<i>B. sinapis</i>	<i>B. sinapistrum.</i>
<i>Erophila verna</i>	<i>E. vulgaris.</i>	
<i>Polygala uliginosa</i>	<i>P. amara.</i>	
<i>Silene inflata</i>	<i>S. Cucubalus</i>	<i>S. inflata.</i>
<i>Stellaria glauca</i>	<i>S. palustris</i>	<i>S. glauca.</i>
<i>Arenaria rubella</i>	<i>A. hirta</i>	<i>A. rubella.</i>
<i>Spergularia marina</i>	<i>S. Salina.</i>	
<i>Tilia grandiflora</i>	<i>T. platyphyllus</i>	<i>T. grandiflora.</i>
<i>T. intermedia</i>	<i>T. vulgaris</i>	<i>T. intermedia.</i>
<i>Radiola millegrana</i>	<i>R. linoides.</i>	<i>R. millegrana.</i>
<i>Geranium Pyrenaicum</i>	<i>G. perenne</i>	<i>G. Pyrenaicum.</i>
<i>Melilotus officinalis</i>	<i>M. altissima</i>	<i>M. officinalis.</i>
<i>M. arvensis</i> (Wallroth)	<i>M. officinalis</i> (Desv.)	<i>M. arvensis</i> (Wallroth).
<i>Trifolium minus</i>	<i>T. dubium</i>	<i>T. minus.</i>
<i>Lotus major</i>	<i>L. uliginosus</i>	<i>L. major.</i>
<i>Prunus spinosa</i>	<i>P. communis</i>	<i>P. spinosa.</i>
<i>Rubus Guntheri</i> (sub-sp.)	<i>R. saltuum</i>	<i>R. Guntheri.</i>
<i>Potentilla procumbens</i>	<i>P. Sibbaldii</i>	<i>P. procumbens.</i>
<i>Rosa pomifera</i> (sub-sp.)	<i>R. villosa</i> , proper.	
<i>R. mollissima</i> (sub-sp.)	<i>R. mollis.</i>	
<i>R. sepium</i> (sub-sp.)	<i>R. agrestis.</i>	
<i>Pyrus pyrastrer</i>	<i>P. communis</i> , proper.	
<i>P. acerba</i>	<i>P. malus</i> , proper.	
<i>P. rupicola</i> (sub-sp.)	<i>P. latifolia.</i>	
<i>P. intermedia</i> (sub-sp.)	<i>P. scandica</i> (Syme.)	
<i>P. fennica</i> (var.)	<i>P. hybrida</i>	<i>P. pinnatifida.</i>
<i>Ribes sylvestre</i>	<i>R. rubrum</i> , proper	<i>R. sylvestre.</i>
<i>Sedum elegans</i>	<i>S. rupestre</i> , proper.	
<i>Callitriche vernalis</i>	<i>C. verna</i>	<i>C. vernalis.</i>
<i>Pimpinella magna</i>	<i>P. major</i>	<i>P. magna.</i>
<i>Eranthe silaifolia</i>	<i>E. peucedanifolia</i>	<i>E. silaifolia.</i>
<i>Caucalis infesta</i>	<i>C. arvensis</i>	<i>C. infesta.</i>
<i>Galium montanum</i>	<i>G. sylvestre</i> , proper	<i>C. montanum.</i>
<i>G. scabrum</i>	<i>G. mollugo</i> , proper	<i>G. scabrum.</i>
<i>G. Parisiense</i>	<i>G. Anglicum.</i>	
<i>Fedia eriocarpa</i>	<i>Valerianella eriocarpa.</i>	
<i>Linosyris vulgaris</i>	<i>Aster linosyris</i>	<i>L. vulgaris.</i>
<i>Matricaria Parthenium</i>	<i>Chrysanthemum Parthenium</i>	<i>M. Parthenium.</i>
<i>Helminthia echioides</i>	<i>Picris echioides</i>	<i>H. echioides.</i>
<i>Hieracium melanocephalum</i>	<i>H. alpinum</i> , proper	<i>H. melanocephalum.</i>
<i>H. pulmonarium</i> (Sm.)	<i>H. nigrescens</i> , proper	<i>H. pulmonarium.</i>
<i>H. Lawsoni</i>	<i>H. anglicum</i>	<i>H. Lawsoni.</i>
<i>H. vulgatum</i>	<i>H. sylvaticum</i> , proper	<i>H. vulgatum.</i>
<i>H. inuloides</i> (sub-sp.)	<i>H. crocatum</i> , proper	<i>H. inuloides.</i>
<i>Taraxacum Dens-leonis</i>	<i>T. officinalis</i> , proper	<i>T. Dens-leonis.</i>
<i>Oxycoccus palustris</i>	<i>Vaccinium oxycoccus</i>	<i>O. palustris.</i>
<i>Statice Bahucensis</i>	<i>S. rariflora</i>	<i>S. Bahucensis.</i>
<i>S. occidentalis</i>	<i>S. auriculifolia</i>	<i>S. occidentalis.</i>
<i>S. reticulata</i>	<i>S. bellidifolia</i>	<i>S. reticulata.</i>
<i>Anagallis phænica</i>	<i>A. arvensis</i> , proper	<i>A. phænica.</i>
<i>Limnanthemum nymphæoides</i>	<i>L. peltatum</i>	<i>L. nymphæoides.</i>
<i>Myosotis lingulata</i>	<i>M. cæspitosa</i>	<i>M. lingulata.</i>
<i>Rhinanthus minor</i> (sub-sp.)	<i>R. Crista-Galli</i> , proper	<i>R. minor.</i>
<i>Mentha hirsuta</i> (sub-sp.)	<i>M. aquatica</i> , proper	<i>M. hirsuta.</i>
<i>Calamintha menthifolia</i> (sub-sp.)	<i>C. officinalis</i> , proper	<i>C. menthifolia.</i>
<i>Galeopsis versicolor</i> (sub-sp.)	<i>G. speciosa</i>	<i>G. versicolor.</i>
<i>Ballota ruderalis</i> (var.)	<i>B. nigra</i> , proper	<i>B. ruderalis.</i>
<i>Chenopodium deltoideum</i>	<i>C. urticum</i> , proper	<i>C. deltoideum.</i>
<i>Polygonum nodosum</i> (var.)	<i>P. maculatum</i> (sub-sp.)	<i>P. nodosum.</i>
<i>P. vulgatum</i> (var.)	<i>P. aviculare</i> , proper	<i>P. vulgatum.</i>

Name in First Edition.	Name in Third Edition.	Synonym, if any.
<i>Oxyria reniformis</i>	<i>O. digyna</i>	<i>O. reniformis</i> .
<i>Betula verrucosa</i>	<i>B. alba</i> , proper	<i>B. verrucosa</i> .
<i>Salix ambigua</i> (var.)	<i>S. incubacca</i>	<i>S. ambigua</i> .
<i>Anacharis</i> (genus)	<i>Elodea</i> (genus).	
<i>A. Canadensis</i>	<i>Elodea Canadensis</i>	<i>A. alsinastrum</i> .
<i>Epipactis rubiginosa</i>	<i>E. atro-rubens</i>	<i>E. rubiginosa</i> .
<i>Cephalanthera grandiflora</i>	<i>C. pallens</i>	<i>C. grandiflora</i> .
<i>Trichonema</i> (genus)	<i>Romulea</i> (genus)	<i>Trichonema</i> .
<i>Sisyrinchium Bermudiana</i>	<i>S. angustifolia</i>	<i>S. Bermudiana</i> .
<i>Smilacina</i> (genus)	<i>Maianthemum</i> (genus).	
<i>S. bifolia</i>	<i>Maianthemum Convallaria</i>	<i>S. bifolia</i> .
<i>Juncus communis</i>	<i>J. effusus</i>	<i>J. communis</i> .
<i>Luzula sylvatica</i>	<i>L. maxima</i>	<i>L. sylvatica</i> .
<i>L. pilosa</i>	<i>L. vernalis</i>	<i>L. pilosa</i> .
<i>Sparganium affine</i> (var.)	<i>S. natans</i> , proper	<i>S. affine</i> .
<i>Actinocarpus</i> (genus)	<i>Damasonium</i> (genus).	
<i>A. Damasonium</i>	<i>D. stellatum</i>	<i>A. Damasonium</i> .
<i>Potamogeton compressus</i>	<i>P. Zosterifolius</i>	<i>P. compressus</i> .
<i>P. mucronatus</i>	<i>P. Friesii</i> .	
<i>Scirpus Rothii</i>	<i>S. pungens</i>	<i>S. Rothii</i> .
<i>Eriophorum angustifolium</i>	<i>E. polystachyon</i> , proper	<i>E. angustifolium</i> .
<i>Carex stellulata</i>	<i>C. cclinata</i>	<i>C. stellulata</i> .
<i>C. vulgaris</i>	<i>C. Goodenovii</i>	<i>C. vulgaris</i> .
<i>Phileum Bahmeri</i>	<i>P. phalaroides</i>	<i>P. Bahmeri</i> .
<i>Chamagrostis</i> (genus)	<i>Mibora</i> (genus).	
<i>C. minima</i>	<i>M. verna</i>	<i>G. minima</i> .
<i>Agrostis australis</i>	<i>Gastridium lendigerum</i>	<i>A. australis</i> .
<i>Calamagrostis stricta</i>	<i>Deyouzia neglecta</i>	<i>G. stricta</i> .
<i>Psamma</i> (genus)	<i>Ammophila</i> .	
<i>P. arcuaria</i>	<i>A. arundinacca</i>	<i>P. arcuaria</i> .
<i>Aira canescens</i>	<i>Corynephorus canescens</i>	<i>A. canescens</i> .
<i>A. flexuosa</i>	<i>Deschampsia flexuosa</i>	<i>A. flexuosa</i> .
<i>A. caespitosa</i>	<i>D. caespitosa</i>	<i>A. caespitosa</i> .
<i>Avena flavescens</i>	<i>Trisetum flavescens</i>	<i>A. flavescens</i> .
<i>A. clatior</i>	<i>Arrhenatherum avenaceum</i>	<i>A. clatior</i> .
<i>Glycceria rigida</i>	<i>Festuca rigida</i>	<i>G. rigida</i> .
<i>G. loliacca</i>	<i>F. loliacca</i>	<i>G. loliacca</i> .
<i>Triticum</i> (genus)	<i>Agropyrum</i> (genus).	
<i>Lycopodium alpinum</i>	<i>L. complanatum</i> , with <i>alpinum</i> as sub-species.	

(To be continued.)

## ON COLLECTING DIPTERA.

By E. BRUNETTI.—No. III.

*[Continued from p. 31.]*

IN the Coleoptera, the order in which, perhaps, carding attains its climax, instances have come under my own immediate observation, of such large genera as Tenebrio, Timarcha, and Broscus, being carded, and Gastrophysa and Coccinella pinned, it being needless to add how irregular an appearance a collection presents when the size of the insect is utterly disregarded, and each collector follows his own sweet will about setting.

So far as beetles are concerned, I think it would be a good plan to endeavour to pin all the species of one genus, and to card all those of another: exceptions, of course, will occur, but the rule could be observed in the large majority of cases.

As regards the actual setting, it is quite unneces-

sary to give the exact positions the legs and wings should take, but it may be remarked that good setting is by no means indispensable.

Lepidoptera may be collected for their beauty, and perfect setting be considered a *sine quâ non*, but, as Diptera, if collected at all, will not be chosen for their personal attractions (if the expression be permissible), but for purposes of study only, good setting may often be dispensed with; though it cannot be denied that a well-set specimen appears to better advantage in a cabinet and can be examined with less difficulty than an unset one.

For the benefit of those who care to set well, let me remark that the wings should be quite horizontal, inclining slightly forward, and two pairs of legs placed behind the wings, not before them; care should be taken to keep the middle pair from being under the wings.

Use thin pins, but ones of moderate length; let there be a good half-inch between the point of the

pin and the lowest part of the insect, so that the forceps may be placed beneath the insect, which is often necessary when the pins are very thin and consequently liable to bend.

By placing the specimen well up the pin, a much higher magnifying power may be employed in its observation when in the cabinet, and the more space there is for the forceps both above and below the insect, the less will be the chances of an accident. In removing specimens from one box to another always use a pair of forceps, the fingers are liable to crush the fly, unless extreme caution is employed.

If specimens are to be carded, care must be taken not to let the wings touch the gum until the rest of the insect is set, as it is difficult to move them when once in the gum and, if elevated, they curl up instantly, giving considerable trouble to reopen them.

Use thin gum tragacanth for carding specimens, and take care that the pubescence is not matted with it during setting.

Let me repeat here, however, that carding had better be avoided entirely.

After returning from an expedition, set all the small flies first; and here, perhaps, I should recommend a method of killing them, for they should always be brought home alive in chip-boxes. The lids of the boxes should be slightly raised, so as to admit the fumes of sulphur and the boxes ranged round a small tin containing powdered sulphur. Light the sulphur, and immediately cover the boxes with a basin, allowing all to remain untouched for half-an-hour.

The insects will then be found dead and perfectly relaxed.

Never kill Diptera by dropping them into hot water, or by means of chloroform, ammonia, or any method that wets them, as the delicate pubescence if once matted can never regain its original appearance.

The larger Muscidae, all the Syrphidae and Asitidae will easily remain relaxed, if placed in a tin half filled with fine sand slightly moistened.

The larger specimens may thus be retained unstiffened for a week or more after capture, but the smaller species and all the Neurocera should be set as soon as possible after their capture, the same day, if convenient.

In conclusion, I should like to make a suggestion of a plan by which young collectors may add to their own collections, and at the same time furnish me with specimens of British Diptera.

If they will collect and pin the specimens, giving the locality and date of each, if possible, forwarding them to me from time to time, and at the end of the season will give me either a list of the species they possess (of any order) or of their desiderata, I will obtain and send in return species new to their collection and of whatever order they may prefer.

A few young entomologists of my acquaintance have agreed to do this, and I am glad to state that

I have already received several small consignments of my favourite insects.

Foreign Diptera, if obtainable, are equally acceptable as British.

Should unset and unpinned flies be sent, care should be taken that the box is quite full, to prevent the insects being shaken about during transit; if this rule be disregarded, much damage will be the result, for the legs become so very brittle soon after death that the least touch is often sufficient to break them off.

I have already extended my paper beyond the limit originally fixed, and could with pleasure dilate still further on the advantages of collecting Diptera, giving directions for their capture and preservation, so long as readers were to be found to peruse them.

Sufficient hints, however, I believe will be found in these notes to enable a beginner to collect Diptera, and this being so the object of my efforts is attained.

My last paragraph shall be—collect Diptera as much as possible, as a favour to myself, if for no other reason, and I will do my very best in return for any one thus assisting me.

---

#### GOSSIP ON CURRENT TOPICS.

By W. MATTIEU WILLIAMS, F.R.A.S., F.C.S.

**EXPLOSION OF EGGS.**—The description on page 47 of last number of this magazine reminds me of an experience of my own some years ago. I had invented a method of preserving eggs, which answered fairly well. This invention was carried out by immersing the eggs for about half a minute in a bath of melted wax or stearine, or better, a mixture of these. This filled up the pores of the shell, and the heat lined its inside with a varnish of coagulated albumen; the two combining to prevent the admission of air and consequent decomposition. I kept some eggs thus prepared about six months, and sent three of them to the kitchen to be cooked for breakfast as usual. They all exploded in the water, the direct effect of the explosions being much improved by the quantity of water thrown into the fire. The domestic was so much alarmed that she refused to cook any more of "the master's eggs." I therefore cooked the remainder myself, and demonstrated the cause of the explosions by pricking pin-holes in the shells of some, and leaving the others unperforated. All the latter exploded, while those that were perforated passed through the ordeal of cookery as usual, proving that it was the expansion of air or vapour imprisoned within the egg by the air-tight shell that caused the explosion. In the cases described by Dr. Blair and Mr. Cross there was probably an abnormal density and impermeability of shell. That the ostrich egg should explode dangerously is



explained by the thickness and tenacity of its shell, which would resist until the elastic tension of the gases within become formidable.

**EXPANSION AND CONTRACTION OF BUILDINGS.**—The use of iron and other metals in building construction demands scientific consideration and skilful arrangements, to meet the effects of varying temperature and consequent variations of expansion. Thus the central arch of Southwark Bridge rises about one inch in the summer, lifting with it the footpath, roadway and all upon them, and is constructed to allow this to occur without undue strain. The ends of the tube of the Britannia Bridge across the Menai Straits rest on rollers, to permit the advance and recession due to heat and cooling, the length of the bridge varying as much as three inches in the course of twenty-four hours. When the sun shines on one side of the tube, that side becomes longer than the side in shade, and the whole structure curves accordingly. The great variation of temperature between the extremes of summer and winter in America causes the Brooklyn Bridge to vary in length to the extent of several feet. Its total length is 3,540 feet, and the temperature ranges from  $-15^{\circ}$  to  $+115^{\circ}$  Fahr., a difference of 130 degrees. As iron expands  $\frac{1}{100}$  of its length between the freezing and boiling points of water ( $180^{\circ}$  Fahr.) the amount is easily calculated. The Washington Monument leans to the east in the morning, and to the west in the afternoon. A plummet line suspended in the interior of the dome of the capitol of Washington swings  $4\frac{1}{4}$  inches from the perpendicular on each side, or  $8\frac{1}{2}$  inches altogether.

**THE SETTING OF CEMENT.**—Among the abstracts of foreign scientific papers published by the Chemical Society, I find two on this subject, one by E. Michel and one by L. C. Levoir, but neither of them contain anything remarkably new. Any bricklayer's labourer could tell us that "the setting of cement is dependent, firstly, on the addition of water, which should be as limited and uniform as possible; and secondly, on the density and intimate mixture of the materials." In telling it Paddy's English might be somewhat different, probably better, as it would not leave us in doubt whether the mixture or the water should be "as uniform as possible." The "thirdly," viz. the conversion of the lime into carbonate, may not be understood by him unless an ex-pupil of a Board School. The most important chemical action which occurs in the setting of cements is the union of the lime with silica, whereby a stony compound, the silicate of lime, is formed. The simplest of cements is common mortar, i.e. lime mixed with silica in the form of sand, the finer the sand and the more caustic the lime (i.e. the more free from carbonate) the better. The jerry mortar now used so villainously in London suburban building is worthless, because dust-hole

siftings or ballast (burnt clay) is used instead of sand by swindlers who still remain unbanged. M. Levoir fully recognises the importance of the formation of the silicate in reference to Portland cement. The obscure part of the subject is the difference between hydraulic and ordinary cements; why some cements may be immersed in water immediately after they are mixed and harden nevertheless, while others would go to slop under the like conditions. I refer, of course, to cements having lime as their basis, not to the glue-like compounds sometimes described as cements.

**METEORITE IN COAL.**—If the fall of meteoric stones is an old-established proceeding, there must be specimens imbedded in the stratified rocks of all ages. This may be the case although none have yet been found, for the simple reason, that the total area of any given formation which human beings have explored bears so small a proportion to the total area of the globe. The non-finding of them in rocks of any particular date no more proves their non-falling at that period than the non-finding of specimens on the present surface of the county of Middlesex proves their non-falling in the present geological epoch. As the best-explored regions of the geological past are those containing coal, it is there that we may expect the first find, and in accordance with this natural probability a fossil meteorite has been found in a block of Tertiary coal. It was described by Dr. Gurlt, at Bonn. The block of coal from which it was taken was about to be used in a manufactory in Lower Austria. It weighs 785 grammes (about  $1\frac{3}{4}$  lbs.) its specific gravity is 7.75; it is as hard as steel; is a mass of iron alloyed, as meteoric iron usually is, with nickel, and combined with some carbon.

**THE SOLAR PARALLAX.**—Ordinary students of nature who are not experts in astronomy, must have been sorely confused by the recent investigations of this subject. Beginning their intellectual life with the school-book statement of ninety-five millions of miles as our mean distance from the sun, which was Captain Cook's measurement and venerated accordingly, they were next informed that the results of the modern, and of course much better, observations of the transit of Venus in 1882 reduced this distance to 91,500,000 miles, and that all the greater celestial distances, as well as the velocity of light, must be reduced in like proportion. This lasted for only a short time when other variations were supplied by Mr. Gill's heliometer observations of the opposition of Mars in 1877. This brought up the distance to somewhat more than ninety-two millions of miles. Since that we have the measurements of the velocity of light, which bring it up to ninety-three millions. It remains to be seen whether we shall go on in this direction until we return to the old-fashioned ninety-five millions of our schooldays.

**FLUORINE.**—The old alchemists devoted their lives to searching for the three arcana, the philosopher's stone, the aurum potable (drinkable gold), that would endue the body with the imperishable properties of the noble metal, and thus give immortality to the drinker, and the universal solvent which was to do much towards rendering the gold thus drinkable. A logical sceptic suggested a difficulty incident to the third of these, viz. that if it dissolved everything nothing could contain it, as any vessel of whatever material would yield to its solvent powers. Modern chemistry has actually supplied us with such an untenable material in the element fluorine. It has been produced for a moment, but combines immediately with whatever it touches, and thus instead of free fluorine, a fluoride of something is obtained. M. Debray, however, has recently reported to the French Academy of Sciences that M. Moissan has at last succeeded in isolating this refractory element. He obtains it in the form of a gas which decomposes cold water with disengagement of ozone; phosphorus burns in it, silicon does the same. It may possibly be a compound with hydrogen, but M. Moissan discusses this hypothesis and concludes that it is really free fluorine. We may hear something more about collecting and retaining it hereafter.

**LONDON FOGS IN PARIS.**—The bucks of Paris imitate Englishmen quite as much as English ladies of fashion imitate French women. Lately the atmosphere of Paris has adopted London fashions, has infringed our patent right in the monopoly of pea soup fogs. The fact is instructive, as it evidently proceeds from the continually increasing use of coal fuel in Paris. The two cities are similarly situated, each in the trough of a long river valley where mists are liable to rest—such mists, if no city were there, would be the ordinary white mists of the country, consisting of minute spheres of water (vesicles have been disproved) surrounding still more minute particles of solid matter. But coal, when burnt in an ordinary fireplace where the combustion is imperfect, gives off tarry vapours and these are condensed upon the water particles as a tarry varnish, which not only colours them but gives them their acrid, irritating character. The coal further increases the liability to fog by sending into the atmosphere particles of sulphur sublimed from the pyrites in the coal. As Aitken has shown, these are most potent fog producers. By subliming an unweighably small quantity of sulphur into the midst of our atmosphere, saturated with water vapour but still clear, he produced an artificial fog so dense that it was impossible to see through a thickness of six or seven yards. Let us hope that Paris and London will co-operate to abate their fogs and abolish the smoke nuisance altogether.

**OYSTER CULTURE.**—I have received the following:—"My attention has been called to a note of

yours in last SCIENCE-GOSSIP on Successful Oyster Culture. The portion alluding to the fact of Mr. Kent succeeding with oysters at the Antipodes, and his qualification for the task, cannot be taken exception to, but as one who has spent much money, care, and attention on the matter in question, and who is still experimenting on a practical scale, I must demur to the latter portion. The temperature in Tasmania is no doubt higher and probably more equable than ours, but for many years neither our native oysters here, imported Americans, small or large, nor imported French, have shown increase. I am thoroughly acquainted with all known systems of oyster culture, and have given the subject my personal and unremitting attention for seven or eight years without success, entirely, so far as I can discover, through rapid and extensive variations of temperature. This would not take effect at greater depths, but at these depths the system advocated is impossible. You say ignorance stands in the way—then why cannot some one enlighten us; we have in vain offered prizes (and won them). Oysters keep decreasing! We want a cycle of years with less rainfall and more summer heat ere we can hope for anything here, for although our oysters occasionally reach the condition of black spat, only a very small proportion of these manage to exist. As the pioneer of 'Oyster Culture' in Scotland, I should be glad to hear of any one who could ensure success in this country.

"W. ANDERSON SMITH."

The subject is of such practical importance and scientific interest that it cannot be too vigorously agitated, and therefore Mr. Anderson Smith's letter is very welcome, as it presents the opposite side to that which I have seen and described in my GOSSIP of last month.

In spite of great respect for Mr. Smith's experience, I am still of opinion that ignorance does stand in the way. I am not using the word ignorance in an offensive sense, by any means, but as I should use it in saying that we are in ignorance concerning the laws of variation of British weather.

As regards extensive variations of temperature it should be noted that John Chinaman had succeeded in his climate, which is one of the most exaggerated in the world as regards such variations, whether we consider the difference between summer and winter or night or day. The climate of Scotland is remarkably agreeable compared with this, or even with those parts of the American coasts which supply us with "blue-points." (I may add, by the way, that on Saturday last I saw large quantities of excellent blue-point oysters offered for sale on costermongers' barrows at sixpence per dozen, pepper and vinegar and the labour of opening included.)

In the "Gentleman's Magazine" of last April, I described the Chinese method of collecting the spat



in the *shallow water* of mud flats and the subsequent transplantings. My authority was Miss Gordon Cummings' "Wanderings in China." Oyster culture appears to be one of their ancient arts, even more ancient than the mussel culture of La Rochelle described in the note preceding. These bivalves, so delicious and wholesome when thus cultivated, have yielded rich harvests during the last 800 years. All this time we have only supplied our markets with the ill-conditioned and often poisonous varieties that happen to settle anywhere, and most abundantly where sea-water is contaminated with town sewage. The climate of Stangate Creek on the Medway has not sensibly altered since I spent five days there on the Bacchante quarantine hulk in the autumn of 1843. I bought delicious oysters by the bushel from the dredgers there, at the rate of about one penny per dozen. It may be sewage, but cannot be climate, that has exterminated them there. If sewage, there are thousands of other available creeks far away from London.

Why have we no oysters in these? Mr. Smith's statement concerning the failure of the prize-taking, etc., is a confession of inability to answer this question, —i.e. of our general ignorance. It is most unfair and foolish to await the results of private investigations of such a subject. It is a national business which the nation should energetically undertake at the national cost. This might easily be repaid by a royalty on all the subsequent oyster fishing, or rental of the oyster beds. It is not probable that amateurs will devote the large outlay of time and money which is demanded, without prospect of remuneration.

#### THE STINGS OF BEES AND WASPS.

WHILST thanking Mr. W. E. Harper for pointing out "in the interest of the many young readers of your interesting paper," the mistake into which I have fallen with regard to the sting of the bee, I trust he will allow me to correct some grave errors in his "correction."

My mistake arose from the use of too low a power in examining the mounted sting of a bee, which had fallen upon the slide in such a position that the apices of the barbs being towards the eye, do not break the beautifully smooth lines of the shaft, and are therefore invisible except by the use of a higher power.

Dr. P. Martin Duncan, F.R.S., in his "Transformations of Insects," says, "The sting of the bee is made up of two very sharp stylets, which are mounted upon scales attached to the last segment of the abdomen, there being two valve-like sheaths which encase and protect them. The poison glands are formed by two twisted tubes, which lead into a large reservoir, the small opening of which is in a tube

which emerges between the piercing stylets. When the bee is about to sting, it contracts the muscles of its abdomen and forces out the stylets, and the pressure exercised in doing this gives out a drop of venom, which runs along the perforating instruments into the wound inflicted by them."

Mr. Harper is evidently under the impression that the sting is torn from the bee, and left in the wound,

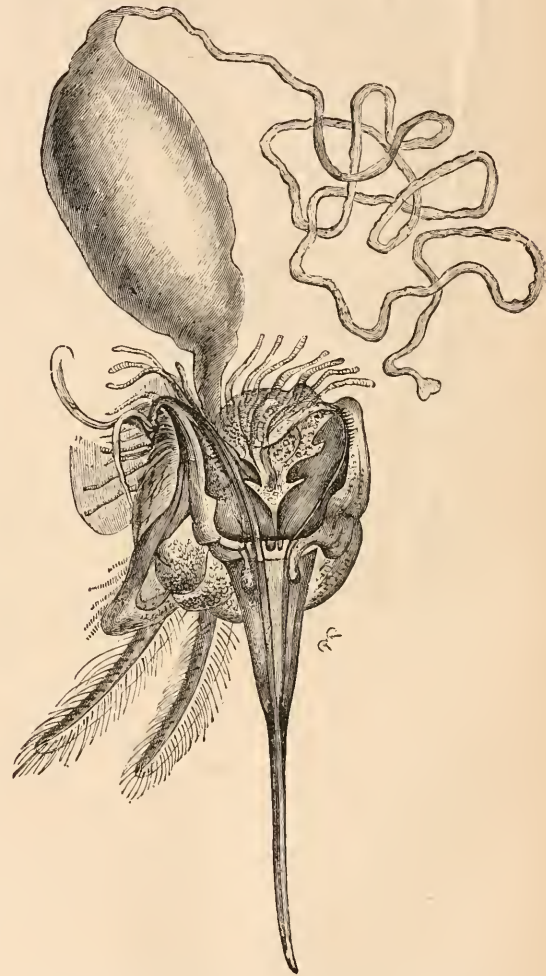

Fig. 24.—Sting, poison-bag, and poison-gland of Humble Bee.  
X 20.

in every instance where it is used. I think this loss of the sting is the exception, as is shown by Hogg to be the case with the wasp; thus, Sir John Lubbock, F.R.S., &c., says, "Bees which have stung and lost their stings always perish;" again, Sir Wm. Jardine, F.R.S.E., &c., in vol. xxxiv. of the "Naturalist's Library," page 41, says, "The darts are each furnished with five teeth or barbs set obliquely on their outer side, which give the instrument the appearance of an arrow, and by which it is retained in the wound it



has made, till the poison has been injected; and though it is said the insect has the power of raising and depressing them at pleasure, it often happens that when suddenly driven away, it is unable to extricate itself without leaving behind it the whole

other intruders into their hives; thus, Rennie, in his "Insect Architecture," page 95, says, "When an ill-fated snail creeps into the hive it is immediately attacked on all sides and stung to death."

Mr. Harper says: "The sting of the wasp being

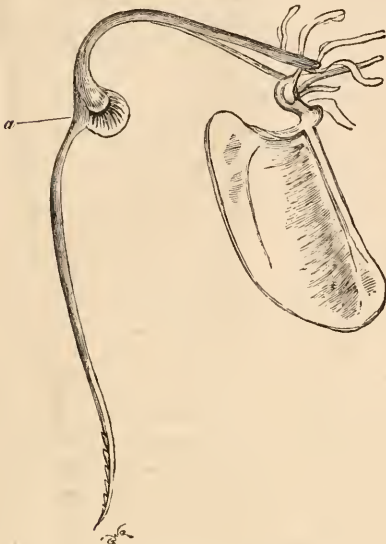

Fig. 25.—Lancet of sting of Humble Bee. X 25.  
a. Projection of lancet.



Fig. 26.—Lancet of Wasp sting. X 120.



Fig. 27.—Sting, lancets, and poison-bag of Wasp. X 25.

apparatus, and even part of its intestines; death is the inevitable consequence." Yet bees are constantly using their stings, in the execution of drones and superannuated workers, in repelling the attacks of marauding bees and wasps, and in putting to death

like the needle is withdrawn at once." Fig. 26 shows the extremity of the sting of a wasp, drawn from the slide used by me whilst writing my note in your issue of December last. It does not, I think, bear much resemblance to a needle.

Let us now compare the above extract from Mr. Harper's "correction," with the following extract from J. G. Wood's "Common Objects of the Microscope." Mr. Wood says of wasps' stings (page 99) "minute prototypes of the many barbed spears of the South

analogous to the ovipositors of other insects." Again Hogg, on the "Microscope" (page 618, 1867 edition), says: "The sting of the wasp consists of two barbed darts which will penetrate the flesh deeply and, from a peculiar arrangement of their serrated edges, their immediate withdrawal is prevented; by the great muscular effort required for this purpose, a small sac or bag near the root is pressed upon. . . . After the fluid is injected, the wasp has the power of contracting the barbed points and then it withdraws the sting from its victim." The accompanying figures are from a paper by Dr. Mills (see SCIENCE-GOSSIP, 1868, page 148).

THOMAS WINDER.

Sheffield, 6th Jan.



Fig. 28.—Side view of two teeth of lancet of wasp. X 500. A, the teeth; B, tube and branches.



Fig. 29.—Front view of two teeth of lancet of wasp.

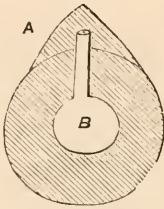

Fig. 30.—Transverse section through one of teeth.



Fig. 31.—Lancet, with duct running through tube. X 50.



Fig. 32.—End of poison-bag of wasp (polariscope object). X 40.

Sea Islanders;" and again, "It is by reason of these barbs that the sting is *always* left adhering to the wound, and is generally drawn wholly out of the insect, causing its death in a short while. The sting is only found in female insects, and is supposed to be

### GEOLOGISING AT FAXE IN DENMARK.

By J. RATCLIFFE COUSINS, B.A., LL.B.

FINDING myself in Copenhagen with several days to spare, I determined on paying a visit to that subject of curiosity, to geologists, the Faxe or Faxe limestone, a singular isolated formation which occurs in Seeland, at Faxe and Stevens Klint. This is apparently the only limestone of Seeland, the rest of the island being formed of boulder clays, gravels, &c., containing huge blocks of gneiss greenstones, and many igneous trap rocks, some of which are very beautiful, and have evidently been brought from the Scandinavian mountains in the same manner as the huge boulders scattered over Russia and North Germany. Amongst all this glacial medley of the Danish Islands and South Sweden, occur several patches, so to say, of limestone closely allied to the cretaceous formation of England and the Continent; namely, S. of Malmö in Sweden, in Skaane, in the island of Saltsholm, and at Faxe and Stevens Klint in Seeland; whilst also in Möen we have almost our identical English chalk beds at the Great Klint in that Island, containing Belemnites, Ammonites, Gryphæa, Ostræa, Terebratula, etc., reminding one very forcibly of our chalk pits at home.

Leaving Copenhagen very early in the morning, and passing the picturesque Dom Kirk of Røskilde, with its many Roman remains, our steam horse soon brings us *viâ* Kjøge, to Faxe, and we commence our operations.

At first sight we see that the limestone is very yellow and full of corals, and on trying our hammers, we find that it is in many places a very tough fellow to deal with, and we spoil several fine specimens in getting the fossils out, notably a beautiful *Brachyurus rugosus*. It is in fact a tough yellow limestone intimately connected with the chalk, and

is in great part composed of a coral reef surrounded by fragments of reef and chalk, very full of fossils closely allied to those found in the common chalk.

The limestone has been quarried extensively at Faxø, and has been used for building in Copenhagen. It also takes a good polish, and many handsome marble ornaments have been turned out of it, of which I purchased several small specimens, made from parts of the coral beds which are quite white.

The corals are very perfect, and present an appearance similar to the corals building at the present day. Amongst the zoophytes are *Oculina*, *Caryophyllia*, *Cladocora*, *Monomyxis*, and *Molthea Isis*.

The quarries make an exquisite hunting ground, and the limestone varies from tough coral reef, etc., at the east end, to soft earthy chalk towards the north and west; this again being followed by tough limestone in a small quarry on the west of the workings.

I could not form any idea of the thickness, but in some places the quarry was sixty feet deep.

On the coast at Stevens Klint, a fine section is obtained, and the Faxø limestone there lies between two beds of chalk, and lying on a bed of chalk with flints, from which it differs very much in appearance, but with which it is closely allied in its fossils, and which fossils such as *Fusus*, *Trochus*, *Cerithium*, *Nautilus*, *Terebratula*, *Ostrea*, and *Echinodermata*, Corals, etc., are closely allied to the chalk of England.

I was not surprised then in the quarries to find that the yellow reef limestone rested on an earthy chalk bed full of fossils, *Belemnites*, *Terebratula*, etc., and were also capped by a bed of white chalk in places containing corals, *Pecten*, *Ostrea*, &c.

Well I made a grand collection of fossils. I had hardly entered the quarries from the south-east when I found two good specimens of *Brachyurus rugosus*, and several fine specimens of zoophytes. In proceeding, I was rewarded on the west side of the quarry by finding a *Nautilus Danicus*, *Belemnites mucronatus*, an Ammonite, *Terebratula*, a shark's tooth, and on finishing my round, I had a heavy bag containing *Brachyurus*, *Pollicipes*, and *Serpulæ*, *Nautilus bellerophon*, *Nautilus Danicus*, *Nautilus fricator* (a friend found), *Pleurotomaria*, *Voluta*, *Cardium*, *Isocardium*, *Arca*, *Pecten*, *Terebratula*, *Cidaris Myeri*, *Goniaster*, numerous zoophytes and a tooth.

Satisfied with my day's work and having been hospitably received by Pasteur Müller, of Faxø, we sailed next day in a small pilot boat twenty-five miles to Stege, to spend two days at the Møen Klint.

WE are sorry to have to record the death, at the ripe age of 83, of Sir Joseph Whitworth, Bart., the distinguished engineer.

## ASTRONOMY AND METEOROLOGY.

By JOHN BROWNING, F.R.A.S.

AT the meeting of the Royal Astronomical Society, held on the 14th of January, a paper by Dr. R. Copeland was read on the Variability of the Spectrum of  $\gamma$  Cassiopeæ. The C line is variable in brightness, but the F line has never been absent. Mr. Maunder agreed with Dr. Copeland that both the C and F line in this spectrum have been variable in brightness.

A paper by Prof. Pritchard was read on the Application of Photography to the Determination of Stellar Parallax. Since last May two hundred negatives have been taken at Oxford of 61 Cygni and the neighbouring stars with which the place of the components of 61 Cygni were compared by Bessel, in 1840, when its parallax was first determined. From measurements of the photographs, Professor Pritchard deduces a parallax of 0.438 for the centre of the binary system. The parallax obtained by Bessel was 0.348. The research will be continued.

A letter was read from Mr. Penrose containing an account of an occultation he had obtained at Athens, on the 18th of December, of the double star  $\gamma$  Virginis. The reappearance took place from the dark limb of the moon. The power used in the telescope was not sufficient to show the components separately, a sudden flash showed the reappearance of  $\gamma$  1, and ten seconds later another flash, which seemed to double the brightness of the star, showed that the second component had appeared.

Mr. S. C. Chandler, jun., of Cambridge, U.S., has discovered two stars are variable. They are of sixth and seventh magnitude, and their period of change is one about fourteen days, and the other about thirty-six hours. In the first the increase of light occupies about four days and the decrease ten days. A large comet has made its appearance in the southern hemisphere. It was seen at Melbourne, on the 29th of January, the tail only being visible. Observers describe it as appearing like a long strong-lit ribbon of light narrowing towards the sun, without any distinct nucleus. It will very probably be visible shortly in Europe, in the southern part of the constellation Eridanus, but as it is diminishing in brightness it may not be visible to the naked eye.

The lenses of the great refracting telescope have arrived safely at the Lick Observatory. It is reported that the Observatory and apparatus will be in a tolerably complete condition in September.

During March, Mercury will be an evening star in Pisces. Venus will be an evening star also in Pisces.

Mars will be an evening star in the first half of the month.

There will be an occultation of Aldebaran; first magnitude on March the 2nd, the disappearance takes place at 5 hrs. 47 min. afternoon, and the



reappearance at 6 hrs. 4 min. afternoon. On March 11th there will be an occultation  $\gamma$  Virginis, mag.  $2\frac{1}{2}$ ; the disappearance takes place at 3 hrs. 7 min. in the morning.

*Rising, Southing, and Setting of the Principal Planets at intervals of Seven Days.*

	D.	Rises. h. m.	Souths. h. m.	Sets. h. m.
MERCURY ☿	5	6 58M	1 16A	7 34A
	12	6 28M	0 59A	7 30A
	19	5 53M	0 20A	6 47A
	26	5 22M	11 32M	5 42A
VENUS ♀	5	7 24M	1 34A	7 44A
	12	7 7M	1 38A	8 9A
	19	6 53M	1 42A	8 31A
	26	6 40M	1 47A	8 54A
MARS ♂	5	7 4M	0 55A	6 46A
	12	6 44M	0 47A	6 50A
	19	6 24M	0 39A	6 54A
	26	6 5M	0 31A	6 57A
JUPITER ♃	5	10 19A	3 25M	8 27M
	12	9 49A	2 56M	7 59M
	19	9 19A	2 26M	7 29M
	26	8 47A	1 57M	7 2M
SATURN ♄	5	0 5A	8 15A	4 29M
	12	11 37M	7 47A	4 1M
	19	11 9M	7 19A	3 33M
	26	10 42M	6 52A	3 6M

*Meteorology.*—At the Royal Observatory, Greenwich, the mean reading of the barometer for the week ending 8th of January was 29.11 in. The mean temperature of the air was 31.9 deg., and 5.8 deg. below the average in the corresponding weeks of the 20 years ending 1868. The general direction of the wind was southerly, and the horizontal movement of the air averaged 11.7 miles per hour, which was 1.5 below the average in the corresponding weeks of 16 years. Rain fell on each day of the week, to the aggregate amount of 0.71 of an inch.

For the week ending 15th of January, the mean reading of the barometer was 29.87 in. The mean temperature of the air was 33.1 and 5.0 below the average in the corresponding weeks of the 20 years ending 1868. The direction of the wind was variable, and the horizontal movement of the air averaged 9.6 miles per hour. Rain or melted snow was measured on three days of the week, to the aggregate amount of 0.19 of an inch.

For the week ending 22nd of January, the mean reading of the barometer was 30.07 in. The mean temperature of the air was 37.1 deg. and 1.9 below the average in the corresponding weeks of the 20 years ending 1868. The general direction of the wind was south-west, and the horizontal movement of the air averaged 11.2 miles per hour, which was 2.6 below the average in the corresponding weeks of 16 years. Rain or melted snow was measured on three

days of the week to the aggregate amount of 0.23 of an inch.

For the week ending 29th January, the mean reading of the barometer was 30.179 in.; the mean temperature of the air was 40.4 deg. and 0.5 above the average in the corresponding weeks of the 20 years ending 1868. The general direction of the wind was south-west, and the horizontal movement of the air averaged 7.7 miles per hour, which was 6.3 below the average in the corresponding week of 16 years. No rain was measured during the week.

For the week ending 5th February, the mean reading of the barometer was 29.96 in.; the mean temperature of the air was 44.2 deg., and 3.7 above the average in the corresponding weeks of the 20 years ending 1868. The general direction of the wind was south-west, and the horizontal movement of the air averaged 16.1 miles per hour, which was 1.9 above the average in the corresponding weeks of 16 years. Rain fell on three days of the week to the aggregate amount of 0.29 of an inch.

The mean temperature for March, is for Plymouth, 45°, Dorchester 44°, London 43°, Norwich, Sheffield, Bradford and Lancaster, 42°.

The average rainfall for March, which is generally a very dry month, is from London to Berwick on the East coast 1 inch, while from the Land's End to Solway Firth along the West coast, it varies from 2 to 3 inches.

RECENT ARTICLES AND PAMPHLETS  
WORTH READING.

"PHOTO-MICROGRAPHY," by F. H. Evans ("Photographic Journal," December 31).—  
"Zoic Maxima, or Periods of Numerical Variations," by L. P. Gratacap ("American Naturalist," Dec.)—  
"On Some Probable Causes of a Tendency to Melanic Variation in Lepidoptera of High Latitudes," by Lord Walsingham ("Transactions Yorkshire Naturalists' Union," Part 8).—"The Sun's Heat," Lecture by Sir William Thomson, reported in "Nature," January 27.—  
"On the Morphology of Birds," by Professor W. R. Parker ("Nature," Feb. 3).—  
"The Rothamsted Experiments" ("Field," Feb. 12th).—"On some Carboniferous Cockroaches," by Dr. Henry Woodward ("Geological Mag." Feb.)—  
"Geological Visit to Brittany," by the Rev. E. Hill ("Geological Mag." Feb.)—"Notes on the Saffron Plant (*Crocus sativa*) and its connection with the name of the town of Saffron Walden," by Joseph Clarke ("Essex Naturalist," Jan. 7).—"On the Causes of Glacier Motion," by W. P. Marshall ("Midland Naturalist," Feb.)—"Twenty-four New Species of Rotifera," by P. H. Gosse ("Journal of Royal Microscop. Soc." Feb.)—"On the Improvements of the Microscope with the aid of new kinds of Optical Glass," by Prof. E. Abbe ("Journal Royal

Microscop. Soc." Feb.)—"The Extinct Animals of the Lake District," by John Watson ("The Naturalist," Feb.)—"On the Pelagic Fauna of our Shores in its Relation to the Nourishment of the Young Food-fishes," by Prof. McIntosh ("Annals and Mag. Nat. Hist." Feb.)—"Photographic Lenses," by J. Traill Taylor ("English Mechanic," Feb. 4 and 11th).

#### OUR SCIENTIFIC DIRECTORY.

*South London Entomological and Natural History Society.*—This society having removed into more commodious rooms in the Bridge House, London Bridge, S.E., all communications are to be addressed to Mr. H. W. Barker, honorary secretary, as above.

*Vale of Aylesbury Naturalists' Club.*—President, Rev. Charles L. Jeayes, B.A.; Secretary, George Fell, jun.

#### SCIENCE-GOSSIP.

THE new edition of the catalogue published by The Woodhouse & Rawson Electric Supply Company is devoted to a description of their well-known electrical supplies, such as incandescent lamps, switches, cut outs instruments, Jensen electric bells, &c. &c. (the particulars of their Upward Battery for domestic lighting, electric gas lighting supplies, and the Welsbach gas burner, are published in separate lists). A price-list is given of all the leading articles used in electrical industries. The company are taking up the useful field of keeping in stock and supplying every article used in connection with electricity.

WE regret to have to record the death of Mr. E. L. Youmans, author of the "Class Book of Chemistry," and the originator of the now well-known "International Scientific Library," at the comparatively early age of sixty-six.

THE Selborne Society, formed for the protection of pretty birds from extermination because they happen to be pretty, will issue letters from time to time on the progress of its work.

THE latest of the Pasteur Reports (which covers the time from October, 1885, to December, 1886) shows that 2,682 subjects were under treatment for hydrophobia, of which only thirty-one, or 1.15 per cent., succumbed.

DURING February, Dr. J. E. Taylor, editor of SCIENCE-GOSSIP, delivered two lectures in connection with the Ipswich Museum, on "The Physical History of the Atmosphere," and two on the "Circulation of Fresh Water on the Globe"; two at Hadleigh and Bury St. Edmunds, on "Australia, its Animals and

Plants"; one at Lincoln, on "The Origin of Landscape Scenery"; one before the Dover Natural History Society, on "Flowers and Fruits"; and one at Beccles, on "Earthquakes and Volcanoes."

THE town of Baku is threatened with destruction by the sudden outburst of a natural naphtha fountain, which broke out on January 15th, so that a column of fire shot up to the height of three hundred and fifty feet.

#### MICROSCOPY.

DIATOMS FROM BANGOR, WALES.—From a small quantity of mud taken from the shore at Garth Point, Bangor, last June, at low tide, I procured several beautiful selected slides, although there was too much foreign matter to allow of my gathering being mounted "spread." The most abundant diatom was *Coscinodiscus radiatus*, the valves of which, of a beautiful violet colour when dry, could be picked out in plenty. The prettily marked *Actinocyclus undulatus* was also common, as well as the nearly hemispherical shells of *Podosira maculata* which, under well-managed oblique illumination, are gorgeously iridescent. Besides there were *Auliscus sculpus*, with its curious pattern of geometrical curves; *Actinocyclus Ralfsii* which possesses exactly the opposite property to *Coscinodiscus*, being colourless when dry and blue or green in balsam; the well-known *Triceratium favus* occurring sparingly; *Biddulphia Rhombus*, a frustule or so of an Actinospherid, one or two Pleurosigmas (?) &c. The "circular" forms by far the most prominent. Probably, had I taken my microscope with me, I might have got a far purer gathering from the surface of the mud. Certainly these "common objects of the sea shore" well repay the trouble of mounting.—G. H. Byran.

A PHENOMENON IN ANILINE STAINING.—I presume E. H. Wagstaff made his cells with the "French polish." He surely did not mount the algae in it; for, if he had, whence his fears as to its "running in"? It would be of interest to know what the actual mounting medium was, so that its solvent effect upon shellac may be ascertained.—A. W. L.

SECTIONS OF SPONGE.—Ordinary sponge may be immersed in mucilage, and then cut. It may be found of use for fresh water. The best way to examine the structure of the statoblasts is in the dry state—fresh specimens being very difficult—but is as follows: Place four or five on a glass slip with a drop of strong nitric acid. Boil this to dryness over a very low spirit lamp; do this three times. Then place the slip on the incline, and pass water over it with a camel's hair pencil until all the remains of the acid are washed out. Next with a sharp, thin knife, like a lancet, divide, in half or in quarters, one or

two more statoblasts, and adjust them round the foregoing (or on a separate slip, if preferred). Add a drop or two of benzole or turpentine to keep them in place, and when dry, which will be in a few minutes, add Ch 3, cover with thin glass, previously just warming the cover; put the slide in a warm place for some hours to harden, and it will then be ready for examination. See J. Q. M. Club, Series II. vol. i. p. 173; vol. ii. p. 252. Carpenter recommends gelatine, which will set on cooling, gum-arabic, spermaceti, or paraffine; a mixture of transparent soap is good, or celloidin.—*I. A. L.*

PREPARING SECTIONS OF SPONGES.—Mr. Sollas' method.—A good representative piece of the sponge is well soaked in distilled water, to remove its contained alcohol. After this, it is placed for an hour in a strong solution of gum, and then transferred to the well of a freezing microtome. Sections of any required thinness can now be cut in the usual way, the razor passing with apparently equal facility through the soft tissues and the hard spicules. Some of these slides—stained and unstained—Mr. Sollas mounted in glycerine, others in C. Balsam, after successive treatment with absolute alcohol and carbolic acid and turpentine. Before preserving sponges in spirit, he recommends a preliminary soaking in a .02 or .03 per cent. solution of osmic acid ( $Os O_4$ ), as the histological characters of the specimens are thus less injured.—*I. A. L.*

SECTIONS OF SPONGE.—I should fancy Mr. Clark would find celloidin a suitable imbedding medium, as it does not need to be dissolved out, being quite transparent. Celloidin is manufactured by Schering, of Berlin, and is to be obtained in cakes (2s. 6d., I think), from A. & M. Zimmermann, 21 Mincing Lane, London, E.C. The general method of using it is as follows:—A portion of the cake is broken into small pieces, and dissolved in equal quantities of absolute alcohol and ether. The solution should have the consistence of "golden syrup." In order to prepare the substance to be imbedded, it should be placed for some time (a day or so) in absolute alcohol, and then transferred to ether for from half-an-hour to one hour, or even two hours, according to its (the object's) density. The object may now be placed in the celloidin solution, where it is left for a period varying from three hours, or less, to twelve hours, or more, according to the density of the tissue. When the substance is quite permeated by the celloidin, it should be placed on a piece of cork, adapted for fixing to the microtome, and on which is a layer of the celloidin solution. In a few minutes the celloidin will set to some extent, and then the whole thing, cork and specimen, is placed in ordinary spirit (60 per cent.), which hardens the celloidin, and in which it may be kept until a convenient time for cutting. The sections may be stained and mounted in glycerine, or cleaned with

oil of bergamotte and mounted in dammar. I should say, for Mr. Clark's special purpose, it would be better to graduate the changes of density of the fluids more carefully, since rapid osmosis often destroys the natural appearance of delicate organisms. Thus, he might immerse the sponge in 50 per cent., and then in absolute alcohol. Again, the celloidin solution might be made much thinner, and allowed to evaporate slowly to the required consistency, dust being carefully excluded. Of course care must be taken to have a sufficient quantity of the diluted solution to cover the specimen when it has evaporated to the requisite extent.—*A. W. L.*

EXTRACT OF LOGWOOD.—In answer to Mr. Hafen, I send the following:—I. *Aqueous Logwood Stain.* Take 60 grms. of dried extract of hæmatoxylin, 180 grms. of powdered alum, and rub them thoroughly together in a mortar, adding slowly 300 cc. of distilled water; mix carefully, and afterwards filter. To the filtrate add 20 cc. of absolute alcohol, and preserve in a stoppered bottle. This solution should be kept in a cool place for at least a fortnight before using. The older it is, the more excellent it becomes. II. *Gibbe's Logwood.* Extract of hæmatoxylin, 6 grms., alumen, 18 grms. Mix thoroughly; while mixing add 28 cc. of distilled water; filter; add to the filtrate 5j of rectified spirits of wine; let it be kept in a stoppered bottle for a week before using. What remains on the filter can be mixed with 14 cc. of distilled water, and left soaking in it for an hour or so; then filter, and add to the filtrate 3ss of rectified spirit. The second solution is as strong as the first. The alum used must be potash without ammonia, and the extract of hæmatoxylin must be English. Besides these there are Klein's logwood stain and Mitchell's, which one I consider the best. They will be found in J. of Postal Society, vol. iv. pp. 239, 240, and from which the above recipes have been taken.—*V. A. Latham, F.M.S., Manchester.*

THE ROYAL MICROSCOPICAL SOCIETY.—The February number of the Journal of the above Society, besides the elaborate "Summary of Current Researches," contains the following papers: "Twenty-four New Species of Rotifera," by P. H. Gosse; "Freshwater Algæ of North Cornwall," by A. W. Benett; "Improvements of the Microscope with the aid of new kinds of Optical Glass," by Professor Abbe; and "Notices of New American Freshwater Infusoria," by Dr. A. C. Stokes.

CORN BUNTING WITH CROSSED BILL.—In December of last year a keeper who lives near here shot a corn bunting with crossed mandibles. It was feeding with sparrows in a farmyard. The bill is exactly the shape of that of the crossbill. The upper mandible is much hooked. I have seen a rook with a crossed bill, and heard of a canary.—*Geo. Roberts, Lofthouse, Wakefield.*



## ZOOLOGY.

A NEW VARIETY OF ROTIFER.—A new and well-marked variety of *Philodina citrina* has recently occurred in a stream near Cheadle, Staffordshire. Its form is strikingly different from that under which the species has been known, as it is very slender, with no clear distinction between the body and the foot. The colour is generally brown rather than yellow, and is not confined to the central parts. Mr. Gosse, who has seen many specimens from the stream already mentioned, thought at first that this form was a distinct and undescribed species, but afterwards concluded that it was a variety of *Philodina citrina*, a species which he had always hitherto considered rare. This variety has the social habits described by Mr. Gosse in "The Rotifera," by Hudson and Gosse, vol. i. p. 101. It is generally rough, with extraneous matter adhering to the surface. The eyes are very minute.—*J. W. Blagg, Greenhill, Cheadle, Staffordshire.*

BRECONSHIRE MOLLUSCA.—The following list of species, sent to me by Mr. F. W. Watton, from Langorse Lake, Brecon, may be of interest as a contribution to the molluscan fauna of the country:—*Valvata cristata*, *V. piscinalis*, *Bythinia tentaculata*, *Planorbis umbilicatus* (= *complanatus* of Jeffreys), *P. nautilus*, type, *Physa hypnorum*, *Limnaea peregra*, *L. palustris*, *L. truncatula*, *Pisidium pusillum*, type and var. *circularis* (3 mill. diam. greyish, rather shiny, almost circular in outline, subtruncate anteriorly, beaks almost central), and *Anodonta anatina*. *Ancylus fluviatilis* was sent from the river Usk, and *Planorbis carinatus* from the Brecon canal.—*T. D. A. Cockerell.*

VARIATION IN HELICES.—A remarkable case has recently come under my notice which may tend to throw some light on the cause and nature of colour-variation in the shells of mollusca. Specimens of *Helix aspersa*, *H. nemoralis*, and *H. hortensis*, collected on the same bank at Torquay by Mr. F. W. Wotton, and forwarded to me for examination, belonged to undescribed varieties of their respective species, all three exactly analogous, and caused no doubt by the same conditions. The peculiarity consisted in the straw-yellow tinge of the ground colour, and the red-brown colour of the banding or markings, as follows: *H. aspersa* v. *lutescens*, ground colour yellow, more or less vivid, bands pale red-brown, lip white; *H. nemoralis* v. *rufozonata*, with red-brown bands, and having the pale-lipped character of var. *hybrida*; *H. hortensis* v. *rufozonata*, with red-brown bands. With the *H. aspersa* from Torquay one specimen also of var. *unicolor* was sent, together with *H. rupestris*, *H. concinna*, *H. caperata*, and var. *fulva*, and other species. A somewhat similar instance occurred in specimens of *H. nemoralis* v. *luteolabiata* and *H. hortensis* v. *luteolabiata*, which

were found by Mr. T. H. James at Truro; in both of these varieties the lip has a decided yellow tinge, in some specimens as vivid as the pink in *roseolabiata*, the variety of *nemoralis* being of course pale-lipped. Altogether there seems to be no longer any doubt that certain variations occur in all allied species under certain conditions, and I think that it is in the careful investigation of these conditions that our hope lies of discovering the true nature of many forms of variation which are at present quite unexplained. Nor is it only in colour-varieties that this holds true. Mr. G. Roberts has found trochiform *H. nemoralis* and *H. arbutorum* living together near Wressle, in Yorkshire; Miss Hele has taken sinistral *H. hortensis* and *H. aspersa* in the same neighbourhood, near Bristol, and the Rev. W. C. Hey found reversed *H. virgata* at Coatham, within a few yards of the spot where he had previously taken reversed *H. aspersa*.\* Such instances as these are frequently brought to light, and seem to me to signify much to those interested in the solution of these problems.—*T. D. A. Cockerell, Bedford Park.*

TURBELLARIA SWALLOWING AIR.—Last summer I was examining some pond water on a slide, when I came across one of the Turbellaria of the group Rhabdocela. Beneath the cover-glass were some bubbles of air; I saw the worm deliberately swallow one of these, two or three minutes after the glass was put on. The bubble remained below the mouth at the top of the straight alimentary canal; it was very large compared with the size of the animal, and extended nearly from side to side. The bubble gradually decreased in size, and in five minutes had disappeared altogether. The air was not ejected from the mouth, but simply absorbed into the body of the worm. As I have not seen this recorded anywhere, it seems to be worth mentioning. Where did the air go, and what became of it ultimately?—*J. G. Greenfell, Clifton.*

THE PARIETAL EYE OF THE LIZARD.—On the bottom of p. 161 in your GOSSIP of last year you make mention of Mr. Baldwin Spenser's communication to the pages of "Nature" on the parietal eye of *Hatteria punctata*. There are to me interesting features connected with this which you omit. It is known that this parietal eye leads back by an optic nerve, which is connected with the pituitary body. Descartes thought this last-named structure in us was the seat of the soul. Hitherto physiologists have given the function of this organ up as almost unknowable. I believe Morse, of America, has described tertiary lizards in which the parietal foramen is a complete orbit, with well-defined processes and roughnesses of the surrounding bone for the attachment of the orbital muscles. Here, then, is a necessary solution of our pituitary body: it is a

\* "Naturalist," 1887, p. 20.

remnant of the origin of our optic nerve as it once was, because of the above elicited fact, and also because of the long authenticated fact of the nearness of our optic nerve roots at present time to that structure.—*J. W. Williams.*

THE YOUNG PLATYPUS.—The great interest excited by the discovery of the eggs of the platypus by Mr. Caldwell, in Queensland, some time ago, will be remembered. But the question whether the platypus was oviparous having been settled, another arose. How did the young platypus manage, as it had long been discovered that the female was so constructed as to suckle its young, and this seemed most singular in the case of an animal provided with the bill or beak of a fowl. The matter has been just set at rest by a discovery made by the Rev. F. A. Hagenauer, at Ramahynch. Mr. Hagenauer was anxious to secure a pair of platypuses for the Royal Park Gardens, and set a couple of his black fellows to work to look for them. In their search they came upon a nest containing a male and female, and, more valuable than all else, a very young member of the family, which seemed as if it had been just hatched. None of the aboriginals had seen such a specimen before, nor is there an account of a white man having made a similar discovery. On examination it was seen that there was no difficulty in the way of the youngster. It was an inch to an inch and a-half in length, and while bearing the shape of its tribe, it had precisely the appearance of a "joey," being of the same colour, and the bill-shaped beak perfectly so as to allow it to attach itself closely to the maternal teat. Mr. Hagenauer had it preserved, and placed it in Professor M'Coy's hands. This discovery will supply all the knowledge that has been hitherto wanting in reference to the platypus.

PLANORBIS COMPLANATUS.—The species described by Jeffreys, and now universally known to conchologists under this name in Britain, is not, as admitted by Gwyn Jeffreys himself in vol. v. of "British Conchology," Linné's species of that name. It is, however, the *P. umbilicatus*, Müller, and *P. marginatus*, Draparnaud, and the former name, having priority, will have to stand, and has now been adopted by most continental authorities, others still describing the species as *P. marginatus*. *Planorbis umbilicatus*, Taylor, from Manitoba, will need a new name.—*T. D. A. Cockerell, Bedford Park, Chiswick.*

THE DEVELOPMENT OF THE TADPOLE.—Speaking of Mr. Rousselet's observation on the ciliated epiderm in the tadpole, I made mention some months back that, in my opinion, it needed confirmation by higher powers, that was of course by means of sections. I find Mr. P. E. Wallis, on p. 44, says, "I fear Mr. Rousselet will meet with no success in his attempt to preserve stained sections," and he gives for his reason "the capillarity between the cilia and the cell" obtaining as soon as the protoplasm becomes

protoplasm no longer—as soon, indeed, as it passes into the "dead protoplasm," so called wrongly, I fear, by some authors. Well, Mr. Wallis, I doubt this. I have some sections of the epididymus, both of a man and of a cat made some years ago, and when I look at them now I can see the cilia beautifully. The same, too, of several mounts of trachea from various animals. I do not see how "this capillarity comes into play." Harden the tadpole in  $\frac{1}{4}$  per cent. of chromic acid, cut your sections with a freezing microtome, stain with logwood, mount in Farrant or glycerine, and withal carefulness, and if ever there were any cilia there, take an honest word that you will spot them.—*J. W. Williams.*

## ANIMAL PSYCHOLOGY.

OBSTINACY IN A DOG.—I happen to live under the same roof as a tan-terrier of abnormal proportions—the result of feeding "too long and too well." This dog, in contra-distinction to many virtues, is gifted with an enormous appetite, and it is through such vulgar weakness on his part that I have been able to teach him a variety of tricks. Now, taking into account his ingenuity for devising means of working upon my feelings in order to gain his coarse ends, I am surprised that he should show such sullen, perverse, and, I may say, irritating obstinacy as the following. Supposing that I, when sitting with another person in the same room, should happen to call the animal to me, he immediately puts back his ears, and proceeds to go and insinuate his nose in the hand of that other person, thereby displaying a sovereign contempt for my request. In turn, if the other person should happen to call him, the dog immediately puts on the same victimised appearance and comes to me. Again, supposing while stroking the animal I pull him towards me, he will promptly struggle to get away; and, on the other hand, if I try to shove him away, he will immediately endeavour to inconvenience me by leaning the full weight of his inflated "corpus" against my leg, and then and there hang his ears forward with a decidedly pensive expression. Now as this habit is universal, I should like to know the cause of this perversity. Why on earth doesn't he come to the person who calls him? There can be no reason in his method as far as I can see; for he certainly, as far as dogs go, is not wanting in intellect. The only solution of the problem I can come to is that the habit is inherent in the dog. There are some children (I actually know one), who, when they are asked to do anything, flatly refuse, not from incapability or natural dullness, but simply from an inherent and undefined feeling of opposition that arises within them on every such occasion. It has occurred to me that some such feeling pervades this dog; I cannot say passes through his mind, because it is a moot point whether

an animal of any sort has such a useful adjunct. If this solution is, as is most probable, unsatisfactory in the knowledge or opinion of any of your readers (for I don't mind owning that it is only set forth for the want of a better, and that I myself am not satisfied); why here, of course, is an opportunity for the said individuals to let the ignorant have the benefit of an opinion founded upon the knowledge of a well-stored mind.—*F. C. D. B.*

REASON IN A DOG.—In Dr. Romane's "Animal Intelligence," reason is defined as "the faculty which is concerned in the intentional adaptation of means to ends." The following incident, which I observed, seems to exhibit reason, as above defined, in a dog. A lady and gentleman were strolling by the Dee, accompanied by a black retriever. The gentleman now and then picked up a bit of stick, which he threw into the river; the dog on every occasion fetching it out and carrying it to his master. At length the latter flung into the stream an old, circular wicker basket or hamper, which had lain on the bank. The dog immediately plunged into the water, and dragged the hamper to land, while his master walked on unconcernedly. After shaking himself, the retriever grasped the hamper by its free edge, and lifting it from the ground endeavoured to carry along this rather heavy load; but the diameter and weight of the hamper were such that on attempting to move forward, the lowest part of the rim pressed against the dog's legs, thus preventing his walking or running. He repeatedly endeavoured, by holding the hamper as far up and forward as possible, to get along, but without success. His master, by this time, was far in front, and the dog, becoming excited, laid down the hamper and began to run round and round about it, barking furiously seemingly in a fit of impotent rage, which appeared to reach a climax when he made a savage attack on the hamper and began to tear it to pieces. I stood laughing at the desperate work of destruction, thinking the dog might ultimately select a fragment from the ruins as a trophy; but my merriment was changed to interest and surprise when the animal, ceasing from his furious labour, again seized the basket by the rim and trotted off triumphantly; having torn out a part from the side and rim of the basket, amply sufficient to permit the motion of the legs in running. Was not this intentional adaptation of a means to an end? —*T. W. Ogilvie.*

SCARCITY OF WASPS AND PLAGUE OF FLIES.—This was also remarked in 1866 in SCIENCE-GOSSIP. A correspondent believes it was from a disease that attacked the grub or larva! Last year I collected several queen-wasps in the spring from their markings. I believe I have more than six species. I should be glad to know some one who can give me information on the subject.—*Rev. S. A. Brennan.*

## BOTANY.

SALVIA PRATENSIS.—In connection with a local plant, that is, a plant which grows only in a certain spot of an isolated neighbourhood, the thought often arises, Why is this? The seeds appear to be abundant, and to ripen. Winds prevail which should scatter the seeds of the local plant in common with those of other plants; the neighbouring soil and situation appear to offer similar conditions for the growth as the spot in which they live, and yet the plants do not enlarge their boundaries. We are acquainted with many circumstances which may lessen the chances of a plant extending its kind. The beauty of a plant leads to its being frequently gathered; and I think that outlying ones—pioneers that would have been to a further extension—are perhaps more likely plucked than others which are nearer their fellows, because they stand conspicuous. When the main body is attacked, and frequent demands are made upon the main stock, the chances of diffusion are lessened, and the remainder become like the cucumber, "so coveted when rare, else base and disesteemed food for the vulgar merely." I was led to these thoughts by the result of many searches for the above plant. About three years since, I came by chance upon some of the plants in full bloom. Next year I went as I thought to the same spot, but though I searched the locality literally for several miles, I failed to find, as I suspect, the exact spot. Though puzzled, I was loth to feel assured I had missed it, and yet could not think the plant had been exterminated. Prosecuting my search another year, I came upon the corner of a field in which were growing a few scattered plants, very small, some having flowering stems a few inches in height. This season, in the same spot, were several full-grown and well-flowered plants. This spot, from the appearance of the soil, and the presence of other flowers, did not look as if it were used for pasture for grazing, or for raising other crops; yet *Salvia* had not extended to other localities. One plant had gone as a pioneer towards the outlet of the field, but none further. Previous full-grown plants may have been taken away bodily, or have been destroyed by frequent plucking. If so, the spoilers left these to perfect their seeds. Or the other large plants may have been crowded out by plants of their own or other kinds; for I found in some spots full-grown plants which showed no flowering-stem, nor was there any sign of any having been plucked. These plants were closely pressed by other fertile plants. About three weeks later I found the plants undisturbed, and their seeds ripening. Some of the ripe and ripening seeds were gathered with the stalks; but many fell out of the calyces whilst being carried home, showing that not much disturbance was needed to scatter them. In the early part of November, I again visited the spot. The plants were



withered, a few decaying leaves here and there only remaining. I much regret I did not go earlier to ascertain, as far as possible, whether the fall of the seeds preceded the breaking down of the flowering-stems.—*H. J. Brown.*

FERTILISATION OF FLOWERS.—I have been very much interested in reading several notes which have appeared in your paper in reference to the fertilisation of flowers, especially in regard to Papilionaceous flowers. I have myself watched the proceedings of bees in a bean field, and have noticed that, although they occasionally enter the flower at the mouth of the tube in the legitimate manner, they in most cases drill a hole through the outside of the base of the tube and suck the nectar through. The nectar is constantly being secreted until the flower fades, and I have noticed bees trying the already drilled holes over and over again, although as your correspondent "Mark Antony" says, they sometimes perforate different parts of the tube in search of a fresh supply. It has seemed to me rather remarkable that in a family so highly developed, and offering so many inducements for cross-fertilisation by insects, some special modification has not been made to prevent this wholesale robbery of nectar without any return (dispersion of pollen), such for instance as an inflation of the calyx as in *Silena*, or a mass of rough hairs as in many genera. Bean flowers are visited by a number of smaller insects, and I suppose cross-fertilisation is due to them, as the reproductive organs are accessible to all forms of flying insects, being placed at the top of the entrance to the flower. I may add that bees treat the garden fuchsia in the same manner.—*John Collins.*

## GEOLOGY, &c.

THE METEORITE AT LITTLE LEVER.—We inquired in our last issue for more information on this subject, and are indebted to Mr. Sykes for the following extract from a Manchester paper at the last meeting of the Manchester Geological Society. Mr. Stirrup submitted some specimens of a supposed boulder which fell in the Stokes colliery, Little Lever, causing the death of a collier. The proprietors stated that the stone was seven feet long, four feet wide, two feet four inches in the thickest part, and two tons in weight. There were several in the roofs of the colliery. Mr. Wild thought they were not boulders but sandstone. Another member said he believed they were pretty plentiful in the forest of Dean, and that they were looked upon there as sandstones. It was suggested by Mr. Watts that on the discovery of such stones the "tappings" of the collier should not be confined to one spot, but should extend some distance. The stones might be loose, although they might in one place sound solid.

THE "METEORITE" AT LITTLE LEVER.—We have received a sample of the so-called meteorite. It is a fragment of mottled sandstone shale, of the ordinary kind met with in the coal measures. The block must have been detached and fallen down. It is very certain the stone is of terrestrial, not celestial origin.—[ED.]

THE GEOLOGICAL SOCIETY AWARDS.—The awards this year are as follows: Wollaston Gold Medal, to J. W. Hulke; Murchison Medal, to Rev. P. B. Brodie; Lyell Medal, to Mr. S. Allport; Bigsby Gold Medal, to Professor Lapworth. The Wollaston Fund was awarded to Mr. B. N. Peach; Murchison Fund, to Mr. R. Kidston; and Lyell Fund to the Rev. O. Fisher.

SPENSER AND GEOLOGY.—In reading the "Faerie Queene" of this grand old poet, I have come across one or two very distinct references to the former geological connection between Great Britain and the Continent which may perhaps be interesting. The one occurs in Book ii. canto x. st. 5, and is as follows:

The land which warlike Britons now possesse,  
And herein have their mighty empire rayssed,  
In antique times was salvage wilderness,  
Unpeopled, unmanured, unproved, unprayed;  
*Ne was it island then, ne was it payssed;*  
*Amil the ocean waves, ne was it sought*  
Of merchants farre for profits therein prayssed;  
But was all desolate, and of some thought  
*By sea to have been from the Celticke mayn-land*  
brought.

The other occurs in Book iv. canto xi. st. 16:

For Albion the sonne of Neptune was;  
Who, for the prooffe of his great puissance,  
Out of his Albion *did on dry-foot pas*  
*Into old Gall*, that now is cleeped France, etc.  
—*J. S.*

## NOTES AND QUERIES.

FERTILISATION OF ANTIRRHINUM MAJUS.—Your correspondent, Mark Antony, in referring to my note respecting the large buds of *Antirrhinum majus* being pierced by bees, expresses a doubt regarding the secretion of honey before the buds expand. I was surprised that one interested in the subject of fertilisation should have overlooked the fact. If he will make a section of a large bud on the next opportunity, all doubt will at once be removed. In support of my statement, I quote from Müller, page 205, pp. 118, where, treating of *Vicia sepium*, he says, "In many cases it is hard to find a flower which has not been robbed in this manner, and often, even unopened buds are robbed." Again, p. 186, "*Bombus terrestris* bites through the tube of *Trifolium pratense*, and reaches the honey with some delay; it has, however, the advantage of obtaining honey even from unexpanded flowers. Mark Antony need not scruple to use the term honey, as applied to the sweet juice secreted by flowers, as it is used throughout the English edition of Müller, and also by Sir John Lubbock on the first page of his new book on flowers, fruits, and leaves. I cannot agree with G. S. S., who regards the act of boring through the corolla as an act of foolishness. He says, "Opening the flower at the base would seem to be a foolish action on the part of the bee,

rather than a sign of increasing intelligence, as it enables other insects to obtain access to the honey which otherwise they would not be able to reach." The bee that usually makes the puncture is *B. terrestris*. In its action we have an illustration of an old proverb. The tongue of this bee is short, consequently, it often finds that the honey is out of reach if it enters the flower in the usual way; it must therefore invent other means, or be deprived of enjoying the coveted sip. The bee adapts itself to circumstances, and does not appear to take into account the effect upon the community.—*Robert Paulson*.

**VITALITY OF DOR-BEETLE.**—Yesterday I found a fine specimen of *Geotrubes stercorarius* (the dor-beetle), which I put in my cyanide bottle, a tolerably strong one, and left there for an hour. I then took it out, dissected it, and gummed each part of the body separately on a sheet of card, except the first pair of legs, which I left on the thorax. I did not notice anything peculiar at the time, but about five hours later I looked at it and saw that one of the tarsi, that on the left fore-leg, was moving. It continued to wave from side to side for some minutes. I also saw the whole leg move very slightly once or twice. This seemed more wonderful as the thorax had been emptied of its contents, and was nearly dry.—*F. J. Waller*.

**MARK ANTONY**, in discoursing on bees, p. 239, Vol. 1886, supplies, to my mind, an argument in favour of instinct as opposed to any reasoning power in these insects. He concludes that "after all it would appear that bees only fly in a direct line on their return to the hive." Further on, quoting Sir John Lubbock, "I have been a good deal surprised at the difficulty which bees experience in finding their way," instancing the fact that a bee taken two hundred yards to a room, and given honey, failed to return; with the statement, also Sir John's, that he rarely found bees return to honey if brought any considerable distance at once. Now, if bees, as a rule, fly in a direct line when returning to the hive, after an erratic course of many hundred yards from it, often to pastures new, how is it that these found a difficulty in returning, if they ever desired to return, to a spot only two hundred yards from the hive? Surely not from an inability to find their way, when they are able to return home direct from long distances by a route perhaps never before traversed. Was it not rather instinct which carried Sir John's bees off to the flower of the field in the very face of his allurements? Would it not rather savour of reason, had they, instead of resuming their wonted method, quitted the instinctive track and forthwith returned to the room, whither they had previously been conveyed, for the honey they remembered to have found there? Sir John found, however, his bees capable of being trained. Does not training itself appeal to this very instinct for its success? Would not strange habits, by training, become assimilated, as it were, into the instinctive economy?—*G. A. Newman, Jersey*.

**A STRANGE BUTTERFLY.**—I have a butterfly, taken at Shanklin, I.W., which I believe is unknown to British collectors. Not mentioned in Newman's, or Colman's, or Morris's, or Wood's works on entomology. The insect measures at least  $4\frac{1}{2}$  inches across, is of a bright Vandyke brown, with black markings similar to black veined white (*Aporia Cratagi*), and has a white and spotted black edge to each wing, with deep black line on inner margin; body is black, with white spots on thorax; is in splendid condition, seemingly fresh from chrysalis.—*J. A. Billings*.

**A QUERY.**—The other day, whilst looking at my aquarium, I saw hanging to a leaf what appeared to be a small leaf suspended by a spider's thread, but on examining it closely, found, to my surprise, to be a small grey slug of about three-eighths of an inch long; it was twisting itself about and gradually letting itself down, till at length it reached the water, when it suddenly dropped. From the time when I first began to watch it, I suppose it must have come down four or five inches. Can any of your readers tell me whether the slug actually spun the web on which it was, or whether it simply clung to a spider's thread, if so, how did it maintain its foothold?—*W. J.*

**PHENOMENAL BUGS.**—I venture to send a short account of an incident which has happened in my experience, and which bears in some respects resemblance to the narrative in your November number with the above heading. About twenty years ago I lived in a house (in Bury St. Edmunds), the back door of which opened on to a path some five or six feet wide, paved with ordinary paving or flagstone. This path ran past first the kitchen, and next that came a washhouse or brewhouse, the further end of which was divided off as a receptacle for coals, faggots, &c. One hot morning in the middle of summer, on going out I found the whole front wall of the washhouse and the adjoining pavement literally brown with fleas. There were myriads upon myriads. Where they came from I have not the slightest idea, nor did it occur to me to ascertain of what variety they were. Where they went to I am equally at a loss to say, but their numbers decreased as the day went on and the next morning not one was to be seen.—*C. I.*

## NOTICES TO CORRESPONDENTS.

**TO CORRESPONDENTS AND EXCHANGERS.**—As we now publish SCIENCE-GOSSIP earlier than formerly, we cannot undertake to insert in the following number any communications which reach us later than the 8th of the previous month.

**TO ANONYMOUS QUERISTS.**—We must adhere to our rule of not noticing queries which do not bear the writers' names.

**TO DEALERS AND OTHERS.**—We are always glad to treat dealers in natural history objects on the same fair and general ground as amateurs, in so far as the "exchanges" offered are fair exchanges. But it is evident that, when their offers are simply disguised advertisements, for the purpose of evading the cost of advertising, an advantage is taken of our gratuitous insertion of "exchanges" which cannot be tolerated.

We request that all exchanges may be signed with name (or initials) and full address at the end.

**E. A.**—The best books on the British Gramineæ and Cyperaceæ are Sowerby's, price 1*l.* 1*s.*

**J. P. COUSIN.**—Accept our best thanks for specimens of *Faxoe* chalk and fossils.

**W. H. L.**—We do not know of any books like that you require, in a popular way, except Beeton's "Dictionary of Natural History," and the "Treasury of Botany." Both are alphabetically arranged.

**H. JACKSON.**—You will get silkworms' eggs by applying to Messrs Watkins & Doncaster, 36 Strand, London.

**W. DUNCAN.**—We received your specimens of *Sertularia abietina*, but have not found any algae to which the red colour can be assigned. Where were they gathered? It looks more as if they had been gathered along some shore where red rocks prevailed, so as to allow the iron to colour them.

**F. B. W.**—Your specimen is certainly not a sponge. It looks like the dried mycelia of some fungus. The best book on British sponges is in three vols. by Dr. Bowerbank, published by the Ray Soc. There is no elementary book on the subject. See "Half Hours at the Seaside" (Messrs. Allen & Co., price 2*s.* 6*d.*). Chapter on "Half an Hour with Sponges."

**J. S. GALIZAC.**—Apply to Mr. W. P. Collins, 157 Great Portland Street, London, for all or any of the monthly scientific journals you require.

**J. S. WALKER.**—See "Notes on Collecting and Preserving Natural History Specimens" (Messrs. Allen & Co., price 3*s.* 6*d.*), Chapter on "Collecting Bones," &c.



G. HEYS.—The lecture on "Earthquakes and Volcanoes," delivered before the Dover Field Club, was reported pretty fully in the *Dover Standard* of Nov. 27th, 1886, which you can obtain from the office.

J. CAMBRIDGE.—Apply for information to the secretary of the Royal Microscopical Society.

E. P. POWELL.—Your diatom (judging from the rough sketch) appears to be a species of *Aulacodiscus*.

J. S. T.—The specimens are (1) *Atrypa reticulata*, (2) *Rhynchonella Wilsoni*, (3) *Hyalites catenulata* (a foss. coral), (4) part of *Orthoceras*, and (5) a fragment of *Astræa* (foss. coral). See Taylor's "Common British Fossils," for descriptions and illustrations.

MR. GORTON.—The following are excellent books on the subjects, price 7s. 6d. each (Routledge & Co.): "British Lichens," by Dr. Laurer Lindsay; "British Seaweeds," by Dr. Landsborough; and "British Mosses," by J. Slack.

### EXCHANGES.

WANTED, Geikie's "Class-book of Geology."—Charles C. Crick, 43 Parliament Street, London, S.W.

WHAT offers for "Studies in Microscopical Science," by A. C. Cole? vol. i., Nos. 27-52, with Preface and Index; with 26 chromo-lithograph plates, quite new. Wanted, good work on fungi, with coloured plates, Berkley's or others.—Mrs. Bishop, The Platts, Watford, Herts.

WANTED, a copy of "The Tourist's Handbook to the Flora of Germany, Switzerland, etc.," published by Lovell Reeve & Co.—R. Postans, Springfield Road, St. Leonard's-on-Sea.

WHAT offers in books for my private collection of shells; classified after Woodward, 150 species (upwards of 300 shells); also some recent corals, some minerals, and a human skull.—A. Hickmott, College Walk, Maidstone.

EXCHANGE, "British Marine Testaceous Mollusca," by William Clark, published by Van Voorst, 15s., equal to new, for Gray's "British Seaweeds."—Charles Woods, King Street, Jersey.

THREE dozen micro objects by Tapping; exchange for "The Microscope," by Carpenter, or offers.—G. A. Barker, 1 Northwood Road, Clapton.

*Zonites glaber*, *Planorbis dilatatus*, *Helix caperata*, var. *ornata*, for almost any of the smaller species of Helicidæ.—T. Rogers, 27 Oldham Road, Manchester.

SIX hundred fronds and pinnae of goldfern, silverfern, maiden-hair, and many other kinds of exotic ferns. Wanted, works on botany, or good collection of British seaweed (named). Also living roots of (L. C., 7th ed.) 243, 1001, 1006, 1021, for equal number of 7, 131, 172, 173, 176, 260, 261, 292, 293, 531, 812, 813, 864, 1000, 1002, 1314, 1315, 1327, 1328, 1330, 1015, 1043.—J. W. Brook, 4 Cliffe, Witley, Halifax.

150 named lichens offered in exchange for others, or for books, apparatus, slides, shells, etc.—R. V. Tellan, Bore Street, Bodmin.

WANTED, fossil and recent shells, genera *Melania*, *Melanopsis*, *Cyrena*, *Potamides*, *Paludina*, *Corbicula*; exchange.—C. Musson, 23 Mapperley Hill, Nottingham.

FOR exchange, "The Naturalist's World," vol. i. Desiderata, British land and freshwater mollusca.—C. H. Pierson, 16 Brunswick Place, Leeds.

"NATURE," wanted weekly, a few days after publication; state exchange required.—Wm. Hardie, 49 Morningside Road, Edinburgh.

WANTED, *Hyalina Draparnaudii*, *Testacella Maugei* and *verticosa*, in exchange for *Clausilia duplicata* (only one or two left), *Helix pisana*, *H. rufescens*, *H. sericea*, *Hyalina nitida*, *Planorbis carinatus*, *Noritina juvenilis*, etc. Also wanted particularly some good living specimens of *Helix pomatia*, *H. nemoralis*, and *H. hortensis*.—Wilfred Mark Webb, 31 Anhoë Road, Brook Green, W.

WANTED, SCIENCE-GOSSIP, any years before 1883, bound or in parts, in exchange for really first-class pretty photos of Irish scenery, antiquities, yachts racing, steamers in motion, etc., size 8x5 1/4 inches. Also offered, Belfast riot photos, snow scenes, photomicrographs of diatomacea, foraminifera, and transparencies from same.—R. Welch, publisher of Irish views, 49 Lonsdale Street, Belfast.

"KNOWLEDGE," Nos. 1-113 inclusive (No. 2 missing), good as new. What offers?—Joseph Anderson, jun., Alre Villa, Chichester.

SHETLAND lepidoptera (Macros and Micros) in splendid condition. Shall be glad to receive offers.—Joseph Anderson, jun., Alre Villa, Chichester.

FIRST-CLASS slides (diatoms, fungi, parasites, anatomical, pathological, botanical) in exchange for micro books, appliances, and objectives, or volumes of SCIENCE-GOSSIP.—Fred. Lee Carter, 25 Lansdowne Terrace, Gosforth, Newcastle-on-Tyne.

WANTED, to exchange British mosses and Hepaticæ. Send list to—F. J. Warner, 22 Hyde Street, Winchester.

WANTED, Gray's "Turlton's Manual of Land and Freshwater Shells." Offered, Harting's "Rambles in Search of Shells," with coloured plates of the species and list of local catalogues; or Latham's "Ethnology of the British Isles," 8vo., 1852, or other books on natural history.—George Roberts, Lofthouse, near Wakefield.

WHAT offers for a Beck's Ranviers micrometer?—W. Armitage, Asteria, South Park Road, Harrogate.

DUPLICATES of common shells will be sent (named) to any beginner in conchology who will send box and stamps for return postage.—George Roberts, Lofthouse, near Wakefield.

PACKETS containing twelve unmounted micro objects of interest, including Kieselguhr fossil earth from Natterlues, rare animal hairs, micro fungi, and seeds of *Pyrola rotundifolia* and *Parnassia palustris*, in exchange for a like number of other good objects, rare zoophytes particularly wanted.—Dr. Webb, 46 West Derby Road, Liverpool.

A COLLECTION of English seaweeds, named and arranged, in album; offers solicited.—Antiquary, Lyme Regis.

EGGS of woodpeckers, kingfishers, cuckoo, grosbeaks, and waxwings, offered for nests with eggs of British or foreign birds.—J. T. Reel, Ryhope, Sunderland.

WANTED, Gray's "British Seaweeds," Huxley's "Physiology," also a good work on marine hydrozoa and polyzoa and an elementary work on botany.—J. W. E., 4 Hyde Road, Eastbourne.

WANTED, histological slides; will give in exchange unmounted marine objects, such as algae in fruit, zoophytes, also shells, Echinus spines, aphrodite or sea-mouse, etc.—J. W. E., 4 Hyde Road, Eastbourne.

WANTED, numbers of "Quarterly Journal of the Geological Society" in exchange for well-mounted micro slides.—Rev. George Bailey, Finchfield, Essex.

MR. GAETANO PLATANIA PLATANIA, Via S. Giuseppe, 14 Acireale, Sicily, desires to begin again the exchanges of shells and fossils.

FOR exchange, a well-made cabinet of forty drawers and collection of lepidoptera.—Robert Barker, 11 Towend Street, Groves, York.

WANTED, vols. of "Northern Microscopist" unbound preferred, to complete set, lowest offers, etc.—N. A. Latham, F.M.S., 10 Portsmouth Street, Oxford Road, Manchester.

DUPLICATES: *S. Ligustri*, *megacarpalia*, *Phragmitidis*, *Lucipera*, *triplesia*, *typica*, *sambucaria*, *tiliaria*, *rhomboïdaria*, *rubiginata*, *crocealis*, *lariciana*, *occultana*, *Goedartella*. Desiderata numerous. Accepted offers answered within three days.—George Balding, Ruby Street, Wisbech.

WANTED, numbers or volumes of SCIENCE-GOSSIP prior to August 1885, excepting several numbers in 1879, 1880; exchange botanical, natural history, and other works.—P. F. G., 80 Leathwaite Road, Clapham Common, London, S.W.

FOR exchange, about 300 species of land, freshwater, and marine shells. Offers solicited; Chinese, Japanese, and Brazilian land shells preferred.—Miss Linter, Arragon Close, Twickenham.

"THE DAWN OF LIFE," Dawson, "Zoological Photographs," Hassel, "Guide to the Isle of Wight," Venables, for freshwater or submarine fossil shells.—W. A. Loydell, 20 Stanley Gardens, Acton Vale.

A VALUABLE collection of British marine, land, and freshwater shells, about 300 specimens, each species in a separate numbered box with detailed catalogue of localities, etc., many rare; exchange magic lantern, good fageolet, portrait lens, any photo apparatus, or offers in books on photography or art.—Corkett, Photographic Artist, Soham, Cambs.

### BOOKS, ETC., RECEIVED.

"Report, U.S. Fish Commissioners," vol. for 1884.—"Hours with a Three-inch Telescope," by Capt. Noble (London: Longman).—"The Garner," vol. for 1886 (London: W. E. Bowles).—"The Coleoptera of the British Islands," by Rev. W. W. Fowler (London: Reeve & Co.).—"Sonnets on Nature and Science," by S. Jefferson (London: T. Fisher Unwin).—"Handbook of Practical Botany," (London: Swan Sonnenschein & Co.).—"The Amateur Photographer."—"The Camera."—"The Garner."—"The Scientific Enquirer."—"The Naturalist."—"The Botanical Gazette."—"Journal of the New York Microscopical Society."—"Belgravia."—"The Gentleman's Magazine."—"American Monthly Microscopical Journal."—"The Essex Naturalist."—"Journal Royal Microscopical Society."—"Economic Naturalist."—"The Midland Naturalist."—"Feuille des Jeunes Naturalistes."—"The American Naturalist."—"Journal of Microscopy."—"Studies in Life and Sense," by Dr. Andrew Wilson (London: Chatto).

COMMUNICATIONS RECEIVED UP TO THE 13TH ULT. FROM: B.—R. B. C.—R. P.—T. W.—A. H.—T. W.—R. C.—A. W. H.—B. D. J.—W. J. H.—C. H. M.—G. F. Jun.—H. A. C.—C. W.—G. H. W.—G. S. B.—C. H. P.—J. R. C.—C. C. C.—W. E. G.—G. E. G.—W. D.—C. H. B.—E. A. S.—A. O.—B. B. W.—W. E. Q.—W. M.—W. H.—C. T. M.—G. P.—W. K.—A. P. W.—G. A.—B.—R.—V. T.—A. E.—J. W. W.—J. W. B.—J. S.—W. W.—T.—R.—T.—W. W.—L. S.—W. I. W.—G. R.—W. C. F.—T. W. W.—R. T.—J. T. F.—R. D. P.—J. A.—F. W. E.—F. L. C.—R. W.—M. W.—I. W.—D. K.—G. I. G.—REV. S. A. B.—A. W. L.—H. W. K.—J. T.—H. H.—C. P.—B. T.—I. W. O.—W. E. W.—G. P.—REV. G. B.—G. W. E.—H. J.—G. B.—T. T. R.—F. E.—W. H.—T. D. A. C.—R. B.—N. A.—L.—P. F. G.—F. T. C.—W. H.—L. C. F.—C. W.—J. E. L.—A. P.—W. A. S.—H. W. B.—W. L. M.—&c., &c.





## NOTES ON "GONOPTERYX RHAMNI."

By R. D. POSTANS.



WHEN at Heidelberg last summer I found a considerable number of the larvæ of *G. Rhamni*, and had an opportunity—which I had never before had—of watching the growth of the caterpillar almost from the egg up to the time of its passing into the pupa stage. Perhaps a few notes on these caterpillars may be acceptable.

Observing the food plant (*Rhamnus frangula*) one day during a ramble on the hills above Neunheim, I noticed that one or two leaves had been eaten, and after a very short search I found a caterpillar; in colour of a dull lightish green with a whitish mark down each side. It had placed itself on the upper surface of a leaf, at about the centre; the after part of its body was parallel to the surface of the leaf, but the anterior portion was elevated at an angle of about 20°.

I found this was *invariably* the position of the caterpillar when not eating, and that when so at rest the hinder feet were attached to a sort of web spun on the surface of the leaf, to afford, I suppose, a more secure footing.

The first day I searched I found about fifty specimens. I picked a small twig with each caterpillar (not attempting to remove any from the leaves they were on) and carried home the twigs in a bunch, not being especially careful about shaking them, and I did not lose one.

I put the twigs, just as they were, in a jug of water, and placed this just outside the window without covering them in any way.

No. 268.—APRIL 1887.

The caterpillars never attempted to crawl away, and only moved to eat, which was for the most part done at night.

Every few days I had, of course, to give them fresh food, when I moved them with a feather from the old leaf to a new one. It was in doing this that I satisfied myself as to the web spinning above referred to.

Just before going into the pupa state each larva became almost translucent, so that I could always tell when that stage was imminent.

The caterpillar would then suspend itself either on the under surface of a leaf or—and this was a very favourite place—under the top of the handle of the jug.

They passed into the chrysalis state in a very few hours after suspension, and for a day or two looked like chrysalis cases filled with a light greenish fluid. They however gradually became more opaque, and in about a fortnight the wings (of the male, bright yellow) were distinctly discernible, a sign that the imago would very shortly emerge.

Apparently at Heidelberg *G. Rhamni* is not troubled by the ichneumon, as though I bred some dozens I had not any so affected, but somehow or other there must be a great slaughter of the larvæ, for when I made a careful search for the pupæ, which I did when my own began to hatch out, I could not—though I devoted a whole day to the search—find a single specimen. I should add that the caterpillar is solitary, though three or four specimens may sometimes be found on the same plant; and that, as a rule, it is a night-feeder.

*Rhamnus frangula* is very abundant as a small diffuse-growing bush on some parts of the hills above Neunheim.

*St. Leonards-on-Sea.*

"PROFESSOR HAECKEL is gone to the East"—(a rather indefinite geographical place for an accurate scientific Journal to localise). But we copy from a weekly contemporary that has never yet proved itself wrong!

## ANIMALS AND PLANTS IN AUSTRALIA.

IN the number for August of SCIENCE-GOSSIP, in your article entitled "A Month with the Squatters of Western Victoria," occurs the following passage: "In Australia it is remarkable how they (sheep and cattle) also have learned to adapt themselves to the new fodder and other plants. They know the naturally poisonous Euphorbia, now, as well as their ancestors knew the poisonous plants at home. At first they ate all the plants they came across, and many died, but they soon learned to discriminate. Now, if any sheep or cattle die from eating poisonous plants, it is sure to be the young or newly imported ones." Apropos of which a few extracts from a paper read by Mr. Gordon, on the "Suspected Poison Plants in Queensland," before the Australian Stock Conference, last October, may not prove uninteresting to your readers.

"The number of poison or suspected poison plants sent to me or to the Colonial botanist, from all districts of the colony, is forty-two. Thirty-four of these are common to Queensland and New South Wales, many of them also to Victoria.

"The *Gastrolobium grandiflorum*, the wallflower, Australian or Desert-poison bush, is first deserving of notice. There are belts of this plant through which it is impossible to travel bullocks and sheep without constantly watching them and yarding them at night. Before the line of railway was constructed through the belt on the Great Northern line, parties travelling in charge of valuable stud sheep had to muzzle them during the day, and carry hay for the purpose of feeding them in bush yards during the night.

"The next in order is the *Swainsonia galigifolia*, the dark red flowered indigo bush, with its variations *Coronillefolia* (the rosy flower), and the *Albiflora* (the white flower). This plant is generally recognised under the name of Indigo or Darling pea. It is not an irritant poison, but when sheep once eat it, it is difficult to break them of the habit. They become what the shepherds term "cranky," and separate themselves from the flock. Mr. Staiger, late Government analyst for Queensland, experimented with an extract from the plant, and found it to be a powerful diaphoretic; when applied to frogs, rats, and mice under confinement, the animals literally sweat to death.

"Of the Euphorbias, the *E. drummondii* and the *E. eremophila* are the only two that have been brought under my notice as poisonous. The effects of the former (called by the stockowners the caustic creeper) on sheep are curious. The head swells to such an enormous extent that the sheep has frequently to drag it along the ground, and there is frequently suppuration of the ears. Like the *gastrolobium* analysts would seem to have a difficulty in detecting poison, except in green specimens, and drovers state

that it is only poisonous when eaten before being dried by the sun.

"The *Datura stramonium* and the *D. leichhardtii* (native thorn apple) are both poisonous to cattle, but are rarely eaten except by quiet milkers, or during seasons of drought, when food is scarce.

"The *Nicotiana suaveolens* (native tobacco) and the *Bulbine bulbosa* (the native leek or onion) both cause numerous deaths amongst travelling sheep.

"The *Xanthium strumarium* (Noogoora burr), a plant introduced into Queensland with cotton seed from the Southern States of America, when young and succulent is readily eaten by cattle, and many deaths have been the result.

"The *Xanthium spinosum* (the Bathurst burr) is also of a poisonous nature.

"With both of the above-named plants, losses in stock are as a rule confined to travelling sheep and cattle. Rarely do sheep bred on the runs, on which they are prevalent, eat them, or if they do fatal results rarely occur."

Among other plants condemned by various members of the Conference were the prickly pear, and the Californian thistle, not as poisonous, but on account of the damage they do to the land. In the valley of the Hunter it would cost £10 an acre to clear the land of the prickly pear.

"The roots of the Californian thistle run down eight to ten feet, and then throw out laterals. If the plough went over them and carried away ever so small a portion, a fresh plant grew; its presence was considered to depreciate the land 75 per cent.

"In South Australia the plant known as the variegated thistle grew to a height of ten feet in rich gullies.

"In Tasmania the common thistle has been seen so thick that a man could not ride through them.

"The pine scrub has increased to such an extent in the Murray district that the number of sheep maintained has fallen from 25,000 to 2,000.

"The Bathurst burr causes a most serious loss to wool growers; in some instances the price of wool has been decreased 3*d.* per pound, and in some cases more; the fleece is sometimes double its proper weight, owing to the presence of burrs. A single plant would produce 2000 to 3000 seeds."

Perhaps it is only right to add, all the plants mentioned in Mr. Gordon's paper were identified and named by the Colonial botanist, Mr. F. M. Baily, F.L.S.

HARRY MOORE.

IT is a pleasure to call attention to the Supplementary Catalogue of the books added to the Lending Department of the Newcastle-on-Tyne Public Libraries. It is compiled by Mr. W. J. Haggerstone, chief librarian, and is a model of neat and succinct arrangement.

THE TWO MIRRORS.

By W. J. N.

No. VI.

FROM the results obtained in the last art. we deduced the following important rule with respect to a simple divergent pencil :—

*In order to bring the reflected rays to a focus on the object, the lamp-flame and object must occupy the positions of conjugate foci of the mirror.*

How then are we to determine the positions of these foci? In other words: when a position has been assigned either to the mirror or to the lamp, how are we, from this assigned and therefore known distance, to determine what is the conjugate position for the lamp, or for the mirror respectively?

Let  $\Delta$  be the distance of L from D; that is, of the lamp-flame from the centre of the mirror. Let  $\delta$  be the distance from D to the point of mean focus; that is, of the object from the mirror. Let R be the radius of the mirror, and  $\cos \alpha$  be the cosine of the angle of incidence.

Then, if the mirror be set at a known distance from the object,  $\delta$  is known and we need to find  $\Delta$ . But if, instead, we assign a fixed distance to the lamp,  $\Delta$  will be known and we shall need to find  $\delta$ .

In the first case  $\Delta = \frac{\delta R \cos \alpha}{2 \delta - R \cos \alpha}$ ; and in the

second,  $\delta = \frac{\Delta R \cos \alpha}{2 \Delta - R \cos \alpha}$ . *Example.*—In the last

figure, L is  $4\frac{1}{2}$  inches from D, and  $\Delta$ , therefore, is 4.5. The mirror has a radius of 3 inches (= R); and the angle of incidence is  $45^\circ$ , of which angle the natural cosine is .707. Substituting these values in the formula for  $\delta$ , we have—

$$\delta = \frac{4.5 \times 3 \times .707}{2(4.5) - (3 \times .707)} = \frac{4.5 \times .707}{2(1.5) - .707} = \frac{3.1815}{2.293}$$

= 1.4 inch nearly. In such a case, therefore, the little mirror represented would be correctly set at about  $1\frac{1}{2}$  inch from the object. This is the distance, in the figure, of the point  $f^2$  from the centre of the mirror, as found by projection of the rays.

From one of the above formulæ the student should construct a table of foci for his own mirror. The following table is for a mirror of 8 inches radius.

The table is instructive. If the mirror be  $4\frac{1}{2}$  inches from the object, and the selected angle of incidence be  $30^\circ$ , the lamp should be placed 15 inches from the mirror. This will give a satisfactory result, provided the other conditions are observed, the mirror being in the axis of the instrument, the lamp-wick turned down low, and having one of its corners (not the flat side) turned towards the mirror. It must ever be remembered that only a minute flame, turned with its narrow edge towards the mirror, can, at short distances especially, fitly represent the point L in the figures. If the mirror be brought half an inch nearer the object, the lamp

Table of Conjugate Foci for a simple Divergent Pencil obliquely incident on a Concave Mirror of eight inches radius.

Angle of incidence, formed by axis of pencil with principal axis of mirror.	DISTANCE FOR THE LAMP.			
	Mirror $4\frac{1}{2}$ inches from object.	Mirror 4 inches from object.	Mirror $3\frac{1}{2}$ inches from object.	Mirror 3 inches from object.
deg.	ft. in.	ft. in.	ft. in.	
30	I 3	2 I $\frac{1}{2}$	25 $2\frac{3}{4}$	} Imposs- ible case.
35	I I	I 6	4 4	
40	9 $\frac{1}{2}$	I I	2 0 $\frac{1}{2}$	
				ft. in.
45	7 $\frac{3}{4}$	9 $\frac{3}{4}$	I 2 $\frac{3}{4}$	4 2
50	6	7 $\frac{1}{2}$	9 $\frac{3}{4}$	I 6
55	4 $\frac{3}{4}$	5 $\frac{3}{4}$	6 $\frac{3}{4}$	9 $\frac{9}{10}$
60	3 $\frac{3}{4}$	4	4 $\frac{3}{4}$	6
65	2 $\frac{3}{4}$	3	3 $\frac{1}{4}$	3 $\frac{9}{10}$

must be raised a little and removed  $10\frac{1}{2}$  inches further from the mirror. A great loss of light will result, the intensity of the light upon the surface of the mirror varying, as we have seen (Fig. 21), inversely as the square of the distance. The difference in this case will be represented nearly by the ratio  $15^2 : 25^2$  or 9 : 25, so that nearly two-thirds of the light will be lost. If the mirror be brought half an inch still nearer to the object, the theoretically true position of the lamp would be more than 25 feet distant; which tells us that for that position of the mirror we should have to give up our simple divergent pencil, and use a parallel one instead. Were the mirror again moved half an inch, its distance from the object being reduced to 3 inches, neither a divergent nor a parallel pencil could be focused on the object. The incident rays would, in that case, need to be convergent. Taking the table as a whole, it will be noticed that when the lamp is within a reasonable distance of the mirror, the mirror will need to be much further from the object than when a parallel pencil is employed. For instance, if the angle of incidence be  $45^\circ$ , the mirror of 8-inch radius should for a parallel pencil be  $2\frac{3}{4}$  inches from the object (see vol. for 1886, p. 266); whereas  $4\frac{1}{2}$ , 4, or  $3\frac{1}{2}$  inches would be suitable distances for use with our simple divergent pencil, as will appear from an inspection of the table.

When a compound divergent pencil is employed, the positions assigned to the lamp, in the table for simple pencils, will not apply. A deduction must be made, which involves some further calculation.

Fig. 33 represents such a pencil emanating from the point l, and intercepted by the bull's-eye at a distance slightly less than that of its principal focus. In passing through the bull's-eye the rays are refracted, and their new lines of direction become the same as those of a simple pencil emanating from the point L. Having LD given in our table for



simple pencils, as the distance for the lamp corresponding to the focus  $f^2$ , if we can calculate the distance  $L$  and deduct it from  $L D$ , we shall obtain the required distance  $l D$ . The distance  $l G$  must be less than  $FG$ , or the refracted rays will not be divergent. Let us suppose that a pencil of convenient size for the mirror is formed when the point  $l$  is  $\frac{1}{4}$  inch nearer to  $G$  than  $F$  is.  $FG$  and  $l G$  will then both be known. If  $l G$  be called  $U$ , and  $L G$  be  $V$ ,  $V - U$  will represent the required distance  $L l$ . Let  $FG$  be called  $P$ .

may greatly affect the character of the ultimate pencil.

Divergent pencils enable us to set the mirror at extreme distances from the object, and so to obtain an ultimate pencil whose rays are very little oblique to the axis of the microscope. The compound form has in certain cases the advantage of giving a more brilliant illumination, by admitting of a nearer position for the lamp.

(To be continued.)

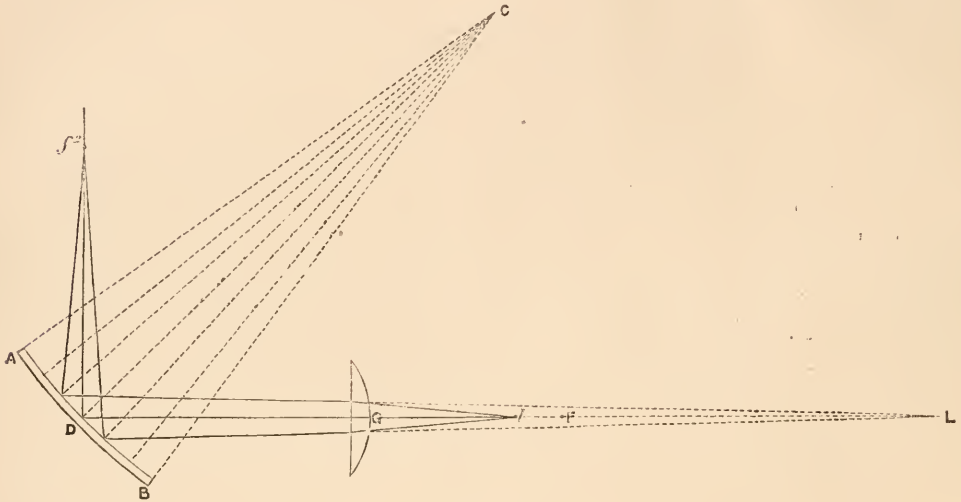

Fig. 33.

Then  $V = \frac{P U}{P - U}$ . Therefore  $V - U = \frac{U^2}{P - U}$ , which gives us this RULE: Square the exact distance between the flame and bull's-eye. Divide the product by the difference between that distance and the focal length of the bull's-eye. Deduct the quotient from anyone of the lamp distances for simple pencils, and the remainder will be the distance for the lamp suitable to that form of compound pencil.

*Example.*—Suppose the bull's-eye to be a small one, having a focal length on its convex side of 2 inches, and that it stands at a distance of  $1\frac{3}{4}$  inches from the flame.  $V - U$  will then be  $\frac{(1.75)^2}{.25} = \frac{3.0625}{.25} = 12.25$  inches. If from any of the longer distances in the table,  $12\frac{1}{4}$  inches be deducted, the remainder will be the distances for the lamp when the bull's-eye is in the position supposed. Were the bull's-eye  $\frac{1}{8}$  in. further from the flame, the necessary deduction would be  $\frac{(1.875)^2}{.125} = 28\frac{1}{4}$  inches, a difference of result so startling, that it may be specially commended to the notice of any tyro who supposes that success can be obtained without attention to minute details. An error of  $\frac{1}{8}$ -inch in the position of a small bull's-eye

#### THE CHICKWEED WINTER GREEN (*TRIENTALIS EUROPEA*).

By R. S. WISHART, M.A.

**S**OUTH of the Tweed this plant is very rarely found, and when it does cross the Border it appears to be confined to the hills about Cumberland and York, where it exists but sparingly. In Scotland it is not abundant till you cross the Forth, at least, and get into Perthshire, and if you wish to find a plentiful supply you should stray in some of the parts of this or its neighbouring counties eastward, and visit certain localities where botanists and ramblers from large towns go less frequently. Any little that we have seen concerning this pretty plant in Britain appears to have been written from an English point of view, and leads one to suppose that the species is much rarer than it really is, and that the habit of the plant is more constant than as a matter of fact it is found to be. Both of these conclusions are likely to be arrived at from examining a few casual specimens, but if you want to see the plant in all its glory and to know its habit aright you must set yourself in some such place as where our specimens were gathered, where all the hilly woods for miles around are literally

covered with the *Trientalis* and where every day during the season you may find countless specimens gracing woodland and moor with lovely white flowers.

The stem of the plant as it is usually found, is simple and bears a few small scale leaves on its lower



Fig. 34.—Chickweed winter green (*Trientalis Europaea*).

portion, while the upper part of the axis which bears the ordinary foliage leaves is shortened so as to present them as if in one whorl. Here the axis ends with a bud which most commonly does not develop, and the leaves are therefore displayed in a terminal whorl-like arrangement. The number of the leaves varies from about four to nine; but from five to seven will be

found on by far the greater number of plants. In shape the leaves vary from obovate to lanceolate, and they always taper more or less to a stalk and have their broadest part towards the apex. This, of course, is a mechanical necessity for leaves that are arranged in a rosette-like fashion; they must be narrowed at the common axis, where there is no room for expansion, while their blades may assume a sufficient area for nutritive purposes towards the circumference of the system. On luxuriantly growing plants the largest leaves exceed three inches in length, but the usual size is less than this.

The flowers arise in the axils of the leaves, and are borne on long stalks which raise them up and show them to good advantage over the green foliage. Among British plants the flower is unique in having most commonly seven petals and seven stamens, and for this reason it stood alone in Britain among the Heptandria of Linnæus. But it must not be supposed that it goes nearly always by sevens, for you may find any number from five to nine, seven always predominating. Of a hundred specimens once counted at random at a particular spot we found nine with five petals, twenty-two with six, forty-three with seven, twenty with eight, and six with nine. This, however, cannot be taken as decisive of more than the fact, that there may be many flowers found which are not heptamerous. At other spots you might get the numbers to vary considerably from the above; we have at some places failed to get any with nine petals and observed that few had eight. In all cases the development of the flower decides that there must be the same number of stamens as petals, and we may consequently find any number of stamens from five to nine.

The *Trientalis* belongs to the Primulacæ, and resembles the pimpinell with its rotate corolla and the arrangement of its stamens, but it necessarily differs from the whole order whose flowers are usually pentamerous, while those of the *Trientalis* are but rarely so. Our plant is the only species recorded in Europe, and there is but one, the *T. Americana*, on the other side of the Atlantic. Some botanists take the two to be the same, so that the only difference may be a geographical one. Dr. Hooker gives the distribution of our species as "north of the Alps and Italy, Siberia to Kamtschatka," and this goes to show that it is a lover of northern latitudes.

Besides the usual plant there is another form of which no notice seems to have been taken in books, but which ought not to be overlooked, as occurring frequently in certain localities in Scotland. This is the case where the axis is prolonged beyond the usual whorl of leaves, and a second whorl-like system of smaller leaves developed at a higher level. From the axis of one or more leaves, in either or both whorls, flowers may arise, but as the development is acropetal, the lower flowers are usually fading before the higher ones have opened. The fact that large

numbers of the less common form often grow together, forming considerable patches in localities where the ordinary form is abundant, would lead to the probability of that being a distinct variety of *T. Europæa*. If this is so it would further indicate, that through such a variety the species is in a transition state, and that it is striving, by adding a story to its height, to compete the better with its grassy neighbours in the common struggle for existence.

Other forms also occur with one or two axillary branches, but, as such, are not so common or constant, they do not give so much promise of forming a permanent variety. The fact, however, that they are sometimes met with ought to be recognised as existing, although only occasional forms of the species.

In winter, the *Trientalis* seems to disappear entirely from view. A party of us had a diligent search for plants about the end of March last year in a wood where we knew there was plenty, but we could not find a leaf or a stem showing itself among the miscellaneous mass of withered foliage with which any wood is covered at that season. The *Trientalis* is essentially a visitor of the summer, and while it is at its best about the end of June, or the beginning of July, by the first of August the flowers are getting very scarce. It is, therefore, only during a short part of the year that this plant flourishes, but it is a favourite with all lovers of flowers who make its acquaintance, and its graceful appearance amply rewards a search for it where it is a stranger. Speaking from a Glasgow point of view it is probably not found in Clydesdale, except at one secluded spot in Renfrewshire, where, from its being confined to a little space, it may have been introduced by some admirer. When it once gets a footing in favourable soil it spreads very rapidly. We have seen instances of this in the case of woods, which about half-a-dozen years ago had not a plant, and are now all covered with luxuriant specimens.

To cultivate this little gem you require an open, peaty soil, for this is the kind of ground in which it delights to dwell. Decaying leaves and bits of wood in the act of rotting are the leading constituents in the favourite soil of the *Trientalis*. The roots do not go deep in the earth, but they run considerable

distances near the surface; and when you dig them up carefully you find that they like to lie in close contact with some decaying branch, or to pierce their way through the softer ones, so as to bring the young rootlets and the root hairs into immediate connection with what evidently supplies the plant with suitable soil food. As a garden plant, when successfully cultivated, it can rival many of the "prouder beauties," and not less there than in the unfrequented hilly wood, can its lovely flowers claim the attention which delicate beauty commands.

RECENT ARTICLES AND PAMPHLETS WORTH READING.

ON a Diagram for a Model of the Solar System to Scale," by Arthur Cottam ("Trans. Hertfordshire Nat. Hist. Soc.," January).—"On the Schwendener Theory of the Constitution of Lichens," by Fred. Leroy Sargent ("American Monthly Microscopical Journal," February).—"On the Causes of Glacier Motion," by W. P. Marshall ("Midland Naturalist," February).—"The Birth of Matter" ("Eng. Mechanic," Feb. 25).—"The Relations between Geology and the Mineralogical Sciences" (the Annual Address to the Geological Society, by Professor Judd), ("Nature," Feb. 24 and March 3).—"The Earthquake" ("Nature," March 3 and 10).—"Cerebral Localisation" ("Nature," March 10 and 17).—"Recent Discoveries of Carboniferous Vegetation in Yorkshire" ("Trans. Leeds Geol. Association," Part ii.).—"The Relations between Evergreen and Deciduous Trees and Shrubs," by F. T. Mott ("Midland Naturalist," March).—"On Melanism," by T. D. A. Cockerell ("Entomologist," March).—"Agricultural Experiments with Iron Sulphate as a Manure," by Dr. A. B. Griffiths ("Journal of Chemical Society," March 10).—"The Literary Value of Science," by Neville Lynn ("Garner," March 1).—"A Key to the Rotifera," by Dr. T. S. Stevens ("Journal of the Trenton Nat. Hist. Soc." Jan.).—"Tobacco-Growing in England" ("English Mechanic," March 11).—"Wonderful Plants" ("Gardeners' Chronicle," March 5).

HOOKER'S STUDENT'S FLORA AND THE LONDON CATALOGUE.

[Continued from p. 56.]

I CANNOT help thinking that a Plant List, arranged alphabetically with the synonyms of different authors, would be of great value just now. It would not be difficult of preparation by any one having access to the various British Floras, and would form a useful companion to the "London Catalogue," or indeed to any one of the "Floras" now published.

The following are mainly changes of rank and position, with but few alterations of name:—

Sub-species . . . . .	<i>Ranunculus fluitans</i> . . . . .	Elevated to rank of species.
" . . . . .	<i>R. tripartitus</i> . . . . .	" " "
" . . . . .	<i>Lepidium Smithii</i> . . . . .	" " "
" . . . . .	<i>Viola sylvatica</i> . . . . .	" " "
" . . . . .	<i>V. arenaria</i> . . . . .	" " "
Variety . . . . .	<i>Cerastium latifolium</i> . . . . .	" " "



Species . . . . .	<i>A. Norvegica</i> . . . . .	Reduced to sub-species.
Variety . . . . .	<i>Herniaria hirsuta</i> . . . . .	Elevated to rank of species.
Sub-species . . . . .	<i>Hypericum tetrapterum</i> . . . . .	" " "
" " " " " " " "	<i>H. undulatum</i> . . . . .	" " "
Species . . . . .	<i>Ononis arvensis</i> . . . . .	Expunged.
Variety . . . . .	<i>Lotus hispidus</i> . . . . .	Elevated to rank of species.
Sub-species . . . . .	<i>Prunus avium</i> . . . . .	" " "
" " " " " " " "	<i>Rosa pimpinellifolia</i> . . . . .	Suppressed, included in <i>R. spinosissima</i> .
" " " " " " " "	<i>R. involuta</i> . . . . .	Elevated to rank of species.
" " " " " " " "	<i>R. Hibernica</i> . . . . .	" " "
" " " " " " " "	<i>Saxifraga umbrosa</i> , proper . . . . .	Suppressed, included in <i>S. umbrosa</i> .
" " " " " " " "	<i>S. Geum</i> . . . . .	Elevated to rank of species.
" " " " " " " "	<i>S. hirsuta</i> . . . . .	Suppressed.
" " " " " " " "	<i>S. Andrewsii</i> . . . . .	" " "
Species . . . . .	<i>S. caespitosa</i> . . . . .	Suppressed as being inseparable from <i>S. hypnoides</i> , except as a form.
Sub-species . . . . .	<i>S. decipiens</i> . . . . .	Reduced to variety.
" " " " " " " "	<i>S. hirta</i> . . . . .	" " "
Sub-genus . . . . .	<i>Pulicaria</i> . . . . .	Elevated to rank of genus, and takes in <i>Inula dysenterica</i> , which becomes <i>P. dysenterica</i> , and <i>Inula Pulicaria</i> , which becomes <i>P. vulgaris</i> with former names as syn.
Variety . . . . .	<i>Gnaphalium rectum</i> . . . . .	Elevated to rank of sub-species as <i>G. sylvaticum</i> proper, with former name as syn.
" " " " " " " "	<i>G. Norvegica</i> . . . . .	Elevated to rank of sub-species.
Excluded species . . . . .	<i>Centaurea paniculata</i> . . . . .	" " species.
Sub-genus . . . . .	<i>Cnicus</i> . . . . .	" " genus.
" " " " " " " "	<i>Silybum</i> . . . . .	" " "
Species . . . . .	<i>Hieracium collinum</i> . . . . .	Relegated to excluded species.
New species . . . . .	<i>H. Dewari</i> . . . . .	" " "
Genus . . . . .	<i>Mulgedium</i> . . . . .	Suppressed, included in <i>Lactuca</i> .
Sub-genus . . . . .	<i>Wahlenbergia</i> . . . . .	Elevated to rank of genus.
" " " " " " " "	<i>Specularia</i> . . . . .	" " "
Genus . . . . .	<i>Monotropa</i> . . . . .	" " order, and <i>M. hypopytis</i> becomes <i>H. multiflora</i> , with former name as syn.
Genus . . . . .	<i>Cicendia</i> . . . . .	Is divided; <i>C. filiformis</i> becoming (genus) <i>Microcalla filiformis</i> , whilst <i>C. pusilla</i> is retained.
Species . . . . .	<i>Myosotis repens</i> . . . . .	Reduced to sub-species of <i>M. palustris</i> .
" " " " " " " "	<i>M. alpestris</i> . . . . .	Reduced to sub-species.
Genus . . . . .	<i>Lathrea</i> . . . . .	Transferred from <i>Orobanche</i> to <i>Scrophularinæ</i> .
Variety . . . . .	<i>Nepeta Glechoma</i> , proper . . . . .	Expunged.
" " " " " " " "	<i>N. parviflora</i> . . . . .	" " "
" " " " " " " "	<i>N. hirsuta</i> . . . . .	" " "
Genus and species . . . . .	<i>Prunella</i> . . . . .	Become <i>Brunella</i> , with former as syn.
Order . . . . .	<i>Paronychiæ</i> . . . . .	Becomes <i>Illecebracæ</i> , and includes genera <i>Corrigiola</i> , <i>Herniaria</i> , <i>Illecebrum</i> , and <i>Scleranthus</i> .
Excluded species . . . . .	<i>Herniaria hirsuta</i> . . . . .	Elevated to rank of species.
Variety . . . . .	<i>Scleranthus annuus</i> , proper . . . . .	Expunged.
Sub-species . . . . .	<i>Chenopodium ficifolium</i> . . . . .	Elevated to rank of species.
Variety . . . . .	<i>Atriplex littoralis</i> , proper . . . . .	Suppressed.
" " " " " " " "	<i>Polygonum aquaticum</i> . . . . .	" " "
" " " " " " " "	<i>P. terrestre</i> . . . . .	" " "
" " " " " " " "	<i>Rumex sanguineus</i> , proper . . . . .	" " "
" " " " " " " "	<i>R. viridis</i> . . . . .	" " "
Species . . . . .	<i>Euphorbia coralloides</i> . . . . .	Relegated to excluded species.
Order . . . . .	<i>Ulmacæ</i> . . . . .	Expunged, and the species included in <i>Urticacæ</i> .
" " " " " " " "	<i>Cannabinæ</i> . . . . .	" " "
" " " " " " " "	<i>Betulacæ</i> . . . . .	Expunged, and its two genera <i>Betula</i> and <i>Alnus</i> are transferred to <i>Cupuliferæ</i> .
Sub-genus . . . . .	<i>Neottia</i> . . . . .	Elevated to rank of genus.
Genus . . . . .	<i>Gymnadenia</i> . . . . .	Expunged, and is now included in <i>Habenaria</i> with former name as syn.
" " " " " " " "	<i>Neottina</i> . . . . .	" " "
Species . . . . .	<i>Alisma natans</i> . . . . .	Elevated to rank of genus as <i>Elisma</i> , its species becoming <i>E. natans</i> .
Genus . . . . .	<i>Triglochin</i> . . . . .	Transferred from <i>Alismacæ</i> to <i>Naiadacæ</i> .
" " " " " " " "	<i>Scheuchzeria</i> . . . . .	" " "
Sub-species . . . . .	<i>Potamogeton natans</i> , proper . . . . .	Expunged.
" " " " " " " "	<i>P. polygonifolius</i> . . . . .	Elevated to rank as species.
" " " " " " " "	<i>P. lonchites</i> . . . . .	" " "
" " " " " " " "	<i>P. acutifolius</i> . . . . .	" " "
" " " " " " " "	<i>P. filiformis</i> . . . . .	" " "
Species . . . . .	<i>Eleocharis caespitosa</i> . . . . .	Transferred to <i>Scirpus</i> .
" " " " " " " "	<i>E. pauciflora</i> . . . . .	" " "

Species . . . . .	<i>E. parvula</i> . . . . .	Transferred to Scirpus.
Genera . . . . .	Isolepis and Blysmus . . . . .	Are suppressed, and their species included in Scirpus; <i>Blysmus compressus</i> becoming <i>S. caricis</i> with former name as syn.
Excluded species . . . . .	<i>Carex Davalliana</i> . . . . .	Elevated to rank of species.
Sub-species . . . . .	<i>C. paradoxa</i> . . . . .	Transferred from <i>C. teretiuscula</i> to <i>C. paniculata</i> .
Genus . . . . .	Triticum . . . . .	Becomes Agropyrum.
Sub-species . . . . .	<i>T. pungens</i> (Agropyrum) . . . . .	Transferred from <i>junceum</i> to <i>repens</i> .
" . . . . .	<i>T. acutum</i> . . . . .	" " "
Genus . . . . .	Selaginella . . . . .	Elevated to rank of order, including in it genus Isoetes.

Chorley, Lancashire.

F. J. GEORGE.

**PATHOLOGY AND ITS RELATION TO EVOLUTION.**

THE lectures of Mr. J. Bland Sutton on Pathology and its Relation to Evolution, at the Royal College of Surgeons, this session, beside possessing interest to the members of that college in general, have a still more interesting and profounder interest to naturalists. Hence I do not consider it impertinent nor inapposite in the pages of this journal, commanding as it does an exceeding great circulation among workers in science both at home and abroad, to summarise the chief features of the substance-matter of these lectures, and moreover to look at them from a generalised and open point of view. In a bold, and almost in a novel sense, has Mr. Sutton brought the laws of evolution to bear on many facts which belong more especially to our own domain of work.

The purport of Mr. Sutton's lectures is to illustrate the second law of evolution as laid down by Huxley\* that "certain parts have undergone complete or partial suppression"—and I shall follow in this short review the lines of the syllabus as closely as is consistent with explanatory details.

1. *The os centrale*.—In the diagram (Fig. 35) of the hand of a baboon, will be noticed a little bone marked *c* in the drawing,—the *os centrale*—wedged in between two tiers of bones (carpus), the one rank in intimate relation with the bones in the forearm, the other in immediate nearness to the metacarpus. This bone you meet with as you search the branches and branchlets of the zoological tree, beginning at the tailed amphibians and working upwards to the primates. Some time back there were three observers—Henke, Rayher, and Rosenberg—who "spotted" a nodule of cartilage in the same position in the human foetus, but which, as development proceeded, disappeared—an observation that has been confirmed many times over and over again since then. Euber, Turner, and others, found it afterwards in adult hands, and now we have a computation that in four cases out of a hundred it is persistent. When not so it fuses with the radiale. Here then, as Mr. Sutton rightly concludes, is distinct evidence of the suppression of an element in man's

carpus, but how many might have been suppressed he leaves an open question, for Weidersheim says the axolotl might have had two or even three of these bones.

2. The second point is concerned with the pineal body, which I have heretofore spoken about in a note in these pages.

[I must premise that, with regard to suppressed parts, Mr. Sutton would hurry us into the not unlikely belief, that owing to and from the very nature of their suppression they are liable to disease and aberrant growths.]

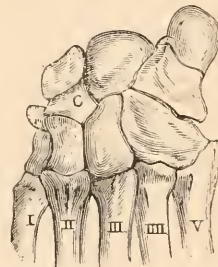

Fig. 35.—The Manus of a Baboon. C, os centrale. I, II, III, III, V, first, second, third, fourth, and fifth metacarpals.

That the pineal body is one of these suppressed organs is pretty evident from the recent work of Graaf and Spencer (Mr. Spencer's paper in "Nature" of last year will be remembered, and also an elaborate and beautifully illustrated article in the recent "Quarterly Journal of Microscopical Science"), who have shown that it is still represented as a little median eye in the parietal foramen of lizards. In amphibians of the pre-tertiary epoch it seems to have been functional and in good account. But Nature, like a good mother, but withal a fair amount of spleen and ill-will, sometimes develops a teratoma, or else as is the generality of her caprice, a cyst in the selfsame body.

3. *The lost incisor tooth of man*.—And now with regard to a matter that had almost become common-talk at the ingle-nook—the lost incisor tooth of man. This is one of the clearest evidences of suppression that we can possibly think of. Professor Albrecht was the first to notice the reappearance sometimes of a third incisor, and since then we have had hosts of

\* "On the Arrangement of the Mammalia," Proc. Zool. Soc. 1880, p. 649

confirmatory observations by many. We have but two incisors normally on each side in the premaxilla, but man in reality inherits three, one of which in the process of development, becomes suppressed. Which one, is of very little moment, some say it is the third, but the majority of observers tend to the belief that it is the second or the middle one. Mr. Mattieu Williams spoke of Professor Schmidt's paper in the "Popular Science Monthly," on page 107 of last year in his "Gossip on Current Topics," and as therein is contained a succinct but full account I need not descant further than this. But for a brief space compare the arrangement of the tooth-territory of any mammal with the same of a shark. They are exactly correspondent each with each in that they are both developed from the involution of epidermis, which, in the fœtus, bends in to form the buccal



Fig. 36.—Section through the prostate gland to show the *sinus pocularis*.

4. A very interesting and instructive case is this one. A section through the prostate gland of a man, would exhibit such an anatomy as may be seen in the diagram underneath. (Fig. 36.)

It is observed to be a structure surrounding the neck of the bladder, with a pouch somewhat pear-shaped running backwards and upwards in its substance, yclept *sinus pocularis* and with a duct, the common ejaculatory duct passing along through its upper surface-portion. This prostate and *sinus pocularis* is developed from that very same part of the Müllerian duct which becomes the vagina and cervix uteri in the female; and moreover these parts of the female reproductive organs, exactly correspond to that portion of the oviduct which in the oviparous vertebrates has the especial function of secreting the shell. But in the recesses of the prostate gland in

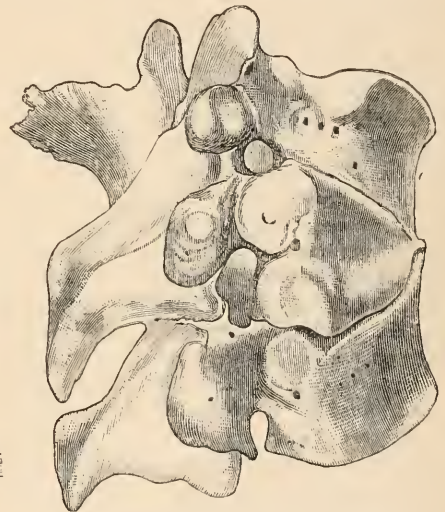

Fig. 37.—A half-vertebra from the spine of a man. After Reid.

cavity, and called in the language of the embryologist the stomodœum. In the mouth of the mammal, they are localised to definite and circumscribed areas; in that of the shark, on the other hand, there seems to be no law of place, and they are scattered in profusion of number, hither and thither—anyhow. From this Mr. Sutton concludes that man, in his process of development, has had many teeth quashed in the evolution of his species, the particular lost incisor being the last in order of suppression. So much so, indeed, with what we would expect of atavism—teeth, supernumerary teeth, sometimes assert their ancestry by appearing in us, varying from a properly-covered enamel organ to a conical mass of dentine. Working on his lines of pathology, Mr. Sutton also entices us into the opinion that some forms of odontomata, and multilocular cystic growths of the jaws, are to be explained as originating in the obsolete rudimentary germs of such teeth as these often recurring ones.

the adult are found small granulations of carbonate of lime. And Mr. Sutton says thus, as the prostate with its glandular loculi was developed from the same segment of Müller's duct as the shell-forming section of the oviduct of birds and reptiles, and, as in them, it was engaged in depositing carbonate of lime in animal matter, so man has in his prostate a witness testifying to common ancestry with the feathered tribes, low down among oviparous vertebrates.

*Supernumerary vertebræ.*—In *Psittacus undulatus*, an Australian parrot, there are more vertebræ found in the fœtal than in the adult condition. In the Ornithoscelida, a fossil Reptilian genus, the number of sacral vertebræ amounts to four or five, while in the existing species the normal number is two. Professor Kitchen Parker finds that the earlier stages of development in the green turtle there are fifty-one somatomes, but only forty-one are existent in the



adult, the number of the difference having become suppressed, seven in the neck and three in the caudal region, suggestive of a Plesiosaurian-like ancestor with a much longer tail and neck. In a human embryo of the fifth week—when it is from 9–10 mm. long—there are 38 vertebræ; at the 6th week the 36th, 37th, and 38th, coalesce together to form one, and when the embryo attains the size of 19 mm. it is minus in number 4 vertebræ, having 34, the normal number in the adult. Dr. Goodhart (J. Anat. and Phys. ix. p. 9) describes a vertebral column of a foetus in which  $4\frac{1}{2}$  instead of 7 cervical vertebræ were present. Professor Humphrey, on p. 123 of his work on the Human Skeleton, describes a case by Otto, in which  $\frac{1}{2}$  of the 11th dorsal vertebra was absent; and another by Sandifort, in which  $\frac{1}{2}$  of 7th cervical, and also of the 9th and 10th dorsal vertebræ were deficient. And there is in the Museum of Middlesex Hospital a skeleton of a full-grown female, in which associated with, and the cause of, lateral curvature of the spine  $\frac{1}{2}$  of the 3rd dorsal vertebra is absent.

And not only is there sometimes absence of a half-vertebra, but there also occurs now and then an additional one. In *Python sebae*, Professor Albrecht has described in the eleventh volume of the "Bulletin du Musée Royal d'Histoire Naturelle de Belgique" for 1885, a case of this kind, in which the skeleton, consisting of 333 vertebræ, there was a half-vertebra intercalated between the 195th and 196th segment on the left side. Rokitsanski, in his "Pathological Anatomy," vol. iii. p. 230, records a case in the human subject in which there were four  $\frac{1}{2}$  vertebræ with corresponding half arches and processes in addition to the normal number, and these were so placed as to counterbalance one another, and form four curves in the spine, two in the dorsal, one in the dorso-lumbar and one in the sacral region. This last case is only satisfactorily explicable on the ground of the suppression of mesoblastic somites during development, and that man at one period—or at any rate his ancestors in the evolution of things—had more than our own number of thirty-four and were functional. There is in our own anatomy evidence of this, in the arrangement of the cervical nerves to show that one element at least has, in comparatively recent times, undergone abortion in that portion of our vertebral column. Again it is beyond confutation, that as the movements of the hand increase in delicacy so do the number and size of the cervical vertebræ diminish. In birds, where the movements of the beak rival in precision those of the hand, we have a greater number of neck vertebræ, and their mobility is made more easily adaptable by means of the saddle-shaped articulations.

When we bring into our remembrance the fact, that sharks and serpents may possess 300 vertebræ—in *Alopecias vulpes* there are 365—and compare this to man's number, this alone ought to make us suspect suppression. And this is still more marked when we put alongside the frog with his 9 vertebræ only, and

beside these again the whole race of mammals. We should at any rate expect the frog sometimes to have occurring in his spine an additional vertebra, and there is no disappointment, for Bourne, in the "Quarterly Journal of Microscopical Science," vol. xxiv. 1884, in a paper "On Certain Abnormalities of the Common Frog" reports a case in which there were ten vertebræ, the additional one being in the sacral region, and a similar specimen has been described by Howes, in "Anatomischer Anzeiger" for 1886.

(To be continued.)

#### EOZOON CANADENSE, THE PSEUDO-DAWN OF LIFE.

By J. WALTER GREGORY.

BY the recent visit of Sir Wm. Dawson, attention has again been directed to the controversy which raged so fiercely some twenty years ago, as to whether Eozoon were fossil or not. Inspired by this visit, and armed with the mass of new material placed at their disposal by the death of Dr. Carpenter, Professor T. Rupert Jones, and his able collaborator, Mr. Sherborne, are preparing a book in which to defend Eozoon from the attacks made upon it in the Memoir of Professor Moebius, and the still more recent volume of Professors King and Rowney. As Moebius's Memoir has never been translated, and the work of the Galway Professors is too technical for those who do not enter the subject with the proper mineralogical training, a sketch of its history and a brief statement of the case against Eozoon may not be amiss. The whole subject is certainly one of absorbing interest, as the origin of life on the earth is probably the most important of the unsolved problems that still perplex the record of its early history. The answer to the enigma remains shrouded in a fog and as yet we possess no guide through its gloom and no scientific light strong enough to dispel its mists and remove this fascinating field of enquiry from the hazy lands of speculation to the ever-widening regions of determined fact. All classes of thinkers have engaged in the search, but hitherto their efforts have been in vain. Physicists have advanced their guesses to the existence of some life-bearing meteorite; chemists have striven to crown their long course of successful achievement in the manufacture of organic products by the creation of life itself, geologists have hoped by the study of its earliest forms to discover the lines along which biological research must proceed, and materialists have published their theories to answer their great Sphinx riddle. But the problem has resisted alike the dreams and theories of philosophers, and the retorts and microscopes of scientists, and the banner of the theologian still waves triumphant on the last

rampart of the doctrine of Special Creation and external interference with the uniformity of nature.

The assistance geology could render in the quest was but trivial, as the palæontological record—imperfect at the best—after affording a constantly lowering grade of organization with the increasing age of the deposits examined, snapped at the base of the Cambrian system, leaving as the oldest known fossils, those so comparatively complex as brachiopods and crustaceans. Below lay huge masses of metamorphosed and igneous rocks, some five or six miles in thickness, and in these apparently the story of the dawn of life on the planet had been obliterated beyond hope of recovery. But scientists do not readily despair, and as by more diligent hammering, the list of fossiliferous schistose and metamorphic rocks in other parts of the globe gradually increased, American geologists plucked up courage and expressed the confident hope that some traces of life might be exhumed. Hence it was that the announcement of the discovery of a fossil in the Lower Laurentian rocks of Canada, vouched for by such men<sup>†</sup> as Carpenter, Logan, Dawson, and Hunt, roused no ordinary excitement in the geological world, and was received as an earnest of much still to be unearthed; and when it was further stated that it was a foraminifer, it agreed so perfectly with current theories as to what the oldest fossil ought to have been, that it is little wonder that geologists accepted it with practical unanimity.

It was in 1864 that Professor Dawson made the momentous announcement, that he had discovered strong arguments for the organic origin of a remarkable Lower Laurentian rock, composed of irregular layers of serpentine and calcite, which had long before attracted attention as affording the first specimen of a new mineral named "loganite," and which Logan had then suggested might have had an organic origin. These suggestions were repeatedly renewed, and in 1863 a specimen was actually figured in one of the Reports of the Canadian Geological Survey as probably a Laurentian fossil; about the same time another band of the structure was discovered at Grenville, and of this Dawson had a series of slides prepared for the microscope, in order to settle a point at issue between himself and Sterry Hunt; on examining them he found, to his intense delight, what he regarded as conclusive evidence of the organic nature of the rock in the so-called "proper wall." He forwarded specimens to Dr. Carpenter, who, in one of calcite and serpentine, discovered a system of canals not present in those of dolomite and loganite which Dawson had examined. This was considered to be absolutely conclusive of their foraminiferous nature, and in 1865 a joint paper by Sir Wm. Logan, Professor Dawson, and Doctors Carpenter and Sterry Hunt appeared in the Journal of the Geological Society, in which the microscopic structure, stratigraphical relations and zoological

affinities of the supposed fossil were described. These views were not long allowed to pass unchallenged, for they were opposed by Mr. W. H. Bailey, the well-known palæontologist, in the Geological Magazine, and Professor Harkness at the Birmingham Meeting of the British Association. In the same year Professors King and Rowney, who have been the most persistent opponents of the theory, began in a letter to the "Reader" their long uphill fight against it, and which they continued next year by a Memoir in the "Journal of the Geological Society." Meanwhile, the announcement had stimulated the energies of geologists in other fields where Pre-cambrian rocks are exposed, and soon a goodly list of other localities of Eozoon was known; Gumbel obtained it in Bavaria, at Steinhag, near Oberzell, and near Passau on the Danube, and in higher beds a species which he named *Eozoon Bavaricum*. M. Favre found it in a serpentine limestone in the Alps; Hochstetter and Fritsch, in Bohemia, Pusyrewski in Finland, and Sandford from the Lower Silurian rocks of Connemara, a discovery which was "verified," to use the term applied to the process, by Professor Rupert Jones. Supported by this additional information, and reinforced by men such as Lyell, Murchison, Gumbel—in fact by all the leading geologists of the day—Eozoonists carried all before them, and though with several honourable exceptions, answered their few opponents in the dogmatic hi-cockalorum style of men absolutely certain of their own correctness. "I should now no more think," wrote Carpenter, in his so-called "Final Note on Eozoon," "of attempting to convert the Galway infallibles (i.e. King and Rowney) than of trying to convert the Pope."\* Similarly, when, in 1871, Mr. Mellard Reade ventured to obtrude his objections before the public, and to point out that the various replies were mere reiterations of the statements in dispute, he was firmly told by the same authority to "shut up," and readers of "Nature" were invited not so much to weigh the respective arguments, as to choose between the combatants, whether they would follow Dr. Carpenter or Mr. Reade. Dr. Carpenter closed the controversy by remarking,† "since I do not feel called upon to expend valuable time in giving to Mr. T. Mellard Reade the instruction he requires to qualify him for discussing this question, I now leave him to the enjoyment of his own opinion, whenever he shall have shown by work of his own, his competence to criticise the observations of others." He however kindly promised to do so.

Since that date "the sceptical tendency of our age," as Dawson in his "Dawn of Life" mournfully calls it, has been veering farther and farther from this belief, and after death had removed one of its most zealous supporters, in the person of Sir Charles Lyell,

\* "Annals Mag. Nat. Hist.," ser. 4, vol. xiv. p. 371.

† "Nature," vol. iii. p. 386.

the cause began a rapid decline, and, mainly owing to the papers of King and Rowney, it was soon narrowed to a struggle between the mineralogists on the one hand and the biologists on the other. During the next few years defections grew apace, and in 1879 the most serious blow was at hand. Professor Karl A. Moebius, the eminent German authority on the Rhizopoda, had been much struck by the resemblance of Eozoon to a new genus of foraminifera which he had found in 1874 on the coral reefs of Mauritius, and had named *Carpentaria raphidodendron*; impressed with the value of his discovery, as elucidating and confirming the organic nature of Eozoon, he resolved to fling himself into the discussion, re-examine the whole of the evidence, and then, by the aid of his



Fig. 38.—Section at Côte St. Pierre (Dawson). *a*, gneiss band; *b*, limestone with eozoon band; *c*, diorite and gneiss.



Fig. 39.—Diagram of vitreous foraminifera, showing double septa (*b*, *b'*), stolon passages (*a*, *a'*) and intermediate skeleton (*c*).

new genus, to demolish all opposition and establish for ever the "animalität" of Eozoon. He announced his intention, and invited geologists to send him specimens. Eozoonists promptly complied with his request, and materials from all parts were poured upon him. Credner, of Leipzig; Hochstetter, of Vienna; Du Bois Raymond, of Berlin, and Dawson, of Montreal, all forwarded him their specimens. *Eozoon Bavaricum* he received from Fritsch, and Gumbel's collection from Sadebeck; Leydig, of Bonn, sent those from the cabinet of Max Schultze, while Carpenter entrusted him with a large number of his choicest specimens, some of which he had never before allowed to leave his possession. From these, Eozoonists expected that Moebius would adduce an array of facts and arguments that would place their theory beyond dispute, and correspondingly bitter was their disappointment when they learned that as he ex-

amined the vast series of the most typical forms placed at his disposal, he gradually lost faith and finally lapsed into the ranks of their opponents. It was the story of Balaam over again; he had set out on his journey to curse, but he had blessed—and blessed with a weight of authority and power which no other man possessed. From that hour Eozoonism was doomed, and if it still lingers in the minds of a few geologists it is different from the creed militant of fifteen years ago.

But it is time to turn from the controversy to Eozoon itself; but, before doing so, however, it is necessary to make two digressions, first to examine the stratigraphical relations of the rock in which it occurs, and secondly to examine the shell structure of

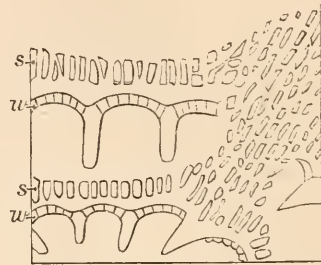

Fig. 40.—Section of part of *Calcarina*, showing tubulated proper walls (*w*, *w'*) and canal system through intermediate skeleton (*s*).

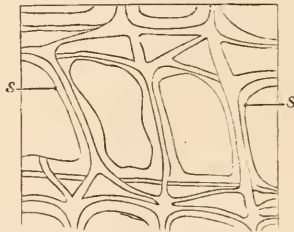

Fig. 41.—Section of *Naummulina larvigata*, showing canal system of septa (*s*).

the foraminifera in order to recognise the morphological relationship supposed to exist between them.

The Laurentian rocks, largely developed in North America, typically in Canada, are a vast series of metamorphic rocks, divided into two groups. The lower, some 20,000 feet in thickness, is composed entirely of metamorphic rocks, mainly gneiss and mica schist, interstratified with which are great beds of quartz and crystalline limestone, one of which is as much as 1500 feet thick. Distributed through it are conglomerates and beds of magnetic and specular iron ore, and veins and beds of graphite which Dawson estimates would equal in quantity the coal seams of an equal area of the carboniferous rocks. The upper series, of some 10,000 feet of stratified crystalline rocks, mainly gneisses and felspathic rocks, characterised by the abundance of labradorite, lies unconformably upon it. It is in the lower series that



Eozoon occurs; the first locality from which it was recorded was Burgess, in Ontario, but as many of the best specimens have come from the Grenville band of limestone at Côte St. Pierre, it will be better to describe that. Eozoon occurs there, as a serpentinized band of limestone, in a massive limestone, interstratified between a layer of gneiss above and a thick bed of diorite and gneiss below. (Fig. 38.)

Many structures in these rocks Canadian geologists considered had long given presumptive evidence in favour of the existence of Laurentian life; they pointed to the vast beds of graphite (probably introduced as liquid hydrocarbons) as representing the last stage

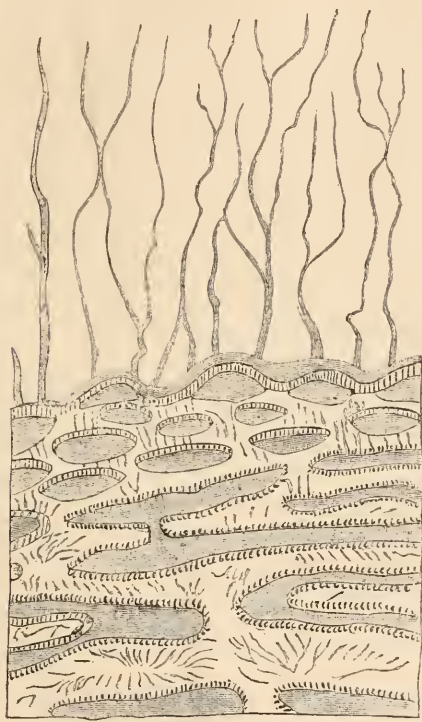

Fig. 42.—Dawson's Restoration of Eozoon.

—that beyond anthracite—in the metamorphism of vegetable remains; they contended that the calcite had been deposited by some organic agency like the limestone beds of later date, and that the iron ores were due to the reducing action of plants similar to that of the *Gaillonella ferruginca* of the Swedish lakes.

The shell structure of the foraminifera need not detain us long, as a mere recapitulation of its terminology will suffice. The foraminifera, as everybody knows, consist of simple masses of protoplasm, in which is immersed a shell or "test," usually penetrated by a series of perforations, through which are protruded extensions of the protoplasm termed "pseudopodia." The shells are either chitinous,

arenaceous (i.e. composed of grains of sand or such like, bound together by a chitinous secretion), hyaline or vitreous, or calcareous. Their structure is generally very simple, as in the lowest it has but a single perforated cell wall, termed the "proper wall"; in compound shells the septum, or proper wall, is usually single, so that that which forms the anterior wall of one chamber serves as the posterior wall of the next; in more complex forms each chamber has its own proper wall, so that in these each septum or "septal plane," consists of two lamellæ, as in Fig. 39. In still more complex forms (Figs. 40, 41) these two proper walls are separated, and between them is developed "the intermediate" or "supplemental" skeleton, through which, if largely developed, ramifies a series of canals containing prolongations of the sarcodæ, serving to preserve the vitality of the skeleton. Between these "body chambers" a further connection is established by "stolon passages," or bands of protoplasm. Thus, in one of the highest members of this order, we should notice the "tubulated body or proper wall," the "intermediate skeleton," and the

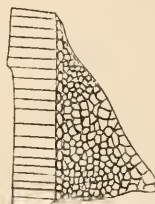

Fig. 43.—Side and front view of proper wall. From Mœbius' "Memoirs," Plate 33, Fig. 41.

"body chambers" connected by "canal systems" and "stolon passages."

Remembering these points, let us turn to Eozoon, and we shall see how remarkably all the typical structures of highly organised foraminifera are so closely simulated, that nigh a generation of geologists were led to accept it as such. Fig. 43 represents Eozoon as usually given in our text-books; to the naked eye the rock appears as a series of green and white lamine, which on microscopical examination present a structure strikingly like those of the body chambers of such foraminifera as Nummulites; the so-called "casts of the body cavities" are surrounded by a wall perforated by many minute tubuli or pores, apparently analogous in structure and function to the proper wall of foraminifera. Above this proper wall is a thicker layer of typical calcite, corresponding to the intermediate skeleton, and containing series of "canals" and "stolon passages," or structures apparently similar to them. Thus, we here find simulations of all the typical structures of one of the highest of the foraminifera; proper wall, body chambers, intermediate skeleton, canals, stolon passages—all are represented; hence, urged Dawson and Carpenter, though we can easily understand that

purely crystalline substances may imitate the forms of organic structures, as in the dendrites which build up such exquisite imitations of vegetable foliage, to assume that a mineral structure should agree in so many points, alike in internal structure and external form, would require a series of coincidences in the highest degree improbable. They further pointed out that we have strong reasons for the belief that life did then exist, besides the evidence already referred to, based on the graphite, calcite and iron ores. Sterry Hunt maintains that he has discovered in the beds of iron ore, traces of subaerial decay that point to the reducing and solvent action of substances produced in the decay of plants. Dawson believes he has found some plants in the graphite of the Clarendon limestone, also worm burrows at Medoc, and some bodies that he has named Archeospherinae.

The objection that, even if Eozoon or any other organism had lived in Laurentian times, its relics could never have survived the metamorphism which the rocks have since undergone, Gumbel answers by denying that the rocks have been metamorphosed, declaring they are now in their original condition; while Dawson says,\* "I call this a prejudice," and proceeds to demolish it by referring to what he considers the analogous case of the casts of corals by calcite and silicates, and of the body chambers of foraminifera by glauconite, the latter of which are so well known as fossils from the greensands, and in recent seas as in the Gulf Stream and the Egean. Dawson maintains that such would be obliterated by nothing short of the actual fusion of the rock, and he adduces Sterry Hunt's opinion, that the association of serpentine with Eozoon is exactly on a par with these cases, and that as glauconite is a hydrous silicate of iron and potash, and serpentine a hydrous silicate of magnesia, if we assume that in the Laurentian ocean magnesia played the role of iron and potash in recent seas, we can understand how the Laurentian serpentine was deposited under conditions similar to those of modern greensand.

Briefly summarized, such are the arguments on which Eozoonists rest their case, and from their plausibility and their acceptance by such geologists as Lyell, Dawson and Gumbel, such authorities on the foraminifera as Carpenter and Rupert Jones, such biologists as Schultz, or such mineralogists as Dana and Hunt, the theory held a position which could be stormed only by years of steady work and controversy. Hence it was, with every confidence in its accuracy, that Dawson conjured up his "Restoration of Eozoon." As shown in the figure (Fig. 42) it consisted at its base of simple layers which higher up became "acervuline owing to the deficiency of nourishment of the central and the lower layers making greater and greater demands on those above, and so the skeleton became thinner"; † above it

gave rise to a series of long pseudopodia extended into the ocean to catch the Archeospherinae and other contemporary organisms as its prey, which, as the temperature of the water is estimated by Dana at 200° F., it would find ready cooked and stewed.

(To be continued.)

## GOSSIP ON CURRENT TOPICS.

By W. MATTIEU WILLIAMS, F.R.A.S., F.C.S.

A VENERABLE UNIVERSITY.—In the midst of Jubilees and jubinations, it is noteworthy that Italy had decided to celebrate in the spring of 1888 the eight hundredth anniversary of the University of Bologna. It is well for the education of young Italy that it should publicly honour the great intellectual achievements and early intellectual superiority of old Italy, rather than direct its pride towards the gross though energetic brutality of ancient Rome. When we reflect on the general condition of Europe in the eleventh century, this awakening from the dark period when its intellectual culture was mainly dependent upon wandering missionaries from Ireland, the foundation of an university was a great event, and it is doubtful whether any other continental university can boast so ancient a record as that of Bologna.

PETROLEUM AND HEALTH.—Dr. Bielczyk publishes in a Polish medical journal the results of his observations among workmen employed in petroleum wells. He found that when the gas existing in the shafts of the wells was freely breathed, violent delirium of a maniacal character was produced. This, however, quickly ceased when the workman was brought to the surface. Speaking generally, he says that the mortality among those workmen is not particularly high, and that they seem to be remarkably free from diseases of the respiratory organs, both of an inflammatory and tubercular character, and also from infectious diseases. They are, however, subject to an eruption like acne, affecting the extremities. Dr. Bielczyk found that raw petroleum is an excellent application for fresh as well as for old and foul or torpid wounds.

Having been engaged during a few years in the distillation of cannel coal and shale, which thus produces a compound almost identical with petroleum, I am able to add my testimony to that of Dr. Bielczyk. My men were not so severely exposed to the gaseous exhalations as those who descend petroleum wells, and therefore I saw nothing of the delirium. The retorts were worked in the open air. The worst casualty to which the men were exposed was that of having their faces burned when they opened the retort doors. The inflammable vapour filling the retorts, which were much larger than gas retorts, flashed forth somewhat explosively when

\* "Dawn of Life," p. 93. † Ibid. p. 46.

supplied with air, and a careless or unskilful workman occasionally received the flame fully in his face; beard, whiskers, eyebrows, and eyelashes were singed, and the skin would have been sorely blistered, but for the simple remedy they had somehow learned to apply. This was to rush to a tank of crude oil and wash their faces with it as freely as though washing with water. I saw two cases in which this was neglected, and the men suffered much pain, and some disfigurement, but in all cases where the remedy was promptly applied but little inconvenience followed, and no scars were left. Dr. R. Platt, the medical practitioner of the district (Leeswood and Pont Blyddu, Flintshire), observed that during a severe epidemic of typhus fever, the men engaged in the oil works escaped, their families also. The crude paraffin oil they carried home on their clothing disinfected their cottages completely. The colliers and agricultural labourers of the district, whose homes and modes of life were similar to those of the oil-workers, suffered severely.

Our surgeons are now using vaseline very largely for dressing burns, &c. In doing so they are merely extending the application of the workmen's discovery; vaseline being the hydrocarbon which is chiefly concerned in giving to the crude petroleum, or the crude distillate of the cannel or shale its characteristic viscosity.

MICRO-ORGANISMS IN AIR.—Dr. Percy Frankland and Mr. T. G. Hart made during last year an instructive series of experiments on the micro-organisms in the air, using Hesse's apparatus, and a standard quantity of 10 litres of air. The results, obtained on the roof of the Science Schools of South Kensington, were as follows—

In January an average of 4 micro-organisms for 10 litres of air.			
March	26	March	26
May	31	May	31
June	54	June	54
July	63	July	63
August	105	August	105
September	43	September	43
October	35	October	35

The increased numbers found in crowded rooms is very remarkable, and suggestive of the advantages of fresh air. In the Library of the Royal Society, during the evening conversazione of June last, there were found in 10 litres of air at 9.20 P.M. 326 micro-organisms; at 10.5 P.M. 432, and at 10.15 A.M. of the following day, 130.

NORWEGIAN AND JAPANESE COD FISHERIES.—"Nature" tells us that an official of the Japanese Ministry of Commerce has been despatched to Norway to study the cod-fish industry as there practised. This may appear rather puzzling to many readers, to whom such an industry is regarded as simply a matter of catching the fish and salting them. A great deal more than this is done with codfish in Norway, where some 40 or 50 millions of

fish are caught annually for exportation, besides those consumed at home. Drying is a primary preservative process, and there are two methods adopted; one consisting of tying the split fish together by their tails, then hanging them across poles, young pine or fir-trees arranged horizontally at the height of about five feet from the ground. These drying grounds, when extensive and fully covered, are curious features of the landscape. The fish thus prepared are the "stok-fisk" i.e. stick-fish. Others are dried by spreading them out on the rocks. These are the "klip-fisk." Then there are two branches of the liver industry. First the extraction of the common "fish-oil" so largely used by leather dressers. This is obtained by boiling down cod livers whether fresh or otherwise—mostly otherwise—in huge cauldrons, the odour from which constitutes one of the sensations of a midsummer tour in the Lofoddens. The second industry is the preparation of "medicine oil," known to us as cod-liver oil. This is prepared by expressing selected fresh livers, either cold or with little heat, and treating the product more carefully. Besides these there is a more modern *fishguano* manufacture. Cods' heads, and in some places the stomach and intestines also, are dried, ground to powder, and sold under the above name. As there are large supplies of cod in the water of Northern Japan, the Japanese Government has wisely resolved to obtain the full benefit of the matured experience of the enterprising Norsemen.

A SIMPLE MACHINE.—Babbage cites as the simplest example of a machine or labour-saving appliance, the invention of a girl who was employed in sorting needles, i.e. placing the heads all in the same direction, preparatory to putting them up into packets for sale. They had previously been picked out one by one and pushed to the right or left according to the position of heads and points. The machine was simply a glove finger with a thick piece of leather attached to the part corresponding to the bulb of the forefinger of the right hand. A row of needles was laid on a flat board and pressed down with the left hand, and when this leather thimble was pressed against their ends, all those having their points to the right penetrated the leather sufficiently to be drawn away to the right, leaving all those with their points to the left in their original place, and thus the labour of sorting was greatly abridged by this simple invention.

A similar invention is now in use for counting lead pencils. Strips of wood with 144 grooves are laid on the work-bench. The workman takes up a handful of pencils and rubs them along the board once and back, filling all the grooves, and thus counting one gross. This is almost as simple as the needle-girl's invention. I have not yet learned how much of the money value of the labour saved has been awarded respectively to the two inventors.



CUTTING GLASS VESSELS.—The problem of making a clean cut round a glass tube of considerable diameter, or round a bottle or flask, is one that continually vexes the practical worker in a chemical laboratory. A number of books supply a prescription which the bookmaker has copied very faithfully from his bookmaking predecessors, viz. that a piece of string is to be passed round the bottle or flask, and then soaked in spirits of wine or turpentine and kindled. According to the books, a clean cut will be made corresponding to the string, if the bottle or flask is now suddenly cooled by plunging it in water. According to the experience of all who have tried it, the glass is either cracked in wild random, or it remains unaffected. Perhaps once in fifty times success may be achieved by accident.

Another and far better method has been recently described by E. Beckmann. First a scratch is made with a file, and this is done carefully in the required direction. At both sides of this, pads of wetted filtering (i.e. blotting) paper are wrapped round the object, leaving a space of about  $\frac{1}{8}$ th of an inch between them. The flame of a Bunsen burner or gas blowpipe is applied to the space, starting from the scratch and running round. The crack will follow the flame midway between the two pads. I may add that tubes up to about an inch in diameter are cut very easily by simply notching with a "three square" file, and then breaking as one would break a stick, but with a pulling force combined with the bending. This is familiar to all who work in laboratories, but not so to outsiders, though a very useful "wrinkle" for many outside purposes.

ECONOMICAL PRODUCTION OF THE ALKALINE METALS.—Sir Humphry Davy discovered the metals of the alkalis, sodium and potassium, by separating the oxygen from soda and potash with the aid of a very costly and powerful voltaic battery. Purely chemical methods have since been adopted, the reducing power of heated carbon being the chief agent. In my boyish days of chemical experimenting, or rather chemical trickery, I paid at Dymond's in Holborn one penny per grain for potassium, or at the rate of £2 per oz. troy. It was then reduced chemically. Its present price is 5s. to 6s. per ounce. Sodium about 10s. per lb.

Mr. H. Y. Castner has recently devised a method of producing these alkaline metals which promises to cheapen them considerably. If it is commercially successful, the results will be important, as the metal sodium is used in the reduction of other metals, such as magnesium, aluminium, &c. This method consists in mixing iron that has been reduced in a finely divided state by hydrogen or carbonic oxide, with tar and coking the mixture; then grinding the coke and mixing it with caustic soda or potash. This is placed in a cast-iron crucible and heated in a specially constructed furnace. The alkali is reduced to the

metallic state, and the metal, which is volatile at a high temperature, is distilled over. In this process the alkali is submitted to the reducing action of iron and carbon, both of which have been previously used separately. Gay-Lussac and Thenard used iron turnings heated to whiteness as early as 1808. I can only speak theoretically, having made no experiments on Mr. Castner's method nor seen it in operation, but from such theoretical point of view, it appears most promising.

## ASTRONOMY AND METEOROLOGY.

By JOHN BROWNING, F.R.A.S.

DR. WARREN DE LA RUE, who was the first to photograph astronomical objects successfully, informs me that some excellent photographs have been obtained of Jupiter. When I have had an opportunity of inspecting them, I will give some further particulars.

The Liverpool Astronomical Society has published a Memoir on "Photometric Photometry," which contains a catalogue of 500 stars taken with a stellar camera  $4\frac{1}{2}$  inches diameter, mounted equatorially.

The Rev. J. S. Perry, of Stonyhurst Observatory, Lancashire, in a communication on the Chromosphere in 1886, says: "During the past twelve months the Chromosphere has been measured more frequently than in any year since 1880, and the results should be in consequence more trustworthy. The mean height of this gaseous envelope does not vary much from year to year; but the prominences that spring out of it have scarcely attained in 1886 the height of preceding years, and their number and extent is much diminished."

In April Mercury will be a morning star, situated in Pisces. Venus will be an evening star throughout the month; in Aries until the 10th, when it will enter Taurus. There will be no occultations of interest.

*Meteorology.*—Though fogs and mists have been plentiful, yet outside the region of the Metropolis the amount of sunshine in February was much above the average. In the north-east of England and over the Midland districts, the number of hours' sunshine for the month was 41 in excess of the average number for the past seven years, and in the east of England, the excess amounted to as many as 51 hours.

February was drier than usual, though, contrary to the generally received opinion, it is on the average almost the driest month in the year. In London there was not one-third of the average quantity of rain; and in Mid-Devon the rainfall was less than one-tenth of the average. In the neighbourhood of the Metropolis there has not been so dry a February for twenty-five years.

Rising, Southing, and Setting of the Principal Planets at intervals of Seven Days.

	D.	Rises. h. m.	Souths. h. m.	Sets. h. m.
MERCURY ☿	2	5 0M	10 54M	4 48A
	9	4 45M	10 32M	4 19A
	16	4 32M	10 23M	4 14A
	23	4 18M	10 22M	4 26A
	30	4 6M	10 28M	4 50A
VENUS ♀	2	6 27M	1 52A	9 17A
	9	6 16M	1 58A	9 40A
	16	6 7M	2 4A	10 1A
	23	6 1M	2 12A	10 23A
	30	5 58M	2 20A	10 42A
MARS ♂	2	5 47M	0 23A	6 59A
	9	5 28M	0 15A	7 2A
	16	5 11M	0 8A	7 5A
	23	4 52M	0 0A	7 8A
	30	4 34M	11 52A	7 10A
JUPITER ♃	2	8 16A	1 26M	6 32M
	9	7 43A	0 56M	6 4M
	16	7 11A	0 25M	5 34M
	23	6 40A	11 50A	5 4M
	30	6 7A	11 19A	4 35M
SATURN ♄	2	10 15M	6 25A	2 39M
	9	9 49M	5 59A	2 13M
	16	9 23M	5 33A	1 47M
	23	8 58M	5 7A	1 20M
	30	8 33M	4 42A	0 54M

At the Royal Observatory, Greenwich, the mean reading of the barometer for the week ending 12th of February was 30.39 in. The mean temperature of the air was 34.5 deg., and 5.1 below the average in the corresponding weeks of the 20 years ending 1868. The general direction of the wind was north-east, and the horizontal movement of the air averaged 13.3 miles per hour, which was 0.4 below the average in the corresponding weeks of 16 years. No rain was measured during the week.

For the week ending 19th of February, the mean reading of the barometer was 30.10 in. The mean temperature of the air was 34.8 deg., and 4.1 below the average in the corresponding weeks of the 20 years ending 1868. The general direction of the wind was north-east, and the horizontal movement of the air averaged 11.1 miles per hour, which was 1.4 below the average in the corresponding weeks of 16 years. Rain fell on Friday to the amount of 0.20 of an inch.

For the week ending 26th of February, the mean reading of the barometer was 30.00 in. The mean temperature of the air was 42.9 deg., and 3.2 above the average in the corresponding weeks of the 20 years ending 1868. The general direction of the wind was south-west, and the horizontal movement of the air averaged 13.6 miles per hour, which was 0.8 above the average in the corresponding weeks of 16 years. Rain fell on Monday to the amount of 0.05 of an inch.

For the week ending 5th of March, the mean reading of the barometer was 30.34 in. The mean temperature of the air was 35.9 deg., and 4.5 below the average in the corresponding weeks of the 20 years ending 1868. The direction of the wind was variable, and the horizontal movement of the air averaged 6.5 miles per hour, which was 7.3 below the average in the corresponding weeks of 16 years. Rain fell on Saturday to the amount of 0.01 of an inch.

For the week ending March 12, the mean reading of the barometer was 29.91 in. The mean temperature of the air was 37.5 deg., and 3.1 below the average in the corresponding weeks of the 20 years ending 1868. The direction of the wind was variable, and the horizontal movement of the air averaged 10.7 miles per hour, which was 3.1 below the average in the corresponding week of 16 years. Rain or melted snow was measured to the amount of 0.28 of an inch on Saturday.

The mean temperature for April is at Plymouth, 45°, at Bournemouth, 44°, at London, 43°, at Norwich, 42°.

The average rainfall for April is along the South coast 2 inches, and about London 1 inch; in the Midlands and on the East coast, from 1 to 2 inches, only near the Land's End does it reach to 3 inches.

## SCIENCE-GOSSIP.

THAT historic Coniferous tree, the *Wellingtonia* was re-named *Sequoia*, after an Indian chief, who invented an alphabet of somewhere about fifty-six letters. That seems to be his claim to historic renown, and the reason why he is immortalised by a "Tree of Life" (for the *Wellingtonia* is said to be able to live 4000 years, and nobody can contradict the statement) altered to *Sequoia*. But what about the modern hydro-carbon chemists, and those whose whole life is devoted to the chemistry of products of combustion? The newspaper readers, who send shillings for word-competitions, have never read the "Chemical Society's Journal."

THE volcano of Mauna Loa, in the Sandwich Islands, is stated to have "erupted" once more. That is what active volcanoes are intended for!

It seems that the activity of the Phylloxera is not interrupted during the period of suspended vegetation of the vine; why should it? It lives on the sap or vintage!

MR. H. B. WOODWARD'S important work (second and revised edition) on "The Geology of England and Wales," is announced as "ready." The readers ought to be the same.

WE are very pleased to notice that the Dover Field Club recognise, in an admirable way, the services of the late Hon. Sec. the Rev. T. Robinson (who has left the town for the metropolis), by presenting him with a splendid Binocular Microscope. Mr. Robinson well deserves it, for he is one of the few men who can "enthusiast" other people.

MR. ROBERT ETHERIDGE jun. F.G.S., is going to Sydney, to occupy the important post of Palæontologist to the School of Mines there.

A COLONIAL College and Training Farm (1300 acres) has been started at Hollesley Bay, Woodbridge, Suffolk, where young fellows intending Colonial life are being educated for the special purpose. The idea is a capital one, and is being admirably carried out.

THE Centennial International Exhibition will be opened at Melbourne, on August 1st, 1888, to celebrate the founding of the first Australian Colony (New South Wales) in 1788.

THE devastating earthquakes along the mouth of the Rhine valley, and the French and Italian coasts of the Mediterranean, have kept up the public interest in these phenomena. They appear to be connected with Alpine Mountain-building, for Mont Cenis and the Lepontine Alps were affected in an intense degree. The French Academy are collecting accurate information all over the affected area. If they do it as well as Professor Meldola did the "Essex Earthquake" of 1884, their labour will be of great scientific value.

WE are pleased to receive Mr. W. Collins' No. 16 Catalogue of books (mostly second-hand) in Microscopy, Natural History, and the allied sciences. Students will find it a very useful book of reference.

IN the first number of the "Wesley Naturalist" (price 6d. monthly) we are glad to welcome another coadjutor in the field of "Popular Science." The fact that it is edited by the Rev. Dr. Dallinger, the Rev. H. Friend, and others, is a sufficient recommendation that the magazine will have a successful career.

IT is a pardonable vanity for any man to feel he has done good; and the editor of SCIENCE-GOSSIP never felt this more than after a lecture at Lincoln, in the newly-erected schools of science and art. Dr. Lowe reminded the audience of the course given by the lecturer in Lincoln eight or nine years before, and stated that the scientific interest aroused by those lectures had eventually led to the erection of the building they were then in. The edifice is one of which even Lincoln, with its historically and architecturally famed cathedral, may well be proud. All the newest and best modern appliances for teaching science and art have been adopted. The class-rooms, geological, botanical and physical, as well as the splendid chemical laboratory, are among

the best we have ever seen; and it would be a good and a wise thing for committees who are thinking of starting similar schools if they visited those at Lincoln first. It is marvellous how much (and how well done that "much") has been achieved for the money. To complete the success (as regards the Scientific Department) Dr. A. B. Griffiths, F.R.S. (Edin.), an old and valued contributor to SCIENCE-GOSSIP, has been engaged as principal; and he is throwing all the energy of an enthusiast into his work. No fewer than twenty-six subjects in Theoretical and Practical Science are down in the syllabus to be cheaply taught—in the evening as well as during the day. It made one feel how delightful it would be to be fifteen again, with all the glorious field of study to attack. To nobody in Lincoln is the success of these schools more due than to Mr. R. J. Ward.

DURING March Dr. J. E. Taylor, Editor of SCIENCE-GOSSIP, lectured to the Literary and Scientific Society at Loughborough, on "The Lower Forms of Animal Life;" at the Ipswich Museum, on "Caverns and Underground Rivers," "The Origin of the Sea," and the "Deep Sea Bed and its Inhabitants;" at Manningtree, on "The Underground Circulation of Water;" at Braintree, on "The Origin of Landscape Scenery," "Volcanoes and Earthquakes," and "The Atmosphere: Its Origin and contents." At the Norwich Church of England Young Men's Society, on "A Naturalist's Holiday in Australia." Most of the lectures were illustrated by the lantern, and by specially prepared slides.

WE are pleased to receive the "Medical Annual" for 1887, (London: Hamilton, Adams, & Co.) edited by Dr. Percy Wilde, to which contributory essays and papers on "Diseases of the Heart," "Syphilis," "Diet," "Rheumatism and Gout," "Spinal Disease," "Ovariectomy," "Diseases of the Eye," "Dental Surgery," &c., are contributed by some of the chief medical writers of the day, forming a "Dictionary of New Treatment in Medicine and Surgery," &c.

## MICROSCOPY.

MICROSCOPIC QUERIES.—I want to construct an accurate table of the magnifications of my objectives, from 2 in. up to  $\frac{1}{10}$  with the various oculars from No. 1 to No. 6. The instructions in the Manuals are not precise, and in some particulars are not in harmony. As I have no doubt the information I am requiring will be useful to many besides myself, I will, with the Editor's permission, name the points in the necessary process which I should thank some practical brother microscopist to make clear. First, *from* what point, *to* what point, along the body, should I measure to arrive at the proper distance from the eye-lens to the drawing-paper? Should I measure



from the front lens of the objective to the eye-lens of the ocular, or from the micrometer on the stage? And if not to the eye lens, then to where? If from the micrometer (or other object) on the stage, does that mean that the difference in distance when a 2 in. o.g. is in use as against a  $\frac{1}{4}$  in. must be allowed for in the distance from the eye-lens to the drawing-paper? Second, when deep eye-pieces—No. 4 to No. 6—are used how am I to proceed?—there being no cap sliding off to allow the camera (mine is a Beale's) to be put on in its place, but the eye-lens being a fixture in the disc which screws on to the tube containing the field lens, and thus forms a necessary part of the ocular? I hope I am explicit without being diffuse, and that the information asked for will be kindly furnished in SCIENCE-GOSSIP.—*F. R. Brokenshire, Exeter.*

EXTRACT OF LOGWOOD.—Perhaps M. Hafen would like to follow the formula recommended by H. Gibbes which is as follows:—Extract of hæmatoxylin, 6 grms., alum (potash), 18 grms. Mix thoroughly in a mortar, add gradually, while stirring: Distilled water, 28 c.c. Filter, and to filtrate add—alcohol (not methylated), 1 drachm. Keep the solution in a stopped bottle for a few days before using. For staining, five to ten drops are to be added to half a watch glass of distilled water; this solution should be filtered before use. Sections which have been removed from common alcohol, are to be placed in the dilute solution for from ten to twenty minutes, and then to be washed in distilled water.—*A. W. L.*

MAGNIFYING POWERS.—I am using Howe's "Atlas of Biology." The microscope used in preparing the drawings is one by Zeiss, of Jena. In some instances the magnifying power is indicated thus  $\times 20$ ; but in the majority the eye-piece and object glass used are stated, e.g. D. 3, F. 4. I shall be glad if any reader of SCIENCE-GOSSIP using such a microscope will kindly favour me with a table of the linear magnifying powers obtained by the various combinations of eye-pieces and objectives.—*F. Worgan.*

CASTING IN PLASTER FROM PHOTOGRAPHIC CLICHÉS.—Mr. Thomas Stock has made the following communication to the Edinburgh Geological Society:—It is sometimes desirable to convert a photograph (say of certain of the *microzoa*) into a plaque, which can be mounted on a tablet and exhibited in a case. This can be done by taking plaster casts from reliefs in gelatine. They are productive in two ways. 1. On the commercial dry plate; 2. On clichés of bichromated gelatine. 1. On the commercial dry plate. I have experimented with a few makes, but find the gelatine too soft in most cases. One make (possibly containing bichromate) gives tolerably good results, but different batches differ in their power of resisting the rather

severe treatment to which they are subjected. The treatment is quite simple, and consists of dipping the plate (it must not be alumed) for a few moments into water kept at a uniform heat of 90° Fahr. by an automatic gas regulator. I should think that a plate could be put on the market suited to this particular purpose, and its utility in the photo-mechanical printing processes would ensure a steady demand for it. Whilst the relief is still moist and at its best, pour on No. 1 plaster as in ordinary plaster casting, mixed with a little alum to harden it. When dry, the plaster leaves the gelatine without much trouble, no lubricator being needed. The resulting cast may of course be coloured if desired. 2. On bichromated gelatine. This method is well-known. It has the great advantage of being capable of giving a higher relief if required according to the thickness of the gelatine. On a moderately hard gelatine, hot water may be used, a fact known almost as long as photography. A little caution must be exercised in the choice of a subject. Their microscopical sections are for obvious reasons unsuitable where strict accuracy is required; but when the lights and darks of the clichés (upon which intaglio and relief depend) nearly correspond to the real intaglio and relief of the object photographed, the resulting cast will of course be accurate as well as beautiful.

MR. FRED ENOCK'S ENTOMOLOGICAL SLIDES.—No. 9 of these interesting and instructive series has been issued. The slide contains an exquisitely-mounted oak-apple fly (*Andricus terminalis*), and it is accompanied by the usual sketch of structural and other details which gives to these slides their value.

COLES'S "STUDIES IN MICROSCOPICAL SCIENCE."—Sections 1, 2, 3, and 4, of No. 7 issue of these entertaining and artistically got up "Studies" are to hand, dealing with "Vegetable Histology" (Haustoria), "The Ovary and Ova in Birds," "Pathological Histology" (fatty degeneration of kidney), and "Microbes" (with very useful plate). The illustrations are well up to their high mark; and the slide accompanying each "study" is in Mr. Coles's characteristically neatly-mounted manner.

## ZOOLOGY.

EXPLOSION OF EGGS.—In the last number there is an article on "Explosion of Eggs," page 57. I venture to send my late husband's plan for preserving them, which I adopted successfully years before he brought out SCIENCE-GOSSIP:—Dip a soft brush in oil, cover the eggs with it, put them in a jar or pan, be careful to oil over that part of the shell you have touched with your thumb and finger whilst holding it; put plenty of bran between each layer of

eggs. When the jar is full tie it over with thick brown paper. The eggs, I venture to assert, will not explode when boiled, indeed "Master's eggs" were favourites with our cook; when eaten at three months old you could not tell them from new laid eggs.—*H. M. Hardwicke.*

CORRIGENDA.—Will readers of the note on "The Parietal Eye of Lizards" cross out the *lapsus calami* of "pituitary body," and insert pineal body in its stead. Also of my other note, in the same number, called "The Development of the Tadpole" will they read *epididymis* for *epididymus*.—*J. W. Williams.*

ARION BOURGUIGNATI.—On February 27th, in company with Mr. F. G. Fenn, I found *A. bourguignati* abundant at Isleworth, living with *A. hortensis*, from which it may readily be distinguished by its keel in the young state, and in the adult by the narrower and differently-placed bands, curious peppery-gray appearance, and perfectly white foot-sole. This species, which we have also found at Bedford Park, is new to the fauna of Middlesex. While writing, I may mention that the white variety of *Helix Cantiana*, described by Taylor in 1883 as var. *albida*, was originally named var. *alba* by Colbeau in 1866, which latter name must of course be used.—*T. D. A. Cockerell, Bedford Park, Chiswick.*

CAMBRIDGE ENTOMOLOGICAL SOCIETY.—At the anniversary meeting of the Society, Mr. Brown exhibited a specimen of *C. Clerio* captured in Cambridge. The exhibits also included *A. prunaria*, *N. neurica*, and other moths chiefly captured in Monk's Wood. After the election of officers, the programme for the year was drawn up, and includes excursions to Chippenham, Wicken, Monk's Wood, and other good localities. It was decided that students in other branches of Natural History and other non-members will be welcome at the excursions, and Mr. Alfred Jones (Librarian), 59 Trumpington Street, has kindly offered to receive the names of those wishing to do so, and to supply information to them, which may also be obtained of the Secretary, Mr. C. B. Holman Hunt (St. John's).

SHELLS AT LUCERNE. I spent a couple of hours in the "Gletscher-Garten," when passing through Lucerne last September, and collected the following Mollusca: *Pisidium*—(a single specimen); *Succinea elegans*, Risso (ditto); *Helix arbustorum*, L. (all of a very dark colour); *H. pomatia*, L. (common); *H. rotundata*, Müll. (not very plentiful); *H. incarnata*, Müll. (common and beautifully coloured); *H. hispida*, L. (very few specimens occurred); *H. nemoralis*, L. (*libellula* 12345, and *rubella* 00000); *H. lapicida*, L., *H. obvoluta*, Müll. (occasional specimens); *Hyalina nitidula*, Drap. (in extreme plenty); *H. Draparnaldi*, Beck. (rare); *Clausilia laminata*, Mont. (scarce); *C. plicata*, Drap., *C. cruciata*, Stud.,

*C. parvula*, Stud. (very plentiful on the face of the rock, in all stages of growth: many specimens decoliate); *Cochlicopa lubrica*, Müll. (common just by the "Lion"). Outside the town, I found *Pomatias septemspirale*, Raz., *Pupa frumentum*, Drap., *Helix villosa*, Stud., *Bulimus montanus*, Drap.—*Brockton Tomlin, Pemb. Coll. Camb.*

THE REPRODUCTION OF THE LOST TAILS OF LIZARDS.—In page 38 of the current year of SCIENCE-GOSSIP, F. G. S. appears to doubt whether full-grown lizards can reproduce lost tails.—Last year, in the month of June, I caught a large specimen of *Lacerta vivipara* with but a stump tail, clearly full-grown. Before the end of the summer, a new tail one inch and a half long was produced. I have a young one of the same species which has repaired its tail, and a large specimen of *Lacerta viridis* which has twice lost its tail, that reproduced having been partially again lost and reproduced, the two cicatrices very plainly show the extent of each reproduction. I have also a *Lacerta agilis* which has lost its tail and reproduced it before it came into my possession; there is, or was recently living, in the gardens of the Zoological Society, a *Lacerta agilis*, which has had its tail broken, and at the fracture has produced a second tail without losing the original, so that it now presents the singular appearance of a lizard with two tails. I have noticed that the females are more subject to the loss of tails than the males; they are not quite so agile, and their tails are nipped off by birds after the bodies have entered a hiding-place.—*J. Jenner Weir.*

## ANIMAL PSYCHOLOGY.

CATS.—Cats are not commonly credited with so much intelligence as dogs; but I once knew a cat whose mental powers would compare favourably with those of the dogs mentioned in your last number. This animal belonged to a woman who kept a little school in a back room upstairs on the same floor with another room, occupied by a working man and his wife, who also kept a cat. It may be readily believed that the neighbourhood was more remarkable for the density of its population than for their education, or piety, as was then the case with many parts of London before the School Board had yet asserted its supremacy. Cats' meat was sold on Sunday as on other days of the week. The woman who kept the school however, did not buy it on that day, but procured enough on Saturday to last her cat till Monday. Her neighbour did not imitate her in this, but bought a halfpennyworth of cat's meat on Sunday as on any other day. The conduct of the cats became as different as that of their respective

owners. One Sunday morning while the governess was out, having gone to chapel, the woman who stayed at home with her husband and her cat, called the attention of her good man to the conduct of the two animals. "There is that Tibbie, she is a good cat, a Methodist like her mistress: she does not go down on Sunday to get her meat; but that worldly-minded little wretch of mine, Tottie, down he will rush just as if it were a weekday." Her husband answered: "Do not talk so silly; I am not going to believe that a cat knows the difference between Sunday and weekday." She promptly answered: "Come along and see Tibbie sitting at the top of the stairs waiting for her mistress to come home." Just as they came to that interesting point, Tibbie's mistress appeared, and the matter was referred to her for explanation. This was given in a statement that the meat for Tibbie's dinner had been already placed in a drawer where the cat could smell it, and knew by happy experience, that it would be hers on the return of her mistress, for whom she waited. The devout admirer of her neighbour's cat would not yet be talked out of her belief in its religiousness, affirming that it was the custom of Tibbie to sing over her meat while Tottie swore. Tibbie was afterwards taken by her mistress to live in the country, where she acquired so much knowledge of botany as to be able to distinguish accurately between *Phaseolus vulgaris* and *Phaseolus multiflorus*, liking well to eat the former, but constantly refusing the latter. This capacity for distinguishing between the pods of one species and another by taste, she retained after having become blind, when she was led about the fields by a daughter, whom she had brought up to keep the fifth commandment as well as she had herself kept the fourth.—*John Gibbs.*

**AFFECTION OF MONKEYS.**—The following instance of the affection of monkeys for their young may interest some of your readers. Yesterday I was passing a bridge which carries the Bhopal railway over the Betwa river, and saw a large number of black-faced "langur" monkeys upon it. This morning, passing again the same place, I found that one of a gang of workmen had found a young monkey near the line, and had caught it. He also discovered the body of its mother which had been run over by a train during the night and been killed. A large male monkey, however, followed the man when he took up the young one, and when I saw the latter, it was shrieking and struggling to get to the old monkey (evidently its father), who was seated on the rails about thirty yards from us, eagerly looking for the release of the youngster. I told the man to release the young one, when it ran off at once to the old one, who embraced and fondled it, and eventually ran off with it, holding it with one arm against its breast. I was much struck with the sight, especially as the old monkey was a male.—*G. D. Marston.*

## BOTANY.

"THE DICTIONARY OF PLANT NAMES."—We are genuinely sorry to find that in our notice of Messrs. Britten and Holland's splendid work "The Dictionary of Plant Names," we (through a slip of memory) gave the credit of the publication to the "Early English Text Society." The latter society does not require any extraneous aid of this kind. We ought to have assigned the publication to the "English Dialect Society," whose headquarters are in Manchester, and whose indefatigable Hon. Sec. is Mr. J. H. Nodal, The Grange, Heaton Moor, near Stockport. The high character, the extensive labour and learning, and the immense usefulness of "The Dictionary of Plant Names," makes it important that the right introducers should be known.

## NOTES AND QUERIES.

**REARING BOMBYX RUBI.**—In his article on "Lepidopterists' Work last August" Mr. Finch states that the larvæ of the fox-moth may be carried through the winter by means of a refrigerator. May I inform your readers of a plan, advocated by Mr. Robson, of Hartlepool, a few years ago, for obtaining the perfect insects of this species without any such troublesome process as refrigeration, a plan which I have found very successful? Select the largest and most full-grown larvæ to be found, and placing each in a separate two-ounce chip-box, put the boxes containing them inside the kitchen or parlour fender, leaving them there day and night. In the course of a week or two the continuous heat of the fire will have persuaded the larvæ that spring has come; they will spin their cocoons, and, if left in this situation, the perfect insect will emerge during the winter, at times as early as Christmas, or if desired to obtain the females at the right time for "calling," the boxes with the undisturbed cocoons may be placed in an out-house or cellar through the winter, and exposed to the hot sun during the later spring months. I have frequently found the cocoons on our Wallasey sand-hills, spun up among a tangle of grass and *Rosa spinosissima*, and very tiresome work it is for the hands collecting them, though the rooks appear to find them quite readily, and tearing open the cocoon they devour the pupa, which they evidently consider a *bonne bouche*. Should the larva not have completed the change to the pupal condition, this is also pulled out of the cocoon, but not otherwise interfered with.—*John W. Ellis, F.E.S., Liverpool.*

**GOLDSMITH, ETC.**—It would seem after all that Goldsmith did actually say the gudgeon had no air-bladder; this mistake is on a par with several others he made. It was precisely the same with the arts; he had a visionary project that some time or other, he would go to Aleppo, in order to acquire a knowledge, as far as might be, of any arts peculiar to the East and introduce them into Britain. Dr. Johnson said, "of all men, Goldsmith is the most unfit to go out upon such an inquiry; for he is utterly ignorant of such arts as we already possess; he would bring home a grinding-barrow, which you



see in every street in London, and think he had furnished a wonderful improvement." Boswell says of him, in his "Life of Dr. Johnson," chap. xviii.: "His desire of imaginary consequence predominated over his attention to truth." Johnson had but a poor opinion of Goldsmith as a naturalist, for on one occasion when Goldsmith had taken lodgings at a farmer's house in the Edgware-road (so that he might have full leisure to study natural history), a Mr. Mickle and Boswell went to visit him, but not being at home they went in and found in his apartment, curious scraps of descriptions of animals, scrawled upon the wall with a black-lead pencil. And yet this is the man your correspondent seems surprised should make a mistake. Why he did not make more mistakes can be easily accounted for.—*Mark Antony.*

**BIRDS NEAR DUBLIN.**—The interesting note from a Hampshire rectory about a grey wagtail that came day after day to a window, reminds me of a green wagtail that I used to see coming to a window in the same manner. This was in Ireland, between Dublin and Swords. There were many trees in the neighbourhood of the house, and birds were numerous. From the windows could be seen herons sitting on their nests in high beech-trees, the nests consisting of a few bits of stick, on which the birds appeared to sit astride, with their legs hanging down. In another part of the place was a wood of tall trees inhabited by myriads of rooks; from which three immense flights used to go out for food each morning, in three different directions. Their return at dusk was a sight to behold, the numbers being so unusually large; and the noise of cawing they made in settling for the night, reverberating from the front of the house, sounded like the roaring of the sea. Hooded crows and jackdaws were frequent; also greenfinches, chaffinches, great tits, cole tits, tom tits, and others; the white owl, brown ivy owl, dabchick, and moor-hen. Wood-pigeons were common; when shot, their crops were found stuffed with cabbage from the fields. Gulls often flew over; in one, the crop was found full of worms from the ploughed fields. Partridges and quails were in the neighbourhood. One winter hundreds of peewits came, and remained three days, feeding or resting on the grass. On the outskirts of the flock were observed twenty or thirty golden plovers, and about as many grey plovers.—*W. E. C. Nourse.*

**TOADS IN ROCKS.**—Mr. Sykes asks, at p. 22, "How is it that the stone or coal which is invariably reported to retain 'the exact impression of the little creature' can never be produced?" In the Great Exhibition of 1862, one of the exhibits was a large block of coal which had contained a living toad. After the lapse of so many years it would be unwise to speak positively, but my impression is that the block was split into two parts, and that the small cavity had been divided by the line of fracture. So far as could be decided by an inspection of the parts, no possible means of communication had existed between the cavity and the outside of the block. Nor was there any reason to doubt that the toad had really been found in the cavity. The toad was shown, beside the block, but was dead when I saw it. It was alive, I fancy, when first placed there. In periodicals of the time interesting references might probably be found. Such cases are very singular, but, I am, nevertheless, like Mr. Sykes, an unbeliever.—*W. J. N.*

**THE AUSTRALIAN FRINGED LIZARD.**—Under this heading, Mr. F. Challis, in your issue of January last, asks for a description of a lizard of this name.

Does he not mean the frilled lizard (*Chlamydosaurus kingii*) of Australia one of the Iguanas of the Old World (Agamidæ)? Its usual length is about two feet, with a large frill-like fold of skin round the neck, which the animal can erect or depress at pleasure. It is said to jump by means of its powerful hind legs and tail like a kangaroo. There is an excellent drawing of this lizard in the Natural History Museum Guide Book to the Reptilia. Should this not be the animal that is meant, I must apologise for the above description.—*H. A. Crossfield, South Hackney.*

**WASPS.**—The scarcity of wasps noticed by Mr. Waddell, at p. 21, was observed all over the British Isles last autumn, and commented on in the "British Bee Journal," where several correspondents attributed it to the queen wasps not having been fertilised before retiring to their winter quarters. They were thus as numerous as ever in spring, but in the majority of cases failed to rear brood. Perhaps the cold and wet autumn of 1885 was an assisting cause. Another reason is given in SCIENCE-GOSSIP, Vol. I. p. 257, a disease having attacked the larvæ and destroyed them in large numbers, perhaps what beekeepers call "foul-brood."—*H. W. Lett, M.A.*

**WASP.**—At 3 P.M., on the 29th of January, I took a live wasp (which is now in the Sheffield Museum) from a garden wall here; the day was remarkably warm and sunny.—*Thos. Winder, Sheffield.*

**MALE WASPS.**—In answer to a query of Mr. Reginald W. Christy in the February number: the males of the common wasp can be found by digging up the nests in September, or in some cases at the latter end of August. They are rather lazy in their movements. Occasionally they may be captured at the same time of year, as they fly about leisurely in the sun. There are thirteen joints in the antenna of the male against twelve shorter joints in those of the queen and worker. In *Vespa vulgaris* the male's antenna is half as long again as the queen's. While all the males of the British *vespæ* have the first joint of the antenna yellow in front, the queens of the three commonest species are without this distinctive feature. The queen is a stouter insect, its abdomen being shorter and more tapering posteriorly, with six segments against seven in the male. Of course Mr. Christy knows that the male has no sting.—*F. W. Elliot.*

**WASP STINGS.**—I think W. E. H. is incorrect in stating that wasps' stings are not barbed. They are barbed, but not so much as those of the honey bee.—*Gresham F. Gillet.*

**SCARCITY OF WASPS AND PLAGUE OF FLIES.**—I have frequently dug up wasp nests and found them infested by dipterous and other larvæ which prey upon the grubs and pupæ of the wasps. The maggots force their way through the paper cell-walls and devour the helpless inmates, sometimes completely destroying the colony. But with the perfect insects the tale is reversed, for, as every one knows, wasps are rather partial to their fully-developed enemies. I do not know whether they eat diptera in the earlier stages. Thus we can trace a double connection between a scarcity of wasps and a plague of flies. If in the early summer there is an extra number of fly maggots many wasps will be cut off in their infancy, fewer of them remaining to keep down the flies. There are only seven British species of *Vespa*, so that if the Rev. S. A. Brenan has more than six he has them all. In this neighbourhood (Buckhurst

Hill, Essex) *V. vulgaris* and *V. Germanica* abound, *V. sylvestris* and *V. rufa* are uncommon, while *V. Norvegica* and the hornet are decidedly rare. The seventh species, *V. arborea*, is of course absent. Your correspondent is extremely fortunate to have collected in one year queens of all the species. What is his district? I should be very glad to see his specimens, and, if he desires, to name them for him.—*F. W. Elliott.*

**GAS BENEATH ICE.**—In answer to the inquiry of your correspondent W. C. P., I think there is no doubt that the gas let out from beneath the ice on the pond at Fairburn was what is commonly known as marsh gas, a compound of carbon and hydrogen ( $\text{CH}_4$ ), and a result of the decay of the under layers of the peat bog which are excluded from the air.—*Alice Bradlaugh.*

**CURIOS PHENOMENON ON ICE.**—The inflammable gas which, according to your correspondent W. C. P., was observed beneath the ice on his friend's curling pond, was probably light carburetted hydrogen ( $\text{CH}_4$ ), or "marsh gas," as it is also called. This gas is generated by decomposing vegetable matter, and thus occurs in most stagnant ponds and marshy places.—*W. C. Flood.*

**CURIOS PHENOMENON ON ICE.**—I have no doubt from the data furnished by W. C. P. that the gas which escaped from holes made in the ice of his peat pond was marsh gas, the first of a series of bodies known as paraffins. Marsh gas, methane, carburetted-hydrogen, and fire-damp, as it is variously named, according to its occurrence in nature, frequently appears in stagnant pools, being produced by the decomposition of vegetable matter—hence its designation "marsh gas." In coal mines it oozes out from pores in the coal, where it has been occluded since its formation, and forms the much-dreaded "fire-damp," which on ignition burns, like W. C. P.'s escaping gas, with a scarcely luminous bluish flame. If mixed with the oxygen of air before lighting it causes a terrific explosion, with the production of carbon-dioxide, the "choke-damp" of miners. Although extremely explosive, this gas is not thought to ignite spontaneously. "It is also found in volcanic gases. The gas of the mud volcano at Bulganak in the Crimea is nearly pure methane."—*W. E. Watkins, Barnsbury, N.*

**NOTE OF THE CUCKOO.**—W. C. P. will find that there is nothing new in the cuckoo crying cuck-cuck-coo. It is as Mr. H. Lamb says, a common occurrence. Probably it is not a gift of any cuckoo or cuckoos in particular, but any cuckoo is apt to do so when excited. The bird sings cuckoo in a slow and measured tone, but the cuck-cuck-coo is jerked out in a much more hurried fashion; and it sometimes even cries cuck-cuck-cuck-coo when the notes follow each other in still more rapid succession, as though the bird was under some strong excitement at the time.—*W. Holland, Southampton Street, Reading.*

**THE NOTE OF THE CUCKOO.**—I think Mr. Lamb's suggestion in your January number is incorrect, as I have myself watched a cuckoo from a short distance (twenty yards). It was seated on the top rail of a gate, and afterwards removed to the bough of an oak tree. At intervals it repeated the three notes "cuck-coo-coo." I can see no reason for thinking that it does not voluntarily utter the note by the action of its throat; and should consider it hardly possible to obtain so loud a sound by the means H. L. suggests.—*Gresham F. Gillett.*

**POTERIUM SANGUISORBA.**—I do not see mention of this plant in Dr. P. Q. Keegan's catalogue of wild flowers around Ullswater. I picked it in the meadows at Grassmere last year, where it presents a remarkable appearance, being upright, sepia green in colour, with acuminate leaflets and purplish flowers; whereas, on the Surrey Downs, it is prostrate, yellowish, with ovate leaflets and greenish flowers.—*A. H. Swinton.*

**MIMULUS LUTEUS.**—What does P. Kilgour imply by "annular plant stems"? I presume *annual* is a more common rendering of his meaning, for I cannot find any reference to a *ringed* condition of the stem of *Mimulus luteus*, L., in Sir J. D. Hooker's "Flora of the British Isles," 3rd edition. If my former suggestion be correct, I think P. Kilgour will discover (?) several annual plants in which the fibrovascular ring is completed by the development of Phloëm and Xylem from the interfascicular cambium; that is, if he will give it time to grow.—*A. W. L.*

## NOTICES TO CORRESPONDENTS.

**TO CORRESPONDENTS AND EXCHANGERS.**—As we now publish SCIENCE-GOSSIP earlier than formerly, we cannot undertake to insert in the following number any communications which reach us later than the 8th of the previous month.

**TO ANONYMOUS QUERISTS.**—We must adhere to our rule of not noticing queries which do not bear the writers' names.

**TO DEALERS AND OTHERS.**—We are always glad to treat dealers in natural history objects on the same fair and general ground as amateurs, in so far as the "exchanges" offered are fair exchanges. But it is evident that, when their offers are simply disguised advertisements, for the purpose of evading the cost of advertising, an advantage is taken of our *gratuitous* insertion of "exchanges" which cannot be tolerated.

We request that all exchanges may be signed with name (or initials) and full address at the end.

**I. INGHAM.**—Many thanks for offering to send us a specimen of the "Daily Telegraph's Meteorite." You will see in our last number that a fragment had been sent us, and that was a fragment of ordinary mottled carboniferous sandstone.

**J. T. F.**—The "Popular Science Review" ceased to be published in 1878. Apply to Mr. W. P. Collins, 157 Great Portland Street, for back numbers or volumes.

**A. E. FORSHAM.**—The best books on the subject you mention are Bell's "British Reptiles" (Lovell Reeve & Co.), and Cooke's "British Reptiles" (Allen & Co.)

**J. A.**—We have not heard of Mr. Ady's "Studies" since the last issue was noticed in SCIENCE-GOSSIP, and therefore we conclude they are discontinued. We do not know his address.

**W. H. L.**—You will find in the Microscopical column, and also in articles of back numbers of SCIENCE-GOSSIP, many recipes for preserving animal matter for mounting.

**J. B.**—Sach's "Botany" is of the first order; so is the new edition of "Vine and Prantli."

**E. B.**—You will see our remarks as to the supposed Barnsley "meteorite" above.

**X. Y. Z.**—You had best offer your services to some of the chief microscope makers and dealers in microscopical materials.

**W. J. TABLEY.**—You will find the fullest particulars as to the "plate cultivation" of bacteria, etc., in Dr. Crookshank's "Introduction to Practical Bacteriology," published by H. K. Lewis.

**E. BRUNETTI.**—Will you kindly send us your full address.

## EXCHANGES.

OFFERED, SCIENCE-GOSSIP, 1878, unbound; "Midland Naturalist," unbound; Tripp's "British Mosses," 2 vols.; Watson's "Topographical Botany"; "Lessons in Elementary Botany," by Daniel Oliver; "Countries of the World," 6 vols. (Cassell); "Cities of the World," unbound (Cassell); "Knowledge," unbound, No. 1 to present. Wanted, "The Power of Movement in Plants," by Darwin; "The Expression and Emotions in Man," by Darwin; "The Variation of Animals and Plants under Domestication," by Darwin; "The Naturalist's Journal," "Records of a Naturalist on the River Amazon," by H. W. Bates.—Thomas Hedden, Hainworth, near Keighley.



WHAT offers in exchange for "Illustrations of the Linnean Order of Insects," by W. Wood, F.R.S., published in 1810 in 2 vols., with coloured plates? Offers wanted also for "The Amateur Photographer" for 1885 and 1886.—C. Gregory, c/o Mrs. Sharp, 4 Bateman Terrace, West Kensington, W.

"NOTES on Collecting and Preserving Natural History Specimens," by J. G. Taylor, offered in exchange for tropical marine shells.—W. Jones, jun., 27 Mayton Street, Holloway, N.

I should like to correspond with some one collecting skulls of animals or birds.—Edmund Tye, 21 Gold Street, Northampton.

WHAT offers in curiosities for a good breeding-cage? Good as new.—Edmund Tye, 21 Gold Street, Northampton.

CURTIS'S "Botanical Magazine," first 20 vols., 825 coloured plates, in perfect condition. Will exchange for later vols. of same work or good microscope; or what offers?—J. Fingland, Thornhill, Dumfriesshire.

FORAMINIFERA.—Good mounts of pure *Globigerina bulloides* for exchange.—W. Stott, Lostock, Bolton.

"ZOOLOGIST," vols. i-xii., 1843-1854, complete, bound; what offer for the set? Wanted, the vol. for 1886, for York School Natural History Society.—B. E. Le Tall, 20 Bootham, York.

WANTED, Bell's "British Quadrupeds" and "Reptiles," latest editions in preference. Unaccepted offers not answered.—F. H. Parrott, 35 Doughty Street, London, W.C.

SCOTCH graptolites offered in exchange for good foreign shells. Specially wanted, Philippine land shells and volutes.—Miss F. M. Kele, Fairlight, Elm Grove Road, Cotham, Bristol.

FOSFILLS, minerals and rock specimens, offered in exchange for books on natural history, or any other subject.—M., Culver Lodge, Acton Vale, London, W.

EXCHANGE, side-blown eggs: eider duck, gannet, R. skua, sandwich-tern, ptarmigan, common tern, guillemot and kittiwake. Wanted: buzzards', sparrow-hawks', kites', owls', harriers', shrikes' and cuckoo's.—William Petch, Heley, Sheffield.

THE Droseras, Andromeda, Melicerta, Floscules, Vaginicola, Peridinium, Volvox, Ponderina, Draparnaldia, Aphanothece, diatomaceous material. Wanted, micro slides and apparatus, small slide cabinet, natural history books.—C. L. Lord, 34 Burlington Crescent, Goole.

WANTED, mineral specimens. Exchange Cassell's "Popular Educator," 50s. edition, good condition. Send names.—H. Ebbage, 165 Hagley Road, Birmingham.

WILL exchange for fossils, a book on the collecting, preparing and mounting of diatoms.—T. Sanderson, Wells Road, Malvern Wells.

ALPINE mosses in exchange for those from chalk, particularly *Systegium*, *Seligeria* and rarer *Phasci* and *Gottia*.—W. E. Waterfall, Redland Green, Bristol.

A NUMBER of slides of diatoms for exchange. E.g. *Toxonidea*, *Nitzschia Petitiiana*, *Barbadoes*, Newcastle Estate, Oran, Eseld, "Challenger" dredgings, and many others. Good diatoms preferred. Exchange lists with Rev. A. C. Smith, 3 Park Crescent, Brighton.

A STUDENT who is working the flora of the River Lea valley, would like to correspond with botanists residing in the Herts or Beds portions of the above river.—H. S. C., 71 Aden Grove, Stoke Newington, N.

MICRO lamp. New, in good working order. What offers?—L. Cooper, 6 Park Drive, Heaton, Bradford, Yorkshire.

GANOT'S "Physics"; Wurtz's "Atomic Theory" (International Scientific Series); "Popular Scientific Amusements" (Ward, Lock & Co., profusely illustrated); Tyndall's "Forms of Water." All quite new, and latest editions. What offers? Micro apparatus required.—A. Earland, 3 Eton Grove, Dacre Park, Lee, S.E.

WANTED, foraminiferous material in small quantities, recent and fossil, from all countries. Must be localised. Will exchange same, or mounted slides.—A. Earland, 3 Eton Grove, Dacre Park, Lee, S.E.

WANTED, a moderately large shell cabinet. Micro material in exchange.—T. M. Harvard, Layland, Lancashire.

WANTED, unmounted parasites, will give good exchange in slides. Also foreign correspondents to exchange micro material and slides.—Fred Lee Carter, 25 Lansdowne Terrace, Gosforth, Newcastle-on-Tyne.

WANTED, unmounted specimens of parasites of mammalia, also fleas; good exchange offered.—W. A. Hyslop, 22 Palmerston Place, Edinburgh.

WANTED, reagents and accessories for histology. Have two years of "Knowledge"—Thomas D. Sellers, 1 The Avenue, Preston.

LAND and freshwater shells in exchange for others or marine shells.—W. Gyngell, Wellington, Somerset.

WANTED Wilson's "Hygiene and Sanitary Science." Also a good chemical balance and apparatus for quantitative analysis.—T. W. Lockwood, Lobley Street, Heckmondwike, Yorkshire.

GOOD value in exchange offered for *Terebratula australis*, *Terebratula rubicunda*, *Arypa psittacea*, *Spirifer rostratus*, *Mya arenaria*.—C. F. Cross, Werneth Hall Road, Oldham.

I PREPARE rocks and other hard substances for the microscope, and will give ample exchange for good material.—C. F. Cross, Werneth Hall Road, Oldham.

WANTED, a double or treble nose piece for microscope, in exchange for Collins's Bockett Lamp for microscope in mahogany case.—H. W. Parritt, 103 Camden Street, London, N.W.

STANDARD specimens of American helices offered for foreign marine shells.—J. T. Reed, Ryhope Road, Sunderland.

WANTED, Thorne's "Structural and Physiological Botany" (Longman's)—Grierson, 74 Market Place, Sheffield.

WANTED, Huxley & Martin's "Practical Elementary Biology," latest edition. Will give "Practical Chemistry by Clowes" also four numbers of SCIENCE-GOSSIP for Sept.-Dec. 1885.—E. Bromley, Victoria Terrace, Lightcliffe, Halifax.

FOR exchange, slides of upper and lower jaw of long-eared bat, with teeth in situ, for polariscope; ox parasite, &c.—J. Stroud Williams, Livingstone Villa, Ilfley Road, Oxford.

THE two first numbers of Saville Kent's "Infusoria," for exchange. Offers.—J. Stroud Williams, Livingstone Villa, Ilfley Road, Oxford.

PURCHASE or exchange, a small brass mounted microscope with French triplet, equal nearly to a 4-inch English objective, bull's-eye condenser attached, revolving diaphragm, one deep and shallow eye-piece, on solid bronze stand, with ball and socket adjustment, the whole in case complete, almost new, together with a quantity of thin glass circles various sizes, and two dozen glass slides. Unaccepted offers not answered.—H. J. T., The Rectory, Musbury, Axminster, Devon.

MORRIS'S "British Birds"; six vols. with 365 coloured plates. Morris's "British Birds' Nests and Eggs"; three vols. with 223 coloured plates. "Gallery of British Artists," six vols. Lett's "Atlas," four vols. All as new. What offers in microscope, micro apparatus, &c.? Wanted, SCIENCE-GOSSIP complete, from 1865-86.—W. Tunstall, Wood Vale Mills, Brighouse.

WANTED, British birds' eggs blown with single hole. Will give in exchange North American birds' skins and squirrels. Also British birds' skins.—T. Mottershaw, 11 Manchester Street, Nottingham.

SIX sections of each of the following, well cut and stained, for good histological slides or land and freshwater shells, &c.: *Phanix dactylifera*, *Arceuthobium cactechu*, *Cyperus alternifolius*, *Aspidistra lurida*.—James C. Blackshaw, 4 Ranelagh Road, Wolverhampton.

FIRST class clutches, with data, of American bittern, killdeer plover, Bartram's sandpiper, &c., for other rare eggs not in my collection. Please send lists to W. Wells-Bladen, Stone, Staffordshire.

WANTED, a copy of Hinck's "Polyzoa."—63 Legh Street, Warrington.

DUPLICATES, *Edusa*, *Philodice*, *Selene*, *W. album*, *Pruni*, *Cratageus*, *Cassiope*, *Davus*, *Antiopa*, *Liza*, *Enone*, *Orythya*, *Leucothoe*, *Volina*, *Salmacis*, *Lassinassa*, *Inachis*, *Thydamus*, *Eucharis*, *Plexippus*, *Chrysipus*, *Archippus*, *Core*, *Limnæa*. Unset desiderata. Other exotic butterflies. W. H. Scott, 14 Prospect Hill, Leicester.

THE Lord's Prayer written on glass by Dr. Farrant, President of the R. M. S. L., in the 400,000th of a square inch, equal to writing the whole Bible and Testament twenty-two times in the space of one square inch. What offers?—M. D., 49 Handfield Road, Waterloo, Liverpool.

WANTED, vols. of "Northern Microscopist," unbound preferred, to complete set, lowest offers, etc.—V. A. Latham, F.M.S., 70 Portsmouth Street, Oxford Road, Manchester.

#### BOOKS, ETC., RECEIVED.

"Through the Fields with Linnaeus," by Mrs. Florence Caddy, 2 vols. (London: Longman).—"British Cage Birds," by R. L. Wallace (London: L. Upcott Gill).—"Fancy Pigeons," by J. C. Lyell (London: L. Upcott Gill).—"Catalogue of Scientific and Technical Books" (London: G. Philip & Son).—"The Medical Annual," 1887.—"The Amateur Photographer."—"The Camera."—"The Garner."—"The Scientific Enquirer."—"The Naturalist."—"The Botanical Gazette."—"Journal of the New York Microscopical Society."—"Belgravia."—"The Gentleman's Magazine."—"American Monthly Microscopical Journal."—"The Essex Naturalist."—"The Wesleyan Naturalist."—"Trans. Herfordshire Nat. Hist. Soc."—"Trans. Leeds Geological Association."—"The Midland Naturalist."—"Feuille des Jeunes Naturalistes."—"The American Naturalist."—"Journal of Microscopy."

COMMUNICATIONS RECEIVED UP TO THE 13TH INST. FROM: S. F. E.—J. J. W.—J. C.—W. E. H.—B. B. L.—J. F.—H. M.—W. J. N.—E. T.—G. D. M.—G. M.—M. C. L.—W. J. jun.—C. G.—J. C. P.—G. H.—C. R.—T. H.—B. W.—J. W. G.—C. P.—J. C.—F. H. P.—C. R.—T. W.—REV. A. C. S.—W. B. W.—J. W.—F. R.—C. L.—L. E.—B. T.—S.—H. S. C.—G. H. B.—L. C.—A. F.—T. M. H.—W. P.—W. I.—H. D. S.—D. B.—H. E.—C. J. W.—T. D. A. C.—F. L. C.—W. L.—J. W. W.—M. C. M.—W. A. H.—T. R.—A.—B. C.—F. W. E.—C. F. C.—H. W. P.—J. T.—A.—T. M.—J.—E. B.—C.—W. H. S.—H. I. T.—W. H. L.—T. M.—J.—A.—T. M.—J.—E. B.—J. S.—W.—M. A.—H. I.—A. L.—L.—A. E. H.—G.—E. B.—J. S.—W.—M. A.—J. H.—W. P.—W. W.—J. T.—E. J. S., jun.—W. E.—A. G. S.—F. W.—V. A. L.—Q. S. F.—E. J. R.—L. L. R.—H. G.—H. G.—W. H. B.—J. A. J.—E. J. T.—J. H.—&c., &c.





## NOTES ON AUSTRALIAN FORESTS.

By THE EDITOR.



THE magnificent specimens of woods and timbers, as well as the beautiful water-colour drawings of the flowers of the Australian forests, which everybody saw in the Colonial Exhibition, convey a poor idea of the amazing wealth of vegetable life in Australia during the early summer months. The vivid brightness of the green fern-tree gullies at

the Exhibition were only so many hand specimens of this striking flora.

Even within a few miles of the great and populous cities of Adelaide, Melbourne, and Sydney, vegetable nature is generally undisturbed. The range of the Mount Lofty hills, four or five miles behind Adelaide, abound in fern and grass tree gullies, where parrots are as numerous as sparrows, and opossums furnish abundant sport to the youthful sportsmen. Still further away, towards Mount Barker, the dense forests are untouched except by the clearings, where splendid villas have been dropped in their midst, and room made for gardens wherein all the fruit trees of the world are gathered together.

The suburbs of Melbourne extend much farther into the country; but even there, at such places as Mount Macedon, Fernshaw, and in the Dandenong ranges generally, which latter are plainly visible from Melbourne city, the vegetable kingdom flourishes in uninterrupted luxuriance. The sides of the hills are seamed with gullies, down which the quiet streams trickle, overshadowed and over-canopied by the lace-like umbrageousness of gigantic tree ferns, some of

which, as the *Dicksonia antarctica*, grow to the height of more than thirty feet. Here and there are huge "Stringy Barks" (*Eucalyptus macrorhyncha*), or "Messmates" (*Eucalyptus obliqua*)—both of them gum trees, whose trunks are frequently fifteen feet in diameter. An enormous variety of shrubs, belonging to various natural orders, are competing for existence, and inviting both insects and birds to visit them by the gorgeous colours of their flowers, although the native heaths (*Epacris*) have apparently triumphed as far as abundance goes. Dwarf ferns crowd and cover the cool, moist rocks, about which the forest trees extend; whilst from many of the latter the "Supple-Jack" (*Clematis aristata*) hangs down its dense foliage, having first interlaced the stems together by its rope-like cords. Higher up the hills and mountains we find the Hill Tree fern (*Alsophila australis*), sometimes standing forth like a sentinel in the very face of the sun, its green fronds not unfrequently being fifteen feet long.

Both at Fernshaw and Dandenong you see specimens of the gigantic gum-tree (*Eucalyptus amygdalina*), some of which attain an altitude of 400 feet, and one of which not long ago was found 480 feet long. Concerning this tree, Baron von Müller, the Government botanist, calculated that the timber from it alone, if cut into one-inch planks, would cover a field of nine and a-half acres. "She-Oaks" (*Casuarina*) and "Native Pines" (*Frenela*), both of which are found fossilised in the Eocene strata of England, are among the most prominent of older trees; whilst various gum-trees of less magnitude are glad to grow where the big ones cannot. Nearly all these gum-trees have learned the trick of turning the edges of their leaves towards the sun, so as to diminish the transpiration, or loss of their moisture. The result is an almost shadeless forest. The Acacias, or "Wattles," have met the same difficulty in another way. When the brilliant yellow and primrose-coloured tasselly blossoms of these trees are put forth, the atmosphere is laden with their powerful fragrance, reminding us of the smell of bitter almonds. On the huge trunks of all trees alike, the "Stag-horn fern"

(*Platynerium*), as well as the "Bird's-nest fern" (*Asplenium*) grow in greater or less luxuriance. One shrub, the *Pithecolobium grandiflorum*, is a magnificent sight when decorated with its scarlet blossoms.

In the summer-time these luxuriant glades are the haunts of richly-coloured butterflies and beetles; whilst the Region bird, Rifle bird, green pigeons, various parakeets, &c., enhance the scene by their brilliant plumage. At night, myriads of fire-flies issue forth like shooting-stars. Of all the odours in these primeval woods that of musk seems to prevail most powerfully, except when the "Wattles" are in bloom.

I shall never forget spending a few days in one of these forests. It was about spring time, and all nature was rapidly recovering from its short winter rest. The forest I visited (in company with a hospitable squatter with whom I was staying) was in Western Victoria—a forest which has only just been explored from end to end. We had to drive to the outskirts from where I was staying, for a distance of about twenty miles, in an American "buggy." Our route to the forest lay along greasy, unused, one-chain roads, along which waggons and other vehicles were in the habit of winding their devious ways. In many places it was a euphemistic form of speech to call them roads, for they differed from the rest of the country altogether, except the rough fencing on either side. Gum-trees, dead and living, and also abundance of tree stumps, of all sizes and in all positions, crowded the "road," along which, I hope, few people are obliged to travel by night. Processions of dead trees—studied in black and white—seemed to pass us by as we drove along. They are the scarred remnants of bush fires, and they alone are sufficient to mark the road. Flocks of brilliant green parakeets rise up from beneath our horse's feet; lovely lowry, rosella, and Blue Mountain parrots flash across us in the sunshine like living gems; crowds of cockatoo parrots (*corella*) soar above our heads, numbers of white, sulphur-crested cockatoos screech as if a screeching match were on and every bird was confident of winning. They fly from dead gum-tree to dead gum-tree, and cluster on the branches, as if the latter had broken into blossom. All along the road the Australian "robins" precede us flitting from fence-top to fence-top, and turning their glowing, incandescent red breasts towards us as if asking whether our humbler English robin red-breasts could equal them. The crow-shrikes, or magpies (surely the most delightful as well as the most useful of Australian birds), were everywhere, darting and frolicking in the sun like so many kittens, and piping their lovely flute-like notes like the half forgotten refrain of some old song. The pretty, but more silent and smaller, magpie-larks were almost equally numerous. Occasionally we got a glimpse of the male of the beautiful blue wren, but he was too proud to show much of himself. The yellow wrens were not half so shy or so scanty,

whilst the flycatchers were abroad and busy in great force. The black crows had possession of the semi-cleared country, except where a few jays disputed with them. Overhead a pair of kites or an occasional hawk soared and screamed. But the parrots and parakeets and cockatoos were by far the most numerous and varied of all the feathered tribes, as it is right and proper they should be in an Australian forest. In one place a number of those stately grallatorial birds known as "native companions" were going through all the movements of a quadrille party, bowing to each other, retiring, advancing, and retreating, as if to some unheard music. They are handsome birds, for their crimson heads contrast well with the generally French grey plumage. The ordinary blue cranes were not uncommon, plovers or curlews were numerous, and we saw a few of those much-sought-after birds the bustard, better known to sportsmen, perhaps, as the "turkey."

The forest grew denser and swamper as we penetrated it. There was a thick and almost impenetrable undergrowth of young gum-trees, heath, myrtaceous plants, prickly acacia, climbers, and bracken, and one felt what a capital haunt and breeding-ground such a place must be for snakes. One had to reverse the old proverb about not being able to see wood for trees, for here we could hardly see trees for wood.

Snakes are gradually getting scarcer in Australia. A war of extermination is being waged against them, which is getting hotter and fiercer every day, for there are more people joining in the attack. The more a country gets cleared for pasturage, the less are the chances for snakes. They are then better seen by their natural enemies, among which, perhaps, the most deadly are the laughing jackasses (*Dacelo gigantea*)—a kingfisher which has taken to killing and feeding on snakes instead of on fishes.

We arrived at a clearing in the forest where there are one or two small but comfortable wooden houses, at one of which we passed the night. A good many half-wild cattle roam about (my friend owned 2000). They lead a semi-savage life, a few being trained to come near the station to be fed and milked. A number of rough forest horses, brought up in a similar way, also hung around the place. We mounted these, and rode about eight miles into the more unfrequented parts, where the kangaroos still abound. They had recently been much disturbed through rabbit-shooting, but I saw two red wallaby kangaroos and one "old man" (*Macropus major*). I had never seen them before alive, except in menageries and Zoological Gardens, and as a naturalist and geologist, I was therefore deeply interested in seeing them in their native haunts. They are probably the oldest race of mammals in the world, and their ancestors lived in England during the Secondary Period, which must have been millions of years ago.

The way these animals leaped away and escaped



in the scrub, almost in the twinkling of an eye, was a caution. It seemed impossible that a pair of limbs could be specialised to such rapid and powerful motion. Presently other species of marsupial animals were noted. An opossum was caught in the very act of climbing a tree; three or four specimens of bandicots (one with a young one in her singular pouch) were captured by the dogs, and my diligent outlook for the kangaroo-bear was rewarded by discovering one in the fork of a half-dead gum-tree. His light-grey furry coat was exactly of the same shade as the bark of the tree, so that he is admirably protected thereby. He looked down from his point of vantage with such a serio-comic expression that I could not forbear laughing; but he never moved a muscle.

It was full moonlight during these nights in the forest, and I enjoyed the weirdness of the situation as a new experience. Many a time during the evening I went out in the open air, so as to more thoroughly allow the surroundings to impress me. There was a cloudless sky, and the black-and-white dead trees, some spreading out their naked branches like spectres, others lying in every direction upon the ground, just as they had fallen, added to the ghostly situation. A loud chorus of frogs filled the air with increasing noise, and the laughing jackasses were more numerous and more noisy than I have known them anywhere else. Every tree seemed to have its pair of them. There appeared to be a competitive examination in laughing going on, a sort of avian handicap. These laughing duets appear to have been written from the same score. There is the soprano and the baritone—the latter an unmusical cackle, the former occasionally rising to a theatrical and very stagey laughter. All through the night these birds kept up the sport; nor did they seem to be tired of it all the next day. The crow-shrikes or magpies were also affected by the brilliant moonlight; and every now and then one could hear their flute-like cadences amid the dramatic laughter of the jackasses. In addition, there was a distant chorus of undiscoverable sounds, and an occasional shriek or groan that might be anything, but which was all the more mysterious because it could not be identified.

One may slowly ride horseback (as we did for three days) for weeks in these forest lands—through almost impassable thickets of scrub or bush, through swamps and bogs, and past solemn, quiet lakes where myriads of black swans and mountain ducks are feeding. The fauna and the flora repeat themselves with never-palling delight to the "new chum" who is a naturalist. In a few years these scenes will be no more—the trees will be cut down, the bush cleared, and thousands of happy English homes will replace swamp and bog. For the hands of honest emigrants there is abundance of work in making the wilderness and the solitary places to become glad.

## PATHOLOGY AND ITS RELATION TO EVOLUTION.

[Continued from p. 82.]

TAILED men have been laughed off many times because, in the majority of cases, they have been found to be nothing else than some structural disease, as a fatty tumour, *spina bifida*, or a coccygeal tumour. But Gerlach ("Ein Fall von Schwanzbildung bei einem menschlichen Embryo," *Morph. Jahr. Bd. vi. S. 186, 1880*) has described a case in which there were muscle tissue and *notochord*. And I may add that there is evidence that a longer caudal region at one time existed, for in the embryo the notochord extends beyond the region that corresponds with the tip of the coccyx.

Morphologically considered, the odontoid process corresponds to a portion of the centrum of the atlas. This has three centres of ossification—two at the base and one at the apex; the centra of the vertebræ, excepting this one, have but one nucleus. Johannes Müller detected two nuclei in the sacral vertebræ of birds. And Professor Cope has recorded in the 'Proceedings of the American Philosophical Society,' vol. xix. p. 51, 1880-82, a case of a Ganocephalean, *Eryops megaloccephala*, found in the Permian formation of Texas, where a large intercentrum was interposed between each vertebra, and each centrum consisted of two lateral pieces or pleurocentra. There is, from these evidences, every reason to believe that in the ossification of the os odontoideum we retain a primitive character, "whilst in the occasional existence of a half-vertebra, either in excess or diminution, or accompanied by disturbance in the normal ossification of the column, we have to deal with atavistic phenomena."

Mr. Sutton thus sums up—

"1. During development the human embryo possesses more mesoblastic somites than are utilised in the formation of the permanent vertebral column.

"2. At least one undergoes suppression in the cervical and lumbar regions respectively, and probably many in the caudal region of the column.

"3. Occasionally one, or half of one somite usually suppressed, may persist and give rise to a supernumerary vertebra, or  $\frac{1}{2}$ -vertebra; or the suppression may extend beyond its usual limits, and the total number of segments in the column be fewer than usual.

"4. Under exceptional circumstances, a vertebral centrum may arise from two distinct centres of ossification; this must be regarded as indicating the reappearance of an ancestral character. The study of the spinal column teems with illustrations of the two laws—namely, those of suppression and coalescence."

*Mammæ erratica* or *Supernumerary Mammæ*.—In man and the higher Eutherians, and in the Sirenia



among the lower Eutherians, the teats are situate on the breast. In the cow, mare, ass, and others, they are placed in the inguinal region, while the insectivorous Eutheria hold an intermediate place in this respect, and have their mammæ extending from the chest to the abdominal regions. These are the most common regions, but some lemurs—these are exceptional—have them on the arms; and the bats, such as *Pteropus* and *Galeopithecus*, have their teats in the axilla or arm-pit. Supernumerary mammæ are by no means rare in women. Dr. Mitchell Bruce (*J. Anat. and Phys.* xiii, p. 245) says that out of 207 men he examined 9.11 per cent. had supernumerary nipples, and that out of 104 women 4.807 per cent. exhibited the same feature. No less than sixty-five cases have come under this observer's notice in three years; and without exception these were situate in the front of the trunk, around and about the situation of the ordinary nipple, and were more frequent on the left than on the right side.

I may add that Humboldt, in the third volume of his "Travels," has recorded a case in which, after the death of the mother, an infant was sustained at the



Fig. 44.—Section of an ovary of a human fœtus at the ninth month. R.F., ovum in its follicle. CL, corpus luteum, cyst.

breast of its father. Also that MM. Murat and Patissier in "*Dict. des Sciences Méd.*" mention a man whose mammæ were as fully developed as a woman's, and this was associated with a striking atrophy in the reproductive organs. And Astley Cooper has corroborated this, by a similar case which fell under his own notice.

All these cases show that they nearly always—i.e. supernumerary mammæ—lie in the course of that remarkable anastomosis which is found not merely in man but in animals: on the ventral aspect of the body, going up from the external iliac by way of its deep epigastric branch on the one to the internal mammary artery, by its superior epigastric branch on the other hand.

Darwin, in his "*Descent of Man*," explains the occurrence of supernumerary nipples in man thus: "If we suppose that during a former prolonged period male animals aided the females in nursing their offspring, and that afterwards from some cause (as from the production of a smaller number of young) the males ceased to give this aid, disuse of the organs during maturity would lead to their becoming in-

active." Equally probable, Mr. Sutton says, is it that every mammal at one period was hermaphroditic, and the mammæ persist as remnants of that condition, just in the same way as the parovarium which in the female is functional is represented by the efferent ducts of the male gland. The reader will have noticed that, in Dr. Bruce's record, the number of supernumerary nipples in the male record per cent. is greater than that in the females. This is explained easily on the principle of correlation. In the female, as functional organs, the mammæ require an increased blood supply, which leads to a dwarfing of the other glands. The opposite of this obtains in the male.

To turn now to another instance, and this time connected with the development of ova from the ovary. We have an estimate that in the cod the roe contains no less than 9,344,000 ova, in the haddock and the plaice six millions. Only a small portion of these ever attain the adult condition, for besides being preyed upon by other fish we know that they are subject to fungoid growths. The number of the tadpole-larva of our common frog never grow into their manhood. Alfred Russell Wallace has computed that if we take a bird that produces ten young per annum, one hundred millions in forty years will be the prodigious reckoning of their increase. This is just as true for mammals. Waldeyer has counted 300,000 ova in an ovary of the human female at birth, but as this was necessarily done by sections, some of this number must be cut out, because of the fact that any one ovum must have appeared again in two or more sections.

So far back as 1733 the fact, that Graafian follicles, corpora lutea and ova become mature at the seventh month of fetal life, was known by Valisneri; but this escaped its proper share of attention till Carus, writing in 1837, and Ritchie in 1842, made the knowledge more popular. Since then many workers have considered this, and among these may be mentioned Waldeyer, Beigel, De Sinéty, and Balfour. The second named of these observers has shown conclusively, that not only do ova come to maturity during embryonic existence, but also that they undergo retrogressive changes and form corpora lutea.

Mr. Sutton has collected foetal ovaries of mammals ranging in species from a monkey to a kangaroo, a lemur to a sloth, a Japanese deer to a cat. Among the species selected may be mentioned *Macacus Sinicus*, *Macropus major*, *Lemur catta*, and *Cervus silka*. And he finds that the observations of Beigel cited above are true, not only of man, but also of mammals outside the pale of *Homo sapiens*, and says that there is every reason to believe that it is equally true as regards those vertebrates yet again who hold their standings in the forum of zoological existence, external to the mammalian circle. Then he thinks that this is only to be explained on the grounds of an amphibian ancestry of man, which in turn is evolved from a piscine condition. And then

the conclusion: "In order to maintain themselves in due proportion they must bring forth a large number of offspring so as to guard against the wholesale destruction of their young by their natural enemies. The higher mammals are in a very large measure exempt from this danger, and the necessity for such an extraordinary fecundity as the Ichthyopsida manifest is averted. Nevertheless by virtue of the law of inheritance the ovary possesses an enormous number of ova. Although mammals are thus spared the trouble of bringing such large numbers of young into the world, the suppression of ova acts as an intrinsic source of danger, for these unused follicles become in some instances the sources of ovarian cysts, not in the human female only, but in the individual species throughout the kingdom mammalia. It serves as an excellent instance of the application of evolution to pathology."

There is a zoological law, that the number of mammæ to any given animal varies in direct ratio to the number of young which that animal produces. Remembering this in conjunction with the evidence given above, the only legitimate conclusion to come to is that the suppression of ova in the fœtal ovary and the occurrence of supernumerary mammæ and teats indicate an ancestry in which not only were there a great number of offspring produced, but also in which the females were assisted by the males in giving suck to their young.

There is a most pregnant utterance of Von Baer, known it might be already to some readers. It is thus: "The embryos of mammalia, of birds, of lizards, and snakes, and probably also of Chelonia, are in their earliest stages exceedingly like one another, both as a whole and in the mode of development of these parts, so much so, in fact, that we can often distinguish the embryos only by their size." And then: "In my possession are two little embryos in spirit, whose names I have omitted to attach, and at present I am unable to say to what class they belong. They may be lizards or small birds, or very young mammalia, so complete is the similarity in the mode of the formation of the head and trunk in these animals. The extremities, however, are still absent in these embryos. But even if they had existed in the earliest stage of their development, we should learn nothing, for the feet of lizards and mammals, the wings and feet of birds, no less than the hands and feet of man all arise from the same fundamental form." Hence the enunciation of a law known from the days of this father till now to hold in all perfectness—in the words of Mr. Sutton—"that in the embryological history of a given animal we read a brief epitome of its ancestry—in fact its evolution." Professor Ernst Haeckel has expressed it more fully, by putting it thus and thus, "Ontogenesis" (i.e. the development of the individual) "is the brief and rapid recapitulation of phylogenesis" (i.e. the development of the species) "governed by the physiological functions of trans-

mission and nutrition. The organic individual, during the rapid and brief course of its individual development repeats the most important of those changes of form which its ancestors have passed through during the long and gradual course of their palæontological development in accordance with the laws of transmission and adaptation."

Next, let us look at those examples of atavism, or, if you will, reversion to ancestral conditions, as exemplified and enlarged upon by Mr. Sutton in his lectures which form the subject of the present paper.

Gegenbaur ("Polydactyly as Atavism," *Morph. Jahrb.* Bd. vi. S. 584; also "J. Anat. and Phys.," vol. xvi. p. 615), gives the following caveat well shown in the case of the *os centrale* above: "Atavism consists not in the existence of a latent germ, but in its becoming perfected and further developed." And moreover, Hensel, as well as this last-named anatomist, utters further that, taking the cases of reversion as a whole, the greater number of

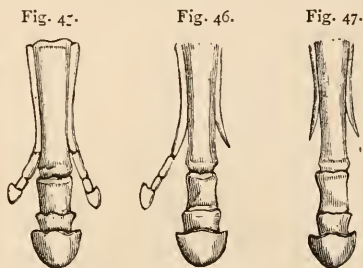

Fig. 45.—The manus of Hipparion with three functional toes.  
Fig. 46.—The manus of a horse with the medial digit functional.  
After Marsh.

Fig. 47.—The manus of the modern horse, one toe functional.

"atavistic parts do not belong to forms palæontologically remote or systematically far distant." This too is illustrated by the selfsame *os centrale*, for it obtains in the higher apes, as the orang and gibbon. But the best illustration perhaps is discovered in the ancestor of our present horse. In the fauna of the Pliocene epoch, one of the most abundant was an animal somewhat of the size of a quagga, known as *Hipparion gracile*, Gaudry; this, the immediate precursor of our old-world horse (Protohippus is the representative of Hipparion in the new world formations), had three digits, all of which were functional, inasmuch as possessing well-developed hoofs, and the evidence evinced by the case of the Cuban horse to be presently described. The ulna bone in Hipparion also was moderately well developed, a feature, which the anatomy of our own horse is deficient, at any rate in adult life. Also Hipparion in its distribution seems to have had a wide radius, for it has been found in the Sewalik hills in India as well as in the European strata.

Go back still to the older Miocene epoch, and a horse (Anchitherium) walked the earth with a well-developed ulna and fibula, and with the three digits all touching the ground.



The genealogy you will see below, where from the same root is shown the development of the rhinoceroses and tapirs on the one hand, and the Macrauchenidæ (a fossil genus for those animals which exhibit a combination of the characteristics of the horse, rhinoceros, and camel) on the other hand.

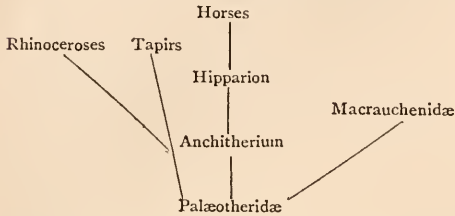

Now a small hoof with a supplemental digit in our modern horse has been observed more than once; but the most instructive case is one recorded and figured by Marsh in a paper on "Horses Recent and Extinct," printed in the "American Journal of Science and Art" for 1879, where the eight hoofed Cuban pony had, in this one instance, a supplemental digit on the inner side of each limb (Fig. 46). This pony was being exhibited as a marvel-wonder in the States, and had the additional hoof shod to walk upon. We must therefore exclude, on the instance of this last feature in this reversion, the statement of Owen, that the splint bones of Hipparion must have "dangled by the side of the large and functional hoof (or third toe) like the pair of spurious hoofs behind those forming the cloven foot in the ox." Hensel's observations show that this inner digit was the last to become suppressed when the manus assumed the condition found in the Equus of to-day, a matter we should have been inclined to suspect, not knowing this, on the grounds of atavistic reasoning. I would also quote Rütmeier's "Researches on the Dentition of the Horse," as a case too in point. He has shown that the definite dentition of the precursory genus is repeated in the milk dentition of the succeeding genus, and "Phylogenesis is unequivocally expressed in Ontogenesis" ("Beiträge zur Kenntnis der fossilen Pferde," Verhandlung der Naturforschenden Gesellschaft in Basel, 1863).

(To be continued.)

### EOZOON CANADENSE, THE PSEUDO-DAWN OF LIFE.

By J. WALTER GREGORY.

[Continued from p. 86.]

THERE were one or two objections which seriously jarred with this interpretation. Foraminifera are generally microscopic in size, and at most but a few inches in diameter: hence the discovery of one covering acres, was matter for surprise,

though to be sure it is American. The idea also of an animal living and prospering in a sea but a trifle below boiling-point, suggested a few grave suspicions, though one might be unable seriously to discredit it.

Let us now turn to an examination of the evidence on which the organic nature of Eozoon has been assailed, and then of that settling its true mineralogical position.

We have seen that its supporters claim that all the essential structures in highly organised foraminifera are here represented, so it will be best to go through them seriatim, to compare them more closely with foraminiferal types, in order not to be misled by superficial similarities; and, perhaps before doing so, to utter a word of warning against the figures usually given in text-books as diagrammatic, representing things not so much as they are but as interpretation reads into them.

First in order come the supposed casts of the sarcode chambers, "serpentin körper" (serpentine bodies) as Moebius calls them; he objects to their organic origin on account of their excessive variability in size, and dissimilarity from such chambers in form and arrangement; in foraminifera these are on one fundamental plan, such as a ball or lentil, crescent or sickle, "which in all the chambers of a foraminiferal species point back to one and the same law of formation," as he says in his Memoir,\* but in Eozoon the only observable regularity is when the contours are similar to those of olivine crystals; this suggestion as to their origin is in agreement with that advanced by King and Rowney, who regard them as mere granules of serpentine, a mineral mostly due to the alteration of olivine or olivine-bearing rocks, and their occurrence in a matrix of calcite as analogous to the crystalloids of parasite in calcite, or those of coccolite, diopside, &c., in Tyree marble.

The case against the proper wall is far more conclusive. In the first place, the researches of both King and Rowney and of Moebius make it clear that it is not truly analogous to the proper wall of foraminifera, as this fibrous layer is supposed to be a series of casts of the pseudopodial tubuli through the chamber walls; but in many specimens the fibres are placed in actual juxtaposition (as in Fig. 4S), whereas in foraminifera they are always isolated tubes scattered through the body wall. Their shape as well as their arrangement militates no less decisively against their foraminiferal nature; in foraminifera they are cylindrical tubes, but in Eozoon are prismatic needles or plates. In foraminifera, without exception, they go to the surface by the shortest possible route, and only curve or emerge at an angle when by so doing they can shorten their length; in Eozoon no such arrangement occurs; they branch off tan-

\* "Der Bau des Eozoon Canadense nach eigenen Untersuchungen verglichen mit der Bau der Foraminifera," "Palæontographica," vol. xxv.



gentially, or obliquely, and may run for considerable distances in the chamber walls. Moebius figures a specimen in which this disregard for a rule absolute among foraminifera is admirably seen (Fig. 49). King and Rowney maintain that this so-called proper wall is but a layer of fibrous chrysolite, due to the alteration of the serpentine, and have pointed out several cases, two of which are figured (Figs. 50 and 51) where a gradual passage can be traced from unaltered serpentine through various incipient stages till thoroughly fibrous; frequently where fissures in the serpentine cross the chamber casts, the walls of the serpentine along the crack are altered to exactly the same fibrous layer as the "proper wall." "It is unnecessary," they say "to add another sentence by way of argument in opposition to the view which ascribes the asbestiform layer to pseudopodial tubulation." In fact, Eozoonists seem to have now generally admitted the inorganic nature of the proper wall. Max Schultze did so in 1874. Professor Rowney has kindly favoured me with an extract from a letter he received in 1882, in which Carpenter abandoned his claim for its foraminiferous nature, though his conversion on this point was first publicly announced by Messrs. Whitney & Wadworth in their memoir on the Azoic System (see Bull. Mus. Compar. Zool. Cambridge, Mass., xi. 1884, p. 535). Professor T. R. Jones has, I believe, also accepted this important modification in the theory.

The intermediate skeleton described by Dawson as uniform and homogeneous, when dissolved in acid is found to contain amorphous masses, pyrites, filiform crystals and fragments of a mineral considered by King and Rowney to be titaniferous iron; the whole structure is completely paralleled in the matrix of other minerals, as that of saccharoidal calcite of chondrodite and pargasite, or of the coccolite marble of Tyree. As this is only of importance in connection with the other structures, it is perhaps unnecessary to add more and we may pass at once to the stolon passages and canals by which it is penetrated. The former appear at first to be exactly analogous to the stolon passages of *Cycloclypeus*, but are found on further examination to be crystals of probably "pyrosclerite," or "white chlorite," a hydrous silicate of magnesia and alumina, which differ from the granules they connect in colour and lustre; two such crystals from Grenville are figured, in the second of which, as the crystal was not long enough to complete the connection, the interspace is filled by a white amorphous rudely laminated mass.

The canal systems are attributed to crystals of such minerals as metaxite, a form of which obtained by the decalcification of saccharoidal calcite from Reichenstein, in Silesia, is figured by King and Rowney. Moebius objects to their organic origin from their dissimilarity to the canals of foraminifera and their absolute irregularity, in illustration of which he gives

a long series of figures (as Figs. 52, 53, 55, and 56). He points out that they may be close together or far apart; may run parallel, or radiate from one or more centres; they may crowd the bodies of the calcareous masses or lie embedded in them, may be simple, ramified or feather shaped, thin and long or broad and short, have fine, club or spoon-shaped terminations; "they are straight, bent knee-wise, undulating or crooked, are irregularly wound or folded, or their bending lies in one plane." In cross section (Fig. 54), they are mostly concavo-convex, but may be biconvex, triangular or rectangular, but seldom circular or elliptical, and all these variations may be noted in the course of one canal. In their relation to the serpentine bodies they are equally erratic, as they may run parallel to the long axis of the body chamber or branch off at every conceivable angle; in one place the canals extend from the neighbourhood of the cell walls, in another, "the branches press from the fibrous layer, or by the interposition of the calcite the stems are separated from it. In a third canal from the same slip are long, slender, unbranched canals close to one another and perpendicular to the surface of the serpentine; in a fourth, short and thick stalks lie far from the serpentine in the middle of the calcite." Such variations are certainly wholly incompatible with an organic origin.

After having thus summarised the arguments to show what Eozoon is not, to complete the case against its organic nature, it but remains to point out what it really is. And just as previously a digression was necessary to review the main points in the structure of its assumed relations, so now we must glance briefly at that so truly called "protean" mineral serpentine. Serpentine is a hydrous silicate of magnesia, generally colloidal, the only crystals known being probably pseudomorphs; it varies extremely and contains an extensive series of varieties and allomorphic modifications. Thus it is:

Massive in common and noble serpentine, retinalite, porcellophite, &c.

Lamellar in antigorite, williamsite, marmolite, thermophyllite, &c.

Fibrous in chrysolite, picrolite, metaxite, baltimore.

Flocculent in flocculite.

Scaly aggregates in Bowenite.

These forms are all essentially of approximately the same chemical composition, differing in the percentage of water and other details, and all graduate into one another, the whole series being truly allomorphic, i.e. being of different forms but of the same chemical composition. To these, many other hydrous silicates are closely allied, such as pyrosclerite, bastite, loganite and chonicrite.

It is always as a modification of or in association with this group of minerals interlamellated with calcite, or sometimes by a dolomite produced by the

partial replacement of the calcite by carbonate of magnesia, that Eozoon occurs. All the various structures supposed to affirm its organic origin are but members of this series of minerals. The proper wall is but a layer of fibrous chrysolite, indistinguishable from that round the nodules described by

the admission, that the case for the organic nature of Eozoon rested on the "assemblage of facts which can only be separately paralleled elsewhere."

To obtain such a structure all we require would be a bed of "lamellated ophite," or thin alternations of serpentine and calcite, produced,\* e.g., by the action

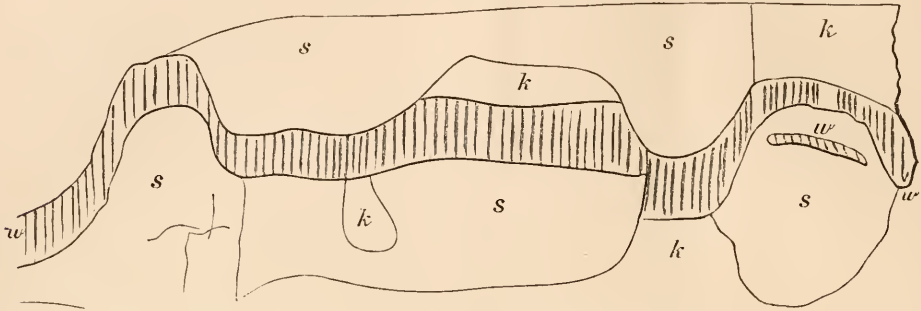

Fig. 48.—Specimen sent to Moebius by Carpenter. *k*, calcite, supposed intermediate skeleton; *s*, serpentine, supposed casts of body chambers; *w*, bard of chrysolite fibres, the supposed proper wall. (Moebius, pl. 35, fig. 48.)

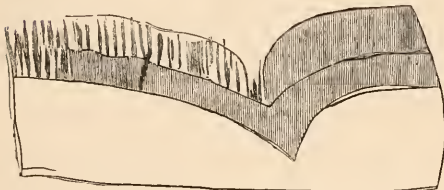

Fig. 49.—Two asbestiform layers (proper walls) on serpentine granule; the fibres are in close contact on right hand side of specimen. The asbestiform layers are white, the serpentine green and translucent. From Grenville. (After King and Rowney.)



Fig. 51.—A supposed "stolon passage" from Grenville. Consists of a crystal of probably pyrosclerite, partially fringed by an asbestiform layer, and connecting two granules of serpentine. (After King and Rowney.)



Fig. 52.—A specimen similar to the last, but the crystal being too short to connect the granules, the interspace is filled with a white amorphous mass.

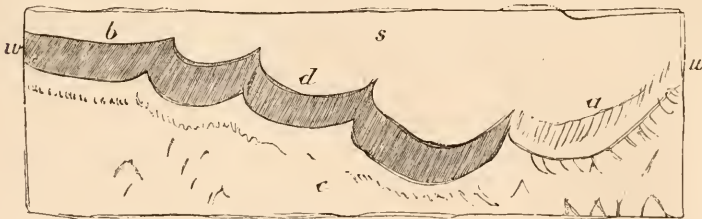

Fig. 50.—Specimen from Grenville, after King and Rowney. *c*, calcite; *s*, serpentine; *w*, asbestiform layer or proper wall, with the fibrous structure completely developed in places (*d*), but in an incipient stage of development at *a* and *b*; the latter shows that the layer is an integral part of the serpentine.



Fig. 53.—Dendroid crystal of metaxite, obtained by decalcification from a matrix of saccharoidal calcite. Figured comparison with figs. 54 and 55.

Delesse, in the ophite of Zeltes in the Vosges, while gradual passages from this to amorphous serpentine are frequently observable as already figured and discussed: the sarcode chambers consist of serpentine granules—"serpentin korper" as Moebius calls them: the intermediate skeleton is the calcitic or dolomitic matrix, the stolon passages are simply crystals of pyrosclerite, and the canals are often metaxite. These points have been practically admitted by even Dr. Carpenter, who was forced into

of water charged with carbonate of lime, on an olivine rock, and from this by heated water or other meta-

\* Professor Alexis Julien insisted upon the tendency of pyroxene and the serpentine produced therefrom, to occur in alternating layers with calcite, in a paper read before the American Association at the Philadelphia meeting in 1884.

morphic agency, the edges of the serpentine grains would be altered to chrysolite, and crystals of pyrosclerite and metaxite would branch through the calcite, which might at the same time be partly dolomitised and then a form mineralogically identical with Eozoon would ensue. When moreover we reflect that though Eozoon is now, or once was, claimed

Connemara, and the Liassic rocks of Skye, nevertheless—widespread though be its distribution alike in time and space—it is always found in the class of altered rocks termed ophites, while in the tens of thousands of feet of sandstones, shales, and limestones in which its preservation would be so much more probable, never a trace has been recorded,

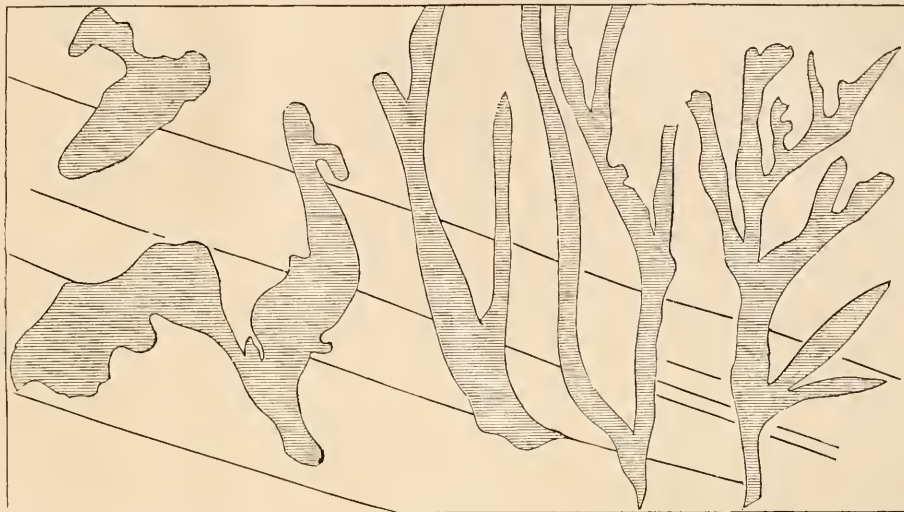

Fig. 54.—System of canals in calcite. A specimen prepared by Dawson and sent to Moebius, who figured it, pl. 30, fig. 20.



Fig. 55.—A club-shaped canal. Moebius, pl. 29, fig. 18.

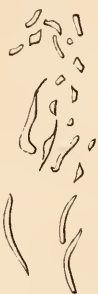

Fig. 56.—Transverse sections of canals. Moebius, pl. 30, p. 21.

then becomes apparent the overwhelming improbability of the realisation of Dawson's once sanguine hope, "I should not be surprised to hear of a veritable specimen being one day dredged alive in the Atlantic or the Pacific."

With objections so weighty against its foraminiferal nature, with analogies so close to unquestioned mineral structures, the claim for the organic origin of Eozoon must be—as indeed it has been by most geologists—abandoned as fallacious. We cannot however drop it without a touch of regret at parting with that which has done such good service in the cause of Evolution. It was discovered at a time when the controversy on the theory was raging its fiercest, when the palæontological record was continually being quoted as evidence against its truth; and hence the widely accepted statement, that the oldest known form of life was, in exact accordance with the theory in dispute, the lowest of which relics could have been preserved, did service the value of which cannot be lightly estimated. Though to-day "when the hurly-burly's done, and the battle's fought and won," and the theory stands safe, almost unopposed, Eozoon would yet be a weighty argument in its support. Hence we cannot abandon it, remembering its service in the past and the value it would be in the present, without a pang, but abandoned it must be. Facts are facts, and however convenient or useful Eozoon might be, its claims

by Eozoonists to occur not only in the Laurentian rocks but elsewhere, as in the Upper Cambrians or Quebec Series in Delaware, in the Silurians of



must be regarded, and the weight of its evidence balanced with minds unbiassed, striving only for the truth.

The story of the controversy contains some valuable lessons: it tells us that what at one time was taught by the greatest of authorities and the ablest of specialists, and accepted by the whole rank and file of the scientific world as the truth, has been proved false; such a memory must impress on all the uncertainty of our beliefs and theories, and the possibility of the most cherished doctrines of to-day being the antiquated superstitions of to-morrow; no more in science than in theology, or in any other department of human thought and enquiry, is there any absolute criterion of truth. If Eozoon has but served to point us to this moral, reminding us that of all dogmatism, scientific dogmatism is the most illogical and the most objectionable, ("Hear, hear," Ed.) and thus helping to keep our minds ever ready for the reception of fresh truths and the modification of present creeds, it will not have lived in vain, if only in the scientific imaginations of its originators.

#### NOTES ON NEW BOOKS.

UNUSUAL pressure of literary work has obliged us to postpone the due notice of several new books of unusual merit, and some of which cannot fail to have an influential bearing on modern scientific thought.

First among these is *The Origin of Mountain Chains*, by T. M. Reade (London: Taylor & Francis). Mr. Reade has long won his spurs as a leading physical geologist, and anything he has to say on this subject is certain to be listened to. In the present work he has digested a marvellous mass of literary material, mainly from the splendid papers and monographs of the U. S. Geological Survey, and reproduced them in such a clear, simple, and yet bold and assertive manner, that the intelligent reader grasps the problem at once. Mr. Reade seriously attacks the theory of secular contraction of the earth's crust, and holds that it is insufficient to produce mountain building. He attracts the reader's attention to "sedimentation," shows that thick beds of sedimentary strata must expand below by virtue of the increment of heat there, must rise, and spread laterally, and also *en avance*. This would cause creeping, folding, perhaps *flowing* of the most solid rocks. The effects of expansion of solids are curiously, but convincingly traced, and the author's profession as an architect gives him many opportunities of bringing his arguments practically home. Mountain building is always associated with sedimentation, whilst faulting may be mainly owing to the contraction of great rock masses. We regret our space does not allow us to do more than barely mention the scope of this important book. We do not hesitate to place it first

among the great geological works of the period. It will not only make its mark, but will provoke that keen and fair discussion of a subject, too apt to be taken for granted, which results in a triumph for truth, and a gain to human knowledge. No geological work equal to it in importance has been published during the last decade.

*The Young Collector—Pond life—Insects*, by A. Butler. *Crustacea and Spiders*, by F. A. A. Skuse; *British Fungi, Lichens, &c.*, by E. M. Holmes and Peter Gray (London: Swan Sonnenschein & Co.). These vols. are a continuation of the shilling series of elementary handbooks to different departments of Natural History. Those of our young readers who wish to take up some special branch of study will find these hand-books exceedingly useful.

*Studies in Comparative Anatomy, The Structure and Life-history of the Cockroach*, by Professor Miall and Alfred Denny (London: Lovell Reeve & Co.). The main portion of this truly valuable work appeared as a series of articles in the pages of this magazine. They were received with much appreciation at the time, but our readers will find their collection in this handsome volume more convenient for use. There have been few books issued recently which contain so much thoroughly good work.

*The Coleoptera of the British Islands*, vol. i., by the Rev. W. W. Fowler (London: L. Reeve & Co.). We are frequently asked to recommend a good and not too expensive work on this subject to students. Henceforth we shall be glad to place Mr. Fowler's neat and well-arranged volume high up on the list. The present volume comprehends only the families from *Adephaga* to *Hydrophilidae* inclusive.

*Handbook of Practical Botany*, by E. Strasburger, edited from the German by W. Hillhouse (London: Swan Sonnenschein & Co.). Students in botany cannot complain of lack of first-rate handbooks. Perhaps no other science possesses so many. Professor Strasburger's work has in some measure revolutionised botany, so that we are pleased to see this well-edited translation made for the benefit of students who use the microscope, for they will find in it a clear and simple statement of vegetable histology.

*British Fungi (Hyemenomycetes)*, by the Rev. John Stevenson, vol. ii. (London and Edinburgh: Wm. Blackwood & Sons). We are very pleased to receive this second volume, which completes Mr. Stevenson's valuable work. To those who cannot afford Dr. Cooke's more expensive (and now somewhat rare) Manual, these two vols. will prove most useful.

*The Birds of Suffolk*, by Professor Churchill Babington (London: Van Voorst). Dr. Babington has been engaged on this book for some years past, and he has taken immense pains with it, often personally investigating the more important occurrence of rare birds, collecting information of all kinds relating to his subject from public and private collections, game-

keepers, &c. The result is a valuable handbook of the ornithology of Suffolk: a county whose sea coast, estuaries, creeks, and rivers are annually visited by numbers of the rarer aquatic birds. Much of the work necessarily partakes of the character of a catalogue, but the "notes" on any of the rarer birds show how much care and trouble have been taken to verify the facts.

*Studies in Life and Sense*, by Dr. Andrew Wilson (London: Chatto & Windus). This collection of essays is readable in the highest degree. Dr. Wilson's style is peculiarly his own: pleasant, flowing, and philosophical. In some of these essays, the reader will find an admirable summary of large questions, such as "The Migrations of Animals," "The Old Phrenology and the New," "What Dreams are made of," "The Problems of Distributions," &c.

*A Voyage to the Cape*, by W. Clark Russell (London: Chatto & Windus). Mr. Russell is a marine painter in words. This book is full of the salt sea breezes and spray; and for people meditating a voyage to the Cape, its perusal will be as much of a pleasure as it will be a profit.

*Animal Anecdotes*, by H. A. Page (London: Chatto & Windus). A delightful book to read, and even to think about. The anecdotes are arranged on a new principle. Not long ago, anecdotes of animals were arranged with a view to demonstrating how mysterious instinct was. But now we believe in such a principle as "Animal Psychology," and we are doing our best to know something of the minds of animals, as well as of their bodies. Mr. Page's charming book will help us in that direction.

*Handbook of Historical Geology*, by A. J. Jukes-Brown (London: George Bell & Sons). This handy vol. is a necessary companion to the same author's "Handbook of Physical and Structural Geology," published about three years ago. Possessed of these two volumes, the earnest student finds ready worked to his intellectual needs the views and theories in every department of geology, as well as sketches of all the chief discoveries. Mr. Jukes-Brown has obtained a deserved reputation for the carefulness with which he both ascertains and arranges his facts. As a manual of geology alone, the present volume is a valuable addition to geological literature. It gives the student a bold and accurate sketch of the ancient life of the globe, from the Azoic Era to the Icenian System.

*Life-histories of Plants*, by Professor D. McAlpine (London: Swan Sonnenschein & Co.). These are a series of careful studies, well illustrated, and dealing entirely with the lower life of the vegetable kingdom. The first and most extensive chapter is devoted to the comparative study of plants and animals on a physiological basis; and the book is worth buying for the sake of this chapter alone. The book is beautifully got up.

*Text-Book of British Fungi*, by W. Delisle Hay

(London: Swan Sonnenschein & Co.). This is by no means such a satisfactory book as Mr. Stevenson's. Perhaps it is only fair to say that it does not claim to be. It is rather intended as an elementary introduction to the study of Fungi; and the young student who is approaching (and not exhausting) the subject, will find it useful. The chapter on "The Chemistry and Toxicology of Fungi," and that on "The Cultivation of Certain Fungi," are valuable.

*Heroes of Science (Physicists)*, by Dr. William Garnett (London: S. P. C. K.). This series is commendable in every way. First, it is making known to the public the noble lives lived by many scientific men; and secondly (as the volumes are written by authors who are fully acquainted with their subjects), they give in a clear manner a summarised, but highly readable and instructive history of the different sciences in which the "heroes" have figured. Thus in the present vol. we have sketches of the life and work of Robert Boyle, Franklin, Cavendish, Rumford, Young, Faraday, and Clerk Maxwell.

*The Proceedings of the Liverpool Literary and Philosophical Society* are always acceptable vols. We have just received vols. xxxix. and xl., both containing thoughtful and valuable papers, printed in extenso. The greater part of vol. xl. is occupied with the "First Report of the Fauna of Liverpool Bay," contributed to by Dr. Herdman, Rev. H. H. Higgins, Professor Milnes Marshall, J. D. Siddall, T. Higgins, Dr. Hicks, Dr. Ellis, Mr. Harvey Gibson, I. C. Thompson, F. P. Marrat, G. H. Fowler, R. D. Darbishire, W. E. Hoyle, T. J. Moore, and others,

*Poets in the Garden*, by May Crommelin (London: T. Fisher Unwin). A beautifully got up book with a lovely coloured frontispiece of hollyhocks. The authoress has diligently collected from our best poets all their best references to our garden flowers.

*British Cage Birds*, by R. L. Wallace; and *Fancy Pigeons*, by I. C. Lyall (both published by L. Upcott Gill). These are continuations of the admirable series of handbooks on pet and domesticated animals which Mr. Upcott Gill has taken so much trouble to bring out. They are nicely got up, and are just the sort of gift-book to give a lad who is fond of animals.

*Hours with a Telescope*, by Capt. Noble (London: Longmans). This is a reprint of the papers which came out in "Knowledge." The young student of astronomy cannot be recommended a better little manual to begin to work with.

*Lunar Science, Ancient and Modern*, by Rev. Timothy Harley (London: Swan Sonnenschein & Co.). A capital popular summary of all that is known and taught about selenology. *Microscopic Fungi*, by Dr. Cooke (London: W. H. Allen). Words of commendation are needless about the value of this little book. It has been too long before the world for criticism to affect it; so we



content ourselves with announcing the fifth edition, and are delighted to do so; *School Hygiene*, by Dr. Arthur Newsholme (London: Swan Sonnenschein & Co.) is a book which every member of school-boards, and every school-master and school-mistress ought to read. *The Greyhound*, by Hugh Dalziel (London: Upcott Gill). A handy and useful monograph of this well-known breed of dogs.

*How to use our Eyes*, by John Browning (London: Chatto & Windus). The fifth edition of one of the most useful and important cheap little books that ever was published.

We have also received *Sonnets on Nature and Science*, by S. Jefferson (London: T. Fisher Unwin), in which one clearly sees how largely the sympathetic study of nature influences the poetic feeling. *A Classified and Descriptive Catalogue of Scientific Books*, (London: Geo. Philip & Son). A most useful work of reference, in which all modern books in every department of science, are catalogued, with prices, publishers, &c., and *The Garner*, vol. i. (London: W. E. Bowers), edited by A. Ramsay, F.G.S. Full of valuable and varied information, besides papers dealing with original work and observation.

*Through the Fields with Linnaeus*, by Mrs. Florence Caddy, 2 vols. (London: Longmans). A delightful, sympathetic, and altogether charmingly written life of the immortal naturalist, written by a cultivated lady, who is evidently familiarly acquainted with Sweden and Swedish life. We have read the vols. through with real pleasure, and henceforth Linnaeus will be to us a personal friend—not a literary or scientific abstraction. Mrs. Caddy's book is a gain both to literature and science.

*Malt and Malt Making*, by H. Stopes (London: F. W. Lyen). This is a large and thoroughly exhaustive treatise on the subject. It forms the most complete manual of malt and malting in our language. The author is a trained scientific man, and an educated writer. No brewer, no maltster, indeed, nobody connected with the important trade of brewing, ought to neglect the study of Mr. Stopes' book. Its range is large, theoretical as well as practical, and shows a thorough acquaintance with the literature, as well as the science of the subject.

## TEETH OF FLIES.

By W. H. HARRIS.

No. 13.—*APHROSYLUS RAPTOR*, WALKER.

*APHROSYLUS RAPTOR*, the subject of the present illustration, is a marine species belonging to the family of the Dolichopidæ, which includes a large number of genera and species. They are generally small bright flies, with a metallic lustre and colouring, brisk and joyous in their movements. The present is rather an aberrant species, and is not

at all a very distinguished member of the family in point of colour. It is about two-tenths of an inch long; slightly built, its legs are fully three-tenths of an inch in length, which gives the fly a very wiry appearance.

It can, however, lay claim to being rather rare, and, unless specially sought for, is not likely to come under the observation of casual visitors to its habitat.

I made its acquaintance while staying at Ilfracombe during the month of July, 1885, while searching the rock pools at low water. Phantom-like it would flit from the damp sea-weed when approached, and with great difficulty could its whereabouts be re-discovered among the varied tints of rock and algae. Occasionally it would be found on the surface of a small

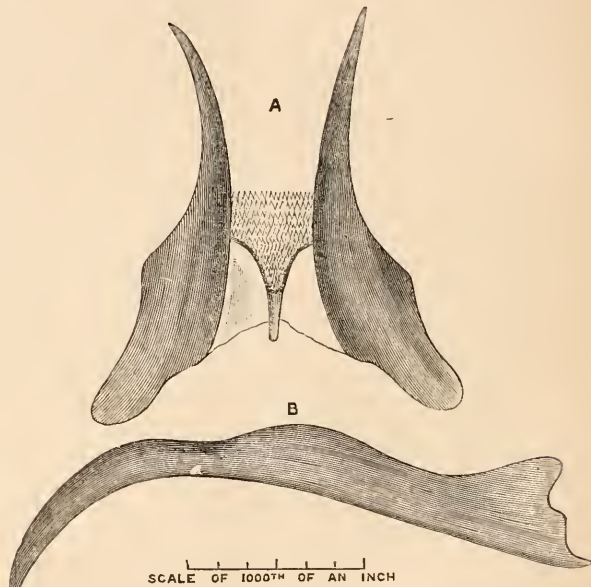

Fig. 57.—Teeth of *Aphrosylus raptor*. A, upper jaws separated, showing the denticulated labrum; B, the single lower jaw.

pool, where it appeared as well able to take care of itself as on land, and would take its flight from thence as readily as a seabird would from the surface of the sea.

Watching one rise from such a position, I followed it to a rock now quite dry. Carefully approaching it, I was surprised to see the region of the mouth reflected a bright silvery light. The first impression was that a drop of water had become entangled in the mouth organs. But a moment's observation dispelled the illusion; the flickering motion of the palpi was the cause. These were in constant motion, and at certain angles reflected the light with a gem-like brilliancy.

The palpi are oval-shaped plates, clad with very fine hair and short dark setæ (probably the external appendages of nerve end organs, as the palpi are



undoubtedly organs of sense). They cover a large portion of the mouth, which is somewhat conical in form and its profile is not a bad miniature representation of a parrot.

Mr. Walker gives a description of this genus in his "Insecta Britannica Diptera," vol. i. page 220, as follows: "Palpi protruded, oval, very large in the male. Proboscis shorter than the head, conical, somewhat compressed, incurved towards the prosternum, receding from the palpi, and armed at the tip with a short spine (the projecting extremity of the tongue)."

A careful dissection of the mouth of this creature shows there are three such spines, that they are veritable jaws, and that they operate quite independently of the tongue. Two of these jaws are situated above, and are shorter than the single lower one which usually projects beyond the tongue. The single lower jaw has a vertical motion, and as it works between the two upper ones a slightly horizontal movement is communicated to them. Both these

similar particles. What useful purpose (if any) it can serve in the economy of nature, in the narrow strip of littoral to which it limits its movements, is a question I must leave to those curious on such points. To me it remains a mystery; but that it is well adapted for the position it occupies there can be little doubt left on the mind of any one who has watched its movements or studied its mouth organs.

*Cardiff.*

#### ON THE FORMATION OF AN INSECTORIUM OR INSECT VIVARIUM FOR THE EXHIBITION AND STUDY OF LIVING TROPICAL INSECTS.

By GEORGE S. PARKINSON.

**I**N the early days of the Royal Aquarium, 1875, when it was about to be started as a scientific resort, it occurred to the writer to submit a suggestion which met with a ready response, and he was

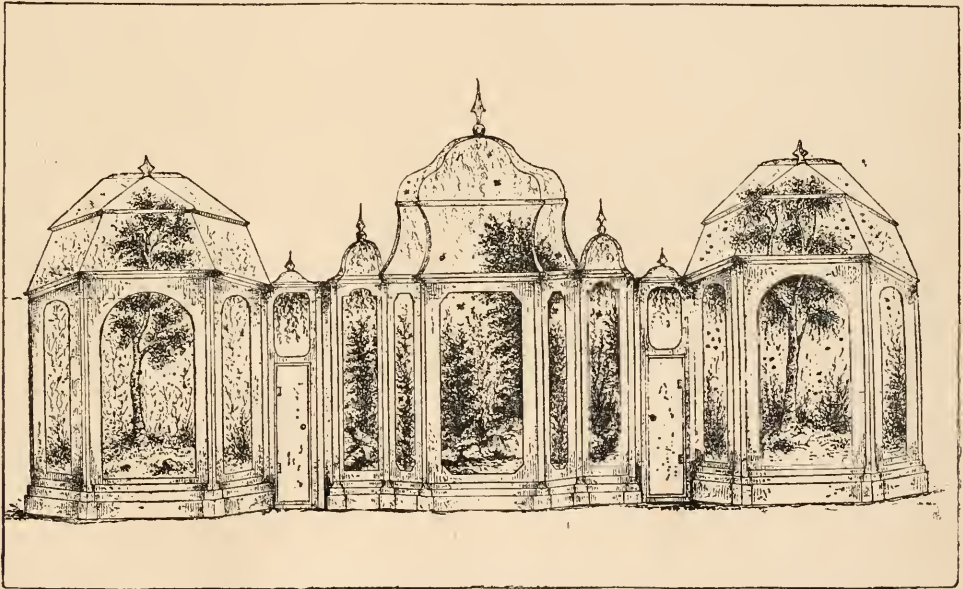

Fig. 58.—Proposed tropical insect vivarium.

upper jaws are furnished with an enlargement on their incurved sides which comes in contact with depressions on the lower jaw, and proves an effective piece of machinery for seizing and crushing food. Immediately above the upper jaws is a region armed with imbricated chitinous points; these continue the process of mastication, while two lobes of the tongue (similarly armed with still finer points) complete the process.

I have little doubt some portion of the food of this creature, in its perfect state, consists of the tender algæ, as small fragments are sometimes found attached to the labrum, and the stomach also appears to contain

requested to write out his views, with the object of forming an exhibition of living tropical insects.

This done—when the great expenses attending the building of the Aquarium became a hindrance to further progress, and beyond the adoption of the word, then first suggested, "Insectorium," as a simple and popular appellation, and which was used to distinguish a few glass cases, a very poor and most unsatisfactory result—the matter came to a standstill, so far as living insects were concerned. But as a resulting consequence, in 1878 a very beautiful exhibition of dead insects, under the title of "The Great National Entomological Exhibition," and the

presiding genius of Mr. J. T. Carrington, the able editor of the "Entomologist" was submitted to public inspection, and deservedly received the highest praises.

A few years later on, 1881, and taking a hint from the above, the idea saw the light at the Zoological Gardens. The attempt here, in the absence of the "modus operandi" was but a slight improvement upon the exhibit at the Aquarium, and although exciting great public interest, and evoking highly laudatory articles in the journals of the day as the beginning of something better, it appears to have remained unprogressive beyond the initial position. The important fact of two highly scientific bodies having shown their willingness to act upon the writer's original suggestion, will, it is hoped, exempt him from any egotism in claiming his priority in an attempt to open wide a new page in the book of Nature, and to exhibit, in a living state, some of her smaller, but no less wondrous marvels, designed and painted by the greatest of Master's hands, and to supplement zoological collections, aquaria, and aviaries, by bringing under popular inspection an "Insectorium," as illustrating a fourth branch of creative power, unseen hitherto, except by those who have explored her more distant and forest-hidden recesses.

We are met at the outset with a hard word—impossibility; if a thing which never has been done cannot be done, then we accept its full import, and, coming from the lips of Science, are almost compelled to retire abashed from the unequal contest; but believing that there is a time for everything, even the development of an Insectorium, we now venture, in all due humility, to submit the following outline sketch as an introduction to the subject, and trust it may prepare the way for others, better able, to take up the matter and to carry it ultimately to a more successful issue.

The accompanying illustration represents three of a series of ornamental glass (or fine wire-work) houses, to be kept at a moist and tropical temperature, and varying in size according to requirement, proposed to be constructed inside and against the walls of a long room, and containing accommodation for butterflies, beetles, fireflies, phasma, cicada, and mantis insects, spiders, scorpions, centipedes, &c., respectively.

For butterflies, the houses should be attractively fitted up with shrubs, climbers and continuous blooming and sweet-scented plants. Also supplied with jars of cut flowers to be daily renewed, and with saucers filled with boiled "foots" sugar and treacle diluted with water to a thinner consistency, and protected by fine wire-work for the insects to settle upon and to probe between, thus furnishing veritable dainty dishes fit to set before such fairy or airy queens. The addition of cork or rockwork would add a picturesque and more complete finish to the building.

For such insects as may exist upon the juices of living plants, the houses should be supplied with the particular plants known to be suitable to meet the requirements of the individual species, such, for instance, as cotton, jasmine, wild thistle, sour sop, banana, pine-apple, cashew, lime, guava, passion flower, gamboge, cocoa, vanilla, citron, rose, castor oil, fig, vine, orange, medlar, pawpaw, &c.

Many of the above are readily procurable over here, and young plants of the others could be obtained without any very special difficulty.

For caterpillars and where the leaves of plants only are needed, a mode for such leaves being sent over from abroad in a perfectly fresh and healthy condition, will be described further on.

Logs of decayed wood would suffice for many of the beetle tribe.

The houses for scorpions, centipedes, millipedes, &c., might be decorated with shrubs, and the ground left rough with stones, &c. A supply of insects would meet their carnivorous requirements. Iron should be used in preference to wood in the construction of the buildings to prevent boring through, and where the larvæ have a tendency to burrow under ground, concrete or stones should be laid at a sufficient depth under the soil to prevent escape.

Jets of warm steam passing into the buildings would furnish a humid atmosphere where required. We should thus have a number of miniature Elysiums wherein insect life could disport itself in beauty and joyousness, instead of being battered to pieces inside small glass shades; the former real "Insectoria," the latter mere delusions and shams.

The first attempts to introduce tropical insects should be confined to their conveyance in the egg, chrysalis, or grub condition, their development into more perfect forms being effected over here, by the aid of hot-house temperature.

Eggs and chrysalides sent from long distances should be retarded from transformation en route, by being enclosed in tin cases or air-tight tubes kept at a sufficiently cool temperature by outer cases, charged with a refrigerating chemical mixture.

One of the most remarkable provisions of creative supervision is to be found in the indwelling power decreed upon insect eggs to resist the most extreme influences of heat and cold, thus providing a wonderful means of preserving the species under this almost invisible and fragile form, and under circumstances which would utterly destroy the insects themselves if subjected to such severe extremes.

Mr. A. Wailly has given his experience in the "Journal of the Society of Arts," with regard to the conveyance of foreign silkworms' eggs, as follows:

"The eggs should be placed in a muslin bag containing the leaves of the food plant, and then the bag should be inserted in a tin box, and the box be hermetically closed. The leaves will thus keep and arrive in as fresh a state as if they had just been



cut off from the tree, although some small portions may decay. If the eggs are sent as soon as they have been laid, they will stand a voyage of fifteen or sixteen days. If the larvæ hatch during the voyage they will feed at once, and many will survive and grow during the three or four days they may remain in the box. The leaves should be suspended, to prevent the droppings of the larvæ remaining on them, otherwise rot or fungus will ensue."

To obtain a regular and continuous supply of leaf-food, several small tin cases should be filled with perfectly fresh sound and dry leaves, and then the cases should be closed so as to be air-tight. These cases should then be packed and forwarded in a larger case, by this means permitting of a daily supply being opened—one case at a time as required—and keeping the rest of the supply fresh until needed.

Lengths of stems or branches of trees can be kept for some time in a fresh and healthy condition by the cut ends being protected from the air by a coating of tar or sealing-wax.

The establishment of a nursery of young tropical plants under glass would be of great value, and experience alone would prove the usefulness of allied species. The hitherto assumed impossibility in obtaining the requisite food to supply the wants of tropical insects, we trust henceforth vanishes, and becomes transferred from the region of "cannot be done" to the more satisfactory position of accomplished facts.

It should be especially noted that the names given in the following pages are selected merely to indicate the direction the management of an Insectorium should aim at. The difficulties in collecting rare specimens, would, no doubt, be great in the early stage of an exhibition of tropical insects, but, when once accomplished, the reward would be still greater, and Science would owe a debt impossible to pay to those willing to bear the heat and burden of the day, in accessibly placing for investigation and study so valuable a treasure at her feet.

With the object once made known, numerous friendly hands in our Colonies would eagerly offer assistance, and, supplied with the proper cases for the conveyance of their contributions, the furthest part of the earth would be ransacked to yield its entomological wonders.

(To be continued.)

THE April number of "The Journal of Microscopy and Natural Science" contains the following original papers, besides notes, etc.: "*Cristatella mucedo*," by R. H. Moore; "The Evolution of the Eye," by Mrs. Bodington; "External Anatomy of the Dor Beetle," by Robert Gills; "The Homologies of Certain Parts of Insects," by A. Hammond, etc.

## GOSSIP ON CURRENT TOPICS.

By W. MATTIEU WILLIAMS, F.R.A.S., F.C.S.

THE COST OF ELECTRIC LIGHTING.—The wild anticipations concerning the electric light which were fostered by company-mongers and prevailed so ruinously among sanguine investors have been effectually refuted; but even now it is very difficult to obtain accurate particulars concerning the cost of its legitimate applications. Amongst these may be particularly specified the application of electric lighting in passenger steamships. Last year I made a short trip in one of the New Zealand ships of Messrs. Shaw, Saville, & Albion. Among all the improvements carried out in these fine vessels none are more striking than the substitution of the electric lamps for the old swinging oil lamps. As colza oil is a very costly illuminant, compared with gas or mineral oils, it is quite possible that in such application an economy may be effected, but in this case, where so much steam generating fuel is used for other purposes, it is not easy to separate the exact quantity consumed in driving the dynamos. The practicability of domestic lighting by electricity mainly depends on the possibility of constructing a primary voltaic battery with constant and economical action that shall require no amalgamation of zinc plates, no corrosive liquid elements, and very little skilled attention. Such a battery may or may not be supplemented with a storage battery. M. Hospitalier has been experimenting with about the nearest approximation to these desiderata that is at present available, viz. a bichromate battery fitted with siphons to secure a continuous automatic change of liquid with secondary batteries connected. He finds that with the utmost economy of working, and purchasing materials at wholesale prices, the cost of a ten-candle lamp is twopence per hour. An ordinary gas burner consuming five to six cubic feet per hour gives a light about equal to this. At three shillings per thousand cubic feet, the cost of such a burner is less than one-farthing per hour. With a co-operative dynamo supplying several houses, the cost would be less than the above.

AN ELECTRIC LIGHTING DIFFICULTY.—A curious result of electric lighting has been recently displayed. It is well known that the electric light has a powerfully fascinating influence on night moths and other insects, so much so that collectors have availed themselves of it. Spiders are doing the same, to such an extent, that the Treasury and other public buildings in Washington have become seriously disfigured by cobwebs since their white fronts have been illuminated by the electric light. The more delicate architectural ornamentation has been concealed, and when the webs are blown down by the wind they hang in slovenly and dirty rags that are by no means acceptable to æsthetic taste.



**OSTRICH FARMING.**—This is one of the most successful of purely modern industries. It had no existence in 1864. At that time the hunting of wild ostriches had effected such havoc that it was feared, with good reason, that ere long the ostrich would be numbered among extinct birds, such as the dodo and the moa. In 1865, about eighty were domesticated in South Africa. In that year the total export of feathers amounted to 17,522 lbs. in weight, valued at £65,730. It is now estimated that there are 150,000 domesticated ostriches living at Cape Colony, giving employment to no less than eight millions of capital. In 1882, the weight of feathers exported amounted to 253,954 lbs. valued at £1,039,989. Since that the value has considerably diminished, owing doubtless to the abundance of supply. Detailed figures of annual results are given by Mr. P. L. Simmons, in the current volume of the "Journal of the Society of Arts," page 83. He further tells us that Mr. John J. Matson, of Springfield, Papanni, New Zealand, has succeeded in acclimatising and rearing the birds there, and has made his first shipment of 2000 feathers of rare beauty. This in spite of many wise warnings respecting the unsuitability of the climate of New Zealand.

**ELECTRIC WELDING.**—I take it for granted, that everybody who has had any experience in the working of powerful batteries must have had the same experience as myself, viz., that of finding the terminal wires adhering firmly together when brought in contact, and so held for a few seconds. We are now told that electric welding is the latest of the industrial applications of electricity, that Professor Elihu Thompson, of Lynn, Massachusetts, has shown that bars of iron, steel, copper, and brass can be welded firmly together in a few seconds by passing through their junction a very powerful electric current, and that he has invented a special kind of transformer, or induction coil, to enable him to accomplish this operation. In spite of all this, I doubt whether this application of electricity has "already reached a thoroughly practical stage," as anticipated by "Nature." It is easy enough thus to weld the ends of mere wires of small sectional area; the spark passing between them simply fuses both ends, but in dealing with broad surfaces the demand for electric power to effect such fusion must increase with area, and it is altogether out of the range of practical work to keep such a supply of electric power in readiness for doing that which a common blacksmith's forge fire or an ordinary "roarer," i.e. a soldering gas jet, does so easily and efficiently. Amateur workmen are apt to regard hard soldering and welding as difficult operations, but not so the practical workman, to whom the welding or brazing together of considerable surfaces is merely a routine job, occupying a few minutes.

It appears from Professor Thompson's own state-

ment that to weld a steel bar  $1\frac{1}{2}$  inches diameter, a current of 6000 amperes in volume, and having an electromotive of one-half a volt, is necessary. Otherwise stated, the use of 35 horse power for one minute is required for this operation, which a blacksmith would perform in five minutes with no other appliances than a forge fire, an anvil, a hammer, and a handful of sand.

**LAND SURVEYORS SUPERSEDED.**—Such will be their fate if the invention of M. Florian de Villepigne fulfils the published descriptions. He has constructed an instrument bearing the ambiguous name of autographometer. It has nothing to do with measuring anybody's autograph, but if carried on a light vehicle and dragged over any given piece of ground it will automatically produce a plan and section showing the form and dimensions of surface, and the differences of level.

**THE VIKING SHIP-MODEL.**—Every tourist who has visited the coast of Norway, north of Bergen, remembers the picturesque *yachts* that carry the salted cod from the Nordland fishing stations to Bergen, from whence they are exported to the inland parts of the southern countries of Europe for consumption on fast days. The high prows and massive stern, the great single mast and sail, and the general build suggest at once that they are direct descendants and representatives of the ships of the sturdy vikings. I found myself and fellow-tourists all arriving at this conclusion, but on examination of ourselves we could give no satisfactory reason for doing so. It now appears that we were right, in spite of such lack of logic. Mr. G. H. Boehmer, with the aid of some recently discovered remains, such as the boat at Tune, and the remarkable find of a first-class viking-ship under the King's Hill tumulus at Gogstad on the Sandefjord—these and ancient rock-sculptures in Scandinavia all conspire, according to Mr. Boehmer, to prove that the Nordland *yachts* are exactly like those used by the old Norsemen as far back as the third century or even earlier.

**ORIGIN OF ATMOSPHERE OZONE.**—A great many theories have been propounded in explanation of the mode of formation of ozone in the atmosphere, the latest of which is that of C. Wurster, whose observations have led him to conclude that it is formed by the action of sunlight on clouds. He states that when clouds are continually formed from above they become highly charged with this active form of oxygen, whilst those formed from below only contain it in notable quantity in their upper layer. This theory has one advantage over many others, it admits of confirmation or refutation both by observation and experiment. Artificial clouds are easily formed, may be confined in glass vessels, and there exposed to sunlight. Ordinary ozonometer paper contained in

the same vessel will at once display the formation of ozone if it actually occurs.

THE DOMESTICATION OF APES.—In the *Revue d'Anthropologie*, Madame Climence Royer, the French translator of Darwin, discusses the ideas of M. Meunier on this subject. She believes that properly trained apes might be good workers though they lack perseverance. In general intelligence she places them higher than dogs, horses or elephants. But they must be expensively fed on fruit, bread and eggs in great quantities, and thus the cost of educating a few generations would absorb much capital before any profitable return would be available. Besides this, the climate of Europe is commonly fatal to them. When they are subjected to much exposure they become victims to pulmonary consumption. Madame Royer is of opinion that the experiment should be made in tropical climates, where apes might be taught to labour in connection with the cultivation of coffee, cocoa, and cotton.

At the old Anthropological Society, which was formed about fifty years ago, and held its meetings at the Hunterian Museum, Windmill Street, Haymarket, I heard an interesting account from one of the members of the domestic usefulness of the large Barbary Ape which, he told us, was employed as a nurse for negro and even white infants. These foster-mothers were devotedly attached to the children, and the children preferred the nursing of the apes to that of their own mothers, on account of the activity of the apes in climbing trees and swinging with the infants in their arms. I am sorry to be unable to remember any further particulars of the locality, but perhaps the publication of this piece of gossip may bring forward the details required from others who have witnessed the proceedings.

I may add that there is one branch of industry for which many species of monkeys are well fitted, viz., the gathering of fruit from high trees, cocoa-nuts, for example. As this is their natural occupation they might be as easily trained to perform it in the service of man, as hawks have been similarly educated. This, of course, in tropical and sub-tropical countries.

THE MALSTRÖM.—In the number of *Ciel et Terre*, March 1st, is a short article on this popular myth; for although there is a current between the small island of Moskenæs and the still smaller islet or rock of Vaerö (two of the Loffodens), which is fairly described as a *Malström* or millstream, the stories describing a horrible whirling chasm in the sea are pure inventions. On my first visit to this region in 1856, I innocently asked the captain of the old steam packet "Constitutione" whether we were near the dreadful whirlpool. He replied with cool irony that, being only a Norwegian sailor that had spent his life in the neighbourhood, he could tell me nothing about it, but referred me to English and French geography books,

as the source from which Norwegians like himself obtained all the information they possessed respecting it. He might subsequently have learned further particulars had he consulted the "Leisure Hour" of November 1883, wherein there is an account of the visit of an American captain, who ran along the edge of the whirlpool "in one of its calmer intervals." He estimates its diameter as about a mile and a half, describes it as "foaming, tumbling, and rushing to its vortex," hissing, roaring, and dashing, presenting "the most awful grand and solemn sight" he ever experienced. He was near it about eighteen minutes and in sight of it two hours. He "should not doubt that instant destruction would be the fate of a dozen of our largest ships were they drawn in at the same moment."

The writer in *Ciel et Terre* describes the simple current to which these absurd stories have been attached in nearly the same terms as I did in "Through Norway with a Knapsack." It is simply a run of the tide through a channel with a sloping bottom. The only times when it is at all dangerous, even to a fishing boat, is during severe storms or complete calms. In the latter case the boat having no way through the water does not answer to her helm, and therefore is at the mercy of the current, and thus may strike some of the rocks which there abound. With a gale blowing against the stream the navigation is also difficult and dangerous for sailing vessels. The name by which the current is best known in Norway is the Mosköstrom. There are many other similar currents in the neighbourhood, the most formidable of which, far more so than the legendary Malström, is the Saltström, which is also a tidal current running through the narrow inlet by which the *Indre Saltenfjord*, a considerable inland lake, communicates with the sea.

#### RECENT ARTICLES AND PAMPHLETS WORTH READING.

"EARTHQUAKES and their Causes" ("Scientific News," April 1).—"On the Causes of the Variations in the Contents of Sucrose in *Sorghum saccharatum*," by Harvey W. Wiley ("Botanical Gazette," U.S.A. March).—"Photo-Micrography," by R. Hitchcock ("American Monthly Microscopical Journal," March).—"The Evolution of the Eye," by Mrs. Bodington ("Journal of Microscopy," April).—"On Oldhamia" ("Nature," March 31st).—"A Ramble in the Farne Islands," by T. H. Nelson ("The Naturalist," April).—"Collecting British Clear-winged Lepidoptera," by J. T. Carrington ("The Entomologist," April).—"Science and the Working Classes," by A. J. Weyman ("The Garner," April).—"Interglacial Land Surfaces in England and Wales," by A. J. Jukes-Brown; and "The Development of Dicotyledons in Time," by J. S. Gardner

("Geological Magazine," April).—"On the Microscopic Fauna of Elevated Alpine Lakes," by Dr. O. E. Imhof ("Annals and Mag. Nat. Hist." April).—"De la Récolte et de la Conservation des Entomostacés d'eau douce," par J. Richards ("Feuille des Jeunes Naturalistes," April). "The Significance of Sex," by Julius Nelson ("American Naturalist," Jan. and Feb.) "A New Departure in the Study of Minerals," by Professor C. F. Marsan ("Trans. Ottawa, Field Naturalists' Club," 1887.) "Primroses," by W. B. Hemsley ("Nature," April 14th).

#### OUR SCIENTIFIC DIRECTORY.

*Liverpool Science Students' Association.*—President, William Narramore. Secretary, John Braek Warriner, 1a North John Street, Liverpool. Treasurer, Robert H. Day.

#### ASTRONOMY AND METEOROLOGY.

By JOHN BROWNING, F.R.A.S.

AT the meeting of the Royal Astronomical Society, held on March 11th, some remarkable photographs of a portion of the constellation Cassiopeia by the Brothers Henry, and a photograph of the Orion nebula taken with an exposure of two hours, were presented to the Society. Mr. Crossby exhibited a new form of measuring rod, and Capt. Abney read a paper "On the Atmospheric Transmission of Visual and Photographically Active Light." The papers were valuable, and the discussions which ensued thereon interesting, but both bristle with technicalities, and it would be impossible to summarise them in the space at my disposal.

Dr. Elkin, an American astronomer, who was present, gave an account of some work he had been engaged on for the last year and a half in determining the parallaxes of the principal stars in the group of the Pleiades, and mentioned that it would take him another year to complete his observations.

At the meeting of the Liverpool Astronomical Society, a paper was read on the absolute dimensions of the star-cluster 13 Messier, between  $\eta$  and  $\zeta$  Herculis. The number of stars in this cluster was computed by Sir W. Herschel at 14,000. If the cluster were considered as a sphere full of stars, assuming the total mass to be equal to twice that of the sun, it would give an average diameter of 45,218 miles for each component, and each star in this wonderful cluster might be separated from the next by 9000 million miles.

The "Sidereal Messenger," an American journal of astronomy, says:—"As regards the Lick Observatory, it may be interesting to some of our readers to know how the great object-glass was packed for trans-

mission from the Clarks to Mt. Hamilton. The lenses were packed separately in 15 to 20 thicknesses of soft, clean, cotton cloth; next came a thick layer of cotton, and then a layer of paper. These packages were then put into wooden boxes lined with felt. No nails were used near the glasses, and the boxes were made the shape of the glasses. These boxes were next enclosed in two others of steel and packed tightly with curled hair. Each steel box was enclosed in another steel box, the insides of which were covered with spiral springs. Both steel boxes were air-tight and waterproof, and the outer chests packed with asbestos to render them fire-proof. Each was then suspended by pivots in strong wooden frames with contrivances for turning each chest one quarter round every day during the journey to California. This is to prevent any molecular disarrangement in the glasses and to avoid the danger of polarization, it being feared that the jarring of the train would disturb the present arrangement of the molecules, unless the position of the glass should be changed, and all lines of disturbance thus broken up."

The same journal contains the following:—

"Rotation Period of the Red Spot on Jupiter.—From eight observations in the spring of 1886, Prof. Young deduces a rotation period for this object of 9 hrs. 55 min. 40.7 sec.  $\pm$  0.2 sec. Comparing this value with those of Prof. Hough for the four preceding oppositions, it appears that the remarkable retardation of the period still persists. Prof. Young also determined the period of a small white spot in a higher latitude than the red spot ( $50^\circ$  S.) and found it considerably shorter than that of the red spot (9 hrs. 55 min. 11.14 sec.); it therefore seems that there are spots on both sides of the red spot travelling more quickly than it does. Prof. Young also adds some remarks on the junction of the southern belt with the red spot described by Mr. Denning in the 'Observatory' for May 1886, p. 188."

On May 1st, Venus will be at the least distance from the sun at three hours afternoon.

On May 5th there will be an occultation of  $\gamma$  Virginis  $2\frac{1}{2}$  magnitude. The disappearance takes place at 0 hr. 25 min. morning, and the re-appearance at 1 hr. 8 min. in the morning.

During May Mercury will be a morning star, entering Aries about the 6th, and Taurus about the 20th.

Venus will be an evening star, entering Gemini about the 13th.

Mars will be too near the sun for observation.

Jupiter will be almost stationary in Virgo.

Saturn will be an evening star in Gemini.

*Meteorology.*—At the Royal Observatory, Greenwich, the mean reading of the barometer for the week ending 19th March, was 29.88. The mean temperature of the air was 31.4 deg., and 9.7 below



*Rising, Southing, and Setting of the Principal Planets at intervals of Seven Days.*

	D.	Rises. h. m.	Souths. h. m.	Sets. h. m.
MERCURY ☿	7	3 58M	10 41M	5 24A
	14	3 49M	11 0M	6 11A
	21	3 46M	11 27M	7 8A
	28	3 52M	0 1A	8 10A
VENUS ♀	7	6 1M	2 29A	10 57A
	14	6 5M	2 37A	11 9A
	21	6 16M	2 46A	11 16A
	28	6 28M	2 53A	11 18A
MARS ♂	7	4 17M	11 45M	7 13A
	14	4 1M	11 38M	7 15A
	21	3 45M	11 30M	7 15A
	28	3 30M	11 23M	7 16A
JUPITER ♃	7	5 34A	10 48A	4 6M
	14	5 2A	10 17A	3 37M
	21	4 30A	9 47A	3 9M
	28	4 0A	9 18A	2 40M
SATURN ♄	7	8 8M	4 17A	0 29M
	14	7 44M	3 52A	0 3M
	21	7 19M	3 27A	11 35A
	28	6 56M	3 3A	11 10A

the average in the corresponding weeks of the 20 years ending 1868. The general direction of the wind was N.E., and the horizontal movement of the air averaged 9.3 miles per hour, which was 3.9 below the average in the corresponding weeks of 16 years. Rain or melted snow was measured on two days of the week, to the aggregate amount of 0.50 of an inch.

For the week ending 26th March, the mean reading of the barometer was 29.55 in. The mean temperature of the air was 40.7 deg. and 1.2 below the average in the corresponding weeks of the 20 years ending 1868. The direction of the wind was variable, and the horizontal movement of the air averaged 18.2 miles per hour, which was 5.5 above the average in the corresponding weeks of 16 years. Rain fell on four days of the week, to the aggregate amount of 0.36 of an inch.

For the week ending 2nd April, the mean reading of the barometer was 29.86 in. The mean temperature of the air was 44.0 deg., and 0.4 below the average in the corresponding weeks of the 20 years ending 1868. The direction of the wind was variable, and the horizontal movement of the air averaged 14.9 miles per hour, which was 2.4 above the average in the corresponding weeks of 16 years. Rain fell on three days of the week, to the aggregate amount of 0.40 of an inch.

For the week ending 9th April, the mean reading of the barometer was 29.73 in. The mean temperature of the air was 42.3 deg., and 4.3 below the average in the corresponding weeks of the 20 years ending 1868. The direction of the wind was variable, and the horizontal movement of the air averaged 19.8

miles per hour, which was 6.7 above the average in the corresponding weeks of 16 years. Rain fell on two days in the week, to the aggregate amount of 0.12 of an inch.

It is specially noteworthy that in the week ending March 19th, the mean temperature was *ten degrees* below the average for the 20 years ending 1868.

In May the mean temperature for London, Derby, and Swansea is 53°, for Yarmouth, York, and Liverpool, it is 52°, and from Berwick to Carlisle it is about 50°.

The average rainfall for May is about one inch on the east and south coasts, and two inches on the west coast of England.

## SCIENCE-GOSSIP.

WE have received from Mr. E. G. Wood a copy of the new and enlarged edition of his useful pamphlet, "A Photograph, and How to take it." Also, from Messrs. Dulau, 37 Soho Square, their last catalogue of botanical books in various languages.

THE Birmingham Microscopists' and Naturalists' Union have removed from 20 Paradise Street, to 1 Broad Street Corner, Easy Row, Birmingham.

Mr. J. W. ELLIS is continuing in the "Naturalist" his valuable notes on the Lancashire and Cheshire Geometridæ.

PARTS 2 and 3 of the "Essex Naturalist" are to hand, and both fully sustain the high opinion we formed of the first.

AFTER nearly forty years' public service at the Royal Institution as Professor—lecturing to the English-speaking world thence like a scientific missionary—Professor Tyndall resigns, and refuses pension or any other reward. That is fitting for such a scientific chieftain, only—all can't afford to do it. Lord Rayleigh is likely to be Professor Tyndall's successor. One unpublished act of governmental kindness ought to be noticed. Professor Tyndall has neither been offered a knighthood nor a baronetcy. That is something to be thankful for, particularly in 1887.

WE have received a reprint of Dr. A. B. Griffiths's valuable paper in the "Journal of the Chemical Society" for March last, on "Agricultural Experiments with Iron Sulphate as a Manure."

THE Geologists' Association made a two days' excursion on Easter Monday and Tuesday to Brighton and Newhaven, under the directorship of Messrs. H. Willett, W. Topley, and W. Whittaker.

THE Report of the Botanical Exchange Club for 1886 has just appeared, published by James Collins, King Street, Manchester. Eighty-nine new records are given.

THE members of the Yorkshire Naturalists' Union have undertaken the important work of cataloguing and describing all the large erratic blocks or boulders of the county. Mr. S. A. Adamson, 52 Well Close Terrace, Leeds, is the hon. sec.

THE last number of the "Transactions of the Ottawa Field Naturalists' Club," indicates that the vigour and enthusiasm of the members have not slackened.

THE last two numbers of the "Victorian Naturalist" (the organ of the "Victorian Field Naturalists' Club"), are to hand, and contain some valuable and readable papers.

PROFESSOR BEDDARD is about to deliver a course of attractive lectures to young people at the Zoological Gardens.

DR. J. E. TAYLOR delivered a lecture on April 18th, at the Firth College, Sheffield, on behalf of the Literary and Philosophical Society, subject—"A Naturalist's Holiday in Australia."

## MICROSCOPY.

MOUNTING IN CASTOR OIL.—Will some fellow-reader of SCIENCE-GOSSIP kindly tell me the best method of mounting in castor oil? Also how to keep it from getting cloudy in winter?—*H. Geer.*

WASP-PAPER UNDER THE MICROSCOPE.—Perhaps the following may prove of interest. It is generally stated in books on natural history that wasp-paper is made from decayed wood, but if the outer covering of a wasp's nest be examined by soaking the paper in turpentine and then mount in balsam, it will be seen that it has been made from living plants. I have micro-slides which show scalariform vessels of fern, stomata, and cells in epidermis of leaf, portions of leaf of plants, the empty husk of wheat, thorns similar to those on bramble leaf, and portions showing cellular structure very finely divided. The paper also shows insect remains, portions of wings, legs, antennæ, etc. One piece of paper shows the compound eye of an insect as clean and perfect as though specially prepared. Paper made by *Vespa vulgaris* shows plant structure most; *V. sylvestris* shows most insect remains; *V. rufa* and *V. germanica* plant structure, but no insect remains.—*T. Moore, 84 Porchester Street, Birmingham.*

NEW SLIDES.—We have received from Mr. W. S. Anderson, Ilkeston, the following instructive and interesting slides, all admirably mounted: Water boatman, ground beetle, bedstraw beetle, sun beetle, larva of the Cinnabar moth, and Iris bug.

COLE'S "STUDIES."—We have received sections 1, 2, 3, and 4 of No. 8 of this admirable and ever-welcome series, with slides of the same to match:—

section of a fallen leaf, illustrating defoliation; spermatozoa of various invertebrata (with slide of those of the earthworm); pathological (with slide illustrating Bright's disease); and the growing-points of stems. All the parts contain the usual highly-finished coloured plates.

THE HEAD OF THE QUEEN BEE.—We have received from Mr. Fred Enock a beautifully mounted slide of this interesting object, showing all the organs of the mouth in their natural form and colour. It is accompanied by the usual illustrated description. No better way of learning practical entomological comparative anatomy could have been designed than Enock's entomological slides.

CAMERA LUCIDA.—In reply to F. R. Brokenshire's query as to the use of camera lucida: I should say from the back lens of the objective to the eye lens of the ocular, but cannot speak with authority on this point. But, as to the second question, my eye-pieces A and B have no cap, but are the full width ( $1\frac{1}{4}$  inch) of the tube. I drilled a hole outside the lens and tapped it for a small screw, then took a piece of thin brass, punched a  $\frac{1}{2}$ -inch hole over which I cemented a cover glass that bent the brass to an angle of  $45^\circ$  and filled a slot in the tail part, as I call it, so that when slipped over the screw, which was moderately tight, the cover-glass stood in front of the lens at  $45^\circ$ . The whole thing would cost something to be expressed in a fraction of a penny, and it answers as well as a five shilling affair.—*Richard Gill.*

## ZOOLOGY.

PATHOLOGY AND ITS RELATION TO EVOLUTION.

—The second figure—section through the postate gland to show *Sinus pocularis*—to illustrate the first instalment of this article should read thus: *a.* bladder; *b.* prostate; and *c.* prostatic portion of urethra; *d.* *Vesicula seminalis*; *e.* *Vas deferens*; *f.* common ejaculatory duct; *g.* *Vesicula prostatica* or *Sinus pocularis*. I should be pleased if the readers of my review would note this rendering of the diagram.—*J. W. Williams.*

THE DEVELOPMENT OF THE TADPOLE.—On page 68, Dr. J. W. Williams doubts my assertion that the cilia of the epidermal cells of the young tadpole are difficult to see in prepared sections, and because he can see the cilia in mounted sections of the epididymis and trachea of man and cat, thinks the cilia of the tadpole can be equally well seen if sections are prepared in the usual routine way, i.e., after hardening with chromic acid, &c. Dr. Williams then goes on to say, that "if ever there were any cilia there, take an honest word you will spot them." I hope Dr. Williams will try to cut sections of tadpoles a fortnight or three weeks old, having first satisfied

himself of the existence of the cilia. I fancy he will experience considerable difficulty in cutting the sections, and perhaps he will learn for himself what I mean by the "capillarity" between the individual cilia and the cell body. These cilia are infinitely smaller and more delicate than those of the human epididymis, or mammalian tracheæ; they resemble those seen on *Paramecium bursaria* or *Opalina ranarum*. It is just this "capillarity," or sticking together, that makes it so difficult to preserve specimens of the infusoria in such a way as to show the cilia.—*P. E. Wallis.*

## BOTANY.

CEPHALANTHERA GRANDIFOLIA AND C. ENSIFOLIA.—In SCIENCE-GOSSIP for April last (p. 91), C. P. in speaking of *Cephalanthera grandiflora* and *C. ensifolia*, says that the flower spike of the latter is smaller than that of *grandiflora* and has "a few loose flowers." On referring to Bentham's "Illustrations of the British Flora," I find that he gives the flower spike of *ensifolia* with five flowers only, whilst there are eight shown on the spike of the other species; so that C. P.'s statements are certainly corroborated by good authority. Under these circumstances, I feel some diffidence in stating that my experience does not accord with that of C. P. and Mr. Bentham. I have been well acquainted with *ensifolia* for some years, and have seen it growing in Germany, Switzerland, and Italy in at least twenty localities. In particular, in the spring of 1882, I found it on one of the mountains near Varese, in large numbers, and I can state positively that, as a rule, the flower spikes on these plants, as well as on those found in Germany and Switzerland, were for the most part longer and more regular and had more flowers on them than most of the spikes of *grandiflora* that I have ever met with. I confess that I have only seen this last species in two localities, one in a wood just above Weggis, close to the path up the Righi. Here, in 1883, I found about a dozen plants, but none of these had more than four or five flowers. The other locality is on the South Downs, where, in 1884, I found it growing in abundance under beech-trees. The spikes in this latter case were slightly larger, i.e. had more flowers than the Swiss ones, but still they were not so long as average specimens of *ensifolia*, nor had they as many flowers. I have never seen *C. rubra* in England, but I found a good many plants of it at Engelberg, two or three years ago. Like *grandiflora*, it grows in open woods which have but little undergrowth, and evidently prefers shade. Bentham says of *ensifolia*, "stations the same as those of *grandiflora*;" but, in point of fact, it is almost always found, not in woods, like *grandiflora*, but in open, though bushy places, and I should say prefers a sunny position. At least, that is my

experience. I have omitted to say that *ensifolia* is, I think, much more generally distributed than *grandiflora*, but it is not usually found in such abundance where it does occur.—*R. B. P., St. Leonards-on-Sea.*

THE WIND AND THE TREE-TOPS.—Since 1875, the writer has observed in various parts of the country, one hundred and fifty-six observed cases of injury to the trunks or branches of trees by wind. Of all ordinary trees, the common red maple appears to suffer most [in hard winds, and the whole one hundred and fifty-six observed cases of injury were confined to the various species of deciduous trees. The writer has seen hundreds of long-leaf pines in Georgia and Florida that had been blown up by the roots, but not one injured in trunk or branch while the tree was yet standing. Also close inquiry in Iowa and a whole summer's observation among the white pines of Tennessee failed to reveal a single case in which a tree of that species was injured by the wind. Of the one hundred and fifty-six observed instances of injury, sixty-one per cent. were limbs split off at the crotch. The crotches of a tree are its weak points. Nature recognises this fact, and guards against the weakness by swelling out the wood about the points of branching. Notably is this true of the white pine. In a large tree of this species, the limbs come out in regular whorls about two feet apart. Midway between each two successive whorls the centre axis of the tree has a minimum size. Above and below this point of least circumference, the trunk gradually swells out to support the successive sets of branches. In sixty per cent. of the observed injuries the trunk divided into two or more large nearly equal branches, and one of these was the injured member. These large limbs swaying in a hard wind act as great levers, and are frequently not sufficiently supported at the crotches. The meaning of all this is that a tree of which the trunk habitually divides into large, nearly equal branches, is much more liable to be injured than one having a strong central axis with many small limbs, as, for example, the white pine. Thus the accumulated effects of the wind have undoubtedly been to develop excurrent forms of tree-top. But the question naturally arises why pines, spruces, &c., have this form in greater perfection than other trees. Well, in the first place, deciduous trees are usually injured by the wind only while in foliage, are practically exposed to the action of the wind for at least twice as great a time each year as are maples, elms, &c. Then, too, according to palæontology, the cone-bearing evergreens came into existence many thousand, perhaps millions of years before any tree that annually sheds its leaves. Thus the coniferous evergreens have had a vastly longer time in which to accumulate the effects of the wind and develop an excurrent form of top than have deciduous trees.—*B. F. Hoyt, in American Naturalist.*



## GEOLOGY, &amp;c.

A LANDSLIP IN DORSETSHIRE.—I happened to be spending a few days in the picturesque village of Burton Bradstock, Dorsetshire, when about 2 A.M. on Friday, March 11th, we were startled by such a landslip and fall of the cliffs—here more than 100 feet high—as had not occurred within the memory of that remarkable personage, the oldest inhabitant. The strata, inferior oolite, consisting of sand intercalated with thin bands of shelly ragstone, resting conformably upon the upper lias, having in all probability been affected by the rains and frosts of an unusually changeable winter, had slipped away from its intractable base—burying upwards of an acre of the adjacent beach beneath thousands of tons of débris. For a few hours before the sea began to play havoc with the ruins, interesting fossils were to be had in abundance. Many of these were of course shattered beyond all hope of reconstruction; but countless numbers of them were to be found in more or less perfect states. Among the fossils thus unexpectedly exposed were various genera of the Brachiopodæ, Cephalopodæ, Conchiferæ, Echinodermatæ, Gasteropodæ, etc., with numerous well-preserved fragments of Monocotyledonous wood.—*C. N. Barham, F.S.Sc.*

## NOTES AND QUERIES.

SEA-BIRDS INLAND.—A young puffin was caught in an exhausted state at Ardsley, near Leeds, on September 17th. A stormy petrel was shot on an artificial lake near Wakefield in October.—*Geo. Roberts, Lofthouse, Wakefield.*

GREY WAGTAILS.—In the first vol. of SCIENCE-GOSSIP another of your correspondents narrates a similar occurrence of this bird tapping at a window. It seems to be a peculiarity of this species.

THE MANGO.—With exception of this, the plantain and two or three others, almost all the really good fruit trees of India are aliens. The custard apple and the pine, the orange, shaddock and lemon, the red banana, pomegranate and guava, all are introductions for which we may thank, in great part, our predecessors, the Portuguese; to them, at any rate, are we indebted for having, by scientific arboriculture, brought the mango to the high degree of excellence it has attained in Western India. Relays of runners posted between Delhi and Bombay were means by which the Emperor Aurungzebe's table was duly supplied with royal "Alphonso" in the season; but to taste them in perfection, gathered ripe from the tree, would necessitate a journey to Bombay or to Goa for the purpose, as it is only on the Mahratta seaboard that the fruit attains its superlative superiority over all others produced elsewhere. Some peculiarity in the soil, combined with essential climatic conditions, no doubt is a *sine quâ non*; and that must be referred to the black sandy subsoil of decomposed greenstone—a kind of basalt—which characterises the geological formation of that part of India;

iron is one of its constituents to which the overlying laterite, a sedimentary deposit, owes its colour and name. The true form of the fruit is oval, obscurely half reniform, at the end nearest the stalk, and this is caused by the presence of a small projection or apiculus, remains of the deciduous style. The ovary is set somewhat obliquely in an annular five-lobed disc, with a lateral style, and the single fertile stamen directly opposite; both style and stamen incurved towards one another: the rudimentary stamens between them, two on each side. Of the freely branched panicle most of the flowers are barren; five perfect stamens and a rudimentary pistil. The inflorescence therefore can hardly be called polygamous; but monœcious rather by abortion; the flowers are small, anthers purple, and petals streaked with orange. A like structure occurs in the cashew nut, another plant of the order with ten stamens, one only perfect. They arise however, from the inner, not as in the mango from the outer border of the disk. Is it therefore disk, properly so understood in the cashew nut, or torus only? This it is which grows, as the nut, so called ripens, into the spongy pyriform mass, having the odd appearance of a fruit with its seed outside instead of within it. The mango has a one-celled ovary with a single ovule suspended from a cord arising from the base of the cell, as in other genera of the order. What is the placentation in this instance? axile or central? If one might venture an opinion, the funiculus having a sigmoidal lateral inflection might be, without any very extraordinary stretch of imagination, regarded as simply a disconnected parietal placenta plant of the plumbaginaceous order. *Statice Armeria*, &c., have also ovules suspended by a cord, but though one-celled and one-seeded like anacards, they must be considered as being only abortively so, for the flowers are pentagynous. *Sporidias* however, among Indian anacards, has five pistils, and a perfect five-celled, five-seeded drupe.—*Edy.*

SOCIABILITY OF MICE.—I have often observed when taking down stacks of oats, the nest of the common mouse (*Mus domestica*), and although an enemy to mankind, they must surely live in the best of friendship. It is by no means uncommon to find two families of young of different ages in the same nest, but I was rather surprised a short time ago to find three distinct litters of young in one nest! They were all in a heap, without any division or separation. One family of six were two or three days old; another litter of seven were aged eight or ten days, while another lot of six were about able to shift for themselves. Whether their unity be for the greater warmth, or to avoid labour, or for the better protection of their young, who can tell, or how each mother can suckle her own in such a promiscuous lot?—*W. Sim, Fyvie.*

CURIOUS SUDDEN DISAPPEARANCE OF A SPRING.—Another curious thing happened at Fairburn last November. Above the curling pond, but the other side of the river—and facing north—is a plantation of Scotch firs, I should fancy some thirty or forty years old. In this plantation is, or rather was, a copious spring of capital water, which was run into the house by pressure some six or seven years ago to supply it with best water, and was found quite adequate. Last summer was cold, dry, and windy, but September and November were the wettest months of the year (except January) and yet after all this rain the spring disappeared in November. The gardener suggests that the trees tapped it. But had that been the case, I should have thought the water

would have failed in the dry months; not after the wettest part of this year. I have been told that several springs in Ross-shire have disappeared in the same way without apparent cause. Can any of your readers enlighten me on the subject?—*W. C. P.*

GOING IN FOR IT.—A correspondent of the *Field* has a duck whose egg-laying propensities are fabulous. The numbers of eggs laid by her are as follows:—In 1878, 211; in 1879, 143; in 1880, 145; in 1881, 156; in 1882, 84; in 1883, 30; total, 769. She has now ceased laying for the last two years, and has never, since her birth, mixed with any of her own species, male or female. Another peculiarity is that she has, since she finished laying, the “curled feathers” on the tail as prominent as any drake.

THE GREAT NORTHERN DIVER.—A beautiful specimen of this bird has been secured near to Birdforth, about five miles to the south of Thirsk. It is considered a great rarity in this district. The bird is thirty inches in length, and measures four feet five inches from the tip of its beak to that of its tail. It was shot on some ice, where it had some difficulty in rising. It is a beautiful specimen, and is just getting its adult plumage. Mr. Robert Lee, naturalist, of Thirsk, has preserved the bird, and it is thought the severity of the weather northward must have driven the bird so far inland.

SCIENCE IN GLASGOW.—Here is how science is culminating in Glasgow. I beg to give the following extract from one of the weekly papers there; it is rather startling. “Whatever we cannot think, or whatever is unthinkable, has, then, no existence at all. Being or existence, then, is quite unthinkable otherwise than in the following:—‘1. Time is endless. 2. Time is beginningless. 3. Space must always have been and must always be. 4. Space has no bounds. 5. Time and space are of necessity. 6. All being or existence is inside time and space. 7. Substance can neither come out of nothing nor go into nothing; therefore, must always have been and must always be. 8. Substance occupies or fills with itself its own space. 9. Substance does not fill all space, or it could not be capable of motion. 10. Substance, though it fill not all space, may have nevertheless an endless extension throughout space. 11. Whether substance have or have not an endless extension throughout space, we can never be able to know of ourselves. 12. Yet, even the smallest particle of substance is of an endless extent in its way, for it goes to the endless depth of the infinitesimal. 13. Substance is spirit, because it moves itself into shapes. 14. Spirit is substance, because it must occupy or fill a space. 15. Spirit is neither time, nor space, nor motion, nor shapes, but must be substance. 16. Time, space, and substance constitute uncreated being or existence. 17. Motion does not occupy or fill a space, though it be in space. 18. Motion can have a beginning to be and a ceasing to be, but not without a cause. 19. Motion has a beginning to be or is created by will-force. 20. Motion has a ceasing to be or is destroyed by coming into direct collision with motion. 21. Shapes into which substance moves itself, and in which it holds itself, are the manifestations of mind. 22. Stars, clouds, hills, trees, bodies, stones, atoms, &c., are actually not substance but shapes. 23. Wood, stone, iron, water, air, the chemical elements, the luminiferous ether, &c., are not different substances, but conglomerate aggregates of different infinitesimal shapes. 24. Shapes can have a beginning to be and a ceasing to be. 25.

Motion and shapes are entirely dependent on substance, space, and time. 26. Motion and shapes constitute created being or existence. 27. Time, space, substance, motion, and shapes are the entire total of all being or existence.’ These, then, I accept upon the basis of thinkability about them; if you reject them because you think thinkability about them is not umpire, then just by so thinking, and by rejecting them just upon the strength of so thinking, you verily acknowledge that thinkability is umpire.—*J. F. Brown, Glasgow.*

THE GEOLOGICAL HISTORY OF THE ECHINUS.—Could one of your obliging correspondents favour us with an article or two on the development of the Echinus as exhibited in successive geological strata?—*J. W. D.*

## NOTICES TO CORRESPONDENTS.

TO CORRESPONDENTS AND EXCHANGERS.—As we now publish SCIENCE-GOSSIP earlier than formerly, we cannot undertake to insert in the following number any communications which reach us later than the 8th of the previous month.

TO ANONYMOUS QUERISTS.—We must adhere to our rule of not noticing queries which do not bear the writers’ names.

TO DEALERS AND OTHERS.—We are always glad to treat dealers in natural history objects on the same fair and general ground as amateurs, in so far as the “exchanges” offered are fair exchanges. But it is evident that, when their offers are simply disguised advertisements, for the purpose of evading the cost of advertising, an advantage is taken of our *gratuitous* insertion of “exchanges” which cannot be tolerated.

WE request that all exchanges may be signed with name (or initials) and full address at the end.

J. L.—The “Journal of the Trenton Nat. Hist. Society” is published by the society at Trenton, New Jersey, U.S.A.

JOHN MOORE (Birmingham).—Many thanks for your slide of wasp paper. The scalariform vessels of ferns appear quite distinctly in it. Your discovery that wasps use living instead of dead vegetable tissue is important.

VERDAD.—We cannot see how you could apply the word “indigenous” to *minerals*, as well as to native animals and plants.

J. W.—The fungus you sent us is an immature specimen, and is related to the *Zasmidium* found on the woodwork of damp cellars.

J. C.—The “Scientific Enquirer” is, we believe, published monthly, edited by Mr. A. Allen, 1 Cambridge Place, Bath, of whom make enquiries.

C. DEACON.—Your object is the freshwater shrimp.

S. MANSE.—The “Economic Naturalist” is published at the Beaumont Park Museum, Huddersfield.

A. DAVIDSON.—You will get Rimmer’s “Land and Fresh-water Shells,” of Messrs. W. H. Allen & Co., Waterloo Place, London.

E. J. TATUM.—You had best apply to Mr. Edward Biddell, Fonnereau House, Cambridge Park, Twickenham, concerning his list of British Birds. The following are good and fairly cheap books on British Ornithology:—H. G. and H. B. Adams’ “Smaller British Birds, Nests, &c.,” 15s. (Bell); “Our Summer Migrants,” by Harting, 7s. 6d. (Bickers); “Handbook of British Birds,” by Harting, 7s. 6d. (Van Voorst); and “British Birds in their Haunts,” by Rev. C. A. Johns, 7s. 6d. (S. P. C. K.)

## EXCHANGES.

“ZOOLOGIST” wanted, the vol. for 1866, for York School Natural History Society. The year was given wrongly in the last issue of SCIENCE-GOSSIP.—B. B. Le Tall, 20 Bootham, York.

WANTED, foreign postage-stamps in exchange for SCIENCE-GOSSIP and other books on natural history.—A. G. A., 15 Koslyn Terrace, Redland, Bristol.

The new British alga (freshwater), *Hildenbrandtia rivularis*, in exchange for rare British or named foreign shells, land and freshwater preferred, or named foreign insects.—W. A. Gain, Tuxford, Newark.

Will give good micro slides for whole insects, &c., well-mounted, for lantern micro. Lists.—H. W. Case, Cotham, Bristol.



EXOTIC butterflies, many fine and rare species in duplicate, including *Morpho alga* (true and very rare), *Urania fulgens* (fine), &c.; also some splendid wings for microscopic mounting.—Hudson, Railway Terrace, Cross Lane, Manchester.

WANTED, numbers of SCIENCE-GOSSIP for Feb. and March of 1871 (74 and 75), also for Jan., Nov., and Dec. 1872 (85, 95, and 96). Will give in exchange two good microscopic slides for each number (clean) to complete my set.—J. J. Andrew, 2 Belgravia, Belfast.

ENGRAVINGS of the British varieties of *Anodonta cygnea*, ten in number, for specimens of varieties, or peculiar or large forms of *Anodonta cygnea*, *A. anatina*, or any of the Unios, British or continental.—George Roberts, Lofthouse, Wakefield.

WANTED, type or vars. of *Bithinia tentaculata* or *Anodonta cygnea*. Offered, *Planorbis complanatus* var. *submarginatus* or varieties of Helices.—Geo. Roberts, Lofthouse, Wakefield.

WANTED, Gray's "Turion's Manual" for Harting's "Rambles in Search of Land Shells," coloured plates.—Geo. Roberts, Lofthouse, Wakefield.

WANTED, *Sph. ovale*, *P. amnicum*, *D. polymorpha*, *P. vivipara*, *Pl. nitidus*, *Pl. parvus*, *Pl. hypnorum*, *L. glutinosus*, *Z. alliarius*, *nitidus*, *excavatus*, *H. lamellata*, *aculeata*, *revelata*, *fusca*, *rufestris*, *B. montanus*, *P. secale*, *P. ringens*, *C. volpiti*, *C. dubia*, *Achatina acicula*, and *Aeme lineata*. Exchange given.—H. Wallis Kew, Louth, Lincolnshire.

SPECIAL offer. Steel egg drill, brass blowpipe, and egg label list, post-free. Wanted collections: old postage stamps, coins, medals and curiosities. Exchange "Natural History," specimens.—W. K. Mann, Wellington Terrace, Clifton, Bristol.

WHAT offers for vols. 16, 17 and 18 of "The Entomologist," unbound, in very good condition? Also for vols. 3 and 4 of "Boy's Own Paper," bound in cloth?—W. H. Langford, 187 Woodborough Road, Nottingham.

FOR exchange, *Salix phylicifolia* var. *tenuis* in exchange for any other willow or sallow, except 1172, 1170, 1174, 1175, 1177, 1183, 1885, L. C. 7th catalogue.—E. Candler, The Priory, Repton, Burton-on-Trent.

WANTED, good pathological material, liberal exchange in slides given. Send lists first to Fred Le Carte, 25 Lansdowne Terrace, Gosforth, Newcastle-on-Tyne.

WANTED, several dozen of black spotted cones, large common sorts to cut up. Also shells from the Philippine Islands, Australia, and New Zealand, in exchange for fossils, British or foreign shells, minerals, polished Devon corals and sponges, micro-sections of corals, &c.—A. J. R. Sclater, M.C.S., 23 Bank Street, Teignmouth, Devon.

WANTED, any kinds of foreign large shells in exchange for fine rock specimens from the trias, such as quartzites, royalties and Murchisonites, with fine specimens of Pyroxene Andesite from South America, fine for cutting sections from.—A. J. R. Sclater, M.C.S., 23 Bank Street, Teignmouth, Devon.

GOOD foreign stamps offered in exchange for shells, fossils, birds' eggs or micro slides.—T. W. Reader, 171 Hemingford Road, London, N.

WANTED, ova of fish, molluscs, &c., also parasites of animals, &c. Good exchange given.—H. W. P., 103 Camden Street, London, N.W.

FOR exchange, "Quarterly Journal Geological Society," 1875-78, "Nature," nos. 862-96 and 777-84, and "Knowledge" (new series) for 1885. Wanted, Flower's "Osteology of Mammalia"; other scientific works or offers.—H. E. Quilter, 4 Cedar Road, Leicester.

WILL exchange photo-micrographs—either prints or transparencies—of botanical subjects, Diatomaceae, Polycistines, Foraminifera, &c., for good micro-slides. Wanted, Beale's and Carpenter's books.—Stewart, 2 Gilmore Terrace, Edinburgh.

FOR exchange, "Quekett Club Journal," vols. IV., V., VI. Wanted, Bell's edition of White's "Selborne," or offers.—E. Smith, Hale End, Chingford.

WANTED, to buy or borrow, Crouan's "Floride du Finistère," and any French books on marine algology. For a loan a liberal equivalent in rare slides of marine algae with reproductive organs (Antheridia, &c.)—T. H. Buffham, Comely Bank Road, Walthamstow.

HUMBOLDT'S "COSMOS," vol. 1; "Arctic Regions" (with map) by P. S. Simonds; "Notes on Collecting and Preserving Natural History Objects," edited by Dr. J. E. Taylor; and "Scientific Recreations" (bound in half-calf), offered in exchange for other books on microscopy, or for any knives or instruments for dissecting.—L. Francis, 16 Wansey Street, Walworth Road, London, S.E.

WANTED, collections of old postage stamps, coins and medals. Offered in exchange, natural history specimens.—W. K. Mann, Wellington Terrace, Clifton, Bristol.

WANTED, clutches of various birds' eggs. Will collectors kindly send lists of what species they are likely to obtain this season?—W. K. Mann, Wellington Terrace, Clifton, Bristol.

WILL give Daubenton's bat, stuffed, in good condition, with data, for greater horse-shoe bat, in flesh or stuffed.—J. Kelsall, 28 Commercial Street, E.

SET of lantern slides on bee-keeping, many of them microphotographs (list sent), in exchange for first-class professional objects, 1-inch objective, or polariscope.—A. Watkins, Broomy Hill, Hereford.

WANTED, a Rutherford's freezing microtome.—L. Francis, 16 Wansey Street, Walworth Road, London, S.E.

WANTED, books by Charles Darwin, Herbert Spencer, or John Lubbock.—L. Francis, 16 Wansey Street, Walworth Road, London, S.E.

WANTED, botanical slides for microscope. Exchange, Hebrew Bible, 1613, with "Interlinear Latin Translation," 8vo. 1300 pp. Original binding. Also Buxtorf's "Manual of Hebrew and Chaldee."—J. Wallis, Deal.

OFFERED, Professor Mivart's "Lessons in Elementary Anatomy"; Page's "Introductory Geology"; Taylor's "Notes on Collecting Natural History Objects." Wanted, British bird skins, chiefly Sylviadae.—J. H. K., 18 Church Street, Commercial Street, E.

"FORTNIGHTLY REVIEW," posted month after date. Wanted, offers of natural history periodicals in exchange.—J. H. K., 18 Church Street, Commercial Street, E.

MICRO books wanted. Good slides given in exchange.—W. Sim, Gourdas, Fyvie, N.B.

OFFERED, unmounted micro-objects, for good slides or other unmounted material.—W. Sim, Gourdas, Fyvie, N.B.

WANTED, Cassell's "Science for All," vols. 1-5. State requirements in books or otherwise. Unaccepted offers not answered.—M. C. L., 37 Portman Square, London, W.

SIDE-BLOWN clutches of lesser redpole, whinchat and grasshopper warbler, and British Lepidoptera, for other eggs.—Thos. H. Hedworth, Dunston-on-Tyne.

WANTED, *H. solida*, *H. ventricosa*, *H. minor*, *T. longispina*, *T. jujubinus*, *M. tenuispina*, *P. crispa*, *N. peloronta*. Exchange glass case 22 inch by 104 inch, depth 2 inches.—W. Jones, jun., 27 Mayton Street, Holloway, London, N.

OPERA glass, good and new. What offers?—John J. Holstead, 19 Millholme Terrace, Carlisle.

WHAT offers for Quekett's treatise on the Microscope; Hogg's Microscope, 4th edition; Carpenter's Microscope, 5th edition?—A. Draper, 275 Broadfield Terrace, Sheffield.

THE leaf of carnivorous plant *Drosera* stained or mounted dry with victims *in situ* for exchange for other slides.—U. Stott, Lostock, Bolton.

MICRO-SLIDES. For disposal, twelve dozen miscellaneous mounts, in polished pine cabinet, comprising anatomical, histological, diatoms, forams, insects, polariscopic, botanical, opaque, &c. &c., all in perfect condition, and many of them professional mounts. Offers requested.—W. Mathie, 42 McKinlay Street, Glasgow.

WANTED, fossils or British shells. Offered, Cassell's "Technical Educator"; Kane's "Arctic Explorations"; Hallam's "Constitutional History of England," "Italian Pictures Drawn with Pen and Pencil"; Wood's "Popular Natural History," and many others.—Robert Cairns, The Grove, Currier Lane, Ashton-under-Lyne.

MICROSCOPIC slides. Spiculæ, histology, crystals, insecta, botany, for exchange for foraminifera slides, &c., or for microscope lamp or accessories.—S. Harrison, Dalmain Road, Forest Hill.

A. STEWARD'S complete 5<sup>l</sup>. 5s. *od.* student microscope, never been used. What offers? Lee, 6 Stackey Street, Heywood, Lancashire.

L. C. 8th edition. Wanted the following:—74, 1136, 1188, 1250, 1308. Will give in exchange: 258, 588, 620, 1808, 1831.—W. W. Reeves, 32 Geneva Road, Brixton, S.W.

#### BOOKS, ETC., RECEIVED.

"Proceedings of the Lit. and Phil. Soc. of Liverpool."—  
"First Report on Fauna of Liverpool Bay," vols. 39 and 40.—  
"Trans. Ottawa Field Naturalists' Club."—  
"Report of Botanical Exchange Club for 1886."—  
"Bulletin of the U. S. Geol. Survey," nos. 30-33.—  
"Cole's "Studies in Microscopical Science."—  
"Science and Art."—  
"Illustrations."—  
"Book Chat."—  
"The Century Magazine."—  
"Scribner's "Monthly."—  
"The Amateur Photographer."—  
"The Garner."—  
"The Naturalist."—  
"The Botanical Gazette."—  
"Journal of the New York Microscopical Society."—  
"Belgravia."—  
"The Gentleman's Magazine."—  
"American Monthly Microscopical Journal."—  
"The Essex Naturalist."—  
"Economical Naturalist."—  
"The Midland Naturalist."—  
"Feuille des Jeunes Naturalistes."—  
"The American Naturalist."—  
"Journal of Microscopy and Nat. Sci."

COMMUNICATIONS RECEIVED UP TO THE 12TH ULT. FROM:  
W. S. A.—H. J. B.—C. N. B.—D. B.—G. R.—C. D.—  
L. P. H. L.—S. M.—C. D.—E. S. P.—H. W. K.—T. K. M.—  
R. T. A.—S. H.—W. C.—B. E.—G. R.—R. W. C.—  
A. P. W.—F. W. R.—E. E.—G. W.—R. A. P.—W. S.—  
F. L. C.—E. C.—T. M. R.—W. H. L.—W. E. H.—C. R.—  
W. J.—H. W. P.—A. T. R. S.—J. M.—A. D.—H.—L. P. L.—  
T. W. R.—W. A. G.—J. W. W.—I. A.—H. E. Q.—  
R. D. P.—W. K.—P. H. M.—B. B. L.—T.—A. G. A.—W. S.—  
E. S.—A.—W.—M. C.—L.—T. H. H.—H. D.—A. D.—J. J. H.—  
W. J., jun.—S. T.—H. B.—L. F.—L. F.—W. M.—W. J.—  
J. K.—I. H. K.—A. H.—J. C.—G. F.—U. S.—C. C. L.—  
J. L.—W. N.—R. C.—W. W. R.—W. M.—S. H.—R. G.—  
W. J.—J. M.—&c. &c.





## MY DRAWING-ROOM PETS.

By CLARA KINGSFORD.

### PART III.



WHEN Tommy had lived with me about one year, I acquired another specimen of *Z. vivipara*, which I named Georgie, and thinking they would be agreeable companions for each other, I introduced the latter into the former's home, but Tommy had too long reigned supreme. He most violently assaulted Georgie, and I had to rescue the poor creature,

half-dead with fright, and provide him a separate home. I always kept their globes in close proximity to each other, and it was truly absurd to see, the first thing each morning, the pugilistic attitude that they assumed towards each other. They had a sham fight, the glass intervening preventing it from being a real one, and it was not until some few weeks had elapsed that their pugilistic spirit gave way to a more amicable one

Georgie soon followed in Tommy's wake, and took to meat as he had done, only in a much shorter time. It needed to be a labour of love to feed these two Lacertians, and it required no little patience and strategy, for neither would eat a piece without it was previously dangled before his eyes for some little time, but as everything comes to an end, so did this. As time went on, they took their food more readily, and upon one occasion of my being from home, and about a year and a half after the advent of the latter, their serve of meat being placed before them, they

found that they must either take it or leave it, they very wisely chose the former course.

How keen is the optic, the auditory, or the gustative nerve of the *Z. vivipara*; how it loves to watch all that is going on around it; how quick to mark the slightest insect form, and bright colours attract its attention. Its ear is turned at the lowest sound; music hath charms for it. How rigid with attention it will become whilst listening to a band of music; soft, sweet babbling chat and chirping evidently affords it pleasure. It is very fastidious, and will not eat off everything, starve rather than swallow a piece of meat off zinc or tinfoil, but its olfactory nerve appears quite the reverse; its power of scenting anything I should say is *nil*.

Timid at first, my saurian pets soon became reconciled to captivity, and quite familiar, would allow me to stroke them; would lick drops of water off the tips of my fingers, and take food from the same, but it was some months ere they would submit quietly to be lifted and handled. However, once their fear was thoroughly subdued, they would voluntarily seek my hand, crawl on to a finger and up my arm on to my shoulder, and it was in the winter that they especially seemed to enjoy being held in the hand, petted and warmed by the fire, and when I returned them to their bed, they would turn and seek my hand again so coaxingly, and when I tried to shake them off, would cling all the more persistently.

It was very interesting and most significant to note how, as time went on, Tommy's habits (I speak specially of him, as he lived the longest in captivity—four years and a half) became modified by captivity, and some entirely given up when the necessity for retaining them no longer remained. Having sufficient warmth and food supplied to him during the winter, he gradually ceased to seclude himself, except on exceptionally cold days and at night, and not always at these times. He would eat at any hour of the day, taking live insect aliment, or meat, which-

ever was offered him, or some of both, and instead of pouncing on his meat, seizing it and shaking it well and rubbing his jaws first on one side and then on the other, as if he had something alive with wings or legs to rub off, he would pick it up piece by piece quite quietly, demurely, and so prettily.

My pets shed their skin once a month, excepting on occasions of their being very weak, when a longer time would intervene between the process, which process, I inferred, must have been somewhat painful to them, as at that time they always refused food and would not allow themselves to be touched.

It always began round the mouth, neck and legs, and lasted a few days, but skinning the tail was a prolonged affair, sometimes lasting weeks. It came off in rings of about two rows of imbricated scales, which were in shape like pointed teeth, whereas the scales of the body were more the shape of imbricated diamonds, and the skin came off in a large piece, the whole length of the body. On one occasion Tommy shed his skin entire.

Their four strange, rag-doll, powerless-looking limbs, with scarcely anything worth calling feet, each of which had five long toes, were all scaled with exquisite precision. Their toes were free and furnished with claws which were delicately formed, curved and very sharp. The top of the head and temples were covered with plates or scuta. A minute plate or bone protected the orbits above their eyes.

Scales may appear a strange covering, but fur, or any kind of warmth-retaining covering is not necessary for a cold-blooded animal like a lizard, which has its circulation so arranged that the heart (with but three cavities) at each contraction, sends into the lungs only a small portion of the blood received from the various parts of the body; so that the bulk of the circulating fluid returns to the system without having passed through the lungs, and undergone the process of respiration. It is this process of respiration that communicates to the blood its heat and to the muscles their irritability.

The lizard being cold-blooded, precludes it from hatching its eggs by sitting on them, and they have to depend entirely for hatching upon the sun, or the soil in which they are deposited; the latter is the case as regards the eggs of the sand lizard (*Lacerta agilis*) and the former as regards the eggs of the common brown lizard (*Z. vivipara*) which are hatched within the body of the parent. This lizard is therefore not only viviparous but ovoviviparous, hence the reason that the female of this lizard is so often to be found during the month of June basking on a sunny sand-bank for the sake of the vivifying heat, as necessary for the exclusion of the young from the egg, the membrane covering which is very thin, and the young (which number four or five) issue forth in a permanent form, and at once lead an independent life.

It being cold-blooded also causes its digestion to be

slow, and to remain in a dormant or torpid state without taking any kind of aliment for a considerable time. Where there is but little wear, but little repair is needed.

The little common brown species is found in Ireland, and some authors say in France, Italy, Germany, Switzerland and Russia. In France, it is not so common as the sand-lizard, whilst in England it is the contrary.

Shady orchards, thickets, sunny banks and heaths are the favourite habitats of this beautiful, perfectly harmless, and really useful little reptile, to which I accord so large a share of admiration and partiality, that I am called enthusiastic, but I feel confident that the most prejudiced person could not accuse it of having anything repulsive in its appearance or manners, or that it is physically unsuited to the duties it has to perform. On the contrary, that it is admirably adapted to fulfil them.

Barton House, Canterbury.

#### ON THE FORMATION OF AN INSECTORIUM OR INSECT VIVARIUM FOR THE EXHIBITION AND STUDY OF LIVING TROPICAL INSECTS.

By GEORGE S. PARKINSON.

[Continued from p. 111.]

THIS paper is intended simply as the record of a few thoughts on the subject of the formation of an "Insectorium," and, to confine it entirely to a popular aspect, all scientific matters, excepting a few hard names, are excluded, as becomes the position of one whose claim to speak upon the subject is that of a lover of Nature, and not that of a student of Entomology.

We now proceed to a selection of "those her valued miniatures to which Nature has given her most delicate touch and the highest finish of her pencil," and merely touching up, as we proceed, with a free pen what would otherwise be a limited catalogue of orders, tribes, and names.

No. 1. *Caterpillars*.—Feed upon the leaves of plants.—Conceive an insect six or eight inches in length, and thick in proportion; beautiful beyond description in the variety of its colours; decked with all the living splendour of Nature's own handiwork: stars, bands, stripes, mosaic in patterns inconceivable, and you have a caterpillar of the tropics—a veritable harlequin appearing for a season on its leafy stage and in readiness for the most wonderful of transformation scenes possible to witness.

No. 2. *Butterflies*.—Lepidoptera Order.—Papilionidæ tribe.—Feed upon the nectar of flowers.—Veritable fairies—buoyant through space, with wings

of gorgeous hue, such as no art could reach; they pass the summer's day sipping the food of fabled gods. In very joyousness of life, they dart from flower to flower, compelling their stately rivals to droop their beautiful heads as in obeisance to their victor's claim.

To name a few varieties as exceedingly beautiful.—*Morpho*, *Caligo*, *Dynastor*, *Siderona*, *Aganistios*, *Pandora*, *Prepona*, *Agrias*, *Agesilaus*, *Argus*, &c.

No. 3. *Fireflies*.—Homoptera Order. Elaterinæ tribe.—Feed upon the flowers and leaves of plants. Brilliant stars, bringing to earth the spangled firmaments as sparks from anvil fly and cloud with wondrous lustre the foliage green. Now here, now there, love's torch displays its light to distant mate, and silent calls to join the dancing myriad throng. Now lights are sudden gone, and darkness for the moment reigns; then burst upon the sight ten thousand lamps of heavenly light and charms with rapture the astonished gaze.

Names.—*Elater noctilucus*. *Elater ignitus*. *Chalcopidius sulcata*. *Lampyrus Italica*. A small variety is common in the West Indies—the writer having easily read books by the light emitted from one or two insects.

No. 4. *Singing Cicadas*.—Homoptera Order. Cicadidæ tribe.—Feed upon the juices of living plants. Clinging to a tree stem, they would greet their visitors with the music of the woods. Cicada, Cicada, Cic-Cic-Cic-Cicada, we hear the sound, and eager creep to spot whence comes, when, lo, 'tis gone!—but yet again, Cicada, Cicada. We look in vain, for Nature's own ventriloquist has played us false.

Names.—*Fedicina munnifera*; *Fedicina opalina*, Brazil; *Toplia saccata*, Australia; *Polyneura ducalis*, India.

No. 5. *Horned Cicadas*.—Homoptera Order. Centronadidæ tribe.—Feed upon the juices of living plants. Divergent are the works of creation, ascending to the sublime in the enamelled wings of the gorgeous butterfly, yet condescending to the absolute grotesque in the remarkable form of the horned cicada.

Names.—*Membracis spinosa*, *Bocidium globulare*, S. America.

No. 6. *Leaf Insects*.—Orthoptera Order. Gryllidæ tribe.—Feed upon the juices of living plants. A wonderful group; and link, as it were, by their marvellous similitude, the insect and vegetable worlds together.

Names.—*Pterochroza ocellata*.—The coloured leaf insect, Brazil. *Pneumora rubens*.—The rose bladder leaf insect, S. Africa. *Pneumora viridis*.—The green bladder leaf insect, S. Africa.

No. 7. *Phasma Insects*.—Orthoptera Order. Phasminæ tribe.—Feed upon the juices of living plants. "The great moisture of the climate of Fernand Vaz, equatorial Africa, is well adapted for the insect world, and would prove a very rich field for a naturalist and

collector. Some insects looked exactly like the leaves on which they remain, others are exactly of the colour of the bark on which they crawl, whilst others looked like dead leaves, and one or two like pieces of dead branches of trees."

Names.—*Cladomorphus phyllium*.—The Brazilian walking-stick. *Batteria sarmentosa*.—The Indian walking stick, E. Indies. *Phyllium sicifolium*.—The walking leaf, E. Indies. *Diura chromos*, *Eclatosoma tiaratum*, *Eclatosoma eurycanthus*.

No. 8. *The Praying Mantis*.—Orthoptera Order, Mantidæ tribe.—Feed upon flies, reptiles, &c. So named from its remarkable habit of lifting up and holding its front legs together for long periods, as if in the act of prayer, but somewhat at variance with so commendable an appearance, we find the praying mantis given to most pugnacious, sanguinary and voracious habits. It is recorded of one kept in captivity, that it consumed daily some dozens of flies, occasionally a large grasshopper, also young frogs, large fat caterpillars, and even lizards three times its own length.

The Hottentot worships it, the Turk venerates it, and the Chinaman keeps it caged for fighting purposes.

The larvae are just as bad as their parents, and will fight and destroy each other.

Names.—*Mantis gongyloides*, *Empula gongyloides*, *Mantis attenuata*; common in China, Turkey, Greece, Brazil.

No. 9. *Crickets*.—Orthoptera Order, Achetidæ tribe. Are omnivorous in their dietary requirements. The cricket in the insectorium might become as familiar an acquaintance as the "cricket on the hearth," and "chirrup," "chirrup," "chirrup," an old friend's greeting, but under an entirely new aspect.

Names.—*Silvotochylus monstrans*.—Large Chinese Cricket. *Deinacrida heteracantha*.—New Zealand tree cricket.

No. 10. *Cockroaches*.—Orthoptera Order.—Blattidæ tribe. Are omnivorous in their dietary requirements. Giant ancestors of our but too familiar black-beetle, and presenting an appearance such as to render us but too thankful for small mercies, in the degeneration of their descendants.

Names. *Blatta gigantea*.—Giant cockroach, Brazil. *Acanthops fuscofolius*, Brazil. *Harpax ocellata*, East Indies. *Blepharis mendica*, Turkey.

No. 11. *Snout Beetles*.—Coleoptera Order. Capricorn tribe.—Feed upon the juices of living plants. Some of the very remarkable formations in which Creative power delights to vary creation-work. Special adaptations for special purposes, and evidences of an inexhaustible omnipotence, unapproached and unapproachable.

Names. *Cyphus Augustus*.—*Platymus ingens*, Brazil.

No. 12. *Giant Beetles*.—Coleoptera Order. Capricorn tribe.—Feed upon solid or decayed wood.



Giants; fit inhabitants of the forests deep, wandering their way amid the mighty fallen, doomed by time and storm to food and dust.

Names.—*Titanus gigas*, *Priusos hayesii*, *Macrodonia cervicornis*, *Enoplocerus armillatus*, *Ctenoscelis serripes*, *Acanthophorus maculatus*.

No. 13. *Floral Beetles*.—Coleoptera Order. Lamellicorn tribe.—Feed upon the juices of living plants. Colours varied with all the rainbow's splendour, living gems, fit setting for Nature's coronet, and designed by the great Artificer's self.

Names.—*Goliathus Drurii*.—Goliath beetle. *Goliathus casimus*, *Mycenorina torquata*, W. Africa. *Inca clathrata*, S. America.

No. 14. *Scavenger Beetles*.—Coleoptera Order. Lamellicorn tribe.—Feed upon decomposed matter. Perform a most important office in the economy of nature; gratitude should therefore take the place of aversion towards such useful and valuable scavengers.

Names.—Egyptian Scarabæus.—*Scarabæus macrochus*. Kangaroo beetle, Mexico.

No. 15. *Spiders*.—Trachearia Order. Feed upon insects, &c.—Spiders like balls of ivory; spiders like balls of ebony; spiders of rainbow hue; spiders green; spiders red; spiders wonderful; spiders beautiful; spiders terrible;—such are some of the tropical brethren of our useful little friends who lurk in quiet corners and “bother the flies.”

Names.—*Lycosa Tarentum*.—Tarantula spider, Italy. *Mygale versicolor*, large red-bodied hairy spider. *Mygale avicularia*, large hairy spider, Brazil. Trap-door spider, W. Indies.

No. 16. *Scorpions*.—Scorpiodea Order. Feed upon insects, worms, &c.

Name.—*Scorpio arreganphalus*.—Large Asiatic scorpion.

No. 17. *Centipedes*.—Myriapoda Order. Feed upon insects, worms.

Name.—*Scolopendra gigantea*.—Giant centipede, S. America.

No. 18. *Millepedes*.—Thysanoura Order. Feed upon insects, worms, &c.

Names.—*Julus maximus*, Brazil. *Spirostreptus olivaceus*, Africa. *Spiroboles beauvoisii*.—Giant millepede, Galapagos Islands.

**SLUGS.**—It is a fact well known to those who study the habits of slugs that most species of *Limax* have the power of letting themselves down by means of a thread of their mucus. Of the British Limaces, the tree slug (*Limax arborum*, Chant; *marginatus*, Müll.), owing to its habitat, possesses this power to a greater degree than do the others. Personally I have made experiments with a large specimen of *Limax Sowerbii*, and it let itself down three inches or so before dropping. It is also said that the slugs can crawl up the thread again, but I have not yet seen it done.—*Wilfrid Mark Webb*.

## PATHOLOGY AND ITS RELATION TO EVOLUTION.

[Continued from p. 102.]

CHARLES DARWIN, on p. 231 of his “Descent of Man,” and also again on p. 262 of the first volume of his “Animals and Plants under Domestication,” makes mention of the Polish sub-breed of fowls, in which there seems to be every evidence to affirm that the females were the first to



Fig. 59.—Head of a Polish fowl with feathery tufts. After Darwin.

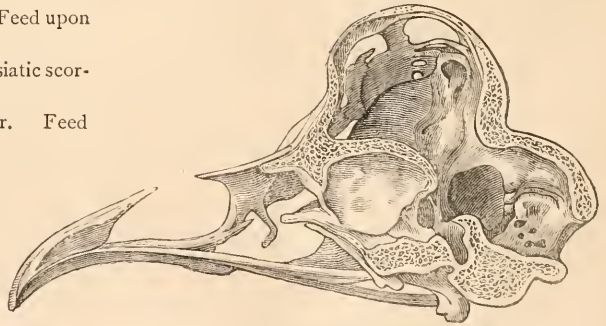

Fig. 60.—Section of skull of the Polish fowl, showing the protuberance.

develop a crest, which was afterwards transferred to the males. The stock from which the whole race of our domestic fowls was derived, is an Indian one, *Gallus Bankiva*.

Look at the two figures above. There you have one figure of the head of a Polish fowl, taken from Darwin, showing the tuft, and another diagram to illustrate the enormous protuberance in the skull of one of these from which the crest arose. This cavity often exhibits membranous spaces. Virchow said this cranial deformity was due to an hereditary encephalocoele—this is a hernial sac of the membranes

of the brain containing cerebro-spinal fluid and cerebral substance—years back in his "Onkologie," and it is consolatory to know that in a work published by him last year, entitled "Descendenz und Pathologie," he still holds the same belief.

But there is an analogous instance that sometimes occurs in man. In spina bifida—a congenital malformation of the spinal canal—and in that form of it more especially specified as "oculta," with some thickening of the parts, and a greater development of fat and muscle fibre near to the seat of the disease, irritation often gives rise to a most abundant crop of hairs. Mr. Sutton regards the crop of feathers in the case quoted above of the Polish fowl, as arising in much the same way at the first time, but which afterwards became hereditary.

Leaving this subject now to proceed to Polydactylism, or the appearance of supernumerary fingers and toes. Darwin in "Descent of Man," in a note at the bottom of p. 37, says that in vol. ii. p. 12, of his "Variation of Animals and Plants under Domestication," he "attributed, though with much hesita-



Fig. 61.—Bifurcation of the third digit of a horse.



Fig. 62.—A similar specimen. Roy. Coll. Surgeons Mus.

tion, the frequent cases of Polydactylism in men to reversion." And then: "I was partly led to this through Professor Owen's statement, that some of the Ichthyopterygia possess more than five digits, and therefore as I supposed, had retained a primordial condition: but Professor Gegenbaur ('Jenaische Zeitschrift,' B. v. Heft 3, S. 341) disputes Owen's conclusion. On the other hand, according to the opinion lately advanced by Dr. Günther, on the paddle of *Ceratodus*, which is provided with articulated bony rays on both sides of a central chain of bones, there seems no great difficulty in admitting that six or more digits on one or on both sides might reappear through reversion. I am informed by Dr. Zouteven that there is a case on record of a man having twenty-four fingers and twenty-four toes! I was chiefly led to the conclusion that the presence of supernumerary digits might be due to reversion, from the fact, that such digits not only are strongly inherited, but as I then believed, had the power of regrowth after amputation, like the normal digits of the lower vertebrata. . . . But at present it is the safest course to give up altogether the idea, that there is any relation between the development of super-

numerary digits and reversion to some lowly organised progenitor of man." (1883 edition.) Bifurcation of the axis of a limb has been described by Albrecht in the mud-fish, and by Howes in *Ceratodus*, and I published some years back a case of a smooth newt in which a bifid tail occurred. In the figure below of the foot of a horse, preserved by Chauveau, in the Veterinary School of Lyons, a good illustration of a bifurcation of the digits is seen:—"In this case the phalanges attached to the main (third) metacarpal have bifurcated." And Mr. Sutton says, "if these are to be regarded as examples of atavism we shall be obliged to find animals with two tails, any number of spare digits or even limbs."

Fig. 62 is from a specimen of the right foot of a horse in the Museum of the Royal College of Surgeons in which a well-developed extra toe is interposed between the inner splint bone and the middle toe. "The second row of carpal bones is preserved and exhibits an additional bone. The animal was shod on both toes." This case shows how careful we must be in making any statement without thought that any given appearance of some abnormality is a reversion. At first sight we have the Hipparion-type. But look close and think—if a case of reversion the thumb must be represented by the inner splint-bone, a matter contrary to the dogma laid down so thetically that those parts which abort last would be the most likely to reappear in successive generations. Then "if we take the pains to compare the specimen with Chauveau's case represented beside it, there remains very little doubt that it is not atavistic but a reduplication of the middle digit—in fact a malformation."

Mr. Sutton adds a caution which we very often see forgotten, "that we must be careful not to confound physiological types with reversions. For example: an erectile tumour is structurally similar to the comb of a cock, yet no one would venture to suggest that the *nævi* which occur so frequently in infants immediately over the anterior fontanelle are to be regarded as reversion to a cock's comb." In concluding, I do not think there can be one "pebble bead of doubt"—to use an expression of Keats—in the mind of any single impartial reader with reference to the logical conclusiveness of these references of Mr. Sutton.

The muse of Mrs. Emily Pfeiffer has made her utter in one of the finest sonnets, that evolution is

"The unknown God on whom we wait:  
His path the course of our unfolded fate."

It is evidently the cynosure around which every exploration and yearning to Nature to unbosom her secrets, must turn, as round a central pivot of creative might.

"The teachers of utility would think that they lost their God, if they did not worship Him who gave the ox horns to defend itself. But I hope I

may be allowed to worship Him, who in the abundance of His creation was great enough, after making a thousand kinds of plants, to make one more in which all the rest should be comprised; and after a thousand kinds of animals, a being which comprises them all—Man.”—Eckermann. *Conversations with Goethe.*

J. W. WILLIAMS.

#### THE SCORPIONS OF MEXICO.

ONE of the greatest, if not the greatest pests in Mexico are the land scorpions (genus of Arachnida), which, at certain seasons of the year, become as numerous in the houses as flies. They swarm in all parts, within the cracks of the wall, between breaks of the tiles of the floor, inside your garments, darting about with inconceivable rapidity, waving their sting, which is located at the end of the tail, in all directions, either for attack or defence. Turn up a rug or table cloth and you disturb a flourishing colony, shake your shoes in the morning and out they dart. Their colour is generally mahogany-hued and their length about two inches, but in some instances they have been seen of more than double that length. Their sting is seldom fatal, but much dreaded by the inhabitants, as it is more or less severe, according to the condition of the system. Victims have been known to remain for days in convulsions, with stomach swelled as in dropsy; while others do not suffer much more than from a wasp or bee sting. Their food consists of beetles and other insects, and also the eggs of spiders. The anterior pair of feet or palpi are modified into pincers or claws like those of a lobster, by which it seizes its prey, piercing this with their stings again and again before beginning the meal. The young are produced in great numbers at very frequent intervals, the mother displaying far more regard for her offspring than their vicious natures seem to justify. During their infancy she carries them about, clinging in great numbers to her back, limbs and tail, never leaving her retreat for a moment, unless overburdened by their weight her hold relaxes from the wall and down falls the whole happy family. When they are bad enough, they generally reward the maternal devotion by destroying the mother, tearing her piecemeal with the greatest ferocity. Geologically the class Arachnida is of great antiquity, as they are found in a fossil state in the coal measures in various parts of the world. The scorpions are the largest and most formidable members of the class Arachnida, and they are, for the most part, confined to the warmer regions of the earth. The genus (*Androctonus*) to which the largest European form belongs, is chiefly represented in Africa, although they occur in Western Asia as well as in Europe. Its name, which signifies “man killer,” indicates the

dread with which they are regarded in Africa, where their sting is productive of painful consequences, but whether it is ever fatal remains in doubt.

DIPTON BURN.

March, 1887.

#### KOCH'S COMMA BACILLI.

HEREWITH an extract from the “Twenty-Second Annual Report of the Sanitary Commissioner to the Government of India” (p. 192, Sec. x.):—

“The most interesting results obtained in the Biological Laboratory (of Calcutta) during the course of last year, so far as the question of cholera is concerned, were those in a series of experiments on the subcutaneous inoculation of the so-called ‘Cholera Comma Bacilli,’ into the bodies of guinea-pigs. They clearly showed that such inoculations are not unattended by serious risks, as in a considerable proportion of the cases they were followed by fatal results, attended with such uniform and characteristic symptoms as could leave no reasonable doubt that a specific pathogenic influence had been at work. An excessive multiplication of the bacilli had occurred, especially along the course of the lymphatic channels. They were present in vast numbers in the subcutaneous lymphatic spaces extending from the site of injection, and which were full of a sanguineo-serous effusion diffused over varying, but always considerable areas. The bacilli were not, however, confined to the subcutaneous lymphatic system, but were present in multitudes in the peculiar adhesive secretion lining the peritoneal cavity. None could be recognised in specimens of blood, but the result of cultivations appeared to show that they were present in it in limited numbers, as pure crops of commas were invariably developed. One very conspicuous and important feature in all the cases was the presence of large numbers of the bacilli within the intestinal canal. In some cases the numbers here were excessive. In all, their presence was accompanied by softening and a tendency to desquamation of the epithelium, and in one case this had advanced so far as to result in absolute denudation of the entire mucous membrane throughout the whole course of the canal. Cultivations clearly showed that the bacilli were specifically identical with the true choleraic commas, and differed from the curved bacilli normal to the intestinal tract in guinea pigs. Although careful search was made, no bacilli could be detected in the substance of the walls of the canal, and certain phenomena appeared to indicate that their transfer from the peritoneal cavity to the interior of the gut was effected, not by general diffusion, but by the agency of ‘carrier corpuscles.’ The phenomena present in these cases do not warrant the definite



conclusion that they were of a truly choleraic nature. They, however, clearly show one thing, for whether the disease were choleraic or not, there can be absolutely no doubt that choleraic commas were present within the intestinal canal in large numbers; and, therefore, that their presence there in any case cannot be taken as conclusive evidence that this was the site of primary invasion of the system by the parasite."

The experiments reviewed above were conducted by Dr. D. D. Cunningham. The importance of my extract must be my apology for its length.

W. J. SIMMONS.

Calcutta.

#### THE DEVELOPMENT OF THE TADPOLE.

HAVING had an opportunity last month of watching day by day the development of this animal, from the first segmentation of the egg to the full-grown tadpole, I paid particular attention to the first appearance and disappearance of the cilia in the epidermis, the presence of which I mentioned in a note on p. 187 of last year's volume, and am now able to give some further particulars on the subject.

I obtained some frog's ova on the 17th of March which had just been laid, and saw the breaking up of the large primitive cell into two, four, eight, sixteen, etc., segments, until a vast number of small cells were produced, and by the next day the morula stage of the embryo was completed. On the third day, a semicircular depression indicated the ingrowth of the epiblast and formation of the blastopore, which was completed the same evening. On the fourth day, the first indication of a dorsal depression, the primitive groove, giving rise to the brain and spinal cord, became visible, and had made considerable progress by the evening of the same day. On the fifth day, the medullary folds closed over the primitive groove, and the line of contact became almost obliterated. Anteriorly, a median depression indicated the formation of the future mouth, and below this were two lateral depressions for the suckers. One blastopore was still visible as a small pore, but no indication of the tail was as yet visible.

At this stage, and on the evening of the fifth day, the cilia made their appearance. I saw the very minute cilia distinctly, when their motion was still very weak; but shortly afterwards they could no longer be seen, on account of their rapid motion. Their presence was, however, clearly indicated by the strong current in the fluid surrounding the embryo within the egg membrane, which current did not exist before. On the following day, the cilia had become much larger, and by careful adjustment of the light, I have seen them every day until the twenty-eighth day, when they finally vanished.

The young tadpoles emerged from the egg on the

seventh day, attaching themselves with the suckers to the gelatinous egg-shells; and before they could swim the action of the cilia was sufficient to propel them slowly through the water.

The cilia do not cover equally the whole epidermis, as would appear at first sight; but a number of single cells only acquire cilia, and these are separated from each other by three or four cells which do not bear cilia. As the embryo grows, the distance between the ciliated cells increases somewhat, and the appearance of "tufts" of cilia is produced.

The cilia are first lost on the tail. On the twenty-fifth day, they were still very active; but after that day they gradually disappeared, and on the twenty-eighth day I saw the last trace of them, being twenty-three days after their first appearance.

I have also seen the cilia with high powers in various ways—by crushing the embryo, making rough sections with the scissors, etc. But the most satisfactory way of seeing them is to proceed as follows: Kill the young tadpole by cutting off his head; then cut off his tail, and place the latter on a glass slide in a drop of water; add a drop of stain, carmine, or logwood; put on a cover glass, and examine at once with  $\frac{1}{4}$  or  $\frac{1}{2}$  in. object glass. All round the edge of the tail the tufts of cilia will be seen still vibrating feebly. In this way I have measured them, and find their length to be about  $\frac{1}{1500}$  in. I have mounted a tail in balsam, after hardening in chromic acid, and it shows the cilia perfectly.

I have also demonstrated the vibrating cilia to the satisfaction of the president and members of the Quekett Microscopical Club, at the March meeting.

As the development of the tadpole is accelerated by warmth and retarded by cold, I must add that I kept them in a small aquarium in my room, where the temperature varied between  $14^{\circ}$  and  $18^{\circ}$  centigrade.

CHARLES ROUSSELET.

#### THE EYES OF THE WATER-FLEA.

ALL eyes, however complex, are developed from a portion of the epithelium of the skin. All that is required for the formation of an eye is a mass of pigment, with a transparent refractive body to concentrate light on it, and a nerve to bring the pigment into relation with the central nervous system of the animal.

When light falls on animal pigment, some change, either chemical or physical, occurs in that pigment, and the conscious effect that this produces in the part of the nervous centre set apart for its reception, is called vision.

An eye may be formed in any part where there is epidermal epithelium. In the leech, for instance, it is found that in several parts of the body individual cells of the skin are modified so as to form lenses,

the ends of which rest on an accumulation of pigment. These form elementary eyes.

The water-flea (*Daphnia pulex*) is possessed of two eyes, one simple and the other compound, or multi-lenticular. The former is of the simplest construction, consisting merely of a small mass of pigment behind a not very highly refractive body: it is represented at *oc*.

The compound eye, though of simple optical construction, is a much more complex organ, and shows

the compound eye of the water-flea is medial and single. This is also noticed in Cyclops, Cypris, and some others.

The illustration was drawn with a camera-lucida from a living specimen. It is magnified about three hundred diameters, and seen in optical vertical section.

The carapace, modified to form a cornea, is seen at *ca*. The space *c.s.* corresponds in position with the aqueous humour of the vertebrate eye, but struc-

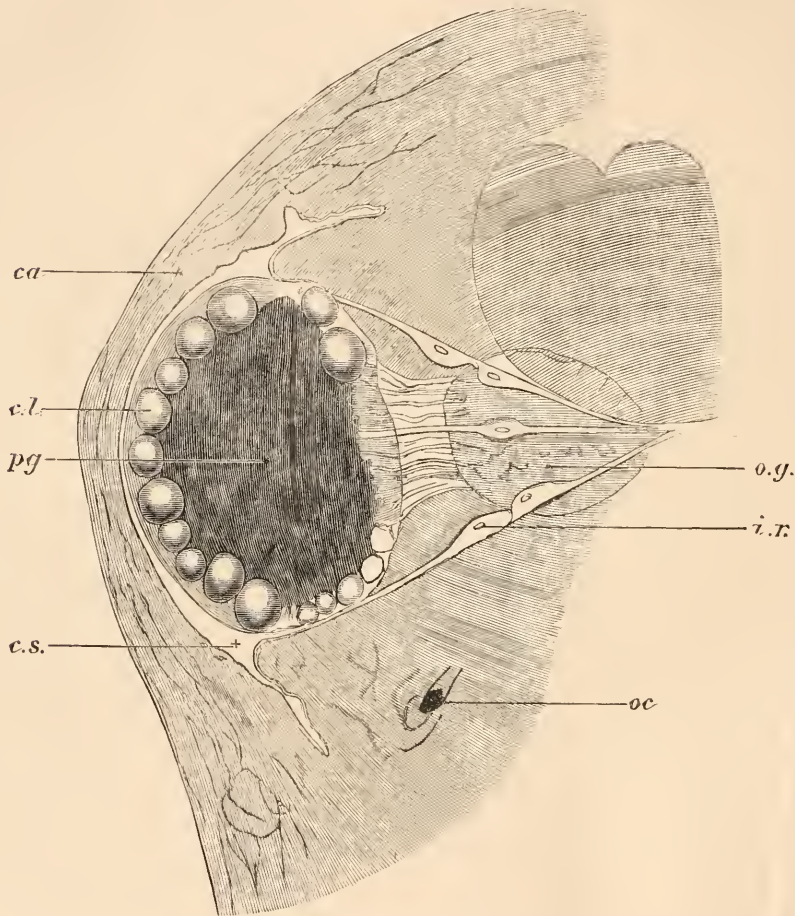

Fig. 63.—Eyes of Water-Flea.  $\times 300$ .

in a marked degree the way Nature adapts herself to circumstances.

The water-flea is transparent, hence there is no need for the eye to be protruded or stalked, as in the higher crustaceans. The transparent carapace, or shell, forms a protection for the eye, whilst not interfering with its visual powers. Again, from the transparency of the animal, there is no need for the eye to be divided into separate halves, as in the higher members of the same family. Accordingly we find

naturally with the conjunctival sac, the carapace *ca* being only a functional cornea. This space is lined with a delicate membrane, which is seen to be doubled on itself at the upper and lower angles; the redundancy at this part is to allow of the eye's being moved with freedom.

The eye itself is an ovoid mass of pigment, represented at *p.g.* It is surrounded on all sides, except at a portion of the posterior surface, with a number of highly refractive spherical lenses (*c.l.*). Advantage

is here again taken of the animal's transparency ; some of the lenses are seen to look directly backwards through the substance of the body. One of these posterior lenses is seen in the drawing to be very well developed.

At *o. g.* is seen the optic ganglion, the ultimate structure of which was not visible. From this to the back of the eye are seen running a number of delicate nerve-fibres ; these can be traced into the pigment, but the way in which they end cannot be seen, owing to the opacity of the pigment.

The movements of the eye are effected by four muscles, corresponding in position and action with the four *recti* muscles of the human eye.

They may be termed the superior, inferior, right, and left muscles of the eye. They are each composed of one or two unstripped muscle cells, with well-marked nuclei. In some specimens the muscle is branched at the insertion into the eye. They arise from a common origin at the back of the optic ganglion. In the illustration, the letters *i. r.* point to the inferior muscle.

The movements of the eye during life are incessant, and the action of the muscles can be readily made out.

Whether the movements are voluntary or not, cannot be ascertained, but from the structure of the muscular fibre, it may be presumed that they are involuntary, since the animal possesses the striped variety in other parts of the body.

JAMES HARVEY.

### THE PYGIDIUM OF THE FLEA.

THE pygidium is somewhat kidney-shaped, and is firmly adherent to the eighth segment of the abdomen, which, by strong muscles, can be drawn beneath the seventh. Being bi-lobed, it forms an arch above the posterior portion of the large rectum, extending from the last pair of spiracles to the anus. In *Pulex irritans*, each lobe is perforated by fourteen cup-like bodies, or areolæ ; these, when seen from the exterior, under a tolerably high magnifying power, have the appearance of disks ornamented with a ring of rectangular rays, as represented in Fig. 64. The number of rays vary from eight to eleven, according to the position of the disk. From a transverse section of the pygidium, the areolæ are seen to extend below the chitinous cuticle, the base of each resembling an

inverted groined arch, the centre of which is pierced by, and supports, a long seta. Externally, each areola is protected by a transparent chitinous dome, perforated at its summit with an aperture sufficiently large to permit free movement in every direction of the long seta passing through it, as seen in Fig. 65. From specially prepared sections of the pygidium, nerves are seen whose ends expand into large globular masses, each surrounding the base of an areola, and

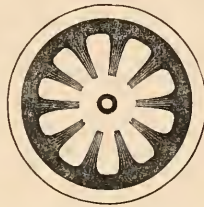

Fig. 64.—Disk-like areola, front view, much enlarged.

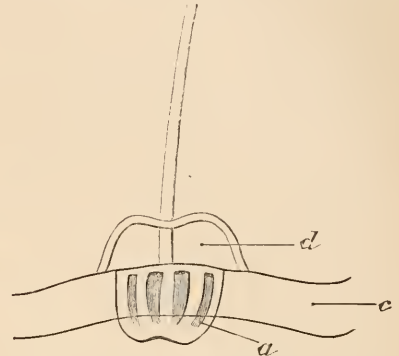

Fig. 65.—a, areola ; c, chitinous cuticle ; d, dome, side view, much enlarged.

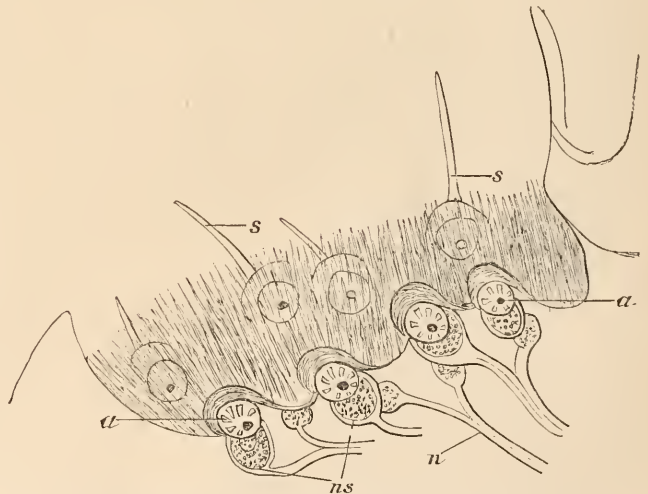

Fig. 66.—Oblique section of Pygidium. s, long seta ; a, areola ; n, nerves ; ns, nerve-swelling. X 210.

enclosing the lower end of the long seta. In some of these swellings a large nucleus is visible, and all appear granular. Fig. 66 is taken from an oblique section of the pygidium, in which nerves and their swellings are seen connected with four areolæ, and portions of others which supply areolæ not visible in this section.

Villaines has observed ganglia in the skin of insects, which give off process to certain hairs ; also Künckel and Gazagnaire have discovered nerve-swellings connecting nerves with specialised hairs in the skin of the



larva of Diptera. In no case have I been able to trace a nerve penetrating the long seta of the pygidium; and evidently the hairs themselves are non-sensory. Though not an auditory organ, it is most probably its equivalent, and may represent more than one sense insufficiently developed to be differentiated, but enabling the animal to perceive movements in the immediately surrounding atmosphere, and thereby escape danger. Such an organ is rendered the more necessary by the flea having only one pair of rigidly fixed simple eyes, which can have but a very small range of vision, and also by their habit of living and feeding where there is but little light. The pygidium is confined to this family of insects, but the cerci of the cockroach may be its analogue.

W. JENKINSON.

Sheffield.

### GOSSIP ON CURRENT TOPICS.

By W. MATTIEU WILLIAMS, F.R.A.S., F.C.S.

**M**AGNETISED WATCHES.—So long as steel continues to be used in the balance-wheel and other parts of watches, their reliability as time-keepers is imperilled by the development of electrical appliances. Nobody who has any respect for his watch should approach within three or four feet of a working dynamo. The "Electrical World" tells a curious story of a lady who was about to visit the station of an electric light company, and who being forewarned of the danger left her watch at home. Nevertheless she found that after this visit her watch lost time whenever she wore it, although it ran correctly when left in her room. Strange ideas concerning personal polarity and animal magnetism naturally entered her mind. These, however, were removed by a gentleman who ventured to suggest that she should try another pair of stays. She did so, the watch behaved properly, and a full explanation of its previous irregularities was supplied. The steel corset supports of the first pair had become magnetised by induction, and they retarded the watch. The oblong shape and position of the elements of the metallic scaffolding that so many women regard as necessary for bodily support are peculiarly favourable to polarisation by induction. The retardation of a watch is, however, but a trivial evil compared with the interference with still more delicate and important machinery, with the retardation of the movements of respiration, and the weakening of all the muscles of the trunk, which are bandaged and deprived of natural freedom of exercise by such artificial "supports." I speak now only of the rigidity of corsets that are worn by reasonable women, quite irrespective of the victims of tight-lacing. These are all under sentence of death, and past praying for.

**ENGLISH SPARROWS IN AMERICA.**—The newspaper naturalists who imagined that sparrows feed on caterpillars, and some years ago agitated very sentimentally for their preservation, were sufficiently successful to induce the Americans to import a supply of feathered vermin. These have now become such a nuisance in the United States that expensive attempts are made to effect their extirpation. They devour cherries, currants, and other small fruit as here; they shell and eat the growing peas; they drive away the singing birds, and those which are really insectivorous, and have slender bills unable to cope with thieves. These and other evils are now fully established; but lately they have appeared in a new character—that of incendiaries. The "Scientific American" tells us that a bar-mill has been on fire three or four times, and in every case the fire was caused by English sparrows picking up old pieces of cotton waste, with which they build their nests in the timbers of the roof. These nests were fired by sparks from the hot iron, or as supposed, though very improbably, by spontaneous combustion. It is true that accumulations of old greasy cotton waste are very liable to such combustion, but the quantity demanded for this far exceeds that in a bird's-nest.

**ENGLISH SOLES IN AMERICA.**—Very different from the above are the results of another importation to America of British species. One of the best of all our fishes—the sole—has been successfully transplanted. I say "transplanted," as the habits of this fish render its naturalisation in a new region very much like transplanting. If placed on a suitable soil it remains there with but little locomotion, and ultimately covers the ground pretty closely. This being the case, nothing is easier than to destroy such a colony by sweeping the ground with a steam or even sailing trawl. I remember when soles of the finest quality were retailed in London at the rate of about threepence per pound, and even at half this price. It was when "the Silver Bank" was discovered. At first the soles were mostly of very large size, gradually they became smaller, finally only slips, and ultimately the fishery was ruined. I have advocated in vain the necessity of penal legislation against the selling or landing of slips, that is, soles less than six inches long. If this were enforced, these delicious fish might still be as abundant and cheap as plaice. Let us hope the Americans will be wiser than our legislators.

**THE WHITEFISH IN ENGLAND.**—In just and most desirable retaliation for our export of soles, the Americans have sent us their whitefish, of which most of us read so much and know so little. Some of those turned into the waters of Burghley Park, a year ago, were lately caught and found to have attained a length of seven inches. The National Fish Culture Association is actively engaged in the

useful work of incubating large numbers of the ova of this species, and will doubtless distribute them judiciously when they are big enough to leave the nursery.

A REVIVAL.—I have been amused on reading in a contemporary publication the following under the heading, "A New Barometer." "Put a leech in a flask of clear white glass, containing half a litre, and rather wide than narrow. Cover the opening with a piece of coarse cloth, and then there will be a convenient barometer requiring no more attention than the changing of the water once a fortnight. If the leech is coiled up at the bottom of the flask there will be fine weather; but when it comes to the surface of the water there will be rain. If it moves about the flask with violence there will be a strong wind; but should it make somersaults, or have convulsions, there will be a tempest." I remember reading a similar account of this *new* barometer in "The Boy's Own Book," or "Endless Amusements," when my intellectual faculties were in the course of development under the stimulating influences of the schoolmaster's cane. This was some years since. By dint of self-denial I saved a sufficient number of coppers to purchase a leech and suitable bottle. But there was something wrong either with the animal or the weather. In spite of great efforts to reconcile their movements with the description I failed. In the extreme case of tempest this may have arisen from my want of skill in diagnosing the symptoms of leech convulsions. I have no recollection of the performance of any somersaults, but can distinctly repicture a very characteristic movement by which the animal became alternately hoop-shaped and straight; but it did this in fine weather and other weather indiscriminately. Further observations in a wider field, supplied by a leech aquarium in the window of a druggist's shop, only multiplied the discrepancies. Some of the leeches went in for fine weather at the same time that others were vigorously predicting storms.

#### THE PRESERVATION OF TELEGRAPH POLES.—

This has now become a business of some importance, the amount of capital invested being very great, and the tendency to decay so serious where wood is still used. Norway is remarkably well served with telegraphic communication. I doubt whether any other country has, in proportion to its population, so large a mileage. The wires there follow not merely the railways, but most of the ordinary roads. A method is now adopted there for preserving the wood, which is said to be eminently successful. A hole about three-quarters of an inch in diameter is started at about two feet from the ground, and bored with a downward slant towards the centre of the pole. About a quarter of a pound of powdered sulphate of copper is rammed into this hole, which is then closed

with a wooden plug. The humidity of the wood gradually dissolves the salt, and the solution diffuses itself through the pores of the wood by capillary action. As it thus spreads the wood assumes a greenish hue, and the supply of salt is renewed as it dissolves and passes from the hole. The antiseptic properties of copper salts are well known. Railway sleepers and many other structural elements may be thus treated.

ANOTHER USE OF LUMINOUS PAINT.—Herr Stehle, the Government Inspector of the Royal Bavarian Theatre, reports that in the National and Royal Court Theatres sheets of cardboard, painted with the word *Ausgang* (way out), have been placed in the corridors and other parts, and that on turning off the gas they become sufficiently visible to guide the audience in the midst of the darkness. As turning off the gas is demanded in cases of partial fire, it is believed that such placards may mitigate the disasters that have occurred, as in the case of the Jewish Club at the East end of London, where seventeen lives were lost in the course of a few minutes.

THE EQUINOCTIAL GALES.—Popular beliefs are very stubborn. "So much the worse for the facts," is the popular verdict when facts are brought against tradition. Among people who never fail in their aspirates, and therefore claim to be highly educated and utterly superior, we continually hear of sea-voyages being postponed in order to escape the equinoctial gales. September is dreaded, and even avoided at much inconvenience, although meteorological records, and the common experience of practical sailors, place it among the least stormy months of the year. The most stormy period of all falls about midway between the autumnal and spring equinoxes, at the farthest possible distance from either, i.e. about the end of December and the early part of January. At the Meteorological Conference of 1884, Mr. R. H. Scott stated these facts in detail, taking an average of fourteen years from 1870. The records of the Meteorological Office show that the most stormy period of the year is that of the winter months. This is perfectly well understood by sailors. Many ships are provided with two sets of sails, winter sails and summer sails; the winter sails being of thicker and stronger canvas than the summer sails, in order that they may resist the stronger winds. I never heard of equinoctial sails, which should be provided if the equinoctial gales were other than mythical.

The evidence supplied by our British records are further confirmed by observations made in other countries. Thus, Dr. R. Müller publishes, in the last April number of "Mittheilungen aus dem Gebiete des Seewesens," an analysis of the records of the Anemometer of Pola, from 1876-86. Sixty-three per cent. of the strong winds and gales in the Adriatic

occurred in the winter season—October to March. On the German coasts the winter percentage of storms amounted to 80 per cent. September showed but 3 per cent. instead of its fair average of  $8\frac{1}{2}$  per cent. March is windy, the stormy winter season not ending until somewhat later; the gales of March are winter gales, not equinoctial.

DEMORALIZED CATS AND MONKEYS.—M. Ludovic Jammes, in a paper communicated to the Academy

## BELEMNITES: THEIR HISTORY AND MODERN ANALOGUES.

By H. E. QUILTER.

IT would be unwise on my part to enter into the history of the knowledge of Belemnites, as it is almost the history of the science of Palæontology.

Belemnites were formerly regarded with superstitious awe, enhanced by the application to them of

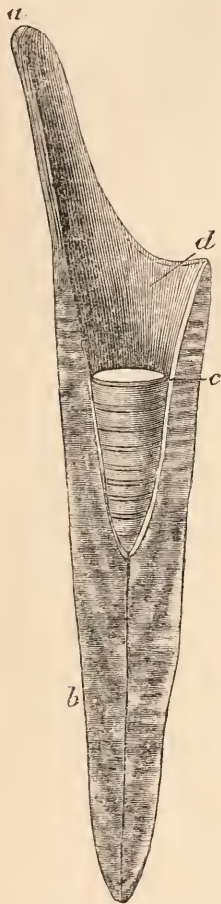

Fig. 67.—Diagram of Belemnite. (After Phillips.) *a*, pro-ostracum; *b*, rostrum, or guard; *c*, phragmacone; *d*, alveolus. Note.—The rostrum and pro-ostracum are shown in section; the phragmacone is entire.



Fig. 68.—*Belemnites abbreviatus*, showing phragmacone in situ.



Fig. 70.—*Belemnitella mucronata*.



Fig. 69.—Phragmacone, showing chambers.



Fig. 71.—*Belemnites hastata*.

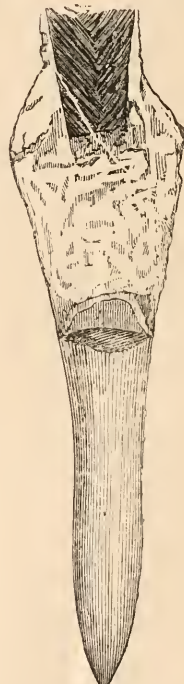

Fig. 72.—*Belemnites puzosianus*.

of Sciences on 25th of April, described some painful cases of cats and monkeys acquiring a love of the fumes of opium through association with the opium-smokers of Camboja and China. "Evil communications corrupt good manners."

M. THOLLON, the eminent spectroscopist, died suddenly at the Nice Observatory on Good Friday.

such names as *Spectrum candela* and *Digite diablo*, while at present they are popularly called "thunderbolts."

They are now however, known as the internal shells or bones of a Cephalopodous mollusc, or cuttle-fish.

This internal shell, or skeleton, is the only part of the animal found fossil. When perfect, or restored, it may be conveniently divided into three parts:—



1. A subcylindrical longer or shorter fibrous body, termed the rostrum or guard; this is the part so commonly found in a fossil condition. In the front or broader end of the rostrum, there is a conical cavity, called the alveolus, containing—

2. The phragmacone. This consists of a conical series of chambers, with a minute globular nucleus at the apex, separated from one another by curved septa, perforated with apertures for the passage of the siphuncle.

The siphuncle passes through the middle of the ventral wall of the phragmacone, the whole series of chambers being enclosed in a thin shell wall.

“The phragmacone is not a chambered body made to fit into a conical hollow previously formed in the sheath (or rostrum), as some have conjectured, but

From the specimens which have been well preserved and brought to light, much has been learned with regard to the external anatomy of the Belemnites. The animals are known to resemble the modern cuttle-fishes, having lateral fins, with eight arms, and two longer tentacles bearing suckers. These suckers were provided with horny hooks. The animal could also eject at will a jet of “ink,” having an ink-sac; the mouth was provided with horny mandibles.

This knowledge of an animal enables us to place it in the scheme of classification now adopted by biologists.

Like the modern cuttle-fishes, the Belemnitidæ sometimes attained a large size. It is conjectured that some were four feet in length. It is probable



Fig. 73.—Restoration of an ancient Belemnite.

Fig. 74.—Internal bones of a recent cuttle fish.

that both sheath and cone grew together, or if any difference there were, the phragmacone must have been of earlier growth, and by its enlargement limited the forward extension of the successively deposited lacunæ of the guard. The phragmacone was formed on the exterior of a secretive surface, and the sheath on the interior of another secretive surface. The last chamber of the phragmacone is very large, compared with the others” (“*Mon. of Belemnitidæ*,” Phillips, *Palæont. Soc.*, 1865–69).

3. The thin shell wall or “*conotheca*” is prolonged forwards into an anterior horny or shelly plate, termed the *pro-ostracum*. This *pro-ostracum* is very rarely found fossil owing to its tenuity, but Huxley believes that it would, if properly preserved, have afforded important generic and specific characters in the classification of the Belemnites.

also they were carnivorous. Their habits have been so well described by Mr. Ansted, that I may be excused quoting him. He says: “We may picture to ourselves these large cephalopodous molluscs reigning paramount, the tyrants of creation, enabled by their rapidity of movement to chase their prey at the surface, by their curious hydraulic contrivance to pursue it to the depths of ocean, and by their numerous arms and great strength, to conquer and bring it within the grasp of their powerful jaws.”

The recent animals of this class are so fierce, that even in our own seas, where they occupy a place comparatively unimportant, they rank among the most destructive of species in proportion to their dimensions; for if once they touch their prey it is enough, neither swiftness nor strength can avail. The shell of the crab and the lobster is a vain

protection, and even animals many times their size have soon been disabled in their powerful and pertinacious grasp.

The species of the genus *Belemnite* range in Britain from the Lower Lias to the Greensand (Cretaceous) formations.

They attain their maximum development in Jurassic rocks, in which are found 112 species, of which sixty-nine species occur in the Lias, while only eight species are found in the Cretaceous.

In the Lower Lias of England the *Belemnites* make a rather sudden appearance, they are small in size, and not at all numerous, but soon become large and common, and in the upper beds of the lower Lias are so numerous as to form *Belemnite* beds.

The zone of *Amalthus oxynotus* in the South of England is called the "*Belemnite* beds" from the abundance of *B. acutus*.

The term "*Belemnite* beds" is given by French and German geologists to the zone of *Egoceras jamesoni*, from their abundance both in individuals and species.

The upper portion of the zone of *Egoceras henleyi*, was called by De La Beche the *Belemnite* bed.

Dr. S. P. Woodward, in his "*Manual of the Mollusca*" gives the following sections and sub-sections of the species of the genus *Belemnites*, which Phillips thought to be the best classification.

Section 1.—ACELI (Bronn). Without dorsal or ventral grooves. Sub-section 1.—*Acuarii*. Without lateral furrows; but often channelled at the extreme point. Type, *B. acuarius*. Lias. Sub-section 2. *Clavati*. With lateral furrows. Types, *B. clavatus*. Lias.

Section 2. GASTROCELL.—(D'Orb.). Ventral groove distinct. Sub-section 1.—*Canaliculati*. No lateral furrows. Type, *B. canaliculatus*. Oolite. Sub-section 2.—*Hastati*. Lateral furrows distinct. Type, *B. hastatus*. Lias.

Section 3. NOTOCELL.—With a dorsal groove, and furrowed on each side. Type, *B. dilatatus*. Cretaceous.

With the apparent extinction of the *Belemnites* proper, a new genus, derived from them, appears; this is the genus *Belemnitella*.

In this genus, the skeleton is very similar to the *Belemnites*, but there is a straight fissure in the guard, at its upper end, on the ventral side of the wall of the alveolus, and the surface is distinctly marked with vascular impressions.

This genus is confined to the upper part of the Cretaceous formation, only five species being known, but they are very numerous. In this comparatively little range there are recognised horizons or zones of *Belemnitella*.

Dr. S. P. Woodward ("*Man. of Moll.*") has described a species of *Belemniteuthis* from the Mid. Oolite (Oxford Clay).

Shell consisting of a phragmacone, like that of a *Belemnite*, a horny dorsal pen, with obscure lateral

bands, and a thin fibrous guard, with two diverging ridges on the dorsal side.

Authorities, however, question the validity of this genus.

Huxley ("*Structure of Belemnites. Mem. Geol. Survey,*" 1864), has also described a species of *Xiphoteuthis*:—guard narrow and cylindrical, containing a very long, deep-chambered, narrow-phragmacone. Pro-ostracum greatly developed, nearly a foot in length, very narrow at its base, widening out anteriorly, and finally terminating in a pointed apex.

One species known from the Lias.

There are three families found fossil, so nearly related to the *Belemnitidae*, although being placed before them in classification, that I may describe them for the purpose of my subjects.

Teuthidæ. (Myopsidæ, D'Orbigny.)

Teudopsis: (Deslongchamps):—Pen lanceolate, produced in front, dilated and spatulate behind.

Five species from the Lias.

Beloteuthis (Münster):—Pen lanceolate, pointed in front, with two small wing-like expansions behind.

Six species described from the Upper Lias by Münster.

Phylloteuthis:—Pen corneous, thin, and sub-ovate, slightly concave below, and convex above, the anterior end narrow.

Cretaceous formation.

Leptoteuthis (Meyer):—Pen horny, hastate, broad in front, pointed behind.

One species from Oxford clay.

Enopoteuthis (D'Orbigny):—Pen lanceolate, arms provided with a double series of horny hooks, concealed by retractile webs.

Now living in Mediterranean and Pacific. One species fossil from Oolite.

Acanthoteuthis (Wagner), Münster:—This genus is founded upon the fossil hooks of a calamary, from the Oxford clay of Solenhofen.

Sepiadæ (Myopsidæ, D'Orb.).

Sepia (Pliny) Linnæus:—Shell broad and thick in front, laminated, and terminating in a prominent "mucro." (or imperfectly chambered apex). From Oxford clay, and Eocene Tertiary, attaining their maximum at the present day.

Spirulirostra (D'Orb.):—The shell consists of a spiral chambered portion, or phragmacone, the volutions of which are separate. This is lodged in a pointed calcareous rostrum.

One species known from Miocene Tertiary.

Beloptera (Blainville), Deshayes:—Shell consisting of a nearly straight chambered portion or phragmacone, perforated by a siphuncle, and lodged in a calcareous rostrum, which is furnished with lateral wings.

SPIRULIDÆ. Spirula (Lamarck, 1801).—Shell nacreous, discoidal, composed of volutions not in contact with each other. The shell is divided into chambers by curved shelly partitions, pierced by a ventral siphuncle.

Nicholson in his "Manual of Palæontology," remarks: "It seems quite probable that the genera *Beleptæra* and *Belemnosis* belong to the *Belemnitidæ*."

From these descriptions there appear to be many fossil forms resembling—if not really allied to, or developed from—the *Belemnitidæ*.

The development of knowledge in the departments of Biology and Palæontology, is fraught with the ancient history of modern life, and is of great assistance in spelling out the history of ancestral forms, or the origin of a form of life under consideration.

In the case of *Belemnites*, the ancestral form from which they had probably developed, was recognised by Buckland ("Bridgewater Treatise," 1837). He describes how a *Belemnite* is a modification of the shell of a *Nautilus*, and then proceeds to show how the sheath or guard corresponds with the apex of the straight cone of the shell, to which there seems no equivalent in the apex of the coiled up cone of *Nautilus*. The anterior horny cup (alveolus) represents the anterior chamber of the *Belemnite*, and contained the ink-bag, and other viscera.

We shall see in the course of this paper, that although Buckland was right with regard to the Nautiloid ancestor of the *Belemnite*, he was wrong in the comparison of the parts.

Professor Lankester has studied the embryology of some of our modern Cephalopodous molluscs, and while agreeing with the probable development of the *Belemnite* from a *Nautilus*-like ancestor, cannot reconcile their modern analogues.

The difficulty is with regard to the shell-gland in the embryo of some of our modern Cephalopoda,\* and I quote at some length his remarks.†

"The position and mode of development of the shell-gland of the Cephalopoda exactly agree with that of the shell-gland as seen in the other molluscan embryos figured in this paper. We are therefore fairly entitled to conclude from the embryological evidence that the pen-sack of Cephalopoda is identical with the shell gland of other mollusca.

"But here—forming an interesting example of the interaction of the various sources of evidence in genealogical biology—palæontology crosses the path of embryology. I think it is certain that if we possessed no fossil remains of Cephalopoda, the conclusion that the pen-sack is a special development of the shell-gland would have to be accepted.

"But the consideration of the shell of the *Belemnites* and its relation to the pen of living cuttle-fish brings a new light to bear on the matter. Reserving anything like a decided opinion as to the question in hand, I may briefly state the hypothesis suggested by

the facts ascertained as to the *Belemnitidæ*. The complete shell of a *Belemnite* is essentially a straightened nautilus-shell (therefore an external shell inherited from a nautilus-like ancestor), which, like the nautiloid shell of *Spirula*, has become enclosed by growths of the mantle, and unlike the shell of *Spirula*, has received large additions of calcareous matter from those enclosing over-growths. On the lower surface of the enclosed nautilus-shell of the *Belemnite*—the phragmacone—a series of layers of calcareous matter have been thrown down forming the guard; above, the shell has been continued into the extensive chamber formed by the folds of the mantle, so as to form the flattened pen-like pro-ostracum of Huxley.

"Whether in the *Belemnites* the folds of the mantle, which thus covered in and added to the original chambered shell, were completely closed so as to form a sack, or remained partially open with contiguous flaps, must be doubtful.

"In *Spirula* we have an originally external shell enclosed, but not added to by the enclosing mantle sack.

"In *Spirulirostra*, a Tertiary fossil, we have a shell very similar to that of *Spirula*, with a small guard of laminated structure developed as in the *Belemnite*. (See the figures in Brown's "Classen u. Ordnungen des Thierreichs.")

"In the *Belemnites*, the original nautiloid-shell is small as compared with *Spirulirostra*. It appears to be the largest in Huxley's genus *Xiphoteuthis*. Hence in the series *Spirula*, *Spirulirostra*, *Xiphoteuthis*, *Belemnites*, we have evidence of the enclosure of an external shell by growths from the mantle (as in *Aplysia*), of the addition to that shell of calcareous matter from the walls of its enclosing sack, and of the gradual change of the relative proportions of the original nucleus (the nautiloid-phragmacone), and its superadded pro-ostracal and rostral elements, tending to the disappearance of the nucleus (the original external shell). If this view be correct as to the nature of these shells, it is clear that the shell gland and its plug has nothing to do with them. The shell gland must have preceded the original nautiloid shell, and must be looked for in such a relation whenever the embryology of the pearly *Nautilus* can be studied. Now everything points to the close agreement of the *Belemnitidæ* with the living *Dibranchiata*. The hooklets on the arms, the ink-bag, the horny jaws, and general form of the body, leave no room for doubt on that point; it is more than probable that the living *Dibranchiata* are modified descendants of the Mesozoic *Belemnitidæ*. If this be so, the pens of *Loligo* and *Sepia* must be traced to the more complete shell of the *Belemnite*.

"This is not difficult if we suppose the originally external shell the phragmacone, around which as a nucleus the guard and pro-ostracum were developed,

\* The shell gland is the cavity in the mantle of the embryonic mollusc in which the commencement of the shell is formed.

† "Quart. Journ. Micro. Science," 1874, quoted by Balfour. "Treatise on Comparative Embryology," 1880.



to have finally disappeared. The enclosing folds of the mantle remain as a sack and perform their part, producing the chitino-calcareous pen of the living Dibranch, in which parts can be recognised as corresponding to the pro-ostracum, and probably also to the guard of the Belemnite. If this be the case, if the pen of *Sepia* and *Loligo* correspond to the entire Belemnite shell minus the phragmacone-nucleus, it is clear that the sack which develops so early in *Loligo*, and which appears to correspond to the shell-gland of the other molluscs, cannot be held to do so. The sack thus formed in *Loligo* must be held to represent the sack formed by the primæval up-growth of mantle-folds over the young nautiloid shell of its Belemnitoid ancestors, and has accordingly no general significance for the whole Molluscan group, but is a special organ belonging only to the Dibranchiate stem, similar to—but not necessarily genetically connected with—the mantle-fold in which the shell of the adult *Aplysia* and its congeners is concealed. The pen, then of Cephalopods would not represent the plug of the shell gland. In regard to this view of the case, it may be remarked that I have found no trace in the embryonic history of the living Dibranchiata of a structure representing the phragmacone; and further, it is possible, though little importance can be attached to this suggestion, that the Dibranchiate pen-sack, as seen in its earliest stage in the embryo *Loligo*, etc., is fused with the surviving remnants of an embryonic shell-gland. When the embryology of *Nautilus pompilius* is worked out, we shall probably know with some certainty the fate of the Molluscan shell-gland in the group of the Cephalopoda."

It will be gathered from the foregoing extract, that Professor Lankester's difficulties are really with the formation of the embryological shell-gland, or pen-sack. Reasoning from other embryological data, it would be expected the embryos of the modern *Loligo* and *Sepia* would furnish some account of their modifications from the original Nautiloid shell. This it does not appear to do in a very clear manner, as the various modifications are ancient enough to have produced corresponding effects in the embryo; although the pen-sack of the Cephalopoda is exactly identical with the shell-gland of other mollusca, a shell is not developed, but in its place a chitino-calcareous pen.

The modern analogues of the Belemnites are therefore the modified descendants of them.

Since their appearance as Cephalopodous Molluscs with an internal shell, modifying influences have been at work, causing the disappearance of the original Nautiloid shell by the deposition around it of calcareous matter, which would originally have been used for the formation of the shell.

Other influences have also had their effects upon the animals and their internal shells, giving rise to our modern genera and species of cuttle-fishes.

We have seen how the Belemnites were ushered in at the commencement of the Liassic Period, and how they have become modified by the ceaseless interaction of influences, until, at the present day, we have the representatives of cuttle-fish interests in the *Sepias*, *Octopi*, and *Loligos*, etc., in the great world of life; and it is noteworthy to observe that the Dibranchiata, not merely in numbers, but also in size, bid fair in our day to rival the developments of the past. To the interest which a complex organization gives our modern cuttle-fish, may be added the interest of a singular past history.

#### ASTRONOMY AND METEOROLOGY.

By JOHN BROWNING, F.R.A.S.

AT the meeting of the Royal Astronomical Society, held on 6th of April, Mr. G. F. Chambers read a paper on a catalogue of red stars, which he had compiled as a result of seventeen years' observations. The catalogue contains upwards of seven hundred stars, nearly six hundred of these being visible in England. The stars are all above the ninth magnitude, and only distinctly orange or red stars are included. Scarcely one dozen stars are decidedly maroon or ruby in colour.

Many stars, mentioned by the two Herschels and various observers as red, now appear of an orange colour. Mr. Chambers points out that there is a great difference in sensitiveness to colour in different persons, particularly to colours approaching red.

Mr. H. Grubb sent a paper on the choice of instruments for stellar-photography. In this, he gives as his opinion, that reflectors are better than refractors for the purpose, because the field of view is flatter in refractors than in reflectors, the distortion appearing to be greater in photographs taken with refractors than in those taken with reflectors. Mr. David Gill described an attempt he is making at the Cape of Good Hope to map, by photography, the whole of the southern constellations.

At the International Congress of Astronomers recently held in Paris, it was arranged that a photographic chart of the whole sidereal heavens should be constructed with telescopes of about thirteen inches aperture. This principal chart will show stars to the fourteenth magnitude. Another chart from negatives with shorter exposures will be made, showing stars down to the ninth magnitude. At present, only the observatories of Paris, Algiers, Bordeaux, Toulouse, Rio Janeiro, and La Plata have agreed to take part in the work; but it is supposed that many others will do so when their governments have consented to supply them with the necessary funds. It is to be hoped that the consent of the English Government will be given promptly.

In June there is no darkness of night, but always either daylight or twilight. The length of true daylight is 16 hrs. 13 min. on the 1st day of the month.

On June 21st the sun enters Cancer, and summer begins. There will be no occultations of interest.

Mercury and Venus will be evening stars.

Mars will be a morning star, and will be in Taurus, not far from Aldebaran, about the tenth.

Jupiter will be an evening star in Virgo.

Saturn will be too close to the sun for observing.

*Rising, Southing, and Setting of the Principal Planets at intervals of Seven Days.*

	D.	Rises. h. m.	Souths. h. m.	S. ts. h. m.
MERCURY ☿	4	4 12M	0 39A	9 6A
	11	4 42M	1 12A	9 42A
	18	5 16M	1 37A	9 58A
	25	5 47M	1 50A	9 53A
VENUS ♀	4	6 44M	3 0A	11 16A
	11	6 58M	3 5A	11 12A
	18	7 19M	3 9A	10 59A
	25	7 35M	3 11A	10 47A
MARS ♂	4	3 17M	11 17M	7 17A
	11	3 3M	11 10M	7 17A
	18	2 51M	11 3M	7 15A
	25	2 40M	10 56M	7 12A
JUPITER ♃	4	3 31A	8 48A	2 9M
	11	3 2A	8 20A	1 42M
	18	2 32A	7 51A	1 15M
	25	2 5A	7 24A	0 47M
SATURN ♄	4	6 32M	2 38A	10 44A
	11	6 8M	2 14A	10 20A
	18	5 45M	1 50A	9 55A
	25	5 22M	1 26A	9 30A

*Meteorology.*—At the Royal Observatory, Greenwich, the mean reading of the barometer for the week ending 16th April, was 30.06 in. The mean temperature of the air was 41.9 deg., and 5.3 below the average in the corresponding weeks of the 20 years ending 1868. The general direction of the wind was N.E., and the horizontal movement of the air averaged 12.7 miles per hour, which was 0.7 above the average in the corresponding weeks of 16 years. Melted snow was measured on Thursday to the amount of 0.01 of an inch.

For the week ending 23rd April, the mean reading of the barometer was 29.85 in. The mean temperature of the air was 49.3 deg., and 1.2 above the average in the corresponding weeks of the 20 years ending 1868. The general direction of the wind was S.W., and the horizontal movement of the air averaged 11.3 miles per hour, which was 0.8 mile below the average in the corresponding weeks of 16 years. Rain fell on Friday to the amount of 0.04 of an inch.

For the week ending 30th April, the mean reading of the barometer was 29.68 in. The mean temperature of the air was 43.5 deg., and 4.7 below the average in the corresponding weeks of the 20 years ending 1868. The direction of the wind was variable,

and the horizontal movement of the air averaged 13.5 miles per hour, 2.3 above the average in the corresponding weeks of 16 years. Rain fell on six days of the week, to the aggregate amount of 1.38 of an inch.

For the week ending 7th May, the mean reading of the barometer was 29.64 in. The mean temperature of the air was 47.7 deg., and 1.7 below the average in the corresponding weeks of the 20 years ending 1868. The general direction of the wind was N.E., and the horizontal movement of the air averaged 9.0 miles per hour, which was 1.6 miles below the average in the corresponding weeks of 16 years. Rain fell on five days of the week, to the aggregate amount of 0.54 of an inch.

For the week ending 14th May, the mean reading of the barometer was 30.11 in. The mean temperature of the air was 50.7 deg., and 0.3 above the average in the corresponding weeks of the 20 years ending 1868. The direction of the wind was variable, and the horizontal movement of the air averaged 12.2 miles per hour, which was 1.8 above the average in the corresponding weeks of 16 years. Rain fell on three days of the week, to the aggregate amount of 0.17 of an inch.

The mean temperature of June is 60° for London and most of the interior of the south of England; but on the south coast it is only 59°, and on the east and west coasts it is only 58°, the lower temperature being due of course to the cooling effect of the sea.

The average rainfall for June is two inches for nearly the whole of England. On a small portion of the west coast of North Wales it is three inches.

RECENT ARTICLES AND PAMPHLETS WORTH READING.

ARTISTIC PHILOSOPHY in Relation to Landscape," by James John Hessey (three papers in the "Amateur Photographer" for April).—“The Water Supply of East Kent; Its Natural Springs and Deep Wells,” by George Dowker (“Geological Magazine,” May).—“The President’s Address,” by Rev. Dr. Dallinger (“Journal Royal Microscopical Society,” April).—“Homeric Astronomy,” by A. M. Clarke (“Nature,” April).—“Water Supply from Wells” (paper read before the Institution of Civil Engineers, by Mr. J. W. Grover, and reported in “The Builder,” April 30).—“The Moon and the Weather” (English Mechanic,” April 29th).—“The Pure Cultivation of Micro-Organisms, with Special Reference to Yeast,” by Dr. C. H. Morris (“Brewers’ Guardian,” April).—“Primeval Man in the Valley of the Sea,” by Worthington G. Smith (“Essex Naturalist,” May).—“President’s Address to the Quekett Club,” by A. D. Michael.—“The Preservation of Larva by Inflation” (“Entomologist,” May).—“The Autumnal Changes in Maple Leaves,” by W. K. Martin and S. B. Thomas (“Botanical Gazette,” April).

## OUR SCIENTIFIC DIRECTORY.

*Wesley Scientific Society.* President, Rev. Dr. Dallinger, F.R.S., Sheffield. Referee, Rev. Hilderic Friend, F.L.S., Worksop, Notts. Secretary and Treasurer, Rev. Wm. Spiers, M.A., F.G.S., 25 St. James's Road, Upper Tooting. Organ, "The Wesley Naturalist," 5s. per annum. Society. Postal.

## SCIENCE-GOSSIP.

THE third annual report of the Watson Botanical Exchange Club has appeared. The editor and honorary secretary is Mr. A. R. Waller, Low Ousegate, York.

MR. WILLIAM BULL's orchid exhibition is now on view at Chelsea, and all who love these singular flowers should make a point of visiting it.

DR. R. VON LENDENFELD has delivered three very successful lectures at the Royal Institution on "Recent Scientific Researches in Australasia," in which he dwells on the evidences of a glacial period in Australia.

WE have received a copy of Mr. Linnæus Greening's paper on "British Newts," read before the Warrington Field Club. It is one of the best on the subject yet published, for Mr. Greening records his own experience in keeping the various kinds.

THE Council of the British Medical Association have recently appointed Mr. Watson Cheyn and Dr. Sidney Martin as Science Scholars for one year. The former proposes to continue his research of bacteria in relation to disease, and the latter to carry on researches on the vegetable albuminose, especially with relation to their alleged toxic action.

IT has been arranged that the Geological Field Class which has again been formed for studying systematically the Geological features of the country near London, under the direction of Professor H. G. Seeley, F.R.S., King's College, will meet on alternate Saturday afternoons in May and June.

THE Canadian Correspondent of the "Liverpool Journal of Commerce" says: The Dominion Government propose to extend the signal service in connection with the meteorological bureau in the North-West and British Columbia.

WE have received a copy of Mr. E. T. Newton's "Classification of Animals." It is a full, complete, and highly useful synopsis of the animal kingdom, with especial reference to the fossil forms. It will prove valuable to teachers and students both of geology and biology. It is published by George Philip, 32 Fleet Street. Price sixpence.

At a recent meeting of the Entomological Society, Mr. E. B. Poulton exhibited a large and hairy lepidopterous larva—apparently a Bombyx—brought from the Celebes Islands by Dr. Hickson, and made remarks on the urticating properties of the hairs of the species, which were said by the natives to produce symptoms similar to those of erysipelas if the larva was handled.

## MICROSCOPY.

THE QUEKETT CLUB.—The last number of the "Journal" of this society contains the following papers:—"On the Finer Structure of Certain Diatoms," by E. M. Nelson and G. C. Karop; "President's Address;" "Fossil Marine Diatomaceous Deposit from Oamaru," by E. Grove and G. Sturt; "The Structure of *Aulacodiscus margaritaceus*," by Henry Morland; "A New Arrangement of Growing Slide," by Rev. A. Pagan; proceeding at meetings, etc.

"JOURNAL OF THE ROYAL MICROSCOPICAL SOCIETY" for April, contains the annual address of the President, the Rev. Dr. Dallinger, besides a paper on "The Differentiation of Tissues in Fungi," by G. Masee (both illustrated); and the usual exhaustive summary of current researches relating to Zoology, Botany, Microscopy, etc. The Supplementary Number, containing a full and copious index to the last volume, is also published.

COLE'S STUDIES.—The last four parts of this celebrated series deal with the following subjects (all illustrated). The "Digestive Glands" of Butterwort, "Reproduction of the Mollusca"; "Kidney in Leucocythæmia" (pathological); and "Roots, Stems, Growing Plants and Leaves (illustrated by vert. sect. of *Eucalyptus globulus* + 50). It is announced that the remaining three sections of the "Studies," completing vol. iv., will be sent all together about July 1st, to save postage, packing, etc. The "Studies" are accompanied by the usual slides.

MOUNTING IN CASTOR OIL.—I have found the best method to be as follows. Make a cell with Ward's "Brown Cement." Fill with the best castor oil and close in the usual manner. If the oil is really good and the glass cover properly cemented, there is no reason why the mount should cloud. For plant crystals such as raphides and the like there is no preservative so good, in my opinion, as this oil.—*Charles F. W. T. Williams, B.A., Theological College, Salisbury.*

ENOCK'S SLIDES.—The latest issue of Enock's entomological slides is unusually interesting. It gives a section of the garden spider (*Epeira Diadema*), showing all the internal organs in the



cephalo-thorax and abdomen. This instructive slide is rendered all the more useful to the student by the illustrated sketch which accompanies it, and which gives referential details of all the organs shown.

## ZOOLOGY.

MUREX ERINACEUS, M. ELONGATUS.—Mr. W. Bendall has sent me for examination a very curious form of *Murex erinaceus*, which I will call *elongatus*; it has the spire much produced, its length being 31 mill., while the greatest diameter of the shell is only 19½ mill., the spiral ribs are well marked, but all the transverse or longitudinal ones are obsolete. It is especially noteworthy that this specimen came from Shellness, Pegwell Bay, which is the same locality as that of a precisely similar aberration of *Purpura lapillus*, of which there is a specimen in the British Museum. This adds another to the many known instances of this nature (see p. 67).—*T. D. A. Cockerell, Bedford Park, Chiswick.*

MOLLUSCA AT LIMPSFIELD, SURREY, APRIL 1887.—The soil of Limpsfield is chiefly of a sandy nature, but there is a ridge of chalk-marl at no great distance from the village, and to this I made my way. I had heard that *Helix pomatia* was to be found there, but owing to the cold they were still hibernating (as indeed were also most other snails), and I failed to find any during my first two visits. However I collected *Helix nemoralis*, *H. aspersa*, *H. caferata* and *ericetorum*—the two latter only as dead shells—*H. lapicida*, *H. rotundata*, *Bulinus obscurus*, *Clausilia laminata*, *Cl. rugosa*, *Hyalina pura*, *Vitrina pellucida* and *Cyclostoma elegans*. On my third expedition, I carefully examined a spot where there were several dead shells of *Helix pomatia*, and at last I found four specimens with their winter opercula buried mouth upwards at the roots of some shrubs. I next turned my attention to the valley, and added to my list *Helix hortensis*, *H. arbustorum*, *H. rufescens*, *H. concinna*, Jeff., *H. sericea* (one specimen), *Zua lubrica*, *Clausilia Kolpithi*—I have not seen this locality mentioned for the latter shell—*Hyalina cellaria*, *Hyal. nitidula*, *Hyal. crystallina*, and the *Hyalina* that has been called “glabra.” Of slugs, *Limax agrestis*, *L. flavus*, and *Arion hortensis*. There was no water to speak of in the neighbourhood, but in a small stream I found *Ancylus fluviatilis* and *Limnaea peregra*. The only species now left to mention is *Anodon cyneus*, which, owing to favourable circumstances, attained to great size and beauty of colouring, for as the pond in which this mollusc was to be found was on sandy soil the shells were not at all eroded, and as it was fed by a stream from the chalk hills lime was there in abundance.—*Wilfred Mark Webb.*

PHYSA FONTINALIS.—Among some *Physa fontinalis*, collected last year in a ditch at Herne Bay by Mr. S. C. Cockerell and myself, were several in which the animal [instead of being grey was bright yellow, and this showing through the transparent shell made them—even when some distance below the surface of the water—very conspicuous objects. The only case I know where any similar coloration has occurred, is that Pascal, in An. Soc. Linn. du Nord, described a *var. flava* of *Lim. palustris* in which the animal was yellow with the buccal mass bright rose-colour showing through. I may mention the *var. albina* is also found here.—*F. G. Fenn, Syon Lodge, Isleworth.*

HYALINA DRAPARNALDI.—There is in my garden here a flourishing colony of what is undoubtedly this species. Besides the differences in the shell between it and *Hy. cellaria*, a well-marked distinction is the blue-black colouring of the soft parts. The locality is interesting as being the most eastern that has hitherto been recorded for the living animal, though from its position amongst decayed bast matting in the vicinity of market-gardens there can be no doubt that it has been introduced.—*F. G. Fenn, Syon Lodge, Isleworth.*

## ANIMAL PSYCHOLOGY.

A MONKEY'S MEMORY.—My cousin has told me about a pet monkey he once had, and of which he was very fond. When he was married this monkey took such a great dislike to his wife that he was obliged to get rid of it, so gave it to a friend living some distance away. For three years my cousin saw nothing of his former pet; at the end of that time he paid a visit to the friend to whom he had given it. This gentleman advised my cousin not to go near the monkey, as it was most vicious with strangers. However, he thought he would like to see if his old favourite would remember him, so he went up close to where the monkey was and sat down; the latter looked at him for a moment, then sprang down to him, took both his hands in its own and smelt them, then immediately caressed and fondled his late master in an ecstasy of delight. After another eighteen months had elapsed, my cousin again paid a visit to his friend, when the monkey did exactly the same thing again.—*A. Pittis.*

EPISODE IN BIRD LIFE.—As I was strolling through my garden one evening last summer, a female blackbird fluttered out from beneath the leaves of rhubarb in a quiet corner of the garden and alighted on the garden wall. This occurred on two or three successive evenings. The bird evidently had some connection with the rhubarb, and care was taken not to give it needless disturbance. About eight or ten days after I first saw it, two blackbirds, a male and

a female, were found dead under a leaf of rhubarb in the same spot from which the female bird used to flutter. The male bird had been dead for some time, the female bird had evidently died quite recently. I could not doubt that it was the same bird that used to flutter from under the rhubarb, as no female bird was seen in that corner of the garden afterwards. I imagine the male bird was ailing or dead under the rhubarb leaves, and the female would not leave him. But what was the cause of her death? Was it grief, or starvation, or both? Or may one bird catch disease from another? Some of your readers, better acquainted with the habits of the blackbird than I, may be able to cast some light on this subject.—*James Fordyce, Bishop Briggs, by Glasgow.*

## BOTANY.

CEPHALANTHERA ENSIFOLIA.—With respect to the remarks of R. W. P., St. Leonards-on-Sea, on this plant, I beg to observe that my experience of it as growing in England entirely agrees with Bentham's description. I have examples now before me, gathered in West Sussex, with only five flowers on each specimen. Those on *C. grandiflora* have usually seven or eight. I have found the two plants growing at no great distance from each other. While *C. ensifolia* is very rare in Sussex, *C. grandiflora* is by no means uncommon.—*F. H. Arnold, Hermitage, Emsworth.*

THE IRREGULAR APPEARANCE OF THE BEE ORCHIS.—In SCIENCE-GOSSIP for January, Mr. John Taylor has reverted to the notes on this subject which appeared in the same in 1881, and justly remarks that no "very lucid explanation" was arrived at. As bearing upon this matter, I will relate a fact that came under my notice just two years ago. In the spring of 1885, before my lawn had been touched by scythe or machines I found a plant of this species growing amongst the grass, and removed it with a ball of earth to another part of the garden where it subsequently flowered. Now the turf from which this plant was taken had been kept closely cut with a machine throughout the previous summer and autumn, as in other years, so that the tubers must have existed without leaves during this period, and yet it flowered the following summer. A few days after transplanting this bee orchis, I detected a second near the same place and purposed transplanting it also, but it escaped my memory until too late—the lawn was mown and no more seen of the second plant. I looked for it last spring and also this, but no trace of it. It seems scarcely possible that the seed dropped one summer should produce a flowering plant the next; yet how otherwise can this have been, with a closely shaven lawn for seven or eight months of the year, unless the tubers can live

and grow without foliage? I cultivate in my garden all the British species of Orchis that I am able to obtain, so that the seed may have been carried to the turf by the wind. The man orchis from the Surrey downs luxuriates with me.—*William Jeffery.*

## GEOLOGY, &c.

AMERICAN JURASSIC MAMMALS.—Professor O. C. Marsh has recently published a paper in which are described the remains of several hundred individuals that have recently come to light. Although fragmentary, the remains are usually well-preserved, comprising the lower jaws, teeth *in situ*, various portions of the skull, vertebræ, and other parts of the skeleton. Placental as well as marsupial-mammals occur in the oldest formations, whence the inference that the former are not derived from the latter evolutionally, as is supposed, but that both of these orders descend in independent lines from a common ancestor.

BOULDERS IN COAL.—At the April meeting of the Leeds Geological Association, Mr. C. Brownridge, F.G.S., read a short paper, entitled "Notes on Four Boulders found in the Black Bed Coal and overlying shales and ironstone at Wortley." Mr. Brownridge, after alluding to the fact that the presence of boulders in the coal measures is becoming an important question, said that these interesting discoveries occur from time to time, some having been found in the coalfields of Leicestershire, Lancashire, and the Forest of Dean; but none hitherto appear to have been recorded from that immediate district. The position where these boulders were found is situate in "No. 1 Black Bed Pit." The whole of this neighbourhood is worked for the Wortley fire-clay. Along with the fire-clay the better bed-coal above is got, and at a still higher level the black bed coal and the overlying ironstone are worked. It was in the last-named beds that the specimens were found. The depth of the black bed coal from the surface is here 30ft. The largest of the boulders is a coarse gritstone, and nearly spherical in shape. Its dimensions are 2ft. 6in. by 2ft., and it has a fairly smooth, polished face, with slight striæ. This example was found embedded in the "bind," or clayey shales, just overlying the coal. The other three boulders (or pebbles) are much smaller in size, varying from 11in. by 9in. to 3½in. by 2½in., and were all found embedded in the black bed coal itself. One of the specimens is a fine-grained grit, the other two being quartzites. The two latter are rather more angular in general shape than the grit specimens, but in all of them the angles are well rounded off and the faces polished. The reason why these stones are thus found located in

such phenomenal positions can only at present be surmised, as the subject is at present rather vague; but the theory has been adduced, that they have been carried down by masses of floating vegetation in a manner similar to that recorded by travellers on the Amazon, where in the swamps and shallows such masses are seen floating, carrying foreign matter along with them. A leading London newspaper in recently reporting a similar specimen gravely alleged it to be a meteorite. This singular idea would, however, be instantly rejected by the most credulous novice as being utterly untenable.

## NOTES AND QUERIES.

**OAK TIMBER.**—It is generally allowed that oak timber was formerly much stronger than it is at present. This is attributed to the fact that our ancestors, being ignorant of the value of bark, cut down their oaks in the winter. Could not the strength of our timber be retained unimpaired, and the bark be equally saved, by barking the trees standing in the spring and cutting them down in the following winter?—*Briton*.

**"JACK-HANGMAN."**—There is a bird in Natal called "Jack-hangman;" it is a little larger than a thrush, and something like a magpie, in colour black and white, that catches the grass-snakes and hangs them up by the back of the jaws on to the thorns of a tree. These thorns are about two inches in length, and one frequently sees a number of these grass-snakes fastened in this manner to these certain trees.—*A. P.*

**DISTRIBUTION OF THE LEPIDOPTERA IN THE BRITISH ISLES.**—As I am compiling notes for a work on this subject, I shall be very glad of local lists of Lepidoptera, which, however incomplete, will be very useful to me. Any information whatever bearing on the subject will be acceptable.—*W. Harcourt Bath, Ladywood, Birmingham.*

**DEVELOPMENT OF FROG SPAWN.**—In reference to the paper contributed by Nina F. Layard, and to show the difference in the rate of development, I append the dates of the corresponding stages observed in some tadpoles taken from a running stream near here:—Fig. 11 (page 32), March 23rd, 1887; fig. 12, March 27th; fig. 13, March 27th; fig. 14, March 27th; fig. 15, March 28th; fig. 16, March 30th; fig. 17, April 2nd; fig. 18, May 2nd. May 3rd, mine are extremely large, and have both hind legs fully developed. The left hind leg appeared April 14th.—*John Eyre, A.A.*

**EARLY APPEARANCE OF PIERIS RAPÆ.**—On Friday, March 11th, a newly-emerged specimen of *Pieris Rapæ* was brought to me which had been caught the day before on the wall of a house. Is not this very early for it to appear? I cannot find an authenticated instance of so early an appearance, except in the case of a hibernated specimen.—*J. A. Jenkinson.*

**CAGED BIRDS AND FREEDOM.**—With regard to the question, whether English birds having been kept in cages are ever fit to live in freedom again, I should like to tell you of a female thrush I had. I was then living in Barnsbury Park, London, and

brought home with me from the country a young thrush which had been taken from the nest. I fed it with a stick every two hours, and it became very tame, following me about the room and perching on my shoulder. When it grew older I placed its cage on a little balcony outside my bedroom window. A large tree was close to the window, and when the spring came a male thrush used to sit in this tree singing to my bird, until at last I determined to let her free. It was some time after the door of the cage was open before she could make up her mind to fly right away, but at last she did, and in a short time the pair built in a large pear-tree in our garden and brought up young ones, the mother still remaining very tame, and answering when we spoke to her. The pair returned to the same place the following year, after that we saw no more of them.—*M. R.*

**A REMARKABLE SHOT.**—A gentleman living near Leek was recently shooting in a wood near his house, and fired at a pheasant at about 150 yards and missed. The bird flew in the direction of the house, and seeing the sun and trees reflected in the drawing-room window, it flew through the plate glass, which is three-eighths of an inch thick, and was found in the room without a feather out of place.—*J. Lea.*

**ALBINO THYME.**—Last summer I found a quantity of thyme (*Thymus serpyllum*), with pure white flowers, growing among sand on the banks of the Dulnain, in Inverness-shire.—*T. W. Ogilvie.*

**MIGRATION OF BIRDS.**—Cutting a theory to pieces is not such easy work as F. C. D. B. says, judging by the result of his own attempt; but he very clearly illustrates the difficulty of building one. Birds having excellent memories, why should it be improbable that, while remembering the salient features of a country sufficiently to direct them in their flight, they should also remember the details of the district in which they were hatched and bred? F. C. D. B. thinks, in one sentence, that the birds' resting-places will suggest "what will guide them" to their next station; and in the following sentence grants there is nothing to direct them between these points. Rather a self-contradictory theory; and it is hardly saved by the "comprehensive impression" which would enable the young birds to find their way over vast tracts with nothing to direct them.—*T. W. Ogilvie.*

**THE SHANKLIN BUTTERFLY.**—The butterfly mentioned by Mr. J. A. Billings in SCIENCE-GOSSIP for March, as captured at Shanklin, is undoubtedly *Anosia plexippus*, indigenous to N. America; his description tallies exactly with that species, and he certainly has a prize, rendered the more valuable from the probability of its not being imported, as it has been seen before on the S.W. coast of this country. In the autumn of 1885, two were captured and a third seen at the Lizard, by Mr. Jenkin, of Redruth, a memo of which I have written at the time as follows, "September, 1885, two specimens *Anosia plexippus* of Linnaeus, four and a half inches across the extended wings which are edged with black, enclosing a double series of white spots, centre rich brown;" and others have been seen and mentioned in the "Entomologist," I believe. These occasional captures prove that this butterfly has obtained a footing in this country, and that its caterpillar would find its food in the periwinkle or allied species, which would be similar to the butterfly weed, its principal food in America.—*Hamilton James.*

**A STRANGE BUTTERFLY.**—From Mr. Billings's description I would suggest that this insect may be *Danaus Erippus* (Cramer), variety *Archippus* (Fabr.),



which measures four inches and more across the wings which are of a deep fulvous colour; the veins being more or less broadly black both above and beneath. The tips of the forewings are black irregularly spotted with fulvous, or, in the typical *Eriippus*, white. This however is S. American, while *Archippus* is a very common N. American butterfly, and in 1877 three specimens were taken in England. There are spots on the thorax, but the body is deep fulvous, with the segments black rather than entirely black. The rest of the description seems correct.—*H. D. S., Beckenham.*

PEREGRINE FALCON—The "Sheffield Daily Telegraph" notes the death, near Retford, of a Peregrine Falcon which measured thirty-eight inches across the wings (from tip to tip).

A QUERY FOR MR. MATTIEU WILLIAMS.—Would your able contributor, Mr. W. M. Williams, kindly explain the following phenomena?

Sun.	Rises.	Sets.
Dec. 21 . . .	8.7 A.M. . .	3.51 P.M.
Jan. 21 . . .	7.56 ,, . . .	4.27 ,,
	or 11 minutes earlier,	36 minutes later.
June 21 . . .	3.44 A.M. . .	8.18 P.M.
July 21 . . .	4.9 ,, . . .	8.3 ,,
	or 25 minutes later,	15 minutes earlier.

I should esteem it a great favour to be enlightened on the point: why in January the days lengthen out on the P.M. and why in July they shorten more on the A.M. side.—*W. J.*

MONKEYS AND THEIR TAILS.—Can any one kindly tell me what measures may be taken to prevent a tame monkey biting off the end of its tail?—*Miss C. Leigh, 37 Portman Square, W.*

STONES IN WOOD.—Three days ago one of our wood-turners, while cutting up some full-grown beech timber with a circular saw, came across something which jarred the saw terribly, and trying to approach the obstruction from another angle, struck upon it again, damaging the saw considerably. Upon riving the block to learn the cause, we found a large, smooth, waterworn, fine gritty sandstone pebble, measuring through its shortest diameter two inches and a half, firmly embedded in what appears, judging from the segments of the rings of growth, very nearly the centre of the tree. I have had the two riven halves cut into convenient sized blocks, the one showing the pebble still, with one half firmly fixed model-wise, and the other showing the mould of the exposed portion of the pebble. The surrounding timber is sound and good, and very little altered, beyond being slightly gnarled and contorted in figure, while the mould has a smooth black surface appearing as though charred by heat.—*Samuel Stowarth.*

EXPLODING GUNPOWDER.—Your correspondent appears to wish to explode gunpowder without the rays of the sun, *i.e.* by cutting off all the rays. How can he expect to obtain any heat from the sun if he places an opaque substance between it and the gunpowder? If I understand right, your correspondent really wishes to know if the coloured, *i.e.* prismatic rays of the sun will have the effect of igniting the powder. I have not made any experiments in this direction myself, but should imagine that this result can only be obtained by the use of a prism, and passing the rays thus separated through a condensing glass. At the same time I do not see of what real

use or advantage this will be when accomplished. *James Searle.*

WILD BIRDS PROTECTION ACT OF 1880.—Will any readers of SCIENCE-GOSSIP inform me if they know of cases where boys or ornithologists have been summoned before the magistrates for collecting wild birds' eggs or nests? And if so, were convictions obtained or not. I have before me a copy of the above Act, and there is no mention of eggs in it, or any sentence or word which could reasonably be construed to refer to eggs. I should also like to know why the lapwing, peewit and plover, are reckoned as being different birds, and similarly sea parrot, coulteneb and puffin, gannet and solan goose, bonxie and skua, tern and sea swallow, guillemot, tarrock, scout, willock, and murre and several others. I should also feel pleasure in knowing from others, what effect the protection afforded by the Act has had on the increase of the species mentioned therein. The Act may be had from Messrs. Eyre and Spottiswoode, London, price twopenny.—*Sheffield.*

SIZE OF MOLLUSCA.—Gwyn Jeffreys (vol. i., Introduction, p. xxxii.) says "Northern Mollusca are generally larger than those of the same species from the south." Macgillivray ("Molluscous Animals of Scotland," p. 18) says "Mollusca are more abundant in warm than in cold climates, and larger and more brightly coloured." Would conchologists give opinions as to which of these two eminent authorities is right?—*Geo. Roberts.*

ANOTHER USE FOR BEES' STINGS.—In your impression for March, Mr. T. Winder has taken a great deal of trouble to prove that my correction of his previous letter was as much an error as that I sought to set right. The fact is that, upon reading Mr. W.'s comment in the December number (where he describes the bee's sting as superior to the finest cambric needle, while that of the wasp is so formidably barbed), I fell into the error of supposing that he had mixed up the two in his mind, as I well knew of the barbs in the bee's sting, but was not acquainted with the sting of the wasp as a micro object, so my allusion to the needle was a quotation from his letter. Being an apiarian of some years' experience, I could only be amused at his remark that I was under the impression that the sting of the bee is left in the wound in every instance; yet, after pointing out the supposed ignorance of mine, Mr. W. goes on to quote from J. G. Wood, that the wasp's sting is always left in the wound. If Mr. W. will enquire of those who have any practical experience in the matter, they will, I think, tell him, as Mr. F. W. Elliot has already done in the February number, that bees leave their sting in the human flesh much oftener than wasps do. During the season I handle thousands of bees almost daily, never using gloves or veil, and of course get a sting or two sometimes, and invariably have to pull them out, while I never remember a wasp leaving its sting, although I have been stung a considerable number of times by them while destroying their nests. Mr. W. has omitted a very important part in his explanation, *viz.* the use of the barbs. May I add that they are attached to very powerful muscles which, as soon as the point of the sting enters the flesh, commence contracting alternately, this alternate pulling at the barbs drives forward the sting, and so it gets further down into the flesh than the thrust of the insect could drive it. As I value personal experience infinitely more than quotations from books, I may add that I have proved this to be the case, and Mr. W. may easily verify it in the following manner. Take a bee care-

fully between the finger and thumb, and allow the sting just to enter the skin of the other hand, immediately this takes place draw away the bee, when the sting will remain. In a short time a sharp prick will be felt as the point penetrates the flesh by the muscular action referred to, followed by more or less pain, as the poison is poured into the wound. In some people this is so painful that it will deter them from repeating the experiment, while, with others, the pain is but slight (in my own case lasting but a few minutes). It would be interesting to enquire why this is the case?—*W. E. Harper.*

**THE FRILL LIZARD** (*Chlamydosaurus*).—I call the following description of the above reptile from Baird's "Student's Natural History" for the benefit of Mr. Fred Challis and others:—"A genus of saurian reptiles or lizards, belonging to the family Agamidae. Only one species is known, *C. Kingii*, a native of Australia. It is an extraordinary-looking animal, about ten inches long, exclusive of the tail, which is twelve. The head is five and a half inches long and one inch broad, and has a curious crenated membrane, like a frill round its neck, covering its shoulders; and when expanded, which it is enabled to do by means of transverse, slender cartilages, it spreads five inches in the form of an open umbrella. It is very irascible, and when frightened, it elevates this frill, and runs to a tree, where it makes a stand and boldly defends itself against its opponent, biting fiercely."—*L. Francis.*

**LEGS OF THRUSH.**—A farmer named Oir, of Clough, co. Antrim, kept a thrush, which he said every seven years cast his legs, when a new pair grew. This was told me by a policeman, who knew the farmer well, and saw the bird in the transition state. The bird was in excellent health. IN SCIENCE-GOSSIP, p. 141, June, 1867—"Leg Legends"—Mr. William Dodgson inserts a query concerning this strange act and gives instances.—The editor attaches a note. (We suspect that the unbelievers are legion.) I think there must be some truth in it, and it would be well to endeavour to throw some light on this seemingly curious fact.—*Rev. S. A. Brennan.*

**BIRDS NEAR DUBLIN.**—*W. E. C. Wourse* is certainly mistaken in his remarks on the heron (page 94); he says: "From the windows could be seen herons sitting on their nests in high beech-trees; the nests consisting of a few bits of stick, on which the birds appeared to sit astride, with their legs hanging down." In the first place, the nest always consists of more than "a few bits of stick," being generally larger than that of the rook; and, secondly, such a ridiculous position is never assumed by the heron, or, indeed, any other known bird; as, despite the length of its legs, its anatomy is so contrived as to allow of its sitting on its nest with as much ease as does the hedge-sparrow on hers. And we might, with just as good reason, expect to see the bird lying on its nest, with its legs in the air, a position not one bit more unnatural than that described by Mr. Nourse.—*Arthur Hollis.*

**BIRDS TAPPING.**—Several of your correspondents have alluded to the grey-wagtail's habit of tapping at windows, but can any one tell me if it also a peculiarity of blackbirds, or assign any reason for their doing so? For the last two months a blackbird has been continually tapping at our windows. He begins about four o'clock in the morning, making noise enough to awake us, and goes on, at intervals, all day. He does not confine his attentions to one window, though he favours some more than others. Last year at the same season, the same thing

occurred, but he was then more easily frightened than this year, as now, although repeatedly driven away, he always returns to the charge, sometimes tapping as long as half an hour continuously. Can he have any motive for this apparently uninteresting, and, at the early hour he commences, somewhat annoying habit?—*I. J. R. M., Leamington.*

**FOWLS EATING FEATHERS.**—Can any of your readers tell me the reason why fowls pick and eat each other's feathers? I have about sixteen fowls, including Dorkings, Brahmas, and Hamburgs. During the last month they have picked one another's small feathers from the backs and on the chest that they are quite raw in those places. I have mixed lime in their run and put brimstone in their water, but it does not seem to cure them. I do not know whether it is natural or whether it is a disease peculiar to one breed. They seem healthy in themselves, two wanting to sit, but they have no feathers under their wings, so that it would be no use to set them on eggs.—*Walter Helps.*

**SLAUGHTER OF WILD ANIMALS IN CENTRAL AFRICA.**—The following account is from a sporting paper of a month ago: "Sir John Willoughby, with Sir Robert Harvey's two sons, Captain Grenville Harvey and Mr. Charles Bateson Harvey, who are on a hunting expedition in the neighbourhood of Kilimanjaro, have been enjoying some fine sport. They have killed 52 rhinoceroses, besides buffaloes, elands, ostriches, giraffes, zebras, and various other kinds of antelope. Out of the 32 species of game which are found in that country they have killed specimens of 22. Their bag in February last amounted in all to 148 head." This is how the process of extermination is going on. The time is not far distant when the most interesting animals of Africa will have followed the bison of North America to the land of shades. It is ridiculous to argue that all this destruction was for the sake of food, as is so frequently done. It would require a good many pot-hunters and a few tribes of natives to eat up such a bag of game whilst in a sweet condition. There is nothing to boast of in slaying even rhinoceroses with the weapons now employed; 'twas very different in the days of old flint-lock, when the hunted often became the hunter. It is a great pity such a state of things should exist, and every true naturalist must deplore it.—*G. Currie.*

## NOTICES TO CORRESPONDENTS.

**TO CORRESPONDENTS AND EXCHANGERS.**—As we now publish SCIENCE-GOSSIP earlier than formerly, we cannot undertake to insert in the following number any communications which reach us later than the 8th of the previous month.

**TO ANONYMOUS QUERISTS.**—We must adhere to our rule of not noticing queries which do not bear the writers' names.

**TO DEALERS AND OTHERS.**—We are always glad to treat dealers in natural history objects on the same fair and general ground as amateurs, in so far as the "exchanges" offered are fair exchanges. But it is evident that, when their offers are simply disguised advertisements, for the purpose of evading the cost of advertising, an advantage is taken of our *gratuitous* insertion of "exchanges" which cannot be tolerated.

We request that all exchanges may be signed with name (or initials) and full address at the end.

**E. E. T.**—The facts to which you allude are well known. There is a variety of the almond in which the sarcocarp remains succulent.

**C. H. COLLINGS.**—The following is a good elementary book, "Ponds and Ditches," by Dr. M. C. Cooke (price 2s. 6d., S. P. C. K.) Other and complete works are: "Manual of Infusoria," by Saville Kent (London: W. H. Allen); "Manual of the Rotifera," by Dr. Hudson and P. H. Gosse (London:



Longmans); and Dr. Carpenter's "Monograph of the Foraminifera," published by the Ray Society.

S. CAMPBELL.—Apply to Mr. W. P. Collins, 157 Gt. Portland Street, London, W., for the prices of the books you mention. He will doubtless have some good secondhand copies at a reasonable price, or can get them for you.

G. ABBEY.—Unquestionably lice are developed from eggs laid by the female insect in the ordinary way, and do not and cannot be developed spontaneously either from dirt or otherwise.

G. E. EAST.—You will find a capital summary of the geology of the Hampshire coast in Bright's "Illustrated Guide to Bournemouth, &c.," published by F. J. Bright, The Arcade, Bournemouth.

NORTHUMBERLAND.—You will find a full account of the bookworm in Blades' "Enemies of Books." Some think the worm is the larva of a beetle (*Scolytus*) identical with that which tunnels in beechwood. There is also the book scorpion (Chelifer), an arachnid.

T. W. W.—We believe the New South Wales Government are setting aside part of the Ilawarra district, just as it is, as a sort of national park, after the method adopted by the United States Government with regard to the Yellowstone region.

P. F. G.—The objects sent are the membranous egg cases of the dog whelk (*Buccinum undatum*).

#### EXCHANGES.

WANTED, various clutches of British birds' eggs.—W. K. Mann, Wellington Terrace, Clifton, Bristol.

WANTED, collections of old postage stamps, coins and medals. Offered in exchange, natural history specimens.—W. K. Mann, Wellington Terrace, Clifton, Bristol.

VOL. II. in six 1s. parts of "Illustrated Science Monthly" for SCIENCE-GOSSIP complete for 1886.—Edward Lee, 13 West Hillary Street, Leeds.

SMALL microscope, 3 powers, in mahogany case; will exchange for Hooker's or Benham's "Handbook of British Flora," or what offers?—L. P. Leah, 5 Exchange Street, Macclesfield, Cheshire.

WANTED, a good astronomical telescope, a powerful microscope, pocket mountain aneroid barometer, pedometer, lantern microscope, also a good set of meteorological instruments; a good selection of valuable works on natural history offered in exchange.—W. Harcourt Bath, Ladywood, Birmingham.

EIGHT packets of good micro material, ready for mounting, in return for one good mounted slide.—A. E., 3 Eton Grove, Blackheath, S.E.

OFFERED, complete volumes or odd numbers of SCIENCE-GOSSIP, unbound. Wanted, fossils, shells, and minerals.—F. C. King, Bank Villa, Fulwood, Preston.

MAGILLIVRAY'S "Manual of British Birds," Asa Gray's "Lessons in Botany," "Nature," 1874, "Longman's Magazine," vols. i. and ii., "Gardening," 1886, "Vegetable World," 16th edition, &c. Wanted, any modern book on botany or natural history, "Popular Science Review" Darwin's and Wallace's works.—T. Illingworth, 4 Alliance Street, Harpurhey, Manchester.

*Limnaea peregrina*, monst. *sinistrorsum*, offered for *L. involuta*, *Vent. alpestris*, *Aeme lineata*, or other local species.—S. C. Cockerell, 5 Priory Road, Bedford Park, Chiswick, W.

WHAT offers for Mantell's "Wonders of Geology" and "Geology of the Isle of Wight," for Buckland's "Geology and Mineralogy," and also "Plant remains from Coal Measures"?—Geo. E. East, jun., 10 Basinghall Street, London, E.C.

EXCHANGE, Echinodermata: *S. purpureus*, *Astronyx loveni*, *Cribrella oculata*. Crustacea: *Hyas carnicus*, *H. coarctatus*, *Stenorhynchus phalangium*, *S. tenuirostris*, *Pagurus Prideauxii*, *P. Thompsoni*, *Lithodes mata* (small and large specimens), *Portunus*, *Holsatus*, *Nephrops Norvegicus*. Wanted, specimens not in collection.—J. R. Murray, 10 St. Paul's Street, Aberdeen, N.B.

DESIDERATA, Neuroptera, also wanted a large number of larvae of *A. carya*; will endeavour to make a good return.—W. Harcourt Bath, Ladywood, Birmingham.

ORNAMENTAL wire aviary cage, 3' 2" x 1' 6" x 3' 2" high, on stand, present value 30s., another, smaller value, 25s. Exchange wanted in micro slide cabinet, entomological cases, entomological specimens, Darwin's works, or offers.—Micro, c/o William Turner, Adelphi Street, Salford.

WANTED, specimens of *Clausilia*, *Bulimus*, and *Vertigo*; good exchange given in land and freshwater mollusca.—C. H. Pierson, 16 Brunswick Place, Leeds.

FORAMINIFEROUS sand from St. Brelade's Bay, Jersey, in exchange for similar material from other English localities, less quantities than one ounce not accepted.—E. Halkyard, Knutsford, Cheshire.

WITH view of exchanging British land, freshwater, and marine shells, send list of duplicates and desiderata to—H. Pollard, 19 Britannia Terrace, New Wortley, Leeds, Yorks.

WANTED, English and foreign books on marine algology. Offered, rare slides of marine algae, showing reproductive organs (Antheridia, Cystocarpus, etc.); or Gosse's "Year at the Shore," Brown's "Manual of Botany," Dowden's "Shakespeare," and other good books.—T. H. Duffham, Comely Bank Road, Walthamstow.

A FEW good specimens of *Clausilia biplicata*, *Cl. Rolphii*, and so called *Hyalina glabra*, &c., for exchange. Wanted, living specimens of *Hyalina Draparnaldi*, *Hyal. alliaria*, *Testacella Maugei*, also other shells.—Wilfred Mark Webb, 31 Aynhoe Road, Brook Green, W.

FORAMINIFERA: selected foraminifera, mounted, opaque, and transparent, for exchange.—W. Stofft, Lostock, Bolton.

WANTED, perfect insects (during the season) in exchange for mounted objects or electric apparatus; name and locality where possible. Tubes or bottles containing them will be returned, and carriage paid both ways.—W. White, 17 York Street, Nottingham.

FOR exchange, a botanist's portfolio of 158 mounted specimens of English and foreign grasses, plants, flowers, etc.; with English and Latin names, sub-tribes, tribes, families, and orders plainly written. Upwards of 30 different grasses are included, and amongst them a specimen of *Lasiurus temulentum* (Darnel), supposed to be the tare of Matt. xii.; also various heaths. Besides these, a smaller one of about 50 specimens, well preserved.—Bertha Truscott, 4 Alma Crescent, Falmouth.

*Anodonta cygnea*, *Planorbis complanatus*, *P. cornuus*, *Physa hypnorum*, *Limnaea stagnalis*, *L. palustris*, etc. Desiderata: *Paludina vivipara* and *contecta*, or varieties of same.—W. E. Collinge, Springfield Place, Leeds.

A FEW slides of the Damour, New Zealand, Deposit, for exchange, each containing some of the noted forms; also other Diatoms. Good diatoms preferred. Send lists to—Rev. A. C. Smith, 3 Park Crescent, Brighton.

BRITISH marine shells wanted in exchange for others.—J. T. Lightwood, Hope House, Lytham.

FOR exchange; 3 store-boxes, corked both sides, 14 ins. x 10; 2 ditto, 15½ x 10½; 1 ditto, 14 x 8; 1 ditto, 10 x 8; 1 zinc pocket ditto; 1 setting-house, 13 x 10 x 5, with 8 boards; 3 loose setting-boards; 1 cyanide bottle; 1 wire ring-net; 1 larva box, pocket; and about 250 well-set moths, butterflies, and beetles. Offers in photo material or violin preferred.—F. C. T., 5 Victoria Road, Forest Gate, E.

*Hypnum hamifolium* of Schimper's "Synopsis" (Irish specimens) in exchange for any of the rarer Bryums.—C. H. Waddell, Kendal.

SEVERAL shilling books on Entomology, etc., by Rev. J. G. Wood and others; also a few minerals, to exchange for foreign marine shells. Will send list.—W. Jones, jun., 27 Mayton Street, Holloway, London, N.

WANTED, Cooke's "Plain and Easy Account of the British Fungi." Exchange, botanical, natural history works, etc.—P., 80 Leathwaite Road, Clapham Common, London, S.W.

WANTED, microscope slides in exchange for Cassell's "Technical Educator" and "Science for All." Also 3rd or 4th objective; exchange, the "Royal Natural History," value £2 3s. 6d.—Ebbage, 165 Hagley Road, Birmingham.

WANTED, specimens of dragon-flies (Odonata) from all parts of the world. Will exchange for them dragon-flies from North America.—Philip P. Calvert, Entomological Section, Academy of Natural Sciences, 19th and Race Streets, Philadelphia, Pa., U.S.A.

A FINE collection of flint, greensand, chalk, lias, carboniferous and English and Canadian silurian fossils; also a few duplicates.—J. A. Floyd, Hospital Road, Bury St. Edmunds.

#### BOOKS, ETC., RECEIVED.

"The Geology of England and Wales," by Horace B. Woodward. Second and enlarged ed. (London: George Philip & Son).—"Official Year Book of the Scientific and Learned Societies of Great Britain and Ireland for 1887."—"Mineral Resources of the United States."—"Geological History of Lake Lahoutan," by J. C. Russell (Washington).—"Pneumatics," by C. Tomlinson, 4th ed. (London: Crosby Lockwood & Co.).—"Cole's "Studies in Microscopical Science."—"Science and Art."—"Illustrations."—"Book Chat."—"The Century Magazine."—"Scribner's "Monthly."—"The Amateur Photographer."—"The Garner."—"The Naturalist."—"The Botanical Gazette."—"Journal of the New York Microscopical Society."—"Belgravia."—"The Gentleman's Magazine."—"American Monthly Microscopical Journal."—"The Essex Naturalist."—"Economic Naturalist."—"Wesley Naturalist."—"Journal of Conchology."—"Economic Naturalist."—"The Midland Naturalist."—"Feuille des Jeunes Naturalistes."—"The American Naturalist."—"Journal of Microscopy and Nat. Sci."

COMMUNICATIONS RECEIVED UP TO THE 12TH ULT. FROM G. E. E.—G. S. P.—I. I.—T. D. A. C.—S. C. C.—A. E.—A. P.—E. E. T.—W. B. J. E.—J. F.—T. H.—A.—F. W.—M. S.—F. C. K.—T. W. H.—E. Q.—A. S. L.—W. J. N.—W. J.—C. R.—H. G.—I. W. G.—P. P. C.—E. L.—E. C.—B. B. L.—B. E. Q.—J. H.—R. Q.—W. M. W.—W. H. B.—E. S.—W. B.—J. R. M.—N. B.—C. R.—J. W.—L. P. L.—W. B.—W. J. S.—N. A. S.—B. B. W.—W. M. W.—E. H.—R. T.—W. H.—B. H.—M. L. S.—C. H. P.—W. H. B.—W. R. T.—S. R.—S. A.—W. J. S.—W. H. B.—R. T.—A. C. S.—W. J., jun.—J. T. L.—F. C. T.—C. H. W.—F. G. F.—W. E. C.—A. H.—D.—B. T.—W. E. S.—S. C.—T. H. B.—W. W.—I. G.—R. M.—G.—C.—G. E. E., jun.—P. G.—H. P.—W. M. W.—G. F. W. T.—W. E. H.—H. F.—W. T.—B. H.—C. H. P.—W. H.—&c. &c.





## AMERICAN SHELL-MONEY.

By ERNEST INGERSOLL.



THE use of a circulating medium to facilitate commerce by simplifying the awkward devices of barter is supposed to indicate a considerable advance toward civilisation in the people employing it. On this score, the North American Indians ought to stand high in the list of barbarians, since they possessed an aboriginal money of recognized value,

although it had no sanction other than common custom. This money was made from sea-shells, and was known by various names, of which, one has survived, popularly—wampum—to designate all varieties of shell beads and money. Sea-shells, indeed, seem to have commended themselves for this purpose to widely different peoples. The great circulation which the cowrie-shell (*Cypræa moneta*) attained in Tropical Africa, India, and the South Sea Islands, will occur to the reader. It was once the coin of those regions in trading with the savages, to the exclusion of everything else; and ships going after cargoes of ivory, palm-oil, sandal-wood, and similar products, were obliged first to provide themselves with cargoes of cowries at Zanzibar, or some other port where they could be bought. All that was required to turn a cowrie into coin, was to find it and punch a small hole in it. But the American money was a distinct advance upon this, since it was a manufactured article. In addition to the exertion of securing this mollusk's shell, there was a large expenditure of labour in fashioning the bead which acted as a coin. Lindstrom (in Smith's "History of New Jersey")

says an Indian's utmost manufacture amounted only to a few pence a day; and all writers enlarge upon the great labour and patience needed to make it, especially at the South, where harder shells seem to have been utilised. Hence the purchasing power of a wampum bead was far in advance of that of a cowrie, the dentalium of the Pacific coast, or any other unwrought shell used as money.

The bead-form was probably an evolution from the use of single small shells, which still prevails to some extent on the western shore of the continent. Many small fresh-water shells, suited for stringing, but unsuited for ornamental purposes, have been found in mounds and graves in the Mississippi valley, and archæologists believe that these were employed as the currency of the tribes of that region. This is very probable, but there seems to be little, or no positive evidence (of record) that such was the case.

The very earliest account of North America shows that this money was in common and widespread service among the natives, as far north as the Saskatchewan, and westward to the Rocky Mountains. Among the far western tribes, who obtained it after a succession of barterings through races living between them and the coast, the beads came to be considered rare and precious, and were devoted almost wholly to ornament; but everywhere east of the Mississippi their circulation commonly as a buying and selling medium seems well assured. The evidences of this are derived, not only from the accounts of early visitors to the tribes of the interior, but by the relics abounding at their village-sites, and in their graves.

This is an exception. Roger Williams wrote in his Key: "The New England Indians are ignorant of Europe's coyne. . . . Their owne is of two sorts; one white, which they make of the stem or stock of the Periwinkle, which they call Meteauhok, when all the shell is broken off." Again, he says: "Their white they call Wampum (which signifies white)." Laskiel, however, tells us that wampum was an Iroquois word, "meaning a muscle." The wampum made from the periwinkle was distinguished in law as late as 1683, in Rhode Island, and in 1679, Wooley,

describing New York, says of it: "They (the Indians) make their White Wampum or Silver of a kind of Horn, which is beyond Oyster-bay," a phrase that certainly would not apply to a bivalve.

It appears certain, then, that the coiled, univalve, periwinkle shells (they are from six to ten inches in length) are of entirely different character from that of the Atlantic side of the continent, but I defer reference to it until later. The Eastern money consisted of elongated beads of two colours—white, or purplish or brownish-black.

The white variety was most plentiful, and of inferior value. It was commonly made from the large univalves *Sycotyphus canaliculatus* and *Fulgar carica*, whose pear-shaped, coiled shells are sufficiently alike to be easily confounded under the vernacular terms "periwinkle," "winkle," or "conch." But sometimes other material was used. Thus, probably, the very earliest mention of it by a European writer—that in the "New England Rarities" of John Josselyn, Gent. (1672)—reads: "a kind of coccle, of whose shell the Indians make their beads called wampumpeage and mohaicks. The first are white," &c., were largely, if not exclusively, used for this inferior grade of currency. It was only necessary to take out one or two small sections of the central column of the spire, and smooth the edges; the hollow cave made them natural beads. Smith's "History of New Jersey" (1767) informs us that this was precisely the plan followed, for it relates that "the white wampum was worked out of the inside of the great conques into the form of a bead, and perforated to string on leather." Still earlier testimony comes from the southern coast. Thus Beverly, in his "History and Present State of Virginia" (1705), records that the riches of the Indians there consisted of "Peak, Roenoke, and such-like trifles made out of the Cunk shell. Peak is of two sorts, or rather, of two colours; both are made of one shell, though of different parts; one is a dark Purple Cylinder, and the other a white; they are both made in size and figure alike." The same author also mentions a poorer kind of money yet, "made of the Cockle shell, broke into small bits with rough edges, drilled through in the same manner as Beads, and this they call Roenoke." Other authorities corroborate this, and prove what I have been led to enlarge upon—the fact that the conchs were used mainly for the white currency—because the popular idea has been that all the shell-money was made from the valves of the Quahang.

This last-mentioned bivalve is one of the commonest mollusks on the shore of Eastern America, south of Cape Cod. It is a thick, somewhat globose shell, which buries itself in the sand under pretty deep salt water. The Indians gathered it alive, by wading and feeling with their toes, or by diving, and ate the animal with great gusto; it remains, indeed, an article of extensive sale in all our present markets

under the name of round clam, hard clam, or quahang, the scientific term being *Venus mercenaria*.

Toward the anterior end of the otherwise white interior of each of the valves of this mollusk's shell, is a deep purple or brownish-black scar, indicating the point of muscular attachment, which fishermen call the "eye." This dark spot was broken out of the shell by the Indians and formed the material of their more valuable coins. In descriptions of it, we meet with a new list of terms and additional confusion. It was worth, on the average, twice as much as the white variety; and the latter was frequently dyed to counterfeit it. Moreover, Laskiel is authority for the statement, that the natives of the New Jersey coast "used to make their strings of wampum chiefly of small pieces of wood of equal size, stained either black or white. These were held far inferior to shell-beads of either colour." I know of no other example of this species of counterfeiting or substitution.

In New England, Roger Williams describes this superior money as follows: "The second is black, inclining to blue, which is made of the shell of a fish which some English call Hens, Po-quauhock." This money, he says, was called "Suckáboock (Súcki\* signifying blacke.)" Josselyn gives Mohaicks as the Connecticut word. Among the Dutch on the Hudson river (and frequently elsewhere), Seawant was the usual term, and they spoke of it as black or white. There the various shades of blue, purple and dull black found separate names, but made no change in value. In notices of it among the early writers, where carelessness is apparent, the words Wampum, Wompam, Wornpon, Wampampege, Wumpumpeage, Wampeage, Peage, Peag, Wampum, Peak, Mohaicks, Suckántiock, Seawan, Seawant, Roenake, Ronoak, and others occur. Seawant appears to have been properly a generic term, indicating any and all kinds of shell-money; Wampum was often used thus, and is now so used altogether, but originally it seems to have meant the white beads alone; while the words Peag (in its various forms), Suckauhock and Mohaicks, represented the black. In Beverly's "Virginia," nevertheless, this is precisely reversed, which leads us to believe that the author made a mistake. Southern writers, however, make Peak generic, while Roenoke is a word unknown at the North. All of these terms are ill-spelled derivatives from roots meaning "shell," and the Indian names for the Venus shows their close affinity with the group. Porcelan was a Dutch appellation, coming, of course, from Europe, and not often heard.

Some of the methods of making this finer sort of bead-coin are interesting. "Before ever they had awle-blades from Europe, they made shift to bore their shell-money with stone." This was around Narragansett, and in the shell-heaps along the New

\* Misprint for Suckáu/ock.

England coast are found these old flint awls of prehistoric design, which may have been spun in some cases by a small bow, such as jewellers employ at present. In Virginia, Beverly found that both sorts of peak were "in size and figure alike, and resembling the English Buglas, but not so transparent nor so brittle. They are wrought as smooth as glass, being one-third of an inch long, and about a quarter in diameter, strung by a hole drilled through the centre." Lawson describes the drilling "which the Indians manage, by a nail stuck in a cane or reed. Thus they roll it continually on their thigh with their right hand, holding the bit of shell with their left; so in time they drill a hole quite through it, which is very tedious work, but especially in making their Ronoak."

Brickell (1737) is worth reading on this point also. The coinage, so to speak, of this shell-money was, therefore, a work of patient labor, and there was no fear of increasing the supply beyond the demands of trade by the worth of one deer-skin, since a savage would rarely make a single bead beyond what sufficed for his immediate necessities. It was a true medium of exchange—real currency. All the early accounts speak of it as "riches," and "money," and "current specie." "This," says Lawson, "is the money with which you may buy skins, furs, slaves, or anything the Indians have; it being the mammon (as our money is to us) that entices and persuades them to do anything, and part with everything they possess, except their children for slaves. As for their wives, they are often sold, and their daughters violated for it. With this they buy off murders; and whatsoever a man can do that is ill, this Wampum will quit him of, and make him, in their opinion, good and virtuous, though never so black before."

The Delawares in fact had a tribal treasury of wampum, out of which were paid the expenses of the public affairs. At certain feasts a great quantity of it was thrown upon the ground to be scrambled for by the youngsters, carnival fashion. Hired servants at these feasts, or anywhere else, were paid in wampum.

It followed, as a matter of course, that the shrewd first traders who came to New York and New Jersey should adopt this currency which all the natives were accustomed to. Receiving it as pay for their merchandise, they used it to buy peltries of the Indians. Thus wampum quickly became a standard of values, the currency of the colonists to a great extent in their transactions with each other, and even a legal tender.

Though the beads were often used separately, the ordinary and approved manner was to string them upon the sinews of animals, or upon cards which might or might not be woven into plaits about as broad as the hand, called wampum belts. The length of these strings varied, but in the north about six feet was found the usual quantity computed by the

Indians, and hence the fathom became the unit of trade. In the Carolinas, according to Lawson, "the strings were measured in cubits, as much in length as will reach from the elbow to the little finger." The Indians themselves were particular as to quality and size of the beads, upon the elegance of its finish (speaking scientifically the amount of labour and time it represented) depended its value. "When these beads are worn out," says Lindstrom, an engineer in New Jersey, in 1640, "so that they cannot be strung neatly and even on the thread, they no longer considered them as good. Their way of trying them is to rub the whole thread full on their noses: if they find it full and even, like glass beads, then they are considered good, otherwise they break and throw them away. Their manner of measuring their strings is by the length of their thumbs; from the end of the first joint makes six beads."

(To be continued.)

## STUDIES OF COMMON PLANTS.

### NO. VII.—CELANDINE (*Chelidonium majus*).

By E. A. SWAN, B.A.

THIS plant, which of course will not be confounded with the lesser celandine, *Ranunculus ficaria*, has many curious characteristics, not the least of which is the leaf; exhibiting, as it does, most clearly a transition state.

In Fig. 75 I have taken at random a leaf-stem containing five leaves, represented about half the natural size, when full grown, and showing the peculiar venation. I must state, at the outset, that the leaf-stem is flat on the upper, and convex on the lower, surface; in fact, it really constitutes the midrib of what, at one evolutionary period, was, or may become, a perfect leaf, but which is now, in the specimen selected, subdivided into five leaves and sometimes more. Indeed the stems, in their infancy, often have a dozen or more leaves on them; but, as a rule, only the five at the end of the stem arrive at any maturity, the others remaining, if at all, in a merely rudimentary condition. Fig. 76 is an outline drawing of a youthful leaf-stem about half the natural size. The midrib, is, in each instance, drawn with a dark line to distinguish it. On either side can be seen what I take to be the remains of the original leaf, and they broaden out at the bases of the smaller leaves. Often, as will be seen by examination, such broadening out is very irregular, and sometimes it and the side leaves are quite fantastic in shape; but, in the first specimen I have chosen, the irregularity is only particularly noticeable in the base of one of the lower leaves, where, on one side, there is a well-marked irregularity, besides an accessory small leaf. Even a cursory glance leads



one to adopt the opinion that here is a state of transition; and it requires little effort of the imagination to fill in the outline of what was, or may become, the perfect leaf; however, to do this satisfactorily, it would be advisable, in view of the foregoing observations, to take a stem of recent growth. I give alternative hypotheses, as there may be difficulty in obtaining distinct proof of either. But, whichever is correct, the arrangement is manifestly more



Fig. 75.—Five-leaved stem of *Chelidonium majus*.

advantageous to the plant than the full-sized leaf would be. For the plant is low, the foliage is abundant and close, and being divided up in the way described, there is a better chance of light and air getting to every part. I can, therefore, quite understand that modification set in from the perfect leaf, by such portions of it as did not catch sufficient of the actinic rays gradually dwindling away, during successive generations. Or, if the alternative hypothesis be taken, the inability to get density of large leaves with sufficient light might account for the leaf stopping short in its growth. Still, I do not look with favour upon this alternative, because I cannot find any evidence in support of it; on the contrary, all the evidence seems to point the other way, for instance, the midrib and the peculiar venation. I can conceive that, at one time, the plant was of more pretentious dimensions than it is now, and then, from climatic and other influences becoming dwarfed, the large leaves thereupon fitted themselves to altered circumstances; but I cannot understand the roundabout way of evolving a large leaf by the ultimate junction of several small leaves,



Fig. 76.—Youthful stem-leaf of *Chelidonium majus*, half natural size.

at any rate in this instance, when the readiest way would be for each individual to increase in size. Nature invariably adopts the simplest and easiest methods of gaining its ends; it is, consequently, more than probable that our specimen is simply a modified large leaf, and not a series of small leaves in process of combination.

Near where the leaves as depicted in Fig. 76 begin, the flower stem usually rises, and this may account for the arrest in growth of the lower small leaves. The flower stem is a stalk which carries two or more stalks, the true peduncles upon it; on each peduncle is a flower.

As to the flower itself, there are two sepals which fall off early after the opening; there are four small yellow petals; the pistil is well-developed as a tangible seed-pod, with whitish stigma; the stamens are numerous, each anther consisting of two coherent pollen bags lightly poised from the centre by a fine thread on the filament. Being so poised, they are moveable as on a pivot, see-saw fashion, longitudinally as well as laterally. I can appreciate the arrangement, as by means of such mechanism the anthers are readily moved, so as to be in the proper position to press effectively against any insect, from whatever quarter it may come. This can the better be understood, when it is remembered that the petals stand well open, and insects are not compelled, as they are in many flowers, to approach by a certain way in which they most rub off pollen, as, for example, through a tube. If it were not for the device in question, I can readily believe they might settle in the centre of a flower, over and over again, and yet never take the first step in fertilisation.

As to the medicinal attributes of the plant, I offer no opinion. It may, however, interest some readers to learn that those annoying excrescences, called warts, are said to be cured by being rubbed with the brownish-yellow juice that exudes from a broken stem. I have never tried the experiment, but can suggest it as one not likely to do any harm, if it does no good. I have also heard that an infusion of the leaves is a famous specific for jaundice and other disorders of the liver, but here, too, I cannot speak from personal experience. I dare say if the plant has any virtue as a medicine for internal application, it is principally due to the presence of potash in appreciable quantity, as evidenced by the abundance of green colouring matters in leaves and stems. But, fortunately, if potash is required, we have a very wide range of plants to select from, without having recourse to celandine.

IN Switzerland it appears that the edelweiss and the Alpine rose are in danger of becoming extinct. In a few years we shall be saying the same of our own delightful primrose, if the latter is to be pulled up in tons, as we lately saw was the case.

## CHATS ABOUT ROTIFERS.

(SYNCHÆTA GYRINA.)

IN April, 1886, I had the good fortune to find a few specimens of this rotifer in a tide pool in the estuary of the Tay, associated with *Mytila tavina*, *Nothocca spinifera*, and *Distemma raptor*, which also were forms new to science. But it soon disappeared from the waters of the Tay, and not a single specimen could be caught, although my fishings were frequent throughout the summer and winter months. But in April, 1887, it has appeared in the same locality in abundance, which proves that it is a spring visitor.

The corona is convex, with five tufts of vibratile cilia, and bearing four curved styles or bristles, with a pair of side auricles, one on each side, and clothed

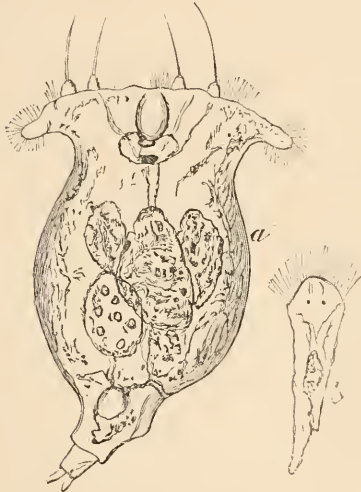

Fig. 77.—*Synchæta gyrina*. a, female; b, male.

with vibratile cilia. The body is oblong or globose, terminating in a club-shaped process towards the foot with two small toes. Its mouth is furnished with a pair of forcep-shaped jaws, with a dark red eye at the bottom or junction of the jaws. The tube leading from the mouth to the digestive organs is quite visible with a power of 60 diameters. The contractile vesicle, which empties and fills once in every 45 seconds, is near the region of the foot.

The water vascular system is very conspicuous in this creature, but to see this, it is necessary to get a specimen under a compressorium under a power of three or four hundred diameters. The lateral canals and vibratile tags in this way are distinctly seen.

The *Synchæta gyrina* is a very vigorous swimmer. It is never at rest one moment, or moving in a straight line. Swimming sometimes in wide circles, at other times in circles not much over its own length, it never tumbles or "somersaults" like its marine

cousin *S. baltica*, or its freshwater cousin *S. pectinata*, or spins round on its toes like its near relation, *S. tremula*. It is perpetually swimming in circles, hence the reason why I have named it *S. gyrina*.

Its food consists of small infusorians of different varieties, which it devours in great numbers.

The eggs of *S. gyrina* are quite round, and are deposited at the bottom on the stones amongst conferva and diatomaceæ. It differs in this from *S. baltica*, as it carries its eggs at its foot until hatched.

I had the good fortune this season to find the male, a very slender creature, not over  $\frac{1}{300}$  of an inch long, with a broad corona covered with vibratile cilia with a pair of conspicuous red eyes. It has no mouth or stomach, but a sack (which may be termed the sperm sack), containing granular matter, fills the lower part of the body cavity, with a tube leading to the penis. I was quite certain that this was the male *S. gyrina*, as I witnessed the process of generation, which takes place while the female is in rapid motion. The male remains in contact over one minute. This operation takes place only with young females. I have never seen a single instance of connection with a full-grown female.

Length of female  $\frac{1}{60}$  of an inch.

„ „ male  $\frac{1}{300}$  of an inch.

JOHN HOOD, F.R.M.S.

Dundee.

## HOURS WITH A THREE-INCH TELESCOPE.

By CAPTAIN NOBLE, F.R.A.S., &c. &c.

ALL beginners in astronomy should gladly welcome this excellent little book. Such a work has long been wanted, and attempts have been made to supply the want, yet though these books have each in their way been useful, none of them have been entirely successful.

This work opens with a clear description of a three-inch telescope, in which the author rightly warns the amateur not to expect to purchase such an instrument of the first quality for £5; a most refreshing peculiarity in such a manual, as most popular works which refer to instruments encourage their readers to expect to obtain them for a sum less than half the cost at which they can be manufactured. Then, after describing the telescope, he gives instructions for testing its quality, to which no exception can be taken, but to which an addition should be made. Captain Noble says that "no illuminated haze should appear about bright stars or planets," he should have added if the sky be clear and the object glass is free from moisture, for a very slight want of transparency in the atmosphere or a mere film of dew on the object-glass will cause the best telescope ever made to show a halo round a bright object.

However, these small criticisms which I shall venture on must not be taken as of any particular consequence. Where there is so much to praise and so little to find fault with, they must be taken simply as a proof that I have read the book carefully from cover to cover, and not, as is too much the habit of reviewers, cut the leaves and smelt the paper-knife.

Various methods of observing the sun are then described, and a most necessary warning given against looking at our great luminary through an instrument of this small aperture without using a screen of coloured glass over the eye-piece. Even these dark screens are not a complete protection to the observer, for I have had dozens of them sent to me for renewal, in which the heat has cracked them, and very many in which it has melted the centre of them. An excellent precaution is to use two pieces of plane-coloured glass in the shade head instead of one. I have never known two such coloured screens to be broken at the same time. If one breaks it is always the one next the sun and furthest from the eyes, and this should be replaced without delay before using it again. But the method of viewing the sun by projection (that is throwing its enlarged image on a sheet of white paper placed at a distance from the telescope) which is recommended is better, though this will not enable nearly so much detail to be seen as can be made out with a proper solar eye-piece.

The moon is then described and a map of the full moon given, together with a key to the map which contains a list of 400 of the principal objects on its surface.

Next there is an excellent description of the occultations of stars and planets by the moon, and the method of observing them. After the moon come the planets, the author waxing eloquent as he describes Venus and Mars. Respecting the last-mentioned planet I may say, in passing, that only an observer whose visual power has been well trained, and is above the average, will see as much of Mars as is shown in the engraving given of the planet with a telescope of three-inches aperture. The account of Jupiter and Saturn and their satellites may be also commended, though the drawing of Saturn has evidently not had justice done to it by the engraver.

After a brief account of the planets Uranus and Neptune, there are instructions for drawing the planets, particularly Jupiter and Saturn, and the book finishes with nine chapters, each supposed to contain an account of observations which may be made on one night, of the stars and nebulae. In these chapters the principal double stars are well described and illustrated with some excellent little engravings, the best I have seen of these difficult objects.

In the preface Captain Noble deprecates comparison between his book and other books of the same kind; but he need fear no such comparison. There are books written with a similar intention to

his, but not one which will, to an equal degree, answer the same purpose. There are again more ambitious works, some of which as catalogues of objects, almost defy criticism. Yet not one of these describes so simply and clearly the smallest telescope which can with advantage be used by the tyro, and the immense number of exquisitely beautiful and interesting objects which may be viewed with such an instrument.

JOHN BROWNING.

---

#### NOTES ON THE PROTECTIVE COLOURING AND HABITS OF LEPIDOPTERA.

By W. HARCOURT BATH.

THE subject of mimicry in connection with Lepidoptera is a very interesting one, but I believe very little patronised by the majority of entomologists. To study it more closely would no doubt reveal many hitherto unknown points in the economy of a great number of species.

There is no necessity to go abroad to obtain examples of mimicry; we have scores of interesting examples in our own country. A walk through the fields and lanes anywhere during the summer-time would afford a very lucrative field for any observant eye.

The larvæ of most of the Geometræ afford many excellent examples of protective colouring and habits. The long stick-shaped sombre-hued caterpillar of the swallow-tail moth (*Uropteryx sambucata*) in particular minutely resembles a twig when stretched out at full length—in which position it often remains motionless for hours, and thus successfully evades the prying eyes of the Paridæ and other insectivorous birds which are continually on the look-out for dainty morsels in the shape of grubs.

A great number of caterpillars which are greenish-coloured find abundant protection in their resemblance to the herbage upon which they feed. The green larva of the small white butterfly (*Pieris rapæ*), for instance, is extremely difficult to discern among its food plants, as it usually, when at rest, lies parallel with the leaf-veins and stalks of the cruciferous vegetables upon which it feeds.

The beautiful caterpillar of the emperor moth (*Saturnia pavonia*) affords another excellent example of protective colouring; the pink and yellow spots with which it is adorned minutely resembling the flowers of its pabulum heath. Many other caterpillars which are not so wonderfully endowed by nature with protective colouring are provided with other means for baffling their foes. Some are provided with spines, as in the peacock (*Vanessa io*), and others with long hairs, as is the case with the tiger moth (*Arctia caja*), such being greatly disliked by the majority of birds.



Many of these hairy caterpillars have the power of causing an intolerable urticating sensation when handled, as is well known in the case of the large and handsome larva of the fox moth (*Bombyx rubi*) which saves them from falling a prey to rooks and other natural enemies. Many larvæ find protection in being brightly coloured, because such, as is well known, are highly distasteful to birds. Then, others are provided with the means of creating a disagreeable odour, as, for example, the caterpillar of the swallowtail butterfly (*Papilio machaon*), which power it employs for the purpose of driving away ichneumon flies and other enemies. For a similar purpose, too, the comical caterpillar of the puss moth (*Dicranura vinula*) possesses a pair of tail-like appendages which it slashes about over its back when annoyed. Its brilliant colouring, and remarkable power of ejecting a fluid at its enemies, combined with its formidable appearance, proclaim it to be one of the most highly specialised of Lepidopterous insects.

The pupæ of Lepidoptera are not less favoured by nature with means of protection than larvæ. Take, for example, the cocoon of the emperor moth (*Saturnia pavonia*), which is so wonderfully constructed that it will allow the imago to escape while excluding the possibility of enemies getting in from without. The cocoon of the puss moth (*Dicranura vinula*) furnishes us with another marvellous example of mimicry. It is frequently spun up in some hole or crevice of a tree, and made to fit in so nicely that the depression is filled up level with the surface of the trunk, and the caterpillar, by gnawing and mixing pieces of the bark with its cocoon, makes it minutely resemble the colour of the tree trunk itself.

The chrysalids of many Rhopalocera, as those of *Papilio machaon*, *Pieris rapæ*, *Vanessa urticae*, etc., are gifted with the power of assuming the colours of objects by which they are surrounded.

Among the imagines of butterflies and moths numerous examples of mimicry may be obtained.

Many of the clearwing moths (Sesidæ) mimic Hymenopterous insects; for example, the hornet clearwing (*Trochilium apiforme*) bears a remarkable resemblance to the stinging hornet, which affords it exemption from falling a prey to many birds.

There are not a great number of Lepidoptera, however, which mimic other animals. The great majority find most protection in their resemblance to vegetation and inanimate objects. The Vanessidæ, for instance, when at rest with their wings closed, wonderfully resemble the objects (tree trunks, palings, etc.) upon which they settle.

The Pieridæ are highly endowed with protective colouring, the veined wings of these butterflies minutely resembling the leaves of plants upon which they shelter. *Gonepteryx rhamni* is another butterfly which I have particularly noticed in mimicking the leaves of its pabulum the buckthorn. It has the habit of nesting on the under side of the leaves which

are of a lighter colour than the upper surface, and which more nearly resemble its own. The tail-like points of its wings represent the apex of the leaves, and in addition the veins of the insect's wings altogether produce an excellent comparison to the leaves of this tree. The little green hair-streak (*Thecla rubi*) also minutely resembles the leaves of trees of various kinds. A great number of Lepidoptera resemble dead leaves, as, for example, do all the Hybernidæ, or winter moths.

The lappet moth (*Lasiocampa quercifolia*) looks exactly like a brown oak leaf.

Many species resemble flowers in appearance, such as *Lycæna argiolus*, to the flowers of the holly, and *Euchloë cardamines* to the flowers of various umbelliferous plants. The buff-tip moth (*Phalera bucephala*) when at rest resembles a piece of stick. Other moths resemble the droppings of birds, such as *Melanthia albicillata* and *M. ocellata*, &c.

Some species resemble splashes of mud and streaks of dirt, while others even resemble the bare ground in colour. The two little butterflies *Cænonympha pamphilus* and *Polyommatus phleas*, when chased, will often close their wings, fall to the ground, and remain quite motionless, trusting to the concealment afforded by their sombre hues.

One insect, the pale brindled beauty moth (*Phegalia pedaria*) I have noticed to closely resemble the lichens and mosses on the trunks of trees with which they are thickly clothed at the time of the year when the insect is most abundant. It is thus very difficult to discern the moth when at rest on the trunk of an oak-tree. It may be observed that this insect, when alive, possesses a beautiful greenish-glossy tinge, which, however, it loses after death. The instinct which prompts moths to rest on or near objects which resemble themselves in colour is really marvellous.

I have frequently observed, in the case of *Bryophila perla*, a great inclination to rest on blue bricked or stone coloured walls, on account of the resemblance which it bears to them in colour. On the other hand, it avoids red-bricked walls, and will never rest on them whenever it can obtain one of the former colour. If it is compelled through circumstances to rest on red-brick walls, it invariably selects the mortar.

I have observed a somewhat similar instance with reference to *Lobophora viretata*, which prefers resting on moss-covered holly-trees to oak-trees, because the former are more thickly clothed with vegetation at the time of the year when it makes its appearance.

Other species of Lepidoptera seek protection by a variety of other means, some of which we must not forget to notice, as they are exceedingly remarkable. *Charaxas graminis* and *Tapinostola fulva*, for instance, will, when disturbed, remain perfectly motionless, and, if touched, will work themselves like a wedge down to the very bottom of the herbage, and thus evade discovery. It is really remarkable what a propensity

some species have for edging themselves downwards in this manner.

Many moths when captured will feign death, such as *Spilosoma fuliginosa* and *Nemeophila plantaginis*, but only cast your eyes off them for a moment and they dart off with the speed of a meteor.

I might give scores of other examples of protean colouring and habits of Lepidoptera equally interesting, but I have already extended this paper beyond the limits which I originally intended, so beg leave to wipe my pen and stop.

*Ladywood, Birmingham.*

#### A YORKSHIRE QUERN.

WHEN gathering "day-stone" on the moors, adjoining the river Derwent, at Coldside, Howden, near Sheffield; the workmen found an almost perfect specimen of the upper stone of a quern,

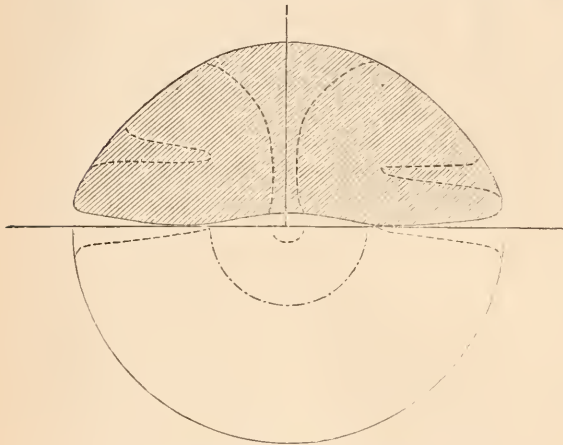

Fig. 78.—Section (ribbed) and Half Plan of Quern.

or hand-mill, which narrowly escaped being broken up for road metalling. Fortunately, it was seen by Mr. Henry Weetman, F.Z.S., of Howden House, and is now safely deposited in the Museum at Sheffield.

Coldside is situate at the foot of the "Castle Rocks," on the talus of the escarpment formed by the outcrop of the Kinder Scout Millstone Grit. The quern is made of stone probably obtained from the above-named bed; and is of so coarse a texture as to approach very nearly to a conglomerate; some of the included quartz pebbles (the "suet lumps" of local masons) being half an inch long.

I enclose a section drawn to scale—two inches to a foot—taken in such a position as to shew the inverted conical "feeding-hole," and the two holes, situate on opposite edges of the stone, into which sticks, or possibly pieces of horn, were inserted to be used as handles in working the mill.

The stone is very neatly worked, and does not

show any chisel marks; the upper surface and edges are stained black, from exposure amongst the heather. The under or grinding surface is unstained and polished, as if from long service. The whole stone appears as if it had been unequally worked, or had ground down on 'one side' rather faster than on the other.

The plan of the stone is almost a circle; right-angle measurements being 1 ft. 1½ in. × 1 ft. 1½ in. The feeding hole is 5 ins. diameter at the top, and narrows to 1 in. at a point 3 ins. down, continuing at that dimension throughout. The handle holes are 3½ ins. deep and taper inwardly from 1½ ins. to ¼ in.; the lower edge of one of these is only half an inch from the under surface of the stone, that of the opposite hole 2½ ins. The under surface of the stone is not flat, but is beautifully worked out, so as to give the least resistance when in use, compatible with sufficient grinding surface; this will be better seen by a reference to the section.

Similar finds are not unknown on these and the neighbouring moors, which are sprinkled over with camps, entrenchments, barrows, and at least one length of Roman Road. Two or three flint arrow heads have been picked up at the spring-heads in the immediate neighbourhood; and at the last conversazione of the Sheffield Literary and Philosophical Society, the Rev. Mr. Gatty showed a very fine collection of flints from the Bradfield moors, which are three or four miles to the east of Coldside. A bronze spearhead, encrusted with gravel, was found a few years ago under the Derwent Edge Rocks. I have been unable to ascertain its present whereabouts.

Perhaps some archæological reader of SCIENCE-GOSSIP will kindly say to what period the quern belongs?

*Sheffield.*

THOMAS WINDER, C.E.

#### TEETH OF FLIES.

By W. H. HARRIS.

##### No. 14.—*CERATINOSTOMA OCEANUM.*

THE fly whose dental organs are depicted in the present illustration is an exceedingly rare species belonging to the family Scatomyzides, Fallen. It occupies a position intermediate between those in the genera *Scatophaga* and *Cordylura*. It was first taken by me on the coast, in the neighbourhood of Cardiff, about the commencement of autumn, 1884. A few specimens only were captured.

It was submitted to Mr. Meade for identification, and after a careful examination, that gentleman pronounced it to be quite new to him, at the same time, he requested that further specimens should be sent him, in order to continue the investigation. Most assiduously did I search the ground where I took the creature originally, up to the month of



November, but not a single specimen could be found, and the pursuit had to be abandoned until the following year.

In the spring of 1885, I found a solitary pair, which I was fortunate enough to capture. Mr. Meade also took a pair in the Isle of Man, during the early summer months, and, although diligently sought for subsequently no further specimens were taken by him. In July, I found one specimen at Ilfracombe, a female; these captures comprise the entire collection I have been able to make of this species. I may safely say I have walked over a hundred miles, specially in quest of this creature, and altogether have been rewarded with about ten specimens—a result I would have conceived scarcely possible had I not so very practically proved it.

pterate muscidae. They are closely allied to the Scatophagidae, but differ from them by having the abdomen of the male more elongated, cylindrical, and furnished with large projecting sub-anal appendages (male organs). They have also shorter wings, less hairy bodies, and usually a thicker soft proboscis, and not of a shining black colour as in the Scatophagidae."

Description of *Ceratinostoma oceanum*.—This fly is of a slate colour, with an olive-green tinge, the abdomen being covered with grey tomentum. The thorax is marked with four olive-brown stripes, the lateral ones being irregular and maculiform in shape, the inner ones linear in front, and moderately wide and straight in the middle and posteriorly. The abdomen has the posterior edge of the segments



Fig. 79.—Teeth of *Ceratinostoma oceanum*.

The fly frequents the debris thrown up by the tide, and rocks not much removed from high-tide level; it is exceedingly wary, and somewhat difficult to capture, taking flight before one can get well within reach of it. It is of a slate colour, with an olive-green tinge, and, as a large portion of the rocks in the Penarth section comprise the tea-green marls of the Rhætic series, the difficulty of following the flight of the creature is very materially increased. In size it is somewhat smaller than the common dung-fly, in shape the sexes differ considerably.

The following description of the genus and species has been kindly placed at my disposal by Mr. Meade, and may be interesting to readers of SCIENCE-GOSSIP who devote any attention to the generally despised Diptera.

General Description.—“The Cordyluride belong to the more highly developed portion of the Acaly-

marked with narrow yellowish lines; these are sometimes indistinct, and it is clothed with very short black or dark grey hairs. The male anal organs are smaller than in most of the other species. The forehead and frontal stripe are black in both sexes. The antennæ are black, but the second joint has a rufous tinge, and white reflexions. The arista, or style, is rather short, thickened at the base and distinctly plumose. The palpi are long, rather dilated at their extremities, of a yellowish-white colour, and clothed with short black hairs. The oral setæ are short. The proboscis is pendulous, horny, and of a shining pitchy black colour. The wings have a slight brownish tinge, and have the third and fourth longitudinal veins divergent at their extremities. The legs are entirely of a leaden greyish-black colour, and are clothed with short reddish hairs, on the under surfaces of the coxæ and



femora as well as on the tarsi, some of the joints of the latter are quite yellow underneath.

The female closely resembles the male, except in the shape of the abdomen, which is fusiform and pointed at its extremity. Remarks: This species corresponds very closely with the description given by Schiner of his *Cordylura lurida*, but differs from it by having the legs almost entirely black instead of being principally yellow; both species are rather aberrant, and seem to form links between *Cordylura* and *Scatophaga*, for they resemble most of the species in the latter genus by having the horny proboscis and striped brown thorax. The entire outline of one of the lobes of the proboscis is given in the illustration, no further dissection being necessary to display the dental organs beyond removing the tip of the proboscis and carefully expanding the lobes. The teeth occupy a large portion of the lobes and are of a deep amber tint. The teeth are operated by a powerful fulcrum, the ends of which are prolonged, and towards their extremities are reversed, terminating in a sharp cutting edge, and form additional organs of dentition; the free ends of three of the teeth are of the blow-fly type. The central tooth is similar to the large one in *Scatophaga stercoraria*, while the main tooth is not represented in any other species yet met with.

Their action must be that of crushing and cutting, by being brought together, as in the case of the dung-fly, there being no other organ, as possessed by *Carica tigrina*, to assist in the process of mastication.

There is an entire absence of pseudo-tracheæ. This peculiarity has been met with previously in one genus only, viz. *Stomoxys*, but their place is supplied in *C. oceanum* by delicate chitinous plates arranged in distinct rows. These have a very strong resemblance to miniature ears of wheat, their office, doubtless, is to assist in the capture of prey, to continue the process of mastication, and to collect and convey to the main trunk the juices so extracted, where they come under control of another organ whose special duty it is to convey them to the œsophagus and supply the cravings of the creature's appetite.

#### GOSSIP ON CURRENT TOPICS.

By W. MATTIEU WILLIAMS, F.R.A.S., F.C.S.

**A DESTROYER OF TASTE.**—In "Nature" of April 14th, is a communication from Mr. W. T. Thiselton Dyer, on a curious property of the leaves of the *Gynmema sylvestre*, an asclepiadaceous plant which grows on the Deccan peninsula, in Assam, on the Coromandel coast, and in some parts of the continent of Africa. If two or three leaves are carefully chewed, the power of tasting sugar is absolutely abolished. General Ellis found that it

also abolished the power of enjoying a cigar. A paper was read on the subject at a meeting of the Nilgiri Natural History Society, by Mr. David Hooper, on March 7th. Mr. Edgeworth, who first noticed this property, states that after masticating the leaf, powdered sugar placed in the mouth tasted like sand. A sweet orange has the taste of a sour lime, the sourness of the citric acid being alone distinguishable; only sweet and bitter flavours are thus destroyed. This indicates that the action is not due to a complete temporary paralysis of the nerves of taste. After a good dose of the leaf sulphate of quinine tastes like chalk. The effect usually lasts two or three hours. According to Mr. Hooper, this property of the leaves is due to an acid which he has separated. He proposed to name it Gymnaic acid.

**CHANGES OF LEVEL ON THE BALTIC.**—The topographical surveys recently carried out in Finland show that the shores of the Baltic are, relatively to the level of the sea, continually rising. Since the surveys of 1810 to 1815 several islands have become peninsulas, and shallows have become islands or beaches. On the south-west coast and in the neighbourhood of the Aland Archipelago, many places that a few years ago were under water are now grazing grounds, market gardens, or corn fields. Maps are now being made which will define and measure the future progress of such changes.

**JUBILEE COOKERY.**—Some flippant paragraphs have been lately published in the newspapers concerning those jubilee celebrations which include the old practice of roasting an ox whole. The paragraphs describe the result as "burnt fat and underdone steaks," and speak of "this wasteful mode of cooking good beef," &c. &c. If the writers had condescended to study so vulgar a subject as the philosophy of roasting, they would have discovered that when an ox is roasted whole in the old-fashioned manner there is far less waste, far less of burnt fat, than when it is roasted in separated joints; that the least wasteful method of roasting a given quantity of beef or other flesh meat is to roast it in one piece. I have expounded rather fully the reasons of this in chapter v. of "The Chemistry of Cookery," and will briefly recapitulate them here.

Roasting, however performed, is a wasteful method of cookery, the reason being that a certain amount of the surface of the meat to be cooked is exposed to a drying heat, and this drying heat is wasteful in proportion to the amount of surface exposed. Now it is obvious to everybody that every time you subdivide an ox, or anything else, you expose two new surfaces. If you divide each half into quarters you expose six new surfaces, if these into eighths, you expose fourteen new surfaces, if these again into sixteenths, you expose thirty new surfaces, and so on; if the ox is cut up into ordinary small family joints, about a hundred

new surfaces become exposed. These being inside flesh surfaces the drying hardening wastefulness is much greater on them than on the outer surface, which is protected by integumentary sheath. This may be proved by weighing different sized joints before and after roasting. It will thus be found that the percentage of loss diminishes as the size of the joints increases. I have witnessed the process of whole roasting an ox and dined on a slice of the result. It was about the best roasted beef I have ever eaten. The only rivals to it were cuts from the "barons" of beef which were, in the olden times, cooked every Thursday (market day) by Benson of Birmingham, for the best of all judges of roast beef, viz. the Midland farmers.

The whole ox to which I refer was roasted at Warwick. Its cookery commenced at midnight, and was completed at 1 p.m. on the following day. Burning of the fat was impossible, it was too far from the fire, and the basting was too industriously applied. It never ceased, and hence, as explained in the chapter above named, the true nature of the cookery was a process of stewing in a bath of fat of a lower mean temperature than that of boiling water. The flavour, tenderness and digestibility of roasted lean meat depends mainly on the retention of its juices. Lean meat is muscle, every muscle and all its fibres and bundles of fibres are enveloped in protecting sheaths which retains these juices. These leak away during cookery when the muscle is cut through.

THE RINGS OF SATURN.—These marvels of the heavens have been making further demonstrations of their marvellousness. Drawings made on the 8th and 15th of February were recently presented to the Royal Belgian Academy by M. Stuyvert, Assistant Astronomer to the Royal Observatory of Brussels, which show that the Cassinian division is encroaching on the outer ring; that ring B is nearly broken up into a series of bright white spots by a number of dusky indentations on the inner border. The dusky ring shows two dark notches, and the division between this and the ring B appeared on February 8th, to be formed by a succession of dark grey spots. Other astronomers have been making similar observations indicating the variability of these remarkable appendages and supporting the satellite theory of the rings; the view of their constitution which represents them as composed of a multitude of small satellites so clustered as to present the appearance of a ring when viewed at such a distance that the spaces between the individual bodies are not visible. If we look along a row of gaslights in a street they appear nearer and nearer to each other as their distance from the eye increases. If the street be of a sufficient length the most distant appear in contact, forming a continuous line of light. There is now but little doubt that such is really the constitution of these beautiful appendages to this planet.

In my essay on "The Fuel of the Sun," published in 1870, I ventured to compare them to the Zodiacal light which similarly surrounds our sun, and to ascribe to both the same origin, viz. meteoric ejections from the parent orb, erupted by the mighty explosions which form the solar prominences in one case, and by the corresponding white cloud-spot prominences in the case of Saturn. The inner dusky ring, which has been compared to a crape veil, is especially subject to fluctuations. Its variability is quite equal to that of the Zodiacal light. It was discovered in 1850 by Mr. Bond in America, Mr. Dawes in England, and Father Secchi at Rome, each independently of the others. Some have even supposed that it then came suddenly into existence, but it is more probable that this simultaneous discovery was due to favourable position and inclination of the planet, combined with full development of its variable elements which appear to be comparatively small meteoric particles.

COLD BATHING.—The investigations of M. Quinquad on the effect of hot and cold baths on respiration, have brought out very remarkable results. According to "Nature," his experiments on dogs show that after cold baths the consumption of oxygen is on an average ten times greater than before, and that hot baths exert a like influence, but in a less marked degree. "Cold baths (and hot as well, but in a less degree) increase pulmonary ventilation; the quantity of air passed through the lungs is double or treble after the bath. At the same time a greater quantity of carbonic acid is expelled." These quantities are very wonderful, so much so that careful repetition of the experiments are demanded to insure their verification. If the quantities are proved to be correct, a further course of research is suggested, in order to determine whether any reaction follows this extraordinary increase of vital activity.

We all know that cold baths are refreshing, and those who take them before breakfast are clearly conscious of their effect on the appetite, but ten times the consumption of oxygen demands nearly ten times the supply of food. Accordingly those physiologists who measure vital energy simply by the heat-equivalent mechanically calculated upon the basis of oxidation must conclude, if M. Quinquad's figures are confirmed, that one dog after a cold bath is equivalent in dog power to ten dogs before immersion. For my own part I do not accept this steam-engine analogy of vital energy; and have endeavoured to refute it in the concluding chapter of "The Chemistry of Cookery," which discusses the physiology of nutrition.

THE NOSE TRIUMPHANT.—In the early days of my practical chemistry studies in the laboratory of the Edinburgh College of Surgeons and Highland Agricultural Society, I occasionally assisted at a "Council

of noses," for the purpose of determining the existence or non-existence of certain aromatic compounds, and frequently pondered on the humiliation to chemical analysis which sometimes followed, as when by the simple dog-like use of olfactory organs greatly inferior to those of a dog, we were able to detect the existence of substances which no chemical reagent could reveal.

This humiliation has recently been elaborately displayed by some experiments of Drs. Emil Fischer and Pensoldt. They used mercaptan and chlorophenol, diffused them through a room of 230 cubic metres capacity, in such wise that the quantities were measurable by the degree of dilution and diffusion. The results obtained were that human olfactory organs were able to detect  $\frac{1}{4000000}$  part of a milligramme of chlorophenol, and the  $\frac{1}{400000000}$  part of a milligramme of mercaptan (a milligramme is  $\frac{1}{283500}$  part of an ounce). Chemical testing was cruelly beaten by the spectroscope when applied by Bunsen and Kirchhoff for the detection of sodium vapour in the air, but in these experiments on mercaptan the unassisted nose detected a quantity 250 times less than the smallest quantity of sodium vapour detected optically by the spectroscope.

MEASURING DISTANCE BY ELECTRIC LIGHT.—The "Electrician" tells us that M. E. Genglaire has devised a simple and ingenious method for enabling an ironclad to determine the range of an object after nightfall. He proposes to mount two powerful electric light projectors, one at the bow, the other at the stern of the vessel, and converge their beams on the object in question. By taking the distance between the two lights as a base line, and measuring the angles of projection at each end of the line, the distance of the object upon which the two lights converge may be easily calculated.

The writer of the paragraph adds that "it is obvious that the method does not pretend to any great accuracy, but it seems to be capable of sufficiently close approximation for the purpose in view, to make it worth while for the Admiralty to try some experiments in this direction."

In this criticism the writer is seriously at fault. Such a method properly conducted admits of remarkable accuracy, as anybody acquainted with the use of the theodolite in trigonometrical surveys will at once understand. Unless the ship be rolling, a distance across the water may thus be measured more accurately than across ordinary and undulating ground by direct application of the chain or measuring tape. On this principle were measured the distances between different parts of Great Britain as laid down on our Ordnance maps; the difference in the application of the principle being that in the case of the Ordnance and other good surveys, rays of light passing from the distant object to the ends of the base line are used; while in this light projection method, the rays proceed

from the ends of the base line to the object. The primary base line of the Ordnance survey was measured on the sands of Lough Foyle instead of a ship's deck. A theodolite arrangement may easily be applied to the light projector by making it take the place of a theodolite telescope.

#### THE CORAL-ROOTS OF SWITZERLAND.

BEFORE the February frosts give way to the early Swiss spring, there are many indications of the forthcoming mountain flora. Here, in the Canton Vaud, we may follow the wild course of the ravine and torrent bed, which gradually narrows between the precipitous crags and spurs of the green



Fig. 80.—*Dentaria pinnata*, half natural size.

Alps as we approach the higher fastnesses. Massive limestone, lichen-covered boulders impede the foaming stream, and tangled masses of the previous year's vegetation clothe the rocky sides. At times the very streams are frozen; huge icicles hang on every side, and botryoidal-shaped ice encasing the very stones, while the far-off trickle proclaims the fact that the waterfalls and streams are still active behind the veil of glittering ice. There is a peculiar charm in the valley at such a time, for no breath of wind can reach us; the sky is intensely blue, and the power of the sun is great. Everything glitters and sparkles in the brilliant light, until we imagine ourselves in fairy-land. And, in truth, it is like some enchanted ground. That spring is at hand is evident, the early snow-flake (*Leucojum vernum*, L.) has already pierced the snowy slopes in profusion, and



the birds twitter on every side in a manner suggestive of nest-building operations. On the branches above, we may note a dozen or more of the singular little crested tit (*P. cristatus*); it is remarkable for its wise-looking face, for all the world like a miniature owl. The crest stands well forward, curling over the head; the eyes are rendered prominent by light brown, surrounded by dark rings, giving a singular appearance to the bird.

But we might pause to note a thousand objects of interest on every side. Our present concern is to describe the several species of *Dentaria*, plants of the cruciferous order, which are possibly unfamiliar to many English botanists.

Even before the severe frosts have departed, we may

contained in each scale. It is true that only a few of the larger scales throw up a vigorous plant, but many tiny shoots are visible. Sever a portion of the root, and a fresh plant will soon be developed. This root-structure is common to all the species, but with regard to *D. bulbifera* there is a further peculiarity.

On the stem of the plant, at the axils of the leaves, buds or bulbules are produced, which fall off at the mature stage, become buried in the ground, and form a future separate plant. It appears to us that we have here a modification of the same power, differently developed in different species. The fleshy scales and the bulbules are surely of the same character. It may be that the stem bulbule was, in the first place, but



Fig. 81.—*Dentaria digitata*, half natural size.



Fig. 82.—Roots of *D. digitata*.



Fig. 83.—*Dentaria bulbifera*, half natural size.

search, in the more sheltered corners, where the leaf-mould has accumulated, almost in the very bed of the ravine torrent, with the certainty of finding at least one species of *Dentaria*. The first indications of the plant consist of a strong, upright stem, which might well belong to the bracken. It forces its way through the frosty ground in a wonderful manner, the head is curled up, and we must wait a few days till the leaf structure unfolds itself, revealing the digitate or palmate, deeply cut leaves, which again prove somewhat puzzling. We begin to think of Hellebores, and yet fail to recognise the characters. If we scrape away the soil, however, the genus of the plant is evident. The curious fleshy scales of the spreading, irregular roots can only belong to a *Dentaria*. These coral-like scales are deserving of notice. A reference to the drawing will show that an incipient plant is

the accidental freak of nature, a fragment of the tooth-like scale being produced at the axil of the leaf and stem. The variety was perpetuated, and we have the separate species. These species of *Dentaria* are well marked and readily identified, chiefly by the bold characters of the leaves.

A little later, in March and April, the lower hill-sides, under spreading chestnuts and walnut trees, the mossy ground will be covered with tiny forests of *Dentarias*—strong, vigorous plants, standing 1 ft. or more above the ground. The foliage is ample, surrounding the delicate heads of the flowers with varied shades of green. The flowers are large, sometimes lilac or pink, but more generally white. The stems are somewhat succulent, requiring a shady situation and moisture; they fade quickly when gathered, but revive in a basin of water. The pressed

specimens make a handsome addition to the herbarium and are easy to arrange.

C. PARKINSON, F.G.S.

GENUS DENTARIA (L.). (Coral Root.)

Plants of the cruciferous order. Having 4 sepals, free; petals 4, opposite, entire; stamens 6, 4 long and two short; ovary free; carpels 2; ovules suspended. Fruit long (siliqua), compressed, not nerved, opening by valves; root scales coral-like, fleshy and irregular, with numerous fibres; the stems of the plant springing from the point of the tooth-like scales.

1. *D. pinnata* (Lam.), stem upright, leafless at the lower part 3-4 leaves alternate, not surrounding the terminal flower; pinnate, the segments being 5-9, lanceolate, pointed and boldly serrated, flowers large, lilac or white. Plant somewhat succulent, growing in moist situations. March, April.

2. *D. digitata* (Lam.), *D. pentaphyllos* (Waldst.), similar to last species, and often growing together with it. Readily identified by the palmate leaves; of 5 ovate-lanceolate segments; flowers rose, lilac or white. March, April.

3. *D. bulbifera* (L.), a rarer plant in Switzerland, but the only species found in England. The upper leaves are entire, serrated, and alternate; the lower leaves ternate or rarely palmate, the bulbules form at the axis of leaf and stem. They are of a purplish hue, drop off at a certain period, and develop into separate plants. April, May.

4. *D. polyphylla* is another species given by Bouvier (Flore des Alpes), leaves verticillate, probably a variety of *D. pinnata*; flowers white, turning yellow as they fade. April, May.

THE DATE, DURATION, AND CONDITIONS OF THE GLACIAL PERIOD WITH REFERENCE TO THE ANTIQUITY OF MAN.

THE following is a summary of a very important paper recently read before the Geological Society by Professor Joseph Prestwich, M.A., F.R.S., F.G.S.

After showing how the discoveries in the valley of the Somme and elsewhere, twenty-eight years ago, led geologists who had previously been disposed to restrict the age of man, to exaggerate the period during which the human race had existed, the author proceeded to discuss the views of Dr. Croll on the date of the Glacial epoch. Dr. Croll, who had at first referred this to an earlier phase of orbital eccentricity, commencing 980,000 years ago, subsequently regarded it as coinciding with a minor period of eccentricity that commenced 240,000 and terminated 80,000 years since. This last estimate was chiefly supported by the amount of denudation that had subsequently taken place.

The efficacy of the increased eccentricity of the earth's orbit in producing the cold of the Glacial epoch was shown to be very doubtful; for as similar changes in the eccentricity had occurred 165 times in the last 100 millions of years, there must have been many glacial epochs in geological times, several of them much more severe than that of the Pleistocene period. But of such glacial epochs there was no valid evidence. Another inference from Dr. Croll's theories, that each glacial epoch consisted of a succession of alternating cold and warm or interglacial phases was also questioned, such alternations as had been indicated having probably been due to changes in the distribution of land and water, not to cosmical causes. The time requisite for such interglacial periods as were supported by geological evidence was more probably hundreds than thousands of years.

Recent observations in Greenland by Professor Helland, Mr. V. Steenstrup, and Dr. Rink, had shown that the movement of ice in large quantities was much more rapid, and consequently the denudation produced much greater than was formerly supposed. The average rate of progress in several of the large iceberg-producing glaciers in Greenland had been found to be thirty-six feet daily. Applying these data and the probable accumulation of ice due to the rainfall and condensation to the determination of the time necessary for the formation of the ice-sheet, the author was disposed to limit the duration of the Glacial epoch to from 15,000 to 20,000 years, including in this estimate the time during which the cold was increasing, or pre-glacial time, and that during which the cold was diminishing, or post-glacial time.

Details were then given to show that the estimate of one foot on an average being removed from the surface by denudation in 6000 years, on which estimate was founded the hypothesis of 80,000 years having elapsed since the Glacial epoch, was insufficient, as a somewhat heavier rainfall and the disintegrating effects of frost would produce far more rapid denudation. It was incredible that man should have remained physically unchanged throughout so long a period. At the same time the evidence brought forward by Mr. Tiddeman, Dr. Hicks, and Mr. Skertchly of the occurrence of human relics in pre-glacial times, had led the author to change his views as to the age of the high-level gravels in the Somme, Seine, Thames, and Avon valleys, and he was now disposed to assign these beds to the early part of the Glacial epoch, when the ice-sheet was advancing. This advance drove the men who then inhabited western Europe to localities such as those mentioned which were not covered with ice. Man must, however, have occupied the country but a short time before the land was overwhelmed by the ice-sheet. The close of the Glacial epoch, *z. c.* the final melting of the ice-sheet, might have taken place from 8000 to 10,000 years since. Neolithic man made

his appearance in Europe 3000 or 4000 years B.C., but may have existed for a long time previously in the east, as in Egypt and Asia Minor civilised communities and large States flourished at an earlier date than 4000 B.C.

In the discussion which followed, the President said the paper was calculated to arouse an animated discussion. Professor Prestwich had only noticed the geological objections to Dr. Croll's hypothesis. The investigations of the Danish geologists in Greenland afforded valuable new data. One most important point for consideration was the age of the valley-gravels in England and Northern France, which Professor Prestwich had so ably treated.

Dr. Evans regretted that he had to differ from the author, and commented on the boldness of giving numerical estimates of geological time. It was questionable whether the astronomical calculations were quite complete. Considering the deposits formed since the Glacial epoch, both marine and fluvial, he doubted whether the dates assigned by the author sufficed. Increased rainfall might account for some of the denudation, but the amount could not have been immensely excessive or animal life would have suffered more than it did. Marine erosion told a similar story to fluvial, as in the case of the southern part of what must have been the old valley of the Solent, which must surely have required more than 10,000 or 12,000 years to remove. Still the ordinary views of extent of time might be exaggerated. The speaker could not accept as conclusive the evidence of the pre-glacial age of man in Wales, and was very doubtful whether the palæolithic implements found by Mr. Skertchly were in beds of glacial date. Some of the palæolithic implements in the Eastern districts were made from pebbles brought into the country by glacial action, and it was incredible that any implements of really pre-glacial age should be of the same type. Pre-glacial man might, however, have lived in other parts of the world.

Dr. Geikie remarked that Sir W. Thomson originally had allowed 100 millions of years geological time, and it was on this view that Dr. Croll's views were founded. Now, however, Dr. Thomson had limited geological time to about 12,000,000 years. The speaker doubted whether this could have sufficed for the known course of geological events. He wished to know the data on which Professor Prestwich's estimates of time were founded. It had been suggested that the upper valley-gravels might be due to the melting of the ice-sheets and not to rivers at all.

Professor Boyd Dawkins also questioned the figures. There are no standards for measuring time in terms of years outside history, in which not only the sequence of events is recorded, but the length of the intervals between them. In geological time we are dealing with a sequence of events separated from one another by intervals, of neither of which have we any certain measure. Dr. Croll's theory is based on the

assumption that the Glacial climate was produced by a change in the relation of the earth to the sun. There is no evidence of this. Nor are natural chronometers to be found in the variable rate of valley-erosion, or of the deposit of alluvium, or of the retrocession of waterfalls. Nor do Sir W. Thomson's varying estimates of past time (ranging from twelve to three hundred millions of years) help us. The antiquity of man can only be measured by the changes which have taken place in geography, in climate, and in fauna, which have been very great. The strata with palæolithic implements in Algiers, Egypt, Palestine, and the Dekkan have not as yet been brought into relation with the Glacial Period.

Dr. Hicks remarked that Professor Prestwich, in giving reduced estimates of geological time, must have been desirous of converting some who seemed still unwilling to accept the evidence obtained, bearing on the pre-glacial age of man, apparently mainly because of the exaggerated amount of time given to the Glacial period by some authors. The evidence as to rapidity of motion of ice in Greenland tended to shorten the necessary duration of the Glacial period. He invited Dr. Evans and all Fellows to be present at the new excavations in Wales, which were to be commenced on June 6th. He described the situation in which the remains of man, claimed to be of Glacial age, and probably Pre-glacial, had been found, and explained the line of investigation about to be adopted.

Mr. J. Allen Brown, after thanking Professor Prestwich and Dr. Evans for their contributions to the discussion of this question, proceeded to notice the results of his own researches in the Thames Valley, and especially in the neighbourhood of Ealing, which indicated, he thought, that a lapse of time incalculably vast must have been required for their production.

Mr. Tiddeman said that the evidence as to the rapidity of motion of the Greenland ice-sheet was most important. He did not think we could safely take the erosion of the limestone around the perched Norber boulders as a measure of the time elapsed since the ice-sheet, because much glacial rubbish may have been removed before the surface of the rock was exposed to weather. The implement adduced by Dr. Evans as proving that palæolithic man was post-glacial in England could not prove that he was later than *interglacial* times; and of an interglacial land-period in England there were the clearest possible proofs.

Mr. Topley referred to the relative condition of land now and fifteen hundred years ago, which, he thought, must be of consequence in this discussion. From the remains of Roman works we might safely conclude that the physical condition of the country was practically unchanged since that date; the fords of the Roman roads are often still in use, and no appreciable amount of valley-erosion has taken place



in 1500 years. Under these circumstances he thought that we could not suppose such great changes as we know to have occurred could have taken place in only six or eight times that period.

The President suggested that Professor Prestwich was not, by any means, the first person to lay down fixed terms of years for the duration and date of the Glacial period; he found very definite terms laid down by other writers, and merely indicated reasons why these should be greatly reduced.

The author did not attempt to fix actual definite terms of years, but only to show that we must not unhesitatingly accept such large measures of time, especially when based, as they were, upon an assumed and unproved necessity. He objected to remain in that state of ignorance with reference to time which some of the speakers seemed to find quite satisfactory. He referred to the observations of the Danish observers on the Greenland ice, as furnishing us with certain definite time-results, the application of which might be expected to settle the question. It was a simple rule-of-three sum. If the Alpine date were supposed to accord with terms of 80,000 and 160,000 years, what are the numbers which should accord with the Greenland data? It is impossible to contend that it would make no difference, which would be the conclusion implied by the observations of some of the speakers.

#### RECENT ARTICLES AND PAPERS WORTH READING.

THE "Economic Geology of Ireland. No. 1. Metal Mining," by G. H. Kinahan ("Journal of Royal Geological Society of Ireland").— "American Jurassic Mammals," by Professor Marsh ("Geological Magazine," June).— "Earthquakes," by A. Ramsay ("The Garner," June).— "On Tresca's Remarkable Investigations into the Flow of Solids under Great Pressure," by W. P. Marshall ("The Midland Naturalist," June).— "The Staining of Animal and Vegetable Tissues," by A. J. Doherty, and "Vision in Insects," by J. B. Pettigrew (Trans. Manchester Microscop. Society).— "History and Biology of Pear Blight," by J. C. Arthur ("American Monthly Microscop. Journal," May).— "President's Address" (R. Adkin) in "Proceedings of South London Entomological Society".— "Condensation of Gases," by A. E. Sutton ("Nature," June 2).— "A Contribution to the Study of Well Waters," by Robert Warington ("Journal of the Chemical Society," June).— "On Leathery Turtles Recent and Fossil, and their Occurrence in British Eocene Deposits," by A. Smith Woodward ("Proc. Geologists' Association," Feb.).— "Bridging the Firth of Forth," by B. Baker, (Lecture delivered at the Royal Institution, reported in "Nature," May 26).

#### ASTRONOMY AND METEOROLOGY.

By JOHN BROWNING, F.R.A.S.

AT the meeting of the Royal Astronomical Society, on May 13th, Colonel Tupman described some photographs of spectra of the stars taken at the Harvard Observatory. The photographs are greatly in advance of any which had previously been taken, and they bid fair to enable the motion of the stars which are approaching or receding from us to be determined with much greater accuracy than has hitherto been possible. Mr. Ranyard explained that the spectra were taken without a slit, by using four prisms which were placed in front of the object-glass of a telescope; the spectrum of a star as a mere line, without breadth, is thus thrown on the photographic plate and this line has breadth given to it by controlling the motion of the driving-clock.

Mr. Knobel read a report of the English delegates who were at the Congress of Astronomers held at Paris on the 16th April to arrange for photographing the stars. There were fifty-seven delegates in all, eight of whom were English. It was unanimously resolved to use only achromatic telescopes to take the photographs, and that all the telescopes used shall be of 35 centimetres, nearly 14 in. aperture.

Mr. N. E. Green described the changes he had observed in the markings on Jupiter and in the belts of the planet during the last twenty-six years. From 1860 to 1868 the equator was occupied by a white band edged with dark belts. From 1869 to 1872 the equatorial region was of a coppery hue, and the belts were narrower. From 1873 to 1879 the coppery colour was fainter, and from 1879 to the present time a most perplexing series of changes in colour and form have taken place.

Between July 1st and the 21st there is no darkness as of night. On July 2nd the earth will be at the greatest distance from the sun at nine hrs. morning. July the 17th there will be an occultation of Aldebaran, a star of the first magnitude. The disappearance takes place at 3 hrs. 16 min. morning, and the re-appearance at 3 hrs. 33 min. morning.

*Meteorology.*—At the Royal Observatory, Greenwich, the highest reading of the barometer for the week ending 21st May was 30.20 in. at the beginning of the week, and the lowest 29.08 in. on Friday morning. The mean temperature of the air was 48.4 deg., and 5.6 below the average in the corresponding weeks of the 20 years ending 1868. The mean was below the average throughout the week, the coldest day being Saturday, when the mean was only 43.1 deg., and showed a deficiency of 11.9 deg. The general direction of the wind was westerly. Rain fell on four days of the week, to the aggregate amount of 0.58 of an inch. The duration of registered bright sunshine in the week was 33.3 hours, against 45.5 hours at Glynd. Place, Lewes.

*Rising, Southing, and Setting of the Principal Planets at intervals of Seven Days.*

	D.	Rises. h. m.	Souths. h. m.	Sets. h. m.
MERCURY ☿ . . . . .	2	6 8M	1 53A	9 38A
	9	6 15M	1 43A	9 11A
	16	6 1M	1 18A	8 35A
	23	5 26M	0 40A	7 54A
	30	4 34M	11 53M	7 12A
VENUS ♀ . . . . .	2	7 53M	3 12A	10 31A
	9	8 8M	3 10A	10 12A
	16	8 21M	3 7A	9 53A
	23	8 31M	3 2A	9 33A
	30	8 39M	2 54A	9 9A
MARS ♂ . . . . .	2	2 31M	10 50M	7 9A
	9	2 22M	10 43M	7 4A
	16	2 15M	10 36M	6 57A
	23	2 9M	10 29M	6 49A
	30	2 3M	10 21M	6 39A
JUPITER ♃ . . . . .	2	1 38A	6 57A	0 20M
	9	1 12A	6 30A	11 48A
	16	0 44A	6 4A	11 21A
	23	0 24A	5 39A	10 54A
	30	11 59M	5 13A	10 27A
SATURN ♄ . . . . .	2	4 59M	1 2A	9 5A
	9	4 37M	0 39A	8 41A
	30	4 14M	0 15A	8 16A
	23	3 51M	11 51M	7 51A
	16	3 30M	10 28M	7 26A

For the week ending May 28th, the lowest reading of the barometer was 29.51 in. at the beginning of the week, and the highest 30.06 in. on Tuesday evening. The mean temperature of the air was 50 deg., and 59 below the average in the corresponding weeks of the 20 years ending 1868. The mean was below the average throughout the week, the coldest days were Sunday and Friday. The general direction of the wind was north-easterly. Rain fell on four days of the week, to the aggregate amount of 0.40 of an inch. The duration of registered bright sunshine in the week was 16.8 hours, against 22.6 hours at Glynde Place, Lewes.

For the week ending 4th June the highest reading of the barometer was 29.80 in. on Tuesday morning, and the lowest 29.40 in. on Thursday evening. The mean temperature of the air was 54.1 deg., and 3.4 below the average in the corresponding weeks of the 20 years ending 1868. The mean was below the average throughout the week until Saturday, when it showed a slight excess. The general direction of the wind was north-easterly. Rain fell on the four days of the week, to the aggregate amount of 1.18 of an inch. The duration of registered bright sunshine in the week was 17.6 hours, against 19.3 hours at Glynde Place, Lewes.

For the week ending 11th June the lowest reading of the barometer was 29.84 in. on Tuesday evening, and the highest 30.29 in. on Friday evening. The

mean temperature of the air was 60.2 deg., and 1.7 deg. above the average in the corresponding weeks of the 20 years ending 1868. The mean showed an excess on each day of the week except Friday, when it was below the average. The general direction of the wind was W.S.W. Rain fell on Wednesday to the amount of 0.07 of an inch. The duration of registered bright sunshine in the week was 54.5 hours, against 48.2 hours at Glynde Place, Lewes.

For the week ending 18th June, the lowest reading of the barometer was 29.95 in. on Monday afternoon, and the highest was 30.18 in. at noon on Friday. The mean temperature of the air was 65.6 deg., and 6.3 deg. above the average in the corresponding weeks of the 20 years ending 1868. The mean showed a considerable excess throughout the week; the hottest day was Wednesday, when the mean was 68.9 deg., and 9.6 deg. above the average. The general direction of the wind was westerly on Sunday and Monday, and easterly during the remainder of the week. No rain was measured during the week. The duration of registered bright sunshine in the week was 84.2 hours, against 86.4 hours at Glynde Place, Lewes.

The mean temperature in July on the west coast of England is 61°, on the east coast 62°, and on the south-east and south coast 63°. In the interior it is generally 63°, but for about twenty-five miles just around London it is 64°.

The mean average rainfall for July is two inches over the greater part of England, except just certain points of the west coast it is three inches.

OUR SCIENTIFIC DIRECTORY.

*Norwich Science-Gossip Club.* President, Mr. Thomas S. Breeze. Treasurer, Mr. Edward Corder. Secretary, Mr. Frank Balls, 7 Queen Street, Norwich.

SCIENCE-GOSSIP.

WE are pleased to see that the members of the Geologists' Association are getting up a testimonial to their Secretary, Dr. Foulerton. No man has done more for the success of the Society.

MR. R. H. NISBETT-BROWN writes as follows:—  
 "Scientific measures are now made in metres and divisions of the metre. The metre is itself a few inches more than a yard long, and is defined by the Act of Parliament which has legalised the use of metrical weights and measures in the British dominions as equal to 39.37079 inches. The metre is divided into *mètres*, a convenient name for its decimal subdivisions, that is, subdivisions each of which is the tenth part of the one before it in the series, and ten times the next after it. The *decimetre*, or tenth part of a metre, is the first of these *mètres*; it is about a hand-breadth, or 1.6 millimetres less than four inches. The next *metret* is the

centimetre, the hundredth part of a metre, and is about a nail-breadth, or 1.6 fifth metres less than  $\frac{1}{10}$ ths of an inch. The third metret is the millimetre, about the distance across a small pin's head, or as nearly as possible  $\frac{1}{25}$ th of an inch. The fourth metret is the tenth of this, and is about the thickness of a sheet of paper, or  $\frac{1}{300}$ th of an inch. The fifth metret is intermediate in size between the diameters of the red and white disks that float in human blood, about the  $\frac{1}{3500}$ th of an inch. The tenth of this, the sixth metret, is the  $\mu$  of the microscopist, about the  $\frac{1}{25000}$ th of an inch. The seventh metret is too small for any microscope to be able to show, and less than the wave lengths of light. The tenth metret is so small that a child during the years of its most vigorous growth is growing at the average rate of between thirty and forty of them every second, and the eleventh metret is the tenth part of this again."

THE Natural History branch of the British Museum in Cromwell Road has just received a most important donation from Lord Walsingham, consisting of a collection of Lepidoptera with their larvæ, mainly British butterflies (Rhopalocera) and certain families of moths (Heterocera), including Sphingidæ, Bombyces, Pseudo-bombyces, Noctuæ, Geometridæ, and Pyralidæ. There is also a fine series of Indian species, collected and preserved at Dharmsala, in the Punjab, by the Rev. John H. Hocking, and specimens of Exotic silk-producing Bombyces, in various stages of their development, obtained mostly from Mons. Wailly. With very few exceptions, the British larvæ, which retain a most life-like appearance, and are placed upon models of the plants upon which they feed, have been prepared and mounted by Lord Walsingham himself; the process adopted having been inflation of the empty skin of the caterpillar by means of a glass tube and india-rubber spray blower over a spirit lamp guarded by wire gauze. This has been found a simpler and quicker process, and one admitting of more satisfactory manipulation, than the alternative system of baking by means of heated metal plates or ovens. The specimens have mostly retained their natural colour, but in the case of the bright green species it has been found necessary to introduce a little artificial dry pigment. The whole collection consists of 2,540 specimens of larvæ, belonging to 776 species, together with a series of the perfect insects of each species.

DR. E. M. CROOKSHANKS has been appointed Lecturer on "Bacteriology" at King's College, London.

THE British Association will meet at Manchester on August 31, under the presidency of Professor Sir Henry Roscoe.

EVERY geologist in the country will be pleased to hear that Mr. W. Whitaker, F.G.S., of the Geological Survey, has been elected F.R.S.

DR. C. S. SHERRINGTON has been elected Professor of Physiology at St. Thomas's Hospital.

PROFESSOR STUDER, the great Swiss geologist, has just died at the ripe age of ninety-three.

WE are sorry to record the death of an old friend and excellent geologist, Mr. Champernowne, F.G.S., of Dartington Hall, Totnes.

WE are pleased to receive Mr. W. P. Collins's last Catalogue of Scientific Books (mostly second-hand). Also No. 81 of Mr. W. Wesley's "Natural History and Scientific Book Circular."

AT the last meeting of the Geologists' Association, Mr. W. J. Abbott read an interesting paper on the "Formation of Gates."

DR. C. T. HUDSON'S interesting paper in the Journal of the Royal Microscopical Society, on "Five New Floscules," has been reprinted.

WE have received a copy of Mr. John Dennant's important paper on "The Post-Tertiary Strata of South-Western Victoria." It is full of valuable original observations and notes.

WE regret having to chronicle the death of M. Boussingault, the distinguished French agricultural chemist, at the age of eighty-five.

MR. MAYALL, of New Bond Street, London, is said to have discovered a means of photographing in colours, which may soon make finely-coloured photographs cost only as many shillings as they have hitherto cost pounds when done by the hand process. The new camera does its work in colours almost instantaneously, and what rich and delicate colouring it produces. Every tint appears to be reproduced with a delicacy of shading and accuracy of form that no ordinary brush could effect. Mr. Mayall has taken, by the new process, a photograph of Princess Christian. The colours by the new process are stated to be indestructible, and are as conspicuous in the folds and tints of a lady's dress as in the colour of her eye or the beauty of her face.

DR. A. B. GRIFFITHS has just published a communication which is of great importance to horticulturists and agriculturists. He demonstrates that iron sulphate is an antiseptic for most of the most virulent epidemics which attack field and garden crops. These diseases are due to microscopic funguses, whose structures are built up in a somewhat different manner to the corresponding parts in other plants. It appears that the cellulose in these funguses is acted upon by iron sulphate, whereas in the higher plants the cellulose of the cell walls is not influenced. The iron sulphate destroys the cellulose of the funguses, but does not affect that of the attacked plant. It is therefore an antidote and destroyer of such parasitic germs and funguses as the potato disease, wheat mildew, &c.



THE crops of winter beans have this year been a failure in the neighbourhood of Peterborough, and a well-known agriculturist sent Dr. Griffiths a number of the plants for examination. The roots of the beans were covered with "small boils," which appeared to be living on the plant and keeping it down. Dr. Griffiths found that these "boils" were due to the growth of a parasitic fungus, and that both the fungus and its spores were entirely destroyed by iron sulphate. Iron sulphate can be purchased at half-a-crown per hundredweight.

"MY MICROSCOPE, and some Objects from my Cabinet; a simple Introduction to the Study of 'the infinitely little.' By A Quekett Club Man," is announced for immediate publication by Messrs. Roper and Crowley. The little volume is dedicated to the president and members of the Quekett Microscopical Club.

A NEW competitor for public favour is announced for September next, "The Naturalists' Monthly," to be edited by Dr. J. W. Williams.

### MICROSCOPY.

AMPHIPLEURA PELLUCIDA.—In SCIENCE-GOSSIP for last November (p. 258), a correspondent enquired for the best way of showing the *Amphipleura pellucida*, sometimes called Acus, from its needle-like form. I believe the most effectual mode is by means of Wenham's Reflex Illuminator, first described in vol. vii. of the "Monthly Microscopic Journal." As whatever Mr. W. states may be thoroughly relied upon, I will give one extract as a sample: "*Amphipleura pellucida* assumed a substantial appearance, not seen in any other way; and at once displayed its striæ with a  $\frac{1}{3}$ th that had never resolved them before." The essay is illustrated by a diagram drawing (greatly magnified) and showing that the new instrument is capable of producing a far greater amount of oblique reflexion than had ever been previously effected. If your correspondent (W. E. Simmons) has an opportunity of examining the aforesaid journal, the xiv. vol. (1875) contains much more about it. To save him time in hunting, I may add that the description in vol. vii. (1872) is at p. 237, and the further information (in vol. xiv.) is on pp. 30, 156, 295, 299.—*Observer.*

THE ROYAL MICROSCOPICAL SOCIETY.—The June part of the "Journal" of the above Society, besides the usual full and accurate "Summary of Current Researches," contains an illustrated paper by Mr. P. H. Gosse on "Twelve new Species of Rotifera."

ENOCK'S SLIDES.—The last of Mr. Enock's issues is the head of the devil's coach horse-beetle

(*Ocyptus olens*) showing, in the clearest manner, all the mouth organs almost as perfectly as in their living state. The sketch accompanying the slide, is of the greatest use to the anatomical entomological student.

MAGNIFYING POWERS.—In reply to F. Worgan, I subjoin Zeiss's magnification of the objectives with the several Huyghenian eye-pieces and with a body length of 155mm.—*P. Jamieson.*

Eye-pieces.	1	2	3	4	5	
a <sub>1</sub>	7	11	15	22		
a <sub>2</sub>	12	17	24	34		
a <sub>3</sub>	20	27	38	52		
a*		4-12	7-17	10-24		
aa	22	30	41	56	75	
A	38	52	71	97	130	
B	70	95	130	175	235	
C	120	145	195	270	360	
D	175	230	320	435	580	
E	270	355	490	670	890	
F	405	540	745	1010	1350	
Water Immersion	G	260	340	470	640	855
	H	320	430	590	805	1075
	J	430	570	785	1070	1430
	K	570	760	1045	1425	1920
Homog. Immersion	L	770	1030	1415	1930	2570
	$\frac{1}{8}$	260	340	470	640	855
	$\frac{1}{13}$	380	505	695	950	1265
	$\frac{1}{18}$	605	810	1110	1515	2020

CAMERA LUCIDA.—In reply to Mr. Brokenshire's first query, the paper should be placed at a distance of ten inches from the eye, the microscope being of course focussed so that the final image appears in the plane of the paper. The linear magnification of the drawing is then equal to the magnifying power of the combination. Any other distance at which objects can be seen distinctly, might have been taken as the standard distance, instead of ten inches, and the measure of the magnifying power would be increased accordingly. But the standard distance being once fixed, all microscopes must be referred to the same standard, and ten inches is almost universally adopted. By placing the paper at a greater distance, the actual magnification of the drawing may be increased in proportion, but the apparent size of the image, measured by the angle which it subtends at the eye, will be practically unaltered by the necessary focussing, and the magnifying power will therefore be the same, and will no longer be equal to the magnification. I hope this is sufficiently clear, for there is rather a tendency to confuse magnification or amplification, which depends on how the micro-

scope is focussed with magnifying power, which is a constant quantity for any combination, and which varies only for different combinations. The two terms are frequently confounded, and this has even been done in mathematical Tripos papers! Neither of them depends on the distinctness with which details of an object are or are not seen.—*G. H. Bryan, B.A.*

## ZOOLOGY.

DURHAM ETC., NATURAL HISTORY SOCIETY.—Part 2., vol. viii. of the Natural History Transactions of Northumberland, Durham, and Newcastle upon-Tyne, have just been issued to the members, and comprise the years 1882, 1883, and 1884. Although this part is not so extensive as many of the previous issues, yet it contains some highly important and interesting matter, among which may be mentioned a number of letters, extending from the years 1849 to 1853, by the late Charles Darwin, Esq., to the late Albany Hancock, Esq., an eminent naturalist. These letters were written about the time that Darwin was occupied with a monograph of the Cirripedia, which was afterwards published by the Ray Society—Mr. Hancock having discovered a form of burrowing barnacle (*Alcipe lampus*) on the Northumberland coast, which he afterwards described in a paper communicated by him to the British Association, at the meeting held at Birmingham in 1849, and this appears to have originated the correspondence between these two eminent naturalists. The part now issued comprises the following papers:—Presidential Address to the Members of the Tyneside Naturalists' Field Club, by the Rev. Canon Wheeler, M.A., giving a detailed account, agreeably to a rule of the club, of the several meetings held during the year 1882 up to May 1883.—Next come Miscellanea, which contains a note by Mr. John Hancock, on the habit of the young cuckoo in ejecting the eggs and young of its foster-parent from the nest. This is a highly interesting paper, and should it come under the notice of those sceptical ornithologists, I think all doubts would be removed from their minds as to the action of the young cuckoos as written by Mr. Hancock. He takes nothing on hearsay; everything he states was witnessed by himself; he was residing at Oaklands, in Surrey, at the time, June 1883, and found a cuckoo's egg in the nest of a hedge accenter on the 17th of that month with four of its own eggs. He watched the nest daily, and on the 27th June, the cuckoo's egg, and two eggs of the accenter were hatched. On the following day one attempt of the young cuckoo to put out accenter's egg did not succeed; at 10.30 A.M. same day, first egg was put out of the nest, at 11 A.M. the first young accenter was pushed out; at 1 P.M. the second egg was pushed out in the presence of

three witnesses. The last of the lot, the second young accenter was ejected, between 1 and 3 o'clock.—Note on the Indian Form of the Spotted Eagle (*Aquila naria*) 1885, by Mr. John Hancock.—Lichen Memorabilia, 1884, by Rev. W. Johnson.—Note on the Birds seen at Nut House, Felling shore, in May and June, 1884, by Dr. Embleton.—Note on the occurrence of Shrimps in the Tyne, by Dr. Embleton.—Note on the visit of a shoal of Tunny to the Northumberland Coast, in June, 1884, by Mr. Richard Howse, also by same on the capture of a very large Tunny near the mouth of the Tyne, August, 1885.—Presidential Address of Alexander S. Stevenson, Esq., describing the meetings of the Club during the year 1883 up to May, 1884.—Presidential Address of G. H. Phillipson, Esq., M.D., D.C.L.—giving a detailed account of the proceedings at the meetings held during 1884 up to May, 1885. The concluding paper of this part is by Dr. Embleton, entitled The Tyne, The Lost Burn and the Stain, a very learned paper showing great research into the origin of these names by the author.—*Dipton Burn.*

## ANIMAL PSYCHOLOGY.

MIGRATION OF BIRDS.—Since I penned the note under this heading on page 42 of this year's volume, I have come across the following note in Paley's "Theology":—"Observation seems at variance with the notion of the older birds teaching the yearlings; indeed, the two classes have been found not to travel together. But the agitation universally observed in birds of passage kept in cages at the season of migration proves clearly that no experience nor instruction will account for the changes of place." Now, as this note was written some time before 1836, I should like to know whether there is any recent and satisfactory evidence from a reliable source which confirms the above observation? The following account of the migration of the fur-seals absolutely satisfies me how untenable my position is—irrespective of the remarks of T. W. Ogilvie:—"The instinct which guides the fur-seals back every year to their breeding islands is miraculous. The breeding places of these seals are confined to five islands in the North Pacific. All through the winter they disport themselves in the waters of the Pacific; in the spring they begin travelling northwards, and arrive nearly the same day every year, May 12th, at the islands. It seems that the seal almost always returns to the island on which it has been born, although not necessarily to the same rookery, and the date of its appearance is one of considerable regularity." Now there can be no salient features to direct seals in their course; nor do I consider that we have any reason to suppose that their intellect is in any way inferior to that of a bird.

Therefore, by analogy, it seems only reasonable to suppose that the unknown power, which directs seals through miles of ocean, also directs birds on their journeys in mid-air. T. W. Ogilvie's remarks somewhat amused me, as showing that he had only taken a cursory glance at my article, without considering for a moment what it really meant. However, as he was right in the main, I have nothing further to say against his observations, except that they exhibit a decidedly unpleasant and sarcastic temperament. I do not notice that T. W. Ogilvie, notwithstanding his assumed superiority, endeavours in any way to enlighten us.—*F. C. D. B.*

## BOTANY.

SEEDLINGS OF HERACLEUM.—On April 29th, under a hedge at Northenden, a few miles from Manchester, I came across a little colony of seedlings of *Heracleum Sphondylium* in which the fruit (cremo-



Fig. 64.—Seedling of *Heracleum Sphondylium*.

carp) still adhered to one of the undivided cotyledonous leaves between which the toothed and hairy first foliage leaf appeared. I send this rough sketch of natural size. The cotyledonous leaves had sheathing petioles, the foliage leaf and its petiole were hairy.—*Bernard Hobson.*

CEPHALANTHERA ENSIFOLIA, ETC.—Bentham, and your correspondents, C. P. and Mr. Arnold, are no doubt right in regard to English specimens of this plant. My observations referred solely to foreign examples. It may, at first sight, appear singular that there should be this difference between native and foreign specimens of the same species,

but I know of two parallel instances. The yellow foxglove (*D. lutea*), so common in parts of Switzerland, usually has a spike about as long as that of *purpurea* in England; but at Heidelberg, where it only occasionally occurs, the spike is quite short, and the flowers do not exceed 15 to 20 in number. Then in Italy, the flower spike of *Polygala vulgaris*, is generally longer than it is in England. I have to-day picked six of the longest spikes I could find, from as many different plants of this species, and having counted the flowers on them, I find the average for each spike is a fraction under nineteen. I have also counted the flowers on a dry spike of the same species, which I got in Italy, three or four years ago, and there are thirty flowers on it. It is, I admit, a fine spike, but I distinctly recollect noticing at the time that the spikes were generally larger than any I had seen in England. With regard to the orchid in England, and the foxglove in Germany, I think the smallness of the spikes, probably consequent on the plants being weak in constitution, may be accounted for by the fact that the plants are so rare, and therefore there must inevitably be less of that cross-breeding which, as Darwin has shown, and specially as regards orchids, is so necessary in some species of plants to ensure a healthy and vigorous progeny. But I do not know that this reasoning can be applied to the *Polygala*. Possibly soil and climate are the chief factors in this case.—*R. B. P., St. Leonards-on-Sea.*

LEPIDIDIUM LATIFOLIUM AND *L. DRABA*.—As *L. latifolium* is not noticed as a Sussex plant in Watson's "Topical Botany," the following may be of interest. In the N. B. G. it is mentioned as growing "by the Lavant, below the garden of St. James's Hospital, Chichester, from which very probably it originally escaped." It was persistent for some time, and I have an example thence 1847, but it has not been observed there recently. Last year, nearly three miles further down the Lavant, when a new cut was made, it appeared in abundance on the newly turned up mud on Appledram Common, where it had not been previously seen, and being such a large, conspicuous plants soon attracted attention. Three years ago, I met with *L. draba* growing outside the Slipper Mill, Westbourne, where it soon disappeared. I removed a few plants which are growing, but which, for two successive years, have shown no sign of flowering.—*F. H. Arnold, Hermitage, Emsworth.*

A NEW BRITISH ALGA.—The curious blotched pebbles found in the Poulter, a small tributary to the Idle, have for a long time been familiar to myself and friends, but beyond the fact that they were due to an alga, no information was to be obtained from the many botanists to whom we sent examples. The Rev. H. W. Lett has recognised in these blood-red patches the rare European *Hildenbrandia rivularis*,



not previously recorded as British. A description is given in the "Scientific Enquirer" for March, under the heading "A Blood Prodigy." The plant is found only in the most rapid portions of the river where it has been narrowed by bridges, or at angles where the sill has been entirely washed away from the pebbles on which it grows.—*W. A. Gain, Tuxford.*

CROCUSES FLOWERING UNDERGROUND.—In digging up my crocuses on May 28, I came upon a group, several of which seem to have flowered underground. I enclose a specimen with two capsules containing a number of pretty rose-coloured seeds. Is this a common occurrence? If not, how is it accounted for? I should add that the ground is very much exposed, and the time of flowering was cut short by the cold March winds.—*J. W. D.*

## NOTES AND QUERIES.

HELIx NEMORALIS AND H. HORTENSIS.—Will any reader of SCIENCE-GOSSIP inform me of the most successful method of breeding these snails? as it is my desire to keep a number for the purpose of experimenting in cross-breeding for the production of varieties, etc. Any information will be acceptable.—*W. Harcourt Bath, Ladywood, Birmingham.*

LATE APPEARANCE OF THE CUCKOO AND THE SWALLOW.—Both these birds have made their appearance very late this year in the Midlands—no doubt owing to the cold. The first swallow was seen by myself on April 23rd and the cuckoo was first heard on the 30th, which are the latest dates that I have known during the last ten years. The grasshopper warbler was heard on April 30th for the first time this year, in a wood in North Warwickshire; this too is very late.—*W. Harcourt Bath, Ladywood, Birmingham.*

HORSE-CHESTNUTS.—From my windows a noble horse-chestnut tree is in full view, the admiration of every passer-by. Last year it blossomed very freely on its eastern side, with comparatively few blossoms elsewhere. This year the bulk of the blossoms are on the western half, and the owner informs me that, since he has known the tree, it has blossomed one year on the east, and the next year on the western side. Is that a freak of nature, or is it of common occurrence; and how explained?—*H. E. Valentine, Boston, Mass.*

CUCKOO.—Whilst out botanising a little in the lanes here, I have frequently heard, during the past few weeks, a cuckoo whose call note contained three syllables, thus, Cuck-koo-koo, Cuck-koo-koo, and was fortunate enough on one occasion to see the bird, which had alighted on a tree a few yards away from me. This removed all doubt about the genuineness of the treble syllable in the call, which I was at first inclined to set down as an echo. Are such variations in this bird's note common? I have certainly never previously heard it, or anything approaching it.—*F. Jas. George, Chorley, Lanc.*

SINGULAR CAPTURE OF A KESTREL.—On April 18th, 1887, a kestrel was captured in Kirkgate, one

of the main streets of Wakefield. It had dashed down upon a skylark and cage which hung on a wall, and got its feet fast in the wires. The bird, an old one, was obtained by Mr. Marson, of Wakefield, and preserved. The lark was only slightly hurt.—*Geo. Roberts.*

BIRDS' NAMES IN SUFFOLK.—The country people of Suffolk call the Tom-tit or Blue-tit the "Billy Biter," because when persons put a hand into the hole where the bird is sitting on her eggs, they would experience a sharp tap, and hear a hissing noise which would make them believe they had been bitten by an adder. Another notion is that if you take a lark's egg, you will break your neck, or meet with some serious accident. The same thing is said about robins' eggs. The call of the yellow bunting gives the name of "a little bit of bread and no cheese" to this bird in Suffolk.—*E. H. Bugg.*

DOUBLE-YELKED CUCKOO'S EGG.—On May 21st, a boy brought me an egg, to see if I could tell him what it was. It is in colour that of a blackbird, but the speckled marks finer than they usually are; in size it is a little larger than a magpie's, and not so pointed. The boy—whom I know well, and believe to be thoroughly to be depended on—assured me that he had taken it, together with three wagtail's eggs, from a nest in the thatch of the hay-rick. Is it possible that it is a double-yelk'd cuckoo's egg?—*K. D., Cofton.*

POSTAL OBSTRUCTIONS TO SCIENTIFIC RESEARCH.—I was looking over a bound volume of SCIENCE-GOSSIP for the year 1870, the other day, and came upon a letter from a correspondent under the signature of G. B. C. Ringwood, in which he speaks with regret of a certain decision of the then Postmaster-General, as to what could be sent by "sample or pattern post," and especially of "specimens of natural history." Henceforward they were forbidden, not being trade samples, to be allowed to pass as such. In the following year, he settled the complaint as to this little finger, by the amputation of the whole set, and took away the sample post altogether. While for many years, probably sixteen, all the continental states have had a pattern or special post, under which innumerable objects of no money value have been carried to and fro, including flowers, we have had for our own people nothing of the sort; as witness, the complaint of a correspondent in the "Standard," who received for a very small postage paid, flowers from the South of France, but who could only return English flowers by paying a heavy postage in comparison. There is no doubt that the withholding from the public such facilities, is a serious injury to scientific research, and really to our agricultural and manufacturing interests. With regard to "specimens of natural history," it is the more inconsistent, as for an unknown period under a tariff that levied a duty on almost every article imported into this country, specimens of natural history were admitted "duty free." Now we put a heavy postal transit duty on them. While we let the newspaper or journal travel for a halfpenny, which describes the specimen, we tax the valueless specimen itself, at 1d. and continually prevent its carriage by post. This is the more inconsistent when we compare our own post-office with the Canadian, in this special matter. In that country a Canadian SCIENCE-GOSSIP would go post free to all subscribers and newsgents all over the United States and Canada (by a special Act of Parliament, passed in 1882, whose preamble states it is for the diffusion of knowledge); all agricultural specimens whether for

sale or not, as bulbs, roots, scions, seeds, cuttings, leaves; and flowers, travel for a halfpenny per 4 oz.; and all casual papers or magazines between one private person and another are charged the same. All specimens of natural history go under this tariff. It is a pity that some of our leading naturalists and men of science do not put these matters formally before the Postmaster-General, as he is reconsidering the sample post, and demand, in the interests of the country generally, that the narrow policy of a department that sacrifices the public convenience and scientific research, to scraping the utmost revenue it can—that such a policy should be permanently abandoned.—*Jas. H. Rawlins.*

**FEATHER-EATING.**—Last year I experienced considerable annoyance from this cause. The only remedy I could find was to kill the fowls. I tried soot and butter, and other nauseous applications to the bird attacked, but to no purpose. My own opinion is that the pernicious habit is incurable, and where a fowl is of value it must be kept isolated; others are best got rid of as quickly as possible, as the habit soon spreads. I have read that the taste for feathers is acquired by too much meat food, which causes blood to collect at the root of the feathers, and this is immediately detected by the other fowls. Your correspondent might try the following, which was recommended in "Poultry" last year, and inform you of the result for the benefit of others. To a quart of water add a tablespoonful of Jeye's perfect purifying fluid. Take a soft brush and apply it to the parts attacked night and morning. If not effectual, increase strength to three or four tablespoonfuls to the quart of water. The fluid costs about 4s. 6d. a gallon, not including tin, and may be obtained of all oilmen and chemists in smaller quantities as required.—*W. E. Bowers.*

**FOWLS EATING FEATHERS.**—The fowls mentioned by Mr. Walter Helps are evidently in too close confinement, and they cannot get the necessary amount of insect food. If this could have been supplied by allowing them to range over sufficient space of ground at intervals, this bad habit would not have been acquired. But it is very doubtful whether it is impossible to break them of it now. The lime and brimstone mentioned do not supply all that they require. I should suggest, in the absence of a larger range, giving them some kind of animal food cooked and cut up. I myself have kept fowls in a small run, and by allowing them to run over a small lawn for about half-an-hour a day, and giving them scraps from the table or bones to peck at, I have never had any difficulty of this kind to contend with.—*Fred W. Clarke.*

**ASTRONOMICAL QUERY.**—In answer to W. J.'s query on page 142 of your last issue, I write to say that it is perfectly true that on Jan. 21 the sun rises only 11 minutes earlier, while it sets 36 minutes later than on the shortest day, but this is by clock time. Relatively to the sun's passage over the meridian, or sun time, there is no difference. All time is measured ultimately by the motions of one or other of the heavenly bodies, and chiefly by that of the sun. As, however, the sun moves irregularly in his orbit, sometimes a little faster and sometimes a little slower, our clocks are constructed so as to move with the mean or average motion of the sun, and the result is that the clock is sometimes before the sun and sometimes after it. The difference between these two periods constitutes what is called the equation of time. Now taking the case mentioned by W. J., we shall find on looking at the almanack that the

equation of time on that day was 11 min. 30 seconds, and was additive both to the apparent time of rising and setting, so that by clock time the sun rose later and set later to that extent.—*T. W.*

## NOTICES TO CORRESPONDENTS.

**TO CORRESPONDENTS AND EXCHANGERS.**—As we now publish SCIENCE-GOSSIP earlier than formerly, we cannot undertake to insert in the following number any communications which reach us later than the 8th of the previous month.

**TO ANONYMOUS QUERISTS.**—We must adhere to our rule of not noticing queries which do not bear the writers' names.

**TO DEALERS AND OTHERS.**—We are always glad to treat dealers in natural history objects on the same fair and general ground as amateurs, in so far as the "exchanges" offered are fair exchanges. But it is evident that, when their offers are simply disguised advertisements, for the purpose of evading the cost of advertising, an advantage is taken of our gratuitous insertion of "exchanges" which cannot be tolerated.

We request that all exchanges may be signed with name (or initials) and full address at the end.

**W. GAIN.**—Many thanks for the pebble blotched with the red stains of *Hildebrandia rivularis*.

**J. W.**—The "jaw-bone" you kindly sent is labelled "Lepidotus Mantelli, Wealden," the owner evidently thinking it was the jaw of a fossil fish. It is not, but one-half of the lower jaw of the recent catfish (*Ictalurus nebulosus*).

A CORRESPONDENT asks how it is that glass can be cut under water with a pair of scissors, without flaws, and as easy as cutting paper?

**H. A. F.**—Smith's "Economic Plants," published by Macmillan at 14s., is one of the best.

**S. SMITH.**—The occurrence of pink flowers in the ground ivy is not frequent, but not rare.

**E. C.**—See Emerton's "Structure and Habits of Spiders" (Trübner, price 7s. 6d.); Staveley's "British Spiders" (Reeve, 10s. 6d.); and Blackwall's "Spiders of Great Britain and Ireland" (published by the Ray Society).

**T. P. G.**—You will get a copy of Eley's "Geology in the Garden," of either of the two scientific booksellers we have referred to. You will find figures of the chief kinds of cretaceous foraminifera in Taylor's "Geological Stories."

**H. E. I.**—We have found methylated spirits a capital means of preserving pyritised fossils of all kinds likely to decompose.

**E. C.**—Write to Mr. W. Wesley, 28 Essex Street, Strand, or Mr. W. P. Collins, 157 Gt. Portland Street, both of whom deal in second-hand scientific works and monographs. They can give you the lowest prices.

**A. J. JENKINS.**—Write to Mr. L. Greening, at the Museum, Warrington, about his pamphlet on nevts.

## EXCHANGES.

DAY'S "British Fishes," unbound, offered for good specimens of accurately localised British shells in quantity.—Wm. Cash, 38 Elmfield Terrace, Halifax.

OAMARU, New Zealand, Deposit. A few slides for exchange. Send lists to—Rev. A. Smith, 3 Park Crescent, Brighton.

*Anodontia cygnea*, fine specimens, to exchange for other or land or fresh-water shells.—J. M. Harvard, Leyland, near Preston.

WANTED, a large shell cabinet.—J. M. Harvard, Leyland, near Preston.

LIVING specimen of the rare freshwater Tubularian hydroid, *Cordylophora lacustris*. What offers?—C. L. Lord, 34 Burlington Crescent, Goolse.

OVER 200 British wild plants named and localised. Many very rare. List sent; what offers?—C. A. O., 7 Cavendish Terrace, Torquay.

DUPLICATES: *Natica monilifera*, *Purpura lapillus*, *Nassa reticulata*, *Trochus zizyphinus*, *Murex erinaceus*, *Solen siliqua*, other marine shells wanted in exchange.—W. Jones, jun., 27 Mayton Street, Holloway, London, N.

BRITISH Birds' eggs in exchange for foreign species.—W. Syngell, Wellington, Somerset.

EGGS, side blown, one hole, separate or in clutches; king-fisher, dipper, stelt, turnstone, stonechat, cuckoo, dotterel, &c., for others.—Jas. Ellison, Steeton, Leeds.

Good specimens of *Clausilia biplicata* from Putney given for vertigoes. Also wanted *Azeca tridens*, and Continental specimens of *Hyalina glabra*, the latter alive.—Wilfred Mark Webb, 31 Aynhoe Road, Brook Green, W.



*S. rivicola*, *P. annicum*, *P. fontinale*, vars. of *Byth. tentaculata*, *Pl. nitidus*, *Pl. nautilus* v. *crista*, *Zon. glaber*, *Zon. purus* v. *margaritacea*, *Helix sericea*, *Cl. laminata*, *Cy. elegans*, and many others, for shells not in collection.—J. A. H., Fern Cottage, Baildon Road, Shipley.

DRAGON flies wanted from all parts of the world for figuring. Lepidoptera given in exchange.—W. Harcourt Bath, Ladywood, Birmingham.

FOR micro slides of Diatoms, Foraminifera, Polycistina, &c., or good botanical subjects, will exchange equal number lantern slides  $3\frac{1}{2} \times 3\frac{1}{2}$  of the Diatoms, Heliopelta, Coscinodiscus, Arachnoidiscus, Orthosira, &c. Also of Polycistina, Foraminifera, botanical, &c., or prints of the same.—Stewart, 2 Gilmore Terrace, Edinburgh.

WILL exchange a copy of Quekett's "Practical Treatise on the Use of the Microscope." Also vol. i. of "Science Monthly," for anything useful in biology, chemistry, or mineralogy. Offers to—Jas. Wm. Horton, Brayford Wharf, Lincoln.

TWENTY-FOUR sections for the microscope, with Latin and English names, ready for mounting. Exchange for two good mounted slides.—F. Dee, 53 Malham Road, Forest Hill.

Maltese land and sea shells for others from other places.—Jos. S. Galizia, 64 Piazza Celsi, Malta.

FIRST eight vols. "Horticultural Society's Transactions," with very beautifully hand-coloured plates. Also six vols. "Floricultural Cabinet," also with hand-coloured plates. Gregg and Lettsom's "Mineralogy"; Richardson's "Geology," for exchange for microscopic apparatus or slides.—S. Harrison, Dalmain Road, Forest Hill, S.E.

MARKED eggs of black grouse, goldcrest, wood wrens, nightingale, grasshopper warblers, hawks, owls, common bunting, bullfinch, swifts, tits, &c.—J. Ellison, Steeton, Leeds.

WANTED, all kinds of insects (butterflies and moths excepted) either alive, or preserved as soon as killed, in weak spirit, and glycerine. Names required if obtainable, in exchange for mounted microscopic objects, photomicrographs, or microfungi (unmounted). W. H. Pratt, 49 Dryden Street, Nottingham.

Six selenite designs for the lantern polariscope, exchange microscopic slides, or anything useful. Wilsheer, 3 Broadway, Catford.

*Cochleopa tridens* var. *crystallina*, offered for *L. involuta*, or its vars.: *H. absoluta*; *A. lineata*, or its var.; *Vertigo*, any var.; *U. margaritifera*, or its var.—F. R. Stephenson, 133 Pellon Lane, Halifax.

WANTED, *Actea spicata*, *Cicuta virosa*, &c., in exchange for *Trifolium Bocconi*, *Euphorbia stricta*, &c.—W. A. Clarke, The Grove, Chippenham, Wilts.

BRED specimens of American lepidoptera, *Samia cecropia*, &c., offered in exchange for other exotic specimens. Must be perfect in setting and condition as mine are.—Mark L. Sykes, Winton, N. Manchester.

SCIENCE-GOSSIP, posted week after date, in exchange for some other similar periodical—each to be returned later to owner.—J. H. K., 13 Church Street, Commercial Street, E.

WANTED, skin of rock pigeon, wryneck, marsh and cole tit, wheatear, woodlark, and storm petrel. Offered, books, &c.—J. H. K., 13 Church Street, Commercial Street, E.

BRITISH mosses, over one hundred named specimens to exchange for micro-slides, apparatus, or books.—G. A. Barker, 1 Northwood Road, Clapton, E.

BINOCULAR by Pillisher, with eyepiece, polariscope and other accessories, with or without  $1\frac{1}{2}$  inch objectives, part exchange as—micro-goniometer, rock sections, minerals, Cole's "Studies," Bischof's "Chemical Geology,"—H. Lowe, Holly Bank, Heaton Chapel.

WHAT offers for "Ritual of the Altar," by Rev. Orby Shipley, published £2 2s. (quite new)? "Greek-English Lexicon," by Liddell and Scott, 5th ed. Wanted, polariscope.—W. H., Newark House, Langney Road, Eastbourne.

WANTED, Miller's "Treatise on Crystallography," and "Systematic Botany," by DeCaisere and Le Maout (Messrs. Hooker's translation).—F. C. King, 82 Fishergate, Preston, Lancashire.

FOR exchange, "Outlines of the Geology of England and Wales," by Phillips and Conybeare. Coloured map and coloured and plain sections. Vol. 1, pp. 479, 1832. Figuier's "Reptiles and Birds," 307 fine illustrations, new, 8vo., 624 pp. "Rock Sculptures on Rombold's Moor," with lithographs, pamphlet, rare. Wanted, Brown's "Illustrations of British Land and Freshwater Shells," or "Continental Anodons and Unios," or others.—Geo. Roberts, Lofthouse, near Wakefield.

A GOOD exchange in anatomical and pathological slides, including some first-class injections, for a good canary singing cage. Norwich or London fancy, or other canaries, Brahma or Leghorn fowls.—Henry Vial, Crediton, Devon.

WHAT offers for a good  $\frac{1}{4}$ -plate mahogany camera and portrait lens, suitable for cards, &c., with stops complete, and also fitted with a dark slide for stereo-pictures with parallel bars, &c.—H. Vial, Crediton, Devon.

WHAT offers for Swift's portable or seaside microscope? with  $\frac{1}{4}$ -inch extra O. G., cost five guineas. Photographic apparatus preferred.—A. Draper, 275 Abneydale Road, Sheffield.

WANTED, foreign stamps in exchange for British shells.—C. Jefferys, Tenby.

EXCHANGE, stuffed teal (without case); also steel drill and brass blowpipe, for the following side-blown eggs, swift, redpole, whinchat, nightingale, wheatear, hooded crow, coot, dipper, ring-ouzel.—E. J. D., 59 City Road, Bristol.

WANTED, specimens of the rarer species of British marine shells. Offered, natural history specimens.—C. Jefferys, Tenby.

WANTED, eggs of the rarer British birds. Offered, other species, shells, &c.—C. Jefferys, Tenby.

WANTED, *Spharium ovale*, *Psidium roseum*, *Planorbis glaber*, *Limnea glutinosa*, *involuta*, *Testacella haliotidea*, *mangei*, *Succinea oblonga*, *Helix concinna*, *obovata*, *Bulimus montanus*, *Vertigo* all species, *Acme lineata*. Offered, natural history specimens.—C. Jefferys, Tenby.

OFFERED, *Limnea glabra* and *Psidium annicum*, either shells or living specimens and other good shells. Send list of duplicates to John R. B. Masefield, Rosehill, Cheadle, Staffordshire.

FLOWERING plants and mosses. Wanted, mineralogical works, or what offers?—J. Harbord Lewis, F.L.S., 145 Windsor Street, Liverpool.

BOTANICAL works for other works of interest.—J. Harbord Lewis, 145 Windsor Street, Liverpool.

WANTED, about six dozen well-mounted, interesting microscope objects, in exchange for foreign stamp collection. 1083 varieties hinge-mounted, in permanent album.—H. Ebbage, 165 Hagley Road, Birmingham.

WANTED, SCIENCE-GOSSIP, 1874-1883, "Knowledge," nos. 144 to end of series; "Cabinet-maker," nos. 1-46. Offered, "Knowledge," nos. 24-61; "Builder," nos. 2226-2301; "English Mechanic," vols. 37, 38, 42-44.—John Grieves, Low Friar Lane, Newcastle-on-Tyne.

WANTED, SCIENCE-GOSSIP, no. 30 (June, 1867), and 1870, pages 9-12, 81-83, 106-108, 155-157 (4 numbers). Will give SCIENCE-GOSSIP for one of following years for the 5 numbers: 1874, 1877, 1881, or 1882. Sherborn, 507 King's Road, Chelsea.

WHAT offers in botanic specimens, home or foreign, mounted on sheets or album, and named, for four volumes of SCIENCE-GOSSIP, unbound 1833, 6 inclusive. R. Hunter, 19 Bishop Street, Hightown, Manchester.

#### BOOKS, ETC., RECEIVED.

"Manual of Bacteriology" by Dr. E. M. Crookshank (London: H. K. Lewis).—"Palaeolithic Man in N.W. Middlesex," by J. A. Brown (London: Macmillan).—"Illustrations of the British Flora," by W. H. Fitch and W. G. Smith, second ed. (London: L. Reeve & Co.).—"The Liver Fluke and the Rot in Sheep," by Edward Halse (London: Ed. Stanford).—"The Fungus-Hunters' Guide," by W. Delisle Hay (London: Sonnenschein).—"Pneumatics," by C. Tomlinson, 4th ed. (London: Crosby Lockwood).—"Tourists' Guide to Suffolk," by Dr. J. E. Taylor (London: Edward Stanford).—"All about Mnemonics," by A. E. Middleton (London: Simpkin & Marshall).—"The Prevention of Consumption," by C. Candler, Melbourne (London: Kegan Paul).—"The Asclepiad,"—"Proceedings of the London Entom. and Nat. Hist. Soc."—"Cole's "Studies in Microscopical Science."—"Science and Art."—"Illustrations."—"Book Chat."—"The Century Magazine."—"Scribner's Monthly."—"The Amateur Photographer."—"The Garner."—"The Naturalist."—"The Botanical Gazette."—"Journal of the New York Microscopical Society."—"Delgravia."—"The Gentleman's Magazine."—"American Monthly Microscopical Journal."—"The Essex Naturalist."—"Economic Naturalist."—"The Midland Naturalist."—"Feuille des Jeunes Naturalistes."—"The American Naturalist."—"Journal of Microscopy and Nat. Sci."—"Wesley Naturalist."—"Journal of Conchology."—"Museum Memorandum Book," by Rev. H. H. Huggins.—"Victorian Naturalist."—"Ottawa Naturalist."—"Journal Quekett Club."—"Journal Royal Microscopical Soc."—"Proceedings Geologists' Association."—"Eight Annual Report North of England Microscopical Soc."—"Report Rugby Scholl Nat. Hist. Soc."—"Trans. Dumfriesshire Nat. Hist. Soc."—"Annual Report Manchester Microscopic Soc."

#### COMMUNICATIONS RECEIVED UP TO THE 13TH ULT. FROM:

F. E.—R. E. P.—B. T.—J. S. G.—H. W. B.—P. P. C.—J. C. F.—J. B. L.—C. S. J.—Rev. H. H. H.—H. M. J. U.—G. A. M.—W. C.—E. H.—Prof. F.—M.—F. R.—F. B.—J. C. W.—S. S.—J. H. R.—H. L.—R. H. N. B.—G. H. B.—G. A. B.—J. W. J.—H. K.—M. L. S.—F. H. A.—R. E. P.—C. P.—J. R. B. M.—J. H. L.—H. E.—H. E. V.—C. J.—J. P. G.—E. J. D.—J. F.—B. B. W.—A. F. R.—J. C. W.—F. D. B.—R. T.—A. D.—F. J. G.—S.—Rev. W. S.—W. K.—H. A.—F.—H. V.—G.—R.—F.—C.—K.—W. H.—T. L.—W. E. B.—J. S.—S.—H.—C.—P.—F.—D.—W. A.—G.—J. W. H.—W. D.—S.—W. J.—F.—W. C.—W. B.—P.—J.—A. H.—J. H. P.—W. H.—W. M.—W. G.—H. E.—J.—T.—W.—J. M.—J. E.—P.—J.—C. A. O.—J. C.—C. L.—J. M. H.—A. J.—J.—E.—C.—Rev. A. C. S.—W. C.—F. R. S.—W. A. C.—W.—S.—B.—G.—W. R.—H. F.—R.—W.—K.—H.—W. K.—A. T. D.—J. E. L.—W. H. E.—G.—R.—J.—H.—T.—D. A. C.—Dr. J. W. W.—J. G.—R. H.—J. E.—W. M. W.—H. M. E.—&c. &c.





## REMINISCENCES OF LARVÆ-BREEDING.

By J. BOWMAN.



**I** WAS very young indeed — perhaps six or seven years of age — when I first began to manifest an absolute fondness for natural history objects, principally of the insect family. I was very fortunate in that we possessed a very large coalhouse, in which I could store my boxes or cages, as I called them; the former name was the more applicable, as most of

my so-called cages had at one time been safely esconced on the fixtures of a draper's or bootmaker's shop. I was fortunate, too, in possessing a sister who was quite willing to canvass the said draper's and bootmaker's establishments in search of any empty boxes they might have on hand; and thus an objectionable part of the pursuit of my hobbies was got rid of in a manner which was pleasing to me. Once I had got a goodly number of boxes in my possession, I very soon found tenants for them, in the shape of lizards, frogs, butterflies and moths, and humble-bees; with the last-mentioned I may say I was very successful. I was generally well informed as to the whereabouts of a humble-bees' nest; and, armed with a spade and an extra large cardboard box, I would proceed to the spot, and digging very carefully round about the nest, I could manage to land it into my box intact, bees and all. Having got the nest safe, I would fasten the lid of the box safely down for a day or two, and then cutting a square piece out of the side, I would thus transform my box into a beehive. I have taken nests in the middle of the summer, and kept them in good condition until the

beginning of winter; but as soon as Jack Frost came in, so soon did my bees give up the ghost. At some future time I may perhaps trouble you with a few of my observations on this interesting little insect, the humble-bee; but now to the subject on hand.

Of the different kinds of "live stock" that I delighted in holding prisoners, of none was I so fond as of the different species of larvæ which I generally had in my possession. To these I devoted most of my time, and for these the ordinary cardboard box of the draper was not, in my estimation, good enough. For these, when I could manage, I would procure an empty fig-box, and by nailing over the top a piece of muslin, or better still, perforated zinc, which I left open at one end, I could manage to fit out a substantial larvæ cage.

Of course, I need scarcely say that the existence of dealers who purvey to the wants of aspiring naturalists, was entirely unknown to me; and even if I had known, the probability is that my parents would have thought twice before they granted me money in order to purchase accommodation for such vermin as hairy oobits, as the majority of caterpillars were, and are still, indiscriminately termed by the good north-country people.

My affection for "vermin" gradually became known in the neighbourhood in which I lived; and at all times of the day some one would knock at the door with one hand, the other tightly clenched, enclosing some strange creature for me. Many of the captives were, as a matter of course, either killed, or, if they happened to be butterflies or moths, spoiled past recognition by the rough treatment they had undergone at the hands of their captors. Some, however, were treated in a more gentle manner; and at this time I have in my cabinet a fine specimen of the oak-eggar (*Bombyx quercus*) moth, and also of the puss (*Dicranura vimula*), death's-head (*Acherontia atropos*), and poplar hawk moth (*Smerinthus populi*), each of which I obtained in this manner. The oak-eggar and death's-head I obtained as perfect insects, and well do I remember the astonishment with which I listened to the distressed, human-like cry of the latter when I

took it up in my fingers. The other two—the puss and poplar hawk moth—I had brought to me in the shape of pupæ, and shortly after my obtaining possession of them, they emerged as perfect insects.

I could always, by a search amongst nettles in the month of July, obtain a plentiful supply of the larvæ of the small tortoiseshell butterfly (*Vanessa urtica*); but in the north the beautiful red admiral (*Vanessa atalanta*), and the gaudy peacock (*Vanessa Io*), are not so easily obtained, being in the neighbourhood of Morpeth, at any rate, considered pretty rare—indeed the latter is seldom seen.

Opening my cage a few days after the capture of my first batch of Vanessaids, I was surprised to see at the bottom, while others were suspended from the top by means of a very short web, a number of what seemed to me at first sight to be lumps of gold; they were, however, nothing more than the chrysalides of *Vanessa urtica*. Some of the pupæ, instead of being gilded, looked as if they had been, on the wing cases at least, washed with silver, while others were a modest sombre brown.

I never had the pleasure of seeing my first batch transferred into perfect insects; for on returning home one day from a predatory excursion to a favourite pond, I found that the river, which ran near our coalhouse, and which was very much swollen by recent rains, had invaded the coalhouse, and on the waters retreating my precious box and pupæ went with them.

From subsequent observations, however, I have noticed that a period of ten or twelve days from the time of their entering the pupa state, suffices to bring them into their perfect state. For a few days before this momentous change, you can see clearly shown through the pupa case, the markings of the butterfly's wings. A friend of mine residing in Liverpool, chanced in his ramblings in the suburbs of that city, to alight on a bush (whitethorn) literally covered with the larvæ of that very common insect—common at least in the localities where it is found at all (in Northumberland I have not seen it)—the gold-tailed moth. You must pardon my wandering somewhat indiscriminately from butterfly to moth—from day to night; I just note memories as they occur to me.

But to resume. The larva of the gold-tail (*Liparis auriflua*), which is a very innocent-looking creature, proves itself to be a tartar when taken hold of by the naked fingers, as my friend found to his cost. He captured a few of them, placed them in a small box, and sent them off by post to me, and thought no more about them. Next day, however, his hands, and not only them, but parts of his face and body that he had touched with them, felt, to use his own words, "as if they had been stung by ten thousand nettles;" but unfortunately, unlike the sting of the nettle, they did not disappear in a short time, for the itching and irritation continued for a number of days, and at times became almost unbearable.

It is said, I think by the Rev. J. G. Wood, that the perfect insect possesses the same qualities in this respect as the larvæ. I have frequently handled the perfect insect, and never experienced symptoms such as were related to me by my friend after he had come into contact with the larvæ.

The specimens sent to me I kept, and in due course they underwent the necessary transformations, and emerged into the perfect state. I obtained both male and female specimens, and in a few days from their emerging from the pupæ, the females deposited their eggs, which being duly impregnated, in a few weeks there came forth a brood of caterpillars—a second generation. It was nearing that part of the year when Jack Frost stalks abroad in the land, and the food-plant of this species was very difficult to procure. I was at a loss what to do. Was I to have my brood destroyed for want of food? I was soon to receive an answer to my query.

I kept my prisoners not in a larvæ cage, as I was afraid of their escape through the perforations in the zinc—they being at this time very small indeed; but I kept them under a common glass tumbler in a very cool part of the house (not the coalhouse), and just as I was beginning to get very anxious over the question—how was I to procure them more food?—they suddenly, it seemed, resolved to eat no more, retired into a chip pill-box, which I had placed in the tumbler to contain their food, and enclosed themselves, separately, in a web (not a cocoon); and thus they remained all winter, the majority of them coming forth in the spring, when they applied themselves industriously to devour the food which I had placed for them, as if they were fully conscious of the time they had lost, and were equally intent on making it up. I need hardly say that I was successful in bringing them to maturity; and when they had reached this perfect condition, I set a number of them free in the neighbourhood of the food-plant, and since then I have neither beheld them nor their progeny. Sad end to such a bold experiment!

A favourite captive of mine was the larva of the tiger moth (*Chelonia caja*)—a species which is easily procured. A careful look-out on the leaves of the dead-nettle, whilst taking a country walk in the month of June, will be sure to reward the collector with an abundant harvest. This caterpillar is a voracious feeder, and nothing seems to come amiss to it. It has a beautiful appearance after having cast its second skin, the long gray hairs which cover its back being then fresh, and smooth as silk.

This species of larvæ,\* too, hibernates during the long winter months, and reappears in the spring to

\* In correcting, I find that this paragraph may be misunderstood by some. The case of a larva of *Chelonia caja* hibernating was that of a specimen, which I had reared from the egg in my own breeding-cage, and not, as might be thought, of one reared in the open air, and at the usual time of the year. I have now in my cabinet the perfect insect into which this larva was transformed.



commence again, its one duty of preparing for the great change which it undergoes about the end of June or beginning of July. I have noticed that, when owing to its having been deprived of food, the larva has been compelled to change into pupa before its time, the perfect insect is invariably smaller than is usual after it has been allowed to change in regular course.

It is always well to keep larvæ well supplied with food, as I have found in the case of a number of caterpillars of the large white butterfly (*Pieris brassicæ*), that when deprived of food, some of them turned into the chrysalis state, and the survivors thinking no doubt that being deprived of their natural food, they were fully justified in resorting to cannibalism, devoured the chrysalides whilst they were yet in a soft condition. This undoubtedly was a neglect on my part which was deserving of reproach, as the food of this species is easily obtainable, consisting chiefly of cabbage-leaves.

Another difficulty I found, in the rearing of *Pieris brassicæ*, was caused by a minute enemy in the shape of an ichneumon fly, with a very black body and yellow legs. This is a persevering enemy, and the larvæ breeder may discover at the last moment that a fine specimen, or a batch of specimens, has been lost, owing to the ravages of this insect. He may glance into his cage, as I have sometimes done into mine, expecting to find the caterpillar of yesterday transformed in the chrysalis of to-day, and be surprised, and when he knows the result, disappointed, by finding the empty skin of the caterpillar encased in what appears to be a thick web of yellow silk, but which, on a nearer inspection, proves to be a number of small cocoons, out of which, in the course of time, a brood of ichneumons will proceed to commence, as their progenitors had done, a fresh warfare on caterpillar life.

The manner in which they proceed is this:—Alighting on the back of their victim, they, by means of an instrument formed somewhat like the teeth of a saw, termed an ovipositor, introduce their eggs into the interior of the caterpillar's body; these eggs in time turn out a number of maggots, who immediately commence a work of devouring their strange habitation, carefully avoiding coming in contact with the vital parts. Thus the poor caterpillar, unconscious of its impending fate, goes on eating day by day, only to provide food for the "eaters" inside. When the fulness of time has arrived they eat their way through the skin, and change, as we have seen, into pupæ, leaving their victims an empty withered mass.

Thus it will be seen that the life of the caterpillar does not always terminate in a satisfactory manner.

A troublesome episode in the career of the larva is the process of changing its skin. A day or so before this moulting occurs, the caterpillar gives up eating, and retires into some quiet corner, where he undergoes this, to him, very painful operation. The old

skin, becoming too small for the growing body, splits down the back, and the caterpillar, with a few struggles, emerges from it, arrayed in a perfectly new skin. Sometimes, however, this operation proves fatal, and the caterpillar dies during the process.

Some novices in the art of larvæ-breeding seem to think that one kind of green food is quite as suitable as another for the wants of the caterpillar; but this is not so. Each species has its peculiar food-plant; and although the caterpillar of *Vanessa Io*, *Vanessa urtica*, *Vanessa atalanta*, seem to be equally fond of the nettle, yet if placed on a gooseberry-bush, they would be quite at sea, and would refuse to partake of the gooseberry-leaf.

And it is worthy of observation that an all-wise Providence has so disposed the perfect insects that they invariably lay their eggs upon, or in close proximity to the food-plant of their species.

Just a word as to the mode of collecting larvæ. I have found a good strong sweep-net, such as sold by Watkins and Doncaster, of the Strand, invaluable in a collecting expedition. The mode of application is simple:—Having come upon a spot covered thickly with vegetation—dead-nettles, etc.—plunge your net into the midst of it, sweeping it from side to side, taking care that the impetus of your second stroke does not throw out of your net the captives made by the first stroke. This will generally be found a pretty lucrative mode of collecting. Another mode is by beating hazel, and other kinds of bushes, with a substantial stick, holding a net or an umbrella underneath, to intercept whatever is dislodged from the bush.

*Morpeth, Northumberland.*

## STUDIES OF COMMON PLANTS.

By E. A. SWAN, B.A.

### No. VIII.—THE HOLLYHOCK.

THE flower is thus composed. Involucre: a whorl of seven or more bracts, and next, a whorl of six or more larger bracts, all set closely.

Corolla: five petals, and, in the double flowers, generally six. Towards the base, each petal gradually thickens on either side, as shown in Fig. 85; and the upper edges of the thickened parts are closely lined with fine hairs. The petals overlap, but leave small openings near the base, between the thickened parts. The opposite sets of hairs, then interlacing, effectually keep out small insects above from the enclosed spaces thus formed, and in which the nectar is secreted, the bracts effecting the same purpose below.

Column rises from the base, formed by the junction of the thickened parts, and, according to the number of petals, is five-sided or six-sided.



Pistils : numerous, forty or more, forming a hollow cylindrical-shaped body, enclosed by the column and surrounding the carpels, which are arranged in a circle as shown in Fig. 86. In the single hollyhock the pistils, as to their upper portions, are generally dark crimson, the petals assuming the same colour, whilst the stamens are bright yellow ; the column, however, is variable, sometimes being crimson, sometimes yellow. In the double hollyhock the column and base are usually yellow, the stamens the same : the pistils, however, vary, sometimes being yellow, but as frequently the same colour as the petals, though generally of a lighter shade.

Stamens : spring in considerable numbers from the top and sides of the column. In the double flower they are interspersed with the centre florets.

In observing a large number of single as well as double flowers, I noticed that the pistils do not appear above the column for some days after the flower opens and the anthers have matured, thus favouring cross-fertilisation. When fully raised they bend outwards—more in the single than the double, because in the latter they are obstructed by florets—and become intimately mingled with the upper stamens, or the stamens and florets, as the case may be ; but I doubt if this is often the cause of self-fertilisation, as it seems to me that fertilisation usually takes place directly the pistils appear, and before they have had time to bend ; that is, if the proper agents have satisfactorily done their work. The habit may, however, be useful as a sort of guarantee against possible failure, by bringing the pistils and anthers so close together that fertilisation might take place the more readily by means of the visiting insects, or even without their co-operation. In the figures the pistils appear separated for only part of their length ; but, as a fact, I believe they are distinct from each other throughout in most plants, and their number, as far as I could ascertain, invariably corresponds with the number of the carpels.

The centre florets of the double flower (see Fig. 85) exhibit, in a wonderful manner, the various steps between stamen and floret. The figure represents a vertical section of the flower, with all but a few florets removed. One floret is cleft at the top, but otherwise, in shape like an ordinary petal ; another is a half floret, with a projection on one side. The next shows a perfect anther in place of the projection ; another is divided, part being floret, part filament and anther ; another looks like a shrivelled floret, with the top turned over.

Of course it may be urged that any particular intermediate form never itself becomes the serviceable shape to which it is apparently tending, as, for instance, a petal, a floret, a stamen, or a pistil, and this is undoubtedly true ; but it is also equally true that beneficial modifications are reproduced in each successive plant until they do reach the goal at which

they aim. So if we could follow through several points the floret with a simple projection, we might trace it upwards to a stamen or downwards to a floret, the projection gradually assuming the form of a stamen or the second half of a floret, as the case may be, according to the direction in which the modification had set in.

Assuming that the double hollyhock is derived from the single, and I suppose there cannot be two opinions about this, it follows that the florets trace back to an ordinary stamen. All the evidence I have adduced points in that direction, and it is no more unreasonable to believe than that a stamen should be evolved from a

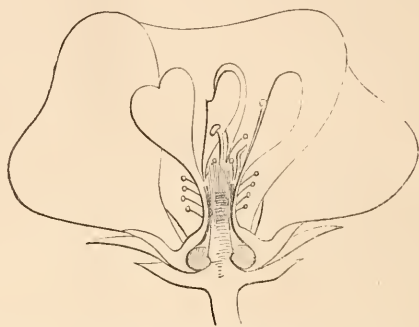

Fig. 85.—Vertical Section of Double Hollyhock, showing a few of the central florets.

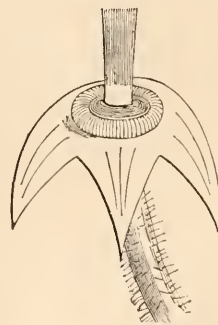

Fig. 86.—Pistils, carpels, and inner bracts, the last turned down.

petal. The modification of parts is incessantly going on, and a particular organ is not always reached by direct steps ; thus I can understand a petal first becoming a stamen, and then a floret by evolutionary process. It may be called reversion ; but whatever term is most applicable to the phenomenon, the case now under consideration shows how marvellously the various parts of a flower can mould themselves to their requirements, applying a gain, or fitting a loss to some useful purpose, and how they can expend lavishly or retrench carefully without being charged with unnecessary extravagance on the one hand, or abortive penuriousness on the other. With plenty and to spare they will support a great number

of brilliant florets, for the attraction of those insects which carry out the chief aim of their existence; with little in hand, they will spend that little in numerous stamens which require only moderate expenditure, taking care to make the pistils bright and attractive as well.

## CHATS ABOUT ROTIFERS.

### No. II.—MASTIGOCERCA BICRISTATA.

A NEW Rotiferon belonging to the sub-order Loricata. Family, *Rattulida*. Genus, *Mastigocerca*, of which there are recorded (in the recently

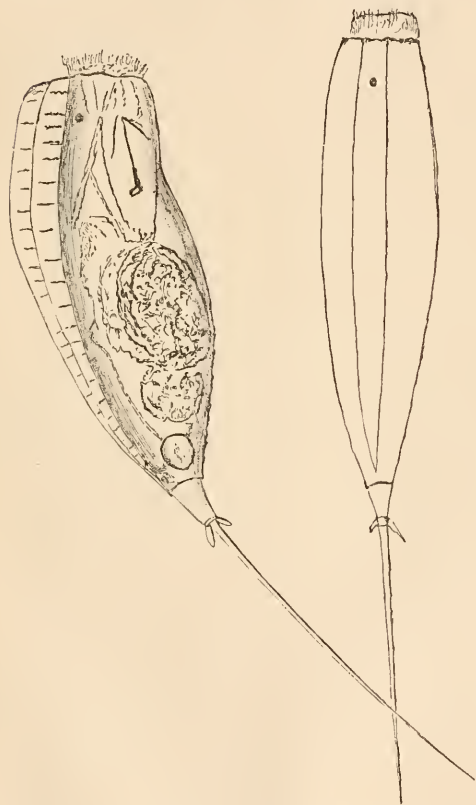

Fig. 87.—*Mastigocerca bicristata*; side view. Fig. 88.—*Mastigocerca bicristata*; dorsal view.

published work by Dr. Hudson and P. H. Gosse), seven species.

I found this one in a marsh pool on Tents Muir, Fifeshire, May 1886, and again in July of the same year in a similar habitat near Blairgowrie, Perthshire.

The addition of this elegant creature brings up the number of species belonging to the genus *Mastigocerca* to eight.

Although the *M. bicristata* is the last, it is by no

means the least, either in size, grace, or beauty, as a fully developed individual measures quite  $\frac{1}{10}$  of an inch in length, from the head to the point of the toe. Note the curves of its smooth lorica on the ventral side, with a pair of corrugated dorsal crests rising with gentle curve to the middle of the lorica, then sloping with slight curve towards the foot for about seven-eighths of the length of the lorica, the foot terminating in a long slender toe, nearly as long as the whole length of the body. Its possession of a bright red eye, together with its transparency, renders the creature a handsome object under a power of 60 to 100 diameters.

Its corona is clothed with closely set vibratile cilia; the head is protruded but a short distance out of the truncated mouth of the lorica; the masticating apparatus is enveloped in a long bag, containing a pair of long slender jaws. The stomach is large, and it is generally filled with a greenish (mixed with a light brown) matter.

*M. bicristata* is a rigid vegetarian, and is frequently seen nibbling the end of a filament of *Conferva*. The creature is constantly turning over and over. In this happy position the observer is enabled to see it from every point of view. Its food consists of *Conferva*, *Desmids*, and even *Diatoms*. I introduced, by a dipping tube, a drop of water containing numbers of *Protococcus pluvialis* into a small zoophyte trough where a few of the *M. cristata* were disporting themselves under the microscope. They fell on the *Protococcus* and devoured them with apparent relish.

The contractile vesicle is conspicuous at the posterior a short distance from the foot. Its pulsations are one in every 13 seconds. The branchial vessels and vibratile tags can be seen in the transparent parts of *M. cristata*.

It deposits its eggs (of an oblong form) amongst *conferva* or vegetable debris. I have never met with the male of this or any other of the species *Mastigocerca*.

Its motions when swimming are very graceful, sometimes rolling on its own axis with the long toe quite straight, as at *a*, Fig. 88. Habitat, marsh pools.

JOHN HOOD, F.R.M.S.

THE CUCKOO.—In reply to F. Jas. George, the variations in the note of the cuckoo are of common occurrence, especially late in the season. I have also frequently noticed a peculiar sound uttered by the cuckoo, generally in its flight, resembling more a hoarse, chuckling cough than anything else to which I can compare it. I shall be glad to know if any one can corroborate my statement, and inform me whether it proceeds from the male or female bird? [Cuckoos have been unusually numerous in this neighbourhood this spring.]—*IV. E. Windus, Bexhill, Sussex.*

## AMERICAN SHELL-MONEY.

By ERNEST INGERSOLL.

[Continued from p. 147.]

SEEING that the profit and wealth lay in the possession of wampum, the burghers, as the easiest way of getting rich, began to make it. With their tools of steel this could be done very rapidly; but with the loss of the painstaking care with which the Indian wrought, came a loss of value, and the wampum very soon began to depreciate. To widen their market, it was carried to New England. Considering the many references to it, and the undoubted fact that it was made there aboriginally, as well as southward, I am at a loss to understand Gowan's statement, that the use of wampum was not known in New England until it was introduced there in October, 1627, by Isaac de Razier, who was acting as a sort of amity-treaty commissioner from the Netherlands to Plymouth. He carried wampum thither and bought corn. To this introduction the pious Hubbard attributes all the wars which ensued between the Puritans and the Indians. "Whatever were the honey in the mouth of that beast of trade [the Dutch] there was a deadly sting in the tail," he wails out, with much more to the same purpose. It was during the administration of William Keift that the wampum currency was of greatest importance in New York. Washington Irving, in his "Knickerbocker's History," chapter vi. gives a humorous account of it and the troubles to which it gave rise. Keift began by endeavouring to flood the colony with this Indian money which the Indians were content to take in exchange for their peltries, but which of course had no intrinsic value. Says the veritable Diedrich:

"He began by paying all the servants of the company and all the debts of the Government in strings of wampum. He sent emissaries to sweep the shores of Long Island, which was the Ophir of this modern Solomon, and abounded in shellfish. These were transported in loads to New Amsterdam, coined into Indian money and launched into circulation.

"And now for a time affairs went on swimmingly . . . Yankee traders poured into the province, buying everything they could lay their hands on, and paying the worthy Dutchmen their own price in Indian money. If the latter, however, attempted to pay the Yankees in the same coin for their tin-ware and wooden bowls, the case was altered; nothing would do but Dutch guilders and such like 'metallic currency.' What was more, the Yankees introduced an inferior kind of wampum, made of oyster-shells, with which they deluged the province, carrying off in exchange all the silver and gold; the Dutch herrings and Dutch cheeses; thus early did the knowing men of the East manifest their skill in bargaining the New Amsterdamers out of their oyster and leaving them the shell.

"It was a long time before William the Testy was made sensible how completely his grand project of finance was turned against him by his eastern neighbours; nor would he probably have ever found it out had not tidings been brought him that the Yankees had made a descent upon Long Island, and had established a kind of mint at Oyster Bay where they were coining up all the oyster-banks.

"Now this was a vital attack upon the province in a double sense, financial and gastronomical. Ever since the council dinner of Oloff the Dreamer, at the founding of New Amsterdam, at which banquet the oyster figured so conspicuously, this divine shellfish has been held in a kind of superstitious reverence at the Manhattoes; as witness the temples erected to its cult in every street and lane and alley. In fact it is the standard luxury of the place, as is the terrapin at Philadelphia, the soft crab at Baltimore, or the canvas-back at Washington.

"The seizure of Oyster Bay, therefore, was an outrage, not merely on the pockets, but the larders of the New Amsterdamers; the whole community was aroused, and an oyster crusade was immediately set on foot against the Yankees. Every stout trencherman hastened to the standard; nay, some of the most corpulent Burgomasters and schepens joined the expedition as a *corps de reserve* only to be called into action when the sacking commenced."

A valiant army under Stoffel Brickerhoff having marched to Oyster Bay, routed the English there, "and would have driven the inhabitants into the sea if they had not managed to escape across the Sound to the main land by the Devil's stepping-stones, which remain to this day monuments of this great Dutch victory over the Yankees." This done:

"Stoffel Brinckerhoff made great spoil of oysters and clams, coined and uncoined, and then set out on his return to the Manhattoes. A grand triumph, after the manner of the ancients, was prepared for him by William the Testy. He entered New Amsterdam as a conqueror, mounted on a Narragansett pacer. Five dried codfish on poles, standards taken from the enemy, were borne before him, an immense store of oysters and clams, Withersfield onions and Yankee 'notions' formed the *spolia opima*; while several coiners of oyster-shells were led captive to grace the hero's triumph.

"The procession was accompanied by a full band of boys and negroes performing on the popular instruments of rattle bones and clamshells, while Antony Van Corlear sounded his trumpet from the ramparts.

"A great banquet was served in the Statehouse, from the clams and oysters taken from the enemy; while the Governor sent the shells privately to the mint and had them coined into Indian money, with which he paid his troops."

To check the evils of this "inflation" a law was passed in the New Netherlands in 1641, prohibiting



the acceptance of anything but fine polished string-wampum, except at five for one stiver, while the polished was worth four for a stiver. These were echoed in Connecticut by enactments that no seawant should be paid or received, except "strunge sutably and not small and great, uncomely and disorderly mixt as formerly it hath beene." In Massachusetts "wampam-peag" was legal tender (Act of 1648) for all debts less than forty shillings, except county notes to the treasurer, the white at eight for a penny and the black at four for a penny. This remained the law till 1661, but wampum served as money there much longer than that date, as it did everywhere else. It would be impossible to get at the volume in circulation, but values are accessible. These remained substantially those I have mentioned, until 1673, when the true wampum had become very scarce, owing to the hoarding of it by the Indians, and its disposal to remote tribes. The Dutch council therefore issued an edict enhancing its value 25 per cent. Such an action as this the red men could not in the least comprehend. Adair says they had a fixed value for every bead, and "bought and sold at the current rate, without the least variation for circumstances, either of time or place; and now they will hear nothing patiently of loss or gain, or allow us to heighten the price of our goods, be our reasons ever so strong." This was a sad case for an Indian trader!

Nearly a century passed, and still the shell-money held a firm place in colonial trade all along the coast. That observant traveller, Dr. Kalm, who visited and wrote about the American settlements in 1784, has much to say of the profits of trading through this medium in Indian goods. "The Indians," he notes, "formerly made their own wampum, though not without a deal of trouble; but at present the Europeans employ themselves that way, especially the inhabitants of Albany, who get a considerable profit by it." This last fact is also mentioned by the Rev.—Barnaby, who further saw it made by whites on Staten Island. It is only a little later, indeed, that Jacob Spicer, the most prominent man in Cape May county, New Jersey, advertised to barter goods "for all kinds of produce and commodities, and particularly for wampum," offering five dollars reward to the person making the largest amount of it. He succeeded in procuring a quantity of the wampum, and before sending it off to Albany [*cf. ante*] and a market, weighed a shot bag full of silver coin and the same shot bag full of wampum, and found the latter most valuable by ten per cent."

At this time and later, wampum was valued both as ornament and money by the Canadian Indians. Kalm saw it among the Hurons and also below Quebec. So slow were the Indians to relinquish it as currency, that wampum continued to be fabricated until fifty years in several towns in New York State (chiefly Babylon, Long Island) to meet the demands for it by the fur-traders.

Glass beads were attempted to be substituted at a very early day, but although they were acceptable to the savages everywhere as a trimming, they never acquired the significance and circulation as money which the genuine shell-beads attained.

Though with the tribes of the central region of North America, commercial transactions were all a matter of barter, and the standard of value, if any existed, varied with the especial local commodity, like buffalo robes on the plains, blankets among the Navajos and Pueblos, or otter skins in Alaska; yet the coast tribes of the Pacific had a true money when the whites first became acquainted with them. This currency seems to have been confined nearly, or quite within the present boundaries of the United States and British Columbia, and it comprised a variety of forms, one of which in the northern, and another sort in the southern part of this area, approached in solid and widely-recognised value the substantial wampum.

The northern and most celebrated of these varieties was the Hiqua, Hikwa, or Hi'aqua, for all these spellings of the Chinoak-jargon words are found. Hiqua consisted of strings of the shell of a mollusk (Dentalium) spiral, quill-shaped, and called by conchologists "tusk-shells." These were gathered off the shores of Vancouver's and the Queen Charlotte Islands, by prodding down into the sea-water long poles with a spiked board at the end, upon the points of which the slender shells were caught. None were quite two inches in length, many much smaller; and among all the Indians north of the Columbia river the unit of measurement was a string of about a fathom's length, or as much as could be stretched between the extended hands of the owner. The larger the size, the greater the value; forty to the fathom was the standard, fifty to the fathom being worth scarcely half so much. Early in the present century a fathom was worth ten beaver skins in dealing with the whites in Oregon. With the advent of the Hudson's Bay Company's traders, however, the hiqua disappeared to a great extent, and values were reckoned in blankets, as is now the case in many parts of Alaska and Arctic America.

South of the fur-trading posts, however, this money survived to a much later date, and is even yet to be seen in certain remote districts. "Those aboriginal pedlars, the Klikitates" and other Columbians, carried it to southern Oregon, and to the Klamath region year after year, whence it spread through all northern California, receiving then the new name, Alli-cochick, and an alteration of estimate. The northern measure between the extended finger-tips was discarded on the Klamath river for a string scarcely half that length. Among the Hupas, still farther southward, the standard was a string of fine shells. Nearly every man had ten lines tattooed across the inside of his left arm, about half-way between the wrist and the elbow; in measuring shell-money he drew one end over his left thumb-nail, and

if the other end reached to the uppermost of the tattoo lines, the five shells (ten years ago) were worth twenty-five dollars in gold, or even more. Only one in ten thousand would reach this distinction, so that the ordinary worth of a string was ten dollars.

"No shell is treated as money at all," says Mr. Powers, "unless it is long enough to rate as twenty-five cents. Below that . . . it goes to form part of a woman's necklace. Real money is ornamented with little scratches or carvings, and with very narrow strips of thin, fine snake-skin, wrapped spirally round the shells; and sometimes a tiny tuft of scarlet wood-pecker's down is pasted on the base of the shell." These marks manifestly were designed to give some sort of sanction—make it represent somewhat the labour put upon the beads with which it had to compete.

For, south of Eel River, and thence throughout all central and southern California, the staple currency was a shell-money resembling the eastern wampum. Hiqua and Alli-cochick were simply shells of some rarity, ground at the tip sufficiently to admit of being strung. The Háwok and illo of California was carefully manufactured, and represented a real cost of labour and time, though they had no intrinsic value.

The first-named, háwok, was of least worth, standing in the place of the white wampum of the east, or our silver. It consisted of circular discs or buttons from a quarter of an inch to a whole inch in diameter, and of the thickness of the shell from which it was cut. For this purpose a heavy bivalve was chosen, and broken into discoidal fragments. These pieces were then ground smooth, and polished by rubbing on blocks of sandstone which often had to be brought from a long distance to the maker's rancheria. This finished, a hole was bored through the centre with a wooden, flint-tipped drill, forced to revolve very rapidly by a buckskin string which wound upon it, unwound and rewound itself in an opposite direction, through the incessant vertical movement of a loose cross-bar in the operator's hand. These Háwok discs were then strung upon sinews, or on cords made of milkweed fibre, but the strings were not of invariable length, though beads of like size must be put together. The very best of this was worth twenty-five cents apiece ten years ago; but the smallest always went by the string. This white bead-money was (and to a certain extent still is) the great medium of Indian trading among themselves.

Their "gold," so to speak, the illo, is made from the shell of the abalone (*Haliotis*) and chiefly from the red species (*H. rufescens*). These shells are cut with flints into oblong key-stone-shaped pieces, from one to two inches in length, according to the curvature of the shell, and a third as broad. Two holes are drilled near the narrow end of each piece, and they are thus strung edge to edge. "Two pieces," wrote Powers, "generally constitute a string, and the large pieces rate at one dollar apiece, ten dollars a string; the smaller in propor-

tion or less, if they are not pretty. Being susceptible of a high polish this money forms a beautiful ornament, and is worn for necklaces on gala days. But as money it was rather too large and cumbersome, and . . . it may be considered rather as jewelry."

A third sort of money, rarely seen nowadays, was fabricated on the islands off the southern coast of California, and along the adjacent mainland. This was called Kol-Kol, and was made by grinding off the apex of the univalve shell of *Olivella biplicata* until a string could be passed through. It was slightly esteemed. Farther south, all these forms of shell-cutting disappear in their capacity of money, retaining only their value as ornaments; so that their use south of California belongs under the head of barter. Thus Bancroft notes of the natives of Sonora: "Pearls, torquises, emeralds, corals, feathers and gold were in former times part of their property, and held the place of money."

There seems to have been an immense amount of this regular money, hiqua, allo-cochick, háwok and illo on the Pacific coast; Powers thinks an average of \$100 worth to each male Indian would not be too large an estimate for California at the time of its discovery by the Spaniards. This portion equaled the value of two grizzly-bear skins, or three ponies, or the price of two wives. However it was not equally distributed, any more than are riches in civilised communities, a point for communists to consider.

The shore tribes were the coiners of this money, and jealously guarded their privileges. With it they bought skins, arms and implements from the dwellers in the Coast Range, where grew animals and materials not to be obtained along the beach. The mountaineers in turn disseminated it far in the interior, where, finally, the beads were prized and worn as ornaments and ceased to circulate. Moreover an enormous waste and destruction was always going on (a fact also true of the Atlantic coast) owing to the practice of propitiatory sacrifices and the widespread custom of burying or burning all the wealth of each man (or noted woman) who died. Thus the demand was always greater than the supply, and a high value maintained. It is astonishing to read how thrifty and shrewd the Indians were in respect to this shell coinage. When the Americans grew numerous, and began to manufacture large quantities of the Háwok, of course its value declined; moreover, with the partial civilisation of the Indians, a new sentiment crept in, and some strange changes in primitive social economy followed.

At present the younger English-speaking Indians scarcely use it at all, except in a few dealings with their elders, like wife-buying or for gambling. A young fellow sometimes procures it as an investment, laying away a few strings of it, for he knows he cannot squander it at the stores; whereas if he really needs a few dollars of current cash he can always

negotiate his shells with some old Indian who happens to have gold or greenbacks. Americans speculate in it here and there to advantage, working upon the clinging love the aged savages retain for the wealth of their youth. These old men save all of it they can possibly acquire, and hoard it like veritable misers, only on great occasions letting their women folks wear any as jewelry. This hoarding is not so much miserly greed, however, as it is a religious notion, since to their minds the shell-money is the only thing worthy to be offered upon the funeral pyre of any famous chief or departed friend, or sent along with their own soul into the Spirit-world.

02345, 003,0, and 00,00 are found at Minster; 00<sub>345</sub> Dartford and Wrotham; 003<sub>15</sub> near Minster (S. C. C.); 0<sub>2345</sub> and (123)(45) near Dartford; 023,0 a conical one (var. *conica*) near Chislehurst; 1<sub>2345</sub>, (123)(45), and 123(45) Minster and Dartford; 12345 Dartford and Ealing, Minster (S. C. C.); 10<sub>345</sub> West Drayton, Middlesex (R. W. Cheadle); 123(45), 0(23)(45), and (12345), Chislehurst.

Var. *petiveria*, ground-colour pale brown, or fawn. 02345 is found on Chislehurst Common, and (123)(45) at Shortlands, West Kent (L. M. C.) Other varieties have been described elsewhere. The variety which appears green when alive, but



Fig. 89.—*Helix hortensis*, var. *minor*. Bickley, Kent.



Fig. 90.—*Helix Bourcierii*. Quito.



Fig. 91.—*Helix moricandii*. Philippines.



Fig. 92.—*Helix Carpentariana*. Florida. (Enlarged)



Fig. 93.—*Helix erronea*. South India.



Fig. 94.—*Helix conoidea*. Mogador.



Fig. 95.—Jaw of *Helix lactea*. Gibraltar.



Fig. 96.—*Clausilia rugosa*, var. *gracilior*. Battle, Sussex.



Fig. 97.—Mouth of *C. biplicata*, "monstridentatum." Near Hammersmith.



Fig. 98.—*Pisidium annicum*, from Crayford fossil-pit. Showing constriction of valve, which is common in the Crayford Pisidia and Sphaeria.

THE VARIATION AND ABNORMAL DEVELOPMENT OF THE MOLLUSCA.

PART IV.

**H**ELIX NEMORALIS, var. *libellula*, ground-colour yellow.

00000 is not rare at Minster, but less common at Chislehurst, 00300 is found at Dartford, Minster, Ealing, and near Southall, 12345 at Minster, Chislehurst, Monkton, etc., the specimen from the last-named locality being unusually large. I found a single specimen of 00305 in the rejectamenta of the Stour at Richborough; it is not a common form, but has been recorded from Sark and also, as var. *bruguieria*, from France. 10345 and 12045 are found near Chislehurst (S. C. C.), but the latter specimen is immature, and would possibly have developed into 12345.

pale yellow when the animal is extracted, may be called var. *fallax*, a sub-variety of *libellula*. I have recently had a specimen from Cabourg, in the north of France.

In some specimens the black pigment is wanting in the shell, and the result is a pale lip and coloured bands. When this happens, as it sometimes does, in *H. hortensis*, the bands only are affected, the lip being naturally white.

Those I have seen of this kind are: *H. nemoralis*, var. *roseozonata-albolabiata*. Bands pink, lip white. Blagdon, near Bristol (F. M. Hele), with formulæ 12345 and 023(45). *H. nemoralis*, var. *citriozonata-albolabiata*. Bands pale brown colour, lip white. Worthing (B. M. Oakshot), formula 12545. *H. hortensis*, var. *roseozonata*. Bands pink. Acton Green and Bickley.

*H. hortensis* var. *viridizonata* has been found in the Spanish peninsula,



*Helix hortensis*, var. *lutca*, ground-colour of shell yellow.

oooo is the common form. 12345 Bedford Park, Eltham, Canterbury (Miss L. Fenn), and other localities; 10345, near Bexley, W. Kent; 00045, one at Chislehurst (L. M. C.); 1<sub>2</sub>345, near Chislehurst; 103<sub>4</sub>5, Warlingham (S. C. C.); 0<sub>2</sub>345, Barnes; 1<sub>2345</sub>, near Chislehurst (S. C. C.); (12)3(45), Eltham; 1(23)(45), 1(2345), (12345), and 1(23)45, Chislehurst, and the two last at Canterbury (L. Fenn); (12)345, Putney.

Var. *incarnata*, ground-colour pink. ooooo, Canterbury (L. Fenn), and other localities, not unfrequently with a dark lip. 12345, Bedford Park; (123)(45) and 1<sub>2</sub>34<sub>5</sub>, Warlingham; 1<sub>2</sub>345, Bedford Park (D. B. C.); (12345), near Chislehurst (S. C. C.).

Var. *baudonia*, ground-colour light brown, or fawn. 1<sub>2</sub>345, Barnes, Surrey.

In comparing *hortensis* with *nemoralis*, we notice that the pink varieties are more common in the latter species, and that the formula 00300 is much more common in the latter than in the former.

The fourth band probably really represents two coalesced bands, so that the formula might be written 123(32)1 for 12345, to show the homology of the bands above and below the periphery.

As regards geographical distribution much remains to be done.

*H. hortensis*, var. *lutca*, 10305 seems to be absent in the South of England, but not uncommon in Belgium and France.

*H. nemoralis* with a formula 00345 is common in some districts, but absent in others, and the same may be said of many other varieties. The distribution of the brownish and purplish varieties of *H. hortensis* in the South of England is very curious. In the London district and north of the North Downs the lilac form (*lilacina*) is prevalent, but in Sussex its place is taken by a very pale purplish variety (*pallida*), while this in its turn gives place to the dark olive-brown shells (*olivacea*) in Devon, Dorset, and Somerset. In all these districts the pink and yellow varieties also occur. The variety, called *interrupta*, with the bands interrupted at intervals, is more common on the continent than in England, and I have never seen a British example of this variety in *H. hortensis*.

It seems probable that there is a rudimentary sixth band below the fifth, for while examining a number of *H. nemoralis* and *H. hortensis*, collected by Mr. A. Belt at Chideock, near Bridport, I noted that (1) in a *nemoralis*, var. *petiveria* (12345) the area above the bands was white, but that below fawn.\* (2) In specimens of *H. hortensis* var. *arenicola* the interfascial area was whitish, but the umbilical area

was greenish-yellow, a very fine whitish line following the lower border of the fifth band. (3) A sixth band below the fifth seemed faintly indicated in one *arenicola*.

The Rev. Hilderic Friend has sent me a very nice specimen of *H. nemoralis*, var. *libellula*, 00300, with a black band and a white lip tinged with pink. The locality is Kiveton Park, Yorks. In looking over some other Kiveton Park examples, I was struck by the fact that the bands 1, 2, 4 and 5 never reached the lip of the shell, and that band 3 only does so in an attenuated form.

Hence, it appears, that shortly before attaining the full growth the organ which produces the black pigment undergoes a change, and either becomes aborted (producing a white lip), or is developed all along the mantle, and so gives rise to a dark lip.

T. D. A. COCKERELL.

## ASTRONOMY AND METEOROLOGY.

By JOHN BROWNING, F.R.A.S.

THE annual visitation of the Royal Observatory, Greenwich, took place on the 4th of June, and the Astronomer Royal has issued his report to the Board.

An important change is about to be made in the buildings. The two computing-rooms are to be enlarged, and above the extended portion of one of the rooms a dome is to be erected 18 feet in diameter, which is to contain the 6-inch equatorial by Cooke, with the apparatus for photographing the Sun attached to the same mounting. This telescope may be used for occultations and various occasional observations.

The work for the ten-year catalogue of stars, from 1877 to 1886, has been completed, and the catalogue will contain about 4000 stars, including as far as possible sixth magnitudes.

The construction of the 28-inch refractor has been delayed by the difficulty of obtaining the glass discs.

The spectroscopic and photographic work has been carried on as usual, as well as the magnetical observations.

The report of the Paris Observatory has also been issued by Admiral Mouchez. M. Cornu has devised a new method of measuring the length of the waves of light. So much work has been done, that I cannot epitomise it in the space allotted to me. Astronomical photography has been carried on with great assiduity, and has been particularly applied to the planets and their satellites. The smallest satellite of Saturn which was discovered the last, Hyperion, has been photographed with an exposure of thirty-five minutes.

A new instrument, named a macro-micrometer, has been devised and used for measuring the relative positions of stars on the photographic plates.

\* It appears also that Westerlund's var. *virescens* was really *viridi-zonata*, (12345) in which the white area above the bands was noticeable. (*Vide 'Nat. World,' Aug. 1885.*)

During the Solar Eclipse of the 19th of August the line of totality will traverse Russia in Europe and Asia, and pass over Japan near Jeddo. One of the most advantageous points will be not far from Moscow.

Dr. Copeland and the Reverend S. J. Perry will go from England. Professor C. A. Young of Princetown Observatory, U.S.A. will observe the eclipse at Kineshma. Mr. Common of Ealing, and Mr. Turner of the Royal Observatory, and two Italian astronomers, Professors Tacchini and Ricco, will be nearer to Moscow. The duration of the totality will be longest in the S.E. of Siberia, where the eclipsed sun will be higher than in Europe. At Irkutsk the totality will last nearly five minutes.

In England the sun will rise partially eclipsed, and this partial eclipse will be over in five minutes.

At the last meeting of the Royal Astronomical Society the papers read were not popularly interesting. Professor Pritchard read a paper on the parallax of 61 Cygni as obtained from the measurement of 330 photographs taken on eighty-nine nights. The result substantially agrees with the parallax values determined by Bessel and Dr. Ball. There is a considerable difference between the values of the parallax of this star as found by different observers. The smallest value for its parallax results from the observations of Professor A. Hall, made with the great 26-inch refractor.

On August 3rd there will be a partial eclipse of the moon; the first contact with the penumbra will be at 6 hrs. 12 min. aft., the first contact with the shadow at 7 hrs. 36 min., the middle of the eclipse at 8 hrs. 49 min., the last contact with the shadow at 10 hrs. 2 min., and the last contact with the penumbra at 11 hrs. 26 min.

There will be no occultations beyond the 5th magnitude.

Venus will be at greatest brilliancy on August 16th.

Mercury will be a morning star.

Venus will be an evening star.

Mars will be a morning star until August 20th, when it enters Cancer.

Saturn will be a morning star in Cancer.

*Meteorology.*—In the Annual Report of the Greenwich Observatory, it is stated that the mean temperature of the year 1886, was 48° 7, being 0° 6 below the average of the preceding forty-five years. The highest air temperature in the shade was 89° 8, on July 6th, and the lowest 16° 5, on January 7th. The mean daily motion of the air was 291 miles, being seven miles above the average of the preceding nineteen years; the greatest was 857 miles, on December 8th, and the smallest 56 miles, on October 8th.

The hours of bright sunshine recorded in 1886 were 1,228, which is about twenty hours above the

*Rising, Southing, and Setting of the Principal Planets at intervals of Seven Days.*

	D.	Rises. h. m.	Souths. h. m.	Sets. h. m.
MERCURY ☿ . . . . .	6	3 43M	11 12M	6 43A
	13	3 17M	10 51M	6 25A
	20	3 11M	10 52M	6 33A
	27	3 43M	11 11M	6 39A
VENUS ♀ . . . . .	6	8 44M	2 44A	8 44A
	13	8 46M	2 31A	8 16A
	20	8 40M	2 13A	7 46A
	27	8 26M	1 50A	7 14A
MARS ♂ . . . . .	6	1 59M	10 14M	6 29A
	13	1 55M	10 6M	6 17A
	20	1 52M	9 58M	6 4A
	27	1 49M	9 49M	5 49A
JUPITER ♃ . . . . .	6	11 37M	4 49A	10 1A
	13	11 15M	4 25A	9 35A
	20	10 52M	4 1A	9 10A
	27	10 31M	3 37A	8 43A
SATURN ♄ . . . . .	6	3 7M	11 4M	7 1A
	13	2 44M	10 40M	6 36A
	20	2 21M	10 16M	6 11A
	27	1 58M	9 52M	5 46A

average of the preceding nine years. The rainfall during that year was 24.2 inches, being 0.5 inch below the average of the preceding forty-five years.

At the Royal Observatory, Greenwich, the highest reading of the barometer for the week ending 25th of June was 30.17 in. on Monday evening, and the lowest was 30.03 in. on Thursday afternoon and at the end of the week. The mean temperature of the air was 60.3 deg., and 0.8 deg. below the average. The general direction of the wind was N.E. No rain was measured during the week. The duration of registered bright sunshine in the week was 61.4 hours, against 55.6 hours at Glynde Place, Lewes.

For the week ending 2nd July the lowest reading of the barometer was 29.95 in. on Monday evening, and the highest 30.28 in. on Thursday morning. The mean temperature of the air was 62.9 deg., and 1.2 deg. above the average. The direction of the wind was variable. No rain was measured during the week. The duration of registered bright sunshine in the week was 44.2 hours, against 51.4 hours at Glynde Place, Lewes.

For the week ending July 9th, the highest reading of the barometer was 30.05 in. at the beginning of the week, and the lowest was 29.71 in. at the end of the week. The mean temperature of the air was 69.3 deg., and 7.5 deg. above the average. The direction of the wind was variable. Rain fell on Tuesday to the amount of 0.04 of an inch. The duration of registered bright sunshine in the week was 70.1 hours, against 71.5 hours at Glynde Place, Lewes.

For the week ending July 16th, the lowest reading of the barometer was 29.59 in. on Sunday morning,

and the highest 30·08 in. at the end of the week. The mean temperature of the air was 67·9 deg., and 4·7 above the average. The general direction of the wind was S.W. Rain fell on four days of the week to the aggregate amount of 0·26 of an inch. The duration of registered bright sunshine in the week was 55·2 hours, against 37·3 hours at Glynde Place, Lewes.

The mean temperature in London and vicinity for August is 64°; for S.E. coast 63°, for Land's End 62°, Hull 61°, and Sunderland 60°.

The average rainfall for August is over the greater part of England 2 inches, in a few places on the W. coast it is 3 inches.

exposure as a land surface, when it underwent great denudation by weathering, began gently to subside. Nothing definite can be said as to the extent of this subsidence, but it is well known that that part which forms now the south-east counties of England, was gradually submerged, when sand banks and shelly deposits were laid down in the shallow waters of the North Sea, and it is these accumulations that are termed "crag." Geikie, in his Text-book of Geology, says: "It is evident in these fragmentary accumulations of the 'crag' series, we have merely the remnants of some thin sheets of shelly sands and gravels, laid down in the waters of the North Sea, while that great lowering of the European climate



Fig. 99.—*Pectunculus glycymeris*.



Fig. 100.—*Nucula Cobboldia*.



Fig. 101.—*Astarte Omalli*.

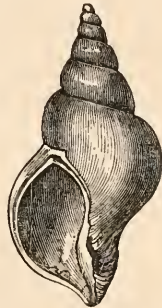

Fig. 102.—*Fusus contrarius*.



Fig. 103.—*Voluta Lambertii*.

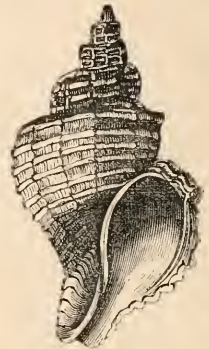

Fig. 104.—*Purpura tetragona*.



Fig. 105.—*Cypraea Europaea*.

#### A VISIT TO THE RED CRAG AND CHALK PITS OF SUFFOLK.

LAST November, being in Suffolk with some friends, I visited one of the red crag cuttings and one of the chalk pits in the neighbourhood of Ipswich. I had heard a great deal about the "crag" formation, but it was all so new to me that I wished much to see it and make a collection of its fossils for myself. This desire was strengthened after seeing the splendid collection in the museum at Ipswich—a place which I would advise any lover of nature, in most of her departments, to visit as soon as possible.

We had a beautiful day, and after driving four miles or so, through lanes bordered with hedgerows on either side, over which the briony berries were clustering in scarlet masses, while the tufts of wild clematis seed clothed everything in a mantle of snow, we arrived at Foxhall Crag Pit.

A few words as to the nature of the "crag" formation will explain it at once. In the Pliocene period in geology, Britain, after a long time of

was beginning which culminated in the glacial period." Many of the "crag" shells still live in Arctic seas.

The "crag" series is subdivided into five groups, of which the red is the second oldest, and it is principally in Norfolk and Suffolk that all of these groups are exposed. The cutting which we visited seemed to be about six or eight feet thick; its natural colour is a deep red, and in some parts it is stained deeper still by a mixture of iron. The section here is very good, and shows the "red crag" resting on the London clay.

The "crag" species of shells are 230 in number. The Foxhall "crag" pit is worked for the purpose of obtaining those valuable phosphatic nodules, called "coprolites." They are gathered by the ton, after being extricated from the "crag," and conveyed to the crushing and chemical works and converted into manure. As there are various opinions as to what those "nodules" really are, I will quote an extract from Dr. J. E. Taylor's book, "Nature's Bye-paths," which gives his opinion. "The well-known red



crag phosphates of Suffolk, are scarcely less interesting to geologists than those of the south of France. They occur as *nodules* often enclosing fossils, but singularly enough, these fossils are never those of the red crag itself, but always those of the much older 'London clay' formation. These crag phosphatic nodules still go by the name of 'coprolites,' from an *antiquated, but erroneous*, opinion that they are the fossil excrement of animals. Instead of this being their origin, however, we know that they represent that portion of phosphorus which has entered into the structures of the soft bodies of those very animals, whose hard parts, bones, shells, &c.,

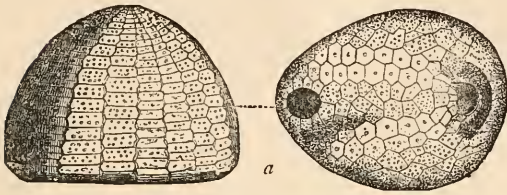

Fig. 106.—*Ananchytes ovata*, a common chalk fossil.

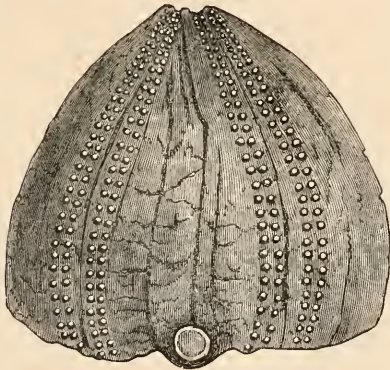

Fig. 107.—*Ananchytes ovata*, internal flint-cast.

also occur in the fossil state; in fact, *phosphoretted hydrogen* set free from the decomposing bodies of the animals which died in the sea along whose floor the 'London clay' was deposited; phosphoric acid, so forming combined with lime, and in this manner the nodules of phosphate of lime were formed by segregation." Another short extract from his 'Geology of Ipswich': "There is every reason to believe that the so-called coprolites or phosphatic nodules, were in reality accumulated on an old exposed *land* surface of the 'London clay' before the area was submerged to form the bed of the 'red crag' sea. Teeth of 'mastodon,' rhinoceros, and deer, are not unfrequently met with associated with bones of older date."

Fossil wood, bones, teeth, &c., of animals chiefly Cetaceans, are met with in the "crag," these having been re-deposited in the crag beds, after having been washed out of the London clay, in which they were

originally imbedded. I am indebted to Dr. J. E. Taylor for several specimens of *Otodus obliquus* (shark's teeth), as well as the beautiful "Box stone" containing *Pentunculus glycimeris*.

The nature of the "Box stones" will be best described in Dr. Taylor's own words:—

"Very singular," he says, "are the roundish masses of coarse sandstone which are met with at the Foxhall Crag Pit. From Foxhall, the bed containing them, extends to Felixstowe, and heaps of them may be seen by the roadside, waiting to be broken up for road mending. They are very curious as representing a lost formation, older than the 'Coralline Crag,' for they are also found under it, which is probably of late miocene age." It is the quarrymen who have termed them "box stones." You strike them with a sharp blow of the hammer, and about one in every ten, will break in halves, revealing the cast of a fossil shell, &c., within. These "box stones" are the broken up and rolled remains of a bed of sandstone, which once covered this part of Suffolk, and which still underlies Antwerp, Brussels, and other places in Belgium. This completes the fossils of the crags, and we next visited a very large chalk pit near the village of Bramford, about three miles from Ipswich. It was a very deep cutting, the walls of pure chalk, towering up like hills above our heads. The men were busy burning it for lime. We were not so fortunate as to chalk fossils, but secured a pretty specimen of *Ananchytes ovata*, an Echinoid of the Cretaceous period. They are locally termed "Fairy loaves." We found them difficult to dig out of the close, compact mass of chalk, the outside shell is so tender. At the same place I found a completely round ball of flint, and on cracking it in two halves I found enclosed a round ball of pure white chalk, which Dr. Taylor told me, when washed, would be found to be full of "Sponge Spicules." Flint is closely connected with sponge organisms of course, and there are different theories as to what flint itself really is.

MINNIE MCKEAN.

#### MY ANTS.

EARLY in the summer, I secured a nest each of red and black ants, digging each up with plenty of the soil and weeds with it, and placing them in separate large tin dishes, standing in larger tins of water, to prevent the ants escaping.

An ant's first thought is to protect its young, and on disturbing a nest, they promptly each seize a larva in their mouths and drag it away, and in a surprisingly short time every larva is removed from sight. I once saw an ant which had, by accident, just had its body completely torn off, seize a full-grown larva, as big as itself, and carry it about apparently as easily and as free from pain as if uninjured, although it

only had a head and the thorax from which its legs spring, all its body being gone.

My ants at once set to work to set their houses in order; first of all, carrying any stray larvæ safely inside the nests, and then making various tunnels and entrances, bringing large quantities of soil from the inside.

They soon find out any food I place on the nests, preferring meat to anything else; and, when possible, they generally make a special entrance immediately beneath the food, so as to convey it unseen into the nest, or, if not, they soon form two busy lines from the entrance to and from it. They are busier at night than in the day, and any great noise soon sends all inside for safety.

In their natural state red ants often conquer the black, and make them their slaves, to wait on and feed them and the red larvæ, which they do so thoroughly that their masters sometimes forget how to look after themselves, and would die if their black servants were taken away.

After a week or two I connected the two nests with a slanting piece of cardboard four inches long, and the next day the red ants were busy running up and down the bridge carrying little pieces of soil, and at first I could not see what for, until by degrees a tunnel was formed on the cardboard, under which they travelled nearly all its length unseen.

A few days after, I found a good many dead red and black ants, and the black ones were crowding to one part of their nest with their larvæ.

Whenever the different colours meet there is a fight, though both seem equally anxious to avoid it if possible; but when no escape, the red seizes the black by one of its legs with its mouth and simply holds fast, being dragged about by the black one, which is the stronger, and which alternately struggles furiously to free itself, sets to and has a good fight with the red one, or strokes it gently with its antennæ, as if treating the whole thing as a joke, and begging it to let go, which, so far as I saw, the red ant never does until its enemy is killed, or both die locked tightly together, the struggle sometimes going on for hours.

A few days later, I found the black ants evidently in great distress, and all their larvæ packed in one corner of the tin, and for the next day or two, they constantly moved their larvæ to different parts of their tin, while the red ones were crowding over the bridge, and evidently driving the black ones from their nest, though never apparently following them outside it.

I now placed a third tin of soil, and connected it, with a similar bridge, to the black ants' nest; and in a few hours the black ants had removed all their larvæ to and had taken possession of it; and so far they have not been molested by the red ones, who have taken entire possession of their old nest.

L'ŒIGLE.

## GOSSIP ON CURRENT TOPICS.

By W. MATTIEU WILLIAMS, F.R.A.S., F.C.S.

**SANITARY ACTION OF RAIN.**—We commonly abuse our climate on account of its humidity. This is a great mistake. Frequent and moderate rain, such as constitutes the characteristic of British climate, is the most effective of all sanitary agencies. It cleanses the ground, and, what is far more important, it cleanses the air. The ammoniacal and other exhalations, continually rising from decomposing animal and vegetable matter, are all more or less soluble in water and are largely removed by gentle rain. Besides these it absorbs and carries down into rivers and thence to the sea the excess of carbonic acid exhaled from our lungs, and produced by our fires and lights.

De Saussure found that a shower of rain removed about 25 per cent. of the carbonic acid from the air over the Lake of Geneva. Also that there was less over the lake than over the neighbouring meadows and the great elevations of the Alps where there was no water. The atmosphere over the sea contains less than one-fourth of the quantity in that over the land. Far away at sea the quantity is inappreciable, and at a given place on the coast it varies with the wind, increasing as it blows from the land and *vice versa*. All these facts show that water in contact with the air absorbs its carbonic acid in a decidedly practical degree. In densely-populated districts this is of considerable importance. The difference is perceptible to the senses after a long drought, as the common expression "refreshing showers" indicates.

**ANTIFAT.**—Turning over some back numbers of the "Gazetta Chimica Italiana," published in Palermo, I come upon the following, headed "The Cure of Obesity," by Dr. Gibb. According to this author bromide of ammonium in small doses determines in fat people an absorption of fat and a diminution of weight with greater certainty than any other known remedy." A succession of advertisers profess to cure this trouble, and it is to be hoped that their nostrums do no more harm than small doses (I mean very small) of bromide of ammonium. Even this must be a disturbing agent if really effective. The only successful cures of obesity that I have witnessed have been achieved by veterinary surgeons, who have cured over-fed lazy lapdogs by simple starvation and daily stimulation to exercise by the administration of whipthong. I do not advocate the application of this system to human patients for personal reasons.

**PHOTOGRAPHS OF THE RETINA.**—Among the absurdities perpetrated by novelists and other yarn spinners when they "do the scientific," is that of affirming that the last object on which is fixed



the earnest gaze of dying man leaves its impression on the retina in such wise, that an expert may find the portrait of a murderer thus photographed on the eye of his victim. Although this is too ridiculous for sober discussion, something actually has been done which at first sight may seem to resemble it.

The "British Journal of Photography" tells us that Dr. Rosebrugh read a paper at the Canadian Institute, in which he described the following feat. A glass transparency was illuminated by the sun, and reflected into the eye by a piece of plate glass placed at an angle of 45° to the rays passing through the transparency. The image thrown on the retina was viewed through the glass from a point situated in the axis of the eye, and a small camera and lens there placed gave an image of the picture on the retina, and it is stated that photographs taken with about five seconds exposure by this means were exhibited to the meeting. "Nature" further states two series of photographs were taken; that the first simply presented views of the optic nerve and retinal blood-vessels; the second series showed not only the retina of the eye, but also an inverted picture of objects to which the eye was directed, pictured upon the retina.

The resemblance of this to the pretended exploits of the story-tellers is very remote, as it does not include the absurdity of the latter, which consists in assuming that the retinal picture is a something which remains fixed. Dr. Rosebrugh simply takes a copy of a picture actually existing and while it exists, an existence which terminates immediately the light rays and the picture from which they proceed are withdrawn.

THE SENSE OF SMELL IN LEECHES.—Mr. A. G. Bourne, writing from Ootacamund, Nilgiris, to "Nature," describes a curious experiment that may be repeated by some of the readers of SCIENCE-GOSSIP. He picked up a stone from the muddy bed of a shallow torpid stream and a few minutes afterwards observed a number of leeches swimming near the spot. On the next day he stirred the surface of the mud with a stick; no leeches appeared. Afterwards he washed his hands in the water without disturbing the mud, and presently a number of leeches rose from the mud in which they live about a foot deep, and swarmed about. The question asked by Mr. Bourne is, whether the leeches were guided by smell or taste of the hands. As evidence of the powers of scent of land leeches, he refers to their coming from the banks on either side of a wide road to a man or horse. The painful experience of all who have travelled far in Ceylon confirms Mr. Bourne's conclusions so far as land leeches are concerned, and it will not be difficult to make further experiments upon our pond leeches in England, as they may be so easily domesticated in a small aquarium.

AN UNIMPROVABLE INSTRUMENT.—In "Ciel et Terre" of July 1st is a history of the Barometer, from which I translate the following: "This instrument found itself at once produced at the very first step in its most perfect form. Much time, much thought and work have been expended upon the endeavour to improve, and even to supersede, the old tube of Torricelli, but in spite of all the fertility of invention thus employed, it remains the simplest and the best of all the barometers we now possess."

It was a fellow-countryman of Torricelli's that exclaimed with profound truth, "*Questo semplice quanto è difficile.*" Oh, how difficult is simplicity; and he might have added, "*e quanto è eccellente.*" The excellence of Torricelli's tube depends on its simplicity; and the same applies to almost every other contrivance, and without any exception to every exposition of natural truth.

In all our meteorological observatories the simple straight tube, filled with mercury and inverted over a small cup or cistern of mercury, is used. The vernier is applied to reading the scale. Methods of filling the tube for the more perfect exclusion of air, and for adjusting the level of the mercury in the cistern have been applied, but still the simple tube remains as at first.

The syphon barometer, with pulley and wheel and index on face, the diagonal barometer, the water barometer, glycerine barometer, are interesting, and supply longer scales, but lack the reliability of the simple tube charged with mercury. Even the aneroid, though so elegant and portable, can only be relied upon when periodically corrected by comparison with Torricelli's tube.

HOMŒOPATHIC TREATMENT OF LUNATICS.—"The Scientific American" relates an interesting cure of insanity on the principle of *similia similibus curantur*. Two monomaniacs, each with troublesome but very different delusions, were set to watch each other, each being made acquainted with the other's mania, and instructed to prevent consequent folly and mischief. Each accepted the charge and its responsibilities, each pitied the other poor fellow, watched him closely, and while doing so each forgot his own delusion and both were finally cured.

I remember a somewhat similar case in an asylum to the inmates of which I occasionally lectured. His delusion was that he had inherited a very large freehold estate, including the whole of Europe. He was confined in consequence of his attempts to enforce his rights by eviction of occupiers, but was much mollified after a while by being indulged in a lesser or secondary delusion of supposing himself to be the proprietor and director of the asylum.

The subject of my lecture on one occasion was "An Ascent of Mont Blanc." After the lecture he came to me and thanked me most courteously for my kindness in amusing and instructing his unfortunate



patients, just incidentally stating that the mountain was situated on his estate, and that he would afford these poor people an opportunity of verifying my description by allowing them to make the ascent for themselves. An attendant then came to take him back to his quarters; he obeyed, but graciously smiling, pointed to this man and another and said to me, "These are some of my servants, I go with them to see that you are supplied with refreshments." He then gave orders for wines, &c. How many vain and conceited lunatics there are outside the asylum and unrestrained, who in like manner deceive themselves in their swaggering efforts to impose on others.

MUNCHAUSEN SCIENCE.—I find the following in "Cassell's Saturday Journal," April 9, 1887, p. 436, under the general heading of "Popular Science." The readers of Hardwicke's SCIENCE-GOSSIP have sufficient knowledge of Natural History to form their own estimate of its veracity:—

"A LIVING FISH LINE.—Down amongst the seaweed stems and pointed rocks you may find a long, black, tangled string, like a giant's leather boot-lace set to soak. Let us trace it in its various folds and twists, and disentangle some of it. We shall then have in hand a tough, slippery, indiarubber-like substance, which might well be pronounced a sea-string, and classed with the long, trailing weeds amongst which we have found it.

"A sea-string it is, but not a weed; it is a living lasso, capable of consuming the prey it encircles within its treacherous folds. From twenty to thirty feet is no uncommon length for this artful, animated fishing-line to reach; but its diameter rarely exceeds an eighth of an inch. It has a mouth, however, capable of considerable distension and holding power. What can appear more innocent than this delicate-looking creeper, trailing here and there as the heaving water swells and flows as the tide comes in? Let an unwary tube-dweller, lulled into a false security, stretch forth its tentacles to meet the welcome wave, and a pointed head encounters them. The mouth effects its tenacious grasp on the yielding tissues, and the tenant of the tube becomes food for the *Nermetes Borlasei*, for such is the name of this cord-like freebooter.

"Pick up this strange creature, and it hangs helpless and motionless, a mere velvet string, across the hand. But put it before the fry of the rock-fishes, or into a vase at home, and we shall see that it lies motionless, trailing itself among the gravel. You cannot tell where it begins or ends. It may seem like a strip of dead seaweed, or even appear to be a tarred string.

"So thinks the little fish that plays over and over it, till it touches at last what is too surely a head. In an instant a bell-shaped sucker-mouth has fastened to its side; in another instant, from one lip, a concave, double proboscis, just like a tapir's (another instance

of the repetition of forms), has clasped it like a finger. And now it begins to struggle, but in vain. It is being 'played' with such a fishing-rod as the skill of a Wilson or a Stoddart never could invent; a living line, with elasticity beyond that of the most delicate fly-rod, which follows every lunge, shortening and lengthening, slipping and twisting round every piece of gravel and stem of seaweed with a tiring drag, such as no Highland wrist or step could ever bring to bear on salmon or trout. The victim is tired now, and slowly, yet dexterously, his blind assailant is feeling and shifting along his side till he reaches one end of him, and then the black lips expand, and slowly and surely the curved finger begins packing him end foremost down into the gullet, where he sinks inch by inch, till the swelling which marks his place is lost among the coils, and he is probably macerated into a pulp long before he has reached the opposite extremity. Once safely down, the black murderer contracts again into a knotted heap, and lies like a boa with a stag inside him, motionless and blest."

In another number of the same journal is an equally sensational account of "the latest method" of disposing of the dead, by electro-plating the corpse. For reasons that I have stated in the last number of "The Gentleman's Magazine," the idea is demonstrably impracticable; to an electro-metallurgist it is an obvious absurdity. It is nevertheless described not as a mere project, but as an actual achievement that is "growing into popular favour." A departed friend or relation is transformed into "a beautiful statue, form, features, and even expression being perfectly preserved," and "no change is brought about in appearance except that face and figure are covered with a shining veil, through which the familiar lineaments appear with all their well-remembered characteristics and expression." It is not my wont to be presumptuous, but in this case I do venture to suggest that for such revelations the general title of Popular Science should be exchanged for that which I have given above.

THE COLOURS OF ANIMALS AND PLANTS.—In the "Proceedings of the Physiological Society" for the current year is a paper by Mr. C. A. MacMunn on Invertebrate Chromatology. Broadly speaking, the sustaining fluid, the blood, of animals is red, while that of vegetables, the chlorophyll, is green. (I note by the way that these colours are complementary, and that the functions of animals and vegetables are similarly related.) When, however, we descend in the animal scale, and thereby approach the vegetable, these contrasts fade, and in some cases the characteristics become exchanged.

Readers of this magazine whose acquaintance with natural history is more extended than mine, will be able to quote exceptional examples of green-blooded animals and red-blooded vegetables. *Delesseria*

*sanguinea* is a splendid example of the latter, many other algæ are almost as striking. Our common sea anemones and antheas present examples not only of flower-shaped animals, but of animals with green juices. Among the commonest of all, the *Actinia mesembryanthemum*, I have found every tint from blood-red and dirty brown to delicate grass-green, these colours residing more or less in the juices of the animal. The *Anthea viridis* is of brilliant emerald green with crimson-tipped tentacles. These are specially abundant in the rock pools of Jersey.

Mr. MacMunn found actual chlorophyll in nine specimens of sea sponge; Ray Lankester has found the same in freshwater sponges. That which is found in the *Anthea cereus* he attributes to symbiotic algæ, *i.e.* to vegetables living within the animal, not as parasites, but as partners. Mr. Geddes some time ago proposed to apply the generic name of *Philozoon* to these unicellular plants. It appears that they mutually co-operate, the expired oxygen of the plant supplying the animal with material for respiration, and the expired carbonic acid of the animal similarly serving the vegetable. The green cells have been transplanted from one animal into the body of another, and have survived in symbiosis, as this curious economical co-operation is named.

## NOTES ON THE ROTIFERA.

### (A PROLIFIC POND.)

EARLY last summer I was fortunate in discovering a most remarkable pond—remarkable not merely for the number, but also for the character of the species of the Rotifera it has furnished me. I had known the pond for years, and passed it scores of times without giving it more than a casual glance, and from the entire absence of visible vegetable life, I assumed the absence of animal. Not even the ubiquitous *Anacharis* was present, and I failed in every attempt to find the humble *Conferva*, whose spores might furnish food, and whose matted thread-like fronds might give necessary shelter to microscopic forms of animal life. It is an artificial pond, situated on a level plot of ground, a portion of which has for some years been cultivated as a flower garden, and there is an entire absence of trees or any shade whatever. To some of the above circumstances, and to the fact that, in order to get to it, it would be necessary to trespass, and more to the fact that in a long ditch or "goit" (which for a part of its course is separated from the pond by about a yard of earth, and two retaining walls below the level of the ground), I had already a "happy hunting-ground," I attribute my carelessness in not "fishing" the pond. Early last summer, however, on arriving at my ditch, I was dismayed to find that the water had been let off, the plants had shrivelled up to mere ghosts of

their former selves, and the exposed mud baked hard and dry in the summer sun; in despair I half turned round on my heels, and as a forlorn hope plunged my muslin net with quinine bottle attachment into the crystal depths of the despised pond. Among numerous minute worms, and jumping Entomostraca, I could with pocket-lens detect many specimens of Rotatorial life. Since then I have paid almost weekly visits to the place, with the result tabulated below. They are not arranged according to any system of classification, but simply put down, with one or two exceptions, in the order in which they occurred.

*Brachionus rubens*; *B. Bakeri*; *B. urceolaris*; *B. angularis*; *B. pala*, and var. *amphicerus*; *Pterodina patina*; *Euchlanis triquetra*; *E. dilatata*; *E. oropha*; *Proales petromyzon*; *Æcistes crystallinus*; *Monura dulcis*; *Furcularia gracilis*; *F. forficula*; *F. micropus*; *Triarthra mystacina*; *Polyarthra platyptera*; *Rotifer macrurus*; *R. vulgaris*; *Philodina erythrophthalma*; *Rhinops vitrea*; *Colurus obtusus*; *Monostyla lunaris*; *Syncheta tremula*; *Floscularia cornuta*; *Asplanchna Brightwellii*; *Diglena forcipata*; *Scaridium longicaudata*; *Syncheta pectinata*; *Notholca scapha*; *Diaschiza Hoodii*; *D. tenuior*; *D. exigua*; *Colurus caudatus*; *Callidina elegans*; *Rotifer tardus*; *Limnias ceratophylli*; *Copeus cerberus*. In all 38 species, which are being added to almost weekly. With regard to the number of species, it has, I believe, been exceeded by only two recorded instances, that of Miss Davies' pond, Woolstone, which yielded 44; and another one of hers having 41; several others, however, run it very close, *viz.* Dr. Collins's old pond, which yielded 36, and another of Miss Davies' which yielded 35. It will be seen that many in my list belong to the aristocracy of Rotatorial life, and not a few of them to the very uppermost crust. Several other forms have come under my notice, but as I have not been able to study them sufficiently for identification I omit them from the list. It will be noticed that three of the above species belong to the order Rhizota, and I ought perhaps to explain, that in dredging, I do occasionally get a little *Conferva*, which grows in small patches on the stones forming the boundary wall, rather deep in the water, and it is to this *Conferva* that the "root-footed" Rotifers are attached. It is perhaps unfortunate, that I have not kept as accurate an account of other forms of life as I have of the Rotifera, because the pond is only less remarkable for its Algæ, its Infusoria and its Entomostraca. Of Diatoms there are species of *Surirella*, *Encyonema*, *Synedra*, *Melosira*, &c. Other Algæ, *Pandorina*, *Cosmarium*, *Closterium* (3 species), and *Pediastrum*; and *Vaucheria*, *Spirogyra*, *Rivularia* and *Draparnaldia* among the *Confervæ*.

Infusoria, &c.—*Amœba*, *Actinophrys* and *Diffugia* (several species), also Savill Kent's *Choano-flagellata*; *Loxophyllum*, *Trachelius ovum*, *Spirostomum*, *Dileptus*, *Stentor*, *Ophrydium*, *Vorticella*, *Vaginicola*

and *Platycola*, both *decumbens* and *longicollis*. Entomostraca—Cyclops, Daphnia, Diaptomus, Cypris and *Bosmina longirostris*. *Hydra vulgaris* and several worms are also common. I give the above from memory; had I taken a full account, the list would have been considerably enlarged, but a sufficient number has been named to show the remarkable character of the pond and to justify the secondary title I have given to these notes.

J. E. LORD.

*Rawtenstall.*

NOTE.—Since the above was written I have brought up the number of species of the Rotifera to 45, by the capture of the following, and so “breaking the record:” *Notommata aurita*; *Dinocharis tetractis*; *Monostyla bulla*; *Furcularia melandricus*; *F. ensifera*; *Diglena grandis*; *Euchlanis unisetata*.—J. E. L.

RECENT ARTICLES AND PAPERS WORTH READING.

“SOME British Freshwater Worms,” by E. C. Bonsfield (“Wesley Naturalist,” June).—“The Mesozoic and Cænozoic Realms of the Interior of North America,” by Professor Cope (“American Naturalist,” May).—“Photographing by Gas-Light,” by John Bartlett (“Amateur Photographer,” June 3).—“Micro-Organisms and Disease” (“Eng. Mechanic,” June 3).—“American Jurassic Mammals,” by Prof. Marsh, part ii. (“Geol. Mag.,” July).—“A Prodrôme of a Memoir on Animal Locomotion,” by Dr. Harrison Allen (“Proceed. Philadelphia Acad. of Nat. Sciences”).—“Is *Monotropa uniflora* a Parasite?” by Dr. G. Baptie (“Ottawa Naturalist”).—“A New Series of Berlin Wools for the Scientific Detection of Sub-normal Colour-Blindness,” by Dr. C. A. Oliver (“Medical News,” Sept. 11th, 1886).—“Raising Diatoms in the Laboratory,” by Prof. S. Lockwood (“Journal New York Microscop. Soc.”).—“The Smut of Corn,” by the Rev. H. Friend (“Wesley Naturalist,” July).—“The Zoological Society of London” (“Nature,” June 23rd).—“Science for Artists” (“Nature,” June 30th).—“Architecture in the Reign of Queen Victoria” (“Builder,” June 25th).—“Préparation et Conservation des Crustacées, Décapodes Brachyures, et Macrourés” (“Feuille des Jeunes Naturalistes,” July).—“History of the County Botany of Worcester,” by Wm. Matthews (“Midland Naturalist,” June).—“The Occurrence and Function of certain Nitrogenous Bodies in Plants,” by W. E. Stone (“Botanical Gazette,” June).—“Geology of the Skipton and Ilkley Railway,” by S. A. Adamson (“The Naturalist,” July).—“The ‘Salting Mounds’ of Essex,” by H. Stopes (“Essex Naturalist,” July).—“Grasses of the South,” by Dr. G. Vasey (“Bulletin No. 3 Dept. Agriculture” U.S.A.).—

“Review of the Progress of North American Palæontology in 1886,” by J. B. Marcon (“American Naturalist,” June).—“Photography, Past and Present,” by Ed. Dunmore (“Amateur Photographer,” July 1st).—“Some Essex Boulders,” by Rev. A. W. Rowe (“Essex Naturalist,” June).—“The Significance of the Yolk in the Eggs of Osseous Fishes,” by E. P. Prince (“Annals and Mag. Nat. History,” July).—“Dimorphism in Fungi,” by Geo. Norman (“Journal of Microscopy, &c.” July).—“On the Water in the Chalk beneath the London Clay in the London Basin,” by Robt. B. Hayward (Ditto).

SCIENCE-GOSSIP.

MR. ALBERT E. COE, of Norwich, writes:—“I have just read the notice on p. 162 of SCIENCE-GOSSIP, of Mayall’s photographs taken in a camera and in colours instantaneously. This is incorrect. The negative is made in the camera as usual without colour; a copy on gelatine is then made which admits of colour being applied by hand to the back and front, in the same way as chrysoleum and like methods. The daily papers were misled in giving their statement, with the result of a general round of “Photographs in natural colours” appearing in periodical papers, instead of which it is a very old process, and one which I experimented with for Sawyer and Bird, many years ago.”

THE activity and zeal of our Canadian brethren is shown by the fact, that the Ottawa Field Naturalists’ Club have brought out their “Transactions” as a monthly periodical, under the title of “The Ottawa Naturalist.”

MR. J. E. BAGNALL reports finding *Dicranum undulatum*, Ehrwart, for the first time as a British plant, near Great Wolford, Warwickshire, on the 31st of May.

THE “Long Excursion” of the Geologists’ Association commences on August 8th, and extends to the 13th. The area selected is Cornwall, commencing at Truro, proceeding to the Pliocene beds at St. Erth, and thence to Marazion, St. Michael’s Mount, Penzance, and St. Just.

THE dinner to Professor Tyndall, on June 29th, was a great success. In the multitude of Jubilee honours it seems singular that his name is left out. Only a few other scientific men’s names have been more prominently before the public for the last half-century. It serves him right—he ought to have been a brewer!

THE meeting of the French Association for the Advancement of Science will be held at Toulouse, commencing on September 22nd.



A BORING for coal at Holt-Sutherland, near Sydney, N.S.W., has been carried to the depth of 175 feet beneath the sea level. Coal was found at a depth of 1573 feet.

The remains of a fossil arctic flora have been discovered in the great stretch of land between Scania and Norrland, in some beds of tufa. Among the plants were *Dryas octopetala* and *Betula nana*, now extinct in the neighbourhood.

COMPLAINT has very properly been made that no representative of science was invited to be present at the laying of the foundation-stone of the Imperial Institute, and yet, if there is one thing which has distinguished the Queen's reign more than another it has been the rapid growth of science.

PROFESSOR STOKES, the President of the Royal Society, delivered the annual address at the Victoria Institute the last week in July.

THE Darwin Medal offered by the Midland Union of Natural History, &c. Societies, has this year been set apart for archæology, and assigned to Mr. E. W. Badger for a paper on the Monumental Brasscs of Warwickshire.

SIR J. W. DAWSON has recently suggested a scheme of federation among English-speaking geologists, whereby uniformity can be secured on all questions of nomenclature and classification.

MR. FRANCIS GALTON is about to deliver some lectures on "Heredity."

## MICROSCOPY.

THE "WHIRLIGIG" BEETLE.—(*Cyrinus natator*).—Many naturalists are not aware that this common beetle, to be seen swimming on the surface of every pond, has four compound eyes, two of which are above the water-line and two below. Mr. Fred. Enock has just sent us a charmingly mounted specimen (with accompanying sketch and details of structure) which shows these interesting organs in the clearest manner. It is the most interesting slide Mr. Enock has hitherto sent out.

OVA OF THE HERMIT CRAB.—Mr. E. Hinton has sent us a most interesting slide of the ova of the hermit crab, showing the filaments which unite the eggs together like a bunch of grapes, and all of them to the abdominal segments of the female crab.

THE CRYSTALLOGRAPHY OF BUTTER AND OTHER FATS.—At a recent meeting of the San Francisco Microscopical Society, an important paper on this subject was read by Dr. Thos. Taylor. A great deal of work is now being done by Dr. Taylor in regard to this important subject, and his investigations thus far show that the fats of different animals differ in

their crystallisation. For example, if small quantities of butter, lard, and beef-fat be separately boiled and slowly cooled, for, say twenty-four hours, the resulting crystals will show very marked differences under the microscope. The normal butter-crystal is large and globular. It polarises brilliantly, and shows a well-marked St. Andrew's Cross. That of lard shows a stellar form, while that of beef-fat has a foliated appearance. In course of time, as the butter loses its freshness, the globular crystals degenerate, and gradually merge into peculiarly rosette-like forms. These different stages of crystallisation could be plainly seen in the photographs exhibited. Specimens of butter crystals had been prepared, and were shown as resplendent objects under polarised light. Favourable comments were made on the excellent work done by this branch of the United States Government in breaking up the traffic in unwholesome and fraudulent butter compounds. This ought to be a hint to our British Government. What are our authorities doing in the matter? The comparison between the great practical interest taken by the United States Government in all scientific matters affecting the agricultural interests of that country, and the profound and careless apathy and indifference manifested by similar authorities in Great Britain, is one reason why agriculture pays in America and does not in England.

## ZOOLOGY.

SCORPIONS IN MEXICO (see Dipton Burn in the June number of SCIENCE-GOSSIP).—I have given some attention to the Fauna of Mexico, ranging from the deadly swamps of Vera Cruz to the cold region of Real del Monte, the latter at an elevation of 10,000 feet; and I have been inside a great many of the houses in Mexico. But whether inside or outside Mexican human habitations, it has never been my lot to see a scorpion, or even to meet with any person in Mexico who ever had seen one. Dipton Burn either gives the readers of SCIENCE-GOSSIP the result of his own experience, or he has obtained his facts secondhand; if the latter, I invite him to give his authority; for, in common with what I believe is held by all genuine workers in the vast field of scientific research, I look upon the circulation of unauthenticated startling facts in natural history as contrary to sound progress in knowledge.—*Edward Charlesworth, Saffron Walden.*

MIDDLESEX SLUGS.—A few days ago, Mr. A. Belt sent me specimens of slugs from Castle-Bar, Ealing, including *Amalia gagates* v. *plumbea*, for which Ealing is a new locality, and a new variety of *Amalia marginata*, found living with the type. This variety, of which two specimens were sent, may be called *bicolor*;

it has black sides and an orange keel and foot, the contrast between the two colours being very marked. The variety called *nigrescens* is an allied, but not identical form, being dark grey with an inconspicuous keel. On May 30, Mr. Fenn and I found *Arion bourguignati* in two new Middlesex localities, Hayes and Hanwell.—*T. D. A. Cockrell, Bedford Park.*

THE PARIETAL EYE IN FISHES.—In "Nature" for July 14th, Mr. J. Beard announces the discovery of the parietal eye in certain fishes, such as the Lamprey (*Petromyzon planeri*) and *P. marinus*, the Hag-fish (*Myxine*), *Bdellostoma*, and *Ammocetes*.

## ANIMAL PSYCHOLOGY.

A CURIOUS INSTANCE OF THE PARENTAL INSTINCT IN YOUNG BIRDS.—On the second day of June a remarkable instance of the above came under my notice. In a cottager's cage in the country, I saw six young thrushes, the product of two nests, one yielding two, the other, four birds. The two were the elder, and appeared to be about seven weeks old, the younger about four weeks; not more, I think, as they were unable to pick sufficiently for themselves. I was informed by their owner that when the younger birds were brought home, they were under the necessity of putting them into the same cage with the others, though fearing they would be regarded by the older birds as trespassers on their domain, and consequently would be treated roughly by them. However, it proved that their fears were utterly groundless, for, as soon as the surprise occasioned by the new arrival had passed away, to the great pleasure of those concerned, the older birds evinced the tenderest solicitude for the welfare of their new friends, and commenced billing and cooing them, which very soon elicited a mutual docility and attachment from the younger birds. Scarcely had these friendly greetings ended, when the older birds commenced feeding the younger, and regarding them with the responsibility of parental affection. Now, although I have possessed not a few birds, young, old, home, and foreign, in my time, I had never witnessed such a scene. I naturally enough expressed my surprise at the circumstance related, upon which I was invited to watch the birds for a few minutes, when, to my great satisfaction, I saw the foster-parents feeding their young charges with all the adroitness which their own parents would have exercised. If either of the younger were backward in opening its beak to receive the prepared morsel, it immediately received a prompting by a chuck under its beak from that of its foster-parent. Nor was that all, for I observed that if the quantity taken up were too great, it was not cruelly thrust into the receptacle of the younger, as I have seen some thoughtless

urchins do, to the evident inconvenience and discomfort of their pets, but it was carefully divided into suitable sized pellets in the mouth, and then dealt out to the nursling as it was prepared to receive it. What greater care, affection, and intelligent solicitude could have been evinced by the parents of these nestlings, than was displayed by these baby-parents I cannot imagine. My main object in writing on this matter is to elicit whether this be a common event. Doubtless some of your numerous readers can inform me.—*Alfred T. Dowell.*

## BOTANY.

THE FLOWERING OF CROCUSES.—The flowering of crocuses in spring might lead one to ask why they are not used in bunches like the snowdrops, violets, and primroses, which are commonly to be had in houses and streets, far from the places where they grew. The obvious reason is that the flower of a crocus has no stalk by which to hold it. During summer the plant exists as a corm, which may live underground from year to year, or may be taken up as in the practice of your correspondent J. W. D., when the leaves and flower are gone, and the seed is ripe, to be planted again in the autumn, where it is to flower in the ensuing spring. The plant is not one that rambles about like the creeping buttercup; but grows from a corm like that of the common buttercup which is called sometimes bulbous, bulbs having been formerly so defined as to include corms. The crocus differs again from that buttercup which it most resembles, in that it forms no aerial stem. Leaves and flowers before appearing above ground are enclosed in a membranous sheath which is in some degree transparent, so that if grown in a pot or glass of water like a hyacinth, the colour of the blossom is visible before it rises above the top of the sheath. When fully developed, the perianth consists of six coherent sepals, if we may use a word which we do not often meet with, but which would give precision in the description of petaloid endogones at least. These coherent sepals form a cup or vase, the inner surface of which bears the stamens, in the midst of which appears the trifid stigma borne upon a style, the base of which does not appear to those who only see the flower, as it is seen by passers by or even by the bees (I cannot well add butterflies, for crocuses flower before butterflies come out). The style is very long, and reaches from below the stigma through the tube at the bottom of the blossom to the ovary which forms its base. The ovary does not rise above the ground, at least till after it is fertilised. Then sometimes it happens that a stalk is formed under the ovary which lifts it above the surface where it opens to shed the seeds upon the ground. This growth of a stalk after the floral organs borne upon it have decayed, affords

a striking illustration of that which forms the characteristic difference between a stem and a root, that whereas a root only grows at its lower end, a stem is capable of growing throughout its length, so as to separate the organs growing on it by long internodes. A peduncle or flower stalk being of the nature of a stem, that of the crocus grows after the flowering. Sometimes, however, as in the case your correspondent mentions, exposure to cold winds may hinder the development of a peduncle and the seeds ripen underground on what had been the base of a flower that bloomed in the ordinary way.—*John Gibbs.*

“AN ELIGIBLE BUILDING SITE.”—The above is within a mile or so of the Alexandra Palace, and lies on the side of an incline. About four years ago, when the foundations of some houses near were dug, the earth was carried on to this piece of ground. Three years ago *Phalaris Canariensis* flourished all over the plot; there also appeared *Saponaria vaccaria*, *Melilotus alba*, and *Linum angustifolium*. Since then *Phalaris* has only appeared sparingly, but *Melilotus arvensis* and *Lepidium ruderalis* flourish, while a few specimens of *Erysimum orientale*, *Carum Carui* and *Camelina sativa* have been found. *Thlaspi arvense* also occurred this year in a circular patch. Another curious circumstance was that *Trifolium repens* was abundant there one year, with a foliaceous calyx, and *Lolium perenne* was often found with a number of spikelets clustered at the top of the spike. How did the seeds of the above get on to that particular piece of land? as they do not seem to grow anywhere near, and *Saponaria vaccaria* is not even in Bentham's Flora.—*J. E. C.*

“ANNALS OF BOTANY.”—The Clarendon Press is about to publish the “Annals of Botany,” which will be edited by Professor Bayley Balfour, of the University of Oxford; by Dr. Vines, of Cambridge; and by Professor W. G. Farlow, of Harvard University, Massachusetts, U.S.A. The papers will be adequately illustrated, and on subjects pertaining to all branches of botanical science, including morphology, histology, physiology, palæobotany, pathology, geographical distribution, economic botany, and systematic botany and classification. There will also be articles on the history of botany, reviews and criticisms of botanical works, reports of progress in the different departments of the sciences, short notes, and letters. A record of botanical works in the English language will be a special feature. With regard to the last point, the editors direct attention to the fact, that many important contributions to botanical sciences are not at present brought before the botanical world with that promptitude which their merit deserves, and many are frequently entirely overlooked, owing to the fact that the periodical in which they appear is not readily accessible to botanists generally. An attempt will be made in

the “Annals of Botany” to remedy this state of affairs; and it is hoped that it may be possible to make the record fairly complete, embracing works published not only in Great Britain and Ireland, but also in India and the Colonies and in America. To enable them to carry out this intention, the editors appeal to the secretaries of local scientific institutions, societies, and clubs, in all parts of the world, to send them early information of all the publication of papers relating to any branch of botany.

## GEOLOGY, &c.

THE WEALDEN AREA DURING THE GLACIAL PERIOD.—MR. J. V. ELSDEN, in a paper on this subject, has given in detail his observations on the angular flint-deposits of the Arun, Adur, Ouse, and Cuckmere basins. He also noticed a sandy or loamy deposit containing angular fragments of ironstone, and generally a few small angular flints that occurred on the surface of the Lower Greensand, and, to a small extent, on the Weald Clay. A block of granite, weighing between five and six pounds, was found on the chalk escarpment at Kihurst Hill. The angular flint-drift occurred mainly on the higher parts of the area, and was wanting in the river-valleys, where, however, river-gravels derived from the denudation of the older deposits were abundantly developed. Not only in the Wealden area, but throughout many of the neighbouring districts, the angular drift consisted of the undenuded remnants of a deposit formed before the present river-valleys were cut, and many of the river-gravels, though newer than the angular drift, were deposited when the valleys had been less excavated than they now are. This was Mr. Topley's view with respect to the northern portion of the Wealden area. Mr. Searles V. Wood's marine theory of the origin of these gravels was discussed, and shown to be refuted by their mode of occurrence. It was, moreover, contended that the drift, although composed of local materials, was probably of subaqueous origin, and not merely subaerial. The discovery of a granite boulder might, if confirmed by other discoveries, lead to a modification of the views generally held as to the physical character of the area during the glacial period.

BOULDERS IN SEAMS OF COAL.—At the last meeting of the Geological Society, a paper on this subject was read by Mr. John Spencer. The discovery of a boulder weighing six pounds, and composed of granite, in the Gannister or Mountain-Mine seam of the Rossendale district, at Old Meadows Pit, near Bacup, Lancashire, had led the author to call attention to the occasional occurrence of similar boulders in various parts of Lancashire and Yorkshire.



Such boulders are always isolated, and sometimes imbedded in the seam, sometimes in its upper surface. They were always waterworn and rounded, and were composed, as far as had been observed, of granite, gneiss or quartzite foreign to the district. After considering the various suggestions that had been made as to the means by which such boulders had found their way into the coal, the author gave the preference to the action of floating ice, both because the presence of fragments from a distance would thus be more readily explained, and because ice-scratched rocks have been found *in situ* in the Millstone Grit, within three miles of the place whence the boulder mentioned was obtained.

HOW COAL WAS FORMED.—At the same meeting of the above Society, Mr. W. G. Gresby read a paper, in which he brought forward evidence in opposition to the view now generally accepted, that coal-seams were formed from vegetation growing on the spot. He showed that during a very extensive experience he had only once or twice detected stems passing into a bed of coal and connected with the *Stigmariaroots* in the underclay. If, as was generally stated, the *Stigmariæ* were the roots of the trees that formed the coal, such instances ought to be common. Not only, however, were they very rare, but the abundance of the *Stigmariæ* was extremely variable, and these roots, instead of becoming more thickly matted together in the uppermost part of the underclay, as they should be if they were roots of the coal-forests, were generally distributed, as a rule, throughout the clay in a manner that showed them to have been in all probability independent organisms. *Stigmariaroots*, when found connected with a stem, were more often on the top of the coal-seam than at the bottom. Other reasons assigned for rejecting the hypothesis, that coal-seams were formed of plants that grew upon the spot, were the occasional absence of underclays, the sharp division between the coal-seams themselves, and the beds above and below them; the distinct lamination of every seam and its division into layers of different mineral character that are persistent over large areas; the presence of foreign bodies in the underclay, and especially of pebbles and boulders transported from a distance; the presence of similar foreign bodies, and occasionally of remains of aquatic mollusca, fish, &c., in the coal itself; and the circumstance, that many coal-seams are impregnated with salt, and are associated with beds containing marine fossils.

THE CUCKOO.—Perhaps it may not be generally known to readers of this journal that the note of the above is a minor third; although the key in all cases is not the same, still to a certainty the third is minor. Several of my musical friends in years gone by have observed the same.—*H. Hall.*

## NOTES AND QUERIES.

HELIANTHUS ANNUUS.—Last year this flower established itself on the ancient arch of Repton School, some twenty-five or thirty feet from the ground. The most eligible theory is that it was dropped there by birds. There is no reason why this flower should not be added to the London catalogue, like many others, as a waif of cultivation.—*E. C.*

COTONEASTER VULGARIS.—Llandudno is, I believe, the only recorded British habitat of this shrub, and which I fear is now exterminated. I should be pleased to know where I can obtain a plant of it.—*J. Clift.*

THE TREE OF KNOWLEDGE OF GOOD AND EVIL.—Last spring when I was sketching a curious old fresco in Chaldon Church, Surrey, I became much struck with the representation of a member of the vegetable kingdom, which, beneath a quaint mannerism in the school of Hogarth, seemed to present some touches of nature, and indeed I possess a popular work dating from the last century with quite as indifferent delineations illustrating it. I will describe it then as a bush, with a straight stalk springing from a telescopic pot, such as I would imagine Chaucer has designated, in his Legend of Good Women, a "turning wheel." This stalk dilated at the nodes, where it gave out opposite branches surcharged with leaves and fruit. At the fifth node it bifurcated into two thorny branches resembling antelope's horns, also emitting clusters of leaves and fruits. The leaves were spatulate and acuminate, and the fruit partially and laterally covered with a husk. When I add the locality for this bush as being the infernal regions, some might despair of its identification, but I prefer here the motto *Nil desperandum*. Now we understand from the preface to Sale's Koran that a Latin translation of that work was made near six hundred years ago, being finished in 1143, by Robertus Rentensis, an Englishman, with the assistance of Hermannus Dalmata, at the request of Peter, Abbot of Clugny, who paid them well for their pains; and in those days when the Saracenic literature had the estimation in Europe actually held by that of Germany, we cannot wonder at its influence being extended to the fine arts. The Mahomedan tree of hell is the *Al Lakkum*, a tree by no means fabulous, since a note to the above-mentioned work says: "There is a thorny tree so called, which grows in Tehâma, and bears fruit like an almond, but extremely bitter; and therefore the same name is given to this infernal tree." I should imagine that the scarlet blossomed Judas tree so ornamental in southern Europe owes its popularity to this old legend, but whence came the artist's model?—*A. H. Swinton.*

A YORKSHIRE QUERN.—In answer to Mr. Winder, I would say that querns are essentially pre-Celtic. In the collection of the Scottish Antiquaries there is one made from the section of an oak, which was found in some carse-land, near the base of Dummyat, one of the Ochil Hills.—*J. W. Williams, D.Sc.*

MEASUREMENT OF TIME.—The measure of civil time is the mean day. The sun is continually either before or after the clock, that is, the sun does not attain its meridian altitude, or south at mean noon every day, but is sometimes before mean noon, and sometimes after.

If it souths before mean noon (that is, if it is before

the clock), the day will be longer in the morning. If it souths after mean noon (that is, if it is after the clock), the day will be longer in the afternoon.

December 21st, the sun is 1 min. 45 seconds before the clock; it rises at 8 hours 6 min., souths 1 min. 45 seconds before 12; consequently the day is about 3 min. 30 seconds longer in the morning.

Rises 8 h. 6 m. or 3 h. 54 m. to 12.  
Sets . . . . 3 h. 50 m. past 12.

January 21st, the sun is 11 m. 32 sec. after the clock, therefore the day is longer in the afternoon by about 23 m. 4 sec.

Rises 7 h. 56 m. or 4 h. 4 m. to 12.  
Sets . . . . 4 h. 27 m. past 12.

June 21st, the sun is 1 m. 12 sec. after the clock, therefore the day is about 2 m. 24 sec. longer in the afternoon.

Rises 3 h. 44 m. or 8 h. 16 m. to 12.  
Sets . . . . 8 h. 13 m. past 12.

July 21st, the sun is 6 m. 7 sec. after the clock, therefore the day is 12 m. 14 sec. longer in the afternoon.

Rises 4 h. 9 m. or 7 h. 51 m. to 12.  
Sets . . . . 8 h. 3 m. past 12.

The times of sunrise, sunset, and before and after the clock, are taken from Whittaker's Almanac.—*W. H. Beverley, F.R.C.S.E., &c., Scarborough.*

POLISHING PEBBLES.—I shall be obliged if any of your correspondents can tell me the best and easiest method of polishing pebbles.—*Rose Ingleby.*

EXTINCTION OF THE PRIMROSE, &c.—On reading your note on page 148 of the present volume of your valuable paper, in which you mention the rapid decrease of "our own delightful primrose," I at once recollected having read a very interesting leader in the "Standard" on the same subject, and thinking it might be interesting to some of your botanical readers, I now venture to send a few extracts therefrom. The said leader was called forth by the complaint of a correspondent against the "wantonness" of botanists, and after pointing out that they are not botanists who go about the country digging up every rare specimen they can lay their hands on, but are "merely dealers in wild plants, the jackals of nurserymen who not only take what they want for an herbarium of their own, but multiply valuable specimens for barter and exchange with other collectors," goes on to give several instances of plants that are rapidly becoming extinct, among which it mentions the primrose, in the following words:—"But as our correspondent reminds us it is not only the plants dear to the Scientific botanist which are on the eve of being uprooted for good and all, but others which, owing to a passing whim, have become popular. For example, every spring half London is smothered in primroses, under the ridiculous and childish idea that it is thus paying honour to the memory of Lord Beaconsfield. In point of fact, the primrose was not his favourite flower. If it had been, to tear up the innocent roots by the thousand, is a sufficiently odd way of commemorating his fondness for it, and the result is, that one of the sweetest of English wildings is rapidly disappearing before the ravages of the rustics who cater to this method of doing honour to an illustrious statesman." In this I quite agree with the "Standard," and think that it is high time an effort was made to put a stop to such unwarrantable proceedings. I do not know anything about the correct way to

commence such an effort, but it is sorrow at seeing the inevitable destruction of a sweet companion of our spring leisure, that makes it seem sinful to sit still and not raise a finger in its defence. Would not some of your experienced readers exert themselves? Could not, for instance, all the Botanical Clubs get up and present a petition (with some well-known signatures to back it) to a member of Parliament who would take an interest in the thing, and get him to put forward a Bill prohibiting the reckless uprooting of our friend? We have "game laws," and societies for the "prevention of cruelty to animals," why should we not have "plant or flower laws," and societies for the "prevention of cruelties to plants"? In Switzerland it is illegal to uproot wholesale the Edelweiss, and in France there is an "Association pour la protection des plantes." How is it that England is behind her continental neighbours? But although this is an interesting and important theme, I am afraid, Mr. Editor, that your geological or entomological readers would not care to see too much of your valuable space devoted to its discussion. I trust, therefore, that you will use every effort in your power to incite others to do the same. Perhaps, before next Primrose Day, we may see our friend free from danger.—*Amator Naturæ.*

## NOTICES TO CORRESPONDENTS.

TO CORRESPONDENTS AND EXCHANGERS.—As we now publish SCIENCE-GOSSIP earlier than formerly, we cannot undertake to insert in the following number any communications which reach us later than the 8th of the previous month.

TO ANONYMOUS QUERISTS.—We must adhere to our rule of not noticing queries which do not bear the writers' names.

TO DEALERS AND OTHERS.—We are always glad to treat dealers in natural history objects on the same fair and general ground as amateurs, in so far as the "exchanges" offered are fair exchanges. But it is evident that, when their offers are simply disguised advertisements, for the purpose of evading the cost of advertising, an advantage is taken of our *gratuitous* insertion of "exchanges" which cannot be tolerated.

We request that all exchanges may be signed with name (or initials) and full address at the end.

GEORGE FORBES (Dundee).—It would give us the greatest pleasure to help you. But querists have little idea of the Editor's difficulty; or the number of letters which some queries involve, not only on his part, but on the part of heroic and poor scientists whom he has too often to communicate with. A lawyer would charge 3s. 6d. for such letters, whether he gave any information or not. We have solemnly thought of editing SCIENCE-GOSSIP gratuitously, and charging Messrs. Chatto & Windus 3s. 6d. each for the letters we have to write! But those generous yet sagacious gentlemen would prefer we went on as before. Some day we may start a "Fund" for one development of SCIENCE-GOSSIP, for the use not of the *million*, but of *many* millions, to which we should be pleased to open an advertisement column free. People with too much money generally use it to make fools of themselves, and why should Science be left out? Your package of mosses sent to be named—or, in other words, for an *opinion*—included ten. A lawyer's single opinion on anything is 6s. 8d. (perhaps his opinion on *mosses* might amount to more), so that you owe the Editor the sum of £3 8s. 8d. before he could possibly answer so many legal enquiries. Do get a cheap book on mosses (there are plenty), and save this trouble! You know and love so much more about things when you find them out yourself.

M. JOHNSTON.—From your sketch and description, we surmise that the "animals" are merely clusters of Unicellular algæ. See Hassell's "Freshwater Algæ," plates and descriptions, whether you can identify your "finds."



A. POLLARD (Pontefract).—In your very short query you do not inform us whether you wish for an elementary or an advanced book on Hymenoptera and Diptera, or whether you wish to study British insects only or include exotic kinds. You had best get first "British Insects," by E. F. Staveley (London: Lovell Reeve and Co.), price about 7s. 6d.

E. BRUNETTI.—Will you kindly send us your full name and address, that we may forward several letters which have reached us in consequence of your interesting articles on Diptera?

THOMAS LANG (East Melbourne, Victoria).—Dr. Kneeland's paper on the physical geology of the Philippine Islands appeared in the "American Journal of Science," 1886.

C. DEACON (Totnes).—The specimen was a species of *Planaria*, or flat white worm. Cambridge's "British Spiders," published by the Ray Society, is the most thorough as regards tests, habits, etc.

B. EWEN.—Please communicate with us more fully on the subject than the space allotted to a large-handed writer allows. Your query was too concise—as queries usually are!

MOSSÉS.—We are constantly receiving parcels of mosses of the simplest and commonest kinds for identification. Any cheap book on the subject, like the shilling collectors' book by Mr. Bagnall, would relieve us of the difficulty. We are not rich enough to send a copy of Mr. Bagnall's book to these slothful muscologists, or we would. It is one of the most delightful of recreations, that of moss-collecting.

CAPT. SEABROOK.—We are especially pleased with the fine specimen of Venus's flower-basket (*Euplectella aspergillum*) you have sent us from the Philippine Islands in token of your appreciation of SCIENCE-GOSSIP. The donation was as grateful this droughty weather as iced champagne!

W. H. HARRIS.—Many thanks to you for forwarding us the above complimentary donation, together with the foraminiferous material collected by Capt. Seabrook. One of your slides is certainly that of a Rhabdophore. If we mistake not, the material will contribute something new to science.

C. WILSON (Southport).—Alas! your specimen reached us so flattened, dried up, and distorted, that neither ourselves nor other botanists cared to attempt the identification. Could you send us a fresh specimen packed in damp moss?

J. E. STEPHENS (Andover).—Your specimen is one of the broom-rapes (*Orobancha minor*), a parasite on the roots of clover, etc. See Taylor's "Sagacity and Morality of Plants" (London: Chatto & Windus), page 249, for sketch of the life-history and functions of this remarkable genus of plants.

A. PEARSON (Milnrow).—There is Sowerby's 16s. work on British flowering-plants, coloured plates (only dwarfed figures); but we would recommend you in preference Fitch & W. Smyth's outline figures (last edition) of all the British flowering-plants, including grasses and carices, price 16s. 6d., published by Lovell Reeve & Co.

F. CLARKE.—Your plants are: 1, *Brassica oleracea*; 2, a var. of *Geranium sylvaticum*; and 3, var. of *Veronica officinalis*.

E. P. POWELL.—We suspect (from the partial sketch) that the diatom is a species of *Arachnoidiscus*.

E. GILL.—The fungus is the first or initial stage of some species, but it is difficult to tell what species.

CAPT. H.—Your specimen is Venus's looking-glass (*Specularia peruviana*), a member of the natural order Campanulaceæ. The species of this genus are chiefly natives of Middle Asia, and one species is found in America.

T. SANDERSON.—Your sketch of fossil shell is evidently *Murchisonia striatula*, from the Ludlow beds.

W. ALGAR.—Many thanks for the specimen of freshwater sponge. The largest we have seen were in the rivers Stour and Gipping, in Suffolk, where we have obtained specimens weighing close upon one pound.

W. K.—The bright scarlet seeds are those of *Adenanthera pavonina*, commonly called the red sandal-wood tree in India.

#### EXCHANGES.

DUPLICATE birds' eggs for exchange, including sparrow-hawk's, kestrel's, carrion crow's, rook's, owl's, jay's, magpie's. Send lists.—E. G. Potter, 19 Price Street, Nunnery Lane, York.

FOREIGN butterflies: many fresh duplicates, including some very rare *Papilio*s, *Catagrammas*, etc. Lists exchanged. Also brilliant wings for microscopic work.—Hudson, Railway Terrace, Cross Lane, Manchester.

"CHEMISTRY: Theoretical, Practical, and Analytical, as applied to the Arts and Sciences," 8 vols., published by Mackenzie at 10s. 6d. per vol., in good condition, in exchange for microscope of equal value.—B. M. W., Treaddow, Hentland, Ross, Herefordshire.

DREDGINGS from the home of the Euplectella, Philippine Islands, Macassar Strait, and Java Sea, in exchange for good slides to form the nucleus of a collection for a master mariner anxious to aid science.—W. H. Harris, 44 Partridge Road, Cardiff.

OFFERED, L. C., 8th ed., 96, 129, 154, 164, 291, 295, 297, 320, 373, 624, 639, 643, 645, 655, 719, 755, 765, 823, 898, 909, 990, 1004-1006, 1008, 1036, 1127, 1130, 1237, 1270, 1339, 1346, 1358, 1363, 1385, 1389, 1525, 1660. Many desiderata, especially Orchideæ.—Miss E. Armitage, Dadnor, Ross, Herefordshire.

SCIENCE-GOSSIP, thirteen years' back numbers for exchange.—John Bracewell, 178 Jubilee Terrace, Accrington.

SIDE-BLOWN eggs of great crested grebe and coot to exchange. Chiefly wanted, those of the less common hawks, especially buzzard.—K. D., Cofton Parsonage, Alvechurch.

WHAT offers for De la Beche's "Geological Manual"? Mineral specimens preferred.—A. Richardson, 39 Editha Street, Stockwell, London, S.W.

*Anodonta cygnea*, var. *intermedia*, very good specimens, beautifully radiated, light green, epidermis good; also *Helix pulchella*, var. *castata*, *Zonites nitidus*, *excavatus*, *crystallinus*; any or all of above for shells not in collection.—F. Rhodes, 26, East View, Eccleshill, near Bradford.

DRAGON-FLIES wanted, fresh and unset. Offered in exchange, collections of Lepidoptera, Coleoptera, flowering plants, grasses, etc.—W. Harcourt Bath, Ladywood, Birmingham.

DRAGON-FLIES wanted from all parts of the world for figuring.—W. Harcourt Bath, Ladywood, Birmingham.

WANTED, clutches of many species of British eggs; osprey's and other good eggs offered in exchange.—W. Wells-Bladen, Stone, Staffordshire.

PLANTS of the best varieties of the Cactus tribe in exchange for shells, books, or offers requested.—E. R. F., 82 Abbey Street, Faversham, Kent.

WHAT offers for SCIENCE-GOSSIP unbound vols. from 1873 to 1882 inclusive, complete, vol. for 1884 and to June 1885, the latter vol. and half coloured plates?—W. Vick, Ipswich.

WHAT offers for the following: four show cases for butterflies, 18 in. x 18 in., glazed and corked, with a few insects in each; also a deal case, 22 in. x 12 in. x 4 in. deep.—W. Towner, 89 Terminus Road, Eastbourne.

WANTED, half a dozen live plants of *Lathyrus aphaca* (yellow vetchling). Exchange Wood's "Common Objects of the Microscope."—R. C. B., 3 Alexandra Villas, Barnes, S.W.

#### BOOKS, ETC., RECEIVED.

"The Comparative Biology and Morphology of the Fungi, Mycetoza and Bacteria," by Prof. de Bary, translated by H. E. F. Garney, and revised by Prof. J. B. Balfour (Oxford: Clarendon Press).—"Bird-Life in England," by E. L. Arnold (London: Chatto & Windus).—"The Commonwealth," by Dr. B. W. Richardson (London: Longmans).—"The Garner," vol. 1, edited by A. Ramsay.—"Science Lectures, delivered before the Sunday Lecture Society, Newcastle" (London: Walter Scott).—"My Microscope," by A. Quekett Club-man (London: Roper and Drowley).—"Tourists' Guide to Wiltshire," by R. N. Worth (London: Edward Stanford).—"Grasses of the South," by Dr. George Vasey (Washington: Government Printing Office).—"Illustrations."—"Book Chat."—"The Century Magazine."—"Scribner's" Monthly.—"The Amateur Photographer."—"The Naturalist."—"The Botanical Gazette."—"Journal of the New York Microscopical Society."—"Belgravia."—"The Gentleman's Magazine."—"American Monthly Microscopical Journal."—"The Essex Naturalist."—"Economic Naturalist."—"The Midland Naturalist."—"Feuille des Jeunes Naturalistes."—"The American Naturalist."—"Journal of Microscopy and Natural Science."—"Wesleyan Naturalist."—"Victorian Naturalist."—"Ottawa Naturalist."—"Journal Quekett Club."—&c. &c.

COMMUNICATIONS RECEIVED UP TO THE 12TH ULT. FROM: H. W.—A. P.—B.—REV. R. H. N. B.—E. F. C.—A. P. W.—P. M. W.—A. P.—R. H. N. P.—E. G. P.—J. B. B.—A. R.—J. C.—A. E. C.—J. W.—R. I.—E. A.—H. W.—E. W.—F. R.—F. E.—W. A.—R. C. B.—J. E. C.—R. H. R.—W. H. T.—A. H. A.—W. V.—E. R. C.—C. W.—W. B.—W. H. B.—REV. J. C. H. M.—T. S. M.—C. R.—A. B. G.—F. R. B.—H. W.—H. R. B.—W. J. S.—E. L.—R. B.—J. E. R.—DR. J. W. W., &c. &c.



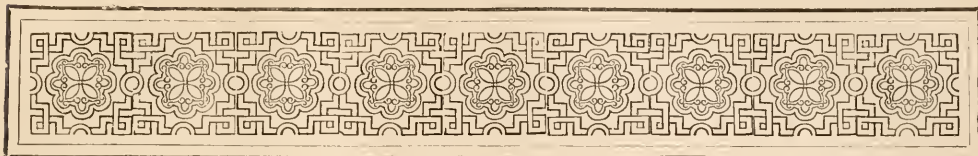

## NOTES ON GRANITE.

By HENRY FLECK, F.G.S.



ROCKS are divided into the two great divisions, Igneous and Sedimentary; the former are again divided into Vitreous and Crystalline. It is to the last—the crystalline igneous rocks—that our attention will be chiefly directed.

The crystalline igneous rocks may be regarded as principally silicates of various substances, such as alumina, magnesia, calcium, iron, potassium, and sodium. These elements in fact make up the great bulk of the earth's crust. Silica exists in various proportions in these crystalline rocks; in some of them the whole of it is combined with the other elements as bases; in others, the silica is present in greater quantity than can so combine, and the excess remains free. Rocks with this excess of silica are termed Acid; those with the smaller quantity (60 p. c. and under) are termed Intermediate and Basic. Granite containing, as it does, upwards of 60 p. c. of silica, belongs to the acid division. It is typically a crystalline-granular admixture of the minerals quartz, felspar, and mica; without any amorphous or micro-crystalline matter. The felspar is the most abundant mineral; next comes the quartz; then the mica. The quartz, however, has not assumed a definite crystallised form, but envelopes the other constituents, and has evidently been the last to crystallise. The felspar is usually white or pink orthoclase, occasionally triclinic felspars, such as albite and oligoclase, are present in small quantity. The mica also is variable

in kind, being usually muscovite or biotite; but sometimes lepidolite, lepidomelane, or other mica.

The felspars are such important constituents of granite, that it will be advisable to devote a little time to the consideration of the principal varieties. As just mentioned orthoclase is the most generally occurring felspar in granite; but occasionally other varieties are present. Now orthoclase is the only common kind which crystallises in the monoclinic system; all the others are triclinic in form. The principal means for distinguishing the triclinic from the monoclinic forms are the determination of the angles made by the principal cleavage planes; and the presence of fine striations on the basal cleavage plane of the triclinic felspars; these striations are absent from the similar planes in orthoclase. It is extremely difficult to distinguish the various triclinic felspars when they occur in small crystals; they have therefore, as a matter of convenience, been grouped together under the name Plagioclase felspars; those crystallising in the monoclinic form being called Orthoclase. Chemically all the felspars are silicates of alumina, with silicates of lime, soda, potash, &c., or any two or three of these bases, which often replace each other to a certain extent in the different species. Orthoclase for instance, is a silicate of alumina and potash; oligoclase is a silicate of alumina and soda, but the latter is usually replaced more or less by lime or potash; albite also is a silicate of alumina and soda; labradorite is a silicate of alumina lime and soda; and anorthite a silicate of alumina and lime. These facts are shown in the Table of Felspars, which also mentions the crystalline system, chemical composition of each of the five principal kinds of felspars. All the species, it is seen, crystallise in oblique forms, generally the triclinic. Their hardness is between 6 and 7 in the usual scale; and specific gravity from 2.59 to 2.78. They have all a perfect cleavage parallel to the basal plane and to the shorter diagonal section; the angle between these planes of easy cleavage being 90° in orthoclase; and varying 3° to 5° from 90° in the triclinic forms. In polarised light

the orthoclastic crystals, when twinned, usually show a median divisional line, on either side of which they depolarise in complementary colours; 'plagioclastic crystal exhibit numerous bands of different colours.

CRYSTALLINE SYSTEM, CHEMICAL COMPOSITION, AND SPECIFIC GRAVITY OF THE PRINCIPAL VARIETIES OF FELSPAR.

Name.	Crystalline System.*	Silica.	Alumina.	Potash.	Soda.	Lime.	Specific Gravity.
Orthoclase	M	64·7	18·4	16·9	..	..	2·39-2·62
Oligoclase	T	61·9	24·1	..	8·8	5·2	2·58-2·7
Albite	T	68·6	19·6	..	11·8	..	2·59-2·65
Labradorite	T	52·9	30·3	..	4·5	12·3	2·67-2·76
Anorthite	T	43·1	36·8	..	..	20·1	2·66-2·78

\* M = Monoclinic.  
T = Triclinic.

The mica found in granite is usually either muscovite or biotite, but other kinds are sometimes found. All the micas are characterised by their highly perfect cleavage parallel to the basal plane; and by the thin laminae being flexible and elastic. The percentage chemical composition of the above two forms is given by J. D. Dana as follows:—

<i>Biotite</i>	Silica . . . . .	40·91
	Alumina . . . . .	17·79
	Iron oxides . . . . .	10·00
	Magnesia . . . . .	19·04
	Potash . . . . .	9·96
<i>Muscovite</i>	Silica . . . . .	46·30
	Alumina . . . . .	36·8
	Potash . . . . .	9·2
	Iron sesquioxide . . . . .	14·5
	Fluoric acid . . . . .	0·7
	Water . . . . .	1·8
		99·3

It will be seen from these analyses that whereas muscovite contains no magnesia, biotite contains upwards of 19 per cent. of it. The latter is in consequence often called magnesia mica; muscovite is sometimes called potash mica. Biotite crystallises in the hexagonal system; muscovite in the rhombic. They have each a specific gravity of 2·7 to 3·1. Biotite is 2·5 to 3 in the scale of hardness; muscovite 2 to 2·5. Lepidolite, a rhombic mica, frequently occurs in granite as a substitute for muscovite, with which it agrees in chemical composition, excepting that the potash is partially replaced by lithium. It usually occurs in fine scales or granules. Lepidomelane resembles biotite, crystallising in the hexagonal system; but it contains more iron and less magnesia; and the folia are brittle. It occurs in some Irish and Cornish granites. Hexagonal micas viewed at right angles to the basal plane between crossed nicols appear dark; under similar conditions the rhombic micas show tolerably strong chromatic polarisation. The hexagonal species are uniaxial; the rhombic biaxial.

Quartz, the remaining essential constituent of granite, is much more simple in its composition than the previously mentioned minerals. It is an oxide of silicon, the only oxide of silicon known. It consists of 53·33 of oxygen, and 46·67 of silicon. Its hardness is 7, and specific gravity 2·5 to 2·8. It crystallises in the hexagonal system, and is usually found in the form of six-sided prisms, terminated by six-sided pyramids. But, as previously remarked, it has not assumed a definitely crystallised form in granite, excepting when it occurs in cavities. It is insoluble in all acids, excepting fluoric acid; but it is acted upon by hot solutions of potash, although but slightly in the case of the purer crystallised varieties. Under the microscope the quartz in granite is seen to contain numerous cavities; some of them are extremely minute, whilst others are large enough to be seen with the naked eye. These cavities usually contain water, or aqueous solutions of chlorides and sulphates of sodium, potassium and calcium. The important bearing of these fluid enclosures will be referred to further on.

Amongst the other minerals occurring in granite are schorl—usually developed in granite near its contact with other rocks—hornblende, magnetite, apatite; and, less frequently, garnets, pyrites, talc, beryl, iolite, andalusite, topaz, cassiterite, and hæmatite. Chlorite, epidote, and pinitite, are also found, as alteration products, and kaolin resulting from the decomposition of the felspars.

Most large masses of granite present differences in texture, and are often traversed by veins, "due in some instances to the segregation of the surrounding minerals in rents of the original pasty magma, and sometimes to the protrusion of a less coarsely crystalline part of the granitic mass into fissures of the main rock."\* Crystalline concretions or fragments are also frequently found in some granites. These also sometimes owe their origin to segregations of the granitic mass, when they are usually ovoid and porphyritic; or they are entrapped masses of other rocks, and are then either schistose or irregular in form.

Dr. Houghton gives the following average composition of granite, as the mean of eleven analyses:—

Silica . . . . .	72·07
Alumina . . . . .	14·81
Iron peroxide . . . . .	2·22
Potash . . . . .	5·11
Soda . . . . .	2·79
Lime . . . . .	1·63
Magnesia . . . . .	·33
Loss by ignition . . . . .	1·09
	Total 100·05
Mean specific gravity	2·66

There are many varieties of granite characterised by the presence or absence of certain minerals, or by the state of development of them. In some, for instance, the mica is absent; in others, the felspar;

\* Geikie, 'Text-Book of Geology.'

in others again, instead of, or in addition to, orthoclase, oligoclase may be present. Or some of the crystals may be porphyritically developed. In all, however, quartz is present.

The typical granite, as we have seen, is essentially a crystalline-granular admixture of quartz, orthoclase felspar, and mica. Porphyritic granite (or granite porphyry) consists of the same minerals, but the felspar porphyritically developed and the rest of the rock fine-grained. Granite of this type is found at Dartmoor, Shap, etc. Granitite is a variety containing oligoclase, in addition to orthoclase. The orthoclase is pink, and the mica blackish-green. There is usually but little mica present, however; quartz and felspar being the principal constituents. Cordierite granite, in addition to the three usual minerals, contains cordierite or iolite (a blue silicate of alumina, magnesia and iron). The mica is sometimes absent; greenish oligoclase is often present.

In haplite there is no mica, the rock being simply a crystalline-granular admixture of quartz and felspar. Graphic granite is a variety of this rock, in which the quartz is developed around, and parallel to the felspar, in such a manner that sections made at right angles to the plates of quartz and felspar present markings resembling Hebrew characters. Pegmatite is a name given to another variety in which also the quartz and felspar have crystallised together, and in which some white mica is usually found. Luxullianite consists of flesh-coloured orthoclase, quartz, and schorl. There is no mica. This rock has not been met with *in situ*, but boulders of it occur in Cornwall. Felstone is a fine-grained rock, with little, if any, mica present. The matrix is composed of quartz and orthoclase, with occasionally granules of plagioclase, and is imperfectly crystallised. When felspar crystals are largely developed, the rock is termed felspar porphyry; or if quartz is porphyritically developed, a quartz porphyry, or Eloan. The base of granulite also is fine-grained, and consists of orthoclase and quartz, but no mica. Several other minerals are, however, often present, such as garnets, schorl, and hornblende. It is usually schistose in structure. In trap granulite the felspar is one of the triclinic species, and, as is usual when orthoclase is replaced by plagioclase, the rock is poorer in silica. In the next rock, greisen, there is no felspar, either orthoclase or plagioclase, but quartz and mica (generally lepidolite) make up the principal mass. Cassiterite usually is found in strings or veins. Gneiss is similar to granite in composition; the chief difference between the two being, in fact, that gneiss is foliated and granite is not. Gneiss may, indeed, be called foliated granite. The constituent minerals are arranged in approximately parallel layers, and it is to this disposition of the mica that the schistose or fissile character of the rock is due. Protogine and cornubianite are varieties of gneiss. The latter is sometimes met with at the contact of granite with slates,

and is granular-scaly in structure. Protogine contains both orthoclase and oligoclase, as well as a variety of talc. It is found amongst the crystalline rocks of the Alps. Syenitic granite is granite with hornblende added to the usual constituents. Syenite is granite, with the quartz absent, or but sparingly present, and the mica replaced by hornblende.

CONSTITUTION OF GRANITE AND ITS PRINCIPAL VARIETIES.

Granite . . . . .	Q	..	O	..	M
Granite Porphyry . . . . .	Q	..	O	..	M
Granitite . . . . .	Q	..	O.P.	..	M
Cordierite granite. . . . .	Q	..	O	..	M .. Cordierite
Haplite . . . . .	Q	..	O	..	
Pegmatite . . . . .	Q	..	O	..	
Luxullianite . . . . .	Q	..	O	..	Schorl
Felstone. . . . .	Q	..	O	..	
Felspar Porphyry. . . . .	Q	..	O	..	
Quartz Porphyry . . . . .	Q	..	O	..	
Granulite . . . . .	Q	..	O	..	
Trap Granulite . . . . .	Q	..	P	..	
Greisen . . . . .	Q	..	O	..	M
Schorl-rock . . . . .	Q	..	O	..	Schorl
Gneiss . . . . .	Q	..	O	..	M
Protogine . . . . .	Q	..	O.P.	..	M .. Talc
Syenite . . . . .	..	..	O	..	Hornblende
Syenitic Granite . . . . .	Q	..	O	..	M .. Hornblende

Q = Quartz  
 O = Orthoclase } Felspar  
 P = Plagioclase }  
 M = Mica

With respect to the weathering of granite: it is found that the decomposition usually takes place by the decay of the felspars, the soluble parts of which are the silicates of potash and soda. These being removed, a large part of the alumina and parts of the silica remain as hydrates, forming kaolin—a silicate of alumina. The quartz is scarcely affected by decomposition; the mica becomes soft and yellow. Granite is sometimes found weathered to a considerable depth—as much as twenty feet in the south-west of England, where it can be dug with a spade.

In granitic veins the rapidity of decomposition is found to depend upon the crystalline condition of the rock; those parts the most perfectly crystallised undergoing decomposition the most rapidly.

It may now be well to glance at the various theories respecting the origin of granite. Is it of igneous, of aqueous, or of metamorphic origin? Each has been claimed for it, and each denied. In a discussion of this kind, a good deal of difficulty arises from the uncertainty attaching to the meaning of the word "metamorphic." In its strict application it means simply "transformation;" but the term is loosely applied, mostly without any attempt to define or restrict its meaning. Used, then, in the most general sense, it does not appear that there are any good reasons for denying a metamorphic origin to all eruptive rocks; since the term metamorphic is not used to define an extent or degree of alteration, but simply to indicate or assert that change of some kind or other has taken place. The crystalline schists, for instance, are metamorphic—they are a changed form of sedimentary rock. These may pass on, by a continuation of the cause—whatever it may be—that produced the original alteration, through a vast series



of changes. They may, perhaps, be depressed, until, coming within the influence of the earth's internal heat, they are fused and converted into a pasty or liquid mass. In this condition they may be acted upon by causes which result in their being ejected from volcanic vents, or forced into rents and fissures, forming lava streams and dykes, and then they would be regarded as truly igneous. But are they not also metamorphic? If, as I have supposed, these rocks resulted from changes wrought upon sedimentary strata—and there is no reason for denying that such changes could take place—then I think they may truly be claimed as metamorphic, having undergone change. But if the term metamorphic be restricted in its application, and defined, let us say, as meaning those rocks only which result from the change of other rocks, but are never eruptive, then, although it cannot be conceded that all granites are metamorphic, since some of them can be proved to be eruptive, yet, at the same time, I do not think it can be denied that some granites, at least, owe their origin to metamorphism. Now to glance at the evidence afforded by granite itself.

As we have already seen, granite is a perfectly crystalline rock without any glassy mass or crystallites. This is a distinctive character, and proves, by reference to the glassy rocks, that it has cooled down from fusion very slowly. Lavas which have cooled rapidly on the surface of the earth, consolidate as true glasses. But when the cooling process has been retarded, time has been given for chemical affinity to act, and cause the separation of certain portions having a definite composition; and in this way microliths and crystallites, or incipient crystals, have been formed. In proportion as this retardation in solidification has been great, so have these crystallites been more and more perfectly developed, the rock at the same time losing its glassy character as it becomes increasingly filled with crystals and crystalline matter.

When rocks are artificially fused and allowed to cool rapidly, they become glassy; if the cooling process be prolonged, they take up a stony character and may develop crystals. But it is impossible that granite can have consolidated from a state of fusion that can be imitated by artificial means. In the first place it is found that the constituents have not solidified in the order of their fusibility. Quartz, the most infusible of the constituents of granite, would naturally be expected to be the first to crystallise on the cooling down of the granitic magma. But it has in fact been the last, and is found to envelop the crystals of mica and felspar, both of them, under normal conditions, much more fusible than quartz in a crystalline mass without having itself taken on any definite crystalline form. Again, granite occasionally contains such minerals as gadolinite, orthite, and allanite, which, when heated to dull redness, lose their physical characters. From these facts it is inferred that granite could not have

solidified from simple igneous fusion, or from such as can be artificially imitated.

By a microscopic examination of the quartz of granite, a clue is given to the true explanation. The quartz is found to contain an enormous number of cavities, more or less filled usually with water containing chlorides or sulphates of sodium and potassium. Sometimes they contain liquefied hydrocarbons or carbonic acid. Speaking of these cavities, J. Clifton Ward says, "A thousand millions might easily be contained within a cubic inch of quartz, and sometimes the contained water must make up at least five per cent. of the whole volume of the containing quartz." The presence of these liquids proves that granite has consolidated under enormous pressure and in the presence of water. The fusion, then, was not simple dry fusion, but was accompanied by abundance of superheated water. It is most probably to the effects of this superheated water that the anomalous conditions of solidification may be due. The pressure under which the rock solidified would be greatly increased by the expansive force of the contained water, and this added to the weight of the superincumbent earth, and the effect of secular contractions of the globe, would be indeed great. It has, in fact, been calculated by Sorby that some granites have consolidated under a pressure equal to the weight of 50,000 feet of rock.

Granite is found occurring as a true volcanic rock and as eruptive masses. In cases where denudation has laid bare the ancient reservoirs of volcanoes, granite is exposed to view, taking the place of that once-fluid mass from which the acid lavas were supplied. Huge bosses of granite rising through, and more or less altering the sedimentary strata, again attest the igneous origin of granite. In some places the granite has not only pushed aside the stratified rocks in its ascent, but has actually caused their disappearance, as if it had melted and absorbed them into itself. In the south-east of Ireland, for instance, there occurs a belt of granite which has eaten its way up through the Cambrian and Silurian rocks, absorbing much of them into its own mass as it rose. Within the margin of the granitic belt numerous patches of schist are taken up, and the surrounding rocks are altered into mica-schist for a considerable distance, and are pierced by veins given off from the main mass.

With respect to granitic veins, it may be here remarked that they vary considerably in texture, some being coarsely crystalline whilst others are fine-grained. They vary also in breadth, from mere filaments to several yards in thickness. Their effect upon mineral veins which traverse them is referred to by De la Beche, in his "Geological Observer," where he observes, speaking of the load at Wheal Alfred, Gwincar, in Cornwall:—"While the fissure traversed the upper and adjoining slate, on the north no great amount of ore was obtained, but upon

entering the elvan (the granitic vein) it became more rich, and while passing through that rock the ore was found to be so abundant as to afford a considerable profit. After quitting the elvan in its descent, and entering the slate beneath, on the south, the lode became poor, and eventually the mine was abandoned from the scarcity of ore, the amount of it in the depths not repaying the cost of raising. The width of the lode was from six to nine feet in the slate above the elvan, increased in the latter to twenty-five feet, and decreased in the slate beneath to ten feet." (p. 778.)

And now with regard to the metamorphic origin of some granites. As before mentioned, some granitic masses were once the reservoirs from which volcanoes were fed. When this mass was in its liquid state it was charged with highly heated water, which, by its expansive force, exerted enormous pressure upon the fluid mass, and tended to force it upwards and outwards in all directions. Where a point of less resistance occurred, there the fluid mass would be forced, and might result in the opening out of a passage to the surface, when the mass would be poured out as lava, and a volcano formed. But whether such a communication were established or not, the granitic magma would be forced against the surrounding rocks, and by its heat, pressure, and the action of the water, more or less metamorphosed them. This metamorphism must sometimes have proceeded so far as to cause the absorption of parts of the surrounding rock into the mass of the granite itself, and by the mechanical and chemical re-arrangement and alteration of adjacent parts of the rock, so have changed them that they were converted into true granite. As the distance from the main granitic mass was increased the effect of metamorphism would diminish, and from granite and gneiss we should expect to find succeeding crystalline rocks, such as mica-schist, less and less altered. Veins would also be forced through the surrounding strata from the main mass, so that igneous and metamorphic granite would be formed at the same time. By subsequent denudation these various rocks would be exposed to view, and we should have presented to us a mass of granite, part of which we see had a metamorphic origin, surrounded by zones of metamorphosed strata, decreasing in degree of alteration the farther they are separated from the central mass, and here and there, the whole metamorphosed series pierced by granitic veins of a truly igneous origin.

But the contact of granite with other rocks does not, by any means, always result in the conversion of parts of the latter into granite. In the case of the Skiddaw Slates, to mention one instance, whilst these have been metamorphosed by intrusive granite and converted into mica-schist, spotted-schist, and clastolite slate yet the junction of the mica-schist with the granite is sharply marked, and "there is no general transition from mica-schist into gneiss

(proper) or from gneiss into granite." (J. Clifton Ward, Q.J.G.S. vol. xxxii.)

To conclude, we find that granite is a perfectly crystalline rock, that has consolidated at a depth below the surface of the earth, from a state of hydroigneous fusion and under enormous pressure, resulting in part from the expansive force of the heated water, and in part from the weight of the superincumbent rock masses. That it is generally of igneous origin, but sometimes parts of it, at least, have resulted from the complete metamorphism of other rocks.

#### AN ODD PAGE IN NATURE'S BOOK.

By the REV. JOHN CROFTS.

"WALK up, walk up, ladies and gentlemen! and see a green pussy-cat with a crimson head and a purple back! Walk up, I say! Here she is, sitting up, all alive, with her two tails over her back, and quite ready to commence her performance! She has just jumped out of her skin, which she is now going to make a meal of! Entrance only one penny!

"Performance about to begin!"

If you saw a showman beating his drum on the steps of a bright yellow caravan, and bawling out these words every now and then at the top of his voice, I dare say you would wonder what sort of "take in" the man had got inside. Of course you would say there never was, and never could be such a thing as a green cat with two tails and a crimson head; and as to its jumping out of its skin and eating it—it was on the face of it impossible and absurd, a regular "take in," and just a showman's way of getting money.

But wait a moment. Perhaps there are pussy-cats that you have never seen, with strange habits that you have never heard of.

I remember, years ago, reading of a boa constrictor in the Zoological Gardens that swallowed its blanket, and I was much struck at the time with the thought of what a very dry and unsavoury meal it must have been. The blanket was given to it, of course, to serve as bed clothes, and for the creature to lie in; but after trying that arrangement for a time and finding it unsatisfactory, I suppose the monster conned the matter over in its wise serpent head, and came to the conclusion that, as its body was not comfortable wrapped up in the blanket, it was worth trying how it would feel with the blanket wrapped up in its body. It was a happy thought, but alas! it was not, I believe, attended with very happy results.

I remember too, as a very small boy, being a good deal impressed upon hearing of a pig that (its owner said) ate its head off! and I wondered much how such an extraordinary feat was accomplished.

But it was not till the other day that I witnessed

with my own eyes a performance quite as extraordinary as that of either the pig or the python:—in fact the very feat that our supposed showman was making so much noise about at the entrance of his yellow show.

You will observe, my dear reader, the comical-looking gentleman who sits facing you below (Fig. 108). Well, it is a performance of his that I refer to. This gentleman actually did walk out of his skin; and I watched him with my own eyes make a nice, square, comfortable meal of it afterwards. I believe it is very rude to stare at a person who is eating, but I could not help staring at him. He did not seem to mind it, however; indeed he made no more of what he was doing than if it were a matter of everyday occurrence. Yet it was an extraordinary spectacle. If I had seen a boy who had just stepped

upon tidiness, and in particular may have impressed upon him as an important rule, "Whenever you have done with an article of dress, fold it up and put it away;" and if this were so, it is evident that in his innocence he had misunderstood the injunction, and thought reference was made to the common method amongst his relations of putting things away. I mean (to use a vulgarism) "putting them away" where the green poplar leaves disappeared—"down the red lane," or rather, green lane; for their "red lane," though ever ready, was never red.

No, I cannot say that I was agreeably impressed with the look of the gentleman at first sight. He seemed to me to wear rather too sanctimonious, "meekly-do-my-dooty" an expression for a straightforward, hungry, honest-minded, caterpillar. It is true I did not know at the time that it was a meal



Fig. 108.

out of his nightshirt quietly sit down on the carpet and commence to make his breakfast off it, I do not think I could have been much more astonished.

When I first observed my friend he was sitting as you see him sitting now; bolt upright, with the skin (out of which he had just scrambled) before him on the leaf, turned partly inside out, and lying—as I have sometimes seen night-dresses lying about the floor in an untidy boys' dormitory—just as he had stepped out of it. He was not, however, of the untidy sort, though he had never had the advantage of a mother's training, poor little chap! for he had been left an orphan very early in life, and the youngest member of a large young family of thirteen, totally unprovided for, and entirely dependent upon their own exertions.

It is possible, however, that one of his elder brothers or sisters may have given him a few lessons

that was spread before him; but even if I had, I do not know that I should have thought any better of him; for I hate hypocrisy, and for a gross-feeding creature like that to make a pretence of saying a "grace before meat" that took a full half-hour at least to get through, was really rather too much. But his attitude! His head was bent a little to one side, his arms crossed on his breast, and he was motionless as a stone, as if so utterly absorbed in his devotions, the little Pharisee! It is uncharitable, perhaps, to say so; but my firm belief is that it was every bit pretence, and that in reality his mind was all the time wholly engrossed in the contemplation of his own excellences, with a kind of gentle undercurrent, no doubt, of pleasant anticipation of his coming meal.

But there is an end to all things; and my friend woke up at last, squared his elbows, and began to



look like business. I had brought him, meanwhile, some fresh poplar leaves, feeling sure he must be hungry after his long fast; so, seeing him now awake, I placed them near him that he might make a beginning. But he took no notice. "He doesn't see them," thought I, and I placed them nearer. Still not the smallest notice did he take of them, but began pawing and fondling the remains of his former self in a somewhat sickeningly sentimental way. I then reflected that animals of that breed might very possibly be short-sighted, so I took a leaf, and in a "poor-beastie-can't-'em-find-it" spirit, held it to his nose that he might have the advantage of its smell; but as he still seemed indifferent, I gently bobbed it once or twice against his aforesaid scent-organ encouragingly. But now he went into a tantrum, drew himself upright as at first, flirted his tails up over his back, and shot out of the end of each a little pink whip-lash with which he threatened me. So I determined to leave him alone, and let him have his own way.

"What is he doing?" said I to myself presently. He had unbent again, and having once more pawed over the remains of his dear self till he came to the black and white tail cases (which were standing erect at the extremity of the skin) he suddenly pulled up short. That, however, was not what caused my inward exclamation. Of course he stopped. So did the Roman army when they reached the *Furculæ Caudinæ*. He, however, was not baulked for long, but presently found a way out of his difficulty. What was his way? Why he simply began at the apex, and munched away both prongs of the fork, one after the other, down to the very base. So if my reader should ever find himself, like my friend, brought up short, and presented with the two horns of a dilemma, he will know what to do. Let him follow my friend's example, and he will soon find the difficulty disappear.

And now, having broken the ice, my friend set to work with a will. But it was a large order. The collier who had undertaken to eat the whole of a bull-calf at one sitting had not a more formidable (and I might add disgusting) undertaking before him than he. But having (if I may so express myself) taken his bull by the horns, he went on cheerfully and steadily till the work was accomplished. Oh, yes, he finished the whole without really flinching once! I certainly did think he showed signs of faltering once or twice, but I suppose now it was only my fancy. The skin was certainly dry in places—that is, to my way of thinking; but then I should call an Irish ulster wanting in juice, and it is quite possible my friend would not.

But what struck me very much was the fact, that here and here the old skin seemed to break out into moisture in the most surprising way. It seemed as if, just where it grew dryest and toughest, it contained small hidden reservoirs of gravy, which only

required tapping to set matters right and juicy again. Whether this were so or not, I am now doubtful, for before the meal was finished, I grew a little suspicious about it, and could not feel quite sure that my friend did not (in a very stealthy and underhand way) help himself to a little Worcester sauce—or some other condiment—that he carried concealed about his person. I was sorry to entertain this suspicion of him, because, to say the least, it does not look well for a person to be helping himself from a secret supply of liquor, frequently and furtively, in this way; and when the hidden supply is brought to light, it rarely proves, I believe, to be in reality either Worcester sauce or salad oil.

But quite apart from this, and without at all allowing my opinion of my friend to sink so low as it must have done in such a case, we all know how natural and certain it is for one suspicion to lead to another; and so I could not help arguing with myself about it as follows:—"Granted that the condiment is Worcester sauce, what then? Why be so stealthy about the use of it? Surely he has as much right to the use of a 'relish'—and with such a meal—as anybody can have. It does look suspicious. I wonder if the performance from beginning to end can be a mere piece of bravado? Does it not look like it? He saw me watching him before he began, I know. Can it be that this disgusting performance suddenly occurred to him as a means of winning for himself a name? Some people would quite as soon be notorious as renowned. May not he be of the number? If so, then I can quite understand this unworthy concealment of the sauce; it all fits in with his low aims, sordid-mindedness, and vulgar bravado."

When I had got thus far, however, I remembered that I had not ascertained for certain that my friend did supply the sauce from about his own person, and I felt that an apology was due to him for my unkind reasoning upon such insufficient grounds.

But by this time he had not only finished his meal, and somewhat obtrusively cleaned his platter, but had actually resumed, with an expression of great complacency, his first position, and his pretended devotions; so I did not interrupt him.

---

#### OUR SCIENTIFIC DIRECTORY.

*Practical Naturalists' Society* (London Branch), St. John's School Mission House, 5, Church Street, Waterloo Road, London, S.E. President, Mr. A. W. Nott. Vice-President, Mr. A. Ramsay, F.G.S. Secretary and Treasurer, Mr. G. K. Gude. All communications respecting the Branch should be sent to the Secretary, 5, Giesbach Road, Upper Holloway, N.

PHOTOGRAPHY BY VITAL PHOSPHOR-  
ESCENCE.

By DR. JOHN VANSANT.\*

SOME months ago there was published in several scientific journals, an article showing how excellent photographic positive prints, on glass or paper, could be made from an ordinary negative by means of the transformed or "stored-up" radiant energy—the phosphorescent luminosity—of certain inorganic substances, especially particular sulphides of calcium and strontium.

Many organic substances also, as is well known, possess this property of storing-up, so to speak, and afterwards emitting, as more or less luminous rays, the radiations to which they have been exposed. Crystallised carbon, in form of the diamond, and white paper may be cited as illustrations of this class. A photographic latent image on a bromide of silver surface, capable of being developed, can easily be produced by bringing into contact, for an hour or so, in the dark, such a sensitive surface, and an engraving, or some ordinary printing on white paper which has just been previously exposed for some minutes to the direct rays of the sun.

But I have now to call attention to the curious act, that the kind of light given out by certain animal organs, and which evidently in its causation has some close relation to the nervous system and vitality of the animal, and belongs to a different class of phenomena from the phosphorescence above mentioned, can also bring about incipient decomposition in a haloid salt and silver. Moreover, it can do this through a sheet of glass of the usual thickness used for photographic negatives, and, consequently, there is a possibility of producing by such light photographic positive prints.

The following experiment, copied from my notes, proves this :

June 8, 1887. This evening, just after dark, I took about a dozen fire-flies (*Lampyris corusca*), which had been captured a few minutes before on the lawn, and enclosed them in a wide-mouthed vial of some 3 oz. capacity, having a piece of fine white bobinet (such as is used for ladies' veils) stretched over its mouth in place of a stopper. Enclosed thus, they would frequently emit the momentary flashes of greenish-tinted yellow light for which they are remarkable, though usually only one insect at the same time would flash. Every few seconds one or another would emit its light for a period which I estimated to average in each case about one-half of a second, and the frequency of the emissions could be increased by gently shaking the vial. When not flashing, the under surface of the three posterior segments of the fire-fly's abdomen, from which the light came, was scarcely at all luminous, but was simply of a bright yellow colour. The flash-

ing was plainly under control of the insect, like its muscular movements. These fire-flies are rather less than three-quarters of an inch long, and the segments which become luminous have, altogether, an area of only about one-eighth of an inch square. The flash is, however, quite bright, so much so that fine print can be easily seen when held close to it.

Repairing to my dark closet with the vial of fire-flies, I placed it to one side, under cover, whilst I arranged and clamped a very sensitive gelatino-bromide of silver dry plate beneath an ordinary negative picture of a landscape on glass, as for contact printing.

The vial of insects was then inverted over the back of the negative, so that only the fine meshes of the bobinet and the glass of the negative with its gelatine film intervened between the fire-fly's light and the sensitive bromide plate. I counted the flashes, occasionally shaking the vial and sliding it over the negative, till fifty flashes had occurred.

The vial was then removed, the sensitive plate separated from the negative, and an attempt made to develop the latent image, if any existed. Alkaline solution of pyrogalol was used, and, in a few minutes, I had the pleasure of seeing a well-marked positive image of the negative picture appear, the plate being somewhat yellow stained, as if from too long an exposure. This was fixed in the usual way with sod. hyposulph., and is now in my possession,—probably the first picture ever produced by the light emitted from a living animal organism.

*U.S. Marine Hospital, St. Louis, Mo.*

NOTES ON *CHÆTOPTERUS VALENCINII*.

WHILE other branches of marine zoology have received a full share of attention from both Scientist and "Tyro," it is astonishing what little has been given to the large and interesting class of annelids; apart, of course, from that of specialists, with the results of their work wrapped up in "Transactions."

On one or two occasions only during the last five years, as far as I can remember, have writers in SCIENCE-GOSSIP favoured us with a few notes on some of its members.

In the endeavour to help in making up such deficiency, I send the above sketch, and a few remarks upon its subject.

This is the *Chætopterus Valenciæ* of Quatrefages, perhaps identical with the *C. insignis* of Baird, but of this I am not certain, as I have found one or two specimens of another species on this coast, too much damaged, unfortunately, to make out much of their structure.

The one at present under notice is an animal which, for grotesque appearance, will readily put

into the shade every other member of the class to which it belongs.

It is about five inches long when at rest, and with its "frills and tuckers" about three-quarters of an inch in diameter.

For the sake of convenience it can be described as formed of four portions; the first eight or nine

are seen under the microscope to be fringed with small, sharp, lanceolate teeth. These are the projecting points of a beautiful fan-like arrangement of bristles of a bright golden colour. On the lower half of the outward edge of the fourth pair these are much stouter, mucronate in form, and black.

The ninth pair of "feet" are much elongated,

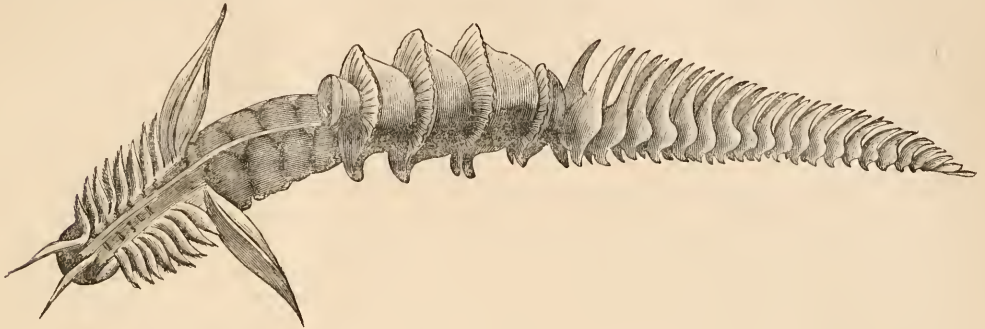

Fig. 109.—*Chaetopterus Valenciini*. Qf. nat. size. (From living specimen.)



Fig. 110.—*Hermothoe malmgreni*. Natural size.

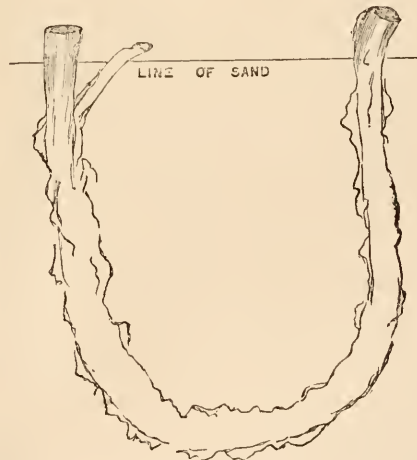

Fig. 111.—Tube of *Chaetopterus*, Quarter natural size.

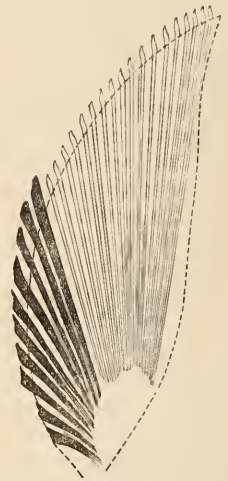

Fig. 112.—Arrangement of Bristles in 4th pair of feet of *Chaetopterus*.  $\times 12$ .



Fig. 113.—Bristle of *Chaetopterus*.  $\times 50$ .

segments forming the head part are firm and elastic. The whole of the remainder of the animal is soft and gelatinous, as if formed of thin membrane inflated with fluid.

Its colour is milky-white and semi-transparent, except the second portion where the alimentary canal is in close proximity to the here excessively thin skin. This part shows black or very dark green.

The first eight pairs of feet (if this term is correct)

lanceolate in form, and have the bristles simply acicular, and arranged in a bundle forming a "mid-rib," giving these appendages firmness with flexibility, and not projecting through the skin.

The second portion of the worm consists of little more than alimentary canal with a delicate white thread running along the dorsal line. This thread, with the constrictions of the segment, give to this part a knotted appearance.



The third portion consists of a series of hood-shaped vesicles, and these (I observed while sketching the animal) maintain a gentle waving motion to and fro; their use, besides being probably branchial, being thus evidently to cause a flow of water through the tube in which the animal dwells, and which will be described immediately.

The last portion of the worm, comprising about half of its entire length, consists of twenty segments; each bearing a pair of appendages of a tapered tubular form, and each containing a bunch of bristles arranged as in the ninth pair.

These segments and their appendages gradually diminish in size towards the end of the worm, ending in a point.

The tube formed and inhabited by *Chætoperus* is about twenty-four inches long, and from three-quarters of an inch to one inch in diameter. In the species described, it is always fixed in the sand in the form of the letter "U." It is open at both ends, and with its ends projecting about two inches above the sand some seven or eight inches apart.

(In the other species which I have alluded to, the tube is horizontal, adhering to the under side of stones, in the same manner as that of *Terebella nebulosa*.)

A curious feature in the tube is that there are always one or two "tail pieces" at one end projecting at about right angles from the main tube. It is difficult to conjecture their purpose, as they do not always communicate with the tube internally.

The tube is of parchment-like consistency, very smooth within, and coated externally with sand and broken shell.

Although this animal is very local, and by no means common in the littoral region, and also very seldom taken with the dredge, it must be fairly abundant in deep water, for portions of its tube can be seen among the weed washed up after every storm. And every observant visitor to the shore must be familiar with them—perhaps taking them for the hollowed out stems of *Laminaria*, which, when denuded of their coating of sand, &c., by the sea, they closely resemble.

A very beautiful worm, allied to the familiar *Polynoe*, with a double row of iridescent pearly scales along its back, inhabits the same tube as the *Chætoperus*. This is *Hermothoe malmgreni*, Lank.

Jersey.

J. SINEL.

EXTINCTION OF THE PRIMROSE.—Referring to the remarks in your current number on this subject, I think "*Amator Naturæ*" need have no fears that this favourite spring flower is becoming extinct. It certainly in this district appears in greater profusion than ever. During my experience of about twenty-five years in this vicinity, I have never seen such a display as we were favoured with during the past spring.—*W. C.*

## ASTRONOMY AND METEOROLOGY.

By JOHN BROWNING, F.R.A.S.

THE partial eclipse of the moon was well seen, at least from my house at Bromley Common. It amused me to find that most persons thought for the first half-hour, that a peculiarly dense cloud had formed, and was stationary in front of the lower edge of the moon. I observed the eclipse through a powerful binocular field glass. This instrument, for the particular purpose, gives better results than a large astronomical telescope. The eclipse began at 7 hrs. 36 min. aft., and finished at 10 hrs. 2 min. aft. At about nine o'clock P.M., the copper colour so frequently seen in a lunar eclipse was clearly visible.

Professor Tacchini states that the solar spots observed at Rome in the first quarter of the present year, were fewer, smaller and less active than those observed in the latter part of the year 1886. There was, however, an outburst of solar activity in June, and one solar spot appeared on the 8th of June, which was visible for several days to the eye without a telescope.

The Royal Astronomical are in vacation; as the majority of the Fellows are men exceptionally active in their business or professional occupations, they are doubtless enjoying their well-earned leisure. Until we have news of the observations of the Solar Eclipse of Aug. 19th, it is not probable there will be much of astronomical interest to chronicle.

In September there will be no occultation of any star above the fifth magnitude.

Mercury will be a morning star early in the month, and an evening star towards the end.

Mars will be a morning star in Cancer till about the 19th, when it enters Leo.

Jupiter will be an evening star, and will be found between Virgo and Libra.

Saturn will be in Cancer throughout the month.

*Meteorology.*—In September the temperature begins to decline on an average three or four degrees. The average temperature on the South coast for September is 59°. Across England from the Bristol Channel to Norwich it is 58°. From the Mersey to the Humber it is 57°. From Lancaster to Flamborough Head it is 56°, and from Wigton and Kirkcudbright through Jedburgh, it is 55°.

At the Royal Observatory, Greenwich, the highest reading of the barometer for the week ending 23rd July was 30.11 in. on Tuesday evening, and the lowest 29.82 in. on Friday evening. The mean temperature of the air was 63.4 deg., and 0.2 deg. above the average. The general direction of the wind was N.E. Rain fell on Sunday to the amount of 0.48 of an inch. The duration of registered bright sunshine in the week was 76.8 hours, against 74.3 hours at Glynde Place, Lewes.

*Rising, Southing, and Setting of the Principal Planets at intervals of Seven Days.*

	D.	Rises. h. m.	Souths. h. m.	Sets. h. m.
MERCURY ♀	3	4 31M	11 36M	6 41A
	10	5 22M	11 59M	6 36A
	17	6 8M	0 17A	6 26A
	24	6 51M	0 32A	6 13A
VENUS ♀	3	8 3M	1 21A	6 39A
	10	7 29M	0 46A	6 3A
	17	6 43M	0 5A	5 27A
	24	5 51M	11 22M	4 53A
MARS ♂	3	1 47M	9 40M	5 33A
	10	1 44M	9 31M	5 18A
	17	1 41M	9 21M	5 1A
	24	1 38M	9 11M	4 44A
JUPITER ♃	3	10 10M	3 14A	8 18A
	10	9 49M	2 51A	7 53A
	17	9 29M	2 29A	7 29A
	24	9 8M	2 6A	7 4A
SATURN ♄	3	1 35M	9 28M	5 21A
	10	1 11M	9 3M	4 55A
	17	0 48M	8 39M	4 30A
	24	0 24M	8 14M	4 4A

For the week ending 30th July the lowest reading of the barometer was 29.46 in. on Tuesday evening, and the highest 29.94 in. on Saturday morning. The mean temperature of the air was 65.4 deg., and 2.7 deg. above the average. The general direction of the wind was S.W. Rain fell on four days of the week, to the aggregate amount of 0.51 of an inch. The duration of registered bright sunshine in the week was 48.3 hours, against 40.5 hours at Glynde Place, Lewes.

For the week ending 6th August, the lowest reading of the barometer was 29.84 in. on Sunday morning, and the highest 30.20 in. on Wednesday morning. The mean temperature of the air was 63.9 deg., and 1.2 deg. above the average. The general direction of the wind was N. and E. No rain was measured during the week. The duration of registered bright sunshine in the week was 63.6 against 69.4 hours at Glynde Place, Lewes.

For the week ending 13th August, the highest reading of the barometer was 30.05 in. on Monday morning, and the lowest 29.62 in. on Saturday at noon. The mean temperature of the air was 65.3 deg., and 2.6 deg. above the average. The direction of the wind was variable. No rain was measured during the week. The duration of registered bright sunshine in the week was 48.5 hours, against 55.0 hours at Glynde Place, Lewes.

From these reports it will be seen that the rainfall from 16th July to 13th August at Greenwich has been only 0.99 instead of two inches. This represents a deficiency of 114 tons to each acre.

In September the average rainfall on the East

and South-East coasts is 2 inches, on the South coast it is 3 inches and on the West and South-West coast it is 4 inches. Over a good part of Cornwall and North and South Wales it is 5 inches. This is about 515 tons to each acre.

MUNCHAUSEN SCIENCE.—Under this heading in SCIENCE-GOSSIP for August appears an extract from Cassell's "Saturday Journal," which is a slightly altered quotation from Kingsley's "Glaucus," which also appears in the "North British Review," No. xliii. p. 38, and to which the above designation does not very gracefully apply. With some allowance for the author's poetic style, and for possibility of error on two points, as mentioned below, the description of *Nemertes borlasii* is very good, and will be endorsed by every one acquainted with the animal. The possible errors to which I allude are, firstly, that of size; "twenty to thirty feet" would be an uncommon length—six to eight feet being, I think, the maximum to which it attains—at least upon these shores; but is it very difficult to form an exact idea of its length, owing to its great elasticity and contractibility—for instance, a specimen measuring say about six or seven feet will, on being killed by plunging into spirits of wine contract to less than the same number of inches, with a corresponding increase of thickness, whatever amount of knot and tangle it may have been involved in disappearing in the process. The second error, and more important scientific one, is where it is put down as the "blind assailant" of the young fish, for it is not very likely that *Nemertes* is blind, with its rather extravagant supply of eyes. I forget their number, and have not a specimen at hand for reference, but I think that they are either twelve or sixteen, arranged in lines on each side of the head. As to its voracity, an instance that came under my own observation just two years ago, will sound much more "Münchhausen"-like than anything in the extract referred to. It is where one of these worms, not thicker than a straw, had made the bold attempt to swallow an octopus. I must, however, say that the latter was not in very good health, but it was living, and *Nemertes* had commenced upon the thread-like extremity of one of its tentacles, and engulfed some six or seven inches, up to where the tentacle was about half an inch in diameter, and the worm's slit-like mouth could stretch no more. Johnston, in the "Catalogue of Worms in the British Museum," again uses the quotation which your correspondent finds fault with in the description of *Lineus longissimus*, a close relative of *N. borlasii*, and often confounded with it, but here the length given is eight or nine feet.—*J. S., Jersey.*

THE Editor has a limited number of dates yet remaining open, for engagements for his popular extemporaneous lectures on geological, botanical, and zoological subjects, illustrated with diagrams and lantern views.

## ON SOME TYPES OF STORM-CLOUD.

**NORMAL ELECTRIC CUMULUS.**—This variety I have formerly described, in the "Transactions of the Meteorological Society," and cited

ous tint, and repulsive force in relation to contiguous masses (see SCIENCE-GOSSIP, July, 1887).

**II. BAG, OR FESTOON CLOUD.**—This is a kind of inverted cumulus. It does not seem to occur except during the actual disturbance, and may be supposed

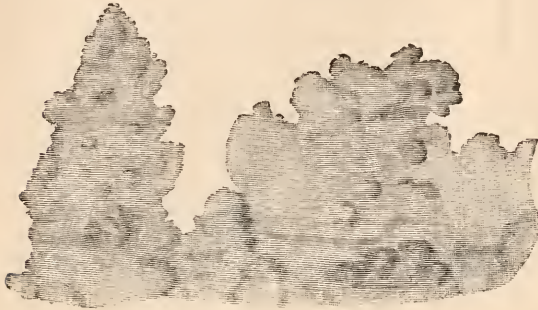

Fig. 114.—Normal Electric Cumulus.



Fig. 115.—Dropping Cumulus.



Fig. 116.—Bag or Festoon Cloud.



Fig. 117.—Saw Cloud.

some varieties in a paper in "Popular Science Review," and SCIENCE-GOSSIP, 1879. The chief characteristics are: Height, extent, hardness and curling, or nodulous form of outline, pale or sulphur-

to have its origin in strong rotary currents. The cloud often forms the under surface of a nimbus pallium, or sheet. It is rare in its perfect forms, but is almost circular at times. Characteristics—



murky or lurid yellow, or brown tints, rapid movement, connexion with heavy squalls, and highly-charged rain-clouds. It is seen mostly in autumn and winter. Locally termed pocky cloud and rainball. (See article above mentioned, "Popular Science Review," 1879.) The smooth, even outline of this form of cloud is sometimes remarkable.

III. SAW-CLOUD.—This form is a composite one, indicating a transitional state of the weather. It is frequently attached to a bank of stratus, some-

is form, because of the peculiar symmetry and of its illustrating the same condition of atmosphere as the foregoing form (Saw Cloud). It has the same general characteristics, but is seen in larger and rounder masses.

SAMUEL BARBER.

NOTE.—In these sketches I adopt English terms and use the Latin ones of Howard by way of reference to existing accounts.—S.B.

(To be continued.)



Fig. 118.—Curling Cumulus.

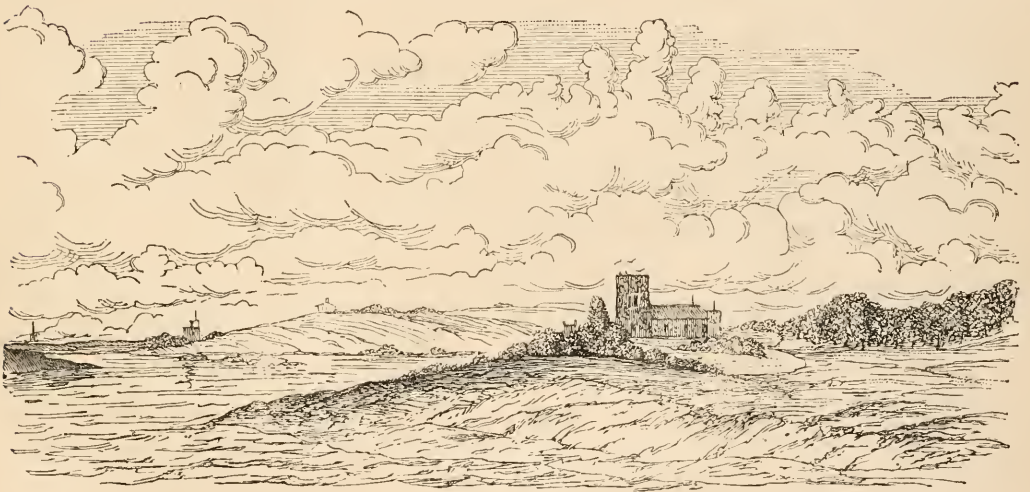

Fig. 119.—Saw Cloud.

times assuming, however, a bead-like form, and detached.

It may then be called "Bead-Cloud," or "Double Saw-Cloud." Attention is drawn specially to this form on account of its being one of the best indicators of a disturbed state of the atmosphere. In my experience it is highly electrical. In rainy summers (e.g. 1879) it is generally an attendant on thunderstorms. Characteristics—association with disturbed and mixed forms of sky; slaty, ashy, and dark tints; great opacity. This cloud should be compared with the double, or "dropping cumulus," which assumes the "bolster" form, and also with the following: viz.:

IV. "CURLING CUMULUS."—This is a variety of No. I., Electric C. I draw attention to it, though it

#### SOME REMARKS ON FUNGI.

By HAYGARTH ADDISON, L.R.C.P., &C.

IT is strange that in an age like this, the *Agaricus campestris*, or common mushroom, should be the only—or nearly only—member of this class used as food in this country by those who have but a slight knowledge of fungology.

We will consider first a few of the culinary fungi, showing that "the" mushroom has not alone all the glory to itself, of being regarded a *bonne bouche*.

Probably the most famous of them all is the truffle, which has been a luxury ever since the days of Pliny. This fungus is found growing under trees and deep in

the soil, they are found on the Hampshire downs. In France, dogs are trained as truffle-hunters, and by their keen scent discover them and "joint" them, as the game dogs do game. The truffle somewhat resembles a large black walnut with a solid brownish interior. The *Agaricus campestris* is the mushroom of our country dinners, though what we get in the London shops as mushrooms are not mushrooms at all, but one of the "toadstools," the *A. arvensis*; the country people reject this black-gilled fungus as poisonous.

Perhaps of all the edible fungi, the morell is the best known; it is imported from Germany, but is also found in Britain, it is said to be very delicious.

With a few remarks of Dr. Badham's we will take our leave of the edible fungi. He speaks thus, in a tone of sorrowful reproach:—"I have indeed grieved to see pounds innumerable of extempore beefsteaks growing on our oaks in the shape of *Fistulina hepatica*; *Agaricus fusipes* to pickle, in clusters under them; puff-balls, which some of our friends have not inaptly compared to sweetbread for the rich delicacy of their unassisted flavour; hydna as good as oysters, which they somewhat resemble in taste; *Agaricus deliciosus*, reminding us of tender lamb kidney; the beautiful yellow chantarelle growing by the bushel, and no basket but our own to pick up specimens on our way; the sweet nutty boletus, in vain calling himself *edulis* when there was none to believe him; the dainty oreades, the *Agaricus heterophyllus*, which tastes like the crawfish when grilled; and the red and green species of agaricus to cook in any way, and equally good in all." We may add also that excellent fungi are a very valuable article of diet, being highly nitrogenous and containing much fat.

Many of the fungi are poisonous, as we know too well, and that fungi which would agree well with one person have been the cause of death in another, has been clearly demonstrated.

For example, the late Dr. Hawkes Tanner mentions in his "Memoranda on Poisons," a case in which a French officer and his wife died from breakfasting off "mushrooms," which others in the house ate without inconvenience! Speaking generally, highly coloured mushrooms with an astringent, styptic taste, a forbidding pungent odour, and which grow in dark and shady places, should be avoided.

As October is a great month for fungus-hunting, it may not be out of place to mention briefly the symptoms and treatment of the poisonous principle contained in some of them.

Gastro-intestinal catarrh with a disordered condition of the nervous system and considerable depression, is the usual result following the ingestion of poisonous fungi. In treating these cases, the stomach and bowels must be thoroughly emptied, and the prominent symptoms are to be relieved according as they occur. After free vomiting and purgation have been induced, rest in bed, with stimulants and warmth are beneficial.

The *Amanita muscaria* is a poisonous species which is used as a means of intoxication in Kamtchatka. The diseases caused by fungi are legion; rust, smut, blight, and mildew are diseases of grain. The disease called ergot, which attacks rye and other grasses, is produced by a fungus; this substance is used in medicine, and is very valuable in stopping bleeding when taken internally. Bread made from grain containing this substance, when eaten for some time, produces mortification of the legs and arms.

Some fungi are produced on living animals; certain warts in the West Indies are affected by a disease allied to muscardine, which affects the silkworm. Many skin diseases in man owe their origin to fungi, thus: the *Tinea tonsurans* produces ring-worm, the *Achorion Schonleinii* is the cause of favus, or the honeycomb ring-worm, and the thrush, or vesicular stomatitis, is caused by the *Oidium albicans*.

The rapidity with which fungi grow is sometimes very remarkable. The *Bovista gigantea* in a single night has increased from the size of a pea to a melon. The force with which they expand has been shown by their raising pavements under which they had been developed.

Lastly we come to the curious fungi, first of which we will take the *Clathrus cancellatus*, a network of trellised coral very beautiful to look upon, but, alas! very poisonous. The cedar apple is found in America, and is often mistaken for the "fruit" of the cedar-tree by many. The bird nest and cave fungus of Pennsylvania are worthy of attention.

---

#### GOSSIP ON CURRENT TOPICS.

By W. MATTIEU WILLIAMS, F.R.A.S., F.C.S.

**A** LONG SURVIVING FALLACY.—We are told by "The Farming World," that an English experimenter finds that, contrary to general opinion, the growth of ivy over a house renders the interior entirely free from moisture; the ivy extracts every possible particle of moisture from wood, brick, or stone for its own sustenance, by means of the tiny roots which work their way even into the hardest stone.

Of course it does! For my own part, I am heartily ashamed of requiring to be told of so obvious a fact, and hope that every reader of SCIENCE-GOSSIP who has not already reasoned it out for himself will be equally penitent. Every leaf of every plant that grows is largely composed of water, and every such leaf is continually exhaling gaseous water, and this water is supplied by rootlet absorption. The ivy differs from ordinary plants in having rootlets on every stem, thus rendering it almost independent of its main ground root. Its notorious killing action upon growing trees when it takes full possession of

them is mainly due to absorption of their juices. If there is any juice in a stone or brick wall, i.e., any moisture, the ivy must have it. Besides this, the ivy directly protects the wall from the wetting action of rain-drift.

**FROZEN MILK.**—The poor milkman has of late been very severely handled. While the dry weather of the Jubilee summer has diminished his normal cow supplies, the vigilance of inspectors has deprived him of his compensatory pump supplies. Science has seriously interfered with commercial enterprise, by supplying means for the detection of the latter. Therefore it is only fair that science should give him a little help now and then. It has done so lately. Messrs. Kaiser, Schmeider, and Henzold, have studied the changes which occur in the freezing and thawing of milk, and have shown how the honest milkman may unwittingly rob himself by supplying some of his customers with unnaturally rich milk, and then be unjustly prosecuted and fined for diluting the remainder.

The above-named experimenters found that when milk is slowly and partially frozen, the ice takes up the greater part of the cream, the unfrozen remainder contains the casein, milk, sugar and salts, but in consequence of its loss of cream appears like diluted milk, and would be described as such if merely tested by the ordinary lactometric instruments. Milk which has been frozen should therefore be well thawed and shaken up, and not sold whilst any ice is visible.

**THE FROST OF 7TH JULY IN BELGIUM.**—"Ciel et Terre" has a long article on this subject, including reports from nearly all parts of Belgium. Early in the morning of July 7th, a hoar frost extended over a wide area near the Eastern frontier, including the following places, where *covered* thermometers indicated the following minima of temperature, Centigrade.

Bourg Léopold . . . . .	deg.	Lamorteau . . . . .	deg.
Maeseyck . . . . .	3·7	Arlon . . . . .	2·8
Verviers . . . . .	4·8	Carlsbourg . . . . .	4·8
Spa . . . . .	2·8	Bastogne . . . . .	1·6
Jalhay . . . . .	0·7	Vielsalm . . . . .	-1·5
Baraque-Michel . . . . .	1·6		
	2·0		

The temperature of the ground exposed freely to radiation was of course much below that of a covered thermometer in every instance, as the frost was one of those due to excessive radiation. The latitudes of Bastogne and Vielsalm where the shattered thermometer fell  $1\frac{1}{2}^{\circ}$  Centigrade below freezing are respectively  $50^{\circ}$  and  $50^{\circ} 20'$  N. latitude, the first corresponding to the southernmost extremity of England, the second to twenty miles farther south. At both places the potato fields were "completely black," and the young shoots of firs, laurels, dahlias, begonias,

haricots, &c., were frozen. Similar accounts were forwarded from other localities to the National Institute of Geography, Brussels.

**HAIL ON THE CONGO.**—Something still more exceptional than the Belgian frost is recorded in the "Mouvement Géographique" of 27th March. It occurred at "Loulouanbourg" in the country of "Babouba" (query "Balonda," of Livingstone), on the 13th August 1886. At about 10.30 A.M. the wind turned to the east, and at midday a great storm arose. At about 1.55 P.M. a fall of transparent hailstones, of more than two centimetres (three-quarters of an inch) in length, and half as much in breadth, occurred and continued for ten minutes. The lumps of clear ice were more or less rectangular in shape. A heavy rain followed, and the thermometer fell from  $34^{\circ}$  to  $19^{\circ}$  Cent. (from  $109^{\circ}$  to  $66^{\circ}$  Fahr.). The natives were terrified, and declared that they had never seen the like before.

About six or seven years ago a Russian philosopher, M. Schwedoff, stated many and very cogent reasons for supposing that hailstones are cosmical meteors, that they come to the earth from outside our atmosphere. At the meeting of the British Association of 1882, Sir William Thomson ridiculed this hypothesis in a very flippant and very foolish fashion. He described it as a "manifest absurdity," on grounds that are curiously superficial and fallacious. He (Sir W. Thomson) showed that in falling through our atmosphere with planetary velocity a lump of ice performs 13,000 times as much work as would raise an equal weight of water one degree centigrade, and therefore, he asserts the ice would be melted, volatilised, and dissociated into its component gases. The first part of this statement may be correct. In deference to Sir W. Thomson's mathematics, I will assume that it is, but when we reflect on the second, it is evident to anybody acquainted with the rudiments of the laws of heat that the "manifest absurdity" is Thomson's, not Schwedoff's.

Everybody knows that masses of iron do fall to the earth as Schwedoff supposes the ice to fall, and the iron must in thus falling through our atmosphere perform just as much work as the ice would. But the heat calculated by Sir W. Thompson as the result of this work is vastly more than sufficient to fuse and volatilise the iron. How then can the iron reach the earth in a solid state? The answer to this is simple enough. The work in question is done in so short a time that the heat, which is all generated *superficially*, has not time to pass through the iron, and thus, as we know, the iron hailstones are fused only on their surface. If this occurs with iron which is a good conductor of heat, what must happen to ice which is almost a non-conductor? Clearly nothing more than purely superficial fusion, evaporation and dissociation. Anybody may prove this by throwing



a lump of ice into a fierce fire and watching the slow progress of its fusion and evaporation. This simple experiment is quite sufficient to demonstrate "the manifest absurdity" of asserting that a fair-sized hailstone could be fused, volatilised and dissociated during the small fraction of a second which would be occupied in its passing through our atmosphere "with planetary velocity." The heat generated on its surface could not penetrate with thawing effect to a depth of as much as  $\frac{1}{100}$  of an inch.

The tropical hailstones above described are directly and fully accounted for by Schwedoff's theory, but require an extravagant strain of possibilities to reconcile them with the text-book theories. Sir W. Thomson writes admirably, but speaks as rashly as an Irish M.P.

**FULGURITES.**—At various times mysterious glass-like tubes have been found in the earth, penetrating to considerable depths in sandy soils. The earliest account of them is by David Hermann, who describes in his book on the curiosities of Massel (a town in Silesia) some tubes 20 feet long that he found on a hill near the town. Their origin remained a mystery until 1790, when a man took refuge under a tree at Aylesford during a storm and was killed by the lightning which travelled along his body and a stick he held in his hand, and then penetrated the soil beneath, making a hole, in the lower part of which the grains of sand were fused at their angles. This was observed and described by Withering, who attributed the appearances presented to fusion by the electric discharge, or "the electric fluid," as it was called in those days. Abundant descriptions have followed; some tubes having a length of more than 30 feet have been disinterred, the substance of their walls being hard enough to scratch glass. Such tubes were found in Cumberland and in Macclesfield; the latter described by Darwin, which after running in a nearly straight line about 23 feet, divided into several branches similar to forked lightning, or as Hermann says, like the branches of a tree.

These fulgurites are usually found in sandy deposits, and Darwin suggests this may not arise from any preference of the lightning for such ground, but from the fact that in such localities the tubes are more easily discovered. Something further may, I think, be added to this, viz. that dryness and consequent bad conduction is necessary.

If the lightning strikes humid soil, it will be diffused in all directions by conduction. In order that it shall continue as a disruptive discharge, it must in the earth, as in the air, have no side conduction outlets. If such tubes were formed in ordinary agricultural soils containing much humus, (which is a fairly good conductor) they would be abundantly discovered in the course of agricultural operations.

**THE PHILOSOPHY OF PRUNING VINES, &C.**—H. Mueller has investigated that subject lately. He finds that the proper time for pruning vines, &c., is while the fruit is ripening, and that the pruning should be directed against the young shoots. The reason for this is that the young shoots require a large quantity of sugar for their development and for their respiration. In the course of my pedestrian excursions through France, and other vine-growing countries, I have observed the merciless pruning just at the most vigorous growing periods, and compared it with the common practice of our gardeners of pruning fruit trees before the leaves are formed; cutting away the leaf buds and leaving the blossom buds.

Looking at the subject theoretically, it appears desirable to allow the leaves to perform their functions towards the nutrition of the whole tree up to a certain stage, while the fruit is forming, and then to cut them away, as the vigneron does, when they rob the ripening fruit of its sugar. There may, however, be practical grounds for the difference of practice which some of the readers of SCIENCE-GOSSIP are able to explain.

**THE INFLUENCE OF FOREST TREES ON CLIMATE.**—In the current volume of "Ciel et Terre," page 149, is an interesting article on this subject, in which it states the particulars of observations at various stations, within and outside of forests, the distances outside varying from 250 to 400 metres. The general results indicate that during the day, the air of a forest is in all cases cooler, and during the night warmer, than that of the open country. The difference is greater in the day than at night, *i.e.* the refrigerating action of the forest dominates; the mean temperature of day and night taken together is lower. The difference is greater in pine woods than in beech woods. This is attributed to the greater protection afforded by the former during winter in resisting radiation from the soil. The mean difference in the temperature of the air shows a variation from  $0.9^{\circ}$  to  $1.3^{\circ}$  Centigrade during the day, and from  $0.6^{\circ}$  to  $0.9^{\circ}$  at night. The difference of temperature of the soil at a depth of two feet was  $3.4^{\circ}$  Cent. cooler in summer and  $0.3^{\circ}$  warmer in winter. These are mean differences. The difference is of course much greater at the extremes of day and night temperature; the forest is much cooler at the hottest hours of the hottest days, and much warmer at the coldest hours of the coldest nights.

MR. B. G. JENKINS, F.R.A.S., has published an admirable London Weather-chart for 1887, based upon his paper entitled "Forecasting the Weather." It is a forecast of the movements of the barometer and thermometer in London from June to December of the present year.

## NATURAL HISTORY JOTTINGS.

## ON WASPS, CHIEFLY.

*(Continued from p. 42, vol. xxi., 1885.)*

**AUGUST 30th, 1883.**—In the bright sunshine this afternoon, a wasp was observed flying about over some patches of cow dung, and occasionally alighting thereon, obviously on the look out for prey. After hawking about and over the dung for some time (during which I frequently saw flies dart out of its way), it eventually pounced upon one of the large orange-yellow dung-flies that are almost invariably found at such substances, seized it with its powerful mandibles, and, after some manipulation, flew off with its prey without biting off the wings, as I have on a former occasion observed the wasp do.

**September 1st.**—To-day I saw four workers of the *Vespa vulgaris* feeding on the carcass of a young pied wagtail that lay on the top of a low dyke. The breast of the bird had been denuded of its feathers, and also of most of the flesh, leaving the bones of the breast and abdomen nearly bare, and exposed. Some of the wasps were fully three-parts concealed within the carcass, and were very actively biting off portions of the flesh from the interior of it, which they, sometimes at least, bore away. Later in the day, on again looking at the dead bird, which lay upon its back, I observed the tip of the abdomen of one wasp projecting from beneath the head, and on turning over the carcass, it was found that a hole had been eaten out in the back of the skull, and that the wasp was feeding on the semi-liquid contents therein.

**September 10th.**—A strong nest of the *Vespa vulgaris* was, to-day, observed to be dying out. There were only a few of the workers flying in and out, and on pulling out the large stone in the face of the dyke behind which the nest had been built, many more were discovered lying dead. Though there were plenty of workers still within and about the nest, living, the majority of them were comparatively sluggish. There were also many males, or drones, in the nest living, some of which had not been long out of the cells; but only one large perfect female, or queen, was found, and she was evidently the old queen, the foundress and mother of the colony. There were six tiers, or platforms, of comb, and in both of the two lowermost there were male nymphs in the cells, still living, though other of the cells contained larvæ and nymphs that were dead and being preyed upon by a dirty-white dipterous (?) larva, which was present in great force. The nest was only five inches in diameter vertically, and six inches horizontally, while the diameter from front to back was much less, as about one-third of the front, in section, had been omitted, the face of the remaining larger section having been brought close up to the back of the large stone lying in front of the nest. This portion of the nest was imperfect, the upper

tiers of comb being clearly distinguishable when the stone was removed, having only been partially covered in with the paper walls, which, as usual, consisted of small convex brittle pieces of wasp-paper, composed of comparatively coarse fragments of rotten wood. Between the nest and the cavity in which it had been built, there was all around a space only large enough to admit of the wasps creeping in and around. The two uppermost tiers of comb had become mouldy. Obviously this nest had been a failure, through a non-development of the perfect females, or queens.

**September 14th.**—To-day numbers of male wasps sat at the entrance to a nest of the *Vespa vulgaris*, within a large cavity caused by the removal, on a former occasion, while attempting to take this nest, of some stones in the face of the dyke in which the nest is built. Several of these were captured, and others took flight on being disturbed.

**September 17th.**—Was again at this nest in the early forenoon, the sun at that time being unclouded and hot, and found the males still swarming about the mouth of it, within the cavity, as well as a few strong on the wing and active workers flying about it, though not so many as on the 14th inst. There were also many of the worker-wasps lying dead within the cavity, as well as a few of the males or drones; but there were present none of the large perfect females or queens, either living or dead. On pulling out another large lower facing-stone, the very large nest was revealed, and was found to contain nine tiers or platforms of comb, a few of the males that had evidently crept back into it during the disturbance to which it had been subjected, and a few dead workers, but not a single queen. There were, however, hosts of empty nymphs, out of which had been devoured the viscera and other organic structures, leaving only the empty skin or integuments; there were thus treated both males and workers, many of which had partially cut through the tough silken cap or covering of their cell, ere succumbing to their fate. Many nymphs there were, too, within whose bodies was located in numbers the small dirty-white dipterous (?) larva observed on Sept. 10th, preying upon the larvæ and nymphs of the nest described under that date; and the question naturally arose whether this larva had been the cause of death in both these instances, or whether death was due to other agencies, and it had since appeared upon the scene, as many other dipterous larvæ do. The nest was of the usual shelled and brittle character, and was attached all around the cavity to fibrous roots and stones, and one of its tiers of comb was in two nearly equal halves or segments, having thus been built up. To all appearance this nest has been a failure, as well as the one taken on Sept. 10th; and both probably from the same cause, namely, the non-development of the large perfect females, or queens; the fact of the males, or drones, lingering so long about the nest favours the idea of a

non-appearance of the queens, since the weather was sunny and hot, and consequently favourable to insect flight. Over ninety males were taken at the nest, and many took flight as I was picking them out of the large cavity at the entrance to the nest. Moreover, others would probably have taken flight during the two intervening days.

*September 17th.*—This evening, in a garden, I saw ripe gooseberries, hanging on different bushes, clothed with wasps, which were eating them out from beneath, some being within the fruits. As many as six and even eight wasps clung to a single gooseberry; and to have gathered the fruit without being stung would have been a somewhat difficult task, such were the numbers of the wasps and the fruits attacked.

*September 19th.*—A very large and strong nest of the *Vespa vulgaris* was to-day in part broken up, and from it many of the large perfect females, or queens, were observed to take flight, flying off in a direct line though heavily, and with a humming deep and peculiar. Worker-wasps carried away from it fragments of the broken-up case or shell; this I have also observed them do on other occasions when a nest has been partially destroyed. From such nests, too, I have observed the workers carrying away dying or dead larvæ, which had probably been dislodged from the cells and injured in the breaking up of the nest.

*September 22nd.*—To-day another strong nest of the *Vespa vulgaris* was dug out of a dyke. There were in it numbers of the perfect females, many males, and plenty of workers, the latter as vicious and aggressive as ever, notwithstanding that their active industry had slackened, and that the colony was obviously nearing its close. On the nest being partially broken up, the perfect females, or queens, rose up out of it and the cavity, and flew off heavily, with a direct flight, and with the deep and peculiar humming sound already mentioned, which differs very perceptibly from the sound emitted by the males or drones, and the workers.

Last year (1882), at Haddington and Gifford, in Scotland, wasps were very numerous during the month of July. Along the side of the river Tyne, a little below the Wauk-Mili, at the former place, numbers were to be seen any sunny morning busily engaged biting off the wood fibres with which they form their paper, from palings and posts, as well as from tree-trunks and stumps from which the bark had been peeled. Also, by the side of a curling-pond, the door and its lintels of the little house in which was kept the curling-gear had scarcely a square inch that was free from the narrow shallow channels due to this agency, and which were seldom free from wasps making up their little pellets of fibres. At the latter place, I had presented to me a beautiful nest of the *Vespa vulgaris* which had been built in a beehive, upon which, as a stand, a hive of bees had been set. After swarming, this hive was joined to another to strengthen it, and the box placed upon

a board upon which were burning rags, to suffocate the unwelcome intruders. It was then found that the wasps' nest had been suspended from the top of the box, having been built around two of the three square wooden bars with which the interior of it was furnished for the bees to suspend their combs from. In this position it was when I first saw it, having been allowed to remain *in situ*. The portion of the two bars that was enclosed in the nest-structure was very much gnawed away, for, probably, material for nest-building. There were five or six tiers of comb in the nest; and the cells were beautifully regular and hexagonal, notwithstanding that they, like the shell or case, were formed of fragments of rotten wood, and were brittle and friable. The lady who kindly gave me this nest, told me that on a former occasion, in this same garden, a colony of wasps had established themselves in an empty barrel, the only medium of entrance and exit being the bung-hole! Also, that wasps are exceedingly fond of fresh herrings, frequently swarming upon those hung up on the outside of cottages to dry.

With further reference to the food of wasps, I may mention that I have seen the queens at the male catkins of the willow, at the flowers of the butterbur (*Petasites*), the gooseberry, and those of a cultivated white saxifrage, in the month of May; and, in June, at the flowers of the rhododendrons. In August, I have taken the male wasp, or drone, at the flowers of the figwort (*Scrophularia*); and, in September, at those of a thistle. In summer, while standing by the nest of the common wasp (*V. vulgaris*), I have seen workers carry in large tipulæ, minus head, limbs and wings; and a spider, minus all its limbs. On April 11th, 1883, however, the conduct of a large and handsome queen wasp puzzled me completely: she was flying about the unexpanded buds of the hawthorn in a hedgerow, alighting and mouthing over them; and on examining a few buds in the vicinity of her operations, I found a drop of pellucid liquor standing on two or three of them. Whence had this drop come? Was this what the wasp was in search of? She alighted and mouthed over several within a small space and a short time; and these buds were not at the bottom of the hedge; nor was she searching for a nest-site. Had she wounded the buds with her mandibles, and caused the liquor to flow for the purpose of obtaining it as aliment? Or, was it an extravasation of the juices of the plant,—a sort of spring honey-dew—of which the wasp took advantage? The weather for several days previous had been peculiar—fine, mild, and growing on the whole, but the air cool and frequently murky, the wind being easterly and north-easterly; the birds sang on all sides and above, and the atmosphere was full of insect life.

In the summer of 1885, I again pried into the habits and domestic economy of the four species of wasps—*Vespa sylvestris*, *rufa*, *Germanica*, and



*vulgaris*—already noticed in my “Jottings,” gaining considerable additional insight into their ways and means; and, moreover, made, or rather renewed (after an interval of seventeen years), an acquaintance with the *Vespa Britannica*, of whose nests I saw five, three of these being original nests, and two secondary nests, as Ormerod\* styles them; that is, nests built on or near to the site of the first or original nests which had been destroyed. Of the three original nests, one, taken on July 27th, was a large and mature nest, containing four tiers or platforms of comb, being very strong in active and aggressive workers, and containing many virgin queens (as well as the mother-queen or foundress), and males or drones in abundance. Of the queens I secured twenty-five, and of the drones no fewer than 110, whilst many others of both sexes made good their escape. This nest was built amongst some dead thorns and a dead gooseberry bush, put into a gap in the hedge at a neglected corner of a fruit-garden; and was built around the stems and branches of two of the dead bushes, at an elevation of little more than a foot from the ground. It was densely surrounded by a rank undergrowth of stinging nettles, tall grasses, and young bines of the raspberry, which had to be cut down to get at the nest, whose entrance was in the bottom a little to one side, small (about one-half inch diameter) and circular. Owing to its position and attachment, the nest was an irregular one; and the three uppermost tiers of comb were far from being circular, but the fourth, lowest and smallest one was nearly circular; and the uppermost tier was 4 inches diameter; the second and third tiers were each about 5½ inches diameter; whilst the fourth and last was 3¼ inches diameter. In the lowest tier, the central cells were sealed for the first time, the circumferential ones containing larvæ and ova. In many instances two or even more ova occupied vacated cells in all the three uppermost tiers of comb; and two larvæ not infrequently occupied the same cell, and were sometimes of considerable size. The ova are oblong, a little curving, and milk-white in colour; and they are affixed by the more remote, pointed end in an angle of the hexagonal cell, standing out therefrom at an acute angle into the cell, which is vertical with the mouth downwards. The larvæ are soiled-white in colour, and their mandibles are mostly directed towards the centre of the tier of comb. The paper of the shell or case, as in the species *Vespa sylvestris* and *V. rufa*, is laid on in numerous large continuous sheets; but is here more variegated with drabs, slate-greys, grey-greens, and olive-greens.

CHARLES ROBSON.

*Elswick, Newcastle-upon-Tyne.*

(To be continued.)

## NOTES ON THE FLORA OF THE NORTH DOWNS.

ABOUT three miles from Maidstone, and stretching round from east and north to west, are these beautiful hills; a long line of brown and dark blue and green hillside, rising in some places to more than 700 feet, and reaching out to the misty distance ten or twelve miles on either side of the town.

At intervals along the steep southern slope facing Maidstone, there are chalk pits, some old and disused, and others which are worked now; and in springtime with the sun shining on them, amidst the delicate pale green larches and the dark, almost black masses of yews, they are very beautiful, standing out bright and white. From a little distance, the general tone in the colour of the hills is a soft brown and sometimes misty blue, and the outline delicately rounded. In clear weather, with an east wind blowing, the great waste spaces are bare and distinct; the trees on the summit with hard clear outlines, and the clumps of yews dark and solemn.

But to thoroughly appreciate the beauties of the North Downs, one must go up to the hillside, climb the steep chalky banks, and wander about the open wastes and the great chalk pits, where there are hosts of plants and many other objects of natural history to be found.

The following is a list of the more important of the chalk plants in this district.

*Helleborus fatidus*, *Aquilegia vulgaris*. (The columbine grows in several localities on the hills; those I have found were large and handsome flowers, white and blue.)

*Papaver somniferum*. (In the flinty cornfields at the foot of the downs, plentiful.)

*Reseda lutea*, *R. luteola*, *Helianthemum vulgare*, *Malva moschata*, *Rhamnus catharticus*, *Anthyllis vulneraria*, *Hippocrepis comosa*, *Ononis arvensis*, *Spiraea filipendula*, *Poterium sanguisorba*, *Rosa rubiginosa*, *R. spinosissima*. (The last two grow on the open hillside.)

*Pyrus aria*. (The beautiful white beam is a very striking object on the North Downs here, with its dark green leaves, showing their silvery white underside when the wind blows up the hills.)

*Silva pratensis*, *Viburnum lantana* (the wayfaring tree grows in all the hedges and copses of the hillside). *Asperula cynanchica*, *Carlina vulgaris*, *Carduus tenuifolius*, *Cnicus acaulis*, *Centaurea scabiosa*, *Senecio crucifolius*. (The latter is more common on the chalk than *S. Jacobæa*, in some localities.)

*Cichorium Intybus*, *Inula conyza*, *Campanula glomerata*, *Chlora perfoliata* (the yellow-wort, the two mignonettes, the rock-rose, viper's bugloss, yellow toadflax, and marjoram, are abundant in the old chalk pits, and on the banks by the rough chalky footpaths.)

*Gentiana amarella*, *G. campestris*, *Lithospermum*

\* “British Social Wasps,” 1868.

*officinale*, *L. arvense*, *Atropa belladonna*. (The deadly nightshade grows in clumps of bushes and small trees in many places on the hillside, also the henbane (*Hyoscyamus niger*).

*Linaria spuria*, *L. Elatine*, and *L. minor*, in the cornfields at the foot of the hills.

*Verbascum Lychnitis*. (I have seen the white mullein in one or two localities in this district.)

*Bartsia odontites*, *Verbena officinalis*, *Nepeta cataria*. (I know of two localities for the latter plant.) *Calamintha Acinos*, *Galeopsis ladanum* and *Ajuga chamapitys* are plentiful in some of the hillside cornfields.) *Cynoglossum officinale*, *Daphne laureola*.

*Buxus sempervirens*, in the woods at Boxley.

*Taxus baccata*. (The yew is one of the chief trees of the North Downs.)

*Juniperus communis*. (Common, but generally small shrubs.)

Seventeen or eighteen of the orchids are found in this district; the following are more frequent on the chalk.

*Aceras anthropophora* (plentiful in some localities).

*Orchis pyramidalis*, *O. ustulata*, *O. militaris*. (The last two very local. I remember, a few years ago, one wet summer's day stepping into a wood, on the northern slope of these hills, with a thick undergrowth of beech, and stooping and looking under the dripping boughs I first saw the handsome purple and white spikes of the military orchis.) *O. fusca* also is found here, I believe. *Hermidium monorchis*, *Gymnadenia conopsea*, *Ophrys apifera*, *O. muscifera*, *O. aranifera* (the last is plentiful in one locality, it is the variety *Fucifera*).

*Epipactis latifolia*, *Cephalanthera grandiflora*, and *Iris fetidissima* grow in the shady woods on the hillside, the purple iris in abundance in some places.

Many other interesting plants are found here, but those I have mentioned are the most important in the flora of the North Downs.

HENRY LAMB.

*Lime Villas, Bower Street, Maidstone.*

## SCIENCE-GOSSIP.

It is intended to form, some time during the present autumn, an entomological society in Birmingham. All who wish to join should apply to W. Harcourt Bath, hon. sec. (*pro tem.*), Ladywood, Birmingham.

THE following has been recommended as a capital method of clarifying muddy water. Filter paper is dipped into a solution of 43 per cent. ferric chloride in 57 per cent. of water, and after thorough saturation is dried between filter paper. In the same way a second piece of filter paper is treated in a saturated solution of bicarbonate of soda. Now, if a piece of the yellow paper that has been treated with ferric

chloride is first placed in muddy turbid water, the fluid is coloured yellow by the iron salt. Next, into the same water, a piece of the same size of the bicarbonate of soda paper is dropped, turning the yellow-coloured water into brown. Thus a ferric carbonate is formed, which absorbs all impurities. The water thus treated can be filtered through a funnel whose neck is filled with a piece of sponge. It will be as clear as crystal, and can be used as drinking-water. For 1 litre (1 quart) of water about 15 square cent. (23.10 in.) of each kind of paper is sufficient. A piece of sponge, weighing 5 grammes (1.6 oz.), filtered 1 litre in 3 minutes.

WE are sorry that the publication of Mr. W. Barwell Turner's projected "Monograph of the Desmidiaceae" has been postponed, owing to ill-health. It will be postponed, so that certain valuable memoirs, now in progress, can be incorporated.

THROUGH the energy and enthusiasm chiefly of an old and valued contributor, Mr. W. J. Simmons, a microscopical society has just been started in Calcutta. We wish it genuine success. The President is Dr. Simpson, and the hon. sec. Mr. W. J. Simmons.

"THE GARNER" is publishing lists of the Birds of Harrogate and the District, by Mr. Riley Fortune.

THE Annual Report and Proceedings of the Liverpool Science Students' Association has just been issued. It contains excellent summaries of the papers read, and of the excursions made by the members.

"INDUSTRIES" states that Herr Ottomar Anschütz, a German photographer, of Lissa, "has succeeded in preparing plates so sensitive that an exposure of one five-thousandth of a second is sufficient. The experiments connected with these improvements were begun in 1882, and were carried out by Herr Anschütz with a large number of animals kept in a small zoological garden attached to his photographic establishment. He began by photographing troops whilst performing evolutions, and large masses of people assembled on occasions of historic importance, progressing then to the photography of animals, such as pigeons, storks, horses, wolves, and stags. In all, 1300 of these photographs have been taken by him up to the present. The rapidity with which the pictures must be taken necessitates the employment of a small lens, and hence the photographs are very small, generally only seven-sixteenths of an inch in length and breadth. These are enlarged to 1½ inch and transferred to thin glass plates. The twenty-four transparent pictures thus obtained are mounted upon an iron disc containing twenty-four windows near its circumference for their reception, and this disc is rapidly revolved before a Geissler tube bent into a spiral. Four Bunsen elements and a large induction coil supply

the necessary high tension current to render the tube luminous. Between the disc and the Geissler tube is placed a ground glass shade, in order to tone down the light, and the beam is thrown through an aperture upon a large screen, so as to render the picture of the object photographed on the glass plates visible to a large audience. The disc is revolved at a speed corresponding to that during which the twenty-four photographs were taken."

Two French aeronauts have ascended to the height of between 21,000 and 22,000 feet, or about a mile less than Glaisher and Coxwell attained twenty years ago.

## MICROSCOPY.

UNUSUAL ABUNDANCE OF VOLVOX GLOBATOR.—This interesting but erratic microscopic organism has been lately unusually abundant in the ship canal which connects Exeter with the sea. On two occasions during the present month (July) I found the water literally teeming with them, while doing a little micro fishing, so much so that I was positively unable to dip a bottle of water that did not contain hundreds. My fishing-ground was close to the Topsham ferry, and the lock-keeper, residing close by, was sufficiently interested in my proceedings to stroll up and civilly offer me any assistance in his power. He had previously noticed what he called the "insect" in the water, and had instructed his children not to drink it. His astonishment at the actual nature of the "insect," which I explained to him briefly, and showed him through my pocket lens, may be imagined. I presume the tropical heat of the past month has been the primary cause of the excessive multiplication which, I take it, is quite unusual.—*F. R. Brokenshire.*

ROYAL MICROSCOPICAL SOCIETY.—The August number of the journal of the above society, besides the usual comprehensive "Summary of Current Researches," contains the following papers:—"On the different tissues found in the Muscles of a Mummy," by Dr. R. L. Maddox; "Remarks on the Foraminifera, with especial reference to their variety and form," by Prof. Rupert Jones and C. D. Sherborn; and "On New Species of Scyphidea and Dinophysis," by J. G. Greenfell.

THE QUEKETT CLUB.—The August number of the journal of this flourishing society contains the following papers:—"On the Calcareo," by B. W. Priest; "On Mounting Media for Diatoms," by H. Morland; "On the Structure of the Head of the Blowfly," by B. T. Lowne; "On Diatom Structure," by T. F. Smith; &c.

## ZOOLOGY.

MUNCHAUSEN SCIENCE.—The writer of the note under the above heading (p. 184 of your August number) does not seem to be aware that the description of *Nemertes borlasei*, which he so condemns, is in the main an extract from "Glaucus" (pages 137-8 of the collected edition), and that Kingsley has himself answered his critics in a footnote which I think is worth quoting: "Certain Parisian zoologists have done me the honour to hint that this description was a play of fancy. I can only answer, that I saw it with my own eyes in my own aquarium. I am not, I hope, in the habit of drawing on my fancy in the presence of infinitely more marvellous Nature. Truth is quite strange enough to be interesting without lies." In Plate viii. will be found a figure showing *Nemertes* in the act of swallowing a *Terebella*.—*G. E. D.*

PUPA RINGENS.—I wish to chronicle what I believe to be an entirely new locality for *Pupa ringens*, Jeff. The locality is on the cliffs about four miles to the east of Amlwch in Anglesea, in a small ravine amongst moss and dead leaves. Dr. Jeffreys does not seem to know of its occurrence in Wales at all: whether any record has been made since his publication I am unaware, and should be glad to be set right on the point. On the whole this district is poor in land shells. I may mention the occurrence of *Conulus fulvus*, Mull., *Hylina pura*, Alder., *Clausilia rugosa* var. *tumidula*, Jeff., and *Balea perversa*, L. (rare). I took a specimen of the Carabid beetle *Cychorus rostratus* under a stone.—*B. Tomlin.*

THE HESSIAN FLY.—May I ask you to allow me, through the medium of SCIENCE-GOSSIP, to enquire how long the Hessian fly (*Cecidomyia destructor*) has been known to entomologists as a British insect? I am aware that I am rather late in sending a communication for the September number, but I think the importance of the subject may be a sufficient excuse for asking you to relax your rule. The Hessian fly is this year to be found in very many parishes in Beds, and my reason for asking how long it has been a British insect is that a theory is afloat that its introduction was brought about, so far as England is concerned, by the importation of German moss litter. Now it is certain that a considerable quantity of moss litter was four or five years ago used by the vicar of this parish, who, in addition to three horses, kept a herd of Guernsey cows, so that if moss litter is culpable, the presence of Hessian fly is accounted for on my farm. But a well-known Bedfordshire farmer to-day told me in Bedford market that he well remembers the "flax and pupæ," thirty years ago. If Hessian fly was known as a British insect thirty years ago, the moss litter theory falls to the ground, and we farmers may hope still to grow wheat in spite



of Hessian fly, as the crop of wheat grown in 1868 was one of the best grown in this century. I may say there is no doubt as to the Hessian fly being found by me, as pupæ sent by me to Mr. Gray, M.P., were said to be undoubtedly Hessian fly pupæ by him. The question is, Is the Hessian fly a new importation, or has it been very often overlooked by farmers and so-called farmer's friends; in short, is the Hessian fly as great an impostor as the Colorado beetle was?—*J. C., Ridgmont, Beds.*

## BOTANY.

BRITISH PLANTS IN AMERICA.—Travelling from New York to Denver, Colorado, I have kept a good look-out for all sorts of mollusca, insects, and plants on the way, and have been much struck by the extreme abundance in some places of our familiar British plants. For instance: *Chrysanthemum leucanthemum* grows profusely along part of the railway-track near New York; *Malva rotundifolia* is one of the commonest weeds at Niagara Falls; *Brassica Sinapis*, *Anthemis Cotula* and *Chenopodium album* are abundant at Chariton, Iowa, and *Setaria viridis* was found at McCook, Nebraska. The familiar sunflower (*Helianthus annuus*) is quite a feature of the scenery in parts of Nebraska and Colorado. One of the most curious native plants found is *Solanum rostratum*, Dunal, occurring from Oxford, Nebraska, to near Pinneo, Colorado; it is a yellow-flowered, handsome plant, with innumerable sharp prickles.—*T. D. A. Cockerell, Denver, Colo., U.S.A.*

NOTE ON HILDENBRANDTIA.—Your notice of this is of great interest, as *H. rivularis* (Lieben.) Agdh., is certainly a rarity. Your correspondent, however, is in error when he speaks of it as a new British record—as it is previously mentioned as English by Kützing, "Spec. Alg." p. 695, 1849, under his marine species *H. rosea*, of which he makes it var. *β. fluviatilis*. Again, as *H. fluviatilis*, Bréb., it is mentioned by H. I. Carter, "Journ. Bot.," Aug. 1864, pp. 225-228 tab. 20. Carter, in his capital little memoir, gives an English locality. As the only fresh-water species in the genus, it seems to have been overlooked by Dr. Cooke in his "Freshwater Algæ." The Alga was originally described by Liebmann as *Erythroclathrus rivularis*.—*W. Barwell Turner.*

CROCUSES BLOOMING UNDERGROUND.—The seed vessel of the crocus is always underground until it develops, when it gradually rises more or less until sometimes two inches above ground. It is quite usual for crocuses to seed. It is not probable, to say the least, that J. W. D.'s crocuses bloomed underground in the sense of a perfect blossom. Were there no blossoms on the groups he mentions? Some

plants will seed although the blossoms be not perfected. I have particularly observed this with wood-sorrel in pots, which without a single fully developed blossom, has seeded freely, the young plants coming up in all the neighbouring pots. I have noticed the same thing with the wood violet. Doubtless, the blossom in both cases has been there so far as reproductive organs were concerned, but the petals were so suppressed, that no blossom—as a blossom—was noticeable. I am not aware if the crocus plays similar pranks.—*Horn.*

COHNIA ROSEO-PERSICINA.—It may be interesting to many who study the fresh-water algæ, to know that the ponds along the sides of Whipscross Road, Walthamstow, contain an abundance of *Cohnia Rosco-Persicina*. Every bottle dipped into the water, brings up a large quantity of this. They are of a rose colour, and form a very pretty contrast with the other green algæ obtained. The cells are of a roundish or oval shape, but as they grow older, they form irregular masses with a number of vesicles sprouting from them. The ponds in which they are found are covered with Lemna. Some of the larger ones reach a diameter about  $\frac{1}{20}$  of an inch. The smallest and younger ones float about in the water, whilst the older and torn ones quickly sink to the bottom. These prolific ponds also contain a good number of volvox.—*Arthur C. Wire.*

VARIETIES OF THE COMMON POPPY.—On a dry and chalky piece of waste land, just out of Ramsgate at the side of the Margate road, which at the end of June was glowing with the vermilion of the common poppy, *Papaver rhæas*, I gathered some curious varieties not noticed in the botanical book I have in use. They were as follows: Firstly, a white variety, whose flower resembled that of a well-known sport of the opium poppy grown in gardens, being white with a purple spot at the base of the petals; secondly, a pale pink variety; and thirdly, a very marked purple variety, the veining of the petals being of that colour, and the stem tinted with it; the whole plant correspondingly coarse, stout, and rank. I transplanted the parent roots to a piece of garden mould, but they seem to have, much to my chagrin, withered and dried up; the desiccated flowers which I have mounted, have quite the look of distinct species, having retained their colours. Were the sports of our wild flowers and our garden flowers run wild, made a subject of study by florists, on this plan of transplantation, doubtless many new facts concerning species manufacture would become a matter of observation.—*A. H. Swinton.*

FLORAL MALFORMATION.—I send herewith a photograph of a singular malformation in the flower of a foxglove (*Digitalis purpurea*). As you will see, the spike of flowers is surmounted by a large cup-shaped flower. When fresh, it was very beautiful, and seemed to be made up of three ordinary flowers,

there being thrice the regular number of stamens and the pistil was very much enlarged. The cup was perfect in symmetry, and measured nearly three inches across; the other parts of the plant were normal. It was gathered by J. W. Crompton very near his house in Rivington a few weeks ago.—*F. J. George, Chorley, Lancashire.*

“THE BRITISH MOSS-FLORA,” by R. Braithwaite, M.D., F.L.S., &c. (London, published by the Author.) All muscologists will be delighted to hail the appearance of the tenth part of this important work. It deals with the families Tortulacea and Weberaceæ, and is illustrated by nine plates and about eighty figures.

## GEOLOGY, &c.

CRYSTALS OF METEORIC CARBON.—In “Nature” Mr. L. Fletcher, keeper of minerals at the British Museum, gives a description of some remarkable cubic crystals which he has found in a meteoric iron from Western Australia. The crystals were about a hundred in number, and weighed altogether only one-twentieth of a grain. Notwithstanding their minuteness, it was possible to determine the hardness, streak, density, crystalline form, and chemical behaviour. The substance proves to be very similar in its general characters to the terrestrial mineral graphite or blacklead, but its crystalline form is quite distinct, and is one which is not uncommon in the diamond, the other allotropic condition of terrestrial crystallised carbon. To this new mineral species the name Cliftonite has been assigned, after Professor Clifton, of Oxford.

## NOTES AND QUERIES.

BRITISH DRAGON-FLIES.—As I am compiling notes for a monograph of these insects, I shall be very glad of any information relating to economy, habits and distribution. The loan of specimens for figuring will also be very acceptable.—*W. Harcourt Bath, Ladywood, Birmingham.*

THE NOTE OF THE CUCKOO.—I can corroborate the statement made with reference to the note of the cuckoo by your correspondent, Mr. W. E. Windus (p. 173). It is of very frequent occurrence, and may be heard regularly every season throughout June. I believe it is made by the male bird only. I noticed it many years ago and I inserted a note respecting it in the “Young Naturalist” for 1881. I believe I attributed it then to an ordinary call note.—*W. Harcourt Bath, Ladywood, Birmingham.*

CUCKOO'S NOTE.—In my note on the cuckoo in the July number of SCIENCE-GOSSIP, I described the peculiar sound I have heard emitted by the bird as “a hoarse chuckling laugh,” not “cough” as inserted.—*W. E. Windus.*

WASP-PAPER UNDER THE MICROSCOPE.—In Gilbert White's “Observations in Various Branches of Natural History,” with Notes by William Markwick, there is the following which may interest Mr. T. Moore (vide p. 116):—“Wasps make their nests with the raspings of *sound timber*; hornets, with what they gnaw from decayed; these particles of wood are kneaded up with a mixture of saliva from their bodies and moulded into combs.” The italics are mine.—*J. W. Williams.*

BEE ORCHIS.—In No. 270, p. 140, of SCIENCE-GOSSIP, W. Jeffery refers to the bee orchis, and seems surprised that the leaves should re-appear when the mowing of the lawn prevents the plant from flowering. The fact is the bee orchids are bulb-as well as seed-producing plants, and will doubtless continue for years to struggle for existence, as does the potato. I have for years removed these plants in spring from their natural ground into my own garden, but never succeeded in getting them to flower the following year. On one occasion, I had a plant in a pot which was laid by, this plant did not make its appearance the following year, but did so and flowered the next following, taking, as it seems, a year's rest. I have rarely missed finding the plant year after year, if I have left any on the ground to reappear. The flower-buds are usually four in number. In 1885 I had a magnificent plant, which produced eleven blossoms. This plant I placed in a large flower-pot, and in the spring of 1886 it came up strong and healthy-looking, but soon showed dark spots on its leaves (this I had experienced scores of times before) which soon withered away. Removing the earth, I found the bulb had been eaten away by a large white grub with a dark-brown head (wire worm?) In this spring (1887), I had another plant served in the same way, and found a similar grub but smaller and darker in colour. Can any one suggest a remedy?—*Worledge.*

BLACK CRABS.—The Jamaica papers state that the district between Bath and Port Morant is infested with black crabs in enormous numbers. They cover the main roads and fields in such quantities that the wheels of passing vehicles and the horses' feet crush them in numbers as they pass along. The oldest inhabitants in the district cannot remember such an extraordinary occurrence. It is said that even the roofs of the houses are covered with the wandering crustaceans. In many books upon travel in the West Indies it is stated that the land crab, once every year, leaves his inland home in multitudes and in regular order marches down to the sea, passing over and not around any and every obstacle that may come in the way.

CUCKOO'S NOTES.—I have seen the letters in Hardwicke's SCIENCE-GOSSIP which appeared lately on the sort of third note made by cuckoos this summer. I heard that, too, in Ireland, in the beginning of June, in co. Louth and co. Antrim, some people remarked that it sounded as if the cuckoos had a cough; but a more remarkable thing about them is that in co. Dublin, about three and a half miles from the city, they were heard cuckooing incessantly between 11 P.M. and 12.30 at midnight—they were not making the third note, but repeating “cuckoos” rapidly and clearly without a pause as long as we could listen. This was in the last week of May. I have not met any one who ever heard night-cuckooing before, and I should be glad to hear if any of your readers remarked it this, or any other, summer.—*A. C. Ward.*



RE-APPEARANCE OF PLANTS.—I think a reasonable solution to the mystery of the sudden appearance of plants enumerated in your last issue by J. E. C., may be that the species formerly grew in the locality where the foundations of the houses were dug, that by some cause buried beneath the soil, their seeds lay dormant until being exposed, on a favourable site, to light and air, they germinated. I have noticed the same occurrence on newly-made embankments and railway cuttings.—*W. E. Windus, Bexhill.*

## NOTICES TO CORRESPONDENTS.

TO CORRESPONDENTS AND EXCHANGERS.—As we now publish SCIENCE-GOSSIP earlier than formerly, we cannot undertake to insert in the following number any communications which reach us later than the 8th of the previous month.

TO ANONYMOUS QUERISTS.—We must adhere to our rule of not noticing queries which do not bear the writers' names.

TO DEALERS AND OTHERS.—We are always glad to treat dealers in natural history objects on the same fair and general ground as amateurs, in so far as the "exchanges" offered are fair exchanges. But it is evident that, when their offers are simply disguised advertisements, for the purpose of evading the cost of advertising, an advantage is taken of our *gratuitous* insertion of "exchanges" which cannot be tolerated.

We request that all exchanges may be signed with name (or initials) and full address at the end.

W. E. W.—The specimen you sent is a piece of Wealden Lignite, of much better quality than usual.

ROMAN.—The best cheap book on pond life is by Dr. M. C. Cooke, entitled "Ponds and Ditches," price 2s. 6d., published by the Christian Knowledge Society.

M. L.—Your shells are: (1) *Patella vulgata*; (2 and 3), ditto, variety; (4) *Purpura lapillus*, young specimen; (5) *Littorina rudis*.

R. B. T.—The fossils are: (1) *Spirifer glaber*; (2) *Spirifer pinguis*; (3) *Terebratula hastata*; (4) *Productus Martini*; and (5) *Productus punctata*.

W. H. KEAN.—The insect you found on the blue butterfly is undoubtedly a tick, but we have not yet ascertained the species.

XENO.—Rimmer's "British Land and Fresh Water Shells," is the best; illustrated with photos of every species. Price 10s. 6d. Published by W. H. Allen & Co.

MISS W.—No. 1 is *Helianthemum canum*; No. 2 *Geranium pratense*; No. 3, Golden Rod (*Solidago virga-aurca*).

### EXCHANGES.

WANTED, "Monographie des Libellulides d'Europe," by de Selys-Longchamps (Paris, 1840); good return made.—W. Harcourt Bath, Ladywood, Birmingham.

WANTED, any magazines containing contributions by de Selys-Longchamps, particularly the following:—"Bullet. Acad. Bruxelles," "Ann. Soc. Ent. France," "Revue Zool.," "Ann. and Mag. Nat. Hist.," "Ann. Soc. Ent. Belge."—W. Harcourt Bath, Ladywood, Birmingham.

WANTED, "Dictionnaire Géogr. de la Province de Liège," par Ph. van der Maelen; good return made.—W. Harcourt Bath, Ladywood, Birmingham.

WANTED, "British Libelluline," by Evans (London, 1845); "Entomologists' Annual for 1857;" "The Naturalist," 1837; and "Entom. Weekly Intellig.," 1856, 1857, 1858.—W. Harcourt Bath, Ladywood, Birmingham.

WANTED, "Die Fossilen Odonaten Solenhofens," by Hagen (1862); also "Stett. Ent. Zeit.," good return made.—W. Harcourt Bath, Ladywood, Birmingham.

WANTED, any odd magazines containing articles on dragonflies; good return made.—W. Harcourt Bath, Ladywood, Birmingham.

WANTED, all the works, pamphlets, and publications relating to dragonflies by de Selys-Longchamps, Hagen, and other authors.—W. Harcourt Bath, Ladywood, Birmingham.

DRAGONFLIES wanted from all parts of the world for figuring; good return made.—W. Harcourt Bath, Ladywood, Birmingham.

WANTED, common British dragonflies, fresh and unset; natural history specimens and books given in exchange.—W. Harcourt Bath, Ladywood, Birmingham.

LEPIDOPTERA (flat set), Coleoptera, collections of flowering plants and grasses, etc.; wanted, dragonflies.—W. Harcourt Bath, Ladywood, Birmingham.

FOSSIL dragonflies wanted; good return made.—W. Harcourt Bath, Ladywood, Birmingham.

WANTED, "Synonymia Libellularum Europæarum," by Hagen (1840); also "Synopsis of the Neuroptera of North America" (Hagen, 1861).—W. Harcourt Bath, Ladywood, Birmingham.

CHEMICAL apparatus, etc.: Morgan's crucible furnace; two burettes and stand; tin still and worm condenser; two copper ovens; two dozen stoppered bottles; ether and hydrofluoric acid bottles; graduated pipettes; and sundry apparatus and chemicals. Exchange for microscope with high power or microscopic apparatus.—A. B. G., Pelham Villa, Earlsam Grove, Forest Gate, Essex.

WANTED, SCIENCE-GOSSIP for Feb. 1884; will give in exchange one mounted parasite.—T. S. Morton, 3 Rosslyn Terrace, Hampstead, London.

WANTED, fresh Pollens (various), must be correctly named, a fair quantity of each preferred; will exchange well-mounted objects, botanical or otherwise, or other unmounted material.—R. Mason, 24 Park Road, Clapham, London, S.W.

FOR exchange, locality series of land and freshwater shells.—W. H. Heathcote, M.C.S., Preston, Lancashire.

WANTED, SCIENCE-GOSSIP, Nos. 129, 131, and 132, 1875.—G. R. Gude, 5 Giesbach Road, Upper Holloway, N.

"BRITISH Wild Flowers," illustrated by John E. Sowerby, and containing, with supplement, 1780 coloured figures, described, with an introduction and key to the natural orders, by C. Pierpoint Johnson, beautifully bound and in excellent condition, never having been used. Would exchange for a first-class high-power English micro-objective, or offers in other micro apparatus.—W. Mathie, 127 Buchanan Street, Glasgow.

CASSELL'S "Countries of the World," "The Sea," and "Illustrated Readings," all unbound and in excellent condition, quite equal to new. Wanted, a good 2 in. English objective, or offers requested.—W. Mathie, 127 Buchanan Street, Glasgow.

RAKE eggs of British birds, one hole, in sets or separate, for commoner kinds.—James Ellison, Stecton, Leeds.

WANTED, wings of Lepidoptera (foreign preferred), suitable for micro mounting, in exchange for other objects.—J. W. Wilshaw, 455 Shoreham Street, Sheffield.

WANTED, back numbers of the "Journal of the Quekett Microscopical Club," Series No. 2.—J. B. Bessell, 8 Elmgrove Road, Bristol.

*Pterocera lambia* and other shells; also large Madrepora, *Fungia patella*. Tropical marine shells wanted in exchange.—W. Jones, Jun., 27 Mayton Street, Holloway, London, N.

WANTED, No. 20, September 1869, of "Student and Intellectual Observer." Would give a volume or a lot of numbers of "Nature."—Canon Grainger, Broughshane, co. Antrim.

WANTED, nests and eggs of ringouzel, reedwarbler, Dartford warbler, woodlark, goldfinch, swift; also eggs of black grouse, red grouse, etc., for other good species.—Thomas Hedworth, Dunston, Gateshead.

WANTED, "Illustrations of the British Flora," by Fitch and Smith (Reeves); exchange in books or otherwise.—W. J. P., 7 Great Bees Street, Greenhays, Manchester.

FOSSIL shells from Hordwell, Barton, and Headon, offered for others from different locality, or anything scientific.—A. E. Salter, 15 Holbeck Road, North Brixton, S.W.

MICRO Specimens "Challenger" soundings, giving No., date, latitude, longitude, and depths. Six tubes of forams, injected and stained animal tissues, cut ready, botanical sections, stained ready for mounting, and a great variety of stained leaves: will exchange for a good double gun, please send maker's name.—Arthur E. Brindle, 113 Ward Street, Hulme, Manchester.

OFFERS wanted for a small collection of polished agates; also imitation precious stones cut and polished.—M., Culver Lodge, Acton Vale, W.

CAMBRIDGE Scientific Instrument Co., rocking microtome, new, what offers?—A. E. Brindle, 113 Ward Street, Hulme, Manchester.

### BOOKS, ETC., RECEIVED.

"The British Moss-Flora," Part x., by Dr. R. Braithwaite.—"Journal Royal Microscopical Society."—"Journal of Quekett Microscopical Club."—"Proceedings Liverpool Geological Society."—"Illustrations."—"Book Chat."—"The Century Magazine."—"Scribner's Monthly."—"The Amateur Photographer."—"The Naturalist."—"The Botanical Gazette."—"Journal of the New York Microscopical Society."—"Belgravia."—"The Gentleman's Magazine."—"American Monthly Microscopical Journal."—"The Essex Naturalist."—"Economic Naturalist."—"The Midland Naturalist."—"Feuille des Jeunes Naturalistes."—"The American Naturalist."—"Journal of Microscopy and Natural Science."—"Westley Naturalist."—"Ottawa Naturalist."

COMMUNICATIONS RECEIVED UP TO THE 12TH ULT. FROM: W. E. W.—G. K. G.—T. E.—A. H. S.—A. C. W.—J. W. C.—J. W. W.—W. H. H.—J. B. G.—E. D.—T. W.—A. T.—W. H. L.—W. M.—M. L.—B. L. J.—F. G.—Dr. H. G. T.—Dr. P. Q. K.—B. T.—J. S.—W. J. P.—A. B. S.—W. S. M.—J. B. E.—J. C.—A. F. H.—K. F. C.—A. E. B.—F. C. M.—A. C. W.—J. C. R.—W. H. R.





## NATURAL HISTORY NOTES IN GERMANY.

By R. B. P.



**I**S I always read with great pleasure the experiences of naturalists in the field, which from time to time appear in SCIENCE-GOSSIP, I think—for I can hardly be singular in this respect—that a few notes on natural history, which I made when in Germany last summer, may be of interest to some of your readers.

Starting one morning about the middle of June, from my quarters at Heidelberg, I crossed the new bridge over the Neckar, and taking the path along the right bank, I made my way leisurely down the river as far as Wieblingen, a village lying on the opposite bank.

Within two or three hundred yards of the bridge I observed fine groups of *Lysimachia vulgaris* and *Lythrum salicaria*, both in full flower. They were growing in a pool formed by the percolation of the water from the river through the stone bank built here for the purpose of narrowing the stream, and so giving a greater depth of water for the barges, which are constantly passing up and down. It was the typical form of *L. vulgaris*, a beautiful plant as all English botanists know; but the variety *punctata*, which I believe is peculiar to Germany, and which I met with higher up the river a few days afterwards, is, I think, even handsomer.

I also noticed, hereabouts, plants, apparently wild, of *Asparagus officinalis* and *Feniculum vulgare*, also two species of verbascum, the stately thapsus, No. 274.—OCTOBER 1887.

and the white form of blattaria; on a plant of the first I saw several full-grown larvæ of the common mullein moth.

About half a mile below the bridge the white-thorn bushes were almost denuded of their foliage by the larvæ of (I think) the gold tail moth, which almost covered these bushes, but as I saw a family of the red-backed shrike (*Lanius collurio*) feasting in their turn on the caterpillars, I think—for I often passed that way, and always saw the shrikes about—that they in time destroyed the greater part of those destructive insects.

After a time the path runs between narrow strips of meadow-land, and here I found *Ornithogalum vulgatum*, growing in profusion; here, too, I saw fresh specimens of the blue butterflies, *P. Icarus* and *P. Semiargus*, with an occasional *P. minima*, and a grizzled skipper that I took for *C. Palemon*.

Later on in the month I had a fine catch of black-veined and marbled whites (*A. crategi* and *M. galathea*) in these little meadows, and, later still, I found the eggs of the former in great abundance on both the black and white thorns close by.

Still further on, I came to the spot where, a few days before, I had secured four or five fine fresh specimens of *C. hyale*, and the hurried inquisitive flight of a whitish butterfly, which I here caught sight of, though at some distance, shewed me at once that I had not yet cleared off the whole brood on my former visit.

Whilst watching *Hyale*, I was surprised, on looking up, to see no less than five kites (*Milvus regalis*), sailing round and round above the river, with their long forked tails now extended and now closed. One of them stooped to the water, and seemed to grasp with its claws at something on, or just beneath, the surface, but I could not see that anything was lifted. I saw the same manœuvre repeated on another occasion—for I used to see this evidently family-party two or three times a week—but I could never make out what the bird's object was, in making these

stoops. Probably it had fish in view, for fish abound in the Neckar.

Seeing some fine blooms of *Iris pseudacorus* at the edge of the river, I went down to gather some, and was almost startled by the sudden rush of a wild duck from some reeds almost at my feet. It was interesting to notice the reluctant way in which she flew up the river, looking anxiously back from time to time, as if to ascertain whether I had found her young ones, which, no doubt were concealed close by, but I could neither see nor hear anything of them.

Just as the duck rose a fine stork passed over my head, at no great height, making for Wieblingen, where there was a nest of young ones, almost fully fledged. Just as the old bird reached the village a gun was fired near by, that scared him greatly, for he immediately rose in circles to a great height, turning his head from side to side, and peering anxiously down, as if trying to discover the source of the noise that had so alarmed him.

By this time it was past mid-day, and I sat down on the bank beside the path to eat my luncheon. I had hardly seated myself when I caught sight of an almost full-grown caterpillar of *Deilephila eufhorbiae*, feeding on the spurge (*E. paralias*) which grows in great abundance all along the path I had been following. As I had never before taken—though I had once before seen—this handsome caterpillar, this discovery was as pleasing as it was unexpected. I may add that a day or two afterwards, I made an excursion purposely to look for these caterpillars, with the result that I found nearly a hundred of them, in all stages of growth.

I do not know whether the difference arises from the difference in sex of the larvæ, but the fact is, that in at least ten per cent. of those I found the usual red markings were replaced by yellow ones.

Just after luncheon I came across quantities of caterpillars of *Z. minos*, and one of *H. fuciformis*, a rather common species in the neighbourhood of Heidelberg. This was feeding on Scabious (its usual food plant), but, though the plant was in abundance here, I could find no more caterpillars, its habit of hiding by day making it difficult to discover.

Before I got quite opposite Wieblingen, I came to some low-lying ground, covered in places by willow bushes, which I searched for caterpillars of *S. pavonia*, minor, as I had been told that only a day or two before they had been found there in considerable numbers by the boys from Nennenheim College.

Twenty or thirty pairs of keen young eyes had, however, done their work very thoroughly, for I failed to detect a single specimen, and the only result of my search was a small brood of fully-grown larvæ of *I. Io*, of which I took half-a-dozen, but they all turned out to have been "struck" by the ichneumon.

When I got opposite Wieblingen, I found the banks alongside the path almost denuded of herbage,

which had no doubt been cut by the peasants for their cows, and as I could not see any butterflies about, I had just made up my mind to return by the river, over the old ground, when my eye fell on a small caterpillar of *P. machaon*, which was on a little stunted plant of the common carrot, that, being on the edge of the path, had escaped the scythe.

This was a welcome find, as I wanted half-a-dozen of these for a friend. I therefore determined to see whether I could not find a few more. But it was more than an hour before I could find a second; a third, however, turned up directly afterwards, and, after another long interval, a fourth, and then a fifth; but the most persistent search failed to bring the half dozen. I was, however, fortunate enough to find a very fine full-fed larva of *S. pavonia* minor, the only other find worth notice.

As it was now getting rather late, I resolved to take a short cut home across the plain, instead of returning by the river-side. And I was very glad that I did this, for as I was passing an apple-tree, which was at no great distance from the path, a bird about the size of a thrush, and showing a good deal of white about the wings, tail, and underparts, flew from the top of the tree, straight away from me. I saw at once, from its peculiar flight, which was rather like the dip-dip of the green woodpecker, that it was a bird new to me.

Whilst I was wondering what it could be, I was surprised to see it suddenly pause in its flight, and hover for a few seconds, like a kestrel. This puzzled me very much, and I began to think that, notwithstanding its unhawklike flight, the stranger must be a hawk, the species of which I could not identify.

However, the mystery was soon solved, for the bird alighted on another tree a few hundred yards away, and I managed by making a careful stalk to get near enough to obtain a clear view of my unknown friend, and I could then plainly see that he was the greater butcher bird (*L. excubitor*), with whose portrait and stuffed skin I was perfectly familiar, though I had not previously had the good fortune to see him in the flesh.

*St. Leonards-on-Sea.*

#### RUDIMENTS AND VESTIGES.

SOME months ago I was struck by the free use of the term "rudimentary," made by Mr. Darwin, in reference to certain organs of the human body; and I was interested to see by your recent issue that exception had been taken to the application of the term by the American naturalist, Mr. J. A. Ryder.

That an evolutionist should adopt such a term in the sense in which it is repeatedly to be found in the "Descent of Man," is a strange contradiction of the

theory of development, and reverses the order of progression.

According to that theory, it has taken untold ages of evolution, advancing by gradations infinitely minute, to produce at length the ideal human form; and if, after all, the organs so painfully and carefully wrought are to be ycleped rudimentary, *i.e.* rude and unwrought, the result can hardly be looked upon as development.

Mr. Darwin left us very little to be proud of, when he dissected the human form, and consigned one organ after another to his list of rudiments.

The whole external shell of our ears, with the various folds and prominences, he tells us is but the rudiment of the convenient, though perhaps unsightly, organ, that could be moved at pleasure.

The semi-lunar fold of our eye is a "mere rudiment" of the third eyelid, so well developed in birds.

Our sense of smell is, we are told again, "inherited in an enfeebled and rudimentary condition, from some early progenitor."

But it would be wearisome to go through the entire catalogue. Teeth, lungs, the very down on the skin, belong to the same category. Indeed, we are strongly impressed with the appalling fact that, after all, our much-admired human form, with its boasted superiority, is but a bundle of rudimentary organs that have never reached perfection.

And even if we adopt the new term proposed by Mr. Ryder, is there not still a suggestion of imperfection in the word "vestige"? That it is an improvement on the term "rudiment" is evident, as at least it does not reverse the order of progression, but even a vestige of that which is no longer required means a fault in the workmanship, which we are loath to allow. I am inclined to think both terms defective, the one suggesting too much, the other too little. Allowing, as we must, man's to be the ideal form, might it not be more correct to speak of the lower forms which preceded it as made up of excrescences and deficiencies, of which his form is the modification and development? To talk, as even Agassiz does, of the os coccyx as the rudimentary tail-bone of an ape, is an insult not to be tolerated by the race.

The tail should rather be regarded as an excrescence, the ape being the rough sketch of the ideal form, before the artist had pared off the superfluous clay.

To a casual observer the huge shoulder bones, and the formidable jaw and teeth of the ape, might argue a superiority over the same organs in man, which would favour the use of the term vestige as applied to the latter; but when we consider the deficient brain of the anthropoid ape and his small skull, we see at once that to keep the balance true, excrescences in one organ were bound to make up for deficiencies in another.

In man there is a harmony, to be found in no other existing organism. He needs no abnormal develop-

ment of the organs of sight or hearing, no prodigious length of arm or unsightly preponderance of jaw, because the brain takes its proper share in the work of self-preservation. To call any one of the organs which compose this last triumph of creative power, either the rudiment of what might be, or the vestige of what has been, seems an insult to the dignity of the creature that was made in the image of God.

NINA F. LAYARD.

## NATURAL HISTORY JOTTINGS.

### ON WASPS, CHIEFLY.

[Continued from p. 211.]

FROM the observations that I have so far made on these five species of wasp, it has appeared to me that the *Vespa sylvestris*, *Britannica*, and *rufa*, are early species; that is, the consummation of the nest or colony, indicated by the evolution of the large perfect females or queens and the males or drones (that are to secure the continuance of the species in another year), is attained early in the season, much earlier than is the case with the *Vespa Germanica* and *vulgaris*; in the nests of the three first mentioned species, the two perfect sexes have appeared by the beginning of August; in those of the two last, not before the latter half of September. Moreover, the nests of the *V. Germanica* and *vulgaris* attain to greater dimensions than do those of the other three species, and contain more tiers or platforms of comb; the two former may each contain as many as nine tiers; whereas, in the three latter, four tiers are the most that I have seen.

Of the two small secondary nests of the *Vespa rufa* mentioned in the first part of this paper,\* built on the sites of the original nests which had been destroyed, one was removed out of its cavity on August 27th, the first nest having been destroyed on August 6th. It was only of the size of a large walnut, was imperfect in the shell or case, and contained one small, though regular, tier of comb consisting of seventeen cells which contained ova and young larvæ, all the cells being occupied. It was built around, and suspended from two fine fibres of some root; and the tier of comb was suspended from the top of the nest by a very long and slender pedicle, the core of the pedicle, in fact, being one of the fine root-fibres suspending the nest. The case or shell only extended to the tier of comb. There was neither queen nor drone at this miniature nest when taken, and only about a dozen workers. The second of these nests was taken on September 6th, its predecessor having been taken on August 18th, and described under that date. I had, however, first observed this secondary nest on August 30th, and it

\* "SCIENCE-GOSSIP," Jan. 1885, p. 15.



was at that time as large and complete externally as it was when taken at the later date. It was nearly two inches in diameter and rounded; and was suspended from the roof of the cavity by a rather large clot of earth, around which the upper part of the nest had been built, the clot itself being held together with and suspended from the roof of the cavity by fibrous roots. The walls of the nest were regular enough outside, but were very irregular within; and there was only one little circular empty cell at the apex of a broad and irregular pillar depending from the top of the shell. The hole of entrance and exit was near the bottom on the inner side of the nest, which contained a solitary worker-wasp, nor were there any others in the cavity or near by, this solitary individual appearing to be the last of its tribe.

### CHATS ABOUT ROTIFERS.

#### No. IV.

#### (SYNCHÆTA LONGIPES.)

THE coronal head is very much rounded, bearing four small protuberances, and two bristles or styles, which doubtless act as feelers.

The organs of locomotion are two large auricles, one on each side, fringed with powerful vibratile cilia,<sup>5</sup> which propel the creature with marvellous

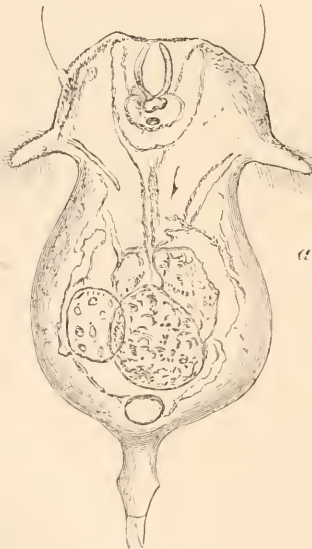

Fig. 120.—*Synchæta longipes*.

speed and power, which may be judged from the fact that it can carry in its mouth, with the greatest ease, a rotiferon quite as large as itself, and without any apparent diminution of its speed.

The body below the auricles, seen from the front, is of a globose form, and terminating with a long

foot. There is a swell on the foot between the trunk and the toes, which imparts to the foot a rhomboid shape.

The *S. longipes* may be readily distinguished from any of the other five species of the same genus, by the fact of its being furnished with only two styles (the others having four or more), as well as by the outline and length of the foot.

I found this *S. longipes* in large numbers in a pond at Emock wood, near Dundee, Forfarshire, July, 1886. I sent phials of different sizes filled with the water to Mr. P. H. Gosse; but it proved a bad traveller, as very few specimens reached him alive, and none in a healthy condition. Mr. Gosse gave it the specific name of "Longipes" (as it possesses a longer foot than any other known species of *Synchæta*), and has given a short description of it in a paper that appeared in the *Journal of the Royal Microscopical Society*, February, 1887. It deposits its eggs among the débris at the bottom of the pond. A newly-hatched individual differs from the adult in the shape of its body. Its trunk, from the auricles to the foot, is conical; but it gradually assumes the round outline of the adult in a few hours, and doubtless Mr. Gosse's figure of it had been drawn from a young specimen.

Its bright red eye is conspicuous in the region of the mastax. The mastax is high up and near the mouth, and furnished with a pair of strong forcep-



Fig. 121.—Young of *S. longipes*.

shaped jaws, which are driven out at lightning-speed to catch its prey. It is the most voracious rotiferon I have met with. Its food consists entirely of rotifers, and it will frequently attack and devour a rotiferon larger than itself. But it has a decided preference for the *Polyarthra platyptera*, which were numerous in the same water.

It invariably seizes its prey by the head with its powerful forcep jaws, never resting to enjoy a meal, but continuing to swim with it in its mouth, at the same time sucking the internal juices, and then dropping the empty lorica to seize another victim, which is often the first polyarthra it meets. The

little *Anurea cochlearis* also suffered from the ravages of this voracious and energetic vixen.

From the mastax a long tube leads down to the stomach, which is filled with a brownish granular matter. A little under the stomach, at a short distance up from the foot, is the contracted vesicle, a transparent bladder, which fills and empties itself in forty seconds. The length of mature specimens is from  $\frac{1}{140}$  to nearly  $\frac{1}{100}$  of an inch.

Its life is vigorous but short, its whole lifetime, from babyhood to old age, being not more than forty hours.

It flourished, and continued to be prolific in the pond for four weeks, when it suddenly disappeared. I have not caught a single individual since. It may again appear at the same season this year, but this peculiarity of sudden disappearance and reappearance is observable in all the synchæta, as well as in other rotifers.

JOHN HOOD, F.R.M.S.

Dundee.

resemblances, rather than by reference to the analysis of their composition. This should be a study by itself, and instances should be taken from the examples already classified on a popular basis.

Our object being now to extend Howard's list by noting more species and giving them characteristic names, we will leave the question of composition for separate treatment. In passing, we may note that "cumulus" has a very varied structure, from fine rain mist to distinct ice crystals. The writer has seen a mock-sun formed in a drifting mass of this cloud. It is most frequent in autumn and winter, and is, for the most part, an attendant upon, and prognostic of, storms. It is frequently seen in the equinoctial gales. The size and height of this cloud are often remarkable, and remind one of Ulysses on his raft, when he uttered the exclamation—'Οιοισιν νεφεσσι περιστεφει ουρανον εδρυν; for they have a most formidable and threatening aspect.

The edges of this form are curling, with many small indentations, and it is best seen in the zenith,



Fig. 122.—Outline of High Rain Clouds. \*

## ON SOME TYPES OF STORM-CLOUD.

### No. II.

"HIGH RAIN-CUMULUS." — The expression "rain-cumulus," as distinguished from "Snow-C.," and "Hail-C.," suggests a fresh classification of clouds upon the basis of their composition, *i.e.* the form, temperature, crystalline property, &c., of their component particles. But it is practically more convenient, and more to the purpose of forecasts, to have the cataloguing of the various forms done in relation to their general associations and characteristic

when the sides of the cloud are viewed from beneath.

It is generally accompanied by wind, and has a rapid motion, forming in the front of an advancing rain-storm, and spreading outward in a vast "pallium" with outline of this character. (See sketch.)

The space between the lower portion of the cloud and the earth is often very great, the upper part being of great altitude.

The sky is often of a very mixed character when these vast sheets of cumulus are seen. The deluge of rain that visited Derbyshire on August 31st, 1887,

was attended by them, and they were accompanied by brilliant white masses of the cloud termed (cumulo-cirrus), and also incipient "festoon" cloud. Respecting the latter cloud, I ought to correct the impression produced by the woodcut in SCIENCE-GOSSIP for September, the effect being much too hard and defined, especially on the upper side. But as the engraving, which does not fairly represent the festoon-cloud, has appeared, I may utilise it by saying that if the curved patches given there were straightened and so seen in a turbid and mixed nimbus sky, they would fairly give an idea of a more rare phenomenon, viz., the cylinder cloud.

This "cylinder" is a connecting link between cumulus and stratus; it is seen at any angle with the horizon, and indicates the presence of a vast quantity of vapour in the atmosphere. It appeared many times during the very wet summer of 1879.

SAMUEL BARBER.

(To be continued.)

#### SLUG GOSSIP.

By DR. J. W. WILLIAMS, M.A., *Editor of the Naturalists' Monthly.*

FOR this communication I want to transcribe from the pages of my note-book such facts and features of the tardy-gaited ones as will most interest the readers of SCIENCE-GOSSIP, and more particularly such of them as in any form or manner relate to the working of, and work done by, our continental brethren on the British species, for by so doing I shall bring the reader up on to the verge of the ever-advancing wave of knowledge in this direction. I shall also refer here and there to the archaic work of our ancestors, especially such as are missed or looked over by the writers of our present text-books, interpolated now and again by remarks of my own.

And first I want to draw the attention of the curious to what old Swammerdam said about the shell of the slug, or, as it was called in his days, the snail's stone. Accounting for the larger kinds possessing "very small membranous plates, while the smaller ones had them often much larger and formed of solid stone," he says, "that the snails change this, their little stone, yearly in the same manner as crawfish change those two semi-convex and plain stones which are likewise placed in their thorax and are properly called crabs' eyes." Swammerdam was a querc fish! The fact never struck him that these shells varied in the various species and genera. But he did a good deal in his time, and I am sure entomological friends will honour his memory, for it was he who first discovered metamorphosis, and in 1685 he dissected a butterfly from its aurelia before the Grand Duke of Tuscany.

Speaking of the shells of slugs reminds me that Mr. Grant Allen states in one of his interesting papers

—I forget in which of his books this is, but the reader will instantly call the article to his memory—that the limaces are higher in the scale of existence than the arions on account of the greater development of their shell, and the testacellæ above the limaces for the same reason. I would call his notice, and that of all readers of the article in question, to the conflicting statement of Mr. Godwin Austen, in his "Land and Fresh-water Mollusca of India" (vol. iv. p. 157), wherein he states that in his opinion those genera with a rudimentary shell and mantle lobes in strong development are higher in the scale of existence than those with a shell more greatly developed. But to proceed:—

#### FAM. I.—TESTACELLIDÆ.

*Gen. Testacella.*—This genus was created by Cuvier in one of the tables accompanying the first volume of his "Anatomie Comparée," which was printed in 1800. Draparnaud and Lamarck adopted the name at nearly the same time (1801). Specimens had been found, however, in France, for a long time previous to the Baron's publishing his tome, by Dugué of Dieppe, in 1740; by Guillemeen, in Niort and Rochelle in 1754; and also by Querhoent, of Croisic, in 1779. From these workers specimens were sent to Cuvier, Draparnaud, and Lamarck. On the other hand, there are those who say that it was Faure Biguet who first discovered the snail slug and called it Testacellus—a name, they say, afterwards changed by Draparnaud and Cuvier to Testacella.

*T. Maugei*, Fer.—Lamarck described this slug in 1801 as *T. haliotides*. Miller, in the "Annals of Philosophy," was the first to describe it as British, and I dare say every reader knows it was first introduced into our fauna by Maugé, who brought it over with some plants for the Bristol Botanical Gardens, from Teneriffe, where it in process of time became acclimated, and it still remains with us.

*T. haliotidea*, Drp.—A Mrs. Smith was the first to describe this slug as a native of our island, who found some shells and afterwards some creatures of the scutulum variety in her garden at Bristol.

During the months of May, June and July, *Haliotidea* lays its eggs—from ten to fifteen in number only—in a subterranean gallery, and not as in other slugs massed together, but separated from each other, from which exclude the young ones in a period averaging from twenty-five to thirty days. They are carnivorous in eating, and not only carnivorous but they are also cannibals. Mr. Lowe, in the 53rd meeting Reports of the British Association, 1883, p. 549, mentions a good case in point of this:—In twenty-four hours 25 specimens put out of sight twenty-five earth-worms and the same number of *L. agrestis*. Cabbage growers, if they knew this, would wish, I opine, that there were more of these slug-eating slugs about, but unfortunately their reproductive powers are very meagre. When found in



dry weather and in winter time buried below the surface—you meet them above the surface during the autumnal months, and before daybreak in April—they will be found covered by a sort of a cocoon tapering towards the shell, and formed by an exudation of their own mucus.

Their length of life is about five or six years, and their young—not as in a good many slugs—are as much like their adult in colour as can be.

M. Dugul, writing as early as 1740, records it as living near Dieppe, under the name of the “Coquillade.” Tapping has described a very slight variety under the name of *Testacellus Medii*, Temple; years ago.

(To be continued.)

## A RED LEAF—A STUDY IN BOTANY.

By G. W. BULMAN.

I HAVE just gathered a very brilliant red leaf from a shrub whose foliage has begun to acquire the autumn tints at a time when other trees are leafless, and have been “chewing the cud” of the various reflections to which it has given rise.

It is as vivid, and a shade deeper in colour than the petals of a scarlet geranium with which I have just compared it. At a little distance the plant looks as though it were studded with bright red flowers or berries. And I need not remind my readers that such brightly coloured leaves are not uncommon at certain seasons of the year. They always appear to me to offer a strange comment, almost a satire, in fact, on certain modern botanical theories with regard to the colours of flowers. I allude to the notion, that coloured petals are specially developed to attract insects, and by the selective action of the latter. Blue and red for bees, yellow for beetles, and white for moths.

For what purpose, we may fairly ask the propounders of such theories, has this leaf now before me assumed such a brilliant hue? Not to guide the honey-seeking bee to hidden stores of nectar, for there are none. Nor do bees visit them in expectation of such. Yet we might fairly expect the insects to seek honey upon such leaves if it were the red petals of honey-bearing flowers which attracted them. Can the colour of the leaf be shown to be any distinct benefit to the plant in the struggle for existence? We are told that the blue, red, and yellow of our flowers was developed because the individual plants possessing such colours were better able to survive. Can this be said of red leaves? Yet we are just as much bound to account for the colours of these as of the varied hues of the blossoms.

I think we may learn two things very clearly from a study of this lovely specimen of the beauty of decay. First that brilliant colours may be developed without the selective action of insects, and secondly that

insects are not always attracted by such colours. Such considerations should make us pause ere we accept the theories alluded to as established truths.

But it is not enough, apparently, to say that colour generally in flowers is developed to attract insects. The theory goes further, and asserts that special colours are developed to attract particular insects. Thus we are assured, on the authority of Sir John Lubbock, that bees show a decided preference for red and blue. Sir John Lubbock has proved it, says one writer. He taught them to take honey off different colours. He is at present engaged, we learn, on equally good authority, in teaching dogs to read. Let us hope that, if he succeeds in so doing, he will not infer that dogs in their natural state have any fancy for having their food labelled.

Surely it would be more philosophical and conclusive to study the habits of bees with regard to flowers, in order to arrive at a knowledge of their tastes, than to trust to any experiments with honey and coloured paper, however well conducted. What then are we taught respecting their tastes in the matter of colour by a study of their natural habits? I will give the result of my own observation. Let my readers run over in their minds the colour of the flowers on which they have most frequently seen the “azure-loving bee.”

It would be difficult to name two more brilliant red flowers than the common poppy and scarlet geranium. On these I have never seen bees. Again, where can brighter blue be found than in the spring scilla, nemophila, periwinkle, and minor convolvulus? As far as my observation goes, bees seldom, or never, visit these. Other red and blue flowers, as scarlet runner, larkspur, and wild hyacinth, are frequented by them. The following white, yellow, and greenish flowers are much frequented: white clover, pear blossom, yellow crocus, dandelion, tropeolum, peregrinum, lime-tree, mignonette, willows. In addition to these, a host of others might be mentioned, of various undecided shades, to which it is difficult to give a name, as favourite resorts of the honey-seeking bee. In the face of all this, it is asserted that bees prefer blue or red! I have seen them pass over beds containing flowers of various shades of these colours to get at yellow ones. I have stood under the lime-tree (*tilia*) covered with its greenish-yellow blossoms, and listened to the hum of the busy insects, as in the neighbourhood of hives in swarming time; and this at a time of year when meadows are gay with flowers of various hues. In the autumn, maples, brambles, and a host of others, put on most brilliant shades of red, and yet fail to attract the bees. Are we to put all this aside because Sir John Lubbock has proved that these insects prefer blue and red?

Such are the thoughts which occur to me in connection with the red leaf with which I began this paper. To others it may tell a different story. To

them it may appear one of the links wanting in the development-of-colour theory. Here, it may be said, is a tendency to a bright colour existing in a plant. Suppose a whorl of green leaves surrounding the stamens to get a tinge of red. That particular flower would succeed better in attracting insects, would consequently be better fertilised, produce stronger progeny, and get an advantage in the struggle for existence. Therefore the colour would be developed and perfected. Such a line of reasoning seems very unsatisfactory since we have colour perfectly developed without the agency of insects, and brilliant colour existing without attracting the latter. It appears to me that upholders of such set fact and logic alike at defiance, and draw largely on the imagination. So much, indeed, as far as regards the latter two, is confessed by one who is no mean authority on the matter.

Facts such as those given above, and tending the same way, could doubtless be multiplied. I will only mention, in conclusion, two more, which seem to have a special bearing on the question.

White hawthorn is, if I am not mistaken, a flower much frequented by bees. It has a very decided tendency to assume a pink shade in fading. The art of the gardener has preserved and perfected this tendency, and we have a bright red variety, common enough in our gardens. Is it not strange, supposing the colour theory to be correct, that, in spite of this tendency and insect preference, their selective action has not evolved a red hawthorn? And is the red variety which man has preserved any better able to propagate its kind by reason of its possessing the colour preferred by its insect friends? If we ask the question of our gardening friends, the answer will probably be "not nearly so well!"

Again, there are certain umbelliferous plants to which bees resort, having a decided shade of pink before expanding; at a time, that is, when the visits of insects could be of no advantage. When fully expanded and ready to receive the latter they are white!

A BOOK-MITE.

THE following drawings illustrate portions of the anatomy of a small pinkish mite, which I found scampering across the pages of a book. (Fig. 123.)

Its mouth parts are unlike those I have observed in mites previously examined by me.

A faint furrow is indicated immediately posterior to the third pair of legs.

The second, third, and fourth pairs of legs are of nearly equal length. The first pair is much longer than the rest, and both these and the fourth pair are inserted further under the body than the second and third pairs. The legs are in two groups, the first

and second being at a greater distance from the posterior group than they are from each other (Fig. 124). The legs are covered with distinct transverse markings, furrows, I believe, judging from the appearance presented on their edges.

All the legs in the mounted object appear to terminate in bristles. Is it likely that claws have



Fig. 123.—Entire Mite. Obj. Seibert, No. 1, Oc. A.  $\times 40$ .



Fig. 125.—Mouth parts. Obj. Seibert, No. III., Oc. A.  $\times 95$ .

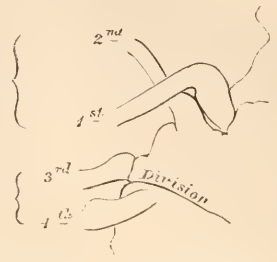

Fig. 124.—Arrangement of Legs.

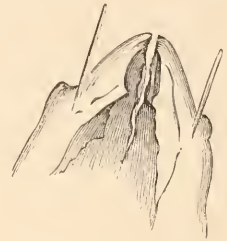

Fig. 126.—Mouth parts. Obj. Seibert, No. VII., Oc. A.  $\times 600$ .



Fig. 127.—Mouth parts. Obj. Zeiss D., Oc. A.  $\times 250$ .

been detached in the process of mounting? The hairs (Fig. 129), which are a noticeable feature on the body and legs, are closely feathered as in the Arachnida. Wavy undulating lines occur over the abdomen. Do these admit of considerable distension of that portion of the body? The lines I refer to somewhat resemble those on the body of

the dog-tick, and an idea of them can be gathered from Plate 6, Fig. 5, of the last edition of the "Micrographic Dictionary" (Epidermis of a *Dermanyssus*). The organs in figure (*a* in Fig. 127) are apparently strong mandibles. It will be seen that, in addition to these, the mite has more highly elaborated mouth-parts, of which details are given in Fig. 127. The delicate organs (*b* and *c*, Fig. 127) are beautiful objects with any power which reaches them. My slide now finds a place in the cabinet we have started in connection with the Microscopical Society here.

As to the details of mounting, I flattened out the mite in a drop of pure carbohc acid under a cover-glass.

## GOSSIP ON CURRENT TOPICS.

By W. MATTIEU WILLIAMS, F.R.A.S., F.C.S.

**A** NEW ROADWAY.—Many useful inventions have been suggested by Nature's mechanism. An example of this is presented by the most recent device in road-making, which has been patented by a gentleman of varied and scientific attainments, Mr. A. C. Ranyard. The requirements of a horse and carriage road are rather contradictory, and consequently present a troublesome problem. For the sake of the carriage wheels, the carriage, and the passengers, it should be as smooth as possible, cannot

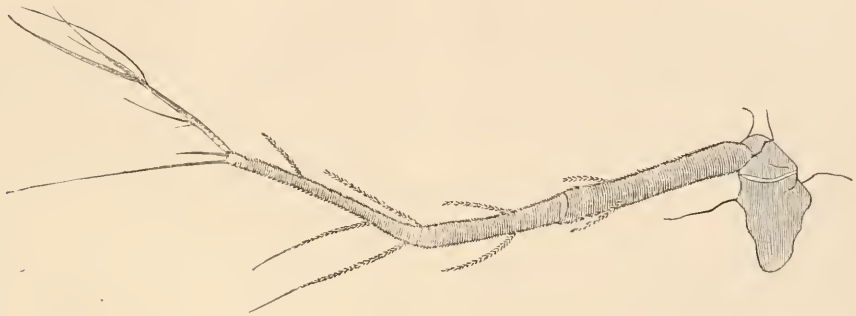

Fig. 128.—First pair of Legs. Obj. Seibert, No. III., Oc. A.

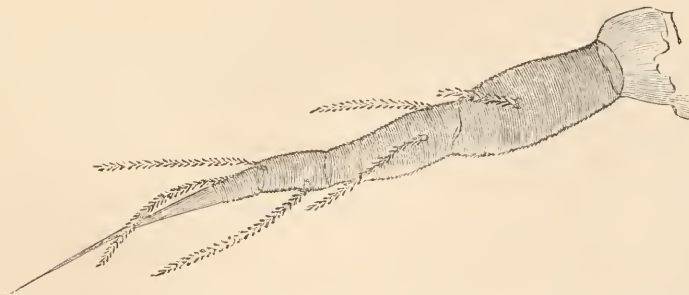

Fig. 129.—Second pair of Legs. Obj. Zeiss D., Oc. A.—Stand: Baker's Histological.

In about an hour's time the acid was washed out, and the object, which fortunately adhered to the cover-glass, placed in dilute glycerine—a detail which, I think, might have been omitted, and which was only resorted to because I originally intended to mount the mite in that medium. At the end of two hours I washed out the glycerine, and placed the object in Beale's carmine solution for twenty-four hours. I washed out the superfluous stain in water, then in dilute spirit; finally in absolute alcohol. I drained off the alcohol, cleared in clove oil, and finally mounted in balsam and benzol.

W. J. SIMMONS.

Calcutta.

be too smooth; but the horse, on the other hand, demands a certain degree, in fact a considerable degree of roughness, to afford him foothold. The cyclist and the horse are seriously antagonistic in this respect.

We have all witnessed the consequences of attending only to the wheel requirements on the smooth asphalt roads, and we still have opportunities of practically studying the old granite-block pavement, which, within my recollection, prevailed throughout all the main thoroughfares of London, when "off the stones" was used as an expression equivalent to out of London.

The new roadway is an imitation of the teeth of



herbivorous and graminivorous animals, especially those of the elephant tribe. In these, the hard enamel and the softer dentine and cement are arranged in perpendicular or nearly perpendicular laminae, edge up; so that as the grinding work of the tooth proceeds, its face shall wear unequally, and thus never become smooth, always retain its serrated structure without the chipping demanded by the miller's grindstones. Mr. Ranyard's roadway is similarly made up of perpendicular plates; the hardest compact, Portland cement, with alternate plates of a softer mixture of cement and sand. Both will wear, of course, but as the latter will wear rather faster than the harder cement, a ridge and furrowed face will be maintained as long as the material lasts.

To avoid jolting, these ridges and furrows must be narrow. A quarter of an inch for the ridge, and three-quarters for the furrow, are named. Regarding the subject from a merely speculative point of view, I cannot help fearing that the quarter inch will be too narrow for steady wear; but this, of course, is merely a matter of practical detail, which can only be determined practically. If three or four times as thick, the jolting would be barely perceptible.

SILVER IN VOLCANIC ASH.—Professor Mallet has found that volcanic ash collected on the Pacific coast in Ecuador, about 120 miles west of the volcano of Cotopaxi, contains one part of silver in 83,600, and that this exists probably in the form of silver chloride. This amounts in value to about £1 sterling for every ten tons. The ash is several inches in thickness, and this presents a commercial problem. Chloride of silver is dissolved by strong brine, and reprecipitated by simply diluting the solution. From this precipitate, pure silver is very easily obtained. Probably half the chloride might be washed out by simply passing brine through the ash. We are told that the whole of the ash fell on one day, July 23, 1885.

MUNCHAUSEN SCIENCE.—I referred the extract I made under this heading, to readers of this magazine who "have sufficient knowledge of natural history to form their own estimate of its veracity," and am glad to learn that it has brought forth some response. Two writers have (see pp. 203 and 213 last number) taken up the subject. J. S. describes the extract as "a slightly altered quotation from Kingsley's 'Glaucus'" and G. E. D. as "in the main an extract from 'Glaucus.'" Kingsley states "three—six—nine" feet as the length of the worm, the writer I quoted stretches this to 20 or 30 feet, which appears to me to be rather more than a slight alteration of Kingsley, or of the "six to eight feet" estimate of J. S. It is not merely a description of a larger specimen, larger in all dimensions, but a monstrous elongation of a phenomenally long creature, only one-eighth of an inch diameter.

The elephant Jumbo was, as nearly as I can remember, a little more than nine feet high. What

should we have said of Barnum, had he described it in his show-bills as 20 or 30 feet high? Are naturalists to be allowed more licence than we permit to the advertising showman?

I read "Glaucus" when it first appeared, was then much engaged in constructing and stocking aquaria, and studying "the wonders of the shore." I found that Kingsley's descriptions of many things were very highly coloured; pretty stories founded on fact. The Parisian zoologists, referred to by G. E. B., evidently viewed them as I did. A still more highly coloured version, with more than twofold and threefold magnifying, put forth as "Popular Science" surely deserves the title I suggested.

GRANITE.—The interesting "Notes on Granite," by Mr. Fleck, in last number, remind me of some remarkable examples of granite veins in granite which I observed many years ago in the course of an exploration of that remarkable geological microcosm the island of Arran. Ascending Goatfell from Brodick, by following the ravine of a small torrent, a well-known landmark, called "the mill dam," is reached. Hereabouts are exposed good sections of the coarse granite, intersected by veins of granite of various degrees of fineness; the thinner the vein, the finer the granulations. The weathering of the coarse granite is also well displayed; the stream carries away the nearly impalpable weathered feldspar, leaving behind the crystals quartz almost completely separated. This locality is well worthy of a visit by those who are studying the vexed question of the origin of granite. Having lost or mislaid my notes of the trip, I cannot speak positively to details; but, if I remember rightly, there are thin veins of granite running into the thicker veins.

A MAGNETIC OIL FILTER.—A curious invention is described in "Engineering" as hailing from Chicago. As everybody must have observed, the oil used for lubricating machinery, soon becomes black, and thickens at the same time. It is evident that the blackening must be due to minute particles of iron that are worn away from the bearings, in spite of the lubrication. The same occurs to the oil on an oilstone used for sharpening tools. If these minute particles were in water, or exposed to air, they would speedily become red oxide; but, protected as they are by the oil, they proceed no further than the black or magnetic oxide, or may even remain metallic. The invention in question is based on this. It is an oil filter for cleaning the oil that has thus been defiled and thickened in doing its duty as a lubricant. It consists of a vessel contracted in the middle and surrounded at this part by a coil of wire through which an electric current is passed. Iron filings placed on the contraction are magnetized by induction, and pick up the minute particles of iron or magnetic oxide. The oil is further filtered mechanically by

felt cloths or sawdust, and is thus, according to the inventors, made fit for use again.

**A NEW FERTILIZER.**—Many experiments have been made on the continent, chiefly in Germany, during the last three or four years, with "Thomas Slag," as a manure, the general results being highly favourable. It is not quite equal to the superphosphates and precipitated phosphates for barley, oats, potatoes, and sugar beet, but the latest experiments show that on moorlands it is quite equal and even superior to them. This slag is obtained in treating pig iron containing a considerable amount of phosphorus by the Thomas-Gilchrist, or basic, process in the Bessemer converter. I should explain that such pig iron is worthless for steel making by the ordinary Bessemer process i.e. when the converter is lined with ganister or other refractory material in which the silica predominates. By using a lining containing so much lime and magnesia as to render it actively basic, the phosphorus when oxidized to phosphoric acid at once combines with the basic lining, forming phosphates of lime and magnesia. The drawback to the process is the additional cost of the lining, which has to be frequently renewed in consequence of this combination and removal as fusible slag, but if such slag obtains a sufficient market value as a manure to cover this extra cost, the Thomas-Gilchrist process is economical in proportion to the difference of cost between the phosphoric and the purer hæmatite pigs commonly used for Bessemer work. So far, it appears that the success is more decided on the continent than in this country. It would probably have been otherwise were we dependent entirely on our own hæmatite ore, but we are now shipping vast quantities of such ore from the Bilbao district of Spain and working it within easy distance of the coast.

**METEOROLOGICAL INSTINCT.**—Professor Cleveland Abbe has done good service to science and common sense in refuting (in a lecture delivered before the Franklin Institute) the popular errors—I may call them superstitions—concerning the power of animals to predict the weather some time in advance. He attributes their migrations and hibernating habits to the inherited results of experience of many past ages, or to natural causes beyond their control.

My own theory of the Southward flying swallow is shamefully unpoetical. He feeds on flying insects, chiefly gnats. A little observation will show that as the cold weather advances from the North, these creatures cease to develop to the perfect form but remain dormant in their pupa and larvæ stages. The swallow simply follows its food, proceeding onwards and southward, if necessary, across narrow straits, such as the English Channel, where the opposite coast is visible to the birds in high flight. Some that find warm quarters and sufficient supplies on this side of the Channel do not all go across. Gilbert White

speaks of those seen in such localities as the mouth of the Lewes river, near Newhaven, coming forth from holes on mild days in the winter. On such days in such places gnats may commonly be seen.

Changes of weather preceded by variations of the hygrometric condition of the air are undoubtedly indicated a few hours in advance by both animals and plants. Thus swallows fly low before rain, because the humidity of the air damps the wings and bodies of the gnats, and disables them from soaring far above the ground. The swallows feed accordingly.

**BENEVOLENT BERRIES.**—One of the most marvellous of the popular superstitions referred to above, is that concerning the holly berries. I have heard full-grown people who have been educated in select schools, or genteel "colleges," calmly and deliberately express their anticipations of a severe winter when the holly berries are abundant, and explain the ground of their belief. They attribute to the holly not only wonderful meteorological foresight, but also a charming self-sacrificing benevolence. It knows all about the coming weather, and also that the poor birds will be liable to famine when their other food supplies are buried by the snow. Therefore it provides for them an abundant supply of its own berries to be plucked from its own bosom. Dr. Taylor has collected some remarkable cases in his interesting volume on "The Sagacity and Morality of Plants," but has not included this.

**SOUNDING THE "SOUNDING SEA."**—On some parts of the coast of Sumatra and the neighbouring islands, the fishermen test the depth of the sea, and also the nature of the sea bottom, by the noises they hear on applying the ear to one end of an oar of which the other end is plunged in the water.

At a depth of 20 feet and less, the sound is a crepitation, similar to that produced when salt is thrown on burning charcoal; at 50 feet it is like the ticking of a watch, the tic tac being more or less rapid, according to whether the bottom is entirely of coral or alternately of coral and mud, or of sand. If the bottom is entirely of sand, the sound is clear; if of mud, it resembles the humming of a swarm of bees.

On dark nights the fishermen select their fishery grounds according to these indications.

**FIGHT BETWEEN A RAT AND STOAT.**—The following was witnessed in this parish by a farmer. He was startled by the squeal of a rat in a flax dub—which is a place dug out for steeping lint or flax—a stoat was on the track of the rat, which made for the water; the animal fastened on the rat's back, which dived; they remained under water for some time, when the stoat had to come to the surface to breathe. The rat shortly afterwards made his appearance, when the stoat again fastened on him and killed him.—*Rev. S. A. Brenan, Cushendun.*

## THE WHITE HELLEBORINES.

THE points of distinction between *Cephalanthera grandifolia* and *C. ensifolia* have supplied a series of notes in SCIENCE-GOSSIP, since I noted the



Fig. 130.—*Cephalanthera grandifolia*.

appearance of one species in the Isle of Wight some two years ago. I can now state with certainty that the plant from the Undercliff was *C. grandifolia*, for several other specimens have since been obtained in

the locality, and the broad leaves, running into large tracts, and flowers were fully developed. This was not the case with the first specimen sent to me.

In my description of *C. grandifolia* and *C. ensifolia* (SCIENCE-GOSSIP, April, p. 91), I stated the former had more flowers on the spike than the latter. Your correspondent, R. B. P., St. Leonards (May number, p. 117), doubts this point of difference between the two plants, although he admits Bentham corroborates my observation. I make my notes, not from a text-book, but from the actual plants in the Italian Lake District. To be more certain on the point, I have had the two species lately sent to me, arriving quite fresh from Switzerland, drawings of which are here given. From half-a-dozen specimens of each, I have selected the average size plants. Before any flower-buds had dropped off these two spikes, *C. grandifolia* had nine flowers, and the spike was much larger than that of *C. ensifolia*, which had eight flowers on a meagre spike. The one plant is larger in all its parts, leaves, tracts, stem, and flower-spike. *C. ensifolia* I have often found with five to seven flowers, *C. grandifolia* with nine to eleven. A closer examination of the column uniting the viscid stigma together with the stamens, reveals a great similarity in construction; the one is more delicately formed than the other; but both have the fertile anthers suspended over the stigma. The stamens appear to me supported by a sort of hinge, some mechanical movement being necessary before fertilisation can be accomplished. This action might, I think, result solely from the influence by the sun, but possibly cross fertilisation is accomplished by the bees. It is certainly true that *C. grandifolia* loves a shaded situation, while *C. ensifolia* seeks the open—a sunny, dry bank for choice. While I fully recognise the marked differences in the two species, I still think both extremely variable. The “sword-leaves” have a tendency to become broad in suitable localities and *vice versa*, and the tracts either to increase or decrease, as the case may be. Both doubtless descend from a common type, but the variety has become sufficiently established and permanent to mark the species.

*C. rubra* is a very brilliant Alpine plant, supplying, I think, a link with the genus *epipactus*; in fact, it is not very easy to understand why modern botanists



have divided the two genera. The White Helleborines are termed *Epipactus* in Sowerby's "Eng. Bot."

The two specimens here figured came to me from Aigle, Canton Vaud. In the same box I had a delightful variety of orchids, the most notable of which was *Ophrys arachnitis*, far commoner in those parts than our more familiar Bee orchis. The two



Fig. 131.—*Cephalanthera ensifolia*.

latter, examined together, can hardly be confused, although, if I am not mistaken, Bentham implies they are synonymous names for one plant. Have any of your correspondents found *O. arachnitis* in England? I should like to know if we possess it.

C. P.

#### MICROSCOPY IN CALCUTTA.

THE Microscopical Society of Calcutta held an interesting meeting at the India Museum, in that city, on the 1st of August last. Dr. W. J. Simpson, the president, delivered an address, in which he directed the attention of members to the work to be done by such a society in Bengal. He concluded with a description of the micro-organisms found in Calcutta butter. It appears that in Bengal, milk is not, as a rule, sufficiently rich to admit of butter being churned from it in its normal state. Milk out there is well boiled. When it is cooling down a small piece of butter, or a teaspoonful of buttermilk, is added to it, and it is then put aside to "set," which it does in from six to twelve hours, forming a white acid mass, called Tyre, which has been said to resemble koumiss. This mass is mixed with water, and churned till the butter separates, when it is collected for use. Dr. Simpson, and Messrs. Simmons and Meade, members of the society, have devoted some time and attention to the microscopical examination of Bengal butter, with the result that they find it always teems with well-developed bacilli, dumb-bell micrococci, and forms of *Oidium lactis* and *Penicillium*. They have occasionally met with even diatoms and Infusoria! In the discussion which followed, Mr. Meade described the method he adopts for the examination of butter; and he attributed the schizomycetes and micro-fungi, referred to by the president, to the use in the manufacture of butter of unfiltered water from foul tanks, in which, as is well known, bacilli swarm. Mr. Simmons, the honorary secretary of the society, while agreeing with the president and Mr. Meade in regarding Infusoria and Diatomaceæ as proofs of the use of tank water, said it was his opinion that butter made by the Bengal process would always have bacilli in it, whether tank water was used or not. He had always found them in the coagulated milk employed in the process, even when he had himself made it most carefully, and was certain that it was not adulterated with any water; and he considered that as the butter, or buttermilk, which is added to the boiled milk to expedite its "setting," always contains bacilli, it really acts as a "ferment." In butter made from good tyre,

with the addition of perfectly pure municipal water, but by the process in vogue in Bengal, he had found the same organisms; and his opinion received further confirmation from the circumstance that he had examined samples of butter made in Calcutta, not by the Indian process, but direct from

rich milk, and in an atmospheric churn, and he had failed to detect bacilli in such butter, so long as it was fresh. He therefore considered bacilli in fresh butter as a proof that it was made by the process adopted throughout Bengal; but not as a proof *per se* of the employment of tank-water. At the close of the meeting Mr. Meade exhibited butter bacilli, and several test tubes, each containing butter, which showed that, in some cases, at least 30 per cent. of water is contained in Bengal butter. The president exhibited cultivations of butter fungi in sterilized potatoes. Among other objects exhibited were the circulation of blood in a frog's foot, arranged diatoms, cyclosis in sections of *Vallisneria*, and a mite, of which a description will be found elsewhere in our pages. The process of manufacturing butter in India seems to stand in need of reform.

#### RECENT ARTICLES AND PAPERS WORTH READING.

"BELGIAN Fossil Reptiles," by L. Dollo ("Geol. Mag," September).—"Comparative Chemistry of the Higher and Lower Plants," by Helen C. De S. Abbot ("American Naturalist," August).—"On the Measurement of the Magnifying Power of Microscopic Objectives," by W. P. Marshall ("Midland Naturalist," Sept.).—"On the Forms of Seedlings and the causes to which they are due," by Sir John Lubbock, Bart. ("Journal Linnean Soc." August).—"The Gentian: Notes and Queries," by Professor Huxley ("Journal Linnean Soc." Aug.).—"The Great Ice Age and Subsequent Formation at Ottawa," by H. M. Arni ("Ottawa Naturalist," Aug.).—"The Geology of Orton Hills," by W. W. Cullwick ("Wesley Naturalist," Sept.).—"The Reptiles of Western India," by J. A. Murray ("Indian Annals Nat. Hist." June).—"The Lepidoptera of Hampshire," by Rev. A. C. Hervey ("Proceedings Hampshire Field Club," No. 1).—"The Study of Insect Life," by W. J. Simmons ("Madras Christian College Mag." April).—"Edison's Method of Generating Electricity direct from Fuel" ("Eng. Mechanic," Sept. 9).

#### A FEW MORE REMARKS ON FUNGI.

I SHOULD like to supplement Mr. Addison's observations on Fungi by some information derived from recent experience. During the last three years, I have been recording the larger kinds of fungi that grow in the county of Bedford. The last published list appeared in Dr. Abbot's "Flora Bedfordiensis," and bears date 1800. The number there described, including microscopical species, is 381. I have given my attention only to those visible to the naked eye, and by the kind assistance of Mr. W. B. Grove, have distinguished 189, mostly Agaricini.

Last year, at Northampton, I obtained a curious one, new to Britain, named *Agaricus proboscideus*.

Last year was a good one for the mushroom and its congeners, for they flourished from the beginning of July, to the end of November, and even in December I was well supplied with specimens. This year, owing to the dry weather, has hitherto been a barren one. The only species that I have found with anything like frequency, is *Polyporus squamosus*, and that growing to an unusually enormous size. I even saw it exhibited at a flower show. In the spring, there was a very extensive growth in both Beds. and Northants. of *Morchella esculenta*, and I find its excellent properties are very generally recognised by the country people hereabouts, although two or three farmers to whom I showed a specimen, said they had never seen anything like it before in their lives, and they would not eat it for £50. *M. crassipes* is also frequent about here. Contrary to most fungologists, I am quite satisfied that the edible fungi generally will never become popular articles of food, and for the following reasons:—(1) The technical knowledge required to distinguish them; (2) the too great resemblance of many of them to poisonous sorts; (3) their perishable qualities, which make them anything but suitable for market; (4) the irregularity and uncertainty of their appearance, to which may be added the difficulty of cultivating them; and (5) the importance attaching to the methods of cooking the various kinds. Upon these points little need be said. Any one who has approached the subject, even after considerable experience in botany, will know what difficulties surround the identification of species in the present state of mycological literature. The species are so varying, that even Dr. Cooke's plates are not reliable. Many eminent authorities, as, for example, Mr. Worthington G. Smith, describe how they have been misled in their gastronomic experiments. In regard to one so highly recommended as *Boletus edulis*, Mr. Smith says he ate several species before he hit upon the right one, especially *B. chrysenteron*, and I have myself eaten *B. badius* for it, without, it is true, experiencing any disagreeable result, but, nevertheless, without relishing it. No one more highly relishes *Marasmius oreades* than I do, and yet I never partake of a dish without fear and trembling, lest I have included the deadly *M. urens*, which once gave Mr. W. G. Smith such a *mauvais quart d'heure*. If I, who have pretensions to some knowledge of the subject, entertain apprehensions of being poisoned, how shall the humble classes, who have little leisure to intimately study anything, become enamoured of these articles of diet without incurring the risks that are bred of rashness and ignorance? A few months ago, I showed a near relative specimens of morell, and we cooked and ate them. Some weeks later, I found my friend was on the point of cooking and eating a specimen of *Phallus impudicus*, which he thought was a young stage of the morell. Now, he was a man of

fair intelligence, and he reasoned in this way; the top with its cavities is smaller and of a paler colour than that of the other, but that is accounted for by its youth; it also has a powerful odour, but a little nutmeg, pepper, and salt, together with the process of cooking, is bound to eliminate that! *Lactarius deliciosus* and *volvens* are other cases in point, as they are variable, and belong to the most deadly genus in the family, with many members of which they may easily be confused, notably *quietus* and *rufus*. The "blue-foot," *Ag. personatus*, has not always a blue stem, and in that state there are many which might be mistaken for it, especially *Ag. humilis*, which, though probably harmless, I have several times gathered for "blue-foot." *Ag. rubescens* is another variable and highly recommended fungus, but so closely allied to some of the most poisonous sorts, that neither plates nor descriptions will distinguish it. It rarely has the scales on the pileus as shown in the figures. In a book lying before me, I see the remark: "It is easily identified by its trick of blushing." Positively, I have cut and torn this fungus, and at the end of four hours the blush has not appeared, although, at the end of twelve, the flesh has become the characteristic colour; but—if specimens are to be kept twelve hours before it can be decided whether they are good to eat, I fear there will be a slight obstacle to their becoming popular articles of diet! A dozen times, at least, have I mistaken *Russula fetens* for *Ag. vaginatus*, and, as Mr. W. D. Hay remarks, "there are some nasty species not unlike it." Instances like this might be multiplied, but I will not weary the readers of SCIENCE-GOSSIP. There are only two which I regard as sufficiently distinct to be gathered by the uninitiated without danger, and they are *Coprinus comatus*, and the large puff ball, and they must be gathered at the right stage of growth.

Is Mr. Addison correct when he states that the mushrooms supplied in London are *Ag. arvensis*, instead of *Ag. campestris*? He speaks of the former as a "black-gilled fungus;" but my experience is that *Ag. arvensis* is not nearly so black-gilled as the real mushroom. Both are very dark in old age. Stevenson says of *Ag. arvensis*—gills white, at length reddish-fuscous; and of *Ag. campestris*, gills whitish, then soon flesh-coloured, and at length umber-fuscous. The italics are his, not mine alone. The former species in the Midland counties is known as the horse-mushroom, and is certainly not regarded as poisonous as an ingredient of ketchup. Mr. Addison does not seem to distinguish between the French and English truffles. Dogs are used to discover various truffles in France, but I know not whether they would be equally successful in "spotting" *Tuber aestivum* which, I may say, is fairly common in some parts of Bedfordshire, especially in Ampthill Park, where they are found when projecting above the soil, as they frequently do. The gamekeepers are aware of their properties and highly prize them. I am informed that

Earl Cowper frequently partakes of a dish gathered on his estate at Wrest Park. Last year in Ampthill, in three hours, I collected seventy species of the Agaricini, including several very rare sorts, and one that had been found only once before. Fungus-hunting is a most fascinating pursuit, for there is an air of weirdness and mystery about the tribe peculiarly its own, and the botanist who feels somewhat *blasé* at the end of a season of successful collecting in other branches of the science will find this department easily accessible, although one that will exercise all his acumen and yet reward him for his efforts. I trust these somewhat disjointed remarks will excite a deeper interest in the Fungi among the wide circle of the readers of SCIENCE-GOSSIP, in which journal I should like to see more frequently their contributions on the subject.

J. HAMSON.

Bedford.

#### ASTRONOMY AND METEOROLOGY.

By JOHN BROWNING, F.R.A.S.

THE weather was rather favourable for the observations of the total solar eclipse at most of the stations in Siberia, but unfavourable at the stations near Moscow. Detailed accounts have not yet been received.

The "Astronomische Nachrichten" states that at the time of the eclipse the sky was cloudy over all the places in Germany at which observers were stationed.

Mr. E. Sawyer of Cambridgeport, U.S., has discovered a new variable star in Canis Major. It appears to vary from about the sixth to the seventh magnitude, and has probably a period of about 1 day  $3\frac{1}{2}$  hours, but the observations made at present have been too few to ascertain this with any certainty. The place of the star is 7 h. 14 m. 21 s., N.P.D.  $106^{\circ} 11'$ . Being the first variable star discovered in the constellation, it will probably be known as R Canis Majoris.

Professor Tacchini has given a brief account of his observations of solar phenomena from April to June, in the "Comptes Rendus." The renewal of solar activity appears to have begun about the 18th of April, after a lapse of a fortnight, without any solar spots having been visible. In May and June they kept increasing both in number and size. Between the 14th and the 18th of May, a group of spots formed near the centre of the disc, about  $8^{\circ}$  or  $9^{\circ}$  south of the sun's equator. This group passed off the disc and reappeared at the eastern side on the 5th of June. One spot was so large that it was visible to the naked eye. In this great spot some remarkable phenomena of the eruptive character were observed.

A comet was discovered by Mr. W. Brooks at



Phelps, Ontario, N.Y., on the 25th of August. At that time it was in the northern part of Cancer.

On the 7th of October, there will be an occultation of Aldebaran, a first magnitude star. The disappearance takes place at 3 hrs. 20 min. morning, and the re-appearance at 4 hrs. 2 min. morning.

On the 13th of October, there will be an occultation of Regulus  $1\frac{1}{2}$  magnitude; the disappearance will take place at 4 hrs. 44 min. morning, and the re-appearance at 5 hrs. 50 min. morning.

Mercury is an evening star; in Virgo till the 11th, when it enters Libra.

Venus is a morning star; enters Virgo about the 25th.

Jupiter is an evening star, situated in Libra.

Saturn almost stationary in Cancer throughout the month.

*Rising, Southing, and Setting of the Principal Planets at intervals of Seven Days.*

	D.	Rises. h. m.	Souths. h. m.	Sets. h. m.
MERCURY ☿ .	1	7 29M	0 45A	6 1A
	8	8 4M	0 50A	5 48A
	15	8 37M	1 6A	5 35A
	22	9 4M	1 14A	5 24A
	29	9 19M	1 16A	5 13A
VENUS ♀ .	1	5 0M	10 43M	4 26A
	8	4 15M	10 9M	4 3A
	15	3 40M	9 43M	3 46A
	22	3 18M	9 24M	3 30A
	29	3 4M	9 10M	3 16A
MARS ♂ .	1	1 35M	9 0M	4 25A
	8	1 32M	8 49M	4 6A
	15	1 29M	8 38M	3 47A
	22	1 26M	8 27M	3 28A
	29	1 22M	8 15M	3 8A
JUPITER ♃ .	1	8 49M	1 44A	6 39A
	8	8 30M	1 22A	6 14A
	15	8 12M	1 1A	5 50A
	22	7 52M	0 39A	5 26A
	29	7 33M	0 17A	5 1A
SATURN ♄ .	1	0 0M	7 49M	3 38A
	8	11 31A	7 23M	3 12A
	15	11 6A	6 58M	2 46A
	22	10 49A	6 32M	2 20A
	29	10 15A	6 6M	1 52A

*Meteorology.*—At the Royal Observatory, Greenwich, the highest reading of the barometer for the week ending 20th of August was 29·87 in. on Monday morning, and the lowest 29·57 in. on Wednesday afternoon. The mean temperature of the air was 57·0 deg., and 4·9 deg. below the average. The direction of the wind was variable. Rain fell on three days of the week, to the aggregate amount of 1·17 of an inch. The duration of registered bright sunshine in the week was 27·1 hours, against 37·6 hours at Glynde-place, Lewes.

For the week ending 27th of August, the highest

reading of the barometer was 29·95 in. on Monday morning, and the lowest 29·58 in. on Friday evening. The mean temperature of the air was 63·7 deg., and 2·6 deg. above the average. The general direction of the wind was southerly. Rain fell on two days of the week, to the aggregate amount of 0·08 of an inch. The duration of registered bright sunshine in the week was 49·1 hours, against 43·5 hours at Glynde-place, Lewes.

For the week ending 3rd of September, the lowest reading of the barometer was 29·11 in. on Friday morning, and the highest 29·68 in. on Saturday morning. The mean temperature of the air was 61·4 deg., and 1·1 deg. above the average. The general direction of the wind was south-west. Rain fell on each day of the week, to the aggregate amount of 1·77 of an inch. The duration of registered bright sunshine in the week was 32·1 hours against 26·1 hours at Glynde-place, Lewes.

The mean air-temperature in October for the Lands End is 54°, for the South Coast from Devonport to Dover it is 53°, from the Bristol Channel, through London to the East coast beyond Ipswich, it is 52°; from Flint through Hereford, Gloucester, Oxford, Bedford, Cambridge, to the sea at the Wash, the temperature is 51°; from Liverpool through Chester, Stoke, Derby, Lincoln and Hull, to Flamborough Head, the temperature is 50°; from Wigtown through Cumberland and Newcastle, it is 49°, and through Lanark and Roxburgh to Haddington, to the Firth of Forth, it is 48°.

The average rainfall for October on the East Coast from Berwick to Ramsgate, is 2 inches. On the South Coast from Ramsgate to Exeter, it is 3 inches; while, on nearly the whole of the West Coast, it is 5 inches.

## SCIENCE-GOSSIP.

MR. J. B. LILLIE MACKAY, A.K.C.L., F.C.S., from the Royal School of Mines, South Kensington, and at present engaged as lecturer in Chemistry at Trinity College, Melbourne University, has been appointed Director of the School of Mines, Sandhurst, Victoria.

WE are sorry to have to note the death of two distinguished geologists; namely, the veteran Belgian Professor Koninck, and Sir Julius Von Haast, of New Zealand.

WE understand that "a Quekett Club-Man" is engaged upon another microscopical manual, "The Student's Handbook to the Microscope," which will treat practically on the working of the instrument. Another well-known microscopist, Mr. T. Charters White, F.R.M.S., &c., is preparing a treatise on the mounting of objects. Both works will shortly be published by Messrs. Roper & Drowley.

It is lamentable to think that lovers of good English as well as of open air observations, will never more be delighted with the writings of Richard Jeffries, the author of "Wild Life in a Southern Country," "The Gamekeeper at Home," etc.

MR. HOWARD GRUBB, the well-known Dublin telescope maker, has received the honour of knighthood.

PROFESSOR SPENCER BAIRD, the distinguished chief of the Smithsonian Institute, and well known American ornithologist, is dead.

THE invitation of the New South Wales Government, made through their agent-general last year, for the British Association to meet in Sydney next January, has been withdrawn.

DR. ALFRED RUSSEL WALLACE has just returned home from a ten months' lecturing tour in the United States and Canada.

THE recent eclipse of the sun excited much attention in Berlin, where 200,000 people waited in the hope of seeing it.

THE first number of the Hampshire Field Club (edited by the Rev. G. W. Minus) promises well as a valuable contribution to the natural history, &c., of the British Islands.

WE have received a copy of Dr. A. B. Griffiths' paper (from the Proceedings of the Royal Society), on "The Nephridia and Liver of *Patella vulgata*," detailing some valuable original researches.

WE have received a copy of Dr. Thomas Alcock's "Natural History of the Coast of Lancashire," published by John Heywood, Manchester. Dr. Alcock has long been known both as an enthusiastic student, and an able populariser of natural science.

MESSRS. KING, MENDHAM & Co., of Fairfax Street, Bristol, have issued a new Illustrated Price List of the Electrical and Magnetic apparatus manufactured by them. Even to those not directly interested in such matters, this brochure is very interesting, as showing the vast number of practical appliances; whilst to practical men it must be invaluable.

WE have received a copy of the Indian "Annals and Magazine of Natural History," which is founded on the lines of the well-known journal of that name, published by Taylor & Francis. Our Indian contemporary is in the first year of its existence, and promises to be a most valuable auxiliary to natural science, especial in the wide field opened out in our Indian possessions.

THE vast and various collection of minerals now shown at the American Exhibition by Professor Foote, are well worthy of a special visit by naturalists and geologists. There are about twelve tons of the best

specimens of their kind ever seen, many being quite unique. Lapidaries are at work cutting and polishing them, and the young geological collector may pick up some valuable "wrinkles," whilst those desirous of obtaining choice cabinets of beautiful minerals can obtain them at prices varying from 1s. to 150l.

## MICROSCOPY.

DIATOMS RAISED FROM SPORES.—Microscopists will be interested in hearing that Professor Lockwood has succeeded in raising diatoms from spores. The diatoms raised in one experiment were from spores whose vitality had lain dormant in total darkness fourteen and sixteen years respectively. He has demonstrated that diatoms have embryonic stages with silicate fronds.

THE HESSIAN FLY.—With commendable thoughtfulness, Mr. Fred Enock issued early in August a slide showing the puparia of this agricultural and much-talked of pest *in situ*, as the fourteenth of his "Entomological Studies," together with a full description and illustration of the insect and its habits.

COLE'S MICROSCOPICAL STUDIES.—All microscopists, whether students or amateurs, will hear with general regret that Mr. A. C. Cole has issued the last of his present series of microscopical studies; invaluable to the student from their histological clearness, and the delight of all from their high artistic finish. Each instalment of these "studies," with their illustrative slides, has been eagerly awaited, until the signature "Cole Deum" has come to be the sign manual of the highest and most delicate microscopical finish. Mr. Cole has perhaps always been at his best in pathological and physiological preparations. His singular adeptness in staining and injecting has been simply invaluable in this connection, as is amply demonstrated in this last issue, which contains slides illustrative of Tubercular Renal Phthisis, Secondary Epithelioma, and Leucocythæmia of the kidney. In each the nuclei are sharply differentiated, marking out the glomeruli and tubules of the rays and pyramids, and bringing the pathological characters out with perfect distinctness. It is unnecessary to praise one or many of the preparations, since unvarying excellence has been the main feature of Mr. Cole's work. The last issue also includes sections of liver-fluke, *Aristolochia siphon*, ovotestis of *Helix*, human tape-worm, leaf of psoralea, petiole of ivy, *Tingis hystricellus*, seed of sun-ray, and odontophore of *Cyclostoma elegans*.

MICRO-PHOTOGRAPHY.—Can any one give me a few hints in micro-photography, and would there be any chance of my succeeding, with no experience in ordinary photography?—*Edwin Goodwin*.

ILLUSTRATIONS IN MARINE ZOOLOGY.—Most naturalists are now familiar with the very interesting zoological slides sent out by Mr. J. Sinel, of Jersey. We have just received the following, all of which are excellently mounted, and admirable illustrations of marine zoology. Mysis (development of, 3 slides), Tucora, adult or nauplius stages, Squilla, Homerus, and Palæmon (Zoea stage), Carcinus (Megalopa stage), Tadpole stage of compound ascidian, ditto, mature, etc.

## ZOOLOGY.

SCORPIONS IN MEXICO.—I can corroborate the testimony of Mr. Dipton Burn as to the existence of scorpions in Mexico (see June number SCIENCE-GOSSIP). I was, in 1882, in charge of a division of the Mexican National Railway, and stationed at the important town of Celaya, about 145 miles N.W. of the capital, and at an elevation of over 5000 feet above sea level. One day (and only a few weeks after my arrival) I had occasion to open the drawer of a small table by my bedside—that had not been opened for some days—when I encountered, and killed among the papers there, a veritable scorpion of the size and color accurately described by Mr. Dipton Burn. My manservant, a native of the place, seeing it, expressed no surprise, and called it by its correct name at once, and without any suggestion from me. I know, from personal experience at Celaya, and elsewhere in Mexico, that scorpions are not uncommon in that country, and I cannot understand why Mr. Charlesworth—(see Aug. number SCIENCE-GOSSIP)—who appears to have travelled in Mexico, should never have encountered nor have heard of them. I, however, do not agree with Mr. D. Burn that they are considered among the greatest pests in that country, nor that they are so numerous as he describes, but their existence there is certain.—*Frederick Simon, M.I.C.E.*

OUR BRITISH MIGRATORY BIRDS IN AFRICA.—Mr. Seebohm, of Sheffield, who has been travelling in South Africa, has written on British migratory birds. Near the coast of Natal he saw hundreds of thousands of common barn swallows and swifts evidently collecting for the purpose of returning to Northern Europe. At Durban Bay he noted vast numbers of birds common to Britain—curlews, wimbrels, greenshanks, common sand-pipers, sanderlings, ring-dotterels, and others, evidently all just completed, or not having quite completed their spring moult, requiring as they did, to get new flight feathers in order to perform such enormous journeys. Mr. Seebohm says that the sanderling, though so extremely common at Durban and Table Bay, does not breed within eight thousand miles of either of these localities; and there are other birds whose length of migration was quite as great.

SCORPIONS IN MEXICO.—In your August number I find some remarks about a statement by Dipton Burn (see June number) that he had not seen any scorpions in Mexico; also (and this seems an extremely strange one) that he had not met with any person there who ever had seen one. Having lived for some time in that country, I am astonished at such a statement, as in firewood, under loose stones, and in old walls built of adobe (large sundried bricks), plenty of these troublesome creatures can be found. Possibly Mr. Charlesworth was there in winter, when they are not so frequently seen as in summer; but for the statement of not having met with any person who had ever seen one, there can be but one explanation: viz. that he did not know the Mexican name for the insect in question, which is called *alacran* there. There also is an animal called scorpion in Mexico, namely a kind of salamander—and speaking about “scorpions” to Mexicans it will be easily understood they never saw nor found these in their houses!—just as little as we see snakes or similar animals in ours.—*R. B.*

## BOTANY.

THE COLOURS OF FLOWERS.—The distinguished German botanist, Professor Sachs, has discovered that the ultra-violet and invisible rays of the solar spectrum are especially efficacious in the development of flowers. If these rays are suppressed, the vegetative organs grow luxuriously, but the flowers are almost entirely suppressed. The professor thinks that extremely small quantities of one or more substances formed in the leaves cause the formative materials which are conveyed to the growing points to take the form of flowers. They act like ferments, so that extremely small quantities of the flower substances act upon large quantities of plastic substances. Assuming there are three distinct regions of the solar spectrum, he shows that these differ in their physiological action. The yellow and adjacent rays cause the decomposition of carbonic acid, and are active in assimilation; the blue and visible violet rays are the causes of the movements of irritation; whilst the ultra-violet rays are those which produce in the green leaves the substances out of which flowers are developed.

THE ORIGIN OF FLOWERS.—If grasses are the most ancient of true flowering plants, how can we understand or believe the theory according to which Grant Allen holds that wheat and grasses are florally degraded lilies? I need not add words to complicate the question, which I put in as plain a form as I can, in order that it may be answered, so as not to give an air of absurdity to scientific teaching.—*John Gibbs.*



SPERGULA PENTANDRA, L.—As I was walking by the river Eden, outside the city of Carlisle, on September 2nd, I came across a spurrey in fruit which attracted my attention. As I always gather the seed for examination, I asked my little daughter for the use of her handkerchief, and on reaching home was delighted to find the fruit differed widely from that of the two forms of *S. arvensis*, with which we are familiar. The seeds were perfectly smooth, with a broad membranous margin, and I have reason to believe it is genuine pentandra. Having only just arrived here from Notts, I have had no time to look up the records, so cannot tell whether it has been noted before.—*Hulderic Friend, F.L.S., 19, Burlington Place, Carlisle.*

JEAN LOUIS THOMAS, who died at Devens last December, was well known and appreciated, as was also his father, as a collector of botanical specimens. This appreciation several authors of the scientific world have proved, by dedicating various species to them under the name of Thomasii. The son did not devote himself to the same speciality as his father and grandfather. He only collects seeds of Alpine plants for sale. The typical herbarium of M. Thomas and his son comprises specimens of the entire flora of Switzerland, which Mrs. Thomas is willing to dispose of, together with a number of duplicates in reserve, also collected by them. Thus an excellent opportunity is afforded to amateurs and scientists of acquiring an interesting collection, and at the same time of helping a family whose income is somewhat limited. It may be applied for treat to Madame Veuve Jean Louis Thomas, à Devens près Bex, canton de Vaud (Suisse).—*C. C.*

AZOLLA PINNATA.—This floating water plant, a native of Carolina, has for several seasons been growing on ponds in the parish of Eastcote, Middlesex. This season it has formed a scum on the ornamental water of Eastcote House, and just at this time (September) it is very attractive, owing to the red tinge on the plants, a colour not at all common with our water plants; here and there may be seen amongst the Azolla small patches of our common duck-weed, its bright green contrasting very strongly with the red of the American plants. The appearance of this plant on English water was first noted in SCIENCE-GOSSIP for November, 1883, when I recorded it as occurring on a small pond at Eastcote; since that date it has been found growing on several ponds in the vicinity. From inquiries I made, it transpired that a gentleman living close by had thrown a handful on the pond mentioned; he had previously cultivated it in his garden, where it had grown well in a sheltered bog bed. It has successfully withstood several severe winters, and is rapidly becoming acclimatised, to the no small bewilderment of rambling botanists.—*John W. Odell, Pinner.*

## ANIMAL PSYCHOLOGY.

THE AFFECTION OF THE COMMON WIDGEON.—For some years a neighbour of mine kept a couple of the common widgeon, male and female. Recently, the little duck died of old age, and it was really distressing to see the apparent agony of the drake at the loss of his mate. After fretting after her until the next morning, he deliberately laid himself down and died on the very spot where the duck was buried.—*H. Higginson, Newferry.*

## GEOLOGY, &c.

MUNCHAUSEN SCIENCE.—We take the following from a weekly contemporary devoted to individual science. Speaking of the extinct animals which he believes must have wandered amid the thickets of a hypothetical forest, which formerly occupied the Mississippi valley, such as the “huge momnuth (*sic*), mastodon, myledon,” the writer says:—“These extensive primeval forests, must have been utterly destroyed by fire. They must have extended to the north beyond the present Lake Superior, and south of the Iron Mountain in Missouri. The intense heat produced by this great conflagration liberated all the metals contained in the minerals in all that vast extent of country, and thus we find the lead found in almost a pure metallic state in Missouri, Wisconsin, and the adjacent states, in horizontal plates of great extent, which were then the depressions of the surface of the country, in a perfectly liquid state, at varied distances, having no connection with each other. This is proved by there being no mineral lodes yet discovered in all that large tract of country. Also in Lake Superior district, we find that the native copper there has been fused. The silver deposit, in a liquid state, has been run into the fissures of the rocks that had been split by the intense super heat, where it became chilled by the flood that evidently followed this grand conflagration. The iron now found in the Ontinergan district in the north, and the Iron Mountain in the south, have been subjected to the same extensive heating.” We commend this method of explaining the occurrence of metals to the author of “She.”

FOSSIL INSECTS.—Dr. Scudder is a man who has devoted many years to the unremunerative and difficult study of fossil insects. His labours have just been given to the world in one of the Bulletins of the United States Geological Survey. No fewer than 2600 true species of fossil insects have been found up to the present time. Of these, the greater part are from the mid-Tertiary formation. There are 31 species of fossil spiders described from the primary formations; as yet, only one species has

been found in the secondary, and 285 in the Tertiary, a large number of the Tertiary species of insects are the "flies in amber," of which the poet spake as being "neither rich nor rare, the wonder's how the devil they got there!"

## NOTES AND QUERIES.

**FEEDING FROGS AND TOADS.**—Can any one tell me how to feed frogs, toads, and newts in an aquarium, the former having been hatched therein?—*Worldge.*

**TAMENESS OF GULLS.**—During the summer while visiting Port Erin in the Isle of Man, a most excellent and edifying spectacle was presented to my notice. It was that of a band of herring gulls reposing quietly on the pier, and being fed by a fisherman. The birds of course were wild, with unclipped wings, and their tameness and confidence were very remarkable. The old man seemed to know them well by individual appearance, as he had familiar pet names for some of them. At Ramsay, too, it was pleasant to see the gannets diving and fishing within a short distance of the strand. These worthy Manx people are evidently not so much disposed to truculency as many of the mainlanders are. The brutal ruffianliness involved in the disposition "to shoot every bird you see" has not as yet been developed amid these good Celtic folk. When birds are not much shot at, they become tame, and help on human kindness. In Bolton Woods (Yorkshire), I let fall some crumbs, and the chaffinches (evidently not much popped at there) hopped and played and pecked thereat. How true it is that the advance of physical force repels *pari passu* generous sympathy and cordiality!—*P. Q. K.*

**THE HOLLYHOCK.**—In the description of the Hollyhock (p. 172), Mr. Swan uses the word "pistils" to indicate the female system of the flower. I have always gathered from botanical authors that the word "pistil" (singular) denoted the general female organ, and that this is composed of one or more carpels, each carpel again being composed of ovary, style, and stigma. He says the "pistils surround the carpels." By "carpels" I suppose the ovaries are meant. Again, he says: "the pistils appear separated for only part of their length." Here the word 'pistils' is evidently used for 'styles.' In furnishing scientific descriptions, and even in the study of common plants, there is nothing like clear, strict, and consistent accuracy in the use of terms.—*P. Q. K.*

**LENGTHY FAST OF A CAT.**—A singular instance of the tenacity of life possessed by cats has just occurred at Chatham Convict Prison. A cat, which was a great favourite in the culinary department of that prison, was missing for more than three weeks, and was almost forgotten. The other day the prisoners at work on a building in course of alteration for workshops, heard a mewing noise. Between the plastering and the floor above was a space of about 9 in. by 12 in., which had been plastered up, and on the plaster being broken down, one of the men looking up saw the paw of a cat between the laths. The cat was quickly released, and proved to be the missing animal. The cat a full-grown one, only weighed 1lb. on its release. It has since been able to walk and eat, and is likely to survive, notwithstanding its long imprisonment.

**SHELLEY'S HALCYON.**—If our poets do now and then misrepresent the characters of our birds, there is no reason, that I know of, why our naturalists should make the matter worse by misinterpreting the writings of our poets. I have not read Mr. "Phil Robinson's" celebrated volume, but I sincerely hope that he is a little fairer to his poets than some highly distinguished persons who have followed in his wake. Is it beyond your province to allow me space to protest against a perfectly astounding imputation on the poet Shelley, to which no less eminent an authority than the Rev. J. G. Wood has lately given utterance in the 'columns of a periodical devoted to the instruction and amusement of young ladies? In one of a series of pleasant articles, entitled "The Brook and its Banks," Mr. Wood, treating of the kingfisher, writes as follows:—"Poets really seem to vie with each other in depicting the bird in so absurd a fashion that no one could recognise it. Perhaps we need not be very much surprised when Cowper (essentially the poet of the town) describes the kingfisher as catching its prey on the ocean; or when Savage, another poet of the town, ranks the kingfisher among the songsters; but it is more than startling when Shelley, of all poets, represents himself as having seen two kingfishers clinging with their backs downwards to a branch, and *feeding upon its berries.*" Now it is utterly incorrect to say that Shelley "represents himself" as having seen anything of the kind. The utmost that can be said of him is that he represents himself as wishing he might see it. The reference, of course, is to Prometheus Unbound, Act 3, Sc. 4. But the words which Shelley there puts into the mouth of the Spirit of the Earth are supposed to be spoken in that ideal age which follows the fall of Jupiter and the liberation of the elements from his control. Describing the delightful metamorphosis which had suddenly come over the Universe, the Spirit announces that—

"All things have put their evil nature off;"

and adds this double illustration of the happy fact—

"I cannot tell my joy, when o'er a lake  
Upon a drooping bough with nightshade twined,  
I saw two azure halcyons clinging downward,  
And thinning one bright bunch of amber berries."

Is it not "more than startling" that Mr. Wood should have so totally missed the point of the above passage? The kingfisher and nightshade have alike cast off their "evil nature" as life-destroyers; the kingfisher by turning vegetarian, and the nightshade by becoming wholesome food. Need this artistic little vignette for a volume on the "sagacity and morality" of the plants and birds of the future startle any one acquainted (as I suppose Mr. Wood is) with Isaiah xi. 6-9? It seems incredible that Mr. "Phil Robinson" can have written anything capable of entrapping his readers into the mistake into which Mr. Wood has fallen; but that somebody owes an apology to the shade of Shelley is tolerably patent.—*C. B. M.*

**THE IVY.**—In response to the remarks of Mr. Mattieu Williams about ivy, let me observe that if what he states were correct, this same ivy should be a terrible nuisance for the walls it climbs, in absorbing not only moisture, but also mortar into leaves. It is well known that cutting the ivy's main ground-root kills the entire plant; its rootlet is consequently a mere fulcrum, not a nutritious organ. It kills bees when it takes full possession of them, because it stifles both respiration and development.—*C. C.*



SCORPIONS IN MEXICO.—From "Modern Society" for August 27, 1887: *Apropos* of this, a curious dish was prepared the other day for a British traveller in Mexico. The attendants served up an omelette, and the servants partook very heartily of the dainty morsel, but the traveller mistrusted the food, owing to certain black particles mixed therein. Inquiring as to the nature of the suspicious ingredients, he could scarcely believe his ears when the reply was given, "Oh, those are scorpions," and an investigation proved this to be true; the lower orders in Mexico thus utilising the young scorpions, which are dug out, hundreds in a nest, their sting being cut off before cooking.

BIRDS NEAR DUBLIN.—I am afraid that your correspondent in the April number of SCIENCE-GOSSIP is mistaken when he speaks of the "brown ivy owl," as amongst the avifauna of the Irish metropolis. It would give me great pleasure to believe otherwise; but the brown or tawny owl does not appear to be ever met with in this island, and certainly does not figure in the "List of Irish Birds," published in 1885, by Mr. A. G. More. Possibly Mr. Nourse refers to the long-eared owl, which is a common denizen of our woodlands, and goes hereabout by the name of the "cat owl," its monotonous mewing call, constantly heard from amongst the grove on moonlight nights or in the dusk of early summer evenings, being of so feline a sound that I have known it mistaken for the wail of a lost kitten.—*C. B. Mofat, Ballyhyland.*

BEES AND LIME-TREES.—By parcel post I send you some twigs of a lime-tree growing here which has smaller leaves, and flowers more freely, than the ordinary lime-trees of the neighbourhood; but which may only be a variety of *Tilia Europæica*. In the corner of the parcel you will find a smaller box containing several bees which I picked up under this tree. They lie scattered under it in great numbers, and many of them have had the thorax scooped out. Can some reader tell me whether I am right in supposing that something in the flower of the lime poisons this particular bee, and that a spider (?) eviscerates the bee after it falls upon the ground? I could find nothing in the act of attacking the bees. I found very few hive bees among the blossoms, and none upon the ground.—*Arthur R. Graham, Holmwood, Weybridge.*

CUCKOO'S NOTES.—I have frequently seen Notes and Queries about the cuckoo in your columns, and as I have for several years amused myself "calling" cuckoos in the spring-time, in order to watch their habits, I will give you briefly the results of my observations. The "hoarse chuckling laugh" referred to by W. E. Windus is made by both sexes of the cuckoo, and, I believe, is more often used than any other note, but it can only be heard a short distance off. When the cuckoo is "called" and is flying to its apparent rival or mate, this "laughing" sound is very often uttered alone, but, besides this, it always follows immediately after its well-known notes. The third note that is sometimes heard is, I believe, invariably used under excitement. I have often "called" cuckoos to within a few feet, and could almost always induce them to utter three notes, and occasionally four, five, and even six, when they would take the following form, cuc-cuc-cuc-cuc-cuc-koo, the notes gradually getting to a higher key, until the koo. Sometimes when excited, the cuckoo is unable to utter any sound except two hisses, which take the place of its ordinary notes. I have frequently heard the cuckoo late at night, especially warm nights.—*Edward Goodwin, Wateringbury, Kent.*

SUGGESTIONS FOR SCIENTIFIC RESEARCH.—It has long seemed to me that there was much waste in time which might advantageously be applied to scientific research. People require some directing power to guide them and point out for what they are to look; in what direction they must apply their attention; they require to know what things are yet unknown. There are doubtless many people most willing to be employed in scientific research, and it would be not only a pleasure to themselves, but an advantage to the world in general for them to be so employed; retired officers, barristers, men of education and without professions, business-men, the poorest labourer, everyone, in short, might have his or her attention directed to some special point in his or her calling, and might become *poetes*, or discoverers to some extent. An intelligent workman would not fail to be a contributor, and some retired men, whose time at present hangs somewhat heavily on their hands, could give able assistance. If the professors of the different sciences would only publish what is required, say yearly in some scientific journal, it would at least be of interest to all to know for what the scientific world was seeking; they might point out the different kinds of trades likely to be of use in this research; masters might encourage their men in exercising their powers of observation, a fresh interest would be given to the work. Meteorology, zoology, physiology, every branch of science would receive crumbs of assistance from various sources, and it is every little makes a mickle! Real organisation is required on the subject and Government to step in and offer rewards. I was reminded again the other day of this lack of directing power by reading Professor Stocke's able directions (to the Arctic explorers) for "auroral research." He points out what they are to observe, the motion of the auroral streamers, sound, etc. etc. If this directing method was more universally applied, it would be of great utility. The outsiders of science would be drawn into its vortex, and its progress considerably accelerated. Science at present is still too select. We ought to work more, all of us, as one great co-operative whole.

MUNCHAUSEN SCIENCE.—I was glad to see the remarks of G. E. D. and J. S., Jersey, in your last number, on the paragraph under this heading in SCIENCE-GOSSIP for August, but I think your readers would be interested in the following extract from the monograph on the British Annelids (Roy. Soc.) by Professor W. C. McIntosh, in his description of *Lineus marinus* which he gives as the synonym for Kingsley's *Nemertes Borlasii*, wherein Professor McIntosh says: "This is unquestionably the giant of the race, and even now I am not quite satisfied about the limit of its growth, for after a severe storm in the spring of 1864, a specimen was thrown on shore at St. Andrews, which half filled a dissecting jar eight inches wide and five inches deep. Thirty yards were measured without rupture, and yet the mass was not half uncoiled."—*T. Bolton, Birmingham.*

CUCKOO AT NIGHT.—In reply to your correspondent, Mr. A. C. Ward, I beg to record that the night-cuckooing is of frequent occurrence in the wood hereabouts, and is familiar to the country people around.—*R. W. M. Johnson, Bexhill-on-Sea.*

LAPIDARY WORK.—I should feel much obliged to any readers of SCIENCE-GOSSIP who could furnish me with the names of any books or articles on this subject, or give me any information on the cutting and polishing of pebbles and fossils. Also where I could obtain the requisite tools for this purpose.—*F. Hayward Parrott, Walton House, Aylesbury.*



AMERICAN MUMMIES.—There is now at San Francisco a collection of newly found mummies, forming one of the most remarkable discoveries ever made in America. The mummies differ from Egyptian ones in that they are generally quite naked, only a few having a loose covering, and they have evidently undergone no process of embalming. The flesh is so thoroughly dried that it resembles parchment, and the corpses are very light. The mummies were found by a party of American goldseekers in one of numerous branches of the Sierra Madre Mountains, near the Gila, in Arizona. One day the goldseekers discovered a cave, the entrance to which was closed with a kind of cement very hard to break. Forcing an entrance, the men found themselves in a kind of antechamber, 30ft. long, hewn out of the living rock. This led into a large hall, in which were lying a number of dried up corpses. The discoverers at once set to work to transport the mummies to the nearest railway station, in spite of the opposition of the Apache Indians, who soon heard of the discovery, and considered the remains to be those of their gods. All the mummies were safely removed to San Francisco, where they excite great interest in scientific circles. The most remarkable among them is that of a mother with her child, which lie together in a loose covering. Another is the corpse of a woman with small feet, arched insteps, long shapely hands, and the whole figure of a different type to that of the modern Indians. The hair of this mummy is long, black, and not in the least spoiled. The remains of its covering is of a blue colour, and quite different in material from the cloth that covers other mummies. Very interesting is the mummy of a man in a sitting posture. It is of gigantic proportions, with broad and powerful chest. The grisly parts of the ears and nose are quite recognisable, and the head is covered with bushy black hair. The eyebrows are sharply defined, and the dry and hard tongue protrudes between the teeth. The members of the Scientific Society of San Francisco unanimously believe these mummies to be those of the ancient Aztecs. The corpses of the women and of the young man shew all the physical peculiarities said to have distinguished that once numerous race. The high cheek bones and slanting eyes, thick skin, and black hair, and general size (about 5 ft. 3 in.) all agree. The mummies will shortly be forwarded to the eastern States.

CUCKOO'S NOTE.—The cuckoo's note, as described by W. E. Windus, is perfectly correct, but generally to be noticed later on than June, never returning to its original note. In its passing skimming flight it would appear to be the male. I suppose it is known this bird's peculiarity, in selecting a bird's nest, generally the hedge sparrow, for deposit of its eggs, with the result of the insufficiency of room and largely required nourishment, the almost total eviction of the sparrow's offspring, and great exhaustion to the foster-mother by their immense appetite. The nest of the water-wagtail, "Yarrells," is said also to be so appropriated. It may not have been observed that there is a bird called the "cuckoo's mate" (so named in Hertfordshire), which announces the arrival, or quickly so, of the cuckoo; the colour of the thrush, not so large, it usually sits on a bush by the side of a path a little away from it and is not alarmed at your presence nor moves when you throw a stone. I have killed one by this means, and that was the name given me, "cuckoo's mate." What is the origin of "cuckoo, cherry-tree?" Certainly it has a liking for cherry-trees, and will perch on the top branches till you come within one hundred feet, and then with a spring and "cuck-cuckoo." They frequent the cherry-trees

in Switzerland, is harmless and not destroyed—has a large mouth which aids its peculiar note—ravenous in appetite.—Henry C. Russell.

A BEE STORY.—In 1885 I was travelling on the Assam Railway on my way to Sadiya, a political outpost at the foot of the Abor Hills. The railway only took me as far as a place called Talup, thirteen miles to the right of which lay Sadiya. At one of the intermediate stations a tea-planter got into the carriage I was seated in, and after a very few minutes we glided into conversation. In India, an introduction is not always required. On hearing that I intended proceeding to Sadiya the same evening, as there is no rest-house at Talup, my newly-made friend (whom I will call L.) very kindly offered me dinner and a bed for the night, at the same time informing me that the Brahmapootra river, which I had to cross on my way to Sadiya, was in full flood, and that the crossing could not be accomplished in less than two hours, by which time it would be quite dark, also that the four miles of road on the other side of the river was dangerous, owing to the presence of tigers and wild buffaloes. On hearing this, I thankfully accepted his offer, and on arrival at Talup proceeded with him to his bungalow. The bungalows in Assam are almost all built on piles to keep them from being flooded. They are usually constructed of wood and the roofs thatched. L.'s bungalow was no exception to the usual style of architecture, and after mounting the wooden staircase leading from the porch, and crossing a small verandah, the main portion of which was occupied with baskets of oranges, pruning knives, hoes, &c., I found myself in the central room, which served both as dining and sitting-room. I took a seat next the table facing the window, and with my back to an *almirall* (store, or linen cupboard), placed against the wall near the door by which I had entered. I had not occupied this seat many minutes before I became aware of a buzzing sound close to my ear, followed by an irritating feeling of being crawled over by wasps or bees. L., seeing my discomfort (I had begun to fling my arms about rather wildly), suggested my taking a chair in one of the corners near the window, which was, he said, free from annoyances of this sort. He then pointed out that the chair I had originally occupied was in a direct line between the *almirall* and the window, and informed me that a large swarm of bees occupied the *almirall*, and had done so for three years, despite his attempts to get rid of them. He had twice smoked them out, and taken all their honey, but they returned each time, and now he had given in to them. I then noticed for the first time that a continual flight of bees took place between the *almirall* and the window, passing right across the length of the table. The window was hung with chinks (blinds made of thin laths or sticks strung together), but the bees appeared to find no difficulty in squeezing their way in or out. The floor was also covered with bees which had fallen, overlaid with honey or pollen. I am fond of bees, but I prefer them at a distance; so, in my present position, felt anything but comfortable until the sun went down and the bees went to bed. I then emerged from my retreat, and on tiptoe approached the *almirall*, the door of which I opened wide. Underneath the lower shelf the bees had attached their comb, and very happy and busy they seemed. It was a large swarm of the larger kind of Indian bee. I was surprised to observe that a lizard and a couple of cockroaches occupied the same *almirall*, and that the bees appeared to treat them amicably. Whilst I was watching, one of the cockroaches approached the apex of the comb, walking, with

feelers extended, along the bottom of the almirall. On arriving within an inch or two of the cluster of bees, he waved his feelers slowly, and appeared to be clearing away the bees from a space on the comb from which to extract honey. Suddenly a bee, whom I suppose he had touched with his feelers, bounced down on the floor in front of him with a buzz, and advanced buzzing and in a threatening manner. Mr. Cockroach promptly fled to the opposite corner of the almirall. This action was repeated several times. Eventually the cockroach had to content himself with any crumbs which had fallen from the comb, and I noticed that he crept right underneath the comb with his feelers carefully lowered, and almost touching the ground. The bees allowed him to pass unmolested. Next morning I took leave of L. and his bees, and proceeded on my way.—*John W. Hensley.*

**MONSTROUS FOXGLOVE.**—A white foxglove in my garden developed a terminal flower similar to that described by Mr. George, although not of abnormal size. I regret that I made no examination of it, but I can state that it set no seed, and remained on the plant until withered.—*A. C. Coxhead, Chaldon.*

**STONE CURLEW.**—Arthur Hollis, St. John's, Antony, Cornwall, will feel obliged to Ornithologists for any notes they may have made during the season on the above bird.

**NEST OF AUSTRALIAN FLY.**—Can any reader tell me the name of the insect described by a friend of mine who has been in South Australia during the present year? He writes: "The gentleman named here has just shown me a peculiar nest of a fly which (like the many other antipodes in this wonderful land, where the north wind is hot, the south cold, trees shed their bark and retain their leaves; quadrupeds have duck-bills and web-feet; fish walk (ceratodus); the face of the moon is upside down, and moves from right to left instead of the reverse; the birds talk but don't sing), contrary to the usual practice, preys upon spiders. The fly makes a nest of mud, in which it bores cells, and, having laid an egg in each cell, provides the chrysalis with a number of large spiders on which to feed; the cells are then closed up with mud, and the fly dies. The chrysalis lives upon the bodies of the spiders (he has found the latter alive, on opening the cells, weeks after being entombed), and when mature, makes an opening for itself in the mud, and becomes a fly like its progenitor, to repeat the operation and die as its parent did before. The fly inhabits mountainous country, near water. One nest he showed me was made by a fly on a book. The fly is somewhat like a wasp, with a waist which would be the envy and despair of a Belgravian belle. My friend assures me he has watched it for weeks, and his observations may be taken as, I think, accurate."—*Geo. Brown.*

**THE FROBEL SOCIETY.**—(17 Buckingham Street, Strand, London.) On Saturday mornings, between eleven and one o'clock, a "Common Object" Loan Collection is open to all teachers who require specimens for their lessons to little ones. Fir-cones, chestnuts, acorns, wheat, oats, butterflies, moths, and seaweed are available at the present moment. But the secretary would feel deeply grateful for any addition to the small stock. A cabbage butterfly was the subject of great wonder to a city-born boy who was sent by his schoolmaster to fetch the "objects" for the week's lesson. "Ain't they peculiar?" was his exclamation, and the acorns were only a shade less marvellous to

him and his friend. Though they knew that acorns grew on oaks, they did not know the acorn when they saw it. Any objects will be gladly received by the secretary.

**A JUBILEE BOULDER.**—A report was presented by Dr. H. Crosskey on the "Erratic Blocks of England, Wales, and Ireland." Dr. Crosskey, after giving an account of the various boulders to be found in this country, said there were a large number of legends connected with the stones. With regard to a boulder found in a village near Leeds, there would, he said, in the future be a happy legend connected with it. The rock was found some time before the Jubilee day, and the inhabitants appeared to have been so astonished by the discovery of this large mass of rock that they connected it with their Jubilee celebration in the following curious fashion. The rock was about six feet long and about four tons in weight. The inhabitants of the village determined to have a grand celebration in connection with the Jubilee. They had service in the parish church, and then formed a procession, attended by the yeomanry and all the notabilities of the district. The stone was removed and placed in a suitable position, and a *feu de joie* fired over it by the hussars.

## NOTICES TO CORRESPONDENTS.

**TO CORRESPONDENTS AND EXCHANGERS.**—As we now publish SCIENCE-GOSSIP earlier than formerly, we cannot undertake to insert in the following number any communications which reach us later than the 8th of the previous month.

**TO ANONYMOUS QUERISTS.**—We must adhere to our rule of not noticing queries which do not bear the writers' names.

**TO DEALERS AND OTHERS.**—We are always glad to treat dealers in natural history objects on the same fair and general ground as amateurs, in so far as the "exchanges" offered are fair exchanges. But it is evident that, when their offers are simply disguised advertisements, for the purpose of evading the cost of advertising, an advantage is taken of our *gratuitous* insertion of "exchanges" which cannot be tolerated.

We request that all exchanges may be signed with name (or initials) and full address at the end.

**J. HUNTER.**—Get Bagnall's "Study of Mosses," in the series of "Young Collectors' Guides," published by Swan, Sonnenschein & Co., at 1s. each. You had best apply to the Director of Kew Gardens for an answer to your second query.

**C. E. GUBBINS.**—The shells are certainly the young of *Pecten operculum*. The others are *Tellina solidula*, and the univalve is *Lacuna crassior*.

**C. O.**—(1) See Denny's "Anopluridae," for full information on parasites. Chapters on "Mites" appeared in this journal four or five years ago, by C. F. George. (2) Cooke's "British Reptiles," and Bell's ditto, are the best on the subject. (3) The insects you found on the gills of the swan mussel are a species of freshwater mite in an early stage of development.

**E. PARKIN.**—The galls on the stems of the poplar leaves are made by an aphidious insect called *Pemphigus bursarius*, Hartig.

**G. CLIFFORD (Paris).**—The specimen is a siliceous rodicle which has formed around organic matter. Similar round hollow flint nodules are very common in the chalk formation, where the silica has collected around spongy material.

**D. B. C.**—"The Story of a Gravel Pit" is in SCIENCE-GOSSIP for 1872. The paper on "Jersey Flint Implements" is in the vol. for 1882, p. 36. There are various references to the subject in the vol. for 1885.

**A. FITTIS.**—The moth whose caterpillar was figured in the Rev. J. Croft's paper last month is the puss moth (*Dicranura vinula*).

**E. L. BECKER (India).**—The story of horse-hairs turning to eels when immersed in water is an old tradition among school-boys. It refers to the hair worm (*Gordius aquaticus*). We are rather surprised to hear there are people still living who declare they have seen barnacles turn to geese. The story, as you are aware, is a very old one, and Gesner figured the transformation in his natural history more than two centuries ago.



A. POLLARD.—For skeletons of typical vertebrates apply to Mr. E. Wade Wilton, Naturalist, Leeds.

R. HENSLÖWE.—The stalked objects on the backs of the leaves of your rose-tree are the eggs of the lace-wing fly (*Chrysopa vulgaris*), a neuropterous insect.

## EXCHANGES.

WANTED, batches of *H. nemoralis* and *hortensis*—fine condition shells—from all parts of the kingdom: will give equal exchange in *Helix pisana*, *virgata*, *caerata*, and *Bulinus acutus*, all in great variety.—C. Jefferys, Tenby.

WANTED, mammal, bird, reptile, and batrachian skins, must be in good order: will give in exchange New Zealand bird skins and skeletons, Tertiary fossils, marine shells, crustaceans, all named, or will specially collect for naturalists for exchange as above.—S. H. Drew, Wanganui, New Zealand.

WANTED, photos of interiors of museums, cases, specimens, etc.; in exchange will give photos of New Zealand scenery, 8 x 6, or photos of country since Tarawera eruptions, showing rift in mountain, etc.—S. H. Drew, Wanganui, New Zealand.

WANTED, the following rough Silurian corals, about the size of the palm of the hand or larger. *Favosites Gothlandica* and the chain coral and other varieties, in exchange for polished corals in beautiful spongy forms, Stromatopora. Also wanted, corals from chalk, oolite, and Favosites from Much Wenlock, in exchange for rough Devonian corals and sponges. Also wanted, the four varieties of shells *Lantinas* for other rare British shells.—A. J. R. Sclater, M.C.S., 23 Bank Street, Teignmouth, Devon.

A NICE specimen of pyroxene andesite from South America, cuts extremely beautiful rock sections for the microscope, in exchange for a few mounted rock sections or quartz minerals or shells from the Cape.—A. J. R. Sclater, M.C.S., 23 Bank Street, Teignmouth, Devon.

WANTED, dragonflies, grasshoppers, and other insects in spirit, also well-set Lepidoptera; exchange micro slides.—H. Ebbage, 1065 Hagley Road, Edgbaston.

TWO vols. of SCIENCE-GOSSIP, with coloured plates, unbound; exchange fossils or marine shells.—Fred Challis, Chelmsford.

EXOTIC butterflies' wings.—Having just received a large consignment of Morphos and other brilliant South American butterflies, most of which have unfortunately got so damaged in transit as to be of no use as cabinet specimens, I have a number of fragments of *M. melaneus* and others to dispose of, suitable for microscopic purposes.—J. C. Hudson, Railway Terrace, Cross Lane, Manchester.

WANTED, chalk and red crag fossils in exchange for others from different formations, also specimens of quartzite from any localities.—A. T. Evans, 385 Cooksey Road, Small Heath, Birmingham.

To coin collectors, etc.: what offers for pennies, date 1864?—A. W. Harrison, Trevor Lodge, Thornton Heath.

WANTED, rocks and fossils from all formations. Send list to—Thomas W. Reader, 171 Hemingford Road, London, N.

WANTED, British and foreign land and marine shells. Stamps or fossils offered in exchange.—T. W. Reader, 171 Hemingford Road, London, N.

WANTED, one or two well-made cabinets in exchange for natural history specimens.—C. Jefferys, Tenby.

WANTED, foreign stamps in exchange for British marine shells.—C. Jefferys, Tenby.

OFFERED, London Catalogue, 8th edition: 59, 73, 137, 138, 153, 252, 291, 309, 346, 370, 415, 614, 725, 810, 808, 905, 919, 936, 939, 1007, 1003, 1016, 1034, 1046, 1126 b, 1133, 1138, 1333, 1404, 1775. Desiderata: 6, 26, 39, 41, 45, 46, 50, 51, 74, 87, 95, 111, 117, 121, 146, 160, 163, 230, 236, 311, 404, 535, 586, 623, 633, 687, 909, 926, 927, 932, 940, 1036, 1043, 1074, 1075, 1324, 1325, 1329, 1334, 1350, 1369, 1379, 1399, 1417, 1420, 1456, 1460, 1464, 1546, 1591, 1597, 1641, 1651, 1703, 1781, 1783, 1784, 1839, 1849, 1855, or common British fossils.

WANTED, *Atrypa reticularis*, Linn., with its various geological and geographical positions: in a number of specimens can be used. Also want British Palaeozoic Brachiopoda in any quantity. Can offer in exchange fine specimens of the American "walking fern," *Campsocharis rhizophyllus* (rare), and good coal measure fossils of Kansas.—W. R. Lighton, Sec., Kansas Society of Nat. History, Leavenworth, Kansas, U.S.A.

*Pholas crispata*, *Tellina crassa*, *Conovulus myosotis*, *Terebratula caput-serpentis*, etc., offered for other British shells new to collection.—J. W. C., Carrville, Alexandra Park, Redland, Bristol.

OFFERED, *Sph. ovale* and *Limnea glabra* for *Helix aspersa*, var. *exalbidata*, or *Acme lineata*. Wanted, a large cabinet, suitable for collection of British land and freshwater shells.—John R. B. Masefield, Rosehill, Cheadle, Staffordshire.

DUPLICATES: *U. margaritifera*, *A. cygnea* (small), *H. virgata*, *hortensis*, *erictoruni*, *Clausilia laminata*, *rugosa*, etc. Desiderata: *H. obsoletula*, *revelata*, *fusca*, *C. Kolpithi*, *biplicata*, *Unto tumidus*, etc.—T. A. Lofthouse, 67 Grange Road, Middlesbrough.

WANTED, *Pisidium nitidum*, *roseum*, *Ancylus lacustris*, *Testacella haliotidea*, *mangei*, *Succ. oblonga*, *Zonites fulvus*, *Helix obsoletula*, *Bul. montanus*, *Pupa ringens*, *marginata*, *Vertigo* (all species), *Baltea perversa*, *Clausilia Kolpithi*, *biplicata*, *Achatina acicula*, *Acme lineata*. Offered, marine shells, Echinoderms Crustaceans, sea birds' eggs.—C. Jefferys, Tenby.

DRAGONFLIES wanted from all parts of the world for figuring. Good exchange given.—W. Harcourt Bath, Ladywood, Birmingham.

WANTED, British dragonflies. Offered in exchange, Lepidoptera, coleoptera, and land and freshwater molluscs.—W. Harcourt Bath, Ladywood, Birmingham.

WANTED, works and pamphlets relating to dragonflies, especially by Hagen and De Selys.—W. Harcourt Bath, Ladywood, Birmingham.

WANTED, botanical, histological, and other sections for the microscope.—Suter, 5 Highweek Road, Tottenham.

FUNGI.—J. Hanson, 19 Victoria Road, Bedford, wishes to correspond with a view to exchange of specimens and mutual assistance in determining species of Hymenomyces.

A YOUNG beginner would be thankful for any object of natural history or natural history books.—Beginner, c/o Mrs. Harper, Cedric Cottages, North Beach, Great Yarmouth.

LANTERN slides (photo-micrographs) of insect subjects (whole and parts), botanical subjects, etc., separately or in sets suitable for lectures. Wanted, polariscope, micro books, or micro slides. Lists exchanged.—Stewart, 2 Gilmore Terrace, Edinburgh.

WANTED, side-blown eggs: hawk, tit, goldcrest, mallard, bunting, linnet, warbler, pheasant, partridge, and others in exchange for rare duplicates, in sets or separate, buzzards, hammers, &c.—J. Ellison, Steeton, Leeds.

WANTED, paper from hornet's nest for microscopic examination; good return made in micro slides.—John Moore, 109 Tower Street, Birmingham.

WANTED, fossil mollusca from freshwater deposits; recent foreign shells offered in exchange.—A. Loydell, 20 Stanley Gardens, The Vale, Acton.

OVER 1000 wild flowers, i.e. about 300 species and duplicates collected in West Cheshire, carefully pressed and ready for mounting. What offers? not plants.—Higginson, Newferry, Birkenhead.

WANTED, a clutch each of hobby, buzzard, pied flycatcher, coal titmouse, crested tit, water pipit, Ortolan bunting, raven, wryneck, turnstone, stork, crane, heron, goose, duck, Caspian and Sandwich terns. Good eggs given in exchange.—W. Wells-Bladen, Stone, Staffordshire.

I SHOULD be glad to correspond with working bryologists for exchange in mosses and Hepaticae, chiefly Alpine and sub-Alpine.—A. P. Lowson, 72 Keptie Street, Arbroath, N.B.

WANTED, mounted specimens of the dart and dart sacs of *Zonites excavatus*, *Helix caerata*, *H. lapicida*, and *H. pisana*. Land and freshwater shells in exchange.—W. E. Collings, Springfield Place, Leeds.

*Hydrobia similis*, *Balia perversa*, and *Z. cellarius*, var. *compacta*, wanted for other shells. Send specimens and state wants to—Mr. Marshall, Sevenoaks, Tonbridge.

CHURCH TOKENS wanted. Will give others in exchange or English and foreign coins, stamps, insects, &c.—R. McAlldowie, 82 Bonaccord Street, Aberdeen.

WANTED, works on stone implements to present value of £2 10s., in exchange for Williams's "Orchid Album," vol. iv. (unbound).—Dr. B. Crawshaw, Rosefield, Sevenoaks, Kent.

## BOOKS, ETC., RECEIVED.

"Seven, the Sacred Number," by R. Samuel (London: Kegan Paul & Co.).—"Introductory Text Book to Physical Geography," by Dr. Page, revised by Professor Lapworth (London: W. Blackman & Sons.).—"Durrant's Handbook for Essex," by Miller Christy (Chelmsford: E. Durrant).—"Science Lectures, delivered at Newcastle" (London: Walter Scott).—"Century."—"Scribner's."—"Gentleman's Mag."—"Belgravia."—"Midland Naturalist."—"Wesley Naturalist."—"American Naturalist."—"Victoria Naturalist."—"Garner."—"Amateur Photographer."—"British Dogs," Nos. 10 and 11.—"Proceed. Geol. Association."—"The Naturalist."—&c., &c., &c.

COMMUNICATIONS RECEIVED UP TO THE 12TH ULT. FROM: J. F.—H. W.—J. S.—H. P. S.—W. B. T.—E. L. B.—J. L.—E. P.—T. D. A. C.—W. H. B.—Dr. J. V.—F. H.—F. E.—Rev. W. R. S.—B. H.—C. O.—Dr. A. R.—G.—C.—H. W.—G. A.—R. C. W.—C. B. M.—A. P.—J. S.—Rev. S. A. B.—T. A. L.—T. L.—F. S.—M. S.—C.—W. A. G.—W. M. W.—W. R. L.—H. T.—C. J.—R. B.—J. C. P.—W. J. S.—F. S.—C. P.—D.—R.—K. M. C.—C. E.—G.—W. H. R.—J. S.—C. D. C. C.—H. E. E.—R. H. W.—E. G.—T. J. P.—M. E. P.—D. B.—A.—H.—J. F.—C. H.—J. W. C.—F. C.—J. R. B. M.—J. W. R.—A. P.—Rev. J. W. C.—A. T.—E.—G.—B.—T.—E.—J. H.—S.—A. P.—Rev. H. F.—H. P.—E. E. A. P.—J. M. B.—T.—W. H. H. L.—W. W. B.—H. H.—A. S.—W. E. C.—A. C.—R. W. M. G.—J. E.—&c.



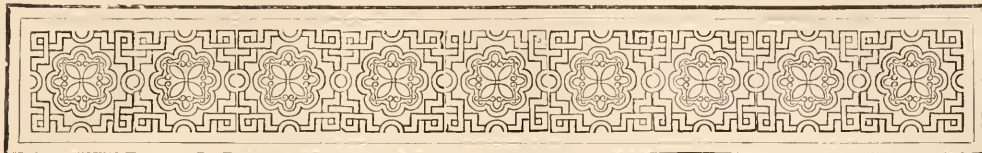

## CURIOSITIES IN DRUGGING.

By ERNEST INGERSOLL.



ONE of the most complete and well-defined departments in the Great National Museum at Washington, is that of *Materia Medica*. It was begun under the care of Dr. J. M. Flint, of the Navy, who was assigned to special duty at the Museum for this purpose; and it now occupies one of the outer tier of rooms immediately beyond the lecture-room and library, and

numbers several thousand specimens. These are arranged on panels and tablets, or in glass jars, are illustrated by a great number of coloured drawings, and an extension of the department in the way of books relating to it, forms one of the most important parts of the library.

Among the first things which Dr. Flint set himself to do was to compile a list of all the articles of *materia medica* in use in the world. These words mean simply "the material of medicines," and the question of good or bad is not involved. His list was simply of those substances which have been employed as drugs, under some sort of recognition.

As the history of medicine was a part, specimens have been sought of the remedies peculiar to former times, and some remarkable notions in medical practice have been disclosed. The medicines and instruments employed by savage and semi-civilised races were also taken in, and among these the greatest curiosities of the whole room are to be found; but the impression grows strong upon the observer,

that there is a very vague line of separation between the medical practice of savagery and that of civilisation. A separate section, under the plan, has been made to illustrate this vague inter-territory called "medical superstitions," and Dr. Flint remarks in one of his annual reports that "illustrative objects may be found not only among the unlearned and uncivilised, but also in the most highly civilised communities, and in use by the most intelligent individuals."

But nothing foreign to medicine, surgery or hygiene—raw materials, preparations, instruments, and appliances—is excluded from the design of the department, which already has made long headway toward its perfection.

The specimens of *materia medica* at hand have been classified under four heads:

1. Animal products.
2. Vegetable products.
3. Products of fermentation and distillation.
4. Inorganic products.

The regular series begins with an exhibit illustrative of the forms in which medicines appear in commerce and are prepared for administration by the pharmacist, such as roots, rhizomes, tubers, and all other forms of crude vegetable drugs; the metals, metallic salts, mineral and vegetable acids, and other chemical products; and the pharmaceutical preparations, both solid and liquid, such as pills, plasters, tinctures, sirups, and the rest. These answer as so many examples of pharmaceutical terms, and embrace no less than twenty-nine crude vegetable drugs, nine classes of chemical products, and fifty-four methods of preparing medicines for administration. Then follow the materials which, when complete, will fully illustrate the pharmacy of the world. The classification begins with animal products, a section which embraces some of the strangest manifestations of doctoring extant. Vertebrate animals yield castor (a highly odorous secretion peculiar to the male of the musk-deer of the mountainous interior of Africa), ox-gall, deer's horn (powdered and burnt), neat's foot oil,

albumen of eggs, spermaceti, ambergris, cod-livers (for oil), fish-sounds (isinglass), toads, frogs, lizards and snakes dried, the prepared shells of turtles, and many others.

One jar from China contains dried toads, said to be "tonic and sudorific." This is only the survival of their use not long ago in Europe and America. "An ointment of toad's fat was supposed to give immense muscular strength, if applied to the body at the moment of conjunction of certain favourable planets. A cubic inch of dried toad worn round the neck on a string was an infallible antidote against many diseases of the body and mind; and a powdered toad, swallowed in spoonfuls, formed a love philter." ("Longman's Magazine," 1883.) "These animals, baked and beat to powder, are taken with orricra root to cure the tympany and many disorders." (Brickell's "Nat. Hist. of North Carolina.") Josslyn, the early New England chronicler, says the fat of the common pond-frog "is excellent for burns and scaldings . . . and also very good to take away inflammation." In Western Africa the women bind living toads on their temples to cure headache.

In China the under shells of tortoises enter into various medicinal preparations in the form of jelly-powders or pills, "reported to be cordial, astringent, arthritic, and useful in diseases of the kidneys; the ashes are given to parturient women and dusted upon wounds and ulcers. Agues, fevers, rheumatism, and other weaknesses are treated by it" (Smith, "Chinese Medicines"). Similar uses were favoured in Europe two centuries ago. Brickell says of the American hawkbill turtle, "Useful in several disorders, such as the gout, hiccicks, epilepsy, sore eyes, and is said to be an antidote against poison."

Dried lizards and snakes are among Chinese medicines, and their labels tell their virtues in the estimation of that people. In Africa the oil of alligators is supposed to have certain properties. Brickell, in his quaint book, tells how valuable the head of a certain lizard "outwardly applied," may be in reducing swellings and other disorders. Serpents have always been highly esteemed as adjuncts to the pharmacopœia. The essential principle in the poison of venomous reptiles, such as the cobra, viper, and rattlesnake, is still considered valuable in certain compounds. In Europe (particularly England) the common people retain much of their ancient trust in the curative power of parts and preparations of the viper; while America is by no means rid of the many superstitions once prevalent in regard to the healing efficacy of the rattlesnake.

Materials entering into medicines derived from the inferior half of the animal kingdom are numerous. The list includes preparations of various insects, such as "wood-galls" of several species; beeswax and honey, cochinal; cocoons of Chinese moths; the earth of the nests of the termite enclosing the dead white ants; the familiar cantharides and many others.

Of mollusks, snails, pearls, and calcined shells are present; while the crustaceans contribute crabs' claws and crabs' "eyes;" and worms give the familiar leech and even the despised earthworm.

From the earliest times in Europe, snails have been in high repute as medicine, particularly in pulmonary complaints. The old books abound in quaint prescriptions for their application. (See, for instance, Lovell, "Edible British Mollusks.") In France and Spain physicians directed their use until the middle of the present century, and in rural districts may still do so. "In olden times it was supposed that the small grite of sand found in the horns of snails introduced into hollow teeth removed the pain instantaneously, and that the ashes of empty snail shells mixed with myrrh were good for the gums." This is taught by Pliny, and is paralleled by the use of pearls, and a powder of calcined oyster shells in certain preparations.

In a similar way I might point out many curiosities of pharmacy made from minerals and plants, in addition to the long list of really beneficent preparations these two sources still yield to the druggist.

No more curious reading in mediæval pharmacy is to be found than that which treats of the mandrake (*Atropa mandragora*). This plant was credited with marvellous virtues. It was celebrated as an ingredient in philtres, or love potions; when torn from the ground it was supposed to shriek, and the person who plucked it was expected to die of madness. It was also believed that, growing under gibbets, the decomposing remains of the unfortunate culprit gave it the male or female form, according to the sex of the criminal suspended above it. The last idea came from its irregular, often bifurcating root, which was often assisted by a little carving into human similitude and thus imposed upon the credulous as something supernatural. Many quaint figures of it exist in the herbals of the Middle Ages, exhibiting this resemblance, which was considered a divine indication of the utility it was intended to serve.

There has been collected in the Museum Library a set of the pharmacopœias of all nations, furnishing a complete list for the whole world "of these substances of *materia medica* whose value as medicinal agents has been established by a large experience, and also those preparations and compounds which, from the frequency or convenience of their use, demand that authoritative titles be given them, and such methods of preparation be established as will ensure uniformity of strength and composition in all cases." From these a Universal Pharmacopœia is to be compiled. An herbarium of medicinal plants will soon be obtained, the more important of which will be exhibited along with coloured drawings.

A most gratifying foundation for this was furnished in the gift from the University of Tokio of the collection of words (chiefly medicinal) which adorns the walls of this room, and a catalogue of which was

published in a late number of the "Proceedings of the National Museum." Each kind of wood is represented by a polished panel about nine by twelve inches in dimensions, upon which are painted in colour accurate delineations of the leaves, flowers and fruit of the tree. Each panel is framed between strips of wood sawn from the outer portion of the tree and covered with bark, and is provided with corner-pieces in the shape of round blocks cut transversely from branches an inch or more in diameter.

Deserving of special mention is a fine collection of cinchona barks, presented through Messrs. Schieffelin & Co., of New York, by the firm of Howard and Sons, of London, which comprises thirty-five specimens of carefully identified barks from the cinchona plantations of India, Ceylon and Java, where the cultivation of the various species of cinchona-tree has become an important industry; important not only to those engaged in it, but to mankind in general, as giving the assurance of a regular and unfailing supply of this most valuable of all known remedies. This collection of East Indian barks is supplemented by specimens of the usual commercial barks from South America; by cultivated barks from Mexico, and by barks and herbarium specimens of the flowering branches of the official species of cinchona from the Royal Gardens of Calcutta. It is hoped that some public-spirited manufacturing chemist will undertake the preparation of the corresponding series of the opium products.

Mineral waters will also find a place in this section, and an extensive contribution, representing most American springs, has already been made by the Schaeffer Mineral Water agency.

The Museum will feel grateful to any druggist or other person who shall assist in the completion of this standard collection, and invites the contribution of any articles rare and curious which belong to the department that has been broadly outlined in the present article, and the value of which to pharmacists and medical men is very great.

AN observer recommends the locomotive as a cheap hygrometer for people living near railroads. When the escaping steam remains long suspended, the air is near its point of saturation with moisture; but when the steam quickly disappears, as if swallowed up, the weather is dry, and there is little prospect of rain. "On a warm summer day," he writes, "I have seen a passenger train ascending a gradient under full pressure without giving the least sign of its motion, or allowing the least trace of steam to escape. At other times the cloud of steam was ten or twelve feet in length, in certain cases it was as long as the train itself, and in very damp weather it extended a long way beyond the rear of the train."

## SLUG GOSSIP.

By DR. J. W. WILLIAMS, M.A., Editor of the *Naturalists' Monthly*.

[Continued from page 222.]

FAM. 2.—LIMACIDÆ.

GEN. *Limax*, Lister; 1678.—De Férussac, in his "Histoire des Mollusques," was the first to separate the limaces from the arions; up to this time they were confounded together. According to Leydig, the internal shells of the limaces consist of more or less calcified cuticle and covered by the corium of the back; this is in a paper in Arch. f. Nat. xliii. p. 209-264, entitled, "Die Hautdecke und Schale der Gastropoden nebst einer Uebersicht der einheimischen Limacinen," to which the reader may refer if he should wish to look up the structure of the integument of the terrestrial and fresh-water mollusca. A more lengthened account would not come within the confines of this paper.

*L. maximus*, Linn. 1758.—An albino of this slug has been described by Paul Fischer in the French Journal of Conchology, on page 299 of the twenty-eighth volume. When irritated, *maximus* dilates its shield. The reader will have noticed, no doubt, very often little mites running over the body of this creature, and not only "of this creature" but of *Arion ater* also; these were first discovered by Réaumur, in 1710, and mentioned by him in the Mém. Acad. des Sciences, to be afterwards called by Gmelin *Acarus Limacum*. They are now, however, known to us as *Philodromus Limacum*, a name given by Jenyns, in the "Magazine of Natural History," vol. iv. 538 and fig. 109. They appear to inhabit the interior of the creature, gaining their exit to the outer world by means of the respiratory orifice, and there they run without any seeming inconvenience to the slug hither and thither over his body, with an astonishing rapidity. The wonder to me is that they are not impeded in their exertions by the slime of their host! The dental formula of *L. maximus* is  $\frac{90 \cdot 1 \cdot 90}{16}$ . I believe Moquin-Tandon says he has

found one specimen in the Jardin des Plantes twenty centimetres in length.

*L. cinereo-niger*, Wolf. D.—Sochæzower (Z. wiss. Zool. xxxv. pp. 30-46) has made some very interesting experiments on this species with oil and turpentine, the result of which are the conclusion, that the olfactory organ is situated in the pedal gland and not in the tentacles, as La Pluche, Moquin-Tandon, and Velten supposed, a fact which corresponds to the previous conclusions of Leidy and Deshayes.

*L. flavus*, Linn.—Mr. Bouillet and M. Morelet have made the interesting observation, that *L. flavus* changes in colour from a bright yellow to a dull olive-green if tormented or kept in confinement.



The fact of this slug forming a thread by which it suspends itself from trees was first noticed by Lister (*Anim. Ang.* iii.), and since then by Latham (*Linn. Trans.* i. 182 and iv. 85), and by many others.

Heynemann says, in *Mal. Blätt.* xvi. pp. 143-147, that *L. flavus* is identical with the Australian species which has been described under the names of *L. breckworthianus*, by Lehmann, and no doubt has been introduced by colonists into that island continent. Linné described this slug as *L. flavus*, the reader knows; but it was described by Lister before him as *L. variegatus*. Lister's original is "*Limax succinei coloris, albidus maculis insignitus*" (*Exerc. Anat.* i. t. l.); this does not accord with the Swede's account, but they are only varietal distinctions.

*L. agrestis*, Linn. 1758.—Forbes, in his "*British Molluscs*," figures a monstrosity of this species with the two upper eye-bearing tentacles united into a single conical prominence.

Hoy, as long back as 1790, spoke of this slug spinning suspensory threads, but this antiquated fact has been newly discovered, it seems, by Eimer (*Zool. Anz.* i. p. 123).

Bouchard observed two individuals lay no fewer than 380 eggs, and as they commence laying on the sixty-sixth day of their age, and they do not reach their full size until the ninety-second day, no wonder they are plagues and pests. Besides, they have three or four families in the year. But M. Laurent has found a fungus in the eggs even before they are excluded from the parent. Gracious Providence, thou art kind!

M. Recluz observed the propensity of this slug for poisonous mushrooms; they will eat *Agaricus muscarius* and *A. phalloides* without hurt, but will pass by as unworthy of notice *Bolletus luridus*. The dental formula is  $\frac{32 \cdot 1 \cdot 32}{100}$ . They are indigenous to Greenland.

*Limax tenellus*. Nilss. 1822.—The first specimen of this slug found in Britain was by Mr. Blacklock, in a wood at Allansford, near Shortly Bridge, in Northumberland.

MM. Ray and Drouet, in their "*Catalogue des Mollusques vivants de la Champagne méridionale*" in *Guér.* "*Rev. et Magaz. Zool.*" 1857, refer this species to the genus *Arion*, and it is quite possible they mistook young specimens of *Arion hortensis* for *L. tenellus*.

*L. levis*, Müll. 1774.—H. Simroth, in *S. B. Ges. Leipzig*, 1883, p. 74, says that female and not hermaphrodite specimens of this species exist. If this be correct, it is a specialisation that must be made great things of in many ways.

Baudon, in *J. de Conch.* vol. xxxii. p. 320, describes a monstrosity without tentacles.

Gen. *Lehmannia*, Heynem.—Why do we English, Scottish, and Irish workers not recognise this genus? Our best continental authorities do, and use it. We

must not be behind the times. Heynemann described it in "*Malakozologische Blätter*," vol. x. p. 211.

*L. marginata*—and why say *Limax arborum*, when this was named so by Bouchard in 1838, and that so by Müller long before in 1774? Who has the priority? I am afraid 'tis Müller.

According to Miss Esmark, in *N. Mag. Nature*, vol. xxvii. pp. 82, 92, and 93, the teeth in young specimens of this slug differ from those in adult. In the young the lateral row has a smaller number of teeth than in full-grown animals, and whereas all the teeth in the young have lateral points, in the adults only the marginal teeth possess them.

Hoy, Shaw, and Latham described a *Limax filans*; this most probably is identical with *Lehmannia marginata*, for these old observers named the slug by that name on account of the faculty it possessed of letting itself down by a thread from the branches of trees.

Gen. *Amalia*, Moq.-Tandon, 1856.—*A. gagates*, Drap. 1801.—The Rev. B. T. Clarke, who first noticed this slug as an inhabitant of the British Isles, found it in several Irish localities. Tate, in his "*British Molluscs*," categorically says this species is littoral in distribution; this I know to be wrong, for I have found it abundantly in the Midlands; and there are other observers who have found it very far inland.

(To be continued.)

#### RECENT ARTICLES AND PAPERS WORTH READING.

"MICROSCOPICAL Advances.—Butterfly Dust, Villi, and Beads," by Dr. Royston-Pigott ("*Eng. Mechanic*," Sept. 30).—"Elieson's Electric Locomotive," and "Steam for Extinguishing Fires" ("*Engineering*," Oct. 14).—"The Alvan Clark Establishment" ("*Scientific American*," Sept. 24).—"Notes on Entomological Classification," by G. V. Hudson ("*Entomologist*," Oct.).—"On the Genus *Lithostrotion*," by James Thomson ("*Trans. Edin. Geol. Soc.*" vol. v. part iii.).—"On the Evolution and Classification of Igneous Rocks," by A. Johnston (ditto).—"President's Address" ("*Journal Royal Soc. N. S. Wales*").—"Modern Views of Electricity;" Full Report of Lecture by Dr. Lodge ("*Nature*," Oct. 6).—"Base of the Carboniferous Limestone," by Dr. C. Ricketts ("*Proceed. Liverpool Geol. Soc.*").—"The Biological Examination of Water," by Romyn Hitchcock ("*American Monthly Microscop. Journ.*").—"On Parallel Structure in Rocks, as Indicating a Sedimentary Origin," by Dr. C. Callaway ("*Geol. Mag.*").—"Perspective," by Hon. J. G. P. Vereker ("*Amat. Photographer*," Sept. 30).—"The Hessian Fly," by F. Maule Campbell ("*Trans. Hertfordshire Nat. Hist. Soc.*" August).—"A Garden of Alpine

Plants," by F. T. Law ("Wesley Naturalist," Oct.).—"Puzzles in Palæontology," by Mr. A. Bodington ("Journal of Microscopy," Oct.).—"The Fernley Lecture," by the Rev. Dr. Dallinger ("Naturalist's Monthly," Oct.).—"Binary Suns," by Herbert Sadler (ditto, Sept. and Oct.).—"The Organic Origin of Chert," by Dr. G. J. Hinde ("Geol. Mag." Oct.).—"Primeval Man in the Valley of the Lea," by Worthington G. Smith ("Essex Naturalist," July).

### DRYING OF PLANTS ON A TOUR.

By M. COPINEAU.

(*Bulletin de la Société botanique de France*, tome xxxiii. Séance du 26 février 1886.)

IN order to prepare botanical specimens successfully for the herbarium, it is of the greatest importance that they be dried quickly, and never be allowed to remain in damp paper—a matter some-

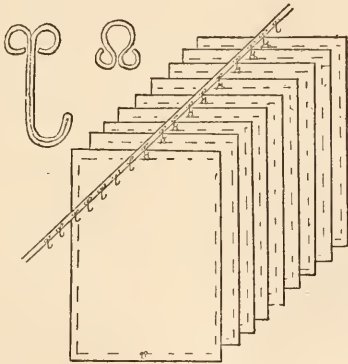
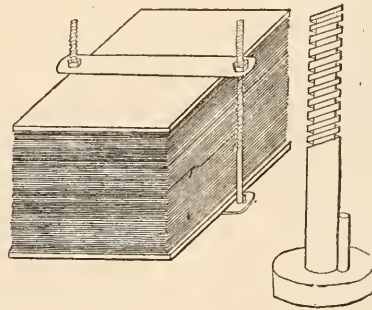

Fig. 132.—Plant-pressing and Drying Apparatus.

I have all my drying pads\* sewn round and near the borders with coarse thread in wide stitches; midway, above and below, the thread is passed through a metal eye, similar to those used by ladies for the insertion of the hooks of their skirts. I then fasten, three or four centimetres apart, to a stout piece of tape, hooks of an elongated form with their bends on the same level as the eyes to which they are to be joined. To dry my pads, I hang my tape by a couple of nails over the fire, or in a draught of air at the open door or window, or simply may be in the room; and to each hook I fasten a pad by means of one of its eyes, which, by the way, must not be too tightly sewn on. The pads isolated from one another, and completely suspended, dry with astonishing rapidity. I can, in a very short space of time—by lengthening my tapes to 50 centimetres—dispose of a considerable number of pads. Not only is the weight of the hooks and tape insignificant, but the eyes, being flat upon the pads, do not interfere in the least with the drying.

With regard to a travelling press, I am indebted



times of no little difficulty; particularly when one is travelling, making large collections, and scantily provided, relatively, with drying paper.

M. Prénanbert, in the meeting, April 28, 1882, exhibited to the society an apparatus by which speedy desiccation may be obtained; but too difficult for transport or to be useful on a tour.

M. Vallot entertained us, June 8, 1883, with a sort of scaffolding of his invention, but the process, all ingenious as it is, nevertheless involves weight to a certain extent; moreover, the construction being somewhat complicated, there would be always a dread of the strings getting entangled, and its action consequently hampered. Finally, it admits only of a comparatively small amount of paper being dried.

I thought it opportune, before the next extraordinary session takes place, and when an opportunity would be afforded of testing it, to indicate to my colleagues the plan which I adopt, and which gives me every satisfaction.

for the following particulars to one of our colleagues, who had it himself from a "brother of the vasculum," M. Rouy. It is, while perfectly simple, as strong as possible, and very handy.

My parcel of plants to be dried and arranged between a couple of unyielding boards is placed between two narrow slabs of steel, pierced at either end with a hole for the passage of a spirally grooved rod, furnished with a stand below and a screw-nut above; these screw-nuts worked with a key ensure as strong a degree of pressure as may be desired. To prevent the ends of the rod from turning in the socket of the stand below when being worked, the lower end of the grooved rod should be made square and to fit the socket, or else it should be provided with a small peg which catches in a notch in the stand; and lastly, to ensure solidity to the apparatus and its working quickly, it were well if the furrow of

\* These, M. Copineau states, are made of four or five doubled sheets of paper, or of eight to ten single ones.

the grooved rod were cut square. The packet once tightened, it requires only to be corded securely; and the press taken to pieces can be used for preparing another set, so that for each company one press is sufficient. Eventually, thanks to it, the parcels both going and returning are sufficiently secure to prevent the joltings on the road from loosening them, to the great damage of your papers going, and especially to your collections returning.

E. DE C.

### TEETH OF FLIES.

By W. H. HARRIS, Cardiff.

#### No. 15.—*SCHÆNOMYZA LITORELLA*, FALL.

ON the 30th of May, 1886, the fly, whose dental organs form the subject of the accompanying sketch, was taken while walking in my garden. At first sight, to all appearances, it was a very ordinary creature indeed. It was small, measuring about three-tenths of an inch in length, proportionately slight, and possessed no very distinctive features to attract attention. The dissection of the mouth-organs alone revealed to me I had made the acquaintance of a stranger; accordingly I at once despatched the creature to Mr. Meade, who has so often kindly assisted me in identifying my captures. I soon had the satisfaction to learn from that gentleman that, apart from the peculiar form of teeth it gave me, it also

furnished him with a species he had never before been as belonging to Great Britain. He had included it in his annotated list of British Anthomyiidae, on the authority of the late Mr. Haliday, who took it on the sea-coast at Holywood in Ireland. It was one of the little-known marine diptera he was anxious to meet with, and hoped I should be able to take some more specimens.

With such an incentive, I was soon off on the search. The coast is about two miles distant from my house; a strong easterly wind had been blowing. Taking my cue from this, I wended my way to the Rumney marshes, and in the course of the morning had the satisfaction to capture several specimens of the species.

The general characteristics of the *schœnomyza*, as given in the list referred to above, are as follow, viz. : " Eyes bare, remote in both sexes; antennæ sub-erect, approximate at their bases, and divergent at their extremities, having the third joint dilated; arista bare, abdomen neither thickened, nor dilated at its extremity; scales of alulets very small and equal; wings with the internal transverse veins placed beyond the termination of the second branch of the first longitudinal veins, anal veins very short."

The mouth-organs in this creature are arranged on a plan similar to that of *Caricea tigrina*, SCIENCE-GOSSIP, 1885, p. 205. The lobes of the proboscis, however, are slightly more flexible. There are three main teeth in each lobe, flanked by two smaller ones, one on either side. All these teeth are provided with a couple of denticles remarkably well developed; the upper portions of the teeth are very dark in colour, hard and brittle; the basal portions light amber and more flexible.

Besides the teeth there are four patches of chitinous plates, which have been compared in the case of *C. tigrina* to gastric teeth. The groups occupying the fore part of the mouth consist of moderately stout plates, and are largely developed, while those situate on the posterior portion are much smaller and the individual plates much finer. A sickle-shaped organ (not figured) composed of very dark and hard chitine is also present; its free movement backwards and forwards against the teeth commences the

crushing of the creature's food, and the four groups of hair-like plates continue the process until it is in condition to be conveyed to the stomach.

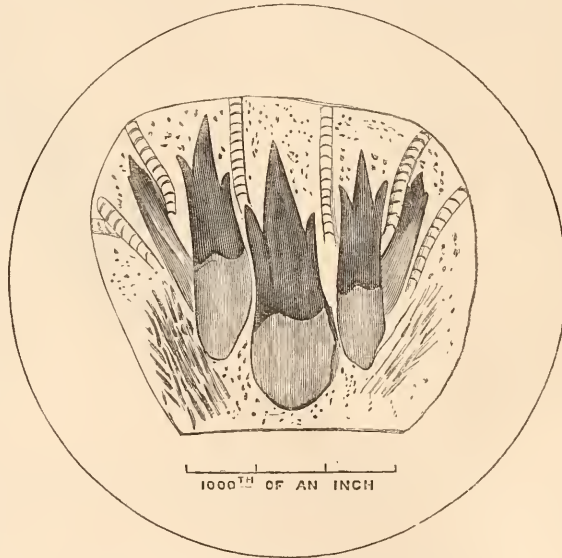

Fig. 133.—Teeth of *Schœnomyza litorella*, Fall.

In the accompanying illustration one lobe only of the proboscis is shown. On comparing it with *Caricea tigrina* it will be noted the basal portions of the teeth are more separated in the present example; that there is not so much disproportion in the size of the main members of the group; that, allowing for the difference of magnification, it is little more than half the size, and therefore represents a very formidable set of organs.



## NOTES ON THE COMMON FROG IN A STATE OF DOMESTICATION.

IT is only from the real observation of the objects of Nature and a correct record of the same that our natural history can reach perfection, and, as an aid to the same, the following extractive summary is given. Towards 10 P.M. on the 9th of June, 1886, when searching for insects, I came upon a small frog (*Rana temporaria*), which I believed to be in the act of trying to take some daddy-long-legs that were dancing near by where it was, but it was somewhat disturbed by me leaping over the dyke by the side of which it was. This frog was brought from Gleniffer, near Alt-Patrick Glen. After being about a day among plants gathered at the same time as itself, it was transferred to a house consisting of a cracked chemical beaker; it was circular, about 3 in. in diameter, and  $4\frac{1}{4}$  in. in height. The beaker was set on its mouth, and fitted into a perforated tin lid, with the roughness of the perforation outwards, and the whole was set into a small saucer, the inside flat portion of which was somewhat narrower than the perforated lid, and which admitted air, and also water by pouring it into the saucer. This frog was not fully developed; it seems the frog takes five years to reach full development, and in this case I suppose the frog had seen the end of the second year, and was entered on its third. Four days after its capture, or on the 13th, I saw it eating flies that were put in its house. On the 24th, put into its house an earthworm, large geodephaga beetle (*Pterostichus niger*), a slater or wood-louse (*Procellio scaber*), one *Geophilus longicornis*, and a somewhat crushed centipede, all of which were quickly eaten, save the centipede. On the evening of the same day it ate several snails. On the 29th, put into its house two horse leeches (*Hæmopsis sanguisorba*), one of which was soon down the frog's throat. I watched the creature to see if it would swallow the other leech, and, as I did so, I saw a change come over its eyes—the pupils were enlarged, and they lost their marked pleased expression; for, by this time, when I came near its house with a chip-box, and began to open it, its eyes became much brighter as it watched me. It did not take the second leech, but even began to look away from it, and the appearance in its eyes still increased; at length it suddenly stood up on its hind legs, and seemed to put each of its fore feet in the sides of its mouth (but the action was so quick that my eye could not follow it), and it quickly drew out the leech which it had swallowed, and became excited, and turned its back to it, and leaped and trampled on both leeches. I opened the house to remove the leeches, when at once the frog sprang from its house, with one of the leeches sticking to its legs—this attachment of the leech must have only happened as its house was being opened. Before this the frog allowed me freely to take it in my hand,

and even sat in my hand to enjoy its water bath in the rush from the water pipe; but now this is what it would not do, and, as I endeavoured to take it to remove the leech from its leg, it leaped wildly away from me. Amid all the frog's mad leaping the leech stuck to it, drawing itself into a knot, till I, at length, got my fingers on it. After being relieved from the leech it leaped into the window flower balcony, and among the flowers I left it for some time, thinking the fear would leave it. But as soon as I attempted to take it, it leaped as madly as ever, and finally made right over the balcony—a height of three stories. I afterwards found the creature on the ground none the worse, and after being put to its house, and having a cold water bath, it became as tame again as it was, and on the 4th July it took a grasshopper off my finger. Soon after this event the frog seems to have changed its skin, but I was not an eye-witness of the actual change, but for some days the characteristic brown marks near the eyes were red flesh, but afterwards the colour was very strongly marked. On the 2nd July, given some slaters and Staphylinidæ beetles, all of which were eaten, save one slater, which remained alive beside it till the 4th, when it died. On the 3rd, given a diet of house-flies, taken with an insect net; 12th, gave it a small yellow humble bee, which was at once taken into its mouth, and with both its fore-feet wiped it out. On the 13th, given 30 house-flies, all of which were eaten, and also a large tory or grub-worm—i.e. the larva of a Tipula, and at the same time a slater was put in, which chanced to fall on its back; and, as it lay wriggling, the frog kicked at it with the hind feet, but never ate it. On the 13th, I put in a large moth to it, which with the wings closed measured about  $1\frac{1}{10}$  in. long, and over  $\frac{3}{4}$  in. across the tip of the wings. At first the frog seemed afraid of it, and trampled on it, but afterwards ate it. The name of this moth is the dark arches (*Xylophasia polydon*). On the same evening the frog willingly partook of a smaller moth, the pale mottled willow (*Cardarina cubicularis*). Afterwards the frog ate eagerly of the dark arches, as on the 26th July, and the 3rd and 4th August, about which time they were very common, and on the 4th, after the moth, it took a large earthworm. On the 17th July it leaped to the top of its house and caught a large flesh-fly; while, on the 18th, it took a large beetle (*Pterostichus madidus*), and in so doing defended its eyes with its forefeet. On the 23rd, it got five earthworms, all of which it swallowed so quickly that I could not follow the action with my eye; short pieces of them were, however, often left hanging from its mouth for a time. After this great feed, I observed several partly decomposed worms lying in its house floor on the evening of the 25th, while, on the morning of the 26th, the frog appeared unwell, being full and blown-like, the skin shining and polished-looking, and its house had a very bad smell, and the glass covered with a white-like matter.

I washed the house and gave the frog a cold water bath, after which it became flat and had its usual appearance of health. On the 28th, I put two beetles (*Pterostichus nadius*) into its house, both of which ran very actively, and the frog leaped violently and trampled on them till they were soon very quiet, but it ate none of them; another beetle was then put in, but it was not eaten; during the night froggy left his house, and was found the following afternoon. On the 6th August, put in his house a large cockroach or "clock" (*Blatta orientalis*), but it was not eaten; the frog afterwards ate a large daddy-long-legs, and another on the morning of the 7th, and again two on the 23rd, but it was some time before all their long legs were wholly swallowed, and it again had another on the 29th. On the 1st of September, I housed a young toad along with the frog. The toad (*Bufo vulgaris*) was only about three-fourths of an inch in length, and for some time it lived along with the frog, generally seated on its back, but it finally disappeared, I believe swallowed by the frog. On the 14th, gave three nearly full-grown larvæ of *Hadena olivacea*, which it swallowed, making great use of its forefeet in defending its eyes; after this, on the 16th, the frog was very uneasy, and its skin of a blackish colour, but after a cold water bath, of which it was very fond, it returned to its usual yellowish colour. On the 18th, for some time it watched a species of julus, but afterwards took a snail in preference to it. On the 22nd, I gave the frog a large earwig (*Forficula auricularia*) which proved the cause of its death.

From such an extractive summary of the frog in domestication, I think certain conclusions may be drawn. In selecting certain animals as food, and rejecting others, does not the frog learn from experience? In no instance do we find this specimen eating of the centipede (*Lithobius forcipatus*), probably because it had eaten of the same creature when in the fields and had learned its mistake. In accordance with this we find that at first it ate slaters or woodlice, but afterwards left them alone. Taking beetles at one time and not at another does not agree so well, but this may admit of another explanation, viz. the state of the frog's health. See the 18th and 28th July, as above. It is a well-known fact that frogs are fond of, and live a good deal on, beetles. In the summer of 1881, I found several specimens of the ghost, or hissing beetle (*Cychrus rostratus*), in the stomach of frogs taken on a broom-covered hill. On the 8th July, when none of the beetles were eaten, there is indication of the creature being more or less sick, as it left its house—a feat it seemed to perform only when in want of water or in a sickly condition. The frog left its house by creeping under the edge of the beaker, and then leaped off the top of the drawers on which its house stood. It thus left its house on the 8th, 19th, and 20th of August, and on some other dates, when it often remained at large in

the room for a day and a night, and as a rule was generally found hidden in one of the children's slippers or boots—a mark of the frog's natural habit to hide in a hole or crevice.

TAYLOR,  
Sub-curator, Free Museum, Paisley, N.B.  
(To be continued.)

## CHATS ABOUT ROTIFERS.

No. V.

(NOTHOLCA SPINIFERA.)

OF the Rotifera the great majority of species belong to fresh water, and until recently comparatively few species were known to us to inhabit the sea: but since 1885 there have been no fewer than twenty new species added to the list as belonging to a marine habitat, and *N. spinifera* is one of them. It belongs to the sub-order Loricata, family Anureadae, and has been classified by Mr. Gosse in genus Notholca.

It is an attractive and interesting Rotiferon. Its body is protected by a purse-shaped lorica (or sheath) of a horny consistence, and is divided into two plates by a deep wide cleft on each side. The dorsal is striated and rather less than the ventral plate in adult individuals, but in young the dorsal and ventral plates are equal. The front of the lorica on the dorsal side is furnished with six spines like the teeth of a saw of irregular length, the two centre ones being the longest.

The chief peculiarity of the *N. spinifera* is the fact that it is provided with a pair of articulated spines, one on each side, projected and folded at the will of the animals by a pair of muscles. The function of the lateral spines is undoubtedly as organs of defence, as the creature is observed to extend the spines on the least approach of danger. The muscles and the nature of the joint are best observed when one or two individuals are secured in a compressorium and examined by a power of three-hundred diameters. From the irritation caused by the cover glass, the animal when in this position is continually extending and retracting its lateral spines, and thus the expansion and contraction of the muscles are very well seen; and the phenomenon is extremely interesting to the observer. The hinge of the spines seems to be a ball and socket joint, which forms a junction between the dorsal and ventral plates. In the cleft on each side, the lateral spines are concealed when retracted, and only visible when projected.

The *N. spinifera* has a large stomach usually filled with brown matter, but the colour depends on the nature of the food within the creature's reach. Its food consists of both animal and vegetable organisms. It feeds on infusorians, spores and antherozoids of algae.

It is furnished with a pair of powerful jaws, which

are constantly in motion. It has a small red eye, situated a little above the mastax. Its head is projected a good distance beyond the front of the lorica. The corona is formed by three rounded lobes with a tuft of long vibratile cilia on each lobe. It is a vigorous swimmer. The head is contracted swiftly within the lorica on the approach of danger, and at the same instant the lateral spines are projected. With its head drawn within the lorica the creature is protected by the six frontal and the two lateral spines.

The water vascular system is conspicuous in specimens that have been kept for a few days in a jar of clear sea water, as the creatures then become very transparent, thus permitting a clear observation of the lateral tubes and vibratile tags; which lead to a large contractile vesicle near the posterior.



Fig. 134—*a*, Dorsal view of *Notholca spinifera*, with lateral spines extended.



Fig. 135.—Side view of *Notholca spinifera*.

I found the *N. spinifera* for the first time in a tide pool in the estuary of the Tay (November, 1885), associated with *Syncheta ballica*, *Pterodina clypeata*, and *Mytilia Tavina*; and have fished it up frequently since at all seasons, both in the cold winter months and in the heat of summer, in various parts of the Tay; but its habitat is by no means confined to the east coast of Scotland, for in July this year (1887), Mr. Boyd, of Glasgow, sent me a bottle of water he had dipped from a tide pool in Loch Long (an arm of the sea on the west coast), which contained a number of specimens of *N. spinifera* in a healthy condition. It does not carry its egg after expulsion, but deposits it on the alga and conferva at the bottom of the pool. It is a hardy rotiferon, and can be kept alive in a marine aquarium for months.

The best way to collect marine rotifera is to filter

through a conical calico bag a large quantity of water dipped from amongst weeds at the sides and bottom of tide pools, and then fill a wide-mouthed bottle with the remains.

Length of full-grown specimens  $\frac{1}{85}$ , young specimens  $\frac{1}{200}$  of an inch.

JOHN HOOD, F.R.M.S.

Dundee.

#### NOTES ON NEW BOOKS.

**T**HE *Geology of England and Wales*, by H. B. Woodward, F.G.S. Second ed. (London: George Philip & Son.) It is now ten years since Mr. Woodward's manual first appeared. It took a leading place in geological literature at once, and has kept it ever since. Of course, within the last decade, geology has considerably extended its boundaries, so that much more has to be said on the geology of this country now than could have been said in 1877. Mr. Woodward has accordingly brought out a new edition of his valuable book, in which all the new matter is included. Practically this second edition is a new and re-written book, nearly double the size of its popular predecessor. We are pleased, however, to observe that the original plan of the work has not been altered. It would have been very difficult indeed to have altered it for the better. One of the most valuable chapters, to the geological student, is that which deals with the numerous researches in the Archæan rocks which have been made within the last ten years. Also, the details of the subdivisions of the Cambrian and Silurian, old red sandstone and carboniferous, as well as of the oolitic formations. The

eruptive and metamorphic rocks naturally come in for much extended notice, thanks to the application of the microscope to rock structures. Mr. E. T. Newton's valuable synopsis of the animal kingdom appended to this work has already been noticed in our columns. A capital geological map of England and Wales, 24 inches by 19 $\frac{1}{2}$ , is included. Altogether, we heartily congratulate Mr. Woodward on the greatly advanced and improved tone of the second edition. It will henceforth be above criticism, for it is a book which critics themselves will be obliged to consult before criticising.

*Manual of Bacteriology*, by Dr. E. M. Crookshank, second edition, revised and enlarged (London: H. K. Lewis). This is another important work which appeared less than three years ago, and, large as the volume then was, it has swollen to nearly double its



original proportions. The Bacteria now form a specialistic study. The study has been very popular, and it is also a very important one. The entire subject, as now discussed, has arisen within the last ten years. Dr. Crookshank's first edition met a want which had been felt so severely that it was out of print within a few months of its appearance. A second edition was demanded, and the author wisely determined to recast some of the chapters, and bring it up to date. Additional chapters have been written on the General Morphology and Physiology of the Bacteria, as well as on Antiseptics, Disinfectants, and Immunity. To the large list of illustrations, which appeared in the first edition, seventy-three fresh ones are added in the second. There is also a bibliography of the Bacteria. The present work, therefore, may fairly be regarded as the best of its kind in existence.

*Comparative Morphology and Biology of the Fungi Mycetozoa and Bacteria*, by Professor De Bary, translated by H. E. F. Garney, M.A., and revised by Professor Isaac Bayley Balfour (Oxford: Clarendon Press). This handsomely got up volume has long been known to specialists in its German form. It is one of the most important extant, for Professor De Bary's life has been mainly spent in the researches which have made the microscopic fungi so well known in our time. The Clarendon Press have done a wise and gracious thing in thus bringing within reach of English-speaking students such a valuable and comprehensive work. The greatest part of the volume is occupied with the *Mycetozoa*—the *Bacteria* only coming in for 45 pp. out of a total of 490. The copious "Explanation of Terms" appended will prove handy for students, seeing how fast terms are multiplying.

*Hydrophobia, an account of Pasteur's System*, by Renaud Suzor, M.D. (London: Chatto & Windus). No medical man ought to be without this book, and very few medical men can afford to be. Pasteurism is dominant, whether people believe in the system or not, and you cannot even afford to despise a system unless you know something about it—although it would be easier to do so. The present volume gives a historical description of hydrophobia from the earliest times down to 1880, when Pasteur first made known his method for dealing with this terrible and much-dreaded disease. The second part is devoted to the various communications which Pasteur has made on the subject, and to all readers who have interested themselves in this important subject, this section will prove exceptionally useful. Lastly, we have a third chapter, dealing with the technicalities of Pasteur's method. The author writes with a full knowledge of his subject, writes directly and to the point, so that the reader is put in possession of Pasteur's facts, discoveries, and views in the shortest, and yet plainest and pleasantest, period of time. It should be added that Dr. Suzor was a delegate from

Mauritius, sent out by that public-spirited little island to Paris, purposely to study Pasteur's system for treatment of hydrophobia.

*Bird Life in England*, by Edwin Lester Arnold (London: Chatto & Windus). Mr. Arnold is an old and valued contributor to SCIENCE-GOSSIP, a sportsman as well as a naturalist, a traveller of experience, and a leading member of the London press. All of these qualifications entitle him to be the author of a readable book. His parentage (if Galton's theory of hereditary genius be true) further lays on him the duty, not only never to be dull, but to be both entertaining and instructive. Further, the subject is a hackneyed one, although always a welcome one. So many young men have given us their opinion on the British avifauna (often founded on shooting some rare specimen, instead of preserving its life) that books on British birds are too numerous. No doubt Mr. Arnold was perfectly acquainted with all this before he wrote the present book. For that very reason, we can understand he may have been loth to publish it. He did not want to add another volume to the lumber-heap—notwithstanding "friends" advised him (as "friends" always do advise inexperienced young authors to publish). But Mr. Arnold has given us a real book, full of quiet, keen observations. He is a naturalist first, and a sportsman afterwards. He describes a duel between a peregrine falcon and a woodcock, of which he was witness, and of all that took place within fifty yards of the observer. He let both escape, whereas a sportsman would have killed them, or have tried to do so. Altogether, Mr. Arnold has given us a delightful book, a sunny, arborescent, fresh-air kind of book, both delightful and instructive to read. It is a genuine gain to British ornithological literature; and we heartily commend it to all of our readers who enjoy "something really good."

*The Commonhealth*, by Dr. B. W. Richardson (London: Longmans). The author is a man who has long made his mark. It is now for people to listen to what he says—not for him to ask them. As a writer of English, he stands in the front rank of contemporary authors. As a genuine and original thinker, few in his profession are in front of him. He is a sanitarian above all things, and this volume is really a series of essays on health subjects. Most of them, if not all of them, were delivered as lectures in various parts of the country, and were in part reported at the time. Now, we have them, fresh from the last touches of their genial author's pen.

*Palæolithic Man in Middlesex*, by J. A. Brown (London: Macmillan & Co.). Anybody desiring to know the latest thing said on the antiquity of man should forthwith procure this pleasant and most deeply interesting book. Just now there is a tendency for the pendulum to swing back in certain geological circles. Professor Prestwich has partly

recanted of his sin in the subject of man's antiquity, and seems to think 10,000 years is enough for him. Mr. Brown's book comes in well as an antidote. Practically, it is the continued result of the author's papers on this subject for some years past, contributed to various learned societies. It is crowded with evidences of wide, as well as the original observation, of large and extensive reading, and of a thorough familiarity with the subject in all its multitudinous departments. It is consequently a valuable manual for students.

*Manual of Zoology*, by Professor H. A. Nicholson. Seventh edition. (Edinburgh and London: W. Blackwood & Sons.) No living writer has done more to introduce students to zoology than Professor Nicholson. His elementary and advanced text-books on that subject are well known, but the present volume is fuller and completer, extending to nearly 1000 pages, and containing 555 illustrations. The fact that the present is the seventh edition shows the position the work has taken, and renders criticism unnecessary. But it is important to note that the author has rewritten and enlarged his work, so as to make it include the newest discoveries as far as possible.

*A Sketch of the Geological History of the Earth*, by Professor Ed. Hull, F.R.S. (London: C. W. Deacon & Co.). This is an admirable, useful, and trustworthy digest of practical geology, dealing with the different geological periods in succession, and tracing the distribution of their strata throughout the world. In addition, the fauna and flora, volcanic phenomena, etc., of each formation are noted. The work will prove very useful for brief reference, and Professor Hull's name is sufficient to make it a successful little book.

*Flora of Sussex*, by the Rev. F. H. Arnold, LL.B. (London: Hamilton & Adams). This well got-up little book gives a list of all the flowering plants and ferns found in Sussex, as well as the localities of rarer species. The author is a botanist of high standing, whose name has been well known to readers of SCIENCE-GOSSIP for fifteen years as one of our best contributors. It has evidently been a labour of love to Mr. Arnold. It is accompanied by a map of the county, with the districts marked, and contains an introduction, description of the seven botanical districts into which he divides Sussex, a history of Sussex botany, bibliography, etc. The whole work is remarkable for carefulness and accuracy, and it will undoubtedly take a good place in our botanical literature.

*Sixth Annual Report (1884-1885) of the U. S. A. Geological Survey* (Washington: Gov. Offices). It is a genuine pleasure to an English geologist to receive these splendidly got-up volumes. Those of our own Geo. Survey are never sent out to English scientific journals, perhaps because of the expense of postage. The present vol. is of high scientific value; the paper by Professor Lesquereux, "On the Flora of the Lar-

amic Group" (illustrated by 65 double plates of fossil plants), being alone sufficient to give it a permanent value. The greater part of the vol. is taken up with descriptions of the physical history and geography of the Upper Mississippi Valley.

*Introductory Text-Book to Physical Geography*, by the late Dr. D. Page. Revised and enlarged by Professor Charles Lapworth (Edinburgh: W. Blackwood). We are pleased to see the re-issue of this work, or rather, the complete revision and alteration, for Dr. Page's was by no means a trustworthy text-book. No man could have been selected for the work of revision who would have done better than Dr. Lapworth. It is now a model elementary text-book of the subject.

*The Liver-Fluke and the Rot in Sheep*, by Ed. Halse (London: Edward Stanford). This is a prize-essay, setting forth in such a clear and easily understood manner the whole history of the subject, that we do not wonder Mr. Halse (another old contributor) took the prize for it at the Agricultural College, Tamworth. It is rather a full and complete summary of the subject than the results of original investigation, although there are not lacking evidences of the latter. The folding plate includes 17 illustrations of the various stages in the life history of the fluke-worm.

*Factors in Life*, by Professor H. G. Seely, F.R.S. (London: S. P. C. K.). This small but attractively got-up book contains three lectures on Health, Food, and Education, by one of the best and most original lecturers of the day. *The Fungus-Hunter's Guide*, by W. Delisle Hay (London: Swan Sonnenschein & Co.). Mr. Hay is making running with his fungus books, and there is a suspicion they are getting too numerous. But the present little book is very handy for the pocket, and the "keys" by which to determine the characters of the different genera and species of funguses are clearly made out. Interleaved pages for memoranda are inserted. *The Student's Handbook to the Microscope*, by a Quekett Club man (London: Roper & Drowley). The "Club-man" is Mr. F. Charters White, one of the most "Clubbable" of men—a devotee to the microscope, so that nobody could have brought out a brochure like this except himself. It is the very book the young beginner wants. *Seven, the Sacred Number*, by Richard Samuël (London: Kegan Paul). This is a work "no fellow" can understand, except the author. *Chemistry and Heat*, by R. G. Durrant (London: Rivingtons). A handy little book for working reference. *Lunar Science*, by the Rev. T. Harley (London: Swan Sonnenschein & Co.). A well-written, brief, and artistically got-up volume, which condenses a wonderful amount of information concerning the moon in a short space. *Science Lectures at Newcastle* (London: Walter Scott). Seven capitally reported and highly readable lectures by G. F. Romanes, H. N. Moseley, Litton Forbes, E. A. Parkyn, H. Nettleship, Andrew Wilson, and F. H. Carpenter. *All About Mnemonics*, by A. E.

Middleton (London: Simpkin & Marshall). A cheap, handy, full, and practical work, both of reference and study. That it has taken well is proved by its having reached a second edition. *Durrant's Handbook for Essex*, by Miller Christy (Chelmsford: Ed. Durrant). A prettily got-up guide to the principal buildings, places, and objects of interest in every parish in Essex. Mr. R. M. Christy is well known to most of our readers as an ardent botanist and naturalist. He is no less successful as a topographer and antiquary. This is demonstrated by the more important and larger work, *The Trade Signs of Essex*, by Miller Christy (Chelmsford: same publisher), a

#### KINNI-KINNIC AND INDIAN PIPES.

By Rev. VINCENT CLEMENTI, B.A., of Peterboro', Ontario, Canada.

THAT the aborigines of America are inveterate smokers is, I presume, a well-known fact; for, without referring at any length to the introduction of tobacco from this continent into Europe, whether by Hernandez, in 1560, or by Hawkins, five years later, the North American Indians were found in the enjoyment of "the weed" nearly seventy years anterior to the earlier of those two dates.

The tobacco-plant, however, requires a warm

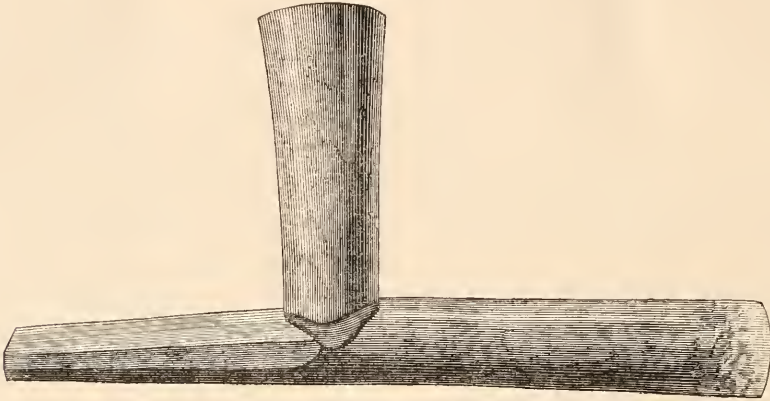

Fig. 136.—(One-third natural size.)

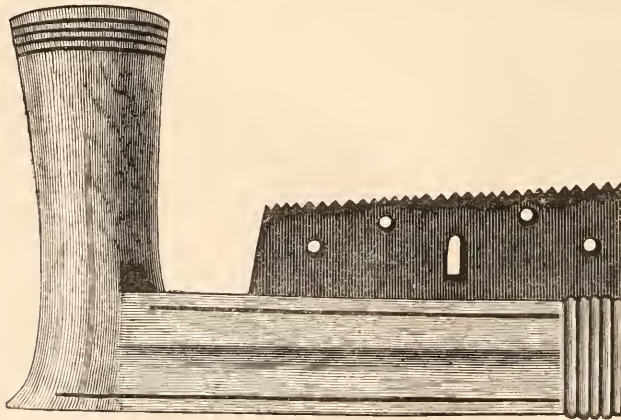

Fig. 137.

pleasantly written account of the origins and meanings of public, local and other signs now or formerly found in this interesting county. The frontispiece of High Street, Chelmsford, in 1762, is worth the money.

*Bird Stories, Old and New*, by Harrison Weir (London: S. P. C. K.). A delightfully artistic, although unpretending and real story-book, turned out by a man who is both an artist and a naturalist, and an ornithologist more particularly. It is the prettiest gift-book of the season.

climate to bring its leaves to perfection, and therefore the Nomades of the Great North-West, when unable to purchase the pure *Nicotiana*, have been in the habit of using other plants for the plenshing of their pipes.

The most common of these substitutes is kinni-kinnic, sometimes written kin nik kin nik, which is the dried bark of the silky cornel, or dogwood (*Cornus sericea*).

Another substitute, although neither so common



nor so much esteemed, is the leaf of one of the Ericaceæ, the heath family, viz. the Prince's Pine, or Pipsifswa (*Chimaphila umbellata*).

Having had a favourable opportunity afforded me of sketching some genuine Indian pipes, and, as they

Fig. 137.—This pipe is made of blackstone, and weighs 8½ oz. It belonged to a Red Lake Chippewa Chief.

Fig. 138.—This pipe came from Fort Garry, and belonged to a half-breed; it weighs 14½ oz. It is made of Soapstone or Saponite. The ornaments, of metal, consist of three turtles, a bird, five horses' heads, &c. The artist was a Sioux Indian.

Fig. 139. This pipe was purchased from a half-breed of Mackenzie's River, and was made by an Indian of that district. It is of green marble, blotched with red very much after the manner of the blood-stone; it weighs 8½ oz.

All these pipes are two-thirds the exact size of the originals, except Fig. 136, the stems only being omitted.

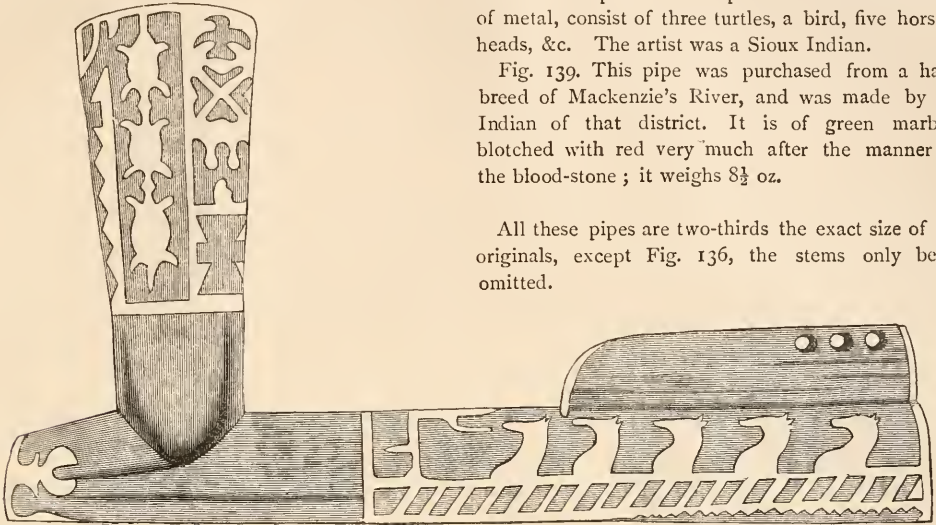

Fig. 138.



Fig. 139.

are exceptionally good types, I enclose my sketches, thinking a representation of them in your periodical may not prove uninteresting to your subscribers.

#### DESCRIPTION OF THE PIPES.

Fig. 136.—This pipe, made of stone, and weighing—as it appears, without the stem—2 lb. 5 oz., was smoked by the Red River half-breeds and the Sioux Indians, on the Plains, when effecting a treaty of peace.

#### EDUCATIONAL COLLECTION OF INSECTS.

By W. HARCOURT BATH, Author of *Handbook of Insects, &c.*

IT may be stated without any fear of contradiction that the loss occasioned by injurious insects—in the British Isles alone—amounts to millions of pounds annually.

Notwithstanding this, strange to say, our government has not hitherto recognised in any form whatever, the researches of the enthusiastic individuals who have undertaken the arduous task of elucidating the economy of the injurious insects, indigenous to these islands, with the commendable object in view of discovering some means for preventing the immense ravages which are periodically committed by them.

Now nearly every government on the Continent wisely recognises the necessity of assisting, in a pecuniary manner, researches of this description by scientific specialists.

The consequence is that the investigations are, as a rule, more thoroughly undertaken, and better results ensue than where they are performed in a private capacity.

This is indeed what we want and ought to have in this country. The multifold advantages attending an official staff of entomological specialists would well repay the small sum which might be annually drawn from the Treasury.

The work of such officials would of course be to

investigate and report on the ravages committed by injurious insects, and the best means for preventing their attacks. Also to give lectures to agricultural societies, and otherwise assist in disseminating useful information among those who are more particularly in need of it.

Now, in order to supply, as far as possible, by other means, this public desideratum, many suggestions have been made at various times; but the one which has probably met with most favour, is the establishment and exhibition of educational collections of insects in our various museums, colleges, public schools, and in other suitable places.

It is with the intention of briefly relating the best means of forming such a collection that the present article has been written.

Owing to our comparative ignorance of the economy of the great majority of insect forms which inhabit these islands, we are often at a loss to determine whether a certain insect is to be classed as injurious or beneficial.

There are many species which appear to be decidedly either one way or the other; while, on the other hand, there are many kinds which are really both injurious and beneficial, in which case it is a question whether the good outweighs the evil, or *vice versa*.

Then there are many insects which are beneficial when in limited numbers, but which are injurious when abundant. It will be seen therefore that there is sometimes a great difficulty in discriminating between our insect friends and enemies, and the only philosophical conclusion is that a good knowledge of entomology is highly essential to the agriculturist for his advancement and prosperity.

In the arrangement of the insects in the proposed collection, no scientific order can with convenience be followed, so that it will be found preferable to adopt the alphabetical as far as practicable.

The following are the headings under which all insects injurious in a particular sphere may be brought together:—

1. Insects injurious to man personally, such as cause him personal injury and annoyance.
2. Insects injurious to stores, provisions, clothes, furniture, and household goods.
3. Insects injurious to domestic animals, cattle, sheep, and poultry.
4. Insects injurious to vegetable crops.
5. Insects injurious to cereal and grain crops.
6. Insects injurious to fruit crops.
7. Insects injurious to forest trees.
8. Insects injurious to garden and greenhouse plants.

Under the above primary headings subsidiary headings might be arranged in alphabetical order, the following of which is an example:—

#### INSECTS INJURIOUS TO VEGETABLE CROPS.

Asparagus — Bean—Beet — Cabbages — Carrots —  
Celery — Herbs — Hops — Lettuce — Onions—  
Parsnips—Peas—Potatoes—Turnips, &c.

Then under each of these sub-headings would be arranged alphabetically the various insects which attack them; for instance:—

##### CABBAGES.

Cabbage aphid—Cabbage butterflies—Cabbage-fly—  
Cabbage gall weevil—Cabbage moths—Cabbage  
powdered wing—Cabbage root-eating fly, &c.

Many insects are injurious to several crops, and specimens of these should be placed under each crop which they attack; thus, for instance, the carrot-blossom moths (*Depressaria dancella* and *Depressaria depressella*) are injurious to parsnips as well as carrots (under both of which headings specimens should be exhibited).

Under the heading of "Beneficial Insects," all the insects which are more or less beneficial should be arranged according to their various uses, of which the following are the principal:—

1. Insects beneficial to man in a commercial point of view.
2. Insects beneficial in consuming offal and decayed vegetable substances, thereby preventing the spread of malaria, &c.
3. Insects beneficial in keeping within proper bounds the undue multiplication of insect pests.
4. Insects beneficial in keeping within proper limits the growth of vegetation (in this country such as feed on weeds).
5. Insects beneficial in keeping the air in a state of continual motion, thereby sustaining it in equal proportions.
6. Insects beneficial in adding to the beauties of nature.

Then there are many insects which are both injurious and beneficial (as we mentioned before), and for these the most philosophical plan, it would seem, is to include them under both of the headings of injurious and beneficial insects.

It will probably be found most convenient and preferable to devote separate cases for the primary headings—some of them indeed will probably require two or three apiece.

Under each specimen should be given the English and Latin names with a brief description (in the case of an injurious insect) of the particular mode of injury caused, and the best known remedies for preventing its attacks, and in the case of a beneficial insect a note explaining its particular uses. The above may be printed, or else legibly written, on a square of white cardboard.

The following are two examples of what we mean:—

Asparagus beetle (*Crioceris asparagi*). The larvæ

of this beetle in some seasons cause much injury by eating off the leaves of the asparagus and gnawing the tender shoots.

*Remedies.*—Syringe the infected shoots with a mixture of soft soap, powdered sulphur, and warm water.

Burying beetle (*Necrophilus vespillo*). This insect is very useful in burying dead animals (such as small birds, moles, and mice) beneath the soil, thus preventing disagreeable smells in hot weather, and excluding the possibility of the dissemination of malaria.

Besides exhibiting the imago of each insect, it is very desirable that the larva pupa and ova should also be shown, or if specimens of any of them cannot be obtained a drawing may be substituted. Specimens of the various food crops with samples of the injury done would add greatly to the value of the collection.

Such a collection as the one we have here suggested would be found both interesting and instructive, and we can recommend the formation of one to anybody as a very pleasant occupation. To every person who desires to promote the welfare and prosperity of himself and fellow-men here is an opportunity not to be neglected.

Any further information I shall be very pleased to supply to the best of my ability.

*Ladywood, Birmingham.*

#### GOSSIP ON CURRENT TOPICS.

By W. MATTIEU WILLIAMS, F.R.A.S., F.C.S.

**P**ECULIAR GYMNASTICS.—Mr. Edward Horace Man has written an interesting volume "On the Aboriginal Inhabitants of the Andaman Islands," in which he describes, among other customs, a habit common among the young men and women of twisting their bodies from side to side, to stretch the muscles of the back after lengthened rest or sedentary occupation. In doing this they produce a succession of sounds like those caused by the cracking of the joints of one's fingers.

This practice is by no means confined to the Andaman Islanders. Among my fellow-students in Edinburgh was a young Turk, by no means a savage, but a highly-educated gentleman, bearing, of course, the title of Effendi. He was working hard for the medical degree, and after a long spell of reading, he refreshed his brain by going through a curious drill or series of exercises. These consisted of sitting cross-legged on the floor, rising and sitting again several times without help from the hands; then making a series of movements of the arms, then cracking all the joints of his fingers, elbow, and shoulder, and finally proceeding with similar cracking of the vertebrae and some of the lower joints. He

told me that such gymnastics constituted a customary part of the training of youths who received a liberal education in Turkey.

Shortly after witnessing this performance I was cruelly snubbed by an anatomist to whom I described it. He demonstrated the impossibility of thus cracking the vertebrae, basing his demonstration on the elasticity of the cartilages which would prevent any momentary separation, and further on the damage which such displacement must do to the spinal cord. He was too eminent, and too well satisfied with his own eminence, to regard my statement of fact witnessed by myself. I was as completely crushed as any of the numerous mariners who have seen a sea serpent and have been sufficiently rash to describe it. Therefore I now find much consolation in Mr. Man's account of the peculiar gymnastics of the Andaman islanders.

**NEW EXPLOSIVES.**—An explosive substance is a solid or liquid which by some means—such as percussion, or other mechanical agitation, or the application of heat—becomes suddenly converted into a gas or mixture of gases; the sudden expansion producing detonation and mechanical violence. Chloride of nitrogen is a simple example. It is a liquid composed of two elements, both of which are gaseous under ordinary conditions, and in the liquid compound are held together by such very weak affinity that they are severed by the slightest shock. The touch of a feather is sufficient to dissociate the liquid into its component gases with fearful explosion.

Gunpowder is a mixture of two solids (carbon and sulphur), the oxides of which are gaseous. To these are added saltpetre, a substance which when heated to about 600° Fahr., gives off active nascent oxygen, which by combining with the carbon and sulphur produce both of the gaseous oxides. Gun cotton is another example, where the fibre is nitrated or supplied with a compound readily giving up its oxygen to the carbon; nitro-glycerine and its modification known as dynamite are other examples. White gunpowder and many of the compounds of the pyrotechnist are similar, with chloric acid instead of nitric as the source of oxygen.

Permanganic acid and the permanganates give up their excess of oxygen with remarkable facility. Upon this their use as disinfectants or deodorants chiefly depends. M. Klobb, of Nancy, has recently produced some permanganic ammonia salts of metals, such as silver, copper, nickel, cobalt, &c., that are remarkable for the beauty of their crystals and their explosive properties. They detonate when warmed or rubbed. The explosion in these cases appears to be due to a liberation of oxygen with ammoniacal gas.

**SOURCES OF GINGER.**—The friends of temperance (and we are all such friends, whether we talk loudly



about it or not) will be pleased to learn—if they have not already discovered for themselves—that during the past summer most of the publicans in and around London have found it commercially advantageous to supply ginger-beer on draught at one penny or three-halfpence per glass. I have made inquiries at some large establishments, and find that this innocent beverage has largely replaced the ordinary malt liquor. It is not absolutely free from alcohol, but is practically a non-intoxicant.

This is connected with something else a long way off, viz. in China. Mr. Charles Ford, Superintendent of the Botanical and Afforestation Department of Hong-Kong, says in his report for 1886, that he is studying, and has taken steps for cultivating, all the kinds of ginger plants used by the Chinese, which possibly include some hitherto unknown elsewhere. He has sent specimens of the underground stems, which constitute the commercial product, to Kew Gardens for investigation.

**BUTTER PRESERVING.**—At a recent meeting of the French Society for the encouragement of Industry, M. Grosfils, of Verviers, described a new method for preserving butter. He takes 98 parts of water, 2 parts of lactic acid, and  $\frac{1}{5000}$  of salicylic acid. The lactic acid dissolves the salicylic acid and prevents its crystallisation. This solution is to be beaten up with the butter which, on taking up about 5 per cent., will contain 1 part of salicylic acid in 100,000. M. Grosfils says that good butter may thus be preserved indefinitely even in hot climates.

However efficient this may be, it is too complex and refined for ordinary domestic use and is not required. In my own small household, we adopt a much simpler method. A supply of butter is purchased in the autumn or later part of the summer, when genuine fresh butter is cheap and good, the cows being then fed on the aftermath; this butter is made into rolls of one or two pounds each, and placed in strong brine, a piece of wood being employed to keep the rolls completely immersed. They remain quite sweet all the winter. The salt penetrates to a depth of about  $\frac{1}{4}$  of an inch, and thus each roll has a coating of salt butter, but all remains fresh within.

**ALUM AND FOUL WATER.**—I have received an American newspaper containing an account of an outbreak of typhoid at Mount Holly, N.J., traced, as usual, to the use of polluted drinking-water. The writer adds the following:—"The most remarkable result of the scientific study of the Mount Holly cases by Dr. Leeds, is the demonstration of the fact, that a quantity of alum so small as not to injure the water for drinking purposes is sufficient, not only to clarify it, but also to reduce greatly its bacterial contents. Dr. Leeds' investigation is of great value and interest, and a further trial of alum

in the capacity indicated will be an important and useful experiment."

This discovery, although it may be quite original on the part of Dr. Leeds, is by no means new. I heard many years ago that it is a common practice in India to add a small quantity of alum to foul drinking-water and let it stand for a while, the result being that the water becomes clarified and harmless for drinking purposes. I repeated the experiment on an aquarium which had become very foul from the death of two large specimens of *Actinia crassicornis*. Two or three teaspoonfuls of strong solution of alum stirred into the water of the aquarium produced a dense cloud of precipitated alumina which gradually subsided, carrying with it the other constituents of turbidity, and leaving the water above brilliantly clear.

When the Crystal Palace aquarium was first filled with sea-water, it became very turbid, and the animals with which it was stocked died. I was consulted by the directors at Mr. J. A. Lloyd's request, and made experiments on a large tank set aside for that purpose. I found that the cause of the mischief was alkalinity due to the caustic lime still remaining in the Portland cement, and clarified the water both by alum and the cautious addition of hydrochloric acid; but as neither of these appeared to be agreeable to the animals, we determined to apply the milder and slower remedy afforded by the carbonic acid of the atmosphere. The opening of the aquarium was postponed accordingly, and the water kept in vigorous circulation for several weeks. This was quite successful.

When the old and classical engine works of Boulton & Watt were demolished about thirty years ago to make space for villas, the Upper Soho Pool was abolished by cutting a trench and running out the water; but it was so fetid when thus disturbed that serious alarm arose, the outflow passing several houses. I was consulted by Mr. Boulton's agent, and prescribed alum mixed with lime. This was effectual, but some hundredweights of alum were required.

**MARTYRS TO LIBERTY.**—In another number of the same paper as that from which the above is taken, is an account of the immolation of birds at the shrine of American Liberty. There was a sudden snap of cold weather in the neighbourhood of New York on Friday morning, 23rd September, and a consequent rush of migratory birds occurred. As they approached Bedloe's Island, they were lured by the flaming torch in the hand of the great Statue of Liberty, and when engineer Eugene Newton and Superintendent Littlefield arrived, they saw a circle of dead birds around the base of the statue. They gathered them in a heap and counted 1375, including more than a hundred different species. The largest bird was a Canadian woodpecker, measuring thirteen inches from wing to wing. The smallest is described

as a "lovely plumaged humming-bird one inch long."

Examination showed that they were not dashed to death, as commonly occurs at ordinary lighthouses when the light is enclosed, but they were burned and blinded, their fall, no doubt, completing the fatality. The vision of birds far exceeds ours in penetrating power, and as the light is visible at a distance of thirty-six miles to human eyes, its allurements to the birds must extend over a very wide circle.

A FEARFUL PROSPECT.—The Chinese are demons in examination work. They now propose to introduce mathematics as elements of the curriculum of their metropolitan and provincial competitions for public employment. Whether these will to any notable extent supersede the existing Chinese classics remains to be seen; but even if they do, neither China nor science will gain much if the customary rote-learning is still carried out. Mathematical prigs are worse than literary prigs, and as the ability for cramming mathematical formulæ varies inversely with the power of applying them philosophically, the senior wranglers of the Celestial empire are likely to present some hideous examples of barren formulating pedantry. May they all remain in China!

ABSORPTION OF WATER FROM WALLS BY IVY.—C. C., page 236, takes exception to my statement concerning the absorption of moisture by the rootlets of ivy, on the ground that if the main stem is cut the plant dies. Surely C. C. must have observed what occurs when the stem of a cut flower is immersed in water! Everybody knows that it absorbs moisture and displays the effect of such absorption irrespective of any main root. A rosebud will not only revive, but open out; the same with other flowers and with leaves. In the spring of last year, a friend sent me, by parcels post from Pau, some boxes of flowers gathered on the Pyrenees; some of these, wood anemones, were very remarkable in this respect. They arrived quite flaccid and drooping, apparently hopeless; but on placing their stems in water in a tall narrow flower vase, they plumped out and revived completely, the water in the vase visibly and measurably sinking. C. C. may study the physical action effecting this by taking a strip of calico, which is simply a collection of vegetable fibres, dipping one end in a tumbler half filled with water, and hanging the other end outside. Or he may take a lesson from another agglomeration of vegetable fibres, viz. a piece of blotting-paper.

STUDENTS of fossil corals should forthwith procure "The Morphology of the Carinæ upon the Septa of Rugose Corals," by Mary E. Holmes, M.A., published by Bradlee Whiddon, Boston, U.S.A.

## ASTRONOMY AND METEOROLOGY.

By JOHN BROWNING, F.R.A.S.

SUCH unfavourable weather was experienced along the greater portion of the central line of the total eclipse of the sun on the 19th of August, that good observations were only made at one station, Petrowsk, where Professor Glusenapp made six drawings, and took two photographs of the corona. The weather was perfect at Tomsk, in Siberia, but the observers were not in possession of instruments that would bear comparison with those used at the stations in European Russia.

In the observations of solar phenomena made at Rome, from April to June, Professor Tacchini has issued, he states that both spots and faculæ were considerably more numerous in May than they were in April, and both were still more numerous in June. It appears from this, then, we are on the eve of another outbreak of solar activity, so observations of solar prominences with a spectroscope will now be most interesting.

The report of the Chicago Observatory contains an account of the work done in 1885 and 1886. During these years 130 new double stars were discovered and measured. Observations of Jupiter have also been made, and of the spots and markings on the planet.

In November, there will be no occultation of any star above the fourth magnitude.

November the 21st, Mercury will be at the least distance from the Sun at 1 hour, morning.

Mercury is a morning star in the last week of the month.

Venus is a morning star throughout the month in Virgo.

Mars will be in Leo till the 22nd, when it enters Virgo.

Jupiter is a morning star, situated in Libra.

Saturn will be in Cancer throughout the month.

*Meteorology.*—At the Royal Observatory, Greenwich, the lowest reading of the barometer for the week ending 17th September, was 29'54 in. on Monday afternoon, and the highest 30'04 in. at the end of the week. The mean temperature of the air was 53'9 deg., and 3'7 deg. below the average. The general direction of the wind was west-south-west. Rain fell on five days of the week, to the aggregate amount of 0'55 of an inch. The duration of registered bright sunshine in the week was 19'2 hours, against 23'4 hours at Glynde-place, Lewes.

For the week ending 24th of September, the lowest reading of the barometer was 30'04 in. at the beginning of the week, and the highest 30'30 in. on Monday morning. The mean temperature of the air was 53'6 deg., and 2'9 deg. below the average. The general direction of the wind was north-north-east. No rain was measured during the week. The duration of registered bright sunshine in the week

*Rising, Southing, and Setting of the Principal  
Planets at intervals of Seven Days.*

	D.	Rises. h. m.	Souths. h. m.	Sets. h. m.
MERCURY ☿	5	9 13M	1 6A	4 59A
	12	8 26M	0 31A	4 36A
	19	6 59M	11 30M	4 1A
	26	5 56M	10 43M	3 30A
VENUS ♀	5	2 57M	9 0M	3 3A
	12	2 57M	8 53M	2 49A
	19	3 2M	8 49M	2 36A
	26	3 9M	8 46M	2 23A
MARS ♂	5	1 17M	8 2M	2 47A
	12	1 13M	7 50M	2 27A
	19	1 7M	7 37M	2 7A
	26	1 0M	7 23M	1 46A
JUPITER ♃	5	7 14M	11 56M	4 38A
	12	6 55M	11 34M	4 13A
	19	6 36M	11 13M	3 50A
	26	6 18M	10 52M	3 26A
SATURN ♄	5	9 48A	5 39M	1 26A
	12	9 21A	5 12M	0 59A
	19	8 53A	4 44M	0 31A
	26	8 26A	4 17M	0 4A

was 19.0 hours against 33.1 hours at Glynde-place, Lewes.

For the week ending 1st of October, the highest reading of the barometer was 30.24 in. at the beginning of the week, and the lowest 29.10 in. on Wednesday afternoon. The mean temperature of the air was 49.6 deg., and 5.7 deg. below the average. The direction of the wind was variable. Rain fell on four days of the week, to the aggregate amount of 0.32 of an inch. The duration of registered bright sunshine in the week was 22.5 hours, against 42.5 hours at Glynde-place, Lewes.

For the week ending 8th October, the highest reading of the barometer was 30.21 in. on Monday morning, and the lowest 29.67 in. at the end of the week. The mean temperature of the air was 51.9 deg., and was 1.5 deg. below the average. The direction of the wind was northerly during the first five, and south-westerly during the last two, days of the week. No rain fell during the week. The duration of registered bright sunshine in the week was 4.9 hours, against 4.5 hours at Glynde-place, Lewes.

The mean temperature in November is 48°, at the Land's End, 46°, at Plymouth, 45°, along the greater part of the South Coast, 45°, on a line drawn through Taunton and Winchester to the coast of Kent; 43°, at Flamborough Head, and 42° at Edinburgh.

The average rainfall for November is 2 inches for the greater part of England; 3 inches on the South Coast, and 4 inches on the West Coast. In parts of Cornwall and North Wales, and also in the English Lake District it is 5 inches and more.

## SCIENCE-GOSSIP.

THE Annual Exhibition of the South London Entomological and Natural History Society will be held at the "Bridge House," London Bridge, on the 16th November, and the Exhibition committee will be pleased to receive exhibits in all branches of Natural History.

A CHANGE in the London University Matriculation syllabus, as affecting the so-called "science" subjects, has induced Messrs. Chapman & Hall to issue a new work on Mechanics. This volume deals with exactly so much of mechanics as is requisite for matriculation at London under the new regulations. The book is written by Edward Aveling, D.Sc., Fellow of University College, London, whose work on Natural Philosophy, to meet the requirements of the former syllabus, is well known.

It was too late last month for us to notice the neat and artistic little pamphlets which Mr. J. Cosmo Melvill, F.L.S., of Kersal Cottage, Prestwich, got up on the occasion of a visit by members of the British Association to inspect his splendid collections of Mollusca and Insecta.

A NOTEWORTHY paper for geologists to study, is Dr. Chas. Calloway's, in the "Quarterly Journal of the Geol. Soc.," for last August, entitled "A Preliminary Enquiry into the Genesis of the Crystalline Schists of the Malvern Hills."

WE cordially recommend Mr. S. A. Adamson's pamphlet on the "Geology of the Skipton and Ilkley Railway," a wonderful bit of carboniferous geology.

NO society is doing more good to the birds (and even to the thoughtless women who are leading to their extermination) than the Selborne Society. It is now issuing a series of capital monthly "Letters" at a penny each. The Hon. Robert Lowe thought it time to "educate our masters," when the Reform Bill of 1867 was passed. It is now time to educate our "missesses"!

WE have received a reprint of Mr. T. M. Reade's suggestive paper in the "Philosophical Magazine" on the "Secular Cooling of the Earth in relation to Mountain Building."

THE following instructions how to sensitise boxwood are interesting:—Photographic etching upon boxwood blocks, such as are used in wood engraving, has been deemed a practical impossibility. We learn, however, that it has recently been accomplished in Russia, and by a method simple and ingenious. The block in its natural condition is, of course, unsuitable. The first step is to fill its pores with insoluble carbonate of copper, by means of two separate solutions, in which it is boiled sufficiently. A polish is then imparted to its surface, asphalt in solution applied to



its back and sides, and finally a sensitised gelatine film placed over the polished face. The subject to be etched is now photographed on the surface, and, by washing, the soluble and unprinted parts of the gelatine removed. A coating of asphalt is next applied to the raised parts, the block steeped in nitric acid of suitable strength (the stronger the better), where it remains one hour, when it is removed and subjected to the action of sulphuric acid for the same time. The portions unprotected are thus changed to nitro-cellulose, which, by brushing, is readily removed in the form of a greenish powder. To complete the process the block is dried and briskly brushed with a stiff brush. The asphalt is lastly removed with benzine, and the block is ready for the press. The practical value as to depth and retention of details we cannot state. It is an innovation, however, that may prove worthy of attention.

"ONE generation passeth away, and another cometh!" We are deeply sorry to have to record the deaths of two personal friends, eminent geologists and naturalists, and both of whom were deeply attached to each other: the Rev. W. S. Symonds, F.G.S., author of "Records of the Rocks," &c., and Sir W. Guise, Bart., president of the Malvern Field Club.

A CAPITAL club, which combines social freedom and relaxation with science, is the "Norwich Science-Gossip Club," now numbering eighty members, after being founded nearly twenty years, and meeting twice a month during autumn and winter. We have just received its "Report of Proceedings," with abstracts of papers, President's Address, &c. All those who meditate starting a "Scientific Free-and-Easy" should write to the Hon. Sec. for details of management and business.

THE new adventure, "The Naturalist's Monthly," looks well, and has some attractive articles. The demand for an enlarged periodical literature of natural history proves how thoroughly these studies are gaining ground among all classes. Our contemporary is ably edited by Dr. J. W. Williams (well known to most of our readers), and is published by Walter Scott, 24 Warwick Lane, Paternoster Row.

A LECTURE was given a few days ago at the American Exhibition, and was very largely attended by mining men. Mr. F. W. Rudler, President of the Geologists' Association, introduced the lecturer, Professor A. E. Foote, of Philadelphia, who stated that of the ninety-five millions of tons of coal produced yearly in the United States, nearly two-thirds of the tonnage and fully two-thirds of the value were from Pennsylvania. The utilisation of natural gas had advanced so rapidly in the twelve years since its introduction that it had supplanted the use of coal in Pittsburg for nearly all purposes. The value of the coal, the place of which it took, would this year

probably amount to £6,000,000. The extinction of the dividends on copper stocks was explained by the enormous production of the Anaconda and other Montana and Arizona mines, and the Calumet and Hecla of Lake Superior. These supplies were practically inexhaustible. Other metals, useful non-metallic minerals and gems, and ornamental stones were referred to. The topaz found on the Amazon Stone of Colorado, the emeralds, rubies, and sapphires of North Carolina, and the chlorastrolite and zonochlorite of Lake Superior were among the most novel and striking of American gems.

## MICROSCOPY.

ENOCK'S SLIDES.—A most interesting slide from this celebrated mounter reached us last month too late for notice, accompanied by the usual drawing and sketch of entomological characters. It was the parasite of the Hessian Fly—now as important an object of study as the latter. It is a splendid object, and so mounted that both sides of the insect can be studied.

"JOURNAL OF MICROSCOPY."—(Edited by Alfred Allen.) The October part of this well-known and highly appreciated journal contains the following papers, besides the usual copious notes, reports, and views:—"Linaria Cymbalaria," by R. H. Moore; "The Photo-micrography of Histological Subjects," by Dr. Y. M. Young; "Puzzles in Palæontology," by Miss Alice Bodington; and "The Structure of Flowers with reference to Insect aid in their Fertilisation," by W. G. Wheatcroft. Most of the papers are nicely illustrated by lithographs.

BUTTERFLY DUST.—In the "English Mechanic" of September 30th is a remarkable article by Dr. Royston Pigott, on "Butterfly Dust, Villi, and Beads." The detection of villi in butterfly dust is a new departure in microscopical work. Mr. Ernest Hinton, of 12 Vorley Road, Upper Holloway, has brought out a capital preparation of the scales of a moth (*Zygaena trigonilic*) which illustrates the above paper on villi in a remarkable manner. All microscopists will be interested in the subject on account of its high importance.

CUCKOO'S MATE.—The bird which arrives with the cuckoo—noted by Henry C. Russell as the "cuckoo's mate"—is the wry-neck, so named from its peculiarity in clinging to the bough of a tree and twisting its neck from side to side; its cry is a shrill quickly repeated whistle. It is, I should think, of insectivorous habits. The origin of the expression connecting the cuckoo with a cherry-tree is doubtless only the alliteration of a nursery rhyme.—*W. E. Windus, Bexhill, Sussex.*

## ZOOLOGY.

ARION FLAVUS.—On September 6th, Mr. Fitzgerald sent to me two or three specimens of this species from Harrogate. It may be known from *A. hortensis* by being smaller, and having no side stripes. The colour is entirely yellow, deepest on the front and tail. The head and tentacles of the specimens sent were jetty, shining black. Length 22 to 26 mill. I have seen the same form on the canal side near Wakefield.—*Geo. Roberts, Lofthouse.*

PLANORBIS NAUTILEUS, VAR.—Through the kindness of Mr. J. A. Hargreaves, of Shipley, near Bradford, I have lately had the opportunity of examining some specimens of the smooth form *Planorbis nautileus*. Some were from Scarbro', and others from South Wales. This form seems to have been ignored by Jeffreys, though it has been known for fifty years, and is specially mentioned by Gray and Brown. I suggest that it be admitted into future British lists under the name of *obsoleta*, or some other name which is descriptive of the shell.—*George Roberts, Lofthouse.*

LIMNÆUS GLUTINOSUS.—I am glad to report another habitat (new, I think) for that beautiful shell *Limnæus glutinosus*, viz. the Basingstoke canal, which runs near this town. I took one yesterday, but was unsuccessful in obtaining more, and much fear the numerous ducks which frequent the canal may account for my not finding it in any quantity.—*Windsor Hambrough.*

DEVELOPMENT OF FLEA'S EGGS.—Under this title in SCIENCE-GOSSIP for 1885, page 252, Mr. Robson gave a very interesting account of the development of the human flea (*Pulex irritans*) illustrated by well-executed diagrams, showing its various changes; and he refers to the experiments of Mr. G. Harkus in maturing this species from eggs, and the difficulty experienced in getting cocoons, owing to the inability of providing them with food. For several years past I have repeatedly tried to obtain cocoons from larvæ of the cat flea, and have as often been disappointed, the larvæ either dying or getting away. In placing the eggs I always gave them a supply of the congealed blood (so wisely provided for the sustenance of its offspring by the instinct of the parent flea), but after consuming this, and failing to obtain fresh supplies of food, I have invariably lost the larvæ. Having resolved to make another attempt this summer, I placed a quantity of eggs, and plenty of the "preserved food" previously mentioned, upon a piece of flannel in a pill box, and deposited it in a warm place to hatch out, which occurred at the end of four days. They were very active and vigorous, and after they had consumed the ordinary food, my mother tried them with small pieces of raw beef; in a few hours this would be covered by the young larvæ greedily

sucking the blood, and leaving the muscular tissues dry, bare, and quite white. They grew very fast, frequently cast their skins, and just previous to spinning, an average sized larva measured full three-sixteenth parts of an inch in length. Mr. Robson speaks of the larvæ of *P. irritans* as hatching out after four days, spinning about eight days after hatching, and the imago emerging from its cocoon in about nine days. According to this, the flea would pass through its various changes in about three weeks. My flea larvæ hatched out on August 8th, commenced spinning September 11th (several days after which there were about thirty cocoons), and on September 21st the first perfect flea, a male, appeared; two days after a female also emerged from its chrysalis; so that the development in this case occupied a period of from forty-eight to fifty days. I may mention that the pair of fleas which have been reared in captivity, have been duly mounted for the microscope, the male specimen forming a very good object, showing, as it does, the whole system of trachæa.—*A. J. Jenkins, New Cross.*

PLUMAGE OF BIRDS AS TRIMMING.—It is pleasing to find that at a conference of ladies held in Bond-street a short time ago on the subject of dress, it was decided that the plumage of small birds should no longer be considered as *fashionable* trimming for robes or bonnets. A curious observer put on record that in one tramway-car in New York he counted eleven women who wore birds. The specimens thus distributed were found to be the heads and wings of three starlings, an entire bird of unknown species, seven warblers representing four species, a large tern, the head and wings of three shore larks, the wings of seven shore larks and grassfinches, one half of a gallinule, a small tern, a turtle-dove, a vireo, and a yellow-breasted chat, and a number of ostrich plumes. Altogether it has been calculated that fully five millions of birds are annually destroyed in the United States alone to supply the home demand, and that at least as many again are exported to Europe and other countries. South America sends many, Europe a few, and a host come from Africa, Australia, the Papuan Islands, and India. In one shop in London there were sold during the four months ending April, 1885, no fewer than 404,464 West Indian and Brazilian bird skins, and 356,389 East Indian ones, besides thousands of Impeyan pheasants and birds of paradise. One collector for the dealers prepared during a three months' trip in South Carolina as many as 11,018 skins, and the same person has lately boasted that on an average he sells 30,000 a year to be cut up for millinery purposes. A single village in Long Island sent in four months 70,000 pelts to New York, and a Paris firm contracted with an enterprising woman at Cobb's Island on the Virginia coast, to deliver to them 40,000 or more gull and tern skins during the past summer—each skin being valued at

1s. 8d. Orioles, tanagers, grosbeaks, cedar wax-wings, blue-birds, meadow-larks, and golden-winged woodpeckers are in great favour. Sea birds of white or delicate shades of colour are so eagerly bought that there are many professional shooters who confine themselves to this branch of commerce. At Flam-borough Head and the Fern Island on our own coast a constant fusillade is going on; and in the Hebrides, Shetlands, and Orkneys the destruction is even greater. One man exports upwards of a thousand a month to France; and in Long Island, near New York, as many as 3000 skins of the sea swallow are sent to market in early spring, when the plumage is at its best. We read in one of those personal descriptions of "society ladies," in which the Americans so delight that a certain belle "had her gown of un-relieved black looped up with blackbirds; and a winged creature so dusky that it could have been intended for nothing but a crow reposed among the coils and braids of her hair."

A RARE CAPTURE.—An osprey, or fish eagle as it is called, was taken alive on a boat in the Bristol Channel on the 22nd September, the owner having kept it alive for ten days. Flesh was given it, which it refused, and so starved, fish being its proper diet. It is a female in immature plumage. It is now being preserved and mounted by *William Shakespeare, Naturalist, Cardiff.*

THE ZOOLOGICAL SOCIETY OF GLASGOW.—The second meeting for the session of this society was held on Monday, 10th October, the Rev. Edward Walters, president, in the chair. One gentleman was proposed for, and Dr. Alexander Paterson, Bridge of Allan, was elected to ordinary membership. Mr. W. Hannan Watson exhibited a fine specimen of Aldrovandi's Pleistodon (*Eumecis Algeriensis*), a large kind of lizard from North Africa, which measured thirteen inches in length. Mr. J. MacNaught Campbell showed some eggs of the European water tortoise (*Testudo Europea*) differing from Clermont's description, being pure white instead of marbled with ash-grey.—*W. Hannan Watson.*

## ANIMAL PSYCHOLOGY.

GULL LANGUAGE.—The following note on the common sea gull (*Larus canus*) may interest readers of SCIENCE-GOSSIP, it is from personal observation during this last summer. A male gull had lived a bachelor life as a tame garden bird for several years. He was transferred to present owner, and placed in the grounds with females already there. In May two eggs were laid, both birds taking a turn at sitting for several weeks. No young hatched, I regret to add. One day we took a live, partly-fledged sparrow as a possible dinner for the gulls. The old chap at once seized the tempting morsel, at the same time calling

the attention of the sitting spouse to his capture. In obedience to her commands, the sparrow was killed, partly plucked, and mumbled. He then intimated distinctly that it was ready, placed it by her side to be at once swallowed whole. Now I want to point out that the gulls here actually conveyed certain ideas by definite sounds, a language.

*He:* See what I've got here!

*She:* All right, get it ready for me.

*He:* It's ready; when will you have it?

*She:* Bring it to me.

Each time, a different sound appeared to one to convey a meaning from one to the other. The female never moved from her nest, but awaited in confidence without even turning her head, the promised food.—*The Sparrow Catcher.*

## BOTANY.

CEPHALANTHERA ENSIFOLIA.—I must admit that C. P. was quite right in what he originally stated about the difference in the spikes of *ensifolia* and *grandiflora*, and my memory has evidently served me badly on this occasion. If C. P. will do me the favour of sending me his address, I shall be very glad indeed to have the opportunity of writing him direct about the Orchis family in which he takes so much interest.—*R. B. Postans, 14 Enys Road, Eastbourne.*

THE HELLEBORINES.—In my article, "White Helleborines," October number, pp. 228, 229, the following palpable misprints occur: "Epipactus" for "Epipactis," "tracts" for "bracts," "arachnites" for "arachnites." I have lately had specimen of *Cephalanthera rubra* from Gloucestershire; the spike has but two flowers, and is barely one-third of the size of the Swiss plant of same species.—*C. P.*

VAUCHERIA SPHÆROSPORA, NORDST.—This alga, new to the British flora, is described by Mr. E. M. Holmes, in "The Essex Naturalist," as lately found near Maldon, in Essex.

OPHRYS ARACHNITES.—In this month's issue of SCIENCE-GOSSIP, C. P. asks if any of your readers have found specimens of *Ophrys arachnites*. I have much pleasure in stating that I have found quantities of this very interesting orchid on the North Downs. Babington puts its localities down as being Sittingbourne and Folkestone. I can only answer to finding them in Folkestone neighbourhood and in other localities ranging from Wye to Folkestone. Should C. P. wish for specimens, I shall be very glad to send him some next season. Some botanists put *O. arachnites* as a variety of *O. apifera*, but to me there seems such marked distinctions between them that it is almost impossible that they should be varieties of the same plant.—*C. F. Steadman.*

"ANNALS OF BOTANY."—The first, or August number, of this new and important venture reached



us too late to be noticed in our last issue. It is edited by Professor I. B. Balfour, F.R.S., Dr. S. H. Vines, F.R.S., and Professor W. G. Farlow, and these eminent botanists are assisted in their comprehensive work by other botanists. The part extends to eighty-eight pages of original botanical articles, notes, and reviews, and forty-two pages of a "Record of Current Literature" of botany. The illustrations and printing are of a high order, for the work is turned out by the Clarendon Press. The original papers are as follows: "On Some Points in the Histology and Physiology of the Fruits and Seeds of *Rhamnus*," by H. Marshall Ward and John Dunlop; "On the Structure of the Mucilage-secreting Cells of *Blechnum occidentale* and *Osmunda regalis*," by W. Gardiner and Ito Tokutaro; "On Laticiferous Tissue in the Pith of *Manihot Glaziovii*, &c.," by Agnes Calvert and L. A. Boodle; and on "Anomalous Thickening in the Roots of *Cycas Secmanni*," by W. H. Gregg. The new "Annals" will be a most invaluable work to all botanists, but the price (8s. 6d.) per part is rather high.

## GEOLOGY, &c.

THE UPPER CRETACEOUS BEDS.—Among the numerous papers indicating zeal, hard work, and the perseverance of pioneers, we cordially recommend the paper published in the Q. J. Geol. Soc. for August last, "On the Lower Part of the Upper Cretaceous Series in West Suffolk and Norfolk," by A. J. Jukes-Brown, F.G.S., and Mr. W. Hill, F.G.S., of Hitchin, Mr. Hill having done the lion's share.

"TERMINAL MORAINES OF THE GREAT GLACIERS OF ENGLAND."—At the recent meeting of the British Association, Professor Carvill Lewis said, the investigations he had made were based upon the important principle, that every glacier at the time of its greatest extension was bounded and limited by a terminal moraine. He had studied supposed exceptions to that law in Switzerland and elsewhere, and found to be contrary to observed facts. Thus the ancient Rhone glacier, stated by Swiss geologists to be without a limited moraine at the time of its greatest extension, was found to have one as distinct as those of the Aare glacier, the Reuss glacier, or the Rhine glacier; and the prevalent idea of a "first glacial epoch," in which the glaciers had no terminal moraines was also unsupported by his observations. He described the various glaciers to be found in England, and concluded by stating the course of the Irish Sea glacier. In the neighbourhood of Manchester the great moraine of this glacier might be followed through Bacup, Hey, Stalybridge, Stockport, and Macclesfield, being as finely developed as the moraines of Switzerland and America. South of Manchester it contained flints and shell fragments,

brought by the glacier from the sea bottom over which it passed. At Manchester the ice was at least 1400 feet thick, being as thick as the Rhone glacier. The great terminal moraine was a very sinuous line, 550 miles in length, extending from the mouth of the Humber to the farthest extremity of Carnarvonshire, and, except where it separates the Welsh glaciers from the North Sea glacier, everywhere marked the extreme limit of glaciation in England, and was an important feature which might well hereafter be marked on the geological map of England.

## NOTES AND QUERIES.

RUDIMENTS AND VESTIGES.—In an article in your last issue, by Nina F. Layard on "Rudiments and Vestiges," there are some statements so totally at variance with my ideas, that I cannot refrain from saying a few words on the other side. In the first place, it is said that to use the term rudimentary, "in the sense in which it is repeatedly to be found in the 'Descent of Man,' is a strange contradiction of the theory of development." This shows what result you may arrive at, by reading a book with a preconceived idea of its teaching. It is true Darwin used the word rudimentary, where many able anatomists and naturalists would now use vestigial, but knowing this, and understanding the double meaning of the word, viz. vestiges of structures existing in early types, and foreshadowings or beginnings of structures in process of development, it is difficult to understand how any one can affirm that it is a contradiction of the theory of evolution. The organs which constitute our present conception of an ideal human form, may be termed rudimentary in both senses of the word: 1st, because either in obeying the unknown laws of variation, or in adapting themselves to circumstances, they still retain vestiges of a primitive form; 2nd, because as progression has been the order of the past, so it may be of the future, and perfect as all our organs are at the present time, we have no reason for supposing that evolution has reached a limit. Of all our organs which we have handed down to us from remote ancestors, some have been developed to meet our requirements, as the brain, others falling into disuse have become partially degenerate. It is only when a sense is necessary to the existence of the organism that it reaches its maximum development, consequently we possess only in a minor degree the nyctating membrane, the acute sense of smell, and the prominent ears of lower animals; while, in their place, we have increased intellectual and moral power. It is to be hoped there are not many readers of Mr. Darwin's volume who can extract from it such erroneous inferences. Our human form instead of being "a bundle of rudimentary organs," is, it is true, composed of organs leaving traces of their primitive origin, but now perfectly developed to meet the wants of an intellectual being. I would ask Miss Layard if an organ is imperfect, because it has its life history stamped on it. Is the cultivated rose an imperfect flower because the botanist can trace back to the wild form from which it has been produced? Is the masterpiece of a painter imperfect because we can trace in his style the school which has educated and produced him? Perfection is a term of the day, for the time it is perfect, but who shall say how soon it may be surpassed and superseded? Miss Layard would take

man as perfection, would judge everything else in comparison with him, and then talks about "abnormal development of the organs of sight or hearing." To imply that an animal in a natural state can have abnormal development of sight or hearing, is a contradiction in terms and a manifest absurdity. Why should we claim perfection for ourselves and deny it to all other organisms, merely burdening them with excrescences, or trimming them with deficiencies? Surely in their physical proportions, all animals are as perfect as man, and as admirably adapted to their surroundings, but to none will we say that evolution, which has done so much, will do no more. They are perfect for the day, but the day may now be passing. Evolution starts from a centre. We see only an outer ring. If looking back along the diverging rays, we can see some small trace of the path each organism has travelled, surely this does not detract from its present perfection. As with the others, so with man, all have come by tortuous ways, and we see only the present result. Then, if by patient investigation, we find the way which he too has come, we may be led to the conclusion that he is of lowly origin, but never to believe that this is in itself an insult or a disgrace. To conclude, Miss Layard shrinks from insulting man by allowing that any of his organs contain either the rudiment of what might be, or the vestige of what has been, and yet would say of a Creator that of all His countless works, one only shows harmony in structure, one only is perfect. This is a singularly curious conception of the work of an Omnipotent God.—*F. G. Fenn, Isleworth.*

CUCKOO.—Is F. James George quite sure he saw the bird? I once heard a similar double note, and, with two gentlemen who also heard it, stole gently into the little copse in hope of seeing the bird without disturbing it. To our great surprise, we discovered sitting in the fork of a tree, a little urchin of a boy, whose perfect mimicry had caused us a number of scratches with thorns and brambles, as well as chagrin at our being so thoroughly taken in.—*J. Wallis, Deal.*

## NOTICES TO CORRESPONDENTS.

TO CORRESPONDENTS AND EXCHANGERS.—As we now publish SCIENCE-GOSSIP earlier than formerly, we cannot undertake to insert in the following number any communications which reach us later than the 8th of the previous month.

TO ANONYMOUS QUERISTS.—We must adhere to our rule of not noticing queries which do not bear the writers' names.

TO DEALERS AND OTHERS.—We are always glad to treat dealers in natural history objects on the same fair and general ground as amateurs, in so far as the "exchanges" offered are fair exchanges. But it is evident that, when their offers are simply disguised advertisements, for the purpose of evading the cost of advertising, an advantage is taken of our *gratuitous* insertion of "exchanges" which cannot be tolerated.

We request that all exchanges may be signed with name (or initials) and full address at the end.

We have received several complaints concerning the conduct of James Ellison, Steeton, West Leeds, in the matter of exchanges of eggs. Of course we cannot guarantee that all the exchanges offered in our columns are bona fide. We do our best to keep them so; but Mr. Ellison has explained the difficulty, and we shall be pleased to insert his exchanges as usual.

F. G. F.—The Society of Amateur Botanists does not exist now. Poor Mr. J. F. Robinson, of Frodsham (one of the best and most unaffected English botanists that ever lived), was the heart and soul of the matter. He is dead, and the Editor never lost a more useful friend.

GEO. BROWNE.—Accept our best thanks for the remarkably artistic and accurate pen-and-ink drawings of microscopical objects.

J. CAPELLA.—Yarrell's "History of British Birds," 4 vols., revised by Professor Newton and H. Saunders, is the best work. The objects on the backs of oak-leaves are: the large ones formed by an insect, *Cynips longipennis*; the small ones are formed by another insect, *Neurobius Reaumurii*. See Taylor's "Half-Hours in the Green Lanes," pp. 195, 197, for illustrations and description.

W. T. HAYDON (Dover).—Accept our best thanks for your slides of sections of union of toothwort with hazel root, *orbanche* with galium, dodder, etc. They are capital illustrations of parasitism.

G. R. M.—You will, we believe, obtain the notes accompanying Twining's Diagrams on "Science Made Easy," from Messrs. W. H. Allen, Waterloo Place. They were formerly published by Mr. David Bogue, 3 St. Martin's Place.

### EXCHANGES.

WANTED, fossils from the Paris basin, or foreign eocene, in exchange for British eocene.—George E. East, jun., 10 Basinghall Street, London, E.C.

WANTED, mounted specimens of blood (stained), representing any order whatever; will try to make a good return in Lepidoptera, wings of same, etc.—Frank G. Jones, 1623 Montgomery Avenue, Philadelphia, Pa., U.S.A.

WANTED, micro material of a histological, embryological, or pathological nature; also mounted slides representing any departments of the above subjects. Will give in return American Lepidoptera, wings of the same for micro objects, or histological material. All communications answered.—Frank G. Jones, 1623 Montgomery Avenue, Philadelphia, Pa., U.S.A.

BINOCULAR microscope with several first-class objectives, various objects, and apparatus; will exchange for tricycle.—E. B., 78 Junction Road, Highgate.

MICROSCOPE, Crouch's Student's Binocular, fitted with Swift's popular condenser and 1-inch O.G., taper front of same maker, in case, etc., all as good as new. What offers? Cost £16.—H. J. Parry, 10 Windsor Terrace, Newcastle-on-Tyne.

BRITISH and foreign oological and conchological specimens offered for others not in collection. Colonial correspondence invited.—Dr. Reed, jun., Ryhope, Sunderland.

DIATOMS.—Selected or spread slides of the Oamaru deposit in exchange for other diatom mounts.—J. B. Bessell, 8 Elm-grove Road, Bristol.

OLD Family Bible, large edition, by Rev. J. S. Sutcliffe (1822), numerous steel plates and commentary. What offers in books or micro material?—W. E. Watkins, 32 Huntingdon Street, Barnsbury, London, N.

Will give complete and good sets of lantern slides with MSS. of "Niagara" and "Far West," for first-class religious sets.—H. W. Case, Cotham, Bristol.

WANTED, *Uranias morphos*, or any brilliant exotic lepidoptera; will give a good banjo, also pair of leggings.—W. Scott, 14 Prospect Hill, Leicester.

ENGRAVINGS of all the British varieties of *Anodonta cygnea* (nine in number), and several of *A. anatina*, for peculiar or local forms of Anodons or Unios, British or continental.—Geo. Roberts, Lofthouse, near Wakefield.

"Rock Sculptures on Rombald's Moor," a rare pamphlet, and about seventy numbers of "Gardening Illustrated," for British or continental land or freshwater shells.—Geo. Roberts, Lofthouse, near Wakefield.

DUPLICATES: *S. rivicola*, *P. annicum*, *A. cygnea* and vars., *U. margaritifera*, *N. fluviatilis* and var., *P. contecta*, *Pl. nitidus*, *Pl. nautilus*, *Pl. dilatatus*, *Pl. complanatus*, *Pl. cornus* and var. *albicus*, *L. stagnalis*, *An. fluviatilis*, *A. lacustris*, *Helix pisana*, *H. rupestris*, and others. Desiderata: *P. roseum*, *L. involuta*, *L. purus*, *L. radiatulus*, *L. fulvus*, *H. lamellata*, *H. aculeata*, *H. fusca*, *H. pygmaea*, *Vertigo*, *Ame lineata*, and others.—W. H. Heathcote, M.C.S., Preston, Lancashire.

DUPLICATES: *A. cygnea*, *vars. inflata* and *zellensis*; *Paludina contecta*; *Planorbis dilatatus*. Desiderata very numerous, especially well-marked varieties of Unios, Anodons, Sphaeriums, and Pseudiums.—Charles Oldham, Ashton-on-Mersey, near Manchester.

WHAT offers for American eocene fossils? Wanted, British or French eocene fossils from Thanet sands, London clay, Bembridge or Headon beds, or Paris basin; send lists. Also Lea's "Contributions to Geology."—George E. East, jun., 10 Basinghall Street, London, E.C.

BEAUTIFULLY constructed Gregorian telescope, by R. B. Bate; four powers, viz. 30, 50, 80, and 110; 2-inch reflector, two small reflectors, two systems of lenses, tripod stand; all in mahogany box, 8½ in. X 4½ X 3½; very clear definition. Wanted, thoroughly good microscope and accessories.—Smith, c/o Mr. Wallis, Deal.

SCALES of Mediterranean fish, cleaned ready for mounting, including Menora, Buga, La-serto, Trilja, Lodola, Botta di Mare, Pagaro, Miletto, only a few of each left; also foraminifera from Menton, France, in exchange for well-mounted slides.—J. R. Marten, 40 London Road, Brighton.



WANTED, microscopical slides, botanical. Exchange, Tiraloschi, "Storia della Poesia Italiana," and other works in Italian, Maltby's "Greek Gradus," Homer, etc.—J. Wallis, Deal.

For exchange, thirty Leclanché cells, sealed ebonite, require recharging; what offers?—J. R. Marten, 40 London Road, Brighton.

FOR exchange, books by Jules Verne, 7 vols., in fair condition: "Mysterious Island," 3 vols.; "Adventures of Captain Hatteras," 2 vols.; "Dr. Ox's Experiment;" "Three Englishmen and Two Russians;" Shells or fossils wanted in exchange. E. O. Meyers, Richmond House, Hounslow, W.

OFFERED, L. C., 8th ed., 91, 139, 203, 359, 415, 480, 547, 624, 966, 1065, 1172, 1358, 1393, 1417, 1424, 1564, 1580, 1608, 1617, 1624. Many desiderata.—W. A. Clarke, The Grove, Chippenham, Wilts.

WANTED, specimens of rocks, fossils, minerals, etc., to illustrate and represent the various beds of the formation of the primary period.—Thomas W. Reader, M.C.S., 171 Hemingford Road, London, N.

WANTED, objects from uncivilised countries, made of stone, bone, or shell; a good exchange offered in Crustaceæ, shells, rocks, minerals, slides, etc.—L. Lovett, West Burton House, Ottram Road, Croydon.

WILL exchange scientific books, etc., lathe and tools, for British coins or books on coins.—F. S. Lyddon, 10 All Saints Terrace, Cheltenham.

WANTED, Cooke's "British Fungi" (a plain and easy account of); exchange "Microscopic Fungi" ("Rust, Smut, Mildew, and Mould"), by same author.—P., 80 Leathwaite Road, Clapham Common, London, S.W.

WANTED, six dozen microscope slides; exchange, "Scientific Recreations," cost 11s., and Cassell's "Science for All," 4 vols., 5th and last now issuing, cost 39s.—Henry Ebbage, 165 Hagley Road, Birmingham.

WANTED, Devonian fossils in exchange for first-class micro slides.—Henry Vial, Crediton, Devon.

WANTED, Dr. Taylor's "Common British Fossils"; can give fossils from red crag, or offer.—J. E. C., 44 Southwood Lane, Highgate, N.

L. C., 8th ed., Nos. 85, 91, 101, 207, 222, 229, 238, 372, 499, 538, 627, 629, 662, 680, 745, 783, 895, 954, 1091, 1211, 1218, 1220, 1330, 1335, 1368, 1422, 1423, 1445, 1446, 1452, 1540, 1552, 1557, 1590, 1605, 1618, 1812, 1823, 1826, 1832. Many desiderata.—Robert H. Meldrum, Cherrybank, Perth.

OFFERED, L. C., 8th ed., Nos. 59, 73, 137, 138, 153, 252, 291, 309, 346, 370, 415, 614, 725, 819, 898, 905, 919, 936, 939, 1003, 1007, 1016, 1034, 1045, 1126, 1133, 1138, 1172, 1209, 1333, 1494, 1775. Desiderata: 6, 26, 39, 41, 45, 46, 50, 51, 74, 87, 95, 111, 117, 121, 146, 160, 163, 230, 236, 311, 494, 535, 586, 623, 633, 687, 909, 925, 932, 940, 1036, 1043, 1074, 1324, 1325, 1329, 1334, 1350, 1369, 1379, 1399, 1417, 1420, 1455, 1460, 1464, 1540, 1591, 1597, 1641, 1651, 1703, 1781, 1783, 1784, 1839, 1849, 1855, or common British fossils, named and localised.—T. J. Porter, Perranarworthal, Cornwall.

CYLONESE and other shells (land, freshwater, and marine) offered in exchange for land shells from New Zealand, New Guinea, China, and Japan.—Miss Linter, Arragon Close, Twickenham.

WANTED, to exchange foreign marine shells for others not in collection; will send list.—W. Jones, jun., 27 Mayton Street, Holloway, London, N.

FOR exchange, some very fine specimens of *Clausilia bifurcata*, Mont., from Putney, and *Caciliarella aculeata*, Beck., from Cookham. Wanted, *Tetastaca Mangel*, *Succinea oblonga*, Acme, Vertigoes, *Helix fusca*, *H. pygmaea*, *H. revelata*; also good foreign marine shells, localised.—Wilfred Mark Webb, 37 Aynhoe Road, Brook Green, W.

DRAGONFLIES wanted, from all parts of the world, for figuring in monograph; good return made.—W. Harcourt Bath, Ladywood, Birmingham.

COMMON British dragonflies wanted; lepidoptera, coleoptera, and land and freshwater shells given in exchange.—W. Harcourt Bath, Ladywood, Birmingham.

WANTED, works and pamphlets relating to dragonflies, particularly by Dr. Hagen and De Selwys.—W. Harcourt Bath, Ladywood, Birmingham.

WANTED, wings of lepidoptera (foreign preferred) suitable for micro mounting, in exchange for other objects.—J. W. Wilshaw, 455, Shoreham Street, Sheffield.

WANTED, Huxley's "Physiology" vol. i. of Jeffreys' "British Conchology." Will give in exchange, Cassell's "Illustrated Book of Canaries and Cage Birds," &c.—W. E. Collings, Springfield Place, Leeds.

BATEMAN'S 3-in. aperture telescope, in case, cost £6. Exchange for a photographic camera to value.—Frederick DuBois, Girdlers' Hall, 39, Basinghall Street, E.C.

SCIENCE-GOSSIP from 1880 to 1885, unbound, in exchange for British birds' eggs or offers.—F. J. Kasell, St. James's End, Northampton.

DIATOM deposit, clean, sufficient for 100 slides, for four good diatom slides.—F. R. M. S., Mottram, Manchester.

WANTED, British bird skins; offered, natural history books. Lists exchanged.—J. H. K., 18 Church Street, Commercial Street, E.

SEEDS of *Silene maritima*, *Myrrhis odorata*, *Anthyllis vulneraria*, *Dianthus deltoideus*, *Cochlearia officinalis*, var. *alpina*, etc., for seeds of other wild plants.—Florence Mosley, Beaumont Park Museum, Huddersfield.

WANTED, European and other foreign lepidoptera; *Papilio podalirius*, *Saturnia pyri*, *S. Io*, *Actia luna*, *Attacus Cynthia*, and many other of the larger species, pupæ, or imago, set or in papers. Offered, lepidoptera, book-pattern store-boxes, choice flower-seeds, etc.—R. Laddiman, Helleston Road, Norwich.

Eggs of Meadow pipit, Snipe, Little Grebe, Landrail, &c. to exchange for others. An Egg Cabinet wanted.—Harry F. Medley, Palmerston Square, Romsey, Hampton.

SEVENTY-FIVE months, including ten red underwings, all taken at sugar this season; will exchange for micro slides or apparatus. What offers?—S. J. T., 1 Woodford Hall Villas, Chelmsford Road, Woodford.

WANTED, curious foreign nuts, berries, seeds, etc.—F. Stanley, Margate.

FOSSILS from chalk, Thanet sands, etc., in exchange for coins or curiosities.—F. Stanley, Margate.

SPECIMENS of *Isnardia palustris*, collected by Borrer. Wanted, L. C., 8th ed., 24, 1493, 1593, 1580, 1651, 1703, 1827.

WANTED, a good mount of *Cecidomyia destructor*; good exchange.—Rev. C. H. Griffith, Strathfield Turgiss, Winchfield, Hants.

COLLECTION of British eggs (with data), side-blown and full clutches, of 30 species, 10 being in nests; also 400 species in pairs, mounted and named, and about 250 odd ones, about 400 eggs altogether. Wanted in exchange, good ova or pupæ of lepidoptera, or Newman's "Lutterflies and Moths;" in good condition.—E. C. Tye, 95 Hall Road, Handsworth, Birmingham.

WANTED, foraminiferous and diatomaceous material in exchange for micro slides of forams from Macassar Straits, and various diatoms and spicules of sponges, both home and foreign, also fossil coal spores.—Robert Pettigrew, jun., 66 Flowerhill Street, Airdrie, N.B.

FOR exchange, a number of Cambrian, Silurian, Devonian, Jurassic, Oligocene, and other fossils. Wanted, fossils from the Carboniferous, Jurassic, Cretaceous, etc. rocks; skulls, or books on general literature.—T. T. Groom, St. John's College, Cambridge.

WANTED, set of about twenty-five stoppered bottles to hold reagents for elementary chemical testing, Bunsen burner, mouth blowpipe, tripod stand, retort stand, beakers, test tubes, etc. Exchange, Cooke's (M. C.) "Microscopic Fungi" last edition (1886), new, coloured plates; Richardson's "Geology" published at 10s. 6d.; Microtome (Beck), catalogued 10s. 6d. new.—Frank Worgan, 34 Cedar Street, Derby.

#### BOOKS, ETC., RECEIVED.

"Manual of Zoology," by Professor Nicholson, 7th ed. (London: W. Blackwood & Son).—"Factors in Life," by Professor H. Seely (London: S. P. C. K.).—"Bird Stories," by Harrison Veely (S. P. C. K.).—"Chemistry and Heat," by R. G. Durrant (London: Rivingtons).—"Sketch of Geological History," by Professor Hull (London: C. W. Deacon).—"Sixth Annual Report, U.S. Geol. Survey" (Washington).—"Journal Royal Microscopical Soc.," October—"Annals of Botany," vol. i., No. 1, August.—"Currency and Bimetallism Examined," by Wm. Birkmyre.—"Journal of Royal Soc. N. S. Wales," August.—"Trans. Geol. Soc. Edinburgh."—"Report Norwich Science Gossip Club."—"Essex Naturalist," 7, 8, and 9.—"American Monthly Microscopic Journal."—"Journal of Microscopy."—"Trans. Hertfordshire Nat. Hist. Society."—"Morphology of the Carina," by Mary E. Holmes.—"Century."—"Scribner's."—"Gentleman's Mag."—"Belgravia."—"Midland Naturalist."—"Wesley Naturalist."—"American Naturalist."—"Victoria Naturalist."—"Garner."—"Amateur Photographer."—"British Dogs," No. 13.—"Proceed. Geol. Association."—"The Naturalist."—&c., &c., &c.

COMMUNICATIONS RECEIVED UP TO THE 12TH ULT. FROM: J. M.—J. L. M.—H. F.—J. H. A. J.—F. E. S.—S.—H. C. R.—H. H. B.—J. B. B.—J. L.—R. B.—A. J. R. S.—R. S. P.—F. H.—W. C. S.—A. N. H.—J. C. M.—J. H. D.—J. H. B.—Rev. H. W. L.—W. H.—J. O. B.—W. A. C.—G. E. D.—W. S.—E. W. M.—W. H. W.—E. H. L.—D. M. H.—H. W. C.—G. R.—S. P.—G. E. F.—E. H. L.—W. H.—R. J.—J. B. B.—J. C.—H. R.—R. B. P.—S. M.—W. J. P.—C. P.—J. E.—S. R.—W. E. W.—A. H. S.—A. S.—H. J.—P.—J. B.—G. D. T. R.—P. H.—J. H. K.—T. J. P.—F. B.—J. B. B.—G. D. T. R.—H. R.—J. E. C.—W. H.—R. H. M.—J. R. L.—J. G.—H. W. B.—W. M. W.—A. J.—E. L.—W. E. C.—W. H. B.—F. J. R.—J. W. W.—F. D. B.—Dr. A.—W. E. C.—W. H. B.—F. J. R.—Dr. J. W. W.—T. A. D.—F. S. L.—H. E.—A. V.—W. A. C.—T. W. R.—P. F. G.—C. O.—V. H.—A. B.—A. E. L.—M. R.—J. R. M.—J. H.—E. H.—T. S.—C. H. G.—G. R. M.—A. H. S.—W. T. H.—E. H.—T. S.—C. H. G.—G. R. M.—H. F.—G. W. B.—W. S.—C. F.—S.—E. C. T.—R. P., jun.—W.—H. H. W.—J. E.—S. J. T.—F. S.—T. T. G.—A. V. W.—A. C. Y.—A. C.—J. H.—A. S.—&c.





## SLUG GOSSIP.

BY DR. J. W. WILLIAMS, M.A., Editor of the 'Naturalists' Monthly.'

[Continued from page 244.]

FAM. 3.—HELICIDÆ.—Subfam. *Arionina*.



EN. *Arion*, Férussac. 1819.—*Arion ater*, Linn. 1758.

Baudon, in J. de Conch., vol. xxxii. p. 320, describes a specimen with the respiratory orifice on the left side, i.e. sinistral. A like condition has been described by Seibert, in *Limax Schwabii*, Frauenf. (Mal. Bl. xxi. p. 198). Leydig (Arch. f. Nat. vol. xliii. pp. 265-273) says that the dark coloured varieties are mostly found

by him in damp localities, and the red ones in dry places. The same writer also says, that what has been described as *Arion tenellus* is in reality the young of *A. ater*. This last is one of the many instances in which young specimens of well-known slugs have been described as new species, another instance of which I gave in a note to the February number of this paper. Mayhap it will be interesting to many to know, that the fact of *A. ater* feeding on dead earth-worms—which has been often noted in the pages of this journal—was first mentioned by Power, on p. 323 of the ninth volume of the Transactions of the Linnean Society.

Krukenberg has been analysing how much water this slug has in its body, and finds it 86 per cent. (Vergl. Phys. Studien, ii. pp. 103, 104.)

H. Simroth, in Nachr. Mal. Ges. 1884, pp. 59-61, says that *Arion ater* grows to its full manhood in about a year. The old adage: "There's nothing new under the sun." This fact had been noticed years ago by many who gave their attention to the

No. 276.—DECEMBER 1887.

slugs in the primitive times of the work. I know Bouchard mentions it.

*Arion ater* lays its eggs between the months of May and September, from seventy to a hundred in number; the young are hatched in from twenty-six to forty days, and they begin to oviposit a month or two before they attain adulthood.

Nunneley remarks, in the first volume of the Leeds Transactions, that this slug lives much longer than the Limaces.

*Arion albus*.—I wonder if we have such a British slug. Mr. Alder was the first to record it so in his "Catalogue of the Molluscs of Northumberland" (p. 30). In it he says: "Our individual was about an inch in length, with the body whitish, having a faint greyish tinge above. The shield and the posterior parts of the body near the tail were of a pale canary colour; tentacles greyish-white; the mucus was deep orange yellow."

A specimen was taken later by Blacklock, in the same district, which was darker in tint, more greenish on the back, and more orange-coloured on the mantle—in this "taking" the tentacles were eyeless, no doubt a deformity.

Possibly it has died out of our fauna, for Bouchard Chautreaux, in Mém. Soc. Ag. Boul. 2nd ser. vol. i. p. 159, says that it is unprolific. The same author also states that it lays its eggs from September to December.

*Arion subfuscus*, Drp.—This new instalment into our slug list was named by Draparnaud, in 1805. Linné in his Swedish fauna, located it under his *L. rufus*. Nilsson, in 1822, called it *A. fasciatus*, while Westerland, writing in 1871, has *L. rufus et subfuscus*. The reader will recognise it by the following descriptive characters: It is of medium size, and cylindrical in outline, with a faint band running along both sides of the body; the hinder portion of the back is sub-carinated and finely scaled; the mantle elongated, and the under portion of the sole becomes attenuated by degrees, terminating in a rounded apex; length 40 to 60, width 6 to 10 mm. Then there are a good

many varieties—*fuscescens*, *rufescens*, *aurantiaca*, *cinerca*, &c.—which have been mentioned elsewhere. One, however—the *V. atripunctata*, of Locard—has been missed over; this is ashy, spotted with black, and has two black bands.

Then again, there have been a good many slugs which have been described as distinct species, but which in reality are but varieties of this one. *Arion bourguignati*, as it was called by Mabille in 1868, is one of these, and this the reader knows is indigenous to our fauna. This is of a greyish-white colour, slightly banded on both sides, and has the foot-fringe striated. The others, which we must accept as varieties merely and not as species, are the following:—*A. ruficolus*, Mab., *aggericolus*, Mab., *rubiginosus*, Baud., *dupuyianus*, Bourg., *paladilhianus*, Mab., *neustriacus*, Mab., and *citrinus*, Westerl.

But on account of the every likelihood of their turning up in process of time as British, I think I had better describe them:—

Var. *ruficola*, Mab. 1868; greenish (occasionally reddish), with obscure bands, and foot-fringe white and striated. At present it is found in France and the west of Germany.

Var. *aggericola*, Mab. 1870, is yellowish-rose, blackish bands, and striated foot-fringe. French.

Var. *rubiginosa*, Baud. 1867; yellowish-red, banded with violet and has the mantle obscurely banded and but slightly granulated. French.

Var. *dupuyiana*, Bourg. 1864, is sky-bluish in tint, with the mantle (not the body) banded on both sides, and the posterior portion of the back distinctly carinated with white. French.

Var. *paladilhiana*, Mab. 1870; greenish.

Var. *neustriaca*, Mab. 1868; reddish-gray with the foot-fringe not striated, and slightly banded on both sides.

Var. *citrina*, Westerl. 1873; citron-coloured, head and tentacles black and back without bands.

In No. 1 of the "Naturalists' Monthly," Mr. Geo. Roberts states that he has taken this species and its variety *bourguignati* from his garden at Lofthouse.

If the reader should wish to look up the specific distinctness of *A. hortensis* and *subfuscus* from *ater* I may just say that he will find a very interesting note by Simroth in Ber. Ges. Leipz. for 1883.

Gen. *Geomalcus*, Allman, 1846.—*G. maculosus*, Allm. 1846.—This slug was first found by Andrews in the autumn of 1842 quietly stretched out on rocks round Lough Carogh, in county Kerry, Ireland, and from him sent to Professor Allman, who described it and founded a new genus for it on p. 297 of the seventeenth volume of the "Annals of Natural History." There its haunts are depicted with such beautiful descriptive word-painting that I am sure both the editor and the reader will excuse me for transcribing from the pages of that journal the following:—"Lake Carogh lies to the south of Castlemain Bay in the county of Kerry, and stretches

nearly north and south five miles. The lake narrows at its centre where huge cliffs, principally of the old red sandstone formation rise precipitously from the margin on either side. On the east side are those of Oulough. The broad surfaces of the rocks are beautifully pictured with a map-like coating of lecidæ and lecanoræ, and on these rocks within a circuit, and at the distance of about 50 yards from the water, the *Geomalci* on a misty or showery day may be noticed quiescently stretched, their richly maculated character being strikingly conspicuous. On the opposite side is the romantic little glen of Limnavar, and on similar rocks at the same range from the water, *Geomalcus* is again met with, particularly the white variety, but more sparingly than at Oulough. On no other rocks around the lake or the country are they to be observed."

*General considerations.*—D. Barfurth has made some interesting observations which go a considerable way towards elucidating the way in which the epiphragma is formed. He finds that the liver of species in the genera *Arion* and *Limax* contains a considerable quantity of phosphate of lime, the phosphoric acid alone contributing one-half of the amount of inorganic substances present; and moreover that this salt lessens in amount during the formation of an epiphragma or the restoration of a broken shell. The same was present in *Helix*. From these observations, it is pretty conclusive, I think, that the office of the liver, in a part at any rate, is to excrete for these purposes phosphate of lime.

In Z. Wiss. Zool. xxvi. pp. 227–337 and 347 there is an interesting paper by H. Simroth on the senses of the snails and slugs from an extensive examination of species in the genera *Arion*, *Helix*, *Cyclas*, *Neritina*, *Planorbis* and *Limnæa*. That observer finds—he bases his observations chiefly on the microscopical examination of the terminal corpuscles, nerves, otoliths, epithelia and cilia—that the three senses of tasting, smelling and feeling are distributed more or less over the body, but that tasting is more prominent in the anterior part of the buccal cavity in terrestrial species, and that smelling is more pronounced in the feelers.

I have often been asked how I preserve my slugs, and I will take this opportunity to tell the reader, though I must ask him not to imagine any originality on my part for the process, because it was published over twenty years ago in a French journal, and chance, while I was looking over for some references to another paper some time back, directed me to it. Since then I have employed it with great and satisfied success. And call it, if you please, Dubreuil's method. The process is simply this:—the animal is killed in cold fresh water, and all the mucus is cleared off; in this it is allowed to remain for six or eight hours, when a little common table salt is added, and after soaking in the solution

for a few minutes it is taken out, dried by resting on blotting paper and slit, by means of a pair of small scissors, along the left side for its whole length, then skinned and the skin cut into three pieces, one to show the back, another the right side, and a third the sole. These pieces are placed on a cardboard and varnished over. I prefer white shellac varnish, to which a little corrosive sublimate may be advantageously added.

In conclusion, I would draw the attention of the workers on the slugs to the fact, that there is inexhaustible work yet to be done as regards their anatomy, physiology, and development. What names could I not recall who knew this? Poli, Cuvier, Savigny, De Lamarck, Tilesius, La Sueur, Meckel, Fischer, Say, Rafinesque, De Blainville, and a host of others come rushing into my memory, down to our own hard-working Ray Lankester, still with us, to tell me that famous work has been done, and that there is still more to do. We must not be thinking that in distribution alone—though I would not disparage this in a good many senses—lies every whit and tittle of the work of the naturalist, somewhat after the fashion of “the music of the moon in the plain eggs of the nightingale.”

“Let no man say from what taggs and jaggs hints may not be cut out for the advancement of human knowledge!” spake truthfully Lawrence Sterne. There is lore enough in this one sentence for any naturalist. The imperative moral—Record!

## NOTES ON THE ROTIFERA

### (*NOTHOLCA SCAPHA*).

By J. E. LORD, Rawtenstall.

IN a recent paper in SCIENCE-GOSSIP, on a prolific pond, I gave a list of thirty-eight species of Rotifera, since brought up to fifty-four, and among these, I have no doubt but that experienced microscopists, those at least who have paid some attention to this interesting class of animals, would note the name of one, which has hitherto been considered as being exclusively marine. *Notholca scapha* belongs to a genus which Mr. Gosse has separated from Anuroca, because the lorica has no posterior spines; is marked longitudinally with alternate ridges and furrows, instead of being tessellated; and the expelled egg is not usually carried. Of the four species recorded in their recent work, two are marine; and of four newer species which Mr. Gosse has described and figured in the December number of the “Journal of the Royal Microscopical Society,” three are marine. This being so, I have thought that the capture of this form in fresh water, was worthy of a special note. My first specimen was glimpsed while examining the gelatinous matter frequently found adhering to the shells of water-snails (*Limnea*), and which is, I presume, secreted by the mollusk. This mucus is a

favourite resort of many species of the Rotifera, either on its own account, or for the sake of the desmids and other minute algae, which are embedded in the gelatinous matrix. I at once saw it was new to me, and a little examination showed it to belong to the genus *Notholca*, but whether it was *N. thalassia* or *N. scapha*, I long remained in doubt, owing to the latter being figured and described as having a lorica as broad as long. In my specimens the lorica was a long oval, owing to its sides being decurved, and the

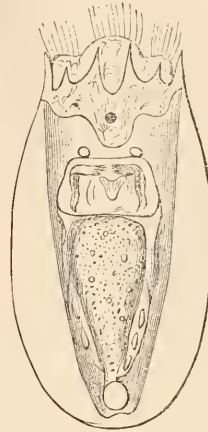

Fig. 140.—*Notholca scapha* (when swimming).



Fig. 141.—*Notholca scapha* (lateral aspect).

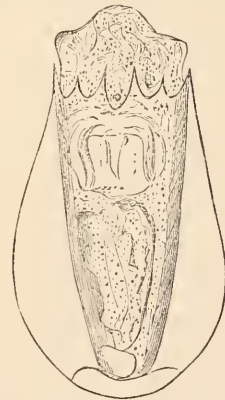

Fig. 142.—*Notholca scapha* (dead specimen).

longitudinal ridges and furrows were inconspicuous. In all other respects the characters were normal. There were the six anterior spines; the single cervical eye; the rather large mastax with its malleate jaws, and two small salivary glands; the water-vascular canals, and small round contracting vesicle. Referring to the illustrations, Fig. 140 represents the dorsal aspect when swimming; Fig. 141, the lateral aspect; and Fig. 142, a dead specimen, showing full breadth of the lorica, which, owing, I presume, to the relaxation of the muscles, has become flattened out. It is a charming Rotifer, and as Mr. Gosse



says: "the wide but thin wing-like expansions of the dorsal plate are very conspicuous by their glassy clearness and by their peculiar form." These wing-like expansions, however, in my living specimens, were always decurved, and when seen end-wise, reminded one of the valves of *Pterodina valvata*. It was very rarely that they presented a full dorsal view, the more general being a latero-dorsal one, when one of the "wings" was clearly exhibited. It will be seen, from Fig. 142, that the dorsal outline of living specimens, is much like that of Mr. Gosse's *N. thalassia*, but that dead specimens, Fig. 3, which were numerous, clearly showed the broadly ovate form of *N. scapha*. Now both these species were sent to Mr. Gosse, by Mr. Hood, in the same bottle of sea-water, from a tide-pool in the Frith of Tay. Is it possible that *N. thalassia* was named from a living, and *N. scapha* from a dead specimen? Mr. Gosse's large experience forbids such a supposition. Unfortunately, my specimens were intolerant of confinement, most of them dying the day after their capture, even when kept in a good-sized bottle in which *Brachionus rubens* and other Rotifera lived and bred for many weeks. I sent a tube to my friend, Mr. Gosse, but they were dead on arrival. He wrote me that he could not distinguish the form from *N. scapha*, but must see living specimens before giving an authoritative opinion. Subsequently I sent him others, immediately after their capture, which were more fortunate, and I have been pleased to hear that they arrived alive. He writes me that "its capture is the most interesting as a fact, for here it was, indubitable, yet occurring in fresh water for the first time in my experience." I think it very probable that all the forms which are considered as marine, are also inhabitants of fresh water, and would be discovered if they were carefully looked for. There can be no doubt but that millions of the Rotifera are constantly carried down to the sea, for although rivers are not a habitat where we should look for these animals, yet, during rainy seasons especially, our ponds, ditches, and reservoirs overflow, and numbers of their microscopic fauna are undoubtedly washed away into our rivers, and so carried down to the sea. It is hardly conceivable, however, that any of them could survive such a sudden transition; but we can fall back upon a much more probable hypothesis. At numerous places along the coast, there are either extensive marshes (or fresh-water lagoons) or ditches, many of respectable size, into which the adjacent cultivated lands are drained, and these are frequently highly suitable to Rotatorial life. Should any of these be so situated as to receive incursions from the sea to a limited extent, say at exceptionally high spring-tides, such a condition of things would, in course of time, tend to eliminate the weaker forms of life—those who failed to adapt themselves to the changed circumstances—leaving the others, the fittest, to survive. The following considerations are, I think, favourable

to this view of the case. They bear only a small proportion to the fresh-water forms, and it is certainly remarkable, and tending somewhat to confirm my theory, that with only one or two exceptions, they all belong to the order Ploima, sub-order Loricata. One would, *a priori*, imagine that the Rotifera of this sub-order, with their integument strengthened and protected by chitinous matter, would be more likely than others, to survive such a change in their environment as must have happened on such a theory. In this order are found Rotifers of the most "restless energy, perfection of structure, and superior intelligence," and whose jaws are highly developed, so that in many cases they can be protruded, and used like the mandibles of insects; and in other respects they are "well equipped for the energetic life, which observation proves them to pursue." Now looking at the question in these aspects, it does certainly appear to me that in all probability most, if not all the marine forms of the Rotifera may be confidently looked for in our fresh waters, and I trust that microscopists in various parts of the country, will take up the study of these charming, though fortunately ubiquitous animals, and record the results of their investigation, in SCIENCE-GOSSIP or other readily-accessible scientific journal.

P.S.—Since the foregoing was written, one of my correspondents, Mr. Bryce, a member of the Hackney Micro Society, has sent me a tube of Rotifers, among which were several specimens of *N. scapha*. He had noticed the form several times, and only the fact of its being found in fresh water prevented him feeling sure of its identity. They were procured from a pond in the North of London, a circumstance which, taken in conjunction with their previous capture in N.E. Lancashire, proves their wide distribution, and renders it very probable that a careful search will reveal them in other localities.  
J. E. L.

## THE AXOLOTL (*AXOLOTES GUTTATUS*).

By W. AUGUST CARTER,

*Of the National Fish Culture Association.*

THIS remarkable animal is a species of Amphibia, although it differs somewhat from others of the same family. The Axolotl first became popular at the time of the Mexican Conquest, when they were discovered in large numbers in the waters surrounding the city of Mexico. On its edible qualities being tested, it was found to be nutritious and appetising, and Hernandez informs us that the "flesh was considered as an aphrodisiac, and that it was wholesome and agreeable, and tasted not unlike eel." It has created considerable controversy amongst naturalists, judging from the multifarious appellations by which it has been known. It was referred to by Shaw as the *Siren pisciformis*; others regarded it as the type of a new genus, while Baron Cuvier considered it to be the imperfect state of a genus already known. The Axolotl is possessed of both lungs and gills, the latter consisting of three processes protruding from each side of the neck, resembling small twigs of trees. The teeth are sharp and situated in rows

upon the palatal region of the mouth, and upon the splenic element of the lower jaw. The tail, which resembles that of the water newt (*Salamandra palmata*), bears upon it an erect fin, which continues along the back of the animal. The head and nose are broad, the eyes very small, and are placed in contiguity to the mouth. The Axolótl rarely exceeds 11 inches in length, although it has been known to reach the size of 13 inches when well fed.

During the past year I studied these creatures at the late South Kensington Aquarium and elsewhere, in order to learn the nature of their habits and characteristics.

I find they are sluggish, lazy animals, being more fish than reptile. Their capacity for climbing is

havoc amongst ova and fry, while encumbered with their *umbilical sac*. At times they are exceedingly voracious in their habits, insomuch that I have seen one attack a gold fish about three inches long, and holding it firmly by the head in its jaws, strive its utmost for upwards of six hours to demolish it. At the end of that time, finding the attempt impracticable, the Axolótl with difficulty disgorged it, owing, probably, to asphyxia setting in. The gold fish was of course lifeless, and minus its eyes, which doubtless had been removed by suction. I find that Axolótl swallow without mastication, but their power of retaining their hold upon their prey is very great, as they will allow themselves to be dragged bodily out of the water rather than forego the object upon which



Fig. 143.—Axolótl.

extraordinary, seeing that they can mount a smooth perpendicular wall, three feet in height, or any object, no matter how smooth its surface. They are very sensitive to sound, or any disturbing influence, and on becoming apprehensive of danger, move rapidly about in a kind of frenzy. They are able to locomote very swiftly by the aid of their fins, tails and feet, and when in active motion present an extraordinary sight. Their visual organs and mouth are adapted to their grovelling existence and mode of extricating food, such as worms, crustaceans, &c., from a considerable depth in the earth. Their mouths are small in comparison with the size of their heads, so that they cannot prove very destructive to fish, though they are very fond of such diet, and play considerable

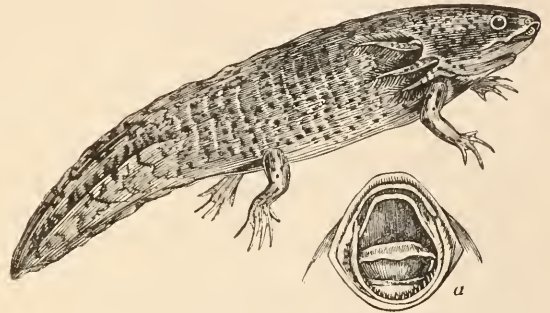

Fig. 144.—Axolótl (side view). a, Mouth, open, showing teeth.

they are feeding. This I proved in the case of the gold-fish referred to, by taking hold of its tail with a view to extricating it from the jaws of the Axolótl, but without success.

The Axolótl is regarded by many as a fish, and indeed, its characteristics are apt to strengthen one in this belief. It is certainly more like a fish than any member of the Batrachian family; nearly all of which cannot exist entirely in water or on land, but must alternate their movements from one to the other.

Now, I find that the Axolótl is capable of living permanently either in water or on land, as I shall proceed to show. Throughout the summer I maintained one of these creatures entirely in water, where it thrived and increased about half-an-inch in length. In the autumn I removed it from the water and placed it in a perfectly dry receptacle, where it has remained ever since. It has in nowise suffered from the change, and appears quite naturalised to its terrestrial existence. I have lined the bottom of its habitat with earth, which I moisten from time to time in order to cause the worms that I have placed therein for the animal's consumption, to rise to the surface, and thus afford it an opportunity to obtain a meal. Unless hungry, it never exerts itself to seize the worms when they appear, or, if it does, in a very half-hearted fashion, so that they easily escape.



When, however, it becomes voracious, it does not wait for its victims to appear, but turns over the earth with its blunted muzzle and seeks them below. I have lately noticed that the two condyles, or gills, situated at the side of the vertebral chasm, appear to be losing their identity. It is possible, that in course of time they may disappear altogether, as the economy of nature does not allow for the maintenance of a disused organ. At present it is breathing solely by the lungs, so that the gills are not called into play, and are therefore not required by the creature. I notice, too, that its colour is changing from dark to light grey, and that its terrestrial function is much stronger than formerly. Its visual organs do not seem so keen as they did during its aquatic existence, but its olfactory capabilities appear intensified. It possesses a peculiar control over its tail, which it utilises in securing food by circumvolving its prey by that organ.

In Mexico the Axolótl is very generally cultivated for edible purposes, and is largely vended in the markets. It is said that the flesh resembles in flavour that of the eel, at all events it is considered quite as great a luxury. I have never partaken of the Axolótl, and am afraid the English would be strongly prejudiced against it from an edible point of view, in consequence of its repulsive appearance, and the malodorous effluvia that arises from it at all times. If the flavour of the flesh resembles that of eels, the appearance of the skin certainly does, and I have no doubt the Axolótl would be quite as appetising, if served with suitable condiments. It would be highly injudicious, however, to introduce it to this country, as it would assume a prominent position in the ranks of the numerous army of destructive agents employed by nature to check the population of our waters.

#### GEMS AND ORNAMENTAL STONES OF THE UNITED STATES.

THE Saturday Evening Lecture in the working men's cause was delivered by Professor A. E. Foote, of Philadelphia, in the Trophy Hall of the American Exhibition, on the above subject, to the largest audience that has assembled during the season. The speaker was introduced with some very complimentary remarks by Mr. F. W. Rudler, curator of the Museum of Practical Geology of Jermyn Street, and president of the Geologists' Association.

One reason why so little is known about American gems and ornamental stones in Europe is that there is a ready market in America for everything of the gem character that is produced there. Thus far, mining for gems has been of a very desultory character, being principally carried on in connection with mica or other mines, or by farmers and others

when they have but little else to do. The Emerald and Hiddenite mines of North Carolina, and the Tourmaline mines of Maine, are the only ones that have been worked systematically. Gems are the purest forms of minerals, and in nearly all cases are the result of crystalline action. If the conditions of crystallisation are perfect, all impurities are excluded. Ruskin, in his "Ethics of the Dust," gives a charming illustration of this by supposing the power of crystallisation to be exerted upon the mud of a path of a manufacturing town. The gems peculiar to America are Chlorastrolite, Zonochlorite, and Hiddenite. Chlorastrolite, or Green Star stone, is a species which was discovered by Professor J. D. Whitney, of the United States Geological Survey, about forty years ago. The only place in the world where it is found is Isle Royale, Lake Superior. This island, belonging to the State of Michigan, forty miles long and five miles wide, and about twenty miles from the mainland, is composed of amygdaloid trap, in the almond-shaped cavities of which the gem principally occurs. This green stone radiates from a centre, and shows a beautiful chatoyance similar to cat's-eye, crocoidilite, and other fibrous minerals. In 1868, when instructor in chemistry in the University of Michigan, I led a party from the university that camped for several months on the island.

For the first time the Chlorastrolite was found in a vein stone associated with native copper and Epidote. The best specimen ever found was secured by our party, and is now in Mr. Foote's possession. The second best one belongs to Mr. Morrison, of London, and the next best one, so far as I know, belongs to an American lady resident in London. About £300 worth are sold annually. Zonochlorite is a green banded stone, similar to Chlorastrolite in composition, but discovered by me at Nespigon Bay, on the north shore of Lake Superior. The full description was published in the Transactions of the American Association for the Advancement of Science, in 1872. It is an entirely novel stone; hardness about 7, takes a very high polish, and if it could be found in sufficient quantities would undoubtedly be extensively used. Hiddenite is a green variety of the well-known species Spodumene. A yellow variety from Brazil has been cut as a gem for many years. This variety has been known for about seven years, and is fully as beautiful and valued as highly as the diamond. It occurs in connection with emeralds in North Carolina. The locality is worked by a stock company, and produces about £500 worth of hiddenite and £600 worth of emeralds annually. One of the finest of these emeralds is in the British Museum. The fullest series of them is in the collection of C. S. Bement, of Philadelphia. One weighs 8½ oz., within a quarter of an ounce of the weight of the most celebrated emerald in England. Of gold quartz, about £28,000 worth is sold annually.



Most of this comes from California, where it is not only used as a gem, but in the manufacture of various ornaments. One of these, an imitation of the Cathedral Notre Dame, is valued at £4000. I saw no specimens in Hungary so good, though the gold penetrating amethystine quartz is very beautiful. Though Californian gold is worth about £3 10s. an ounce, nice specimens of quartz readily bring from £5 to £7 an ounce.

Although the flexible sandstone, the gangue of the diamond in Brazil, is found in mountain masses in North Carolina and other States, no very large diamonds have as yet been discovered. Many small ones are recorded from California, North Carolina, Virginia, and elsewhere. The largest was found at Manchester, near Richmond, Virginia, and weighed  $23\frac{3}{4}$  carats in the rough, and  $11\frac{1}{10}$  carats cut. It was valued when found at £800, and £1400 was loaned upon it later. Professor Whitney states that the largest found in California was  $7\frac{1}{4}$  carats. Rubies and sapphires have been found in the rock in the Corundum mines of North Carolina, and C. S. Bement has an uncut green one in his collection that would give 80 to 100 carats' worth of good stones, one of which would probably weigh 20 carats. This specimen is probably worth £200. The largest red-and-blue crystal weighs 312 lbs., and belongs to Amherst College. The best sapphires are found in the placer mines of Montana. Asteriated corundums are found in Pennsylvania and elsewhere.

About £2200 of quartz or rock-crystal is mined annually. The best localities are Hot Springs, Arkansas, North Carolina, New York, and Virginia. A portion of a mass that must have weighed over 40 lbs. was recently received from Alaska that cut a hand-glass three inches by five. They are frequently dug up in the pre-historic mounds, and were used by the medicine-men and others for telling future events. Amethysts are found in very fine specimens in Pennsylvania, Georgia, Texas, and the Lake Superior region. From the latter region they are very remarkably lined, some specimens showing "phantom crystals" equal to the Hungarian. Near the Yellowstone National Park, and in the Chalcedony Forests of Arizona, are tree-trunks—some of which are 100 feet long—turned to stone by the action of silicated waters. Some of these trees are still standing upright; others having fallen, bridge deep chasms. The once hollow cavities of some are lined with amethyst, others with agate. The Arizona agatised or jasperised wood shows the most beautiful variety of colours of any petrified wood in the world, and about £1500 worth is annually sold for ornamental purposes. Probably the most remarkable locality in the world for smoky quartz, or Cairngorm stone, is Pike's Peak, Colorado. Here it is found in a graphic granite, associated with Amazon stone, which also makes a very beautiful green ornamental stone. Over £1500 worth of this is annually sold. The

largest crystal found—over four feet in length—of good shape, and all suitable for cutting, was recently sold to the Marquis of Ailsa for £20. The rutilated quartz, or Cupid's Arrows, is found in remarkably fine specimens in North Carolina. Perhaps the most remarkable mass is one 7 in. by  $3\frac{1}{2}$  in., now in the Academy of Natural Sciences of Philadelphia. The crystals of Rutile are about the size of knitting-needles. Some of the North Carolina Rutile has been cut, furnishing brilliant gems closely resembling carbonado. The Rutile geniculated till it forms a perfect circle or rosette, from Magnet Cove, Arkansas, is often mounted and worn as a charm. While opals are found at many places in the United States, they do not rival those of Queretaro, in Mexico. Here are found not only the "milky opals that gleam and shine like sullen fires in a pallid mist," but fine, noble, and almost every other variety known. Rhodonite, in specimens suitable for polishing, is found in Massachusetts and New Jersey. At the latter locality were obtained the finest crystals ever seen. The Garnets from New Mexico and Arizona are superior to the Cape rubies from South Africa, and from Alaska the most beautiful crystals ever seen, in a setting of grey mica schist, have recently been obtained.

The New Mexican Turquoise is mined to the value of about £700 annually. It has recently been described very fully by Professor Clarke, Curator of the Mineralogical Department of the National Museum, and is especially interesting as being the material from which the "Chalchuhuits," or most sacred images of the Aztecs, were made. The Indians still regard it as a lucky stone.

Labradorite, lately so popular for gems and ornamental stones, is found in many localities. The Tourmalines of Maine are probably the first in the world. Here are found the Oriental sapphire, ruby, and emerald in perfection. The Shepherd and Hamlin collections contain specimens that are unequalled elsewhere.

Topaz has recently been found at Pike's Peak, Colorado, in large quantity. Some masses weighed two pounds each, and very fine clear white stones have been cut, weighing from 125 to 193 carats. The Topaz so nearly rivals the diamond in lustre and brilliancy that it is difficult to distinguish.

Among ornamental stones should be mentioned a very beautiful variety of Serpentine from Maryland, called Verdantique, which is being largely used in the interior decorations of the Philadelphia Court House. Another variety resembling Jade is the gem Williamsite from Pennsylvania. Alabaster of various colours abounds in many localities, and marbles, some as beautiful as the Mexican Onyx, are found in nearly every State. The lovely Malachite and Azurite, Jet, and many other gems of minor importance, were referred to, but briefly, on account of limited time.

## THE GAGEAS OF SWITZERLAND.

By C. PARKINSON, F.G.S., ETC.

IN our English flora we apparently have but one species of *Gagea*—the *G. lutea*, which is not very plentifully distributed through the country. In Switzerland, however, several species occur, although

Fig. 145.—*Gagea lutea*, two thirds natural size.

I am not prepared to admit that all described have sufficiently definite characters to rank as permanent forms of the genus. Bentham remarks, the differences in the *Gageas* of foreign botanists are chiefly in the number and covering of the bulbs. This is undoubtedly the case, but with reference to at least three species in Switzerland there are other material differences; the rest are not so clearly marked from the typical plant *G. lutea*.

Within the last two years I have endeavoured to collect a series of these plants from different Swiss localities for comparison with each other, and also with the English form sent to me by Mr. G. C. Druce, F.L.S., from the neighbourhood of Northamp-

ton. With one exception, all the species and varieties of *Gagea* here described, find a habitat in moist pastures at different elevations, ranging from 1200 feet to 4000 feet above the sea-level; the time of flowering being in April and May. I should say that the change in altitude is the most important factor in the changing growth, the amount of moisture derived from the soil also affecting the size of the plants: the finest form flourishes at the highest elevation, while the only dwarf *Gagea* is confined to dry and rocky situations.

It may be well first to notice the English and Swiss *G. lutea*—one and the same plant, I think, before distinguishing the other species.

In the English plant the leaf is longer than the flower-stem, somewhat broad and ribbon-like, ribbed and glabrous, attenuated at either end; the umbel of 3-5 flowers, is surrounded by an involucre of three unequal leaves, two being linear and small, the

Fig. 146.—*Gagea arvensis*, two-thirds natural size.

third ovate-lanceolate, and several times larger. The flowers have linear sepals, yellow inside, but strongly tinged with green externally; the bulb is single. The Swiss *G. lutea* (Schultz) has an umbel of 7-9 flowers, with more obtuse sepals; frequently the umbel is divided in two parts, though on the same stem. The involucre is apt to vary. At an elevation of 2500 feet, it is more strongly developed in all its parts than the English form, but is the same in essential points. The figure here given is that of the Swiss species, as the others come from the same locality.

The handsome *Gagea* is *G. Liottardi* (Schultz), which I have found growing plentifully on the Col

de Jaman, some 4000 feet above the sea. It has two bulbs in the same envelope. The umbel of about three flowers is supported by an involucre of broad leaves suddenly tapering to a point, two being equally large, the third small; all three distinctly concave. The sepals are an intense golden yellow, slightly marked outside with green veins, and ovate-acuminate. It appears to me sufficiently distinct from *G. lutea*, to enjoy the specific name. At the same time the changes have probably resulted from the difference in altitude. Grow the same bulbs in the



Fig. 147.—*Gagea Liottardi*, two thirds natural size.

valleys and the plant will gradually revert to the normal type.

*Gagea* (Salisb.), of the Liliaceous order, with single bulb, or several in the same envelope. Flowers, hermaphrodite; perigone of six divisions, free; stamens six, adhering to the perianth, filiform; anthers bilocular, fixed at the base; stigma undivided. One ovary, free, three-celled; capsule triangular; grains globular. Leaves linear or filiform.

#### a. Single bulbs.

1. *G. lutea* (Schultz); single radical leaf, longer than flower-stem, linear, attenuated and striated. Involucre of three unequal leaves, two much smaller than the third; flowers 3-9, yellow, strongly tinged with green externally; sepals obtuse. April, May. Moist meadows.

2. *G. minima* (Schultz); bulb usually single, but

occasionally having two in same envelope. Plant not exceeding two inches in height—leaves filiform: flowers 1-3; sepals lanceolate, bright yellow, veined externally with green. May. Dry pastures among the rocks at Sion.

Var. *G. saxatilis* (Koch); appears a variety of the above. Bouvier in his "Flôre des Alpes" gives the two as separate species, on somewhat slender distinctions. Either way, the two grow together at Sion.

#### B. Bulbs in envelope.

3. *G. arvensis* (Schultz); several bulbs, proliferous, stem short, with 3-4 flowers, having sepals linear, lanceolate, dull yellow, green outside. Involucre of two almost equal leaves, opposite; radical leaves two, longer than stem, twisted back at the end. April, May. Damp meadows in the Valley—foot of the Salvan pass.

4. *G. pratensis* (Schultz); appears very nearly allied to the above. It has three bulbs, not covered; the one bulb supports the flower-stem, the others



Fig. 148.—*Gagea minima*, two-thirds nat. size.



Fig. 149.—Bulb of *G. arvensis*.

send up leaves only, probably developing flowers in succeeding year. To my mind the two species are the same.

5. *G. Liottardi* (Schultz); two bulbs in same envelope. Radical leaf single, longer than flower stem: flowers 2-5, brilliant golden yellow, ovate acuminate, involucre of three leaves, two large, one small, but all distinctly concave. May, June. Col de Jaman.

DR. J. E. TAYLOR, editor of SCIENCE-GOSSIP, gave the first of a series of lectures on popular subjects at the Town Hall, Northampton, during November: subject, "The Deep Sea Bed; its Origin, History, and Inhabitants," and four lectures, in connection with the Ipswich Museum, to large audience; on "The Romance of Our Common Wild Flowers."



NOTES ON THE COMMON FROG IN A  
STATE OF DOMESTICATION.

[Continued from p. 248.]

THE abnormal condition of the frog's skin, etc., mentioned above, on the 26th July and the 16th August, I believe to be the beginning of a disease by which a great number of frogs often die, while the white matter on the glass of its house (on 26th) may have been the early stage of a fungus often very fatal to frogs. In April, 1881, I came across a marked instance of death among frogs with a disease similar to what manifested itself to this specimen in the abnormal state of its skin, etc. I found a number of frogs by the side of a dry sandy road, nearly one-half of which were dead, and the others in a dying state. Their skins had a similar appearance to that described in this specimen. Several of the dead and dying that were dissected had the skin of their bodies extended like a blown bladder, and it was remarkably hard. How so many frogs met with this disease may be accounted for as follows:—About 250 to 300 yards from where the frogs were, there was a loch, in which were a great many frogs, and those found dead and dying may have left the loch in search of food on the grass, in the dewy night or morning, but when the warm April sun arose the short grass became dry, and being unable to find shelter (in the bright day of sunshine that it was), and as the want of water had stopped the action of their skin—the result was death.

During the night between the 24th and 25th August, the frog began to croak, and on the morning of 25th I was beside it when croaking; the bag or membrane below its chin was much extended. When in bed on the night between the 26th and 27th August, I again heard the frog croaking, and also between 7 and 8 P.M. on the 29th, it croaked when there was no small noise with the children.

Observations on this frog confirms the statement, "that frogs only take living insects." In no instance did I observe this frog take any creature but was moving in some way or other, and it often sat and watched with great patience until the insect began to move when this suddenly disappeared in its mouth. I tried the frog to take dead insects by attaching something to make them move, but never succeeded; it once, however, mistook the shadow of a house-fly so moved, at which it sent its tongue, but being once deceived I never got it to do so again. This, I would say, was a lesson from experience; but experience sometimes taught it wrong, as the following instance will show. A medical gentleman, on a visit from Ireland, was anxious to see the frog taking insects, but although house-flies were put in beside it, it took no notice of them, for the reason, I believe, that during that day many flies had alighted on the outside of its glass house, some of which it had tried to capture, but in vain! What it may

have learned regarding leeches, I never again put it to trial; but on the 15th August, I gave it a large black snail (Arion) at which it made several attempts, but was unable to lift it with its tongue. It is possible that the horse-leech may be a real enemy to the frog. A writer in "Nature" of 1st July, 1886, page 194, in writing on the enemies of the frog, mentions that "at Lake Elphinstone (100 miles from Mackay), I once saw a small frog (*H. rubella*) in a house in a very excited condition. On examination, I found a large leech on its tongue. This specimen, with the leech, I gave to Mr. Boulenger of the British Museum, where it may be seen." I observed that this frog changed its colour in no small degree, as it was affected by fear or otherwise. It also had the power, to a limited extent of protruding its eyes from their sockets, and the back of the eye-balls seemed to be used in connection with swallowing; they were often sunken downwards and backwards into its head till they were hidden, i.e. when in the act of swallowing. The movement of the frog's tongue in taking in an insect is so sudden that I could never follow it with my eye, although close beside the creature. In the "Zoologist" for 1845, vol. iii., p. 826, R. Q. Couch, Esq., M.R.C.S.L., writes:—"The rapidity with which this is effected" (i.e. taking of insects with the tongue) "is so great, that it is not at all times easy to notice it, unless within a foot or two of it at the time."

To the farmer and gardener, I would say, the frog is their friend, in the destroying of insects and snails; and it should be protected from foolish cruelty and wicked destruction, so often waged against the harmless creature. To those who are contented to study nature, the frog, as one of God's creatures, is well worthy of study and makes an interesting pet. The cause of this frog's death, as already stated, was its eating a large earwig, which, as the dissection showed, had pierced its gullet. This happened on the 22nd September, and on the afternoon of the 23rd, the frog began to cry in a very strange manner, and, on its house being opened, it sprang out, and then got into a greatly convulsed state; it was put in a little cold water, but lay greatly convulsed for over two hours, but again at night it was as lively as if nothing had happened, and also the day following, and when I last saw it at 9 A.M. on the 26th, but at 1 P.M. it was found dead. The dissection showed that inflammation had set in around the perforations in its gullet. In its stomach were pieces of the earwig, some house-flies, and some earthy matter out of earth-worms that it had eaten.

TAYLOR,

*Sub-curator, Free Museum, Paisley, N.B.*

MESSRS. DULAU AND CO., 37 Soho Square, have just issued a useful catalogue of works on astronomy, magnetism, and meteorology.

## GOSSIP ON CURRENT TOPICS.

By W. MATTIEU WILLIAMS, F.R.A.S., F.C.S.

**GEOLOGY AND INDUSTRY.**—In the Bulletin of the Geographical Society of Belgium is a suggestive paper by M. Louis Navez, on the influence of the various geological formations of the country upon the people. As the variations of altitude, latitude and climate are but small in Belgium, the purely geological influences operate with but little disturbance. M. Navez concludes that the geology of a country is one of the physical agents that limit the free will of man, and determine the location and occupations of communities. An example of this is afforded by the abundance of lime in the soil of the Geer valley, which gives to the straw of the cereals there grown, a special suppleness, strength and whiteness, which has originated the chief industry of the district, viz. that of straw plaiting, an industry yielding a return of four to five millions of francs annually. On the other hand, the absence of calcareous rocks in the main valley of the Lys, and those of its tributaries, renders the water of that river specially suitable for the cleansing of flax, and has thus located an industry and supported the fame of the cloths of Flanders.

Most of my readers must have heard of the efforts that have been made to introduce the cultivation of flax in Ireland, and of its indifferent success. In the course of my journeying through that country I have seen little patches here and there, but no approach to any vigorous industry, and until reading the above concerning the water of the Lys it never occurred to me that the Irish difficulty is fundamentally geological, and therefore practically insuperable. Ireland is essentially calcareous, the mountain limestone is more dormant than the Saxon.

A curious parallel to the Belgian straw plaiting may be added. In travelling from London towards the Midland counties, any passenger may see that the railway cuts into the outcrop of the chalk just in the neighbourhood of Luton and Dunstable, the centres of a venerable straw plaiting and straw bonnet industry. Why this northern outcrop rather than the South Downs should have been selected I do not attempt to explain.

**INHERITANCE OF MODES OF THOUGHT.**—A work of considerable magnitude and importance is now in course of publication in Belgium: "Bibliographie Générale de l'Astronomie" by M. M. J. C. Houzeau and A. Lancaster. It promises to be the most complete history of Astronomy yet attempted. In reference to the resistance formerly offered to the views of the solar system and of gravitation, which are now so freely accepted as a matter of course, the authors ask the following question: "Has the fact that our ancestors had thought in a certain manner

during a great number of successive generations left transmissible traces in their brains?" M. M. Houzeau and Lancaster appear, with some reserve, inclined to an affirmative answer. They add that communities seem to perpetuate among themselves certain traditional opinions that appear to become an integral part of their intellectual chattels (*leur bagage intellectuel*).

This is interesting to evolutionists who attribute the skill of the bee and the beaver, the migration of the swallow, the social virtues of the ant, and other so-called "animal instincts" to inherited habits gradually acquired by the urgency of surroundings and the survival of the cleverest.

**CONFLAGRATIONS AND METEORITES.**—M. Lenger, of Prague, has communicated to the Academy of Sciences of Paris a memoir on "The frequency of conflagrations in relation to the number of shooting-stars." In this, he attributes mysterious outbreaks of forest fires, of hay and wheat stacks, and of isolated houses to the fall of meteorites. He collects the records of these to show that their maxima correspond with the epochs of greatest meteoric showers. He has obtained from the Austrian government the appointment of a commission to collect complete statistics of fires from "unknown causes" that have occurred in Austro-Hungarian territory, and has asked the French Academy to obtain the same for France, but the Academy does not appear to have accepted the invitation.

**THE SINGING OF THE KETTLE.**—A correspondent has sent me the following extract from the "Popular Science News"—date not given—"When water is first heated nothing occurs; but, as its temperature rises, minute bubbles are given off, *accompanied by a simmering noise*. These bubbles are not steam, but air that has been dissolved by water. All ordinary water contains more or less of this dissolved air, which escapes when the temperature is raised. The familiar 'singing' of the tea kettle *is due to this escape of heated air from the water.*"

This I suppose is sent to me on account of the difference between the theory of kettle-singing, there expounded, and my theory which was published some years ago in "A Simple Treatise on Heat." The italics in the above extracts are my own, and indicate the points of difference. My observations, which are simple enough, and may easily be repeated by anybody, prove, in the first place, that the mere escape of the dissolved air from the water takes place silently, is *not* accompanied by a simmering noise; secondly, that the singing of the kettle occurs when the bubbles of steam are forming at the bottom of the kettle, and then suddenly condensing as the cooler water above descends in convection currents, and strikes the bubbles as they start to rise, or even while they are still in contact with the bottom of the kettle. This

sudden expansion and contraction of such bubbles, many of them larger than peas, sets the whole of the vessel in violent agitation which constitutes the singing. Thirdly the *simmering* is simply the result of complete boiling, *i.e.* of the bubbles of steam reaching the surface of the water and bursting in the air, which can only occur when the whole of the water has attained the boiling-point. The sudden change from noisy singing to the barely audible hiss of the simmering is very instructive, and every intelligent laundress and every other good old woman knows that this is the signal for pouring into the teapot.

THE MARQUIS OF TWEEDDALE'S COLLECTION.—Every naturalist, and everybody else endowed with sufficient intelligence to understand the elevating influence of the study of Nature, will join in chorus of grateful rejoicing on learning that Captain R. G. Wardlaw Ramsay, of Whitehill, has presented to the nation the magnificent collection of birds which were bequeathed to him by his uncle, the late Marquis of Tweeddale. Captain Ramsay's gift to the nation is not limited to this noble collection. He adds to it a large number of birds obtained during his military career in the East, and hundreds of other valuable specimens obtained since his uncle's death. In addition to these, Captain Ramsay presents to the nation the splendid Tweeddale library, including nearly 3000 volumes, which M. R. Bowdler Sharpe (see "Nature," Nov. 3) describes as "one of the best in the world, containing many rare volumes which we have not seen elsewhere, and this donation alone is worth several thousands of pounds." These books are to be placed in the British Museum, alongside of the collection of skins, for the benefit of students of ornithology. Mr. Sharpe tells us that the ornithological collection in the British Museum has been raised, by this and other gifts, from a number of 40,000 skins to more than 200,000 during the last fifteen years. We now possess the best ornithological library in the world, and one of the best ornithological collections. Let us hope that our metropolis will make similar progress in other intellectual directions, and thus become something more than merely an unrivalled aggregation of brute physical wealth, which, like agricultural manure, is so useful when distributed and so pestiferous when heaped.

ARCTIC EXPLORATION BY TOURISTS.—Dr. Karl Pettersen, Director of the Tromsø Arctic Museum, says, "It seems to me that every year shows more and more clearly that it is sheer waste of life and money to despatch casual and erratic expeditions to the North Pole. In my opinion, the result would be obtained more easily, surely, and cheaply by despatching every year, for a period of ten or eleven years, a certain number of well-equipped steamers from suitable spots towards the Pole. As the ice masses in the Polar basin are, without doubt, in a constant and varying

motion, this plan would enable one or another of the expeditions to seize the right moment for a dash northwards. We could not of course, be absolutely certain of success, for experience has proved that the state of the ice in a particular locality, at a particular time, does not enable us to predict what it will be in the same locality in the following year. Still the opportunity to reach a high latitude would present itself sooner or later." He further suggests national co-operation for this purpose, and adds that, "In any case, I venture to think that the plan of any expedition should not be finally formed before July, or if possible, August.

Some years ago I made a suggestion somewhat similar to this, but with the advantage of being self-supporting, so far as the pioneering is concerned. (See "Through Norway with Ladies.") My scheme starts with the fact, that a trip to the Arctic regions is now one of the easiest and most enjoyable of all marine excursions. Passenger steamers, incomparably better catered than any of our British excursion vessels, go every week from the southern and western ports of Norway round the North Cape and the Arctic face of Europe to the Varanger Fjord. Passengers from England may embark at Christiansand, Stavanger, Bergen, Aalesund, Trondhjem, and other ports, and sail through magnificent scenery of the fjords and the thousand and one islands of the coast, always on the sea and yet protected from sea sickness. They may reach these ports in two or three days from London, or Hull, or Newcastle, or Leith, etc. Besides these, other similar passenger ships steam two or three times per week as far as Tromsø, lat. 69½. A great and annually increasing stream of tourists from all parts of the world, especially from Britain and America, avail themselves of these, but all are, in one respect, disappointed. They see vast glacier fields inland, they see huge whales in the course of blubber peeling and cutting up at Vadsö, but no icebergs, no drift ice, no more of anything like these than at Margate. Neither would they see them even in the midst of winter, although they reach five degrees north of the Arctic circle.

What I proposed is that the craving of this multitude should be satisfied by weekly trips from Tromsø or Hammerfest to the Arctic ice barrier wherever it may happen to be. The position of this barrier varies most curiously, but, on an average, two or two and a half days from Hammerfest would carry the excursionists to it. Having thus satisfied a natural curiosity, and seen a sight never to be forgotten, they would return, and the captain of the ship would report the result as regards the movements of the ice. This information regularly repeated would doubtless reveal what Dr. Pettersen requires, in order to learn what all other Arctic explorers have sought to learn but have not learned, and cannot learn by casual and erratic expeditions at long and irregular intervals.



ASTRONOMY AND METEOROLOGY.

By JOHN BROWNING, F.R.A.S.

AN interesting discussion has taken place between Professor Hough and Mr. Denning respecting the red spot which has been seen for the last nine years on Jupiter. Mr. Denning says that he has made about 300 observations of this peculiar marking since it became prominently visible and it has exhibited a variable rate of motion. In 1879 it completed a rotation of the planet in 9 hrs. 55 min. 34 sec., now it occupies 9 hrs. 55 min. 41 sec., whence it follows that if this spot really forms part of the actual surface of Jupiter, this enormous planet must have increased the length of its day by seven seconds in eight years, which is utterly inconsistent with probability. The red spot is, doubtless, an unusually persistent feature in Jupiter's gaseous envelope, but its irregular velocity proves it to be separate from the sphere. Its origin is to be attributed to atmospheric phenomena capable of imparting a very pronounced and durable effect.

Professor Hough says the rotation period of Jupiter from the red spot has not materially changed during the past three years. The mean period 1884-5 was 9 hrs. 55 min. 40 sec. 4. Marth's ephemeris for this year is based on a period of 9 hrs. 55 min. 40 sec. 6.

Continued observations of the red spot will now possess great interest as tending to throw some light on the physical constitution of the giant planet.

Professor Kirchoff is dead at the age of 63. The discoveries of this great physicist in spectrum analysis rendered it possible to study the chemistry of the heavenly bodies by the aid of the spectroscope.

December 12th, Venus will be at the least distance from the sun at 11 hours morn.

December 26th, Mars will be at the greatest distance from the sun at 8 hours morn.

There will be no occultations in December of stars less than a 4th magnitude.

In December, Mercury will be a morning star throughout the month.

Venus will be a morning star, entering Libra about the 14th.

Mars will be in Virgo throughout the month.

Saturn will be almost stationary in Cancer.

*Meteorology.*—At the Royal Observatory, Greenwich, the lowest reading of the barometer for the week ending 15th October, was 29·24 m. on Monday morning, and the highest 30·05 in. at the end of the week. The mean temperature of the air was 41·1 deg., and was 10·7 deg. below the average. The direction of the wind was variable. Rain fell on six days of the week, to the aggregate amount of 0·36 in. The duration of registered bright sunshine in the

*Rising, Southing, and Setting of the Principal Planets at intervals of Seven Days in December.*

	D.	Rises. h. m.	Souths. h. m.	Sets. h. m.
MERCURY ☿ . . .	3	5 45M	10 28M	3 11A
	10	6 3M	10 31M	2 59A
	17	6 30M	10 42M	2 54A
	24	7 1M	10 58M	2 55A
	31	7 29M	11 17M	3 5A
VENUS ♀ . . .	3	3 19M	8 45M	2 11A
	10	3 32M	8 46M	2 0A
	17	3 46M	8 48M	1 50A
	24	4 2M	8 51M	1 40A
	31	4 17M	8 55M	1 33A
MARS ♂ . . .	3	0 54M	7 10M	1 26A
	10	0 48M	6 56M	1 4A
	17	0 39M	6 41M	0 43A
	24	0 32M	6 26M	0 20A
	31	0 23M	6 11M	11 59M
JUPITER ♃ . . .	3	5 58M	10 30M	3 2A
	10	5 39M	10 9M	2 39A
	17	5 20M	9 47M	2 14A
	24	5 0M	9 25M	1 50A
	31	4 39M	9 3M	1 27A
SATURN ♄ . . .	3	7 57A	3 49M	11 37M
	10	7 28A	3 20M	11 8M
	17	6 59A	2 51M	10 39M
	24	6 29A	2 22M	10 11M
	31	5 59A	1 53M	9 43M

week was 10·1 hours, against 23·4 hours at Glyde-place, Lewes.

For the week ending 22nd October, the lowest reading of the barometer was 30·05 in. at the beginning of the week, and the highest 30·43 in. on Tuesday morning. The mean temperature of the air was 40·3 deg., and 7·4 deg. below the average. The direction of the wind was variable. No rain was measured on any day of the week. The duration of registered bright sunshine in the week was 13·4 hours, against 33·3 hours at Glyde Place, Lewes.

For the week ending 29th October, the highest reading of the barometer was 30·39 in. on Tuesday evening, and the lowest 29·15 in. at the end of the week. The mean temperature of the air was 43·1 deg., and 3·7 deg. below the average. The general direction of the wind was S.S.W. Rain fell on four days of the week, to the aggregate amount of 0·29 in. The duration of registered bright sunshine in the week was 25·7 hours, against 24·5 hours at Glyde Place, Lewes.

For the week ending 5th November, the highest reading of the barometer was 29·53 in. on Monday evening, and the lowest 28·63 in. on Friday morning. The mean temperature of the air was 45·4 deg., and 1·3 deg. below the average. The general direction of the wind was S.S.E. and S.W. Rain fell on six days of the week, to the aggregate amount of 1·82 in. The duration of registered bright sunshine in the

week was 25.5 hours, against 18.6 hours at Glynde Place, Lewes.

For the week ending 12th November, the lowest reading of the barometer was 29.06 in. on Sunday morning, and the highest 30.04 in. at the end of the week. The mean temperature of the air was 45.3 deg., and 1.4 deg. above the average. The general direction of the wind was N.E. Rain fell on six days of the week, to the aggregate amount of 0.99 of an inch. The duration of registered bright sunshine in the week was 6.4 hours, against 7.1 hours at Glynde Place, Lewes.

In December the fall of the thermometer inland, is considerable, but this is considerably reduced by the action of the Gulf Stream, on our Western and South-Western coasts. The mean temperature of December is 46° at the Land's End; 45° at Haverford West and Truro; 44° at Pembroke and Plymouth; 43° at Carmarthen, Carnarvon and Devonport; 42° at Denbigh, Glamorgan, Taunton and Portsmouth; 41° at Birkenhead, Hereford, Bristol, Winchester, and Canterbury; and 40° at Blackburn, Bolton, Worcester, Oxford, London and the greater part of our East Coast.

The rainfall over the greater part of England, North of Reigate and East of Hereford, is 2 inches. Along the South Coast, it averages 3 inches, while on the West coast and South-West it reaches from 4 to 5 inches, the last named figure representing 516 tons to each acre.

#### A SHADE IN STOCK COLOUR.

By the AUTHOR OF "INSECT VARIETY."

WHEN nature first ruled the parallel lines of care, music was heard and prismatic hues beamed on the earth, for then to know was not to be beloved. Those who have spent the season beside the moire-antique, the ancient rippling sea, and have noticed the proficiency of the dressmaker in convolvulus white, pale saffron, and watery blue, may still have come to consider that shot colour is conducive to certain tones of sentiment, and certainly when we think of a beautiful butterfly it is one of rainbow hues that charms, entrances, transports, and inspires us with an acute sense of the delicately beautiful, that warms the heart and makes us feel as though we lived in a spirit-world more lovely, delightful, and fabulous. Must we infer in sober sadness that this sensuous illusion was merely a defect in our reason? Surely no! When we place the butterfly's eye which we conclude can interpret this diaper passion beneath the magnifying glass, and instead of a glance responsive to our feelings, perceive a meaningless honeycomb of strange glittering facets, capable of no motion, no expression of thought, no rolling in fine frenzy; we

begin to imagine that perhaps after all this delicious sense of scenic harmony, was a portion of the beauty of the landscape intended to delight ourselves. The airy toy is of course miserably short sighted, for experience has taught us so, but so are those blue eyes so greatly praised by dilettanti, and then it was so very animated. Fallacious reasoning! If we shut one of our eyes alternately and notice how much more we can see with the two, it is easy to understand how such goggles must render their possessor more circumspect and wary than we are, and then there is a conviction that the sight is also more microscopic than ours. The female of the purple emperor, as she sits on the topmost oak spray and watches her partner turn his brown patches slanting to the light, observes the long even rows of scales throw their purple shadows, but since she sees at a glance the radiance of love and the battledores that produce it, the divine so invests itself with serpent reason that it would demand the bullet head of a Newton to appreciate it. Robbed of harmony the rainbow hue proper to the nobler sex can only retain its allure as a vulgar bait. But we have still reason to show that it is an acquired character.

Time produces change. I can picture a period in the world's history when the Isle of Thanet, no longer a compeer of that of Portland, was really an island off the coast, and thus I infer it may have come about that rosy sheets of the sea-side bindweed hang upon the hedge-rows at Grove Ferry, on the Stour, now far inland, for although I knew not how to tell soldanella from sepium, I recall that a pretty wreath of this celestial hue picked on the strand at Luss for a summer hat, used to suggest that the river Clyde once flowed into Loch Lomond. Near this bindweed-hung hedge lies a reedy ditch along which the flowering-rush raises its banners, and here, on the 12th of August last, I was beating up game at the fall of dusk. Presently up flew an example of the *Botys verticalis*, or mother of pearl moth, differing from the pale purple type so common among nettle beds in being of a pale straw colour. As the Entomological Society know nothing regarding its claims to being a new species, it will suffice to say that the fore-wings are a little less produced than usual, and it is wholly of a fine straw tint instead of being tinged with that colour, and the reason is that the short blunt rows of scales have been replaced by the long scattered yellow ones; so, as any one can guess, both the purple and its gloss are gone. It is then no longer mother of pearl. Yet I cannot but suppose on medical examination that its mother was a pearl and its father also a pearl, and this question of family becomes quite interesting when we see before us not a stray sport, but the two sexes that thus differ, or species that thus are reputed as such, and which may be on these grounds traced to a common parent.

But butterflies in their distribution, like the race

of man, differ not alone in aspect, but also in their habits, as we may learn from the capricious ways of the common white ones. The rabbit populates the sand hills, and the hare holds to the brushwood, but while summer shimmers over the grass blades and warms the plain, the green vein (*P. Naxi*) is flying with the other whites, and is here, there, and everywhere, so that we never imagine the place of its nativity. As we travel over the mountainous coast of Argyleshire it is quite otherwise, and it is really curious to note how it is confined to the flaggy swamps or tarns in the hollows, where a female having the border spots on the fore wing running into a line will now and then flit past; and on passing north, to Sutherlandshire, the south land of the Vikings (judging from an example in the cabinet of my friend, Mr. King), these dusky shapes assume the hue of the mountain form *Bryonia*, known in the Alps and Dovre Fjeld. The motherly small white (*P. Rape*) is divided in care between the cabbages and red and yellow nasturtiums; or, if nothing better occur, it will entrust its eggs to rape or other cruciferous weed in the fields; but I was quite taken by surprise at the commencement of last August by a flock of large whites (*P. Brassica*), that came flapping in their lubberly way, eager to oviposit on a wayside row of whitlow pepper-wort (*L. Draba*), which from its early associations might be called the Ramsgate runner. These caterpillars, as far as I nursed them, were turning a little dark, for, alienated from the heart of the cabbage, how could they keep fair and plump? when at the critical juncture they fell into infidel hands and were otherwise disposed of, I fear, into the dust bucket. I notice Mr. Kirby tells us that this butterfly is replaced in the Canary Islands by a form with very large black spots, and that in Madeira, which lies between, an intermediate variety is found, resembling that seen in India, and consequently very like the English summer brood.

Some who do not devote their attention to the gradual changes in the world around may start on perceiving that there is nothing here that may be called monstrous or imperfect. A moth has two kinds of scaling on its wings, the one replaces the other, and it loses the character by which we recognised it; a butterfly has two or more instincts which allow it to adapt itself to diverse circumstances; in moral certainty isolation has produced a settled change of appearance. Some day we may record unawares the birth of a new species.

WE are deeply sorry to note the death of Mr. Thomas Bolton, the well-known purveyor of many microscopic objects, at the comparatively early age of 57. Few microscopists are unacquainted with his name and work. A more genuine or sincere lover of nature never lived.

## SCIENCE-GOSSIP.

WE have received No. 85 of Mr. William Westley's useful catalogue of natural history and scientific books. This part is devoted entirely to geology, palæontology, and mineralogy.

THE Second Annual Report of the City of London College Scientific Society has just been issued, with capital abstracts of the papers read and excursions made.

WE regret to announce the death, in extreme old age, of Mr. Edwin Lees, F.L.S., of Worcester, the well-known naturalist, whose contributions have often enriched our pages.

THE Hampshire Field Club, had a capital day's "Fungus Hunt," in the New Forest. Dr. M. C. Cooke and Mr. G. Masseur were among the party, and acted as directors.

IN our last notice of New Books, we gave credit to Mr. T. Charter White as being the author of "The Student's Handbook to the Microscope." Both he and the publishers write to say he is not, and of course we are bound to believe them.

WE have received the "Transactions of the Middlesex Natural History and Science Society." The Society has only been in existence a year, and yet the "Transactions" are as bulky and important as those of much older and longer established societies, showing what energetic progress has been made. This is largely due to the Hon. Secs., Mr. W. Mattieu Williams and Mr. Sydney T. Klein. The entrance fee to the society is only 10s. 6d., and the annual subscription the same, so the list of members ought to be large.

DR. W. G. FARLOW, of Harvard University, is of opinion ("Botanical Gazette," 1887, p. 182) that the number of species of Fungi exceeds that of flowering plants, although, he adds, "it is not true that more species of Fungi have already been described." In countries where the fungal flora has been thoroughly studied, few species of phanerogams are without their special parasite, and Pirotte records no less than 104 species found on six species of vine.

THE life of Charles Darwin, in two vols. by his son, just out, has been the chief event in the book-market for some time past.

MR. JOHN BROWNING'S remarkable little book, "How to Use Our Eyes," has just entered the sixth edition—a sufficient proof of the hit it has made. Large numbers of medical men recommend it as one of the best and cheapest treatises on this important subject.

DR. J. W. WILLIAMS, M.A., Editor of "The Naturalists' Monthly," has written "The Shell-collector's Handbook for the Field," giving directions



as to the collecting and preserving of British land and fresh-water shells, and describing the habitat of each species. This volume will be published immediately by Messrs. Roper and Drowley, of Ludgate Hill, and will give full details of every genus, species, and variety known to the Conchological Society up to date of publication.

Mr. W. H. HARCOURT BATH, of Ladywood, Birmingham, wishes to get the names and addresses of dragon-fly collectors throughout the world. There are few groups of insects which require to be more worked up.

## MICROSCOPY.

ENOCK'S SLIDES AND SKETCHES.—The last issue of these beautiful and instructive specimens (No. 16) is the green parasite fly (*Callimome regius*), bred from oak-galls. It is an exquisite object, and is rendered doubly interesting and instructive by the accompanying illustrative sketch. The amount of trouble and patience which men like Mr. Cole and Mr. Enock bestow on these preparations is far beyond the mere money value of the slides. Mounts like the above, for instance, it would be almost impossible for students to make themselves.

"JOURNAL OF THE ROYAL MICROSCOPICAL SOCIETY."—The October part contains, in addition to the usual copious and clever summary of current researches relating to zoology and botany, a long and beautifully illustrated "Monograph of the genus *Lycoperdon*," by G. Massee.

## ZOOLOGY.

MR. SIMMONS' BOOK-MITE.—In SCIENCE-GOSSIP for October, Mr. Simmons describes a "Book-Mite" as new to him. This mite is one of the Cheyleti, a very interesting family of vagrant predaceous mites, well worthy of microscopic study, and making, when well-mounted, very beautiful objects. I have found them in very curious situations. One I found on the cork of a preserved ginger jar when first opened, and therefore presumably from China; it was, I think, the same species as that of Mr. Simmons, which I take to be, not the true book mite (*Ch. eruditus*), but *Cheyletus venustissimus*. Another I found on the wing-case of a burying beetle; another in a deserted sparrow's nest; others on old hay, &c.; in fact, I suppose they are occasionally to be found anywhere, where other mites may be. The most wonderful and beautiful species that I have seen is one described and figured in the "Journal of the Royal Microscopical Society," for 1878, by A. D. Michael, Esq., named by him *Cheyletus flabellifer*. In this mite, the hairs have

become transformed into scales, having somewhat the shape of a battledore. The two papers by Mr. Michael are well worth perusal, giving as they do, a capital account of these interesting creatures.—*C. F. George.*

THE DARTS OF THE HELICIDE.—At a recent meeting of the Leeds Naturalists' Club, Mr. W. E. Collinge read a paper on the above subject, and illustrated his remarks by reference to a number of drawings figuring the darts and dart-sacs of several varieties of snails. He remarked that as the dart had been known to naturalists for at least 200 years, it was strange that our knowledge of the organ and its functions should still be very imperfect. After describing the dart and dart-sac, and giving a short account of each dart-bearing species, he said that he considered the organ to be a degenerate weapon of defence, which in former ages was probably much stronger and oftener used. In support of this statement, he cited a number of facts showing that in some cases the darts are seldom used in pairing or at other times, and in other cases it was questionable whether it was possible for the animal to use the dart at all; and further, if the animal used the dart only at the pairing season, it seemed hardly likely that it would carry an organ all through the year which could at any time be produced in five or six days. Reference was made to the observations of Gray, Schmidt, Mörch, and Sheppard regarding the relationship between the form of the dart and the markings and bands of the shell; and adverting to the conclusions of the last-named observer, Mr. Collinge thought it was unwise to consider that slight variations in the form of dart were a sufficient basis on which to ground specific differences.

A FEW NOTES OF 1887.—June 16th, I took a "Clouded Border" (*Marginata*) with no markings on underwings. Also in early part of July, a "Blood Vein" (*Amataria*), with the space between the oblique lines filled up entirely with the same colour as the lines themselves. On the 9th July, I observed a number of "small white" (*rapi*) settling on the mud at the sides of the river. As many as forty-two were on one small piece. In August, while passing through Whitchurch (Hants), I saw two "purple hairstreaks" (*quercus*), and a fritillary (probably *paphia*), settling on the ground where it was moist. Do butterflies sip moisture in very hot and dry weather? and why? Is there an insufficiency of nectar? August 8th. I found several specimens of a white variety of *Anagallis tenella* in a bog on Greenham Common, Newbury; near it were *Drosera rotundifolia* and *D. intermedia*, *Hypericum Elodes*, *Scutellaria minor*, and the blue marsh grass. The "grayling" (*semele*) was flying plentifully on the higher heathy ground. A patch of *Mimulus lutea* (*guttata*) seemed to be well established on one of the banks of the Enbourne river, near Newbury.

THE STATOBLASTS OF THE POLYZOA.—A short time ago while collecting rotifera and infusoria, I came across numerous polyzoaries of what I believe to be, from the form of the branching cells, *Plumatella repens*. This locality, while fairly rich in microscopic fauna and flora generally, had never previously yielded any of the polyzoa, and the interesting fact of the above discovery set me to look up our authorities on the subject. Now there is one point in its life-history which seems to require some elucidation, as naturalists differ somewhat in their account of it. I refer to the manner in which the statoblasts or winter-ova escape from the parent mollusc, and what becomes of them afterwards. The "Microscopical Dictionary" says, that when mature, according to Beneden, they escape at an orifice near the disk; and that this statement is denied by Professor Allman. Carpenter does not touch on the point, but Hogg, speaking of *cristatella*, says the statoblasts are concealed by the animal among tangled masses of decayed grasses and confervæ. He subsequently however quotes J. Newton Tomkins on *Acyonella fluviatella*, who says, "numerous ova (statoblasts) were detached and floated on the water;" afterwards sinking down to the bottom about January. Now I felt quite certain that I had read somewhere that they sink to the bottom of the water, and as it appeared to be a simple matter of fact which could be easily tested, I went early in September, in the hope of procuring specimens, and, if possible, settling the point. I was not fortunate enough to find the living animals, so could not be certain of the species, but I managed to get a mass of the polyzoaries of what I take to be *plumatella*. These were all in a state of decay, and while in my possession rapidly sloughed away. Of course I at once put them in one of my aquaria, and awaited further developments. I examined a portion microscopically at once. No trace of the polypides could be seen, but in the irregularly branching cells numerous statoblasts were visible, while others had already been set free by the sloughing away of a portion of the polyzoary. The process of disintegration rapidly proceeded in the aquarium, and hundreds of statoblasts were set free. Three or four days afterwards, on looking at the aquarium, I noticed a large number of minute dark bodies floating on the water, which I took to be the thecae of ferns, a basket of which hung over the aquarium. However, on placing a few under the microscope, they were found to be the statoblasts. So far then as this particular species is concerned, the statoblasts do not "escape during the life of the parent through an orifice near the disk," but are set free by the decomposition of the parent. Mr. Tomkins is proved to be right as to the floating; and in all probability he will prove to be correct in his accounts of their subsequent sinking, but of this I cannot yet be sure. It is, of course, quite possible that in other genera,

the process may be different, and it would I think be interesting if some of our microscopists, who have paid especial attention to this class of animals, would record their experience on this particular point.—*J. E. Lord, Rawtenstall.*

## BOTANY.

ASTER CAMPESTRIS IN COLORADO.—On the 16th August, I found several specimens of an aster, kindly identified for me by Dr. J. M. Coulter as *A. campestris*, Nutt., at Twin Lakes, in Lake Co., close to the lower end of the upper lake. This species is new to the flora of Colorado, not having been found hitherto nearer than Idaho and Montana, and is probably very rare in this State, since I have not observed it elsewhere, and even the district in which it was found had been carefully explored, without its previous discovery. I found *Saponaria vaccaria* and *Setaria viridis* growing by the mouth of Two Elk Creek, in Eagle Co., where, however, they are without doubt aliens.—*T. D. A. Cockerell, West Cliff, Custer Co., Colorado.*

FUNGUS CROP OF 1887.—It would be interesting to know what effect the past dry season has had upon fungi in different parts of the country. In the neighbourhood of Kendal there has been an almost complete absence of the species which are usually so abundant in pastures, with the exception of the common mushroom. Scarcely a *Hygrophorus* or *Lycoperdon* was to be seen, and *A. granulatus* was entirely absent. It was the same in the case of banks and dry portions of woods which had been rendered hard and dry by the long drought, but in damper places which had not suffered so much there was a fair abundance of fungi after the rain came. The *Boleti* do not seem to have suffered from the heat, and *B. edulis* was never so fine or plentiful. *Paxillus involutus* was also very abundant.—*C. H. Waddell, Kendal.*

LATE FLOWERS.—The following is a list of plants noticed by me in blossom during the past three days (1st to 3rd of November), a list which might doubtless have been considerably larger had not the effect on the ground of the recent rains been such as decidedly to localise botanical exploration.—*Ranunculus Lenormandi*, *R. Flammula*, *R. acris*, *R. repens*, *Fumaria officinalis*, *Nasturtium officinale*, *Cardamine hirsuta*, *Sisymbrium officinale*, *Sinapis arvensis*, *Lepidium Smithii*, *Capsella Bursa-pastoris*, *Viola sylvatica*, *V. tricolor* var. *arvensis*, *Polygala vulgaris* (blue, white and pink), *Stellaria uliginosa*, *S. media*, *Cerastium triviale*, *Malva sylvestris*, *Geranium Robertianum*, *Linum catharticum*, *Ulex Gallii*, *U. Europæus*, *Trifolium pratense*, *T. repens*, *T. procumbens*, *T. minus*, *Vicia sepium*, *Potentilla reptans*, *P. Tormentilla*, *Fragaria vesca*, *Rubus macrophyllus*,

*Geum urbanum*, *Epilobium obscurum*, *E. montanum*, *Spergula arvensis*, *Pimpinella Saxifraga*, *Angelica sylvestris*, *Heracleum Sphondylium*, *Daucus Carota*, *Torilis Anthriscus*, *Sherardia arvensis*, *Valerianella oolitorea*, *Knautia arvensis*, *Scabiosa succisa*, *Bellis perennis*, *Solidago Virgaurea*, *Anthemis nobilis*, *Matricaria inodora*, *Chrysanthemum segetum*, *C. Leucanthemum*, *Tanacetum vulgare*, *Gnaphalium uliginosum*, *Achillea Millefolium*, *Senecio aquaticus*, *S. Jacobae*, *S. vulgaris*, *Centaurea nigra*, *Carduus lanceolatus*, *C. palustris*, *Lapsana communis*, *Hypochaeris radicata*, *Thrinicia hirta*, *Spargia autumnalis*, *Leontodon Taraxacum*, *Sonchus oleraceus*, *S. asper*, *Crepis virens*, *Hieracium Pilosella*, *Fasione montana*, *Calluna vulgaris*, *Erica cinerea*, *E. Tetralix*, *Chlora perfoliata*, *Gentiana campestris*, *G. Amarella*, *Echium vulgare*, *Myosotis caspitosa*, *M. arvensis*, *Linaria vulgaris*, *Pedicularis sylvatica*, *Euphrasia officinalis*, *Veronica polita*, *V. arvensis*, *Calamintha officinalis*, *Prunella vulgaris*, *Galeopsis Tetrahit*, *Stachys arvensis*, *Teucrium Scorodonia*, *Lysimachia nemorum*, *Anagallis arvensis*, *Plantago lanceolata*, *Atriplex angustifolia*, *Rumex crispus*, *Polygonum aviculare*, *P. Persicaria*, *P. Hydropiper*, *Euphorbia helioscopia*, *E. exigua*, *E. Peplus*, *Parietaria diffusa*, *Eriophorum polystachion*, *Scirpus fluitans*, *Holcus lanatus*, *Trisetum flavescens*, *Arrhenatherum avenaceum*, *Poa annuus*, *Serrafalcus mollis*. The number of species is 107. There has been an unprecedented autumnal outburst of Charlock in stubbles, &c., all over the country. Fields coloured yellow with the bloom of this weed form one of the most conspicuous features in the landscape at present. Has anything similar been observed in England?—*C. B. Moffat, Ballyhyland.*

## GEOLOGY, &c.

GEOLOGY AND HISTORY.—Dr. Sorby devoted about seven weeks last spring to the study of East Kent by land, by water, and in early and modern historical writings. He was much assisted by Mr. George Dowker, of Stourmouth, and other local friends, with whose conclusions his own independent researches led him to agree very closely. In a lecture recently delivered at Firth College, Dr. Sorby described some of the facts bearing on only one particular part of the district. It was shown that in pre-historic times there must have been a wide channel between Thanet and what some classic writers call the continent of Britain. Some think it was the place visited for trade by the Phœnicians. In Roman times the so-called Wantsum was still a most important line of communication between the Straits of Dover and Thanet, and the southern end must have been a splendid harbour, unequalled on any part of the coasts as a means of communication with the con-

continent. It is said that the oysters were exported to Rome. The great fort of Richborough was founded by Vespasian, and garrisoned by an entire legion. Reculvers at the other end of the strait was occupied only by a cohort. The ruins of Richborough Castle are now very fine, and many most interesting objects have been found both there and at Reculvers. The ruined church in this latter place seems formerly to have been a Roman temple or basilica. In early Saxon times the harbour at Richborough must have been excellent, and, both from a military and naval point of view, Ebsfleet must have been unsurpassed for the landing of the Invaders, as also in later times for the landing of St. Augustine, the first Christian missionary sent to the English. It was shown that several common errors connected with the question probably are due to a want of maritime knowledge on the part of the writers, who overlooked the fact that the ships would bring up in a place secure from terrible storms and not on an open coast. In an early Saxon document relating to the abbey at Minster, it is curious to read of Jesus as “the new divinity of the nation.” During all these times no doubt great changes were taking place in the harbour, but still Sandwich remained the most noted port in England for many hundred years, as shown by a list of the great historical events connected with the town. Some of the early records are very amusing, and throw much light on the character of the times, such as drowning criminals in a stream near the town, and leaving their dead bodies to float out to sea, as best they could, and punishing people for speaking disrespectfully of the clergy or the mayor’s wife. Complaints of the imperfect navigation are first met with in the fifteenth century. Dutchmen were employed over the harbour and marshes, and evidence of their influence may be now seen in nearly every old street. At the time of Henry the Eighth, the navigation had become so bad that he twice came down to examine the subject, and granted all the property of the three churches to try to improve the river. In the reign of Anne, a commission decided that nothing could be done. The cause of all these changes was shown to have been a reversal of the direction in which the shingle is drifted along the shore by the waves in storms. In early times this was from north to south, but later from south to north, thus causing the river to double back in a most remarkable way. The change could be explained in a very satisfactory manner by supposing that, in accordance with tradition in early times, there existed a considerable tract of land dry at high-water, where now lie the Goodwin Sands, which is said to have been destroyed by the sea in 1097. The depth of water up to Sandwich is probably not materially less, being now enough for vessels of considerable tonnage, but the channel is so full of sudden bends that navigation would be almost impossible without a steam tug. Even Dr. Sorby’s yacht, the Glimpse, required careful handling when



towed up and down. The long steamers of the present day could not turn. A brief account was also given of the great changes which have occurred on the coast of Suffolk. Here the great and famous City of Dunwich, the seat of St. Felix, the first Christian Bishop of East Anglia, has been almost entirely destroyed, not as at Sandwich by the accumulation of deposits, but by the inroad of the sea. This has carried away not only the once famous harbour, but almost the whole site of the town, leaving one solitary ruined church as a survivor of forty-eight. In conclusion, the lecturer contended that this border land between geology and history was a most interesting subject for study, not only in relation to the probable antiquity of the present configuration of our coast, but also as throwing light on most important historical events in early times.

## NOTES AND QUERIES.

**A STRANGE WASP'S NEST.**—During the month of October, I had a very complete wasp's nest given to me; it was not very large, but the curious part was, that the leg of a small bird was projecting horizontally from one side. The question is how it got there, and how the wasps were able to build their nest completely round it, whilst it was in a horizontal position? The bird is, I believe, a wren. Can any readers of SCIENCE-GOSSIP explain it or cite similar occurrences?—*C. F. George.*

**EARLY CATKINS.**—As I think it is very unusual to find at this time of year catkins on the hazel, I enclose a specimen gathered at Wargrave-on-Thames this week.—*Addison Crofton.*

**CASTOR.**—Is your contributor correct in applying (Curiosities of Drugging, SCIENCE-GOSSIP for Nov.) the term "Castor," to a highly odorous secretion peculiar to the male of the musk-deer of Africa? I have always understood that it was peculiar to the beaver (*Castor Fiber*).—*Moyhitt.*

## NOTICES TO CORRESPONDENTS.

**TO CORRESPONDENTS AND EXCHANGERS.**—As we now publish SCIENCE-GOSSIP earlier than formerly, we cannot undertake to insert in the following number any communications which reach us later than the 8th of the previous month.

**TO ANONYMOUS QUERISTS.**—We must adhere to our rule of not noticing queries which do not bear the writers' names.

**TO DEALERS AND OTHERS.**—We are always glad to treat dealers in natural history objects on the same fair and general ground as amateurs, in so far as the "exchanges" offered are fair exchanges. But it is evident that, when their offers are simply disguised advertisements, for the purpose of evading the cost of advertising, an advantage is taken of our gratuitous insertion of "exchanges" which cannot be tolerated.

We request that all exchanges may be signed with name (or initials) and full address at the end.

**PULEX.**—Kindly send us one of your proposed papers to look over.

**ALGÆ.**—There is no cheap work on freshwater algæ. You will find much relating to them in Dr. Cooke's "Ponds and Ditches." Dr. Hasall's "Freshwater Algæ," 2 vols., may somewhere be got secondhand of the scientific booksellers. In the earlier volumes of SCIENCE-GOSSIP you will find many illustrations and sketches of Desmids and allied forms.

**MISS LAYARD.**—Your reply on "Rudiments and Vestiges" reached us too late for insertion this month.

**S. A. H.**—Get Rye's "British Beetles." There is also a cheap book by the Rev. J. G. Wood, published by Routledge at 1s., on the common kinds.

**W. H. H., Bath.**—We shall be very pleased to receive your contributions on dragon-flies.

**T. P. K.**—Dr. Cooke's "Microscopic Fungi" is unapproached by any other for all the purposes a young student requires.

## EXCHANGES.

**DUPLICATES.**—Wings and other parts of butterflies, dragonflies, moths, and beetles for microscopical work, in exchange for specimens of dragonflies, or works relating to dragonflies.—W. Harcourt Bath, Ladywood, Birmingham.

**DUPLICATES.**—Land and fresh-water shells, Lepidoptera, Coleoptera, British flowering plants and grasses, etc. Desiderata—dragonflies, extra British or foreign.—W. Harcourt Bath, Ladywood, Birmingham.

**WANTED,** works by Dr. Hagen and De Selys relating to dragonflies. Many valuable works relating to all branches of natural history offered in exchange.—W. Harcourt Bath, Ladywood, Birmingham.

**DRAGONFLIES** wanted from all parts of the world for figuring in monograph; also wanted, both larvæ and pupæ of any dragonflies, either living or dead.—W. Harcourt Bath, Ladywood, Birmingham.

FOR exchange, good captain's telescope, original cost £5; also "Book of Designs," very scarce, original cost £1 1s. Wanted, dragonflies, either British or foreign (in good condition).—W. Harcourt Bath, Ladywood, Birmingham.

**COLLECTION** of British butterflies and moths, about 100 different species, and collection of British beetles, about 50 different species, many very local and rare; data given with all. Dragonflies wanted in exchange.—W. Harcourt Bath, Ladywood, Birmingham.

**SCIENCE-GOSSIP** from 1867 to 1874, the 8 vols. bound in 4 vols., perfectly clean. Desiderata, Gray's edition of Turton's "Conchology," vol. 1, of Jeffrey's "Conchology," etc., or offers.—W. E. Collinge, Sprinfield Place, Leeds.

**WANTED,** foreign postage-stamps; will give shells, land, freshwater, and marine, also a few books.—A. G. A., 15 Roslyn Terrace, Redland, Bristol.

**EGGS** of ring-ouzel, dipper, grey wagtail, golden-winged woodpecker, laughing gull, etc., for other eggs not in collection.—James Ingleby, Eavestone, near Ripon.

**SEVERAL** dozen fossils from the Barton beds and Hordle to exchange for fossils from other formations. Send list to—Miss Hinuber, Belmore, Lymington, Hants.

**OFFERED,** "Fortnightly Review," Jan. to Oct. 1887, inclusive, clean; "Nature," April to Aug. 1887, twenty-one consecutive weeks, in monthly parts, clean. Wanted, books on birds, or skins of wryneck, grass-hopper, marsh, and garden warblers, bearded, marsh, and coal tits, red-backed shrike, pied flycatcher.—J. H. K., 18 Church Street, Commercial Street, E.

**FORAMINIFEROUS** gatherings wanted from any part of the world. Good exchange offered either in like material, or in named species of forams, many rare, or, if preferred, in assorted micro slides, well mounted, including spread diatoms from Oamaru.—A. Earland, 3 Eton Grove, Dacre Park, Lee, S.E.

**TO FOREIGN** correspondents: good exchange offered as above for gatherings of shore sands or dredgings, or washings of fossil clays or sands containing forams. Wanted particularly, washings of the Miocene clays and sands of Vienna and Moravia.—A. Earland, 3 Eton Grove, Dacre Park, Lee, S.E.

**WILL** give good value in rock or other sections for rubbings of brasses or good photos of geological or other scientific subjects.—C. F. Cross, 56 Werneth Hall Road, Oldham.

**WILL** exchange Huxley's "Practical Biology," perfectly new, latest edition, and Beale's "How to Work with the Microscope," for mineralogical specimens.—G. van Casteel, 24 Kennington Grove, Upper Kennington Lane, S.E. No cards.

**WANTED,** British and foreign shells; state desiderata.—Fred. Dolamore, Bournemouth.

**OFFERED,** micro material, twenty-four varieties, for two good slides or other unmounted objects.—W. Sim, Gourdas, Fyvie, N.B.

**TWELVE** photographs of microscopic objects, chiefly diatoms; will exchange for a Jubilee sixpence.—W. Mathie, 127 Buchanan Street, Glasgow.

**GOOD** foreign stamps offered in exchange for rocks, fossils, polished stones, and corals.—Thomas W. Reader, 171 Hemingford Road, London, N.

**WANTED,** Tertiary and Oolite fossils, also rocks and minerals from Cornwall and Cumberland.—Thomas W. Reader, 171 Hemingford Road, London, N.

**WILL** exchange this year's "Naturalist's World" for shells or offers in books.—J. E. Beckett, Trinity Place, Friars Lane, Great Yarmouth.

**FOR** exchange, a large number of rare animal parasites, mounted and unmounted; really good micro slides taken in exchange. Send lists.—W. A. Hyslop, 22 Palmerston Place, Edinburgh.

**MICRO** slides: a further series of "fabric" slides in exchange for other first-class mounts. Desiderata—Foraminifera spicules, micro photos, etc.—Walter Henshall, The Hollies, Bradbury, near Stockport.

WANTED, back numbers or volumes of "Grevilla" in exchange for back numbers of "The Journal of Microscopy" or "Journal of Botany" for 1883.—C. H. Waddell, Kendal.

For exchange, some anatomical sections ready for mounting. What offers?—C. H. Waddell, Kendal.

WANTED, ammonites not in collection, British or foreign. Many duplicates of fossils, etc., in exchange.—John Hawell, Ingleby Vicarage, Northallerton.

WANTED, diatomaceous earth from Mejillones in Bolivia, South America; can give in return diatomaceous earth from Oamaru, New Zealand.—E. Michalek, r Fleischmarkt, Wien, Austria.

WANTED, larva, pupa, and perfect insect of the Hessian fly, mounted or unmounted; good exchange in slides; write first.—J. Boggust, Alton, Haits.

"OUTLINES of Geology," by Phillips & Conybeare, coloured map and coloured sections, large octavo, 1822; "Zoologist," unbound, for 1887; Fiquier's "Birds and Reptiles," profusely illustrated, 1883, for other books or anything useful.—George Roberts, Lofthouse, Wakefield.

SCIENCE-GOSSIP, unbound, from 1879 to Sept. present year, including sixteen coloured plates; what offers? Also "Northern Microscopist," unbound, 1881-3.—P. Webster, King's End, Ruislip, near Uxbridge, Middlesex.

"MICROGRAPHIC Dictionary," by Griffith & Henfrey, 2nd ed., cost 52s. What offers?—P. Webster, King's End, Ruislip, near Uxbridge, Middlesex.

WANTED, physiological, pathological, and other good material. Will give well-mounted slides.—Fred. Lee Carter, 25 Lansdowne Terrace, Gosforth, Newcastle-on-Tyne.

WANTED, micro appliances, books, objectives, microtomes, etc. Will give slides in exchange: anatomical, pathological, botanical parasites, zoophytes, diatoms (selected and spread), micro fungi, etc.—Fred. Lee Carter, 25 Lansdowne Terrace, Gosforth, Newcastle-on-Tyne.

A few dozens selected diatom slides from Oamaru, etc., highest class, offered in exchange for lantern transparency of scenery, &c. Mutual approval.—G. Conser, Ballymurphy, Belfast.

OFFERED, eggs of chough, pine gro-beak, dotterel, Manx shearwater, storm petrel, gannet, guillemot, razor bill, puffin, corn bunting, ten clutches of heron, seven mut swan, water rail, cormorant, kittiwake, herring and great black-backed gulls, great skua, kestrel, stonechat, dipper, goldcrest, reed bunting, bullfinch, magpie, eider duck. Wanted, perfect clutches, satisfactory data.—R. J. Ussher, Cappagh, Lismore, Ireland.

OFFERED, L. C., 8th ed., 119, 135, 180, 193, 237, 272, 313, 379, 641, 648, 707, 757, 883, 909, 954, 1191, 1198, 1223, 1287, 1283, 1302 d, 1318, 1339, 1409, 1417, 1475, 1479, 1497, 1515, 1533, 1629, 1623, 1724, 1636, 1804. Many desiderata.—G. K. Gude, 5 Gies-bank Rd., Upper Holloway, London, N.

OFFERED, good clutches of kestrel, dipper, ring, ouzel, reed bunting, golden plover, sandpiper, curlew, grey lag goose (one clutch), pochard, common gull, herring gull, lesser black-backed gull, great black-backed gull, great sheen, Manx shearwater, stormy petrel, all British and recent. Wanted, many British species.—Dr. Davidson, Sanquhar, N.B.

WANTED, Lepidoptera from all parts of the world; will try and make a good return in American Lepidoptera or unmounted micro objects. Histological sections also wanted.—Frank G. Jones, 1623 Montgomery Avenue, Philadelphia, Pa., U.S.A.

WANTED, elementary micro slides for a young men's institute. They will be thankfully received by—A. Wildy, 48 Albion Road, South Hampstead, N.W.

WANTED, Webb's "Celestial Objects for Common Telescopes"; will give in exchange, both perfectly new, Noble's "Hours with a Three-inch Telescope," and Phillip's Planisphere, giving stars for every hour in the year, rising and setting of sun, etc.; or English and foreign stamps.—B. Truscott, Woodlane, Falmouth.

WANTED, L. C., 7th ed., Nos. 834-1042, 1347, and others; a large number of rare plants to offer for selection in exchange.—C. A. O., 7 Cavendish Terrace, Torquay.

OLOGICAL and conchological specimens for exchange. Colonial correspondence invited.—Dr. Reed, jun., Ryhope, Sunderland.

WANTED, rare foreign stamps, coins, and medals in exchange for natural history specimens.—W. K. Mann, Clifton, Bristol.

WANTED, specimens of dragonflies (Odonata) from all parts of the world; will exchange for them such specimens of natural history as I may be able to collect, according to the wish of the exchanger.—Ph. P. Calvert, Entomological Section, Academy of Natural Sciences, 19th and Race Streets, Philadelphia, Pa., U.S.A.

WANTED, a photo camera, with lens and accessories, complete, in exchange for microscope by Nacet, three obj. glasses,  $\frac{1}{2}$ ,  $\frac{3}{8}$ , and  $\frac{1}{4}$ , three eyepieces, condenser, etc., in mahogany cabinet, cost £5 5s secondhand from C. Baker, High Holborn, this year; has hardly been used.—George Fell, jun., Aylesbury.

MICRO slides (over 300) offered in exchange for any books or scientific apparatus.—A. Downes, 5 Royal Park Road, Clifton, Bristol.

WANTED, a genuine clutch, with full data, of eggs of golden eagle, must be Scotch.—G. T. Phillips, Wokingham, Berks.

OFFERED, L. C., 7th ed., Nos. 31, 57, 59, 588, 595, 699, 809, 1021, 1024, 1043, 1149, 1287, 1283, 1417, in exchange for others.—A. Sangster, Ivy Cottage, Cattie, Oldmeldrum, N.B.

WANTED, Cape Guinea, Ceylon, China, Japan, and New Zealand shells in exchange for British shells, Polih Devonian corals, Trias rock specimens, Devonian greensand fossils, sections of all Devonian corals for micro purposes; also fine specimens of *Pyroxene andesite*, from South America, that cuts fine rock sections.—A. J. R. Selater, M.C.S., 23 Bank Street, Teignmouth, Devon.

WANTED, *Pholas crispata*, *Terebratulina caput-serpentis*, *Lautina communis*, *P. britannica*, *P. pallida*, *I. exigua*, *Trochus granulatus*, *Puncturella noachina*, *Emarginula reticulata*, *Hyalaea trispinosa*, *Iecten niveus*, *P. Autonitii*, *P. Dauticus*, *P. Tigerrus*, *P. striatus*, *P. Jurinus*, *P. Purio*, large size; rare British shells in exchange.—A. J. R. Selater, M.C.S., Bank Street, Teignmouth, Devon.

OFFERED, *Vert. antiopeum*, *substriata*, *Ci. Rolphii*, *Pupa ringens*, *Zon. excavatus*, *Sph. ovale*, vars. of Anodonta. Wanted, *S. oblonga*, *virescens*, *L. involuta*, other vert. or conchological books, or papers.—J. A. Hargreaves, Charlestown, Shipley, Yorkshire.

WANTED, good fruiting specimens of *Sbaranium affine* and *S. minimum*; rare plants in exchange.—Beely, 14 Ridinghouse Street, W.

*Clausilia Rolphii*, *Unio margaritifera*, or any variety of Unioidea; or any other shells not in collection, British or foreign.—Fred Rhodes, 26 East View, Ecclehill, Bradford.

*Eumenes coarctata*, some splendid cells containing live grub of this rare insect, all British. What offers?—F. Dolamore, Avenue Road, Bournemouth.

WANTED, flies, dragonflies, bugs, or any insects except British lepidoptera; unset specimens will do, British or foreign. If any collector will send me a box of such, I will return it filled with British lepidoptera.—S. L. Mosely, Beaumont Park Museum, Huddersfield.

LEAF of *Hippophae rhamnoides*, unmounted, in exchange for any interesting micro object.—C. R. Dykes, 3 Norfolk Crescent, Bath.

FABRIC SLIDES.—Amongst these I have a separate series specially to show adulteration in fabrics, as in unions of silk and cotton and woollen and cotton, also to show deceptions in fabrics by sizing, finishing, and weighing. Will exchange for first-class micro and magic lantern slides.—Walter Henshall, The Hollies, Begbury, near St. Cleur.

WANTED, vol. iv. Morris's "British Birds" and vol. iv. Brei's "Birds of Europe," first editions, for vol. i. Morris, or state wants.—W. P. H., 26 Market Place, Newark.

BRITISH butterflies and moths, bees and other hymenoptera, beetles, bird skins, &c., for British birds' eggs, shells, Natural History, and other books. Only really good specimens sent out or received.—W. H. Harwood, Colchester.

PREPARED objects for micro-mounting, diatoms, fungi and zoophytes, etc.—George T. Read, Paradise House, Paradise Row, Stoke Newington, London, N.

#### BOOKS, ETC., RECEIVED.

"Lectures on Bacteria," by A. de Bary (Oxford: Clarendon Press).—"Living Light," by C. E. Holler (London: Sampson Low).—"Dictionary of Place Names," by C. Blackie (London: John Murray).—"The Creator, and what we may know of the Methods of Creation," by Dr. Dallinger (London: T. Woolner).—"Elementary Treatise on Light and Heat," by the Rev. F. W. Aveling (London: Relfe Bros.).—"Elementary Mineralogy," by F. Rutley, 3rd ed. (London: Murby).—"Catalogue of British Mollusca," by Chas. Jeffreys, and "Catalogue of British Land and Fresh Water Mollusca," ditto (Gloucester: H. W. Marsden).—"Other Suns than Ours," by R. A. Proctor (London: W. H. Allen & Co.).—"Proceedings Folkestone Nat. Hist. Soc."—"Trans. Middlesex Nat. Hist. and Science Soc."—"Proceedings Bristol Naturalists' Society."—"Report Liverpool Geol. Association."—"Report Hemel-Hempstead Nat. Hist. Soc."—"The Lake Age in Ohio," by E. W. Clapole.—"Essex Naturalist."—"American Monthly Microscopic Journal."—"Journal of Microscopy."—"Century."—"Gentleman's Mag."—"Belgravia."—"Midland Naturalist."—"Wesley Naturalist."—"American Naturalist."—"Victoria Naturalist."—"Garner."—"Amateur Photographer."—"British Dogs," No. 13.—"The Naturalist."—&c., &c., &c.

COMMUNICATIONS RECEIVED UP TO THE 12TH ULT. FROM: T. P.—Dr. A. D.—H. M. J. U.—F. G. I.—F. N.—A. L.—F. R.—F. D.—P. P. C.—T. D. A. C.—H. B. W.—F. G. J.—W. H. B.—A. W.—Dr. R., jun.—C. A. O.—G. S.—B. T.—J. C.—C. L. G.—H. D. W.—E. C.—W. M.—R. D. P.—A. J. J.—A. J. R. S.—A. G. A.—T. W.—J. J.—J. A. H.—W. A. C.—C. T. H.—J. E. L.—J. H. K.—C. B. M.—A. E.—R. D.—C. F. C.—C. V. C.—F. D.—W. S.—J. W. R.—J. B. B.—F. J. G.—W. A. H.—C. H. W.—A. S. J.—W. H.—J. H.—E. M.—J. B.—A. B.—J. W.—J. C. W.—F. L. C.—W. H. B.—A.—H.—G. C.—F. G.—R. J.—U.—C. H. G.—J. O.—Dr. K.—T. W.—E. C.—C. R. D.—G. A. T. F.—S. P. M.—A. A. D.—N. A. L.—T. D. A. C.—G. S. P.—J. S.—W. P. M.—W. P. H.—H. W. L.—W. H.—K. D., &c.



## INDEX TO VOL. XXIII.

- ABOUT CROWS, 17  
*Abaxas grossulariata* and its Food  
 Plants, 21  
 Absorption of Water from Walls by Ivy,  
 257  
 Acid. New Uses for Solid Carbonic, 38  
 Adder Swallowing her Young, An, 21  
 Adders and their Young, 22  
*Æpophilus Bonnairei*, a Submarine In-  
 sect, 5  
 Affection of Monkeys, 93  
 Affection of the Common Widgeon, The,  
 235  
 Africa, Our British Migratory Birds in,  
 234  
 Africa, Slaughter of Wild Animals in  
 Central, 143  
 Air, Sea, 39  
 Albino Thyme, 141  
 Albino Varieties, 17, 45  
 Alcohol, Another Source of, 7  
 Alga, A New British, 165  
 Alum and Foul Water, 256  
 America, British Plants in, 214  
 America, English Soles in, 130  
 American Jurassic Mammals, 140  
 American Mummies, 238  
 American Shell-Money, 145, 174  
*Amphipleura pellicida*, 44, 163  
 Anecdote of a Spider, 42  
 Animal Psychology, 17, 42, 68, 92, 139,  
 164, 188, 235, 261  
 Animals and Plants in Australia, 74  
 Annals of Botany, 189, 261  
 Another Use of Bee-stings, 23, 142  
 Another Use of Luminous Paint, 131  
 Anti-Fat, 182  
*Antirrhinum majus*, Fertilisation of, 70  
 Ants, My, 181  
 Ape, The Domestication of, 113  
 Aphodii, A Swarm of, 21  
 Aquarium Notes, 47  
 Arctic Exploration by Tourists, 276  
 Are Growing Leaves of the Yew-tree  
 Poisonous? 47  
*Arion Bourguignati*, 92  
*Arion flavus*, 20  
 Artisan Wells, Blind Fishes in, 6  
 Ash, Silver in Volcanic, 226  
*Aster campestris* in Colorado, 281  
 Astigmatism in Microscopical Observers,  
 15  
 Astronomy and Meteorology, 33, 63, 88,  
 114, 136, 160, 178, 202, 234, 257, 277  
 Atronomical Query, 167  
 Australia, Animals and Plants in, 74  
 Australian Fringed Lizard, 23, 94  
*Axiurus Cronlandensis*, 43  
 Axolôtl, The, 268  
*Azolla pinnata*, 235
- BALTIC, CHANGES OF LEVEL ON THE, 154  
 Pears, Dancing, 20  
 Beds, the Upper Cretaceous, 262  
 Bee Orchis, 215  
 Bee Orchis, Irregular Appearance of, 45  
 Bee Stings, Another Use of, 23  
 Bee Story, A, 238  
 Bee, the Head of the Queen, 116  
 Bees and Flowers, 29, 45  
 Bees and Lime-trees, 237  
 Bees and Wasps' Stings, 46  
 Bee's Stings, 46  
 Beetle, the Whirligig, 187  
 Beemattes, their History and Modern  
 Analogues, 132  
 Belgium, Frost of the 7th July in, 207  
 Benevolent Berries, 227  
 Berries, Benevolent, 227
- Birds, a Curious Instance of the Parental  
 Instinct in Young, 188  
 Birds, Migration of, 42, 141, 164  
 Birds' Names in Suffolk, 166  
 Birds near Dublin, 94, 143, 237  
 Birds Tapping, 143  
 Bitter-sweet, 20  
 Black Crabs, 215  
 Blind Fishes in Artesian Wells, 6  
 BOOKS, NEW, NOTES ON:—  
 All About Mnemonics, by A. E. Middle-  
 ton, 251  
 Animal Anecdotes, by H. A. Page,  
 107  
 Bird-Life in England, by E. L. Arnold,  
 250  
 Bird Stories, by H. Weir, 252  
 Birds of Suffolk, by Prof. Babington,  
 106  
 British Fungi, by Rev. J. Stevenson, 106  
 British Fungi, Lichens, &c., by E. M.  
 Holmes and P. Gray, 106  
 British Fungi, Text-Book of, by W.  
 Delisle Hay, 106, 280  
 Chemistry and Heat, by R. C. Durrant,  
 251  
 Classified Catalogue of Scientific Books,  
 by Geo. Philip, 107  
 Coleoptera of the British Islands, by W.  
 W. Fowler, 106  
 Comparative Morphology and Biology  
 of the Fungi, by Prof. De Bary, 250  
 Crustacea and Spiders, by F. A. Skuse,  
 106  
 Durrant's Handbook to Essex, 252  
 Factors in Life, by Prof. H. Seely, 251  
 Flora of Sussex, by Rev. F. H. Arnold,  
 251  
 Handbook of Historical Geology, by A.  
 Jukes-Brown, 107  
 Handbook of Practical Botany, by Prof.  
 Strasburger, 105  
 Heroes of Science, by Dr. W. Garnett,  
 107  
 How to Use Our Eyes, by John Brown-  
 ing, 108  
 Hydrophobia, an Account of Pasteur's  
 System, by Renard Suzor, M.D., 250  
 Introductory Text-Book to Physical  
 Geography, by Prof. Lapworth, 251  
 Life-Histories of Plants, by Prof. D.  
 McAlpine, 107  
 Liver Fluke and Sheep Rot, by Edward  
 Hale, 251  
 Lunar Science, by Rev. T. Harley, 107  
 Manual of Bacteriology, by Dr. E. M.  
 Crookshank, 249  
 Manual of Zoology, by Prof. Nicholson,  
 251  
 Microscopic Fungi, by Dr. M. C. Cooke,  
 251  
 Origin of Mountain Chains, by T. M.  
 Reade, 106  
 Palæolithic Man in Middlesex, by J. A.  
 Brown, 250  
 Practical Botany, Handbook of, 106  
 Proceedings of Liverpool Literary and  
 Scientific Society, 107  
 School Hygiene, by Dr. A. Newsholme,  
 251  
 Science Lectures at Newcastle, 251  
 Sixth Annual Report, U. S. A. Geo-  
 logical Survey, 251  
 Sketch of the Geological History of the  
 Earth, by Prof. Hull, 251  
 Sonnets on Nature and Science, by S.  
 Jeffries, 108  
 Student's Handbook to the Microscope,  
 251
- BOOKS, NEW, NOTES ON (cont.):—  
 Studies in Comparative Anatomy—The  
 Cockroach, by Prof. Miall and A.  
 Denny, 107  
 Studies in Life and Sense, by Dr.  
 Andrew Wilson, 107  
 Text-Book of British Fungi, by W.  
 Delisle Hay, 107  
 The Common Health, by Dr. Richard-  
 son, 250  
 The Geology of England and Wales, by  
 H. B. Woodward, 249  
 Through the Fields with Linneus, by  
 Mrs. F. Caddy, 108  
 Trade Signs of Essex, by R. Miller  
 Christy, 252  
 Voyage to the Cape, by W. Clark  
 Russell, 107  
 Young Collector—Insects, by A. Butler,  
 106  
 Book-Mite, A, 224  
 Books, Notes on New, 105, 243  
 Botany, 17, 44, 69, 93, 117, 140, 165, 188,  
 214, 234, 261  
 Potany, Annals of, 189, 251  
 Boulder, A Jubilee, 239  
 Boulders in Coal, 140  
 Boulders in Seams of Coal, 183  
 Breconshire Mollusca, 67  
 British Dragon-Flies, 215  
 British Moss Flora, 215  
 British Petrography, 19  
 British Plants in America, 214  
 Butter, Preserving, 256  
 Butterfly, A Strange, 71, 141  
 Butterfly Dust, 259
- CAGE BIRDS SURVIVING THE WINTER, 54  
 Caged Birds and Freedom, 141  
 Calcutta, Microscopy in, 229  
 Cambridge Entomological Society, 92  
 Camera Lucida, 116, 163  
 Can Free-cage Birds Survive? 23  
 Canals of Mars, 40  
 Carbon, Crystals of Meteoric, 215  
 Carnivorous Pitcher Plant, A, 5  
 Casting in Plaster from Photographic  
 Clichés, 91  
 Cat, Lengthy Fast of a, 236  
 Cats, 92  
 Cement, the Setting of, 58  
*Cephalanthera ensifolia*, 149, 165, 261  
*Cephalanthera grandifolia*, and *C. ensi-  
 folia*, 117  
*Chaetopterus valencini*, Notes on, 200  
 Changes of Level on the Baltic, 154  
 Chapters on Fossil Insects, 47  
 Charring Timber, 6  
 Chats about Rotifers, 149, 173, 220, 248  
 Chickweed, the Winter Green, 76  
 Clean and Dirty Pigs, 40  
 Climate, Influence of Forest Trees on, 203  
 Clouds, On Some Types of Storm, 204  
 Coal, Boulders in, 140  
 Coal, Boulders in Seams of, 183  
 Coal, Meteorite in, 58  
 Choina Rosco-Persicina, 214  
 Cold Bathing, 155  
 Cole's "Studies in Microscopical Science,"  
 15, 41, 91, 116, 138, 233  
 Colours of Animals and Plants, 184  
 Colours of Flowers, The, 234  
 Condensation of Gases, 39  
 Conflagration and Meteorites, 275  
 Congo, Hail on the, 207  
 Cookery, Jubilee, 154  
 Core-roots of Switzerland, 156  
 Correspondents, Notices to, 24, 47, 71, 95,  
 119, 143, 167, 191, 216, 239, 263



- Corrigenda, 92  
 Cost of Electric Lighting, 111  
*Cotoneaster vulgaris*, 180  
 Crab, Ova of the Hermit, 187  
 Crabs, Black, 215  
 Crocuses Blooming Underground, 166, 214  
 Crocuses, The Flowering of, 188  
 Crow, The, 42  
 Crows, About, 17  
 Crystallography of Butter and other Fats, The, 187  
 Crystals of Meteoric Carbon, 215  
 Cuckoo, 166, 173, 190, 262  
 Cuckoo at Night, 237  
 Cuckoo, Note of the, 23, 95, 215  
 Cuckoo with False Note, 47  
 Cuckoo's Mate, 259  
 Cuckoo's Notes, 215, 237, 238  
 Curiosities in Drugging, 241  
 Curious Instance of the Parental Instinct in Young of Birds, A, 188  
 Curious Phenomenon on Ice, 46  
 Curious Sudden Disappearance of Springs, 118  
 Curlew, Stone, 239  
 Cutting Glass Vessels, 88
- DANCING BEARS, 20  
 Date of the Helicidae, 286  
 Date, Duration, and Conditions of the Glacial Period with Reference to the Antiquity of Man, 158  
 Demoralised Cats and Monkeys, 132  
 Descent of Man, 18  
 Destroyer of Taste, 154  
 Development of a Flea's Egg, 260  
 Development of Frog Spawn, 32  
 Development of the Tadpole, The, 22, 44, 68, 116, 127  
 Diatoms from Bangor, Wales, 65  
 Diatoms Raised from Spores, 233  
 Dictionary of Plant Names, A, 18, 93  
 Diptera, On Collecting, 11, 30, 56  
 Directory, Our Scientific, 40, 65, 114, 138, 161, 199  
 Distribution of the Lepidoptera in the British Isles, 141  
 Diver, the Great Northern, 119  
 Dog, Obstancy in a, 68  
 Dog, Reason in a, 69  
 Domestication of Apes, The, 113  
 Dor-Beetle, Vitality of, 71  
 Dorsetshire, A Landslip in, 118  
 Double-yelked Cuckoo's Egg, 166  
 Dragon-flies, British, 215  
 Drugging, Curiosities in, 241  
 Drying of Plants on a Tour, 245  
 Dublin, Birds near, 94, 143, 237  
 Dumbledores, 20  
 Durham, etc., Natural History Society, 164  
*Dytiscus marginalis* in Draper's Snop, 149
- EARLY APPEARANCE OF *Pieris Rapa*, 141  
 Echinus, The Geological History of the, 119  
 Economical Production of the Alkaline Metals, 88  
 Economical Products of Plants, 7  
 Educational Collection of Insects, 253  
 Eels, Norwegian Superstition concerning, 21  
 Effects of the late Severe Weather on Mice, 47  
 Egg, Development of a Flea's, 260  
 Egg, Double-yelked Cuckoo's, 166  
 Egg, Frightful Explosion of an Ostrich, 47  
 Eggs, Explosion of, 47, 91  
 Electric Lighting Difficulty, 111  
 Electric Welding, 112  
 Electrical Absurdities, 23  
 Eligible Building Site, An, 189  
 England, Terminal Remains of the Great Glaciers of, 262  
 England, The Whitefish in, 130  
 English Lake District, Minerals and Flowers of the, 1  
 English Soles in America, 130  
 Enock's Slides, 91, 138, 163, 259  
 Entomology and Geology, 17  
*Eosoon Canadense*, The Pseudo-dawn of Life, 82, 102  
 Episode in Bird Life, 139  
 Equinoctial Gales, The, 131  
 Evolution, Pathology and its Relation to, 80, 99, 116, 124
- Exchanges, 24, 48, 72, 95, 119, 144, 167, 192, 216, 240, 263, 283  
 Expansion and Contraction of Buildings, 58  
 Exploding Gunpowder, 142  
 Explo-sion of Eggs, 47, 91  
 Extinction of the Primrose, etc., 191, 202  
 Extirpation of the Lepidoptera, 23  
 Extract of Logwood, 41, 66, 91  
 Eyes of the Water Flea, 127
- FALCON, PEREGRINE, 142  
 Fearful Prospect, A, 257  
 Feather-eating, 167  
 Feathers, Fowls Eating, 143  
 Feeding Frogs and Toads, 236  
 Fertilisation of *Antirrhinum majus*, 70  
 Fertilisation of Flowers, 70  
 Few more Remarks on Fungi, 230  
 Fight between a Rat and a Stoat, 227  
 Fisheries, Norwegian and Japanese Cod, 87  
 Fishes, the Parietal Eye in, 188  
 Flea, the Eye of the Water, 127  
 Flea, the Pygidium of the, 129  
 Flies, Scarcity of Wasps and Plague of, 69, 94  
 Flies, the Teeth of, 28, 108, 152, 246  
 Floral Malformation, 214  
 Flowering of Crocuses, The, 183  
 Flowers, Bees and, 20, 45  
 Flowers, Fertilisation of, 70  
 Flowers, the Colours of, 234  
 Flowers, the Origin of, 234  
 Florine, 59  
 Fly, Nest of Australian, 239  
 Fly, the Hessian, 17, 213, 233  
 Flea, the Plague of, 22  
 Forests, Notes on Australian, 97  
 Fossil Insects, 235  
 Fowls Eating Feathers, 143, 167  
 Foxglove, a Monstrous, 239  
 Frightful Explosion of an Ostrich Egg, 47  
 Frill Lizard, the, 143  
 Fröbel Society, The, 239  
 Frog, Common, in State of Domestication, 247, 274  
 Frog-Spawn, Development of, 32, 141  
 Frost of 7th July in Belgium, 207  
 Frosts, Thunderstorms and, 45  
 Frozen Milk, 207  
 Fulgurites, 268  
 Fungi, a Few More Remarks on, 230  
 Fungi, Some Remarks on, 205  
 Fungus, Crop of 1887, 261
- GAGEAS, THE, OF SWITZERLAND, 272  
 Gales, the Equinoctial, 131  
 Gas Beneath Ice, 95  
 Gases, Condensation of, 39  
 Gems and Ornamental Stones of the United States, 270  
 Geological Association, the, 18  
 Geological History of the Echinus, 119  
 Geological Society Awards, 70  
 Geologising at Faxø in Denmark, 62  
 Geology, etc., 18, 46, 70, 118, 140, 189, 215, 235, 262, 282  
 Geology and Entomology, 17  
 Geology and History, 261  
 Geology and Industry, 275  
 Geology, Spenser and, 70  
 Germany, Natural History Notes in, 217  
 Ginger, Sources of, 255  
 Glasgow, Science in, 119  
 Glass to Gases, Impermeability of, 6  
 Going in for it, 119  
 Gosdmith, etc., 93  
 Gossamer in Spring, 21  
 Gossip on Current Topics, 5, 38, 57, 86, 111, 130, 154, 182, 206, 225, 255, 275  
 Granite, 226  
 Granite, Notes on, 193  
 Great Black-backed Gull, 43  
 Great Northern Diver, the, 119  
 Grey Wagtails, 21, 118  
 Gull Language, 261  
 Gull, Great Black-backed, 43  
 Gulls, Tameness of, 236  
 Gunpowder, Exploding, 142
- HAIL ON THE CONGO, 207  
 Head of the Queen Bee, 116  
 Health, Petroleum and, 86  
*Helianthus annuus*, 190  
 Helices, Variations in, 67
- Helix hemoralis* and *H. hortensis*, 166  
 Helicorines, the White, 228, 261  
 Hellebore, Seedlings of, 165  
 Hessian Fly, the, 17, 213, 233  
 Hildenbrandia, Note on, 214  
 Hollyhock, the, 236  
 Homoeopathic Treatment of Lunatics, 183  
 Hooker's Student's Flora and the London Catalogue, 54, 78  
 Hornet and Wasp, 19  
 Horse-chestnuts, 166  
 Hours with a Three-inch Telescope, 149  
 How Coal was formed, 190  
*Hyalina Draparnaldi*, 139
- ICE, CURIOUS PHENOMENON ON, 46, 95  
 Illustrations in Marine Zoology, 234  
 Impermeability of Glass to Gases, 6  
 Influence of Fossil Trees on Climate, 208  
 Insects, Chapters on Fossil, 49  
 Insects, Educational Collection of, 253  
 Insects, Fossil, 235  
 Instinct of Spider, 22  
 Instrument, an Unimprovable, 183  
 Irregular Appearance of the Bee Orchis, 140  
 Irregular Appearance of *Tolypella intricata*, 44  
 Ivy, the, 236  
 Ivy, the Absorption of Water from Walls by, 257
- JACK-HANGMAN, 141  
 Japan, the Magic Mirror of, 12  
 Jean Louis Thomas, 235  
 Journal of Microscopy, 250  
 Journal of the Royal Microscopical Society, 138  
 Jubilee Boulder, A, 239  
 Jubilee Cookery, 154
- JUSTREL, SINGULAR CAPTURE OF A, 166  
 Kinnikinnick and Indian Pipes, 252  
 Koch's Comma Bacilli, 126
- LAND SURVEYORS SUPERSEDED, 112  
 Landslip in Dorsetshire, 118  
 Lapidary Work, 237  
 Larva Breeding, Reminiscences of, 169  
 Late Appearance of the Cuckoo and Swallow, 166  
 Late Flowers, 281  
 Leaf, A Red, 223  
 Leeches, Sense of Smell in, 183  
 Legs of Thrush, 143  
 Lengthy Fast of a Cat, 236  
 Lepidoptera, Notes on the Protective Colouring and Habits of, 150  
 Lepidoptera, The Extirpation of, 23  
*Lepidium latifolium* and *L. draba*, 165  
 Lichens, The Synthesis of, 18  
 Life, Episode in Bird, 139  
 Light, Measuring Distances by Electric, 156  
*Limax agrestis*, var. *alba*, 16  
 Lime-trees, Bees and, 237  
*Limax glutinosus*, 260  
 Little Bustard in West Sussex, 43  
 Living Fish Line, A, 184  
 Lizard, Australian Fringed, 23  
 Lizard, The Frill, 143  
 Lizard, The Parietal Eye of the, 67  
 Lizards, The Reproduction of the lost Tails of, 92  
 Logwood, Extract of, 41, 66, 91  
 London Fogs in Paris, 59  
 London, White Sparrows in, 23  
 Long Surviving Fallacy, A, 206  
 Lucerne, Shells at, 92  
 Lunar Rainbow, 23  
 Lunatics, Homoeopathic Treatment of, 183
- MACHINE, A Simple, 87  
 Magic Mirror of Japan, The, 12  
 Magnetic Oil Filter, 226  
 Magnetised Watches, 130  
 Magnifying Powers, 91, 163  
 Male Wasps, 46, 94  
 Malström, 113  
 Mammals, American Jurass'c, 140  
 Man, The Descent of, 18  
 Mango, The, 118  
 Mars, the Canals of, 46  
 Martyrs to Liberty, 256  
 Measurement of Time, 199

- Measuring Distance by Electric Light, 156  
 Metals, Economical Production of Alkali-  
 line, 38  
 Meteorite at Little Lever, The, 70  
 Meteorite in Coal, 58  
 Meteorological Instinct, 227  
 Meteorology, 88  
 Meteorology, Astronomy and, 33, 63, 88,  
 114, 136, 160, 178, 202, 231, 257  
 Mexico, Scorpions in, 187, 234, 237  
 Mexico, The Scorpions of, 126  
 Mice, Effects of the late Severe Weather  
 on, 47  
 Mice, Sociability of, 118  
 Micro-Photography, 233  
 Microscope, Wasp Paper under the, 116,  
 215  
 Microscopic Queries, 90  
 Microscopical Observers, Astigmatism in,  
 15  
 Microscopical Science, Cole's Studies in,  
 15  
 Microscopical Society, Journal of the  
 Royal, 138  
 Microscopy, 15, 41, 65, 90, 116, 138, 153,  
 187, 213, 233, 259, 280  
 Microscopy in Calcutta, 229  
 Microscopy, Journal of, 259  
 Middlesex Slugs, 187  
 Migration of Birds, 42, 141, 164  
 Milk, Frozen, 207  
*Mimulus luteus*, 45, 95  
 Minerals and Flowers of the English Lake  
 District, The, 1  
 Mirrors, The Two, 25, 52, 75  
 Mole's Eyes, 20  
 Mollusca at Limpsfield, Surrey, 139  
 Mollusca at Breconshire, 67  
 Mollusca in the Ealing District, 43  
 Mollusca, Size of, 142  
 Mollusca, The Variation and Abnormal  
 Development of the, 177  
 Monkeys, Affection of, 93  
 Monkeys and their Tails, 142  
 Monkeys, Demoralised Cats and, 132  
 Monkey's Memory, A, 139  
 Monstrous Foxglove, A, 239  
 Moss-Flora, The British, 215  
 Moss, Query as to, 22  
 Mounting in Castor Oil, 116, 138  
 Mummies, American, 238  
 Munchausen Science, 184, 203, 213, 226,  
 235, 237  
*Murex erinaceus*, *M. elongatus*, 139  
 My Ants, 181  
 My Drawing-room Pets, 27, 121
- NATURAL HISTORY JOTTINGS, 209, 219  
 Natural History Notes in Germany, 217  
 Natural History Rambles, 31  
 Nest of Australian Fly, 239  
 New British Alga, A, 165  
 New Explosives, 255  
 New Fertiliser, A, 227  
 New Reader of SCIENCE-GOSSIP, 22  
 New Slides, 15, 42, 116  
 New Uses for Solid Carbonic Acid, 38  
 New Variety of Rotifer, 67  
 Norwegian and Japanese Cod Fisheries, 87  
 Norwegian Superstition concerning Eels, 21  
 Nose Triumphant, The, 155  
 Note, Cuckoo with False, 47  
 Note of the Cuckoo, 23, 95, 215  
 Note on *Hildenbrandia*, 214  
 Notes and Queries, 19, 46, 70, 93, 118,  
 141, 166, 190, 215, 230, 252, 283  
 Notes on Australian Forests, 97  
 Notes on *Chaetopterus Valenciæi*, 200  
 Notes on *Gonopteryx rhannii*, 73  
 Notes on Granite, 193  
 Notes on New Books, 106, 241  
 Notes on the Common Frog, in a State of  
 Domestication, 247, 274  
 Notes on the Flora of the North Downs,  
 211  
 Notes on the Protective Colouring and  
 Habits of Lepidoptera, 156  
 Notes on the Rotifera, 185, 267  
 Notes on 1887, 280  
 Notices to Correspondents, 24, 47, 71, 95,  
 119, 143, 167, 191, 216, 239, 263, 283
- OAK, TIMBER, 141  
 Occurrence of *Limax cinereo-niger* in  
 Sussex, 43
- Odd Page in Nature's Book, An, 197  
 On Some Types of Storm-Clouds, 204,  
 221  
 On the Formation of an Insectorium, or  
 Insect Vivarium, for the Exhibition and  
 Study of Living Tropical Insects, 109,  
 122  
*Ophrys arachnites*, 261  
 Orchids, Seasonal Variations in the Occur-  
 rence of, 18  
 Orchis, Bee, 215  
 Orchis, the Irregular Appearance of the  
 Bee, 140  
 Origin of Atmosphere Ozone, 112  
 Origin of Flowers, 234  
 Ostrich Farming, 112  
 Our British Migratory Birds in Africa, 234  
 Our British Slugs, 10, 44  
 Our Scientific Directory, 40, 65, 114, 138,  
 161, 199  
 Ova of the Hermit Crab, 187  
 Oyster Culture, 59  
 Ozone, Origin of Atmosphere, 112
- PALÆOLITHIC WORKSHOP, 46  
 Parallax, the Solar, 58  
 Parietal Eye in Fishes, 188  
 Parietal Eye of the Lizard, 67  
 Pathology and its Relation to Evolution,  
 80, 99, 116, 124  
 Peculiar Gymnastics, 255  
 Peregrine Falcon, 142  
 Petrography, British, 19  
 Petroleum and Health, 86  
 Pets, My Drawing-Room, 27, 121  
 Phenomenal Bugs, 71  
 Phenomenon in Aniline Staining, 41, 65  
 Philosophy of Pruning Vines, etc., 208  
 Phosphorescence, Photography by Vital,  
 200  
 Photographs of the Retina, 182  
 Photography by Vital Phosphorescence,  
 200  
*Physa fontinalis*, 139  
*Pisieris rapæ*, Early Appearance of, 141  
 Pigs, Clean and Dirty, 40  
 Pipes, Kinni-Kinnic and Indian, 252  
*Pistidium roseum* in Surrey, 16  
 Pitcher Plant, A Carnivorous, 5  
 Plage of Flies, 22  
*Planorbis complanatus*, 58  
*Planorbis lineatus*, Walker, 16  
*Planorbis nautileus*, 260  
 Plant Names, a Dictionary of, 18  
 Plant, Query as to, 21  
 Plants, Colours of Animals and, 184  
 Plants, Reappearance of, 216  
 Plants, Studies of Common, 147, 171  
 Plants, the Economical Products of, 17  
 Plants, Variations in, 51  
 Platypus, the Young, 68  
 Plumage of Birds as Trimming, 260  
 Poisonous Nature of the Yew, 21  
 Polishing Pebbles, 191  
 Poppy, Varieties of the Common, 214  
 Postal Obstructions to Scientific Research,  
 166  
*Poterium sanguisorba*, 95  
 Prehistoric Art, 7  
 Preparing Sections of Sponges, 66  
 Preservation of Telegraph Poles, the, 131  
 Preserving Polyzoa, 42  
 Primrose, Extinction of the, 191, 202  
*Pupa ringens*, 213  
 Pygidium of the Flea, The, 129
- QUEKETT CLUB, THE, 138, 213  
 QUEEN, a Yorkshire, 152, 199  
 Query for Mr. Mattieu Williams, A, 142
- RAIN, SANITARY ACTION OF, 182  
 Ramble, A Winter's Day, 35  
 Rambles, Natural History, 31  
 Rare Capture, A, 261  
 Rat's Teeth, 19  
 Reappearance of Plants, 216  
 Rearing *Bombyx rubi*, 93  
 Reason in a Dog, 69  
 Recent Articles and Pamphlets worth  
 Reading, 35, 64, 78, 113, 137, 160, 186,  
 230, 244  
 Red-backed Shrike, the, 19  
 Red Leaf, a, A Study in Botany, 223  
 Remarkable Shot, A, 141  
 Reminiscences of Larvæ-breeding, 169
- Reproduction of the Lost Tails of Lizards,  
 the, 92  
 Re'ina, Photographs of the, 182  
 Revival, A, 131  
 Rings of Saturn, the, 155  
 Robin, Tameness of a, 14  
 Rock Sections, 23  
 Rocks, Toads in, 21, 94  
 Rosella, 47  
 Rotifer, a New Variety of, 67  
 Rotifer Infested with Trichodina, 43  
 Rotifera, Notes on the, 185  
 Rotifera, The, 16  
 Rotifers, Chats About, 149, 173, 220, 248  
 Royal Microscopical Society, 16, 66, 163,  
 213  
 Rozella, 47  
 Rudiments and Vestiges, 218, 262
- SALVIA PRATENSIS, 69  
 Sanitary Action of Rain, 182  
 Saturn, the Rings of, 155  
 Scarcity of Wasps, 21  
 Scarcity of Wasps and Plague of Flies, 69,  
 94  
 Science Gossip, 15, 40, 65, 89, 115, 138,  
 161, 186, 212, 232, 258, 279  
 Science, a New Reader of, 22  
 Science in Glasgow, 119  
 Scorpions in Mexico, 187, 234, 237  
 Scorpions of Mexico, The, 126  
 Sea Air, 39  
 Sea-Birds Inland, 118  
 Seasonal Variation in the Occurrence of  
 Orchids, 18  
 Sections of Sponge, 42, 65, 66  
 Seedlings of *Heracleum*, 165  
 Sense of Smell in Leeches, 183  
 Setting of Cement, The, 58  
 Shade in Stock Colour, 278  
 Shanklin Butterfly, The, 141  
 Shell-Money, American, 145, 174  
 Shelley's Halcyon, 236  
 Shells at Lucerne, 92  
 Ship-Model, the Viking, 112  
 Shrike, the Red-backed, 19  
 Silver in Volcanic Ash, 226  
 Simple Machine, A, 87  
 Singing of the Kettle, 275  
 Singular Capture of a Kestrel, 166  
*Sirex gigas* and *S. juvenens*, 21  
*Sisyrrinchium Bermudianum*, 18  
 Size of Mollusca, 142  
 Slaughter of Wild Animals in Centra  
 Africa, 143  
 Slug Gossip, 222, 243, 265  
 Slug Variation, 16  
 Slugs, Middlesex, 187  
 Slugs, Our British, 10, 44  
 Sociability of Mice, 118  
 Society, Cambridge Entomological, 92  
 Society, the Frobels, 239  
 Solar Parallax, the, 58  
 Some Remarks on Fungi, 205  
 Sounding the "Sounding Sea," 227  
 Sources of Ginger, 255  
 Spenser and Geology, 70  
*Spergula pentandra*, 235  
 Spider, Anecdote of a, 42  
 Spider, Instinct of a, 22  
 Sponge, Sections of, 42, 65, 66  
 Sponges, Preparing Sections of, 66  
 Spores, Diatoms Raised from, 233  
 Spring, Curious Sudden Disappearance of  
 a, 118  
 Staining, a Phenomenon in Aniline, 65  
 Strobilists of the Polyzoa, 281  
 Stings, Another use for Bees', 142  
 Stings, Bees and Wasps', 45, 60  
 Stint, Fight Between a Rat and a, 227  
 Stone Curlew, 239  
 Stones in Wood, 142  
 Strange Butterfly, A, 71, 141  
 Studies, Cole's, 15, 41, 91, 116, 138, 233  
 Studies of Common Plants, 147, 171  
 Submarine Insect, A, 14  
 Successful Oyster Culture, 39  
 Suffolk, a Visit to the Red Garg and Chalk  
 Pits of, 180  
 Suffolk, Birds' Names in, 166  
 Suggestions for Scientific Research, 237  
 Swallow, Late Appearance of the Cuckoo,  
 and the, 166  
 Swarm of Aphodii, A, 21  
 Switzerland, the Coral Roots of, 156

- Sycamore, 21  
 Synthesis of Lichens, the, 18
- TADPOLE, THE DEVELOPMENT OF THE,**  
 22, 44, 68, 116, 127  
 Tameness of a Robin, 14  
 Tameness of Gulls, 236  
 Taste, a Destroyer of, 154  
 Teeth of Flies, 28, 108, 152, 246  
 Telegraph Poles, the Preservation of, 131  
 Te'scope, Hours with a Three-inch, 149  
 Terminal Moraines of the Great Glaciers  
 of England, 262  
 Thrush, Legs of, 143  
 Thunderstorms and Frosts, 45  
 Thyme, Albino, 141  
 Timber, Oak, 141  
 Toads, Feeding Frogs and, 236  
 Toads in Rocks, 21, 94  
*Toxypella intricata*, Irregular Appearance of, 44  
 Topics, Gossip on Current, 5, 38, 57, 86,  
 111, 130, 154, 182, 225, 255  
 Tour, Drying of Plants on a, 245  
 Tree of Knowledge of Good and Evil, 190  
 Trichodina, Rotifer Infested with, 43  
 Triumphant Simplicity, 6
- Turbellaria Swallowing Air, 67  
*Tussilago Petasites*, 20  
 Two Mirrors, 25, 52, 75
- UNIMPROVABLE INSTRUMENT, AN,** 183  
 Unusual Abundance of *Volvox globator*,  
 213  
 Upper Cretaceous Beds, the, 262
- VARIATION AND ABNORMAL DEVELOPMENT OF THE MOLLUSCA,** 177  
 Variations in Helices, 67  
 Variations in Plants, 51  
 Varieties of the Common Poppy, 214  
*Vaucheria sphaerospora*, Nordst., 261  
 Venerable University, A, 86  
 Vessels, Buttering Glass, 88  
 Viking Ship-model, The, 112  
 Vines, Philo-sophy of Pruning, 208  
 Visit to the Red Crag and Chalk Pits of  
 Suffolk, 180  
 Vitality of Dor-beetle, 71  
*Volvox globator*, Unusual Abundance of,  
 213
- WAGTAILS, GREY,** 118  
 Wasp, 94  
 Wasp, Hornet and, 19  
 Wasp Paper under the Micro-cope, 116,  
 215  
 Wasp Stings, 94  
 Wasps, 94  
 Wasp's Nest, 46  
 Wasps, Scarcity of, 21  
 Wealden Area During the Glacial Period,  
 189  
 Whirligig Beetle, the, 187  
 White Helleborines, 228, 261  
 White Sparrows in London, 23  
 Whitefish in England, 130  
 Wild Birds, Protection Act of 1880..142  
 Wind and the Tree-tops, 117  
 Winter's Day Ramble, 35  
 Wood, Stones in, 142
- YEW, POISONOUS NATURE OF THE,** 21  
 Yorkshire Quern, A, 152, 190  
 Young Platypus, the, 68
- ZOOLOGICAL SOCIETY OF GLASGOW, THE,**  
 261  
 Zoology, 16, 43, 67, 91, 116, 139, 161, 187,  
 213, 234, 280  
 Zoology, Illustrations in Marine, 234

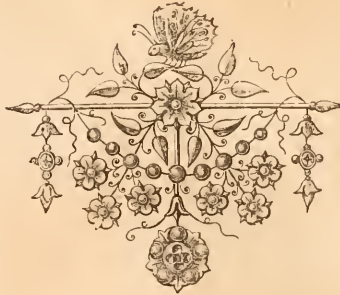







WH 1A QY Y

10603



