

幼 稚 園 工 作

一 百 六 十 組

編 纂 者

朱 銘 新 蔡 菊 清
虞 哲 光 沈 百 英

商 務 印 書 館 發 行





幼雅園工作

第一六十二組

點慕著

朱銘新 蔡允
虞哲光 蔡允
英百

商務印書館發行

一幼稚園工作 百六十組 編輯大意

- 一 本書專供幼稚園教師在工作課內作參考之用。
- 二 本書根據幼稚園課程標準，並對照本館出版幼稚園讀本編輯。
- 三 本書共四集，每集包括四十組材料，合計一百六十組。每集每組都與幼稚園讀本每冊每課相聯絡。
- 四 本書與幼稚園故事一百六十篇，幼稚園常識一百六十課，幼稚園音樂一百六十首，幼稚園遊戲一百六十種相聯絡。
- 五 本書內容，包括沙箱裝排、積木裝排、填色畫、自由畫、摺紙、剪紙、剪貼、編紙、粘土、紙漿、縫紉、竹、木……等各項工作。
- 六 本書關於映繪的圖，特別放大，以便直接應用；關於參考的圖，略為縮小，以省篇幅，騰出地位，多加參考材料。
- 七 本書再版時，當隨機汰除舊材料，增加新材料。
- 八 本書純屬參考材料，關於研究部份，另詳幼稚園教育叢書中幼稚園的工作一冊，擔任幼稚教師者，可同時參閱。

一幼稚園工作 百六十組 **總說明**

目標

幼稚園工作課的重要，只要看了教育部頒行的幼稚園課程標準中關於工作一項的目標，便可知道。這目標計分四項：

- (甲) 滿足對於工作的自然需要。
- (乙) 培養操作習慣，增進工作技能，并鍛鍊感覺能力。
- (子) 發育粗大的基本動作，以爲後日精細動作發育的基礎；
- (丑) 使關於身心的各種動作，常常有表演的機會；
- (丙) 訓練關於羣體的活動力，例如：
 - (子) 自信、自重、堅忍、專心、勤奮、互助、熱心、服務等的精神；
 - (丑) 自動的能力；
 - (寅) 領袖才和服從領袖的精神；
 - (卯) 批評能力和接受批評的度量；
 - (辰) 不浪費時間和材料的習慣；
 - (巳) 遵守秩序的習慣；
 - (午) 愛護公共的用具。
- (丁) 發展智力。

(子)鍛鍊思想。

(丑)培養發表、創造、建設的能力。

(寅)發展欣賞能力。

二 內容

幼稚園工作的內容，依課程規定，尚嫌簡略，茲更增補如下：

(一)沙箱裝排——在沙箱或沙盤中，利用各種玩具、物品，堆裝觀察研究過的許多主體的東西，如村舍、城市、山景、園景、江河、動物場、植物園或其他模型等。

(二)積木裝排——用大小積木等裝排成房屋和其他建築物等。

(子)大積木分三種：第一種長半呎到三呎的三吋扁方柱體，計有半呎、一呎、二呎、三呎四種，共一百五十塊。第二種為柱體，計有二吋的立方體、二吋立方的對角三角體、四吋高一吋厚的柱體、扁長方體等五種，共二百塊。第三種有長條及凹形方木兩種，共十二條又八塊。大積木宜於室外，在空地上玩弄。可裝房屋、架橋梁、搭成船車桌椅等物，令一二兒童坐臥其間，倍覺特殊趣味。

(丑)小積木分四種：第一種立方體八塊。第二種扁長方體八塊。第三種小立方體二十一塊，三角體六塊，小三角體十二塊。第四種小扁長方體十八塊，柱體六塊，扁方體十二塊。小積木宜於桌上玩弄。

(三)填色畫——教師先把圖樣用油印印好了，再發給兒童，令他們自由填色。這種材料，宜乎初學的兒童，而且不宜多用。

(四)木印畫——用木質或橡皮刻成各種蟲魚鳥獸，令兒童用墨水印在紙上，然後填色或補背景。使無力自由作畫者，能成特殊興趣。

(五)輪廓畫——用木板或厚紙製成各種圖形，（外輪或挖空為陰性）令兒童平放在紙上，然後用鉛筆沿着邊緣，鈎下輪廓。

(六)創造畫——畫意畫法，完全由兒童設計創造，從前往往叫他自由畫。因為自由畫三字，好像毫無指導，令兒童漫不經意的畫去，失卻自由

畫的本意，所以爲矯正一般人的觀念起見，改稱爲創造畫。

(七) 圖案畫——畫一些極簡單的連續模樣。用彩色畫，用蠟筆畫，用剪貼，或用枝條橫斷面打印都可以。

(八) 剪貼——用單色或多色的彩色剪貼，起初先由教師在紙背上印好了圖，令兒童依樣剪下，練習了多次，可令兒童自由剪貼，貼上去的底紙，雖不必講究，但色彩必須與剪成的東西相配合。

(九) 扯紙——在兒童不會使用剪刀前，可令兒童扯紙，扯好了，也照剪貼法貼起來。

(十) 摺紙——摺疊時應注意整齊。範教時可用很大的紙做樣子。摺好了，或者照剪貼法貼起來，補畫背景或其他，或者就在摺成的東西上加添附屬的東西，做成一個玩具。

(十一) 織紙——用彩色紙條，縱橫交錯，織成圖案花紋。

(十二) 剪紙——用鉛畫紙、地圖紙、馬糞紙等剪成圖樣，再加彩色或附屬東西，做成各種玩具。

(十三) 泥工——用純淨的粘土，做成模型，如動物、水果、玩具等類。粘土乾燥後，防牠龜裂，可在打漿時調和桑皮紙漿，使溼而不易裂開。

(十四) 紙漿——用廢紙浸爛，調以漿糊，便可同粘土一樣做成各種東西。

(十五) 米粉——用麵粉與糯米粉，放在鍋內煮滾，到半生半熟時，搗成糕狀，便可應用。

(十六) 縫紉——縫紉的動機，大概由玩弄玩偶而來，如裝飾玩偶的房屋，或爲玩偶做小衣服、小被、小窗簾等。這種工作，應由年齡稍大的擔任，年齡較小的兒童，擔任簡易的工作。

(十七) 刺紙——硬紙上預先印好了刺孔的地位，令兒童用線縫紉成爲果類、鳥獸類或其他圖形類，注意距離均勻，大小相稱。

(十八) 織工——能用最粗的梭、織綫帶、編織針、編織架，織成玩具或玩偶用的物件，或有藤條、麥桿、紙條、草葉、麻繩、絨線、柳條等編成玩具。

(十九) 木工——用簡單木工器具，如錐、鋸、釘、鉋之類，並能計畫做成幾種簡單的玩具模型如（牀、桌椅、秋千架）等，而且知道做的方法和順序。

(二十)竹工——用竹絲、竹篾、竹枝、竹根、竹管等製成各種玩具。

(二十一)園藝——種菜、種豆、種普通花卉及園地整理等。木書不使畫出圖樣，只畫一個圓圈，中間寫明園藝的工作。

(二十二)七巧板——七巧板有新舊兩種，形式如下：採用時，在小班裏，可把搭湊的線紋畫出，使兒童依樣模倣；在大班裏，只要畫出一個輪廓，令兒童自己構思。

其他如簡筆畫、鉛絲工、混合玩具，不能一一舉出，在本書都可查得。

三 教法

幼稚園課程標準中教育方法要點，關於工作部分的，有如下幾項規定：

(一)工作的大部分，應由兒童個別活動，由教師個別指導。——此等活動，可將全部作業分為若干項目，例如：(圖畫、剪貼、積木……)。由兒童分組合作，分工活動。但須注意二事：

(1)分組，以兩三人為一組，合作一事為最有效。

(2)分工，兒童往往未做完這事，又去做那事，或半途而廢，或苟且塞責。教師應該訓練他們，使他們有責任心。訓練的方法，或用表記錄，能做完的，與以獎的符號，否則與以戒的符號；或對做完的與以好感，對未做完的，表示冷淡。

(三)從兒童自由活動中，發現設計的題材，例如：(一個兒童在沙箱中栽種白菜，教師發現後，便可集合許多兒童設計種菜。)這是設計教學中一個很好的機會，應該利用。

(四)在設計中應有的一切活動，應該早就體察兒童的能力，把兒童不能做，或做不成功的部分省去，以免兒童因不能做而廢止，或因中途失敗而懊喪。

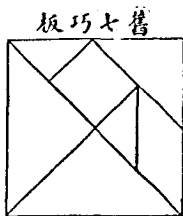

板巧七新

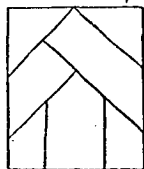

(四) 要利用廢物、天然物和日用品。廢物如舊書、舊報、破皮、無用的玻璃片、玻璃瓶、布片、破盤片……；天然物如果核、樹葉、花瓣、種子、蛤壳、貝壳、鳥羽、石子……；日用品如肥皂、洋燭……，都可利用了做成工作材料。這不但省錢，并可啓發兒童的創造力。

四 用法

- (一) 工作指導，應重兒童創造。本書所有材料，僅供教師參考，不能以此為範本，令兒童仿作。
- (二) 本書各組材料，多少無定，各類如（剪紙、摺紙、泥工……）也不同等俱備；完全以教材為中心，能適用何類作業發表，即採用何類作業。
- (三) 本書各組材料，不需完全採用，可視當時情形，摘取一部份。
- (四) 實際指導時，如發現新穎材料，儘可增添採用。——如蒙將新穎材料，惠寄敝館，則曷勝感荷！

幼 稚 園 工 作 目 錄

第 一 集

- 第一組.....牛
- 第二組.....羊
- 第三組.....草
- 第四組.....花
- 第五組.....樹
- 第六組.....鳥
- 第七組.....門
- 第八組.....窗
- 第九組.....燈
- 第十組.....火
- 第十一組.....水
- 第十二組.....茶
- 第十三組.....糕
- 第十四組.....餅
- 第十五組.....碗
- 第十六組.....桌
- 第十七組.....瓜
- 第十八組.....豆
- 第十九組.....魚
- 第二十組.....肉
- 第二十一組.....肉
- 第二十二組.....備
- 第二十三組.....鴿
- 第二十四組.....鴨
- 第二十五組.....河
- 第二十六組.....船
- 第二十七組.....橋
- 第二十八組.....路
- 第二十九組.....城
- 第三十組.....山
- 第三十一組.....星
- 第三十二組.....雲
- 第三十三組.....風
- 第三十四組.....雨
- 第三十五組.....雷
- 第三十六組.....蝴蝶
- 第三十七組.....哥哥
- 第三十八組.....弟弟
- 第三十九組.....姐姐
- 第四十組.....妹妹

第 二 集

- 第一組.....種花
- 第二組.....找花
- 第三組.....拔草
- 第四組.....洗衣
- 第五組.....洗菜
- 第六組.....生火
- 第七組.....洗衣
- 第八組.....掃地
- 第九組.....洗手
- 第十組.....漱口
- 第十一組.....吃飯前
- 第十二組.....吃飯後
- 第十三組.....爸爸來
- 第十四組.....媽媽來
- 第十五組.....早上
- 第十六組.....晚上
- 第十七組.....畫隻白兔
- 第十八組.....畫隻老鼠
- 第十九組.....做個梨
- 第二十組.....做個旗
- 第二十一組.....寶寶吃餅
- 第二十二組.....引他不哭
- 第二十三組.....一個老老
- 第二十四組.....菜子
- 第二十五組.....車子
- 第二十六組.....車來
- 第二十七組.....馬來
- 第二十八組.....大路上
- 第二十九組.....轎路上
- 第三十組.....火車開
- 第三十一組.....飛機來
- 第三十二組.....紅黃金魚
- 第三十三組.....飛邊青蛙
- 第三十四組.....蚊子
- 第三十五組.....蒼蠅
- 第三十六組.....蜜蜂
- 第三十七組.....蝴蝶
- 第三十八組.....蜻蜓
- 第三十九組.....知了
- 第四十組.....小鳥兒

第 三 集

- 第一組.....好哥哥
- 第二組.....好弟弟
- 第三組.....一同走
- 第四組.....分開走
- 第五組.....來游戲
- 第六組.....學雞啼
- 第七組.....學鳥叫
- 第八組.....小雀叫
- 第九組.....到園裏
- 第十組.....園裏花
- 第十一組.....小白雞
- 第十二組.....小白狗
- 第十三組.....小黃狗
- 第十四組.....追花狗
- 第十五組.....小小老鼠
- 第十六組.....小羊不見了
- 第十七組.....三隻羊
- 第十八組.....哥哥騎馬
- 第十九組.....馬兒會跑
- 第二十組.....馬跟牛
- 第二十一組.....小黃牛
- 第二十二組.....爸爸出門
- 第二十三組.....哥哥出門
- 第二十四組.....買香布
- 第二十五組.....穿新衣
- 第二十六組.....客人來家
- 第二十七組.....肥皂泡
- 第二十八組.....肥皂泡
- 第二十九組.....風吹吹
- 第三十組.....一條線
- 第三十一組.....不怕風
- 第三十二組.....拍大哥哥
- 第三十三組.....踢打錢
- 第三十四組.....踢呀
- 第三十五組.....吃果果
- 第三十六組.....爸爸回來過新年
- 第三十七組.....過新年
- 第三十八組.....石山此
- 第三十九組.....小狗歡喜
- 第四十組.....麻雀一社鼠

第 四 集

- 第一組.....新年裏
- 第二組.....哥哥敲鼓
- 第三組.....小雞啼
- 第四組.....起得早
- 第五組.....搶到外邊玩
- 第六組.....外邊搶寶
- 第七組.....外邊跳舞
- 第八組.....學哥哥
- 第九組.....哥哥做大鳥
- 第十組.....老鷹捉小雞
- 第十一組.....肚裏空
- 第十二組.....青天高
- 第十三組.....月亮高
- 第十四組.....月亮圓
- 第十五組.....月夜圓
- 第十六組.....國旗
- 第十七組.....天會變
- 第十八組.....放紙風
- 第十九組.....騎白馬
- 第二十組.....城門高
- 第二十一組.....小燕子
- 第二十二組.....小麻雀
- 第二十三組.....小燕子
- 第二十四組.....拍大麥
- 第二十五組.....揀豆子
- 第二十六組.....牛耕田
- 第二十七組.....捉迷藏
- 第二十八組.....捉迷藏
- 第二十九組.....你往那裏去
- 第三十組.....你從那裏來
- 第三十一組.....小兵隊
- 第三十二組.....我拉你的手
- 第三十三組.....我願意做好買賣
- 第三十四組.....我要身體好
- 第三十五組.....一個瓜
- 第三十六組.....冬瓜冬瓜
- 第三十七組.....蝴蝶飛
- 第三十八組.....螢火蟲
- 第三十九組.....蝴蝶
- 第四十組.....蝴蝶



牛 組一第 集一第

畫色填

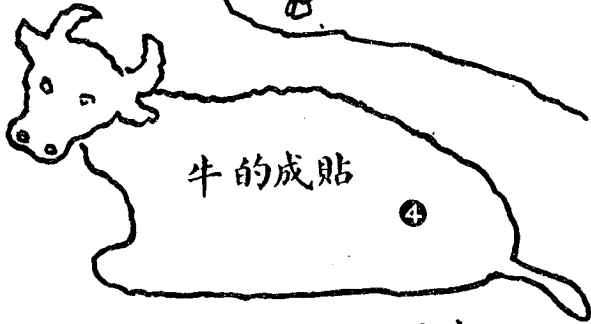
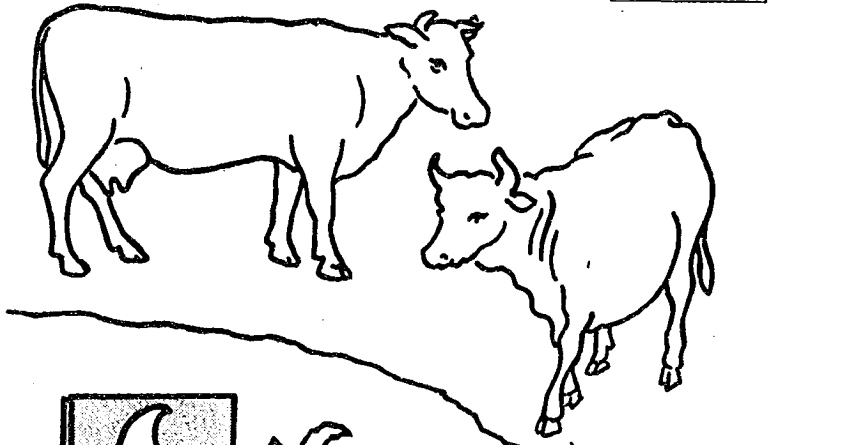

尾牛

扯紙工

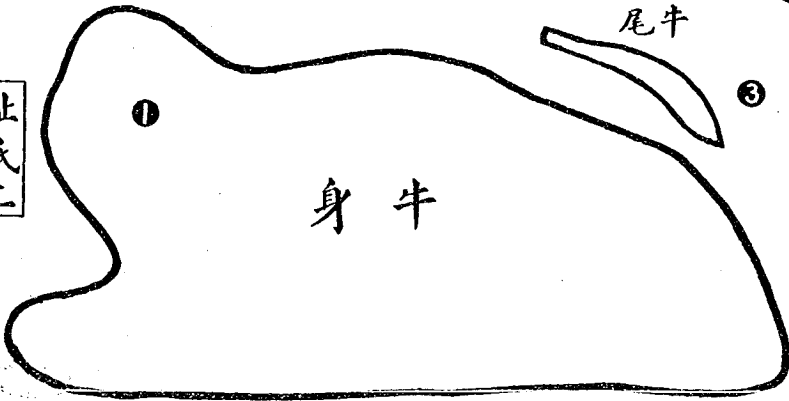

牛 組一第 集一第

畫色填

草 顏 再
上 色 加
填 畫 牛

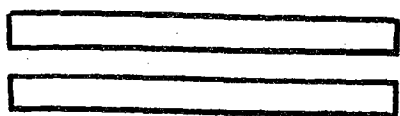
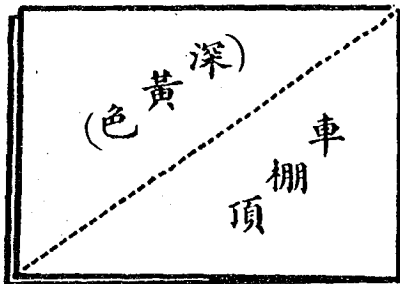
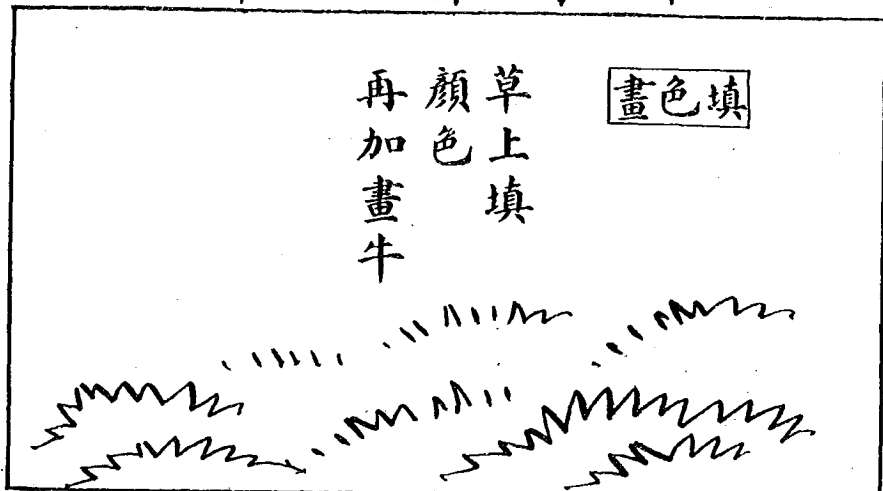

(色黃枯) 柱棚車



(色黑) 座車

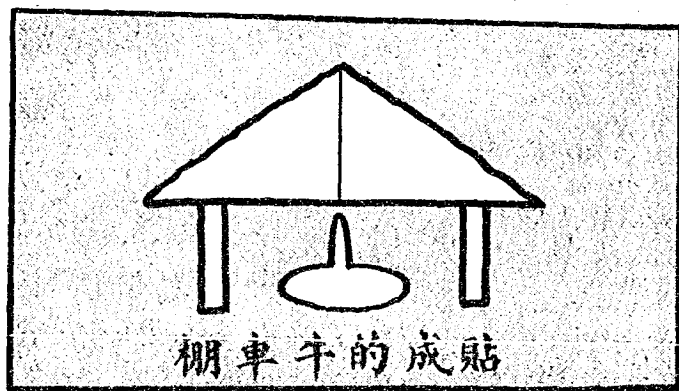

棚車午的成貼

扯紙工

羊 組二第 集一第

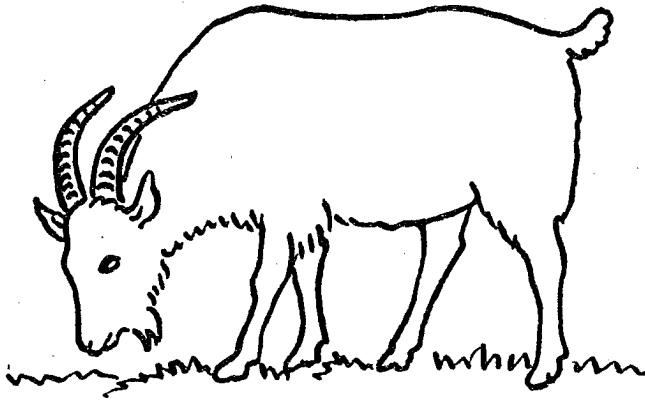

填色畫

羊

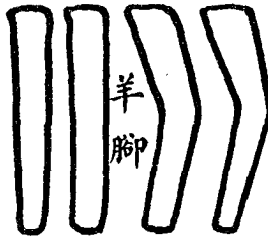

工紙扯



第一集 第二組 羊

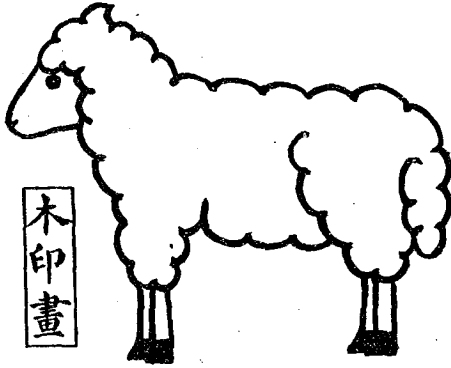

木印畫

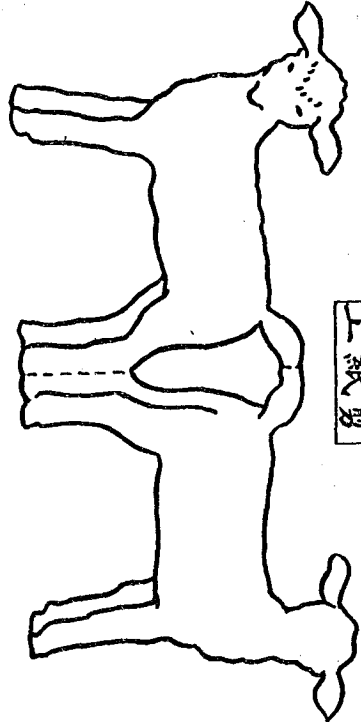

工紙剪

樹葉貼成的羊

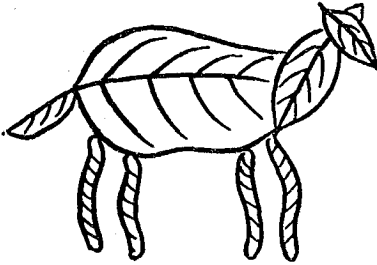

羊棚

積木裝排

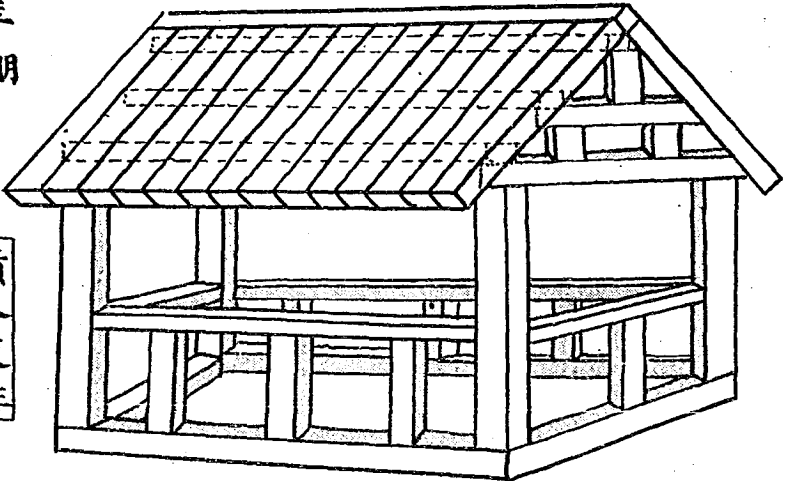

第一集 第三組 草

填色畫

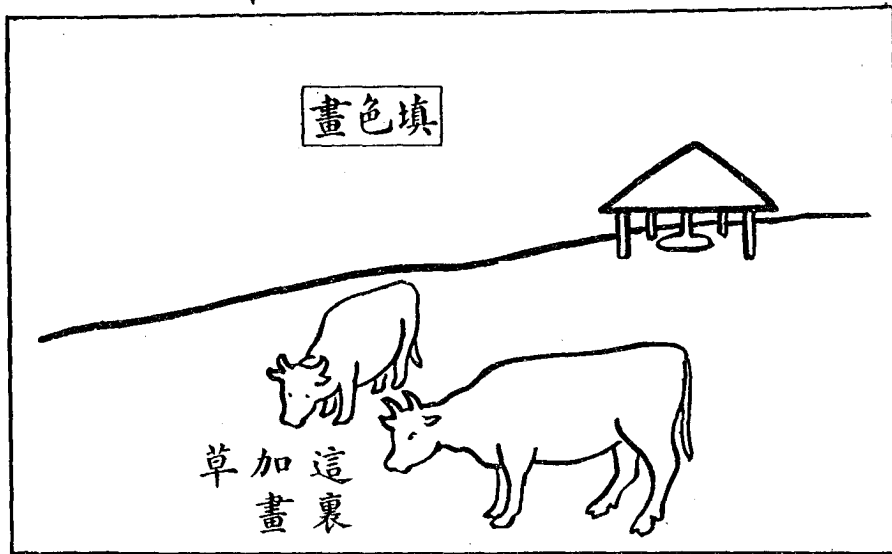

這裏
加草
畫

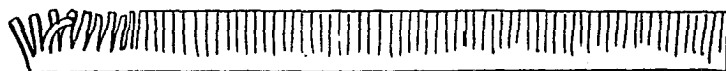

用紙條工 用綠紙剪草

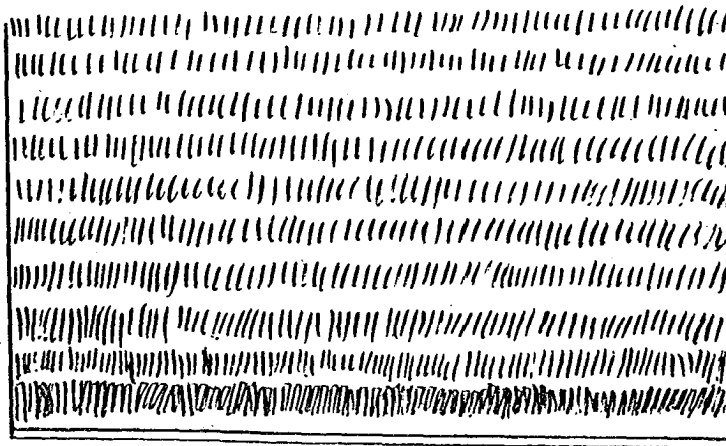

貼成的草

第一集 第三組 草

填色畫



校園內
去拔野草

把羊具在草上
牛玩紙放地的
牧場

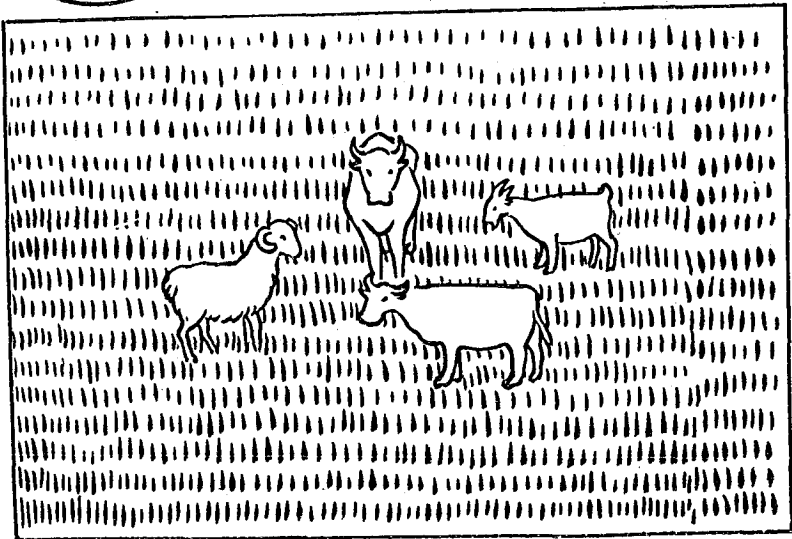

填色畫

輪流澆花
除草

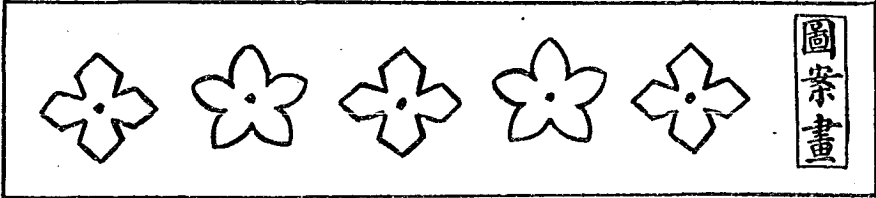

第一集 第四組 花

紙工

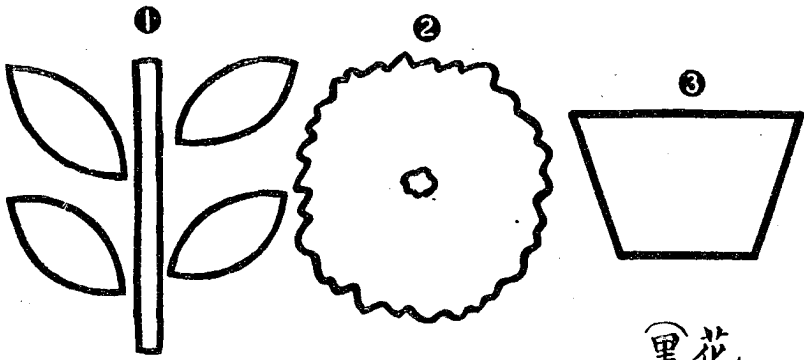

①
枝葉和
(綠色)

②
花
(紅黃)

③
花盆
(黑色)

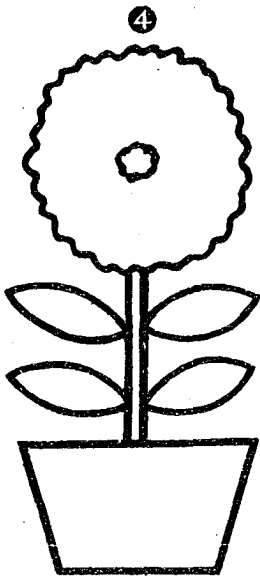

④

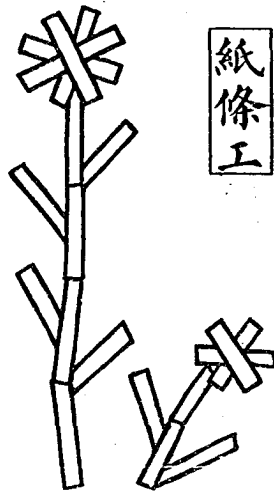

紙條工

第一集 第五組 樹

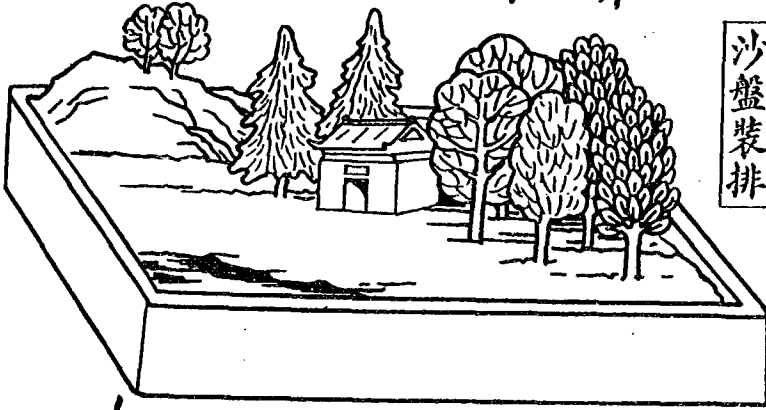

沙盤裝排



三角形

五角形

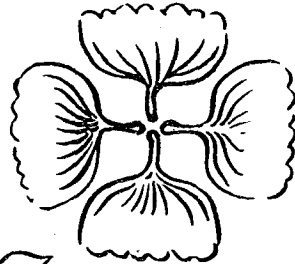

方形

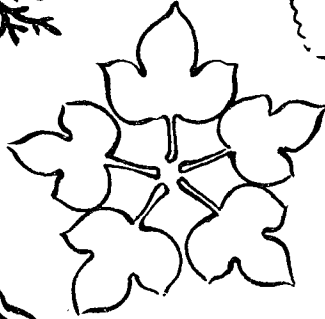

菱形



圓形



帶形

第一集 第五組 樹

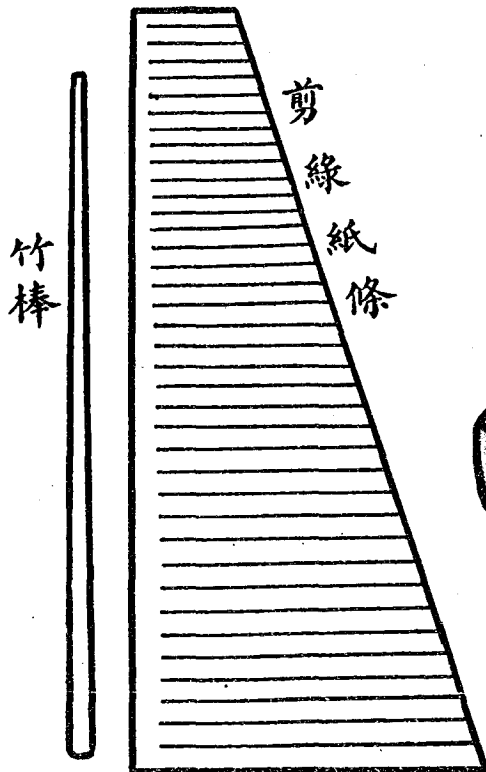
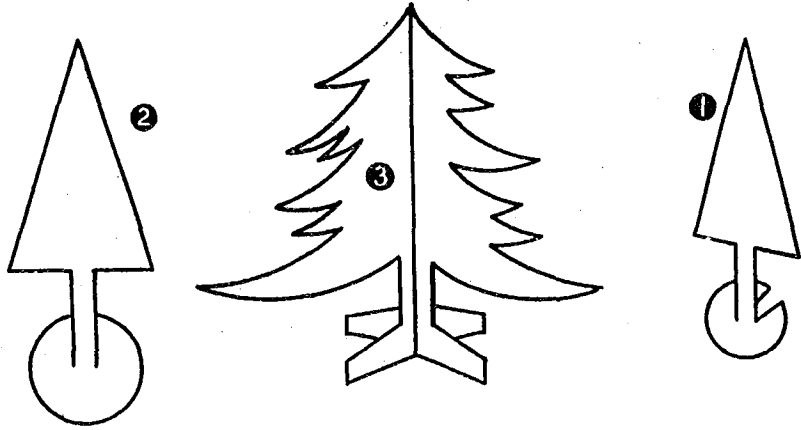

把剪成的綠紙條捲在竹棒上，插在泥塊上。

鳥 組六第 集一第

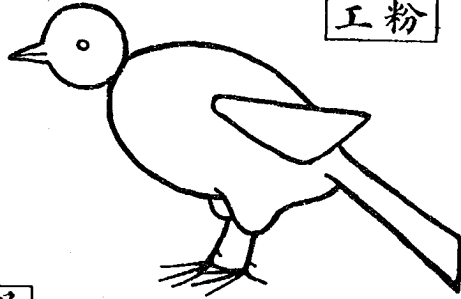

工粉

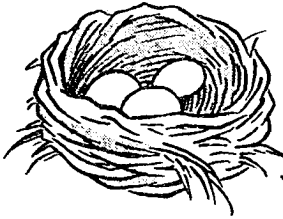

泥工
鳥窩

缸食鳥 工泥

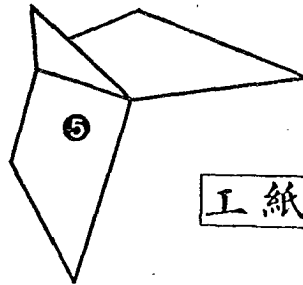
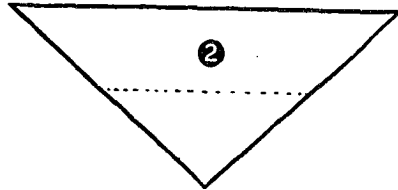
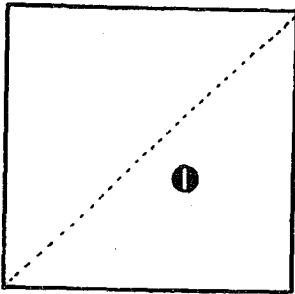
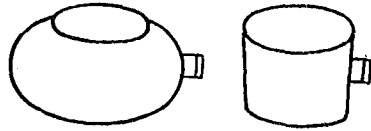

工紙摺



鳥 組六第 集一第

鳥 飛 畫 加 畫 色 填

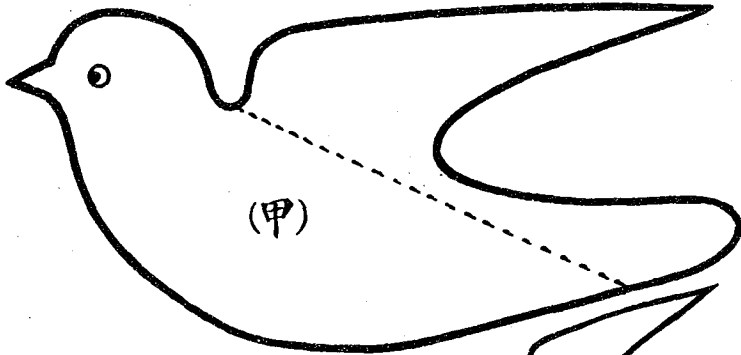
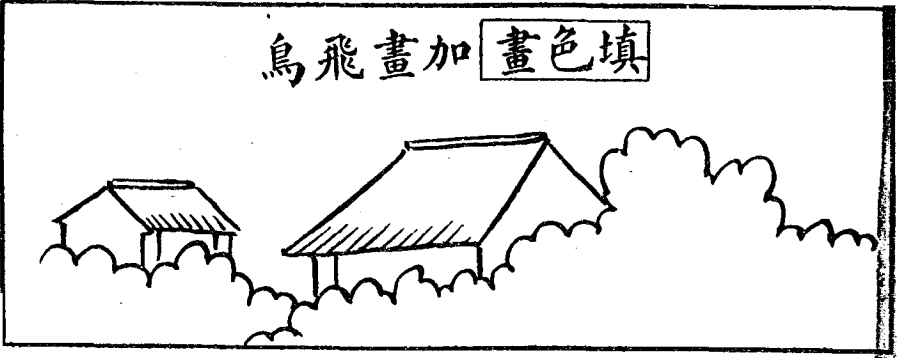

工 紙 剪

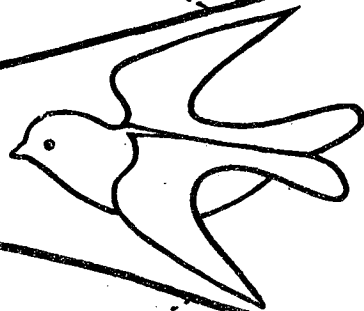

做 成 的 樣 子

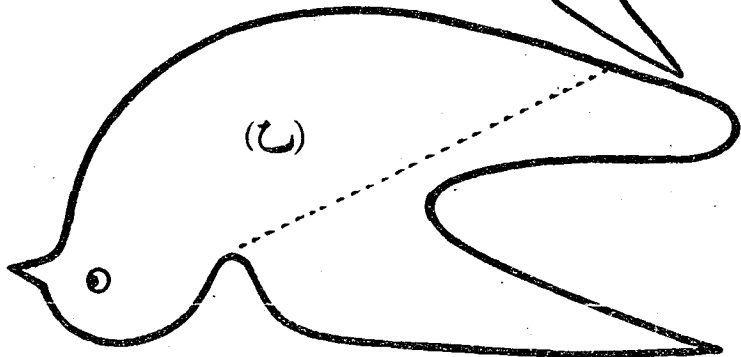

第一集 第七組 門

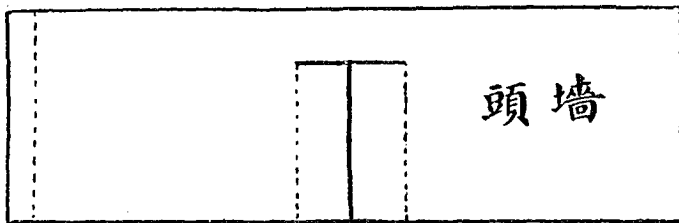
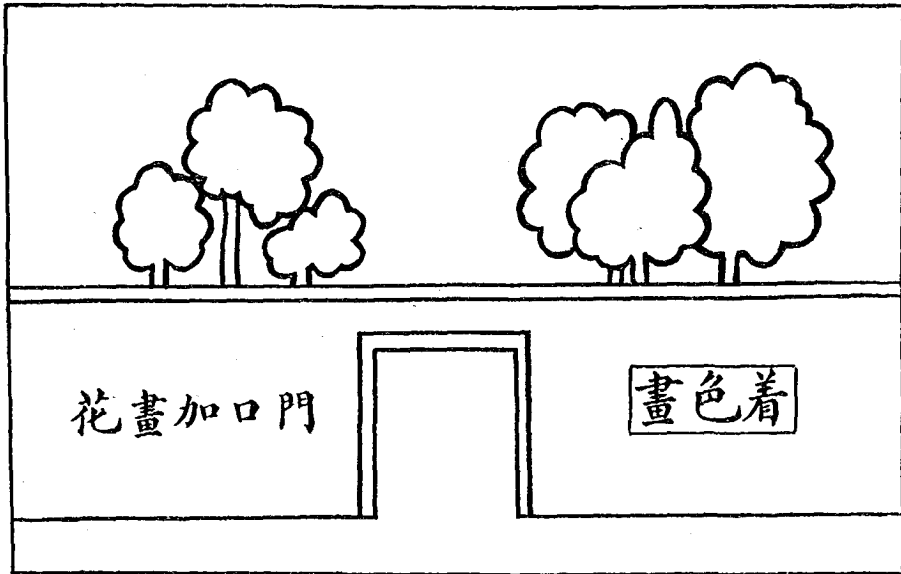

剪紙工

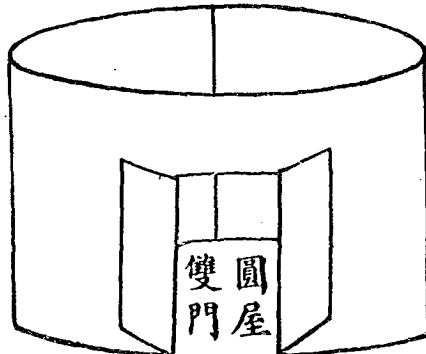
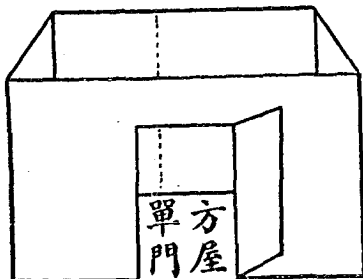

第一集 第七組 門

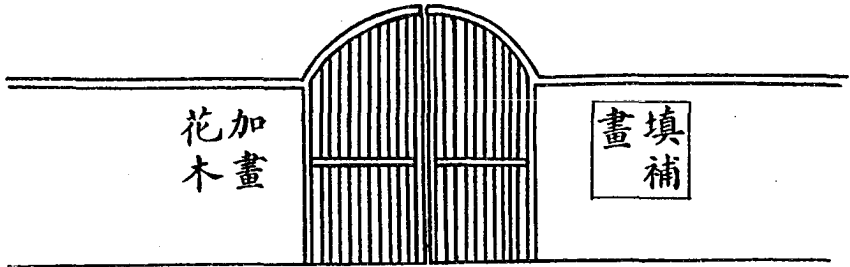

門成桿用
帘的編麥

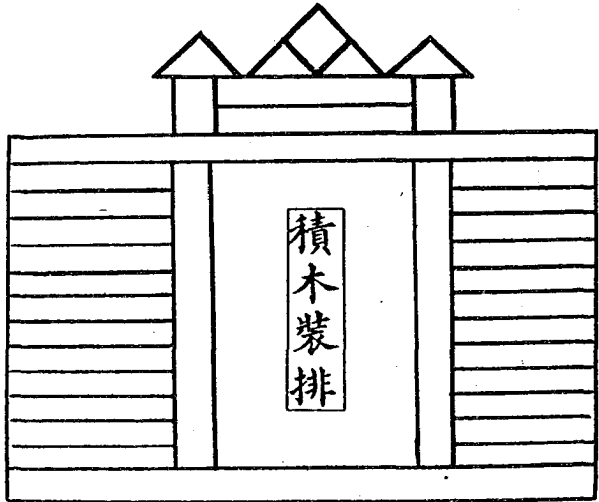
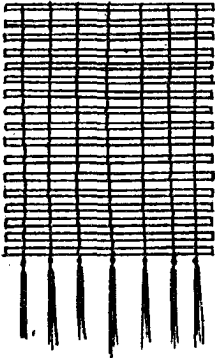

竹編或用
籬成香竹
門的棒絲

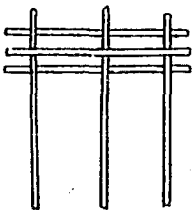

板巧七舊

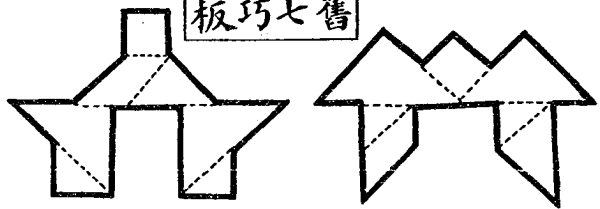

第一集 第八組 窗

貼窗紙花

花邊圖案

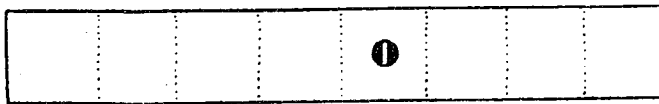
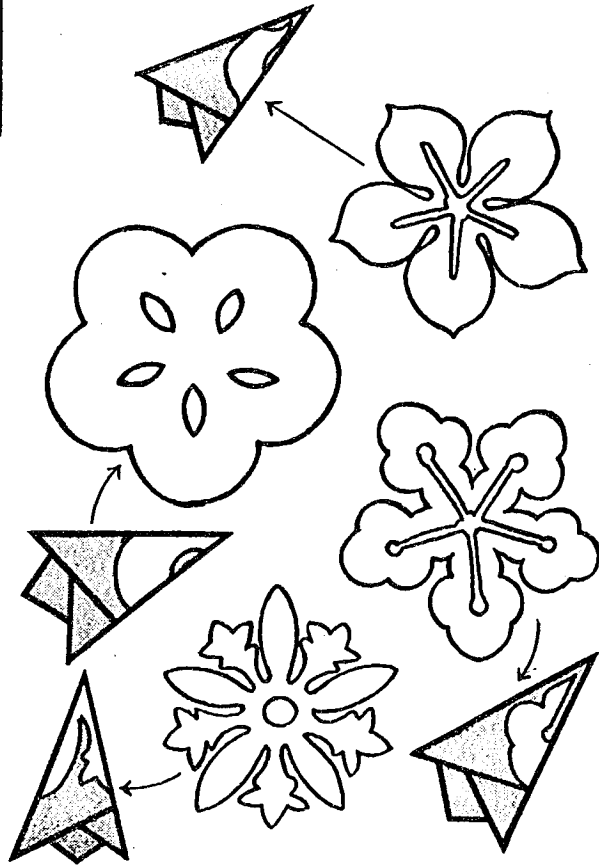

窗上花邊

剪紙工



第一集 第八組 窗

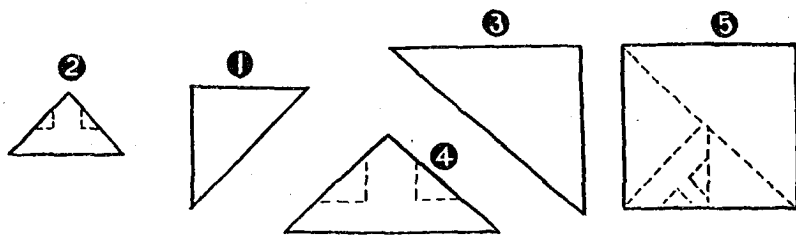

摺剪工

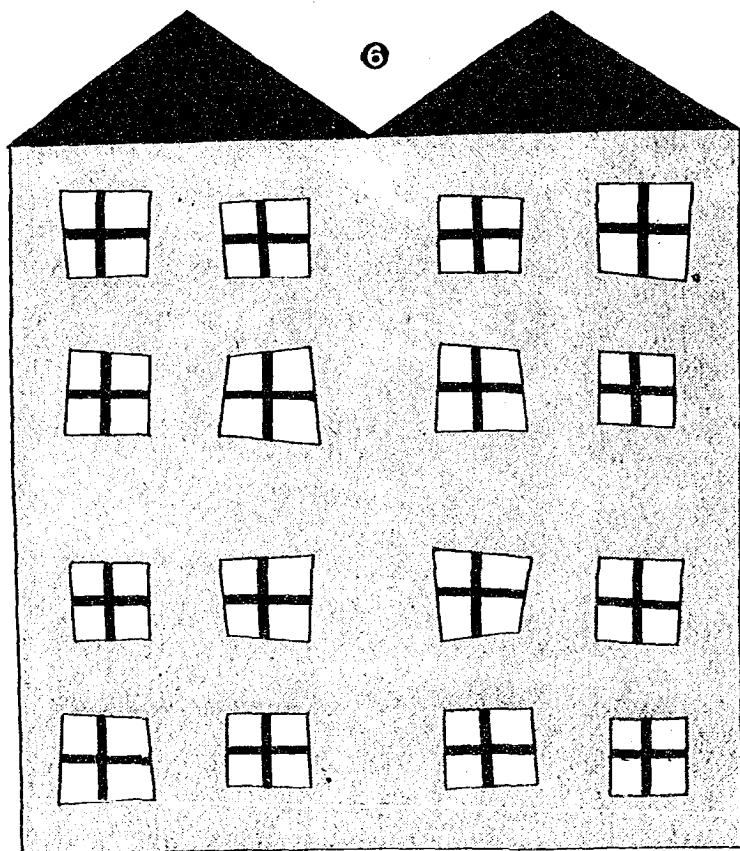

第一集 第九組 燈

着色畫

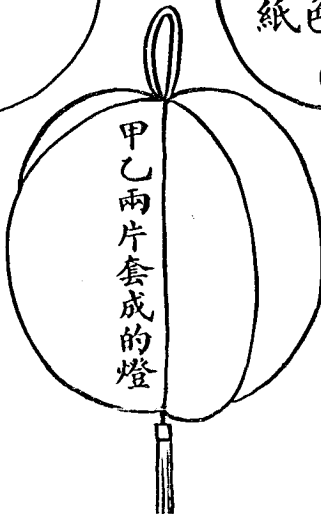
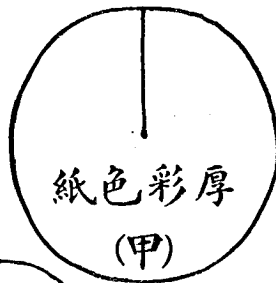
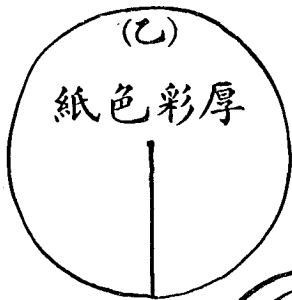

剪紙工

第一集 第九組 燈

剪紙工

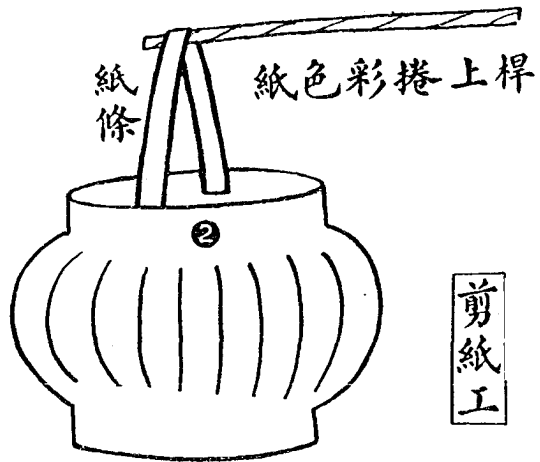
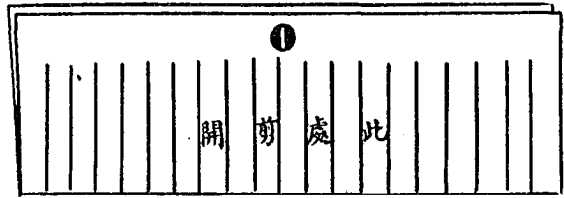
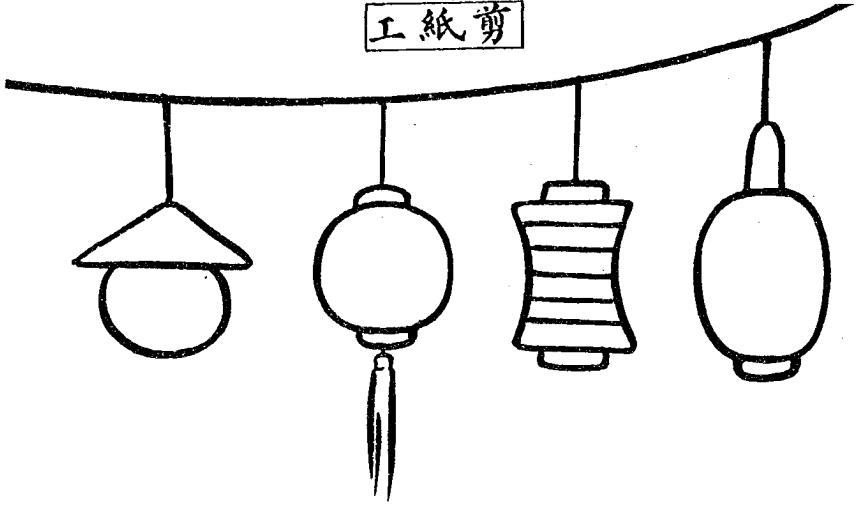

火 組十第 集一第



①



②

救火用的梯子

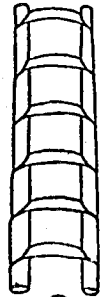

③

工泥

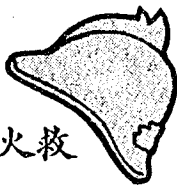

帽火救

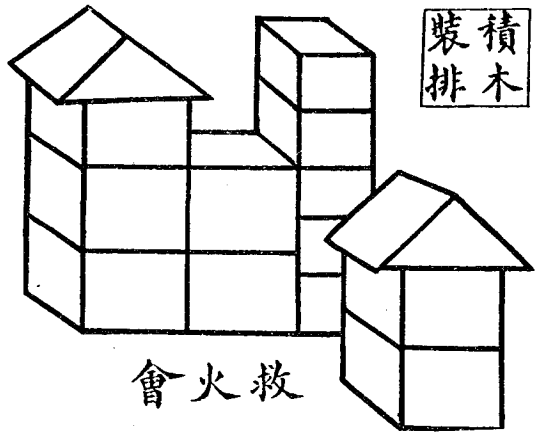

裝積
排木

會火救

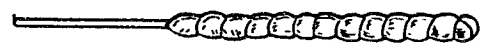

柄的鎗水



(做管竹) 鎗水

人救火加
火和畫

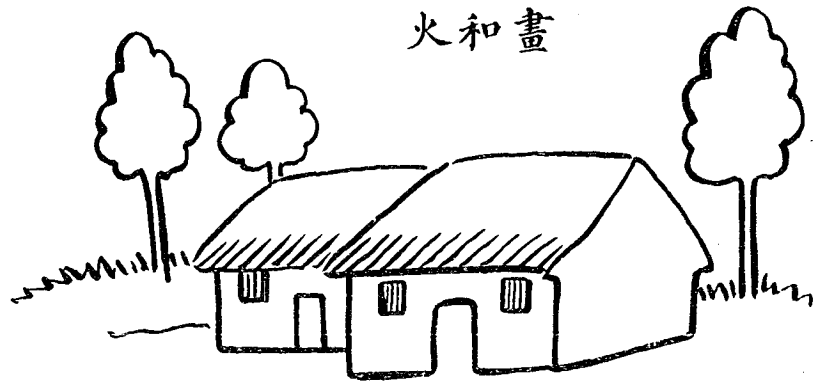

第一集 第十組 火

心匣

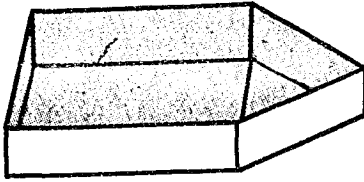

匣殼

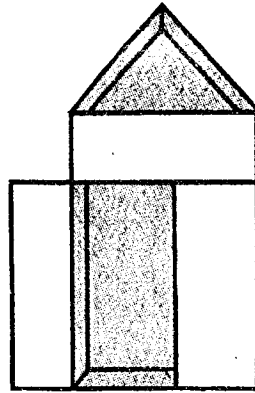
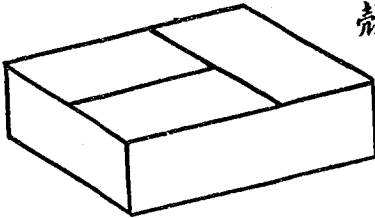

火柴匣做成的房屋

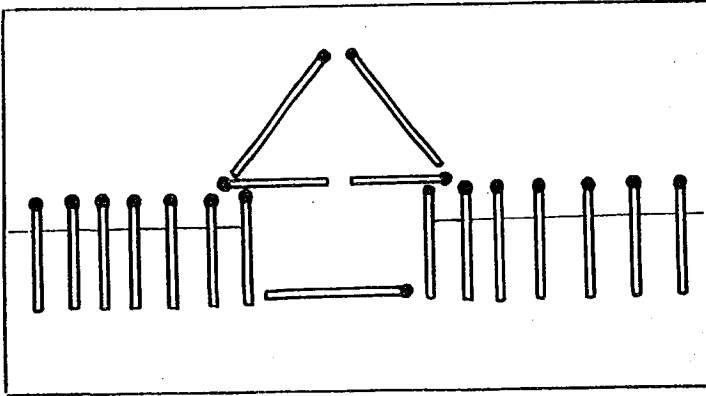

火柴梗搭成的屋和籬笆

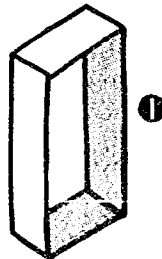
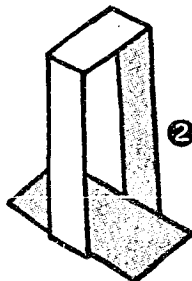
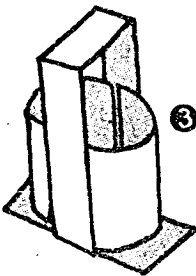

火柴匣做的提籃

水 組一十第 集一第

着色畫



第一集 第十一組 水

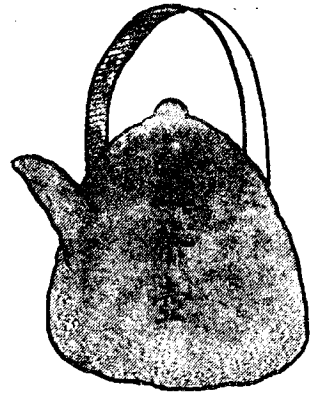

積木井

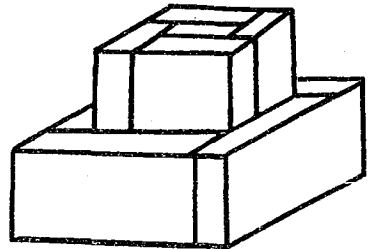

茶 組二十第 集一第

瓶葉茶

工線穿

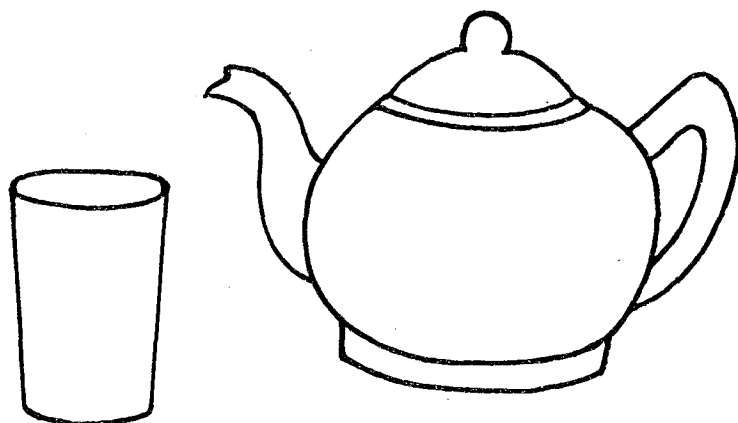
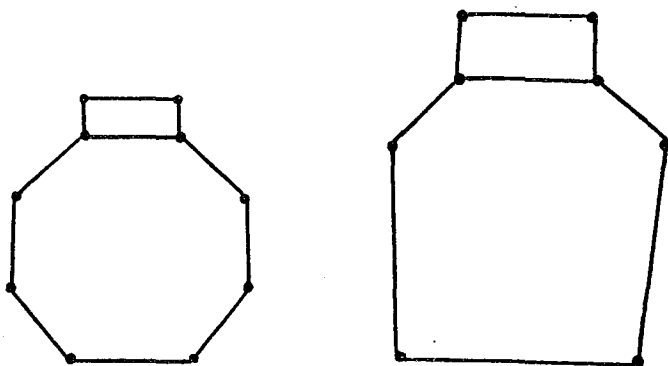

紋花畫加上杯茶壺茶

茶 組二十第 集一第

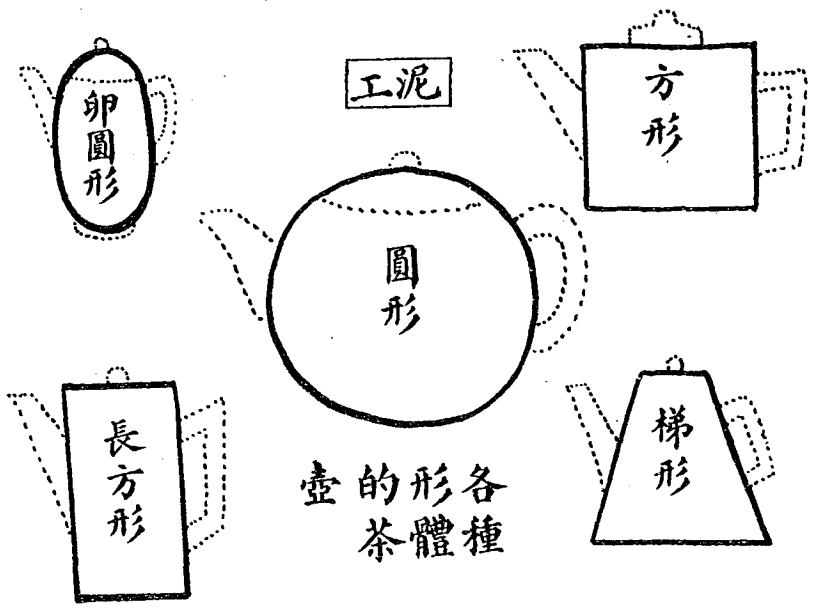
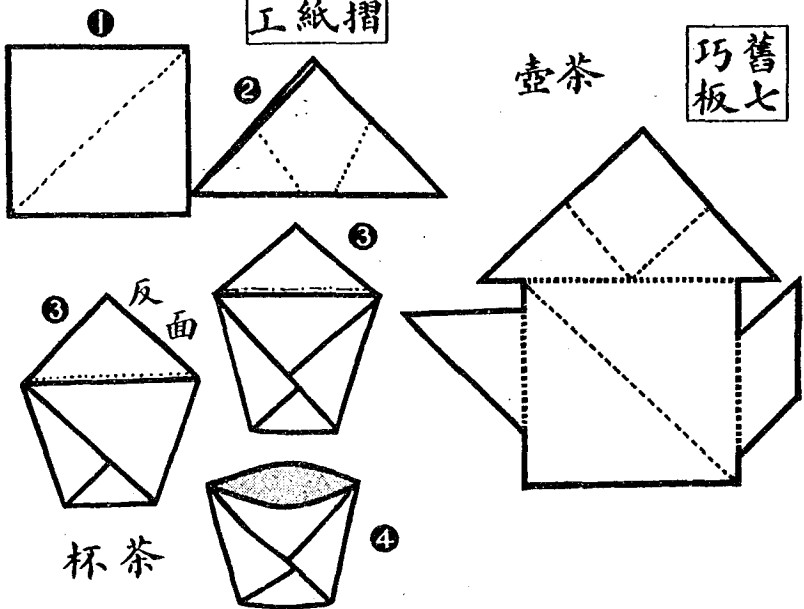

畫色填

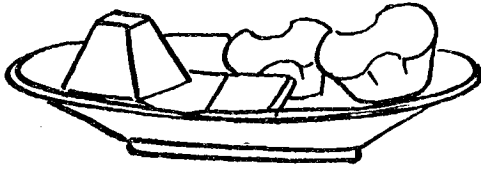

做用
糕粉

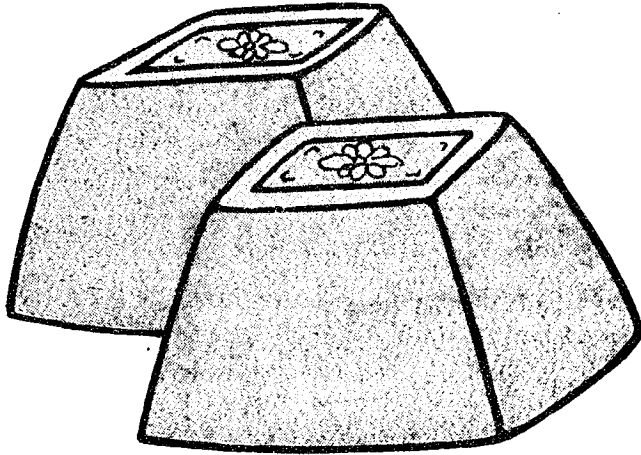

泥工

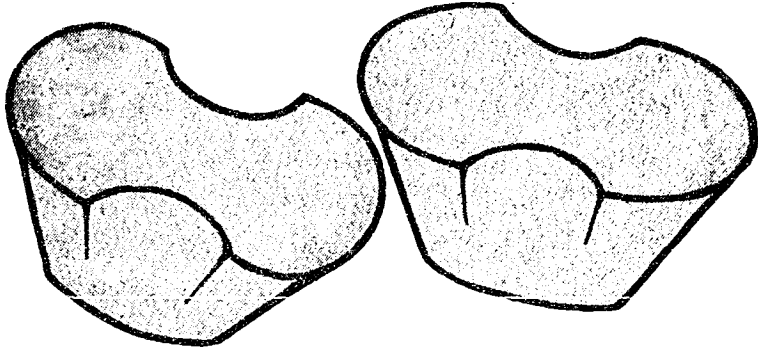

糕 組三十第 集一第

畫色填

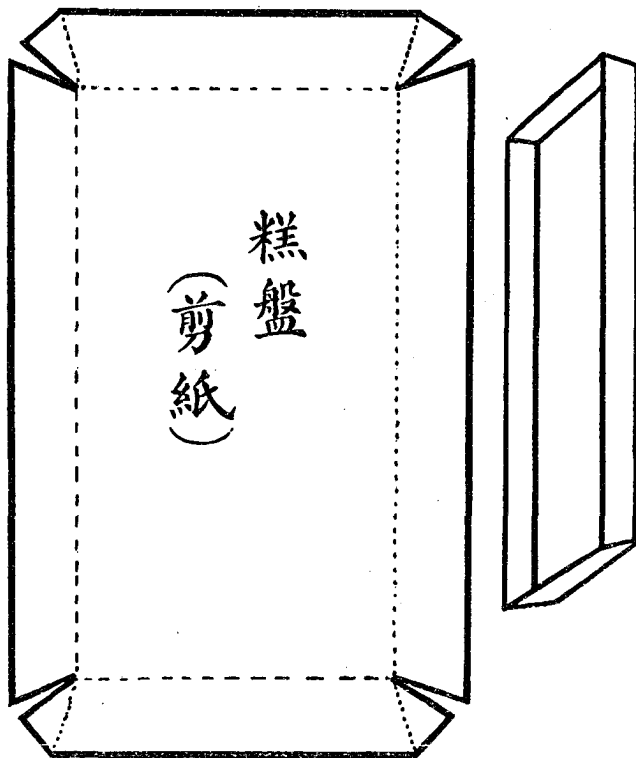
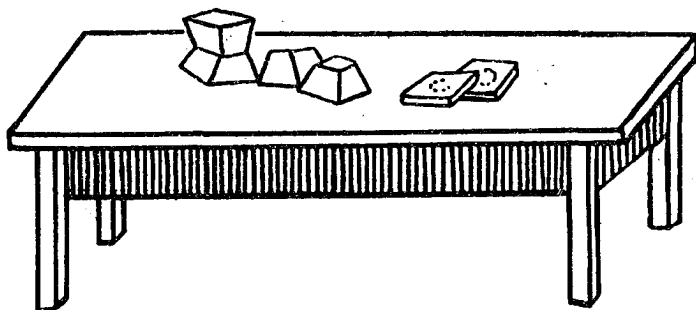

餅 組四十第 集一第

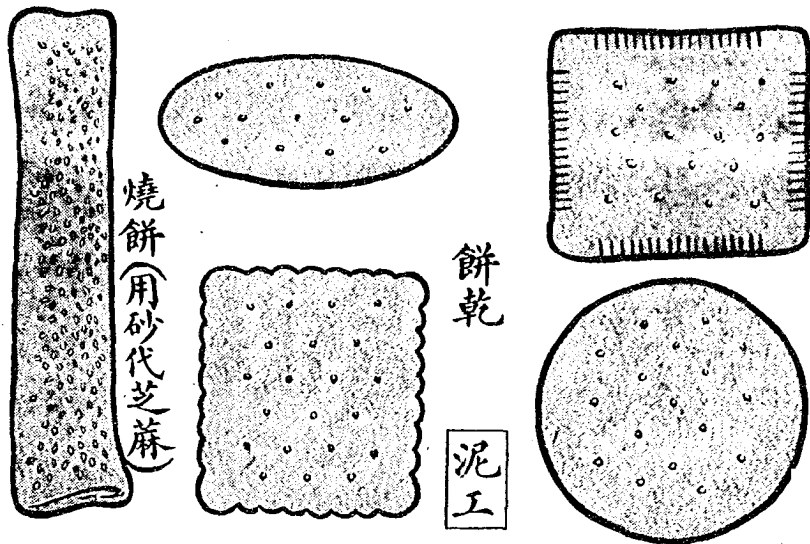

餅烤



調合



糖



粉



餅烘行實

餅 組四十第 集一第

工紙剪 爐餅燒

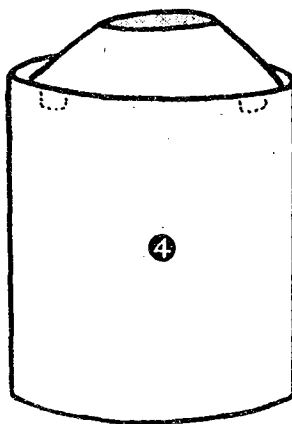
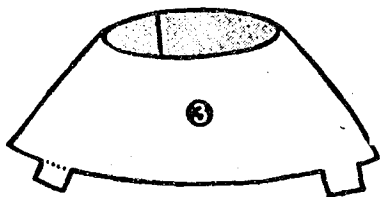
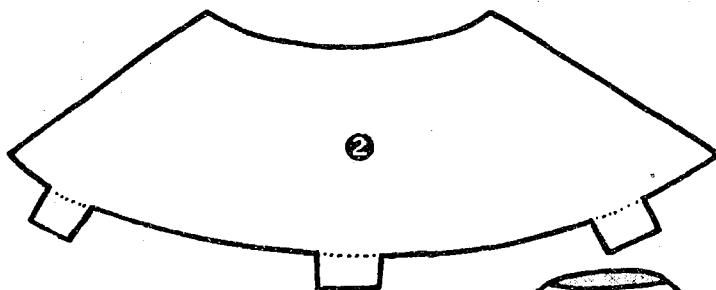
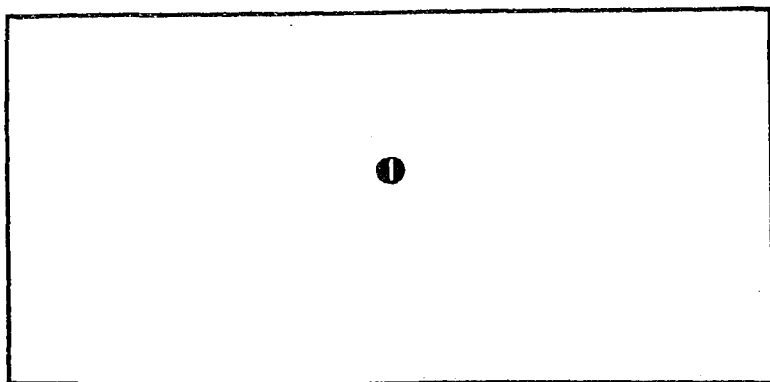

飯 組五十第 集一第

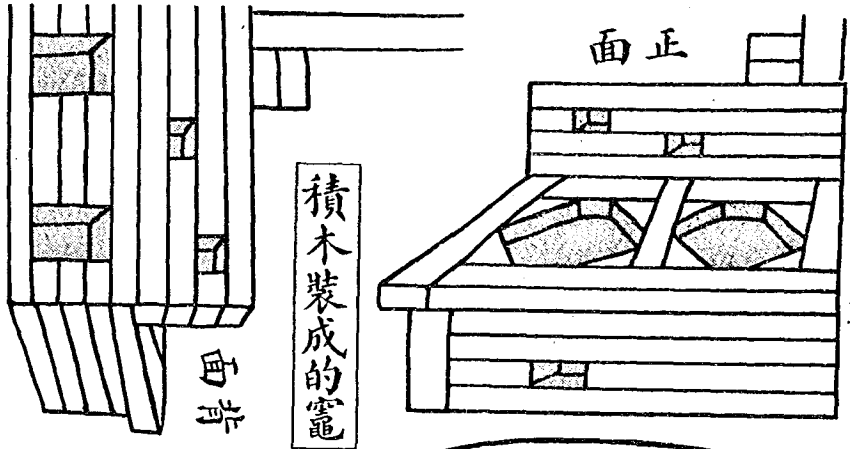

的摺剪
碗成紙

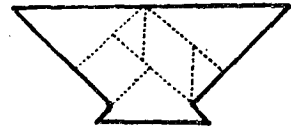
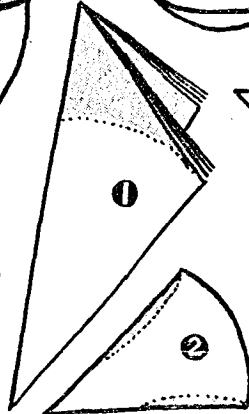
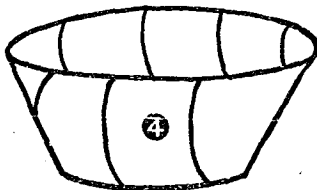
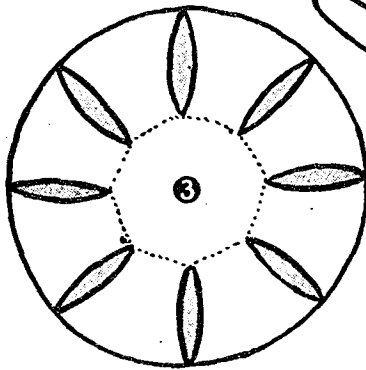

碗

舊七巧板

飯 組五十第 集一第

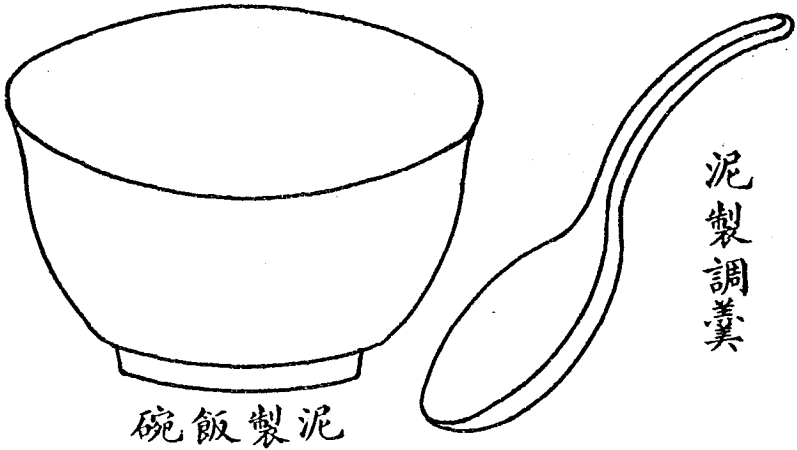

泥製調羹

碗飯製泥

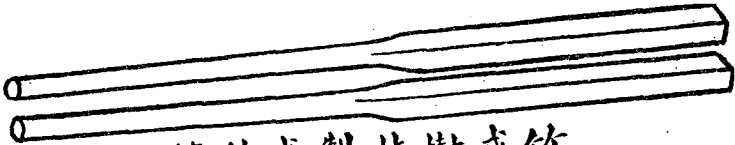

筷的成製枝樹或竹

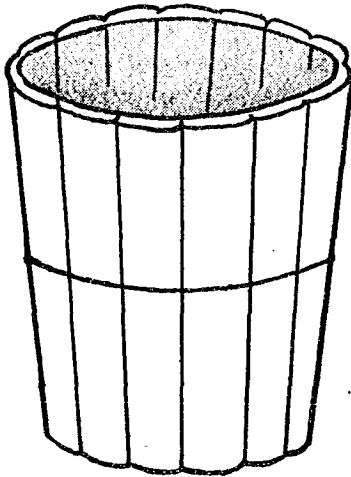

泥工
盛飯的桶

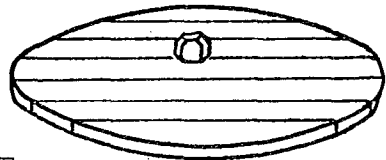

蓋

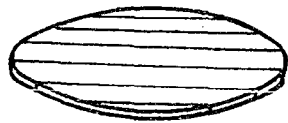

底

第一集 第六十組 菜

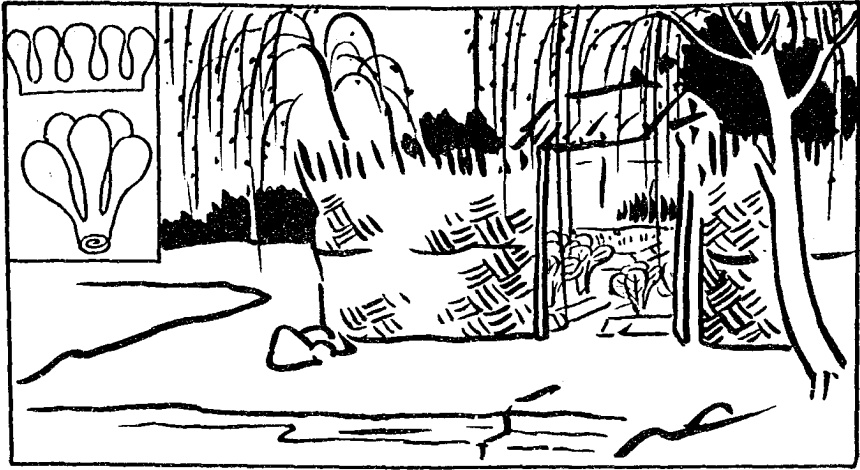

填色畫

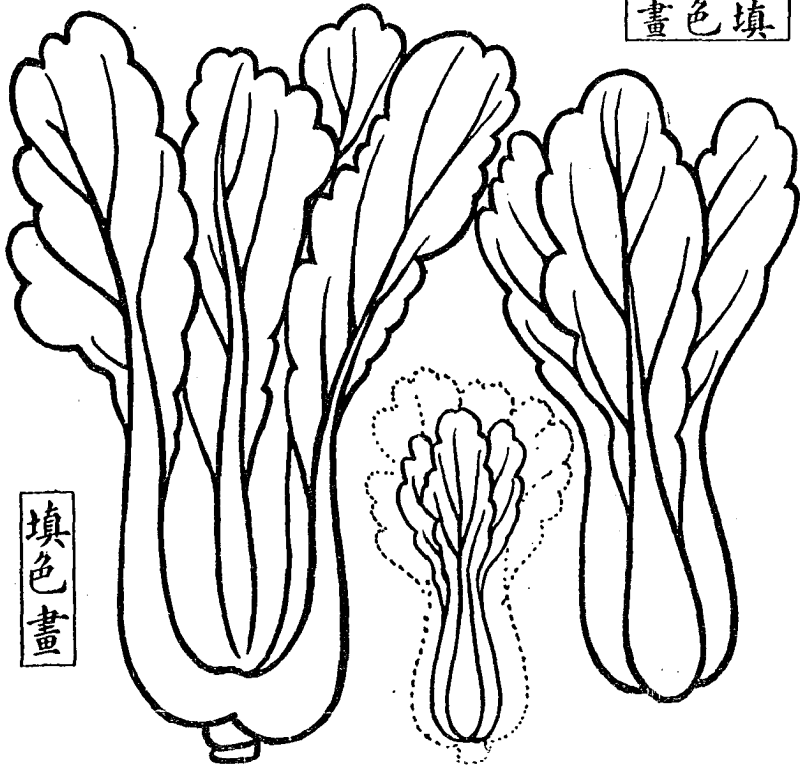

填色畫

第一集 第六十組 菜

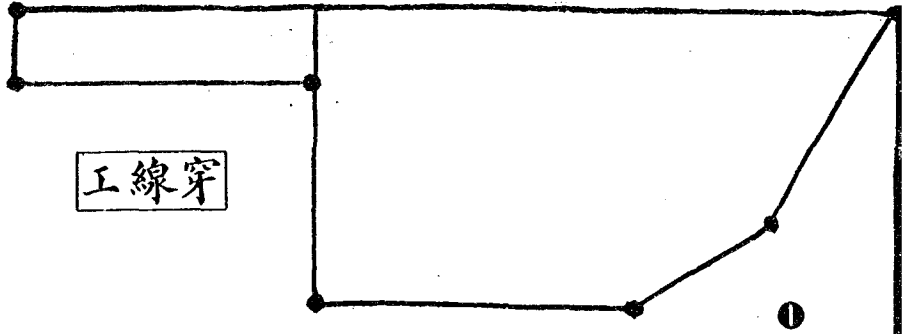

農場種
菜或煮
菜吃

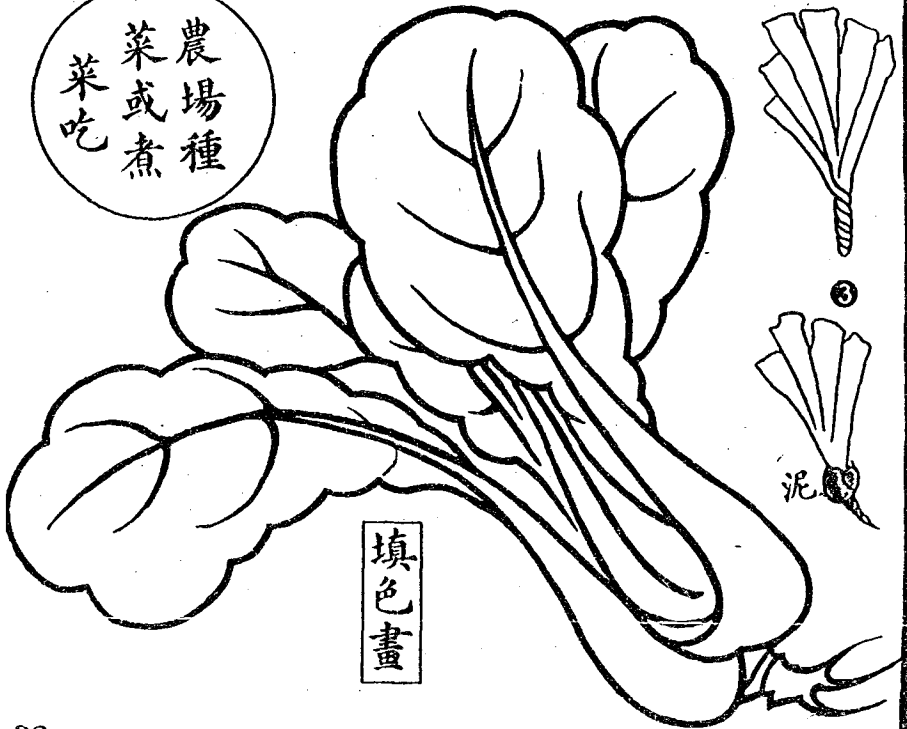

畫色填

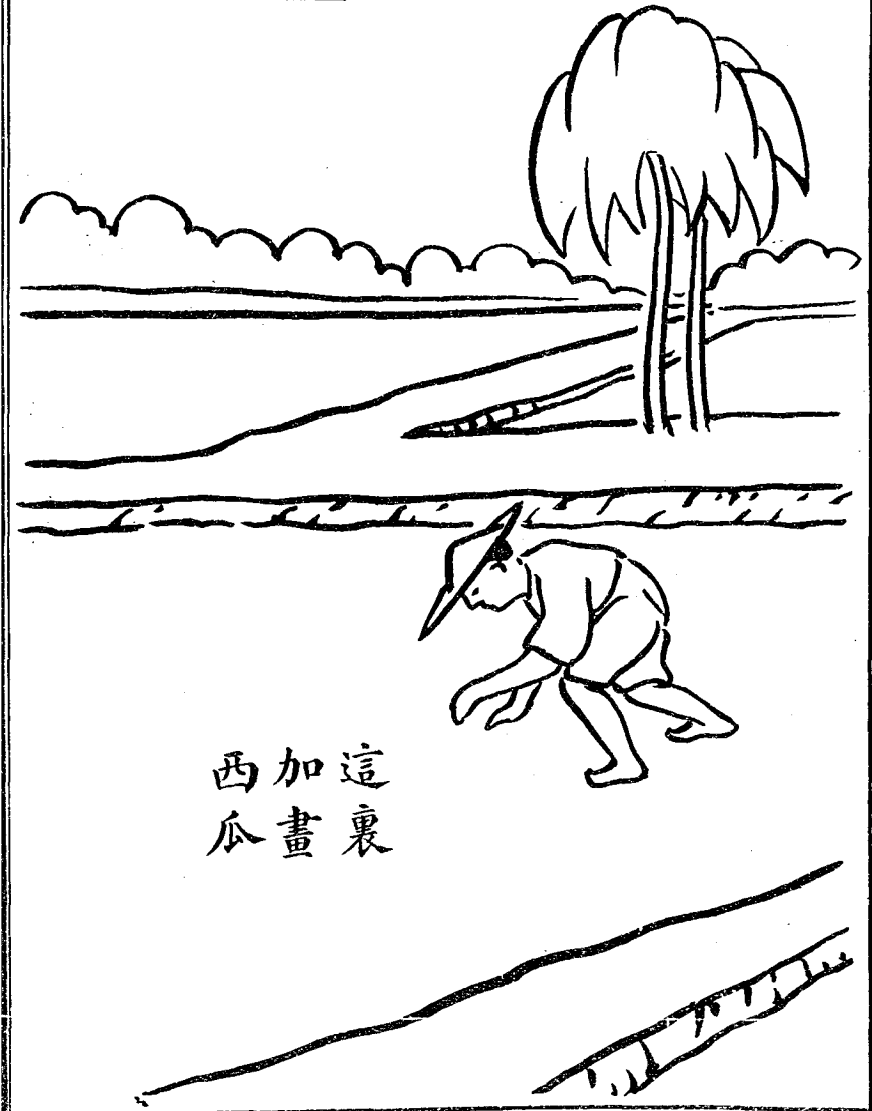

西加這
瓜畫裏

瓜 組七十第 集一第

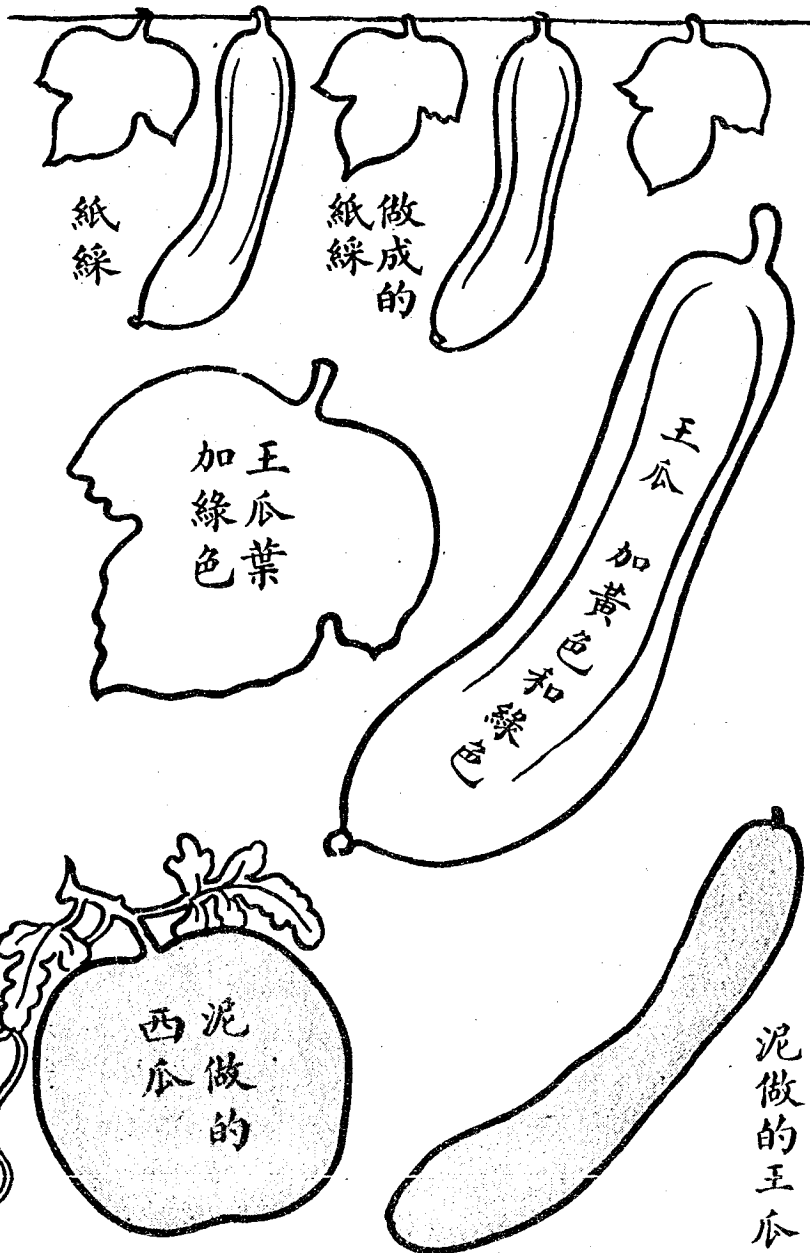

第一集 第十八組 豆

手指上自己畫
臉譜再用豆殼
做帽子戴上去

豆殼帽

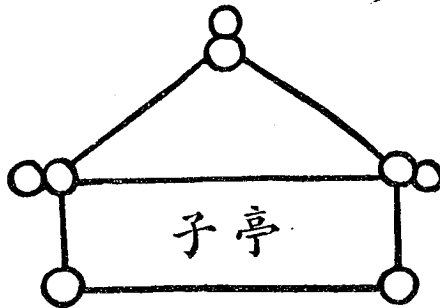
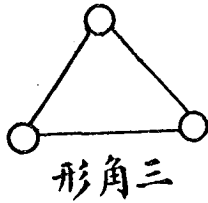
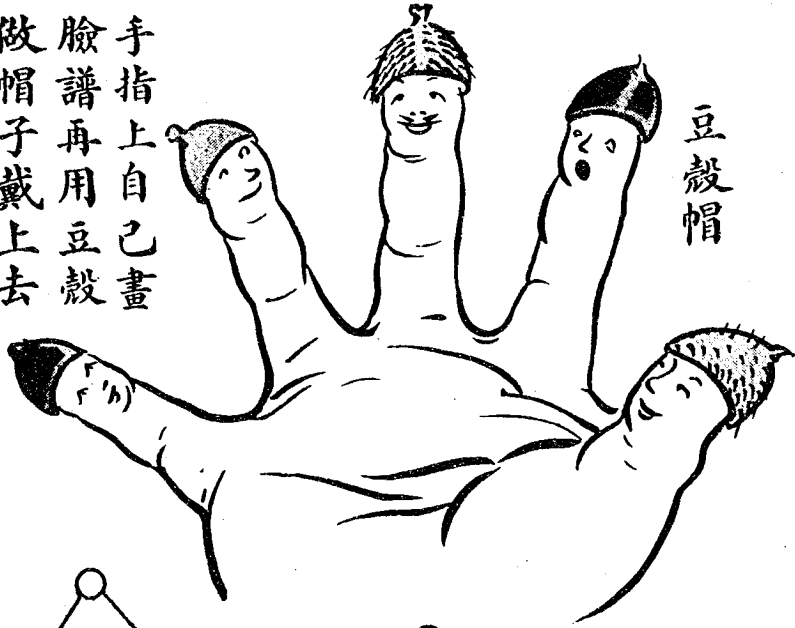

將大豆浸胖了，
用竹絲穿起來。

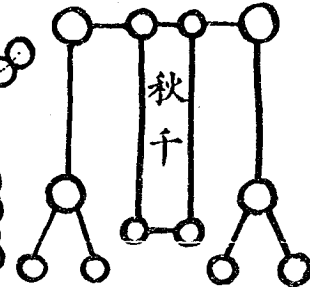
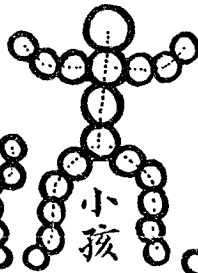
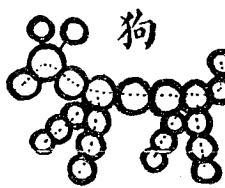
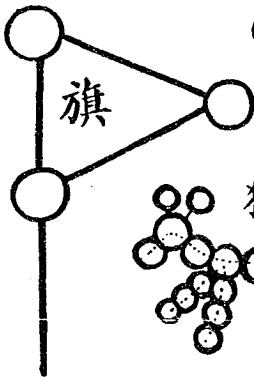

第一集 第十八組 豆

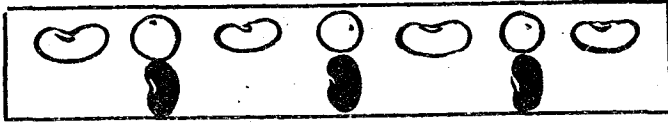

豆的圖案

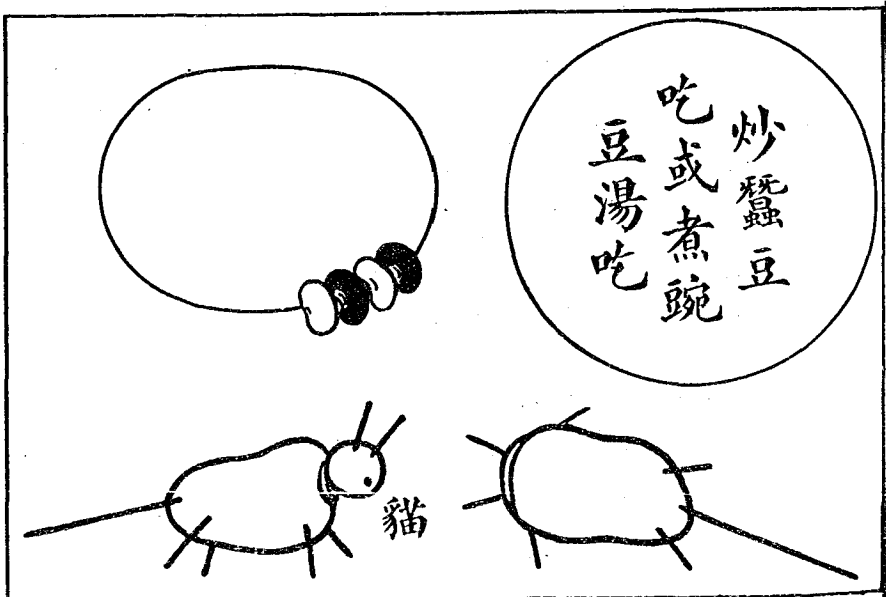
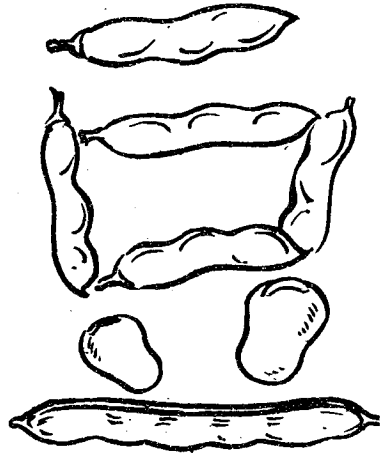
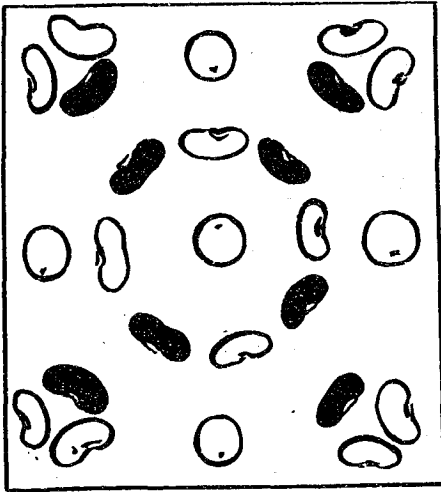

魚 組九十第 集一第

畫色填

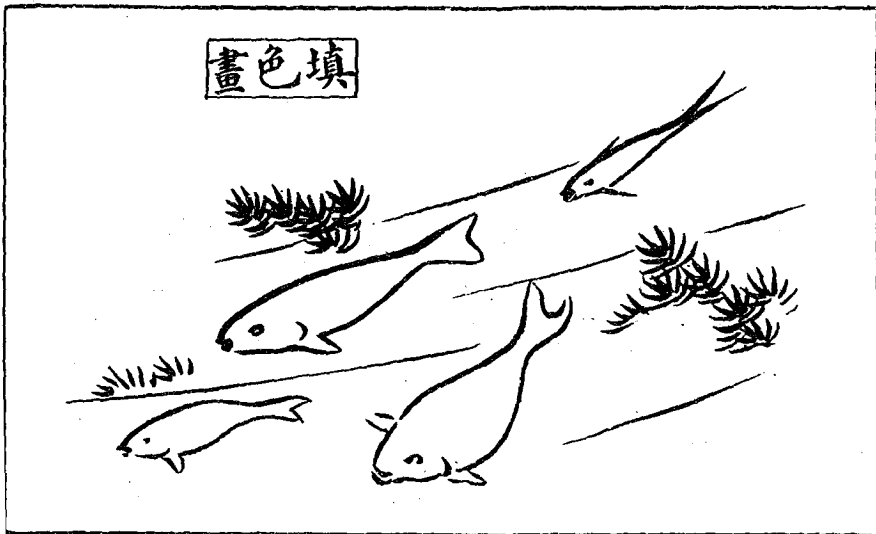

硬紙工

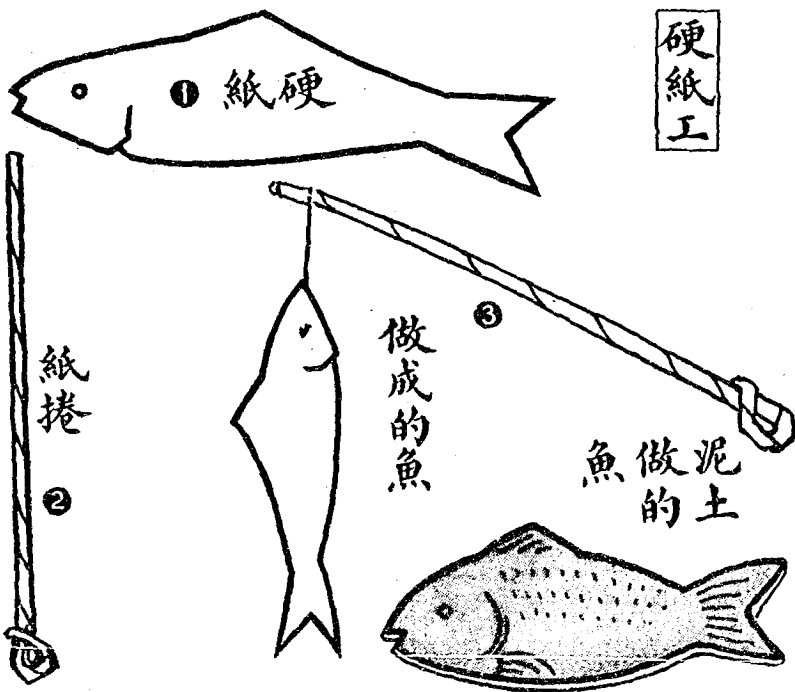

魚 組九十第 集一第



木刻印

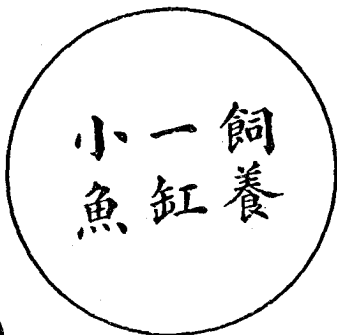

飼養
小魚
一缸

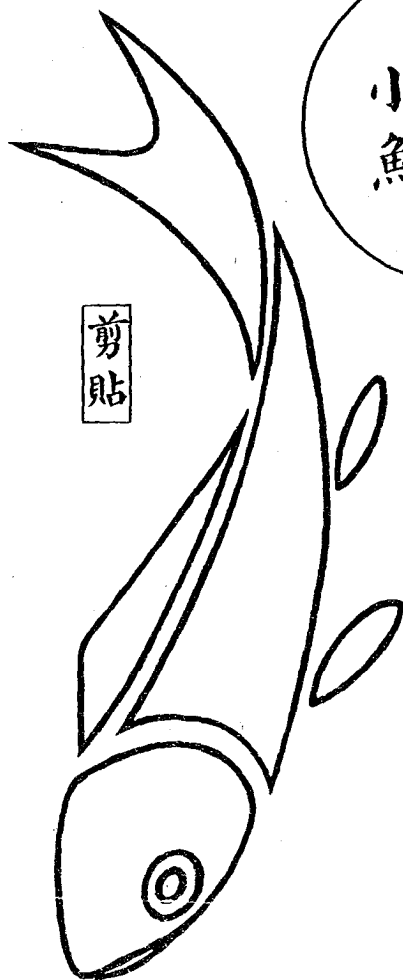

剪貼

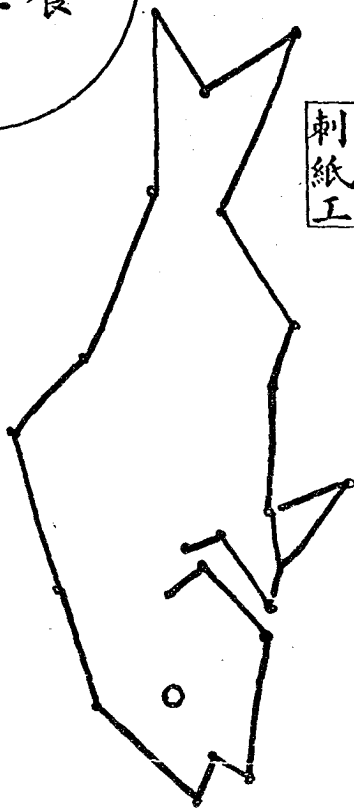

刺紙工

肉 組十二第 集一第

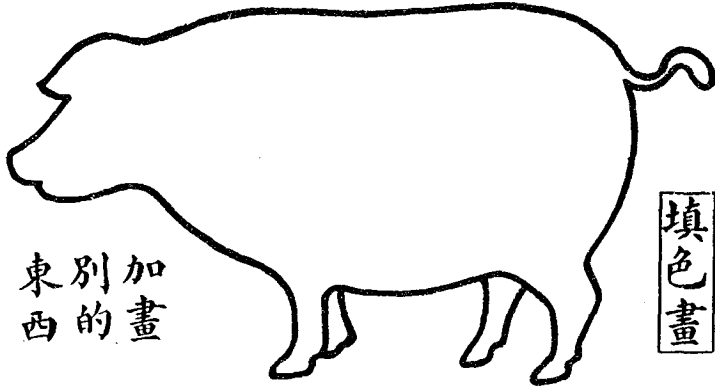

東別加
西的畫

填色畫

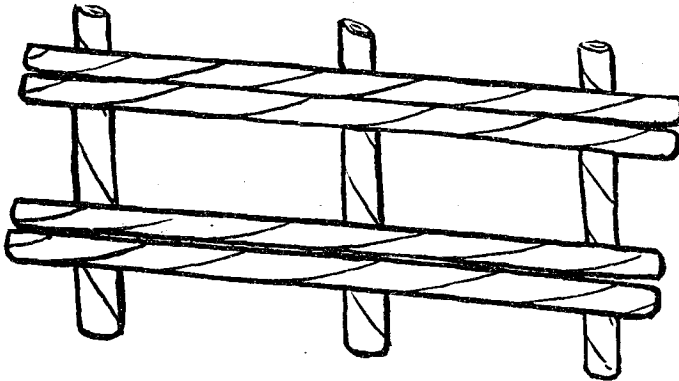

捲紙工

豬柵

缸食豬

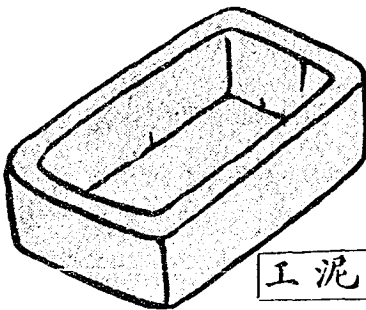

工泥



簡筆畫

肉 組十二第 集一第

泥工

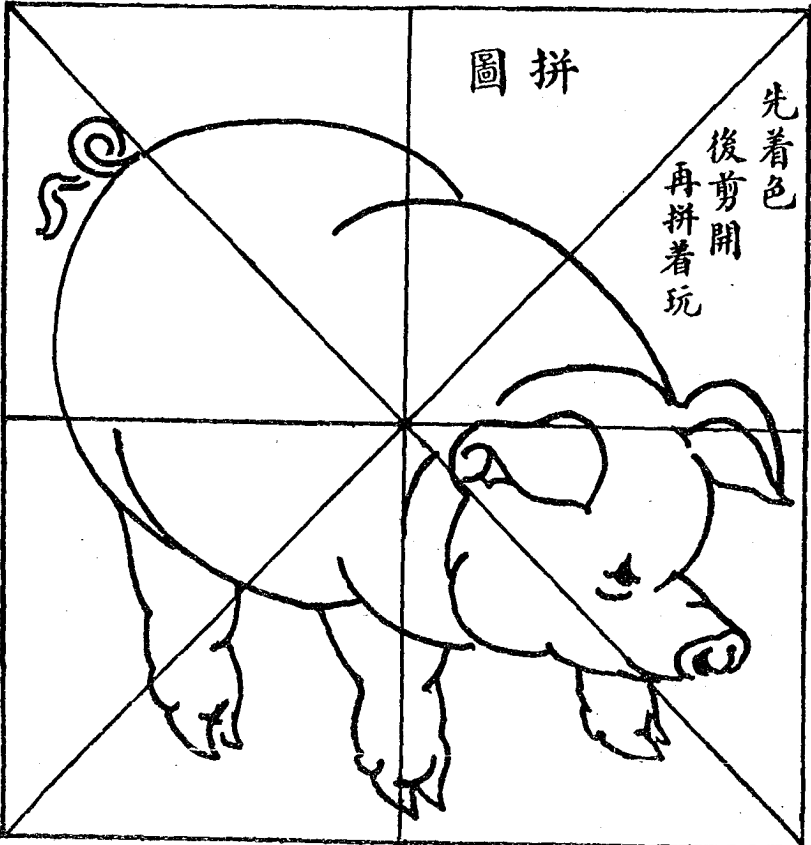
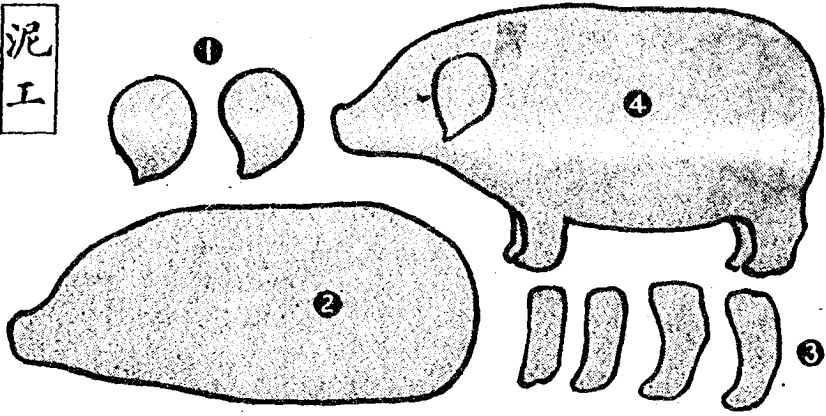

圖拼

先着色
後剪開
再拼着玩

狗 組一十二第 集一第

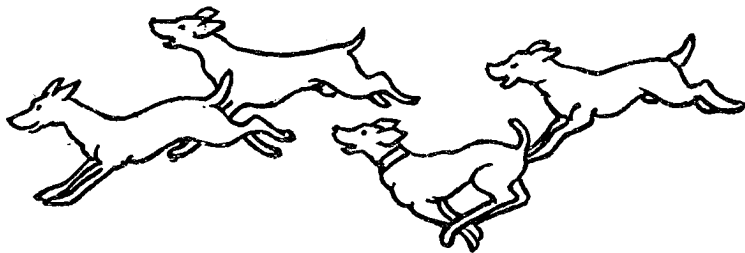

簡
筆
畫



圖
案
填
墨

畫
色
填

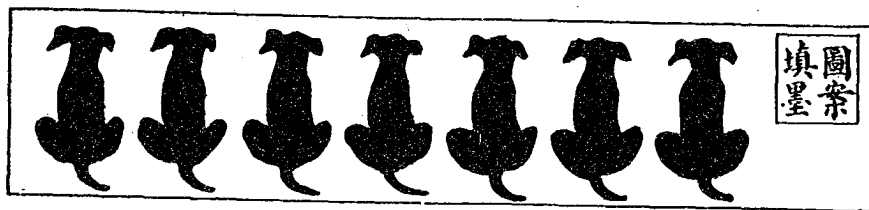
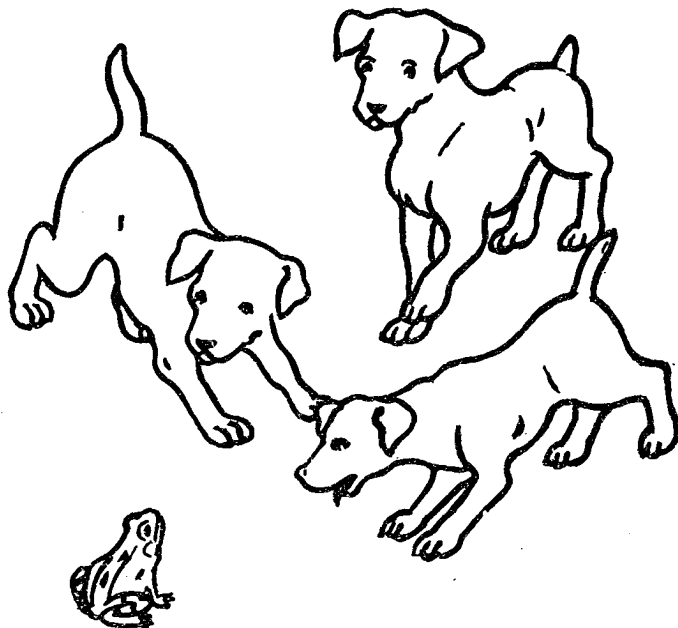

狗 組一十二第 集一第

新七巧板

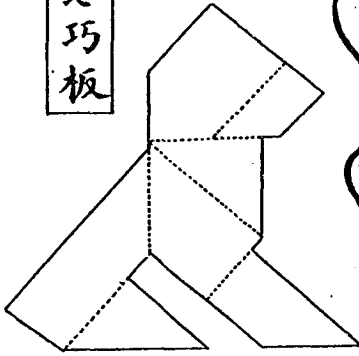

積木裝排

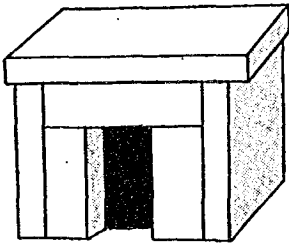

狗舍

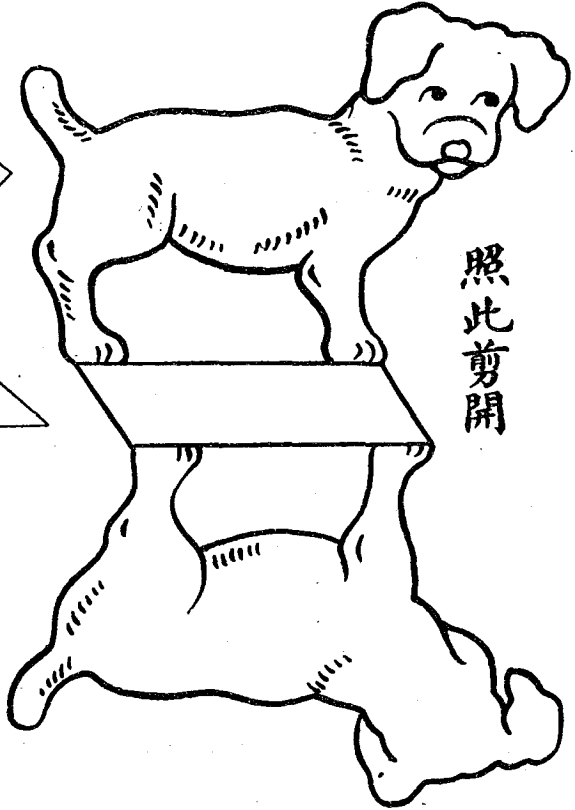
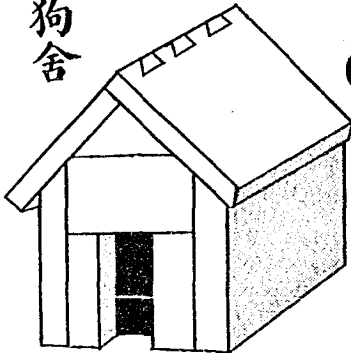

照此剪開

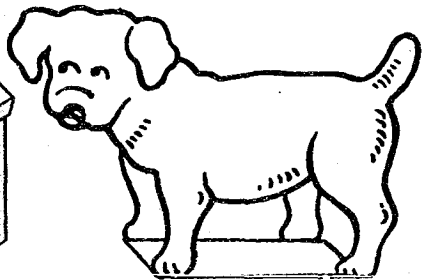

照此貼攏

貓 組二十二第 集一第



剪紙工

園裏養
一隻貓
每天輪
流飼養

紙條工

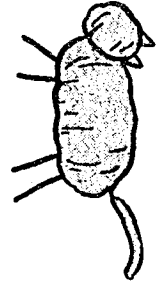

紙條工

樹葉貼成的貓

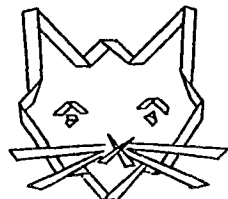
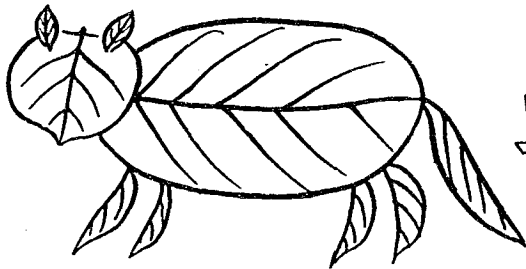

貓頭



簡筆畫

貓 組二十二第 集一第



填色畫

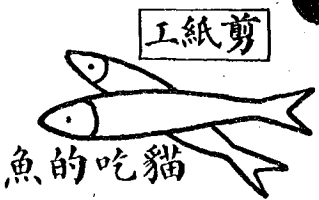

工紙剪

魚的吃貓

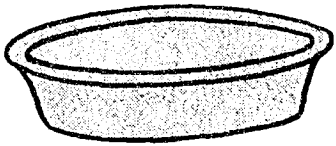

泥工

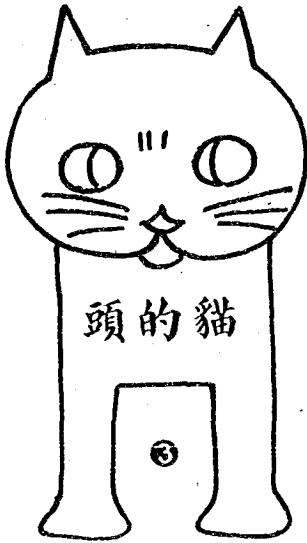
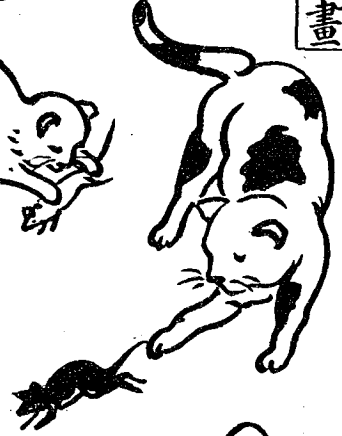

貓的頭

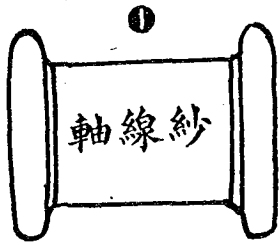

紗線軸

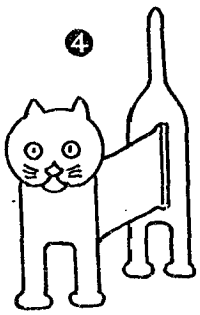

做成的樣子

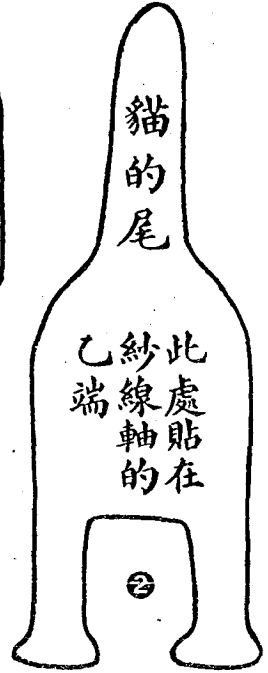

貓的尾

此處貼在
乙端
紗線軸的

雞 組三十二第 集一第

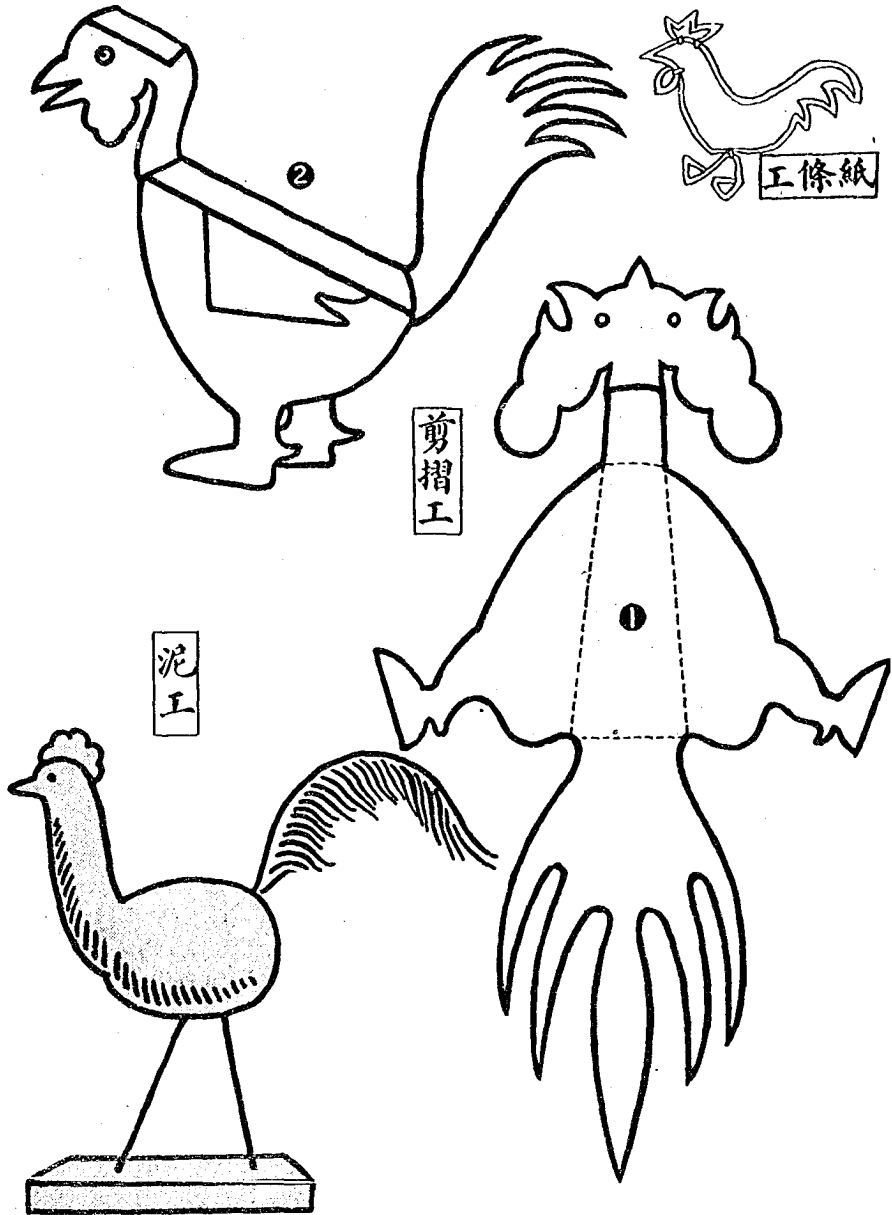

雞 組三十二第 集一第

排裝盤沙

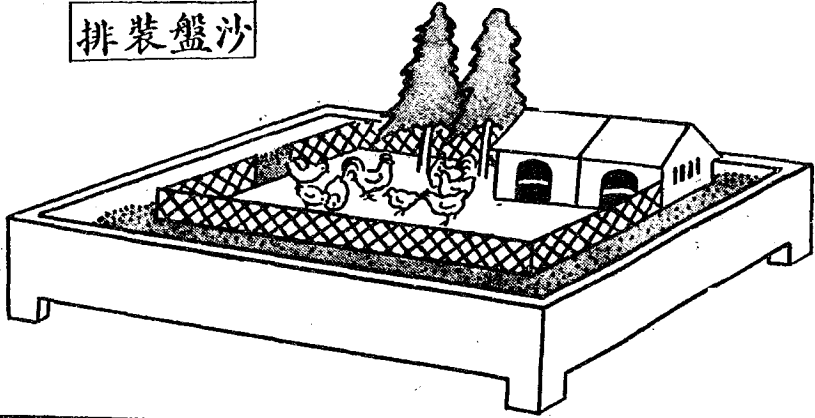

畫板黑

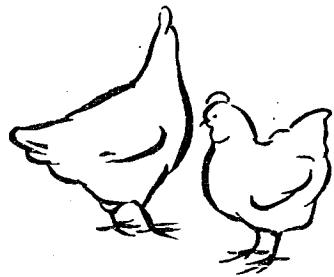

先着色
次剪開
再拼裝玩

拼圖

鴨 組四十二第 集一第

排裝盤沙

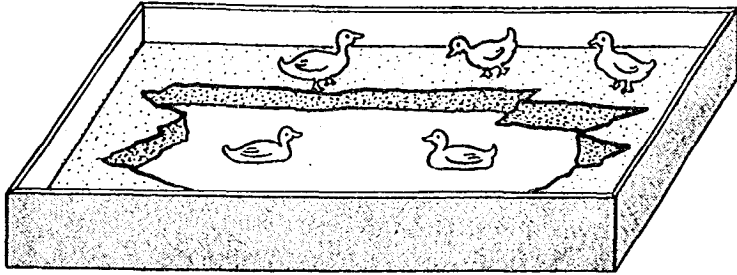

			案圖
			貼剪
填色畫			紙條工

鴨 組四十二第 集一第

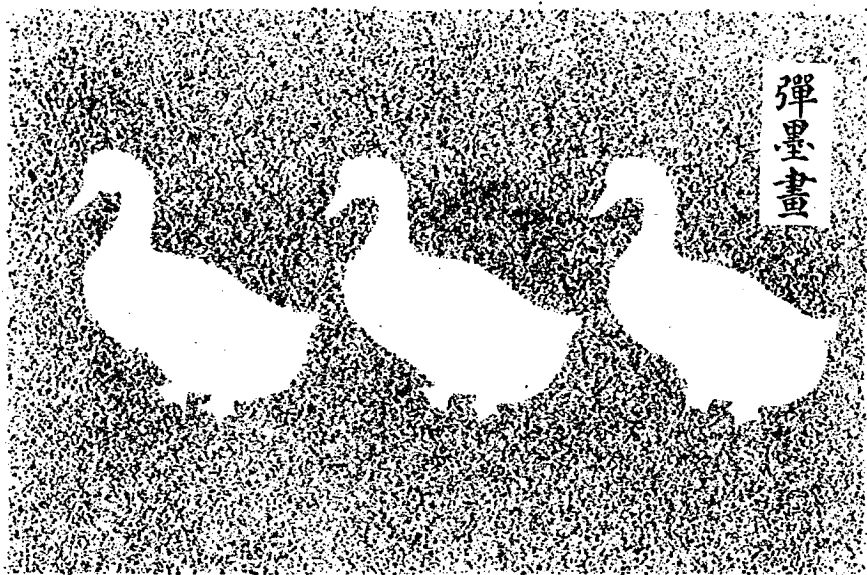

彈墨畫

工紙厚

子樣的成做

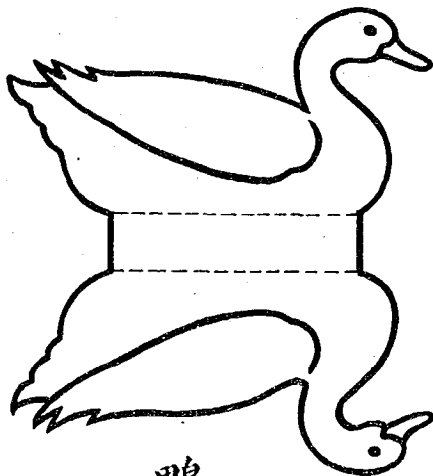

鴨

第一集 第二十五組 河

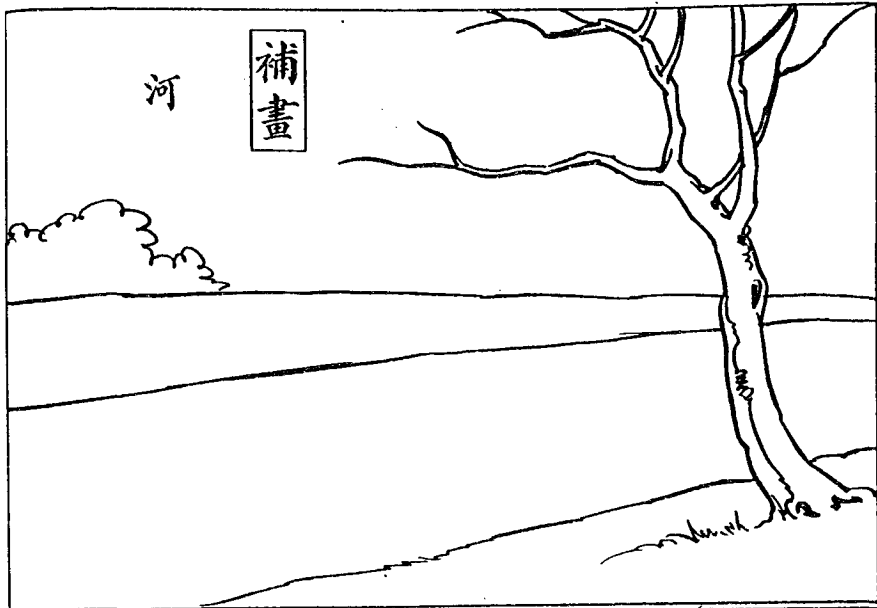

河

補畫



沙盤裝排

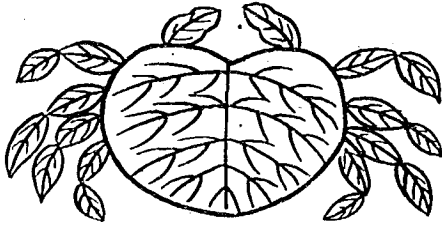

葉貼

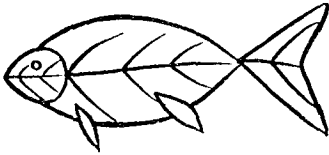

貼紙工

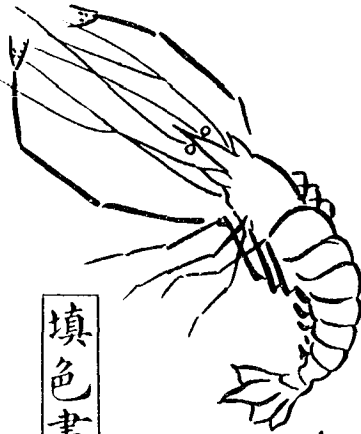

填色畫

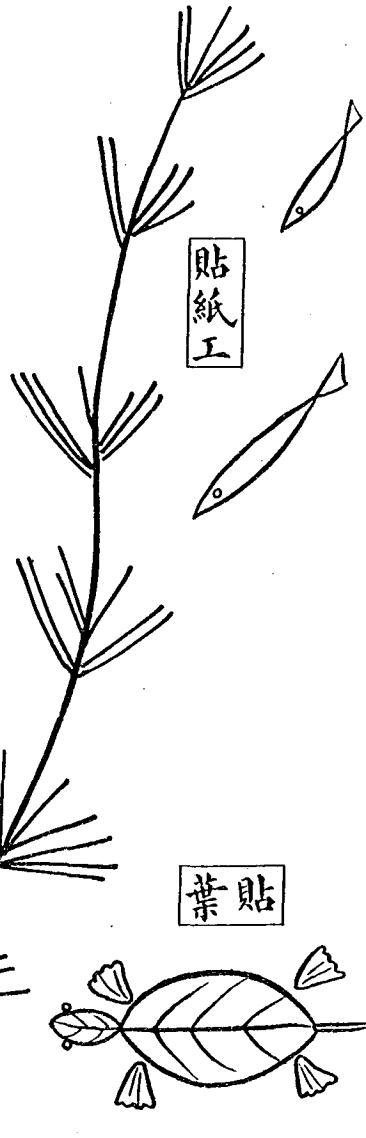

葉貼

第一集 第二十六組 船

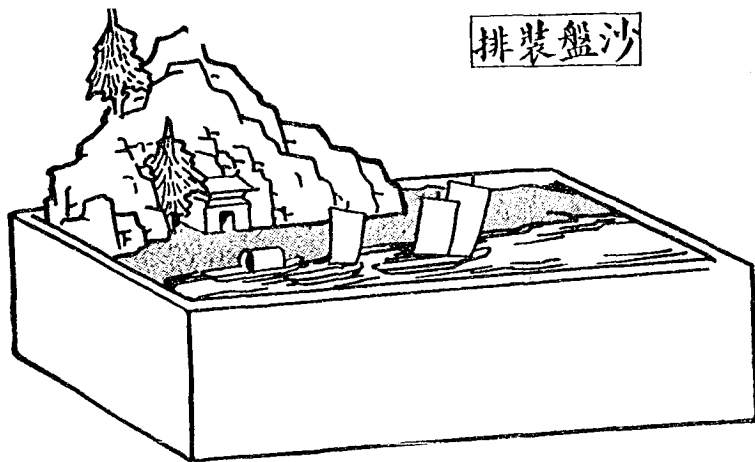
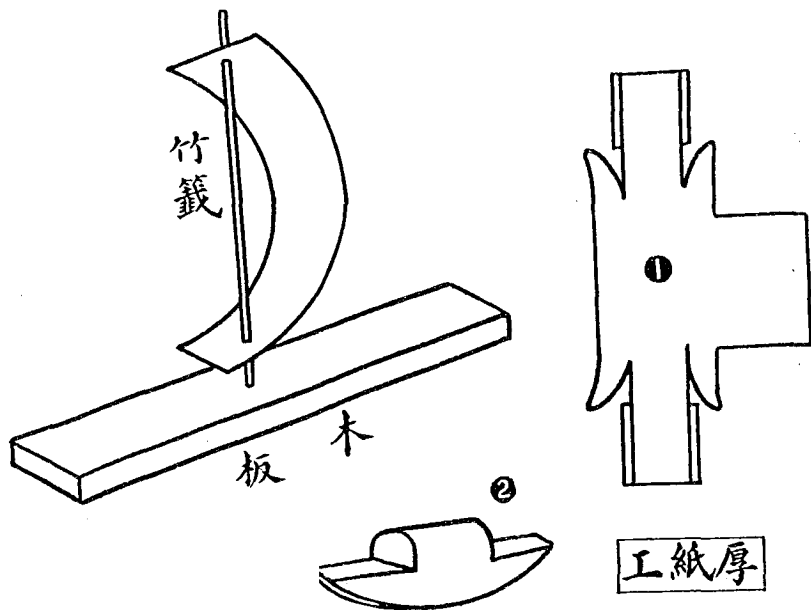

第一集 第二十六組 船

貼紙工

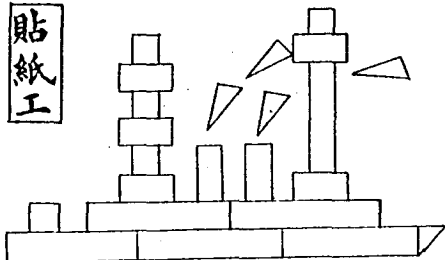

填色畫

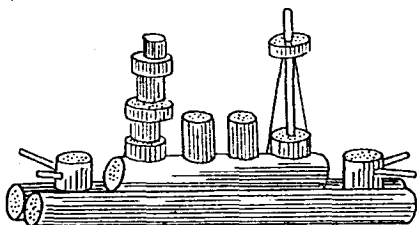

高梁桿的做兵艦

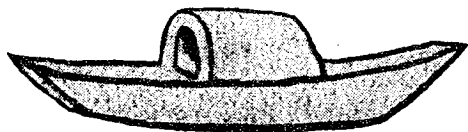

泥做的船

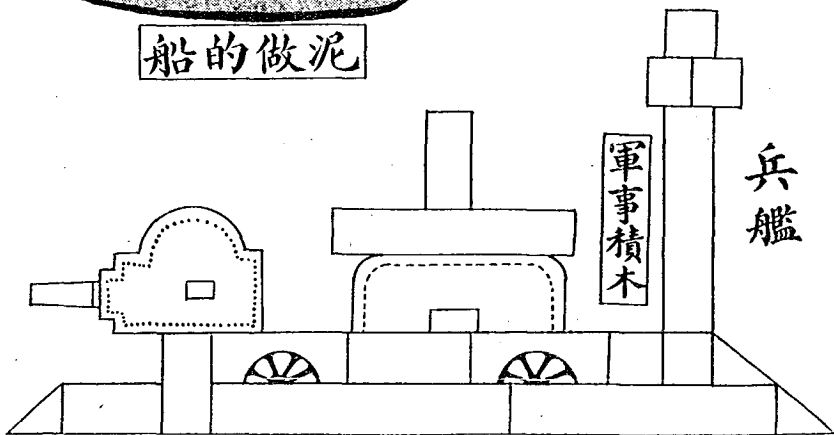

軍事積木

兵艦

橋 組七十二第 集一第

排裝盤沙

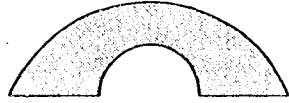
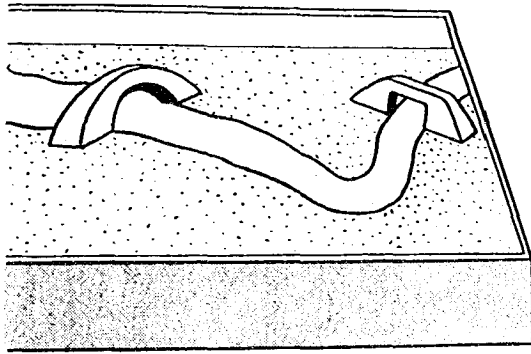

工泥

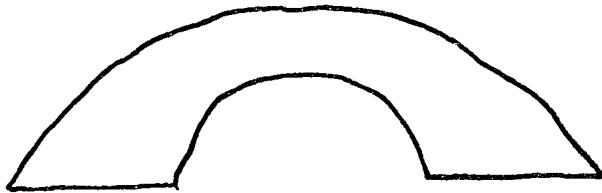
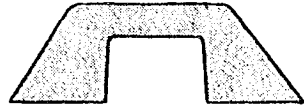

工紙剪

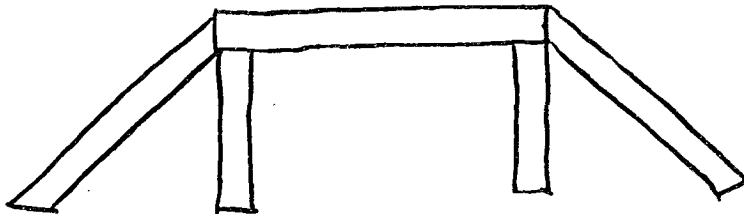

橋 組七十二第 集一第

謎畫

9 8
10 7

5 4
6 3

14

橋

13

15

11

12

1

2

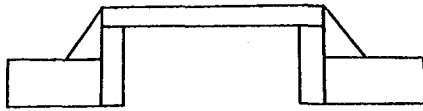

積木裝排

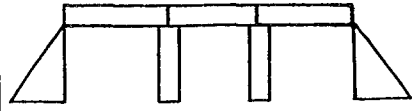

積木裝排

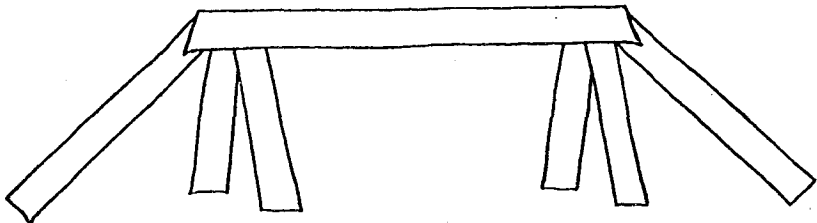

紙條工

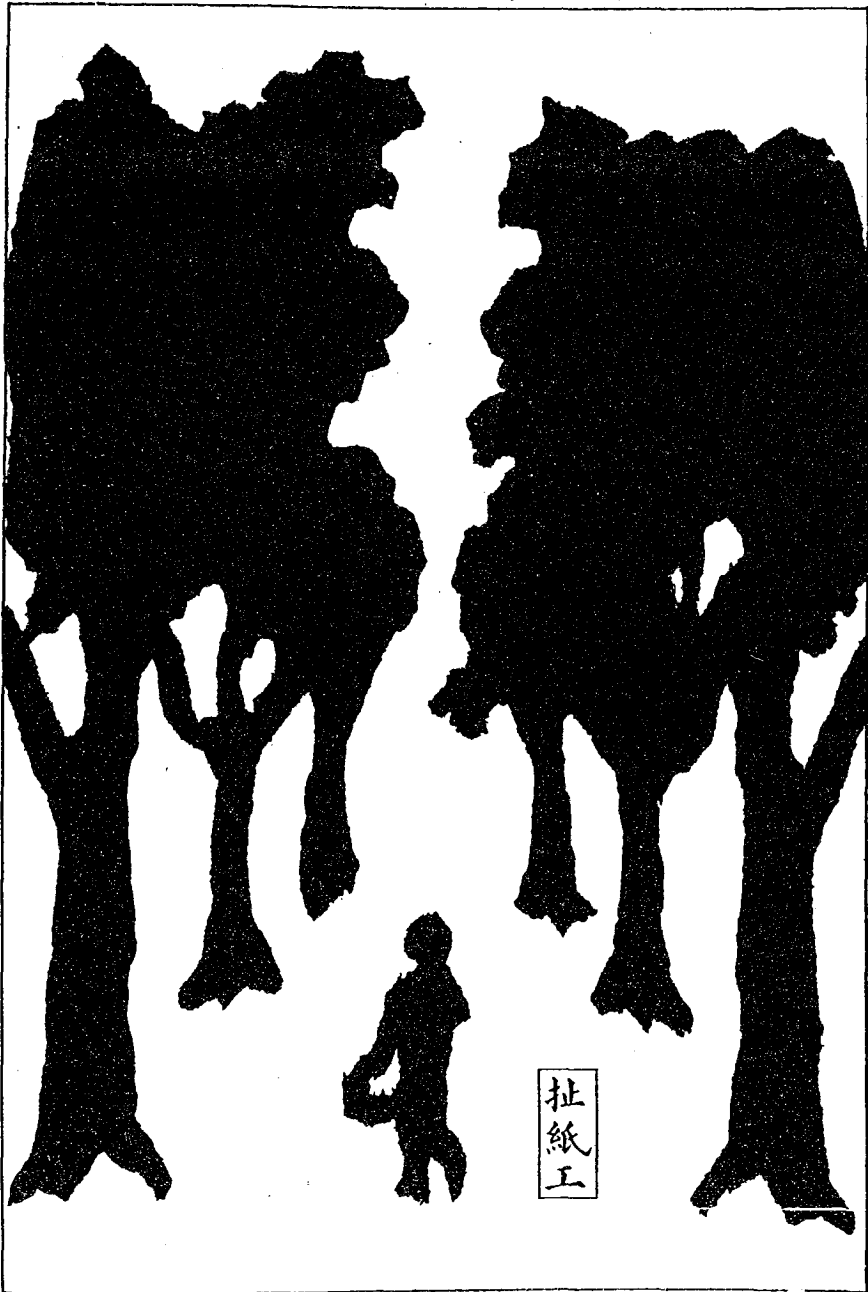

路 組八十二第 集一第

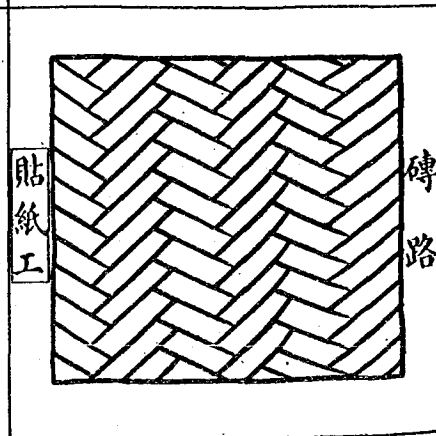
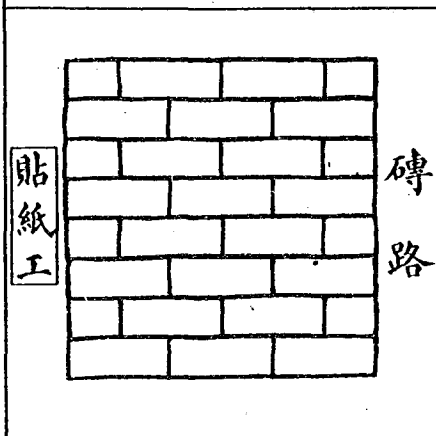
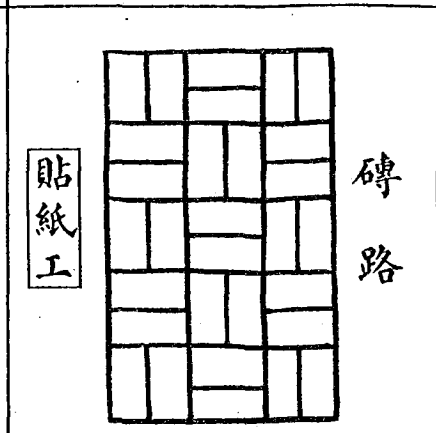
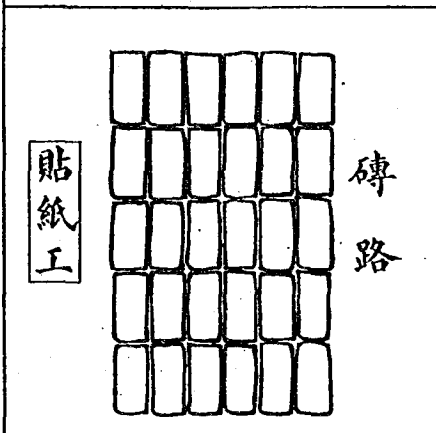
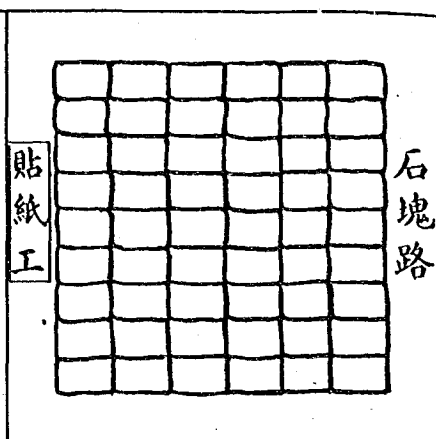
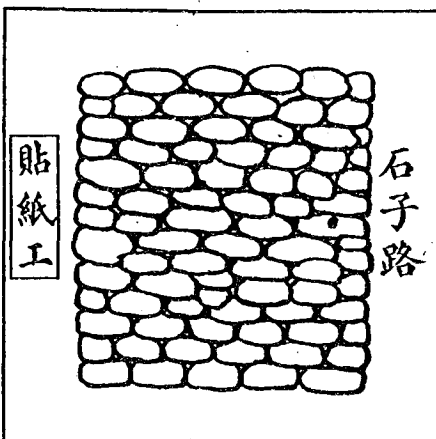

城 組九十二第 集一第

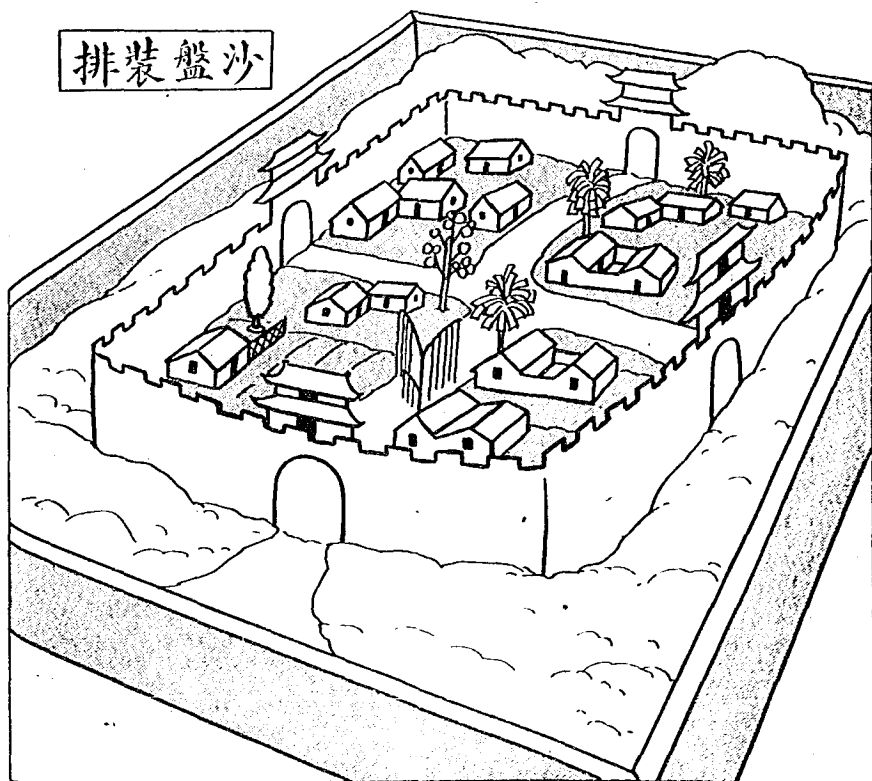
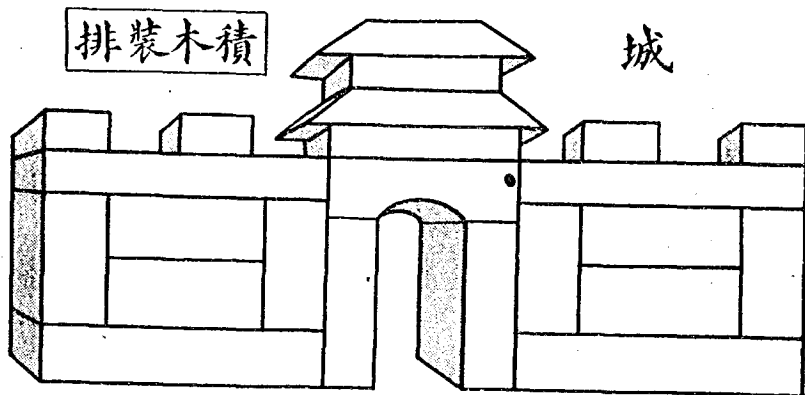

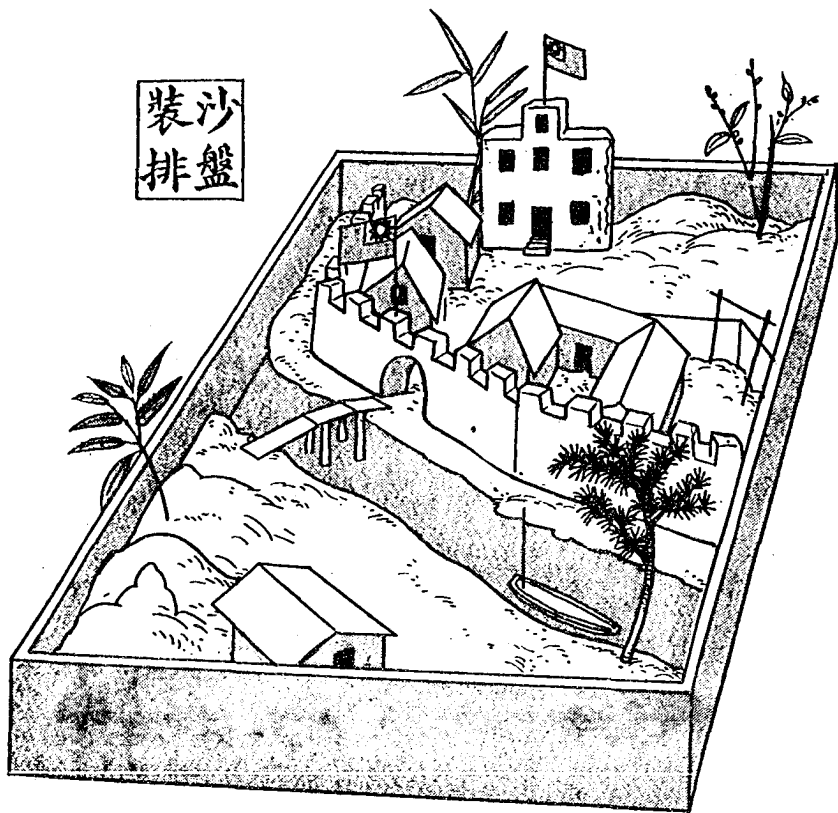
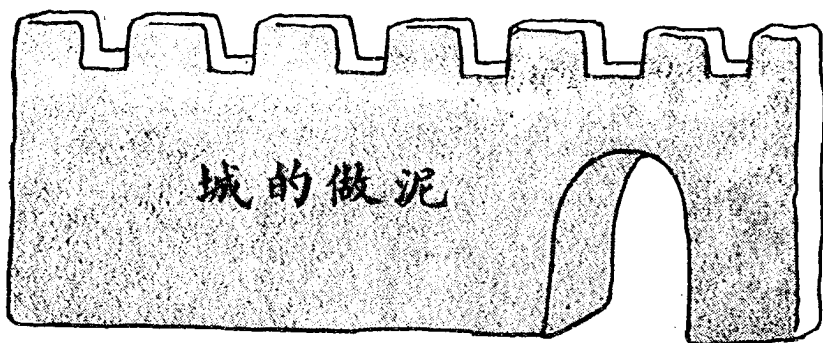

山 組十三第 集一第

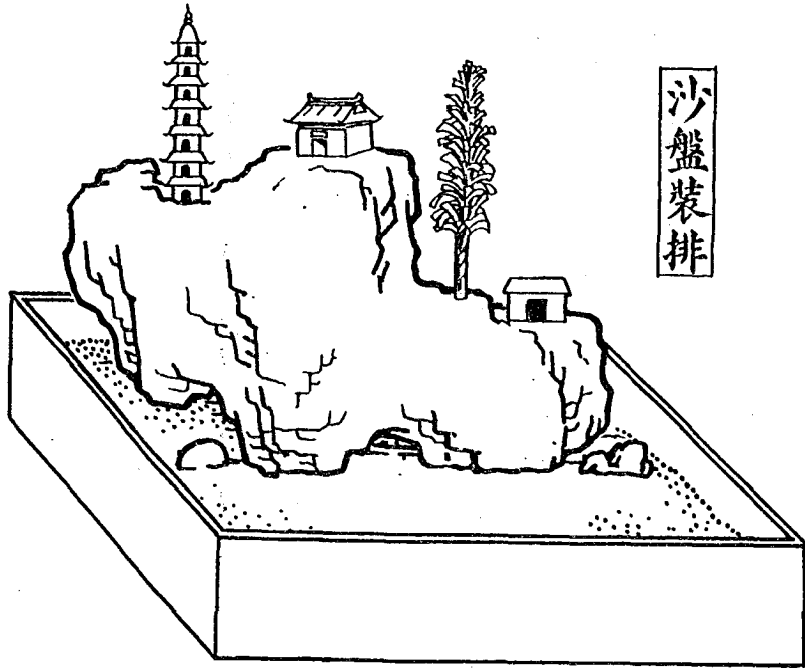

沙盤裝排

品物排裝

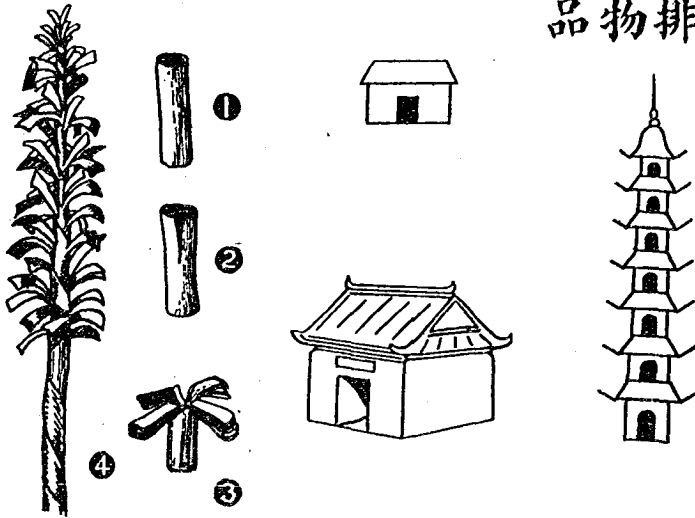

山 組十三第 集一第

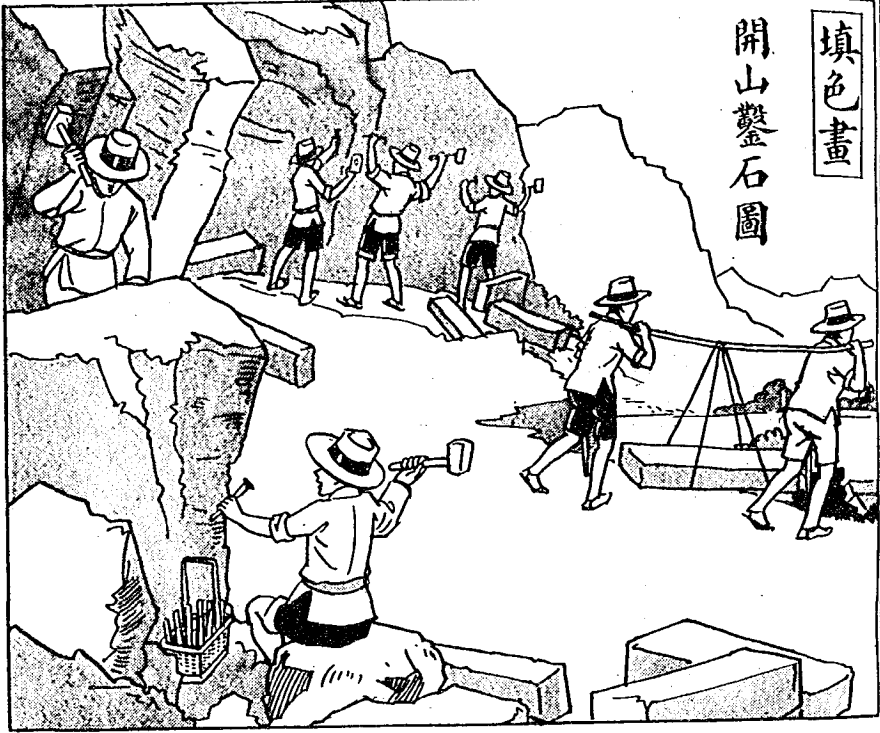

填色畫

開山鑿石圖

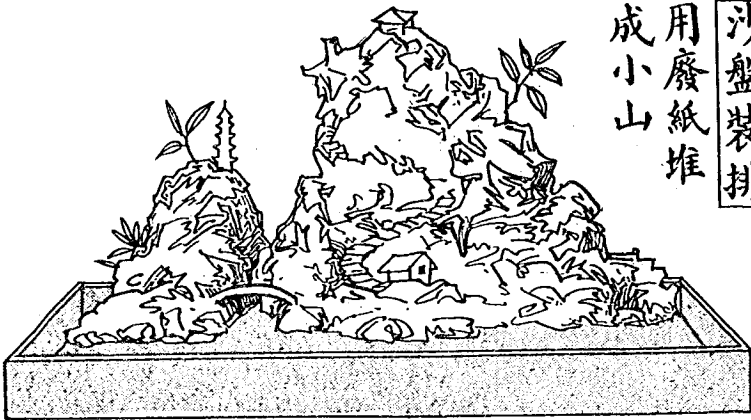

沙盤裝排

用廢紙堆
成小山

星 組一十三第 集一第

穿線工

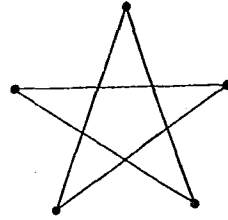
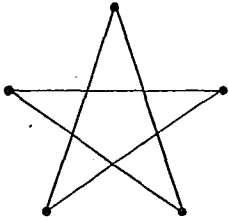
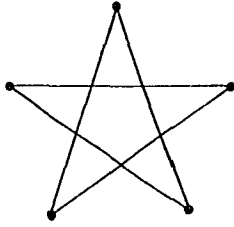
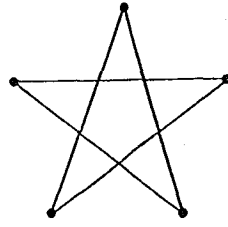
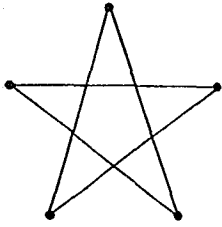

工紙硬

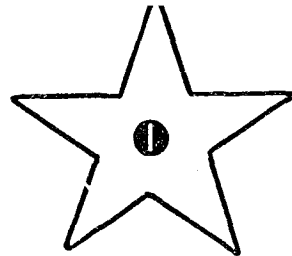
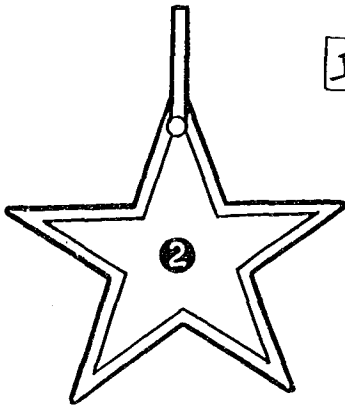

星 組一十三第 集一第



貼紙工



剪紙工

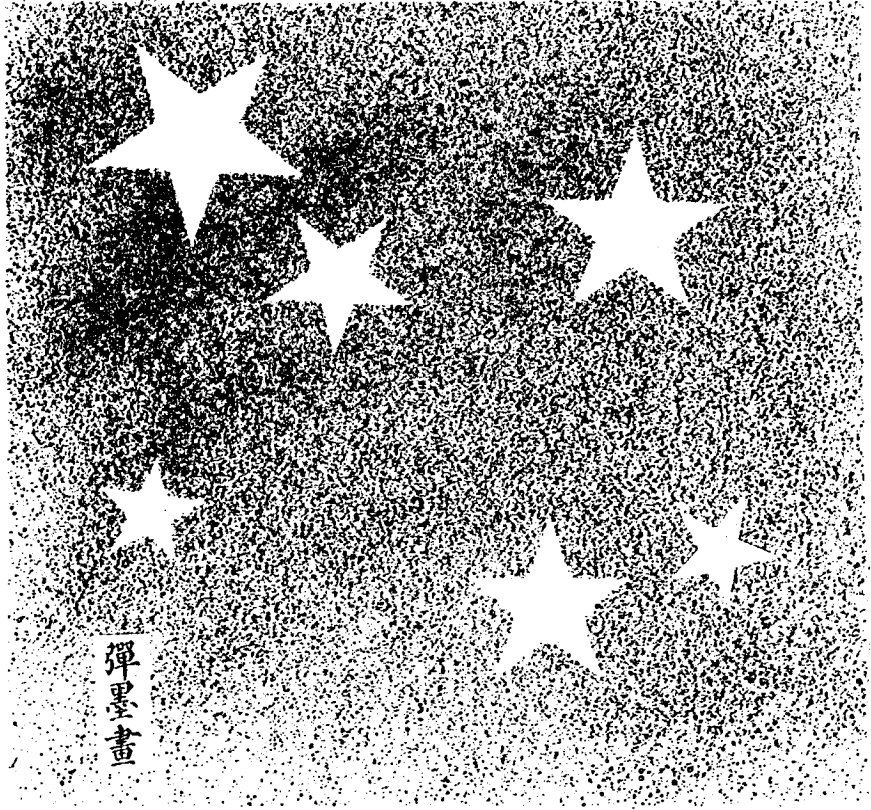

彈墨畫

雲 組二十三第 集一第

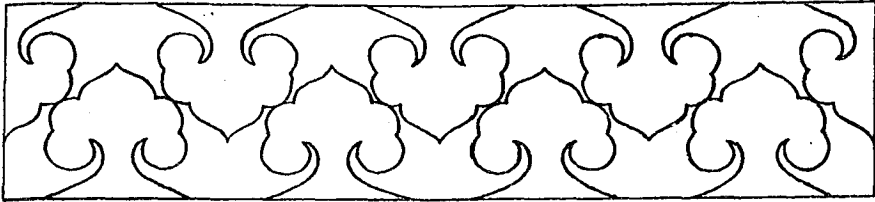

色着案圖

⑥

①

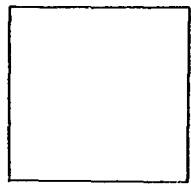
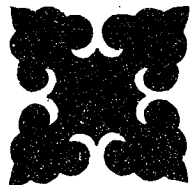
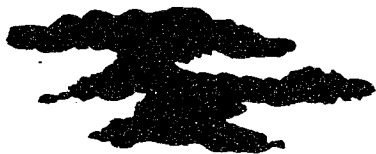

②

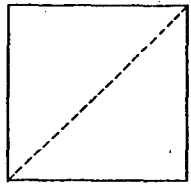

③

撕紙工

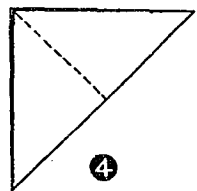

④

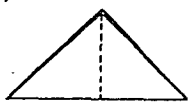

⑤



剪紙工



飛機

填
色
畫

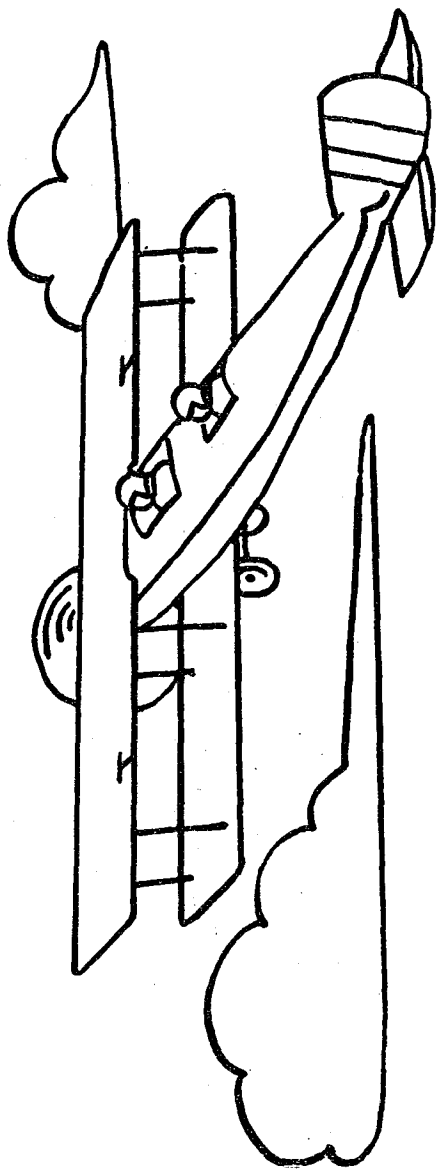
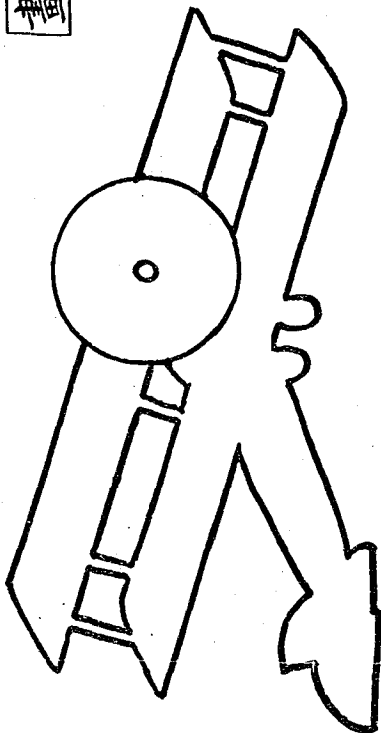

風 · 組三十三第 集一第

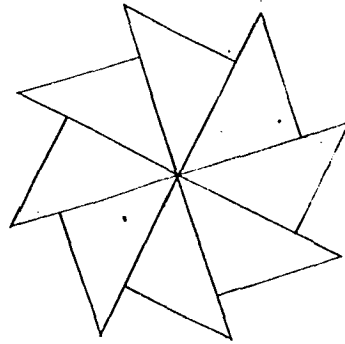
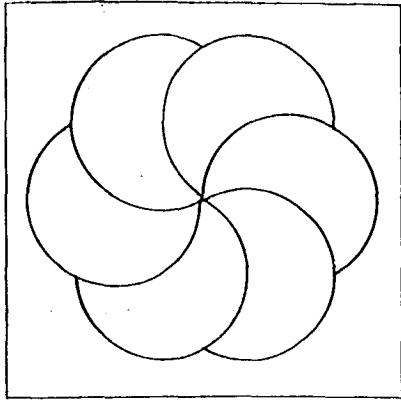

工貼剪

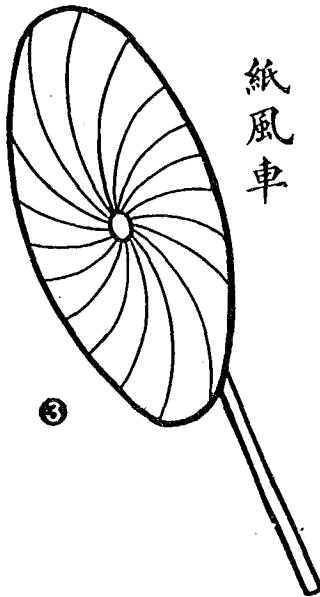

紙風車

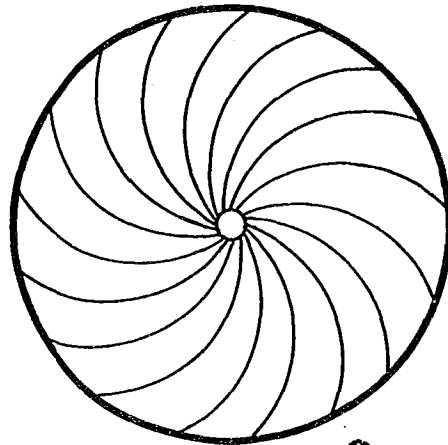

工紙貼

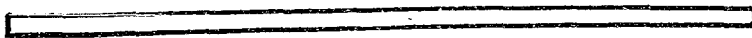

②

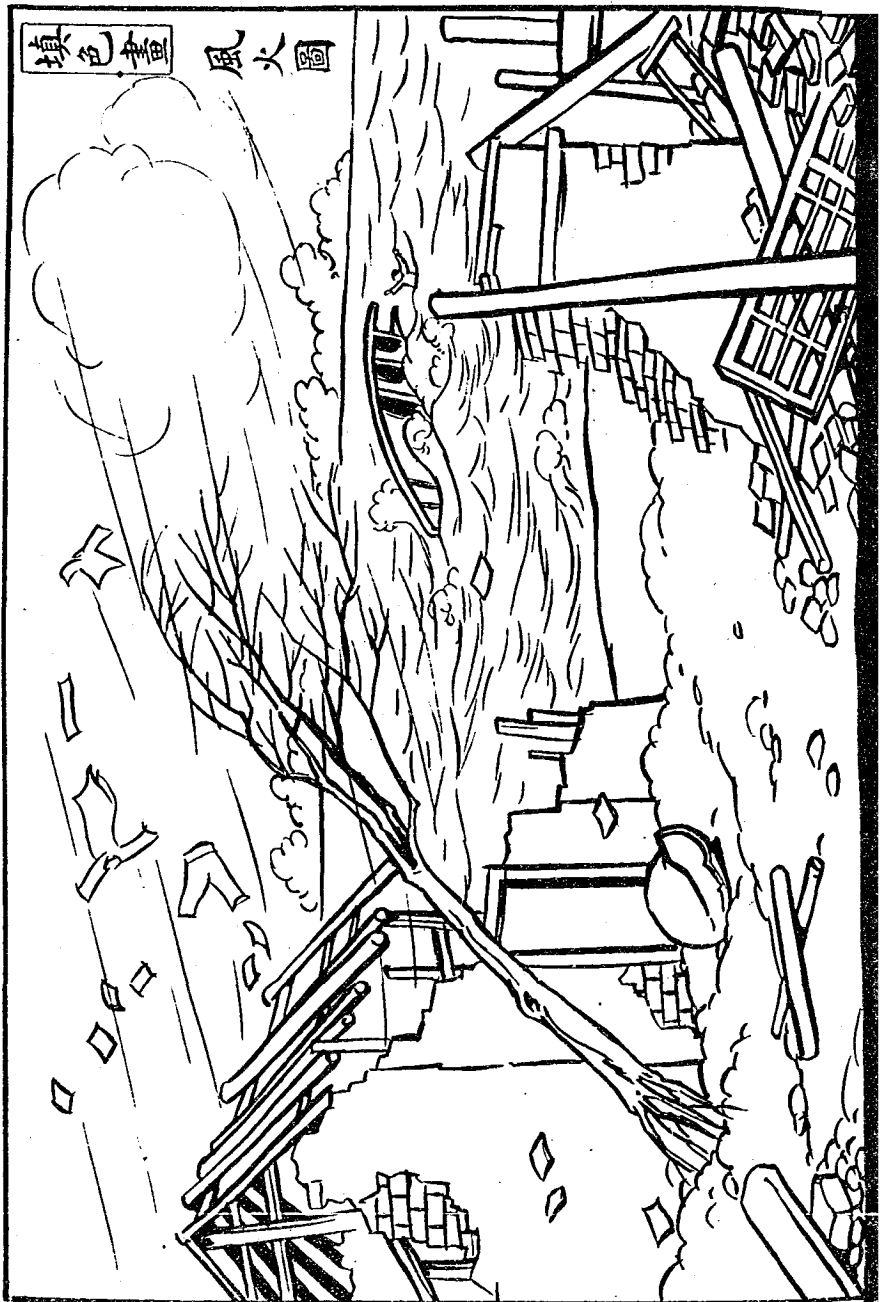



填色畫

加畫雨

第一集 第三十四組 雨

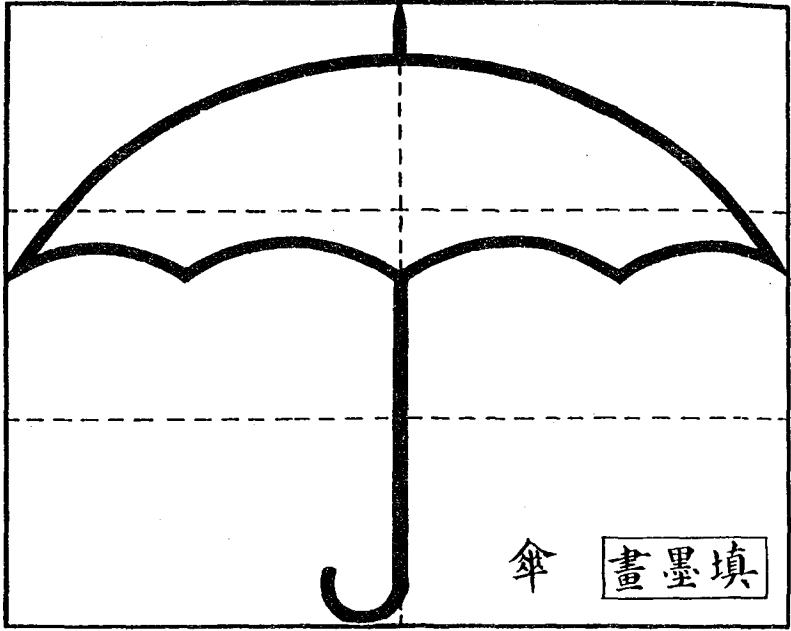

爸爸 組五十三第 集一第

工紙貼

帽子

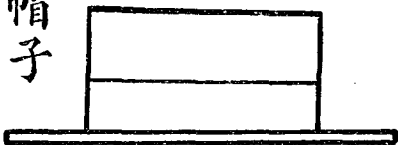

鏡眼的做絲鉛

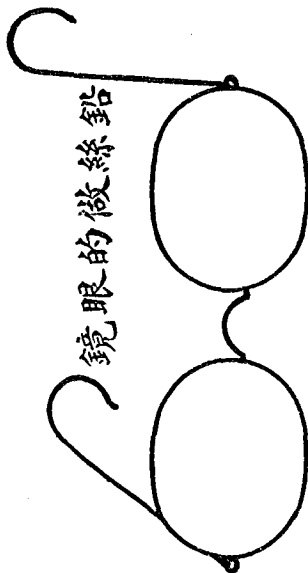

睛眼



填充畫

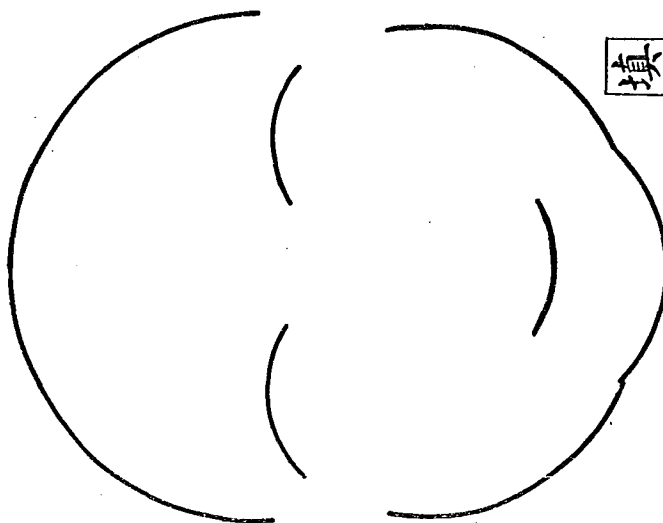

自己加
頭髮眼
睛鼻子
耳朵或
眼鏡



商人



教師



工人



軍人

填色畫



醫生

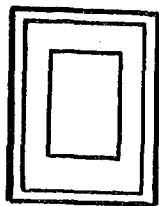

填色畫

工紙剪



媽媽 組六十三第 集一第

篦

工紙剪

梳木

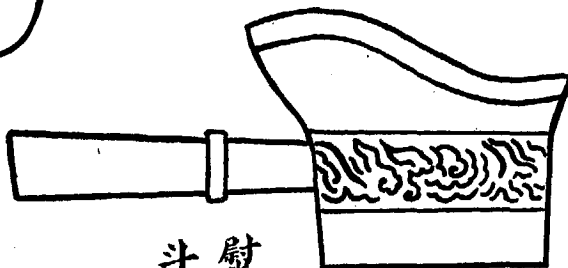
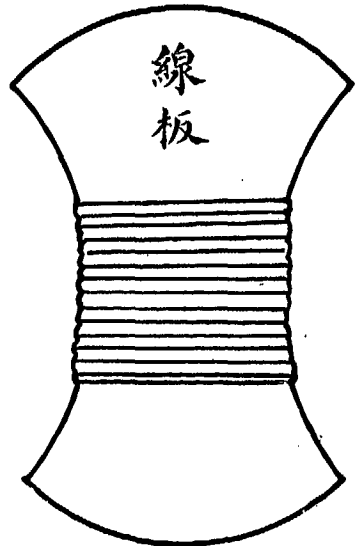
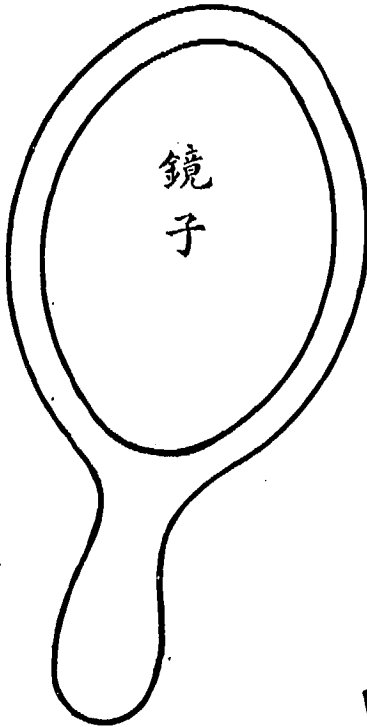
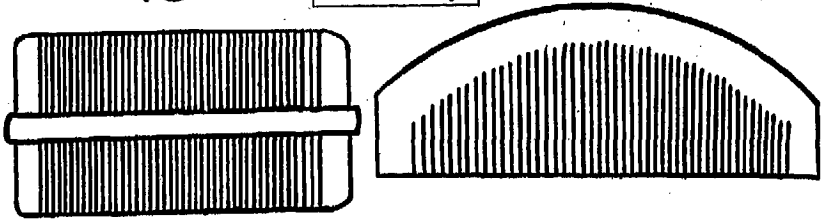

拼圖

先着色
後剪開
再拼着玩

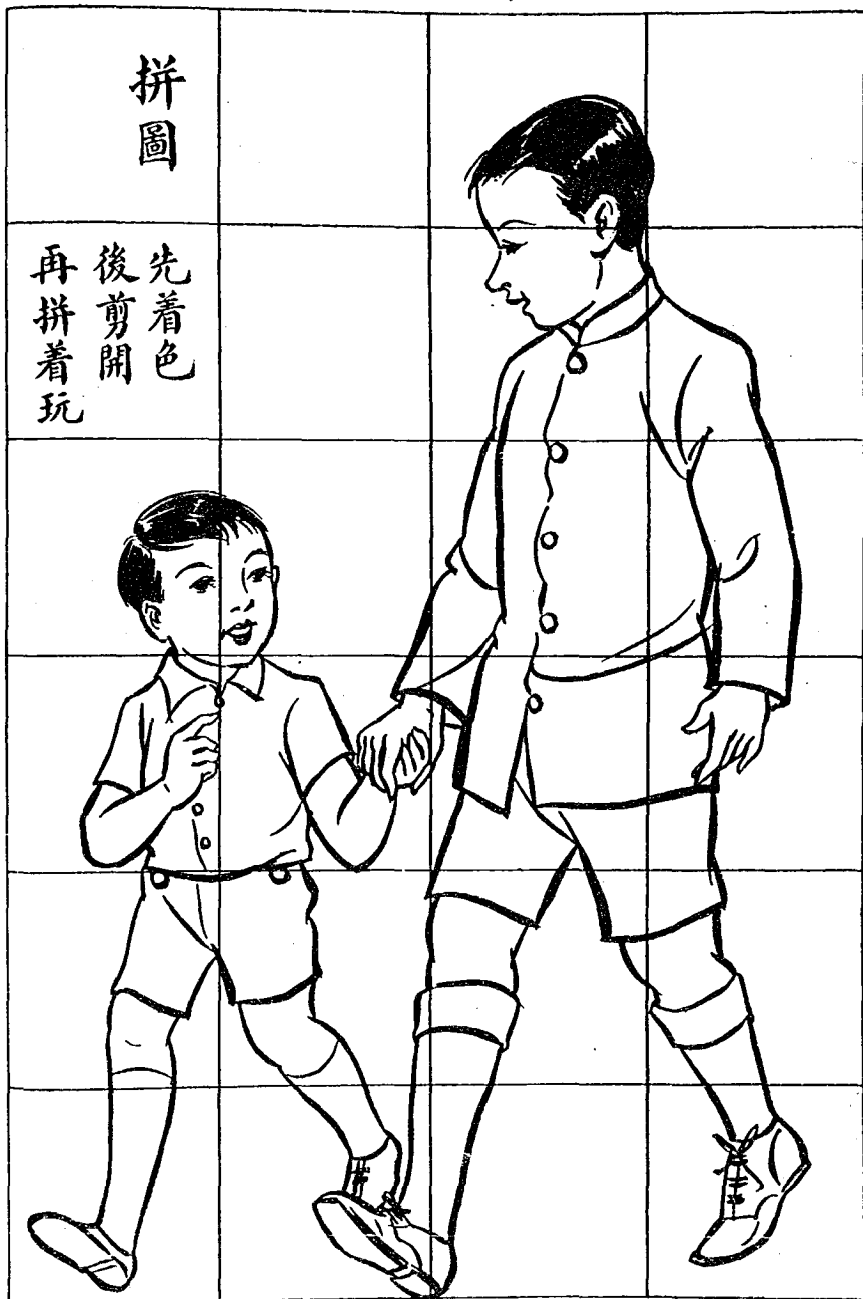

①

簽書

夾紙

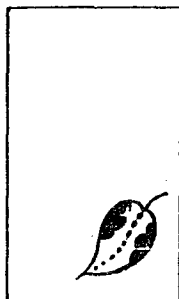
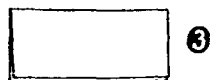
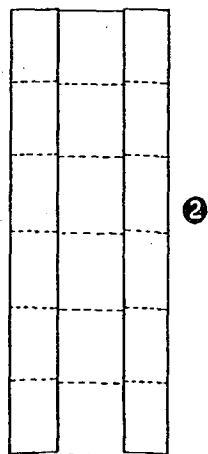
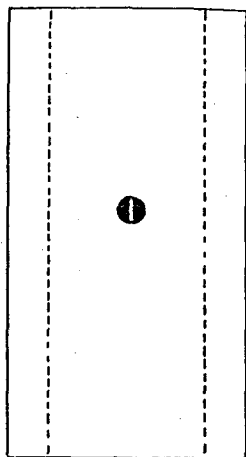
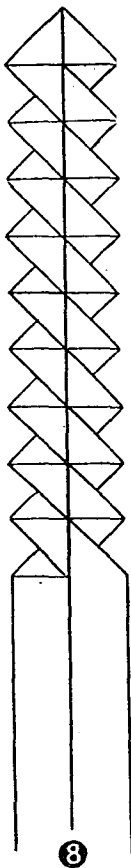
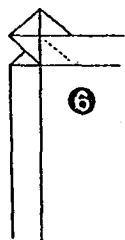
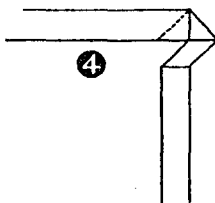
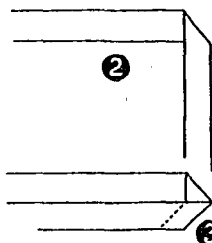
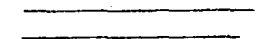

紙夾上畫的花樣

硬紙工

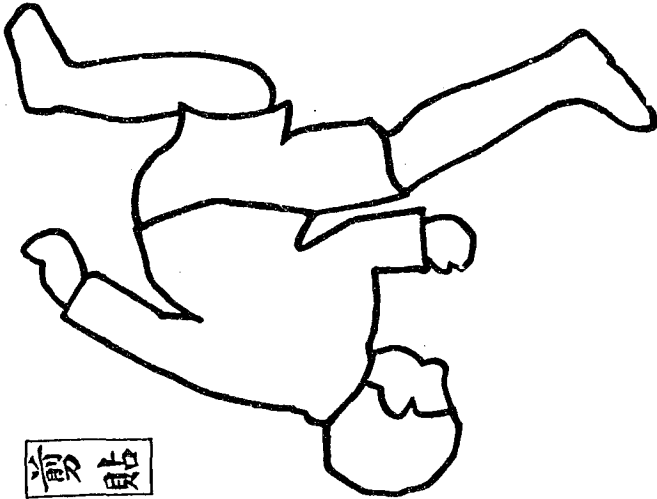
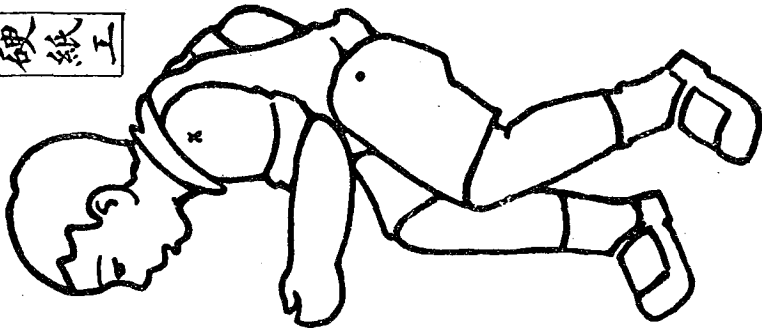

剪貼

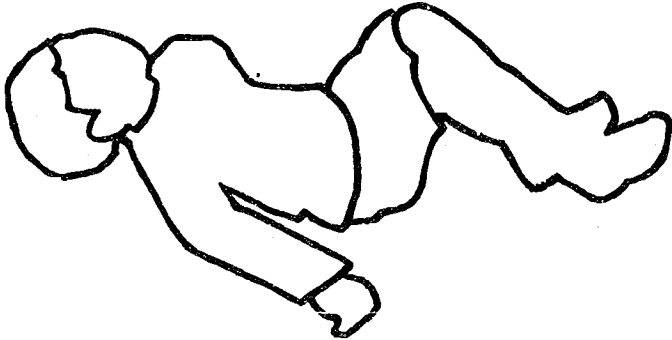

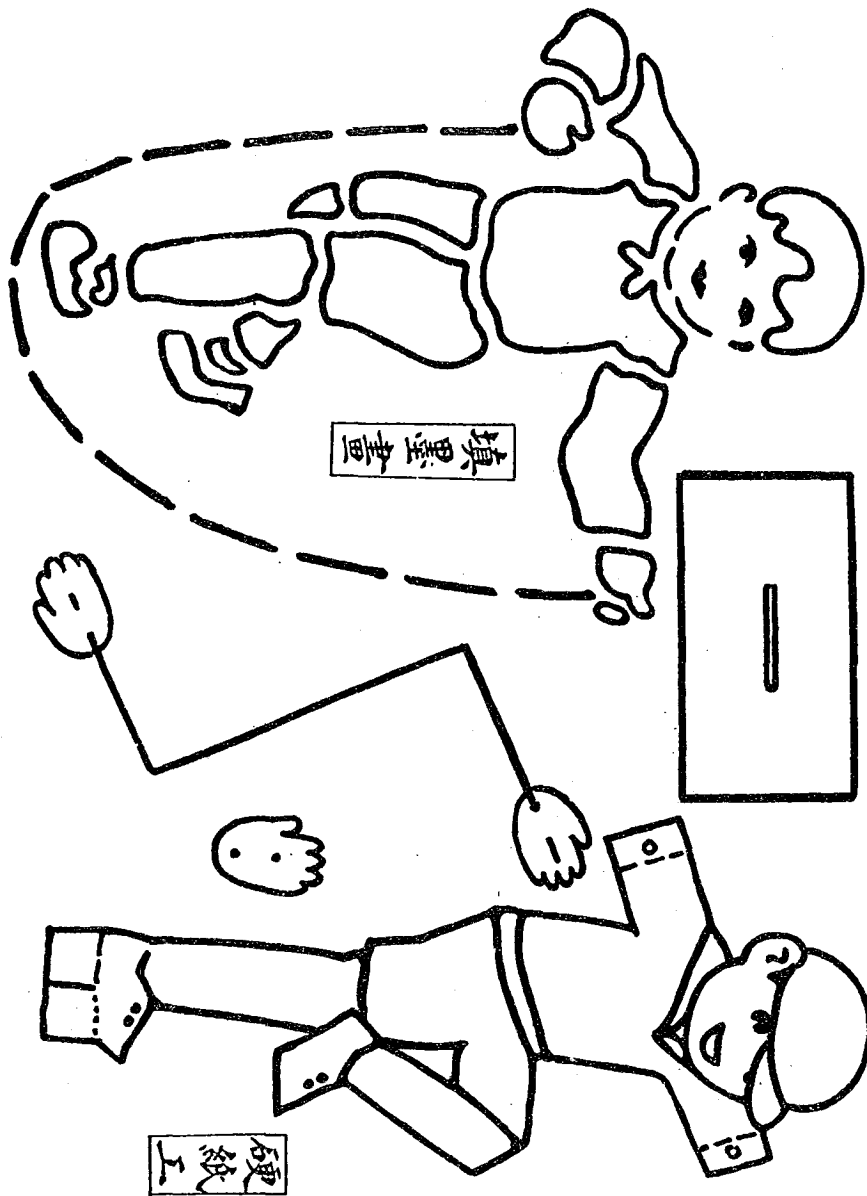

穿線工姐姐

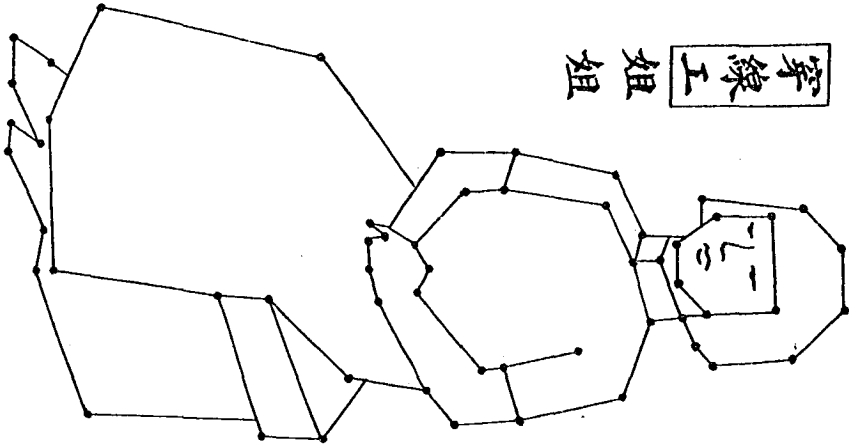

手車上的蓬子

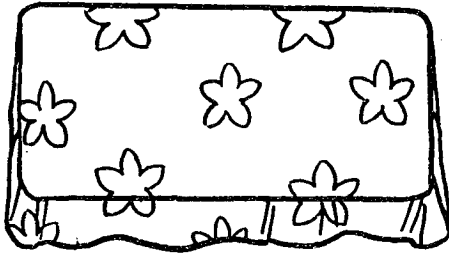

果子做的小娃娃

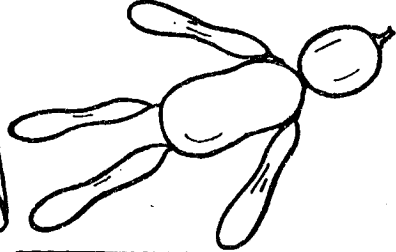

小娃娃戴的帽子

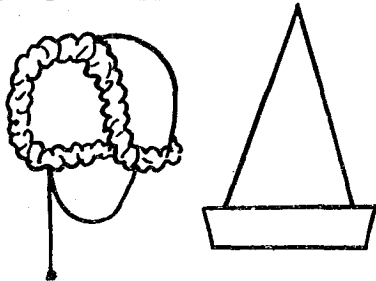

泥做的車手

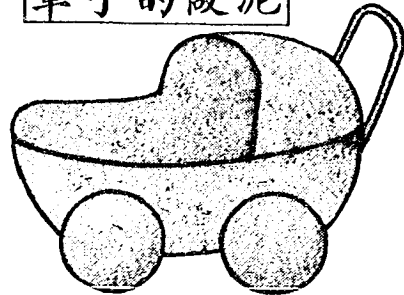

小娃娃睡覺用的東西

紙做的枕

紙做的被

做床的紙毯子

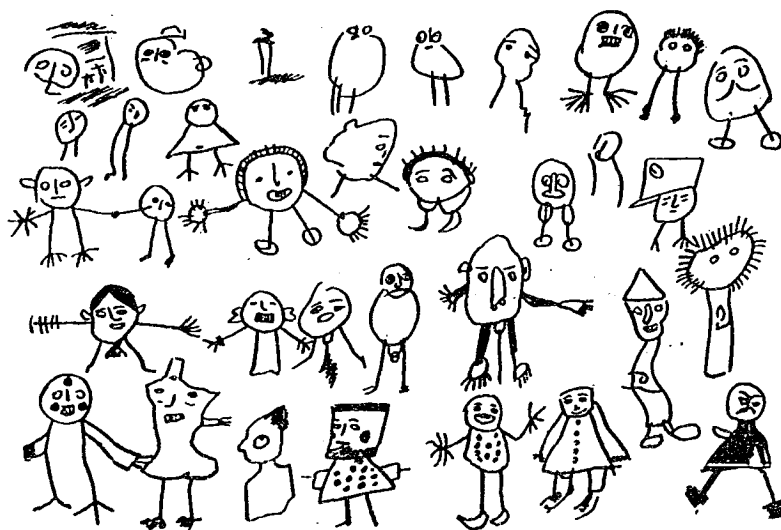
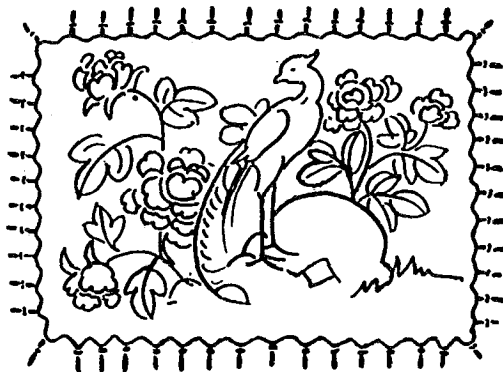
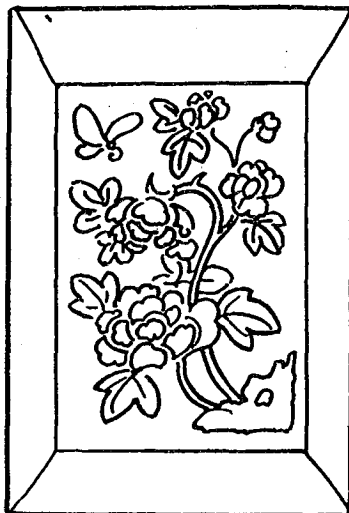
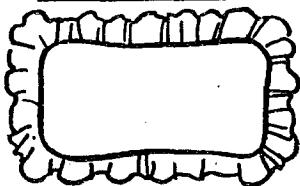

人物畫舉例

第一集 第十四組 妹妹

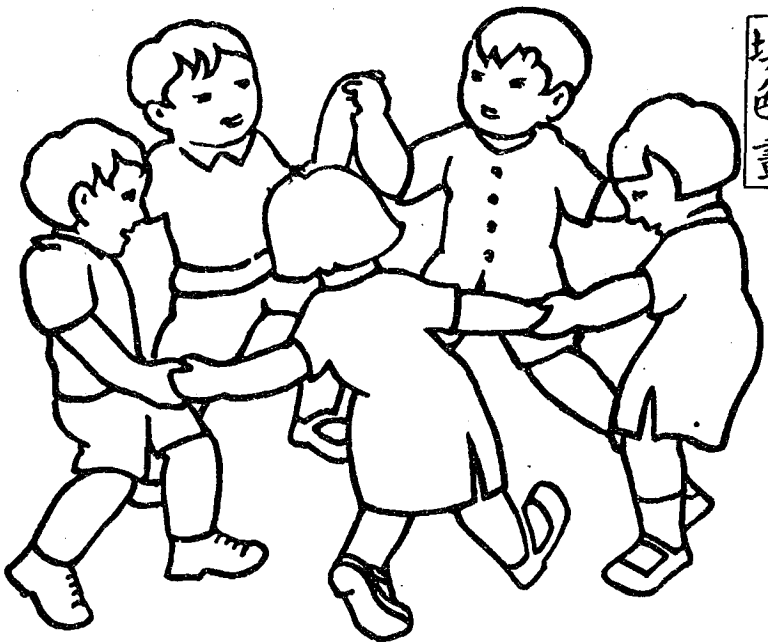

填色畫



填墨畫

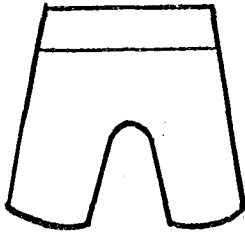

子褲

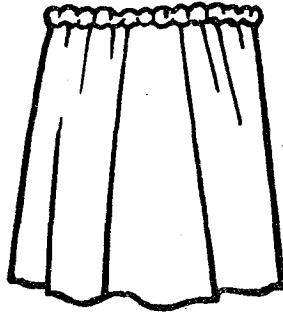

子裙

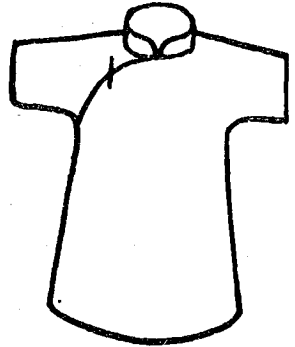

衫短

服衣的穿娃娃小

例舉畫物人



花種 組一第 集二第

畫色填

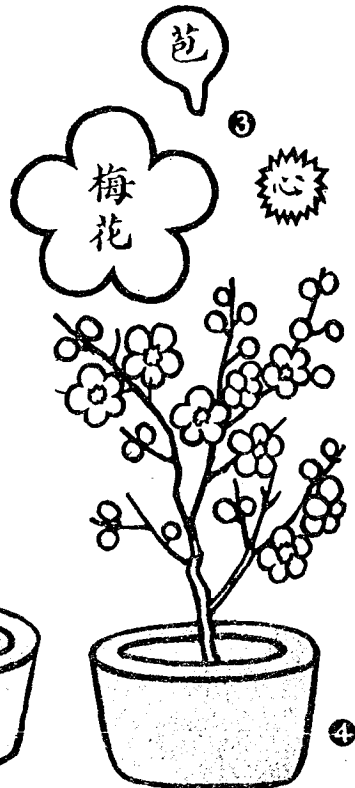
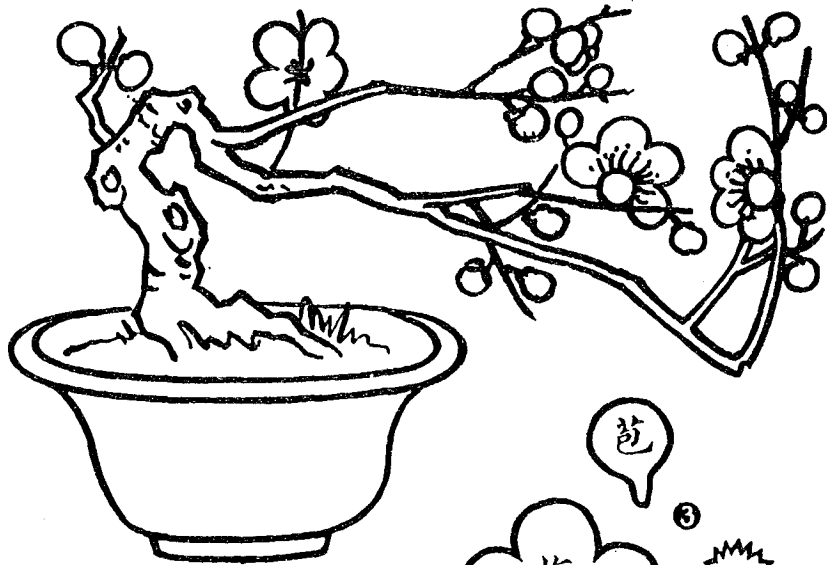

花種 組一第 集二第



剪貼工



襯紙用深色

花澆 組二第 集二第

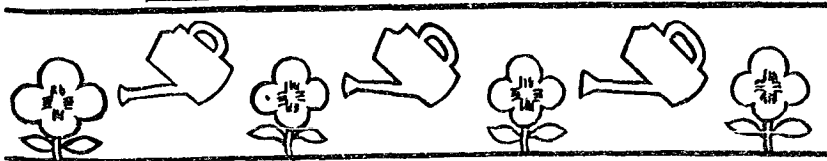
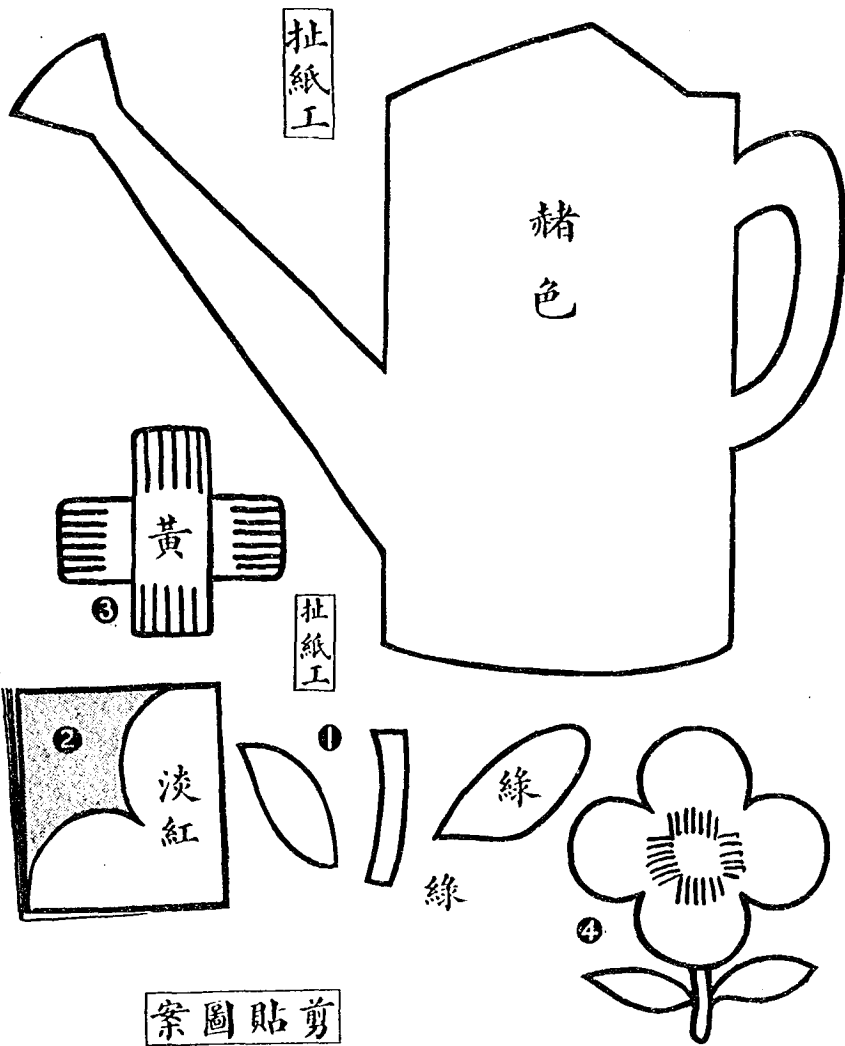

花澆 組二第 集二第

工泥

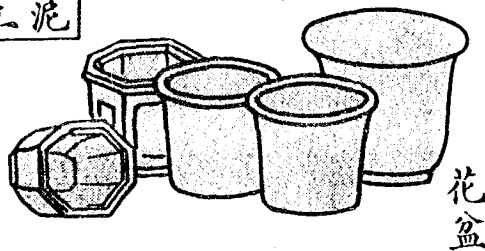
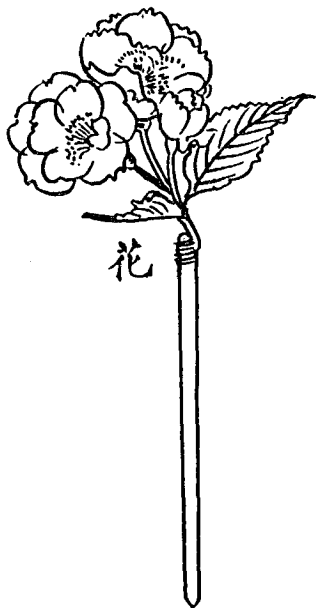

填色畫

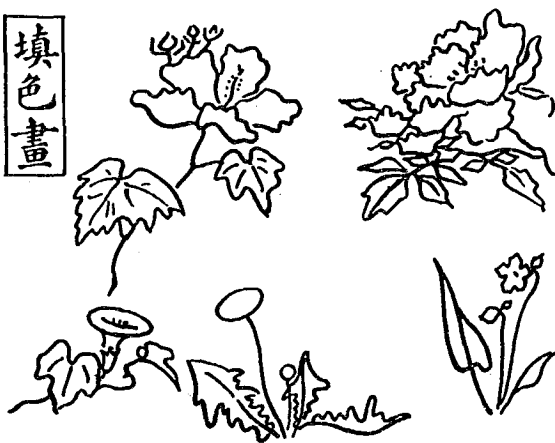

剪貼工

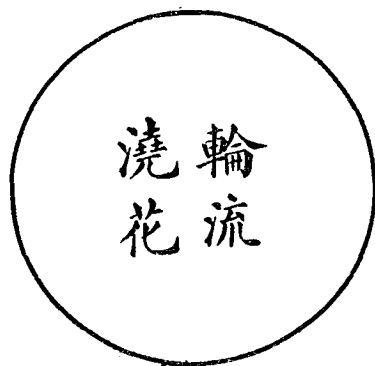
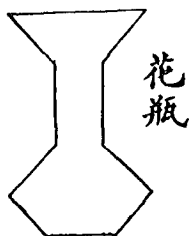

香燙的圖



平塗畫

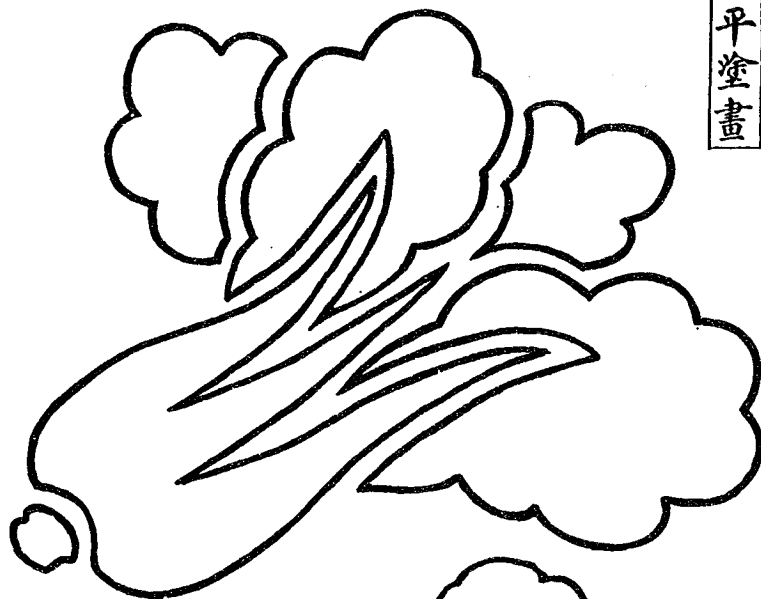

填色畫





鍋邊
黑色

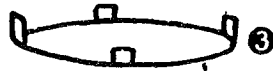
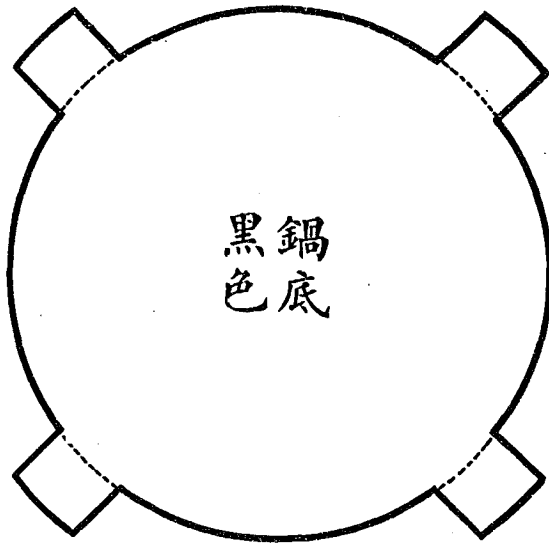

工條紙

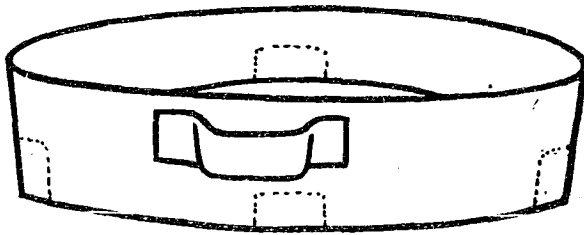

菜洗 組四第 集二第

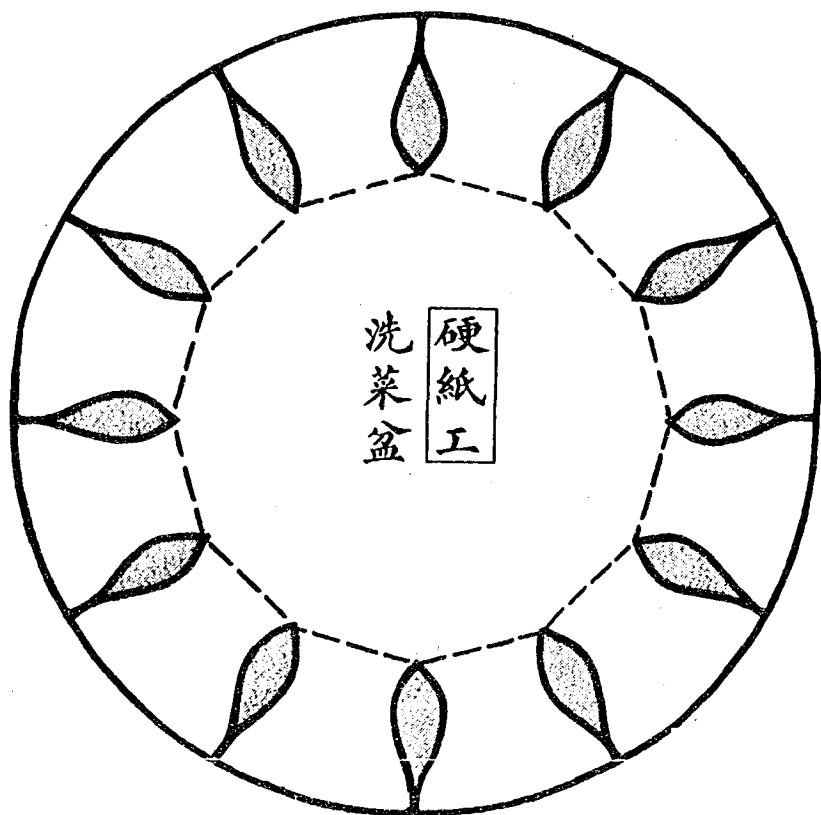
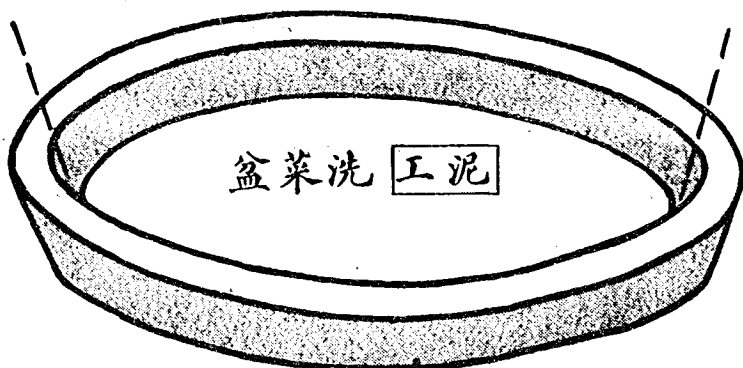

鍋洗 組五第 集二第

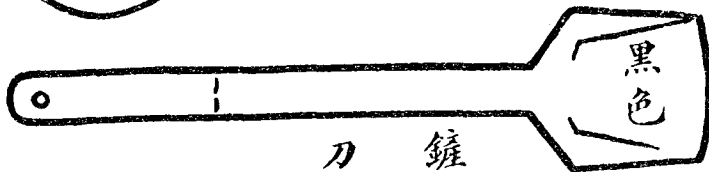
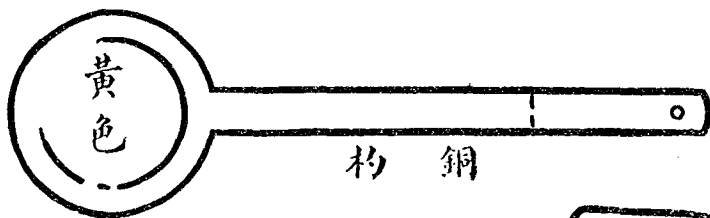
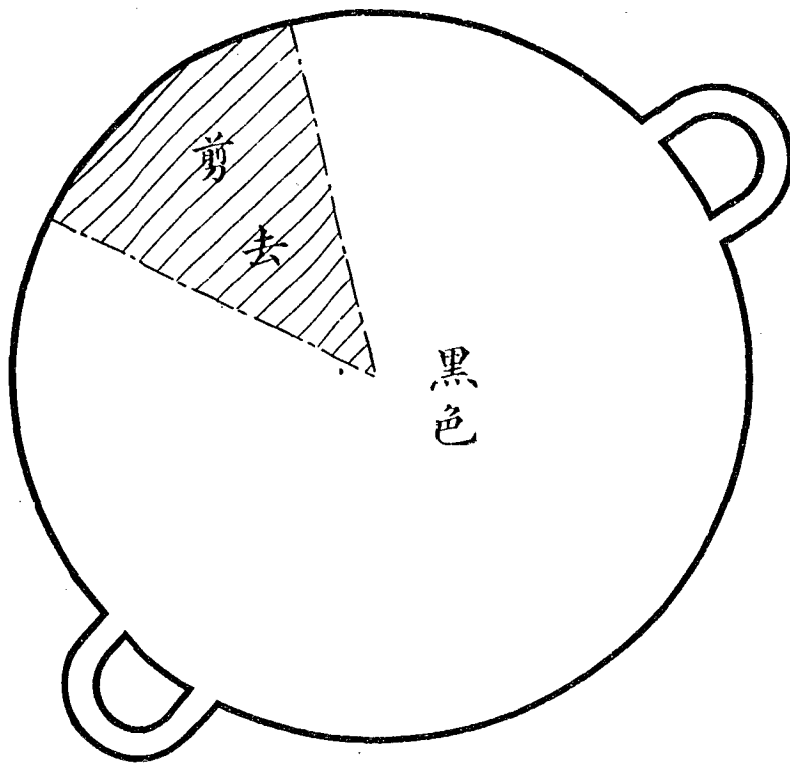

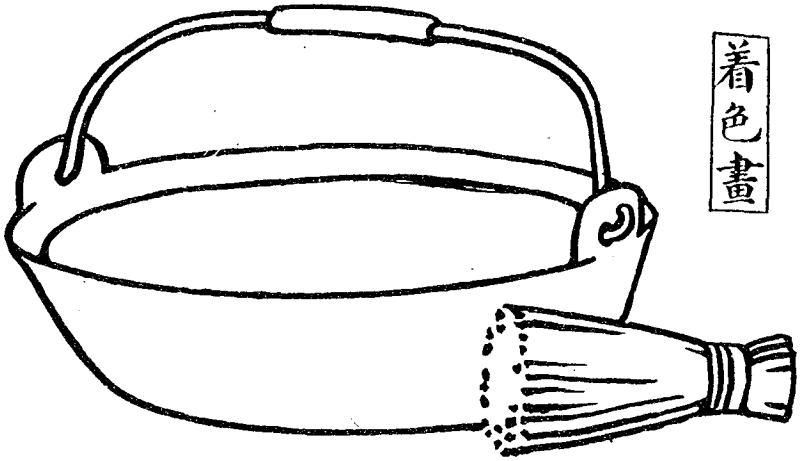

着色畫

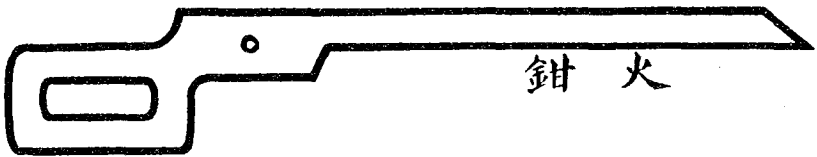

火鉗

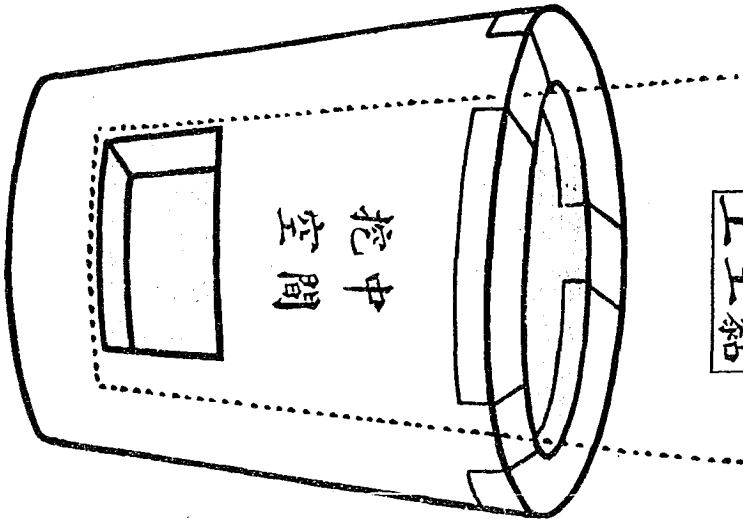

工土器

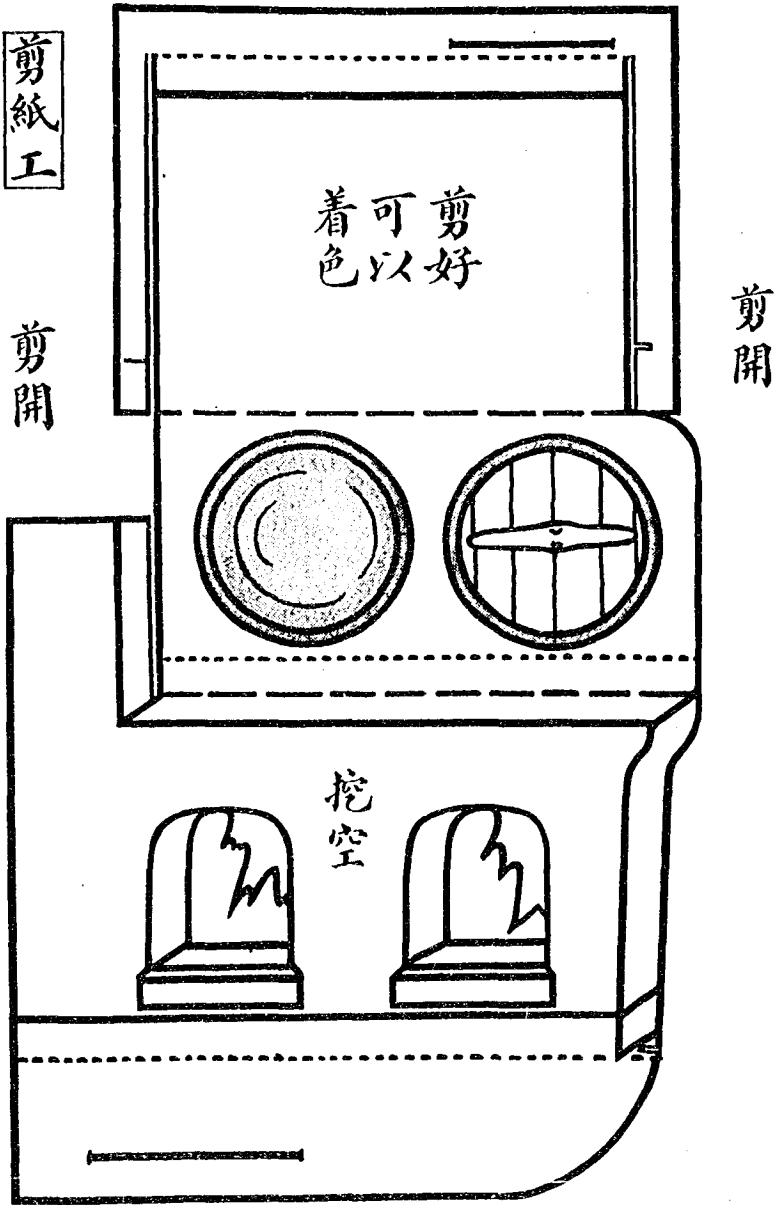

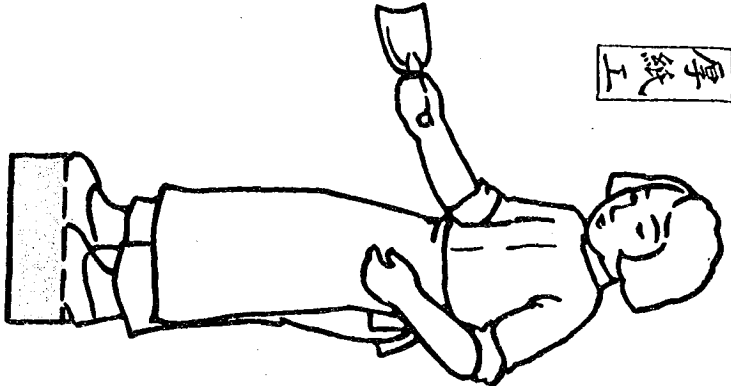

泥工

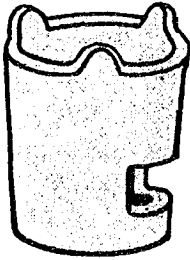

風爐



1



厚紙工

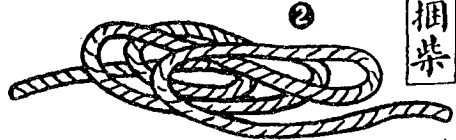

捆柴

2

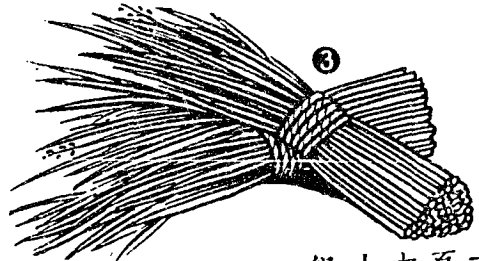

3

衣洗 組七第 集二第

帕手洗己自

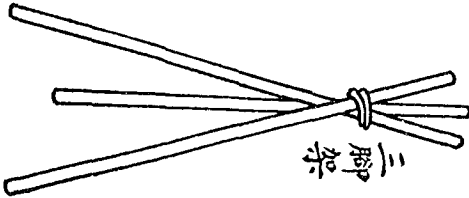
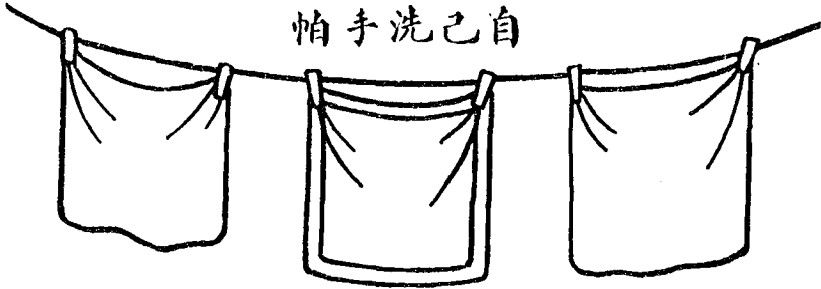

架三



刷板製泥



皂肥製泥

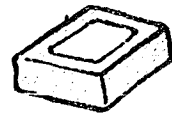

衣洗 組七第 集二第

剪花布用
成紙或花

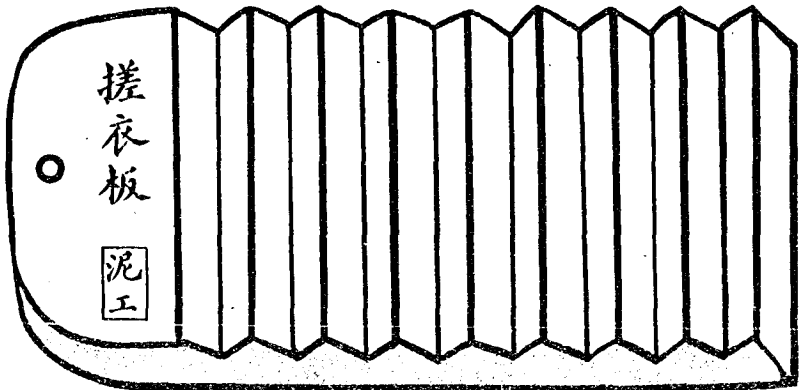
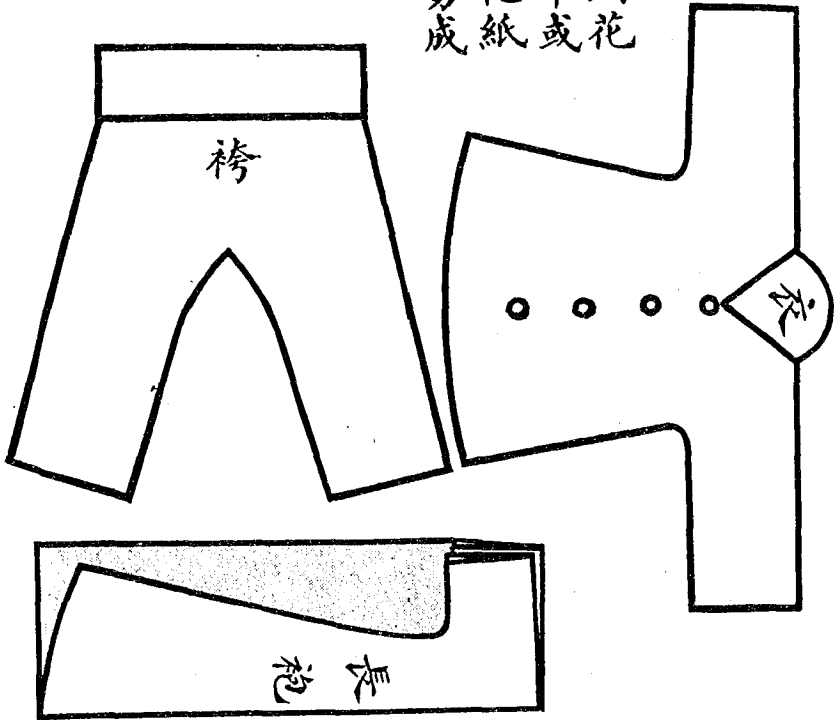

地掃 組八第 集二第

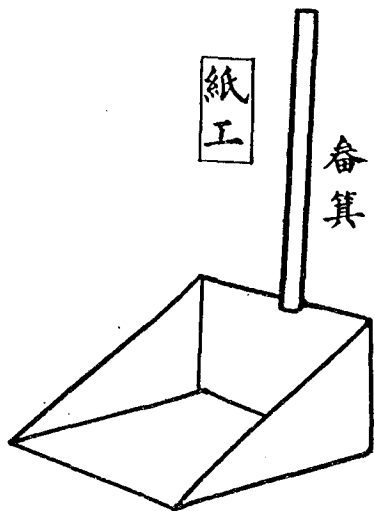

帚用竹枝紮

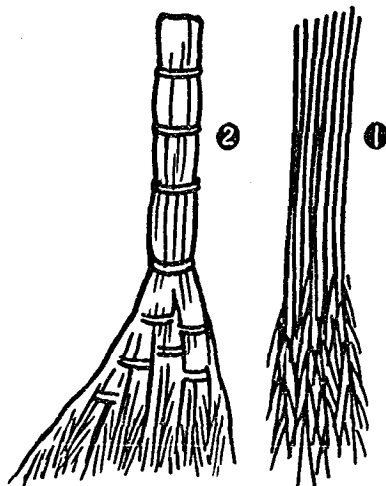

地掃 組八第 集二第

工紙摺

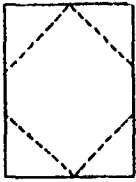

①

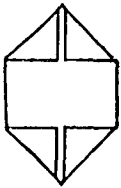

②

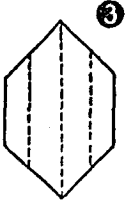

③

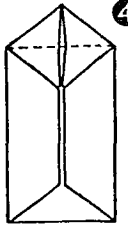

④

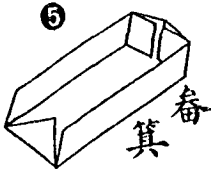

⑤

箕
畚

箕畚的做匣柴火

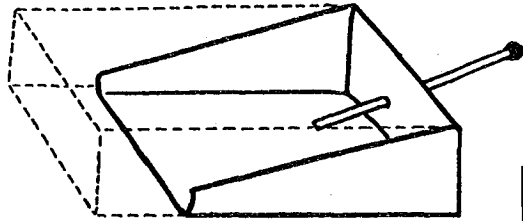

箕畚的成做紙張一

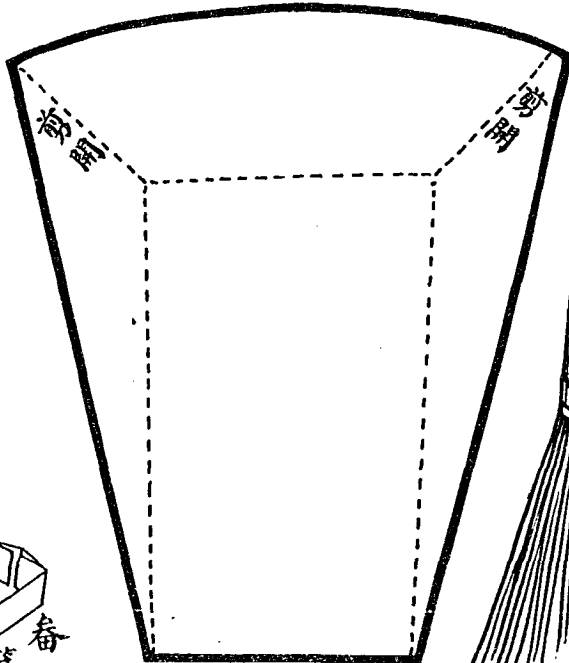

紫掃帚

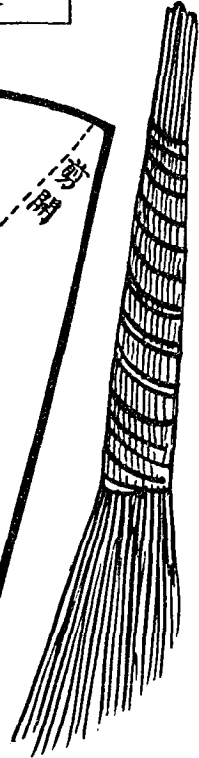

手洗 組九第 集二第

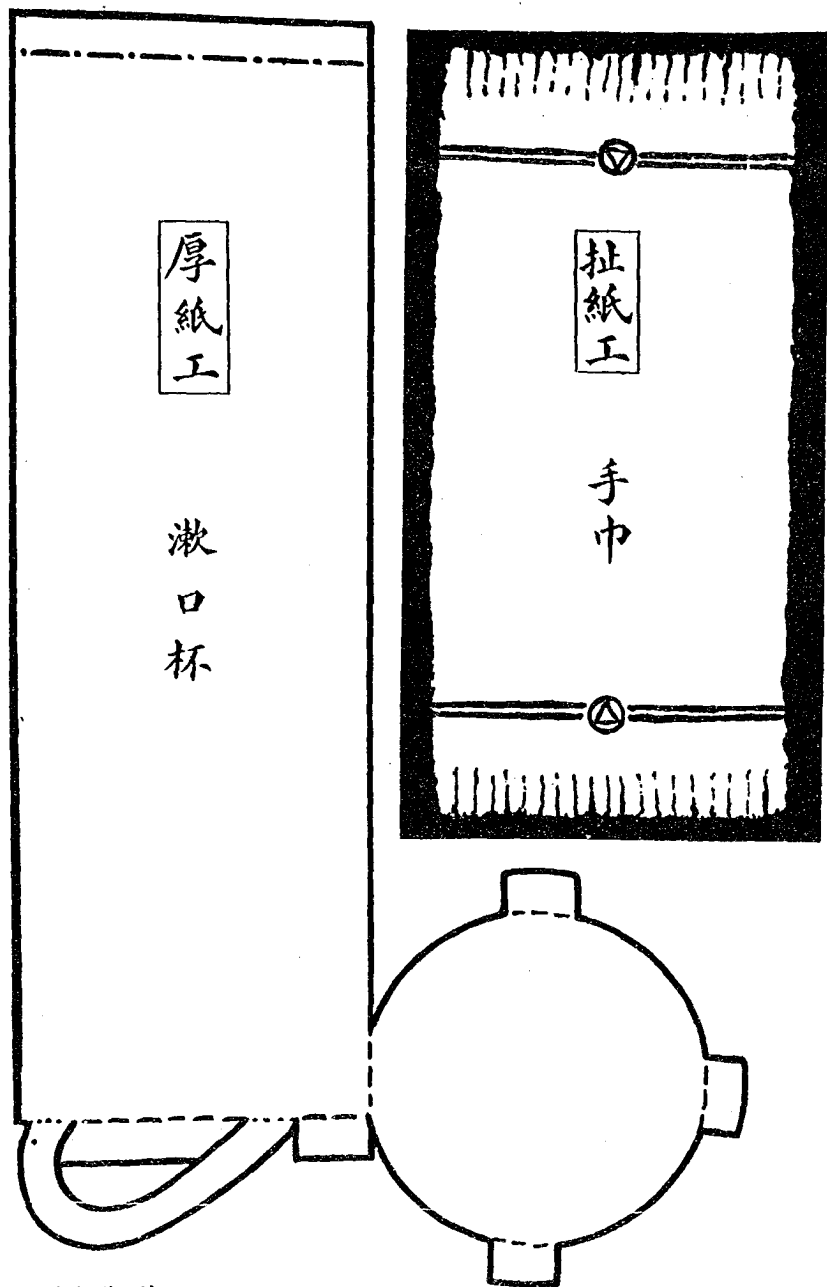

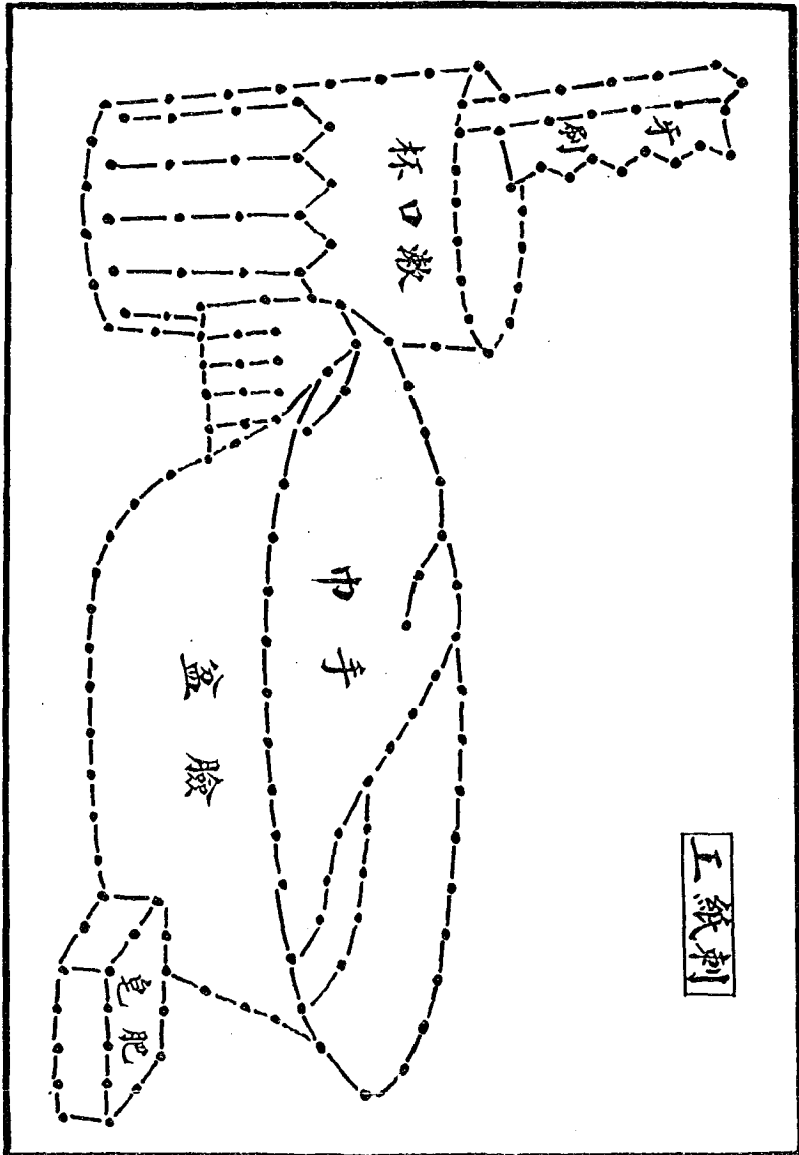

工紙刺



剪紙工

牙刷



漱口杯

厚紙工

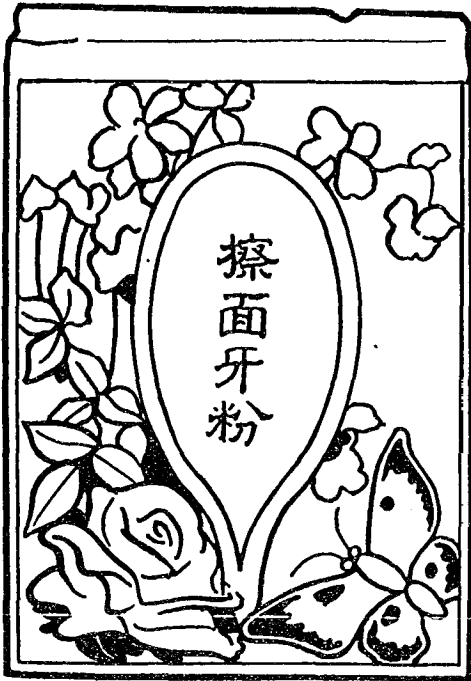

擦面牙粉

填色畫



口漱 組十第 集二第

畫板黑

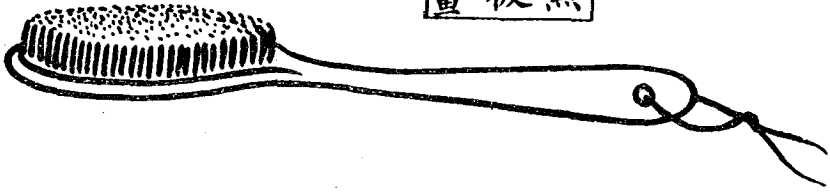

刷牙



泥工

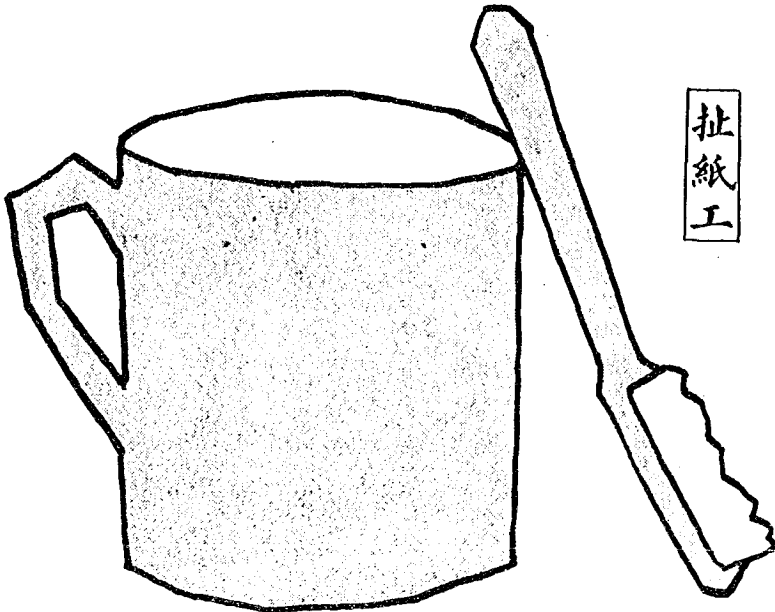

扯紙工

填色畫

針用硬紙剪成

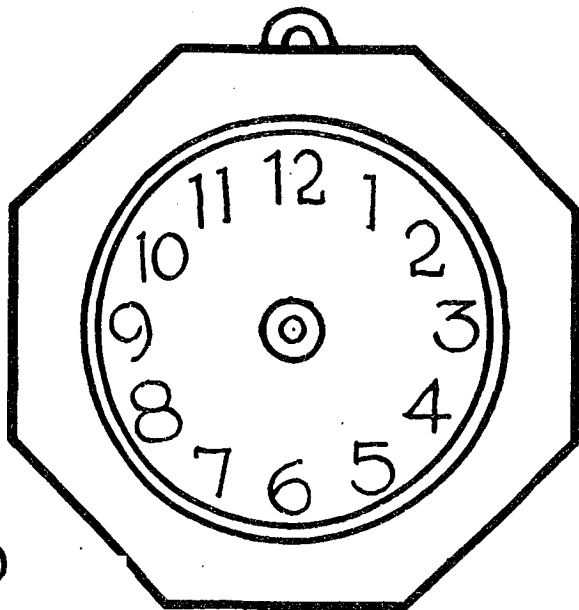

填色畫

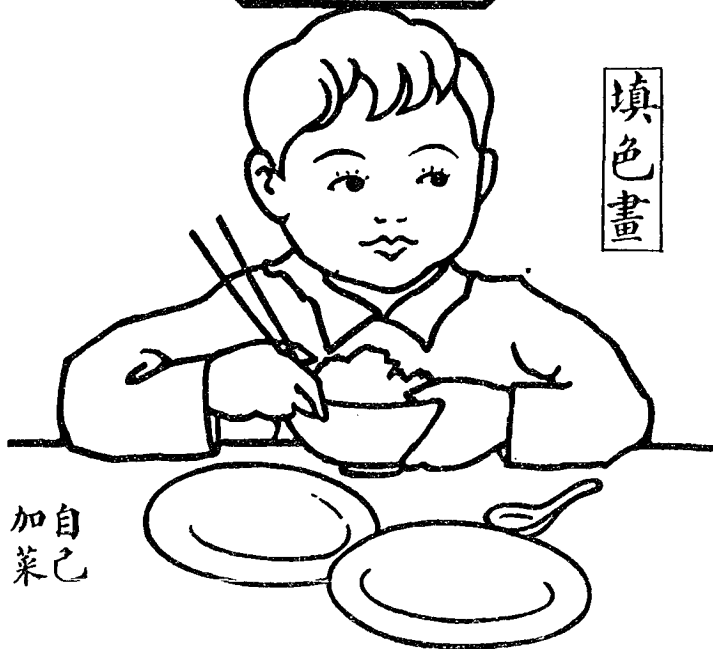

自己加菜

前飯吃 組一十第 集二第

菜夾



飯吃



填色畫

碗洗



飯盛



後飯吃 組二十第 集二第



後飯吃 組二十第 集二第

拼圖

先着色
後剪開
再拼着玩

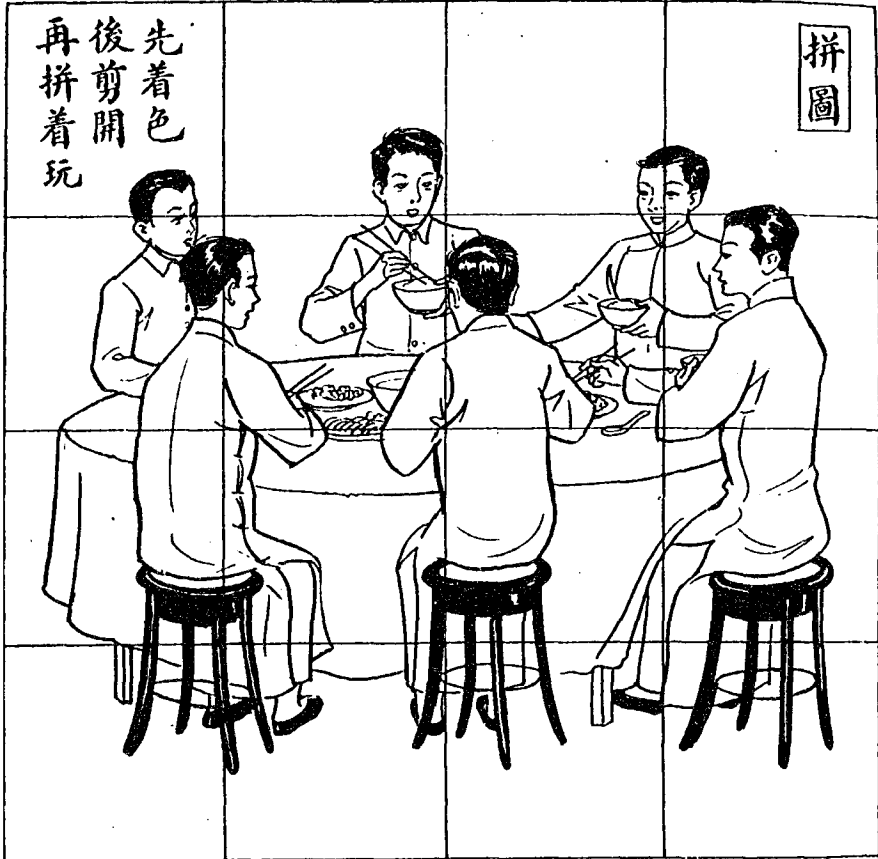

填色畫



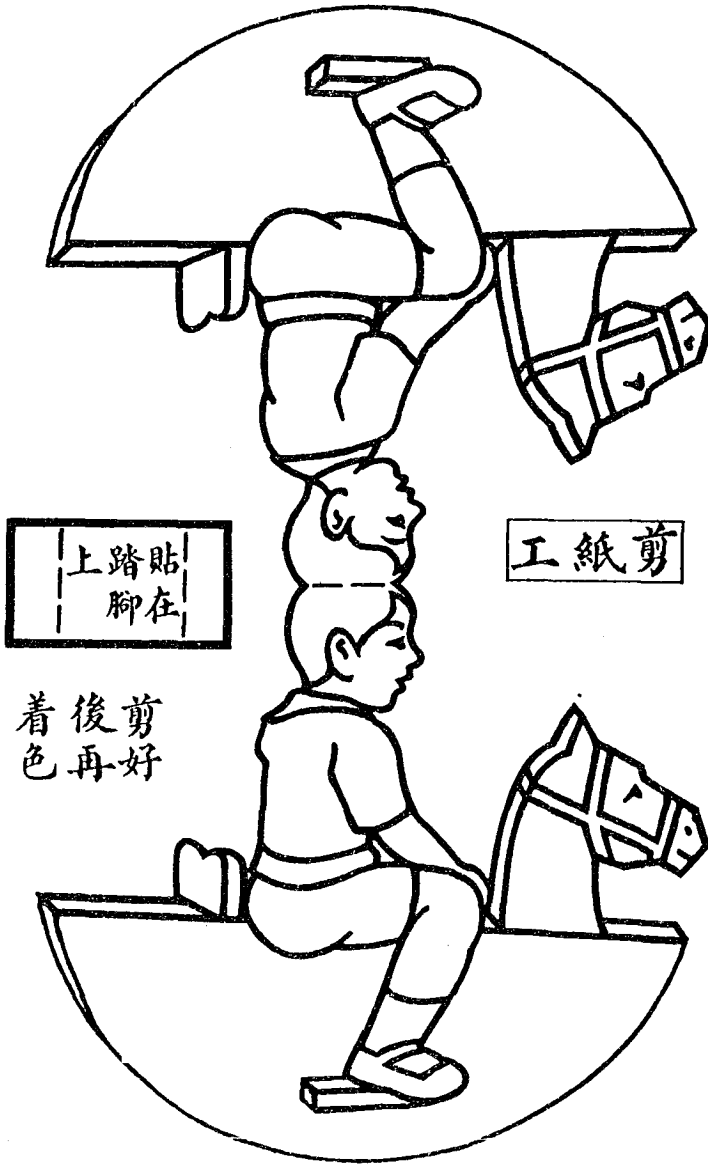

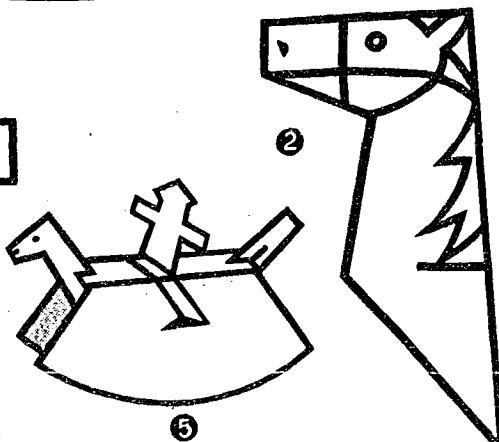
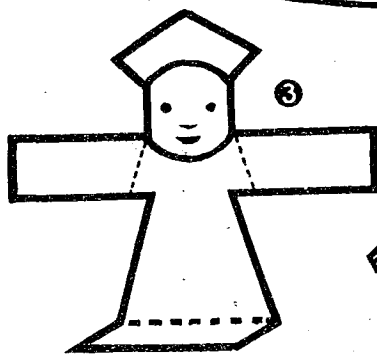
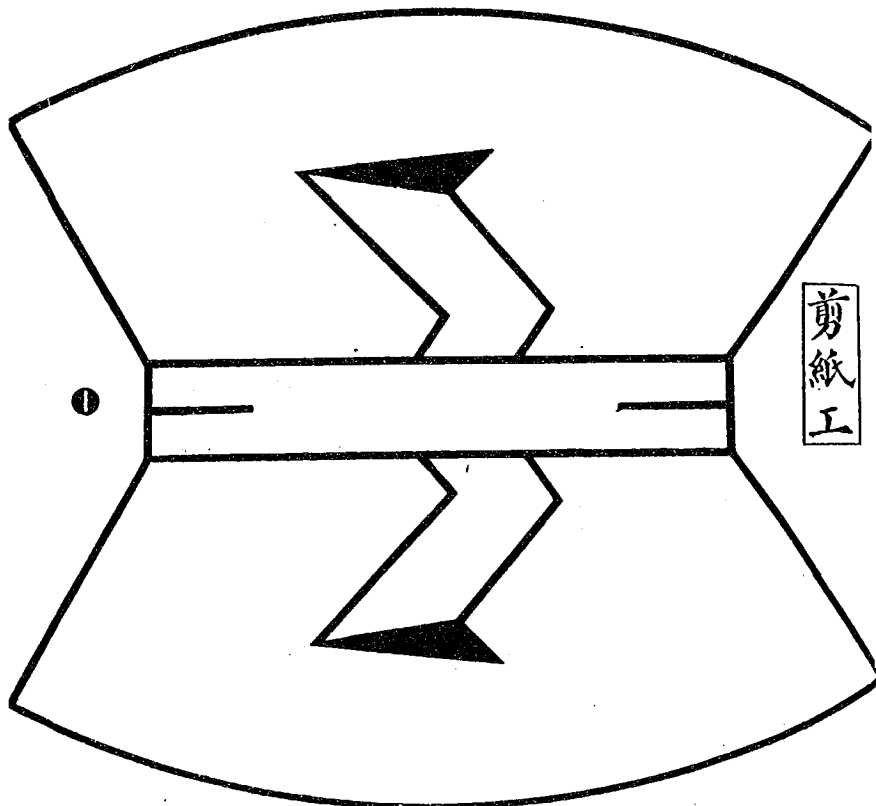

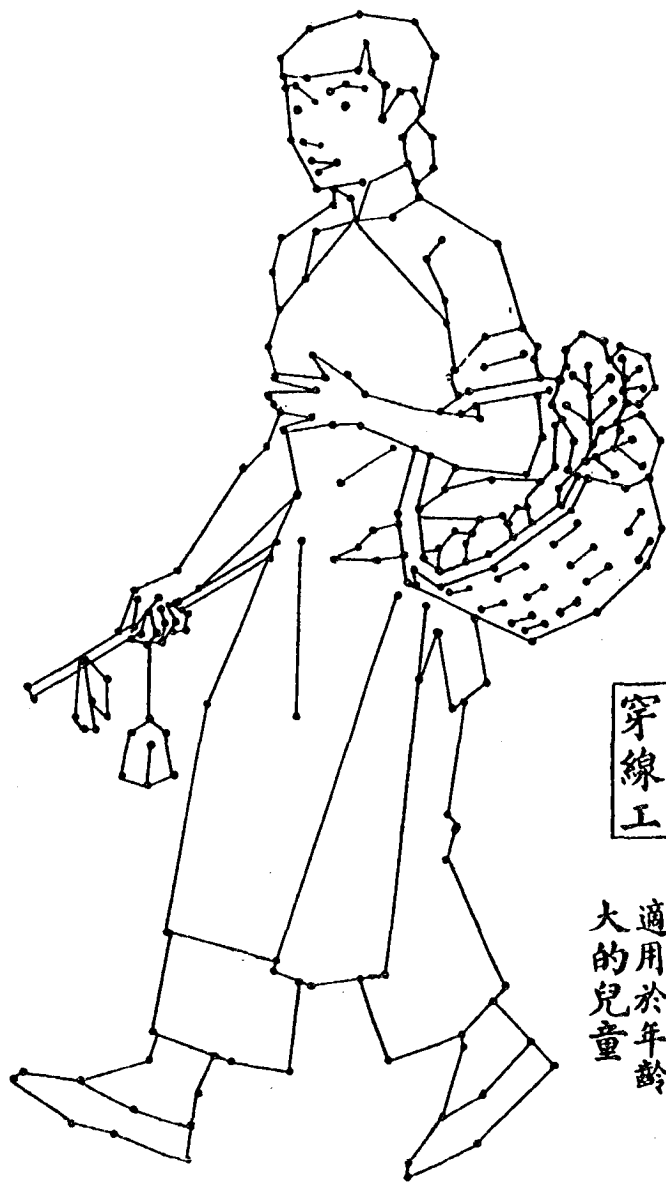

穿線工

適用於年齡
大的兒童

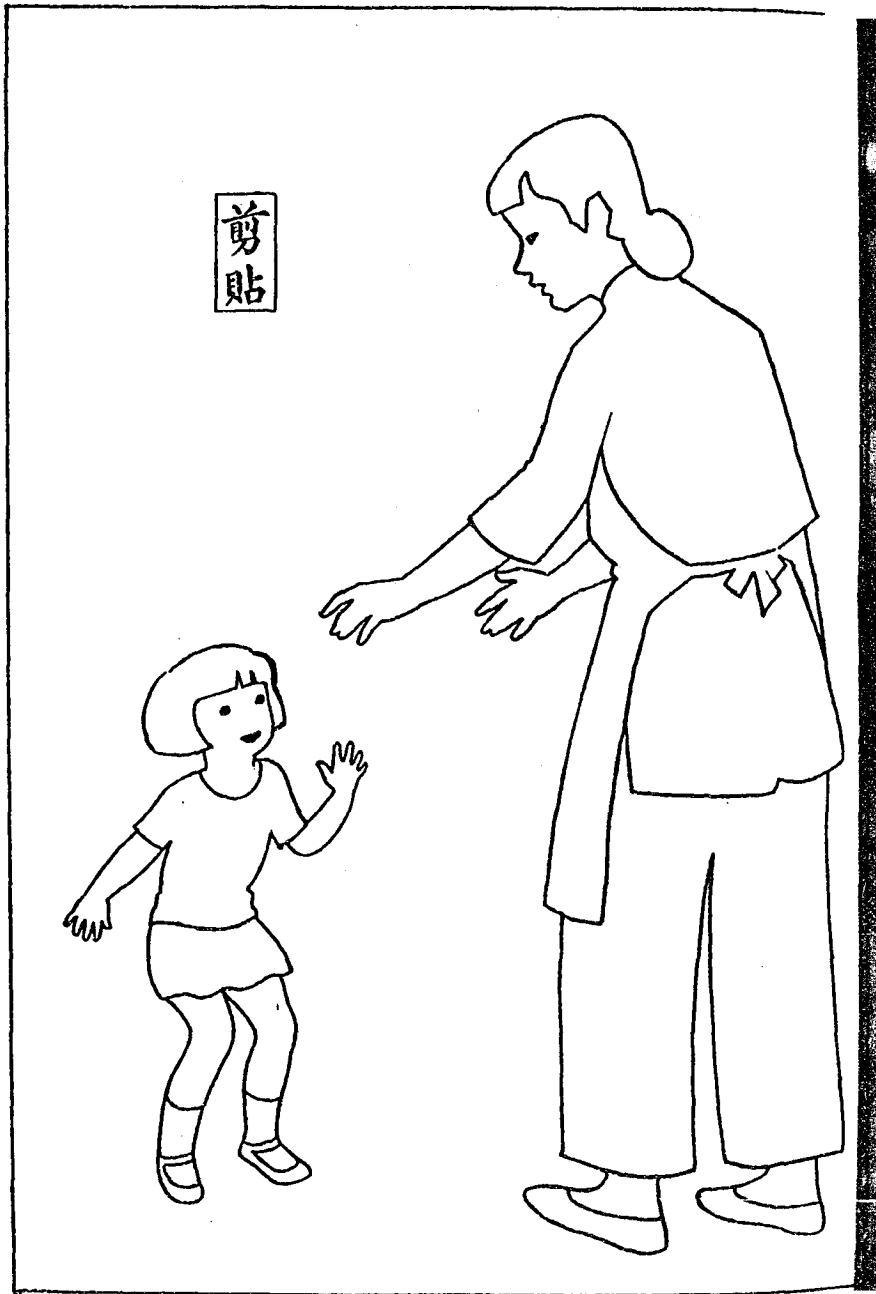

上早 組五十第 集二第

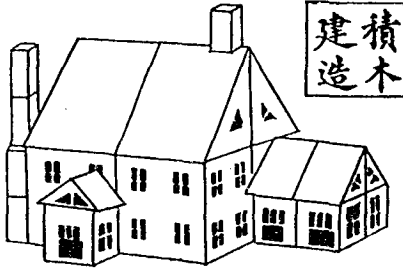

積木
建造



身起



填墨畫



穿衣



刷牙



洗臉

畫色填

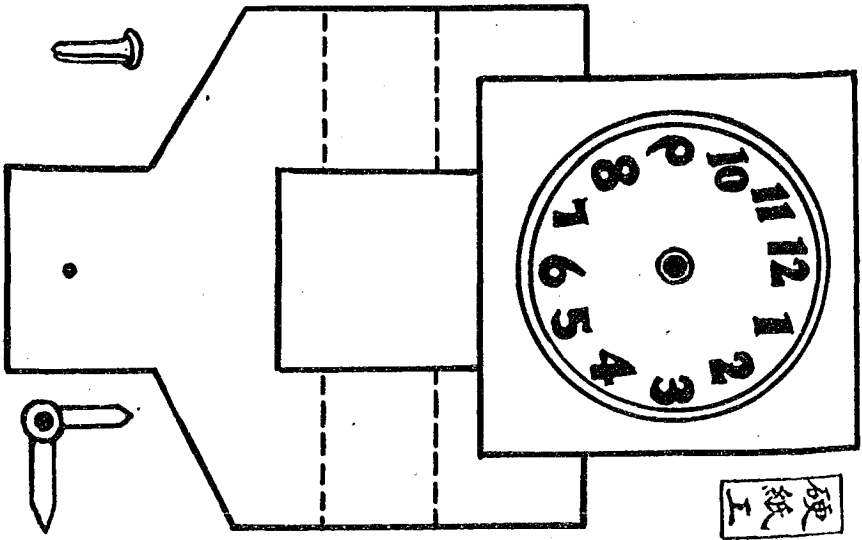
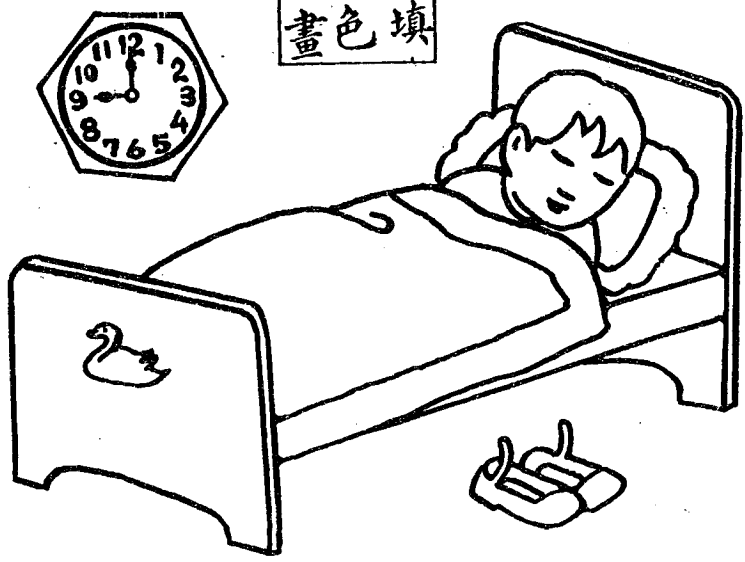

硬紙工

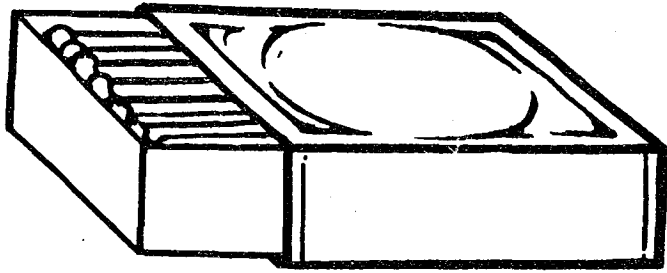

畫色填

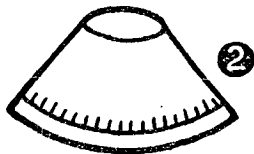
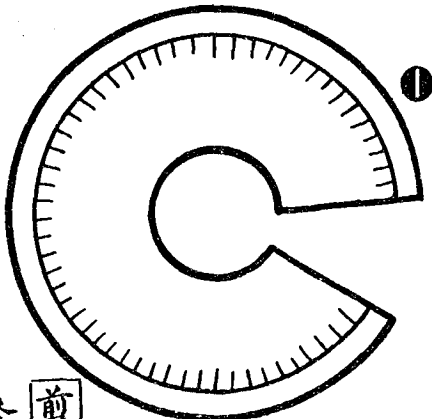

燈罩
剪紙工

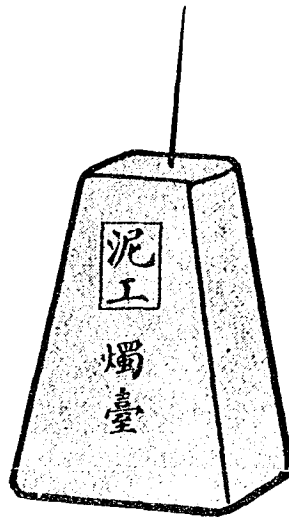

火油燈

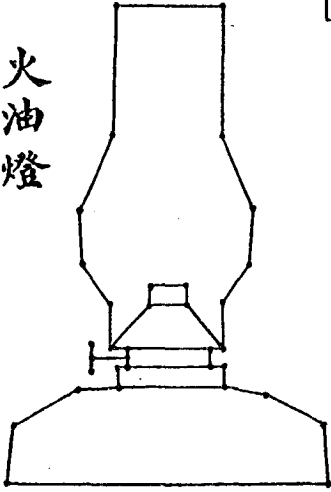

工線穿

電燈

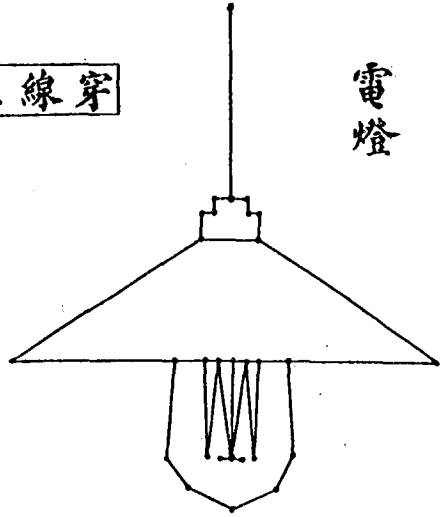

手影

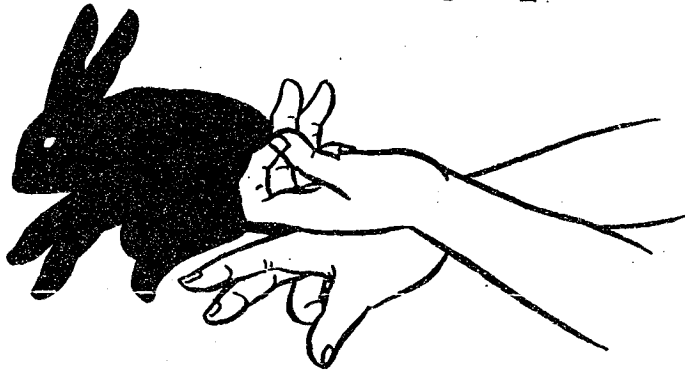

手影

兔白隻畫 組七十第 集二第



畫筆簡

補畫

加青菜

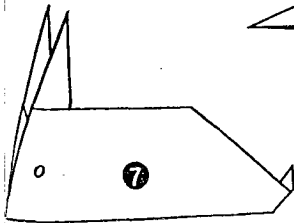
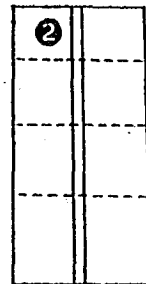
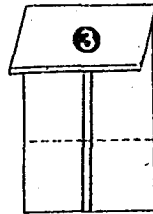
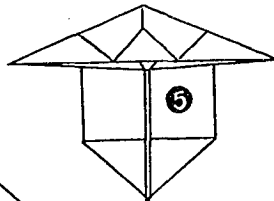
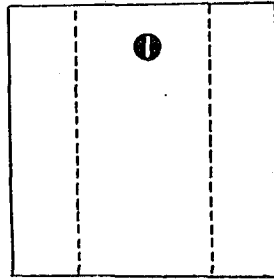
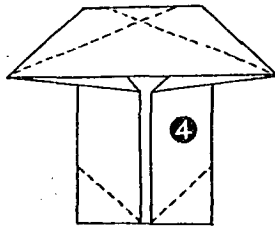
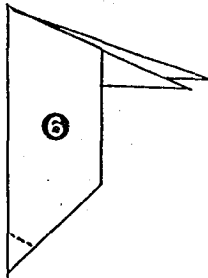
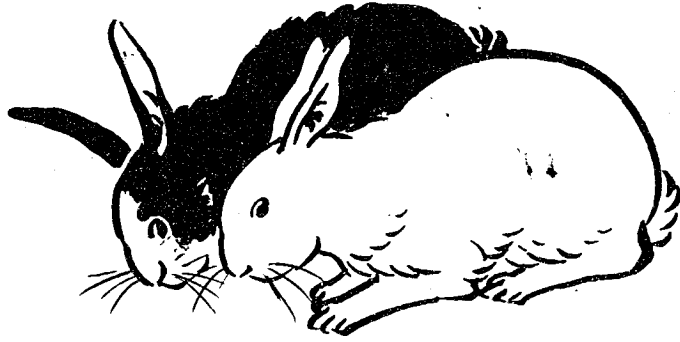

兔紙

工紙摺

兔白隻畫 組七十第 集二第

板巧七新

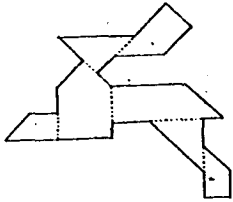

剪紙工

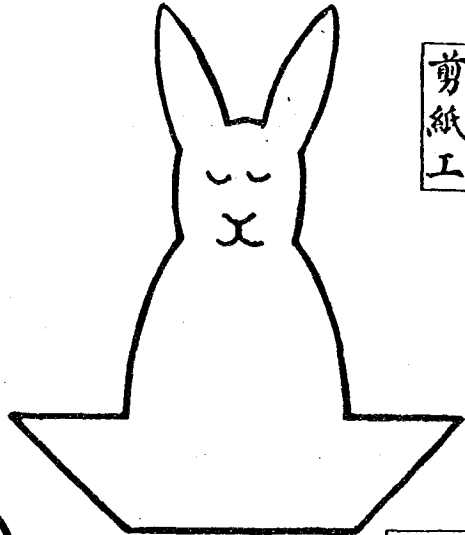

工紙貼

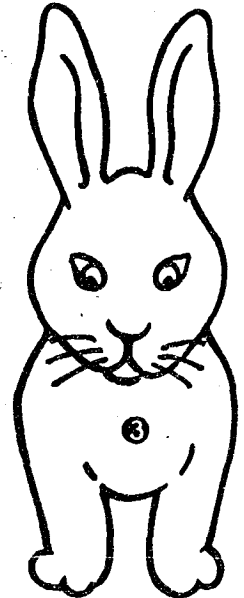
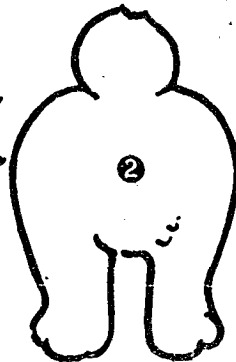
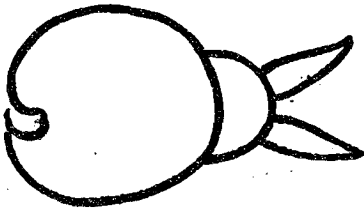
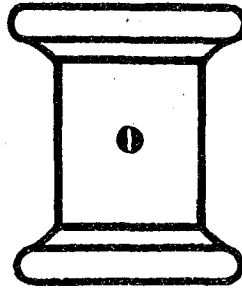
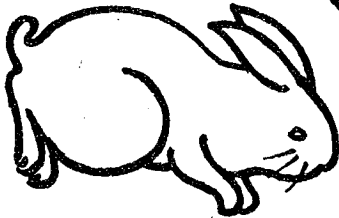

黑板畫

蛋偷鼠老

工貼剪

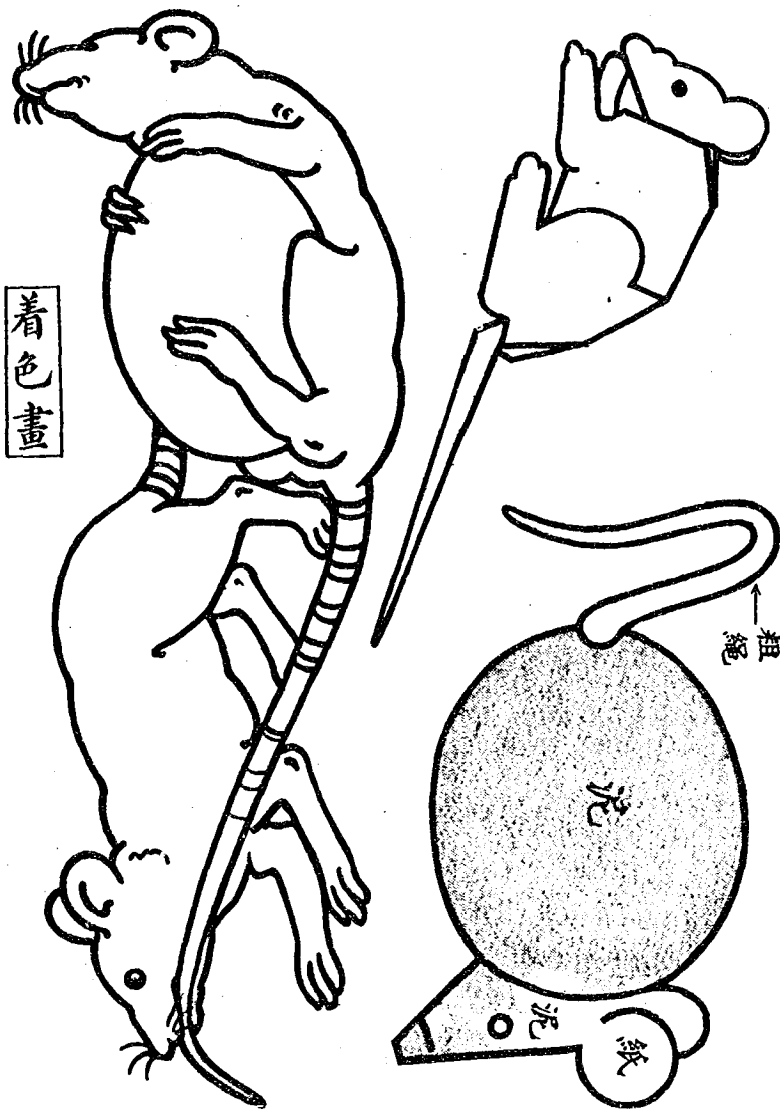

鼠老隻畫 組八十第 集二第

形全

尾 腳

身體

頭

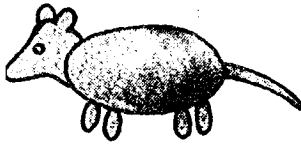

泥工

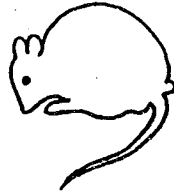
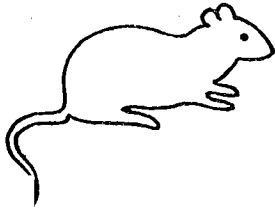

貼紙工

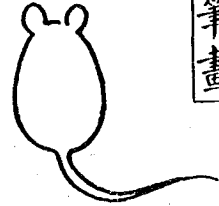

一筆畫



填色畫

黎個做 組九十第 集二第

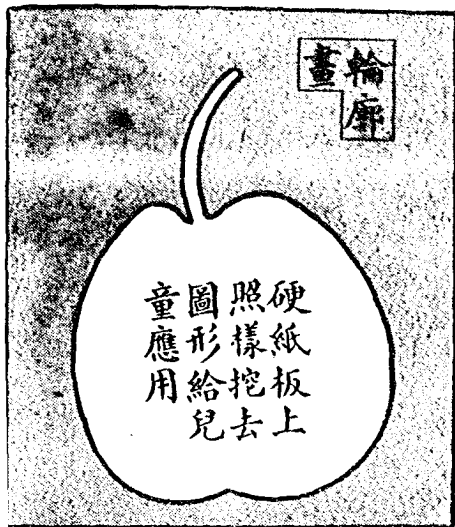

樹葉
貼成
的黎

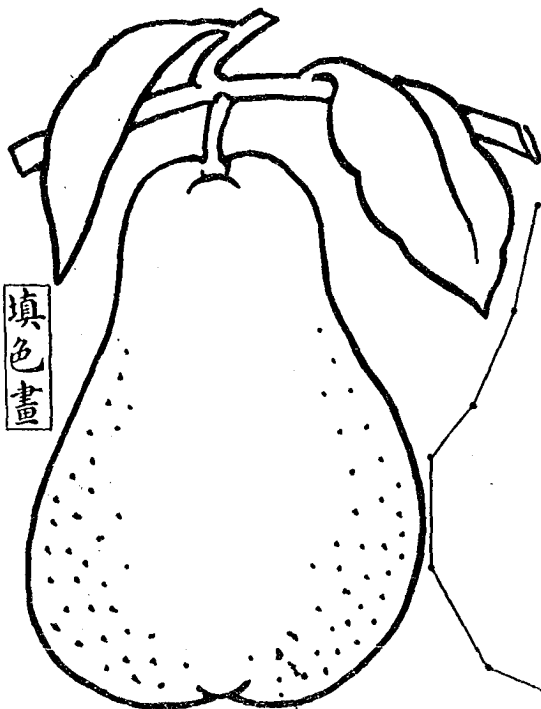
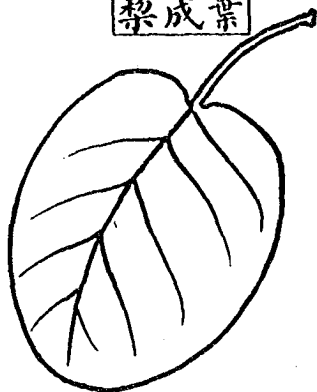

穿線工

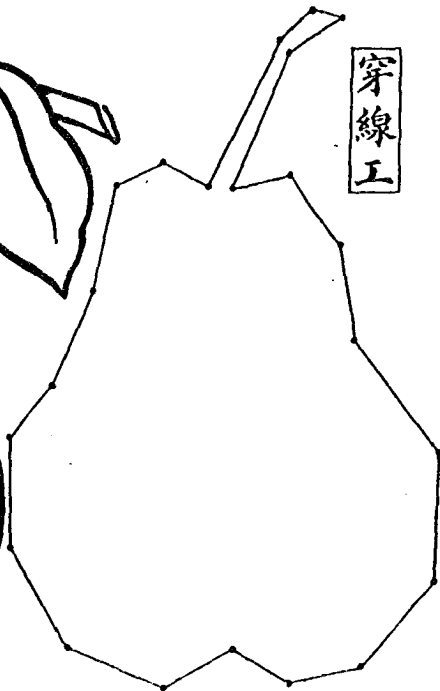

工泥

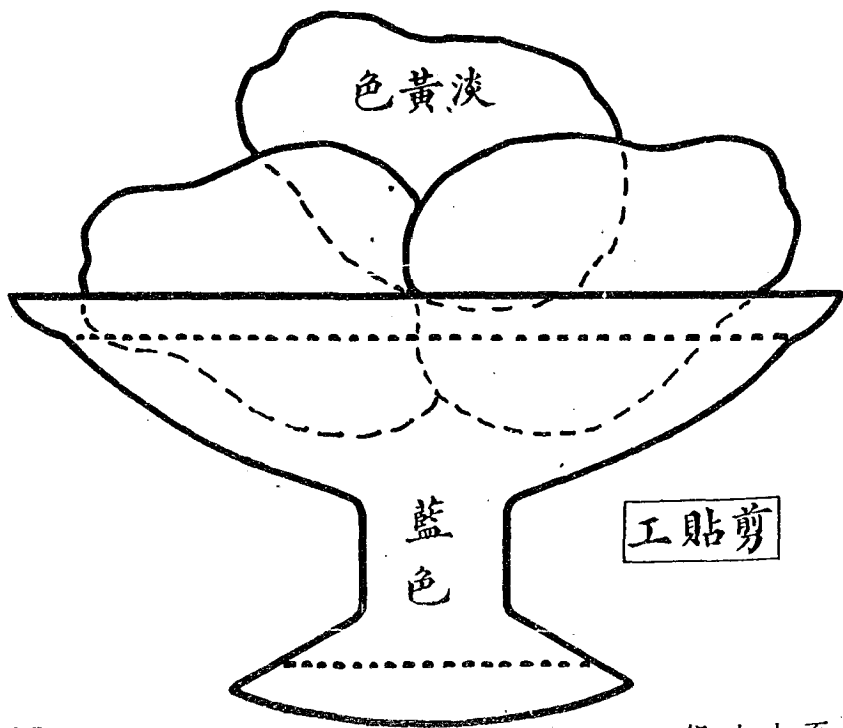
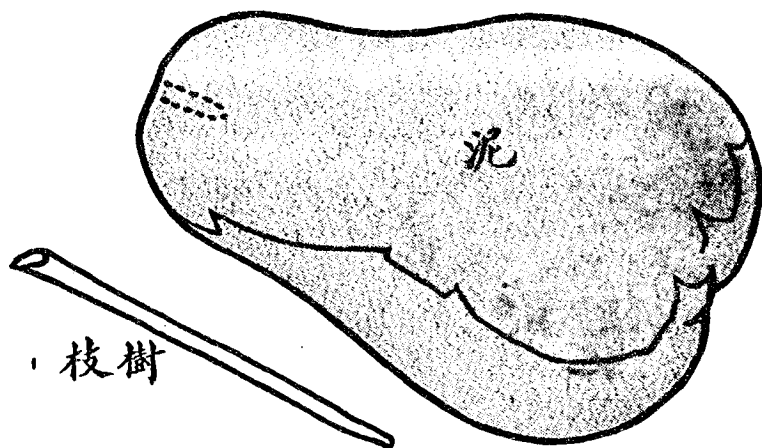

旗國做 組十二第 集二第

填色畫

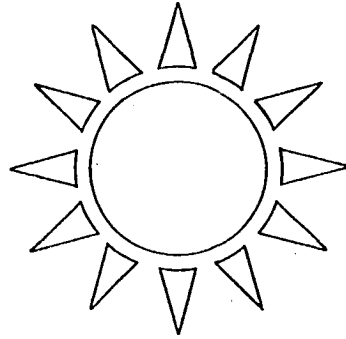

旗面做 組十二第 集二第

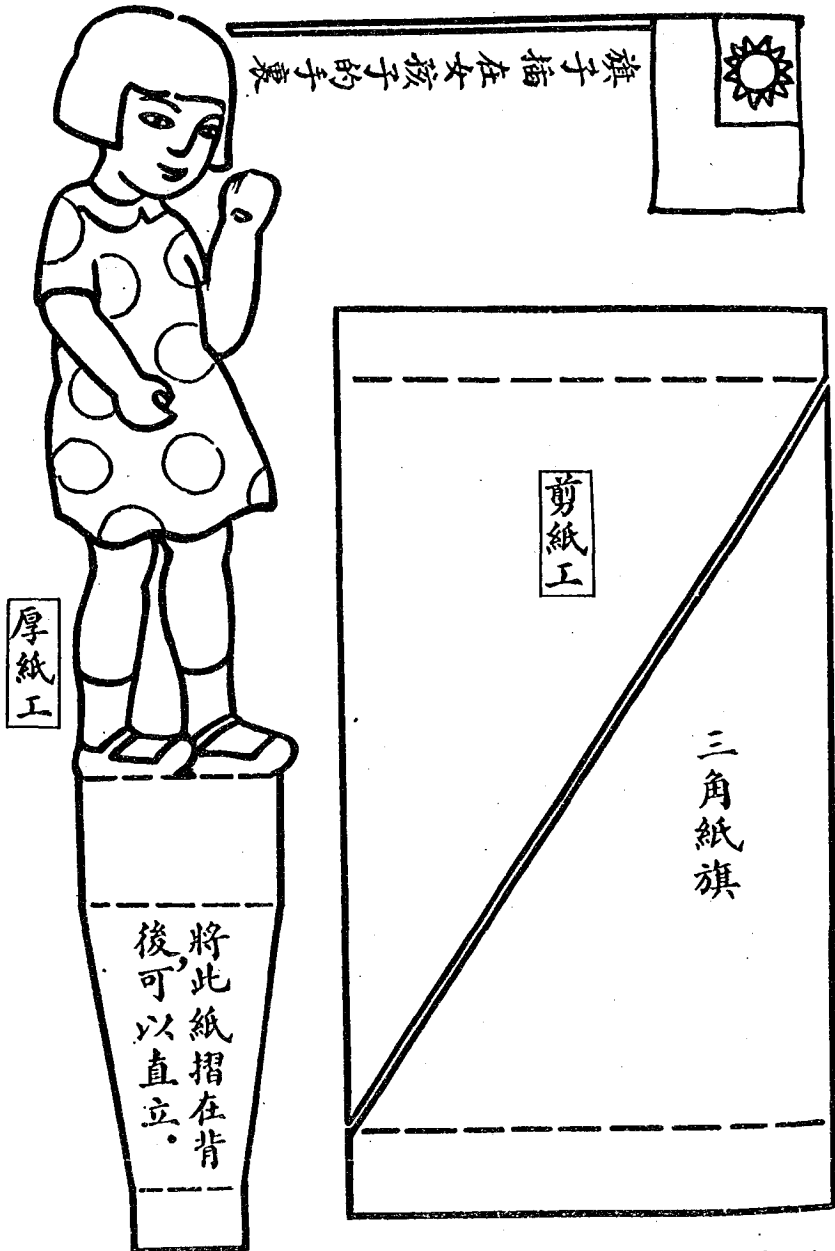



用厚質鉛畫紙
剪成圖樣，再着
色，用釘連起來
可以活動。

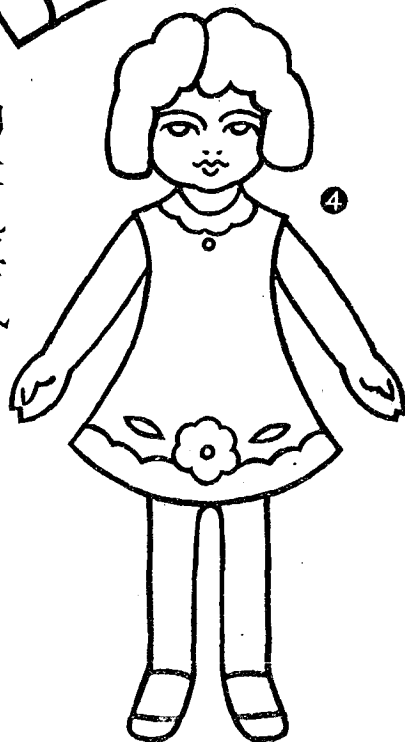

餅吃寶寶 組一十二第 集二第

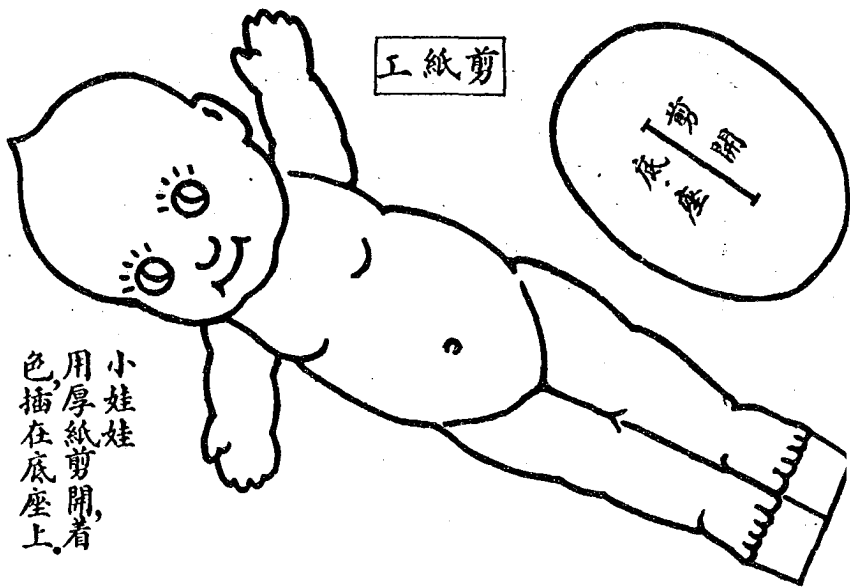

小娃娃
用厚紙剪開，
着色，插在
底座上。

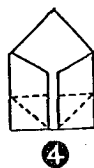
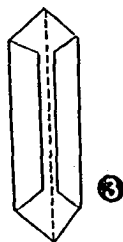
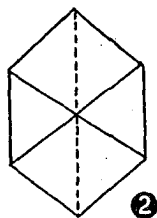
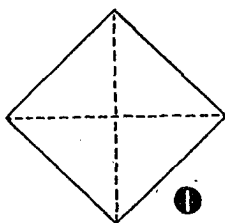

工紙摺

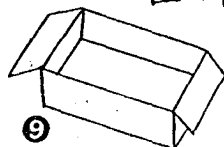
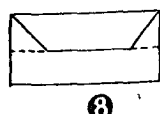
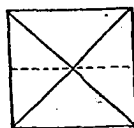
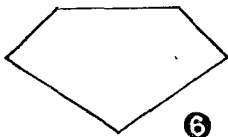
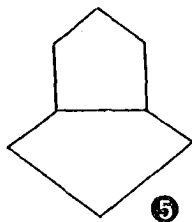

匣餅

覺睡寶寶 組二十二第 集二第

牀上加畫被褥等物
帳子也可以加畫花樣

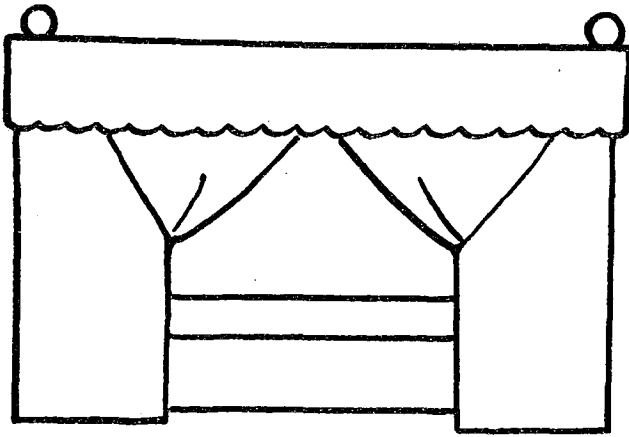

着色畫

牀的成貼條紙用

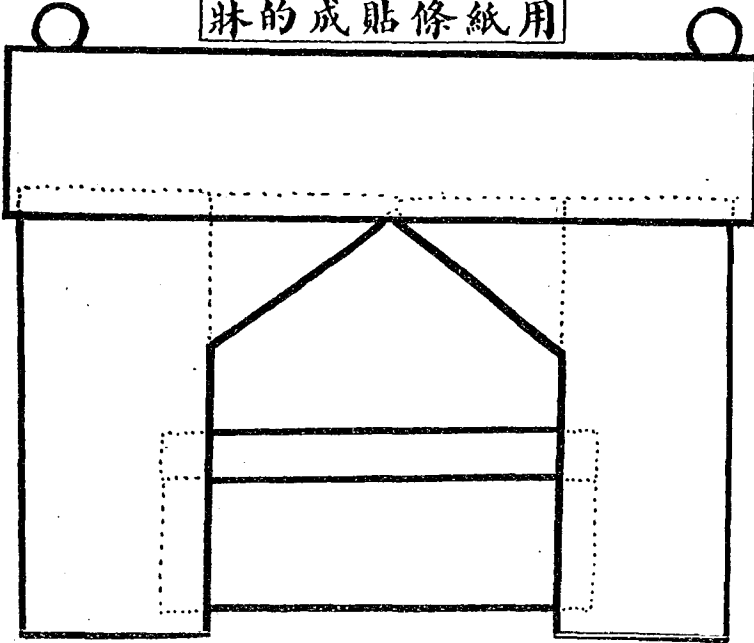

覺睡寶寶 組二十二第 集二第

牀上可添畫
應用的東西

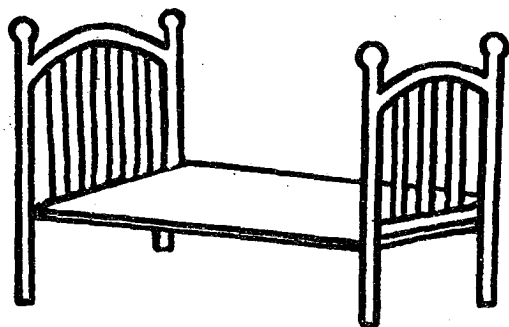

填色畫

①

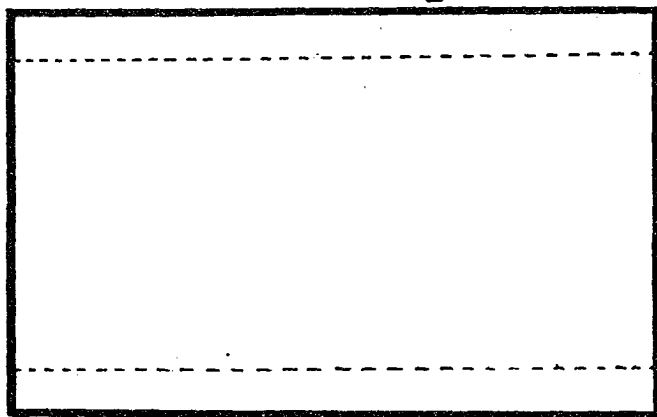

剪紙工

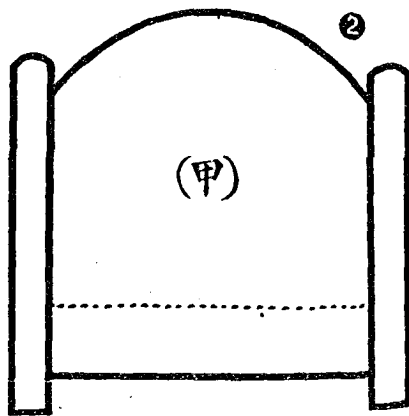
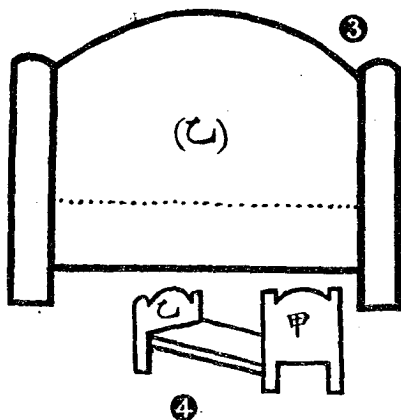

④



小泥人

棉花人



①



②

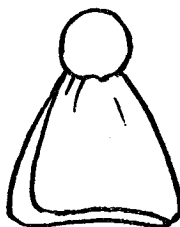

③



填色畫

小
娃
娃

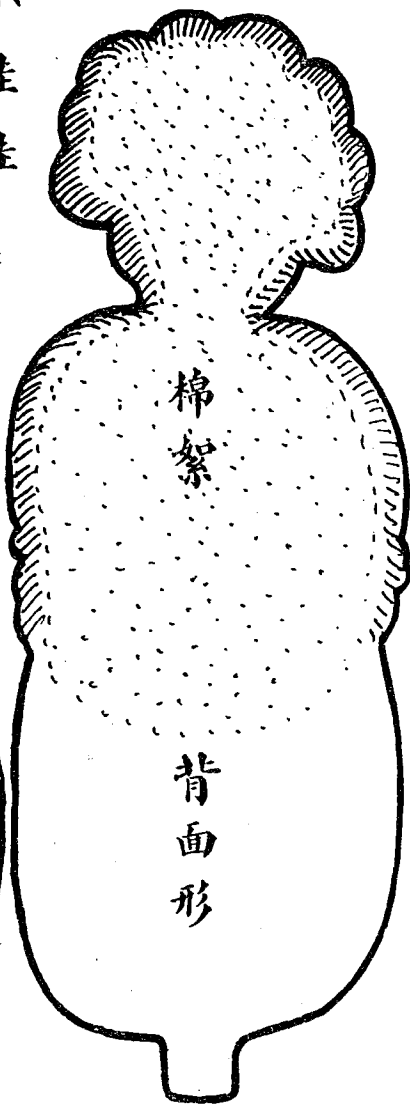
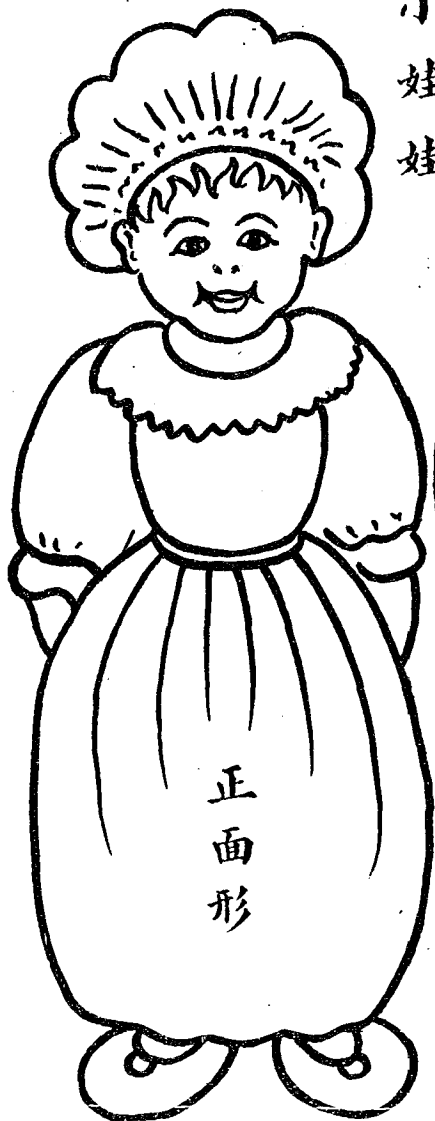

老老個一 組四十二第 集二第

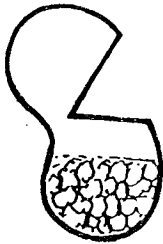
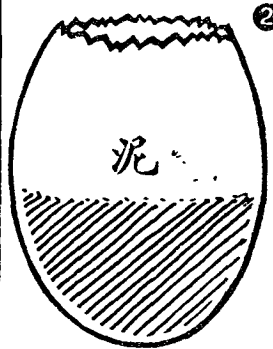
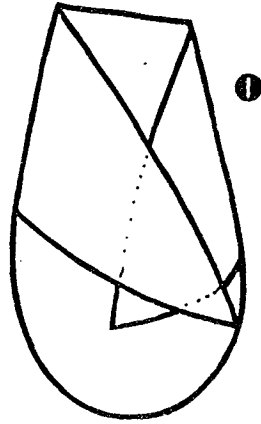
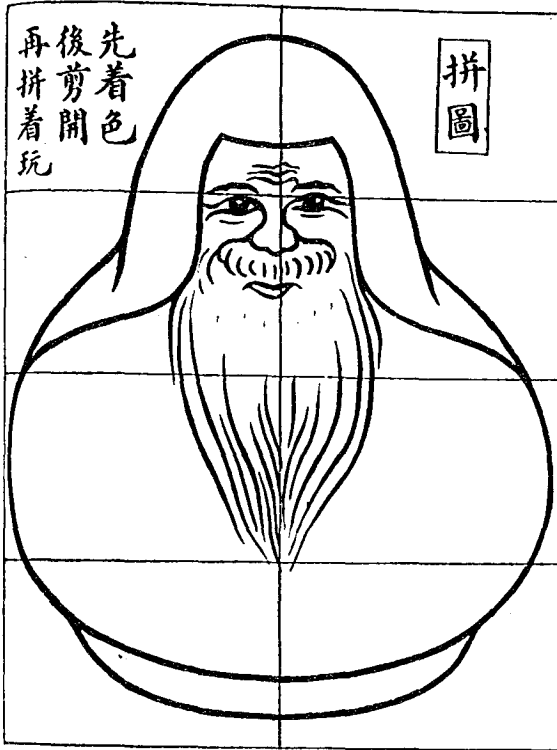

蠶繭
不倒翁

蛋殼
不倒翁



填色畫

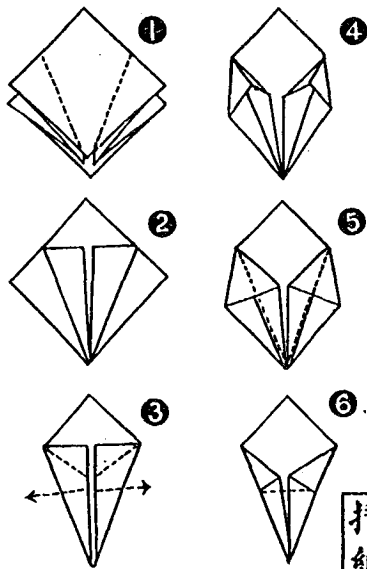

摺紙工

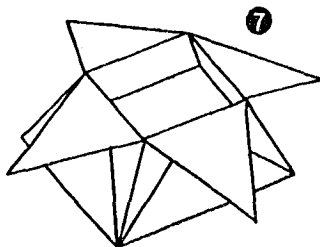
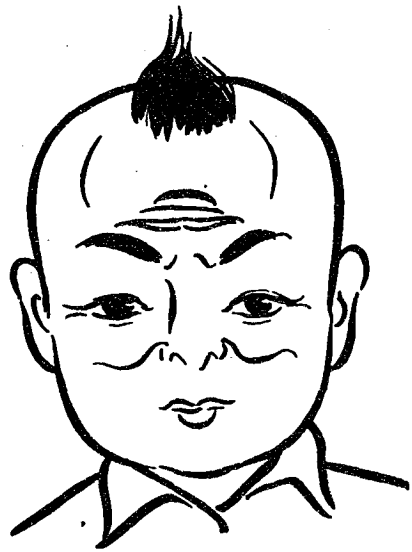

匣紙

老視孩，為正圖，顛
人為倒小視，倒

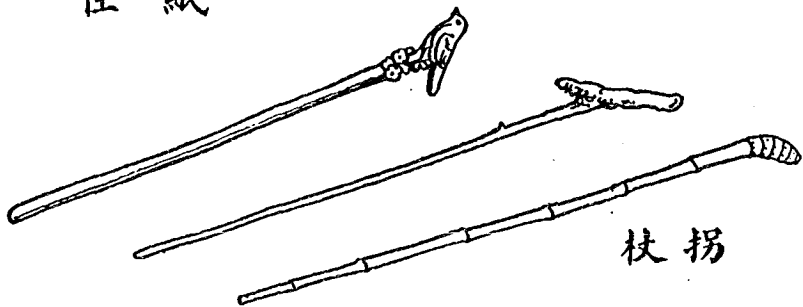

杖拐

子桌 組五十二第 集二第

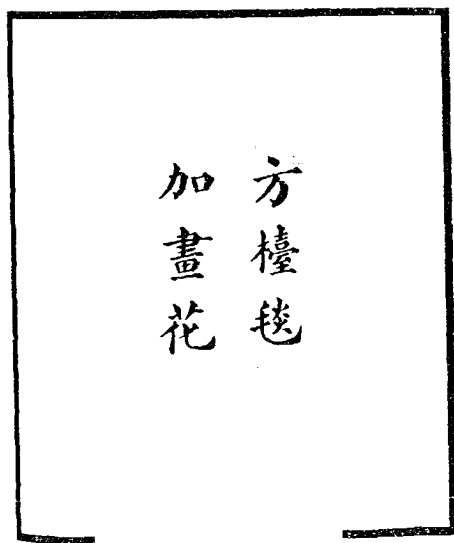
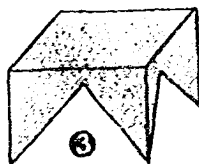
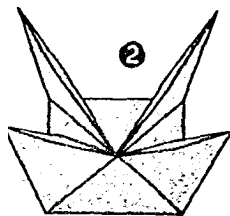
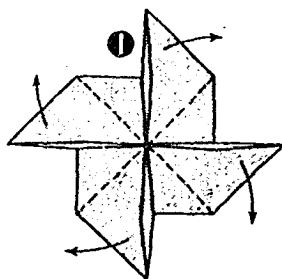
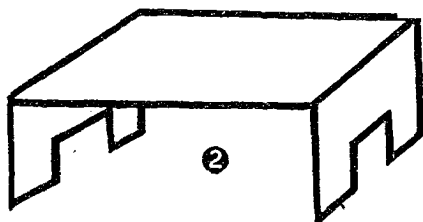
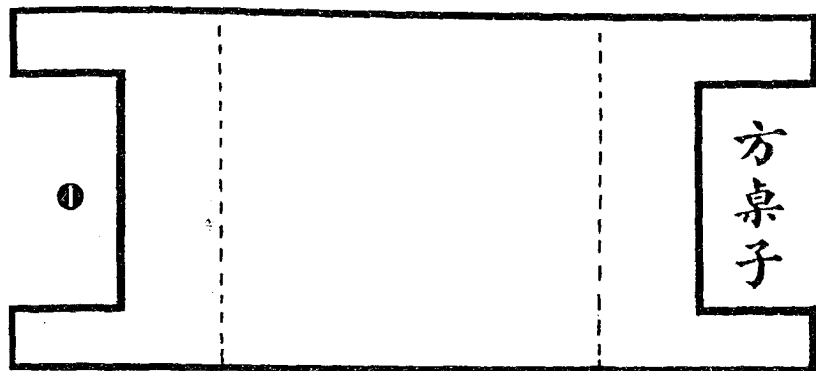

子桌 組五十二第 集二第

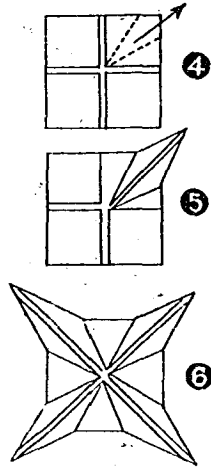
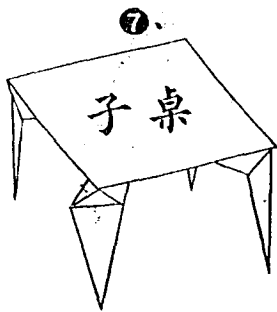

工紙摺

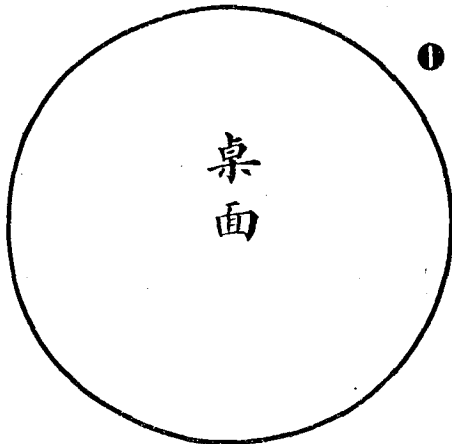
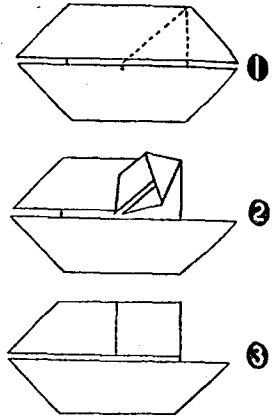

①

②

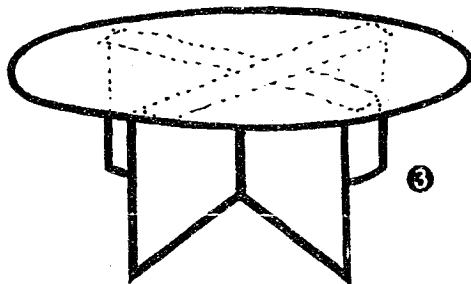
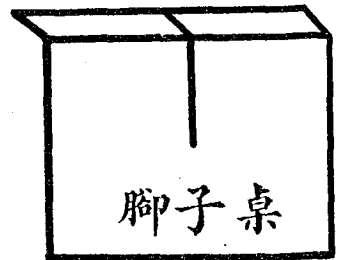

③

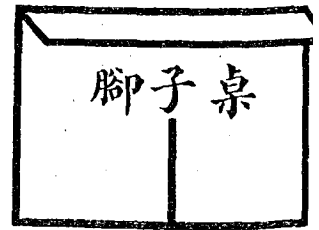

子車 組六十二第 集二第

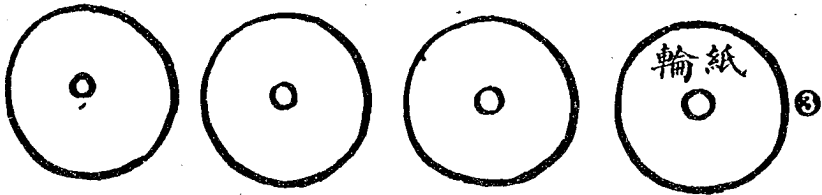
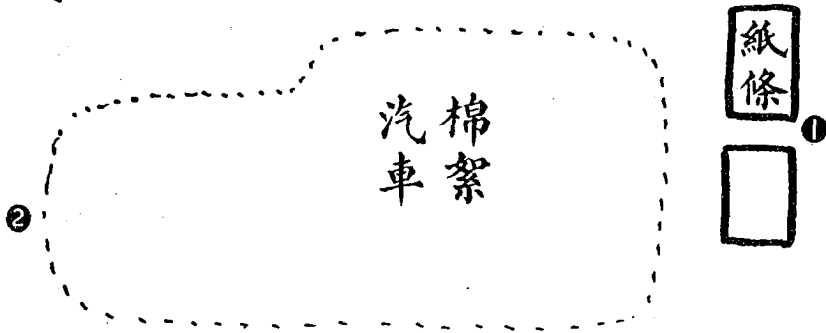
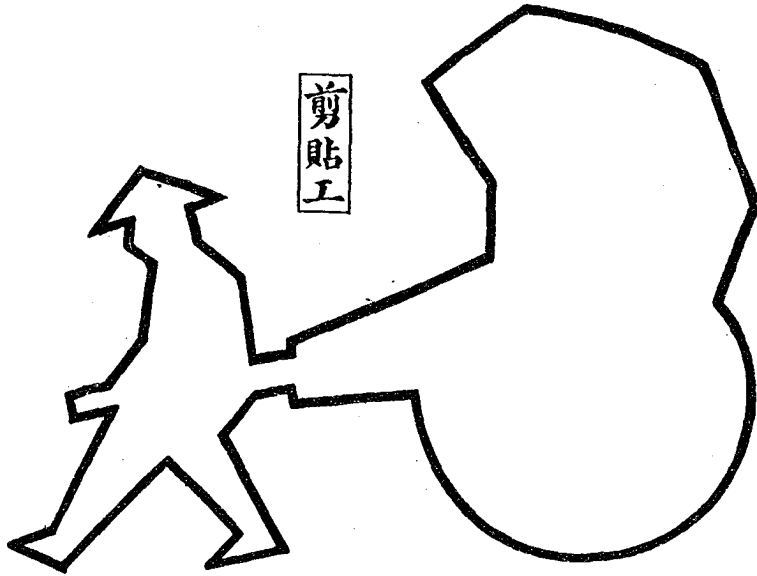

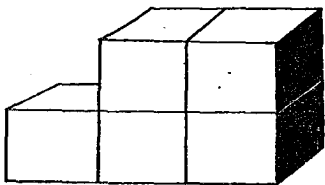

車汽 排裝木積

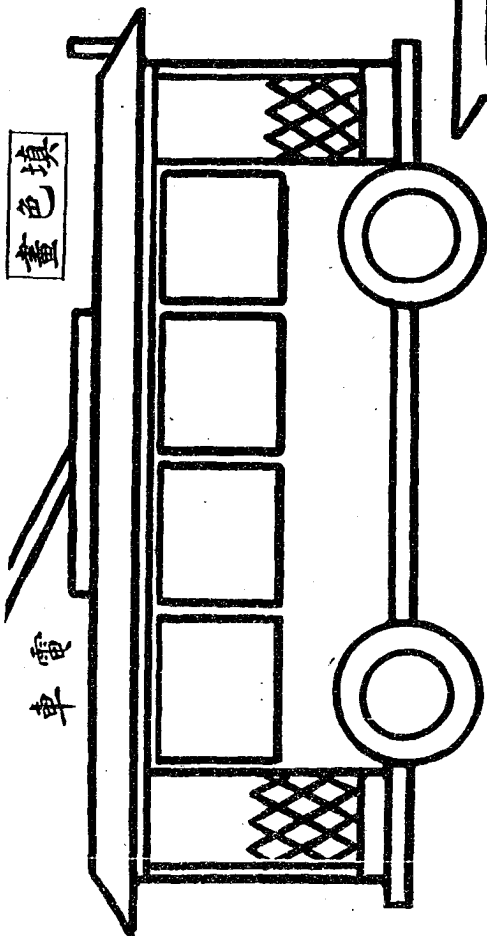

畫色填

車電

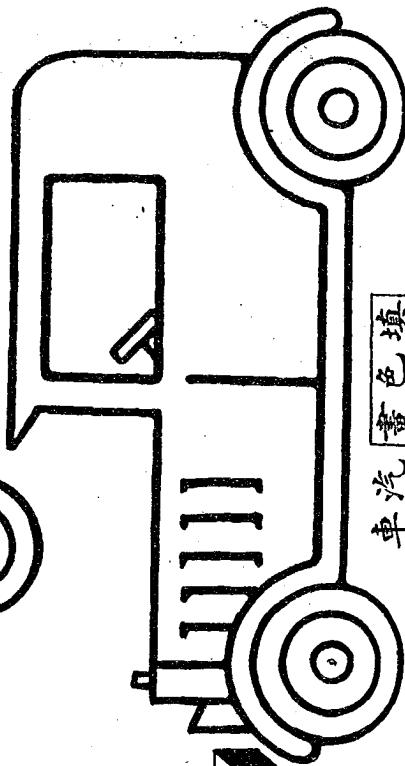

畫色填
車汽

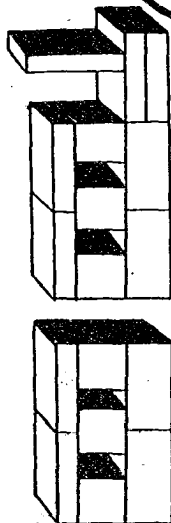

排裝木積
車火

來車 組七十二第 集二第

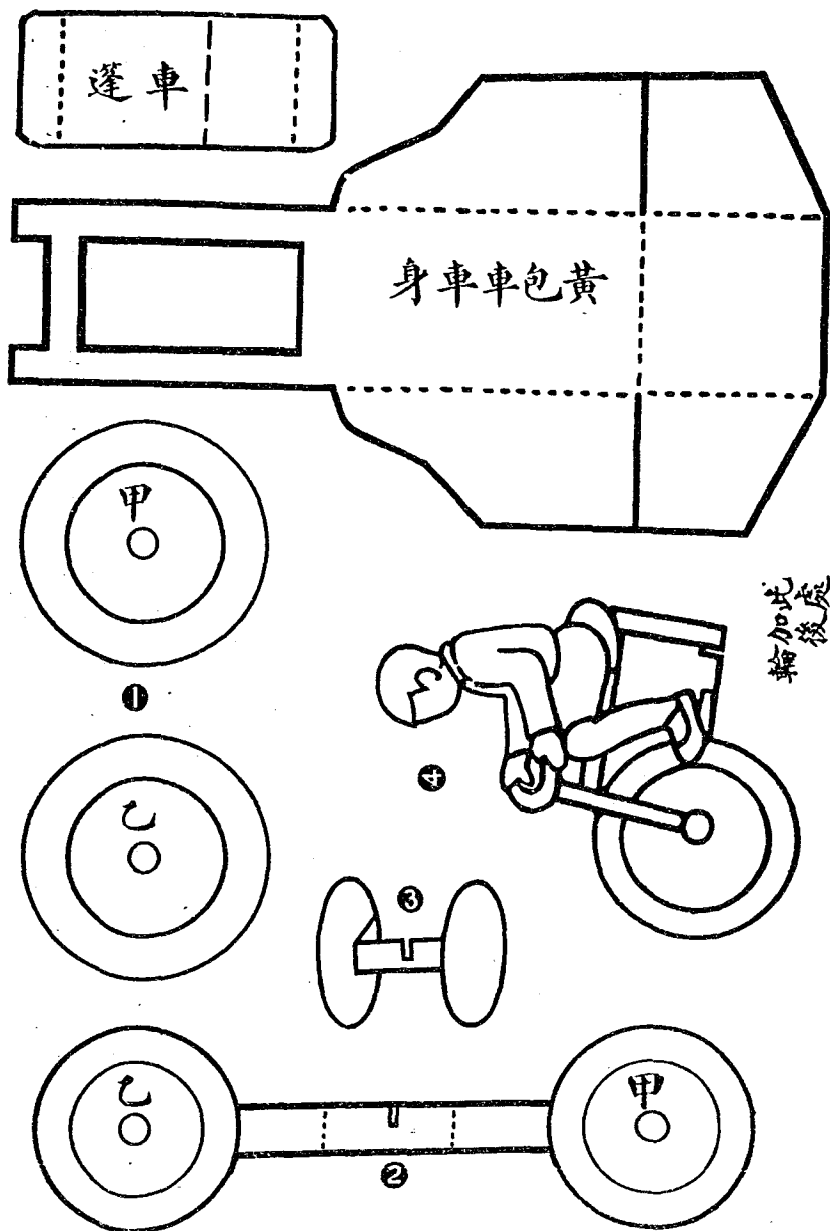

來車 組七十二第 集二第

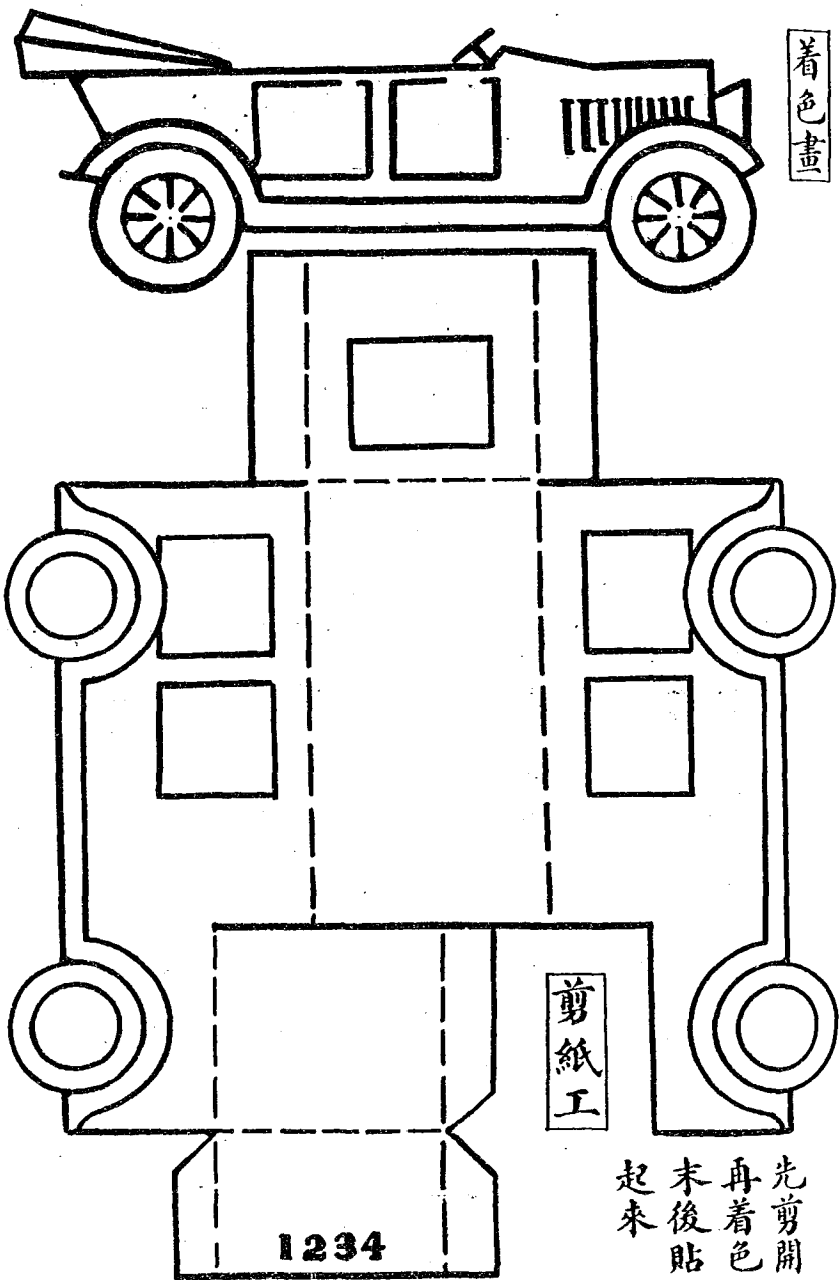

着色畫

剪紙工

先剪開
再着色
末後貼
起來

1234

來馬 組八十二第 集二第

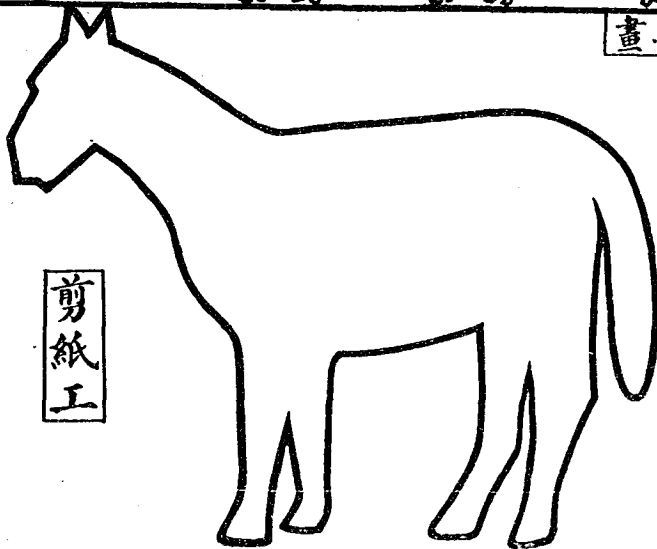
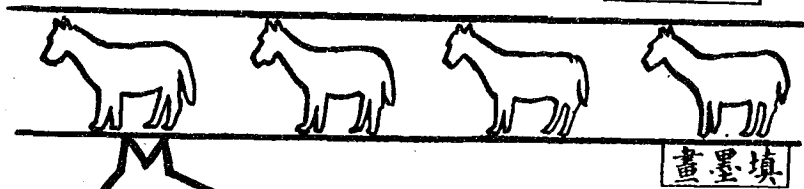
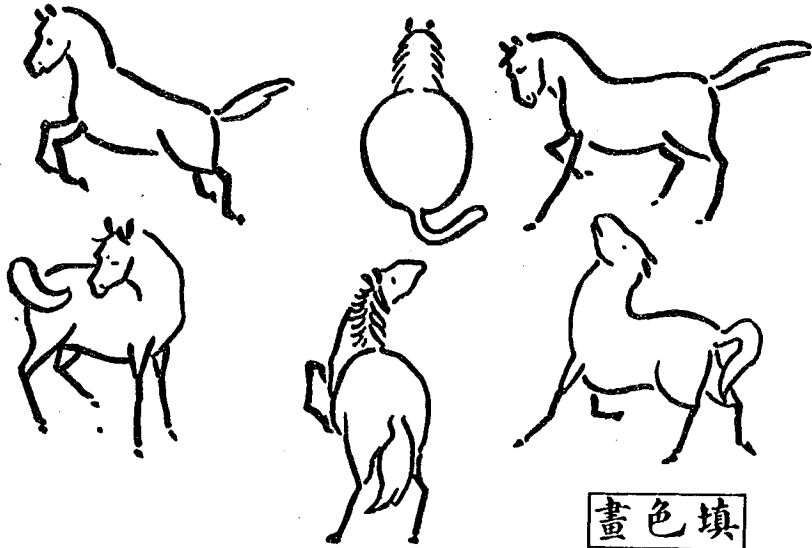

來馬 組八十二第 集二第

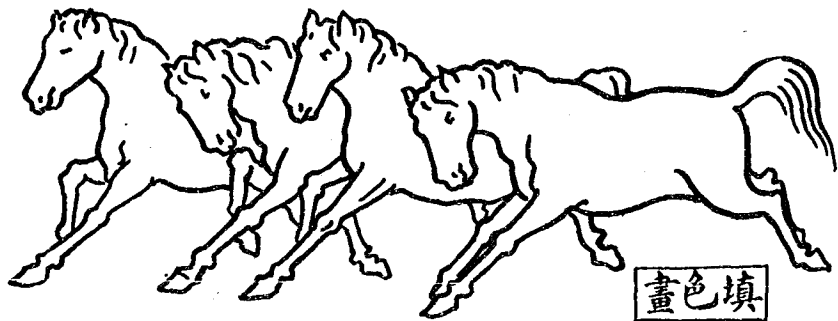
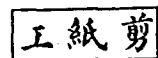
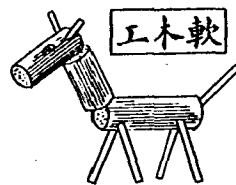
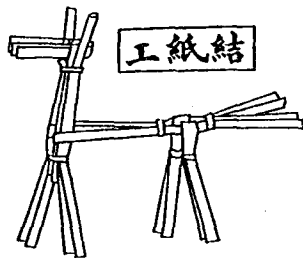
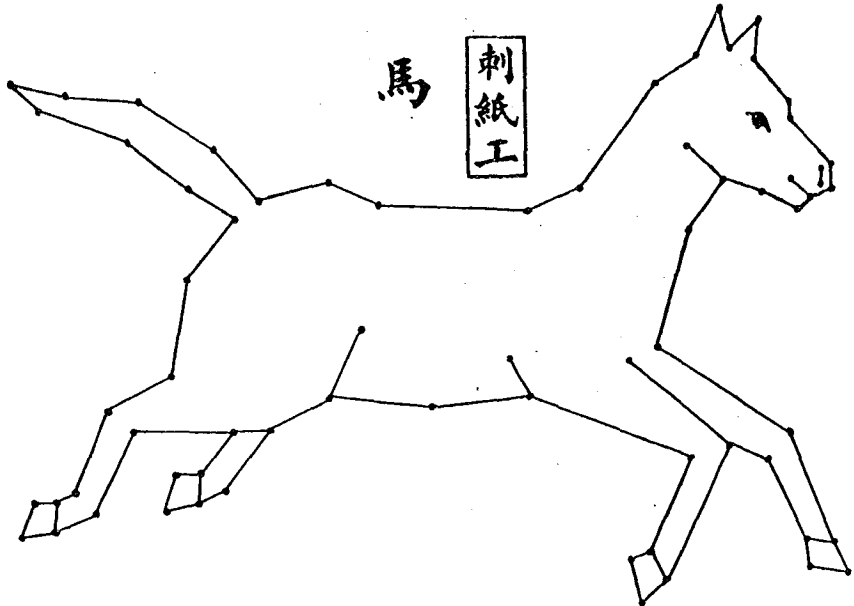

填色畫

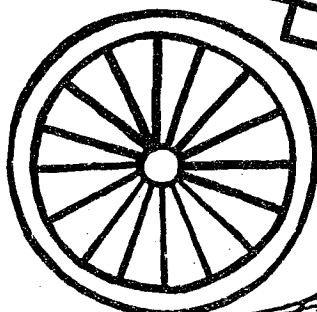
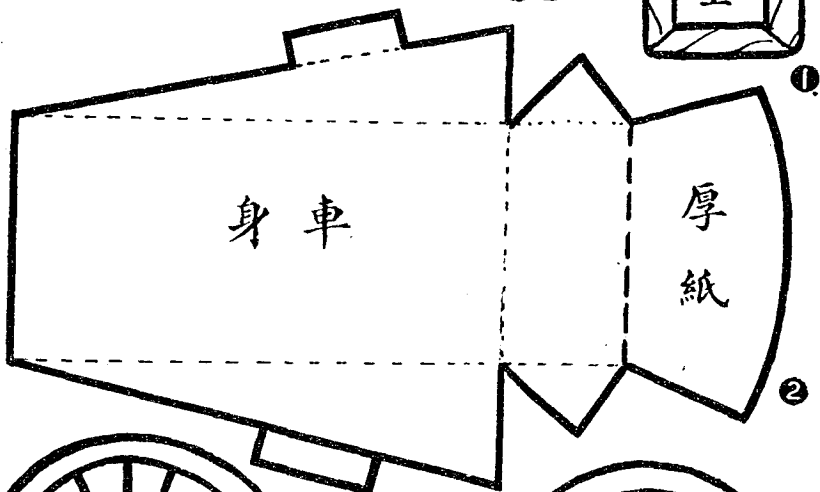
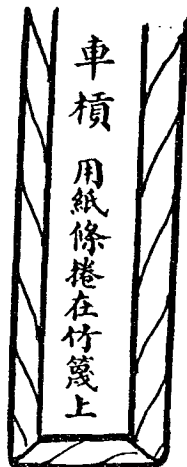
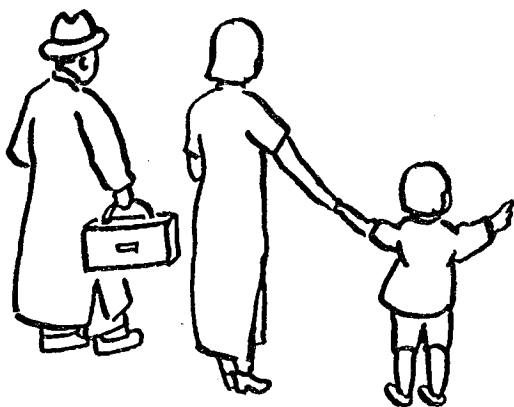

車輪

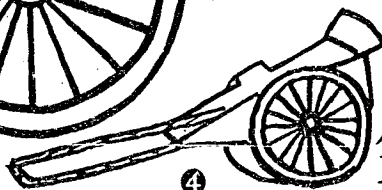
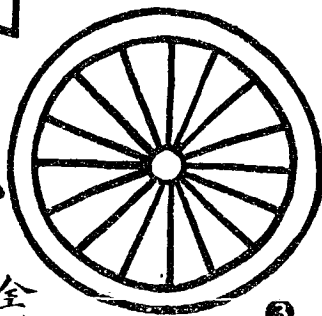

全形

上路大 組九十二第 集二第

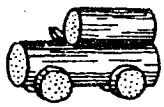

汽
車

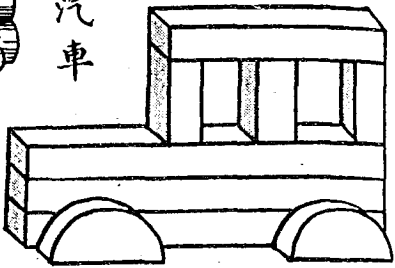
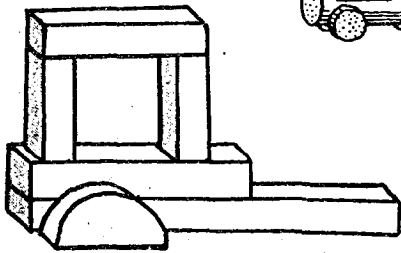

車包黃

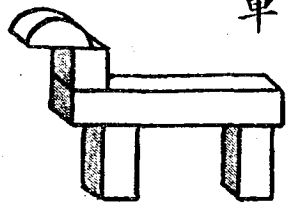

車馬

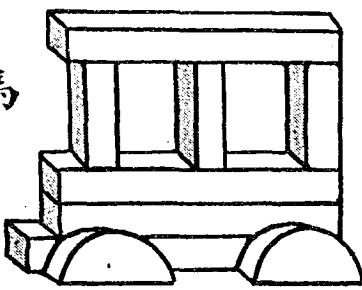

積木裝排

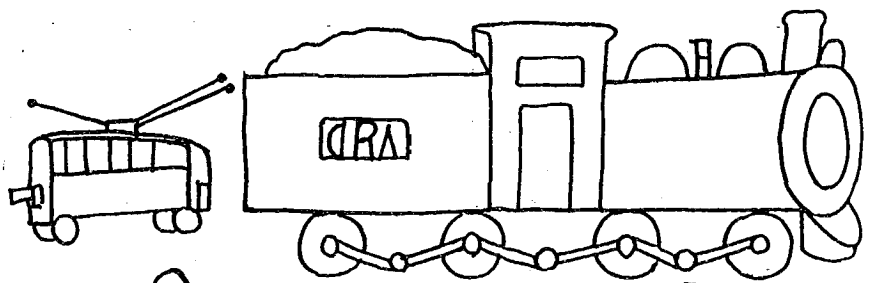

簡
筆
畫

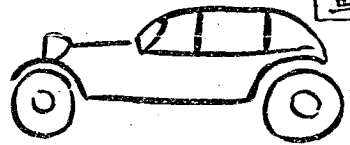
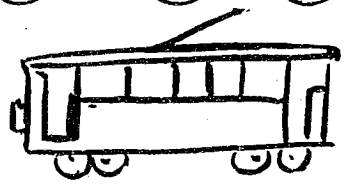



高梁
桿成
的做
火車

火柴
做的
火車

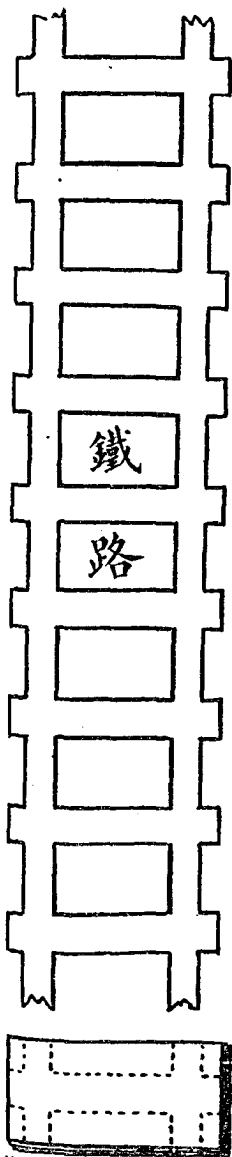

鐵

路

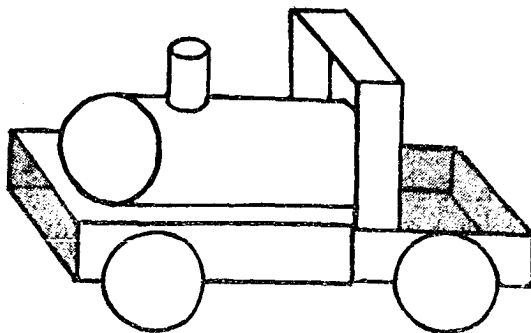
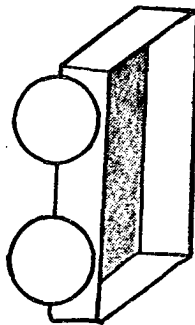
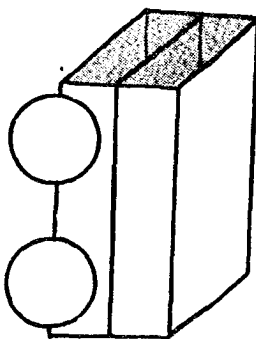

上路鐵 組十三第 集二第

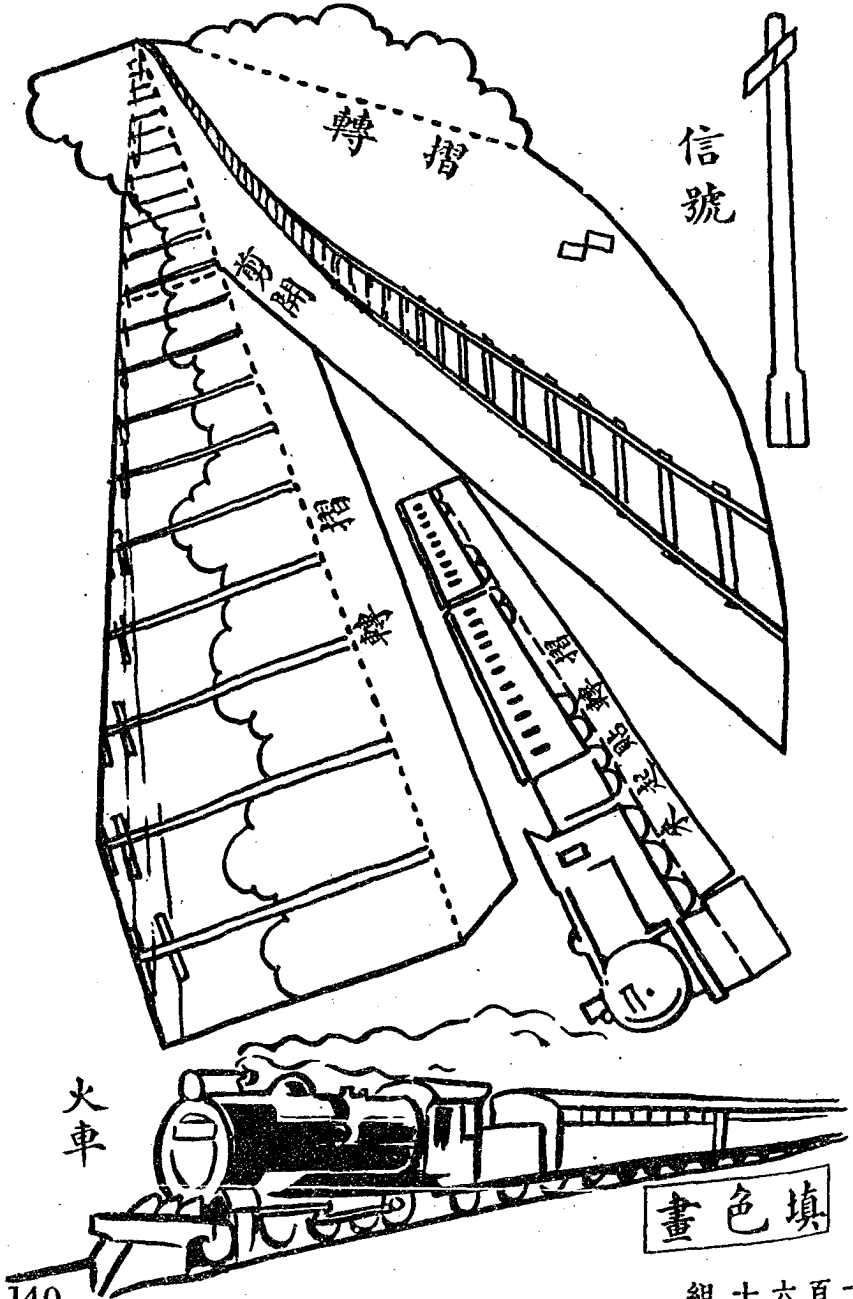

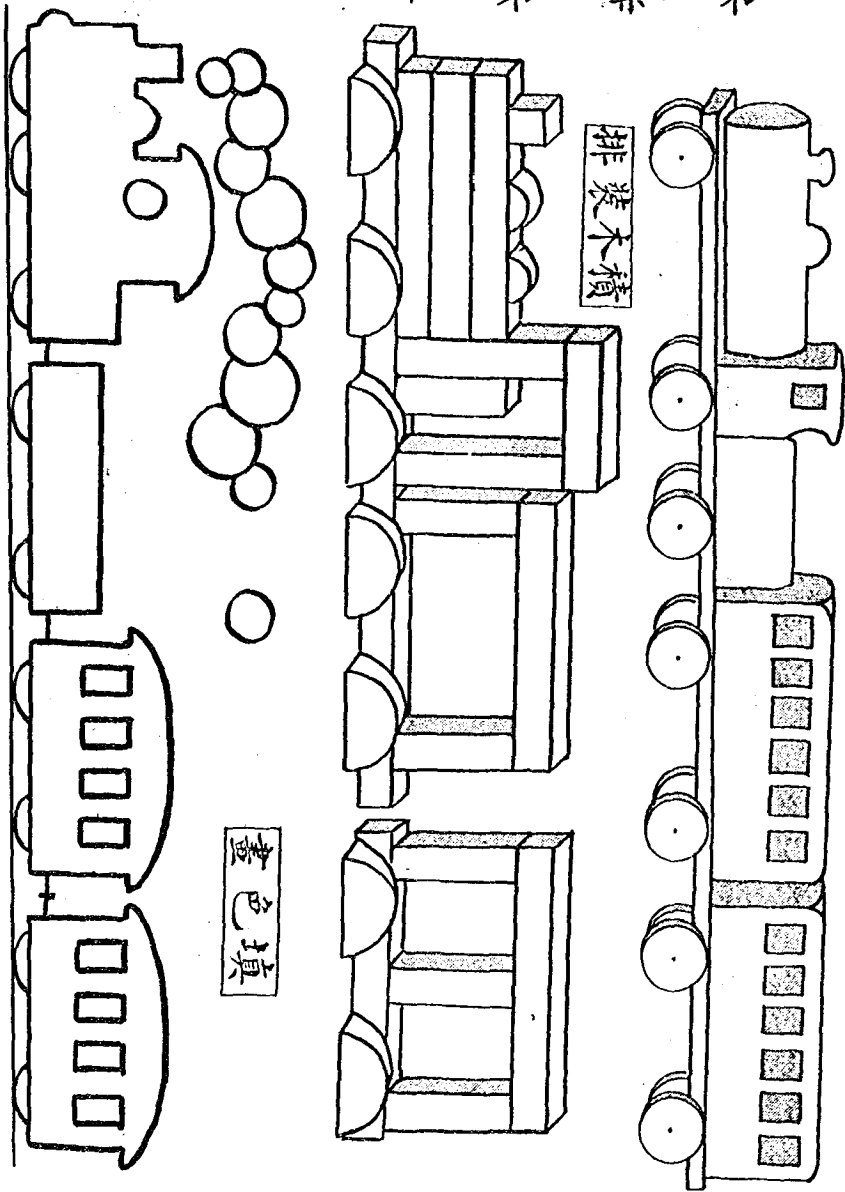

開車火 組一十三第 集二第

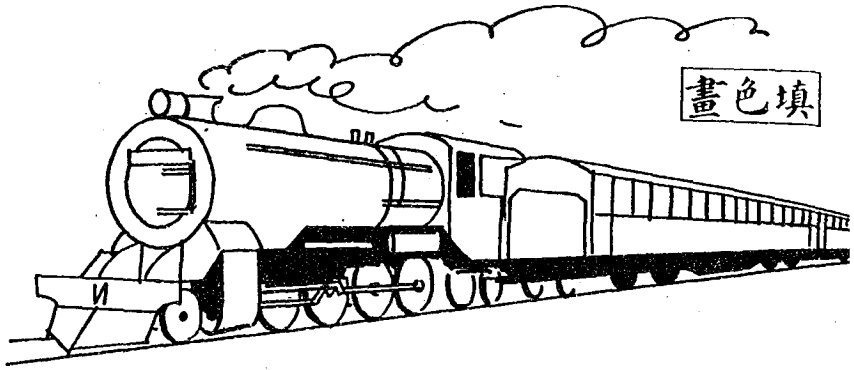

畫墨塗

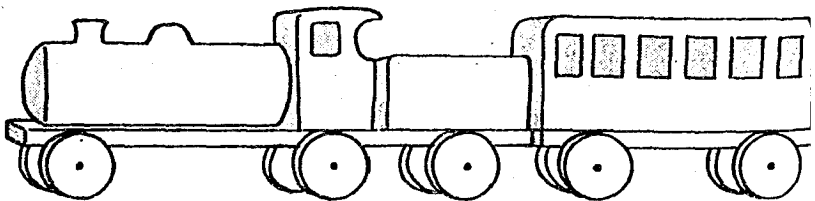
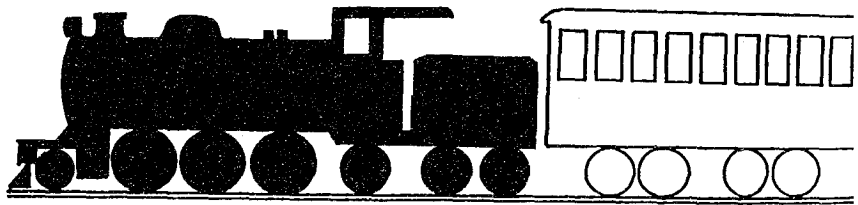

車火木積玩

來機飛 組二十三第 集二第

排裝木積

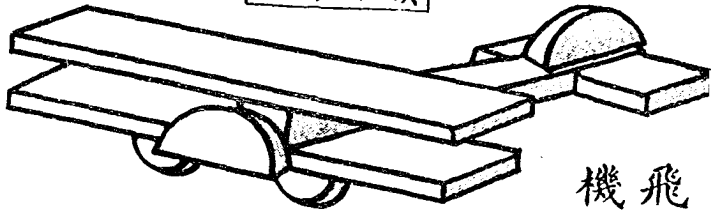

機飛

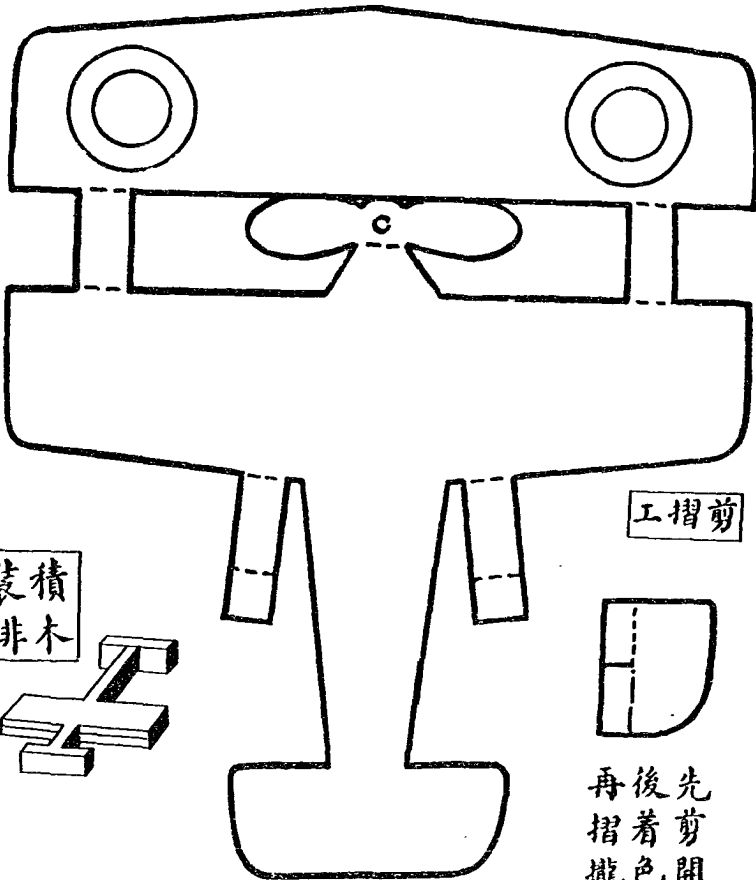

工摺剪

裝積
排木

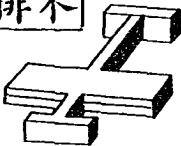

再後先
摺着剪
攏色開

來機飛 組二十三第 集二第

板巧七新

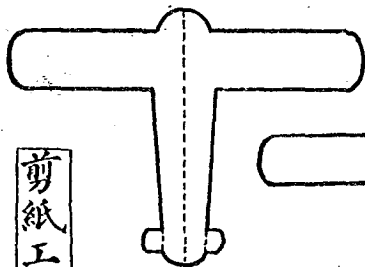

剪紙工

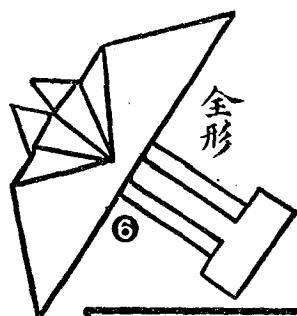
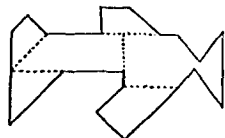
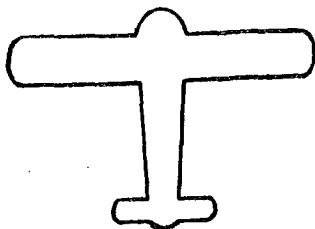

工紙摺

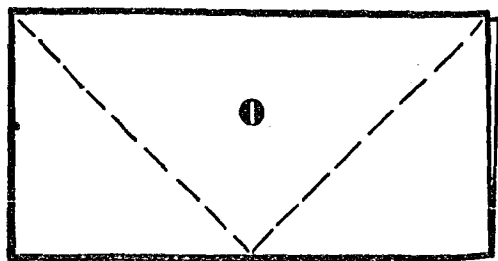
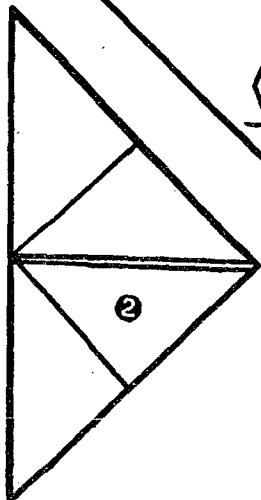
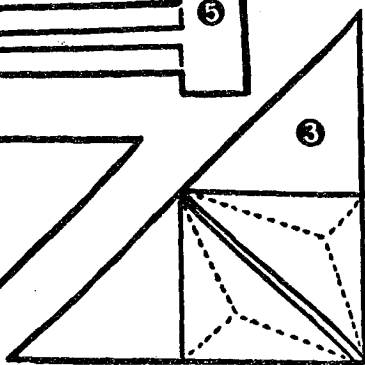
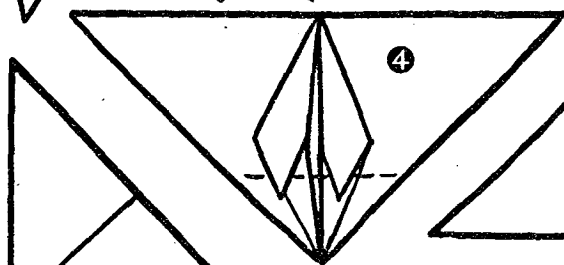
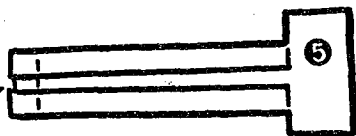

魚金裏缸 組三十三第 集二第

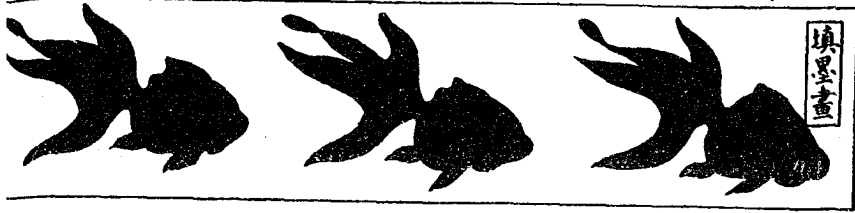

填墨畫

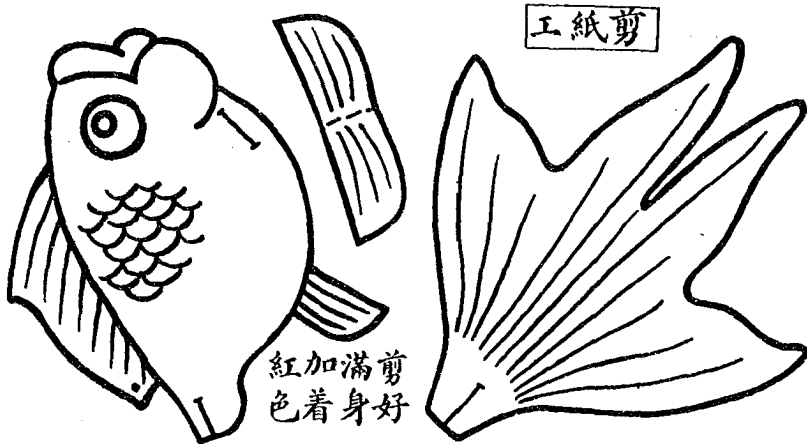

工紙剪

紅加滿剪
色着身好

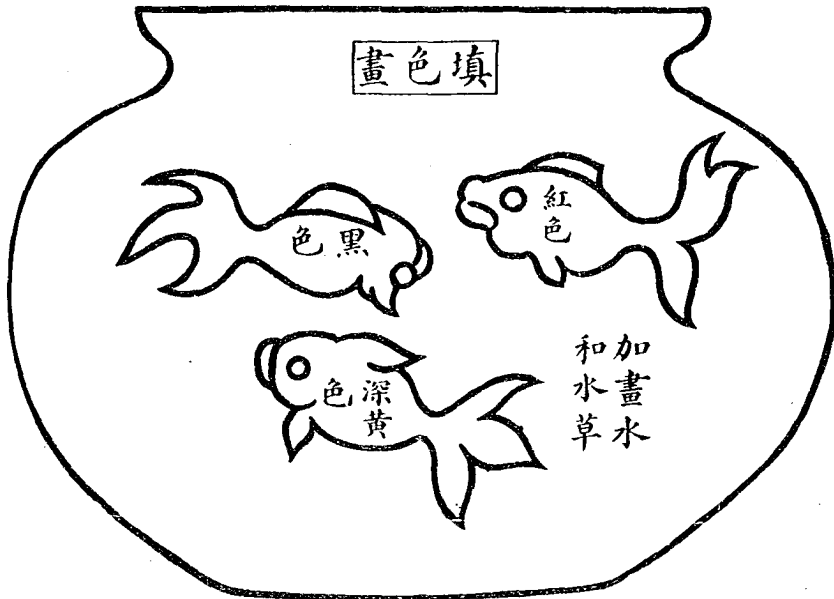

畫色填

色黑

紅色

色深黃

和加畫水
水草

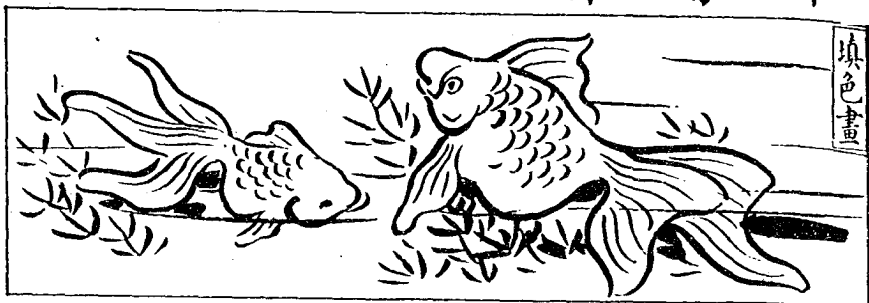

填色
剪紙工

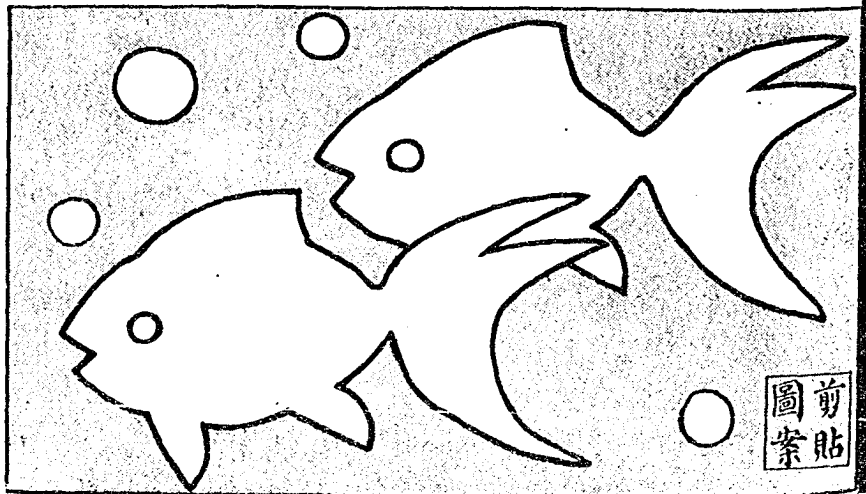
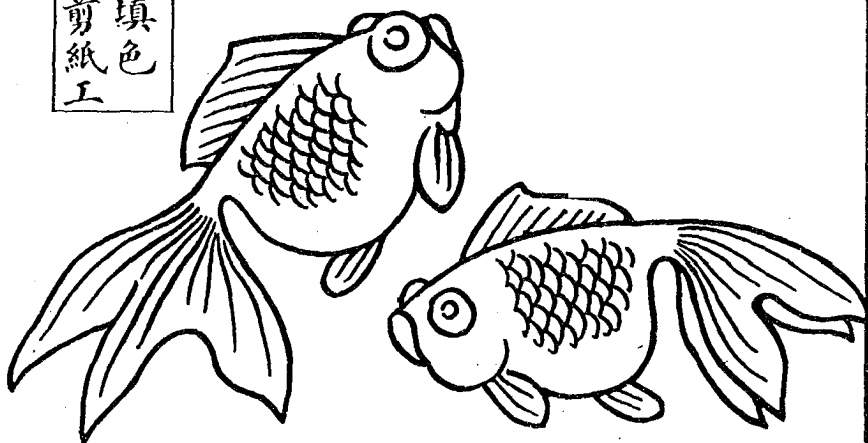

畫色填



摺紙工

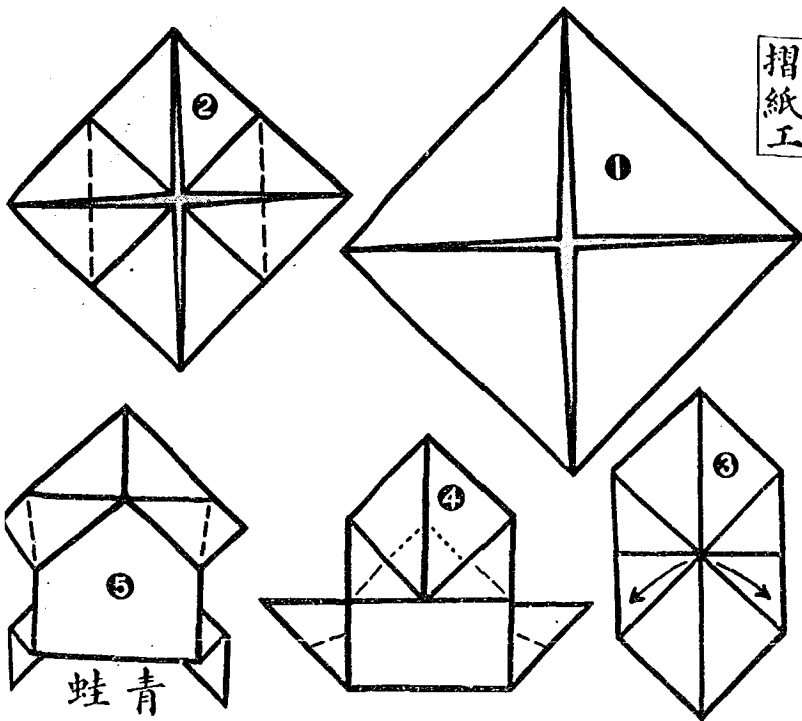

蛙青

蛙青邊池 組四十三第 集二第

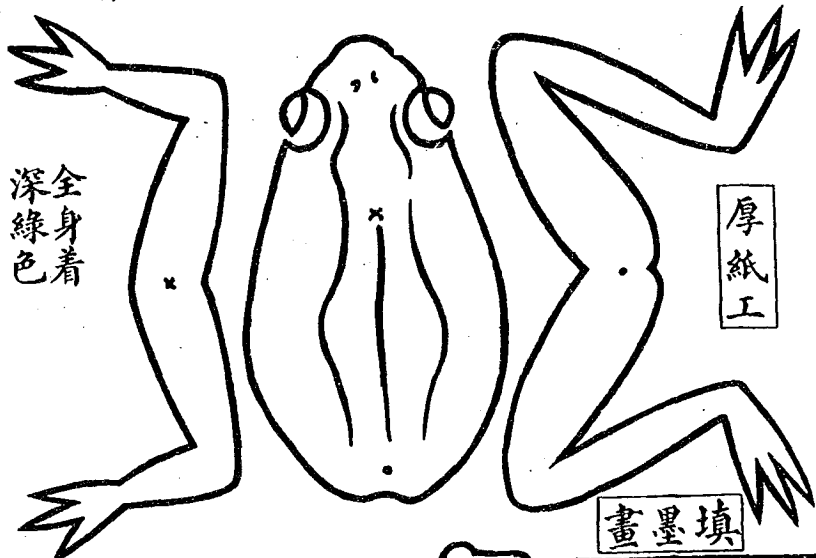

全身着
深綠色

厚紙工

畫墨填

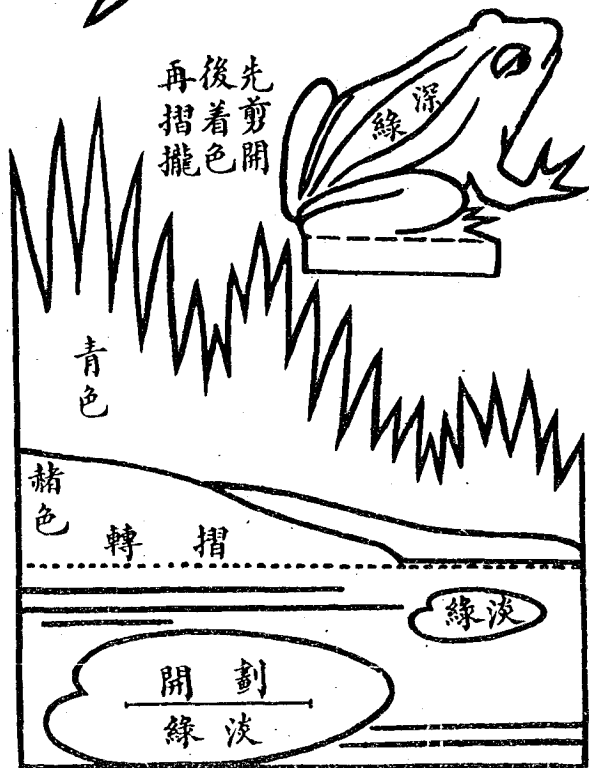

先剪開
後着色
再摺攏

深綠

青色

赭色

轉摺

淡綠

開劃
綠波



組十六百一

子蚊 組五十三第 集二第

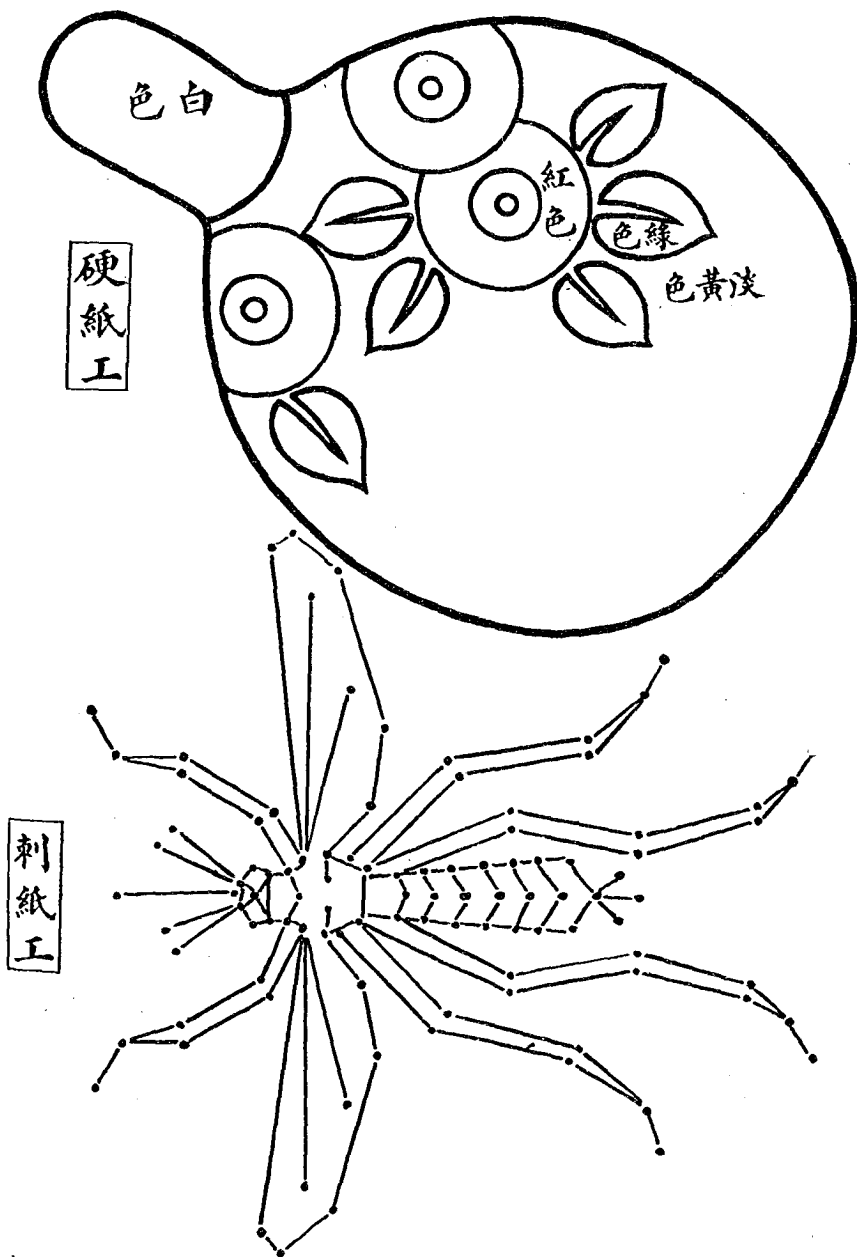

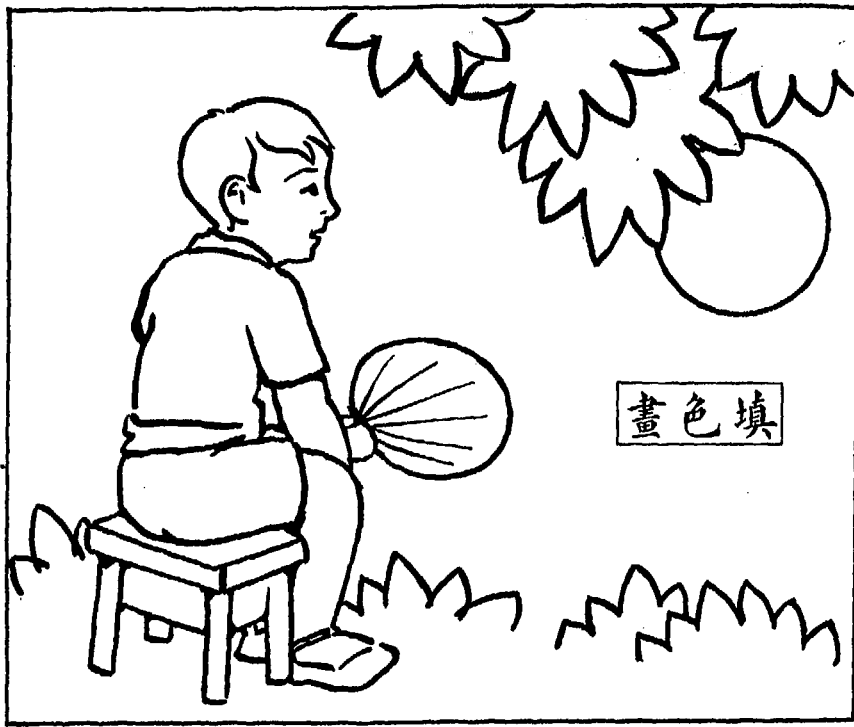

畫色填

膀翅做紙

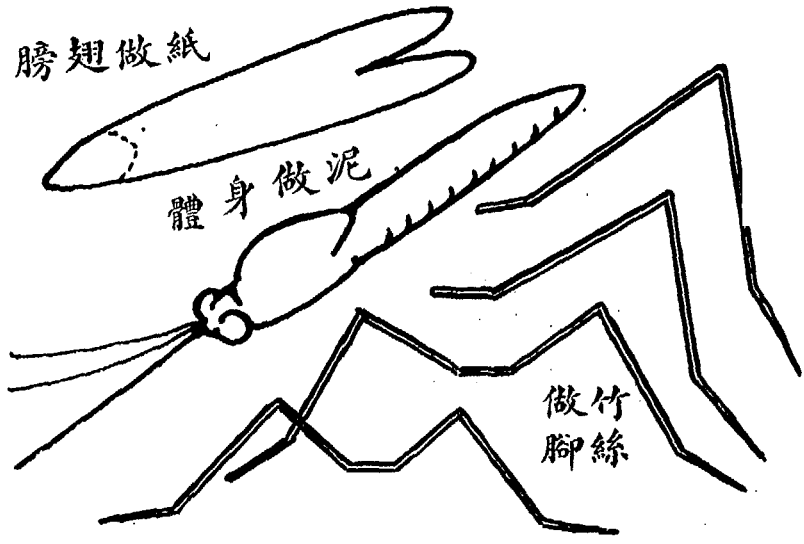

體身做泥

做竹腳絲

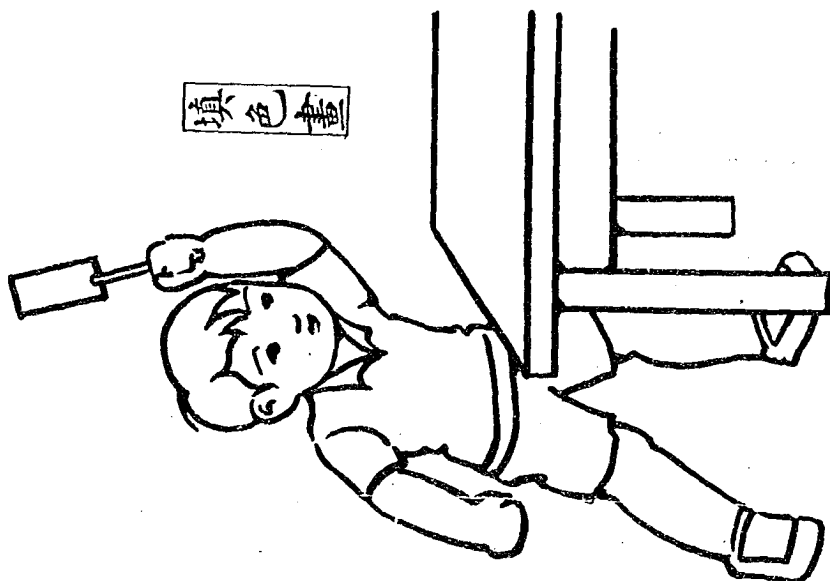
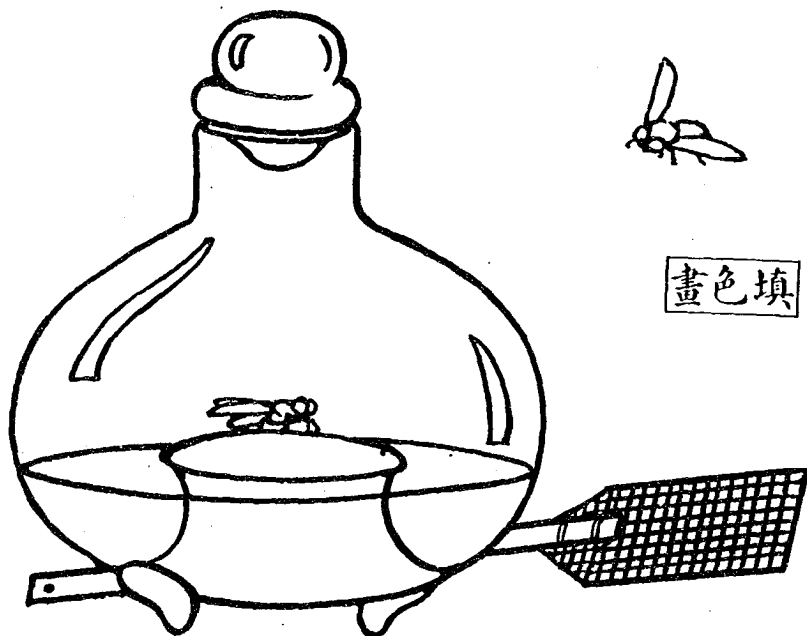

蜂蜜 組七十三第 集二第

畫色填

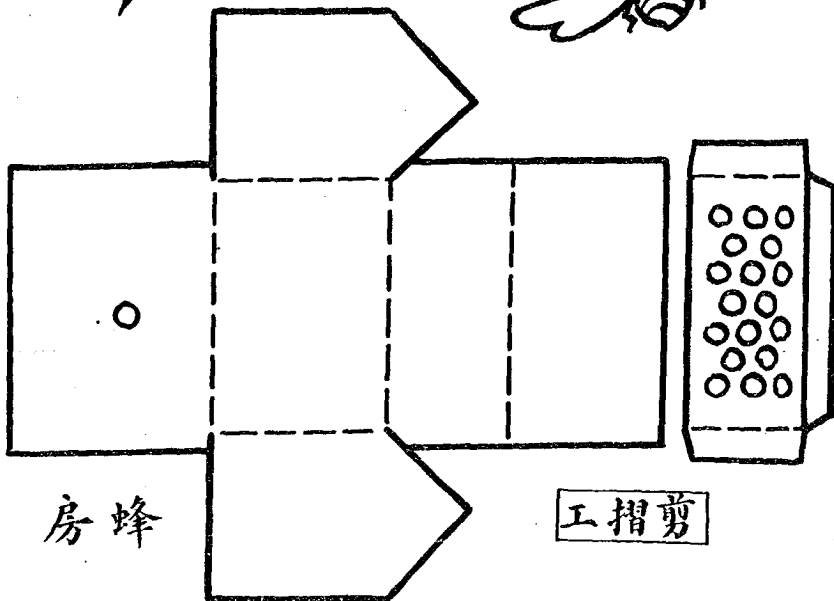
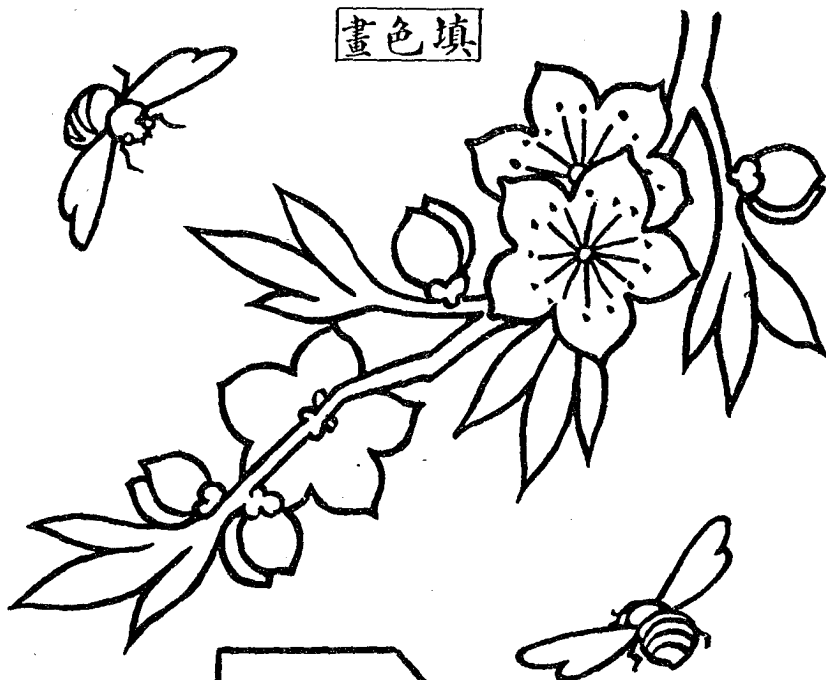

房蜂

工摺剪

填色畫

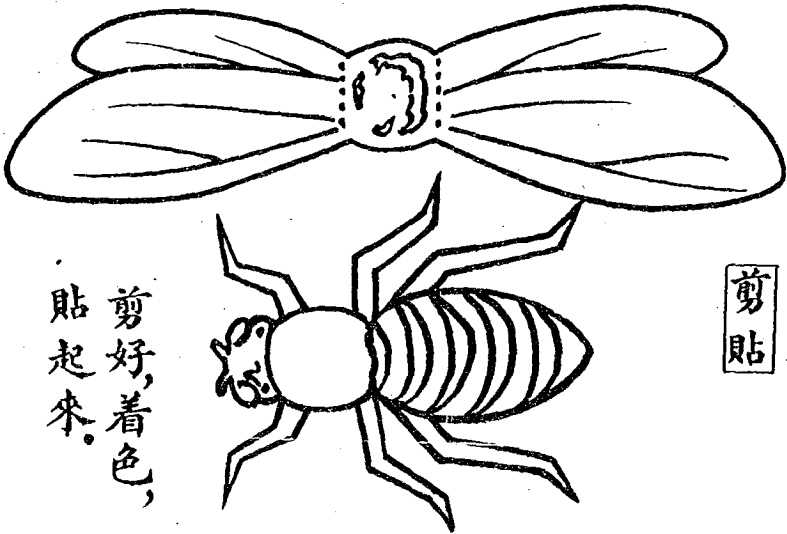
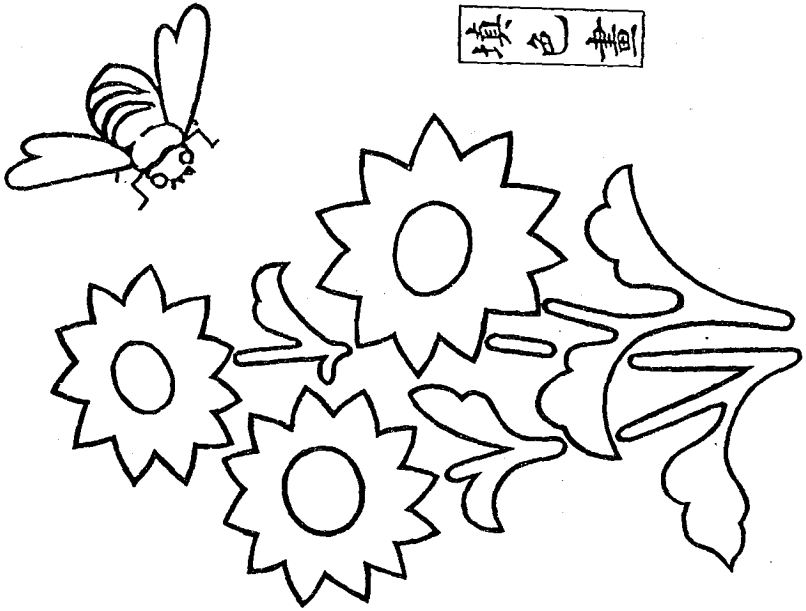

剪好，着色，
貼起來。

剪貼

蜻蜓 組八十三第 集二第

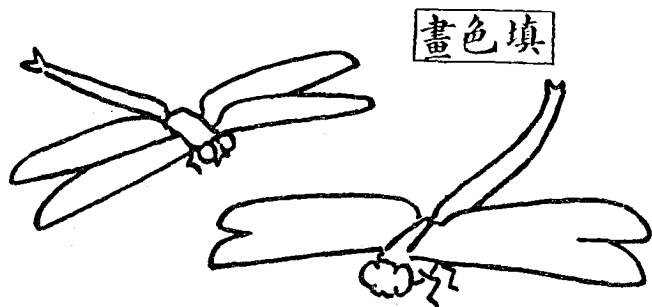
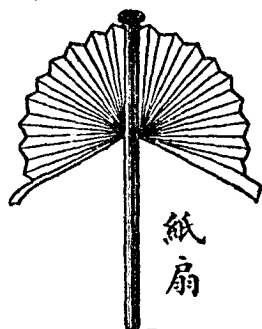
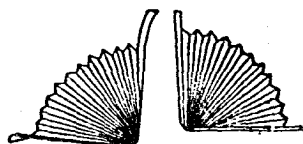
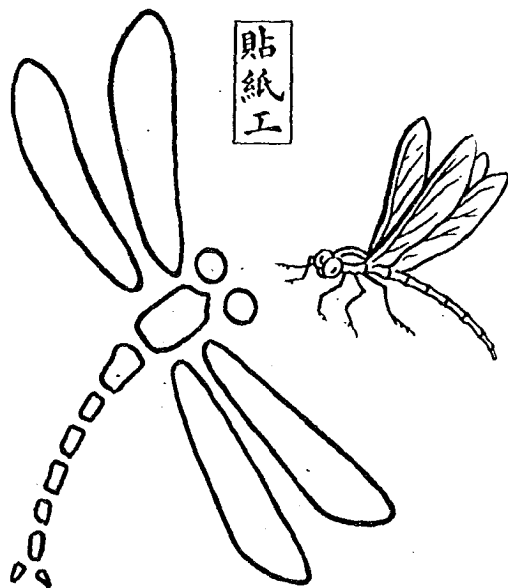

圖紙折

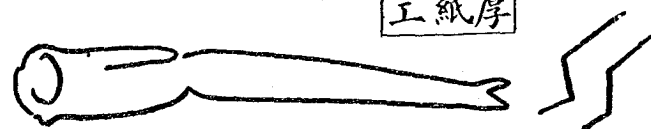
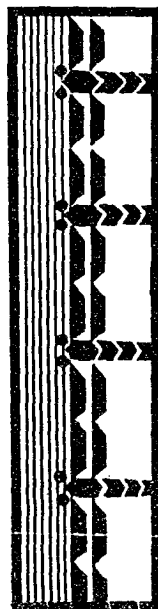
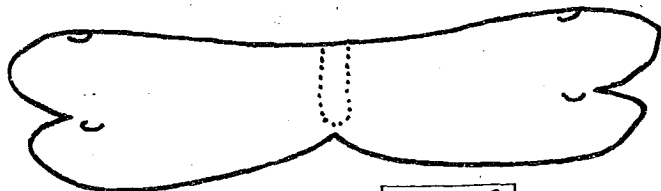

第二集 第三十八組 蜻蜓

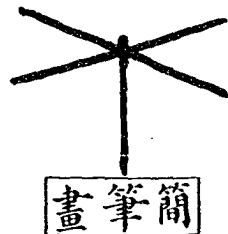
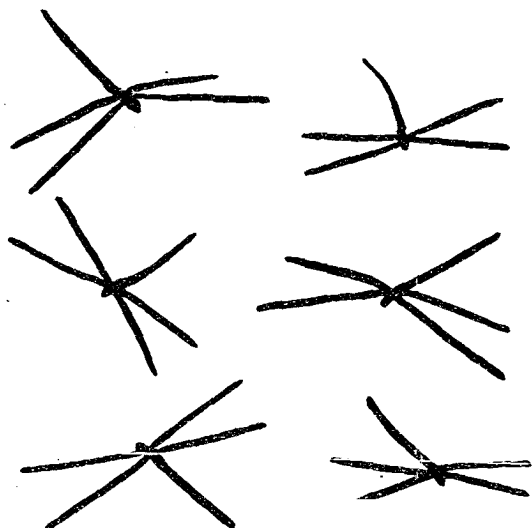
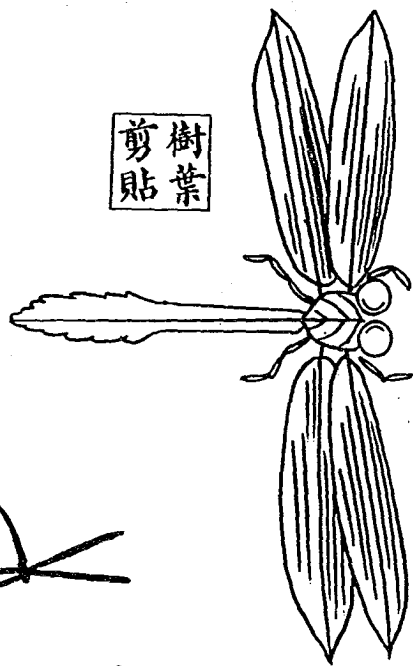
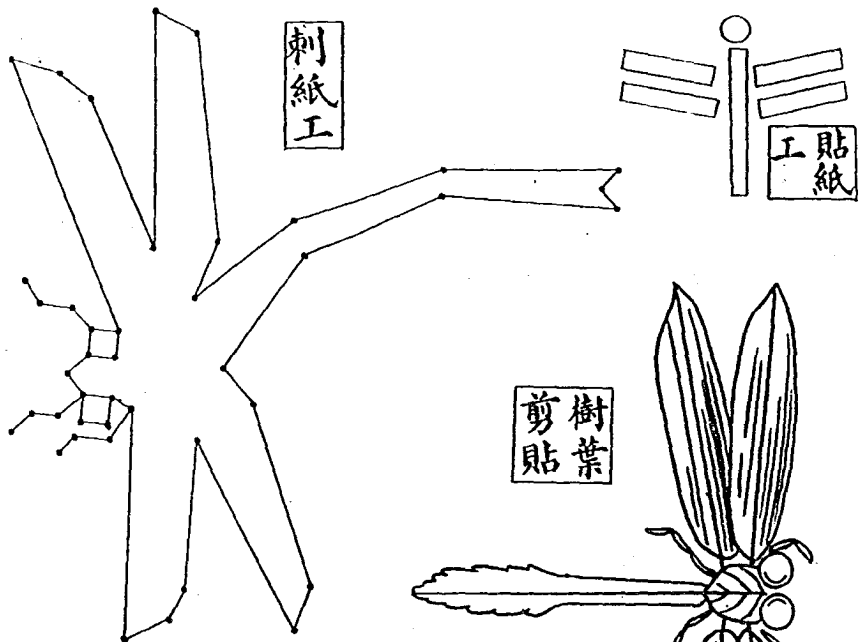

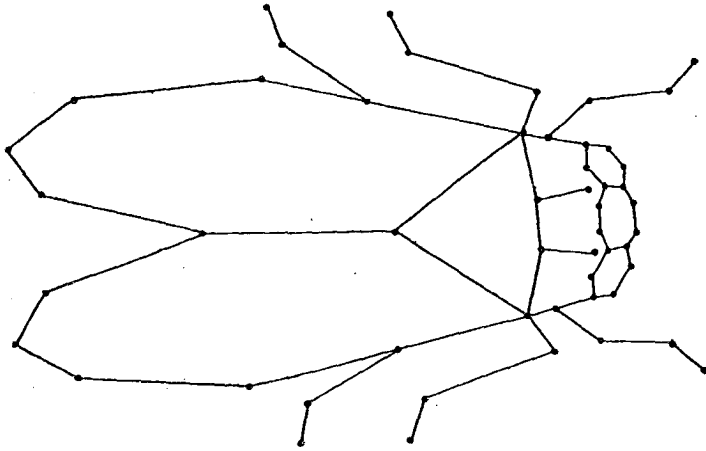
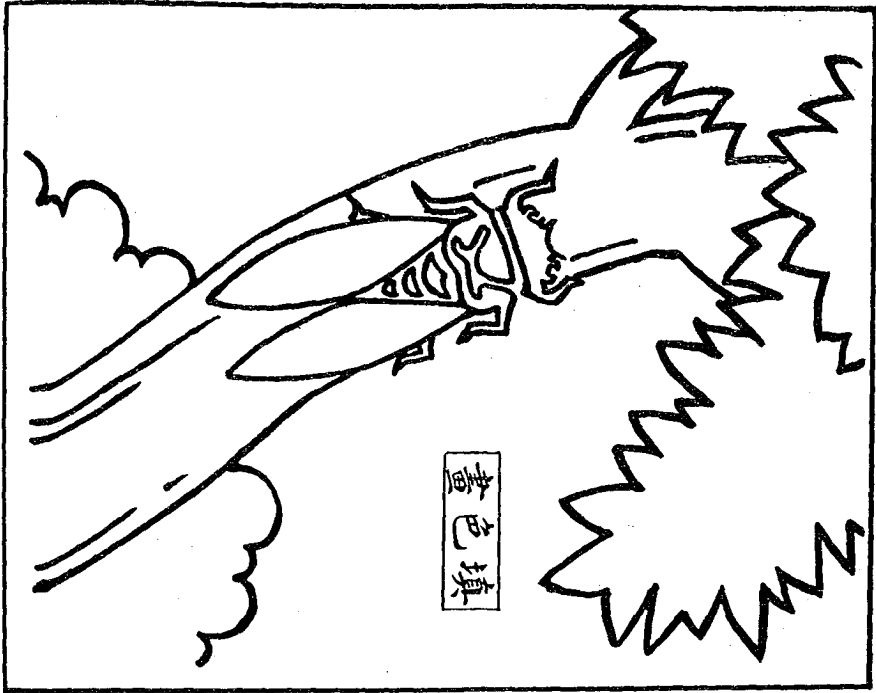

了知 組九十三第 集二第

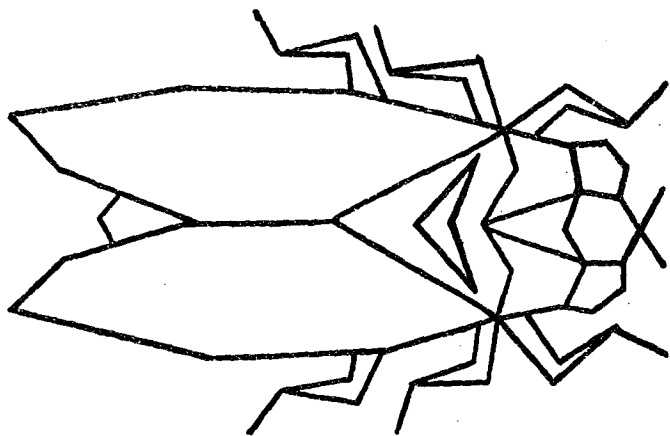

塗色畫

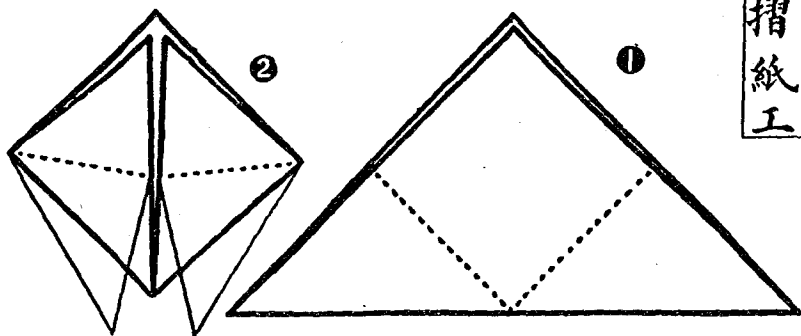

摺紙工

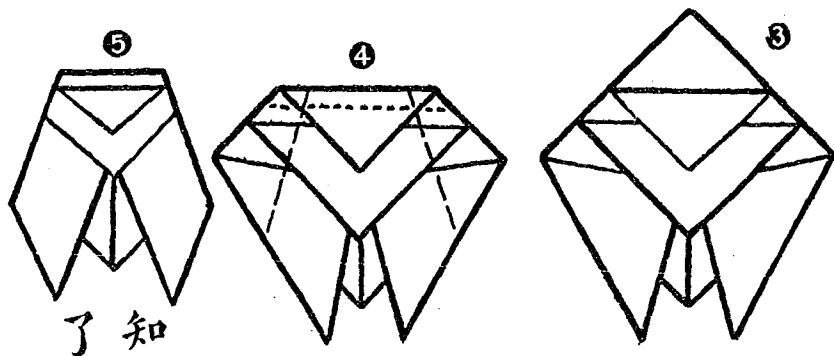

了知

兒蟲小 組十四第 集二第

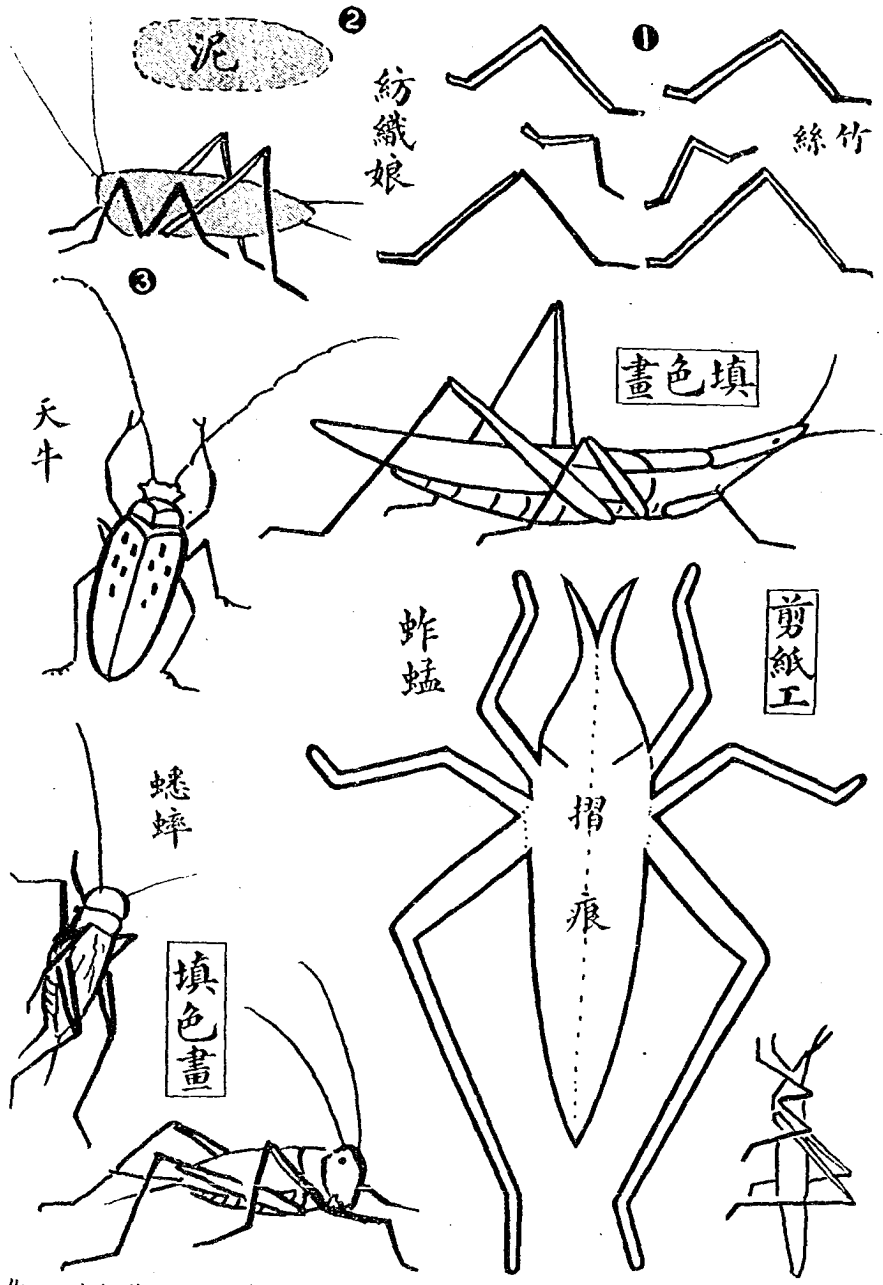

兒蟲小 組十四第 集二第

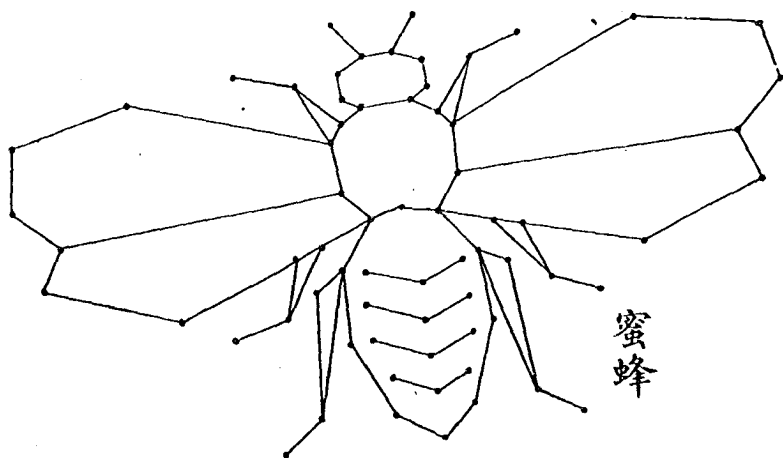
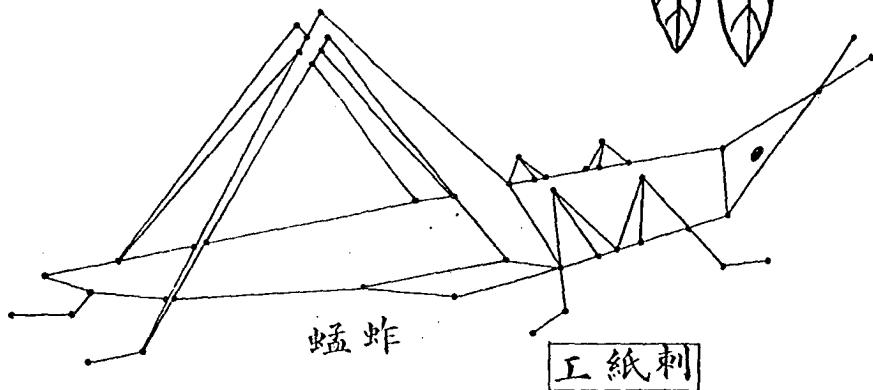
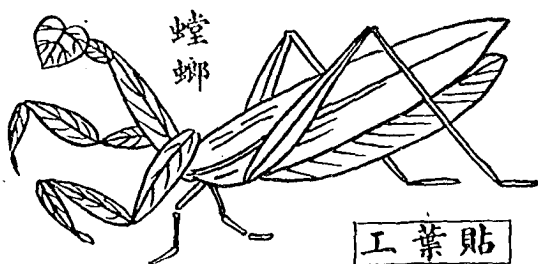

哥哥好 組一第 集三第

填色畫

自己加背景



①



②

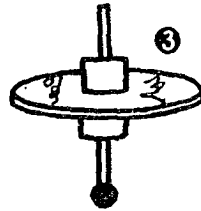

③

混合工

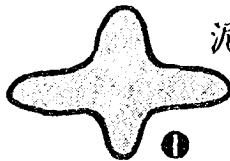

①



②

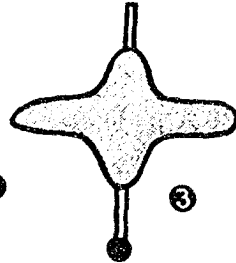

③

哥哥好 組一第 集三第



填色畫

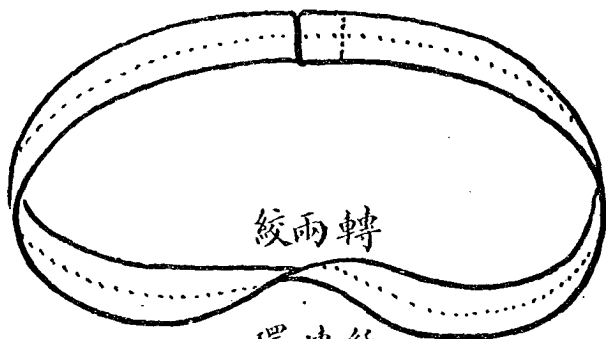
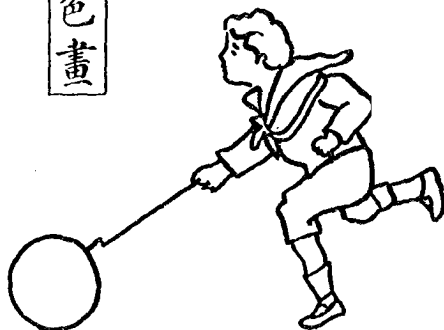

絞兩轉

環連紙

紙條工

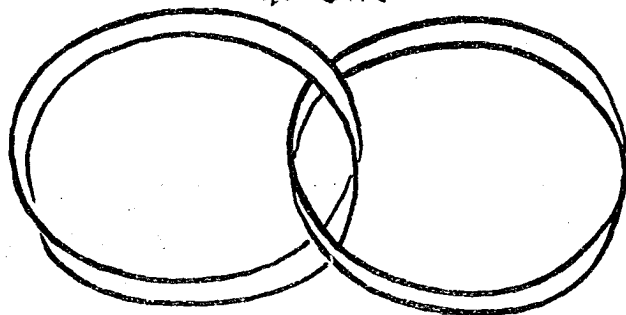

第三集 第二組 好弟弟

摺紙工

紙鋼琴

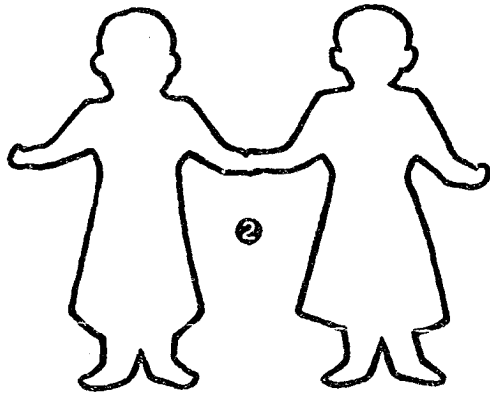
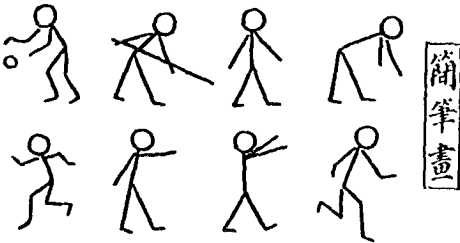
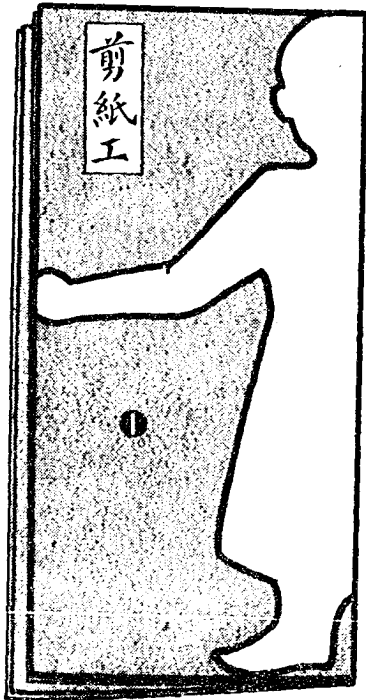
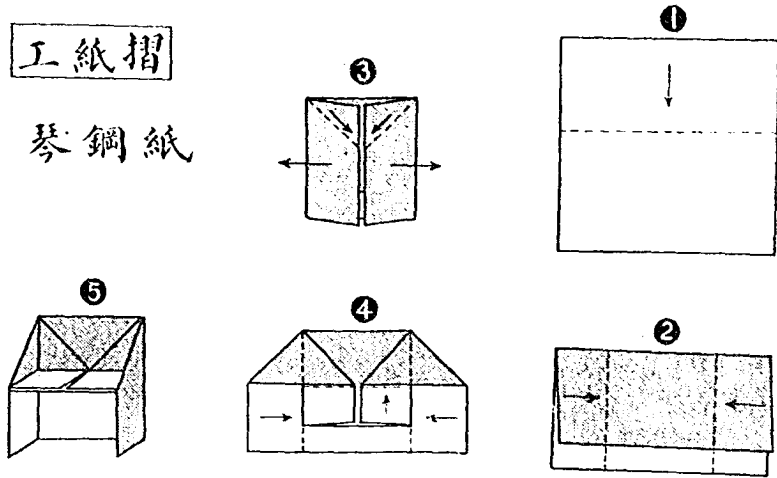

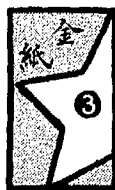
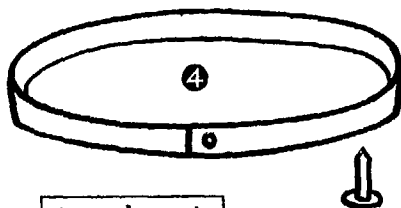
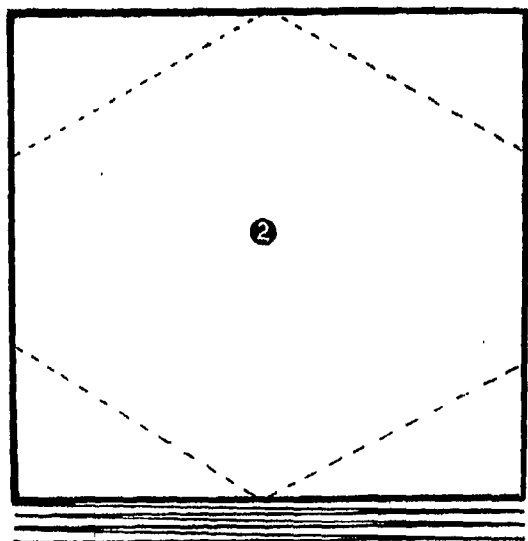

跳舞帽

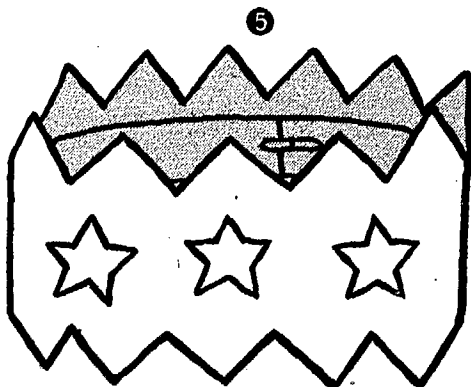

厚紙

①

走同一組三第集三第

填色畫

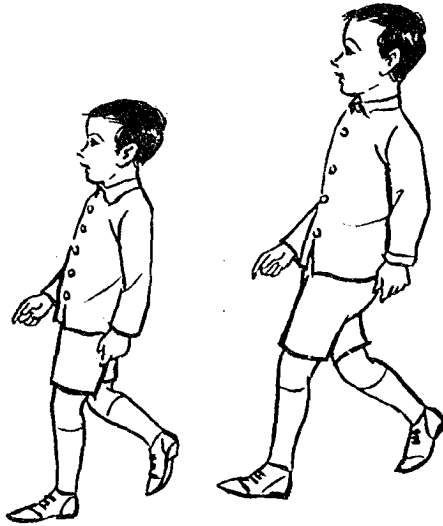

扯紙工



工合混

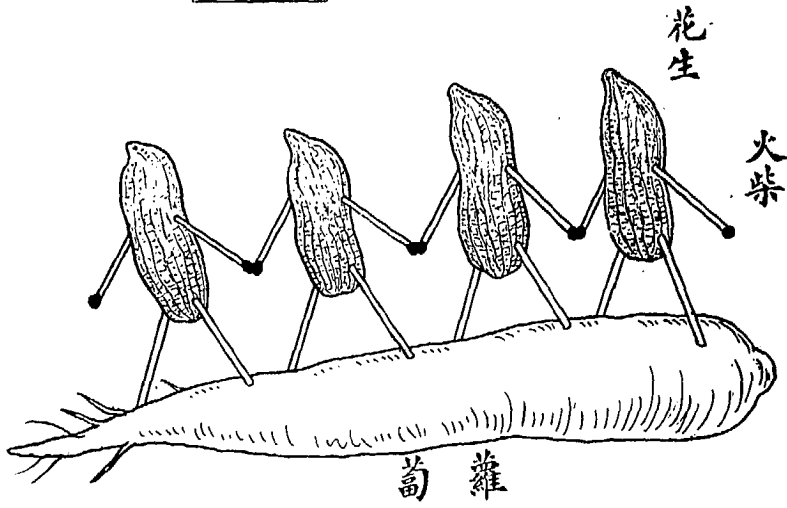

填色畫

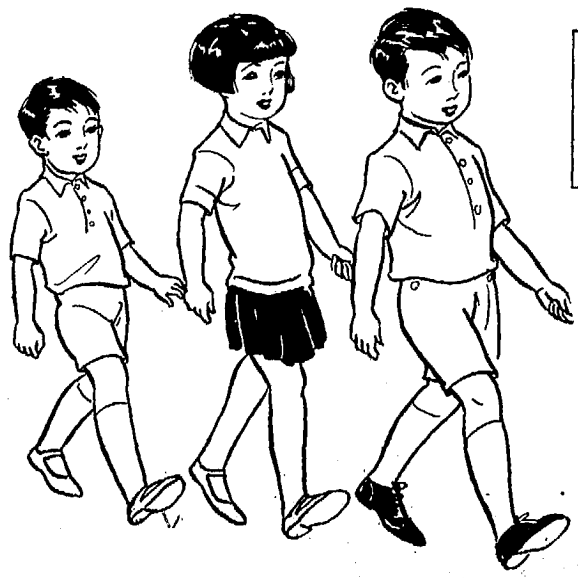

走開分 組四第 集三第

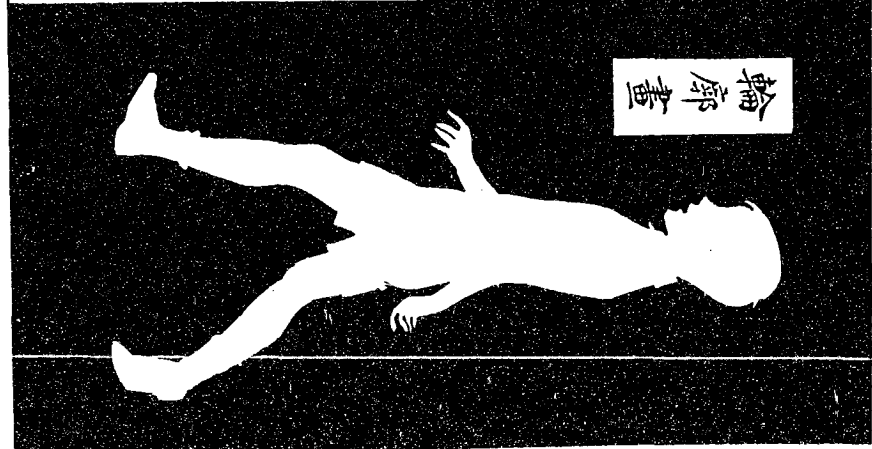
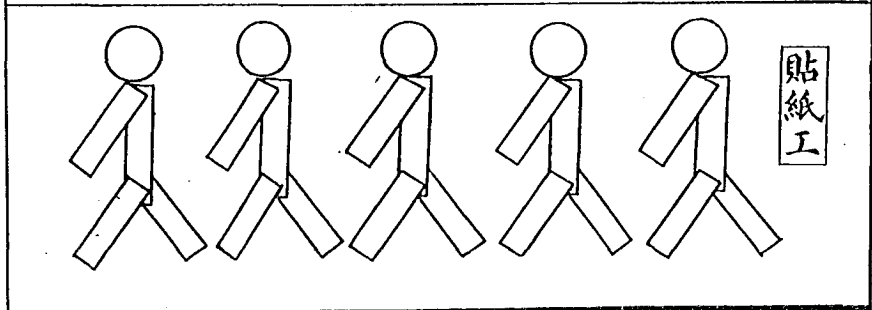
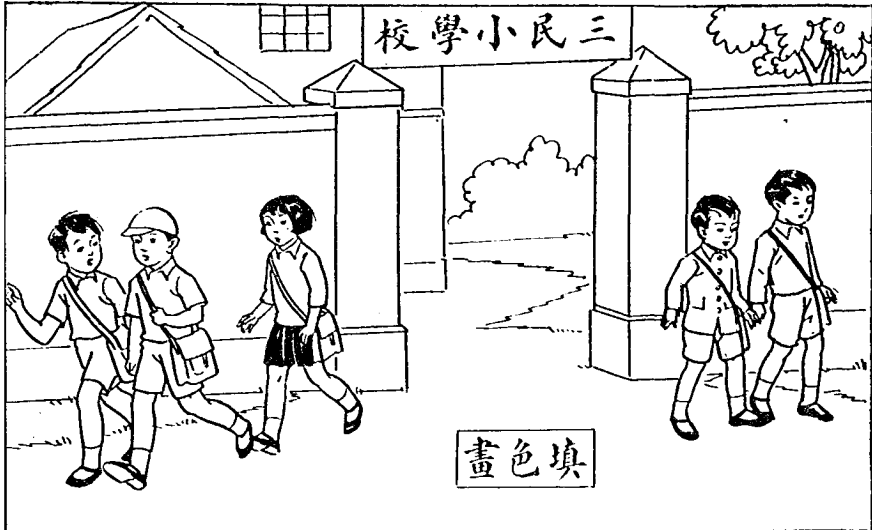

走開分 組四第 集三第

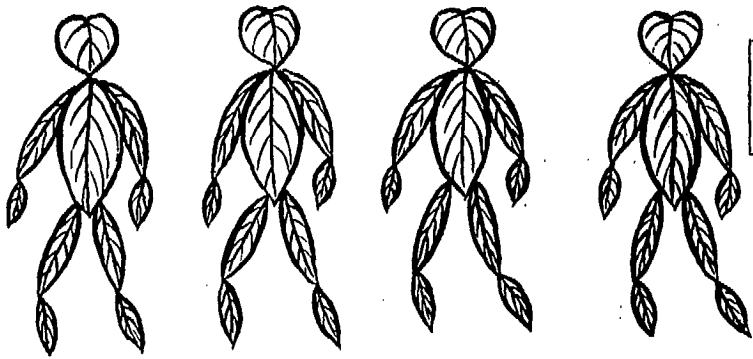

貼葉

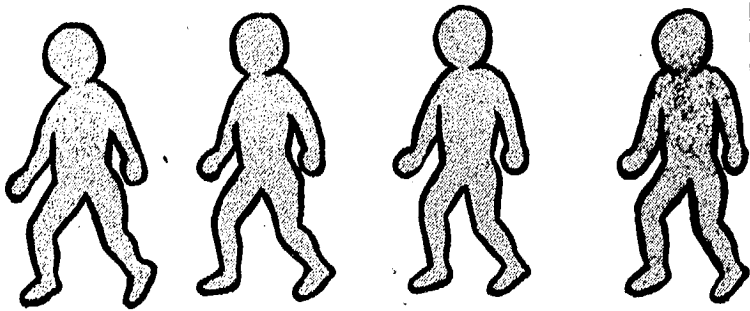

泥工



沙盤裝排

戲遊來 組五第 集三第

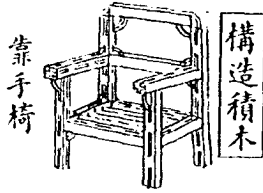

工紙摺

帽紙

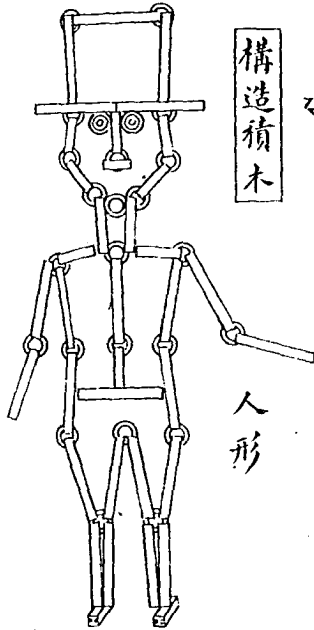
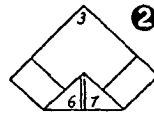
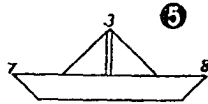
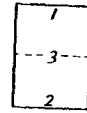
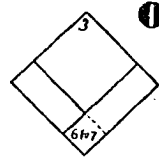
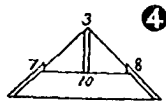

樹葉剪貼

葫蘆

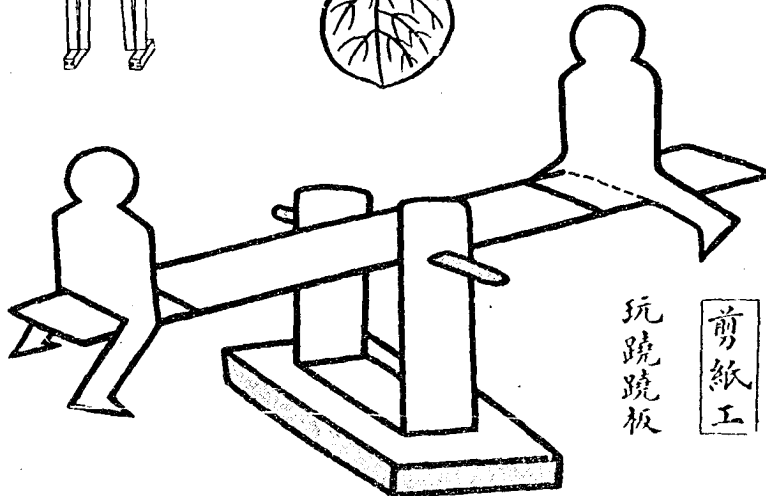
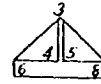
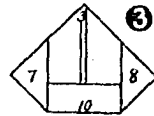

戲遊來 組五第 集三第

建築積木

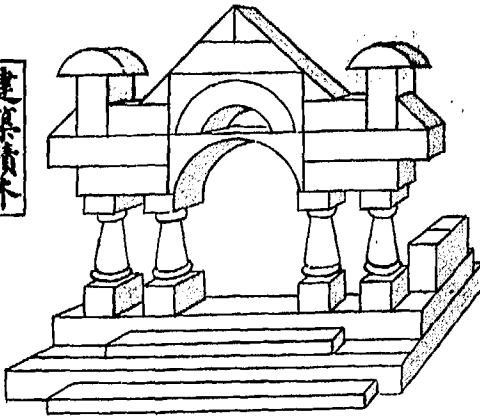

囊豆



繩圈

投圈架

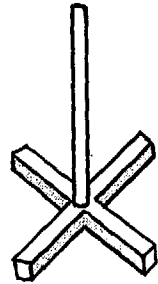

子鍵紙

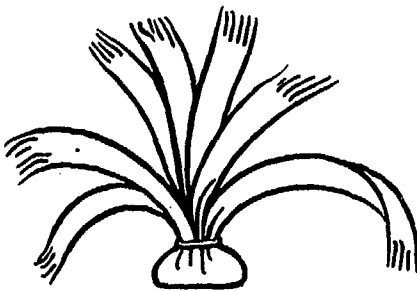

②

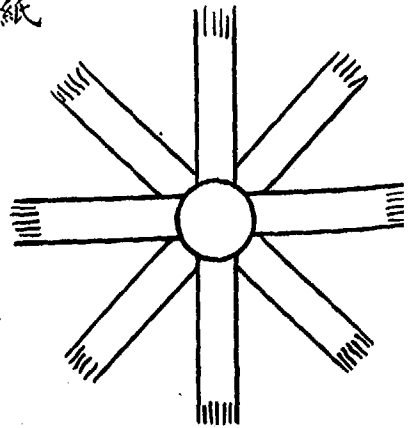

①

啼雞學 組六第 集三第

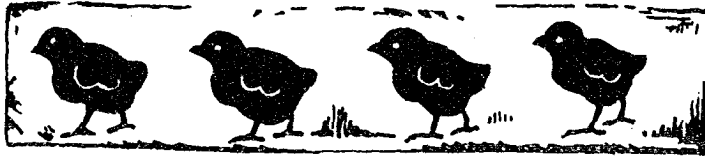

小雞木
印圖紫

雞小的裹殼蛋

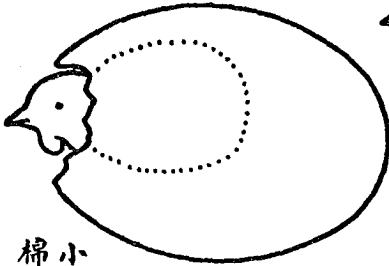

小雞用
棉絮做

工泥

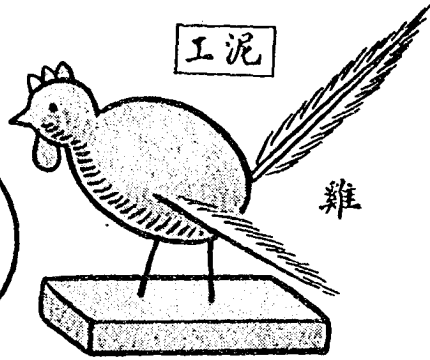

雞

工線穿

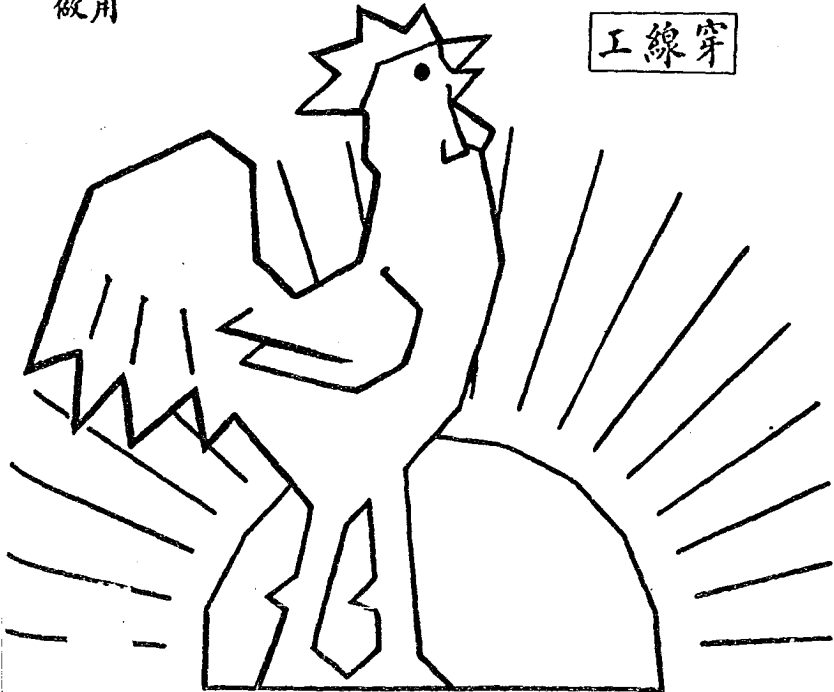

啼雞學 組六第 集三第

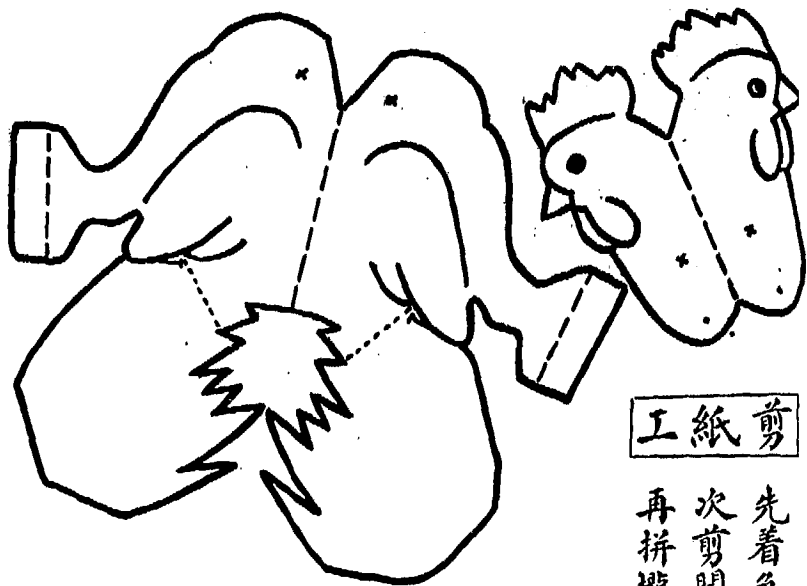

工紙剪

先着色
次剪開
再拼攏

例舉畫童兒

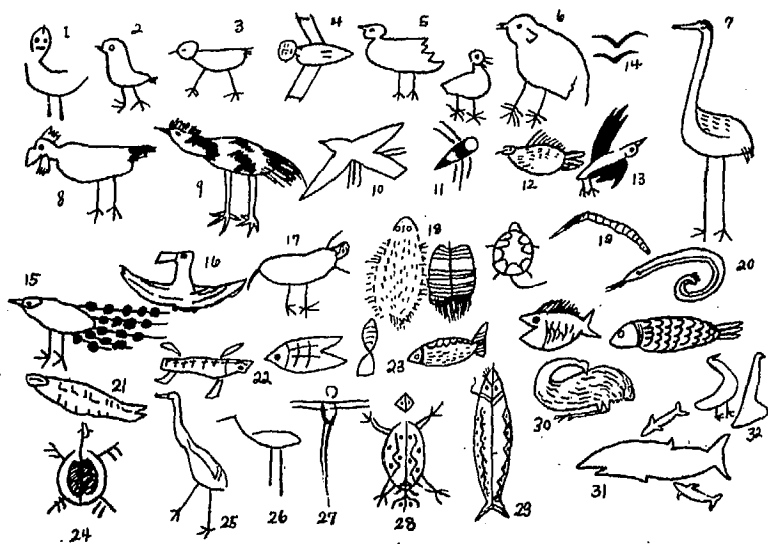

出鳥老 組七第 集三第

填色畫

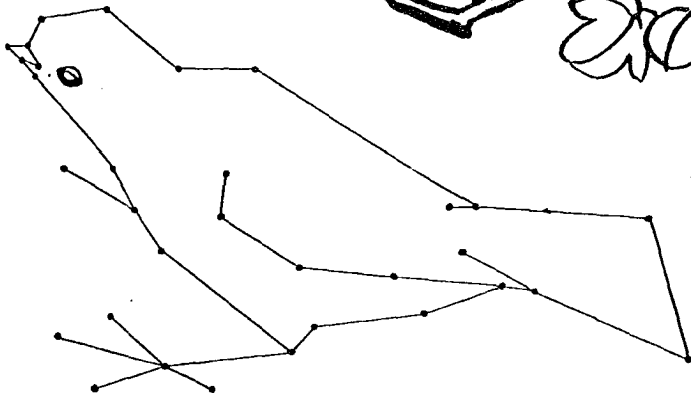
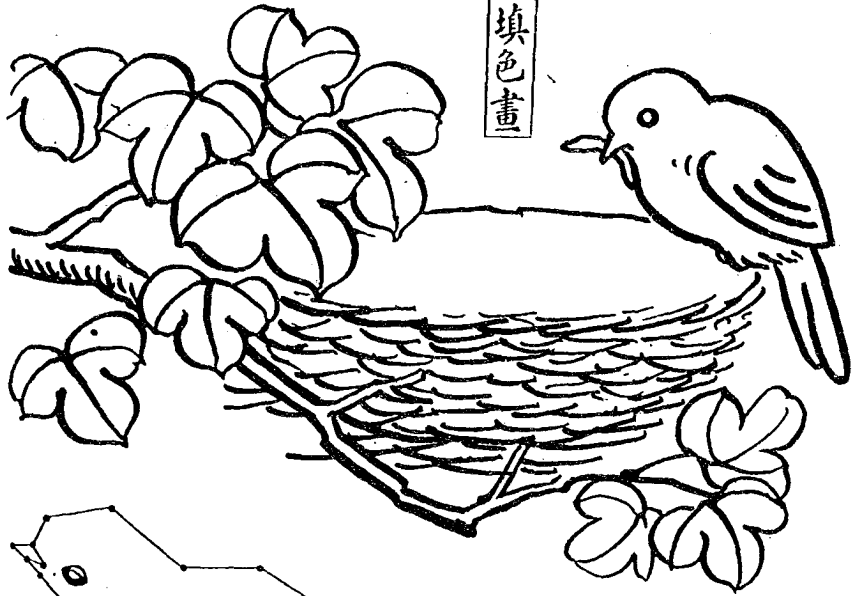

穿線工

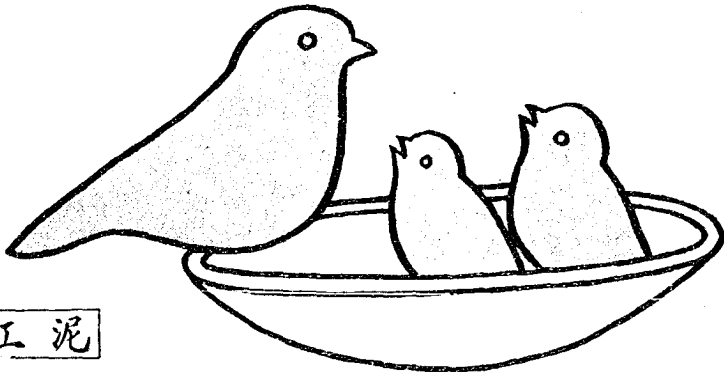

工泥

出鳥老 組七第 集三第

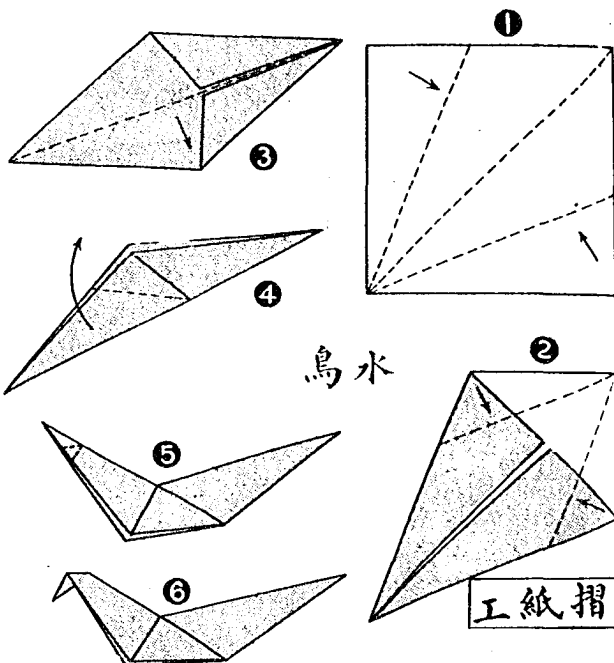
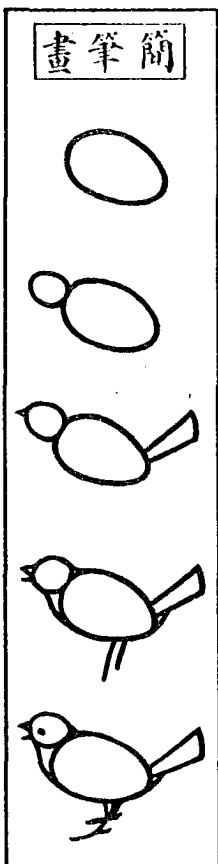

舊七巧板

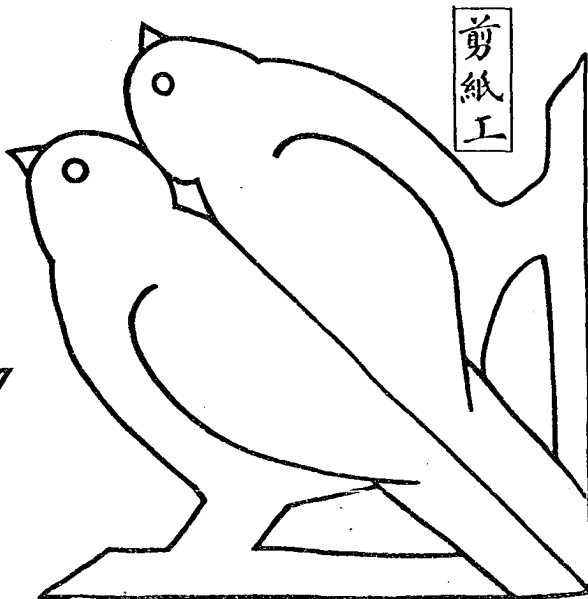
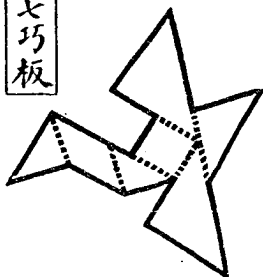

叫雀小 組八第 集三第

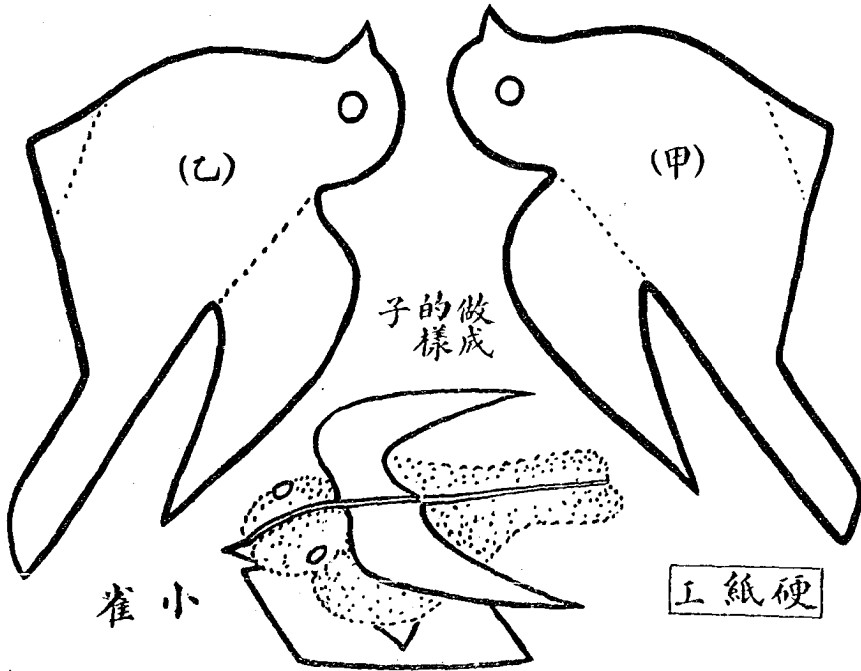
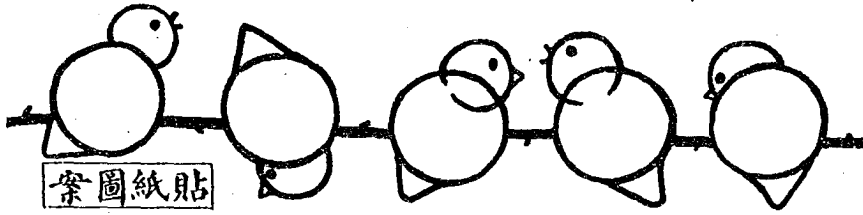

叫雀小 組八第 集三第



畫墨填

工紙刺

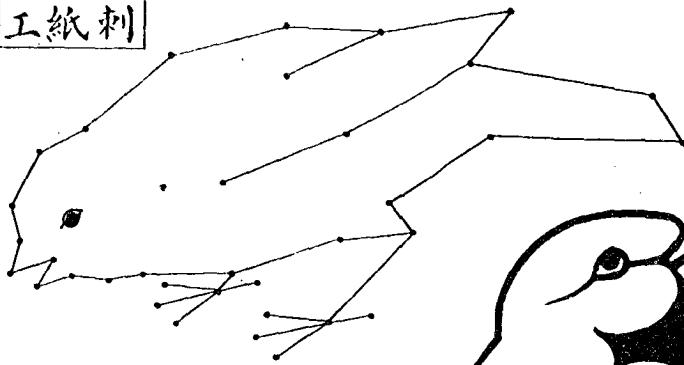

高粱秆
做的小鳥

填色畫

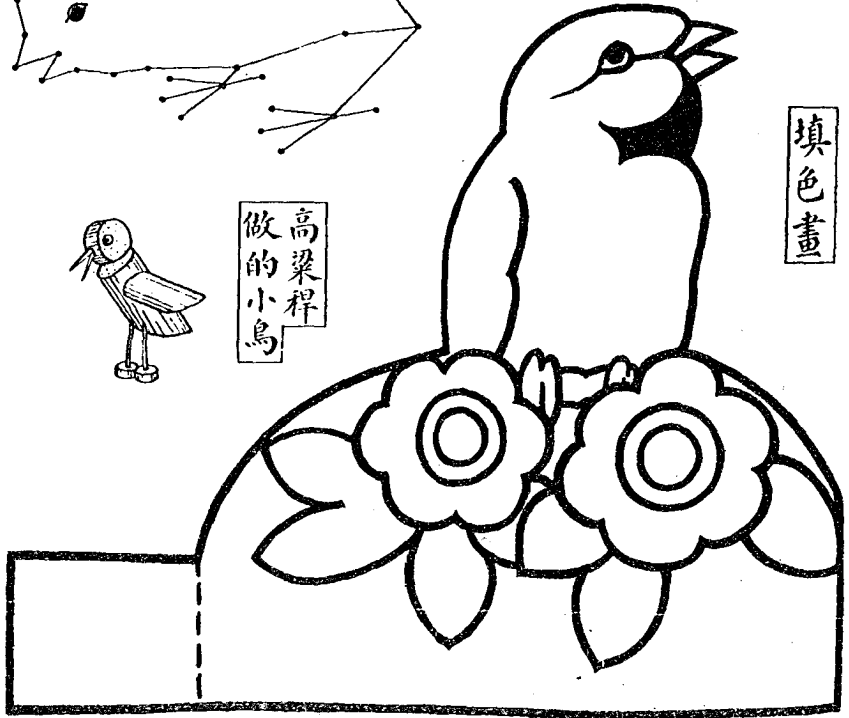

排裝盤沙

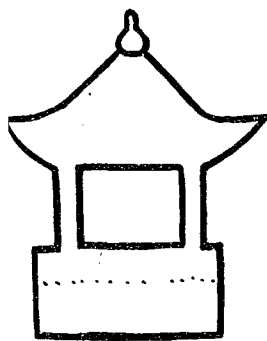

可以加在沙盤裏的東西

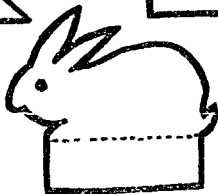

裏園到 組九第 集三第

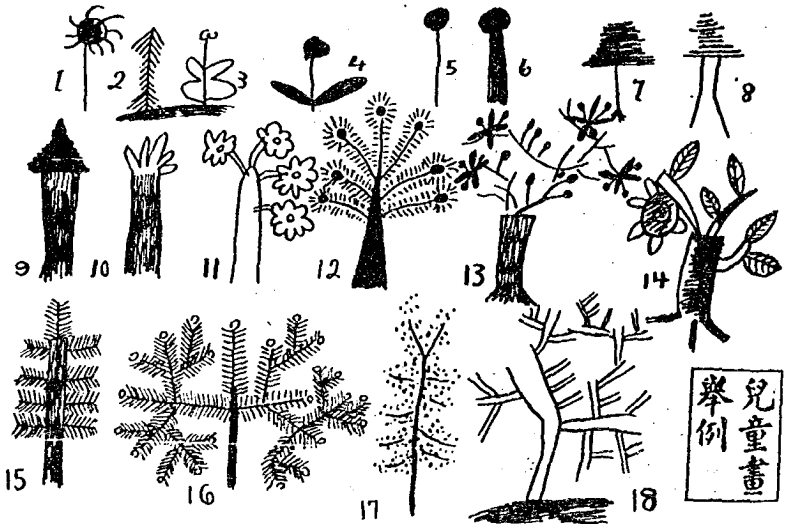
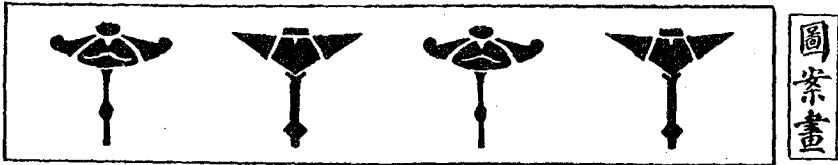

花裏園 組十第 集三第

工紙扯

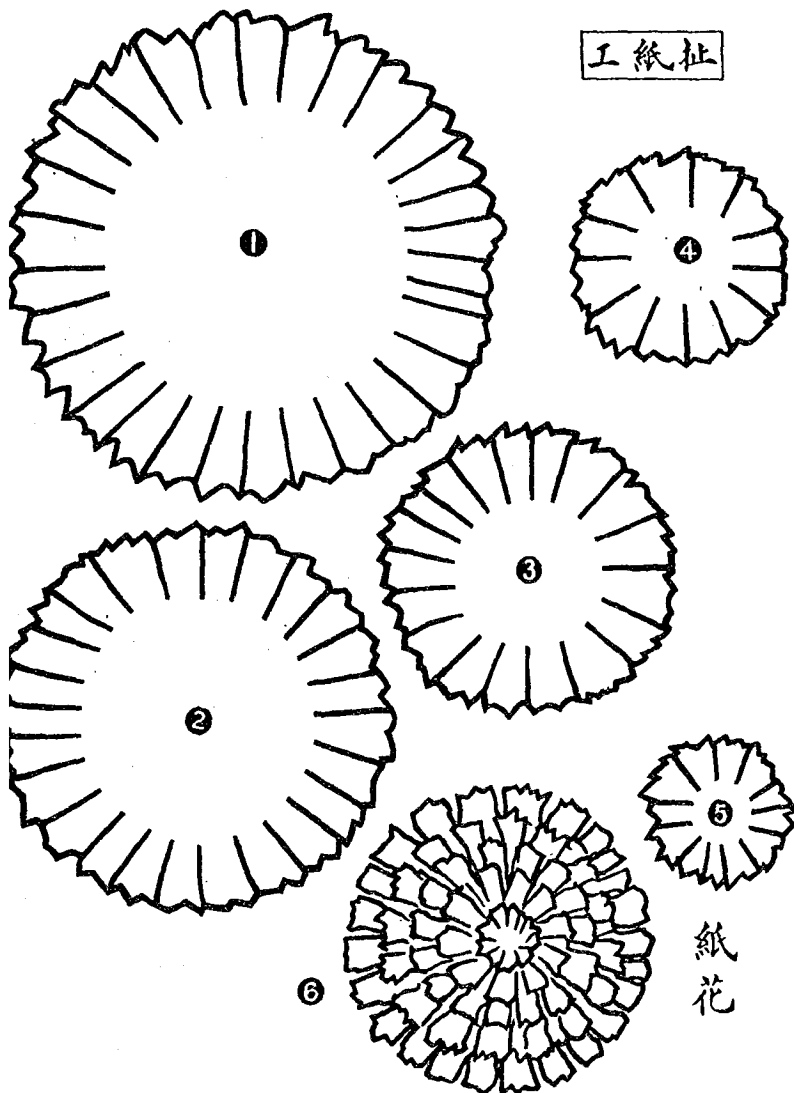

紙花



花裏園 組十第 集三第

用線
香曼的
花弁

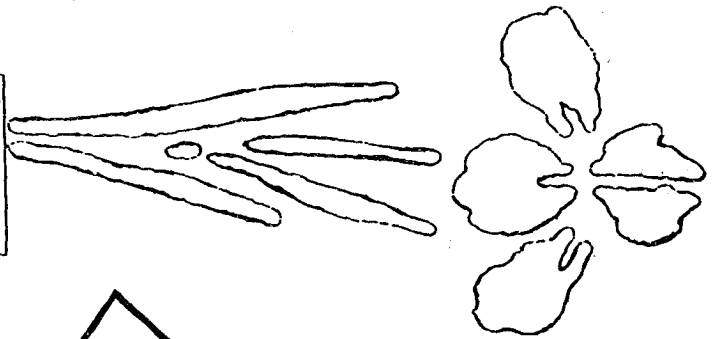

用真
花葉
貼成
的圖

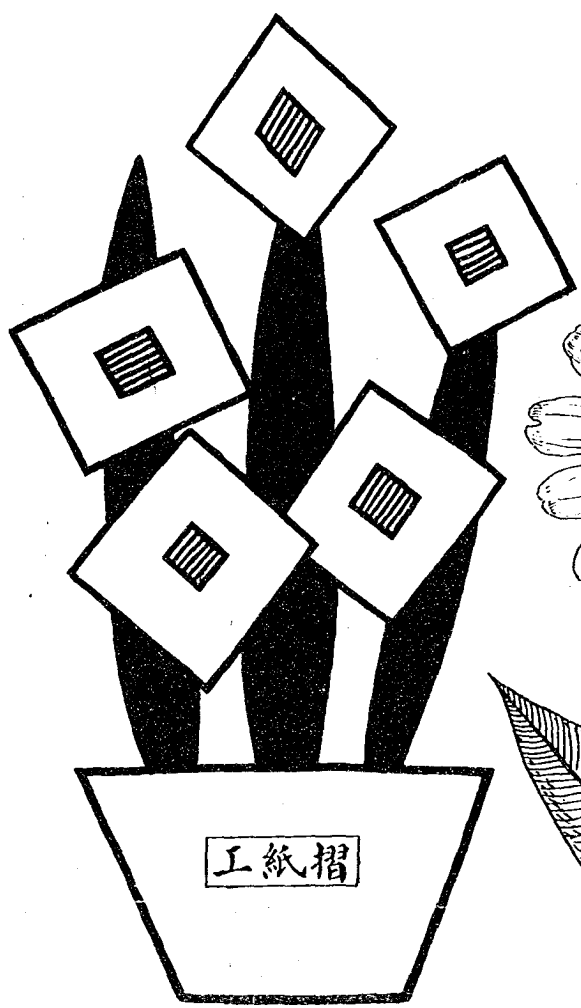

摺紙工



雞小殼蛋

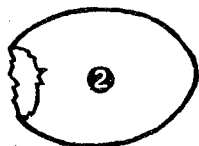
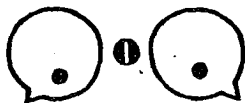
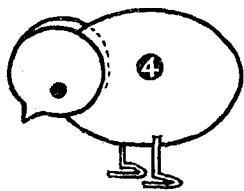

泥工

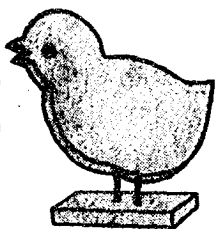

填墨畫



雞白小組一十第 集三第



填色畫

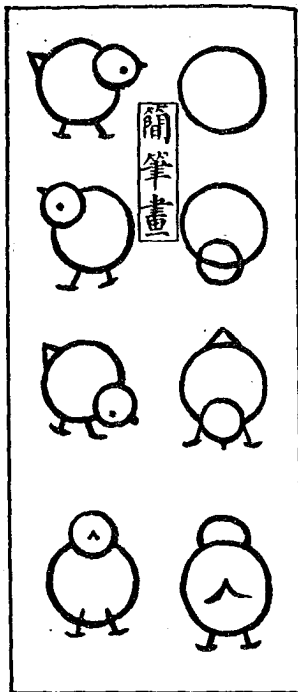

簡筆畫

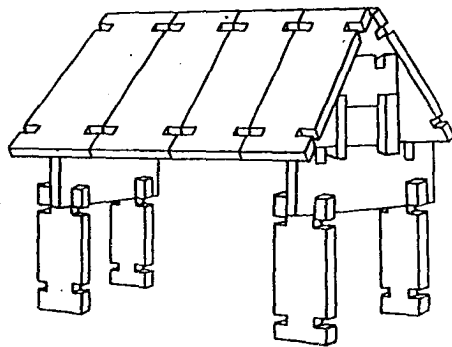
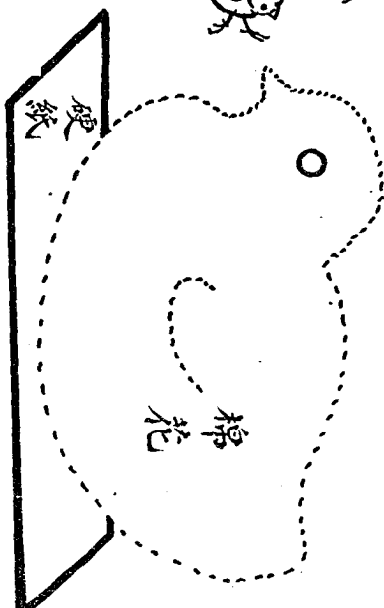

木積造構



畫筆簡



軸線

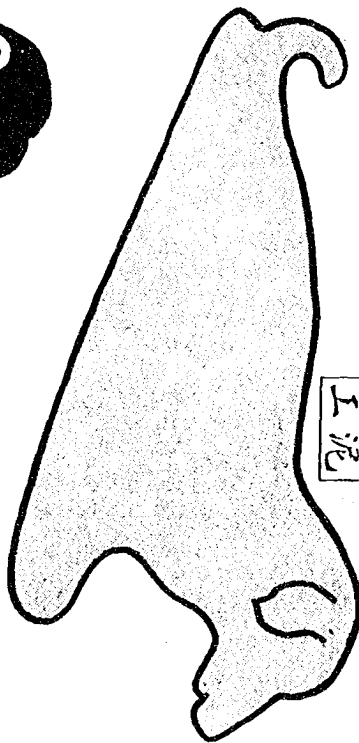

上泥

填色畫

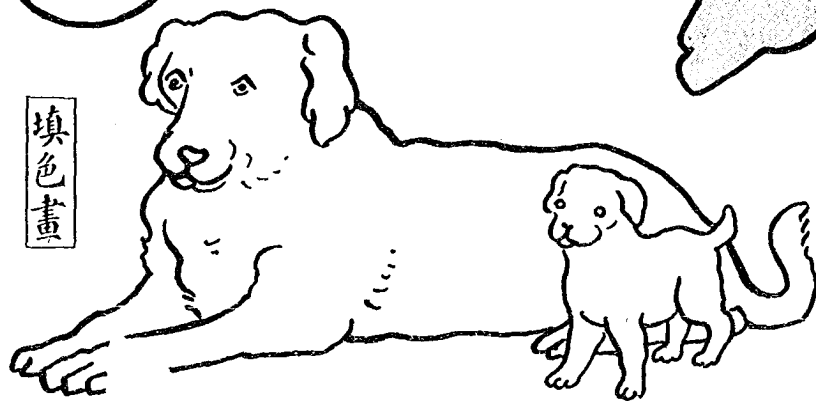

狗黃小 組二十第 集三第



簡
筆
畫

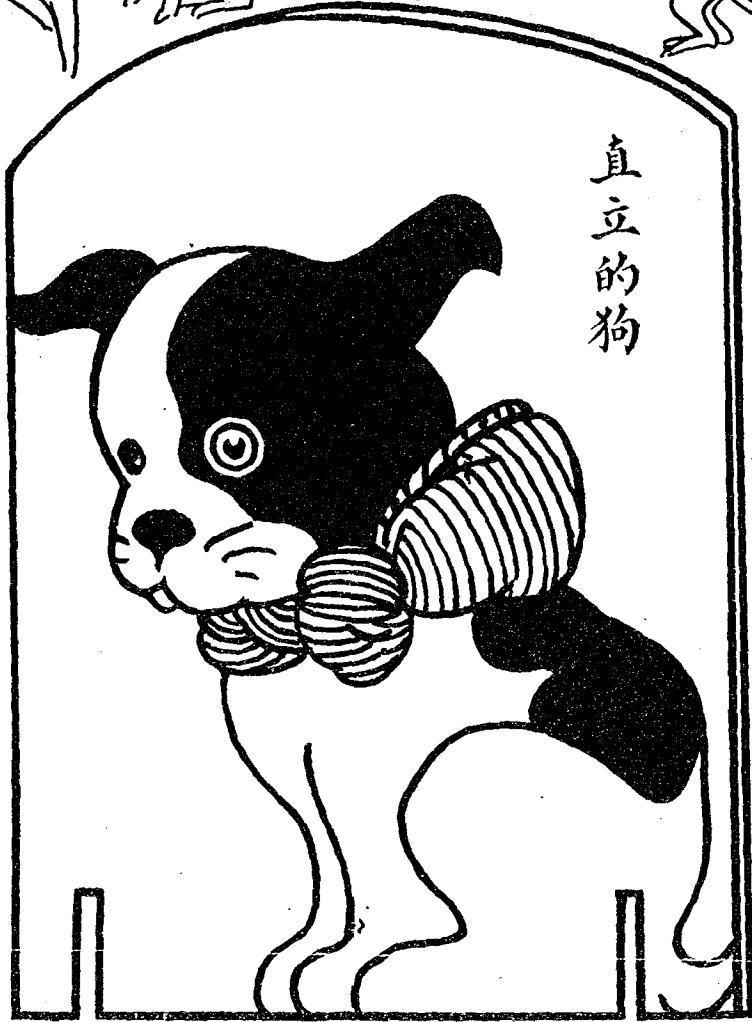

直
立
的
狗

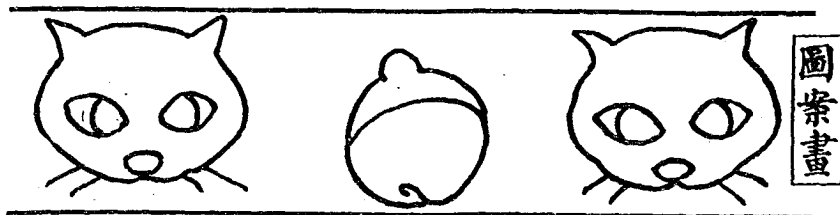

假面具

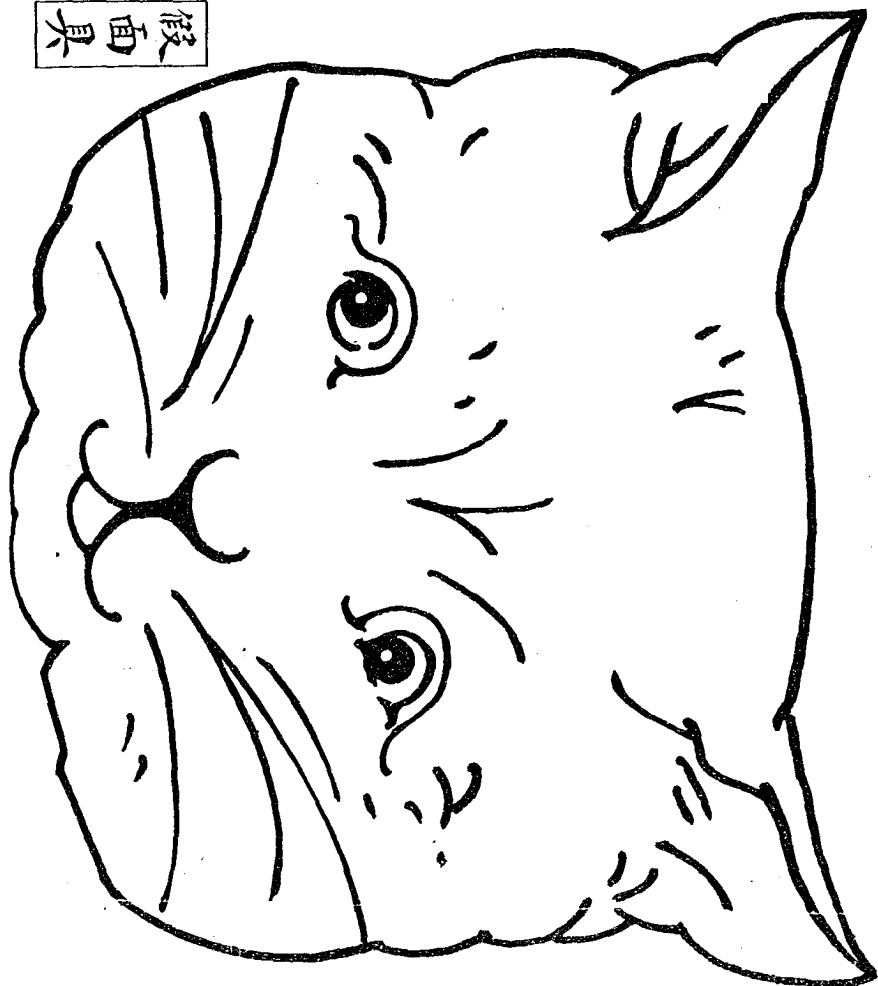

貓花追 組三十第 集三第



畫印木

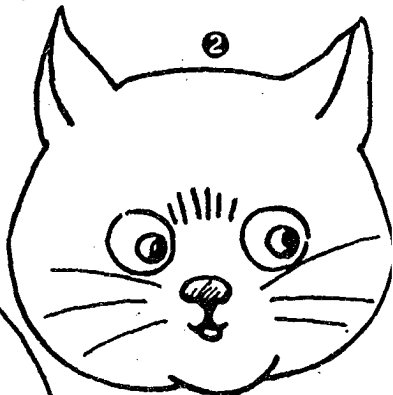

②

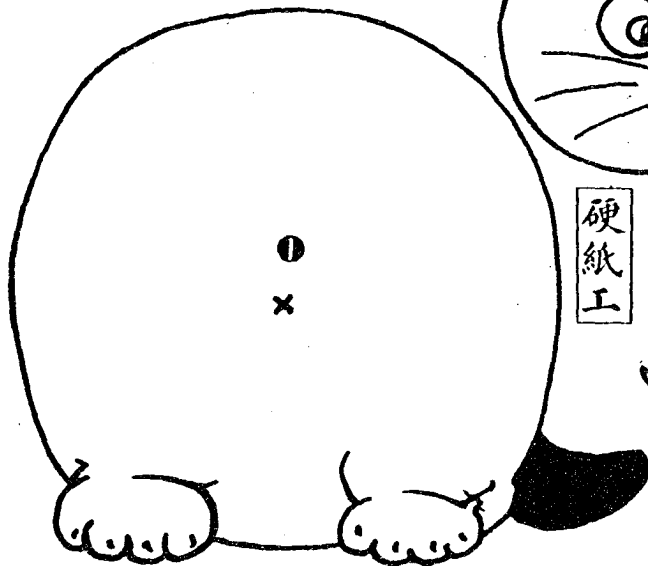

①

x

硬紙工



③

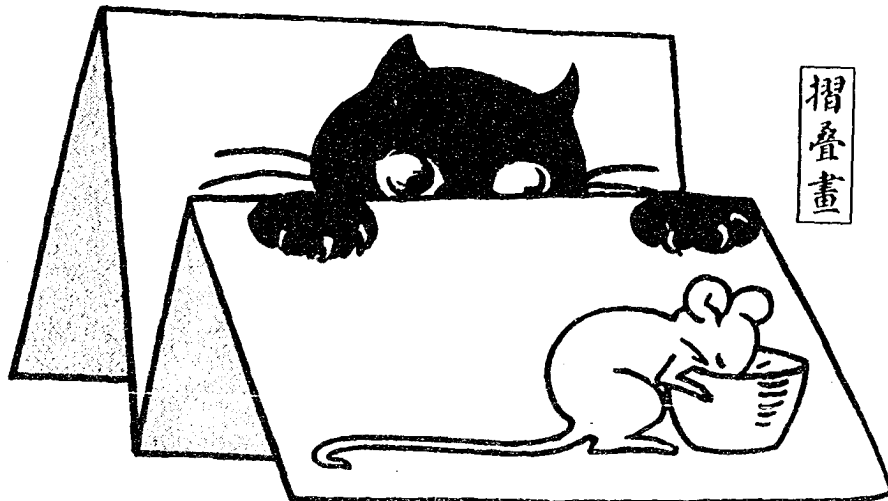

摺疊畫

鼠老小小 組四十第 集三第



畫筆簡

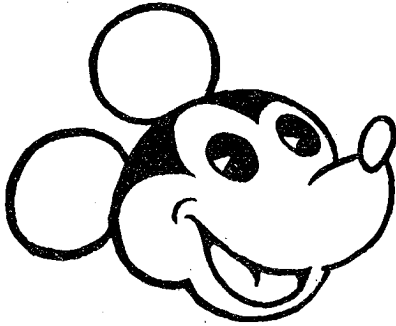

滑稽鼠面



貼剪葉樹

填色畫

工紙刺

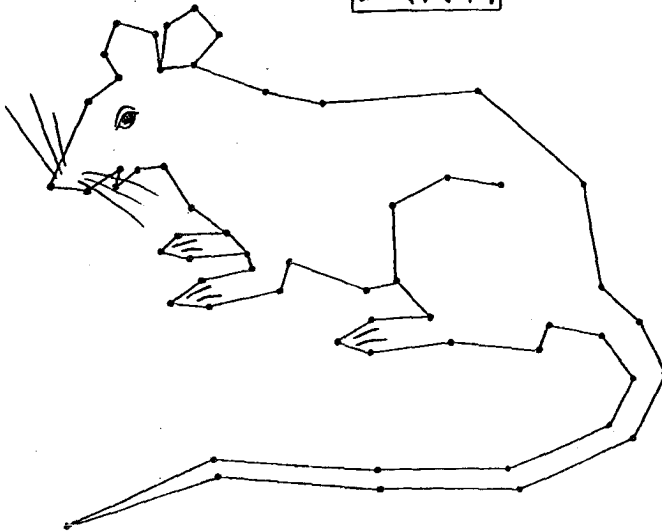

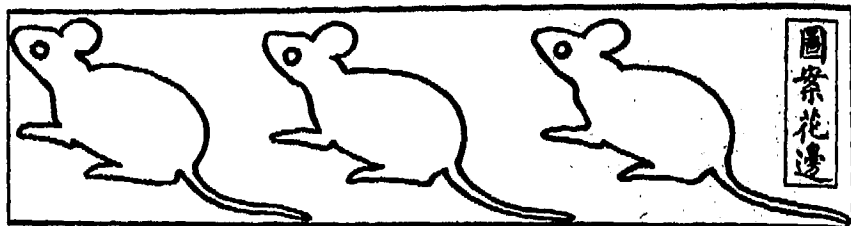

鼠的害

填色畫

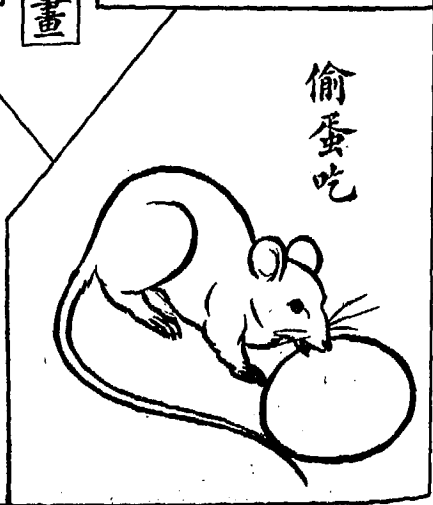
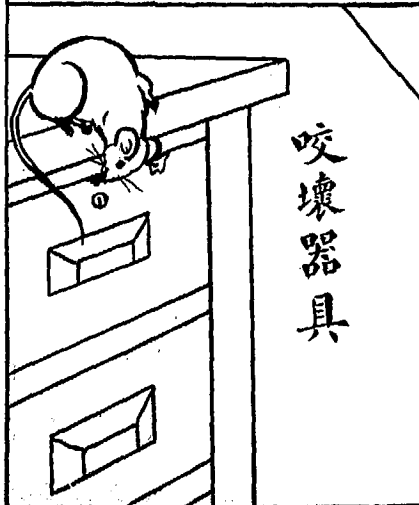



貼剪



畫筆簡

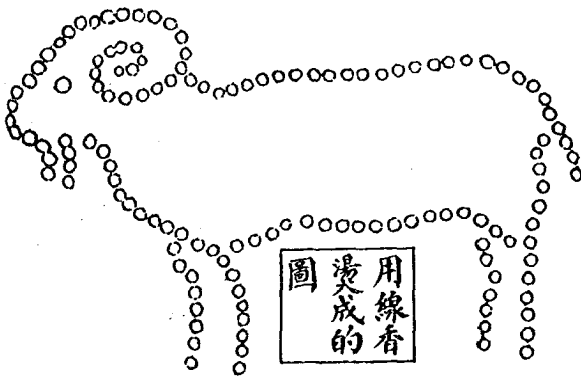

用線香
燙成的
圖

了見不羊小 組五十第 集三第

畫色填

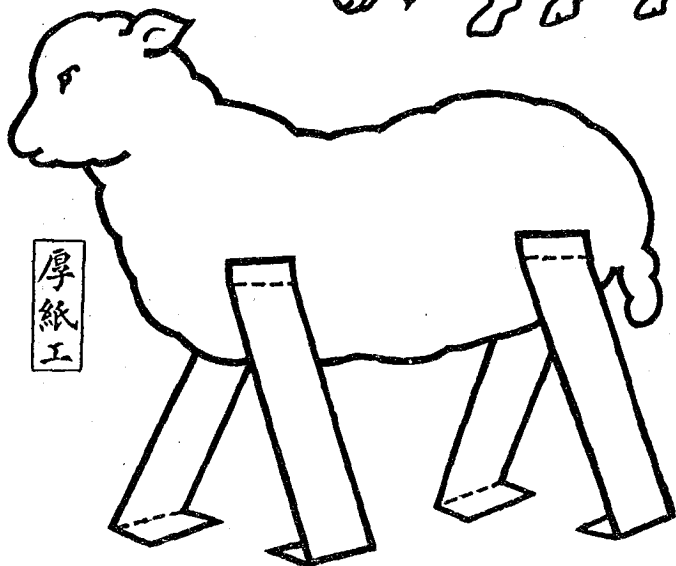

厚紙工



圖案畫

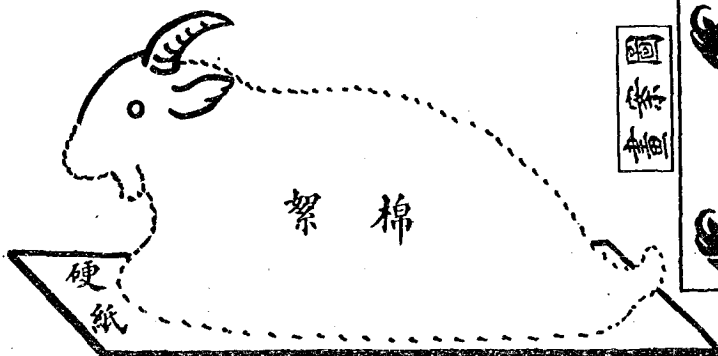

硬紙

羊隻三 組六十第 集三第

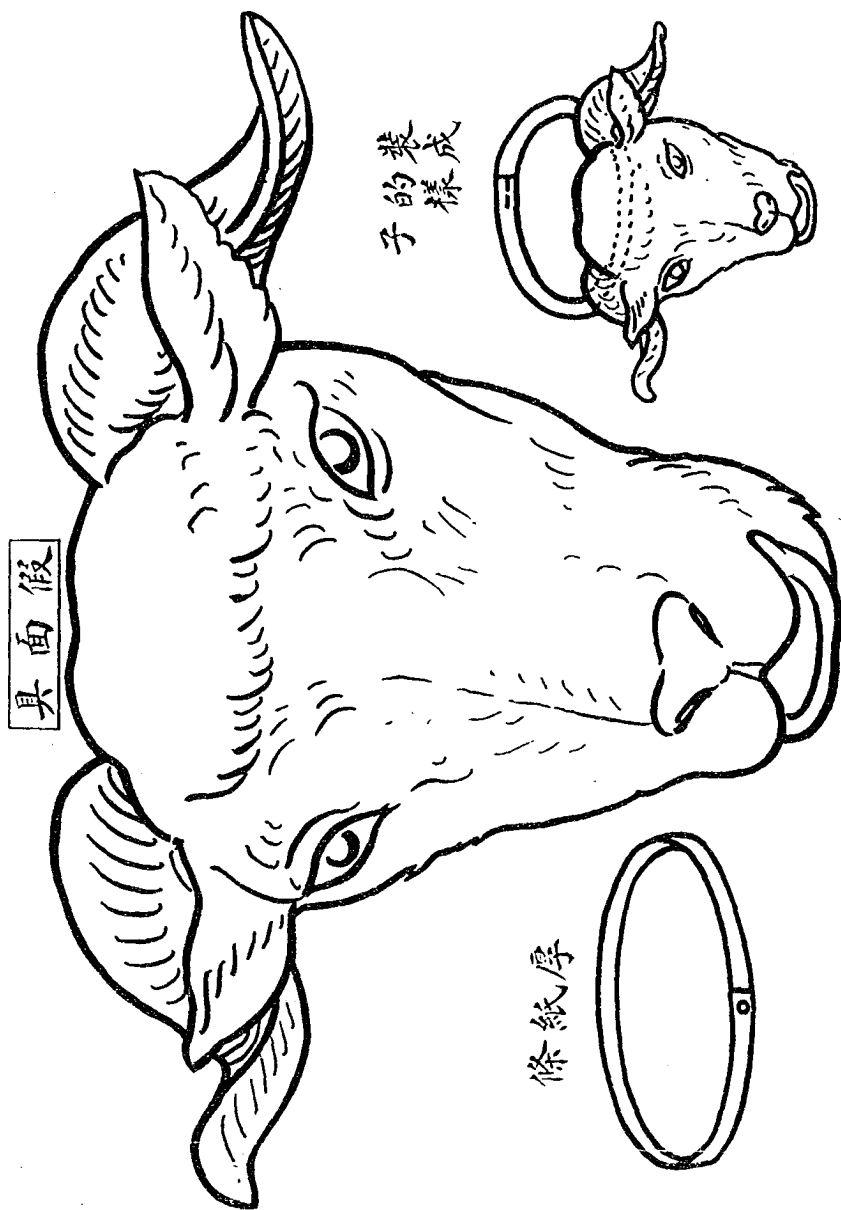

具面假

裝成
子的樣

條紙厚

羊隻三 組六十第 集三第

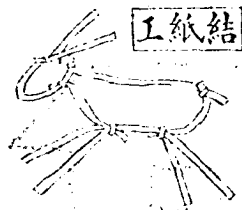

工紙結

工紙穿

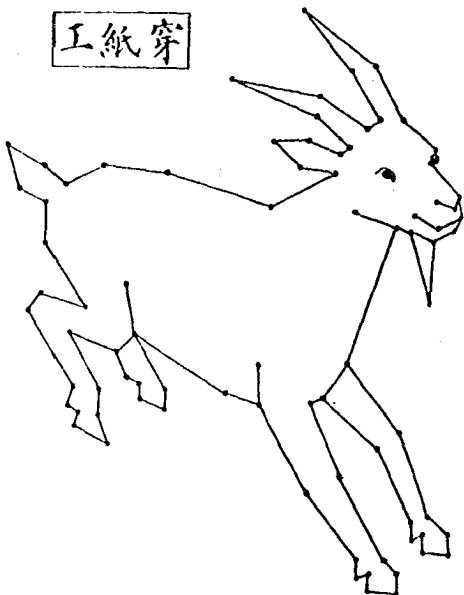

工泥

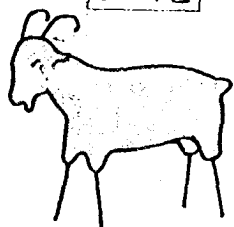

畫筆簡

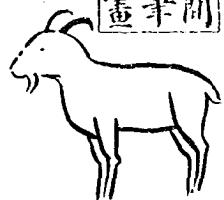

例舉畫童兒

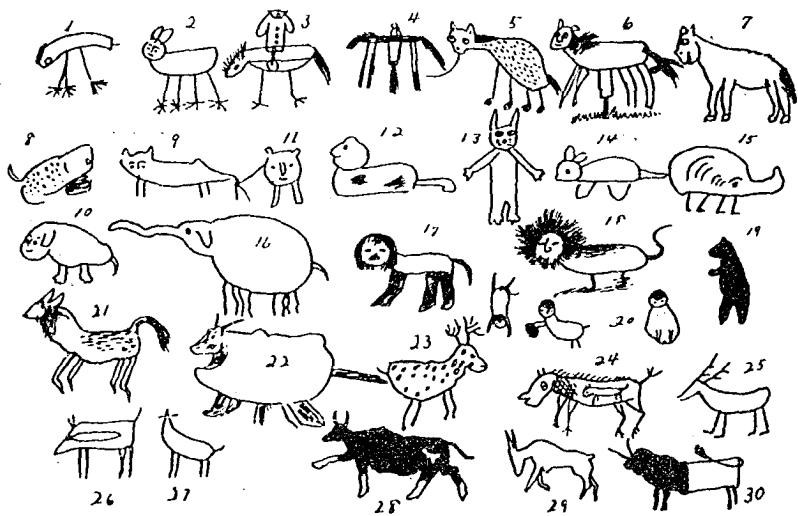

馬騎哥哥 組七十第 集三第

貼剪

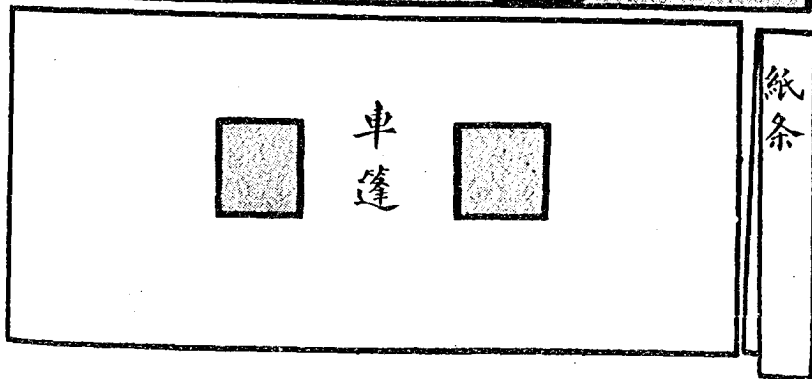
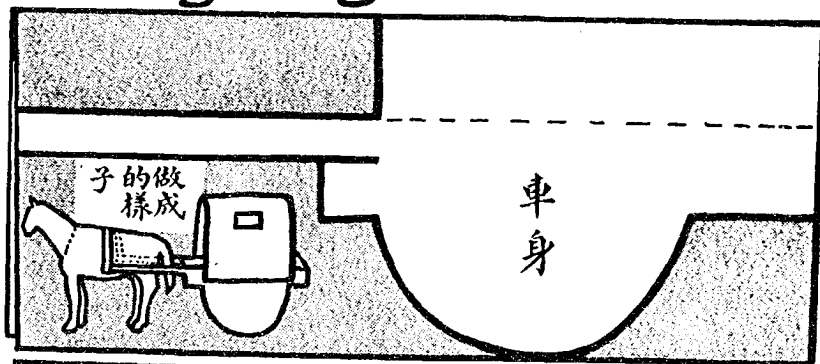
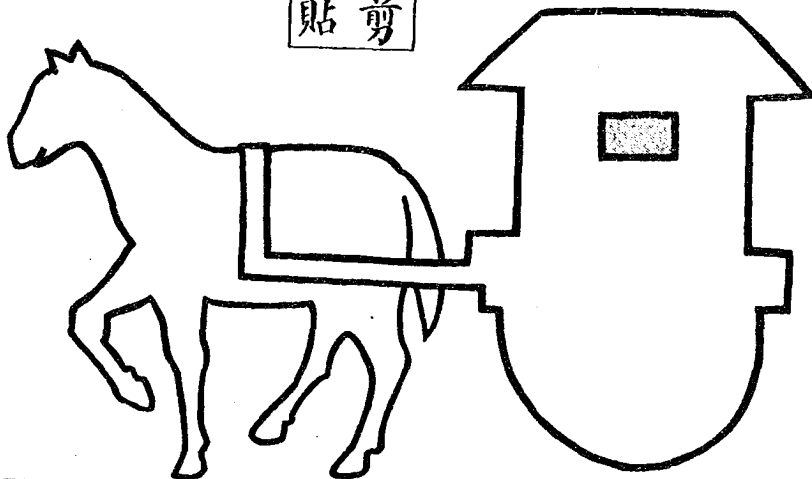

馬騎哥哥 組七十第 集三第

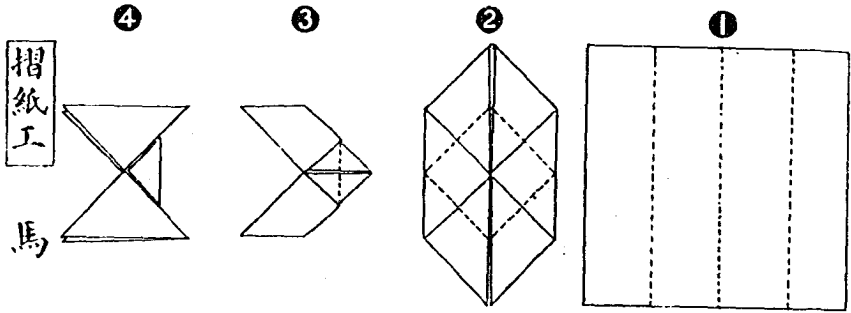

摺紙工

馬

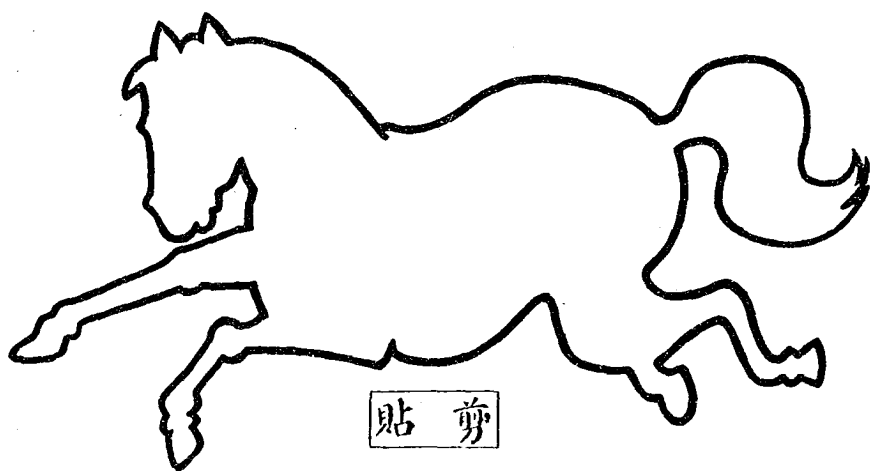

貼剪

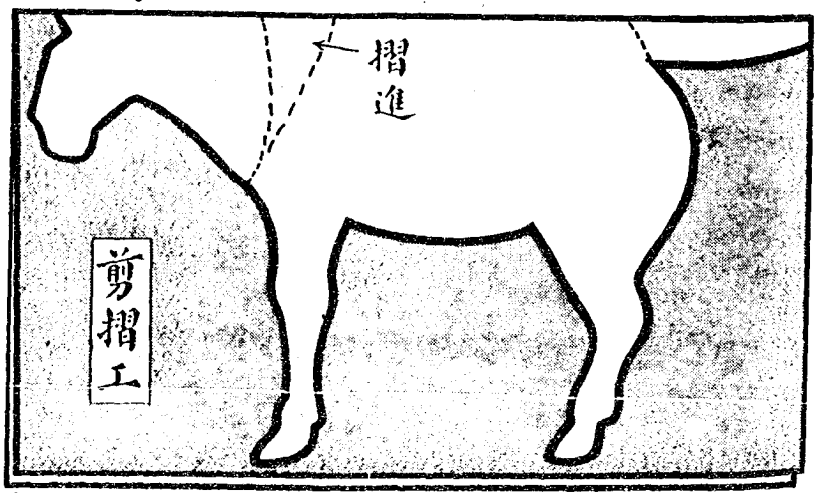

剪摺工

跑會兒馬 組八十第 集三第

高梁
的馬
做

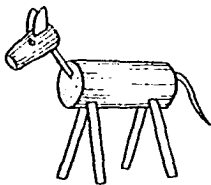

混
合
工

厚
紙
工



竹
馬

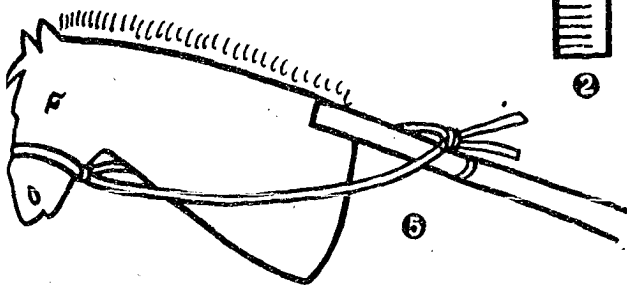
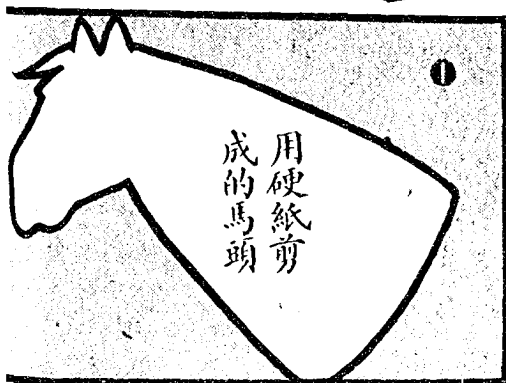

跑會兒馬 組八十第 集三第

畫筆簡

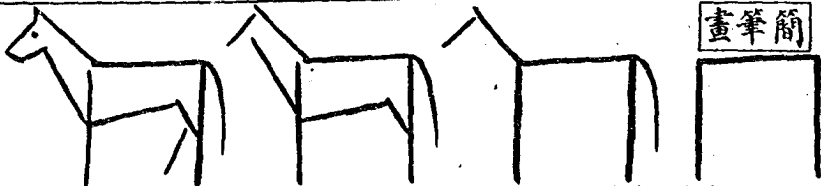

先填色
後剪開
再拼着玩

拼圖

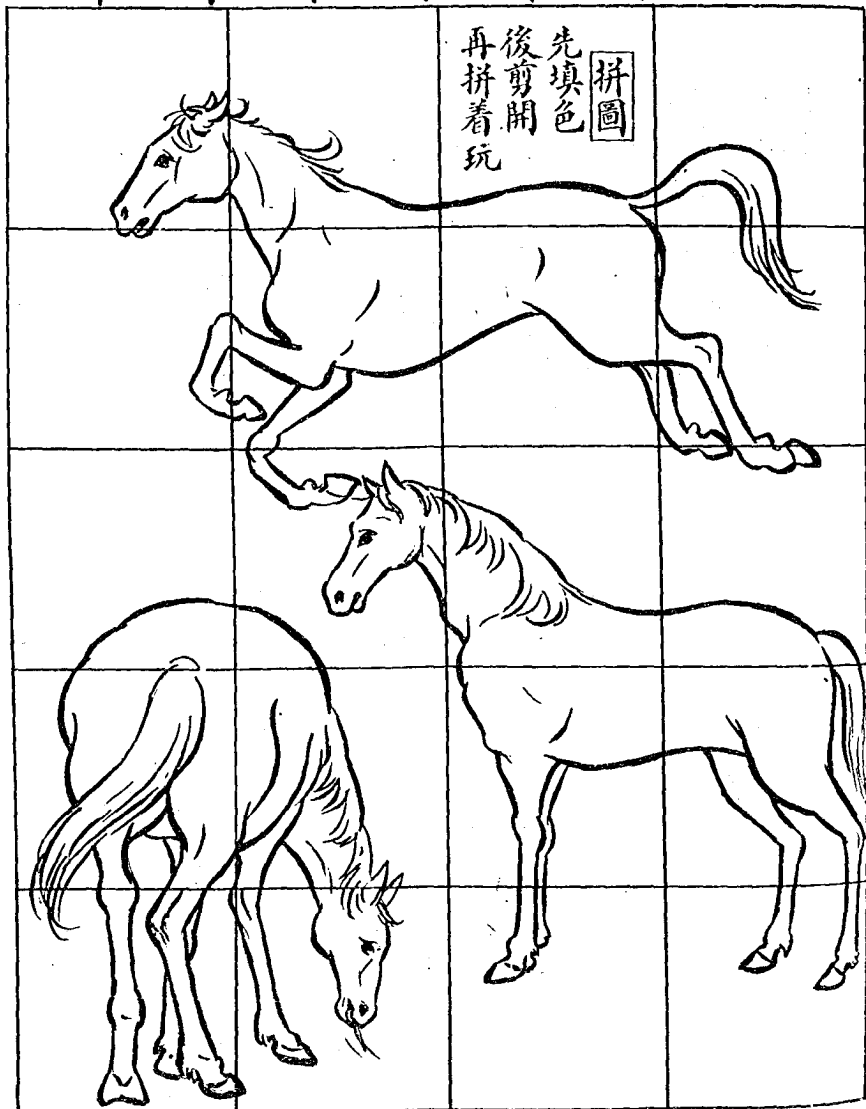

牛跟馬 組九十第 集三第

畫迷動活

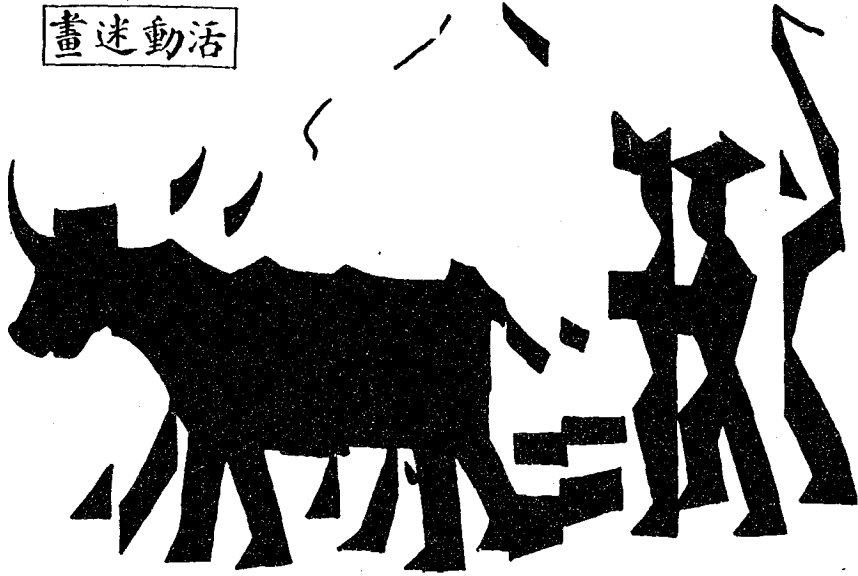

牛跟馬 組九十第 集三第

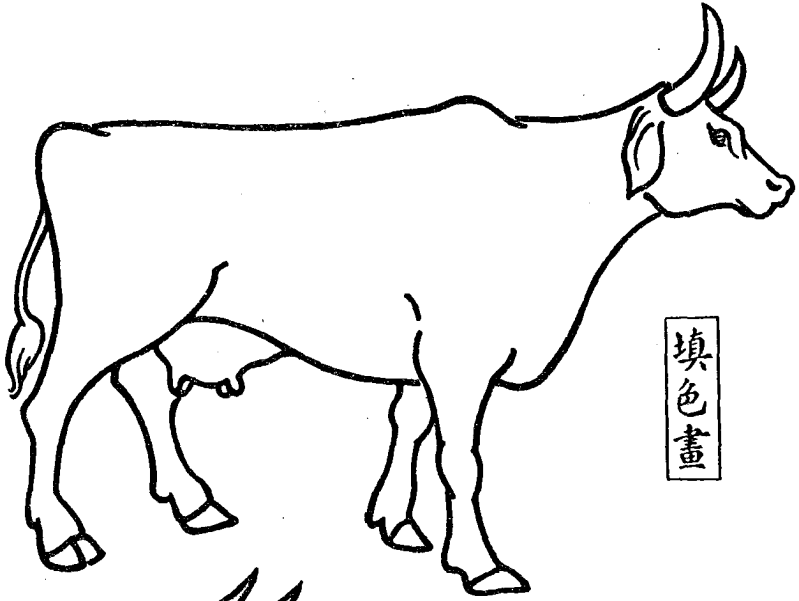

填色畫

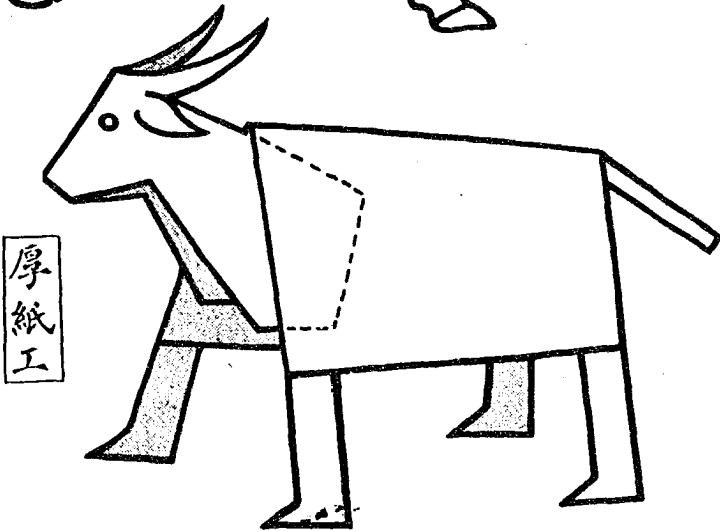

厚紙工



牛黃小 組十二第 集三第



畫案圖

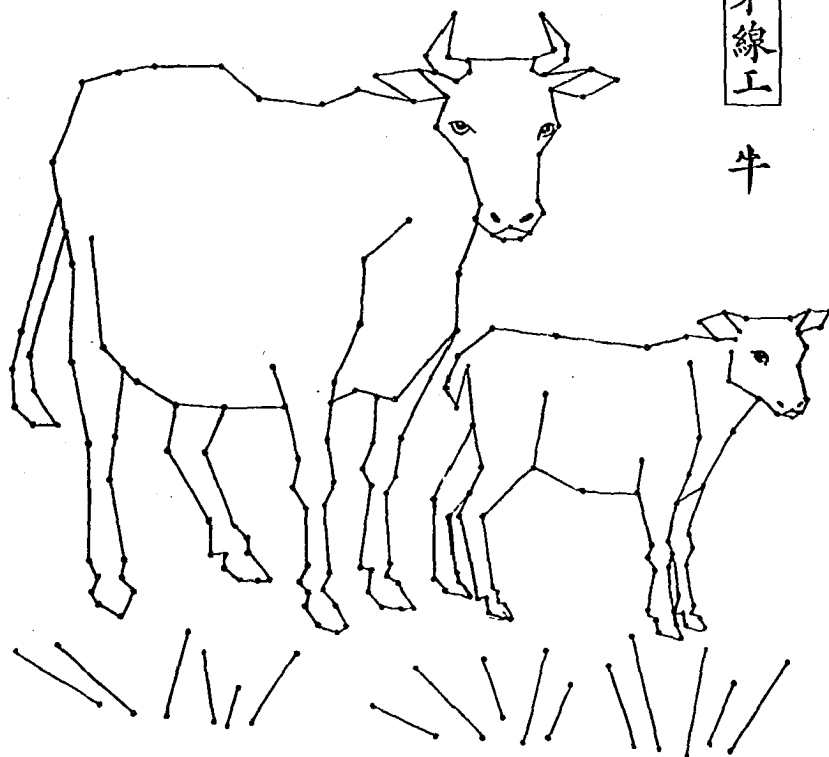

穿線工

牛

牛黃小 組十二第 集三第

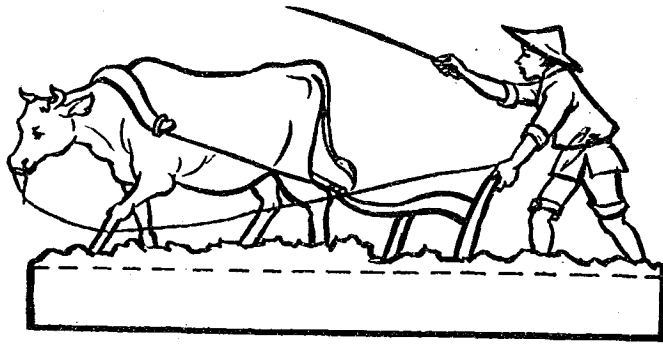

先填色
再剪開

厚紙工

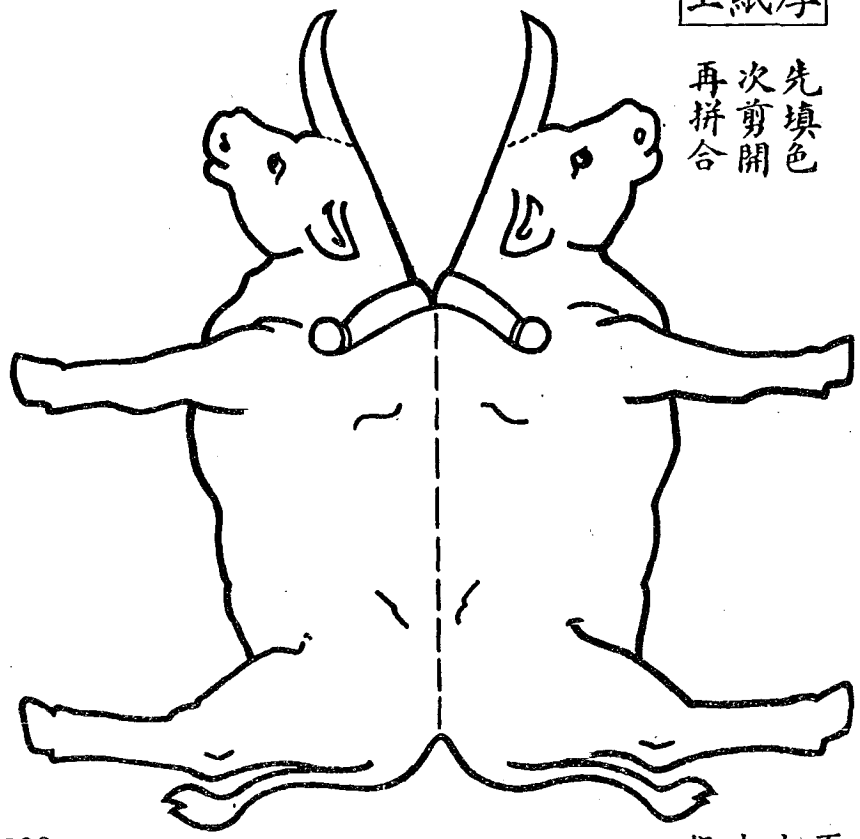

厚紙工

先填色
次剪開
再拼合

門出爸爸 組一十二第 集三第

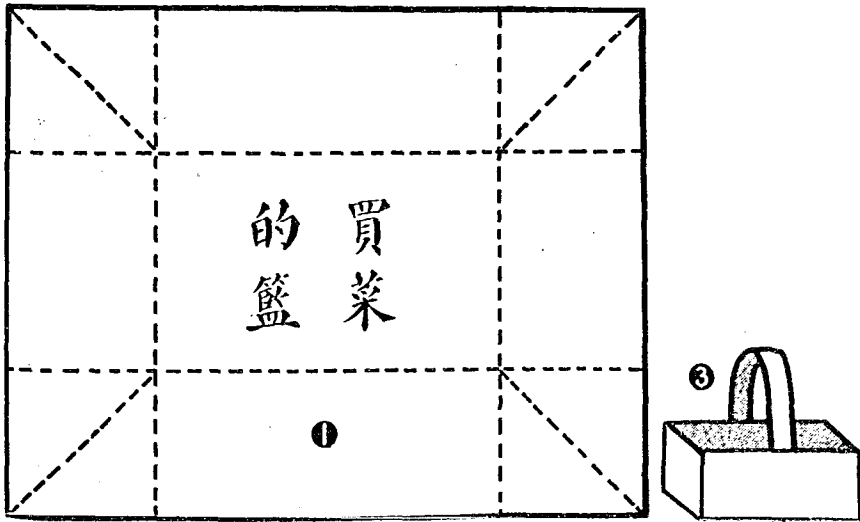
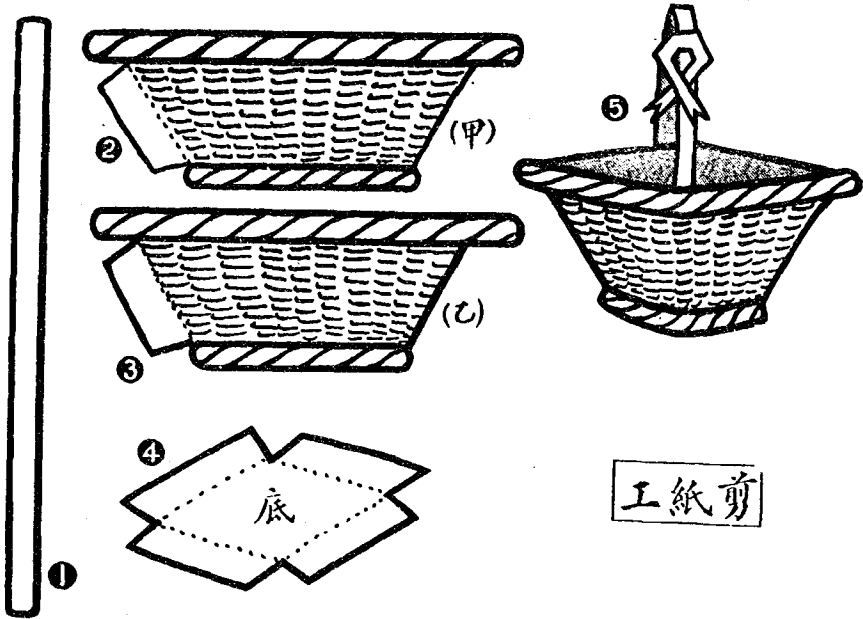

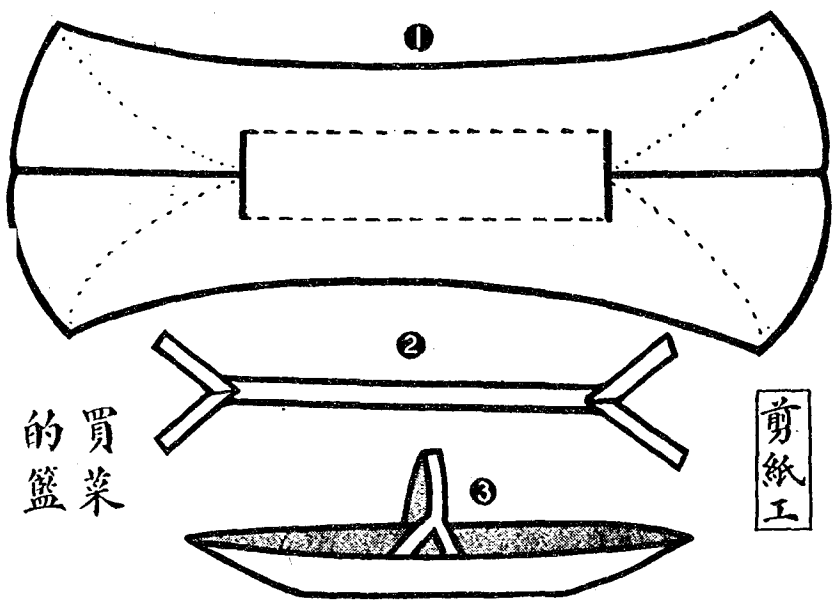

的買
籃菜

剪紙工

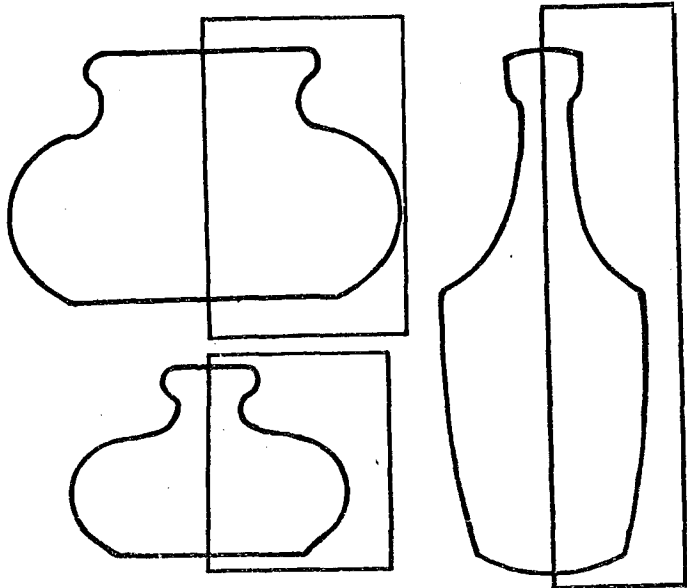

剪紙工

幾種油瓶

門出哥哥 組二十二第 集三第

書小釘

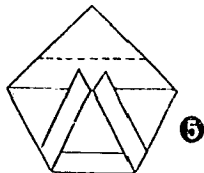
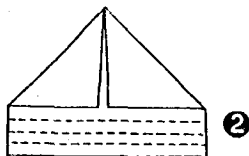
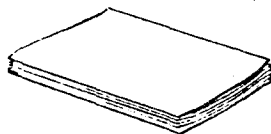
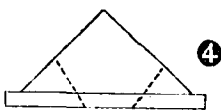
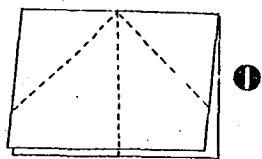

裝釘

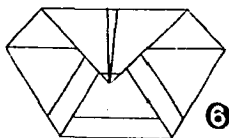
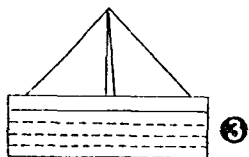
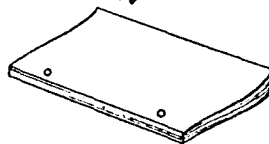

裝線

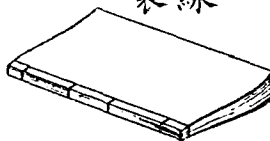

袋物雜

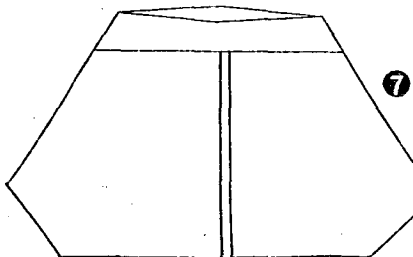

裝面包

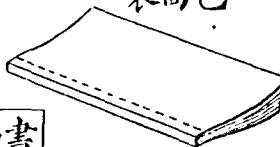

案圖面書

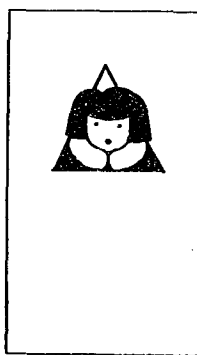
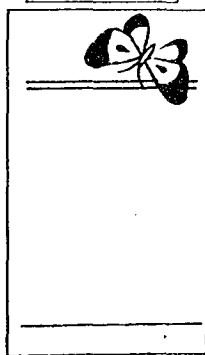
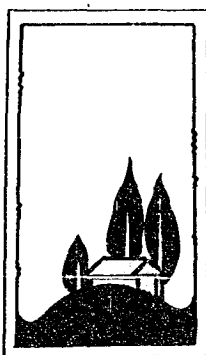

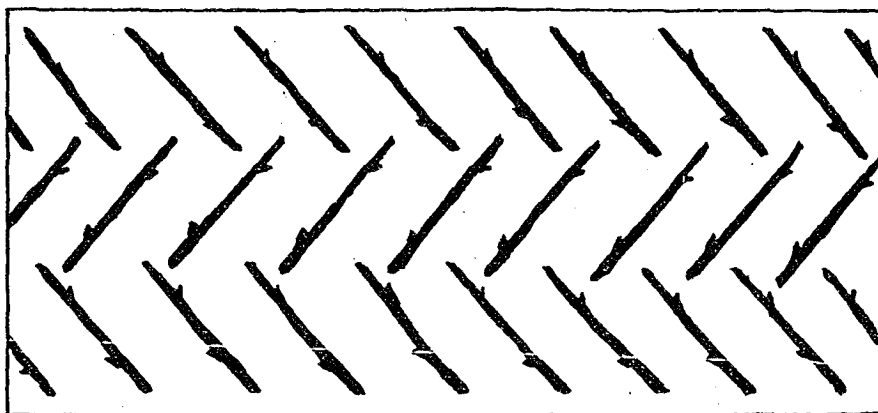
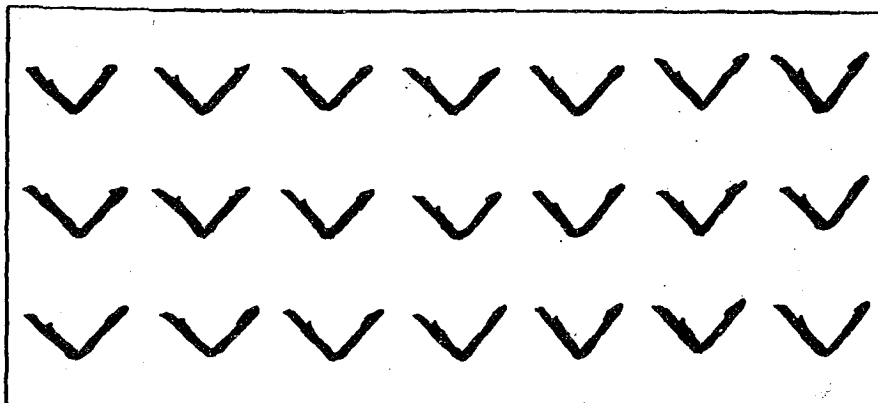
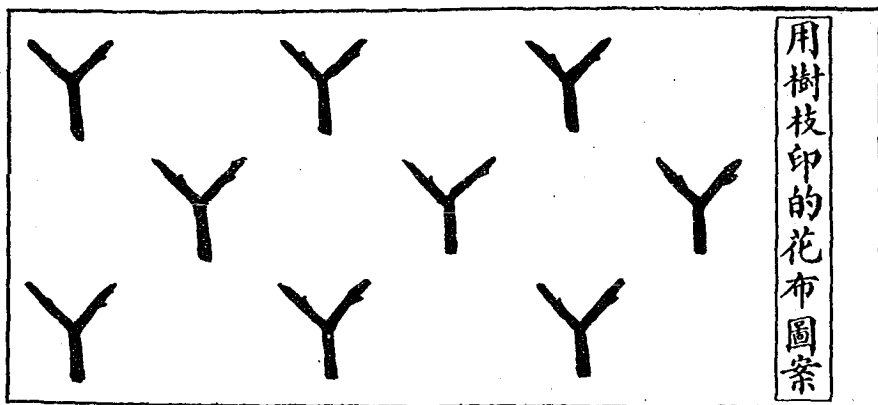

布青買 組三十二第 集三第

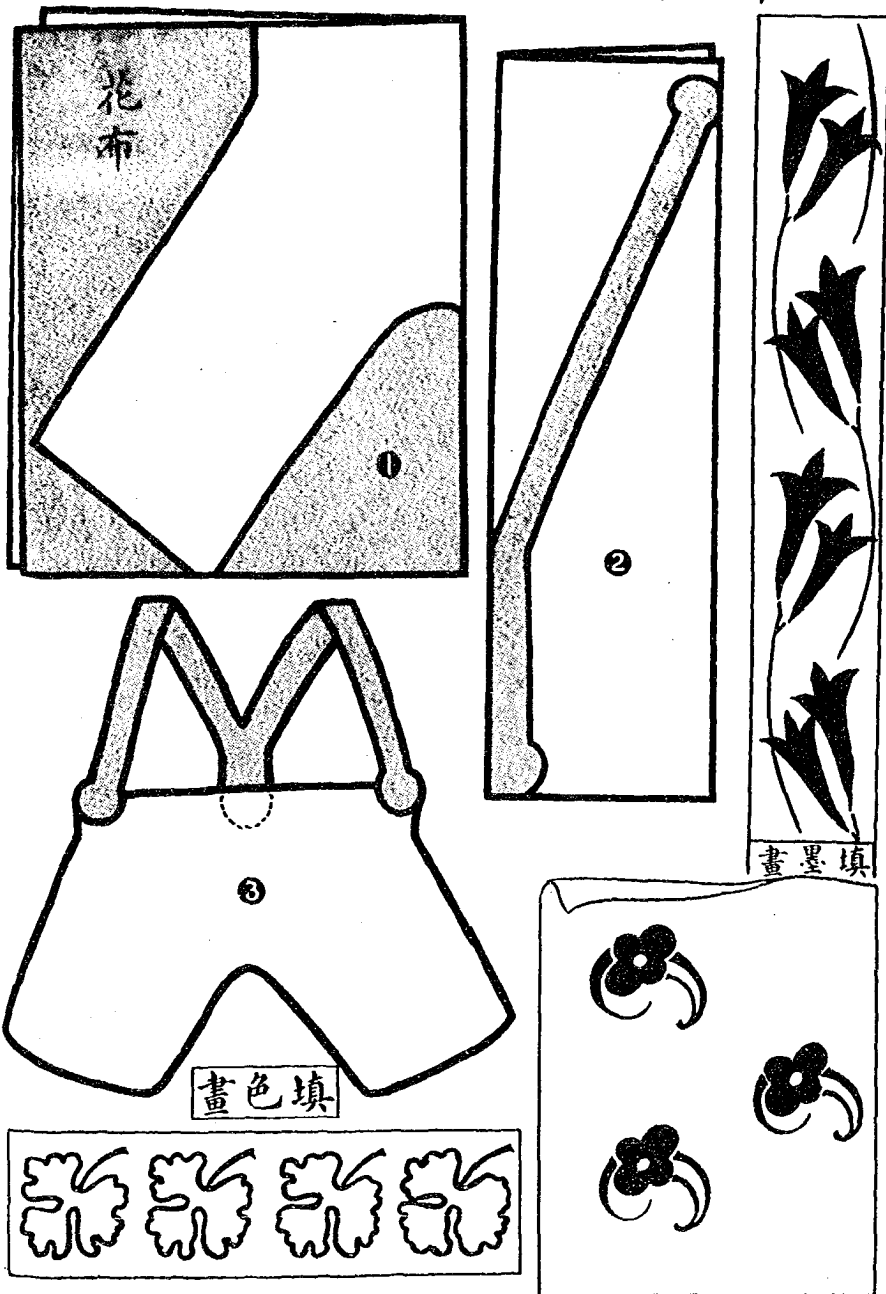

工紙摺

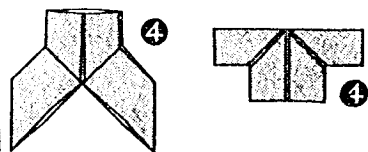
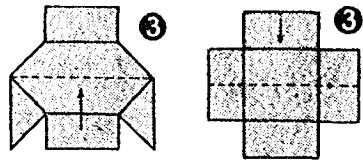
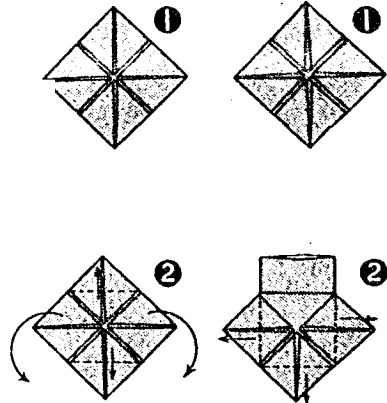
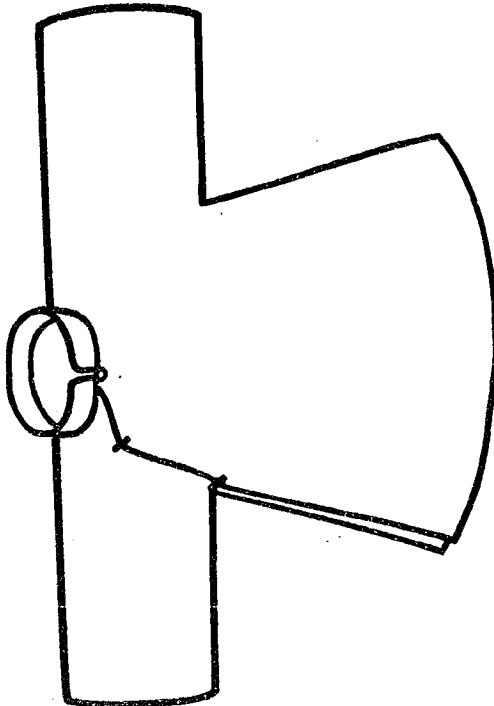
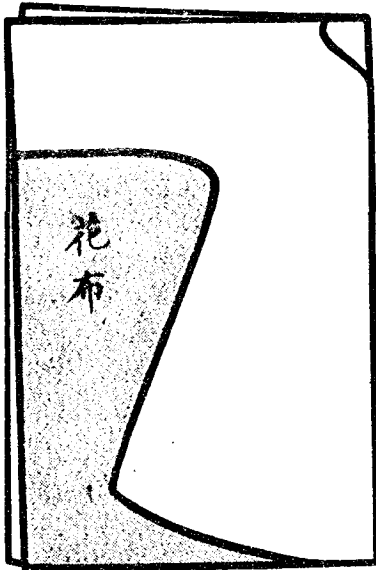

褲

衣

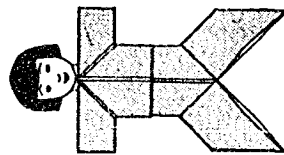

衣新穿 組四十二第 集三第

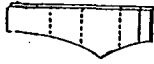
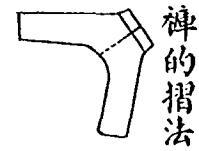

法摺衣短

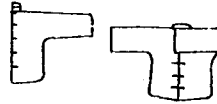
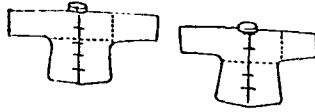

法摺衣長

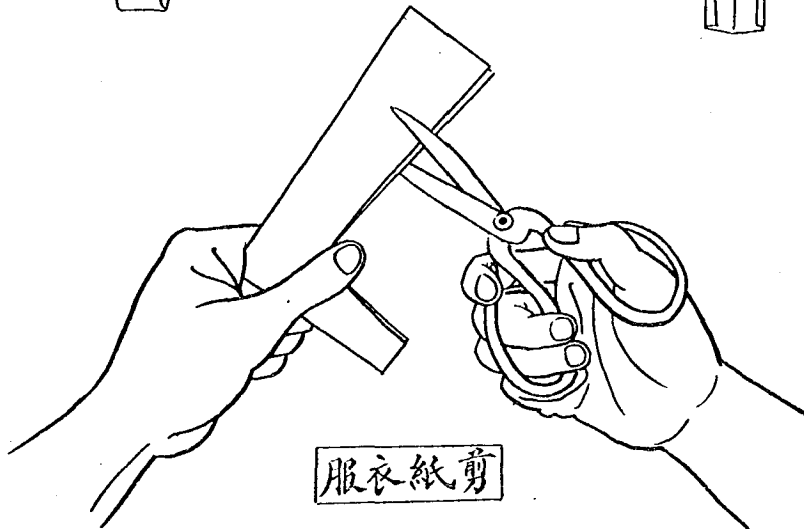
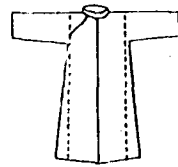
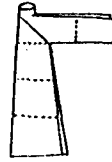

衣新穿 組四十二第 集三第

工線穿

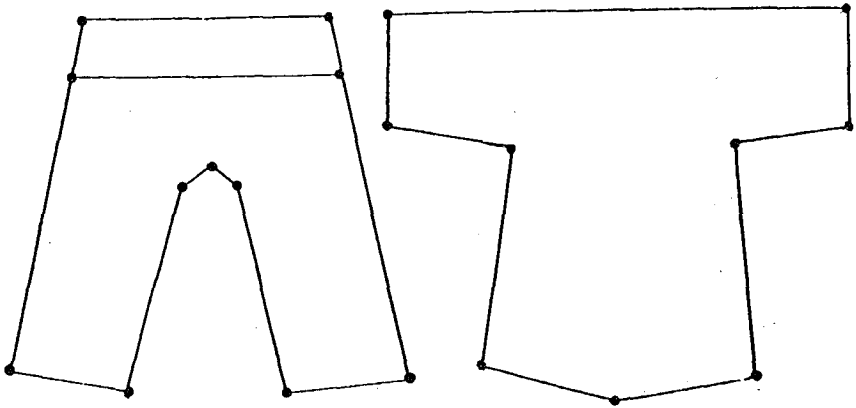

畫色着

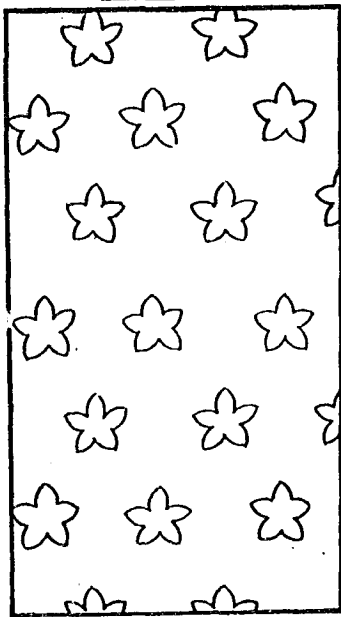

布做的衣服

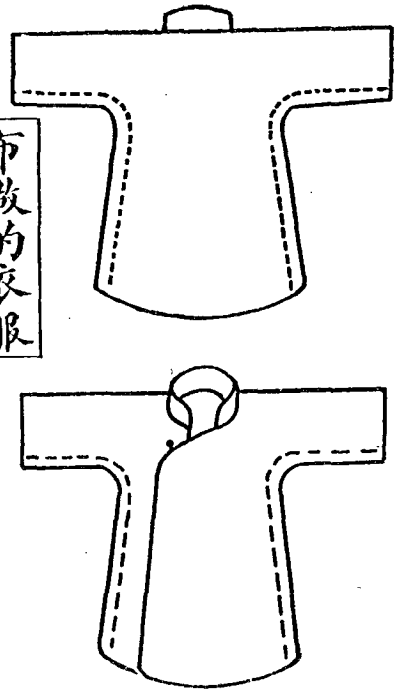

畫色填

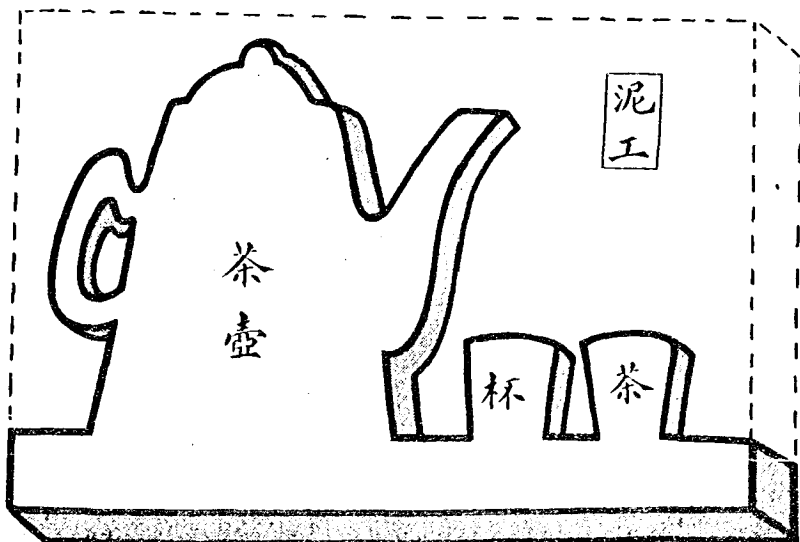

人客 組五十二第 集三第

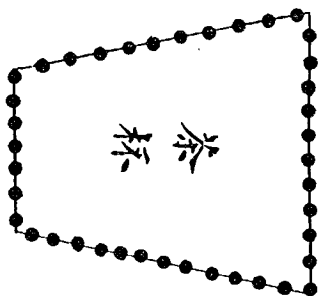

工珠穿

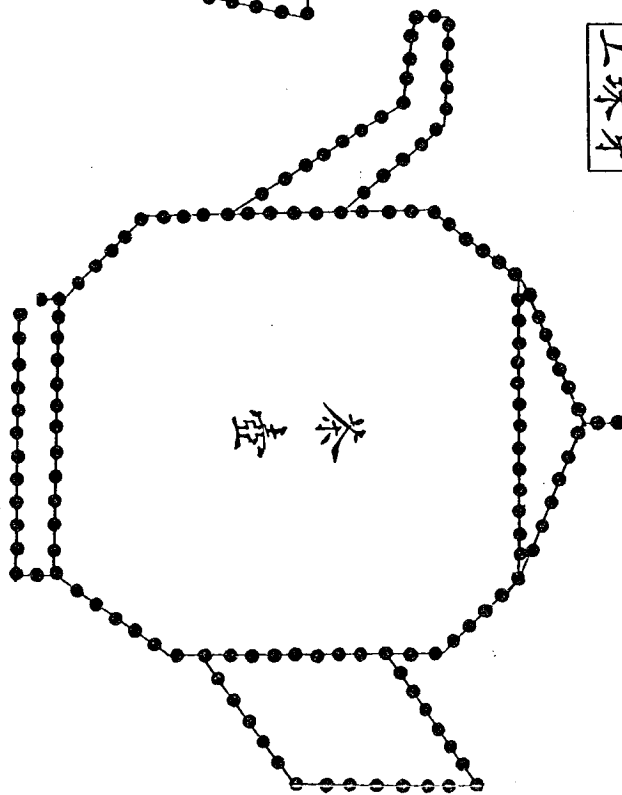

法包紙種幾

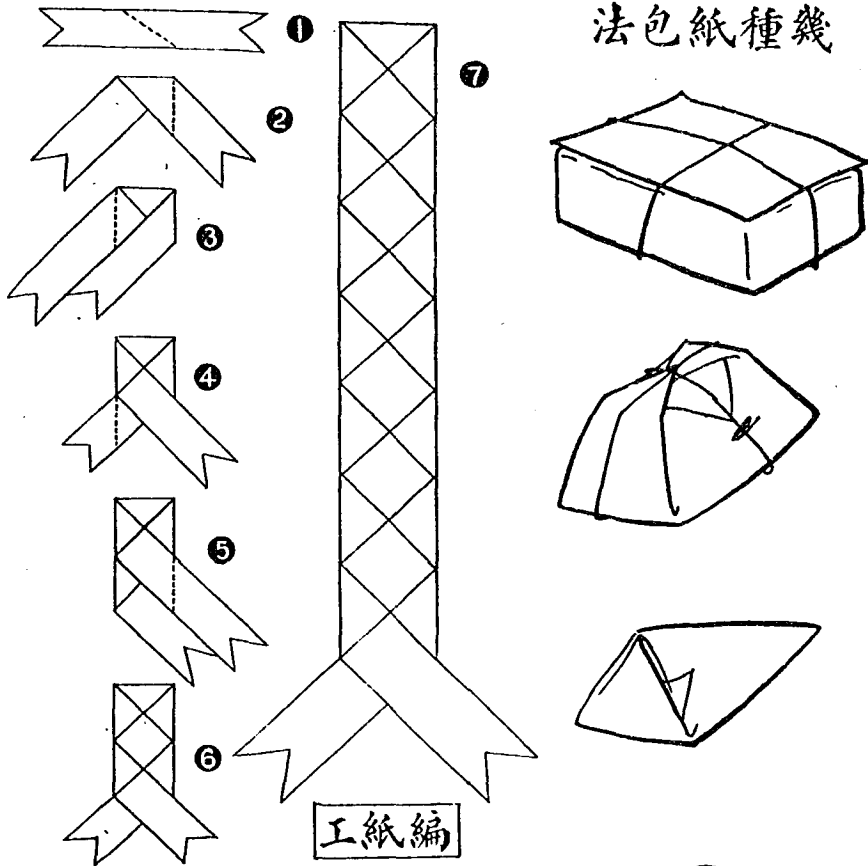

工紙編

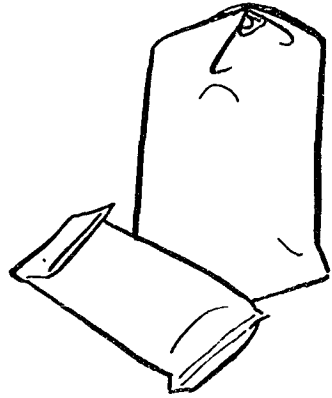
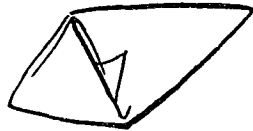
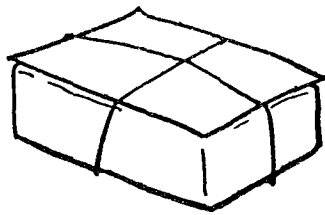

做一種點
心作為給
客人吃

家來人客 組六十二第 集三第

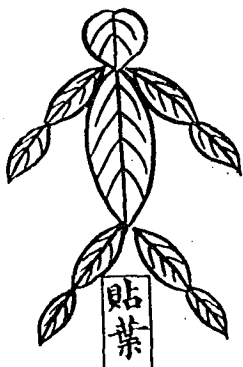

杯酒

壺茶 工紙摺

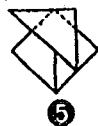
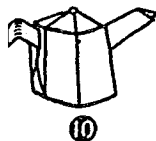
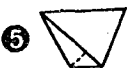
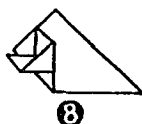
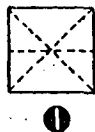
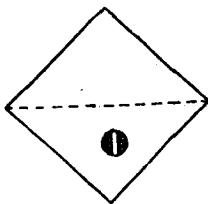
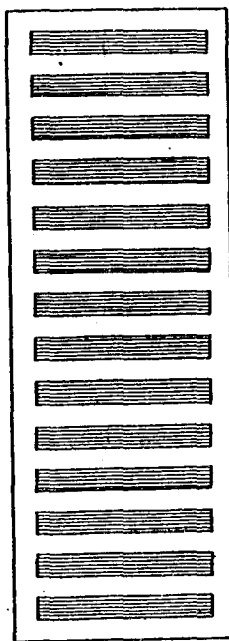

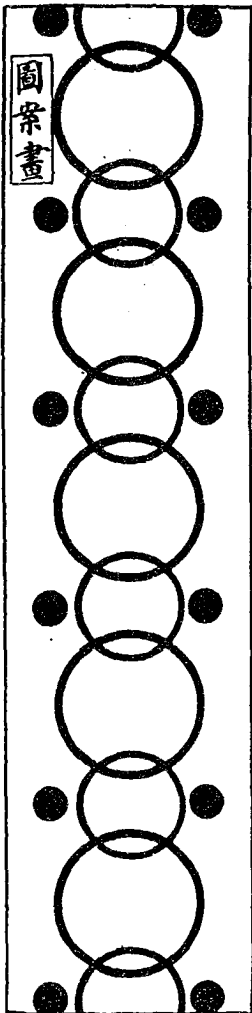

圖案畫



作工園稚幼

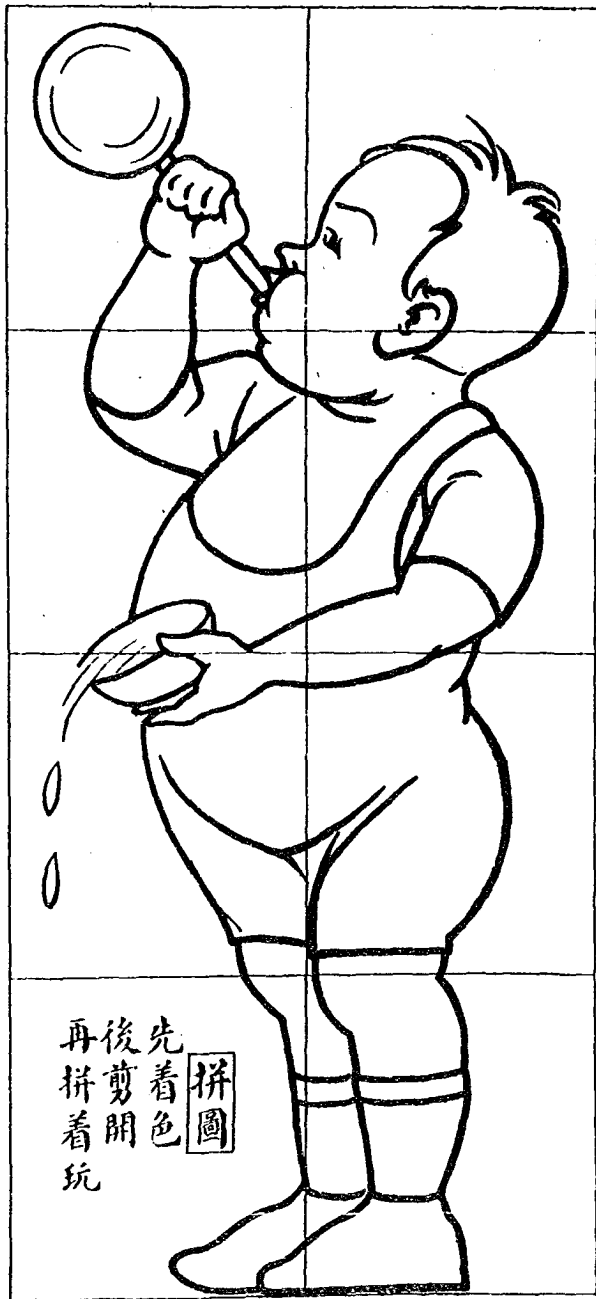

拼圖
先着色
後剪開
再拼着玩

添畫

先填色，再加畫肥皂泡。

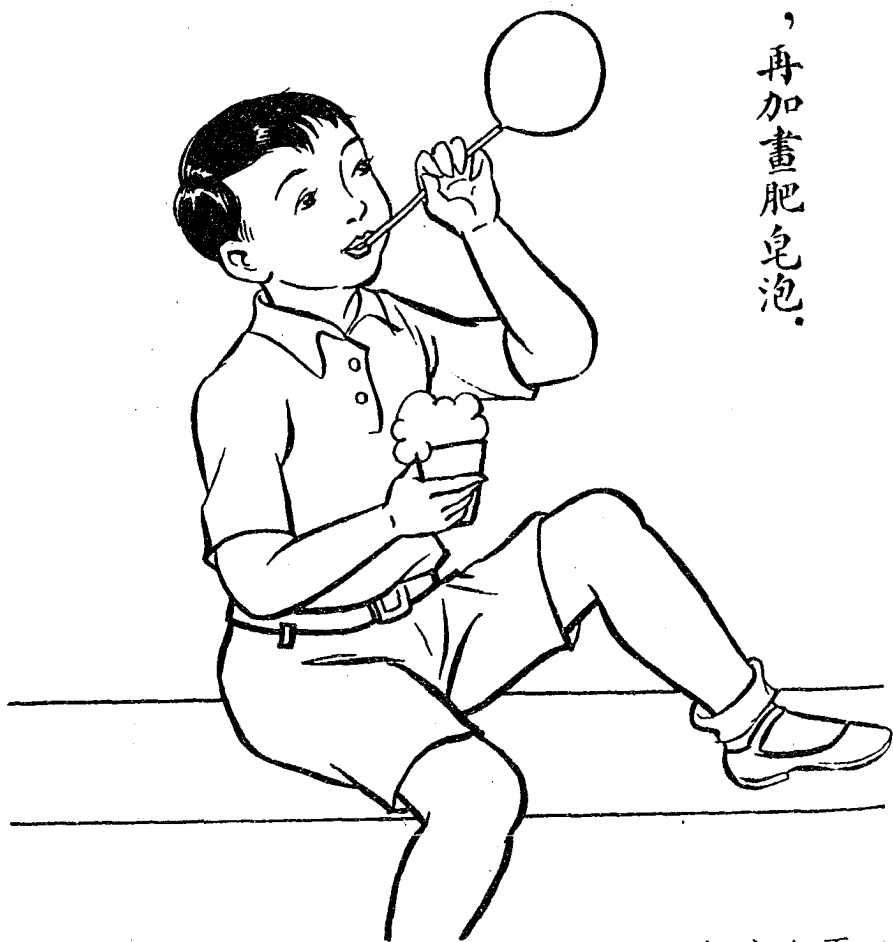

球氣輕 組八十二第 集三第

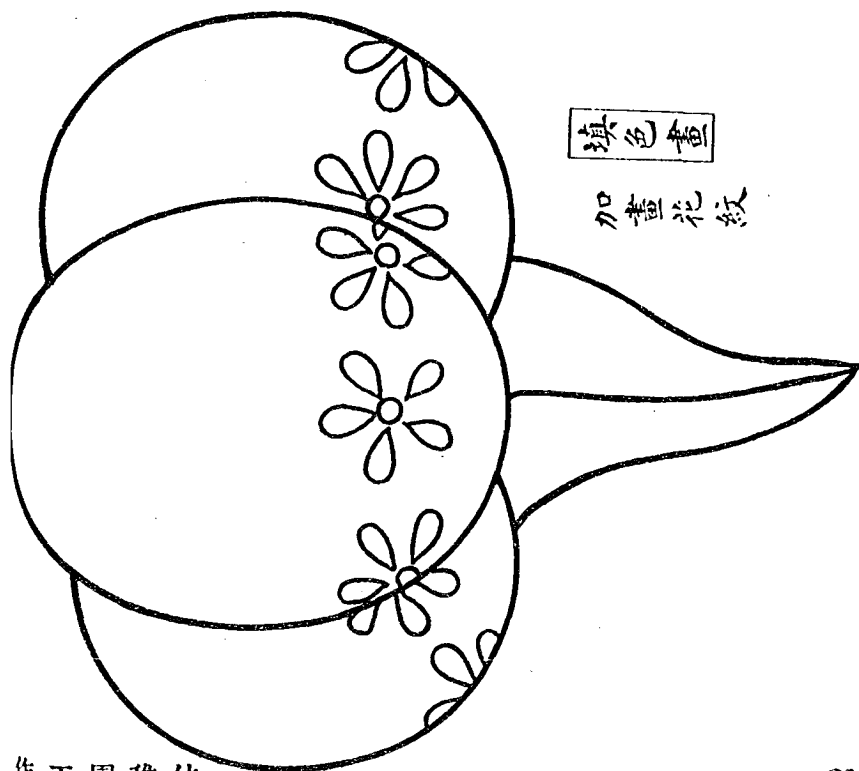
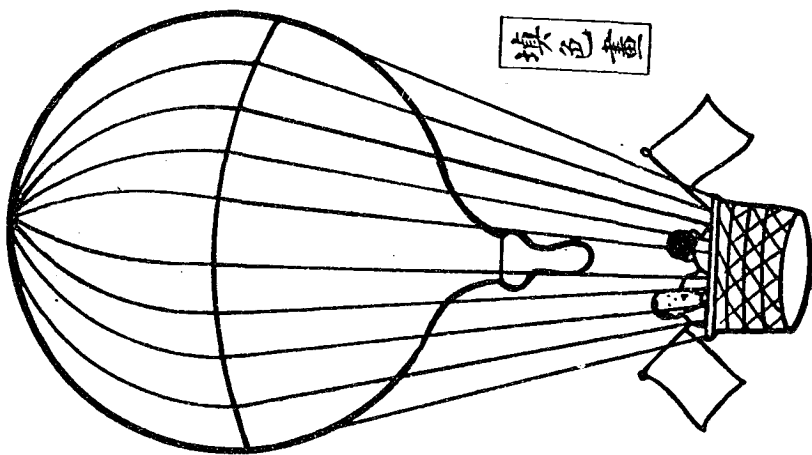



填色畫

氣球上可加畫花紋

吹吹風 組九十二第 集三第

工紙剪

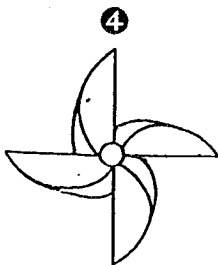
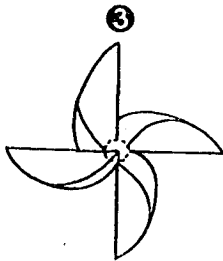
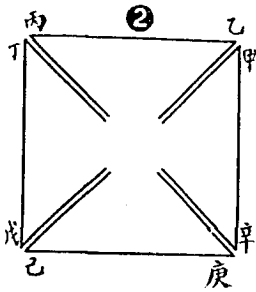
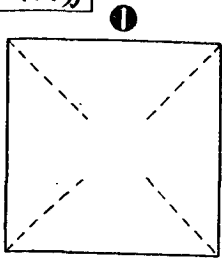

工紙摺

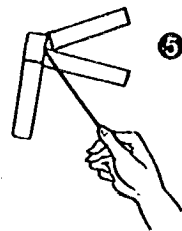
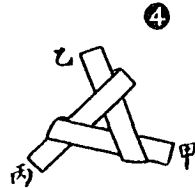
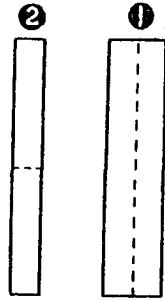
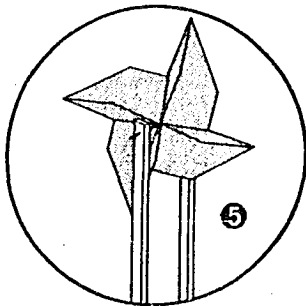
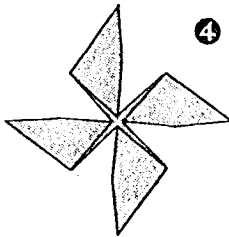
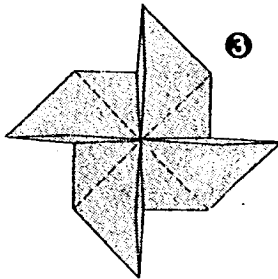
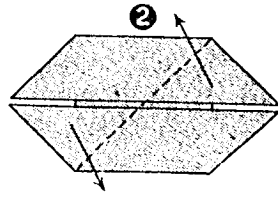
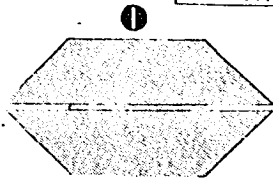

車風紙

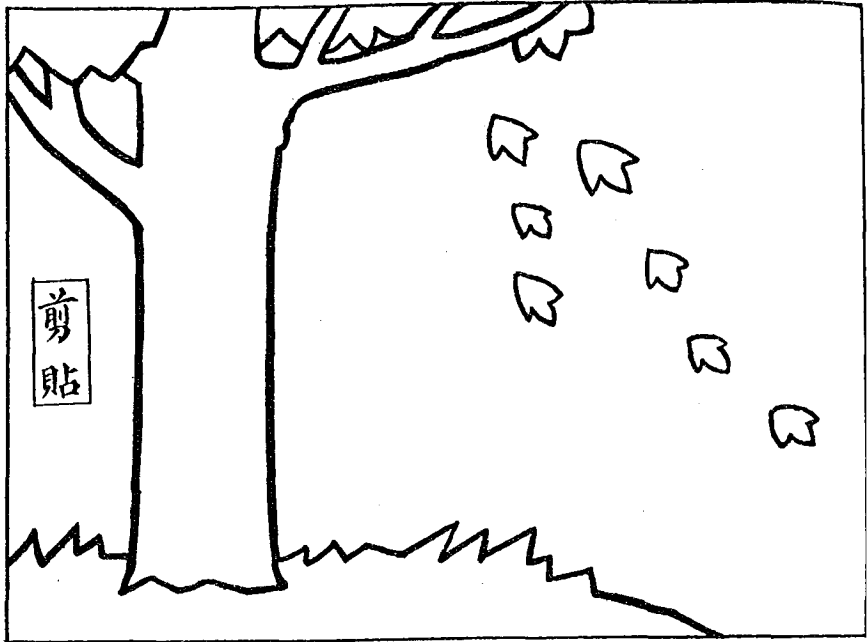

線條一 組十三第 集三第

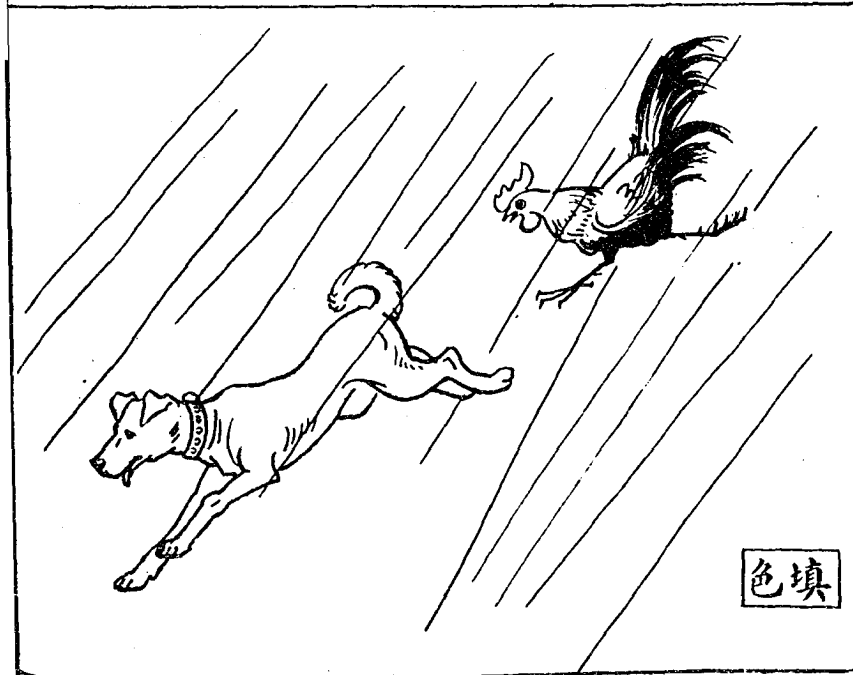
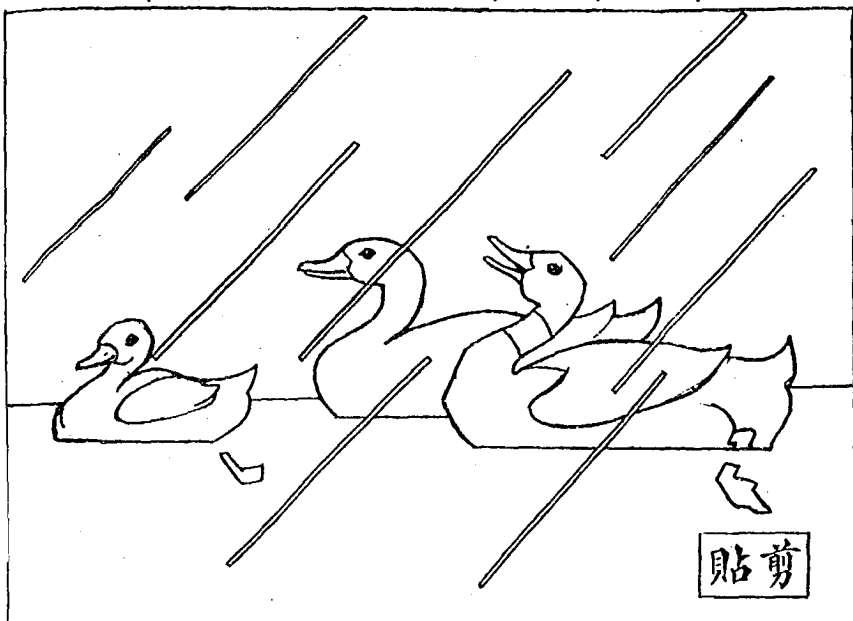

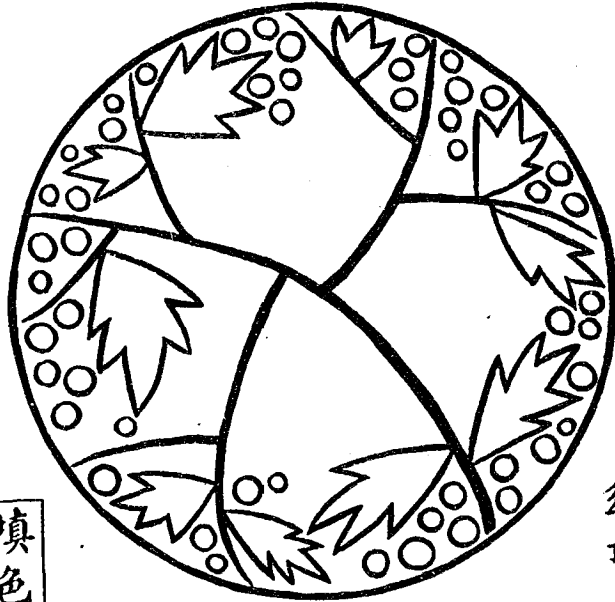

填色畫

傘頂花樣

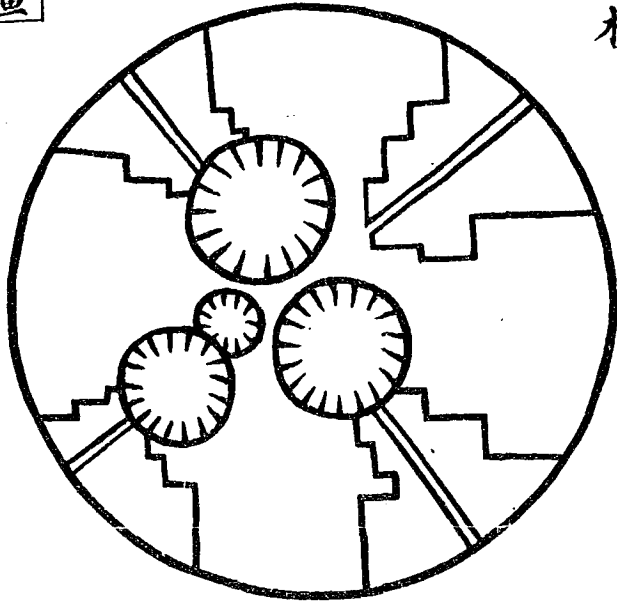

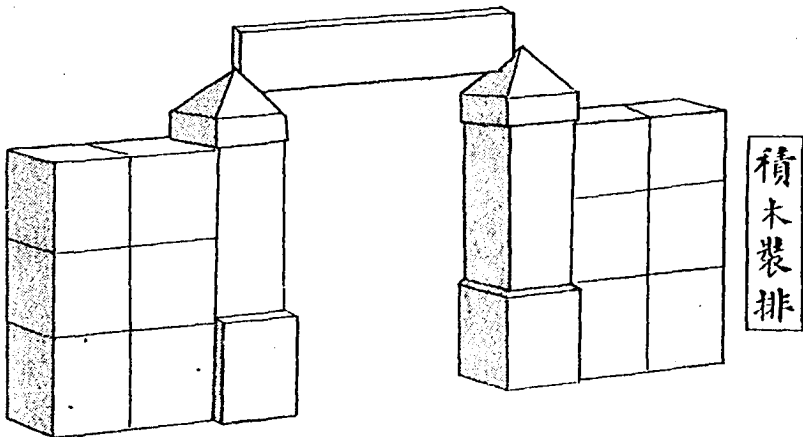
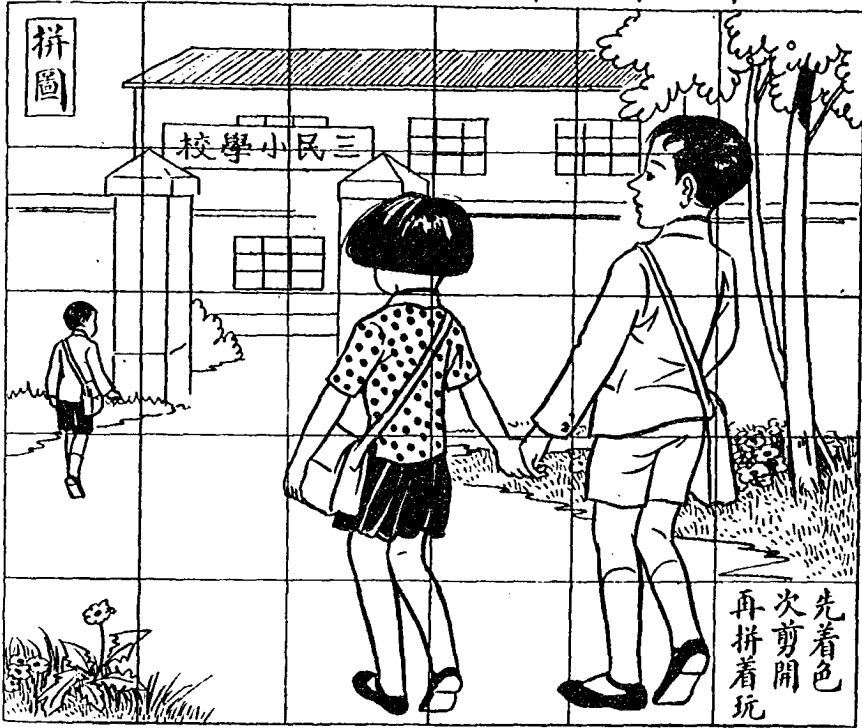



紋花畫加

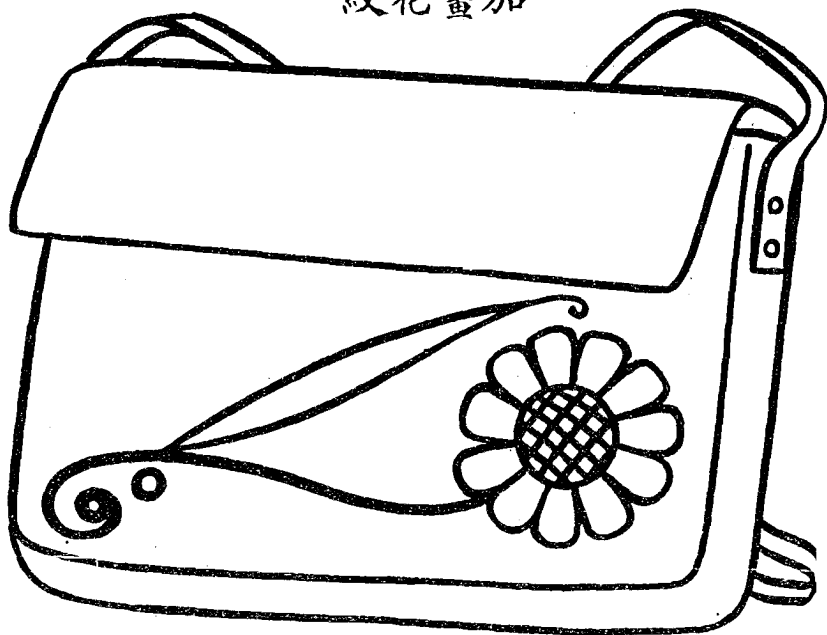

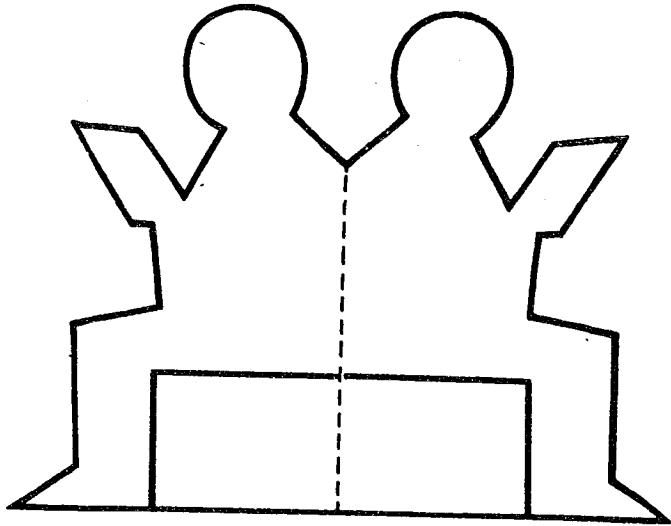

剪紙

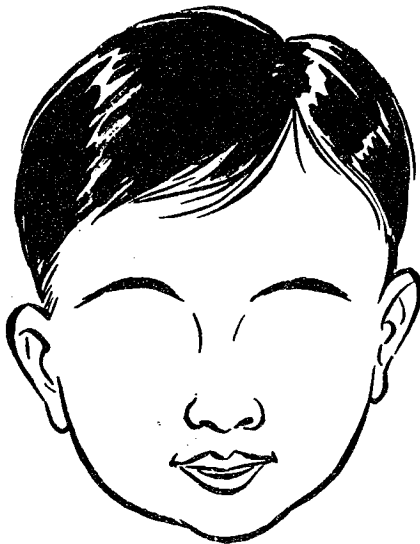

睛眼畫添

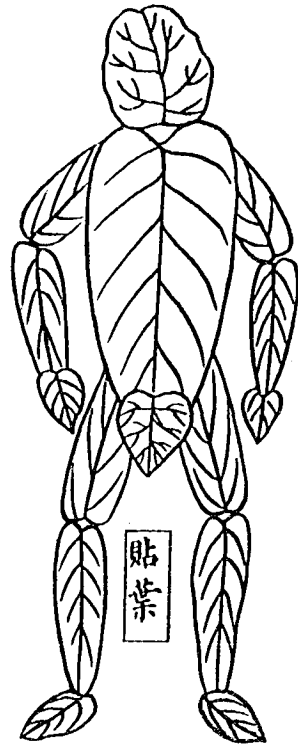

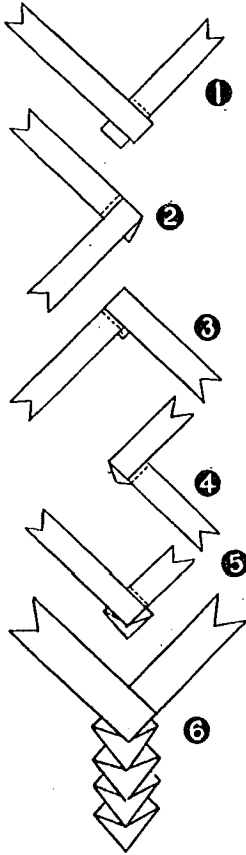

組紙工

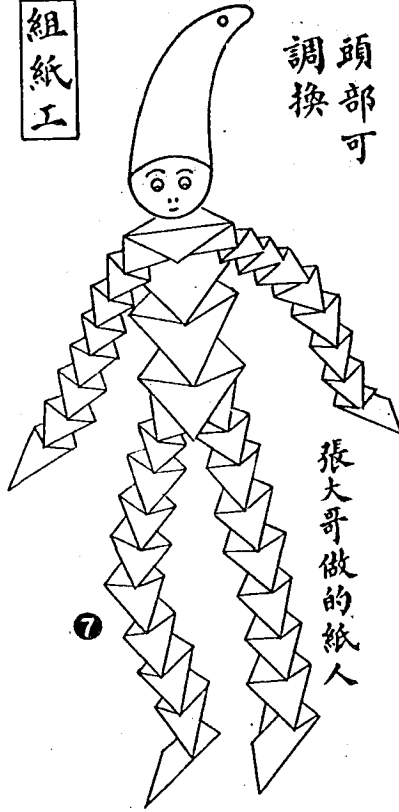

頭部可
調換

張大哥做的紙人

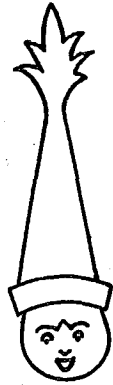

工紙剪

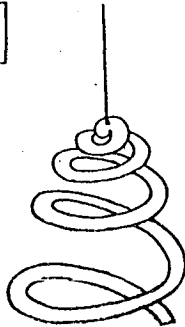
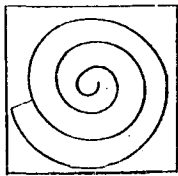

張大哥做的紙蛇

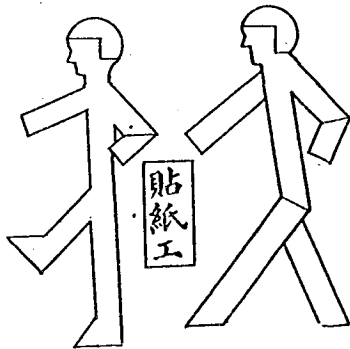

貼紙工

鐵打張 組三十三第 集三第

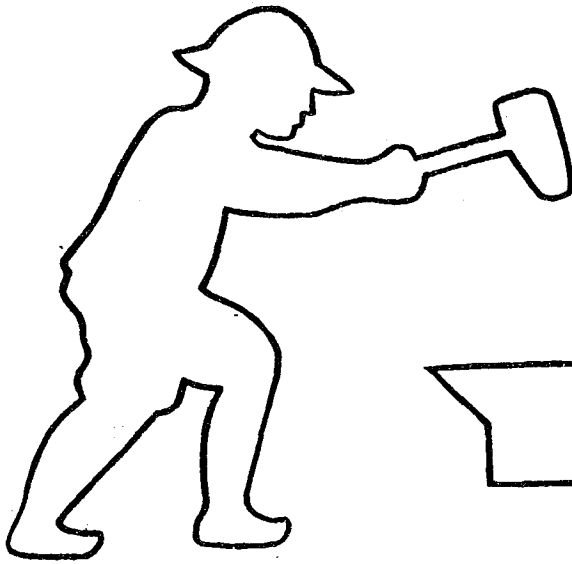

剪貼

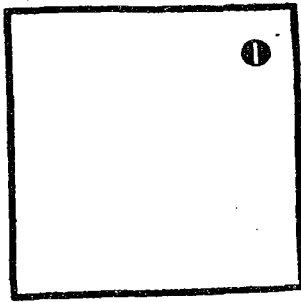

工紙摺

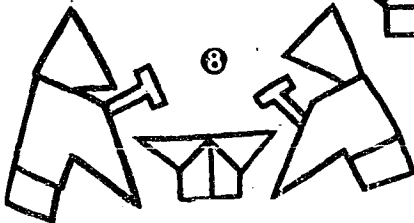
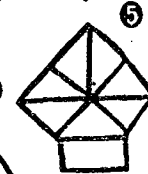
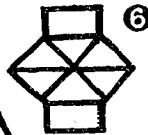
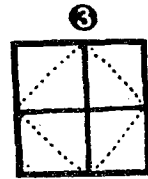
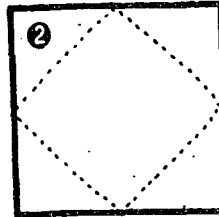

鐵打張 組三十三第 集三第

器鐵種各剪紙



先着色
後剪開
再拼着玩

拼圖

呀鋸 組四十三第 集三第
子鋸紙

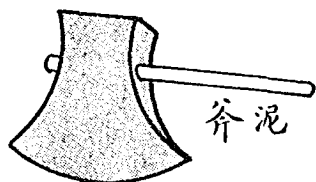

斧泥



頭狼泥

子鑿泥

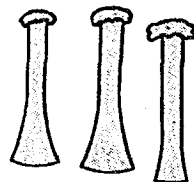

面子桌

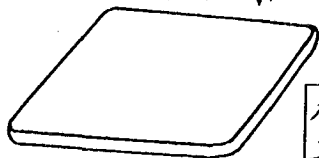

腳子桌

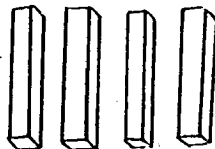

木工

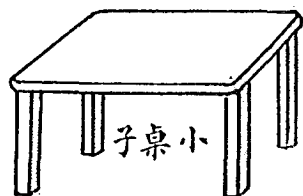

子桌小

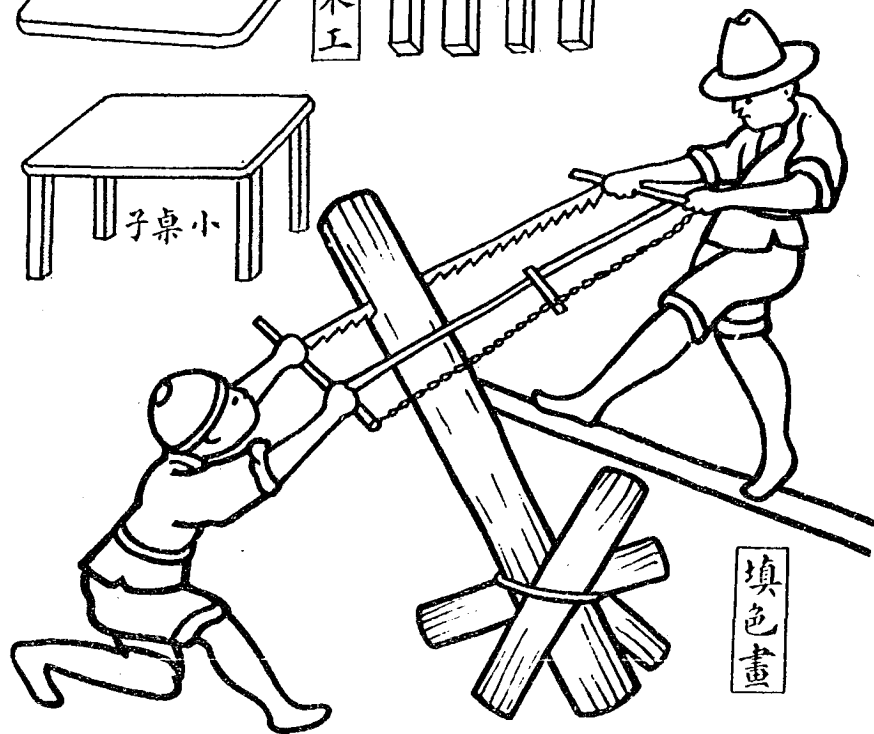

填色畫

第三集 第三十四組 鋸呀

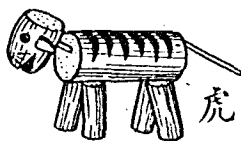

虎

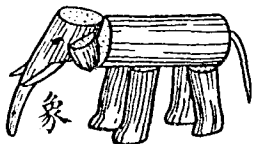

象

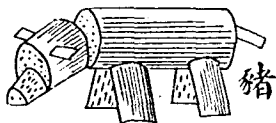

豬

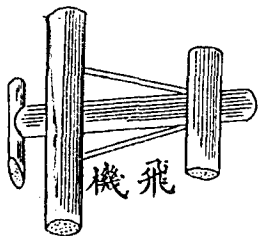

飛機

新巧板

鋸木人

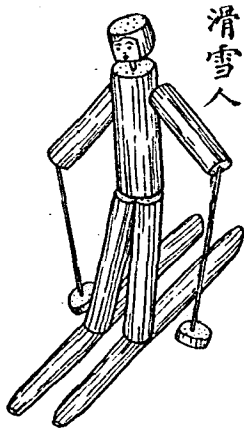
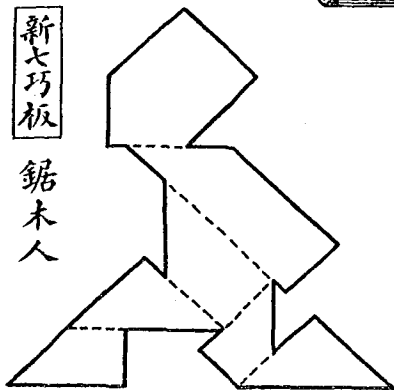

滑雪人



燭臺

軟木工

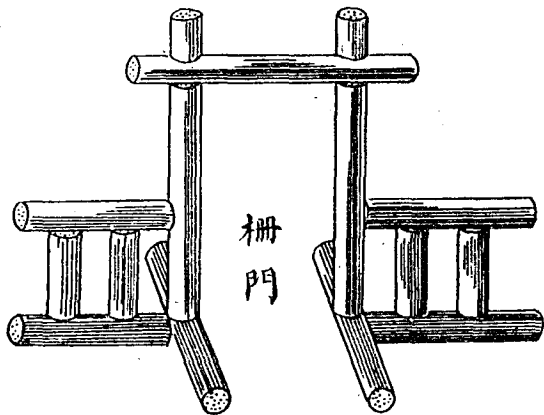

柵門

飛機

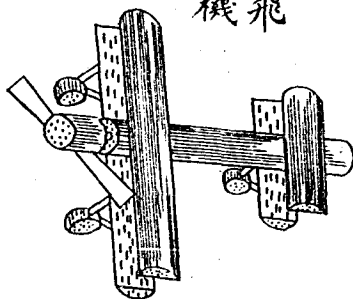

果果吃 組五十三第 集三第



填色畫

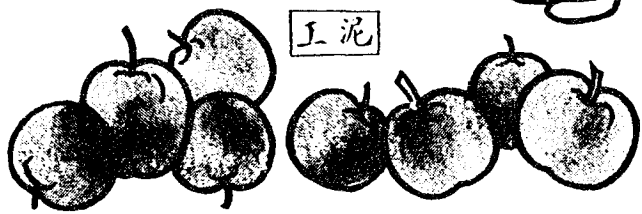

上泥

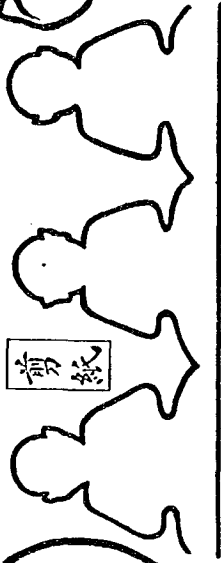

剪紙

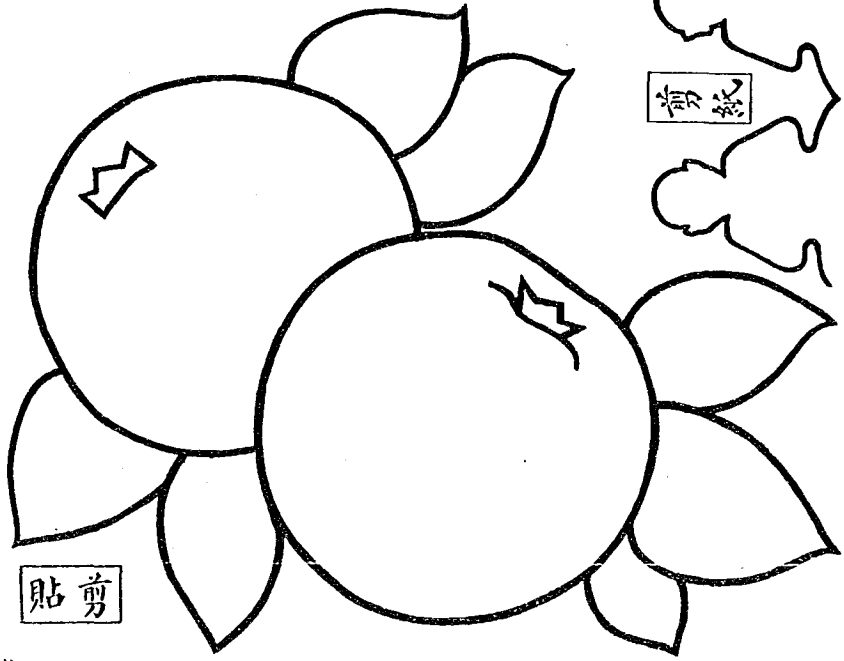

貼剪

果果吃 組五十三第 集三第

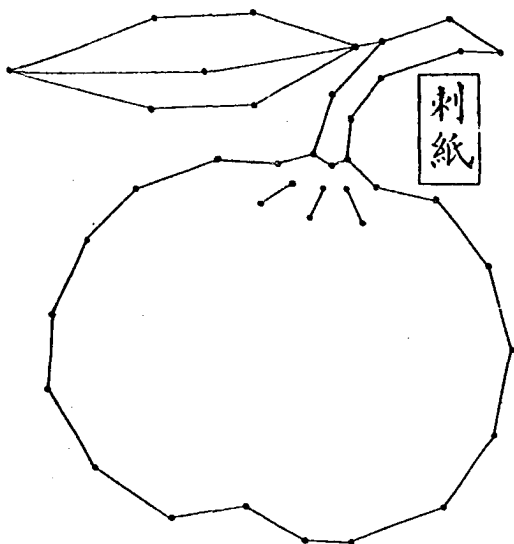

刺紙

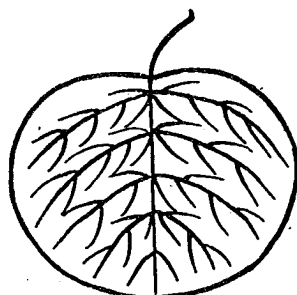

樹葉
貼成
果的
子

工泥

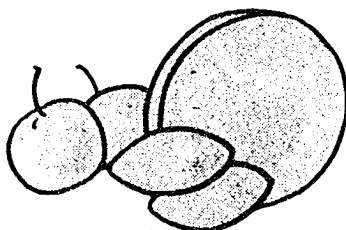

填色畫



工泥



腿



雞



魚



糕

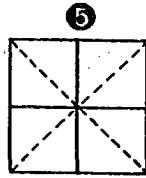

5

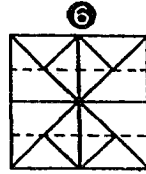

6

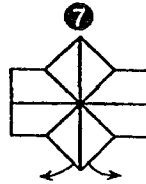

7



8

子椅

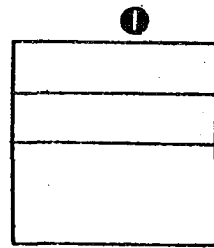

1

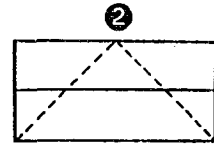

2

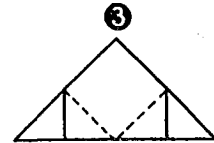

3

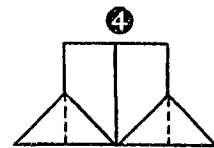

4

摺紙工



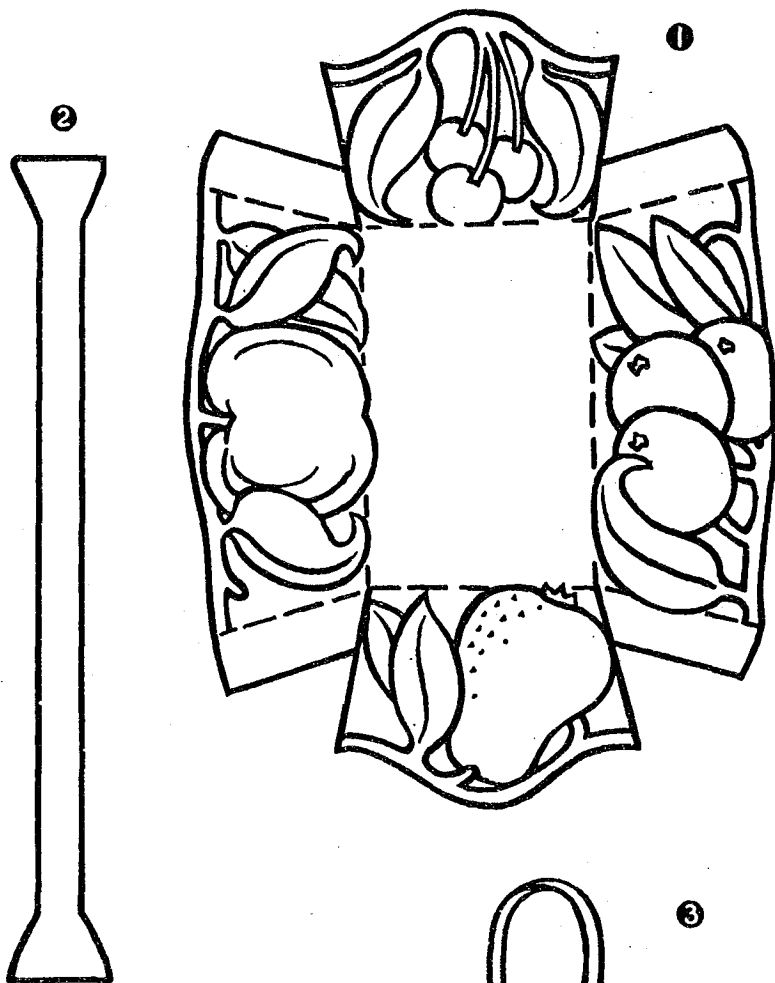

籃果紙

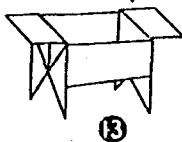
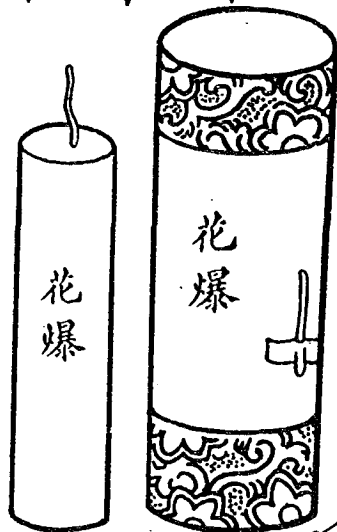
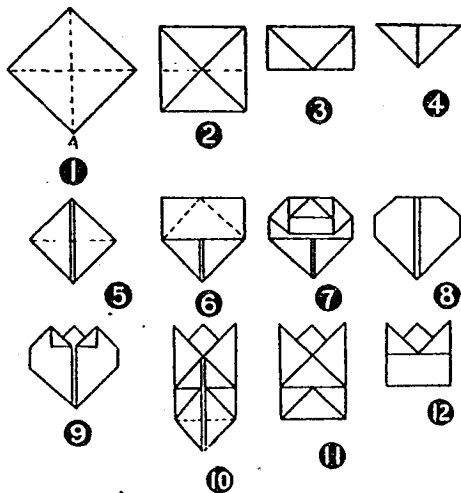

匣糕 工紙摺

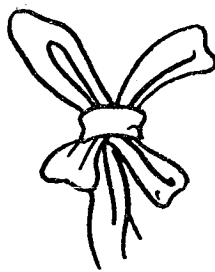
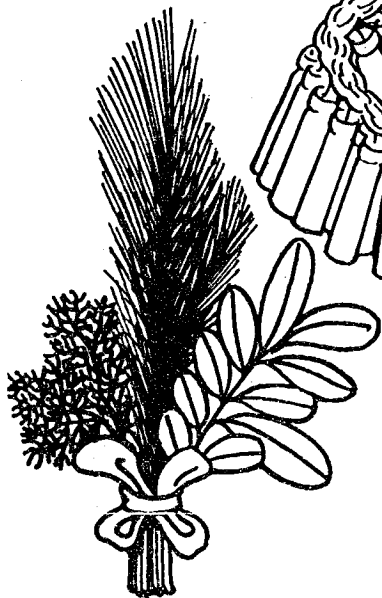
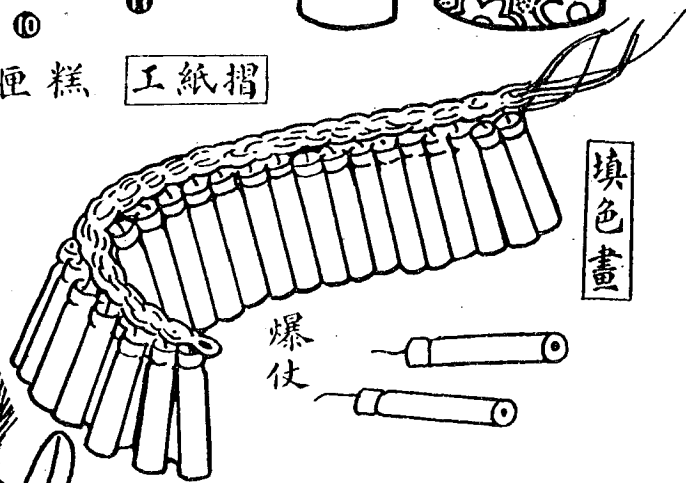

打蝴蝶結

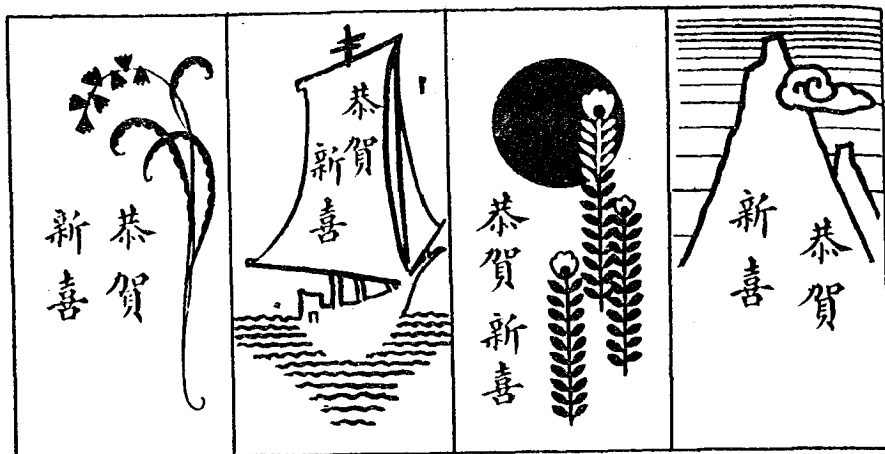

片年賀

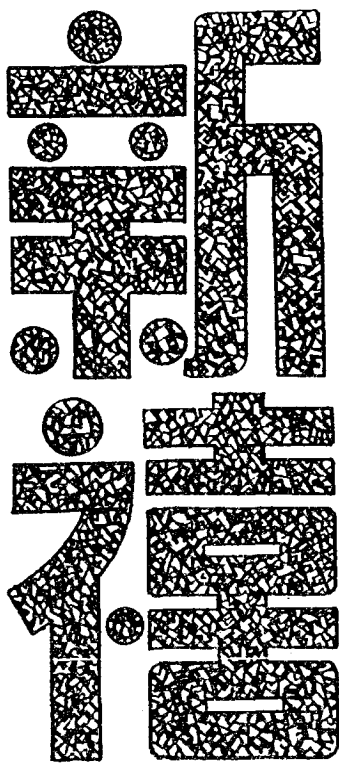

用膠水寫字 將紙屑貼上去

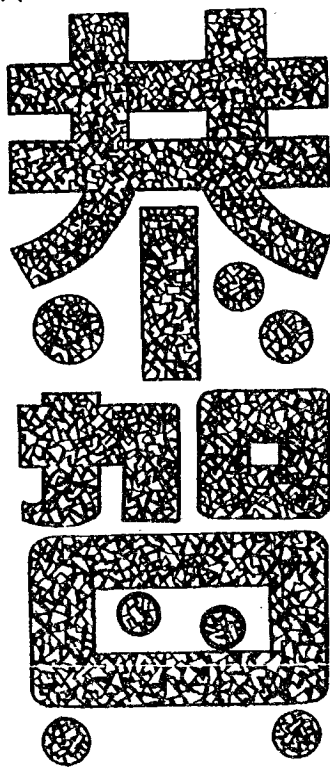

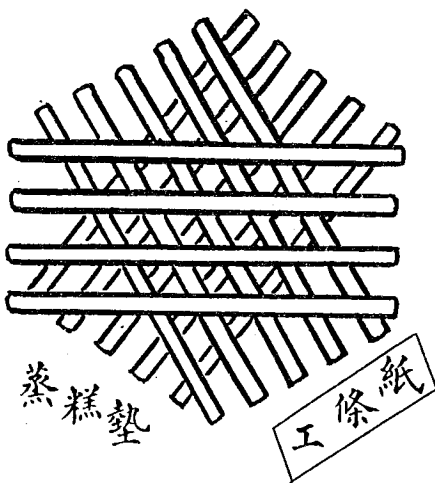
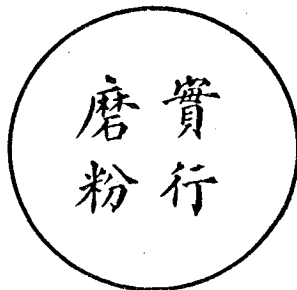

糕墊蒸

糕蒸 填色畫



填色畫

工泥

畫謎

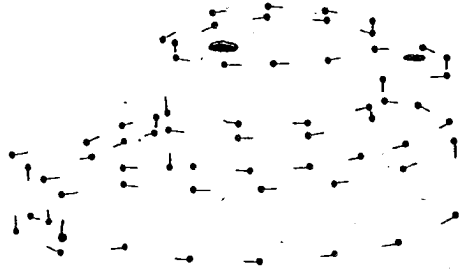
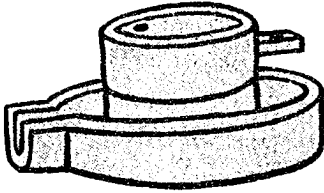
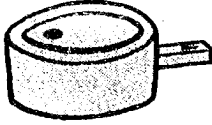

填色畫



磨粉



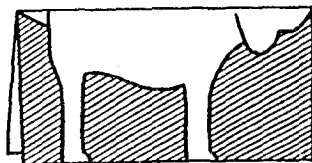
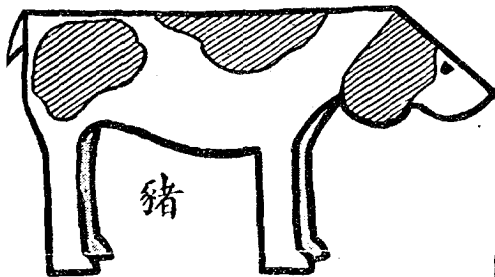
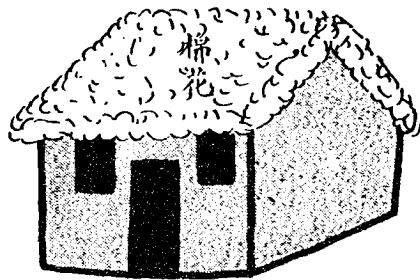
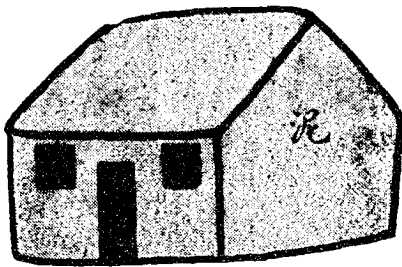
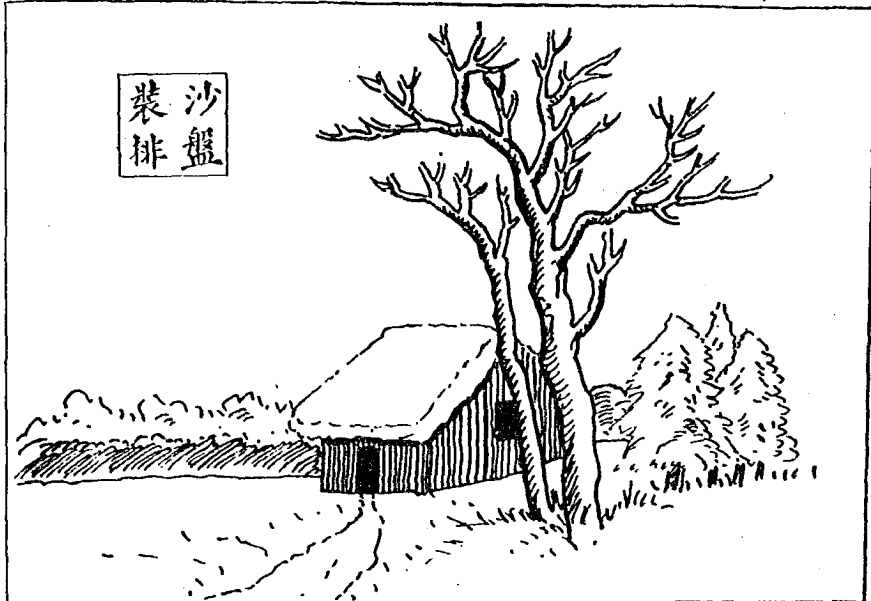

工紙剪

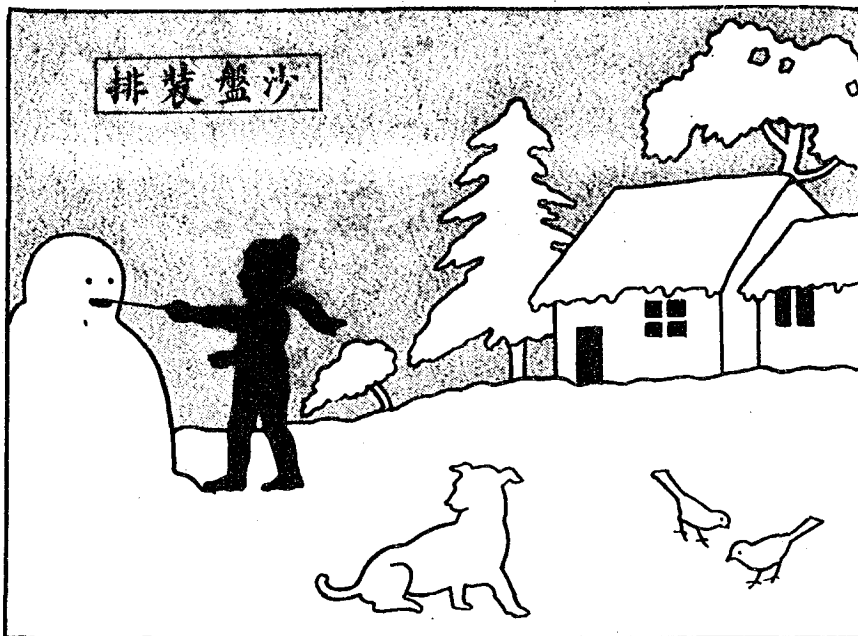

排裝盤沙

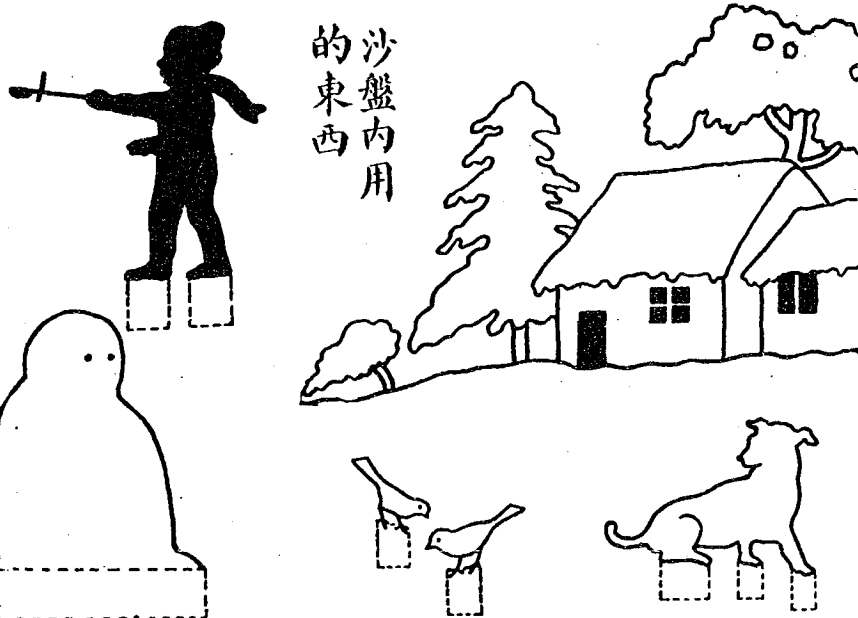

沙盤內用
的東西

氣肚一雀麻 組十四第 集三第

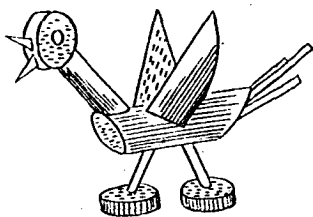

工泥

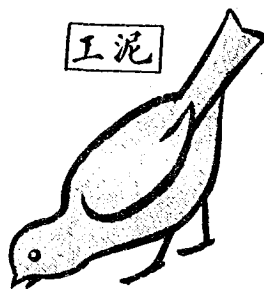

高梁的
做鳥的

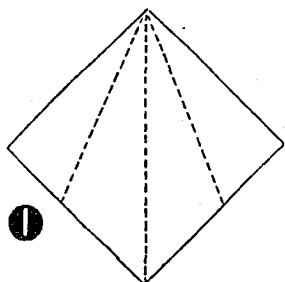

1



4

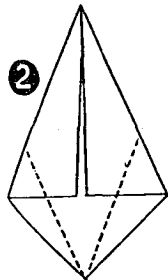
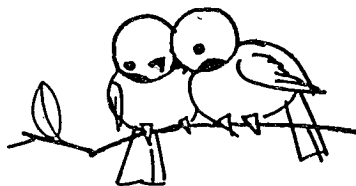

2

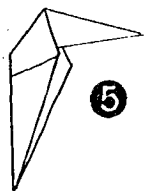

5

填色畫

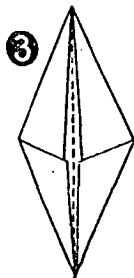
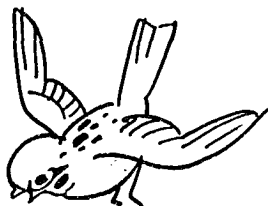

3

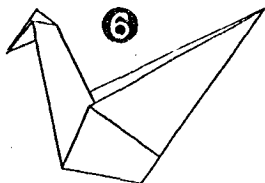

6

雀麻

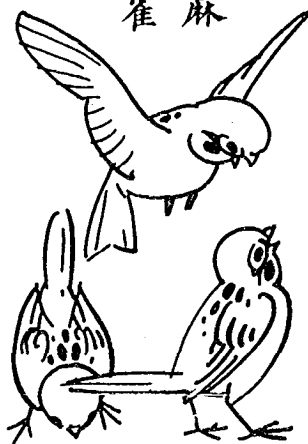

工紙摺

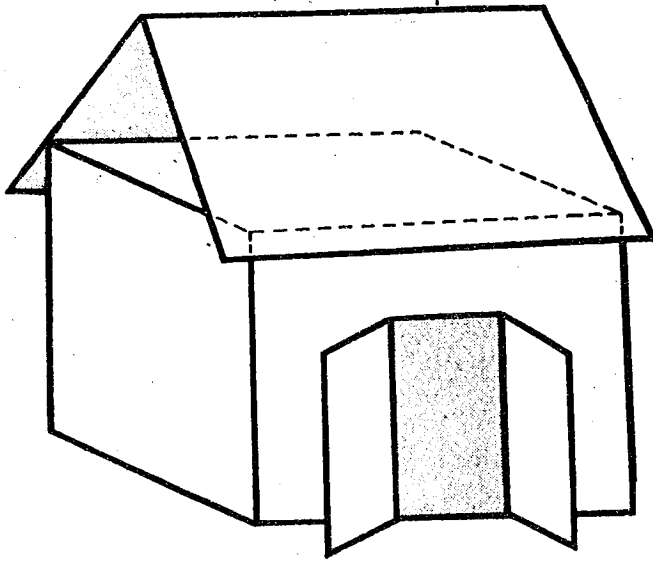

厚紙工

小屋

例舉畫童兒

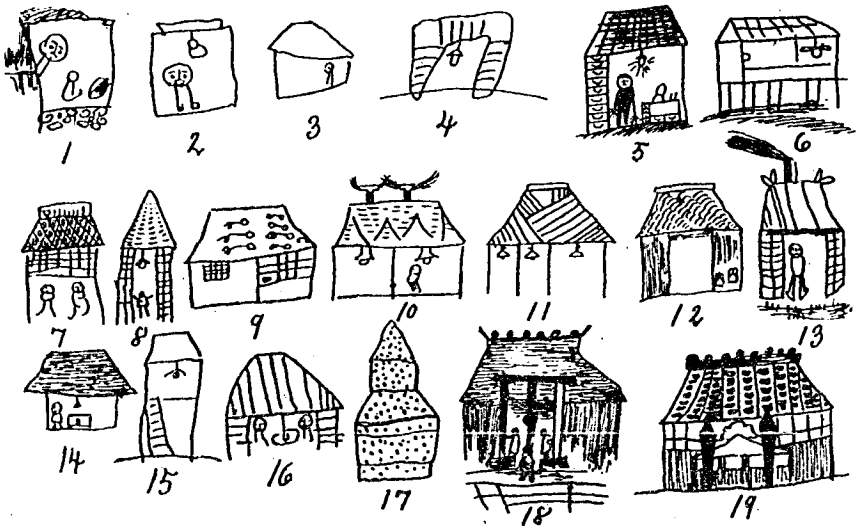

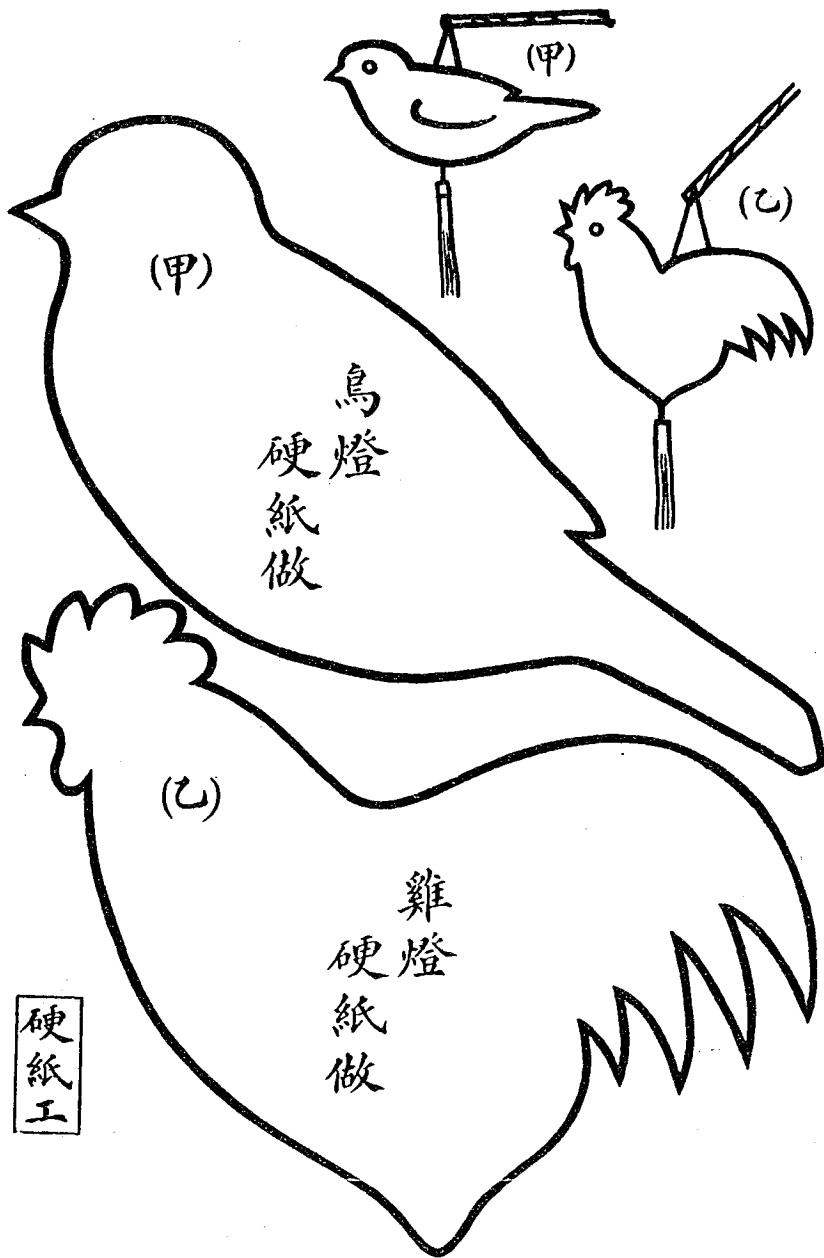

用 黑 點 印 成 的 字

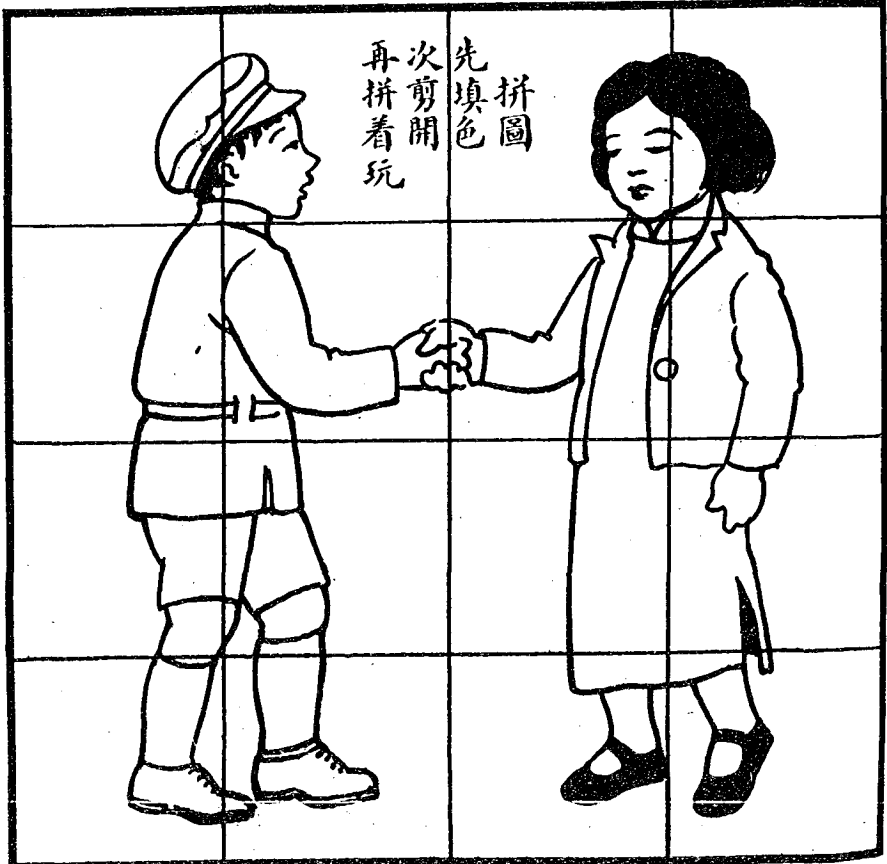
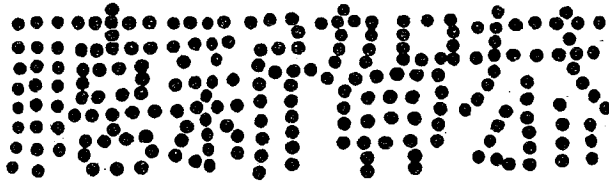

鼓敲哥哥 組二第 集四第

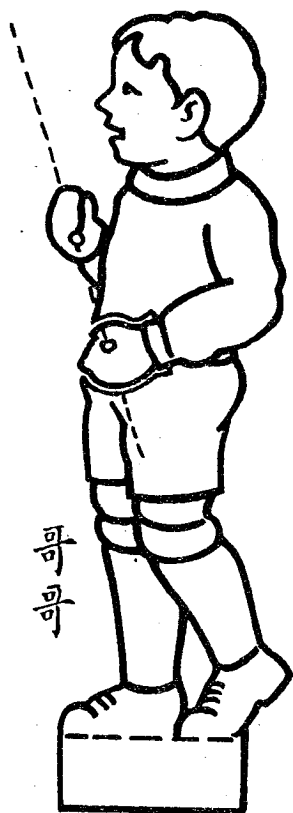

哥哥

後剪開



絲竹

先填色

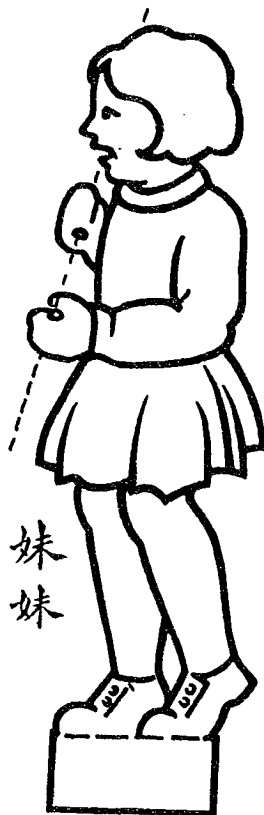

妹妹

鼓小

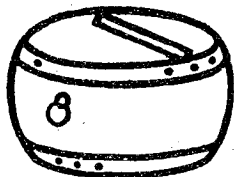

喇叭

鑼小

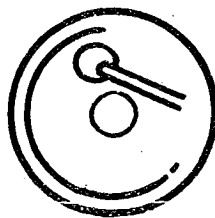

鼓敲哥哥 組二第 集四第

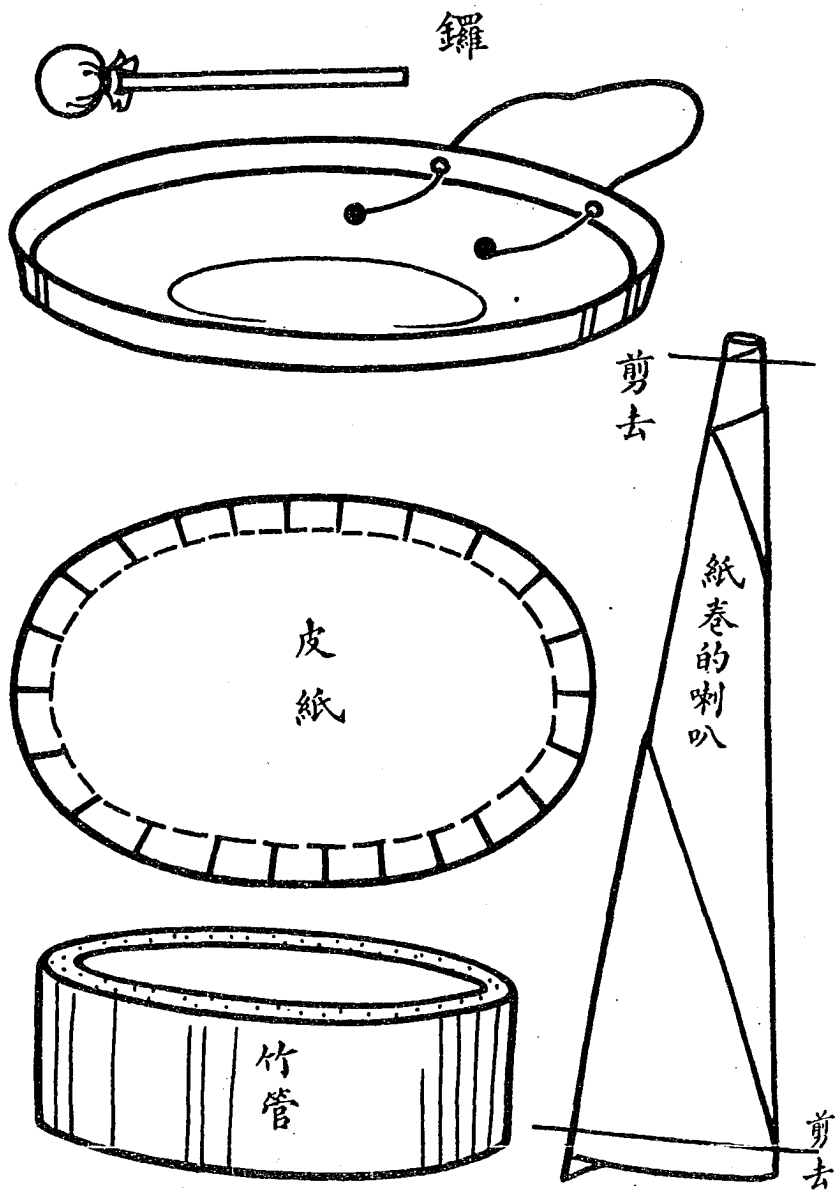

啼雞公 組三第 集四第

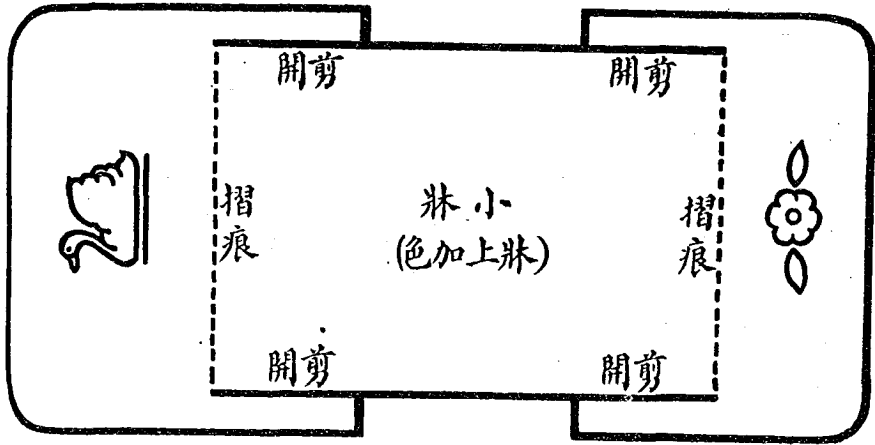

工紙剪

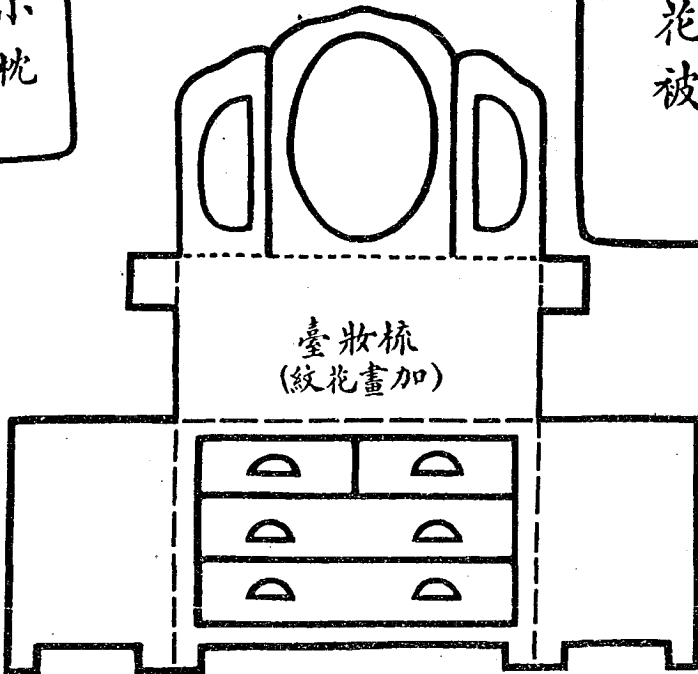

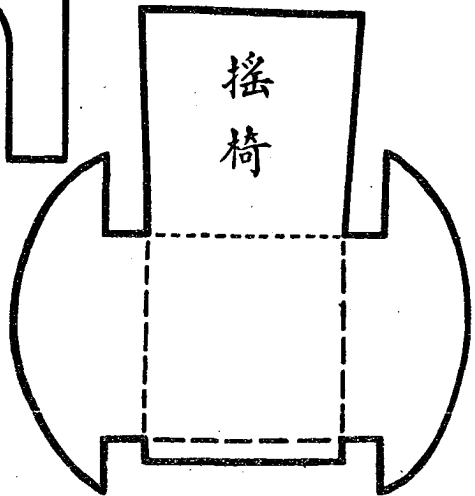
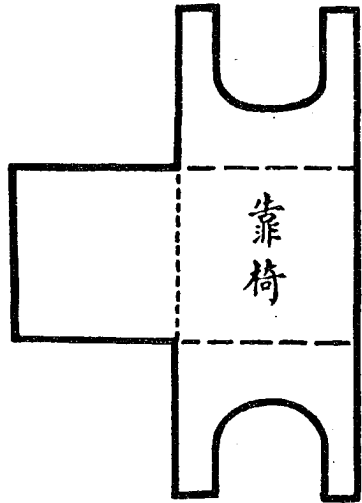
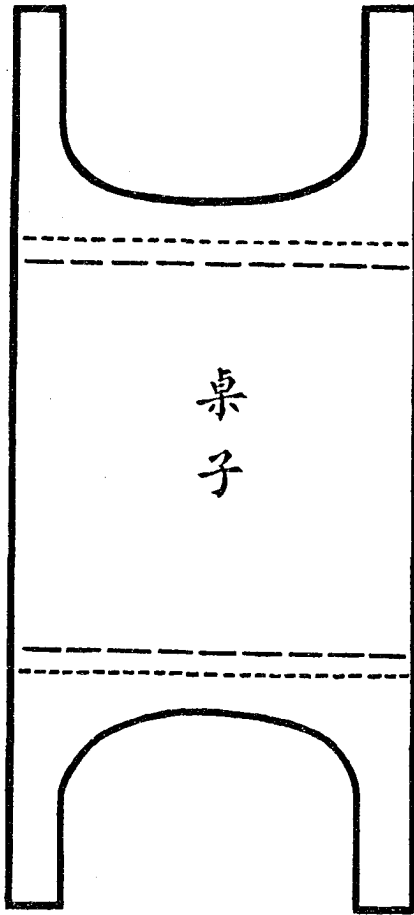

側視形

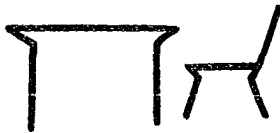

早得起 組四第 集四第

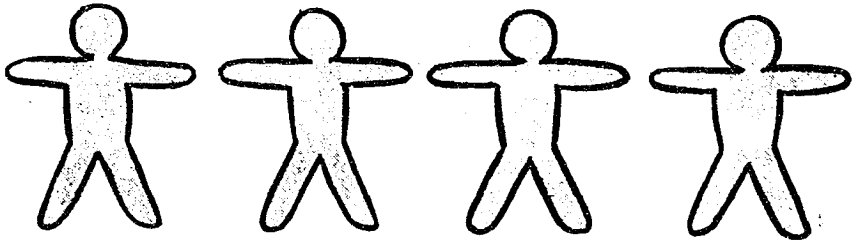

工泥

剪貼

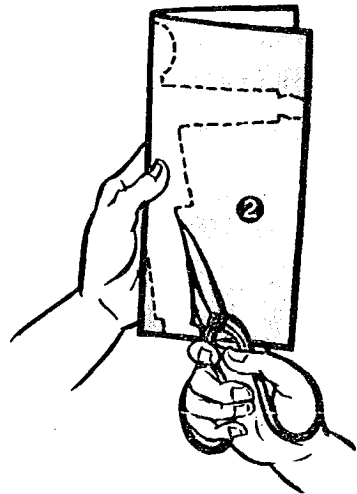
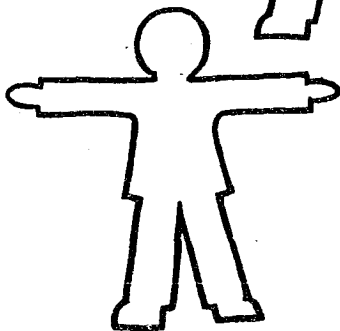
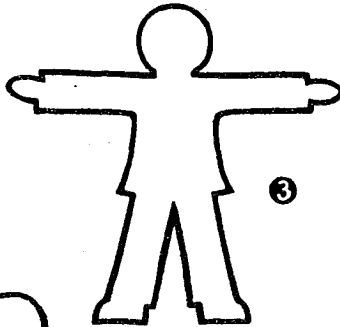
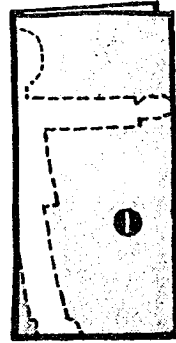
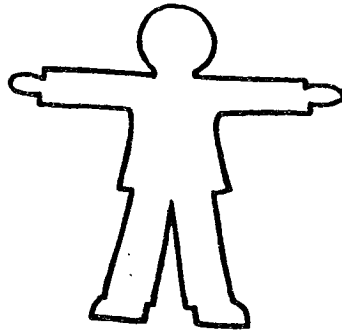

早得起 組四第 集四第

木積造構

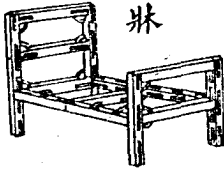

牀



①

工紙摺

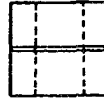

②



③



④

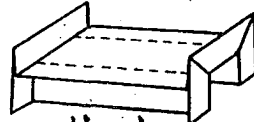

⑤

牀小

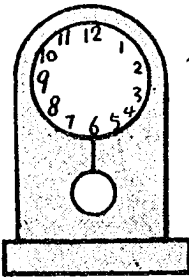

鐘
(粘土)

(粘土)

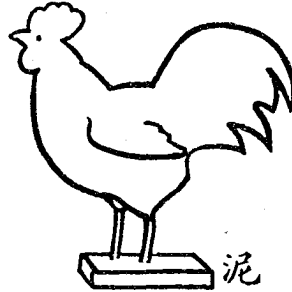

泥

厚紙工

建築積木

鐘樓

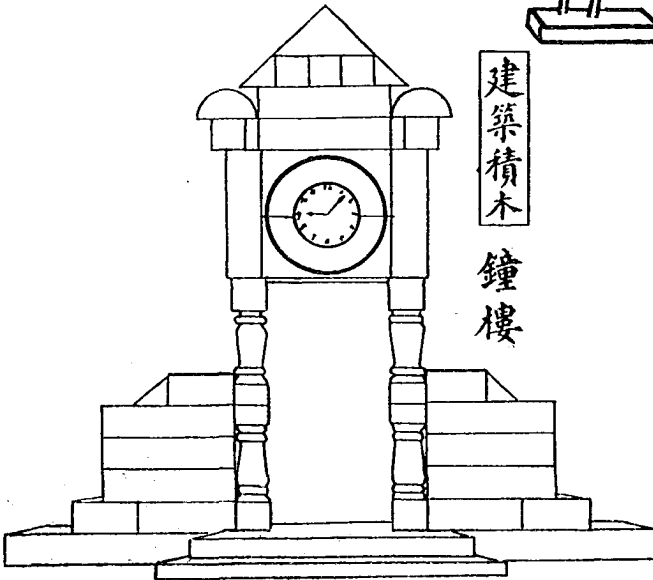

橋婆外到搖 組五第 集四第

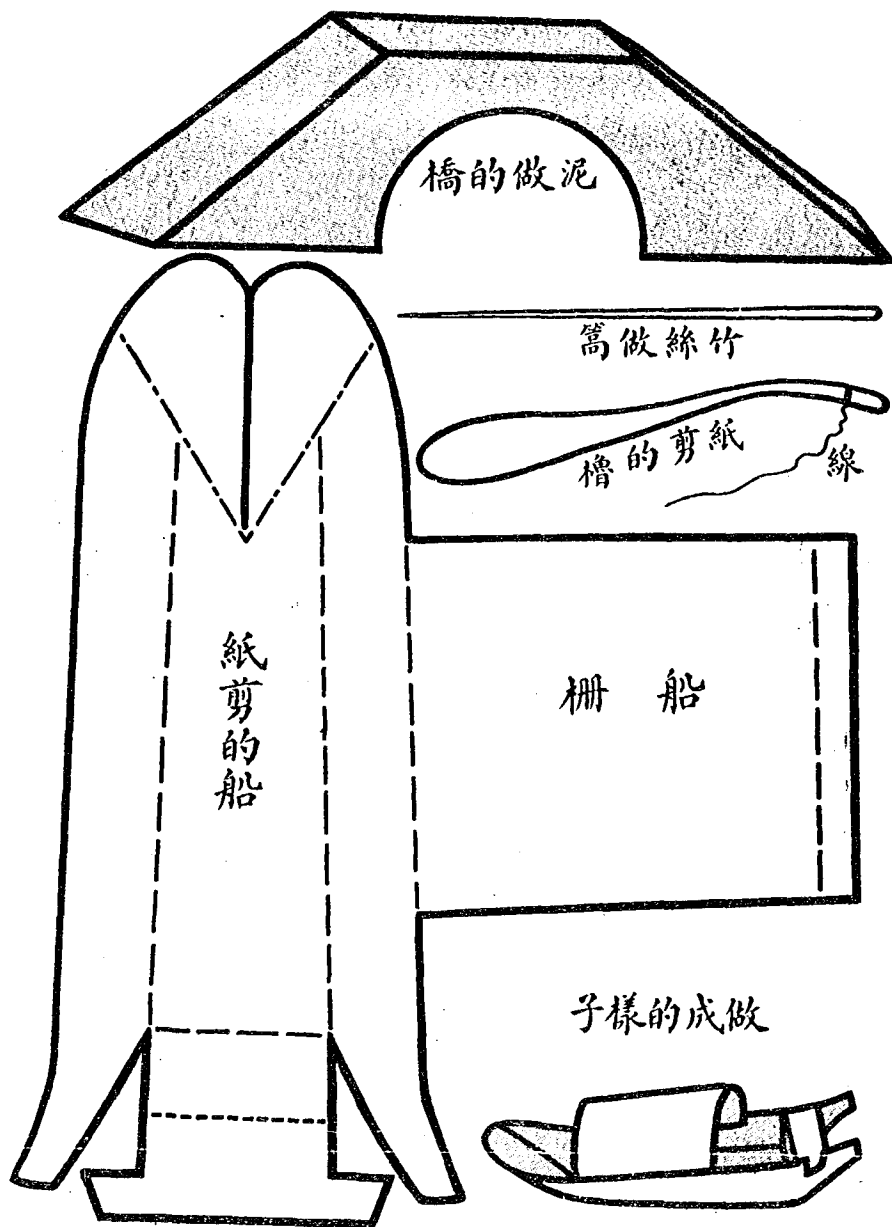

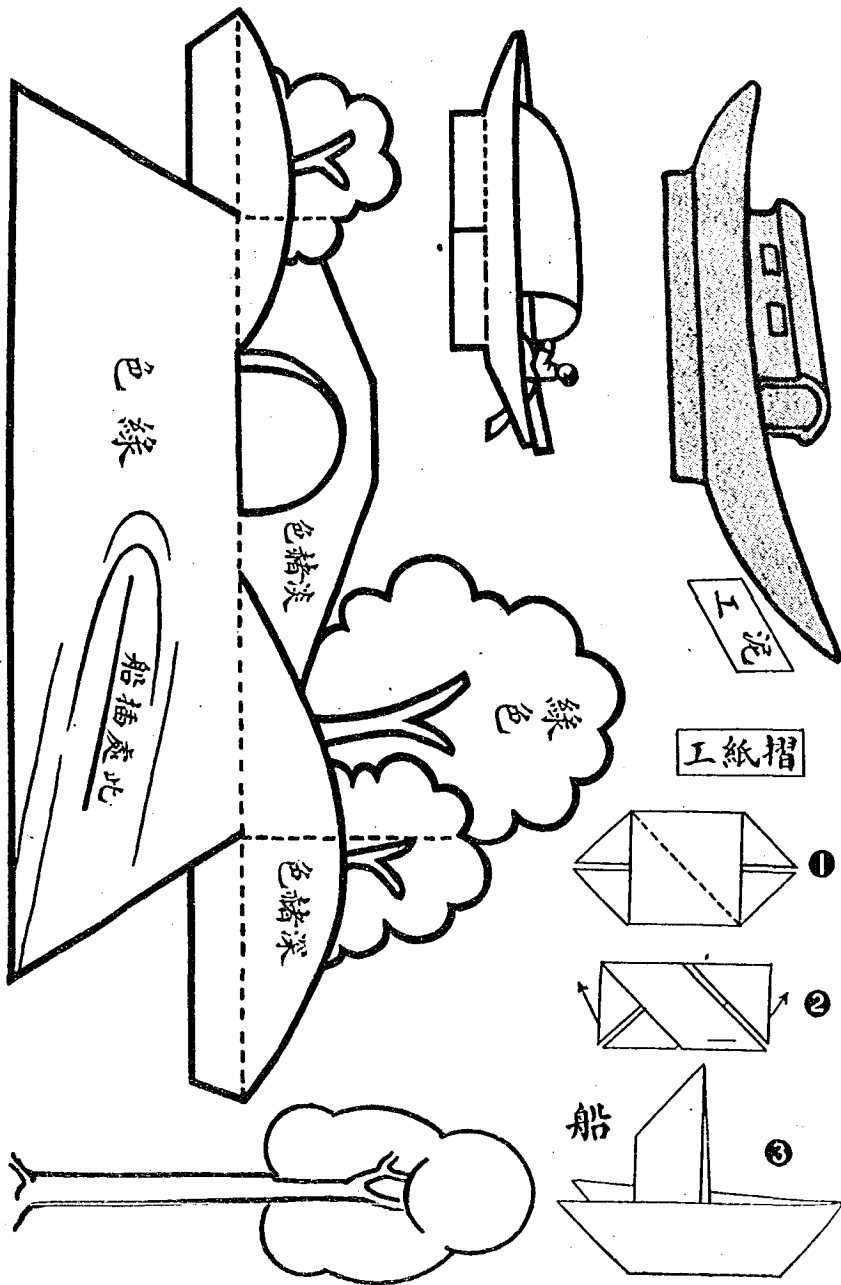

拼圖
先填色
次剪開
再拼着玩

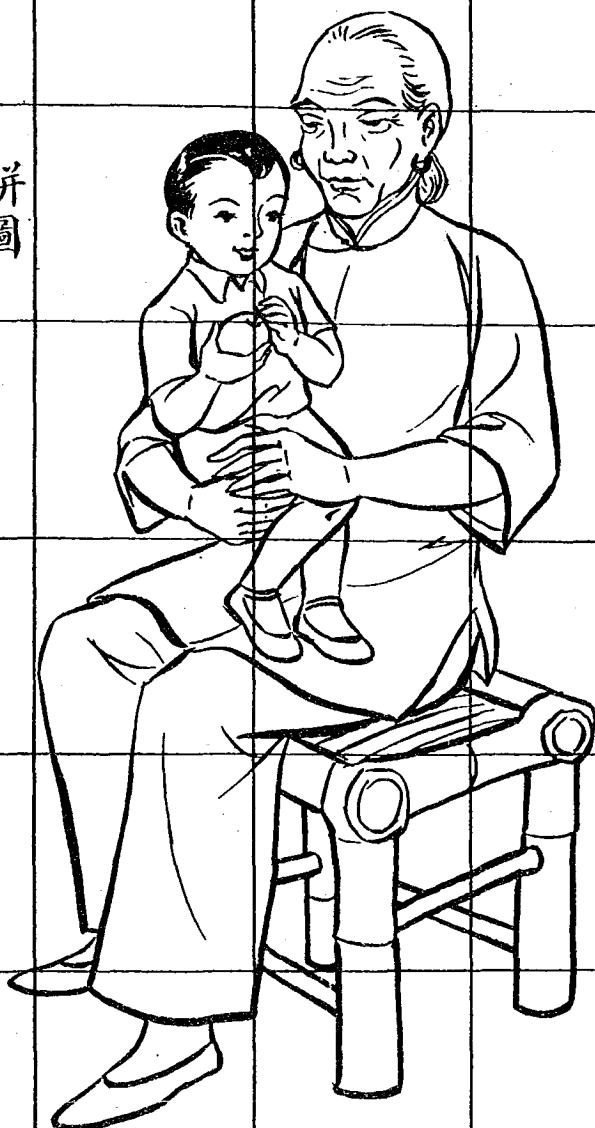

寶寶抱婆外 組六第 集四第

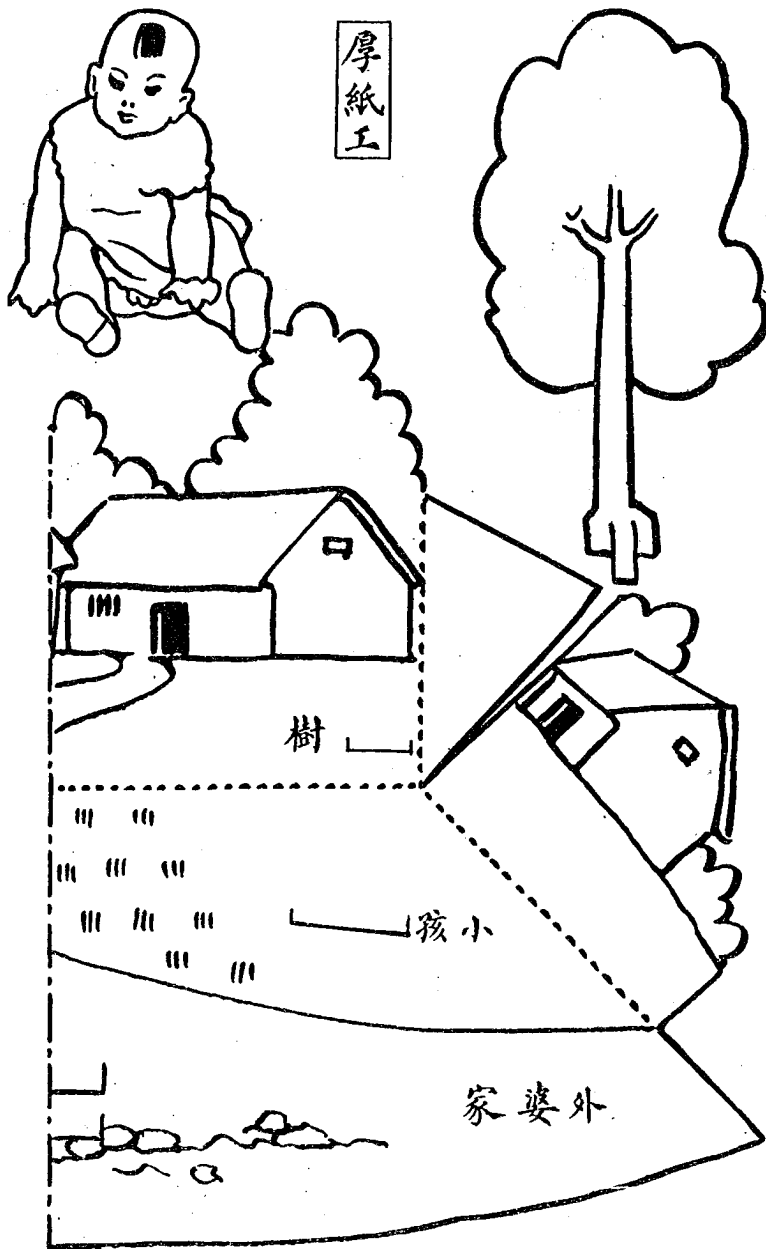

跳弟弟 組七第 集四第

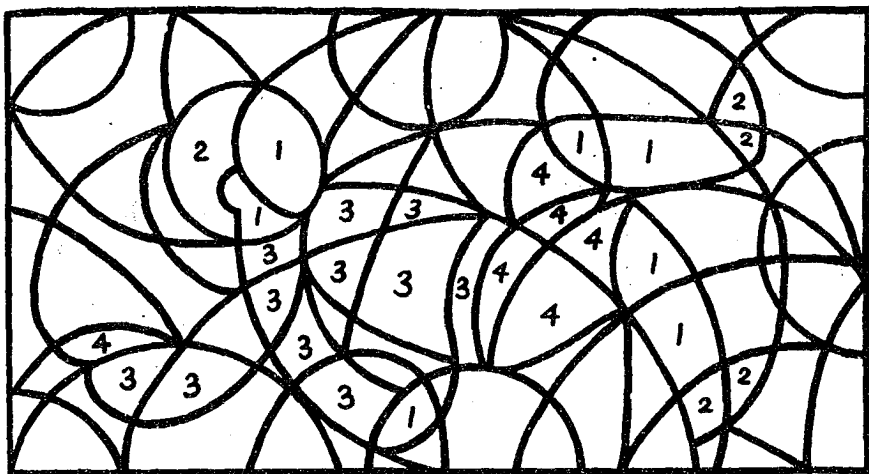

把下圖剪下
來，衣帽上
加畫花紋。

上圖 1 着淡紅色
2 着黑色
3 着藍色
4 着黃色



畫色填



背面的貼法

先着色
再剪開
後貼起

娃娃小抱娃娃大

哥哥學 組八第 集四第

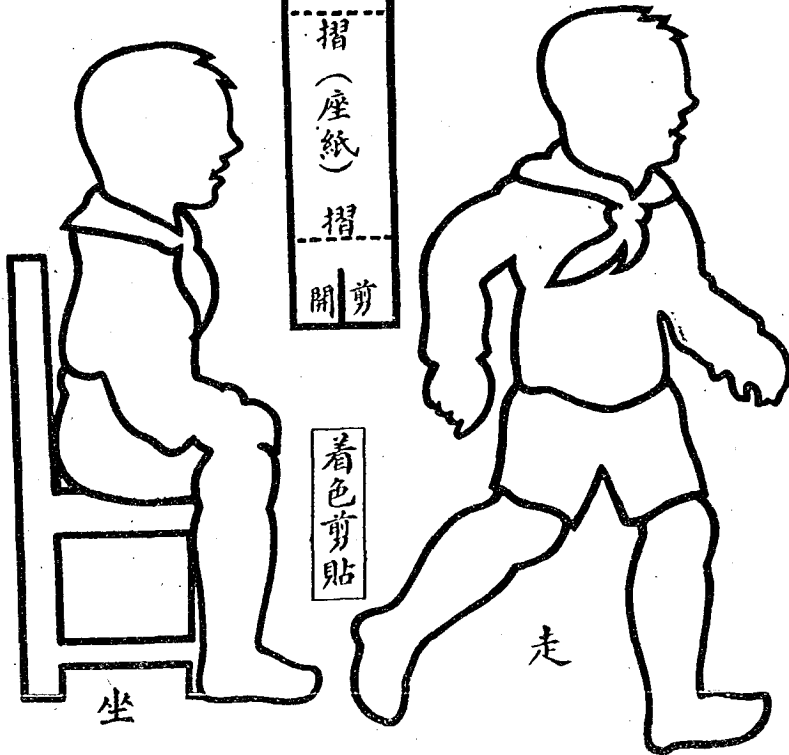
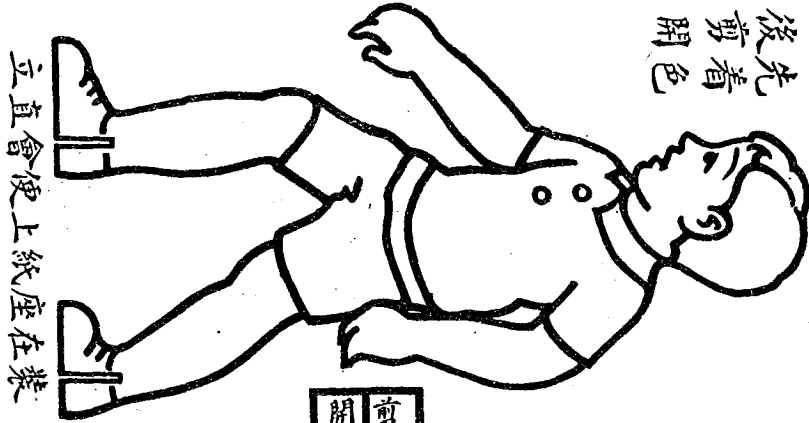

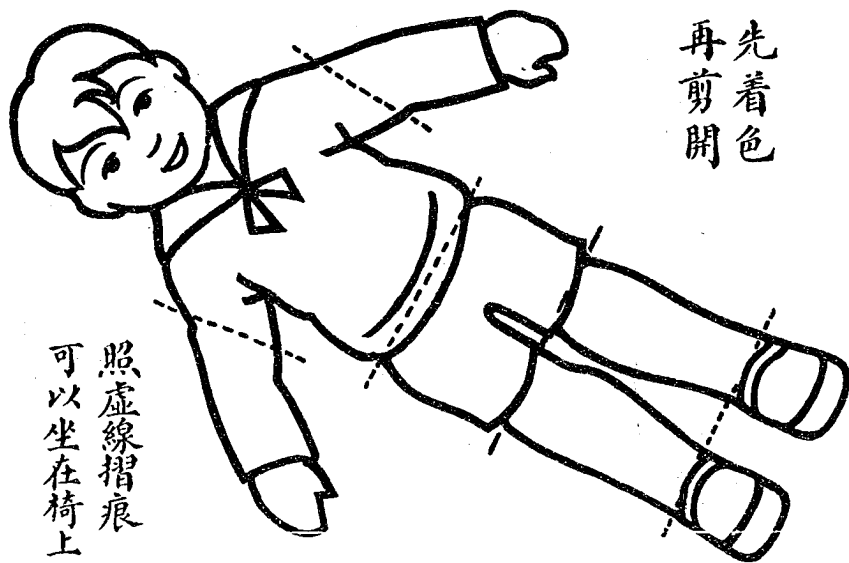
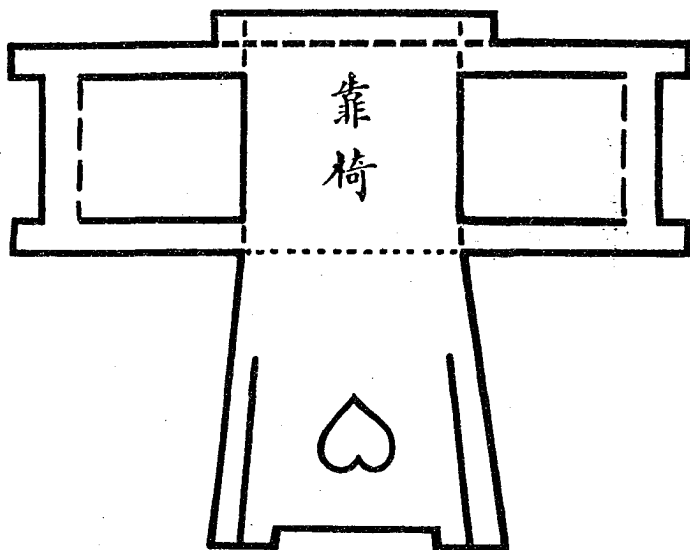

先着色
再剪開

照虛線摺痕
可以坐在椅上

鳥小和鳥老

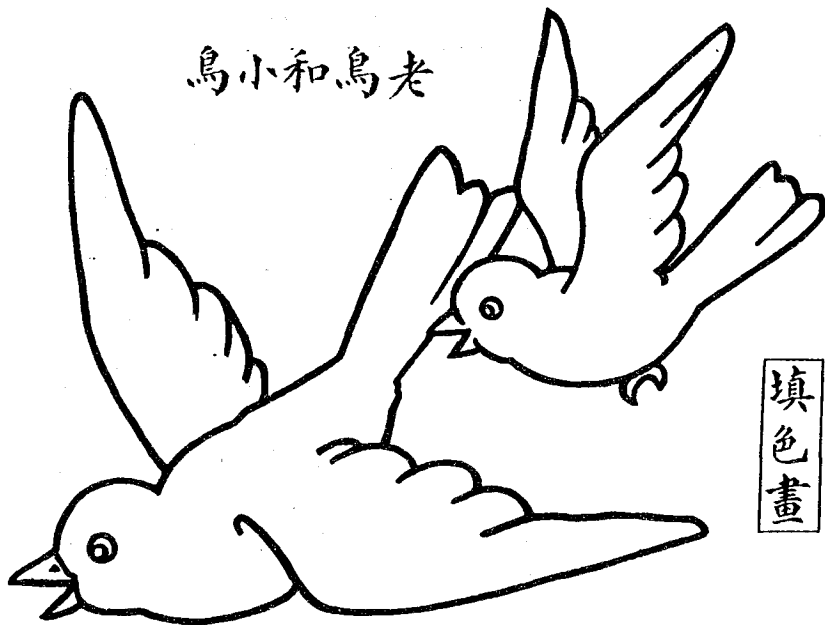

填色畫

工粉米

工紙摺

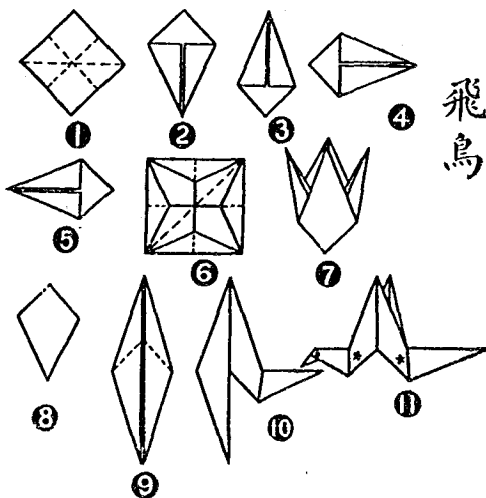
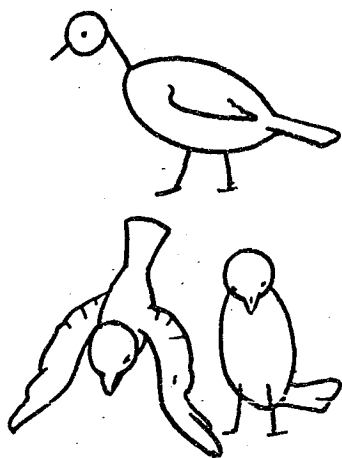

飛鳥

鳥大做哥哥 組九第 集四第

貼剪

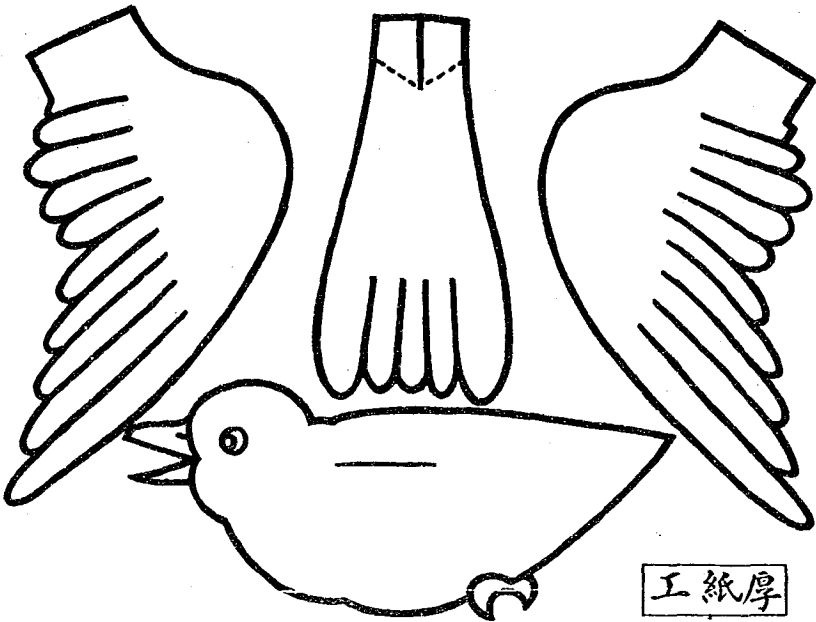
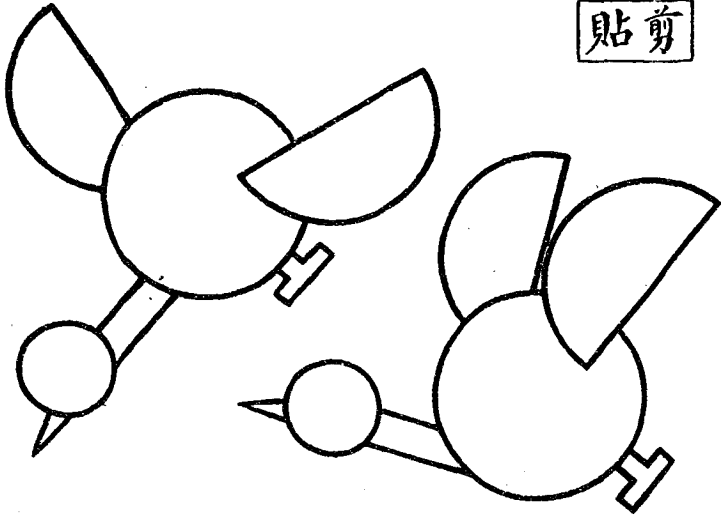

工紙厚

鷹捉雞

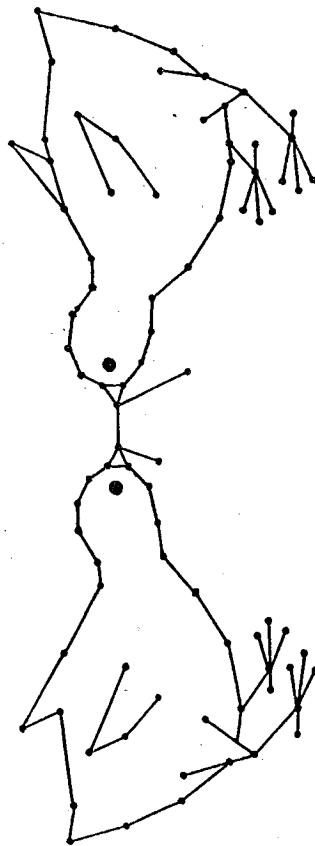

雞捕鷹的成貼葉樹

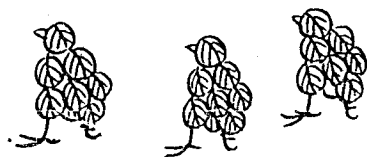

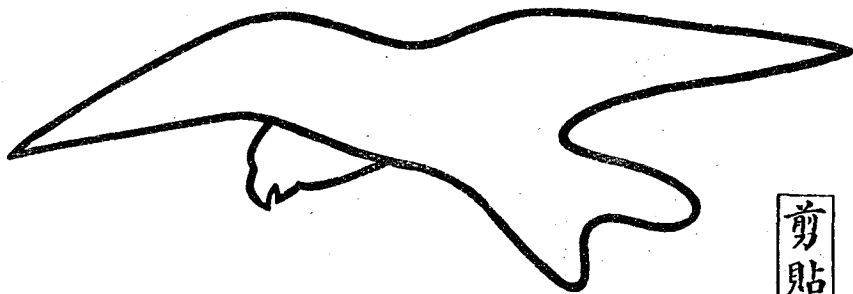

剪貼

雞小捉鷹老

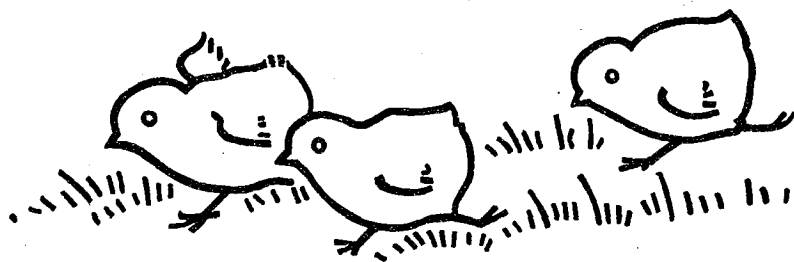

鷹立

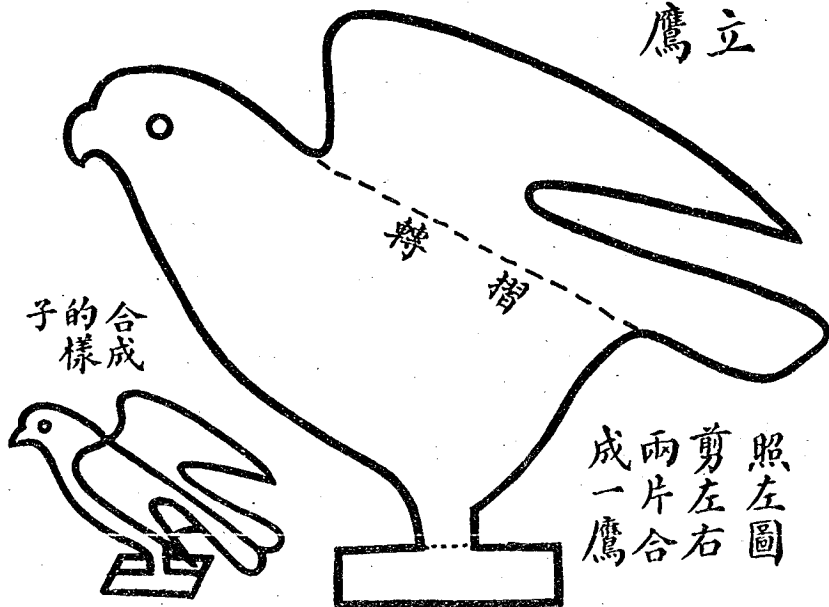

子的合成樣

照左圖
剪左右
兩片合
成一鷹

空裏肚 組一十第 集四第

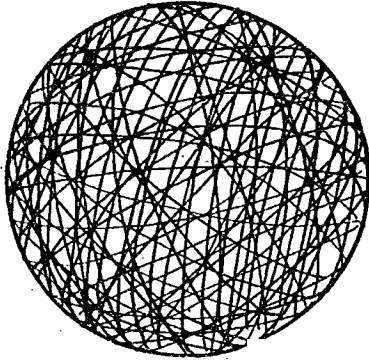

棉線球

中間是棉花

球皮色五

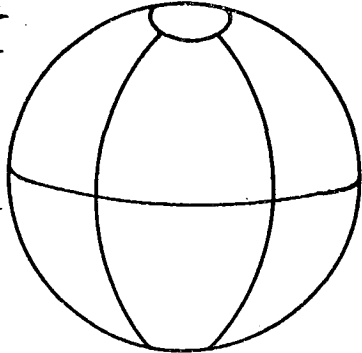

色填己自

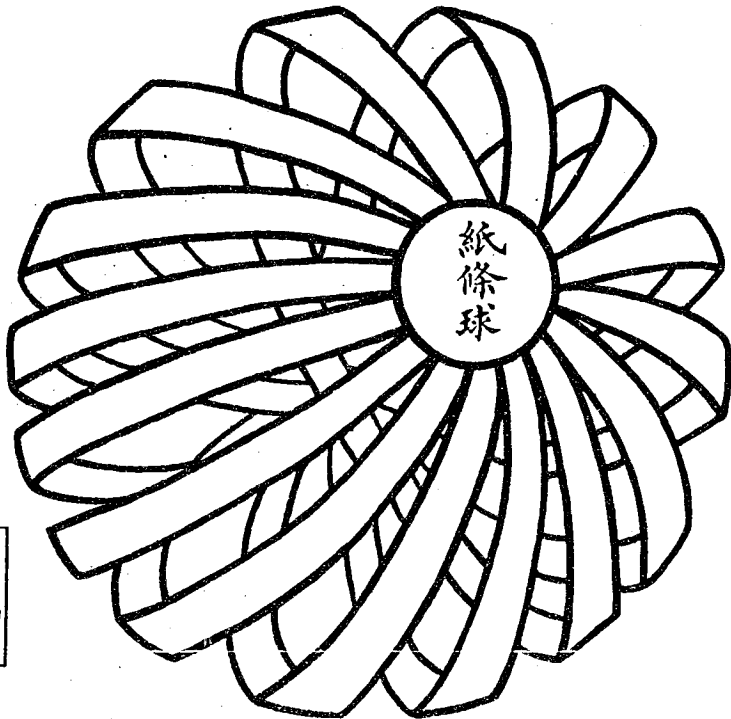

貼紙工

空裏肚 組一十第 集四第

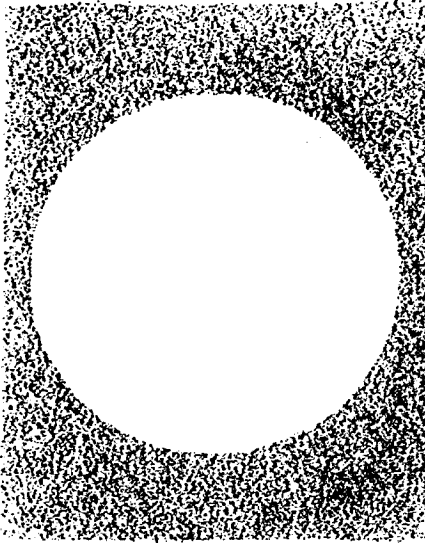

彈墨畫

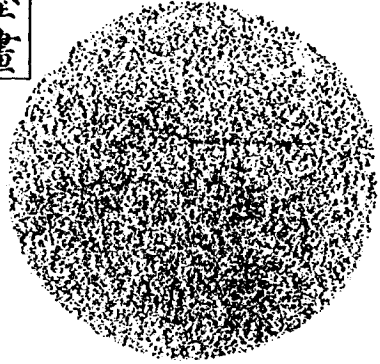

三種圓球形貼成幾個圖樣

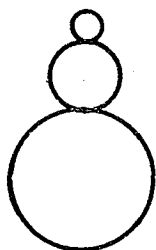
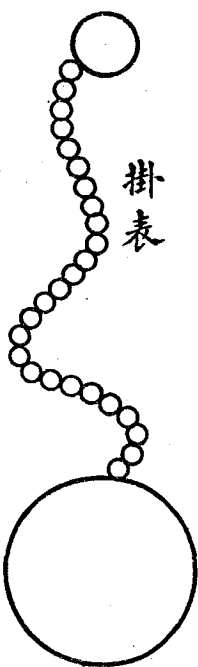

蘆胡

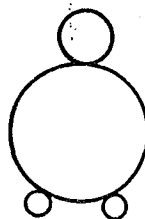

子孩

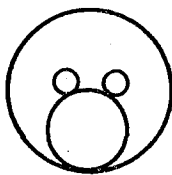

鼠老

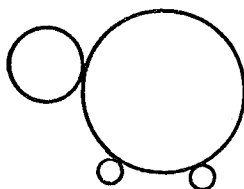

兒兔

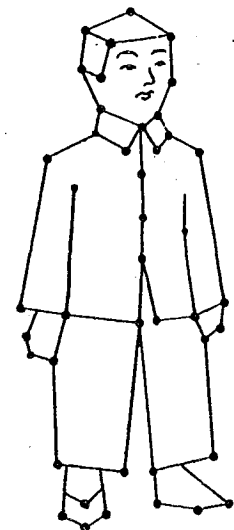

工線穿

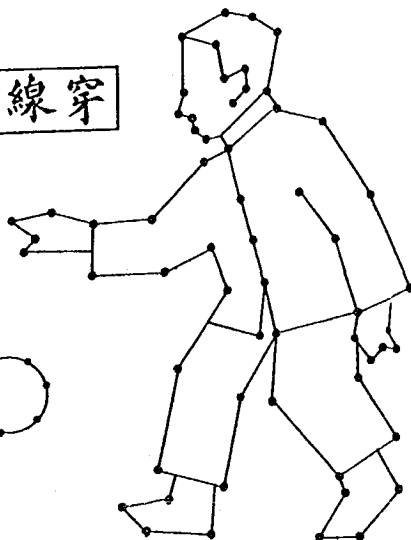

硬紙工

台球板

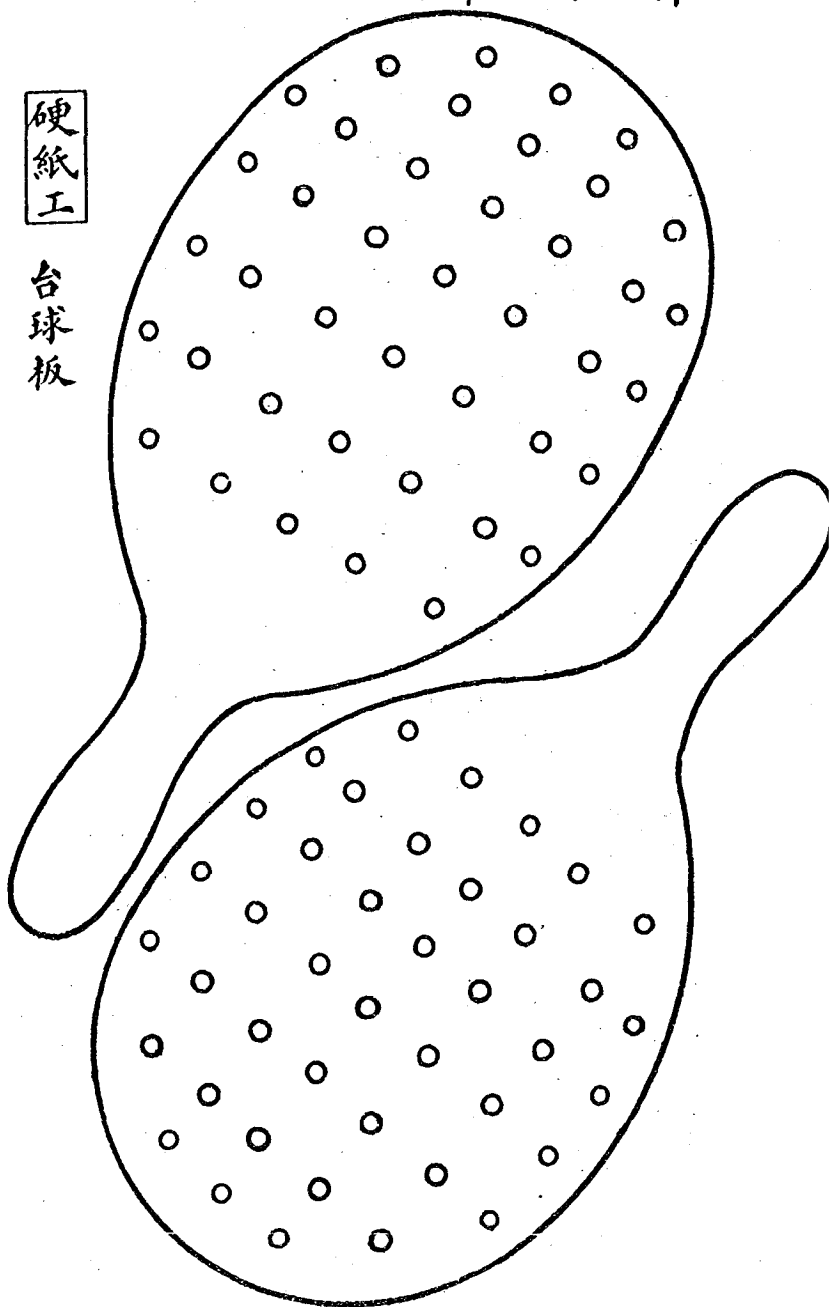

高亮月 組三十第 集四第

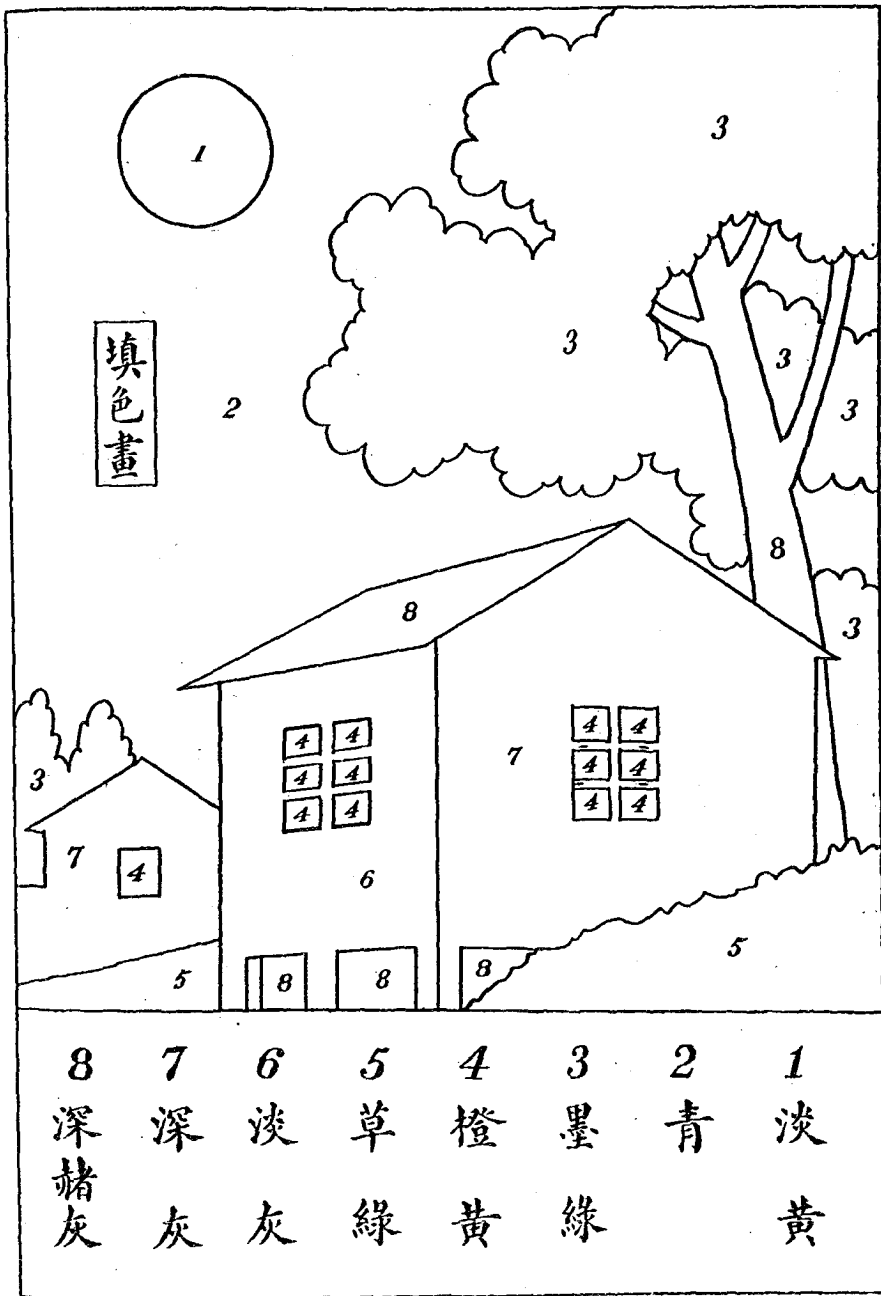

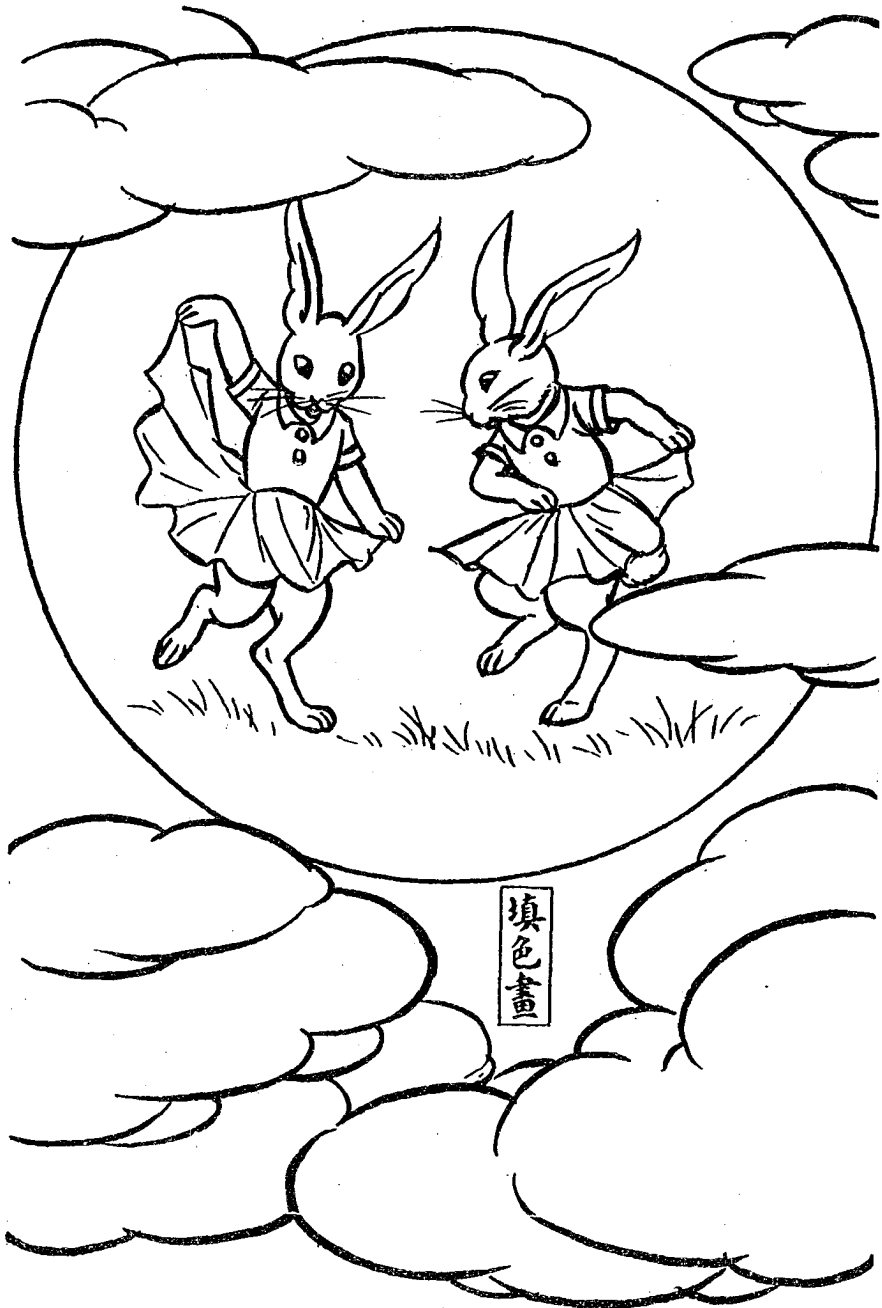

圓亮月 組四十第 集四第

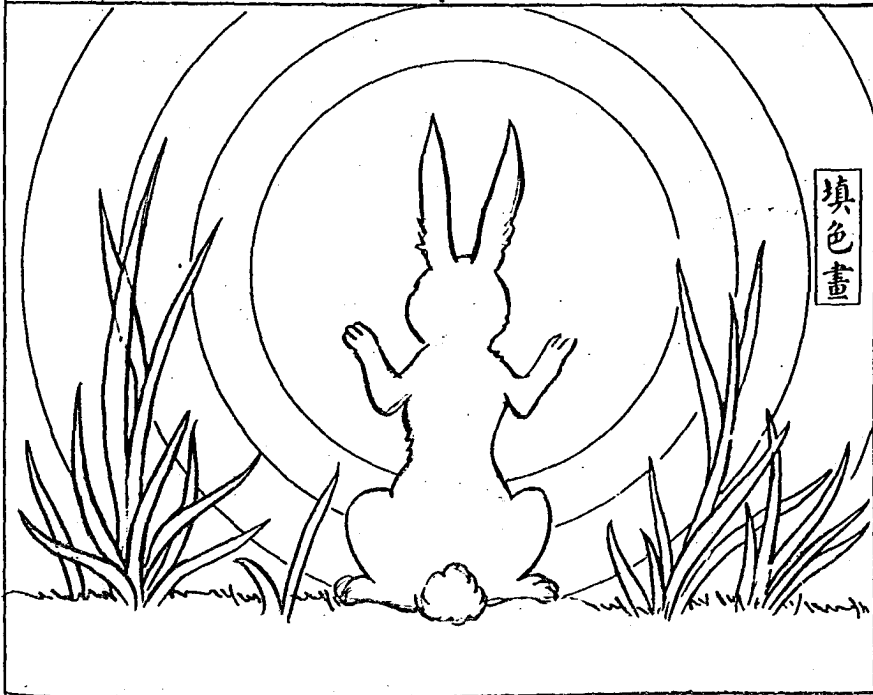

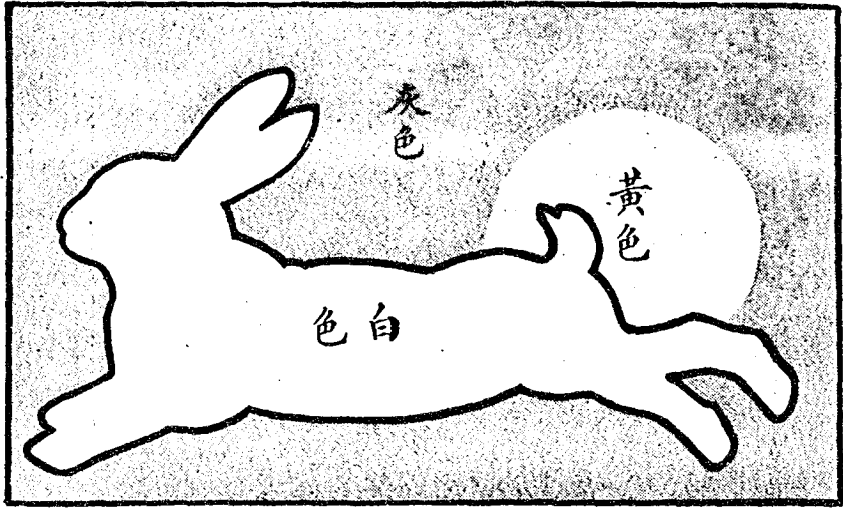

貼剪 月拜子兔

果水盤一

畫色着

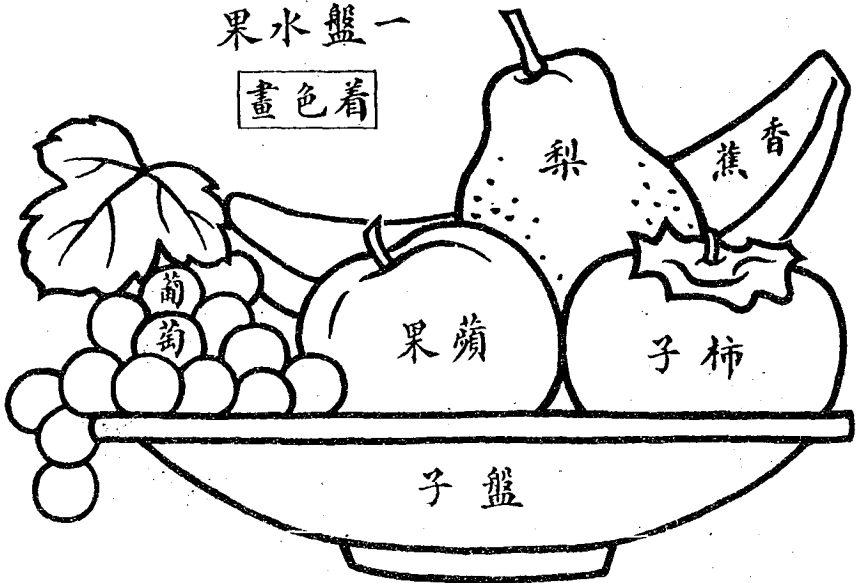

畫國旗着色

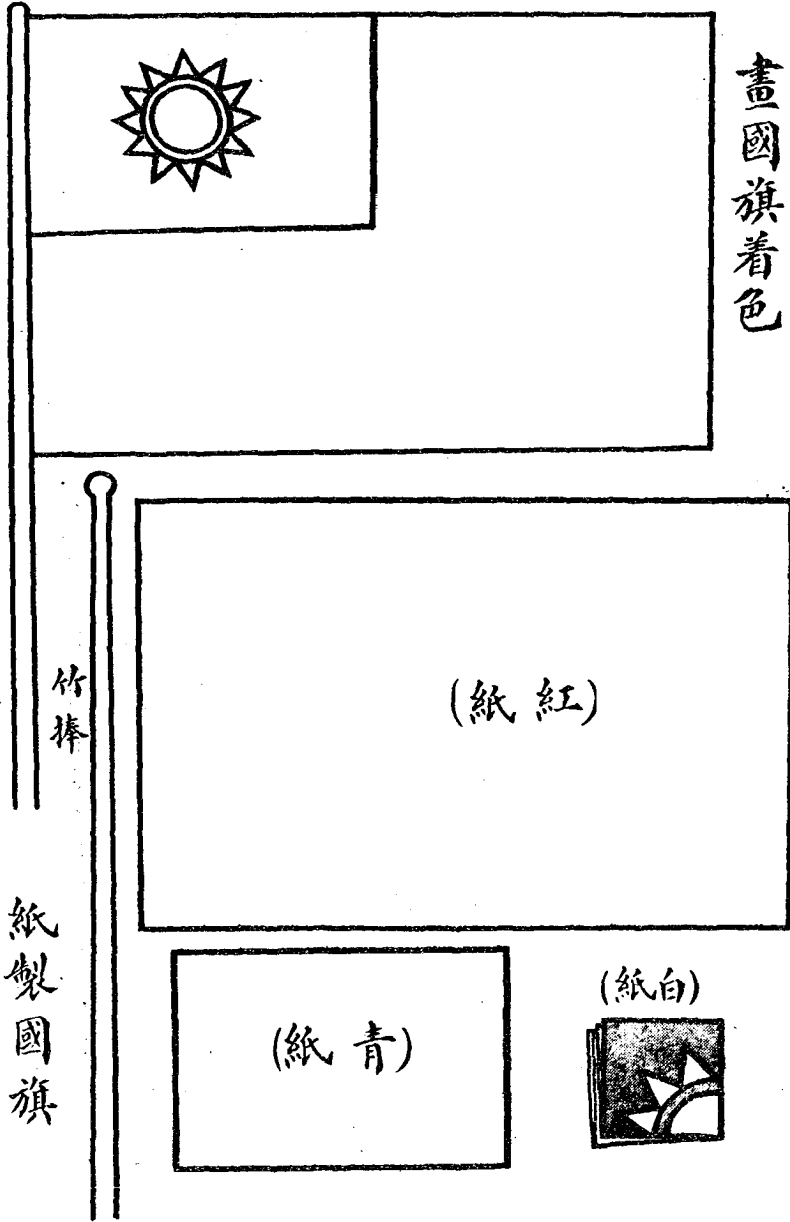

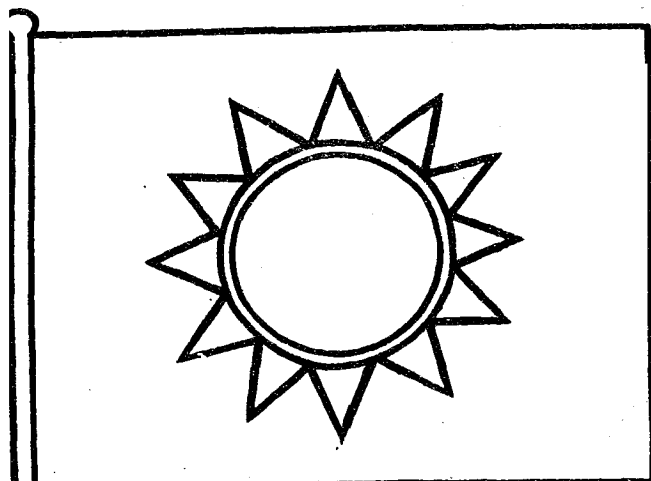

畫黨旗着色

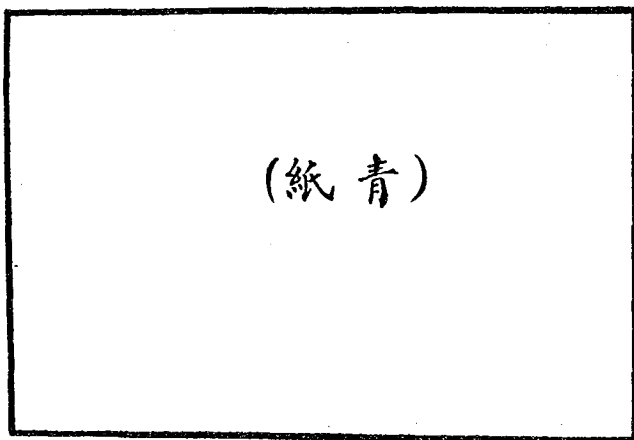

(紙青)

竹枝

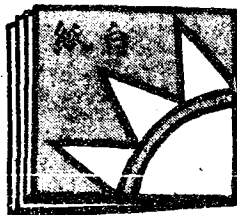

紙製黨旗

旗國 組六十第 集四第

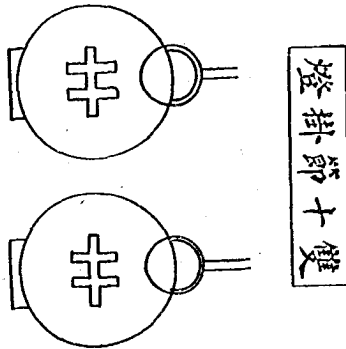
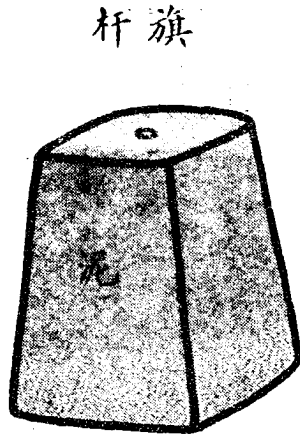
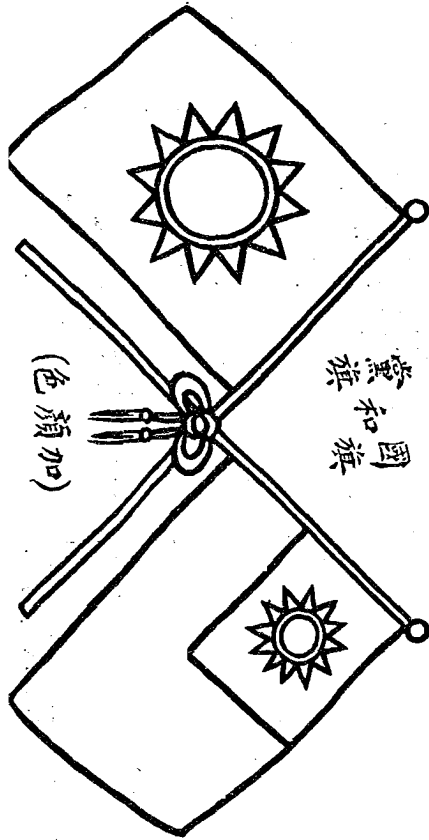

旗國 組六十第 集四第

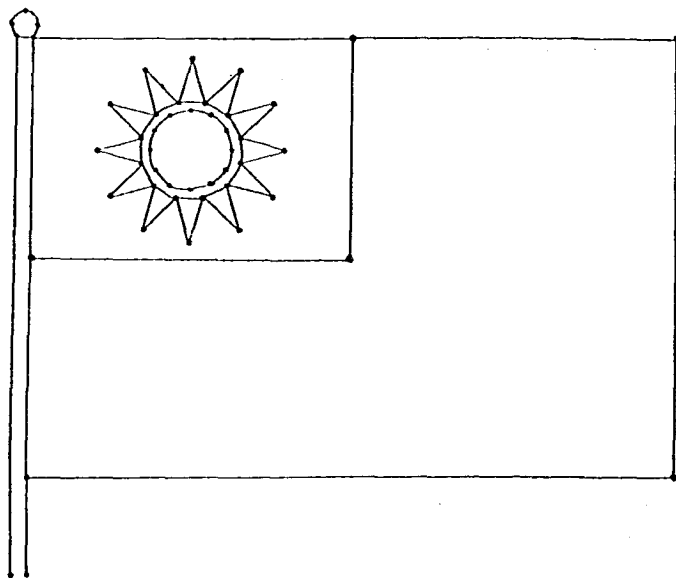

穿線工

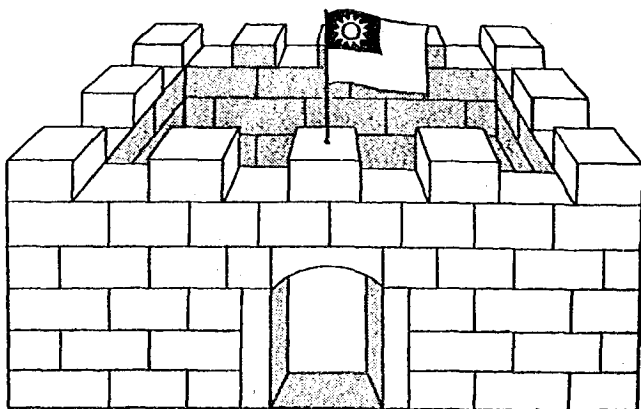

積木裝排

變會天 組七十第 集四第

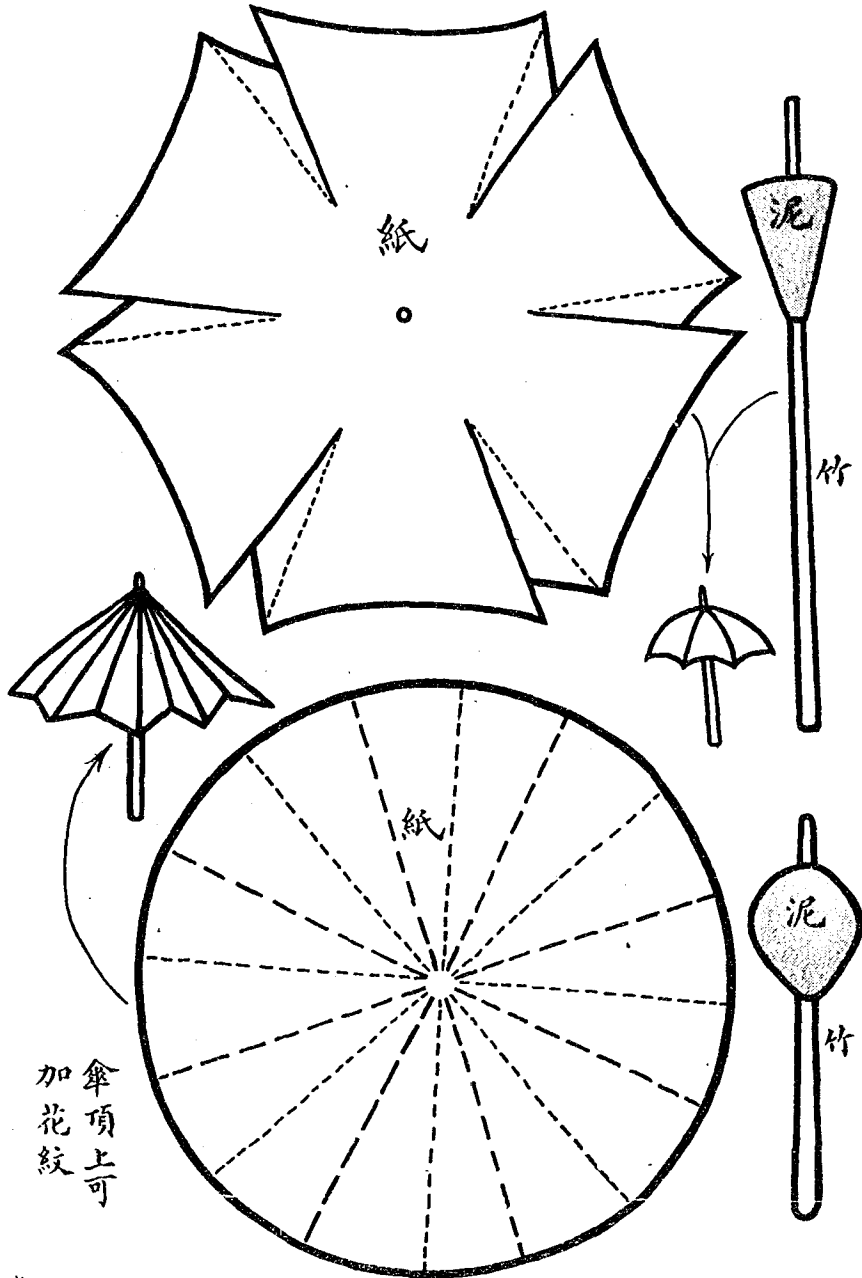



傘

工貼剪

雨傘

貼紙工



箬帽

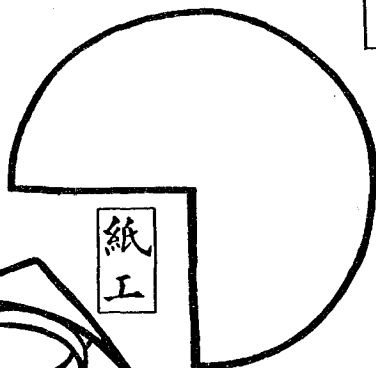

紙工

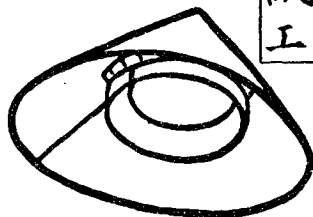

靴皮

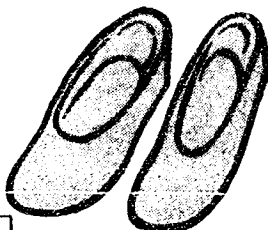

套鞋

工泥

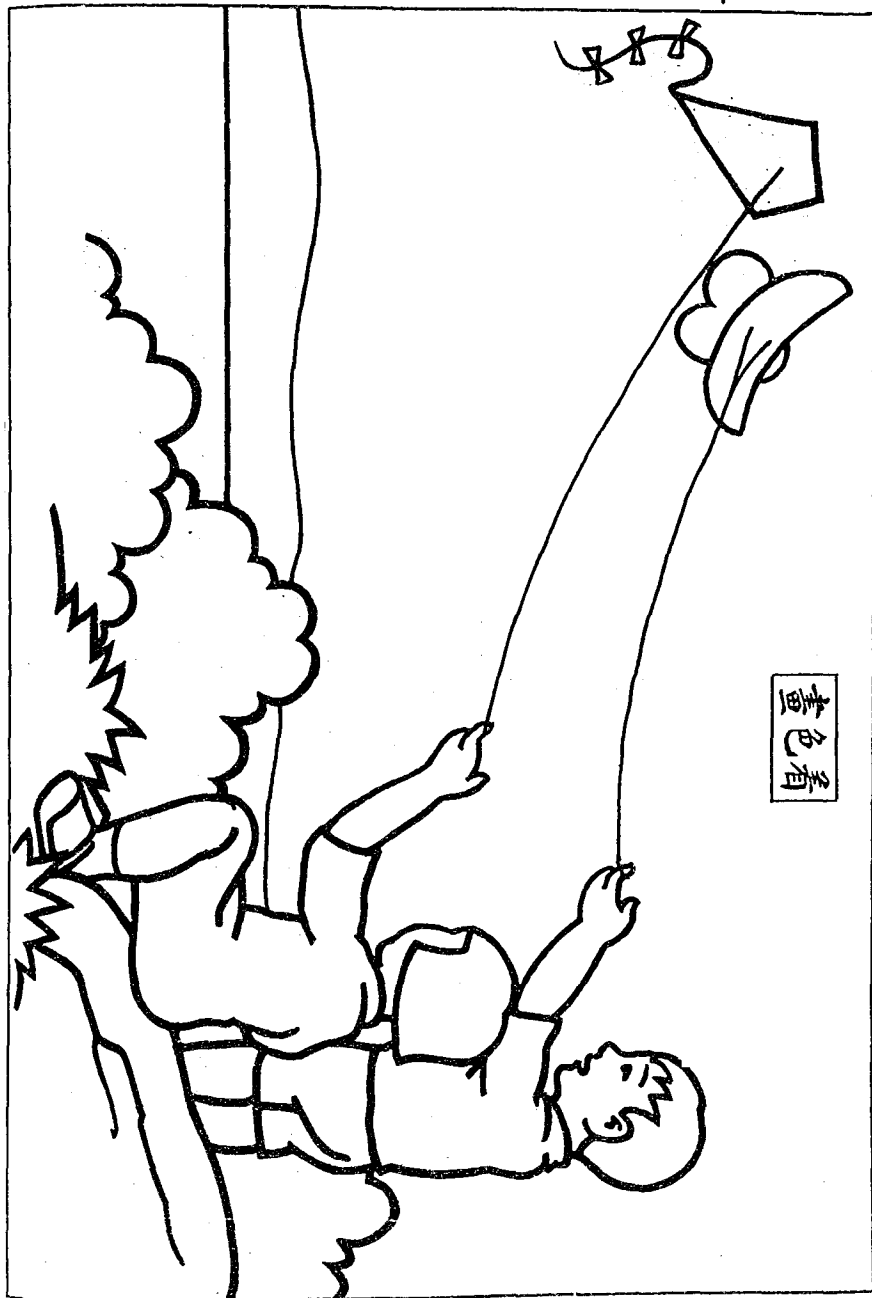

雞紙放 組八十第 集四第

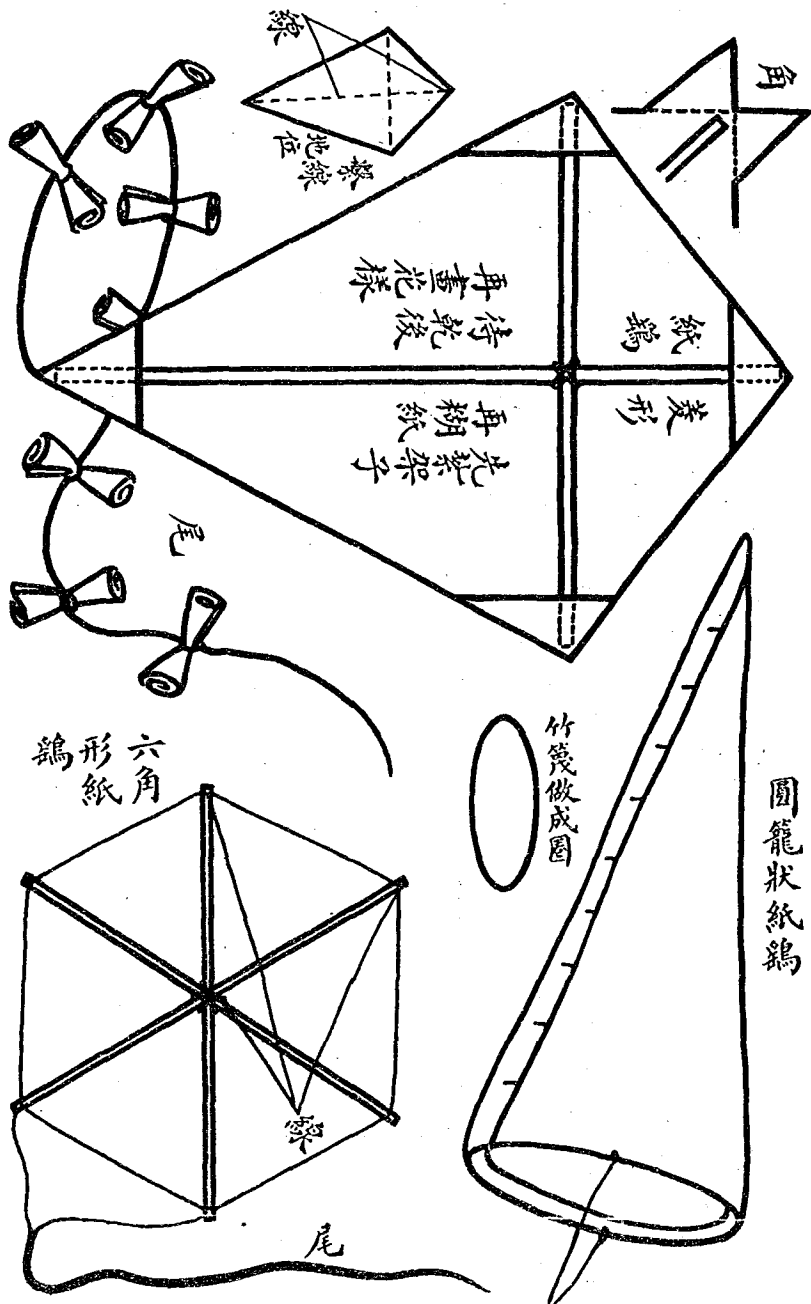

馬白騎 組九十第 集四第

馬白騎



同馬和法做的人

先着色
次剪開
後貼攏
成直立
的馬

馬白騎 組九十第 集四第

工紙摺

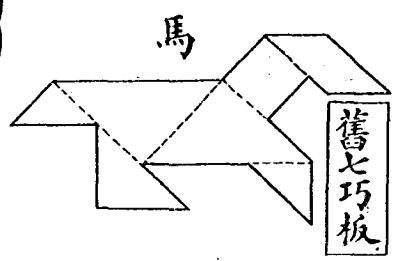
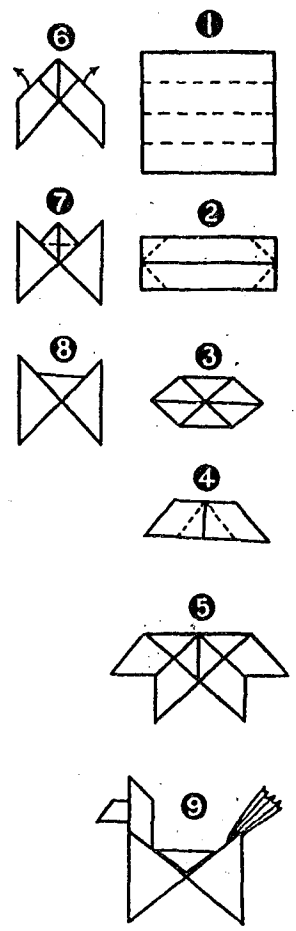
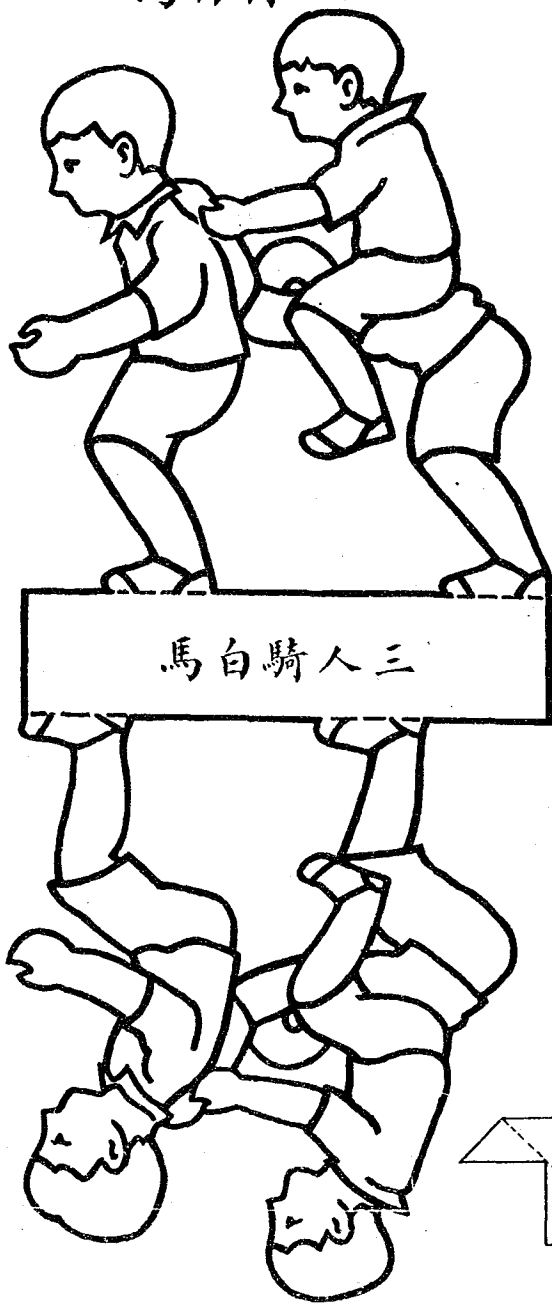

高門城 組十二第 集四第

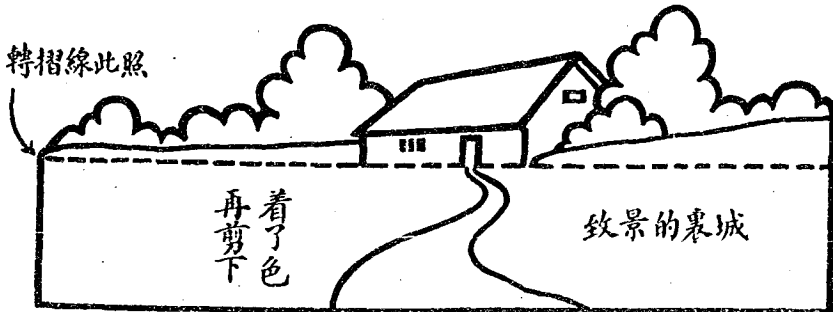
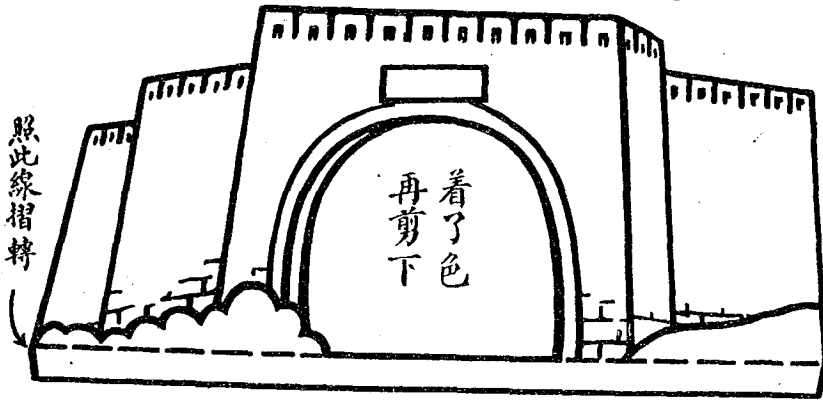
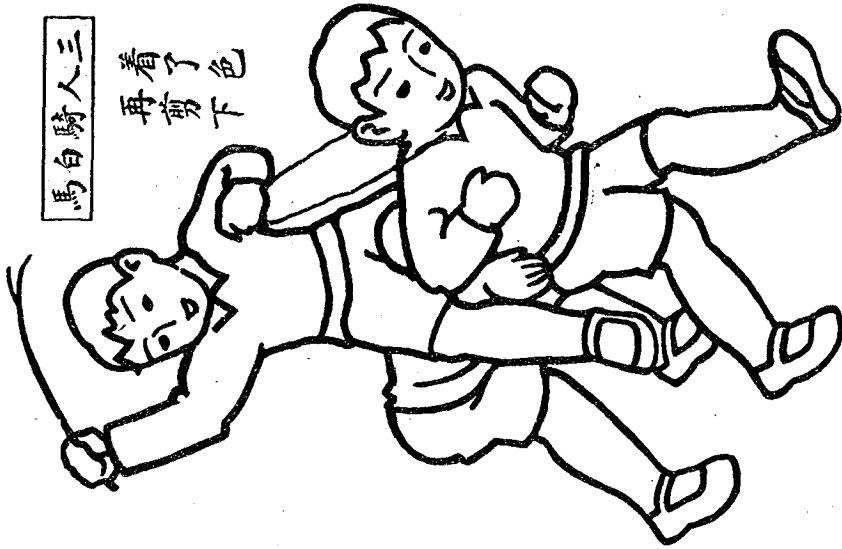

高門城 組十二第 集四第

穿城門

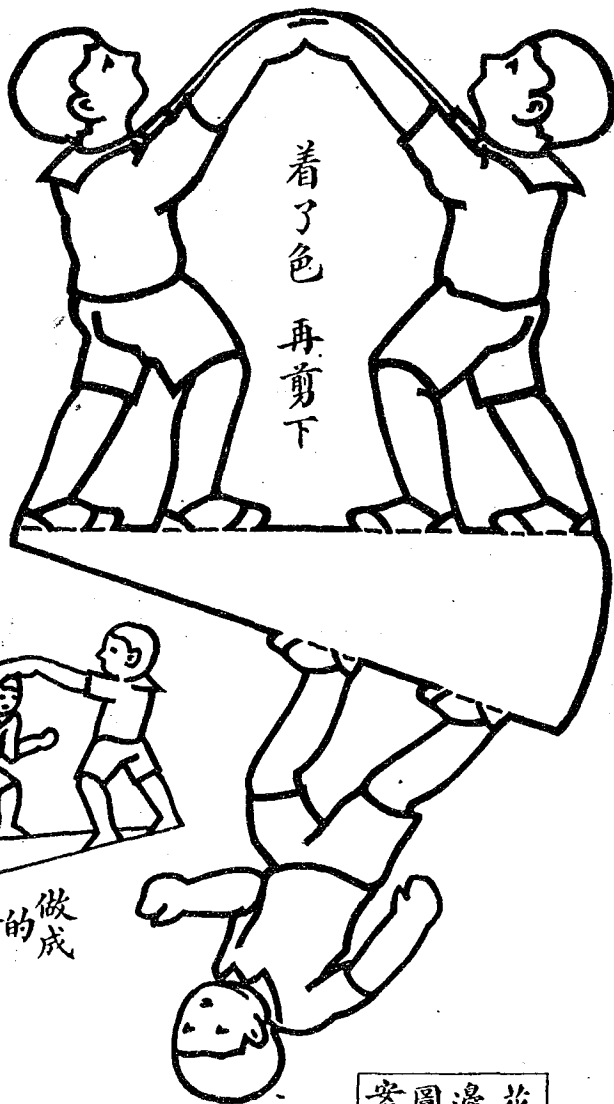

做成子的樣子

案圖邊花

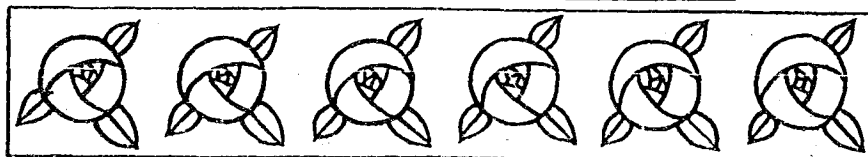

雀麻小 組一十二第 集四第



紫圖邊花

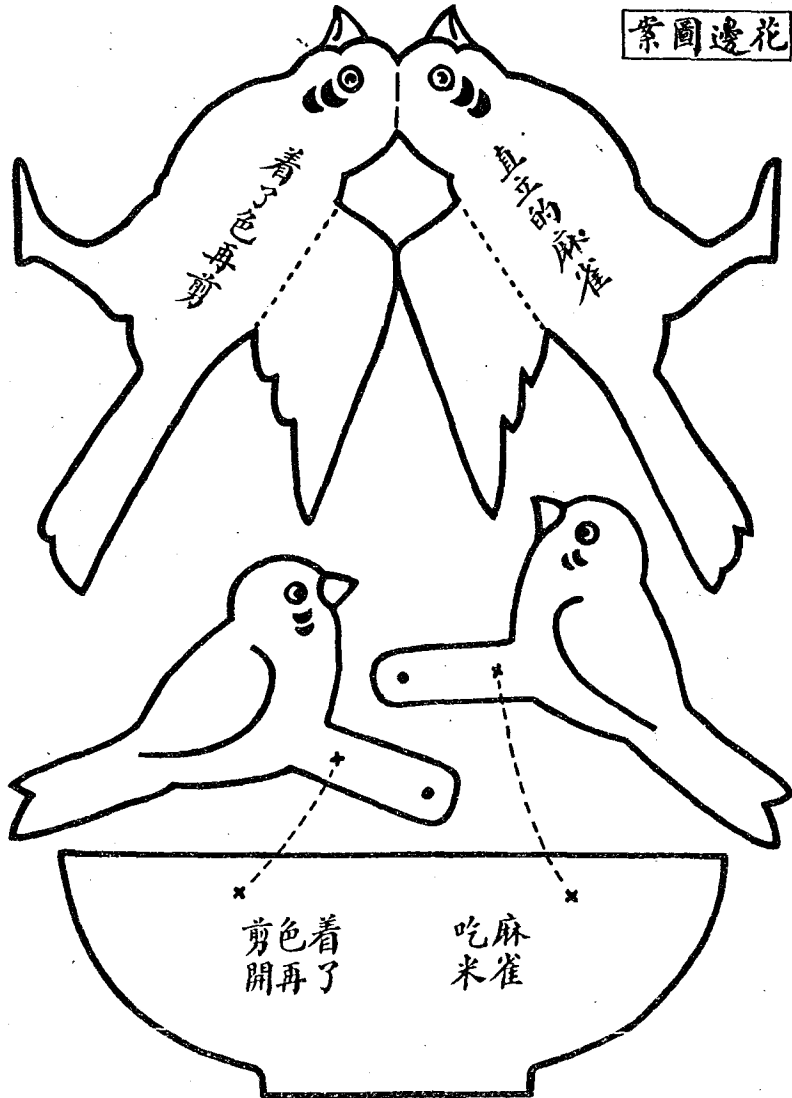

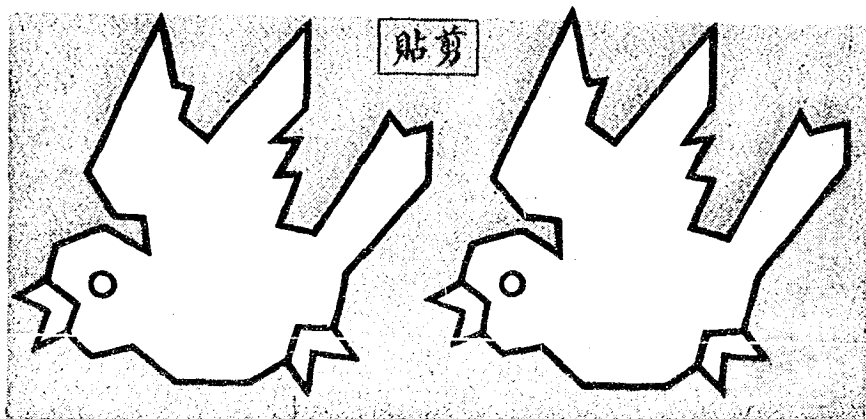
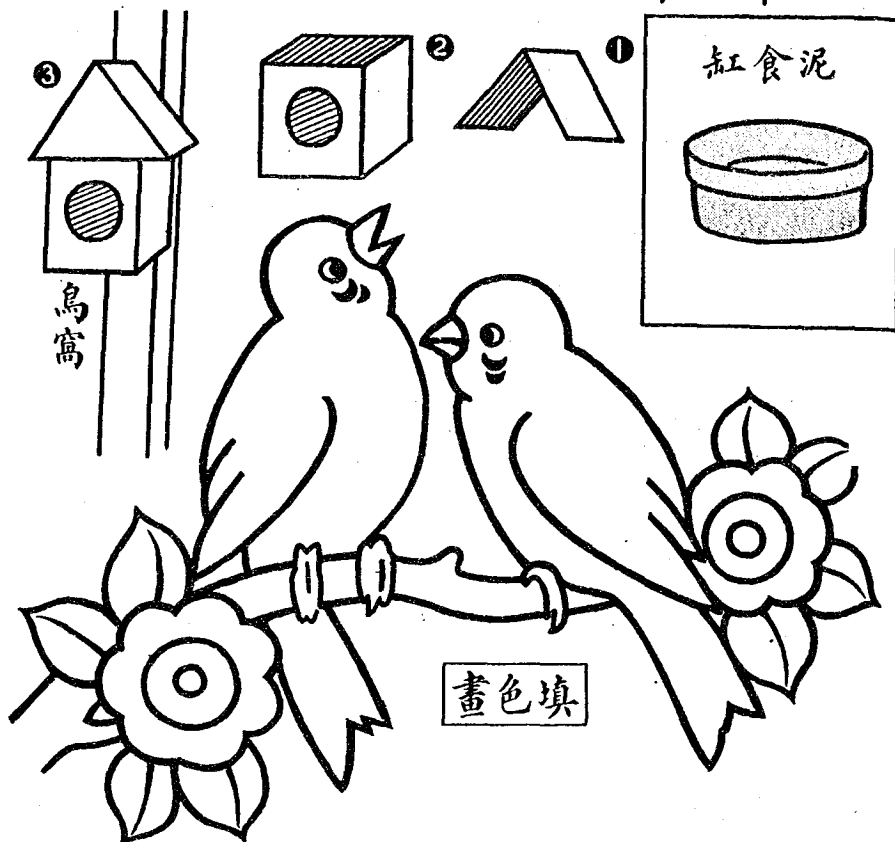

填色畫

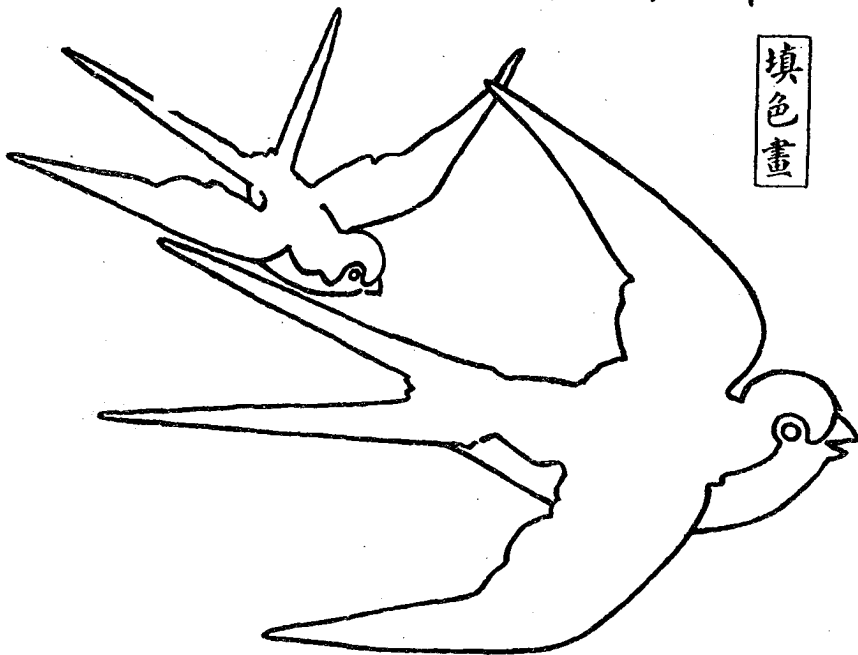

貼葉工



子燕

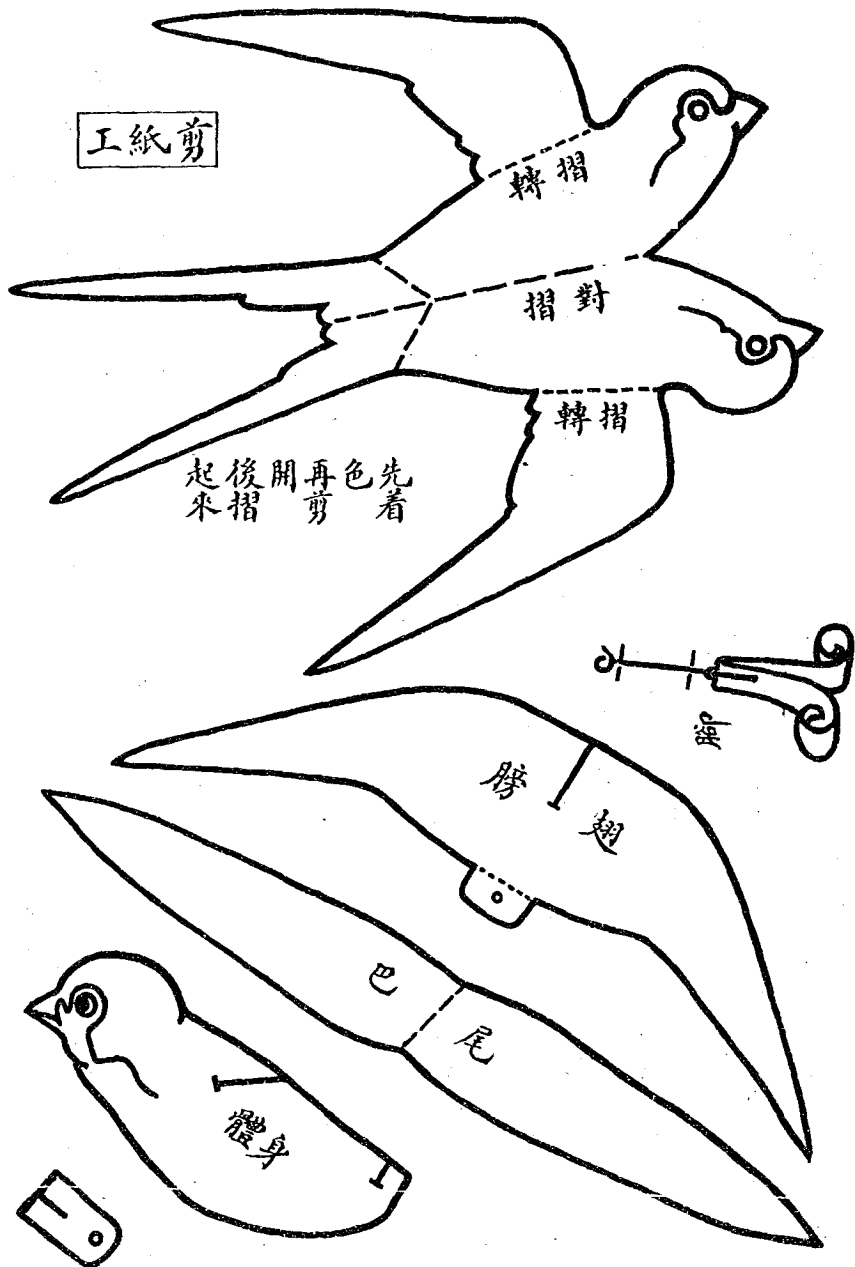

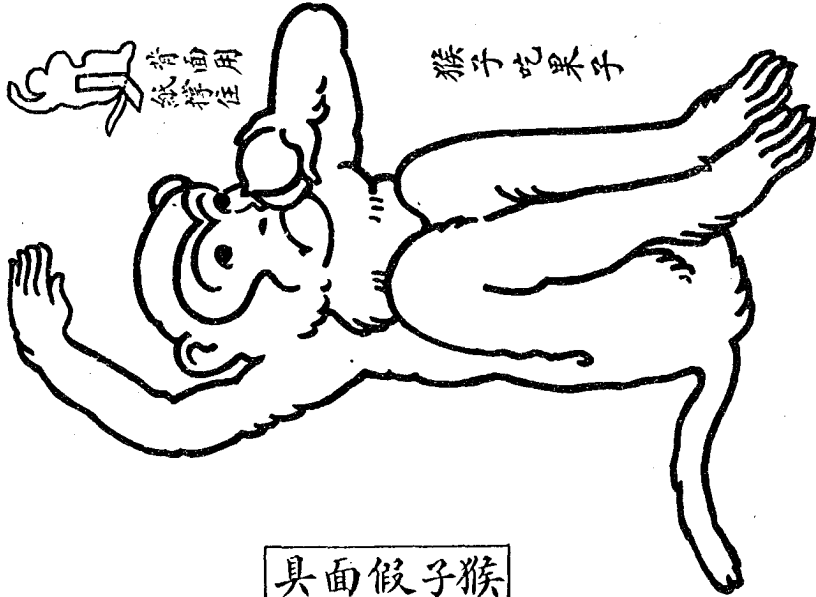

具面假子猴

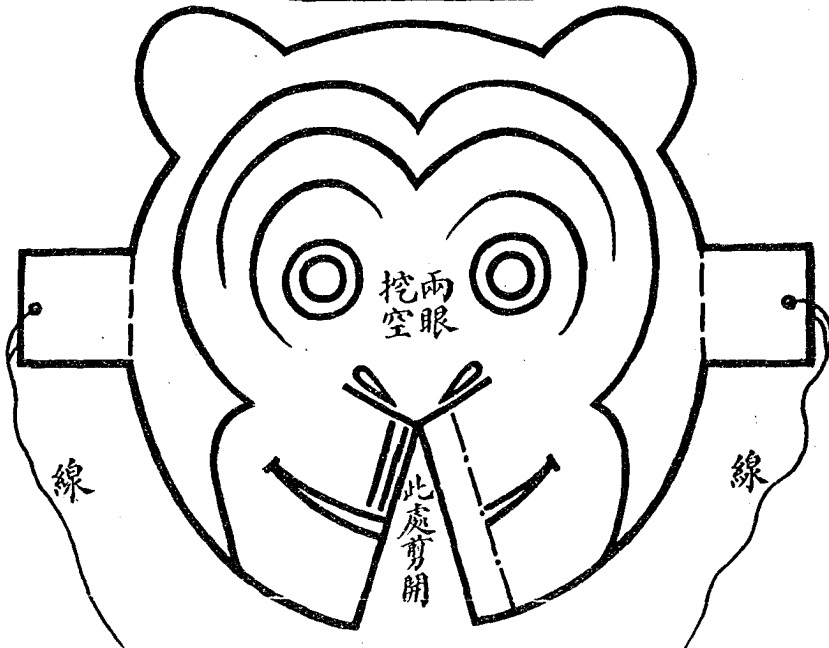

子猴小 組三十二第 集四第

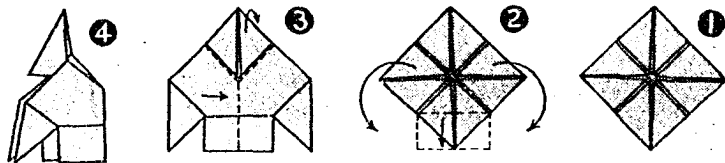

摺紙工

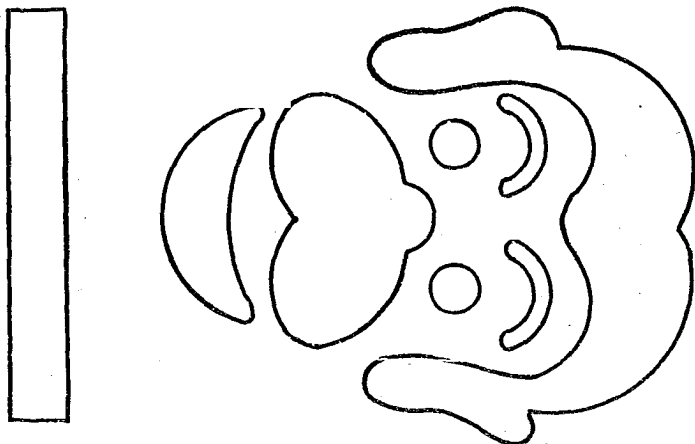
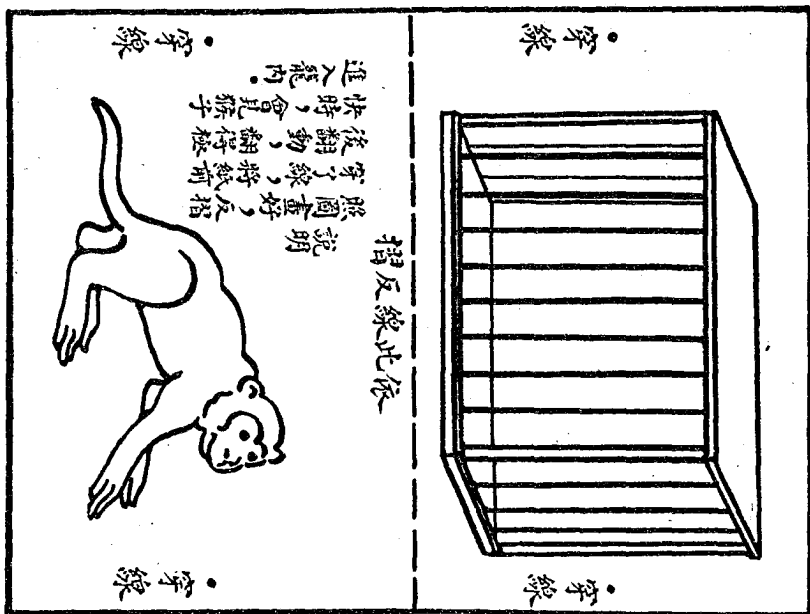

工紙剪



鼠松 組四十二第 集四第

剪紙

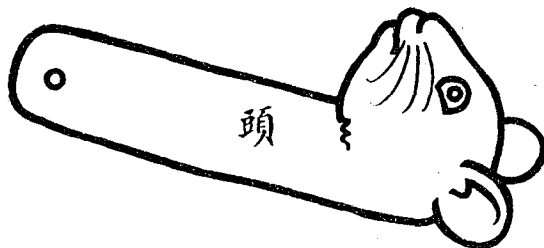

室教飾裝以可條長一成貼對十幾了剪

鼠松 組四十二第 集四第

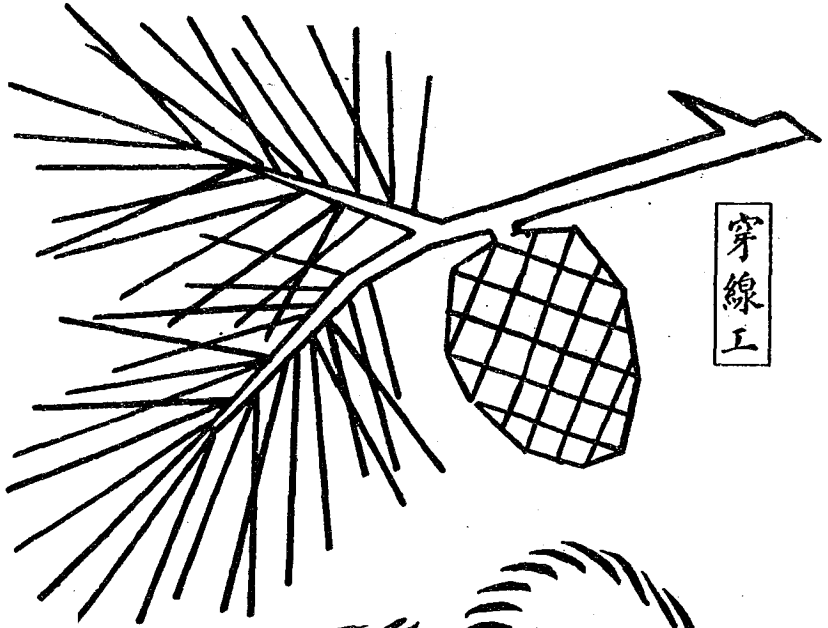

穿線工

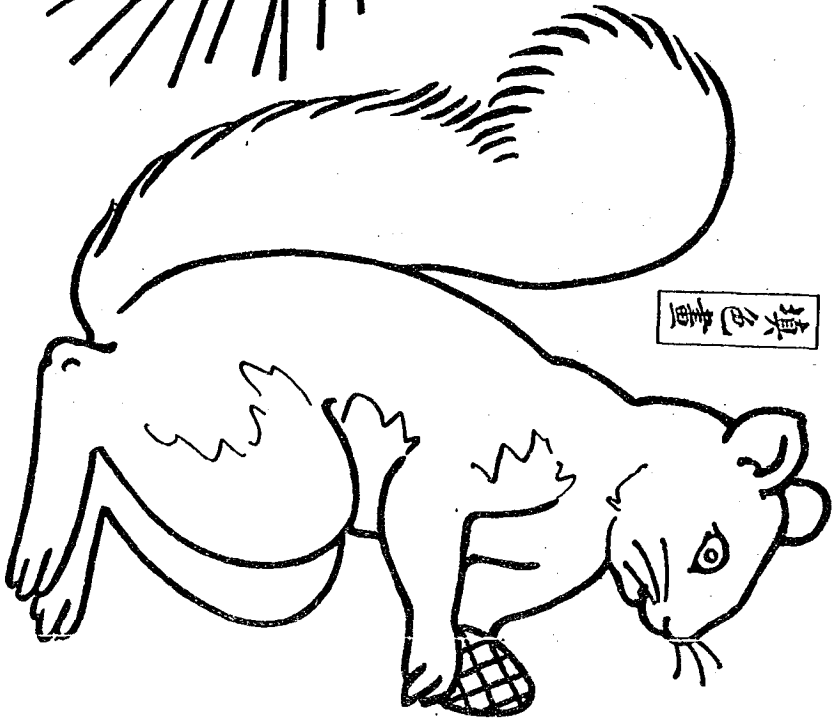

填色畫

填色畫



麥大拍 組五十二第 集四第

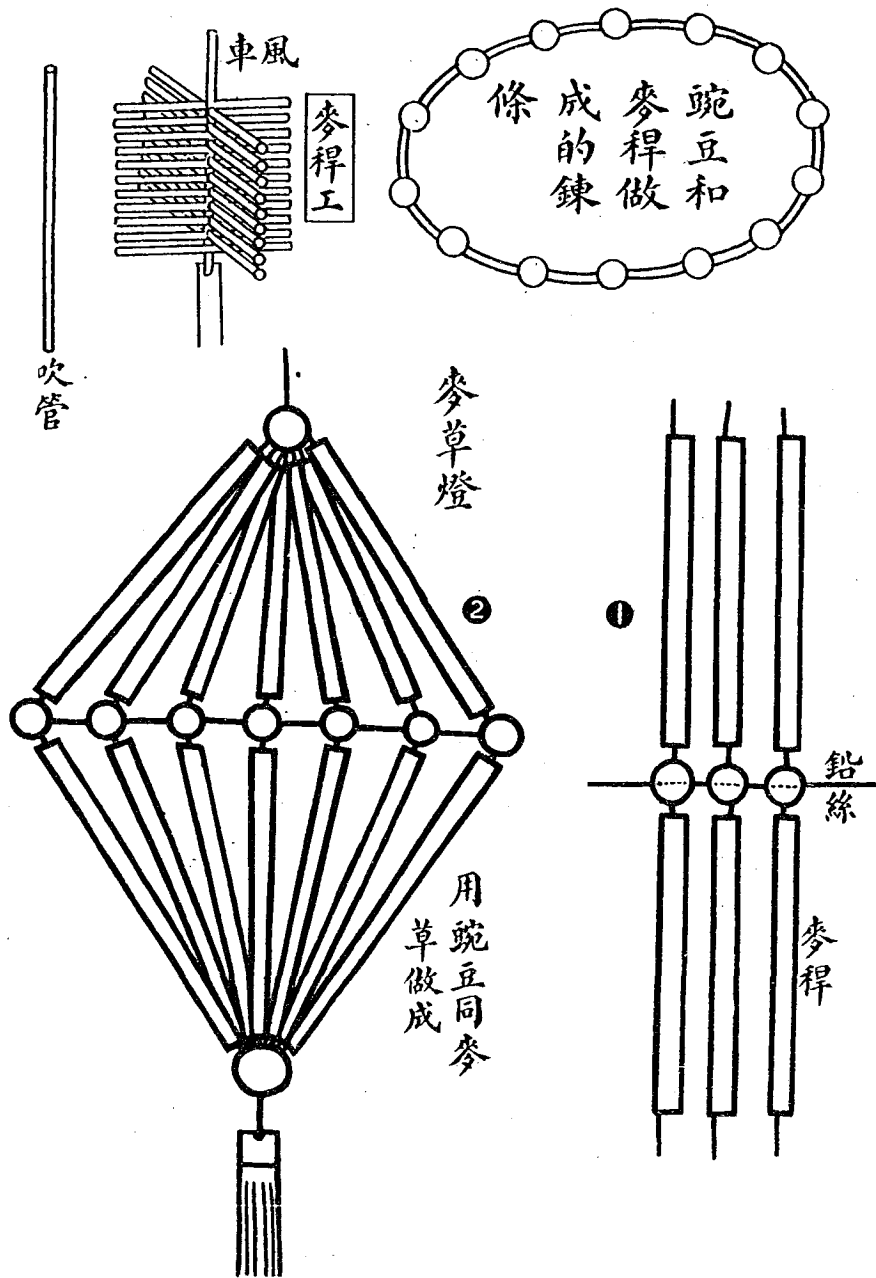

子豆採 組六十二第 集四第

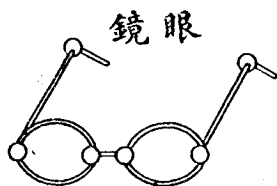

鏡眼

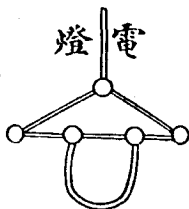

燈電

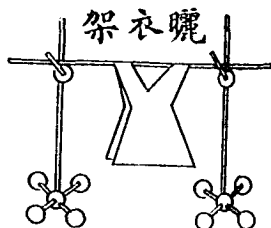

架衣曬

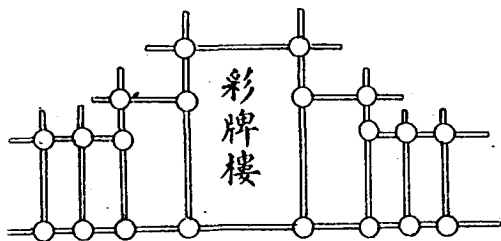

彩牌樓

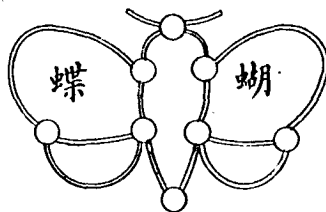

蝶

蝴

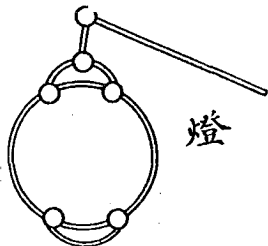

燈

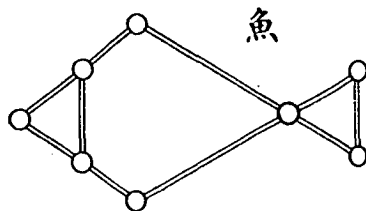

魚

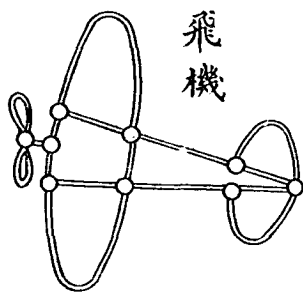

飛機

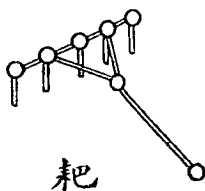

耙

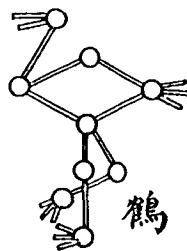

鶴

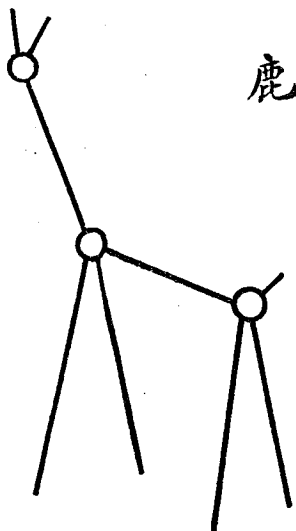

鹿

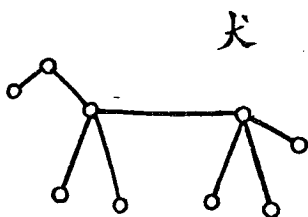
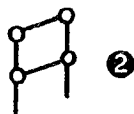
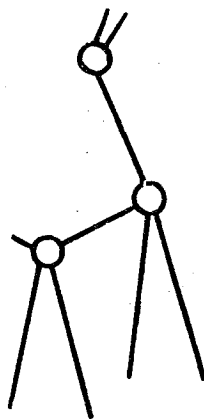
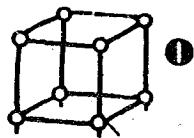

犬

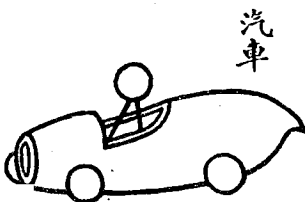

汽車

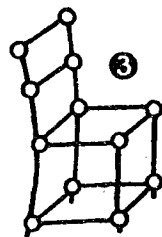

子椅

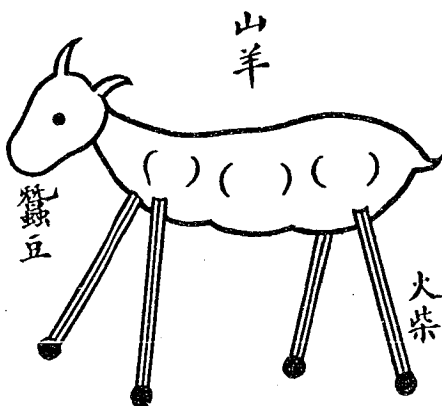

山羊

蠶豆

火柴

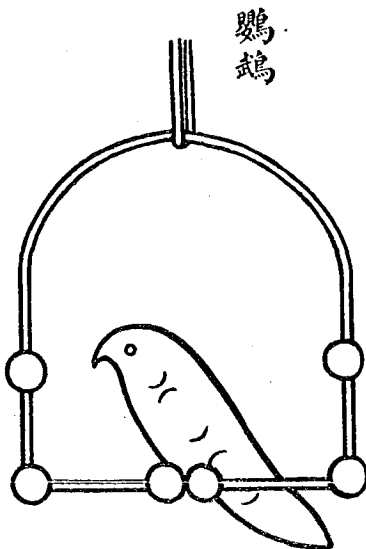

鴉鴿

田耕牛 組七十二第 集四第

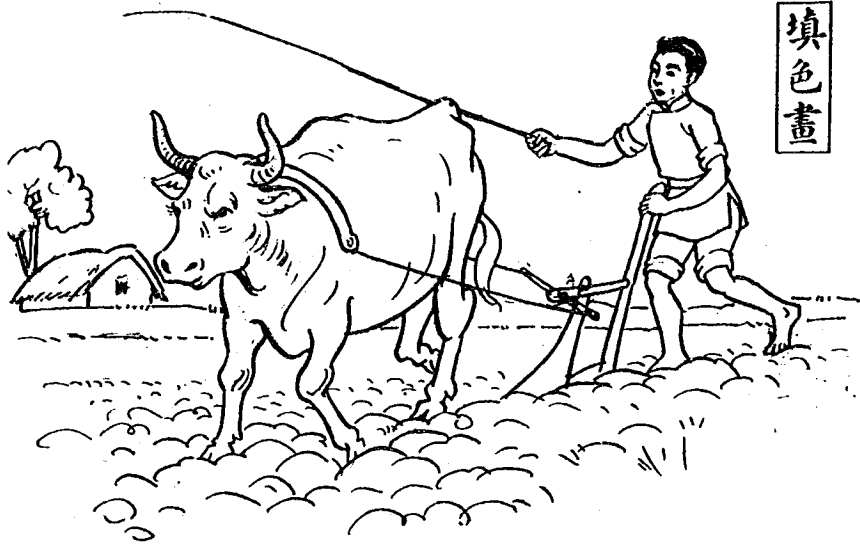

填色畫

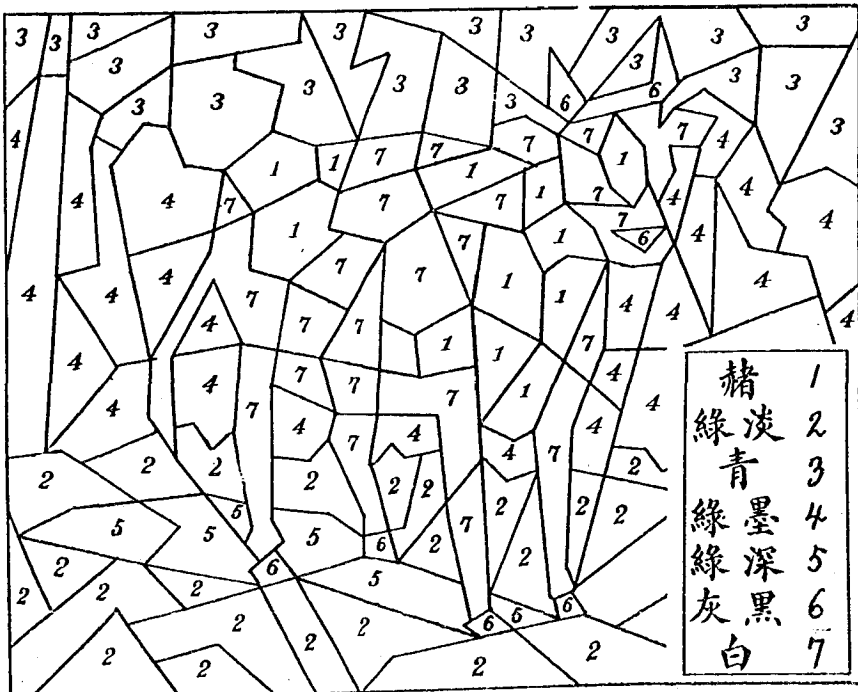

赭	1
淡	2
綠	3
青	4
墨	5
深	6
綠	7
灰	
白	

田耕牛 組七十二第 集四第



工紙刺

工紙摺

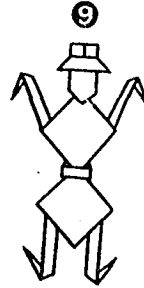
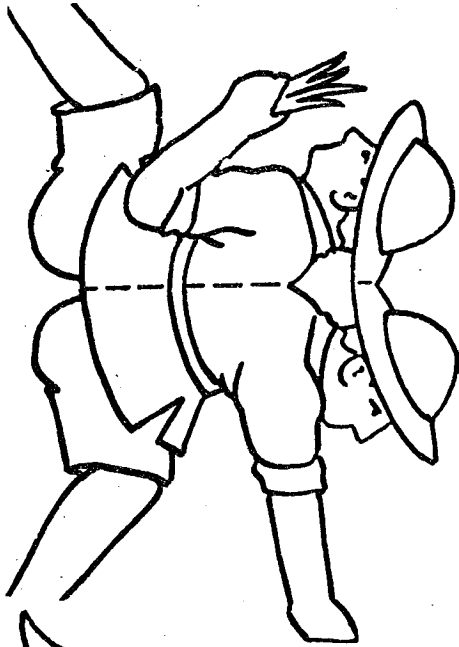

人紙

剪紙工

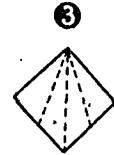
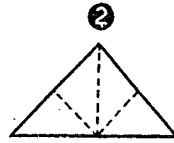
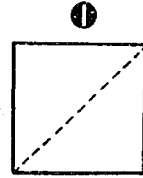
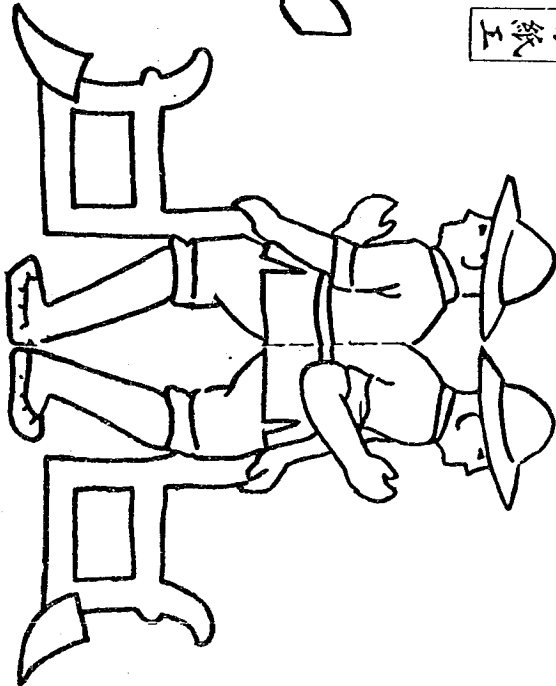

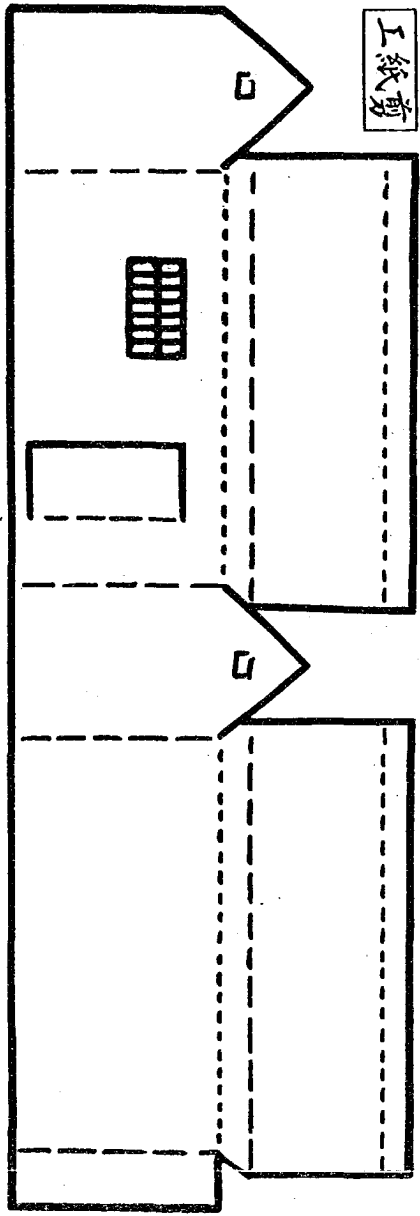
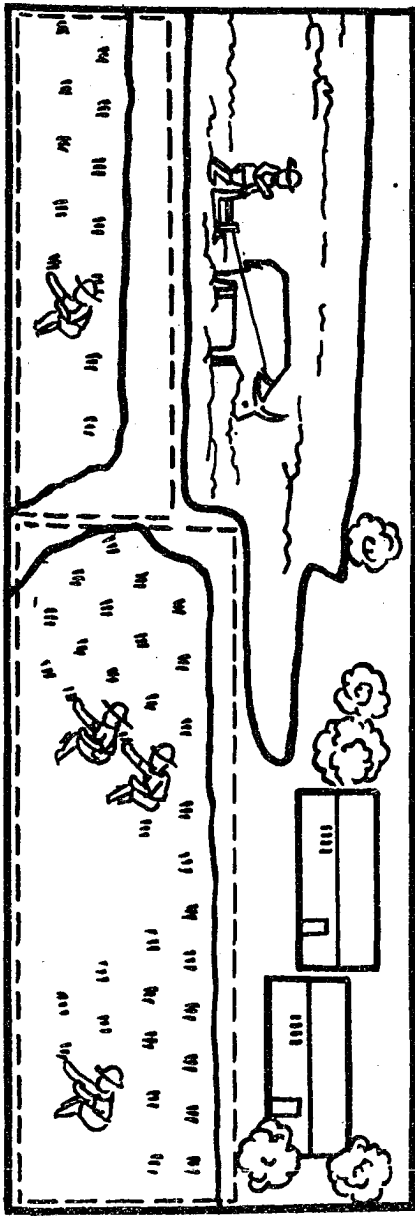

畫色填

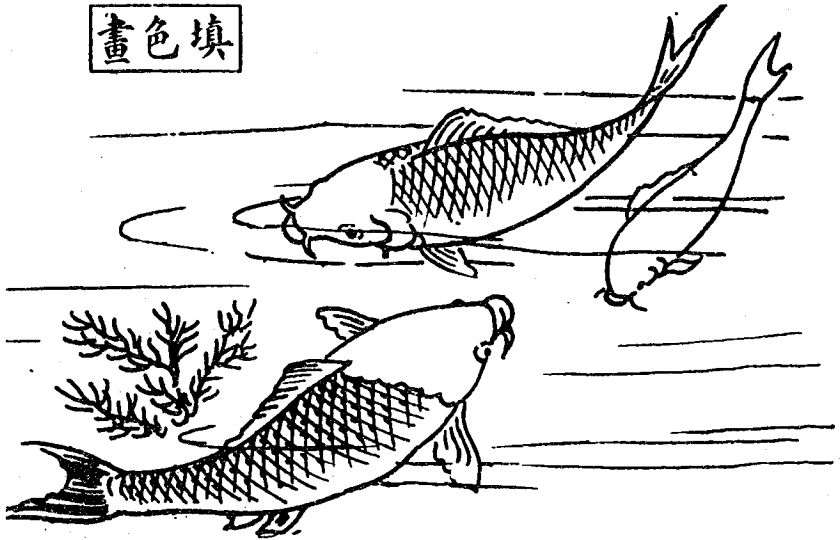

謎畫



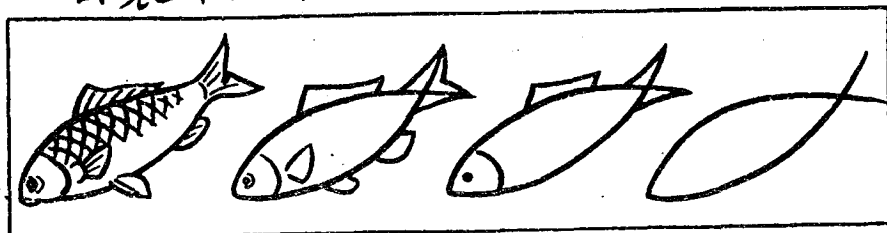

畫筆簡

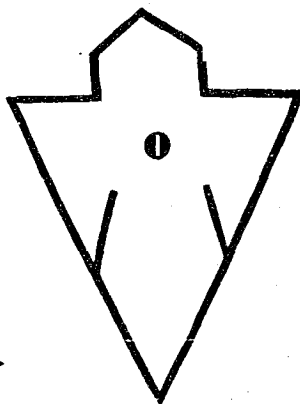
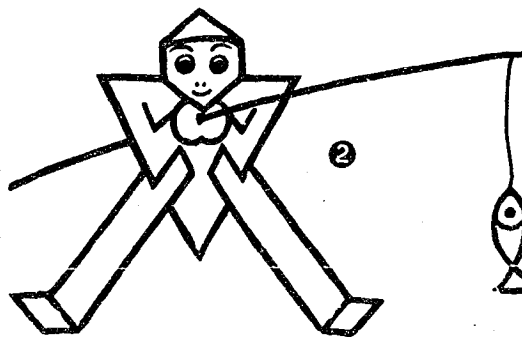
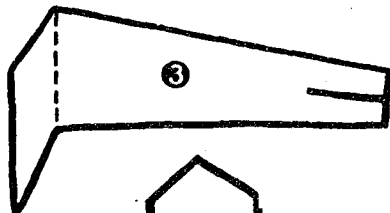
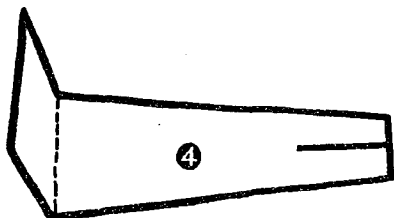
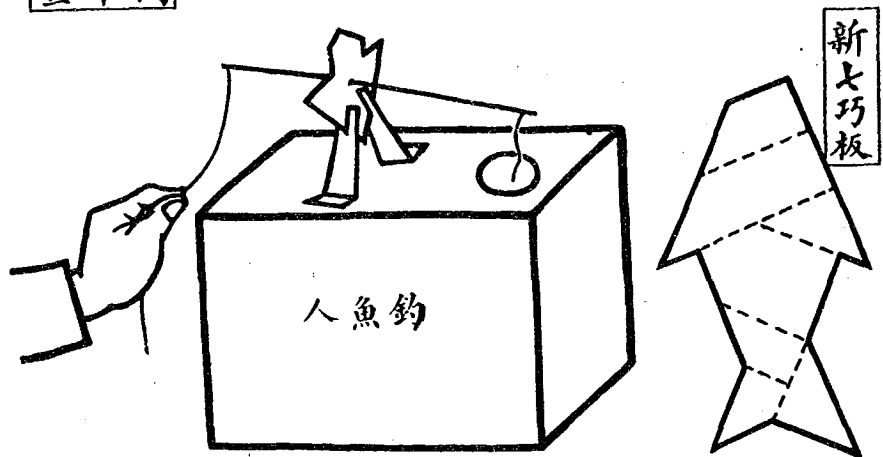



填色畫

煮新鮮
的菜吃

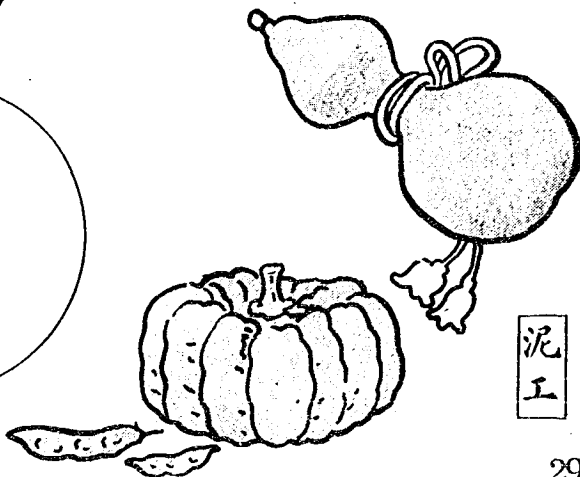

泥工

畫色填

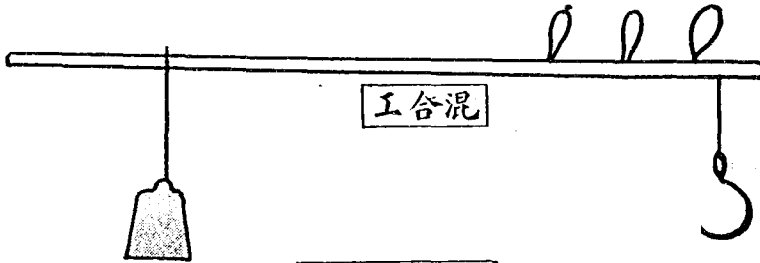
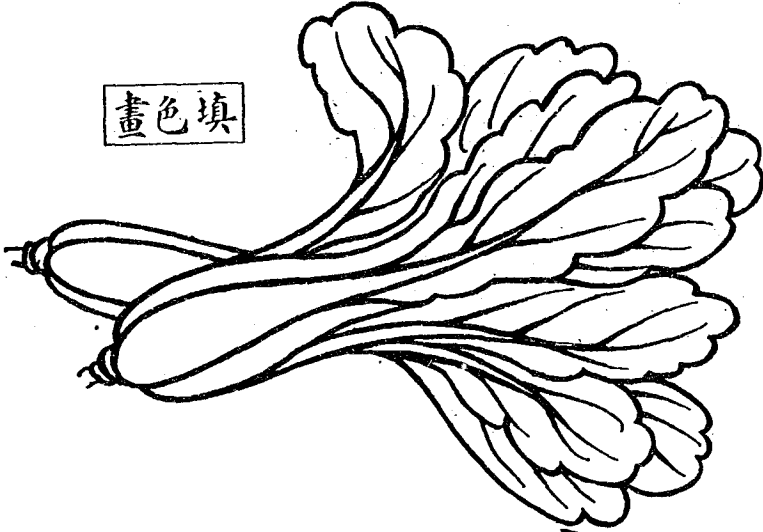

工合混

色填案圖

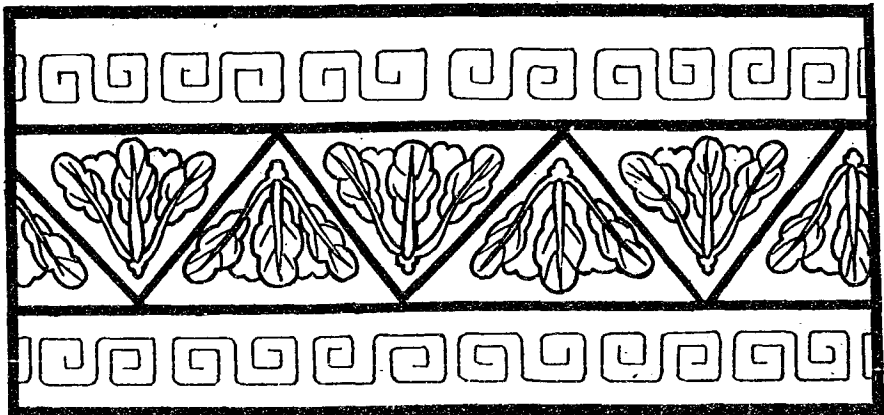

隊兵小 組一十三第 集四第

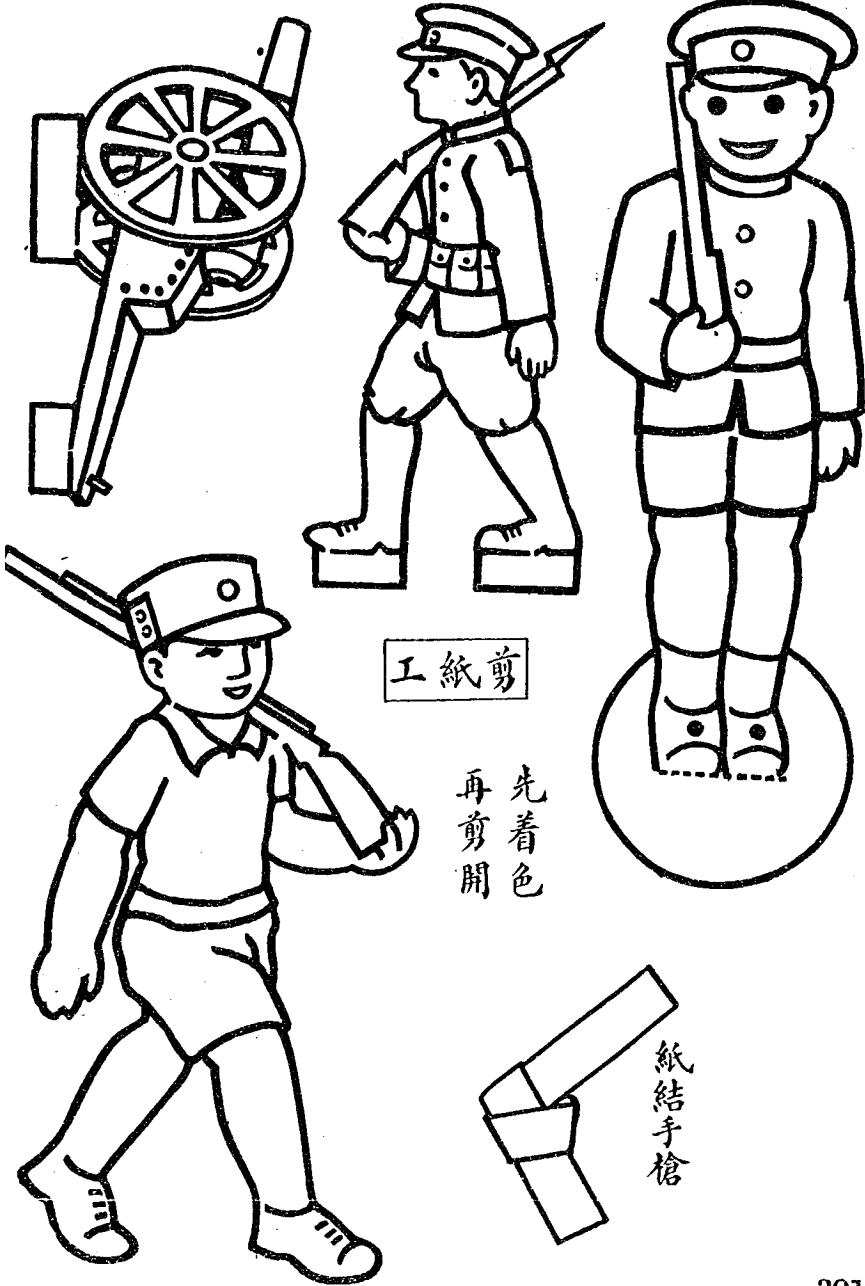

工紙剪

先着色
再剪開

紙結手槍

隊兵小 組一十三第 集四第

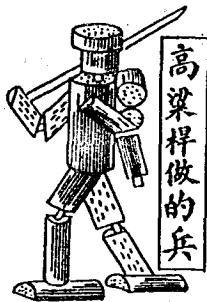

高梁桿做的兵

軍事積木

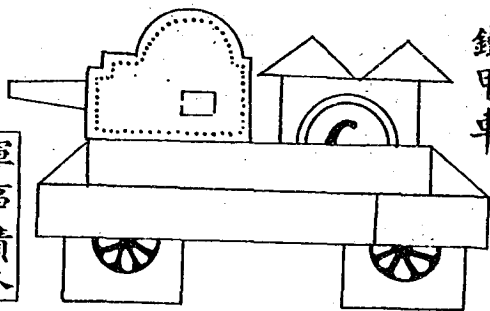

鐵甲車

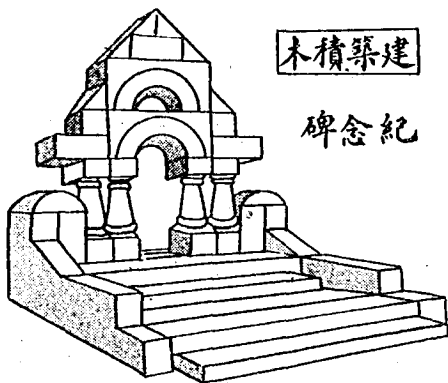

木積築建

碑念紀

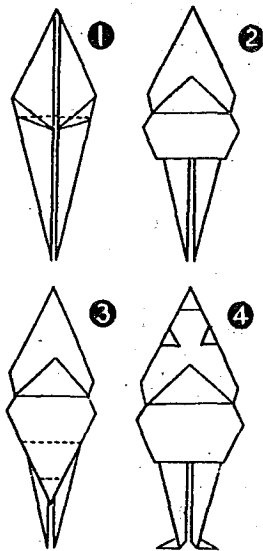

木積事軍

炮射高

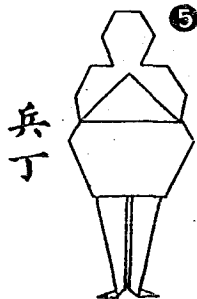
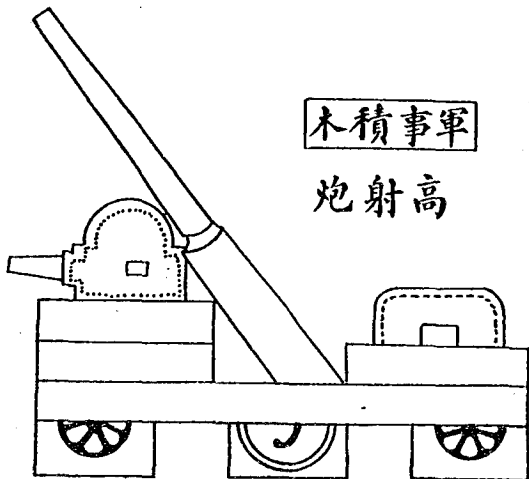

兵丁

摺紙工

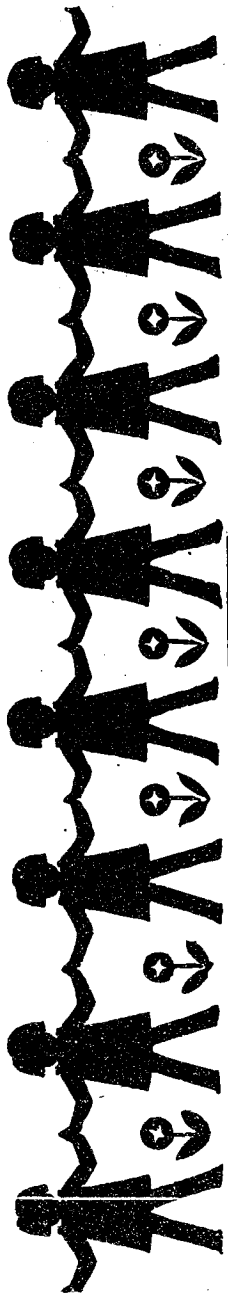

畫墨填

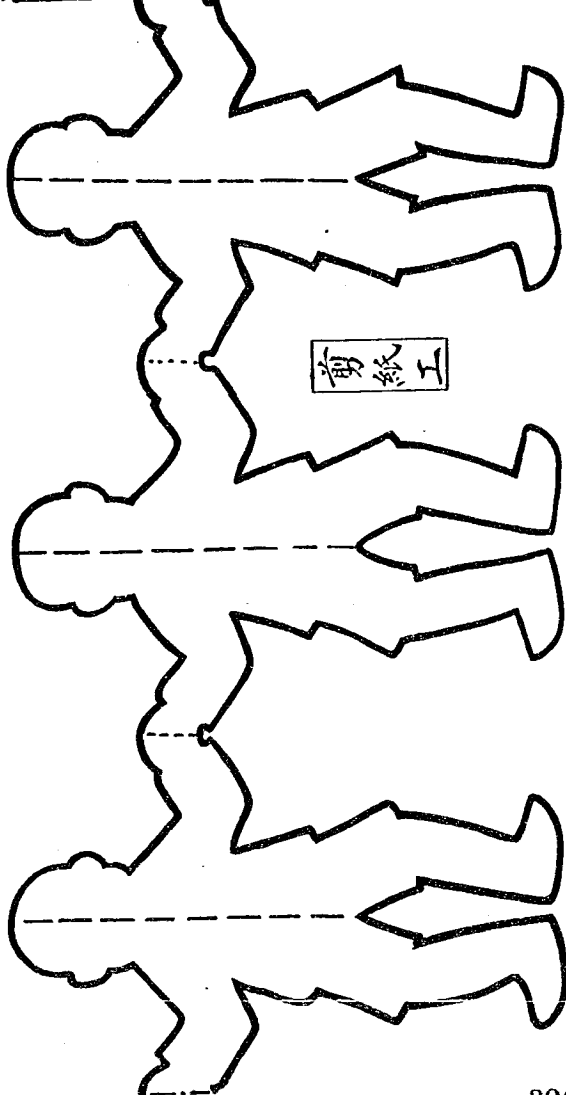
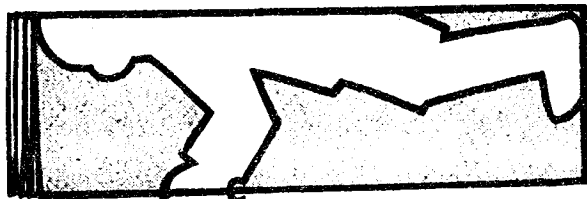

剪紙工

填色畫

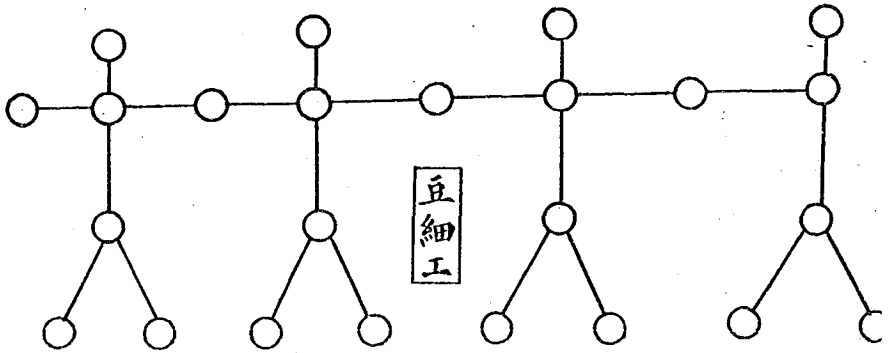
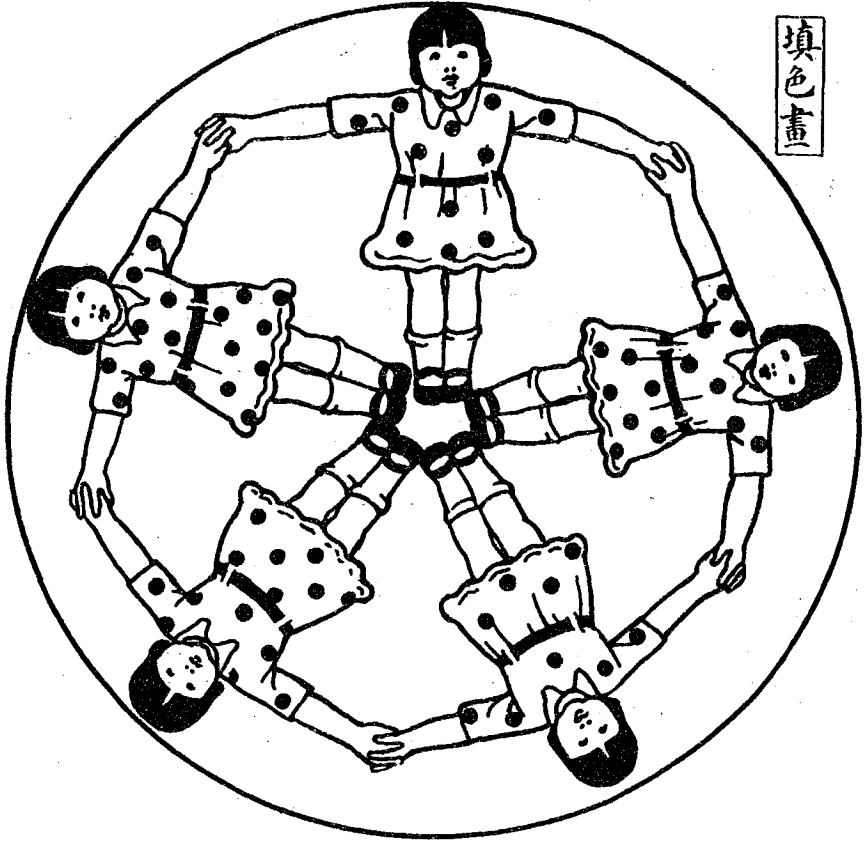

豆細工

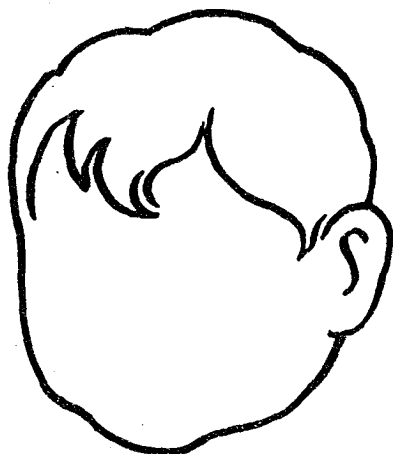

官五填

工紙剪

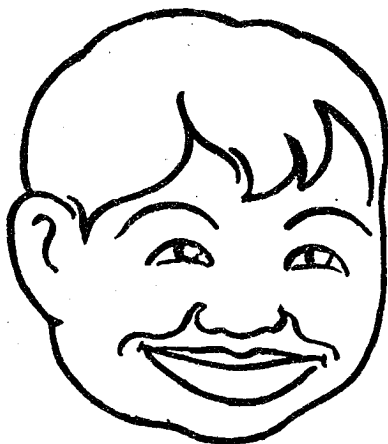

填色繪



抹桌



洗手帕

畫色着



進食



掃地

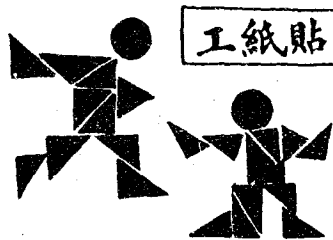

工紙貼

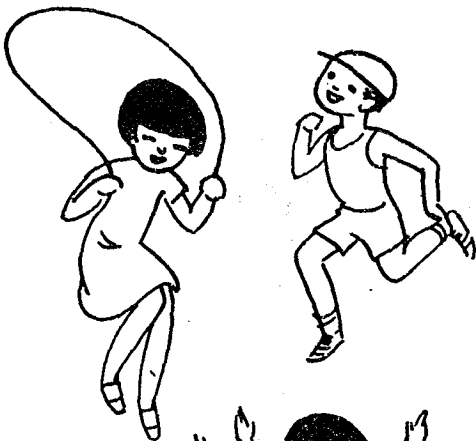
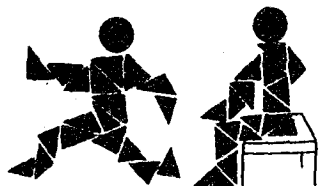
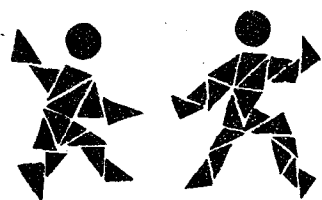

黑板畫舉例

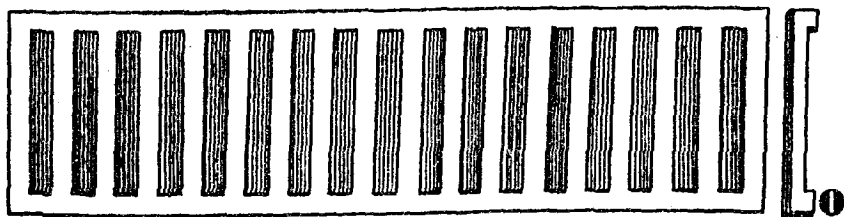

畫墨填

剪紙

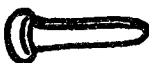
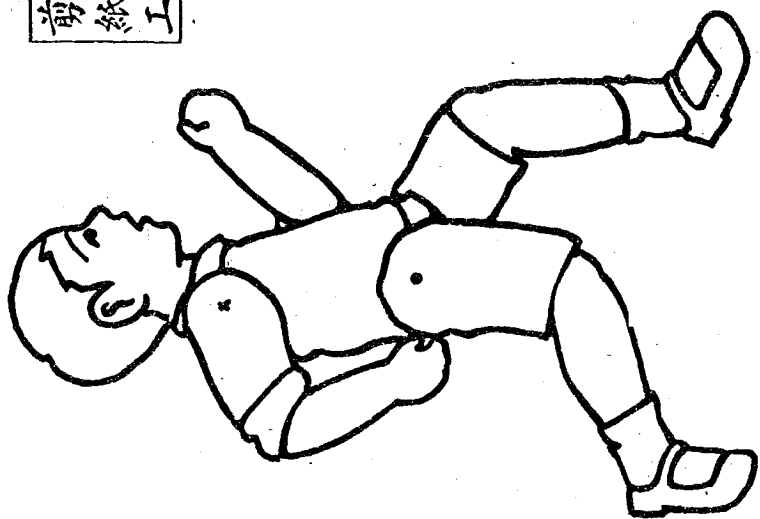

①



②



③



瓜個一 組五十三第 集四第



色填案圖



填色畫

畫色填

工泥

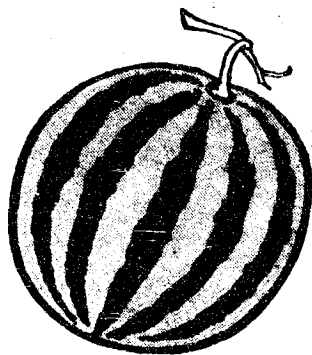
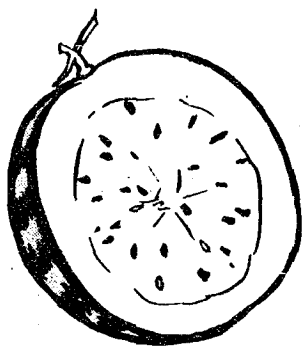

西瓜雕刻



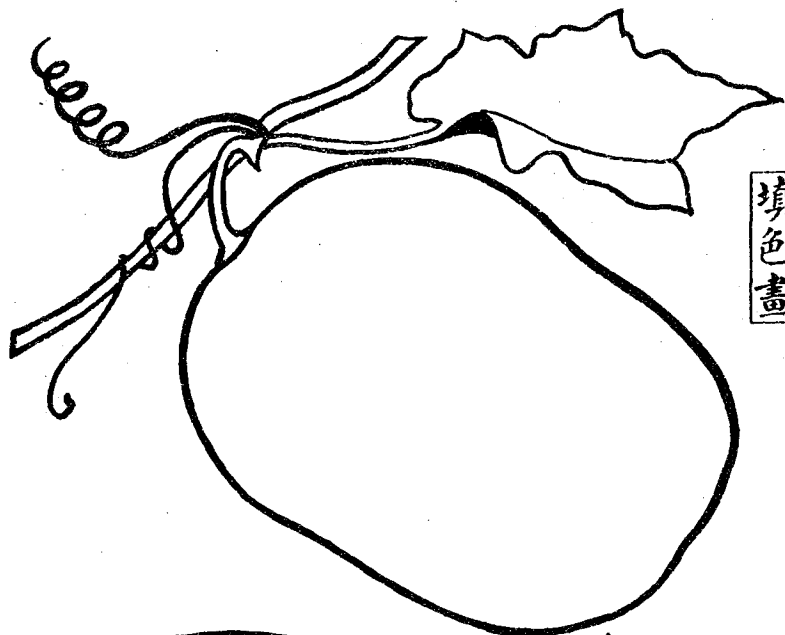

填色畫

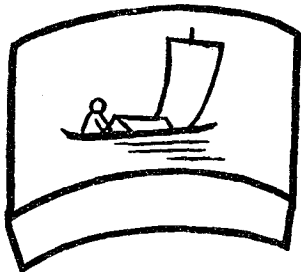

用冬瓜雕成的花紋

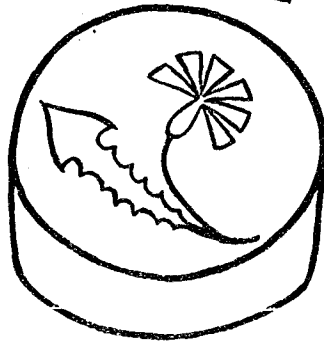
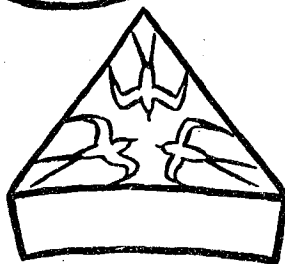

瓜冬瓜冬 組六十三第 集四第

畫色填

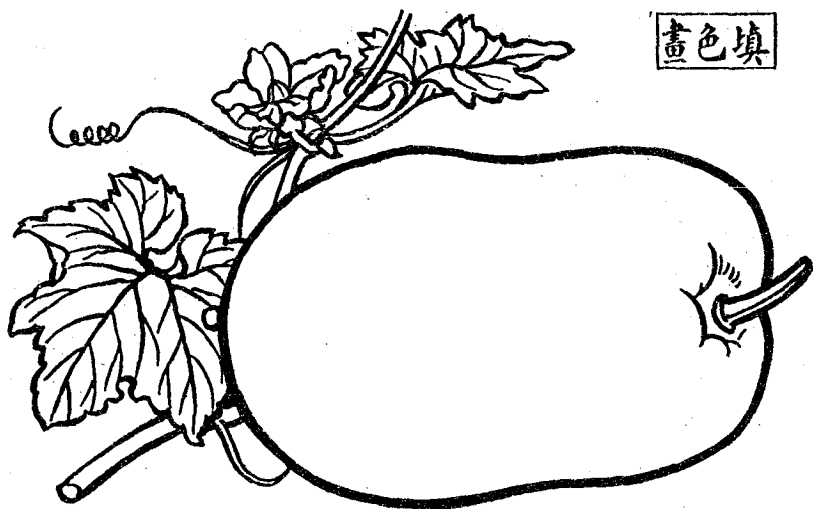

用冬瓜子
貼成的圖

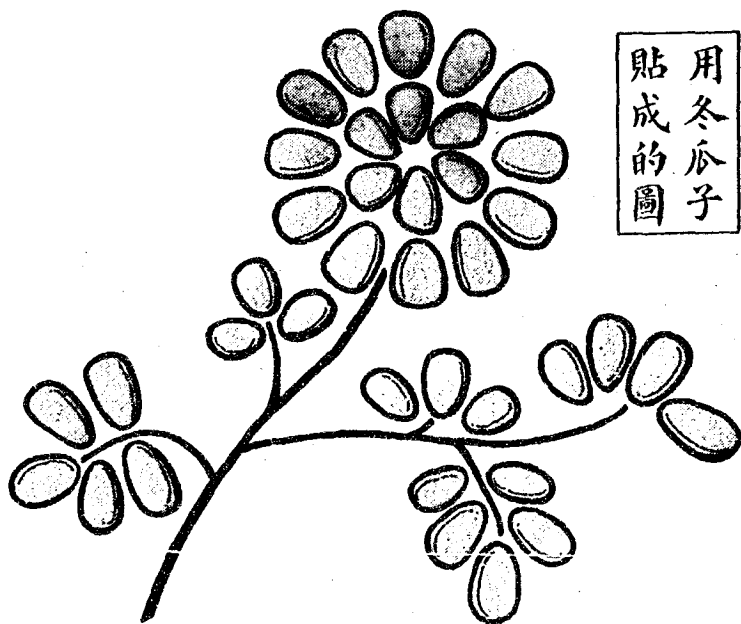

飛蝶 組七十三第 集四第

畫色填

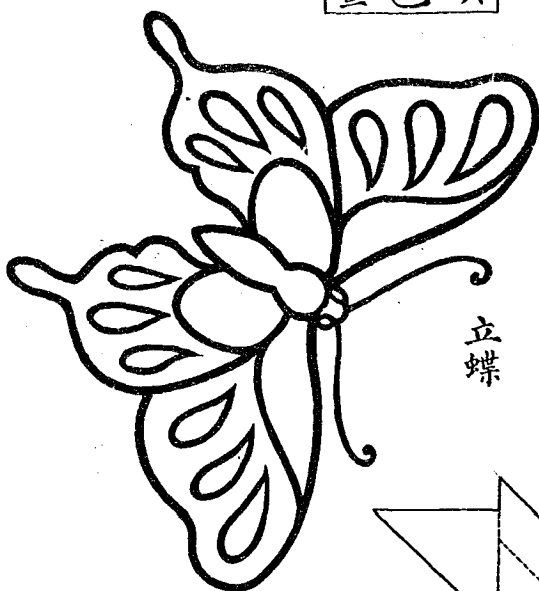

立蝶

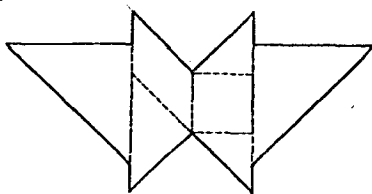
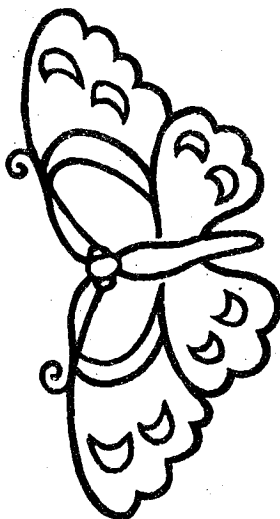

舊七巧板

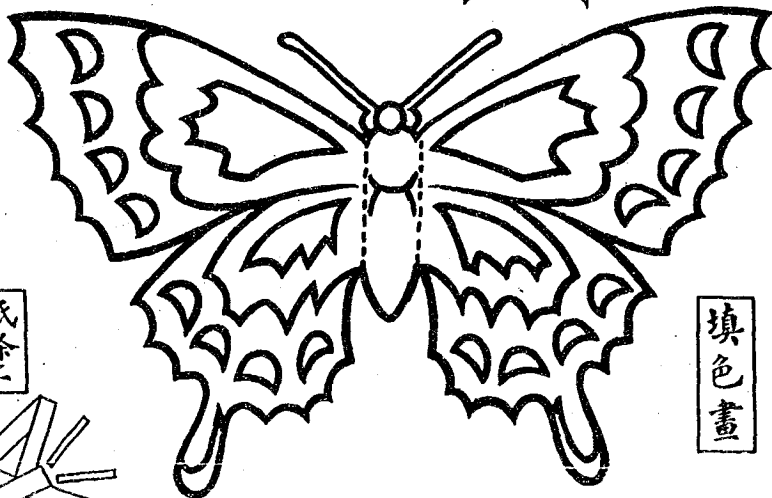

紙條工

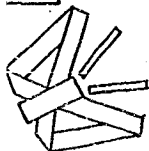

填色畫

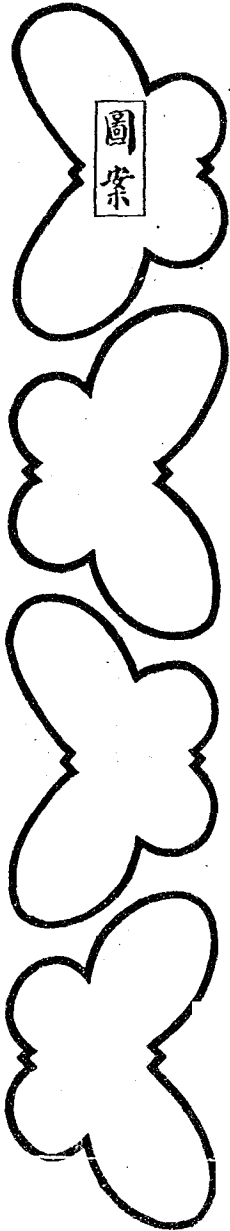

圖案

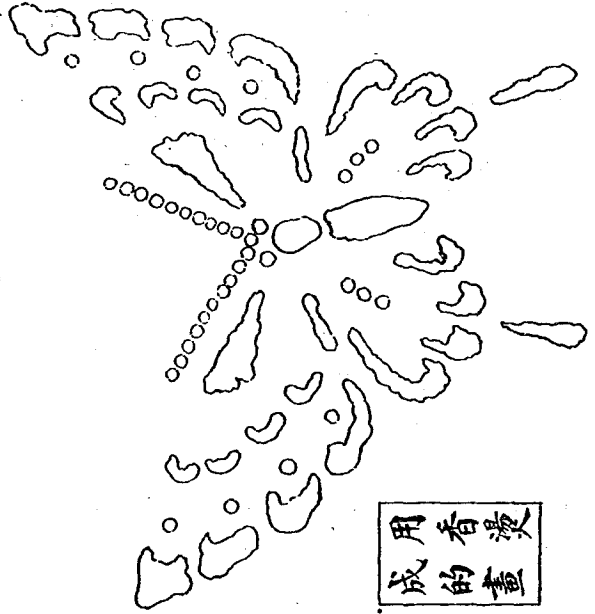

用香燙成的畫

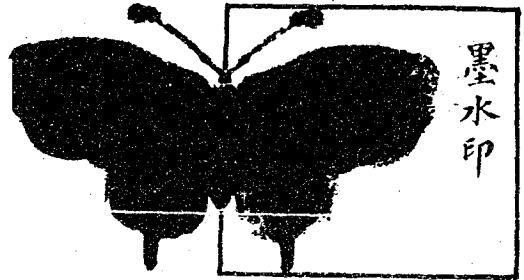
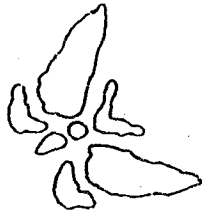

墨水印

螢火蟲 組八十三第 集四第

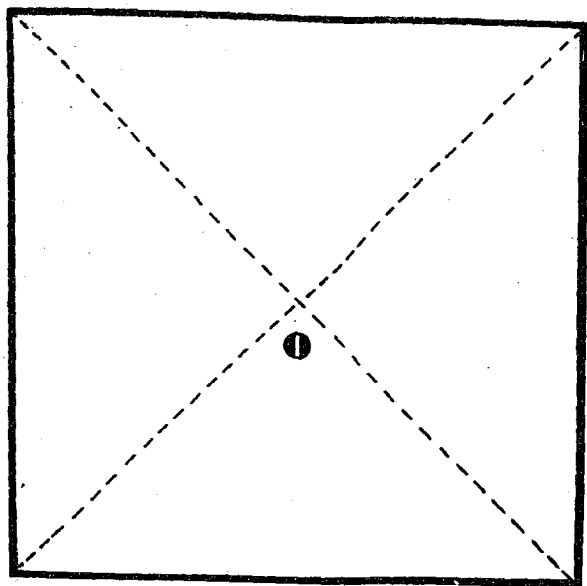

螢火蟲燈

摺紙工

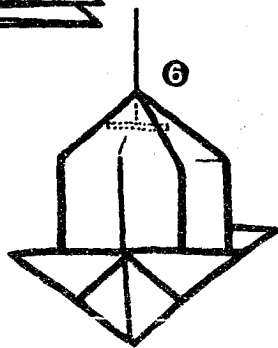
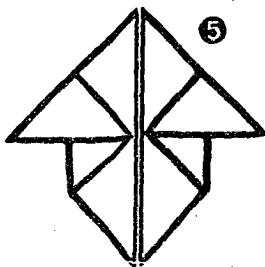
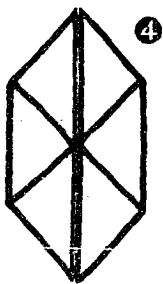
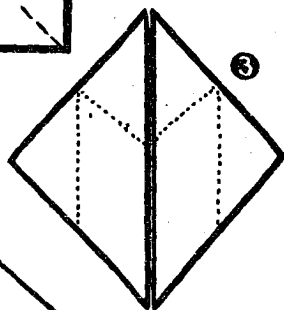
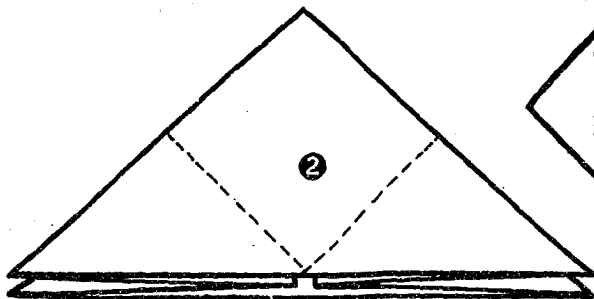

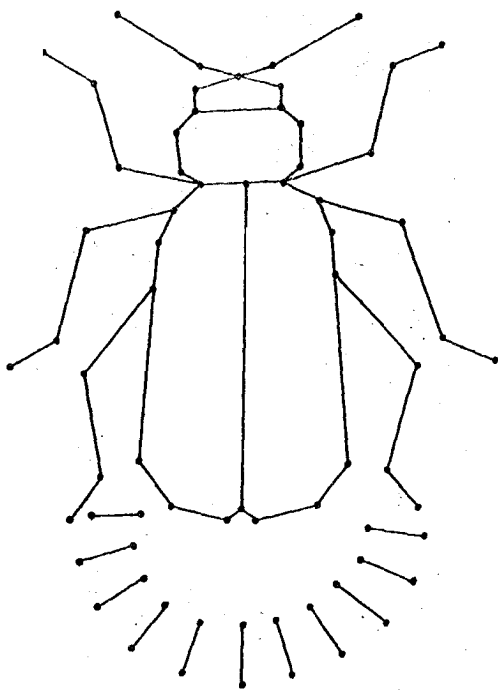

穿線工

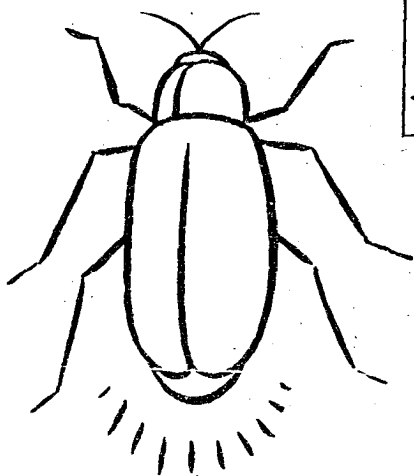

塗色畫

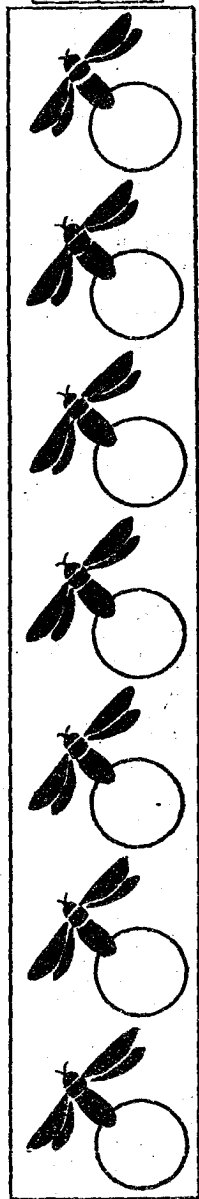

樹葉剪貼

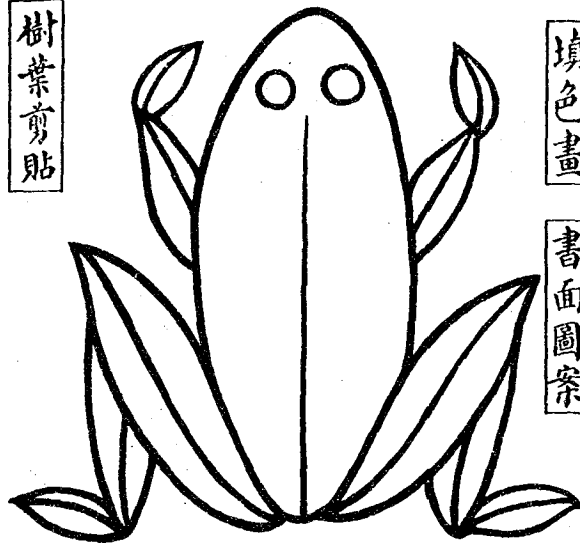

填色畫

書面圖案

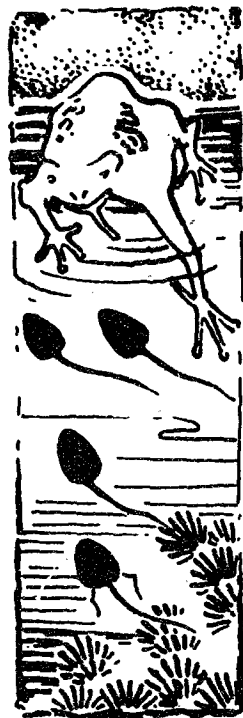

工紙剪

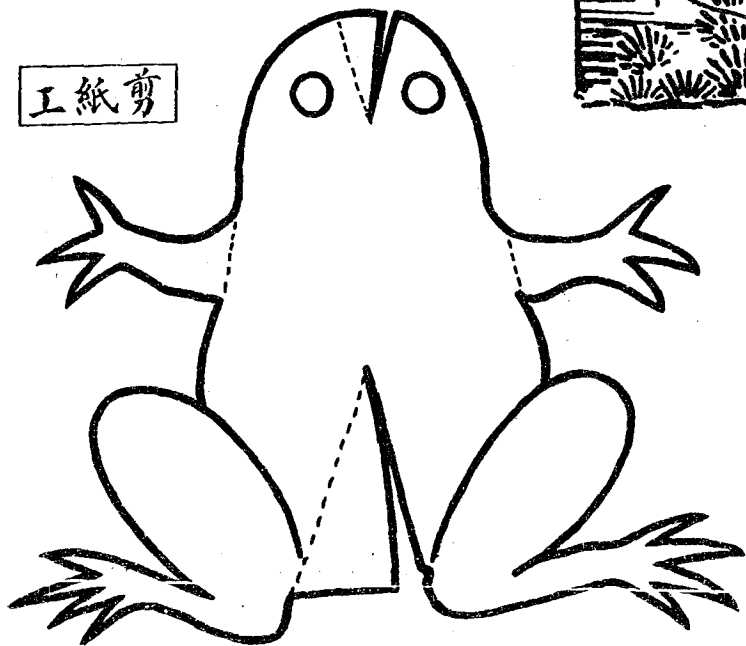

第 四 集 第 三 十 九 組 蟾 蝦

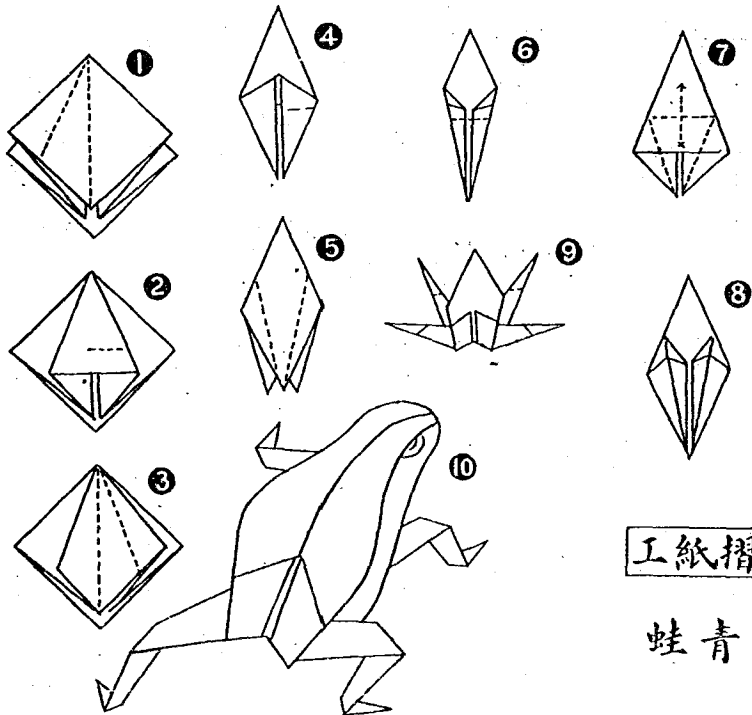
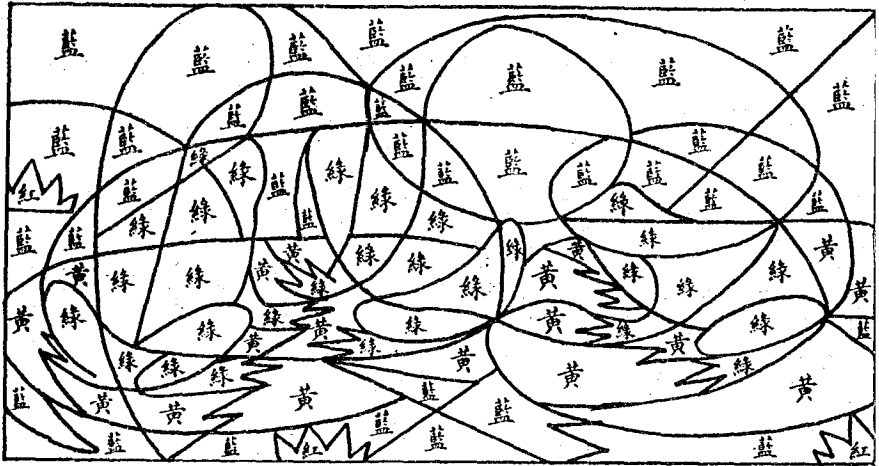

蟻媽 組十四第 集四第

蟻媽加 畫色填

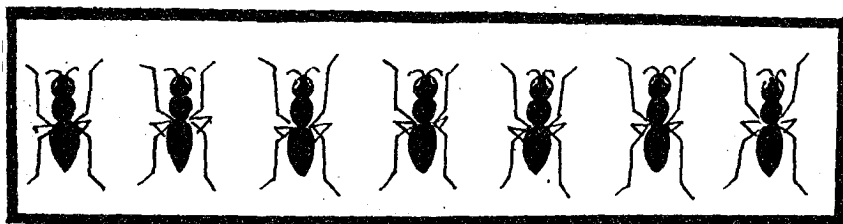
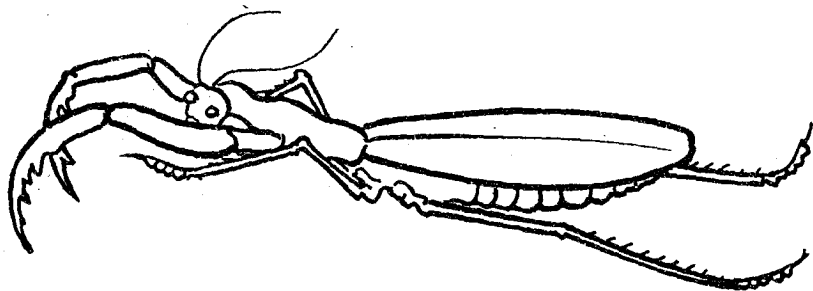

畫案圖

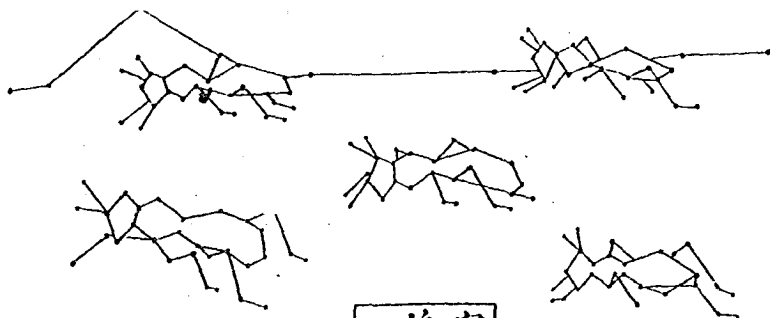

工線穿

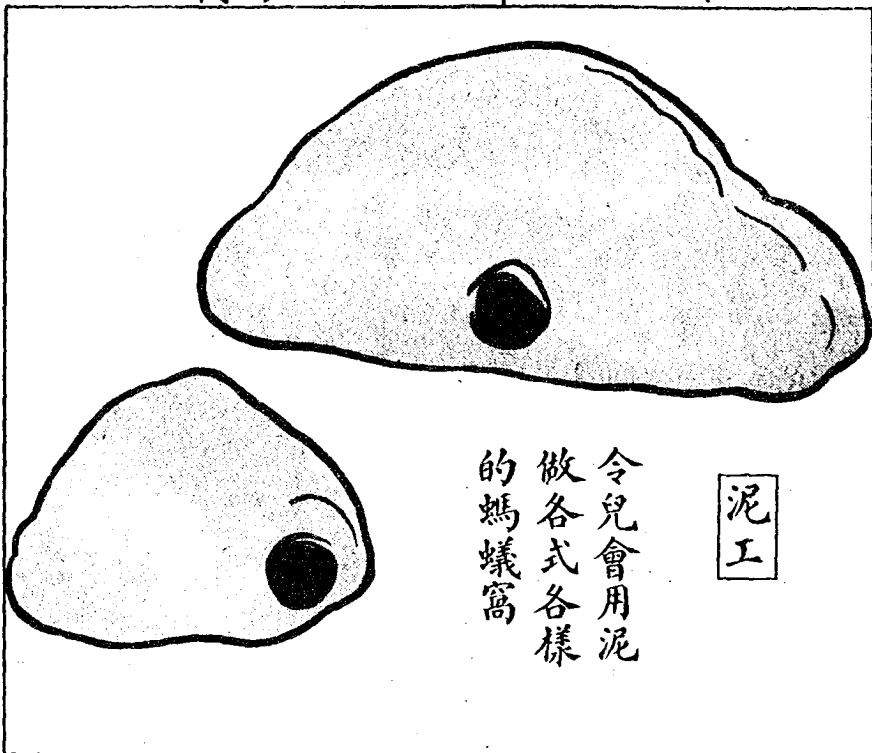

泥工

令兒會用泥
做各式各樣
的媽蟻窩

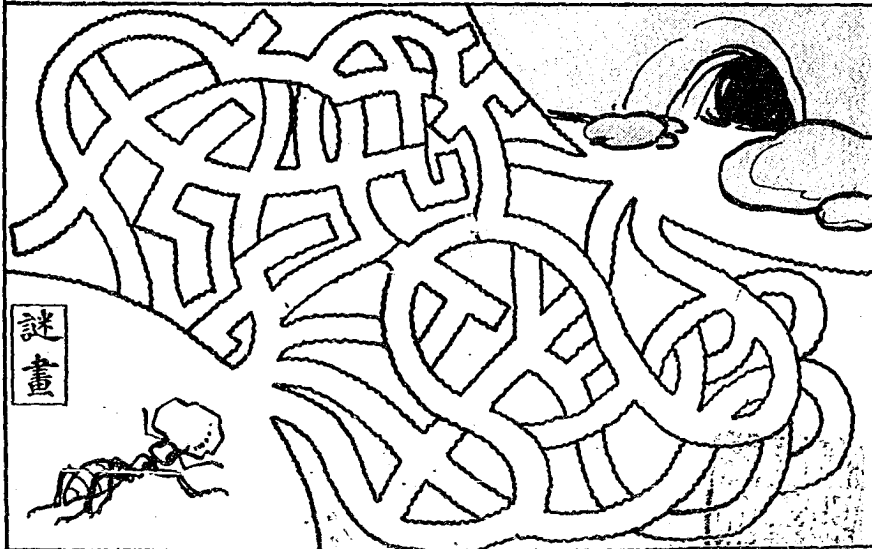

謎畫

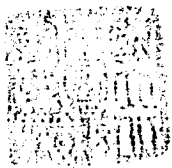

中華民國二十五年十二月初版

(Copyright)

幼稚園工作一百六十組一冊

每冊實價國幣壹元

外埠酌加運費匯費

編纂者

虞朱蔡沈
哲銘菊百
光新清英

發行人

王雲
上海河南路
五

印刷所

商務印書館
上海河南路

發行所

商務印書館
上海及各埠

版 翻
權 印
所 必
有 究

#52

712359