

PLUMBING AND HOUSEHOLD SANITATION

† *In Aqua, Pura Auraque Salus* †



J. PICKERING PUTNAM.

PLUMBING
AND
HOUSEHOLD SANITATION

BY THE SAME AUTHOR

Lectures on
The Principles of Household Drainage

Delivered before the Suffolk District Medical Society, and the Boston Society of Architects, at the Massachusetts Institute of Technology. With over 300 Illustrations.

From the Editor of the Sanitary Record, London.

By permitting me to reproduce these "admirable articles in the Sanitary Record, you will greatly oblige me and serve the cause of Sanitary Science in England."—The Editor.

Sanitary Plumbing

Reprinted from the American Architect and Building News. With over 400 Illustrations.

"These investigations have been set forth quite fully in illustrated communications to the American Architect, which papers certainly mark a very important step forward in Sanitary Literature."—Col. Geo. E. Waring, Jr., in the Century Magazine for December, 1884.

"This important work of the laboratory has been under the direction of Mr. J. Pickering Putnam, of Boston, and I am sure that his experiments and investigations are the most comprehensive, and thorough and valuable that have ever been made on the subject of Household Sanitation"—Address before the Academy of Sciences at Rochester, New York, by Wm. E. Hoyt, C. E., S. B., Chief Engineer of the B., R. & P. R. R. Co., and at one time Chief Engineer of the Massachusetts State Board of Health. Ticknor & Co., 1886.

The Open Fireplace In All Ages

Republished from the American Architect and Building News. Quarto, with over 300 Illustrations.

"This is undoubtedly the most extensive and critical work on this subject in the language. The author takes up the subject of heating and ventilation and treats it in extenso, showing existing defects, giving a full historical résumé of the theme, and ends by criticism and practical suggestions."—Chicago Journal.

"A very beautiful book, artistically and practically."—Louisville Courier-Journal.

"It is brimful of good suggestions."—N. Y. Graphic.

"The book is excellent from cover to cover, and a real contribution to useful literature."—Boston Advertiser.

ALSO THE FOLLOWING MINOR WORKS:

"Architecture Under Nationalism," pub. by "Am. Architect," 1890.

"The Metric System of Weights and Measures," pub. by Library Bureau, 1877.

"The Outlook for the Artisan and His Art," pub. by C. H. Kerr & Co., Chicago.

"Improved Plumbing Appliances," pub. by Wm. T. Comstock, N. Y., 1887.

"General Principles of House Plumbing," in Buck's Handbook of Medical Sciences. Wm. Wood & Co., N. Y., 1886. Etc., Etc.



BATHS OF DIOCLETIAN. Restauration by Edmond Paulin. A.
Published in "Restauration des Monuments

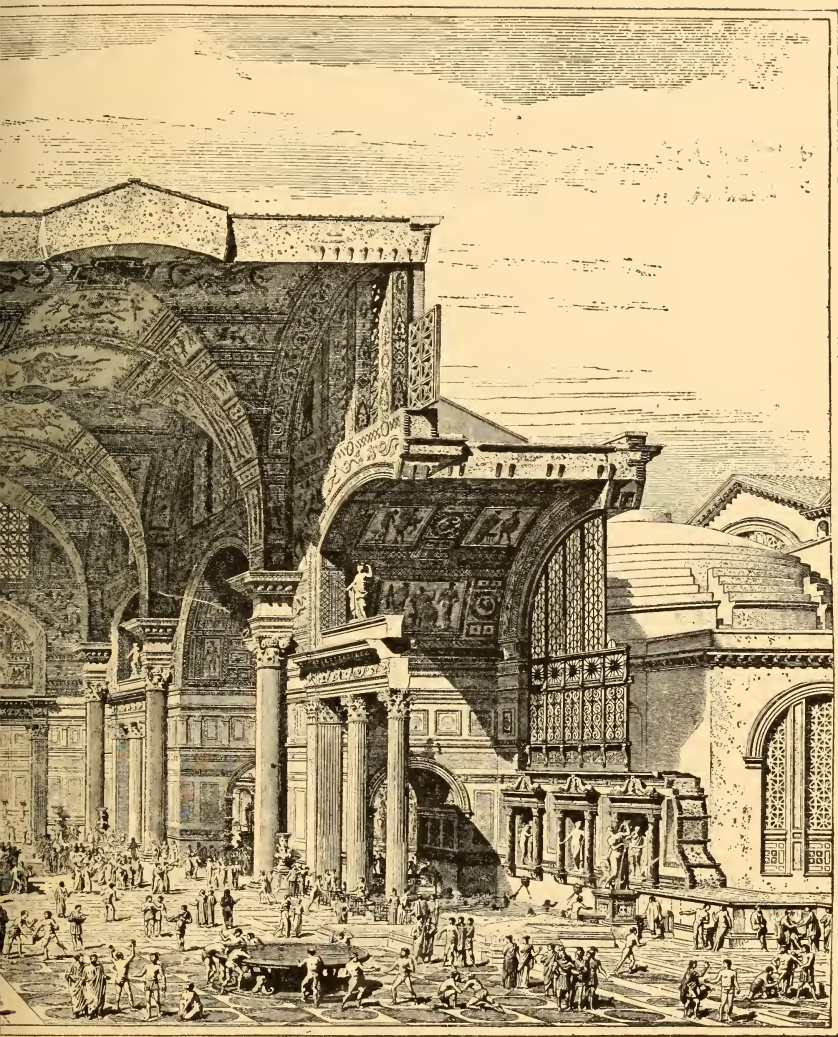

A. CHATELAIN 19 31 87

et. Recipient of the Grand Prize of Rome, Academy of France.
ques.' Firmin—Dido et Cie, Paris, 1890.

PLUMBING
AND
HOUSEHOLD SANITATION

BY

J. PICKERING PUTNAM

MEMBER OF THE BOSTON SOCIETY OF ARCHITECTS AND OF
THE AMERICAN INSTITUTE OF ARCHITECTS

A COURSE OF LECTURES DELIVERED BEFORE THE
PLUMBING SCHOOL OF THE NORTH
END UNION, BOSTON



GARDEN CITY NEW YORK
DOUBLEDAY, PAGE & COMPANY

1911

T196123

P8

copy 2

COPYRIGHT

1911

BY J. PICKERING PUTNAM.

5

11-88830

©CLA286132

TO THE BOSTON SOCIETY OF ARCHITECTS

WHOSE UNTIRING AND DISINTERESTED EFFORTS IN BEHALF
OF BETTER BUILDING LEGISLATION ENTITLE THEM TO PUBLIC
RECOGNITION AND GRATITUDE, THIS LITTLE WORK
IS RESPECTFULLY DEDICATED.

CONTENTS

	<i>Page</i>
PREFACE. —Purpose and Scope of the Work. Boards of Health are urged to provide themselves with Testing Apparatus enabling them to demonstrate the superiority of the Simple or One Pipe System of Plumbing over the complicated one now in vogue in most Cities and Towns, and relieve the Public of a very great and unnecessary Burden, Cut the Cost of Plumbing in Two, and yet at the same time increase Its Safety and Convenience. Authorities Consulted	11
INTRODUCTION. —The Significance in Sanitary Plumbing of the Modern Science of Bacteriology and Chemistry, and a Summary of the Conclusions in the direction of greater simplicity to which they lead. Important Benefits which would result from Filtering the Air of Cities of Dust and Bacteria through Proper Sewer Ventilation. The Ten Laws or Commandments of Plumbing	18
CHAPTER I. —Historical. Illustrations of Science and Art Employed in Plumbing	27
CHAPTER II. —Influence on the Community of Sanitary Engineering	43
CHAPTER III. —Bacteria in their Relations to Sanitary Engineering. The Marvelous and Intensely Interesting Recent Discoveries in Bacteriology and the Great Importance of this Science to the Sanitary Engineer	49
CHAPTER IV. —Sewer Air. Ancient and Modern Views of Its Nature and Composition. Conclusions of Modern Science as to the Freedom from Disease Germs of Sewer Air, and as to why they are unable to survive long in Sewage itself, and why they Cannot Rise from Liquids nor Damp Surfaces. Researches and Conclusions of Modern Scientists on the Effects of Breathing Sewer Air	66
CHAPTER V. —Dr. Carmichael's Experiments and Conclusions as to the Reliability of Water Traps for Excluding Gases and Germs. Similar conclusions by other well-known Scientists. Experiments on Filtration	90
CHAPTER VI. —Further Studies on Micro-Organisms in Sewer Air, and in the Outer or Street Air of Cities Above the Sewers	110

CONTENTS.

	Page
CHAPTER VII. —The Main House Trap and the Reasons why its Use should be Prohibited by Law. Why the House Drains should be Used as Sewer Ventilators. Author's Experiments, Calculations and Conclusions as to the Imense Value of Such Ventilation and the Amount of Air Filtration and Purification from Dust and Germs of the Air of Cities it would effect	125
CHAPTER VIII. —Sewer Ventilation, and the Reduction of the Death Rate of Cities through Proper Sewerage	140
CHAPTER IX. —Traps. General Considerations and Classification	151
CHAPTER X. —Mechanical Seal Traps and Their Tendency to Clog	154
CHAPTER XI. —Water Seal Traps and Their Classification into Cesspool and Self Cleansing Traps. Dangers of Cesspool Traps	168
CHAPTER XII. —Street Gullies. Why They Should be Made to Aid Sewer Ventilation	175
CHAPTER XIII. —Seal Retaining or Anti-Siphon Traps, and Their Philosophy and Development	184
CHAPTER XIV. —The Two Plumbing Systems, the Simple and the Complicated. The Hydraulics and Pneumatics of Plumbing	233
CHAPTER XV. —Trap-Testing Apparatus. Experiments on Siphonage, Back Pressure, Evaporation, and Clogging of Traps, and Author's Researches and Demonstrations Before Sanitary Engineers, Boards of Health and others	241
CHAPTER XVI. —Self Siphonage and Momentum	288
CHAPTER XVII. —Water Flushing. Its Great Importance and Deplorable Neglect in Practice and Plumbing Legislation..	296
CHAPTER XVIII. —Evaporation of Trap Seals	304
CHAPTER XIX. —Capillary Action on Trap Seals	315
CHAPTER XX. —The Evils of Back Venting Traps	331
CHAPTER XXI. —Wash Basins, Ancient and Modern, and the General Principles which Should Govern Their Construction	339
CHAPTER XXII. —Classification of Lavatories. Plug and Chain Waste Cock Outlet Lavatories	350
CHAPTER XXIII. —Valve Outlet Lavatories	362

CONTENTS.

	Page
CHAPTER XXIV.—Plunger Outlet Lavatories	369
CHAPTER XXV.—Standpipe Outlet Lavatories. Improved Lavatories	379
CHAPTER XXVI.—Kitchen and Pantry Sinks. Should be Constructed on Principle of the Automatic Flush Tank	393
CHAPTER XXVII.—Public Baths. Interesting Examples, Ancient and Modern	411
CHAPTER XXVIII.—Latrines and Water Closets and Their Classification	419
CHAPTER XXIX.—Defects of Valve and Plunger Closets	440
CHAPTER XXX.—Interesting Ancient, Modern and Foreign Examples and Wherein They are Unsatisfactory	450
CHAPTER XXXI.—Improved Closets	462
CHAPTER XXXII.—Modern Trap Jet Closet: their origin and development. Latest Improvements	471
CHAPTER XXXIII.—Soil and Drain Pipes and Their Classification	502
CHAPTER XXXIV.—Lead Calked Joint. Its Serious Defects: Its Use Doubles the Cost of the Piping by necessitating Extra Heavy Pipe	516
CHAPTER XXXV.—Flange, Sleeve, and Screw Joints	538
CHAPTER XXXVI.—Leakage of Pipes and Joints and the Grave Danger of Gas and Water Leakage, and the Immense Volume of Loss Sustained by the Public	561
CHAPTER XXXVII.—Improvements in Pipe Jointing. Rigid and Flexible Joints	570
CHAPTER XXXVIII.—General Arrangement of Plumbing Work. Bath Room Ventilation Outside Windows Unnecessary ..	595
CHAPTER XXXIX.—Author's Report to Boston Board of Health on Siphonage and Evaporation of Traps	601
CHAPTER XL.—Critical Review of Dr. Teal's interesting illustrated "Dangers to Health," in the Light of Modern Bacteriology	630
CHAPTER XLI.—Slow Sand Filtration	661
CHAPTER XLII.—Plumbing Laws. Critical Analysis. Code Recommended by the Author	672
CHAPTER XLIII.—Recapitulation	696
CHAPTER XLIV.—Author's Address before Am. Inst. Archts.	707

PREFACE.



To the Reader.

Since the purpose of this course is to treat of the best and simplest method of obtaining healthy homes and to show by what means the utmost convenience in plumbing work may be obtained with safety and economy, no attempt will be made to describe in catalog form all the interesting appliances manufactured to-day. Indeed, it would be impossible in a small volume to do even partial justice

to their almost countless numbers. Each enterprising manufacturer requires for the cataloging of his sole individual productions, a ponderous volume, sumptuous and costly enough to pay for a small king's ransom. Before long, of course, in accordance with a law of economics which allows of no exception, a very big Trust will take charge of the whole business and place the goods before the public in a simplified form. Then the consumers will constitute the stockholders and price lists will become less mysterious and more satisfactory.

But in the meantime the work of combining the descriptions of all the myriads of artistic and tempting creations in a single volume or set of volumes for ready reference must be left to some specialist in business cataloging like "Sweet's" Indexed Catalog of Building Construction which

PREFACE.

will place them all before the architect and his client in such a form that they can actually be found when they are wanted. But "Sweet's" will not be able to discriminate against some of these goods in favor of others, even in the interest of the public, because the same individual cannot to-day serve both as business agent and critic at the same time. An old and reliable authority assures us that a man cannot at one time serve two masters.

The business cataloging, therefore, being provided for elsewhere, the public will now only require a knowledge of the scientific principles which should guide them in their selection and use of these goods. It will be found that all the plumbing appliances and methods of construction in use to-day may be grouped under certain classes or types, and that by means of such classification any one may, without laborious technical training, be enabled to discriminate independently between the good and the bad, even though the bad may possess in some cases the most pleasing external appearance.

Accordingly we have arranged in this volume a classification and explanation not of appliances but of types and methods of construction which will enable the reader to judge for himself independently, and acquire all the modern plumbing conveniences and sanitary advantages with the greatest safety and at the same time with the least expense.

The reader is warned that he will find in these pages many ideas and conclusions which are not considered orthodox among many plumbers and framers of plumbing legislation.* The existing state of things has been freely criti-

*Some practitioners, very properly estimating highly the "practical" side of the plumber's work, have questioned the ability of a non-practitioner in plumbing or a "theoretical" man to fully comprehend an art which is so technical in its nature. While an architect does not deny that he must be something of a theorist in the interest of progress, he nevertheless contends that the nature of his work requires him to be essentially and first of all practical. Although he may be unable to wipe a joint or set a fixture with skill, he is nevertheless trained to fully comprehend the philosophy and purpose of these proceedings. The very first thing he discovers in the practice of his profession is that there is no sound theory which is not based on facts and on facts alone.

cized whenever it has appeared, after exhaustive experimentation and investigation, that simpler and better methods are possible. It is now possible for anyone to demonstrate for himself with little expense whether or not the contentions made herein are correct, without going through all the tedious and costly experiments which have led up to them, and if the writer wished to lay claim to having performed some slight service in his several years of effort along these lines, perhaps an item might be in his having called attention to and in a measure having developed the means and implements needed for such demonstration.

His chief claim, however, is in having labored for many years to show to legislators and to the public in general (with definite, favorable results on plumbing legislation in more than one city), the importance of very greatly simplifying our plumbing; in having first pointed out the significance of recent bacteriological discoveries in providing further justification for these simplifications, such, for instance, as the omission of the main house trap, whereby an exceedingly important purification and dust and germ filtration of the air of cities through the agency of the moist surfaces of the sewers and individual house drains, is effected; and finally in having devised certain practical means for obtaining these simplifications hitherto considered impossible.

It is hoped that Boards of Health will avail themselves of some simple standard form of apparatus and methods of demonstration which any plumber can construct of ordinary piping, with cistern, vacuum gauge, and ordinary quick-closing valves, and relieve a long-suffering public of a burden in plumbing construction, still required in the majority of cities and towns of the United States, which is, to express it in the mildest terms, a most gigantic blunder. The cost of such apparatus would be more than paid for by the saving in the plumbing of a single building.

PREFACE.

It is quite as important and useful a part of the work of an investigator to build up as it is to tear down. It is indeed, in a certain sense, useless to criticize an existing state of things unless some practical remedy can be offered to take its place. No apology seems, therefore, required for the presentation here of certain new methods and appliances which have been developed in the course of these studies to meet the new conditions advocated, nor for the protecting of some of them by patents. Yet the writer recognizes that however much the public may desire to see an inventor share with it a small part of any benefit which may be derived from his efforts, he is nevertheless, and, so long as a destructive form of competition continues to form the basis of the business relations between men, must be, regarded rather in the light of an "innovator" to be opposed and punished by all who are financially interested in the existing order of things.* Therefore, it is the industrial system and not the individuals affected which is responsible for the long continuation of abuses from which the public might otherwise be quickly freed, and for the tardy recognition the inventor receives. Any return at all should really be regarded by him as more than he ought to expect under such conditions, and the writer should feel really much gratified that he has so far been able to escape from this unequal contest with some of his bones unbroken.†

*Pipe dealers are financially interested in maintaining the elaborate system of piping required by back venting and main house trap installation, while plumbers have nothing to gain by it, but rather much to lose, since what money goes into unnecessary piping is lost for better fixtures and more of them, and the public, alarmed by all the complication, becomes distrustful of all plumbing and tends to do away with its benefits as far as possible.

†In spite of these discouragements, some words of recognition have now and then been received from disinterested parties which have given renewed courage and perseverance at times when they seemed most needed. Among them are the following from no less of an authority than William E. Hoyt, C. E., S. B., Chief Engineer of the Buffalo, Rochester & Pittsburg Railroad Company and at one time chief engineer of the Massachusetts State Board of Health: "Not long after the adoption of the fallacious device of back venting, it became evident that more efficient means of guarding against the

It should be added that these investigations and innovations have been made in the course of regular professional practice, and have, therefore, been conducted in the unprejudiced spirit of an architect working for the interest of his clients, and in some cases with their substantial aid and co-operation. The improvements and their protection, are the result and not the cause or original purpose of the

dangers of sewer-air were necessary and persistent effort was directed toward devising better methods of house drainage. The result has been the attainment of a new order of things by the recognition of scientific principles previously ignored. Without referring now directly to the experiments and investigations, we may consider briefly certain principles which have been established by them. The first and cardinal principle of science as applied to house-drainage is simplicity. In the place of a wilderness of pipes tangled in hopeless confusion about every fixture, modern science demands that there shall be only a simple and positive system which shall act with directness and certainty in every case. The old air pipes from traps are discarded. There are fewer joints and the danger from leakage is lessened. Instead of traps that easily lose their seal, notwithstanding the relief pipes attached, traps are now used that in themselves will resist the hostile influences of evaporation and siphonage. The new system demands that basins, sinks, baths and water closets shall be so constructed as to act after the manner of flush tanks, and scour the whole system of waste pipes at each discharge. It requires that there shall be no hidden and inaccessible recesses in plumbing fixtures, where filth may collect and putrefy so as to become offensive and dangerous. The absolute prevention of serious evils is considered of far greater importance than means to palliate them.

For the development of this science credit must be given mainly to an accomplished sanitariatist of Massachusetts, Mr. J. Pickering Putnam, whose experiments and investigations on subjects relating to household sanitation are unquestionably the most thorough and complete that have ever been put on record. The first of this series of experiments was made for the Board of Health of Boston in 1883. Subsequently, special demonstrations were shown before the Suffolk District Medical Society of Massachusetts, the Boston Society of Architects, and others. The results have been published in the "Boston Medical and Surgical Journal," the "American Architect," the "Sanitary Record" of London, and other periodicals." Wm. E. Hoyt, C.E., S.B., in an article on "Safety in House-Drainage," published in "The Popular Science Monthly," for July, 1888.

If Mr. Hoyt has been a little over generous in his words of encouragement, it will not be allowed to have a permanently injurious effect upon the writer's character, but be considered as in a measure offsetting the rebuffs received from others not so favorable to progress as Mr. Hoyt.

The late Col. George E. Waring, in an article published in the Century Magazine for December, 1884, on the "Principles and Practice of House Drainage," wrote of the writer's investigations and writings equally pleasantly, saying of them that "they certainly mark a very important step forward in sanitary literature."

In another place equally encouraging words by other well known authorities will be quoted, only enough here being needed to reassure the reader and cheer him forward in the study of this somewhat dry subject, if a treatise on hydraulics may be so designated.

PREFACE.

investigations. If they are actually improvements on what existed before (the need of improvement being clearly recognized) then they are the best in the particular class to which they belong up to the date of their presentation, and as the purpose of this writing is to advocate the best, they will necessarily have to be described as such irrespective of their authorship, and even in some cases to the exclusion of other things in the same class, which are believed to be not so good. It must be left to the common sense of the reader to judge of the soundness of the reasoning in each case, and of the just motive and sincerity of the author. The quotations in the foot-note are only given for the purpose of placing the reader, who might naturally be prejudiced by these circumstances, in a more impartial and receptive frame of mind for judgment.

An apology should be made for the name "plumbing," which has curiously enough been taken from the very metal, lead (Latin, *plumbum*), which we are learning should rarely be used in its unalloyed form in plumbing at all. Brass and iron are rapidly taking its place. Lead is inelastic, inert, feeble, treacherous, unreliable for plumbing and dangerous on account of the fire it requires in the house for its manipulation. The ancient alchemists called it Saturn. The modern plumber should modify this name to Satan, and debar his entrance and his fire altogether from the house.

To sanitary engineers one of the most important works which have been published in the last decade is the record and critical examination of the researches of bacteriologists entitled "Sewer Gas and Its Influence Upon Health," by H. Alfred Roechling, C. E., which the writer has freely quoted in these lectures, and for which he desires here to express his obligation. More recent and equally valuable are the researches in the same field of our own Professor Charles Edward A. Winslow, of the Massachusetts Insti-

ACKNOWLEDGMENTS.

tute of Technology, whose aid is gratefully acknowledged.*

Thanks are also extended to Professor Edward S. Morse for his courtesy in permitting the use of his remarkably interesting sketches which have been taken from one of his masterpieces entitled "Japanese Homes and Their Surroundings," published by Harper Brothers, New York.

Also to William Paul Gerhard, C. E., for valuable aid in connection with furnishing copies of the plumbing laws of a very large number of cities and towns of the United States; to Mr. David Craig for many practical suggestions; Mr. Craig, while acting as President of the National Association of Master Plumbers and of its sanitary committee, has performed a valuable public service in furthering the investigations conducted for the committee by Prof. Winslow,† and later their publication; to the writings of Dr. Antoine Magnin, Prof. H. W. Conn, Dr. Niel Carmichael, Mrs. and Prof. Percy Frankland, Viollet le Duc, Col. George E. War- ing, Dr. Teale, and many others whose works are referred to and duly acknowledged in the text, to "Domestic Engineering" for a number of valuable articles which have been quoted and credited where mentioned, and, finally, to Mr. Samuel Hubbard, Director of the North End Union, of Boston, through whose invitation the course of lectures forming the nucleus of this work, was given before his pupils.

J. PICKERING PUTNAM.

535 Beacon St., Boston.

*The National Association of Master Plumbers has within the last few months through its Sanitary Committee, made some very important investigations on the question of the carriage of bacteria by sewer air. This most careful and valuable work was entrusted to Prof. Winslow, and seems to entirely remove the doubts on the subject cast by the publication of Major W. H. Horrocks of the English Army Medical Corps, and corroborates the conclusions of Laws and Andrewes, Roechling and others. The work is being printed by the Master Plumbers' Association, and is a very valuable contribution by them and its author to the literature of the subject, and to the welfare of the public.

†These conclusions of Prof. Winslow as published in this report agree with and corroborate the results attained by the author and published in the "Inland Architect" of Nov. 8, 1908, and in "Domestic Engineering" in 1900, 1903, 1906 and 1908.

INTRODUCTION.

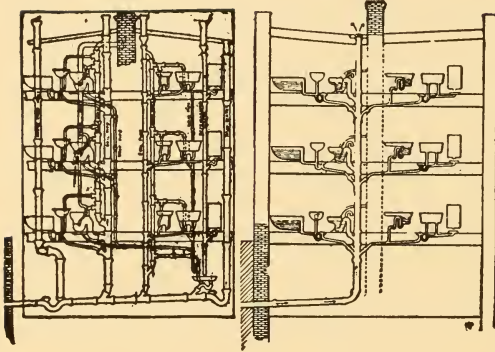

Fig. 2. Complexity and Danger. Type of system of extreme complication to which we are tending.

Fig. 3. Simplicity and Safety. Type of system recommended as a substitute.

At the time when these lectures were first delivered, in the winter of 1899-1900, the plumbing laws of Boston and of nearly every other city of the United States enforced a system of piping and trapping which almost doubled the cost

of the work in new buildings and more than doubled it in repair work over what was necessary, besides greatly lessening its convenience and safety.

Every fixture was required to have a separate trap, and every trap had to be independently revented by a special "back vent" pipe extending up to the highest fixture in the building. A disconnecting trap was required between every building and the public sewer, which prevented the best and only known really effective method of ventilating the sewers; and no better method of jointing cast iron pipes was allowed than the unscientific, unreliable and very costly lead calked bell and spigot joint.

These worse than useless and very burdensome requirements have held the people like a vise for the last quarter

of a century in spite of the protests during all that time of many of the leading sanitary engineers and plumbers.

Within a very few years, however, some of the more wide awake and progressive cities have seen the folly of this course and have given their citizens the benefits which the modern simpler and more scientific methods and discoveries have provided, and every year is adding to their number. But as the plumbing laws of the majority of places are based upon the ideas of more than a decade back, the only possible way to present anything of the least value in this important department of architecture is to break entirely away from the conventions of ordinary practice and base all our conclusions upon direct personal investigations and absolute demonstration. Our treatment must therefore necessarily become largely critical and argumentative throughout, and, although this method of handling the subject is certain to arouse from many quarters adverse criticism and possibly some bitterness, it is nevertheless evidently unavoidable, and will also have the great advantage of making the matter vastly more interesting and we hope much more intelligible to the reader.

The arguments used by the writer as early as 1884 in behalf of this simpler plumbing system have been of late greatly reinforced by the discoveries of the bacteriologists. The data they have furnished and their significance from a sanitary standpoint have been summarized by him in his publications before 1909, as follows:

(1) A sound water seal affords a reliable barrier against the entrance of sewer air and all kinds of germs.

(2) Dust and germs falling into water or against the wet surfaces of sewers and drain pipes are, under normal conditions in the drains, arrested and prevented from rising again into the air so long as the surfaces remain wet.

(3) Abnormal conditions prevail in the drains when

INTRODUCTION.

splashing or bubbling occurs in the sewage under the influence of which fine droplets may be projected into the surrounding air. If these droplets contain germs and are minute enough to be wafted in the air currents passing through the pipes the germs therein may remain in the air until they again fall against the wet surfaces. Even germs have a definite weight and the speed of their descent under the influence of gravity has been calculated, which gives also the speed of an air current necessary to support or move them.

(4) It is possible that small particles of sewage which have dried against the upper parts of the walls of the sewers may be detached therefrom by air currents and in this manner under rare instances allow of the escape of germs into the sewer air. The probability of this action is denied by some investigators, but affirmed by others. It may be admitted as a possibility.

(5) Disease germs seem to be unable to survive long in sewage, the non-pathogenic germs therein far outnumbering them and destroying them by their products.

(6) Fewer germs are found in the air of sewers than in the outer air above the sewers, and those which are found in the sewer air are dissimilar in kind from those in the sewage but similar to those in the outer air.

(7) The number of germs present in the air of well ventilated sewers exceeds that in less well ventilated sewers, and varies with variations in the content of the street air, implying that their origin is from without and not from within the sewer.

(8) The majority of investigators have failed to isolate specific disease germs from the air of sewers, and it may be stated in general terms that they are not to be found there under normal conditions. Yet a few well known investigators have obtained cultures in the air of sewers of germs

apparently coming from the sewage under normal conditions, and it is generally admitted that the splashing, bubbling or drying of the sewage may release them under rare conditions in good practice. *Their numbers in sewer air must, however, in properly constructed sewers be so small in the whole volume of the sewer air, that their effect regarded from a sanitary standpoint may be considered as negligible.*

From the above data and from his own experiments the writer has derived the following general conclusions affecting Sanitary Engineering.

(1) It is known that disease germs, especially those of consumption, may be disseminated in the air above the sewers, and may, especially in times of epidemic, abound there in large numbers, and unquestionably in larger numbers than in the air of the sewers themselves.

Under such circumstances street air passing through the sewers and house drains becomes filtered by them and emerges from the pipes freer from its dust and germs than when it entered, and must in fact before reaching the tops of the stacks above the roof be entirely freed therefrom.

(2) Air currents rising through the soil pipes in buildings act like smoke in chimney stacks, taking a spiral course as they ascend. In so doing, as well as in passing around bends and angles, every particle of air tends to strike against the inner surfaces of the pipes more or less often before reaching the roof. The result of this phenomenon is that any dust and germs which might enter the house drainage system from the public sewer is bound to be arrested somewhere along the wet surfaces of these pipes, and be ultimately destroyed. Hence with good plumbing the possibility of the entrance of a disease germ into the house from plumbing pipes becomes practically nil. If there is any danger whatever of contracting disease from air in the sewer itself so ventilated, all such danger is thus eliminated for

INTRODUCTION.

residents in the houses connected therewith. More questionable germs are consumed every twenty-four hours in the ordinary food and drink or inhaled from the outer air than would probably be obtained from the soil pipe air in a lifetime.

(3) The omission of the disconnecting or main house trap converts every house drain into a sewer vent and insures the destruction of any dust and germs, pathogenic or otherwise, which may under normal or abnormal conditions be found in the sewer.

The rate of purification of the air of cities by this method of filtering it through the sewers and house drains is very great, amounting, by my calculation, to over a million and a half cubic feet per minute for every square mile of the city's area, or to the ventilation produced by a ventilating chimney 68 feet in diameter conducting air at a speed of 419 feet a minute.

(4) The use of the main house trap obstructs sewer ventilation, and results in forcing any foul and dangerous odors it may contain as well as any possible disease germs into the street through the sewer gratings.*

(5) The use of the "back vent" pipe with traps tends to destroy their water seal by evaporation, where unvented anti-siphon traps are capable of retaining their seals under all conditions encountered in plumbing practice, and for many months without refilling.

(6) Drain piping may now be installed in such a manner as to be permanently sound and reliable.

(7) Splashing and bubbling in sewers may be avoided by their proper construction and regulation.

(8) If there be any danger whatever from the pos-

*The money saving alone from omitting the main house trap and its necessary connections and the extra piping it involves in a city of the size, say, of Boston, would amount to a sum sufficient to build and equip ten handsome public school houses, or in general, two for every square mile of a city's area.

sible presence in rare and isolated cases of disease germs in the air of the sewer, that danger may be practically eliminated by ventilating the sewer through the house drains and using sound piping and unvented anti-siphon traps. Under such conditions there is indeed a possible danger of contracting disease from dust and germs coming in through open windows, but none from the plumbing system, because the former may and the latter cannot transmit the germs.

In my suggestions for improvements and modifications founded on the above deductions hereafter to be described in detail in these pages, I have been guided by the following ten rules or principles:

(1) The Law of Simplicity. The tendency at present is toward undue complication. The plumbing work has been growing each year more elaborate and costly, more difficult to set correctly and more difficult to comprehend and repair when correctly set, so that the public have become alarmed and confused. They despair of being able to understand the intricate system of piping and machinery for the supply and waste fixtures. The result is a general feeling of insecurity and a tendency to forego plumbing fixtures wherever their presence is not an absolute necessity. Our watchword should be "simplicity." Rather than reduce the number of our conveniences, let us reduce the amount of machinery connected with them, provided we can do so without reducing the security they are intended to afford.

(2) The Law of Accessibility. Another leading principle is that all plumbing work in a house should be everywhere, without exception, accessible, and as far as possible visible and ornamental. Pipes should never run behind plaster when it is possible to expose them on walls and ceilings. There is nothing in a neatly arranged line of metal piping that one needs be ashamed of. On the contrary, when skill-

INTRODUCTION.

fully placed and neatly jointed, in a workmanlike manner, as would be the case when a good plumber knew they were to be forever exposed to view, these bright metal pipes, polished or white enameled, become quite ornamental when mounted with handsome clamps and symmetrically arranged with taste and judgment.

(3) The Law of Avoidance of Mechanical Obstructions. A third principle is to avoid all mechanical obstructions, such as balls, valves, gates and all other impediments to the water-way, and in a system of water carriage to do all trapping by means of a water seal alone:

Mechanical devices form no reliable security against the passage of sewer gas. These valves and balls cannot be made to fit their seats with such accuracy as to exclude liquids and gases, or microscopic germs, even when new. They soon become more or less fouled with dirt and corrosion and then their inefficiency becomes evident even to the eye. A sound water seal, however, properly protected, is found to be entirely reliable in excluding noxious matters of all kinds. Moreover, we are obliged to rely upon a simple water seal whether we desire to or not, because our water closet traps are and must be constructed without mechanical obstructions. It is useless to apply mechanical closures to our smaller traps if we leave the large water closet traps without them.

(4) The Law of Tightness and Flexibility of Jointing. A fourth principle is that all joints should be permanently tight, and to secure this evident desideratum no material should be used in jointing which is injuriously affected by any of the substances brought in contact with them, or by changes in temperature, concussion or shrinkage.

(5) The Law of Soundness of Material. A fifth principle is that all material used be sound, and all pipes of even thickness and capable of resisting a suitable pressure test.

TEN COMMANDMENTS OF PLUMBING.

(6) The Law of Thorough Ventilation. A sixth principle is that all main lines of soil and drain pipes should be thoroughly ventilated from end to end.

(7) The Law of Adequate Flushing. A seventh principle is that all parts of the waste receptacles and pipes be thoroughly flushed with water from end to end in such a manner as to remove all foul matter instantly from the house as soon as it is generated.

(8) The Law of Automatic Operation. An eighth principle is that the working of all parts of the plumbing system should be as far as possible automatic.

(9) The Law of Noiseless Operation. A ninth principle is that the operation of all parts of the work should be noiseless.

(10) The Law of Economy and Prevention of Water Waste. Finally, all parts of the work should be economical in construction and designed in such a manner as to avoid the chances of waste of water and damage of property through leakage.

These ten broad principles must be accepted by all sanitarians. I designate them as the ten laws or commandments of plumbing. They are self-evident, and may be at once adopted as axioms without discussion. It is to be regretted that in the manner of applying them in practice, however, we do not find the same universal harmony.

535 Beacon St., Boston.

Jan. 1st, 1911

L'HYGIENE.



CHAPTER I.

SCIENCE AND ART IN PLUMBING.

"It is held as a fundamental principle in science that every opinion, before it is admitted as true and taught to others, shall first be established by proper proofs, which must not in any way run counter to established truths, such as, for instance, that twice two are four and not five. Inferences and conclusions which are opposed to such truths are rejected by science."—Liebig.

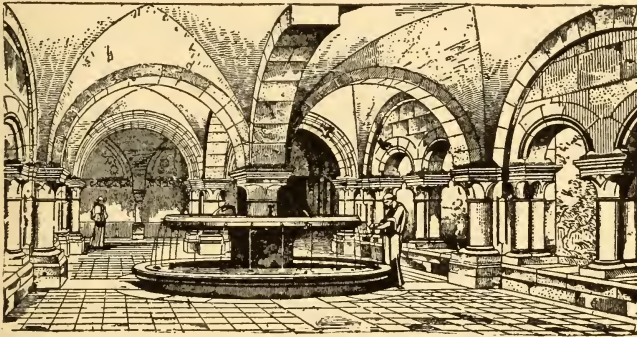

Fig. 4. Lavatory of the Monks in the Abbey of Fontenay, France.
From Viollet le Duc.



○ EXECUTE the plumbing of a modern building after the methods now prescribed by the laws of many cities in such a manner as to provide perfect security and convenience would involve so great an expense as to be beyond the means of the ordinary house owner. A very general impression prevails that complete safety in this domain is unattainable and that all the plumbing should be relegated to some detached building or at least to a room especially devoted to it and ventilated by a window

of ample size opening directly upon the outer air. This is, however, a popular fallacy. It is possible to enjoy the advantages of plumbing fixtures with safety and economy wherever convenience dictates, and to present the grounds for this assertion and show the manner in which the work may be done is one of the objects of these papers.

It is no very flattering commentary upon our methods of self government today that both legislation and common practice in one of the most important domains of household sanitation have, for a long time, been directly opposed to the actual demonstrations of science, and to the teachings of acknowledged authorities.

Yet such is the fact. The public has preferred to suffer very serious dangers and submit to a very burdensome form of taxation rather than, by independent experiment on suitable apparatus, to establish the truth for itself by proper proofs where conflicting opinions as to facts originally existed. It has assumed the right to legislate, but not always to investigate, and this even in a case where direct investigation was clearly essential to serviceable legislation.

Since, however, no attempt at exhaustive or satisfactory public investigation and experiment had been made, so far as I could ascertain, to establish a sound basis for plumbing legislation, and since the public records of private investigations were both incomplete and fundamentally conflicting, I decided, in 1883, to make an attempt myself to obtain sufficient data for independent judgment by careful original experiment.

These investigations were made originally in behalf of a medical client, who, like myself, considered sanitation a feature of primary importance in the construction of his house, and soon resulted in a conviction that the complications of the system of plumbing in vogue were worse than useless.

They led subsequently to a more elaborate series of experiments, with the aid of Major L. F. Rice, C. E., for the Boston City Board of Health in 1884 and still later in 1885 to others at the Massachusetts Institute of Technology, where the simpler system of plumbing, including the abandonment of back-venting and of unnecessary trapping was advocated before the Suffolk District Medical Society of Massachusetts, the Boston Society of Architects, and others; to a series in the city of Worcester and elsewhere; and to a critical study of the subject of household sanitation extending up to the present time.

They have, I think, established certain facts which had previously been in dispute, and suggested certain improvements in methods and in details which will be referred to in their proper place.

Suffice it to say, for the present, that in accordance with the precept of Liebig, quoted as our heading, nothing has been accepted, or will here be presented as a fact unless it has been established as such by positive demonstration; and with the aid of the excellent apparatus which Mr. Hubbard* has here erected for us, we shall be enabled to present to you some of these demonstrations in an attractive as well as instructive form. In order to make our meetings as satisfactory and fruitful as possible, it is hoped that every one present will make a note of any points which may not be perfectly clear to him, or of any deductions with which he may not be fully in accord, and mention them in the discussions following the lectures, so that the reasoning leading to these deductions may be re-examined or more clearly stated.

Just as a healthy mind and body are the first requisites for the enjoyment and usefulness of life, so the items of

*Mr. Samuel Hubbard, Director of the North End Union, under whose auspices these lectures were originally given.

house construction which affect its healthfulness should be the first concern of those in charge. They require and justify the attention and decorative treatment of the architect as much as do lighting, ventilating, warming, roofing, fire-proofing, painting, floor or wall construction; for architecture consists in nothing but the proper assemblage of all these parts, and style in architectural design is nothing but a graceful expression of the truth in treating them and in combining them into one harmonious whole.

It is sometimes objected that the architect cannot be expected to have the equipment of civil and sanitary engineer as well as that of architect; that to permit of this he must first be relieved of half his present cares and responsibilities. It is certainly true that he should be relieved of many burdens, legal and commercial, which have no bearing whatever upon the art and science of architecture. Cooperation and system will ultimately afford him this relief.* But architecture can no more stand as a living art without its engineering base controlling everywhere the outward form than can an animal stand without its muscles and skeleton. The arrangement of the plumbing pipes and fixtures influences the entire plan from foundation to roof. Some of the rooms are designed almost exclusively for the plumbing, and all are more or less dependent upon its arrangement. The walls and beams must be slotted and framed for its reception, and differently for each different kind of fixture or system of piping, as well as for the lighting and heating apparatus. Hence the architect may feel that upon him will ultimately lie the responsibility not only for the healthfulness, convenience, attractiveness and cost of the particular work over which he may have immediate

*A further consideration of this subject is given in my pamphlet entitled "The Outlook for the Artisan and His Art," published by C. H. Kerr & Co., Chicago, Ill.

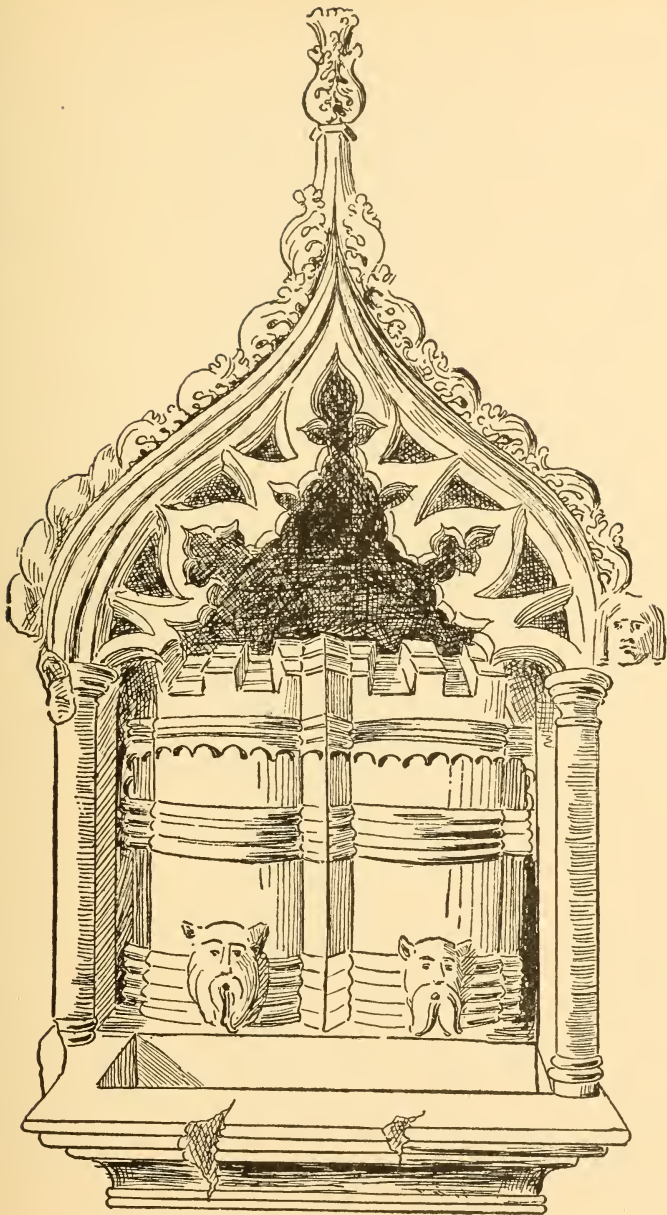

Fig. 5. A Fourteenth Century Cistern and Basin.

charge, but also, in a great measure, for the general status of plumbing art and legislation throughout the country.

A few illustrations from the architectural monuments of the past will show in what manner and with what loving care the architect of former days was permitted to dignify the simple plumbing work of his time.

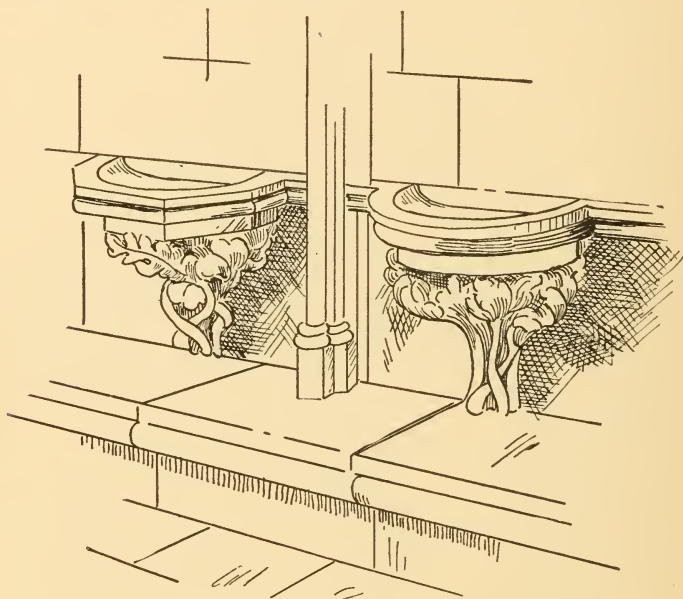

Fig. 6. Early Carved Basins.

Our initial cut, Fig. 4, shows a most interesting fountain lavatory in the Abbey of Fontenay, France, which was for the use of the monks, fifteen of whom at a time could wash their hands in the spacious basin. They were accustomed to come to their ablutions in a most orderly manner, marching in single file along the arcade, and entering the basin court through one arch, and after the ceremony, filing out again through another.

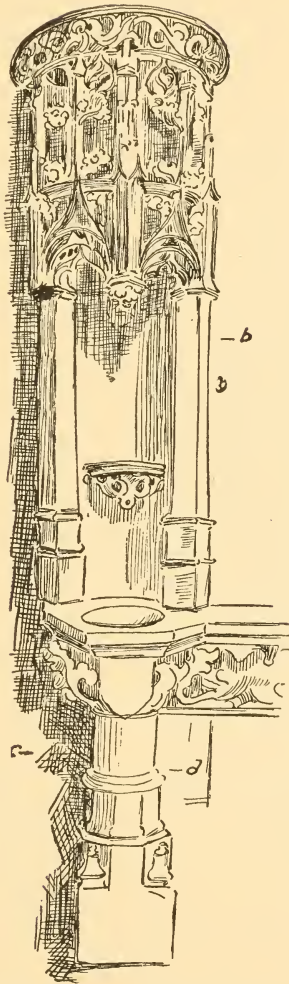

Fig. 7. Early Carved Basin.

Unfortunately these beautiful communal basins, so decorative from an architectural point of view, were every-

where destroyed in France by the monks themselves when they abandoned the custom of washing at the same time and together.

Here, Fig. 5, is a picture of a 14th century cistern and basin in Battle Hall, Sussex, England,* and Figs. 6 and 7 are other highly decorated basins in Gothic design of the

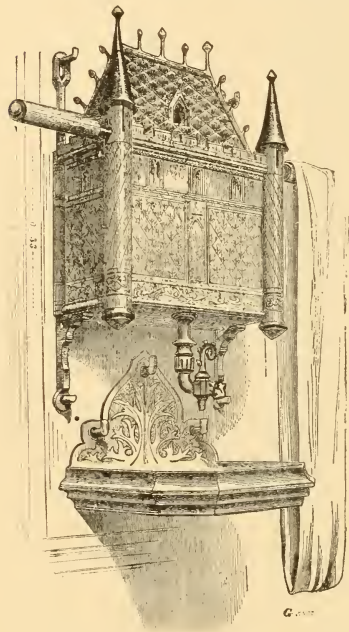

Fig. 8. Drinking Fountain and Lavatory.

13th and 15th centuries.†

Fig. 8 is a design of a fountain executed by Viollet le Duc in mediaeval style. It is constructed of copper engraved and stamped in high relief. The cistern is filled by lifting the roof. Below is a lavatory for the hands, and towel racks are built into the corner towers.

Figures 9, 10, 11, 12 and 14 show the artistic manner in which the mediaeval architects designed their exterior lead and stone water leaders, and how skilfully the plumbers, who were then, as the name implies, workers in lead in all its forms, executed these designs. Figures 9 to 14 show water spouts, gutter connections, and roofing details. The last two show how the edges of the sheets of lead were bent up and

*From "Domestic Architecture of the Middle Ages," published by J. H. Parker, London, Vol. 2, p. 46.

†From Viollet le Duc, Dictionnaire de l'Architecture, Vol. VII, pp. 196-197. Figs. 9 to 19 are all from Viollet le Duc.

covered so as to make expansion joints without the use of solder. The section D shows the manner in which the sheets were rolled together.

Figure 15 shows us the great beauty of plumbers' lead scroll work in the grand epoch of mediaeval art.

Figs. 16 and 17 are two French mediaeval baptismal fountains.

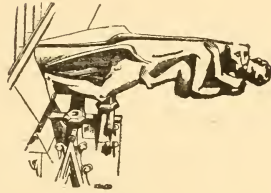

Fig. 9.

Figure 18 shows one of the richly carved and beautiful lavatories which adorned some of the monasteries and palaces in the middle ages. They were often placed in the

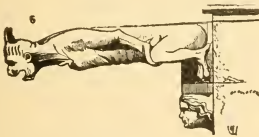

Fig. 10.

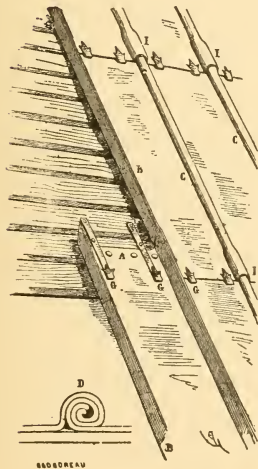

Fig. 12.

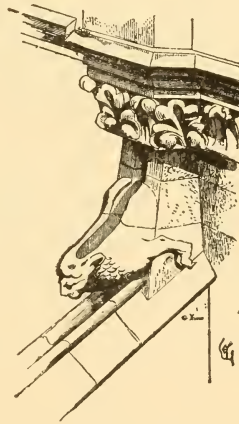
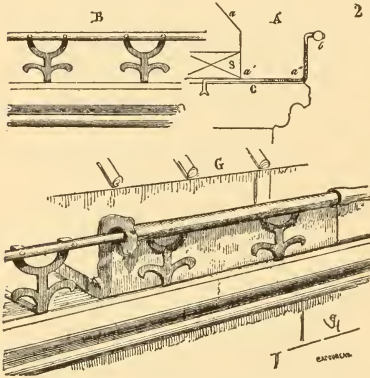

Fig. 11.

grand hall itself, and consisted of great basins of marble, copper or lead, intended for the daily use of the host and

PLUMBING AND HOUSEHOLD SANITATION.

for his guests before a repast. They were provided with quite a number of little gargoyles or jets to throw the water upon the hands of the users. All these ornamental lava-



Figs. 13 and 14.

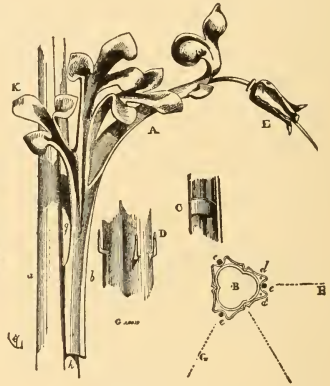

Fig. 15.

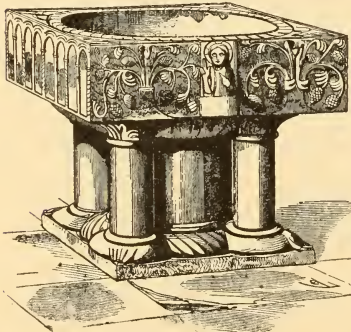

Fig. 16. Baptismal Font in the Church of Saint Peter at Montdidier, France. 12th Century.

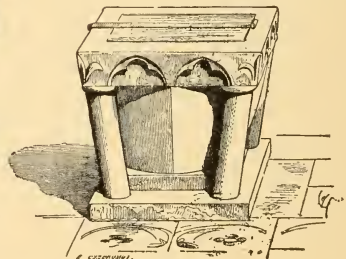

Fig. 17. French Baptismal Font of the 13th Century.

tories have disappeared from the monasteries since the revolution of 1793. They usually had the form of a large tank, long and deep, with an open trough or sink in front to receive the water. This lavatory adorned the abbey of

Saint Armand of Rouen and contained the coats of arms of the various abbesses. It was cast in bronze in the 13th or 14th century and was made in three compartments, each devoted to a particular order in the convent.

Figure 19 shows one end of this lavatory in detail.

Figs. 20 and 21 are compositions by Bouchet** and represent public baths in Pompeian style, the pictures being,

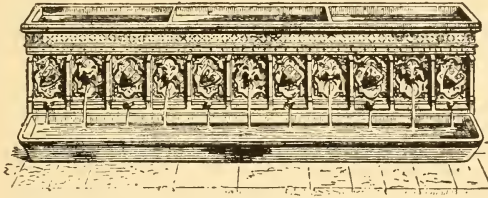

Fig. 18. Lavatory in the Abbey of Saint Amand at Rouen.*

however, rather designed in the spirit of Pompeian architecture than taken from actual restorations. You see how the architects, hydraulic engineers and plumbers have co-operated to produce resorts so charming as to constantly tempt the citizens to habits of cleanliness.

Fig. 22 is a Nymphée or beautiful bathing "Grotto" of a wealthy Roman patrician. This involved a somewhat more complicated system of hot and cold water supply. Self-closing faucets had not been specified, and so the five fixtures on the right and left of the tub had to be left running "full bore" at all hours of the day and night. Fig. 23 is an illustration of the splendid art of India applied to water works. It represents the waste weir outlet of Kangra tank, Ahmedabad, India.

Finally, our frontispiece shows the magnificent Baths of

*From "Dictionnaire du Mobilier Francais, Vol. I. By Viollet le Duc. Published by A. Morel, Paris.

**From "Compositions Antiques," by Jules Bouchet, Paris.

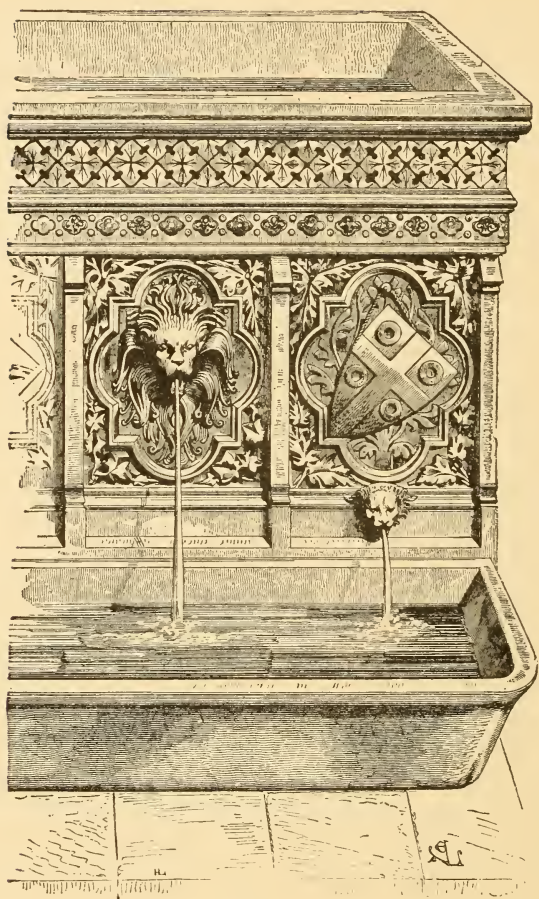

Fig. 19.

Diocletian, the beautiful drawing being the production of Edmond Paulin, winner of the Grand Prize of Rome, of the French School of Fine Arts.

Figs. 1 to 19 are from Viollet le Duc's "Dictionnaire de l'Architecture."

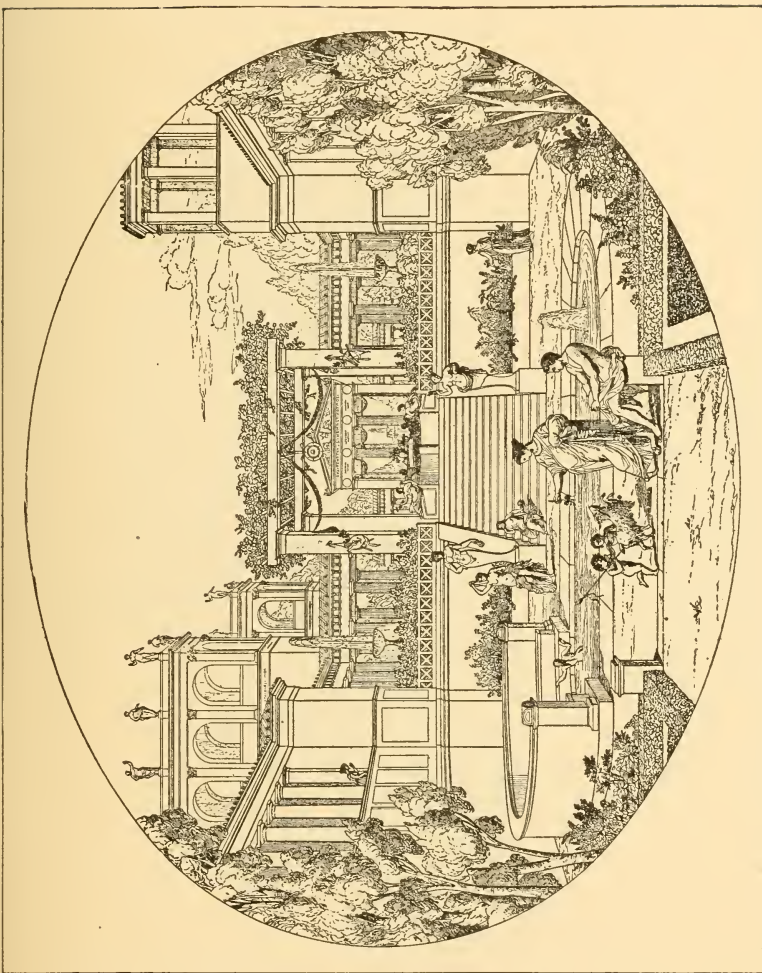

Fig. 20. Public Bath in Pompeian Style. From Bouchet.

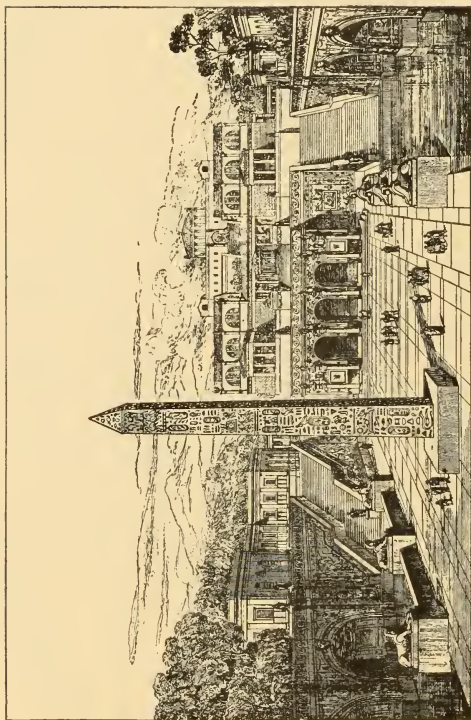

Fig. 21. Public Bath in Pompeian Style. From Bouchet.

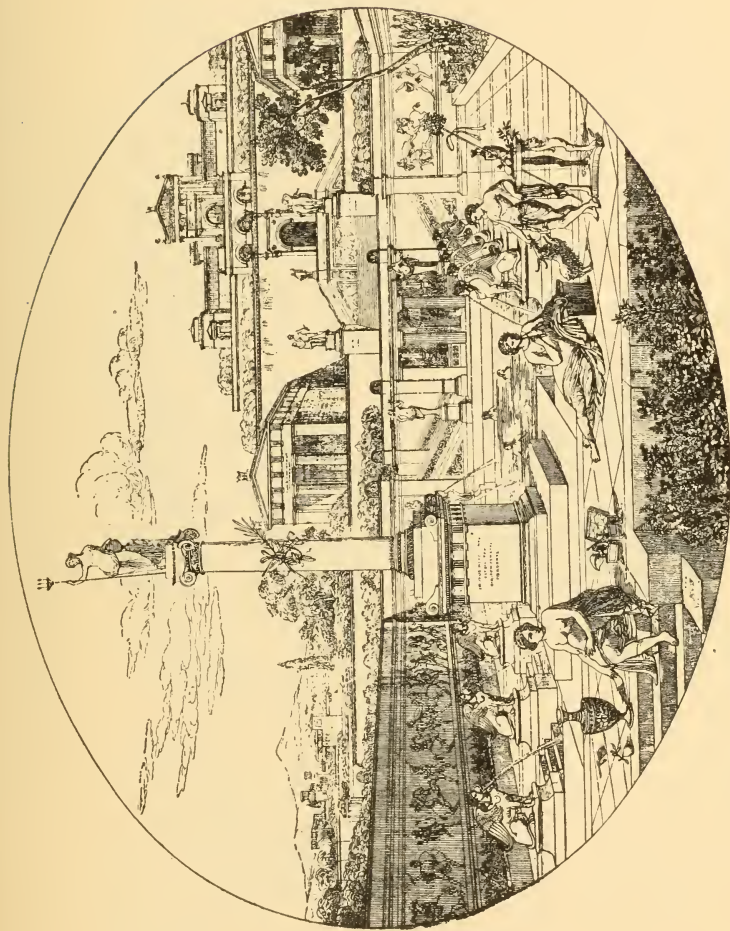

Fig. 22. Roman Bathing Grotto, or "Nymphaeae." From Bouchet.

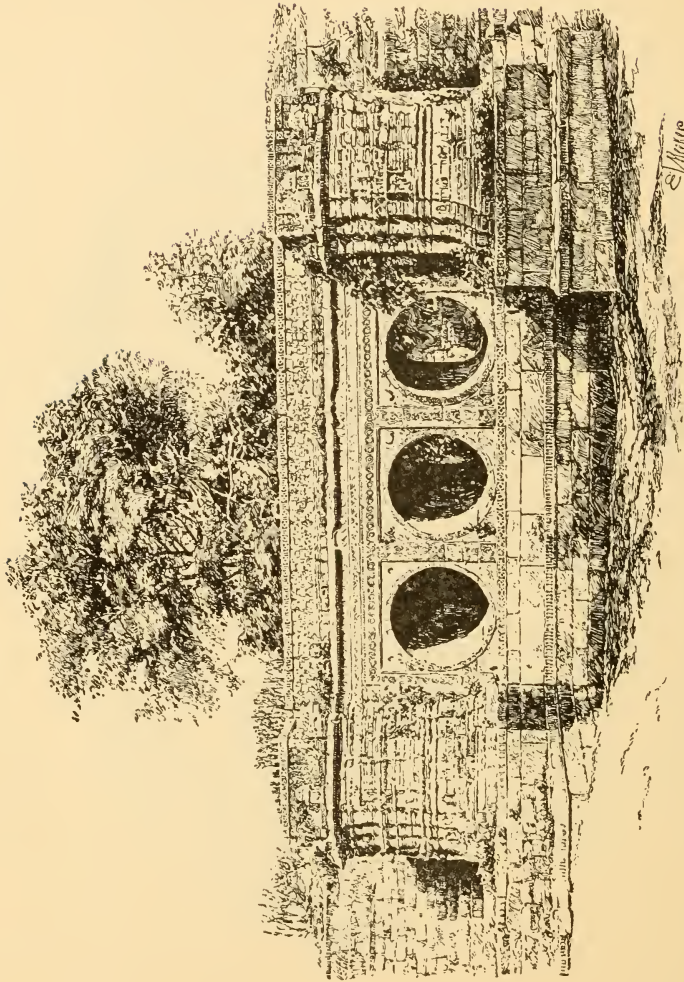
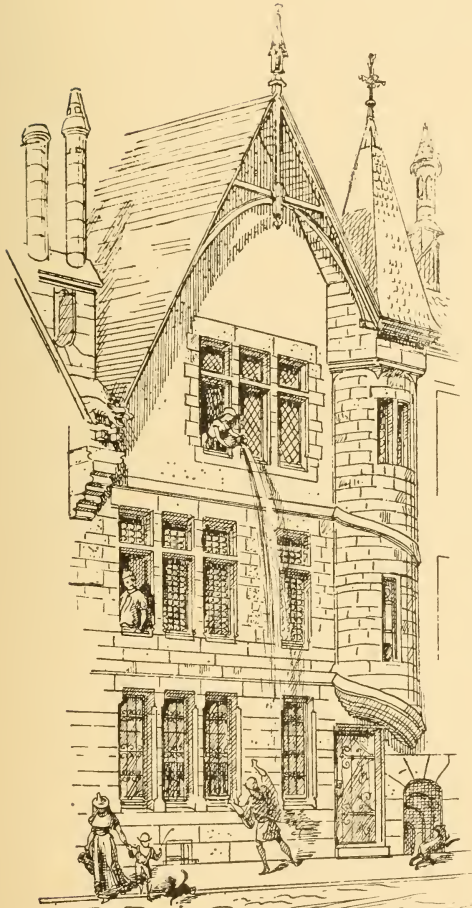

Fig. 23. Waste Weir Outlet of Kangra Tank, Ahmedabad, India.
From The Sanitary Engineer and Construction Record.
This view is one of the most beautiful examples of hydraulic construction in the world.

CHAPTER II.

INFLUENCE ON THE COMMUNITY OF SANITARY ENGINEERING.

A mastery of the principles of household sanitation is essential not only for the welfare of the individual owner and occupants, but also to a greater or less extent for that of all neighboring property owners. Disease originating in one locality may "dispatch invisible messengers of death to poison the air" miles away, and both science and philanthropy now unite in teaching us that every man is in large measure responsible for the well being of his fellow men, and nowhere more clearly than



*Disposal of Household Wastes
in the XIVth Century.*

Fig. 24.

in the domain of household sanitation is it shown that man is in reality his brother's keeper. Nowhere is the doctrine that society is an organism in which the individual members correspond to the separate cells of the animal organism in being mutually dependent for their complete health and development more clearly illustrated than here. Nowhere is it made more evident that sanitation should become the subject of wise legislation to the end that the health of the community may not be prejudiced either by ignorance or poverty.

In the middle ages cities even as magnificent as Paris and London were very dirty places, the streets being described as more foul than the most abominable sewers, the horse manure standing in them, according to one writer, sometimes as much as "a yard deep." It is recorded by the royal physician Rigord that one day while King Philip Augustus was looking for recreation from his audience chamber window, he saw some citizens' carriages passing below "when the substance forming the street, being stirred up by the revolution of the wheels, emitted a stench so powerful as to overpower Philip. This so disgusted the king that he urged the citizens to pave the streets; and to assist in effecting the purification of the city, he built a wall around the cathedral to prevent it from remaining longer a common corner of convenience."

Fig. 24 shows the common manner in which house refuse was disposed of in these beautiful cities. The people seemed ignorant in those days of the first principles of household sanitation and hygiene and the result of their ignorance was the spread of the cruel plagues and pestilences everywhere in the populous districts, mowing down both rich and poor alike in their relentless path.

The floors of their dwellings in those ungodly times were not drained, but as refuse collected upon them, straw was

spread over the matter to cover it, and this was so rarely removed "that the lower part remained sometimes for twenty years together!" Mr. Bayles* quotes the old chroniclers as saying of the ladies of that day, that "they wore clean garments on the outside, but the dirty ones were often worn underneath until they fell away piecemeal from their unwashed bodies." "The people prayed," says Bayles, "for deliverance from sickness and death, but forgot their garbage heaps, their foul streets, dirty houses and personal uncleanness."

Much as we are shocked at hearing these stories of the old chroniclers, we have, after all, much less reason to congratulate ourselves on our progress since those dark ages than is generally supposed because we have been criminally slow in applying for the general good knowledge which we have since acquired. Mediaeval conditions still exist in the tenements of the poor, a rebuke and a menace to modern society, because we have not yet learned that the real and only perfect welfare of each lies in the perfect welfare of all. Our ground for congratulation is proportional only to our progress in the acceptance of this truth. To this is due our sanitary legislation and the aid society gives in the execution of these laws to those too poor to make application of them themselves. Mr. Simon of the English Local Government Board, writes: "It seems certain that the deaths which occur in this country are fully a third more numerous than they would be if our existing knowledge of the chief causes of disease were reasonably well applied throughout the country; that of deaths which in this sense may be called preventable, the average yearly number in England and Wales is about 120,000; and that of the 120,000 cases of preventable suffering which thus in every year attain their final place in the death register, each unit

*"House Drainage and Water Service," by James C. Bayles.

represents a larger or smaller group of other cases in which preventable disease not ending in death, though often far-reaching ill effects on life has been suffered.† Then there is the fact that this terrible continuing tax on human life and welfare falls with immense overproportion upon the most helpless classes of the community: upon the poor, the ignorant, the subordinate, the immature; upon classes which, in great part through want of knowledge, and in great part because of their dependent position, cannot effectually remonstrate for themselves against the miseries thus brought upon them, and have in this circumstance the strongest of all claims on a legislature which can justly measure, and can abate their sufferings.”

The next picture, Fig. 25, shows a tenement house of New York described by Leeds* in the “Technologist” for February, 1870. It illustrates a dwelling quite as wretched and unsanitary as anything to be found in the dark ages, and infinitely more disgraceful as existing under the full light of modern science. It recalls to us the lines of Burns, quoted by Baldwin Latham in this connection:

“Man’s inhumanity to man
Makes countless thousands mourn.”

But Mr. Latham in his inaugural address as President of the Society of Engineers of London, shows that in addition to the injustice and cruelty of permitting these unsanitary conditions to exist, there is also great economic folly in it. He took for illustration the town of Croydon showing an expenditure in sewerage and general sanitary improvements of \$975,000. He then showed figures which made a saving of over \$1,200,000 in the short space of thirteen years in the increased effectiveness of labor due to these sanitary meas-

†Dr. Lyon Playfair calculates that for every unnecessary death we have twenty-eight cases of sickness.

*A Treatise on Ventilation, by Lewis W. Leeds. Wiley & Sons, New York. P. 166.

ures, and concludes in these words: "Although it has here been attempted to put a money value on life we individually feel that life is priceless, and that we may look to the 2,439 persons saved from the jaws of death in this single town (of Croydon), as the living testimony of the great value of sanitary work. To allow to perish by sanitary neglect is

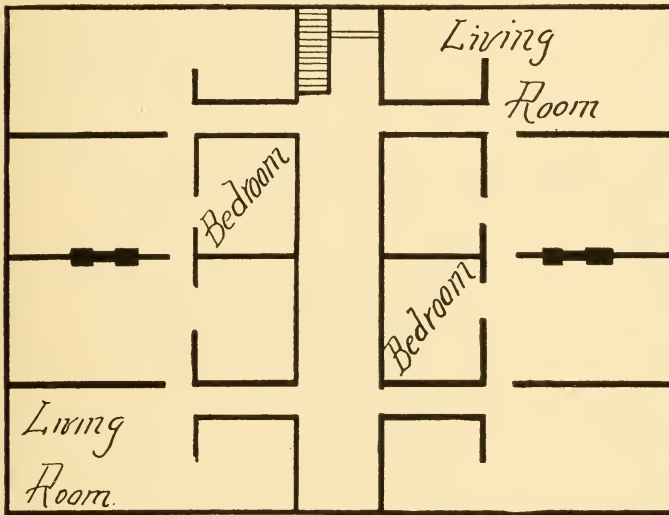

Fig. 26. Plan of New York Tenement House.

just the same as to take so many persons out of their homes, and forcibly put them to death; and yet if this were done the whole nation would revolt at the crime. Yet in how many instances do our local authorities calmly look on while poor and innocent victims are condemned to breathe poisoned atmosphere, or drink poisoned water which is a great crime in the eyes of humanity."

Some of the worst of these dens are being removed to give place to better. But the question is, how the former

PLUMBING AND HOUSEHOLD SANITATION.

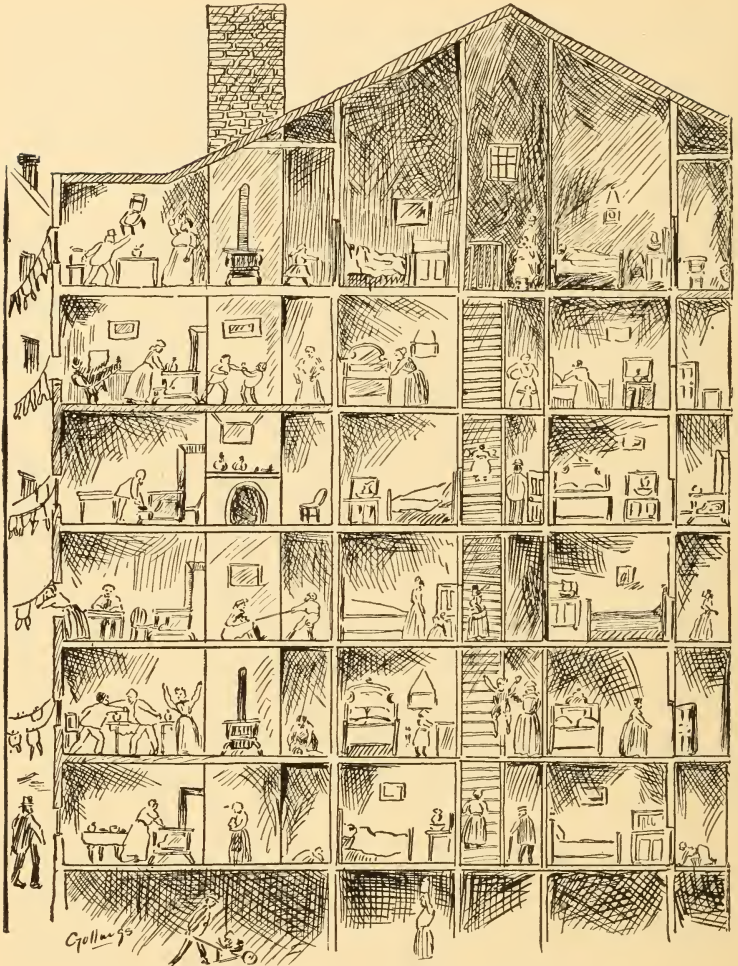

Fig. 25. Section of a New York Tenement House.

inmates will be able to pay the higher rents the improved quarters command until the public recognizes its full duty and true self-interest in the matter.

CHAPTER III.

BACTERIA.

Before we can properly judge of the relative merits of different systems of sewerage and plumbing, or of different



Fig. 27. Mediæval Metal Worker and Plumber.
From Viollet le Duc.

kinds of appliances used in them, or of the effect of sewage decomposition upon our health, we must study the nature of the substances with which we have to deal. The discoveries of the last few years have radically altered our methods of treatment of sewage, both within and

without the building. We have through these discoveries, learned why it is that sewage must be quickly removed from our neighborhood instead of being allowed to remain in cesspools long enough to undergo putrefactive decomposition, and why and how oxidation should be accomplished, and it is chiefly through the revelations of the microscope in the mighty world of microorganisms that this all important knowledge has been given to us.

The science of bacteriology has become to the sanitary engineer, in a certain sense, the most interesting and important of all sciences, though dealing with the most infinitesimal of all known living organisms. Without its aid he has been groping about in darkness. With it he proceeds

boldly forward on firm ground to the goal of perfect sanitation.

Let us, therefore, go with the biologist into his laboratory for a while and view with him the marvels of the microscopic world, the little beings upon whose activity all life on our planet depends, the agency through which new life returns from death; the silent, untiring builder, infinitesimal and impotent as a single individual, but gigantic and irresistible as a collective force.

The word "bacterum" or "microbe" means to most people, even today, something terrible and destructive, because only within the last few years have we learned the vastly greater importance of these organisms for good than for evil, and see in them our indispensable friends. There are black sheep among them, but they are as few, comparatively, as the criminals in human society who constitute the "rogues' gallery." There is no family of visible plants which begins to compare with these microscopic ones in importance.

Although there are now known to be several hundreds or perhaps even thousands, of different species of bacteria, they have only a few general forms which correspond respectively to spheres, rods, and spirals. Our Fig. 28* illustrates all of these forms. At the top we see in Figs. 1 to 5 of the plate, the spherical bacteria, called micrococci. Although they all look alike, they are nevertheless all of entirely different species, those in Fig. 2 being disease germs, and the remainder being germs of fermentation. Fig. 6 is a yeast bacterium which forms the beautiful rose-colored patches on cooked potatoes. Next below come the rod formed bacteria, Figs. 8 to 16, some of which are in process of division into shorter pieces, the usual method of multiplication of bacteria. Those in Fig. 10 come from the

*From "The Bacteria," by Dr. Antoine Magnin, translated by Dr. G. M. Sternberg.

BACTERIA.

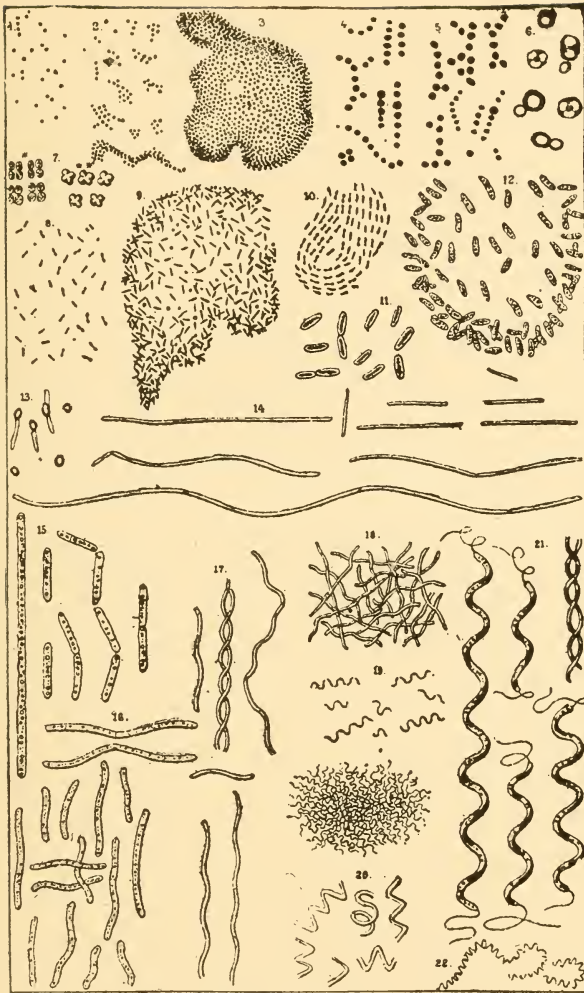

Fig. 28. Bacteria.

surface of sour beer. The remaining figures show the spiral bacteria. Fig. 17 is named in this plate as the "vibrio ser-

pens," and Fig. 21 the "spirillum volutans." Fig. 19 the "spirillum tenui," single and felted into "swarms."

All these organisms are far too minute to be visible to the naked eye. The spheres vary from one to six one-hundred-thousandths of an inch in diameter, and the rods and spirals have a thickness about the same as the diameter of the spheres, and a length varying all the way from a little more than their thickness up to long threads of a thousandth of an inch or more.

Frankland,† speaking of the size of bacteria, says we could have a population of them one hundred times as great as that of London settled on a single square inch, without any complaint of overcrowding, but giving each individual organism one four-hundred-millionth of a square inch of space, which is quite adequate for a citizen in the commonwealth of these Liliputians.

It is in their enormous and almost incredible power and rapidity of multiplication that their importance lies, some species having been observed under the microscope to divide every half hour or less. They infest all our surroundings, entering our nostrils with every breath we take, swimming in every draught of water, and are in full possession of every inch of ground we stand upon.

They do not, however, descend to very great depths in the soil, few existing, according to Prof. Conn,‡ below four feet. At the surface they are very abundant, and if the ground is moist and full of organic material the number may range here from a few hundred to several millions per grain. In the ocean they are found at all depths within a hundred miles from the shore, as well as in the sediment at its bed. At the rate of reproduction observed, each bacterium would have over sixteen million descendants in a

†"Our Secret Friends and Foes," by P. F. Frankland.

‡H. W. Conn, "The Story of Germ Life." D. Appleton & Co., N. Y.

day, and over 281 billion in two days, aggregating in weight about a pound. At the end of the third day, if the process were uninterrupted, the descendants would weigh about 16 million pounds, and in five days they could, if properly nourished, fill the entire Atlantic ocean solid full. Fortunately, however, Nature supplies the bacteria with a number of enemies most wonderfully adjusted to keep them within proper bounds.

Now this marvelous power of growth is chiefly due to a fact which gives the bacteria their extreme importance in Nature, especially to the sanitary engineer. Other plants require simple substances like carbon dioxid (CO_2) and water for their nourishment, but the bacteria are able to feed upon the complex organic material of animal and plant structure. They tear this structure after death to pieces, chemically speaking, and prepare it for new forms of life. The discovery of the conditions under which this is done is revolutionizing the science of sewage disposal.*

Some species of bacteria have, in addition to the power of reproduction by simple fissure, a second method by means of spores which develop within them, and the manner in which the spores grow serves as one of the points by which the different species of bacteria are distinguished from one another. The spore serves the purpose of keeping the species alive under conditions of adversity, through its wonderful power of resisting extreme heat (in some cases for a short time, even above that of boiling water), severe cold, desiccation, and all sorts of rough usage, which would speedily destroy the parent germ. Indeed they are, says Frankland, "the hardiest forms of living matter which science has yet revealed."

*See Frankland and Conn, from whom the facts in some of these passages relative to bacteria have been taken, and even in part, in a few cases, the wording itself, to some extent interspersed with my own.

PLUMBING AND HOUSEHOLD SANITATION.

Some, but by no means all, species of bacteria have the power of active movement, the study of which forms one of the most fascinating microscopic spectacles which exist. "The varied motion," says Frankland, "of the countless swarms of individuals following their sinuous paths across the field of the microscope, in all directions, and in the three dimensions of space, much after the fashion of a cloud of midges playing in the sunshine, produces an irresistible impression upon the observer, that each individual microbe is assisting in and conscientiously performing its part in a highly complex and thoroughly organized Scotch reel, conducted at express speed." This motion is supposed to be produced by flagella, which lash the liquid with great activity and give the plants so strongly the effect of animals that it is almost impossible to believe what the authorities tell us of their being among the lowest forms of simple vegetable life similar to the oscillaria or green thread-like plants known to the botanists.

Before studying the action of bacteria in their role as sanitarians and fertilizers of the soil, it is important to say a word as to their use in the arts. Many important industries are now known to be absolutely dependent upon them as agents of fermentation and decomposition. Sometimes they split up the molecules of the substances upon which they act into simpler molecules and sometimes they build them up into more complex ones, in all cases changing their chemical natures, and thereby forming numerous useful products which could not exist without them. The world is only beginning to realize their tremendous usefulness in these ways.

There are, in the first place, many industries which may be classified as maceration industries, or based on the decomposition powers of bacteria. Hardly any organic substance is able to resist their softening influence, and man

BACTERIA.

has taken advantage of this power in many arts. Thus linen, jute, hemp, and other vegetable fibrous growths require fermentation to free the valuable fibers from the woody parts with which they are associated in nature. Aided by moisture and the proper temperature the bacteria soften the fibers and thereby permit of the separation of the useful from the useless parts. This so-called "retting" process is not allowed to continue long enough for the bacteria to injure materially the valuable fibers, but only long enough to facilitate their dissolution from the rest.

The preparation of sponges for use is also accomplished by bacteria. They decompose the soft tissues constituting the body of this marine animal so that it can be removed by washing from the skeleton, which forms the sponge of commerce. Leather is prepared for the tannery by bacteria. The hide with the hair on it is steeped in warm water until partial decomposition enables the hair to be easily removed with a knife. The manufacture of citric, lactic, butyric acid, vinegars, indigo, tobacco, opium and many other substances is accomplished by the aid of bacteria in producing fermentation. In all of these processes a different species of bacterium does the work, the proper kind appearing, by some wonderful provision of nature, immediately when the proper conditions are provided for it. They seem to be ever on the alert to serve us, and hasten to the spot where needed and there multiply with marvelous rapidity until the number of workers required to accomplish the desired result in the best manner and shortest time possible has appeared.

Butter and cheese making can only be accomplished by the aid of bacteria of various kinds, and it is probable that any desired flavor will be produced by the scientific dairy-

man of the future by cultivating and introducing the special kinds of bacteria which experience teaches will yield the desired result.

We come now to the species of bacteria most interesting to the sanitary engineer, to those which provide plants and animals with food during life and take care of them after death. Upon these all life on the globe is dependent and would cease if their labors were suspended for any considerable length of time.

Plants and animals both require food, but while animals can live upon plants, plants are unable to obtain their entire nourishment directly from animals or other plants. Their elements must first be taken apart in order to provide food simple enough for continuing their life, and these simple products must be restored to the earth, which would otherwise soon be exhausted of its plant food instead of remaining year after year for untold ages as fertilizers. All this is done by bacteria. Moisture alone is not able to disintegrate the hard trunks of trees and the bodies of animals when they die. It could not soften their tissues and convert them to gases and elements suitable for plant food. Were it not for bacteria, which alone possess this power, the earth would soon be completely covered with dead bodies, leaving no possible room for further growth of plants and animals. This bacterial action is what is known as decay, and it is called "decomposition" when it takes place in the presence of oxygen, and "putrefaction" when oxygen is debarred. Sanitary engineers have just begun to learn the vast difference between these two forms of decay and to put their knowledge to practical use in their systems of sewerage and plumbing. They have learned that entirely different species of bacteria are employed in these two processes, and that upon their success in cultivating the one or the other depends the value of their efforts.

Fig. 29 shows the cycle of life and the part played therein by the different kinds of bacteria.

At the bottom of the circle is mother earth. It contains some of the principal ingredients which form the food of plants, and above all compounds of nitrogen called nitrates. Carbon dioxide and water are also required by plants and these are obtained partly from air. Other compounds in the soil which plants use are salts of potassium, phosphorus and some other elements, but these are here omitted for simplicity as of less importance in this connection.

The roots of the plants shown on the earth at the left take up the nitrates from the soil, and their leaves absorb the gases from the air, and with the energy furnished by the sun's rays build these simple compounds into more complex ones shown in the circle above the plants as the second step. They are sugar, starches and fats, forming the complex food required by the animal kingdom, indicated by the figures of a man and a horse at the top of the cycle. Some parts of these foods are at once decomposed by the animals and given back to the air from their lungs and pores in the form of carbonic acid and water, and we have shown these in our picture by dotted lines returning at once again to the plants at the bottom. But this quick return does not occur with the nitrogenous foods. These require further treatment and must continue around the circle of changes, forever repeated in nature's great laboratory. Animals build these nitrogenous foods into new albumens, reducing part directly into urea, which is excreted. But a plant can neither feed directly either upon the nitrogen compounds stored in the bodies of the animals nor upon those which are thrown off by them during life. It cannot feed upon the flesh, fat, bones nor excreta which

*I am indebted to Prof. Conn for the idea of representing Nature's food cycle graphically, but the special design is my own.

constitute the products of animal life as shown in our picture at the right of the animals. They must be reduced to simpler forms, and the third step in the food cycle is taken by the decomposition bacteria. The animals have died, as we see, and the bacteria are already engaged in their work as scavengers. Our drawing shows, at each step, the particular form of bacterium actually found at work at that stage, and copied from life, as revealed by the microscope, and in the four outer corners we have reproduced photographs of the four principal types of bacteria most interesting to us in this connection as sanitary engineers. You see, therefore, thrown upon the screen, individual members of this valuable community as they actually appeared while engaged in their great work of food preparation and sanitation. Only they are here magnified by the electric rays to several hundred thousand times their real dimensions. They are our great little co-workers, the faithful engineer's assistants, the patient, industrious, eager, non-complaining plumber's helpers. We may take a lesson from these helpers in their unceasing, ever-cheerful toil.

"Ever at toil," they bring "to loveliness
All ancient wrath and wreck."

These organisms exist in the air, soil and water, always on the alert for any organic substance requiring their presence, and no sooner is it provided, instantly, as if by magic they appear and begin to break it up for plant food! A portion of these cleavage products takes the form of carbonic acid gas and water, which are dissipated in the air and return at once, as shown by the dotted lines, to the plant. But the other portion, containing nitrogen, is broken up into ammonia, NH_3 , or into compounds called nitrites. But these are too simple for plant food. The chemical destruction by this particular detachment of helpers has

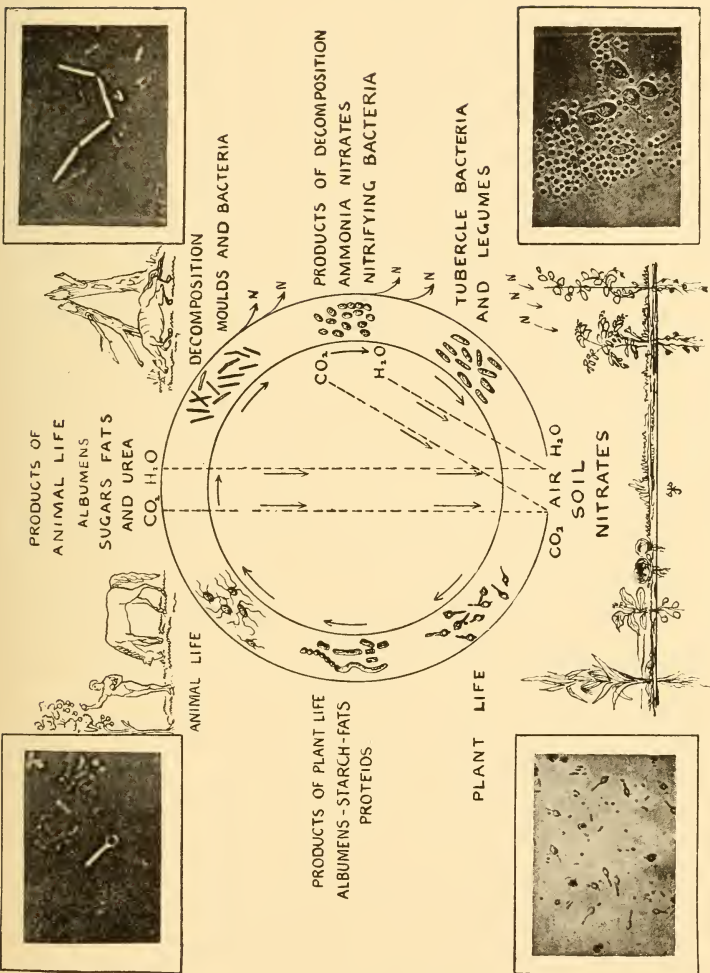

Fig. 29. The Cycle of Life.

too thorough, and another gang of workmen must be employed to complete the process begun by the first before the food is quite ready for the plants.

We come now to the species of microorganisms which, for us sanitarians, is perhaps the most interesting and important of all—the bacteria of nitrification. They exist everywhere, especially in fertile soil, and they are so very valuable and commendable that I have induced a few of them to sit for their photographs for this occasion. They appear at the right of the circle and are nearly spherical in shape. These bacteria, by further oxidizing the nitrites and ammonia, prepare the food finally for the plants, and form the last link in the chain that binds the animal to the vegetable kingdom, for the nitrates and nitric acid which they form are left in the soil where they can be seized upon by the roots of the plants and then begin again their journey around the food cycle.

Thus the nitrifying bacteria perform the great final function of waste disposal and sewage purification by both removing the matters in decomposition without offense or danger and providing the means for new life at the same time. They differ therefore entirely from the bacteria of putrefaction, which create products not only dangerous and offensive but incapable of supporting new life.

In our food cycle some of the processes of decomposition throw off a portion of the nitrogenous matter into the air in the form of free nitrogen, and this is out of the reach of plants, because plants do not possess the power alone of extracting free nitrogen from the air. Hence unless the plants can obtain some external aid in reaching this nitrogen it will be gradually exhausted by dissipation in the atmosphere, and life upon the earth become gradually extinct. But here again we have found, within the last few years, that we can again count upon our busy friends, the bacteria, only in this

case there are two distinct species operating in concert in our service. They act in at least two different ways in reclaiming from the atmosphere more or less of this dissipated nitrogen; first by coöperating with each other, one kind turning the ammonia into nitrous acid, and the other kind the nitrous acid produced by the first into nitric acid, and second, by coöperating with some of the higher plants belonging to the great family of legumes, including the pea, bean and clover plants. The bacteria which thus combine with these legumes in collecting the nitrogen are shown in the lower right hand corner of our circle, and the legumes themselves are seen growing in the earth below them. The bacteria form in colonies or nodules on the roots of the legumes as shown, and here in this humble position, perform unseen the marvelous and all-important function we have described.

The explosion of gunpowder, nitroglycerine, dynamite and other compounds of saltpetre also dissipates free nitrogen in the air, though saltpetre itself is a good food for plants.

So while hostile armies of human beings meet on the field of battle and waste nitrogen by blowing one another to pieces with gunpowder in the service of Mammon, the more humane and thrifty armies of bacteria run to the field to take care of the dead and gather up again the valuable nitrogen squandered by men, and the poor farmers spend their meager earnings buying nitrogenous fertilizers to take its place.

Thus our food cycle is complete. Beginning with the nitrates in the soil, the food matter circulates from soil to plant, from plant to animal, from animal to bacterium, and from bacterium through other bacteria back to the soil, and so on again in a never ceasing circulation.

Disease germs play a comparatively unimportant part

among the bacteria, and might be stamped out altogether were men only half as alive to their own best interests as are the bacteria themselves. Nevertheless I have shown them in the cycle in the upper left hand corner as one of the agents of the death of animals. The germs in the circle showing flagella are the bacilli of typhoid fever. Those in the photograph at this corner were found in the blood of a yellow-fever patient. Disease germs secrete, during their growth, poisons which have been separated and studied, some of them being the most virulent of which we have any knowledge. These poisons produce the violent symptoms of the disease.

The bacteria shown in the circle under the typhoid bacilli are the kind which produce pleasant flavors in butter and are used commercially for the ripening of cream, but they closely resemble many species active with the products of plant life. The other three corner photographs were chosen simply because they represent germs having forms similar to those in our circle, the two lower coming from potatoes in different stages of decomposition.

Even in the first formation of the soil we are dependent upon bacteria. Soil is partly produced by the weathering or crumbling of rocks into powder, which is partly a physical action, but which appears also to be partly due to acid secretions of bacteria which soften the rocks so that the physical agencies work upon them more rapidly. The soil also contains certain sulphates, phosphates and silicates which are deposited by the aid of bacterial action. But the more important element of soil fertility lies in its nitrogen compounds which are supplied partly as already explained by bacteria acting together or with legumes, and partly by the action of bacteria on fertilizers applied to the soil. The manure is not suitable as plant food until its highly complex compounds of nitrogen are reduced by bacteria to its

simpler forms. This is done with the aid of oxygen. Science is teaching us how to avoid waste of sewage material as fertilizers, by aiding the bacteria through special chemicals in their work of restoring nitrates and salts of ammonia to the soil. These chemicals reduce to useful salts the free ammonia, nitrogen and nitrites the bacteria produce and thus aid in preventing their dissipation in the air. Hence it is that the problem of the sanitary engineer, so far as it concerns the fertilization of the soil, appears to resolve itself into a proper handling of bacteria.

In the early periods of the world's history and in thinly populated districts, waste matters could be simply spread over the ground with comparatively little danger to the health. Air and bacteria had plenty of room in which to do their work unaided by art. Where it was spread about favorite trees or over the lawn intermittently and in modest quantity the result was entirely satisfactory, so much so indeed, that this method is the one modified only by being carried out on a larger scale, which modern science is leading us back to, as the best for entire cities. But as people began to crowd together in towns and cities, and land surface became more and more limited, refuse began to be buried underground in cesspools, and the dangers coming from putrefaction developed and increased with the growth of the communities until the need of scientific treatment was realized and the sanitary engineer and plumber were born. Unfortunately the leaching cesspool with all its noisome horrors is still the favorite monstrosity of many towns and villages, their most approved location being within friendly reach of the family well. The ground between becoming more and more charged with filth until the "old oaken bucket" draws disease and the doctor as well as sparkling water into the house. Col. Waring gives these two rules as the cardinal principles of modern sewerage. "Organic wastes must be

discharged at the sewer outlet in their fresh condition—before putrefaction has set in;” and (2) “They must be reduced to a state of complete oxidation without the intervention of dangerous or offensive decomposition.”

Sewage consists of all the water-borne refuse of a community, its most important elements from the sanitarian’s standpoint consisting of the wastes of the kitchen and pantry sinks and water closets. These matters once in the sewers become after a very short time substantially the same in appearance, odor and composition, and must receive substantially the same care, precautions and treatment. Both consist mainly of organic food matter, only in one case it has been eaten and digested and in the other case it has not. It averages in proper sewerage systems about one part in a thousand of water, and the object of sewage purification is to detach and render harmless that one part of organic material as economically as possible and leave the effluent water pure. The contents of water closets, may, it is true, have the distinction of containing at times certain specific disease germs, but these germs can only live for a time and may be found in any household waste water. The Liernur system of sewerage is based on separating water closet from other wastes by means of a separate pipe system, but nothing is gained by attempting this. Infected refuse should, if possible, be burned or all pathogenic germs in it destroyed by disinfection in the sick room, where they are produced, before being discharged into other sewage. But the main thing which the science of biology has taught us as sanitary engineers, is that the bacteria of putrefaction are to be everywhere avoided as producing offensive products injurious to the health both of man and animals on land and of fish in the sea, and that the bacteria of quick decomposition and nitrification are to be cultivated as reducing sewage to useful materials absolutely without danger or offense of

any kind. It is found that the latter bacteria and the environment of fresh air, in which they flourish, are the enemies of those of putrefaction and disease and that they will destroy them when arrayed against them in sufficient force.

A consideration of the different methods of sewage disposal which are the result of modern sanitary science will form the subject of another lecture, our purpose for the present merely being to show why it is essential to avoid everywhere seats of putrefaction, cesspools and fermenting chambers of every description large or small and hurry the sewage away as rapidly as possible in order that it may be delivered in a fresh state to places where the friendly bacteria may dispose of it to the best advantage.

It may seem, at first thought, a trifling matter to insist upon the abandonment of such small cesspools as pan closet receivers, grease traps, pot traps and small unscoured dead ends of every kind in our sewerage and plumbing systems, but when we remember that in large cities and towns these little cesspools must be multiplied by thousands or hundreds of thousands, we see that the aggregate of putrefaction generated in them all when emptied into the sewers, gives to our enemies, the dangerous class of bacteria, a very considerable equipment for harm, and enables them to resist far longer the friendly battalions of our allies.

CHAPTER IV.

SEWER AIR.

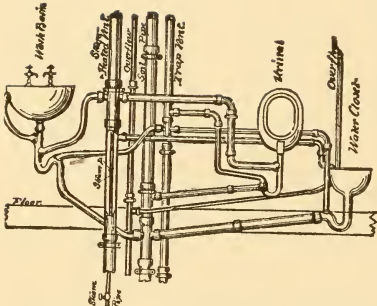

Fig. 30. Complexity with Inse-urity.

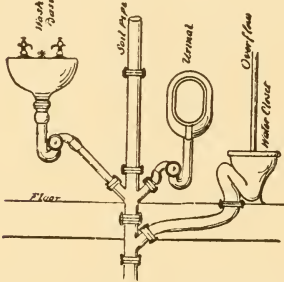

Fig. 31. Simplicity with Security.

BEFORE taking up my subject where we left off at our last lecture we will look at a picture illustrating two systems of plumbing as radically different from each other as any two things can be (Figs. 32 and 33.) The first, Fig. 32, represents the waste system of a small apartment house of three flats and gives, in addition, to two separate stacks of soil pipes, also a set of "back-vent" pipes as generally recommended by many

plumbers today. There is also a separate rain-water stack, a main house trap with its special ventilating stack, similarly approved. Besides these many advise a special stack for local vent, as well as a drip pipe from the principal fixtures. Finally in some localities an exterior sewer vent pipe is called for by the sewer department.

All of these except the sewer vent I have introduced in

SEWER AIR.

the same figure in order to present what many would consider an absolutely perfect outfit. It is copied from a drawing presented as a "model" by one of the leading plumbers in the country, except that I have added, as a finishing touch, the drip pipe frequently recommended for extra fine

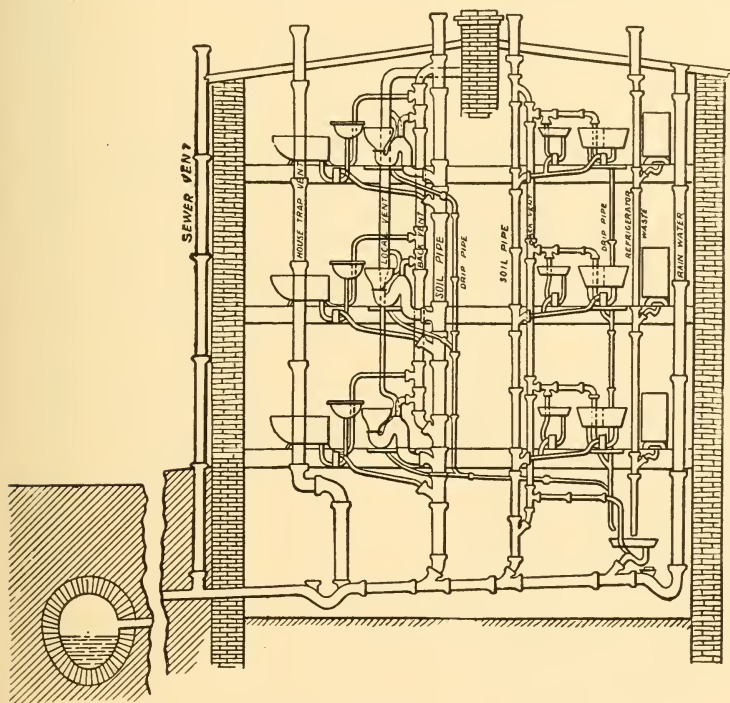

Fig. 32.
Complicated plumbing, showing the modern tendency.

work. An exterior sewer vent to the roof should also be added where the disconnecting trap is used.

In Fig. 33 I have treated precisely the same fixtures in a somewhat simpler manner.

Now I have no doubt many of you have wondered

PLUMBING AND HOUSEHOLD SANITATION.

why it was necessary to administer quite so powerful a dose of bacteria in a modest course on house plumbing. But if I show you presently that it is precisely the discoveries made upon these very marvelous organisms within the last two or

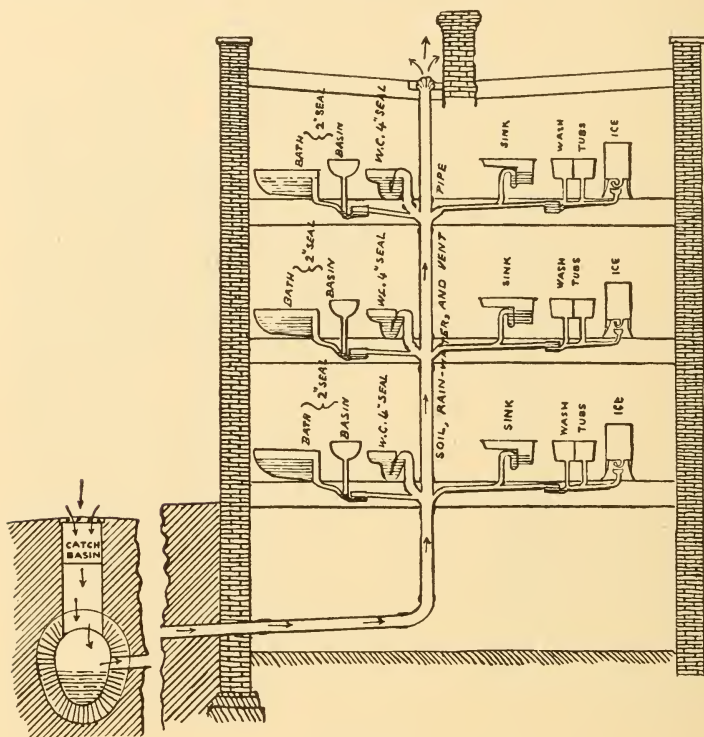

Fig. 33.
Simpler and better plumbing which should be substituted
for the complicated system.

three years which have justified our declaring the simpler of these systems to be by far the safer and better of the two, you will not, I am sure, regret the time we have spent upon them.

SEWER AIR.

If it has been shown that the air of sewers does not swarm with disease germs, as has hitherto been supposed, and is freer from all forms of bacteria than the outer air above them, and that, in well ventilated sewers, this air is entirely innocuous, then, clearly, the disconnecting trap and its vent become useless, and should be omitted, so that the soil pipe may serve as an additional means of ventilating the sewers.

If, finally, it has been proven that, in connection with such a sewer, a sound and permanent water seal is a reliable barrier to the passage of odors and micro-organisms of any kind through the traps of fixtures, and that such a seal can now practically be obtained by a correct form of the seal alone, then, clearly, back venting becomes a back number, and the soil pipe can also be used as a rain water conductor, flushing itself.

I am perfectly aware that to sustain this very heretical position to your satisfaction, the proofs I bring forward must be unanswerable and very clearly presented.* The claim is a very vital and important one destroying, as it does, with a single sweep, a vast network of piping, which has been for a long time regarded as a necessity beyond all question. Therefore I shall make no excuse for treating the matter somewhat methodically and thoroughly, and shall endeavor to array the proofs in such order as will render them most easily intelligible. It is for this reason that we have in our first lecture investigated to some little extent the habits of some of the microscopic world of bacteria.

The next thing we must do is to become scientifically acquainted with sewer air; and in the next illustration I shall

*This position was considered more heretical in 1899—at the time these lectures were delivered, a time when trap venting was almost universal, and even defended by a few engineers of some repute—than today, when cities and towns are rather rapidly abandoning the back-venting of traps, the use of the main or disconnecting trap and other old superstitions.

PLUMBING AND HOUSEHOLD SANITATION.

show you pictures of two kinds of sewer air, one the kind you find in well-constructed and thoroughly ventilated sewers, the other, however, residing chiefly in the imagination of the public and supposed to contain deadly poisons and all sorts of disease germs. The last is the kind plumbers seem to have in their minds when they erect in the houses of their wretchedly abused clients those formidable barricades of pipes shown in Fig. 2.

The first drawing, Fig. 34, illustrates a well built stone sewer of a modern city, and is very similar to one of the



Fig. 34. Paris sewer.



Fig. 35. Samples of disease germs supposed to exist in an unventilated sewer.

large sewers of Paris which I inspected in 1871. This sewer was so clean and well ventilated that it was not only much freer from germs than the street above it, but it was even without any offensive odor, so much so indeed that hundreds of people, both ladies and gentlemen visit them annually, as one of the particularly attractive sights of the metropolis. Compared with some of the filthy ones in our great cities, this sewer is a veritable health resort.

I made the trip just as you see presented in the picture. The truck in which we rode was propelled by the water itself, containing in this case, perhaps, one part of sewage to

SEWER AIR.

2,000 parts of water. It had a sliding gate descending from the rear of the car into the sewage against which the stream pressed, the car wheels running on the sidewalks on each side. We found the place quite as sweet and clean, quite as light, and quite as quiet as our famous Boston "Subway" and we were not once "held up" during the entire trip by pathogenic bacilli, either singly or in gangs, as some of the ladies evidently expected to be. I have drawn more "windows" in the sewer than there really were, because they should have been there, and in the future undoubtedly will be. The walls should be lined with white enameled bricks or tiles. Properly ventilated it would be the best place to carry gas, light, water and other pipes and wires.

The other picture, Fig. 35, is a correct drawing of a sewer built in an uncomfortable place described by Bunyan in his "Pilgrim's Progress," and contains a great many germs of an exceedingly ferocious disposition, and is described by Bunyan as the place to which all those plumbers are consigned who have, during their lifetimes, imposed upon a confiding public a larger number of waste pipes (called by Bunyan "wasted" pipes) than the conditions actually require.

By sewer air is meant the air of drainage systems, and consists in a mixture of air with vapor and a number of gases of the decomposition of sewage in varying proportions according to the system of waste disposal employed, together with floating solid matters, and a small number of bacteria.

The most important of these gases of decomposition are carbon dioxide, carbon monoxide, ammonia, sulphuretted hydrogen, carbonate of ammonia, ammonium sulphide, methyl sulphide, and a number of volatile organic compounds, which, though they give sewer-air its peculiar odor, are present in too small quantities for accurate chemical deter-

PLUMBING AND HOUSEHOLD SANITATION.

mination. Average sewer air in properly constructed sewerage systems contains a less number of micro-organisms than the external air of cities, and far less than the air of crowded rooms, because these organisms, being "particulate" are retained by the water and damp surfaces of the sewers when they come in contact with them. According to the careful and elaborate experiments on the comparative bacteria of sewer air and sewage itself in the sewers of Laws and Andrewes* made for the London County Council, and of numerous other investigators whose testimony we shall quote, it has been found that the microorganisms in the air are totally unlike those in the liquid below it, whereas they do correspond with the organisms in the air outside of the sewers.

The air of sewers contains less oxygen than exterior air, because some of it combines with carbon in converting the sewage into carbon dioxide.

I shall use the term "sewer gas" to designate the air of cesspools and foul sewers, as distinguished from the air of modern well-constructed and well ventilated sewers. More correctly speaking it should designate the actual gases of decomposition before it is mixed with pure air at all.

Of the chemical constituents of the air of sewers, more or less diluted with normal air, carbon dioxide† is the gas usually found in the largest volume, and is the invariable product of all organic decomposition. It is the "choke damp" of coal mines, and is fatal when inhaled in a highly concentrated form. Being heavier than air, it tends to fall to the ground and remain in the sewers rather than rise from them into the house, unless a strong current induced by heat or other agency raises it. In well-ventilated sewers this

*J. Parry Laws and F. W. Andrewes, London County Council Reports, No. 216, 1895.

†Carbonic acid of the older chemistry.

gas is incapable of producing the ordinary phenomena of so-called "sewer-gas" poisoning.

The weight of this carbon dioxid is clearly shown by the simple experiment of blowing cigarette smoke into a glass tube and observing the manner in which it settles to the bottom of the tube, the exhaled air being largely composed of this gas.

Carbon monoxid* is present in sewers only in exceedingly minute quantities, and even then it is generally due to the leakage of illuminating gas into them.

Nitrogen, found in sewer air, is incapable of supporting life when uncombined with oxygen, but it is not known to possess any poisonous properties, and in fact its amount in sewers varies little from that in ordinary air.

Sulphuretted hydrogen is a poison when imbibed in no stronger mixture with air than one part in 250, but its odor is so powerful and disgusting that its presence in very small quantities would be insufferable, and it is not found in well ventilated sewers in quantity as great as in an ordinary laboratory where the gas is generated without injury to the operators. Indeed, as Baylies says, a laboratory would not smell natural without it, and yet chemists constantly breathing it, have not been found to suffer any more from typhoid and gastric fevers, cholera, diarrrahea, general debility or any other of the derangements supposed to be due to the inhalation of sewer air, than those who never enter a laboratory.

"Students of analytical chemistry have been made sick by inhaling sulphuretted hydrogen, but not seriously, and yet a house in which the smell of this gas was as strong as it usually is in many laboratories at any hour of the day or night, would be considered untenable."

As for ammonia, it may be inhaled in doses far stronger

*Carbonic or carbonous oxid according to the older terminology.

than it ever occurs in properly constructed and ventilated sewers, not only without injury, but if we may judge from the fondness shown by ladies for the smelling salts bottle, with very positive benefit.

Therefore the dangerous element in sewer air must be sought in what is called organic vapor, which is an indefinite name for something of which no definite knowledge has so far been attained. The very recent researches of Dr. Alessi† corroborate this conclusion.

In spite of the very general testimony of modern authorities as to the reality of the dangers of breathing certain kinds of sewer-air in confined places, there have been misbelievers who have characterized the wide-spread fear of sewer-gas as groundless panic, and the records of the great epidemics as mere sensational stories. Therefore it is necessary to follow and fully understand the recent very important investigations and discoveries of scientists in this domain, not only as an aid to personal security, but also because they have a very important bearing upon the methods of sewerage and plumbing, which should be adopted to conform to the new light they have shed.

It was very natural that, before the science of bacteriology had enlightened us, sewer-gas should be regarded with a very great and vague terror as of an unknown enemy awaiting us in the dark.

So we find exaggerated fears on the one hand and a false sense of security on the other, both based on an ignorance of the nature of sewer-gas, and of the proper method of dealing with it.

On the part of the terrorists it was common to hear the air of even well ventilated sewers described as a form of concentrated pestilence laid on our houses with the soil pipe

†G. Alessi "On Putrid Gases as Predisposing Causes of Typhoid Fever Infection," *Journal of the Sanitary Institute*, London, 1895.

connections as one would connect a fuse to explode a mine. Doctors and sanitarians seemed to vie with one another in arousing the greatest possible amount of alarm. A physician quotes a professor of hygiene as saying, "Sewer-gas is so subtle that its presence is many times not detected, and yet so laden with the germs of disease that diphtheria, scarlet fever, typhoid fever, and other fatal maladies are the sure event to those who dwell in such air-poisoned houses." Indeed, it might almost be said that about every disease or indisposition to be found in the medical calendar has been at one time or another attributed to sewer-gas poisoning.

On the other hand, the scoffers pointed to the experiments of Carmichael, Wernich, Miquel and others, and declared that disease germs could no more escape from sewage than a sausage could jump out of a kettle of water, and that the fear of sewer-air was altogether irrational. The plumber, they said, is a sufficient refutation of "their notions," for he works at the very jaws of the sewers and flourishes on their breath. They seemed to ignore the fact that plumbers do suffer, when exposed to foul gases, and that the most prudent of them take the precaution to keep the "jaws of the sewers" well gagged while they are at work upon them. It is their custom to complete the plumbing work before the sewer connection is made, so that sewer-gas is not allowed to play about the building with such unrestrained license as many seem to imagine. But, as compared with workers in other trades and professions, plumbers lead an out-of-door life largely in buildings but partly completed or closed in, and must be in the full vigor of youth to carry on to the best advantage their somewhat arduous calling, and the experiments of Alessi show that the system undoubtedly becomes inured to some extent to inhaling the products of decomposition.

These factors enable them to withstand the enervating effects of exposure to sewer-air better than others, and so far as the pathogenic bacteria are concerned, it is in the feeble body, debilitated by confinement and impure air that they make most headway when once they gain entrance, against the armies of the white corpuscles or "Leucophytes" with which nature has so wonderfully provided us as a body guard.

But Dr. F. L. Dibble,* of Philadelphia, has made the most vigorous protest against the reign of sewer-gas terror in his "Vagaries of Sanitary Science." His writings, however, like those of his more violent adversaries, were published more than fifteen years ago when his peculiar deductions were more excusable than they would be today. He writes as follows: "It was soon after 1850 when the gases of the sewers first began to be talked about; but it was not until about the year 1857 that it was decided, not by chemical experiment or by any other investigation, but by a whim of the sanitarians, that there should be a distinct substance known as sewer-gas.

"The most discordant and contradictory properties were at once imputed to it. Sometimes its gravity caused it to descend into the bowels of the earth; again, by its surpassing levity, is ascended to heaven. Its powers of lateral diffusion were illimitable; it would permeate masonry eight feet thick; its backward pressure was enormous; then, unlike other gases, instead of finding vent at the manholes and large openings of the sewers, it had such affinity for the human system, to poison and destroy it, that it remained pent up until it could find egress through some crack or pin-hole, and escape into our dwellings. Sometimes it had a vile odor; again it had a faint, mawkish smell. but the climax of danger was reached when it was odorless,

*"Vagaries of Sanitary Science."

'Poisoning by sewer-gas,' says the London Lancet of 1882, in condemnation of the water carriage system, 'which has no smell, is the cause of many maladies. We take the rattle off the tail of the snake that he may better bite us with impunity. Better let the atmosphere of a house be nauseating from the fumes of recent faeces or pestilential from the fumes of a cesspool than poison its inhabitants with the demon sewer-gas skilfully laid on by a system of closed drains.' Ventilating them by gratings in the street 'is Machiavelian in its refinement of folly and wickedness.'"

The doctor has also a kind word for the plumber of that day, of whom he wrote: "This guide, philosopher and friend proceeded without delay to fabricate and set traps for us, which he said would shield us from the deadly vapor. He had no sooner put one in than it was shown that the gas was generated in such quantities in the sewer that it was forced past the trap. The next one he placed went through that inscrutable process of 'siphoning out,' and we were worse off than if we had no traps at all. We must now ventilate them; when this was done, the joints began to leak, and he said the materials of the pipes were so weak that it could not stand the peppermint test; and in some way that future improvisation alone would explain, it was proclaimed that sewer-gas escaping from a pin-hole would cause disease much more surely than if it were passing out in volumes a foot in diameter. There was no safety but tearing out all of the old fixtures and replacing them with new ones. After their renewal we were no better off, for not a day passed that the sanitary dervishes did not relate the poisoning of whole families by sewer-gas."

This makes entertaining reading, but we know now that the mistake the doctor made was in failing to distinguish between what was dangerous and what was not. His dia-

tribes, however, were useful in instigating more careful study of the facts, though he was entirely justified in his strictures on the increasing complication of plumbing and on the back venting of traps.

These disputes among the sanitarians might have been avoided if they had defined the kind of sewer-air they were discussing. If one side had reference to the air of such sewers as the underground sanitariums of Paris, I have shown you, with their aquatic pleasure parties, and the other had in mind the mephitic gases of horribly foul cess-pools, their discussions must necessarily be interminable.

The very discussions, however, gave rise to eager inquiries for statistics and closer observations on the part of scientists, so that now we have a long record of observed cases of injury to the health of persons exposed to sewer-gas of various kinds.

These statistics can be read by the layman as well as by the physician, and one of the best and most interesting reviews of them has been made by a civil engineer, Mr. Roechling.* Indeed the physicians and scientists lack often the time to master the applications of their own researches and discoveries to sanitary engineering and plumbing. Thus one of the most recent works on sanitation and hygiene written by a physician devotes a chapter to plumbing and sewerage which contains many errors in design and principle. His instruction, for instance, that every soil pipe branch serving two or more water closets should be extended up above the highest fixture in the house or above the roof, would please the pipe dealer, but tend to bankrupt the average owner, besides adding immeasurably to the complication and leakage possibilities, especially in large houses and hotels. His rule should have been worded

*"Sewer Gas and Its Influence Upon Health," by H. Alfred Roechling, C. E. Biggs & Co., London, 1899.

“every stack of soil pipe should be extended up through the roof.” To extend also every branch to the roof would add complication even the most rugged pipe dealer would hardly dare to advocate. In a cut introduced to illustrate good plumbing, many undesirable things are shown, some merely slight errors in drawing, as where a trap is shown without any seal, and other errors in principle, as where fixtures discharge into vent pipes, where branch pipes enter the soil pipe with T instead of Y joints, and where very small vent pipes are carried up great lengths

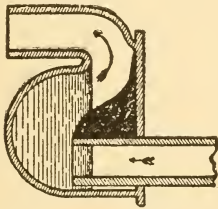

Fig. 36. D Trap set on its side.

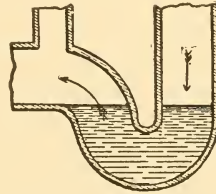

Fig. 37. Vented S Trap.

above the highest fixture and through the roof, instead of joining the soil pipe just above the highest fixture whereby both unnecessary expense and complication, as well as danger from closure by frost and snow would have been partially avoided.

Another drawing shows a D trap, Fig. 36, placed in a manner quite novel in plumbing practice. But the most important inaccuracy is that, whereas in the D trap, accumulations of grease and dirt are shown in ample quantity in the unscoured parts, the vent opening of the S trap adjoining the D is shown entirely free from deposit.

Now this vent opening, being entirely outside of the waterway of the trap, must receive even less scour than the comparatively innocent corner of the D trap. By what miraculous intervention of Providence then, has this vent

mouth cavity escaped contamination when the D trap corner has been packed solid full? What friendly influence, too, has protected the cavity at the right side of the D and neglected the left side? As a matter of fact the mouth of the vent pipe will clog even easier than the unscoured portions of the D or pot trap because as long as warm, fatty vapors rise in the vent pipe, they will deposit and congeal more or less grease along its cool sides at varying distances above the mouth, thus adding to the desposits caused by splashing and liquid contact. In short the mouth of the vent pipe forms an unscoured "pocket" quite as dangerous as any of those other pockets, now universally condemned, which constitute the one great characteristic defective feature of all "cesspool" traps.

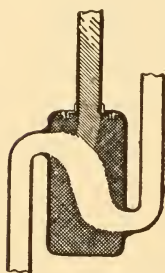

Fig. 38. Vented Pot becoming an Unvented S Trap.

If the D or any other form of cesspool trap actually clogs at times as the doctor rightly says it does, and the passageway through it gradually approximates the form of the S trap, as shown in Fig. 37, then evidently the vent pipe mouth at the top of the cesspool trap will be shut off by this same deposit, and whether the S trap be constructed of grease or of lead its vent mouth will be similarly closed.

I think anyone making a full and careful study of the records now obtainable of the effects of breathing sewer-air must come to a conclusion somewhat as follows: The danger from inhaling sewer-gas is in proportion to its concentration and poisonous composition. Where cesspools or very foul and ill-ventilated sewers are used, as is frequently the case in unprogressive, badly administered and ignorant communities, and very frequently in small towns and villages, the dangers may be very serious and con-

stant, while where a well-ventilated and well-constructed sewerage system has been provided, as in the best administered large cities, the danger is comparatively small.

Nevertheless decomposing organic matter accumulates more or less along the soil and drain pipes of houses as they are usually constructed, even in the best sewered cities, and the products of such decomposition, if continuously breathed, in somewhat concentrated form, tend to produce a general impairment of the health predisposing the system to typhoid fever, and probably also to other infection, and lowering the vital forces of resistance to any form of specific disease.

As a preliminary to a better understanding of the subject it should be borne in mind that normal atmospheric air contains on an average, in 10,000 volumes, only about three volumes of carbonic acid, the oxygen and nitrogen standing in the relation of 2,090 to 7,910. If the carbonic acid increases to the amount of 50 to 100 volumes in the 10,000, it becomes fatal to human life, and with sulphuretted hydrogen 10 to 12 volumes in 10,000 becomes fatal. Yet these amounts are constantly exceeded in unventilated cess-pools and foul sewers.

A choked sewer of Paris was found by Clanbry to contain 201 volumes of carbonic acid, and 299 volumes sulphuretted hydrogen in 10,000 volumes of air.

In another case he found 340 volumes of carbonic acid and 125 of sulphuretted hydrogen in a Paris sewer, and an average of 230 of carbonic acid and 81 of sulphuretted hydrogen in 19 cases.

Letheby found 53.2 volumes of carbonic acid in a London sewer; Miller an average of 10.6 in 18 cases and of 30.7 in 6 cases in London; Beetz an average of 31.4 in 8 Munich sewers; Laws an average of 69.2 in three London

sewers, and 93.1 in another London sewer, even as late as 1892.

Cesspools are likely to be as bad or worse.

It goes without saying that the analysis of the air of most sewers of more recent date does not show such alarming amounts of poisonous gases and they should not show any dangerous amount at all, but instances of the kind do still occur, and, in the case of cesspools, dangerous foulness is very common.

Alessi says: "It is known that 18 cubic metres (yards approximately) of excremental matter can give out in 24 hours about 18 cubic metres of gas, of which 10 cubic metres are of fatty acids and hydro-carbons; from 5 to 6 cubic metres are carbonic acid; from 2 to 3 are of ammonia; 20 litres (quarts) of sulphuretted hydrogen. These gases, considered separately, constitute for man and animals the most poisonous substances, and their combination produces very rapid deleterious effects."

There is no excuse today, however, in the light of our knowledge of sewer and plumbing ventilation, for allowing these gases to accumulate in our sewers and drains in such concentration as to be injurious. Nevertheless foul cesspools and sewers still exist in the less enlightened parts of the country, and a few words are needed relative to the danger of breathing the products of decomposition in concentrated form.

Dr. Hankel,* in recording cases of injury from breathing cesspool air, has classified the effects into, (1), the mild form; (2), the fairly severe form; (3), the severe form, and (4), the chronic form. The first, he says, is well known among sewer men, the symptoms being the feeling of a heavy load upon the head and chest, and in worse

*Ernst Hankel, "Ein Todesfall durch Einathmen von Cloakengas," 1895.

cases, vomiting, severe pains in the abdomen, diarrhoea, giddiness and weakness, with disturbance in the action of the heart and lungs.

In the second form the skin becomes cold and covered with cold perspiration. Severe pains are felt in the stomach, throat and muscles. "Delirium, convulsive twitchings of the muscles, fainting fits, singing and talking, have frequently been observed at this stage." Then follow unconsciousness, convulsions, and other serious symptoms.

In the third, or severe form, death occurs. The workman, on entering the very foul cesspool "collapses all at once as if he had been struck by a bullet," the entrance being accompanied sometimes by severe convulsive fits, vomiting, foaming at the mouth, etc.

The chronic form has been observed in laborers in mines and chemical works, and is not applicable to plumbing.

Many cases have been reported, on good authority, of deaths through cesspool air poisoning of the severe form from very foul cesspools. They have occurred in places where the products of decomposition and putrefaction were in a highly concentrated state, and under circumstances admitting of no doubt whatever as to their cause. They illustrate what may be termed the "direct" or "mephitic" (probably chemical) action of sewer gas, as distinguished from the "indirect" or "predisposing" action.

In addition to these practically demonstrated cases, we have the records of a different class of accidents resulting in death, which must be accepted as caused directly or indirectly by cesspool air, not with the positive proof of the first, but with sufficient evidence to leave no doubt in the minds of the physicians reporting them, or of the courts in several cases where they formed the subject of lawsuits. They are, in a certain sense, more interesting than the others, because they occurred under conditions more com-

mon, that is, under conditions in which the public as a whole are involved and not merely the comparatively small number who are obliged to work in the sewers.

The accumulation from year to year of similar records brings the evidence closer and closer to the value of positive demonstration, and at any rate it will be wise for the public to accept them as such inasmuch as they constitute the best proof to be obtained until individuals are found public spirited enough to voluntarily surrender themselves in the interest of science to such experimentation as has been made by Dr. Alessi* on animals.

We come now to the other forms of sewer-gas poisoning designated by Hankel as the "mild" and the "fairly severe" forms. But before presenting a few of the recorded cases, it is important as a preparation for properly understanding them to review the recent researches of Dr. Alessi on the effect of sewer-gas in predisposing the system to special disease infection. His experiments were made upon animals of different kinds, and resulted in showing that after exposure to the influence of putrid gases, including sewer-gas, inoculation with the germs of certain diseases killed them, but that these germs failed to kill when the animals had been kept under normal condition.

He took rats, guinea pigs and rabbits, and exposed some of them to sewer and other putrid gases. The rest he kept as a control experiment, under normal conditions, and after a while inoculated all of them with the baccillus of typhoid fever and the bacterium coli communis, and then he carefully observed and recorded the results produced on both sets of animals, including microscopic examinations with cultures of their organs and blood.

In a second set of experiments he studied "whether the

*G. Alessi "On Putrid Gases as Predisposing Causes of Typhoid Fever," *Journal of the Sanitary Institute*, 1895. Vol. XVI, p. 487.

chemical substances which are commonly given out in a state of gas from putrid fermentations can also exercise separately a similar influence on the animal organism."

The experiments were conducted with so much care, thoroughness and precaution that they cannot fail to convince the reader of the correctness of his conclusions, which Dr. Alessi states as follows:

"From my researches, taken together, I think I am authorized to conclude as follows:

"1. The inspiration of putrid gases predisposes the animals (rabbits, guinea pigs, rats) to the pathogenic action of even attenuated typhoid bacilli, and of bacterium coli.

"2. This predisposition is due to the combination of gases given out by putrid fermentations, and not to any one separately.

"3. It is probable that this experimental predisposition is diminished by prolonged breathing of the said gases.

"These conclusions, then, serve to confirm what some authors had epidemiologically foreseen, and social hygiene had practically and painfully confirmed."

The gases which, taken separately, were found not to predispose the animals to typhoid infection, were retilindol a very strong smelling product of putrefaction of albuminous substances, ammonia, sulphuretted hydrogen, methyl sulphide, carbonic acid, carbonic oxide, and ammonium sulphide. "Not only," says Dr. Alessi, "did the gases taken separately, have no predisposing effect, but even some of them when mixed, for which reason I may be allowed to suppose that both the exhalations arising from faecal and the exhalations arising from organic matter in putrefaction, are not composed of simple mixtures, but are much more complicated than might be believed. And the predisposing cause might also have its seat in those fetid substances of neutral character, which it is im-

possible either to understand or determine, whether from their small quantity, the insufficiency of analytical methods, or from the imperfection of those which we have."

Dr. Alessi experimented on 312 animals, of which 179 were exposed to the sewer-gas and 133 were kept in fresh air. Of the exposed animals 143 died when inoculated with the bacteria; whereas of the animals not exposed only three died, all of which were rats.

He found that the animals acquired the predisposition to infection more easily during the first two weeks than after that time, which may explain in a certain degree why individuals who habitually breathe sewer-air become habituated to it and acquire a certain immunity from intestinal and other infections.

Sanitary engineers have frequently raised the question for discussion whether it will be best to seek security by perfecting our sewerage system to the extent of rendering the air within it as innocuous as the outer air, or whether we must, as it were, "bottle up" the sewers under the assumption that sewer-air must always be dangerous under any degree of dilution with pure air, or exposure to sun light, and direct our energies to confining sewer-gases to the sewers themselves, a course which must necessarily tend to vastly increase the expense and danger of house plumbing.

It seems to me that difference of opinion on this subject is unjustifiable in view of the data which scientists have now prepared for us.

All sewers should be thoroughly ventilated and their air rendered entirely innocuous. House drains should aid in ventilating the sewers, the disconnecting or main house trap and all "back venting" should be rigidly prohibited by law, and the whole interior piping system be vastly simplified.

SEWER AIR.

I base my position, in part, on the recent researches and discoveries of a great many distinguished modern investigators who are in accord in concluding that the number of germs in sewer-air is small and less than in outside air; that the bacteria found in sewer-air are not the same in kind as those found in the sewage itself, but are the same as those found in the air outside the sewers; that disease germs are and demonstrably must be rarely found in sewer-air and can live but a very short time in sewage itself; that disease germs cannot detach themselves from the surface of water at rest, nor from the damp surfaces of sewers; that bacteria in sewer-air, whether reaching the sewers from the external air or from the bursting of bubbles or drying of the sewage, tend to fall by gravity into the water of sewers or to be driven by air currents against moist surfaces in the sewers and drain pipes, from which they cannot again arise spontaneously; that sewers can be and frequently are so well constructed and ventilated that the air within them becomes entirely innocuous; and in part from my own investigations and conclusions. By taking advantage of modern discoveries and progress a simple system of house drainage without the disconnecting trap and back venting can be made perfectly safe whereas the complicated system now generally in vogue cannot be so made.

Thus we find that plumbing has become a science based upon some of the most profound and delicate researches, in both the visible and the invisible world and that the arrangement of our piping is governed by the habits of the minutest living beings known to the microscope.

The following conclusions referred to in our introductory chapter have been practically accepted by all investigators as demonstrated:

(1) Dust and germs cannot rise from wet surfaces or from water or sewage under normal conditions. Abnormal

PLUMBING AND HOUSEHOLD SANITATION.

conditions in sewers producing splashing and bubbling may in practice allow a few germs to escape into the air, but these conditions may be obviated by proper construction and regulation.

(2) A sound water seal forms a reliable barrier against sewer-air and germs.

(3) It is possible that germs may be lifted by air currents in sewers from dried surfaces, but so strong a current appears to be required for this that in practice the number may be considered as negligible from the point of view of the sanitarian.

(4) Disease germs do not live long in sewage in competition with other germs.

(5) Fewer germs of any kind are found in the air of sewers than in the outer air above them.

(6) Disease germs may abound in the outer air, but in sewer-air their number is so small as to be negligible from a sanitary standpoint.

From my own investigations and the above conceded facts I feel justified in drawing the following deductions:

(1) The back venting of traps destroys their seal by evaporation and renders them useless as barriers against sewer-air.

(2) Splashing and bubbling in sewers may be prevented by proper construction and regulation.

(3) The use of disconnecting traps shuts off the only effective method of sewer ventilation and forces foul sewer-air into the streets.

(4) The best way to filter the air of cities and towns of dust and germs is to ventilate the sewers through the house drains in which these impurities are caught and destroyed.

(5) Permanently reliable pipe jointing is obtainable.

(6) Hence all danger from sewer-air may now be avoided by such ventilation and the use of reliable traps and piping.

It remains now to review, in brief detail, the investigations of some of the highest authorities leading up to these conclusions, and my own experiments and reasoning from which they are deduced.

CHAPTER V.

INVESTIGATIONS OF MODERN SCIENTISTS ON THE QUESTION OF THE PASSAGE OF GASES AND GERMS THROUGH WATER TRAPS.

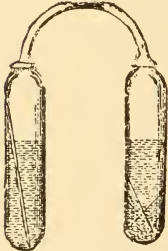

Fig. 39. Apparatus for determining whether bacteria can pass through water in traps.

Dr. Carmichael's experiments were made to ascertain to what extent the contents of the soil pipe, both gases and germs, are able to pass through a sound water trap.

Dr. Andrew Fergus had shown that concentrated gases would pass through a water trap, and had had glass tubes bent in the form of a trap to show this. Ammonia was detected on the other side of the trap in 15 minutes, sulphuretted hydrogen from 3 to 4 hours, and carbonic acid in $1\frac{1}{2}$ hours. But the gases were presented to the under surface of the water in a very concentrated condition, probably not under 50 per cent. Dr. Carmichael wished to see what the result would be with ordinary sewer gas from a very foul soil pipe, both with gases and with germs, and he therefore experimented on the trap of a pan closet, the kind generally used in Glasgow at the time. The conditions were as shown in Fig. 40. Two other pan closets entered the soil pipe, which was ventilated above the upper closet by a 2-in. pipe up to and through the roof. The lower end of the soil pipe passed untrapped and unventilated into the drain. The mouth of the sewer was submerged at high tide so that sewer gases tended to be pressed back toward the houses, so that as trying conditions as possible were presented.

Dr. Carmichael took off the basin and pan from the water-closet and screwed a zinc plate air-tight over the receiver, as shown. Through this plate passed two lead pipes with stopcocks extending about eight inches above the plate.

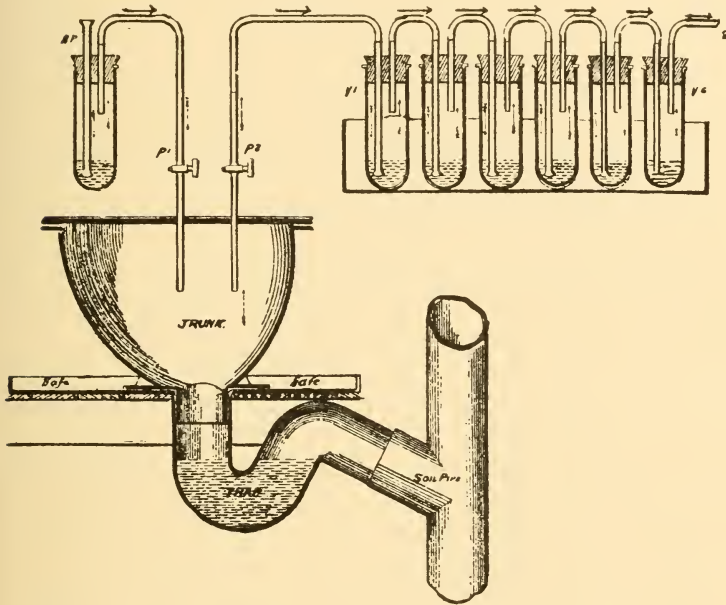

Fig. 40. Apparatus for determining if gases and germs from a foul soil pipe can pass through trap seals.

The sewer air from the receiver was drawn by an aspirator through six glass vessels of water arranged in a row, as shown. The air was introduced into the receiver from the room after having been washed by passing through the liquid in the single glass vessel at the left. The water in all the vessels was charged with a strong solution of caustic potash which is capable of absorbing carbonic acid, the first substance to be sought for in the sewer air. The aspiration

was continued for twenty-four hours in each of a large number of tests made for the gas. The average amount of carbonic acid which passed through the trap seal in twenty-four hours was a little over 7 grains.

For the ammonia testings sulphuric acid was used in the water of the seven vessels instead of potash. The amount of this gas which passed through the trap in 24 hours was 1-400th to 1-200th of a grain. The amount of sulphuretted hydrogen in the same time was about 1-100th of a grain.

"These are the quantities," says Dr. Carmichael, "of the only sewage gases existing in the soil pipe, in estimable quantities, which pass through an ordinary water closet trap in 24 hours."

The doctor made another series of tests with a new lead W. C. trap, as shown in Fig. 41, so as to make certain that the gases found were in no way peculiar to the filth in the old trap. Almost identically the same results were obtained, but the amounts of ammonia and sulphuretted hydrogen were very slightly less, which might show that the filth in the receiver and old trap may have been responsible for a small percentage of the gas produced.

He also made the experiments again with the soil pipe 2-inch vent closed at the top. This increased the amount of gases passed through the water seal to 32 and 17 grains in the case of the carbonic acid. The sulphuretted hydrogen was increased from 1-100th to 1-90th of a grain in the 24 hours. Diffused through the atmosphere of a house these quantities are from a health point of view absolutely harmless. "Thirty-two grains (the largest quantity) of carbonic acid is less than the quantity of the same gas given off when a bottle of lemonade is drawn." A man exhales in the same time about 400 times the amount which passed through the trap from an unventilated and very foul soil pipe. The 1-100th of a grain of ammonia and the 1-60th of

CARMICHAEL'S TESTS.

a grain of sulphuretted hydrogen would, of course, be utterly unnoticeable. As for the foetid organic vapors, mere traces of these exist in the sewer-air, and if they do pass through the trap they would be in quantities too minute for detection. "We are able, however, to state in more exact

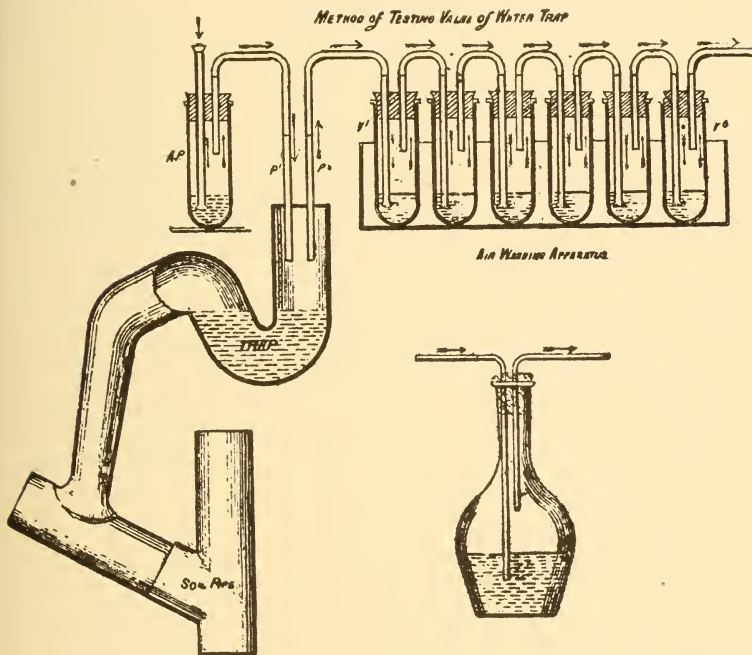

Fig. 41. Apparatus for determining if gases and germs from a clean soil pipe can pass through water in trap.

terms something as to the quantity in which they may come through. These vapors are organic; as already stated, they are carbo-ammoniacal, they are therefore decomposed by Wanklyn's process for the estimation of nitrogenous matter, as ammonia, and are, therefore (if they do pass through the

trap), included in the ammonia; and consequently less (probably very much less) than the 1-100th of a grain in 24 hours. This, I need scarcely say, must be harmless."

CAN BACTERIA PASS THROUGH A TRAP.

We now come to the much more important question as to whether organic particles, bacteria, can pass through the trap. A simple but crude method of examining the question consists of a microscopical comparison of water through which soil pipe air has been drawn, with water through which air over the trap has been drawn. No particles were found, by this method, to have passed through the trap. The organic particles are rendered so heavy by soaking with water that they are neither raised with the aqueous vapor nor by wind blowing over the surface, as has been proved by Dr. Frankland and many others. But "marshes and swamps, in a dry season, when the water is low and the particles are drying on the muddy sides, and on the vegetation on the banks, are frequently very pestilential." Mr. Baldwin Latham says: "One thing is certain, with reference to malaria, that all authorities are agreed, that it is never extricated from a water surface." Dr. Carmichael set to work to prove these matters conclusively. He used a "culture" liquid capable of cultivating any germs added to it, and after sterilizing it in a temperature over 212° F. he introduced into it the air taken from the trap to be tested. If after keeping the liquid at cultivation temperature, say from 60 to 120 deg. Fahr., for several weeks, it remains clear, then, no germs could have been in the air, and the water seal must have prevented their passage. If, on the other hand, the air had germs in it, they would multiply enormously in the infusion, rendering it opaque and perhaps producing growths of fungi.

The apparatus used is shown in Fig. 42. A glass flask

CAN BACTERIA PASS THROUGH A TRAP?

containing the culture solution, a hay infusion, was connected on the one side with a U-shaped glass trap containing water, and on the other with an aspirator as shown. The hay infusion and the water in the U-shaped trap were both sterilized by boiling. The U-shaped trap was connected on its other side with the soil pipe side of the water-

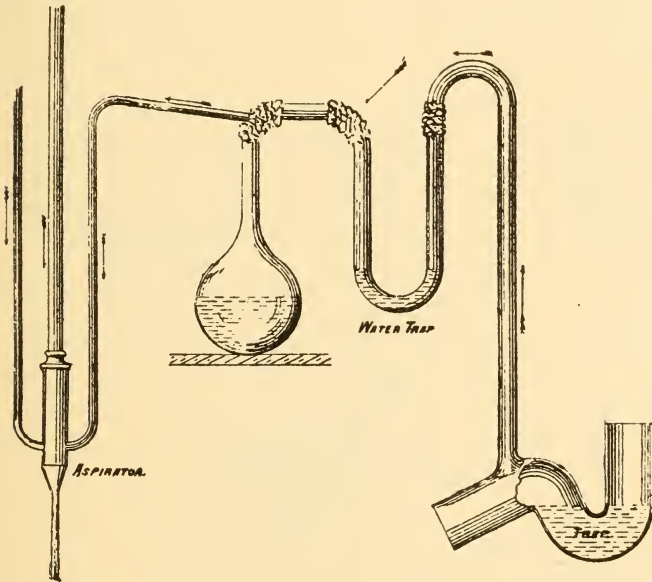

Fig. 42. Apparatus for determining whether bacteria can pass through water in a trap.

closet trap. It will be seen from this arrangement that any germs coming from the soil pipe which passed through the water trap would be carried in the air current over to the infusion and would cause it to putrefy. But no such particles passed through the trap seal, for the hay infusion remained perfectly clear though the experiments were continued for five months. The tests were made both with and

PLUMBING AND HOUSEHOLD SANITATION.

without the aspirator, and various kinds of culture liquids were used. Tests were also made with the U-shaped trap omitted, and in these cases the infusions began to putrefy in a few days, showing that the water trap really prevented the germs from passing.

These experiments seemed conclusive; but lest it might be objected that germs might rise from the liquid of the trap and fail to be carried over, or that an ordinary water-closet

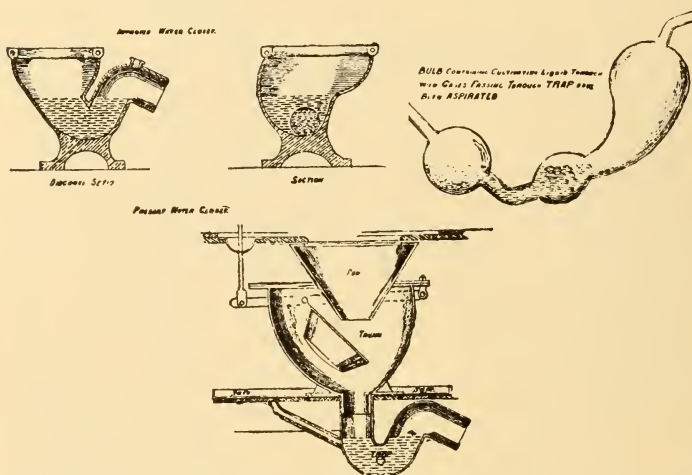

Fig. 43. Apparatus for determining more critically whether bacteria can pass through water in traps.

trap might behave differently from the glass one employed, Dr. Carmichael made a still more crucial series of tests as follows: Nitrogen bulbs, Figs. 39 and 43, were charged with a strong cultivating liquid called Pasteur's solution, and sterilized. The lead W. C. trap, connected with the soil pipe, was also sterilized by heating it to 350 to 400 degrees Fahr., and the bulbs were connected with the house side of the trap with an air-tight connection already described in connection with the first experiments. The other

CAN BACTERIA PASS THROUGH A TRAP?

end of the bulb vessel was connected with the aspirator. In order to let air into the trap chamber above the water seal a filtering tube was used so that no germs could come to the bulbs unless they passed over the W. C. trap seal. The whole apparatus was most carefully and thoroughly sterilized. The filtered air was drawn by the aspirator into the chamber over the trap seal and then bubbled continuously through the liquid in the bulbs for from 24 to 36 hours, and the bulbs were then allowed to stand in a warm room at 75 to 100 degrees Fahr. for several months, and the experiments were repeated in the most rigorous and careful manner. The liquids in all the tubes and flasks, though kept for from two to five months at cultivation temperature, remained perfectly clear, and even when examined with a most powerful microscope used for germ studies and multiplying 900 diameters, exhibited no trace of life. Dr. Carmichael concludes as follows:

“Water traps are, therefore, for the purpose for which they are employed, that is, for the exclusion from houses of injurious substances contained in the soil pipe, perfectly trustworthy. They exclude the soil pipe atmosphere to such an extent, that what escapes through the water is so little in amount, and so purified by filtration, as to be perfectly harmless; and they exclude entirely all germs and particles, including, without doubt, the specific germs or contagia of disease, which, we have already seen, are, so far as known, distinctly particulate.”

Dr. Carmichael, in describing the pan closet used in his experiments, Fig. 43, says: “If you examine such a trunk (receiver) as is found in almost every house in Glasgow, you will find it coated over, to the thickness, frequently, of an inch or more with filth.” He then recommended the short hopper he showed in the picture above the pan closet.

The two glass vessels shown in the initial cut to

this chapter, illustrate another experiment made by Dr. Carmichael, to see if germs would rise from the surface of water at rest. He placed cultivating liquid in each of the tubes and connected them together at the top by a rubber

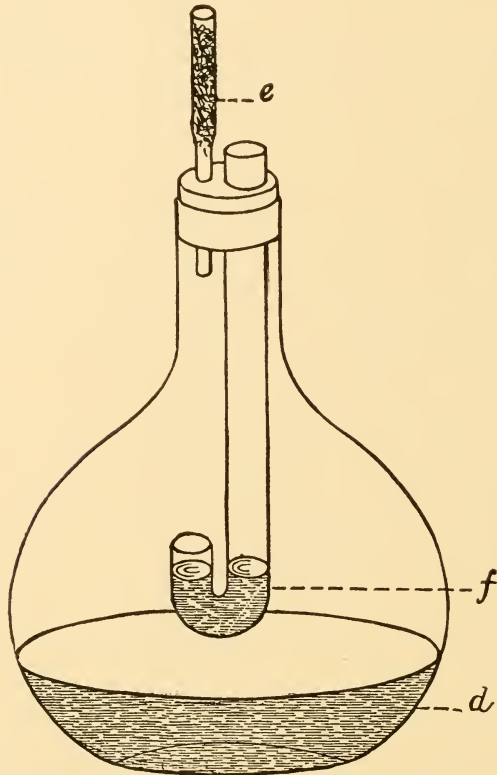

Fig. 44. Apparatus for determining whether bacteria can escape from a liquid at rest.

tube. Into each tube had been placed a small capillary tube filled with a putrid liquid and hermetically sealed at both ends. The cultivating liquid was sterilized in both large tubes. Then one of the small capillary tubes was

CAN BACTERIA ESCAPE FROM A LIQUID AT REST?

broken by shaking and its putrid contents thus mixed with the infusion in its enclosing vessel. The germs did not pass over into the other vessel, even though the test was continued for five years uninterruptedly.

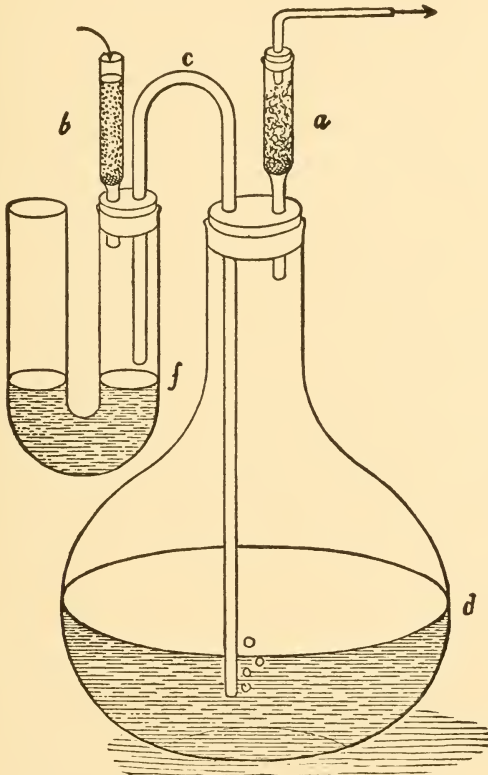

Fig. 45. Apparatus for determining if a current of air can take up germs from a liquid at rest.

STUDIES OF PUMPELLY AND SMYTH.

The experiments of Professors Pumpelly and Smyth for the National Board of Health at Washington are extremely interesting and fully corroborate those of Carmichael.

In their first series made to determine whether bacteria or other particulate matter can disentangle themselves from a liquid, water, sewage and putrefied substances were suspended, as shown in Fig. 44, in a bent tube over a sterilized beef infusion in a room where the temperature ranged between 20 and 35 degrees Centr. The flask containing the infusion was closed air tight by a rubber stopper, through which the tube passed, which held the sewage in a small bowl or trap at its lower end. The stoppers contained also a small asbestos filled filter tube. In this form of the experiments the air around the sewage was in a state of rest.

CAN BACTERIA DISENTANGLE THEMSELVES FROM LIQUIDS.

In another form the apparatus shown in Fig. 45 was used to investigate whether a current of air could take up germs from a liquid at rest. The sewage was placed in a U-shaped tube which formed the trap, and was connected with a flask containing the culture liquid by means of narrow tubing, as shown. This tube passed through rubber stoppers which close the tops of the flask and one arm of the trap. An aspirator tube packed with an asbestos filter was connected with the flask through its rubber stopper, and air was drawn at any desired rapidity through the apparatus, being filtered before entering the trap by an asbestos filter in a small glass tube connecting with the trap through its rubber stopper.

Finally a third form of apparatus, shown in Fig. 46, was used to see if a liquid can part with germs when bubbling, in consequence of the evolution of gases produced by its own fermentation, or of the aspiration of air through its mass. The sewage in this case was held in a small test tube, the filtering tube supplying air descended nearly to the bottom of the sewage so that, as it was drawn through it by the aspirator, it created a bubbling or boiling of the liquid. The aspiration was produced by connecting the aspirator tube

EXPERIMENTS ON FILTRATION.

with a large flask of water and then drawing off the water through a stop cock connected with the bottom of the flask at any desired speed. The results of these experiments were given in the report as follows :

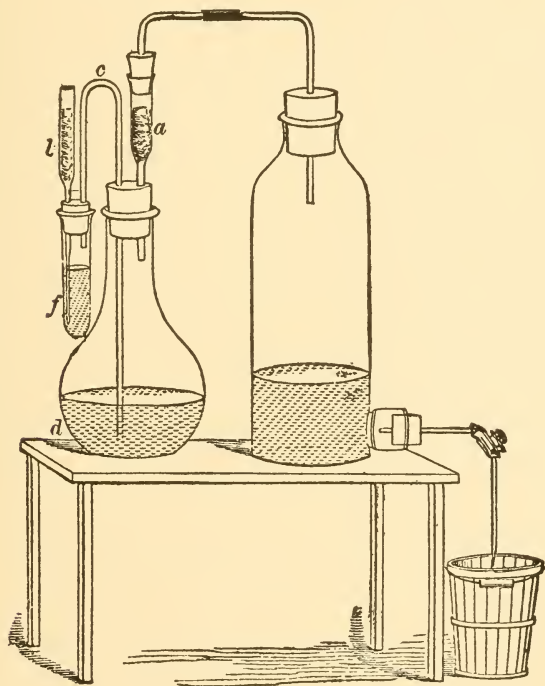

Fig. 46. Apparatus for determining if a liquid can part with germs when bubbling.

“At normal summer temperatures no germs were given off from the decomposing liquids whenever their surfaces remained unbroken, even though in some of the experiments the air was continuously conducted over them in a slow current. When the surfaces of the liquids were broken,

however, by the bursting of bubbles, germs were invariably given off and the sterilized infusions infected, no matter how slowly the aspiration was conducted."

In order to be sure that germs were not conveyed along the inner surface of the bent connecting tube between the trap and the flask containing the infusions, by capillary action, the bend in this tube was kept perfectly free from moisture during the entire time of the experimentation by means of a gentle heat.

"As the tubes," says the report, "were constantly covered with films of moisture from condensed vapors there was no possibility of the bacterial growths drying around the surface edges of the infusions in the inner arms; nor, were that to happen, would it seem probable, judging from Wernich's experiments, that germs could become detached and taken up by the air in the flasks."

The experiments of Naegeli, Wernich, Miquel and others clearly show, also, that under normal conditions germs are not given off to the surrounding air through the evaporation of a liquid containing them, nor from thoroughly moistened sand or solid matter of any kind.

FURTHER STUDIES OF PUMPELLY AND SMYTH.

The studies of Pumpelly and Smyth on soils as filters of different compositions and structures are very important and were made to ascertain:

1. Their action as filters for air or gases, generally.
2. Their action as filters for water and other liquids.

When we consider that every foul and defective cesspool is a center of pollution to the ground water which supplies our wells, and to a certain extent also the reservoirs for cities, we can understand the importance of determining to what extent average soils can filter them. Our houses become the ventilating chimneys for the surrounding ground,

sucking in the air from its pores, and when this air is polluted by sewage it is important to know if these impurities can be removed from it by filtration. The experiments showed that the filters, especially where wet, were able, as might be expected from what we have learned about bacteria adhering to damp surfaces, to entangle and retain the germs which had been floating in the air, whereas when the germs were in water none of the filters tried could, for the same reason, extricate them from it. The germs could not escape from the water, but had to follow it between the grains of the filters.

Our next two pictures show the apparatus used for making these investigations (Figs. 47 and 48). Fig. 47 shows a simple test tube slightly contracted at the center, having an infusion of beef or some other easily putrescible substance at the bottom. A small piece of copper gauze rested on the shoulder formed by the contraction in the tube above the infusion, and upon this copper gauze as a support rested the substance to be tested in each case as a filter. The height of the filter column varied from about a sixteenth of an inch to about six inches. Nearly ninety filters were tried of asbestos, sand, loess, charcoal, animal charcoal and coal ashes. This apparatus and the others to be described showed that dry soils, even in comparatively coarse grains form good filters for germ-laden air, and the wet filters are still more efficacious than dry; and that putrid soils not only retain the germs which they already possess, but also extract others from air passing through them. The infusions under the filters remained sound for months, though separated from the bacteria floating in the surrounding air only by a very small layer of the filter.

In the second series of experiments the apparatus shown (Fig. 48) was used to show the effect of the filters upon a current of air passing through them. A flask provided with

an air-tight rubber stopper was used. The filter was placed in a tube passing through the stopper and rested on a copper gauze within the tube. The aspirator tube also passed through the stopper and its lower end was protected by a filter in order to prevent microbes from entering the flask

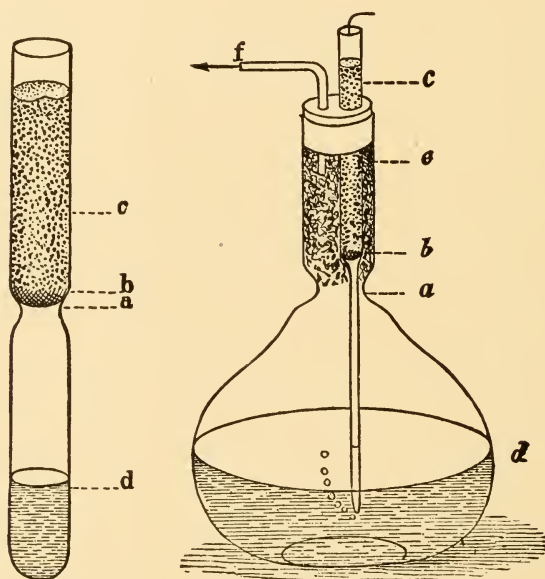

Figs. 47 and 48. Apparatus for testing air filters.

through it while it was disconnected with the aspirating mechanism which we have already described. The beef infusion was put in the bottom of the flask. The filters were subjected in this, and in another apparatus shown in the test tube Fig. 48a, at intervals during five months to rapid currents of air beginning at the rate of 1 quart in from 4 to 7½ hours and increasing to 1 quart in 1½ minutes. The two filter columns in the bent tube apparatus were about 4 inches (10 centimeters) high each, and consisted of sand screened

EXPERIMENTS ON FILTRATION.

through 30 to 50 meshes per inch; in others fine sand, 100 grains to an inch, was used, and in still others asbestos

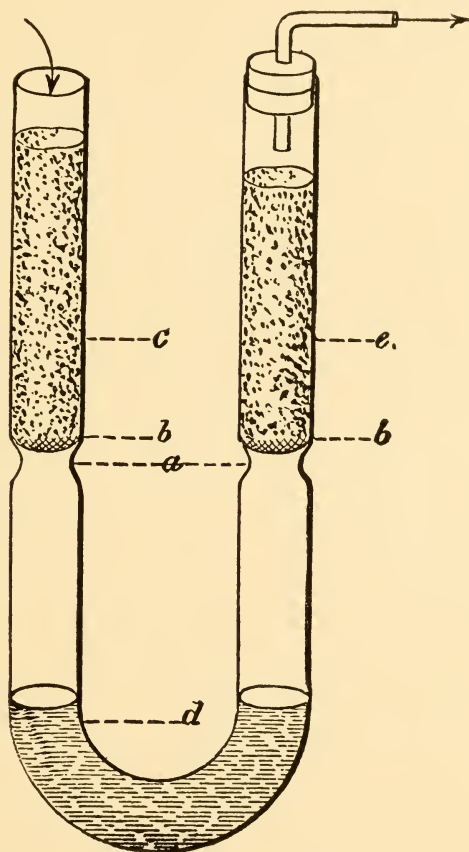

Fig. 48a. Apparatus for testing air filters.

packed rather tightly. All the filters stood these extremely trying tests, the infusions remaining intact.

The experiments show that as long as the grains are

small, all the substances tested, filter perfectly all organisms from the air passing through them.

Very different were the results of the attempts to filter germs from liquids.

In these experiments there were tried in the first apparatus consisting of the simple test tube, three sets of filtrations, the liquids being respectively (a) fresh infusions, (b) putrid infusions, and (c) water.

In the first set the filters employed were sand, charcoal, and animal charcoal, the finest of each being 100 grains to the inch, and asbestos in columns of about $6\frac{1}{2}$ inches high. All failed to filter out the germs except two filters out of twelve of asbestos, and of the finest animal charcoal; the remaining asbestos and the coarser animal charcoal 15 to an inch and the vegetable charcoal in all grades failing equally with the sand.

Similar filters were used in the second set of experiments (with putrid infusions). In this set only tightly packed asbestos stood the test; in all others the infusions passed through turbid.

In the third set (filtration of water) the substances tested were in columns $6\frac{1}{2}$ inches high, of tightly packed asbestos, charcoal, some 25, others 50, and others 100 grains to the inch; animal charcoal, some 15 and others 100 grains to an inch; loess, kaolin, coal ashes, sand of 25, 30, 50 and 100 grains to the inch, respectively.

The experiments were conducted so that only a drop or two of water should reach the infusion at first; more water being passed after intervals of several days, where the infusion remained uninfected.

Of these the tightly packed asbestos stood repeated filtrations for ten days, after which the infusion putrefied. Of the finest animal charcoal filters, one out of four filtered out

the germs. The other three stood repeated filterings during 17 to 20 days, after which the infusion became infected.

The coal ashes were subjected to repeated filtrations during 10 to 19 days, after which the infusions broke down. With the loess the infusions were affected after six to eight days.

With kaolin and sand they broke down in from one to eight days, except two, which lasted 19 and 20 days respectively. In all the others the first drop that passed through infected the infusion.

The experimentors now made a bold jump from columns of a half a foot to columns 22 and 100 feet in height, and in them the filter used was sand mixed 18 and 100 grains to the inch. The apparatus used is shown in the coiled pipes in Fig. 49. To obtain sterilized columns of such a length the sand was intensely heated and poured into a lead pipe, which was then coiled. It was then placed in a furnace and heated to between 250 and 300 degrees Centr., and then the lower end attached to the flask containing the infusion, as shown on the floor by the table. The flask was ventilated through a tube protected by sterilized asbestos, as shown.

The whole was then allowed to rest several weeks to be sure that the infusion had been properly sterilized. The pipe was then very slowly filled with water from the faucet. The first water that passed through each of the 22 and 100 foot columns carried infection with it.

The following conclusions were drawn from these experiments:

"I. All the substances operated on are excellent filters in eliminating germs from infected air passed through them, except when they are of a coarse grain—10 to 20 grains to an inch—when the interstitial cavities become probably much less labyrinthine. And all these filters withstood the tests

of currents having many thousand times the maximum velocity attained in the soil.

"II. All natural substances tried thus far, except the finest animal charcoal, and perhaps tightly packed asbestos, failed to eliminate wholly the germs from liquids."

Of the natural soils tried we find sands entirely without power to filter germs from water, and probably in columns 10,000 feet long as well as 100 feet. The loess and kaolin have more power, and in greater heights of columns it is possible they would be effective. The filtering capacity seems to be proportional to the smallness and intricacy of the interstitial cavities; and in dry air filters there is a critical limiting point beyond which there is no filtering.

With liquids, far greater fineness and compactness of grain and intricacy of passage is needed than with air. While sand of even 20 grains to the inch is an excellent air filter, it is worthless for water, even as fine as 100 grains to an inch and in very long columns, and the critical limiting point below which soils begin to exercise any filtering action on water probably verges on the size of the particles of an impalpable powder.

"From these results it appears very clearly," says the report, "that sand* interposes absolutely no barrier between wells and the bacterial infection from cesspools, cemeteries, etc., lying even at greater distances, in the lower wet stratum of sand. And it appears probable that a dry gravel or possibly a dry very coarse sand interposes no barrier to the

*Successful water filtration through ordinary sand requires a surface coating of some much finer substance than the sand itself. This coating, in slow sand filtration, is automatically deposited partly by bacterial action, and in rapid mechanical filtration it is chemically precipitated. In both systems the amount of the coating must be periodically regulated in order to maintain the proper speed of filtration. This regulation of the amount of coating, which is sometimes called the "dirt covering" or "schmutzdecke," forms the most costly part of the operation of a filter. A number of plans for reducing this expense are now being developed, of which one by the writer is outlined in a later chapter on "Filtration."

EXPERIMENTS ON FILTRATION.

free entrance into houses built upon them of these organisms which swarm in the ground-air around leaching cesspools, leaky drains, etc., or in the filthy made-ground of cities.

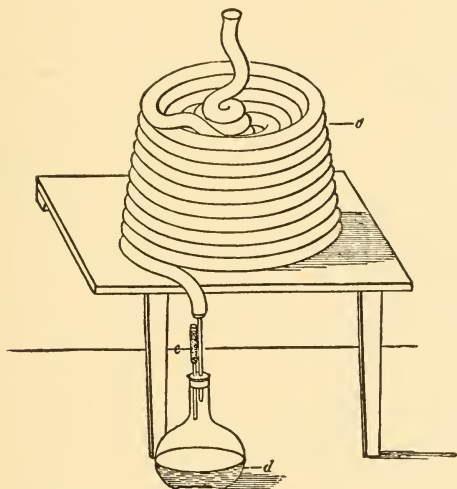

Fig. 49. Long coil of pipe filled with sand.

“And from the results obtained from the two series of experiments, viz., in filtering air and in filtering water, we can now draw one very important practical conclusion which cannot be too strongly emphasized. That a house may be built on a thoroughly dry body of sand or gravel, and its cellar may be far above the level of the ground-water at all times, and it may yet be in danger of having the air of its rooms contaminated by germs from leaching cesspools and vaults; for, if the drift of the leaching be toward the cellar, very wet seasons may extend the polluted moisture to the cellar walls, whence, after evaporation, the germs will pass into the atmospheric circulation of the house.”

CHAPTER VI.

MICRO-ORGANISMS IN SEWER AIR.



The methods for the study of micro-organic life in air are of comparatively recent date and are daily being improved. According to Roechling about six sets of investigations into the bacterial flora of sewer air have within recent years been made, and from them in complete corroboration of other researches made before by less perfect methods and apparatus.

They show that sewer air contains few germs as compared with outer air, sewer air containing on the average from 2 to 9 germs where outer air contained 15 per quart. These germs are related to the germs of the outer air, but not to the sewage itself, which contain an enormous number of germs, a quart containing sometimes as many as 5 billion. Disease germs are not found in sewers with the single exception of the germ of suppuration (*staphylococcus pyogenes aureus*) and up to the present time* only one of the many observers (Uffelmann) has been able to discover even this pathogenic germ

*This was written before the experiments of Major Horrocks had been made.

in sewer air. Splashing of sewage, as when a branch sewer enters another or a main sewer with a high fall, may cause a fine state of division of sewage in virtue of which germs may be carried some distance through the air, "even 50 or 60 yards" according to Laws, from which our remedy lies in so arranging the connections as to avoid splashing.

If the sewage falls against the inner curved surface of the drain it may be arranged to do this without splashing even from a considerable height. The experiments of Laws showed that a branch drain emptying its sewage into an egg-shaped sewer 11 ft. high by 9 ft. wide from about the middle of its height produced practically no effect upon the number of micro-organisms in the sewer air.

The experiments of Laws in London and Ficker in Breslau seem to show that germs cannot be given off from the slimy skin which forms on the inner surface of sewers on account of the dampness of the air in them. Mr. Laws says in regard to this: "It is really remarkable to find that no organisms are given off from the walls of a sewer which has been empty and open to the air at both ends for such a lengthened period as 12 days. The sewage with which the sewer had been kept full for several periods of 24 hours would contain no less than three to four millions of organisms per cubic centimeter (about $\frac{3}{8}$ in. cube) and immense numbers of these must of necessity have been clinging to the walls of the sewer. . . . The velocity of the air current used in the above experiments was 5 ft. and 15 ft. per second, respectively, the latter being far in excess of any current that would normally obtain in a sewer."

Ficker found that a current of air of several yards a second could not lift up germs from a half moist soil, nor even germs which had dried on several substances and adhered to them.

Hesse experimented to see how far germs could be car-

ried in air currents in pipes and sewers before falling against and adhering to their sides. In one experiment with a 2-in. pipe a yard long, coated with nutritive gelatine, he found that the air current deposited a large number of bacteria on the first quarter, less on the second, still less on the third, none at all on the last quarter. Ficker experimented in this line with 4-inch pipes and found the germs were carried as much as 23 feet.

Disease germs find the conditions in the sewers unfavorable to their life and propagation. They cannot survive against the myriads of other germs that crowd the sewage and in their slow death in fighting against these they gradually lose their virulence or power for mischief long before their actual death takes place.

Kirchner says: "We are entitled to say with a probability bordering on certainty that presumably pathogenic germs will never be found in sewer air."

Messrs. Laws and Andrewes went so far as to classify elaborately and comparatively the various kinds of germs found in the outer air, in sewer air and in the sewage itself, and they found the same kinds in sewer air as in the outer air, but a totally different kind in the sewage. They even go so far as to say that so far as they are aware, not a single colony of any of the many species which they found predominate in sewage has been isolated from sewer air.

These investigators even assert that "moderate splashing carried out so as to imitate the inflow of a lateral drain or house sewer produces no variation in the sewer air even within such a short radius as four feet from the disturbance." In view, however, of the absence, still, of accord on this point among all investigators, it is well to avoid such splashing as far as possible.

As for the typhoid fever germ, how very difficult it is to catch it, even in sewage, is clear, says Mr. Roechling, from

the report of Messrs. Laws and Andrewes. Although they used the greatest care, they were not able to find this germ once, in ordinary London sewage. Even in the typhoid fever hospital drain inside the hospital grounds, they were able to find only two colonies, and in this drain a quarter of a mile away not a single typhoid germ was found. They probably were killed by other bacteria who were their enemies and vastly exceeded them in numbers; for many harmless germs thrive in sewage, as disease germs appear not to.

Accordingly from all these investigations we may conclude that the cases of typhoid fever and other diseases to which we have alluded were not due to disease germs entering the houses in the air of the sewers, but to contamination of the food or water supply by sewage polluted water, or by insects, especially house flies, passing from infected substances to the food or bodies of the inmates, the sewer air simply predisposing the system to infection.

A few words now about different methods of sewage disposal are necessary to enable us to treat intelligently the house plumbing connecting with and dependent upon it.

Mr. Roechling** well defines "decomposition" as the process of complete oxidation or mineralization, in which the organic matter in the presence of an ample supply of oxygen is converted into its new compounds of water, carbonic acid, nitrous and nitric acids without the creation of foul smells; and "putrefaction" as the process of incomplete oxidation, in which, in the absence of oxidation, foul smells are produced "which poison the atmosphere."

Decomposition is conducted by the "aërobes," bacteria which can only exist in the presence of oxygen, but putrefaction with its foul and injurious smells is accomplished by

**"Sewer Gas and Its Influence Upon Health." H. Alfred Roechling. Biggs & Co., London, 1899.

hordes of ænaërobes who "finally perish in the ever increasing carbonic acid or in other substances of their own making."

It is stated that the number of bacteria of decomposition which are found in the average dejecta of an adult male exceeds thirty thousand millions, and it is held that, where disease germs exist among these, they succumb after a short struggle for existence with the swarms of the aërobes.

A properly constructed system of sewers is one which delivers all waste matters at the sewer outlet in a fresh condition, that is in a condition in which they might flow through a perfectly smooth and well washed street gutter without attracting attention by their odor. The sewers must be thus constructed and as free from odors as such a street gutter. To accomplish this, all unscoured areas or chambers in the drainage system and foul dead ends of every description in the house or out of it, must be avoided as centers of putrefaction.

VIEWS OF OTHER AUTHORITIES.

Dr. A. Jacobi in a paper read before the Congress of American Physicians and Surgeons at Washington as early as 1894, sums up as follows:

"I may be finally permitted to add the oral testimony of more than a dozen European medical men and dozens of Americans. Every one was asked by me: What do you know of the production of a specific germ disease out of, or through, sewer air? The uniform answer was: There is a general vague impression among the public, but I never saw a case or could prove one.

Some of the conclusions to be drawn from this paper would be as follows:

The atmosphere contains some specific disease germs, both living and dead.

They are frequently found in places which were infected with specific disease.

In sewer air fewer such germs have been found than in the air of houses and school rooms.

Moist surfaces—that is, the contents of cesspools and sewers, and the walls of sewers—while emitting odors do not give off specific germs even in a moderate current of wind.

Splashing of the sewer contents may separate some germs, and then the air of the sewer may become temporarily infected, but the germ will sink to the ground again.

Choking of the sewer, introduction of hot factory refuse, leaky house drains and absence of traps may be the causes of sewer air ascending or forced back into the houses. But the occurrence of this complication of circumstances is certain to be rare.

Whatever rises from the sewer under these circumstances is offensive and irritating. A number of ailments, inclusive, perhaps, of sore throats, may originate from these causes. But no specific diseases will be generated by them except in the rarest of conditions, for specific germs are destroyed by the process of putrefaction in the sewers, and the worse the odor the less the danger, particularly from diphtheria.

The causes of the latter disease are very numerous, and the search for the origin of an individual case is often unsuccessful.

Irritation of the throat and naso-pharynx is a frequent source of local catarrh; this creates a resting place for diphtheria germs, which are ubiquitous during an epidemic, and thus an opportunity for diphtheria is furnished.

Of the specific germs, those of typhoid and dysentery appear to be the least subject to destruction by cesspools and sewers. These diseases appear to be sometimes referable to direct exhalation from privies and cesspools. Very few cases, if any, are attributable to sewer air.

A single outlet from a sewer would be dangerous to general health because of the density of odors (not germs) arising therefrom. Therefore a very thorough and multiple ventilation is required.*

The impossibility or great improbability of specific diseases rising from sewers into our houses, protected as they are, or ought to be, by good drains and efficient traps, must, however, not lull our citizens and authorities into indolence and carelessness.

For the general health is suffering from chemical exhalations, and the vitality of cell life and the powers of resistance are undermined by them."

Naegeli experimented by enclosing putrescent and putrescible liquids in sealed vessels together for over three years without air infection taking place, and by drawing air through sand wetted with putrescing liquid and then through sterile infusion without infecting the latter.

Sir Edward Frankland of England found that "the moderate agitation of a liquid does not cause the suspension of liquid particles capable of transport by the circumambient air," but that "the breaking of minute gas bubbles on the surface of a liquid consequent upon the generation of gas within the body of the liquid is a potent cause" of such suspension, and that therefore the stagnation of sewage or constructive defects in sewers may form cesspools of putrefaction in the sewers and generate gases which may form these bubbles. Such defects in sewer construction are totally unnecessary, and cesspool accumulations should, as I have said, never be allowed.

In 1883 P. Miquel* published the results of his experiments on the comparison between sewer and street air in

*"The Sidewalk Ventilators in New York City are almost all obstructed."

*"Les Organismes Vivants de l'Atmosphere," Paris.

MICRO-ORGANISMS IN SEWER AIR.

Paris, and from 1893 to 1899 he made periodical tests which were given in the following table:

BACTERIA IN COUNTRY AIR, CITY AIR, AND SEWER AIR,
PER CUBIC METER.

Year.	Country Air.		Sewer Air.
	Montsouris.	Hôtel de Ville.	
1893.....	285	8,435	5,015
1894.....	230	9,775	2,920
1895.....	330	7,615	2,590
1896.....	...	6,205	3,965
1897.....	197	5,410	3,875
1898.....	...	5,200	2,075
1899.....	...	6,595	2,910

Uffelmann experimented with a house drain in 1886-7, taking nine samples at intervals during a year. He found an average of 3 bacteria per liter of sewer air. Petri found 1 bacterium and 3 molds in 100 liters of air in a Berlin sewer on one occasion and no bacteria and 1 mold on another.

Carnelley and Haldane* made important studies on sewer air in England in 1887. They found less bacteria in the sewers than in the streets in almost all cases, averaging 9 per liter in the former and 16 in the latter. They concluded that "The micro-organisms in sewer air come entirely, or nearly so, from the outside, and are not derived, or only in relatively small numbers, from the sewer itself." They found a considerable increase, however, under violent splashing. They found less bacteria in the air in contact with quietly flowing sewage rather than more, on account of the wet surface.

Robertson** found less bacteria in the air of the sewers

*T. Carnelley and J. S. Haldane. "The Air of Sewers," proceedings of the Royal Society of London, 1887, XLII, pp. 394 and 501.

**"A Study of Micro-Organisms in Air, Especially Those in Sewer Air, and a New Method of Demonstrating Them." British Med. Journal, Dec. 15, 1888.

of Penrith than in the street air, averaging 4 to 6 respectively. More bacilli were found in the former and more cocci in the latter.

Laws found that even splashing in sewers was unlikely to produce appreciable infection, and that sewage falling into an egg-shaped sewer, 11 ft. x 9, from the middle of its height, produced practically no effect on the number of germs.

J. McG. Smith (Sixth Annual Report of the Metropolitan Board of Water Supply and Sewerage, 1893) found as an average of 20 tests 225 germs per liter in the sewers of Sydney, the particular forms being without exception organisms common in street air.

In 1894 Dr. A. C. Abbott of Philadelphia found germs were transported on a current having a velocity of 16.5 cm. per minute, but not by one of 8.6 per minute or less. Dr. Abbott's conclusions were that the danger of bacteria being transmitted under natural conditions was practically negligible.

Dr. Charles Harrington* says "The majority and the best of German investigators, such as Flügge, Rubner, Gärtner, Soyka, Prausnitz, and others maintain that sewer air and sewer gases are quite incapable of conveying the germs of typhoid fever and other infective diseases. It is true that some of the gases given off in the putrefaction processes which go on in sewers are more or less poisonous, but whether they are capable of producing any injurious defects depends very much on the amount inhaled and on the degree of concentration. In any event they are certainly incapable of producing any infective disease in the absence of the specific germ."

Mr. Allen Hazen writes that Col. Ruttan has "investigated the plumbing in a considerable series of houses in Win-

*A Manual of Practical Hygiene, Phila. and N. Y., 1901.

nepeg with the general result of finding that plumbing is not associated with typhoid fever. In fact his statistics show a somewhat larger proportion of cases of typhoid fever in the houses where the plumbing is good, than in those places where it is defective."

Mr. Hazen sums up the best current American opinion in the following sentence "After many years of experience and long continued investigation there is not the slightest reason to believe that infectious diseases are carried by the air of sewers."*

G. C. Whipple** says "Typhoid germs do not readily leave a moist surface. Sticky by nature they adhere until desiccation loosens their dead cells. For this reason sewer air is not to be looked upon as a direct means of infection."

In 1907 Major W. H. Horrocks* of the Royal Army Medical Corps of Great Britain in some analyses of sewer air at Gibraltar found under certain conditions germs carried from the sewage into the air. His principal deduction from these tests was stated as follows: "Specific bacteria present in sewage may be ejected into the air of ventilation pipes, inspection chambers, drains and sewers by (a) the bursting of bubbles at the surface of the sewage, (b) the separation of dried particles from the walls of pipes, chambers, and sewers, and probably by (c) the ejection of minute droplets from flowing sewage."

This paper created some excitement among sanitarians in the world, and caused many to return almost to the old time terror of "sewer gas."

But closer examination of the experiments of Horrocks and of his summary of conclusions does not appear to jus-

*Engineering News, LIII, 246.

**In the latest American Text Book on Typhoid Fever (Typhoid Fever, New York, 1908).

*Proceedings of the Royal Society, Series B, Vol. LXXIX, No. E 531, p. 255. Feb. 7, 1907.

tify any such alarm. These conclusions as stated by himself were only such as had practically been admitted by previous investigators we have already quoted.

In some of his experiments Major Horrocks used strongly foaming soapy solutions and vigorous splashing resulting in the ejection of a few germs (*B. prodigiosus*) from the sewage in the same way with other investigators. In another case he obtained a few germs from quietly flowing sewage. But this again had been observed by others and ascribed to the drying of sewage on the sides of the pipes, or from the transmission through it of fine bubbles caused by decomposition or chemical action in the sewage. Certain germs are known to dart rapidly through the fluids in which they exist under the action of flagella, cilia or whips attached to their bodies. Others have a slow serpentine, spiral or creeping motion and it might, at first thought, seem possible for the swiftly darting kinds to leap out of the water like a flying fish and thus escape into the air. A flying fish can leap from the water and remain a few moments in the air. But the germ has not the peculiar muscular, flexible, and springy body, fins and tail of the flying fish. The long flagella of the germ presents precisely the construction which would prevent aerial flight especially when heavy with water soaking. Cuttle and jelly fishes more nearly resemble the flagellated bacteria and these do not fly about in the air. To expect such action on the part of even the swiftest darting germ would be as reasonable as to expect to see a devilfish paddle himself with his long tentacles up to the surface of the ocean and soar away above the clouds. Mariners have not as yet recorded having seen this feat and microscopists are as little likely to have to tell the tale about disease germs. That germs do not progress by their own motive power through air was indicated by Pasteur when he proved that it was not necessary to insist upon hermetic sealing or cotton

MICRO-ORGANISMS IN SEWER AIR.

filters to keep them from gaining access to a flask of infusion. It is now well known that if the neck of the flask be drawn out into a long tube and turned downwards, and then a little upwards, even though the end be left open, no contamination will gain access. The force of gravity will prevent them from ascending the long arm of the tube into the neck of the flask and impregnating the infusion.

Moreover Major Horrock's bacterium prodigiosus has a very slow and sluggish motion. His conclusion that germs may probably escape from minute droplets ejected from flowing sewage seems perfectly natural and requires no special explanation.

A repetition of Major Horrock's experiments by another well known bacteriologist* recorded in the following table showed similar results, and in this case also the germs ejected were so few as to be, from a sanitary point of view, considering the great volume of the air into which they were transmitted, entirely negligible, as he showed in various ways and from the following table.

BACTERIA IN AIR OVER FOAMING LIQUIDS.

B. prodigiosus per liter.

Experiment.	In liquid.	In air.		
1	630,000,000	0	0	0
2	680,000,000	0	0	0
3	230,000,000	0	1	0
4	5,000,000,000	0	1	3
5	1,000,000,000	0	0	0
6	2,700,000,000	1	0	0
7	1,800,000,000	0	0	0
8	4,400,000,000	0	0	0

He found that even under conditions of foaming and bubbling very favorable for ejecting bacteria into the air from

*See report of Prof. C. E. A. Winslow's experiments for the National Association of Master Plumbers.

liquids containing many millions and even billions of bacteria per liter,* the number so ejected was so very small as to be practically negligible. Most accurate methods of detection were employed, so that there should be no question of detection of any germ released from the liquids swarming with them. Prof. Newman** gives a provisional list of normal sewage bacteria as follows: (1) *Coli communis*, (2) *proteus vulgaris*, (3) *B. enteriditis sporogenes*, (4) liquefying bacteria, *B. subtilis* and *B. mesentericus*, (5) non-liquefying bacteria, (6) *sarcinæ*, yeasts and moulds. No pathogenic bacteria are included in this inventory. "Doubtless," he says, "such species (e. g., typhoid) not infrequently find their way into sewage. But they are not normal inhabitants, and though they struggle for survival, the keenness of the competition among the dense crowds of saprophytes makes existence almost impossible for them. * * *

There is no relationship between the microbes contained in sewer air and those contained in sewage. Indeed, there is a marked difference which forms a contrast as striking as it is at first sight unexpected. The organisms isolated from sewer air are those commonly present in the open air. Micrococci and moulds predominate, whereas in sewage bacilli are most numerous. * * *

Pathogenic organisms and those nearly allied to them are found in sewage, but absent in sewer air. * * *

Lastly, only when there is splashing in the sewage, or when bubbles are bursting (Frankland) is it possible for sewage to part with its contained bacteria to the air of sewers. * * *

The interior of the cavity of the mouth and external respiratory tracts is a moist perimeter from the walls of which no organisms can rise except under molecular disturbance. The position is precisely analogous to the germ-free sewer air as established

*About a quart.

**Demonstrator of Bacteriology in King's College, London, in his work entitled "Bacteria," published by John Murray, London, 1899.

by Messrs. Laws and Andrewes for the London City Council. The popular idea that infection can be 'given off by the breath' is contrary to the laws of organismal pollution of air. The required conditions are not fulfilled, and such breath infection must be of extremely rare occurrence. The air can only be infective when filled with organisms arising from dried surfaces. The other series of investigations were conducted by Drs. Hewlett and St. Clair Thomson, and dealt with the fate of micro-organisms in inspired air and micro-organisms in the healthy nose. They estimated that from 1,500 to 14,000 bacteria were inspired every hour. Yet, as we have pointed out, expired air contains practically none at all. * * * From the two series of experiments which we have now considered we may gather the following facts:

- (a) That air may contain great numbers of bacteria which may be readily inspired.
- (b) That in health those inspired do not pass beyond the moist surface of the nasal and buccal cavities.
- (c) That here there are various influences of a bactericidal nature at work in defense of the individual.
- (d) That expired air contains, as a rule, no bacteria whatever.

* * * "It should be noted that the bacilli of diphtheria are capable of lengthened survival outside the body, and are readily disseminated by very feeble air currents."

Miquel found during a six years' investigation of the air of Paris an average of 4,000 bacteria per cubic meter in that of Montsouris Park. Flügge, taking an average of the middle of the city, but only about a tenth as many in 100 bacteria per meter, estimates that "a man during a lifetime of seventy years inspires about 25,000,000 bacteria, the same number contained in a quarter of a liter of fresh milk."

The number of bacteria in the air diminishes in cities rap-

idly in proportion to the altitude, Miquel finding 750 per cubic meter in the Rue de Rivoli, but only 28 at the summit of the Pantheon. Whereas at the seashore there might average a hundred per meter, the number diminishes as the distance seaward increases, and the maximum distance seaward, according to Dr. Fischer's experiments, to which germs can be transported lies between 70 and 120 miles, beyond which they are almost invariably absent. "Of particular interest in these experiments," says Frankland, "is the very distinct manner in which they show that the microorganisms which are present in sea-water are not communicated to the air, excepting in the closest proximity to the surface, even when the ocean is much disturbed."

All these facts co-operate to show that wet surfaces do not give up their germs to the air under normal conditions.

CHAPTER VII.

THE DISCONNECTING TRAP AND THE REASONS WHY ITS USE SHOULD BE PROHIBITED BY LAW.

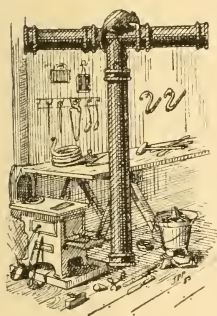

THE fact that the air of sewers is freer from all forms of micro-organisms than is the outer air above them accounts for the immunity with which people may work in well ventilated sewers, and explains the reason why the great Paris sewers, for instance, are so safe, visited every year by thousands of travelers from all parts of the world, with no case on record of resulting disease.

It has been related that the most remarkably located hotel in the world was built in these Paris sewers almost immediately beneath the Madeline church to accommodate the municipal scavengers. The interior was described as being singularly neat and clean, and as serving between sixty and seventy breakfasts and dinners to the workmen therein, and these sewer laborers are as healthy as are any other class of laborers in the city.

In view of all the facts, it becomes evident that the disconnecting trap and its vent are really worse than unnecessary. They are a positive injury as obstructing ventilation and waste discharge, as complicating the plumbing, as forcing odors generated in poorly ventilated sewers directly into the crowded streets, sometimes greatly to the annoyance of the people, and, above all, of depriving us of one of the most effective means now known of filtering the air of cities and towns of dust and disease germs. Their use

should therefore be prohibited by law so that every soil pipe may serve as an effective means of ventilating the sewers and reducing the number of floating impurities in the outer air. This latter advantage I have not as yet seen advanced, though it is of the utmost importance, especially in times of epidemics.

So important is this matter and yet so little is it understood by the public that we ought to call a little further attention to some of the more recent investigations which have been made into the number and kind of bacteria found in the air of the streets and as to their fate when they find access into the sewers through the ventilating inlets.

Analyses of the air in the Paris sewers have been regularly made at stated intervals and it is found that this air contains on the average more carbonic acid and ammoniacal nitrogen than the street air, but only half as many germs of any kind, while most of the investigators have failed to find any disease germs at all there. In these investigations it has been found also that the humidity in the sewers is great and practically constant.

In the air of the sewers of Berlin Petri found that there were only a very small number of micro-organisms as compared with that of the streets.

Similar results were obtained by other investigators in the sewers of London, Dundee, Westminster, Bristol and Sydney in Great Britain, where classifications of the various kinds of bacteria were made. In all these researches it was found that sewer air is, as far as germs are concerned, very much purer than outside air, and that these germs came not from the sewer but from the outer air; that a decrease in the number of germs in the outer air was followed by their decrease in the sewer air; that the kind of germs in the sewer air was the same as that in the outer air, but different from those contained in the sewage itself. Laws and Andrewes, who were commissioned by the county council

to study the bacteria in the London sewers, state that the number of micro-organisms existing in sewer air appears to be entirely dependent upon the number existing in the outer air at the same time and in the same vicinity. They say that if the organisms existing in sewer air were derived from those existing in sewage, then the flora of sewer air should bear a very close resemblance to the flora of the sewage, but that they in reality bear no resemblance whatever to one another. They say, indeed, "we may go even further and state that, as far as we are aware, not a single colony of any of those species which we have found predominant in sewage has been isolated from sewer air. We consider, therefore, that the study of the sewage bacteria on which we have been engaged fully confirms the conclusions previously arrived at from the study of the micro-organisms of sewer air, viz., that there is no relationship between the organisms of sewer air and sewage." * * *

"In the conclusions to Part I of this report we endeavored to show that sewer air has no power of taking up bacteria from the sewage with which it is in contact. A strong argument in favor of this view is the fact that the very organisms which are most abundant in sewage are precisely those which are absent from sewer air. In the course of previous experiments on sewer air, the nature of the organisms in some 1,200 liters of sewer air was carefully determined. Not once was the bacillus coli communis or any of the predominant organisms of sewage found, though we have shown above that the former is present in sewage in numbers varying from 20,000 to 200,000 per cubic centimeter. If this be so, how infinitely improbable becomes the existence of the typhoid bacillus in the air of our sewers. That sewage* is a common medium for the dissemination

*This is before the disease germs are destroyed in the sewers by coming in contact with the other bacteria which find in sewage their natural element and which are non-pathogenic

of typhoid is certain; that sewage-polluted soil may give up germs to subsoil air is possible; but that the air of sewers themselves should play any part in the conveyance of typhoid fever appears to us, as the results of our investigations, in the highest degree unlikely."

Now the house drains and soil pipes, being much smaller and longer in proportion to their sectional area, and being more uniformly moistened on their inner surfaces when in use, and having more bends and angles in proportion to their length than the public sewers, are correspondingly more effective in removing any bacteria which may enter them from the sewers. Hence the air of the house drains will, as is quite evident, and as I shall endeavor to make visible by experiments, be found to be still freer from germs than even that of the sewers themselves.

As has already been pointed out, the danger from the inspiration of sewer air is generally believed to lie in predisposing the system to harm from disease germs coming from other sources. This predisposition is probably due to the gases given out by putrid fermentation, such as carbonic acid, ammonia, sulphurated hydrogen, hydro carbons and volatile fatty acids, and the danger is in proportion to the concentration of these poisonous matters. This danger may be reduced to a minimum or altogether removed by thorough ventilation. In order to provide a simple ocular demonstration of the manner in which sewage and the moist surfaces of sewers arrest these fine particles when they are brought in contact with them, gradually clearing the air of them entirely, I constructed several experimental drain pipes of metal and glass tubing and of different lengths, varying from ten to twenty-five feet, some being straight and others bent.

These pipes were thoroughly moistened on the inside

DISCONNECTING TRAP SHOULD BE PROHIBITED BY LAW,

with water, and a specified quantity of dry fine dust was placed at one end of each, and the attempt was made to blow the dust through the pipes from end to end by means of bellows. Before describing our experiments it is important to point out the relation which dust bears to disease and how it serves to disseminate bacteria through the air. Mrs. Frankland* says in her most valuable work, entitled "Bacteria in Daily Life," published in 1903: "That it is no exaggeration to describe streets from the bacterial point of view as slums is to be gathered from the fact that much less than a thimbleful of that dust which is associated with the blustering days of March and the scorching pavements of summer may contain from nine hundred to one hundred and sixty millions of bacteria. But investigators have not been content to merely quantitatively examine street dust; in addition to estimating the numerical strength of these dust battalions, the individual characteristics of their units have been exhaustively studied, and the capacity for work, beneficent or otherwise, possessed by them has been carefully recorded. The qualitative discrimination of the bacteria present in dust has resulted in the discovery of, among other disease germs, the consumption bacillus, the lockjaw or tetanus bacilli, bacteria associated with diphtheria, typhoid fever, pulmonary affections and various septic process. Such is the appetizing menu which dust furnishes for our delectation. There can be no doubt, therefore, that dust forms a very important distributing agent for microorganisms, dust particles, aided by the wind, being to bacteria what the modern motor-car, with its benzine or electric current, is to the ambitious itinerant of the present day. Attached to dust, bacteria get transmitted with the

*Mrs. Percy Frankland, Fellow of the Royal Microscopical Society, Honorary Member of Bedford College, University of London, and joint author with Professor Frankland of "Micro-Organisms in Water," "The Life of Pasteur," etc.

greatest facility from place to place, and hence the significance of their presence in dust."

It is also now believed that typhoid fever may be spread by dust, the germs having been discovered in it. A typhoid fever epidemic at Athens a few years ago was believed on good evidence to have been spread by the wind on typhoid dust particles, and epidemics of typhoid in other places have recently been traced to the same cause, the dejecta of sufferers from the disease having been thrown in places where it became dried and afterward distributed by the wind.

"That the bacillus of consumption," says Frankland, "should have been very frequently found in dust by different investigators is hardly surprising when it is realized that the sputum of phthical persons may contain the tubercle germ in large numbers, and that until recently no efforts have been made in this country to suppress that highly objectionable and most reprehensible practice of indiscriminate expectoration. Considering that the certified deaths from phthisis in 1901 in England and Wales only reached the enormous total of 42,408, and bearing in mind the hardy character of the bacillus tuberculosis when present in sputum, it having been found alive in the latter even when kept in a dry condition after ten months, it is not too much to demand that vigorous measures should be taken by the legislature to cope with what is now regarded as one of the most fruitful means of spreading consumption."

Boards of health and high authorities both here and abroad have stated that tuberculous sputum is the main agent for the conveyance of the virus of tuberculosis in the air from man to man, and that indiscriminate expectoration should therefore be suppressed.

Dr. E. Concornotti has recently made a very elaborate study of the distribution of disease germs in air, with the result that out of forty-six experiments in which the ch77-

acter of the bacteria found was tested by inoculation into animals, thirty-two yielded organisms which were pathogenic.

Messrs. Valenti and Terrari-Lelli found similar results in their systematic study of the bacterial contents of the air in the city of Modena. In their report they state that the narrower and more crowded the streets the greater was the number of bacteria present in the air, and the more frequently did they meet with varieties associated with septic disease.

Schäffer has shown that leprosy bacilli may be disseminated in immense numbers by the coughing of leprosy patients, while it has been estimated that a tuberculous invalid may discharge a billion tubercle bacilli in the space of twenty-four hours, and the dried sputum of consumptive persons has actually engendered tuberculous symptoms in the lungs of animals which were made to inhale it. In as many as 71 per cent of bovine tuberculosis cases the respiratory organs were the seat of the disease. A case is mentioned by the well known veterinary authority, M. Nocard, of a whole stall of animals becoming infected through the workman attending them being consumptive. He slept in a loft over the cows, and his tuberculous sputum in the form of dust was conveyed to the stalls beneath and so spread the infection. The disease is known to have been spread, on the other hand, from animals to men in the same way.*

It has been found by analysis of air containing large numbers of bacteria that showers greatly reduce their numbers, as it reduces the amount of dust in the air, and that prolonged rains may clear the air of dust and bacteria entirely. This accords with the action of the water and wet surfaces of sewers in filtering the air of germs, and if the sewers and house drains are long and wet enough in proportion to

*Frankland's "Bacteria in Daily Life."

the amount of air passing through them, all dust and germs may be filtered from this air entirely.

Laws says "It is really remarkable to find that no organisms are given off from the walls of a sewer which has been empty and open to the air at both ends for such a lengthened period as twelve days. The sewage with which the sewer had been kept full for several periods of twenty-four hours would contain no less than three to four million organisms per cubic centimeter, and immense numbers of these must of necessity have been clinging to the walls of the sewer. * * * The velocity of the air current used in the above experiments was five feet and fifteen feet per second, respectively, the latter being far in excess of any current that would normally obtain in a sewer."

"Various experiments," says Roechling, "have been made with a view to ascertain how far germs can be carried away by air currents in pipes and sewers. Hesse, who first investigated this point, took a 2-inch glass tube about one yard long, the inside of which he had covered with a layer of nutritive gelatine, and sucked air through it at a slow rate. When examining the tube afterwards he found that a large number of bacteria had settled in its first fourth, that the number was somewhat less in the second fourth, and that it still further decreased in the third fourth, and that no bacteria at all had settled in the last fourth."

Ficker remarks that in his experiments in the Hygienic Institute at Breslau a current of air, with the velocity of several meters per second, was not able to lift up specific germs from half-moist soil, and that a current of the same strength was not capable of carrying away germs which had dried on several substances and adhered to them.

AUTHOR'S EXPERIMENTS AND SUGGESTIONS FOR IMPROVING THE AIR OF CITIES.

Various kinds of dust, from fine lint up to fine and coarse

sawdust, were used successively in my own experiments. Dry powdered substances of different kinds, such as whiting cement and fine flour, were also used. Bacteria, being fine particles of organic matter, resemble these fine dusts in the manner in which they may be wafted about on air currents and are retained by water.

In no case could any of the particles which came in contact with the wet sides of the pipes be seen to be blown off again. If any escaped they were too few and small to be detected. The bellows were large and strong, capable of producing at will either a powerful draught through the pipes or a faint and almost imperceptible current. With the short pipes it was possible to drive some of the particles through in a strong draught because these did not have time to come at all in contact with the moistened surfaces, but with pipes twenty-five feet long and one and a half inch in inside diameter none could be forced through even under a pressure strong enough to put out the flame of a candle at the further end. Where bends were introduced the same result was obtained with shorter pipes. Fig. 51.

With gentler pressures still shorter pipes sufficed to entirely filter the air of all particles, however dry and finely powdered; and, in the very slowly moving air currents found in the average sewer, a very short travel is sufficient to arrest all dust or bacteria of every kind.

The same experiments were then tried with the pipes thoroughly dried on their inner surfaces. In these cases all of the dust was easily blown through all the pipes after a more or less prolonged application of the air pressure, the surfaces of bends arresting for some time some of the particles by back eddies, but all eventually passed through.

With jointed pipes, however, as might be expected, some little of the dust and powder would be permanently retained in the fine cracks of the joints.

The interiors of the pipes were next coated with sewage and moistened, and the experiments were repeated under these conditions with the same results obtained in the first experiments with pipes moistened with water alone. No particles once coming in contact with the moist surfaces could ever be detached again, however strong the air current, so far as could be observed.

Only the particles of dust which happened to travel from end to end in the middle of the air blast escaped from the pipes, and, as before said, this only occurred with short pipes and in currents stronger than those which prevail in ordinary sewers. As has been said, it is generally conceded that bacteria may rise through water in the center of bubbles bursting on the surface, or in droplets caused by agitation or spraying. But in well ventilated and properly constructed sewers such splashing and bubbling may be largely avoided. But should they occur, the very few bacteria thereby escaping into the air of the sewer could only travel a short distance, as we have shown, before they would again be caught and, if of the pathogenic kind, be quickly destroyed.

Finally, the pipes containing the particles of dust of various kinds imprisoned in the moisture and organic refuse along their inner surfaces were thoroughly dried by exposure for several days to the dry air of the laboratory, and then the air blasts were repeated to see whether the dried particles of matter caked against the walls of the pipes would give up the dust and bacteria blown against them when they were wet. None of the dust escaped, so far as could be seen. Under the most powerful blasts pieces of caked refuse would occasionally be torn off the surfaces to which they would normally adhere, but these were heavy and fell directly to the ground as soon as they were blown from the pipes. The dust particles still remained firmly

imprisoned in these masses of scale and were therefore as powerless to do injury as if they had never been detached from the part of the pipe against which they originally fell. The masses containing the separate particles of dust or bacteria were simply transferred from one part of the pipe system to another. The reason for this is obvious. Wet sewage, containing many kinds of glutinous and fatty matters, forms, when it dries, a more or less pasty mass, which hardens into a tenacious cake, and in these experiments appeared to hold the dust or bacteria enmeshed in its mass as firmly as it did when it was in its moist state.

Thus we see that the sewers really form vast filters, as it were, for clearing the air which passes through them of germs of disease, and it is the province of the science of sanitary engineering to make the most of this wonderful provision of nature in man's behalf by co-operating with her methods and increasing to the utmost extent the ventilation of the sewers and drains.

We know, for instance, that, especially in times of epidemics, the air of the streets contains many disease germs. If we could erect in front of our windows and doors continuously moistened filters of such a construction that no particle of air could enter the house without first coming in direct contact with some part of the moist surface of the filter, and if the filter could be provided with a germicide maintained constantly active, it is certain not only that the inmates of these houses would be shielded from the diseases conveyed by germs as long as they remained within the protection of the filters, but also that the germs themselves in the locality would gradually be diminished in numbers until, if the traps were numerous enough, all might ultimately be destroyed.

Now the sewers form precisely such filters, and if copiously ventilated by pure air currents induced by making

every house drain a suction pipe, no offensive odor could come from the sewers, and all the air thus drawn in from the streets would be freed from dust and germs.

How short-sighted and foolish it is, then, to legislate against such beneficent ventilation and purification by requiring a barrier to be interposed at every house drain outlet, by which the only really practicable way of thoroughly ventilating the sewers is prevented.

There is no way known of setting up such screens as I have described in front of our windows. But it is easily possible to utilize the sewers already provided for us and equipped with a most marvelously effective dust arrester and germicide.

I do not say that with such perfectly constructed and ventilated sewers as these it would be wise in times of epidemics to nail up our windows and ventilate from the sewers, because the house drains and soil pipes will always contain foul gases, which it will justify the use of our best science to exclude from the house, and because the smallest of the city sewers would have to be enlarged for such service to the size of a Hoosac tunnel. But I do say that any air which might accidentally enter the house through them would be safer to breathe, so far as disease germs are concerned, than that which would enter through the windows, and that no odor would enter the house from the sewers themselves, however much might be generated in the private drains, because the warmth of the sewage and of the house would always create an upward draught in cold weather and fresh air would enter the sewers through the street openings everywhere provided for it. In hot weather citizens could take their choice between disease germs from the windows and an occasional odor from the private drain.

Supposing, now, that the houses of an average city average twenty-five feet in width on the street lines, if we were

to ventilate the sewers through every house drain we should have suction openings every twelve and one-half feet into the sewers, and these drains being four inches in diameter, we should have about twelve and one-half square inches of suction area for every twelve and one-half feet of sewer, or one square inch for every foot of sewer in a city. For supplying the air to the sewers corresponding street openings would be provided.

If we assume an average of twenty-five miles of streets in every square mile of a city we have for a city containing 100 miles of street about 528,000 square inches or 3,666 square feet area of sewer ventilation, which would be equivalent to a round ventilating flue sixty-eight feet in diameter or to 130 round flues six feet in diameter each.

Supposing the average height of the houses in our city to be fifty feet, and that the quantity of air discharged per minute through the 4-inch ducts of the 42,240 houses in our city of a mile square be estimated. Assuming that these ducts draw up the air at the rate of 419 feet per minute per square foot of ventilating area for an average difference of temperature in winter between the air of the house and that of the street of 30° F. (calculated under the

formula $V=240\sqrt{\frac{h(t_1-t)}{491.4}}$ in which V stands for the

velocity of the current, h the height of the building, t_1 the interior and t the exterior temperature, and allowing 50 per cent for loss by friction), we have a ventilation produced by all the 42,240 ducts of 1,536,054 cubic feet of air per minute.

Allowing five occupants for each house, we have somewhat over 200,000 inhabitants in our city of a mile square and our sewer ventilation would thus filter the air at the rate of over seven cubic feet per minute for every inhabit-

ant, or if we make a much larger allowance for friction and assume a smaller difference of temperature between the inner and outer air, we have a sewer ventilation of say from one to five cubic feet of air per minute for each inhabitant. The warmth of the sewage produced by the introduction of warm water into the drains would under these circumstances always produce suitable ventilation even in the summer months.

Thus the sewer ventilation produced by the omission of the main house trap and its vent would not only be the most perfect that can be devised, but it would reduce the

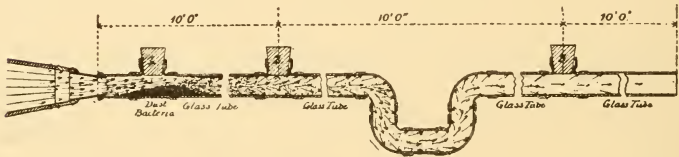

Fig. 51. Apparatus for determining the degree of retention of bacteria by the moist surface of sewers and drains.

cost of the whole sewerage system by a large percentage, in fact, over half a million dollars in our city of a mile square. In rebuilding the city of San Francisco probably several millions could be saved in this manner.

Fig. 51 shows our glass and metal sewer and drain pipe as arranged for the lecture room. The measured pile of dust to be experimented with is shown at the bellows end of the pipe. The first opening provided with a stopper is for the introduction of the dust. The other openings are to permit of tests being made upon short or long pipes and upon straight or bent pipes, as desired.

The arrows indicate the direction of the air currents

AUTHOR'S SUGGESTION FOR FILTERING THE AIR OF CITIES.

and the manner in which the dust particles are blown against the moist inner surfaces of the pipes to which they adhere. The bend in the middle of the pipe may be placed either horizontally or vertically. When vertical it becomes a trap and arrests, when full of water, all dust and germs.

CHAPTER VIII.

SEWERS.

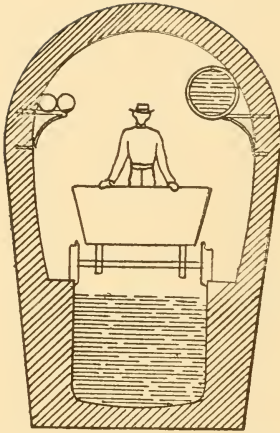

Fig. 52. Section of Paris sewers.

Figures 52 and 53 represent sections of large Paris sewers. They carry both the house drainage of all kinds and the street washings and rain or storm water. They come under the "combined" system of sewerage as distinguished from the "separate" system in which rain water is separated from the house wastes.

The egg-shaped sewer (Fig. 50, initial cut) is the usual form now employed. Where a flat invert is used, as in Fig. 50, greater convenience is obtained

for cleaning the flat portion, giving better foothold for the men. But for the conveyance of small quantities of sewage the regular egg form is better.

The section, Fig. 53, shows a form of sewer in which the gas pipes are submerged in a channel on one side filled with water to prevent leakage of gas.

The advantage of the separate system is that the flow is uniform and the dilution of the sewage is at its minimum, in which condition the valuable manurial part can be separated and the water purified and emptied into rivers or the ocean at a minimum of expense. In places where the grades are such that the rain water can be carried off in surface

SEWERS.

gutters to the ocean or river courses, the expense of the separate system is obviously much less than would be the combined. But where a double system of sewers would be required, as, for instance, in Paris, the cost would be greatly increased. The section in Fig. 55 shows a method by which the separate system might be used in a single sewer pipe, the drain water being shown in its maximum flow in the larger conduit and the house sewage in the smaller. By carrying the rain water pipes from the street gutters over

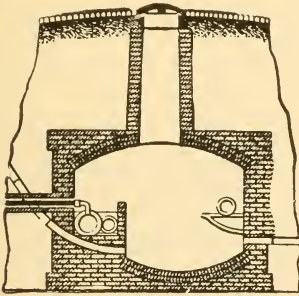

Fig. 53. Section of Paris sewers.

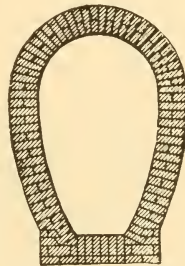

Fig. 50. Section of Egg-Shaped Sewer.

the house drainage conduit the position of their outlets might be so adjusted with reference to the latter that the first washings of the street would fall into it, and the storm water, as the storm increased in volume, would afterwards leap over it and fall into the larger conduit.

Whatever system be adopted, the sewer should be ventilated sufficiently often to render the air in the sewer perfectly pure, and such ample light should be provided as to give the double advantage of convenience of inspection and the freedom from the undesirable anaërobic germs to which strong light is inimical.

Frankland shows in a plate we have reproduced in Fig. 56 in a very interesting manner, the effect of sunlight on

disease germs. He placed the letters spelling the name of the particular disease germ upon which he experimented, cut out of opaque paper, upon a plate of gelatine inoculated with the germ, and exposed the plate to diffused sunlight. The germs protected by the paper letters multiplied rapidly, while all those in the unprotected parts of the plate were

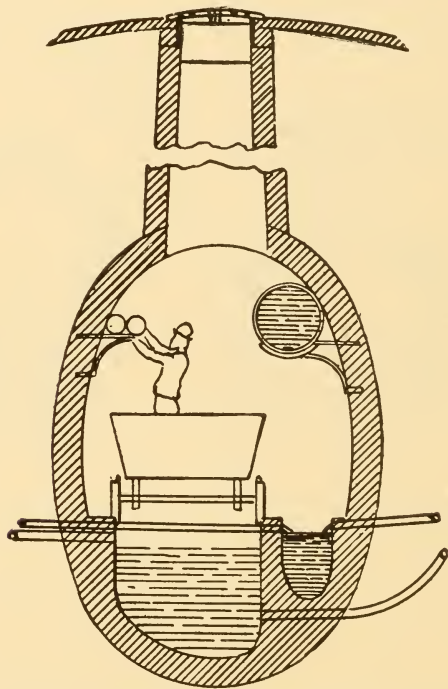

Fig. 55. Writer's method of combining both conduits of the separate system of sewerage in a single sewer.

destroyed, so that when the paper had been removed the disease germs had written their own autograph, as shown in the picture.

Ample lighting as well as ample ventilation is a sanitary measure everywhere.

SEWERS.

The inner surfaces of all sewers should be lined with glazed materials; and in large sewers with white glazed or enameled tiles to increase the light reflection and insure greater cleanliness.

Now that draught animals in our streets are gradually being supplanted by machine motors, the streets will soon be paved with smooth materials and be kept perfectly clean.



Fig. 56. Autograph of cholera germs.

This will tend to greatly simplify sewerage and effect a much more general adoption of the separate system enabling us to come much nearer the ideal of waste water purification and recovery of its useful manurial part, at a minimum of outlay.

Figs. 57 and 58 show old Paris sewers, the illustrations

being taken from Victor Hugo's "Les Miserables." These sewers carried the storm waters and house drainage with the exception of part of the W. C. refuse which was at that time almost exclusively collected in cesspools. Today the cesspools are gradually being removed and everything will soon be conducted directly into the sewers. The waste from the street urinals and the liquid overflow from the house cesspools was, however, taken into the sewers long before the crusade against cesspools was undertaken. Nevertheless the sewage today contains probably far more water in proportion to the bacteria within than it did at the time of Jean Valjean, because the supply of water to the closets fully offsets any additional impurity they furnished. Moreover, sink water and urine form the most dangerous parts of the house water. But the unscientific manner in which these old sewers were constructed and operated made them little better than elongated cesspools, as compared with the magnificent and cleanly conduits they appear today.

In 1882 Paris still had 80,000 cesspools and 30,000 shallow drinking water wells, most of which were contaminated and entirely unfit for use.

These pictures show the appearance of the old Paris sewers in 1805, when Bruneseau visited them with a view to their improvement. Fig. 57 presents the engineer making what Victor Hugo calls "the formidable campaign"—the "nocturnal battle against asphyxia and plague." Eight out of the twenty workmen gave up the battle in the middle of it. The ladders for measuring would sink three feet deep in mud, and the lanterns would scarcely burn in the mephitic atmosphere, the men fainting from time to time. There were horrible pits in the ground in which one man suddenly disappeared. The walls were hanging with fungi. Among other things they found the skeleton of an ourang-outang, which had disappeared from the Jardin des Plants in 1800

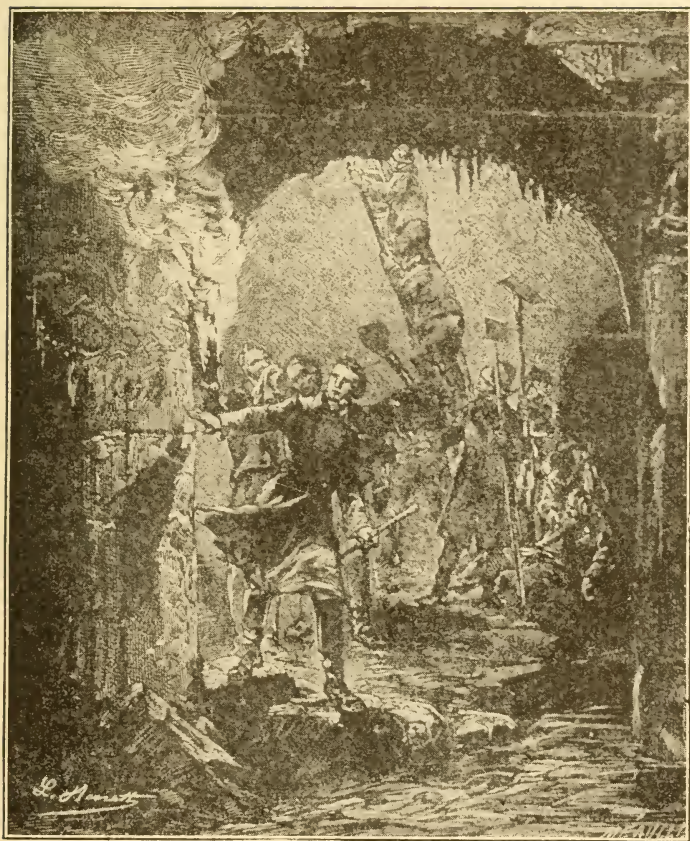

Fig. 57. Bruneseau visiting the old Paris sewers.

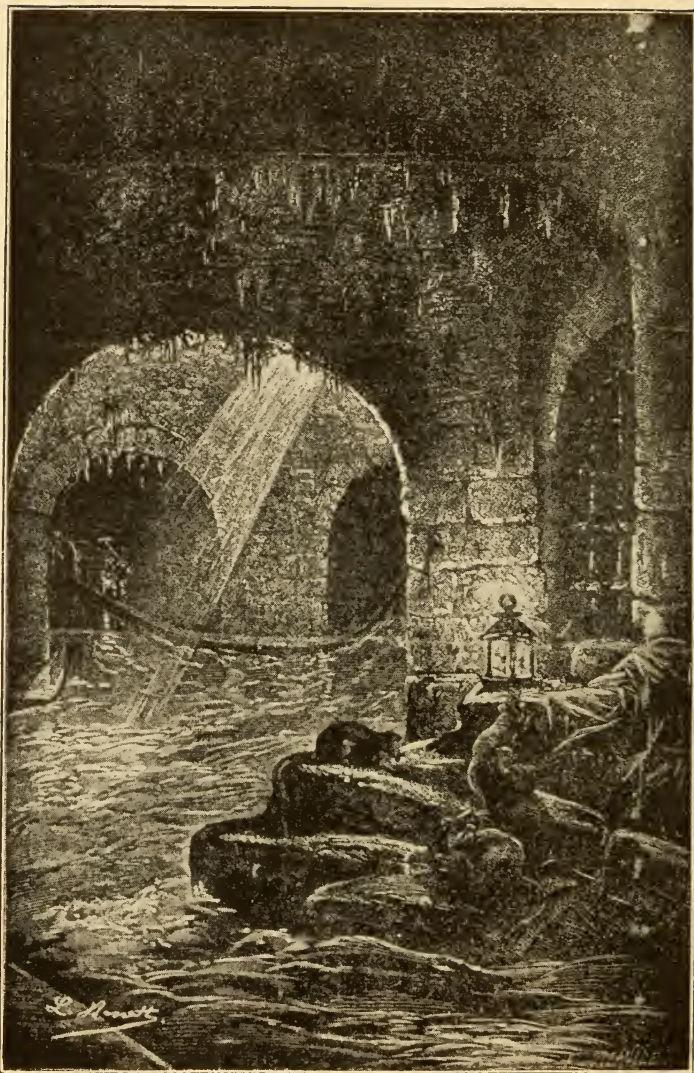

Fig. 58. Junction of old Paris sewers. From Hugo's "Les Misérables."

and drowned itself in the sewer. They found, also, on the other hand, valuable objects, coins, gold and silver, jewelry and precious stones.

Fig. 58 gives the point of junction of several of these old sewers, described by Hugo as "winding, cracked, unpaved, full of pits, broken by strange elbows, ascending and descending illogically, fetid, savage, ferocious, submerged in darkness, with gashes on its stones and scars on its walls."

The various methods of sewage purification now in operation in various parts of the world have shown the water carriage system of disposal to be far in advance of any dry system.

Erwin F. Smith in his treatise on "The Influence of Sewerage and Water Supply on the Death Rate in Cities," read at the sanitary convention in Michigan, July, 1885,* shows by charts I, II and III the reduction of the death rate of cities occasioned by the introduction of sewerage systems, and in spite of their antiquity they form as powerful arguments in favor of good sewerage as can be found.

His conclusions are:

(1) Typhoid fever and cholera decrease in proportion as a city is well sewered.

(2) There is no direct relation between diphtheria and sewers.

(3) The general death rate falls after the sewerage of a city, and, other things being equal, never again reaches the maximum of its anti-sewered condition.

(4) The cost of building and maintaining sanitary works is inconsiderable, in comparison with the direct pecuniary loss, by sickness and death, which their absence entails.

*Reprinted from Supplement to Annual Report Michigan State Board of Health.

CHART I.— DEATHS from TYPHOID FEVER to each 10,000 INHABITANTS before, during, and since the INTRODUCTION of SEWERAGE & WATER-SUPPLY.

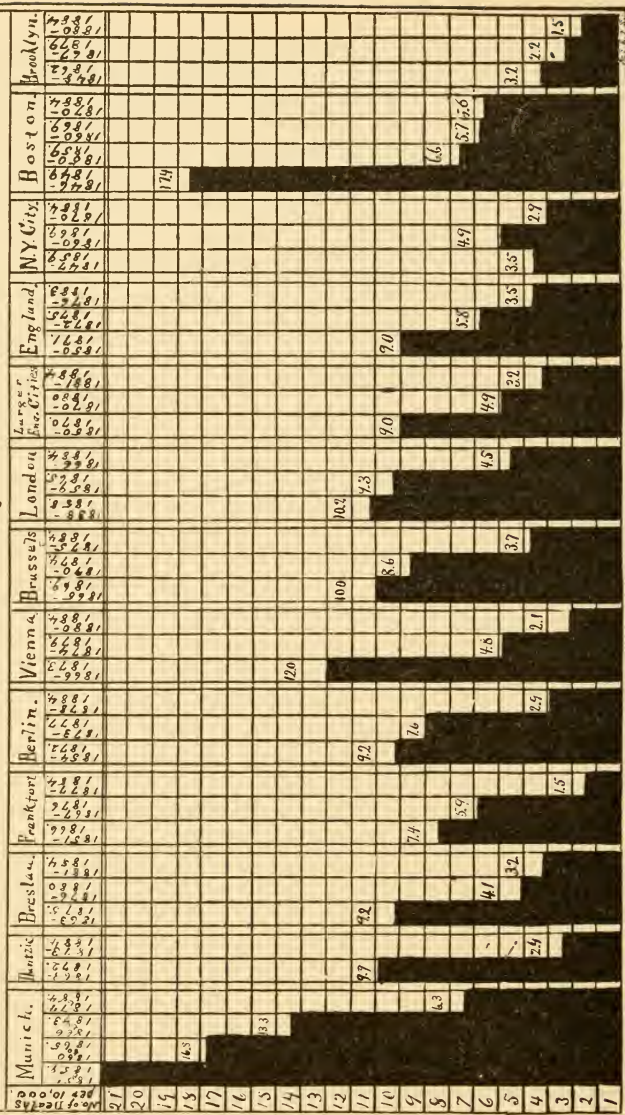

FIG. 58.

CHART II. DEATHS FROM TYPHOID FEVER to each 10,000 INHABITANTS in SEWERED & UN-SEWERED CITIES. Av. of 5 yrs., 1880-84, unless otherwise stated.

A. Cities with good sewers and a general water-supply.		B. Cities without sewers, or very imperfectly sewered.	
No. of Deaths per 10,000		No. of Deaths per 10,000	
1	Munich	1	Vienna
2	Danzic	2	Brooklyn
3	Frankfort	3	New York
4	Breslau	4	Eng. Cities
5	Hamburg	5	London
6	Berlin	6	Paris
7	Hamburg	7	Marseilles
8	Berlin	8	Turin
9	Breslau	9	Naples
10	Frankfort	10	Palermo
11	Danzic	11	Palermo
12	Hamburg	12	Palermo
13	Berlin	13	Palermo
14	Hamburg	14	Palermo
15	Berlin	15	Palermo
16	Hamburg	16	Palermo
17	Berlin	17	Palermo
18	Hamburg	18	Palermo
19	Berlin	19	Palermo
20	Hamburg	20	Palermo
21	Berlin	21	Palermo
22	Hamburg	22	Palermo
23	Berlin	23	Palermo
24	Hamburg	24	Palermo
25	Berlin	25	Palermo
26	Hamburg	26	Palermo
27	Berlin	27	Palermo
28	Hamburg	28	Palermo
29	Berlin	29	Palermo
30	Hamburg	30	Palermo
31	Berlin	31	Palermo
32	Hamburg	32	Palermo
33	Berlin	33	Palermo
34	Hamburg	34	Palermo
35	Berlin	35	Palermo
36	Hamburg	36	Palermo
37	Berlin	37	Palermo
38	Hamburg	38	Palermo
39	Berlin	39	Palermo
40	Hamburg	40	Palermo
41	Berlin	41	Palermo
42	Hamburg	42	Palermo
43	Berlin	43	Palermo
44	Hamburg	44	Palermo
45	Berlin	45	Palermo
46	Hamburg	46	Palermo
47	Berlin	47	Palermo
48	Hamburg	48	Palermo
49	Berlin	49	Palermo
50	Hamburg	50	Palermo
51	Berlin	51	Palermo
52	Hamburg	52	Palermo
53	Berlin	53	Palermo
54	Hamburg	54	Palermo
55	Berlin	55	Palermo
56	Hamburg	56	Palermo
57	Berlin	57	Palermo
58	Hamburg	58	Palermo
59	Berlin	59	Palermo
60	Hamburg	60	Palermo
61	Berlin	61	Palermo
62	Hamburg	62	Palermo
63	Berlin	63	Palermo
64	Hamburg	64	Palermo
65	Berlin	65	Palermo
66	Hamburg	66	Palermo
67	Berlin	67	Palermo
68	Hamburg	68	Palermo
69	Berlin	69	Palermo
70	Hamburg	70	Palermo
71	Berlin	71	Palermo
72	Hamburg	72	Palermo
73	Berlin	73	Palermo
74	Hamburg	74	Palermo
75	Berlin	75	Palermo
76	Hamburg	76	Palermo
77	Berlin	77	Palermo
78	Hamburg	78	Palermo
79	Berlin	79	Palermo
80	Hamburg	80	Palermo
81	Berlin	81	Palermo
82	Hamburg	82	Palermo
83	Berlin	83	Palermo
84	Hamburg	84	Palermo
85	Berlin	85	Palermo
86	Hamburg	86	Palermo
87	Berlin	87	Palermo
88	Hamburg	88	Palermo
89	Berlin	89	Palermo
90	Hamburg	90	Palermo
91	Berlin	91	Palermo
92	Hamburg	92	Palermo
93	Berlin	93	Palermo
94	Hamburg	94	Palermo
95	Berlin	95	Palermo
96	Hamburg	96	Palermo
97	Berlin	97	Palermo
98	Hamburg	98	Palermo
99	Berlin	99	Palermo
100	Hamburg	100	Palermo

Fig. 60.

CHART III. Deaths from Asiatic Cholera in American & European Cities, during the epidemic of 1865-6. Designed to show the protective influence of Sewerage & Water-supply. The cities of Group I. were abundantly supplied with good water and in most cases were also well sewered. The cities of Group II were incompletely sewered, or entirely destitute of modern sewers and very dirty. Their water-supply was scant or open to inspection, being generally very deficient both in quality and in quantity.

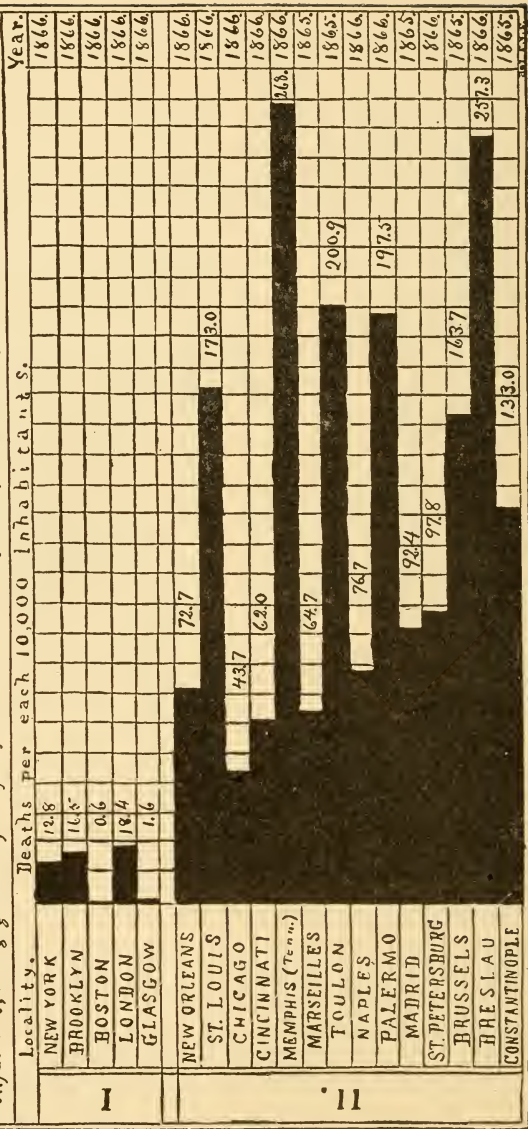
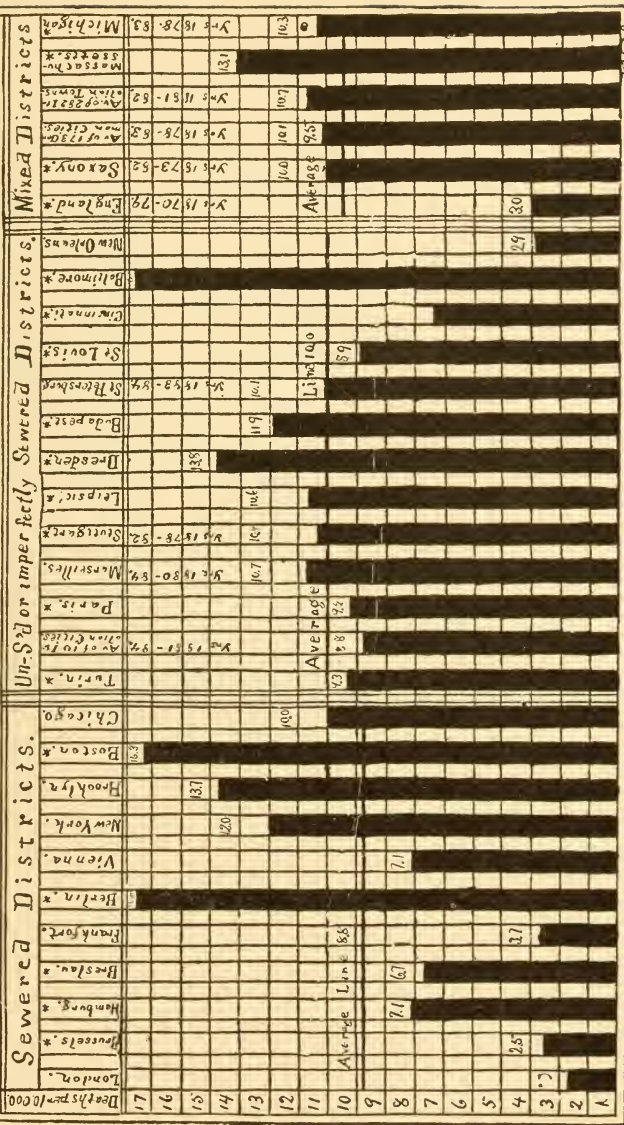

Fig. 61.

CHART IV. DEATHS FROM DIPHTHERIA TO EACH 10,000 INHABITANTS IN SEWERED & UN-SEWERED DISTRICTS. Av. of the 10 yrs., 1875-1884, unless otherwise stated. (The * shows that event is included.)



APPROXIMATE ESTIMATE OF THE COMPARATIVE AVERAGE
 COST OF PLUMBING WORK UNDER THE PRESENT
 COMPLICATED AND THE NEW SIMPLE SYSTEM



Complicated System



Simple System



Simple System in Alterations

In considering the various items of comparative cost of plumbing under the old and new systems we may classify the chief items of simplification as follows:—

(1) The back venting of traps should be prohibited. In estimating the saving which would come from this item we find that no close figure can be given without making a very extensive study of the different conditions involved, aided by exhaustive statistics. Very high buildings would require, for effective back venting, such an increase of size of pipe for each additional story to overcome friction, that the cost of the back vent pipes would far exceed that of the waste pipes. In buildings of the average height the cost should about equal that of the waste pipes. We may take Figs. 264 and 265 for fair examples of the two methods of piping for such buildings, except that in Fig. 264 the back vent pipes have not been sufficiently enlarged in the upper stories. (See Chap. XLIV.)

(2) Flexible joints and "Standard" thickness of pipes should be substituted for lead caulked and rigid joints with "Extra heavy" thickness. "Standard" thick cast-iron pipes weigh about half as much as "Extra heavy," and the cost of the former, considering the comparatively high cost of hand caulking is less than half that of the latter. See Note on pages 694 and 695.

(3) The use of the main house trap and its foot vents and other piping involved should be prohibited. The percentage of saving in this item depends upon the amount of piping which would be considered by different persons as necessitated by the use of this disconnecting trap. It would sometimes amount to a very large sum.

(4) The law calling for separate traps under each of several connecting fixtures should be modified. This would also sometimes amount to quite a large percentage, especially where back venting is difficult.

(5) The law requiring water closet rooms to be ventilated by special air shafts lighted by external windows should be modified to permit of their ventilation through effective ventilating pipes or ducts. This requirement sometimes involves the loss of exceedingly valuable room and outer wall space without any advantage, as explained in detail on pages 595 to 598, and the average saving possible in this item runs up to a very high figure.

(6) The law forbidding soil pipes to serve also as rain water conductors should be changed where the combined system of sewerage is used. This would there save one or more stacks of large pipes from roof to basement.

(7) The use of the hydraulic test for piping should be prohibited, because, while very expensive and altogether useless, it puts a strain on the piping far beyond what could ever be encountered in practice, and which, like excessive boiler pressure tests, for instance, may result either in destroying the property at once, or in developing unseen defects liable to appear disastrously in the future.

Taking all these large items together, and several smaller ones not here mentioned, the author believes the relative costs of the two systems of plumbing may be fairly represented by the comparative sizes of the squares shown in our initial cut. (See Chap. XLIV.)

CHAPTER IX.

TRAPS.

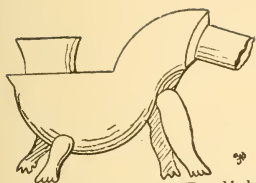

Fig. 62. Old English D Trap, styled the "Goose" Trap, probably in honor of the man who invented it.

A trap is a siphon placed in the drain to catch some of the water discharged from a fixture and form with it a barrier for the entrance of air from the drains into the house. The water forms what is called the trap "seal." In addition to the water seal some form of mechanical closure has sometimes

been added in the form of a valve, gate or ball, under the supposition that a water seal alone could not afford sufficient security. But the mechanical devices have now been found to create serious obstructions to the flow of the water, and to become, in time, corroded or in other ways more or less defective. At the same time it has been clearly shown that a sound water seal can be attained which affords entire security, and alone, so that the complication of a mechanical seal becomes entirely superfluous.

The four principal enemies of the water seals of traps are siphonage (which is the suction acting on trap seals produced by a partial vacuum in the waste pipe behind a falling plug of water discharged from a fixture), evaporation, back pressure and clogging by sediment accumulation. These enemies of trap seals will be examined in full detail in subsequent chapters.

Under the supposition that all traps are liable to lose their water seal through siphonage, momentum and back pressure, or allow of the transmission of gas bubbles under back pressure unless protected by special ventilation, the

“back vent” law was passed requiring a separate vent pipe to be carried from the outgo of every trap into a special ventilation duct, independent of the soil pipe ventilator, up as far as to a point above its connection with the highest fixture. At the time when this provision was framed no simple and reliable self-cleansing water trap was known, which could resist the severest tests of siphonage, momentum and back pressure which might be encountered in plumbing.

Had such a trap been known, as is now the case, the back vent law would obviously never have been made.

The common round or “pot” trap, though not self-cleansing, can nevertheless be made large enough to be practically proof against siphonage, and it may be periodically cleaned by hand if it is found to clog with sediment; but no trap, and least of all the S trap, can resist the destructive effect on its seal of the rapid evaporation produced by the ventilating current required by this law. The seal is destroyed by evaporation in a very short time, varying with the rapidity and dryness of the current and the volume of water in the trap.

Special trap venting is now considered undesirable for many other reasons which give rise to dangers much greater than that which it pretends to remove, the danger from evaporation, for instance, being, as houses are now plumbed, much greater than that from siphonage. Traps are left in disuse, and subject to the danger of loss of seal by evaporation much oftener than is generally supposed. Thus they are unused in city houses which are left unoccupied during summer; in country houses which are unoccupied during winter; in hotels and apartment houses during the quiet seasons, or at times when they are only partly filled; in private houses in the spare chambers reserved for visitors; in business offices between the expiration and renewal of

their leases ; in schoolhouses and all public and private office buildings at times of vacation ; in houses or chambers closed on account of the absence of their owners for travel, sickness, death or any other cause ; in case of drought, or "cut-off" of water supply for repairs of pipes, rebuilding or other cause ; in extra fixtures in houses, and in other places, and at other times which will, upon reflection, occur to the reader. In a few days after a trap has thus been abandoned to the influence of the ventilating current, the time varying with the dryness and velocity of the current and with the volume and amount of exposed surface in the body of the trap, its seal will be destroyed by evaporation.

Corrosion of well-flushed waste pipes of moderate length by sewer air is never to be feared with ventilated soil pipes. It is believed that there is no authenticated case on record of such corrosion. Indeed, the induction through the branch pipes of soil pipe air is by no means an advantage when ample pure air from the room is available after every flushing from a properly constructed fixture. When the main soil pipe is properly ventilated the diffusion of gases, the absorptive power of water for gases, and the frequent water flow through branch pipes afford them sufficient protection when the pipes are in use. When the pipes are not in use the waste matters adhering to their inner surfaces dry up, and it is believed that what decomposition then takes place goes on so slowly that its corrosive effect on the pipe is practically inappreciable. We have shown that besides the constant draught on the water seal by evaporation, the vent pipe increases the unscoured area of the trap, and if any portion of a trap not directly scoured by water passing through it is liable to collect sediment, and ultimately clog up, then the mouth of the vent pipe is also subject to this danger. It thus, in a measure, defeats one of its own objects—i. e., to provide a safe trap which shall be self-cleans-

ing and contain no chamber or corner which shall not receive the full scour of the water passing through this trap. Now, the ventilating openings of traps having been so often found clogged and even completely closed by sediment, we see that this precaution is no certain protection against siphonage and momentum.

CLASSIFICATION OF REQUIREMENTS OF TRAPS.

A proper trap should possess the following characteristics:

- (1) It should do its work by means of a water seal alone.
- (2) It should be self-scouring.
- (3) It should be capable of resisting the severest strains of siphonage, momentum and back pressure that can ever possibly be brought to bear upon it in properly constructed plumbing, even when this plumbing is unscientifically used by the occupants, and this without the aid of special trap ventilation.
- (4) It should contain a body of water large enough to be practically proof against evaporation.
- (5) It should be simple, of durable material and economical to manufacture, with smooth porcelain enameled surfaces.
- (6) It should be so constructed that its interior can be inspected without removing the trap.
- (7) It should have a tight-fitting, easily accessible clean-out cap, to admit of removing easily any valuable or foreign substance that may have lodged in any part of it.
- (8) It should offer the minimum of resistance to the flow of water through it.
- (9) It should be ornamental in appearance.
- (10) Finally, it should be independent of the fixture to which it is attached and should be easily connected or disconnected.

TRAPS.

At first thought it would seem as if some of the above requirements were incompatible or even positively antagonistic. How can a trap which is perfectly self-scouring and simple be made to resist the most powerful action of siphonage, momentum or back pressure without the aid of some mechanical seal? It is nevertheless possible to obtain this result, and the manner in which it is done will be shown hereafter.

CLASSIFICATION OF THE DIFFERENT KINDS OF TRAPS.

Traps may be divided into two principal classes:

I. Mechanical traps.

II. Water seal traps.

Each of these may be again subdivided as follows:

I. Mechanical traps may be subdivided into:

(a) Hinged-valve trap.

(b) Gravity-valve trap.

(c) Floating-ball trap.

(d) Gravity-ball trap.

(e) Mercury seal trap.

II. Water seal traps may be subdivided into:

(a) Sediment traps.

(b) Self-cleansing traps.

These two classes may again be subdivided as follows:

(a) Sediment traps may be subdivided into:

(1) Air-vent traps.

(2) Reservoir traps.

(b) Self-cleansing traps may be subdivided into:

(1) Siphonable trap.

(2) Anti-siphon trap.

Finally self-cleansing anti-siphon traps may again be subdivided into:

(a) Deep seal traps.

(b) Shallow seal traps.

MECHANICAL SEAL TRAPS.

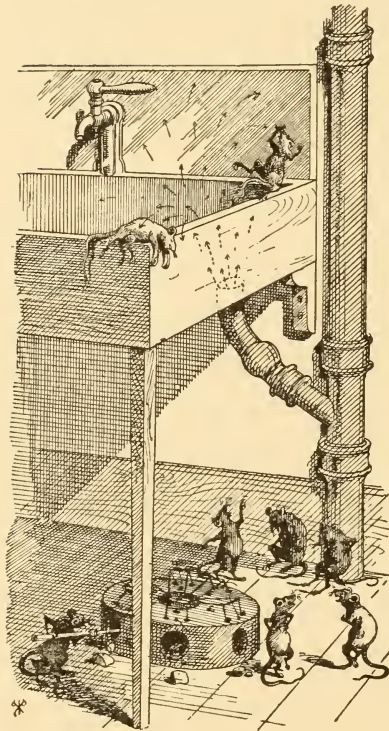

Fig. 63. Peculiar form of trap found under the sinks of a tenement house whose landlady had received notice from the Board of Health to have traps put under every plumbing fixture.

Mechanical closures alone, without the water seal, are of as little use in plumbing traps, in excluding sewer gas, as could be the mechanism shown in Fig. 63, which shows the peculiar form of mechanical trap found under all the sinks of a tenement house whose landlady had received orders from the Board of Health to have "traps put under every plumbing fixture." The old lady obeyed the order to the letter, but in doing so exposed an ignorance of household sanitation so dense that even the rats themselves became rudely derisive and hilarious. They carried their ridicule so far as to withdraw the cheese from the traps by means of skewers in order to

demonstrate the futility of mechanical gates in traps. Two investigators climbed up into the sink to ascertain the result of the woman's stupidity and, in still further contempt, simulated instant death, as you see, from the "deadly" sewer gas which emanated from the unprotected waste pipe, while

TRAPS.

four others were obliged to hold their sides to prevent them from splitting with their vulgar laughter.

These almost incredible facts are recorded to show the astonishing amount of ignorance displayed by the public of the functions of traps and plumbing work generally. All our good lady knew about drainage was that she emptied slops into the sink, and that the slops then went "the devil knew where."

Mechanical seal traps, like pan, valve and plunger water-closets, have served their purpose, and must now be laid aside in the general march of progress.

Before the necessity of ventilating the main soil pipe was felt, and when the science of plumbing was still more undeveloped, back pressure in every trap from the sewers was a thing to be guarded against where the sewers were foul, and balls, gates and valves in traps were invented to supply an actual want. Now, however, the universal and most desirable custom of ventilating every stack of soil pipes, and a better understanding of the hydraulics and pneumatics of plumbing has done away with this requirement, and the mechanical seal serves no longer any other purpose than to obstruct the proper flow of the waste water through the pipe, and to collect sediment, besides causing a false sense of security in case of evaporation or siphonage of the water seal. It is evident that the mechanical seal is entirely superfluous, since everything a trap is required to do can be done by other better and simpler means. Moreover, we cannot apply mechanical seals to water-closet traps, and this fact alone shows the uselessness of applying them to smaller traps, since we must rely on the water seal alone in some of the fixtures in all houses.

It has been claimed by some makers of ball traps that the rotary movement of the ball in the water scours the sides of the trap and prevents the collection of sediment, just as

shot when shaken up in a bottle will aid in cleansing it. This is, however, not the fact, as both experience and theory have proved. Ball traps which have for some time remained more than usually clear of sediment owe their cleanliness, not to the movement of the ball, but to the scouring action of the water, which proves, to a certain extent, effective in spite of the ball. The ball breaks, more or less, the force of the water flowing through the trap, and by just so much diminishes its scouring effect. To claim the reverse is an evident absurdity calculated only to mislead, and is easily disproved by practical experiment and by examining ball traps which have been in use for a short time. Many make the mistake of supposing that, because shot or any similar substance will help cleanse a vessel when the vessel is shaken, the mere presence of the bodies in the vessel will do the same under a current of water. This is a mistake. We cannot violently shake up the trap on a fixture as we do a detached bottle, and a current of water powerful enough to shake up the shot or ball without such movement of the vessel would easily shake up and remove any other sediment which might pass into the trap.

When traps are so connected up with flexible pipes that they can be violently shaken every few days, as our grandfathers tell us the old-fashioned schoolmaster was accustomed to shake up unruly boys for the purpose of removing their cussedness from them, the trap ball may be made to serve the same purpose, and will perhaps be equally effective. Until that time the water flushing will be retarded by every form of obstruction in the trap, whether intentional or accidental, and a current of water powerful enough to shake up the ball effectively will easily shake up and remove any other sediment entering the trap, as we have said. Coarse sand, gravel, coffee grounds or similar sharp substances in the waste water will add to its scour-

TRAPS.

ing effect in removing grease from the pipes; but this is due to the momentum acquired in falling with the water from the fixture, and to the sharp, cutting edges of the substances. Thus tea leaves, having no sharp edges, when admitted with the waste water, serve only to clog the pipes.

But coffee grounds, though often recommended, are not regularly stored away by the thrifty housekeeper for flushing drains. She would prefer a well-formed fixture, constructed as will hereafter be explained, which will do the work for her more scientifically and reliably.

A slimy filth, or a thick, matted coat composed of decomposing organic matter, collects around the ball or valve and their chamber in greater or less quantity, according to the size and strength of the water flow through the trap. Hairs and lint soon collect under and stick to the working parts and prevent their closing tightly, and hinges corrode in the vapor or water until the mechanism refuses to close at all beyond a certain point. Their obstructive power gradually increases until even what little cleansing power the water possessed at the outset may be entirely destroyed. The mechanical seals of traps are valueless as regards siphonage, because this action takes place in the direction in which the mechanical obstructions open. Immunity from the evil effects of siphonage depends, as will be hereafter shown, entirely upon the form and dimensions of the waterway of the trap.

It is sometimes claimed by the manufacturers that the presence of a hollow elastic ball in a trap would prevent bursting should the water in the trap freeze. If the ball extended from the top to the bottom of the trap and its sediment chamber, it might protect it from the effects of frost. But this is not the case. Above and below the ball the freezing water is evidently no more affected by the ball than if the trap contained no water except in these

places. Experience proves this to be the case, for the hollow ball traps burst like other traps when exposed to frost severe enough to freeze suddenly the water beyond the parts occupied by the ball, and to break a glass of the same form and size not containing a ball.

In our drawings illustrating various types of traps in use, all the traps have been drawn to substantially the same scale and size of inlet pipe, so that their relative sizes can at once be seen. This will prove very useful in enabling us to judge of their merits, especially as far

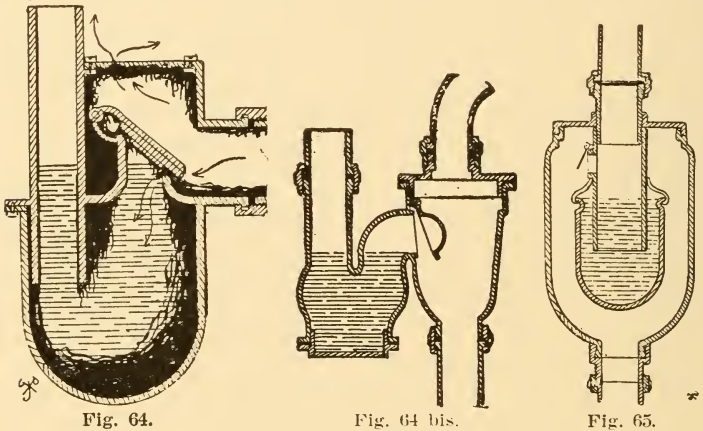

as concerns the probable scouring effect of the water current on their walls.

(a) *Hinged-Valve Trap.*

Figs. 64, 64 bis and 65 show three forms of the hinged valve. If the valves in these traps could only be maintained clean and operative, they would somewhat protect the water seal from evaporation produced by the ventilating current. The swellings in the bodies of these traps very slightly increase their power of resistance to siphonage, but

the enlargement would have to be carried much further before they could be safely used without ventilation, and the retardation of the water passage due to the valve would then increase the rapidity of fouling inevitable with all forms of pot traps. The hinged valve is the worst kind of mechanical closure that can be used in the smaller house traps, the slightest corrosion or sediment at the hinge rendering the mechanism inoperative.

(b) Gravity Valve Trap.

Fig. 66 shows a valve trap invented by Col. Waring, but afterwards frankly condemned by him in his general con-

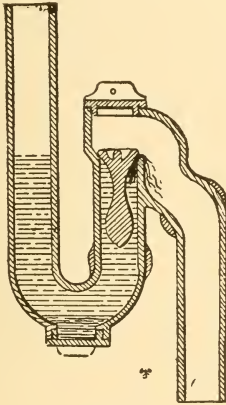

Fig. 66.

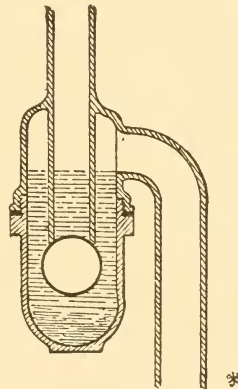

Fig. 67.

demnation of all mechanical traps. The valve chamber is, however, reduced to a minimum, and the trap in operation is perhaps as a whole as self-scouring as any mechanical seal trap known. The arrangement of the valve is such as to preserve the water seal of the trap for a considerable time, even under a powerful ventilating current. Siphonage unseals it, nevertheless, quite easily. This and other mechanical seal traps would be useful on account of their

power of resisting the back pressure were there no simpler means of accomplishing the same result.

Fig. 67 represents a trap which has enjoyed a great popularity. In resistance to siphonage it is equal to a bottle trap of the same size, but has the advantage in this respect over such a bottle trap that when the water seal is broken the ball would still float up against its seal, and form under some circumstances a partial seal of itself. Unfortunately the roughness of the ball surface or of any form of mechanical closure would prevent its providing proper protection against the passage of sewer air in such a case.

Under the ventilating current produced by back venting this type of trap suffers precisely as much as an ordinary bottle trap holding the same quantity of water, the evaporation proceeding from the sewer side. The ball affords no protection against evaporation because it is on the house side where the evaporation is so slow as to be practically negligible compared with the sewer side. The amount of water which the ball displaces more than offsets the delay to evaporation caused by its partial closure of the inlet pipe.

(d) Gravity Ball Trap.

Figs. 68 to 73 represent different forms of gravity ball traps, or traps in which the mechanical seal is formed by a ball resting on the top of a bend in the inlet pipe, and partially closing the passageway by its weighty bulk. The seal, as in all mechanical traps, is dependent upon the accuracy of the fit of the valve or ball and its seat. This fit is never absolutely air tight, even when new, as may be seen by emptying a new trap of its water, and, when quite dry, testing it for the passage of air or gas between the mechanical closure and its seat. However smooth and accurate their surfaces may appear to the eye, the particles forming them are colossal masses, as will be seen under a microscope, compared with the infinitesimal atoms forming

TRAPS.

the elements of air and gas, which defy the highest magnifying power to render them visible. These surfaces, rough as they are, even when new, as compared with the substances they are intended to exclude, very soon become still rougher by the deposit of a sediment composed of all kinds of impurities carried by the waste water, so that the fit can never be tight, of whatever substances the valve and seat

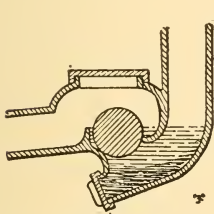

Fig. 68.

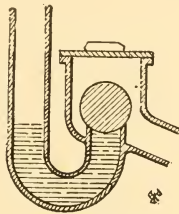

Fig. 69.

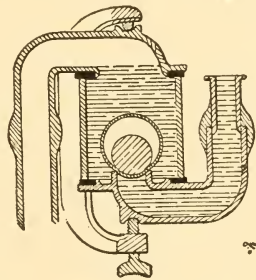

Fig. 70.

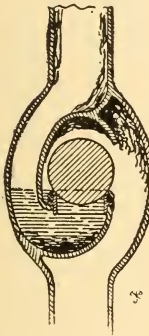

Fig. 71.

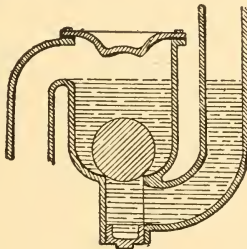

Fig. 72.

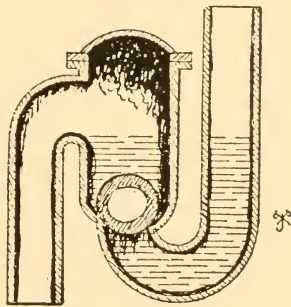

Fig. 73.

be made. When somewhat stiffened with age the sphere becomes still more defective in shape, and its weight cannot press out the irregularities of the surfaces. When the valve and seat are wet, a seal may sometimes be formed against the passage of air, but the seal is due to the water and not to the valve, and the water seal alone would be equally efficient, since, as we have already seen, we have

to do with air and gases in their normal condition and not under pressure. None of these traps are siphon proof unless ventilated. Like the gravity valve, they resist evaporation under the ventilating current for a long time, and in this respect are better than the floating ball trap, for the gravity ball and valves, as will be seen by referring to the drawings, hinder the ventilating current from licking up the water seal beneath the ball. The floating ball offers no such resistance. Evaporation goes on as rapidly as if no ball existed. This is, under the present law requiring special trap ventilation, a matter of great importance, though one which is generally overlooked in comparing mechanical seal traps with one another.

Fig. 82 represents a gravity ball or valve trap designed for kitchen sinks. It is intended to take the place of the unfortunate bell trap, now so universally condemned.

It consists of a lead receiver with a brass grating on top. The receiver holds about half an inch of water, into which the hollow valve or ball dips. The valve has a circular rim around its bottom, corresponding to the groove in the receiver which holds the few drops of water, and with it forms the feeble seal. The quantity of water is so small that evaporation easily destroys the seal in a short time, even without special vent. The trap is extremely liable to become clogged with the substances passing through kitchen sinks. This often leads to a removal, by ignorant servants, of both valve and strainer, which, of course, destroys the seal. Such a trap is little better than the ordinary bell trap, even though there is the slight advantage claimed for it by Baldwin Latham that the bell is not attached to the strainer. All such forms of sink traps are to be unconditionally condemned.

Figs. 83 and 84 represent the ordinary bell sink trap, and Fig. 85 is an improvement thereon in having the water seal independent of the grating. In both of these traps the water seal is too small. Both are destroyed by the

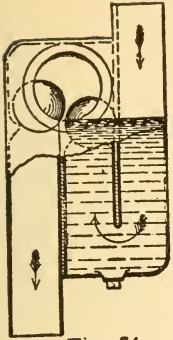

Fig. 74.

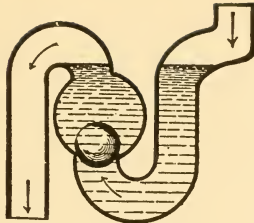

FIG. 143.—Turner's Trap.

Fig. 75.

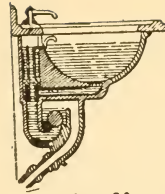

Fig. 80.

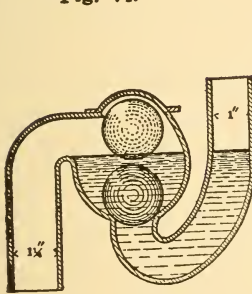

Fig. 76.

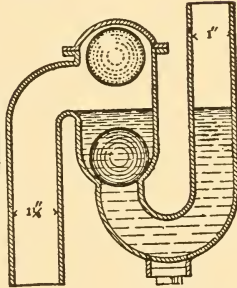

Fig. 77.

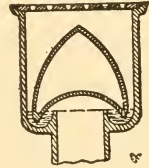

Fig. 82.

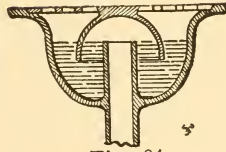

Fig. 84.

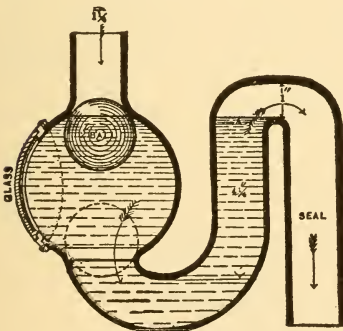

Fig. 78.

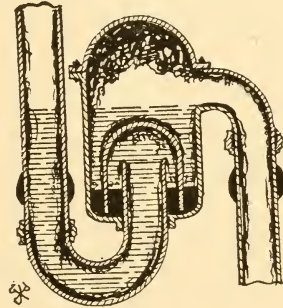

Fig. 81.

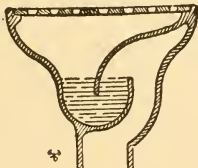

Fig. 79.

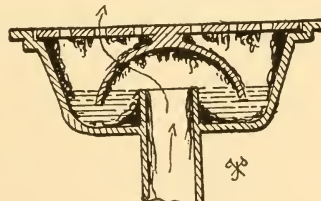

Fig. 83.

slightest disturbance of atmospheric pressure in the waste pipes, and are condemned by all sanitarians.

This trap, Fig. 81, is far too expensive and complicated ever to become popular or practical, and is no less of a cesspool than the common round or pot trap, which is equally effective in excluding sewer air. The seal of this trap cannot be broken by siphonage, nor can that of a pot trap, if it be made large enough.

Yet the law requires the ventilation of both of these traps. The mercury seal trap must be constructed of some material not easily corroded by mercury or water.

Figs. 74 to 79 show five more ball traps, described by Mr. Gerhard. The first has a double gravity valve. "A glass in the upper side of the trap," says Mr. Gerhard, "enables one to inspect the working of the ball valves, which is as follows: When in rest there is, in addition to the water seal, a mechanical seal, which is half immersed in water. The second ball valve at the outlet also shuts off by its weight, but in case of undue pressure this would tend to lift the ball, leaving around it a waterway through which the water flows out. In rising, the first ball touches the second ball, which is also lifted, to allow the water to pass freely. As soon as the discharge ceases, both valves drop back into their seat." Under siphonage the valve nearest the outlet, and under back pressure that on the inlet side, will close, and so long as the trap continues clean these balls would aid in protecting the seal. But better methods have now been devised for accomplishing this, and the two balls form a double impediment to the water scour.

The remaining drawings in this slide show Mr. Gerhard's improvements in ball traps, which at that time were valuable, but which have since been supplanted by improved water seal.* The last is certainly ingenious and as good a

*Wm. Paul Gerhard "Drainage and Sewerage of Dwellings." Wm. T. Comstock, N. Y.

mechanical trap as could be devised for resisting siphonage or back pressure.

Figs. 86, 87 and 89 represent the McClellan Trap Vent, a simple device to take the place of the back vent pipe. Figs. 86 to 88 give sections of the device, and Fig. 89 shows the manner in which it is connected up with different fixtures. Siphoning action lifts a small cup out of a mercury seal and allows air to pass from the room under the cup as shown by the arrows to break the partial vacuum in the soil pipe. This device is much better than back venting. But where grease would accumulate in the throat of the back vent pipe it would here, and the mechanical parts are open to the objections already referred to in other mechanical traps.



Fig. 86.

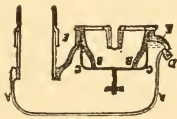

Fig. 87.

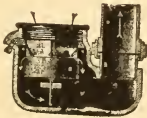
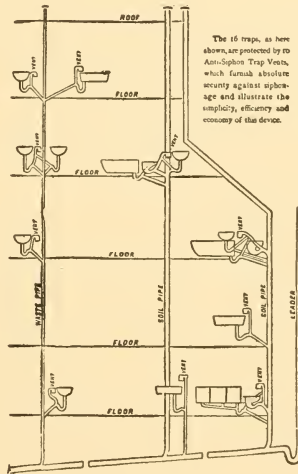

Fig. 88.



The 16 traps, as here shown, are protected by 10 Anti-Siphon Trap Vents, which furnish absolute security against siphonage and illustrate the simplicity, efficiency and economy of the device.

Fig. 89.

CHAPTER XI.

WATER SEAL TRAPS.

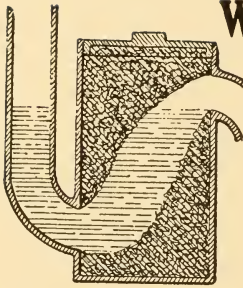

Fig. 90. Common
"Pot." "Round" or
"Cesspool" Trap.

WATER seal traps bear the same relation to mechanical traps that the hopper water-closet bears to pan, valve and plunger closets. They accomplish their work of removing the wastes and excluding sewer gas much more perfectly by the simple action of the flushing stream, and by the water seal which it forms, than do the complicated machines already described, and they must be placed far ahead of them. Here again the

leading sanitarians are in accord; but as is the case with hopper closets, so it is with water seal traps, there is the greatest difference in the manner in which the different kinds perform their duties.

Our first general division of water seal traps is into (a) Sediment or Cesspool Traps, and (b) Self-Cleansing Traps.

(a) Sediment Traps.—Sediment traps may be designated as those whose inner surfaces are not cleaned by the scour of the water passing through them, but which gradually become coated with a deposit of filth. The deposit is due to the improper form and size of the water passages, which sometimes cause the current to pass through them sluggishly and without exerting upon them sufficient friction to keep them clean, and sometimes furnish chambers or pockets in which no movement at all takes place.

We have subdivided sediment traps into (1) Air-Vent Traps, and (2) Reservoir Traps.

(1) *Air-Vent Traps.*

Fig. 91 represents a trap having an air valve. The exclusion of soil-pipe air, therefore, depends entirely upon the accuracy of the fit of this valve alone, without the aid of water. We have already explained that such a valve could never be made gas tight, even when new, where its weight is expected, as here it must be, to perform its purpose of protecting the water seal below from siphonage. Such an air valve, if applied at all, should be placed above the trap far enough from the waste water to be beyond the reach of contamination therefrom. As here placed, the hinge

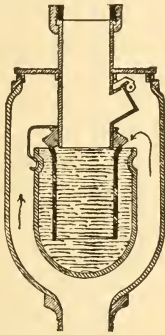

Fig. 91. Air Vent Trap.

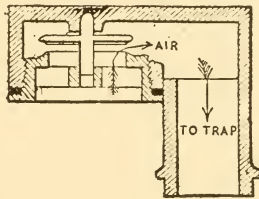

Fig. 91b. Morey's Air Vent.

would quickly become corroded enough to deprive it of the sensitiveness of action necessary to prevent the destruction of the light body of water in the trap by siphonage. Nevertheless, the idea underlying this trap is good; namely, to apply a very small air valve far enough above the trap seal to be entirely out of the way of water splashing and sufficiently sensitive to supply air to the waste pipe before siphoning action can overcome the feeble inertia of the water seal. It is the principle of the Morey and McLellen vents.

(2) *Reservoir Traps.*

Figs. 90 to 105, inclusive, represent various forms of

sediment collecting traps. The most famous in this country is the pot trap (initial cut), Fig. 90. The unfortunate D trap, common in England, is shown in Figs. 92 to 98. This D trap is as much despised here in America as our favorite pot trap is in England. It is difficult to account for the national fondness for either of these abominations, now very cheaply made by machinery, after so much better de-

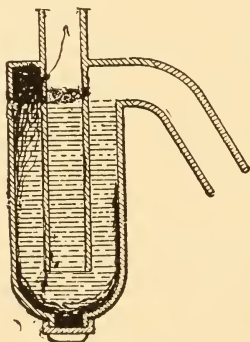

Fig. 91e.

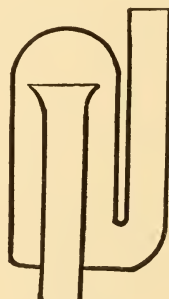

Fig. 91d

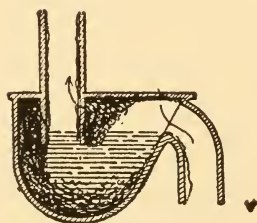

Fig. 92.

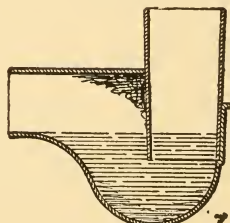

Fig. 93.

vices have been furnished. But both forms, as well as the globe trap (Fig. 100) and bottle trap (Fig. 91) are hard to siphon when the size of the body is made large enough in proportion to that of the inlet and outlet pipes, and this fact, together with the ease with which they could be manufactured by hand on rainy days, has made them favorites,

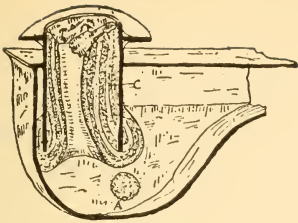

Fig. 94.

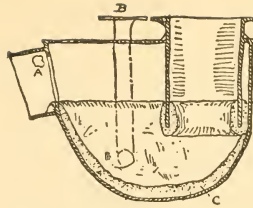

Fig. 95.

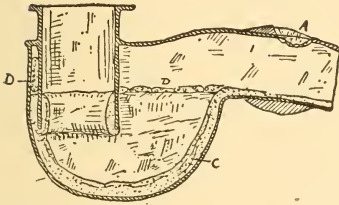

Fig. 96.

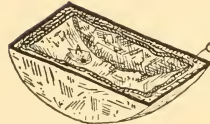

Fig. 97.

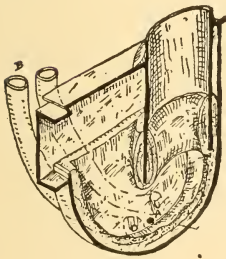

Fig. 98.

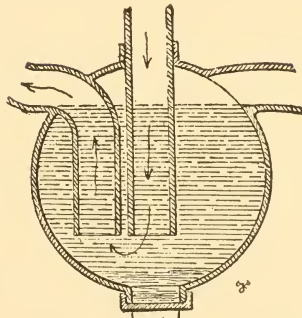

Fig. 100.



Fig. 101.

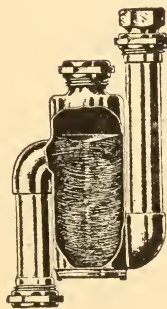

Fig. 101a.

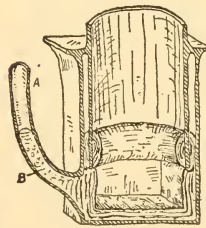

Fig. 99.

in spite of the absence of all science in their form and construction

Although the pot trap is liable to collect sediment and become at times very foul within the cesspool chamber, it may, nevertheless, be made antisiphonic, and, if the walls are sound, the foul gases within it cannot escape into the house under normal conditions. All they can do is to remain in the trap until they are driven out by the next current of water that passes through it; only with unventilated soil pipes do these cesspools become a source of serious trouble. Yet if a choice had to be made between the evils of an unventilated pot trap and a ventilated siphon trap there should be no hesitation in preferring the former.

The bottle trap (Figs. 91 and 100) are equally good with the floating ball trap of equal size in resisting siphonage and in every other respect, and they are much to be preferred to it, inasmuch as they are not encumbered with any mechanical part.

Fig. 91 bis shows an inverted bottle trap, the interior pipe becoming the outlet instead of the inlet. In this case, the outlet pipe is sometimes flared out, trumpet shaped at the end. This may somewhat increase its resistance to siphonage, but it also evidently tends to obstruct the water flow, and forms a nucleus for the collection of sediment, hairs, lint, etc. A better way to increase the antisiphon feature is to increase the diameter, if a bottle trap is to be used at all.

Fig. 62 is an old form of D trap called the "Goose" trap, a cesspool trap of rarely appropriate name.

Figs. 94 to 99 represent some cesspool traps at the Museum of Hygiene at Washington, and described by Mr. Glenn Brown, architect, some of them having been presented by Mr. S. Stevens Hellyer of London. They show the heavy deposits formed in these unflushed cesspools and

the chemical action on their metal work, especially where soil pipes are unventilated under abnormal conditions.

In the first figure, which is a water-closet trap, the inlet pipe is almost closed by deposits, and the waste pipe entrance (A) from another fixture is completely closed up.

Fig. 97 shows a piece sawed off from the bottom of a D trap. Over a third of the entire area of the trap seems to have been taken up with the deposit.

Fig. 98 is a section of a lead D trap having an incrustation below the water line averaging over an inch in thickness. Two waste pipes entering below the water line were nearly closed by deposits, the waterway remaining in them being not over $\frac{3}{8}$ inch in diameter. The analysis of the incrustation in this trap showed calcic phosphate, 37.12 per cent; plumbic phosphate, 1.45 per cent; calcic carbonate, 32.11 per cent; volatile and organic matter, 17.82 per cent, and water, 11.50 per cent.

Figs. 95 and 99 show waste pipes completely closed in traps which had been in position forty-five or fifty years.

Fig. 101 is a pot trap having its inlet and outlet pipe connections arranged in such a manner as to improve the scouring action of the water passing through it. But a fixture having its outlet large enough to fill the waste pipe "full bore" and constructed so as to be discharged "full bore," must be used with such traps, as indeed with all traps, if the cleansing power of the flush is to be of any service.

Figs. 102 and 103 show a bathtub trap.* Its purpose is to permit of cleansing it from the floor level. Made of sufficient diameter it would easily resist siphonage and is very convenient where it is necessary to sink the body of a trap between floor joists. Figs. 104 and 105 show ordinary pot traps in the same position.

*Made by the Webb Manufacturing Co. of Boston.

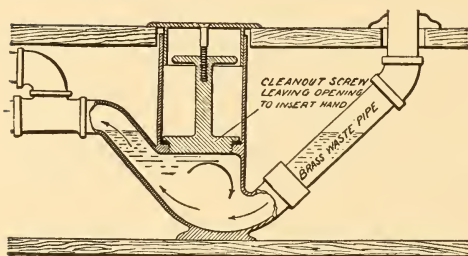

Fig. 102.



Fig. 103.

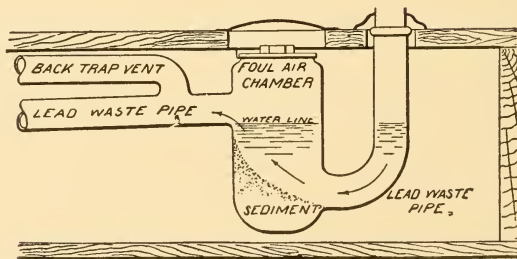

Fig. 104.

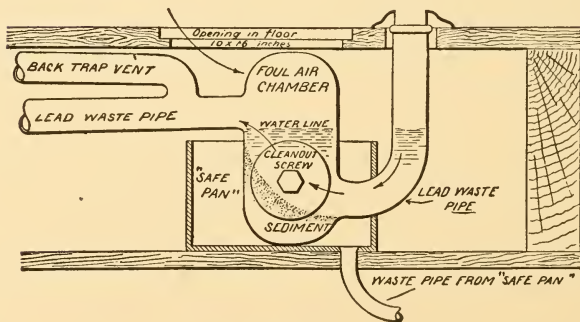

Fig. 105

CHAPTER XII.

STREET GULLIES AND SIPHONABLE TRAPS.

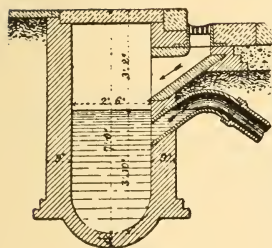

Fig. 107.

THE next figures are taken from Baldwin Latham's "Sanitary Engineering" and show sediment traps used for Street Gullies. These traps ought to gradually disappear from use and will do so as soon as communities see the importance of building good sewers and properly ventilating them. The street sewer inlets will then serve as sewer inlet vents and the traps will be done away with. The silt-basins must also disappear with the disuse

of horses. Automobiles will require perfectly smooth pavements, which are not entirely without drawbacks now, on account of the danger to horses from slipping. These smooth pavements will then be kept perfectly clean and the ventilating openings into the sewers will be very simple and inexpensive.

Until such time, however, street gullies and sediment traps will be used, and the drawings show the principle upon which they are constructed.

"Gullies are liable to fail in times of frost, especially in very cold countries, as the gullies and traps get completely frozen up, and, when a sudden thaw takes place, they are found locked up with ice, so that the water cannot readily escape, and the streets, in consequence, get flooded. The remedy for this is to remove the water in the gully as far as possible from the surface, and the gullies are constructed

with special reference to the breaking up of the ice in the traps should it accumulate. Figure 110 represents the section of a street gully which has been used at Carlsruhe, Germany. The gully is made in two portions, with a trap in the division wall. Should the trap get frozen, the stone S is removed from that portion into which the trap discharges, and a suitable tool may be inserted to break up the ice.

* * * In all cases gullies are liable to become untrapped

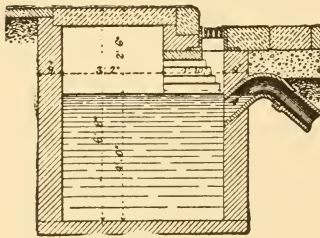

Fig. 108.

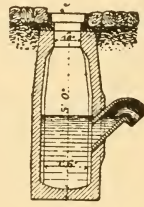

Fig. 109.

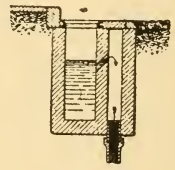

Fig. 110.

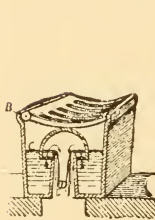

Fig. 106.

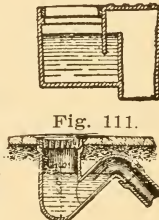

Fig. 111.

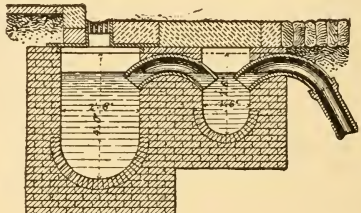

Fig. 112.

from leakage or from evaporation, therefore, to insure the integrity of the traps, they should have the water constantly renewed in dry weather. * * * All gullies should be regularly scavenged, not less frequently than once every six or ten days, as matters are often passed into them, which decay and give off an offensive effluvium if left too long in the gully. * * * Gullies are usually provided with grated coverings * * * which should be arranged at right angles to the traffic, or otherwise narrow-wheeled ve-

hicles are liable to get injured in the openings between the bars of the gratings.*

Figure 106 is a representation of a gully trap which is an improvement upon the common Bell trap, the bell not being attached to the cover, but being loose, and having a perforated bottom and dropping down on the center cone D. The top grating is hinged and can be raised so that the trap can be easily cleaned out. B is the level of the street surface, and C of the water. The arrows indicate the direction of the passage of the water to the drains.

Figure 107 is a London gully-hole with a cesspool constructed under the sidewalk in order to facilitate its cleansing in narrow streets of great traffic. The solid matter is collected in the bottom of the cesspool and removed from time to time through the stone manhole in the sidewalk.

Figure 108 is a larger gully with cesspool under the sidewalk. It contains room for a large amount of road detritus to be periodically moved as described for Fig. 107. Fig. 109 is a street gully with earthenware trap. The gully itself is made of concrete in one piece, strengthened with wrought iron bands cast within the concrete. This construction has been used in the city of Dantzic where the climate is very severe.

Figures 111 and 112 are gully traps suitable for yards, but the curved bottom of the latter with the outlet near it, renders it liable to transmit detritus into the sewers where a large volume of water passes through it.

Figure 113 shows a double trap London street gully, the smaller catch-pit is not so easily evaporated out as the larger one, which is more exposed, and the emptying of the larger one still leaves the gully trapped.

Figures 114 and 115 show a cast-iron gully having sev-

*Baldwin Latham.

eral good points where traps are desired at all. First it has a trap which is as reliable as possible at all times, the usual traps losing their seals when the level of the water is reduced by the removal of deposits. Second, very little evaporation goes on in summer, and freezing in winter is

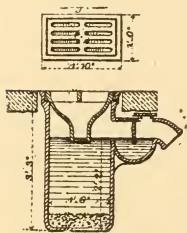

Figs. 114 and 115.

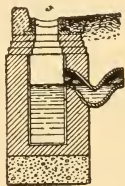

Fig. 116.

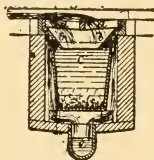

Fig. 117.

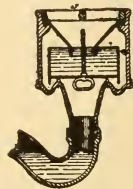

Fig. 118.

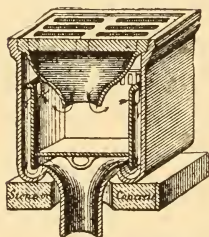

Fig. 119.

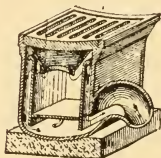

Fig. 120.

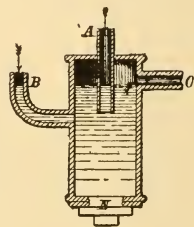

Fig. 121.

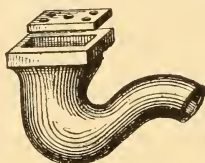

Fig. 122.

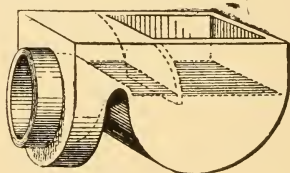

Fig. 123.

impeded. Third, there is ample space for road detritus. Fourth, it has a flushing aperture in the small trap. Fifth, it is economical and requires no brickwork in setting.

Figure 116 shows a gully used by Mr. Denton for many years, having advantages similar to the last. Finally Figs.

STREET GULLIES AND SIPHONABLE TRAPS.

117 and 118 show gullies having removable sediment boxes. The gratings are made separate for convenience in casting and in lifting off. The boxes above the trap lessen evaporation in dry weather and can be removed and emptied into the scavenger's cart readily by one man.

The next figures show a number of disconnecting house traps described by Denton, all being more or less cesspools. with square top. Figure 123 is a horizontal house trap.

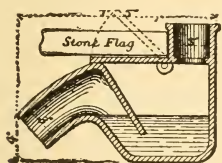

Fig. 124.

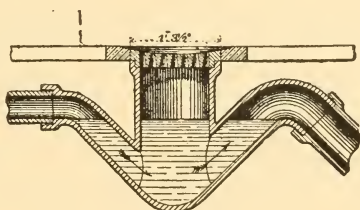

Fig. 125.

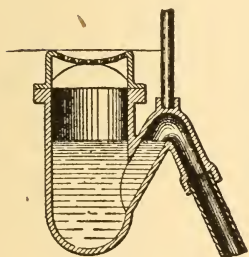

Fig. 126.

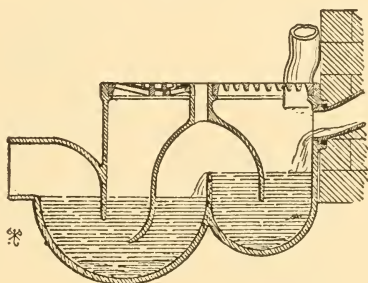

Fig. 127.

All should and will be done away with as fast as the people learn the value and economy of well ventilated sewers. The slide also gives a number of grease and sink traps.

Figure 121 is a species of grease traps having a catch-basin at the bottom. Fig. 122 is an earthenware sink trap. Figure 124 is a rainwater pipe trap which, however, can not be depended upon unless means are provided for constantly renewing the water therein. Figure 125 is a running

house trap with gully combined. A gully trap so used will always be sure of a seal while the house is occupied, because it takes the house waste and is not dependent upon rainy weather. Fig. 126 is another gully trap showing how it may be ventilated by a pipe rising along the outer wall of a house.

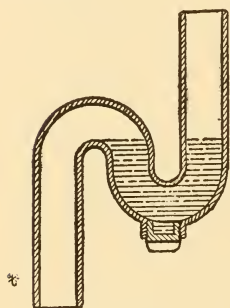

Fig. 128.

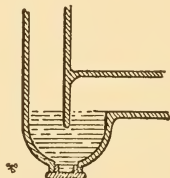

Fig. 129.

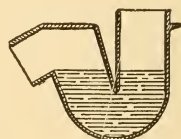

Fig. 130.

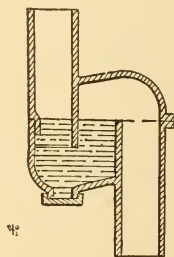

Fig. 131.

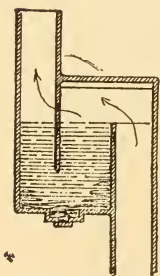

Fig. 132.

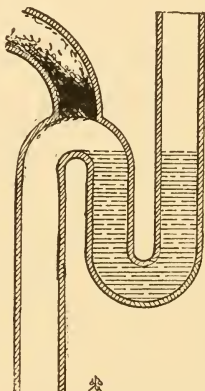

Fig. 133.

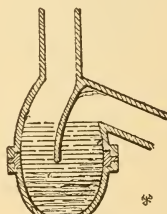

Fig. 134.

Fig. 127 shows a triple seal trap, used in England, and is introduced to show the madness to which main house trapping is sometimes carried. The water in this trap occupies two compartments separated from each other designed to prevent the one seal from polluting the other if

the water in it should in any way become foul. The middle part of the trap receives the surface drainage, and also provides an escape for any sewer air which might be forced through the outer seal; all parts open directly into the outer air through gratings. The three dips are intended to afford extra security against the passage of sewer air. This trap is, of course, very objectionable on account of the great obstruction it offers to the passage of the drainage, and of its expense.

SELF CLEANSING TRAPS.

are those which are scoured throughout by the water which passes through them. They may be subdivided into (1) those which lose their water seal under the action of siphonage or momentum, and (2) those which are capable of resisting such action.

(1) *Siphonable Traps.*

Figures 128 to 134 represent different forms of siphonable traps. A very feeble suction is all that is necessary to break the seal of any of them. The modified forms possess no appreciable advantage over the common S trap of equal depth of seal in this respect.

Fig. 134 is an S trap with a small sediment chamber at its bottom. This chamber was introduced with the idea that it would give the trap greater resistance against siphonage. It has, however, no advantage whatever in this direction, since its enlargement is all below the seal proper.

Fig. 135 represents a complicated device for replenishing the seal exhausted by siphonage, evaporation or other cause. The device would evidently soon become inoperative, and is too expensive and delicate to deserve more than a passing notice. Fig. 133 shows the manner in which the ventilating

opening of an S trap becomes clogged sometimes to a height of more than two feet from the mouth, and the same would result with the water supply pipe intended to refill the trap in Fig. 135 because it could evidently never be under water pressure.

Figures 136 and 137 are other illustrations of an excess of ill-directed zeal. The purpose is to refill an S trap automatically after siphonage, a small reservoir chamber being attached to the trap in such a manner as to deliver to it through atmospheric pressure a fresh supply of water whenever its level in the trap seal falls slightly below the normal. It works on the principle of the inverted bottle chicken

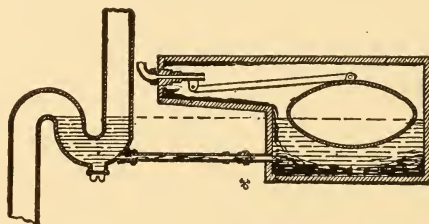

Fig. 135.

feeder, and is itself replenished by a small feeder pipe operative when the supply cock of the fixture is opened for use. This complicated and costly device was conceived many years ago when the fear of sewer gas was at its greatest. It is true that the water pressure would be likely to keep the small openings in the reservoir chamber free from deposit and the trap well scoured out, but the trap might be siphoned while the fixture cock was not in use for a considerable length of time so that the entire device would serve only to inculcate a false sense of security, even though evaporation might not empty the supply vessel in a year.

STREET GULLIES AND SIPHONABLE TRAPS.

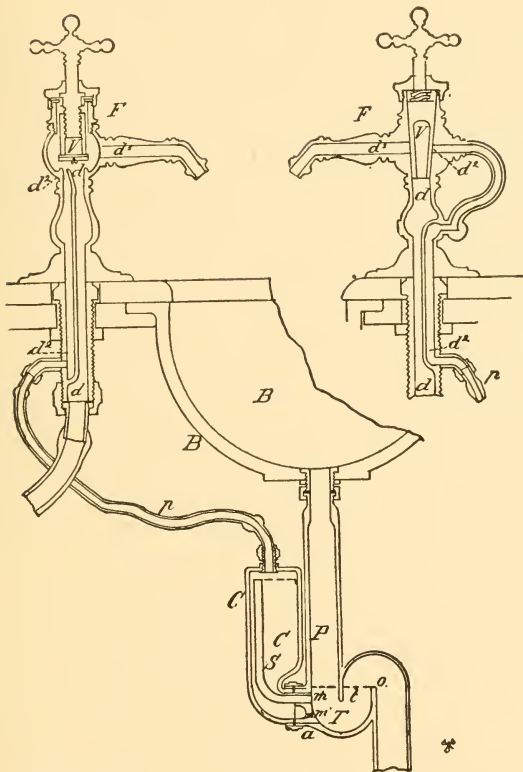

Fig. 136.

Fig. 137.

CHAPTER XIII.

SEAL RETAINING TRAPS.

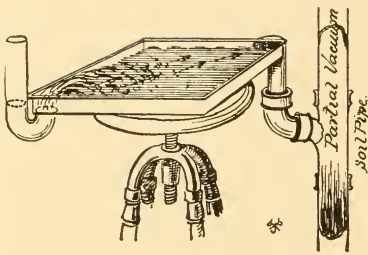

Fig. 138.

We have considered briefly the various agencies which tend to destroy the seals of traps, and have presented several vital objections to the methods of protection generally attempted.

Internally all kinds of mechanical seals, balls, gates and valves, both single and double, as shown in Figs. 64 to 81, inclusive, have been tried. Externally ingenious and complicated devices for refilling the seals after their destruction, like that shown in Figs. 135 and 136, have been attempted. But all of these devices have failed for want of simplicity and reliability.

Finally the "back vent" pipe was conceived of, and for a time it was supposed that the great remedy had been attained. A few rough and unscientific laboratory tests made on siphonage, which seemed to corroborate the idea, at once gave rise, in several large cities, to a law rendering special trap venting obligatory. At the time this law was enacted the common "round" or "pot" trap of large size had shown itself to be capable of resisting siphonage when new and clean, but it was recognized that under some conditions, as when used with kitchen and pantry sinks, clogging was certain in time to render it inoperative. The object of the vent pipe was to afford protection without the use of these

SEAL RETAINING TRAPS.

cesspool traps, but the practical result has been that cesspools have become, since the enactment of the law, more prevalent than ever, because not only has the use of the pot trap, under various changes of form and name, continued undiminished, but the mouth of the vent pipe has added a cesspool to traps which were otherwise substantially self-cleaning, as has already been shown.

Thus not only has the original purpose of the law been frustrated, but the very evil it was intended to remove has been actually augmented by it. The pot trap is converted by grease into an S trap, and the S trap by the same agency acting in the mouth of the vent pipe, into a cesspool trap. The vent pipe was applied to protect the S trap, but is itself destroyed by the very same agency which destroyed the pot, and the only wonder is that this inevitable result was not anticipated before the law was passed.

Having now found this belief in back venting to be fallacious, safety must be sought in some other direction.

Siphonage must be guarded against, not by adding to the trap a limb of indefinite length and connecting it with the external air, but by forming the trap itself in such a manner that *its own water-way shall serve as a special air-vent passage*, and permit the air of the room to supply the partial vacuum in the soil pipe without drawing the water out of the trap before it.

In constructing the trap provision must be made also for resisting back pressure, evaporation, capillary action, leakage and all other adverse influences.

If a trap can be devised which shall be as self scouring as a straight pipe of the size of the waste pipe itself, and at the same time be capable, unvented, of resisting a siphoning strain powerful enough to completely empty an S or small pot trap fully vented in accordance with the law, and if the construction of this trap is such that it forms its own

vent pipe and causes fresh air to pass through its own body whenever it is used and whenever siphoning action occurs, so that it actively assists the main soil pipe vent in aerating the waste pipe system in the most effective manner; then it becomes clear that the continuance of this law on the statute books is a very gross imposition upon the public. When, in addition to this, we know that the vent pipe is utterly unreliable on account of clogging and other influences already fully described, and that it involves the very positive and important objection of rapidly destroying by evaporation the seal it was intended to protect; where other simpler methods now known are entirely free from these difficulties; the enforcement of such a law becomes an inexcusable outrage upon the public, whether such enforcement be due to selfish private interest or unjustifiable ignorance, and the investigation of the whole matter by an impartial commission appointed by the Federal, State, or Municipal authority, becomes a very serious duty in behalf of the people which has already been far too long neglected.

Although it has always been declared impossible, from the nature of things, to render a simple unvented S trap absolutely secure against siphonage this has nevertheless now, in effect, been fully accomplished.

EVOLUTION OF A PERMANENT ANTI-SIPHON WATER-SEAL TRAP.

To obtain these results, without internal complication or external aid, is only possible by taking full advantage of the various laws which govern the action of fluids in plumbing. The difference in the specific gravity of air and water, and the consequent difference of momentum of the two fluids under equal rapidity of motion, and the relative attractive and cohesive forces of the particles of the two fluids, give

SEAL RETAINING TRAPS.

us reliable means of separating the air from the water in their passage along the inner walls of the trap as simply and unfailingly as chaff is separated from the grain in the winnowing machine.

I have given as the second of the three methods tried for protecting the seals of traps from loss by siphonage, the use of a large unventilated "pot" or "reservoir" trap. I have shown that a small pot trap will not resist siphonage, and that none which is less than eight inches in diameter can be relied upon in all cases; that a five-inch pot trap might sometimes be siphoned out by discharges from fixtures under conditions which may occur in practice; that a four-inch pot trap siphons out much easier; that an ordinary three-inch trap has very little resisting power, and that two and a half inch and two-inch traps are altogether useless, and but little more than S traps.

But unfortunately the larger forms of pot traps are, as has been said, not self cleaning. They are cesspools and violate one of our main principles of plumbing which prohibits the retention of decomposing waste matter anywhere within the system. They are also very bulky and expensive in use of material.

In order to better study these movements, we have had a large number of traps constructed in whole and in part of glass.

The initial cut, Fig. 138, shows one of our experimental glass traps in perspective, so constructed. The body is thirteen inches square and an inch and a half deep. The inlet and outlet arms are made of inch and a half pipe. The inlet end descends below the bottom of the drum instead of entering the side, as is customary.

Under siphoning action the seal standing in the inlet bend rises into the drum and simply stands one side while air passes through the trap from the fixture above the

water in the drum, as shown by the arrows in the drawing, and breaks the partial vacuum in the soil pipe. The storm having blown over, the water seal quietly returns from the drum or reservoir chamber into the bend and restores the original conditions as a reed rises after the fury of a hurricane has passed.

Thus the trap *becomes its own back vent pipe*, a back vent pipe which has no inaccessible body waiting for mischief, which provides entire security, and yet which adds absolutely nothing to the expense.

As will be seen, a small portion of the water in the trap will be thrown out at the first application of the siphoning strain, but as soon as the level of the water in the reservoir chamber has been lowered a little below the overflow point, far enough to provide for the wave action produced by the air blast, no further loss of water can be occasioned even by the severest strain that can be brought to bear upon it. This trap was found capable of withstanding a strain severe enough to empty an S trap fully vented under the most favorable conditions with a new clean vent the size of the bore of the trap and only fifteen feet long. It perfectly illustrates the fact that the principle of resistance to siphonage lies not in depth but in breadth of seal. The maximum of strength comes with the maximum of horizontal dimension, but with a minimum of height.

The trap is, however, still open to the objection that it is not self-scouring. The sediment chamber is not so large as it would be in a deeper drum trap. The cesspool feature has been eliminated only in one of its dimensions.

Fig. 193 shows the manner in which a pot trap of this form, though absolutely antisiphonic, could clog with grease under a sink.

The third method of obtaining the desired security is,

as stated, to obtain some form of trap which shall be both antisiphonic and self scouring at the same time.

In our experiments with pot traps of various diameters, from eight inches down to two inches, we have found that with traps of equal depth their resistance to siphoning action very rapidly increased with the increase of their diameter; that with traps of equal diameter their resistance to capillary action increased with their depth; that resistance to back pressure increased with the increase of water capacity of the trap and with its depth below the fixture it serves; and that resistance to fouling action and clogging increased as the sectional area of the body of the trap approached that of its inlet and outlet arms; and that, finally, resistance to evaporation increased with the increase of water capacity of the trap and of its distance from air currents. I have moreover lately found that a shallow seal trap may be designed in such a manner as to protect the seal of a water closet trap from siphonage, as will hereafter be shown.

From this it would appear, at first thought, that to obtain a trap capable of affording the maximum resistance to all these adverse influences at once and under all conditions would be impossible, because the desiderata above enumerated seem to be in direct conflict with one another, a large diameter being needed to resist siphonage and a small one to resist clogging, while evaporation and capillary action seem to demand a deep seal and thorough scouring, and water closet trap protection a shallow one. But a closer investigation will make clear that these desiderata are not necessarily incompatible with one another, as the following experiments and reasoning will show.

The trap must be so formed, in the first place, that its sectional area shall in no place exceed the area of the fixture waste pipe which it serves, because otherwise it would not possess the maximum of self scouring power.

This requirement confines us to the use of some form of plain piping, either straight or bent, in the construction of the trap.

In the second place it is evident that a sufficient amount of this piping will be required in the formation of the trap to provide the necessary water capacity for resistance to back pressure and evaporation.

In the third place all the piping used must be on a horizontal plane in order to preserve the required minimum depth of water seal.

Finally, for the purpose of insuring against loss of seal by capillary action, the seal of the trap must be separated from its connection with the drain pipe by a distance great enough to offset the maximum of capillary forces ever encountered in plumbing practice.

The first form of trap answering to these requirements with which we experimented was, therefore, the simplest form, namely, that of a straight pipe placed horizontally, as shown in Fig. 139.

This trap consists of the seal proper shown on the left side of the figure, which is made of $1\frac{1}{2}$ -inch bent tubing, the seal being not over a half an inch in depth; a long horizontal body consisting of a plain round pipe likewise $1\frac{1}{2}$ inch in diameter, or of exactly the same sectional area as that of all parts of the seal tubing; and at the opposite end of this pipe the sewer connection piece, which is again of sectional area everywhere equal to that of all the parts of the trap.

I call the first part of this trap the "trap seal proper," the second, the "reservoir chamber," and the last, the "outlet connection."

The outlet connection has its overflow point $\frac{3}{4}$ inch above the bottom of the reservoir chamber, so that when this chamber stands full of water the entire depth of water seal measures only $1\frac{1}{4}$ inches.

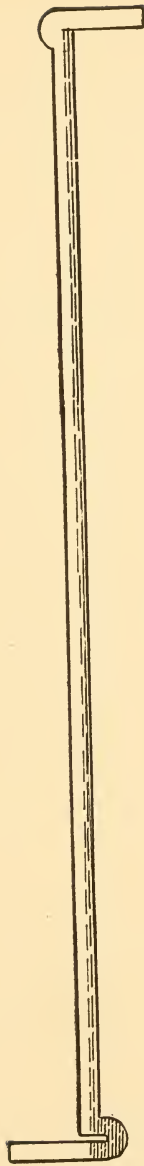

Fig. 139.

First step in the evolution of a permanent anti-siphon self-scouring shallow-seal trap.

The trap was constructed of round metal tubing $1\frac{1}{2}$ inches in diameter, the reservoir chamber being ten feet long.

The principle of resistance of this trap to siphonage lies in the air space over the long reservoir chamber and in the shallowness of the water seal. The water constituting this shallow seal, yielding readily to the siphoning action, is thrown out of the seal proper and distributed over the surface of the water in the long chamber, and only slightly raises the level thereof. A part of it is carried out into the waste pipe. Then air from the fixture side of the trap, having ample room above the water to pass through the chamber without disturbing the water below it, breaks the partial vacuum in the soil pipe, and restores the atmospheric equilibrium in the pipe system.

The small seal in the trap proper is then quickly replenished by water flowing back into it from the long reservoir chamber without materially reducing its level.

A small amount of water is driven out of the trap by each subsequent repetition of the siphoning action, but less and less is lost each time because the air space above the water is each time correspondingly enlarged, and the resistance to siphonage accordingly increased until a point is reached when no further reduction of its level by siphonage is possible.

The reason why air and not water escapes through the reservoir chamber, is because the water thrown up from the seal proper by the siphoning action forms a spray which, striking the top of the reservoir, adheres to it and, in virtue of the greater attractive and cohesive force already referred to of the particles of this fluid, permits the lighter air to pass through it and escape.

But there are two very evident objections to this simple arrangement of the parts of the trap: the first being its in-

SEAL RETAINING TRAPS.

convenient and unwieldy form, and the fact that a very slight sagging of the body would be sufficient to destroy its action; and the second, that in the event of the siphoning action being exceedingly powerful, a water wave is set up

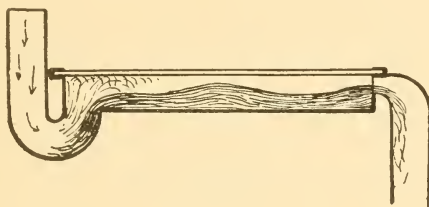

Fig. 140.
Wave formed by siphoning action.

in the tube body which acts like a solid piston in driving out before it the rest of the water therein, so that this form of trap could only be relied upon to resist siphoning action of moderate intensity.

Our next inquiry was, therefore, to discover some way by which this water wave or piston might be broken up, and the air behind it allowed to escape to the outlet without exhausting the reservoir in its passage.

The most natural method was to simply bend the pipe body back and forth on itself abruptly, and the most compact form possible in which our ten feet of tubing can be bent in this manner being that of a square, our next experimental trap took this form, as shown in Figs. 141 and 142.*

Our reservoir in this case consisted of a metal box 13 inches square on the inside, having a glass top and eight partitions set in such a manner as to produce a continuous

*These and all the subsequent drawings of our horizontal traps have been made to the same scale of one-eighth the actual size in order to facilitate comparison between them.

zigzag waterway through the trap, the water having at all parts a sectional area exactly equal to that of the trap proper shown at the left of the figures, and of its inlet and outlet arms.

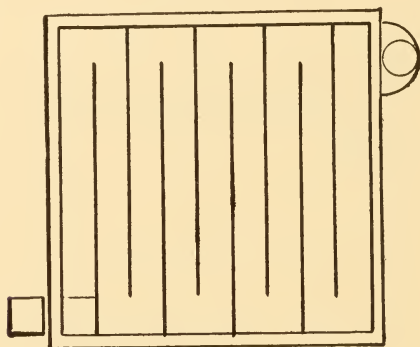

Fig. 141.

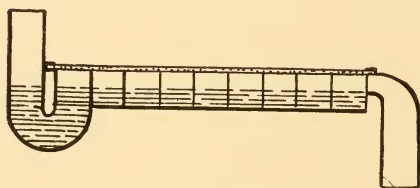

Fig. 142.

Second step. Breaking up the waves by abrupt ends. Plan and section of square trap.

At each return bend of the pipe the wave created by the siphonage is partly reflected back, and broken up, and the air thus finds an opportunity to force its way through to the outlet without appreciable reduction of the water level in the reservoir chamber.

Tested on the apparatus shown in Fig. 241 this trap was found able to withstand indefinitely the most powerful

SEAL RETAINING TRAPS.

siphonage which could be applied, a strain which in a single discharge, destroyed the seal of a fully vented S trap, Fig. 143, even though the vent pipe was new and smooth, and of the full size of the bore of the trap and only ten feet in length!



Fig. 143.

S-trap emptied by one siphoning action, leaving only a few drops in the bottom of the trap, at the level of the dotted line. A vent pipe 10 feet long was attached to the vent outlet shown.

The same strain easily emptied an unvented 4-inch pot trap, Fig. 144, and siphoned out an S trap having a seal six feet deep!

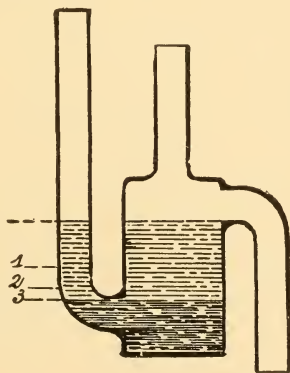

Fig. 144.

Pot trap, which lost its seal after three siphoning actions on our apparatus, shown in Fig. 221.

Yet our new trap easily withstood this enormous pressure ten times repeated, losing only $\frac{3}{8}$ inch in the first two applications of the strain, and nothing more in the remaining applications. In another test it lost $\frac{1}{2}$ inch in the first three applications and no more thereafter.

The trap will hold its seal more securely than a pot or cesspool trap of more than nine inches in diameter, whether the pot be vented or unvented (Fig. 146), because in either

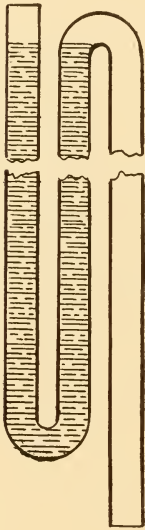

Fig. 145.
S-trap, with seal 6 feet deep, which lost its seal, tested on the same apparatus.

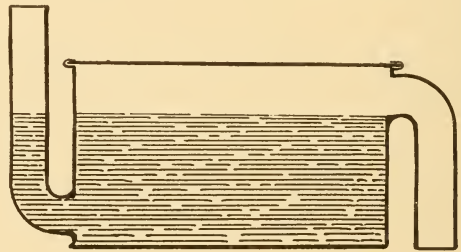

Fig. 146.
Pot trap nine inches in diameter.

case the movement of the water at the top of the pot is very sluggish and this favors early clogging with greasy scum, gradually converting it into an S trap.

Hence we have here obtained an absolutely antisiphon self-cleaning trap of practical form.

But there are yet two serious objections to this form. The first being its great size, and the second the resistance

SEAL RETAINING TRAPS.

which the numerous return bends make to the outflow of the water in its normal use. Small eddies are generated at each bend, which retard the quick and free escape of the waste water without in any way increasing the scouring action thereof.

Tested for friction it was found that it required 35 seconds for the water of a 12-gallon tub to escape through this trap as against 21 seconds for the same amount of water under the same conditions passing through a trap of this same size but constructed as shown in Fig. 138 without the partitions.

In order to obviate the first objection of the inconveniently large size of the trap, we next experimented with

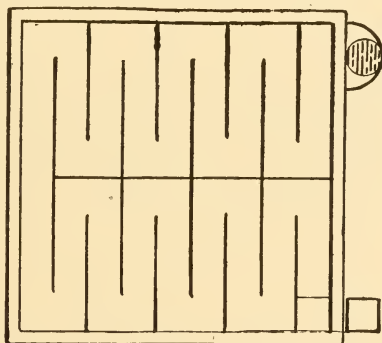

Fig. 147.

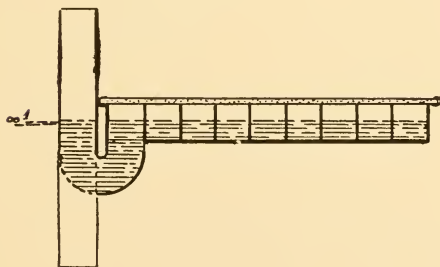

Fig. 148.

smaller sizes, successively reducing the horizontal dimensions from 13 to 10½ inches, and then to 9, 8, 7, and finally 6 inches. Moreover the shape of the partitions was varied in order to ascertain the most effective and easily constructed arrangement.

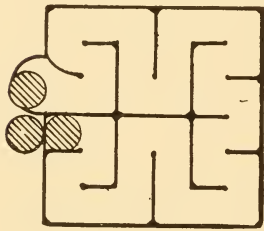

Fig. 149.

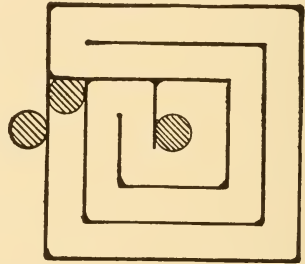

Fig. 151.

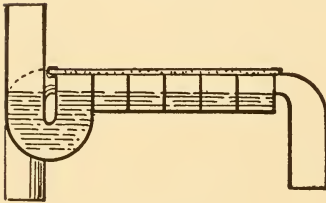

Fig. 150.

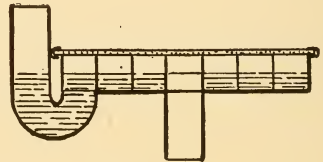

Fig. 152.

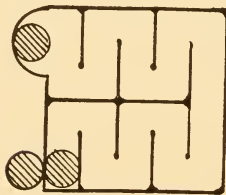

Fig. 153.

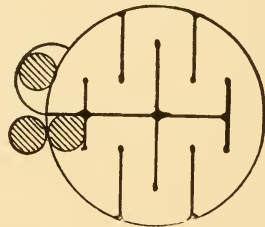

Fig. 154.

Figs. 147 to 161, inclusive, show the various forms we have examined, and in Table I the test made on some of these forms are recorded. The results of the tests may be briefly summed up as follows:

SEAL RETAINING TRAPS.

SEAL RETAINING TRAPS.

(I) With traps of the kind under consideration the power of resistance to siphonage is in proportion to the horizontal length of the waterway in the trap. The largest

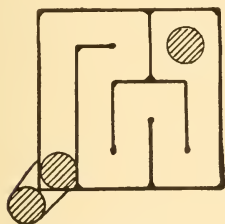

Fig. 155.



Fig. 156.

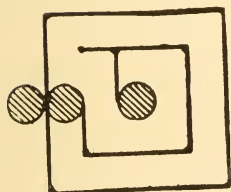

Fig. 157.



Fig. 158.

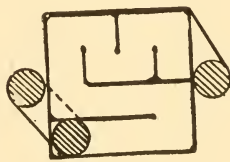

Fig. 159.

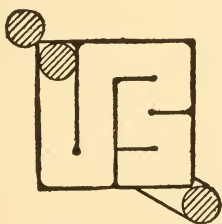

Fig. 160.

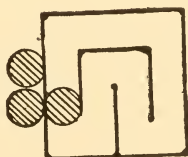

Fig. 161.

is capable of resisting the most powerful siphonage that can possibly be brought against it on any apparatus which can be built for making a plumbing test of which we are aware,

TABLE I.
EXPERIMENTS ON SIPHONAGE. SEVEREST STRAIN.
 Slowing Aggregate Loss of Water in Traps in Fractions of an Inch After
 Each Siphoning Action.

Traps Tested	Number of Each Test.									
	1	2	3	4	5	6	7	8	9	10
S-Trap Fig. 143 1½ in. Seal 10 ft. Vent & One Return Bend	Seal Broken	Trap Emptied*								
4-inch Pot Fig. 144 3¼ in. Seal	2 in. out	2 1-2 in. out	2 3-4 in. out	3 Seal in. Bro- ken						
4 inch Pot 20 ft. of Vent Pipe & 5 Return Bends	3-4 in. out	1 in. out	1 1-2	1 3-4	2	2 1-4	2 3-8	do.	do.	do.
Long Trap Fig. 139	Seal Broken									
S-Trap 2½ ft. Seal	Seal Broken									
S-Trap 4½ ft. Seal	Seal Broken									
S-Trap 6½ ft. Seal	All but 10 in. out	All but 6 in. out		do.	do.	do.	do.			
13 in. Square Trap. Fig. 193	5-16 in. out	11-32 in. out	3-8 in. out	do.	do.	do.	do.	do.	do.	do.
13 in. Square Trap. Fig. 141	1-4 in. out	3-8 in. out		do.	do.	do.	do.	do.	do.	
13 in. Square Trap. Fig. 147	1-16 in. out	do.		1-8 in. out	do.	do.	do.	do.	do.	do.
13 in. Spiral Trap. Fig. 178	3-8 in. out	1-2 in. out	17-32 in. out	do.	do.	do.	do.	do.	do.	do.
10½ Spiral Trap. Fig. 183	1-2 in. out	do.	do.	do.	do.	do.				
10½ in. Spiral Fig. 180	1-2 in. out	9-16 out	do.	do.	do.	do.	do.			
8¼ in. Spiral	1-2 in. out	3-8 in. out	7-16 in. out	do.	do.	do.	do.	do.	do.	do.
7 in. Spiral	1-2 in. out	do.	do.	do.	do.	do.	do.	do.	do.	do.
6¼ in. Spiral	1-2 in. out	do.	9-16 in. out.	5-8 in. out.	do.	do.	do.	do.	do.	do.
6 in. Spiral	3-4 in. out	7-8 in. out	1	do.						

*Only 1-8 inch of water left in bottom of Trap.

and much more powerful than any that can be brought to bear upon it in plumbing practice.

This same statement holds good down to the six inch size, the only difference being that the amount of water forced out of the reservoir chamber by the strains will be slightly greater in the smaller than in the larger sizes, as will be seen by reading the table. The two smaller sizes, namely, the 7 inch and the 6 inch, will resist any siphoning action, however long continued, which can be encountered in actual plumbing practice.

By slightly increasing the depth of the trap, in these smaller sizes, however, the resistance can be made to approximate that of the largest sizes. Thus by increasing the depth of the 7 inch trap by half an inch its resistance can be made substantially equal to that of the 10 inch and the 13 inch traps, and by increasing the depth of the 6 inch trap by an inch the same result can be attained in this case.

(2) The variations in arrangement of the partitions shown in the various figures given above, do not essentially affect their power of resistance to siphonage nor the cost of their construction.

Figs. 162 and 163 show two other arrangements of the partitions. The corners of the partitions may be rounded as shown in these drawings without greatly affecting the resistance of the trap, a slight increase in the length of the water-way fully restoring any loss of area thus occasioned.

Fig. 164 shows four ordinary S traps connected together.

I have drawn them for the purpose of comparison with Fig. 163. Such an arrangement of S traps would, of course, result in "air binding." But by venting them at the crown this is obviated.

Now the only difference between these two arrangements

is that in Fig. 164 the S traps are placed vertically and in Fig. 163 they are placed horizontally. The forms and sizes of the traps in both cases are absolutely the same. But the entire character of the S trap has by this simple change of position become marvelously and radically altered.

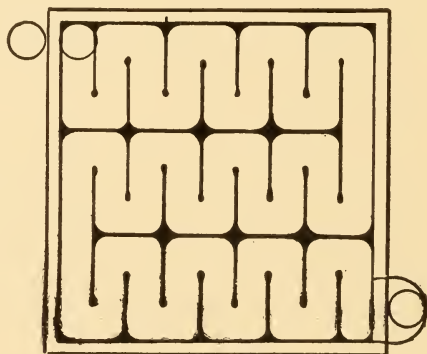

Fig. 162.
Another arrangement of the partitions.



Fig. 163.
S-traps placed horizontally.



Fig. 164.
S-traps placed vertically.

SEAL RETAINING TRAPS.

In its ordinary vertical position the trap is now known to be utterly unreliable and therefore in effect worthless, presenting, as it does, the feeblest possible resistance to all the adverse influences which tend to destroy a water seal in plumbing, and for this reason the common S or siphon trap should never be used except for water closet seals, and then only under conditions of arrangement which will render their seals secure and reliable. In its horizontal position, on the contrary, it becomes absolutely invulnerable, and acquires all the qualities to be desired.

Thus the feat of rendering an S trap antisiphon without the aid of a vent pipe, as claimed at the beginning of this chapter, has been accomplished. By this treatment our S trap becomes in effect vented through its own inlet pipe, whereby the entire volume of fresh air needed to supply the strongest siphonage ever encountered and to ventilate the waste pipe system is made to pass directly through the body of the trap itself without the slightest danger of destroying its seal in its passage.

(3) We find, however, that the free and rapid discharge of the waste water in normal use is diminished in proportion as the turns required in its passage through the trap are abrupt and varied.

Thus the traps shown in Figs. 147 and 162 retard the flow more than those shown in Figs. 138 and 141, and the opportunities for sediment deposit are greater in the latter than in the former. Hence of these forms the former have two important advantages.

Experiments were also made on horizontal traps with combinations of curved and straight partitions as shown in Figs. 165 to 177, inclusive. They showed about the same power of resistance as the traps having all rectangular partitions, but were, for the same reasons, subject to the same defects.

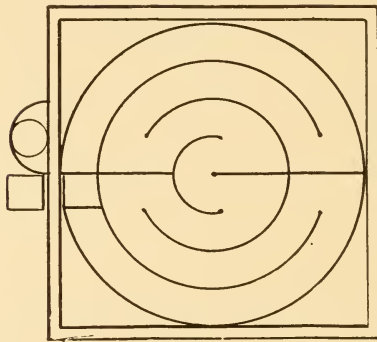

Fig. 165.

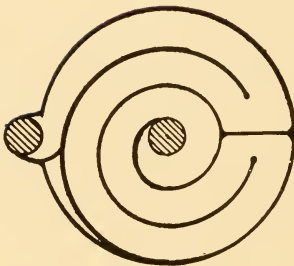

Fig. 166.

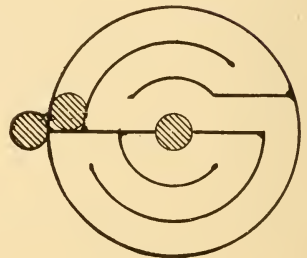

Fig. 167.

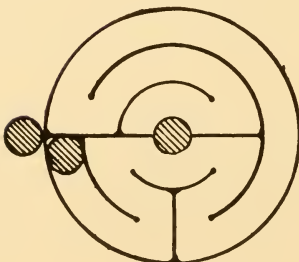

Fig. 168.

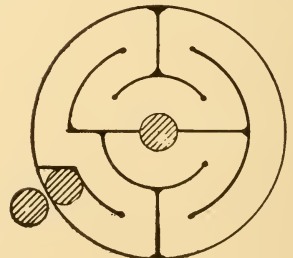

Fig. 169.

SEAL RETAINING TRAPS.

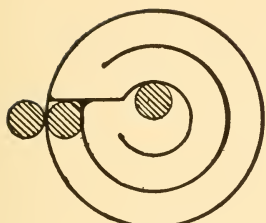

Fig. 170.

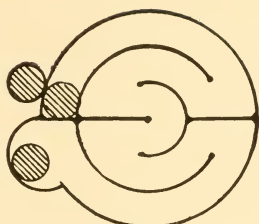

Fig. 171.

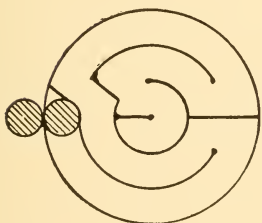

Fig. 172.

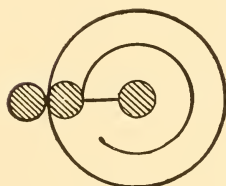

Fig. 173.

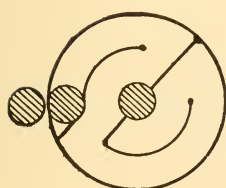

Fig. 174.

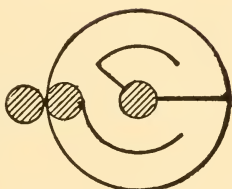

Fig. 175.

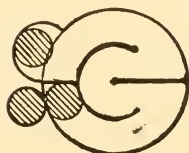
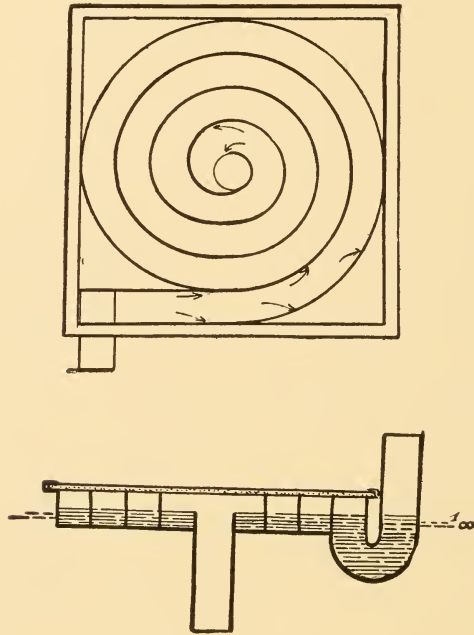

Fig. 177.

Figs. 164 to 177 inclusive. Horizontal Traps with Combined Curved and Straight Partitions.

We have found that these defects can be obviated by taking advantage of the principle of centrifugal force. Accordingly we constructed the partition in the form of a spiral as shown in Figs. 178 and 179.

This improvement constitutes our third step, and in it we have attained a form which combines the advantages of all the preceding ones and eliminates completely their defects. We can reduce the horizontal dimensions as much as be-



Figs. 178 and 179.

Third Step. Plan and section of Horizontal Trap with Spiral Partitions.

fore without destroying the power of the trap to withstand the severest tests of siphonage.

We have done away with the comparatively clumsy method of using abrupt turns and baffle walls to separate the

SEAL RETAINING TRAPS.

air from the water when siphoning action takes place, and have substituted for it the simpler and more scientific and effective agency of centrifugal force.

Air under powerful siphonage rushes through the trap with tremendous speed, causing some of the water in the reservoir to whirl around with the air like a miniature whirlpool and cyclone. The water, being the heavier of the two elements, is thrown outwards by its spiral movement against the outer walls of the partition, while the air hugs the inner walls because along them lies the quickest and easiest outlet to the drain pipe where the partial vacuum to be filled by it exists.

This action of the two fluids is easily followed by the eye if the upper side of the experimental traps be made of glass. It is made still more plainly discernible if lumps of earth, small stones and other substances a little heavier than water be mixed with it. These are clearly seen to hug the outer walls as they whirl around on their way to the outlet, while the air bubbles, always present in the water at the time of siphoning action, seek the inner side or more direct passage outwards, which is for them the line of least resistance.

The resisting power of this trap is, as shown by the table, as great as that of any of the preceding traps, while its form permits of a much more rapid discharge than the others in proportion to the length of its waterway, and it has the maximum of scouring action, and absolutely no obstruction or baffle in any way of the water discharges at any point beyond what is encountered in a perfectly straight smooth pipe. It has a sufficient volume of water to withstand back pressure and evaporation, and the distance between the trap proper and the drain outlet is sufficient to obviate capillary action.

I believe, therefore, that in this we have attained the principle of the perfect anti-siphon plumbers' trap.

PLUMBING AND HOUSEHOLD SANITATION.

Examined for friction, or self scouring properties, these spiral traps showed themselves, as might be expected, far superior to the others, as indicated by the friction tests recorded in Table III.

TABLE III.

Experiments on Water Scour.

Showing Time in Seconds Required for Water in Cistern Shown in Fig. 241 to Pass Through Traps.

Traps tested.	Number of tests.		
	1st Test.	2d Test.	3d Test.
	Sec.	Sec.	Sec.
4-in. Pot Trap, 3 1-2-in. Seal ..	25	24	25
Straight Pipe	22	22	22
7 1-2-in. Pot, 4-in. Seal	32	32	32
13-in. Sq. Trap, Fig. 138	21	21	21
13-in. Sq. Trap, Fig. 141	35	35	34½
13-in. Sq. Trap, Fig. 147	55½	55½
13-in. Spiral, Fig. 178	27	27	27
11-in. Spiral, Fig. 181	32	32	32
11-in. Spiral, Fig. 180	32	32	32
11-in. Spiral, Fig. 182	28	28	
7-in. Spiral, Fig. 185	30	30	29

The 13-inch spiral trap, tested on the apparatus shown in Fig. 190, discharged the 12 gallons of water from the tub in less than half the time required by the rectangular trap of Fig. 147, 27 seconds being required for the former and 55½ seconds for the latter. The tank holding 12 gallons, the first discharged about two quarts per second, and the second less than one quart. Moreover, it required from 5 to 10 seconds for pieces of paper, small lumps of earth and other articles thrown into the water to pass through the rectangular trap, whereas these matters were whirled through the spiral trap in less than half the time. Heavy substances, like small lumps of iron and lead, were retained in the rectangular traps, but were always easily and quickly whisked through the spiral trap and carried over into the waste pipe.

SEAL RETAINING TRAPS.

Now the scour exerted by the water in passing through the reservoir chamber of the spiral trap was found to be as effective upon the walls of the chamber as upon the dip of the trap proper, because it is in the dip of a trap that heavy matters are most likely to be caught and retained, not only because the bend is most sudden at this point, but also because these matters have here to be elevated by the amount of the depth of the seal, while in the reservoir chamber they have only to be pushed along a smooth horizontal surface.

When the waste outlet of a plumbing fixture is very much smaller than the area of the waste pipe connected with it, the water loses its scouring force and greasy matters will gradually accumulate along the walls not only of traps but even of the straight waste pipes themselves, as has been explained and illustrated in a previous chapter. Now our spiral trap is evidently no more able to resist the fouling effect resulting from improperly constructed fixtures than would be the straight waste pipe itself. But it has this all important advantage over a vented S trap, that whereas in the latter the vent pipe opening being the first part to be clogged by greasy deposits, the whole trapping system becomes at once destroyed, and this without any warning to the user; with the former the sediment being equally distributed over the inlet pipe and body of the trap, this reduction of the area of the waterway cannot in any way reduce the antisiphonic character of the trap, because it simply converts it into a smaller trap, having the same relative properties and principle of action. Indeed the sediment will tend to accumulate where the resistance to the scour is greatest, which is at the dip, and in this case the area of the trap proper will constantly diminish with relation to that of the reservoir chamber, in which event the resistance to siphonage will if anything tend to increase rather than diminish.

Therefore the trap will resist siphonage as long as there is any water way at all left in the trap. Yet when the discharge is entirely stopped by sediment, or retarded to a point of inconvenience, it will, of course, announce itself and necessitate opening and cleansing.

The same advantage holds in the comparison of this trap with a pot trap or any other form of plumbers' trap constructed on the unscientific and faulty "vertical" principle, which, strangely enough, is the one on which plumbers' traps have always heretofore been erroneously designed.

As has already been explained in a former chapter we have subjected our traps to strains of various degrees of intensity, the severest being much stronger than any which could be encountered in plumbing practice, for the purpose not only of proving a degree of resistance beyond all possible question on the part of the antisiphon traps tested but also of permitting a more thorough comparison between the various forms of traps under consideration, and especially between unvented antisiphon traps and ordinary S and pot traps fully vented in accordance with the present plumbing laws.

It only remains to determine how far it is best to contract the horizontal dimensions of our trap in order to obtain on the whole in practice the most desirable results.

Our next experiments therefore were made to decide this question. Figs. 181 to 189 inclusive show the various sizes of spiral traps experimented upon arranged in the order of the tests.

The endurance of each of these traps is recorded in the Table I. The depth of seal in all was the same as in all the preceding horizontal traps; *i. e.*, $1\frac{1}{4}$ inches. The most that could be forced out of the 13-inch spiral trap even after numerous successive repetitions of the ordeal was $\frac{3}{8}$ inch in one set of experiments and $17\text{-}32$ inch in another.

SEAL RETAINING TRAPS.

The $10\frac{1}{2}$ -inch spiral (Figs. 180 and 181) lost only $\frac{1}{2}$ inch under the same tests. The $10\frac{1}{2}$ -inch spiral trap lost 9-16 inch. The $8\frac{1}{4}$ -inch trap lost 7-16 inch and the 7-inch lost 9-16 inch, all under the same tests.

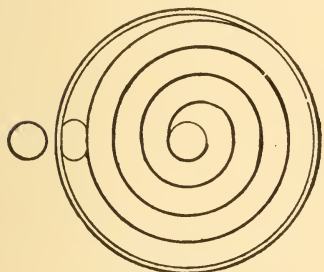

Fig. 180.

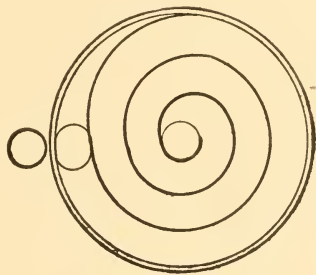

Fig. 182.

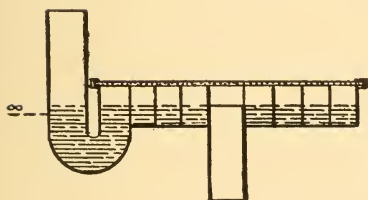

Fig. 181.

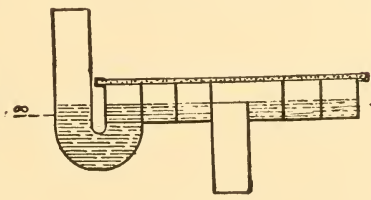

Fig. 183.

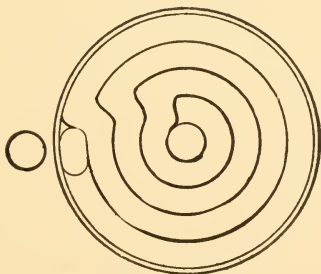

Fig. 184.

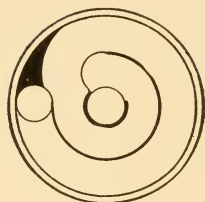

Fig. 185.

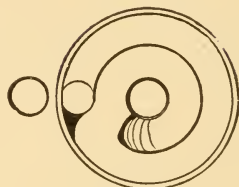

Fig. 186.

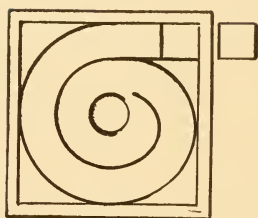

Fig. 187.

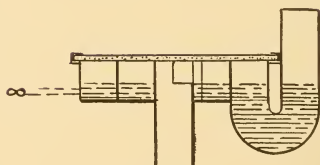

Fig. 188

Experiments were also made with a 6-inch spiral trap, and this lost $1\frac{1}{8}$ inch after four of these severest strains in succession. These strains long continued would have ultimately broken the seal of so small a trap. But it withstood all other strains as shown, and proved itself capable of easily withstanding any strains of siphonage which can ever be encountered in actual plumbing practice.

The arrangement of partitions shown in Fig. 184 seemed to give results not appreciably different, so far as siphonage is concerned, from those of Figs. 180 and 182. But the sharp bends between the inlet and the outlet arms somewhat increased eddies and the friction in normal use and obstructed the free discharge of heavy substances in the waste water.

SEAL RETAINING TRAPS.

The small opening shown in Fig. 187 between the outlet pipe and that part of the spiral which is nearest to it produced a scarcely appreciable effect in the siphonage tests. It would, however, be objectionable as a cause of complication and possible obstruction and its use was abandoned.

In Figs. 186 and 185 corners were rounded off as indicated by the black places in the drawings. This reduced the resistance to siphonage by so small an amount that its advantages in facilitating scour much more than offset the loss. In Fig. 186 the bottom of the trap at the inner end of the spiral is curved gently upwards in order to do away with any sharp corners and barriers. This also improved the scouring properties of the trap without appreciable injury to its resistance to siphonage.

Before describing our final step it will be interesting to record certain curious facts noted in making our experiments on our horizontal traps not heretofore observed or recorded, so far as I am aware.

For the purpose of studying the movements of waste water through very large shallow traps we had the one we have shown in Figs. 189 and 195 constructed with a glass top, the length and breadth being 13 inches each and the depth $1\frac{1}{2}$ inches. The seal proper was, as in the other cases, only half an inch deep, and the water stood $\frac{3}{4}$ inch deep in the reservoir chamber when full up to the overflow, making a total seal of $1\frac{1}{4}$ inches under normal conditions.

The actual movement of the water in this trap, under both siphonage and friction tests, proved quite different from what might naturally be expected. One might suppose that under the pressure (or "suction" as it is popularly called) of a powerful siphoning action, air and water would be forced straight across the reservoir from inlet to outlet arm along the line of the least apparent resistance, in a straight and rapid current somewhat as shown in our figure,

with return eddies on each side of the main current. It would also be natural to expect some such current to be formed when water was discharged through the trap with considerable force from a fixture connected up as shown in Fig. 190, where we have used a 12-gallon tank set 19 inches above the trap, to represent normal discharges from an ordinary bath tub.

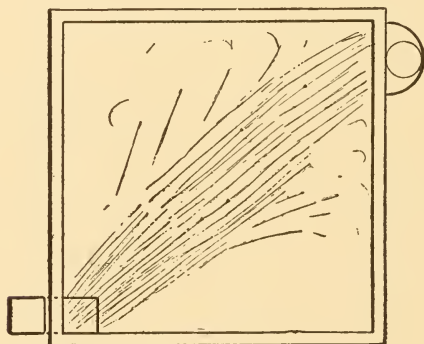

Fig. 189

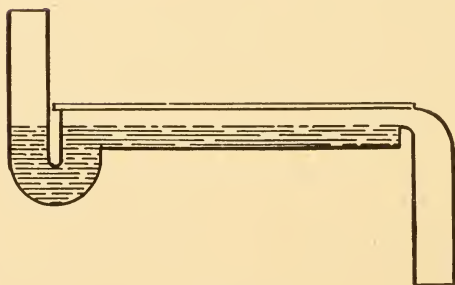
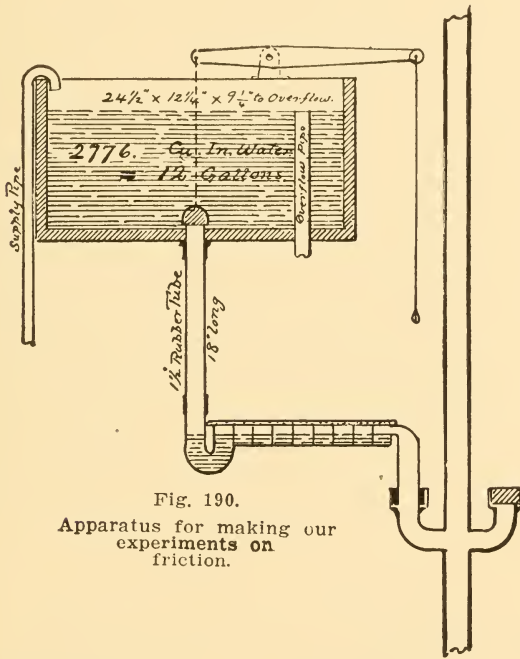

Fig. 189a.

Plan and section of thirteen-inch trap without the partitions.

SEAL RETAINING TRAPS.

The actual course of the water in these cases was, however, altogether different from our theoretical assumption. Under siphoning action, the course of the water presented the appearance shown in Fig. 191. The water was projected violently upward from the inlet mouth, and, striking the



glass top of the trap, was reflected in a strong spray downward and outward with the formation of bubbles extending nearly half way across the trap.

At the same time powerful waves were set up which tended to form rings around the inlet mouth spreading out-

wards in all directions to the four sides of the trap about as shown in the drawing.

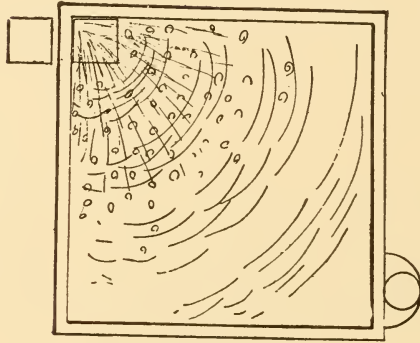

Fig. 191.
Movement of water in our large flat trap
under siphoning action.

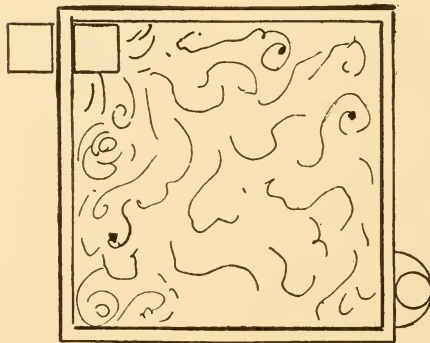

Fig. 192.
Movement of water in the same trap
under the normal discharge of water.
Water from the fixtures it serves.

It was for the purpose of breaking down these waves in the manner already described that we constructed the vari-

SEAL RETAINING TRAPS.

ous arrangements of partitions in the traps we have illustrated.

On the other hand the course of the water under a normal discharge of waste water through it from the fixture it serves, as from a bath tub represented by the tank in our Fig. 190, with which these tests were made, was even more at variance with the expected.

The water, though coming with great force under the head shown in the cut, seemed nevertheless to eddy about quite leisurely and sluggishly in all sorts of directions, forming, to all appearances, quite meaningless and uncalled for curves and spirals, with occasional unaccountable dartings toward unexpected points. It appeared to meander about, as one might say, "with its hands in its pockets," and not by any means to rush direct to the outlet opening with the frantic haste and decided manner we had confidently expected and planned for it. Fig. 192 gives quite an accurate idea of the curious antics played by the current. The black specks in the drawing indicate pieces of heavy solid matter thrown into the water for the purpose of better studying its peculiar movements. These at times jumped about quite quickly, and at other times lay motionless for a while as if deliberately resting for some violent effort a moment later.

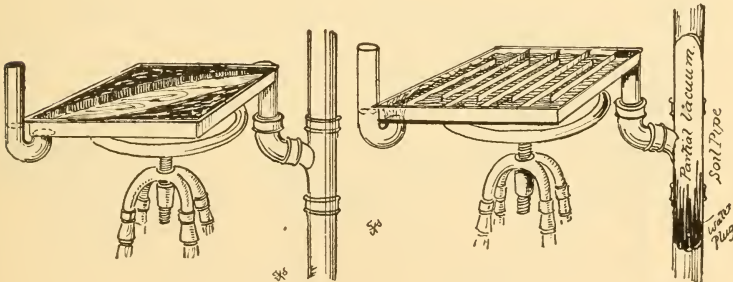

Fig. 195.

Fig. 196.

PLUMBING AND HOUSEHOLD SANITATION.

Fig. 195 and 196 show our 13-inch glass experimental traps in perspective. The large horizontal dimensions of the first give it still the cesspool quality, and the figure shows how it would clog in time with grease under a sink. The second cut shows it divided so as to produce the water scour.

Our fifth and final step consisted in constructing the parts of the trap in such a manner as to permit of economical manufacture and easy opening and closing for examination while in use. Figs. 197 to 200 inclusive show two forms adopted, the first being adapted to be placed above the floor level and the second below the floor and serving two or more fixtures at once, as, for instance, a bath tub and one or more adjacent set basins.

The cover may be made of brass or of tile impervious to air and water, of octagonal shape and designed to harmonize with the tile or mosaic floor of a modern bath room. This

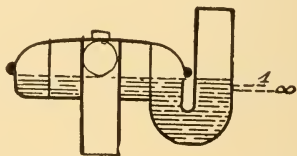
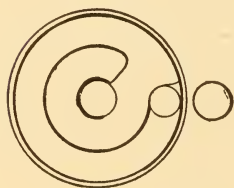

Figs. 197 and 198. Spiral Basin Trap.

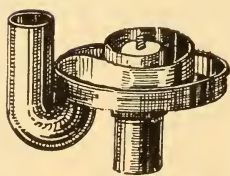
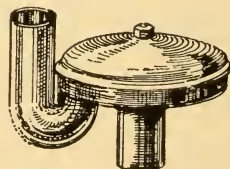
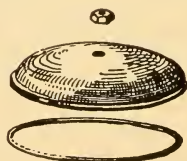

Fig. 199.



Figs. 200 and 201.

SEAL RETAINING TRAPS.

form, however, the writer has not used, a later form being preferable.

Figs 201 to 205 inclusive give perspective views of these traps as they would appear both closed and open.

The floor trap is shown in Figs. 206, 207 and 208, serving

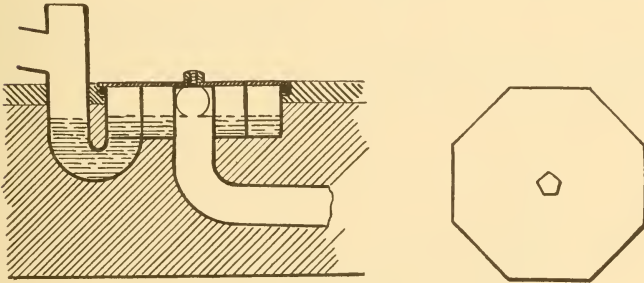

Figs. 199 and 200. Spiral Bath and Basin Trap, as actually constructed.

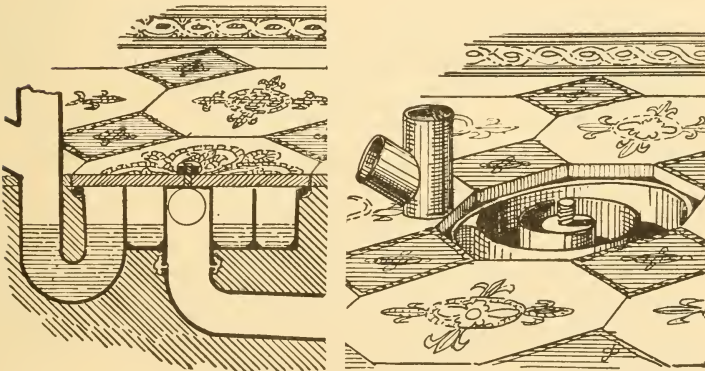

Fig. 204.

Floor Trap, with Tile Cover, set in Tile Work, and made tight by a large Elastic Gasket.

Fig. 205.

Floor Trap, shown with cover and Gasket removed.

PLUMBING AND HOUSEHOLD SANITATION.

three fixtures, namely, the bath tub, the basin and also the water closet connected with its own deep seal trap. In order to permit of this triple service the inlet arm of the trap is branched above the floor to take the basin waste

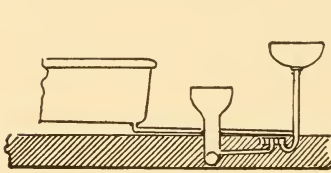

Fig. 206.

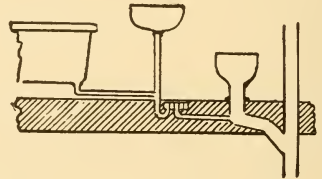

Fig. 207.

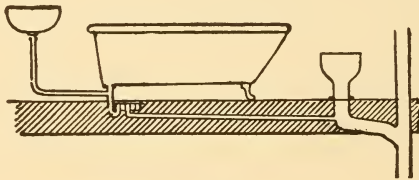

Fig. 208.

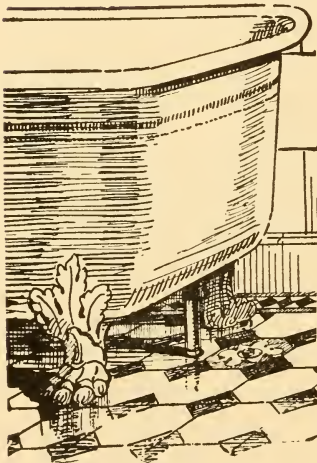

Fig. 209a.

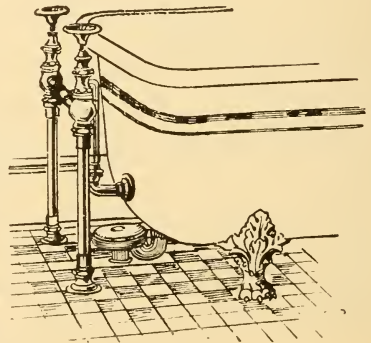

Fig. 209.

Bath Tub, showing preferable arrangement of trap entirely above the floor.

SEAL RETAINING TRAPS.

pipe, and its outlet arm connects with the outlet of the water closet trap.

If now the seal of this closet trap is made deep enough, the shallow trap will protect it unfaillingly from siphonage by supplying air through its seal to break the siphoning action.

This trap may be constructed under a considerable variety of forms, as shown in Figs. 210 to 224, to suit varying conditions, either the inlet or the outlet pipe passing through the centre of the reservoir or refilling chamber as desired. Or either arm may be placed out of the centre of the trap, as shown in previous drawings.

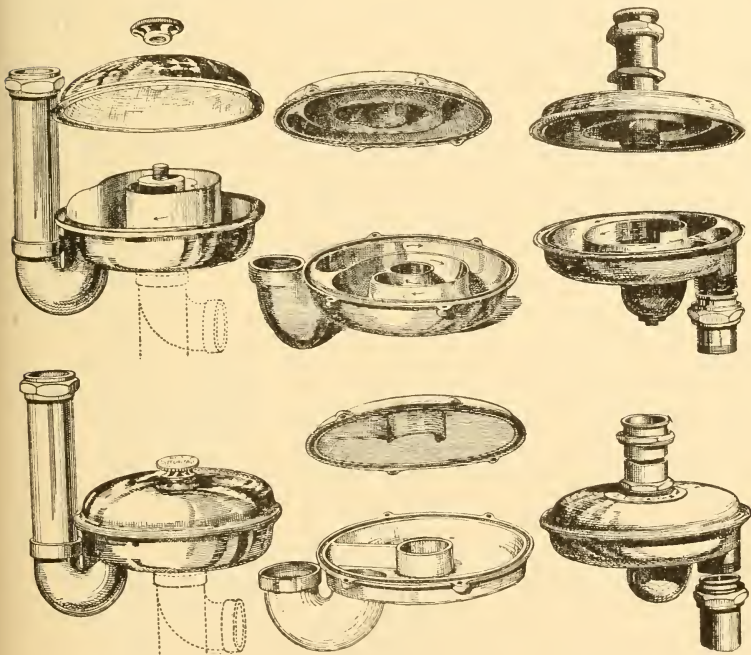

Figs. 210 & 211.

Figs. 212 & 213.

Figs. 214 & 215.

PLUMBING AND HOUSEHOLD SANITATION.

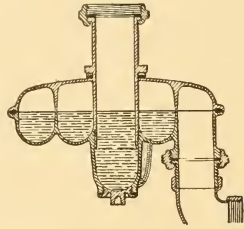
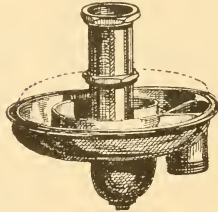
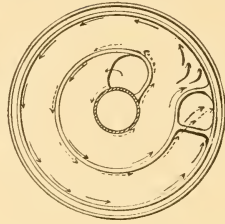
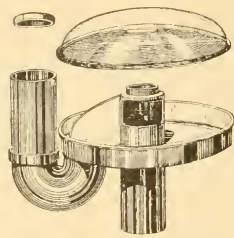

Figs. 216 & 216a.

Fig. 217.

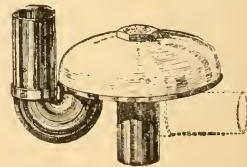
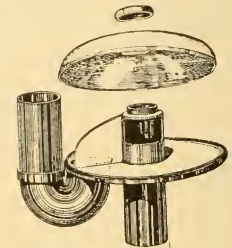
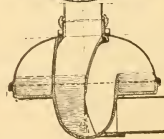
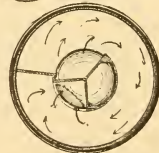
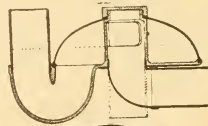
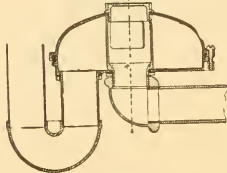
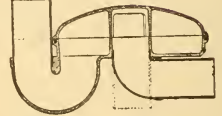
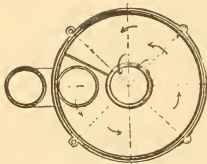

Figs. 218 & 219.

Figs. 220 & 221.

Figs. 222, 223 & 224.

SEAL RETAINING TRAPS.

Figs. 225 to 227 represent the writer's earlier trap, the "Sanitas," which he developed from the pot trap as de-

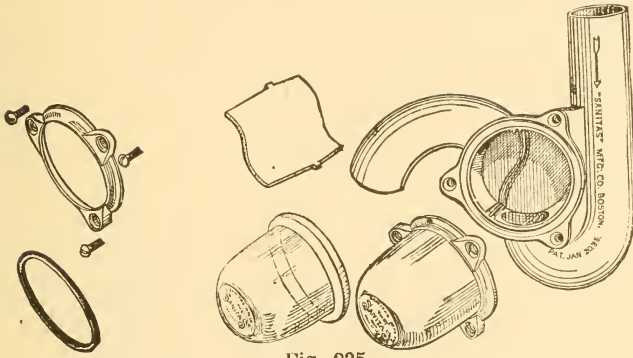

Fig. 225.

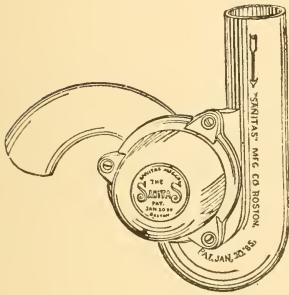

Fig. 226.

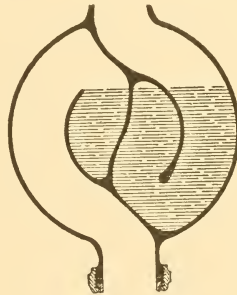

Fig. 227.

scribed in 1884, 5 and 6, in his little works entitled "Improved Plumbing Appliances" and "The Principles of House Drainage." This trap has been improved upon in the later studies herein described which developed the more scientific "Securitas" device, and in which were avoided the defects in the Sanitas of too great a vertical extension and too many abrupt and sharp turns. By doing away with these objectionable features the "Securitas" trap has attained a self-cleaning property equal to that of the simple

S or ordinary siphon trap, for the bottom of the "Securitas" reservoir chamber can be curved upwards at the angle of junction with the small cross partition if desired. In practice, however, it is found better to leave this angle a little abrupt in order that small articles like rings or jewels, often accidentally finding their way into a trap, may not be swept into the sewer. The corner is too small to constitute an objectionable sediment pocket, but just large enough and conveniently enough located to safeguard small valuables without creating any corresponding objections. Being directly in the path of the strongest water flush ordinary sediment and greasy matters will not lodge there. This feature is sufficiently appreciated by users to justify its retention, although it might easily be done away with and all corners fully rounded if desired to complete the ideal round pipe section throughout.

Figs. 226 and 227 show most clearly the objectionable feature referred to of the too great height of our first trap. In consequence of this unnecessary vertical extension, a larger proportion of its water seal is forced out under siphoning action than with the later device, which for this reason proves more self cleansing with even greater siphonage resistance, and also has the very important advantage of forming a simple and perfectly effective back vent for a deep seal water closet trap, as already described.

Figs. 228, 229 and 230 show a few of the experimental traps made by the writer before the development of his Sanitas trap, and some ineffectual efforts made in the wrong direction to take advantage of the superior specific gravity of water over air, by giving the two fluids a rotary movement within the body of the trap, and attempting to separate them from each other by centrifugal force in a vertical plane. In these early experiments the mistake was made of adhering to the perpendicular construction everywhere

SEAL RETAINING TRAPS.

adopted at the time and even continued in the Sanitas trap. It was only on discovering that the strength and value of a trap in every way lay in its horizontal extension that success was finally attained. Had the trap shown in Figs. 228 to 230 been built horizontally rather than vertically the problem would have been settled much sooner. It is true that



Fig. 228.

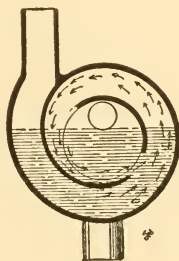

Fig. 229.

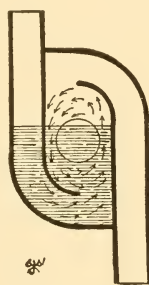

Fig. 230.

the principle of the horizontal design was, to some extent, followed in the steps leading to the Sanitas trap, but it was only partially adhered to in the final form of the trap, and yet whatever of success it has had* I attribute chiefly to the horizontal element in its design.

The simplest forms of our "Securitas" trap are shown in Figs. 233 to 237. As will be seen by the drawings, all parts of the water way have an area substantially equal to that of the inlet or outlet pipes, giving it the self-scouring principle of the common S or siphon trap.

*As to this matter, testimony of others known as impartial experts may seem to the reader more convincing than any self praise the author may indulge in, and therefore one or two remarks of recognized authorities may properly be quoted here. Col. Waring, for instance, writes in the "Century Magazine" of the trap as follows: "As an incidental result of his experiments on siphonage, Mr. Putnam, by gradual stages, arrived at the invention of a trap which seems to be a practical one, and which, subjected to tests that were sufficient to break the seal of any ordinary trap even with fair back ventilation, maintained its seal undisturbed. Mr. Putnam's trap, the form of which is illustrated herewith, stands in its normal condition, entirely full of water. Under strong siphonic

When constructed of iron white enamelled, both inside and out, it forms a very attractive fitting, corresponding with the smooth white surfaces of the modern plumbing fixtures and bath room tile finish, and like them, it retains its smoothness and cleanness indefinitely without the rubbing and polishing required by ordinary metal work, nickel plated or otherwise. The shallow construction of the trap allows it to go easily between the bottom of a bath tub and the floor as shown in Figs. 209 and 367, avoiding the inconveniences attending traps reaching below the floor. Fig.

action about one-half of this water follows the air toward the drain; this amount being removed, the deflecting surfaces of that portion of the apparatus thus emptied suffice to rob the air-current of its spray, and under no test that has yet been applied, with an open topped soil pipe, can the seal be broken. The interior of the trap is well exposed to view, and the arrangement for cleaning in of the glass cap to remove an obstruction would be a very small price to pay for the absolute security which Mr. Putnam seems to have achieved. Since the above was written, I have tested Mr. Putnam's trap, finding it effective in withstanding siphonage and substantially self cleansing. It seems to me the best trap that I have seen.

This trap or something like it may probably come into universal use for washstands, baths, and laundry tubs—for urinals also where separate urinals are used." Further on in the same article Col. Waring says: "Not only as confirming my own view, but as an illustration of very thorough and careful experimental work, attention may properly be called to an investigation carried on for the City Board of Health of Boston by J. Pickering Putnam, Esq., an architect of that city. These investigations have been set forth quite fully in illustrated communications to the 'American Architect,' which papers certainly mark a very important step forward in sanitary literature. The deductions to be drawn from these investigations are these," etc. From the "Century Magazine" for December, 1884.

Wm. E. Hoyt, C. E., S. B., Chief Engineer of the B. R. & P. R. Co. and at one time Chief Engineer of the Massachusetts Board of Health, says of the trap and other appliances in an address delivered at the annual meeting of the Academy of Sciences in Rochester, N. Y., January, 1886: "I have briefly sketched, in one place, the methods of these scientific investigators. You have seen how patiently and cautiously Mr. Putnam has worked in the development of his Sanitas trap; how, step by step, he advanced, applying all the time scientific principles in the various successive changes of form, which resulted finally in the complete attainment of the object he had in view.

The other ingenious appliances for which we are indebted to Mr. Putnam are all of equal merit. I know of nothing to compare with them in convenience, efficiency and safety. They should be regarded in the same light as valuable discoveries in medical science. By the use of these devices we are able to avoid, in a great measure the evils resulting ordinarily from bad plumbing."

The "Sanitary Record" of London writes of the Sanitas trap on Sept. 15, 1885: "Mr. Putnam, an architect of Boston, undertook,

236 shows its appearance beneath a basin, and Fig. 367 in a modern bath room.

Diagram Fig. 231 shows the strength of the "Securitas" trap in resisting siphonage as compared with other traps. The record of the eight traps given first in this table is taken from that obtained for the City Board of Health, except that in this table the loss of water at each siphoning strain is given in percentages of the whole seal. The figures under each trap show the number of siphoning strains or tank discharges applied without refilling. The performance of the "Securitas" trap is a record taken under a siphonage strain of 20 inches of vacuum on a pneumatic

some time ago, an extended series of experiments with traps, in behalf of the City Board of Health of Boston. These investigations were published and illustrated in the 'American Architect' at the time, and led to the development of the remarkable trap which Mr. Putnam has called the 'Sanitas.' This trap has gained the unqualified approval of many of the leading engineers of America.

"In February of this year Mr. Putnam lectured before the Suffolk District Medical Society, on the 'Principles of Sanitary Plumbing,' and he exhibited before a large audience an exhaustive series of experiments with various apparatus.

The same journal, in a later issue, publishes a letter of D. J. Ebbets, in which he writes: "Now there are several traps that may safely be used to defy the severest siphonage encountered in actual practice, but only one of these can claim to be self-cleansing—namely, Mr. Putnam's Sanitas trap. This trap is extensively used in America. It is the best example that we have at present of an anti-siphonic trap.

"In America, where, partly on account of the severity of the winters, it is usual to fix the soil-pipes internally, and to connect all waste-pipes with the soil-pipes, it becomes generally necessary to ventilate the ordinary S-trap, introducing a complication which is very bewildering to the ordinary plumber, and the adoption of which entails a considerable addition to the cost of the plumbing work. Besides this complication and expense, there are certain evils which are inseparable from such ventilation; so that in America, at any rate, where self-cleansing antisiphonic traps are to be obtained, it would appear to be rather unwise to continue the use of ventilated S-traps."

Mr. Walter S. Pardee, Supervising Architect of the Board of Education of Minneapolis, Minn., writes of the trap that it "stands well here, I am glad to say, and the law was changed last fall to permit its use (unvented) where back ventilation is not desired," etc. Other cities have done the same. Mr. Pardee adds: "To tell the truth about the matter, I was led to inspect your trap more closely than I would otherwise have done, from the fact that it appeared to be the result of philosophical inquiry rather than of mere guess work.

To quote further laudatory remarks in favor of the writer's appliances would seem to savor somewhat too much of a dealer's trade advertisement, and the above will therefore be assumed to be sufficient for our purpose of providing a little outside unbiased testimony to corroborate the writer's descriptions and contentions.

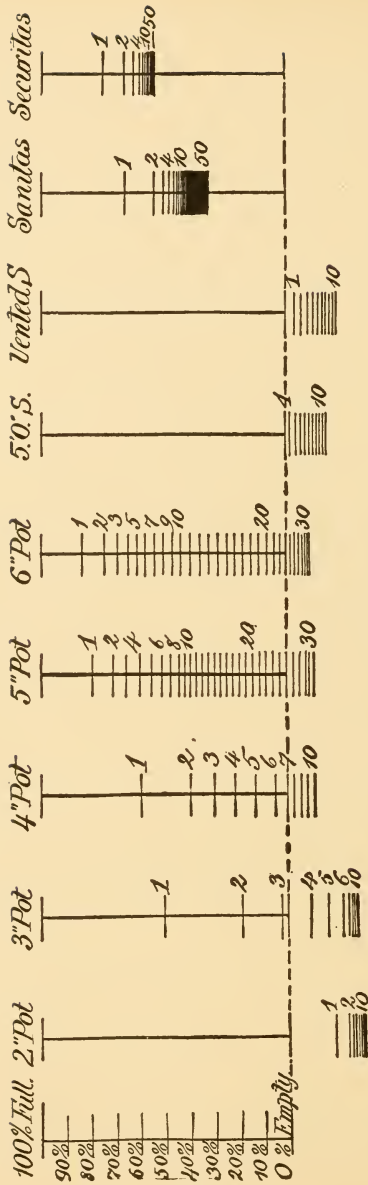

Fig. 231.

SEAL RETAINING TRAPS.

testing apparatus. The other traps were subjected to about 15 inches of vacuum on a hydraulic apparatus. The Securitas trap was not tested at the same time with the rest, as it was not invented at that time. Later tests on all these and other traps show substantially the same results.

Fig. 232 shows the same strains on the Securitas by a different form of diagram.

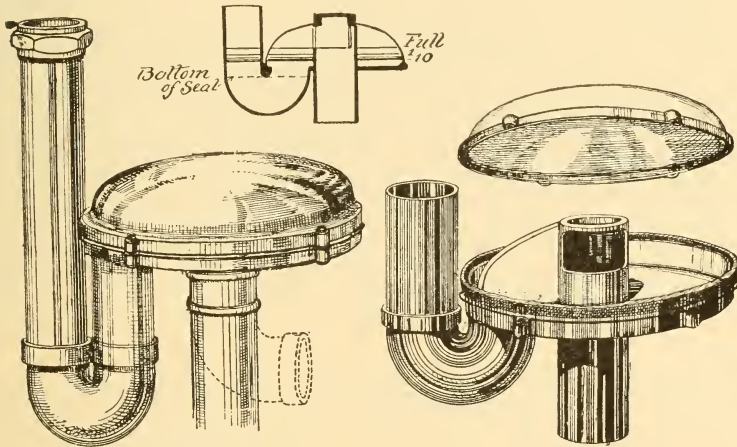

Fig. 233.

Fig. 233a.

As shown in Fig. 233a the water makes only a single revolution in passing through the refilling chamber. In Fig. 233 a deep seal is used, not for any advantage to the traps, but because a deep seal is sometimes called for in plumbing laws through the mistaken idea that a deep seal is needed for efficiency.

Figs. 234 and 235 show the appearance of the trap constructed of porcelain enameled steel and Figs. 234a and 235a show it in nickel plated brass, the latter being piped for a running or bath tub trap, and the former for a basin.

If desired the top cup may be secured to the lower, as shown in Figs. 222 to 224, by an upper nut instead of by the bolts shown in Figs. 233 to 235. A rubber washer under the nut makes a tight joint, and the law

which in some places requires all such joints to be under water is in the light of modern science clearly unjustifiable. Lead caulked bell and spigot joints, which the law allows, are scarcely ever tight after use, whereas steam fitters' joints with paper gaskets are tight against any pressure. Our upper rubber joint is on the same principle, and is, moreover, under water pressure at every discharge of the fixture which constantly verifies its tightness.

Porcelain enameling on steel has now been carried to a very high degree of perfection as illustrated by its great durability in cooking utensils, where it has to stand the test of the roughest usage, even holding boiling water on a red-hot stove. The usage is not so severe in plumbing. Very rough usage will, of course, crack the enamel. But equally rough usage will destroy the appearance of any ornamented construction. Porcelain enamel is not new in plumbing, its use in bath tubs, basins and closets having long been successful. It is only new in traps, and with this improvement the entire bath room outfit, including walls, fixtures, traps and piping may be constructed, harmoniously, of white enamel, giving an effect of very great beauty.

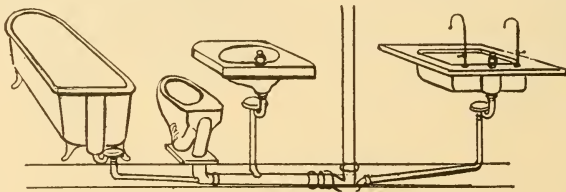

Fig. 237.

Fig. 237 shows four fixtures constructed and set with the simple piping we have advocated. The simplicity of this arrangement is to be compared with the complication shown in Fig. 262, page 266, which is reproduced from a drawing by Mr. Hoyt to illustrate his interesting article on safe plumbing published in 1888 in the "Popular Science Monthly." The same four fixtures are provided in both cases but the cost of the complicated arrangement is more than double that of the simple one. In the former there are 71 joints and in the latter only 14. In the former bell and spigot hand caulked lead joints are used. The strains on the hubs

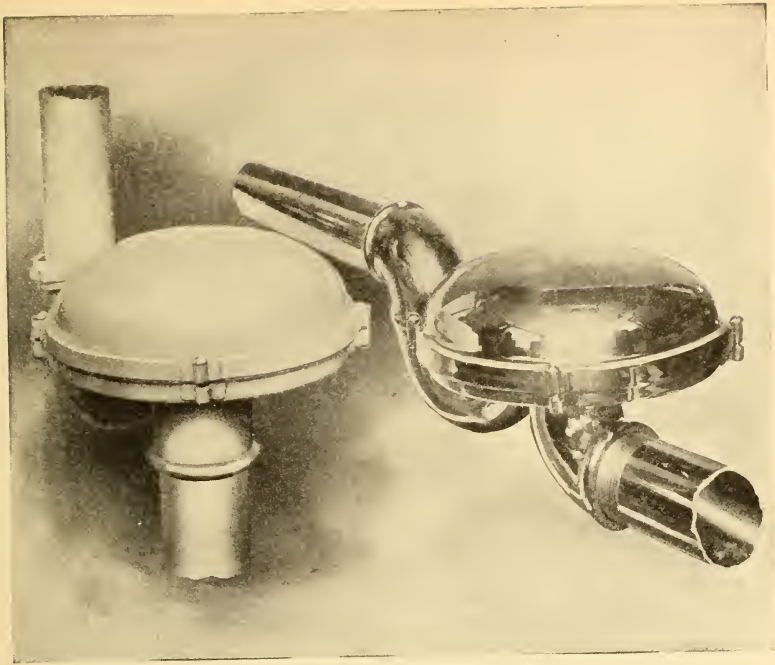

Fig. 234.

Fig. 234a.

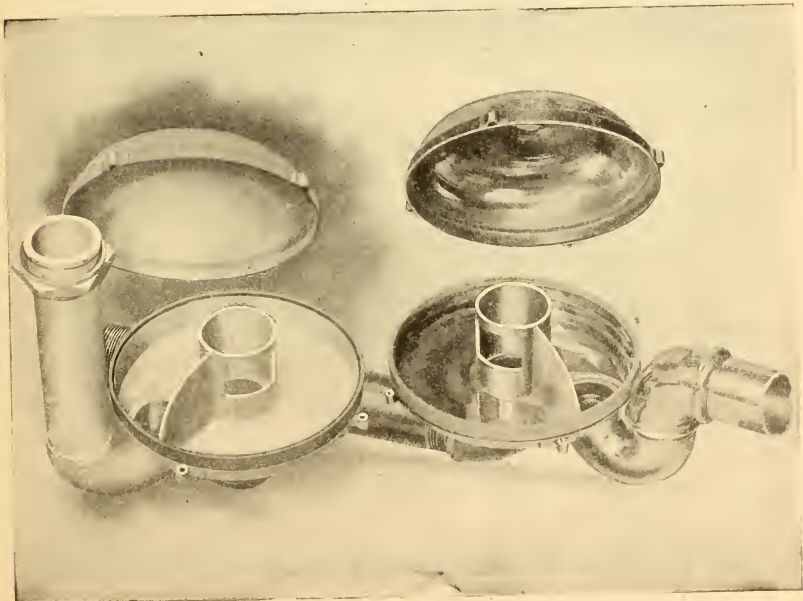

Fig 235.

Fig. 235a.

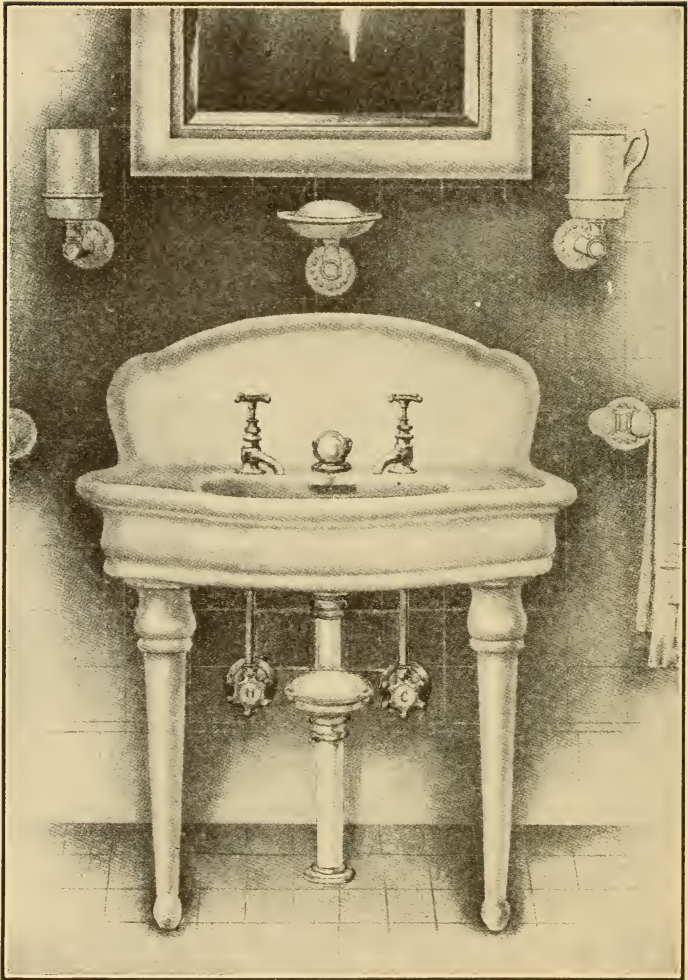

Fig 236. Rearranged from Catalog by Courtesy of Federal Huber Co. made by the caulking hammer and the rigidity of the joint require here the use of extra heavy piping. Whereas the flexible joints used in the simpler system allow of the use of "standard" weight piping with entire safety. This constitutes still another important item of economy.

CHAPTER XIV.

THE TWO PLUMBING SYSTEMS.



HERE are, as I have already indicated, two schools or systems of plumbing which may be characterized as the “complex” system shown in Fig. 32, and the “simple system” of Fig. 33, the first involving two or three times as much elaboration and expense as the second, and rendering it almost impossible for the prospective purchaser of a house to determine whether it is safely plumbed or not.

We have already explained some of the reasons why the simpler system is the best. A public sewer becomes very well ventilated and practically safe when its ventilation is effected by making every house drain and soil pipe a ventilating flue. The sewer then has, in cities, in addition to the usual public ventilating openings on the streets and elsewhere, also special 4-inch suction tubes every ten or fifteen feet throughout its entire length, assuming the houses on both sides of the street to average between 20 and 30 feet in width each.

The temperature in the houses is at all times either warmer, as in winter, or colder, as in hot days in summer, than the air of the street and of the sewer, and thus creates a constant and thorough sewer ventilation. We have

shown somewhat exhaustively that if disease germs are brought into our houses in air currents, they come in the air outside of the sewers, either above or below ground, and not in the sewer air itself, and we know that whatever putrescible matter, excepting street washings, is to be found in the sewers, comes from the house drains themselves. Assuming, then, that the houses average say 26 feet wide and 50 feet high, the number of running feet of soil and drain pipe in each would average at best not less than 100 feet, and the interior surface of this house drain pipe being of iron and not so well scoured as the glazed inner surfaces of the sewer, would therefore contain more decomposing matter than that part of the sewer in the street which serves each separate house. It would be absurd, therefore, to insert a disconnecting trap and double or treble the amount of piping in a house for the mere purpose of excluding this extra drain pipe air, even if it were not demonstrated that this very complication increased rather than diminished the chances of its entrance. More than half of this complication is due to the absolutely and at all times worse than useless so-called "back vent" system, a system founded on misconception and perpetuated by ignorance, prejudice and humbug. Indeed, so far as the science of plumbing is concerned, this system is already a back number, for the leading authorities in plumbing and sanitary engineering have placed themselves squarely in opposition to it.

Of course it will be useless to study the various plumbing fixtures of a house and the proper methods of connecting them up with the piping until we know what that piping is to be, and accordingly our first duty is to tackle this "back vent" monster and destroy it, for being a thirsty creature, it will, if left on guard over us, be certain in time to lick the water seal out of our traps, or else, by gorging

itself with grease, to lose all consciousness and abandon the trap seal altogether to its enemies.

Like the cholera germ, this most pernicious infliction cannot stand light. The science of hydraulics and pneumatics is fatal to it and shall form for it our club of extermination.

The Hydraulics and Pneumatics of Plumbing.

The agencies which tend to destroy the water seal of traps are siphonage, evaporation, back pressure, capillary action, leakage and accumulation of sediment.

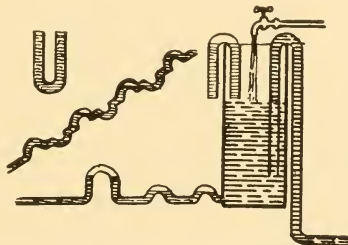

Fig. 233. Diagram to illustrate the phenomenon of siphonage.

Siphonage.

Our next drawing illustrates the principle of siphonage. A trap consists of a U-shaped bend in a pipe forming an inverted siphon, as shown on the left-hand side of Fig. 238. By filling this trap with water and turning it upside down we see that there is no greater weight of water in one leg than in the other, and therefore there is no tendency on the part of the water to run from one end of the tube or siphon more than from the other so long as the two legs are of the same length. They both pull down from the top with equal force and tend to form a vacuum in the bend. But if we lengthen one leg so that the water in it becomes heavier than that in the other, it will run out, while atmospheric pressure will force the water in the short leg up to the top and out of the tube, because though

the atmospheric pressure at the bottom of the long tube is very slightly greater than that at the bottom of the short tube, the air column being a few inches longer, this extra pressure of air counts as nothing against the weight of the same number of inches of water column. Now, if the shorter leg of the siphon be dipped in a vessel of water, as shown in the illustration, the atmospheric pressure which before acted on the bottom of the water in the short leg is transferred to the surface of the water in the vessel and will act in emptying it down to the bottom of the short leg and illustrate the well known action of siphoning. The water in the vessel and in the short arm of the siphon constitutes a trap. The long arm is the outlet arm of the trap, and when water from the basin or any other fixture to which the trap is attached flows through the trap and down the long arm, it sets up this siphoning action, which will continue until the trap seal is reduced to a point slightly below the bottom of the short arm of the siphon, or so-called "upcast limb," of the trap, thereby breaking the seal. Frequently a sufficient amount of water trickles down from the fixture and sides of the pipe above the trap after the siphoning action to partially restore the seal. This direct action of the water of a fixture in breaking its own trap seal by siphoning is called "self-siphonage."

A more common form of siphonage, however, is illustrated in Fig. 239, where the seal of the trap is broken by the discharge of some fixture other than the one to which it is attached, and usually in a story above it. Here the discharge of a water closet in the upper story destroyed the trap seal below; the falling column of water from the upper closet rarified the air in the soil pipe behind it as it went. To fill this partial vacuum following the water plug air tended to press into the soil pipe through every opening. The friction of the rough sides of a tall stack

THE TWO PLUMBING SYSTEMS.

of soil pipe, even though it be open at the roof, will often cause more resistance to air in its attempt to fill this partial vacuum than will the inertia of the water in any fixture trap below. In the case shown by the picture the outer air found a much easier access to the interior of the soil pipe through the trap seals than by any other way,

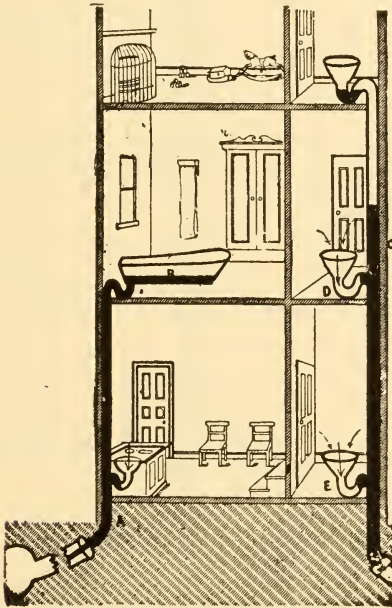

Fig. 239. Trap Siphoning.*

and so it broke these seals and thus opened a free entrance to soil pipe air into the house. The seal of the upper closet would be emptied by the same action.

*From "Dangers to Health. A Pictorial Guide to Domestic Sanitary Defects," by T. Pridgin Teale, M. A. Pub. by J. J. Churchill, London.

PLUMBING AND HOUSEHOLD SANITATION.

On the left hand side we see the action of siphonage on a lavatory trap caused by the discharge of a bath tub above.

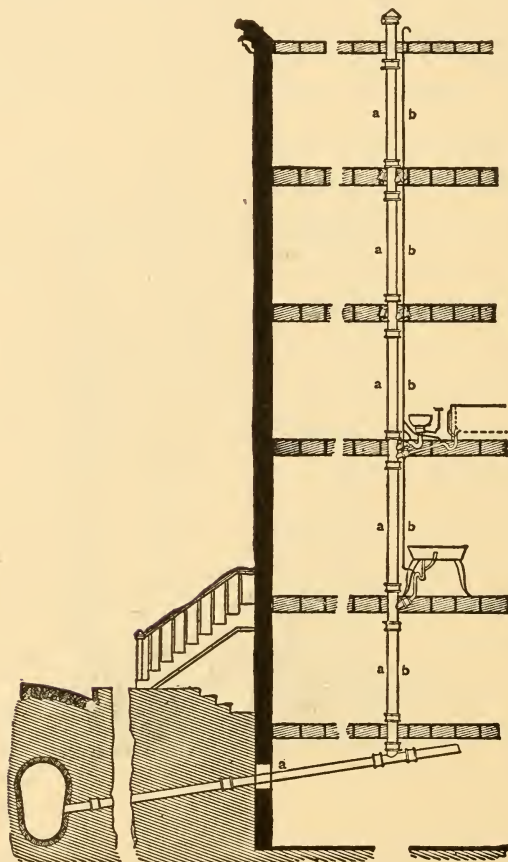

Fig. 240. Diagram to Illustrate Back Venting. (From Bayles.)

Three Methods of Protecting Trap Seals.

Three methods have been employed with a view to preventing the destruction of the seal by siphonage. The most

THE TWO PLUMBING SYSTEMS.

natural method and the one which has been used now for about a quarter of a century is to ventilate each trap by connecting it with a special ventilating pipe constructed for the purpose.

Mr. James C. Bayles describes this method in 1878 in his "House Drainage and Water Service," as one would describe a method at that time not long established, using a cut which I have reproduced here (Fig. 240). It is, however, now generally admitted that the vent pipe shown by Bayles in the cut could not afford even a temporary protection on account of its small size.

Incidentally it may be said that Mr. Bayles rightly objects to the use of a main house trap, saying that in his judgment such a trap does vastly more harm than good. Among other reasons he gives for this is that it hinders the ventilation of the sewer. "When the pressure upon the air confined in the sewer," he says, "is increased from any cause, it should have an outflow through every house drain. When from any cause a partial vacuum is created in the sewer, every house drain should be an inlet for air. In other words, we should allow the sewers to breathe through the main waste pipe of every house, besides giving them as many breathing holes in addition as can be provided." The waste piping of houses can now be done without difficulty so as to secure permanently tight work.

The second method of guarding against the loss of seal by siphonage is to make the body of the trap so large that a sufficient quantity of water will always adhere to its sides after siphoning to restore a seal. This is the principle of the pot or cesspool trap.

The third method is to construct the trap of such a form as to render it both antisiphonic and self cleaning at the same time.

The first method adds enormously to the cost and com-

plication of the work and gives rise to greater dangers than those it was designed to cure. Nevertheless it has become popular with many, and is responsible for the so-called "trap-vent" law, once excusable because nothing better was for some time known, but now worse than absolutely indefensible in the light of our present knowledge, as inviting the entrance into our homes of sewer-gas, now that simple methods are known for keeping it out.

In regard to the practical working of trap back venting two things have been made clear. First, that it is not always efficient in preventing siphonage even when new, and very frequently fails when old. And, second, that it is always more or less active in destroying the trap seal through *evaporation*.

The second method is both inexpensive and simple, and is much more efficient and reliable in resisting siphoning action than the first. It has, however, the serious disadvantage of involving the use of cesspools or centres of putrefactive decomposition in the house, and brings, in the aggregate, a vast amount of pollution into the public sewers tending to frustrate our best efforts in the direction of their complete purification. They are also liable to be converted by grease accumulation into ordinary S or siphoning traps and thus entirely lose their original power of protection.

The third method is the simplest and least expensive of all, and has demonstrated itself to be perfectly reliable and satisfactory. Nothing but ignorance and selfish private interest has stood in the way of its exclusive adoption.

Let us now examine these three methods carefully in detail since the question is not only one of the most important and interesting ones in the whole domain of sanitary plumbing, but its investigation will throw light upon every other part of our subject.

CHAPTER XV.

TRAP TESTING APPARATUS.

Siphonage and Back Pressure.

THE trap vent pipe was, as I have said, originally supposed to afford a reliable cure for siphonage, and under that supposition the trap-vent law was made, and is in operation in the majority of cities and towns which have any plumbing laws at all.

For the purpose of testing the efficiency of the trap vent when it is new and clean, and therefore at its best, Mr. Hubbard has had the apparatus erected which you see in Fig. 241. The cut shows you the entire apparatus, including the parts not visible in the room.

On the floor of the attic space above this lecture hall is our large supply tank, having a capacity up to the overflow of 40 gallons of water. From the bottom of this tank descends a 2-inch iron and glass pipe with two branches at a height of three feet from the floor for taking the traps to be tested. The piece of

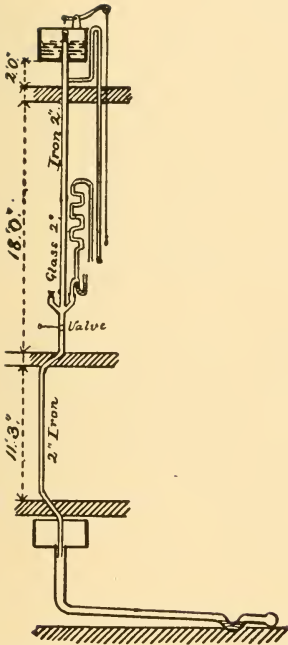

Fig. 241. Apparatus for Trap Testing Erected at the North End Union for this Course of Lectures.

glass pipe is 4 feet long and has been inserted in order to enable you to follow the course of the water and study the manner in which air mixes with it in its descent from the tank under varying conditions of the tank valve vent. The valve in the tank is a 2-inch standpipe valve, and the top part of the 2-inch waste from the tank is vented by an inch pipe, descending to within five feet of the floor and, for the present, corked up at the lower end. Below the trap branches is a throttle valve by means of which we shall be able to illustrate the effect of "back pressure," as will hereafter be explained. Below the floor of this hall the 2-inch waste passes through the room below and discharges into a 25-gallon tank below the floor, as shown.

The tank empties through a 3-inch pipe, which connects with the soil pipe at the basement floor, being trapped on its way with a 3-inch running trap.

Now we may suppose that our tank represents a bath tub and the 2-inch iron pipe its waste, and that in the story below two basin wastes enter this waste through the two trap branches which you see, and that our traps are intended to serve these two fixtures. So far we have conditions corresponding to those in actual practice with new work where the rooms are very high.

The siphoning action may, however, if we wish, be made considerably more severe than is found in ordinary practice by corking up the top of this standpipe valve of our tank, which corresponds with the standpipe outlet valve of a bath tub, and also corking up the vent pipe coming from the top of the 2-inch tank waste, so that no air can enter the waste except through the fixture traps to be tested. Though in practice it often happens that house owners will close up the overflow outlets of their fixtures in the fear of "sewer gas" with corks and putty; and snow and frost will frequently close up the vent opening.

TRAP TESTING APPARATUS.

In order to represent "back-vent" piping we have here also some speaking tubing and bends, which we shall apply to the crowns of the traps to be tested and by this means investigate the effect of friction in retarding the action of this back airing.

By means of this apparatus we shall be able to determine (1) whether or not seals of traps in common use can be broken even when newly and fully vented and in accordance with the law, under conditions which can be and frequently are encountered in plumbing practice; (2) what effect corrosion, incrustation and various forms of clogging in the pipes have upon the traps seals; (3) the relative power of various forms of traps in resisting siphonage, and (4) whether any form is capable of resisting the severest possible siphoning action that can be encountered in plumbing practice.

Before, however, making our experiments with this apparatus, which will require light in the lecture room, we will complete our lantern slide work, comparing our plant with those used in my previous experiments for the Boston City Board of Health and at the Massachusetts Institute of Technology and elsewhere, pictures of which will be shown on the next two slides.

This cut (Fig. 242) shows the Board of Health apparatus. It is composed of ordinary piping erected exactly as it is in regular practice in house plumbing. A vertical stack of 4-inch soil pipe was erected without bends from the outlet above the roof to the horizontal run under the basement floor, a distance of 70 feet 9 inches. The soil pipe was run up straight in this manner in order to furnish the conditions for the severest possible tests for siphonage and back pressure. At the same time it formed the arrangement most commonly met with in practice. The unbroken fall of the water through such a pipe evidently creates the

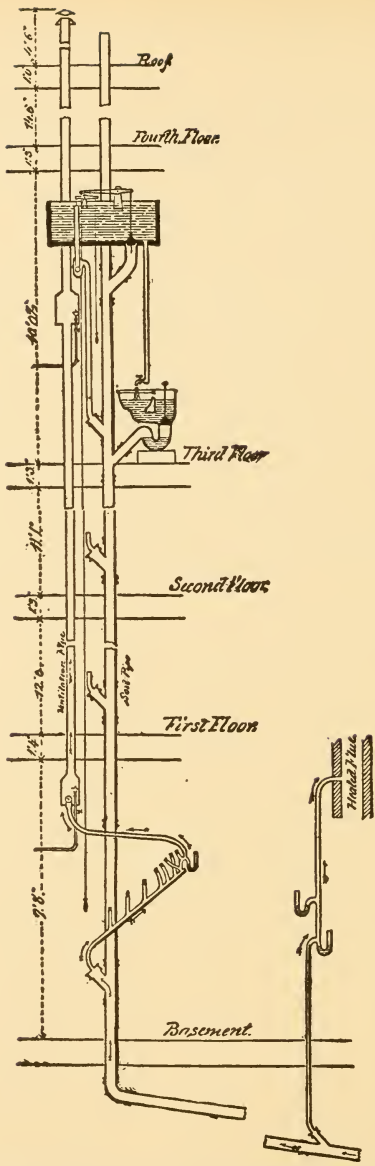

Fig. 242. Apparatus Used in the Experiments Made by the Author for the Boston City Board of Health.

TRAP TESTING APPARATUS.

most powerful compression of the air in advance of it and the greatest rarification behind it.

Just below the fourth floor was placed a large cistern 44 inches long by 16 inches wide and 15 inches high up to the overflow, inside measure; or of 46 gallons capacity, as against 40 gallons capacity, which we have here. The cistern served to illustrate the action of a bath tub, by having a 1½-inch discharge pipe at its bottom trapped with a Bower's large sized trap, and entering the soil pipe just above the entrance of the water-closet waste. The water-closet used was a plunger closet, at that time popular. To expedite its filling a large service pipe from the cistern was used, and the water was allowed to fill the closet through a brass compression-cock. The water-closet was supplied with a regular overflow pipe so that, when full, its capacity was always the same, i. e., 4½ gallons. The plunger of this closet having no overflow, its operation produced as powerful a siphoning action as is possible with any plumbing fixture, and indeed the use of plunger closets is partly for this reason gradually diminishing everywhere.

To test the effect on traps below of emptying the tank after the manner of a flush tank, a 4-inch outlet valve and waste pipe were fitted up in the manner shown.

Outlets were left on each story below the water-closet for testing the traps at various heights on the stack. The soil pipe was ventilated at the top full size, and had the usual foot vent. Back pressure was generated by the bend just below the basement floor.

In order to permit also of a series of experiments on evaporation a 4-inch galvanized iron flue was erected by the side of the soil pipe. This flue terminated just below the first floor in a galvanized iron lantern, with a glass door on its front side. A 1½-inch rubber tube was connected with the bottom of the lantern, and an anemometer

was placed above the point of connection in an enlargement made to receive it. The anemometer was so arranged and placed that it could measure accurately the current of air passing through the rubber tube in either direction. The galvanized iron flue could be tested either cold or heated by gas-jets, as shown in the drawing. A second lantern was placed on the third floor with a similar appliance for heating the flue.

A 1½-inch lead waste-pipe was connected with the soil-pipe just above the basement floor. This branch waste had a number of ventilating openings made upon it, and a deep seal S trap at its end. The trap had three ventilating openings in its outlet arm, one at the crown and the others below the crown, as shown. All the vent openings both on the trap and on the branch waste were provided with small connecting tubes, so arranged that the rubber ventilating flue could be readily attached to either. The openings were, furthermore, all provided with closely fitting corks so that they could be hermetically sealed.

By this arrangement the effect of ventilation at different points of the trap or its waste-pipe upon its water seal could be accurately tested. Further tests in evaporation were made by connecting a second branch waste below the first with a brick flue heated by a stove.

In order to make an accurate record of these experiments the diagrams shown in Fig. 244 were made. In these the trap seal is represented by a vertical line between two circles. The upper circle represents the outlet arm of the trap in section, and the lower circle the inlet arm. The horizontal lines show the level of the seal after each discharge.

The small diagram (Fig. 243) illustrates a simpler form of apparatus upon which I made a large number of experiments on siphonage. I assumed that as severe a test

TRAP TESTING APPARATUS.

for siphonage to which a trap could be subjected in practice would be that which would be sufficient to siphon out an 8-inch pot trap or a ventilated S-trap constructed in the usual manner. Such a test may be made by connecting the trap with a 2-inch waste-pipe from a large bath tub, emptied through an outlet large enough to fill the waste-pipe full-bore, the waste plug being successively raised and lowered

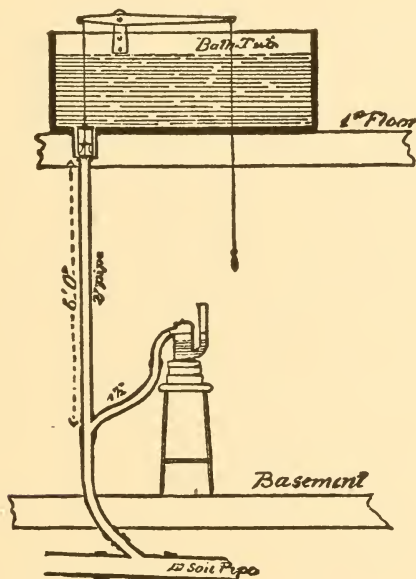

Fig. 243. Simple Apparatus for Trap Testing.

a number of times while the water is escaping. The siphoning action produced on a $1\frac{1}{2}$ -inch branch connected with such a waste at a point six feet below the tub is sufficient to destroy in one second the seal of a $1\frac{1}{4}$ -inch S-trap of the ordinary construction, having a vent opening at the crown, of the same size with the base of the trap ($1\frac{1}{4}$

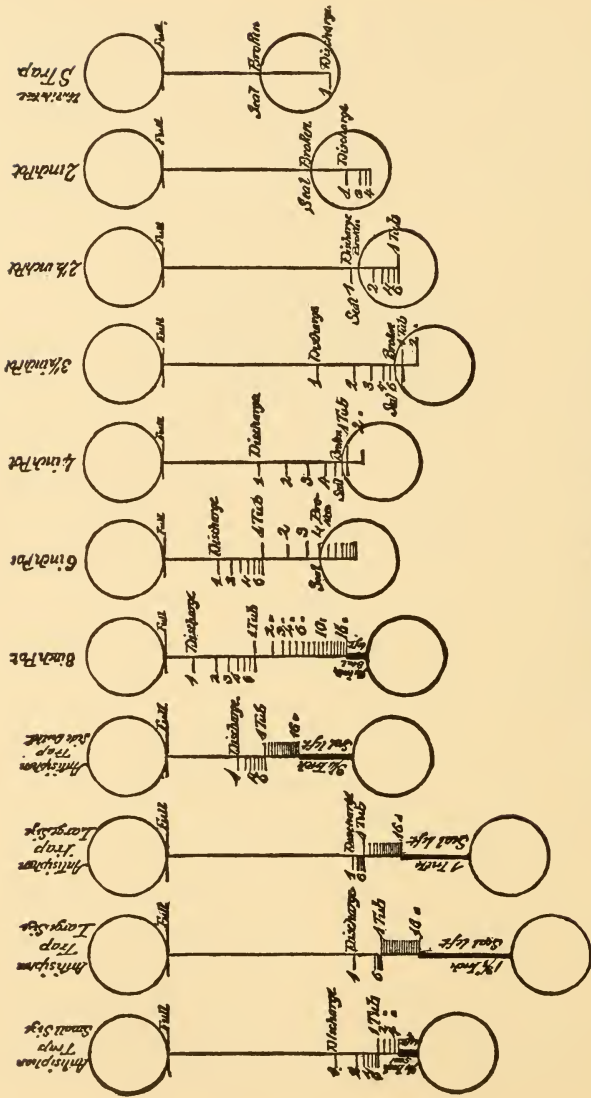

Fig. 244. Diagram Showing Test for Siphonage.

TRAP TESTING APPARATUS.

inches), and connected with a $1\frac{1}{4}$ -inch ventilating pipe of smooth, new lead, sixteen feet long. It will also destroy the seal of an ordinary S-trap having a vent opening at the crown $\frac{3}{4}$ inch in diameter, without any vent-pipe attached thereto, and will siphon out a pot trap 8 inches in diameter having a seal four inches deep.

The tank in this little apparatus, which in principle resembles ours here, had a capacity of 100 gallons. The waste-pipe was 2 inches in inside diameter like ours, but only 6 feet long to the trap branch, while ours is 17 feet long to the testing branches.

The outlet plug, like ours, was large enough to fill the waste-pipe full-bore.

The next figures (245 to 249) give the sections of some of the traps tested, the horizontal lines corresponding with those in the diagrams. Each test was repeated a number of times, the results being each time almost absolutely identical. A single discharge of 15 gallons destroyed the seal of a $1\frac{1}{4}$ -inch S-trap vented with a $1\frac{1}{4}$ -inch pipe 25 feet long, attached at the crown. With this vent-pipe shortened to 15 feet two discharges of 15 gallons each broke the seal. Shortened to 9 feet 7 discharges broke the seal.

In the pot traps tests 15 gallons were used at each discharge. They all lost their seals, as shown, except the 8-inch pot, tested in the later experiments for the Board of Health, to be described in another chapter, which lost all but a quarter of an inch of its $3\frac{1}{4}$ -inch deep seal after the tank had been emptied 16 times. The 6-inch pot required four and the 4-inch pot two tanks full to break their seal.

On the Board of Health apparatus, also several other traps were tested at the same time with the pot traps, but as only two were able to preserve their seals against the tests applied, and as most of them had already been tested in the experiments made for the National Board of Health

and their tests published, by which their power of resistance as compared with that of a ventilated S-trap and to a pot trap, was made known, it was thought unnecessary to record the failures again in our tests.



Fig. 245. S Trap.

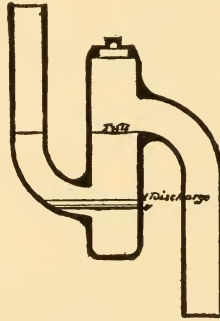

Fig. 246. 2 in. Pot.

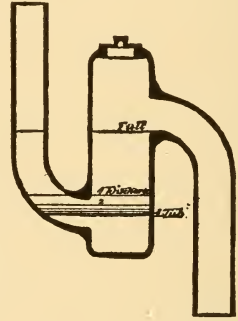

Fig. 247. 2½ in. Pot.

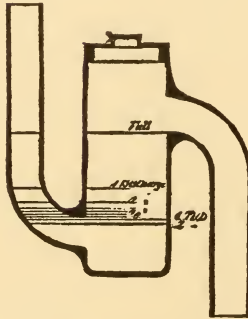

Fig. 248. 3½ in. Pot.

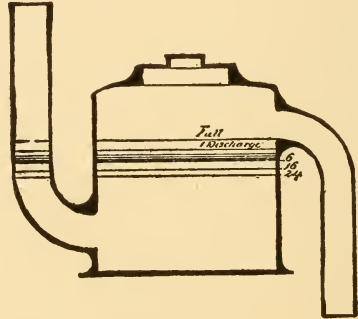

Fig. 249. 8 in. Pot.

Tests for Siphonage on Traps of Different Sizes.

The tests for siphonage were made on pot traps unventilated and on ventilated S-traps, the traps being placed on the Y branch outlet on the second floor at a distance of about 11 feet below the bottom of the water-closet trap, since at this point the siphonage proved to be most severe.

TRAP TESTING APPARATUS.

The tests were made with the closet alone, and also with the closet and bath-tub combined.

The result of the experiments was that the discharge of the water-closet was sufficient to unseal the S-trap even though it was ventilated at or below the crown in the manner prescribed by the plumbing regulations with vent pipes of the full size of the trap. It made no material difference as to siphonage whether the vent-pipe be applied immediately at the crown or at a considerable distance below it. Had the pipes been partially clogged by sediment or rust the results would, of course, have been even more serious.

An unventilated S-trap was, of course, completely siphoned out by a single discharge of the closet, leaving only a few drops of water in the bottom of the bend.

A $1\frac{1}{4}$ -inch S-trap having a $1\frac{1}{4}$ -inch vent hole in the crown and a $1\frac{1}{4}$ -inch pipe of smooth clean lead 17 feet long attached to the opening, had its seal broken in three discharges.

A $1\frac{1}{2}$ -inch S-trap with $1\frac{1}{4}$ -inch vent, constructed as shown in the slide, and having 7 feet of 1-inch pipe attached to one of the vent openings, the others being closed, lost its seal after 5 discharges. With a 17-foot vent-pipe 4 discharges sufficed. When the bath-tub discharge was added to that of the water closet a single discharge broke the seal with the 17-foot vent-pipe and swept nearly all the water out of the trap.

Experiments on the Pot Traps.

The pot traps tested on these occasions measured respectively 2 inches, $2\frac{1}{2}$ inches, 3 inches, $3\frac{1}{2}$ inches, 4 inches, 5 inches, 6 inches and 8 inches in diameter, and from these tests we found that their power of resistance to siphoning depends upon their size, and more particularly upon the diameter of the body, a half-inch excess of diameter

affording a very considerable excess in depth of seal. With equal depth the resistance will be in direct proportion to the diameter. The 2-inch pot lost its seal in one discharge of the water closet, a 2½-inch pot in two discharges, a 3-inch in four discharges, a 3½-inch in seven discharges, a 4-inch in seven discharges, a 5-inch in 22 discharges, a 6-inch in 27 discharges and an 8-inch lost 1½ inches of its seal in 24 discharges, and would probably have resisted for several hundred discharges. In well arranged plumbing, however, a pot trap having a body 8 inches in diameter and having 1½-inch or 1¼-inch connections, may be considered perfectly safe so far as retaining its seal is concerned, so long as its seal is not contracted by deposits.

An examination of the sectional drawings of all the traps will show at a glance the effect of each discharge on its water seal, the horizontal lines giving the exact level of the water after each discharge.

The next figure (250) shows the apparatus erected at the Massachusetts Institute of Technology already referred to.* It consisted of a stack of four-inch soil-pipe with two water-closets set ten feet above the wastes of the traps to be tested. The closets were a Zane and a Jennings, both quite popular at the time these experiments were made. The soil-pipe had a number of bends to exemplify the bends,

*Mr. Wm. E. Hoyt, C. E., writes of these tests as follows:

"A few weeks ago I visited a mechanical laboratory, where, for over two years, a series of experiments has been conducted on household sanitation. Neither time nor money has been spared to make these experiments and investigations thorough and complete. Here, several skilful sanitarians have been diligently at work in all this time to improve our system of house drainage. One of these men is well known in Europe, as well as this country, by his scientific investigations and his writings. Let us see what they have been doing. Time will allow a reference to one or two things only.

"These men wished to know just how traps and ventilation pipes and other contrivances really worked, under all possible conditions, in houses fitted with modern appliances, and to ascertain this, they bought a lot of full sized drain-pipes and ventilation-pipes and traps and water closets, and set them up in their laboratory just in the way they are put into our houses, except that they economized space, as I shall show you by a drawing. (Diagram C.) Fig. 250.

TRAP TESTING APPARATUS.

more or less of which are usually required in any tall building. The vent-pipes are on the right and were of 2-inch cast iron pipe, also with bends. Openings were left in both stacks of pipe, as shown in the drawing, to permit of a great variety of experiments with long and short piping, and with from only 1 up to 8 on the soil-pipe stack, and from 1 to 13 on the trap-vent stack.

In this way the apparatus was made to correspond with that in any form of house we desire to imitate. Some of the tests were very severe, but no more so than often encountered in plumbing practice. If we are to be forced by the law to put our clients to the great expense and danger of ventilating every trap, we have the right to demand, first, that the means employed shall actually afford us the security it pretends to, and not fail at the first critical moment; and second, that no other simpler and better means exist for securing the desired result.

We found that the discharge of either or both closets instantly broke the seal of an unvented S-trap whether the soil-pipe were the full length or shortened to half its length by opening the middle plug. When the falling water in the soil-pipe produces the partial vacuum behind it as it descends, if the soil-pipe extension above it is short and closed at its top, the action is at its maximum because

With these great testing machines they showed the City Board of Health of Boston some exceedingly interesting experiments, which proved to that august body that their official ideas about plumbing fixtures were in many respects entirely wrong. The Boston Society of Architects came also to see these experiments, and, later, they were shown before the Suffolk District Medical Society of Massachusetts. The fame of these investigators extended soon to Europe; and an earnest request was made by eminent sanitarians in England to allow the result of these investigations to be published there in the interests of sanitary science. This important work of the laboratory has been under the direction of Mr. J. Pickering Putnam of Boston; and I am sure that his experiments and investigations are the most comprehensive and thorough and valuable that have ever been made on the subject of household sanitation." William E. Hoyt, C. E., S. B., Chief Engineer of the Buffalo, Rochester & Pittsburgh Railway Company, in an address on "Household Sanitation," delivered before the Rochester Academy of Sciences, Jan. 11, 1886.

there is very little air to expand. If the pipe is short and open at the top it is at its minimum. If it is long and closed still the action is powerful, but if it is long and open above, a medium effect is produced, and this was the condition we had in these tests.

We next ventilated our S-trap with a vent-pipe the full size of the bore of the trap. Leaving the soil and vent

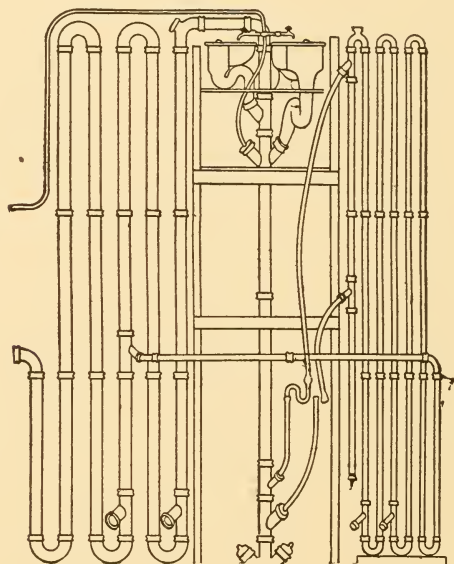

Fig. 250. Apparatus for Trap Testing used at the Massachusetts Institute of Technology.

pipes full length, we found three discharges of the two closets was sufficient to destroy the seal. Thus we showed that with the long stack of pipe our ventilation signally failed. We next cut off half the bends and half the length of both soil and vent-pipe, leaving a medium length of

TRAP TESTING APPARATUS.

each of forty-five feet of new pipe, and we found that four discharges of the two closets destroyed the seal.

In the next experiment we broke the seal with two discharges using a 1¼-inch vent pipe, and afterwards broke it with four discharges on shortening the vent to 15 feet. This gave a shorter vent-pipe than we should ever be likely to encounter in practice. Hence if the friction produced in this short length of pipe is enough to prevent the effectiveness of the vent, anything longer than this would have destroyed it still easier. This shows that our expensive venting is utterly untrustworthy. In the Boston Board of Health tests the same results were obtained by the discharge of a single plunger closet.

The tests were made on a 2-inch by 4-inch Y. In our experiments for the City Board of Health we were severely criticized by "The Sanitary Engineer" for using a 4-inch by 4-inch Y branch, which we were told, would produce an action at least four times as powerful as the smaller branch. In order to test this point we connected our waste with the 4-inch by 4-inch branch shown immediately below the 4-inch by 2-inch branch and made preparation to repeat the last test under the new conditions. We cautioned the audience who were seated nearest the trap to hold firmly to their seats, which had been tightly screwed to the floor in order to prevent them from being sucked bodily into the drains by the prodigious siphoning power of the 4-inch by 4-inch branch claimed by "The Sanitary Engineer." On discharging the closets, however, we found no appreciable difference in the two Ys, and the gentlemen in the first row were then advised that they could confidently release their hold upon the furniture.

When the mouth of the vent-pipe has become partially closed by the gradual deposit of sediment, the supply of air through it is proportionally retarded, and it becomes

less and less of a safeguard against siphonage. We had made a great many experiments in this field and found the resistance exactly proportioned to the size of the vent-pipe.

The stack of pipes shown in Fig. 251 shows a trap vent pipe 125 feet long in a tall apartment house, which in compliance with the building law I was obliged to specify. As you see by the drawing the lavatories are placed over

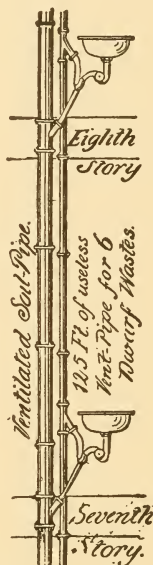
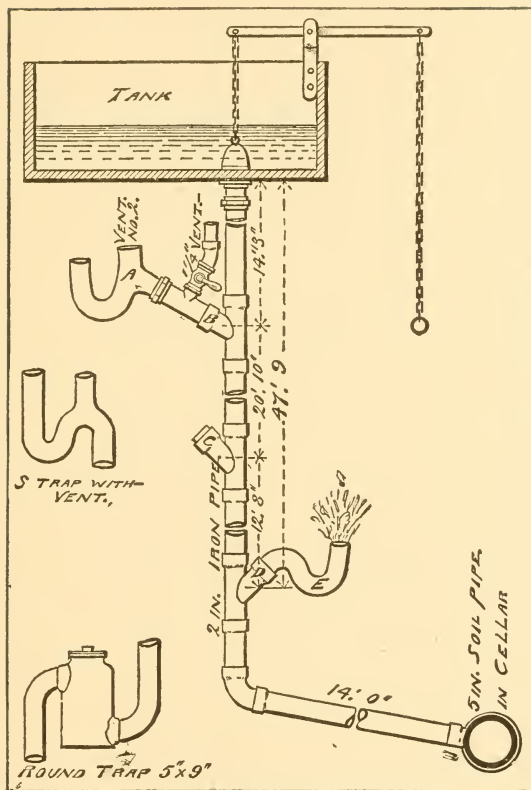

Fig. 251. Trap Vent Pipe 125 ft. long in a tall Apartment House.

one another in such a position that the distance from their traps to the main ventilated soil pipe is not over 18 or 20 inches. These short branch wastes were powerfully flushed at each usage of the fixtures by a stream of water filling them "full bore," and discharging at the rate of nearly half a gallon a second. Traps were specified which cannot by any possibility be siphoned out, nor even have their seals

TRAP TESTING APPARATUS.



S-trap A had a vent as marked Vent No. 2; all other traps were ventilated by the stop-cock attached to Y-branch B, where all traps were tested.

With Vent No. 2 open and stop-cock closed, it was not possible to remove any water from the S-trap, but with Vent No. 2 closed and stop-cock open, the seal of the trap was broken. S-trap with vent shows the form of trap which the committee recommends.

Trap E was placed on Y-branch D to show back pressure, but Y-branch D, as well as Y-branch C was closed during experiments on syphonage.

Fig. 252. Worcester Trap Tests.

seriously lowered. No better illustration of the wastefulness of this requirement could be found. The owner in this case lost over a thousand dollars for the privilege of seriously endangering through evaporation, the water seal of every

trap which is not kept constantly in use throughout the hotel.

Fig. 252 shows the apparatus used in the Worcester experiments, and Fig. 253 is an illustration of some of the dangers incurred by the use of the trap vent-pipe.

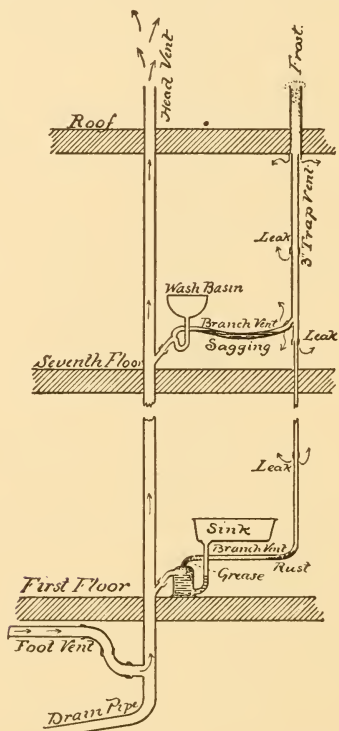

Fig. 253. Trap Vent System in a Tall Building.

The master plumbers of Worcester made some tests on the apparatus shown here. The S-trap shown on the highest branch was tested for siphonage, and its seal broken when

TRAP TESTING APPARATUS.

ventilated through the $1\frac{1}{4}$ -inch vent next the soil pipe, the vent No. 2 being closed.

This cut (Fig. 253) was used to illustrate a paper on trap ventilation I read before the Boston Society of Architects in 1891. The top of the vent-pipe is shown clogged up by frost. One of the basin trap vents is trapped by a sag in the pipe, and the mouth of the sink trap-vent is clogged by grease.

In regard to the partial or total closure of the mouth of the "back vent" pipe by grease deposits, it is not even necessary that one should have had any experience in plumbing work at all to enable him to realize the importance of this item in condemnation of the back vent law. One would have to go back several eras beyond the dark ages to find any one who had not observed how melted grease congeals upon a cold surface and how tenaciously it adheres thereto. The first savage who knew enough to roast his meat over a fire and serve it on a stone was perfectly familiar with these properties of melted grease, and would not have to ask a "sanitary plumber" if it would deposit itself along the walls of a cold waste pipe under a kitchen sink. Let us reason at least as much as the primitive savage and find out why the framers of our plumbing laws ignore these simple lessons in physical science. Every plumber has seen vent pipes fouled by greasy deposits, which often completely close up its outlet and sometimes fill it solid full for several inches beyond its mouth.

It is sometimes urged that these deposits can, from time to time, be removed. Evidently. But in practice this simple remedy is oftener neglected than observed, partly because the inside of the vent pipe mouth is usually rather inconvenient of access; partly because whatever danger there may be from such deposits is seldom announced to

the house owner until it is too late; and partly because, as a matter of fact, where a reasonably good form of trap is used, a clogged vent pipe is, like a dead Indian, a safer and better thing to have in the house than one which is free and fully equipped for business.

In any case, it is beginning to be understood by students of sanitary engineering who have as much as one eye open that a device intended for protection, which requires more watching than the thing it was designed to protect, affords but a false sense of security, and in this instance often leads to the use of traps which possess no power in themselves to withstand the action of siphonage when the vent pipe becomes inoperative. Therefore, when the public are compelled to back vent all the traps, they are obliged to incur also the expense of using antisiphon traps as well.

Advocates of the back venting of traps will frankly admit that traps having large unscoured areas, often called "cess-pool" traps, like the old fashioned D trap, or very large pot traps, are objectionable, especially under kitchen or pantry sinks on account of the accumulation of grease and dirt in these unscoured parts.

Now, the vent mouth opening, being entirely outside of the waterway of the trap, must receive even less scour than any part of the waterway of a cesspool trap. As a matter of fact, the mouth of the vent pipe will clog much more quickly than any part of a cesspool trap, because the warm, fatty vapors are drawn up into the vent pipe and there deposit and congeal more or less grease along its cool sides at varying distances above its mouth, thus adding to the deposits caused by splashing and liquid contact. In short, the mouth of the vent pipe forms an unscoured "pocket" far more dangerous than any of those other pockets now universally condemned, which constitute the one great characteristic feature of all "cesspool" traps.

TRAP TESTING APPARATUS.

Writers on plumbing who advocate "back venting" hold that the simple "S" trap, being self-scouring, is the best to use when protected from siphonage by back venting, and they are fond of illustrating this "excellent" combination by a diagram like our Fig. 254.

But these same writers are also fond of telling us that cesspool traps, like the old fashioned D traps, or like large "pot" and "bottle," and all "mechanical" seal traps, having large unscoured chambers in their waterway, are certain in time to become more or less clogged, especially under sinks, on account of these unscoured areas or "sediment pockets," and they explain correctly how they gradually become converted into "S" traps by illustrations like Figs. 255 and 256.

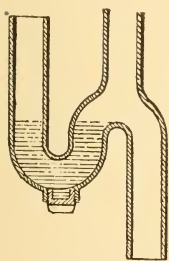

Fig. 254.

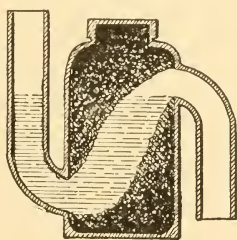

Fig. 255.

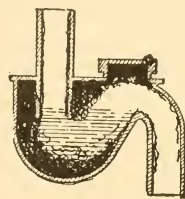

Fig. 256.

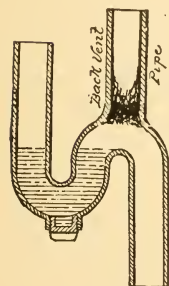

Fig. 257.

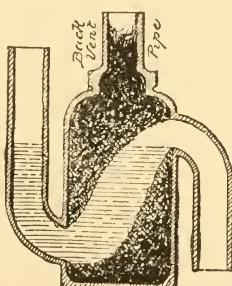

Fig. 258.

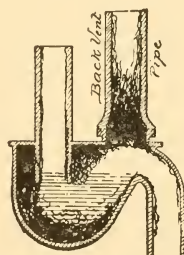

Fig. 259.

TRAP TESTING APPARATUS.

They are perfectly right in the matter of the gradual filling up of all unscoured pockets. Why, then, do they so carefully avoid showing this clogging in the mouth of the back vent pipe at the crown of the "S" trap? Under what law of physics or chemistry, or by what miraculous intervention or friendly influence has this, the most unscoured pocket of all, escaped contamination altogether, when all the other pockets shown in the cesspool traps have been packed full? And why do they always entirely avoid showing the "back vent" pipe in their representations of the befouled "cesspool" traps when they drag them out to be soundly and very properly lashed by their criticisms?

A truthful representation of these various traps should show them equipped with the back vent pipes required by the present law, when they would appear as in Figs. 257 to 259, inclusive.

The public have been hoodwinked so long by the misrepresentations of these writers that we sometimes feel like doubting the famous assertion of Abraham Lincoln that you can not deceive "*all the people all the time.*"

For an intelligent nation like ours to have swallowed the "back vent" humbug for a quarter of a century in this progressive age seems dangerously near a refutation of the saying we have always taken such pride in quoting.

The best and perhaps the only way to prevent grease accumulations in traps and throughout the entire waste pipe system is to require the use of fixtures everywhere constructed on the principle of the flush tank.

The result of the reading of this paper was a unanimous vote on the part of the Boston Society of Architects to forward to the proper city authorities a recommendation

to repeal the back vent law. A committee was appointed and counsel employed to attend to the matter. The efforts of the society, however, in this direction have never met with success, and they have not ascertained with entire certainty from what source the opposition came.

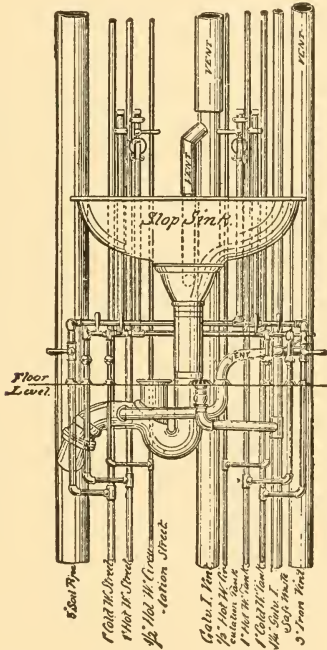

Fig. 260. Complicated Piping in a House on 5th Ave., New York.

The next two cuts present a few illustrations of unnecessary complication in plumbing. The first (Fig. 260) shows the piping of a stop sink in a house lately built on Fifth avenue, New York. The sink forms one of four built over each other in successive stories, and all the pipes shown

TRAP TESTING APPARATUS.

in the drawing are built for their service. Each sink is vented just below its strainer into a large galvanized iron ventilating flue. The trap is vented into a 3-inch cast iron flue. A lead safe is used under the sink at the floor and connects with a 1¼-inch iron pipe leading to the cellar. So much for a slop sink.

No expense has been spared to render the mechanical part of this job perfect, and it is, in fact, a very beautiful piece of workmanship. Yet it is not good plumbing. In the first place the trap seal is trebly besieged for evaporation. In the second place no proper means of flushing the apparatus has been provided. In the third place the outlet and trap vent pipes, which both enter cold flues, are worse than useless. In the fourth place the safe and its waste pipe are superfluous; and in the fifth place the whole fixture is an unnecessary nuisance in a private house. Even where a proper flushing rim is provided for slop-hoppers servants will not make proper use of it, and the fixture soon begins to emit a disgusting odor

I have added a house trap vent pipe and an interior rain water conductor, because these are common accessories. To be consistent the lead safe waste pipe should also be vented, for if it is ever to come into service at all its service will consist in carrying off dirty water. A trap at its bottom will inevitably soon have its stagnating seal evaporated out, and air from the basement will rise through it into the rooms, carrying with it the impurities coming from the entire length of the pipe. With a simpler system of plumbing one of the chief objects of a safe and its waste pipe would be eliminated, and this item of expense, complication and danger would be avoided.

The next cut (Fig. 261) shows a portion of a wash basin and bath-tub in another New York residence. Part of the casing has been removed to show the work. What wonder

TRAP TESTING APPARATUS.

that the poor plumber makes his frequent and serious blunders in the connection of his pipes—"by-passes"—so called! What wonder that the unhappy house owner becomes utterly discouraged at the sight of all this confusion, and thenceforth resolves to make it his chief mission in life to dissuade his friends from indulging like him in the luxury of set plumbing!

The money thrown away on all this worse than useless

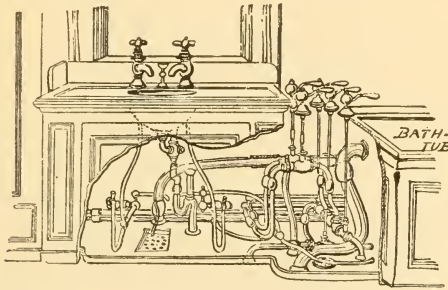

Fig. 261. Complicated Plumbing in another New York Residence.*

piping should have been devoted to obtaining stronger and better fixtures, setting them in a handsome and workmanlike manner and cooperating with the city fathers in installing a scientific and beautiful system of street sewers.

Finally Fig. 262* shows in perspective still another illustration of the extravagances complication has introduced into plumbing work. It is from a house in New York City and this one part of it contains 72 joints. In another place I shall show how better results could have been attained with 16 joints.

Another illustration of trap testing apparatus upon which interesting experiments on siphonage have been made is given in Fig. 263. This apparatus was used at the Museum

*Figs 261 and 262 from "Safety in House Drainage," by W. E. Hoyt, C. E., in Pop. Science Monthly for July, 1888.

of Hygiene, U. S. Navy Dept., at Washington, and they showed substantially the same results as the experiments already described.

We see in Fig. 264 again some of the many ways in which the back vent pipe fails especially in the modern "sky-

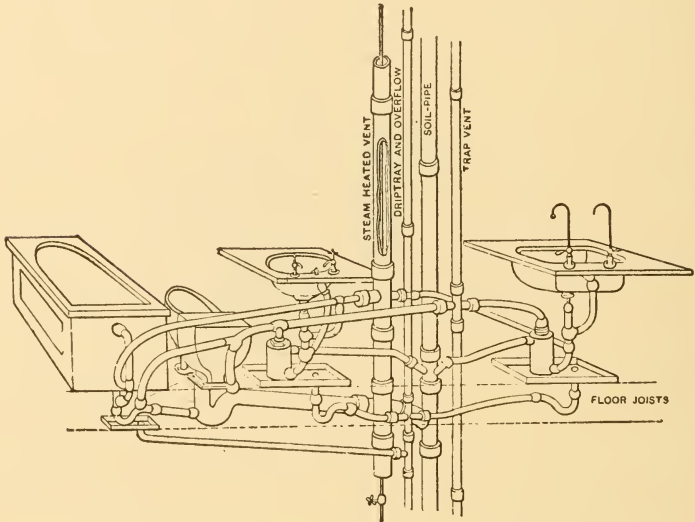

Fig. 262. Complicated Plumbing in a New York Residence.

scrapers." Clogging with grease is shown over the sink trap in the top story, which is now known to be so very common. At every quick bend under a long vertical run of iron vent pipe rust is certain to collect in large quantities as shown in the basement. A comparatively small amount of flaking-off of rust or sediment in such a place, especially with such tall stacks, may quickly destroy the efficiency of even the largest-sized vent pipes. Sagging, as shown higher up on the tenth story, is another frequent cause of failure.

TRAP TESTING APPARATUS.

Water and sediment collect in the sagged portion, and failure is the result. Finally hoar frost and snow often close

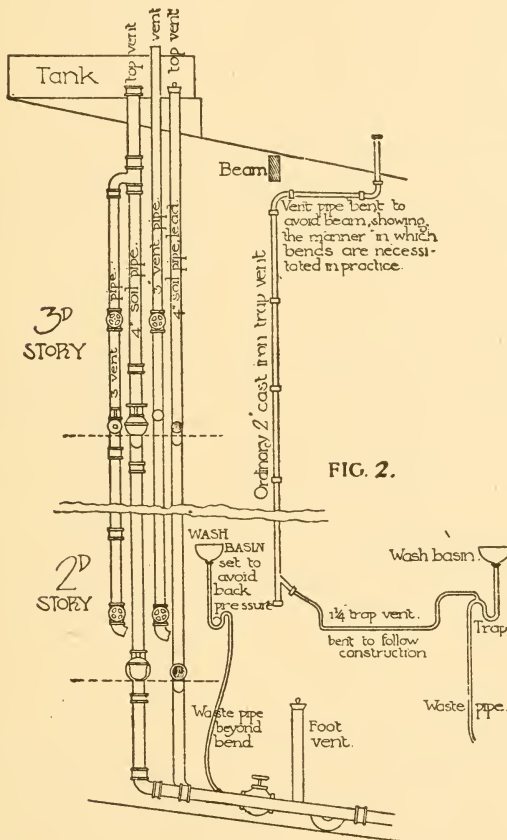
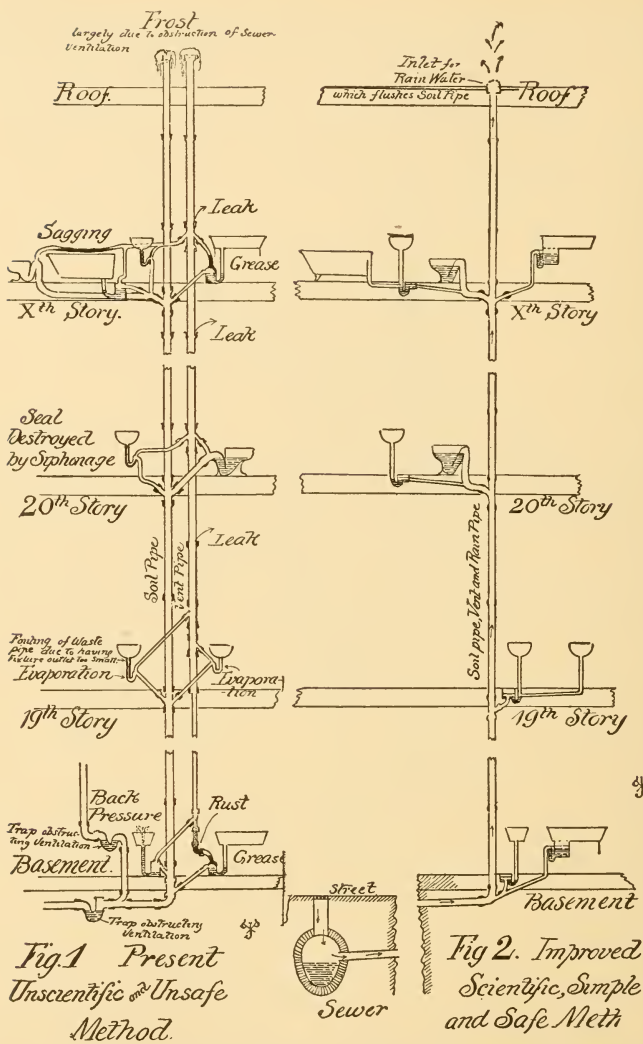

FIG. 2.

Fig. 263. Apparatus for Trap Testing Used at the Museum of Hygiene at Washington.

the upper opening of the pipe above the roof, producing again failure. When the main house trap is omitted frost cannot accumulate at the top of the main soil pipe because

PLUMBING AND HOUSEHOLD SANITATION.



Figs. 264 and 265. Two Diagrams comparing together the Complex and Simple Systems in a Modern Tall Office Building. From the "Inland Architect and News Record" for Oct., 1905, article by J. P. Putnam.

the warm air of the sewers will then constantly rise through the pipe and would melt any snow as fast as it could form. But the back vent pipe could not be so protected when it ascends independently through the roof. The introduction of an intercepting trap at each building destroys the only practical and effective method now known of ventilating the sewers and rendering the air within them absolutely innocuous. Hence this trap becomes the sole creator of the nuisance it was designed to prevent.

The chances of leakage in the back vent pipe are evidently increased in proportion to the increase of piping, and, what is more important still, no water flush passes through the vent pipes to announce to the eye the presence of leaks, and consequently the mischief may go on without the knowledge of the occupants.

It does not seem to occur to our lawmakers that a back vent pipe between thirty and forty stories high would have to be enlarged so much to offset friction as it climbed up from story to story that there would hardly be any room left in the upper stories for the occupants unless they planned to do their business inside the pipe itself. An enlargement such as is shown in our cut, which is simply taken from the sizes required in common practice, would be ridiculously inadequate. The modern skyscraper is performing at least one useful service in bringing the back vent law to a "Reductio ad absurdum." Thus it may be said that the rolling mill is coöperating with the microscope in revolutionizing the practice of sanitary engineering, since to the latter we owe the discoveries in bacteriology which have, almost within the last decade, sufficed to fundamentally alter our views as to the nature and proper treatment of sewage; and to the former the astonishing development of high building which is opening our eyes to the folly of over-complication.

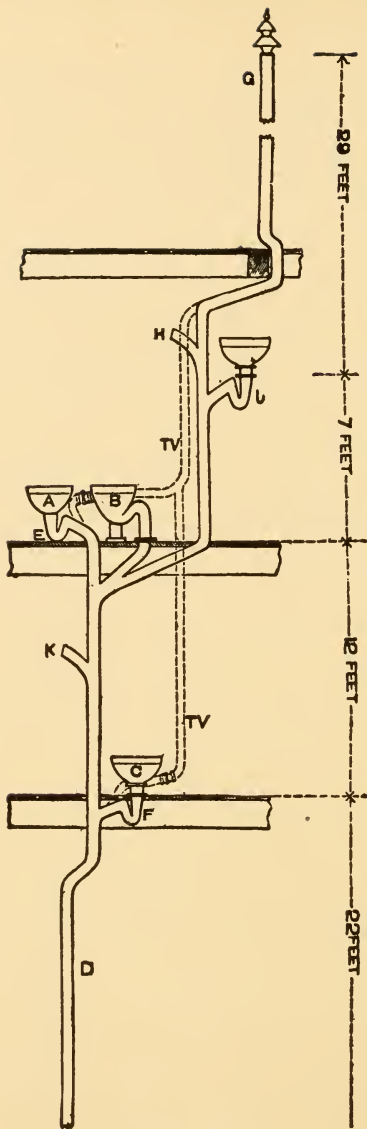

Fig 267.

TRAP TESTING APPARATUS.

Thus one evil involves another. Unnecessary complications exact others which are necessitated by them, and a

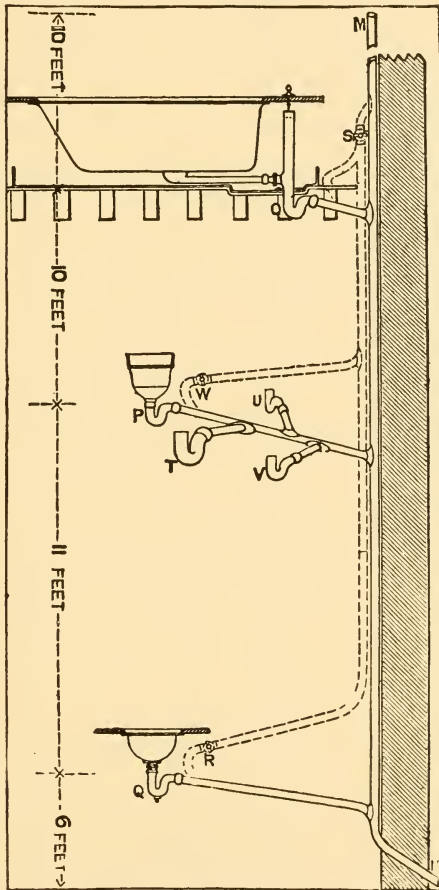

Fig. 268.

departure from the all-important rule that "other" things being equal the simplest is the best" is certain to result in an endless train of cares and troubles.

The next figures show the apparatus used by S. Stevens Hellyer of London* in 1882 for testing traps for siphonage. Three slop sinks were fitted up with $1\frac{1}{2}$ -inch cast lead traps, as shown in Fig. 267, and attached by $1\frac{1}{2}$ -inch branches to the main vertical waste pipe, also $1\frac{1}{2}$ -inch in diameter. A pailful of water thrown into the upper hopper siphoned $\frac{3}{4}$ of an inch out of each of the two lower traps. Another pailful unsealed them. When the air pipe at the top of the main waste pipe was stopped up this discharge of the top sink also siphoned its own trap.

Mr. Hellyer then ventilated each trap as shown by the dotted lines, and repeated the tests. This time scarcely a sixteenth of an inch appears to have been drawn out of the lower traps, although the water was vibrated in them.

With a trap at F at the bottom of the stack, back pressure was so great at the lower sink trap that it forced a spray of water 12 or 18 inches from the trap out into the sink.

Fig. 268 shows another arrangement used by Hellyer in his experiments. The perpendicular main waste pipe was here 2 inches in diameter and had three 2-inch branches, the upper for a bath, the middle for a slop-hopper and the lower for a wash basin. The middle branch had also several different sized traps on it.

When the traps were not ventilated each of them could be unsealed by the discharge of the bath tub. Indeed all four of the lower small traps were unsealed at once, but these ventilated the large trap on the middle branch and protected it partially. But it also lost an inch of its seal.

When the traps were ventilated, as shown by the dotted lines, only one trap lost any water. This was the trap U, which lost $\frac{1}{8}$ of an inch.

* "Lectures on the Science and Art of Sanitary Plumbing," London, 1882.

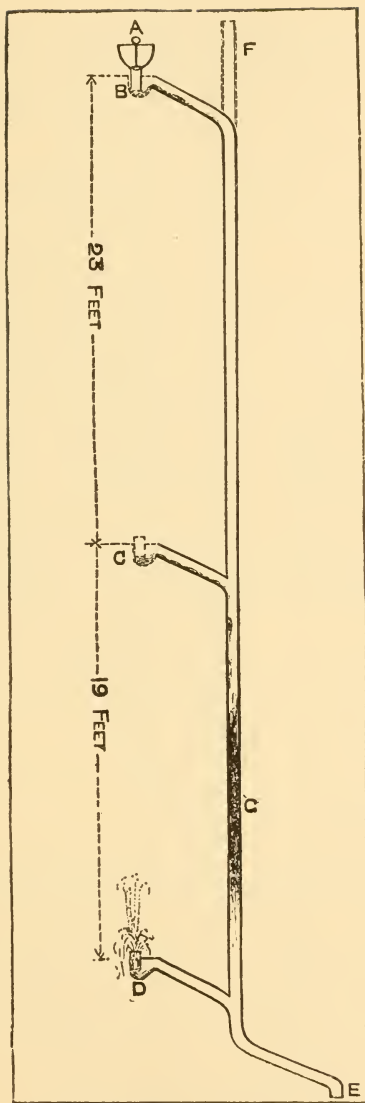

Fig. 269.

(7) Had he known the inevitable consequence of the law in introducing unintentional defects and by-passes, mistakes which have alone vastly more than offset any possible advantages back venting could provide.

Mr. Hellyer would have found several other very serious objections to trap venting which I have referred to in other places.

Mr. Hellyer's conclusions and recommendations resulting from these experiments were that every trap should be "back vented," and it is probable that this hasty conclusion and the wide circulation his publications enjoyed are largely responsible for the tremendous mistake of the trap vent law, a mistake which, regarded from the standpoint of pecuniary loss alone, has already cost the public hundreds of millions of dollars.

Mr. Hellyer would have found his vent pipes would have failed to protect the trap seals under any of the following conditions :

(1) Had the vent pipes been partially reduced in area by sediment deposit at the bottom or by frost at the top, or by rust anywhere in its length.

(2) Had the overflow pipe of the bath tub been plugged as is very frequently the case.

(3) Had the modern siphon jet or other closets having a strong and rapid flush been used in the tests.

(4) Had the vent pipe been very long and rough or contained an unusually large number of sharp bends.

(5) Had the experiments been prolonged sufficiently to try the effect of evaporation in the trap seals produced by the ventilating current.

(6) Had he investigated capillary action.

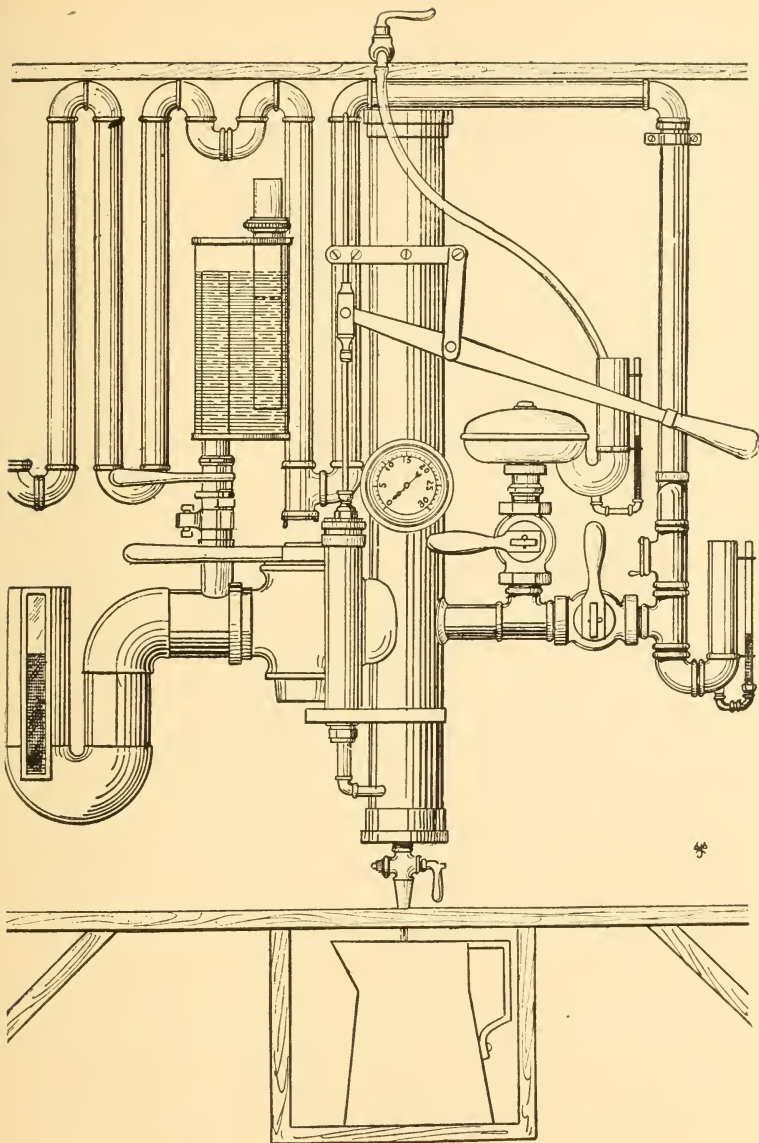

Fig. 271. Author's Pneumatic Trap Testing Apparatus.

It must be borne in mind that the value of our tests lies in showing not only the absolute but also the relative power of resistance of unventilated anti-siphon traps and the ventilated S trap. In making a comparison it would not be sufficient nor conclusive to show that unventilated anti-siphon traps are as efficient as the vented S under certain moderate strains. Their value can only be fully demonstrated when it is shown that they are superior to the vented S, not only under moderate but under every possible condition that can be encountered, and even under strains greater than are met with in ordinary practice, and clearly the larger the range of tests the more conclusive the comparison. We should be justly open to criticism if, in making our tests we stopped anywhere short of a thoroughly comprehensive and exhaustive comparison of all forms of traps under every form of strain, from the mildest to the severest which could be applied.

We have found that a single discharge of about four gallons from our tank was able to break the seal of our $1\frac{1}{4}$ -inch S trap with a $1\frac{1}{4}$ -inch clean new vent pipe only 6 feet long and having upon it a single return bend. And we found that the same trap could be siphoned out by two such discharges with a 6-foot vent pipe roughened on the interior surface as by rust even without any bend at all on the pipe. This test was made with the air pipe under the tank valve closed as by sediment or frost. Our air pipe takes the place of a ventilated trap under a bath tub, to which our tank corresponds. The overflow to the tank was closed as is sometimes done with the overflow pipe of bath tubs.

We then tested the vented S, with the air pipe open, and found that its seal could be broken by two discharges of four gallons each, the length of the trap vent pipe being 18 feet and having two return bends.

Now it is not necessary for us to show whether or not this strain was more severe than was ever possible in

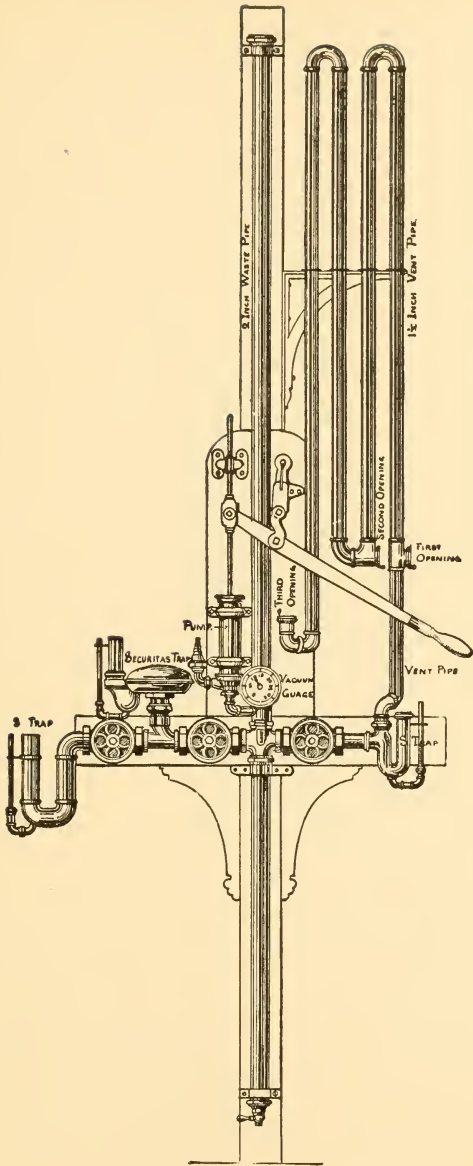

Fig. 272.

plumbing practice, because our chief purpose then was to compare the vented S with other traps unvented, and we found in our experiments that our 5-inch pot trap was able to withstand without loss of seal more than a dozen discharges made under precisely the same conditions as were applied to the vented S, including the very severest.

The superiority of the large sizes of our unvented pot traps over the vented S in the matter of resistance to

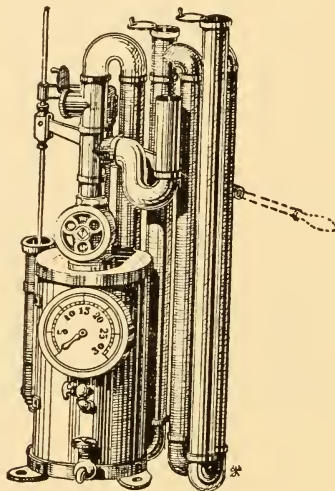

Fig. 273.

siphonage was, therefore, absolutely demonstrated under conditions in which the whole apparatus was comparatively new.

Our contention is, then, that an unvented pot trap of large size is safer as a protection against siphonage than a vented S, and that the former will retain its power of resistance to siphonage longer than the vented S. In places where grease or other sediment is liable to collect

in the scouring waterway of traps, it is still more liable to collect in the unscoured mouth of the vent pipe, and the pot trap cannot be clogged by frost, whereas the vent pipe can and often is so closed.

In every other respect the superiority of the unvented anti-siphon trap system over the vented S system is too evident to need further discussion.

Each state board of health should be equipped with some simple form of testing apparatus like that shown in Fig. 271 or like the pneumatic apparatus recently devised by the writer and shown in Figs. 272, 273 and 273a.

They may be made by any plumber or coppersmith without difficulty in a few days. A very considerable economy can be realized if several duplicates of the apparatus are made at the same time.

In all the demonstrations in siphonage of which I am aware up to the present time, the tests have been made by hydraulic apparatus, such as have been herein exemplified. But of late I have found that a pneumatic apparatus permits of a much greater accuracy of determination, especially in making comparative tests. By using a suction pump, as shown in Figs. 271, 272 and 273, we are able to reproduce at will any degree of rarification in the soil pipe desired to correspond with the varying conditions encountered in plumbing practice, as well as strains far beyond the usual ones for the purpose of comparing different traps and systems of plumbing with one another, and a vacuum gauge enables us to apply precisely the same degree of vacuum to every trap tested, so that results of great accuracy and scientific value are obtainable.

Of course, it will be objected at first thought that the pneumatic test does not reproduce in actual form the precise phenomena encountered in ordinary plumbing work, but a little reflection will show that the results are identical

so far as they affect our inquiries. The agency which produces siphonage is the partial vacuum in the soil pipe, and this rarification is effected by the rapid movement of a piston. Whether the piston be in the barrel of a pump or whether it be in the soil pipe itself is altogether immaterial so far as concerns the effect of the partial vacuum on trap seals. The pneumatic apparatus possesses the great advantage over the hydraulic of enabling us to vary the force of the strain applied to the traps to any extent desired, while only one degree of rarification can be obtained by the falling water plug in any one plant. The siphoning action in both cases is extremely rapid, almost instantaneous.

In the case of the falling water piston, the action takes place in the flash of time required for the piston to pass by the small mouth of the branch waste pipe serving the trap. A fraction of a second suffices for this.

In the case of the air pump apparatus the speed of the action is measured by the time it takes to move the valve lever connecting this branch waste pipe with the soil pipe. This requires but a fraction of a second, and the speed may be regulated to correspond accurately with the hydraulic action. Moreover, a vacuum gauge may be applied to the soil pipe in both kinds of apparatus and thus the action may be proved to be in both cases identical in speed, power and effect. The duration of the siphoning strain may be increased by increasing the size of the main pipe representing the soil pipe from which the air is to be exhausted.

In order, however, to be satisfied as to the similarity of the effect produced on the gauge and trap seals, one has only to have erected side by side apparatus of both kinds, as the writer has done before several audiences, and it will be found that when the vacuum gauge registers the same degree of rarification in both soil pipes, the effect on the traps in each is the same.

TRAP TESTING APPARATUS.

It is possible on our pneumatic apparatus to produce a strain equal to a vacuum of twenty-six inches, and yet we find the large sizes of drum traps and other anti-siphon traps capable of resisting, unvented, this strain even many times repeated without refilling. The first application of the strain lowers the seal considerably, the second and third less, and thereafter subsequent applications without refilling have little effect upon it, and finally a point is reached when no appreciable further reduction can be attained, however often the strain is repeated.

The vented S trap, on the other hand, is incapable of resisting a vacuum of a single inch when the vent pipe is long and crooked, or when it is partially roughened or closed by deposits. A few inches of vacuum will destroy its seal even when the vent pipe is new and clean and as short and straight as it is possible to make it in practice.

The apparatus shown in Figs. 271 to 273 inclusive are easily and cheaply constructed of brass tubing, polished and nickel plated, with a vacuum pump constructed with special accuracy so as to enable it to produce and maintain a vacuum as perfect as is possible. There is, therefore, no excuse for any board of health or plumbing inspector's office to be without such a plant, because its use would demonstrate the folly of the trap vent law and save to the citizens, by its repeal, more than the entire cost of the apparatus in a single good-sized building.

Fig. 273 is a very small, compact form of portable apparatus devised by the writer for lecture service. It measures less than two feet in height and if constructed of aluminum may be very conveniently transported by hand in a canvas or light leather case.

A simple hydraulic apparatus may be constructed and used side by side with the pneumatic outfit where it is

desired to demonstrate the identity of the results produced by the two systems. But, as before said, the usefulness of the hydraulic plant is limited to a very narrow range of tests and it is less accurate and comparatively unscientific. It involves, moreover, the consumption of a very large amount of water where the pneumatic plant can be operated without any expense whatever.

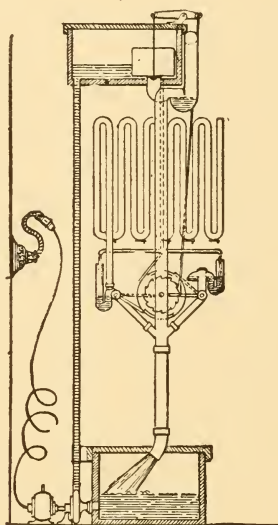

Fig. 273a.

Fig. 273a represents another form of apparatus for lecture service. Its action is entirely automatic. A small electric driven pump shown at the lower tank raises the water continuously from this to the upper tank by the electric current taken from an ordinary electric light fixture, through the small pipe shown at the left side of the tanks.

When the upper tank is full it discharges automatically,

TRAP TESTING APPARATUS.

and its discharge operates alternately the valves connecting the traps with the central waste pipe so as to produce upon them the siphoning action, and thus makes simultaneously a comparative as well as an absolute test of any traps desired. The central ratchet wheel governs the siphoning and refilling of the traps. The action continues as long as the current is kept on, and the tests are thus made at a minimum of expense with a maximum of convenience.

With either of these simple forms of testing apparatus one stands entirely independent of outside testimony as to the relative efficiency of the trap venting and of the anti-siphon systems, and can see for himself in a few minutes the truth in such controversies as have been published, relative to the Worcester tests, for instance.

There is no excuse whatever for any doubt in the matter, and no one thereafter would dare to publish any inaccurate or misleading statements in this very important domain, knowing that any board of health or building inspector's office can authoritatively refute such misstatements at once. In order to make the tests of the efficiency of different traps on our pneumatic apparatus, it is necessary to first close all the stop cocks shown in the drawings by wheel or lever handles between the traps and the main pipe, and exhaust the air in this pipe by means of the vacuum pump, until the vacuum gauge shows the degree of rarification desired to correspond with what would be encountered in any case of plumbing to be represented.

After filling the traps with water, one opens the stop-cock between the trap to be tested and the pipe system, so as to allow air passing through the trap to break the partial vacuum therein. This air will follow the path of the least resistance. In the case of the S trap the special air vent pipe is provided between the trap seal and the waste system under the supposition that it will present an easier path for the air than the trap itself, in which the water seal

might be expected to afford greater resistance to the air passage than the friction of the sides of the vent pipe.

The apparatus shows that this is not the case. The ordinary lavatory S trap is shown on the right-hand side of the apparatus vented at the crown with a "back vent" pipe the full size of the bore of the trap, and of considerable length, but having openings at different points provided with stop valves to show the effect of longer or shorter vent pipes in plumbing work. The longer the vent pipe and the greater the number of bends in it, the greater the obstruction by friction to the passage of the air through it, and the lower its efficiency as a means of protecting the trap seal from siphonage.

It is evident, therefore, that the degree of vacuum in the pipe system required to break the seal of a vented S trap is inversely proportional to the length and diameter of the vent pipe, and our apparatus is designed to show the effect of any possible degree of vacuum on any possible length and size of vent pipe, and it will again be seen on this apparatus that the seal of an S trap can be broken by a vacuum considerably below that which may be obtained in ordinary plumbing practice, even when the trap has a perfectly clean vent pipe of moderate length, provided a few bends are introduced in running the vent pipe.

If the friction is increased by more or less clogging the siphonage is by so much easier.

The only weak point in the employment of the ordinary unvented "pot" or "drum" trap of large size as a substitute for the system of back venting is that such a trap is not self-scouring.

This weak point is referred to by advocates of back venting as sufficiently important to justify the condemnation of the whole system of unvented trapping.

We have explained the fallacy of this argument by showing that the vent pipe is *still less* self-scouring, and that, once clogged, it can not be so easily cleansed. Nevertheless, it must be admitted that the cesspool element in all reservoir traps is a very undesirable feature, and that not the least of its objections is the fact that it furnishes the opposition with an argument, however inadequate, against the use of the simpler system of plumbing.

Moreover, the use of cesspools in a system of house drainage is contrary to the first principles of sanitary engineering, and an evil which may be of comparatively slight importance when confined to the small proportions of a single fixture trap, becomes of very great importance when multiplied by thousands or hundreds of thousands in the complete drainage system of an entire city or town.

It is also perfectly true that the clogging up of the ordinary drum trap converts it in time into an S trap, and completely deprives it of its anti-siphon feature. So long as it is allowed to remain clogged, a system based upon the use of such traps loses its efficiency and, however far superior it may be to the "back vent" system, it can not yet lay claim to permanent efficiency with automatic action.

Hence it is all-important to know if the cesspool element of the common anti-siphon trap can be eliminated and the self-scouring property of the simple S trap or of a straight piece of smooth pipe of equal area can be combined with the anti-siphon quality of the ordinary drum trap.

For over a quarter of a century persistent and untiring efforts have been made to attain this combination, until at last it became generally believed that the two requirements were really antagonistic to one another, and that the solution, therefore, was as impossible as the discovery of flexible glass or transparent rubber, a large body of water and a deep seal being assumed to be necessary to withstand siphon-

age and the exact reverse being needed to produce the maximum of self-scouring effect.

It was found that resistance to siphonage increased with the increase of water head in the seal of the trap, and it is sufficiently evident that even in an S trap a seal deep enough to balance the weight of the atmosphere, say 32 feet, would be able to resist any siphoning action which could be brought to bear upon it, since Nature's abhorrence of a vacuum ceases under a water pressure of 32 feet. Accordingly, the idea has prevailed that depth of seal is an essential quality in anti-siphon traps, and nearly all such traps have been and are being constructed on this assumption.

It has been clearly shown that this idea is fallacious, and that exactly the reverse is essential to meet all the requirements of the problem.

It does not follow that because a depth of seal of 32 feet is capable of resisting completely siphoning action, there is no other equally efficient manner of accomplishing the same result without the objections attending the perpendicular form.

These objections are, first, the impossibility in practice of finding sufficient room under a fixture to give an unvented S trap the depth of seal required for adequate protection against the strongest siphonage encountered in plumbing practice. Four or five feet of such seal would be essential in an unvented S trap for entire safety. I have broken the seal of such a trap nearly six feet deep on different forms of apparatus.

Secondly, the resistance to the outflow and consequently the lowering of the scouring effect of water through the use of so deep a trap, and, finally, the prohibitive cost of its manufacture and installment.

Fortunately, there is another method of overcoming siphoning action besides that of opposing direct resistance

thereto, namely, the diametrically opposite one of *reducing the resistance to a minimum*. This is accomplished by forming the shallowest possible seal, but constructing the trap in such a manner that the seal shall simply move to one side for a moment and allow the air of siphonage to pass, and then return to its place. It is an application of the principle which gives success to the reed in competition with the oak. It bends to the storm and rises again when its fury has passed, while the oak is shattered by its opposition.

Nor does it follow, fortunately, that because a seal is very shallow it must on that account be a correspondingly weak one. As I have shown, a trap may be constructed in such a manner that the shallowest possible seal may have a strength so great as to be absolutely irresistible. A seal a quarter of an inch deep may be made in such a way as to withstand indefinitely the severest test of siphonage, back pressure, evaporation and all other adverse influences to be encountered in plumbing. It will withstand unvented a strain of siphonage powerful enough to destroy the seal of a fully vented S trap or of a drum trap of the largest diameter.

In my various experiments on the behavior of different sizes and forms of drum traps when subjected to siphoning action, I have found their resistance to be in direct proportion to their diameter rather than to their depth of seal. Indeed, the latter has, within the narrow limits practicable in construction, no appreciable influence whatever.

CHAPTER XVI.

SELF-SIPHONAGE AND MOMENTUM.



Fig. 274.

SELF-SIPHONAGE takes place when the waste water flows through the trap "full bore" from the fixtures. As usually constructed, wash basins have outlets far too small in proportion to the size of the waste pipe and trap. The strainer cuts off a considerable portion of the passageway, and the hairs, lint and other sediment

which soon invariably collect on the strainer cut off another large portion, leaving an outlet sometimes not more than equivalent to a $\frac{1}{2}$ -inch or $\frac{5}{8}$ -inch pipe. The waste pipe and ordinary S trap are usually $1\frac{1}{2}$ -inch or $1\frac{1}{4}$ -inch in diameter, so that the stream of water admitted to flush and scour them is reduced to less than a quarter or a sixth of their capacity, and we wonder why our trap and waste pipes are never thoroughly scoured. An S trap is no more self-cleaning when the water stream admitted is less than a quarter or a sixth of its capacity than would be an ordinary pot trap having a stream of the same size relatively to itself passing through it. In other words, a $1\frac{1}{2}$ -inch S trap attached to a $\frac{1}{2}$ -inch waste flowing "full bore," or to a waste having a $\frac{1}{2}$ -inch inlet, is no more self-scouring than would be a 3-inch pot trap attached to a 1-inch waste also flowing full bore, and therefore such an S trap becomes practically then a "cesspool" trap.

This is a consideration of great importance, but one which appears generally to be lost sight of, and our plumb-

ing laws are defective in not recognizing it. It is one of the principal causes of the collection of sediment in branch wastes and ordinary S traps which have a false reputation of being universally self-scouring. They are evidently only so when properly set, and when the waste water from the fixture is permitted to flow through them rapidly and "full bore." It cannot pass rapidly "full bore" unless the outlet and strainer give an open waterway as great or greater than that of the waste pipe and trap. It should be greater in order to allow something for friction and sediment. A trap having a very deep seal retards too much the rapidity and strength of the water current passing through it; hence it should be made as shallow as possible consistent with other requirements.

Assuming, now, that we have properly set our trap in such a manner that a rapid stream of water passes through it full bore wherever the fixture is used in a legitimate manner, we shall find that, where an S trap is used, a siphon is formed by the outflowing waste water, which, without ventilation, breaks the seal of the trap. Hence the vent must be placed either at the crown or near enough to it to break the longer leg of the siphon. The momentum of the falling water assists the action of self-siphonage, and it is necessary for perfect protection against these two forces to vent very near the crown.

To make a practical test of the truth of this I had a wash basin fitted up with an outlet large enough to fill a $1\frac{1}{2}$ -inch waste pipe and S trap full bore. Through this outlet the basin was emptied in $2\frac{3}{4}$ seconds, and the seal of the trap was completely destroyed by the siphonage and momentum of the falling water. The trap was an ordinary cast lead trap, having the usual seal of $1\frac{1}{4}$ inches, and was connected with a waste pipe of the same size with the bore of the trap. With a waste pipe very much larger

or smaller than the bore of the trap the seal is not so easily broken by self-siphonage, for obvious reasons.

SEDIMENT COLLECTION IN S TRAPS CONVERTING THEM INTO CESSPOOLS.

In order to ascertain if the smallness of the outlet of a fixture could actually convert an S trap into a cesspool trap, as I have above asserted, and to study the effect of ventilation in removing deposits from cesspools, I have made a number of experiments on sediment collection and removal. I believe all unprejudiced and well-informed sanitarians now admit that the special vent pipe is no longer to be recommended as a protection against siphonage, for the reasons I have mentioned. All admit, however, that the main stacks of soil pipe should be thoroughly vented at head and foot. The object of this is to dilute the gases of decomposition to such an extent as to render them as harmless as possible, and then to remove them from the premises. Liberal ventilation hastens somewhat the oxidation of the foul matters in the pipes, but not enough to form an active agent in removing solid impurities.

There has been nevertheless a great deal of misunderstanding and idle theorizing on this subject among writers and practitioners in sanitary plumbing. There are advocates of indiscriminate venting who profess a preference for air pipes even to a thorough water scour, the most radical ones going so far as to affect for the latter comparative indifference, saying, "If compelled to choose between oxygen and suds, we should give the former preference every time."*

Let us now, therefore, abandon theories and authorities and seek for facts to guide us in forming an independent judgment on this very important question. The only question, then, now in dispute is: Do traps and branch waste

* James C. Baylies in the "Sanitary Engineer."

AUTHOR'S EXPERIMENTS ON SEDIMENT REMOVAL BY AIR FLUSHING.

pipes require the application of special vent pipes to prevent an accumulation within them of solid deposits and corrosive gases?

The first experiments were made on solid and the second on gaseous impurities. Under the first heading it was necessary to determine, first, if and to what extent the removal by oxidation of the refuse matters in our waste pipes goes on under a ventilating current under the varying conditions possible in practice; second, at what rate the accumulation of sediment or solid deposit goes on under the same circumstances; third, to what extent a water scour is able to prevent and remove solid deposits without the aid of the special vent pipe; and fourth, to what extent traps and branch waste pipes are self-ventilated without the aid of the special vent pipe in good plumbing practice.

The first tests were made as follows:

I had pipes evenly coated with deposits found in house-drain pipes and under the conditions met with in ordinary practice, and made, first, a series of extremely delicate and careful experiments to determine the value of air currents in pipes as a scouring agent.

The maximum rate of this scouring or cleansing was first ascertained by performing the tests under all those conditions which are found to be most favorable to it. Thus the rate of oxidation is greatest when the ventilating current is most rapid, when the temperature is highest and when the largest surface is exposed to the current.

The first experiments were, therefore, performed under these conditions. The waste pipes used were of the diameter of ordinary branch wastes, $1\frac{1}{2}$ inches, and were 6 inches long. They were connected with a heated flue by means of an ordinary $1\frac{1}{2}$ -inch vent pipe in the manner usual in practice, so that the ventilating current should traverse

the pipes to be tested from end to end. The time of the year was in midwinter, in January and February.

The pipes were uniformly smeared on the inside with substances found in house drains, using in some common soil from a soil pipe, and in others soap solutions found in lavatory wastes. The deposits were first thoroughly dried in the pipes in order to enable them to be accurately weighed in the laboratory, and they were afterwards moistened three times a day throughout the tests, about as they would be in ordinary practice.

The weight of the deposit in the pipes containing soil was 3.652 grains. That of the lavatory waste was 3.1685 grains. The deposits were then thoroughly moistened with clean water applied with a dropping tube and the pipes connected with the ventilating flue. The velocity of the air current passing through them was then accurately measured and found to be very strong, averaging 8 feet a second, and this velocity was maintained throughout the whole series of tests by means of a stove connected with the main flue, into which the ventilating flue opened. This movement is evidently as rapid as would ever be met with in plumbing practice. The thermometer at the pipe during the tests averaged about 80° F.

Great care was taken throughout to insure that no foreign substance whatever should get into the pipes tested. No dusting or sweeping was allowed in the rooms and only pure water was used to moisten the deposits. An evaporation of the water used would show a weight of bacteria and other solid matter too small to be detected by our scales. In short, every precaution was taken to obtain reliable results.

After an exposure of a week, under these conditions, to the air current, the pipes were again placed in the air bath for an hour, and the deposits in them thoroughly dried at

AUTHOR'S EXPERIMENTS ON SEDIMENT REMOVAL BY AIR
FLUSHING.

a temperature of 230° F. Upon weighing, it was found that both deposits had gained in weight. The soil had gained 0.4955 grains and the soapy mixture 0.0130 grains.

The tests were then repeated under the same conditions for a second week. This time the gain of the soil was reduced to 0.4775, and the weight of the lavatory waste was increased to 0.0315 grains.

The bacteria of decomposition and nitrification had evidently not put in their most effective work, and it is probable that the conditions as to light and moisture were not favorable for it. So far the air passed through the pipes was pure air from the room. In the next experiments the ordinary air from the house soil pipe was used and its velocity was 7 feet per second. At the end of a week the soil had lost 0.0575 grains and the lavatory matter 0.0352 grains, which was equivalent in the first case to 1-70th of the entire weight of the deposit and in the second to 1-100th part. Either of these amounts dissolved in water and spread uniformly over the surface of clean pipes of the size of those used was found to be altogether imperceptible to the eye, and the complete purification of these pipes by ventilation under the most favorable circumstances would at this rate require from 70 to 100 weeks, or from 1½ to 2 years, supposing there were no addition made to the deposit during the interval through use of the fixture.

We then made the tests with the deposits kept dry as might be the case in pipes under fixtures temporarily in disuse, with approximately the same results, and from all the experiments we reached the conclusion that the solid deposits in the interior of soil and drain pipes are removed so slowly by the oxidation produced by ventilation as to be practically valueless.

The second point investigated, namely, the rate of accu-

mulation in pipes of deposits in ordinary plumbing, required no special experiments. We have ample data in our everyday experience in plumbing. Considering, first, the worst conditions, namely, those of the cold waste pipe from the ordinary kitchen or pantry sink, we know that the accumulation of grease in these will be so rapid as to entirely clog up the pipes in a short time where special precautions are not taken to flush out the pipes from time to time with hot water or some solution of caustic alkali, or where sinks constructed on the principle of an automatic flush tank to be hereafter described, are used. So far as the ventilating current is concerned, however, its well known and generally admitted tendency is to congeal the grease and increase the clogging rather than to diminish it.

Consider next the case of an ordinary soil pipe. We find that the tenacious soil will adhere stubbornly to the pipe in masses where it strikes until it is washed away by a powerful fall of water, and that it is not equally distributed in a thin film all over the surface. Parts will be found which are never touched by the waste matter, and parts which are alternately fouled and then scoured clean again. Generally large masses of deposits will be formed in the cavities of the joints or in holes in the castings. In short, the deposits in soil pipes are not slowly distributed favorably for oxidation, but are formed in lumps suddenly, and are either as suddenly removed by the flushing water or are deposited in cavities which largely screen them from the influence of the ventilating current, and therefore in this case also the influence of aeration in removing the solid matter is comparatively very slight. The accumulations of heavy matter will continue in time to increase until they leave an opening only large enough to allow room for the ordinary water flushing stream to pass.

Take next the waste pipe from a lavatory. We find the

solid deposits here of two kinds, one collecting in clots or masses in corners or unscoured areas, as lumps of soap, hairs, lint, etc., and the other coating the pipes in thin films as of soap-suds. The former are deposited suddenly, and are either swept away by the water or caught in the unscoured cavities and remain there, partially screened from the air current, until other similar substances accumulate above them. The ventilating current, therefore, can have no appreciable effect in removing these masses of matter.

Where, on the other hand, the traps and waste pipes are so constructed and flushed that no such masses can collect, the only kind of deposit that can form in the interval between the flushing will be of the second kind, namely, a thin film of matter like soap-suds, and this the next discharge will remove.

It remains to be seen what effect a powerful water flushing has on these deposits, and this brings us to our third consideration.

CHAPTER XVII.

WATER FLUSHING.

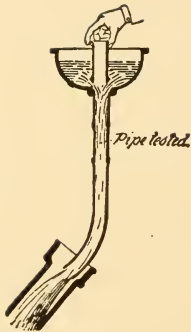

Fig. 275. Experiments on Water Flushing.

IN order to obtain a direct comparison of the relative value of a thorough water and of the greatest possible air flushing, the same pipes, tested as already described under the air current, and containing identically the same deposits, were next tested under a good water flush. They were attached to a properly constructed lavatory, as shown in Fig. 275, and cold water was discharged through them in the usual manner. Although the deposits were dry and hard, they were almost entirely washed away after ten discharges. After fifteen discharges the amount of deposit left on both pipes was less than half a grain. When the substances were soft on the application of the test they were removed at once and entirely by a single discharge.

From these investigations we have found that the water flushing was infinitely more rapid and thorough in its cleansing power than the air flush. Now there is nothing to prevent every lavatory from being so constructed as to properly flush the waste pipes at each discharge. In fact, there are a great many reasons why it should be looked upon as an absolute necessity in good plumbing.

Hence special trap and branch waste vent piping is, for the purpose of removing solid deposits, not only inefficient, but also entirely unnecessary.

We come now to the fourth consideration:

SELF-VENTILATION OF TRAPS AND BRANCH WASTE PIPES.

But supposing it had been shown that special trap ventilation were necessary instead of the reverse, it would still be superfluous to apply the special vent pipe, because the ventilation in proper plumbing is thoroughly accomplished without it, and in several ways.

If our main stacks of pipes are open above and below, as they should be, and thus thoroughly aired, the branch wastes will be ventilated in the first place by the well known law of the diffusion of gases.

In the second place, a movement of fluids up or down the main stack creates in the branches suction strong enough sometimes even to destroy the seal of ordinary traps. This suction, be it strong or feeble, always produces an interchange of air in the branches.

Finally, a third and still more important way in which natural aeration is produced is by the usage of the fixture itself. Every time the water is discharged a column of pure air is drawn from the room into the waste pipe after the water column. Everyone has observed how the air follows the water, and is drawn through it in the form of an inverted cone or funnel, generally with a loud sucking noise. When the fixture is properly constructed, with an outlet large enough to fill the waste pipe "full bore," a column of air equal to the size of the water column is drawn after it, completely filling the waste pipe with pure air from the room. In short, ample air follows every discharge to accomplish all that the soil pipe air of the trap vent could do in the interval between the usages of the fixture. The pure air from the room could not possibly be rendered so foul in the interval as the soil pipe air would be, as they are constructed to-day, before it entered. This is equally true whether the fixture be used often or seldom,

provided it be properly constructed and set, and whether the branch waste be long or short.

Thus the special trap vent is superfluous for scouring, not only because the traps may be fully vented without it, but also because a good water flushing accomplishes all and infinitely more than the air could do.

REMOVAL OF GASEOUS IMPURITIES.

The chief difference between the main soil pipe and the small branch wastes in relation to venting is that the foul air in the former cannot, and in the latter case can, in good plumbing, be thoroughly changed by flushing and diffusion. Hence, in the main wastes, special venting is necessary to remove gaseous impurities and in the small branch wastes it is not. What has already been said in regard to the capacity for the removal of solid impurities from the smaller waste pipes of a good water flush holds with still greater force in relation to gaseous impurity. The lighter gases are instantly removed by the water stream and replaced by pure air from the room, and this substitution is as much more desirable than the substitution of soil pipe air as the former is richer in oxygen and freer from injurious elements than the latter.

BACK PRESSURE.

“Back pressure” in plumbing is a force acting in a direction precisely opposite to that of siphonage. It indicates that the air in the drains is under compression, where with siphonage it is under rarification. Hence it tends to force the water of traps from the drains outwards into the house where siphonage tends to force it inwards from the house into the drains. This compression of air in the drains may be caused either by the movement of fluids in the house pipes themselves or by external influences acting

upon the air of the sewers, such as the pressure of wind and tide at the sewer openings or a change in the temperature or volume of sewage within the pipes. With properly ventilated soil pipes the expansion or contraction of the air or wind or other pressure in the sewers can have no influence on the seals of interior fixture traps, but where an intercepting house trap is used, it is clear that a sewer vent must also be furnished at the trap to protect it from such influences.

The influences which act within the house pipes to create back pressure are: First, the compression of the air in the main soil pipe by waste water passing through it; second, the pressure of the wind; and third, the suction of open fires and ventilating outlets throughout the house.

If a large body of water is thrown suddenly into the soil pipes from one of the upper fixtures in a house, it drives the air in advance of it as it falls like a plug through the pipe. Were there no resistance to the passage of the air, such as is caused by friction, or a sudden bend in the pipe, the air would pass through a properly ventilated pipe in front of the water without compression, but the rough interior of the soil and waste pipes, and sudden bends in their course, causes considerable resistance to the escape of the air in advance of the water, causing condensation of the air, and giving rise to the phenomenon we are discussing, and this "back pressure" is sometimes strong enough to drive the water out of the traps in a sudden jet or fountain. I have completely emptied a 4-inch pot trap, having a seal four inches deep, by this action, even though the soil pipe was properly vented at both top and bottom. Fortunately, however, a very simple remedy exists for back pressure. This force never exceeds a few ounces to the square inch in properly arranged plumbing, and may easily be resisted by a column of water from 12 to 18 inches in

height. Hence a trap which would be completely emptied when standing alone, as shown in Fig. 252, 276 or 278, will easily resist the pressure when attached to and placed some little distance below a fixture or when the inlet arm is simply lengthened as shown in Fig. 277. With a common S trap the resistance to back pressure in this figure is twice as great as in the first. The limit of resistance of an S trap is the weight of a column of water twice as high as the



Fig. 276. Effect of Back Pressure.

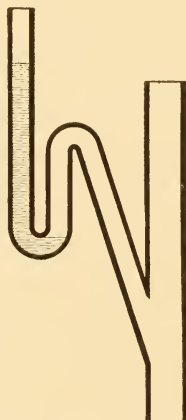

Fig. 277. Back Pressure resisted by position of the Trap below the Fixture.



Fig. 278. Effect of Back Pressure.

depth of its seal. But though the soil pipe air may be blown through the trap when it surpasses the limit of resistance of the seal, yet the fixture above the trap will catch the water thrown up and restore it to the trap.

With a pot trap, however, the power of resistance is much greater, since it contains water enough to rise under the influence of back pressure to a very considerable height in an inlet pipe. Now, so far as my experiments have shown, the severest back pressure that can possibly be brought to bear upon a water trap in a properly plumbed

building having ventilated soil and drain pipes can be resisted by a column of water from 14 to 16 inches high. Hence, if a trap in such a building is placed under a fixture in such a manner that the bottom of its seal shall stand from 14 to 16 inches below the outlet of the fixture it serves, it may be considered perfectly safe against loss of seal or soil pipe air transmission by back pressure. For it will be found that if the column of water in a trap is high enough to resist this back pressure, it will entirely exclude the entrance of sewer gas or soil pipe air so compressed in the pipes. In other words, the air will not, under such circumstances, ever be driven through the water column in bubbles, as is sometimes feared. Hence in setting traps under kitchen sinks where back pressure from water falling from fixtures above is to be feared, the traps should always be placed low enough below the outlet of the sink to permit of the formation of a water column high enough to resist the back pressure. Otherwise the water may be blown out of the trap into the sink, and sewer air will follow. If such action follows every time any fixture above is discharged, the constant repetition of such injection of sewer air into the room may result in serious consequences.

Now, the main house trap is a frequent cause of heavy back pressure in the basement of a house owing to the friction caused by the resistance of its seal, and this furnishes another argument in favor of its abandonment.

In the experiments in back pressure made in my investigations for the Board of Health, the traps were tested on the basement floor (see Fig. 242) just above the horizontal run of the soil pipe. The tests were divided into (A) those in which the traps had no vertical extension of the inlet arm, and (B) those in which the inlet arms were extended.

An S trap having the ordinary 6-inch length of inlet arm

above the seal was first tested. The first discharge of the water closet alone threw the water out of the trap, projecting it several feet in the air, and broke the seal. The experiment was often repeated with the same result. Fig. 278.

(A) A 4-inch pot trap lost its seal in four discharges (see Fig. 276). The top of the inlet arm stood 2 inches above the top of the seal.

An 8-inch pot lost 2 inches of its seal in seven discharges. The top of the inlet pipe stood 3 inches above the top of the seal.

The same trap lost $3\frac{3}{4}$ inches by fourteen discharges of the water closet and bath tub together.

(B) With a vertical extension (Fig. 277) of 16 inches, a $1\frac{1}{2}$ -inch cast lead S trap retained its seal entirely whether tested with the discharge of the water closet alone or with water closet and bath tub together; but in all cases air was forcibly driven through the water forced up into the inlet pipe, because the volume of water in the trap was insufficient to outweigh the back pressure.

An S trap having 5 inches of seal without extension lost its seal in all cases, but with an extension of 16 inches the water was not thrown out under the severest discharges. With this trap, moreover, the large volume of water was with the extension sufficient to overbalance the pressure of the air, and no bubbles were driven through the trap. The same deep seal S trap was then tested after half its seal had been removed as by evaporation or other accident. In this case the trap acted exactly as did the ordinary shallow-sealed, ordinary cast lead S trap, and always allowed air to be driven through it.

A 4-inch pot trap with the 16-inch extension neither lost any of its water nor allowed any air to escape through its seal under any of the severest conditions.

BACK PRESSURE.

The same trap with a 6-inch extension, bringing the top of the extension 8 inches above top of seal, lost its entire seal in two discharges of the water closet and bath tub together. The volume of the water in the trap was sufficient, but the pipe was not long enough to allow of the formation of a column sufficiently high to resist the air pressure.

An 8-inch pot trap with either a 9, 12 or a 16-inch extension lost no water and allowed no air to pass under either of the tests. But with a 6-inch extension the water was driven out of the trap.

A piece of $1\frac{1}{2}$ -inch waste pipe, 12 inches long, holds about $\frac{3}{4}$ of a pint of water. A 15-inch piece holds a pint. Hence a trap used with such a waste pipe should have a capacity of not less than $\frac{3}{4}$ pint.

In our apparatus erected for this course we shall be able to illustrate "back pressure" in every degree of force, from an amount scarcely measurable up to that which will throw the entire contents of our tank upon the lecture floor, according as the valve just below the trap testing branch be left open or completely closed.

CHAPTER XVIII.

EVAPORATION.

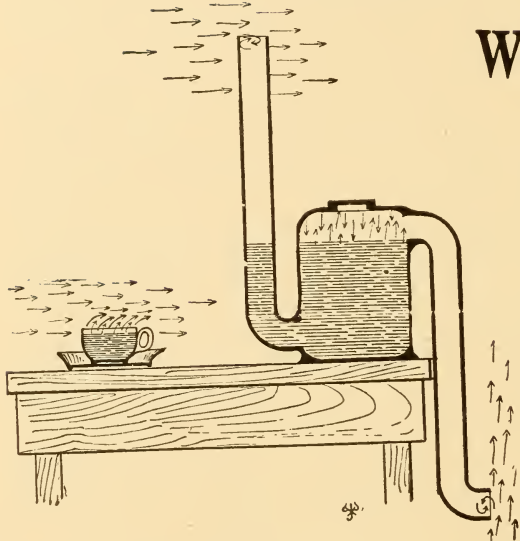

Fig. 279. Diagram illustrating the Air Movements above the Water Seal of a Back Vented S-Trap, and of a non-vented Antisiphon Trap. The former quickly losing and the latter retaining its seal.

WITH unventilated traps evaporation of their seal goes on with extreme slowness, and with such traps containing a considerable body of water, no danger from this cause need be anticipated unless the building be left unoccupied and unwatched for years at a time.

If the trap is adequately ventilated, however, its seal will be gradually lowered, and if the ventilating flue connects with the trap at or near the crown, the induced air current licks up the water with a speed proportional to the efficiency with which it performs its duty as a ventilator, and will destroy the seal of an ordinary small S trap in from four days to one or more weeks, according to the rapidity and dryness of the current. If the flue connects with the trap at any point below its seal it is powerless to prevent self-siphonage.

Some years ago, after the enactment of the trap vent law, the Brooklyn newspapers published, in the interest of the public, the following warning, showing that the officers of the Public Health Department had already experienced some of the evils of the trap vent law: "The Commissioner of Health desires to direct the attention of householders to the danger of occupying houses which have been for any considerable time without occupants. It is the practice of many persons to leave their dwellings for several months in the summer, during which time the water in the traps of basins and other fixtures is liable to evaporate, and thus permit the unobstructed entrance of sewer gas into the dwellings. When the families return in the fall they are exposed to these sewer emanations, and it is believed that cases of serious, if not, indeed, fatal sickness have been due to this cause. Whenever houses are so left, provision should be made to have the traps filled at least every two weeks by a competent and trustworthy plumber, and if possible to have all the windows of the house opened for twenty-four hours before its re-occupation." This notice was given the public after the city had fastened upon them the trap vent law. They then felt constrained to advise every house owner, under peril of serious danger to health, to employ some honest and skilful expert to stand constantly on the alert to undo the danger done by this law. We will not calculate here the number of traps owned by the several million inhabitants of Greater New York, nor the exact size of the army of trustworthy plumbers which would be required to overhaul dwellings for the purpose of attending to apparatus intended to be made by the new law automatic. But were all the traps ventilated in accordance with this law, it is certain that their fortnightly refilling and the opening of all the house windows in consequence of their not having

been refilled weekly would consume infinitely more time than would be required to clean out the same number of unventilated pot traps, if their use was the only alternative, as often as their condition required, and, as a collector of greasy sediment, the vent pipe is no better than an elongated cesspool trap itself. Had the Commissioner of Health published advice to the householders to employ some competent and trustworthy plumber to cork up or tear out once and for all from their houses all these incompetent and untrustworthy back vent pipes which were responsible for the trap seal evaporation, instead of raiding the premises every fortnight to try to repair in a measure the mischief they had done, he would have performed a really valuable service to the alarmed and unhappy absentees on their summer vacations, and have reassured the much-suffering public at large at the same time.

Sometimes an owner is advised to fill all the traps with oil as security against evaporation. This method is troublesome and expensive, and should the house owner or any of his friends or employes happen to require to visit the premises during the season of its inoccupancy, he would be obliged to obtain or carry with him on each occasion a gallon or so of oil and refill the traps of any fixtures used during such a visit. Inasmuch as such phenomenal foresight could hardly be expected, especially in cases of unexpected or unforeseen visits, the practical objections to this method are sufficiently obvious, though it often sounds well to propose it.

While it is evident that back venting must gradually destroy the seal it was commissioned to protect, it is also evident, as an examination of our Figure 279 will make clear, that a pot trap or an anti-siphon of good water capacity is capable of preserving its seal against loss

by evaporation during an entire winter or summer season if unvented.

If vented, a current of air is constantly in motion over the seal when the vent pipe is actually performing the office for which it is installed, and it carries off vapor from the seal as fast as it rises.

One may easily test this by filling a large pot trap having arms long enough to reach to the floor and to a basin and placing it by the side of a cup of water as shown in Fig. 279. In my experiments for the City Board of Health the evaporation is shown to be very rapid from the sewer side of a vented trap and almost nothing from the house side of the same trap.

EXPERIMENTS FOR THE BOARD OF HEALTH ON EVAPORATION PRODUCED BY BACK VENTING.

These experiments were made on the basement floor. They were subdivided into (A) those in which the vent pipe was conducted into a cold flue, and (B) those in which it was conducted into a heated flue.

(A) Tests with a Cold Ventilating Flue.

A 1¼-inch S trap having a seal 4⅝ inches deep was attached to the end of the branch waste in the manner shown in Fig. 242. A 1½-inch rubber ventilating pipe was taken from the 1¼-inch ventilating opening at the crown of the trap and conducted into a cold 4-inch galvanized iron ventilating flue, shown in the drawing. This flue passed through two occupied offices (basement and first floor) whose temperature was maintained at about 68 degrees F. during the term of the experiments, and through a chemical laboratory (second floor) whose temperature was maintained at about 60 degrees F. For the remainder of its height the flue passed through a cellar and stairways whose temperature was maintained at about 45 degrees F. No

artificial heat was applied to the flue. The velocity of the movement of the current of air in the flue was measured by the anemometer. The daily rate of loss of seal by evaporation and the velocity of the current in feet per minute is shown in Fig. 281.

We see that the loss averages about an eighth of an

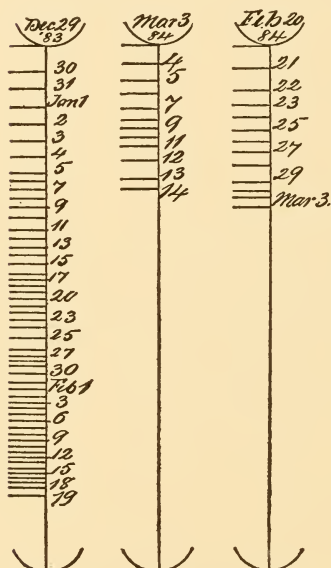

Fig. 281. Record of Evaporation with Cold Flues.

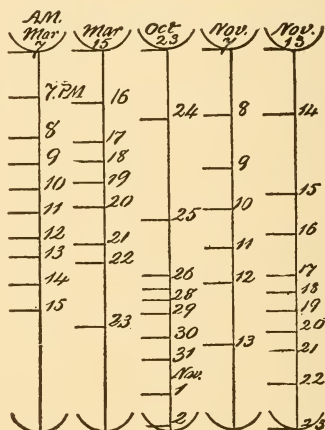

Fig. 282. Record of Evaporation with Heated Flues.

inch per diem. It amounts to about a quarter of an inch the first day, and gradually diminishes as the level of the water descends in the trap, and the distance of its surface from the ventilating current increases, to a little less than $\frac{1}{8}$ inch per diem. Hence an ordinary S trap having a $1\frac{1}{2}$ -inch or a $1\frac{3}{4}$ -inch seal might lose its seal in from nine to eleven days under similar conditions.

The experiment was repeated several times at different

parts of the year from the middle of December to the middle of May, with substantially the same results.

The same trap was now tested at the middle opening, whose center was 2 inches below the crown. The rate of evaporation was somewhat slower, as shown. This experiment was carried on only 11 days, inasmuch as by this time $1\frac{1}{2}$ inches of the seal had been destroyed, and the seal of many ordinary S traps does not exceed $1\frac{1}{2}$ inches or $1\frac{3}{4}$ inches. The same trap was now ventilated at the lowest point, i. e., 6 inches below the crown. The evaporation in this case was exceedingly slow, and after the first two or three days was almost inappreciable.

A number of experiments were then made on S traps unventilated, but open at both ends, as is the case in practice. The loss of water was almost inappreciable, not exceeding $\frac{1}{32}$ nd or $\frac{1}{16}$ th of an inch in ten days.

(B) Experiments on Evaporation Produced by a Heated Ventilating Flue.

A $1\frac{1}{2}$ -inch trap having a seal $3\frac{1}{4}$ inches deep was tested. A $1\frac{1}{2}$ -inch wrought iron gas pipe 6 inches long connected with the crown of the trap with a brick flue 8x12 inches heated by a stove. (See Fig. 282.)

The diagrams shown in Fig. 282 represent five tests, two made in March, one in October, and two in November. Here again the perpendicular lines represent the depth of the seal of the trap. The upper arc represents conventionally the outlet mouth and the lower arc the inlet mouth of the trap. The horizontal lines show the position of the water level in the trap at the same hour in the morning of each day recorded in figures on the diagram. We see here a very rapid diminution of the seal. The average loss per diem exceeded $\frac{1}{3}$ of an inch. The smallest loss is $\frac{1}{8}$ inch,

and the largest nearly $\frac{7}{8}$ inch. The fixture side of the trap was closed during the tests.

A second series of experiments was made with an ordinary $1\frac{1}{2}$ -inch cast lead trap having a seal $1\frac{1}{2}$ inches deep. The trap was connected with the heated flue at a point 3 inches below the crown. Four tests were made. The loss of seal was much slower than in the former tests because of the distance of the mouth of the vent pipe from the top of the water. The rate of evaporation, however, in these four tests averaged one-seventh of an inch a day, the greatest loss in any one day being $\frac{3}{8}$ inch. In all these experiments on evaporation it was found to make no material difference in the results whether the fixture end of the trap was open or closed, showing that the evaporation at this point was inappreciable.

In the experiments on evaporation with the cold ventilating flue, in the first experiment with the vent at the crown, the anemometer recorded an average rate of movement of the ventilating current of 94 feet per minute.

In the second test, with vent at the crown, the average was 85 feet per minute; with the vent 2 inches from the crown the average was 109 feet per minute. The velocity of the current during the cold months of the year was quite uniform. In the summer months, however, it was exceedingly variable, sometimes equaling that of the cold season and sometimes ceasing altogether, or retrograding. In the cold months the relation between the rapidity of evaporation and the velocity and dampness of the air current was not accurately determined, the rate of evaporation being quite uniform in spite of considerable barometric fluctuation and change of velocity.

But in summer a change of the conditions of the atmosphere produced a very marked change in the rate of evaporation. On a few occasions of damp or rainy weather in

the summer months, where the cold brick flue was used without a ventilating cap on top, the seal actually gained slightly in depth from condensation on the cold flue of the damp air of the soil pipe, or from an actual descent of moisture down the chimney. These accretions, however, were very rare, not occurring more than three times in the whole duration of the experiments.

The scientific investigation of this branch of the subject would require more elaborate apparatus and much more time than was at our disposal; yet what records we made were made with great care and accuracy.

From these experiments we found (1) that a rapid evaporation of the water seal of traps takes place when they are ventilated at or near the crown, and that the evaporation goes on both in winter and in summer, and in ordinary unheated flues as well as in flues artificially heated. The evaporation is most rapid in winter or with flues artificially heated, and slowest in summer, especially in damp weather. Hence it may be stated generally that the rapidity of evaporation depends upon the velocity, temperature and hygrometric condition of the atmosphere. (2) That in winter the evaporation produced by ventilation is so rapid as to destroy the seal of an ordinary $1\frac{1}{2}$ -inch machine-made S trap in from four to eleven days, according to the nature of the current.

(3) That without ventilation, or with the ventilating flue taken from a considerable distance below the crown, the evaporation of the water seal of traps is exceedingly slow, and that unventilated traps having a considerable water capacity may be considered perfectly secure against this danger unless they are unused for years at a time.

It would obviously be impossible to devise a form of apparatus for experimental purposes which should cover all the varying conditions liable to be met with in plumb-

ing practice. The position of the trap on the soil pipe branch, the manner and position of connection of the branch with the main pipe, the amount of usage the pipes sustained, the manner in which the ventilating flues were constructed, would all produce their effects upon the results. Nevertheless, in every case where the ventilating flue performed the office of producing a movement of the air within the pipes for which it was intended, and this air was not absolutely saturated with moisture, an event very rare in well ventilated sewers and house drains, the evaporation must of necessity go on in the manner recorded as the result of these experiments.

How far the variation of the conditions would affect the rapidity of the loss of seal must be left to other investigators to determine, and it is hoped that the National Board of Health will at some early day take up this whole matter, and by a most thorough and judicial series of exhaustive experiments put a final end to all doubt and discussion on the part of the public in this extremely important department of sanitary building.

The apparatus used in our tests for the Boston Board of Health was fitted up exactly as is customary to fit up plumbing for actual use.

The entire length of the soil pipe was kept much of the time wet during the experiments on evaporation, by discharges through it made for the tests on siphonage and back pressure, precaution being of course taken by having the inlet end of the trap always corked up so as to be secure against loss of seal through these agencies. The inlet at the end of the soil pipe system, where the fresh air was taken in to produce the ventilating current above the trap, was distant as much as 60 or 70 feet from the traps tested, so that the air was obliged to traverse a considerable length of damp soil pipe, the greater part being

nearly horizontal, on its way to the trap, and it may therefore be assumed it was conducted over as large an area of moist surface as it would ordinarily encounter in practice.

Moreover, the results of our experiments in this direction correspond with the experience of many sanitary engineers, health inspectors and plumbers who have had occasion, since the enactment of the plumbing laws in various parts of the country, to observe the effect of the provision requiring branch ventilation on the water seal of traps.

GENERAL CONCLUSIONS FROM THE EXPERIMENTS ON SIPHONAGE, BACK PRESSURE AND EVAPORATION.

From these tests I conclude as follows:

(1) The ordinary form of machine-made small S trap with shallow seal and without special ventilation is incapable of resisting the action of siphonage or back pressure, even in a very mild form.

(2) A small S trap even when made of unusually deep seal is incapable without special ventilation of resisting the action of siphonage or back pressure in a mild form.

(3) Small S traps when ventilated at the crown, with vent pipes having a diameter the full size of the bore of the trap, and of no unusual or excessive length, are incapable of resisting the severe action of siphonage produced by the simultaneous discharge of any powerful flushing water closets and ordinary bath tubs under ordinary conditions likely to be encountered in practice. Water closets producing a powerful flushing of the soil pipes when discharged should not be prohibited on account of their siphoning power, because the periodical flushing of the soil pipes by their use is productive of great good, and their siphoning action may be counteracted by other means.

(4) Special trap ventilation when the vent pipe is ap-

plied at or near the crown of the trap induces a current of air over the water which rapidly destroys the seal.

(5) Trap ventilation when the vent pipe is applied at a point so far below the crown as to avoid the danger of evaporation leaves the trap open to the danger of self-siphonage, as well as of severe siphoning action. The position of the vent pipe on the trap does not (at least within the limits covered by our experiments) materially affect the action of siphonage.

(6) Pot traps of the ordinary sizes are incapable, without special trap ventilation, of resisting the severest action of siphonage liable to be encountered in plumbing.

(7) Pot traps of the largest size are open to the objections attending all cesspools, and should never be allowed.

(8) Anti-siphon traps, may be constructed in such a manner as to resist permanently, without back venting, all the adverse forces to be encountered in plumbing.

CHAPTER XIX.

CAPILLARY ACTION.

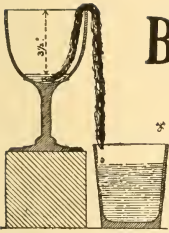

Fig. 283. Capillary Action Forming Short Siphon.

BESIDES the well known enemies of the water seal of traps already described, another exists which is, however, more insidious and no less fatal in its action. It works like the vampire, silently and stealthily, drawing the life from the trap without warning of any kind, and often leaves open the gates of the sewers without detection. Where the trap is constructed entirely of opaque material the absence of the water seal cannot be seen, and where glass is used it soon becomes coated with an opaque film, so that the source of the leakage of sewer air into the house cannot be seen and, as capillary action is unsuspected, the presence of sewer air is attributed to some other cause.

Capillary action is the subtle thief which does this mischief. Hairs, lint, bits of twine, paper, sponge or matted fibrous filth of a great variety of kinds are the tools with which it operates. A small quantity of any of these substances, forming a continuous mass or chain from the water in the trap to and over into the outflow, will, under certain conditions, soak up and slowly drain off the water from the trap until the seal is destroyed. Let us examine the conditions favorable to this action and ascertain by what means, if any, it may be prevented.

In books on the subject of capillarity we find the theory explained with scientific accuracy. The precise amount of

elevation of liquids in tubes of very fine bore, nominally of the diameter of a hair (capilla), is calculated in these treatises to a nicety, and we are in some of them referred for complete satisfaction and elucidation particularly to the gigantic work of La Place on "Celestial Mechanics" (tenth book, supplement). Knowing from the study of this interesting work that the tension of the surface of contact of two liquids or bodies is represented by the equation

$$T_{12} = \int_0^c (x_1 - x_{01}) \rho_1 + \int_0^c (x_2 - x_{02}) \rho_2^d v_2,$$

what more need the practical plumber have to cause the whole subject of the capillary effect of sediment in traps and the best methods of dealing with it to burst upon his delighted understanding in a flood of light? All he requires is a knowledge of the higher mathematics and some skill and ingenuity in arranging his data for calculation. He knows from the treatises that the finer the bore of the tube the higher the liquid will rise in it, provided the surfaces are of a kind the liquid can wet; that plane surfaces which can be wetted by a liquid will exert a similar attraction on liquids, provided they are put near enough together, not exceeding 1-10 of an inch apart, and that the attractive power is in proportion to the proximity of the surfaces and independent of the thickness of the bodies underlying them. But he will not find in the treatises what the exact effect will be on liquids of the interposition of numerous plane and rounded surfaces such as are presented by the sediment found in traps, under the peculiar conditions of surroundings, temperature and moisture met with in plumbing. Inasmuch as these peculiar conditions would render his calculations somewhat more complicated and difficult, and as the books have not investigated the subject

sufficiently, a study of this particular branch of the subject from a practical rather than a theoretical standpoint seems needed.

What is the capillary effect of large and small quantities of the sediment found in traps, and how can the loss of water by this agency be prevented?

It is evident, first, that the substances exerting the capillary action can conduct the water only to a certain limited distance above and beyond its surface, and that the rapidity of the removal of the water in a closed vessel will be in proportion to the shortness of the distance required to be raised; second, that capillary action in an open vessel greatly increases the loss by evaporation, and that the rapidity of the removal of the water in vessels of similar form but exposed to different degrees of change of air will be in proportion to the velocity and hygrometric condition of the air currents. Hence, if we use a trap having a seal of proper form, and do not allow the air above the trap to be changed in such a manner as to cause evaporation, aggravated by the spreading out of the water through capillary action, the trap will be secure against loss of seal through this agency.

To ascertain the distance which water will travel above the seal of a trap under the influence of capillary action, a number of experiments were made with various materials, such as are liable to collect in traps in practical use, including among them those which are found to have the maximum of effect in conducting the water by capillary action. The experiments were made both in ordinary open glasses and in different kinds of traps, both open and closed.

The first tests were to ascertain the perpendicular distance. Figs. 283 to 286 show the manner in which I made the tests with ordinary goblets. A number of these glasses were supported on blocks and filled with water. Over

their edges were hung the different substances to be tested, one end extending below the bottom of the water in the goblet, and the other to the top of a tumbler placed below it, as shown in the figures, to receive the water drawn from

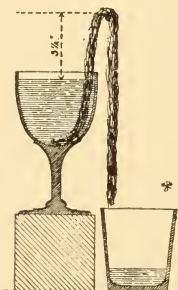

Fig. 284. Capillary Action Forming Longer Siphon.

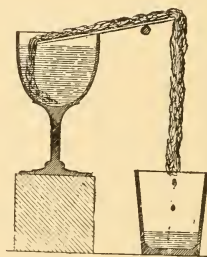

Fig. 286. Capillary Action with Horizontal Extension.

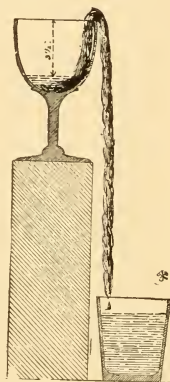

Fig. 285. Capillary Action with Long Siphon.

the goblets. The substances tested were matted hair-felt, lamp-wicking, both with and without its covering; jute; hemp-cord, unraveled and separated into fine fibres; hemp-cord in its natural braid, and pieces of string. Of all the

CAPILLARY ACTION.

substances tested, jute, such as is used by plumbers in caulking joints, proved to be the most effective in removing the water by capillary action, and this is the substance I shall use in our tests to-night. Different amounts of each substance were used in making the experiments. In each case experiments were made both with a small quantity of each material and with a mass large enough to completely fill the waste pipe. As might be expected, the water was most quickly removed when the quantity of the substance tested was large enough to completely fill the pipe. These experiments showed the limit of the carrying power in an upward direction with these materials under capillary action to be $4\frac{1}{2}$ inches. The water was rarely lifted more than 3 inches or $3\frac{3}{4}$ inches. The majority of the water carried into the lower glass was moved during the first ten or twelve minutes, the rapidity of the action gradually decreasing as the water descended, becoming extremely slow when the level was reduced about 2 inches, and generally ceasing altogether and the fibres becoming entirely dry at the top when the water in the upper vessel was reduced about $3\frac{1}{2}$ or 4 inches.

In emptying a vessel of water by means of a bent tube forming a siphon, the excess of length of the outer over the inner limb of the siphon governs, as I have shown, the rapidity of the flow. With capillary action, however, though the outer limb must always be longer than the inner, yet beyond a certain fixed point the excess appears to have no marked influence. A small predominance of the outer limb, as shown in Figure 283, or just enough to overbalance the column of water in the inner limb, carries off the water as rapidly as the long limb shown in Figure 285.

The results of the experiments with ordinary open vessels were as follows:

(a) Hair-felt. This is a material which closely resembles the matted deposit of short hairs which form so large a proportion of the deposit in traps and waste pipes. Strips of this felt one-quarter of an inch thick and of various widths and lengths were tested under different conditions. Tested with the glasses arranged as in Figure 283, with a strip three-quarters of an inch wide, it lowered the water in the glass 2 inches in the first ten minutes, but required four hours and a half to diminish the level another inch. After this no more water was carried over into the lower vessel, but the rate of evaporation of the water in the goblet was considerably increased by the hair-felt, which lifted the water to a certain height and distributed it over the fibres of the felt, thereby exposing a very large surface to the action of the air. A piece of felt 2 inches wide tested in a similar manner gave similar results. An increase in the width or length of the felt did not make, in this case, an increase in the amount of the water transferred from the upper to the lower vessel corresponding to the increased size, but increased the velocity.

(b) Lamp-wicking. A material closely resembling the soft, porous lint formed in traps and waste pipes. This was tested both with and without its cylindrical fibrous covering, as it comes prepared in the market for use in lamps. The wicking was cylindrical in form and about $\frac{1}{4}$ inch in diameter. It was first tested without its cover. Placed as shown in Figure 283, the wicking lowered the water only $1\frac{1}{4}$ inches in seventeen and one-half hours, after which no further transfer took place. Placed as in Figure 284, $1\frac{3}{4}$ inches were transferred in the same time. With the wicking covering on, only half the amount of water was transferred in the same time.

(c) Jute. A hempen, unwoven cord, with long, fine fibres, used by plumbers in caulking. This substance pro-

duced the strongest capillary action, and acts like very fine hair and lint. Arranged as in Figure 283, a piece $\frac{1}{4}$ inch in diameter transferred $1\frac{1}{2}$ inches in fifteen minutes and $2\frac{1}{2}$ inches in four and three-fourths hours. Another piece, 1 inch in diameter, transferred 2 inches in fifteen minutes, and the whole 4 inches in four and three-fourths hours. Another piece, supported as shown in Figure 284, raised the water $4\frac{1}{2}$ inches, after which the lower end of the long arm dried up, and what water was thereafter raised from the goblet was carried off by evaporation, but not transferred to the lower glass.

(d) Hemp-cord, unravelled and separated into fibres, was in no case able to raise the water above 4 inches from its surface.

(e) Twisted or braided, as it comes in cord for the market, it could not transfer more than 2 inches from glass to glass.

(f) Pieces of linen twine (eight pieces) could not transfer more than $\frac{3}{4}$ inch.

Beyond these points the various substances invariably dried up at their lower ends, after which, of course, whatever water was taken from the upper vessel was removed by evaporation.

Tests were then made on various similar fibrous substances, both in the manner described and also enclosed in small, $\frac{1}{4}$ -inch bent lead tubes, to prevent evaporation from effecting the action. In no case, except with sponges, could the water be raised over $3\frac{1}{2}$ inches, and rarely over 3 inches by these substances. The outer arms dried up before the water in the upper glasses was lowered 3 or $3\frac{1}{2}$ inches. Without the lead tubes, the outer arms dried up sooner than with them, hence less water was carried over into the lower glasses, but more was lost by evaporation. The loss of water was greater without the tubes, but the

action was slower, since the drying up of the outer arms prevented the rapid removal by the combined capillary and siphoning action.

Fig. 286 shows the manner in which tests for the limit of horizontal and inclined distances were made. It was found that an increase in horizontal distance facilitated the drying of the mass, and therefore correspondingly diminished the siphoning action.

I will now place pieces of jute $\frac{1}{2}$ inch in diameter in each of the three glasses on the table, just as you see them represented in the picture, and in a few minutes we will observe the action they have produced. The water stands in each goblet exactly on a line with the top of the glass.

From the experiments I have so far described, and numerous other tests made in the same manner, we learn that the extreme limit of the lifting power of very small quantities of the long, fibrous substances which might lodge in traps so as to exert a capillary action is within three inches. Sponge is the only substance known to the writer as likely to be found in waste pipes which has a lifting power exceeding this. The limit of sponge, even in large masses, appears from the tests made at the same time with the others, to be 8 inches; but as the general shape of a sponge is spherical, and never filiform, and as no sponge large or long enough to extend upwards this distance or anything approximating it, and then down again the same distance into the waste pipe, could possibly be squeezed into a trap without stopping up the waterway altogether, the consideration of this material and all others of similar form need not enter into our calculation.

TESTS WITH TRAPS.

Thus far the experiments have been made in the open air in ordinary open vessels. The tests were made in the

CAPILLARY ACTION.

shade, and in a temperature varying between 60 and 70 degrees F., or the ordinary temperature of house interiors. To render these results of more practical value they should be compared with the tests made on the same materials in the actual positions found in practice—i. e., in the trap itself. The tests were, therefore, made both in detached traps and in traps fixed in position and properly attached to the drain pipe.

TESTS WITH ORDINARY S-TRAPS.

A $1\frac{1}{2}$ -inch S-trap having $1\frac{1}{2}$ -inch seal was arranged as shown in Figure 287. A string of jute $\frac{1}{4}$ -inch in diam-

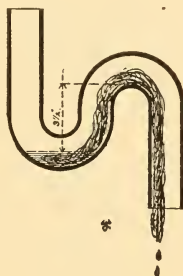

Fig. 287. S-Trap having its Water Seal Destroyed by Capillary Action.

eter was introduced so as to extend from the bottom of the trap over the outlet and down several inches below the bottom. The experiment was repeated five times, the results each time being nearly identical. In the first half minute the water in the trap was lowered $\frac{1}{2}$ inch. Five minutes sufficed to lower it 1 inch, twenty minutes $1\frac{1}{4}$ inches; a half-hour usually sufficed to break the seal, and about three hours was enough to leave the trap almost dry.

The quantity of jute was afterward increased to 1 inch

in diameter, which was the maximum possible, inasmuch as it was sufficient to fill the trap as full as it could ever possibly get in practice. In every case enough water was drawn out of the trap to break the seal in less than half an hour. Two minutes generally sufficed to lower the seal an inch. Hair-felt emptied the trap in from nine to fifteen minutes.

TESTS WITH POT-TRAPS.

A number of pot-traps were then tested. An 8-inch pot-trap having $3\frac{1}{8}$ -inch seal was arranged as shown in Figure 288, the mass of jute being 1 inch in diameter. It required twenty-four hours to lower the water $1\frac{3}{4}$ inches. Two days reduced it 1 13-16 inches; three days, $1\frac{1}{4}$ inches; seven days, 1 15-16 inches. After this no further change took place in the trap. Evaporation was too slow to make any perceptible difference in several days, since the trap was not ventilated.

A vessel of water about the same size and form with the 8-inch pot-trap, but freely open above to the air, so that evaporation could go on, and having a piece of jute $1\frac{1}{2}$ inches in diameter hanging over its edge, as in Figure 283, lost 5 inches of water in five days. A portion was carried over as in the 8-inch pot-trap into the vessel below, but the rest was removed by evaporation hastened by the capillary action.

A 6-inch pot trap similarly arranged lost $2\frac{1}{8}$ inches in one day, 2 5-16 inches, $2\frac{3}{8}$ inches and 2 7-16 inches, in two, three and five days, respectively, after which no apparent further change took place, the experiment lasting several days longer.

A $3\frac{1}{2}$ -inch pot lost $\frac{5}{8}$ inch, 1 inch, 2 inches, $2\frac{3}{4}$ inches, $2\frac{7}{8}$ inches and 3 inches in one, six, fifteen, forty-eight, seventy-two, 144 hours, respectively, after which no further change took place.

CAPILLARY ACTION.

Figs 288-b and 288-c show the manner in which the unvented "Sanitas" trap is able to retain its seal under capillary action. The fibrous matter not being able to raise the water high enough to break the seal. The horizontal extension of the unvented "Securitas" trap combined with the elevation of its outlet, provides similar protection. Moreover, the construction of these traps is such that it would be impossible, without special manipulation, to so weave a

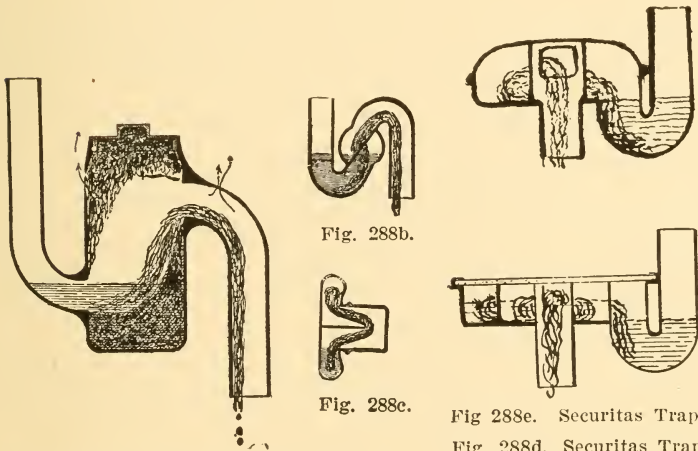

Fig. 288. Pot Trap losing its Seal through Capillary Action.

Fig. 288b.

Fig. 288c.

Fig 288e. Securitas Trap.

Fig. 288d. Securitas Trap Antisiphon Traps Resisting Capillary Action.

mass of fibrous material through the trap that it could connect the lower with the upper bend in such a manner as to place the former within the influence of capillary attraction. This reasoning was corroborated by prolonged tests.

Thus we see that the effect of capillary action in traps detached from the drains is similar to that in open vessels, with the exception that in traps unvented no perceptible loss took place through evaporation, and that after the limit of perpendicular distance at which the capillary force

can act has been attained, no further loss of water is perceptible. In open vessels, on the contrary, the draught on the water goes on indefinitely by rapid evaporation aided by the distributing process effected by the capillary action.

TESTS OF THE EFFECTS OF CAPILLARY ACTION IN VENTILATED AND UNVENTILATED S-TRAPS FIXED IN POSITION.

To test the loss by capillary action on ventilated S-traps as compared with the loss on the same when unventilated I attached an S-trap having a $4\frac{5}{8}$ -inch deep seal to a branch waste entering the soil pipe, after having half filled the trap with jute as shown in Figure 288. With the trap unventilated the loss by capillary action was as follows: In the first five minutes $\frac{1}{2}$ inch; in the first forty-five minutes 1 inch; in twenty-four hours 3 inches; in three days $3\frac{1}{4}$ inches; in four days $3\frac{3}{8}$ inches. Thereafter no further perceptible change took place. It made no perceptible difference whether the basin side of the trap was opened or closed, showing that evaporation in an unventilated trap is practically imperceptible.

The experiment was then repeated on the same trap, ventilated at the crown, into a cold flue with the following result: In one hour $1\frac{1}{2}$ inches had been removed; in 5 hours $1\frac{7}{8}$ inches; in 22 hours $2\frac{1}{2}$ inches; in two days $3\frac{1}{4}$ inches; in 3 days $3\frac{1}{2}$ inches; in 4 days $3\frac{3}{4}$ inches; in 5 days 4 inches. Thus the loss continued at the rate of about $\frac{1}{4}$ inch a day by evaporation, after the outer end of the jute mess had entirely dried up. This rate of evaporation was nearly double what it would have been had it not been assisted by the capillary action. From this we see that ventilation greatly increases the danger arising from capillary action, often rendering the latter dangerous in cases where, without ventilation, the seal would not have been broken.

CAPILLARY ACTION.

To test this point still further I placed two ordinary drinking glasses, filled with water side by side. The first was treated as shown in Fig. 284, with a mass of jute hung nearly 5 inches above the surface of the water and having one end immersed in it as shown in the figure, the other extending below the bottom of the glass. Owing to the height from which the jute was suspended the water did not rise to the point of support; consequently the outer arm was dry, and whatever loss of water was observed was, therefore, due to evaporation.

The glass having the water alone lost by evaporation only $\frac{1}{4}$ inch in seven days, while that having the jute lost 1 inch, or four times as much in the same time.

FRICITION.

A consideration of very great importance in trap construction and arrangement is the amount of retardation to the passage of the waste water caused by the friction against its interior surfaces.

In order to obtain the quickest delivery and maximum of scouring action on the waste-pipes below the trap, it is important that the trap should afford the minimum of obstruction to the flow of the water. Many traps, especially gravity-ball and other mechanical traps, are so formed as to greatly retard the flow of the water. With many ball-traps, when the water is permitted to escape from the fixture through the waste pipe "full-bore" above the trap, the ball is so forcibly driven against the outlet mouth of the trap as to very seriously obstruct its further passage, and prevent its exerting its full scouring effect on the pipe below.

An ordinary S-trap offers the least resistance to the flow of the water, the gravity ball trap the most, if we except certain forms of mercury-seal traps.

An ordinary bath tub arranged as shown in Fig. 243 will discharge through $1\frac{1}{2}$ -inch waste pipe, 9 feet long, descending perpendicularly and without a trap, at the rate of 1.4 gallons of water per second.

An ordinary unventilated $1\frac{1}{2}$ -inch S-trap, with a seal $1\frac{1}{2}$ inches deep, will retard the flow only 23 per cent, or it will discharge at the rate of a little more than one gallon a second.

Another $1\frac{1}{2}$ -inch unventilated S-trap emptied the tank at the rate of 1.1 gallons a second.

The same trap ventilated prolonged the time of emptying the tank from 90 to 113 seconds, thereby retarding the flow 23 seconds or 26 per cent. The ventilation also created a loud and somewhat terrific roar during the entire duration of the discharge caused by the suction of the air at the vent opening. Without any trap, the tank discharged in 73 seconds. With a hinged valve trap, unventilated, it required 126 seconds. With the same trap ventilated a very much longer time or 163 seconds was required; the ventilation retarding the flow 37 seconds or 30 per cent.

A 4-inch pot trap, unventilated, required 104 seconds. The same ventilated required 144 seconds, or 38 per cent.

A 4-inch bottle trap, unventilated, required 94 seconds. A gravity ball trap required 226 seconds.

In both of these ventilation reduced the flow from 30 to 35 per cent, by calculation.

Thus we see that the average retardation of the discharge from a bath tub, and the consequent loss of scouring effect, caused by ventilation, is very great and amounts to about 30 per cent, or nearly a third of the whole when the outlet is arranged to discharge through a perpendicular waste "full bore," and where the vent pipe is short. When

a long vent pipe is used the percentage of loss is somewhat less. The discharge of a wash basin having an outlet large enough to fill the waste-pipe "full-bore" gave similar relative results for different traps.

SUMMARY OF TEN OBJECTIONS TO SPECIAL VENTILATION.

I find, therefore, no advantage whatever in trap ventilation. The disadvantages, however, are very serious, and may be summed up briefly as follows:

(1) It destroys the trap seal by evaporation when applied at or near the crown. With S-traps this position of the vent is necessary to prevent self-siphonage.

(2) It can not always protect the trap from siphonage even when newly applied in the most approved manner.

(3) It increases the unscoured area of the trap, making it a cesspool. It is a very strange piece of inconsistency to condemn the cesspool trap on account of its unscoured chamber and yet adopt in its place a ventilated S-trap, because by so doing the very thing we wish to avoid is reproduced in an aggravated form; the mouth of the vent pipe forming a sediment chamber which is not only greater in extent of surface, more easily fouled and less easily cleansed than that in the pot trap, but one which is far more dangerous in as much as its fouling, even to a limited extent, involves the destruction of the whole system. I have found by repeated tests that the water discharged from a large outlet basin and trap placed where it should be near the floor, is thrown up from 10 to 18 inches into the vent pipe at every discharge. Thus a large sediment chamber is formed which has an area of nearly 100 square inches. Beyond this, congelation of fatty vapor foulds to

an indefinite extent, and it is no uncommon thing to hear of a vent pipe filled with grease for several feet above a sink trap.

(4) It retards the outflow of the waste water and its consequent scouring effect about a third when arranged to discharge perpendicularly "full-bore."

(5) It complicates the plumbing and adds to the danger of leakage through bad joining and increased material.

(6) It aggravates the danger arising from capillary action.

(7) It increases the corrosion of branch wastes by retarding the rapidity of flow and scouring effect allowing sediment to collect more rapidly than it otherwise would, and brings soil pipe and sewer air in contact with the branch wastes to take the place of the pure air of the house, which follows every discharge of the fixture. Moreover, as soon as the mouth of the vent pipe begins to get clogged by sediment and grease, the air current it was intended to produce is partially or wholly arrested, and we then have an interior surface of foul piping equally exposed to corrosive action with the unventilated pipe, but more than double in quantity.

(8) Finally it seriously increases the cost of plumbing, an increase which amounts to as much as from five to ten per cent on the total cost of the plumbing in new work, and indefinitely in old work in which the trap ventilation sometimes becomes by far the greatest part of the work to be done.

CHAPTER XX.

BY PASSES.

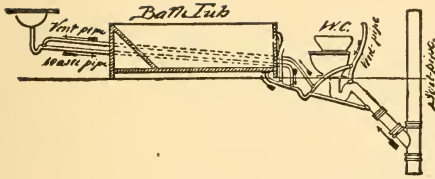

Fig. 289.

One of the evil effects of the complication of piping due to the trap vent law is that it renders the plumbing more difficult to arrange, repair, and understand. The proper placing of the vent-pipes often

requires considerably more skill on the part of the workmen than is expected of or found in them. The result is a very frequent misplacement of the pipes, which sometimes remains undiscovered by the plumber, and even by the owner, until made known by foul odors or more serious evils.

Figs. 289 to 293 illustrate the manner in which this complication leads to trouble. The vents in these cases were all put according to the letter of the plumbing law, and seem at first sight to be correctly placed, but upon closer examination it will be discovered that they are not only themselves utterly valueless as ventilators, but that they destroy the value of all the traps. They form by their peculiar combinations open passageways for the entrance of sewer-air from the soil-pipe into the house. The errors appear to have been brought, after the completion of the work, to the attention of the board of health.

These first five drawings are from the "Sanitary Engineer." The arrows show the manner in which the sewer-

air may find its entrance by circuitous route into the dwelling. In Fig. 289 three fixtures are trapped and vented. The wastepipe of the wash-basin enters that of the bath-tub inside of the bath-tub trap. Had it entered beyond the trap, the difficulty would have been avoided. But inasmuch as it is not unusual, where no vent-pipes are used, to enter

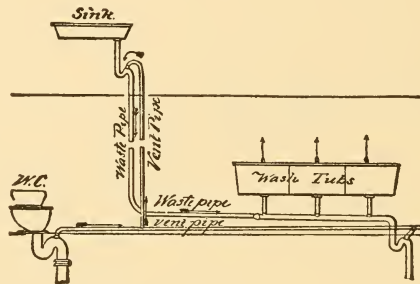

Fig. 290.

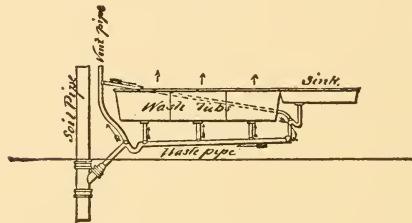

Fig. 291.

short branches on the house side of the trap, the error is not an unnatural one for the plumber to make. It is one which is not easily detected at a glance, and which might never be observed by the house-owner or anyone who was not an expert. The warmth of the air in the house and the draught of the fire-places would often be sufficient to create a reverse current in the vent-pipe, and produce the movement shown by the arrows. It will be observed that

the bath-tub trap is vented on both sides. The effect of this is to increase the destructive action of the ventilating current on the water seal of the trap. An S-trap, having the usual depth of seal of $1\frac{1}{2}$ in. or $1\frac{3}{4}$ in., would lose this seal in a few hours if the current were rapid, or within two or three days with an ordinary current. The water closet trap being, as shown, larger than the others, a cur-

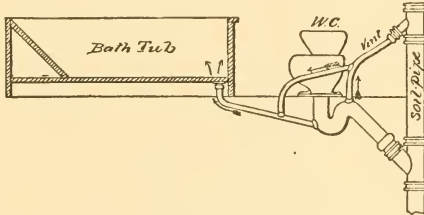

Fig. 292.

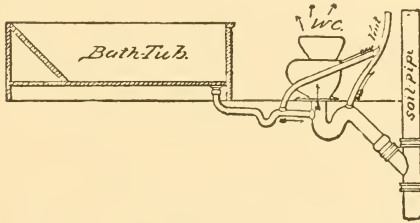

Fig. 293.

rent might easily be formed over the bath trap simultaneously on both sides of the trap.

Figs. 291, 292, 293 give similar examples. In all cases the mistake lays in entering the waste of one fixture on the wrong side of the trap of another. In each illustration one of the traps will be found to have a double action exercising against its water seal.

As here arranged, we have excellent conditions for producing self-siphonage of the wash-basin trap. When a

basin having an outlet as large as the one shown is discharged by lifting the plug it will fill its waste pipe "full-bore," and the contents of the basin up to its overflow opening will fill the pipe full as far as to the horizontal runs of the pipe. This long arm of the siphon will at once pull over the water in the short arm as soon as the basin is empty, and the suction on the trap will continue until the water column has traversed the entire length of the branch waste, thus giving the siphoning action ample time to suck out any water that may trickle down into the trap from the basin after the discharge. This action will be the more positive the longer the branch waste and the greater its pitch, attaining its maximum with the perpendicular position of the waste pipe.

Fig. 294 exhibits still more forcibly the absurd confusion this system leads us to when we attempt to carry it out completely in its logical consequences. We have here the vent and waste pipes for three simple fixtures, which are taken with some modification from a house in New York, where they have been exhibited with pride by their perpetrators. These fixtures and arrangements are repeated on each of several stories. We have shown only the waste and vent pipes. When to these, we imagine, are added the necessary hot and cold water supply and service pipes, we can form a pleasant idea of the condition of things our "branch-waste" ventilating engineers are bringing us to. The fixtures have the double vent, recommended by some of our sanitary engineers and plumbers. The upper vent enters a flue or pipe heated by an interior steam-pipe, as shown, and is called the overflow and local vent pipe. None of the shallow traps used could withstand the action of these strong air-currents more than a few days or even hours. In consequence of this, house-owners often close up the overflow openings of wash-basins and bath-tubs with putty

or corks in the hopes of rendering themselves secure against the odors resulting from evaporated trap seals. And this closure of the air supply to traps through overflow passages greatly increases the danger of trap siphonage, as we shall hereafter show.

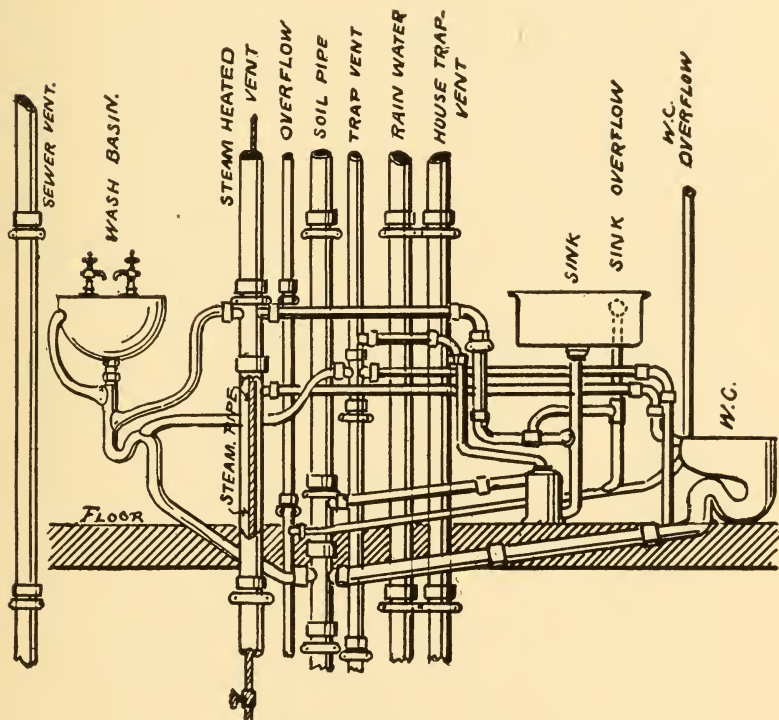

Fig 294.

Observe the complication of the plumbing involved by the use of these wriggling, intertwining ventpipes, which, like venomous snakes, literally crawl about, ready to poison as well as puzzle and alarm the unhappy houseowner or

plumber who unskillfully handles them, with the noxious vapors which they are designed to carry off in their bodies. In the economy of nature the serpent is found to have certain useful purposes, but the trap-vent has none, and should suffer the serpent's curse and be crushed out of existence as soon as possible.

One of Boston's leading plumbers said to me one day: "We know perfectly well that the 'back-vent' law is an imposition upon the public, but the law was brought about by the influence of the early sanitary engineers and the sanitary engineers must, therefore, be the ones to get it taken off again." But the plumbers are doing better than this remark implied, for many of them are co-operating with the sanitary engineers in their efforts to have this burden removed.

The public are becoming so much alarmed at this increasing complication that they are reducing the conveniences of plumbing in their buildings to the smallest amount possible, where its comforts might otherwise be enjoyed in perfect safety. It is throwing an undeserved distrust upon the whole system of water-carriage.

PAST EXPERIMENTS ON SIPHONAGE MADE BY HELLYER,
WARING, PHILBRIC, BOWDITCH, AND OTHERS.

The experiments on the effects of siphonage made and published in this country and in Europe before those I have already described, were made chiefly with pan and hopper closets, and in such a manner as to produce a much feebler siphoning action than is obtained by the use of valve or plunger closets. A pan-closet produces a very slight siphoning action, and this closet is comparatively seldom used to-day, although it is by no means extinct. Valve and plunger closets are fast giving way to the improved forms

of hopper closets, but there are, nevertheless, thousands still in use in all parts of the country.

Even when the bowl of a pan-closet is filled to the brim and emptied, as in the experiments of Col. Waring for the National Board of Health, by means of a plug, the obstructions to the downfall of the water offered by the sides of the receiver and the inertia of the water standing in the trap, prevent a disturbance at all comparable with that caused by the discharge of powerful flushing closets. The value of a closet as a flushing-tank for the drain pipes is almost exactly proportional to its siphoning power. The investigations of Col. Waring are valuable particularly in showing the siphoning power on branch wastes of the discharge of bath-tubs into the main soil pipes, an arrangement extremely common, and in establishing the utmost limit of the siphoning power of the pan-closet, the one then most widely known and used. With the basin filled to the brim and suddenly discharged, the siphonage produced immediately broke the seal of unvented S-traps, but could not unseat a vented S.

In the experiments of Bowditch and Philbrick a short hopper closet, the next in general use at that time, was employed, and, to secure as useful results as possible, the closet was charged with water from a two-gallon pail, in the manner usually done when it is used as a slop-hopper. Such a use of the short hopper forms a far severer test than its ordinary flushing, though not severer than may often be produced with the powerful flushing of modern fixtures. More powerful siphoning action is often produced in practice in houses than was given by these tests, and the deductions based upon them which gave rise to the trap-vent law in many cities must be radically changed. For they showed that an S-trap, ventilated as they did it, and subjected to this strain, was secure, whereas a heavier strain

or a different method of venting may break its seal as I have described.

The experiments of Hellyer in England form a better basis for plumbing legislation, inasmuch as his tests were made with those water-closets and other fixtures in common use in England which produce a much severer effect.

CHAPTER XXI.

WASH BASINS.

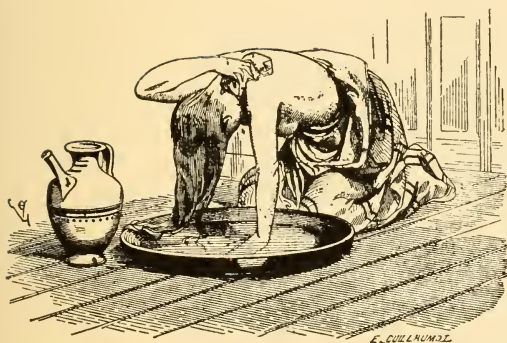

Fig. 294. Fifteenth Century Lady at Her Toilet
from Viollet le Duc.†

The wash basins of the ancients were generally double, or provided with pitchers, and this is shown in the sculptures and paintings of Egypt and in the figures on the bas reliefs and pottery of Grecian antiquity.

Figure 294 shows the manner in which these early lavatories were used. They were quite large and made of silver or copper with pitcher to correspond. They were smooth on the inside so as not to retain dirt or soap, but engraved sometimes very richly on the outside. In use they were placed upon the floor, and the bather was obliged to rest upon the knees, and in this way the basin was used as a bath tub, not only for the head and hands, but for the whole body.

I am indebted to the kindness of my friend Prof. Edward S. Morse for permission to reproduce a number of illustrations of Japanese bathing appliances from his most delightful and instructive work entitled "Japanese Homes and Their Surroundings," in this course. Simple con-

†Dictionnaire du Mobilier Francais, Vol. 2. Published by A. Morel, Paris.

veniences exist in Japanese houses for taking a hot or cold bath, as we shall show under Bath Tubs, but wash basins are more primitive. "In the country," says Prof. Morse, "a Japanese may be seen in the yard or by the roadside washing his face in a bucket or shallow tub, and at inns and even in private houses one is given a copper

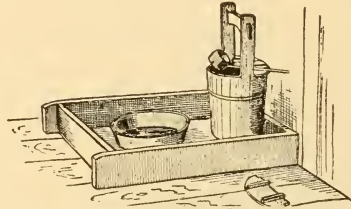

Fig. 295. Japanese Wash Basin.†

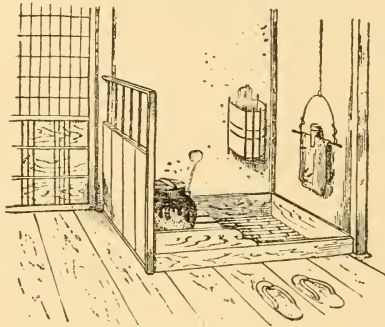

Fig. 296. Japanese Wash Basin.†

basin, and, a bucket of water being brought, he uses a portion of the verandah as a wash stand." The one shown in Fig. 295 shows how the Japanese of modern times perpetuate mediæval customs, the shallow trough on the floor corresponding with the carved silver or copper utensils of

†From "Japanese Homes and Their Surroundings," by Edward S. Morse.

WASH BASINS.

the ancient days. The Japanese lavatory consists of a shallow trough resting on the floor at the end of the verandah or passageway containing a copper basin and a stout water bucket with cover.



Fig. 297. Simplicity in Plumbing Appliances. Japanese Lady at Her Toilet.*

The bather must crouch upon the ground in order to use this basin, like the people of the past.

Another illustration of floor lavatory is shown in Fig. 296. It was placed at the end of the verandah. "A low partition formed a screen at one side; within the recess thus made was a low shelf for the pottery water jar. The

*From *Japan Illustre* by Aime Humbert Libraire de l'Hachette et Cie, Paris. 1870.

floor of the sink consisted of bamboo rods placed close together, through which the spilled water found its way by proper channels to the ground without. A paper lantern hung against the wall, and dipper and towel rack were conveniently at hand."

The ornamental woodwork in these lavatories is often

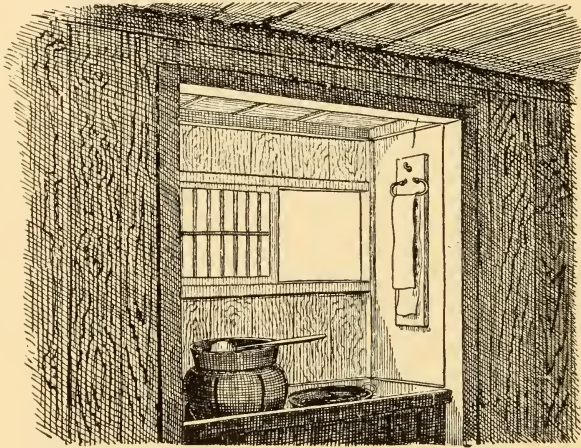

Fig. 298. Japanese Wash Stand.*

very attractive, but the waste water disposal is exceedingly primitive and objectionable in every way.

It is difficult for us, moreover, to understand how the Japanese find comfort in the cramped position necessary to use these low set wash basins.

Fig. 298 shows a form of lavatory more familiar to us. It is a private house in Tokio in a recessed portion of a passageway behind a suite of rooms. Sliding windows with white paper panes admitted light to this most attract-

*From Prof. Morse's "Japanese Homes,"

WASH BASINS.

ive and carefully finished toilet room with its quaint towel rack and neat and simple natural furnishings. The water jar is of rich brown pottery, the dipper of wood and the basin of copper. Prof. Morse says of it: "It may seem odd for one to get enthusiastic over so simple an affair as trough and a few honest contrivances for washing the hands and face; nevertheless such a plain and sensible arrangement is a relief, in contrast to certain guest chambers at home, where one wishing to go through the rather vigorous performance of dashing into the water with his elbows outstretched finds these free movements curtailed to the last degree by a regiment of senseless toilet articles in the shape of attenuated bottles, mugs, soap dishes with rattling covers and diminutive top-heavy pitchers crowded about his wash basin, and all resting on a slab of white marble. Things are inevitably broken if they are brought down too hard upon such a bottom. After such recollections, one admires the Japanese sink, with its durable flat-bottomed basin, capacious pottery jar for water, and ample space to thrash about in without fear of spattering the wall paper or smashing a lot of useless toilet articles in the act."

This comparison is with our portable basin and pitcher, the neat Japanese wooden sink taking the place of our troublesome and uninviting slop pail with its perforated cover, upon which the tormented bather is expected to guide the waste water from the basin after use with unerring hand or find half its contents on the carpet. Neither arrangement, however, can compare for a moment with our hygienic and generous city laboratories, where ample space is provided by a broad slab for free and luxurious bathing, and a judicious arrangement of soap dish and other conveniences on a special shelf above. We must, however, in our cities sacrifice a portion of our thrash-

WASH BASINS.

the waste pipe and trap. The result is imperfect flushing of these pipes and traps, gradual accumulation of filth in

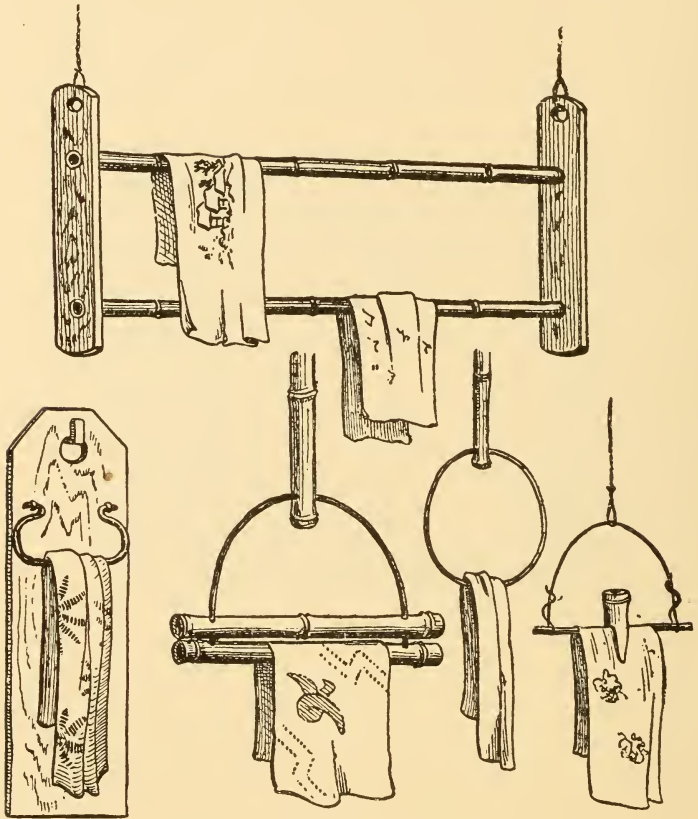

Fig. 299. Japanese Towel Racks.*

them, and the various serious evils to which such accumulations give rise.

Not only then should every wash basin be constructed

*From Prof. Morse's "Japanese Homes."

ing about for the advantages of immediate and convenient removal of the waste water after use by the mere turning of the waste water handle, and thus doing away with the sink or slop pail receiver, which, whether in America or Japan, must retain in its corners more or less sediment from the dirty water discharge, however carefully it is cleansed in the daily rounds of the chambermaid.

Fig. 279 shows some of the simple and interesting rustic towel racks used by the Japanese. They are made of bamboo and suspended in the various ways shown. "The simplest kind is in the shape of a ring of bamboo suspended by a larger bamboo, to the end of which it is attached. Another form, and a very common one, is a yoke of bamboo, the lower ends of which are firmly secured to a larger bamboo, confining at the same time a piece of bamboo which slides freely up and down on the yoke, and by its own weight resting on the towel which may be thrown across the lower bamboo. Another form consists of a loop of bamboo suspended to the side of a board which is hung against the wall.

"The towels are pretty objects, being of cotton or linen, and usually have printed upon them sketchy designs in two shades of blue."

Coming now from the appliances of other times and people to our own requirements, we find the form and construction of our lavatories a matter of much greater importance than is generally supposed. We are to abolish trap venting and obtain the cleansing of our branch waste pipe system through water flushing. All our plumbing fixtures must therefore be constructed on the principle of the flush tank; that is, they must have discharge outlets as large in their clear waterway as the waste pipes to which they are connected. As usually constructed, the outlets are still altogether too small in proportion to the size of

on the principle of the flush tank, but it should be so constructed as to encourage its actual use as such, or, in other words, so as to render it more convenient to use it properly as a flushing apparatus than improperly as a simple open funnel to guide the water, used running from the faucet into the waste pipe. Both economy and safety as well as convenience are dependent upon such construction.

It will be found on accurately measuring the clear waterway in the outlets of the majority of lavatories now in use that when the space and function of the strainer are considered, the efficiency of the flush is very greatly reduced, and with all lavatories of the older styles having the conventional forms of basin and sink strainers the amount of waterway is not more than equal to that of a $\frac{1}{4}$ -inch pipe. A very short usage soon reduces this meagre opening, through the collection of sediment and lint, to a still smaller stream. The waste pipes are usually $1\frac{1}{4}$ to $1\frac{1}{2}$ inches in diameter, a capacity which is given for the purpose of ensuring the safe removal of the water delivered by two supply faucets running full force, under medium or high city pressure, and escaping through the outlet and overflow passages combined, together with a possible simultaneous discharge of other adjoining fixtures entering the same waste. Now a half or three-quarter-inch stream of waste water trickling through pipes capable of delivering many times as much, fouls but does not scour them. I have taken out such waste pipes and found them more than half filled with slime and filth, and in places where the pipe ran nearly horizontal, or made sharp bends, I have found them nearly filled with the putrefying mass. No amount of ventilation can cleanse such pipes. But the sediment was soft and gelatinous, and would easily have been swept away by the powerful discharge of a basin filling the pipes "full bore."

As already described, I caused a piece of waste pipe in which coating of sediment had been collecting for a long time to be flushed by a wash basin constructed with a large outlet after removing the plug and chain basin through the use of which the sediment had been deposited. From the new basin the water rushed at the rate of about half a gallon a second. After two or three discharges it was found that almost all of the coating of greasy sediment and slime had been removed by the powerful friction of the water.

It must be borne in mind that the scouring effect of a stream of water (irrespective of its size) which fills the waste pipe "full bore" is entirely different from that which only partially fills it. The former flows with a velocity and force determined by the weight of its entire column, or under a head equal to its perpendicular length; while the latter falls without head, because the air breaks the continuity of the water column, and then the velocity and force occasioned by the head is entirely destroyed.

Now, with a very small flushing stream an S-trap becomes equivalent to a pot trap, and its fouling tendency is as great as a pot trap having a waterway bearing the same proportion to the size of its body that the contracted basin outlet bears to the body of the S-trap, and the same holds even with a straight waste pipe itself.

As the first aim and principle of sanitary engineering is to remove foul matters as rapidly and completely as possible, so, in the present connection, our first care should be to see that our fixtures are formed with outlets large enough to fill the pipes full bore in order to accomplish this result.

Had the framers of our present plumbing laws included a provision requiring all lavatories to be constructed on this principle, instead of insisting upon the worse than useless trap and branch waste ventilation, the public would

have been benefited in many more ways than one. No reason is given why the laws should now continue to exist with these serious imperfections, and no good reason can be given.

It remains to be seen how soon the good sense of the public will demand their correction.

Besides the important sanitary advantage of a rapid discharge, we have others of economy and convenience. To empty an ordinary basin with contracted outlet requires a very considerable amount of time and patience. The result is that people fall into the habit of washing from the faucet rather than from the basin, and a great waste of water is involved. A quick waste and convenient method of operating and controlling it results in a saving of water and very great convenience in usage. A knowledge that a sudden discharge of a basinful of water through the pipes acts as an important sanitary measure, after the manner of a flushing tank, in cleansing them from end to end, leads to a legitimate use of the basin, and an economy of water, a consideration which the public in times of droughts will not be slow to appreciate.

A critical examination of the leading types of fixtures now in use is necessary to enable us to understand clearly what features are to be recommended, and what are to be avoided. Such a classification is also indispensable to enable us to judge at once for ourselves the merits of any fixture we may be called upon to examine. It systematizes our ideas, and in this lies its chief difference from a mere "cataloguing" of plumbers' supplies, which oftener results in confusion. From these considerations it is evident that our drawings must illustrate, not imaginary types, but those in actual use, in order to be of any practical benefit as a guide in selection, and hence we shall in most cases select some special fixture as a standard representing its class.

WASH BASINS.

CLASSIFICATION OF REQUIREMENTS FOR BASINS.

The ideal wash-basin should possess the following characteristics :

(1) It should be so formed as to permit of a discharge rapid enough to fill the waste pipe "full bore."

(2) It should have a suitable overflow without concealed or inaccessible passage.

(3) The whole of the fixture and all of its parts should be easily accessible at all times.

(4) Its outlet passage should be controlled by a mechanism requiring but a single, simple movement to operate it, and the minimum of strength or effort.

(5) It should be easy to set, and have no parts liable to clog or get out of order.

(6) Its outlet mechanism should be so constructed as to require no fitting or adjusting.

(7) It should have a minimum of surface exposed to the water used.

(8) It should be simple, durable, economical and pleasing in appearance.

CHAPTER XXII.

CLASSIFICATION OF THE DIFFERENT KINDS OF BASINS.

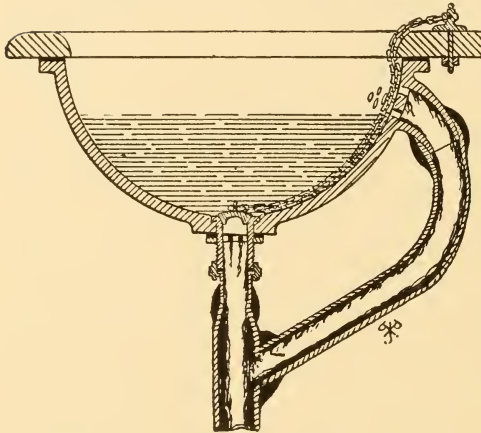

Fig. 301. Ordinary Wash Basin with Plug and Chain Outlet.

- (a) Plug-and-chain outlet.
- (b) Waste-cock outlet.
- (c) Valve outlet.
- (d) Plunger outlet.
- (e) Floating-plug outlet.
- (f) Standpipe outlet.
- (g) Receiver outlet.

Basins having open overflows into:

- (a) Funnel outlet.
- (b) Standpipe outlet.
- (c) Rear outlet.

Each of the above classes may have for its supply either ordinary standing faucets or nozzles supplying water at some point or points below the basin rim.

I have divided basins into two general classes: (1) Those having concealed overflow passages, and (2) those having open overflow passages. Each of these is subdivided as follows:

Basins having concealed overflows into:

CLASSIFICATION OF THE DIFFERENT KINDS OF BASINS.

I.—CONCEALED OVERFLOW BASINS.

This class of fixture violates one of the first conditions of sanitary plumbing. A portion of the apparatus intended to carry off waste water at irregular and uncertain intervals, by which it becomes fouled without the possibility of

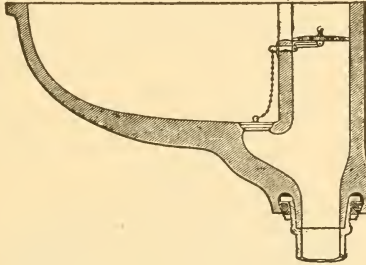

Fig. 302. Section of an All Porcelain Plug and Chain Basin.

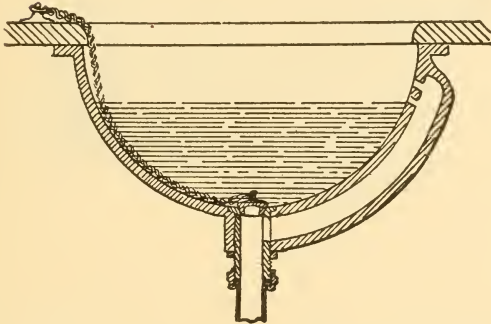

Fig. 303. Section of Plug and Chain Basin with Overflow Passage Cast with the Basin in One Piece.

cleansing through water flushing action, is placed in such a position that it cannot be seen nor reached without disconnecting the whole fixture.

Our first subdivision of this class is the ordinary (a)

PLUG AND CHAIN OUTLET BASIN.

We see here (Fig. 301) a concealed overflow pipe con-

structed of lead and so placed as to be altogether inaccessible. Being above in open communication with the air of the room, it taints it with the decomposing soap and filth with which its sides soon become coated, and this odor and the fear of sewer gas leads to the common practice among house owners of stopping up the holes in the earthenware leading into the overflow pipe at considerable inconvenience to themselves and increase in siphoning action upon traps below.

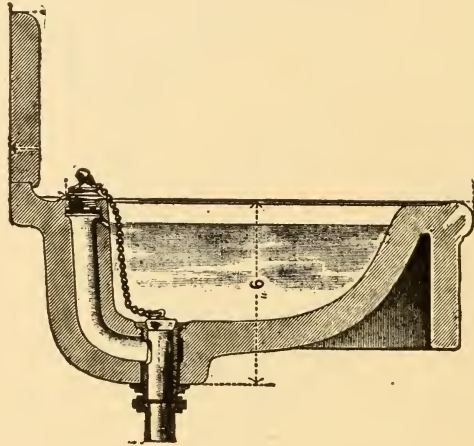

Fig. 303 bis.

The ordinary wash-basin has no proper flange for connection with the lead overthrow pipe, and the joint in the majority of cases is not a reliable one at this point. The connection of the lead overflow pipe with the waste pipe must be made above the trap, and must be wiped with solder, so that two joints are necessitated at the overflow, which add both to the expense of the work and to the chances of imperfection and leakage. It is an exceedingly common thing to find the overflow pipe wrongly connected.

PLUG AND CHAIN BASINS.

It is sometimes entered below the trap, sometimes attached directly to the trap vent, and sometimes connected with the wastes of other fixtures in such a way as to open through the vent pipes an indirect avenue into the house for sewer air, as we have shown in our illustrations of "by-passes."

It forms, in short, an unnecessary and dangerous complication to the plumbing, which more than offsets any slight saving in the first cost of these cheap fixtures, and they should never be used.

The plug and chain feature which characterizes this type of basin is another defect. The chain, lying in every suc-

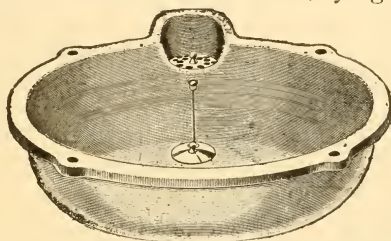

Fig. 304. All Porcelain Plug and Chain Basin.

cessive formation of dirty water, collects gradually in the recesses of its links an unknown variety of filth, which cannot be absolutely removed, on account of its irregular form, without the use of special alkalies, or constant scrubbing with a brush, a process I have never seen applied to it effectively. The length of wire used in an ordinary basin chain averages six feet, and has a surface of about fourteen square inches, a surface which, in consideration of the peculiar adaptability of the form of the links for retaining dirt presents a very formidable area of pollution.* To those persons who use their reasoning powers in these matters, the idea of washing the face in water defiled by a chain transferred immediately from the dirty water of some un-

*A chain of average cleanness might easily contain more than a grain of dirt unnoticed in its links, which bacteriologists have shown may contain over a million bacteria.

known predecessor is with good reason exceedingly repulsive, and when the nature of disease germs in water before it reaches the sewer are considered the danger of contagion where the predecessor may have chanced to be a sufferer from skin or other contagious disease the feeling of repulsion is justly increased. The chain, moreover, frequently breaks, and then the hand must be plunged into dirty water to remove the plug. The position of the chain and plug at the bottom of the bowl is peculiarly inconvenient, inasmuch as they are in the way of the hands, which ought to

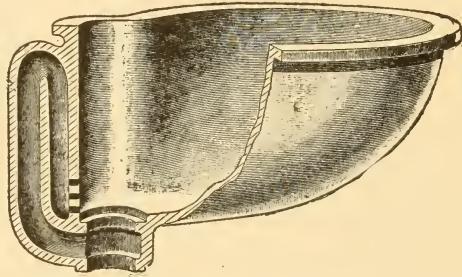

Fig. 305. All Porcelain Plug and Chain Basin.

meet a smooth, unbroken surface of earthenware, rather than the hard and irregular lines of the brasswork. If this latter consideration appears to some trivial, it does so only because custom has rendered us callous to such defects; the defect none the less exists, and acquires importance through the frequency of its repetition and the constant use of the fixture in which it occurs. The fact that it is altogether unnecessary, either for economy or for any other reason, is a sufficient argument for its abolition. Thus we find none of the eight desiderata enumerated in our table of requirements that the wash-basin, still in most common use, possesses.

PLUG AND CHAIN BASINS.

Figures 302, 303, 304 and 305 represent in section and in perspective all-porcelain plug and chain basins. Figs. 302, 303, 304 and 305.

Figure 306 represents a plug and chain basin with a flushing rim supply. The disadvantages of this arrangement are quite as great as the advantages. Water cannot be drawn into a separate vessel from this form of supply, and this is often quite important. Moreover, the flushing rim greatly increases the cost of the fixture. The object

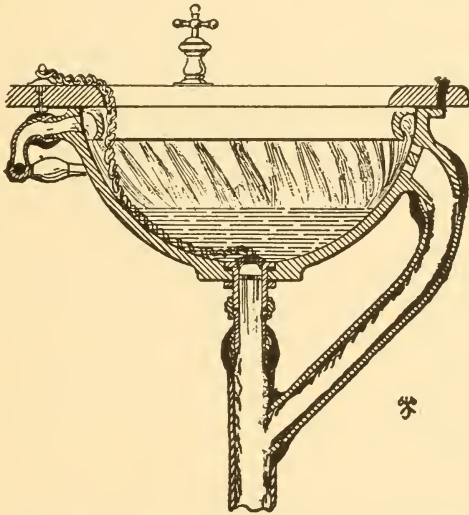

Fig. 306. Plug and Chain Basin with a Flushing Rim Supply.

of the flushing rim is to cause a partial cleansing of the sides of the basin by the running water before filling.

Constructing the overflow pipe in one piece with the basin, as shown in Figs. 302 to 305, gives a great advantage. The danger of defective overflow connections is thus avoided, and the setting of the basin is very much easier. A closure of the overflow holes of this basin affords an actual temporary safeguard against the evils arising from evaporation

of the water seal caused by trap ventilation, where a fixture is left unused for any length of time, provided the outlet be also tightly closed and both closures be closely watched. But in this case the danger of damage from overflow appears.

Figure 307 represents a basin with a plug and stem outlet, the earliest form constructed by the writer.

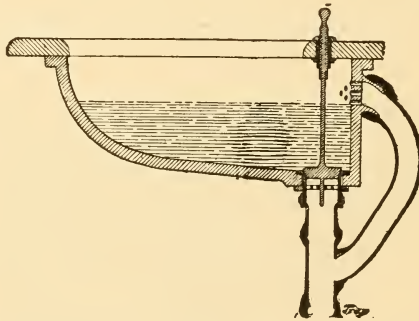

Fig. 307. Basin with a Plug and Stem Outlet.

(B) WASTE COCK OUTLET.

Here the outlet passageway is controlled by an ordinary ground brass water-cock.

The general type may be further subdivided into three kinds: (1) Those having perpendicular waste-cock moved by a rod passing through the marble slab; (2) those having a horizontal waste-cock worked from the front of the stand below the bowl; and (3) those in which the waste-cock is operated by a lever movement.

As an illustration of the first kind we have the so-called "Boston Waste," Fig. 308, which is very popular. There is probably no form of basin fitting more faulty in principle than this. It contains two independent, inaccessible and invisible foul water passages, one forming the overflow

WASTE COCK OUTLET BASINS.

passage, and the other the outlet passageway between the strainer and the waste-cock.

This latter passage forms an elongated cesspool for the defilement of the clean water entering the basin. After using the fixture, the waste water escaping through this channel deposits part of its dirt, particularly floating matters and soapsuds, all along its sides, and leaves it there to be taken up and applied in a diluted solution to the hands

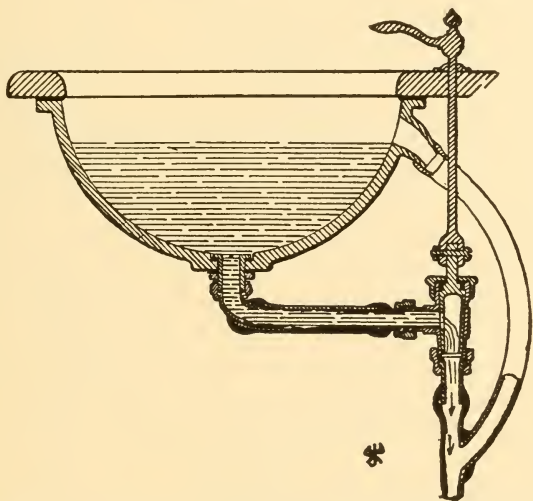

Fig. 308. Waste-Cock Outlet Basin, the "Boston Waste."

and face of the next comer. Six wiped solder joints, one putty joint and five threaded joints, making twelve in all, are required to adjust the waste pipes of the regular Boston Waste apparatus and its trap below the basin slab cannot be relied upon as a sure seal at all times against sewer gas, because we cannot depend upon its always being turned off after use, this device becomes valueless.

No wonder the plumber is often in requisition to keep in

order such complicated machines so long as they are allowed to remain in use. Not the least of its defects is that the passageway for the waste water through the ground

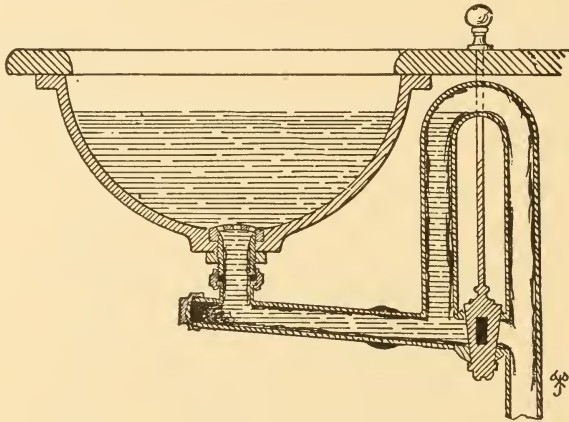

Fig. 309. The Waste-Cock Outlet Basin with Syphon Overflow.

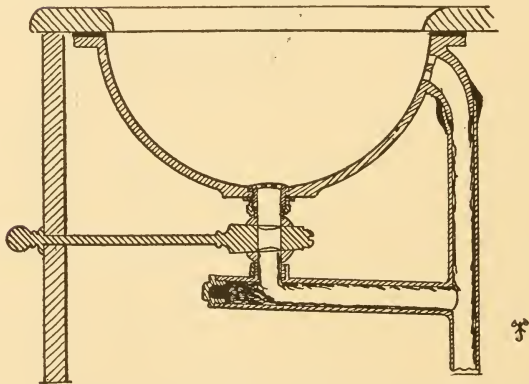

Fig. 310. Waste-Cock Outlet Basin with Horizontal Plug.

cock is usually so small (about a quarter of an inch wide in some types) that the least deposit of sediment is liable to radically impede this meagre flow.

WASTE COCK OUTLET BASINS.

The "Boston Waste" cannot be too highly condemned and should be prohibited in all plumbing ordinances, as should all restricted outlet basins, because with these allowed, no proper sewerage system can ever be attained. The great extent of the use of fixtures constructed on the principle of the "Boston Waste," in spite of its high cost, shows how little knowledge the public has in these matters, and how important it is that their attention should be called to them.

In Fig. 309 we have the Boston Waste complicated with still another disorder. The overflow pipe, instead of opening into the upper part of the basin, descends and re-enters the waste pipe on the inner side of the waste cock. This doubles the length of the inaccessible cesspool between the outlet and the waste-cock. Its object was apparently to trap the overflow pipe; but as the waste-cock cannot be relied upon as a sure seal at all times against sewer-gas, because we cannot depend upon its always being turned off after use, this device becomes valueless.

Figure 310 represents the second kind of waste-cock outlet basin in which the waste-cock is horizontal, and operated through the riser or woodwork of the washstand. This arrangement necessitates encasing the basin to some extent in finish, a requirement which adds another to its many disadvantages. In other respects it is similar to the "Boston Waste" already described.

Figure 311 illustrates by a special apparatus, possibly never executed in its entire perfection, the third kind of waste-cock outlet basin. The fixture shown is an English invention devised by some one who had seen Mr. Bunyon's sewer already described. It is useful to illustrate the evils of over-complication. The machinery is moved by cranks and levers connected with a pedal in front of the stand. How the inventor could have imagined anyone would be

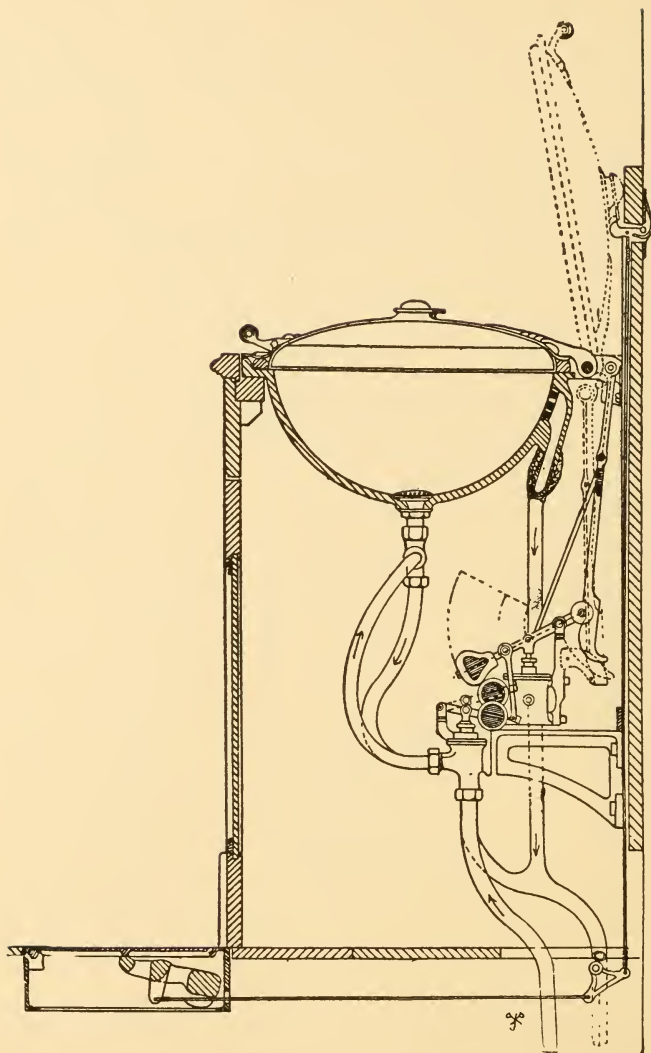

Fig. 311. Waste-Cock Outlet Basin with Lever Movements.

WASTE COCK OUTLET BASINS.

found willing to pay for so complicated a piece of brass-work is difficult to understand. In the device a lid is employed to cover the basin when it is not in use, and there is a thick rubber gasket not quite so large and costly as an automobile tire around the basin to form a sewer gas tight packed joint with the lid which is held pressed against the packing when closed by a strong spring. Two waste-cocks, one for the main outlet, and the other for the overflow, and one or more supply cocks are used, and these cocks are connected with the lid in such a manner that, when the lid is raised or lowered, the supply and waste-cocks are respectively opened and shut. The waste-cock thus does not serve as a seal against sewer gas, and a separate trap, not however shown, would be necessary. The lid mechanism would require the strength of a stone crusher to operate this net work of valves and levers even when new, and it never seems to have occurred to the inventor that dirty water would soon take away what little mobility they might have in the beginning.

CHAPTER XXIII.

(c) VALVE OUTLET BASIN.

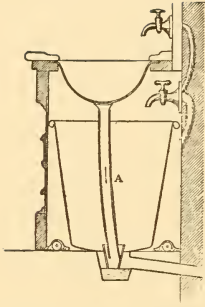

Fig. 316. French "Perfected" Bath Room Apparatus.*

Our next type of wash-basin corresponds in principle with the valve water closet. The outlet is closed by a valve working in a small chamber or receiver, which, like the water closet receiver, is liable to become clogged with sediment. Moreover, the concealed machinery necessary to work the valve complicates the apparatus, and like all machinery, especially that which works under dirty water, is liable to get out of order.

We have further subdivided this type into three kinds, i. e., those with (1) chain movement; (2) lever movement, and (3) gravity movement.

Figure 312 illustrates the first kind. We have here two elongated cesspools and a receiver cesspool. No overflow passage is shown in this drawing, though provision for overflow is of course as necessary as in any of the preceding examples.

A valve arranged as shown here would never work satisfactorily. The slightest impurity adhering to it or its seat would cause it to leak, and a little roughness or corrosion on the hinge might prevent its closing altogether.

Figure 313 represents a valve outlet basin operated by lever movement. The drawing shows a double bottom, the

*Portable wash basin over fixed bath tub, from Joly, chapter headed "Appareils Economiques Perfectionnes." From the American point of view, the arrangement, especially the trapping, does not seem quite "perfect."

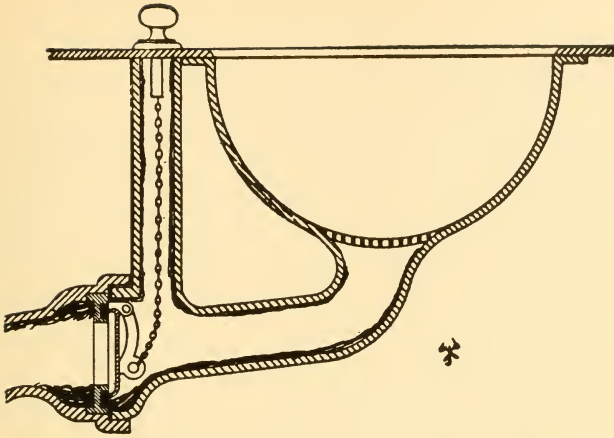

Fig. 312. Valve-Outlet Basin with Chain Movement.

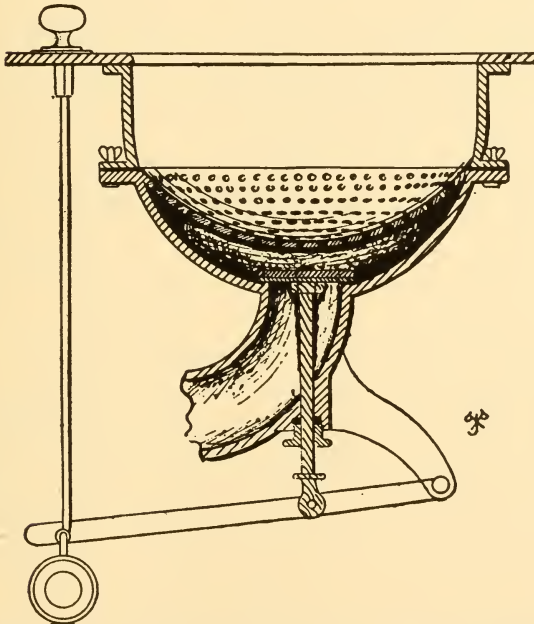

Fig. 313. Valve-Outlet Basin with Lever Movement.

upper one being perforated throughout its entire extent, and forming an enormous strainer. The valve receiver occupies the whole space between the two basins. The amount of inaccessible fouling space is here very large and of peculiarly objectionable form, the many perforations and corners being calculated to retain a great deal of filth. The waste water escaping through so many holes would pass without force or scouring effect, and the cleansing of such a strainer

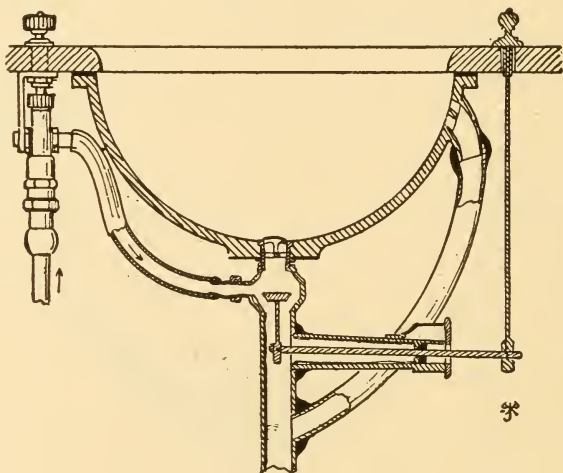

Fig. 314. Valve-Outlet Basin with Outlet Supply.

would be practically an impossibility. Some overflow passage, not shown on the drawing, would be required.

Figure 314 shows a basin of the same kind with a smaller receiver. The supply enters below the strainer, which is evidently objectionable for several reasons. In case of fluctuation in the water supply pressure, foul water might be drawn from the basin into the supply pipes. Moreover, the dirty deposits in the valve receiver would always be mixed with the first clean water entering the basin.

VALVE OUTLET BASIN.

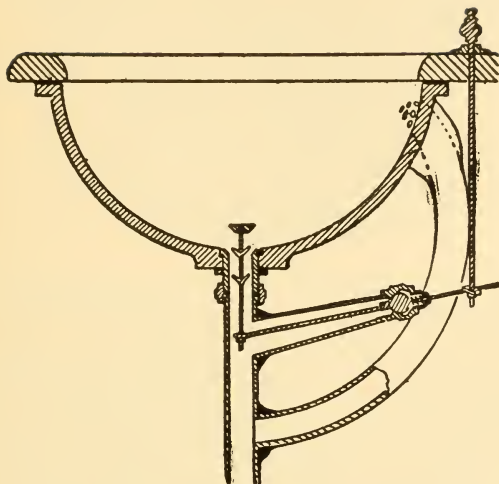

Fig. 315. Valve-Outlet Basin with Improved Lever Movement.

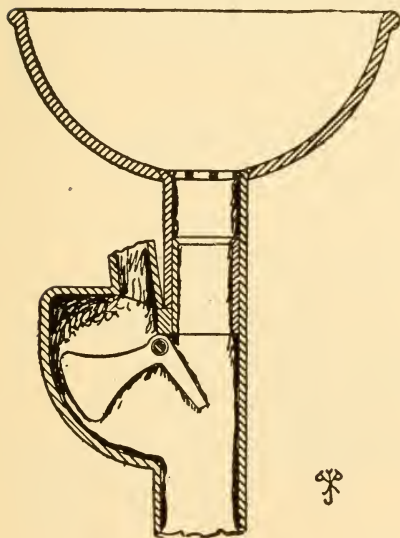

Fig. 316.

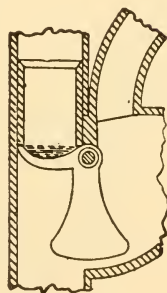

Fig. 317.

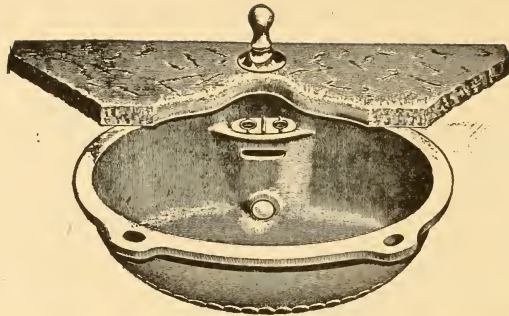

Fig. 318.

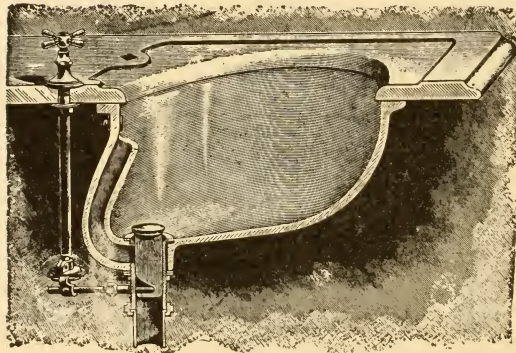

Fig. 319.

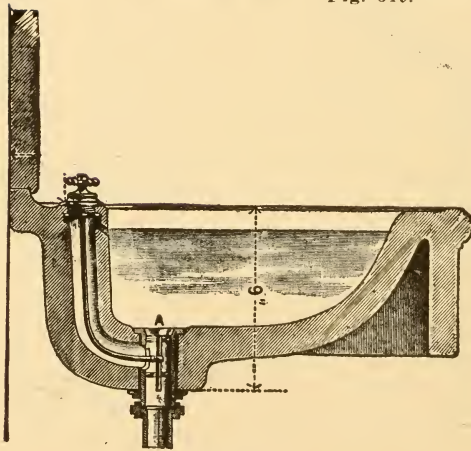

Fig. 320.

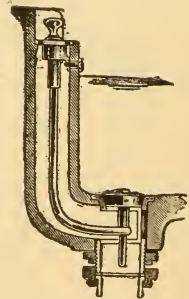

Fig. 322.

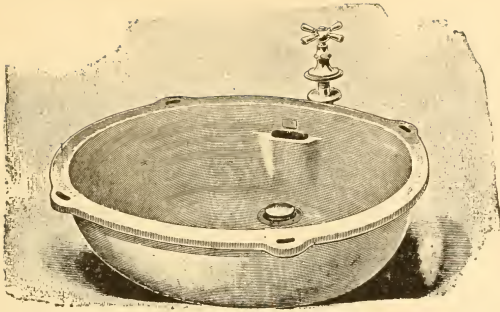

Fig. 323.

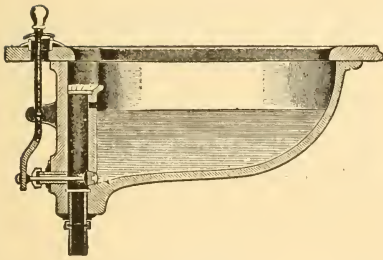

Fig. 324.

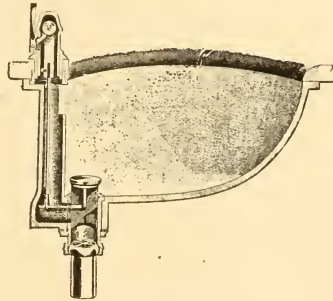

Fig. 325.

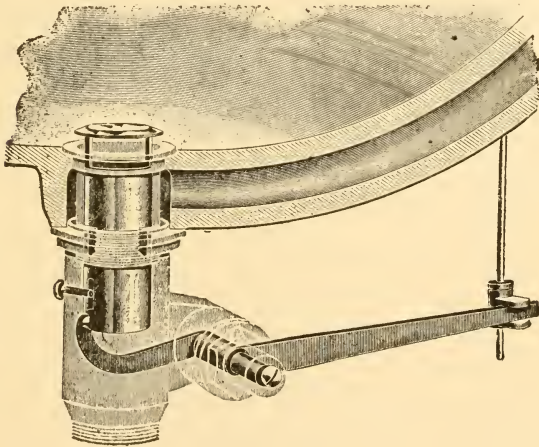

Fig. 326.

Figure 315 shows an improvement on the last device because the receiver above the valve is eliminated altogether.

Figures 316 and 317 give the third subdivision of our valve outlet basin, namely, that in which the valve is operated by the weight of the water falling upon it. Comment on such a device is scarcely necessary, it being sufficiently evident that its action would be extremely unreliable and unsatisfactory. The valve is made flat or cupped on its upper surface. In the latter case water held in the cavity of the valve is supposed to assist in forming a seal.

Figures 318 to 326 represent other forms of Valve Outlet Basin, all to be recommended for their simplicity, large outlets and cleanliness, there being no fouling chambers at the outlet. Where the overflow passages are accessible for cleansing, these fixtures are in all respects excellent.

CHAPTER XXIV.

(D) PLUNGER OUTLET BASIN.

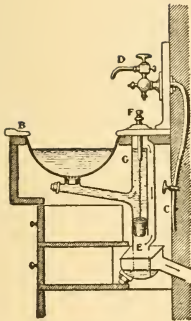

Fig. 333.

Our plunger outlet basin corresponds with the plunger outlet water closet, and has its defects. A great defect is its several inaccessible fouling chambers. The type may be subdivided into two styles, namely: (1) That having a solid plunger, and (2) that having a hollow plunger.

Figure 327 represents the first style. The plunger is supposed to retain the water in the basin by the friction of a packing ring of some elastic material against the inner walls of the plunger chamber. A D-trap appropriately used under the plunger completes a device which, for extent of fouling surface, cannot easily be surpassed. Fig. 328 is an improvement on the last type. There are less fouling surfaces and the outlet passages are made of smooth earthenware. The plunger chamber is made accessible by unscrewing the plate at its top, and the horizontal channel below the strainer is the only part that cannot be reached.

Figure 329 is a still further improvement, inasmuch as the horizontal chamber is done away with by having a perpendicular back to the bowl. The overflow passage is faulty. It should have been constructed after the principle of the preceding fixture, or better still, in the form of a simple standpipe on the plunger. The chief defect, however, is in having the clean water come in contact with the fouled sur-

face of the plunger chamber. The valve should always be placed directly at the outlet opening to avoid this defect.

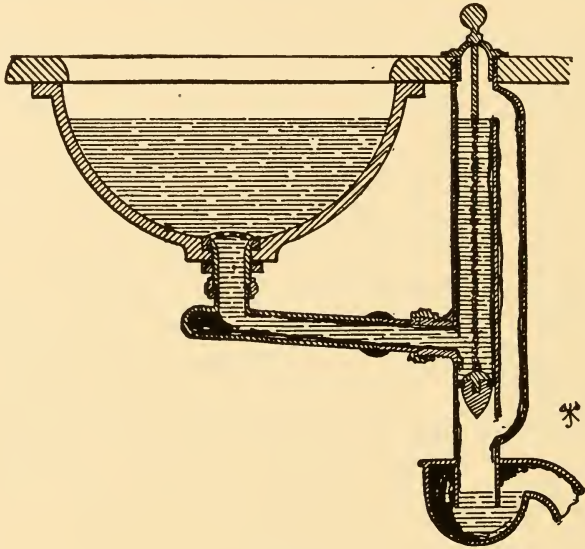

Fig. 327.

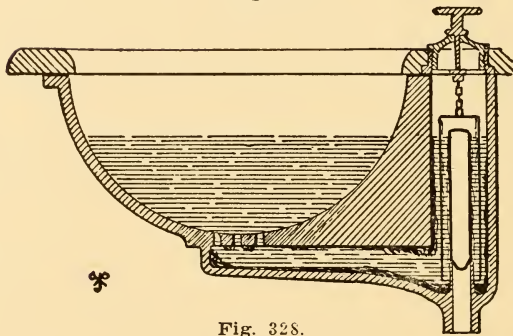

Fig. 328.

Figure 330 represents the second style of plunger outlet basin in which the plunger is hollow. We have, however, here again the favorite cesspool triply emphasized.

PLUNGER OUTLET BASIN.

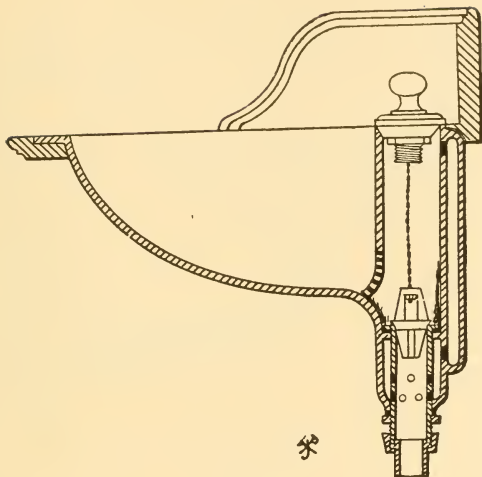

Fig. 329.

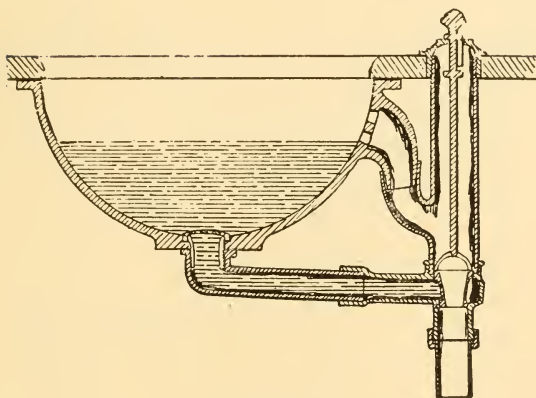

Fig. 330.

(E) FLOATING PLUG OUTLET BASIN.

The object of this device, Figs. 331 and 332, is to do away with the special overflow opening in the basin

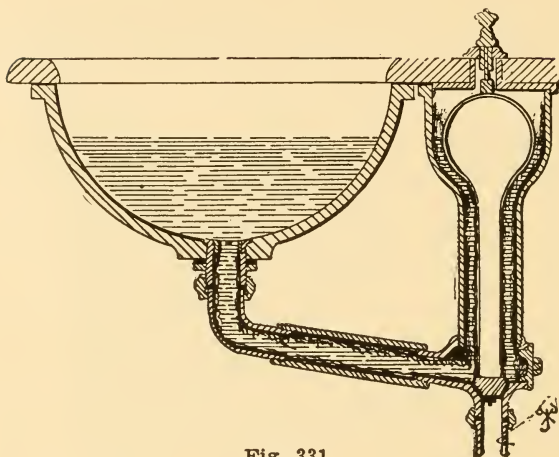

Fig. 331.

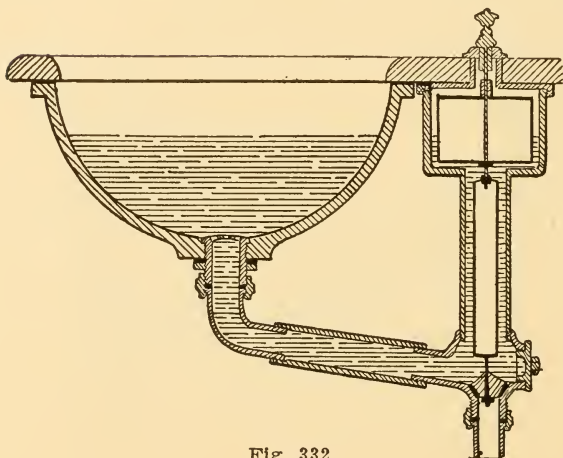

Fig. 332.

walls. The plunger or plug has a hollow vessel at the upper end of its stem, and the receiver is enlarged at this point to give room for it. When the water in the basin approaches

PLUNGER OUTLET BASIN.

the point of overflowing, the plunger is buoyed up by the float (the water seeking its level in the plunger and float

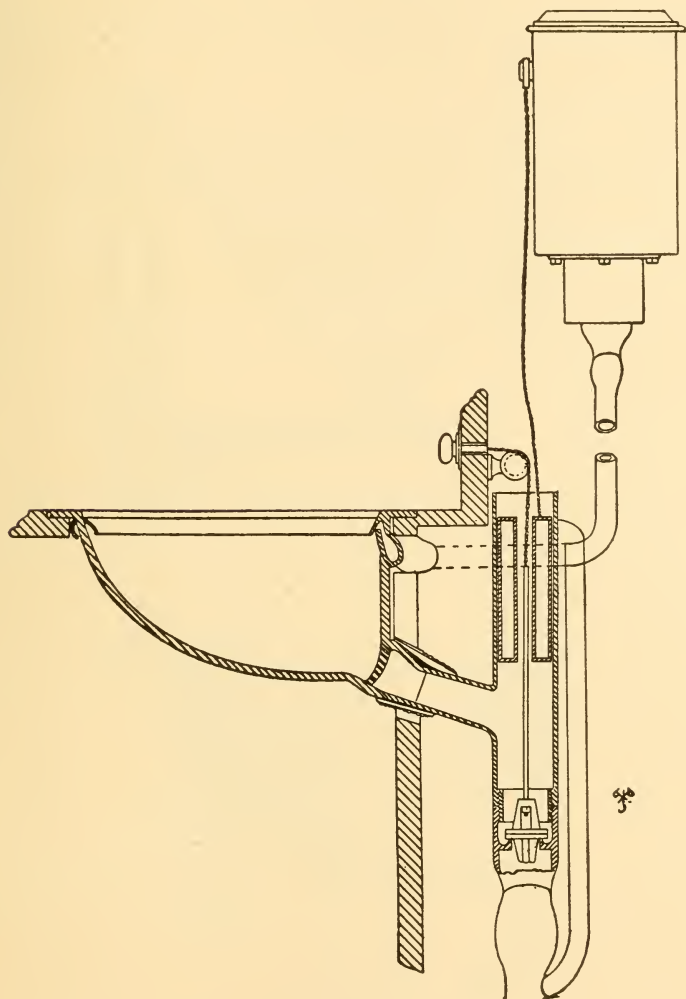

Fig. 334.

PLUMBING AND HOUSEHOLD SANITATION.

chamber), and the outlet is opened, letting the superfluous water in the basin escape.

(F) CONCEALED STANDPIPE OUTLET BASIN.

The object of this arrangement is the same as the float-

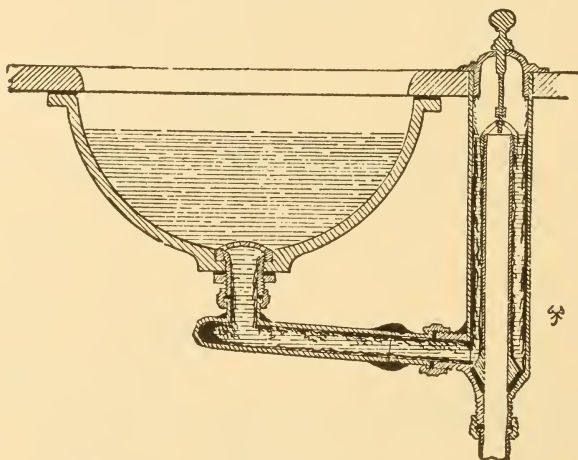

Fig. 335.

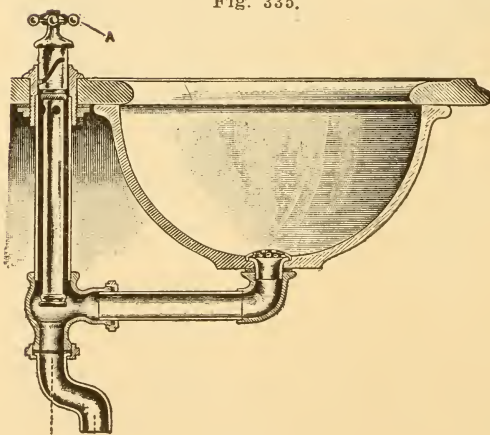

Fig. 336.

CONCEALED STANDPIPE OUTLET BASIN.

ing plug in the preceding apparatus. It enables the special overflow opening to be dispensed with, the hollow plunger rod serving instead. Figs. 334 to 336 show the standpipe as constructed with a metallic chamber.

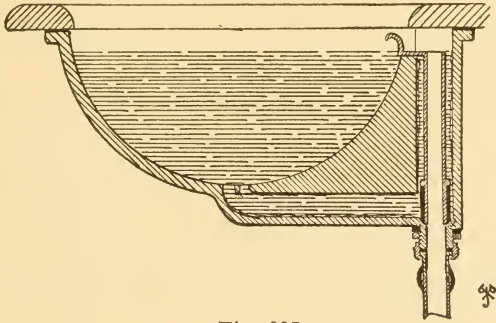

Fig. 337.

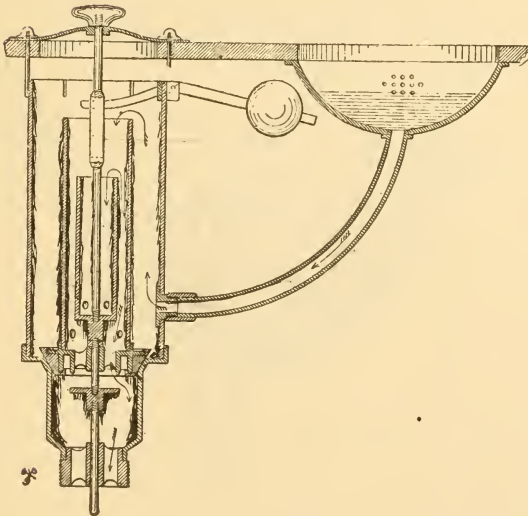

Fig. 338.

Figure 337 shows a concealed standpipe outlet basin made in all earthenware.

Figure 338 is a very complicated form of concealed standpipe Outlet Basin with an enormous amount of fouling surface.

(G) RECEIVER OUTLET BASIN.

The principal object of this device is to obtain a quick discharge. It consists of two basins, one within the other, the inner one pivoted, as shown in Fig. 339, in such a manner as to permit it to be revolved by means of a projection on the front edge, raising which empties the entire contents of the basin into a lower basin or receiver. Only half of the receiver is accessible, hence it inevitably becomes foul in use.

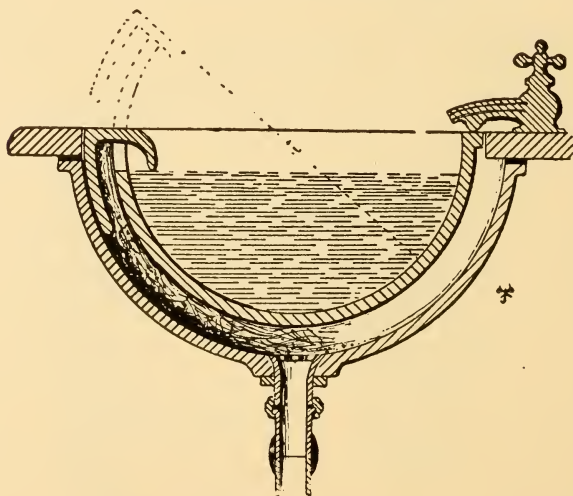

Fig. 339. Receiver Outlet Basin.

PLUNGER OUTLET BASIN.

II.—BASINS HAVING ACCESSIBLE OVERFLOW PASSAGES.

In this class of fixture every part, both of the basin proper and of its fittings and passages, is visible and easily accessible, and kept clean from top to bottom without unscrewing or undoing any part. We find three subdivisions: (a) the funnel outlet basin; (b) the standpipe outlet basin, and (c) the rear outlet basin.

(A) THE FUNNEL OUTLET BASIN.

Figure 340 illustrates our first subdivision. In general form it is similar to the one just described, but it has the

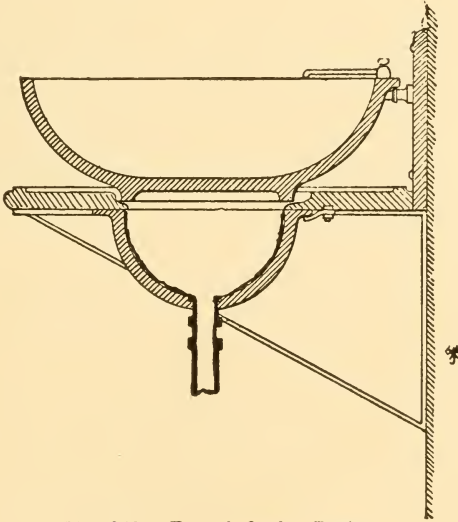

Fig. 340. Funnel Outlet Basin.

advantage of enabling the entire surface of the lower basin to be reached for cleansing purposes. The interior of the outlet pipe may be inspected and, if desired, periodically cleansed throughout. It is intended that the upper basin should be lifted after use, and the waste water emptied

into the lower basin or funnel. In case of overflow, the water runs over the edge of the upper basin and falls into the lower, whence it escapes into the waste pipe. It is evident that to avoid the trouble of lifting the basin it may be provided with lugs or pivots upon which it may be revolved as in the preceding example.

Both of these types are altogether faulty in being based on the receiver principle, which also adds greatly to the cost and danger of breaking. The receiver is an entirely unnecessary complication, and the basin has never been largely used in practice except in marine service.

Basins are sometimes provided with a flushing nozzle for connection with the water supply. The flushing device is added to insure a perfectly clean overflow passage whenever the owner sees fit to operate it. A leakage of water-cock at this point would give rise to an unperceived waste of water. This fixture is constructed with a large outlet on the principle of the flush tank, and is in this respect highly to be commended.

(E) THE REAR OUTLET BASIN.

The basin answering all the desiderata I have enumerated at the beginning of this lecture should have an outlet larger than its waste pipe and conveniently operated within the basin itself. It should be absolutely simple, having neither niche, chain nor standpipe, and its overflow passage should be as clean and accessible as any other part of the fixture.

CHAPTER XXV.

(B) STANDPIPE OVERFLOW BASIN AND (C) DIRECT OUTLET BASIN.



First Rear Outlet.
Lavatories and their Early
Setting.

Before 1883 lavatories were made, as a rule, with concealed overflows, strangely enough, and open standpipe overflow basins had not been introduced. The first basin of this kind was beaten out in the winter of that year, 1883, of sheet lead after the writer's drawings and afterwards moulded in a local terra cotta yard in yellow clay and baked, and

the name "Sanitas" was given to this new type.

Mr. Gerhard, in one of his European treatises on Plumbing,* writes of it in 1897 as follows:

"The prototype of all basins of this construction is the "Sanitas" wash basin, invented several years ago by the Boston architect, Putnam, which is shown in plan and transverse section in Fig. 341, and in perspective in Figs. 342,

"Entwässerungs-Anlagen Amerikanischer Gebäude von Wm. Paul Gerhard, Civil and Sanitary Engineer in New York, in Fortschritte auf dem Gebiete der Architektur. Stuttgart 1897. Verlag von Arnold Bergstrasser."

343.** This device is in many respects fundamentally different from the kinds of basins hitherto described, and is distinguished by the advantage of having a simple, convenient and sanitary construction. The basin is made either round or elliptical, and has at its back a niche or recess, in which is placed in clear and open view a standpipe valve.

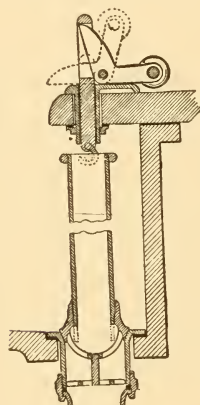

Fig. 344.



Fig. 341b.

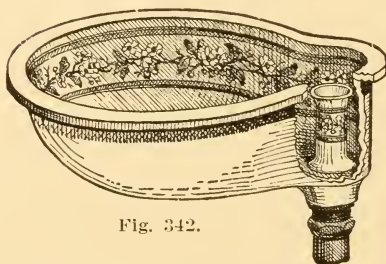

Fig. 342.

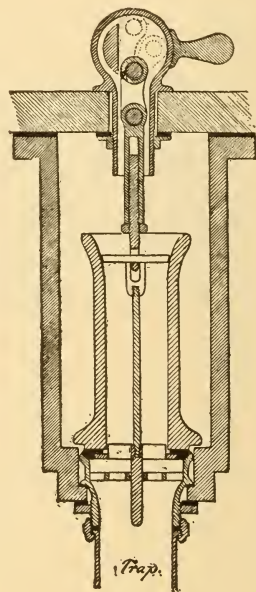

Fig. 341.

As this serves at the same time as an overflow pipe, we have in it a new form of overflow construction for basins. All parts of the basin and its fittings are in sight and easily accessible, and it contains no concealed chamber or parts of

**The Figures in Mr. Gerhard's treatise give other views of the Sanitas basin.

STANDPIPE OVERFLOW AND DIRECT OUTLET BASINS.

any kind, as is the case with many of the basins of other styles for the collection of sediment. The overflow pipe is made detachable, but can nevertheless be easily cleaned without removal." Mr. Gerhard then describes the appliance in detail and concludes as follows: "The many acknowledged advantages of the 'Sanitas' basin produced the result that a great number of basins of similar construction were put upon the market. Nevertheless, in spite of all the recognized advantages of this kind of basin, the American public were fond of the concealed overflow type, and even the recommendations of the leading sanitary engineers have not

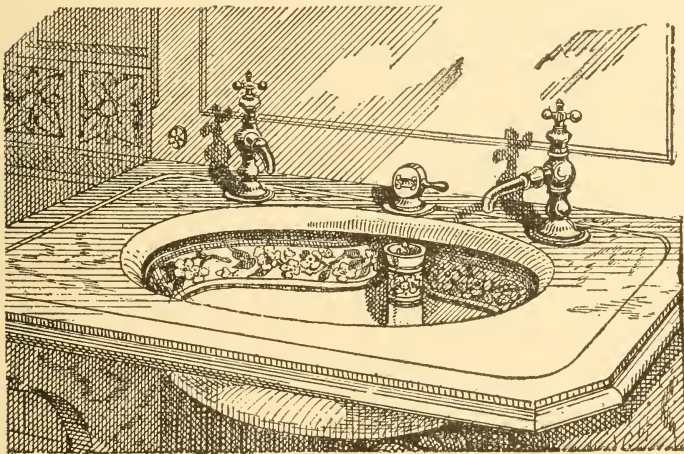

Fig. 343.

as yet succeeded in bringing this type of basin into universal use."

Again, in "Good Housekeeping," Mr. Gerhard writes in 1886: "Much the best form of basin of which I have knowledge is the standpipe outlet basin or 'Sanitas' wash basin."

After a description of the basin he continues: "It is thus seen that the great desideratum, that the fixture should act as a flush tank for its waste pipe and trap, is here accomplished," etc.

Fig. 344 shows one of the earliest forms of the Sanitas Lift

There are a number of better basins than this on the market today, and Mr. Gerhard would probably now be unable to give this one such high recommendation. Since the year he wrote, many other basins have been built with

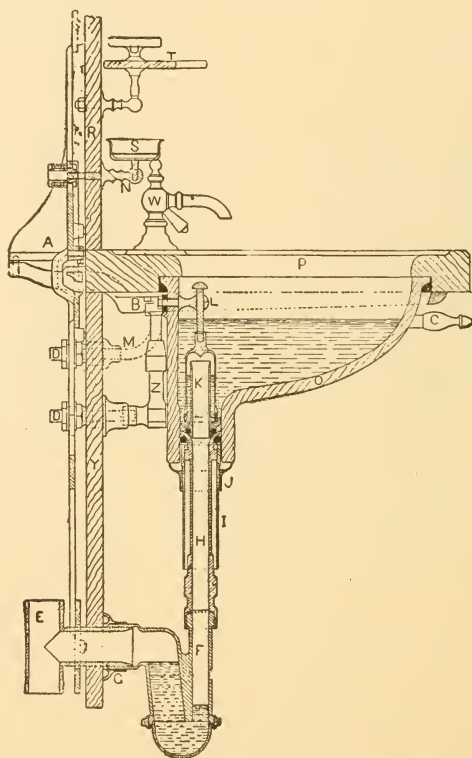

Fig. 335.

STANDPIPE OVERFLOW AND DIRECT OUTLET BASINS.

large outlets capable of performing the work of the flush tank and many in which all cesspool chambers have been avoided, as in the excellent types shown in Figs. 317 to 326, inclusive, which in reality leave little to be desired in essentials.

Fig. 345 shows a somewhat more complicated form of standpipe overflow basin which appeared later. It has a regular automatic flush pot discharge.

The standpipe overflow type of basin has the disadvantage of presenting a certain amount of surface exposed to the washing water beyond what is absolutely necessary.

A still further improvement is possible in which even greater simplicity is attained without sacrifice of any valuable feature. Figs. 346 to 361 show a number of the writer's designs. The exterior surfaces of both the stand-

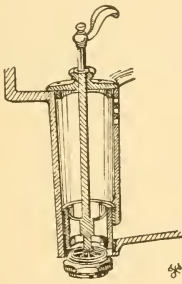

Fig. 346.

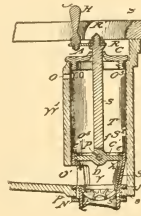

Fig. 347.

pipe and of its niche are done away with, while equal accessibility of all parts is still preserved as in some of the types described. The standpipe overflow is simply molded in with the rear of the fixture as a fixed part of it and the discharge is effected not by lifting the standpipe but by operating a valve of proper construction within it. This valve should stand directly against the outlet opening in the wall of the fixture, as shown in these figures, so

PLUMBING AND HOUSEHOLD SANITATION.

that there be absolutely' no unnecessary amount of surface in the interior of the fixture, and the whole valve as well as the interior of the overflow passage should be easily accessible for cleansing.

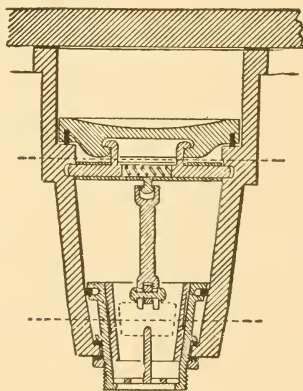

Fig. 348.

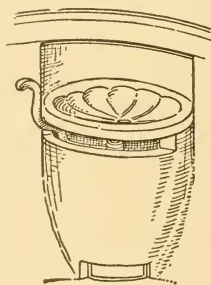

Fig. 349.

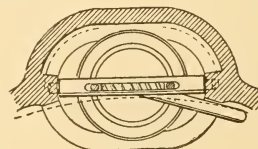

Fig. 350.

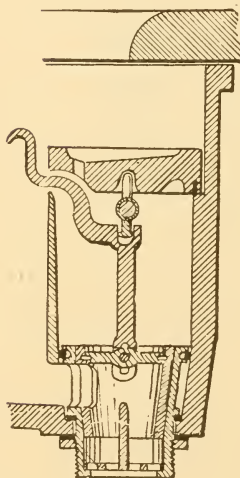

Fig. 351.

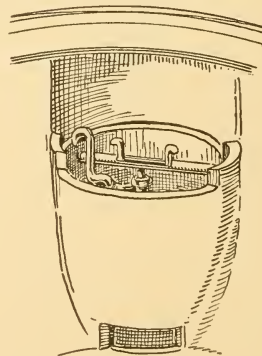

Fig. 352.

STANDPIPE OVERFLOW AND DIRECT OUTLET BASINS.

The mechanism for controlling the valve should be simple and its operation self-explanatory to the user.

Where the fixture is intended for use in public places the construction shown in Figs. 346 to 353 renders it im-

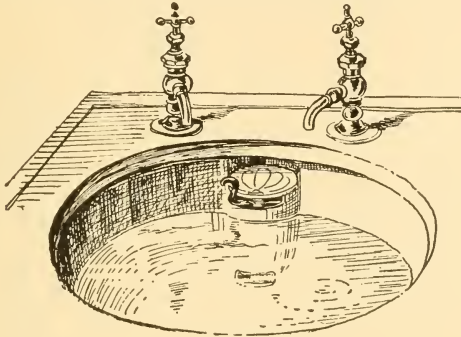

Fig. 353.

possible for anyone to remove and carry off the operating brass work. The drawings explain the manner in which this is done in this instance.

For private houses the still simpler mechanism of Figures 346 and 347 suffices. The ground plug is easily lifted out for cleaning the overflow passage. The end of the handle has a downward curve which suggests and aids in slightly lifting it for easier turning, and the movement

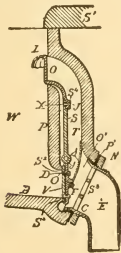

Fig. 1.

Fig. 356.

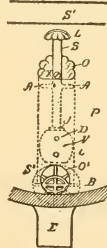

Fig 2.

Fig. 357.

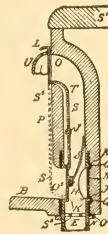
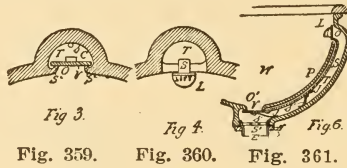

Fig. 3.

Fig. 358.

is so easy that a light touch of the finger is sufficient to open or shut the outlet.



It is better to construct the entire fixture of hard earthenware or enameled iron and in one piece, as is now customary, because the whole fixture is stronger, easier to support, cheaper and better than the comparatively old-fashioned combination of earthenware and marble put together with plaster and supported on metallic legs or brackets. The use of the enameled iron construction for the entire fixture and its outlet passages insures safety against a possible fracture of the material of the outlet by a sudden expansion of the metallic waste valve work when very hot water is used. This is a consideration of importance.

All that is needed to support the fixture is a few screws driven into the bathroom wall through holes in the back of the fixture, no special legs or brackets being required. Fig. 363 shows the section of the outlet mechanism for a fixture so constructed.

Figs 356 to 361 give other simple forms of the writer's valve outlet basins, illustrating the principle of a valve operating directly at the basin outlet by a very simple mechanism which sufficiently explains itself.

THE SECURITAS BASIN.

Figures 362 to 365 illustrate the writer's latest improvement in basins to which he has given the name "Securitas," for the reason that it provides, in the simplest manner, abso-

STANDPIPE OVERFLOW AND DIRECT OUTLET BASINS.

lute sanitary security against contamination of the clean water by any concealed or inaccessible parts, and at the same time by virtue of having no projections, recesses, irregularities or roughnesses in any part of its contour, it provides entire security against inconvenience or mechanical injury in use.

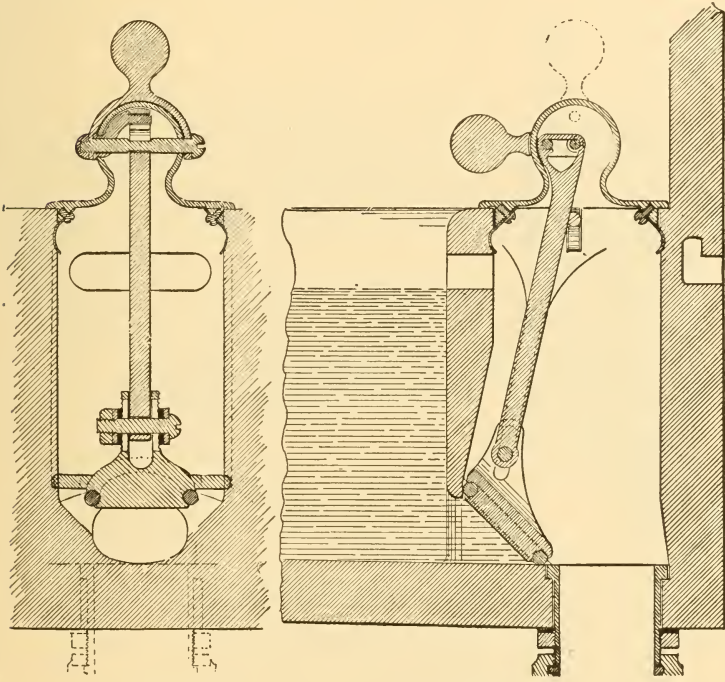

Fig. 362.

Fig. 363.

The peculiarly simple working parts being constructed almost entirely of white enameled iron there is nothing to require refinishing and nothing of intrinsic value to tempt the honesty of thieves or vandals in public places. Therefore virtue is promoted as well as comfort and art.

The shining white surface of the operating mechanism

harmonizes with the color and texture of the fixture itself and presents with it a very attractive appearance. When the same white enamel is used also in the trap as shown in Fig. 365 the effect is still more striking and attractive. The whole outfit has then always, after any length of usage, the

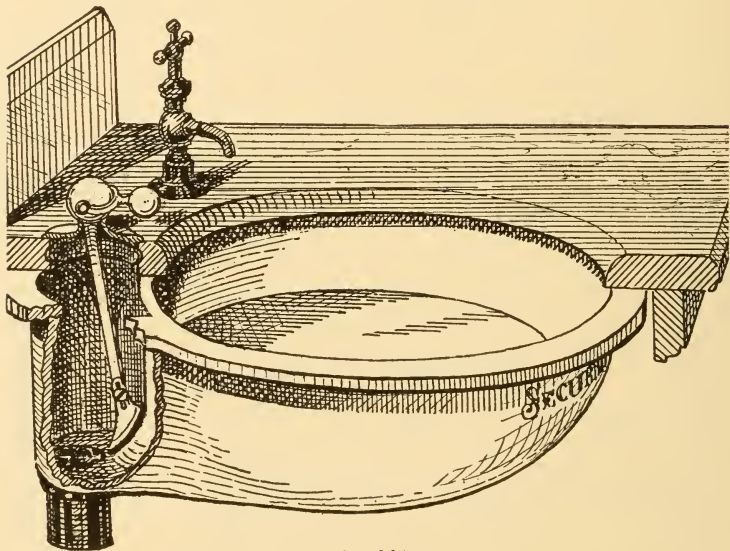

Fig. 364.

same perfectly clean and bright appearance as it had the day it was first installed.

Figs. 364, 365 and 366 give perspective views of the device, and Figs. 362 and 363 sections showing details of its Waste Outlet Mechanism. The movable standpipe overflow and its niche are done away with, and a single overflow and outlet passage, easily accessible and convenient for cleansing without presenting any fouling surface to the clean water, takes its place.

The interior of the basin is entirely unobstructed, no

STANDPIPE OVERFLOW AND DIRECT OUTLET BASINS.

brasswork or projection of any kind being in the way of the user.

The valve stem, also of enameled iron, is made adjustable as shown, and is operated by a simple enameled iron lifting device sufficiently explained by the drawings. The handle consists of a small sphere connected by a yoke with a lever

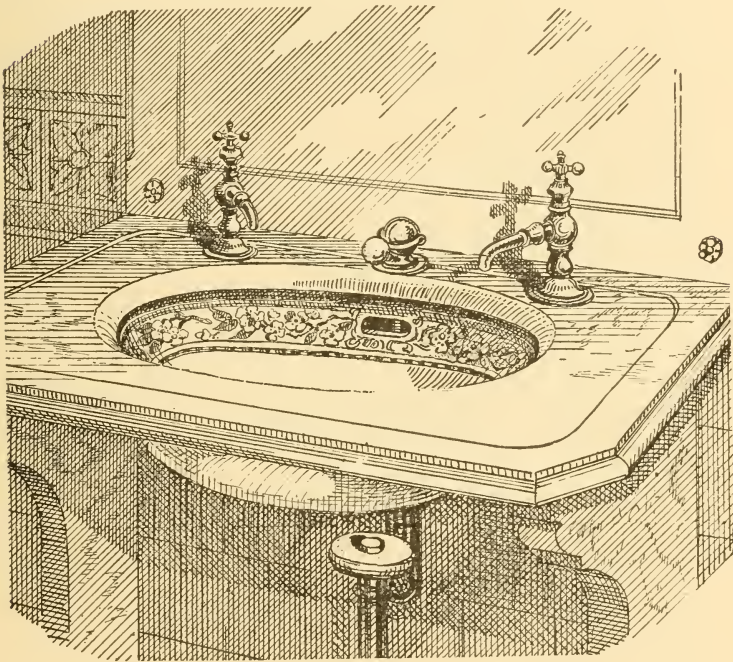

Fig. 365.

within a larger sphere, and the lever directly actuates the valve in the manner shown. The weight of the handle and its leverage aid the weight of the valve and its stem in forc-

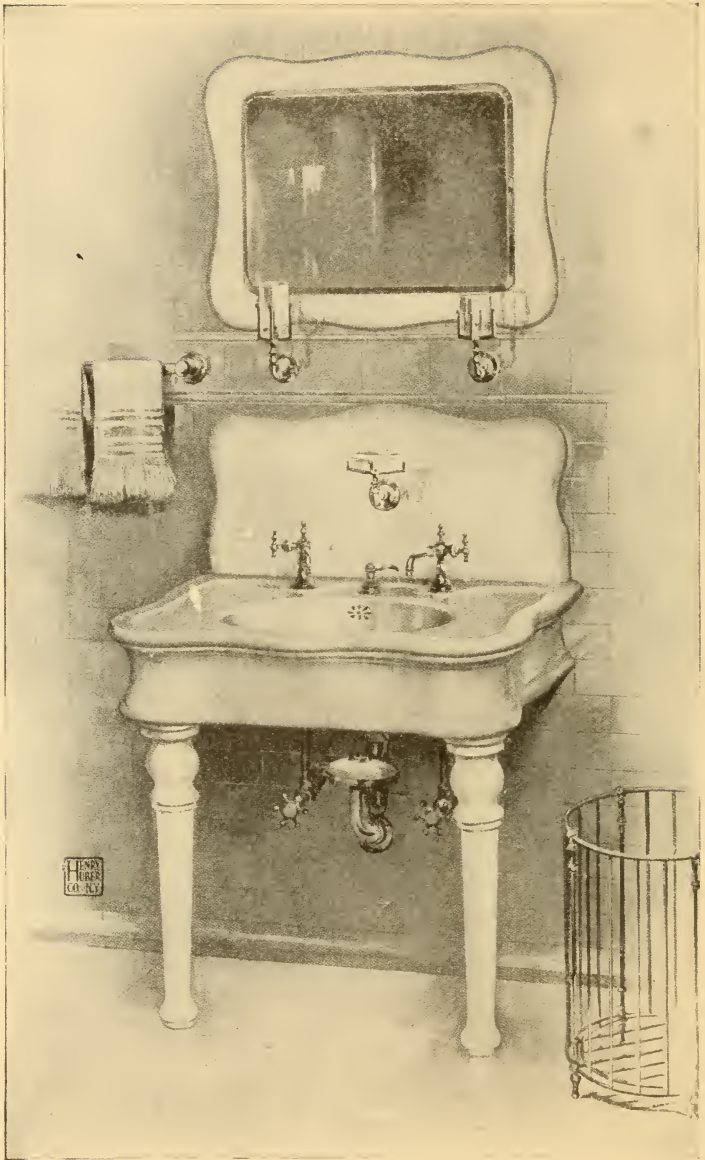

Fig. 365a. "Securitas" Wash Basin and White Enameled Trap. Re-arranged from Catalog by Courtesy of Federal-Huber Co., N. Y.

ing the soft valve packing tightly against its seat. When open the handle stands at the dead point directly above its pivot in line with the valve so that the valve cannot accidentally close, and yet a touch in the right direction is all that is necessary to cause it to close automatically and noiselessly. The form immediately suggests the correct method of operation, so that a course of lessons in handling is not required.

The valve packing consists of a simple soft rubber ring sprung around the valve in a groove provided for it. The whole mechanism provides the maximum of strength and convenience with the minimum of expense and complication.

The operating mechanism is easily removed for cleansing the outlet chamber by simply lifting it up against the slight pressure of the four small springs in their slots. It is replaced by a corresponding reversed pressure. The springs are strong enough to prevent all rattle in use, but afford but very feeble resistance to removal, a slight side pressure removing two of the springs at a time. This method of removal might be too easy were the parts constructed of brass or other metal of intrinsic value for the reason already given.

But with enameled iron having no selling or pawning value, there is no object in requiring a complicated or inconvenient method of taking apart. Hence the economy of the device provides a special feature of convenience to the user beyond its usual advantage to the pocket.

The valve is guided to its seat by the two small sidehorns cast on its outer rim engaging in corresponding side grooves molded in the pottery as shown.

In virtue of this arrangement the valve cannot possibly be inserted in any other than its right place, and the whole device becomes automatic and fool proof. The stem having been once adjusted by the manufacturer or plumber to the

depth of the basin, there is nothing further to be done by anybody, no screws, or nuts to be removed or replaced in usage or cleaning, no rods or levers to be manipulated, and no standpipe, stopper, chain, or other obstruction to try the user's patience. The overflow passage is made large enough to admit the hand for easy and thorough cleaning. Thus all the requirements mentioned as necessary to produce our ideal basin seem herein to be fulfilled.

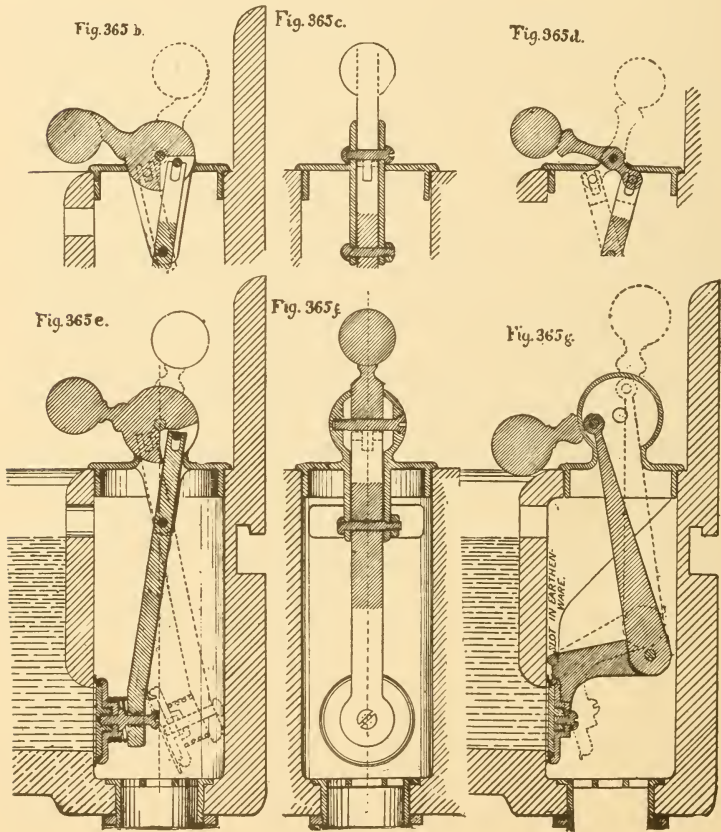

CHAPTER XXVI.

KITCHEN PANTRY SINKS AND BATHS.

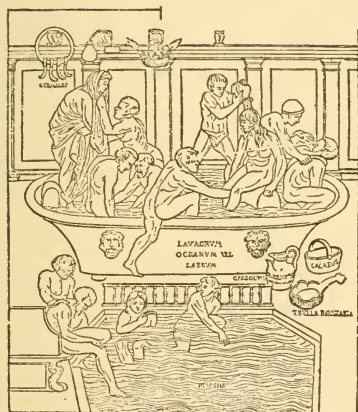

Fig. 366. An Ancient Painting of
a Roman Bath, from Joly.

Of all plumbing fixtures none are more dependent upon a proper form of discharge than those into which grease and organic refuse coming from dish washing are brought. Nowhere is the application of the principle of the flush tank more needed than here, because in no other manner than by thorough intermittent flushing can the greasy matters passing through them be disposed of without rapid clogging of the waste

pipes. To remove these matters from the dishes used in cooking and serving food hot water is necessary, and this liquefies the grease. If the volume of water into which this melted grease is led is not sufficient to partially congeal it and carry it through the waste pipes with a powerful rush, it will congeal upon and putrefy in these pipes until a serious nuisance is formed. In ordinary sinks in general use, the melted grease dribbles through the sink strainer and chills upon the inside of the waste pipe and in the mouth of the vent pipe and all other corners of the trap before it has traveled a rod from the sink. In chilling, it forms a coating in these places so hard that it is subsequently often very difficult to remove, and soon causes annoying stop-

pages. The obstructions can sometimes, but not always, be removed by pouring a hot solution of potash into the pipes until the grease dissolves and becomes converted into soap.

When proper cleanout caps have been arranged in the sink waste pipes, an obstruction can sometimes be reached and scraped out by proper tools; but such opportune openings are seldom found when and where needed, and the removal of this putrid matter is, at best, so exceedingly offensive and unwholesome an operation that it is usually deferred so long as possible, and the foul putrefaction goes on in the waste pipes out of sight.

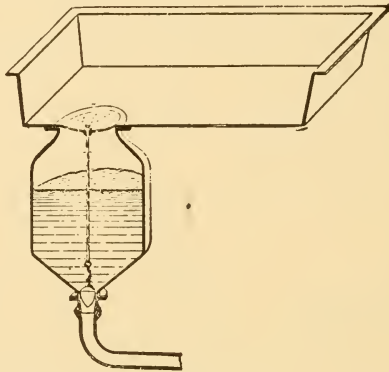

Fig. 366a. Col. Waring's Flush-pot Sink.

The late Col. Waring was, I believe, the first to call attention to the need of constructing sinks on the principle of a powerful flushing tank, and he invented a sink which I have reproduced in section in Fig. 366a. It consists of a large flush pot which can be attached to a sink of any kind. Col. Waring describes it as follows: "The flush pot is an entirely new departure. It holds back everything, water and all, until it is filled. The pot under the sink holds six or seven gallons. Its contents are then discharged—the whole

volume suddenly—with such scouring force as to prevent adhesion to the walls of the waste pipe. It is entirely simple in its construction and needs no special thought. When the water ceases to run from the sink, the cook knows that she must lift the plug of the flush pot. The strainer may easily be removed at will. The whole interior, then exposed to view, is within easy reach of a cloth, so that it may be kept as clean as a soup kettle. We thus secure the entire removal of the whole of this greatest source of foul decomposition before its putrefaction begins. In discharging the flush pot, the handle should be raised only until the stop strikes the lower side of the strainer. The strainer should not be removed except for cleansing. It should never be removed while refuse of any kind is in the sink.”

Unfortunately the average cook is neither a philosopher nor a sanitarian, nor does she disturb herself about the distinction between the friendly bacteria of decomposition and the criminal classes of putrefaction, and she does not care about the bacteriological and chemical constitution of the air of sewers. Consequently she is too apt to forget all about operating the outlet plug, and there have been instances where this has led to a disastrous overflow of dirty water over the floor, and to a simultaneous outburst of language of similar complexion from the irate cook, followed by an unceremonious discharge by her of the Colonel's offending plug and its consignment for good and all to the demnition bow-wows. She also takes this occasion to eulogize unconsciously the famous sanitary engineer and author of this device as she wonders how anyone could ever have been such a fool as to plug up a sink outlet, which of all places should be left wide open for the “instant and complete removal of waste matters into the drains as soon as they are formed,” and to add insult to injury she lifts out the Colonel's strainer and brushes into the capacious flush pot all solid matters

too coarse to pass through the strainer, seeing that the flush pot outlet has been kindly made large enough to save her all the trouble of removing them from the sink by hand.

The sink shown on Figs. 366b and 366c is one devised by Mr. Gerhard. It is divided by a perforated partition wall forming a strainer into two parts, a shallow and a deep part.

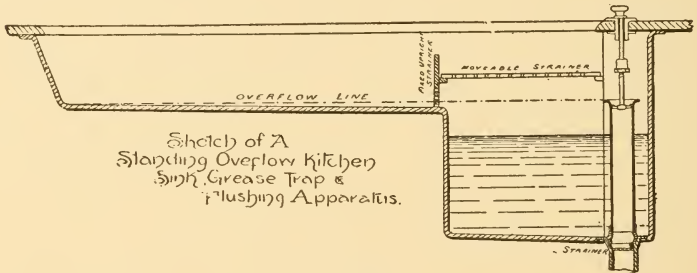

Fig. 366b.

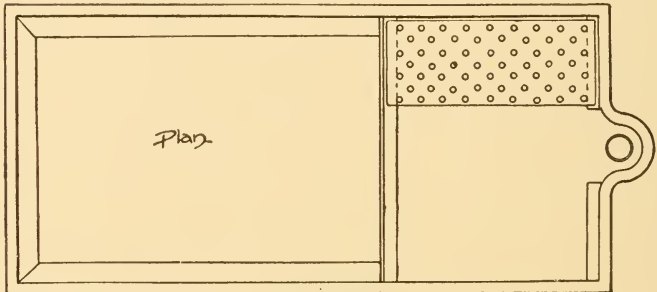

Fig. 366c.

The shallow part is used in the same manner as an ordinary sink. When the deep part is filled to the overflow line of the standpipe it can be discharged as a flush pot by lifting the standpipe. This part of the sink serves the further useful purpose of enabling dishes, pots, etc., too large for convenient handling in the shallow dish to be effectively washed in the deep body of water furnished by the flush pot.

KITCHEN PANTRY SINKS AND BATHS.

The chief difficulty in the mechanism of each of these devices is that they are not automatic in action and the users will not take the trouble required to operate them properly. They will not hold up the plug or standpipe while the water is escaping. There is too much work to be done elsewhere, and it is too easy to simply remove the plug or standpipe and let the water take care of itself. We must recognize this creditable desire of cooks and pantry maids

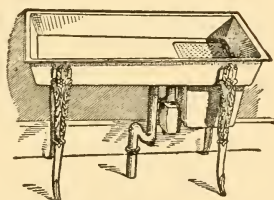

Fig. 366d. First Automatic Flushing Sink.

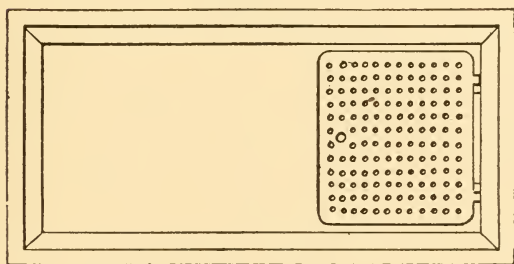

Fig. 366e. Plan of the Automatic Sink.

to be always on the active rush and make the mechanism of our flush pot absolutely automatic if we wish it to become popular and practical.

Figs. 366d to 366f represent in perspective, section and plan the writer's first device for complete automatic operation. It has been assumed at the outset as an indispensable condition in the design of the apparatus that absolutely

nothing should be dependent upon the intelligence and care of the servant, and that by no possibility could the waste passages become clogged, either by accident or by design. In short, that the operation should be entirely automatic, and that the form of the outlet should be such that no solid refuse *could possibly gain access to it.*

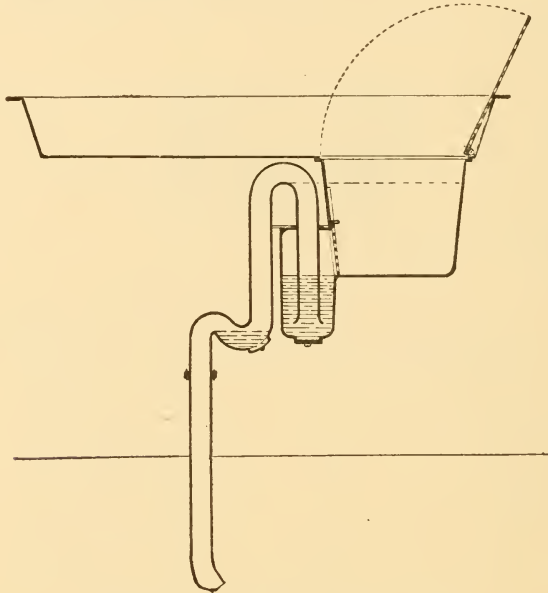

Fig. 366f. Section of Automatic Sink.

It consists of the combination of a square flush pot with an ordinary kitchen sink, in such a manner as to provide a sink of the ordinary appearance and form above, but having a deep portion or flush pot at the end, with an automatic discharge.

An upper or horizontal strainer covers the entire flush pot and is hinged to one end of the sink, so that it may be opened when it is desired to use the deep part of the

KITCHEN PANTRY SINKS AND BATHS.

sink. The sink is discharged by means of a self-acting siphon, and a vertical strainer is interposed between the flush pot and its siphon. The short arm of the siphon is trapped with a seal-retaining trap just behind the vertical strainer. This strainer slides upwards in a groove to give access to the trap when desired, but closes again automatically by its own weight as soon as released. Clean-out openings are provided at the trap and weir chamber, and gives access to every part of the waste system. No bones and solid refuse can be scraped into the discharge outlet and dropped into the waste pipe, because this pipe ascends instead of descends at the outlet; and should the trap be clogged, it will simply cause the water to cease to flow out until the obstruction is removed, which can easily be done by simply raising the lower strainer and lifting out the obstruction by hand.

The operation of the sink and flush pot is as follows: The sink is used in the ordinary manner until the flush pot fills to the height of the siphon overflow. When this point has been reached, the next discharge of a quart or two of water suddenly emptied from the washing pan charges the siphon and causes the entire contents of the flush pot to rush out through the waste passages, filling them full bore, and scouring them from end to end. The solid matter and large lumps of grease will be left on the bottom of the flush pot, and must be removed by the servant in the proper manner, inasmuch as they cannot possibly be removed in any other way.

Thus the great annoyances, expenses and dangers arising from the discharge of sink refuse are avoided. The additional cost of the actual flushing apparatus over that of an ordinary kitchen sink is trifling. But the sink contains its own trap. The trap is also anti-siphonic, and hence requires no back venting.

PLUMBING AND HOUSEHOLD SANITATION.

The deep portion of the sink may be conveniently used for washing large kitchen utensils which require deeper water than is to be had in ordinary sinks.

Figs. 366h and 366i show the writer's recent improve-

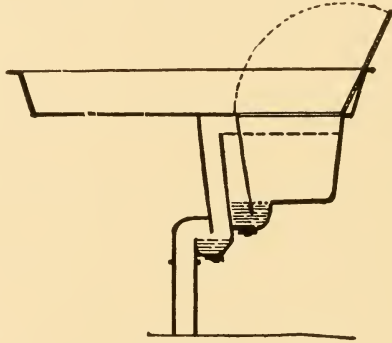
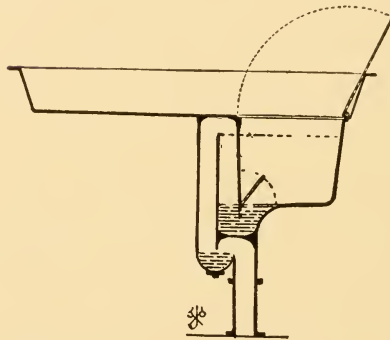

Fig. 366g. Section of "Securitas Sink.



Trap 366h. Section of "Securitas" Sink.

ments on this sink, to which he has given the name "Securitas" to distinguish it from the old "Sanitas" design. The advantages are greater simplicity and economy and a much better appearance. The trap is a simple return bend,

KITCHEN PANTRY SINKS AND BATHS.

which with the flush pot as a reservoir chamber and the long upcast limb is anti-siphonic. Back pressure is, as we have shown, to be expected in basements, and not siphonage. The flush pot renders back pressure entirely harmless, as is evident.

The weir chamber is placed preferably under the trap and the whole flush pot attachment thus becomes compact enough to be cast in a single piece. The outlet is enlarged at the strainer to give more room for the water to escape, and the strainer is hinged to the bottom so that it closes automatically and cannot be removed by the cook. This form of trap and strainer is much easier to clean than the old form of bottle trap originally used, and it does away with the need of a clean-out screw under the trap. Fig. 366g shows a form having the weir chamber facing to the left instead of under the trap. This gives room for a trap clean-out should it be preferred.

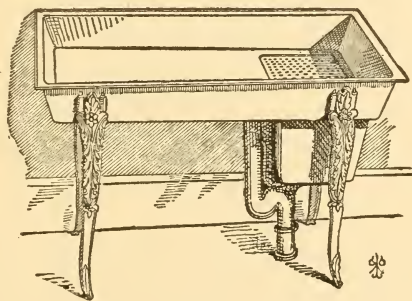

Fig. 366i. Perspective of Securitas Sink.

BATHS.

Fig. 366 from Joly represents in the ancient baths almost all the operations practised in the public baths after

the exercises of the gymnasium, namely, rubbing with the flesh brush, massage, nerve adjustment or manipulation and douche bathing. These processes, imitated in the East, are similar to our Turkish baths.

JAPANESE BATHS.

Prof. Morse compares the bathing facilities of the Japanese with ours. Whereas with us ample bathing facilities are confined to a comparatively few rich people, in Japan "nearly every house among the higher and middle classes possesses the most ample arrangements for hot baths; and

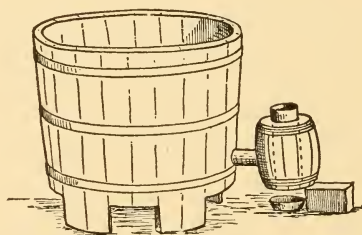

Fig. 366j. Bath-Tub with outside Heating Chamber. From Morse's "Japanese Homes."

even among the poorer classes, in the country as well as in the city, this convenience is not wanting, with the added convenience of public baths everywhere attainable if desired."

Fig. 366j shows a common form of Japanese bath tub with arrangement for heating the water attached to it. This stove consists of a small wooden water barrel having a copper smoke flue passing through it in which charcoal is burned. The water passes through a large bamboo tube having a little square door within the tub which the bather may close if the water becomes too hot. "These tubs," says Prof. Morse, "stand on a large wooden floor,

KITCHEN PANTRY SINKS AND BATHS.

the planks of which incline to a central gutter. Here the bather scrubs himself with a separate bucket of water, after having literally parboiled himself in water the temperature of which is so great that it is impossible for a foreigner to endure it."

Sometimes the bottom half of the bath tub is made of iron, as in Fig. 366k, and the fire is then built directly be-

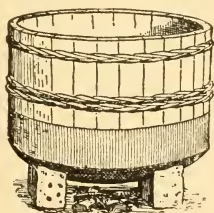

Fig. 366k

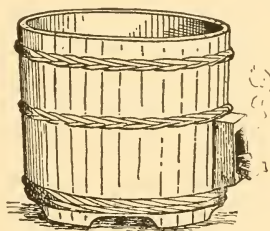

Fig. 366l

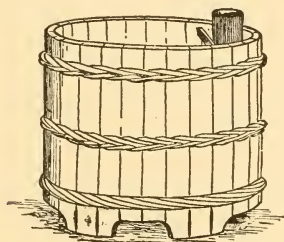

Fig. 366m. Bath-Tub with Inside Flue.

neath it, the bather standing upon a rack of wood to protect his feet from burning. "This tub is called a Goyemon buro, named after Ishikawa Goyemon—a famous robber of Taiko's time, who was treated to a bath in boiling oil."

In Fig. 366m a copper tube forming the smoke pipe passes directly through the bottom of the tub. The bottom of the tub forms the fireplace, a simple wire grating supporting the charcoal, the combustion of which rapidly heats

the water. A shallow pan below the grating forms the ash pit.

In Fig. 366n the bath tub is in two sections, separated by a perforated partition of the room, the heating apparatus being on the further side of the partition.

The bath tub, like all other plumbing fixtures, should have as little woodwork as possible about it.

The first tubs made in modern plumbing work consisted of a wooden box lined with lead, some of which exist today. The lead cannot be polished clean and therefore always presents an uninviting appearance. The metal is also so soft that it cannot retain a smooth surface. Next came

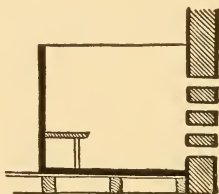

Fig. 366n. Bath-Tub in Section, the heating oven being outside the Room. From Morse.

the zinc tub, which could be kept cleaner and cost less than lead, but is not so durable. It is never now used except in the cheapest kind of work. The copper tub succeeded the zinc, the metal being from 12 to 20 ounces per foot in weight and forming a lining to a wooden frame. This copper tub, heavily coated with tin, has enjoyed popularity in the best houses until the advent of the porcelain tub, when it was found that the appearance of copper, especially when the tin plating became partly worn off, was quite unendurable in appearance, and quite too easily dented to remain fashionable, and it was required to take a secondary place in favor of the Royal Porcelain all earth-

KITCHEN PANTRY SINKS AND BATHS.

enware, or porcelain-lined tub with its snowy whiteness and its icy coldness to the touch until well warmed up by hot water. Cast iron tubs, plain, painted and galvanized, appeared before the porcelain-lined iron, but had only a short career of usefulness, the paint and galvanizing soon wearing off and leaving a very dirty, rusty article, much despised by all but the poor and unfortunate.

Cast iron enameled tubs are now so well made that the porcelain lining adheres firmly to the iron and makes a very beautiful and durable finish. It is not so durable, however, as the all crockery tub which, once paid for and properly set, will last as long as the foundations of the house will support its weight. The solid crockery is even colder to the touch than the enameled iron, but it forms a very beautiful though exceedingly heavy and expensive fixture nevertheless.

A very good form of tub, recently introduced, is made of copper-lined sheet steel with cast iron supports of ornamental design and polished wooden rim. This is an open fixture, light and easy to handle, and has much about it to commend. Similar in construction to the sheet steel tub is one made of a very heavy sheet copper. It has the advantage of being entirely rust-proof and quickly warmed, but does not present the inviting appearance of the porcelain surface.

Fig. 368 shows a "needle" bath standing free in the corner of a bathroom having marble or tiled sunken or dished floor. Jets are arranged on all sides as well as above and below. These shower baths are supplied with hot and cold water and mixing devices so that the temperature required for comfort as well as health or medical benefit can quickly be attained.

Fig. 369 shows in section the construction of a slow-closing faucet devised by the writer to measure and econ-

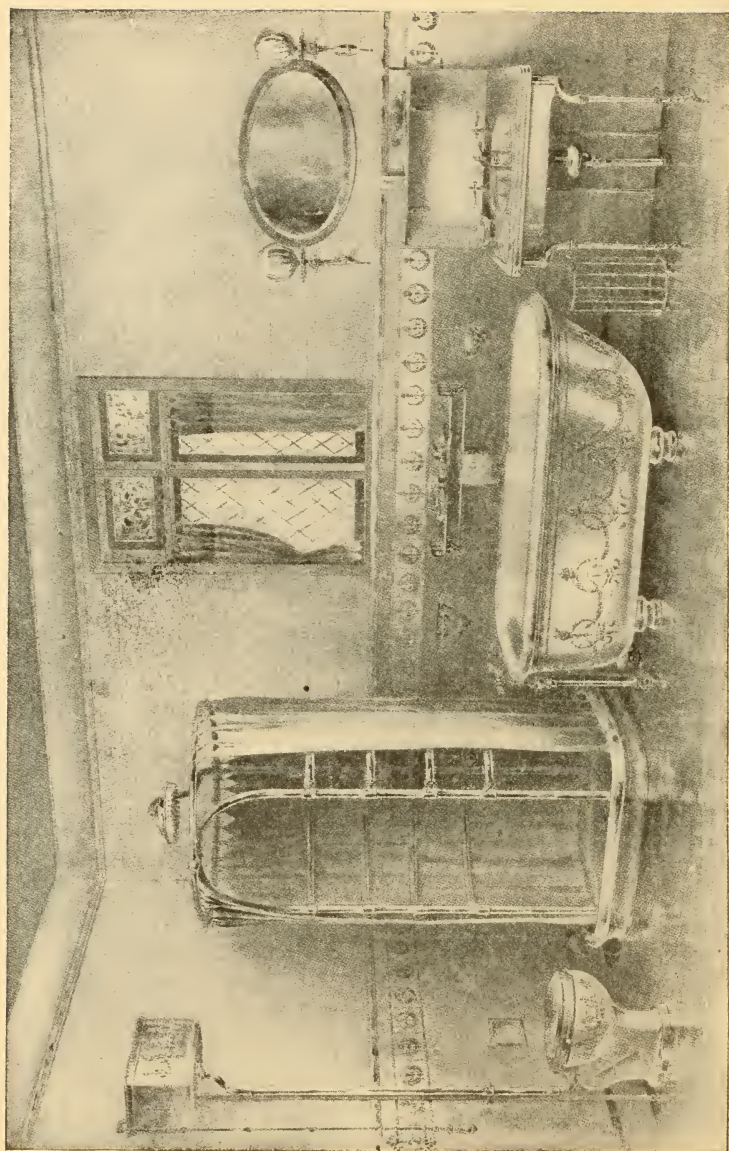

Fig. 367. Modern Bath Room. Copyright 1907 by the J. L. Mott Iron Works.
The Writer has introduced his "Securitas" Basin and White Enameled Traps into the Drawing.

KITCHEN PANTRY SINKS AND BATHS.

omize water. No packing is required around the valve stem. The valve closes with the pressure, instead of in the usual manner, against it. Hence a comparatively flexible spring is used; and in virtue of this and of the peculiar

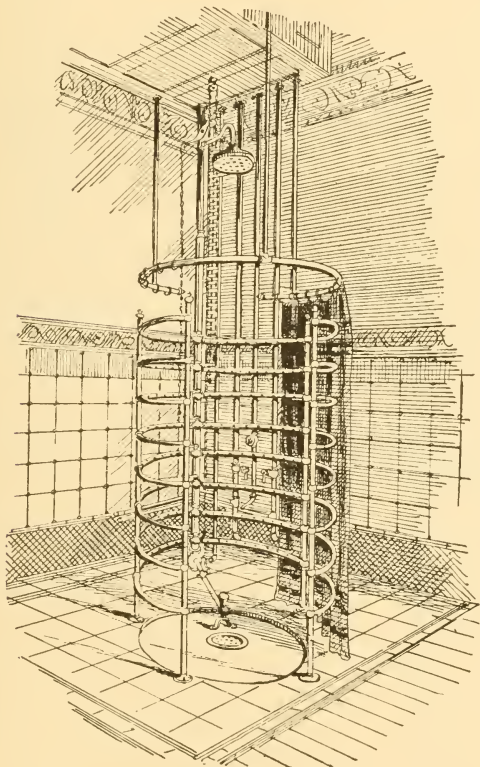
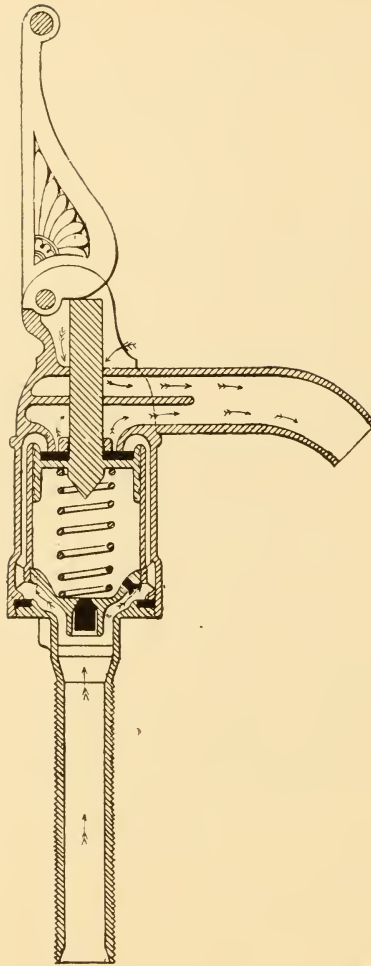

Fig. 368. Needle Bath.

construction of the handle it is easily operated, and the spring being never under heavy tension when the faucet is closed, wear is minimized. When the valve closes against the pressure evidently very powerful springs have to be



Figs. 369 and 369a.
Section and Perspective
iew of the Writer's
Slow Closing
Faucet.

used, difficult to operate, and constantly deteriorating under the permanent strain to which they are subjected. Moreover, with ordinary faucets the strength of the spring must

KITCHEN PANTRY SINKS AND BATHS.

evidently be greater than the heaviest water pressure ever likely to be used on the faucet valve, so that a considerable waste of power is necessary; and, since the life of the spring is gradually exhausted with age, and the pressure is liable to be varied in the water mains, either permanently or temporarily, the faucet is soon liable to leak. Moreover, the wearing of the packing required around the valve stem of ordinary faucets is a constant source of leakage and annoyance. In using them it is necessary not only to exert a considerable strain of the fingers in overcoming the pressure of the heavy spring, but to sustain the strain during the whole time the water is running. This proves to be so very inconvenient (especially when, with hot-water faucets, the handle becomes so hot as to burn the fingers) that all kinds of devices are resorted to to tie the handle down, and thus the whole object of the device, for insuring against water waste, is frustrated. When the handle is suddenly released, a severe shock is sustained by the recoil of the spring, which injures and sometimes bursts the water pipes.

This faucet is designed to do away with these difficulties. A slight touch of the handle, with instant release, is sufficient, with the exercise of very little power, to draw any desired amount of water, from a quart to a couple of gallons, from this faucet. The handle is in the form of a lever and moves forward in an arc in the direction of the nozzle. Drawing the handle down through the complete quarter circle opens the valve completely and gives the whole amount of water for which the faucet is originally adjusted when set. Turning the handle through a half or a quarter of this arc gives correspondingly a half or a quarter of this amount of water, and thus a very great saving of water is effected, an advantage which the

metered-house owner and the water companies greatly appreciate.

Moreover, the user is enabled to make use of the water while it is running, and thus avoid the annoying waste of time necessary with other self-closing faucets in holding the handle down.

A small adjusting screw is provided at the bottom of the chamber under the spring, by means of which the quantity of water to be delivered at each full opening of the handle is regulated when the faucet is set. It is best to regulate the amount by the capacity of the basin it serves, up to the overflow point. This faucet closes slowly automatically, and cannot hammer under the heaviest pressure ever used. Hence there is no possible danger of swelling or bursting of pipes through its use.

The spring chamber is closed by a floating valve, which opens when the water is turned off of the house; and all parts of the faucet are then drained off, rendering damage by frost impossible.

Instead of packing around the valve stem, the principle of water suction is employed in this faucet to make tight. The closing of the faucet is slow, direct and soft, and does not come to its seat with the turning or grinding movement which ordinarily cuts away washers at the seat.

The difficulty, however, with this device, in common with all hydraulic devices depending upon close-fitting plungers for their operation, is a liability to stick in gritty waters. Hence they should only be used where the water supply is pure or well filtered, as is now not uncommon, and as indeed always should be the case everywhere.

CHAPTER XXVII.

PUBLIC BATHS.

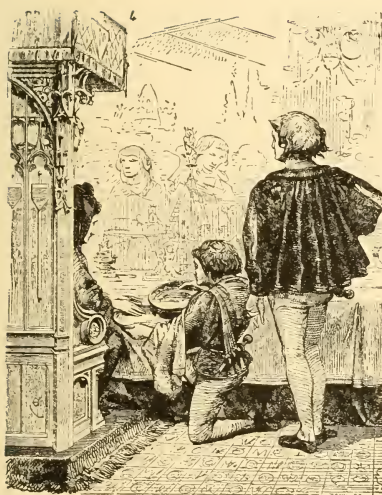

Fig. 371. Mediaeval Bathing at a Public Banquet.

and silver beautifully embossed with jewels and enameled with coats of arms, sometimes costing several hundred dollars each. But during the feast the company would throw bones and other refuse from their plates upon the floor, which the dogs looked for as their accustomed share. So that cleanliness at these interesting mediæval feasts presented a picturesque diversity of form, particularly as

In England, during the Middle Ages, bathing the hands in public sight in the banquet hall was the fashion. When the tables at their great feasts were spread, attendants entered the hall with basins, ewers and napkins and carried them round to the company, who washed their hands before they sat down to dinner. Sometimes the guests were summoned to wash, however, in the lavatory before meals by the blast of trumpets. The ewers and basins

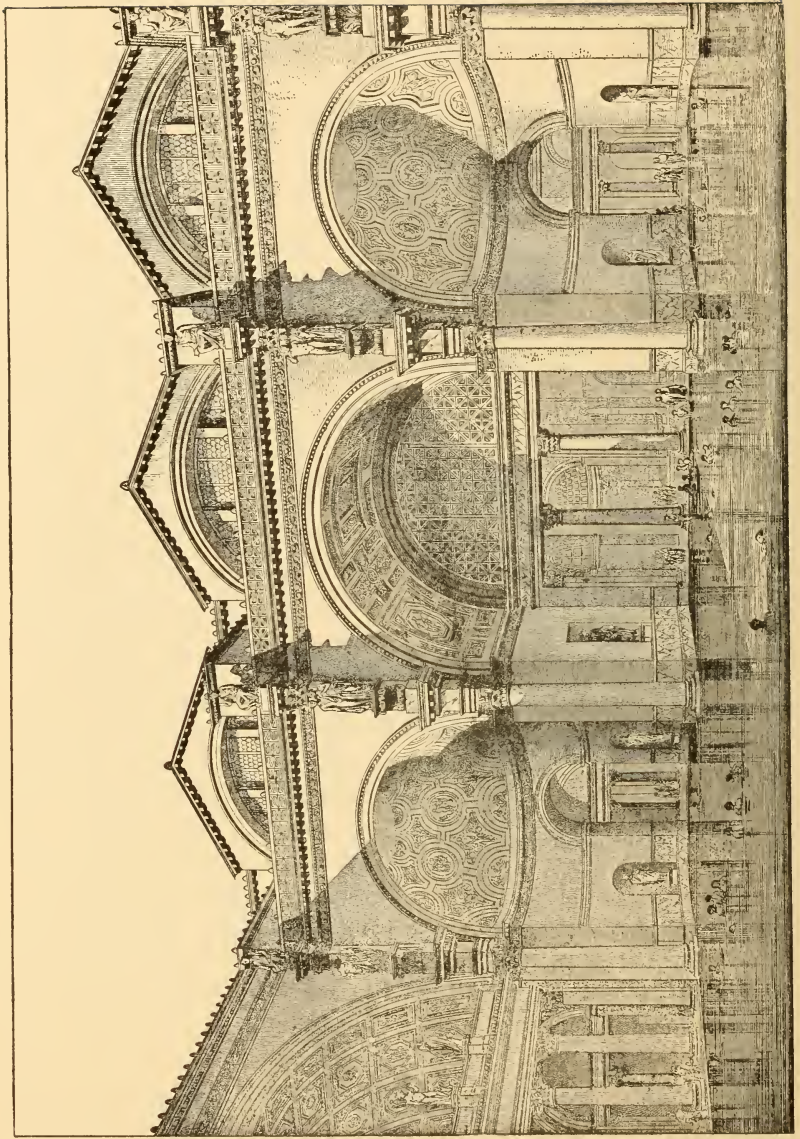

Fig. 372. Baths of Caracalla. From Viollet le Duc's "Entretiens Sur l'Architecture."

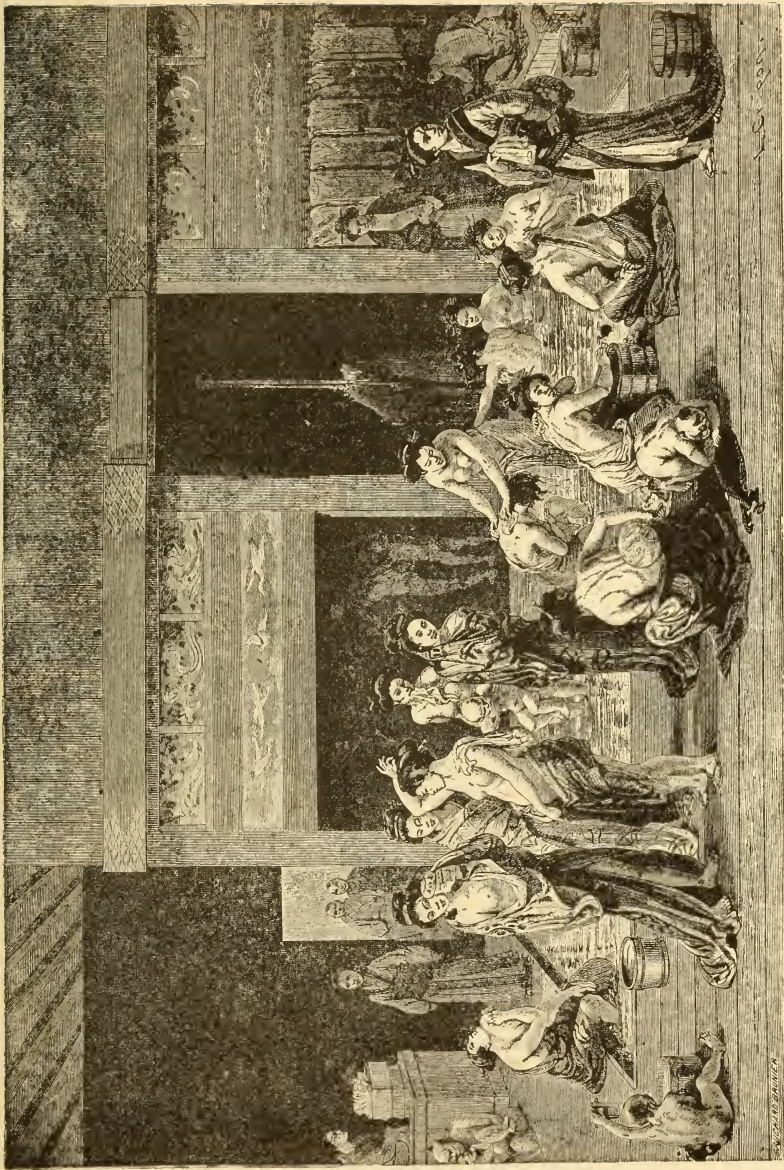

Fig. 373. Japanese Public Bath.
From *Le Japon Illustré* by Aime Humbert Hachette et Cie, Paris, 1870

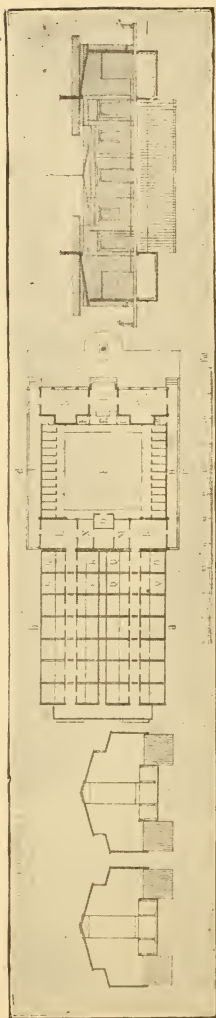

Fig. 375. Plan of German Public Bath.

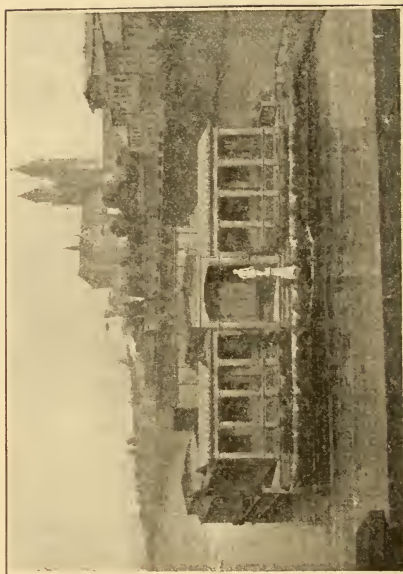

Fig. 374. German Public Bath. Perspective View

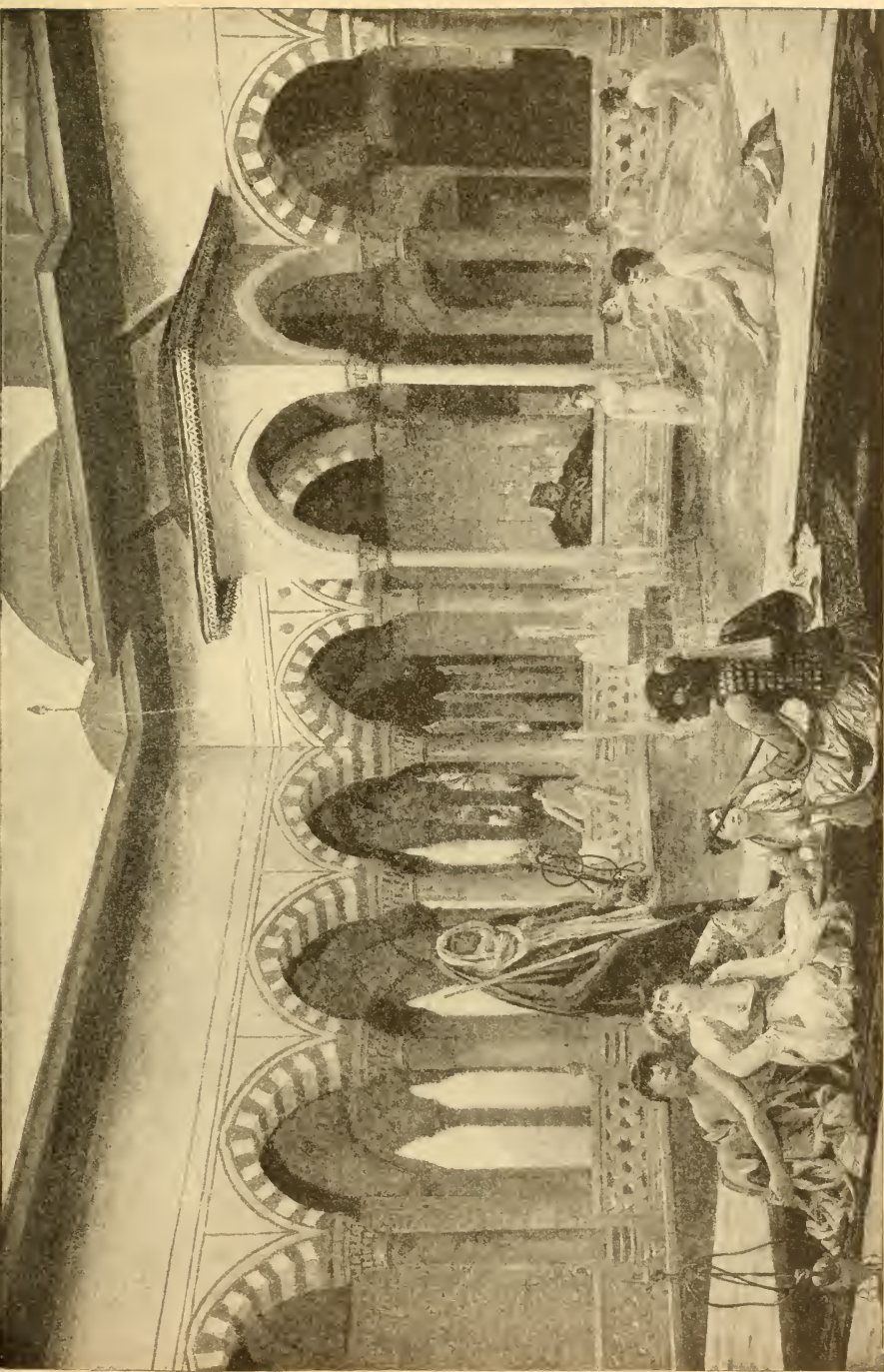
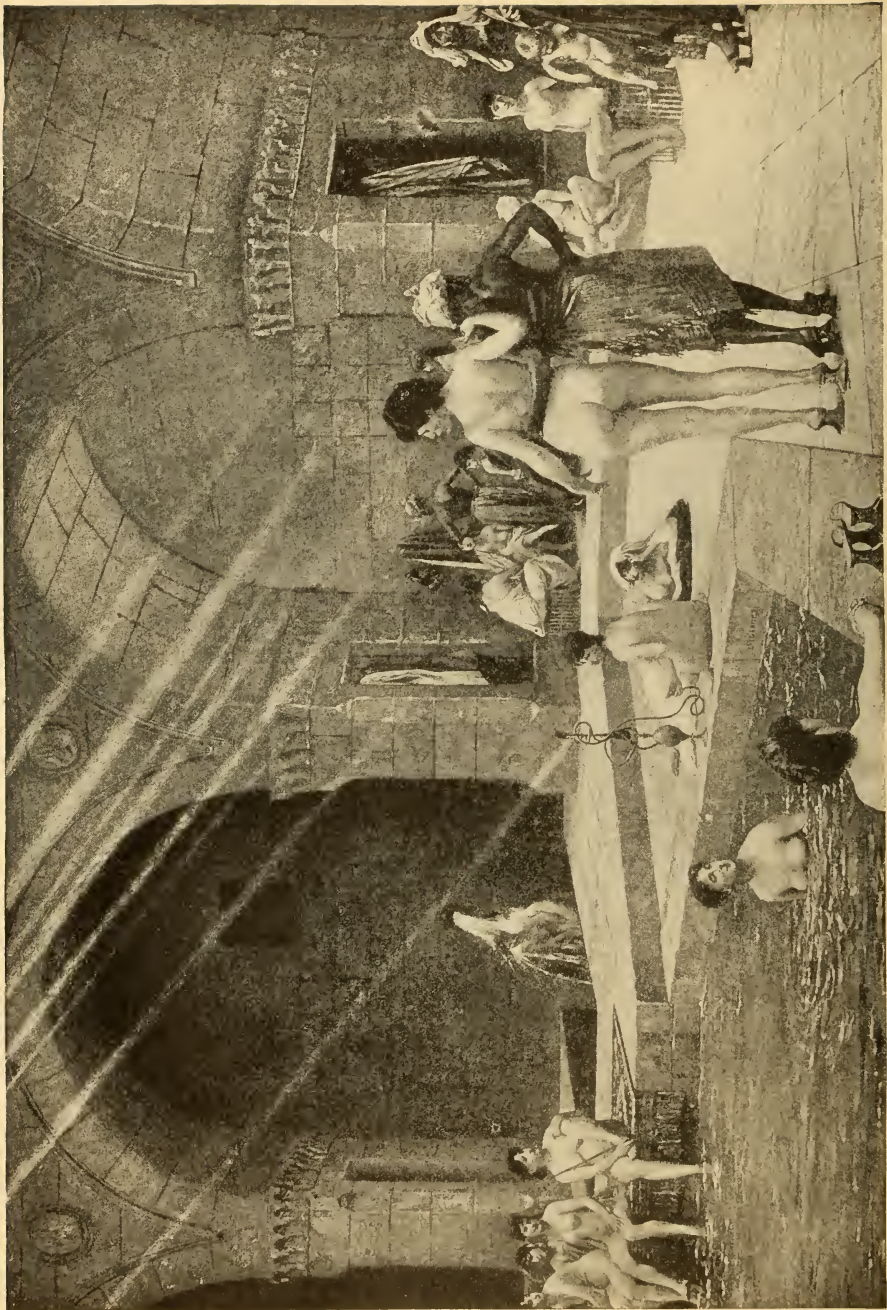
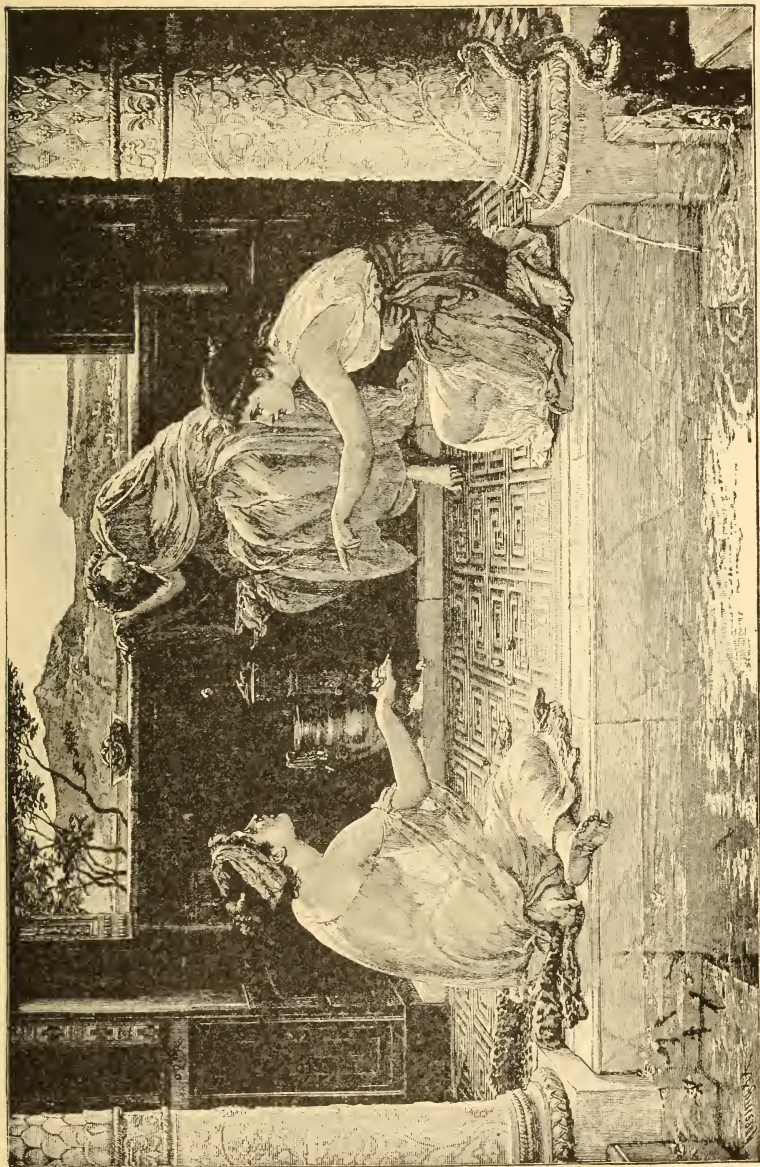

Fig. 375a. Terrace of the Seraglio. The Swimming Pool. From Gerome's Famous Painting.





375c. "When the World was Young." From Painting by E. J. Poynter, P. R. A., Royal Academy, 1892. From "The Magazine of Art," Vol. XX. Cassel Publishing Co., N. Y.

fingers were used before the 14th century in place of spoons and forks.

Fig. 372 is Viollet le Duc's restoration of the famous baths of Caracalla. These contained magnificent swimming halls of cold, hot and tepid water. The picture shows the "frigidarium" or great cold water bath, which is the largest in the establishment. It is open to the sky under the principle that protection from rain is unnecessary for bathers in cold water in a climate like that of Rome.

The warm bath, "tepidarium," seen in the view beyond the great arches, is roofed over, as is also the hot bath, "caldarium."

Fig. 373 represents a Japanese public bath.

Figs. 374 and 375 show a beautiful little German public bath from the Berlin "Skizzen Buch." The façades are treated with rich colors in Pompeian design. The plan shows the entrance terrace in front, reception rooms, one for ladies and the other for gentlemen, at the right and left of the entrance; a small buffet and dining room adjoining the entrance, with connecting kitchen, a large square central swimming bath, and dressing rooms, and separate small bathing rooms for men and women, and a common piazza in the rear for use after the bath.

Figs. 375 a and 375 B are from Jean Leon Gerome's famous paintings at the Paris Salon. From plates presented by the Standard Sanitary Mfg. Co. Fig. 375c is from E. J. Poynter's "When the World was Young."

CHAPTER XXVIII.

WATER CLOSETS.

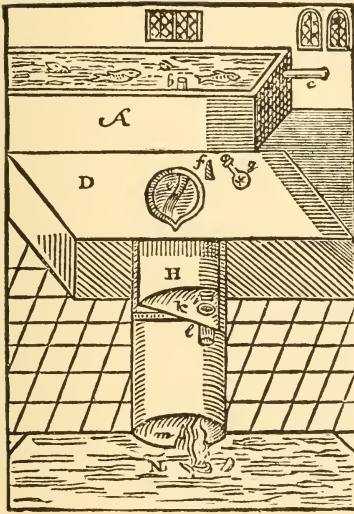

Fig. 376. Earliest Form of Water Closet Apparatus Since the days of Rome. (From the Popular Science Monthly.)

Dr. John S. Billings refers* in the Popular Science Monthly of January, 1889, to two old English pamphlets which contain the first description and illustrations of a water closet which had appeared since the days of old Rome. They were written in 1596 and described by their author as "A New Discourse of a Stale Subject," and as an "Anatomy" wherein is described "plainly, openly and demonstratively declared, explained and eliquidated how unsavory places may be made sweet, noisome

places made wholesome, filthy places made cleanly. Published for the common benefit of builders, housekeepers and house owners, by T. C., traveller, apprentice in poetry, practiser in music," etc. The author, John Harrington, describes his water closet, his picture of which we have reproduced in Fig. 376, in the following quaint but rather

*"House Drainage from Various Points of View." Popular Science Monthly for January, 1889.

unnecessarily strong language: "When I have found, not only in mine own poor confused cottage, but even in the goodliest and stateliest palaces of this realm, notwithstanding all our provisions of vaults, of sluices, of gates, of pains of poor folks in sweeping and scouring, yet still this same whoreson, saucy stink, I began to conceive such a malice against all the race of them that I vowed to be at deadly feud with them till I had brought some of the chiefest of them to utter confusion, and conferring some principles of philosophy I had read, and some conveyances of architecture I had seen, with some devices of others I had heard, and some practices of mine own I had paid for, I found out this way that is after described and a marvelous easy and cheap way it is.

"Here is the same, all put together that the workman may see if it be well. A, the cistern; b, the little washer therein; c, the supply pipe; d, the seat board; e, the pipe that comes from the cistern; f, the screw (to start the flush); g, the scallop shell to cover it when it is shut down; H, the stool pot (or receiver); i, the stopple (or plug); k, the current (or flushing stream); l, the sluice (or waste pipe); m, N, the vault into which it falls; always remember that the servant at noon and at night empty it, and leave it half a foot deep in fair water."

Fig. 377 shows quite a different style of closet equally interesting and curious, but more decorative, though of considerably earlier date and not so sanitary. It is fairly illustrative of the somewhat pompous and pretentious Roman architecture with its curved throne-like back and royal carved lions' legs. It is now preserved in the Louvre in Paris.

Fig. 378 shows the construction of latrines in the palace of Courcy, France, in the 13th century. They were arranged in such a manner as to avoid odor and all other

WATER CLOSETS.

inconvenience. They were built in the interior angle between a tower and the main building in such a location that the waste matters were received in a rocky crevice in the forest surrounding the castle. The closet room adjoined

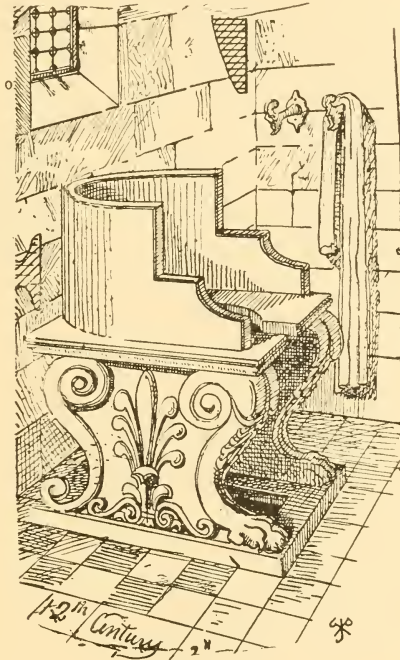

Fig. 377.

a passageway communicating with the chambers and the staircase. In the plan B is the main building, C the tower. From the wall of the former to that of the latter the wall B-D was built on corbels to mask the water closet seat E. At F is a urinal with its pipe shown in the elevation H at the spout below the small window G. I is a section looking toward the window and showing the seat and win-

PLUMBING AND HOUSEHOLD SANITATION.

dow in elevation. Thus the closet room was quite open to the air both above and below, and secured perfect ventilation.

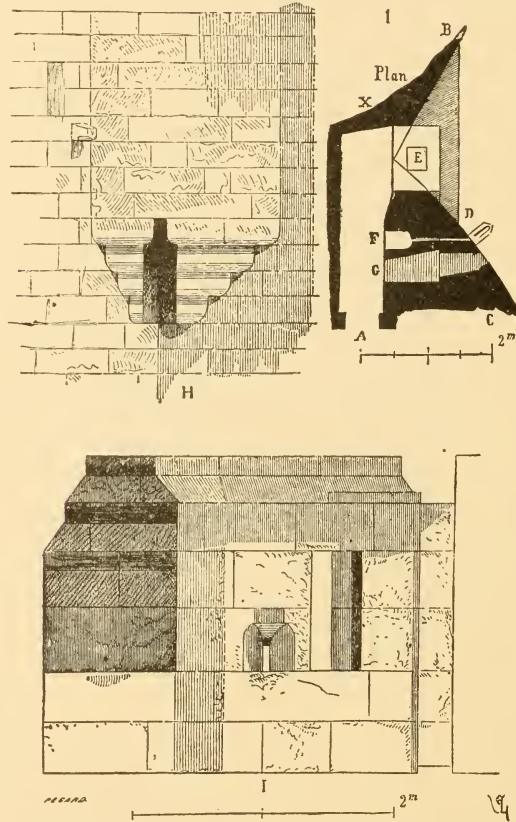

Fig. 378. Latrines in the Palace of Courci, France. 13th Century.*

The next Fig. 379 shows a closet in the castle of Landsperg which still exists intact, and which like that at Courci

*From Viollet le Duc's Dictionary of Architecture.

WATER CLOSETS.

discharges directly into the open air. The seat is carried on a bracket projecting clear of the wall and is covered by the stone nichework shown in plan and perspective.

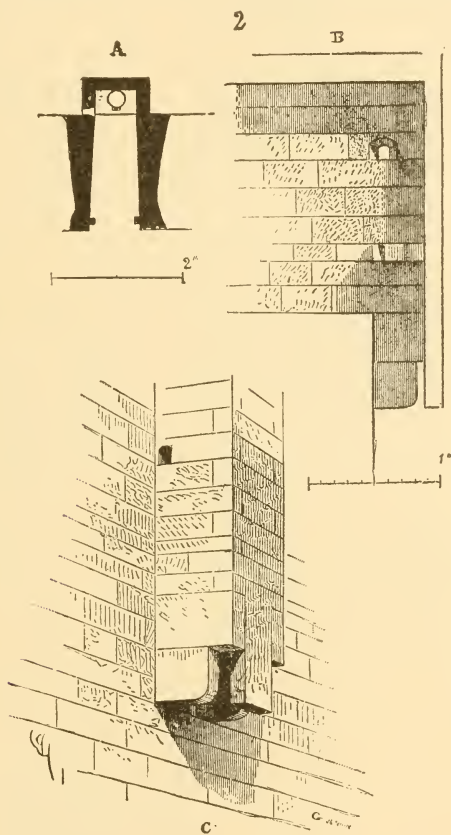

Fig. 379. Latrines in the Castle of Landsberg.*

The chateaux of the middle ages were also provided with large cesspools which were the subject of great care on

From Viollet le Duc's Dictionary of Architecture

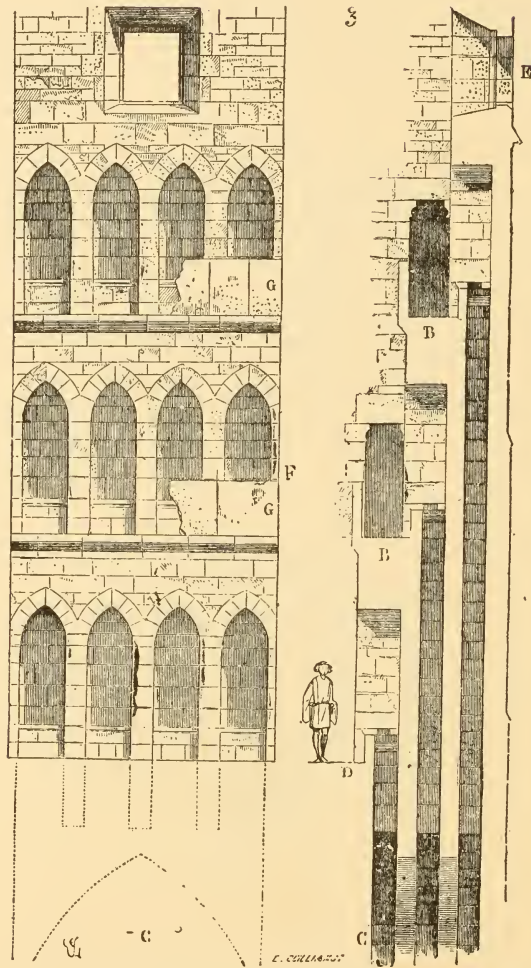

Fig. 380. Latrines in the Chateau de Marcoussis, France.*

the part of the builders. They were vaults in stone and well ventilated, with doors for cleaning out. In castles

From Viollet le Duc's Dictionary of Architecture

WATER CLOSETS.

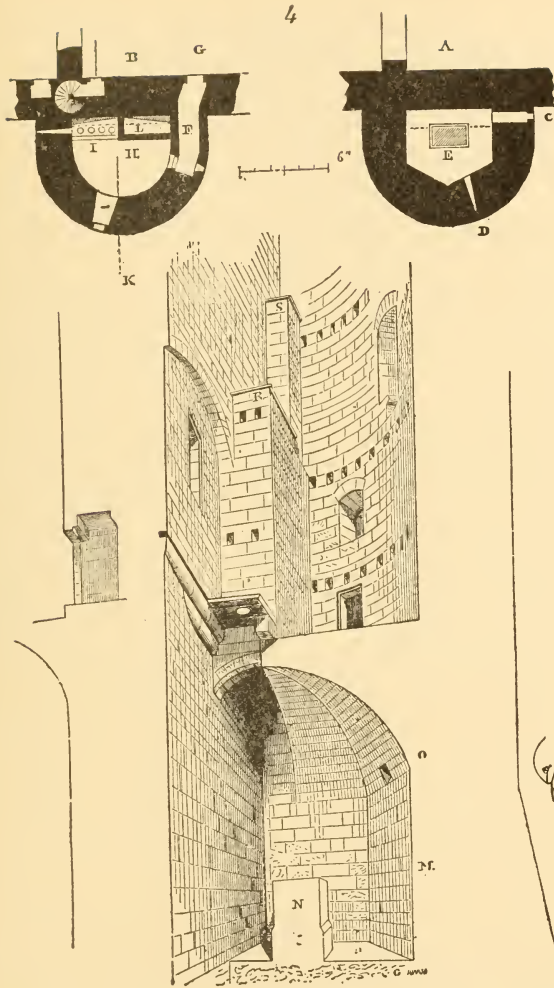

Fig. 381. Latrines in the Castle of Pierrefonds, France.*

designed to shelter large garrisons, there was always a separate tower or structure reserved for the latrines. Fig.

From Viollet le Duc's Dictionary of Architecture

380 shows the latrines of the chateau de Marcoussis in France, built in the 13th century, built in a narrow structure opening upon a small court. Several closets (four in this case) were placed side by side on each story and were connected by long chutes with the cesspool shown at the bottom. The building was open freely to the air on one side from top to bottom, and on the opposite side was provided with a large window as shown.

The next, Fig. 381, shows the latrines in the castle of Pierrefonds, built in the 15th century, to which a tower adjoining the rooms of the garrison was entirely devoted. A is a plan at the level of the ground and of the cesspool. C is the clean-out door. D a ventilator. E is a stone platform in the centre of the cesspool to facilitate emptying. B is a plan of the first floor. F is a passageway leading from the chamber G to the closet room H, which has a suite of four latrines at I, and the chute L, which serves the latrines in the stories above. The passageways F, connecting the various rooms with the latrines were provided with doors at both ends and were well ventilated, as were also the latrines themselves, which, moreover, were easily emptied from time to time; and thus these mediaeval arrangements were really very much better than the miserable structures with their abominable cesspools which serve us in the average country towns of the present day.

Violet le Duc, in giving us these descriptions of the latrines of mediaeval castles, warns his readers against the stories about "oubliettes," with which the modern guide beguiles amateurs in their visits to these feudal ruins, describing how the cruel lords designed them as places from which they hustled their unsuspecting enemies into the abyss below. Nineteen times out of twenty, he says, these "oubliettes," the descriptions of whose horrors so strongly

WATER CLOSETS.

move the visitor, are nothing more than very common place latrines, just as many of the chambers of torture pointed out by the guides are nothing but ordinary kitchens.

CLASSIFICATION OF REQUIREMENTS.

The ideal water-closet should possess the following characteristics relating to: (1) the method of flushing; (2) the form; (3) the material; (4) the construction, including methods of connecting with soil and supply pipes, and provisions for ventilation; (5) the cost; and (6) the appearance.

(1.) The Flushing.

(a) Should be so contrived as to thoroughly remove all waste matter immediately and carry it completely into the waste-pipe.

(b) Should pass through the closet rapidly and concentrated in a mass or large volume so as to act powerfully in flushing the closet and drains.

(c) Should thoroughly scour all parts of the closet and trap.

(d) Should act noiselessly.

(e) Should be effected by a single simple movement, and require the minimum of strength or effort.

(f) Should be effected without spattering.

(g) Should do the work with the minimum of water.

(2.) The Form.

(a) Should be as simple as possible, and the extent of surface to be flushed as small as possible to facilitate the scouring, and there should be no surface, angle, or corner which does not receive the scouring.

(b) Should be compact, allowing the closet to be put in the smallest possible space.

(c) The level of the standing water in the bowl should not be over six inches below the top of the closet bowl.

(d) The sides of the bowl above the water level should be substantially perpendicular.

(e) The form of the bowl and trap should be such that the whole interior of the former and the deepest part of the latter may be visible and accessible from the outside.

(f) The form of the closet should be such as to allow of its convenient use as a slop-hopper or urinal as well as a water closet.

(g) The bowl should have in it a body of standing water of sufficient area and depth to receive and deodorize immediately all the waste matter it receives.

(3.) The Material

should be tough and durable, with a perfectly smooth surface, which cannot be injuriously affected by the waste matters, changes of temperature, or any of the influences which are brought to bear upon it.

(4.) The Construction.

(a) Should be as simple as possible and have no pan, valve, gate, plunger or other obstructions to the water way.

(b) Should be such that the water in the trap when properly connected up with other fixtures cannot be destroyed by evaporation, siphonage or suction.

(c) The closet should be constructed strong enough to hold the seat without the aid of any external support.

(d) It should require the minimum of labor in setting and permit of disconnecting with the minimum of effort.

(e) It should provide for thorough local ventilation.

(5.) The Cost

of material, manufacture and setting should be at a minimum.

PAN CLOSETS.

(6.) The Appearance.

should be neat and ornamental, so as to require no casing or woodwork to conceal it.

Water closets may be divided into four classes or types.

I. Pan closets, II. Valve closets, III. Plunger closets, and IV. Hopper closets.

The first three are mechanical seal closets and the last simple water seal closets. Nevertheless the first really depend solely on a water seal as well as the last, because their overflows are usually provided with a water trap in any case. The real use of the mechanical seals is not to form an extra security against the entrance of sewer-air, as is commonly supposed, but to hold a certain amount of water in the bowl, so long as they can be kept water tight.

THE PAN CLOSET.

By good rights this closet should have no place at all in our list, or anywhere else, because it possesses absolutely none of the good features to be sought for in closets; but for this very reason as well as on account of the very extended use it has had in the past and still has at the present day, no type could serve better for the purposes of illustration and warning.

Our cut, Fig. 382, shows the Pan closet on the right as drawn by Dr. Teale, with a deposit all around the interior of the receiver about an inch thick. This drawing shows also the Doctor's idea of a substitute, but this was recommended before the invention of Jet closets. The seal in the short hopper is shown not over a half an inch deep, showing that siphonage was but little known until within comparatively recently.

We will see by referring to our table of requirements for a perfect closet that this type (Fig. 383) violates every

rule. The first rule refers to the manner of flushing. It is sometimes claimed that the pan closet has at least an advantage under this head in that it requires less water for flushing than any other. It is difficult to understand how a thoughtful person can make such an error as this, and no better means of showing the need of a thorough flushing

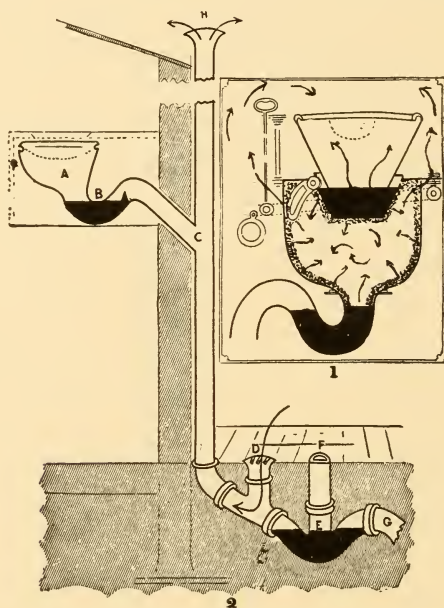

Fig. 332. Pan and Hopper Closets.*

could possibly be found than by explaining the results of the lack of it as shown in the Pan closet. Hence I shall ask you to follow with me in imagination the course of the flushing streams through a Pan closet, provided your imagination will consent to making this disagreeable trip into this Inferno of plumbing, and see what it actually does.

*From Teale.

PAN CLOSETS.

The small quantity of water which descends when the pan is lifted only *appears* to flush the closet, but actually does nothing of the kind. It simply transfers the waste matters from the pan to the receiver below, where a part remains for an indefinite length of time, and undergoes putrefactive decomposition. Each subsequent flushing adds more or less to the deposit thus originated, until the entire surface of the closet below the pan becomes coated with a mass of filth which sometimes attains a thickness of an

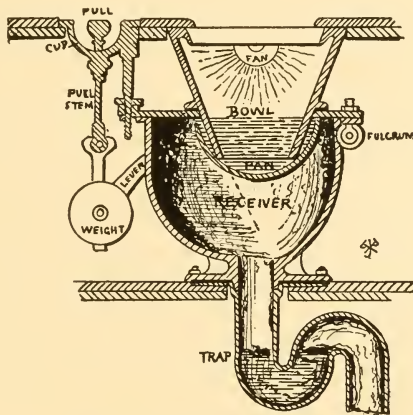

Fig. 383. The Pan Closet.

inch or more, and cannot be removed without taking the closet to pieces and burning it off. In fact the flushing stream itself does not remove the waste matter from the receiver, but simply refills the pan after it has been tilted. Hence the power for flushing acquired by the fall of the water from the cistern to the closet is entirely lost. The work of ejecting the wastes from the receiver into the soil pipe must be accomplished, if at all, by the discharge above it of the contents of the pan, the mere trickling of the flush-

ing stream over the edge of the pan, when it has been filled, having no effect whatever upon the matters previously dropped into the receiver and trap. Hence it rarely happens that a single flushing is sufficient to carry the wastes into the soil pipe. A second tilting of the pan is necessary and often several are required, and the wastes must therefore of necessity remain as long as the closet thereafter remains unused, and accordingly it is liable to give rise to putrefactive fermentation on every occasion when the toilet room is for any reason left unoccupied for any length of time, as may happen in unoccupied rooms or houses, under the conditions already enumerated in connection with the evaporation of trap seals.

With the Pan closet, therefore, the formation of the parts is such that the immediate removal of the waste matter into the soil pipe and the proper scouring of the closet and soil pipe is absolutely impossible, and it may therefore be said that the quantity of water required for the purpose is at a maximum. Sprinklers or flushing rims have been added to sprinkle the inner surface of the receiver at the same time with the upper flushing. The effect of this addition is to complicate the machinery and heighten the cost of the closet and the consumption of water. The accumulations of filth are, by such an arrangement, delayed in those places which happen to receive the jet of water from the sprinkler, but hastened in others behind the ring, which the spray cannot reach. It does not reach the under surface of the pan and bowl, between which the wastes are sometimes caught and compressed out of sight by careless usage; the upper surface of the receiver, and especially the surface of the sprinkling ring itself and the parts surrounding it. These parts receive the spatterings from the discharge and the condensation of the gases and vapors of

PAN CLOSETS.

decomposition, and tend to become finally encased with a coating of filth which an ocean of flushing water, so applied, could not remove.

The surface of the receiver is sometimes coated with enamel to prevent the adhesion of wastes, but after a few years' use these surfaces become roughened by a fine deposit, and the incrustation begins as before. The parts which receive the direct impact of the falling water resist longest, but inevitably succumb in the end. Porcelain and earthenware receivers have also been made, but the result is the same as with enameled iron. With no other type of closet are the evils of faulty construction so clearly illustrated as with the Pan, and its one supreme virtue lies in its usefulness as a warning. It may be called the most shining example of the blackest faults in plumbing apparatus.

The machinery of the Pan closet is most ingeniously devised for the production of a chorus of disagreeable noise, more or less energetic and appalling as the age of the closet increases, first comes the creak of the pan axle, then the rush and splash of the flushing stream descending from the cistern; then a repetition of the pan machinery on a different key as the rusty crank returns, and a report as the pan strikes the under side of the bowl, and the heavy balance weight on the pull comes back to its bearing; and, finally, from the cistern above, a bold, defiant crowing sound occasioned by the rush of air back into the supply pipe, apparently terminates the undesirable concert, much to the disgust and confusion of the occupant.

When the pan is tilted, the movement causes a spattering due to the resistance of the confined air in the receiver, which sometimes projects a small body of water high up into the air.

The Form of the Pan closet is (a) complicated and bulky.

(b) Its receiver occupies so much space below the bowl that there is no room for the trap above the floor. This is a most serious fault. The trap should never be buried out of sight and out of reach. Should it lose its water seal through evaporation, siphonage, or other cause, or become in any way defective, the loss cannot be seen, and poisonous gases may make their way unobserved into the house.

(c) In all Pan closets the bowl is too wide, and the surface of the standing water at its bottom too small and too far down below the seat. It is found that the lower the water stands in the bowl the greater the spattering occasioned by the falling wastes. This surface can safely be brought within six inches of the seat without inconvenience in the use of the closet, and this distance, where the flushing is effected properly, and without spattering, is the best.

(d) The bowl should be narrower, and the sides should be more nearly perpendicular. A narrow bowl is, within reasonable limits, equally convenient whether used as a closet, urinal or slop hopper. In all these respects the Pan closet is, with the exception of the dry hoppers, the best example known of defective form.

(e) No part of the trap, and but a very small part of the receiver, is visible from the outside. The accumulation of filth in these parts goes on without the knowledge of the owner, nor, if known, could it be reached and removed.

(f) The presence of the pan renders the use of this closet as a slop hopper unsafe, because it causes spattering and overflowing when large quantities of slops are suddenly thrown into it. There should be no obstruction to the full outflow of the water.

The Material or combination of materials used in the Pan closet forms another defective feature; the iron rusts and

PAN CLOSETS.

the copper corrodes, and the whole apparatus, ugly as it is at its best when new, becomes truly monumental in its hideousness when rusted, browned and scarred with old age.

The Construction.—(a) The pan, receiver, and all the machinery connected with them are unnecessary, because the waste can be better removed without them, and they form no additional security against the entrance of sewer-air. Until within a few years it was regarded as important to hide the trap and working parts of plumbing from view, under the assumption that they must necessarily retain at times waste matter offensive to the sight. Now, however, we have learned that with properly constructed fixtures all waste matters can be entirely and instantly removed after use, and that it is not only advantageous but necessary for perfect security that all parts should be visible to insure their proper use and cleanliness.

Consequently we see that the pan and its bulky receiver are worse than superfluous since they require hiding, and that the labor and money thrown away upon these useless complications might be saved for improving and strengthening useful parts.

(b) There is nothing in the mechanism of the Pan closet to provide against the loss of its water seal through evaporation or siphonage, though such a provision is possible. The loss of the water in the trap would remain undiscovered so long as the odor of the entering products of decomposition escaped observation, and it is known that the most dangerous of the carbon compounds of putrefaction are odorless.

(c) There are two joints between the bowl and the trap where there should be none.

The connection between the bowl and the receiver being, in the regulation Pan closet, made with putty alone, with-

out bolts or screws of any kind, a slight shock will make a crack in this connection, and Pan closets are at any time liable to be rendered leaky at this joint. The crack being out of sight and above the water line, there is nothing to give warning of the entrance of foul air. This is *one* of the ways in which foul air may enter.

The receiver, usually coated with filth, acts, in fact, as nothing more or less than a retort for the generation of foul gases which escape at numerous holes seemingly provided for the purpose.

Every time the pan is tilted, the water discharged into the receiver displaces a corresponding bulk of foul air, giving a *second* way by which gases of decomposition are sure to enter.

The brass pan journal passes through the receiver shell, leaving generally at the point of entrance a *third* passage for foul air.

The joint between the receiver and trap is made in the usual Pan closet job, with putty alone. This joint naturally cracks in time through shrinkage, settling or jarring, leaving a *fourth* passage for dangerous emanations.

The shell of the receiver is usually cast very thin, and the castings are seldom airtight before painting or enameling. After several years' use, it is liable to become perforated with an indefinite number of small holes, which give X additional chances for the entrance of impurities.

The bowl and its connection with the receiver are not strong enough to form a support for the closet seat, and therefore this woodwork requires an independent frame for its support, in violation of our rule in this regard.

(d) In setting the Pan closet the receiver is screwed into the floor over a flange made in the leaden trap, putty and paint being used for the joint. The trap has to be placed

PAN CLOSETS.

between the floor beams, and its connection with the soil must be made in a contracted space. The proper adjustment of the various parts of the closet and its connection with the cistern valve is more difficult, and requires more time on the part of the plumber than is necessary for the best sanitary water closets.

The Cost of manufacture evidently depends upon the number, material and complexity of the parts, and the manner of putting them together. The Pan closet consists of nineteen different parts, not including bolts and nuts, or fifty-one pieces including them. A perfect closet can be made of a single piece.

To make these Pan closets with all their parts so that they shall yield a profit to the manufacturer, to the dealer, and to the plumber, when sold at the low price to which competition has reduced them, is only possible by reducing the weight and the quality of the materials and workmanship to the minimum. They are therefore usually of the most flimsy character.

The Appearance.—The beauty of the Pan closet is not so great as to tempt the owner to omit the casing, and in fact the casing never is omitted, though a device so dangerous should always be exposed to full view in order that such defects as occur on the exterior may be discovered as soon as possible. But the outside machinery collects dust in every crevice which cannot be removed, and this has given rise in the French Pan closets to the custom of inclosing all the working parts within the body of the receiver, swelling it to an abnormal size for the purpose. Here it soon corrodes and becomes coated with filth like the rest of the interior in a very short time.

In short, it is impossible to conceive of a device more ingeniously contrived than the Pan closet to embrace in a

single feature as many hygienic vices; and, under the outward effect of security, as many real dangers.

SANITARY ENGINEERS.

Not very long ago I passed a small plumber's shop having a large show window. There was room enough in this window to display a handsome and instructive system of sanitary appliances, arranged in such a manner as to inspire the beholder with a sense of the wisdom and skill of the proprietor. The exhibit in this window, however, consisted of three huge pan water-closets in a row, extending from one side of the window to the other, with a few antiquated basin faucets, plugs and chains lying on the floor at their feet. The sign above read, "Sanitary Engineer."

We deplore the ignorance of the public in insisting upon having such unsanitary fixtures; but how can we expect anything better of them, so long as professors of hygiene themselves thus recommend them with triple emphasis and to the total exclusion of what is really good?

X. Y. Z.,

BUILDER, PLUMBER, PAINTER,

GLAZIER, CARPENTER,
RANGE AND STOVE MAKER,
HOT WATER ENGINEER,

Pump Maker and Sanitary Engineer.

Water-Closets Fixed on the Newest Principles.

WRITING, GRAINING, MARBLING.
FOUNTAINS ERECTED.

UNDERTAKER.

Mr. Hellyer, in his "Sanitary Plumbing," gives us a copy of a plumber's sign in London, quite similar in effect to the one just described, for you see this man also called himself a "sanitary engineer," in spite of the fact that he had placed

WATER CLOSETS.

a pan closet and a D trap on one side of his business card and a combined water-closet tank and drinking water cistern on the other.

In preparing this sign for our purpose I added the word "undertaker," knowing that one who claimed so much with so little equipment would be likely to have to bury his employers as his final act of service in their behalf.

As Mr. Hellyer wisely says, such signboards should rather be taken as "warning boards," in order that he who readeth may run away.

CHAPTER XXIX.

VALVE AND PLUNGER CLOSETS.

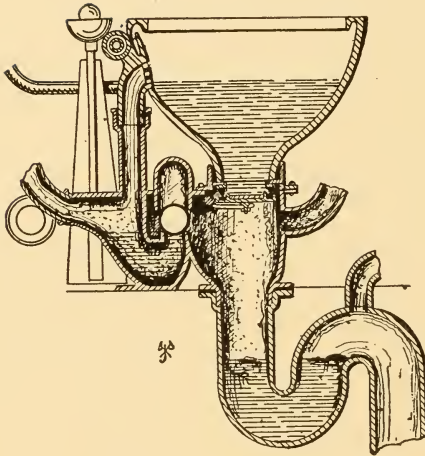

Fig. 384. Valve Closet.

A few years ago, before the need of systematic ventilation of the sewers and soil-pipe began to be felt, and back pressure from the foul sewers forced the sewer gas through the water seal of traps in bubbles, a tight-fitting

valve or plunger was felt to be needed in water-closets, and as these closets were at first built without overflows, the valve or plunger did actually seem to perform a real service.

Now, however, the circumstances are altered. It is found that an overflow is necessary in these closets, and this overflow passage is rarely provided like the trap with a valve or other mechanical closure. Hence, any gases which could pass an ordinary water seal could pass through these closets by way of the overflow passage quite regardless of and quite as easily as if the valve or plunger in the trap never existed. Moreover, the ventilation of the sewer and soil pipes renders back pressure comparatively harmless, so that the only pos-

VALVE AND PLUNGER CLOSETS.

sible useful office of the valve or plunger is no longer called for.

The same objections to the mechanical seals of water-closet traps which have been described for the smaller fixture traps hold with even greater force with water-closet traps. They cannot be made permanently tight and effective.

The only object of the valve or plunger, therefore, is to retain a certain quantity of water in the bowl to receive the waste matters, and prevent their striking the dry surface of the closet bowl, to which they would adhere, and as this result can now be accomplished equally well without them, and by simpler means, it is obvious that they are utterly superfluous.

The efficiency of the large body of water suddenly emptied from the bowl for flushing out the water-closet and pipes forms a good point in these closets, but it is sometimes partially negated by the obstruction of the valve and plunger themselves when they are but slightly raised in use or defective through rust and sediment. But this function is equally well performed by simpler and better means.

The receiver or container of the valve and plunger is open to the same objections as that of the pan, differing only in degree, and the overflow passage, not required in the pan-closet, forms a second filth collector, and increases the complexity and cost of the apparatus. The sudden discharge of the larger body of water in the bowl is very liable to empty the trap below by its momentum and siphon action, requiring a special provision for its automatic refilling.

These and other considerations have led sanitarians to differ as to the relative merits of the pan, valve and plunger closets when they were in vogue, though there seemed to be no sufficient reason for such difference. It is only important

to analyze the types now because they illustrate forcibly various defects in plumbing appliances which should be strenuously avoided, and they are also interesting to some extent historically.

THE VALVE CLOSET.

Valve closets were those which have the outlet of the bowl closed by a movable valve or plate, usually held in place by a lever or spring. Fig. 385 represents a valve closet having

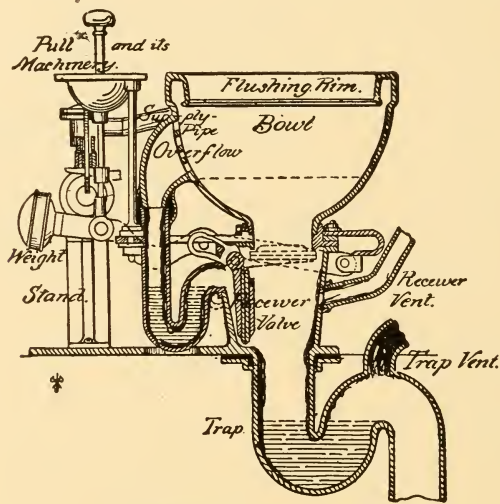

Fig. 385. Valve Closet.

the trap below the floor. Fig. 384, a valve closet with a ball in the overflow. These and the type in which the trap is placed above the floor, Fig. 386, have been considered among the simplest and best of their class. All others differ from these merely in slight and comparatively unimportant details. Some valve closets were made without any water trap at all below the valve. These were totally unreliable because no valve has as yet been discovered which is not liable at

some time to leak, especially when used in water-closets.

Beginning, as before, with

THE FLUSHING.

We see, by examining the drawing, Fig. 385, that the cleansing effect of the stream could never reach those parts of the receiver which lie behind the valve and around its hinge, nor any part of the overflow passage. Hence, these parts were sure, sooner or later, to become foul, and they were exactly the parts in which foulness would impede the proper working of the valve and closet, and occasion leakage of the

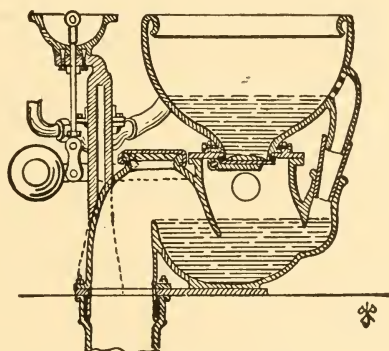

Fig. 386. Valve Closet.

water from the bowl. The receivers of both the pan and the valve closets can be enameled and provided with special cleansing jets, and closets having these improvements have been manufactured, but the overflow passage cannot be so scoured, and I know of no closet in which the attempt to do so has been made. Finely divided waste dissolved in the water and making its way into the overflow passage, as it very frequently did, was bound soon to foul it, and once the deposit began it could not be arrested except by taking the closet to pieces. The extent of surface which *cannot* be

reached by special scouring streams is, therefore, greater in the valve than in the pan closets, and this goes far to offset the advantage it has in the smallness of its receiver.

(b) The valve, like the pan, breaks the force of the flushing stream from the cistern due to head and thus prevents its passing through the receiver and trap in a compact volume, occasioning a total loss of the advantage the water head from the cistern might give and in the better types of closets does give. Here again the valve and pan closets are equally defective.

(c) The same causes for the production of disagreeable noises in flushing exist in both kinds of closets. Most valve closets are superior in workmanship, as well as in price, to the pan closets, but so far as *principles* of construction are concerned, the valve closet has no superiority over the pan.

(d) To operate the machinery of a valve closet requires more strength than is the case with the pan. It is indispensable that the valve press very firmly against its seat in order to retain and sustain the large body of water in the bowl above it, while no such pressure is evidently required in the pan. To overcome this greater pressure a greater effort is required, so that in this respect the valve closet is inferior to the pan.

(e) In the matter of complication of arrangement for the simultaneous opening of the closet and cistern valves through levers, cranks and wires, the valve and pan closets are evidently equally defective.

(f) When the water-closet is used as a slop hopper, and a large volume of water is suddenly emptied in the bowl the obstruction occasioned by the valve to the outflow of the water is likely to cause spattering, while the pan, on the contrary, though it forms an obstruction, allows the water to escape in a measure as it is poured in, and the danger of

VALVE AND PLUNGER CLOSETS.

spattering and overflowing is thereby somewhat diminished. The valve closet overflow affords less of a security in this respect. Hence, here again the valve closet loses in comparison with the pan. When, as often happens, the valve is suddenly closed at the moment the waste matters are passing out, and catches these matters, it presses them against the valve-seat, whence they can never be removed by flushing, but remain to decompose until they are scraped off with great difficulty. The same objection holds with the pan closet, but such an obstruction on the valve causes it to leak, and as soon as the water has escaped from the bowl the odor of the adhering matters becomes intolerable. Thus once more superiority must be granted to the principle of the pan closet over the valve.

The form of the valve closet is (a) complicated by the overflow not required in the pan closet. In other respects, the machinery of the closets is similar and all this complication unnecessary in closets. (b) The trap and receiver are invisible and inaccessible from the outside, like those in the pan closet. (c) As is the case with the pan, there is nothing in the mechanism of the valve closet to provide against the loss of its water seal through evaporation, siphonage, etc. It has been proposed to ventilate the receiver with a special vent pipe to carry off the odors generated therein and protect the trap below from being unsealed by the momentum of the water discharged by the valve. But a single pipe would not be sufficient, because an exhaust as well as a supply pipe would be necessary to create a movement or change of air, and this would add enormously to the expense. Were there no receiver these two pipes would not be required. (e) The valve closet is equally defective with the pan in requiring a frame around the closet to protect it and receive the weight of the seat. (f) The valve mech-

anism is more complicated in construction than the pan. It requires a very carefully turned seat and a rubber packing which is very perishable. Hence repairs are necessary even oftener than with an equally well made pan closet.

The cost of manufacture is evidently considerably greater than that of the pan closet, on account of the overflow and of the principle of the valve, which requires both greater strength and delicacy of form and adjustment. It is correspondingly more liable to get out of order, and hence is more expensive to keep in repair.

DEDUCTIONS.

Thus we find in the valve closet every defect of the pan and at the same time others which are peculiar to itself. Both have their hidden "chamber of horrors," which exhale noisome odors into the house at all times, and more particularly when their machinery is operated. The cess-pools become perpetual automatic gas retorts and defeat their own object of removing all organic decomposition immediately from the premises.

THE PLUNGER CLOSET.

Plunger closets are those which have the outlet closed by a plunger or plug fitting over or into it, and held in place by its own weight.

Figs. 387 to 391, inclusive, represent plunger closets having a solid plunger, the overflow passage being in the rear behind the plunger.

Fig. 392 is a hollow plunger closet, the overflow being through the plunger itself. This is the simplest form of plunger closet, but it allows effluvium from matters which may be left floating in the trap to escape into the room through the plunger and around its handle.

Figs. 389 and 390 show a plunger closet having its over-

VALVE AND PLUNGER CLOSETS.

flow trapped with a plunger or valve. It is the only plunger closet except the Jennings which has a mechanical seal for the overflow, and the only closet in which the overflow cannot be destroyed by siphonage. The complication arising from the mechanical trapping of the overflow and the enormous size of the receiver form serious objections to this form of closet. Were there no better and simpler mode, however, of preventing the action of siphoning in water-

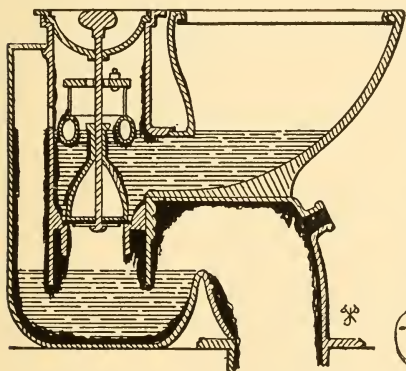

Fig. 387. Plunger Closet.

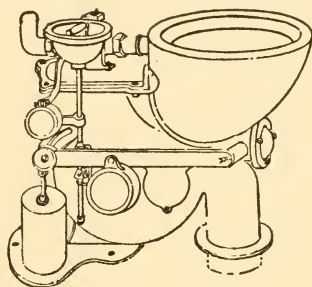

Fig. 388. Plunger Closet.

closets, it would stand high in spite of the inherent defects of its class.

Figs. 389, 390 and 391 represent the class of plunger closets which has a chamber or cistern for the supply cock and regulating float connected with the plunger chamber. This form of closet is very objectionable. The float chamber becomes foul like the plunger chamber, and the two chambers together then form a species of cesspool even worse than that of the pan closet.

The above may be considered types of all known plunger closets. Some are made without water traps under the

plunger, but these, like trapless valve closets, are totally unreliable. In regard to

THE FLUSHING.

We find here a much larger extent of surface of receiver which never receives a scouring of water than in the valve

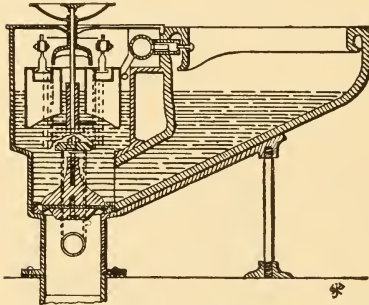

Fig. 389. Plunger Closet.

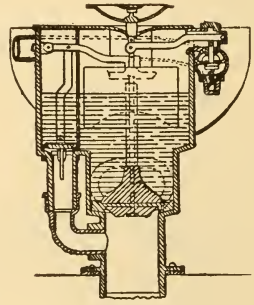

Fig. 390. Plunger Closet.

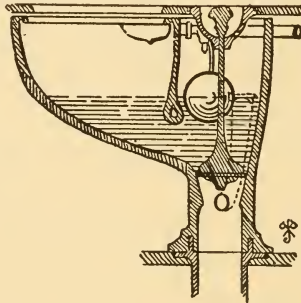

Fig. 391. Plunger Closet.

closet. The flushing stream passes under the plunger receiver, and not through it, as it does through the valve receiver. The plunger receiver must also from its nature be larger than that which is sufficient for the valve.

VALVE AND PLUNGER CLOSETS.

These two circumstances render it much more easily fouled.

To operate the machinery of a plunger closet requires still more of an effort than is the case with the valve, because the dead weight of the plunger has to be lifted direct without the aid of the leverage of the crank which is employed with the valve. The weight of the plunger must be sufficient to retain the water in the bowl by its pressure against its seat.

In all other respects the flushing of the plunger closet is attended with precisely the same defects as that of the valve closet.

The same criticisms which are applicable to the valve

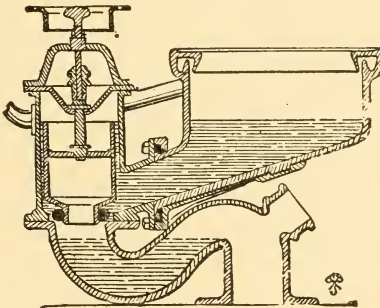

Fig. 392. Plunger Closet.

closet in relation to its form, material, construction and cost apply with equal force to the plunger closet, and the same

DEDUCTIONS

may be made in its comparison with the common pan closet, i. e., it is superior to the ordinary flimsily made pan closet, but greatly inferior to its most improved and solid construction, and, in general, it is inferior to the pan closet in the principle of its construction and operation.

CHAPTER XXX.

ANCIENT AND FOREIGN APPARATUS.

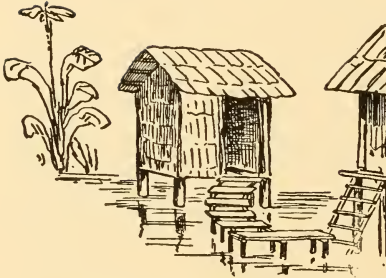

Fig. 393. Sanitary Conveniences of the Malay Peninsula.*

Progress in all things comes from studying and profiting by the errors of the past. The reason why the water carriage system of sewage disposal is gradually supplanting the dry methods the world over is because we have learned through bitter experience with cesspools and all other arrangements for retarding the removal of organic waste, that water carriage is the safest and best. But our progress has been slow because we have too often despised the lessons of the past. Everywhere horrible cesspools still abound throughout the land to the peril of our people, because we are still, as a people, ignorant of their dangers, and the terrible scourges which their use in various forms has brought upon nations.

One of the most useful things you, as sanitarians and plumbers, can do, both for yourselves and for the public, is to study the cause of these plagues which, especially in the Orient, have devastated the land, and with the equipment this study will provide, urge everywhere the substitution of good plumbing for the dry carriage system, whether in the form of earth closets, cesspools, or pail systems. For

*From "Latrines of the East." by Prof. Edw. S. Morse.

this reason I shall review with you very briefly some of the earliest methods of waste disposal and call your attention to their effect upon the public health, in order that your advocacy of plumbing may be based upon a knowledge of the past.

As the result of ignorance of the first principles of sanitary science, "the Orient stands as a continual menace to the nations of Europe. The people are utterly ignorant



Fig. 394. Ancient Egyptian Dwelling.

of the germ theory of disease, and consequently the persistent violation of all sanitary laws follows as a matter of course."

We find in Egypt, thousands of years before the Christian era, according to Viollet le Duc, privies built very much like our country cesspools, placed as shown in our next cut, Fig. 394,* which represents an Egyptian rural dwelling

*From Viollet le Duc's "Habitations of Man."

PLUMBING AND HOUSEHOLD SANITATION.

under the first three dynasties. It consists of a central room open to the court, and two bed-chambers, one on each end, the garden being in front, with a pantry for provisions at one of the corners opposite the dwelling. The latrines

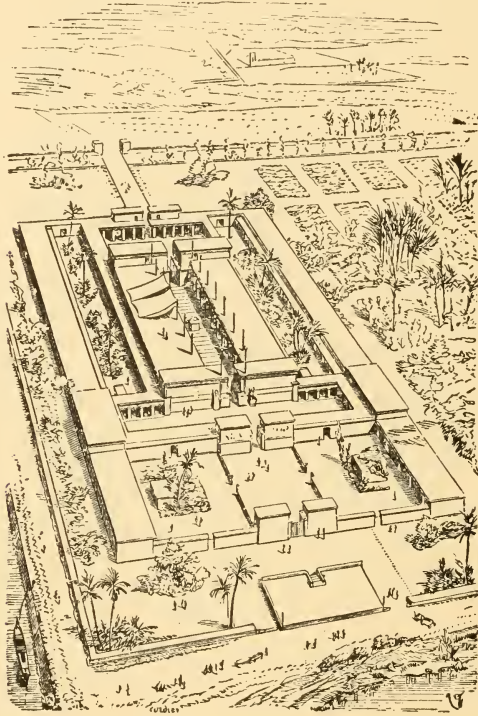

Fig. 395. Palace of a Governor of Ancient Egypt.

were in the small building at the other corner of the garden, quite inconveniently distant from the living rooms, with dove cots and fowl house along the garden wall. The cooking was done in the open air.

The palace of a governor or monarch is shown in Fig. 395. The bed rooms are in the right and left of the main building on each side of the great pillared hall open to the sky. The kitchen is in the center of the right-hand court in the foreground, and the water tank in the court opposite. The servants' rooms in the two wings behind the kitchen and tank.

The latrines are shown in the center of the building just behind the small colonnades at the right and left of the main building. Here again we find these conveniences very inconveniently located with reference to the bed rooms, especially those at the further end of the building. And I need not relate to you the visitation of the plagues of Egypt, known to every reader of history and the Bible. It was formerly said that these terrible scourges were brought upon the people by the wrath of the Lord, because of the hardening of the heart of Pharaoh against the children of Israel. But later investigations have led us to believe that the condition of the Egyptian cesspools had more to do with the plagues than either the wrath of the Lord or the obdurate heart of the king. Now the privies of our own farmers' houses in the first years of the twentieth century are no more scientifically treated and located than were those of ancient Egypt. So far, then, as our country towns are concerned, we have done worse than merely stand still for over 5,000 years, because the climate of Egypt enabled the house owners to visit these out-of-door latrines far more comfortably and safely than is possible with us.

Fig. 396 shows one of the earliest water closets of which we have record. It is one described by Liger as used in ancient Rome. We see the two water closets in the corner, one of them having the seat removed to better show the construction. The flushing stream follows a course which

would seem to us quite uncomfortable in water closet construction. It passes along a trough in front of the closets, then enters and flushes a floor urinal at the right side of

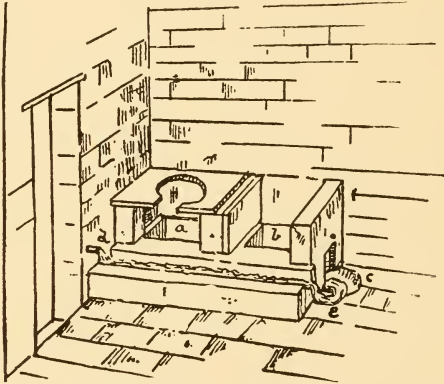

Fig. 396. One of the earliest forms of Roman Latrines.*

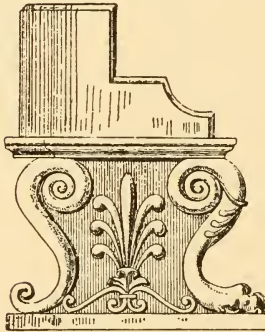

Fig. 397.

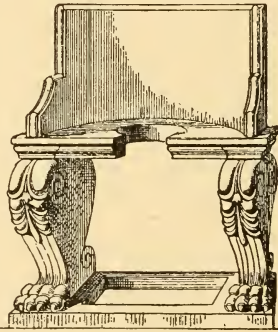

Fig. 398.

Side and Front View of Marble Seat.*

the water closet, and finally passes under the closets themselves. This small stream is much more demonstrative than it would be effective in its circuitous course. Figs.

*From F. Liger, "Fosse d'Aisance," p. 53.

397, 398 and 377 represent a curved marble of porphyry seat dating from the time of Constantine and preserved in the Louvre, Paris.

We are again indebted to Prof. Morse for permission to reproduce a number of sketches from his "Latrines of the East,"* in which is portrayed a most important feature of Oriental life and character in the author's inimitable style. The sketches are his own.

The Chinese dispose of their sewage, not by sewers, but by scavengers, street gutters and canals. "At Shanghai," says Prof. Morse, "as one enters the native town he en-

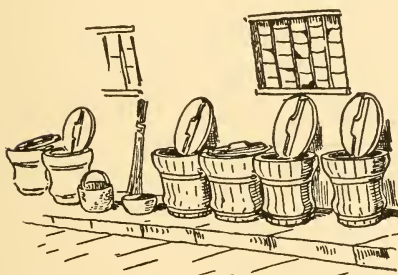

Fig. 399. Chinese Scavenger's Buckets.†



Fig. 400. Chinese Earthenware Urinal.

counters men bearing uncovered buckets upon the ends of a carrying stick; these are removers of night soil, and they have their regular routes through the city. If one follows these scavengers he sees them going to the banks of a canal near by and emptying the buckets with a splash into a long scow, or other kind of boat, which, after being filled, is towed away to the rice fields in the country. The stuff is often spilled in the water by careless emptying. The canal has no current, at least not enough to disturb the great ooze

†"Latrines of the East," by Edward S. Morse. Reprinted from *The American Architect* of March 18, 1893.

and sickly yellow condition of the water, which is thick with foulness; yet beside this boat people are dipping up the water for drinking and culinary purposes. Smallpox, at the time of my visit, was epidemic in the town, and I brushed past men in the narrow alleys who were covered with eruptions; everywhere the ground was slimy with filth, and the state of the town was indescribable." Fig. 399 shows the large wooden buckets with close-fitting covers which were used in the better class of Chinese houses, and were emptied every day by a scavenger. They served the purpose of the pails in the English so-called "pail system" of sewage disposal. These buckets ornamented the back yards of Chinese landlords as ash vessels do ours at home.

In these back yards, also, are sometimes seen the most primitive possible kinds of open-air earth closets, composed of large earthen jars embedded in the ground, and against one edge a low framework of wood. Piles of ashes from the stoves are placed near by, and this is spread with the material as in all earth closets.

Square urinals made of stoneware are used, as shown in Fig. 400. "These," says the author, "are used by old people, and I was told that they also served as pillows or head rests."

Fig. 401 shows one of the public latrines of Canton, the existence of which is always evident to the nostrils, owing to their very filthy condition. A urinal runs along in front of the stalls as shown, and the absence of any kind of water flush is largely responsible for their unsavory character.

Fig. 402 shows a Japanese dry closet, which are private and in striking contrast with the foul places of China and Corea, which are, as a rule, public. Below the rectangular floor opening is the receptacle in the form of a large earthen

jar or half an oil barrel sunk in the ground, emptied every few days by men who pay for the privilege. The author

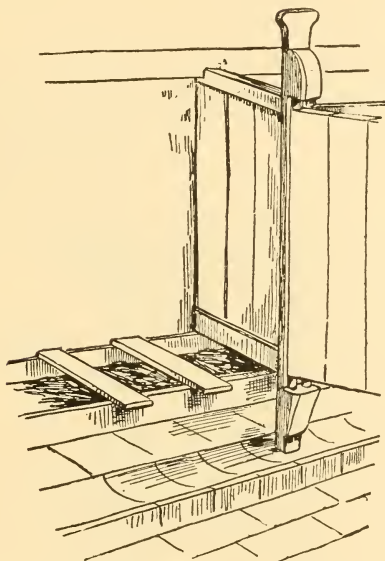

Fig. 401. Public Latrines at Canton, China.

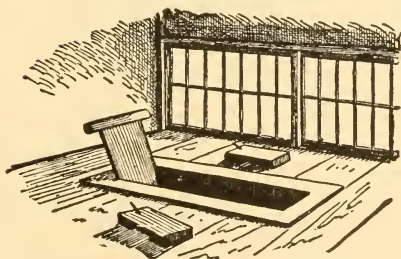

Fig. 402. Japanese Dry Closet.

was informed that the substance is so highly valued that in Hiroshima, in the renting of the poorer houses, if three persons occupied a room together its value paid for the rent

of one, and if five occupied the room no rent was charged. "The result of the transference of this material into the country leaves the shores of a city absolutely pure. No malarious flats nor noisome odors, arising from littoral areas, curse the inhabitants, as with us."

Fig. 403 shows the door of a closet in Tokio inlaid in designs in different colored woods, so exquisitely clean and beautiful that the place might properly be called, as the

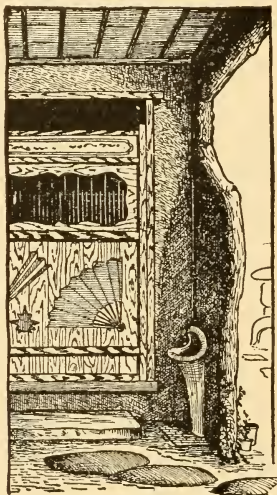

Fig. 403. Japanese Privy Door and Urinal.

author says, a cabinet. "The urinal is usually of wood, though porcelain ones are often seen. The wooden ones are in the form of a tapering box secured against the wall of the closet. Sometimes sprays of a sweet-scented shrub are placed in these and often replaced."

Fig. 404 gives a view of the exterior of one of these cabinets. It is in an inn at Hachi-ishi, near Nikko. The ap-

proach is shown by the planking in the foreground with a pair of wooden clogs, which are often provided, to be worn in this place. "From this, at right angles, runs a narrow

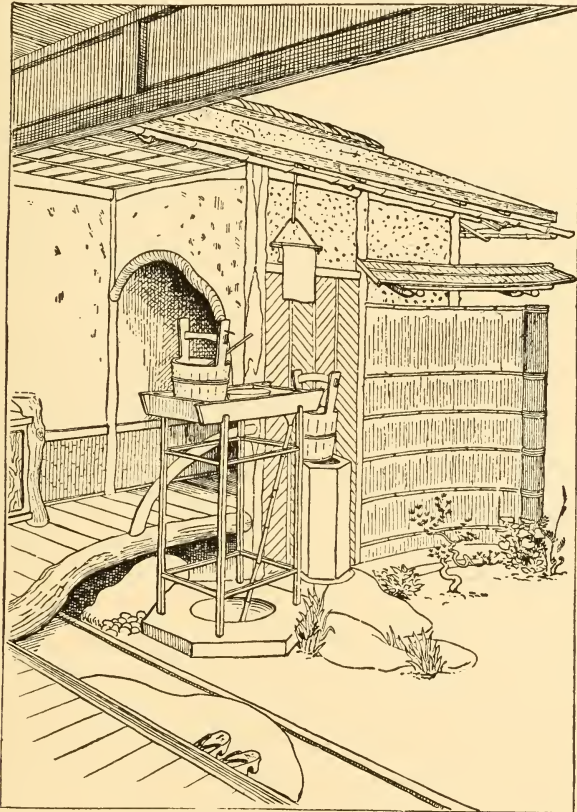

Fig. 404. Japanese Privy.

platform, having for its border the natural trunk of a tree; the corner of a little cupboard is seen at the left, the ceiling is composed of netting made of thin strips of woods, and

below is a dado of bamboo. The opening to the first apartment is framed by a twisted grape-vine, while other sticks in their natural condition make up the framework. Beyond the arched opening is another one closed by a swinging door; and this is usually the only place in the house where one finds a hinged door, except, perhaps, on the tall closet under the kitchen stairs. Outside a little screen fence is built, a few plants neatly trimmed below—and a typical privy of the better class is shown. The wooden trough standing on four legs and holding a bucket of water and a wash basin is evidently an addition for the convenience of foreign guests. The chodzu-bachi with towel rack suspended above, as already described, is the universal accompaniment of this place.”

Fig. 393 shows a closed privy such as is seen on the Malay peninsula built over running water, somewhat removed from the house, and having a little bridge running to it.

In China, Java, Sumatra, India, Russia, Greece, and in the Orient generally, the grossest negligence and ignorance prevails in the disposal of all forms of organic waste matters, most shocking and disgusting to the traveler. But, after all, what can be more barbarous than our own country cesspools, which are foul and pestilential beyond description? Where they adjoin the houses their poisonous odors penetrate to the living rooms; where they are removed several yards, great exposure to the weather, very dangerous to the health, especially in winter, is involved in reaching them.

The Massachusetts State Board of Health has said of them that “they are a disgrace to civilization,” and “the march of civilization is in no way more correctly marked than by perfection in water closets. If to this rule a uni-

versal application were given it would place our farmers, as well as the vast majority of our rural population, well back in the ranks of barbarism."

For this we are far more to blame than the ignorant people of the East, because our libraries are full of literature on sewage disposal for cities, towns, villages and isolated country seats, teaching our people how surface and sub-surface irrigation and other scientific methods of sewage disposal may be successfully employed with the water carriage system, rendering these abominable cesspools, as well as the pollution of our rivers and harbors by direct discharges from sewers, utterly unnecessary.

CHAPTER XXXI.

HOPPER CLOSETS AND IMPROVED CLOSETS.

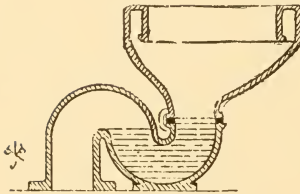

Fig. 406. Dry Hopper.

We come now to the class of water closets which is independent of valves, gates, plungers or mechanical seals or obstructions of any kind, and which accomplish both the removal of the wastes and the exclusion of sewer gas by the simple ac-

tion of the flushing stream and by the water seal which it forms.

These closets have received the general name of "hopper closets." They do their work more effectively and by simpler means, and afford equal or better security against sewer gas than the complicated machines heretofore described, and must be placed far ahead of them. There is no point in plumbing in which sanitarians are more in accord than in this. But it must be borne in mind that there is the greatest difference in the different kinds of hoppers, and it is to the improved kinds that we refer in our comparison with other closets.

Hopper closets have usually been classified as "long" and "short" hoppers; i. e., those having the trap above and those having it below the floor level.

The trap should, however, never be placed below the floor except where it is necessary to avoid the effects of frost, and, as this is a condition which applies equally to all styles

HOPPER CLOSETS AND IMPROVED CLOSETS.

of closets, it marks no distinguishing characteristic, and can form no proper basis of classification for any special type. Abandoning, therefore, this old classification, and adopting for our basis the most important characteristic features of the closets, we make two general divisions, and further detailed subdivisions.

The general divisions are (1) Those which have no standing water in the bowl to receive and deodorize the waste matters and prevent their striking and adhering to dry surfaces. These may be called "dry" hoppers. The water stands only in the trap. (2) Those whose bowls are formed to retain a permanent body of water in the bowl so that no part of the interior can be soiled by waste matters striking them. These we may call "improved" hoppers.

DRY HOPPERS.

Fig. 406 represents a wash-down water closet of this class having the trap above the floor, and when the water seal is small it is usually called a "short" hopper.

Fig. 407 represents the same kind of a closet with the trap below the floor, and is then called the "long" hopper. It is intended to be used in cold places where the water in the trap can only be protected from frost by burying the trap in the ground. It is sometimes said that the wastes are more easily ejected from the trap of the long hopper on account of the greater weight and momentum of the falling water. But what little may be gained in this direction is far more than offset by the disadvantage of having an increased dry surface to be fouled above the trap, and as there is no difficulty in ejecting the contents of a trap above the floor when the flushing stream is properly constructed, this form of hopper is most strongly to be condemned except where frost renders it a necessity. Even

where great cold is to be guarded against, however, it is better to properly pack the trap above the floor where this can be done. The trap of the long hopper is so low down as to be practically out of sight, and when unsealed by momentum or otherwise the accident may easily escape discovery.

The seal of the dry hoppers is much too shallow, a con-

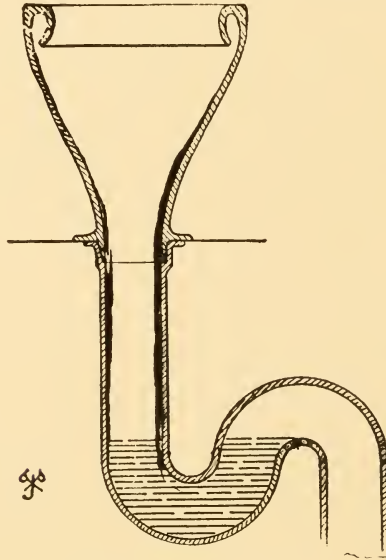

Fig. 407. Long Hopper.

sideration of the first importance in water closets, as will be hereafter shown.

It will be seen from the drawings that the surface of the water in the trap of these closets is entirely insufficient in area to receive the wastes, which fall upon the dry sides of the bowl, and require constant attention and disagreeable labor to remove them. On account of this defect, dry hop-

HOPPER CLOSETS AND IMPROVED CLOSETS.

pers are sold at a low price, and they are bought to save in first cost, under a mistaken idea of economy. They should never be used in the better class of houses because the trouble necessary to keep them clean will not be endured; nor in the poorer classes because the trouble will not be taken, and the closet soon becomes a nuisance in the house. Or if, by exception, cleanliness in this direction be insisted on, the extra labor and consumption of water soon offsets the saving in first cost.

It is easy to see that the water required for cleaning the dry hopper is very much greater than for the improved kind, whether the scouring be done by the strength of the flush or by manual labor, for, as is well known, soil adheres with the greatest tenacity to a dry surface. In view of this fact, dry hoppers have to be constructed with a copious and powerful flush, and there is a strong temptation for the user, and especially for servants having them in charge, to try to remove the tenacious substances by prolonged flushing in order to avoid a disagreeable manual labor. This practice occasions a waste of water far greater than most people imagine.

An effort has been made to overcome this objection by using a valve or cistern constructed to give a small preliminary wash before using. But this complicates the construction and adds to the water consumption, adding enough to the first cost to pay for a hopper of proper construction, and to the subsequent operating expense, to pay interest on the very best fixtures. The preliminary wash, moreover, is really quite insufficient for the purpose.

Improved hoppers may be subdivided into seven classes, as follows (a) tilting basin, (b) air-vacuum, (c) wash down, (d) trap jet, (e) siphon, (f) wash out, and (g) self-sealing closets.

TILTING BASIN CLOSET.

Fig. 408 represents a water closet of this class. Its peculiarity consists in having a double bowl, like the Jennings tilting wash basin. The outer basin is connected with an ordinary S trap and is stationary. The inner basin is pivoted to tilt after use and empty its contents into the station-

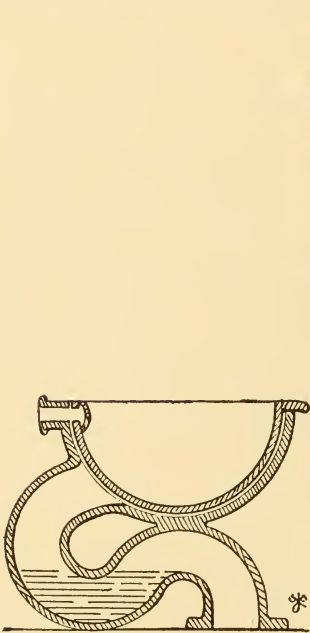

Fig. 408. Tilting Hopper.

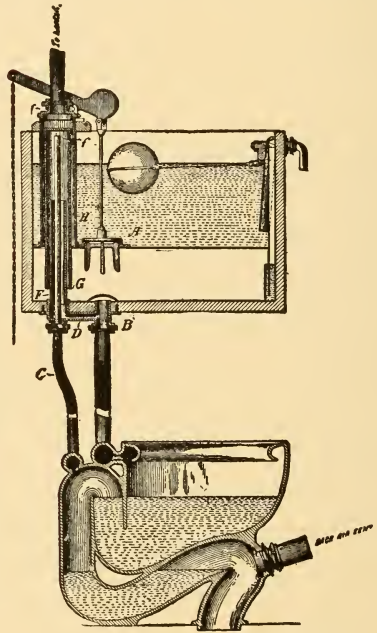

Fig. 409. Air Vacuum Closet.

ary basin, whence they are supposed to pass out into the soil pipe. The tilting is done by hand. This is a very bad and clumsy arrangement. The stationary bowl corresponds with the receiver of the pan closet and partakes of its defects. The inner bowl conceals the trap, which should be visible, adds greatly to the complexity and cost of the closet

HOPPER CLOSETS AND IMPROVED CLOSETS.

without having any advantage, and necessitates a disagreeable manual labor in tilting.

AIR VACUUM CLOSET.

Fig. 409 represents a water closet having a double trap, the space between the two being for a vacuum chamber. The vacuum is formed by the operation of the cistern which, in supplying the flush, withdraws air from the traps to take the place of the water. This is one of the first closets having a scientific form of basin and standing water therein, but the complication of the cistern and double trap are against it, and are now found to be superfluous in water closet construction.

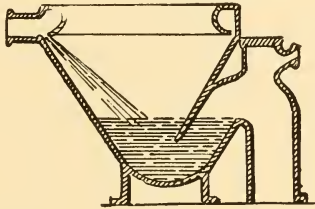

Fig. 410. Wash Down Closet.

WASHDOWN CLOSET.

This form of closet, Fig. 410, depends for its flushing upon the power of a stream or of streams and separate jets striking from above the surface of the water and its waste matters standing in the bowl. The quantity and surface of this water must be small, as otherwise the flushing stream, however powerful and copious, so applied proves inadequate to the task of ejecting the contents completely from the bowl and trap. The substances floating in the water are tossed and twirled about for some time before they come under the influence of the stream and jets calculated to submerge them. The water "piles up" in the bowl and a great waste is occasioned.

The force of the water is not judiciously applied. When the surface of the water standing in the bowl is large enough to perform its office of receiving the dejections with certainty and thoroughness their removal, if possible at all, is accomplished only with still greater wastefulness, and the roar of the cataract of water required forms, particularly when metered, no welcome music for the consumer. This type of closet was the most widely used of all before the advent into general use of the siphon jet closet, about 1885.

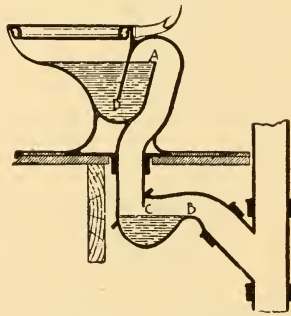

Fig. 411. Col. Waring's Original Siphon Closet, called the "Dececo."

SIPHON CLOSET.

Fig. 411 represents a type of closet invented by Col. Waring, in which the wastes are discharged by siphoning action. A weir chamber is used below the trap to assist in charging the siphon. In the figure the weir chamber is shown below the floor, and is made in a separate piece from the rest of the closet. In later constructions the weir chamber is placed above the floor and made in a single compact piece with the rest of the closet. In order to charge the siphon the water is let into the basin through the supply pipe and the flushing rim until it overflows the outlet of the trap, and falls into

HOPPER CLOSETS AND IMPROVED CLOSETS.

the weir chamber below. The falling water drives out the air between the trap and weir, and if the quantity of water is sufficient it closes the inlet of the weir before it can escape through the outlet. This prevents air from entering the siphon. As soon as the siphon thus formed lowers the water in the bowl to the bottom of the dip of the trap air follows it and breaks the siphon. When the contents of the weir chamber fall below the inlet, and allow air again to enter the siphon. The bowl is refilled by the after wash. This was at one time a very popular form of water closet.

WASHOUT CLOSET.

Washout closets are those in which the basin is made to hold a certain quantity of standing water while the trap is placed below its level, usually entirely below the bowl. The

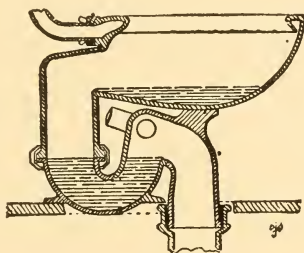

Fig. 412.

outlet from the basin into the trap is above the level of the standing water. Hence these closets are sometimes called "side outlet" closets. In Fig. 412 is shown a washout closet made of a single piece of earthenware, and having the supply pipe opposite the outlet into the trap. This closet is also made with an earthenware body and an iron trap, and having the supply pipe in the rear. The flushing stream sweeps across the bottom of the bowl with considerable

force and drives the waste before it into the trap. Whether or not the trap itself be emptied depends upon the length of time the flushing is continued after the bowl is cleared.

A defect in this form of closet is in the presence of the extended pipe surface between the basin and the trap, and of its upper corners near the cleanout opening, which partakes of the nature of a receiver. It would be better if this dry pipe or canal were not required. The smaller and more compact the surface of a water closet is the better. The trap is deep down out of sight and is somewhat inconvenient of access when it is necessary to empty it of its water, as is the case with water-closets of summer residences which are to remain unoccupied during the winter.

A *second* defect lies in the unscientific manner in which the flushing is accomplished, leading to a waste of water. Of that which rushes across the basin only a portion takes effect directly upon the waste matters, the rest spends its force upon the sides and back of the bowl to no advantage, and rebounding amuses itself in twirling the lighter substances about in small eddies for a time before it shoots them into the trap. In a perfect system of flushing no water should be wasted. Every drop should serve a useful purpose, and devote its entire energy to ejecting the wastes and the wastes only, solid and dissolved, but not the pure water, for as we have seen it is important for the most economical disposal of sewage, that it be diluted as little as possible.

A *third* defect is in the position of the trap, it being such that the water is either partially or wholly out of sight, so that it is impossible to know the condition of its contents, or even if it retains its water seal at all.

A *fourth* defect is in the spattering occasioned by the violence of the water flow, and a *fifth* in the excessive noisiness of the flushing.

CHAPTER XXXII.

TRAP JET CLOSET.

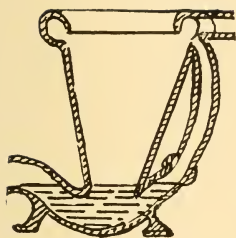

Fig. 413 represents a kind of hopper closet invented in England about half a century ago by Thomas Smith. In this closet the flushing stream is applied to much better advantage for emptying the basin and trap than in the preceding.

To overcome the inertia of the heavy body of standing water in the bowl and trap, a jet of water is introduced directly into this water below its normal level, and in the direction of its outflow. A given stream or head of water acts far more effectively in communicating motion to an inert volume of liquid, when it enters directly within that body than when it strikes its surface from some point above or outside of it. In the latter case the force of the water is exhausted, partly by friction in passing through the air, which tends to divide it into a spray, and partly by the impact against the water surface by which it is turned and partly deflected. The remainder of the flushing stream enters from above in the usual way. The lower jet tends to prevent the "piling up" of the water in the basin.

This is the prototype of what has become within the last ten years the most popular and most scientific form of water closet known.

Fig. 414 represents this closet in section.

Thomas Smith appears never to have been rewarded in any way for this invention by the unappreciative public as he should have been, but enjoyed the usual fate of an inventor whose ideas subsequently become of service to the world, that of oblivion. Hence this little tribute to his memory.

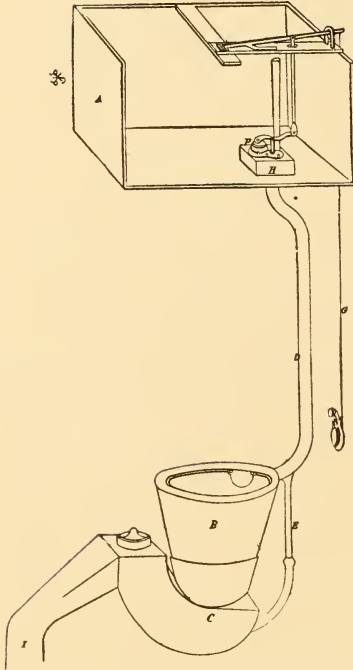

*Fig. 413. Reproduction of English Patent Office Drawing of the Thomas Smith Patent of 1842.

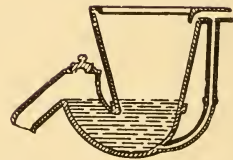

Fig. 414. Section of the English Siphon Jet Patent of 1842 of Thomas Smith.

In 1876 another Smith, surnamed William, this time from California, secured a patent for a combination of siphon jets, as shown in his patent drawing, Fig. 412B, but soon found in practice that only the single jet of his English

*Thos. Smith's English Patent of 1842, with English Patent Office Coat of Arms.

TRAP JET CLOSET.

brother Thomas, was of any real value, and he never used his own invention. Nevertheless, since the world seemed to have forgotten poor Thomas way off in the antipodes, William claimed himself to be the sole and original inventor of the siphon jet closet, and proclaimed that he was the only one who ought to enjoy the privilege of making them. Accordingly in 1888, secretly aided and instigated, as the story goes, by unlimited and unscrupulous outside capital, he brought a most unrighteous suit against the makers of the

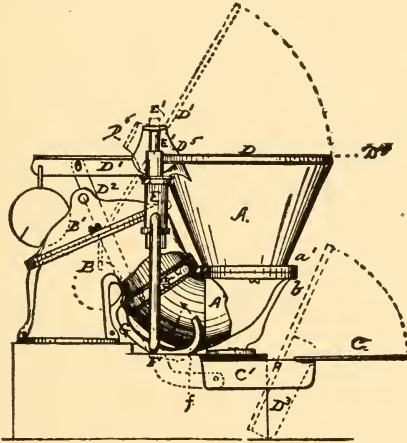

Fig. 412-b. Modification by William Smith, of California.

“Sanitas” closet without the shadow of a just reason and lost his case, as a little common sense would have shown would be inevitable, after much expense and annoyance to everyone connected with the affair. In the more civilized “dark ages” such highwayman’s villainy was sometimes roundly punished by an indignant public. But in these days the public are too busy with their own petty individual commercial robberies to mind such a commonplace indignity as the attempted clubbing in the dark by a bullying giant of

some poor inventor. They are even too much occupied to applaud feebly when the bully sometimes, as in this case, receives his well merited whipping. These wicked marauders performed nevertheless the useful service of advertising the siphon jet principle as valuable public property. The episode adds one more to the long and wearisome list of persecutions the average hard working inventor is still subjected to by the unscrupulous as a sacrifice to the moloch of capitalism. It is certainly fortunate for the cause of progress in the world that inventors as a class are ignorant of the dismal history of their past. For if they were not most of them would have chosen say, street sweeping, as a more blissful and lucrative occupation than the work for which nature seemed to fit them. The time has certainly arrived when the State should insure adequate reward to the useful inventor or at least legal protection in the use of the patent it grants him both in the interest of progress and of justice and public welfare.

The requisites for a water-closet are, (1) *simplicity*, (2) *quickness and thoroughness of flushing*, (3) *freedom from all unscoured parts*, (4) *economy in construction and water consumption*, (5) *compactness and convenience of form*, (6) *amplitude of standing water in the bowl*, (7) *accessibility and visibility of all parts*, including trap, (8) *smoothness of material*, (9) *strength and durability of construction*, (10) *facility and reliability in jointing*, (11) *security against evaporation and siphonage*, (12) *ease and convenience of flushing*, (13) *noiselessness in operation*, and (14) *neatness of appearance*.

The pan-closet must be discarded, because it violates every one of the above requirements.

The valve and plunger closets must be discarded, because they violate all but the sixth and twelfth requirements.

TRAP JET CLOSET.

The ordinary so-called long and short hoppers are to be rejected, because they violate the second, third, fourth, sixth, tenth, eleventh, and thirteenth requirements. There is no standing water in their bowls to receive and deodorize the soil, so that they are constantly fouled. A preliminary flush is sometimes arranged, to partially obviate this trouble, but this contrivance is not to be relied upon. The method of connecting the common hopper with the soil-pipe is usually defective, the seal is too shallow to withstand even a slight evaporation and siphonage, and they are exceedingly noisy in operation.

All closets which depend upon a double trap violate rules 1, 4, 7, 11, and 13. Should anything get lodged in the lower trap, it is generally impossible to get it out without taking the entire apparatus down; and when the lower trap is formed in a single piece of earthenware with the rest of the closet, an obstruction therein could not, in some cases, be removed without breaking the closet open.

The side-outlet, or so-called *wash-out* type of closets, have a shallow bowl flushed by a strong stream of water, which is intended to drive the waste matters out of the bowl into a shallow trap underneath; they violate rules 1, 2, 3, 4, 7, 11, 12, and 13.

The flushing is usually attended with spattering. The standing water in the bowl is not sufficiently deep, and the manner of flushing is noisy and ineffective, the lighter wastes frequently whirling round and round for some time before being driven out. The trap is inconvenient of access, and its seal is very shallow, and easily broken by siphonage, evaporation, or incorrect setting, and being out of sight, the evil may not be discovered until the damage is done. The pipe surface between the basin and the pipe is easily fouled and difficult to clean,

PLUMBING AND HOUSEHOLD SANITATION.

In the effort to obtain a water-closet which should fulfill all of the above-mentioned requirements, the writer made use of a principle of hydraulics new in the practice of plumbing, namely, that of supporting a water column by atmospheric pressure acting only at its lower end. The principle is explained by the simple laboratory experiment of the inverted bottle in the basin of water (Fig. 415). If an ordinary bottle be filled with water and inverted in such a manner that its mouth shall be immersed below the surface

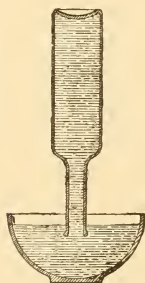

Fig. 415. Inverted Bottle.

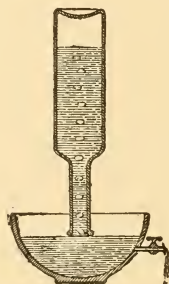

Fig. 416. Water Exhausted from the Bowl.

of water in a basin below, the water in the bottle will be supported by atmospheric pressure acting on the surface of that in the basin. Let now this surface be lowered by any cause, and we shall find that it will be instantly restored from the bottle as soon as it sinks below its mouth, as shown in Fig. 416.

This principle was applied to water-closet construction in the manner illustrated in Fig. 417. The water-closet represents our basin, and its supply pipe our inverted bottle, which is closed at its top by the cistern-valve. If water is exhausted from the closet bowl by evaporation, siphonage, or any other cause, a fresh supply descends automatically

TRAP JET CLOSET.

from the pipe as soon as the surface sinks below its mouth. Inasmuch as in the construction of the closet, this mouth is placed above the bottom of the water-seal, it is evident that water will instantly descend from the pipe before the seal can be broken. This seal is quite deep, and the mouth

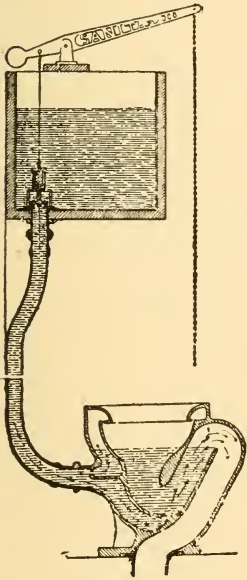

Fig. 417. Diagram illustrating the principle of the apparatus.

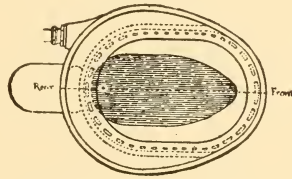

Fig. 418. Plan of closet.

of the pipe is midway between the top and bottom of the seal that is below the normal level of the standing water in the bowl.

Fig. 422 represents the actual construction of the closet. The action of the apparatus is as follows:—

The cistern-valve being raised, the balance of atmospheric

pressure is restored, the water column in the pipe instantly begins to move, and, since it connects with the water in the closet below its level, it acts noiselessly and effects a thorough flushing.

A novelty in the general principle of construction involves corresponding novelties in many details.

The lower end of the supply-pipe is not simply opened at a single point below the water level, but is conducted to two places independent of each other, the first being intermediate between the overflow of the trap and the bottom of the seal, as is shown in Fig. 417, and the second at the bottom of the trap. The first forms the mouth proper of the "inverted bottle" and supplies water to the flushing rim, and the second furnishes a jet which lifts part of the water out of the trap and bowl by its propelling power. Since both jets enter below the level of a large body of standing water in the bowl, their noise is deadened, and, as the supply pipe always stands full, they act instantly, and the flushing of the closet is very rapid. The lower jet causes the water and waste matters in the closet to sink into the neck of the bowl. Meanwhile the upper jet fills the passages and annular chamber leading to and surrounding the flushing rim, overflows, and, descending into the neck of the bowl, falls upon and drives out the waste matters collected in the neck quietly and without waste of water.

The cistern-valve being again closed, movement in the supply-valve immediately ceases, and the water in the flushing rim and passages leading thereto, falls back into the closet and restores the normal level of the standing water in the bowl and trap.

The form of the closet bowl is shown in plan in Fig. 418. The standing water has the shape best calculated to receive and deodorize the waste matters falling into it. It is deepest

TRAP JET CLOSET.

at the back of the closet, and very deep at the point where the wastes strike. Its surface is long and comparatively narrow, and is not round or elliptical, as has heretofore been customary.

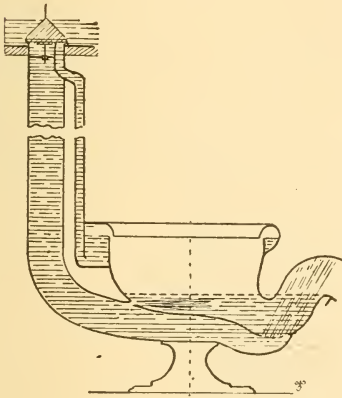

Fig. 419.

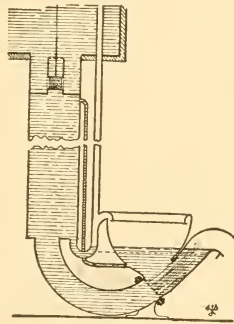

Fig. 420.

Two of the writer's Experimental Closets.

By examining Fig. 422 it will be observed that the the under surface of the bowl is horizontal from front to rear, except at the outlet, and that this surface is immersed under an inch or so of water. It will also be observed that the water-slots in the flushing rim are largest in the front and rear, and gradually diminish as they extend round to the sides. The result of this conformation is that the upper flushing water jumps on top of the waste matters and acts to the best possible advantage in driving them quickly out, and the closet can be easily flushed in three seconds by less than a gallon and a half of water.

A stream of water may be rendered noiseless, however rapid and powerful its movement, by properly directing it

into a body of water considerably larger than itself, provided the point of entrance be below the surface. It is not sufficient to do this in the manner usual in the old form of English and French siphon-jet closets, because the jet in these at once throws the standing water out of its way, and then makes an uproar even more appalling than the ordinary flushing stream. In these "siphon-jet" closets, the water used for cleansing the upper part of the bowl, when used in combination with the jet in the trap, is not only insufficient to keep the lower jet covered, but makes a most disagreeable clamor of itself, after the usual manner with modern closets.

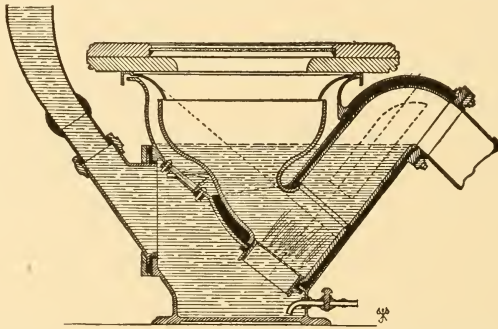

Fig. 421. A third one of the Experimental Closets.

The upper flushing stream should furnish a body of water nicely calculated to keep the lower stream just covered, and should itself be noiseless. The former result is easily attained by simply adjusting the size of the upper and lower flushing openings with reference to each other; the latter by constructing a special chamber into which the upper flushing stream may be projected before it enters the bowl. The upper part of this chamber forms an annular ring and surrounds the flushing rim. Being above the level of the standing water in the bowl, it receives only clean water. Being constructed in such a manner as to drain itself back

TRAP JET CLOSET.

into the closet bowl after each flushing action, it stands, like the flushing rim proper, empty at all times excepting during the moment of flushing. The upper jet dis-

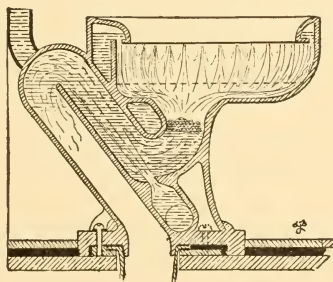
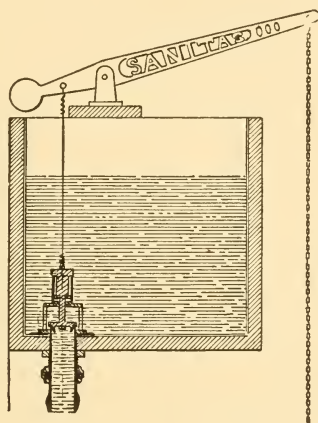

Fig. 422. Section of the Sanitas W. C. Outfit.

charges into the standing water in the lower part of this chamber, and its sound is instantly and entirely deadened. The water rises in the annular chamber and overflows

through the flushing rim to descend quietly into the bowl, lubricate its sides, and assist the lower stream in ejecting the wastes and flushing the closet and drain-pipes.

It will be observed, by referring to the perspective drawing, that the closet is provided with a cistern overflow con-

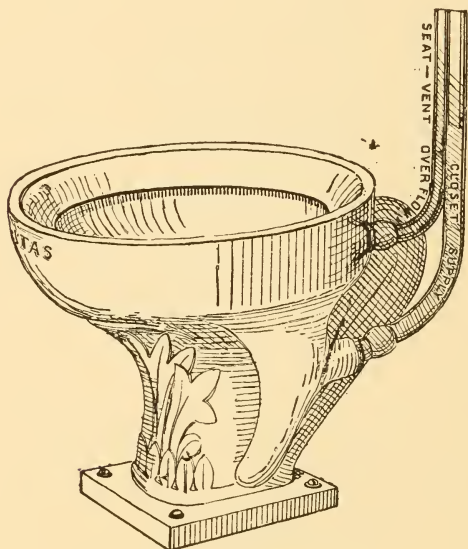

Fig. 423. Perspective View.

nection at the flushing rim. The same pipe may serve also as a ventilating pipe. By connecting this with a proper ventilating flue above the cistern, in the manner shown in the drawing, Fig. 420, the seat and bowl of the closet may be ventilated. Such ventilation is serviceable at the moment of usage of the closet, but it is not needed for the bowl and trap themselves, which are kept odorless by their construction

TRAP JET CLOSET.

and arrangements for flushing. It is well, however, always to ventilate toilet-rooms, and as good a place as any to locate the ventilating outfit is under the seat of the water-closet in the manner described.

Figs. 419, 420 and 421 explain the principle of this closet. Several jets were tried at first in the form of a rose as shown, but a single jet or two jets were finally found most effective for the ejector as shown in 422. Fig. 423 shows the appliance in perspective.

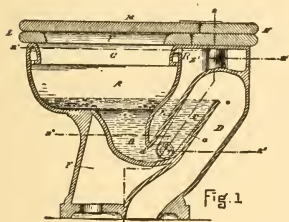

Fig. 425.

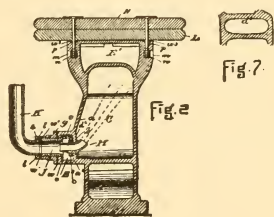

Fig. 426.

Longitudinal and Transverse Sections of the First Raised Jet Closet.

Figs. 425 and 426 represent sections taken from the writer's original designs of his further improvement which was the first closet made with the jet above the bottom of the trap, partly for the purpose of sound deadening and partly to improve the appearance and the power of the flush.

Mr. Wm. Paul Gerhard in his German work on plumbing published in 1897, in Stuttgart, Germany, describes at some length a number of features of the "Sanitas" closet, which seemed to him advantageous as compared with the makes or styles prevailing at the time, and shows that closets built on

the siphon jet principle of flushing nearly all appeared after the introduction of this appliance, and "suddenly enjoyed a great popularity." The "Sanitas" fixture he says "has nowhere a superfluous or undesirable angle, corner or surface to get foul," has a large and properly formed water surface, "and the arrangements for water flushing are novel," etc., and he goes on to describe the other features which were at that time new, somewhat as we have already pointed them out. The majority of appliances at that time had a number of objections and says Gerhard,* also, "labored under the disadvantage of making a great noise in flushing." These objections caused the public to appreciate the advantages of the new principle, and as a matter of fact the success of this closet immediately led to a great number of imitations until finally the siphon jet closet became practically the only one in general use.

THE SECURITAS WATER-CLOSET.

Figs. 427 to 431 show later improvements in this device developed by the writer in connection with his shallow seal "Securitas" trap and designated by the same name.

The principal points of these recent improvements are, first, a much deeper seal; second, a construction of the upper or rim flush so as to require the water to enter the bowl absolutely free from pressure and without the customary rim perforations. This insures noiselessness at this point. Third, an inclined shelf all around inside at the neck of the

*"Entwasserungs-Anlagen Amerikanischer Gebaude" Nr. 10 in "Fortschritte auf dem Gebiete der Architektur" Stuttgart 1897, Verlag von Arnold Bergstrasser

TRAP JET CLOSET.

bowl so arranged as to break the fall of the upper flush and render it noiseless again at this point; fourth, a construction of the siphon jet at the level of the dip of the trap in accordance with designs originated by the writer in his earlier experiments in attaining noiseless action as shown in

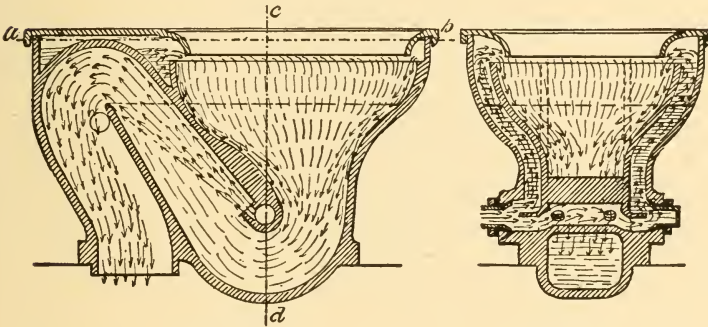

Fig. 427.

Fig. 428.

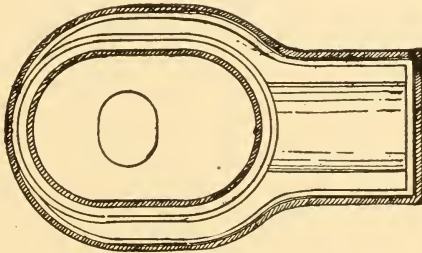

Fig. 428a.

Sections and Plan of the First Step in the Later Improvements.

Figs. 425 and 426, but with the improvement now of giving the jet an oval form and a special method of co-operating with an immediately adjoining jet supplying the upper flush, as shown in Fig. 429, for the purpose of completely balancing the action of the two jets; fifth, a very great increase

in the power of the jets whereby their action becomes much quicker and more effective in every way; sixth, a curving of the upcast limb of the trap around the siphon jet in such a manner as to force the flushing stream across the path of the jet whereby the waste matters are caught up at once and whirled directly into the waste pipe without hesitation or back eddies; and finally, seventh, an enlargement of the waste pipe end of the fixture beyond the crown of the trap so that it shall exceed the size of the trap itself for the purpose of preventing the siphon action, generally sought for to assist the jet in discharging the wastes. This siphonic or suction action is most unscientific and undesirable because it renders the flushing of the apparatus dependent upon a fortuitous and varying suction pull differing with each different installation, rather than upon a scientifically adjusted jet power, permanently regulated by a definite water head established for each fixture by distance below the main house-cistern in the attic above the jet. This regulation is accomplished by a very simple small auxiliary valve beyond the main valve, or flushometer, directly connected with each closet.

It nicely regulates the duration of the flush to the amount required and thus prevents all water waste.

Moreover, the siphonic, or suction action, tends to uncover the jet and invariably gives rise to noisy action, sometimes very loud, especially when the jet is exposed.

The breaking of the suction, moreover, adds a most disagreeable gulping noise at the end of the action. These objectionable features are avoided by the use of the exclusive jet action of discharge without siphonage.

All these various modifications combine to produce an extraordinarily rapid and positive discharge of the waste matters with a minimum consumption of water and a maxi-

TRAP JET CLOSET.

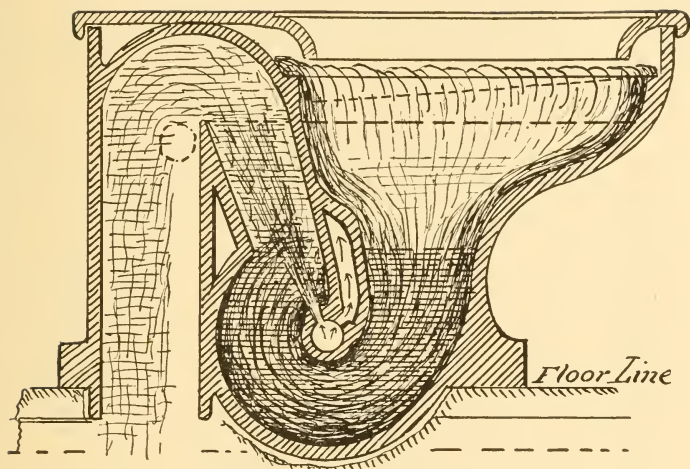

Fig. 429. Longitudinal Section of Final Improvement.

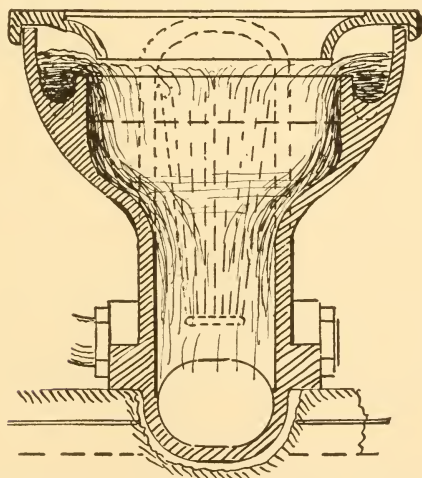

Fig. 430. Transverse Section of Final Improvement.

num noiselessness. This quiet instantaneous action produces an almost magical effect. On operating the flush valve the water level in the bowl instantly drops while the upper

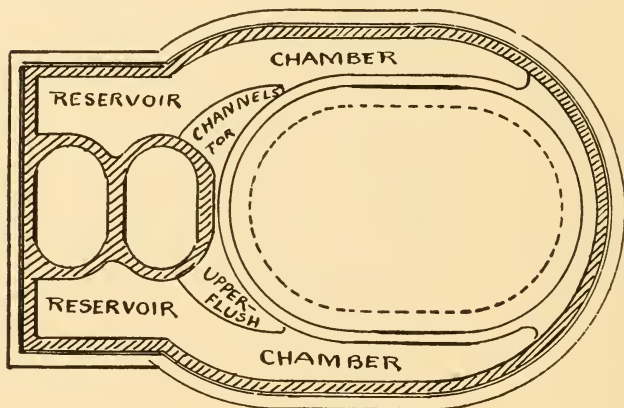

Fig. 431. Plan of Final Improvement.

flush noiselessly wells over the edge in a thick layer, glides down to the neck ledge, and the jets being nicely proportioned to each other, keeps the water supply above the dip, muffling the lower jet while the waste matters disappear. Scarcely has the action fairly begun when it is finished and clean water is seen to rise again in the bowl from the reservoir chamber as noiselessly and almost as quickly as it disappeared. Nothing can resist the power of these jets working in co-operation in the deep funnel of the bowl, and the lightest substances are whisked away with the same quiet relentless certainty that a cork rides over the edge of Niagara.

In order still further to insure that there shall be no siphon or suction action of the drain end beyond the trap,

TRAP JET CLOSET.

a short air pipe may be run from a small hole beyond the crown of the trap into the main soil pipe behind the closet. This, however, is not indispensable, but only a refinement.

The very deep seal of this fixture, especially when aided by the shallow seal trap, renders this closet absolutely anti-siphonic, for the reasons already described, so that the last argument raised for back venting becomes groundless.

Figs. 427 to 428 represent the steps leading to the perfected design 429 to 431.

Fig. 432 shows an early method of replenishing the seal of a siphon closet indefinitely and automatically after siphon-

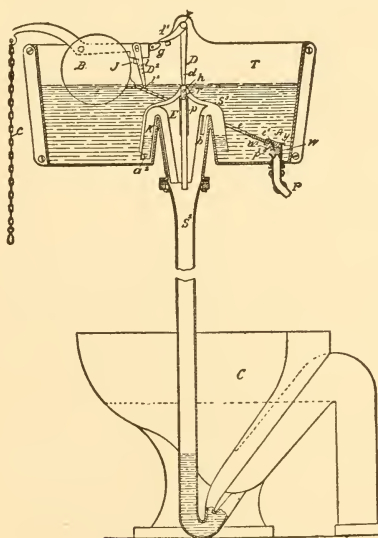

Fig. 432. Writer's Early Device for Perpetual Refilling of Trap Seal Reduced by Evaporation, Siphonage or Other Cause.

age or evaporation. The lowering of the water in the trap through any cause opens the cistern supply valve automatically by atmospheric pressure variation, and closes it again as soon as the trap fills. But the simpler method of seal

PLUMBING AND HOUSEHOLD SANITATION.

protection devised later and described above now renders this more complicated device superfluous.

Fig. 433 shows in section one of the numerous direct flush-

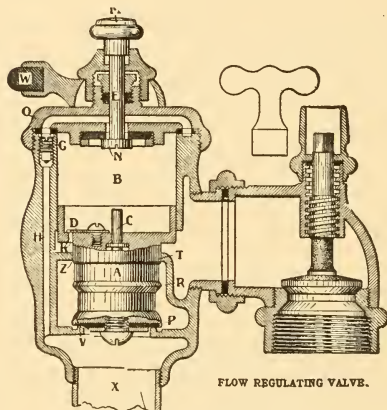

Fig. 433. Flush Valve.
(By permission of Nethery Hydraulic Valve Co., N. Y.)

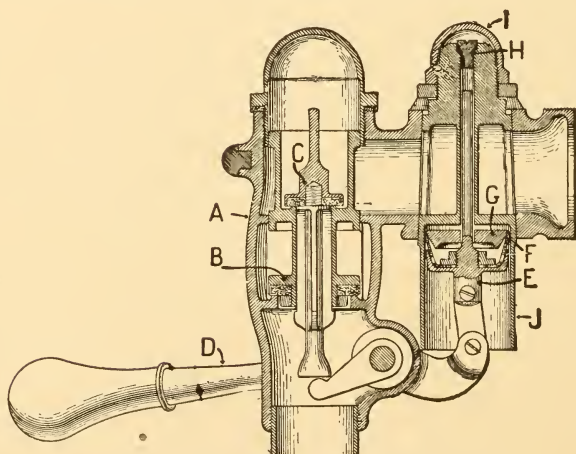

Fig. 434. The "Boston" Flush Valve.
(By permission of the Phillips Flushing Tank Co., Boston.)

TRAP JET CLOSET.

ing valves in common use now for pressure service without individual closet cisterns.

Fig. 434 shows another kind of these direct connected valves, Fig. 434a a third kind, and Fig. 435 a convenient method of attaching it to a closet, and the closet to the wall.

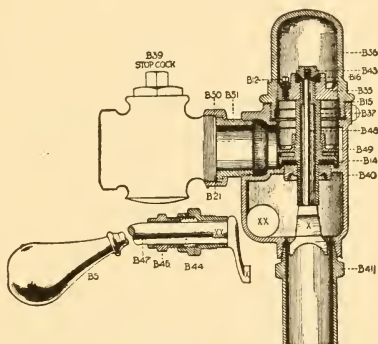

Fig. 434a. Sectional View of Flushing Valve.*

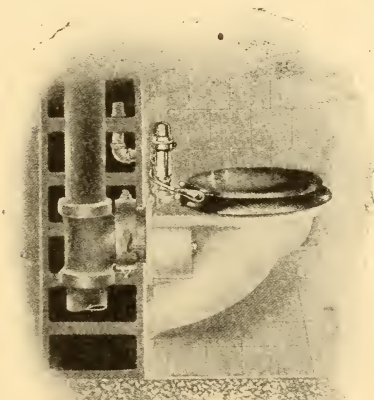

Fig. 435. The Flushometer Attached to a Water Closet Having Its Support on a Fireproof Wall or Partition.†

*Called the "Watrous Aquameter." Made by the Federal Huber Co., N. Y.

†The Water Closet made by the same firm.

Fig. 436 shows the ordinary form of siphon jet closet now in vogue. The action of the jet is aided by a suction pull on the drain pipe side of the trap created by the form of the down cast limb beyond the trap, and this suction being variable in strength, sometimes uncovers the jet and allows its full roaring noise to be heard.

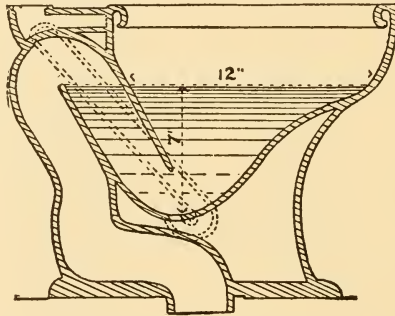

Fig. 436. Ordinary Form of Siphon Jet Closet Obtaining Siphon Action in Waste Pipe.

Let us now examine our table of desiderata and see in how far our "Securitas" closet, Figs. 429 to 431, conforms thereto.

1. *Simplicity.* We find in it the simplest form possible with closets. The trap and the bowl are one and the same thing. Each forms half of the other. The flushing is accomplished by the pressure of the water only, and without machinery of any kind in the closet. We have, in fact, the simplicity of the short hopper, which is the simplest form of water-closet known.

2. *Quickness and thoroughness of flushing.* The maximum of rapidity of flushing is attained by having the supply-pipe always full of water, so that the action at the lower end takes place simultaneously with the operation of the valve, and all delay and loss of power occasioned by the water falling from the cistern through the pipe and against the resistance of the enclosed air is avoided. Where the

TRAP JET CLOSET.

power is taken from a common cistern at the top of the building serving all the stories below, or where it is taken direct from the city main, the same result is obtained by the use of a pressure valve or a flushometer of some form, the water being reasonably free from grit as it should be through proper sedimentation or filtration. The combined action of the two lower jets of water is, moreover, as already described, such as to accomplish the removal of the waste matters with the utmost speed, in virtue of their co-operation.

The *thoroughness* of the flushing or cleansing action, with a given quantity of water, is evidently in direct proportion to the rapidity and direction of the action, it being assumed that the surfaces to be flushed are properly constructed to receive it, as is the case with the closet under consideration. The form and volume of the standing water in the bowl is such as to protect the sides from being fouled by adhesive matters. The solid and heavy wastes, which are the adhesive ones, cannot fall against these sides. If liquid or semi-liquid matters are projected against them they will not stick. Therefore these sides require not so much great *force*, as a *uniform distribution* of the flushing water. The parts which require scouring force are those below and beyond, including the trap and the main soil and drain pipes, and it is these parts which in this closet receive it. The scouring action on the pipes is here equal to that of the plunger closet, while it exerts less siphoning action on fixtures below the latter, because air freely follows the discharge and prevents the formation of a vacuum.

3. *Freedom from all unscoured parts.* The closet contains no cesspool in its construction, and has the minimum extent of surface, interior and exterior, possible in a water-closet.

4. *Economy in construction and water consumption.*

Being constructed of a single piece of earthenware of compact and simple form, this desideratum is met. The consumption of water is reduced to a minimum, in the manner already explained. No loss of power is sustained in the supply-pipe, and each drop in the closet acts in the most effective manner, in concert with the rest, to produce a rapid and thorough flush.

5. *Compactness and convenience of form.* The closet occupies the minimum of space, as may be seen from the drawings.

6. *Amplitude of standing water in the bowl.* The standing water has the proper form and depth, and its surface is calculated to stand at the most desirable distance below the seat of the closet. It will be seen, upon reflection and experiment, and in testing different forms of water-closets, that the nearer the seat the surface of the standing water can be brought without causing inconvenience the less liability there will be for spattering.

7. *Accessibility and visibility of all parts, including the trap.* A study of the drawings will show that this desideratum has been attained.

8. *Smoothness of material.* The closet being constructed of glazed earthenware in a single piece, and everywhere with easy bends, this requirement is fully answered.

9. *Strength and durability of construction.* The compact and simple form of the closet, the central position of the base under the bowl giving it equal and firm support, and the soundness and reliability of its soil-pipe connection, give it the greatest strength and durability possible with water-closets.

10. *Facility and reliability of jointing.* There is but a single, simple, and strong brass coupling connection to be made with the supply, and a single connection with the

TRAP JET CLOSET.

waste-pipe. The small coupling at the flushing rim for a seat vent and cistern overflow may be used or closed up, as desired.

11. *Security against evaporation and siphonage.* The new principle of supply already described, together with the unusual depth of the water-seal, renders this closet practically secure against loss of seal through evaporation and siphonage. A further protection consists in the use of a Securitas trap under an adjoining fixture so that a partial vacuum in the soil pipe caused by siphonic action will be broken by the fresh air passing through the shallow trap without destroying its seal.

12. *Ease and convenience of flushing.* It is only necessary to actuate the valve and immediately release it again to obtain a sufficient, and no more than sufficient, flush. The trap and bowl refill themselves automatically after the flush. The valve may also be operated by a simple seat or door attachment, if desired.

13. *Noiselessness in operation.* It has hitherto been assumed that it would be impossible to combine noiseless action with a powerful and rapid water scour. Nevertheless, this has been accomplished in the manner already described; and the closet may be used as is agreeable to civilized people, without the "flourish of trumpets," usually attending the occasion.

14. *Neatness of appearance.*

In order to complete the idea of having everything in the bath room finished with a pure white enameled surface, the writer devised a pull to be made of opal glass or porcelain filled with white plaster, as shown in Fig. 437. Having the texture and surface appearance of the earthenware of the closet and other plumbing fixtures as well as of the soil and waste pipes which may also be porcelain enameled in the finest work, as described in connection with his new

PLUMBING AND HOUSEHOLD SANITATION.

pipe system, it harmonizes with them in appearance, and requires no scrubbing or burnishing to keep it permanently as bright as when new.

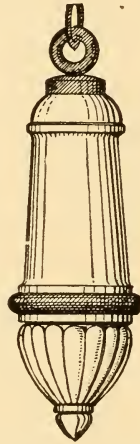

Fig. 437. The Sanitas Opal W. C. Pull.

COUPLINGS.

Figs. 438 to 440 show the writer's device for coupling pipes to earthenware, to which he gave the name "Sanitas."

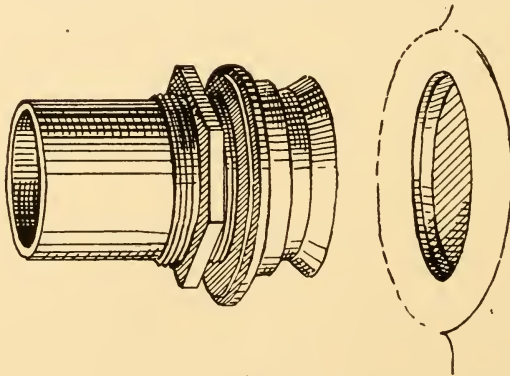

Fig. 438.

COUPLINGS.

This coupling consists of a brass tube with a trumpet-shaped mouth fitting into a corresponding inverted trumpet-shaped opening in the earthenware, together with an elastic gasket and coupling nut. The hole in the earthenware is made just large enough to receive, with a reasonable amount of play room, the trumpet end of the brass tube. The rubber gasket is moulded just large enough to slip over the threading of the tube, by means of which the whole is tightened up.

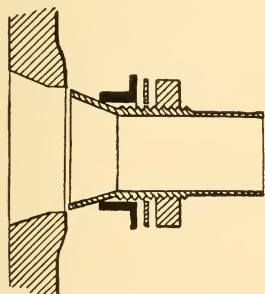

Fig. 439. Sanitas Coupling, ready to be connected.

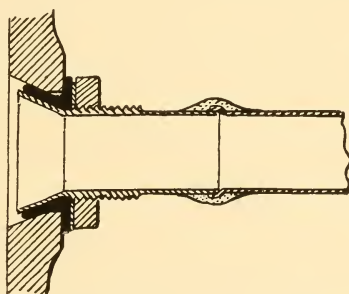

Fig. 440. Sanitas Coupling, connected.

The simple method of making the connection is as follows:—The supply pipe to be connected with the earthenware is first soldered to the small or spigot end of the tube, having the brass washer and coupling nut in place. The rubber gasket is then stretched over the trumpet end of the tube, and pushed down until it occupies the position in Fig. 439. The trumpet end and gasket will then slip into the hole in the earthenware, and the joint is finally made tight by screwing up the coupling nut, which may be done with the hand even, without the use of a wrench or any tool whatever. But the use of an ordinary wrench will of course render the tightening easier. The coupling when connected in place is shown in section in Fig. 440. It may be taken apart by simply reversing the operation of putting together. The nut

is first unscrewed and the pipe pushed about one-half inch into the earthenware. This enables the rubber gasket to resume its original shape, as shown in Fig. 439, the outside shoulder of the gasket preventing its being pushed in with the pipe. The whole may then be withdrawn from the pottery.

By using this coupling, tightness may be secured even if the surfaces of the earthenware are not perfectly true and smooth. The elastic gasket has a bearing on both inner and outer surfaces of the earthenware, giving double security against leakage; and inasmuch as no hard surface comes in contact with the earthenware, there is no danger of fracturing the latter in tightening up, as so frequently happens with other couplings, to the great expense and annoyance of the plumber. The longer the coupling stands, the tighter and safer it becomes; since the rubber gasket, after years, glues itself to the surfaces of contact so tightly that, were it not for the outer shoulder of the rubber gasket, it could not then be disconnected from the closet except by cutting it out with a knife. Soon after its introduction the majority of the potteries of the United States adopted the "Sanitas" coupling as their standard under a royalty arrangement with the manufacturers.

URINALS.

As they are generally made, urinals are very objectionable things in private houses.

For public places an automatic flushing cistern is frequently used, and this is perhaps the only certain method of insuring a sufficient flush for single urinals constructed in the usual way. But it involves a great consumption of water, inasmuch as the flushing goes on always, whether it be required or not. This is not only very wasteful, but also dilutes the sewage by so much more, and thus renders

its disposal by land irrigation or filtration correspondingly more difficult.

For private houses it is much better to allow the water closet to serve also as a urinal. It is sometimes advisable to set the closet on a platform so that the top of its bowl shall be at the height of a urinal, the platform extending out a little beyond the front of the bowl, so that the fixtures may be used equally conveniently as a water closet or as a urinal as desired. This is also sometimes advantageous in giving more pitch to the waste pipe from the closet. The bowl, containing already a large body of standing water, dilutes the urine and prevents its fouling the sides. Habit

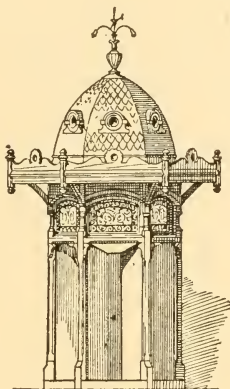

Fig. 441.

with water closets leads to its flushing after its use as a urinal at times when the ordinary form of urinal would have been left unflushed. But should, by any chance, the flushing be neglected, the next use of the fixture as a water closet would insure its cleansing. Moreover, by combining the two fixtures in one, economy both of space and first cost is obtained, while the offensive appearance

and odor of the urinal is avoided, and the consumption of water is greatly diminished. Here again the plumbing is advantageously simplified.

In public buildings, however, such as hotels, railway stations, manufactories, school or club houses, where proper and systematic attention may be expected, urinals may become not only desirable, but absolutely necessary.

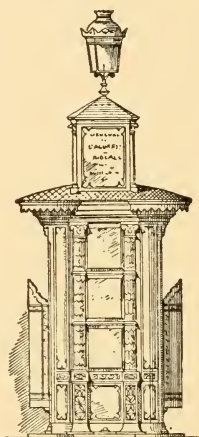

Fig. 442.

Figs. 441 and 442 represent two ornamental public urinals.

They should be provided in various places in the main thoroughfares easily accessible to the public as an important sanitary measure.

It is best to have the flushing effected by some automatic device operated by a treadle arrangement or by the door of the apartment in which the urinal is placed, or else by a special attendant, so that as little water as possible need be added to the sewage, for reasons already explained.

PUBLIC SANITARIES.

It is calculated that for stall urinals having a constant water flushing, the consumption of water often equals a half a gallon per minute per stall.

The width of the stall should not be less than two feet, as some persons will not enter a narrow stall. The best of ventilation should always be provided in the room where urinals are placed. The divisions should not exceed five feet in height. Beyond this there is only a waste of material, and more to be kept clean. It goes without saying that the smoother and more impervious the material of which these stalls are made the better.

CHAPTER XXXIII.

SOIL AND DRAIN PIPES.

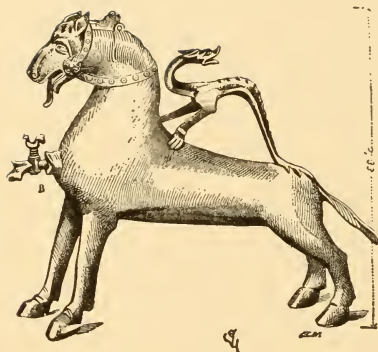

Having shown simple ways in which offensive or dangerous gases may be securely trapped off and debarred from entering the house through the various fixtures at their points of connection with the water and soil pipes, it now remains to provide against a possibility of leakage in the drain pipes them-

selves, for if these are unreliable and badly jointed all our pains with traps and fixtures will be of little use.

The term "soil pipe" is, by custom, applied to the perpendicular portion of the main waste pipe. The horizontal part is called the "drain pipe."

THE MATERIAL AND METHODS OF JOINTING.

The material for our pipes naturally forms the first subject for consideration, inasmuch as upon it their proportions, treatment and arrangement in a great measure depend.

By far the most suitable material yet discovered for soil and house drain pipes is iron, and the most important matter connected with its use is the formation of the joints between the separate pieces.

SOIL AND DRAIN PIPES.

Lead has been almost entirely abandoned in this country for soil and drain pipes, on account of its want of strength and elasticity; its comparatively high cost; its liability to be perforated by vermin, nails or corrosion; and of the greater time and labor required to make the joints. Large lead pipes often sag of their own weight and tear away at their points of support. The action of alternate hot and cold water also produces a destructive effect upon the material. It expands under the influence of heat, but does not return again to its original dimensions, and accordingly it can be said to undergo perpetual change, creeping constantly from its original position; and unless held in place by special provisions it would undoubtedly in time walk off by itself out of the premises altogether. Good stories are told of old leaden roofs which have crept entirely off the building and fallen into the street.

S. Stevens Hellyer said in one of his early publications in comparing lead with other materials for soil pipes: "This may seem a curious question to ask of plumbers; as well ask a shoemaker of what material should boots and shoes be made! Everybody knows that the latter would say, 'There's nothing like leather,' as the former is sure to say, 'There's nothing like lead.' * * * Allowing experience to be my schoolmaster, I answer lead, especially for our climate." Mr. Hellyer claims the following points of superiority for lead: Its greater smoothness; great resistance of corrosion; greater ductility for bending to suit the various positions it has to occupy; more perfect joints; greater adaptability for connecting with branch wastes; and greater compactness, which allows it to be placed in slots or niches smaller than those which are required for iron. He admits the following objections: Its deterioration under alterations of temperature which tend to work

it until it breaks; its sagging; its expensiveness; its liability to be perforated by rats or carpenter's nails; its greater weight; and the requirement of greater skill in making the joints.

The advantages which Mr. Hellyer claims for lead have within late years lost their force. Improved methods of protecting and jointing other materials have placed them in these respects far ahead of lead, as will be shown hereafter. White enamel is now applied to cast iron in such a manner as to render the surface as smooth as that of new lead, and this art has been serviceable particularly in bath tubs and other fixtures, though it is also used in piping. But in use lead soon loses its smoothness and the sewage adheres to the surfaces of the pipe to a greater or less extent and roughens it, in time, with a hard deposit of greater or less thickness according to the usage of the pipe, so that the difference in smoothness at the outset in favor of lead as compared with our iron pipe is of small consequence after a few years' use. The numerous cast bends and fittings now made and adapted to every possible turn or angle liable to be encountered in arranging the pipe renders the ductility of the lead pipe no longer of any advantage. Finally, other and more suitable materials are now joined in such a manner as to render them quite as compact as the lead pipe.

Stone and brick drains cannot be effectively flushed, on account of the roughness of their interior surfaces. Moreover, they are porous to a certain extent, and the cement with which they are laid is always more or less pervious to waste.

Copper is easily corroded by the acids of decomposition, and is, moreover, too expensive except for exceptional cases which need not be considered here.

SOIL AND DRAIN PIPES.

Zinc, tin and galvanized sheet iron are totally unsuitable and not to be considered for a moment. In the worst kind of "jerry buildings" they are, however, occasionally used.

Cast and wrought iron are the materials which are now generally used, and they have proved themselves for this purpose the best. They are light, cheap, stiff and strong and they corrode so slowly that if of the proper thickness they will last as long as the house itself is likely to.

The experiments of M. Gaudin, made in 1851, show the maximum rate of loss by rust of uncoated cast iron pipe exposed to the action of clean fresh water on both sides to be a little over an eighth of an inch per century. His experiments extended over a period of thirteen years. With the present method of protecting iron its life can be very greatly prolonged, indeed even the use of the ordinary bituminous coating (coal tar pitch) has proved, when it is properly applied, to be able to keep the pipe quite intact under certain conditions for twenty years. The life of a soil pipe, even when quite thin and uncoated, has been found by experience to be so great that it is not unreasonable to suppose that the greasy matters contained in house drainage serve to protect the pipe in a measure from the acid components of the sewage.

Cast iron is brittle, but when iron of the proper softness is used, and when the castings are of sufficient thickness, its brittleness need not be an objection.

Wrought iron is smoother, denser, more uniform in thickness and tougher than cast iron and can be absolutely tightly jointed by threading, and is more and more used each year for soil and drain pipes. Wrought iron when exposed uncoated to clean fresh water will rust quicker than cast iron under the same circumstances. On this ground many persons have opposed its use for plumbing. But in view of the extreme slowness of the action of rust in both cases,

especially when covered with the fatty deposits which coat the inner walls of these pipes, and in view of the ease and cheapness with which the surface may be protected before laying, this argument loses its force. Experience shows it to be in all respects a reliable and most satisfactory material for the larger sizes of soil and drain pipes.

JOINTS.

Equally important with the question of the material is the manner in which the several parts are put together, inasmuch as upon this depends not only the safety of the work, but also, in a measure, the choice of the material itself. The question of joining or coupling the pipe will therefore next be considered.

CLASSIFICATION OR REQUIREMENTS.

An ideal joint for waste pipes should possess the following ten characteristics, which may be called the ten commandments of pipe jointing:

(1) It should be airtight even under heavy pressure, and even under considerable deflection.

(2) It should be unaffected by the expansion and contraction of the pipes.

(3) It should be capable of resisting severe jars and strains, both compressive and tensile, such as are occasioned by its own weight and by settlement and movement in the building. In other words, it should be flexible.

(4) It should be of such a form and nature as to admit of its being as easily taken apart for repairs or alterations as it is put together, and this without damage to any part.

(5) Its form and construction should be such as to allow it to be made and put together rapidly, to follow easily the irregular contour of the construction, and to be used immediately after fixing in place.

(6) It should require no caulking or hammering, which is liable to fracture the pipe or its lining.

(7) It should be so formed that any imperfection either in the materials used or in the manner of putting them together can be easily detected from without, without expert aid, since only in this way can the owner be protected against accident or fraud.

(8) It should be compact enough and so constructed as to enable it to be put together and used in contracted places and slots.

(9) It should cause no obstruction to the waterway, and leave no space or pocket for the deposit of sediment.

(10) It should be simple, durable, indestructible, economical, and unobjectionable in appearance.

A pipe joint which shall answer the above desiderata would evidently be suitable for water, gas and other fluids under pressure, as well as for drains.

CLASSIFICATION OF THE DIFFERENT KINDS OF JOINTS.

Pipe joints may be divided into five general classes:

I. The bell and spigot joint.

II. The flange joint.

III. The sleeve joint.

IV. The screw joint.

V. The flexible joint.

These may be subdivided as follows:

I. The bell and spigot joint into:

(a) The hand-caulked lead joint.

(b) The machine-caulked lead joint.

(c) The rubber ring joint.

(d) The cement packing joint.

II. The flange joint into:

(a) The spigot and socket flange joint.

- (b) The spherical flange joint.
- (c) The loose ring flange joint.
- (d) The wedge and key flange joint.
- (e) The plain non-adjustable flange joint.
- (f) The plain adjustable flange joint.

III. The sleeve joint into:

- (a) The lead packing sleeve joint.
- (b) The plain ring sleeve joint.
- (c) The divided ring sleeve joint.
- (d) The bolted ring sleeve joint.

IV. The screw joint into:

- (a) The flanged screw joint.
- (b) The inner ring screw joint.
- (c) The outer ring screw joint.
- (d) The plain screw joint.

V. The flexible joint into:

- (a) The rotary play joint.
- (b) The longitudinal play joint.

The ordinary flanged joint secured by bolts, as used by engineers for gas, steam and water pipes, is unsuitable for plumbing purposes on account of the restrictions it presents in obtaining the proper directions, and to meet the different branches used in piping a house. At every point slight variations of direction are required to avoid the beams and other members of construction, and to meet the different fixtures at the proper angle.

The steamfitters' flanged joint has not the flexibility which allows a piece of piping to be turned slightly on its axis in this or that direction before fixing, as is necessary. Hence the ordinary bell and spigot joint, caulked with lead, was substituted for the flanged joint in plumbing. It enabled the plumber to cant the pipe in any direction, or to

revolve it on its axis to conform with the irregularities of the construction and fit every contour.

But this joint is in every other respect the most barbarous, expensive and unscientific device imaginable, and it is difficult to understand how it can have acquired the popularity it has. Only one of the new conditions imposed by plumbing has been met in this device; the condition of flexibility in arrangement, as already described. But this condition has been met only at the sacrifice of others far more important. The caulked joint is neither tight nor permanent; it cannot be made to resist water or gas under pressure, and it is soon destroyed by alterations of heat and cold in the pipes, such as is often produced by the passage through them of hot water or steam. It is expensive both in time and material. It requires expert labor to adjust, but defies expert labor to take it apart again without more or less destruction of the piping. Even the process of putting together involves a hammering which endangers the integrity of the pipe, and the most experienced and careful workman often cracks it in the process.

The safe use of white enameled pipe is out of the question with the caulked joint, because the jarring produced by the caulking tool tends to crack the enamel.

The bell or hub and spigot joint, however, is still used everywhere, and is perhaps found in nine-tenths of the plumbing work in buildings today. Its great importance therefore demands further careful and critical examination. The use of the joint should be prohibited by law. In view of all its faults, and its great and undeserved ascendancy over mankind, it might be styled the King of Evil Joints.

This joint is made usually with lead (the "Saturn" of the ancient alchemist, and the "Satan" of the modern plumber) and oakum or jute. A gasket of jute or similar fibre is

inserted into the cavity of the bell or hub, and the spigot end of the length next above it is set firmly down upon it, or the gasket is rammed in with a tool after the lengths are set up. The gasket is used to prevent the lead from running out of the joint and obstructing the bore of the pipe at some point below, besides wasting the lead.

The lead is now poured upon the gasket from a ladle, and shrinks as it cools. The caulking tool must then be used to expand it again and drive it into the cavities and pores of the iron. A faithful and skillful operator can, by perseverance, succeed in fitting the lead into the iron at all parts of its circumference, so as to make it light for a time, just as a painstaking dentist can drive the gold, by patient labor, into the cavities of a tooth and temporarily arrest its decay. But the process in both cases is slow and uncertain. The dentist confines his caulking to a single small spot, well within his reach, and he labors with extraordinary care. Yet the filling often fails when put to the test, even though the mouth is not as a rule alternately subjected to such severe strains of expansion and contraction produced by alternating heat and cold as in the iron piping.

The plumber must work quickly over an extended field, often in awkward positions. He must perform a very delicate task with very clumsy tools. The metals to be welded together are often so placed that it is impossible, without the utmost skill and patience, to reach them properly. The result is that when put to the test the joint almost always fails. The presence of the lead prevents the formation of a good rust joint. Extra heavy pipe and hubs are required to withstand the blows of the caulking tool. Lighter pipes cannot be made tight without danger of cracking the iron. I have made a number of tests on pipes of different thicknesses with the aid of an experienced

pipe layer and caulker. With double thick pipe, joints could be made which would stand the hydraulic test or a water pressure equal to that produced by such a test at the bottom of an average city house. Almost invariably a second caulking was found necessary after the plumber had carefully done the work once in a manner which he considered sufficient, and had pronounced it completed. The single thick pipe could not be made to stand the water pressure test at all. It was cracked by the caulking iron before it had been made tight. Were the hydraulic test made, now often recommended to be applied to all the cast iron soil pipes set up within the last year in city houses, not one in a hundred would hold water. The experiments of Col. Waring and other authorities in this direction fully corroborate this statement. Col. Waring says: "I have recently had occasion to test the soil pipes of a large house of the best class, where the greatest effort was made to secure tight work, where the joints were so exposed that there was no difficulty in caulking them thoroughly, and where there was every reason to suppose that every joint was absolutely tight. On closing the outlets and filling the pipes with water the whole system leaked like a sieve."

It is now generally acknowledged that a plumber's caulked joint is rarely either air or water tight, though a vast amount of lead and labor is spent on them to make them so. When we reflect that the sole aim and object of a soil pipe joint is to make a gas and water tight connection between pipes, we see that the method commonly employed is an absurdity and reflects little credit upon human ingenuity.

Now the very persons who are loudest in their defense of cast iron hub and spigot piping, in spite of the acknowledged impossibility of making with it a single permanently tight joint throughout the entire building, are yet the most

strenuous advocates of the costly special trap vent law.

They accept the certainty of a hundred openings in the soil and drain pipe system, and yet subject the house owner to tremendous expense in applying an absolutely ineffective watch over a few trap seals, seals which with proper traps could not possibly be destroyed, even without the vent.

The inconsistency is sufficiently glaring.

Expansion and contraction in the iron piping caused by hot water or steam soon widens the original openings between the lead and iron in the joints. The expansion of the spigot is in such cases greater than that of the hub because it is on the inside nearest the heat and comes directly in contact with it, while the hub is protected both by the spigot and the caulking. Hence the lead is temporarily compressed between the spigot and the hub, and, being inelastic, does not resume its original bulk when the pipes cool again. A minute opening is thus formed round the spigot, and the joint leaks. The opening may be very small, even microscopic, but it is sufficient to permit the still smaller particles of soil pipe air to freely pass, and when we reflect that the opening extends entirely round the pipe and is repeated at every joint in the building, the aggregate leakage becomes quite formidable.

The longitudinal expansion and contraction of the soil pipe also affects, often still more seriously, the caulked joint. When a length of pipe contracts the spigot is drawn away from the hub of the adjoining pipe, and if the second pipe is held fast, the hub cannot follow it. The two must, therefore, separate slightly, and the movement draws the lead ring outwards with it. The spigot then returns again under the influence of expansion, but the lead ring does not necessarily return with it, but often remains protruding slightly from the socket, and the joint leaks. This process

SOIL AND DRAIN PIPES.

may be repeated until the lead has been drawn out a considerable distance from its proper position. Every plumber knows how common a thing it is to find the lead thus protruding from the socket in the pipes which have been for a certain time in use in trying positions.

The caulked joint is incapable of resisting any severe tensile strain which is often brought to bear upon it by the weight of any member of construction or by the settling of the house. The only thing which offers any resistance to such a strain is the small ring of lead between the two metals. This may be extremely feeble where but a small quantity of lead is used and the caulking has been spared.

Another serious objection to this joint is the difficulty of disjoining pipes in which it has been used for alterations. The usual way to take out a pipe once so put together is to break it to pieces, and then remove it by degrees.

There is, in fact, no practicable alternative; for to melt off the lead would not only be expensive and dangerous, but involve the disjoining of quite a number of lengths of pipe in order to enable a single spigot to be lifted two inches, or enough to disengage it from its hub. Now, alterations in buildings are necessarily so frequent that this objection becomes a serious one.

The necessity of using fire in a house in process of construction for melting the lead necessary to make this joint is also a formidable objection to it, on account of the danger of igniting the surrounding carpenters' litter and burning down the house.

No melted lead is required today in plumbing, brass screw jointed pipe being preferable.

Still another very serious objection is the temptation

this joint opens for fraud. The lead may be partially or even wholly omitted without very great risk of detection, since it is out of sight, and frequently immediately covered by a coat of paint. The caulking may be still more easily slighted. If the hydraulic test is not demanded by the architect, a coat of paint or a little putty will easily make the joint stand the smoke or peppermint test. A few of the joints well within the reach of the house owner may be filled with genuine lead, while all those which are covered by floor boards, or are not easily accessible, may be composed of paper and sand and covered with putty. Possibly a thin coating of lead may be poured on top to present an honest appearance, and satisfy the suspicious and shrewd house owner who goes about probing the nearest joints with his penknife in order to ensnare the "rascally plumber."

The "Sanitary Engineer" narrates a striking illustration of audacious fraud in the use of paper and sand joints, as follows

"I cannot better describe it than to quote a conversation I recently had with a journeyman plumber who had been looking for employment. He said: 'I was looking for work, and went into a shop on Second or Third street—I am not sure which—and asked for a job. I was told that they needed no more help, and the clerk proceeded to inform me that they had a man who was able to iron-pipe two ordinary three-story and basement houses in a day. I pretended to doubt this statement, when he said, "Why—bet the boss five dollars he could do it, and he did it and won the five dollars." I asked the man, who was standing by, how it was possible to even stick the lengths together, or even caulk them at all. He replied, "Oh, I just put a little paper in each joint, poured in some sand, and then

SOIL AND DRAIN PIPES.

when the pipe was all up, I went over the job with my pot and ladle and poured a little lead on the front of each hub." This frank admission fairly indicates the character of a great deal of work that has been done this summer in many parts of the city."

CHAPTER XXXIV.

THE BELL AND SPIGOT JOINT.

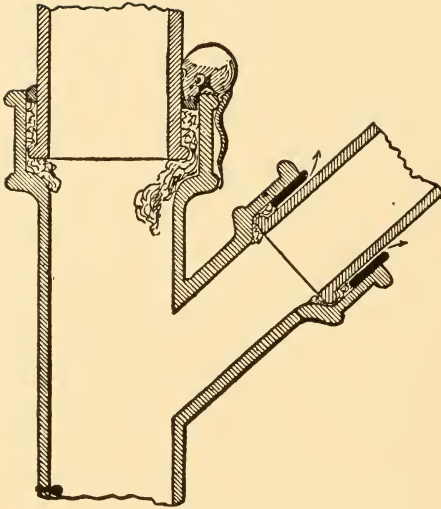

Fig. 444.

Our Figs. 444 and 444a show a defective joint produced by carelessness, which is only another name for fraud. The jute has been driven beyond the end of the spigot, forming an obstruction to the waterway and the nucleus of a deposit which may ultimately choke up the drain. By careless

packing of the jute, also, lead may be dropped through the crevices in the packing, and itself form an obstruction in the pipe. A large amount of lead is thus lost to the honest master plumber by his workman.

Where putty is used over the jute packing instead of lead, rats and mice may eat away the putty, or it may be cracked by jars or settlements in the building, and an entrance for sewer air be thus opened.

LOSS OF WATER IN STREETS.

Mr. Gerhard, in his excellent book, "Hints on the Drain-

THE BELL AND SPIGOT JOINT.

age and Sewerage of Dwellings," well says: "No other part of a common plumbing job shows so many defects as a stack of iron soil or waste pipe; there is scarcely another detail in a system of drain pipes for a dwelling in which so much rascality or criminal stupidity is shown as in the manner of making joints in iron pipes, and this is especially the case whenever architects or builders tolerate such pipes to be built into walls, inasmuch as, under such circumstances, defective joints are readily covered up and brought out of sight. The manner of applying the gaskets of oakum; the quality of the melted lead; its purity; the temperature to which it is kept in the pot on the fire; the manner of pouring the lead, and, finally, the operation of caulking it after shrinking—these are all details worthy of careful consideration, but, unluckily, seldom looked after in plumbing a dwelling. * * * It has been my personal observation that honest and conscientious plumbers—with the best possible intentions to do only first-class work—were frequently unable to caulk the lead of joints sufficiently tight without splitting the hub of the pipe. In other cases the joint could not be made tight owing to the impossibility of reaching all parts of the lead in a joint with the usual caulking tools, the soil pipe being located in a recess or partition."

The only method of ascertaining whether pipes and joints are sound is to apply a pressure to them after they have been in use in the house long enough to insure their having been subjected to hot and cold water effects. Before such use the minute annular openings around the spigot due to expansion could not have been formed. To apply this pressure test when all the fixtures have been connected up and in use is inconvenient, and it is very difficult to find records of such tests having been made. The hydraulic test is

probably the one most used where a strong pressure test is demanded, but this test is unscientific, because it brings too heavy a pressure to bear on the lower parts of the system and little or nothing at the top. Consequently, defects in the top stories, due to hot water influence on the caulking, would not receive the test desired and might easily escape detection. A thorough pneumatic test is much more scientific.

The water supply mains for cities and towns in this country and Europe are generally of cast iron with lead caulked hub and spigot joints.

The *American Architect* for Jan. 13, 1900, has the following in regard to these water mains: "Accordingly, however, to Mr. James C. Bayles, whose authority as an expert can hardly be questioned, the leakage from water mains in cities is even more important than that from the gas mains. Few persons, probably, will be prepared for the assertion that at least half of all the water which enters the mains of the city water systems leaks out in the streets, never entering the houses at all; yet in England, where the matter has been carefully investigated, it is found that in the majority of public waterworks the leakage in the mains is at least one-half the total supply; that it is very frequently two-thirds, and that in many cases it is three-fourths, or even more; while, according to the English report from which Mr. Bayles quotes, in America the loss is still greater; that is, in many towns in England, and still more in America, three gallons of water are allowed to soak away into the streets for every gallon that is delivered in the houses of the consumers. Applying to this condition of affairs the same rule as that applicable to gas supply, the inference is that municipal water takers pay, in this country, about four times as much for water as they would if

THE BELL AND SPIGOT JOINT.

the mains were properly laid. Officials of water boards understand this well enough, although, as Mr. Bayles says, every engineer and official connected with water supply seems to be sworn to conceal the facts in the case; and he hints that the inspectors of houses for leaky fixtures and annoyances of the same sort are simply a solemn farce, intended to draw public attention away from the real source of waste."

"Nine gas explosions recently occurred in the sewers of New York in one day, all caused by leakage from gas mains." In one of the largest American cities the leakage from the mains is known to have averaged eight hundred and seventy thousand cubic feet per year per mile of main. * * * It is probable that something like one-third of the gas delivered from the retorts is lost before it reaches the consumers, and millions of dollars must be paid every year by householders in our large cities for gas which they do not get, but which is expended in poisoning the atmosphere which they breathe, and in endangering their lives and those of the public."

The water mains should be housed in open tunnels as described in connection with sewers in these articles.

The plumber naturally is not fond of applying the hydraulic or other high pressure test, especially after fixtures have been connected up. He knows, in the first place, that a thorough pressure test will invariably betray a host of leaky joints and defective pipes, unless his work has been done with extraordinary care, and is attended with unusually good luck, and it is not every plumber that has as yet provided himself with the proper appliances for closing all openings in a satisfactory manner in pipe and fixtures. Thus, though a pressure test is, with cast iron pipe, of the utmost importance, architects find it exceed-

ingly difficult to enforce its application. Where it is called for in the specification and its enforcement is expected, the wise plumber raises considerably his figure in competition for the work. The hydraulic test requires an expense which plumbers can ill afford to incur.

Speaking of the great importance of applying the pressure test, the "Metal Worker" says: "A pipe may be tight and apparently sound, yet of so thin a substance that the least pressure will destroy it or break it through. Joints may be tight at the moment, though barely filled with a thin coating of putty blown out almost at a single breath. Such pipes, thought tight for the moment, are not safe against the slightest pressure, and at any time may be liable to have their continuity broken by a slight jar. The longer we study this subject the more completely do we become convinced that the true remedy for this state of things is a test of the soil pipes by pressure. Scamping is so easily done, and is so difficult of detection, that it seems impossible to avoid it, even in the best jobs which may be constructed. A large proportion of the work is done in difficult situations, where the workman has every temptation to save himself labor and discomfort, and in such situations poor work is the rule rather than the exception. * * * The real objection to such a test is to be found in the fact that it calls for perfect workmanship throughout. It demands just what every house builder and house owner wishes to have, but just what it is very difficult to obtain from even the best plumbing establishments in the city. In gasfitting, which is much less difficult than plumbing work, no sane man would dare to trust a large job without carefully testing it under pressure."

It is sometimes required in practice that each pipe used be tested for soundness at the foundry before coating them. The straight lengths can be tested under pressure more

THE BELL AND SPIGOT JOINT.

easily than the branches and bends. Hence the oil test is resorted to, and the strength or thickness of the pipe is not by this method made known.

In order to save as many joints as possible these pipes are cast in rather long pieces. The attempts to cast pipe of small diameter, say of two, three or four inches, in the usual lengths of five feet result in a frequent serious inequality in the thickness of the metal.

I was obliged to make, at one time, a number of experiments on other kinds of cast iron jointing in connection with some researches on furnace and boiler construction. One of these furnaces, which was advertised by its builders to be absolutely gas tight, contained quite a number of joints. The owners claimed that so much care was bestowed on each joint that leakage was a sheer impossibility. I particularly objected to the joints between the cast and wrought iron pipes in the construction, but the makers claimed that their method of jointing was peculiar and could not fail. "A fine new furnace* was exhibited to show the excellence of the workmanship. I still objected until challenged by the makers to give proof of any of the numerous furnaces put up by the company having ever leaked gas. Without taking the time to visit any or all of the 500 or more gentlemen whose letters of recommendation adorned the descriptive circular of the firm, I expressed myself satisfied if the fine new sample furnace then on exhibition would itself stand the test.

"With the assurance that I was at liberty to make any reasonable test I pleased, I ordered the furnace to be turned over and water poured into it. To the complete astonishment of the proprietors and of the careful workmen stand-

*"The Open Fireplace in All Ages," by J. P. Putnam.

ing around, the water which had been poured in poured out again through nearly every one of the score of careful joints until the furnace seemed to dissolve and float away in its own tears."

The lead caulked joint, when faithfully made, is very expensive in material and labor. The amount of lead required for each joint, including waste, is estimated at about a pound for every inch in the diameter of the pipe. Thus an ordinary four-inch soil pipe, caulked, consumes four pounds of lead in each joint. The average length of time required by a skillful pipe layer to make a single joint is estimated at twenty minutes, not including, of course, the planning of the pipe system or the cutting and general arrangement of the pipe sections for their proper positions, a part of the work which has no connection with the kind of joints used.

Another point which is defective is the direction in which the energy spent in caulking must be applied. The surfaces to be welded together, as it were, are at right angles with the power applied instead of being in a direct line with it, as it should be. Hence a great loss of energy is sustained, and in order to render it possible to apply power in sufficient quantity to do the work it must be applied successively at small portions of the joint at a time instead of simultaneously over the whole. From this results a loss of time, and the peculiar form of the hub renders it necessary that the caulking be done through the medium of a tool by hand, which increases the loss both of time and energy. The edge of the tool cannot be made to fit exactly the space between the bell and spigot, but must be considerably smaller in order to allow for variations of casting and setting. Hence it acts like a blunt chisel, partially embedding itself in the lead at each blow of the hammer instead of ex-

THE BELL AND SPIGOT JOINT.

erting a uniform pressure exactly at the points desired. The proper use of the tool under these circumstances requires considerable skill on the part of the workman, and, as the effectiveness of the caulking depends much upon the manner in which the tools are handled, the quality of the joint is largely dependent upon the skill of the operator, whereas it should evidently be entirely independent of skill, the required degree of skill not being always at hand and being more expensive when obtained than machine power scientifically applied. A still further loss of energy is accordingly sustained, inasmuch as it is contrary to the theory of chances that, even presupposing the most perfect skill of manipulation, the precise position and direction best suited to the varying conditions of the metals to be welded, should be given to the caulking iron at every blow. From these conditions we deduce the following law regarding the form of pipe joints, namely:

(1) The joint should be so constructed that the power required for its formation may be applied to the best advantage, and its application should be independent of special skill on the part of the workman.

Instead of filling the joint with lead, it has been suggested to use some alloy which expands in cooling. But this would still be open to the objection of losing its hold after compression due to the expansion of the spigot by heat, or to the longitudinal expansion of the soil pipe by the same agency, and, moreover, most of the alloys that expand on cooling are too expensive. Old type metal is perhaps one of the cheapest alloys which has been suggested for this purpose, but the antimony it contains renders it too hard and brittle. Belvidere bronze or Spence's metal, an alloy of iron and sulphur, has been tried in England. It is also brittle, and has the additional disadvantage of re-

quiring the pipes to be heated to insure its running all around the hub.

Mr. Gerhard, in his "Sanitary Engineering of Buildings," gives formulæ for a quick and for a slow setting iron cement to take the place of lead. The former is composed of

98 parts fine cast iron borings,
 1 part flowers of sulphur,
 1 part sal ammoniac.

to be mixed with boiling water before use. The latter is composed of

197 parts fine cast iron borings,
 1 part of flowers of sulphur.
 2 parts sal ammoniac.

The writer finds the rust joint rarely satisfactory, being brittle and soluble in water.

More recently, a patented compound of steel and iron, with other ingredients, called "Smooth on Joints," has been introduced, which is made up by the plumber into a paste without using heat and used in the pipe joints, where it soon solidifies and hardens. This compound, it is true, possesses the great incidental advantage that it does away with the necessity of plumbers' melting pots and furnaces in non-fireproof buildings, and therefore removes the danger of fire, but it is not waterproof, a very serious defect.

The writer has made a great many experiments with rust joints and a great variety of cement joints made with various compounds. They are usually unsatisfactory, especially when made by ordinary mechanics after published formulæ, either on account of their great solubility in water, their gradual disintegration after standing for considerable lengths of time, their great brittleness, or their slow setting.

We find that the ordinary hand caulked hub and spigot joint possesses only one of all the desiderata necessary for

an ideal joint. It is unreliable, incapable of resisting the effects of expansion and contraction, or heavy strains, requires unusual skill in its formation, affords every opportunity for fraud by covering up the traces which might lead to its detection, and it is expensive. It is compact, and has some facility in conforming to the irregularities of the structure for which it is intended, but even in this respect it leaves much to be desired.

If now we examine the form of this joint from a scientific standpoint with a view to determining the principles which give rise to its failure, we shall arrive at the following conclusion: Its inability to resist changes of temperature is due to the fact that the bell and spigot are so placed relatively to each other and to the interior of the pipe that they cannot be equally affected by changes of temperature, from within or from without; while the packing is so placed that when the pipe is heated, say from within, it is obliged at every point of its circumference to receive the full compression due to the excess of expansion of the entire diameter of the spigot over that of the bell. In other words, the *smallest* dimension of the packing ring is obliged to receive nearly the entire variation of size of the *largest* dimension of the spigot. The thickness of the ring is reduced by the expansion of nearly the entire diameter of the spigot, and owing to the absence of the property of elasticity in lead, the reduction in the thickness of packing ring is permanent while the alteration in the size of the spigot is only temporary. From this consideration we deduce the following laws with regard to the form of pipe joints:

(2) No bell and spigot joint having packing between the bell and spigot is capable of withstanding the effects of the lateral expansion and contraction of the pipes unless the packing has an elasticity sufficient to restore the alterations in its thickness produced by the difference of expansion and

contraction of the entire diameter of the spigot over that of the bell.

(3) No doubt even a defective joint will in time take up under certain conditions enough sewage and rust to enable it to withstand a very limited amount of air and water pressure and appear sound. But such a joint is not a lead but a DIRT or grease joint, which is a highly unscientific and undesirable formation. It is no recommendation to a pipe joint that it can only be made air and water tight after it has become filled with sewage, and it is well known that on all buildings where steam or very hot water are liable to

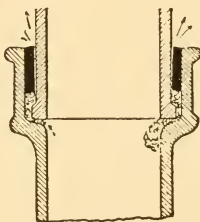

Fig 444a.

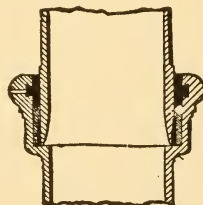

Fig. 445.

be run through the piping, even DIRT will not render the joints tight.

Fig. 445 represents a form of bell and spigot joint devised with a view to keep the lead from being drawn out of the socket by the longitudinal expansion and contraction of the pipe. The socket has internal annular grooves for the purpose, and a pour hole for the lead. A sleeve of lead is also pushed down to the bottom of the socket to keep the yarn or jute out of the pipes. These refinements fail to remove even the minor objections to the bell and spigot joint, and increase the cost and labor. The groove in the socket increases the cost of casting without in any way preventing the caulking from being worked loose by the expansion and contraction of the pipe. It undoubtedly,

THE BELL AND SPIGOT JOINT.

however, retards the lead from protruding from the bell under the influence of a longitudinal play of the pipes.

Figs. 446 and 447 give another form of bell and spigot joint devised with the same end in view, but in this case the pressure for caulking is applied at an opening in the side. A groove is formed around the spigot end of the pipe and a corresponding groove around the inside of the socket, and these grooves, coming opposite one another when the spigot of one pipe is placed in the socket of the other, form

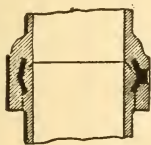

Fig. 446.

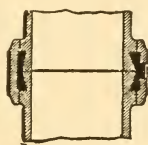

Fig. 447.

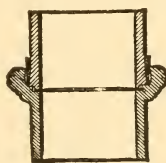

Fig. 448.

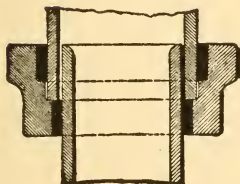

Fig. 449.

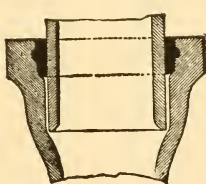

Fig. 450.

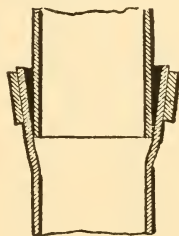

Fig. 451.

together an angular chamber into which the melted lead is poured through the opening or gate in the socket. The caulking is intended to be done by an iron mandril driven into the gate. It is probable that by this process the caulking would not be made tight at the points most distant from the gate.

Figs. 448, 449 and 450 show bell and spigot joints caulked by using cold lead rings forced in place by hammering. In the first figure the outer surface of the spigot end of the

pipe may be cylindrical or wedge-shaped, tapering towards the body of the pipe, and having grooves or depressions formed round the part which enters the socket of the adjoining pipe. The extremity of the spigot is of less diameter than the rest of it, thus forming a shoulder to abut against the shoulder inside the pocket. The socket has a groove or depression formed internally, and at their inner end a double shoulder for the shoulder and end of the spigot to rest upon. A band of lead, wedge-shaped or tapering, is inserted between the spigot and the socket, and is forced in from the outside by hammering or by other means; the lead thus may be made to fill the grooves or depressions respectively on the socket and on the surface of the spigot in order to form a tight joint. An India rubber, or other elastic packing ring, may be used in combination with lead.

In Figs. 448 and 450 the lead may be used either cold or melted as desired. The socket at the lower part is made only large enough to just receive the spigot. Above it is enlarged enough to hold the lead packing. An internal annular groove is formed on this part to better secure the lead. The packing is either run in, as is usual, in a molten state, or by winding a lead wire several times round the spigot, and afterwards caulking it in the same manner with the molten lead packing. The end of the spigot is rounded internally to prevent abrasion of electric wires when the pipe is used for their conveyance.

Finally, Fig. 451 shows a bell and spigot joint devised for thin wrought-iron pipes, to be caulked in the usual manner. One end of each pipe is bell mouthed for the reception of the spigot end. A ring or sleeve is driven over the bell mouth so as to bring one edge of the ring about even with the edge of the bell mouth. This is then hand caulked in the usual manner.

THE BELL AND SPIGOT JOINT.

MACHINE CAULKED BELL AND SPIGOT JOINTS.

Figs. 452 and 453 represent a joint caulked by hydrostatic pressure. This form of bell and spigot joint, though subject to the objections already described as inherent in this class of joints, is nevertheless free from the difficulties of hand caulking. In the interior of the bell a groove is cast (Fig. 452) about one-half an inch square in cross-section, with rounded corners, and within it is a cast lead ring or gasket flush with the interior surface of the bell. A clear space of, say, one-eighth of an inch all around is allowed between the spigot and the bell for easy entrance. The end of the spigot is thickened. It is guided into a concentric position

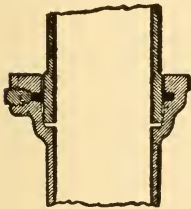

Fig. 452.

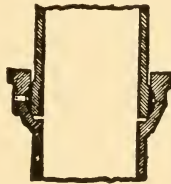

Fig. 453.

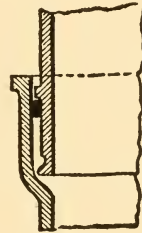

Fig. 454.

with the bell by the conical or tapering form of the interior of the latter. When the sections are entered, a forcing jack is screwed into a threaded opening in the bell, and a thick, semi-fluid material is thereby forcibly injected into the opening, finding its way between the lead gasket and the bottom of the groove, partially displacing the gasket therefrom, and forcing it into tight contact with the spigot at all points of its circumference. The forcing jack is then removed and a screw plug inserted.

By this method of caulking the power is scientifically and uniformly, if not directly, applied, and by the use of an enormous hydrostatic pressure. A temporary tight joint may

be obtained without the need of manual skill. All the lead is utilized, none being wasted, as in hand caulking, and no lead melting on the spot is required.

The forcing jack is strong and simple, weighing about fifty pounds, and can be managed by a single ordinary workman. The forcing material is coal tar pitch, thickened with whiting and sand, or with clay and coarse iron borings.

Inasmuch as the pressure is applied only at a single point on the circumference of the bell, the caulking is greatly facilitated in contracted places. This method of caulking requires but a small proportion of the labor of the hand made joint, much less lead, and does away with the need of oakum. But, of course, the joint will not stand hot water or steam, because no ring of lead surrounding a pipe will return again to close contact after enlargement.

Fig. 453 shows a somewhat improved form of this joint. The most conspicuous difference between the two forms is that there is no groove in the bell, but instead the groove is made in the gasket itself as shown in the drawing. The gasket lies in a double inclined seat in the bell, and comes flush and level inside. When the forcing compound is injected the effect is to force the two wedge-shaped sections of the gasket apart, driving each into its seat firmly and solidly. The power is thus used to better advantage, it being applied to forcing the gasket into the inclined spaces between the spigot and the bell. The lead caulked bell and spigot joint, however, being radically defective in principle, a refinement in the machinery for caulking is not worth while.

THE RUBBER RING JOINT.

Rubber joints, or those in which rubber gaskets are used between the bell and spigot, may be made tight as long as the rubber retains its life and elasticity. The gaskets are

SOFT PACKING JOINT.

made of vulcanized India rubber, cylindrical in section, so that they will easily roll when slipped on the end of the pipe. But to procure India rubber well cured and of good quality is difficult and costly, and the material has not been used for joints to any great extent in this country.

Fig. 454 shows this kind of joint. The spigot has a ring or shoulder on its end, and a groove just within the ring. The rubber ring is stretched over the shoulder and placed in the groove. A second shoulder collar is cast on the spigot beyond the groove, to prevent the rubber from being blown off under high pressure. The rubber ring is forced up to this shoulder when the pipes are put together.

SOFT PACKING JOINT.

Under this heading are included all joints packed with red lead, putty, cement or other material which is plastic when applied. Joints well made with red lead may be made tight against pressure, when used in connection with the proper form of couplings as in screw-jointed pipes.

Sulphur and pitch joints have been made with a composition consisting of equal parts of these substances. This composition is used to some extent in the arts for making joints analogous to those in soil pipes.

Fig. 455 gives another form of soft packing joint. Neither of these joints is capable of withstanding the hydraulic test, however long they may be allowed to set. The joint consists of a double socket. Near one end of the pipe, and around the outside, a cupped or recessed collar is formed, which, with the continuation of the pipe, forms a socket. The joint is made by forcing the projecting inner ring of the first socket into the socket of the following length, until it butts tight against a shoulder formed inside of the small socket. The outer ring of the smaller socket then enters the larger socket, forming, with the packing, the joint.

Fig. 456 shows a third form. This joint is, however, designed more particularly for use with earthenware pipes. A tapering ring of plaster of Paris or cement is cast on the end of the spigot, by the use of carefully turned moulds. The socket end has a corresponding ring cast on its internal surface to exactly fit the ring on the spigot.

The ends of the pipe are then covered with coal tar, grease, tallow, paraffine, or other suitable varnish or lubricating material, and inserted one within the other. The joint is dependent upon the accuracy of the fit of the two ends to render it air and water tight.

Fig. 457 represents a bell and spigot joint with soft packing in which bolts are used to hold the joint together and

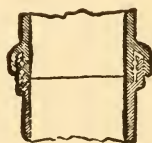

Fig. 455.



Fig. 456.

compress the packing. A collar is slipped over the spigot end of the pipe before the spigot is inserted into the socket. Part of this collar is to enter the mouth of the socket and compress the packing therein. Any suitable means can be employed for forcing and keeping the collar against the packing. By using loose sockets and collars plain pipes may be jointed in this manner.

Fig. 458 illustrates a soft packing joint put together by threaded rings. The socket end of the pipe is cast with an external screw thread, and has an internal annular projection near its end. A nut or collar is screwed on the socket by means of a projecting rim. The spigot, covered with a packing ring, is slipped into the socket. The collar, having

SOFT PACKING JOINT.

been previously slipped over the spigot is then screwed on the socket, and the annular projection on the collar squeezes the packing into the socket against the projecting rim.

The annular projection on the end of the spigot is intended to prevent the accidental withdrawal of the pipe from the socket. Between the packing ring and the bottom of the socket, there is sufficient space to allow the spigot a certain amount of longitudinal play.

Figs. 459, 460 and 461 represent one more soft packing joint. The object of this device is to form a plumber's joint on cast iron pipes, without caulking and without turn-

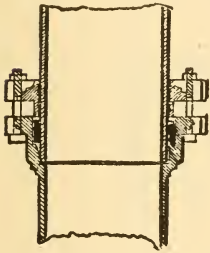

Fig. 457.

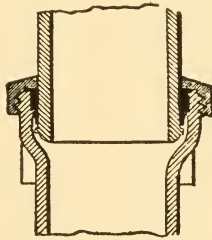

Fig. 458.

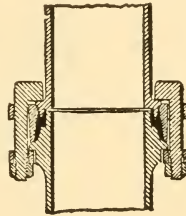

Fig. 459.

ing, threading or finishing the ends of the pipes, but using them rough as they come from the foundry. One end of the pipe has a double annular shoulder cast upon it a short distance from the end; the other end has a smaller single annular shoulder cast at the extreme end of the pipe, and at the outer edge of the shoulder a small annular projection. A ring of metal is placed on the second or outer shoulder of the end of the lower pipe to be joined, which has the double shoulder uppermost. This ring forms with the end of the pipe a triangular or wedge-shaped annular groove, which is then filled with packing in the groove, and forms the joint. The packing consists of a rust joint paste. The

pipes are brought together by means of screws passing through lugs or ears on the detachable rings as shown. The contrivance allows either pipe to be turned on its axis in any direction when setting it and it forms a rigid steam tight joint when the packing hardens. This is an early device of the writer, but is too complicated, and it would be better to omit the spigot projection on the upper pipe annular ring, because then the pipes could be disconnected at any time by removing the bolts and breaking the outer ring.

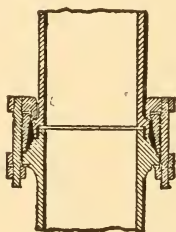

Fig. 460.

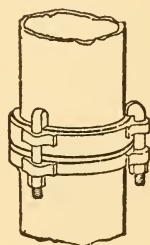

Fig. 461.

MACHINE TURNED BELL AND SPIGOT JOINT WITH LUGS AND BOLTS.

This joint (Fig. 462) is for cast iron pipe, and has a tapered opening in the hub end and a corresponding tapered spigot on the opposite end, but slightly larger in diameter so that after it enters a hub, power is required to draw them together, and this power is applied by means of bolts until the beveled surfaces have been forced into positive contact. To prevent corrosion some anti-rust mixture, such as plumbago or red lead, is specified to be smeared over the machined surfaces of the joint immediately before putting together. This joint is quickly set up and requires no lead melting. It is claimed to be tight under light or heavy

MACHINE TURNED JOINT.

pressure, and even to admit of some slight play at the joint. It is called the "Universal" joint, and is made by the Central Foundry Co. of N. Y.

It is a little difficult to see how any flexibility is to be obtained with this joint under pressure without the use of some form of soft packing which when the spigot end of a pipe is slightly rotated in the hub end might be forced by

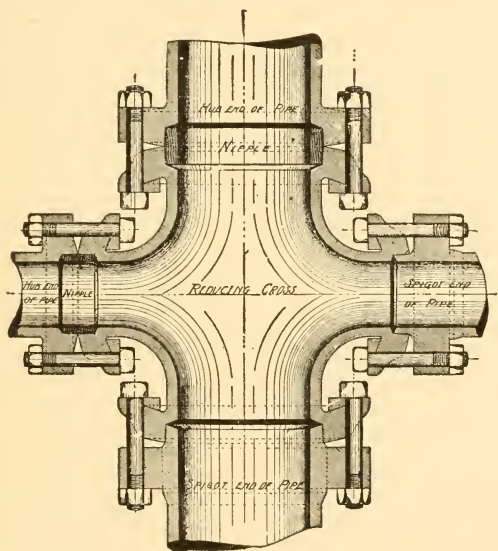

Fig. 462.

the internal pressure of the liquid or gas they convey into the cavity opened by the rotation. But this the makers do not use. Nor is it clear to one who has not had experience with this new joint, how a longitudinal contraction of the pipes can take place under change of temperature without opening up the joint slightly and allowing of leakage under pressure. The manufacturers make very strong claims for it in this respect and if they prove to be justified the "Uni-

versal" joint cannot be too highly praised. It remains to be ascertained what the effect of age in corroding the joint or hardening the anti-rust mixture will be in the matter of leakage under shocks or bending strains.

The joint seems to be, however, immeasurably superior to a lead caulked bell and spigot joint, and shares with the threaded joint in immunity from injurious effects of electrolysis.

Fig. 462a is another machine turned joint forming a ball and socket joint by the use of which pipes can be laid at an angle of several degrees out of alignment either way.

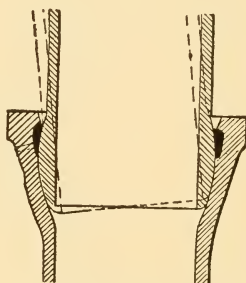

Fig. 462-a.

But once made up the joint is rigid. Nevertheless it would seem to be possible to set this ball and socket joint in such a manner as to secure a certain degree of rotary flexibility without leakage, but longitudinal strains could not be provided for in it. The tunnel and ground surfaces could be coated with graphite or other anti-rust lubricating compound, and the outer space, shown in solid black in the drawing, filled with melted lead. The lead would prevent the pipes from being drawn apart under mild strains, and flexibility could for a time be attained.

The joint is intended, however, to be used as a rigid rust

MACHINE TURNED JOINT.

joint, with the outer lead ring for a key to prevent separation. This joint seems to the writer to be far superior to any ordinary lead caulked bell and spigot joint. When the space between the metal to be joined is small so that the ends of the pipes are nearly or quite in contact a rust joint has its best chance for success. Such a joint however is objected to by many plumbers, says Bayles, because it becomes so rigid that it cannot be taken apart again without destroying it.

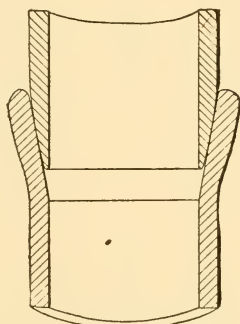

Fig. 462b.

Fig. 4626 is a turned rust joint. It is made by turning the inside of the hub and the outside of the spigot to fit each other.

It has the disadvantages of all rust joints already referred to.

CHAPTER XXXV.

(II.) THE FLANGE JOINT.

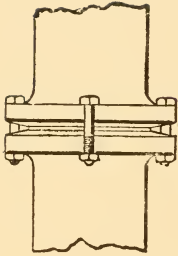

Fig. 463.

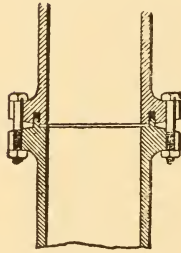

Fig. 464.

Flange joints are those which are made with flanges forming bearings for bolts or clamps, by means of which the pipes are secured together. Our first example is:

(a) The Spigot and Socket flange joint represented in Figs. 463 and 464. The pipes are here

made with circular flanges, one having an annular groove on one end, and the other a corresponding annular projection or spigot, both being slightly beveled. The flanges have four or more slots in their periphery at uniform distances apart. A suitable packing ring, usually of lead, is placed in the groove and compressed by screwing up the bolts which pass through the slots. The ordinary steam-fitters' flanged joint differs from this in having plain level surfaces without groove or spigot. The steam-fitters' packing consists of paper, leather, rubber, or composition rings with or without putty, red lead or other filling. The surface of the flanges is for the best work, planed off, to give proper tightness, and instead of slots, holes are usually used to take the bolts. These kinds of joints are unsuitable for plumbing purposes, because they are not adjustable and do not admit of slight variation in direction of the piping, as is absolutely necessary in plumbing work. The machine

THE FLANGE JOINT.

planing of the steam-fitters' flanged pipes, moreover, involves too great an expense to render the joint practicable for plumbing purposes.

Figs. 465, 466 and 467 show a joint devised with a view to overcoming the first of the above-mentioned objections

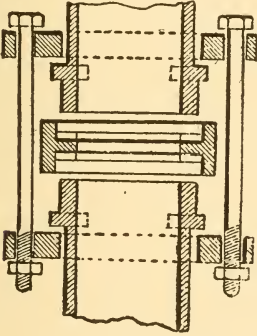

Fig. 465.

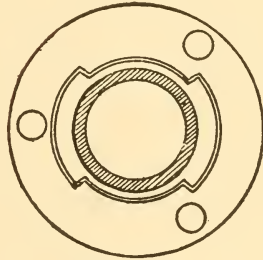

Fig. 466.

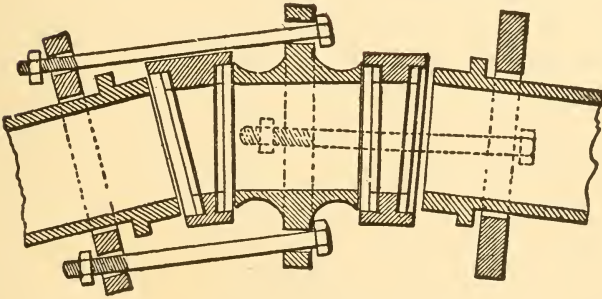

Fig. 467.

to the ordinary flange-joint. On each side of the pipe are cast curved projections or collars extending only partially round its circumference. A flanged collar, recessed to correspond with the curved projections, is slipped over the end of each pipe and turned partly round behind the projections. The flanges are thus held securely on the pipe,

which may be adjusted in a variety of positions. An annular connecting piece, recessed to receive packing rings, is placed between the pipes to be joined. These connecting pieces are made with one or both faces at any desired angle to the bore of the pipes. A short portion at each end of the pipes is made somewhat thicker than the main length, so that at the extreme ends a wider surface of metal is obtained for the packing ring to rest against. Fig. 467 shows the same joint with the bevelled connecting pieces to give a change of direction to the piping.

There are several objections to this form of joint. The

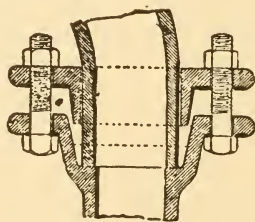

Fig. 468.

slotted collars occupy too much space and are liable to be easily broken in screwing the pipes together, especially at those points where the flange is weakened by the bolt hole and yet has no support immediately below. Moreover, the arrangement, though allowing a certain amount of play of the pipes in adjusting them, still limits their movement and would cause considerable annoyance in handling. The very long bolts are expensive and awkward. The heads and nuts do not rest square on their bearings when the bevelled connecting rings are used. The bolts are, therefore, easily broken in screwing up, as I have found in experimenting upon them in this connection, unless bevelled washers are used, which still further increases the cost.

THE FLANGE JOINT.

Moreover, lead for packing is entirely unsuitable, since longitudinal expansion of the pipes will compress the lead, and subsequent contraction will then leave an annular opening for the escape of air or water.

Fig. 468 gives another form of flange joint devised with the same end in view. At one end of each length of pipe is a cone-shaped socket, having at opposite sides two lateral projecting lugs with bolt holes. On the other end of the pipe, which is plain, is placed a loose flanged collar which has bolt holes to coincide with the holes in the lugs of the

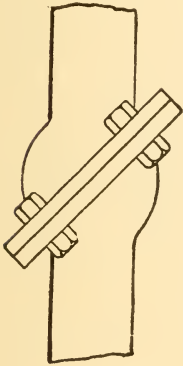

Fig. 469.

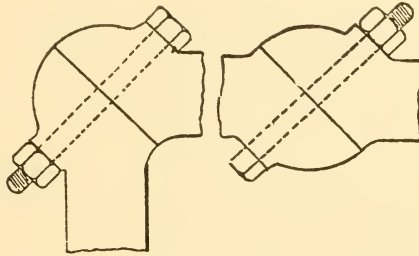

Fig. 470.

Fig. 471.

socket, into which the end or neck of the collar is free to enter. A packing ring of India-rubber, hemp, or other elastic compressible substance, is placed on the end. The neck of the collar is then slid forward into the socket, and is brought to bear upon the packing by means of bolts, which are passed through the bolt holes. The joint is neither permanent nor tight under pressure. Moreover, it offers no resistance to longitudinal strain under which the two pipes might be drawn apart. If lead is used as a pack-

ing it would be compressed by both longitudinal and lateral expansion by heat and upon cooling again leakage is caused.

(B) THE SPHERICAL FLANGE JOINT.

Figs. 469, 470 and 471 show another device for variable adjustment of the pipes. The parts at the points of junction are of spherical form, and the parts of the spheres where the junction takes place are inclined, by preference, to an angle of 45 degrees with the axis of the pipes, and are fitted with suitable packing and bolted as shown. This form of joint is evidently unsuitable for plumbing purposes. Should the bolt be made to pass through the center of the pipes, as shown in the last four figures, it would form an obstruction to the flow of the

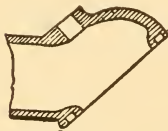

Fig. 472.

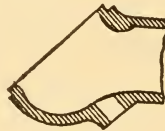

Fig. 473.

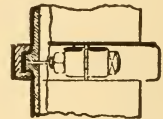

Fig. 474.

sewage. If, on the other hand, the bolts are made to pass through the flanges, the amount of possible variation of adjustment would be limited to the number of holes made in the flanges, and the piercing of these holes would not only add to the expense in proportion to their number, but also weaken the flange. Another serious objection lies in the sewage fouling caused by the spherical sockets.

(C) THE LOOSE RING FLANGE JOINTS.

Around each end of the pipes to be jointed is formed a projecting annular flange or rib of rectangular sections, 474 and 475. A band of rubber is placed over the joint and upon this band a cast-iron collar or belt in two halves. The

THE FLANGE JOINT.

edges of the iron band turn inwards so as to form shoulders on each side of the rubber band to protect them. The joint is perishable and unreliable under pressure.

Figs. 476 and 477 represent another form of the same kind of joint. The pipes are formed with a bevelled flange. A rubber ring is used, as before, as packing, but the ring is placed between the ends of the pipes instead of around the joint. The metallic ring which holds the pipes together is double-wedge shaped in sections and slotted so as to allow it to be passed over the flanges. A bolt with a wedge-shaped head is used to hold the whole in place.

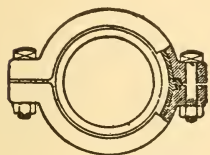

Fig. 475.

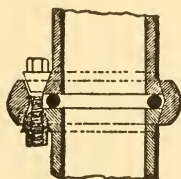

Fig. 476.

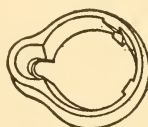

Fig. 477.

(D) THE WEDGE AND KEY FLANGE JOINT.

The flanges are here, Figs. 478, 479 and 480, connected by means of dove-tailed wedges or cotters and keys, instead of the ordinary bolts and nuts. Instead of the ordinary slotted openings, which are usually formed in the flange at each end of the pipe for the connecting bolts, the openings have a dove-tailed form as shown in plan Fig. 480. When the faces of the flanges, with their intermediate packing, are placed in position to be connected, dove-tailed cotters or wedges are passed through the dove-tail opening in the flanges, in the direction of the length of the pipes, and drawn up tight by keys driven through slotted holes in their ends. This construction is too bulky, inflexible and complicated for plumbing.

(E) THE PLAIN NON-ADJUSTABLE FLANGE JOINT.

(Fig. 481.)

The flanges of the joint used for illustration have on their meeting surfaces annular grooves, circular or otherwise, to receive a packing ring, similar in form and composed of vulcanized India-rubber, hemp, or other suitable elastic material. The grooves of the flanges must be of corresponding size, so that one-half portion of a packing ring may lie and be compressed in each when the flanges

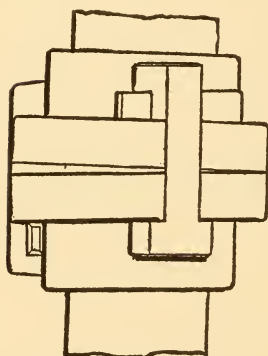

Fig. 478.



Fig. 479.

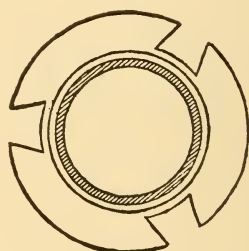

Fig. 480.

are drawn together. The object of the grooves is to prevent lateral derangement of the packing ring under the influence of steam or water pressure in the pipes. The flanges of this joint are sometimes square with rounded corners, instead of round, and in the corners are the holes for the connecting bolts. This joint is also inflexible and unsuitable for plumbing work. The packing intended to be used with it would soon lose its elasticity, and would occasion a leak when the pipes expanded and contracted longitudinally. Moreover, the annular space inside of the packing ring is an objectionable feature as forming shoulders on which

THE FLANGE JOINTS.

matters passing through the pipes might adhere and cause stoppages.

(III.). THE SLEEVE JOINT.

The object of the sleeve joint is to form a connection between pipes having plain ends without flanges, hubs, threading or projections of any kind. The first division under this class:

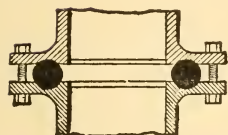
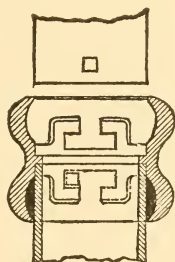

Fig. 481.



Figs. 483 and 484.

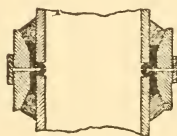

Fig. 485.

(a) The lead packing sleeve joint illustrated in Figs. 483 and 484. This joint was devised for use with wrought iron pipes, in which it was desired to form connections like those on ordinary cast iron bell and spigot pipes and avoid weakening the pipe by thread cutting. It produces an even, smooth interior of the same diameter with the pipe, and could be made to form in part a rust joint. The lugs or rivets on the ends of the pipe engage in the recesses in the couplings and form a resistance to longitudinal strain. The joint is intended to have packing introduced, but the space is too contracted on the outside to permit of caulking.

It is a form of bayonet joint. It has no flexibility to facilitate setting and would be unsuitable for plumbing work.

Fig. 485 shows a lead packed joint designed to be made with lead in its cold state, aided by cement. The joint is somewhat complicated and difficult to make. It is composed of a leaden ring of peculiar construction, two cast iron coupling rings, cement for solidifying the joint, and a hoop for covering the coupling rings. The leaden ring is a band of milled or rolled sheet lead with a groove in the center. To join the rings, the band is cut to the length corresponding with the outer circumference of the pipes to be connected. It is then bent into the form of a ring, and the two ends are soldered or burned together by means of a blowpipe. The ring is placed over the ends of the pipes and pressed tightly against it by light blows of a hammer, or by means of a metallic band with pincers, or by a cramp in such a manner that the lead shall be thoroughly embedded in the pipe.

In the groove in the leaden ring temporary sheet iron discs, formed in two parts and held together by hooks, are then placed. The two coupling rings are then pushed against the disc, which by resisting allows of and facilitates the junction, at the same time preventing the groove from being flattened or closed. The junction being completed, the disc is removed and the outer hoop is placed over the whole, and cement is put in the empty spaces between the coupling rings and the pipes beyond the lead ring.

The groove in the leaden ring is designed for the purpose of giving a certain flexibility to the joint, and allowing of expansion and contraction of the pipes, and I introduce it on account of its ingenuity and to illustrate the pains taken in the effort to overcome the destructive effect on lead packing by expansion and contraction.

THE SLEEVE JOINT.

The method here tried is ineffective, and the joint is open to all the objections of the ordinary lead caulked bell and spigot joint.

Figs. 486 and 487 represent a sleeve joint in which rubber is used for packing. A hollow cylinder or shell is constructed of brass or iron, and has belts cast upon it for additional strength. The ends are bevelled or inclined inwards towards the pipe, so as to contract the opening for

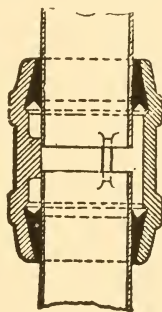

Fig. 486.

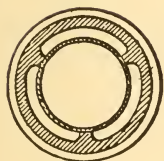

Fig. 487.



Fig. 488.

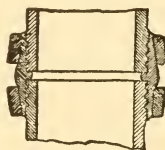

Fig. 489.

the insertion of the pipe, and to form recesses into which are forced annular conical India-rubber rings or other similar packings. These rings or packings are so formed that when internal pressure is applied they press against the contracted ends of the cylinder to give rigidity to the joint, but when flexibility is desired, the webs are omitted.

Fig. 488 shows one side of a pipe having a cold lead packing ring. The pipe is shown partly in elevation and

the packing and clamping rings in section. The ends of the pipes are here provided with slight enlargements or collars. A strip of lead, shaped to fit the enlarged ends, and having a central rib underneath to project into a space left between the ends of the pipes, is lapped around so as to embrace the ends of the pipes. A circular band or collar is then tightened round the lead by a "press collar," and finally all is secured by binding rings. The ends of the pipes abut against the central rib of the lead and prevent shifting of the packing when the binding rings are driven on. These rings are formed to fit the outer surface

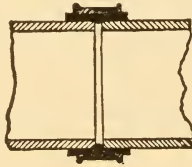

Fig. 490.

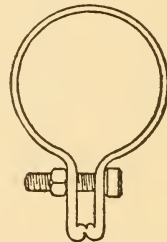

Fig. 491.

of the pipe, in order that their binding pressure may be equally distributed.

Fig. 489 shows a sleeve joint in which the ends of the pipe are grooved or corrugated and connected by means of a lead ring compressed into the corrugations. This lead ring is of double conical form externally, and has at the middle of its length an internal annular rib which forms an abutment for the ends of the pipes to be coupled. The joint is completed by forcing over the opposite ends of the leaden sleeve conical clamping rings, which, when driven home by means of a hammer or cramp, will compress the lead into the annular grooves. Collars, brackets or ears

THE SLEEVE JOINT.

may be cast on the pipes at some little distance from the ends, to prevent injury to the joint or pipe in ramming the earth about it when it is used under ground.

In all these lead packed joints the same weakness is inherent. They fail under expansion and contraction of the pipes, the corrugations forming no more protection in restraining this force than a rope of sand.

Figs. 490 and 491 show a sleeve joint in which a rubber band is used for packing, secured by means of an elastic metallic strap. The India-rubber in a broad band is made to embrace the two ends of the pipes. Over the band is then placed a metallic strap, which is drawn together by means of screws or wedges. The tightening of the strap

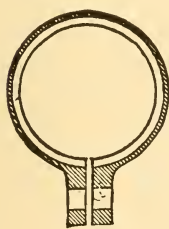

Fig. 492.

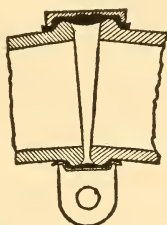

Fig. 493.

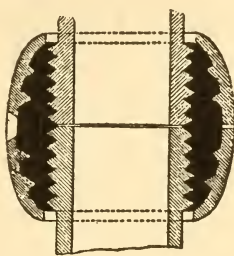

Fig. 494.

forces the India-rubber band into a number of annular grooves with which the strap or ends of the pipe are furnished.

Figs. 492 and 493 show a joint similar to the last, except that a small bead is formed on the ends of the pipes, and the sleeve is bevelled, or wider on one side than on the other, to enable the pipes to be connected on an angle. The edges of the metallic collar used to compress and hold the rubber packing sleeve are turned down, as shown, so as to bring the packing close down over the beads. The

collar is strained on by means of a bolt and nut, in the same manner with that in the joint preceding.

Fig. 494 shows a sleeve joint for cement or melted lead packing. A movable or shifting sleeve or jacket is placed over the ends of the pipes, and has openings for the introduction of the packing. The ends of the pipes are grooved, and corresponding grooves are cast on the inside of the sleeve. These are intended to protect the pipes from longitudinal movement. The joint is bulky and expensive.

DIVIDED RING SLEEVE JOINT.

Figs. 495, 496 and 497 represent a sleeve joint connected by means of half rings bolted together. The general prin-

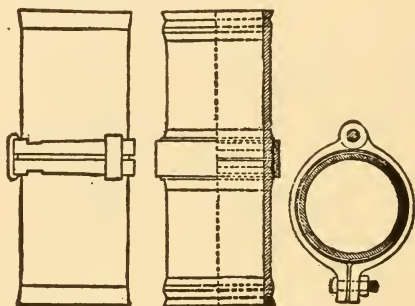

Figs. 495, 496 and 497.

ciple of this consists in lapping soft leaden or metallic packing round the meeting ends of the pipes, and forcing this packing into intimate contact with the surface of a screw clip or hinged collar, the pipe ends externally, and the packing internally, having annular grooves and ribs, which respectively bed the ribs on the pipes into the grooves in the packing, and vice versa, when the hinged collar or clip is temporarily closed around them by a screw. The collar is afterwards removed, and a hoop of wrought iron, conical

THE SLEEVE JOINT.

internally, is driven on over the lead. Instead of using the lead alone, India rubber may be used in connection therewith; the lead packing may be made conical, to correspond with the collar and hoop, and the annular grooves and ribs on the pipe ends may, of course, have an endless variety of shapes.

The use of divided rings and bolts enables the joint to be easily disconnected at any time.

In Fig. 498 the ends of the pipes have formed on them annular ribs or projections with intermediate grooves, and over these ends a vulcanized India rubber belt is compressed by means of a metallic collar made in halves, and bolted

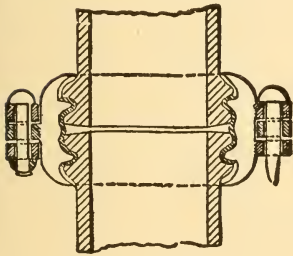

Fig. 498.

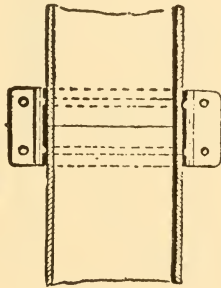

Fig. 498-b.

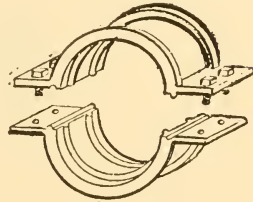

Fig. 498-c.

as shown. The collar has corrugations corresponding with those on the pipes.

In the joint shown in Figs. 498b and 498c the divided ring is clamped together in a different manner from the preceding, and pipe ends are entirely plain. The clamps are provided with internal ribs and their uniting surfaces have projections and corresponding recesses to prevent misplacement, and the escape of the packing into the pipe under pressure. A packing of lead or other material placed between the pipes and the collar, and between the two halves of the collar, forms the joint by compression. In each end

of the half collars there is a depression or cavity, forming together, when the two half collars are united, a box or chamber in which a piece or block of India rubber is inserted and compressed. This closes the open space left between the ends of the half rings, and prevents injury to it when the rings are drawn together.

THE BOLTED RING SLEEVE JOINT.

In Figs. 499, 500 and 501 three separate rings are employed, and they are secured together by long bolts. The pipe ends are quite plain. Two loose collars are slid, one

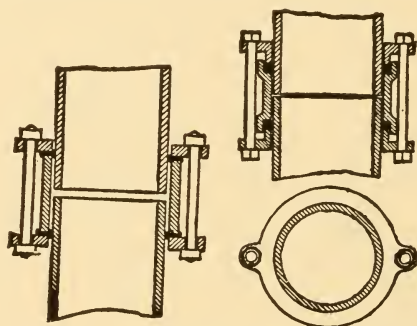

Fig. 499.

Fig. 500.

Fig. 501.

against the end of each collar, and next, upon one of the pipes, is slid a flat tubular ring. When the two pipes are placed end to end the ring is slid back over the joint one-half on one pipe and the other half on the other, so that the tubular ring covers the junction. By means of nut bolts the two collars are then drawn toward each other, and the annular packings thereby compressed between them and the ends of the intermediate tubular ring, and forced to expand laterally into close contact respectively with the surfaces of the two pipes forming the joint. The annular packings may be of vulcanized India rubber, and made

THE SCREW JOINT.

smaller in diameter than the ends of the pipes in order that they may have a tendency to close tightly round them, or a gasket saturated with tallow or red lead in a plastic state may be employed.

In one form of the device the tubular collar has its ends enlarged so as to form sockets to receive the packing rings, and the loose collars have corresponding shoulders cast upon them to enter the sockets and press the packing rings against the pipes.

SCREW JOINTS.

The screw joint possesses a great advantage in being perfectly and permanently steam, gas and water tight when properly made, and when the pipe and threading are of the proper kind.

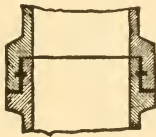

Fig. 502.

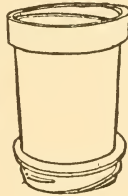

Fig. 503.

It is capable of withstanding the effects of expansion and contraction, and of all kinds of strains and jars which the pipe itself can sustain, and it is extremely compact, occupying, in fact, the minimum of space in a building.

Its disadvantages are its high cost, the expense of setting up, the space required for turning the pipe and fittings, in setting up the piping, and the difficulty and expense of disconnecting for alterations or repairs.

THE FLANGED SCREW JOINT.

Figs. 502 and 503 represent the first class of screw joints which we have designated as the flanged screw joint. It is

intended especially for cast-iron pipe, and its principal feature consists in casting or constructing upon the spigot end of a pipe two or more threads, the inside of the socket of the pipe to which it is attached being cast with corresponding grooves. There is also a collar formed on the spigot end. The complete joint is formed by covering the spigot and socket ends of the pipe with a layer of cement or other quick-setting substance and screwing the two pipes together. By a slight turning of the pipes or either of them on their axes the connection is made. Instead of casting or otherwise permanently attaching threads upon the spigot end of the pipe, the pipe may be moulded with suitable grooves in which threads of steel or iron are afterwards

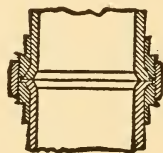

Fig. 504.

placed. By using a paste of iron filings and sal ammoniac an excellent rust joint could be made by this arrangement. But the coarseness of the thread and the difficulty of insuring the cement following the thread against the friction of screwing up are defects which seem inherent in the device. It could not be relied upon to retain, at all parts of the threading, sufficient binding material to insure a perfect joint. Moreover, the joint lacks flexibility in setting up, so that the fittings could not be adjusted at different angles or to different positions with facility.

Fig. 504 shows another form of flanged screw joint, the threaded parts being on detachable sleeves. This joint might be included with equal propriety under the preceding

THE SCREW JOINT.

class of sleeve joints, inasmuch as its tightness is dependent rather upon rust or other packing between the sleeve and the pipes, than upon the threading. But where the rust makes the pipe and its sleeve practically one piece, the joint becomes ultimately a true screw joint. This joint is intended either for cast iron or else for soft metal, which would allow of the ends to be slightly flanged out, as shown, to hold the threaded collars. The joint is subject to the same disadvantages as the above described screw joints, with the additional defect of the liability of the collars becoming loosened in screwing on the outer sleeve.

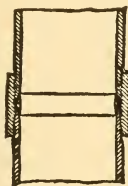

Fig. 505.

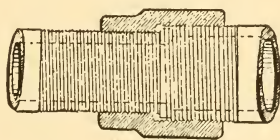

Fig. 506.

(6) THE INNER RING SCREW JOINT.

In Fig. 505 a simple form of screw joint is shown, having as its object better resistance against pressure. The novel feature is the use of a small metal ring inside the two ends of the pipes, where the joint is formed in connection with a packing ring of suitable material. The end of the pipes are drawn together by means of a separate threaded ring or rings. The inside metal ring is bevelled slightly on the two edges, and the inner edges of the pipe ends are bevelled to correspond, so that the ring can only extend a little way into the pipes. By screwing the two ends of the pipe together, the packing is compressed against this inner ring and the joint is formed.

This complication is unnecessary, as plain screw joints are now made which offer as smooth an interior surface as this, and in a much simpler and better manner.

Fig. 506 shows what we have called "the outer ring screw joint." It differs from the ordinary coupling ring or collar, in having the ends differentially threaded to correspond with similar threading in the pipes. In other words, the pitch of screw threads on each of the pipe ends is dif-

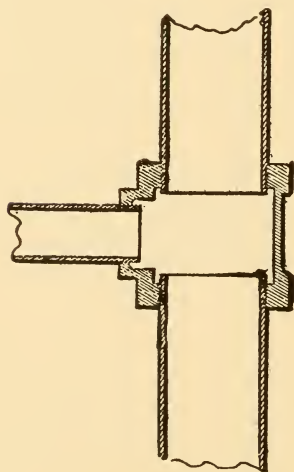

Fig. 507.

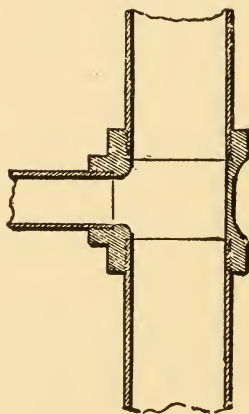

Fig. 508.

ferent. When the collar is turned round it advances more quickly on one pipe than on the other, thus causing the pipes to approach each other, and come into tight contact.

THE PLAIN SCREW JOINT.

Fig. 507 represents the ordinary screw joint as used by steamfitters for wrought iron pipe work.

Figs. 508 to 512 show an improved screw joint formed with a view to forming a smoother connection between the

THE SCREW JOINT.

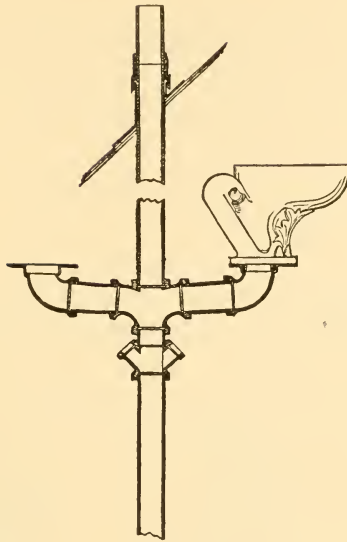

Fig 509.

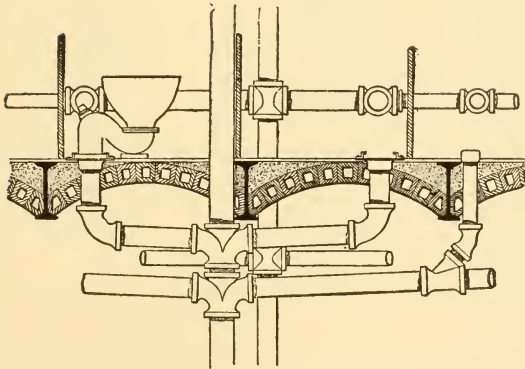

Fig. 510.

pipes. It will be seen that, with the ordinary steamfitter's screw joint interior depressions are left when the pipe is screwed up, which will collect sewage. In this system, how-

ever, the fittings are tapped with a shoulder, so that when the pipe is screwed home its interior and that of the fitting form a practically continuous line. A small recess only is left between the end of the pipe and the shoulder, depend-



Fig. 511.

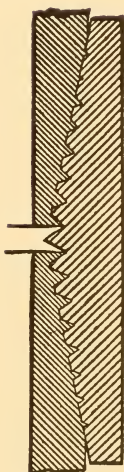

Fig. 513.

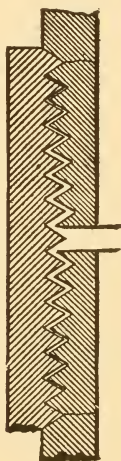

Fig. 514.

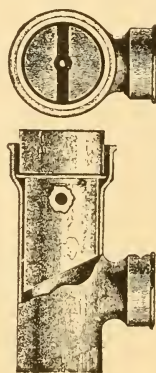

Fig. 515.
Fig. 516.

ing upon the closeness with which the pipes are screwed up in practice. The thread is cut slightly tapering, and about eight threads per inch on pipes of from two to six inches in diameter. The threading is done on powerful tapping machines.

THE SCREW JOINT.

There is an advantage and a disadvantage in the taper threading. In Fig. 513 is shown on a large scale, somewhat exaggerated for clearer illustration, a threading gradually tapering until it vanishes at the exterior of the pipe. The strength of the pipe is maintained by this method of tapering, and all the threads have a bearing, but it prevents any adjustment in length of the pipes when setting up. Fig. 514 shows the ordinary threading. The pipe here, being weakened by the full depth of the threading, is liable to crack at the points shown in the drawing, and only a certain number of threads do the work of the whole. The wrought iron pipes are screwed into the couplings or fittings by means of chain-tongs, on which a man can exert a powerful leverage, thus securing, with the aid of a paste of white and red lead and oil, a perfectly tight joint. The pipes are cut and fitted at the factory by preference, or on the premises if necessary. The bends, branches and other fittings used with the straight lengths of wrought iron are constructed of cast iron.

In cases where it is necessary to disjoint wrought iron piping, one of the fittings has to be broken and the wrought iron straight piece adjoining can then in some cases be unscrewed. There is less danger of accidentally cracking more than one piece of pipe than is the case with ordinary lead calked cast iron bell and spigot pipes. On the other hand, the cutting of cast iron pipes for alteration is easier than that of wrought iron. Wrought iron pipes require costly machinery for proper cutting and threading, and the lengths must be measured accurately and put together by skilled mechanics. The joint, moreover, has not the slight amount of flexibility of setting which is a merit with the hub and spigot type. It does not allow the pipe or fitting to be canted slightly in any direction for convenience in connecting up.

PLUMBING AND HOUSEHOLD SANITATION.

Figs. 515 and 516 represent a sanitary device for filling the idle ends and branches of sewer and water pipes.* It does away with the ordinary sediment chamber in these "dead ends" in the manner shown in the drawings, and is an excellent fitting. Sediment in these "dead ends" corrodes the ordinary clean out cap, creating in effect a rigid rust joint, so that the cap cannot be removed when desired.

*The invention of Mr. David Craig, Plumber, of Boston, Mass.

CHAPTER XXXVI.

LEAKAGE OF PIPES AND JOINTS.

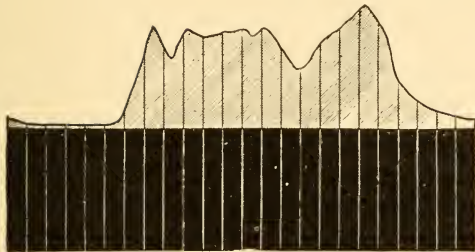

Midnight. 8 a. m. Noon. 6 p. m. Midnight.

The vertical lines of division in this diagram represent the hours from midnight to midnight. The parallelogram in solid block represents the continuous leakage of water which goes on day and night in practically unvarying volume.

American practice is not, on the average, better than British practice in water works engineering.

Fig. 519.

The following extracts from a letter to Mr. Dean of the Central Foundry Co. from Mr. James C. Bayles regarding the waste of water and gas through leakage in distribution will be of

interest as showing the very great need of further efforts toward the improvement of pipe construction and jointing.

RELATION OF USE TO LEAKAGE IN WATER SUPPLIES.

To put the average leakage of water mains and services in this country at fifty per cent of the intake, would be far within the truth. Mr. William Hope, C. E., an eminent British water works engineer, stated the truth briefly in his paper before the Institution of Civil Engineers as follows:

“Even now a majority of the water undertakings of this country lose by leakage more than one-half the total quan-

tity of water supplied from the source. The proportion is often higher, and rises in many instances to three-fourths or more, while in comparatively new countries, such as America, Australia and New Zealand, the proportion so lost is still greater."

Nearly all the water distributed in cities and towns is carried by cast iron mains laid with hub and spigot joints.

GAS LEAKAGE.

For American cities I am of the opinion that from 12 to 15 per cent of total output would be a fair average for leakage loss. In some instances it is very much greater. Losses of 25 to 30 per cent are not exceptional, and I have known a company with all wrought iron mains put together with screw joints to have a leakage loss of 60 per cent. In large cities losses materially exceeding an average of half a million cubic feet per mile of main per annum do not surprise the well informed gas engineer.

Expansion and contraction are constant. Pipes in the ground are never at rest, but lengthen and shorten with each variation of temperature. This movement is slight, rarely exceeding two inches in a thousand feet through the range of a year, but it is irresistible. If not accommodated it will accommodate itself. The forces acting upon a pipe are so much stronger than any iron ever made that the rigid pipe is inevitably broken. I attribute 80 per cent. of normal main leakage to the destructive influence of expansion and contraction.

To this may also be attributed the great leakage found at service taps. To expect that two lines of pipe laid at right angles one to the other, rigidly connected and each expanding and contracting longitudinally, will remain in gas

LEAKAGE OF PIPES AND JOINTS.

or water tight connection is to expect a miracle, and modern engineering does not deal with occult phenomena.

Unequal settlement results from many causes too well known to need explanation. It opens joints or causes fractures according to circumstances. Pipes which cannot bend are readily broken by vertical or lateral displacement.

Disintegration by oxidation and electrolysis need no discussion.

Jar, shock and vibration affect pipe lines in proportion to their rigidity. Lines of pipe so laid as to be flexible and expandable, even with narrow limits, are very little affected by these disturbing influences.

The screw joint of wrought iron pipe is as rigid as the pipe itself. For this reason the threads, being less strong than the pipe wall, are liable to strip under the action of contraction and expansion. I have seen a line of pipe taken apart by hand which it required four men at each joint to put together. The hub and spigot joint is a crude stuffing box placed with an inelastic material. I have seen a line of hub and spigot pipe laid in one day and tested bottle-tight at 6 p. m. leak at 7 a. m. the next morning from the shrinkage due to taking the temperature of the trench over night. The chief advantage of the hub and spigot joint is that when packed with lead it will permit a certain amount of slip and thus to some extent relieve the strains tending to fracture. That it is always a leaky joint is a fact too well known to need the support of argument. When packed with cement, as in much of the modern gas practice, leakage at the joints is minimized, but fractures are much increased. The difference as affecting net leakage is not material, but a great many engineers prefer to deal with occasional great leaks due to breakage rather than with innumerable small ones at joints.

4. MAIN LEAKAGE AND THE PUBLIC INTEREST.

If the consequences of main leakage which are of public concern were limited to the waste of what is lost thereby, it would be difficult to make the matter appear important.

In the case of water it would be argued that it "cost nothing" originally and should be "as free as air" to the user. If some loss in distribution was admitted, it would be contended that measures of waste prevention would cost more than waste replacement, and that it is better public economy to lose two gallons in distributing three than to conserve two and a half and lose only one-half. This might be plausible, but it would be essentially untrue. Few municipalities are so situated that their sources of supply of potable water are equal to the triple demand of leakage, waste and use. A normal increase of use may be counted on; waste will increase in more than arithmetical ratio unless checked by metering and of leakage we may be sure it will keep well ahead of both use and waste together. As the height of buildings is increased more pressure is needed for fire purposes and circulation. The escape of water from a given defect in a conduit varies under different pressures as the square roots of the pressures compared. For example: A defect in a pipe which under a pressure of forty-five pounds will leak 12,960 gallons in twenty-four hours (and a round hole one-fourth inch in diameter, or its equivalent, will do this) at sixty pounds will leak 14,431 gallons, and at ninety pounds will leak 18,600 gallons. This is theoretical. In practice, as pressures are increased old leaks grow larger and new ones are developed. With a defective distributing system, the relief of increased pressure is usually very transient. It does not always, if often, increase the available supply. The resulting evils, besides an increased and ultimately burdensome public expenditure, are scarcity of water for such pub-

LEAKAGE OF PIPES AND JOINTS.

lic uses as street sprinkling and washing, sewer flushing, etc., a low pressure service which must be supplemented by house pumping and an inadequate fire protection. New York is now "threatened with a water famine." Without main leakage it would have in its present supply all the water needed for three times its present population, and might safely postpone plans of water works extension until near the close of the present century.

In the case of gas the evils of main leakage are many and serious. The least of these is the economic waste which must be paid for by charging it to consumption.

It enormously increases the fire hazard.

It is attended with an indeterminate danger to the public health.

It puts life in jeopardy from frequent street and sewer explosions.

It involves the constant destruction of unreplaceable pavements for main repairs which, if neglected, would quickly render the city uninhabitable.

Of the fire hazard of gas leakage, Circular No. 559 of the National Board of Fire Underwriters says:

"Facts concerning the leakage of illuminating gas in distribution, lately brought to the attention of the National Board of Fire Underwriters, in connection with fires occurring in New York and other cities, show the importance of a thorough investigation, from the insurance standpoint, of the relation between the spread of asphalt and other impervious pavements, and the fire risks in buildings fronting on streets and avenues thus paved. The occurrence in New York during the past year of a number of fires and explosions which, studied in the light of facts before this committee, may be assumed to be due to the leakage of gas mains

PLUMBING AND HOUSEHOLD SANITATION.

under impervious pavements, warrants the belief that the attention of fire underwriters should everywhere be directed to this important subject, to the end that it may be investigated under all conditions and from widely separated points of view."

"This statement is accompanied by a startling array of facts and figures which, from any less authoritative source, would seem in the highest degree sensational."

"Of the health risk of gas leakage, especially in the case of water gas, the data at hand is still incomplete. It has, however, been taken up for clinical study by the New York County Medical Association and data already collected by members of its Committee on Hygiene, in looking for gas and finding it in dangerous quantities in the homes of persons suffering from persistent sickness resembling malaria but not responding to other treatment than a change of residence, indicate that illuminating gas in sewers and in the air of dwellings accounts for much of the sickness and no small part of the mortality peculiar to cities, and especially for the prevalence of anæmic conditions among the occupants of inferior and badly plumbed houses."

"Carbon monoxide absorbed from the air by the lungs, enters into chemical combination with the hæmoglobin of the blood, which has for it an affinity about four hundred times greater than for oxygen. When about 70 per cent of saturation is reached death ensues inevitably. Distressing and often dangerous symptoms, especially in the case of persons with defective heart action, are noted at about one-third of saturation. Dr. John Haldane, Professor of Physiology, Oxford University, says:"

"Carbonic oxide or carbon monoxide (CO) is a very poisonous gas. Judging from experiments on animals, air containing anything more than 0.4 per cent would, after a

sufficient time, always cause death in a man though anything over 0.2 per cent would in many cases prove fatal."

"I deem it safe to affirm that illuminating gas is the worst and perhaps the only generally dangerous element of so-called 'sewer gas.' Through house drains it works into houses, and from defects in waste pipe it escapes into living and sleeping rooms. CO may almost always be detected in connection with defective plumbing, the danger of which it enormously increases.

"Gas which has escaped from underground leaks does not usually carry any odor with it. Filtration through earth, even for a short distance, makes it odorless from the removal of the added illuminants. This quality greatly increases its danger. I am of the opinion that if gas is not distributed with a very much smaller leakage loss than is now considered consistent with good average practice, the time is not far distant when the suppression of the gas industry in cities, as an intolerable public nuisance, will become a necessity."

Respectfully,

(Sig.) JAMES C. BAYLES, M. E., Ph. D.

"MAIN LEAKAGE A MENACE TO PUBLIC SAFETY AND
HEALTH.

Leakage from water mains greatly increases the difficulty of maintaining at times of fire sufficient pressures. When it is considered that the rate of fire consumption in percentage of average, when average equals 100 gallons per day, is for a town of 1,000 inhabitants 1,000 per cent, for a town of 5,000 inhabitants 450 per cent, and a city of 50,000 inhabitants 140 per cent, whilst even in cities of 100,000 as much supply is demanded in time of fire as the requirements of the city itself, it can be readily understood how serious

PLUMBING AND HOUSEHOLD SANITATION.

the conditions are arising from defective distributing systems. Take for instance the very recent fire at the Parker Building in New York, where several lives were lost and much property destroyed because of the inability to obtain sufficient pressure to even supply the fire engines. This is not an unusual example, and in fact almost innumerable similar cases could be cited.

I quote the following from the circular on the Universal pipe joint of the Central Foundry Company:

Mr. Dexter Bracket, Engineer of the Distribution Department of the Metropolitan Water Works, in a Report on the Measurement, Consumption and Waste of Water to the Metropolitan Water and Sewerage Board, gives the following table of water waste:

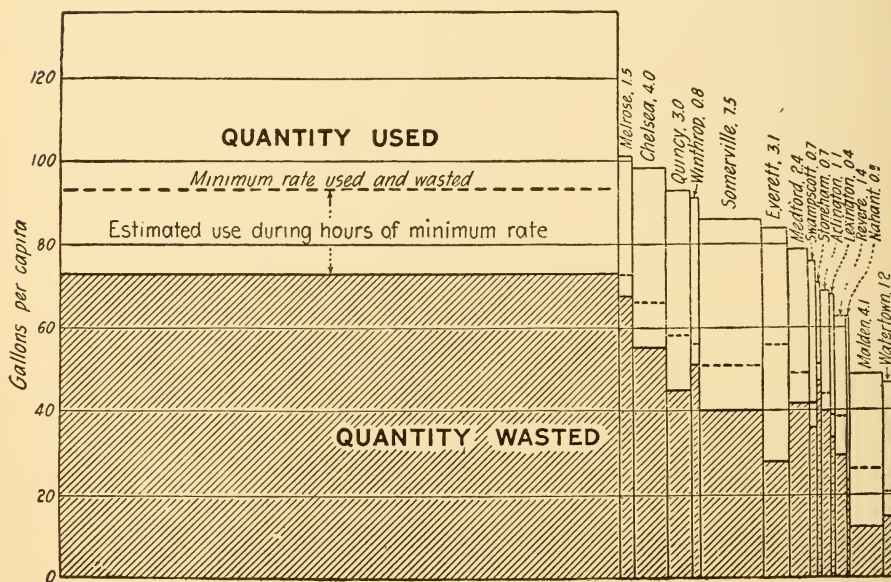

Fig. 520.

LEAKAGE OF PIPES AND JOINTS.

With the extension of the use of water gas, which is much less easily detected by odor than the illuminating gas from retorts, the subtle dangers to health have been greatly increased.

A New York county medical association has taken this matter up and information already collected points to the fact that many persons suffering from persistent sickness resembling malaria do not respond to any other treatment than changing their abode, thus indicating that illuminating gas reaching dwellings through services and sewers, poisons the air and is responsible for much of the sickness and no small part of the mortality peculiar to cities.

The catastrophies which constantly occur in large cities through gas explosions are so frequently a matter of news in the daily papers as to make unnecessary further mention of them here, whilst the breaking down through street excavations of the concrete crown of roads and pavements, thus irreparably damaging them, is only too constantly a matter of daily observation of all citizens. The destruction of trees and grass by the leakage of gas into the ground is also well known.

CHAPTER XXXVII.

IMPROVEMENTS IN PIPE JOINTING.

Of the various kinds of joints thus far reviewed we have found the ordinary bell-and-spigot joint the most defective. As has been shown, it is faulty (1) in the manner in which the packing material is applied, and (2) in the position in which it is held; (3) in the lack of any provision for protecting it against the effects of strains in any direction, due to variations of temperature or other cause, by which the spigot soon becomes loosened from the packing in the socket; (4) in the temptation it presents for carelessness and fraud; (5) in the difficulty of disjointing it for repairs or alterations; (6) in its inflexibility, and (7) in its costliness.

These defects are inherent in the nature of the joint. The calking may, it is true, be done by hydrostatic pressure or other mechanical means, and some of the difficulties involved by the customary laborious and unsatisfactory manual process might be avoided, but the old way is adhered to, and all the defects as a matter of fact remain. The use of grooves cast in the bell or spigot with a view to holding the lead in place may, in certain cases, alleviate the evil effect of strains or jars, but it evidently cannot remove it.

The sleeve joint is, in principle, another form of bell-and-spigot joint. It has all the objections of the latter, and adds one of its own, in that it doubles the number of calkings and packings required, and complicates the form. Its object appears to be the connection of wrought iron pipes upon which bells or caps cannot be readily formed in a single piece.

IMPROVEMENTS IN PIPE JOINTING.

The screw joint is also particularly intended for wrought iron pipe. It is a great improvement upon the foregoing two classes, removing the first four, but not the last three defects.

The flange joint is suitable for cast iron and removes many of the defects enumerated above. It has, however, as we have so far illustrated it, the serious defect of being non-adjustable, and it is absolutely inflexible or inelastic. Moreover, as heretofore used, the flange joint cannot be made tight under pressure without considerable expense in fitting or planing the faces of the flanges, and the means employed for bringing the flanges together have been imperfect and unsatisfactory, requiring considerable working room, and rendering their use in contracted spaces inconvenient or altogether impossible.

Flexibility in pipe jointing seems to be generally considered by designers as either undesirable or unattainable, absolute rigidity being the ideal sought.

Nevertheless I am now convinced after a quarter of a century's experiment and study of the subject that no rigid joint will ever be entirely successful in plumbing, gas or water piping, and that flexibility is really an absolutely essential quality.

In plumbing the shrinkage or settlement of the building after the pipes have been installed, and the racking caused by severe changes of temperature due to the alternate passage of cold and hot water or even steam through the pipes are bound in time to destroy either the joint or the fixture to which it is connected.

In gas and water piping settlements in the streets, so frequently torn up and rebuilt, and distorted by the construction of new buildings, and the continual changes of temperature following the changes of the seasons, crack

open the rigid joints and cause the colossal losses to which we have already called attention.

The water carriage system of disposing of the organic wastes of a community has been shown to be the most economical and satisfactory one now known, but such a sewerage system is manifestly of little value without the co-existence of a public water supply, because otherwise the efficient flushing of the sewers and plumbing fixtures, especially of the water closets, becomes too expensive and unreliable for satisfactory results.

A public water supply is also essential as a rule for ensuring pure drinking water, and, for domestic and commercial purposes, a soft water instead of the hard water obtained from wells.

A public supply is also essential for proper fire protection. It is more economical for the people to contribute to the maintenance of a public water supply than to stand the high fire losses and insurance rates resulting from the want of one.

Other important public uses of a general water supply are street sprinkling and watering of parks, public and private lawns and fountains and the like, and the benefits coming from a good public water supply increase the value of the property of any community, however small, far beyond the cost of its installation. Hence it is only a question of time when such supply will become practically universal.

Inasmuch as the joint of the usual cast iron pipe of our public water mains is the weakest part of the system, it is that which must be held responsible for most of the leakage occurring. A rigid joint, moreover, has no power to protect the pipe itself from fracture under external pressure, as has the flexible joint.

The comparatively rare actual fracture of the pipe itself, however, would be more likely to be made known by a

IMPROVEMENTS IN PIPE JOINTING.

sudden lowering of the pressure on the system as at the pumps, and lead to its repair. But the joints leak all the time soon after laying and cannot be made tight, but must, on the contrary, inevitably grow worse every year. As the streets are dug up from time to time, the pressure on the mains becomes more and more unequal, and the contraction and expansion due to the conveyance alternately of nearly freezing winter water and comparatively warm summer water through the pipes, working upon an almost absolutely inelastic material like lead, must in time open the joint. Lead can never of itself return to its place in the bell and spigot joint when once compressed or when gradually drawn from its socket by the constant longitudinal play back and forth of the comparatively elastic iron, so that serious leaks should be expected at every joint, and they do there develop and go on increasing as the disturbing causes are repeated until they reach the enormous proportions so many able investigators have recorded.

MONEY LOSS THROUGH BAD JOINTING.

It is pretty generally agreed that an average of 50 gallons of water per day for each individual is a liberal allowance for all purposes.

The enormous quantities (150 to 300 gallons per head per day) registered by some of the large cities of the United States and paid for by the people, indicate a very large percentage of loss. The chief causes of such loss are leaky mains, bad plumbing and carelessness, the last item being greatly reduced by metering the service.

Authorities* place the average loss through leakage in the joints in the mains at a shockingly high figure, equalling half of the entire supply, or considerably more in many cases

*See American Architect and Building News for Jan. 13, 1900, already quoted in these articles.

than the total amount allowed as a liberal average requirement for each consumer.

Assuming this liberal allowance for each individual to be 50 gallons per diem, and that a public supply is the most economical, then those of the 84 million of people of the United States enumerated in the last census who pay for the public supply are actually paying for something near double what they use. If we assume, furthermore, an average meter rate of from 10 to 20 cents per 100 cubic feet, they pay for 50 gallons per day of wasted water at the rate of say 15 cents per 750 gallons, or 1 cent for 50 gallons, which amounts to paying \$3.65 per year for an unscientific system of pipe jointing.

Inasmuch as even this tax is, as we have said, more economical than to obtain water through individual effort without public supply, we may assume that ultimately all the citizens of the United States will be glad to enjoy the privilege of paying 50 per cent. for leakage, unless some more scientific form of jointing is adopted, and the average, \$3.65 loss per citizen per year, will aggregate the trifling sum of over three hundred millions of dollars a year.

The United States census for 1900 gives the total value of gas sold in the United States for the census year as \$69,432,582.00. Calculating a proportionately similar waste from bad gas joints we have for the annual leakage in the mains of both water and gas in this country not far from half a billion dollars.

Therefore even a small improvement in the matter of pipe jointing is worth while. A joint which would save only 10 per cent. of this loss would mean an annual money saving alone of many millions of dollars and corresponding sanitary advantages.

*See very interesting article by James C. Baylies on Gas Leakage in "Domestic Engineering" for July and August, 1902.

IMPROVEMENTS IN PIPE JOINTING.

AUTHOR'S ATTEMPTS TO IMPROVE PIPE JOINTING.

Our first experiments in pipe jointing were made in 1883, and were conducted on the inadequate idea that if a perfectly rigid joint could be economically constructed the problem would be solved.

It was assumed that if such a joint could be made adjustable in setting up, and approximately as rigid when assembled as the pipe itself, the utmost attainable would be accomplished.

The joint then devised, and originally called by the writer the "Sanitas" joint, as constituting part of his "Sanitas" system of plumbing appliances, is shown in Figs. 522 to 535, inclusive. Recently, however, the small spigot on one of the flanges has been added, forming an important improvement in this joint, and, by way of distinction, the name "Securitas" has been given to the improved form, including it with his other recent improvements in sanitary appliances going under this name.

THE "SECURITAS" FLANGED JOINT.

To avoid the difficulties connected with the threading and screwing together of wrought iron pipe, and to permit of the use of cast iron without the defects involved in hand calking, this joint was devised and put into successful use in house building by the writer. In general terms it may be described as an adjustable flanged joint with lead gaskets for packing forced in place by bolts after the manner of flanged steam pipes without the employment of skilled labor. It is a steamfitter's joint with improvements which adapt it for plumbing, gas and water carriage where a rigid joint is desired.

The pressure is applied by two ratchet wrenches, Figs. 529 and 530, constructed for the purpose and used simul-

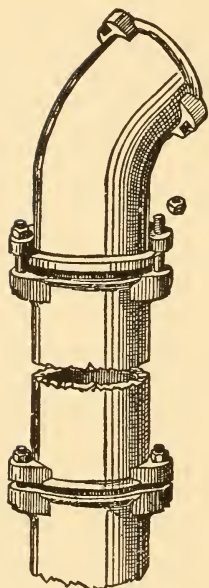

Fig. 521.

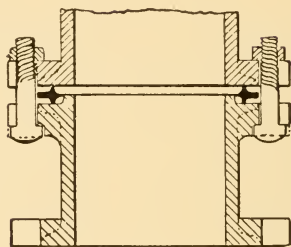

Fig. 522.

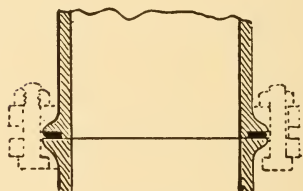

Fig. 523.

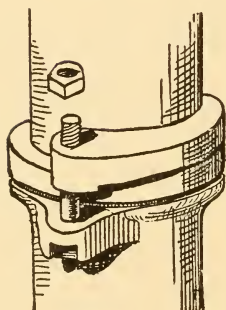

Fig. 524.

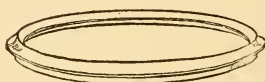

Fig. 525.

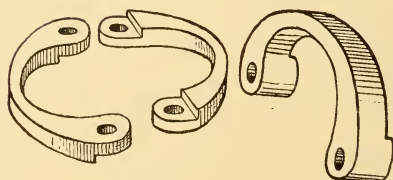

Fig. 527.



Fig. 526.

IMPROVEMENTS IN PIPE JOINTING.

taneously, one working left and the other right handed, as shown in Fig. 531. This avoids the necessity of securing the pipes while the nuts are being screwed up, and causes both sides to be compressed alike, since the wrench which has given and received the greatest pressure ceases temporarily to turn until the other has caught up with it. This permits the joint to be made up in very contracted places, as shown in the figure, and by a single ordinary unskilled

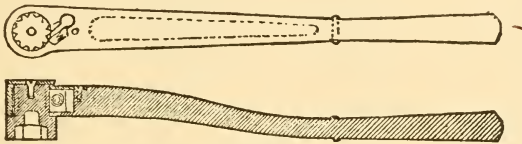

Fig. 529.

Fig. 530

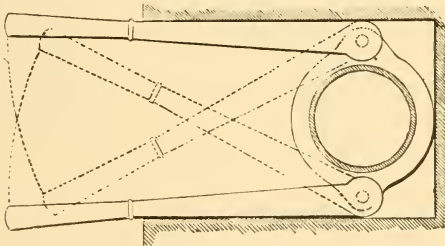

Fig. 531.

workman in less than twenty seconds after the pipes are once set in place. To calk an ordinary bell-and-spigot joint in the usual defective manner is estimated by good authorities as requiring, on the average, the pipes being in place, as many minutes. Moreover, two men instead of one are required for it; one, the plumber, to do the calking, and the other, the helper, to handle the fire and melt the lead.

The amount of lead used for calking our flanged joint is

about one-eighth that required for the ordinary joint. The lead gasket for four-inch pipes weighs half a pound, and for two-inch pipe one-fourth of a pound, while the rule for calking ordinary joints is to use one pound of lead for every inch in the diameter of the pipe. We also save the fuel,

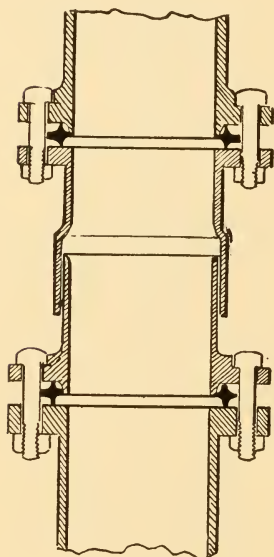

Fig 532

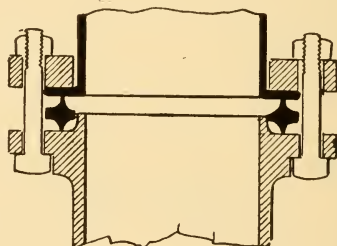

Fig. 533.

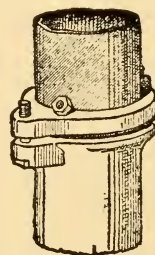

Fig. 534.

oakum, etc., used in making ordinary joints, and avoid the danger of fire from lead melting in the house.

Fig. 525 shows the lead packing ring in perspective, and Fig. 526 shows its star-shaped section in actual size for plumbers' pipes. It is crushed to less than half its thickness into every pore and crevice of the iron by the pressure of the two half-inch bolts screwed up easily by a man of ordinary strength with the fourteen-inch ratchet wrenches,

IMPROVEMENTS IN PIPE JOINTING.

until the spigot on one pipe comes to a bearing on the flange surface of the other, Fig. 523. In this way the workman is informed when the joint is made up, and the lead packing thus protected cannot be affected by the expansion or contraction of the pipes. The expansion of the two flanges being the same, no injury can be done to the joint by hot water or steam, as was demonstrated by repeated tests.

The strong bolts prevent leakage by sagging or horizontal tension of the pipes up to the point of the rupture of the iron, while the ordinary bell-and-spigot joint depends for its

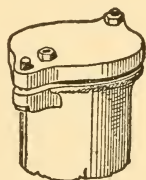

Fig. 535.

resistance to such a strain only on the friction of the lead calking against the sides of the iron.

The flush flanges enable any piece of the piping to be taken out for alterations without breaking it, and the opportunity and temptation for the use of sand, paper, putty or other fraudulent packing is prevented, since all the packing used is directly visible from the outside when set in place.

Branches and fittings of various kinds similar to those used in wrought iron screwed piping enable any change of direction to be obtained with entire facility, as is made clear by the drawings. All pipe cutting, which is both very diffi-

cult, expensive and dangerous to the pipe, is avoided, because a sufficient number of different short lengths and bends or angles are supplied to meet every requirement, the jointing being so easy and quick that a variety of lengths becomes worth while and entails no practical difficulty.

Being cast in short lengths, the pipes may be made of more uniform thickness, and as the calking requires no hammering, even porcelain or glass-lined pipe might be used with safety if desired.

The simple manner in which lead and iron pipes are connected with this joint is shown in Figs. 533 and 534.

Fig. 535 shows without further explanation how the pipes may be capped for the hydraulic or other test, and Fig. 532 has a turned brass expansion or slide joint with a fibrous packing inserted.

To test the resistance of this joint to alterations of steam and cold water pressure before using these pipes in practical building, I had several lengths of four-inch piping connected together and closed up at the ends, and coupled the whole with a steam boiler, the pressure gauge indicating about 30 pounds of steam pressure. The steam was left on until the pipe-flanges and bolts had all become thoroughly heated through. The coupling was then immediately transferred to the cold water supply from the city main, and after the steam had been let out the cold water was suddenly turned on until the piping was filled. As the experiments were performed in midwinter, the tests were as severe as possible. The cold water was then poured out and steam again immediately applied. This alternating application of steam and cold water was repeated in the tests a dozen times successively on the same joints. During the entire process no sign of leak, either of steam or water, was obtained, and no creeping or alteration of the gasket occurred.

IMPROVEMENTS IN PIPE JOINTING.

It is well known that no bell-and-spigot joint will stand such a test, even after the most careful calking, as indeed is evidenced by the plumbing laws which prohibit the discharge of exhaust steam into plumbing drains.

This joint has also the advantage of causing no obstruction to the waterway, and of leaving no appreciable space or pocket for deposit.

But flange joints are not flexible, and are therefore incapable of protecting the pipe line against the effects of street settlement, expansion and contraction and other adverse influences already referred to as affecting water and gas mains. In plumbing work a rigid jointing is always liable to cause the fracture of the fixture connections, especially when they are made of earthenware, in all cases of shrinkage or settlement of the building and of expansion and contraction of the pipe lines.

The Durham system of wrought iron screw jointed piping attempts to partially overcome this difficulty by supporting some of the fixtures directly upon the rigid branches of the main pipe lines independently of the floors. But this only transfers the strain from one part of the fixture to another, because even if, by this means, the fixture itself could be compelled to follow the movement of the main piping, or to remain with it when the walls settle or the floor beams shrink, the flushing apparatus of the fixture cannot be similarly connected, and therefore the rupturing strain must still remain, and the device becomes practically inefficient. The rigid system of jointing is responsible for most annoying and vastly expensive losses by fracture and leakage generally misunderstood or unaccounted for by the owner.

A realization of this fact will be most effectively impressed upon an observant owner of any high building in which hot and cold water are alternately used in large quantities, as in hotels.

Investment in such a building presented the writer with such an opportunity for expensive experience along this line.

Wrought iron piping was here used for the soil pipes, the building having been planned and erected by the writer before his efforts to obtain a permanently reliable joint had been made. The great need of it had not then been made so painfully clear to him as to seem to justify a very considerable expenditure of time and money in "experimentation."

The final result has been the development of a flexible joint which has withstood for several years very severe tests, which have been continued up to the present time.

One of the tests has consisted in placing one of the joints under a water pressure varying from 45 to 50 pounds to the square inch off and on for three years, moving the pipes at the joint from time to time, sometimes while the pressure was off and sometimes when it was on, without producing the slightest signs of leakage.

The last tests were made within the present month (Nov. 1910), and having proved themselves successful, the writer feels himself now justified in publishing here, for the first time, a description of this joint, and also justified in naming it

THE "SECURITAS" FLEXIBLE JOINT.

Two kinds of motion at the joints must be provided for, one longitudinal and one rotary, and the experiments seem to show that, while the exterior form of the joints may be the same for both kinds of motion, the interior construction must differ for each, it being inadvisable as well as unnecessary to provide for both kinds in the same form of joint. Accordingly, two forms of construction have been produced, to be used simultaneously in the same pipe system, one to provide for a longitudinal and the other for a rotary play of the pipes, the first to be confined to straight pipe lengths and the other to bends and fittings.

IMPROVEMENTS IN PIPE JOINTING.

We have thus a dual pipe jointing system, Figs. 536 to 539, illustrating the construction for straight pipes, and Figs. 540 to 547 for bends and fittings.

Fig. 548 shows the means by which these joints are made up.

We have quite recently succeeded in obtaining a composition which has about the consistency of fresh putty when in the condition used by glaziers, with three very important other qualities, the first being a permanent plasticity due to the combination in the substance of a special form of non-drying oil, the second being practical indifference to all changes of temperature between the degrees of freezing and boiling water, and the third an extraordinary adhesiveness.

Our first work consisted in perfecting this composition after long experimenting with a very large number of substances, and testing it under all sorts of conditions for many years, until we were convinced of its practical reliability in all of these essential qualities required. After many years' exposure to dry air the compound has suffered no appreciable diminution of plasticity, and it appears capable of retaining all its desirable qualities in the joint indefinitely.

Describing first the plain pipe joint for longitudinal play, Figs. 536 and 537 show longitudinal sections of the device, and Fig. 538 is a horizontal section of the same. Fig. 539 shows the supporting and adjusting mechanism. As may be seen, the joint consists of the plain or spigot end of one pipe inserted into a spherical shaped enlargement of the opposite end of another pipe, the space between the two being filled with the permanently pliable compound already referred to. The spherical enlargement has between it and the main body of the pipe to which it is connected a short cylindrical enlargement of internal diameter just sufficient to receive the plain or spigot end of the other pipe, and of

length sufficient to allow the latter to play back and forth longitudinally within the cylinder under the influence of

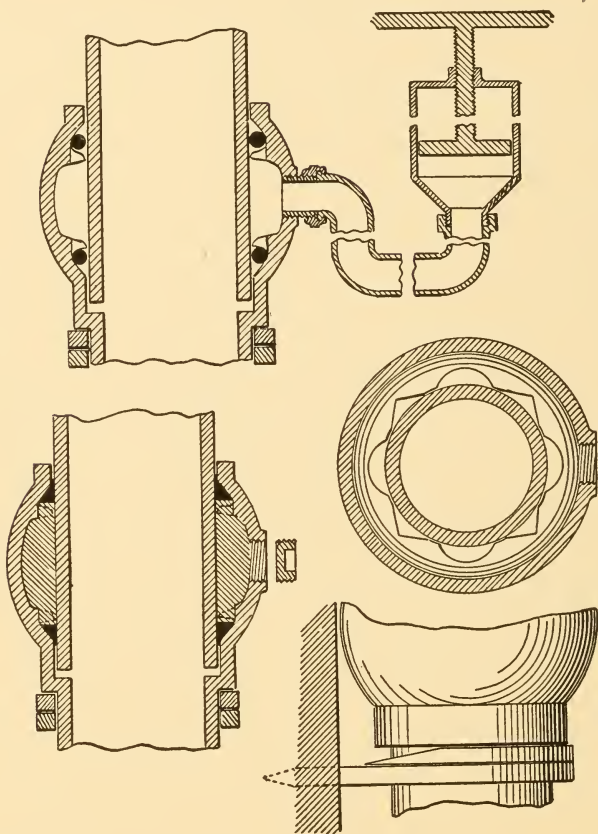

Fig. 536.

Fig. 537.

Fig. 538.

Fig. 539.

expansion and contraction of the pipe line. The outer end of the spherical enlargement has a diameter just sufficient to receive the plain or spigot end of the other pipe. The

IMPROVEMENTS IN PIPE JOINTING.

pliable composition is forced into the space between the cup and spigot through a threaded hole in the side of the former, and is prevented from escaping by two soft, pliable gaskets at each end of the cup surrounding the spigot. In virtue of this arrangement the greater the internal pressure of fluids passing through the pipe system the more forcibly the elastic composition is forced against the gaskets and the more impervious they become. Accordingly, the greater the pressure the tighter becomes the joint. On the other hand, the great toughness and tenacity of the filling compound, and its permanent indifference to changes of temperature, present an absolutely impassable barrier to liquids or gases conveyed through the pipes under slight or atmospheric pressure, or even under more or less of a vacuum. The gaskets may be permeated with a material impervious to gases of any kind, and the filling composition is itself of a nature peculiarly adapted to withstand corroding chemical action.

The passage of boiling water, alternating with cold, through the pipes has no injurious effect on the materials forming the joint, nor does ice cold water nor a freezing outer environment produce any material reduction in the pliability and tenacity thereof.

The pliable compound is forced very quickly and easily into the joint under the pressure of the pumps shown in Fig. 548, and the pressure is afterwards maintained or even increased, if desired, by screwing down the small cap provided to close the opening after the pumping apparatus has been disconnected, but the principle of the construction of the joint does not seem to require the application of any special degree of pressure in inserting the filling material.

After the joint has been set up the filling may be applied and capped up in less than ten seconds on a four-inch pipe, and the jointing may be made as illustrated in this

figure in situations absolutely inaccessible for ordinary methods of jointing, and its cost is far below that of any other joint of which the writer is aware.

A turned joint assembled by means of bolts has recently been placed on the market for street mains with a claim to some small degree of flexibility. But the expense of turning and bolting remains, and it is difficult to see how such a joint can be made either practically flexible or permanently tight under distorting influences.

A very important feature of advantage in the Securitas joint is the ease with which it may be disconnected at any time, as in case of desired alterations or extensions, and another very important advantage consists in its doing away with all use of heat in its construction. Cylinders containing the pliable compound for a large number of joints may be conveniently forwarded by mail or otherwise at a minimum of expense, the cylinders being constructed to fit the pumps in which they are used, and returnable for refilling at any time, and the pumps may be operated either by hand or by hydraulic air or steam pressure, or even by the weight of the workman, leaving his hands free for other work.

The joint occupies the minimum of space and is of very pleasing appearance.

The fibrous rings of the joint are held in place by annular shoulders or projections cast on the inner side of the spherical enlargement, as shown in Figs. 536, 537 and 538, the projections extending inward far enough to nearly touch the outer surface of the spigot. The upper surfaces are bevelled so as to guide the spigot centrally when it is inserted into the cup.

In order to provide properly for the longitudinal movement of the pipes under the influence of changes of temperature or shrinkage and settlement of the building the

IMPROVEMENTS IN PIPE JOINTING.

spigot is first lowered into the bell end of the pipe below until it touches the shoulder at the connection of the cylindrical enlargement with the main pipe. The pipe is then lifted a short distance corresponding with the amount of play room desired. To enable this play room to be easily attained in setting the pipes, and to regulate its amount with exactitude, and absolutely independent of the skill or scientific attainment of the journeyman plumber, the mechanism shown in the cuts has been devised. The stack is supported by hangers surrounding the pipes just below the external shoulders of the cylindrical enlargements below the cups. The hangers are placed in contact with shoulders when the spigot end of the pipe has been brought in contact with the inner shoulder of the cupped end. The upper pipe is then raised from the shoulder until the free space below the spigot has attained the exact size required for the best results, by driving a wedge of iron between the bell shoulder and the hanger, the thickness of the wedge being the gauge of the proper space required. The pliable compound is forced in after the proper adjustment has been made, and the joint is completed.

Figs. 540 to 547 show the construction of the Securitas ball and socket joint designed to provide for rotary movement.

The joint has the same exterior form and the same pliable compound for packing as the straight pipe joint, but one-half of the spherical space between the bell and socket is filled with a fine Portland cement and sand concrete cast upon the spigot to form the ball of rotation, a sheet metal disc separating this hard from the soft packing.

In this joint the mouth or opening of the cup is a little larger than the exterior diameter of the spigot end, so as to receive the same, and also leave room for considerable lat-

eral play when the inner pipe is rotated around the centre of the cup as an axis.

In order to enable the Portland cement to take as perfect a spherical form as possible without going to the expense of machine turned work the interior surface of the

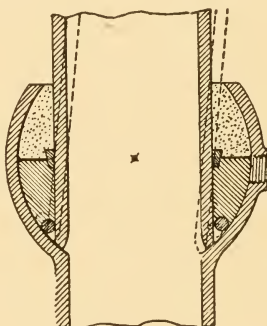

Fig. 540.

cup is coated with asphaltum at the factory in the usual manner, and it is provided, also at the factory, with a further coating of paraffin by dipping. These two coatings produce a very smooth inner surface thick enough to fill up all the rough irregularities of the casting with a comparatively soft material, so that when the concrete sphere and socket joint is formed with the paraffin for a lubricator, which is capable of rotation without injury to either part. The force required to rotate this joint is small compared with those which are brought to bear upon the pipe system by the expansion and contraction of the iron or by the shrinkage or settlement of the building. The softness of the paraffin lining permits the pipes to rotate under a comparatively

IMPROVEMENTS IN PIPE JOINTING.

small leverage of pipe length. To permit of the sheet metal disc being inserted in the cup it is cut across so that it can be bent into the form of a spiral and easily inserted into the

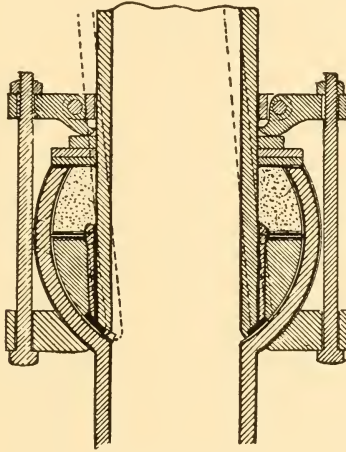

Fig. 541.

cup around the spigot as a corkscrew would be inserted. The disc is inserted at the pipe factory before the pipe is coated with asphaltum. The coating then covers not only all parts of the pipe but also the disc on both sides, and serves to bind the disc securely to the inner side of the cup and hold it firmly in position while the spigot end is being introduced through the hole in the disc, besides making a tight partition between the two kinds of cement when they are forced into the joint.

Flexible gaskets are used in this joint in the same way as in the plain pipe Securitas joint to retain the packing compound. The gaskets are made slightly larger than the spigot end, in order that the latter may be easily introduced

into them. When the pliable compound is forced into the joint the gaskets are pressed firmly in place around the end of the spigot, as shown. One gasket is placed just above the end of the spigot, and another higher up, so as to bear against and make tight with the sheet metal ring, as shown in Figs. 540 and 542.

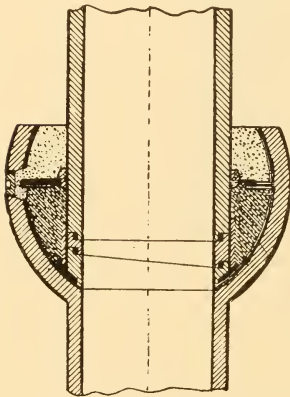

Fig. 542.

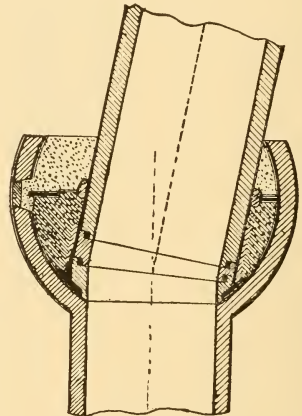

Fig. 543.

The Portland cement is first inserted either in a rather thick or stiff state through the opening around the bell or in a thinner or fluid state through a special threaded opening shown in Fig. 544. The pliable compound is afterwards inserted in the manner already described after the Portland cement has set, the small threaded plug inserted, and the joint is complete.

The larger the pipe the smaller, comparatively, the amount of cements required. Thus in a street main, shown in Fig. 548, the joint takes up relatively a much smaller amount of room than in a small plumbers' pipe, shown in Fig. 540.

IMPROVEMENTS IN PIPE JOINTING.

For calking large street mains the pressure may be economically and very quickly applied by steam pressure, a portable boiler and steam pump being moved from joint

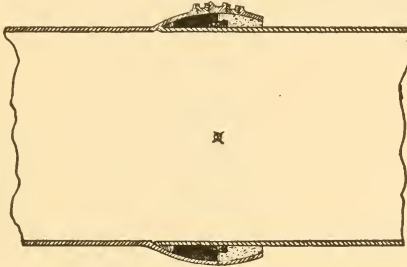

Fig. 548.

to joint, the boiler providing the energy both for pumping and locomotion, the only hard labor necessary consisting of opening and closing a valve after connecting the hose with the joint, and then capping up the supply nozzle.

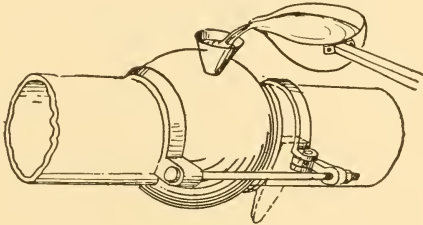

Fig. 544.

Figs. 541 to 547, inclusive, show a method of the writer's for obtaining bends in piping of considerable angle without employing special fittings and without producing uneven interior surfaces or pockets. Two small bevelled rings are

placed in the joint under the spigot, under the spigot end. When it is desired to set the two pipes in straight alignment, so that the axis of one shall be a continuation of that of the other in the same direction, one of the small rings is placed upon the other in such a position that their two inclined edges shall exactly offset each other; or, in other



Fig. 545.



Fig. 546.

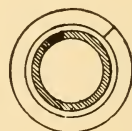

Fig. 547.

words, that the widest side of one ring shall come over the narrowest side of the other, making the arrangement shown in Fig. 542. When, on the other hand, it is desired that the two pipes shall be set at the greatest possible angle with each other, the relative arrangement of the two small rings is exactly the reverse, the two wide sides coming over each other. An intermediate arrangement of the rings will produce an angle in the pipe alignment intermediate between the two.

In order to facilitate the setting of the pipes in the exact angle desired without protractors or guesswork, figures are cast on one of the rings, Fig. 546, which denote the exact number of degrees the upper pipe will slope beyond the straight line when the small arrow cast on the other ring, Fig. 545, is placed over that particular figure. Thus, if the arrow is placed over the sign O, the axis of the two pipes will form no angle with each other, and the pipes will be known to be in exact alignment. If the arrow is placed over the figure 5, the pipes will incline with each other at an angle of exactly 5 degrees, and the pitch thus attained

IMPROVEMENTS IN PIPE JOINTING.

may easily be carried up as high as 10 or 15 degrees, producing, in the case of large street mains, a considerable degree of convenience and economy. The degrees between 0° and 5° and between 5° and 10° and between 10° and 15°

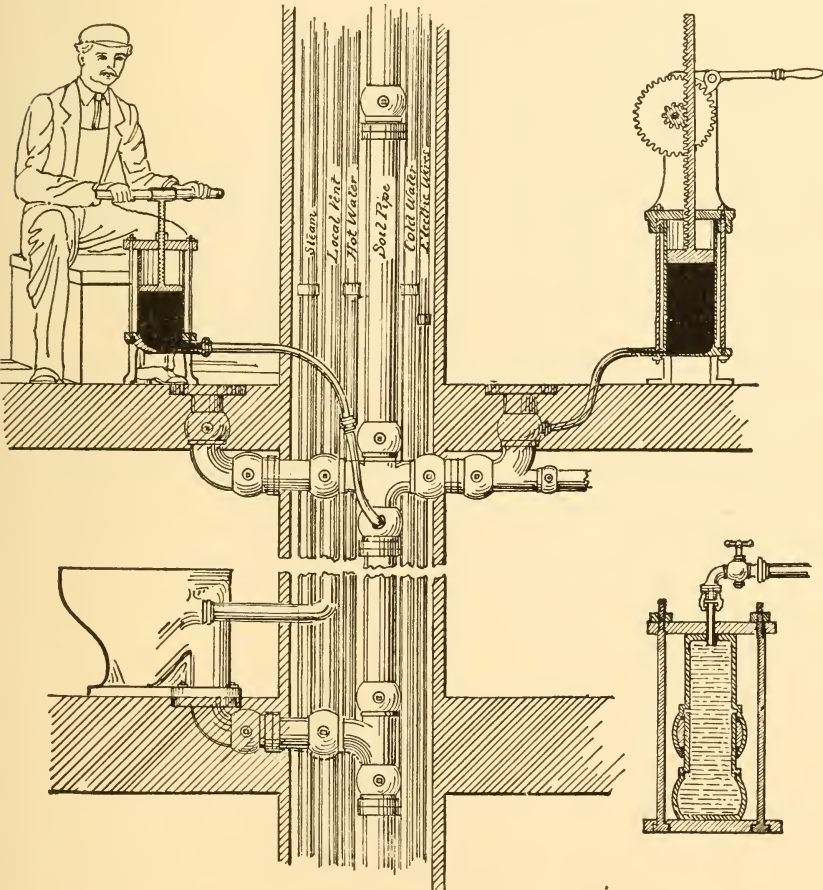

Fig. 548.

may be designated by simple notches in smaller pipes, and the small rings have cup and spigot edges not only to insure accurate setting but also to permit of the use of small gaskets to serve as barriers for the escape of the hard and soft cements when forced in to make up the joint.

If the Portland cement is to be applied in a liquid state it is necessary that the annular opening of the cup around the spigot pipe should be temporarily closed in order to prevent the escape of the cement. Figs. 541 and 544 show a form of mechanism we have designed to effect this easily and quickly.

The small sleeve, shown in Fig. 541, around the spigot end has for its object to permit of both a longitudinal and a rotary play in the same joint, a complication, however, which in practice might never be required. Small perforations in this sleeve permit the elastic filling compound to fill the space between the sleeve and the pipe.

Thus we have obtained the flexible joint long needed for safety, convenience, and economy. It permits of the safe use of "Standard" in place of "Extra heavy" thickness in pipes, as explained in the note on Pages 694 and 695. The very great saving in the weight of the pipe and in the making up of the joints reduces the cost of this system of piping to less than half that of the ordinary barbarous and unreliable bell and spigot joint now in vogue.

CHAPTER XXXVIII.

OPEN SETTING FOR PLUMBING WORK.

THE GENERAL ARRANGEMENT OF PLUMBING WORK.



All the piping of a house should be as far as possible in full view. Nothing should be walled in or covered over and rendered inaccessible. One of the first rules of modern sanitary work is to bring everything out of

the darkness into light and air, where defects, if they occur, can at once be detected and removed. We are accustomed to running our steam pipes in plain sight, and rendering them by gilding or silvering as ornamental as possible, and this custom is now found to be proper also for plumbing pipes, which can be even more handsomely treated with white porcelain enamel. Where they pass through parlors or reception rooms, they should stand behind movable panels or doors. A little ingenuity on the part of the architect will generally enable this to be done with good effect. The owner should be so proud of his plumbing that his first impulse will be to entertain his guests with the exhibition of his attractive and scientific arrangements for their safety while under his roof, and the hinged panels should be treated with the full artistic consideration their importance justifies.

BATH ROOM VENTILATION.

Thorough ventilation is a most important feature in

bath-room construction. A window opening on the outer air is usually provided and, in many plumbing regulations exclusively required as a sufficient means to this end. The substitution of interior ventilating flues not being permitted, however ample its size and powerful its draft.

Now when a bath-room window is opened, especially in winter, the ventilation produced consists of a rush of air into instead of out of the room, and the effect produced is precisely the opposite to what is desired. Instead of removing the bad air of the bath-room from the house, as it should, it simply forces it from the bath-room into the living-rooms, parlors, dining-rooms and reception rooms, where its presence is least to be desired. Moreover, window ventilation is only operative when the window is opened, and this is very apt to be neglected when most needed. People in bath-room costume, or lack of costume, are generally opposed to draughts.

A properly constructed ventilating flue, on the contrary, is always operative; and, more than that, it is always operative in exactly the right way, that is, in hurrying all bad air entirely up to the roof, and out of the house, with a speed and volume proportional to its effectiveness. Not only is the air of the bath-room kept constantly pure by this form of ventilation, but the adjoining rooms are also correspondingly ventilated and the whole house is benefited in proportion to the effectiveness of the flue action. For anyone who fears the presence of disease germs in the air of a bath-room it is evidently all the more important that the ventilating current should be continuous, and correctly directed, or, in other words, scientific and useful, instead of fortuitous and injurious.

It is a curious fact that those who have the least knowledge of the science of plumbing are generally the ones

BATH-ROOM VENTILATION.

who have the most unreasoning fear of germs in the air of bath-rooms, and, at the same time, the most senseless ideas as to how to get rid of them, and these unscientific persons are the most stubborn in insisting upon the necessity and sufficiency of window ventilation for bath-rooms. The cost of plumbing is thus again immensely and foolishly increased, and valuable window space is sacrificed for no useful purpose in ventilation whatever.

As for sunlight, which would sometimes be admitted as an incidental advantage of window bath-room ventilation, this is useful everywhere, but always more useful in living-rooms than in bath-rooms. Since window area is very precious, especially in city houses, it should be reserved for the places where it is most needed, and that is not in bath-rooms. Sunlight is hostile to disease germs, but modern science has demonstrated that germs are, as we have seen, equally hostile to sewers and plumbing pipes, so that it is now known to be no longer required for bath-rooms, whereas for all other rooms in a house it is very valuable, and usually essential for healthfulness. Artificial light is entirely sufficient for bath-rooms and, properly placed, is more useful there than sunlight, because it may be applied in such a manner as to increase, or even develop alone by its heat, the ventilation of the flue. A good bath-room ventilating flue may renew the entire air of a bath-room every ten minutes, and since all this air purification must effect by just so much the adjoining rooms of the house, the great superiority of this method over the costly window ventilation is obvious.

Instead, therefore, of legislation insisting upon window ventilation for bath and toilet-rooms, where disease germs are feared in sewer gas, it would be far more rational to prohibit this method for such rooms because of the objec-

tion that it will inevitably drive the foul air into the house and to require the ventilation to be done by adequate ventilating flues, constructed in such a manner as to ensure the discharge of this bad air out of and above the roof of the house.

It is interesting to note the very remarkable progress which has been made in these matters within the last few years. Fig. 554 shows the elaborate manner in which plumbing was only twenty-five years ago buried out of sight as if it were something to be mortally ashamed of. The fixtures themselves were not disguised. They were even decorated to the last degree and with the utmost ostentation. But, strangely enough, all evidences which were needed to insure the users that the plumbing was entirely safe and could be freely enjoyed without fear of danger, were carefully concealed from view.

Now nothing is tolerated which is not in open sight as shown in Fig. 552, and the exterior surfaces of the fixtures are treated even more decoratively than the interiors were before. What can be more sensible and attractive than the display of these brightly polished working parts of the fixtures, which insure sanitation as well as decoration?

Fig. 554 is from Hellyer's treatise on plumbing published in 188.., shows a very healthful treatment of enclosed plumbing. Nothing could be more charming than the arrangement of this bath and dressing room, as will be seen by examining the plan on the left. But today the safety of the users would be considered as well as their æsthetic sense by opening up the piping and tiling the floor as well as the walls.

Fig. 555 gives another attractive piece of plumbing work taken from Mr. Hellyer's interesting book. It shows a part of a very tiny cottage whose owner was too poor to have

THE GENERAL ARRANGEMENT OF PLUMBING WORK.

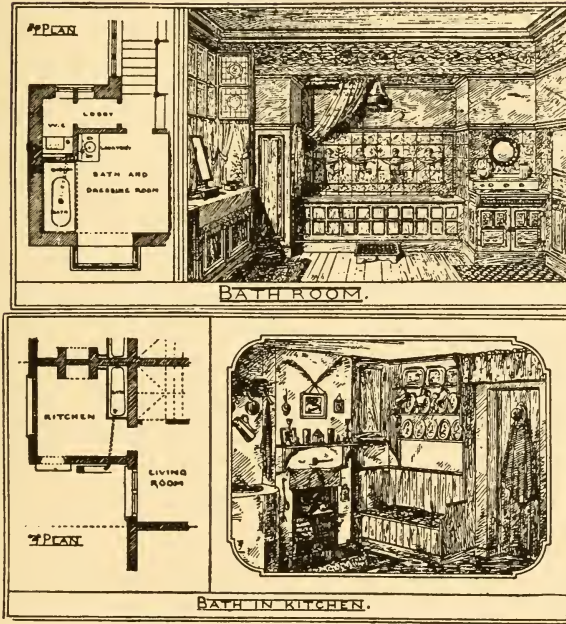

Fig. 554.

Fig. 555.

a regular bath room. But he was determined to have a bath tub at any cost for his hard-working housewife and built it in a warm corner of the kitchen disguised as a seat. However unconventional this may seem, the idea is nevertheless by no means to be despised, for this man saw that cleanliness was none the less next to godliness because obtained at some sacrifice.

CHAPTER XXXIX.

THE SIPHONAGE AND EVAPORATION OF TRAPS.*

Report to the Boston City Board of Health.

To the Boston City Board of Health:—

Gentlemen:—The experiments heretofore made in this country on the siphonage of traps have faithfully shown the siphoning power of those fixtures which are in most common use; and have established the relative strengths of the various forms of best known traps in resisting such power.

You have seen that these experiments have been made and recorded with a degree of care which renders it superfluous to experiment further in the same field. But the fixtures in common use are not the ones which produce the most powerful action of siphonage, and as they are not the only ones used, it is evidently necessary, in order to present a full and correct view of the subject, to supplement the former experiments with others made in a new direction.

The tests have hitherto been made with common pan and hopper closets. It remains to investigate the action of plunger-closets,† and these will serve to illustrate also the maximum power of valve-closets, which we assume to occupy a position, in respect to siphonage, intermediate between plunger and ordinary hopper closets.

*Reprinted from the "American Architect and Building News" of 1884, giving the Author's first public Report on Trap Siphonage and Evaporation, made for the Board of Health in 1883 and 1884.

†The modern siphon jet closets produce an effect of siphonage similar to that produced by the plunger closets in common use at the time of this report.

In the former experiments a single round or pot trap was tested; but since these traps may be made of various sizes, from that which has a body but little larger than that of an ordinary 1½" S-trap, up to the largest whose body measures 8 or 10 inches in diameter, and as their power of resistance to siphonic action is totally dependent on their size, the smallest being but slightly more resistant than an S-trap of equal depth of seal, and the largest being practically unsiphonable, you have recognized the necessity, in order to arrive at correct conclusions as to the efficiency of this trap, of testing them all, and publishing the results in regular tabular form.

The third subject which your Board has given us for investigation is one upon which nothing has to our knowledge as yet been published; but which has, in view of the recent plumbing regulations enacted in different parts of this country, assumed a vast importance. The special ventilation of traps in the manner now customary, induces a current of air over the water-seal, which lowers its level more or less rapidly according to the velocity, temperature, and hygometric condition of the air current.

It is sometimes recommended by sanitary engineers and plumbers to connect the vent-pipe with a heated flue, in order to insure an upward current. Accordingly we have made our tests on trap-ventilation both with heated and with cold flues, and in order to give them as wide an application as possible, we have tested the traps in various positions, and applied the vent-pipes to various parts of the trap.

Finally, we have studied the effect of *back pressure* on traps, and in this direction as well as in the others, we have endeavored to apply tests as severe as could ever possibly be encountered in practice.

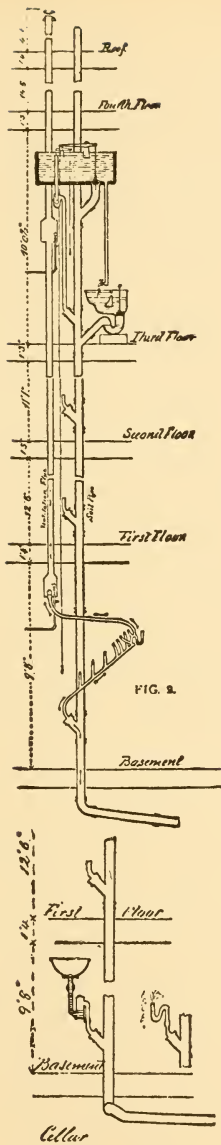

Fig. 1 (555).
Apparatus for Trap Testing.
603

The apparatus used for making our tests is illustrated in the accompanying drawings.

Figure 1 represents a straight stack of 4" soil-pipe, such as is used in ordinary house-plumbing. The stack is built exactly perpendicular, and without bends from the outlet above the roof to the horizontal run under the basement floor, a distance of 70' 9". The soil-pipe was run up straight in this manner in order to furnish the conditions for the severest possible tests for siphonage and back-pressure. At the same time it forms the arrangement most commonly met with in practice, and the one most to be recommended. The unbroken fall of the water through such a pipe evidently creates the most powerful compression of the air in advance of it, and the greatest rarification behind it.

Just below the fourth floor is placed a large cistern, 44" long, 16" wide, 15" up to overflow, inside measure; or of 46 gallons capacity. The cistern served also to illustrate the action of a bath-tub, by having a 1½" discharge-pipe at its bottom trapped with a Bower's large size trap, and entering the soil-pipe just above the entrance of the water-closet waste.

The water-closet used was one of Zane's plunger water-closets, a kind well known, and widely used in this country. To expedite its filling a large service-pipe from the cistern was used, and the water was allowed to fill the cistern through a brass compression-cock. The water-closet is supplied with a regular overflow-pipe, so that, when full, its capacity is always the same. This capacity is a little over 4½ gallons in the closet used in these experiments.

To test the effect on traps below of emptying the tank after the manner of a flush-tank, a 4-inch outlet-valve and waste-pipe were fitted up in the manner shown.

Outlets were left on each story below the water-closet

for testing the traps at various heights on the stack. The soil-pipe was ventilated at the top full-size, and had the usual foot-vent. This completes the apparatus for the experiments on siphonage and back-pressure.

For the experiments on evaporation a 4" galvanized-iron flue was erected by the side of the soil-pipe. This flue terminated just below the first floor in a galvanized-iron lantern, with a glass door on its front side. A 1½" rubber tube was connected with the bottom of the lantern, and an anemometer was placed above the point of connection in an enlargement made to receive it. The anemometer was so arranged and placed that it would measure accurately the current of air passing through the rubber tube in either direction. The galvanized-iron flue could be tested either cold, or heated by gas-jets as shown in the drawing. A second lantern was placed on the third floor, with a similar appliance for heating the flue.

A 1½" lead waste-pipe was connected with the soil-pipe just above the basement floor. This branch waste had a number of ventilating openings made upon it, and a deep-seal S-trap at its end. The trap had three ventilating openings in its outlet arm, one at the crown, and the others below the crown as shown. All the vent openings both on the trap and on the branch waste were provided with small connecting tubes so arranged that the rubber ventilating flue could be readily attached to either. The openings were, furthermore, all provided with closely fitting corks, so that they could be hermetically sealed. By this arrangement the effect of ventilation at different points of the trap or its waste-pipe upon its water-seal could be accurately tested. Further tests on evaporation were made by connecting a second branch waste below the first with a brick flue heated by a stove.

PLUMBING AND HOUSEHOLD SANITATION.

Figs. 2, 3, 4, 5, 6, 7, 8, 9, 10, 11, and 12, show various traps tested in these experiments. Other traps were tested at the same time with these at the request of the manufacturers. Still others were sent us on the invitation of your Board; but as none of these traps except those shown, were

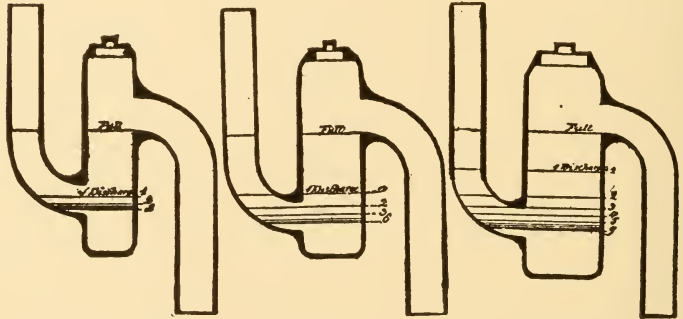

Fig. 2 (556).

Fig. 3 (557).

Fig. 4 (558).

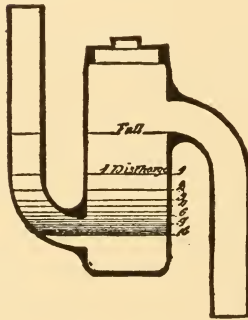

Fig. 5 (559).

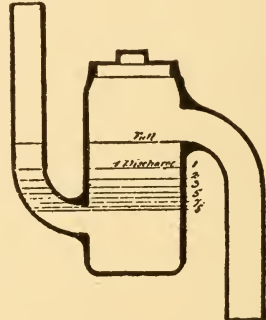

Fig. 6 (560).

able to preserve their seal against the tests applied, and as most of them have already been tested in the experiments for the National Board of Health, and the tests published, by which their power of resistance as relates to that of a ventilated S and to a pot-trap was made known, it has been

REPORT TO THE CITY BOARD OF HEALTH.

thought unnecessary to publish the results obtained in these experiments. The records on any of these traps will, however, be cheerfully sent to its proprietor upon his request.

Our tests fall under three general divisions: (I) Siphonage; (II) Back-Pressure; (III) Evaporation.

I. EXPERIMENTS ON SIPHONAGE.

These experiments are subdivided into (A) those on ventilated S-traps; and (B) those on pot and other traps, unventilated. Except where otherwise specified, the tests were made at the outlet on the second floor, at a distance of about 11' below the bottom of the water-closet trap, since at this point the siphonage proved to be most severe.

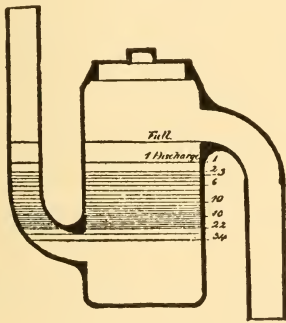

Fig. 7 (561).

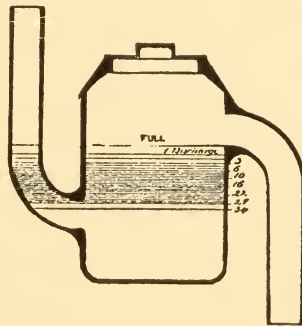

Fig. 8 (562).

(A) EXPERIMENTS ON VENTILATED S-TRAPS.

These experiments are again divided into:—

(1) Those in which the siphonic action was produced by a trapped plunger-closet, with and without the combination of a bath-tub.

(2) Those in which a *trapless* plunger-closet was used.

(1) *Experiments on the Siphonage of Ventilated S-Traps*

by a Trapped Plunger Water-closet.

The tests were made first with the water-closet alone.

(a) An unventilated S-trap was, of course, completely siphoned out by a single discharge of the closet.

(b) A $1\frac{1}{4}$ " ordinary cast-lead S-trap, having a $1\frac{1}{4}$ " vent-hole at the crown, and a $1\frac{1}{4}$ " pipe of smooth clean lead $17'$ long attached at the opening was then tested. Three dis-

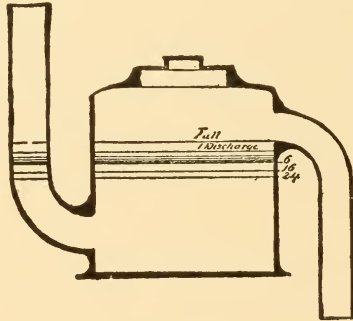

Fig. 9 (563).

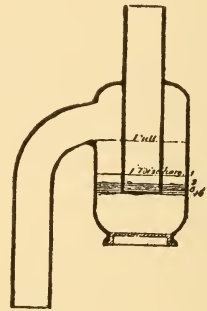

Fig. 10 (564).

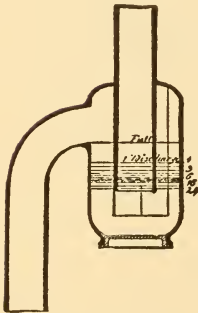

Fig. 11 (565).

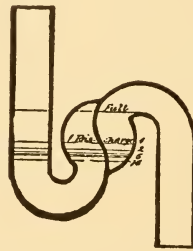

Fig. 12 (566).



Fig. 13 (567).

charges of the closet were sufficient to break the seal. The experiment was repeated several times with the same result.

(c) A $1\frac{1}{2}$ " cast-lead S-trap, constructed as shown in Figure 13, was tested. The vent opening at the crown was $1\frac{1}{4}$ " in diameter; the others were $1\frac{1}{2}$ " in diameter.

REPORT TO THE CITY BOARD OF HEALTH.

A $1\frac{1}{4}$ " pipe 7' long was attached to the vent opening at the crown, the others being closed. Five discharges of the closet sufficed to break the seal.

The pipe was increased to 17'. The seal was then broken by *four* discharges.

This opening was then closed and the long pipe was attached to the middle vent. The first discharge of the closet lowered the seal $1\frac{1}{2}$ ". The second broke the seal.

The lower vent was then tested with the same pipe, 17' long. Four discharges were required to break the seal.

(d) The effect of the discharge of the water-closet while the bath-tub was emptying was then observed.

An ordinary $1\frac{1}{4}$ " S-trap was first tested. With a vent opening the full size with the bore of the trap, but without vent-pipe, a single discharge of the water-closet and bath-tub together lowered the seal $\frac{1}{8}$ ". A second discharge failed to lower the water any further.

(e) A $1\frac{1}{4}$ " vent-pipe 7' long was then attached to the opening. The first discharge nearly broke the seal; the second not only broke it but left the water standing $\frac{1}{2}$ " below the mouth of the inlet-pipe. Three other tests gave the same results.

(f) The vent-pipe was then lengthened to 17'. A single discharge broke the seal, and swept nearly all the water out of the trap. Three repetitions of the test produced the same results.

The vent-opening was then reduced to one inch, and no vent-pipe attached. Two discharges broke the seal.

(g) The $1\frac{1}{2}$ " common cast-lead trap was then tested.

Tested with the $1\frac{1}{4}$ " vent open at the crown, but without any vent-pipe attached to it, a single discharge lowered the seal $\frac{1}{4}$ ". A second discharge produced no further effect.

(h) With a $1\frac{1}{4}$ " vent-pipe 7' long attached to this open-

ing seven discharges sufficed to break the seal.

(i) With the vent-pipe increased to 17', two discharges not only broke the seal but nearly emptied the trap. Substantially the same result was obtained upon repeating the experiment twice.

(j) A 1½" pipe 20' long was attached to the vent opening. Two discharges broke the seal.

The vent-opening was then reduced to 7/8"+, and no vent-pipe attached. Two discharges broke the seal.

(k) The *middle vent* was then tested. With a vent-pipe 1¼" in diameter (inside measure in all cases being understood) and only 8" long, the water-seal was lowered ½" by two discharges. A third discharge did not increase this loss.

(l) With a 1¼" pipe 7' long attached a single discharge broke the seal.

(m) A 1½" pipe 20' long was attached; a single discharge broke the seal.

(n) The *lower vent* was then tested. A 1½" pipe 20' long was attached. Two discharges broke the seal. A repetition of the experiments produced substantially the same result.

It must here be noted that the connections between the traps to be tested and the branches on the soil-pipe were made by means of 1¼" copper tubes soldered into a lead cap on 4" Y-branches, as shown in Figure 13. The outlet arms of the several traps tested were slid over this 1¼" copper tube, and made tight with putty. The connection being only 1¼", when 1½" traps were tested, the suction on their seal was evidently somewhat restricted by the contraction. Hence the records of the experiments on traps having 1½" outlets may safely be accepted as well within

the limits of actual power of the siphonage produced at this point on the 4" Y-branches.

The above recorded tests were all made on the second floor at a distance of 11' below the water-closet trap. Back-pressure was here hardly perceptible. Tested on the first floor the siphonic action was much weaker, but a slight back-pressure was observable. On the basement floor the siphonic action was quite feeble, but back-pressure was exceedingly strong.

Deductions from the Experiments with the Trapped Plunger-Closet.

From the experiments thus far recorded we learn that the siphonic action which may be produced by a trapped plunger water-closet under certain simple conditions which are likely to be encountered in plumbing, is sufficient to unseal small S-traps, such as are ordinarily used for lavatories, though they be ventilated either at or below the crown in the manner prescribed by the plumbing regulations with vent-pipes of the full size of the trap, and that it makes no material difference as to siphonage whether the vent-pipe be applied immediately at the crown or at a considerable distance below it. This action takes place even when the pipes are clean and new. When partially closed or clogged with sediment the results would be even more serious.

(2) *Experiments on the Siphonage of Ventilated S-Traps by a Trapless Plunger Water-Closet.*

(a) The tests were made first with the water-closet alone. A 1¼" ordinary cast-lead S-trap having a vent-opening at the crown the full size of the trap (1¼") was tested without a vent-pipe. The first discharge of the closet reduced the seal ¼"; the second ½"; the third produced no further effect.

The same trap was then tested with 17' of 1¼" pipe attached to the vent-opening. Four discharges of the closet destroyed the seal.

On another occasion the same trap with 7' of 1¼" pipe attached to the vent-opening lost its seal in four discharges.

A 1½" S-trap was then tested at the outlet on the first floor. With the water-closet alone, and a 1½" vent-pipe 20' long attached to a 1¼" opening in the crown of the trap three discharges removed ⅝" of the seal.

The same with a 1¼" vent-pipe 7' long lost its seal in ten discharges.

(b) The tests were next made with the water-closet and bath-tub discharging together.

A 1¼" S-trap with 20' of 1½" vent-pipe lost its seal in five discharges. With 17' of 1¼" pipe a single discharge broke the seal; with 7' of 1¼" pipe seven discharges sufficed and on a second trial only three discharges.

Tests were then made on the floor below (first floor). The 1½" S-trap with 1¼" vent at the crown and 17' of 1¼" pipe lost its seal in three discharges. In a second and third trial the seal was destroyed in two discharges.

The same, with a 1½" vent-pipe 20' long, lost its seal in four discharges.

A 1½" S-trap vent-opening at the crown, and a 1¼" vent-pipe 17' long lost its seal in four discharges, and on a second trial in a single discharge.

Deduction from the Experiments with the Trapless Plunger-Closet.

From these tests we find that the effect of siphonage produced by the discharge of a trapless plunger-closet is not appreciably severer than that produced by one having a trap, provided the trap is constructed of smooth material,

has a shallow seal, and is placed near the water in the bowl. The increase of friction is in this case so slight that the manner in which the water discharges into the soil-pipe is not materially modified.

(B) EXPERIMENTS ON POT AND OTHER TRAPS UNVENTILATED.

These experiments are divided into:—

(1) Those in which the siphonic action was produced by a trapped closet.

(2) Those in which a trapless plunger-closet was used.

(3) Those in which a flush-tank was used.

(1) *Experiments on the Siphonage of Unventilated Pot and other Traps by a Trapped Plunger Water-Closet.*

(a) The tests were first made with the water-closet and bath-tub discharging together. The pot-traps had 1½" or 1¼" inlet and outlet arms.

A 2" pot-trap had its seal broken, and the water lowered ½" below the top of the inlet mouth by a single discharge. Five discharges lowered the water nearly to the bottom of the mouth (see Fig. 2).

A 2½" pot-trap lost its seal in two discharges (see Fig. 3).

A 3" pot-trap lost its seal in four discharges (see Fig. 4).

A 3½" pot-trap lost its seal in seven discharges (see Fig. 5).

A 4" pot-trap lost its seal in seven discharges (See Fig. 6).

A 5" pot-trap lost its seal in twenty-two discharges (see Fig. 7).

A 6" pot-trap lost its seal in twenty-seven discharges (see Fig. 8).

An 8" pot-trap lost 1½" of its seal in twenty-four discharges (see Fig. 9).

A 4" bottle-trap lost its seal in fifteen discharges (see Fig. 10).

A 4" Holland's trap retained $1/16$ " seal after forty discharges (see Fig. 11).

A "Sanitas" anti-siphon trap retained over $3/4$ " after fifty discharges (see Fig. 12).

The loss of water in the Holland's trap in the last ten discharges was exceedingly slow, showing this trap, which is similar in outward appearance to the 4" bottle-trap, to offer much greater resistance to siphonic action than a bottle-trap of the same general dimensions.

The rate of loss in the "Sanitas" trap constantly diminished after the first few discharges. Several experiments were made on this as on the other traps. Figure 12 shows the effect of sixteen discharges. Figure 25 represents in diagram the record of another experiment on the same trap where the test was prolonged to fifty discharges. It will be observed that the loss towards the end was scarcely perceptible. In the first ten discharges in this experiment the seal was lowered $17/8$ ". In the next ten the loss was only one-eighth of an inch, which is equivalent to one-eightieth of an inch for each discharge. In the third ten discharges *i. e.*, one whose top stood 6" above top of seal was first tested it was still further reduced to one-sixteenth of an inch. In the fourth to less than one-sixteenth of an inch, and in the last ten to still less, or about one thirty-second of an inch. As there still remained over $3/4$ " seal the trap may be considered as practically unsiphonable.

Figures 14 to 24 inclusive represent in diagram the result of the experiments already described on "pot" and "bottle" traps.

The perpendicular lines represent the depth of seal of the traps.

REPORT TO THE CITY BOARD OF HEALTH.

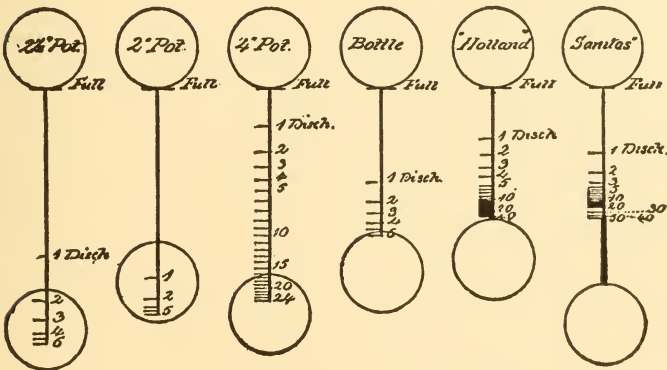
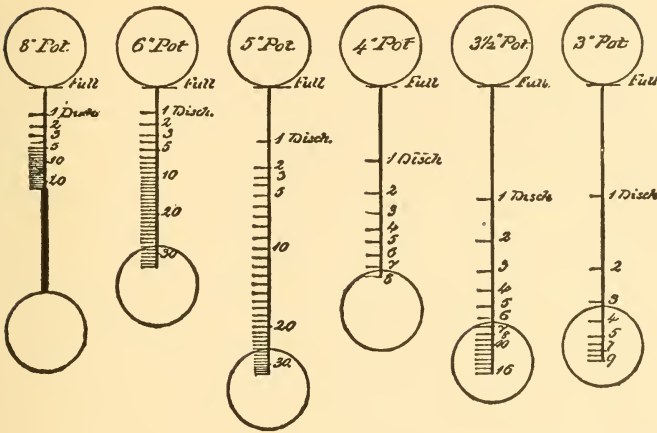

Fig. 14 (568). Fig. 15 (569). Fig. 16 (570). Fig. 17 (571). Fig. 18 (572). Fig. 19 (573).
 Fig. 20 (574). Fig. 21 (575). Fig. 22 (576). Fig. 23 (577). Fig. 24 (578). Fig. 25 (579).

The circles indicate conventionally the outlet and inlet mouths of the traps, and the horizontal lines the loss of water at each discharge.

(b) A 4" pot-trap was then tested with the water-closet

alone. Its seal was broken by sixteen discharges (See Fig. 22).

(c) a $3\frac{1}{2}$ " *pot-trap* was then tested with the flush-tank. The first discharge almost and the second entirely broke the seal. Nevertheless, in other experiments made with the flush-tank the siphonic action proved less severe than that produced by the simultaneous discharge of the water-closet and bath-tub.

Deductions from the Experiments on Pot and other Traps.

From the above experiments we learn that the power of resistance of "pot-traps" depends upon their size, and more particularly upon the diameter of the body. It will be observed that the depth of seal of the 4" pot-trap is only $2\frac{1}{2}$ ", while that of the $3\frac{1}{2}$ " pot-trap is $3\frac{1}{2}$ ". This accounts for the similarity in the results of the tests on these two sizes. A half an inch excess of diameter of the body offsets, in the first series of tests, one inch excess in depth of seal.

It will be observed that, had the seal of all the traps tested been the same in depth, *i. e.*, $2\frac{1}{2}$ ", the resistance would have been in direct and regular proportion to the diameter. Thus, in the first series of tests—

A 2" pot would have lost its seal in less than one discharge.

A $2\frac{1}{2}$ " pot would have lost its seal in one discharge.

A 3" pot would have lost its seal in two discharges.

A $3\frac{1}{2}$ " pot would have lost its seal in three discharges.

A 4" pot would have lost its seal in seven discharges.

A 5" pot would have lost its seal in ten discharges.

A 6" pot would have lost its seal in twenty-eight discharges.

An 8" pot would probably have resisted over one hundred discharges.

Hence (1) the resisting power of pot-traps of equal depth of seal is in direct proportion to the diameter of the body.

(2) No pot-trap whose body does not exceed in sectional area 15 times that of each of its arms or connecting pipes can be accepted as anti-siphonic under all conditions likely to be encountered in plumbing.

(3) Pot-traps having bodies 6" in diameter and having 1½" or 1¼" connections may, however, be considered safe when they are not exposed to the repeated action of plunger water-closets of the largest water-capacity.

II. EXPERIMENTS ON BACK PRESSURE.

These experiments were made on the basement floor, just above the horizontal run of the soil-pipe. They may be subdivided into (A) those in which the traps were tested without vertical extension of the inlet arm; and (B) those in which the traps had their inlet arms extended. The water-closet used was a Zane's trapped plunger-closet.

(A) Experiments on Traps without Vertical Extension.

(a) An S-trap having the ordinary length of inlet-arm, under the discharge of the water-closet alone. The first discharge threw the water out of the trap, projecting it several feet in the air, and broke the seal. The experiment was often repeated with the same result.

(b) The same result attended the discharge of the water-closet, simultaneously with the bath-tub, only that the greater power of the action threw out more water from the trap, leaving the level considerably below the top of the mouth of the inlet-pipe. Several repetitions of the test produced the same result.

(c) The above experiments were repeated with a trap-less plunger-closet. The results were substantially the same.

(d) A 4" pot-trap lost its seal in four discharges of the

water-closet alone. The top of the inlet-arm stood 2" above the top of the seal.

(e) The same trap lost its seal in a single discharge of the water-closet and bath-tub together.

(f) The same traps were tested with a trapless plunger-closet, with substantially the same results. Figure 26 shows the manner in which the water is blown out of a large pot-trap by back-pressure.

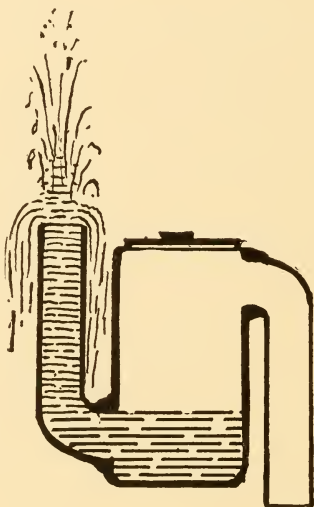

Fig. 26 (580).

(g) An 8" pot-trap lost 2" of its seal in seven discharges of the trapped-closet discharged alone. The top of the inlet-pipe stood 3" above the top of the seal.

(h) The same trap lost its entire seal of 3¾" by the fourteen discharges of the water-closet and bath-tub together.

(B) *Experiments on Traps with Vertical Extension.*

(a) An ordinary, 1½" cast-lead S-trap with an extension of 1' 4" of 1½" lead-pipe attached to the top of its inlet-

REPORT TO THE CITY BOARD OF HEALTH.

arm, making the top of the extension 22" above the top of the seal was tested. No water was thrown out of the trap by the discharge of the water-closet, either trapped or untrapped, and whether alone or together with the bath-tub; but in all cases air was forcibly driven through the water forced into the inlet-pipe, because the volume of water in the trap was insufficient to outweigh the back-pressure.

(b) The same result attended the tests made with a 24" extension-pipe.

(c) An S-trap having 5" of seal without extension lost its seal in all cases; but with an extension of 1' 4" the water was not thrown out by discharges of the water-closet alone, or in combination with the bath-tub, and whether the closet was trapped or trapless. With this trap, moreover, the large volume of water was, with the extension sufficient to overbalance the pressure of the air, and no bubbles were driven through the trap.

(d) The same deep trap was then tested after half its seal had been removed, as by evaporation, or other accident. In this case the trap acted exactly as did the ordinary shallow-sealed, cast-lead S-trap before described, and always allowed air to be driven through it.

(e) A 4" pot-trap was then tested with the 1' 4" extension, bringing the top of the pipe 18" above the seal. No water was driven out of the trap, and no bubbles forced through the water under any of the four conditions under which the tests were made as described for the others.

(f) The same trap with a 6" extension bringing the top of the pipe 8" above the top of the seal lost its entire seal in two discharges of the water-closet and bath-tub together. The volume of the water in the trap was sufficient, but the pipe was not long enough to allow of the formation of a column sufficiently high to resist the air-pressure.

(g) An 8" pot-trap with 1' 4" extension lost no water, and allowed no air to pass under either of the four tests.

(h) The same results attended the tests on this trap, having an extension of only 12".

(i) The trap was next tried with 9" of extension, with the same results.

(j) The extension was finally reduced to 6" bringing the top of the pipe 9" above the top of the seal. In this case the water was driven out of the trap.

(k) A "Sanitas" trap was then tested, and the results were substantially the same as with the 8" pot-trap.

Deductions from the Experiments on Back-Pressure.

From these experiments we learn (1) that in traps which are unventilated back-pressure may be resisted by constructing them in such a manner that they shall contain a large volume of water, and by setting them far enough below the fixture to admit of the formation in the waste-pipe above the trap of a column of water large enough to outweigh the back-pressure of the air.

(2) That the back-pressure in the tests herein recorded was sufficient to balance a column of water between 9" and 12" long, plus the depth of the water forming the seal. Calling the depth in the average trap 3", our water-column was not less than 12" or 15" in height. This is equivalent to one thirty-second or one twenty-fifth of an atmosphere, (0.43 or 0.56 lbs. to the square inch.).

(3) The back-pressure likely to be encountered in properly-plumbed houses will probably never exceed that obtained in the tests above recorded, since all the conditions most favorable to produce it were here combined. Hence any trap may be considered safe against back-pressure which is so formed as to contain a body of water large enough to

REPORT TO THE CITY BOARD OF HEALTH.

fill the waste-pipe full to a height of 12" or 15" (including its own seal), and which is so set as to admit of the formation of this column.

(4) The following is the water capacity of the traps tested.

The 8" pot-trap holds 5 quarts or 10 pints.

The 6" pot-trap holds 3 quarts or 6 pints.

The 5" pot-trap holds $2\frac{1}{2}$ quarts or 5 pints.

The 4" pot-trap holds $2\frac{3}{4}$ pints.

The $3\frac{1}{2}$ " pot-trap holds $2\frac{1}{2}$ pints.

The 3" pot-trap holds 2 pints.

The $2\frac{1}{2}$ " pot-trap holds $1\frac{1}{4}$ pints.

The 2" pot-trap holds $\frac{3}{4}$ pint.

The $1\frac{1}{2}$ " S-trap, with 5" seal, holds $\frac{3}{4}$ pints.

The $1\frac{1}{2}$ " S-trap, with $1\frac{3}{4}$ " seal, holds $\frac{3}{8}+$ pints.

The $1\frac{1}{4}$ " S-trap, with $1\frac{3}{4}$ " seal, holds $\frac{1}{4}-$ pints.

The "Sanitas" holds $1\frac{1}{2}$ pints.

A piece of $1\frac{1}{2}$ " waste-pipe 12" long holds about $\frac{3}{4}$ of a pint of water. A similar piece 15" long holds a pint. Hence a trap used with such a waste-pipe should have a capacity of not less than $\frac{3}{4}$ pint. Accordingly, all unventilated $1\frac{1}{4}$ " S-traps and all unventilated $1\frac{1}{2}$ " S-traps having less than 5" seal are incapable of resisting the back-pressure liable to be encountered in plumbing.

III. EXPERIMENTS ON EVAPORATION PRODUCED BY TRAP-VENTILATION.

These experiments were made in the basement floor, as already explained.

They may be subdivided into (A) those in which the vent-pipe was conducted into a cold flue, and (B) those in which the vent-pipe was conducted into a heated flue.

(A) *Experiments on Evaporation Produced by a Cold*

Ventilating Flue.

(a) $1\frac{1}{4}$ " (scant) S-trap having a seal of $4\frac{5}{8}$ " deep was attached to the end of the branch waste in the manner shown in Fig. 1. A $1\frac{1}{2}$ " rubber ventilating pipe was taken from the $1\frac{1}{4}$ " ventilating opening at the crown of the trap, and conducted into a cold 4" galvanized iron ventilating flue,

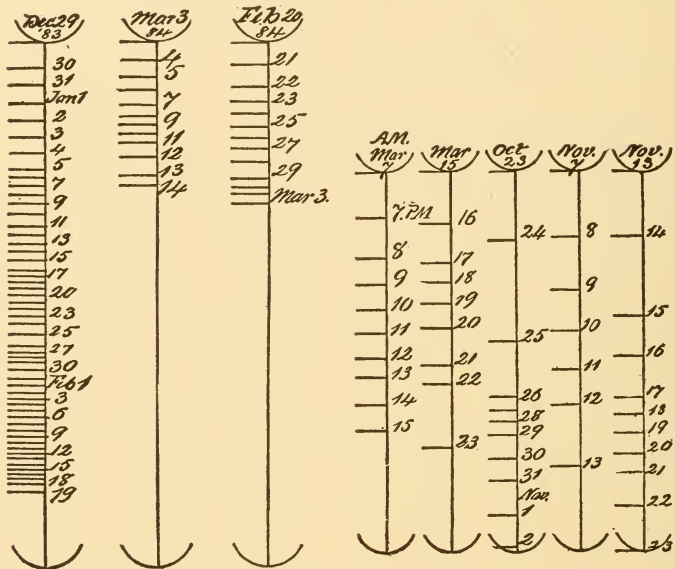

Fig. 27 (581) Fig. 28 (582) Fig. 29 (583) Figs. 30 (584) 31 (585) 32 (586) 33 (587) 34 (588)

shown in the drawing. This flue passed through two occupied offices (basement and first floor) whose temperature was maintained at about 68° Fahrenheit, during the term of the experiments, and through a chemical laboratory (second floor) whose temperature was maintained at about 60°

Fahrenheit. For the remainder of its height the flue passed through a cellar and stairways, whose temperature was maintained at about 45° Fahrenheit. No artificial heat was applied to the flue.

The velocity of the movement of the current of air in the flue was measured by the anemometer. The daily rate of loss of seal by evaporation, and the velocity of the current in feet per minute is shown *in actual size* by the accompanying diagram, Fig. 27* to 29.

We see that the loss averages about an eighth of an inch *per diem*. It amounts to about a quarter of an inch the first day, and gradually diminishes as the level of the water descends in the trap, and the distance of its surface from the ventilating current increases, to a little less than an eighth of an inch *per diem*. Hence an ordinary S-trap having a $1\frac{1}{2}$ " or a $1\frac{3}{4}$ " seal would lose its seal in from nine to eleven days.

(b) The experiment was repeated several times at different parts of the year, from the middle of December to the middle of May, with substantially the same results. Fig. 29 represents the record of a second of these experiments.

(c) The same trap was now vented at the middle opening, whose center was 2" below the center of the upper opening. The rate of evaporation was somewhat slower, as shown by diagram, Fig. 28. This experiment was carried on only eleven days, inasmuch as by this time $1\frac{1}{2}$ " of the seal had been destroyed, and the seal of ordinary machine-made S-traps does not exceed $1\frac{1}{2}$ " or $1\frac{3}{4}$ ".

(d) The same trap was now ventilated at the lowest point, *i. e.*, 6" below the crown. The evaporation in this case was exceedingly slow and after the first two or three days was almost inappreciable.

*These cuts have since been reduced to about 1-2 their original dimensions, so that they are now about on-half full size.

(e) A number of experiments were then made on S-traps *unventilated* but open in both ends as is the case in practice. The loss of water was almost inappreciable, not exceeding $1/32$ or $1/16$ of an inch in ten days.

(B) *Experiments on Evaporation Produced by a Heated Ventilating Flue.*

(a) A $1\frac{1}{2}$ " trap having a seal $3\frac{1}{4}$ " was tested. A $1\frac{1}{2}$ " wrought iron gas pipe 6" long connected the crown of the trap with a brick flue 8"x12", heated by a stove. See Fig. 1.

Diagrams, Figs. 30, 31, 32, 33 and 34, represent five tests, two made in March, one in October and two in November of 1883. Here again the perpendicular lines represent, in *actual* length, the depth of seal of the trap. The upper arc represents conventionally the outlet mouth, and the lower arc the inlet mouth of the trap. The horizontal lines show the position of the water level in the trap at the same hour in the morning of each day recorded in figures on the diagram.

We see here a very rapid diminution of the seal. The average loss *per diem* exceeded one-third of an inch, or exactly four-elevenths of an inch. The smallest loss is one-eighth of an inch, and the largest nearly seven-eighths of an inch. The fixture side of the trap was closed during the tests.

(b) A second series of experiments was made with an ordinary $1\frac{1}{2}$ " cast lead trap having a seal $1\frac{1}{2}$ " deep. The trap was connected with the heated flue at a point 3" beyond the crown. Four tests were made. The loss of seal was much slower than in the former tests because of the distance of the mouth of the vent-pipe from the crown of the trap. The rate of evaporation, however, in these four tests averaged one-seventh of an inch a day, the greatest loss in any one day being three-eighths of an inch. In all

these experiments on evaporation it was found to make no material difference in the results whether the fixture end of the trap was open or closed, showing that evaporation at this point was inappreciable.

In the experiments on evaporation with the cold ventilating flue, in the first experiment with the vent at crown, the anemometer recorded an average rate of movement of the ventilating current of 112,567', or 20½ miles, every twenty-four hours, or, with the correction for friction applied, of 94' per minute.

In the second test, with vent at crown, the average was 85' per minute; with vent 2" from crown the average was 109'.

The velocity of the current during the cold months of the year was quite uniform. In the summer months, however, it was exceedingly variable, sometimes equaling that of the cold season, and sometimes ceasing entirely, or even retrograding.

In the cold months the relation between the rapidity of evaporation and the velocity and dampness of the air current was not accurately determined, the rate of evaporation being quite uniform in spite of considerable barometric fluctuation and change of velocity.

But in summer a change of the conditions of the atmosphere produced a very marked change in the rate of evaporation. On a few occasions of damp or rainy weather in the summer months, where the cold brick flue was used without a ventilating cap on top, the seal actually gained slightly in depth, from condensation on the cold flue of the damp air of the soil-pipe, or from an actual fall of rain or moisture down the chimney. These accretions were, however, very rare, not occurring more than three times in the whole duration of the experiments.

The scientific investigation of this branch of the subject

would require more elaborate apparatus and much more time than have been at our disposal, yet what records we have made have been made with accuracy.

Deductions from the Experiments on Evaporation.

From these experiments we find (1) that a rapid evaporation of the water seal of traps takes place when they are ventilated at or near the crown, and that the evaporation goes on both in winter and in summer, and in ordinary unheated flues, as well as in flues artificially heated. The evaporation is most rapid in winter or with flues artificially heated, and slowest in summer, especially in damp weather. Hence it may be stated generally that the rapidity of the evaporation depends upon the velocity, temperature and hygrometric condition of the atmosphere.

(2) That in winter the evaporation produced by ventilation is so rapid as to destroy the seal of an ordinary 1½" machine-made S-trap in from four to eleven days, according to the nature of the current.

(3) That without ventilation, or with the ventilating flue taken from a considerable distance below the crown, the evaporation of the water seal of traps is exceedingly slow, and that unventilated traps having a considerable water capacity may be considered perfectly secure against this danger unless they are left unused for years at a time.

It would obviously be impossible to devise a form of apparatus for experimental purposes which should cover all the varying conditions liable to be met with in plumbing practice. The position of the trap on the soil pipe branch, the manner and position of connection of the branch with the main pipe, the amount of usage the pipes sustained, the manner in which the ventilating flues were constructed, would all produce their effects upon the results. Never-

REPORT TO THE CITY BOARD OF HEALTH.

theless in every case where the ventilating flue performed the office of producing a movement of the air within the pipes for which it was intended, and this air was absolutely saturated with moisture, the evaporation must of necessity go on in the manner recorded as the result of these experiments. How far the variation of the conditions would affect the rapidity of the loss of seal must be left to other investigators to determine. The apparatus used in the above recorded tests was fitted up exactly as is customary to fit it up for actual use. The entire length of the soil pipe was kept much of the time wet during the experiments on evaporation, by discharges through it made for the tests on siphonage and back pressure, precaution being, of course, taken by closing the inlet end of the trap against loss of its seal through these agencies, and the inlet at the end of the soil pipe system, where the fresh air was taken in to produce the ventilating current above the trap, was distant as much as 60' or 70' from the traps tested. Hence the air was obliged to traverse a considerable length of damp soil pipe, the greater part being nearly horizontal, on its way to the trap, and it may therefore be assumed it was conducted over as large an area of moist surface as it would ordinarily encounter in practice.

Moreover, the result of our experiments in this direction accords with the experience of many sanitary engineers, health inspectors and plumbers who have recently had occasion, since the enactment of the plumbing laws in various parts of the country, to observe the effect of the provision requiring branch ventilation on the water seal of the traps.

GENERAL CONCLUSIONS DEDUCED FROM THE EXPERIMENTS ON SIPHONAGE, BACK PRESSURE AND EVAPORATION.

From the foregoing experiments we deduce the following:
(1) The ordinary form of machine-made small S-trap

with shallow seal and without special ventilation is incapable of resisting the action of siphonage or back pressure, even in a very mild form.

(2) A small S-trap, such as is used for lavatories and bath-tubs, even when hand-made, and of unusually deep seal, is incapable without special ventilation of resisting the action of siphonage or back pressure in a mild form.

(3) Small S-traps, when ventilated at the crown with vent pipes having a diameter the full size of the bore of the pipe and of no unusual or excessive length, are incapable of resisting the severe action of siphonage produced by the simultaneous discharge of certain forms of plunger water-closets and ordinary bath tubs under ordinary conditions likely to be encountered in practice.

Water-closets producing a powerful flushing of the soil-pipes when discharged should not be prohibited on account of their siphoning power, because the periodical flushing of the soil pipes by their use is productive of great good, and their siphoning action may be counteracted by other means.

(4) Special trap ventilation when the vent pipe is applied at or near the crown of the trap induces a current of air over the water which rapidly destroys the seal.

(5) Trap ventilation when the vent pipe is applied at a point so far below the crown as to avoid the danger of evaporation leaves the trap open to the danger of self-siphonage as well as of severe siphonic action. The position of the vent pipe on the trap does not (at least within the limits covered by our experiments) materially affect the action of siphonage.

(6) Pot-traps of the ordinary sizes are incapable, without special trap ventilation, of resisting the severest action of siphonage liable to be encountered in plumbing.

(7) Pot-traps of the largest size are expensive, and are

REPORT TO THE CITY BOARD OF HEALTH.

open to the objections attending all cesspools. The positions of their clean-out caps are faulty, inasmuch as they are above the water line, and would fail to announce, by a leakage of water, a faulty adjustment of the cap.

(Signed) J. P. PUTNAM,
L. FREDK. RICE.

4 Pemberton Sq., June, 1884.

CHAPTER XL.

REVIEW OF DR. TEALE'S INTERESTING WORK ON "DANGERS TO HEALTH."

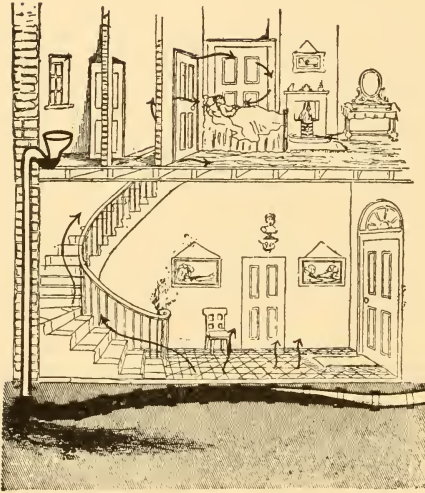

Fig. 589. Drain under house with fall wrong way. Broken pipe at the junction with "soil pipe."

In the original course of these lectures before the North End Union a number of very striking illustrations from Dr. Teale's "Dangers to Health"* were reproduced upon the screen for the purpose of presenting effective warnings against certain forms of improper work, as well as to call attention to the very marked change of feeling in regard to

"sewer gas" which has developed within the last few years.

At the time this book was written sewer air was supposed to swarm with disease germs, Dr. Teale writing in his introduction: "Moreover, the conviction struck deeply into my mind that probably one-third at least of the incidental illness of the Kingdom, including perhaps much of childbirth illness

* "Dangers to Health. A Pictorial Guide to Domestic Sanitary Defects." By T. Pridgin Teale, M. A., Surgeon to the General Infirmary at Leeds. Published by J. & J. Churchill. London, 1878.

and some of the fatal results of surgical operations in hospitals and private houses (surgical calamities, Sir James Paget would call them), are the results of drainage defects, and therefore *can* be and *ought* to be prevented."

The world had not at the time of the publication of this book had the advantage of the discoveries in bacteriology recently made as to the freedom of sewer air from pathogenic germs, and hence Dr. Teale makes the breathing of

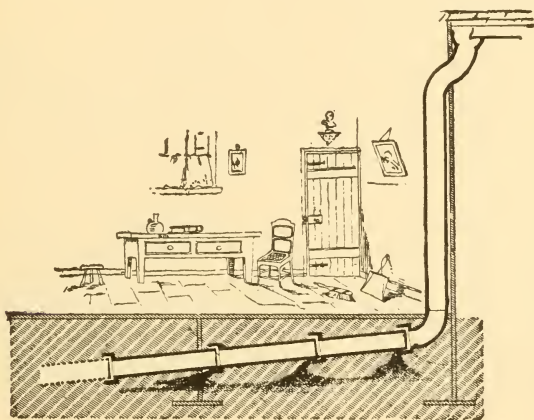

Fig. 590. Pipes laid with the flange down hill.

sewer air the direct rather than a possible occasional indirect cause of many of the fatalities described.

Nevertheless the warnings he utters are most interesting and serviceable, although the exact form of danger was not so clearly understood as it is today, and I have grouped his pictures together in one chapter, where I could better contrast the more modern interpretation of the defects he illustrates with his own view of them, and that of leaders of the medical profession of his day.

The initial cut, Fig. 589, illustrates a case of sickness re-

corded by Dr. Teale from a leaky drain, due to very poor grading, and Fig. 590 another similar case. In the first a broken joint at the foot of the soil pipe, probably caused by the settlement of the masonry wall which the soil pipe ran. Breathing the sewer air had the same effect upon the patient above that breathing any bad air would have caused. It diminished the vital forces and lessened the chances of victory of the white corpuscles, so that when she drank the

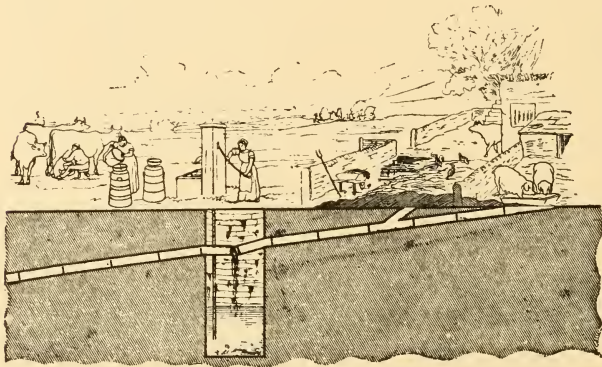

Fig. 591. Drain leaking into a well. Water leaking into the milk cans.

milk from the dairy, as shown in Fig. 591, they were unable to resist the disease germs conveyed by it.

In this picture, Fig. 591, the drain pipe from the pigsty and cowshed actually passed through the well, the settlement of which, or some other accident, broke the pipe, and the result was that all the milk from that farm contained sewage germs, either from the direct admixture with it of this well water, or else by rinsing the cans and other dairy implements with this water.

These pictures hint to us that a public milk supply is at least as important as a public sewerage system.

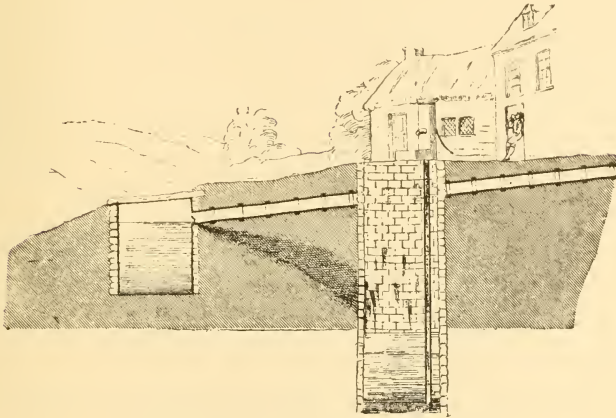

Fig. 592. Cesspool leaking into a well.



Fig. 593. New Vicarage Cesspool overflowing into a Tank.

It seems astonishing that anyone should have ever made a pipe connection between cistern and cesspool, but it has frequently been done, and this picture, Fig. 592, may serve

as a useful warning, for there seems to be no folly which human beings will not sometimes commit.

Dr. Teale reports that typhoid fever broke out at this house, and here illustrates what was believed to be the cause.

Fig. 593 shows another accident, explaining how diseases spread in country towns and villages and how unnecessary it is to assume that sewer air itself contains the disease

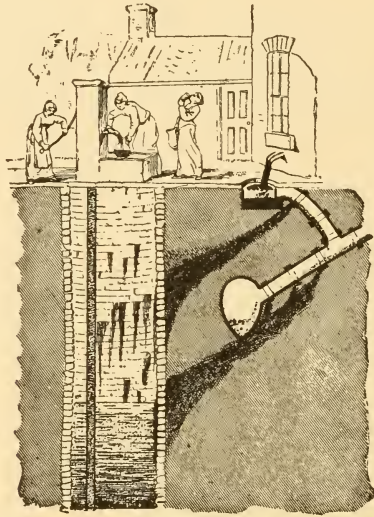

Fig. 594. How people drink sewage. Drain leaking into a well.

germs when faulty plumbing conducts it into the house. This picture shows the case of a newly built vicarage for which the rainwater tank served also as an overflow tank for the cesspool, instead of the reverse, as was intended.

Fig. 594 shows a most painful occupation more frequently seen in nearly all country towns than is generally supposed.

Fig. 595 shows a remarkably undesirable condition of things, four cesspools connected by a leaky drain, all ventilated through the rooms of the house. Nevertheless the occupants managed to live. If disease germs abounded in

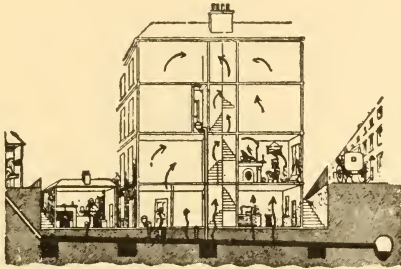

Fig. 595. Plenty of "deadly sewer gas," but occupants still live.

the air of sewers, as is supposed by some even today, not a soul would be living in such a house and town as this, nor, indeed, anywhere in England or elsewhere, so universal are leaky drains. We know now that, had the cesspools been omitted and the sewers been well built and jointed and ventilated through the soil pipes of every house, neither odor nor danger of any kind to health could have resulted.

Fig. 596 was contributed to Dr. Teale's list by a physician. In this house four cases of typhus and typhoid fever had occurred, one resulting in death. The dairy was directly over the drain. The joints in the flagging were purposely left open, as shown, in order that water and any spilt milk might be swept directly into the drain, and the doctor believed the air in the house had been poisoned by emanations from the defective drain resulting from the decomposition of organic matter and milk therein.

The first case of typhoid was undoubtedly contracted somewhere from contaminated food or drink. The other

cases may possibly have come from typhoid germs dissipated through the air from dried sewage from the leaky drain below the house.

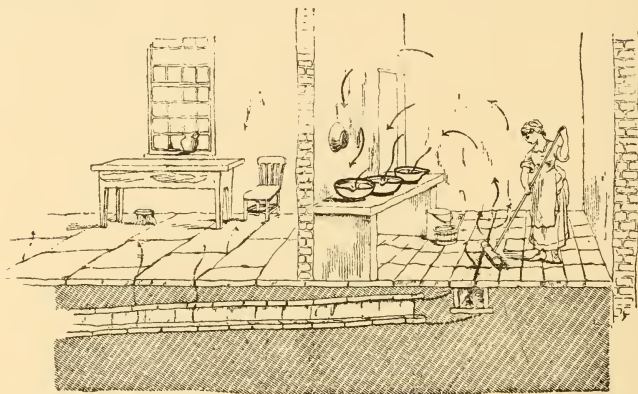

Fig. 596. "Dairy Sweepings."

Fig. 597 is an illustration of a gentleman's house in which typhoid fever broke out, and thence spread into the village. On examination it was found that the water-closet discharged into an ordinary stone drain, almost without any fall, which ran under a tiled entrance hall. The drain had become choked, and the sewage had found its way under the flooring of the passageway and rooms. It was assumed that disease germs were disseminated by air currents through the house from the dried sewage under the floors and formed the direct cause of the fever outbreak. But today the fatality would be explained as in the last illustration.

Another physician sent to the doctor a sketch forming the subject of Fig. 598. The living room had been built over an old forgotten drain and cesspool. Typhoid fever broke out in the house from which one patient recovered and another died, and it was supposed at the time to be

REVIEW OF DR. TEALE'S WORK, "DANGERS TO HEALTH."

directly due to disease germs in the sewer air. But it would now be said that the constant breathing of the foul

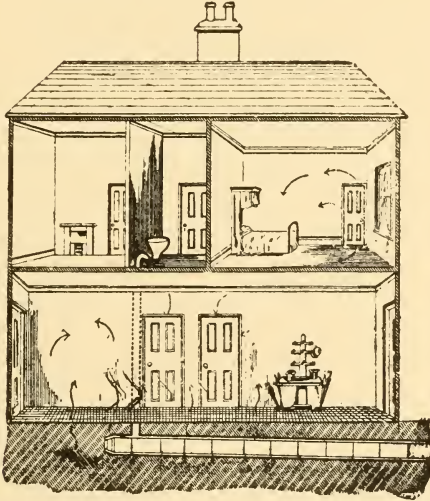

Fig. 597. Leakage under the tiling, and forming a large cesspool under the house.

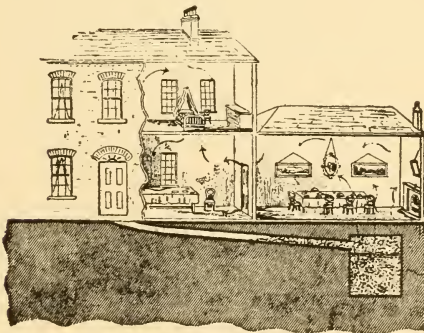

Fig. 598. Addition to a house built over an unsuspected cesspool.

PLUMBING AND HOUSEHOLD SANITATION.

air of the drain presumably lowered the vitality so that the typhoid germs, entering the system from some other source, found a soil favorable for its growth.

Fig. 599 is an illustration showing direct pollution of both air and water supply at the same time. It gave an excellent opportunity for the foul air to lower the vitality of the occupants, so that the use of polluted water found a fertile field for the inoculation of disease. The sewer connection was faulty, as were also the connections of the plumbing fixtures, the very dangerous form of bell traps

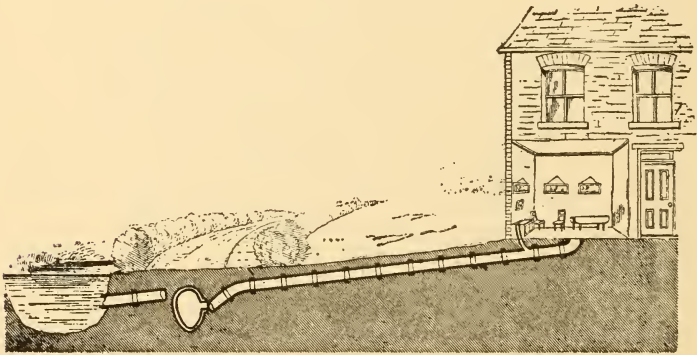

Fig. 599. Disconnected and Misconnected.

being used. A maid servant and a boy were seized with typhoid fever here, the former dying, probably from drinking from the pond.

Another case of death by typhoid fever occurred in the house of a surgeon of Leeds, which Dr. Teale illustrates (Fig. 600) and describes. There had been illness in the family for some time before the attack of typhoid, from which the surgeon and a maid servant both suffered, the latter dying. Emanations from the cesspool A were supposed to have directly caused the disease.

Fig. 601 shows the manner in which a leak in a cesspool connection has polluted the cellar of a neighboring building. Dr. Teale cites the case of the death of two children from diphtheria, and of suffering from chronic sore throat in a house thus contaminated. A similar case, shown in Fig. 602, was reported to Dr. Teale by an artist, who sent him the

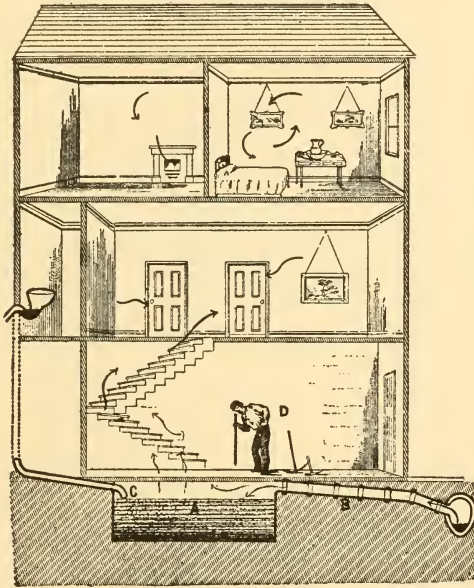

Fig. 600. A, Rain water tank under cellar floor, with overflow into drain. D, Workman "sounding with crowbar" for suspected "tank" or "cesspool."

sketch of the defect in drainage of a house in which a fatal case of typhoid fever had occurred.

In the first case, Fig. 601, complaints of the dampness and offensiveness of the cellar had been ineffectually made to the agent of the landlord, but they dared not complain to the landlord himself for fear of dismissal. In this manner

children are sometimes sacrificed and whole neighborhoods endangered by poverty and dependency, and the need of rigid sanitary legislation in behalf of people unable to protect themselves is here strikingly exemplified. For, although

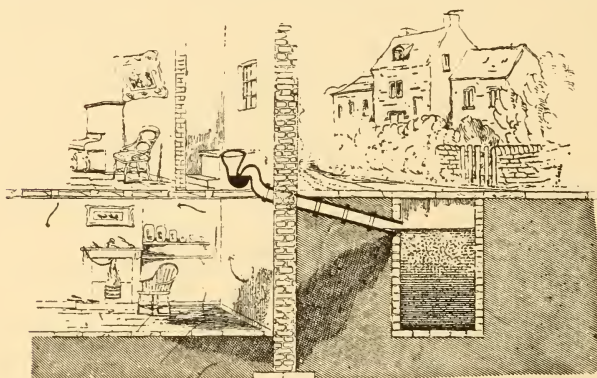

Fig. 601. Dampness of house from overflow of cesspool.

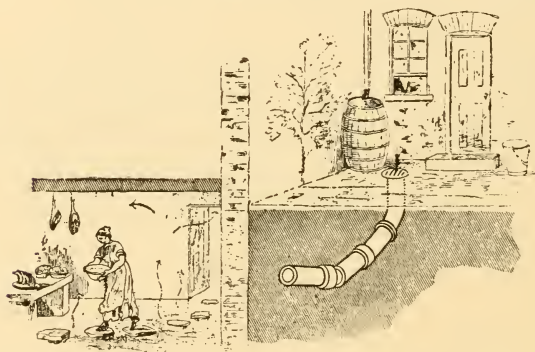

Fig. 602. Danger from next door neighbor's drain.

in this particular case the drains may have had nothing to do with spreading the specific disease, they were nevertheless supposed at the time to have carried it, and the moral obligations were therefore the same.

Prof. Bostic Hill* in 1895 described a case of probable poisoning of about a hundred people who had eaten soup exposed to sewer air, one of whom died. Prof. Hill gives in full in the account his own reasons for ascribing the poisoning to sewer emanations. Figs. 603 and 604 illustrate the manner in which the sewer was vented by a pipe run-

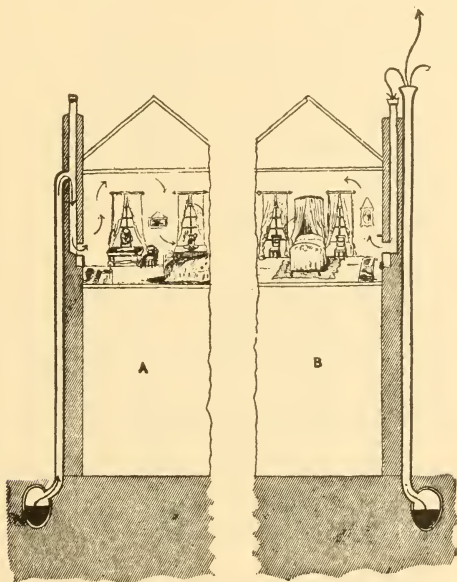

Fig. 603. A, Ventilating pipe of drain turned into bedroom chimney. B, Ventilator of drain discharging close to a chimney pot.

ning up by the side of the building in which the soup was kept. It is not an uncommon source of danger, and an outbreak of typhoid fever at Cambridge, England, some years ago, was attributed to this cause. The picture, Fig. 604, shows a schoolhouse in which a fatal case of typhoid fever occurred. It was attributed to the entrance of sewer air

* "Enteric Fever at Melton Mowbray." Report, 1881.

through the chimney flue, as shown. The soup which occasioned the poisoning described by Prof. Hill was made heavy from beef and rabbit. An outbreak of typhoid fever could not have been produced in the manner described. If the germs could have been conveyed through the air at all, it would not have been the air of the soil pipe, but rather

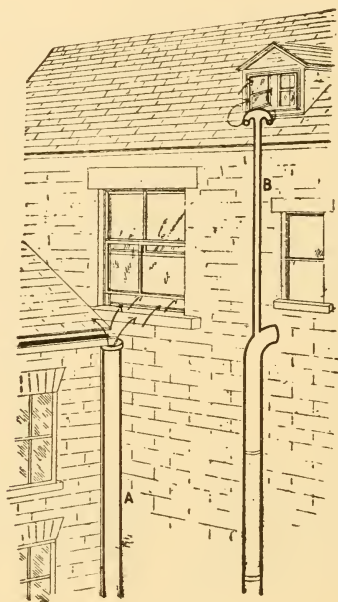

Fig. 604. A, soil pipe communicating with sewer and opening just below bedroom window. B, Ventilator of soil pipe discharging close to the attic window.

the air of the house or street, because the sewer and soil pipe act, as we have shown, as filters in arresting and destroying them. It would be as reasonable to attribute typhoid fever to that part of a water from a well contaminated with typhoid germs which had been thoroughly boiled and fil-

tered, when that part which had not been disinfected had been still more freely imbibed.

Fig. 605 shows a very similar contamination of such meats in an infirmary at Leeds, where sink drains were found practically untrapped in every instance and were believed to have caused certain outbreaks of diarrhœa which occurred at the hospital.

Finkelburg* reports a case which shows the rapidity of action of sewer gas when generated in sufficient volume.

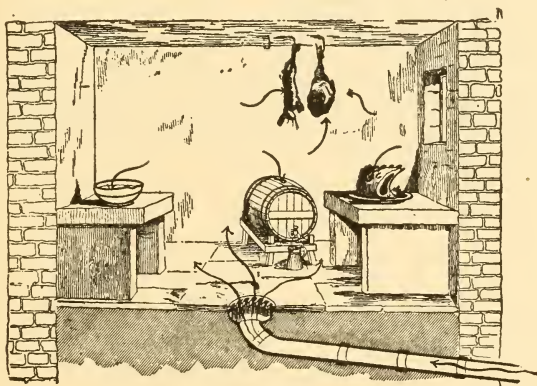

Fig. 605. Bad keeping cellar. "No wonder the meat won't keep, the beer turns sour, and the milk disagrees."

The basement of a house of detention four feet below grade was flooded by the backing up of sewage from a sewer. Thirteen brushmakers in a room not far distant were taken so seriously ill as to have to be removed to the hospital. The next illustration, Fig. 606, illustrates this case. The cellar has been flooded by the backing up of sewage from a clogged-up drain, the stoppage arising from the use of a 6-inch pipe between two 4i-nch pipes.

* "Vierteljahrschrift für gerichtliche Medizin. N. F. X. X., page 301.

PLUMBING AND HOUSEHOLD SANITATION.

Most of the brushmakers fell ill on the day after the sewage had been pumped out, during which operation a pestilential odor pervaded the premises. While the liquid

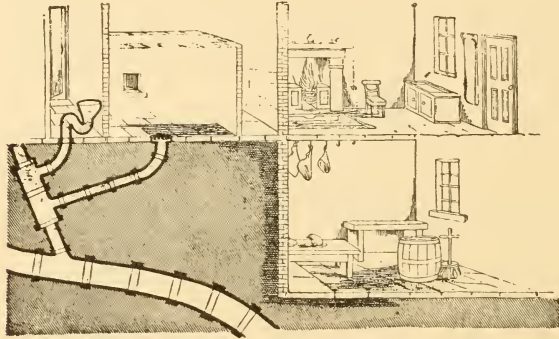

Fig. 606. Six-inch pipe between two four-inch pipes.

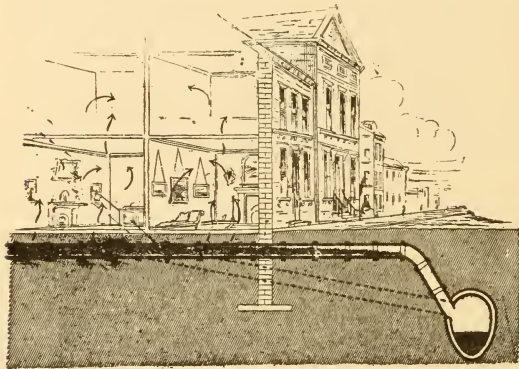

Fig. 607. Economy in digging at the expense of fall.

sewage covered the floor, bacteria could not arise from it. But after the pumping out, the drying of the floor would set free the micro-organisms, so that a strong air suction could distribute them through the building above.

REVIEW OF DR. TEALE'S WORK, "DANGERS TO HEALTH."

Backing up also occurred in the case shown in Fig. 607, where, you see, too little fall has been allowed for the drain.

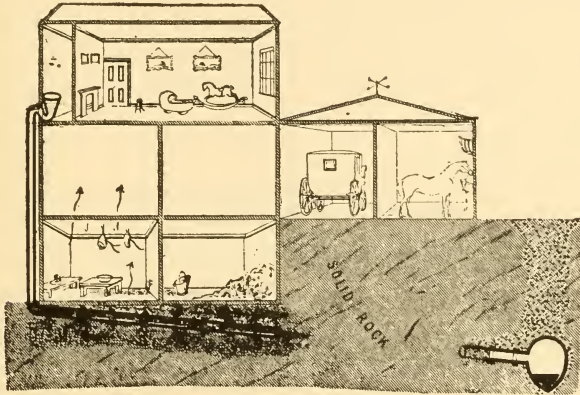

Fig. 608. "To be continued in our next." The authorities saw the junction.

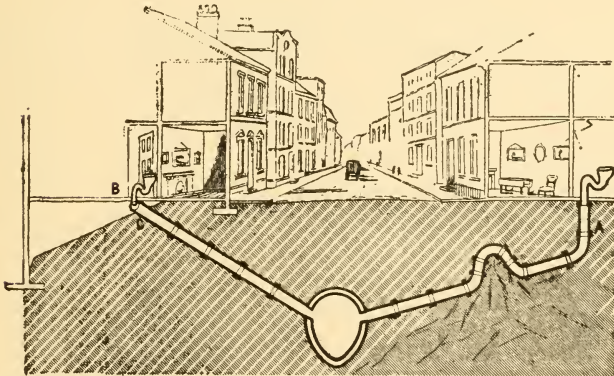

Fig. 609. A, Drain "taking" a rock; sewage "refusing." B, W C, Discharging into Basement of a House.

The next pictures show two other cases of backing up recorded by Dr. Teale, Figs. 608 and 609. In the first the contractor had discontinued the house drain on its way to

the sewer on account of a rock which came between the two. The result was that all the waste from the water-closet had been soaking away into the ground from the time when the house was built, seven years before the discovery of this defect, and the children had all the time been ailing. Here also bacteria could escape from drying earth, as well as the dangerous gases of putrefaction, and contaminate the milk and meat in the kitchen over the drain.

In the other picture, Fig. 609, backing up occurred from a sharp upward bend in the drain to enable it to climb over a spur in a rock and save the contractor from the work of blasting. Another defect is shown in this picture at the point of connection of the water-closet outlet pipe with the house drain. These defects in drain "grading" were described by Mr. Teale as very common, being reported to him on many occasions by eye-witnesses. They are strong arguments for requiring all drains outside of the house to be laid by a properly organized public health department, rather than by contract, thereby eliminating the element of profit. Where public health is concerned the importance of this principle is more easily understood.

Of course, with the modern system of laying all drain pipes of well jointed iron, a pipe might be laid considerably more out of alignment than could be the case with tile drains.

Dr. Teale gives still another illustration of food poisoning by sewer gas, which I reproduce in the next picture, Fig. 610. This took place at a villa in Cannes, France, where a lady was sent for her health. Her maid fell ill of typhoid fever, and upon investigation it was found that a water-closet on the second floor discharged into a large tank or cesspool in the basement, and that the cesspool overflowed upon the floor of the room which was next to the larder and kitchen. Thus the products of putrefaction ap-

REVIEW OF DR. TEALE'S WORK, "DANGERS TO HEALTH."

peared to have contaminated the food supply and entered the bedrooms, occasioning, it was believed, either directly or indirectly, the typhoid case.

Fig. 611 represents the scene of a case of diphtheria

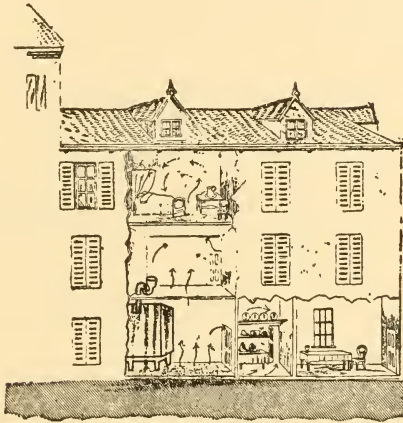

Fig. 610. A villa at Cannes.

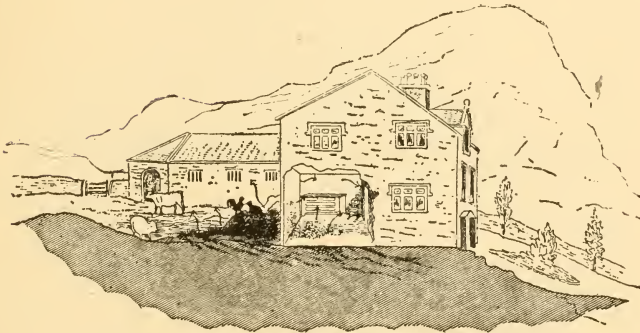

Fig. 611. Manure heaps against house walls.

PLUMBING AND HOUSEHOLD SANITATION.

occasioned, it was believed, by the putrefaction of a heap of manure from the barn yard, which was piled up against the wall of the dwelling house and penetrated the walls and floors.

A case of an outbreak of enteric fever was reported to be caused by the backing up of sewage infected by typhoid

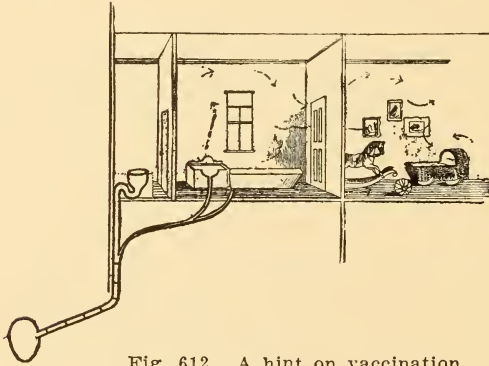

Fig. 612. A hint on vaccination.

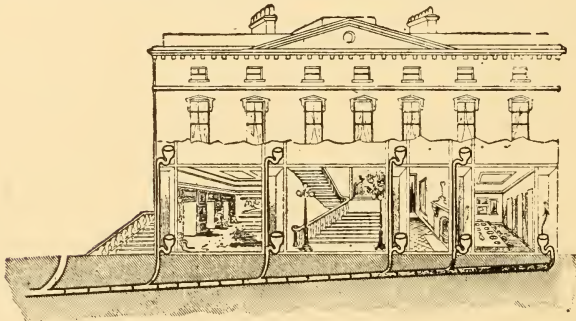

Fig. 613. An "eligible mansion" in Scotland let for the season.

germs, as was supposed, the sewage drying in the pipes, and then the sewer air entering the houses through untrapped drain inlets and plumbing fixtures. The two pictures, Figs. 612 and 613, show the conditions described.

REVIEW OF DR. TEALE'S WORK, "DANGERS TO HEALTH."

In the second of these pictures all the upper water-closets siphoned themselves and the ones below them when they were discharged, and a stoppage in the drains gave rise to putrefactive decomposition.

In the other picture is recorded a supposed case of serious illness of a healthy child due to sewer gas infection after vaccination. Abscesses formed on the finger and ankle. The waste pipes of a basin and a bath near the nursery

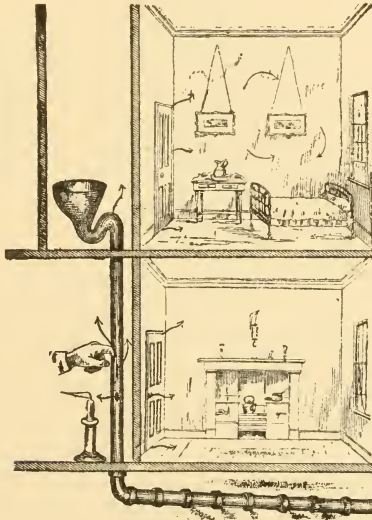

Fig. 614. Leaden soil pipe secured and crumbling from old age.

were untrapped. The sewer appears to have been inadequately ventilated.

Dr. Fergus and others show (Fig. 614) that the corrosion of lead pipes in plumbing, causing not pin holes only, but crowbar holes, is a chemical effect of concentrated sewer gas, the corrosion going on with greatly increased rapidity where pipes are foul and unventilated. What will

destroy metal pipes is also injurious to the delicate tissue of the lungs, and it is certain that our safety is in proportion to the amount of dilution of the dangerous gases by fresh air. Dr. Fergus considered the duration of ventilated soil pipes when made of soft lead from 18 to 20 or more years, but when unventilated of but very few years. In



Figs. 615 and 616. Guests have too little, butler too much liquid.

the case shown in the picture Dr. Teale described the lead as "so rotten that it crumbled like shortcake."

In Figs. 615 and 616 we have a curious case of accident, due to the house owner being unaware of the presence of a cesspool under his cellar. The dining room is shown in

the upper half of the picture with the landlord anxiously ringing for more wine for his thirsty guests. The wringing of an unexpected brand of whine from the poor butler resulted from his piercing the wrong cask below and bringing up a sample of stronger flavor and apparently greater antiquity than the host desired.

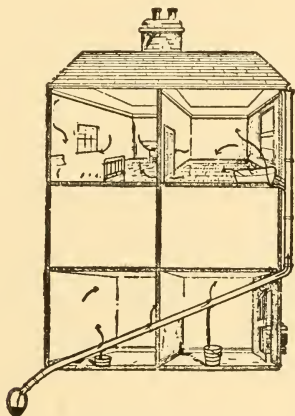

Fig. 604. A, Soil pipe communicating with sewer and opening just below bedroom window. B, Ventilator of soil pipe discharging.

The next picture, Fig. 617, shows lead-caulked joints of a soil pipe and rainwater conductor opened by hot water from a bath tub in the second story. The occupant of this house suffered from erysipelas of the face, attributed to the breathing of sewer gas.

The next pictures show two other cases of defective plumbing. In Fig. 618 the waste pipe was originally connected with a bath tub, which was taken up, but the waste pipe was left open. In the room marked B an old sink

PLUMBING AND HOUSEHOLD SANITATION.

waste pipe was treated in the same manner. Result, "constant bad odor, sore throat," says Dr. Teale.

Fig. 620 gives an illustration of the loss of water seat by evaporation in unoccupied houses, or in unused spare rooms.

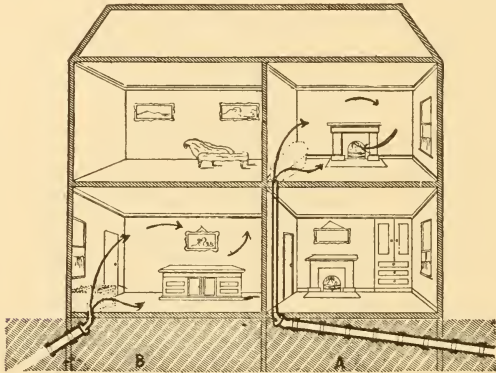

Fig. 618. "A" Bath waste pipe cut off and left open to the drain, "B," Sink waste pipe ditto.

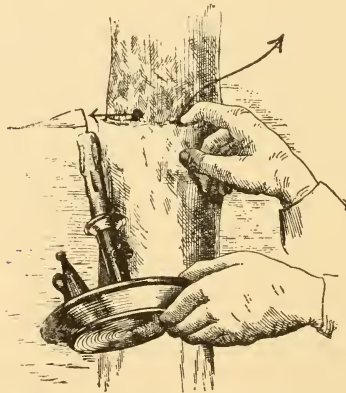

Fig. 619. Putty Joints in Leaden Soil Pipes.
Fig. 619 shows one of the disadvantages of the use of lead in plumbing.

Fig. 621 shows an arrangement of fixtures taken from a house described by Dr. Teale in which each discharge of the water-closet siphoned the wash basin trap with the greatest

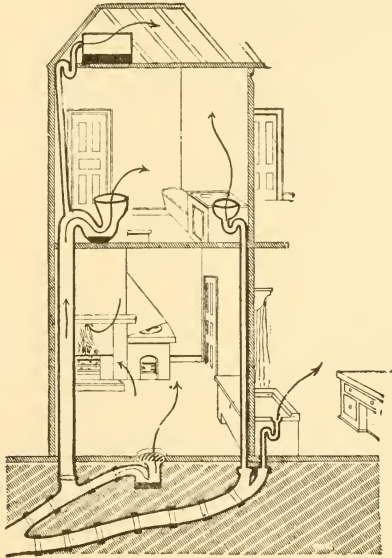

Fig. 620. Disused Trap. Evaporation of water.
Direct communication with the drain.

ease. The gentleman occupying the bedroom from which this illustration was taken was suffering from erysipelas of the face, and was about to undergo a surgical operation. His surgeon refused to perform any operation until the lavatory pipe was cut off from the drain and made to discharge into the open air. In the climate of England this treatment is a safe one so far as freezing is concerned, but is not permissible here. Thus the poor patient was obliged to shoulder two heavy bills, his physician's as well as his plumber's. The use of an anti-siphon trap would have avoided the latter. As here arranged, we have excellent conditions for producing self-siphonage of the wash basin

trap. When a basin having an outlet as large as the one shown is discharged by lifting the plug, it will fill its waste pipe "full bore" and the contents of the basin, up to its overflow opening, will fill the pipe full as far as to its connection with the soil pipe. This long arm of the siphon will at once pull over the water in the short arm as soon as the basin is empty, and the suction in the trap will continue until the water column has traversed the entire length

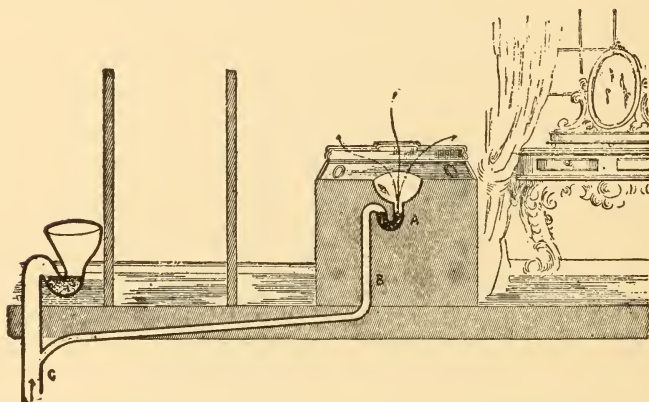

Fig. 621. "Lavatory in bedroom trapped, but discharging into soil pipe of W. C."

of the branch waste, thus giving the siphoning action ample time to suck out any water that may trickle down into the trap from the basin after the discharge. This action will be the more positive the longer the branch waste and the greater its pitch, reaching its maximum with the perpendicular position of the waste pipe.

The next four figures give some examples of bad joints and their effects. In Fig. 622 we find the junction between the metal soil pipe and the tile drain has been broken through the settlement of the ground around the joint, which has broken the cement and allowed the sewage to escape into a well under the house. This house was formerly used by

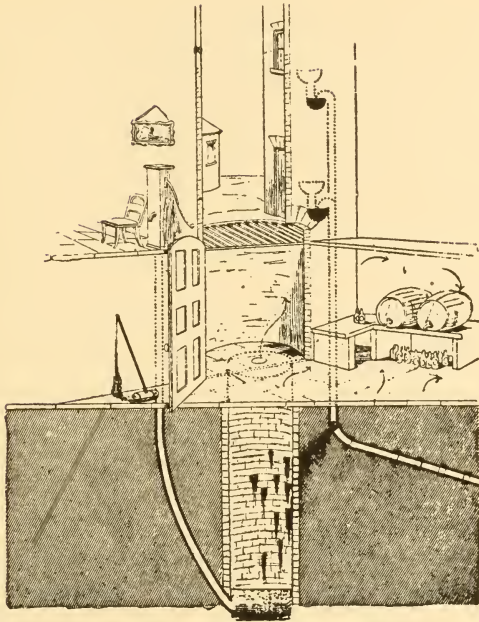

Fig. 622. 'Broken junction of drain and soil pipe, and fouling of well under a house.

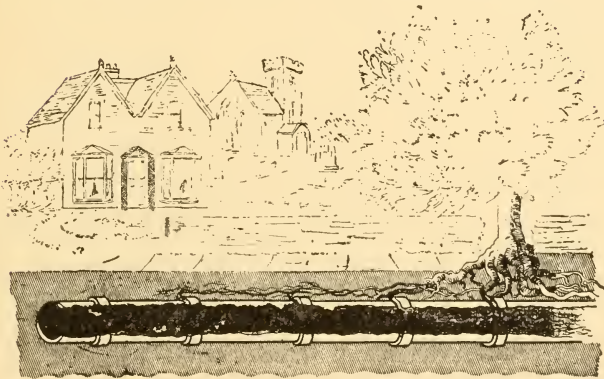

Fig. 625. Tree roots entering pipes laid with inferior mortar.

Dr. Teale, from whom we take the illustration, and who reported sickness in the house due to this leakage.

The office keeper in this house (Fig. 622) reported to Dr. Teale that before this fault was discovered "she hardly ever passed a week without a sick headache; that her children were constantly ailing, and that she could keep neither meat nor milk." Since correction Dr. Teale says they have been in "good health, and the meat and the milk have kept well."



Fig. 626. "Jerry builder" buying "seconds."

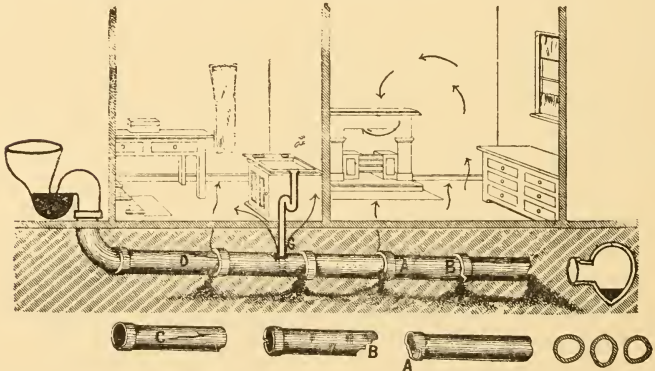

Fig. 627. Drain made of "seconds"—manslaughter under an "alias."

Fig. 625 illustrates the manner in which tile drains may be perforated by the roots of trees when they are put together with inferior mortar, and the next two pictures (Fig. 626) are snapshots secured to show the manner in which a good builder may save quite a sum of money in using tile pipes for hygienic construction where wrought iron pipe cannot be bought advantageously. This builder's only reason for buying "seconds" for this job was that he had already bought out all the "thirds" for another piece of sanitary engineering, and therefore could not obtain any more of them. The picture below (Fig. 627) shows the skillful and conscientious manner in which our worthy friend laid these pipes under a kitchen and pantry, where he calculated they would do the most good.

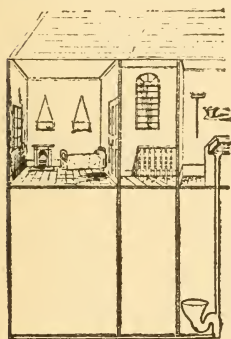

Fig. 629. Untrapped sink waste.

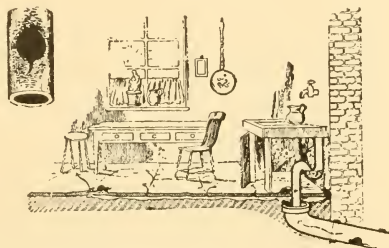

Fig. 630. Rats and the tale they tell.

Fig. 629 records a case of sewer gas poisoning supposed by Dr. Teale to be due to an untrapped sink waste. Two children were taken seriously ill with inflamed sore throat attributed by the doctor to this defect.

Fig. 630 shows defective jointing under the sink which had been boxed in so that the defects escaped attention. Rats are apt to mean sewer gas holes where soil pipes are

PLUMBING AND HOUSEHOLD SANITATION.

made of lead, as was the common custom in England when Dr. Teale wrote his book. They gnaw through the lead to get at the water or fat in the sink waste. They also make runs under the drains and thereby let the pipes down, as shown in the picture.

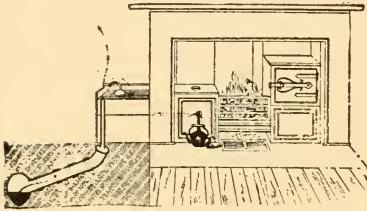

Fig. 631. Cistern feeding L boiler with overflow into drain.

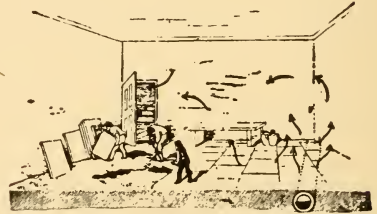

Fig. 632. "On the wrong scent,"
No plans of the drains.

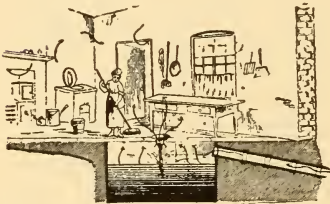

Fig. 633. Dish stone in scullery untrapped, and opening direct into a rain water tank, with overflow into drain.

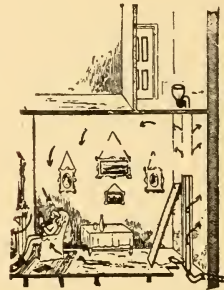

Fig. 634. Dangers coming from concealing the plumbing pipes.

Fig. 632 shows the effect of bad jointing in a cellar of a house having no drain plans. The owner was obliged to have the whole cellar flooring raised before the drain was found. Dr. Teale entitles this picture "On the wrong scent," and shows the drain hunters excavating in the corner of the cellar the furthest off from where the drain actually was.

Figs. 631 and 633 give very common defects, the first showing a cistern feeding a kitchen boiler and having its overflow connected directly with the drain, and the second showing a rainwater tank under a house having an untrapped dish stone or grating and an overflow into the drain. Sewer gas is meandering at pleasure all about the kitchen and scullery.



Fig. 636. Vicarage rendered unhealthy by infiltration from churchyard.

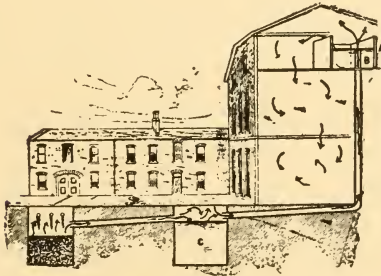

Fig. 638. Cisterns ventilating cesspool.

The remaining figures, 634 to 638, are sufficiently explained by their titles and need no further comment in view of what has already been said.

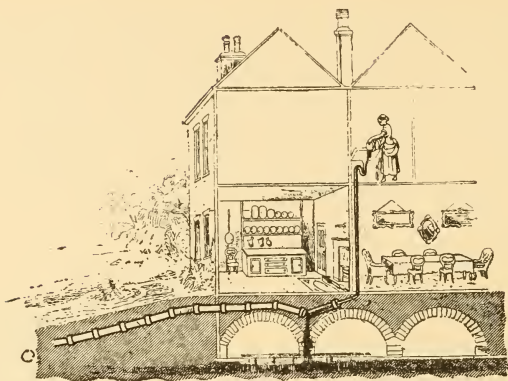
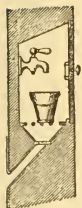

Fig. 637. Cellar kept damp twelve years by slopwater.

CHAPTER XLI.

SAND FILTRATION.

Sand filtration, both slow and rapid, is becoming yearly more popular for water purification and methods of washing the sand to maintain the filter up to the highest efficiency are being constantly improved.



As generally practiced, however, this sand washing process is still the most expensive part of filtration.

Several times a year the upper layer of sand has to be laboriously scraped off by hand, carted away, and washed in machines of greater or less complexity and costliness. Moreover, the shovels or hand tools used for this scraping cannot be so manipulated as to remove the upper sand layer with uniformity and much more sand has to be washed than is necessary. A considerable amount of sand is washed away and lost, and the washing itself, left to ordinary workmen, must often be imperfectly done.

Devices for stirring up the sand in place under water, and removing the dirty water by suction as it is formed have been tried with more or less success. But these machines have seemed to the writer, as far as he is informed about them, to be unnecessarily complicated and expensive in operation. He has designed the device shown in Figs. 639 to 642 for a quick automatic scraping and washing of a layer of sand of uniform and minimum thickness. It has been designed especially for a plant for filtering the water of a brook for a small community. The cleaning is to be done while the filter is in use so that no shut down and consequent duplication of the plant is required.

The filter is planned to be built about three hundred feet from the brook and its water level is substantially constant within a few inches, because it enters a lake just below the filter. This maintains the ground water at a permanent level and simplifies the problem of filtration by providing a uniform head throughout the year. This level is indicated by dotted line on the drawing. The water is partially filtered in passing from the brook through gravel from eight to ten feet deep, and enters first a sediment reservoir and thence through a regulating valve into the filter.

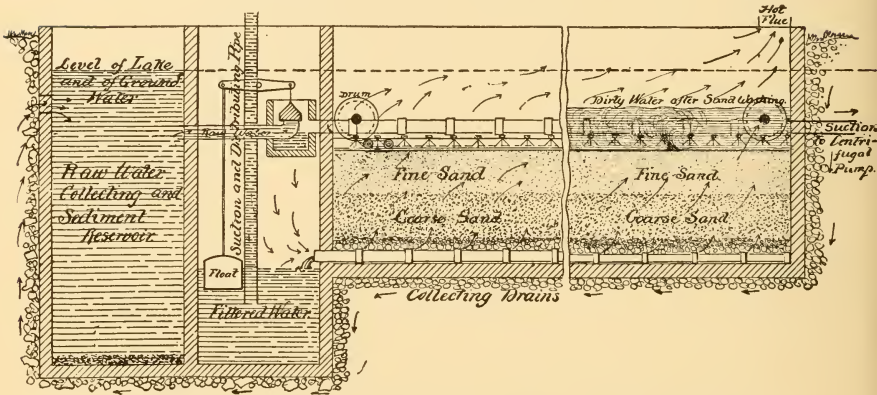

Fig. 639. Longitudinal Section of Writer's Slow Sand Filter.

The filtration may be accomplished in this plant either on the usual plan of constant contact, or by intermittent contact or on the sprinkling plan recently advocated by Miquel as far more effective than either. The drawings show modifications and details of my own.

The sprinkling filter allows of constant and much more abundant aeration throughout the entire bed than is possible with other systems, while the water slowly descends. The water is distributed over the sand at the speed of

SAND FILTRATION.

about one drop a second for every square inch of filter area by means of small enamel covered troughs, half round in section, and supplied by a main pipe running the whole length of the filter bed.

The sand is washed in place without interrupting the operation of the filter by running a two-edged galvanized iron scraping knife rapidly from one end of the bed to the other.

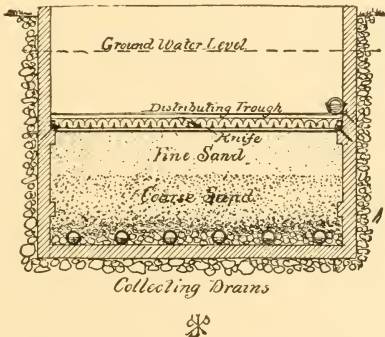

Fig. 640. Transverse Section of Filter Bed.

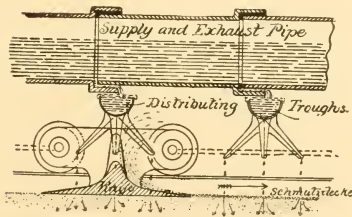

Fig. 641. Transverse Section of Trough and Knives.

the other under the water by means of a machine motor, the ends of the knife being furnished with small wheels or rollers which run on tracks on each side of the bed. To permit of this the beds are made long and narrow, the width being limited by the practical length of the knife,

which in this case has sufficient strength with a length of twelve feet. The length of the bed may be as great as desired. In this case it measures one hundred and seventy feet. Any number of knives and beds may, of course, be built side by side, and operated by the same motor and a single set of shafting. The knives have prongs cast upon their upper surfaces as shown, to aid in breaking up the "schmutzdecke," as the dirty surface of the sand to be scraped off is sometimes called. This surface or skin to be removed is usually very thin, and sometimes matted together almost like a carpet when vegetable growths or algæ develop in it, and in such cases considerable agitation of

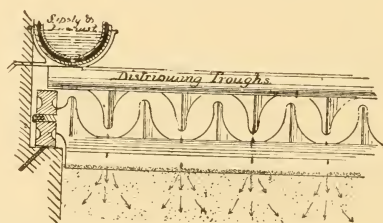

Fig. 642. Detail of Knife and Troughs.

the skin or schmutzdecke is necessary to properly break it up. The prongs, together with a specially rapid travel of the knives accomplish this, and the knives may be run back and forth several times if necessary to secure sufficient agitation and cleansing.

The dirty water is then pumped out by a centrifugal pump of size sufficient to remove all the water before the sediment to be removed has had time to deposit itself. A six-inch suction pump is used in this instance. The water is removed through the same tile pipe, with its evenly distributed openings, which is used to feed the filter, so that no violent suction is brought to bear on any one part of the bed. This feed pipe is supported by brackets built into the

SAND FILTRATION.

concrete walls of the filter, and is laid eight or ten inches above the surface of the sand so as to give room for the small transverse secondary feed pipes or troughs below it which are supplied with water through small round openings left in the cement joints of the main feed pipe.

The troughs are in their turn placed high enough above the bed to permit of the passage under them of the scraping and stirring knife. The feed water is distributed by the troughs over the bed by means of small drip points cast on their under surfaces as shown in the details, which alternate with the knife prongs and aid them in breaking up the *schmutzdecke*.

The water overflows the edges of the troughs which are laid as nearly horizontal as possible. The covers prevent the dirty water from clogging the troughs during washing, and also aid in regulating the water distribution. The height of the main pipes above the sand surface regulates the proportion of the dirty water which can be removed by the pump. Several inches are left for the purpose of "re-seeding" the filter because, as has already been stated, clean sand alone is incapable of properly filtering water, a certain amount of bacterial or equivalent deposit being necessary to start the purification and therefore to render possible the continuous operation contemplated by this plant. The energy required to propel the scrapers in this filter is very small, and the economy of operation is therefore correspondingly great. The knives being adjustable, may not only be regulated to remove the exact amount of surface sand desired to produce the best results, but at the same time they level off the bed in the most perfect manner. No sand is lost, however fine it be, because just sufficient time may be left between stirring up the deposit and pumping out to permit of the resettlement of the sand but not of the lighter silt and other undesirable matter.

Automatic washers have been invented, as stated, for washing the sand in place. But those with which the writer is familiar operate to agitate and wash the deposit in such a manner as to involve the loss of some of the valuable sand of the filter, and they do not provide any means of automatically reseeding the filter, which must therefore be subsequently done by hand or by running to waste the filtrate for a number of days to permit of a reformation of the required amount of bacterial gelatinous deposit to restore effectual working by natural process.

PORTABLE SLOW SAND FILTERS.

Figs. 643 to 646 represent a portable "sprinkling" filter for house use designed by the writer.

The sand is held in one or more sections of earthenware pipe and the raw water enters a sprinkler through four small pipes, at the top, and thence discharges by means of a sprinkling trough over the surface of the sand in numerous very small streams, the amount in aggregate being equivalent to one drop per second for every square inch of surface of the filter. Air enters the space between the bottom of the sand vessel and the pure water receptacle forming the base of the apparatus, and rises through the sand as the water descends. A tight cover connected with a heated ventilating flue produces a forced draught, and an effective aeration.

The result of this slow percolation of the water through the sand with the accompanying constant and abundant aeration is to cultivate aerobic bacteria in sufficient force and activity to completely dispose of all organic matter, including all harmful or pathogenic germs, and their spores, in the raw water, and yield an effluent of the utmost possible purity. The bacteria themselves

SAND FILTRATION.

develop in numbers just sufficient to consume the food supplied by the water, and live as long as this food or organic matter continues. An increase or diminution of organic impurity in the raw water, or the quantity of water filtered, results in a corresponding change in the

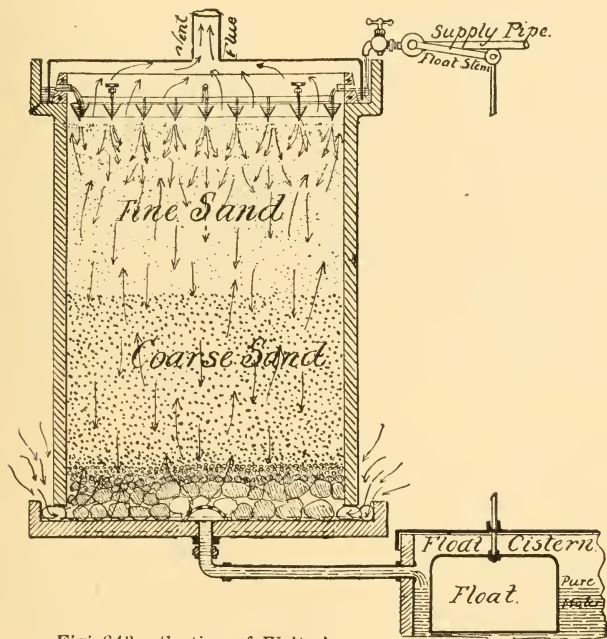

Fig 643. Section of Writer's Portable Filter.

number of these friendly bacteria, and the surface of the sand, therefore, is never clogged so long as the impurities deposited on it are organic. Inorganic matter is easily removed by scraping at intervals of considerable length, depending upon the nature of the water to be filtered.

The efficiency of a filter working upon this principle is very largely dependent upon the equal distribution of the raw water over the sand. This distribution is effected in the filter under consideration by means of perforated troughs connected together and designed as

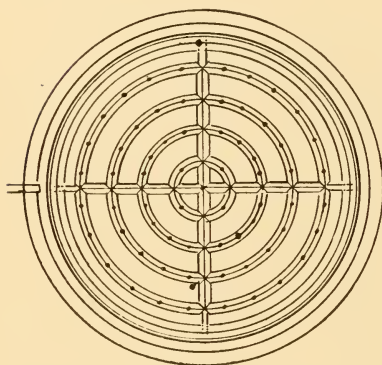

Fig. 644. Distributing Trough.

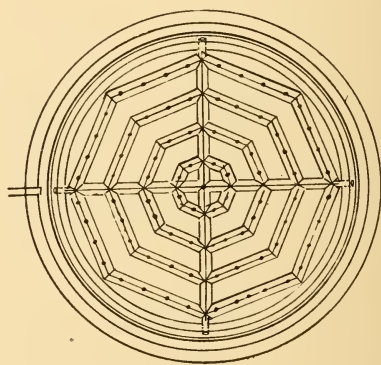

Fig. 645. Another Form of the Distribution.

shown in the drawings, and fed from the water supply pipe through one or more small supply pipes connected directly or indirectly with a regulating stop-cock. The main supply pipe is controlled in an auxiliary float cistern connected with a pure water collecting cistern. These small feed pipes are made large enough to ensure against any possible stoppage by sediment, and to furnish the maximum amount of water required at any time of the largest demand.

In hotels, the collecting cistern if installed for drinking water supply, should be fitted up with galvanized iron coils from the refrigerating plant, in which case it would usually be better to have a separate cistern for the regulating float.

SAND FILTRATION.

Such a plant as this ensures the utmost possible purity of drinking water, uncontaminated by ice, which should never be used for refrigerating unless it is made of filtered water, or contained in a separate vessel, whereby the drinking water is cooled without the ice coming in direct contact with it. The illustration shows such a plant built by the writer this summer in the Charlesgate Hotel, Boston.

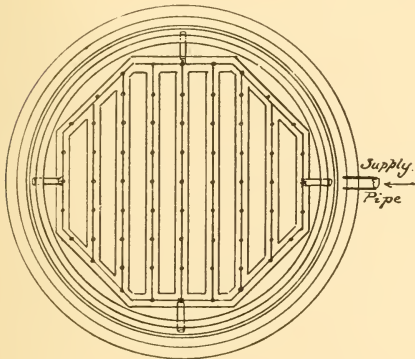

Fig. 646.
Another Form of Distributor.

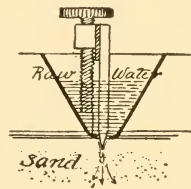

Fig. 647.
Detail of Distributor.

The distribution of the water over the sand is effected as follows: A ring of concrete, reinforced by iron wires, is moulded on the inside of the hub shoulder of the pipe forming a water channel all around nearly as deep as the height of the hub. The water supply-pipe, with its float-valve discharges into this channel, and keeps its water level up to that of the four little outlet pipes moulded into the concrete ring, a little distance above its bottom. This forms a water seal for the enamelled iron or copper ventilating cap of the filter, as shown, and prevents the draught of the ventilating flue from being

weakened by the entrance of any air which has not passed through the sand from bottom to top.

Four small pipes, whose united capacity is equal to that of the main supply pipe, lead the water from the water channel, through the concrete ring, into the "distributor" proper. This distributor consists of a number of perforated interconnected distributing troughs, into which the four small pipes discharge. The troughs are V-shaped in section, set with the apex down, and the perforations are evenly distributed along their bottoms. Small brass plungers having ends fit into these holes, and not only regulate and equalize the water distribution through them, but also conduct the water from each hole directly downwards to the sand. The plungers are fastened to a frame, and arranged upon it in such a manner and position that all may be raised or lowered together and equally by means of thumb-screws set at opposite corners of the frame. The holes in the troughs are oblong in shape, measuring about 1-10 by 1-4 of an inch. The plungers are of the same dimensions at the top, but reduced at the lower end to 1-10 of an inch. Their lower ends extend through, and a little below, the bottom of the holes leaving, always, at least one-half of the holes open when the amount of water required is large. When less water is required through each hole, the frame is lowered by the thumb-screws and the bevel on the plungers gradually reduces the capacity of the holes until the proper size is attained.

Should the holes become more or less clogged by sediment they may be easily and quickly cleared by simply screwing down the frame until the plungers completely fill the holes and force out the obstructions. They are then raised again to their proper operating position.

SAND FILTRATION.

The V-shape of the troughs provides perfect distribution without obstructing the upward movement of the ventilating air through the sand surface. The distributor is stamped out of sheet copper, or of sheet iron afterwards porcelain enamelled.

During the hours of most rapid use the float in the collecting cistern, or its auxiliary float tank will be lowered so as to open the raw water supply valve full bore, and water will then enter the distributor troughs at its maximum rapidity, and rise in the troughs until a water head is developed in them sufficiently high to force this greater quantity of water through the perforations into the filters.

The entire operation thus becomes absolutely automatic, and a sufficient number of bacteria live in the filter between maximum supplies to take care of all organic impurity when it comes. The water dropping from each plunger point distributes itself in the sand in an inverted cone-shaped area—so that at a distance below the sand, inversely proportional to the number of points, the cones unite. It is therefore important that the points should be as near together as possible to produce the maximum of efficiency.

Inorganic impurities in the raw water, deposited upon the sand from the points, for a long time, really aid the working of the filter by forming underneath each point a small saucer-shaped auxiliary distributor which may gradually be converted into an inverted cone or stalagmite. Therefore the sand surface may, with certain kinds of raw water, as a fact, never have to be scraped or cleaned at all, or, if scraped at very long intervals, the labor involved is so very slight as to be practically negligible.

CHAPTER XLII.

PLUMBING LAWS.

A PLUMBING CODE RECOMMENDED BY THE AUTHOR.



IN conformity with requests at different times of commissions appointed by three cities for the revision of their plumbing regulations, and acting as expert for these commissions, I have drawn up several codes and give herewith one embodying the best points.

I have before me copies of the codes of thirty-seven cities and towns, seventeen of which embody the simpler and more modern and scientific principles, omitting the requirement for the back venting of traps. The rest adhere to the antiquated methods advocated a quarter of a century ago when the experiments of Hellyer, and of Bowditch and Philbrick were published, which seem to have been largely responsible for the present complication. Their recommendations, which might have had some excuse at that time, are no longer applicable to the present conditions.

Greatly improved methods, materials and appliances in plumbing have entirely altered the data. Main stacks of soil and waste pipes are now universally ventilated from top to bottom, as was not the case at that time. Fixtures are constructed with better flushing devices. Large drum and other traps have been found to be secure against syphonage and back pressure and evaporation without back venting. Means of keeping the air of sewers and drains well aerated and perfectly safe have been devised, and we know more

about the constitution of sewer air and what can be done to render it innocuous than we did in those days.

I have given in the previous pages my reasons for the various improvements I have advocated in my proposed code, and will only call especial attention here to section 7, calling for an equally rigid standard test to be applied to back vented syphon traps, as well as to unvented anti-syphon traps, before either shall be accepted as an adequate protection against syphonage, back pressure, evaporation or clogging.

Such an impartial test has never to my knowledge heretofore been required by any plumbing regulations.

Yet in the light of our present knowledge of the undisputed unreliability of back venting in many cases, and of the equally undisputed much greater if not entire reliability of the anti-syphon trap system in all cases, what can be more absurd and unscientific than the omission of the requirement of a standard test for the former when it is rigidly exacted for the latter?

I would also here call attention to the fact that in most plumbing codes most of the knotty questions, such as the efficiency of any particular form of trap or system of trapping, or the advisability of omitting the main house trap, and others of like import, are slurred over by providing that they shall be left to the judgment of the inspector, building commissioner or board of health officer in charge. Yet what is more evident than that such an individual is not only incapable of settling questions which the highest authorities have as yet not all agreed upon or which could not from the nature of things be decided without a standard test? An impartial and exhaustive expert investigation is requisite properly to determine many of these questions. Public officials have sometimes held office for political reasons

and for short periods, and they stand always under more or less pressure of influence or favoritism.

Standard tests should always be called for in all cases where tests alone can demonstrate the fitness of any device or principle, and when exacted they should be of such a kind as to determine the data required both scientifically and positively. Sanitary plumbing must cease to be considered a subject for off-hand judgment or guesswork. It is an exact science and must be treated scientifically or the public will continue to suffer inconvenience and ill health and pay twice as much for the work as is necessary or desirable.

Boards of health and plumbing inspection should be required to equip themselves with apparatus suitable to make the standard tests. The outlay would save nearly half the cost of plumbing to the public and would itself cost less than the back venting of a single small building.

I also call attention here to my section on Cast Iron Pipe Jointing. In some plumbing codes today the jointing of cast iron pipes is limited to the ordinary lead and oakum calked bell and spigot joint, which many of the best authorities today believe to be one of the worst forms of construction possible.

Some codes go further and specifically debar all "cement" joints. Now such a rule debars all steam fitters' and gas pipers' red or white lead and oil cements and the use of all of the other useful compounds now classed under the name of "cements," such as rubber cement, iron and sal ammoniac cement, and every kind of oil cement whether elastic or rigid. The word "cement" is applied to all binding materials used for cementing or binding bodies together. The dictionaries and standard works on cements, such as Standages', Phin's and Dawidowski's, include all binding materials as cements, and classify them according to their qualities, principal constituents or to the materials they

unite, such as oil cements, rubber cements, red or white lead cements, elastic cements, heat resisting cements, earthenware and iron jointing cements, sal ammoniac cements, steam and gas fitters' cements, lime and stone cements, etc. These are all better than the calked lead joint, and for the public to allow them all to be debarred on account of the prejudice or ignorance of the law maker is absurd and childish, depriving themselves of all that is best and discouraging invention, on the vain and preposterous assumption that their wisdom or that of their law maker embraces everything possible whether of the past, present or future.

William Paul Gerhard, the eminent sanitary engineer, who has done so much by his careful study and writing on sanitary engineering in removing popular prejudices in this domain, writes in a lecture delivered before the Vermont Association of Health Officers*: "Back-air pipes are liable to stop up at the crown or upper bend of the trap from congealed grease or other semi-solid matter. They then become inoperative, and hence give a false sense of security. In Cologne, Germany, all back-air pipes which an investigating committee had cut open, were found choked with either grease or coffee grounds or cobwebs. In St. Paul, Minn., an examination by a plumbing inspector showed that from a total of twenty-three houses twelve houses had the vent pipes from kitchen sink traps completely stopped up by congealed grease and particles of vegetable matter, or lint from kitchen towels. Of the eleven others, only one house had a sink vent-pipe which was perfectly clear and unobstructed, and this was found to be due to the fact that hot water and lye was used once a month in the pipes. In seven out of eleven houses a soft, slimy substance was found adhering to the interior of the vent pipes for two or three inches above

*"Plumbing: The Modern, the Old and the Advanced Systems." Lecture by Wm. Paul Gerhard, C.E., of New York, reprinted from Bulletin of Vermont State Board of Health.

the crown of the trap, and in the other three the vents were partially stopped up. The vent from the S trap under the kitchen sink in my own house has been found partially stopped up five times in ten years, and would doubtless have become entirely stopped up before the end of this period if I did not have same cleaned once a year.

"In northern latitudes where soil and vent pipes above the roof may become closed by frost, traps will readily be syphoned under such conditions.

"Trap vent pipes increase the liability of the seal of S traps being destroyed by evaporation. The trap vent pipe, if placed much below the trap seal, does not protect the pipe against self syphonage or loss of seal by momentum. This is a point to which very little attention has been paid.

"The late Colonel Waring stated that, 'Continued experience and observation tend more and more to confirm the opinion that the back-venting of traps, aside from its great cost, does more harm than good; that is to say, that a trap is more likely to lose its seal if it is back-vented than if it is not.'

"An English expert on drainage called 'a diagram of house plumbing protected by ventilation pipes as prescribed by most American authorities a bewildering nightmare of complicated ingenuity,' to which statement many of you will doubtless heartily assent.

"The fact is, S traps with vents are perfectly safe only IF the vent pipes are of sufficient area, IF they are not of too great length, IF there are no sudden bends and not too many of them, IF they are free and unobstructed, and IF their fixture is used every day. The conclusion is therefore inevitable that, as ordinarily arranged, vent pipes are useless complications.

"I wish that time would permit me to make a more elaborate comparison between the two methods in order to impress

PLUMBING LAWS.

upon you the important fact that the improved and simplified system is far superior to the one commonly required by rules and regulations.

"To the health officers of these towns or cities which are about to make plumbing regulations I suggest that the better way is to make it at least optional with the architect or owner of a building whether he will choose the common or regular system with double piping and incur an unnecessary expense, or use the advanced, improved, simplified and safer method.

"I am more than ever convinced that the 'one pipe system,' as I have sometimes called it, is the coming system, and that within the next few years even the rules and regulations of our larger cities will be amended accordingly."

Speaking of the cost of venting Mr. Gerhard says: "Trap vent pipes increase the cost of plumbing and the money paid for them to plumbers is spent quite uselessly. A calculation undertaken by a careful investigator showed that the amount of piping is increased by thirty-three per cent, and the number of pipe joints by sixty-six per cent."

"Modern Sanitation"* has the following in the number for September, 1907:

"The pendulum of opinion, like the pendulum of time, ever swings from one extreme to the other; and what is considered good practice in one decade in the light of subsequent research proves to be no better than other methods that are condemned.

"It is only within the past four years, however, that the efforts of the advance guard of sanitation have borne fruit and that recognition of non-syphon traps has been accorded in the plumbing codes of cities.

"Cleveland is the latest city to be added to the list."

Section 21 of the Cleveland code reads as follows: "Anti-

*Published by the Standard Mfg. Co., Pittsburgh.

syphon traps that stand the test prescribed may be used without back venting on fixtures requiring two-inch and smaller traps, provided the developed length horizontal or vertical from a soil or waste pipe stack or house drain does not exceed ten feet."

"A condition," continues "Modern Sanitation," "of the foregoing provision that recommends itself to all who are interested in sanitation is the requirement that non-syphon or refill traps successfully withstand a prescribed test before being put on the approved list. By having a standard test for traps, and a code that permits the use of any trap passing that test, the door is shut against favoritism or a discrimination against any individual or firm who wish to have their goods used. A standard test for non-syphon traps that is fair to manufacturer and at the same time safeguards the public should be adopted by every city in the Union having plumbing laws. This test should be uniform throughout the state and should have the approval of the American Society of Plumbing Inspectors and Sanitary Engineers, or some equally representative body of men, who in all fairness would prescribe the tests to be withstood. Such a condition in the plumbing trade is much to be desired; then if a firm or individual designs a new type of non-syphon or refill trap, they can submit it for a test without fear of favor and have it adopted or rejected on its merits or demerits.

"Objection to the use of non-syphon and refill traps in many quarters arises from the mistaken opinion that the use of such traps, by cutting down the amount of plumbing work in a building, interferes with the profits of the plumbing contractors. Such an opinion is wholly wrong. In fact the converse is true. More profit is to be realized from the sale of goods than from the labor of installing them, and a house owner who can install two bath rooms or one bath room and some bed room lavatories with non-syphon traps for what

he could pay for one bath room with a whole lot of unnecessary vent piping concealed in the walls and partitions, will install the former every time. The plumbing contractor makes his percentage of profit on an installment of equal amount without an equal amount of work, consequently his profit is greater, for if he turns over a 10 per cent profit in two weeks, his net profit, time considered, is greater than if the same work took four weeks. Furthermore, with a given capital, a greater volume of work can be handled each year, thus increasing the gross profit in a business.

“As a corollary to the foregoing, it can safely be said that the plumber who gives his patron two bath rooms with non-syphon traps for a certain price, will meet with far greater success in his business than his rival who fits up but one bath room with vent pipes for the same price. It is pleased customers that advertise your business, and the best way to please a customer is to make every dollar paid show in fixtures.”

“The Inland Architect and News Record” for November, 1905, urged the following:—

“Boards of health or plumbing inspectors should equip themselves with apparatus suitable to test the appliances they allow to be used, that the public may be relieved at once of the burden of back venting if it be found that it is continued solely for the benefit of dealers in piping. We would suggest that the architects, both personally and through the American Institute and its various chapters in the large cities, where they are obliged to charge their clients with this expense, lend their influence to urge the authorities to appoint such expert commissions as may seem to them to be best, for the purpose of making the investigations we have advocated.”

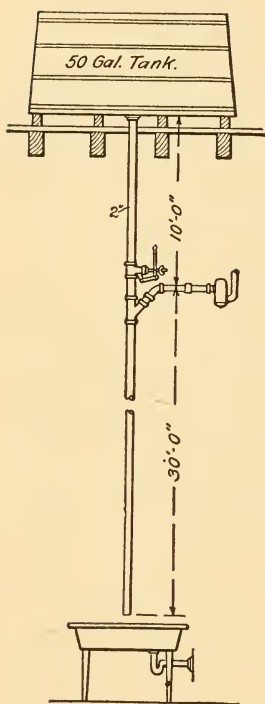

Fig. 549.
Trap Testing Apparatus.

Fig. 549 shows the standard testing apparatus suggested by "modern sanitation" for general use.

It consists of a fifty-gallon tank ten feet above the trap connection, with a 2-inch down pipe and a quick opening valve on the pipe above a V branch for the trap.

The method of testing to consist of discharging the entire contents of the tank by opening and closing the valve every five seconds. No movable parts to be allowed in the trap when the test is being made.

A short time ago a prominent lawyer, for whom I was building a house and an office building, said he had in mind to test the right of the building authorities to oblige him under the law to install back air pipes with his anti-syphon traps, on the ground that the form of such traps, together with their inlet and outlet pipes, provided in themselves the best possible and only permanently reliable back air pipes, because their efficiency could not be destroyed by clogging or evaporation. Closure by clogging would stop the outflow of water and render cleansing imperative. Their principle of construction was such as to allow the air of the room to pass through their own seals without injury to them and then to pass on and up to the roof through their waste and soil pipes, thus attaining what the law must accept as the only permanently effective back air pipes possible. He claimed that the inspector could not oblige him to adopt that

PLUMBING LAWS.

one of two methods of back airing which had proved without question to be both unreliable and short lived, when another method was contained in his anti-syphon traps and their waste pipes which was now well known to be both reliable and permanent.

In conclusion I submit herewith a plumbing code which I believe will prove beneficial not only to the public, whose welfare should, of course, be paramount since the law is made for them; but also to the architects, engineers and plumbers, and all whose business it is to serve the public in this domain.

PLUMBING REGULATIONS.

Section 1. Plans and Specifications. The plumbing and drainage of all buildings, public and private, additions and alterations thereto, shall be executed under the direction of the Health Officer, in accordance with plans and specifications previously approved in writing by the local or State Board of Health; and suitable drawings and descriptions of said plumbing and drainage shall, in each case, be submitted and placed on file with the Secretary of the local or State Board of Health aforesaid. No part of the work shall be covered or concealed in any way until after it shall have been examined by and tested in the presence of the Health Officer.

After a plan has been approved, no alteration of the same shall be allowed except on the written application of the owner.

All material must be of good quality and free from defects; the work must be executed in a thorough and workmanlike manner.

Section 2. Registration. No plumber shall engage in or work at the business of plumbing unless he shall have first registered his name and place of business in the office of the Board of Health, and no person shall by display of sign or plumbing material advertise as a plumber unless he shall have

PLUMBING AND HOUSEHOLD SANITATION.

been registered or licensed therefor. Notice of any change in the place of business of a registered or licensed master plumber shall be immediately given to the Board of Health.

Section 3. Notices. Every plumber, before doing any work in a building, shall, except in the case of repair of leaks, file at the office of said Board of Health, upon blanks for that purpose, an application for a permit.

Section 4. Connection with Sewer or Drain. The plumbing of every building shall be separately and independently connected outside the building with the public sewer, if such sewer is provided, or with a proper and sufficient private drain or sewer laid outside of the building, and if a sewer is not accessible, with a proper irrigation or purification system or cesspool. Several buildings may have a common sewer connection.

Section 5. Traps. The waste pipe of every plumbing fixture shall be connected with a water seal trap having an airtight and water-tight clean-out of sufficient size to give convenient access for cleaning all parts of the trap.

Section 6. Trap Protection. Traps shall be protected from loss of seal through syphonage, evaporation and clogging. Either non-syphoning traps, mechanical air vents or back air pipes may be used for such protection provided they conform to the requirements of a standard test for syphonage, evaporation and clogging applied to them in accordance with Sections 7, 8, 9 and 10.

(Alternative. A much better and simpler provision would be as follows:

Section 5. Traps. The waste pipe of every plumbing fixture shall be connected with a non-syphoning water seal trap having an airtight and watertight clean-out of sufficient size to give convenient access for cleaning all parts of the trap. Back air pipes for special trap venting shall not be used.

In this case Sections 6 and 11 will be omitted. But for places where the public are not yet convinced of the importance of this change, but prefer to leave back venting still optional, the first form and Sections 6 and 11 are given as a temporary compromise.)

Section 7. Testing Apparatus. The test for efficiency in resisting syphoning action shall be applied by a standard testing apparatus constructed as follows: The apparatus shall be either hydraulic or pneumatic. When the hydraulic appara-

PLUMBING LAWS.

tus is used it shall be constructed as shown in Figure 1. When the pneumatic is preferred it shall be constructed as shown in Figure 2. Both are recommended as useful in checking one another. Or any modifications of these devices conforming to their principles or capable of measuring the siphoning and other actions occurring in plumbing work for which they are constructed, may be used.

Section 8. Hydraulic Apparatus. In the hydraulic apparatus a water supply connection at S is required with ball cock and float and a large water tank of X* gallons capacity; a two-inch vertical main pipe P from the tank having a trapped waste receptacle W at its lower end; a two-inch branch pipe B for connecting up the trap to be tested; a vacuum gauge G on the branch; a quick opening valve V on the main pipe above the branch, a second valve V' on the branch B, and another valve V'' at the lower end of the pipe below the branch. Also a back air connection A for coupling on the back-air pipes Figure 3.

The test on this apparatus shall consist in connecting the outlet arm of the trap, filled with water, to the branch pipe B by means of a coupling nut or other air-tight connecting device and discharging the contents of the tank through the main pipe by successively opening and closing the upper valve V ten times, leaving the valve open for five seconds each time, the lower valve V'' remaining open during the test. The size of the tank is governed by the size of the water supply pipe and water pressure available. It should be sufficiently large to supply water for the ten successive discharges after one filling, the water entering the tank from the supply pipe continuously during the test.

The energy of the syphoning action produced by each of these ten discharges is ascertained from the pressure gauge G before the trap tests are made by closing the valve V' and reading the gauge during the discharges. The purpose of the valve V'' is to close the pipe when making the evaporation tests.

Section 9. Non-Syphoning Traps. Non-syphoning traps shall be considered effective and acceptable when they are found

*Size prescribed below.

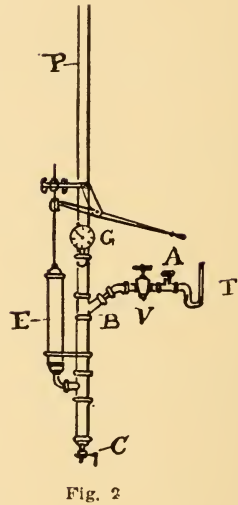
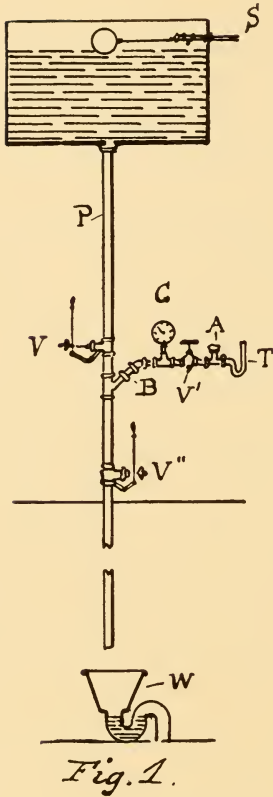

capable of maintaining a seal of not less than one Xth of an inch after the ten successive applications without refilling of the syphoning strains above described. The severity of the strains will be partly dependent upon the length of the main two-inch pipe from tank to waste receptacle. But it should be equal to the strains required to lower the seal of a four-inch round or pot trap having one and one-half inch inlet and outlet arms from four inches in depth to one Xths of an inch in the ten discharges.

Section 10. The Pneumatic Apparatus shall be constructed as shown in Figure 2, and shall consist of a two-inch vertical

PLUMBING LAWS.

pipe P ten feet long hermetically closed at the top and having a small water outlet cock C at the bottom. An air exhaust pump E and a vacuum gauge G shall be connected with this pipe at a convenient height from the ground as shown. A two-inch trap testing branch B provided with a quick opening valve V shall be connected with the main pipe just below the pump connection. Also a back air connection A for coupling on the back air pipes Figure 3.

The trap to be tested is secured to the branch pipe in the same manner as in the hydraulic apparatus. The strain to be applied is obtained by closing the valve V and pumping the air out of the pipe until the vacuum gauge indicates five inches of vacuum. This strain is now applied to the trap by opening the valve V which forces the air through the trap seat and breaks the vacuum in the main pipe. A repetition of this action ten times without refilling the trap constitutes the standard test required. Any trap maintaining a water seal one Xth of an inch deep after this test shall be accepted as an effective non-syphoning trap.*

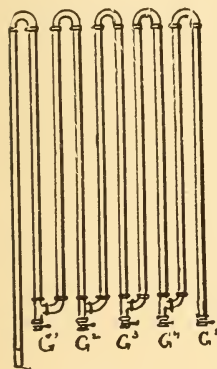

Fig. 3.

To couple on at A
Figs. 1 & 2

Section 11. Back Air Pipes will be allowed as protection for traps against syphonage when they stand the same test connected with the trap which is applied as standard to non-syphoning traps. For test purposes vent pipes made of thin tubing and connected up as shown in Figure 3 shall be employed. A sufficient number of pipe lengths and bends shall be used in the test to produce an amount of air friction corresponding with that of the vent pipe to be used in the actual building, and for purposes of Easy Calculation the surface friction of a one and one-half inch pipe shall

*The pneumatic apparatus permits of further comparative tests in the relative efficiency of different kinds of traps, or systems of trapping, by permitting the application of higher degrees of vacuum, and it also provides an accurate means of testing the comparative efficiency of non-syphoning traps with syphon traps protected by mechanical vents or by back air pipes either new or partially clogged with sediment.

PLUMBING AND HOUSEHOLD SANITATION.

be taken as x times* that of a two-inch pipe, and y times that of a three-inch pipe, and z times that of a four-inch pipe, and w times that of a five-inch pipe, and in the same proportion for larger pipes. Hence where a certain length of one and one-half inch pipe is found to reach the limit which will protect the trap in the standard test, x , y , z , or w times, this length will form the limit when the vent pipes are increased in area accordingly. The friction of a quarter bend shall be taken as equivalent to x * feet of pipe of the same bore as that of the bend.

In tall buildings the size of the back vent pipe shall be increased for each story by an amount determined by the friction tests for each such additional length.

The back air pipe used in the test shall be applied at the opening A on the branch pipe B. Different lengths are obtained by opening or shutting the gates G^1 , G^2 , G^3 , G^4 , etc.

Back air pipes shall be nowhere less than one and one-half inches in diameter and nowhere less than the diameter of the trap they serve.

Back air pipes shall not be accepted as protection against syphonage for kitchen or pantry sink traps nor for any trap regularly used for discharging greasy waste.

All back air pipes shall be provided with clean-out screw caps at every 90 degree bend on vertical runs for the periodical removal of rust flakes or other deposits, and these caps shall be opened and the deposits removed as often as they accumulate in quantity sufficient to reduce the bore or the pipe by one-third of its area, whereby its effectiveness in protecting the trap from syphonage may be destroyed.

Suitable provision shall be made to prevent the upper end of the back air pipe from being obstructed by frost or snow in cold weather.

The Joints of all back air pipes shall be tested for tightness as provided for in Sections 34 to 40.

Section 12. Mechanical Vents. Where mechanical vents are accepted as meeting the requirements of this section, suitable provision shall be made to ensure their mechanical parts against being rendered inoperative by rust, sediment or other cause.

*These proportions to be calculated and substituted for the algebraic expressions here given.

PLUMBING LAWS.

Section 13. Protection of Water Closet Trap Seals. A shallow seal non-syphoning or refilling trap shall be accepted as a suitable back air vent for a water closet syphon trap provided the trap shall have proved acceptable under the standard test, and provided it shall be placed near enough to the water closet trap to be effective, and provided the depth of seal of such non-syphoning trap shall not exceed one quarter the depth of seal of the water closet trap, so that the water seal of the non-syphoning or refilling trap shall yield to the syphoning strain and admit air to break the vacuum before the deep seal of the water closet trap is affected.

Section 14. Evaporation. The test for resistance to evaporation shall consist in connecting up the trap with the testing apparatus and closing the valve V" and allowing the trap to stand for thirty days without refilling. The trap shall be accepted as fulfilling the requirements when it shall be found to have lost less than one-xth of an inch of its seal through evaporation in this time.

When the trap is a syphon trap or intended to be protected by a back air pipe, the test apparatus of back air pipes (Figure 3) shall be applied and a current of air shall be induced through the back air pipes by means of a suction pump or fan at a speed of one foot a second as measured by an anemometer. If less than one-xth of an inch of the trap seal is removed by evaporation in thirty days under this test, the trap and its back air pipe shall be accepted in this respect.

Section 15. Back Pressure. For preventing back pressure all soil pipes shall be connected with the horizontal drains and all horizontal runs by long bends, and no running or other trap of any kind shall be permitted in the horizontal drains or between the house drain and the public sewer.

Section 16. Clogging. To prevent clogging the discharge of all fixtures shall be so constructed as to permit of the waste pipes being filled "full bore" after use and no trap shall be accepted which shall contain at any part a cesspool chamber having a sectional area measured at right angles with the flow of the water current through the trap of more than twice the sectional area of the inlet arm of the trap. Exception shall be made for grease or other special traps as provided in Section 32.

Section 17. A Single Trap for Several Fixtures. Several fix-

PLUMBING AND HOUSEHOLD SANITATION.

tures may be connected with one trap, provided the trap is not over five feet from the outlet from any fixture.

Section 18. Earthenware Traps shall have heavy metal floor plates secured to the trap flange, and the joint shall be made gas tight.

Section 19. Supports. Soil pipes or iron waste pipes shall be supported by clamps to the wood work, iron drive hooks to brick walls, or bolted clamps to iron girders.

Section 20. Chemical Laboratories. The installation of fixtures and waste pipes in chemical laboratories shall be constructed in accordance with plans approved by the Board of Health.

Section 21. Stable Fixtures. The drainage of stable fixtures shall be constructed according to plans approved by the Board of Health.

Section 22. Refrigerator Wastes and Drip Pipes. All drip or overflow pipes shall be extended to some place in open sight, and shall not be connected directly with the drain pipe, unless protected by an unvented antisiphon trap. No waste pipe from a refrigerator or other receptacle in which provisions are stored shall be directly connected with a drain or other waste pipe, unless protected by an unvented antisiphon trap.

Section 23. Pipes and Fittings. The diameters of soil and waste pipes shall not be less than those given in the following table:

	Inches.
Soil pipes	4
Main waste pipes	2
Main waste pipes for kitchen sinks on five or more floors	3
Branch waste pipes for laundry tubs.....	1½
Branch waste for kitchen sinks.....	1½
Branch waste for urinals.....	1½
No branch waste for other fixtures shall be less than.....	1¼

Except that a three-inch soil pipe, with the approval of the commissioner may be used for one water-closet where it is not practicable to use four-inch pipe.

When brass ferrules are used they shall be best quality, bell-shaped, extra heavy cast brass, not less than four inches long, and not less than the following weights:

PLUMBING LAWS.

Diameters.	Weights.
2½ inches.....	1 pound 0 ounces.
3½ inches.....	1 pound 12 ounces.
4½ inches.....	2 pounds 8 ounces.

One and one-half inch ferrules shall not be used.

Soldering nipples shall be of heavy cast brass or of brass pipe, iron-pipe size. If cast, they shall not be less than the following weights:

Diameters.	Weights.
1½ inches.....	0 pounds 8 ounces.
2 inches.....	0 pounds 14 ounces.
2½ inches.....	1 pound 6 ounces.
3 inches.....	2 pounds 0 ounces.
4 inches.....	3 pounds 8 ounces.

Section 24. Lead Pipes. All lead waste pipes shall be of best quality, known in commerce as "D," and of not less than the following weights per linear foot:

Diameters.	Linear Foot. per Linear Foot.
1½ inches (for flush pipes only).....	2½ pounds.
1½ inches	3 pounds.
2 inches	4 pounds.
3 inches	6 pounds.
4 and 4½ inches.....	8 pounds

Section 25. Brass Pipes. Brass pipes for soil, waste, vent and back air pipes shall be thoroughly annealed, seamless, drawn brass tubing of not less than number X Stubbs gauge.

Threaded connections on brass pipe shall be of the same size as pipe threads for same size of pipe and be tapered.

Section 26. Cast-Iron Pipe. Cast-iron pipe shall be uncoated, sound, cylindrical and smooth, free from cracks and other defects, of uniform thickness and of the weights shown in the following table. If buried under ground they shall be coated with asphaltum or red lead.

PLUMBING AND HOUSEHOLD SANITATION.

Pipe, including the hub, shall weigh not less than the following average weights in pounds per five foot lengths.*

	If Hand Caulked Lead Hub and Spigot Joints are Used	If Machine Made Rigid Joints are Used	If Flexible Joints are Used
2 inches	27½	20	17½
3 inches	47½	30	22½
4 inches	65	45	32½
5 inches	85	60	42
6 inches	100	75	52
7 inches	135	100	75
8 inches	170	125	85
10 inches	225	175	115
12 inches	270		165

Section 27. Wrought-Iron and Steel Pipes shall be not less than the average thickness and weight set forth in the following table:

Diameters	Thickness	Weights per Lineal Foot
1½ inches	.14 inches	2.68 pounds
2 inches	.15 inches	3.61 pounds
2½ inches	.20 inches	5.74 pounds
3 inches	.21 inches	7.54 pounds
3½ inches	.22 inches	9.00 pounds
4 inches	.23 inches	10.66 pounds
4½ inches	.24 inches	12.34 pounds
5 inches	.25 inches	14.60 pounds
6 inches	.28 inches	18.76 pounds
7 inches	.30 inches	23.27 pounds
8 inches	.32 inches	28.18 pounds
9 inches	.34 inches	33.70 pounds
10 inches	.36 inches	40.06 pounds
11 inches	.37 inches	45.02 pounds
12 inches	.37 inches	48.98 pounds

*See Note on Page 694.

PLUMBING LAWS.

Threaded part of the pipe if less than one and one-half inches long, shall be of the thickness and weight known as "extra heavy" or "extra strong."

All wrought-iron pipe shall be equal in quality to "Standard," and must be properly tested by the manufacturer.

Fittings on wrought-iron vent pipes may be the ordinary cast or heavy malleable steam or water fittings. Fittings for "Plumber's tubing" shall be heavy weight, with sharp threads.

Fittings for waste or soil or refrigerator waste pipes of wrought-iron or brass pipe shall be smooth and sound cast-iron or brass, recessed and threaded drainage fittings, with smooth interior waterway and threads tapped, so as to give a uniform grade to branches of not less than one-quarter of an inch per foot. All fittings except cast-iron or brass fittings for wrought-iron pipes shall be galvanized.

All joints for wrought-iron or brass pipe shall be screwed joints made up with red lead, and the burr formed in cutting shall be carefully reamed out.

Section 28. Fixture. Waste Outlets to be large enough to fill their pipes "Full Bore." All fixtures other than water-closets shall be provided with strong metallic strainers placed over the outlets. The openings of all such strainers shall be equal to the area of the waste pipe, so that these pipes may be discharged "full bore." Every kitchen and pantry sink shall be constructed on the principle of a flush tank, and shall be provided with a flush pot of not less than 20 gallons capacity, constructed to discharge itself automatically as soon as filled.

Section 29. Drain Pipes, Etc. Drain and connecting ventilating pipes shall be of sufficient size, and made of extra heavy cast-iron pipe if under ground, and if above ground made of extra heavy-cast-iron, wrought-iron of standard weight. Cast-iron drains shall extend not less than ten feet from the inside face of wall, beyond and away from the building.

Drain pipes shall be properly secured by irons to walls, suspended from floor timbers by strong iron hangers, or supported on brick piers. Proper manholes shall be supplied to

reach clean-outs and traps. Every drain pipe shall have a proper fall and shall be extended from a point ten feet outside the inside face of the wall, unobstructed, to and through roof, and may also serve as rain water conductor where the combined system is used. The drain pipe shall be supplied with a Y branch with a brass clean-out or iron stopper as directed on the direct run, at or near the point where the drain leaves the building. Changes in direction shall be made with curved pipes, and all connections with horizontal or vertical pipes shall be made with Y branches unless otherwise approved by the commissioner. All drain pipes shall be exposed to sight where practicable within the building, and shall not be exposed to pressure where they pass through the wall.

Section 30. Tight Joints. All joints shall be made air and water tight and shall stand the tests for tightness specified in this act.

Section 32. Special Traps, etc. Every building from which in the opinion of the superintendent of sewers, grease may be discharged in such quantity as to clog or injure the sewer shall have a special grease trap satisfactory to the superintendent of sewers. Every building in which gasoline, naphtha or other inflammable compounds are used for business purposes shall be provided with a special trap, satisfactory to the superintendent of sewers, so designed as to prevent the passage of such material into the sewer and ventilated with a separate pipe rising to a point four feet above the roof.

The waste pipe from the sink of every hotel, eating house, restaurant or other public cooking establishment, shall be connected to a grease trap of sufficient size, easily accessible to open and clean, placed as near as practicable to the fixture that it serves.

Section 33. Arrangement of Piping. All piping shall be as straight and direct as possible, and so arranged that it may be readily inspected, cleaned and repaired. If any part of a house drainage or plumbing system is so located or so constructed that obstructions therein cannot be removed without breaking pipes, such part shall be provided with proper accessible clean-outs. No trap shall be so placed as to be inaccessible.

PLUMBING LAWS.

Section 34. Inspection and Tests. All new piping shall be given two tests by the plumber in charge; first the roughing in with five pound air test, second and final with peppermint or smoke and in the presence of the inspector or authorized deputy. The material and labor for the tests shall be furnished by the plumber.

No drainage or plumbing system, or part thereof, shall be covered until it has been inspected as herein prescribed.

When a plumbing or drainage system is completed and the water turned on and the traps filled, it shall be inspected and given the final test. When the location or style of any fixture is changed it shall be inspected.

Section 37. Peppermint Test. Where the peppermint test is used for the final test, two ounces of oil of peppermint must be provided for each stack up to five stories and basement in height; and for each additional five stories or fraction thereof one additional ounce must be provided for each stack.

Section 38. Smoke Test. The drainage system of all new buildings shall be given their final test with smoke by a proper smoke machine. After the whole system is completely filled with dense pungent smoke, an air pressure equivalent to one inch water column shall be applied and left standing at least ten minutes. If there is no leakage or forcing of trap seals, the system shall be deemed air or gas tight.

Section 39. Notification of Inspector. The plumber shall notify the Inspector in writing when the work is ready for inspection. The application for the final inspection shall be made within ten days after the completion of the work.

Section 40. Defective Work. If tests show defects the defective work or material shall be replaced and the test again applied.

NOTE.

One of the greatest wastes in the present complicated plumbing system is in the extra thickness of cast iron piping necessitated by the fracturing strain on the hubs caused by the process of hand caulking with lead of the bell and spigot joint, called for in most plumbing laws, as well as by the rigidity of the joints themselves.

A scientific flexible joint would enable pipes of "standard" thickness to be used where now "extra heavy" are required to stand these strains on the joints. This about doubles the weight and cost of the cast iron piping.

"Standard" pipe is amply strong enough to stand the strains of shrinkage and settlement of the building materials even in new work provided flexible joints are used to take up these strains, as already described in our chapter treating of flexible joints, and it is amply thick enough, so far as rusting is concerned, to outlast the life of any building in which it is used. Therefore the public are sustaining a very heavy and unnecessary burden on account of the failure of plumbing legislation to recognize these modern improvements in jointing.

The brass piping now required is also far heavier than is necessary. Flexibility in the brass piping is obtained by arranging the piping in the manner practiced by steam fitters, angles and elbows taking up the play in places where the elasticity of the pipe itself is considered insufficient.

PLUMBING LAWS.

Taken in connection with the other items of saving we have referred to in this treatise, including the omission of the main house trap and of the back venting of traps, etc., our simple system of plumbing costs less than half as much as the complicated system in vogue and provides far greater convenience and security.

CHAPTER XLIII.

RECAPITULATION.



The following review of this course of lectures was published in the Boston Transcript of March 24, 1900:

A PLEA FOR SAFER PLUMBING.

REVISION OF THE PRESENT LAWS IS
DEMANDED.

*Millions of Dollars Spent on Worse Than Useless Plumbing
Under the Present Burdensome Building Laws—A
Simple System Better for Health as Well as Economy—
What Modern Science Has Demonstrated.*

A course of ten lectures on "Plumbing and Household Sanitation," illustrated by about two hundred lantern slides, has just been completed at the North End Union by J. Pickering Putnam, architect. The course has developed matter of exceptional interest to the general public, as calling attention to certain grave defects in our present plumbing laws, and suggesting methods of removing these defects founded on recent additions to our knowledge of the laws of sanitation and sewage disposal by eminent specialists in these matters. This course will be published in full by "Domestic Engineering" of Chicago. It has been condensed into a single paper read before the Boston Society of Architects, which is in part as follows:

"The present state of legislation and practice in house plumbing and sewage disposal is in many respects faulty, involving serious danger and great unnecessary expense.

RECAPITULATION.

“Here Fig. 1 is an illustration of the waste piping of a house containing three tenements, and showing the complication to which our present plumbing laws are leading us. The drawing is a reproduction of a plate published by

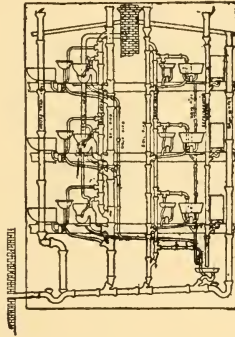

Fig. 1 (648). Complication with insecurity.

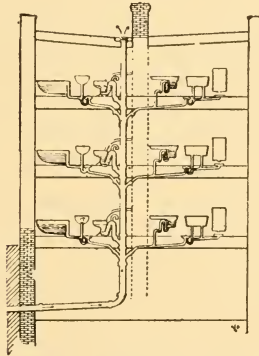

Fig. 2 (649). Simplicity with security.
Reduced from cuts in Transcript article.

a representative plumber as a model for the guidance of the craft, and a proper interpretation of laws now in force in most large cities and towns throughout the country, except that I have added the exterior sewer vent pipe and the

drip pipes, not drawn in the original, but usually recommended. The whole of it, however, is not required by the building laws. A literal interpretation of the Boston law would also require another pipe not shown in this drawing, namely, a back vent pipe for the refrigerator traps shown at the left of the rainwater pipe.

"Fig. 2 shows all the piping that is required not only for perfect sanitation, but for even vastly greater security than could be obtained under the present ordinances with the complication resulting therefrom.

"Now, the laws in a few cities and towns permit plumbing to be done in accordance with the second simpler and more scientific system, which has been recommended by men of the highest engineering authority, and in view of the very great difference in cost between these two systems, it is evident at once to anyone that very strong arguments must be produced by those favoring the more complicated arrangements before legislators are justified in compelling the public to adopt them instead of the simpler one. It would not be sufficient for them to prove that their system was simply just as good as the simpler one, for the public would evidently prefer the latter as being less costly and easier to keep in order. They must prove two things more, namely, first, that the simpler system does not afford perfect safety; and, second, that the complex system does do this.

"As a matter of fact, they have proved neither; whereas, on the contrary, the reverse has been positively demonstrated, both by experience and by the revelations of modern science.

"It has been shown that the complication not only absolutely fails to perform the service expected of it, but that it has even introduced new and unexpected evils far greater than any it essayed to remove. It has also been clearly demonstrated that the simpler system actually is capable of

RECAPITULATION.

furnishing complete protection. Now, there are a few very simple considerations which can be pointed out very briefly, and be easily understood by anyone, and which alone in reality prove this to be true.

“The latest plumbing laws of Boston, those of 1898, contain thirteen sections governing the actual plumbing work; the rest relate to plumbers and inspectors. Of these thirteen sections I find eight are, in the light of the most recent conclusions of reliable investigators both here and abroad, either inadequate or altogether faulty, and I believe that unless these sections are very soon amended the public will find they have been grossly misled, and will demand reasons for it better than can be given.

“Of these eight sections, the two most objectionable are 128 and 125, the former calling for the back venting of every fixture trap, and this involves the use of most of the complication shown in the first picture. These pipes first came into use not many years ago, when sanitary water-closets began to supplant the old-fashioned pan closet. The new closets gave a better and stronger flush and were found to disturb the seals of fixture traps below them. A partial vacuum was produced in the soil pipe by the heavy plug of water falling from the closet, and this was observed sometimes to destroy the seal of ordinary small S traps. Certain experimenters at that time found that the seals of these traps could be protected by ventilating them at the crown, and they immediately published their discovery, and the plumbers immediately took the matter up and pushed it so vigorously that it very soon became the subject of one of the most unfortunate and burdensome building laws ever inflicted upon the people. In the few years since this trap-venting custom took root the much-abused public has spent many millions of dollars in worse than useless piping.

“A very short time after the first experimenters had rec-

ommended trap-venting other experimenters found several objections to the practice not foreseen by the first in their very hasty recommendations, and the later experimenters similarly published their objections. They found the mouth of the vent pipe, where it connected with the trap, quickly collected sediment, and, especially under kitchen and pantry sinks, very often became completely closed up by grease and fatty vapors. They also found the top of the vent pipe where it passed up through the roof of the house sometimes got closed up by snow and frost, in both of which cases it became worse than useless as affording a false sense of security and standing in the way of the adoption of so-called non-siphoning traps, like the common pot and bottle traps, which at about that time were discovered to be capable of resisting siphoning action entirely and, if built large enough, permanently, without any vent pipe at all.

“More important than all, these later investigators found that the vent pipe, by bringing a constant current of air directly over the water seal of the trap to which it was attached, licked up this seal with a rapidity exactly proportional to its efficiency as a ventilating agent; and so quickly did it in this way destroy the very seal it was delegated to protect that boards of health were obliged soon after the introduction of the trap-vent law to issue circulars to the house owners, warning them of this great danger and directing them to have some reliable plumber refill the traps every two weeks or oftener all through the summer season and at all other times when their houses were closed during the absence of the owners.

“It was also found very soon that the great complication to the plumbing which this custom of trap-venting introduced seriously added to the danger of leakage through bad jointing and the increased use of material, and that it gave

RECAPITULATION.

rise to dangerous and frequent so-called 'by-passes,' which are blunders in connecting up the vent pipes in such a manner as to open direct communication between the drains and the house.

"These and other grave objections to back-venting led the later experimenters to try very hard to have the trap-vent laws repealed. But it was too late, the people interested did not rush in so zealously as they did before, and Error ran twice round the world while Truth was barely able to cross the threshold.

"At last, however, the defenders of trap-venting, completely driven to the wall, were obliged to admit that the vent pipe did sometimes clog up and did set an air current in motion near the trap seal, and that this current must in time evaporate out the seal, because if the vent were attached to the trap much below the seal it would afford no protection against 'self-siphonage' or loss of seal by 'momentum,' and they were obliged to admit that it added somewhat to the complication and therefore to the danger of bad joints and defective material and arrangement, and they therefore abandoned the advocacy of the law on the ground of protection against siphonage, but still adhered to it on the ground that it was needed to purify the branch waste pipes by aeration.

"But here again they were badly beaten by the opposition. These showed that the branch waste pipes could be infinitely better purified by a powerful water flush followed by an equally powerful pure air flushing from the room through the fixture above the trap than by ventilation with foul air alone from the soil pipe through the back vent pipe. They argued that the plumbing laws should stipulate that every fixture should be constructed on the principle of the 'flush tank' by having outlets and outlet valves large enough to fill their waste pipes and traps full bore at every discharge.

“This was as wise as it was important, but still the matter was not zealously taken up and placed before the legislators, and this simple and useful provision has never yet been incorporated in our plumbing ordinances.

“Nevertheless, there are public-spirited men among the plumbers, as in all callings, and these men have united with the sanitary engineers in condemning the law. One of the ablest plumbers of Boston said to me (confidentially, however, as to his name) that the law was now a gross imposition upon the public, but that the burden had been brought upon them by the early sanitary engineers, and that in all probability it would be left to the sanitary engineers to lift it off again. Many other leading plumbers in different parts of the country have since privately admitted the same thing.

“In 1891 the Boston Society of Architects voted against the trap-vent law and endeavored to have it repealed. But their efforts were without success.

“In section 125 our plumbing statutes stipulate that ‘every drain pipe shall be supplied with a suitable trap placed with an accessible clean-out at or near the point where it leaves the building.’

“This involves an inner vent pipe often rising to the top of the house, as shown in our first picture, and sometimes also a sewer vent pipe from the outer side of the house trap, which sometimes again runs to the top of the house.

“Now, cities and towns should invariably be provided with well constructed and well ventilated separate sewerage systems, and the latest discoveries in sanitary science, land irrigation and filtration and in bacteriology have made evident why and how this should be done.

“In well built and fairly well ventilated sewers, like the modern sewers of Paris, the air is perfectly safe to breathe, and these sewers are daily visited by travelers. All sewers

RECAPITULATION.

should be constructed in this manner, but better ventilated, and the air within them being then entirely innocuous, so far as disease germs are concerned, and in all respects safe in proportion to the extent and liberality of their ventilation, it follows that every house drain should be built of sound, well jointed piping and serve as extra ventilation or breathing tube for the sewers. Hence the use of this main or 'intercepting' house trap should be prohibited by law, cesspools abolished and the sewers improved and perfected with the aid of the money this simplification saves to the public.

"Thus the question of house plumbing is closely connected with that of the sewerage systems of cities and towns, and these again with one another throughout the entire state and country. The question of sewage disposal is too broad to be considered as a municipal problem simply. It concerns the condition of the water courses throughout the state, and cities and towns bordering upon these streams and rivers can only be properly treated together as a whole in one broad, comprehensive scheme. Again, the investigations and experiments to which I have referred, in determining the effect of siphonage, back pressure, evaporation, capillary action and flushing action in plumbing, should be made by the state for all of its cities and towns together. In this way much more exhaustive and satisfactory researches and conclusions can be obtained with the same money outlay than by leaving each city or town to investigate the matter for and by itself.

"In our second diagram it will be observed that all the plumbing fixtures have been constructed on the principle of the flush tank. That is, their outlets have been made as large in their clear waterway as the waste pipes serving them and, where possible, their discharge has been made automatic. This automatic discharge is always possible, and, for good results, necessary, with kitchen and pantry

sinks, of which one is shown a little to the right of the center of the picture.

"It will also be observed that only three traps are required on each story to serve six fixtures. There are four strong reasons for this, one of which is that it saves both expense and complication. A second and still more important reason is that this arrangement protects the seal of the water-closet from siphonage. The small trap is, in this case, a common pot-trap of great width but comparatively small depth. This renders it anti-siphonic. A slight modification of the form of this trap will render it also self-scouring. But its seal is only two inches deep, while the seal of the water-closet is four inches. Accordingly, the pot-trap, being rendered by its form anti-siphonic, permits air to pass through its water seal under siphoning action without destroying that seal. Thus it serves as a back vent pipe for the water-closet seal. For the latter, being twice as deep, cannot be broken so long as a shallower trap seal connects with it. This is a law of plumbing hydraulics which we can easily understand without further explanation, and it is strange that it has not been made use of in plumbing before this by the practical plumber.

"A third and equally important reason for placing the traps at or near the floor level instead of close to the fixture, as required by the law, is that it protects their seals from the effects of back pressure because the pipe above the trap is long enough to form a water column of length sufficient to resist the atmospheric pressure produced by this action.

"Finally, a fourth important reason is that the traps receive a much better scour when arranged in this manner than under the usual arrangement. The basin trap is scoured by the entire discharge of the bath tub,

"The reason why cesspools in traps should be avoided is because they give rise to that form of fermentation which

RECAPITULATION.

is called putrefactive decomposition, and although it may seem to be rather a trifling thing to debar them in house traps, yet when we reflect that a dozen such small cesspools in a single house must be multiplied by thousands or hundreds of thousands, when considered from the standpoint of the purification and proper management of the public sewers, it becomes a very important consideration indeed. For putrefaction generates the anærobic or dangerous classes of bacteria which work without oxygen and which are hostile to the friendly or ærobic bacteria which thrive best in large volumes of fresh air. The modern principles of sewer construction require the sewage to be carried through the sewers and deposited upon the irrigation or filtration fields in its fresh state before putrefaction begins. In this state it leaves the sewer air innocuous and also forms a better fertilizer, whereas in its putrid state it becomes an element of danger in both places, and is even destructive to fish life, when it is carried directly into the ocean as at Boston. In its fresh state sewage forms a useful food for fish.

“The recent researches of Laws, Andrewes and others show, first, that the number of germs of all kinds in sewer air is much smaller than in the air of the streets above them, and that this is due to the fact that the germs come in contact with the sewage and damp walls of the sewer and drain pipes, from which they cannot under normal conditions again escape. Second, that the bacteria found in sewer air are not of the same kind as those found in the sewage itself, but are of the same kind as those found in the outer air above the sewers, showing that the bacteria come, therefore, not from the sewage, but from the outside air above them. Third, that disease germs are unable to live long in sewage, where myriads of bacteria of decomposition, hostile to them, but friendly to man, abound; and that as a matter of fact

disease germs have not been found in the air of sewers in the very careful experiments so far made.

"In corroboration and explanation of these conclusions the experiments of Carmichael, Wernich, Miquel, Naegeli, Pumpelly and Smyth and others show that germs cannot detach themselves from the surface of water at rest at normal temperature, nor from the damp surfaces of sewers, showing that the water seal of a trap forms an effective barrier against their passage into a house.

"Hence sewers can be constructed and ventilated in such a manner that the air within them becomes innocuous, and it is then evident that a simple system of house drainage without a main or intercepting trap and without back-venting can be made perfectly safe."

CHAPTER XLIV.
 BETTER PLUMBING AT HALF THE COST.*

*Mr. President
 and Members of the Institute:*

I have here drawings representing two methods of plumbing the same house, one sometimes called the "two pipe" system, being designed in conformity with the average

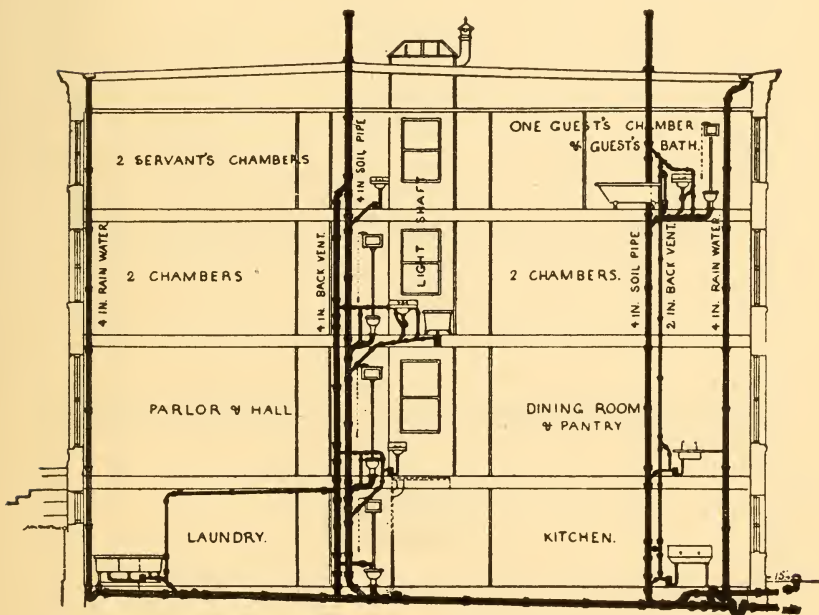

Fig. 650

*Paper read before the 44th Annual Convention of the American Institute of Architects at San Francisco, Cal., Jan. 18, 1911. By J. Pickering Putnam Delegate from the Boston Chapter A. I. A.

PLUMBING AND HOUSEHOLD SANITATION.

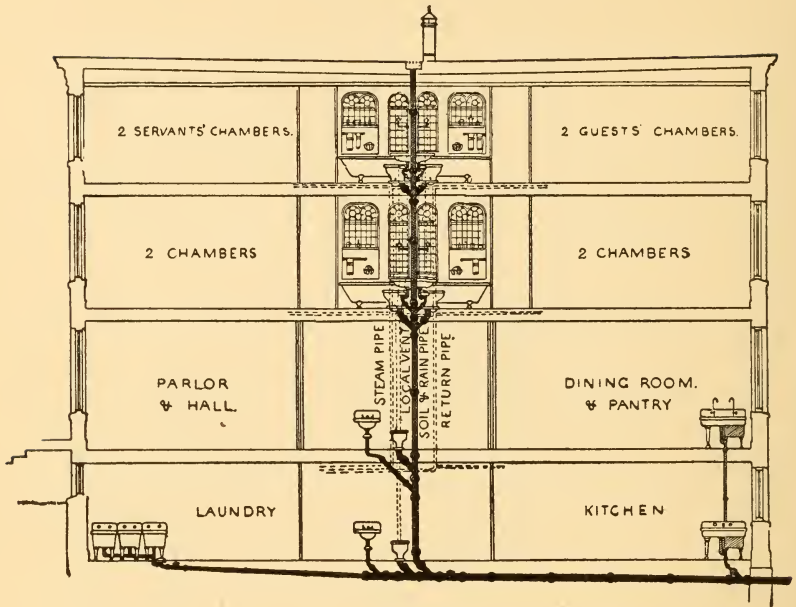

Fig. 651

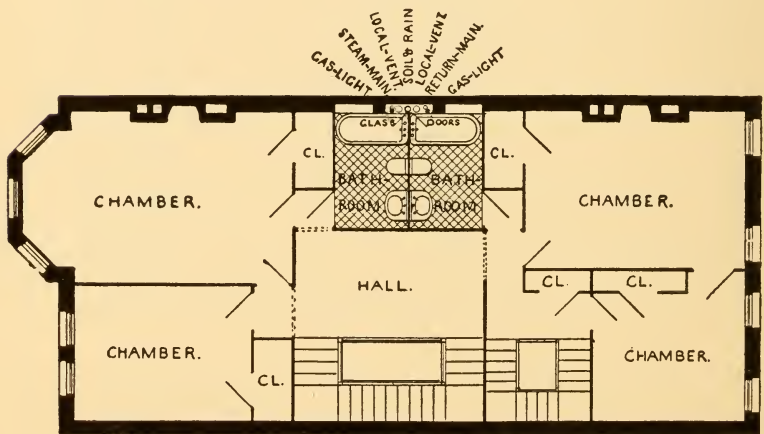

Fig. 652

plumbing laws prevailing in the United States, and the other in accordance with a simpler or so-called "one-pipe" system which promises before very long to take the place of the more complicated and costly one. The plans are, with a few unimportant modifications, of a house in Boston which I have recently rebuilt in part and enlarged, and which, therefore, show plumbing substantially as it had actually been executed under Boston laws.

The simpler arrangement is the one I recommend but which the owners could not obtain on account of the plumbing ordinances. The cost would have been less than half that of the one which was executed, and its convenience and safety immeasurably greater. This statement of cost is corroborated by the estimates of three leading plumbers which I give herewith.

In the two-pipe arrangement in this building there are two independent rain water conductors, both trapped at the bottom before entering the house drain. In the simpler arrangement a single conductor is used, and it serves also as the only soil pipe required. It descends in an ample ventilating slot or recess in one of the party walls at about middle distance between the front and the back of the house.

The use of antisiphon traps on the fixtures does away with all need of back venting.

The bath room in the two-pipe arrangement has an outer exposure on the south front with a window for direct light and ventilation, while in the one-pipe plan the bath room occupies less valuable space near the centre of the house, where it receives continuous ventilation through heated flues and ample artificial light.

This house is occupied only in the nine cold months of the year, and is closed during the summer. Hence, when the bath room windows in the two-pipe arrangement are

opened for airing, the ventilation acts of necessity in a direction exactly opposite to that which is intended because the warmer column of air in the house rises to allow the colder and heavier column from without to enter. The result is that all the bad air in the bath room, including all the imaginary disease germs still supposed by many to be inseparably connected with plumbing pipes, are blown straight into the house and distributed impartially through the various living rooms, parlor, reception and dining room for the equal benefit of all the occupants. This being lawful and fashionable is still accepted by the unreasoning public as the best possible arrangement.

The simpler plan provides a constant, powerful, upward and outward ventilation carrying all bad air and possible odors directly out of the house, incidentally ventilating the entire building and doing its work automatically and without the dangerous draughts necessitated by window ventilation.

Now that modern science has demonstrated the absence of disease germs from sewer air, we know that direct sun's rays are not required in bath rooms, and that, in fact, proper artificial lighting is actually preferable because it furnishes in its heat the motive power adapted to produce or increase the ventilation of the room.

On the other hand, sleeping and living rooms do need direct sunlight, so that the interior arrangement of the bath room performs the double service of ensuring for it immeasurably better ventilation, and of reserving all window space for the rooms which actually require it.

In our complicated arrangement the use of extra heavy lead-caulked cast-iron pipes is enforced by the law no doubt because thinner pipes could not stand the severe strains applied to the pipe by the caulking iron and by the hydraulic test, and because shrinkage and settlement in the building

materials are bound to fracture thin pipes and plumbing fixtures where rigid lead-caulked joints are used.

In our simpler plan, on the other hand, we have designed to use flexible joints and to abolish the use of lead caulking and the hydraulic test altogether. In this case, pipes of so-called "standard" thickness, weighing just half as much as the "extra heavy" pipes, are known to be amply thick enough to serve in plumbing work with safety for a lifetime, and inasmuch as the new flexible jointing has been proved to be permanently reliable and less than half as expensive to make as the utterly unscientific and unreliable lead-jointing now in vogue, we are able to cut in two the cost of every foot of cast-iron piping used in the plumbing of the building.

Finally, the "main house" or "disconnecting" trap with its foot vent pipe has been omitted in our improved plan, in virtue of which, when this omission becomes generally adopted, the sewers will become so amply ventilated through every house drain and soil pipe that the air within them will surpass in purity that of the famous Paris sewers now visited by thousands of visitors of both sexes every year, as one of the very interesting sights of the gay metropolis.

The money savings effected by all these improvements are shown by the following careful plumbers' estimates already referred to.

In the two-pipe arrangement there are two main 4-inch extra-heavy soil-pipe stacks, which is the average number found in both city and country houses throughout the United States. These have here 100 feet of pipe, 40 joints and 18 fittings and cost for all material and labor, including applying the hydraulic and all other tests required by the law, as well as the usual fair plumber's profit, \$133.00 (omitting the odd cents for brevity).

PLUMBING AND HOUSEHOLD SANITATION.

One of these main soil pipes might be dispensed with as shown in the simple plan.

Next there are the two rain-water stacks usual in city houses, either inside the house, to avoid freezing, or outside, one for the front and one for the rear.

These require here 85 feet of 4-inch extra-heavy pipe with 20 joints and 9 fittings, and cost, by the plumbers' estimates (taking in each case the average between the three figures submitted), \$115.00.

Both of these pipes should be done away with where the the combined system of sewerage is used, because the 4-inch soil pipe stack is more than amply large enough to take care of all the rain from the roof, and because the combination of the rain with the soil pipe greatly improves the flushing.

We have next the 4-inch main drain pipe, with its 45 feet of extra heavy pipe, 21 joints and 9 fittings, costing \$85.00.

Then come the branch waste pipes, which cost \$65.00.

Next the two stacks of useless back-vent pipes with their branches having 180 feet of pipe of various sizes, 40 joints and 19 fittings, and costing \$91.00.

Finally there is the main house trap and its fresh air inlet pipe, costing \$30.00, a fair average for this foolish obstruction to ventilation and sewage outflow. It involves an average of at least 20 feet of 4-inch extra-heavy piping, a dozen joints, and half a dozen fittings including the trap itself. When the fresh air inlet pipe is carried up to the roof, as is often considered advisable for the purpose of carrying sewer gas away from the street level and up above the roof, on the same principle which directs that all soil and drain pipes shall discharge not less than 10 or 15 feet away from any window, then the cost of this item mounts up to double the figure we have given above as a fair aver-

age, but as the ordinances do not require this upward extension I have not included it.

The average allowance for testing, when the hydraulic and other tests for tightness are required by law, is put by plumbers at \$25.00.

The hydraulic test is a very costly and entirely inexcusable extravagance, involving an undue strain on the lower end of the stacks and none at all at the top.

All the above items foot up to \$615.00 for the sanitary drainage.

The fixtures shown in this plan are good but simple cast-iron enameled fixtures, and cost with their traps \$290.00.

To this must be added a number of expansion joints in the main cast-iron stacks, to diminish fracture in piping and fixtures due to settlement or shrinkage of the building, where rigid joints are used, for which I think a moderate allowance would be \$60.00. Adding these two items to the drainage cost we have a total of \$965.00.

The cost of the cold and hot water supply and circulation pipes, including the copper boiler, is \$254.00, making a grand total for all the plumbing and water supply of \$1220.00.

In this plan the upper story bath room occupies the southwest corner of the house and has one window. As a rule both bath rooms are thus supplied with outer exposure on the mistaken idea that windows with sun exposure are essential in bath rooms for perfect sanitation.

Turning now to our one-pipe simpler plan in which all the bath rooms occupy the centre of the house, the southwest corner then becomes available for bed-chambers in which direct sunlight and outer air is without question essential for complete sanitation. The two extra bedrooms thus acquired when both the main bath rooms are moved from an outer exposure to the interior of the house, means

a large increase of rental value.

The cost of the single, flexible-jointed soil pipe and its branches of "standard" thickness required under this one-pipe plan, is \$51.00 by the plumbers' estimates as before, figuring in the same manner.

The drain pipe, also of "standard" thickness and flexible-jointed, figures out at \$32.00. The testing of all the pipes in this system by a sensible, scientific smoke and low air pressure test, costs only \$3.00.

The number of feet of piping in the entire one-pipe system of all sizes and "standard" weight amounts to only 115 against 475 feet of extra-heavy pipe in the two-pipe system, which is equivalent to 950 feet of standard pipe, so that the single system contains less than one-eighth as many pounds of cast-iron piping as the complicated system. The number of joints and fittings in the two systems is in similar proportion.

Assuming the same fixtures to be used in the two systems, the total cost of the sanitary drainage in the simple system, including the \$68.00 for setting the fixtures, amounts to only \$155.00, which is almost exactly one-quarter the cost of the corresponding work in the two-pipe system.

Adding to this the cost of the fixtures themselves, amounting as before to \$290.00, we have a total for the whole sanitary plumbing in the one-pipe system of \$445.00 against \$963.00 in the other, which is less than half.

Add now for the water supply piping, as before \$254.00, we have a total of \$709.00 as against \$1217.00, or a little more than half.

But from the saving of the outer bath room space for a bed-chamber or for two bed-chambers, where, as is usual, both bath rooms have outer exposures our \$1217.00 must evidently be increased by the value of these two extra bed-

rooms.

The average value per cubic foot for houses of this class is estimated at between 25 and 30 cents. It was in this case found to be 30 cents. The bedrooms measure 10 feet by 12 feet, and are 10 feet high, giving a cubical contents of 1200 feet, which at 30 cents a cubic foot gives an increased sale value of \$360.00 per room or \$720.00 for the two. The loss of interior closet value due to placing these bath rooms in the centre of the house, is nearly offset by the space consumed and construction-cost of the three-story air-shaft and roof ventilating skylight required by the law for the lower water closets in the two-pipe system.

It seems, therefore, fair to say that the luxury of having outside window and sun exposure for these two bath rooms adds \$720.00 to the real cost of the two-pipe plumbing when comparing it with the single pipe system, and this gives us \$1937.00 for the real cost of the former against \$709.00 for the latter.

In other words, the two-pipe system costs here \$519.00 more than twice as much as the one-pipe system.

Under no form of reasoning can the greatly increased value of the property due to the addition of two such sunny bedrooms be overlooked, except under the assumption that the conclusions of modern science as to the freedom of sewer air from disease germs are unfounded, and that consequently the old-fashioned idea that sunlight is still needed in bath rooms for the purpose of destroying such sewer germs, and that the most effective bath room ventilation is to be obtained by temporarily opening windows upon the outer air rather than by the scientifically regulated and constantly active suction of heated ventilating flues.

The motive power I have installed in the house under consideration consists, first, in the main supply and return pipes of a vapor system of heating, and, second, in the

heat of the lighting burners. These burners furnish a brilliancy of bath room illumination superior on the whole to window light, not only because windows supply no light at all at night, but also because the shades must be drawn during the day for privacy, whereas cheerful and brilliant illumination may be had at all times in the inner bath rooms, ornamented or tempered to any extent desired, by leaded glass, as indicated.

Even direct fresh air may be introduced at very slight additional expense by the aid of a duplicate set of air supply pipes built in the general heated flue, connecting each bath room independently with the outer air. This direct air supply will then be tempered in stormy, freezing weather by the adjoining steam and return mains and by the light-burners, and its volume may be easily regulated by dampers.

Both of these refinements are practically unattainable when outside windows are alone depended upon.

Part of the saving effected by our new arrangement may properly be applied toward installing better plumbing fixtures and more of them. Accordingly in the simpler plan two complete bath rooms have been added to the outfit, and solid earthenware has been substituted for galvanized iron in the service sinks and laundry trays. In addition to this, automatic flush-pots have been installed on the sinks, forming an important measure of protection against grease clogging in the kitchen waste pipes.

The amount of money-saving which would be effected by the simplifications I have advocated above becomes still more startling when applied to whole cities.

According to our census, the average cost of all buildings annually erected in recent years, in the 49 principal cities of the United States, has been over six hundred million dollars per year. The average cost of the plumbing in these buildings is estimated by good authority at 7 percent

AUTHOR'S ADDRESS BEFORE AM. INSTITUTE ARCHTS.

of the total, which makes its annual cost about 42 millions, of which, according to our figures, between 15 and 20 millions might have been annually saved.

Taking for example the year 1906, which was somewhat better than the average building year, the cost of buildings erected in San Francisco in that year was nearly 35 millions, of which nearly 21-2 millions went into plumbing, and of this about a million could have been saved if the difference in the cost of the two systems of plumbing in that year was as I have described. In the future rebuilding of this city a most unusual opportunity seems to be afforded in this direction for both money-saving and sanitary advantage.

New York City erected in the same year nearly 156 millions' worth of new buildings, of which the plumbing probably cost 11 millions, from 4 to 6 of which might have been saved.

Chicago erected that year 65 millions' worth of building, 41-2 millions of which went into plumbing, and a couple or so of millions was thrown away; and our city of Boston erected in the same time 23 millions' worth of buildings, throwing away between 6 and 7 hundred thousand dollars in useless piping.

I believe the Am. Institute of Architects is better able to effect a reform in this department of building than any other body of men in the country, because, while absolutely disinterested, they are better equipped than any other body to view the situation broadly and scientifically, and to exert upon legislators the kind of influence which will compel them to take action in behalf of the public against the pressure of selfish interests and the inertia of ignorance and indifference.

Upon us, at any rate, lies a grave responsibility in the matter of bringing about this reform, because it is to us

PLUMBING AND HOUSEHOLD SANITATION.

that our clients, the public, look to safeguard their interests and health in all departments of building construction.

I would suggest that some immediate action be taken by the Institute, recommending such simplifications as it is now prepared to make, and that also a committee be appointed by the president to investigate the situation and report their findings with recommendations for further action in the direction of simplicity at the earliest possible moment.

In the meantime I have prepared a simplified plumbing code, which is a modification of codes I had been asked to prepare for the use of a number of cities, and which have been in part adopted by them, after conservatism had, however, expunged several provisions for simplification which seemed to me to be among the most important.

This code, together with some observations and demonstrations in sanitary plumbing, giving in some detail my grounds for the recommendations I have made in this paper, which the limit of time allowed me has prevented my even briefly reviewing here, form the substance of a little book to be published this month by Doubleday, Page & Co. of New York, which I have dedicated to the Boston Society of Architects, in recognition of their conscientious efforts in revising the building laws of our city. I refer to it as a means of filling out some of the defects of omission which you may find in this paper.

APR 12 1911

LIBRARY OF CONGRESS



0 020 108 845 8