

陶齋吉金錄

古  
320  
894  
25

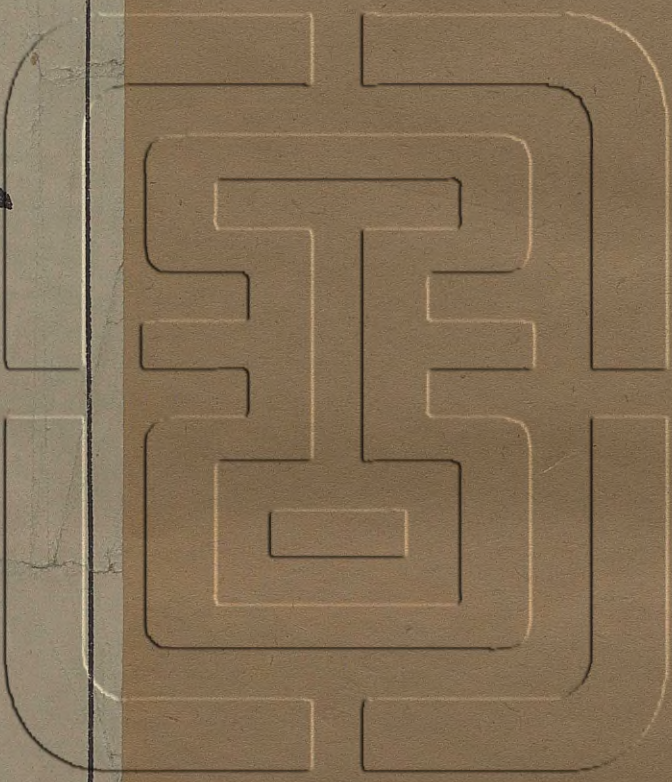

16  
17  
18  
19  
20  
21  
22  
23  
24  
25  
26  
27  
28  
29  
30  
31  
32  
33  
34  
35  
36  
37  
38  
39  
40  
41  
42  
43  
44  
45  
46



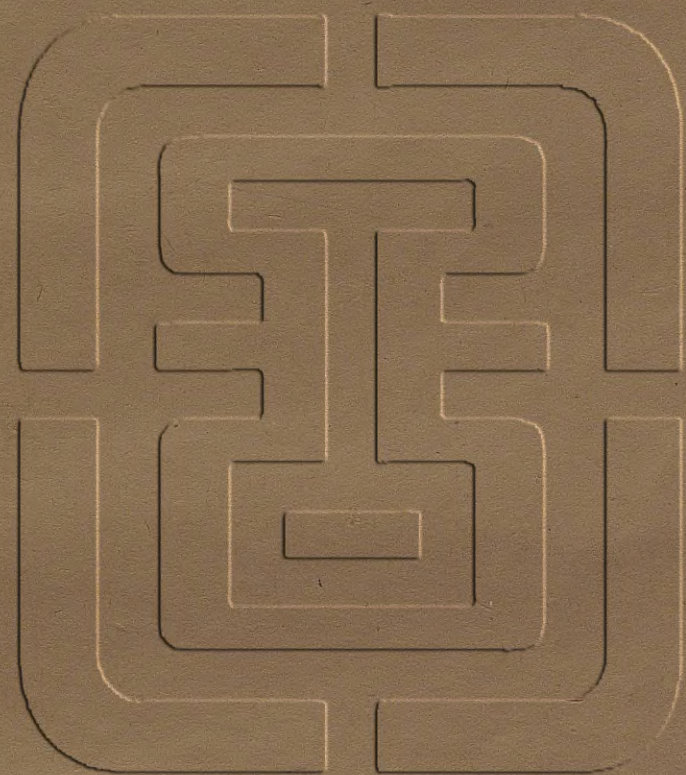
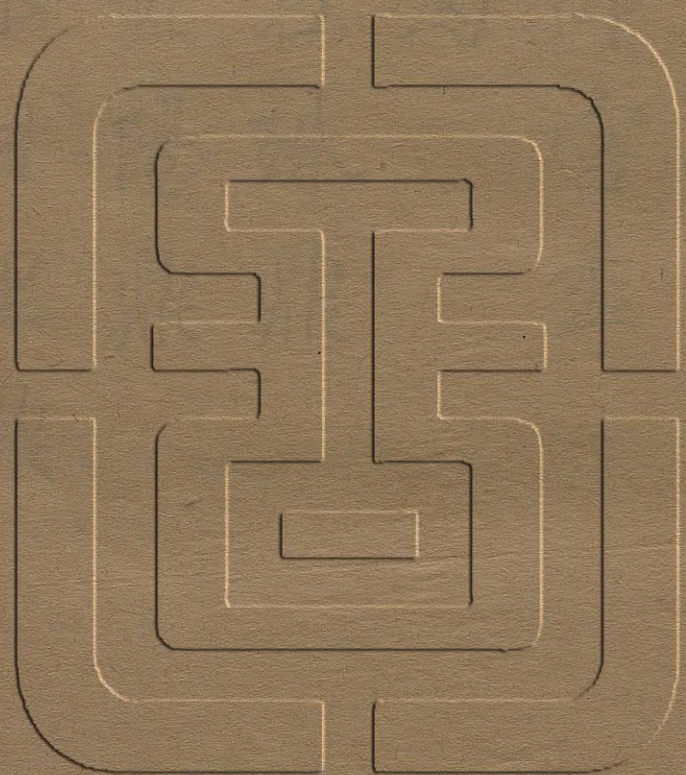



陶齋吉金錄卷五目錄

秦重金壘

秦郃宮壺

秦丙

秦右殊鼎

宜陽鼎

尔甘里鼎

永里鼎

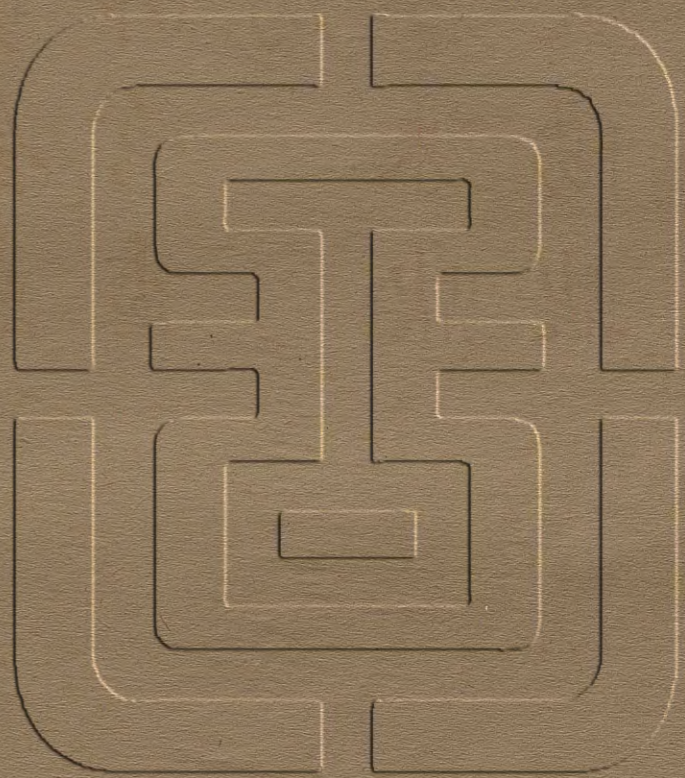



衛鼎

寇公鼎

上官鼎

漢府鼎

西鼎

雖鼎

盤屋鼎一

盤屋鼎二

濕成鼎

犛車宮鼎

中水鼎

汝陰鼎

平陽鼎

長楊鼎

荀少夫鼎

壽成鼎

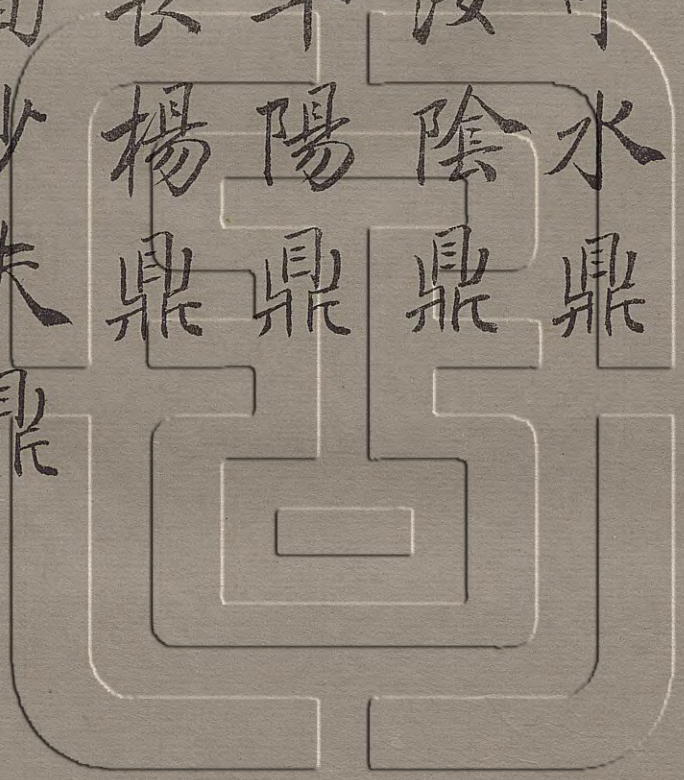
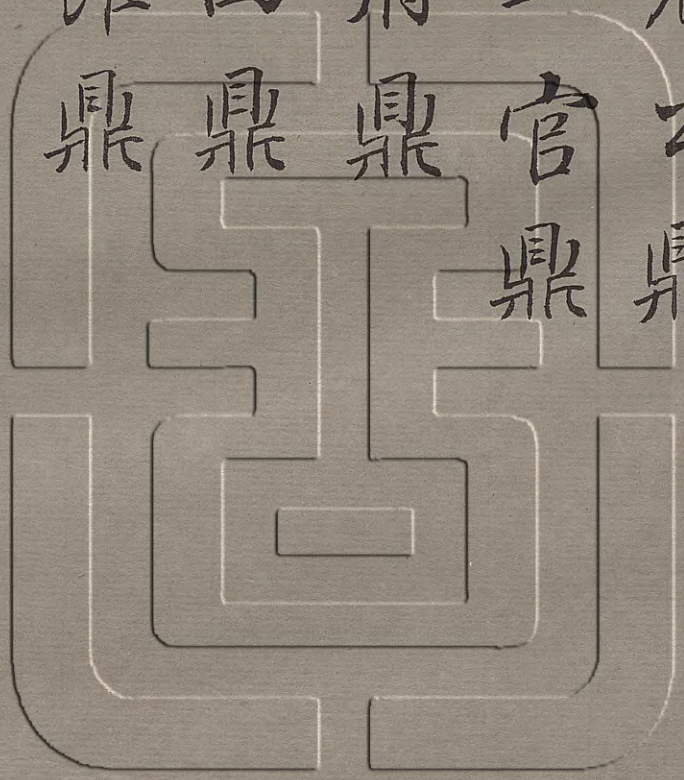

陶齋吉金錄

六



長安鼎

大衛無極鼎蓋

秦高都劍

鄭武軍斲劍

官率劍

陰平劍

帛平侯劍

漢黃龍劍

宜富劍格

潘螭劍

秦寺工殘戈

武庫戈

八羗戈

左將戈

漢武子戈

造戈

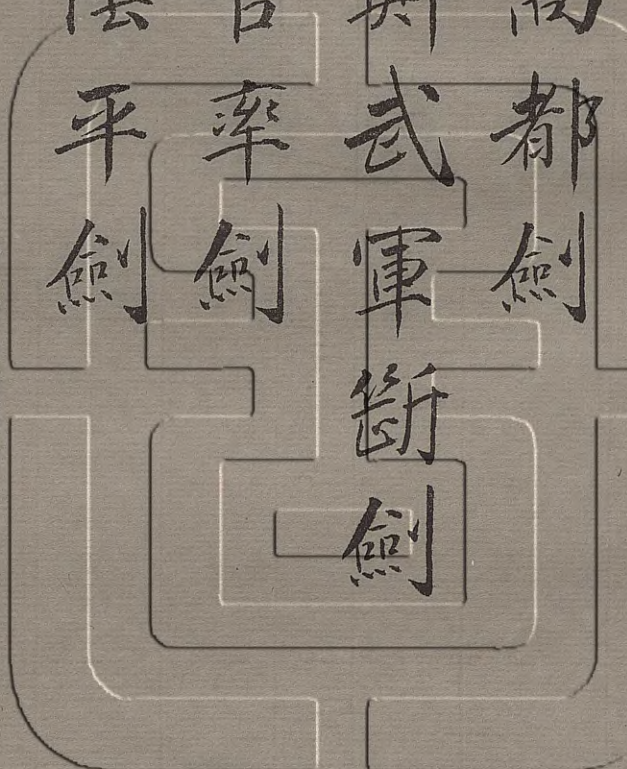
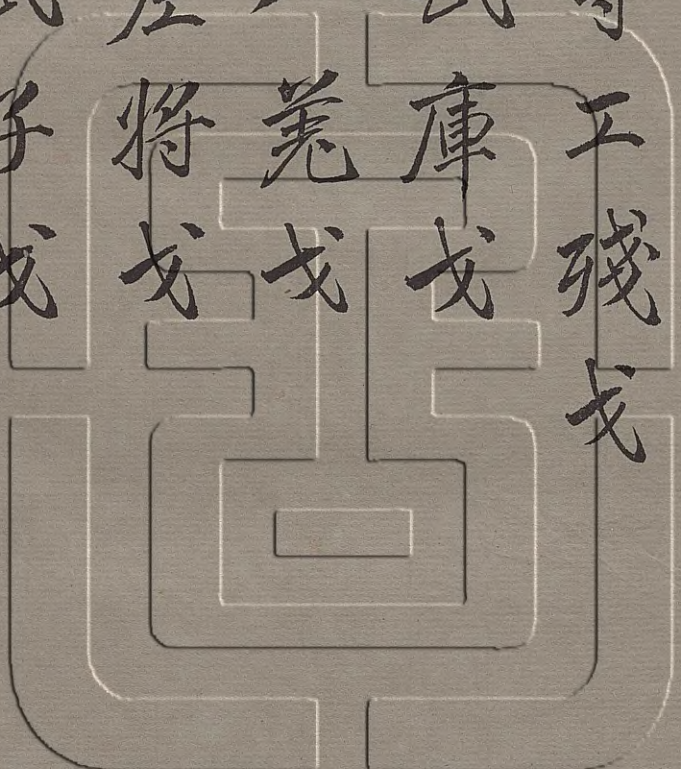



秦重金田罍

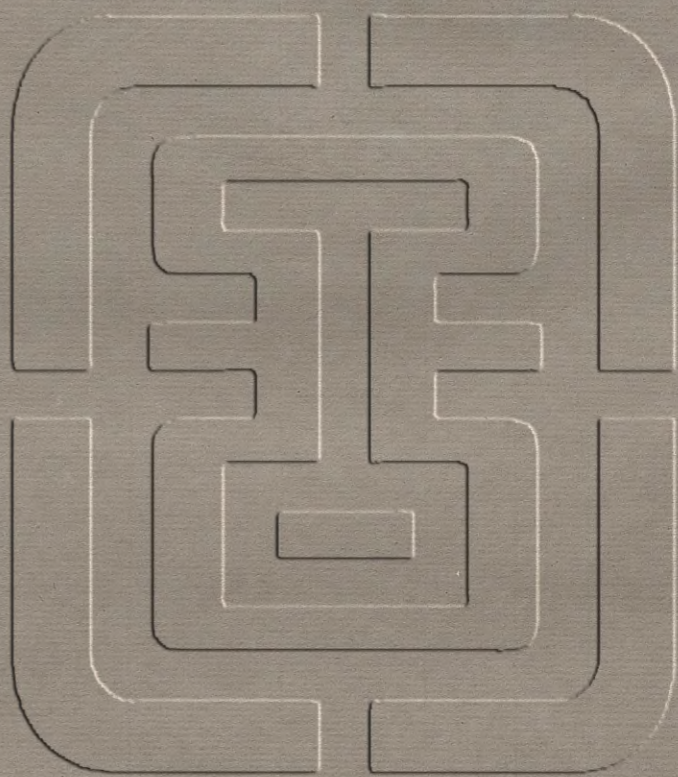



右高六寸七分深七寸三分口徑  
三寸七分腹徑七寸八分底徑三  
寸九分

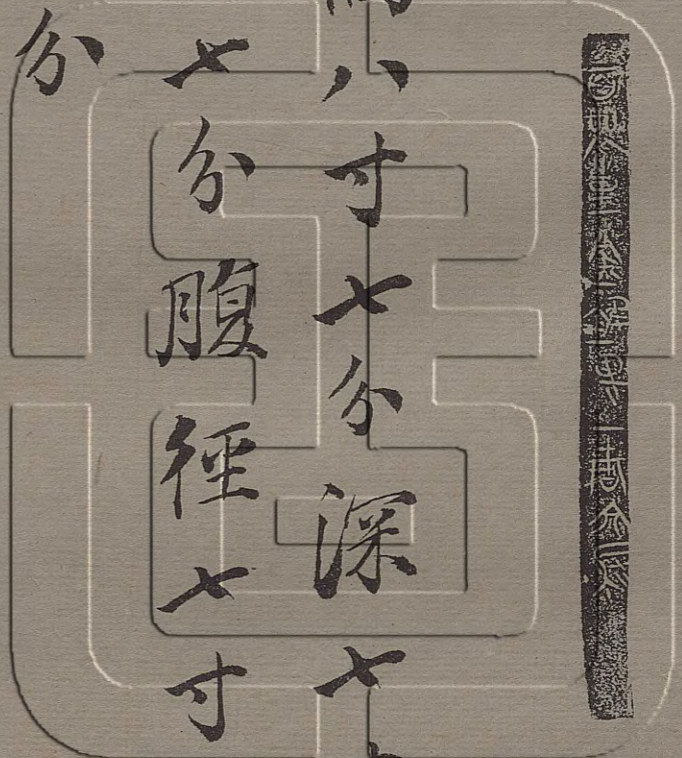

秦郃官盃

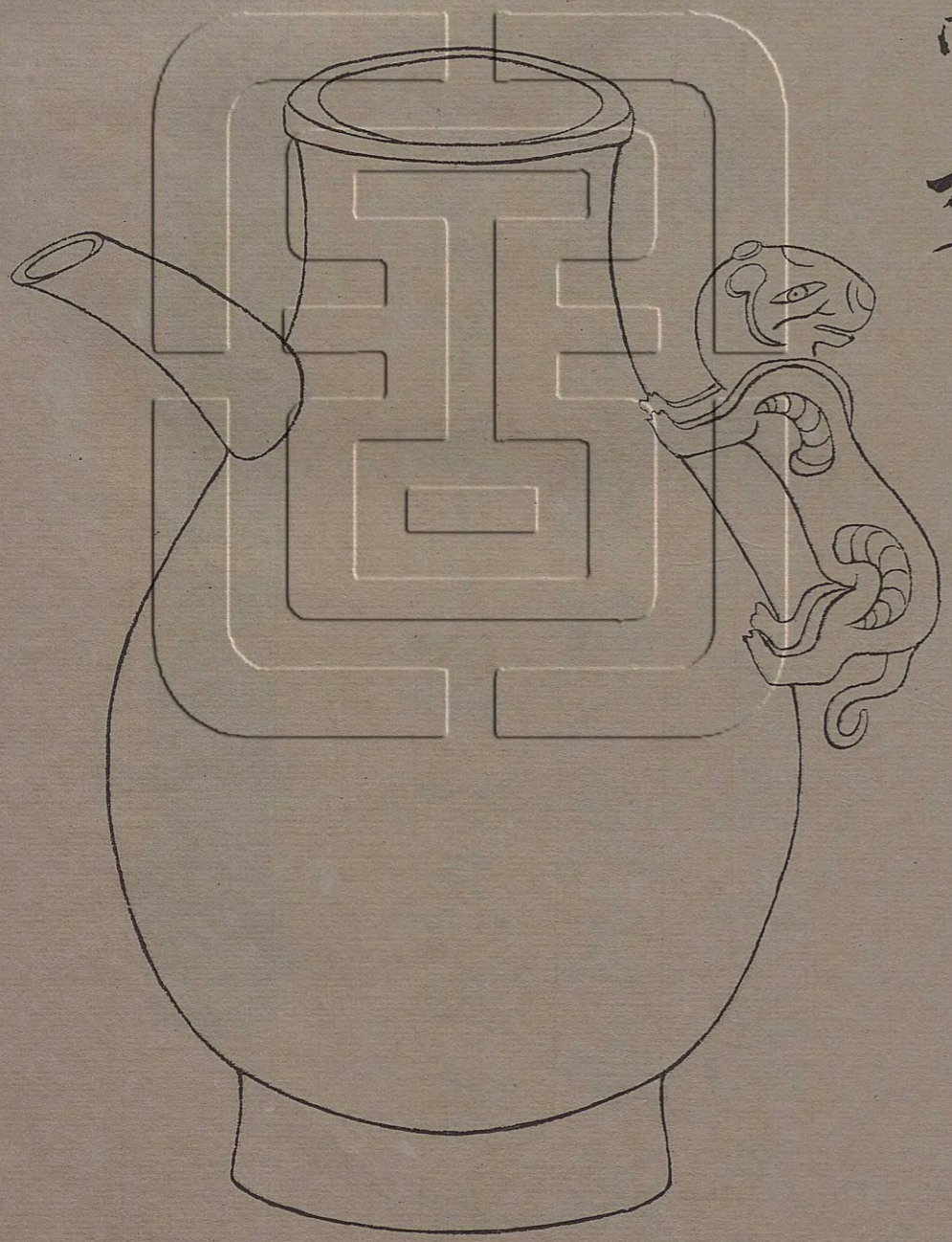



右高十尺五寸二分深一尺四寸六分  
口徑五寸三分腹徑一尺五寸流四  
寸四分虎身長五寸五分高二寸  
六分



秦 匊 原形

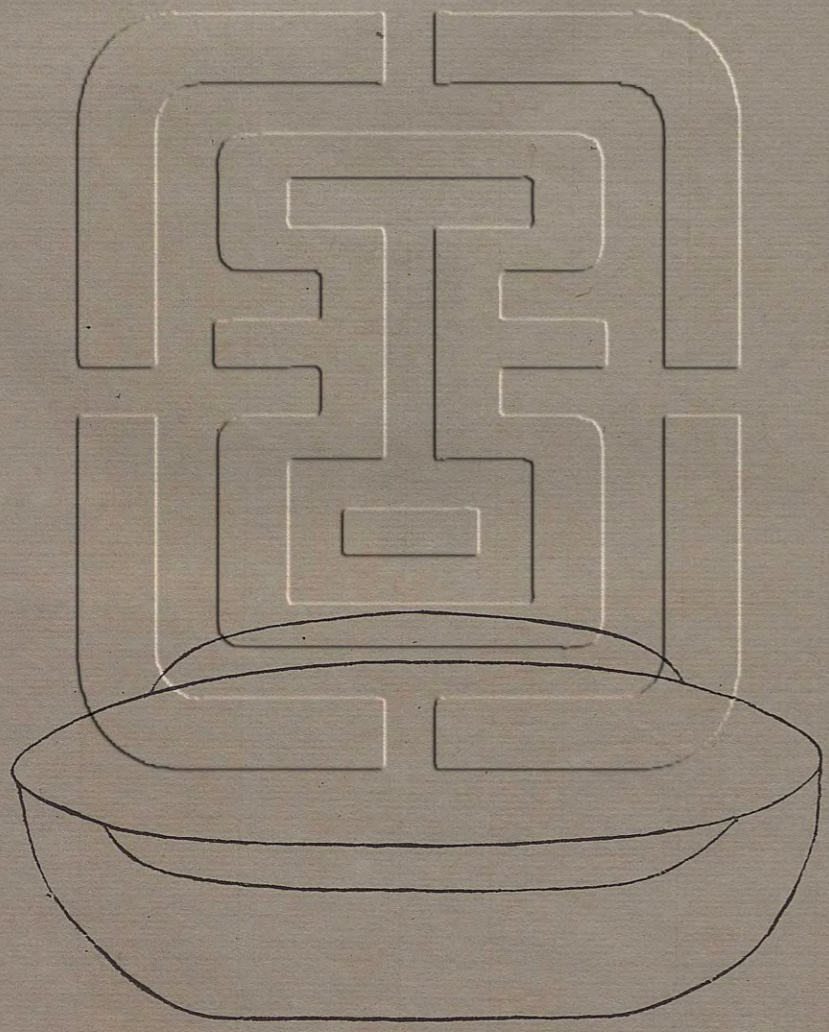



秦右殊鼎

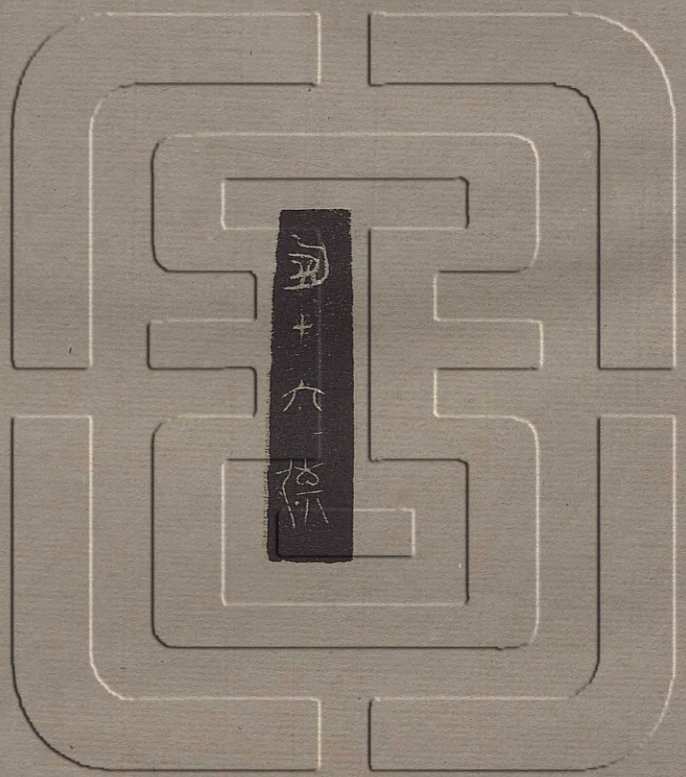
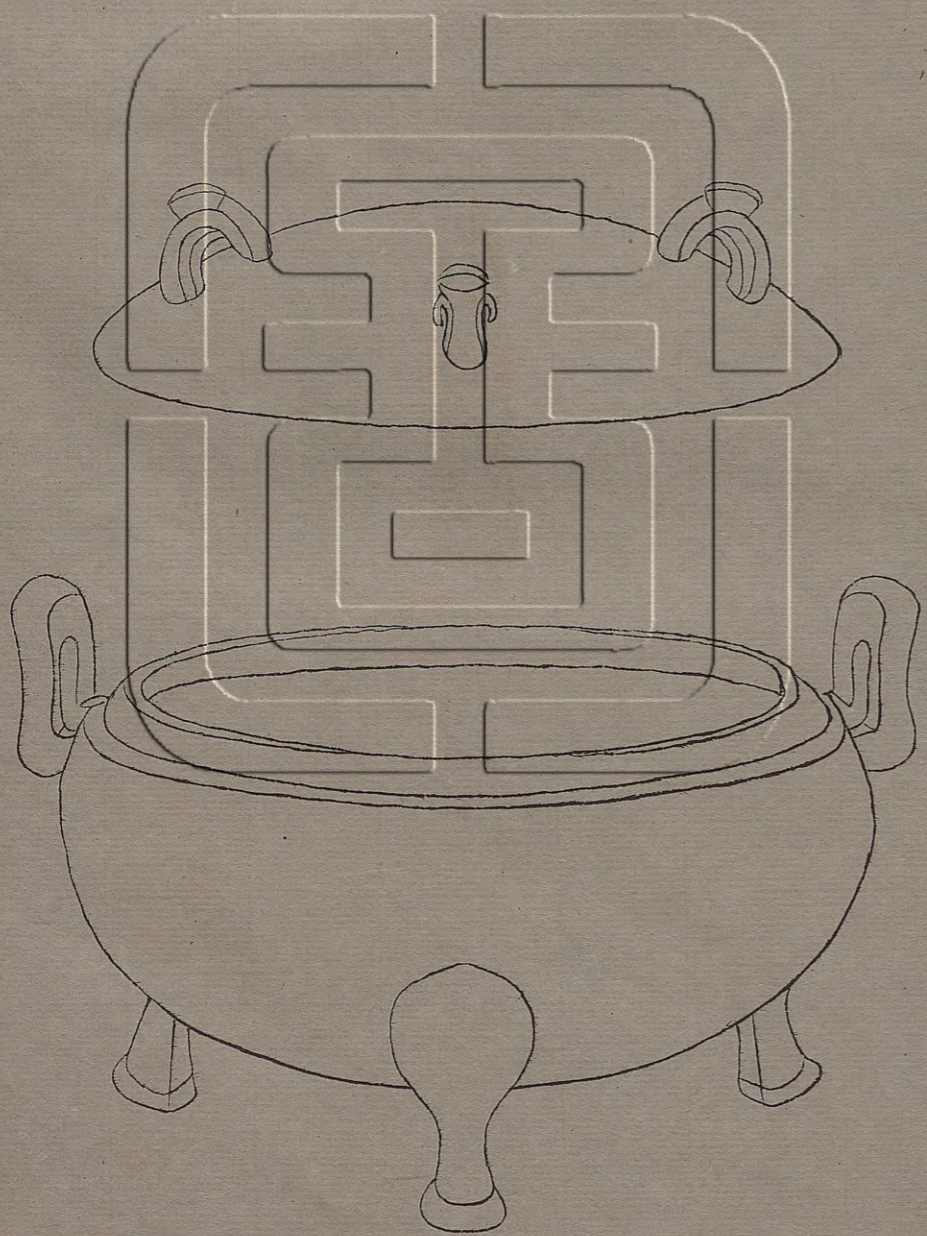



秦宜陽鼎

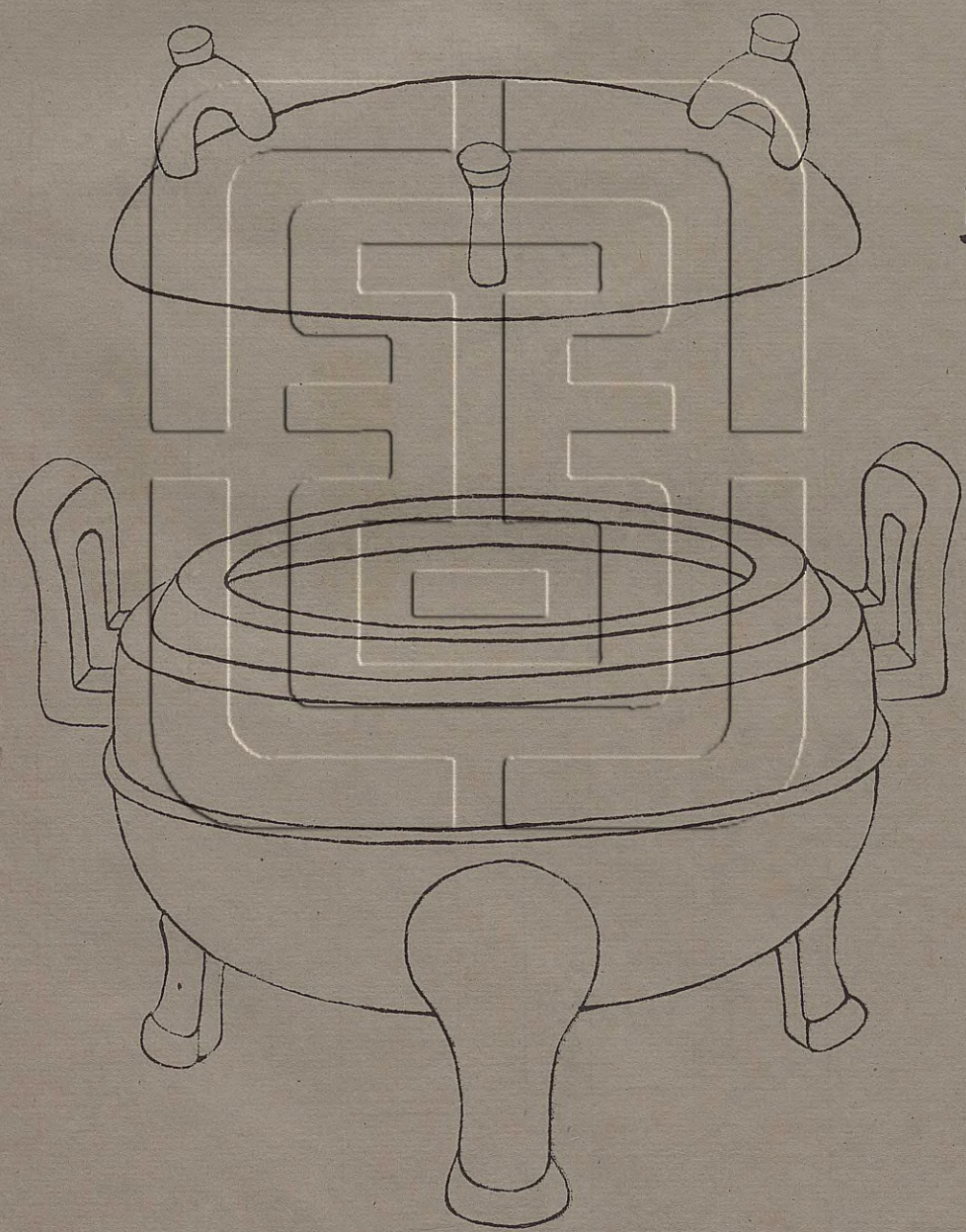

右高五寸七分深四寸四分口徑  
七寸腹徑八寸九分耳高二寸五  
分潤一寸四分蓋高一寸八分徑八  
寸三分





二尺九兩  
廿二

本又市



陽  
十二分兩  
一兩  
二分

蓋

器

右高七寸四分深五寸五分口徑  
七寸八分腹徑一尺三分耳高三  
寸一分濶二寸一分蓋高二寸二分  
徑八寸九分

秦尔甘里鼎

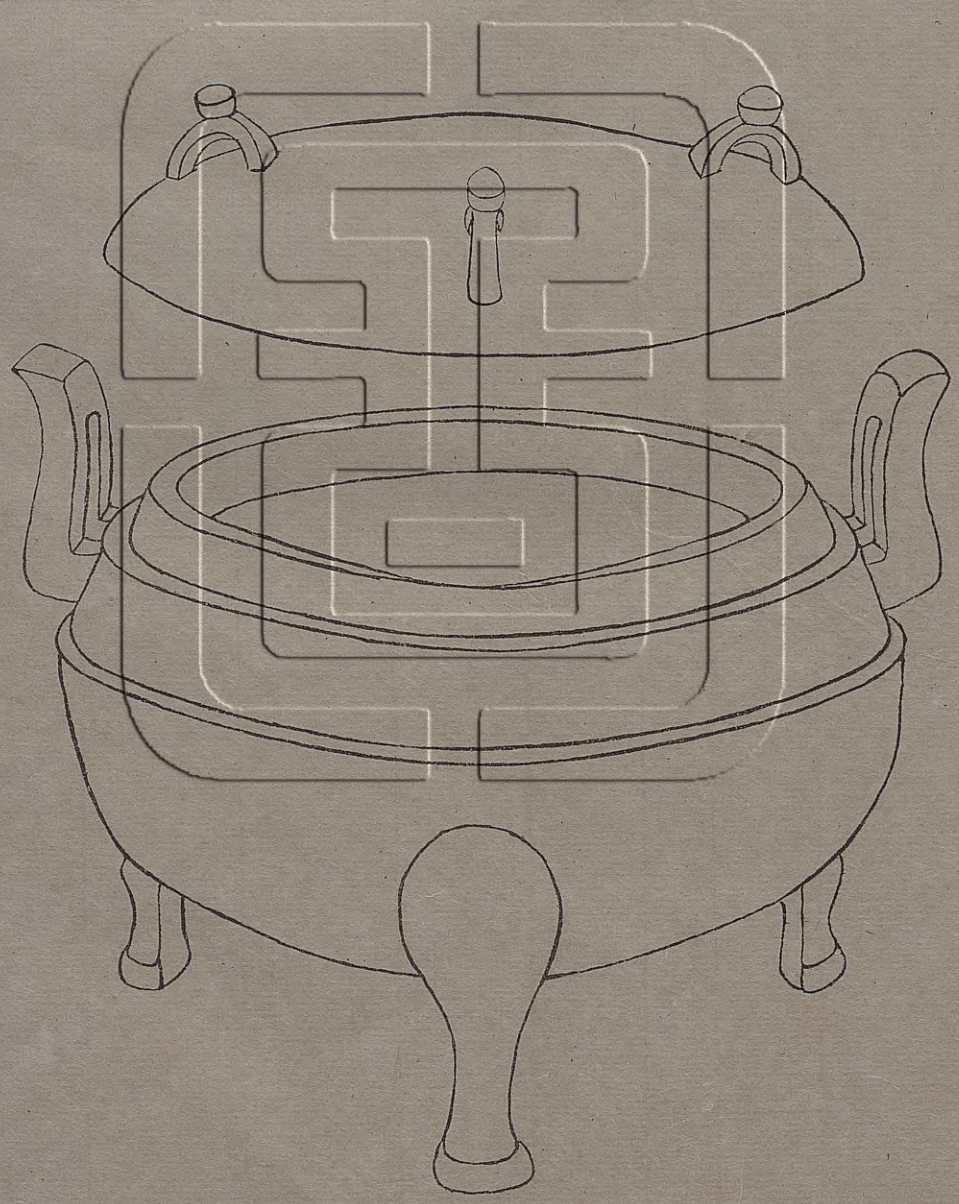



秦永里鼎

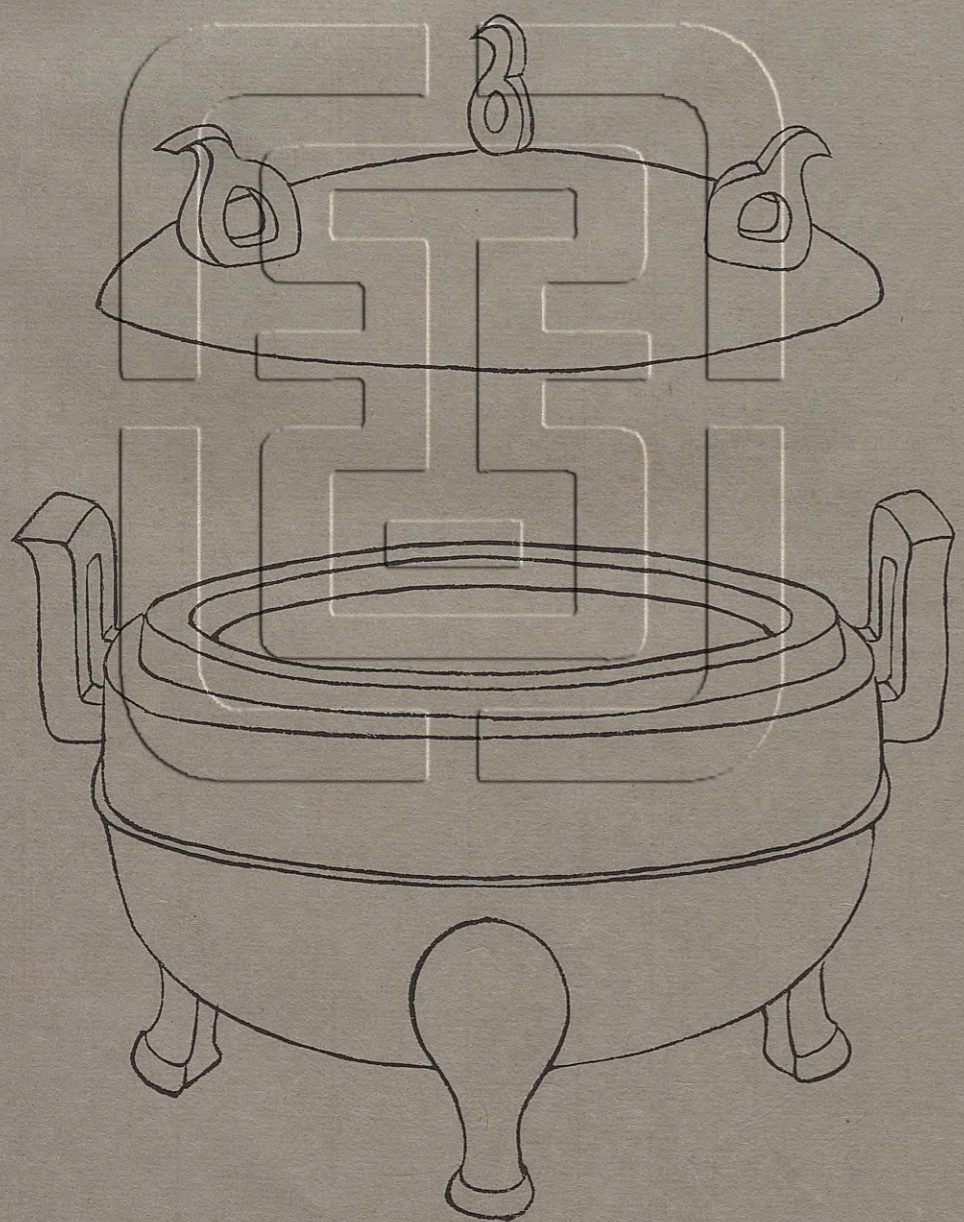

右高六寸八分深四寸九分口徑  
七寸八分腹徑九寸耳高二寸三  
分濶一寸九分蓋高一寸徑八寸  
六分



蓋



秦衛鼎

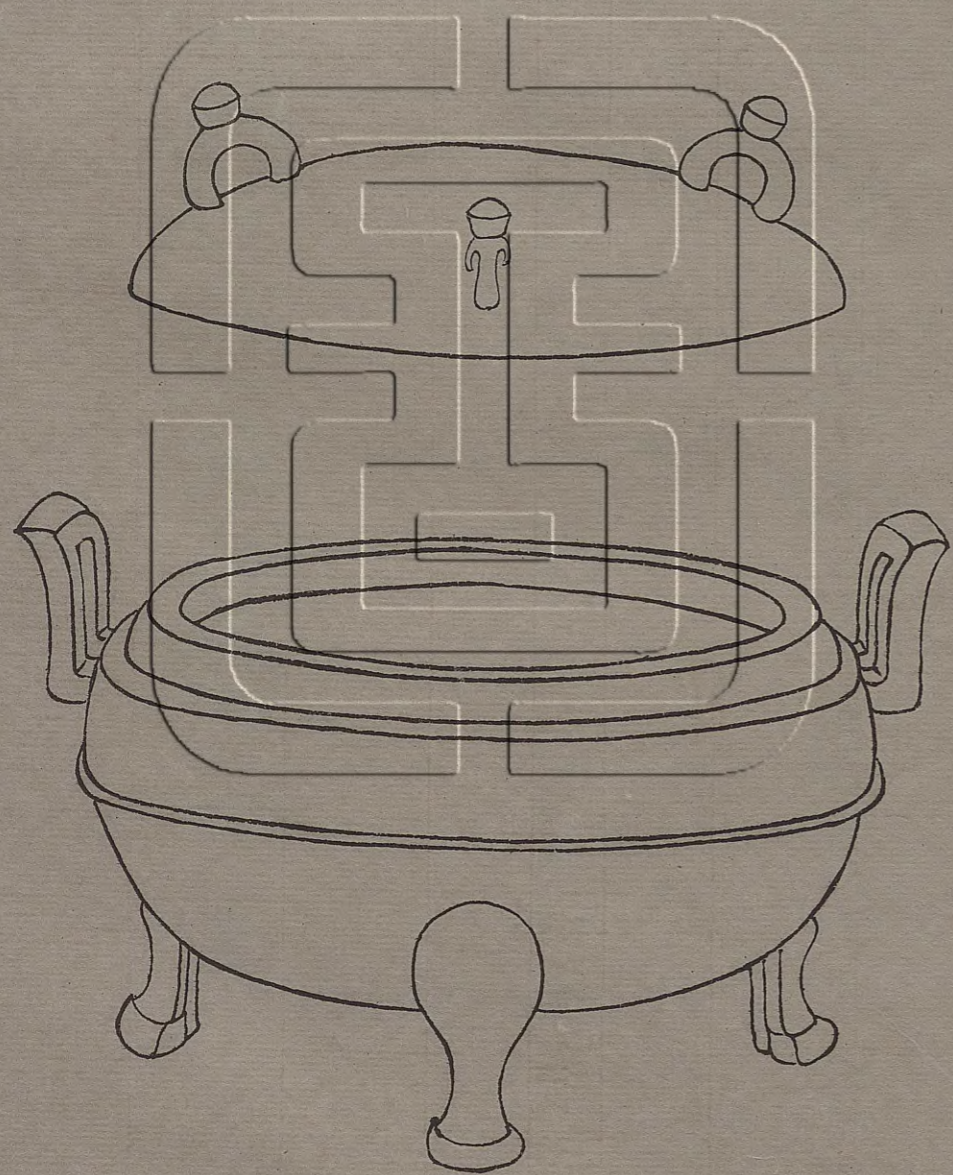

右高六寸七分深五寸七分口徑  
七寸五分腹徑九寸九分耳高二  
寸八分濶二寸蓋高二寸徑九寸  
五分



器



秦冠公鼎

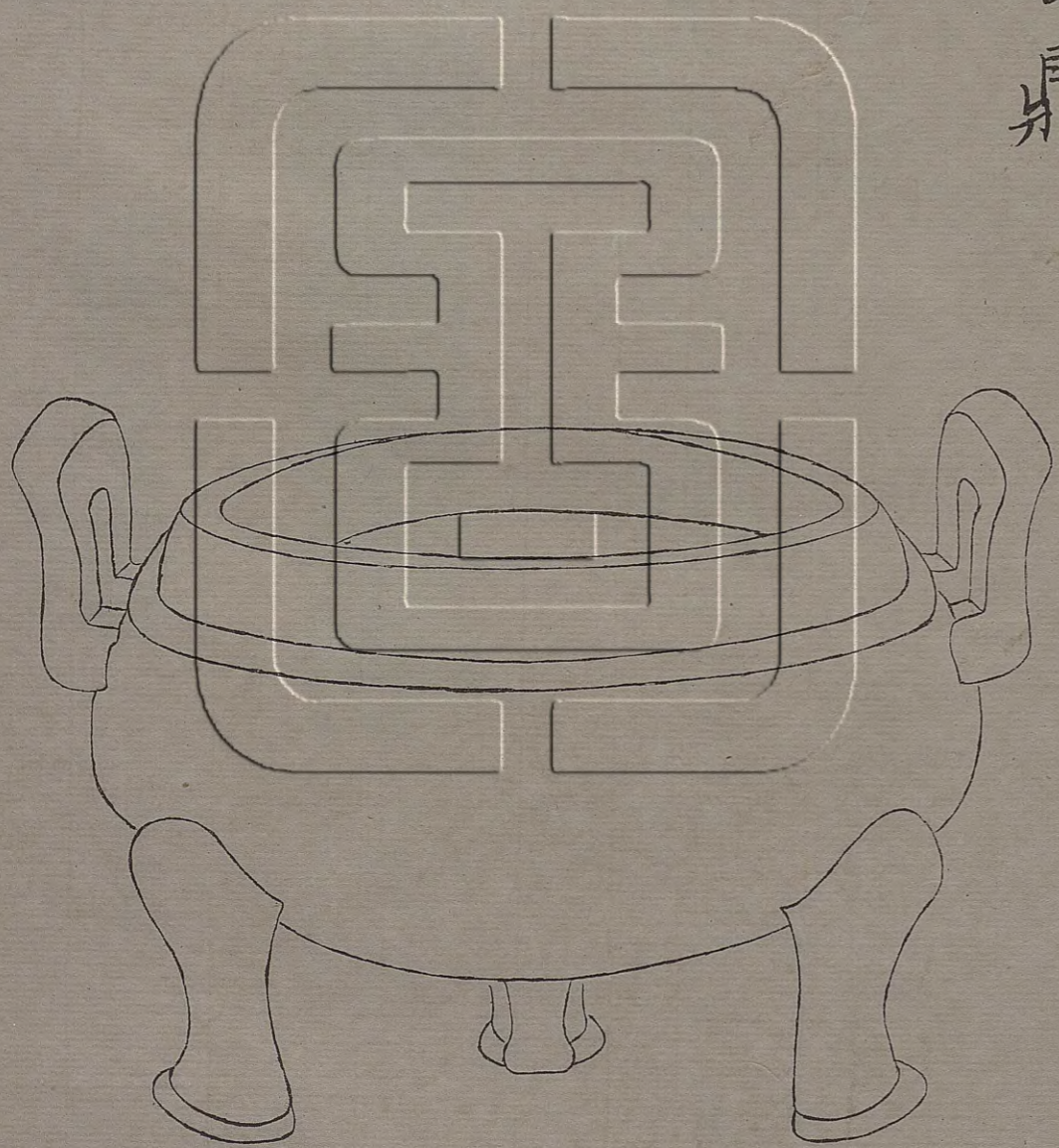

右高五寸五分深四寸三分口徑  
五寸七分腹徑八寸三分耳高二  
寸二分潤一寸四分蓋高一寸四分  
徑七寸五分

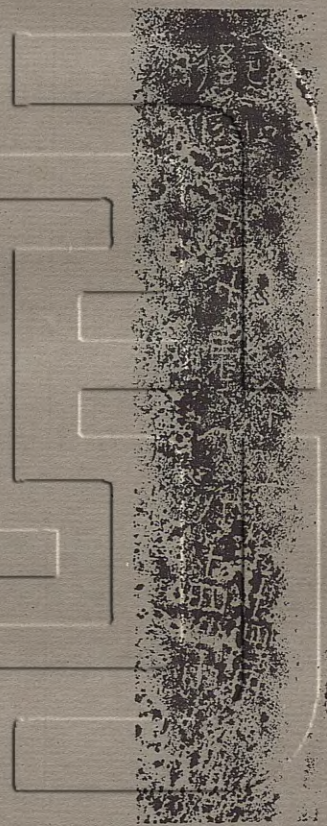

蓋



秦上官鼎

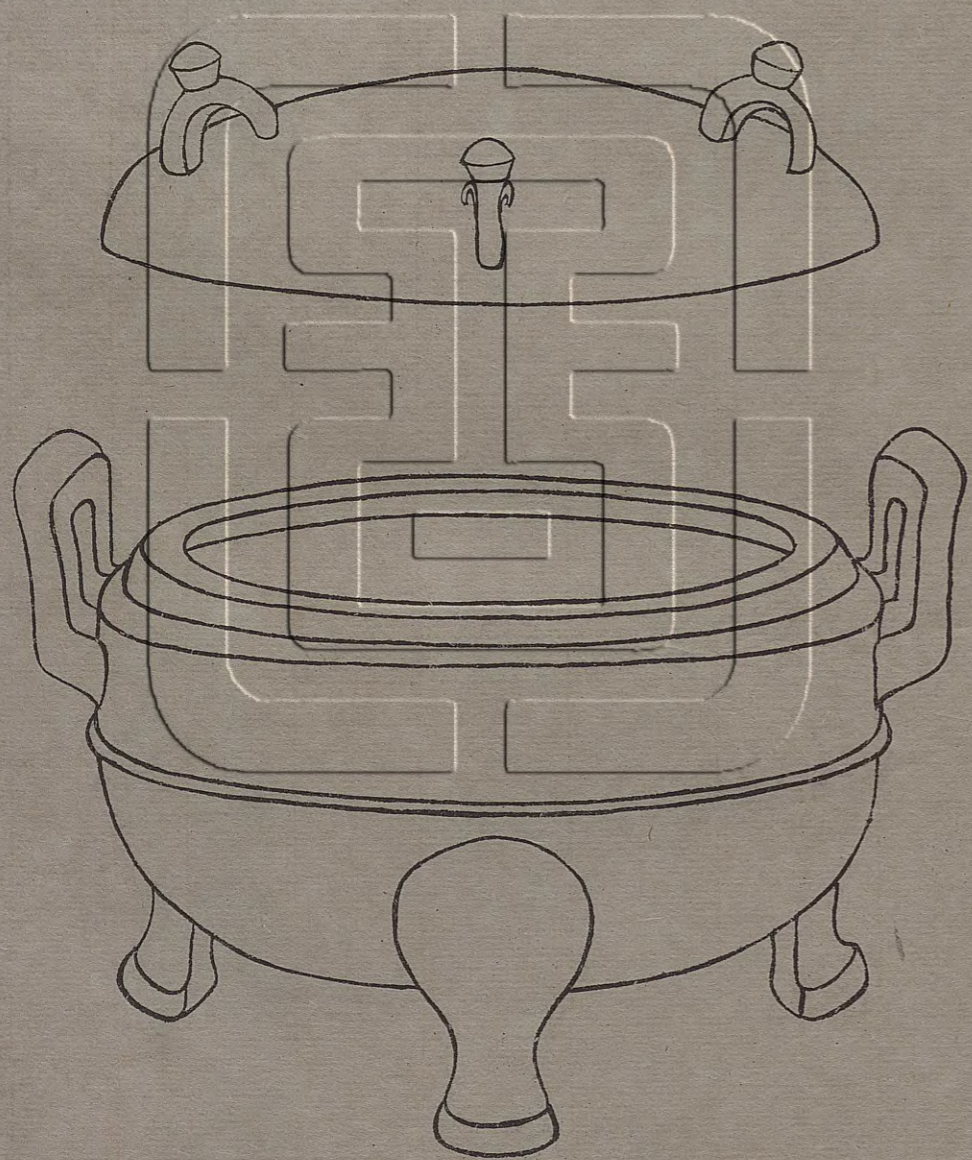

右高五寸二分深四寸八分口徑六寸四分腹徑八寸五分耳高二寸六分濶一寸五分

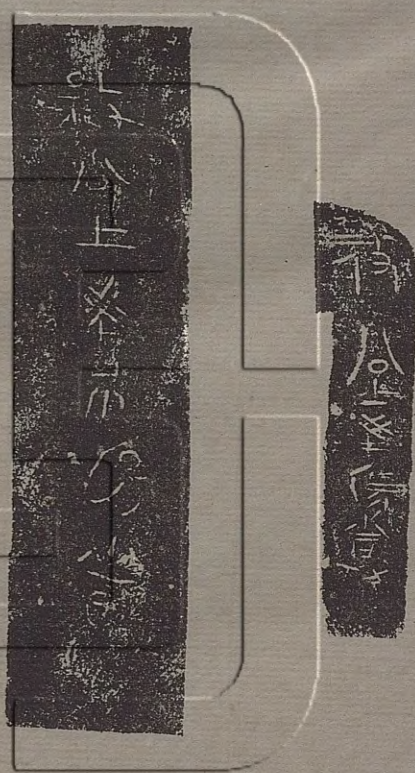

腹

耳



器

右高六寸十分深五寸二分口徑七寸六分腹徑七寸六分耳高二寸八分濶二寸三分蓋高二寸徑九寸一分

漢府鼎

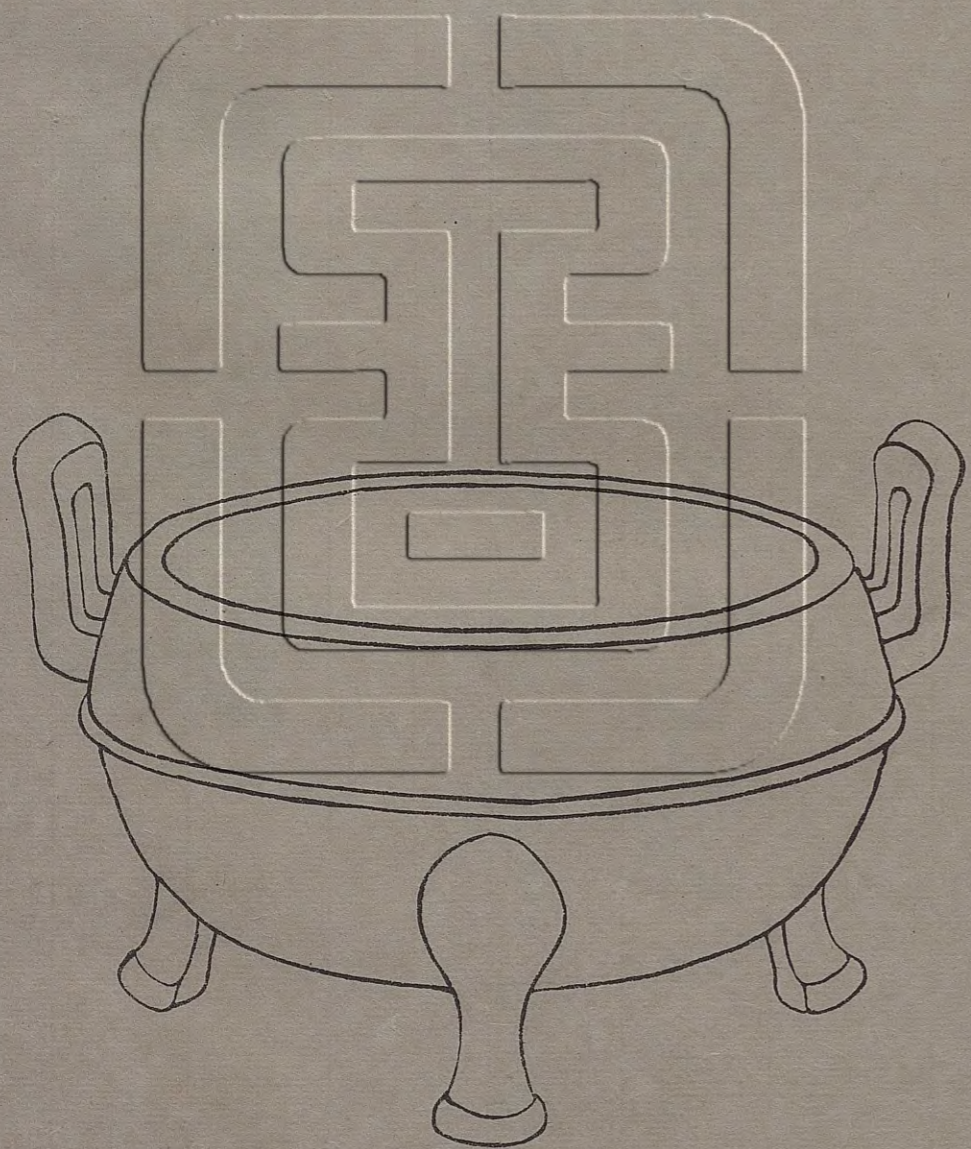

同  
齊  
書  
錄

陶  
器  
錄



漢西鼎

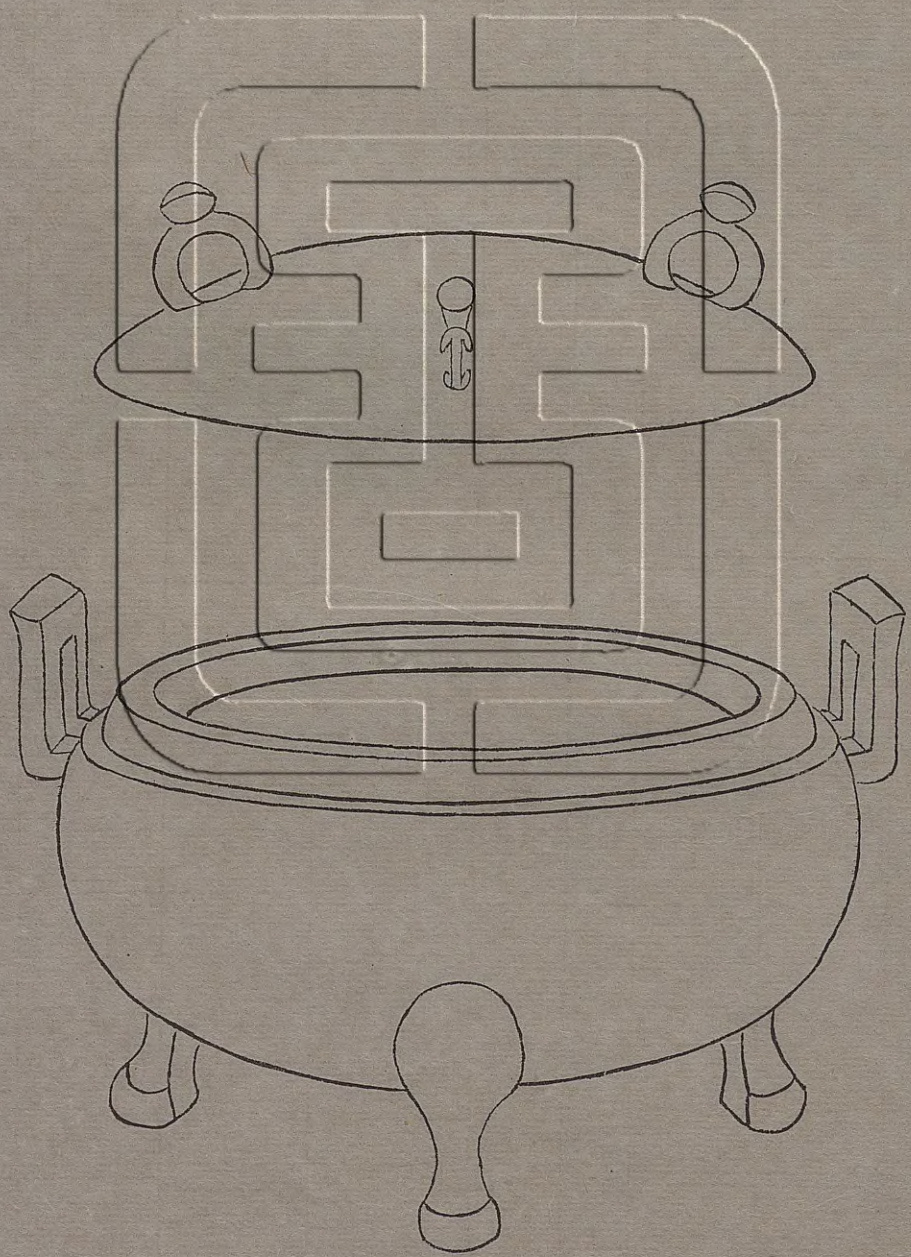

右高五寸九分深四寸八分口徑九寸一分耳高二寸濶一寸七分

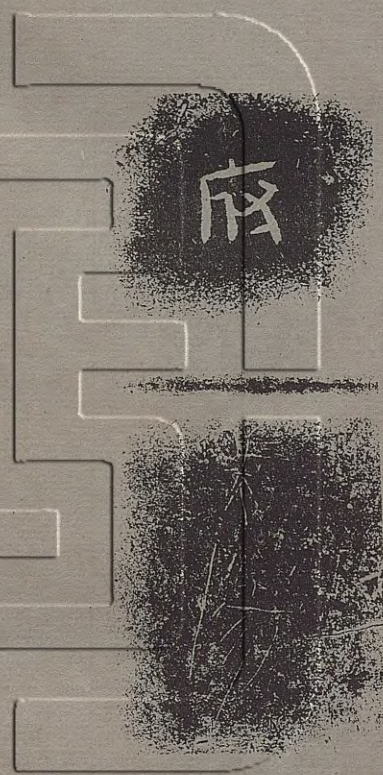

器

陶齋吉金錄

陶齋吉金錄



漢羅鼎

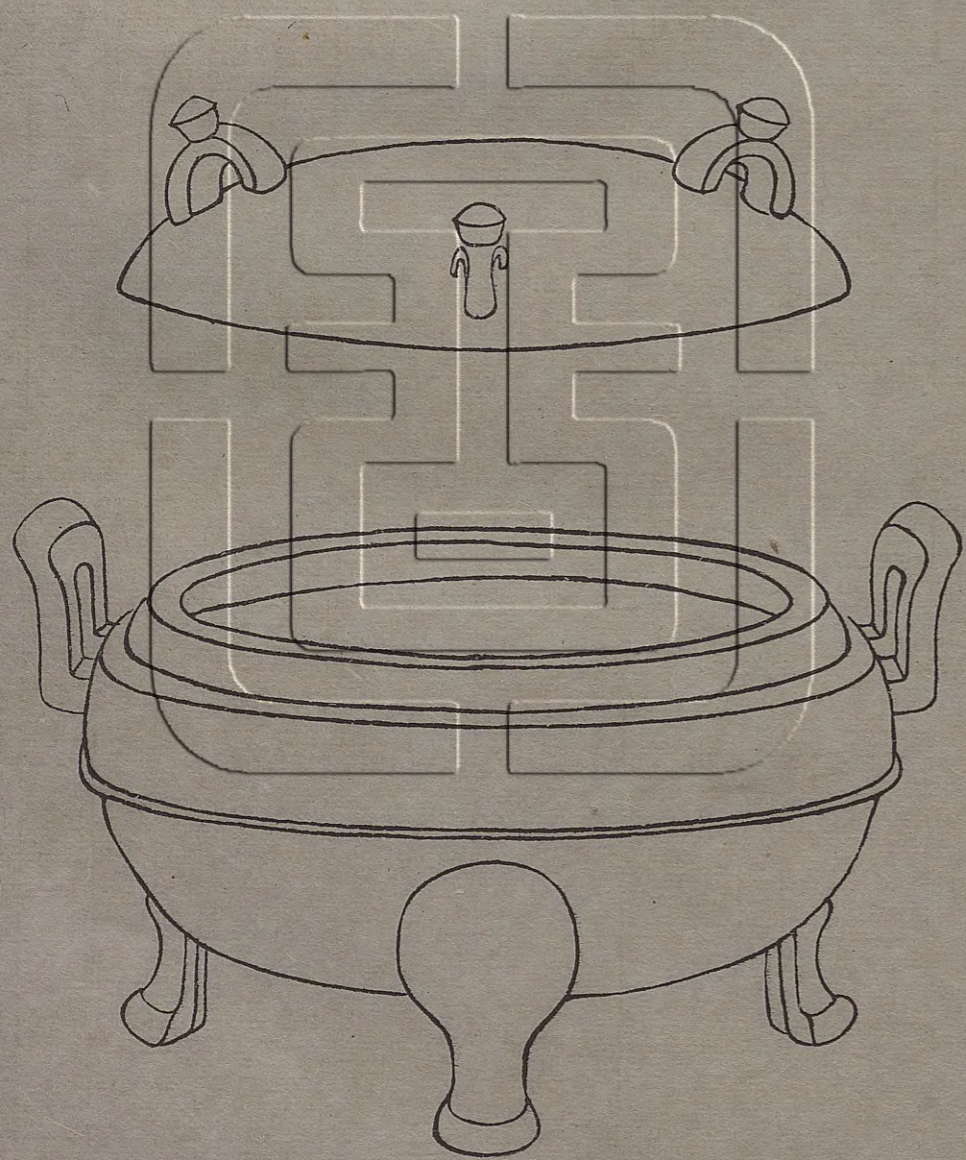

右高五寸二分深四寸三分口徑六寸一分腹徑七寸九分耳高一寸八分濶一寸一分蓋高一寸五分徑七寸六分

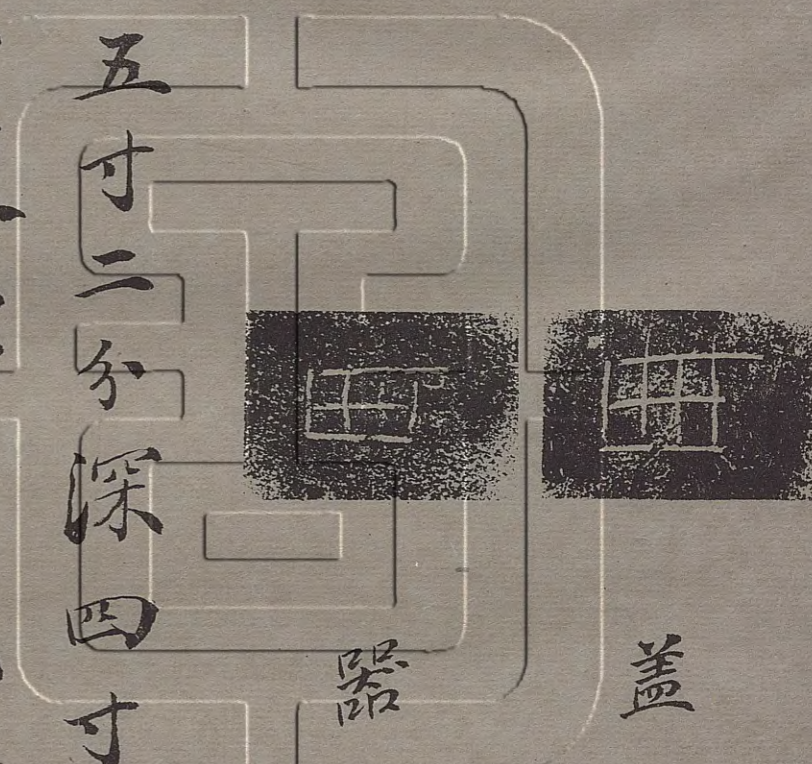

漢羅鼎



右高六寸一分深四寸四分口徑  
 六寸一分腹徑七寸耳高二寸五  
 分濶一寸一分蓋高一寸四分徑  
 七寸六分

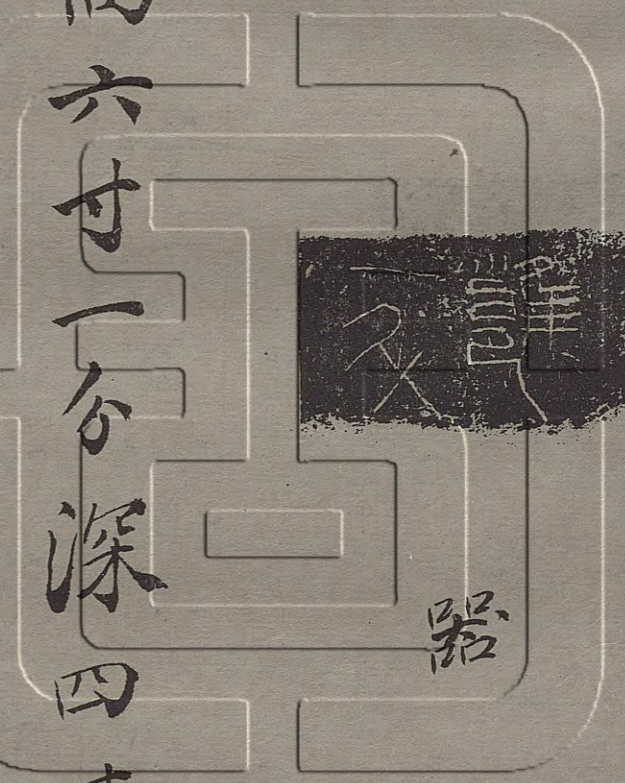

漢  
盤  
屋  
鼎  
一

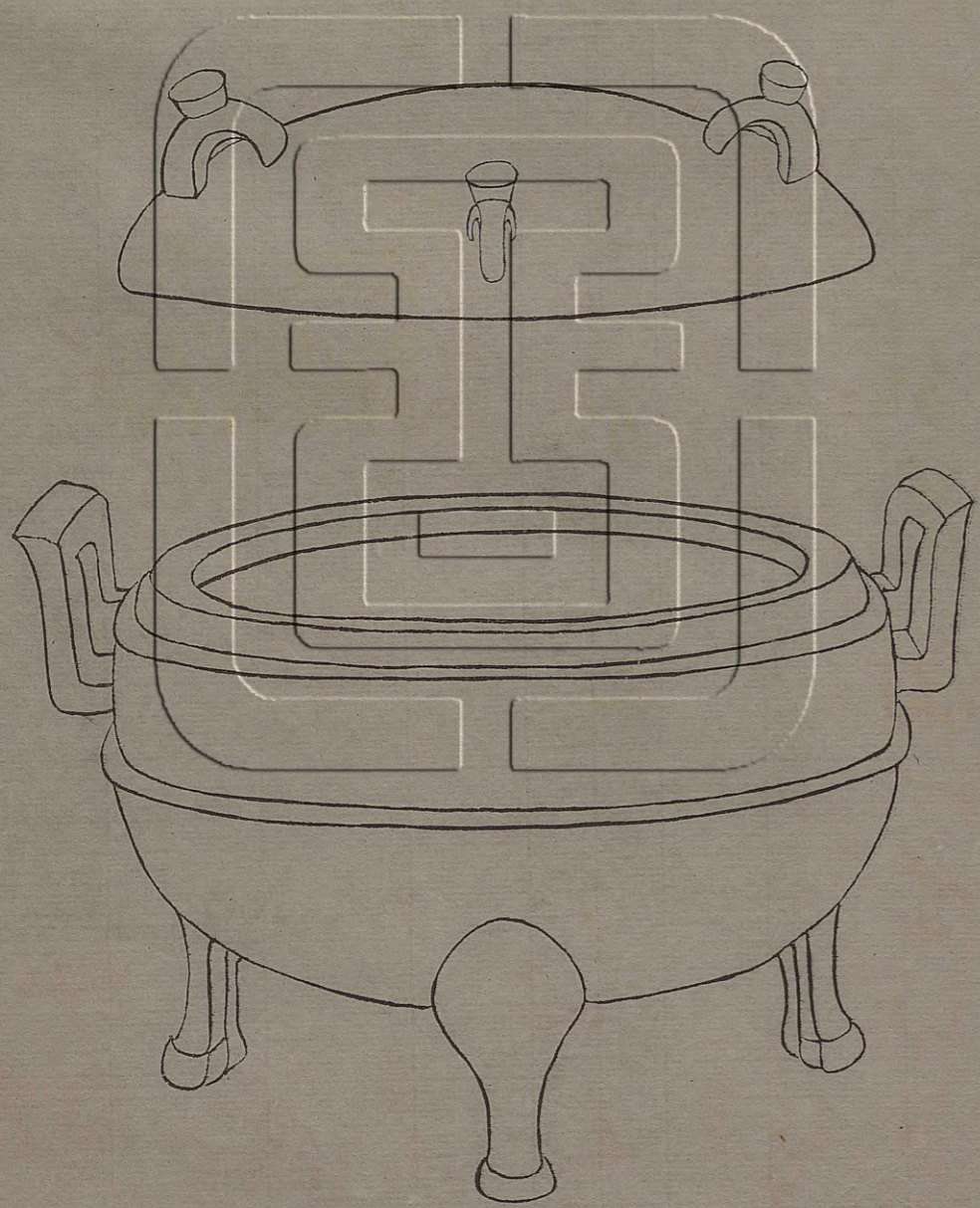



右高八寸八分深五寸一分口徑  
 一尺一寸六分腹徑一尺三寸三  
 分耳高三寸潤二寸一分蓋高  
 二寸五分徑一尺二寸八分

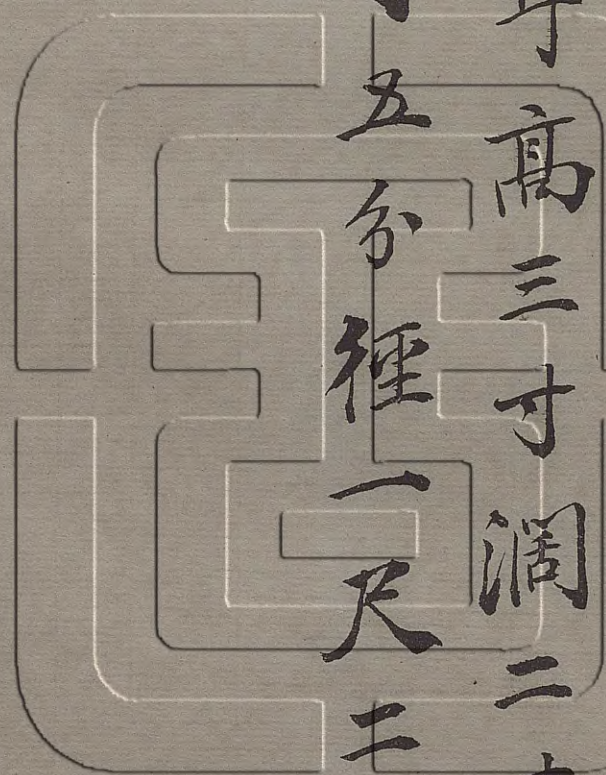

器

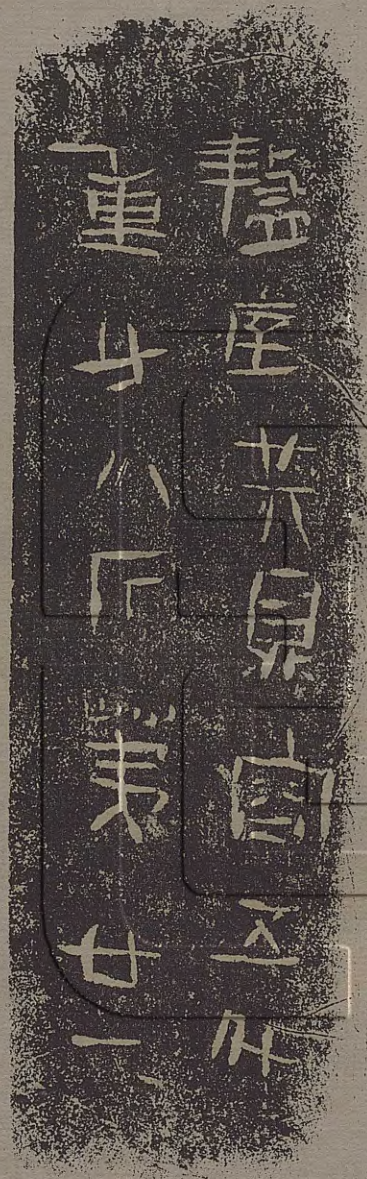

器

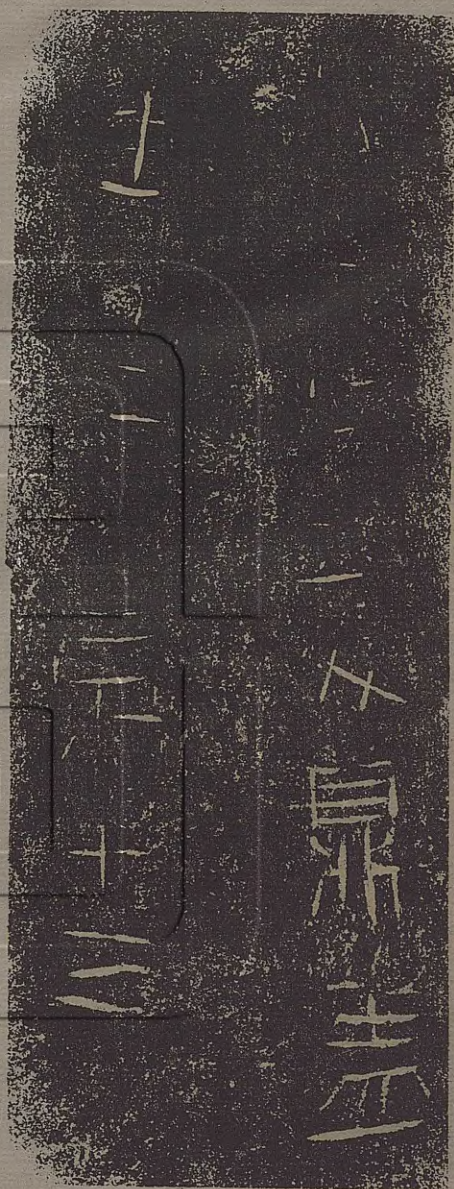

蓋



陶齋吉金錄

十五

漢 螭 屋 鼎 二

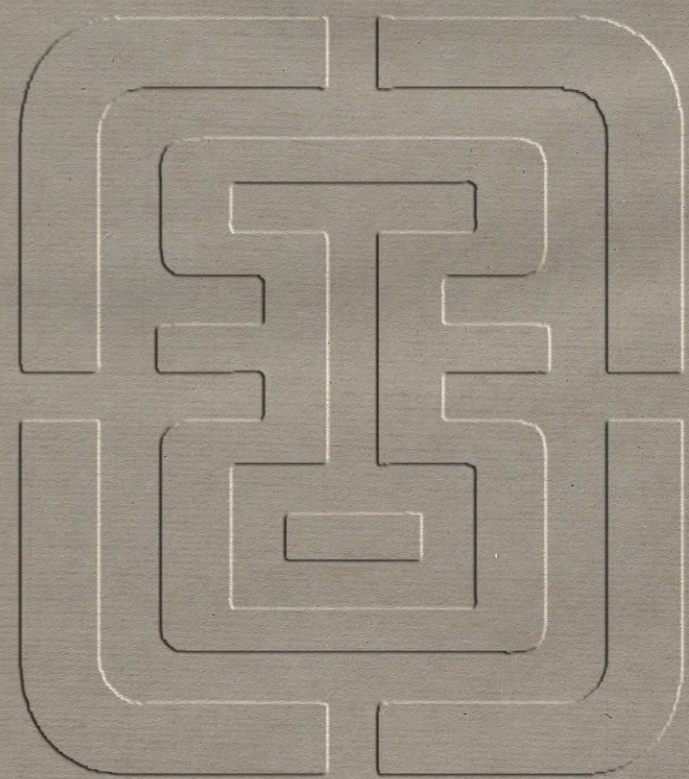
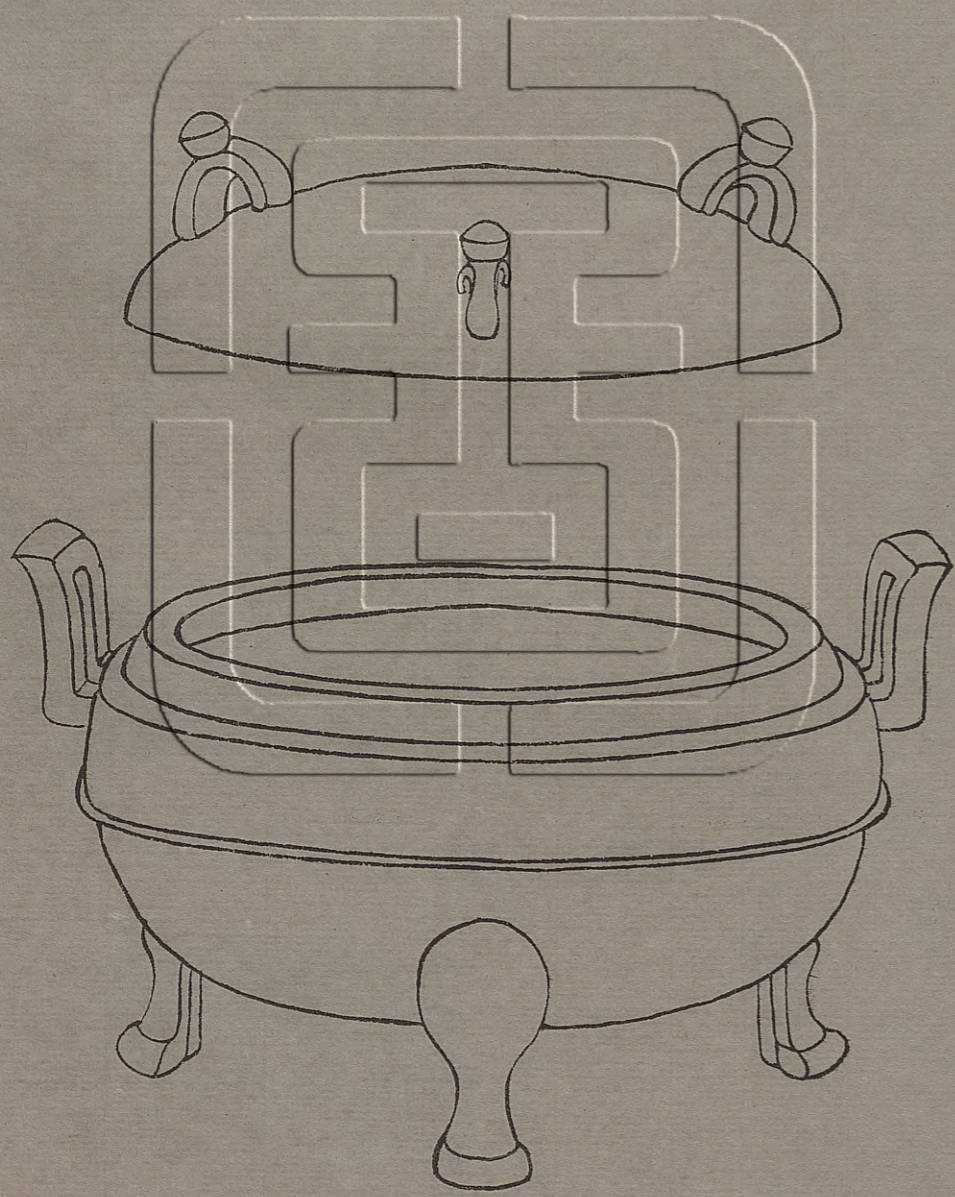



漢濕成鼎

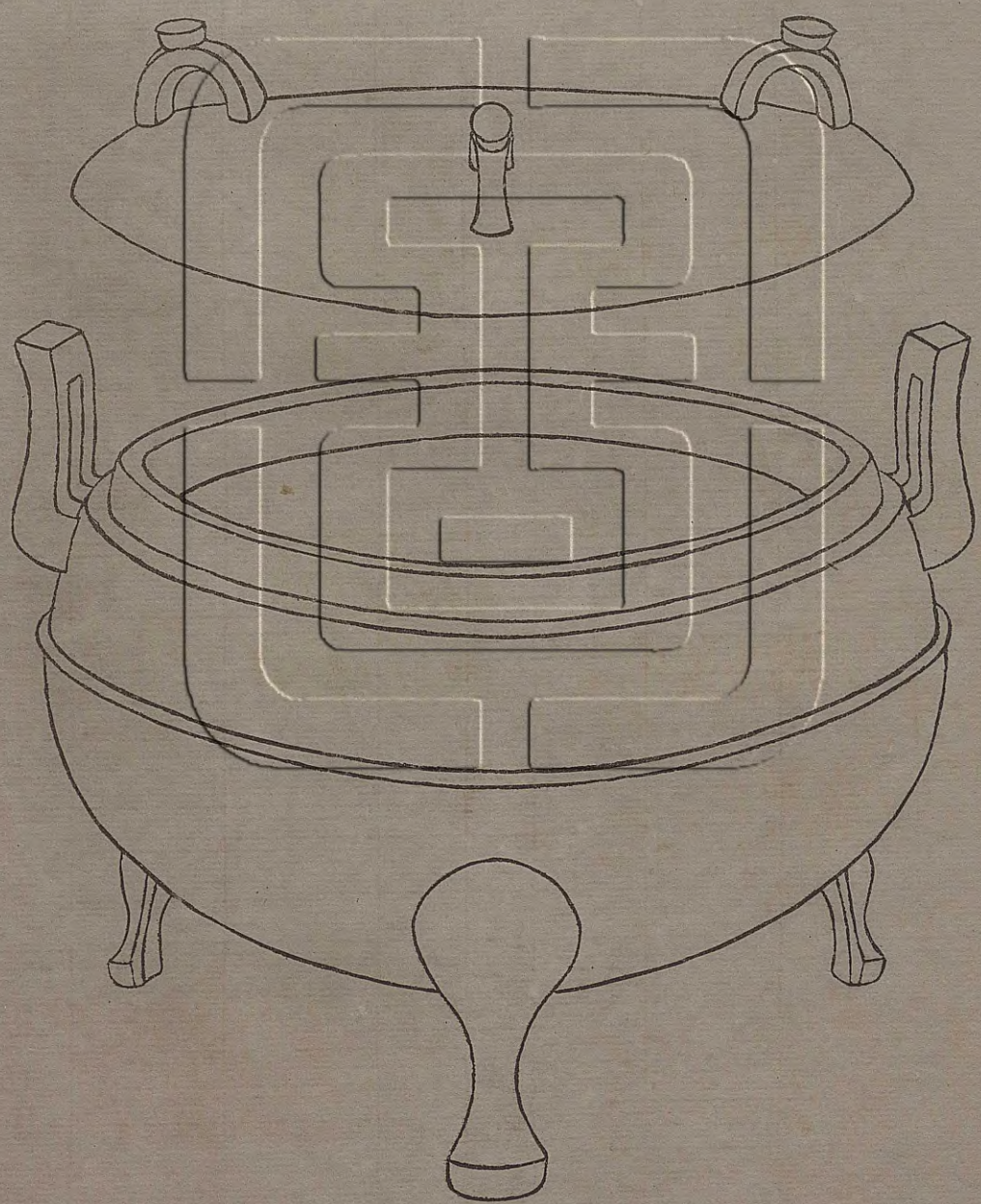

右高五寸七分深四寸三分口徑五寸八分腹徑八寸二分耳高二寸一分闊一寸四分蓋高一寸四分徑七寸六分



器



器



蓋



蓋



陔餘叢考  
卷之六  
禮考  
金錄

景成銅鼎蓋重五斤

蓋

景成銅鼎容三升重十二斤

器

右高七寸四分深五寸七分口徑八寸八分腹徑一尺五分身高二寸一分潤一寸八分蓋高二寸一分徑一尺

漢犂車宮鼎

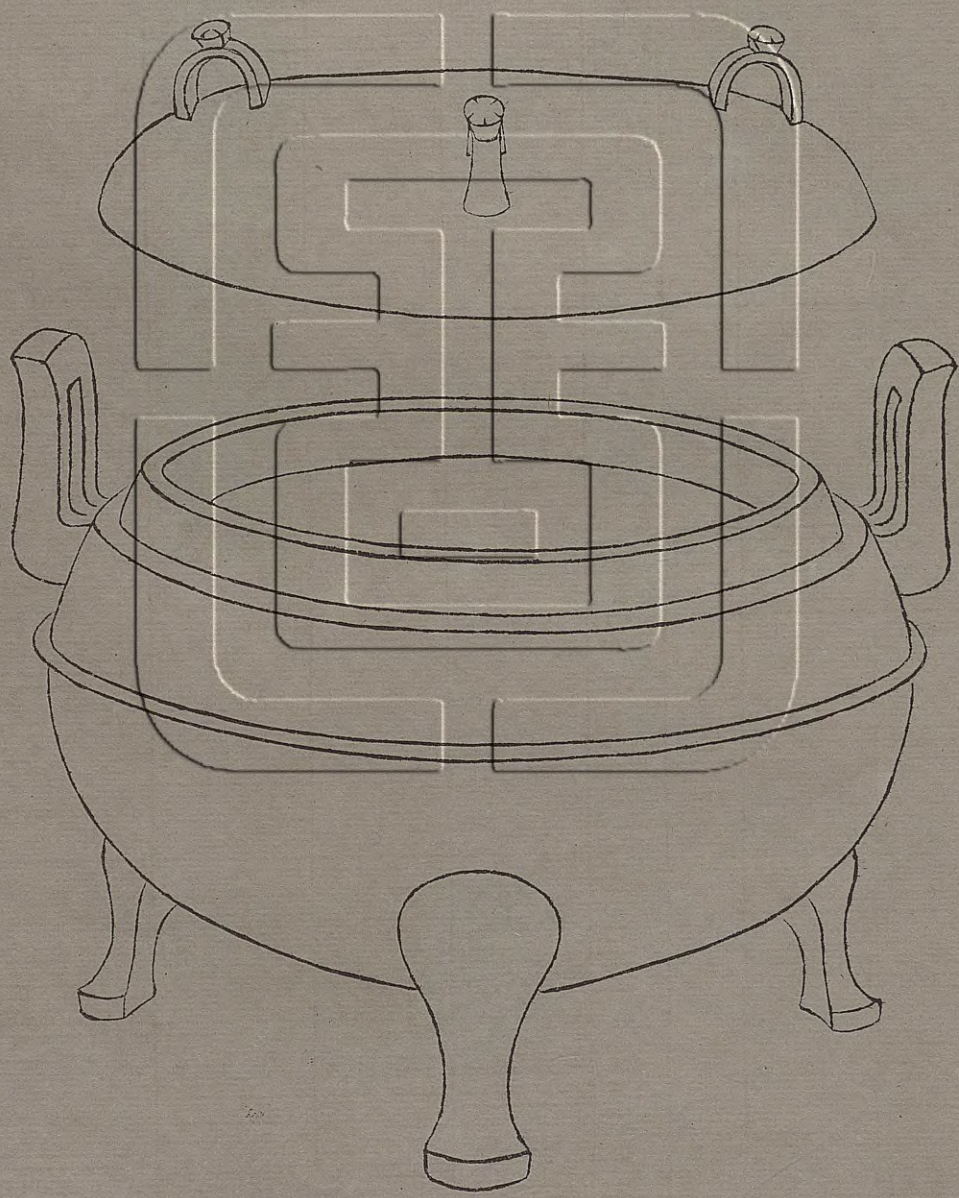

陶齋吉金錄



陶齋吉金錄

漢中水鼎

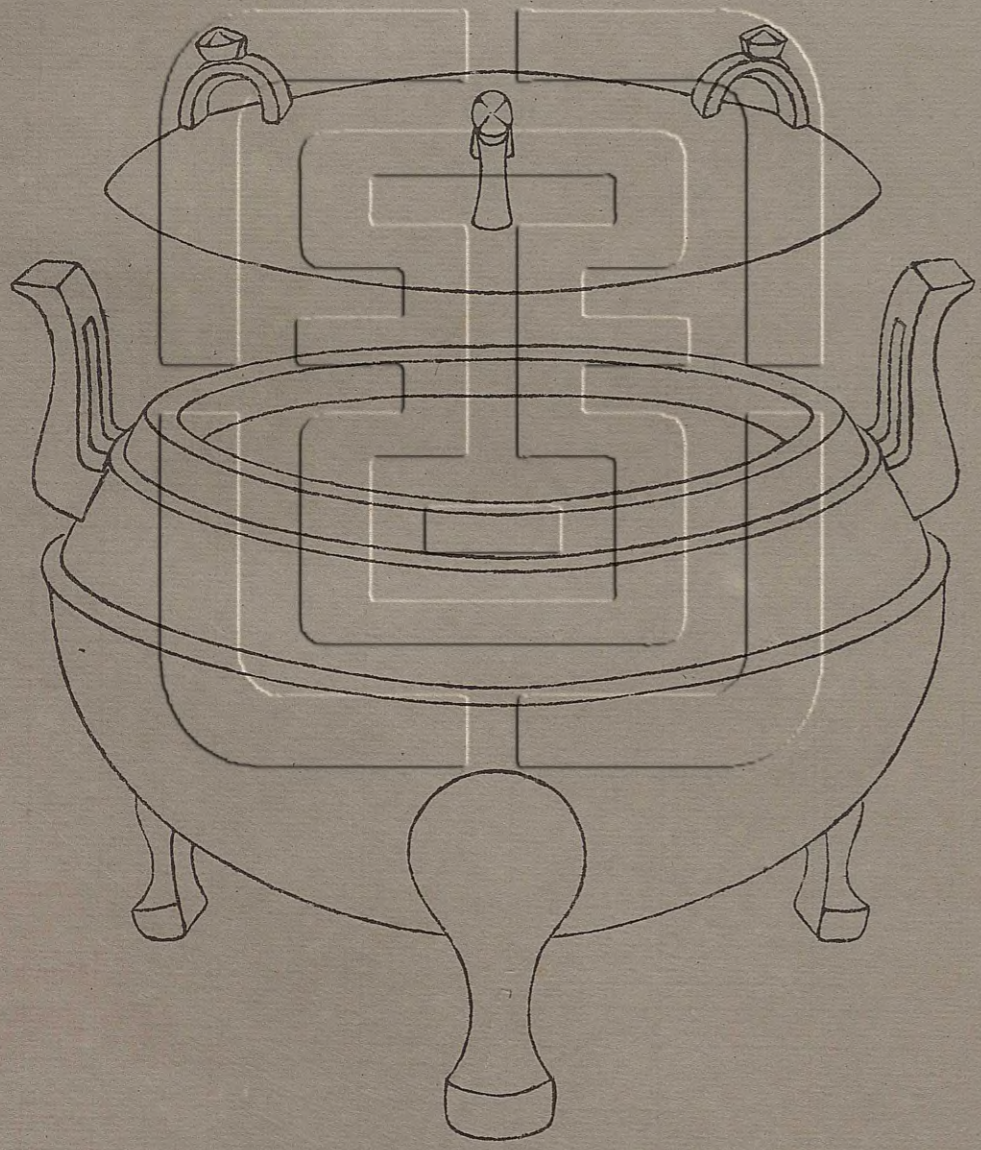

右高五寸八分深四寸六分口徑六寸二分腹徑六寸九分耳高二寸二分潤一寸六分蓋高二寸二分徑六寸七分

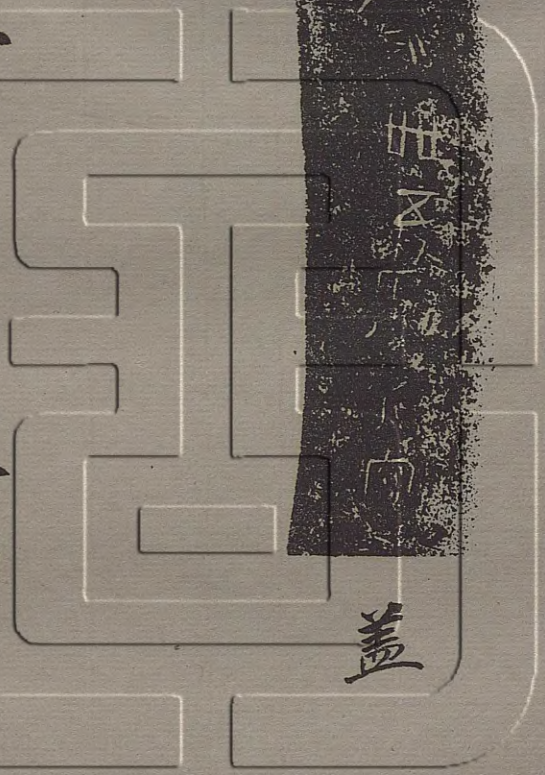

蓋

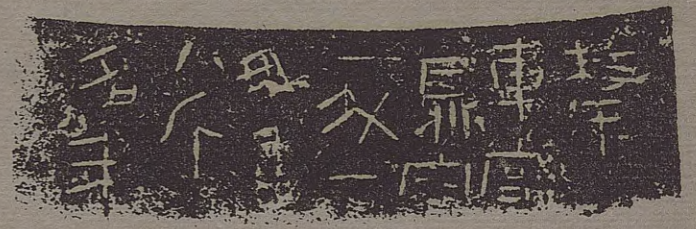

器

陶齋吉金錄

十九



漢汝陰鼎

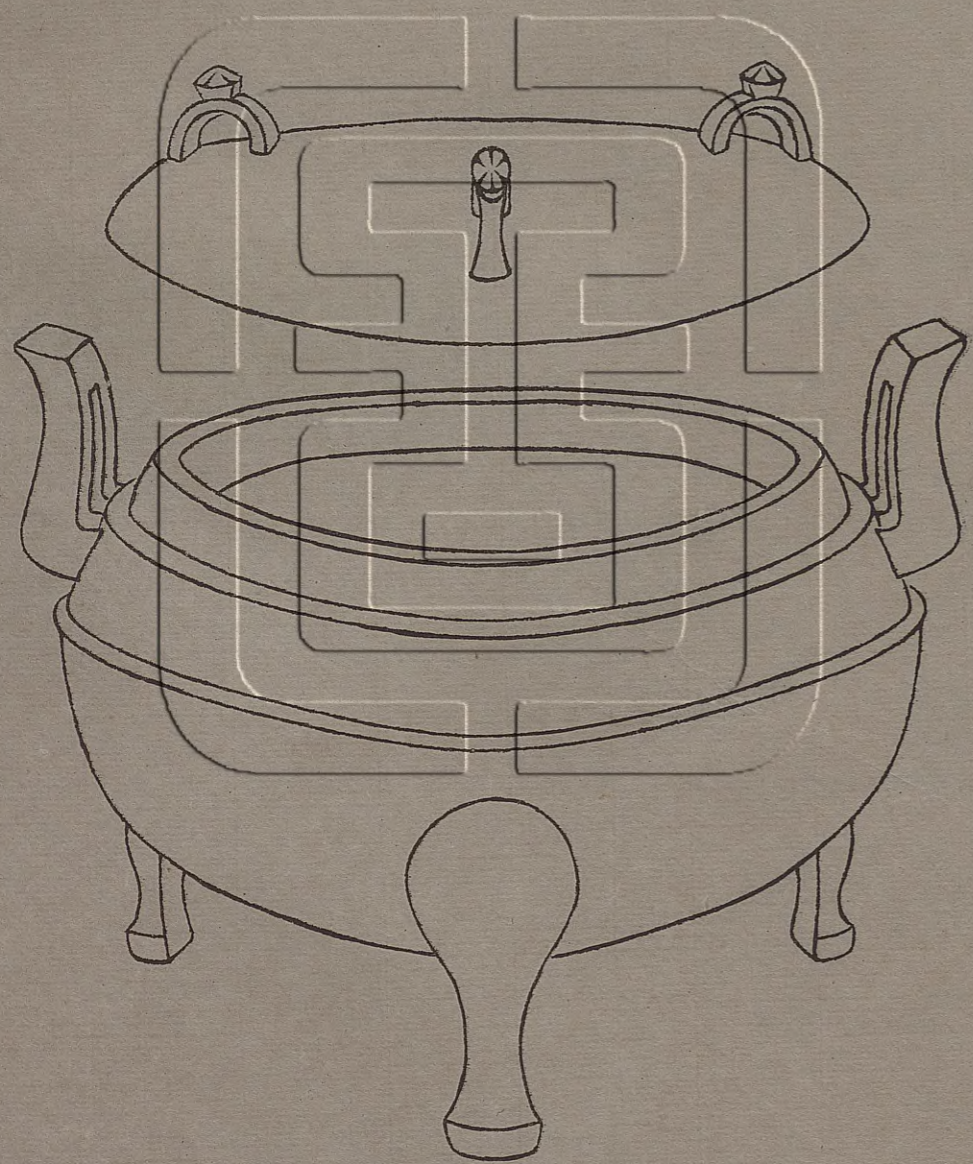

右高六寸深四寸二分口徑六寸  
七分腹徑八寸二分耳高二寸一分  
闊一寸五分蓋高一寸三分徑七分

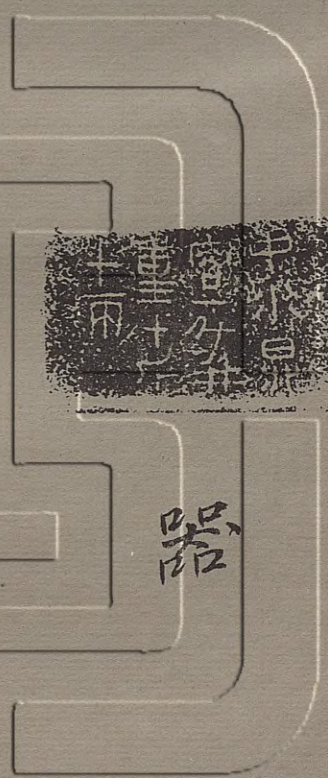



漢平陽鼎

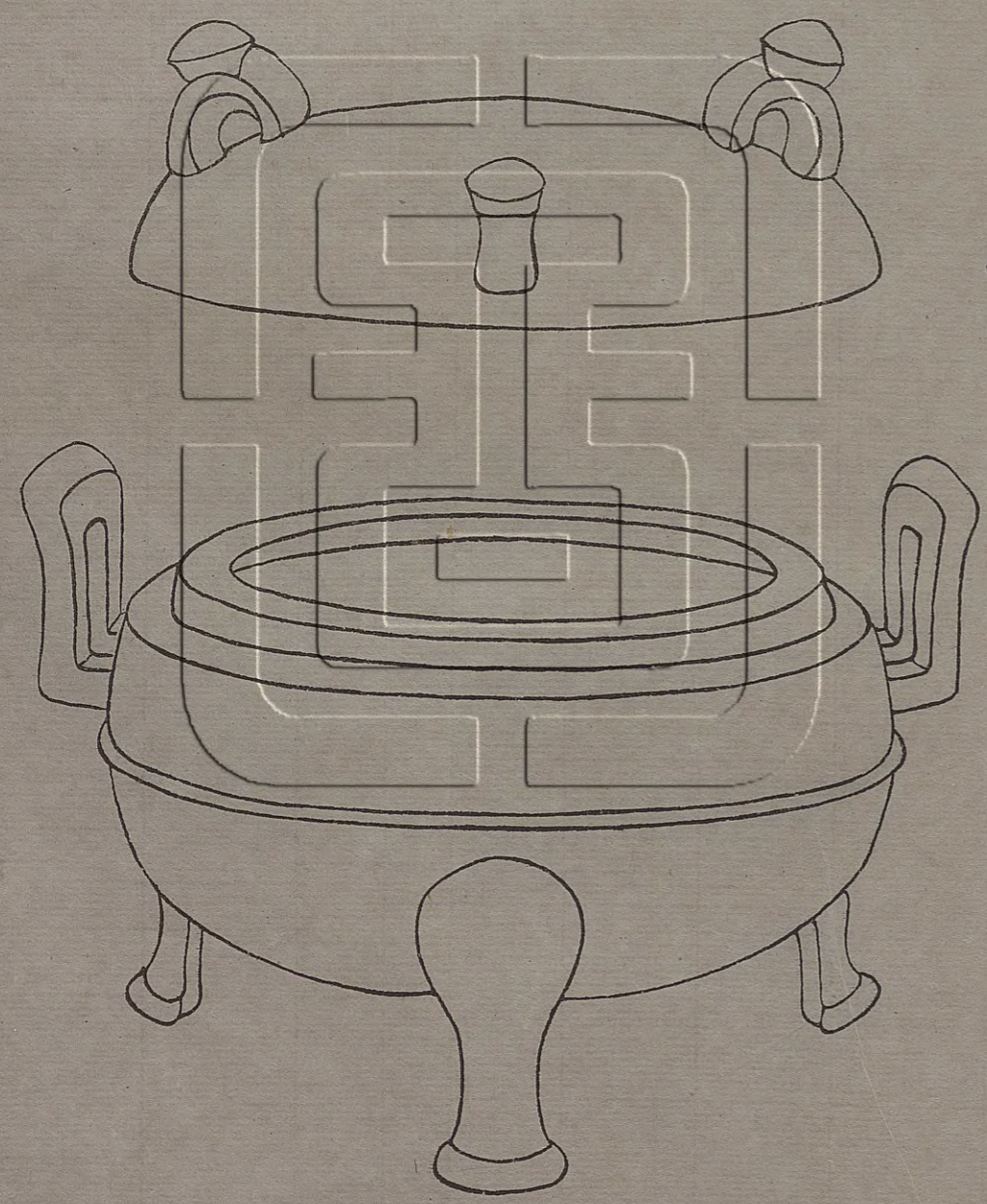

右高六寸六分深四寸七分口徑  
七寸四分腹徑八寸八分耳高二  
寸一分潤一寸六分蓋高二寸徑  
八寸四分

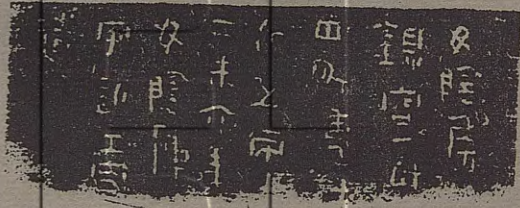

器



漢長楊鼎

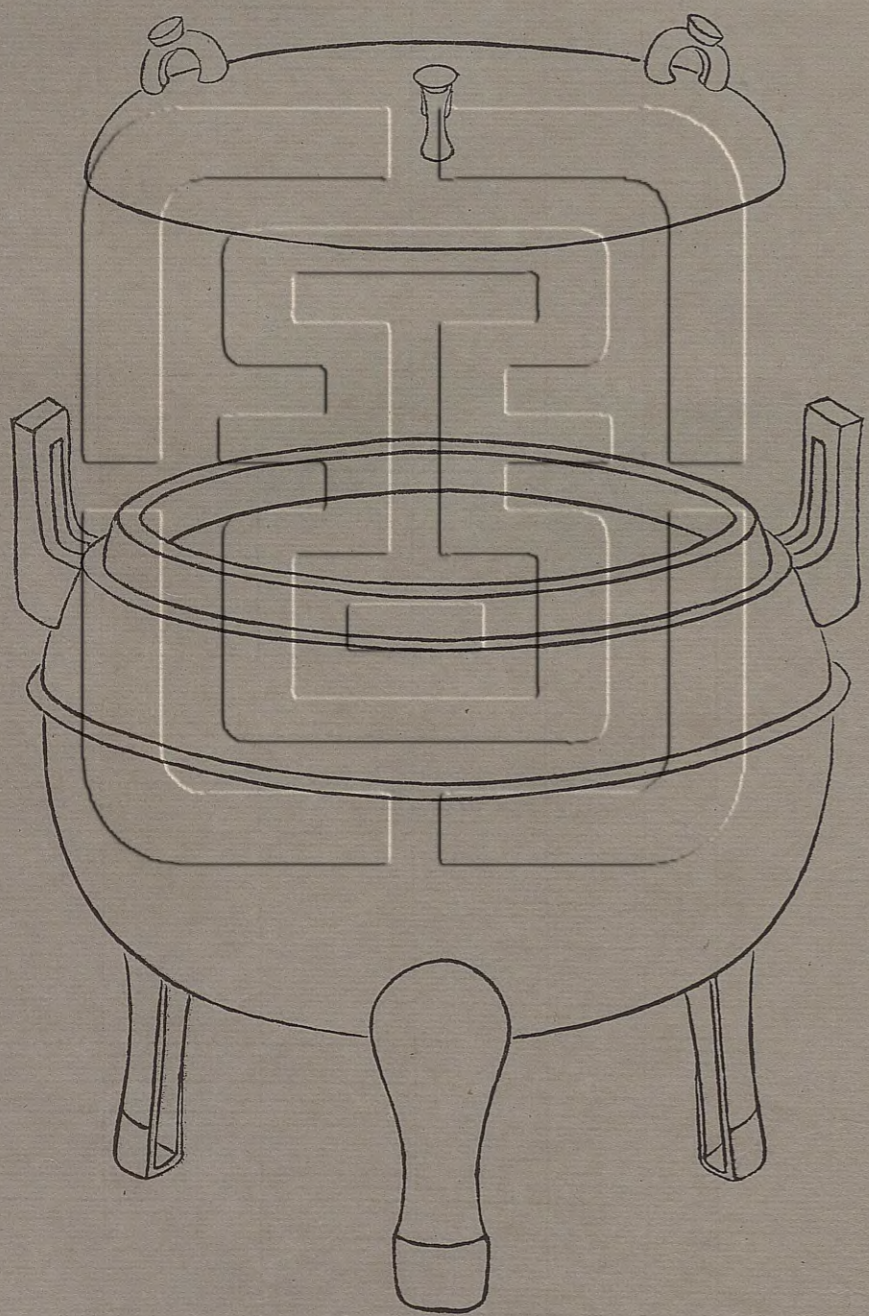

右高五寸六分深四寸七分口徑  
六寸七分耳高二寸五分濶一寸  
五分蓋高一寸八分徑八寸三分

平定縣志卷之十一 禮樂

蓋



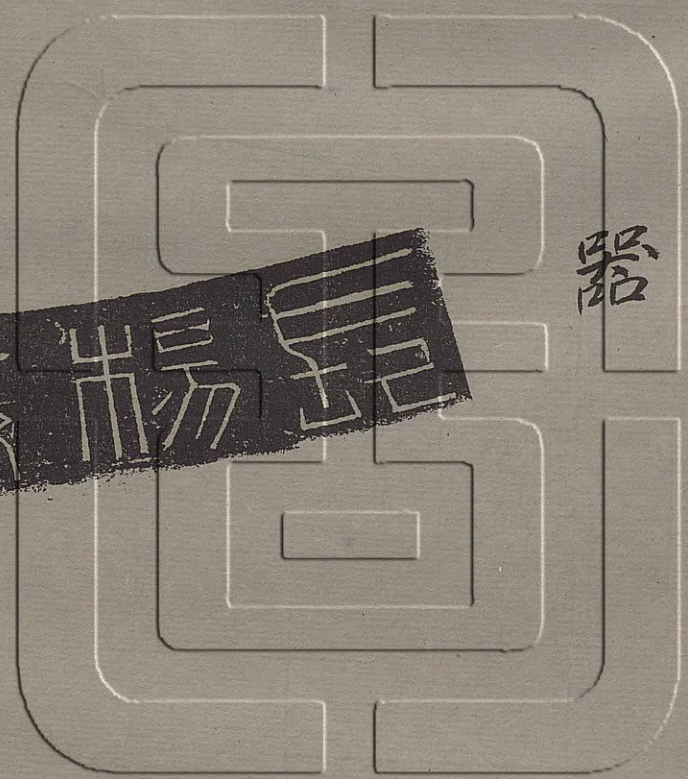
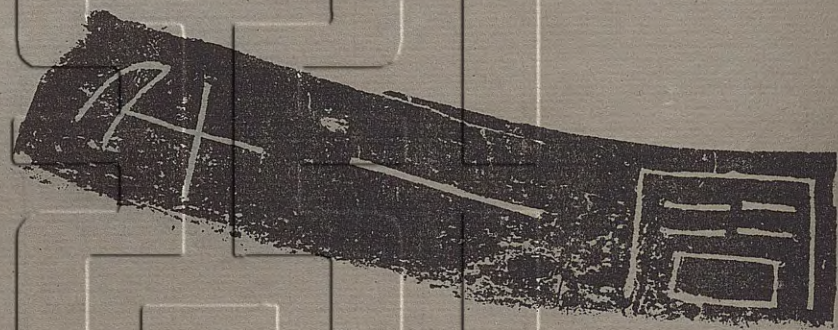
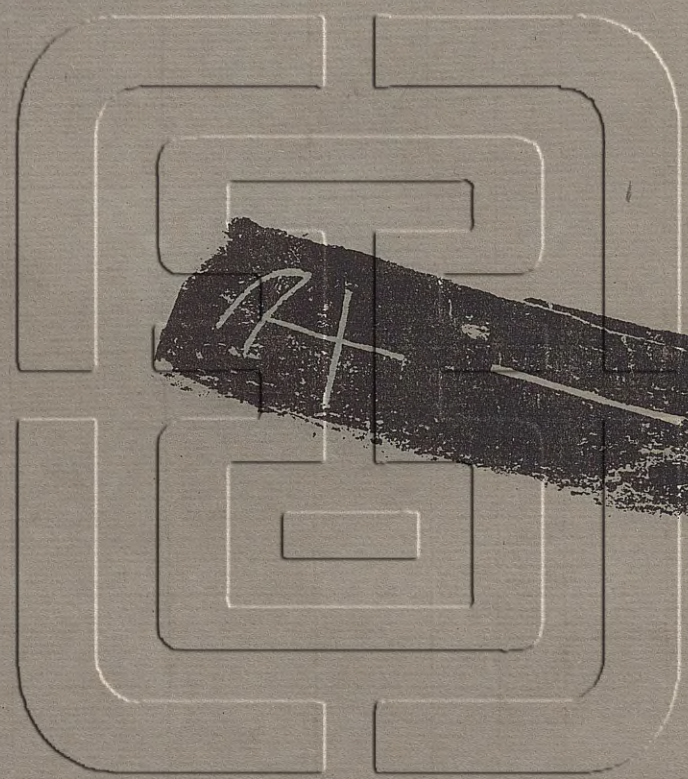

器



右高六寸六分深四寸三分腹  
 徑七寸三分耳高二寸五分潤  
 一寸二分蓋高一寸五分徑六  
 寸七分

漢荀少夫鼎

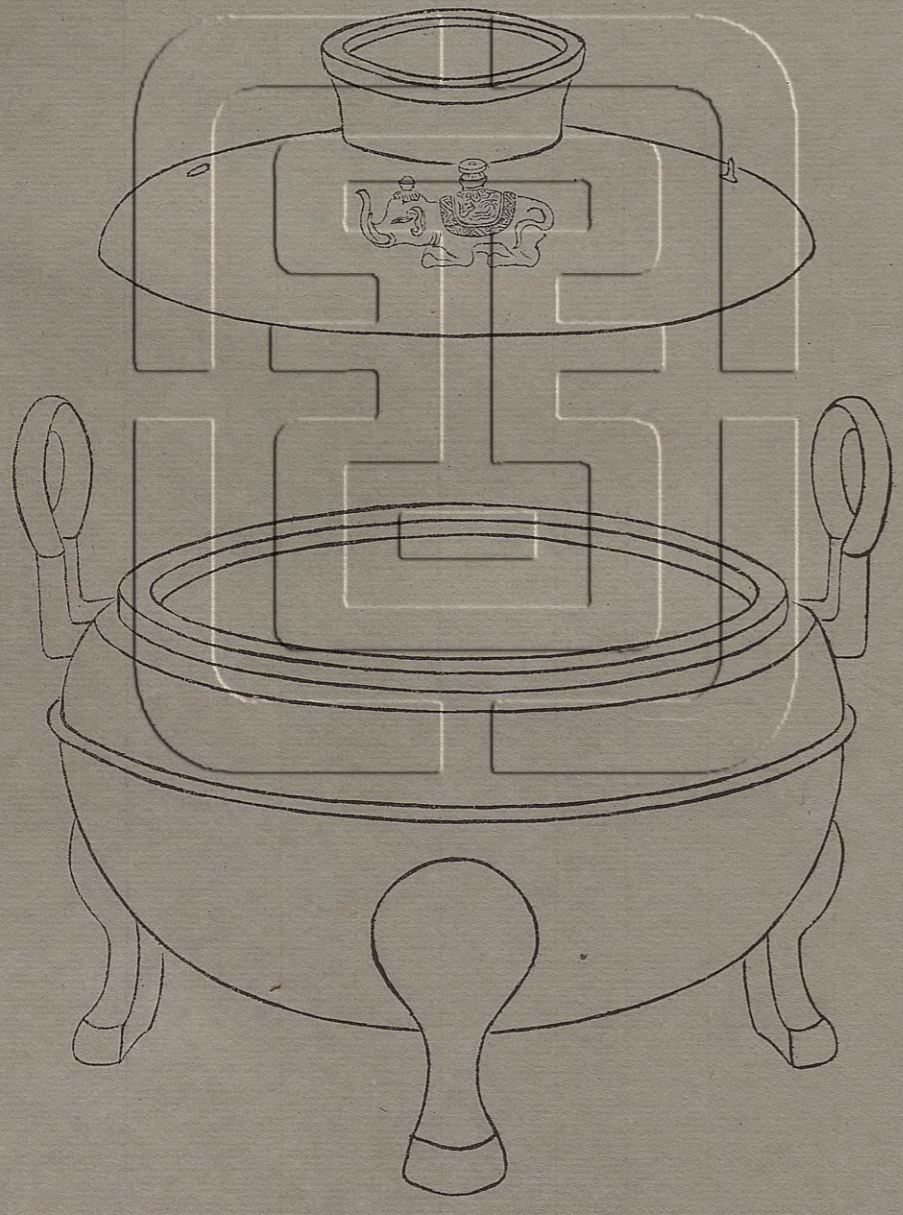



陶  
禮  
吉  
金  
錄

三  
四

同出亦鼎蓋漢大斤

蓋

同出亦銅鼎同四漢卅三斤

器

右高一尺一寸二分深九寸三分口  
徑一尺四寸五分腹徑一尺七寸九  
分耳高四寸四分濶四寸蓋高四  
寸徑一尺五寸八分

漢壽成鼎

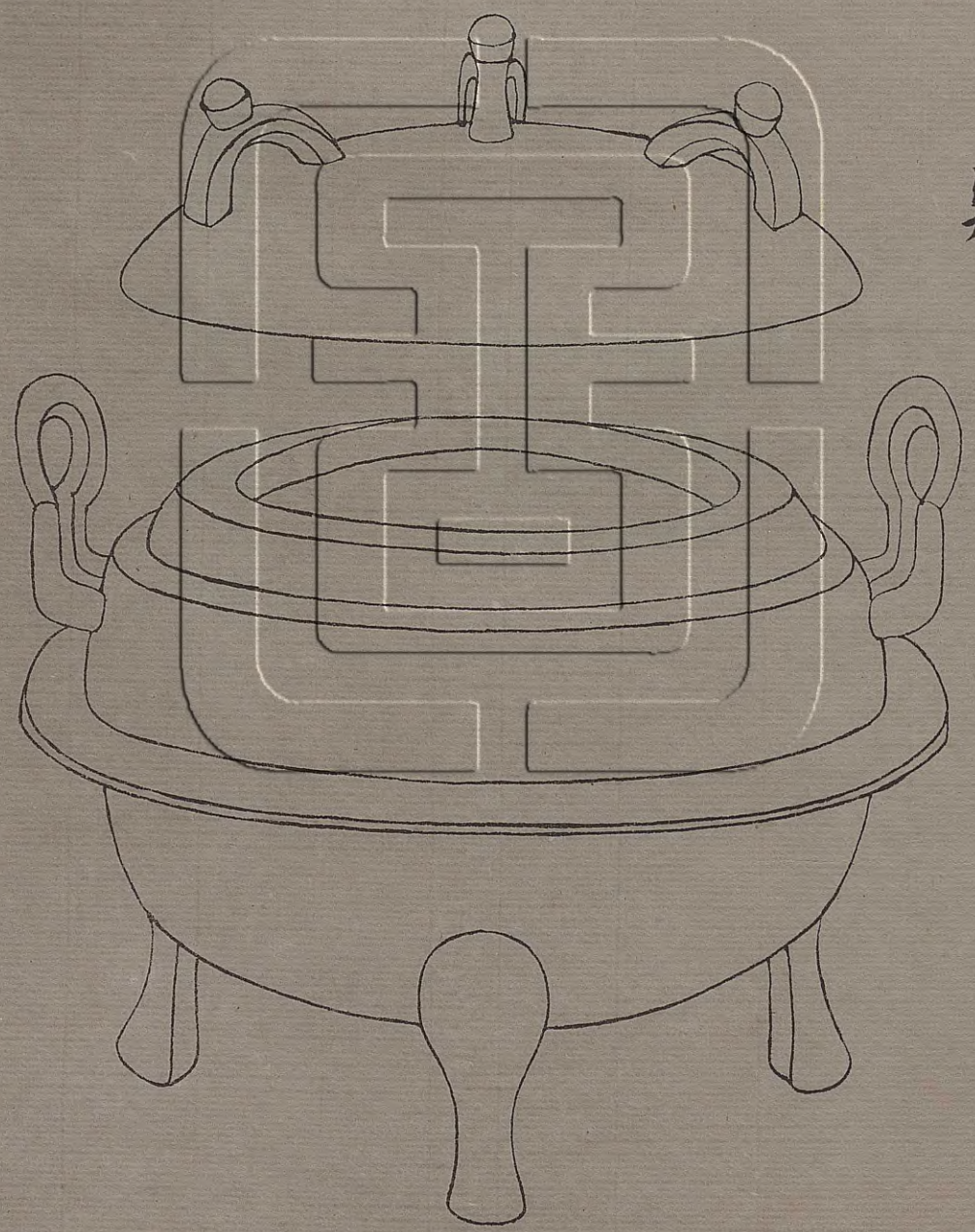



陶  
器  
金  
鐘

二十五

蓋

成業文王

器

鐘

銅

二十

年

十二

月

二十

年

真

鐘

鐘

鐘

右高七寸二分口徑六寸腹徑  
八寸一分耳高二寸二分潤一寸



六分蓋高一寸五分徑七寸七分

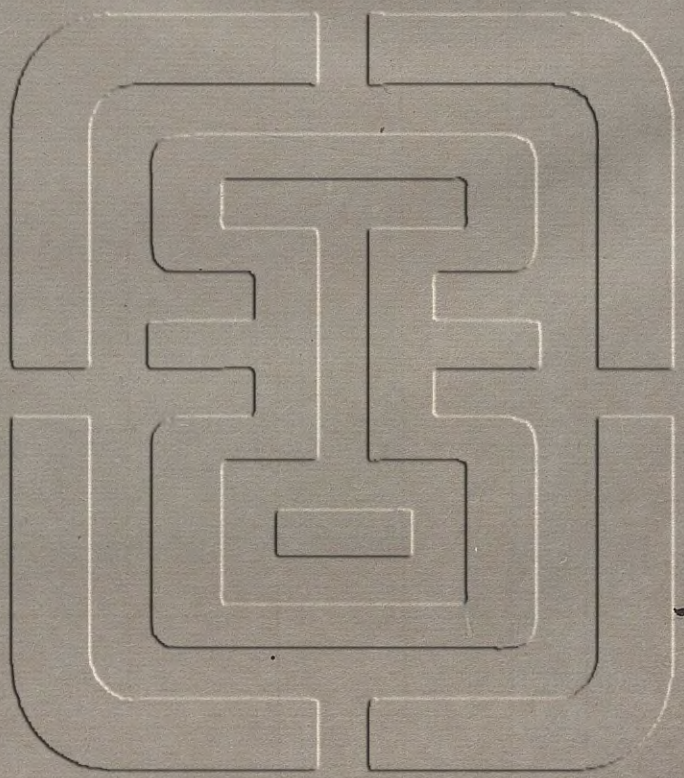

漢長安鼎

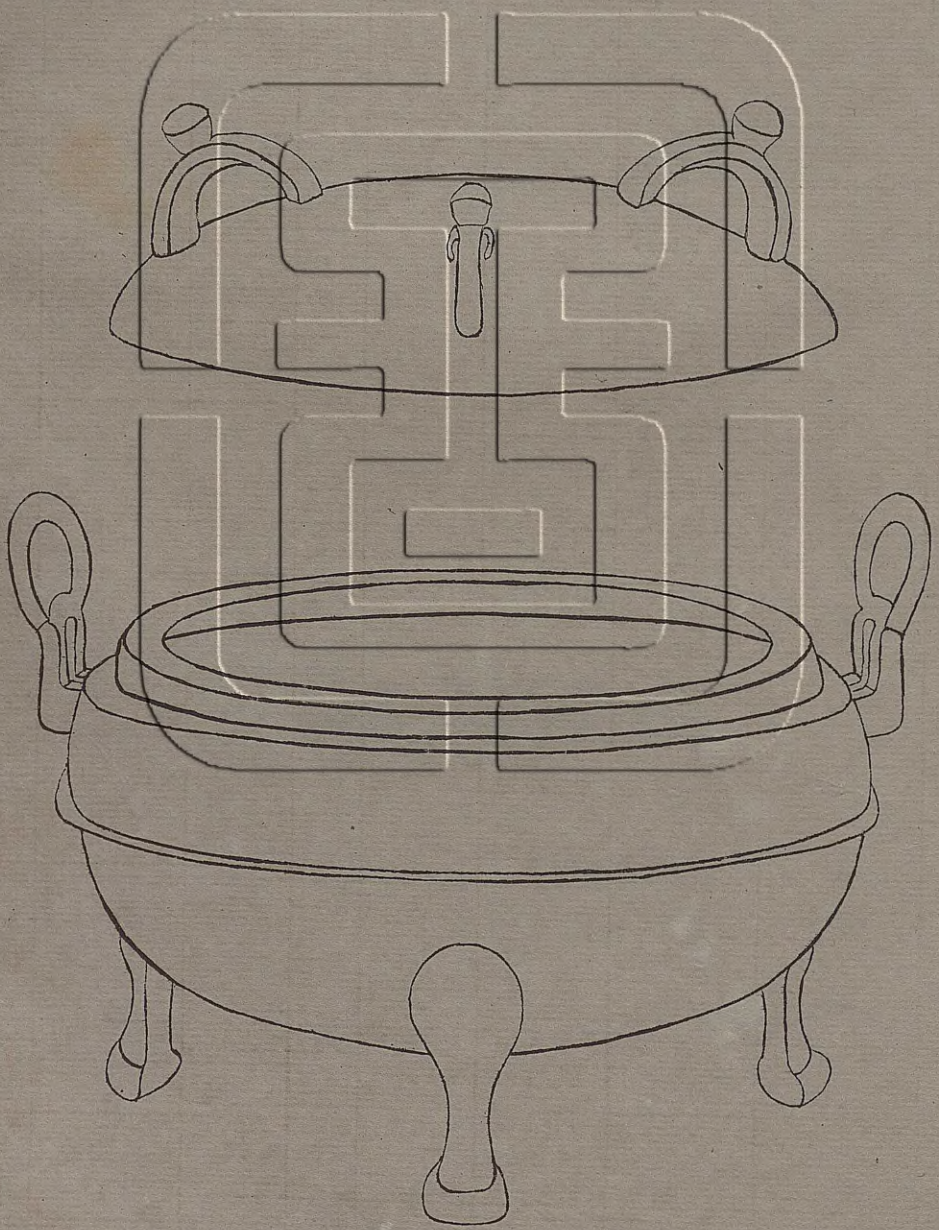



長安成廟銅鼎三足鼎蓋合重九

蓋

成廟成廟銅鼎三足合重十二斤六兩連蓋三

器

季十月王臣造后丞輔掾譚守合重九

右高六寸五分深四寸六分口徑  
六寸五分腹徑七寸二分耳高二  
寸七分潤二寸二分蓋高一寸五分  
徑八寸八分

漢大衛無極鼎蓋

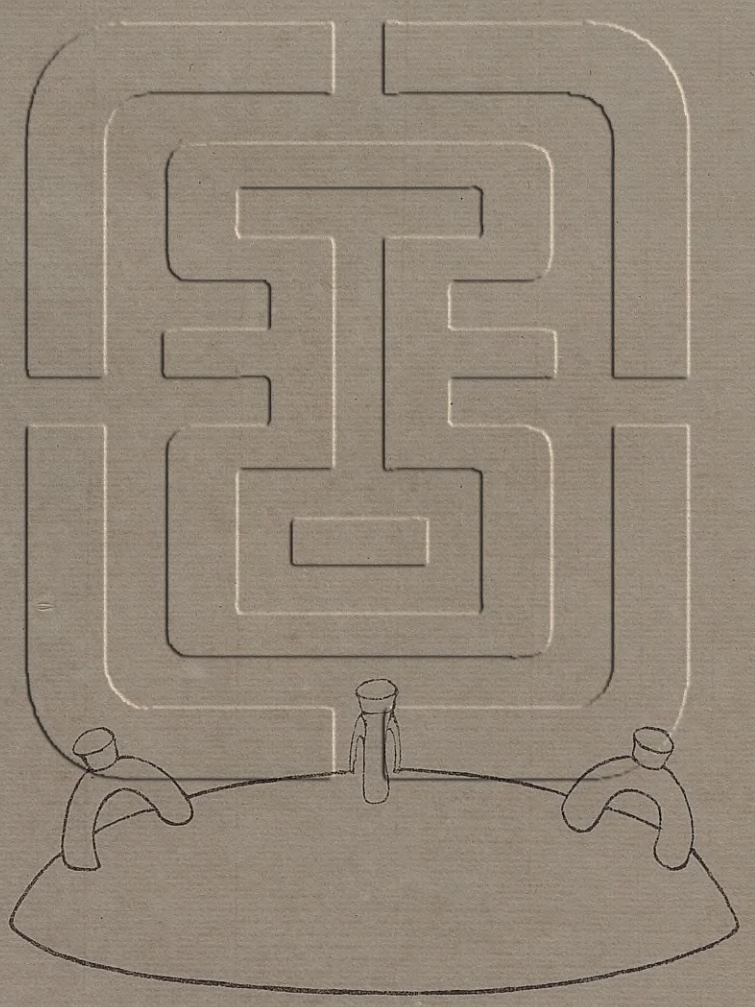



秦高都劍

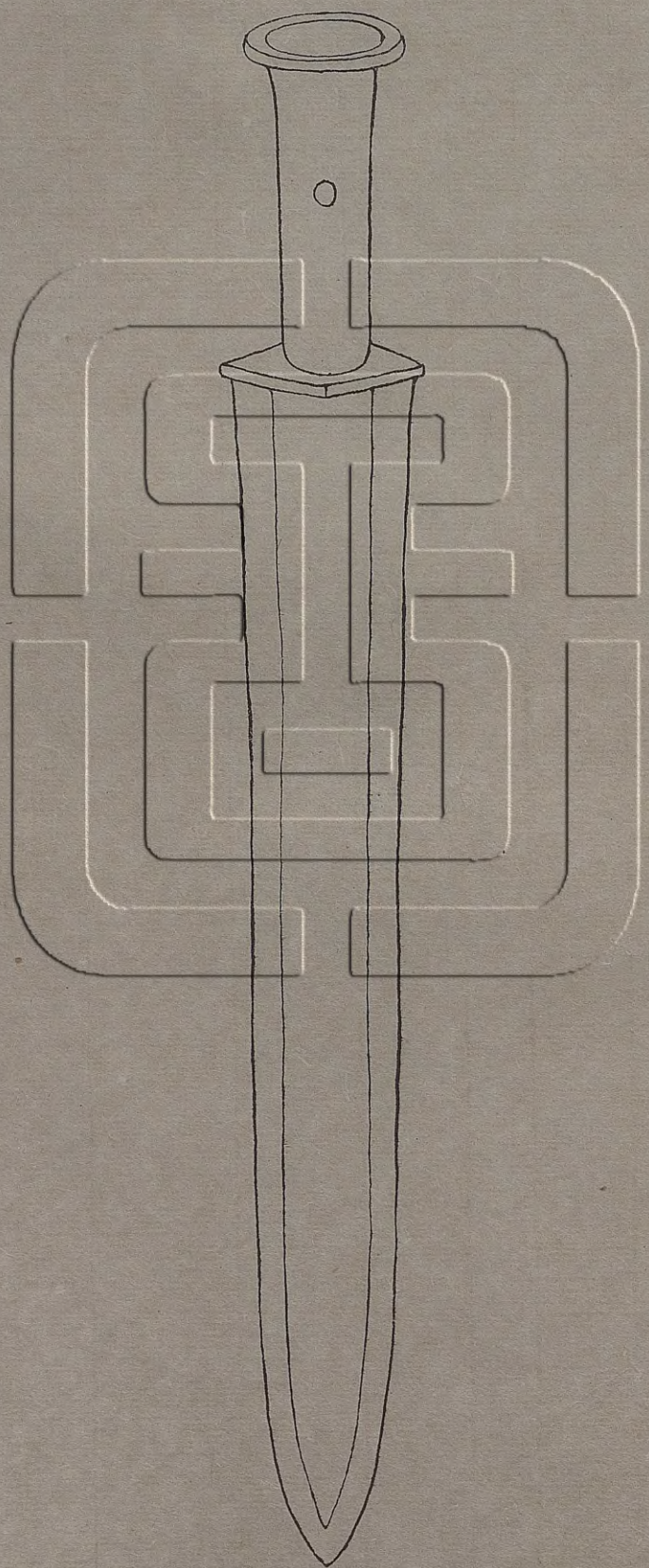

右高一寸三分  
徑五寸八分

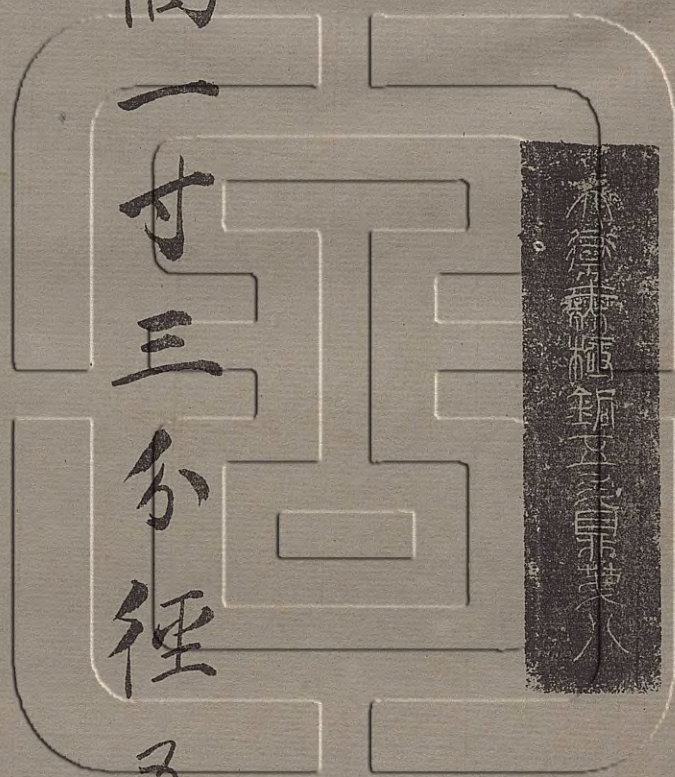

秦高都劍新正三泉堂







右通長一尺二寸三分



夏中周正元

秦官率劍

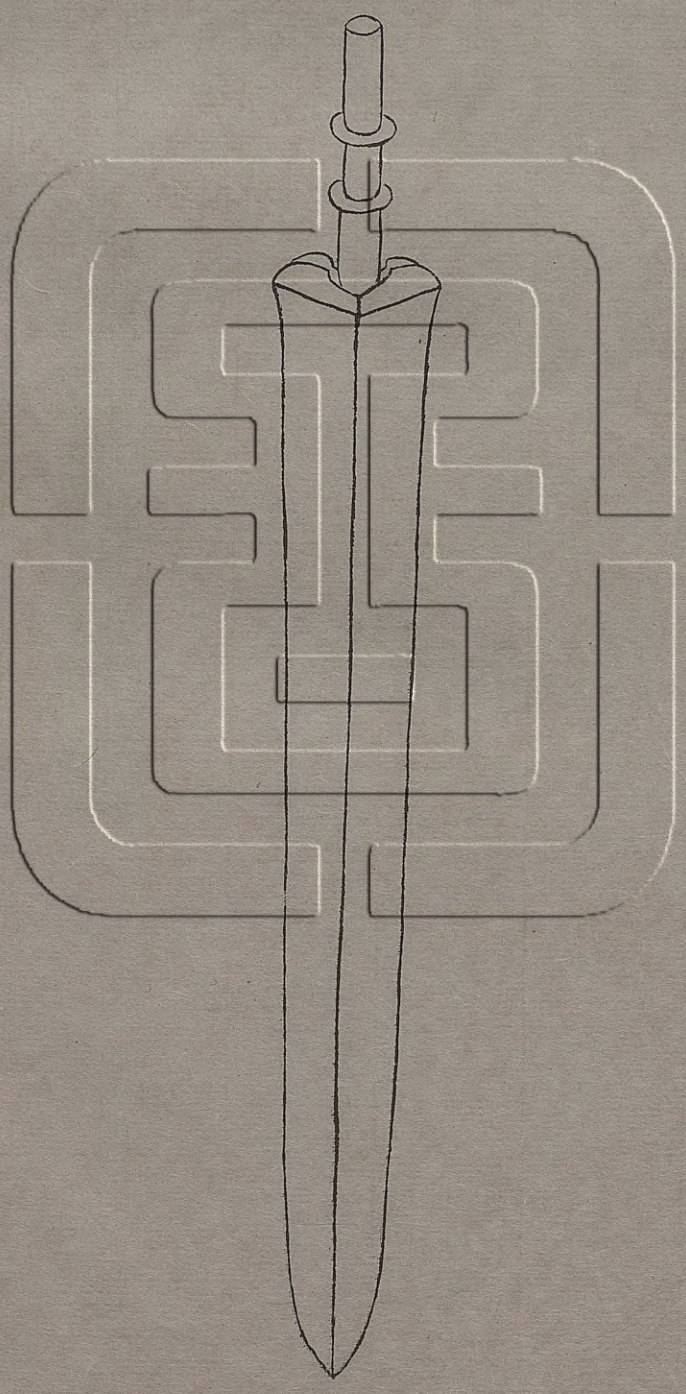



右通長一尺九寸

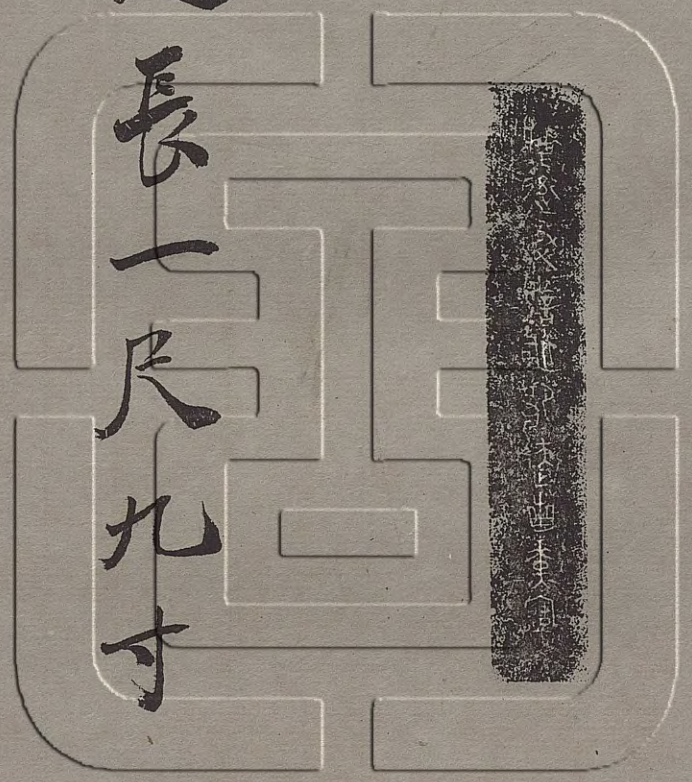

秦陰平劍

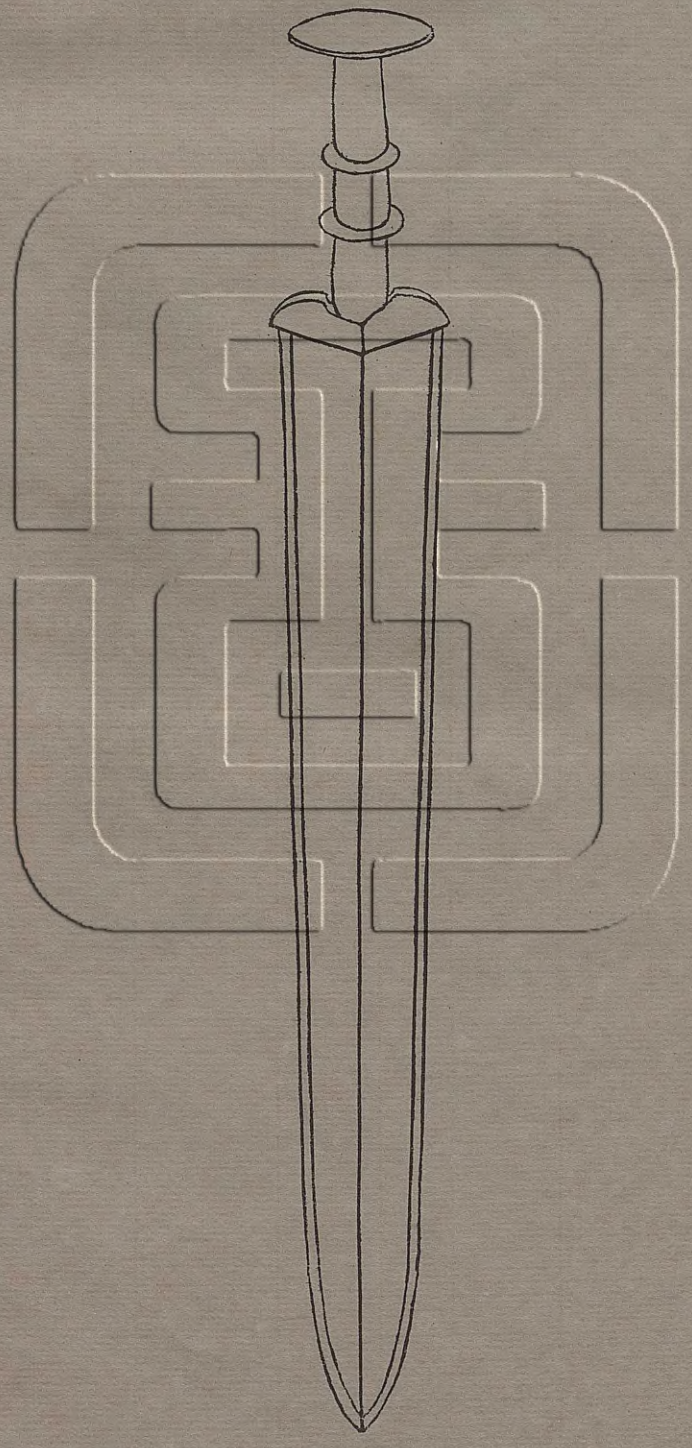



右通長一尺九寸七分



陸乘臣庫正贈

秦帛平侯劍

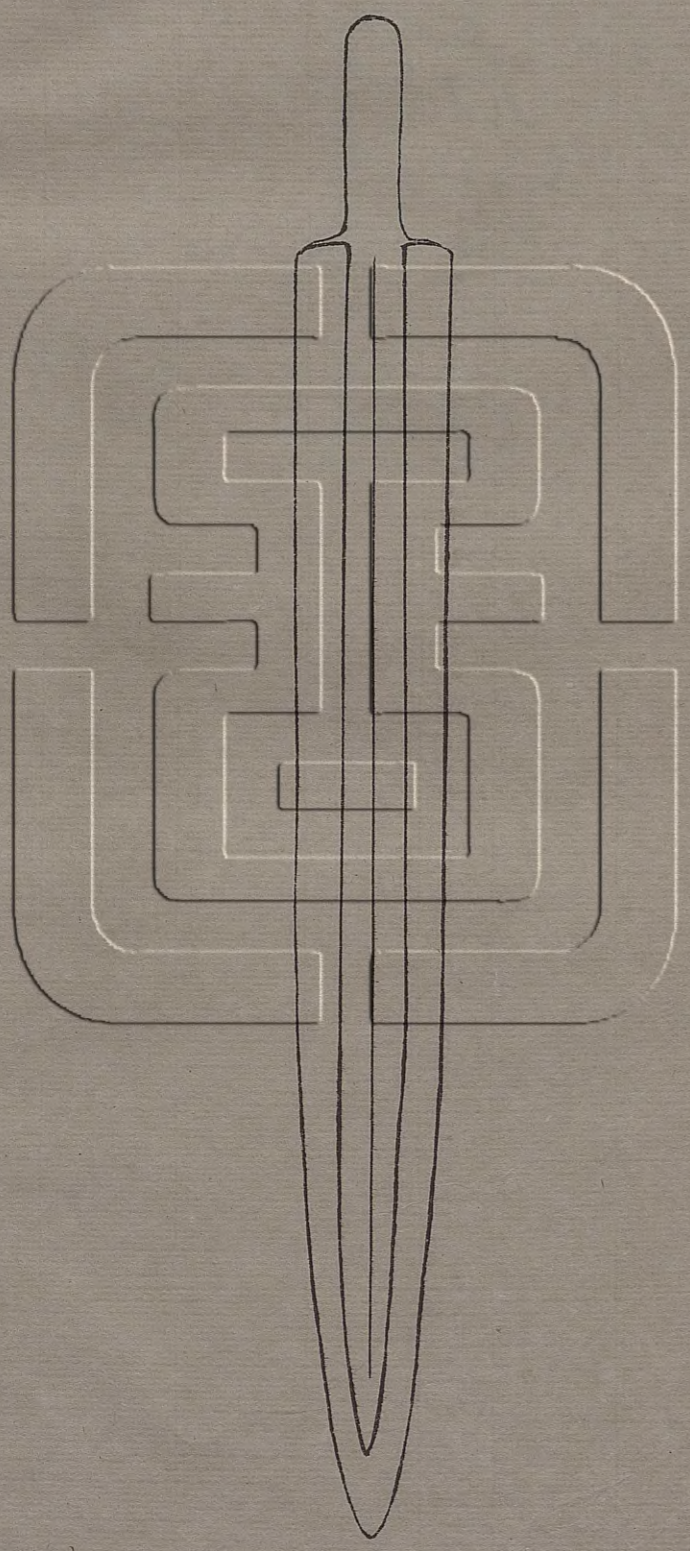







右通長一尺九寸八分

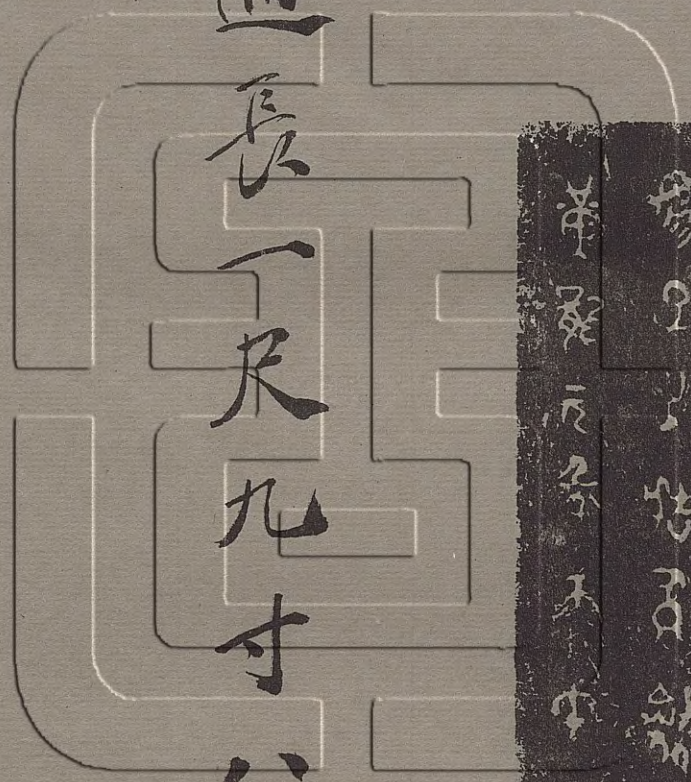

漢宜富劍格原形

漢宜富劍格原形

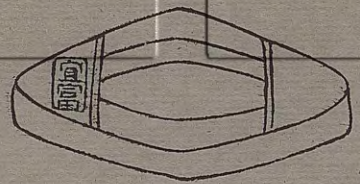
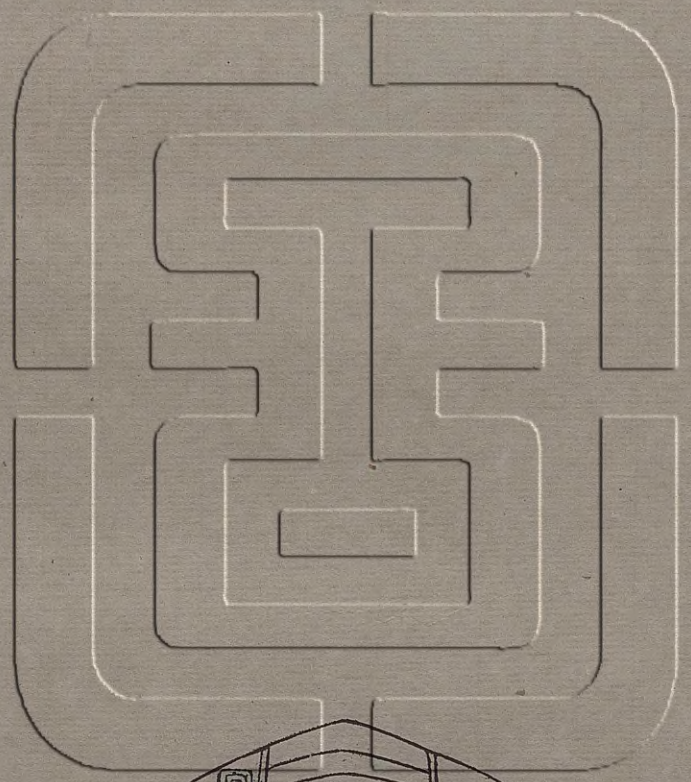



漢蟠螭劍

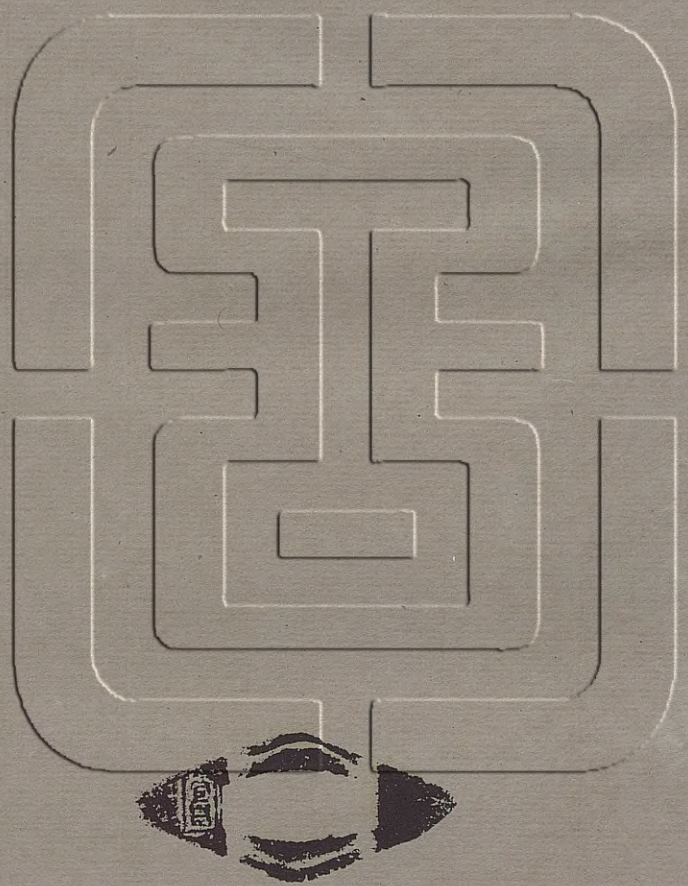
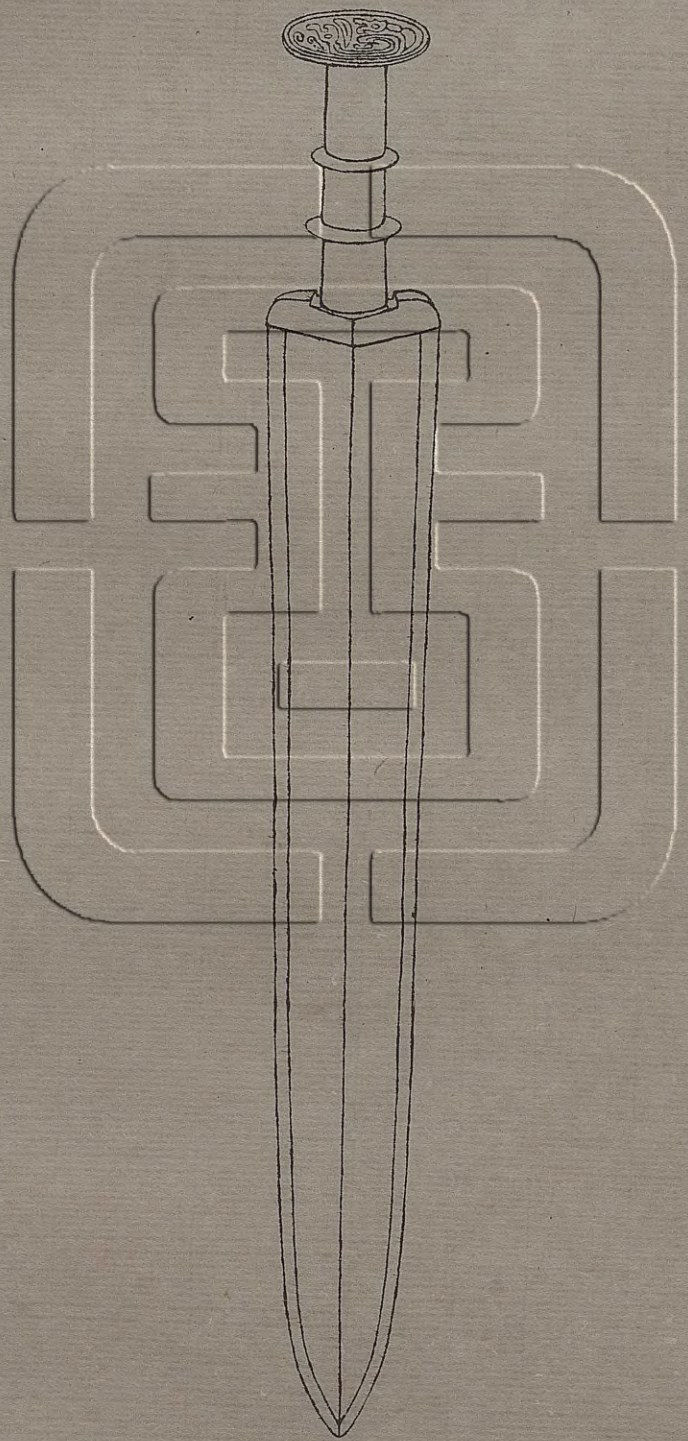



右通長一尺九寸四分



秦寺工殘戈 原形

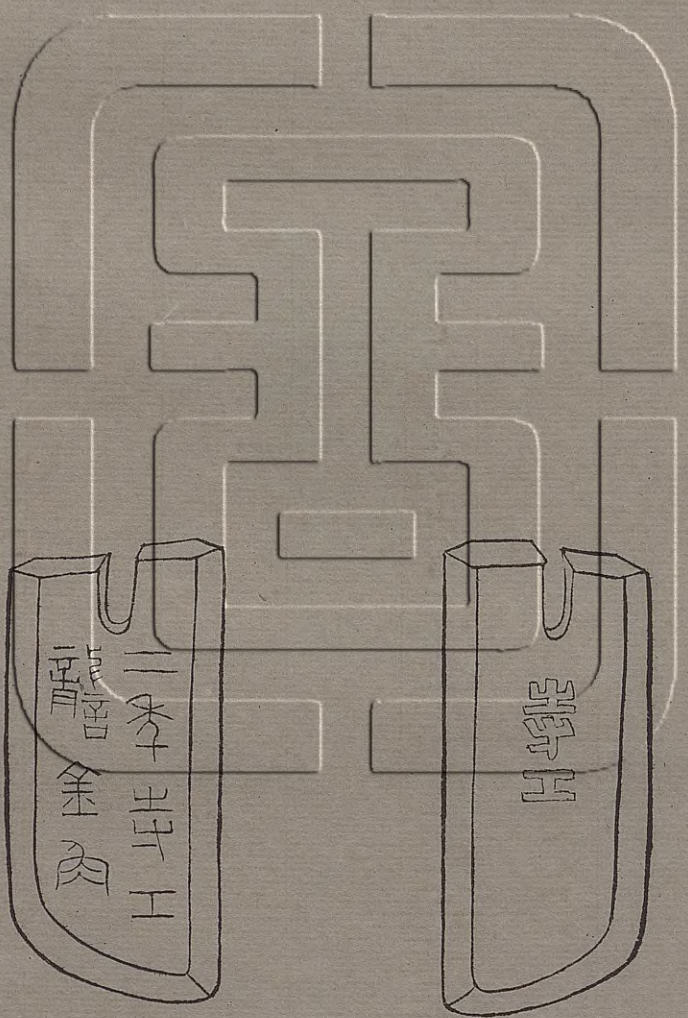



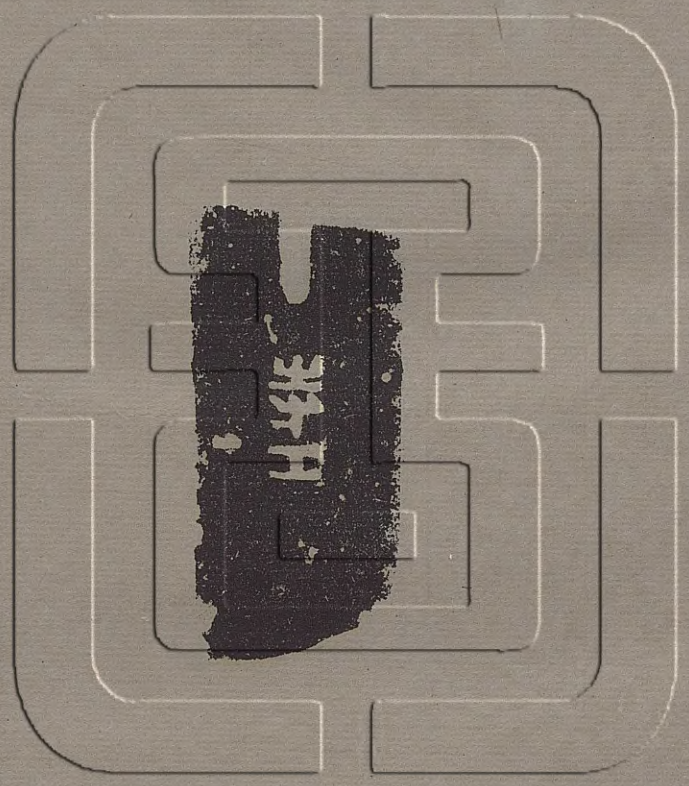

秦武庫戈 原形

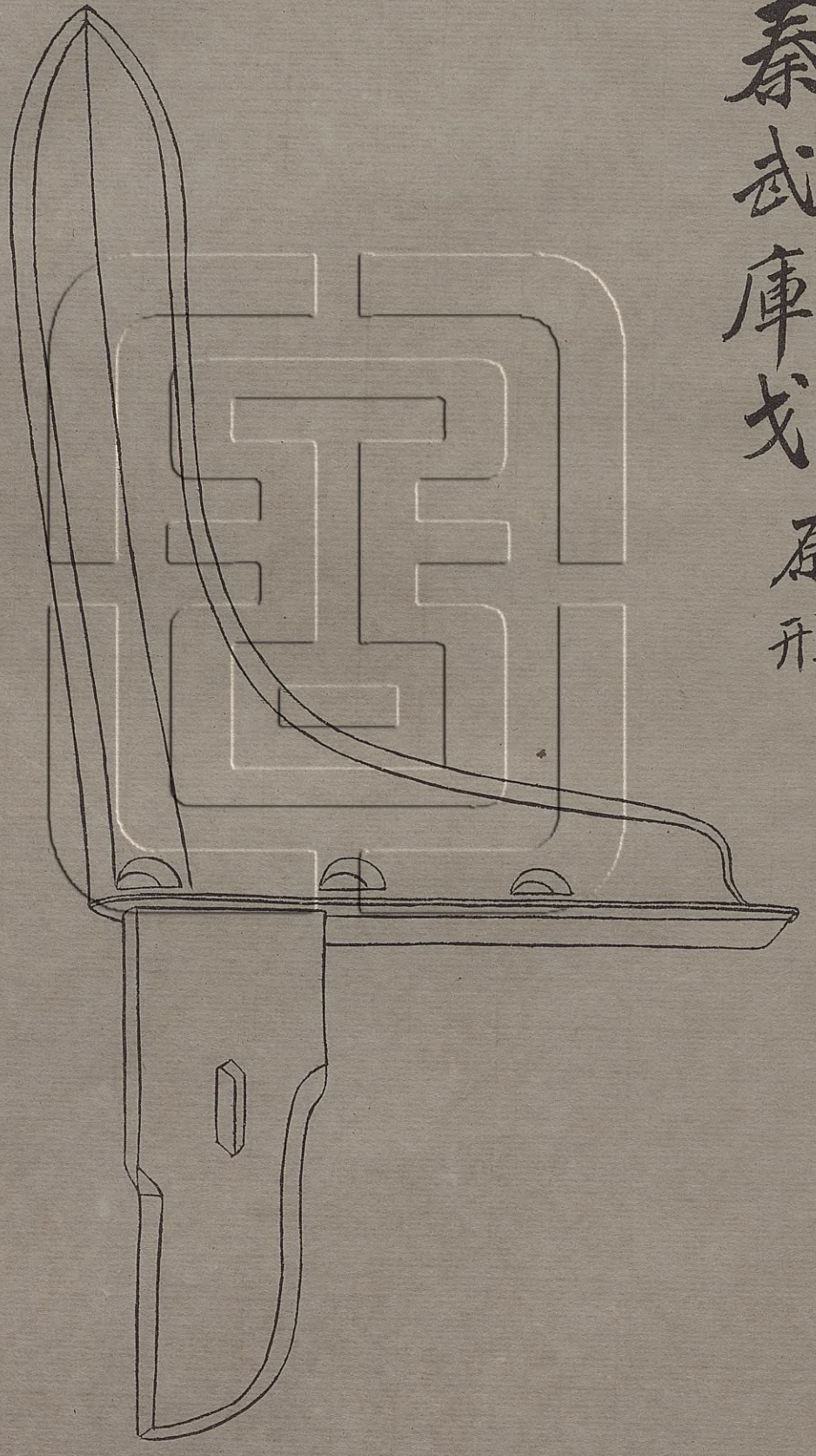



秦八羗戈原形

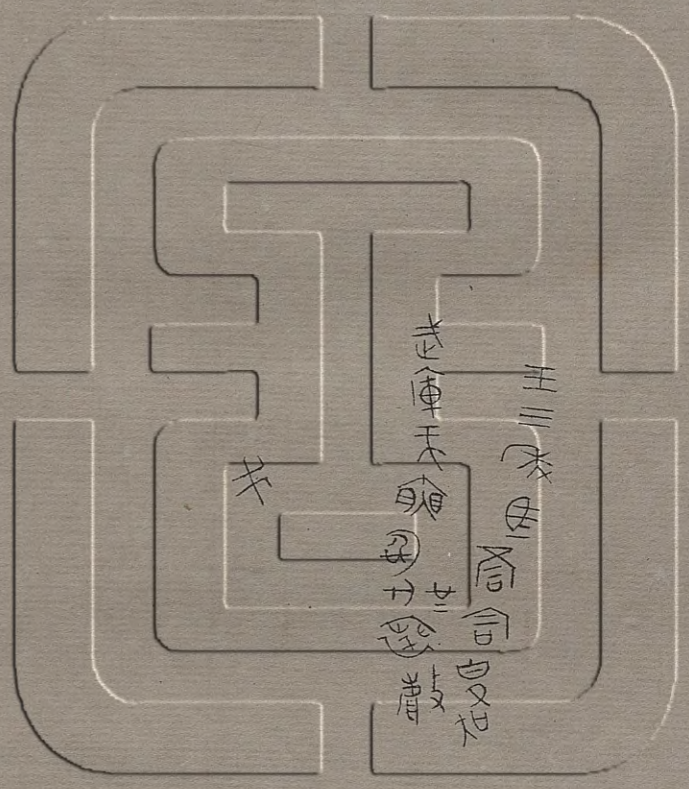
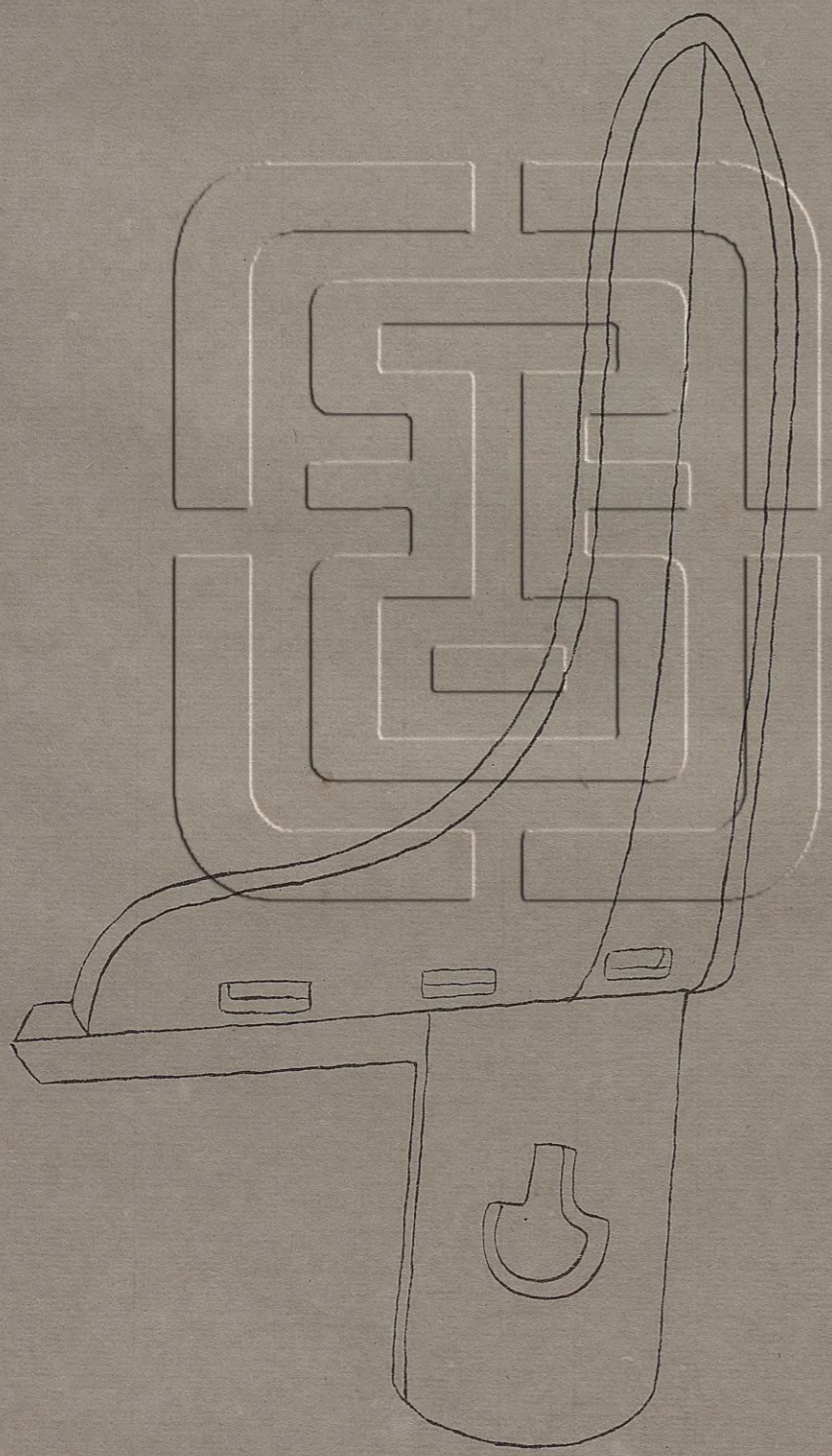



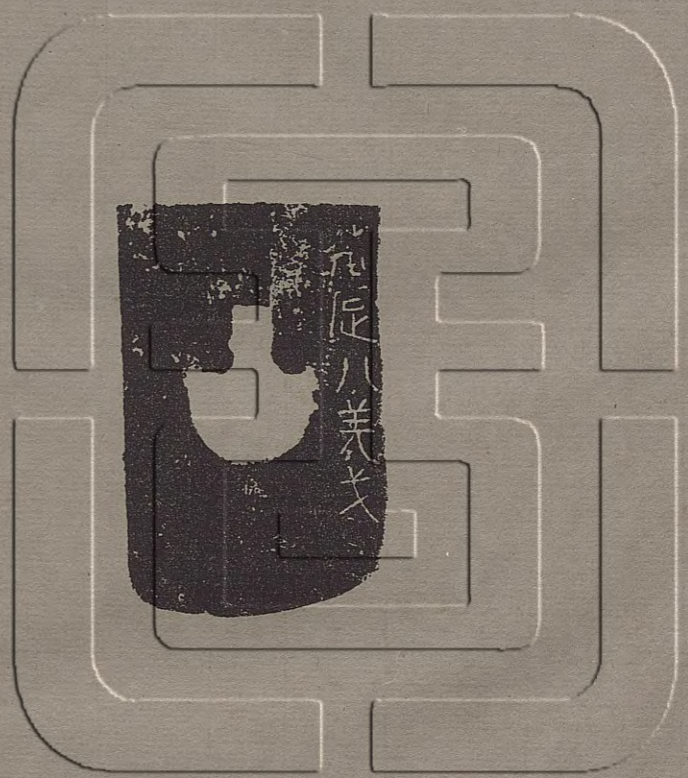
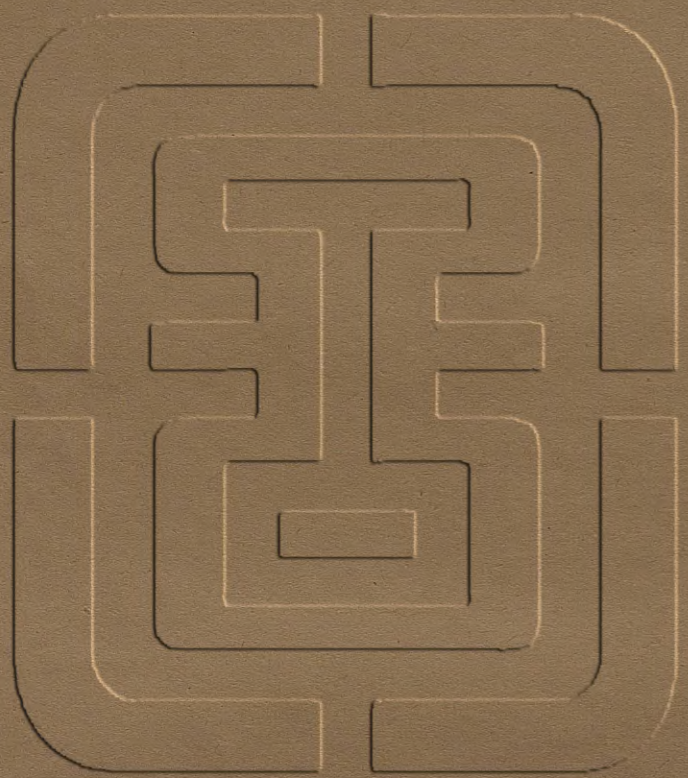

隆  
齋  
書  
金  
鏡

三十九



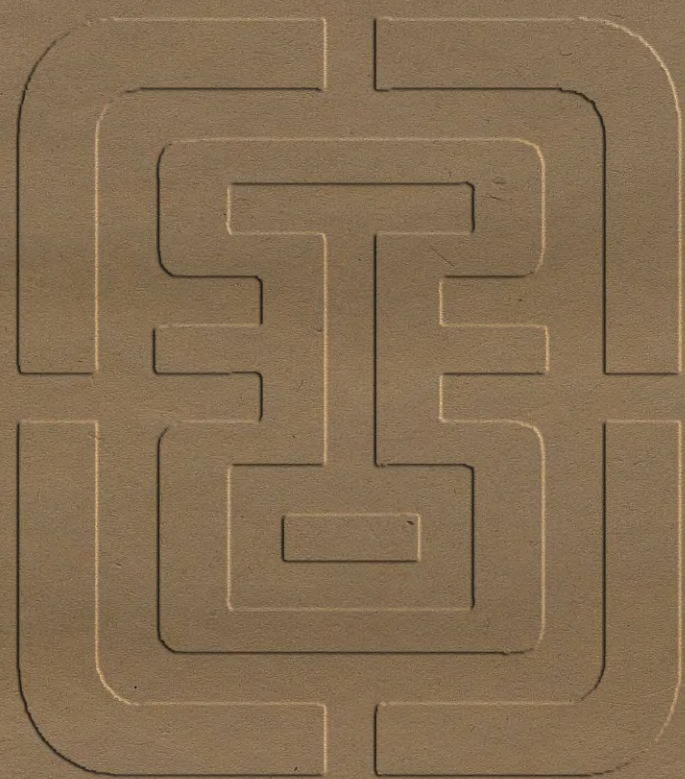



1 | 2 | 3 | 4 | 5 | 6 | 7 | 8 | 9 | 10 | 11 | 12 | 13 | 14 | 15 | 16 | 17 | 18 | 19 | 20 | 21 | 22 | 23 | 24 | 25 | 26 | 27 | 28 | 29 | 30 | 31 | 32 | 33

Centimetres

# Kodak Color Control Patches

© Kodak, 2007 TM: Kodak

Blue

Cyan

Green

Yellow

Red

Magenta

White

3/Color

Black

