

Historic, Archive Document

Do not assume content reflects current scientific knowledge, policies, or practices.

6273

Michell's



HIGHEST QUALITY
SEEDS

HENRY F. MICHELL

1018 MARKET ST.,
PHILADELPHIA



Philadelphia, January 1, 1899.

SPECIAL ANNOUNCEMENTS



- No. 1.—We guarantee safe arrival of all goods purchased from us—customers take no risks.
- No. 2.—We guarantee satisfaction in all dealings with us—customers may rely fully upon us.
- No. 3.—If for any reason our goods should not be exactly what the customer desires, they may be returned to us within reasonable time and the money will be immediately refunded or account credited for full amount.
- No. 4.—If desired we will gladly procure for our customers any **SEEDS, PLANTS**, or other articles not offered in our catalogue, but quoted in any other catalogue. Customers will kindly mention in their orders the firm offering the Seeds, Plants or articles wanted and the prices quoted for same, and we will ship with our own goods, thus saving extra expense and work for our customers.
- No. 5.—We make no charge for packing cases, baskets, packages or barrels, and pack as lightly as possible, consistent with safety, so as to reduce the cost of carriage.
- No. 6.—Correspondence, advice, etc. We are always glad to give any information in our power to our customers on any subject pertaining to our business, also special prices or estimates when requested.
- No. 7.—We pay the postage on all seeds in packets and ounces purchased from this catalogue. We only charge postage on bulk quantities, viz.: At the rate of eight cents per pound. Peas and Beans at the rate of fifteen cents per quart, and Corn at the rate of ten cents per quart.
- No. 8.—We make no charge for cartage or delivery of goods to any railroad station, steamship line, or express office in Philadelphia.

No. 9.—To Gentlemen wishing the services of a gardener. We have on our register the names of very good men who are open to take a position. We will be careful to recommend only such men would be most suitable, and with best of references.

No. 10.—To Gardeners wishing situations. We constantly have calls for first-class gardeners, and to supply such openings we cheerfully ask gardeners who are in want of a position to apply to us, and we will endeavor to find a suitable place for good men.

We positively make no charge for this service, either to employer or employee, and exact no obligation whatever, as we consider it a strictly BUSINESS MATTER and part of our business.

ALL OUR SEEDS are grown expressly for us by the most reliable Specialists and our customers may rely upon getting only the very best **FRESH TESTED SEEDS**.

We personally inspect the crops during the growing season both in this country and in Europe.

Our Stock and Assortment of

GARDEN TOOLS AND IMPLEMENTS

is very large and of the LATEST IMPROVED MAKES, at the Most Moderate Prices.

We carry in stock Everything for the Garden, Lawn and Greenhouse.

How Best to Remit

Remittances should be made either in the form of a P. O. Money Order, Bank Draft, Express Money Order, Express Purchasing Order, or Registered Letter. Remittances in any other way are entirely at the sender's risk.

Give full Shipping Instructions

on each and every order you send. To avoid chance of error, never write letters on the same sheet as your order.

HENRY F. MICHELL,

WAREHOUSE:
1017-1019 Ludlow St.

1018 Market Street,
PHILADELPHIA.

TELEPHONE 52-60A.

HENRY F. MICHELL.
FRED'K J. MICHELL.

To the Florists or Wholesale Trade.



PRICES QUOTED IN TRADE LIST ARE NET.

Seeds, Bulbs and Supplies NOT QUOTED in Trade List are subject to the following discounts from our Retail Catalogues:

On Vegetable Seeds	25%	discount.
“ Flower Seeds	33 $\frac{1}{3}$ %	“
“ Bulbs	25%	“
“ Implements and Supplies	10%	“
“ Fertilizers and Insecticides	10%	“
“ Sundries and Miscellaneous Goods	10%	“

HENRY F. MICHELL,
SEEDS, BULBS AND IMPLEMENTS

No. 1018 Market Street

**HENRY F. MICHELL
FRED. J. MICHELL**

PHILADELPHIA, PA.

ORDER SHEET.

Please tear this out and use in ordering.

PLEASE DO NOT WRITE IN THIS SPACE.

HENRY F. MICHELL, SEEDSMAN,

1018 Market Street.

HENRY F. MICHELL,
FRED'K J. MICHELL.

TELEPHONE 52-60 A

PHILADELPHIA, PA.

IF PINTS and QUARTS of BEANS, CORN, ONION SETS and PEAS are desired sent by MAIL, please ADD to Catalogue Prices, 15 cents per quart, 8 cents per pint; also 8 cents per pound on other Seeds.

Received
Charge or Paid?
Filled by?
Shipped via?
Date of Shipment?

Name
Post Office
Express Office (if different from P.O.)
County
State

A.MOUNT ENCLOSED.

P. O. Order, \$
Cash, . . \$
Draft, . . \$

State here whether wanted by
MAIL, EXPRESS OR FREIGHT.

Date 189.....

SPECIAL NOTICE!

If desired, we will gladly procure for our customers any Seeds or other articles not offered in our Catalogue, but quoted in any other Seed Catalogue. Customers will kindly mention in their orders the firm offering the articles required, and the prices quoted.

SPECIAL NOTICE.

During 1899 we will distribute \$100.00 in Cash Prizes at the Regular Monthly Meetings and at the Chrysanthemum Show of the Pennsylvania Horticultural Society, as follows:

	At the June Meeting:	1st Prize	2d Prize	At the Chrysanthemum Show in November:	1st Prize	2 Prize
At the February Meeting (\$5.00): For the best plate of Mushrooms . . . \$3.00	2d Prize	\$2.00	\$1.00	Bects (table) 6	\$3.00	\$2.00
At the March Meeting: Best 4 plants of Cinerarias 3.00				Celery, 6 stalks, any variety	3.00	2.00
Also for the best 4 plants of Calceolarias, 3.00				Cabbage, 6 heads	3.00	2.00
At the April Meeting: Display of 12 Hyacinth blooms, either } in pots or pans, } 3.00	1st Prize	2 Prize	3d Prize	Mangel Wurzel, 6 roots	3.00	2.00
At the May Meeting: 3 best heads of Cauliflower 3.00	5.00	3.00	2.00	Mushrooms, 1 dish	3.00	2.00
				Spinach, 6 heads	3.00	2.00
				Potatoes, 1 peck	3.00	2.00
				Tomatoes, hot house, one dish, named	3.00	2.00
				Lettuce, 6 heads	3.00	2.00
				Cucumbers, hot house, 3 specimens	3.00	2.00

QUANTITY.	PRICE.		TOTAL AMOUNT
	\$	Cts.	

NAMES OF ARTICLES WANTED.

QUANTITY.

NAMES OF ARTICLES WANTED.

PRICE.
\$
Cts.

TOTAL AMOUNT

Novelties and Specialties in Vegetable Seeds.

ALL DESCRIPTIONS AS GIVEN US BY THEIR RESPECTIVE INTRODUCERS.



GIANT DWARF BEAN "Emperor William Improved."

One of the best varieties for forcing or open ground.

Its pods attain an astonishing length, even to 10 ins.

Everyone who grows it will be highly pleased with it.

20 cts. per original pkt.



New Parsley "Dwarf Perfection."

This is the finest and most valuable parsley ever raised. The habit is regular, and the exquisitely fine and prettily curled leaves are set so closely that the plant is almost globular. The color is a wonderful bright pea-green, and in flavor it surpasses all other varieties known. Valuable for garnishing purposes.

At the General Horticulture Exhibition at Hamburg, 1897, this new parsley was awarded the large silver medal.

20c. per original pkt., 2 pkts. 35c.

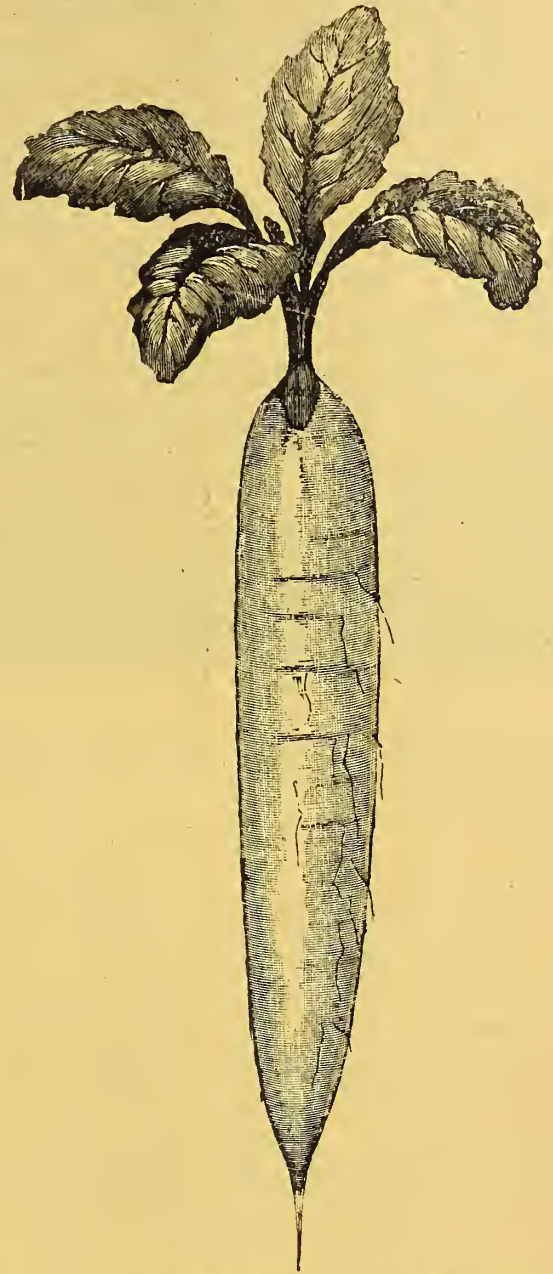

NEW RADISH "ICICLE."

This magnificent novelty receives its name from the almost transparent whiteness of the root, which has no comparison among all existing radishes. The leaves are short; the taste exceedingly fine. If well cultivated, "Icicle produces its 3½ to 4 inches long, cylindrical roots within 22 days from date of sowing. A long, white alabaster-like Forcing-Radish has not yet existed, therefore, this novelty is certain of a wide distribution, as it is equal to the other sorts in earliness and good flavor.

15c. per original pkt., 2 pkts. for 25c.

NEW RADISH, "JEWEL."

Olive-shaped, of a beautiful scarlet color, and the flesh is tender and delicious in flavor. The foliage is very short. 15c. per original pkt.





New Forcing Cucumber "Covent Garden Improved".

An improvement on Rochford's Improved.

Considered to be the very best variety yet introduced. It is a marvelous producer.

Per pkt. of 10 seeds, 25 cts.

RYTOW'S Dwellinghouse Cucumber.

This novelty is most interesting to those who have no garden, but it will also earn much approval from those who cultivate it in the open or in frames. The adjoining illustration is taken from a photograph of this Cucumber, as several of them have been cultivated for me in various places by amateurs—ladies, gentlemen and children.

The cultivation is very easy. The best method is to sow the seeds singly in pots of about 2½ inches diameter and transplant after about four weeks, taking care not to damage the ball, into larger pots of 4 to 5 inches diameter. For potting this cucumber, a somewhat sandy garden soil must be used; the pots should be placed in a room in which the temperature never gets below 50° F. Avoid keeping too moist. After the development of the 8th or 9th leaf, cut off the end shoot to quicken its fruiting. Entirely developed the fruit attains a length of over 1 foot, but if it is desired to attain the best results, it is advisable to cut off the first fruits as soon as they reached a length of 7 inches.

Every one having a flowerpot to hand and sufficient room at the window, can have the pleasure, through this novelty, of eating home grown cucumbers; they taste twice as good as others.

Original pkts. containing 8 seeds, 20 cts.



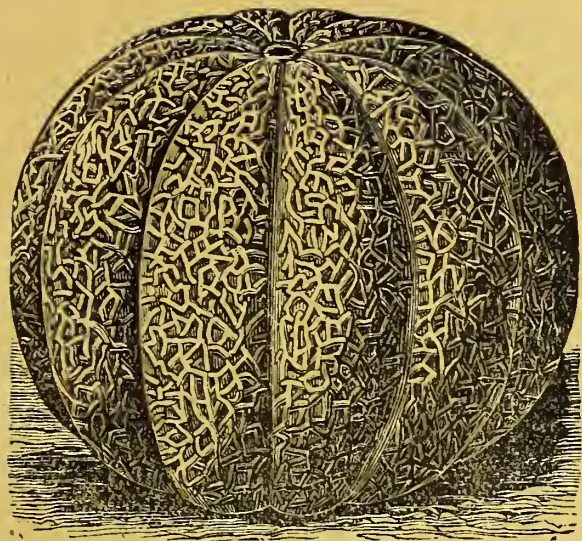

New Musk Melon (Cantaloupe) Paul Rose

The best Musk Melon introduced for many years. It is a successful cross of the Osage with the Netted Gem and combines the sweetness of the former with the fine netting of the Gem.

In time of glut the "Paul Rose" was eagerly called for and quickly sold at prices four or five times higher than any other melons on the market.

Per pkt. 10c., per oz. 20c., per lb. \$1.25.



ALLAN'S
DWARF TELEPHONE

PEAS.

We have for a long time realized the value of a pea with dwarf vines, bearing large, handsome pods, with peas of highest quality; without the long vines of the Telephone, more dwarf than the Stratagem. We have for years been breeding up a pea that will fill the above requirements: Height, under high culture, eighteen inches; habit, dwarf stocky, healthy and vigorous, remarkably uniform, very productive; season, medium, from five to seven days earlier than Stratagem; pods, long, frequently five inches in length, remarkably well filled, often containing ten peas. Every gardener should plant one or more rows of this variety.

50 cts. per qt., 4 qts. for \$1.50.

Radish

"First
Number."

The finest, extra early, scarlet, oval-shaped Forcing-Radish now in existence. The roots of this new variety are very handsome and oval-shaped, the color is a splendid scarlet. The foliage is short, and three leaves only are generally produced. 20c. per original pkt., 2 pkts. for 35c.



New Radish, "Triumph."

This is a peculiar and valuable novelty.

The root is globe shape and strikingly handsome for its horizontal, bright scarlet stripes on a white ground.

Although it is fit for open ground, it is of greater value for forcing purpose, being quite short leaved and of very quick growth, and the warm moistness of hot beds renders its peculiar color more prominent.

15c. per original pkt., 2 pkts. 25c.

NOVELTIES—FLOWER SEEDS.



Ageratum, Blue Perfection (Lorenz). Is of the darkest shade amongst the large flowering varieties, and coming entirely true from seed, it is a most valuable plant for borders and beddings.
No. 20. 15 cts. per original pkt.; 2 pkts., 25 cts.

New Dwarf

Mignon Asters.

(Benary).

Just as the leading classes of Asters, such as the Victoria, Chrysanthemum and Paeony-flowered, have each in the past given rise to dwarf-growing sections, so now the beautiful and extremely popular Mignon class has also produced a form with a low habit of growth. About 10 in. high, the plant branches just above the soil and the elegant stalks bear a profusion of lovely and refined semi-globular flowers. This new variety is of striking beauty and will doubtless take a leading place among the dwarf classes. For beds and borders, for cutting and as a pot plant, it cannot fail to prove of immense value.

No. 1103. White, 15c. per original pkt.
No. 1104. Crimson, 15c. " "



Aster New "Daybreak." A sport from the branching type, the color is a beautiful shell pink, the habit is graceful, erect and produces an immense mass of perfect double flowers. No. 69—15 cts. per pkt.; 4 pkts. for 50 cts.

Hohenzollern Aster. The very largest aster yet introduced, will eclipse for size and quality all other large flowering Pure White varieties. Can be cut with extra long stems and will pay handsomely as cut flowers. No. 1105, per orig. pkt., 25 cts.

The brilliant salmon pink flowers of this splendid novelty represent quite a striking new color in Balsams. It is in every respect as fine as my last year's introduction "alba perfecta," and even superior in the perfection of form of its very double blossoms. This superb variety is a wonderfully free bloomer and comes absolutely true from seed; its magnificent appearance drew forth the eulogiums of all visitors to my grounds during the past summer.

No. 137. 15 cts. per original pkt.; 2 pkts., 25 cts.

New Dahlia

Zimapani.

(Bidens Atrosang Superba).

Beautiful brilliant scarlet daisy-like flowers, very valuable for cutting.

We can highly recommend this novelty to our customers.

No. 160. 15 cts. per pkt.



• • •
BALSAM,
Improved
Camellia
Flowered,
"Prince
Bismark"

(Benary.)





New Thistle Cent. Am. Alba.

NEW THISTLE.

CENTAUREA AMERICANA ALBA.

This native annual flower is also known as the Star Thistle. It is showy when in bloom and a free and hardy plant. Although an annual it grows to a large size in one season, and the immense heads of double, fluffy blooms are quite as showy as pæonies, or hollyhocks. The color is almost pure white.

The stems shoot up from one to three feet, sturdy and strong, branching near the ends and each branch bearing a bloom.

It is an excellent plant for cut flowers, the flower lasting several days when cut.

E Haentze, the leading florist of Fon du Lac, Wis., wrote us: "I consider it a very handsome and beautiful novelty which will be to your credit. The flowers are excellent material for cut and design work."

No. 251, 10 cts. per packet; 25 cts. per eighth ounce.



New Candytuft Little Prince.

NEW GIANT HYACINTH FLOWERED WHITE CANDYTUFT.

The flower spikes measure as large as 7 inches high and 7 inches in circumference, with 120 to 140 florets to each spike. Most excellent for cutting purposes as well as for garden bedding.

No. 189, 15 cts. per pkt.; 2 pkts. 25 cts.

NEW DWARF MORNING GLORY.

(Convolvulus Tricolor Compactus). CHOICEST MIXED COLORS.

A bed or a pot of the new beautiful Convolvulus Tricolor Compactus produces an attractive sight as the below illustration, reproduced from a photograph, will show.

No. 321, 15 cts. per original pkt.; 2 pkts. for 25 cts.



New Dwarf Morning Glory.

NEW WHITE CANDYTUFT LITTLE PRINCE—(Benary.)

It is from the beautiful Empress Candytuft that I have obtained this most charming new dwarf variety. Though only half the height of the parent, say 4 to 6 inches it forms just as massive spikes of large pure white flowers, which, standing erect, are grouped candelabra-wise round the main stem. In some plants further side branches, often to the number of 3 or 4, are developed, giving the plant quite a bush-like form. This new Candytuft is of an extremely robust constitution and continues considerably longer in full bloom than the Empress. When planted in masses it produces a splendid snow-like effect. The numerous visitors to my grounds this summer were greatly struck with its unique beauty. I consider it one of my best introductions.

No. 190, 20 cts. per original pkt.; 2 pkts. for 35 cts.

NEW YELLOW ICELAND POPPY.

Papaver Nudicaule Sulphureum.

Pale sulphur colored variety of the popular Iceland Poppy.

Annual perennial blooms the first season from seed.

No. 2350, 15 cts. per pkt.; 2 pkts. 25 cts.



New Yellow Iceland Poppy.



New Paris Daisy "Chamæleon."

(*CHRYSANTHEMUM CARINATUM TRICOLOR.*)

Large-flowered new variety of this showy annual, so valuable for its yield of cut flowers. The ground color of the flowers is a light coppery-bronze, with bright purplish crimson, the blackish purple disk being surrounded by a golden yellow circle. These distinct colors on each flower on one plant produce beautiful contrast. Of great value for cutting purposes.

No. 274, 20 cts. per original pkt.; 2 pkts. 35 cts.



New Marguerite Carnation "Excelsior."

Positively the best and most splendid specimens of this class which have, as yet, been obtained. They are the result of artificial and carefully combined crossings with large-flowering varieties, especially with yellow and yellow-grounded Carnations. They are dwarf; they blossom much earlier than the ordinary Marguerite, and perpetually in bloom. Are of the most varied and beautiful colors, from the purest white to every possible shade of red and yellow and striped.

No. 239, 20 cts. per pkt.; 3 pkts. for 50 cts.



NEW Mammoth-Leaved Dwarf • COLEUS

With this novelty we have the pleasure of introducing a new class of Coleus, especially adapted for carpet-bedding. Attaining but a height of 6 to 8 inches, and producing their leaves in great profusion, the seedlings need no cutting back whatever, all there is to be done is to pinch out the small flower-stems. The leaves, being of lasting substance and nearly of the same size as those of the tall-growing varieties.

Choicest Mixed Colors. True from seed.

No. 245, 20 cts. per original pkt.; 3 pkts. 50 cts.



New Feathered Cyclamen

"BUSH HILL PIONEER,"

First Class Certificate Paris, 1897.

First Class Certificate Ghent., 1897.

Flowers white of great substance with a strikingly distinct crest or feather of the same color upon the face of each petal.

This, the first variety of its kind, is undoubtedly destined to be the forerunner of an entirely new strain of Cyclamen, the feather adding enormously to the substance and lasting properties of the flower.

No. 315, in sealed pkts., 60 cts. each.



NEW Variegated Foliage • CANNA

The leaves are of a light green, thickly splashed and barred with red and yellow and margined with clear crimson, which color appears throughout their whole surface. The plant is so decidedly striking as to arrest attention the moment it is seen.

Fresh seed, No. 205, 15 cts. per original pkt.; 2 pkts. 25 cts.

New Indian Pink Queen of Holland.

(*Dianthus Hedd. Albus.*) (*Benary.*)



A pure white variety. A certain percentage show a small ring, sometimes yellowish, sometimes rosy, round the centre, but this rather enhances than detracts from the beauty of the flower. It is needless to say that they make a very pretty effect in the garden and are, besides, excellent for cutting.

No. 365. 20c. per original pkt., 3 pkts. 50c.



New Large Flowered Fringed Petunia

"Miranda."

I beg to call especial attention to this remarkably fine novelty. It has been obtained from that charming variety known as "brilliant rose," but the color is much more intense and merges gradually towards the throat into scarlet. I believe I have in this beautiful new variety made a close approach to obtaining a true scarlet Petunia. The flowers are superbly fringed. No. 2311, 20c. per pkt., 3 pkts. 50c.

New California Poppy.

Eschscholtzia Douglasii.

We can confidently recommend this California Poppy on account of its extraordinary early flowering, being in full bloom at least a fortnight earlier than the other kinds. The flowers measure 1½ to 2 inches across, and are of a pure golden yellow color, with a dark yellow centre. Very showy.



No. 408. 15c. per original pkt., 2 pkts. 25c.

New Gaillardia Grandiflora Compacta.

New compact growing varieties of the hardy perennial Gaillardias, forming round bushes of about 12 to 15 inches in height, and bearing its long-stemmed blossoms perfectly upright. The colorings of the flowers are exactly as rich and varied as those of the tall-growing varieties. As the plants produce their flowers most profusely, and in constant succession from June to the autumn, this novelty with its improved habit will



prove to be one of the most desirable of all hardy perennials grown for cut flowers.

No. 455. 15c. per pkt., 2 pkts. 25c.

New Gerardia Hybrida.

Can just as easily be cultivated as an annual, as the Pentstemon gentianoides hybrids. The plants attain a height of 1½ to 2 feet, forming a pyramidal bush thickly set with Pentstemon-like flowers, varying in all shades from light pink to dark purple.



No. 437. 15c. per pkt., 2 pkts. 25c.

Lobelia Erinus pumila splendens...

This novelty represents the most remarkable and magnificent
.....variety of its kind.....



The freedom of blooming is unsurpassed, and for bedding in summer this sort will prove the best on account of its very dwarf and compact growth.

The flowers show the deepest purple thus beautifully contrasting with the large white eye.

No. 559.
10c. per pkt.
3 pkts., 25c.

New Pansy, Empress Auguste Victoria

A charming new variety of the Giant Pansies. The prime colour is a pretty porcelain white. The upper two petals are violet-edged, while each of the three lower petals is marked with a large violet-blue spot, contrasting very pleasantly with the golden-yellow eye. At the Horticultural Exhibition at Hamburg this novelty was awarded a Silver Medal

No. 773.
20c. per pkt.
3 pkts., 50c.

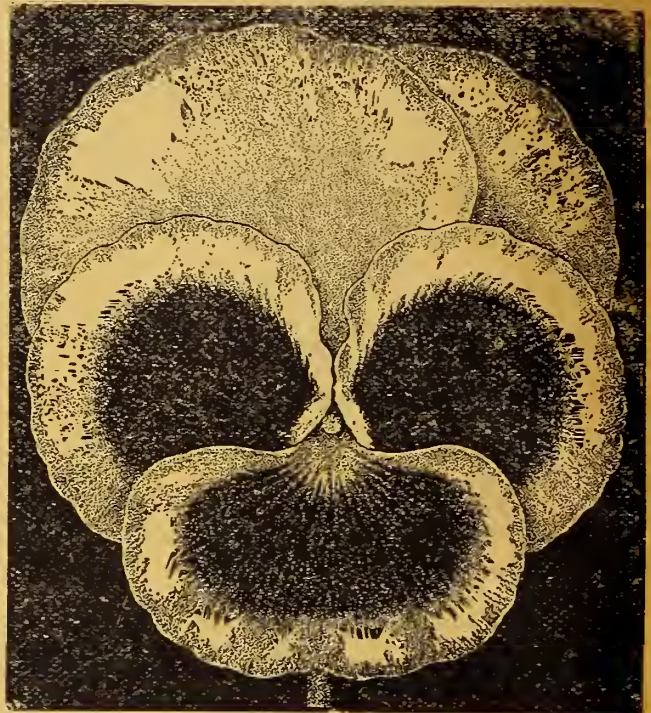

New Climbing Nasturtium "GOLDEN QUEEN."

It gives me much pleasure to be able to enrich this deservedly favorite class of climbing Nasturtiums with a new variety bearing flowers of a pure golden yellow color, without any spots, an introduction which will doubtless prove very welcome.

No. 696, 15 cts. per pkt.; 2 pkts. 25 cts.

KENNEDYA NIGRICANS.—AUSTRALIA NOVELTY.

A beautiful climber of wonderfully rapid growth, with glossy green leaves and yellow flowers marked with black. It makes a dense, impenetrable wall of dark green, and will climb thirty or forty feet. When covered with its lovely yellow flowers it makes a brilliant show. It will stand several degrees of frost, and is a most popular plant for trellising.

No. 534, 20 cts. per pkt.



New Golden Bouquet Sunflower.

New.... Forget Me Not "Stricta Coelestina."



Myosotis "Stricta Coelestina"

A Myosotis striking by its very unique structure. All branches grow straight perpendicular, without even bending to the side. By this compact growth every plant forms a regular pillar or column. This habit makes this variety particularly useful as a pot plant. The wonderful sky blue of this free flowering Myosotis greatly enlarges its value.

No. 616. 20c per pkt, 3 pkts. for 50c.

NEW SUNFLOWER "GOLDEN BOUQUET."

This variety is distinguished by its surprising earliness. If sown in April it begins to flower in June or July, and continues producing new flowers until end of summer or beginning of autumn. The plant grows about 3 feet high, forming a rather regular pyramidal bush, richly branched from base to top, each branch bearing on long slender stems a multitude of golden yellow flowers of from 2 to 2½ inches across, offering invaluable material as cut flowers. It is perennial but can also be treated as an early flowering annual; an excellent decorative plant for the garden.

No. 492, 15 cts. per pkt.; 2 pkts. 25 cts.

Roemer's Superb Giant Prize Pansy "Bronze Color."

The strain includes the different shades of light and dark bronze, that makes the large flowering section so desirable. But the flowers of this novelty are up to three inches across, of good substance and noble form, the three lower petals are marked with distinct blotches.

No. 768, 20 cts per pkt.

Roemer's Superb Giant Prize Pansy "Prince Bismarck.."

By this novelty I am able to offer this distinct color in the Giant Pansies. The flowers measure up to 3 inches in diameter and are of a rich yellowish-bronze color. The well defined eyes are of a dark brown color.

No. 771, 25 cts. per pkt.

Lobelia Cardinalis Atrosanguinea.—(Benary.)

In this fine new Lobelia the cardinalis group will be enriched by a very valuable variety. It is thoroughly distinct by reason of the deep blood red color; has the same noble habit and the foliage is just as dark and handsome as that of the L. C. Queen Victoria.

No. 560, 20 cts. per pkt.; 3 pkts. 50 cts.



NEW SUNFLOWER, "ORION."

Effective new variety. The petals of this novelty are twisted like those of the best Cactus-shaped Dahlias. Excellent for bouquets.

No. 500. 15c. per pkt., 2 pkts. 25c.



..New Pelargonium..

Hybridum Grandiflora Nanum.

This novelty produces the very finest colorings in the flowers. The foliage is very thick and quite ornamental. Greenhouse or house plant. No. 703, choicest mixed, all colors, 25 cts. per pkt.



Petunia Hybrida "Snowball"

A new, very dwarf variety that comes true from seed. Its beautiful, satiny white flowers are well shaped and cover the whole plant with one mass of blooms. Admirably adapted for bedding and pot culture, also for cemetery use. It stands heat and draught equally well. No. 742, 15c. per pkt.; 2 pkts. for 25c.

Petunia Grandiflora

Ruffled Giants. This novelty is the result of careful hybridizing by one of the Petunia specialists. The flowers are of extra-large size with deep throat, distinguished from the large flowering fringed section by the fluting, giving the appearance as if artificially ruffled. The colors are not surpassed by any other strain. No. 739, 20c. per pkt.; 3 pkts. 50c.



New Petunia "Adonis"

I have recently succeeded in raising this new hybrid, which in reason of its floriferousness has gained great praise from all connoisseurs. The flowers are adapted to all purposes: bordering, groups or single pots. The color is a fiery carmine reflecting blue which is most noticeable when opening. The throat is pure white, which gives a very attractive appearance. No. 2310, 15c. per pkt.; 2 pkts. 25c.

New Mammoth Flowering Petunia "VENUS"

Color a splendid carmine with white of such a charm and beauty, as not seen before amongst Petunias. This novelty was awarded the Large Silver--State-Medal at the Harrisburg Exhibition. No. 744, 15c. per pkt.

New Mammoth Flowering Petunia "FAVORITE"

This new Petunia is a variety; the flowers are of an *extraordinary large size and greatest perfection.* No. 745, 15c. per pkt.

New Double Petunia "BRILLIANT PINK LILIPUT"

The dwarf and freely branching plants grow about 8 inches high and are covered with lovely little flowers of a brilliant pink tint, on which the regular stripes stand boldly out. No. 743, per pkt. 20c.



NOVELTIES IN SWEET PEAS.

New Dwarf Sweet Pea,
ALICE ECKFORD CUPID.

From personal inspection of this new variety for the past two seasons we consider it the most charming of the new Cupids, or dwarf race of Sweet Peas. The blooms are of fine, erect form, and borne in close clusters of three on stiff stems, displaying most attractively the charming, blended coloring. The standards are a rich, creamy-white, suffused or blended with a delicate shading of soft flesh pink; the wings are silvery white with a faint pink flush.

Sold only in our original sealed packets.
No. 1016, per packet of 24 seeds, 25 cts.; 5 pkts. for \$1.00, or \$2.00 per dozen packets.
In half-size packets (each containing twelve seeds): per pkt. 15 cts.; 2 pkts. for 25 cts.; or 10 pkts. for \$1.00.

New Sweet Pea—Burpee's EARLIEST OF ALL

"Every florist and gardener will be eager to have this distinct new strain, when we state that it is identical with the *Extra Early Blanche Ferry*, except that it is more dwarf in growth and comes into full bloom at least ten days earlier."

We have received most enthusiastic letters as to the unique value of EARLIEST OF ALL, both for forcing and open ground. The illustration was engraved from a photograph of a spray of flowers, exactly natural size.
No. 1018,
Per pkt. 10 cts.
Per ounce 40 cts.



New Sweet Pea,
"NAVY BLUE."

An early distinct color (not tint) from any existing variety of Sweet Pea. General color-effect dark blue; standards brilliant royal purple; wings pure violet; the whole flower elegantly veined in sharp relief. A most vigorous grower. Blooms of generous size, parchment-like texture and remarkable substance. Stems usually bear three flowers, occasionally four.
No. 1019, in full-size packets, each containing twelve seeds: Per pkt. 25 cts.; 5 pkts. for \$1.00.
In half-size packets, each containing six seeds: Per pkt. 15 cts.; 2 pkts. for 25 cts.; 10 pkts. for \$1.00.

COPYRIGHTED 1898 BY W. A. B. & CO.

New Sweet Pea, STELLA MORSE.

See illustration engraved from a photograph.

The blossom opens with quite a suggestion of yellow—a most fascinating shade of deep cream—which becomes a little lighter as the flower grows older. About the third day it is a delicate primrose with a faint rose-pink on the edge (perhaps one could call it a bluish-pink edging)

which cast a pleasing blush tint to a mass of the blooms, without destroying the creamy-yellow effect. It has the most perfect form, being of the largest grandiflora type and grows on long stems, with three and four flowers to the stem.
It is a thrifty, vigorous grower and a profuse bloomer.
No one has seen this new Sweet Pea without being at once in love with it.
No. 1017, 10 cts. per pkt.; 35 cts. per ounce.



"JADOO" FIBRE

A New Material in
Which Every Plant Thrives
Without Earth.



TRADE-MARK

REGISTERED.

Protected by Letters Patent.

"JADOO" LIQUID

Both Meat and Drink
to Plants.

THESE materials are omni-suitable. The gratuitous testimony of hundreds of customers bears out the fact there is hardly a known plant in cultivation that some grower has not found to flourish the better for their use.

Transplanted in Jadoo Fibre and watered with Jadoo Liquid, plants do not flag. They grow stocky, are more hardy, show more brilliant foliage and finer and more continued bloom. Fruits and vegetables have their flavor enhanced as well as the size and quantity increased, seeds germinate, and cuttings root in a surprisingly short time. There being no manure in any form in its constitution, its cleanliness as well as the absence of all noxious weeds, commends it.

Pots being two sizes smaller, the difference in the cost of pots materially lessens the cost of the Jadoo Fibre. Labor is saved because repotting and watering are less frequently required, and its lightness for house and decorative plants makes it easier to handle.

Concentrated "Jadoo" Liquid

Is simply invaluable in Pot Culture, and it is the cheapest Fertilizer sold. Both meat and drink to plants. Revives drooping Plants, strengthens the weak and nourishes the strong; above all, it increases the size, causes greater profusion of bloom, and heightens the colors of all Flowers and Plants. Can be used on Flowers and Plants that are grown in Earth or "Jadoo" Fibre.

Hints on Growing Plants in "Jadoo" Fibre.

In sowing seeds in "Jadoo" Fibre an even surface must first be obtained, either by *sifting* the "Jadoo" Fibre, or by putting a little fine soil or sand on the top of it.

Seed properly sown in "Jadoo" Fibre is certain to come up. Every single seed will germinate, provided it has life in it when sown.

Necessity for Cleanliness in Pots.

It is especially desirable that the pots used should be perfectly clean, as otherwise the roots adhere to the pots, and the great advantage of the "root action" of "Jadoo" Fibre is spoilt by their getting broken when shifted to fresh pots.

Potting.

Use pots in all cases two sizes smaller than you would in earth.

In all cases use the "Jadoo" Fibre just as you would earth, but *press it tight* round the roots. If Fibre is fairly moist the plant will not require watering for three or four days. "Jadoo" Fibre being very retentive of moisture, great care must be taken not to over-water. If by accident plants get dry, soak them thoroughly by standing the pots in a tub of water with the chill off. Use pots for the final shift one-third less in size than if grown in earth—*i. e.*, if a 10-inch pot would generally be used, put in a 7-inch one.

If transplanting from earth to "Jadoo" Fibre, let the plant get fairly dry, then shake off as much earth as possible without injury to the roots, and press the "Jadoo" Fibre firmly round the roots.

If the "Jadoo" Fibre shows any tendency to rise in the pot, after the plant has been potted some time, *press it back again*, so that there may be no possibility of a space remaining between the "Jadoo" Fibre and the bottom of the pot.

For every kind of plant not hereafter specially named, pure "Jadoo" Fibre can be used, but a mixture of one-third earth will of course be more economical, and will in no case be injurious.

Ferns.

Pot very tight, adding a little silver sand. For *A. Farleyense* use two parts "Jadoo" Fibre, one part loam and one part sand.

Primulas and Calceolarias.

It is better to use one-third loam mixed with two-thirds "Jadoo" Fibre for these plants, with a good sprinkling also of sand.

Liliums, Begonias, Hyacinths, in fact all Bulbs, do splendidly in "Jadoo" Fibre. Treat exactly as in earth.

Hard-Wooded Plants,

Such as Azaleas, Epacris, Camellias, etc., put the "Jadoo" Fibre *very firm*, using a free admixture of sand.

Chrysanthemums.

Use "Jadoo" Fibre exactly as you would earth. Last shift to be into 8-inch or 9-inch pots. Do not fill these further than two inches from the top of pot till the buds are set, then fill with "Jadoo" Fibre. When pots are full of roots (*not before*), water with diluted "Jadoo Liquid, gradually increasing its strength.

Carnations.

Mix sand freely with the "Jadoo" Fibre. During the winter keep the pots in cold frames with boards under them, giving plenty of air, as a closed frame is the cause of "spot" in Carnations.

Orchids.

Use "Jadoo" Fibre in the same proportion as you would peat, with a little sand, moss and charcoal mixed with it. "Crock" the pots or baskets in the usual way. *Use no water till the plant is established, and then sparingly, about once a week or so, according to circumstances.* Dilute "Jadoo" Liquid will be found specially adapted for watering Orchids, especially aerial ones.

W. W. LUNT, Esq., of Boston, Mass., says, the method I have used is this: For Cattleyas, Laelias and the like, shake out all the fine particles the same as when using peat, using only the most fibrous parts, adding about half the quantity of small nodules of charcoal. This makes the compost reasonably open, and the air gets at the roots to some extent. For Cypripediums and such as are to be grown in pots, use the finer parts, making the compost somewhat more open with additional charcoal, and if possible water with the "Jadoo" Liquid diluted with rain water.

It must be remembered, both with Orchids and all other plants grown in "Jadoo" Fibre, that over-watering is the chief thing to be avoided.

Roses, Azaleas, Epacris, Camellias, &c.

Pot *very firm*, using two parts "Jadoo," one part loam and one part sand.

Primulas, Cinerarias and Calceolarias.

For sowing the seed and first potting into 3-inch pots, use three parts "Jadoo," one part loam and one part sand, afterwards "Jadoo" freely mixed with sand.

Gloxinias and Caladiums.

Use two parts "Jadoo," one part loam, and one part sand for first potting. Afterwards use "Jadoo" freely mixed with sand.

Bedding Plants.

Lobelias, Petunias, and other sorts raised from seed, should be pricked off in boxes about two inches apart—they should be hardened off towards the end of May, when they can be divided and “planted out” in beds for the summer. No “check” whatever will be experienced by the plants when treated in this way, even if they are coming into bloom when planted out, and if watered in the ordinary way, they will flourish through the driest summer.

Lobelias and other annuals treated in this way form a perfect mat of roots in the boxes, which can be broken off without the slightest injury to the plants.

Cuttings.

Geraniums, etc., may be struck in “Jadoo” Fibre, either in pots or boxes, and usually root in half the time they would take in earth, and also root much more strongly than in earth. If struck in boxes they can be cut out into balls for bedding-out, when they will receive no check even in the driest season.

Strawberries in Pots.

Root the runners in “Jadoo” Fibre ; make the first shift in half “Jadoo” Fibre, half loam ; afterwards use loam entirely. Flavor will be greatly improved by this, and even if the use of “Jadoo” Fibre is confined to rooting the runners only in it, a much stronger crown will be formed than if the runners are rooted in the usual way in earth.

Strawberries in the garden or field can be propagated as follows : Where it is desired to put a plant, stamp a hole in the earth with some tool that will shape it something like a three inch flowerpot. Pack this hole full of “Jadoo” and train a runner from parent plant into it. It will take root and form a new and prolific plant.

Fruit Trees in Pots.

Every species of fruit tree will give a large return of fruit if grown in moderate-sized pots in “Jadoo” Fibre, and will require *no* feeding first year; afterwards, use moderate amount of “Jadoo” Liquid, *but not till the fruit is set.* In the case of Peaches and Nectarines, keep them in a sheltered place till the cold winds are over—covered, if possible, with an old light—then move to the sunniest part of the garden. The lightness of “Jadoo” Fibre makes this practicable.

Fruit Trees

In open ground. Put a spadefull of “Jadoo” Fibre below and above roots when planting. This will enormously increase fibrous roots, and therefore give a larger yield of fruit, besides insuring that the tree suffers no check in transplanting.

Vine Borders

Half loam, half “Jadoo” Fibre with some charcoal and broken bricks, makes the best Vine border in the world. When the grapes are “set,” use “Jadoo” Liquid, diluted 20 to 1.

Vegetables.

POTATOES.—Dig the trench the usual depth, then put in a small quantity of “Jadoo” Fibre, place the Potatoes on this, cover with “Jadoo” Fibre and then place four inches of soil on top of this. The distance between plants should be 18 inches and between the rows two feet. On this basis it will require about one and one-half tons of “Jadoo” Fibre to the acre.

CELERY.—Sow in frames in “Jadoo” Fibre ; when planting out put “Jadoo” Fibre at bottom of trench ; **this greatly improves clearness of skin and flavor.**

MUSTARD and CRESS is much improved by being sown in “Jadoo” Fibre, as it comes up *perfectly clean without any dirt adhering to the leaves.*

ASPARAGUS.—Sow into a thick bed of “Jadoo” Fibre, cover with earth so that the “Jadoo” Fibre may not come within four inches of the surface. **Asparagus will come to full bearing one year sooner in “Jadoo” Fibre than if the bed is made in the ordinary way, and will give a much larger yield.**

Cucumbers, Melons and Tomatoes.

Use *half* loam, half Fibre, well mixed together. If grown in *pots* shift them as gradually as usual, but the final shift should not be larger than 12-inch. When shifting into this, only half fill the pot at first, gradually filling it up as the plants advance in growth, so that the roots may be thrown out far up the stem. As soon as the pot is filled with roots, commence watering with "Jadoo" Liquid, using it at first diluted 48 to 1—*i. e.*, one-half pint to a three gallon can of water—and gradually increasing the strength as the plants are "set" with fruit to 24 to 1—*i. e.*, half a pint to a two-gallon can.

If grown in a *bed*, the treatment is the same, but the "Jadoo" Fibre must be gradually "heaped up" round the stem.

METHODS OF USE.

THE FORCING BED.—To raise uniform, strong and healthy plants for transplanting, the bed should be prepared with finely divided, moist "Jadoo" Fibre evenly distributed and packed to the depth of about an inch or more according to the nature of the plant.

If the seed is small sow evenly and not too thick, after which water it freely to wash the seeds well down into the "Jadoo."

LARGE SEEDS may be sown in the "Jadoo" either over the surface or in drills and given a thin covering of "Jadoo" well watered afterwards.

WHEN PLANTS ARE VERY SMALL, like Lettuce, the "Jadoo" should be mixed with loam into which the roots can be pressed with the thumb and covered.

TRANSPLANTING. WHERE THE PLANTS ARE LARGE, they can be taken up with a ball of "Jadoo" attached to the roots. To this is added a small handful of "Jadoo" firmly packed about the roots in the hole and covered with earth. This feeding the plant through the strong root action it produces, will prevent flagging after transplanting and will retain moisture during a long drought.

Table Decoration.

"Jadoo" Fibre is *especially* adapted for growing plants for table decoration. They should be grown in pots a size smaller than the china vases in which they are to be put on the table, so that they can be moved in and out of them without injury to their roots. Plants like Grevilleas can be kept in the smaller sized pots for years in "Jadoo" Fibre.

Window Boxes.

Grow the plants in pots in "Jadoo" Fibre until they are in bloom or showing their flower buds, then shake out and place in boxes, filling up interstices with "Jadoo" Fibre. The great advantage of this is, that the window-boxes look well at once, instead of waiting for plants to get established. Plants can be removed when out of bloom, and exchanged for others, without injuring those that remain.

Hanging Baskets.

Treat just the same as window-boxes. Besides being less than half the weight of earth, they never drip, the water being held as if in a sponge. This is often found a great advantage.

In this and many other ways in which "Jadoo" Fibre can be used, its excessive cleanliness and lightness make it invaluable. Even large pots can be handled by ladies with ease; in fact it is almost ideal material for ladies.

DIRECTIONS FOR USING JADOO LIQUID.

Mix the Liquid in the proportion of 48 parts Water to 1 part Liquid. Shake well before mixing, and always shake before using.

On Plants in "Jadoo" Fibre use the diluted Liquid only once or twice a week. On Potted Plants in soil use just as often as you would water.

The Cheapest and Best Fertilizer that can Be Bought.

MANUFACTURED ONLY BY

THE AMERICAN JADOO CO., PHILADELPHIA, PA.

For sale by **H. F. Michell**
1018 Market Street Philadelphia, Pa.



**Primula
floribunda
grandiflora
isabellina**

This new well fixed variety bears flowers of a soft and very pleasing pale sulphur yellow, contrasting beautifully to the lively green foliage.

No. 812, 15c. per pkt.



**Primula
capitata
(cashmeriana)
alba.**

New white-flowering hardy perennial variety of this lovely earliest blooming Primrose, reproducing itself true from seed. The flowerheads are very large.

No. 814, 20c. per pkt., 3 pkts. for 50c.

New Ox-Eye Daisy.

(*Rudbeckia Bicolor Superba*).

This annual variety represents a very welcome addition to the collection of these popular annual and perennial plants so extensively used for cut flowers at present. Growing about 2 feet in height, it forms a many branched dense bush, and produces its long stemmed flowers in the greatest abundance. The disc is brown, the ray florets are yellow with large velvety-brown spots at the base. Very useful for cutting. No. 784, 10c. per pkt., 3 pkts. for 25c.



**Viola cornuta
Papilio.**

Splendid new variety of the "Bedding Pansy" class. Resembling in shape of its flowers those of the original species *Viola cornuta*, it surpasses it by double the size and its very uniform and vigorous growth. The color is lovely violet with dark eyes. A group of this novelty in full bloom looks like a mass of blue butterflies and presents a beautiful and distinct aspect. No. 959, 20c. per pkt., 3 pkts. 50c.

New French Poppy "Slate Blue".

Dwarf in habit and entirely new in color. Hardy annual. The flowers are perfectly double. No. 845, 10c. per pkt., 3 pkts. 25c.

New Sweet Scented Clover.

Produces large flowers of a lilac red color, the foliage is bright golden yellow. Quite a desirable novelty. No. 978, 15c. per pkt., 2 pkts. 25c.

New Sulphur Yellow Marigold "Liliput."

[*Tagetes Patula*.]

The third distinct variety in this class of very dwarf or Liliput Marigold. Growing only 4 to 5 inches in height by a diameter up to 6 inches, forming neat compact plants that are covered with very small but perfectly double flowers of a bright sulphur yellow color. A valuable variety for carpet beddings, edgings, masses, but as well very useful for growing in pots. No. 970, 15c. per pkt., 2 pkts. 25c.

New Statice Siberica Pyramidalis.

A most valuable perennial, produces perfect shape bushes, covered with an abundance of dainty white flowers. This is without doubt one of the most necessary plants for cut flower purposes, as the foliage is also cut with the flowers. No. 863, 15c. per pkt., 2 pkts. 25c.



VERY
HARDY,

VERY
FRAGRANT.

VERY
VIGOROUS.

New Hybrid BURBANK LILY.

A cross between *Lilium Pardalinum* (Panther Lily or Leopard Lily) and *Lilium Washingtonianum*. Produced by that "Wizard of Horticulture," Luther Burbank.

The beauty and value of this new Lily can be but faintly shown by either words or illustrations. It must be seen in its maturity and fullest development to be justly appreciated. The originator had the rare success to combine in this hybrid the especially valuable characteristics of both parents. From *L. Washingtonianum* came the wonderful fragrance which is so intense that, with a favorable wind, it can often be detected at a distance of four miles. *L. Pardalinum* is very hardy, very free flowering, multiplies very rapidly, and can be successfully grown by anybody and everybody, all of which characteristics are reproduced in the "Burbank." There are many handsome lilies which bloom beautifully the first year or two after planting and then, through not reproducing themselves readily, grow less and less each year, and finally die out altogether. With the "Burbank" this is just reversed. The vigor and amount of bloom that are attained the first year, or in the first two years even, do not anywhere nearly equal what is reached after the bulbs have been longer established. Taller spikes, more flowers and larger flowers are produced each season, single bulbs forming, in the course of a few years, grand immense clumps with 1,000 to 2,000 or more blooms from each clump. Single spikes of flowers are from one to three feet long, and bear from 25 to 150 individual blossoms. Color of flowers, yellow with brown spots. Because of its hardiness, vigor, fragrance and beauty, but especially on account of the rapidity with which it reproduces itself, the "Burbank" is the lily "for the million."

Strong blooming bulbs 30c. each, \$3.25 per doz.

New Chrysanthemum "WM. L. ELKINS,"

Received the First Prize for the best new Seedling of Yellowish Bronze type at the Penna. Horticultural Society's Chrysanthemum Show, Nov., 1898. It is a very large flower, easy grower and makes a good heavy foliage

Mr. Elkins has offered \$25.00 in two prizes for the BEST 6 CUT BLOOMS of Chrysanthemum "Wm. L. Elkins." 1st prize \$15.00; 2d prize \$10.00. To be competed for at the Chrysanthemum Show of the Penna. Hortic. Society in Nov., 1899.

Strong plants will be ready about March 1st. 40c. each, \$4.00 per doz.

Novelties and Specialties in Dahlias.



Specimen Plant of New White Dahlia "BLIZZARD" from photograph, grown under the Single Stem Branching System as described in the new book "THE DAHLIA" by L. P. Peacock. See page 41.

Henry F. Michell. *Exquisite New Cactus Dahlia.* Of immense size, an entirely new combination of shades and new form (see illustration). It is almost impossible to describe the colors, which range from soft yellow to deep orange red, the shades and tints blending with perfect harmony. This variety is one of the most valuable acquisitions in many years; it is not only a free bloomer, but the flowers measure 6 to 7 inches in diameter. Price, strong roots 25 cents each, \$2.50 per doz. The following prizes will be offered at the September Meeting and Dahlia show of the PENNSYLVANIA HORTICULTURAL SOCIETY:

THE "MICHELL PRIZES", \$10 00 AS FOLLOWS:

For the best 12 cut blooms of Dahlia "Henry F. Michell"—1st prize \$5 00, 2d prize \$3 00, 3d prize \$2.00.

La Favorite. The finest pure white Cactus Dahlia to date, and pronounced by such florists as Mrs. H. H. Battles, Robt. Kift, Hugh Graham and Edwin Lonsdale to be equal to the best Chrysanthemum as a cut flower. The flowers are of largest size, snow-white, beautiful fluffy Chrysanthemum form, and above all a profuse bloomer. Price \$1.00 each, \$10.00 per doz.



Dahlia Henry F. Michell.

Viridiflora. *The Green Dahlia.* The great Dahlia curiosity. The plant is strong, dwarf and vigorous growing, and extremely profuse in its bloom, being literally covered with the full green flowers in various stages of development. A most valuable curiosity. Price 25 cents each, \$2 50 per doz.

Wilhelm Miller. Another beautiful new Cactus Dahlia of very large size and bright rosy lake color; an early and profuse bloomer. Price 25 cents each, \$2 50 per doz.

Our Special Offer...

One strong clump of each of the ten superb new Prize Winning DAHLIAS on this page for



... \$3.90 ...



or the Eight (8) without Blizzard and La Favorite for



... \$2.15 ...

TEN RARE NEW DAHLIAS.

Admiral Dewey. An exquisite new Cactus Dahlia of perfect form and fine branching habit. The color is the richest imperial purple and is pronounced the finest of this shade by the leading growers. Price, strong field grown roots, 50 cents each.

Aginaldo. A fine large Cactus Dahlia with broad flat flowers and printed petals. The color is a rich reddish salmon, tinting to old gold; an early, profuse and constant bloomer. A great improvement over Panthia which it will supersede. Price, large roots, 50 cents each.

Blizzard. Too much could not be said in favor of this superb snow-white show Dahlia. It is the earliest of all large Dahlias to bloom, and continues a mass of flowers until killed down by frost. The flowers are of a medium to large size, of perfect form, snow-white, and are borne on long stems, making them invaluable for cut flower purposes. This is the new seedling exhibited the past two years as P, No. 12, and is now offered for the first time. (See photograph of a plant in full bloom). Price, strong plants grown in 3 inch pots, ready after April 15th, 50 cents each, \$5 00 per doz.

Clifford W. Bruton—New Pure Yellow Dahlia. One of the most valuable varieties and the finest decorative Cactus Dahlia ever introduced. The flowers are large, 5 to 6 inches in diameter, and always full to the centre. The color is a solid pure yellow of the clearest richest shade. Unlike many other varieties there are no green centres, even when the buds are first expanding. The plant is a very vigorous grower and profuse bloomer, while the flowers are produced on long graceful stems, making them invaluable for vases and decorations. *Diploma and first prizes by American Institute and American Dahlia Society.* Price, strong clumps, 25 cents each, \$2 50 per doz.

Folio Variegata. *The New Variegated-leaved Dahlia.* The first and only variegated-leaved Dahlia to succeed in America. It has received great attention at various exhibitions. The plant is a free grower, of branching habit. The leaves are bright, glossy green, heavily margined and tipped creamy white, edged red. It is the most valuable variegated-leaved plant in cultivation, and should be in every collection. It is of easiest cultivation, and being a tender perennial, the roots are simply lifted, stored away for the winter, and planted out in the spring. Thus its position can be changed each year. Unlike other varieties, you do not need to bloom it, for it is always beautiful. When in bloom, the large double white, amber and magenta blended flowers show off the plants to greater advantage. Price 40 cents each, \$4.00 per doz.

Iridescent. The nearest approach to a blue Dahlia; of fine form; good size, and an extremely profuse bloomer. The color when well grown is exquisitely lovely, being bright orange, overlaid clear red and suffused and margined pure blue, giving the flower a beautiful iridescent effect. Price, strong roots 25 cents each, \$2 50 per doz.



New Cactus Dahlias, Showing a few types of this charming class.

RELIABLE, FRESH TESTED VEGETABLE SEEDS



Asparagus

Spargel (Ger.) Asperge (Fr.)
 One ounce will sow forty feet of drill,
 15 lbs. to the acre.

In early spring sow the seed, after soaking it twenty-four hours in warm water, in drills one foot apart, and one inch deep. The soil should be very rich and well worked. Later thin the plants to three or four inches apart in the rows and cultivate often thoroughly through the summer; transplant the following spring into permanent beds, deeply trenched and well mixed with decayed manure.

Canover's Colossal. The standard variety, of large size, tender and of excellent quality. Pkt. 5c., oz. 10c., 1 lb. 40c., 10 lbs. \$2.50.

Barr's Mammoth. Pkt. 5c., oz. 10c., 1 lb. 50c., 10 lbs. \$3.00.

Palmetto. An early, prolific and very desirable variety. Pkt. 5c., oz. 10c., 1 lb. 50c., 10 lbs. \$3.50.

Asparagus Roots

Two Year Old, Extra Healthy
 and Strong Roots.

Plant two year old roots into permanent beds, which should be well and deeply manured and trenched to the depth of 18 inches. Set the plants in rows from 3 to 4 feet apart and two feet in the rows, spreading out the roots, and cover gradually during the season to 6 or 8 inches. On the approach of winter cover with manure or compost; fork the beds early in spring, and apply a dressing of salt at the rate of 600 lbs. an acre. Cut for use the second year after planting.

Palmetto or Eclipse. Per 100 80c., per 1000 \$5.00.

Columbian Mammoth White. Per 100 \$1.00, per 1000 \$6.00.

Canover's Colossal. Per 100 75c., per 1000, \$4.50, per 2000 \$8.00.

Barr's Mammoth. Per 100 80c., per 1000 \$5.00, 500 of one variety at 1000 rates.

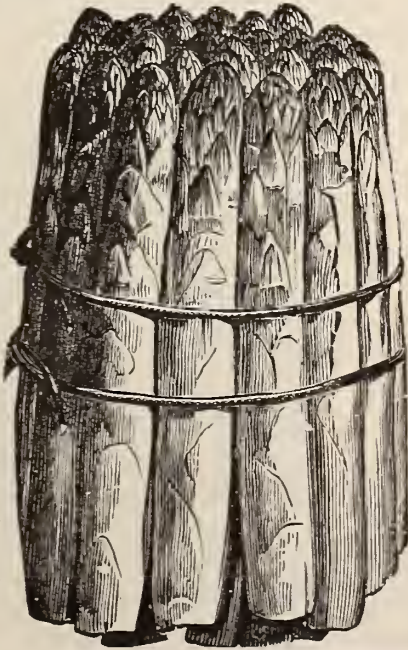

Artichoke (Ger.) **ARTICHOKE** Artichaut (Fr.)

Green Globe. Pkt. 5c., oz. 30c.

Jerusalem Artichoke Roots. This variety is not produced from seed. They are sometimes used as a table vegetable when picked, but their greatest value is for feeding stock. Qt. 15c., pk. \$1.00, bush. \$3.00.

Runkel Rube (Ger.) **Beets** Betterave (Fr.)

One ounce will sow fifty feet of drill, 5 lbs. per acre.

The soil best suited for beet culture is that which is rather light and well enriched. Sow in drills one foot apart and one inch deep, as early as the ground can be worked; when the plants are large enough thin out to stand six inches apart in rows; continue for a succession as late as the middle of July. Keep well cultivated.

Varieties for Table Use

Bastian's Extra Early Turnip. The best beet for the market gardener and family use; very early, of quick, large growth, fine turnip form and bright red color; a good forcing variety. Pkt. 5c., oz. 10c., 1 lb. 50c.

Crosby's Egyptian. An improved, perfectly smooth, Egyptian Beet. Much thicker than the original early, of better color and quality. Pkt. 5c., oz. 10c., 1/4 lb. 20c., 1 lb. 60c.

Carter's Excelsior. A variety of superior quality; color of flesh is perfect, being fine grained with smooth skin and small tops. Pkt. 5c., oz. 10c., 1/4 lb. 20c., 1 lb. 75c.

Arlington Favorite Blood Turnip. Extra early; exceedingly sweet, rich blood red. Pkt. 5c., oz. 10c., 1 lb. 85c.

Egyptian Turnip. Extra early. Pkt. 5c., oz. 10c., 1 lb., 50c., 5 lbs. for \$2.00.

Edmand's Blood Turnip. An early variety, possessing good qualities; flesh dark red, sweet and of good flavor. Pkt. 5c., oz. 10c., 1 lb. 50c., 5 lbs. \$2.00.

Eclipse. Remarkable for its rapid growth, extreme smallness of top and extra fine quality. Perfectly smooth and round, skin and flesh intense red. An excellent sort for forcing. Pkt. 5c., oz. 10c., 1 lb., 50c., 5 lbs. \$2.00.

Extra Early Bassano. A very early flat variety, tender, juicy, flesh white and rose colored. Pkt. 5c., oz. 10c., 1 lb. 50c.

Lentz Early Turnip. Pkt. 5c., oz. 10c., 1 lb. 50c., 5 lbs. \$2.00.

Bastian's Half-Long Blood. A valuable variety to follow Bastian's Extra Early; for winter use plant about the middle of July. Pkt. 5c., oz. 10c., 1 lb. 50c., 5 lbs. \$2.00.

Improved Long Blood. A good late variety for fall and winter use; sweet and tender. Pkt. 5c., oz. 10c., 1 lb. 50c.

Swiss Chard. Grown for its leaves only; the middle of the leaf is served like Asparagus; the other portions of the leaf are used like Spinach. Pkt. 5c., oz. 10c., 1/4 lb. 20c., 1 lb. 60c.

Sugar and Cattle Beets

Improved Imperial White Sugar. An improvement on the other varieties of Sugar Beets; more hardy and containing a greater percentage of sugar. Lb. 30c., 5 lbs. \$1.25.

Lane's Improved White Sugar. This sugar attains a large size and grows considerably above the ground; fine for feeding. Oz. 5c., 1 lb. 30c., 10 lbs. \$2.50.

MANGEL=WURZEL. (See next page.)



23 lbs.
MICHELL'S
Mammoth Long Red
Mangel-Wurzel

We offer \$5.00 in 2 Prizes
 for the best 6 Mangel-Wurzel Beets ex-
 hibited at the Philadelphia Chrysanthe-
 mum Show in November, 1899.

BEET
Mangel-Wurzel

Five pounds are sown to the acre.

Sow in April and May in thoroughly plowed, well-manured soil, in drills two inches deep and about eighteen inches apart. Thin out to twelve inches and keep the weeds down by frequent hoeing and cultivating. Low ground is best adapted for mangel-wurzels.

Mammoth Long Red. This is an enormously productive variety, yielding from fifty to seventy tons to the acre, a single root often weighing from twenty to thirty pounds. It is the best long red mangel and very valuable for stock feeding. Oz., 5c., lb. 30c., 10 lb. lots, \$2.50.

Golden Tankard. The best yellow mangel in cultivation. Relished by milch cows and sheep. Maturing earlier than other large sorts. Oz. 5c., lb. 30c., 10 lb. lots, \$2.50.

Red Globe. Oz. 5c., lb. 30c., 10 lb. lots, \$2.50.

Yellow Globe. Oz. 5c., lb. 30c., 10 lb. lots, \$2.50.

Norbiton Giant. Large, small top, one of the best long red varieties. Oz. 5c., lb. 30c., 10 lb. lots, \$2.50.

BROCCOLI Chou-Brocolis (Fr.).

Orange's Autumn White Cape. This is the best variety grown; can be grown where cauliflower is an uncertain crop. Pkt. 10c., oz. 30c., 1/4 lb. \$1.00. lb. \$4.00.



Bohne (Ger.) **BEANS** Haricot (Fr.).
 One quart will plant about 200 hills or a drill 100 feet long.

DWARF OR SNAP SHORT

Plant soon as danger from frost is past, in light, warm soil, in drills two inches deep and two feet apart, three inches apart in the drill, or in hills three or four feet apart. Avoid cultivating when wet with rain or dew, as it will injure the crop; hoe often when dry. Plant every two weeks for succession.

GREEN POD VARIETIES

Improved Extra Early Red Valentine. One of the very best sorts for private use or market. The pods are round, fleshy, tender and remain longer in a green state than most varieties. Good for pickling. Pkt. 10c., qt. 25., pk. \$1.25, bush. \$4.50.

Best of All. The pods are six inches long, very fleshy, succulent, and of rich flavor; produced early and abundantly. It is one of the most valuable green-podded beans for family use. Pkt. 10c., pt. 15c., qt. 30c.

Early Mohawk. The hardiest of the early varieties, and will endure a slight frost. Pkt. 10c., qt. 25c., pk. \$1.25, bush. \$4.50

Early Long Yellow Six Weeks. A hardy and prolific variety, a good and reliable cropper. Pkt. 10c., qt. 25c., pk. \$1.25, bush. \$4.50

Boston Pea or Navy Bean. An excellent variety, very productive; for baking they excel all other sorts. Pkt. 10c., qt. 25., pk. \$1.25.

White Kidney or Royal Dwarf. Pkt. 10c., qt. 20c., pk. \$1.00, bush. \$3.75

White Marrowfat. Extensively grown for sale as a dry bean for winter use. excellent shelled, either green or dry. Pkt. 10., qt. 20c., pk. \$1.00, bush. \$3.75

Sion House (forcing). Qt. 40c.

**Y
E
L
L
O
W
P
O
D
O
R
W
A
X**



WARDWELL'S EARLY KIDNEY WAY
 One of the earliest of all Wax Beans. It is nearly a week earlier than the Golden Wax, and yields one-third more, almost entirely free from rust and spots. The pods are long and very tender, stringless, of excellent quality. Pkt. 10c., qt. 30c., pk. \$1.25, bush. \$4.50.

BEANS, Wax or Yellow Pod—Continued.

Dwarf Golden Wax. (Rust Proof.) Very early and productive, of excellent quality, and entirely free from rust, besides being very crisp and tender and keeps longer than any other after picking, which renders it valuable for distant shipping. Pkt. 10c., qt. 30c., pk. \$1.25., bush. \$4.50.
Black or German Wax. Pkt. 10c., qt. 30c., pk. \$1.25.
White Wax. Pods delicate, waxy white, half transparent. Pkt. 10c., qt. 30c., pk. \$1.25.
Saddle-Back Wax. A cross between the Yosemite Wax and the Black-Eyed Wax, pod large, long, round, very solid and absolutely stringless; an excellent variety. Pkt. 10c., qt. 30c., pk. \$1.50.
Perfection Wax. For vigor of growth and immense productiveness it is scarcely equaled by any other Dwarf Wax Bean. The magnificent, large, golden-yellow pods are handsome, stringless, tender, and of very rich flavor. Pkt. 10c., qt. 30c., per peck \$1.50.
Roger's Lima Wax. Flat broad pods of rich quality. Pkt. 10c., 30c. per qt.

Pole Beans

Plant in hills four feet apart, six to eight beans to hill, eyes downward, afterward thin to three plants in a hill. Set poles eight to ten feet high before planting.
Early Golden Cluster Wax. Pods very tender, six to eight inches long, of large size, borne profusely in large clusters of three to six; beautiful golden-yellow color, which they retain long after being picked. Snaps easily, is stringless, cooks tender, delicious flavor. Pkt. 10c., qt. 40c.
Lazy Wife's. Pkt. 10c., 30c. per quart.
Horticultural or Speckled Cranberry. Pkt. 10c., pt. 15c., qt. 30c., pk. \$2.00.
Scarlet Runner. Pkt. 10c. qt. 30c.

English or Broad Windsor Beans

Used only as shelled beans. Plant in strong, heavy soil, in drills three feet apart and two inches deep. Pkt. 10c., qt. 30c.



Burpee's Bush Lima.

LIMA BEANS

These are more tender and require rather more care in culture than the Bush Beans, and should be sown two weeks later. They succeed best in sandy loam, which should be liberally enriched with short manure in the hills, which are formed, according to the variety, from three to four feet apart; from 5 to 6 seeds are planted in each hill about two inches deep. Rough cedar or similar poles, about seven or eight feet long, should be used for Lima Beans to climb on. They should be set in the ground at least eighteen inches, so as to prevent being blown over.

Stangen Bohne (Ger.). **Pole Varieties** Haricots A Rames (Fr.).

One quart will plant 150 hills.

Ford's Mammoth Podded Large. The most valuable and prolific variety. Pods six to nine inches long; seed grown from original stock. Pkt. 10c., qt. 40c.

LIMA BEANS—Continued.

Michell's Selected Large Jersey. Has proven exceedingly satisfactory; beans are very tender and luscious. An extra selection of seed stock; large fine beans, all hand-picked. Pkt. 10c., qt. 30c., pk. \$2.00.
King of the Garden. Vigorous grower, requiring but two vines to each pole, producing a continuous bloom and fruitage to extreme end of season. Pods are of enormous size, many specimens measuring from five to eight inches, producing as high as six beans to the pod, perfectly formed and of superior quality. Pkt. 10c., qt. 30c., pk. \$2.00, bush. \$7.00.
Siebert's Extra Early. The earliest pole lima. Very productive and tender. Pkt. 10c., pint 25c., qt. 40c., peck \$1.75.
Dreer's Improved. Earlier and more prolific than Large Lima; beans smaller, extra quality. Pkt. 10c., qt. 30c., pk. \$2.00.
Extra Early Jersey. Pkt. 10c., qt. 35c., pk. \$2.00.
Small Lima or Sieva. Pkt. 10c., qt. 30c., pk. \$1.75.
Horticultural Lima. A new variety of the highest merit. It is a cross between Dreer's Pole Lima and Dwarf Horticultural, combining the excellent quality of the Dreer Lima with the earliness, hardiness and flavor of the Horticultural, being fully three weeks earlier than any other Lima. Pkt. 10c., pt. 15c., qt. 30c., pk. \$2.00.
Early Black Lima. Pkt. 10c., qt. 40c.

Dwarf or Bush Lima

Dreer's Bush Lima. A splendid variety. Pkt. 10c., pt. 20c., qt. 40c., pk. \$2.50.
Henderson's Bush Lima. The earliest of all Limas. Pkt. 10c., qt. 30c.
Burpee's Bush Lima. The only bush form of the true Large Lima Bean, comes absolutely true from seed. Pkt. 10c., pt. 20c., qt. 40c. Per peck, \$2.00.

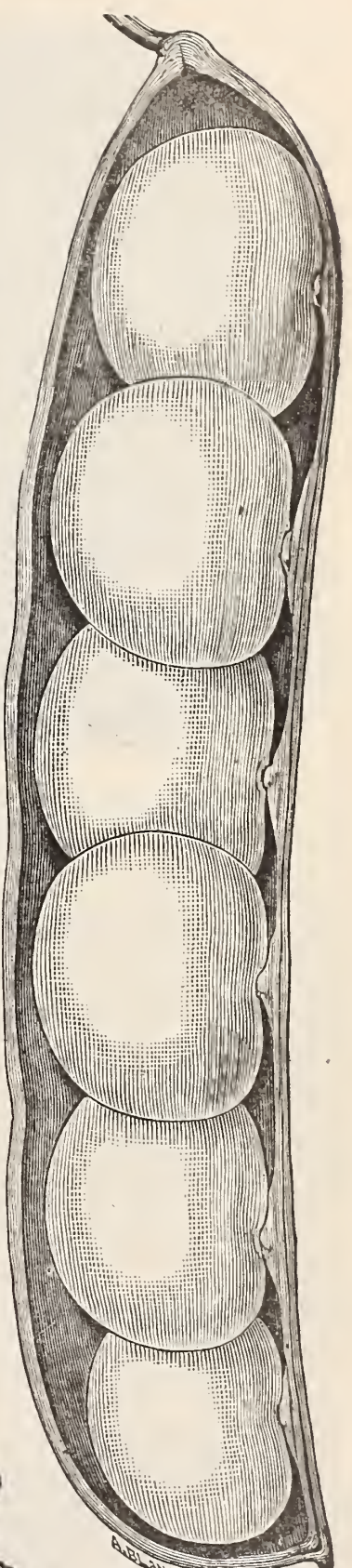

Michell's Selected Large Jersey Lima.

Brussels Sprouts

Brusseler Sprossen (Ger.).
 Chou Le Bruxelles (Fr.).
 Produces small heads from side of stalk, which are in perfection for use in autumn after early frosts. Sow in May, transplant in June one foot apart each way and cultivate like winter cabbage. A most delicious vegetable very easily grown.

Matchless Improved.
 Pkt 5c., oz. 25c., 1/4 lb. 75c.
Sutton's Exhibition.
 Per original pkt. 25c.

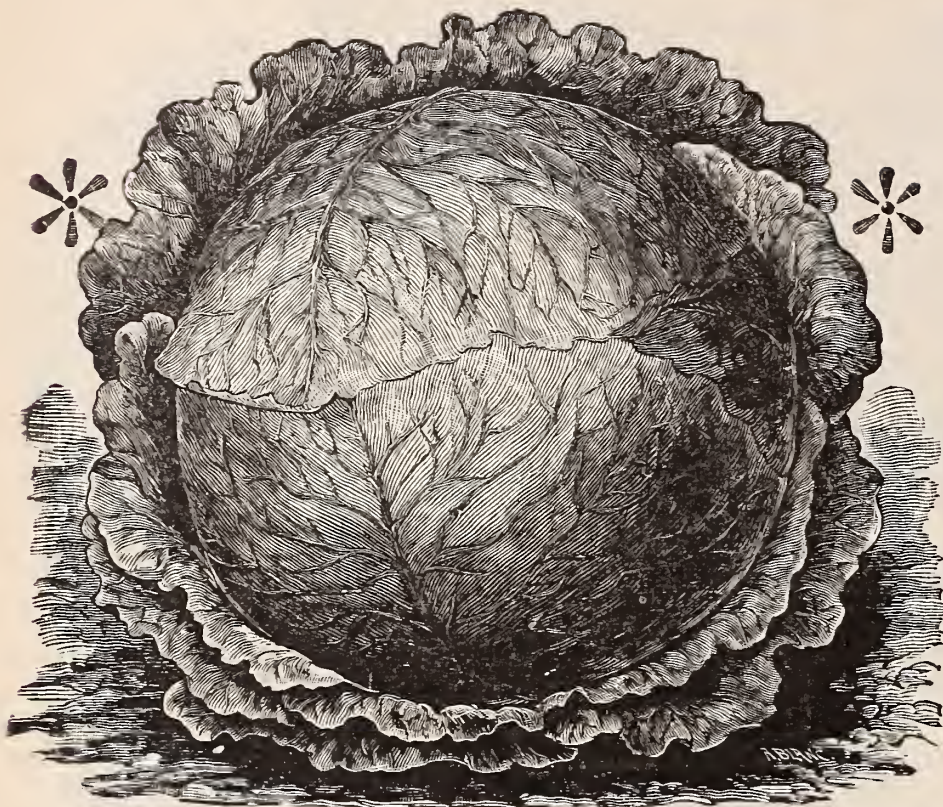

"All Seasons" Cabbage.

Cabbage

Kopfkohl (Ger.).

Chou Pomme ou Cabus (Fr.).

One ounce will produce about 2000 plants. Our Cabbage seed is all grown from selected heads only, by a specialist on Long Island.

The requirements for a good crop are rich soil, deep plowing, high manuring and good seed. Sow seeds in January or February in hotbeds, and transplant latter part of April or early in May to open ground, or an early sowing in open ground is the custom. Set the plants in rows two feet apart, and 12 to 18 inches apart in the row. For second early sow in April and transplant in May. For late crop sow in May and transplant in July, setting plants in rows three feet apart and two feet in rows.

Early Jersey Wakefield. A favorite market gardeners' variety, very early, following the Oxheart, of good size and quality and always sure to head; extra fine selected stock, Pkt. 10c., oz. 25., lb. \$2.00.

Large Early York. A good old standard variety. Pkt. 5c., oz. 20c., lb. \$1.50.

Large Charleston Wakefield. Selected, large solid heads, of good quality, about one week later than Early Jersey Wakefield. Pkt. 10 cts., oz. 25 cts., lb. \$2.50.

Early Winningstadt. A solid tender variety, good for either early or late. Pkt. 5c., oz. 20c., lb., \$2.00.

All Head Early. Large and solid and always certain to make hard heads. Pkt. 10c., oz. 20c., ¼ lb. 75c.

Henderson's Early Summer. A second early variety, with large solid heads, coming in a few days later than the Wakefield. Pkt. 10c., oz. 25c., lb. \$2.00.

Early Drumhead. A second early, large, solid, flat-heading variety. Pkt. 10c., oz. 30c., lb. \$2.25.

All Seasons Selected. A new drumhead variety, producing good sized heads, of superior richness of flavor, desirable either for early spring or fall use; a good winter keeper. Pkt. 5c., oz. 20c., lb. \$2.00.

Extra Selected Late Flat Dutch. The favorite Philadelphia winter market variety, short stem and large solid flat heads; superior stock. Pkt. 5c., oz. 20c., lb. \$1.50.

Large Late Drumhead. A favorite winter variety with market gardeners; extra large solid heads. Pkt. 5c., oz. 20c., lb. \$1.50.

Perfection Curled Drumhead Savoy. The largest solid heading curled sort, of excellent flavor. Pkt. 5c., oz. 25c., lb. \$2.00.

Early Green Curled Savoy. Pkt. 5c., oz. 25c.

Red Dutch Drumhead. A large red-heading variety for pickling. Pkt. 5c., oz. 20c., lb. \$2.00.

We offer \$5.00 in Two Prizes for the best Six Heads of Cabbage exhibited at the Philadelphia Chrysanthemum Show in Nov. 1899.

Cabbage Plants

Early Sorts. All the leading varieties ready April 1st. 100 40c., 1000 \$3.00.

Late Sorts. Ready July 1st. 100 30c., 1000 \$2.00.

SPECIAL PRICES ON LARGE QUANTITIES.

Carrot

Mohre (Ger.).

Carotte (Fr.).

One ounce to 100 feet of drill, three pounds to the acre.

A light sandy loam, well tilled and manured the previous year best suits the carrot; for early crops sow as early as the ground can be worked, in drills ten inches apart, and thin to five inches in the row.

Very Early Short-Horn Scarlet or French Forcing.

An early forcing variety; small root and excellent flavor. Pkt. 5c., oz. 10c., ¼ lb. 30c., lb. \$1.00.

Early Scarlet Horn. The favorite early red variety, fine grained and good flavor. Pkt. 5c., oz. 10c., ¼ lb. 20c., lb. 75c.

Early Half-Long Scarlet. A very desirable pointed-root variety, coming in between the Scarlet Horn and the Long Orange; early, of fine flavor and good color. Pkt. 5c., oz. 10c., ¼ lb. 20c., lb. 75c.

Danvers Half-Long. The best variety for general crop; is of rich orange color, a very heavy yielder and splendid keeper; a first-class Carrot for all soils, and valuable both for table use and stock. We have an extra fine strain of seed of this favorite sort. Pkt. 5c., oz. 10c., ¼ lb. 20c., lb. 75c.

New Rubicon Half-Long. An entirely distinct Carrot. It is the best in shape, and its deep red orange-colored flesh is the finest in quality of all. It is earlier than the Danvers and about the same length; extremely well adapted for early forcing, for growing outside at any season of the year, being a wonderfully heavy cropper on any kind of soil. Pkt. 5c., oz. 10c., ¼ lb. 30c., lb. \$1.00.

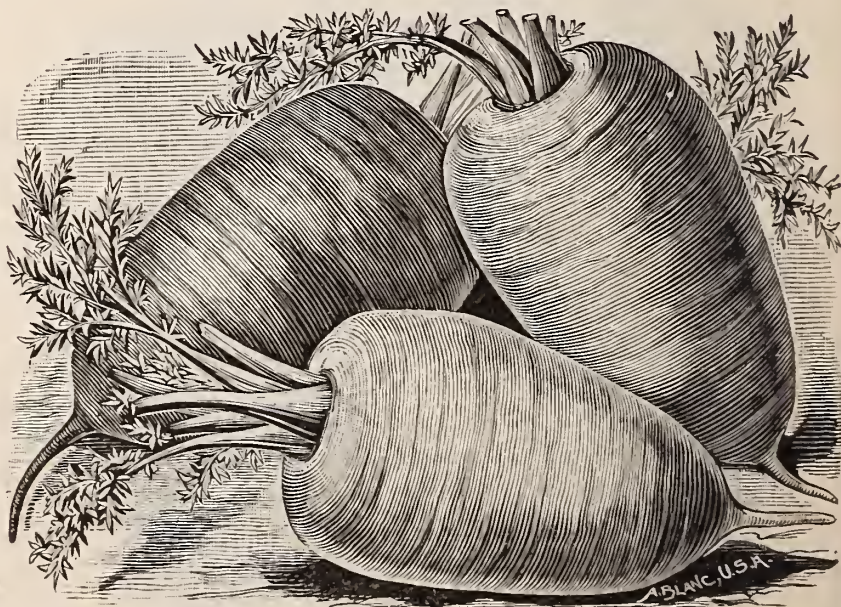

Guerande or Oxheart. A desirable variety on soils too hard and stiff for the longer growing sorts, as it is not over five or six inches long. It frequently grows as thick as long, thus making it really as large as the longer sorts. Pkt. 5c., oz. 10c., ¼ lb. 20c., lb. 75c.

Chantenay Half-Long. Resembles the Nantes; very productive. Pkt. 5c., oz. 10c., ¼ lb. 20c., lb. 75c.

Nichol's Improved Long Orange. Deep orange color, good flavor, yields heavily; is of excellent table quality, and is also the best for stock. Pkt. 5c., oz. 10c., ¼ lb. 20c., lb. 75c., 5 lb. lots 60c. lb.

M
I
C
H
E
L
L
,
S

S
P
E
C
I
A
L



Michell's Special Strain Selected Erfurt Cauliflower.

We offer \$5.00 in Two Prizes for the best Three Heads of Cauliflower exhibited at the Philadelphia Chrysanthemum Show in November, 1899.

CAULIFLOWER

Blumen-Kohl (Ger.) Chou-Fleur (Fr.)
One ounce produces about 1500 plants.

Sow for early use about the middle of September or October, in a bed of rich earth, transplant in frames and cover with sashes and shutters during severe weather, giving them the light and air every mild day, or they may be had nearly as well by sowing the seed in a hotbed in January or February; when the plants are large enough, transplant three inches apart in boxes or in other hotbed until time to plant out; if hardened off, they are seldom injured by planting out as early as ground can be properly prepared, two and a half feet apart each way; keep well hoed, and bring earth gradually up to their stems, watering freely in dry weather, and especially when they begin to head.

Michell's Special Strain, Selected Erfurt. One of the earliest in cultivation, small-leaved dwarf, for forcing or open ground, producing very solid, pure white heads of the finest quality; ordinary seasons every plant will produce a marketable head. Pkt. 20c., quarter oz. 75c., oz. \$2.50.

- Earliest Snow Storm.** Earliest and best for forcing; dwarf, with short outer leaves, can be planted two feet apart each way; sure to make large fine heads; must be kept growing constantly, will not stand a check at any period of its growth. Pkt. 25c., oz. \$5.00. \$1.50 per 1/4 oz.
- Early Snowball.** A splendid early dwarf variety, producing magnificent white heads. Pkt. 20c., oz. \$3.00. 75c. per 1/4 oz.
- Half Early Paris.** A popular, white, sure heading variety, good for early or late use. Pkt. 10c., oz. 50c.
- Lenormand's Short Stem.** A large, late short-stemmed variety, with well formed white heads. Pkt. 10c., oz. 50c.
- Veitch's Autumn Giant.** One of the finest late varieties of robust habit, heads large, compact. Pkt. 10c., oz. 50c.
- Sutton's First Crop.** Per original pkt. 50c.
- "Belgian Eclipse".** The very best early variety for growing out doors, does also excellent in frames. 25c. per pkt.

Cauliflower Plants. Strong plants Best varieties. Ready about April 1st. 25c. per doz. \$1.25 per 100.

Chives. Strong plants 10c. each, \$1.00 per doz.
CARDOON.

The midribs are the edible parts, desirable for soups or stews, after being blanched in the same manner as celery. Sow in April in drills one inch deep; when one year old, transplant in trenches of well manured ground three feet apart and one foot in the rows. The roots remain from year to year. Pkt. 10c., oz. 40c.



Kresse (Ger.) **CRESS** Cresson (Fr.)

Sow thickly in early spring in drills one foot apart, and follow every two weeks with a new sowing as it quickly runs to seed. Water-cress should be sown along the margin of ditches, ponds, or better still, of slow running streams. It requires no care except to free it at first from weeds.

Extra Curled or Pepper Grass. Fine flavor, can be cut several times. Pkt. 5c., oz. 10c., lb. 50c. **Upland Cress.** Perennial, grown in the same manner as spinach; resembles water-cress in flavor. Pkt. 10c., oz. 50c.

Brunnenkresse (Ger.) WATER-CRESS Cresson de Fontaine (Fr.). The pleasant and peculiar flavor of the water-cress, and also the hygienic properties have caused it to be highly esteemed for table use. Its culture can be carried on anywhere where there is sufficient supply of fresh, pure water; it is not even necessary it should be running water; it can be renewed often



Water Cress.



Corn Salad.

enough to keep it clean and pure. It can be grown without water even, in tubs half filled with good soil and kept in a moist, shady position with an occasional watering. **True Erfurt.** Pkt. 10c., oz. 40c., lb. \$3.50.

Acker Salat (Ger.) CORN SALAD Mache (Fr.). For early spring use sow the seed in September thickly in drills quarter-inch deep. Protect with litter when cold weather comes and winter over like spinach. One ounce will sow 35 feet of row. **Large Round Leaved.** Pkt. 5c., oz. 10c., lb. 50c.

CHICORY

Large Rooted. Pkt. 5c., oz. 10c., 1/4 lb. 25c., lb. 80c.

Gartenkerbel (Ger.) CHERVIL Cerfeuil (Fr.).

Curled or Doubled. Pkt. 5c., oz. 15c., lb. \$2.00.



Michell's "Far Superior Many Heart".

CELERY PLANTS

All the leading sorts ready July 1st. Per 100, 40c., 1000, \$3 50

Celery

Sellerie (Ger.)

Celeri (Fr.)

One ounce of seed will produce about 2000 plants.

Sow the seed late in March, or early in April, on fine, well worked soil. Cover slightly, or better still, roll or press it. Shade the young plants for a week or ten days, and do not let the soil dry out. Cut them once or twice before setting out to make them stocky. When from four to six inches high transplant into broad shallow trenches or to level ground, setting dwarf sorts in rows three feet apart, and tall sorts four feet apart, six inches apart in the rows. To store for winter use select well drained ground, dig trenches one foot wide and deep enough to cover tops of plants. Pack stalks in this in an upright position, covering with boards to shed the water, and in severe weather protect with straw or leaves.

Michell's "Far Superior Many Heart." We can especially recommend this variety to every grower of celery; its quality is superior to most other varieties, an excellent keeper over winter and produces plenty of heart which is now the most important point in celery. Pkt. 10c., 40c. per oz., \$1.00 per $\frac{1}{4}$ lb., \$3.50 per lb.

Smith's Perfection Half Dwarf. This extra strain is the finest for private or market gardeners. Very large and solid, with a full golden heart; when matured the heart bursts through the outer stalks, and is of a nutty flavor. The very best late keeper. Pkt. 10c., oz. 30c., $\frac{1}{4}$ lb. 80c., lb. \$3.00.

Perle Le Grand. Its beautiful, full golden heart and rich nutty flavor are unapproached by any other variety. It is not only a good early celery, being among the first fit to use, but surpasses all others as a winter keeper. Pkt. 10c., oz. 40c., $\frac{1}{4}$ lb. \$1.25, lb. \$4.00.

Improved Dwarf Golden Heart. Heart large and full, of a golden yellow, excellent for either market or private use; solid, of excellent flavor, and keeps well. Pkt. 5c., oz. 20c., lb. \$2.00.

Giant Pascal. A superior keeping sort. The stalks are very large, thick, solid, crisp, and of a rich nutty flavor. The heart is golden yellow, very full and attractive in appearance. Pkt. 5c., oz. 25c., $\frac{1}{4}$ lb. 75c., lb. \$2.50.

Boston Market. A short, bushy, white, solid, excellent flavored variety, constantly in demand. Pkt. 10c., oz. 25c., $\frac{1}{4}$ lb. 75c., lb. \$2.50.

White Plume, Improved. (True Stock.) The best for early use, crisp, solid, nutty flavor. Pkt. 10c., oz. 25c., lb. \$3.00.

Sutton's White Gem. Per original pkt. 40c.

Golden Self-Blanching. Compact, large, solid, crisp, and of a nutty flavor, with a rich golden heart. Pkt. 10c., oz. 30c., lb. \$3.50.

Self-Blanching Paris Pink. The very best pink variety yet introduced. Its quality is very highly praised by celery growers and has given universal satisfaction. Pkt. 15c., oz. 50c., $\frac{1}{4}$ lb. \$1.50.

Red Solid or Rose. Pkt. 5c., oz. 25c.

Henderson's "Pink Plume". Very solid and crisp, extra early and a long keeper. A self-blanching variety, and requires but a slight earthing-up or banking. Pkt. 10c., oz. 30c.

Heartwell Perfection. Pkt. 5c., oz. 20c., lb. \$2.00.

Celeriac, or Turnip-Rooted. Large, early Erfurt variety. The root cooked or sliced and used with vinegar, makes an excellent salad. Pkt. 5c., oz. 20c., lb. \$1.50.

Soup or Flavoring Celery. Used for soups, stews, etc., and not for sowing. Oz. 5c., lb. 30c.

We strongly advise using **Rosin-Sized Paper** for covering celery over winter. 75c. per roll of 500 square feet.

We offer \$5.00 in 2 Prizes for the best 6 stalks of Celery of any named variety or varieties exhibited at the Philadelphia Chrysanthemum Show in November, 1899.

Cucumber

Gurke (Ger.)

Concombre (Fr.)

One ounce of seed will plant about fifty hills, or two pounds per acre.

For early use sow in hothouse on small sods overturned, or in small pots plunged in earth. As soon as danger from frost is over, transplant with sod, so as not to disturb the plants, into hills in the open ground. For general crop sow from about the first to the middle of May in rich, mellow, warm soil. Use a shovelful of well-rotted manure in each hill and cover it two inches deep with fine earth. On this sow the seed, about eight or ten seeds to a hill; cover one-half inch with earth and press down. When danger from bugs is past thin out to four plants to a hill. For pickles, plant from June to middle of July.

Livingston's Evergreen. Very hardy and probably the most prolific of all varieties. Very early, and the cucumbers retain their beautiful green color longer than any other sort. It is one of the very best varieties for slicing. Pkt. 5c., oz. 10c., $\frac{1}{4}$ lb. 25c., lb. 80c.

Early Russian. The earliest variety; the fruit is of small size and produced in pairs. Pkt. 5c., oz. 10c., lb. 65c.

Early Frame. A good old popular variety, of medium size. Pkt. 5c., oz. 10c., lb. 65c.

[CUCUMBER continued on next page]



CUCUMBER—Continued

- Livingston's Emerald (New).** A new and most excellent rich green variety, either for outdoor culture or for growing under glass. Pkt. 10c., 3 pkts. for 25c.
- Improved Early White-spined.** The favorite market variety, largely used for forcing, and extensively grown South for shipping North early in the season; of medium large size, deep green, crisp, fine flavor, and very productive. Pkt. 5c., oz. 10c., lb. 60c.
- Everbearing.** Pkt. 5c., oz. 10c., lb. 60c.
- Tailby's Hybrid.** A variety hybridized with the White-spined and English prize, retaining the beauty of the Long English and hardness of the White-spined; of large size and excellent for slicing; splendid forcing variety. Pkt. 5c., oz. 10c., lb. 75c.
- Jersey Pickle or Green Prolific.** One of the best pickling varieties; dark green, tender, crisp, and great productiveness, of fine flavor, and good for table use. Pkt. 5c., oz. 10c., lb. 60c.
- Long Green Turkey.** The leading long green variety for pickling; of excellent quality and productiveness, fruit dark green, firm and crisp; can be gathered any size while young for pickles. Pkt. 5c., oz. 10c., lb. 60c.
- Small Gherkin or Burr.** Also known as the West India or Jerusalem Pickle; used only for pickling while young and tender. Pkt. 5c., oz. 20c., lb. \$1.00.

ENGLISH PRIZE FORCING CUCUMBER

Sow the seeds in small pots about the middle of January; when they have grown to three leaves plant in a prepared hill of rich, loose soil in the centre of a sash.

We offer \$5.00 in Two Prizes for the best Three Hot-house Cucumbers exhibited at the Philadelphia Crysanthemum Show in November, 1899.

- Blue Gown.**
- Pearson's Long Gun.**
- Telegraph.**
- Tender and True.**
- Ston House Improved.**
- Marquis of Lorne.**

Any of above at 20c. per pkt.

- Rochford's Market Garden.**—A most valuable variety, considered to be one of the very best. Pkt. 25c.
- "Ideal"**—A most prolific and reliable variety. 25c. per pkt.
- Sutton's Matchless.**—50c. per original pkt.

CORN.—Field Varieties.

- Early Yellow Canada, or Flint.** Qt. 15c., bush. \$1.50.
- Cloud's Early Yellow Dent.** Qt. 15c., bush. \$1.50.
- Chester County Mammoth.** Qt. 15c., pk. 50c., bush. \$1.50.
- The 100-Day Bristol.** The largest eared, earliest Yellow Dent corn in cultivation. Qt. 20c., pk. 50c., bush. \$1.50.
- Golden Beauty, Improved.** The best and most productive, having extra large, broad golden grains and good sized ear. Qt. 15c., bush. \$1.35.
- Leaming Early Dent.** Qt. 15c., bush. \$1.40.
- Hickory King.** A White Dent Field Corn. The stalks are strong and bear two and occasionally three ears; the cob is remarkably small. Very productive. Qt. 15c., pk. 50c., bush. \$1.75.
- Blount's Prolific White Ensilage.** This variety bears 4 to 6 ears per stalk, grain plump and white; it is very productive, and is also considered the best variety for making ensilage. Qt. 15c., pk. 50c., bush. \$1.50.

Pop Corn.

- Golden Queen.** Lb. 10c., 3 lbs., 25c., 100 lbs. \$5.00.
- White Rice.** Lb. 10c., 3 lbs. 25c., 100 lbs. \$5.00.

SWEET OR SUGAR CORN

Zuckerkorn (Ger.) One quart will plant 100 hills, 8 quarts to the acre. Mais. (Fr.)

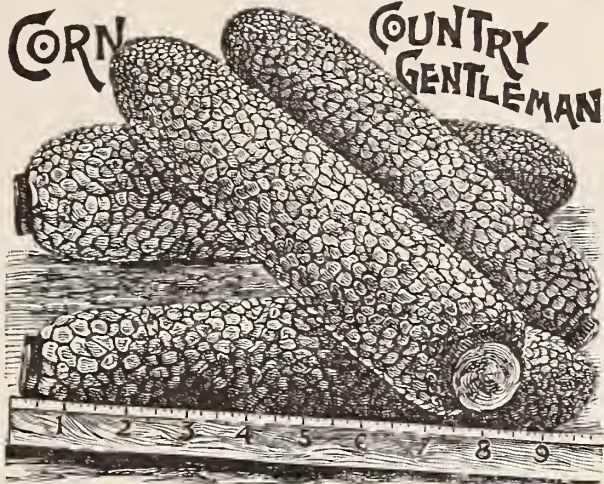

Make the first planting about May 1st, and sow every two weeks thereafter until the middle of July for succession. Plant in hills from three to four feet apart according to size or variety.

Our Sugar Corn is grown by the most reliable grower in the Connecticut Valley and can be relied on.

- Improved First of All.** The very earliest sweet corn. Pkt. 5c., qt. 20c., pk. \$1.00.
- Michell's Delicious.** Unrivaled in flavor and sweetness. Pkt. 10c., pt 20c., qt. 35c.
- Adam's Extra Early.** The earliest variety for table use. Pkt. 5c., qt. 15c., pk. 80c., bu. \$3.00

- Crosby's Extra Early.** A favorite variety, very early, productive, ears rather short and of a rich sugary flavor. Pkt. 5c., qt. 20c., pk. \$1.00.
- New England, or Early Eight-rowed.** Qt. 20c., pk. \$1.00.
- Stabler's Extra Early.** Of larger size than usual for the early kinds; fine flavor. Pkt. 5c., qt. 20c., pk. \$1.00.

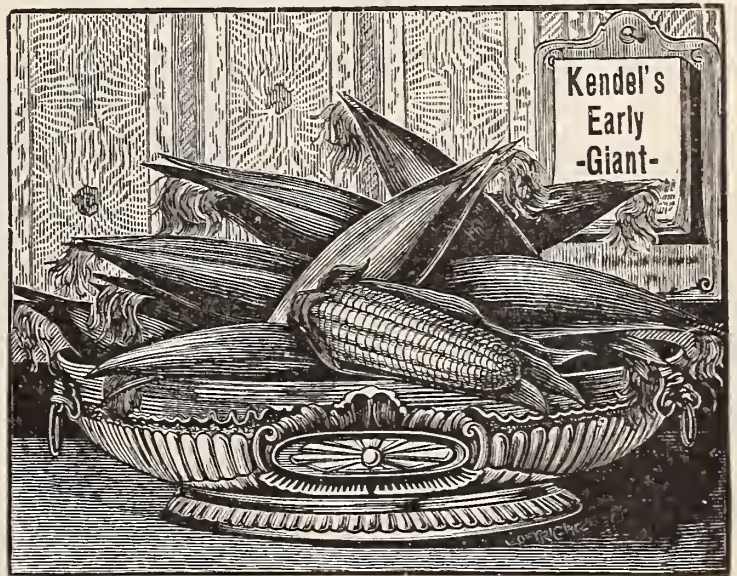

- Kendel's Early Giant Sweet.** We can especially recommend this extra early variety as it produces a PERFECT good sized ear, which is of very sweet flavor. Per qt. 30c., 4 qts. \$1.00.
- Early Mammoth.** Qt. 20c., pk. \$1.00.
- Squantum.** An excellent early variety of the finest quality for table, fine large ears and deep grain. Qt. 20c., pk. \$1.00.
- Triumph.** Ear large, productive, flavor rich and sweet; a fine market variety. Pkt. 5c., qt. 20c., peck \$1.00.
- Little Gem, or Shoe Peg.** Pkt. 5c., qt. 20c., peck \$1.00.
- Black Mexican.** Pkt. 5c., qt. 20c., peck \$1.00.
- Stabler's Nonpareil.** The second best early corn. It has the most desirable qualities of any sweet corn, yields large ears, delicious flavor. Pkt. 5c., qt. 20c., peck \$1.00.
- Country Gentleman.** Will delight the most fastidious epicure, retaining its delicate tenderness and flavor even when a little old. The ears are not only of good size, but are produced in great abundance frequently bearing four good ears, while the average is three good ears to the stalk. The cob is very small, giving great depth to the kernels, but the great merit is its delicious quality. Pkt. 5c., qt. 20c., 4 qts. 60c., peck \$1.00.
- Roslyn Hybrid.** A medium late variety will yield a heavy crop, producing a large ear, very sweet and delicious. Ear 10c., pkt. 5c., qt. 20c., pk. \$1.00, bush. \$3.50.
- Egyptian.** A fine large variety somewhat resembling the Evergreen; flavor peculiarly rich and sweet. Qt. 20c, peck \$1.00.
- Mammoth Sugar.** The largest late sort, very productive, of fine flavor. Pkt. 5c., qt. 20c., pk. \$1.00, bush. \$3.50.
- Stowell's Evergreen.** One of the sweetest, ears large, deep grained, of excellent quality, remaining green longer than any other variety. Pkt. 5c., qt. 20c., pk. \$1.00, bush. \$3.50.

Dandelion

The seed should be sown early in the spring in drills twelve inches apart, about one-quarter of an inch deep, thin out to six inches in the drills; the following spring it will be fit for use.

Thick-Leaved or Cabbaging. This variety is double the size of the common. Pkt. 10c., oz. 40c., lb. \$4.00.

Endivien (Ger.). **Endive** Chicoree Endive (Fr.).

Sow one ounce for fifty feet.

For early use sow about the middle of April; but for the main crop in June or July in shallow drills; when two or three inches high transplant to one foot each way; when full grown blanch the inner leaves by tying up the outer ones at the top, but tie up only when the leaves are dry; keeps only a short time after blanching.

Improved Green Curled. An improvement on the old Green Curled variety. Pkt. 5c., oz. 20c., $\frac{1}{4}$ lb. 50c., lb. \$1.50.

White Curled (self-blanching). This is the finest White Curled variety, grows to a large size, always crisp and very tender. Pkt. 5c., oz. 20c., $\frac{1}{4}$ lb. 50c., lb. \$1.50.

Broad-Leaved Batavian. Leaves broad, light green, nearly plain; used in stews and soups. Pkt. 5c., oz. 20c., $\frac{1}{4}$ lb. 50c., lb. \$1.50.

Giant Fringed (Oyster Endive). A strong growing variety with a large white heart and broad stems; good for fall and winter. Pkt. 5c., oz. 20c., $\frac{1}{4}$ lb. 60c., lb. \$2.00.

Knoblauch (Ger.). **Garlic Sets** Ail (Fr.).

Per lb. 30c.

Hop Vine Roots

Ready in April. Per doz. 50c., per 100 \$2.50.

Herbs

Anise Seed. Pkt. 5c., oz. 10c.

Borage. For bees. Pkt. 5c., oz. 15c.

Caraway. Perennial. Pkt. 5c., oz. 10c. [lb. 60c.

Coriander. Pkt. 5c., oz. 10c. [lb. 60c.

Dill. Pkt. 5c., oz. 10c., lb. 75c.

Fennel. Perennial. Pkt. 5c.

Hop. Perennial. Pkt. 10c.

Horehound. Perennial. Pkt. 5c., oz. 30c.

Lavender. Perennial. Pkt. 5c., oz. 20c.

Pot Marigold. Pkt. 5c.

Rosemary. Perennial. Pkt. 5c., oz. 30c.

Saffron. Pkt. 5c., oz. 15c.

Sage. Pkt. 5c., oz. 15c., lb. \$1.50.

Summer Savory. Pkt. 5c., oz. 15c., lb. \$2.00.

Sweet Basil. Pkt. 5c., oz. 20c., lb. \$2.00.

Sweet Marjoram. Pkt. 5c., oz. 20c., lb. \$2.00.

Thyme. Perennial. Pkt. 5c., oz. 30., lb. \$3.50.

Wormwood. Perennial. Pkt. 5c., oz. 30c.

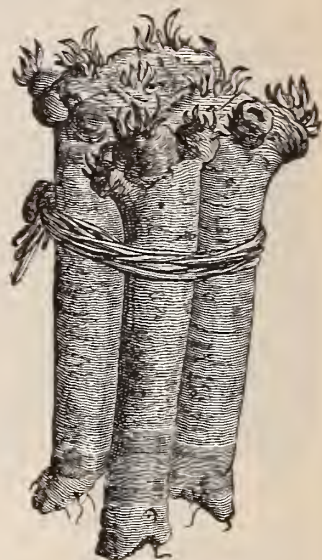

Horse Radish.

Horse Radish Roots

Extra strong roots will produce large size radish the first season, Per doz. 15c., per 100 50c., per 1000 \$4.00.

Chives. Strong clumps 10c. each, \$1.00 per doz.

.....

Michell's

Selected

New York

Improved

.....



Michell's Selected Stock New York Improved Large Purple Egg Plant.

Eierpflanze (Ger.).

Egg Plant

Aubergine (Fr.).

One ounce of seed will produce about 1000 plants. Grown by a specialist in New Jersey.

Sow the seed in a hotbed in March or April, when about three inches high pot the plants and plunge in earth; transplant in open ground in May or June according to the warmth of the season. Uniform heat is essential to this plant, and it rarely recovers from the least chill in its early growth. Set out according to richness of soil, two or three feet apart each way.

Michell's New York Improved Large Purple. The leading variety; large, round, dark purple, most productive variety. Pkt. 10c., oz. 30c., $\frac{1}{4}$ lb. 75c. \$2.50 per lb.

Early Long Purple. The earliest and hardiest, very productive. Pkt. 10c., oz. 25c., $\frac{1}{4}$ lb. 75c.

Black Pekin. Pkt. 10c., oz. 30c.

Egg Plants .

Ready May 15th.

New York Improved. True and pure. Pot grown per doz. 50c.; hotbed grown, per doz. 30c.; per 100, \$2.00.

Winter Kohl (Ger.) **Kale or Borecole** Chou-Verts (Fr.)

They are more hardy than cabbage, and are improved by frost, but the time and manner of sowing, and the culture are identical with cabbage.

- Dwarf Green Curled.** Very hardy, leaves numerous, frilled and of excellent quality. Pkt. 5c., oz. 10c., 1/4 lb. 20, lb. 75c.
- New Imperial, or Long Standing.** A beautiful curled and crimped sort, selected by a Philadelphia market gardener; of strong, vigorous habit, perfectly hardy, bright green color and very attractive in appearance. It is superior to all other sorts, and will stand longer without shooting to seed than any other variety. Height about two feet. Pkt. 5c., oz. 10c., 1/4 lb. 25c., lb. 75c.
- Tall Purple Scotch.** Finely curled, one of the best sorts. Pkt. 5c., oz. 10c., 1/4 lb. 30c., lb. \$1.00.

Knoll Kohl (Ger.) **Kohl=Rabi** Chou-Raves (Fr.)

For early use sow in hotbed, transplant and cultivate like early cabbage. For winter use sow the middle of June or first of July in rows, eighteen inches apart, thin out to eight inches in the row.

- Early White Vienna.** Pkt. 5c., oz. 25c., 1/4 lb. 60c., lb. \$2.00.
- Early Purple Vienna.** Pkt. 5c., oz. 25c., 1/4 lb. 60c., lb. \$2.00.

Martynia

Proboscidea. The seed pods are used to a considerable extent for pickling when gathered green and tender. Sow in the open ground in May, and transplant two feet apart. Pkt. 10c., oz. 30c., 1/4 lb. \$1.00, lb. \$3.00.



S
E
N
S
A
T
I
O
N

Lattich (Ger.) **Lettuce** Laitue (Fr.)

One ounce for 150 feet of drill, or 1000 plants.

Lettuce thrives best in rich, moist ground. For the principal early crop sow the seed in September in the open ground; transplant when large enough into cold frames, and protect the plants during the winter in the same manner as early cabbage; set the plants out early in April, or sow the seed in hotbeds in February or March, and transplant to a southern exposure. Always thin out well or the plants will not head. When wanted as a cut salad sow the seed thickly in rows or broadcast.

We offer \$5.00 in Two Prizes for the best Six Heads of Lettuce exhibited at the Philadelphia Chrysanthemum Show, Nov. 1899.

- Michell's Very Best.** Produces a medium size perfect head of the very best quality. Good for outdoor or frame growing. 10c. per pkt.; 30c. per oz.; \$1.00 per 1/4 lb.
- Big Boston.** It is about one week later in maturing, but its solidity and greater size of head will make it a most valuable sort. A most desirable variety either for forcing in cold frames or open ground planting. Pkt. 5c., oz. 25c., 1/4 lb. 65c., lb. \$2.00.
- Black Seeded Simpson.** Produces a compact mass of leaves, nearly double the size of the ordinary Simpson, standing well the summer heat. Pkt. 5c., oz. 15c., 1/4 lb. 40c., lb. \$1.25.
- Boston Market.** White seed. Hardy and crisp; earliest heading variety; one of the best for forcing. Pkt. 5c., oz. 15c., 1/4 lb. 40c., lb. \$1.50.

LETTUCE—Continued.

- California Cream Butter.** Most refreshing in appearance and particularly rich and buttery to the taste. The heads are of good size. It is medium early and one of the best summer varieties. Pkt. 10c., oz. 20c., 1/4 lb. 60c., lb. \$2.00.
- Defiance.** One of the very best Lettuces. Of fine quality, crisp and tender, and remains in prime condition a long time before going to seed. Pkt. 5c., oz. 15c., 1/4 lb. 40c.
- Denver Market Forcing.** A very good curled sort, produces good size, solid heads. Pkt. 5c., oz. 15c., lb. \$1.25.
- Early Cabbage or White Butter.** A favorite for sowing in the spring or fall, nearly hardy, requires only a slight protection; produces fine well-formed heads. Pkt. 5c., oz. 15c., 1/4 lb. 40c. lb. \$1.25.
- Early Curled Simpson.** Does not head, but forms a close, compact mass of leaves; very early, excellent for forcing. Pkt. 5c., oz. 15c., 1/4 lb. 50c., lb. \$.50.
- Early Tennisball.** Black seed. Forms a close, hard head, the best forcing sort. Pkt. 5c., oz. 15c., 1/4 lb. 40c., lb. \$1.25
- Forcing Emperor (True).** A medium-sized, compact-growing, very early variety; very crisp and tender and unequalled for forcing. Pkt. 5c., oz. 20c., 1/4 lb. 50c.
- Golden Queen.** A very desirable early variety, second to none for forcing. At first glance it seems to be of medium size; but it forms all solid heads with little or no waste, so that there is really more to it than in any Lettuces double the size. Very crisp, tender and juicy. Pkt. 5c., oz. 15c., 1/4 lb. 40c., lb. \$1.50.
- Grand Rapids Forcing.** An excellent variety, grown most extensively in the West, but has given the best satisfaction wherever grown; does not produce a hard head. Pkt. 5c., oz. 15c., lb. \$1.25.
- Hanson Improved Hard Head.** A superior curled heading variety. Pkt. 5c., oz. 15c., 1/4 lb. 40c., lb. \$1.25



Extra Selected Michell's Best Dutch Butter Lettuce.

- Iceberg.** Quick grower, hard, handsome heads, exquisite in flavor, there is no handsomer or more solid Cabbage Lettuce in cultivation — in fact, it is strikingly beautiful. The large, curly leaves which cover the outside of the solid heads are of a bright light green with a very slight reddish tinge at the edges. Pkt. 5c., oz. 20c., 1/4 lb. 60c., lb. \$2.00.
- Kingsholm or Paris Cos, Romaine or Celery.** Long upright heads of narrow leaves, which are tied at the top, making it crisp and refreshing, withstanding the summer heat. Pkt. 5c., oz. 20c., 1/4 lb. 75c., lb. \$2.50.
- Royal Cabbage or Summer Drumhead.** A standard summer variety. Pkt. 5c., oz. 15c., lb. \$1.25.
- Salamander.** Summer variety, forming good-sized heads. Pkt. 5c., oz. 15c., 1/4 lb. 40c., lb. \$1.50.
- Sensation.** The very best for open ground, will stand the hottest summer. Beautiful light yellowish green color. Forms solid heads. Pkt. 10c., oz. 30c., 1/4 lb. \$1.00, lb. \$3.00.
- Sutton's Favorite.** 40c. per original pkt.
- Sutton's Giant.** 25c. per original pkt.
- Silver Ball Improved.** Excellent for summer; very firm and compact; rich flavor. Pkt. 5c., oz. 20c., 1/4 lb. 50c., lb. \$1.25.
- Spotted Early Dutch Butter (Michell's).** Producing fine large heads of excellent quality, and one of the best forcing and market sorts; stands the heat well in summer. Pkt. 5c., oz. 15c., 1/4 lb. 40c., lb. \$1.25.
- White Russian Summer.** One of the best sorts to withstand the extreme heat. Pkt. 10c., oz. 30c.
- "Wonderful"**. The largest cabbage head lettuce, very tender and crisp and has no bitter taste, stands the heat. 10c. per pkt., 40c., per oz.

LETTUCE PLANTS

Ready in April

Best heading varieties. Per 100 40c., per 1000 \$3.00.



Large Musselburgh Leek.

Leek

Lauch (Ger.).

One ounce to 100 feet.

Poireau (Fr.).

Plant the seed in April, in drills one foot apart and one inch deep. When six or eight inches high, remove the plants to deep, rich soil, setting them in rows twelve to fifteen inches apart in the rows; plant as deep as possible, and during growth draw the earth to them to blanch stems. One ounce will produce about two thousand plants.

London Flag. Hardy, large, strong plant, with broad leaves. Pkt. 5c., oz. 15c., $\frac{1}{4}$ lb. 40c., lb. \$1.25.

Large Musselburgh. Of enormous size, leaves large and broad. Of very mild, pleasant flavor. Pkt. 5c., oz. 20c., $\frac{1}{4}$ lb. 40c., lb. \$1.50.

Giant Carentan. Pkt. 5c., oz. 20c., lb. \$1.50.

Musk Melon.
(Cantaloupe)

Melone (Ger.).

Meion (Fr.).

One ounce for seventy-five hills; two and one-half pounds to the acre.

A rich, warm, sandy soil is the best for the musk melon. Plant the seed when the ground is warm. Plant from six to twelve seeds in hills six feet apart each way, and when danger from bugs is past, thin to three vigorous plants in a hill. When the shoots are a foot long pinch off the tips to make them branching and strengthen the vine. Thin out the fruit if it is excessive, the remaining melons will thereby increase in size and ripen earlier.

Be careful not to grow pumpkins, squashes or cucumbers near musk melons.

*
Mussel-
burgh
Giant
Leek
*

MUSK MELON—Continued.

Ex. Ea. Cape May Netted (*Cantaloupe*). Flesh of best flavor. Productive and very early. Pkt. 5c., oz. 10c., lb. 75c.

Paris Breakfast. Especially desirable for growing under glass, or starting under glass and then transplanting to the open ground. 15c. per pkt.

"The Banquet." Medium-sized; the flesh is uniformly deep; of a dark rich salmon color. Pkt. 5c., oz. 10c., $\frac{1}{4}$ lb. 25c., lb. 75c.

Emerald Gem. A small early melon, flesh salmon colored, thick and luscious. Pkt. 5c., oz. 15c., $\frac{1}{4}$ lb. 30c., lb. 75c.

Cosmopolitan. This grand Musk Melon combines the firm, sweet flesh of the French Cantaloupe and the delicious flavor of the American Musk Melon. Very sweet, melting and high flavored. Pkt. 5c., oz. 15c., lb. \$1.00.

Jenny Lind. The earliest variety, netted, of small, round size, excellent flavor. Pkt. 5c., oz. 10c., $\frac{1}{4}$ lb. 20c., lb. 60c.

Golden Jenny. A small early variety, good flavor. Pkt. 5c., oz. 10c., $\frac{1}{4}$ lb. 20c., lb. 60c.

Green Citron Netted. Med. size. deeply netted, nearly round, flesh thick and of a delicious flavor. Pkt. 5c., oz. 10c., $\frac{1}{4}$ lb. 20c., lb. 60c.

"Tip Top" (*Livingston's*). This has proven to be one of the sweetest varieties yet introduced and we highly recommend it. Pkt. 10c., oz. 20c., lb. \$1.00.

Sutton's Scarlet Flesh. Highly praised for its sweetness. 40c. per original pkt.

Montreal Market. Largest of the nutmeg varieties, uniform in shape, netted, flesh green, quality remarkably good. Pkt. 5c., oz. 10c., $\frac{1}{4}$ lb. 25c.

Netted Pineapple or Nutmeg. An excellent melon, of medium size. Pkt. 5c., oz. 10c., $\frac{1}{4}$ lb. 25c., lb. 75c.

Extra Early Hackensack. Large size, attractive appearance, excellent flavor. Pkt. 5c., oz. 10c., lb. 60c.

Casaba or Persian. Of extraordinary size, very delicious and fine flavor. Pkt. 5c., oz. 10c., $\frac{1}{4}$ lb. 20c., lb. 60c.

Water Melon

Wasser Melone (Ger.).

Melon D'Eau (Fr.).

One ounce to thirty hills; four pounds per acre.

In light soil, with hot sunny exposure, the water melon thrives best. Plant in hills eight to ten feet apart each way, and cultivate like musk melon. To secure the largest fruit, have but one or two melons to a vine.

Dixie. A large variety, surpassing all others as a shipper, in fine eating qualities and great productiveness. It is ten days earlier than Kolb Gem, rind thin, ripening within one-quarter inch. Strong grower, very heavy setter. Flesh of a rich scarlet; sweet, juicy and tender. Pkt. 5c., oz. 10c., lb. 60c.

Cuban Queen. One of the largest varieties, ripening to the very centre, heavy cropper, flesh bright red, tender and melting. Pkt. 5c., oz. 10c., lb. 50c.

Kolb Gem. Pkt. 5c., oz. 10c., lb. 50c.

Iron Clad. Pkt. 5c., oz. 10c., lb. 50c.

Dark Icing. The flavor of this variety cannot be excelled. It is very solid, rind very thin. Pkt. 5c., oz. 10c., lb. 50c.

Light Icing or Ice Rind. Pkt. 5c., oz. 10c., lb. 60c.

Mountain Sweet. Early, large, oblong, dark green, thin rind; flesh red, solid, rich and sweet. Pkt. 5c., oz. 10c., lb. 50c.

Pride of Georgia. Pkt. 5c., oz. 10c., lb. 50c.

Scaly Bark. Pkt. 5c., oz. 10c., lb. 50c.

Striped Gypsy or Rattlesnake. An early variety, large, oblong; skin green, mottled and striped. Pkt. 5c., oz. 10c., lb. 50c.

Citron. For preserving only, small, round, flesh white and solid, with red seeds. Pkt. 5c., oz. 10c., $\frac{1}{4}$ lb. 25c., lb. 75c.



The Dixie Watermelon.

Michell's
Superior
Brand



Mushroom Spawn

"Michell's Superior" English Milltrack. Strictly fresh and reliable. We supply a number of the leading and largest growers of Mushrooms with our Superior Spawn, and we have received a large number of testimonials of its high quality. 15c. per brick, \$1.75 per doz. bricks, 25 lbs. for \$2 50, \$8.00 per 100 lbs. (Directions for growing free.)

French Spawn, per 3 lb. box \$1.00.

We offer \$5.00 in 2 Prizes for the best dish of Mushrooms exhibited at the Philadelphia Chrysanthemum Show, November, 1899.

Wm. Falconer's Book on Mushroom Culture, Price \$1.35.

Robinson's Book on Mushroom Culture, Price 50c.

HARRISBURG, PA.,

DEAR SIR:—Your Mushroom Spawn has proved of very high quality with me. I have been picking constantly since Nov. 10th. I have now two beds in full bearing. Shipped you this day via Adams Express, a box of mushrooms to place in your window to demonstrate the purity of your spawn. Very respectfully,
Gardener to Jas. Boyd, Esq.

CHAS. H. RONEY.

MUSTARD

Senf (Ger.)

Moutarde (Fr.)

White or Yellow. For salads and flavoring purposes. Oz. 5c., lb. 30c.

NASTURTIUM

Kresse, Indianische (Ger.)

Capucine Grande (Fr.)

Indian Cress.

The seed pods, which resemble capers, are gathered while green and tender for pickling, and the leaves are used for mixing with salads. Sow early in spring in drills about one inch deep, in light, rich soil, when all danger of frost is over.

Tall. The most profitable pickling variety. Pkt. 5c., oz. 15c., ¼ lb. 25c., lb. \$1.00.

Dwarf. Beautiful colors, mixed. Pkt. 5c., oz. 20c., ¼ lb., 35c., lb. \$1.25.

Okra or Gumbo

Esbarre Hibiscus (Ger.)

Gombaud (Fr.)

One ounce to 20 feet; one pound to 300 feet.

Sow in May, in hills or drills, three feet apart. If in hills, thin out to three plants; if in drills, to ten inches apart in the drills. Seed thickly and cover one inch deep. The young green seed pods are used for soups or like asparagus.

Improved Dwarf Green. The most desirable sort, very productive, bears long pods which remain tender a long time and are free from hard ridges. Pkt. 5c., oz. 10c., ¼ lb. 20c., lb. 60c.

White Velvet or Creole. Pkt. 5c., oz. 10c., lb. 75c.



Improved Dwarf Green Okra

Onion Sets

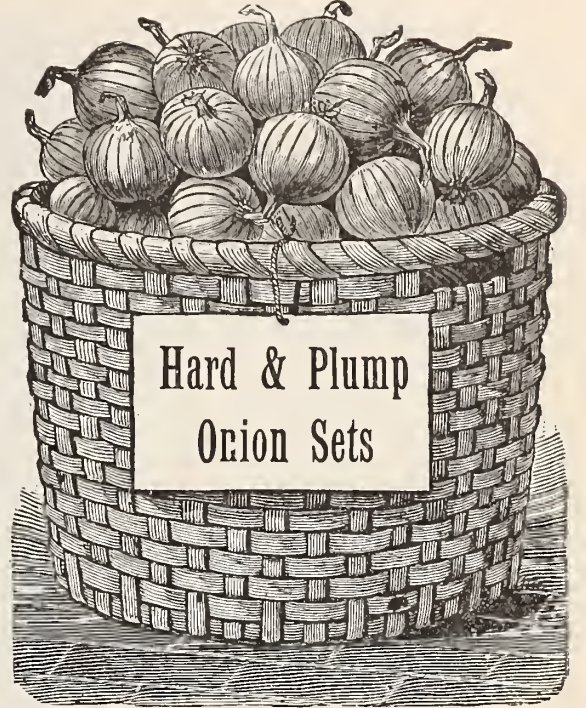

ONION SETS. Subject to Market changes.

	Pint	Quart	4 Qts.	Peck	Bush.
YELLOW	\$0.10	\$0.15	\$0.50	\$0.80	\$2.50
WHITE10	.20	.70	1.25	4.00
POTATO ONION.....	.15	.25	.75	1.25	4.00
SHALLOTS15	.25	.85	1.50	5.00
TREE OR TOP10	.20	.60	1.00	3.00

GARLIC SETS. 25c. per lb.; 10 lbs. for \$2.00.

Onion

Zwieble (Ger.)

Ognon (Fr.)

One ounce for 100 feet of row; six lbs. to an acre.



For sets, sow the seeds as early as possible, in the spring, very thickly, in drills. As soon as the tops die off in summer, remove them to a dry, airy place; and early in the following spring, replant them by placing sets in shallow drills twelve inches apart, and about four inches apart in the drills. They may also be grown to full size during the first season by sowing thinly in drills one foot apart and about one-fourth

of an inch deep, in March or early in April, well manured, and thinning them out to stand three or four inches apart in the drills. They delight in a strong, rich, deep, loamy soil, and succeed well if grown successive years on the same ground.

Extra Early Red. Pkt. 5c., oz. 20c., lb. \$1.50.

White or Silver Skin. A mild-flavored early variety, extensively grown for pickling. Pkt. 5c., oz. 20c., ¼ lb. 60c., lb. \$2.00.

Yellow Danvers. An excellent early oval, straw-colored variety, of mild flavor, productive and a good keeper. Pkt. 5c., oz. 15c., ¼ lb. 35c., lb. \$1.25.

Prize Taker Mammoth Yellow. Beautiful straw color, of large round form, very rapid grower; attains full size in one season. Pkt. 10c., oz. 25c., lb. \$2.00.

Yellow Strasburg or Dutch. The leading market variety, a good keeper; bright straw colored skin and somewhat flattened shape. Pkt. 5c., oz. 15c., ¼ lb. 35c., lb. \$1.25.

Large Red Weathersfield. Grows to full size the first season from seed, almost round, large size, deep red color, and keeps well. Pkt. 5c., oz. 15c., ¼ lb. 35c., lb. \$1.25.

Southport Yellow Globe. Pkt. 5c., oz. 20c., lb. \$1.75.

Southport White Globe. Pkt. 10c., oz. 30c., lb. \$3.00

White Barletta. An extra early pure white Onion. An excellent pickling variety. Pkt. 5c., oz. 20c., ¼ lb. 60c., lb. \$2.00.

ONION CULTURE, by a Practical Grower, 20c. per copy.

Parsley

Petersilie (Ger.) Persil (Fr.)
One ounce sows about 100 feet of drill.

Seed germinates very slowly, plants sometimes not appearing for three or four weeks; soak seed a few hours in lukewarm water before sowing.

Double Curled Covent Garden. Finely curled dwarf. Pkt. 5c., oz. 10c., ¼ lb. 25c., lb. 75c.

Extra Curled Perpetual. Leaves tender, crimped and very curly; excellent for garnishing. Pkt. 5c., oz. 10c., ¼ lb. 25c., lb. 75c.

Fern Leaved. Valuable for garnishing. Pkt. 5c., oz. 10c., ¼ lb. 25c., lb. 90c.

Sutton's Garnishing. 25c. per original packet.

Champion Moss Curled. Beautifully crimped and curled. It can be cut the year round, rarely runs to seed. Pkt. 5c., oz. 10c., ¼ lb. 25c., lb. 75c.



Parsnip

Pastinake (Ger.) Panais (Fr.)
One ounce to 150 feet; five pounds to the acre.

Sow early in spring in drills fifteen inches apart and one-half inch deep; when plants are two or three inches high, thin out to six inches in the rows, cultivate often until the leaves cover the ground. These roots are improved by frost, and can be left in the ground over winter.

Improved Sugar or Hollow Corn. The best variety; very smooth, of excellent flavor. Pkt. 5c., oz. 10c., ¼ lb. 20c., lb. 60c.



Covent Garden Curled Parsley.

Pfeffer (Ger.)

Pepper

Piment (Fr.)

One ounce will produce about 100 plants.

Sow in hotbed in April, and transplant the plants to open ground in warm, settled weather to rows two feet apart and eighteen inches in the rows, or when all danger of frost is past, sow at once in the open ground and thin to the same distance as above. Any rich fertilizer, if applied and stirred into the soil when the plants are six inches high, will be found of great benefit.

Large Sweet Bell or Bull Nose. Large variety, mild, rind thick, fleshy; best for pickling and pepper sauce, or filled as mangoes. Pkt. 5c., oz. 25c., ¼ lb. 65c., lb. \$2.00.

Large Sweet Spanish. Pkt. 5c., oz. 25c.

Golden Dawn. Beautiful golden yellow, quite sweet, without any fiery taste; very productive. Pkt. 5c., oz. 25c.

Cayenne Long Red. Pkt. 5c., oz. 25c., ¼ lb. 75c., lb. \$2.50.

Ruby King. Bright scarlet, large productive sort. Pkt. 10c., oz. 25c., ¼ lb. 75c., lb. \$2.50.

Celestial. Pkt. 5c., oz. 25c.

Coral Gem. Pkt. 10c., oz. 40c.

Red Cherry. Pkt. 5c., oz. 25c.

Small Chili. Very hot; used for seasoning and for pepper sauce. Pkt. 5c., oz. 25c.



Sweet Bell or Bull Nose Pepper.

Pepper Plants

Ready May 15th

Large Sweet Bell and Red Cayenne

Dozen 20c., 100 \$1.25.

PEAS

Erbse (Ger.)

Pois (Fr.)

One quart to 100 feet of row.

Extra Early Sorts.

Peas succeed best in light, dry, loamy soil. Early and dwarf sorts require richer soil than the late varieties. If manure is used, let it be old and well rotted, or there will be a rank growth of vines with few pods. Sow the early, smooth, round sorts as early in the spring as the ground can be worked. Seeds of wrinkled varieties are more liable to rot if the ground is cold, and must be planted later. Sow seed in single rows, three feet apart, for dwarf sorts, and four for tall sorts, or in double drills, six to eight inches apart, one inch apart in the drill, and not less than four inches deep, for late sorts seven to eight inches deep. Deep planting prevents mildew.

Michell's Dandy Extra Early. Selected from first crop of Eureka's and are the best extra early pea in the market. Pkt. 10c., qt. 25c., 1/2 pk. 75c., pk. \$1.25, bu. \$4.00.

Eureka Extra Early. Earliest, most prolific variety. For a late fall crop it has few equals; height twenty inches. Pt. 15c., qt. 25c., 1/2 pk. 75c., pk. \$1.25, bu. \$4.00.

Nott's Excelsior. The earliest and best dwarf pea in cultivation. Height, 15 inches. As hardy as the earliest market sorts, but in quality equal to the Little Gem. It out-yields that variety and the American Wonder 20 to 30 per cent. The pods are one-third longer, and each pod contains from 6 to 8 large peas which are of unusually fine flavor and tender. Pkt. 10c., qt. 30c., 1/2 pk. 90c., pk. \$1.50, bu. \$5.00.

Alaska. An extra round pea, resembling Kentish Invicta. Of good flavor and color; height two feet. Pkt. 5c., qt. 25c., 1/2 pk. 75c., pk. \$1.25, bu. \$4.00.

Improved Daniel O'Rourke. A valuable sort of good flavor, productive and early. Pkt. 5c., qt. 25c., 1/2 pk. 75c., pk. \$1.25, bu. \$4.00.

American Wonder. The earliest wrinkled variety in cultivation; of dwarf and robust habit, growing from ten to twelve inches high. Will mature in thirty-three days from time of planting. Qt. 30c., 1/2 pk. 90c., pk. \$1.50, bu. \$5.00.

McLean's Little Gem. Dwarf first early, green-wrinkled marrow. Very prolific, superior flavor; one foot high. Pkt. 5c., qt. 25c., 1/2 pk. 75c., pk. \$1.25, bu. \$5.00.

Premium Gem. A fine flavored dwarf, wrinkled variety. Height 18 inches. Qt. 25c., 1/2 pk. 75c., pk. \$1.25, bu. \$4.50.

Blue Beauty. Compact, and bears a profusion of excellent peas; 18 inches. Pt. 15c., qt. 25c., 1/2 pk. 65c., pk. \$1.00, bu. \$4.00.

Gradus (New). Wrinkled variety. Considered to be better than all others. 50c. per qt.

Second Early Varieties.

Bliss' Abundance. Ripens about one week after the earliest kind. Six to eight inches apart in the rows is the nearest that the plants should stand; one and a half feet high. Pkt. 5c., qt. 25c., 1/2 pk. 75c., pk. \$1.25, bu. \$4.50.

Heroine. One of the grandest; should be in every garden; it is the greatest acquisition we have had in new peas in many years. Pt. 20c., qt. 30c., 1/2 pk. 85c., pk. \$1.50.

Pride of the Market. A medium early dwarf pea of vigorous habit and very productive; one and a half feet high. Pkt. 5c., qt. 30c., 1/2 pk. \$1.00, pk. \$1.75.

Shropshire Hero. A most desirable wrinkled variety producing well-filled pods; 2 1/2 feet. 30c. per qt., 4 qts. for \$5.

McLean's Advancer. A fine variety, prolific, well-filled long pods, tender, and of delicious flavor; 2 feet. Pt. 15c., qt. 25c., 1/2 pk. 75c., pk. \$1.25, bu. \$4.50.

Daisy (New). One of the sweetest and most prolific varieties; second early. 35c. per qt.

General and Later Varieties.

Everbearing. A good pea for summer and autumn use, pods 4 inches long, and contain 6 to 8 peas of rich flavor, very sweet and tender; 2 feet. Pt. 15c., qt. 25c., pk. \$1.25, bu. \$4.50.

Telephone. Immensely productive, of the finest quality, and excellent sugary flavor; four feet high. Pkt. 5c., qt. 30c., 1/2 pk. \$1.00, pk. \$1.75, bu. \$6.00.

Improved Stratagem. Wrinkled marrow, large size peas of excellent quality; 2 1/2 feet high. Qt. 30c., 1/2 pk. \$1.00, pk. \$1.75, bu. \$6.00.

Champion of England. One of the best and most popular wrinkled varieties in cultivation, of delicious flavor; a profuse bearer; five feet high. Qt. 25c., 1/2 pk. 65c., pk. \$1.25, bu. \$4.00.

Juno. One of the best of the late wrinkled peas, with large pods filled with delicious peas of large size. Pkt. 10c., pt. 15c., qt. 30c., 1/2 pk. \$1.00, pk. \$1.75.

Duke of York. A very highly recommended wrinkled variety. 4 feet. 30c. per qt., 4 qts for \$1.00.

Blue Imperial. A favorite summer market gardener's variety; good bearer and of fine flavor; three feet high. Pkt. 5c., qt. 25c., 1/2 pk. 75c., pk. \$1.25, bu. \$4.50.

Fillbasket. Large, prolific, pods long, round and closely filled; one and a half feet high. Qt. 30c., 1/2 pk. 85c., pk. \$1.50, bu. \$5.50.

Yorkshire Hero. A splendid wrinkled marrow for market and kitchen gardens; two and a half feet high. Pkt. 5c., qt. 25c., 1/2 pk. 65c., pk. \$1.25, bu. \$4.50.

Dwarf Sugar, (edible pod). Pkt. 10c., qt. 40c.

Melting Sugar. A new and prolific variety of delicious quality; 5 to 6 feet. Pt. 20c., qt. 40c.

Royal Dwarf White Marrowfat. A favorite late variety; three feet high. Qt. 15c., 1/2 pk. 35c., pk. 60c., bu. \$2.00.

Black-eyed Marrowfat. Extensively grown, hardy, productive, four feet high. Qt. 15c., pk. 60c., bu. \$2.00.



Michell's Dandy Extra Early.

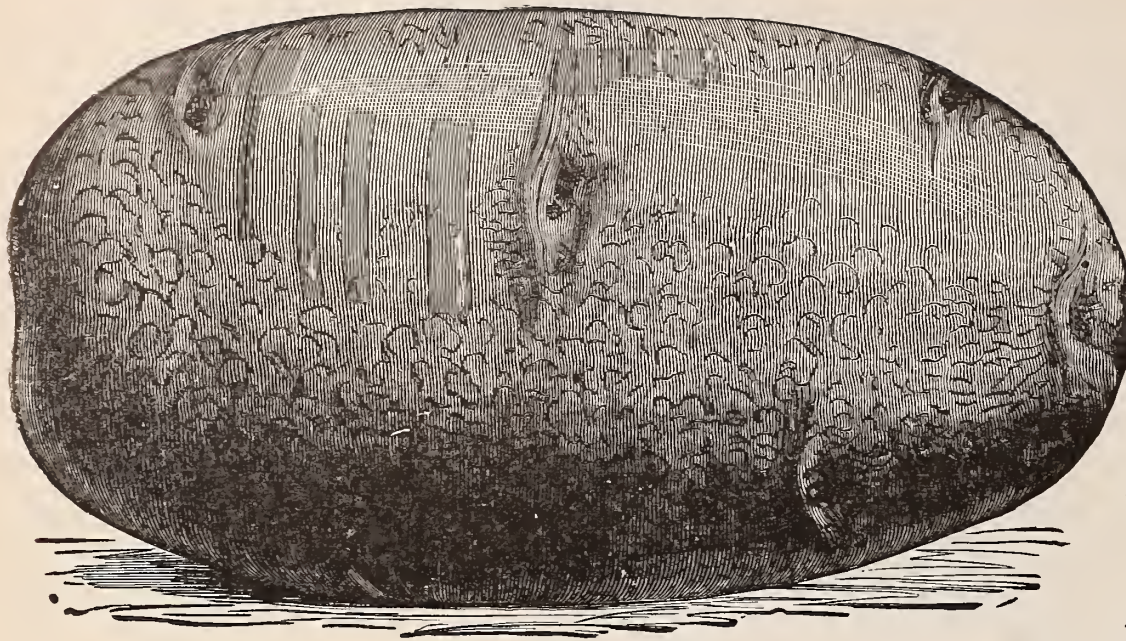

Northern-Grown Potato,

Advantages of Changing Seed Potatoes

There is no other crop that we raise that is so much benefitted by the introduction of fresh seed from time to time as the potato. They seem to take on new life and prosper wonderfully, provided the change is to a well-selected stock, and the further north it is grown, the better. Our best customers will not plant their own raising of seed at all, but buy of us every year. They can grow nearly double the crop on the same land that they can from their own raising, and the tubers are smoother, handsomer and of better quality and more salable in the markets.

Sweet Potatoes

Yellow Nansemond. A thick variety, very productive, and the best for general culture. Pk. 60c., bush. \$2.00, bbl. \$4.00.

SWEET POTATO PLANTS

Ready May 10th

Yellow Nansemond. 100 25c., 1000 \$1.50, lots of 5000 \$1.20 per 1000.

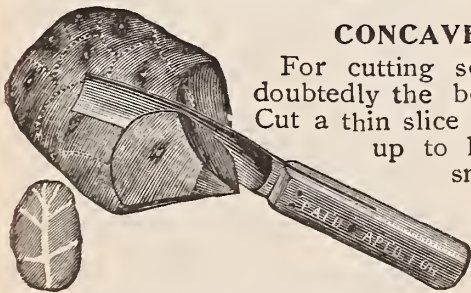

CONCAVE POTATO KNIFE

For cutting seed potatoes. This is undoubtedly the best knife for the purpose. Cut a thin slice from centre of potato, hold up to light and see feeders as in small cut.

25 cents each
postpaid

Potatoes

Kartoffel (Ger.) Pomme de Terre (Fr.)
Plant ten bushels to the acre.

The soil best suited to the potato is a rich, sandy loam; being a gross feeder, it requires a liberal application of manure; if stable manure is to be used it should be well rotted and not allowed to come in contact with the tubers. No other crop are the results from the use of phosphates so manifest as on the potato; almost invariably the tubers are brighter, smoother and freer from rust and the destructive influence of wire worms. The best fertilizers are plaster, lime, super-phosphate of lime, and bone dust, for heavy and wet soils especially, as they promote growth and, at the same time, prevent disease. Plant as early in spring as the ground can be thoroughly worked, in rows three feet apart and one foot in the rows.

NOTICE—Our Seed Potatoes are all **NORTHERN GROWN.** Customers may rely upon getting the very best stock in the market.

PRICES MAY Fluctuate somewhat. **SPECIAL PRICES** will be quoted on application.

Rural New Yorker, No. 2. A valuable variety of large size, very smooth and a great cropper; in quality unexcelled. Pk. 50c., bush. \$1.50, bbl. \$4.00.

Freeman (New). Considered to be the finest early potato to this date. Pk. 60c., bush. \$2.00, bbl. \$4.50.

Early Rose. A leading variety for earliness, quality and productiveness. Pk. 50c., bush. \$1.50, bbl. \$4.00.

Early Rose (Michigan grown). Pk. 50c., bush. \$1.50, bbl. \$4.00.

Early Ohio. A seeding of the Early Rose, ripens about a week earlier, excellent quality. Pk. 75c., bush. \$1.75, bbl. \$4.75.

Beauty of Hebron. A little earlier than Early Rose, very productive, a good keeper. Pk. 50c., bush. \$1.50, bbl. \$4.00.

State of Maine. Medium early, good keeper. Pk. 50c., bush. \$1.50, bbl. \$4.00.

Burbank's Seeding. A medium early variety, producing a large crop. Pk. 50c., bush. \$1.50, bbl. \$4.00.

Mammoth Pearl. Medium late, free from rot, never hollow; skin and flesh white, cooks like a ball of flour; very productive and good keeper. Pk. 50c., bush. \$1.50, bbl. \$4.00.

White Star. Baked or boiled, its color, floury texture and delicious flavor are unsurpassed; excellent keeping quality. Pk. 50c., bush. \$1.50, bbl. \$4.00.

Irish Daisy. One of the best new late or main crop potatoes yet sent out. Pk. 60c., bush. \$1.60, bbl. \$4.00.

We offer \$5.00 in Two Prizes for the best basketful (about ½ bushel) of Potatoes, exhibited at the Philadelphia Chrysanthemum Show in November, 1899.

Kurbis (Ger.) **Pumpkin** Potiron (Fr.)

One ounce to fifty hills. Three pounds to the acre.

Sow in good soil in May, when ground has become warm, in hills eight to ten feet apart each way, or in field corn about every fourth hill; plant at same time with corn, always avoid planting near other vines, as it will hybridize.

Cashaw. Long yellow crook neck, the best for table use or feeding stock; fresh yellow, solid, fine grained and sweet. Pkt. 5c., oz. 10c., lb. 50c.

Large Cheese. One of the best for table use, skin orange, flesh yellow and sweet. Pkt. 5c., oz. 10c., lb. 50c.

Large Tours or Mammoth. Grows to an immense size, often weighing over one hundred pounds. Pkt. 5c., oz. 10c., lb. 60c.

Connecticut or Large Common Yellow Field. Grown principally for feeding stock. Oz. 5c., qt. 20c., bush. \$4.00.

True Tennessee Sweet Potato. A splendid pie and cooking pumpkin. Pkt. 5c., oz. 10c., ¼ lb. 20c., lb. 60c.



Radish

Radies (Ger.).

Radis (Fr.).

One ounce to seventy-five feet of row.

Radishes delight in light, rich, mellow soil, and to be crisp and tender, must make rapid growth. For very early use sow in a gentle hotbed in January, and continue sowing every two weeks until September, choosing the varieties suited to the season; sowings should be made in drills ten inches apart, and the plants should be thinned to two inches apart in the row. Sow winter radishes in July and take up before severe frosts and store in sand or earth in a cool cellar.

Early Sorts

- Earliest White Globe Forcing.** The earliest and very best white variety, oval in shape. Pkt. 5c., oz. 15c., lb. \$1.25.
- Round Red Forcing or Button.** The earliest and the best of the turnip varieties for forcing. Pkt. 5c., oz. 10c., ¼ lb. 20c., lb. 60c.
- Round White Forcing.** Pkt. 5c., oz. 10c., ¼ lb. 20c., lb. 60c.
- Fireball.** Brilliant scarlet color, crisp, tender, of mild flavor; useful only as a forcing variety or for early spring use. Pkt. 5c., oz. 10c., ¼ lb. 25c., lb. 75c.
- Cardinal or Scarlet Globe.** The very best forcing variety, is of globular shape and brilliant cardinal red color. Pkt. 5c., oz. 10c., ¼ lb. 25c., lb. 75c.
- White Box, Philadelphia Grown.** Perfectly round, smooth skin, pure white and free from any sharpness or bitterness; a remarkable quick grower, with small top. Pkt. 5c., oz. 10c., ¼ lb. 20c., lb. 60c.
- Early French Breakfast.** Oblong shape, rapid growth, very mild and tender, of a beautiful scarlet color, tipped with white. Pkt. 5c., oz. 10c., ¼ lb. 20c., lb. 60c.
- Brightest Scarlet, Half Long.** Entirely distinct, being a vivid scarlet color, tipped with snow-white. Pkt. 5c., oz. 15c., ¼ lb. 25c., lb. 75c.
- Long Scarlet Short Top or Salmon.** The standard variety; long bright scarlet with small top. Pkt. 5c., oz. 10c., ¼ lb. 15c., lb. 50c.
- Sutton's Earliest of All Scarlet.** Turnip shape. 20c. per oz.

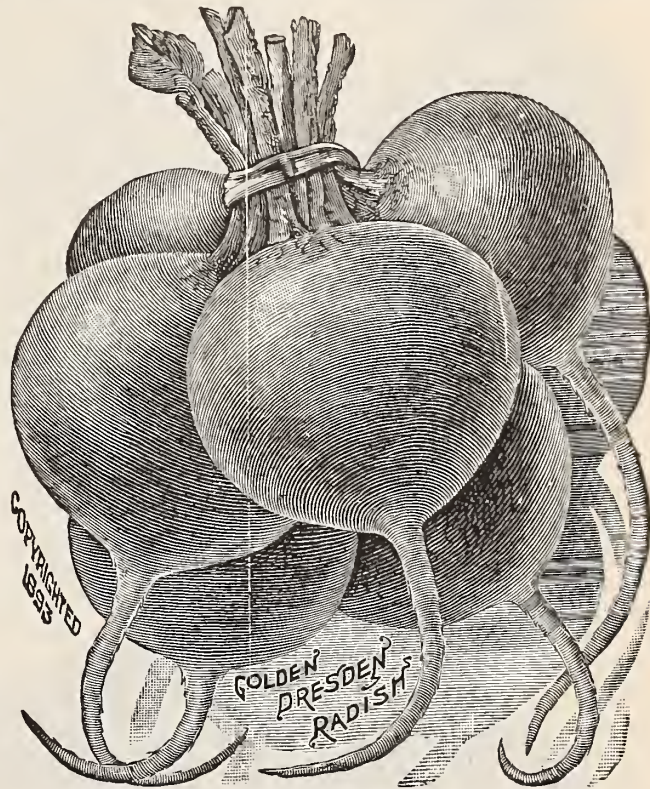

Summer Sorts.

- White Delicacy (New).** Oblong shape, excellent quality. Pkt. 5c., oz. 10c., lb. \$1.00
- Becker's Chartier.** Color bright salmon scarlet, shading to white as it approaches maturity; it is very crisp, tender, and of mild and pleasant flavor. Pkt. 5c., oz. 10c., ¼ lb. 20c., lb. 60c.
- Golden Globe, Dresden (New).** Pkt. 5c., oz. 10c., ¼ lb. 25c., lb. 75c.
- Large White Summer Turnip.** Large, turnip-shaped, white, crisp and mild. Pkt. 5c., oz. 10c., ¼ lb. 20c., lb. 60c.
- Large Yellow Summer Turnip.** Like the above except in color. Pkt. 5c., oz. 10c., ¼ lb. 20c., lb. 60c.
- Long White Lady Finger.** A fine white, crisp and mild variety. Pkt. 5c., oz. 10c., ¼ lb. 20c., lb. 65c.
- White Strasburg.** Oblong, of a pure white color, and mild flavor. Pkt. 5c., oz. 10c., ¼ lb. 20c., lb. 60c.

Winter Varieties.

- Scarlet China Winter.** One of the best fall and winter varieties, bright rose color. Pkt. 5c., oz. 10c., ¼ lb. 20c., lb. 75c.
- Long Black Spanish Winter.** Pkt. 5c., oz. 10c., ¼ lb. 20c., lb. 60c.
- Round Black Spanish Winter.** Like the above, except form. Pkt. 5c., oz. 10c., ¼ lb. 20c., lb. 60c.
- California White Winter.** Long. Pkt. 5c., oz. 10c., lb. 75c.

RHUBARB

Rhabarber (Ger.).

Rhubarbe (Fr.).

- Linnaeus.** Well-known market variety; early. Pkt. 5c., oz. 15c., ¼ lb. 20c., lb. \$1.50.
- Victoria.** Pkt. 5c., oz. 15c., ¼ lb. 45c., lb. \$1.50.

RHUBARB ROOTS.

Set in spring and they will furnish leaf stalks the following season. We offer the largest and best variety.
Victoria. Clumps. Each 10c., doz. \$1.00, 100 \$6.00.

SQUASH

Kurbiss (Ger.).

Courge (Fr.).

One ounce to fifty hills.

Squashes should be planted in a warm, light, rich soil, about the middle of May or June. Plant in well manured hills, in the same manner as cucumbers and melons—the bush varieties three or four feet apart each way, and the running kind six to eight feet. Eight to ten seeds should be sown in each hill, thinning out after danger from bugs is over, leave three or four of strongest plants to a hill.

Early Sorts

- Early White Bush or Patty Pan.** The best early variety; grows to a large size and bears an abundant crop. Pkt. 5c., oz. 10c., ¼ lb. 20c., lb. 60c.
- Golden Custard.** Of similar size and shape to the White Bush, but of rich golden yellow color and fine flavor. Pkt. 5c., oz. 10c., ¼ lb. 20c., lb. 60c.
- Yellow Crook Neck.** Early productive, and of good quality; skin orange-yellow. Pkt. 5c., oz. 10c., ¼ lb. 20c., lb. 60c.

Summer and Fall Sorts

- Fordhook.** A new winter squash of great merit; of a handsome, bright yellow color. Pkt. 5c., oz. 10c., ¼ lb. 25c., lb. 75c.
- Butman.** Pkt. 5c., oz. 10c., ¼ lb. 20c., lb. 60c.
- Hubbard.** A general favorite, and one of the best late table varieties; of large size, flesh fine grained, dry and of excellent flavor. Pkt. 5c., oz. 10c., ¼ lb. 25c., lb. 75c.
- Vegetable Marrow.** Pkt. 5c., oz. 15c., ¼ lb. 35c., lb. \$1.10.
- Boston Marrow.** About ten days later than the brush varieties; a good keeper, of excellent flavor, flesh orange colored and fine grained. Pkt. 5c., oz. 15c., lb. 75c.
- Sweet Nut.** Medium size, flesh rich and very sweet; enormously productive and valuable both as a summer and a winter squash. Pkt. 5c., oz. 10c., lb. 75c.



Early White Bush or Patty Pan Squash.



Salsify

Haferwurz (Ger.) Salsifis (Fr.)
(OYSTER PLANT)

One ounce of seed will sow about fifty feet of drill.

Sow in early Spring in drills fifteen inches apart and one to two inches deep, thin to six inches apart. Soil should be very deep and mellow in order that the root may grow straight down. Store same as carrots for winter use, or they can be left in the ground until spring.

Mammoth Sandwich Island. This variety is of enormous size, twice as large as the ordinary French; pure white, very tender and delicious. Pkt. 5c., oz. 15c., ¼ lb. 40c., lb. \$1.25.

Long White. The favorite market variety, and best flavored. Pkt. 5c., oz. 10c., ¼ lb. 30c., lb. \$1.00.

Sage

Holt's Mammoth. Strong roots. Each 10c., doz. \$1.00, 100, \$5.00.

Sorrel

Sandwich Island Salsify Broad Leaf French. Pkt. 5c., oz. 15c.

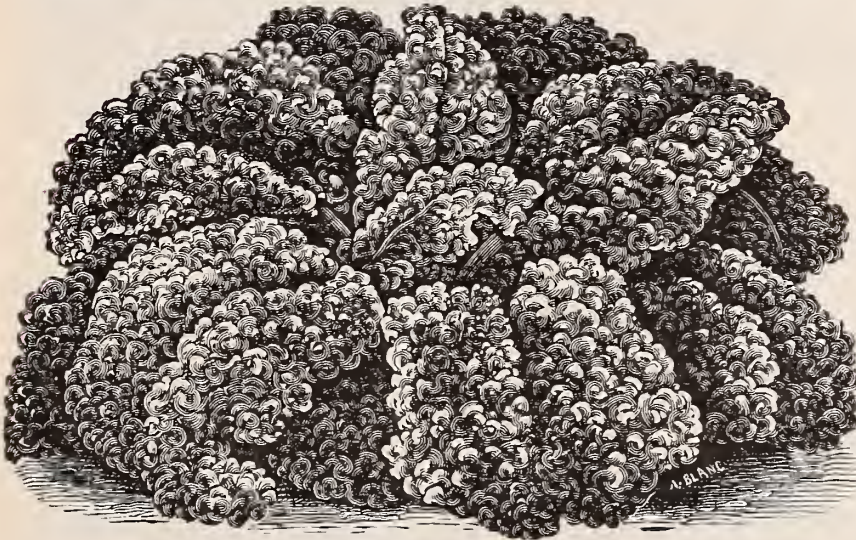

Bloomsdale Savoy Spinach.

(Spinat (Ger.))

Spinach

Epinaud (Fr.)

One ounce to 75 feet of drill, or at rate of ten pounds per acre.

Select very rich, well-drained soil, and sow in drills one foot apart and one inch deep. For spring and summer use, make the first sowing early in March, and continue at intervals of two or three weeks until the middle of July. Sow in August and September for winter or early spring use, and protect with a covering of straw during severe weather.

Victoria Long Standing (New). This thick variety is distinguished by the exceedingly dark green color of the leaves, and also for its long-standing qualities. Pkt. 5c., oz. 10c., lb. 35c.

Bloomsdale Round-Seeded Savoy. The hardiest large Savoy leaved; curled and crimped, with thick, fleshy leaves; the best for family and market purposes, and the best of all sorts for fall sowing. Oz. 10c., lb. 35c.

Long Standing Round-Seeded. Will stand two weeks longer than any other sort before shooting to seed. The best for spring sowing on account of seeding so late. Oz. 10c., lb. 35c.

Prickly-Seeded, or Fall. The hardiest variety. Oz., 10c., lb. 35c.

New Zealand. This variety endures heat and draught; excellent for summer use; produces a large quantity of leaves throughout the season and can be cut from continuously. Pkt. 5c., oz. 10c., ¼ lb. 25c., lb. 80c.

TARRAGON ROOTS (Estragon).

Used largely for flavoring. 20c. each, \$2.00 per doz.



Tomatoes

Liebes Apfel (Ger.)

Tomate (Fr.)

One ounce will produce about one thousand plants.

Sow the seed in March or April in the hotbed, or in a box in a sunny place in the house. To make very healthy, stocky plants, they may be transplanted when about two or three inches high. When five or six inches high, if the ground has become warm, transplant to the open ground. Set plants four feet apart.

Acme (Pink). Pkt. 5c., oz. 20c., ¼ lb. 60c.

Atlantic Prize. One of the earliest of all varieties. Pkt. 5c., oz. 25c., ¼ lb. 75c.

Beauty. Crimson, with a pinkish tinge, grows in clusters, large size; very smooth and solid. Pkt. 5c., oz. 20c., ¼ lb. 60c., lb. \$2.00.

Bright and Early. One of the very best extra early varieties. 10c. per pkt., 3 pkts. for 25c.

Honor Bright. Livingston's latest introduction and considered to be his very best rich red variety. 10c. per pkt., 3 pkts. for 25c.

Imperial (New). Earliest and best tomato in existence. Color bright red, very solid and smooth. Pkt. 10c., oz. 30c., lb. \$3.00.

Livingston's Favorite. Ripens evenly and early; very prolific, good flavor, few seeds, flesh solid. Pkt. 5c., oz. 20c., ¼ lb. 60c., lb. \$2.00.

Livingston's Perfection. Early, deep red in color, with few seeds. Pkt. 5c., oz. 20c., ¼ lb. 60c., lb. \$2.00.

Lorillard. Excellent variety for forcing under glass, very solid; from four to five fruit per bunch. Pkt. 10c., oz. 25c., ¼ lb. 75c., lb. \$2.50.

Matchless. Pkt. 10c., oz. 25c., ¼ lb. 75c., lb. \$2.50.

Mayflower. One of the earliest, highly recommended for forcing, of a bright red color. Pkt. 10c., oz. 25c., ¼ lb. 75c.

Paragon Selected. Early; a heavy bearer and produces fruit until killed by frost. Pkt. 5c., oz. 20c., ¼ lb. 60c., lb. \$2.00.

Ponderosa. The largest tomato in existence. Pkt. 10c., oz. 40c., ¼ lb. \$1.25.

Red Cherry. Used for preserving. Pkt. 5c., oz. 25c.

Red Mikado. Pkt. 10c., oz. 25c., ¼ lb. 80c.

Stone. Fruit very large, bright scarlet, very smooth, ripening evenly to the stem without a crack; and not subject to rot. Pkt. 10c., oz. 25c., ¼ lb. 75c., lb. \$2.00.

Sutton's Best of All. Best for forcing. 40c. per original pkt.

Thorburn's Long Keeper. Pkt. 5c., oz. 20c., ¼ lb. 60c., lb. \$2.00.

Trophy Selected. Seed is saved only from the finest ripe specimens. Pkt. 5c., oz. 25c., ¼ lb. 75c., lb. \$2.50.

Yellow Pear. Used for preserving. Pkt. 5c., oz. 25c.

Yellow Prince (Livingston's). The very best large round yellow tomato. Pkt. 10c., oz. 30c.

TOMATO PLANTS—Ready May 15th

We have these grown in very large quantities by a specialist, and can supply the following standard sorts true to name:

PARAGON

SELECTED TROPHY

BEAUTY

IMPERIAL

MIKADO

LIVINGSTON'S STONE

Transplanted plants, doz. 20c., 100 \$1 00, 1000 \$8 00; not transplanted, 1000 \$5.00.

Ruta-Baga



SOW 1 1/4 TO 2 POUNDS PER ACRE.

Fry's Private Stock Purple Top Ruta-Baga. (Philadelphia grown). This is the great favorite among our best farmers and gardeners. Perfect shape and best in every way. 10c. per oz., 30c. per 1/4 lb., \$1.00 per lb.

Improved Yellow, Purple Top Ruta-Baga or Swede. (Long Island grown). The leading market variety, and principally grown for stock as well as for family use; hardy productive, flesh yellow, solid, sweet fine grained and of good flavor. Pkt. 5c., oz. 10c., 1/4 lb. 15c., lb. 50c., 3 lbs. \$1.25

Robertson's Golden Ball. Pkt. 5c., oz. 10c., lb. 50c.
Yellow Aberdeen. Pkt. 5c., oz. 10c., lb. 40c.

Turnip

Herbst Rube (Ger.) Navet (Fr.).
One ounce for 100 feet, two pounds to the acre.
 For early use sow the small sorts as soon as the ground can be worked in the spring in drills fourteen inches apart. Ruta-bagas thirty inches. As the seed is fine it should be covered but slightly, except in very dry weather. Of the early varieties, thin the plants to six inches apart and the Swedes to one foot. For fall and winter use the early kinds should be sown from the middle of July to the middle of August, and Swedes from the middle of June to the fifteenth of July.



NEW CROP TURNIP

Purple Top Flat Strap Leaf Turnip.

Snowball. Extra early, perfectly round, pure white, very solid, sweet, short top. Pkt. 5c., oz. 10c., 1/4 lb. 25c., lb. 75c.
Extra Early Munich, Purple Top. A very early variety, white flesh, of fine grain and good flavor. Pkt. 5c., oz. 10c., 1/4 lb. 15c., lb. 50c.
Early White Flat Dutch. An early white-fleshed variety of quick growth, mild flavor and excellent quality. Pkt. 5c., oz. 10c., 1/4 lb. 15c., lb. 40c., 3 lbs. \$1.00.
Early White Egg. An egg-shaped variety for spring or fall sowing. Pkt. 5c., oz. 10c., 1/4 lb. 15c., lb. 50c.
Early Red or Purple Top Flat. This strap-leaved variety is the principal sort for early spring and fall use; top is red or purple, flesh fine grained, of mild flavor and a good keeper. Pkt. 5c., oz. 10c., 1/4 lb. 15c., lb. 40c., 3 lbs. \$1.00.
Purple Top White Globe. Either for table or stock, is a heavy producer, early, of rapid growth and an excellent keeper. Pkt. 5c., oz. 10c., 1/4 lb. 15c., lb. 40c., 3 lbs. 1.00.

Yellow Globe or Amber. One of the best for a general crop, excellent for table use or feeding stock, and keeps well until late in the spring. Pkt. 5c., oz. 10c., 1/4 lb. 15c., lb. 40c., 3 lbs. \$1.00.

...MISCELLANEOUS SEEDS...

FLAX SEED. 10c. per qt., \$2.25 per bu.
OSAGE ORANGE SEED. 40c. per lb., \$6.00 per bu.
Tobacco Seed. Connecticut Seed Leaf. One of the best varieties for cigar wrappers. Pkt. 10c., oz. 30c.
Pennsylvania Seed Leaf. The most noted selection grown in Lancaster County. Pkt. 10c., oz. 30c.
Havana. Pkt. 10c., oz. 50c.
Teosinte. (Reana Luxurians). Excellent forage plant, used for ensilage. Oz. 10c., lb. \$1 00.
Tares or Spring Vetches. Used for plowing under; sow one bushel to the acre. Lb. 8c., postpaid 15c., bu. \$3.00, \$4.50 per 100 lbs.
Winter Vetches (Vicia Villosa). For sowing in autumn. 8c. per lb., per bu. of 60 lbs. \$3.50, per 100 lbs. \$5.00.
Sugar Cane. Early Amber. The earliest and most productive variety. Sow four quarts in drills and eight quarts broad cast to the acre. Qt. 20c., bu. \$3.00.
BROOM CORN. Improved Evergreen. Qt. 15c., bu. \$3.00.

BIRD SEEDS. Fresh, Re-cleaned.
CANARY (Sicily). Qt. 15c., 4 qts. 50c., \$3.00 per bu.
MIXED BIRD SEED " 15c., 4 " 50c., 3.00 "
HEMP SEED " 12c., 5 " 50c., 2.00 "
RAPE SEED " 15c., 4 " 50c., 3.00 "
SUNFLOWER SEED " 10c., 4 " 30c., 1.75 "
MILLET SEED " 10c., 4 " 30c., 1.25 "
MAW SEED. 15c. per lb., 4 lbs. for 50c.
CANADA PIGEON PEAS. Qt. 10c., pk. 30c., \$1.10 per bu., \$2.00 for 2 bushels.
UNHULLED RICE. 20c. per qt.
CUTTLE FISH BONE. 3c. each, 35c. per lb.
LETTUCE SEED. 5c. per oz., 20c. per lb.



FARM SEEDS

OATS. All the best and most profitable varieties. 75c. to \$1.25 per bushel. Sow $2\frac{1}{2}$ to 3 bushels per acre. (Special price quoted on application).

WHEAT. Grown especially for seed. Best varieties such as **Fultz, Red Mediterranean, Fulcaster, Gold Coin, etc., etc.** About \$1.25 per bushel. (Special price quoted on application). Sow $1\frac{1}{2}$ to 2 bushels per acre.

RYE. Winter and Spring. Best seed stock. Prices on application. Sow $1\frac{1}{2}$ bushels per acre.

BUCKWHEAT. Japanese, Silver Hull and Common. About \$1.00 per bushel. (Special price on application). Sow about 1 bushel per acre.

BARLEY. For seeding purposes. \$1.25 per bushel. (Special price on application). Sow 2 to $2\frac{1}{2}$ bushels per acre.

CANADA FIELD PEAS. Very profitable as a hay and forage crop, also a very early nutritious dry or green feed. Sow in March or April at the rate of $1\frac{1}{2}$ bushels per acre broadcast with $\frac{1}{2}$ bushel oats as a support; cut for hay before the peas mature. Excellent pigeon feed when dry. Pk. 40 cts., bu. \$1.10, 2 bu. bags \$2.00.

SOUTHERN BLACK-EYED COW PEAS. A small white variety with black eye. Sow in May or June for plowing under. Much used for green manuring purposes. Use two to three bushels to acre. Pk. 45c., bu. \$1.00. Special price will be quoted for larger quantities.

MANGEL WURZELS. All the very best sorts. For prices and full description see page 2. Sow about 5 lbs. per acre.

CARROT. **Improved Long Orange.** This is the best and most satisfactory variety for stock feeding. 75c. per lb., 5 lb. lots and over at 60c. per lb. Sow 3 to 4 lbs. to the acre.

“ **Danver's $\frac{1}{2}$ Long.** Highly recommended for stock feeding. 75c. per lb., 5 lb. lots and over at 65c. per lb.

CORN. All the best sorts such as **Chester Co. Mammoth, Golden Beauty, Leaming Dent, etc., etc.** For list of varieties see page 7. Plant 8 to 10 qts. per acre.

PARSNIP. Used by many farmers for stock feeding. **Improved Hollow Crown.** 60c. per lb., 5 lb. lots and over at 50c. per lb. Sow 4 to 5 lbs. per acre.

PUMPKIN. Valuable food for stock. Sow 3 lbs. per acre. See page 14 for list of varieties and prices.

RUTA BAGA. See page 17 for best varieties and prices. Sow 2 lbs. per acre.

MILLET SEED. **German Southern or Golden Millet.** Extra re-cleaned and true stock; about \$1.25 per bu. Special price quoted on application. Sow 1 bushel per acre.

HUNGARIAN GRASS or MILLET. Best quality; about \$1.15 per bu. Special price will be quoted on application. Sow 1 bushel per acre.

TIMOTHY SEED. Extra prime re-cleaned; about \$1.75 per bu. Special prices will be quoted on application. Sow $\frac{1}{2}$ bushel per acre.

CLOVER. **Red.** Extra choice re-cleaned “Buckeye” brand. The very best, entirely free from weeds. \$5.25 per bushel. Special prices will be quoted upon application. Sow $\frac{1}{3}$ bushel (20 lbs.) per acre.

“ **Crimson or Scarlet.** Excellent for cutting as feed or for plowing under, makes a good substitute for manure or other fertilizer; can be sown from June to October 15th; about 20 lbs. per acre. Extra choice seed \$3.25 per bu. Special price quoted on larger quantities.

“ **Alfalfa or Lucerne.** 15c. per lb.; \$6.00 per bu. of 60 lbs. Special prices with sample will be quoted on larger quantities. Sow 20 lbs. per acre.

“ **Alsike.** Best quality, extra clean. 15c. per lb.; \$6.60 per bu. of 60 lbs. Sow 10 lbs. per acre.

“ **White Dutch.** Extra choice quality, 25c. per lb.; 10 lbs. for \$2.00; \$10.80 per bu. of 60 lbs. Sow 12 to 15 lbs. per acre. This is the clover largely used for lawn, although it is also valuable for permanent pasture use.

...GRASS AND CLOVER SEEDS...

Our Grass and Clover Seeds are of the very finest quality, extra clean and free from weeds, and can be relied upon to give the best of satisfaction. We have a large number of unsolicited testimonials from customers who have sown our seed.

We make a specialty of supplying Country Clubs with the proper grass seed for Golf Links, Tennis Courts, &c. &c., also special makes of Lawn Mowers. Special information as well as special prices will be cheerfully given. We can refer to a number of Clubs whom we supply.

Don't forget to fertilize the Lawn or Grass Plot. Well fertilized ground stands the extreme drought much better than ground which is poor.

We recommend

**MICHELL'S
..PURE BONE.
MEAL**

\$30.00 per ton; \$3.50 per 200-pound sack; \$2.00 per 100 pounds; or 5 pounds for 25c.; also

**Canada
Unleached Wood
Ashes**

We have the pure ashes and can be relied upon. \$18.00 per ton f. o. b., Phila., or \$12.00 per ton f. o. b., Canada, thus saving freight charges: \$2.50 per barrel of 250 pounds.

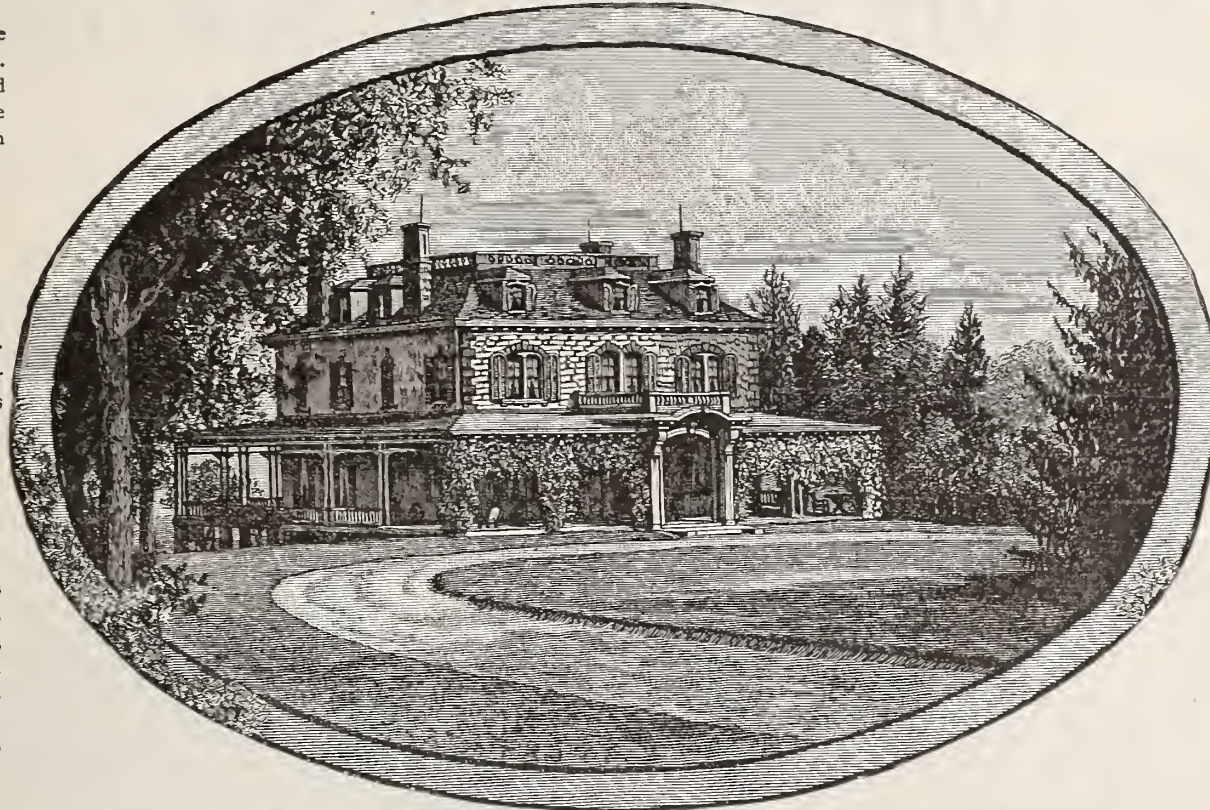

Sown with MICHELL'S "NON-SUPERIOR" Evergreen Lawn Grass Seed.

HOW TO MAKE A LAWN

Some previous cultivation, or at least a thorough turning over should be given. A clayey loam is the best foundation for a good lawn. Let the surface be graded to the level wanted in all parts and well rolled—a light raking following this will prepare for the seed sowing, which should be done as early in the spring as the ground can be worked, provided the ground has not already been prepared in the fall. The very best time, the ground being in order, is about April 1st. Three to four bushels per acre should be sown; the latter amount is best, for the young plants are but small and if thick, cover the ground better and make a smoother and more even turf. Mowing should be done at least once a week in favorable growing weather, and even in dry weather it should be cut twice a month. Do not allow the clippings to remain on the ground, except they are very short.

Michell's "Non-Superior Evergreen" Lawn Grass Seed. This mixture is made of the finest varieties, presenting the appearance of the lawn like a bed of dark green velvet. We can safely say that there is no better mixture in the market. The seeds used are all fresh and re-cleaned, and enough white clover is added to make it strong and durable. Qt. 25c., pk. \$1.00, bush. [20 lbs.] \$4.00; five to ten bush. lots, \$3.75. *Please note that we give 20 lbs. to the bush., which is nearly 1 1/2 bushels.*

Fairmount or Central Park Lawn Mixture. A very fine mixture, which we can highly recommend. Qt. 20c., pk. 75c., bush. [15 lbs.] \$2.75; five to ten bush. lots, \$2.50 bush.

Fine Mixed Lawn Seed [15 lbs. per bush.]. \$2.25 per bush.; 5 bush. lots and over, \$2.00 per bush.

Michell's Lawn Tennis Mixture. Contains a special mixture of short growing varieties. Bush. of 20 lbs. \$4.00.

Golf Greens Mixture. This is a new mixture of our own; made up especially from such grasses as will grow very short and make a solid surface to withstand heavy wear. Bush. of 20 lbs. \$4.00. Ask for special price on quantity.

Shady Lawn Mixture. Specially adapted for lawns on which there are trees, and where the usual grass seeds do not thrive. Pk. \$1.25, bush. of 16 lbs. \$4.00.

Flint's Mixture for Permanent Pasture Lands. This is a mixture, made of ten of the best and most hardy grasses, to form a permanent pasture. Sow two bushels to the acre. Bush. [20 lbs.] \$3.25; five bush. lots \$3.00 bush., ten bush. lots \$2.90 bush.

Timothy Seed [Prime]. About \$1.75 per bush.

Extra Fancy Cleaned Kentucky Blue Grass. One of the most valuable sorts for lawn purposes, and as a pasture grass is indispensable. This grade is the best for sowing lawns. Qt. 15c., bush. [14 lbs.] \$1.75. Original eight bush. sacks at \$1.60 bush.; special prices on larger quantities.

Canadian Blue Grass. Adapted especially to high, dry situations. Per lb. 15c., bush. of 14 lbs., \$1.60, \$9.50 per 100 lbs.

Wood Meadow Grass [*Poa Nemoralis*]. Particularly adapted for pleasure grounds and lawns; will grow under trees where few other grasses can exist. Lb. 30c., \$27.50 per 100 lbs.

Natural Green Grass. Forms a heavy sward, but does not retain its color as well as blue grass. Qt. 20c., bush. [14 lbs.] \$2.00.

Herd or Red Top Grass. Qt. 15c., bush. [10 lbs.] \$1.00, sack of 50 lbs. \$4.00. Special price quoted on larger quantities.

Fancy Herd or Red Top. Extra re-cleaned seed, free from chaff [32 lbs. per bush.], 20c. per lb., \$15.00 per 100 lbs.

English Rye Grass [*Perennial Rye*]. Qt. 15c., bush. [24 lbs.] \$2.00; five bush. lots \$1.80 per bush., \$7.00 per 100 lbs.

Italian Rye Grass. \$2.00 per bush. [22 lbs.], \$7.50 per 100 lbs.

Orchard Grass. For pastures, sowing under orchards or shady places. Lb. 20c., bush. [14 lbs.] \$2.10, \$14.00 per 100 lbs.

Crested Dogstail. An excellent grass for hard, dry soils, valuable for pastures or lawns, 25 lbs. to the acre. Lb. 35c., 100 lbs. \$27.50.

Hard Fescue. Thrives well in dry situations where many other grasses fail; 30 lbs. to the acre. Lb. 20c., 100 lbs. \$14.00.

Meadow Fescue. English Blue Grass. An excellent grass for permanent pasture or hay; the foliage is highly nutritious. Lb. 12c., \$9.00 per 100 lbs.

Sheep's Fescue (*Festuca Ovina*.) Sow 40 lbs. to the acre. Lb. 20c., 100 lb. \$15.00.

Sweet Vernal (*Perennial*). Very fragrant. Lb. 50c., five lbs. \$2.25.

CLOVER SEED

White Dutch Clover. The best variety for lawns; remains green throughout the season; highest grade of seed only. Lb. 25c., 10 lb. lots 20c. lb., 100 lbs. \$18.00.

Alsike or Swedish. Valuable for pasturage or ensilage. Lb. 25c., 100 lbs. \$11.00.

Alfalfa or Lucerne. Sow early in spring to secure a good stand before winter. Lb. 15c., bush. [60 lbs.] \$6.00, 100 lbs. \$10.00.

Bokhara Clover. Excellent for bee food. Lb. 25c., 10 lbs. \$2.25.

Red Clover. The seed we offer is re-cleaned and free from weeds. Lb. 11c., bush. [60 lbs.] about \$5.25. Subject to market changes.

Scarlet or Crimson Clover. Lb. 10c., bush. \$3.25, \$5.00 per 100 lbs.

Millet (Prices Fluctuate)

Common Millet. Qt. 15c., bush. [48 lbs.] \$1.10.

German or Golden Millet. Qt. 15c., bush. [48 lbs.] \$1.25.

Hungarian Millet. Qt. 15c., bush. [48 lbs.] \$1.15.

Egyptian or East India Pearl Millet. Grows from eight to ten feet high. Sow three to five pounds per acre. Lb. 25c., 10 lbs. \$2.00.

HAVING HAD A NUMBER OF INQUIRIES FOR SEEDS
SENT OUT BY THE WELL KNOWN SEED FIRM OF

MESSRS. SUTTON & SONS, READING, ENGLAND,

We have made arrangements with that firm for some of their Leading Specialties which we will send out in Original Packets at SUTTON'S PRICES.

...SUTTON'S FLOWER SEEDS...

ANTIRRHINUM

(Snapdragon.) Hardy perennial.

Sutton's Aurora

A pleasing and effective strain of intermediate Snapdragon, exhibiting a great variety of rich markings on a dainty salmon-rose ground. Height 15 inches. **25c. per original packet.**

NOVELTY

CALCEOLARIA

Greenhouse Annual.

Sutton's Perfection

Profusion of bloom, large and well-formed flowers, diversity and splendor of coloring, combined with a dwarf and vigorous habit, these are characteristics which have secured the supremacy of our magnificent strain of Calceolarias. To maintain its pre-eminence we continue to cross the finest flowers, and from these our seed is saved. Mixed colors. **75c. per original packet.**

CINERARIA

Greenhouse Annual. Height 1 foot.

Sutton's Superb Mixed Colors

We continue to receive a great number of letters from customers, expressing astonishment and delight at the immense size splendor and variety of coloring, symmetrical form, and profusion of flowers borne by plants of our Superb Strain. **60c. per original packet.**

COCKSCOMB

Sutton's Prize Dwarf

The finest strain of crimson Cockscomb in existence. "Your Prize Dwarf Cockscomb is a grand strain. I took twenty-four plants to Penrice Show, not for competition. The combs measured 35 inches from point to point, and 12 inches across. Height 6 inches."—Mr. CHAS. PLEASANTS, *Gardener to THOS. PENRICE, Esq.* **35c. per original packet.**

GIANT CYCLAMEN

Sutton's Giant, Mixed

"The Cyclamens are splendid: the foliage extra fine, and plants in 7-inch pots have from 70 to 108 extra fine blooms which stand five inches above the foliage. I showed three pots at the meeting of the Gardeners' Association on February 26, and received a first-class Certificate for them; they were declared to be the finest specimens ever seen."—Mr. A. CAMPBELL, *Gardener to the Right Hon Lord ARDILAUN.* **60c. per original packet.**
A Collection of Six Varieties of Sutton's Giant Cyclamen, each variety separate \$2.50.

GLOXINIA

Sutton's Prize, Mixed

"No description, without being open to the charge of exaggeration, can adequately convey any idea of their beauty."—THE GARDEN. We will only add that the leaves are very handsome, and are remarkable for the manner in which they curve over and hide the pot. The erect flowers are produced with unusual freedom, and are brilliant, varied, and rich in color. **60c. per original packet.**

MIGNONETTE

Sutton's Giant

One of the finest Mignonettes yet introduced; highly recommended. Height 2 feet

"We have tried many varieties of Mignonette, but Sutton's Giant is a long way in advance of all we have seen."—Mr. J. OLIVER, *Gardener to the Right Hon. the Earl of RAVENSWORTH.*

25c. per original packet.

PETUNIA

Sutton's Superb, Mixed, Fringed

Exceedingly handsome free-flowering varieties; brilliant and effective in beds and borders.

35c. per original packet.

PRIMULAS

Sutton's Giant, Mixed, Fringed

This strain comprises all the most brilliant colors. The size of the flowers is the largest to be procured.

\$1.25 per original packet.

VERBENA

Sutton's Superb Bedding Mixture

"I took First Prize for twelve bunches of Verbena in a competition of fourteen stands at the Bath Autumn Show. The colors were most brilliant, and the three beds I had of them were much admired."—Mr. T. J. TATE, *Gardener to W. PUMPHRY, Esq.* **25c. per original packet.**

SUTTON'S...VEGETABLE SEEDS...

BRUSSELS SPROUTS

Sutton's Exhibition

"A grand strain of Brussels sprouts; the stems perfectly covered with hard buttons of fine quality."—Mr. R. LYE, *Sydmonton Court Gardens.*

25c. per original packet.

CAULIFLOWER

Sutton's First Crop

"Certainly the best Cauliflower I have ever grown for early use. I cut some excellent heads on May 16, pure white."—Mr. F. HAYLER, *Gardener to C. A. PRIOLEAU, Esq.*

50c. per original packet.

FRAME CUCUMBER

Sutton's Matchless

"Sutton's Matchless is the finest Cucumber I have ever grown. The length of one was 26 inches, and I have had a lot 24 inches long."—Mr. A. MYSON, *Gardener to F. R. RODD Esq.*

50c. per original packet.

CELERY

Sutton's White Gem

Sutton's White Gem Celery cannot be surpassed for early use. Sown in February it can be dug the first week in August.

40c. per original packet.

LETTUCE

Sutton's Favourite

"Your Favourite Cabbage Lettuce is a grand exhibition variety, very tender, and stands a long time before going to seed."—Mr. H. BUND, *Gardener to Captain W. VERE HOPEGOOD.*

"Sutton's Favorite Cabbage Lettuce is splendid. We have been cutting beautiful heads all through this trying summer, weighing from two to four pounds."—Mr. G. LOVELOCK, *The Gardens, Normanton Park.*

40c. per original packet.

Sutton's Giant

"CABBAGE LETTUCE, SUTTON'S GIANT.—Very fine Lettuce, compact, and exhibit no tendency to bolt, even in hot, dry weather. They are of capital flavour.—ACER."—AMATEUR GARDENING.

"The largest and best flavoured variety I have ever grown. It was much admired."—Mr. G. TYLER, *Gardener to C. A. JONES, Esq.*

25c. per original packet.

MUSK MELON

Sutton's Scarlet

"The best Melon I ever grew; but little seed, very thick flesh, and the heaviest Melon for its size I have seen. Lord Ripon pronounced it to be the finest flavoured Melon he remembered tasting."—Mr. F. KNELLER, *Studley Royal Gardens.*

40c. per original packet.

PARSLEY

Sutton's Selected Garnishing

"Sutton's Garnishing Parsley is a picture."—Mr. A. BAKER, *Gardener to Captain LEWIN.*

25c. per ounce packet.

RADISH

Sutton's Earliest of All

"Your Earliest of All Radish was quite a week earlier than others sown at the same time."—Mr. A. E. GROOMBRIDGE, *Gardener to the Right Hon. Lord BATEMAN.*

20c. per ounce packet.

TOMATO

Sutton's Best of All

"I have grown Tomatoes for 20 years, but I have not met with anything to compare with Sutton's Best of All. Robust constitution, very free setter, splendid full-weight solid fruits the best of colour and flavour."—Mr. H. HOLLOWAY, *Gardener to A. BROWN, Esq.*

40c. per original packet.

Fresh Tested
Reliable

FLOWER SEEDS

Strictly of the
Finest Quality

For \$1.00 select to amount of \$1.25.

For \$2.00 select to amount of \$2.50.

For \$3.00 select to amount of \$4.00.

For \$5.00 select to amount of \$6.50.

For the Convenience of Customers we have numbered all the Flower Seeds, which saves a great deal of time and labor. For instance, if you wish 1 pkt. of Alyssum Little Gem, order 1 pkt. No. 23, etc. Please be careful to give the correct number, as a mistake in the number would result in getting the wrong seeds.

- Abronia.** Trailing plants, producing clusters of sweet-scented, verbena-like flowers; effective in beds, rock-work or hanging baskets. Half hardy annuals; height, six inches.
- 1 Umbellata.** Rosy lilac, with a white eye. Pkt. 5c.
- Abutilon.** Sown any time before April, in a temperature of sixty degrees, they will produce fine flowering plants the first season.
- 4 Choice Mixed.** All colors; two to six feet high. Pkt. 15c.
- Aconitum (Monk's Hood or Wolfsbane.)** A hardy perennial, producing curiously shaped flowers in abundance.
- 7 Napellus.** Very pretty blue and white flowers; three feet high. Pkt. 5c.
- Adonis (Flos Adonis.)** Also known as Pheasant's Eye. Hardy annuals of easy culture, with pretty fine-cut foliage.
- 13 Aestivalis.** Dark crimson flowers, with a light centre; one foot high. Pkt. 5c.
- 14 Agathea Cœlestis.** Beautiful blue flowers. Pkt. 10c.



Large-Flowered Dwarf Blue Ageratum.

Ageratum

For large beds or borders, in bloom all summer; half-hardy annuals.

- 16 Large-Flowered Dwarf Blue.** Pkt. 5c., per oz. 30c.
- 17 Large-Flowered Dwarf White.** Pkt. 5c., per oz. 30c.
- 18 Large-Flowered Dwarf Mixed.** Pkt. 5c. per oz. 25c.

Ampelopsis (Miniature Virginia Creeper or Japanese Ivy). A hardy perennial from Japan; leaves turn to scarlet in autumn; will adhere to brick or stone walls.

21 Veitchi. Pkt. 10c., oz. 30c.

Achillea. Useful for cut flowers or for placing in cemeteries; hardy perennial; eighteen inches high.

10 Ptarmica Plena. Pure white double flowers. Pkt. 15c.

Amaranthus (Half-hardy annuals).

33 Cruentus (Prince's Feather). Erect flowering, bright scarlet. Pkt. 5c.

34 Caudatus (Love Lies Bleeding). Blood red, drooping; three feet high. Pkt. 5c.

35 Gordoni or Sunrise. Bronzy crimson foliage, shading off to brilliant scarlet tufts of leaves on top of stalk, lower leaves having a scarlet band through centre. Three feet high. Pkt. 10c.

36 Salicifolius (Fountain Plant). Pkt. 5c.

37 Tricolor Splendens (Joseph's Coat). Leaves red, yellow and green; three feet high. Pkt. 5c., oz. 50c.

38 Mixed. All sorts. Pkt. 5c.

S
W
E
E
T

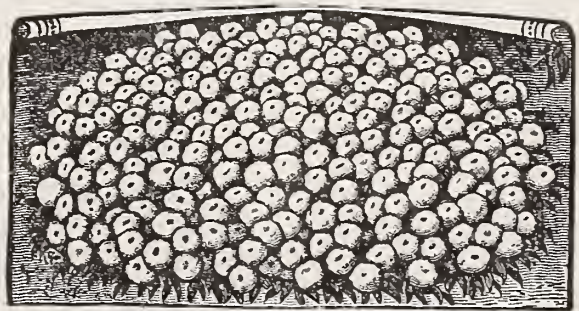

"Carpet of Snow" Alyssum.

A
L
Y
S
S
U
M

Alyssum

Free flowering plants for beds, edgings or rock-work, or winter blooming; the annual variety blooms all summer.

23 Little Gem. Of dwarf, compact habit, each plant covering a circle fifteen to thirty inches in diameter. It begins to bloom when quite small, and the plants are a solid mass of white from spring until late in autumn. Pkt. 5c., ¼ oz. 15c., oz. 50c.

24 Sweet Alyssum. White. Pkt. 5c., oz. 25c.

25 "Carpet of Snow". Pure white, grows only 2 or 3 inches high, very spreading. 5c. per kt., 50c. per oz.

26 Saxatile Compactum. Showy golden yellow flowers; hardy perennial, blooms the first season; one foot high. Pkt. 5c.

Anemone (Wind Flower.) A very pleasing hardy perennial, easily grown from seed, producing large flowers early in the spring; one foot high.

45 Coronaria, Mixed. Scarlet, purple, blue, white, strip'd. Pkt. 10c.

Antirrhinum (Snapdragon).



A most showy and useful border plant; large flowers of most brilliant colors, with beautifully marked throats; succeed in any good garden soil; very effective in beds;

hardy perennials, blooming first year if seed is sown early. One foot high.

48 Queen of the North. The finest of all Snapdragons, forms an excellent plant one foot high; each plant occupies a space of 1 to 1½ feet, and is densely covered with large white flowers. A beauty for beds and borders, also valu-



Antirrhinum or Snapdragon.

able for pot culture. Pkt. 10c., ¼ oz. 25c.

49 Dwarf Mixed. Finest Tom Thumb. Pkt. 5c., oz. 40c.

50 Tall Mixed. Pkt. 5c., per oz. 30c.

51 Imported Collections. Ten dwarf varieties, 40c.

52 Imported Collections. Ten tall varieties, 40c.

Asperula. A hardy annual, with clusters of small, sweet-scented flowers; one foot high.

108 Sweet Woodruff. A favorite German ingredient for flavoring wine or "Maitrank". Beautiful light blue flowers. Pkt. 5c., oz. 50c.

Auricula. A well-known favorite; seed saved from splendid varieties; half-hardy perennial, six inches high.

115 Mixed. Pkt. 20c.

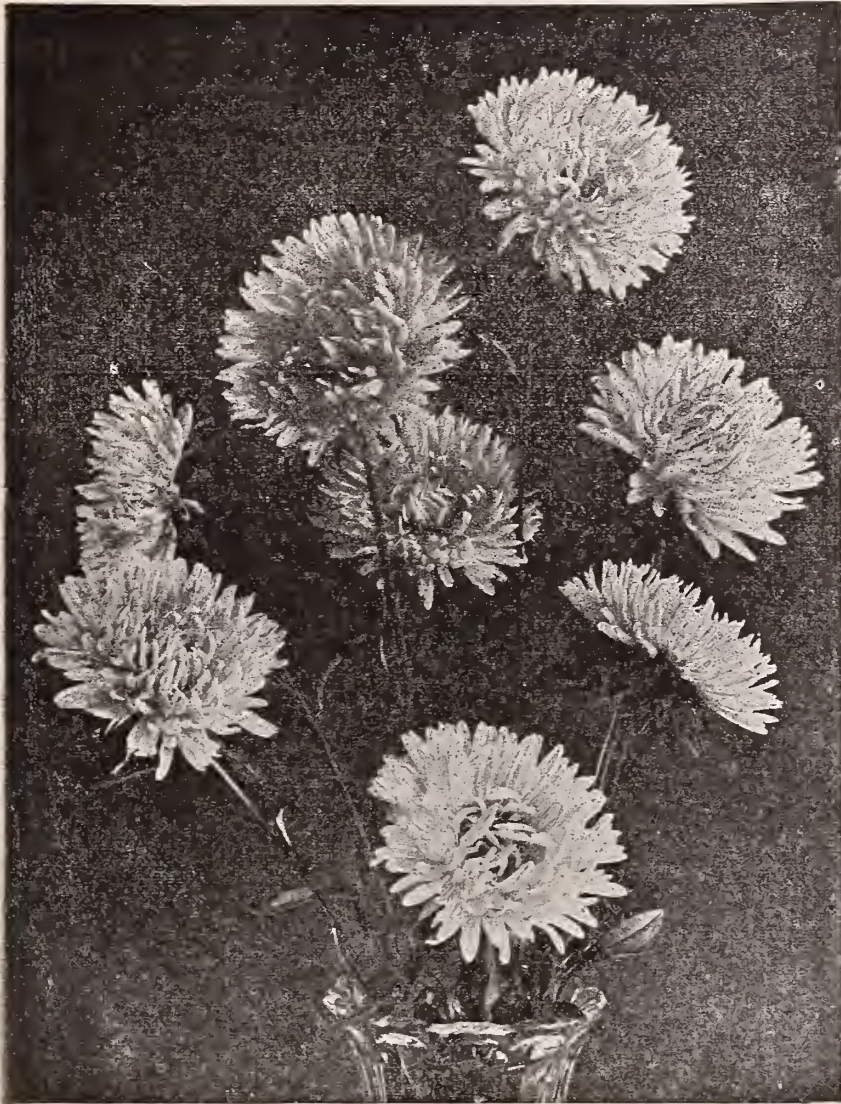

Branching Asters (Semple's True Strain) from a Photograph.

Asters (Queen Margaret)

There is no flower which combines so much beauty and variety of habit and shape, with such brilliancy and richness of color, as this; it is splendid for bedding, bordering or pot culture. Give it rich soil and plenty of water for the best results. The seed we offer has been saved from the very best double flowers only.

Semple's Branching Large Flowering. Without doubt the best garden aster, produces flowers of immense size on very long stems, which make them a most desirable cut flower.

- 88 Semple's Bright Red. Pkt. 10c., 1/8 oz. 30c.
- 89 " Pure White. Pkt. 10c., 1/8 oz. 30c.
- 90 " Shell Pink. Pkt. 10c., 1/8 oz. 30c.
- 91 " Lavender. Pkt. 10c., 1/8 oz. 30c.
- 92 " Blue. Pkt. 10c., 1/8 oz. 30c.
- 87 " Choicest Mixed. Pkt. 10c., 1/8 oz. 30c., oz. \$2.00.

Improved Victoria Asters.

- 63 Blue pkt. 10c. 1/8 oz. 30c. | 66 Scarlet pkt. 10c. 1/8 oz. 30c.
- 64 Pink " 10c. " 30c. | 67 Purple " 10c. " 30c.
- 65 White " 10c. " 30c. | 68 Finest Mixed. " 10c. " 30c.
- 70 Dwarf Pyramidal Bouquet. The plants form a complete bouquet of flowers. Mixed, one foot high. Pkt. 10c.
- 71 Cocardeau or Crown. With white centres, bordered with bright rich colors. Pkt. 10c.
- 76 Vick's White Branching. Very long stems, pure white, four inches in diameter. The blooms have the appearance of large and graceful Chrysanthemums. Pkt. 10c., 1/8 oz. 30c.
- 80 Perennial Mixed. Hardy, herbaceous plants. Pkt. 10c.
- 81 Aster—Mignon Mixed. Semi dwarf; bear, when well grown, forty to fifty flowers of a beautiful shape. Pkt. 10c.
- 82 Mignon, Pure White. Pkt. 10c., 1/8 oz. 30c.
- 83 Yellow Betteridge's Quilled. The flowers being quilled and very double show the most clearly pronounced yellow among asters. Pkt. 10c., 3 pkts. 25c.

Comet Asters



Jewel or Ball Shaped Asters.

A new and most beautiful class, obtained from the well-known "Pæony Perfection," forming perfectly round flowers.

- 93 Sky or Light Blue, pkt. 10. | 94 Reddish Violet, pkt. 10c.
- 95 Pure White, pkt. 10c. | 96 Bright Pink, pkt. 10c.
- 97 Brilliant Scarlet, pkt. 10c. | 98 Mixed, all colors, pkt. 10c.

One pkt. of each of the above, 6 pkts. in all, 50c.

Truffaut's Prize Asters.

Improved Pæony-Flowered. Very double, large and finely shaped, the petals beautifully incurved. Considered the finest aster for garden or for cutting. One and a half feet.

- | | | | | | |
|-------------------------|-------------------|------|--------------------------------------|-------------------|------|
| 56 Pure White | Pkt. 1/8 oz. 10c. | 30c. | 59 Glowing Crimson Scarlet | Pkt. 1/8 oz. 10c. | 30c. |
| 57 Light Blue | 10 | 30 | 60 Finest Mixed | 10 | 30 |
| 58 Pink | 10 | 30 | 61 Purple Violet | 10 | 40 |

Comet Asters.

A very handsome class, resembling the popular Japanese Chrysanthemum.

- 72 Pink and White. Pkt. 10c. | 44 Pure White Giant. Pkt. 10c.
- 1100 Rich Carmine. Pkt. 10c.
- 1101 Blue. Pkt. 10c.
- 1102 Peach Blossom. Pkt. 10c.
- 46 Choicest Mixed. All colors. Pkt. 10c., 30c. per 1/8 oz.
- 73 Dwarf Chrysanthemum-Flowered. Mixed. Pkt. 10c.
- 74 Dwarf Queen. Choicest mixed. Pkt. 10c., 1/8 oz. 30c.
- 75 Triumph. The color is peculiarly brilliant, pure scarlet. Each plant bears at least thirty to forty flowers of exquisite beauty. Pkt. 10c., 3 pkts. 25c.
- 78 German Quilled, Mixed. Perfectly double quilled flowers of beautifully mixed colors; two feet high. Pkt. 5c., 1/4 oz. 30c.
- 79 China or German, Mixed. Pkt. 5c., oz. 60c.

Queen of the Market Extra Early Asters.

Very choice class. About three weeks earlier than any other class.

- 39 Pure White. Pkt. 10c. | 40 Rich Pink. 10c. per pkt.
- 41 Bright Scarlet. Pkt. 10c. | 42 Blue, all shades. 10c. per pkt.
- 43 Choicest Mixed, all colors, 10c. per pkt., 30c. per 1/8 oz.

One pkt. of each of these, 6 pkts. in all, 50c.

New Half Dwarf Multiflora or Paris Asters.

We cannot recommend these too highly for free flowering and most satisfactory asters, either for cutting or garden bedding.

- 1106 White. Pkt. 10c. | 1108 Blue. Pkt. 10c.
- 1107 Rich Pink. Pkt. 10c. | 1109 Rich Scarlet. Pkt. 10c.

IMPORTED COLLECTIONS OF ASTERS.

- 84 Finest Quilled. Ten varieties, 50c.
- 85 Truffaut's Pæony Perfection. Twelve varieties, 75c.
- 86 Victoria. Eight colors, each separate, 50c.
- 77 Pictorial collection of 10 best classes, each variety separate, 50c.

Aquilegia (Columbine.)

- 100 **Chrysantha** (*Golden Spurred*). Strong grower, forming bushy plants three feet high, bearing all through the season an abundance of bright golden yellow flowers. Pkt. 10c.
 101 **Cœrulea**. Flowers are very large, violet blue, and inner petals pure white; two feet high. Pkt. 10c.
 102 **Single**. All colors mixed. Pkt. 5c., oz. 30c.
 103 **Double**. All colors mixed. Pkt. 5c., oz. 40c.



Balsam (*Lady Slipper or Touch-Me-Not.*)

- Improved Camelia-Flowered**. Very choice strain.
 123 **White Perfection**. Very double. Pkt. 10c., oz. \$1.00.
 124 **Pink**. Very double. Pkt. 10c., oz. \$1.00.
 125 **Scarlet**. Very double. Pkt. 10c., oz. \$1.00.
 126 **Mixed**. Choicest. Pkt. 10c., oz. \$1.00.
 127 **Mixed**. Very fine. Pkt. 5c., oz. 50c.
 129 **Collection**. Six varieties, each separate. Pkt. 30c.
-
- 120 **Balloon Vine**. A favorite climber. Pkt. 5c., oz. 20c.
 121 **Balsam Apple**. Very useful. Pkt. 5c., oz. 25c.
Beans. Very rapid climber; flowering profusely, and admirably adapted for covering screens, etc.
 138 **Scarlet Runner**. Fiery Scarlet. Pkt. 5c., pt. 20c.
 139 **White Runner**. Pure white. Pkt. 5c.
Bidens (*Dahlia Zimapani*). A free flowering tender annual, having beautiful foliage and bearing fine and attractive flowers. One foot high.
 159 **Atrosanguina**. Rich dark crimson, with yellow anther. Pkt. 10c.
Brachycome (*Swan River Daisy*). Free flowing plants, covered during the greater part of summer with a profusion of pretty Cineraria-like flowers. Half hardy annual.
 163 **Iberidifolia Mixed**. Light blue and white. Six inches high. Pkt. 5c.
Beet. The ornamental-leaved beets are most useful for planting in ribbon beds or in groups.
 155 **Red Chilian**. Brilliant red foliage. Pkt. 5c., oz. 15c.
 156 **Yellow Chilian**. Golden yellow. Pkt. 5c., Oz. 15c.
Browallia. One of our favorite bedding plants, covered with rich, beautiful flowers during the summer and autumn months, growing freely in any rich soil; blooms finally in winter if sown in August. Half hardy annuals, eighteen inches high.
 170 **Elata Grandiflora Cœrulea**. Large sky-blue flowers, with a white centre. Pkt. 5c.

TUBEROUS



BEGONIA

Begonia (*Tuberous-Rooted Varieties.*)

- 153 **Choicest Strain**. Single Mixed. Pkt. 15c.
 144 **Double Mixed**. Choicest strain. Pkt. 25c.
 145 **International Prize**. Saved from best English, French and German tuberous-rooted varieties. Pkt of about 500 seeds. 25c.



Begonia Vernon.
Begonia.

- 142 **Vernon** (*Semperflorens*). A remarkably effective variety, with rich orange carmine flowers and bronze colored foliage. Very effective for bedding, being covered with bloom from May until late in the autumn. Pkt. 10c., 30c. per $\frac{1}{8}$ oz., containing over 5,000 seeds.
 149 **Queen of Carpet Bedders**. A dwarf variety of the well-known Begonia Vernon. Grows only five inches high, forming compact, round plants, with bright red flowers and dark leaves, a most effective plant for carpet beds, etc. Pkt. 15c., 4 pkts. 50c.
 140 **Crimson Gem**. The most brilliant variety; flowers deep, rich red, foliage bronzy crimson; very effective for bedding. Per pkt. 15c.
 141 **Duchess of Edinburgh**. White, suffused with blush pink; very large flowers. Excellent for bedding. Per pkt. 15c.
 147 **Erfordi**. Beautiful variety. Pkt. 15c.

Campanula (*Canterbury Bells*)

- 199 **Choice Mixed Double**. Pkt. 5c., 50c. per oz.
 200 **Choice Mixed Single**. Pkt. 5c., 30c. per oz.
 201 **Cup and Saucer** (*Calycanthema*). Most beautiful varieties; choice mixed. Pkt. 10c.

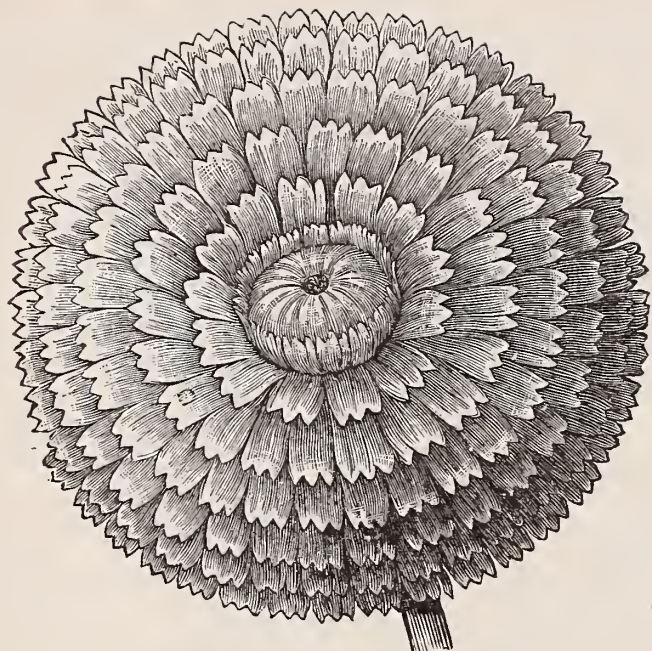

Calendula (*Pot Marigold*.)

Showy, free-flowering, hardy annuals, growing in any good garden soil, producing a fine effect. One foot high.

- 175 **Grandiflora** (New). Beautiful large double yellow flowers. Pkt. 5c., oz. 30c.
- 176 **Meteor**. A splendid variety. Pkt. 5c., oz. 20c.
- 177 **Prince of Orange**. This novelty surpasses the Calendula Meteor; the stripes around each petal are of a deep orange color, making a brilliant appearance. Pkt. 5c., oz. 30c.
- 178 **Sulphurea**. Double. Very handsome sulphur yellow. Pkt. 5c., oz. 40c.
- 180 **Orange King** (New). Very large double, rich dark orange. Pkt. 5c.

Canna (*Indian Shot Plant*).

- 206 **Madam Crozy**. Large red with yellow border. Pkt. 5c., oz. 20c.
- 209 **A. Bouvier**. Rich crimson. Pkt. 5c., oz. 20c.
- 210 **Chas. Henderson**. Bright scarlet. Pkt. 5c., oz. 20c.
- 211 **Florence Vaughan**. Best yellow. Pkt. 5c., oz. 20c.
- 207 **Crozy's New Dwarf**. Choicest mixed. Pkt. 5c. oz. 20c.

Canary Bird Flower

(*Tropæolum Peregrinum* or *Canariense*.)

196

One of the most charming climbers, bearing an abundance of bright yellow-fringed flowers. Pkt. 10c.

C
A
L
L
I
O
P
S
I
S



Calliopsis Golden Wave.

Calliopsis or Coreopsis

- Showy and useful free-flowering plants, of easy cultivation. Hardy annuals.
- 224 **Golden Wave**. A very showy sort, with large yellow flowers, two inches in diameter. Pkt. 5c., oz. 30c.
 - 225 **Lanceolata**. A hardy perennial sort, bearing large flowers of a golden yellow color. Pkt. 10c., oz. 75c.
 - 226 **Mixed**. All the choicest kinds. Pkt. 5c., oz. 25c.
 - 228 **Nigra Speciosa**. Rich crimson. Pkt. 5c.

C
O
R
E
O
P
S
I
S



Giant Empress Candytuft.

Candytuft (*Iberis*.)

- 183 **Empress or Snow Queen**. A complete mass of pure white flowers; immense size. Pkt. 10c., oz. 40c.
- 184 **White Rocket** (*Amara*.) Large trusses of pure white flowers. Pkt. 5c., oz. 20c.
- 185 **White Tom Thumb**. Grows six inches high and forms a round bush about sixteen inches in diameter, covered with large white flower-heads of great substance. Pkt. 5c., oz. 50c.
- 186 **Fine Mixed**. All the above tall growing varieties; one foot high. Pkt. 5c., oz. 15c.
- 187 **Sempervirens**. A profuse white blooming hardy perennial; one foot high. Pkt. 10c.
- 188 **Collection of Six Annual Sorts**. Pkt. 25c.

Castor Oil Bean

(*See Ricinus*.)

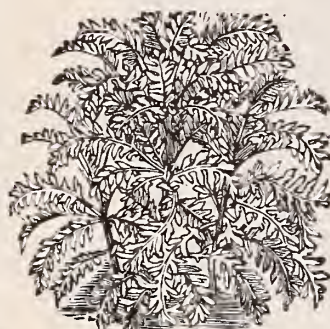

Centaurea Gymnocarpa.



Centaurea Candidissima.

Centaurea (*Ornamental Foliage Sorts*.)

- 249 **Gymnocarpa**. Fine cut, silvery gray foliage. Pkt. 10c., 500 seeds 25c., 1000 seeds 40c.
- 250 **Candidissima**. Splendid silvery, broad-cut leaves; one foot high. Pkt. 10c., 1000 seeds 50c., 500 seeds 30c.

Coreopsis

[*California Sunbeams*].

227 **Lanceolata Grandiflora**.

These lovely improved varieties are much larger than any heretofore offered; the flowers are beautifully formed: some saucer-shaped, others flat, some exquisitely incurved, while others are like great buttercups. The petals are broad, with irregularly fringed edges. Some are very light yellow, others a deeper shade, darker around the eye. Pkt. 10c.



MARGUERITE



Marguerite Carnation.
Carnation

CARNATIONS

- 231 **Marguerite.** A very beautiful class of Carnations. May be grown as an annual, the plants commencing to bloom four months after sowing in the open ground, and continuing to bloom with increasing profusion as the plants increase in size. If seed is sown in April plants commence to bloom in August. The flowers are very double and beautifully fringed, and have the sweetest and most agreeable perfume. Choicest mixed; all colors. Pkt. 10c., 1/8 oz. 50c.
- 232 **Marguerite, Double, Pure White.** Pkt. 15c.
- 238 **Marguerite, Double, Yellow (New).** Distinct. Pkt. 15c.
- 234 **Finest German.** Mixed. Pkt. 25c.
- 235 **Very Early Vienna.** Mixed. Pkt. 10c.
- 236 **Fine Mixed.** Pkt. 10c.

Calceolaria

- An ornamental plant, and a universal favorite for decorating the greenhouse or conservatory.
- 218 **James' Superb Strain.** Superfine mixed. Pkt. 50c.
- 214 **Hybrida Grandiflora, Tall, Mixed.** Large flowering, completely covered with beautiful, rich, self-colored flowers; saved from choice collections; all colors. Pkt. 25c.
- 216 **Hybrida Grandiflora Pumila Compacta.** Dwarf, compact, robust growth, producing immense trusses of large and varied brilliant self colored and spotted flowers. 1 foot high. Pkt. 40c.
- 217 **Rugosa, Mixed (Shrubby).** For bedding; the finest colors. Pkt. 50c.
- 215 **Sutton's "Perfection".** Very choice mixed. Per orig. pkt. 75c.

Castor Oil Bean (See Ricinus.)

Coreopsis (See Calliopsis.)

- 254 **Centrosema Grandiflora.**
(Butterfly Pea)



Centrosema

A hardy perennial vine of rare and exquisite beauty, and absolutely new to cultivation. It blooms in June from seed sown in April, and bears profusely large, inverted, pea-shaped flowers, ranging in color from rosy violet to purple with a broad, feathered, white marking through the centre; while the large buds and back of the flowers are pure white, the stem and foliage are very graceful and of a delightful odor. It is well adapted for every garden purpose, and especially as a climber, running six to eight feet in a season. Pkt. 10c., 3 pkts. 25c.



CINERARIA.

Michell's Giant
Prize Cineraria.

- 279 **Dwarf Giant Prize.** Mixed; all colors; best sort as a pot plant. Pkt. 35c.
- 280 **Tall Giant Prize.** Mixed; desirable to grow as a decorative plant, also for cutting. Pkt. 35c.
- 278 **James' Giant Strain.** Half dwarf, mixed. Pkt. 50c.
- 276 **Prize Crimson.** Half dwarf. Pkt. 40c.
- 277 **Prize White.** Half dwarf. Pkt. 40c.
- 285 **Prize Blue.** Half dwarf. Pkt. 40c.
- 281 **Dwarf Mixed.** Flowers not quite as large as the "Prize". Pkt. 25c.
- 297 **Sutton's "Superb".** Mixed colors, extra large, fancy. Pkt. 60c.
- 282 **Tall Mixed.** Same as above, but taller in growth. Pkt. 25c.
- 283 **Choicest Double Mixed.** Beautiful. Pkt. 50c.
- 284 **Maritima Candidissima.** White foliage, for borders. Pkt. 10c.



Cypress
Vine

A favorite climbing vine

- 293 **White** Pkt. 5c.,
oz. 25c.
- 294 **Scarlet.** Pkt. 5c.,
oz. 25c.
- 295 **Mixed.** Pkt. 5c.,
oz. 25c.

Cypress Vine.

Chrysanthemum

(Paris Daisies or Marguerites.)
Showy and effective garden favorites, extensively grown for cut flowers.



Painted Daisy Chrysanthemum.

- 269 **New Large White "Perfection".** Flowers nearly 5 inches across, beautiful. Pkt. 15c., 2 pkts. 25c.
- 271 **Burridgeanum Eclipse.** Crimson with white edge, and inner white circle. Pkt. 5c.
- 272 **Frutescens Grandiflorum.** The popular White Paris Daisy. Pkt. 10c.
- 273 **Segetum Grandiflorum.** Yellow Paris Daisy. Pkt. 10c.
- 270 **Choiced Mixed.** All colors. Pkt. 5c.
- 275 **Large Flowering Autumn Varieties.** Including Japanese and Chinese. Pkt. 15c.



New Dwarf Early Flowering Cosmos.

COSMOS

An autumn flowering plant. The large flowers are born profusely, and present a charming appearance when the plants are in full blossom as they wave to and fro in every passing breeze. Seed should be sown early in spring and the plants transplanted in the open border when danger from frost is past. If young plants are starved a little it will have the effect of bringing them into bloom earlier.

- 257 "Dawn". (New dwarf, early flowering). Starts blooming in July and remains in bloom until killed by frost. The color is white tinted with pink, grows only about four feet high. Pkt. 10c., 3 pkts. for 25c.
- 256 Large-flowering Fringed. Most exquisite and perfect flowers with petals overlapping. Of the most lovely of all the varieties. Per pkt. 15c., 2 pkts. for 25c.
- 262 Camelliaflora. White, pink and red; mixed; splendid varieties, with very large overlapping petals of great substance, resembling Single Camellias, but much larger, more beautiful; very chaste and lovely. Per pkt. 15c., 2 pkts. 25c.
- 264 Single Dahlia, Flowered. Crimson Splendid flowers of the deepest, richest shade; very large, resembling Single Dahlias in shape. The contrast between the brilliant red flowers and rich green of the foliage is very striking. Pkt. 15c., 2 pkts. 25c.
- 263 Tints of Dawn. New, distinct varieties. Flowers have a white ground, finely flecked or flushed a delicate pink; very beautiful. Per pkt. 15c., 2 pkts., 25c.
- 258 Mammoth flowering Pure White. Pkt. 10c., 1/4 oz. 25c., oz. 75c.
- 259 " " Pink Shades. " " " " "
- 260 " " Rich Crimson. " " " " "
- 255 " " Yellow. Pkt. 10c., 3 pkts. for 25c.
- 265 " " Orange Yellow (Novelty). 15c. per pkt.; 2 pkts. for 25c.
- 261 " " Choicest Mixed of all colors. 5c. per pkt., 20c. per 1/4 oz., 60c. per oz.
- 266 " " Fancy Varieties. Mixed of all largest flowers. 10c. per pkt., 30c. per 1/4 oz.



Giant Empress Celosia.
CELOSIA OR COCKSCOMB.

- 219 Glasgow Prize or Pres. Thiers. Pkt. 10c.
- 220 New Giant Empress. Pkt. 10c.
- 221 Plumosa (Feathered). Dwarf scarlet. Pkt. 10c.
- 222 Choice Mixed. Pkt. 10c.
- 223 "All Aglow". Extra large heads, most beautiful scarlet color. Pkt. 10c.
- 230 "Paris Pink Comb". Very desirable and showy. Pkt. 10c.
- 225 Sutton's Prize Dwarf Scarlet Comb. Pkt. 35c.



Cobaea Scandens.
COBÆA SCANDENS.

A climber of rapid growth, flowering the first season if sown early in the house or hotbed. In sowing place the seeds edgewise and merely cover them with light soil.

- 305 Purple. Pkt. 10c., oz. 60c.
- 306 White. Pkt. 15c.

COLEUS.

- 244 Choicest Selection. Mixed. Pkt. 25c.



CENTAUREA (Cyanus).

- 286 Yellow (*Suaveolens*). Pkt. 5c., oz. 25c.
- 287 Emperor William, Single Blue. Pkt. 5c., oz. 60c.
- 288 Pure White. Pkt. 5c., oz. 30c.
- 292 Pink. Large flowering. Pkt. 10c., oz. 50c.
- 289 Choice Mixed. All colors. Pkt. 5c., oz. 25c.
- 290 Double Blue. Pkt. 10c., 1/4 oz. 35c.
- 291 New Dwarf Mixed. Pkt. 10c.
- 296 "Margarita". New mammoth flowering Corn Flower. The blooms which are snow white measure 3 to 4 inches across and are very fragrant. Pkt. 10c.

MORNING GLORY



COPYRIGHTED 1895 BY A. BLANC

Convolvulus Major.

Climbing Varieties.

- 326 Single. All colors mixed. Pkt. 5c., oz. 10c.
- 327 Collection of Morning Glory. Ten varieties, 40c.
- 530 New Double. All colors mixed. Pkt. 10c.
- 524 New Imperial Japanese, large Flowering Morning Glory.

Exceedingly vigorous in growth, decorative in foliage. The flowers are nearly always of immense size, frequently six inches across, and mostly all of entirely new colors, such as ashy grays, bronzy reds, browns, shades of sea green, blues bordered with red, purples marbled with black, whites spotted with blue, flamed streaked, marbled, fringed edges and all of incomparable beauty. Pkt. 10c., 3 pkts. 25c., 75c. per oz.



Giant
Cyclamen

Cyclamen Giganteum

Beautiful mottled leaves, broad petals and stout flower stalks.

- 309 **Rubrum.** Red. Pkt. 35c., 100 seeds \$1.25.
- 310 **Album.** White. Pkt. 35c., 100 seeds \$1.25.
- 311 **Roseum.** Pink. Pkt. 35c., 100 seeds \$1.25.
- 312 **Mixed.** Pkt. 25c., 100 seeds \$1.00.
- 314 **Persicum.** Choice mixed. Pkt. 10c.
- 313 **Sutton's Giant.** Choicest mixed. 60c. per orig. pkt.
- 315 **Sutton's Giant.** Collection of six best named sorts \$2.50.

Clematis. Soak the seed in warm water for twenty-four hours before sowing; hardy perennials; fifteen feet high.

265 **Flammula** (*Virgin's Bower.*) Producing beautiful clusters of small, white, fragrant flowers. Pkt. 10c.

266 **Jackmani Type.** Large flowering, mixed. Pkt. 20c.

CLEOME Pungens (*Giant Spider Plant.*) Singular-looking rose-colored flowers; the stamens look like spiders' legs, and present a very attractive appearance; annual; three feet. Pkt. 5c.



Dahlia

Tuberous-rooted half-hardy perennials; blooming the first year from seed if sown early. Protect the roots during winter in a dry cellar in sand.

330 **Large-Flowering Double.** Saved from the finest flowers. Mixed. Pkt. 10c.

332 **Collection of Six Sorts.** Each separate. Single 50c.

333 **Tom Thumb.** (*Single.*) New varieties in beautiful mixed colors; a highly interesting class of neat, compact and dwarf habit, growing about one foot in

Single Dahlias from Seed.

height, very free flowering, invaluable for cutting purposes. They bloom the first season from spring sown seeds. Pkt. 10c.

334 **Giant** (*Single.*) Very large flowers, all colors, mixed. 15c.

Datura (*Trumpet Flower.*) In large clumps and borders of shrubbery they produce an excellent effect, flowering the first year from seed if sown early. Half-hardy perennials, 3 feet high.

344 **Double Golden.** Pkt. 5c.

345 **Double Mixed.** Pkt. 5c.

346 **Brugmansia.** Large white fragrant trumpets. Pkt. 15c.

347 **Cornucopia Variegated.** (*New.*) Pkt. 10c., 3 pkts. 25c.



Japan Double Dianthus.

PINKS

Dianthus (*Pinks.*)

Classed among the most popular flowers in cultivation, producing a great variety of brilliant colors and profusion of bloom.

- 357 **Extra Double China.** Choice mixed. Pkt. 5c., oz. 30c.
- 358 **Choicest Double Diadem or Japan.** Mixed colors. Pkt. 10c., oz. \$1.50.
- 359 **Large-Flowered Fringed.** Pkt. 10c.
- 360 **Double Pure White.** Pkt. 5c., oz. 50c.
- 361 **Extra Double Scotch.** Hardy. Pkt. 15c.
- 362 **Single Pheasant's Eye.** Hardy. Pkt. 5c.
- 363 **Garden or Clove Scented.** Mixed. Pkt. 10c.
- 364 **Collection of China and Japan Dianthus.** Twelve varieties, each color separate. Pkt. 40c.

Dianthus

Single Sorts

- 368 **Eastern Queen.** Beautifully marbled. Pkt. 10c.
- 369 **Crimson Belle.** Crimson, very large, finely fringed. Pkt. 10c.
- 371 **Salmon Queen** (*New.*) Pkt. 10c.
- 370 **Choicest Mixed Single.** Large flowering. Pkt. 10c.

Daisy (*Bellis Perennis.*)

The seed is saved from the finest double varieties. Daisies can be easily raised from seed sown in the spring.



Single Pinks.

338 **Snowball.** A large and very double pure white daisy of the "Longfellow" type. The flowers are borne on long stems, and are excellent for cutting. Pkt. 10c.

339 **Longfellow.** Of unusual size, very double dark rose flower. Pkt. 10c.

340 **Mixed.** Very choice. Pkt. 10c.

Digitalis (*Foxglove.*) A handsome and highly ornamental hardy perennial.

353 **Monstrosa** (*Mammoth Foxglove.*) The largest and best type; all colors mixed. Pkt. 10c.

354 **Gloxinaeflora.** Gloxinia-shaped flowers. A lovely type; all colors mixed. Pkt. 5c.

Delphinium (*Perennial Larkspur.*) Sow very early in spring or in August and September.

373 **Formosum.** Beautiful spikes of brilliant rich blue flowers with a white centre. Thirty inches high. Pkt. 10c.

374 **Nudicaule.** Spikes of bright scarlet flowers. Pkt. 10c.

376 **Zalil.** Beautiful sulphur yellow. Pkt. 10c.

375 **Hybrid Mixed.** Pkt. 10c. See also Larkspur.

379 **Dictamnus** (*Fraxinella.*) A hardy perennial, fragrant, free-flowering, herbaceous plant. Pkt. 10c.

380 **Dracæna Indivisa.** For vases. Pkt. 10c., oz. 60c.



Helichrysum (Straw Flower).

⌘
Straw
Flowers
⌘

Everlastings

- 383 **Acroclinium.** Double-flowering. Pkt. 10c.
- 384 **Acroclinium.** Single-flowering. Pkt. 5c.
- 385 **Ammobium Alatum Grandiflorum.** Pkt. 5c.
- 390 **Helichrysum Monstrosum.** Choice mixed. Pkt. 5c.
- 391 **Rhodanthe.** Choice mixed. Pkt. 5c.
- 392 **Statice Suworowi.** Pkt. 10c.
- 393 **Xeranthemum Superb. Fl. Pl.** Mixed. Pkt. 10c.
- 394 **Collection** as above, one pkt. each for 40c.

⌘
California
Poppies
⌘



Eschscholtzia (California Poppy).

- 407 **Golden West.** Magnificent large orange flowers measuring 4 to 6 inches across. 15c per pkt., 2 pkts. for 25c.
 - 402 **Orange** (Hardy annual). Pkt. 5c., oz. 20c. | 401 **White.** Pkt. 5c.
 - 403 **Mandarin.** Hardy annual. Pkt. 10c.
 - 404 **Cardinal Rose.** Hardy annual. Pkt. 10c.
 - 405 **Choice Mixed.** Hardy annual. Pkt. 5c., oz. 25c.
 - 406 **New Giant "Hunnemania".** Yellow, 2½ feet. Pkt. 15c.
-
- 397 **Eupatorium (Fraseri).** Hardy perennial, white flowers. Pkt. 10c.
 - 414 **Fern Seed.** Choice mixed. Pkt. 15c.
 - 415 " " **Adiantum** (Maiden Hair). Mixed. 15c. per pkt.
 - 409 **Euphorbia [Variegated Snow on the Mountain].** Attractive foliage, with white and green bracts on the tips of each branch, veined and margined with white. Pkt. 5c.
 - 410 **Heterophylla [Mexican Fire Plant, Painted Leaf].** Pkt. 5c.
 - Feverfew [Matricaria Eximia].** Free-flowering herbaceous plants succeeding in any garden soil; hardy annual eighteen inches.
 - 413 **Grandiflora, Double White [M. Eximia].** Pkt. 10c.
 - 422 **Freesia [Refracta Alba].** Very easily grown bulbs which can be readily produced from seed. The flowers are pure white with yellow throat, and are exquisitely fragrant. Pkt. 10c.
 - Foxglove.** [See *Digitalis*.]
 - Forget-Me-Not.** [See *Myosotis*.]
 - 426 **Fuchsia [Lady's Ear Drop].** Mixed. All colors. Pkt. 15c.



G
A
I
L
L
A
R
D
I
A

Gaillardia

Splendid bedding plants, continuing in beauty during the summer and autumn; half-hardy annuals.

- 451 **Picta Mixed.** Pkt. 5c., oz. 20c.
- 452 **Picta Lorenziana.** Called the double variety on account of the fullness of the flower. Pkt. 5c., oz. 60c.
- Hardy Perennial Gaillardias.** Will bloom the first season if sown early.
- 454 **"James Kelway," New Perpetual Blooming.** A beautiful giant flowering Gaillardia from Europe, with magnificent flowers, measuring five or six inches across, of the brightest scarlet, with a golden margin and fringed edges. A most persistent and perpetual bloomer. Pkt. 15c., four pkts. 50c.
- 453 **Grandiflora Superba.** The most beautiful of all the Gaillardias; choice mixed, all colors. Pkt. 10c., oz. 75c.

- 433 **Geranium—Zonale, Mixed.** A superb strain of the largest and finest varieties; mixed colors. Pkt. 10c.
- 434 **Apple Scented.** Sow in light soil, and keep moist until they germinate. Pkt. 10c.
- 436 **Gentiana [Blue Gentian].** A charming hardy perennial. Pkt. 10c.
- Gomphrena [Globe Amaranth Bachelor Button].**
 - 386 **White.** Pkt. 5c.
 - 387 **Orange.** Pkt. 5c.
 - 388 **Red. Nana Compacta.** Suitable for bedding. Pkt. 5c.
 - 389 **Mixed.** Pkt. 5c.
- Gesneria.** A beautiful hothouse, bulbous-rooted plant, producing brilliant colored flowers; requires a light, rich soil.
- 439 **Mixed.** Pkt. 25c.
- Glaucium [Horn Poppy].** An ornamental foliage plant, recurved, silvery leaves, deeply cut to the rib. Flowers are orange yellow, bell-shaped and drooping; hardy biennial, two feet high.
- 447 **Corniculatum.** Pkt. 5c., oz. 50c.
- Golden Feather.** [See *Pyrethrum*.]
- Godetia.** An attractive hardy annual. The plants bloom profusely, and bear showy flowers of rich and varied colors.
- 473 **Choice Mixed.** Pkt. 5c.
- 474 **Gloriosa (New).** Satiny blood red. Pkt. 10c.
- Gourd [Cucurbita].**
 - 477 **Calabash [The Dipper].** Pkt. 5c.
 - 478 **Hercules' Club.** Club-shaped. Pkt. 5c.
 - 479 **Egg-Shaped.** Fruit white like an egg. Pkt. 5c.
 - 480 **Orange-Shaped, or Mock Orange.** Pkt. 5c.
 - 481 **Luffa [Dish Rag or Bonnet Gourd].** Pkt. 10c.
 - 482 **Tricosanthes [True Serpent Gourd].** Pkt. 5c.
 - 483 **Fine Mixed.** From a large collection. Pkt. 5c., oz. 20c.



G
L
O
X
I
N
I
A

Gloxinia. (*Grassifolia Grandiflora.*)

- 442 **International Mixture.** The best strain in existence, embracing all the choicest self and tigered flowers. Pkt. 25c.
- 444 **Queen Victoria.** Best pure white. Pkt. 20c.
- 445 **Scarlet Queen.** Best bright scarlet. 20c. per pkt.

- 485 **Grevillea Robusta.** A very beautiful and graceful decorative plant with fernlike foliage; excellent for decorations. Pkt. 10c.
- 489 **Gypsophila.**
Paniculata. White flowers, beautiful for bouquets, imparting a light, airy appearance; hardy perennial; 2 feet. Pkt. 5c.

Hyacinth Bean—(Dolichos.)

- A rapid growing plant for covering arbors, trellises, etc.
- 519 **Mixed.** All colors. Pkt. 5c., oz. 10c.

Ipomœa (Large Morning Glory.)

- 524 **New Imperial, Mixed.** Pkt. 10c., 3 pkts. 25c.
- 526 **Grandiflora Superba.** Large blue flower, with broad white border. Pkt. 5c., oz. 20c.
- 528 **Mixed.** All colors. Pkt. 5c., oz. 15c.
- 527 **Noctiflora. (Moon Flower).** Pkt. 10c., oz. 60c.

Grasses—Ornamental.

- Cut when in full bloom, tie in small bunches and hang up in a dry, dark place, with heads down. Sow in May and transplant.
- 459 **Arundo Donax (New Zealand Pampas).** Pkt. 10c.
 - 460 **Avena Sterilis (Animated Oats).** Pkt. 5c.
 - 461 **Briza Maxima (Quaking or Rattlesnake Grass).** Pkt. 5c.
 - 462 **Bromus Brizaeformis.** Pkt. 5c.
 - 463 **Coix Lachrymæ (Job's Tears).** Pkt. 5c.
 - 464 **Eulalia Japonica.** Pkt. 5c.
 - 465 **Gynerium Argenteum (Pampas Grass).** Pkt. 10c.
 - 466 **Hordeum Jubatum (Squirrel Tail).** Pkt. 5c.
 - 467 **Pennisetum Longistylum.** Pkt. 5c.
 - 468 **Stipa Pennata (Feather Grass).** Pkt. 10c.
 - 469 The above collection, one pkt. of each, 50c.

Heliotrope.

- Seeds sown in the spring will make fine plants for summer blooming.
- 514 **Giant Hybrids Lemoines.** Produces extra large flower spikes in abundance. Pkt. 15c., 2 pkts. 25c.
 - 515 **Mixed.** Pkt. 10c. | 516 **Collection of six sorts.** Pkt. 40c.

Helianthus or Sunflower.



Oscar Wilde Sunflower.

- 498 **Stella (New).** Very large single flowers. Pkt. 10c.
- 493 **Oscar Wilde.** Single yellow with black centre. Pkt. 5c.
- 494 **Dwarf Double.** Pkt. 5c.
- 495 **Cucumerifolius Single.** Pkt. 5c.
- 496 **Double Globe.** Pkt. 5c.
- 497 **Mammoth Russian.** Pkt. 5c., qt. 10c.

Hibiscus

- Showy ornamental plants for mixed beds or shrubby borders.
- 501 **Palustris.** Large pink flowers; hardy perennial; three feet high. Pkt. 5c.
 - 502 **Crimson Eye. (New).** Pkt. 10c.

Impatiens Sultani

- 523 Of compact neat habit of growth, and almost a perpetual bloomer. The flowers are of a brilliant rosy-scarlet color, about one and one-half inches in diameter. Pkt. 15c.
- 522 **Impatiens Hybrida.** Choicest mixed of all colors. Pkt. 20c.

Hollyhock.

FRINGED PERPETUAL BLOOMING "ALLEGHENY".

- Blooms the first season from seed if sown early. Its points of merit are: The novel shape of the flower and the fringed edges, and its large size, from 5 in to 7 in. diameter. In addition hereto the color is something fine, and the appearance of the petals convey the idea that they were made of crushed silk, on account of the delicate colors. The immunity from disease is a good point, and the fact that at each axil are 3 to 4 buds, which all develop, is also a good point; this prolongs the blooming season. They come 90 per cent. true from seed.
- No. 510. Choicest mixed of all colors. 15c. per pkt., 4 pkts for 50c.
 - No. 513. Beautiful pink. 20c. per pkt.
 - No. 514. Rich scarlet. 20c. per pkt.
 - No. 515. Maroon. 20c. per pkt.

Hollyhock.

Chater's Improved Double.

- Our seed has been saved from the best-named varieties. Seed sown in June and July will flower the following summer; hardy.
- 504 **Pink. Extra Double.** Pkt. 10c., ¼ oz. 40c., oz. \$1.25.
 - 505 **White. Extra Double.** Pkt. 10c., ¼ oz. 40c., oz. \$1.00.
 - 506 **Red. Extra Double.** Pkt. 10c., ¼ oz. 40c., oz. \$1.25.
 - 507 **Yellow. Extra Double.** Pkt. 10c., ¼ oz. 40c., oz. \$1.25.
 - 511 **Chater's Collection,** Twelve colors, each separate, \$1.00.
 - 512 " " Six colors, each color separate, 50c.



New Hollyhock "Allegheny".

- 508 **Salmon. Extra Double.** Pkt. 10c., ¼ oz. 40c., oz. \$1.25.
- 509 **Mixed. Extra Double.** Pkt. 10c., ¼ oz. 30c., oz. \$1.00.

531 **Japanese Hop Vine** (*Humulus japonicus*). A very ornamental and fast growing climbing plant. Undoubtedly one of the best climbers for covering verandas, trellises, etc., never suffering from the heat, but retains its fresh color until late in the summer. Pkt. 10c.

532 **Variegated Japanese Hop Vine**. Pkt. 10c.

535 **Kenilworth Ivy** (*Linaria Cymbalaria*). A charming small, neat trailing plant, suitable for baskets, vases, pots and rock work. Pkt. 10c.

Lantana. One of the most desirable bedding plants, constantly in bloom.

538 **Mixed Colors**. Pkt. 10c.

Lavender. An aromatic plant, the leaves and flowers of which are dried and used for scenting clothing, rooms, etc.

541 **Blue**. Pkt. 5c.

Larkspur Annual Sorts.

544 **Dwarf Double Rocket**. Mixed colors. Pkt. 5c., oz. 25c.

545 **Tall Stock Flowered**. Mixed colors. Pkt. 5c., oz. 25c.

546 **Sinensis**. Large spikes of bright blue flowers. Pkt. 10c., oz. 60c.

For Perennial Larkspur see *Delphinium*.

Lobelia.

A dwarf plant with delicate, graceful foliage and pretty, fine flowers. For hanging baskets, pot culture or bedding.

548 **Barnard's Perpetual**. One of the finest Lobelias grown. Brilliant blue flowers, with white blotch. Highly recommended for pots, vases or bedding. Pkt. 10c., 3 pkts. for 25c.

549 **Crystal Palace Compacta**. A densely compact miniature variety, which, during the summer months, is studded with rich deep blue flowers, forming a perfect ball. Best for borders. Pkt. 10c.

550 **Emperor William**. A very compact variety, with fine, sky-blue flowers. Pkt. 10c.

551 **Crystal Palace Speciosa**. Of trailing growth; flowers of a superb ultramarine blue. Pkt. 10c.

559 **Pumila Splendens** (New). Large purple flowers with large white eye. Pkt. 10c.

558 **Double Flowering**. Compact bushes covered with rich deep blue double flowers. Pkt. 10c.

552 **Royal Purple**. Very rich violet purple without any trace of blue, very effective thus showing off its clear white eye. Pkt. 10c.

553 **Gracilis**. A favorite trailing blue sort. Pkt. 5c.

554 **White Gem**. Forms a perfect ball of snow-white flowers; very charming appearance. Pkt. 10c.

556 **Mixed**. All colors. Annual. Pkt. 5c.

555 **Cardinalis** (*Cardinal Flower*). A hardy perennial native variety, with spikes of brilliant scarlet flowers. Pkt. 10c.

561 **Linum** (*Scarlet Flax*). One of the most effective and showy bedding plants; hardy annual; one foot high. Pkt. 5c., oz. 20c.

564 **Lily of the Valley—Convallaria Majalis**. Lovely plants, bearing pure white fragrant bell shaped flowers. Pkt. 10c.

565 **Lophospermum Scandens**. Splendid climber. Pkt. 10c.

Lychnis. Handsome plants for massing in beds and borders, blooming the first year if sown early; hardy perennials.

568 **Haageana Mixed**. One foot high. Pkt. 10c.

569 **Haageana Scarlet**. Makes a brilliant effect. Pkt. 10c.

Lupinus. [*Sun Dials*.] The seeds should be sown where they are to bloom, as they do not transplant well.

572 **Mixed**. All colors of annual varieties. Two feet high. Pkt. 5c., oz. 15c.

575 **Marvel of Peru** (*Four o'clocks*).—**Choice Mixed**. Pkt. 5c., oz. 15c.

592 **Maize**.—**Striped-Leaved Japanese**. An ornamental corn, beautifully striped with green and white. Pkt. 5c., oz. 15c.

Mimulus (*Monkey Flower*). Showy, profuse flowering plants. Fine for greenhouse, or moist shady situations.

619 **Tigrinus, Choice Mixed**. The finest tigered and spotted varieties, rivaling the *Calceolaria* in its brightness. Pkt. 5c.

620 **Moschatus** (*Musk Plant*). Fine for hanging baskets, etc., small yellow flowers, fragrant foliage. Pkt. 5c.

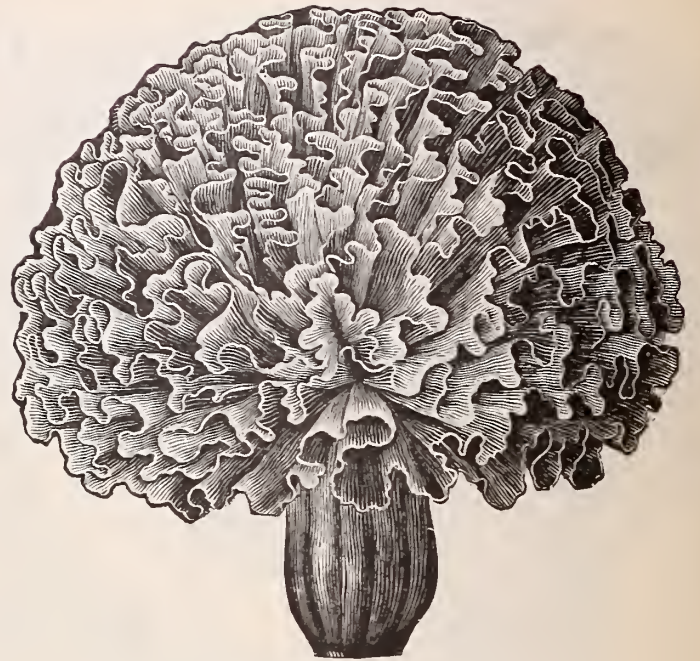

Marigold (*Tagetes*).

587 **Legion of Honour** ("Little Brownie"). Single flowering, compact bushes; six inches high. Begins flowering extremely early. The flowers are golden yellow, marked with a large spot of crimson velvet. Pkt. 5c.

579 **Gold Nugget**. Dwarf. Immense double flowers of a shade of golden yellow, resembling Australian gold. Pkt. 10c., oz. 40c.

580 **El Dorado**. The flowers are three to four inches in diameter, perfectly imbricated and double. Pkt. 10., oz. 40c.

581 **Lemon Yellow**. Large flowering, very showy. Pkt. 5c.

582 **Large African**. Tall, double, orange brown and yellow mixed. Two feet high. Pkt. 5c., oz. 30c.

583 **Dwarf French**. Mixed; double. 1 ft. high. Pkt. 5c., oz. 40c.

584 **Double Pulchra**. The plants grow only twelve inches high; the numerous bright flowers stand out in bold relief. Each flower is perfectly double, of rich golden yellow with deep velvety-brown centre. Pkt. 10c.

585 **Collection Dwarf Marigold**, 6 varieties, 25c.

586 **Collection of Large African Marigolds**, 6 varieties, 25c.

588 **Gold Ring**. Beautiful rich red single flowers with a gold ring around each petal. Pkt. 10c.

See also *Calendula* and *Tagetes*.

Mignonette (*Reseda Odorata*).

626 **Golden Machet**, (New). Large spikes. Pkt. 10c.

627 **Machet or French**. Without doubt the best as well as the sweetest sort in existence. Pkt. 10c., oz. 75c.

628 **Allen's Defiance**. The largest of all. Pkt. 10c.

638 **Quaker City**. The flower spikes are of great substance. Rounded at the top, of a handsome gold-red color, and unusually rich, sweet fragrance. Pkt. 10c., ¼ oz. 25c.

629 **Bird's Mammoth**. Pkt. 10c. oz. \$1.00

630 **Miles Hybrid Spiral**. Of dwarf, branching habit, with spikes from eight to ten inches long. Pkt. 5c., oz. 50c.

631 **Parson's White**. Large spikes, very fragrant. Pkt. 5c.

633 **Golden Queen**. Very attractive golden yellow. Pkt. 10c., oz. 25c.

634 **Sweet Scented**. Pkt. 5c., oz. 15c.

632 **Gabriele**. Pkt. 10c., oz. 75c.

635 **Grandiflora**. Plants pyramidal. Pkt. 5c., oz. 30c.

637 **Sutton's Giant**. Produces very heavy flower stems. Pkt. 25c.

636 **Collection of Mignonette**, ten varieties. Pkt. 50c.



Machet Mignonette.

IF YOU NEED AN INSECTICIDE

For ALL-ROUND greenhouse work, fumigating and syringing, the

“ROSE LEAF”

EXTRACT OF TOBACCO INSECTICIDE is the

BEST and the CHEAPEST on the Market.

Price, Five gallon can, \$4.25

“ **One gallon can, 1.25**

We believe you will find “ROSE LEAF” a valuable adjunct to your general equipment, and trust you will favor us with an order.

HENRY F. MICHELL, 1018 Market Street, Philadelphia, Pa.

Maurandia

A most beautiful climber of rapid and slender growth, producing an abundance of pretty, tube-shaped flowers, which continue to bloom until late in fall. Ten feet high.

- 595 **Pink.** Pkt. 10c.
- 596 **Barclayana.** Purple. Pkt. 10c.
- 597 **White.** Pkt. 10c.
- 598 **Mixed.** All colors. Pkt. 10c.

Mesembryanthemum (*Ice Plant*.)

- 602 **Crystallinum, White.** Pkt. 5c.
- 603 **Cordifolium Variegatum.** Pkt. 10c.

Moon Flower (*Ipomæa*).

- 527 **Noctiflora.** Blooms the first season from seed. At night and during dull days the plants are covered with an abundance of large, pure white, fragrant flowers, five to six inches in diameter. It grows very rapidly, and will cover a large surface. Pkt. 10c., oz. 60c.
- 522 **Heavenly Blue.** Flowers four to five inches across, in large clusters of light blue with a yellow throat. This climber is so completely covered with bloom as to almost cover the foliage. It is also a splendid conservatory climber. Pkt. 15c.



New Forget-Me-Not "Nixenaugé".

Myosotis (*Forget-Me-Not*).

Neat and beautiful little plants, succeeding best in a shady, moist situation. Half-hardy perennials, blooming the first year from seed, if sown early.

- 607 **Alpestris Victoria.** Of bushy habit, bearing large, bright blue flowers. The plant attains a diameter of eight to ten inches, and when fully grown is globular in shape and perfectly covered with flowers. Pkt. 10c., oz. \$3.00.
- 608 **Alpestris Cœrulea** (*Alpine*.) Bright blue. Pkt. 10c.
- 609 **Eliza Fanrobert.** The most robust grower; specially adapted for outdoor growing; flowers very large, blue. Pkt. 10c.
- 615 **"Nixenaugé."** The real Forget Me Not, flowering during the whole summer when other varieties have gone to seed. The flowers are as large as those of dissitiflora "Perfection" but of greater duration, beautiful sky blue and on long stems. The treatment is the same as Myosotis alpestris. Pkt. 15c.
- 610 **Dissitiflora.** Compact habit; pinkish blue. An attractive bedding plant; six inches high. Pkt. 10c.
- 611 **Palustris Semperflorens.** The most desirable sort for cutting or greenhouse use. Pkt. 10c.
- 612 **Mixed.** All sorts. Pkt. 5c.

- Mimosa Pudica.** [See Sensitive Plant.]
- Morning Glory.** [See Convolvulus and Ipomæa.]
- 625 **Musa Enseta, Banana.** Fresh seed. Pkt. 10 seeds, 25c.

Nierembergia Gracilis. Half-hardy perennial, perpetually in bloom, flowering the first year if sown early; desirable for baskets or vases; one foot high.

- 644 **White.** Tinted with lilac. Pkt. 10c.
- 647 **Nicotiana Affinis** (*Ornamental Tobacco*). A very pretty large-flowering species of tobacco, producing large, pure white, fragrant flowers. Pkt. 5c.
- Nemophila.** Hardy annuals; one foot high.
- 650 **Insignis.** Bright blue flowers, white centre. Pkt. 5c.
- Nolana.** Desirable plants for hanging baskets, bearing bell-shaped flowers. 654 **Mixed.** Pkt. 5c.

Oxalis

Beautiful small plants, suitable for the greenhouse, baskets or outdoor culture; flowering the first year if sown early.

- 661 **Floribunda Rosea.** Very desirable for hanging baskets and vases. Pkt. 10c.
- 662 **Mixed.** Pkt. 10c.
- 663 **Tropæoloides.** Very desirable border plant, foliage dark copper color. Pkt. 10c., ¼ oz. 50c.

Œnothera (*Evening Primrose or Sun Drops*).

- 658 **Hardy Annual.** Mixed colors. Pkt. 5c.
 - 704 **Perilla** (*Nank. Atrop. Laciniatus*). Very showy bronze foliage, adapted for large beds. Pkt. 5c.
 - 705 **Pelargonium.** (*Lady Washington Geranium*). Grand plants for pot culture, colors are rich in the extreme and beautifully marked. Height, 1 to 2 feet. Finest mixed. Pkt. 25c.
- Pinks.** [See *Dianthus*.]



Portulaca

Must be sown in sandy soil, in a sunny situation.

- 769 **Choicest Mixed Single.** All colors. Pkt. 5c., oz. 35c.
- 770 **Choicest Mixed Double.** Pkt. 10c., ⅛ oz. 50c.

Polyanthus. These rank among the prettiest of plants for borders, rockeries, etc. When once established they grow in any common soil, but they succeed best in rich soil, and a position somewhat moist and shaded.

- 774 **Choicest English Mixed.** Including the gold laced. Pkt. 15c.
- 775 **Double Mixed** (*Hose in Hose*). Pkt. 15c.

Pyrethrum [*Feverfew*].

Yellow Foliage Sorts for Bedding.

- 778 **Aureum** [*Golden Feather*]. Best for edging. Pkt. 10c., oz. 80c.
- 779 **Selaginoides** [*Fern Leaved*]. Pkt. 10c.

Pyrethrum

Flowering Sorts (Perennial).

- 780 **Hybridum.** Hardy perennial bearing large flowers ranging in color from light pink to deep red; bright yellow centres; one of the prettiest and best of hardy plants; two feet high. Pkt. 10c.
- 781 **Roseum** [*Dalmatian, or Persian Insect Powder Plant*] Flowers bright rose, of large size. Pkt. 10c.
- 782 **Uliginosum.** Giant white daisy. Pkt. 10c.

Passiflora (*Passion Flower*.)

- 700 **Southern Beauty.** Beautiful climber, hardy, with protection blooms profusely; colors blue, white, pink and red, in mixture. Pkt. 10c., 3 for 25c.

N
A
S
T
U
R
T
I
U
M
S

NASTURTIUMS



Nasturtiums are among the most useful and beautiful of annuals for bedding, massing, etc., owing to their compact growth, richness of color and profusion of blooming. They flower most profusely when planted in a poor soil.

Climbing Nasturtiums

Specially adapted for trellises, verandas, vases and hanging baskets.

- 685 **Madam Gunther's Hybrids.** For richness and variety of colors these new hybrids have no equals among Nasturtiums. The foliage is mostly dark, contrasts very effectively with the rich colors. They are climbers and are free and continuous bloomers. Pkt. 10c., oz. 25c.
- 686 **Crimson.** Pkt. 5c., oz. 20c.
- 687 **Violet.** Pkt. 5c., oz. 20c.
- 688 **Straw-Colored Striped.** Pkt. 5c., oz. 20c.
- 689 **Orange.** Pkt. 5c., oz. 20c.
- 690 **King Theodore.** Dark foliage and almost black flowers. Pkt. 5c., oz. 25c.
- 691 **Scarlet.** Pkt. 5c., oz. 20c.
- 692 **Mixed.** All colors. Pkt. 5c., oz. 15c., lb. \$1.25.
- 693 **Collection of Climbing Nasturtiums, 12 varieties** 50c.
- 694 **Lobbianum, Choice Mixed.** Especially adapted for greenhouse or conservatory. Pkt. 5c., oz. 25c.
- 695 **Spitfire, Bright Crimson.** Pkt. 10c., oz. 40c.

New Climbing Nasturtium

- 684 **"Vesuvius."** The most lively colors of all yet known and admired sorts of *Tropæolum Majus* are still by far surpassed through this novelty. The color is a dazzling fiery-rose, may be termed the most effective and brilliant of all large flowering Nasturtiums. Pkt. 10c., oz. 40c.

Tom Thumb or Dwarf

- 666 **Liliput.** An entirely new class of Dwarf Nasturtiums, smaller than the Tom Thumb, the dainty little Flowers are produced in the greatest profusion, well above the small bushy foliage. The seed is much smaller than the one in the Tom Thumb Nasturtiums and similar to that of the Lobbianum section, the best evidence that we have an entirely new break in the *Tropæolum* family. All colors in choicest mixture. Pkt. 5c., oz. 25c.
- 667 **Aurora.** A new dwarf. The plant forms a perfect globe and is literally covered with yellow, blotched with crimson flowers, completely hiding the foliage when in full bloom. Pkt. 5c., oz. 25c.
- 668 **Ladybird.** A new and distinct sort. The ground color is a rich golden yellow, each petal barred with a broad vein of bright ruby crimson; very showy and charming. Pkt. 5c., oz. 25c.
- 669 **Scarlet.** Pkt. 5c., oz. 25c. 670 **Yellow.** Pkt. 5c., oz. 25c.
- 671 **Pearl.** Pkt. 5c., oz. 25c. 672 **Spotted.** Pkt. 5c., oz. 25c.
- 673 **King Theodore.** Almost black. Pkt. 5c., oz. 25c.
- 674 **Pink.** Pkt. 5c., oz. 25c.
- 675 **Golden King.** Deep golden yellow flowers. Pkt. 5c., oz. 25c.
- 676 **Empress of India.** Splendid new dwarf variety, with very dark leaves and crimson flowers. Pkt. 5c., oz. 25c.
- 677 **Cloth of Gold.** Beautiful for borders or edging. Foliage bright golden yellow; flowers scarlet. Pkt. 5c., oz. 25c.
- 678 **Dwarf or Tom Thumb Mixed.** All colors. Pkt. 5c., oz. 15c. $\frac{1}{4}$ lb. 35c., lb. \$1.25.
- 679 **Collection of Dwarf Nasturtiums, 12 varieties, each color separate,** 50c.



Michell's Giant Exhibition Pansy.

Pansy

- 746 Michell's Giant Exhibition Pansy. In mixture. A strain which we have secured from one of the leading pansy specialists in Germany, to which we added the cream of the Paris strain, also the choicest to be had from Scotland. It can be relied on to give flowers of immense size, very heavy texture, and of the most brilliant colors. Pkt. 25c., 1/2 trade pkt. 50c. 1/8 oz. \$1.00.
- 748 Bugnot's and Cassier's Mammoth French Mixed. Pkt. 25c., 1/8 oz. \$1.00.
- 749 Trimardeau [True]. Excellent large flowers, each petal blotched; choice mixture. Pkt. 15c., four pkts. 50c.
- 744 Giant White. Pkt. 25c.
- 745 Giant Yellow. Pkt. 25c.
- 750 Ne Plus Ultra. Immense flowers of the most beautiful colors. Pkt. 25c., three pkts. 60c.
- 751 Odier [Five Blotched]. A beautiful strain of various-colored, large, handsome, perfectly formed flowers. Pkt. 15c.
- 752 Finest Mixed Imported. Pkt. 10c., oz. \$1.50.
- 753 Very Fine Mixed. All colors. Pkt. 5c., oz. \$1.00.

Pansies in Separate Colors

Selected seed from the first crop of blooms true to color and of large size.

- 754 Lord Beaconsfield. Violet and white. Pkt. 10c., oz. \$1.25.
- 755 Faust [King of the Blacks]. Pkt. 10c., oz. \$1.00.
- 756 Emperor William. Ultramarine blue. Pkt. 10c., oz. \$1.00.
- 757 Belgian Striped. Pkt. 10c., oz. \$1.00.
- 767 Mahogany Color. Pkt. 10c., oz. \$1.00.
- 758 Snow Queen. Very large, satiny white. Pkt. 10c., oz. \$1.00.
- 759 Yellow Gem. Pure yellow, without eye. Pkt. 10c., oz. \$1.00.
- 760 Gold Margined. Pkt. 10c., oz. \$1.00.
- 761 Silver-Edged. Pkt. 10c., oz. \$1.00.
- 762 Blue. Pkt. 10c., oz. \$1.00.
- 763 Yellow. Pkt. 10c., oz. \$1.00.
- 766 Havana Brown. Pkt. 10c., oz. \$1.00.
- 764 Collection of choice imported Pansies, each color separate. Six varieties. Pkt. 40c.
- 765 Collection of twelve varieties 75c.
- 768 French, New Large Stained. Magnificent flowers of large size and fine color. 25c. per pkt.
- 771 "Pres. Carnot" (New). Very rich purple. 15c.



Petunia

- 731 Giants of California. Most of the flowers are exquisitely fringed on the edges, and of enormous dimensions (four to five inches across) but their great merits lie in the varieties of colors, blotchings and stripings. Pkt. 25c., five pkts. \$1.00
- 733 Large-flowering Fringed, Mottled and Striped. Finest strain of single petunias procurable. Pkt. 20c., 1/8 oz. \$1.00.
- 734 Hybrida Nana Compacta Multiflora ("The Star"). Dwarf habit and profuse bloomer, eight inches high. Pkt. 10c.
- 740 Pure White. Pkt. 10c.
- 735 Very Choice Mixed. Blotched and striped. Pkt. 10c., oz. \$1.00.
- 736 Fine Mixed. All colors. Pkt. 5c., oz. 60c.
- 737 Collection of large-flowering single petunias, six varieties, 50c.
- 738 Collection of Large Flowering, single. Twelve varieties \$1.00.



Double-Fringed Petunia.

- 732 Double-Fringed and Hybridized. Selected and hybridized with the greatest of care, and can be relied upon to produce a large percentage of double flowers of bright colors. Pkt. 25c., five pkts. \$1.00.

Pentstemon

- 706 Beautiful half hardy, herbaceous plants. Choice mixed. 10c. per pkt.



Phlox

Phlox Drummondii.

A very hardy annual, invaluable for bedding, masses and cut flowers, from its bright colors, which vary from the purest snow white to the deepest blood red, and the unusual length of its blooming season. There is no annual which can compare for beauty, duration of bloom, brilliancy of colors and usefulness to the phlox.

Grandiflora Varieties.

Grown by a Specialist

- 708 **Alba, Pure White.** Excellent for cutting. Pkt. 10c., oz. \$1.00.
- 709 **Coccinea.** Scarlet. Pkt. 10c., oz. \$1.00.
- 710 **Striped.** Brilliant scarlet striped with white. Pkt. 10c.
- 711 **Pink.** Delicate and bright shades. Pkt. 10c.
- 712 **Stellata Splendens.** Brilliant red, with large white star. Pkt. 10c.
- 715 **Collection of twelve varieties.** Pkt. 75c.
- 713 **Choice Mixed.** Contains twenty-five colors. Pkt. 10c., oz. 75c.
- 714 **Very Fine Mixed.** Pkt. 5c., oz. 60c.

Dwarf or Compact Varieties.

(Strictly True.)

- 719 **Snowball.** Pure white. Pkt. 10c., $\frac{1}{8}$ oz. 50c.
 - 720 **Fireball.** Brilliant scarlet. Pkt. 10c., $\frac{1}{8}$ oz. 50c.
 - 721 **Pink.** Beautiful shade. Pkt. 10c., $\frac{1}{8}$ oz. 50c.
 - 722 **Scarlet.** Striped with white. Pkt. 10c., $\frac{1}{8}$ oz. 50c.
 - 724 **Choice Mixed.** Dwarf. Pkt. 10c., oz. \$2.50.
 - 723 **Double White.** A profuse bloomer. Pkt. 10c.
- The above dwarf varieties are especially desirable for borders, growing only 6 to 8 inches high, and are covered with flowers.

Phlox—Other Varieties.

- 725 **Double Scarlet.** Pkt. 10c.
- 726 **Frimbriata (Star of Quedlinburgh).** Entirely distinct from the other type of phlox. Each petal is elongated and pointed. Beautiful colors in mixture. Pkt. 10c.
- 727 **Hardy Phlox (Phlox Decussata).** These rank among the finest herbaceous perennials for beds and borders; mixture of the finest flowers. Pkt. 10c.
- 728 **Double Yellow (New).** Pkt. 10c.

Chinese Primrose

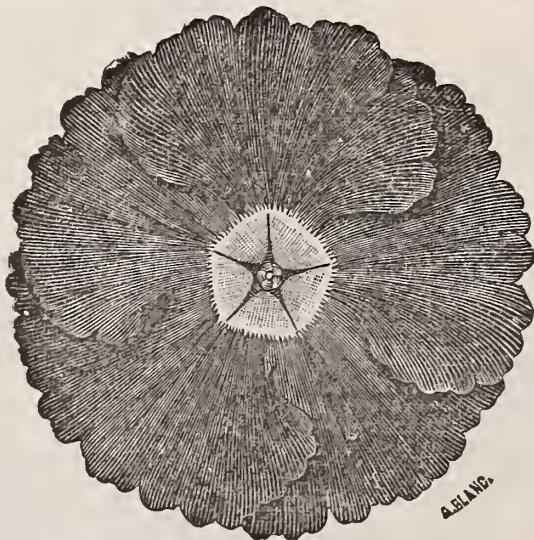

Michell's Prize Fringed Primula.

Primula (Sinesis Frimbriata—Chinese Primrose.)

- 794 **Michell's Prize Mixture.** Grown by a primula specialist, who has received prizes wherever he has exhibited the plants. The seed is of crop of 1895, and can be relied upon Pkt. 25c., $\frac{1}{32}$ oz. \$1.00, $\frac{1}{8}$ oz. \$3.75.

PRIMULA—Continued.

- 795 **Williams' Superb Strain.** The finest English mixture; can be relied upon to produce satisfactory results. Pkt. 40c.
- 796 **Kermessina Splendens.** Brilliant red with yellow centre. Pkt. 25c.
- 797 **Holborn Blue.** Fully fifty per cent. will come blue if given warmer treatment than other sorts. Pkt. 40c.
- 798 **Alba Magnifica.** Large white flowers with citron eye. Pkt. 40c.
- 801 **Sutton's Giant Mixed Fringed.** Per original pkt. \$1.25.
- 799 **Collections** containing eight separate varieties, all fringed and named. Pkt. 75c.
- 800 **Fern Leaved, Choice Mixed.** Pkt. 25c.

Double Primrose.

- 804 **Pure White.** Pkt. 50c.
- 805 **Choice Mixed.** Pkt. 50c.

Primula—Other Sorts.

- 808 **Primula Floribunda.** Yellow, fragrant. Pkt. 25c.
- 810 **Forbesi (Baby Primrose).** Very free flowering; beautiful, small pink flowers in great profusion. Pkt. 25c.
- 809 **Obconica Grandiflora.** Flowers much larger than the old variety, excellent for cut flowers or pot plant. Pkt. 15c.

Hardy Primrose.

- 811 **Primula Veris (English Cowslip).** Flowers of different colors, yellow, brown and yellow edged, etc., very fragrant. Pkt. 10c.
- 813 **Primula Vulgaris.** The common hardy English variety, light canary yellow color. Pkt. 10c.

- 791 **Rosa Rugosa (Japanese).** One of the handsomest in cultivation. Forms a sturdy bush four to five feet high, covered with dark green glossy foliage crowned with large single roses three inches in diameter, borne in clusters of ten to twelve flowers. The flowers are of bright rosy crimson, followed by large handsome scarlet fruit during the autumn months. Pkt. 25c.

- 792 **Rose—Hybrid Polyantha or Fairy.** These beautiful little roses are borne in large clusters, and will flower throughout the summer until frost, from seed sown early in the spring. Flowers are of various colors, most of them double, although a few of them will come semi-double and single. Mixed colors. Pkt. 15c.

Schizanthus (Butterfly Flower).

- 817 **Papilionaceus Mixed.** One of the finest annuals in cultivation. The flowers are as handsome as some of the orchids, and productive continually. Pkt. 5c.

- Silene (Catchfly).** Adapted for beds, borders or ribbon-gardening, of easy culture, growing in any garden soil; hardy annual; one foot high.

- 861 **Mixed.** Producing charming flowers in profusion. Pkt. 5c.
- 862 **Pendula.** Beautiful pink flowers—excellent for cutting. Pkt. 10c.



Poppy

Showy and ornamental plants with large flowers of brilliant colors. Very attractive in large beds, clumps and mixed borders. They are of very easy culture, and succeed in any garden soil; the seed should be sown where it is to remain, as they do not stand transplanting.

Single Varieties (Annual).

- 826 **New Fayal.** The seeds of these poppies came originally from the Fayal Islands. They are charming dwarf poppies, double and single; like crinkled tissue paper and are very imaginable poppy color, deepest red, terra cotta, salmon, exquisite pink, snowy white, pink and gray. Pkt. 15c., 4 pkts. for 50c.
- 817 **Shirley Poppies.** These charming poppies are generally single or semi-double. The range of color extends from pure white, through the most delicate shades of pale pink, rose and carmine, to deepest crimson. The blooms, if cut when young, will stand for several days. Pkt. 5c., 50c. per oz.
- 834 **"Double Shirley"**. Beautiful, choicest mixed. Pkt. 10c.
- 818 **Umbrosum.** Rich vermilion with a deep shining dark purple spot. Pkt. 5c., oz. 50c.
- 819 **Danebrog.** Flowers of a brilliant scarlet, bearing a silvery white spot on each of the four petals, resembling a cross. Pkt. 5c., oz. 40c.
- 827 **Iceland Mixed.** The colors range from the purest white and yellow to the deepest glowing orange scarlet, and have a delicious fragrance. The profusion of flowers is really astonishing. They are very fine cut flowers and will last a week if cut as soon as they are open. Mixed Colors. Pkt. 10c., three pkts for 25c. Iceland Poppies can also be treated as perennials.
- 833 **Iceland.** Double scarlet. New. Pkt. 10c.

**I
C
E
L
A
N
D**



Oriental Perennial Poppy.

SINGLE ANNUAL POPPIES.—Continued.

831 **Tulip Poppy.** No adequate idea can be gained of the strikingly beautiful effect presented by a bed or mass of this magnificent poppy when the plants are in full bloom, the color being, even when seen from a distance, of such a glowing scarlet as to perfectly dazzle the eye, suggesting at once a bed of scarlet tulips. The plants grow about fourteen inches high, and produce from fifty to sixty flowers, well above the foliage. Pkt. 10c.

Double Varieties (Annual).

- 825 **Mikado.** Striped Japanese. Very handsome. Pkt. 10c.
- 820 **Crimson King.** Flowers perfectly double and round as a ball. Pkt. 10c.
- 835 **Giant Peony Flowered Nankeen, Yellow.** (New). Pkt. 15c.
- 821 **Snowdrift.** Pure snow white, very double, of large size. Pkt. 10c.
- 846 **Giant Peony Flowered Snowball, White.** (New). Pkt. 15c.
- 822 **Fairy Blush.** Very double pink flowers, elegantly fringed. Pkt. 10c.
- 823 **Peony-flowered.** Large and very double; mixed colors. Pkt. 5c., oz. 20c.
- 824 **Imported Collections** of Dwarf Double Poppies, six varieties 25c.

Poppy, Perennial Sorts

This class of poppies has become one of the most popular flowers of late, so that no garden is complete without them. Seed can be sown early in the spring and they will bloom the first season. Seeds can also be sown in August and September in the open ground and they will bloom early the following summer.

- 828 **Giant Orange.** Pkt. 10c., three for 25c.
- 829 **Giant Scarlet.** Pkt. 10c., three for 25c.
- 830 **Collection** of eight varieties. Each color separate. 40c.
- 832 **Oriental Hybrids Mixed.** Extra choice strain. 10c. per pkt., 3 pkts. for 25c.

Ricinus [Castor Oil Bean].

Stately, strong-growing plants, with very ornamental foliage, particularly well adapted as centre plants of groups of cannas, Japanese maize, caladiums, dahlia, etc. Height, four to fifteen feet.

- 785 **Cambodgensis.** This new sort grows from six to eight feet high, with large, palm-like leaves of the darkest bronzy maroon; stalk and stem nearly black. Very effective. Pkt. 5c., oz. 30c.
- 786 **Borboniensis Arboreus.** Very large and beautiful foliage; fifteen feet high. Pkt. 5c., oz. 20c.
- 787 **Gibsoni or Duchess of Edinburgh.** Dwarf branching habit, deep red foliage: five feet high. Pkt. 5c., oz. 25c.
- 788 **Sanguineus.** Blood-red stalks and clusters of red fruit; eight feet high. Pkt. 5c., oz. 20c.
- 790 **Mixed.** All sorts. Pkt. 5c., oz. 15c.
- 789 **Zanzibariensis (Palma Christi).** An entirely new and distinct class. The plants attain great dimensions, presenting a splendid aspect with their gigantic leaves, which range from a brilliant coppery bronze to light and dark green; the ribs also are of bright colors and contrast nicely with the leaves. Pkt. 5c., oz. 30c.

Solanum (Jerusalem Cherry)

A very useful pot plant for winter decoration, of a dwarf branching habit; leaves small and oval-shaped; bearing in the greatest profusion bright scarlet globular berries. Very ornamental.

- 866 **Hendersoni.** One foot. Pkt. 10c.

Sensitive Plant (Mimosa Pudica).

850 Curious and interesting plants, with pinkish-white flowers; the leaves close and droop when touched or shaken; they require a mixed soil of peat, loam and sand. Pkt. 5c.



Ricinus Cambodgensis (Castor Oil Bean).

**Castor
Bean**



**Scarlet
Sage**

Salvia (Scarlet Sage).

A favorite bedding plant, bearing long spikes of flowers in great profusion from July to October; half-hardy perennials, blooming the first year from seed; three feet high.

- 836 **Splendens** (*Scarlet Sage*). Bright Scarlet. Pkt. 10c., $\frac{1}{4}$ oz. 50c.
 837 **Coccinea**. Very free flowering, brilliant scarlet. Pkt. 5c.
 838 **Clara Bedman** (*New Dwarf*). One of the showiest and most brilliant in existence; its habit is very dwarf and has twice as many flowers on the plant at one time as Splendens. Pkt. 15c., 4 pkts. 50c.
 839 **Patens**. Rich blue. Pkt. 15c.
 840 **Bonfire**. The finest yet introduced, very compact, only $2\frac{1}{2}$ ft. high, produces very large scarlet flower spikes. Pkt. 10c., $\frac{1}{8}$ oz. 50c.
 841 **Golden Foliage** (*New*). Brilliant scarlet flowers. Pkt. 10c., 4 pkts. for 50c.

Strawberry (Trailing).

(*Fragaria Indica*).

- 412 These are very interesting and attractive plants, producing fruit similar in shape and color to a strawberry. Very desirable as a greenhouse plant. Per pkt. 10c.

Streptocarpus.

- 865 **Veitch's New Hybrid Mixed**. Beautiful greenhouse perennials of dwarf, neat habit. Seedlings produce from two to five blooms on a stem the first season. As the plant becomes older the flowers are produced in greater abundance. 25c.

Saintpaulia Ionantha.

- 875 The leaves are dark green; flowers, violet-like both in color and shape, but one and a quarter inches in diameter, and gracefully borne on stalks two to three inches high. The plant is of neat and compact habit. Pkt. 25c.



Salpiglossis "Emperor".

Salpiglossis.

A class of highly ornamental autumn flowering plants with beautifully veined and tinted funnel-shaped flowers similar to a fancy Petunia, rendering them very effective in beds and borders. A very choice annual, 18 inches high.

- 842 **Grandiflora**. Fine mixture of new large flowering varieties. Pkt. 5c.
 843 **Collection** of six separate colors of the large flowering varieties. Pkt. 30c.
 844 **Emperor** (*New*). The very handsomest yet introduced. Choicest mixed colors. Pkt. 15c.

Sedum (Stone Crop).

- 853 A pretty and useful little plant, growing freely on rockwork, hanging baskets, etc.; mixed colors and varieties; hardy perennial; three inches high. Pkt. 10c.

Smilax

- 858 Soak the seed for twenty-four hours in warm water before sowing. Pkt. 10c., oz. 50c., lb. \$4.00.

Stevia Serrata

- 864 Free-blooming plant, bearing a multitude of fragrant white flowers; suitable for summer or winter blooming. Pkt. 10c.

Scabiosa (*Mourning Bride*).

One of the handsomest summer plants, producing in great profusion very double flowers in a variety of shades and colors; a splendid flower for table bouquets; hardy annuals.

- 877 **Grandiflora** (*New*). Enormous size, very double flowers of brilliant colors. Mixed 10c. per pkt., 3 pkts. for 25c.
 884 **Caucasica**. One of the handsomest of hardy perennials, especially valuable for cutting, the blooms lasting a long time in water; lilac-blue; 3 feet. Pkt. 10c.
 883 **Dwarf Mixed**. Double, all colors, one foot high. Pkt. 5c., oz. 25c.
 878 **Double White**. Pkt. 5c., oz. 25c.
 879 **Double Blue**. Pkt. 5c., oz. 30c.
 880 **Double Pink**. Pkt. 5c., oz. 30c.
 881 **Double Red**. Pkt. 5c., oz. 30c. | 882 **Double Yellow**. Pkt. 5c.



S
T
O
C
K
S

S
T
O
C
K
S

Stocks

- 885 **Princess Alice** (*Cut and Come Again*). Perpetual blooming, growing about two feet high. If sown early, it commences blooming in June and continues until destroyed by frost. It throws out numerous side branches bearing clusters of very double, pure white fragrant blossoms, and is excellent for cutting. Pkt. 10c., $\frac{1}{8}$ oz., 50c.

Ten-Week Stocks (*Large-flowering Dwarf Sorts*.)

Very desirable as a pot plant or for outdoors. The seed we send out is from pot-grown plants, therefore will produce at least seventy per cent. of large double flowers. For early flowering, start the seeds in a greenhouse or hotbed, and transplant into the garden in May after all danger of frost is over; half-hardy annual.

- 887 **White**. Pkt. 10c., $\frac{1}{8}$ oz. 50c.
 888 **Blood-Red**. Pkt. 10c., $\frac{1}{8}$ oz. 50c.
 889 **Blue and Purple**. Pkt. 10c., $\frac{1}{8}$ oz. 50c.
 890 **Pink**. Pkt. 10c., $\frac{1}{8}$ oz. 50c.
 895 **Mixed**. All colors. Pkt. 10c., $\frac{1}{8}$ oz. 50c.
 891 **Snowflake**. Best white for pot culture. Pkt. 15c.
 892 **Wallflower-leaved, Mixed**. Pkt. 10c.
 897 **Wallflower-leaved, White**. Pkt. 10c.
 899 **Wallflower-leaved, Blood-Red**. Pkt. 10c.
 893 **Intermediate Blooming**. Choice mixed. Pkt. 10c.
 894 **East Lothian**. Choice mixed. Pkt. 15c.
 896 **Collection** of eight varieties; ten-week stocks. Pkt. 50c.

Virginian Stock

- 898 **Mixed**. All colors. Pkt. 5c.

Sweet William (*Dianthus Barbatus*).

A well known plant which has been greatly improved of late years producing splendid effect in beds and shrubbery; hardy perennial; $1\frac{1}{2}$ feet high.

- 867 **Auricula-flowered, Mixed**. A beautiful class of "eyed" single varieties, all colors. Pkt. 5c., oz. 40c.
 868 **Double Mixed**. The finest colors saved from a splendid double collection. Pkt. 10c., oz. \$1.00.

Sweet Sultan

- 873 **Choice Mixed**. Pkt. 5c., oz. 25c.



Michell's Gilt Edge Mixture of Eckford's Sweet Peas.

PRICE OF SWEET PEAS.

MICHELL'S SELECTED "Gilt Edge" Eckford's large flowering in choicest mixture made up by ourselves of only the brightest colors and large flowering sorts. 5c. per pkt.; 10c. per oz.; 20c. per 1/4 lb.; 65c. per lb.; 5 lbs. for \$3.00.

Fine Mixed. All Colors. 15c. per 1/4 lb.; 50c. per lb.; 5 lbs. for \$2.00.

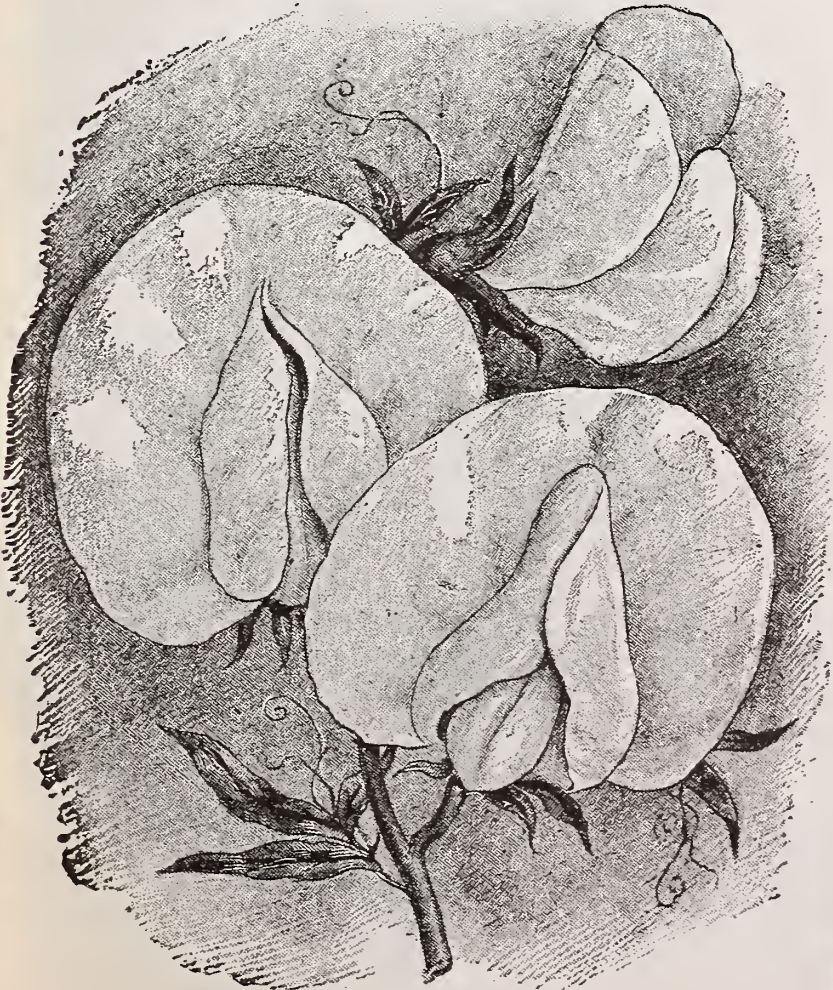

NEW CROP 1898

Michell's Selected
"GILT EDGE"
Eckford's Large
Flowering
..SWEET PEAS..

When properly grown, are nearly double the size of the ordinary varieties, of perfect form, and present combination in marking and colors heretofore unknown in this exquisite flower. The seed should be sown as early as the ground can be worked in the spring to enable the vines to get a good strong growth before the warm weather comes. Prepare the ground by thoroughly working in a large quantity of well-rotted manure, sow the seed and cover two inches deep. As fast as the flowers come into full bloom or fade they should be cut off, for if the seed pods are allowed to form, the plants will stop blooming. Seed may also be sown late in the autumn.

	Per pkt.	Per oz.	Per 1/4 lb.	Per lb.
1005 Aurora. White flaked with orange salmon; very large	\$0.10	\$0.15	\$0.30	\$1.00
901 Apple Blossom. Bright rose and pink	.05	.10	.25	.75
918 Blanche Ferry. The popular white and pink variety	.05	.10	.25	.75
917 Blanche Ferry. Extra early. Ten days earlier than the above	.05	.15	.30	1.00
924 Blanche Burpee. Very large, pure white	.05	.15	.30	1.00
902 Boreatton. Very large flower, deep maroon color	.05	.10	.25	.75
925 Cupid. Dwarf white	.05	.15	.30	1.00
1012 Cupid. Dwarf pink (New)	.10	.25	.75	2.50
903 Cardinal. Large cardinal scarlet	.05	.15	.30	1.00
9 7 Countess of Radnor. The finest lavender blue	.05	.10	.25	.85
904 Emily Henderson. One of the best white	.05	.10	.25	.75
1001 Fire Fly. Deep rich brilliant scarlet	.05	.15	.30	1.00
1013 Grey Friar. Beautiful watered purple on white ground	.05	.10	.25	.75
906 Indigo King. Rich indigo color	.05	.10	.25	.75
921 Katherine Tracy. Soft clear brilliant pink	.05	.10	.25	.75
908 Lottie Eckford. White, edged with lavender blue	.05	.10	.25	.75
909 Miss Hunt. Standard carmine salmon, wings soft pink	.05	.10	.25	.75
1004 Mikado. Cerise ground, lined with white stripes	.05	.10	.25	.75
1010 Mrs. Eckford. The best yellow variety	.05	.15	.30	1.00
912 Monarch. Deep bronzy maroon and deep blue	.05	.10	.25	.75
910 Orange Prince. Orange salmon and pink	.05	.10	.30	1.00
911 Primrose. Pale yellow	.05	.10	.25	.75
919 Princess Beatrice. A rich pink variety	.05	.10	.30	1.00
913 Queen of England. Pure white	.05	.10	.25	.75
1006 Red Riding Hood. New and quite odd in shape, rich red	.05	.15	.30	1.00
922 Senator. Rich brown and chocolate striped	.05	.10	.30	1.00
914 Splendor. Superb pink shaded with crimson	.05	.10	.30	1.00
1014 Venus. One of the very best pink varieties	.05	.10	.30	1.00
915 Collection containing 20 ounces, one ounce of each variety separate	\$1 50			
923 Collection containing 20 packets, each variety separate	.75			
1002 Collection containing 10 packets, each variety separate	.40			
916 Michell's Mixture of all Eckford's large flowering varieties	.05	.10	.20	.65
1003 Fine Mixed. All colors, very good			.15	.50

Everlasting Peas.

- 920 **Choicest Mixed.** Hardy perennial. Will bloom the first season if sown early. Pkt. 5c., oz. 30c.
- 1015 **Pure White.** Pkt. 10c., oz. 40c.
- 299 **Yellow.** (Crotolaria Retusa). 10c. per pkt., 3 pkts. for 25c.

"IMPORTANT"
...SPECIAL NOTICE...

Trouble is at times experienced in getting **WHITE** varieties (white seeded) Sweet Pea seeds to germinate. We therefore advise sowing these shallow, barely covering them, (which should be with sand). **KEEP THEM ALMOST DRY** until well started, say 2 to 3 inches high, they can then be covered up more, and hilled up like the other varieties.

Tagetes (*Single Marigold*).

A dwarf Globular compact, bushy plant, densely covered with flowers, valuable for borders as well as beds. Half hardy annual.

969 **Pumila Golden Ring**. Orange color. Pkt. 5c.

Torenia

Splendid for vases, hanging baskets or borders out of doors; they are covered until late in the season with one mass of bloom.

970 **Fournieri** — **Princess Helen of Montenegro**. (New). Pkt. 15c.

971 **Fournieri Grandiflora**. Flowers much larger and more showy than Fournieri. Pkt. 10c.

973 **Bailloni**. Flowers bright golden yellow with a brownish red throat. Pkt. 10c.

974 **White Wings**. Pkt. 15c.

Thunbergia (*Black Eyed Susan*).

Rapid growing climbers, thrive in light, rich soil; very pretty; borne profusely during the season. Fine for vases rustic work, etc.

940 **Alba Oculata**. White, dark eye. Pkt. 5c., oz. 40c.

941 **Alata**. Buff, dark eye. Pkt. 5c., oz. 40c.

642 **Aurantiaca**. Orange, dark eye. Pkt. 5c., oz. 40c.

944 **Mixed**. All colors. Pkt. 5c. oz. 40c.

Tropæolum. (*See Nasturtium, page 30*).

945 **Valeriana**. Very showy border hardy perennial; growing in any garden soil, doing well in the shade; producing large corymbs of flowers, fine for bouquets. Mixed colors; two feet. Pkt. 5c.



COPYRIGHTED BY
WILMORIN-JANORIEUX & Co. 1893

Michell's Mammoth Flowering Verbena.

935 **Aloysia Citriodora**. Fragrant lemon-scented foliage. Pkt. 10c

Verbenas.

Easily grown from seed. If sown early in spring they will flower quite early in the season. Indispensable for bedding and edging. The seed has been saved from one of the finest collections.

928 **White Mammoth**. Pkt. 10c.

929 **Scarlet Mammoth**. Brilliant, large eye. Pkt. 10c.

930 **Blue**. With large eye. Pkt. 10c.

933 **Very Fine Mixed**. Pkt. 5c., oz. \$1.00.

934 **Michell's Mammoth Choicest Mixed**. These cannot be surpassed for size and color. Pkt. 10c., 1/8 oz. 50c., oz. \$2.50.

Lemon Verbena.**Vinca** (*Madagascar Periwinkle*).

946 **Rosea**. Rose, with dark eye. Pkt. 10c., oz. \$1.00.

947 **Alba**. White, with crimson eye. Pkt. 10c., oz. \$1.00.

948 **Alba Pura**. Beautiful pure white. Pkt. 10c., oz. \$1.00.

949 **Mixed**. Pkt. 10c., oz. \$1.00.

**Viola Cornuta.**

Very desirable for borders or beds to make a solid color effect. Sow seeds early and transplant.

957 **"Admiration"**. Large purple flowers. Pkt. 15c., 30c. 1/8 oz.

958 **"Perfection"**. Large lavender flowers. Pkt. 15c., 30c. 1/8 oz.

Violet (*Viola Odorata*).

Thrives best in a shady situation, in a rich deep soil, hardy perennials.

954 **Single Blue Czar**. Very sweet scented flowers. Pkt. 10c.

955 **Single White**. Very fragrant and free flowering. Pkt. 10c.

956 **Single Mixed**. White and blue. Pkt. 10c.

Wallflower.

Well-known fragrant garden plants, blooming early in the spring, with large spikes of flowers; they should be protected in a cold frame in the winter, and planted out in May; half-hardy perennials.

960 **Single Mixed**. All colors. Pkt. 5c.

961 **Finest Double Mixed**. All colors. Pkt. 10c.

962 **Collection** containing 8 double varieties each separate. Pkt. 50c.

Wild Flower Garden. 966 A mixture of about 100 popular annuals and perennials; will make a good effect wherever sown. Pkt. 5c., oz. 15c., lb. \$1.00.



Choicest Mixed Zinnia.

Zinnia (*Youth and Old Age*).

979 **Haageana**. Choicest mixed single. Pkt. 5c.

980 **Improved Pompone**. Differing from older ones in habit of growth and immense size; very double flowers of various striking colors; plants are dwarf and bloom freely for a long period. Pkt. 10c., oz. 60c.

981 **Tom Thumb**. A miniature Zinnia, forming compact, round bushes, six to twelve inches in height and eight to fifteen inches in diameter, covered with flowers of the brightest colors. Pkt. 10c., oz. 75c.

982 **White**. Pure white flowers. Pkt. 10c., oz. 50c.

983 **Striped or Zebra**. Pkt. 10c., oz. 50c.

984 **Robusta Plenissima or Giant**. Flowers five to six inches across, perfectly formed, very double and of striking colors. Pkt. 10c., oz. 50c.

985 **Gen'l Jacqueminot**. Rich crimson, handsome. Pkt. 10c., oz. 75c.

988 **Curled and Crested**. Beautiful new type, all colors, choicest mixed. Pkt. 10c.

986 **Extra Choice Mixed**. Saved from selected double flowers only. Pkt. 5c., oz. 30c.

987 **Collection**, in imported pkts., six separate colors. Pkt. 25c.

...BULBS AND PLANTS...



Amaryllis.

Amaryllis.

Seedlings. Largest flowering and brightest colors. 3c. each; \$3.00 per doz.

Johnsont. Very large flower, rich crimson scarlet color, striped with white. Each 30c., per doz. \$3.00 Extra large bulbs 50c each, per doz. \$5.00.

Treatiæ Alba. Pure white. Each 5c., per doz. 50c.

Treatiæ Rosea. Bright rose. Each 5c., 50c. per doz.

Belladonna Major. Bright pink. Each 15c., per doz. \$1.50.

Formosissima (Jacobæ Lily). Crimson blooming. Each 15c., per doz. \$1.25.

Abutilons. Each 10c., per doz \$1.00.

Acalypha Macafeana.

A beautiful variegated foliage bedding plant; can be used for ornamental and sub-tropical bedding. Each 15c., per doz. \$1.50, per 100 \$8.00.

Asparagus Plumosus Nanus.

Strong plants 25c. to 50c. each; \$2.50 to \$5.00 per doz.

Asparagus Sprengeri (New). 25c. each; \$2.50 per doz.



Gold Medal Tuberos-Rooted Begonias.

Begonias (Tuberos-Rooted—Large Bulbs).

The bulbs which we sent out last spring produced excellent results. The size of blooms were mammoth, and the colors very rich. We have already booked a number of orders for these bulbs from customers who purchased of us last spring, and from others who saw them while in bloom.

White, Yellow, Pink, Bright Scarlet, Deep Red. Each 8c., per doz 75c., per 100 \$5.00, per 1000 \$40.00.

Choicest Mixed, Single. Each 6c., per doz. 60c., per 100 \$4.00, per 1000 \$35.00.

Double. Separate colors. Each 20c., per doz. \$2.00, per 100 \$10.00.

Choicest Mixed, Double. Each 15c., per doz. \$1.50, per 100 \$9.00

Bouvardias.

White, Pink, Red. Each 15c., per doz. \$1.50.

Calla Lilies.

These are very ornamental and flower freely. The foliage is beautifully spotted, and the flowers are pure white.

Spotted, or Variegated Foliage. Each 10c., per doz. \$1.00

White. Each 10c. per doz \$1.00, per 100 \$8.00

Black. Each 15c., per doz. \$1.50.

Coleus.

Golden Bedder. Per doz 75c., per 100 \$4.50, per 1000 \$40.00.

Queen Victoria. Per doz 75c., per 100 \$4.50, per 1000 \$40.00.

Vershaeffelti. Per doz. 75c., per 100 \$4.50, per 1000 \$40.00.

Also all other leading sorts.

Cinnamon Vine.

One of the most rapid creepers. Hardy. Each 5c., per doz 50c.

Hardy. One of the best climbers, bearing numberless bunches of violet-brown flowers, which have a pleasant cinnamon odor. It begins to bloom early in the spring, and continues several weeks. In good soil and location it will grow thirty to forty feet high. Each 25c., per doz. \$2.50.

Alternanthera.

(Used for carpet bedding and edging).

Aurea Nana. Bright golden yellow.

Amœna Spectabilis. Crimson pink and brown; the finest and brightest. Per doz. \$1.00, per 100 \$4.50, per 1000 \$40.00.

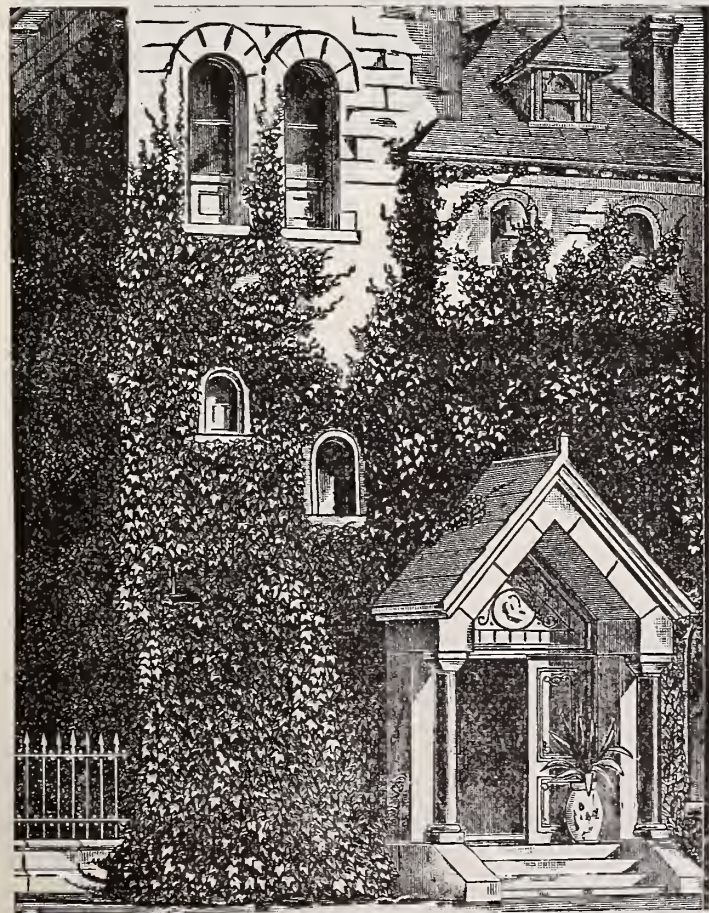

Ampelopsis Veitchii.

Ampelopsis Veitchii (Japanese or Boston Ivy).

A perfectly hardy ampelopsis of Japanese origin. It grows as rapidly as the old Virginia Creeper, and attains a height of fifty feet. It clings firmly to any wall, tree, etc., becomes more popular every season, and is without question one of the best climbing plants for covering brick or stone walls that can be grown. Two-year old plants, each 25c., per doz. \$2.50, per 100 \$12.00, one-year old strong young plants, per doz. \$1.50, per 100 \$9.00.

A
M
P
E
L
O
P
S
I
S

CANNAS. The Best Varieties.

We have a large supply of Cannas, grown under contract for us by one of the leading growers in this country. They can be relied upon to be true and sure-blooming roots, mostly all with two or three shoots.

Alphonse Bouvier. Rich velvety red; very large truss and flower; petals broad and wavy. Each 8c., per doz. 75c., per 100 \$5.00.

Austria. A splendid variety; grows five feet high; leaves 15 to 18 inches long and 8 to 10 inches broad. Flowers 6 to 7 inches across and borne erect in immense trusses; color pure deep golden yellow, truly magnificent. 10c. each, \$1.00 per doz., \$6.00 per 100.

"Alsace" (White Canna). A vigorous grower with green foliage, four feet high. An early and continuous bloomer. Spikes of flowers full, dense, crowded with flowers, which, upon opening, are of a delicate sulphur yellow, changing very soon, however, to a creamy white without spots. 10c. each, \$1.00 per doz., \$6.00 per 100.

Burbank (New). Very large flowering, rich yellow, with very substantial heavy light green foliage. Height about four feet. 10c. each, \$1.00 per doz., \$6.00 per 100.

Charles Henderson. A grand variety of a fine crimson color. 3½ feet in height, a desirable companion to Florence Vaughan. Each 8c., per doz. 75c., per 100 \$5.00.

Chicago. Four feet, green foliage. The large flowers open out nearly flat, petals 1½ inches wide and five in number; in this respect the Chicago fairly out-classes all Cannas. The color is a clear, deep vermilion scarlet. 15c. each, \$1.25 per doz., \$8.00 per 100.

Columbia. A perfect gem; color rich cardinal red; of branching habit, sometimes has three or four trusses of bloom on the same spike, all open at the same time producing a mass of blooms at an even height. Price 15c. each, \$1.25 per doz., \$8.00 per 100.

Eldorado. Bright clear yellow, lightly marked with crimson, light green foliage. The best yellow Canna for general effect, being a very profuse bloomer. 10c. each, \$1.00 per doz., \$6.00 per 100.

Egendale. Valuable as a bedding variety, bronzy foliage, with large bright cherry red flowers of good shape and substance. It is of compact uniform growth, height four feet, is considered one of the very best dark foliage varieties. Each 10c., per doz. \$1.00, per 100 \$6.00.

Florence Vaughan. Bright rich golden yellow, spotted with bright red; the flowers which are large size; of great substance and perfect form, are borne in large heads and in the greatest profusion; the foliage is massive and of a rich green color, three feet in height. Each 10c., per doz. \$1.00, per 100 \$6.00.

Flamingo. Crimson, flowers over four inches in diameter, heavy in texture; they cluster around the stem in an even manner, giving the truss the grace and finish of a Hyacinth spike; its habit is perfect, strong and compact, growing about three feet high. Each 15c., per doz. \$1.50, per 100 \$7.50.

Golden Border. Three feet high. The flowers are canary yellow, slightly spotted with red; foliage green. Each 10c., per doz. \$1.00.

Italia (Orchid-Flowered Canna). Rich golden yellow with a broad blotch of dark crimson maroon in the centre of each petal and throat. 10c. each, \$1.00 per doz., \$6.00 per 100.

Maidens Blush. The best pink variety. 15c. each, \$1.50 per doz., 8.00 per 100.

Madame Crozy. Brilliant vermilion scarlet; bordered with deep golden yellow. The foliage is green, broad and massive; the habit of the plant is compact and vigorous; height four feet. Each 8c., doz. 75c., 100 \$5.00.

President Carnot. A distinct bronze foliage variety, with very large flowers of a rich vermilion scarlet. 10c. each, \$1.00 per doz., \$6.00 per 100.



Canna "ITALIA"

Philadelphia. (New). This is one of the finest of the new sorts. The flowers are intense deep crimson borne well above the plant, foliage bright green, plant very dwarf; three feet. 20c. each, \$2.00 per doz., \$12.00 per 100.

President William McKinley.—Novelty 1898. Color brilliant crimson. Plant dwarf, growing from 2½ to 3 feet high in rich soil. Foliage deep green, with heavy chocolate margin. An abundant and very early bloomer. The trusses are large, of good shape and held well above the foliage, and the growth is compact and even. The effect when massed is extremely brilliant, the rich crimson color contrasting finely with the deep green foliage. 50c. each, \$5.00 per doz.

Pierson's Premier. One of the dwarfest of the new Cannas. Growing very compact and free. The flowers are very large and borne in immense trusses. The color is dark scarlet bordered with rich golden yellow. This variety has no superior as a bedder. 10c. each, \$1.00 per doz., \$7.00 per 100.

Queen Charlotte. Rich crimson scarlet with wide gold border on every petal. A very handsome plant, medium in height, compact grower, broad, green leaves, profuse bloomer. Each 10c., per doz. \$1.00, per 100 \$5.00.

Mixed Dwarf French. Containing the best sorts only. Each 6c., per doz. 60c., per 100 \$4.00.

Robusta Perfecta. Very tall growing, dark foliage; variety specially adapted for the centre of Canna beds. Each 8c., per doz. 75c., per 100 \$5.00.

Tall Sorts Mixed. 6c. each, 60c. per doz., \$4.00 per 100.

VERY EFFECTIVE PLANTS FOR LARGE BEDS

Caladium (*Elephant's Ear*)

Epecially adapted as a Border for cannas and tall-growing grasses.

	Each.	Doz.	100
Small Sound bulbs	5c.	\$.50	\$4.00
Medium size sound bulbs,	10c.	1.00	7.00
Large " " "	20c.	2.00	11.00
Extra Large (Mammoth)	30c.	3.00	16.00

Fancy Leaved Caladiums

Best New Varieties. Including the choice transparent sorts. 25c. each, \$2.50 per doz.

Fancy L. Caladiums. General, or Older Varieties

In 9 best and most distinct named varieties. 20c. each, \$2.00 per doz., \$12.00 per 100. Choicest Mixed. 12c. each, \$1.25 per doz.



Caladium (*Elephant's Ear*).



Fancy Leaved Caladium.

Carnations

...VARIETIES OF SPECIAL MERIT...

We have made arrangements with the best growers to furnish us strong and healthy rooted cuttings early in the spring.

PINK. *Wm. Scott, Daybreak, Albertini, Victor, Mrs. James Dean, New York.*

WHITE. *Flora Hill, John Young, Alaska, Lizzie McGowan, Alba Superbissima.*

YELLOW. *Major Pingree, Eldorado, Gold Nugget, Buttercup.*

SCARLET. *Jubilee, Portia, Thomas Cartledge, Bon Ton.*

VARIEGATED. *Helen Keller, Armazinda, Mrs. Geo. M. Brandt.*

DARK RED. *Empress, Meteor, Anna Webb.*

Price of the above standard varieties, strong rooted cuttings, per doz. \$1.00, per 100 \$6.00.

...SPECIAL...

Strong field-grown clumps of all varieties of Carnations will be ready August 1st.

Clematis

HARDY PERENNIAL CLIMBERS

Clematis have, up to date, been mostly imported from Holland. Their climate is too mild for our extreme winters, therefore cannot stand same. The following recommended are raised in Philadelphia by a Clematis Specialist and give good results.

COLLECTION OF LARGE FLOWERING

- Alexandra.** Pale reddish violet.
- Andre Leroy.** Lavender.
- Belle of Woking.** Double purple, free bloomer.
- Duchess of Edinburgh.** Double pure white, fragrant
- Gypsy Queen.** Dark velvety purple.
- Henryii.** Creamy white.
- Jackmani.** Violet purple.
- Madame Edouard Andre.** Deep crimson.
- Madame Baron Veillard.** Pinkish lilac.
- Seiboldii, or Ramona.** Dark lavender.

Strong two-year-old plants in pots, 50c. each, \$5.00 per doz.

SMALL FLOWERING CLEMATIS

- Davidiana.** Deep lavender.
- Flamula.** Is covered with fragrant white flowers.
- Graveolens.** The best of the yellows.
- Paniculata.** This is a new Japanese, pure white flowers of most pleasing fragrance.
- Coccinea.** Thick bell-shaped scarlet flowers.

Strong two-year-old plants 25c. each, \$2.50 per doz.

NOTICE: We can also supply all other varieties of Clematis.

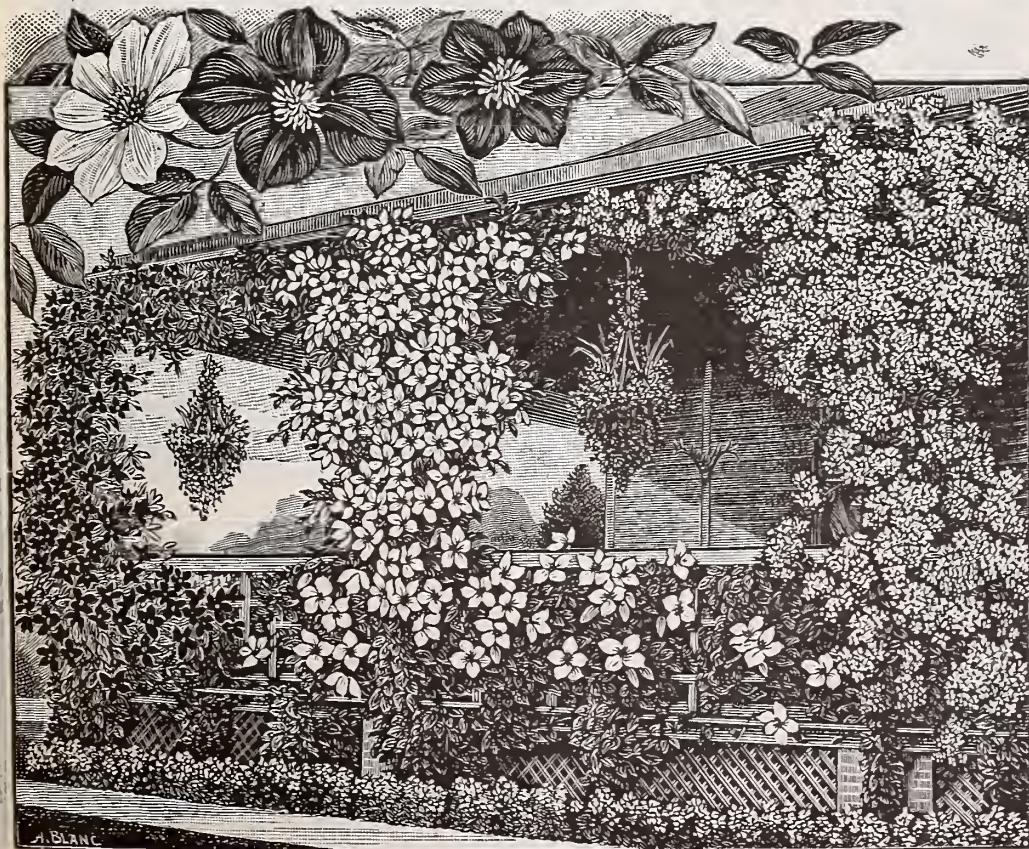

Clematis



CHRYSANTHEMUMS

Hardy Chrysanthemums

These have lately become very popular on account of their perfect hardiness and large variety of colors. We can supply thirty-five varieties. The following six are especially desirable.

Einyford Gem. Rich red.
Golden M'lle Martha. Bright golden yellow.
Maid of Kent. White.
Regulus. Cinnamon color.
Rose d'Amour. Very fine pink.
Wm. Sabey. Canary yellow; fine reflexed.

Strong Pot Grown Plants \$1.00 per doz., \$6.00 per 100.

Strong Field Grown Plants, heavy stock, \$2.00 per doz., \$14.00 per 100.

Chrysanthemum Plants

Best up to date sorts selected with great care from varieties which HAVE WON PRIZES AT THE RECENT EXHIBITIONS.

Best White. Mayflower, Western King, Queen, White Ivory, Frank Hardy, Mrs. Geo. Peabody, Miss Helen Wright, Evangelina, Merry Monarch, Philadelphia, Mrs. H. Robinson, Niveus.

Best Yellow. Modesta, Harry Hurrel, Golden Gate, Golden Trophy, Pennsylvania, Pres. Graham, E. Dailedouze, Maj. Bonaffon, Miss Gorgiana Pitcher, Golden Wedding, Minerva, Gold Standard, Mrs. Pullman.

Best Pink. F. B. Hays, Pink Ivory, Lady Playfair, Helen Bloodgood, Mrs. Perrin, Mrs. Murdock, Maud Dean, Viv. Morrel, Catharine Leech, Mrs. Geo. West, Ada Prass, Mrs. C. F. Berwind, Bayard Cutting.

Best Bronze. Pluto, Barrington, Sunrise, M. Nixon, Egyptian Tuxedo.

Best Crimson. Mrs. J. Shrimpton, G. W. Childs, Defender, Autumn Leaves, Quito, Autumn Glory.

Strong, healthy plants will be furnished in spring from 2 inch pots. Per doz. \$1.50; per 100 \$8.00. The full collection of the above, one plant each, fifty in all, \$5.00.



Giant Paris Daisies.

PARIS DAISY PLANTS.

These are certainly very desirable for cut flowers, as they are constantly in bloom. The flowers are very large, measuring fully three inches across. A specialist is growing these plants for us. We can recommend them highly to our customers.

"Giant of California". White. Strong young plants, 20c. each, \$1.50 per doz., \$11.00 per 100.

"Etoile de Lyon". Yellow. Strong young plants 20c. each, \$1.50 per doz., \$11.00 per 100. (25 at 100 rates).



Cyclamen.

CYCLAMEN GIGANTEUM.

The very finest large flowering varieties. 25c. each, \$2.50 per doz.

Extra fine large specimen plants. 50c. to \$1.00 each, according to size.



Cluster of Nymphaea Dahlias.

DAHLIAS.

Our Dahlias are grown for us by the Dahlia Specialist, W. P. Peacock, of New Jersey, which is sufficient guarantee of their being true to name and of first quality. Mr. Peacock does not sell at retail, but we have arranged to supply any one of the hundreds of varieties of Dahlias grown by him in addition to the following select list of prize winners.

NINE NEW DAHLIAS OF SPECIAL MERIT.

<p>"Blizzard" "Henry F. Michell" "La Favorite" "Admiral Dewey"</p>	<p>See Novelty page H for Descriptions</p>	<p>"Aguinaldo" "Iridescent" "Clifford W. Bruton" "Wilhelm Miller" "Folia Variegata"</p>
---	--	--

TWELVE BEST BOQUET OR POMPON DAHLIAS.

- Beatrice.** White suffused lavender; very profuse flowering.
- Eleganta.** New. Pinkish white tipped deep pink.
- Elfin.** Primrose, changing to creamy white, fine.
- Fairy Queen.** Sulphur yellow, edged carmine; very profuse.
- H. C. Winters.** Very fine pale yellow tipped fawn.
- Klein Domatia.** Rich orange buff, extremely profuse.
- Little Valentine.** Beautiful form, rich dark purple.
- Leila.** Flesh mottled and variegated with rich crimson.
- Prince Charming.** New. White tipped purplish pink.
- Snowclad.** The finest snow-white. Profuse bloomer.
- Vivid.** Bright dazzling scarlet; very fine form.
- Yellow Bird.** Fine yellow, with long stems for cutting.

Price, strong clumps, each 15c., per doz. \$1.50, per 100 \$10.00.

Fifteen Best Double Large Flowering Dahlias.

- A. D. Livoni.** Pure soft pink, a superb variety.
- Arabella.** Large pale primrose, exquisitely shaded.
- Buff Pink.** Sulphur, tipped peach, edged purple.
- Elegans.** Rosy purple, striped and tipped white.
- Herbert Turner.** White suffused and veined blush pink.
- Hope.** Large and full. White tipped deep lavender.
- John Sladden.** Nearly black; large, full fine form.
- Keystone.** Pink striped crimson, large and fine.
- Lady G. Herbert.** White, tipped crimson and maroon.
- Margaret Bell.** Very large and free, rosy purple.
- Margaret Bruant.** Large, snow-white, profuse bloomer.
- Miss Florence Shearer.** Beautiful clear soft lilac.
- Pluton.** A superb pure yellow prize taker.
- Ruby Queen.** Ruby red, richly shaded; very fine.
- Willie Garrett.** The finest rich dazzling red.

Price 15c. each, \$1.50 per doz., \$10.00 per 100.

FIFTEEN BEST CACTUS DAHLIAS.

- Black Beauty.** Large fine form; maroon shaded black.
- Bronze Cactus.** Buff yellow overlaid and penciled bronze and red.
- Constancy.** New. rich reddish orange shaded bronze, tipped white.
- Countess of Pembroke.** Delicate rosy lavender, of exquisite form and finish.
- Crimson Giant.** Very large, deep crimson, shaded maroon; fine.
- Evadue.** Soft primrose tipped creamy white; edged soft pink.
- Gilt Edge.** New. Rich gold striped pure white, distinct and effective.
- Grand Duke Alexis.** Large, pure white flaked pink, beautifully quilled.
- King of Cactus.** Rosy crimson magenta; flowers 7 inches across.
- Maid of Kent.** Intense cherry red tipped white; a beautiful variety.
- Nymphæa.** Still the most valuable and popular variety. Pure light shrimp pink tinted lighter toward the centre. Water lily form, a strong grower and profuse bloomer. (See illustration).
- Panthia.** Rich reddish salmon; fine form, distinct.
- Wm. Agnew.** New. Very large intense dazzling red; profuse bloomer.
- Wm. Pierce.** Rich butter yellow; a strong grower and good bloomer.
- Zulu.** Deep rich maroon almost black; of perfect form; distinct and effective.

Price 15c. each, \$1.50 per doz., \$10.00 per 100.

TWELVE BEST SINGLE DAHLIAS.

- Annie Hughes.** Fine carmine pink; good form, free bloomer.
- Brilliant.** Brilliant scarlet; large fine form, one of the best.
- Enchantment.** A beautiful shade of red; base of petals yellow.
- Fern Leaved.** A dwarf free flowering red with fern like foliage.
- Fragrant.** New. Orange scarlet with slight but distinct fragrance.
- Fashion.** Crimson maroon flamed purple; light disk around center.
- Harold.** Dark maroon, almost black; fern like foliage.
- Jumbo.** New. Very large; buff striped red; an early and profuse bloomer.
- Miss Roberts.** A fine large free blooming yellow.
- Sandusky.** A soft shade of salmon, fine shape, strong free bloomer.
- Seratipelala.** Fine red with serated notched petals; distinct.
- Snow Queen.** The best single white; fine form with long stems.

Price 15c. each, \$1.50 per doz., \$10.00 per 100.

DAHLIAS IN SEPARATE COLORS. Very Fine.

CHOICE VARIETIES UNDER COLOR.

- Red Shades, White, Pink Shades, Yellow Shades, Variegated.**

Strong clumps, 12c. each, \$1.25 per doz., \$9.00 per 100.



Mixed. All colors. Double. Strong clumps 10c. each, \$1.00 doz.
Mixed. All colors. Single. Strong clumps 10c. each, \$1 00 doz.

..NEW BOOK..

"THE DAHLIA"

A practical treatise by Lawrence R. Peacock. It is clear, concise, yet comprehensive. Beautifully illustrated with ten full page photo-engravings, made expressly for the book, and with an embossed paper cover. Invaluable to all interested in Dahlias. Price by mail prepaid 30 cts.

Special Offer. We will present a copy of "THE DAHLIA" free of charge to all ordering Dahlias from us to the amount of \$3.00 or more. See page "H" for Novelties.



L. B. H. C. COPYRIGHTED 1885

Gladiolus

(Large-Sized Bulbs.)

- All Colors, very Choice Mixed.** Each 4c., per doz. 25c., per 100 \$1.75, per 1000 \$14.00.
- White and Light Colors.** Each 5c., per doz. 40c., per 100 \$2.75, per 1000 \$20.00.
- Yellow Shades.** Each 5c., per doz. 40c., per 100 \$3.00.
- Scarlet and Crimson.** Each 4c., per doz. 25c., per 100 \$1.75, per 1000 \$15.00.
- Pink and Variegated.** Each 5c., per doz. 40c., per 100 \$2.25 per 1000 \$20.00.
- Lemoine's Butterfly.** Extra fine mixed. Each 5c., per doz. 40c., per 100 \$2.25.
- Childsi.** A distinct mammoth race, much stronger and more vigorous than any others. They bloom freely, many plants producing 3 to 5 spikes of bloom. The flowers are of great substance and of exceptional large size, frequently 6 or 7 inches across. Mixed of all bright colors. 8c. each, 75c. per doz., \$5.00 per 100.

Geraniums.

All the best and most satisfactory bedding varieties. \$1.20 per doz., \$8.00 per 100, \$75.00 per 1000.

Gaillardia Grandiflora

Of hardy perennial plants; beginning to flower in June they continue the entire season. Being perfectly hardy they require absolutely no protection. The flowers are large, from 2½ to 3½ inches in diameter, produced on long stems, excellent for cutting. The centre is dark red-brown, the petals are variously marked with rings of brilliant scarlet crimson, orange and vermilion, and often a combination of all these colors in one flower.

Strong Clumps, for immediate effect, 15c. each, \$1.50 per doz., \$10.00 per 100. Strong young plants which will flower freely this summer, 10c. each, \$1.00 per doz., \$8.00 per 100.



Lemoine's

"Butterfly"

Gladiolus



Helianthus (Sunflower).

Multiflorus fl. pl. (Double Hardy Sunflower). An extremely useful, hardy plant; bears profusely large double flowers of a bright yellow. Each 15c., per doz. \$1.50.

Maximiliana. Large double golden yellow flowers. Each 15c., per doz. \$1.50.

Hyacinthus Candicans

Summer Blooming Hyacinth. Extra large bulbs. Each 5c., per doz. 50c.

Hollyhocks

(Chater's Double.)

Strong Plants. Will bloom the first season. White, Yellow, Pink, Scarlet, each 20c., per doz. \$2.00.

Mixed. 15c. each, doz. \$1.50

Honeysuckles

(Woodbine.)

Halliana. Flowers pure white, turning to yellow. Fragrant, hardy evergreen; flowers freely.

Variegated. Foliage beautifully mottled yellow and green. Each 25c. to 50c. per doz. \$2.50 to \$5.00.

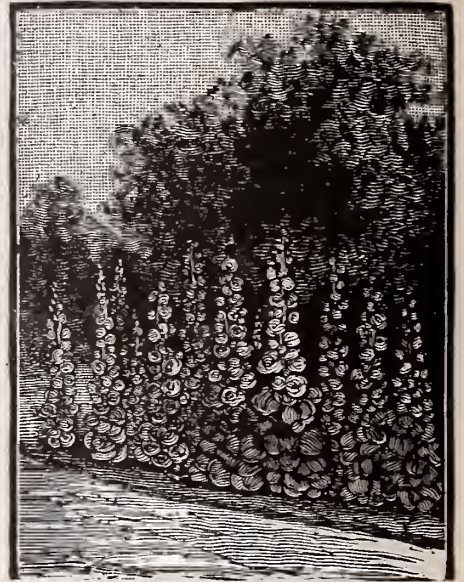

A Bed of Hollyhocks.

Hydrangea

Paniculata Grandiflora. The popular hardy Hydrangea. Strong plants, each 25c., doz. \$2.50; extra large plants, each 50c., doz. \$5.00.

Iris Kämpferi (Japanese Iris).

Hardy. Strong roots. Will bloom this season.

Mixed. Of all colors. Each 15c., per doz. \$1.50.

Named Varieties. Each 25c., per doz. \$2.50.

Lilies (Hardy).

Auratum (Golden-banded Japan). Extra large bulbs, 11 to 13 inches in circumference. Each 20c., per doz. \$2.00, 100 \$10.00. Bulbs 9 to 11 inches in circumference. Each 15c., per doz. \$1.50, per 100 \$8.00. Bulbs 7 to 9 inches in circumference. Each 10c., doz. \$1.00, per 100 \$6.00.

Lancifolium Speciosum Album. Extra large bulbs. Pure white Japan Lily. Each 20c. per doz. \$2.00, per 100 \$12.00.

Lancifolium Speciosum Rubrum. Very large bulbs. Each 15c., per doz. \$1.50, per 100 \$10.00.

Lancifolium Speciosum Roseum. Extra large bulbs 15c. each, \$1.50 per doz., per 100 \$10.00.



Lilium Auratum.

Tigrinum (Tiger Lily). Each 10c., per doz. \$1.00, per 100 \$8.00.

Madeira or Mexican Vine

Large Selected Bulbs. Each 5c., per doz. 40c.

Manettia Vine Each 15c., per doz. \$1.50.

GLOXINIAS

One of the handsomest summer blooming plants. Flowers three inches in diameter; upright, colors crimson, violet, rose, scarlet, white and beautifully spotted. They attain the greatest perfection if grown in light, rich soil in a shady, well ventilated frame. After they are done growing, they may be kept in a warm, dry cellar, or under the stage of a greenhouse. Mixed colors.

Each 10c., per doz. \$1.00, per 100 \$6.00.



Choicest
Hybrid
Gloxinias.

Perennial Iceland Poppies

Range in color from the purest white and yellow to the deepest glowing orange scarlet, and have a delicious Lilac-like fragrance. The profusion of blooms which they produce is really astonishing, often a hundred flowers on a single plant, and they are produced in succession from the beginning of June to October. Mixed colors, each 15c., per doz., \$1.50.

Perennial Phlox

The Perennial Phloxes are among the most desirable hardy herbaceous plants, and should be planted largely; they succeed in any position and can be used to advantage either as single specimens in the mixed border or as large clumps or beds in the garden. In 25 separate and best varieties, each 15c., per doz. \$1.50, per 100 \$10.00.

MOON FLOWERS (*Ipomœa*.)

- Noctiflora (White).** Young plants. Each 10c., per doz. \$1.00.
- Noctiflora (White).** Strong plants. Each 15c., four 50c., doz. \$1.25.
- Hardy Day Blooming.** Extra large selected roots. Each 15c., doz \$1.50.
- Ipomœa Learii (Blue Moon Flower).** Intense violet blue flowers, six inches in diameter. Each 10c., twelve for \$1.00.
- Ipomœa Mexicana (Pink Moon Flower).** Large pink or rose colored flowers, a grand companion to the above, being tuberous-rooted it can be wintered the same as a Dahlia root. Each 15c.

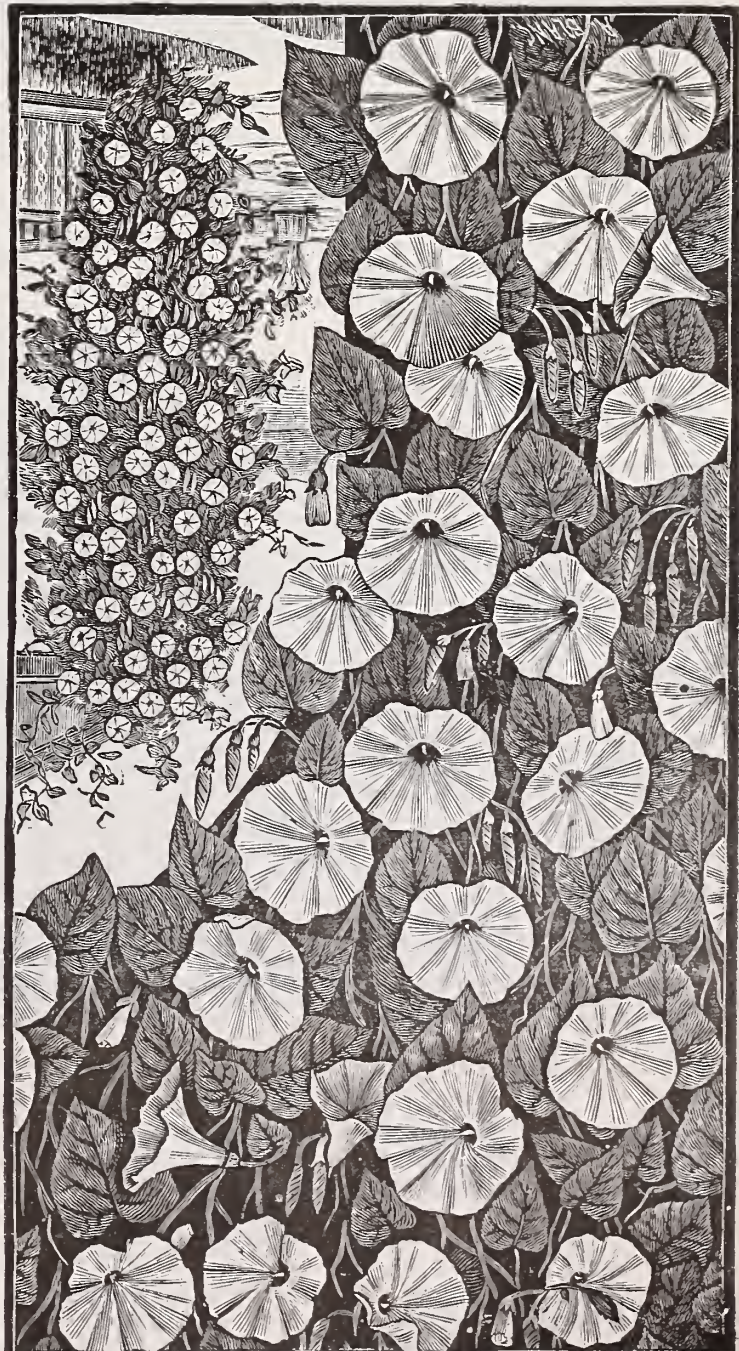

Moon Flowers.

Oxalis. Very desirable summer bloomers.

Deppi. White. 15c. per doz., \$1.00 per 100.

Lasiandra. Pink. 15c. per doz., \$1.00 per 100.

Montbretia. One of the most satisfactory of all the summer blooming bulbs.

Crocsmiaeflora. The best variety; deep golden orange flowers. 30c. per doz.; \$2.25 per 100.

PÆONIES



PÆONIES (Herbaceous).

Extra fine large clumps with three and four eyes **Finest Varieties.**

Double Pink. Each 25c., per doz. \$2.50, per 100 \$15.00.

Double White. Each 25c., per doz. \$2.50, per 100 \$15.00.

Double Red. Each 25c., per doz. \$2.50, per 100 \$15.00.

Double Mixed. Each 20c., per doz. \$2.00, per 100 \$13.00.

Tenuifolium. Fine feathery graceful foliage; flowers very rich crimson. Very highly recommended. 25c. each, \$2.50 per doz.

Tuberose.



Tuberose. Extra large blooming bulbs.

Excelsior Pearl. Each 4c., per doz. 25c., per 100 \$1.50, per 1000 \$10.00.

Tall Double. Each 4c., per doz. 25c., per 100 \$1.50, per 1000 \$10.00.

"Albino". The flower spikes are very large and evenly filled; flowers in July and August. The tube and expanded sepals being of the purest waxy white, making it one of the most valuable plants ever introduced for cut flowers. The odor is less heavy than that of the ordinary Tuberose. Each 5c., doz. 50c., per 100 \$3.00.

Rhododendrons. We have made arrangements with one of the largest and most reliable nurseries, and can supply very fine plants, well set with buds at \$1.00 each, \$12.00 per doz., \$95.00 per 100. These plants will bloom and produce a fine effect this coming season.

Tigridia (Shell Flower).

Beautiful summer flowering bulbs, producing large flowers, exquisitely spotted; flowering from July to October.

Conchiflora. Orange with crimson spots. Each 5c., per doz. 40c., per 100 \$3.00.

Pavonia Grandiflora. Red, with yellow spots. Each, 5c., doz. 40c., per 100 \$3.00.

Grandiflora Alba. White flowers, spotted with maroon. Each 5c., per doz. 40c., per 100 \$3.00.

Tritoma Uvaria Grandiflora.

(Red-Hot Poker Plant).

Rich orange red flowers. Each 15c., per doz. \$1.50.

Verbenas.

Choice Mixed Colors. Per doz. 75c., per 100 \$5.00.

Wisteria (Glycine)

Sinensis. The best blue. Each 30c. and 50c.

Sinensis Alba. White. Each 50c.

Hardy Shrubs.

Extra Strong healthy plants, blooming size. We can supply all the best varieties. 30c. each, \$3.00 per doz., \$20.00 per 100.

Nut Trees.

Grown by a specialist. They are now much in demand on account of the satisfactory results they produce.

Japan Chestnut. Hardy, productive, large, good quality. Price \$1.00 each.

Numbo Chestnut. Hardy, large nuts, good, bears young. Price \$1.00 each.

Pecan. Nuts oblong, sweet, thin shelled, good quality, heavy bearer. Price 50c. each.

Japan Walnut. Rapid grower, nuts sweet, good quality, bears young. Price 50c. each.

English Walnut. Large, nut fine flavored, thin shelled, bears young. Price 50c. each.

Butternut. Bears young, good grower, productive, nut sweet and fine flavored. Price 50c. each.

One each of the above \$3.25.

P. S.—We have made arrangements with one of the largest and most reliable nurseries to supply us with all the best varieties of **Fruit and Ornamental Trees.** Catalogue and price list on application.

..American Gardening..

The best *Weekly* illustrated journal of Horticultural and Gardeners' Chronicle New publisher \$1.50 per year If you have a garden or greenhouse, either large or small, you need the best up-to-date information to derive the best results.

PUBLISHED BY

JAMES G. WITHERS,

136 Liberty Street, - New York.

Subscriptions also received by us.



**New
Climbing
Rose
"Royal
Cluster"**

Hardy, Double White, delightfully fragrant, medium size, quite double. A vigorous climber, free from disease, blooms very freely and bears immense clusters, 119 roses and buds having been counted on one cluster. Continues a long time in bloom; it is really the most magnificent white hardy climbing rose yet introduced.

2 1/2 inch pots. 25c. each; \$2.50 per doz.
3 inch pots. 35c. each; \$3.50 per doz.
2-Year-old. Extra strong. 50c. each; \$5.00 per doz.

Roses—Standard Sorts

True to name. Fine plants. Grown over winter in cold houses, which produce the best results for outside planting.

- American Beauty. Crimson. The best hybrid tea.
- Baltimore Belle. White climber.
- Bridesmaid. Pink. (Tea.)
- Bride. Pure white. (Tea.)
- Capt. Christy. Pink. Perpetual.
- Coquette des Alps. White. Ever-blooming.
- Crimson Rambler. Climbing.
- Dinsmore. Rich crimson. Perpetual.
- Glorie de Dijon. Perpetual.
- Gen'l Jacqueminot. Crimson. Perpetual.
- Glory of Mosses. Pink. Moss.
- Hermosa. Pink. Ever-blooming.
- La France. Pink. Hybrid tea.
- Maman Cochet. Pink. Ever-blooming.
- Mrs. John Laing. Pink. Perpetual.
- Marchal Neil. Yellow climbing. (Tea.)
- Meteor. Crimson. (Tea.)
- Papa Gontier. Carmine. (Tea.)
- Perle des Jardins. Yellow. (Tea.)
- Prairie Queen. Red climbing. Perpetual.
- Ulrich Brunner. Scarlet. Perpetual.

We can furnish all other varieties of Roses.

Extra Strong Plants. Grown in 5-inch pots. 40c. each, \$4.00 per doz., \$25.00 per 100.
Strong Young Plants. 15c. each, \$1.50 per doz., \$10.00 per 100.
3-Year Old, Extra Strong. Grown on their own roots, best varieties. 50c. each, \$5.00 per doz.

Rugosa Roses

The Rugosa Roses form strong hardy bushes 3 to 5 feet in height, covered with handsome glossy green foliage, and clusters of beautiful single flowers. They bloom nearly all summer, and are covered during autumn and winter with red seed pods.

- Crimson. Extra strong plants, 40c., per doz. \$4.00.
- Pure White. Extra strong plants, each 40c., per doz. \$4.00.

Water Lilies.

Water gardening is no longer experimental. The continued success in the culture of Aquatics has made them very popular until now they are considered indispensable, and a branch in decorative art that no well kept garden is complete without them. The hardy varieties may be planted as soon as vegetation commences in the spring. If not convenient to grow them in a pond or lily tank (which is preferable), they may be grown in tubs, several varieties being adapted to this mode of culture. A warm sheltered position, yet with full exposure and sunshine should be selected. Fill the tubs two-thirds full of turfy soil enriched with decomposed hot-bed or farmyard manure; cow manure is very desirable; cover with two inches of sand and fill with water. The crowns of the plants should be placed just under the surface of the soil.



Nelumbium Speciosum (Egyptian Lotus). This grand lotus is perfectly hardy. The flowers when just expanding are of a beautiful rosy pink color; when open they are of a creamy white and pink, and are very fragrant. Each 75c. and \$1.50.

Nymphæa Alba Candidissima. This is a large flowered variety of the English Water Lily; flowers white, a continuous bloomer, very desirable. Each 75c., doz. \$2.00.

Nymphæa Odorata. The well-known white fragrant pond lily. Each 20c., per doz. \$2.00.

Nymphæa Marliacea Chromatella. The best yellow water lily in cultivation; the habit of the plant is like N. Candidissima, flowering freely the entire season. Each 50c.

Nymphæa Marliacea Albida. The best of hardy white lilies. Price 75c. each.

Nymphæa Marliacea Carnæa. Magnificent flowers of a flesh tint. Price \$1.00 each.

Nymphæa Marliacea Rosea. One of the choicest of hardy pink lilies. Price \$1.50 each.

Nymphæa Odorata Gigantea. This is a superb variety and should be in every collection; similar in all respects to N. Odorata, but the flower is very large and full. A Southern variety of the N. Odorata type. Each 20c., doz. \$2.00.

Nymphæa Odorata Rosea (Cape Cod Water Lily). One of the best pink hardy Nymphæa in cultivation; it possesses all the desirable qualities of the white flowered species, hardiness, freedom of bloom and delicious fragrance. Each 50c.

Nymphæa Odorata Sulphurea. One of the very best new water lilies, with large, yellow fragrant flowers. It is very free blooming and has the fragrance of N. Odorata. The leaves are deep green, beautifully mottled with reddish purple or brown spots; a great acquisition. Each 50c.

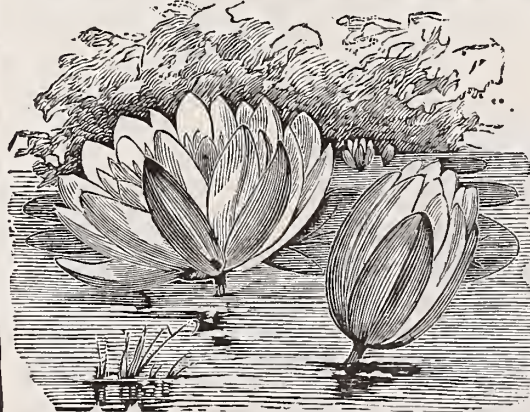

Nymphæa Zanzibarensis Azurea. Deep rich azure blue, very free and continuous bloomer; delicately scented. Each 50c.

Nymphæa Scutifolia. Clear light blue, very free flowering, continuous until frost. Each 75c.

Nymphæa Zanzibarensis Rosea. This is like N. Zanzibarensis in every respect, except that the flowers are a beautiful deep rose color. Each 50c.

Nymphæa Dentata. The largest and best white, night-blooming variety; flowers of the largest size; long, pointed buds, on strong stalks, opening horizontally; leaves deep green, with serrated edges. Each 50c.

Nymphæa Devoniensis. This is one of the very choicest Water Lilies in cultivation, and indispensable in a moderate collection. The flowers are a brilliant rosy red, produced on stout stalks standing above the water, and are from ten to twelve inches across. The leaves are deep green with reddish shade. Each 50c.

Water Hyacinth. Very interesting and beautiful; floats on the surface of the water and produces fine spikes of light rosy lilac flowers. Each 15c., per doz. \$1.50.

Water Poppy (Limncharis Humboldtii). Flowers beautiful clear yellow; must be grown in shallow water; very attractive. Each 15c., per doz. \$1.50.

Water Snowflake (Limnanthemum Indicum). In growth the plant resembles a water lily, with leaves from three to five inches across; flowers white. Each 15c.

Cyperus Papyrus (Egyptian Paper Plant). Each 25c. and 50c.

SPECIAL OFFER.

For \$1.00 we will supply one each of PINK, BLUE and WHITE HARDY WATER LILIES. Our selection only.

Water Lily Seed

Nymphæa Zanzibarensis. Pkt. 15c.
" " Rosea. Pkt. 15c.
" " Azurea. Pkt. 15c.
" Gracilis. Pkt. 15c.

SMALL FRUITS, ETC.

Currants

Currants should be planted on good soil, which must be kept rich and well worked. Sprinkle ashes around the roots occasionally, to keep the borers away. The currant worm may be destroyed by sprinkling the bushes with powdered white hellebore while they are wet with dew. Where it has been applied, the fruit should not be used without first being washed.

Black Naples. Vigorous and productive; used for jelly and jams, and highly profitable for market in some sections. Two years, per doz. \$1.25, per 100 \$7.00.

Fay's Prolific. Color rich red. Two years, each 15c., per doz. \$1.25, \$7.50 per 100.

Red Dutch. Medium size; in large bunches; the old and well-known currant of the garden. Two years, per doz. \$1.00, per 100 \$6.00.

White Grape. The best white variety; large, sweet and good; best for the table; a good bearer. Two years, very fine, per doz. \$1.00, per 100 \$6.00.

Blackberries

Plant in good rich soil, in rows five feet apart, and three or four feet apart in the row. After the fruiting season or in early spring, cut out all the dead wood. Should be planted early, before the buds start. A good top dressing of stable manure, applied annually, produce large crops. Keep the ground clean and well worked.

Erie. An excellent early berry; ripens its entire crop at once. Berries good size, black, firm, sweet and of good quality. Per doz. 60c., per 100 \$3.00.

Kittatinny. Large, juicy, sweet and excellent; hardy and productive. Considered the best and most profitable late berry. Per doz. 50c., per 100 \$2.50.

Wilson's Early. A well-known and desirable variety; ripens early. Per doz. 50c., per 100 \$2.50.

Wilson's Junior. Of large size, unsurpassed productiveness, fine flavor and early. The largest and best early blackberry yet introduced. Per doz. 50c., per 100 \$2.50.

Gooseberries

Treatment same as for Currants.

Downing. Large pale green; soft, juicy and good for family use. Two years, per doz. \$1.00; per 100 \$6.00.

Houghton's Seedling. Medium, pale red, vigorous. Two years, per doz. \$1.00, per 100 \$6.00.

Industry. Although a foreign sort, it has done admirably, being a vigorous grower and an immense yielder, and showing no signs of mildew. We confidently recommend it for the garden, being unequalled for size, flavor, productiveness and vigorous growth. Color dark red. Each 25c., per doz. \$2.00.



New Strawberry Raspberry.

Tested here for three years, and constantly growing in favor; one of the most beautiful fruits ever seen. Berries the size and shape of the largest strawberries; bright, rich glowing scarlet; fine for jams, jellies and cooking. Bush grows 18 inches to two feet high, bears the first season and continues fruiting for three months; dies down in winter, but is entirely hardy, and does well everywhere regardless of drought or heat. Every garden should have some of these really good berries, they are sure to please. \$1.50 per doz., \$6.00 per 100.

NEW
Strawberry
Raspberry;
OR
Tree
Strawberry

Raspberries

Plant in rows five to six feet apart, two to four feet apart in the row. Cut the tops off within a few inches of the ground when planted. Pinch the vigorous young shoots several times during the summer; they will then grow stout enough to stand without staking.

Brandywine. Large; bright red, hardy and productive; an old variety, extensively grown. Per doz. 50c., per 100, \$2.50.

Cuthbert. Large, firm, deep, rich crimson, of excellent quality; perfectly hardy and very productive. Per doz. 50c., per 100 \$2.50.

Philadelphia. Dark crimson; a variety grown for market, on account of its hardiness and productiveness. Per doz. 75c., per 100 \$3.00.

Gregg. A large black variety; fruit firm, of excellent quality and a good shipper. Per doz. 50c., per 100 \$2.00.

Japanese, or Wineberry. Large clusters of red berries, excellent for jelly or preserving. Each 10c., per doz. \$1.00.

Hardy Grape Vines.

Very strong two year old roots, true to name. Each 25c., per doz. \$2.50, per 100 \$12.50.

Catawba. A very good keeper; red sweet and rich, with pleasant flavor. Does best against buildings.

Concord. One of the most profitable of all hardy grapes. Bunch and berry large; black, juicy and sweet.

Duchess. Medium size; greenish white; excellent quality; compact bunch. Ripens with Concord.

Lady. Bunch compact and of good size; berry yellowish green; flavor sweet, rich and sprightly.

Martha (White Concord). Large, pale yellow; strongly resembles the Concord in all points except color; hardy and vigorous.

Moore's Early. Bunch and berry round and large; black, with a heavy blue bloom.

Niagara. Bunches very large and very compact; berries large, light greenish white, skin thin but tough, and does not crack; quality good.

Salem (Rogers' No. 22). Large; bright redish brown; fine rich, aromatic flavor.

We also have some extra strong vines of the above sorts at 50c. each, per doz \$5.00.

Foreign Grape Vines, for indoor graperies. All the best varieties. One year old vines, each 75c., per doz. \$7.50. Strong two year old vines, each \$1.50, per doz. \$15.00.

Strawberry Plants—Extra Strong

All the leading and tested varieties. Per doz. 25c., per 100 \$1.00, per 1000 \$5.00.

Pot Grown Strawberry Plants

Ready August 1st. Per 100 \$3.00, per 1000 \$25.00.

Hedge Plants

CALIFORNIA, or JAPAN PRIVET.

An exceedingly beautiful, nearly evergreen; shrub pyramidal form; very vigorous and hardy; leaves deep green, bright and very glossy; bears spikes of fine, white flowers in June; highly ornamental. This is decidedly superior to all other plants for edges. Especially adapted for hedges at the seashore; very easily transplanted. Beware of spurious kinds of privet which are being offered for the above and which are not nearly so desirable; ours are the genuine California, or Japan privet (*Ligustrum Ovalifolium*). Most of them have been transplanted and are furnished with an abundance of fine fibrous roots, are well branched and are sure to give satisfaction.

One year old, 1 to 2 feet high. Per 100 \$2.50, per 1000 \$20.00

Two years old, 2 to 2½ feet high. Per 100 \$3.50, \$30.00 per 1000.

Three years old, 2½ to 3 feet high. Extra fine. Per 100 \$5.00, per 1000 \$35.00.

Osage Orange

Extra strong two year old plants. Per 100 \$1.00, per 1000 \$7.50.

..Highest Quality.. **FERTILIZERS** ..Guaranteed Pure..

ASHES (Canada Unleached Hard Wood).

These contain all of the fertilizing elements except nitrogen. Ashes correct sourness in the soil, rendering sandy soils more capable of retaining fertilizers and making clay soils less stiff and more easily worked. They drive away insects, and are indispensable for all crops requiring potash. They are very beneficial for garden and field crops. Apply about 1000 lbs. to the acre. Per 100 lbs. \$1.50, bbl. of 250 lbs. \$2.75, ton of 2000 lbs., in barrels, \$18.00, carload lots of about 20 tons, in bulk, \$12.50 per ton.

THE COST OF WOOD ASHES can be reduced \$3.00 per ton by customers giving us their order 2 to 3 weeks ahead, to enable us to ship it direct from Canada to the customer. Special rate on application.

Michell's (Strictly Pure and Fresh) Bone Meal.

In fertilization nothing takes precedence in importance over animal bones, because they furnish the soil with the essential requisite of nitrogen as well as phosphoric acid. On the average, 1000 lbs. of good bone dust contain about 38 lbs. of nitrogen and nearly 25 per cent. of phosphoric acid; to put it familiarly, 1 ton of good bone dust contains as much nitrogen as 8 1/2 tons fresh stable manure, and as much phosphoric acid as 110 tons of same. The most substantial fertilizer for plants and lawns. 3 lb. box 15c., 5 lb. bag 25c., 10 lbs. 40c., 25 lbs. 75c., 100 lbs. \$2.00, sack of 200 lbs. \$3.50, ton \$30.00.

PURE GROUND BONE.

Coarser than bone meal; apply 400 lbs. to the acre. 25 lbs. 75c., 100 lbs. \$2.00, sack of 200 lbs. \$3.50, ton \$30.00.

PURE BONE FLOUR.

Ground perfectly fine; excellent for pot plants or beds where an immediate effect is wanted. 5 lbs. 25c., 25 lbs. \$1.25, 100 lbs. \$2.50, bag or bbl. of 200 lbs. \$4.50, ton \$40.00.

SUPER-PHOSPHATE (High Grade).

ANALYSIS: Ammonia, 4 to 6 per cent.; bone phosphate, 24 per cent.; Available Phos. Acid, 6 to 8 per cent.; Sulph. Potash, 1 to 2 per cent. It stands without a rival as the largest crop producer at the smallest outlay. It is a complete manure. You can buy phosphates that cost \$5.00 to \$10.00 per ton more, but you can't buy one that will give larger increase in crops. Harrow or drill in, using 200 to 300 lbs. per acre; if applied broadcast, use 300 lbs. per acre. 25 lbs. 90c., 100 lbs. \$2.00, 200 lbs. \$3.25, per ton \$28.00.

No. 1 BONE PHOSPHATE.

An excellent guaranteed grade. Analysis: Ammonia, 2.25 to 3.00; Available Phosphoric Acid, 9.25 to 11.00; Potash, actual, 2.50 to 3.50. A very quick acting fertilizer for general use. \$3.00 per sack of 200 lbs., \$25.00 per ton.

PERUVIAN GUANO.

1 1/2 lb. box 15c., 3 1/2 lb. box 25c., 10 lbs. 50c., 100 lbs. \$3.00, sack of 168 lbs. \$5.00, per ton \$52.00.

NITRATE OF SODA.

For all crops. Contains the largest percentage of nitrogen; equal to 19 per cent. of ammonia. It is very quick in action, and hastens maturity of crops fully two weeks. *Should not be applied until the plants are above the ground,* when 100 to 150 lbs. per acre should be sown with other fertilizers, or mixed with phosphates. Shipped in double bags. 50 lbs. \$2.00, 100 lbs. \$3.50, 200 lbs. \$6.00, per ton \$44.00.

AGRICULTURAL SALT.

For topdressing lawns or asparagus beds. Apply early in spring, at rate of 800 to 1000 lbs. per acre. 200 lbs. \$1.25, ton \$8.00.

MAPES' CELEBRATED FERTILIZERS.

Prices quoted here are f. o. b. Phila. It is, however, more advantageous to the customer to have them shipped direct from Mapes' factory, as the price will be 25c. less per sack, and \$2.00 less per ton than prices here with quoted, only paying one freight charge.

	Sack of 200 lbs.	Ton of 2000 lbs.		Sack of 200 lbs.	Ton of 2000 lbs.
Potato manure, . . .	\$4.50	\$39.00	Complete manure, for general use,	\$4.25	\$38.00
Corn " " " "	4.25	36.00	" " " " for heavy soils,	4.50	39.00
Cabbage & cauliflower manure	4.25	38.00	" " " " for light soils,	4.50	41.00
Fruit and vine manure, . . .	4.25	39.00	Vegetable " " for all soils,	4.50	41.00
Grass and grain spring top-dressing,	4.25	40.00	Early vegetable and truck manure,	4.50	41.00

PRICE OF "JADOO" FIBRE

5 lb. box 30 cts., 10 lb. box 50 cts., 25 lbs. for \$1.10, in full bag lots, about 130 lbs. 3 cts. per lb., per ton or 1/2 ton lot 2 1/2 cts. per lb.

PRICE OF "JADOO" LIQUID.

25 cts. per pint bottle, \$2.00 per doz. pint bottles, \$3.50 per 2 dozen pint bottles in case; per 2 gallon can, \$1.50; per 5 gallon can, \$3.75; per 10 gallon can \$7.50.



TRADE MARK

REGISTERED

Protected by Letters Patent.

Sharpless & Carpenter's Potato, Corn and Truck Guano.

Guaranteed analysis: Actual Potash, 6 to 8 per cent; Ammonia 1 1/2 to 2 1/2 per cent.; Available Phos. Acid, 6 to 8 per cent. Price \$3.50 per sack of 200 lbs., \$30.00 per ton.

HORN SHAVINGS.

A very valuable and rich fertilizer, especially for roses, chrysanthemums, etc., 10c. per lb., \$5.00 per 100 lbs.

EXCELSIOR PLANT FOOD.

Odorless and very reliable. 10c. per 1/2 lb., 20c. per 1 lb. pkge.

KAINIT

One of the most useful fertilizers. Apply at the rate of 1000 lbs. per acre. Should be spread during winter. 100 lbs. \$1.25. 200 lbs. \$2.00, per ton \$15.00.

BOWKER'S CHEMICAL FERTILIZER.

For general forcing (indoors or out) apply at the rate of about one pound to each hot-bed sash, or six pounds to every one hundred square feet of bed, thoroughly worked into the soil to the depth of two or three inches.

For forcing lettuce, cabbage, tomato plants, etc., apply from four to six pounds per one hundred square feet, thoroughly mixed with the soil. Half the quantity may be applied a month later.

For carnations, violets and similar plants use at the rate of four to six pounds for every 100 square feet, or two to three pounds may be applied at one dressing, and then a month later apply two or three pounds more. More explicit directions sent on application. 10 lbs. 50c., 25 lbs. \$1.00, 50 lbs. \$1.75, 100 lbs. \$3.00.

BOWKER'S AMMONIATED FOOD FOR FLOWERS.

Made especially for plants grown in conservatory, house or garden. Clean, free from offensive odor. Full directions with each package. Package 25c., by mail 40c.

COTTON SEED MEAL.

\$3.00 per 100 lb. sack, \$25.00 per ton. Special price will be quoted on larger lots.

PULVERIZED SHEEP MANURE (Fresh),

A most excellent fertilizer. 2 lbs. 15c., 4 lbs. 25c., 10 lbs. 50c., 25 lb. bag \$1.00, 50 lbs. \$1.50, 100 lbs. \$2.25, per ton \$32.50.

CLAY'S FERTILIZER.

Imported manure especially recommended for flowers or vegetables, to bring the highest perfection. Should be used in potting soil, and spread on staging of greenhouses planted with flowering plants. Per bag of 25 lbs. \$2.00, 50 lbs. \$3.50, 100 lbs. \$6.50.

MURIATE OF POTASH.

50 lbs. \$2.25, 100 lbs. \$3.50, original bag of 224 lbs. \$6.00.

LAND PLASTER (Calcined).

25 lbs. 50c., 100 lbs. \$1.00, bbl. \$1.50, ton \$8.00.

Fertilizer Materials. So. Carolina Rock. Dissolved Phosphate. Dissolved Bone Black. Sulphate of Ammonia. Dried Blood. Tankage. Dried Fish. Sulphate of Potash. Sulphate of Magnesia. Sulphuric Acid. Lowest market prices on application

Descriptive information and copies of testimonials on "Jadoo" free on application.

SPECIAL NOTICE.

The American "Jadoo" Company will offer cash premiums at all exhibitions in 1898 for all plants that were grown in Jadoo Fibre, as also all plants that were grown in soil and watered with Jadoo Liquid that win first scheduled prizes.

Send for Descriptive circular.

INSECT DESTROYERS.

Ant Exterminator. Very effectual for destroying ants in gardens and lawns. Per page, 25c., 50c., \$1.00.
Bordeaux Mixture. For black rot, downy mildew, and anthracnose of grape, potato blight, potato rot, leaf blight of cherry, pear, quince, and other fungus diseases. 5 lbs. 60c., makes 25 gallons spray; 10 lbs. \$1.00, makes 50 gallons spray; 25 lb. box, makes 125 gallons, \$2.50.
Bordeaux Mixture. In liquid form, 40c. per qt., \$1.00 per gallon.
Caterpillar Lime, Ermish's. Cans of 5 lbs. \$1.00, 10 lbs. \$1.75, kegs of 25 lbs. \$3.75, 50 lbs. \$6.75.
Copperdine. For black rot, carnation rust and anthracnose of the grape, pear leaf blight, apple scab and powdery mildew. One gallon can (makes 100 gallons wash), per qt. 50c., per gal. \$1.50, five gal. can, \$6.25.
Dalmatian or Persian Powder. Pure 1/4 lb. 15c., lb. 40c.
Fir Tree Oil. For destroying insects, such as mealy bug, red spider, scale, thrip, green fly, etc. Full directions with each can. Qt. \$1.50, pt. 75c., 1/2 pt. 50c., small bottle, 25c.
Fir Tree Oil Soap. Per can 25c. and 50c. each.
Fostite. Prevents mildew. Five lbs. 50c., 25 lbs. \$2.00.
Gishurst's Compound. Extensively used for preventing and destroying green fly, mildew, thrip, mealy bug and scale. Box 50c., 3 lb. box \$1.00.
Good's Caustic Potash Whale Oil Soap. Per 50 lb. keg \$3.00, per lb. 10c.
Grape Dust. Best remedy for mildew. 5 lb. pkge. 30c., 100 lb. keg \$5.00.
Hellebore. For destroying rose slugs. With directions. Lb. 25c., 1/2 lb. 15c.
Kerosene Emulsion. For plant lice of any kind, cabbage worms, scale, insects on apple, pear, orange, lemon and other trees. 5 lb. can 60c., makes 50 gallons of spray; 25 lb. can \$2.50, makes 250 gallons of spray.
Kraft's Palm Wash. 75c. per qt., \$1.40 per 1/2 gal., \$2.65 per gal.
Kraft's Tonic and Insecticide. 25c. per bottle, 75c. per qt., \$2.65 per gal.

WEED KILLER (FAIRMOUNT).
 A great English remedy for killing weeds in gravel and other walks and drives. Price 75c. per can, sufficient to make 25 gallons liquid; large can \$1.25, will make 50 gallons.

Fumigators.

Perfection, No. 1, holds 1 pk. of stems, \$3.00.
Perfection, No. 2 holds 1/2 bush. of stems, \$3.50.
Perfection, No. 3 holds 3/4 bush. of stems, \$4.00.
Perfection, No. 4 holds 1 bush. of stems, \$5.50.
The "New Model." Manufactured by a practical gardener. No. 1 \$3.00 each, No. 2, \$4.00 each, No. 3, \$5. each.
Eureka, No. 1, height 12 in., for a house 10x20 ft., \$1.25.
Eureka, No. 2, height 16 in., for a house 12x40 ft., \$1.75.
Eureka, No. 3, height 20 in., for a house 15x100 ft., \$2.25.
Eureka, No. 4, height 24 in., for a house 20x100 ft., \$3.25.
Tobacco Stems. (Fresh.) For fumigating. 5 lbs. for 25c., \$1.00 per bbl., \$2.00 per bale of 250 lbs.

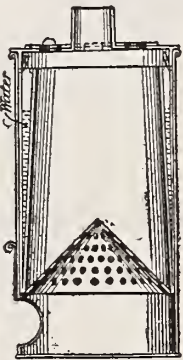

Water Tank Fumigator.

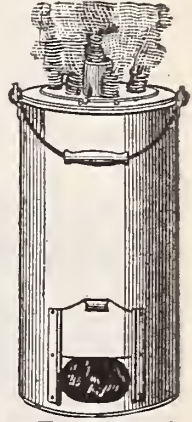

"Perfection"

Lemon Oil Insecticide.



The Best and Cheapest Insecticide in the Market. Used now by nearly all the leading growers. It effectually destroys Mealy Bug, Scale, Thrip and Red Spider.

Half Pint, 25c. Pint, 40c.
 Quart, 75c. Half Gal., \$1.25
 Gal., \$2.00 5 Gal. Kegs, \$9.00
 10 Gallon Kegs, \$17.50

Lemon Oil

London Purple. Cheaper and less dangerous than Paris green. Lb. 20c., 5 lbs. 90c. Special price on larger quantity.
Nikoteen. One of the most economical and powerful nicotine extracts. One part to 600 of water is sufficiently strong to kill all insects, except scale, for which use one part to 400 parts of water. Per pint \$1.50. Outfit for using Nikoteen \$3.00, complete.
Paris Green, Pure. Lb. 25c., 5 lbs. \$1.20, 14 lb. buckets \$3.00.
"Pillar Catter." The most effectual device yet introduced to prevent caterpillars from infesting trees. Per yd. 15c.
Quassine. Per gal. \$1.25.
Rose Leaf Extract of Tobacco. Per qt. 50c., per gal. \$1.25, 5 gal. \$4.25.
Seal Oil Soap 1 lb. can 25c., 10 lbs. for \$2.00.
Slug Shot. 5 lbs. 25c., 100 lbs. \$4.25. Bulk, in barrels weighing about 225 lbs., 3 3/4c. per lb.
Sulphur. A preventive and cure for mildew. Lb. 7c., 5 lbs. 30c., 100 lbs. \$4.00.
Tobacco Dust. Cheaper than snuff and quite as effectual. Sure remedy for green fly. 5 lb. pkge. 25c., 100 lb. \$3.00.
Tobacco Soap (Pinners). For destroying insects, parasites and their eggs, infesting either plants or animals. Lb. 40c.
Tobacco Stems, Fresh. For fumigating. Lb. 10c., bbl. \$1.00, bales of about 250 lbs. \$2.00, per 1/2 ton \$6.00, per ton, \$11.00.
Whale Oil Soap. For destroying and preventing insects on plants, trees, vines, etc.; for washing down the bark of trees, grape vines, etc. In cans, with directions, 20c., 35c., and 50c.; in bulk, 10 lbs. 90c.

BELLOWS

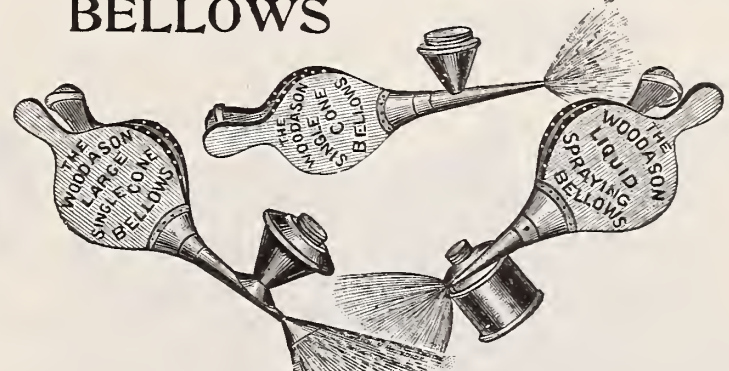

BELLOWS

For Applying the Insect Destroyers.
Large Double Cone. Each \$2.75 **Liquid Spraying. Each \$1.00**
Large Single Cone. Each \$1.75 **and \$2.00.**
Small Single Cone. Each \$1.00 **Sulphur Bellows. Each \$1.50**

THE CLEVELAND WEED EXTRACTOR.



Removes the weed bodily, including the root.
 The curved edge of blade enters and loosens the soil; pressure on the lever then causes the toothed jaw to grasp the weed, and a slight pull suffices to dislodge same without disturbing the surrounding sod.

Price 75c. each.

THE STANDARD PARIS GREEN DUSTER. \$5.00 each; large size double gun, \$7.00 each.

KNAPSACK SPRAYER



Deming's Best.
 Copper, - - \$11.00

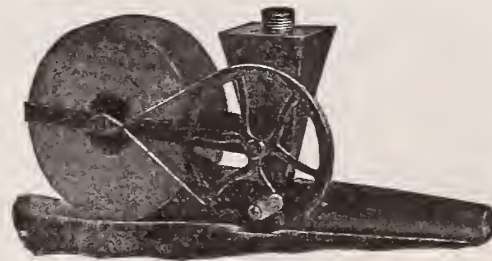

MAC MICHAEL'S SULPHUR AND INSECTICIDE BLOWER

This is the most satisfactory distributor of Sulphur and other Insecticide in powder form. Will never wear out. Satisfaction guaranteed. Price \$4.75.

LAWN MOWERS, ETC.

Philadelphia Lawn Sweeper.

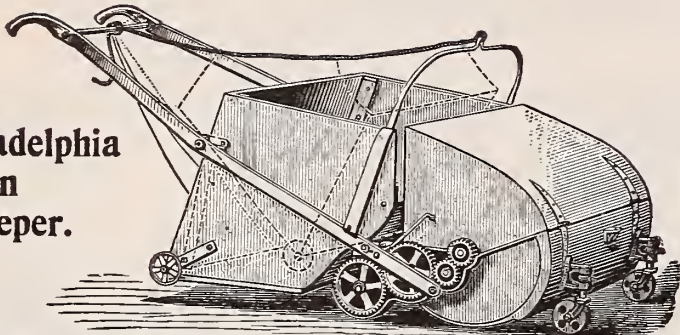

A simple machine for cleaning the lawn. A driving roller gives motion to a revolving brush placed directly in front, causing it to sweep the sod clean and throw the sweepings backward from the top of the brush into a large box in the rear of the roller. The box can be dumped without stopping. Sweeps 40 inches wide. \$52.00.

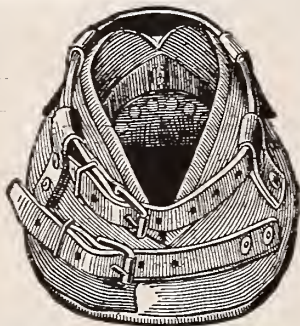
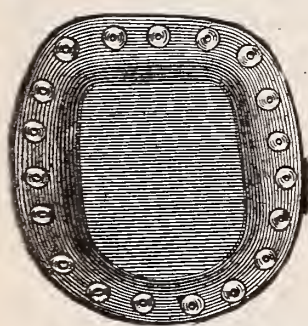

Lawn Boots for Horses.

Made of best Quality Leather.

All Hand Riveted.

With extra Toe Piece. Price per set of four, \$7.50.

Philadelphia Horse Lawn Mower.

36 inch - \$95.00
30 inch - 60.00

Pennsylvania and Continental Pony Lawn Mowers.

Width of cut 25 in., \$27.00.

"Pennsylvania" Horse Lawn Mower.

Open cylinder with draft irons, 30 in. cut, \$65.00

Seat, Shafts and Springboard for these mowers \$12.00 extra.

Close Cylinder, 30 inch, with draft irons\$60.00

38 inch, with draft irons 78.00

With seat and shafts \$12.00 extra.

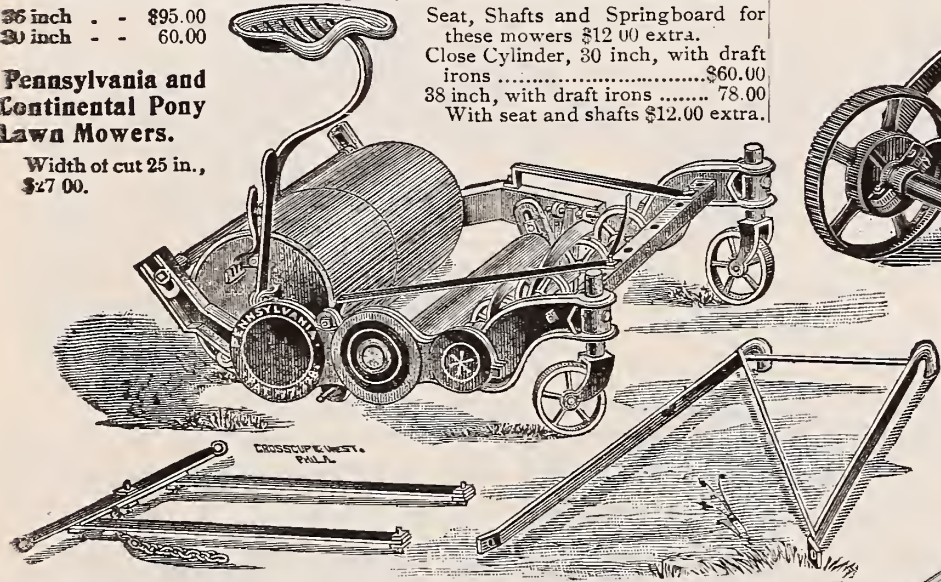

New Victory "Ball Bearing" Lawn Mowers. High Wheel.

(10 Inches.)
14 inch, \$8.50 | 16 inch, \$9.25 | 18 inch, \$10.00 | 20 inch, \$10.75
22 inch, \$11.50 | 24 inch, \$12.50

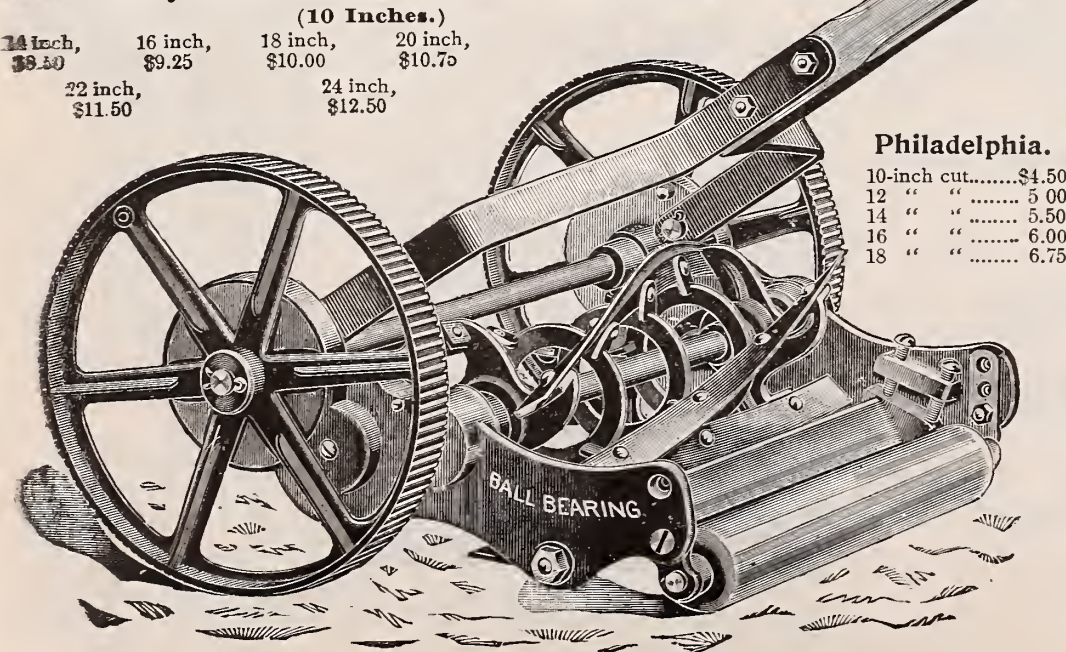

Philadelphia.

10-inch cut.....\$4.50
12 " " 5.00
14 " " 5.50
16 " " 6.00
18 " " 6.75

THE EUREKA LAWN MOWER SHARPENER.

The best and most practical device. Price \$1.00 each.

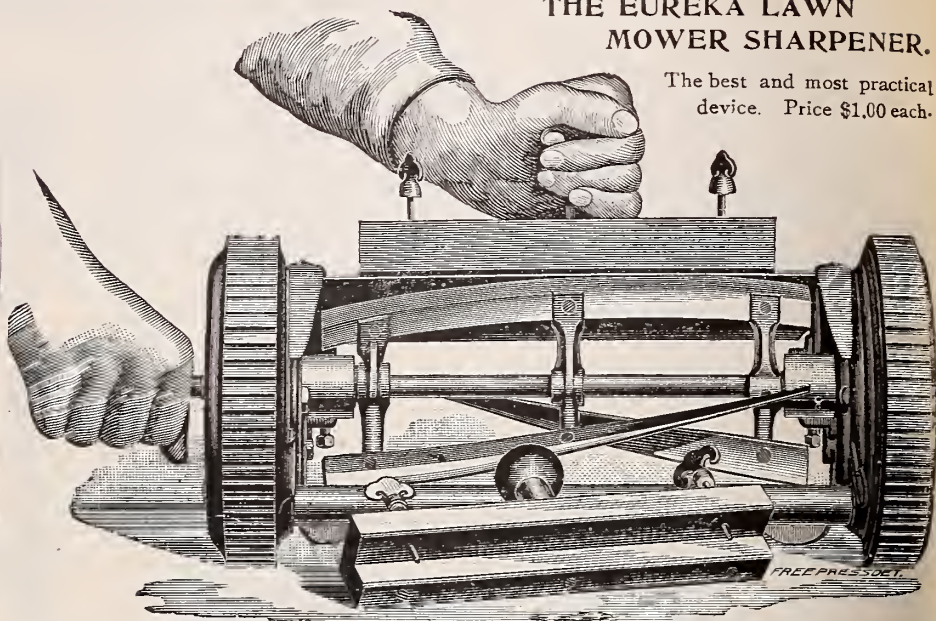

TRIUMPH GRASS CATCHER.

Adjustable, practicable and cheap.

10, 12, and 14 inch, 50c. each.
16, 18, and 20 inch, 75c. each.

THE PENNSYLVANIA LAWN MOWER with BRAUN'S GRASS CATCHER ATTACHED.

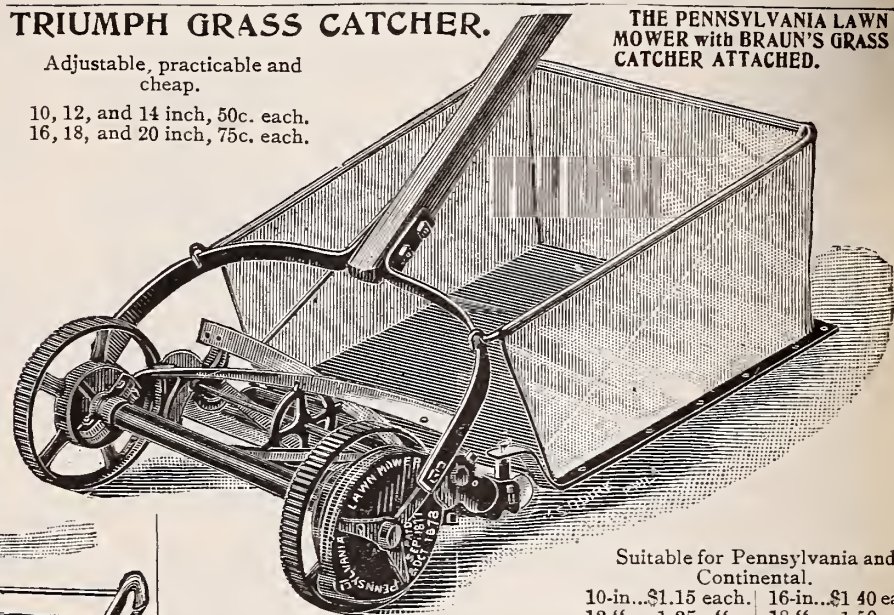

BRAUN GRASS CATCHER

Suitable for Pennsylvania and Continental.
10-in...\$1.15 each. 16-in...\$1.40 each
12 " ... 1.25 " 18 " ... 1.50 "
14 " ... 1.30 "
Suitable for Pennsylvania and Continental High Wheel Lawn Mowers.
15-in...\$1.40 each 21-in...\$1.75 each
17 " .. 1.50 " 25-in, Pony \$2.00 each
19 " ... 1.60 " each.

CLIPPER HAND MOWER

10-in.....\$5.50
12-in..... 6.50
15-in..... 7.50
18-in..... 8.50

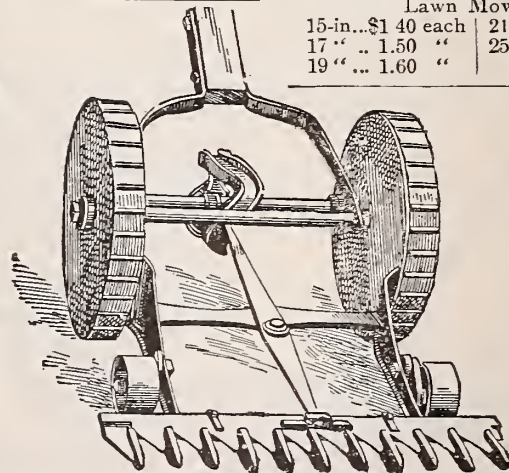

Pennsylvania and Continental Mowers.

Strictly reliable. Every mower is guaranteed to give satisfaction.
10-inch, low wheel.....\$4.75 15-inch, high wheel.....\$9.00
12 " " 5.25 17 " " 10.00
14 " " 6.00 19 " " 11.00
16 " " 6.75 21 " " 12.00
18 " " 7.50 25 " "Pony".....27.00

The "NEW DEPARTURE" Lawn Mower.

No sharpening. 10-in. cut...\$3.25 | 12-in. cut...\$3.50 | 14-in. cut \$3.75 | 16-in cut \$4.25
No setting.

GIRARD LOW WHEEL.

10-inch \$2.50 | 12-inch.....\$2.75 | 14-inch.....\$3.00

GIRARD NEW HIGH WHEEL.

11-inch.....\$3.50 | 16-inch.....\$3.75 | 18-inch.....\$4.00

Coldwell's Improved Horse Mowers.

These mowers are used on the Public Parks of Paris, France, New York City, Brooklyn, Baltimore, Chicago and Buffalo, etc., and have also been furnished to the U. S. Government for the past five years.



Coldwell's Horse Lawn Mower, mowing the lawn at Vassar College.

All the Horse Mowers are furnished with side draft attachment, which keeps the horse on the cut grass only. Each mower warranted to give complete satisfaction. Low prices (strictly net).

PRICE LIST:

Coldwell's Improved Horse Mowers.

25 in. (no shafts)	\$37.50
30 in. with seat and shafts	60.00
35 " " "	75.00
40 " " "	90.00

P. S. Where only draft irons are required we deduct \$6.00 from the prices of the 30, 35 and 40 inch mowers. We Prepay Freight on Coldwell's Horse Mowers.

Chain Horse Mower (New).

The first Horse Mower with a satisfactory Grass Catcher Attachment on the market. Saves a tremendous lot of labor.

We have added to our list a new Double Chain Horse Mower made especially to use with a Grass Box Furnished with either 6 or 9 blades. It is a strong, light running, durable machine without shafts or seat.

25 inch, with grass box	Price \$50.00
30 " " "	" 65.00

New Golf Greens Mower...

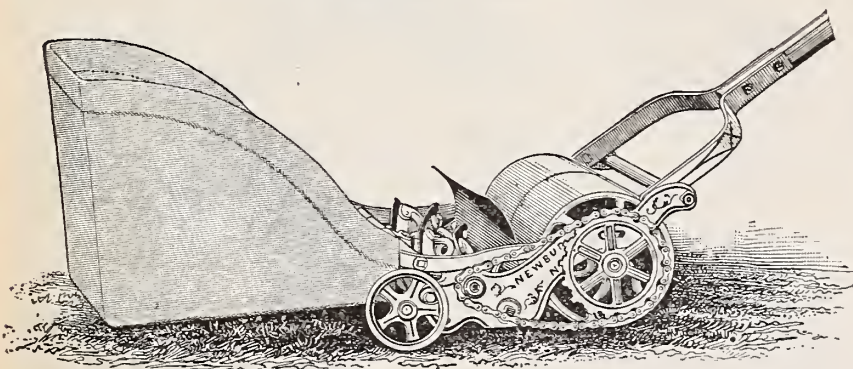

Roller Mower.—Used on the leading Golf Links in this Country; offered with either four or six blades in the Revolving Cutter.

Special Price will be quoted on application.

Coldwell's Golf Roller Mowers

Are considered the finest cutting and lightest running Roller Mower made in the world. It is furnished with either four or six blades, with or without grass box and with either chain or gear. It has no equal where fine work is required.

..Horse Boots for Lawn..

Extra well made; will wear out two sets of cheap boots; \$7.50 per set of four.

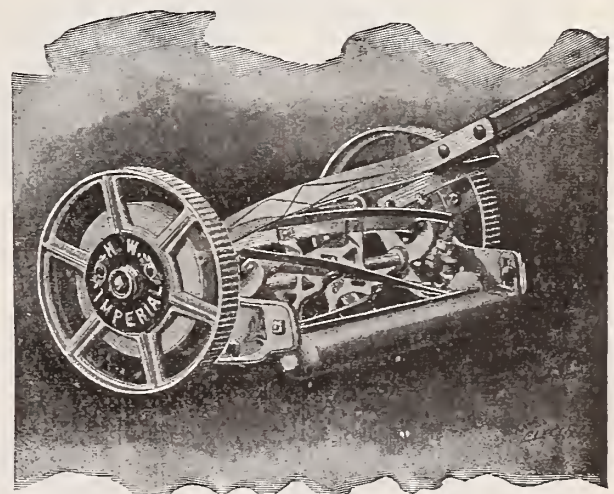

The Famous "Imperial" High Wheel.

GUARANTEED LAWN MOWER.

Imperial Hand Lawn Mowers.

Very desirable where a well kept lawn is wanted.

	4 Blade.	5 Blade.
14 inch cut	\$7.50	\$8.00
16 " "	8.25	9.00
18 " "	9.00	10.00
20 " "	10.00	11.00

Latest Improved Grass Catchers

FOR THE IMPERIAL MOWERS.

14 inch,	16 inch,	18 inch,	20 inch,
\$1.50	\$1.65	\$1.80	\$1.95

Low Wheel Imperial Mowers.

12 inch cut,	14 inch cut,	16 inch cut,	18 inch cut,
\$5.50	\$6.50	\$7.50	\$8.50

"PLANET JR." FARM AND GARDEN TOOLS.

Space will not permit our showing and describing all of the "Planet Jr." tools, but we will send a fully illustrated catalogue free for the asking to any who desire it. "Planet Jr." goods are standard machines; the best; yet great improvements have been made for 1899. You can rely on getting a bottom price from us on any of the "Planet Jr." goods.

"PLANET JR." No. 3 Hill Dropping Seed Drill.

We all know that a seed sower that does not drop in hills is fast becoming a thing of the past. Why? Because all crops that are to be grown from seed and thinned to a regular stand should be planted in hills at just the distance apart the plants are desired; for in drilling, unless the seed is sown unnecessarily thick, there will not always be a plant at the proper spot, and the crop is therefore irregular. This means that a seed sower should drop in hills, and at various distances. The new No. 3 "Planet Jr." drops at 4, 6, 8, 12 and 24 inches apart, and also in a continuous row, without injury to the seed and can be changed from hill to drill instantly, or from one distance to another very quickly. The index is at the top of the handle, with hair-breadth adjustment and instantaneous cut-off.

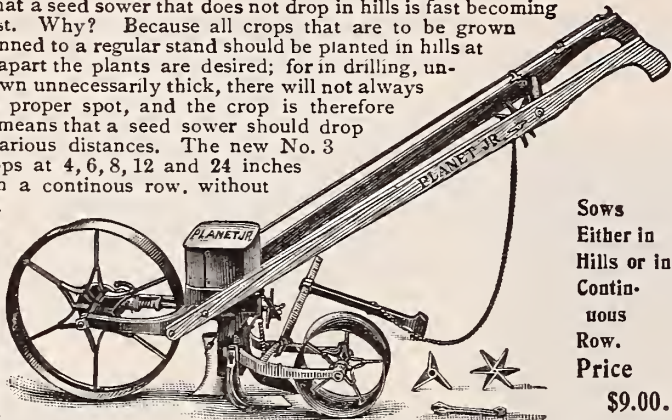

Sows Either in Hills or in Continuous Row. Price \$9.00.

"PLANET JR." No. 4 Combined Hill Dropping Seeder and Single Wheel Hoe.

This is exactly the same style of seeder as the No. 3 "Planet Jr." Hill Dropper. It is smaller in capacity, though still of good size, holding two quarts. It drops in hills at 4, 6, 8, 12 and 24 inches apart and in drills any thickness, handling the smallest paper of seed perfectly, and is simple, durable and very light running. Throws out of gear instantly by simply raising the handles. The drill is detached and the tool frame substituted by moving but one belt. It then becomes one of the most admirable Single Wheel Hoes of the "Planet Jr." family.

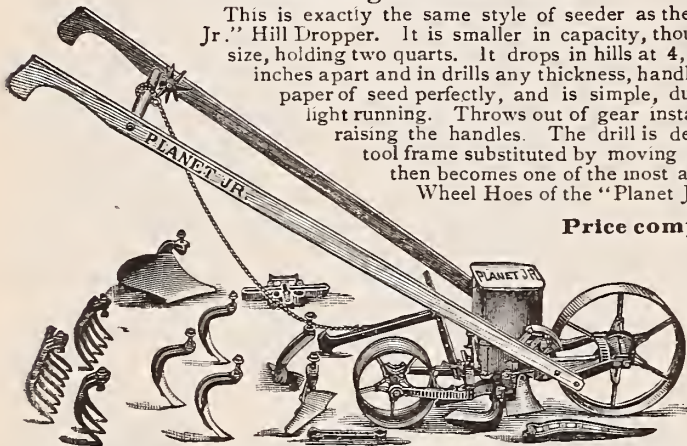

Price complete \$10.00. As a Drill only, \$7.00.

"PLANET JR." No. 11 Double Wheel Hoe, Cultivator, Rake and Plow.

This tool combines in itself the good points of its predecessors, with valuable new ideas. It has 11 inch wheels which can be set at four different distances apart; the frame is malleable, with ample room for tool adjustment, and can be set at three different heights. The handles are adjustable, and being attached to the arch, are entirely undisturbed in making changes of the height of frame, width of wheels or in the adjustment of the tools themselves. The arch is of stiff steel unusually high. The design of the frame is novel, allowing all changes of tools to be made without removal of the nuts from the standards. A pair of model rakes and a pair of new style hoes are added to the usual equipment—seven pairs of tools in all. The variety of work possible with this machine is incredible, covering the whole range of wheel hoe work, both in the garden and on the farm, and has our unqualified endorsement.

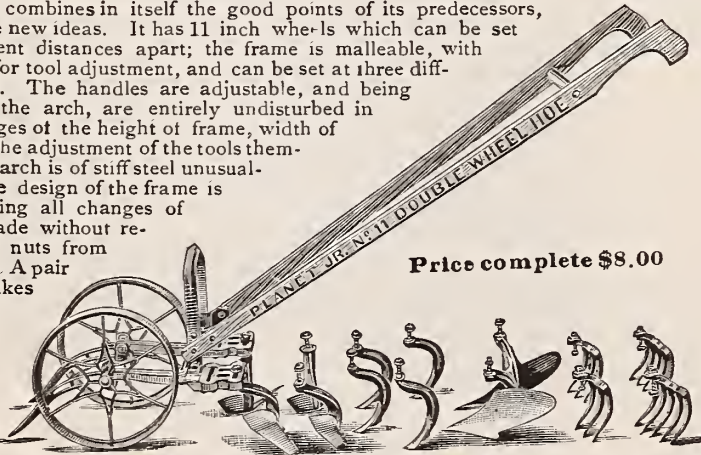

Price complete \$8.00

"PLANET JR." No. 12 Double Wheel Hoe.

This tool is identical with No. 11 except that it has a less complete equipment, as shown in the cut, but at a correspondingly less price. The set of tools with No. 12 is what gardeners need most.

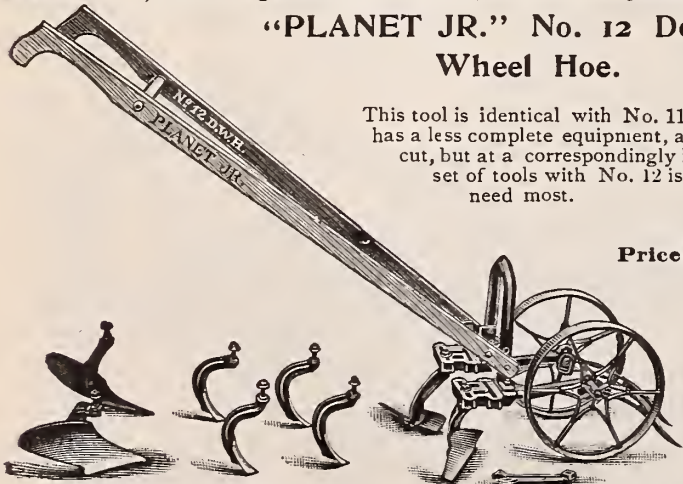

Price \$6.00

The "PLANET JR." No. 13 Double Wheel Hoe.

This tool is the No. 11 with 6 inch hoes only, this pair of tools being most generally useful at all seasons. Any or all of the No. 11 tools may be added at any time, and are sure to fit. Price \$4.00.

"PLANET JR." No. 15 Single Wheel Hoe, Cultivator, Rake and Plow.

This latest and best Single Wheel Hoe, improved for 1899, has an 11 inch wheel, with broad face, and a conveniently arranged and a very full set of tools, several of them being of new, special design, such as have been found to perform Wheel Hoe work in the very best manner. It is very light and strong and easy running. Has adjustable handles, and frame, especially adapted for quick changing of teeth. It is a most perfect Wheel Hoe for market gardeners or for private places. The frame changes in height, and the wheel to the other side of the frame, when both sides of the row can be hoed at one passage.

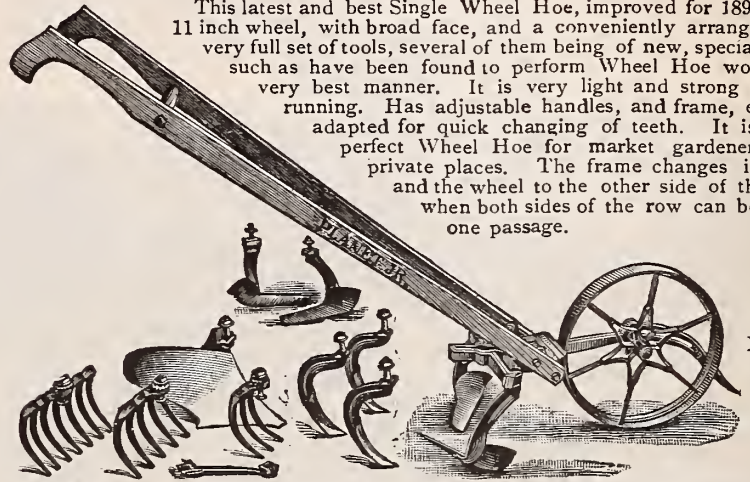

Price \$6.00

"PLANET JR." No. 17 Single Wheel Hoe.

This also has the same frame, handles, etc., as No. 15, but is supplied only with a pair of 6 inch hoes, a set of cultivator teeth and a plow, a sufficient outfit for most gardening work. The others can be added at any time.

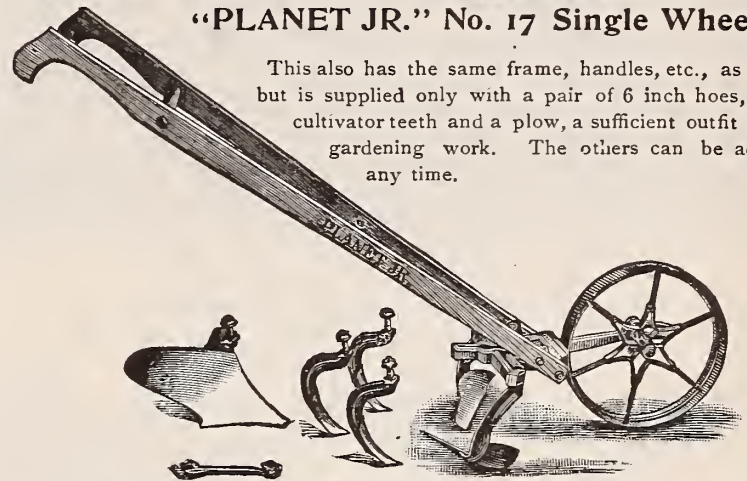

Price \$4.00

The "PLANET JR." No. 18 Single Wheel Hoe.

With the same frame and handles as No. 15, it has one pair of 6 inch hoes only, but they are the most constantly useful through the season of all the list. The remainder you buy as wanted. Price \$3.00.

THE "FIRE-FLY" PLGW.

This tool is invaluable for those who have small gardens. The mould-board is tempered and polished steel. The depth may be changed very quickly. Price \$2.00.

"PLANET JR." Harrow and Cultivator.

Price, Plain, \$4.90; with Wheel, \$6.15; Complete, \$7.50.

This tool has rapidly grown into favor with farmers, market gardeners, and strawberry growers. It has a high frame and the chisel-shape teeth cut an inch wide each. The foot lever pulverizer is a capital addition for preparing ground for the seed drill or for plant setting, and controls the depth of the rear teeth. Hand levers regulate both width and depth while in motion; it contracts to 12 inches and expands to 32 inches. It cultivates deep without throwing dirt upon the plants, and the smooth, round-throated teeth turn strawberry runners without injuring them. For cutting strawberry runners we make a special attachment, consisting of a 10 inch flat steel disc mounted on an out-rigger. Strawberry Runner Cutter Attachment extra \$1.50.

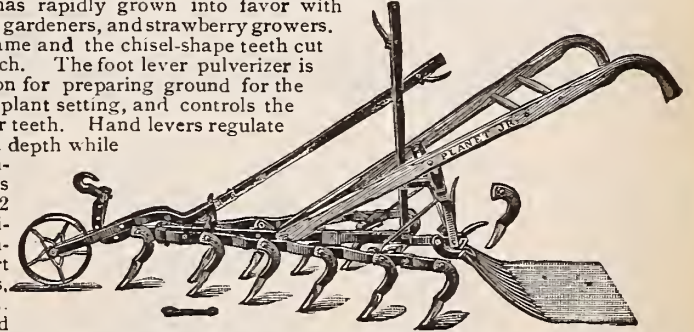

"PLANET JR." No. 8 Horse Hoe.

Price as in cut \$7.50; without Depth Regulator \$7.00. No. 4 Horse Hoe, complete \$5.50. No. 9 Horse Hoe, complete 6.50.

Probably no other cultivating machine is so widely known as the "Planet Jr." Combined Horse Hoe and Cultivator. It is so strongly built as to withstand incredible strain, yet it is light and easy to handle.



Every part is perfected to make the tool comprehensive to the intelligent farmer, who knows the best is always the cheapest.

"IRON AGE" Garden and Farm Implements.

Below we illustrate and describe some of the leading "Iron Age" Farm and Garden Implements; giving only a condensed description of same, but to all who desire a detailed description of the various tools, we will send free the "Iron Age" catalogue. We wish to call your attention especially to the "Iron Age" Hill and Drill Seeder, and the No. 7 "Iron Age" Horse Hoe, both of which are for 1899, and will be found to give the best of satisfaction.

The "Iron Age" Double Wheel Hoe.

At a glance one can see the great usefulness of this tool. In cultivating onions, beets, turnips, radishes, etc., it is invaluable, saves hours of hard labor. It can be made into a practical single wheel hoe in a moment's time. An axle is sent with every double wheel hoe for this purpose. The wheels are 16 inches high, enabling the wheel hoe to run easy and without yielding to the depressions of the soil as a low wheel will do. The frame being made of tubing coupled to malleable castings gives great strength together with lightness. All the tools shown in the cut go with the machine for the price \$6.00



Price \$6.00

Side Hoes only, \$3.50

The "Iron Age" Combined Seed Drill and Wheel Hoe.

It is a seed drill, double wheel hoe, a single wheel hoe, and cultivator, plow and rake.

It is converted into a perfect seeder by the drill attachment, which is quickly and easily placed in position, and which is simple in operation, having no gearing, screws or springs to get out of order. The adjustment for various seeds is perfect, the cam index allowing the seed slide to be instantly adjusted to the slightest variation desired.



Price \$9.00

The "Iron Age" Single Wheel Hoe.

Price \$4.50.

Simple, strong, but very, very light in weight. It is a pleasure to use it, it requires so little labor. No garden complete without one.

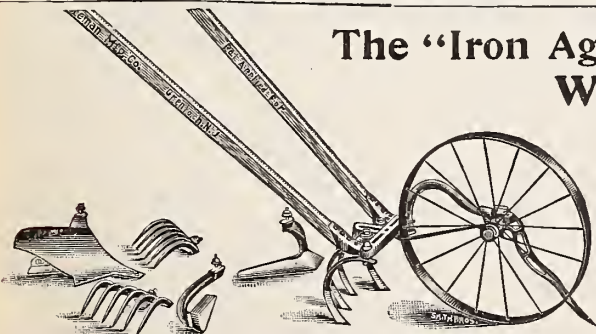

The "Iron Age" Double Wheel Hoe

Shown with WEEDER Attachment applied. Breaks up all lumps and pulverizes the soil. No Double Wheel Hoe complete without one.

Price for this Attachment only \$1.00.

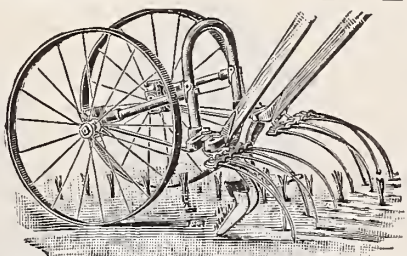

The No. 7 "Iron Age" Horse Hoe

Price \$8.00 as in cut; without Furrow Closing Attachment \$6.75.

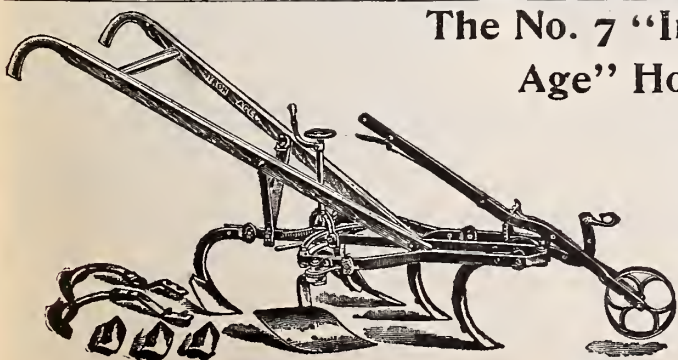

This Seeder is without question the most complete tool ever offered by the manufacturers of the "Iron Age" Implements. The **Wheel** is 16 inches high, made of steel, with a two inch tread. The **Opening Plow** is clog proof and can be instantly adjusted. The **Hopper** is low, therefore, the delivery of the seed is close to the ground; thus making possible, accurate spacing. Capacity 4 quarts. The **Agitator** is a revolving bush which makes it a sure feed and sows absolutely all of the seed accurately, and without injury.

The distance of spacing the seed can be instantly changed, and it will drop at 4 1/2, 6, 9, 12, 18, 36 inches apart.

The change from a Hill Dropper to a Row Drill can be instantly made, or vice versa.

The amount of seed can be minutely adjusted by our patented cam index one feature which has made the New Model so famous.

It is light, strong, capacious, simple and finely made; in fact, the most severe critics can find no fault with it.

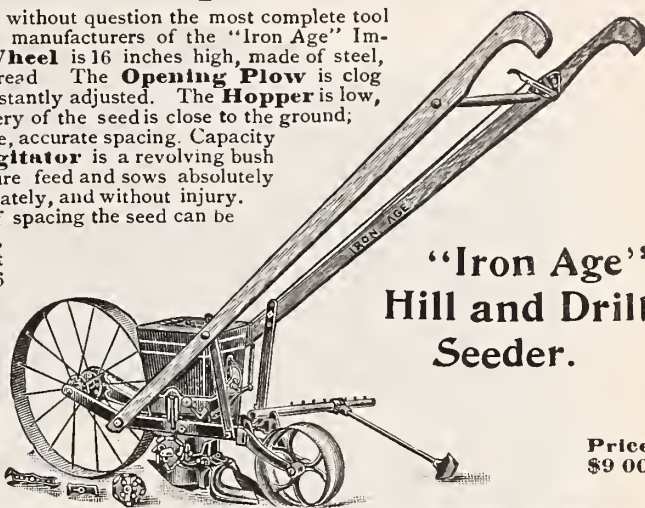

"Iron Age" Hill and Drill Seeder.

Price \$9.00

"New Model" Seed Drill.

We have sold the New Model Drill for years, and it always gives satisfaction. It is strongly made, sows any kind of seed with regularity, and is one of the most salable drills.

Price \$6.00.

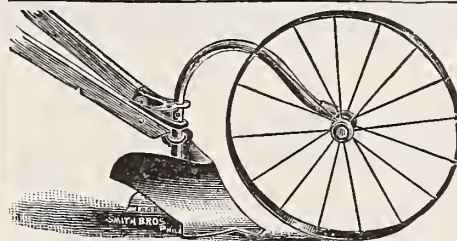
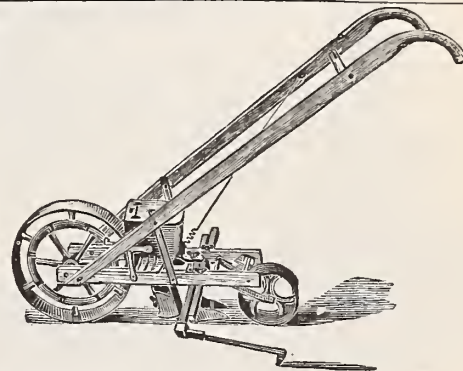

The "Iron Age" Wheel Plow.

Price \$2.25.

Light, strong and durable.

"Gem of the Garden" Wheel Hoe.

This is an excellent Wheel Hoe that has stood the test of time, and no better Wheel Hoe is on the market to-day for the price \$3.50.

"Gem" Double Wheel Hoe

Same as the single, except has two wheels which allows working both sides at once. Price \$4.50

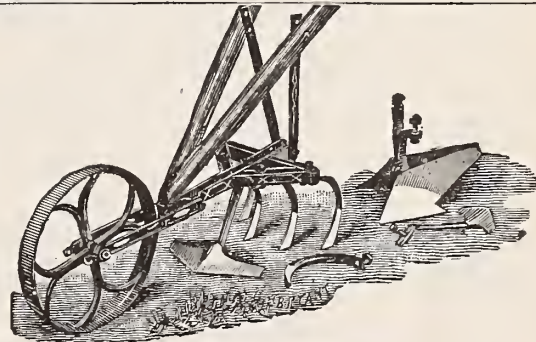

The "Iron Age" Double Wheel Hoe

Shown with Land Side Plow attached.

Performs its work equal to any Wheel Plow. Price for this attachment only, 80 cts.

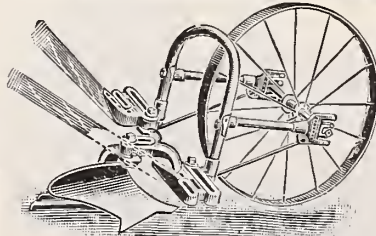

The No. 6 "Iron Age" Horse Hoe.

Price \$7.50 as in cut; without Furrow Closing Attachment, \$6.25.

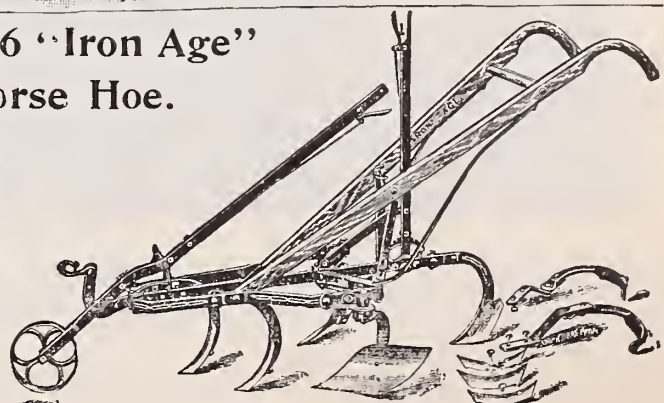

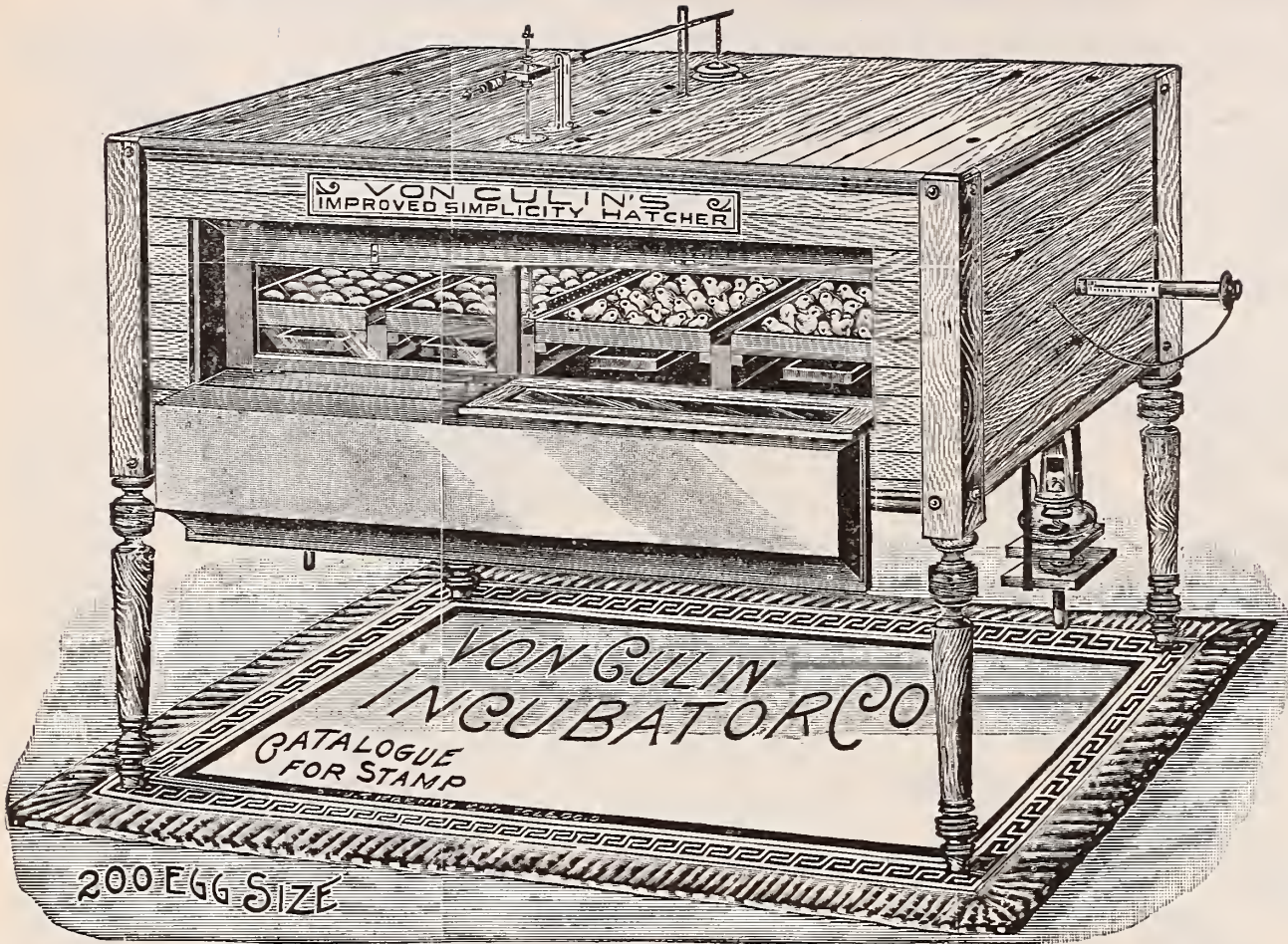

Von Culin Incubators

Guaranteed to hatch 20 per cent. more than any other machine made or you can return the machine after 30 days trial.

Guaranteed to burn one-half the oil and takes but one-tenth the attention any other machine and if it don't do all this, you can return it after 30 days trial.

First Prize Medal at World's Fair, 1893.

First Prize Medal at Canadian Exposition, 1894.

First Prize Medal at Nashville Exposition, 1897.

First and only Prize awarded at the Omaha Exhibition, 1898.

250 First Prizes at small State Fairs.

Von Culin's Brooders.

For convenience and simplicity it has no equal. It is impossible for chicks to crowd. This is an Indoor Brooder.

You cannot afford to trifle with brooders that have not had a practical test and are only built to sell.

Do not forget that this brooder is exactly the same principle as those used in the large brooding houses built and operated by C. Von Culin and others.

Price, No. 1. Capacity 80 chicks \$7.00
 " " 2. " 140 " 9.00

We can supply all other sizes, also Outdoor Brooders.

Illustrated catalogue of Incubators and Brooders free on application.

The VON CULIN INCUBATORS are extensively used and very highly recommended by

Mr. Peder Pedersen, manager for John Pitcairn, Esq., Bethayres, Pa.

Mr. Lewis Rigler, manager of the poultry department for Hon. David Martin, Holmesburg, Pa.

PRICE LIST VON CULIN INCUBATORS.

	Our Net Price
No. 0 —25 eggs capacity	\$15.00
No. 1 —80 " "	22.50
No. 1½—100 " "	25.00
No. 2 —140 " "	29.00
No. 2½—200 " "	35.00
No. 3 —250 " "	40.00
No. 4 —432 " "	54.00
No. 5 —600 " "	70.00

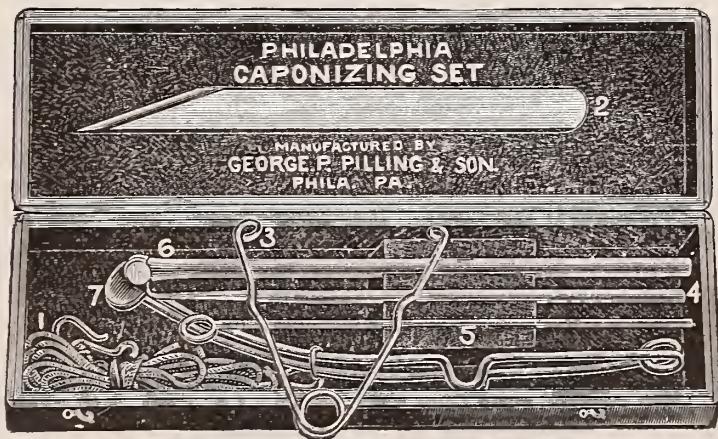

Wigmore Caponizing Outfit.

With full instructions, in paper case \$2.25
 Or in leather case 2.50

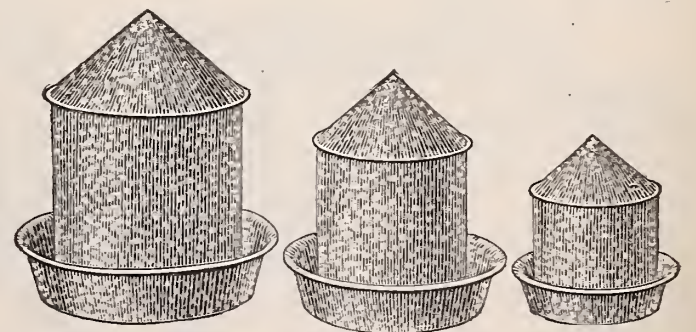

Philadelphia Poultry Fountain.

The above cut illustrates our "Philadelphia" Fountains. They are made in two parts, the pan and the cone. They are thus easily cleaned and filled. All thoroughly galvanized.

PRICE : { No. 1. (2 quarts), 35c. each; \$3.50 per dozen.
 " 2. (4 quarts), 50c. " 5.00 "
 " 3. (8 quarts), 75c. " 7.00 "

POULTRY SUPPLIES.

Fresh Foods for Poultry, etc.

- Animal Meal.** (Bowker's.) 5 lbs. for 20c., 10 lbs. 40c., 25 lbs. 75c., 50 lbs. \$1.25, 100 lbs. \$2.25.
- Barley.** Per qt. 15c., bush. \$1.00.
- Bone (Granulated).** The use of ground bone tends to keep fowls in good health, and materially aids laying hens. 5 lb. pkge. 20c., 25 lbs. \$1.00, 100 lbs. \$2.25, 200 lb. bag \$4.00.
- Buckwheat.** For pigeons and young poultry. Per qt. 10c., peck 30c., bush. \$1.00.
- Clover Meal (Pioneer).** Best quality. 5 lbs. 25c., 25 lbs. 75c., 50 lbs. \$1.00, 100 lbs. \$2.00.
- Charcoal (Ground).** A little ground charcoal mixed with the soft feed in the morning, once or twice a week, keeps them healthy. 1 lb. 10c., 5 lbs. 40c., 10 lbs. 75c.
- Cut Clover Hay.** Excellent food for winter and early spring. 40 lb. bag \$1.00, 100 lbs. \$2.00.
- Chick Manna, or Food for Little Chicks.** Specially prepared for little chicks when first hatched. Should be the first and only food, and continued for 10 or 12 days before feeding anything else. Directions for feeding on each package. 1 lb. pkge. 10c., by mail 25c.; 5 lb. pkge. 40c., 60 lb. box bulk \$4.20.
- Death to Lice Powder.** (Lambert's.) 15 oz. box 25c., 48 oz. box 50c., 100 oz. box \$1.00.
- Eggs.** Thoroughbred poultry; for hatching; 30 varieties. Satisfaction guaranteed. Per 13 \$1.50, per 26 \$2.50.
- Incubator Eggs.** Per 100 \$6.00.
- Eggs (Nest).** Porcelain, each 3c., per doz. 30c. Medicated, each 4c., per doz. 40c.
- Gape Cure.** (Madoc.) 6 oz. can 20c., 7/8 lb. can 35c.
- Hemp Seed.** Used largely for feeding birds and pigeons. Per qt. 15c., peck 60c., bush. \$2.00.
- Imperial Egg Food.** For making hens lay winter and summer; keeps the fowls in the best condition. 1 lb. pkge. 30c., by mail 45c.; 2 1/2 lb. pkge. 70c., by mail \$1.00.
- Meat for Poultry (Prepared).** This is prepared with great care. It is the finest thing we know of to cause hens to lay during the winter; extremely profitable to feed. 10 lbs. 40c., 50 lbs. \$1.25, 100 lbs. \$2.25, 500 lbs. \$12.00, ton \$42.00.
- Mica Crystal.** For digestion. 5 lbs. for 15c., 10 lbs. 25c., 25 lbs. 40c., 100 lbs. \$1.00. Two grades, fine and coarse.
- Oyster Shell (Fresh Ground).** The finest article to feed for shell making. 5 lbs. 10c., 25 lb. bag 40c., 100 lbs. 75c., ton \$12.00.
- Peas (Canada Field).** Per qt. 10c., peck 50c., bush. \$1.00.
- Pratt's Food.** Will make hens lay all the year, and is excellent for feeding to young chicks. For large fowls mix one ounce with the food for fifteen or twenty. For fifteen or twenty chicks give one-half ounce every other day. 1 1/2 lb. pkge. 25c., 5 lb. pkge. 60c., 12 lb. bag \$1.25, 25 lb. bag \$2.50.
- Roup Preparation.** Sure cure. 1/2 lb. pkge. 20c., 1 lb. pkge. 40c.
- Roup Pills.** (Havens.) Per box 25c., per doz. boxes \$2.50, per box of 250 pills \$1.00.
- Rust's Egg Producer.** 1 lb. 25c., 2 1/2 lbs. 50c., 6 lbs. \$1.00, 10 lbs. \$1.50, 25 lbs. \$3.50.
- Sheridan's Condition Powder.** 4 oz. pkge. 25c., 2 1/4 lb. can \$1.00, six 2 1/4 lb. cans \$5.00.
- Sunflower Seed, Mammoth Russian.** Per qt. 10c., peck 50c., bush. \$1.75.
- Swinging Feed Trays for Poultry.** Saves all waste of food. Very practical. 18 inch \$1.00, 27 inch \$1.25, 36 inch \$1.50.

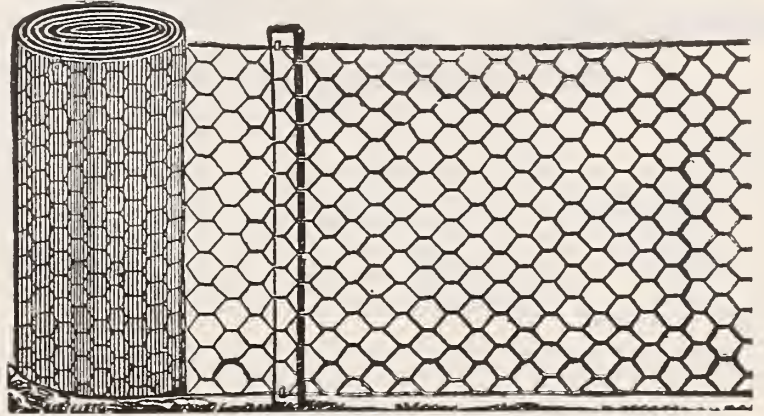

Galvanized No. 19 Wire Netting

Notice these low prices (less than 1/2 cent per square foot) for No. 19 Wire, galvanized after the netting is made, which makes its stronger and more durable.

The best thing for making poultry yards; better looking and cheaper than laths, and permits more light and air to enter.

12 in. wide, per bale 150 lineal ft.....	\$0 65	42 in. wide, per bale 150 lineal ft.....	\$2.25
18 " " " 150 " " " " " " " " " "	0.95	48 " " " " 150 " " " " " " " " " "	2.40
24 " " " 150 " " " " " " " " " "	1.20	60 " " " " 150 " " " " " " " " " "	3.00
30 " " " 150 " " " " " " " " " "	1.65	72 " " " " 150 " " " " " " " " " "	3.60
36 " " " 150 " " " " " " " " " "	1.80		

Any required length cut from above sizes at 1 cent per square foot. Galvanized Staples for fastening, 10 cents per pound.

Mann's Standard Bone Cutter

No. 1-C, \$5.00. No. 1-B, without legs, \$7.00. No. 2, Weight 142 lbs. Price \$17.50.

The simplest and most economical machine that can be made for converting green bones, with the meat and gristle attached, into poultry food.

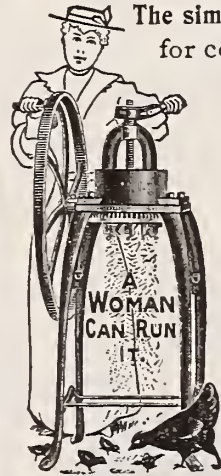

The machine weighs 142 pounds.

The knives are made of the finest tool steel, and can be easily removed and sharpened when necessary.

Capacity, one-half pound to one pound per minute.

The above cut represents our latest improved hand machine.

Mann's Clover Cutter.

The best machine for that purpose on the market. Without legs, \$8.00; with legs, \$10.00.

Wilson's Best Oyster Shell and Dry Bone Mill

Weights 39 lbs. Price, \$4.50. With legs, \$6.50.

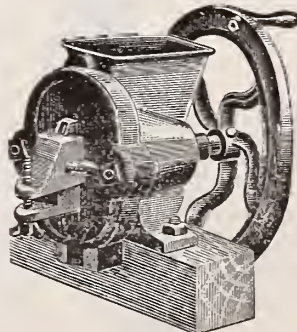

This mill is adapted for grinding oyster shells, dry bones, corn, meal, etc.; and, by means of a regulating wedge on the back, can be made to grind to any desired fineness.

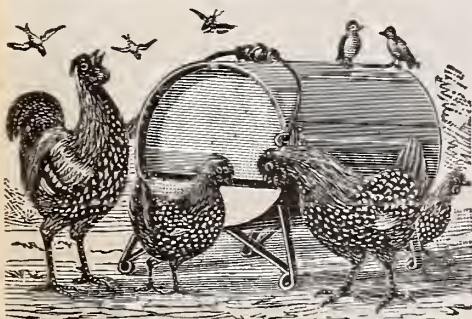

Poultry Drinking Fountains

All the most improved and reliable kinds; both in galvanized iron and stoneware. Prices, 20c. to \$1.00, each.

THE BEST BOOK ON POULTRY

"PROFITS IN POULTRY." A practical treatise on the business, giving designs for houses, artificial incubation, preparing for market, caponizing, etc. Price \$1.00.

Wigmore's No. 1 Caponizing Set. Set consists of one fine steel knife and forceps, one nickel-plated spreader, improved German silver cutting and twisting scoop, with fine hook on opposite end, one fine German silver probe, and four German silver hooks attached to cords for quickly securing the fowl. In box \$2.25, in case \$2.50. Book on "Practical Caponizing and How to Make Poultry Pay" free.

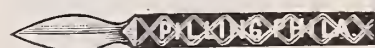

French Poultry Killing Knife. Made of fine steel. Price, with full instructions, 50c. each.

"Progressive" Killing Knife. Highly recommended. Price, with full instructions, 50c. each.

WATERING APPLIANCES, HOSE, ETC.

Length of Barrel, 13 1/2 in.; diam., 1 1/8



Syringes.

Deakin's Brass Garden Syringes.

No. A.	1 stream and spray hose, 12 x 1 inches.....	\$1.85
No. B.	1 " " " " 13 x 1 1/4 ".....	2.50
No. C.	1 " " " " 14 x 1 1/2 ".....	3.00
No. 2.	1 " " 2 roses, 13 1/2 x 1 1/8 ".....	3.60
No. 5.	1 " " 2 " " 18 x 1 1/2 ".....	5.75
No. H.	18 inches long, 1 1/2 inches in diameter.....	2.00

Zinc Syringe, Large Size, each \$1.00.

A. & W. Hose Band



No special tools required. Engage the lever in the farthest notch it can reach, press down lever, then hammer down ears and the lever is locked. The lever cannot slip. Each 5c., per doz. 45c.

Water-Tight Hose Coupler.

Absolutely...
...Water-Tight

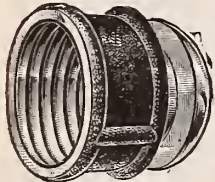

No. 3.

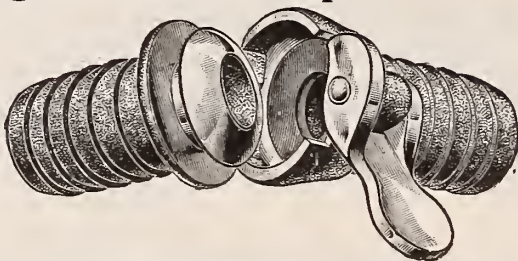

Disconnected.

Instantaneous in operation. Simplicity itself. Can be operated by a child. No screws to get out of order. Nothing to get damaged or broken. Per pair 25c., per doz. pairs \$2.50.

Rubber Hose

Armored Hose in 25 and 50 feet lengths, 3/4 in. 16c. per foot.

We have made arrangements with two leading hose manufacturers to supply us an extra grade of durable hose, which they guarantee. Our price will be found about one cent per foot less than at most of the dealers in hose.

Extra 4-ply, in 50 feet lengths, per foot, 13c.
Extra 3-ply, in 50 feet lengths, per foot, 10c.
Competition, 3-ply, in 50 feet lengths, per foot, 6c.

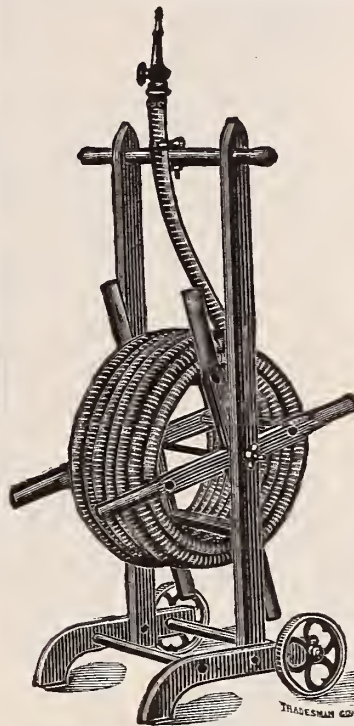

GEM HOSE NOZZLES

For throwing fine or coarse spray, or straight stream. Each 30c.

HOSE MENDERS

1/2 inch 5c. each, doz. 45c.; 3/4 inch, each 5c., doz. 50c.; 1 inch, each 8c., doz. 75c.

The Improved "Bordeaux" Spray Nozzle

The "Bordeaux" Nozzle is the simplest and best combination spraying nozzle on the market. It throws solid stream or a fan-shaped spray adjustable to any fineness. It will also throw a long distance coarser spray for spraying very large trees; features possessed by no other spray nozzle. It can be used with any Spray Pumps. Furnished with 1/2 and 3/4 inch hose connection. Price 1/2 inch pipe and 1/2 inch hose, as per cut, 75c.

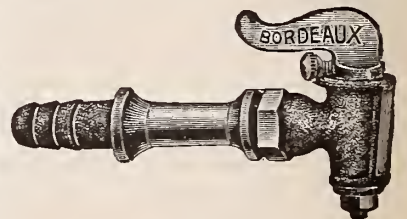

"Vermorel" Nozzles, 75c. each.

Deming's Best Spray Pump

Pump, Barrel and Truck, complete outfit, \$15.00.



Fig. 510.

ACME HOSE CROOK AND SWIVEL JOINT.

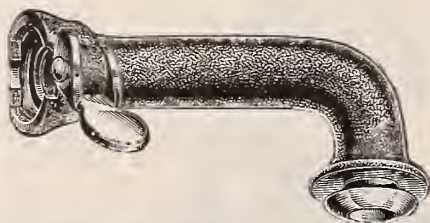

Saves the hose and doubles its life. Attached to ground pipe or spigot. Bending of the hose is unavoided, and the usefulness of the hose greatly increased. Hose does not wear out from the friction of the water, but from the constant bending and twisting to which it is subjected. The use of the crook removes the greatest cause of wear. Each 50c., per doz. \$5.00.

Improved Hand Force and Lift Pump.

On base with Air Chamber and Brass Piston Rod. Will throw water a distance of 80 feet. \$7.50.

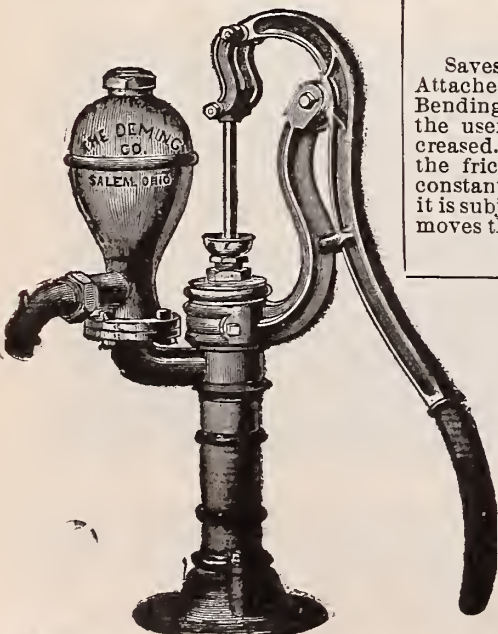

A full Treatise and Practical Directions for Spraying Trees, Etc., free upon application.



THE "PERFECT SUCCESS" COMBINATION SPRAY PUMP

For Spraying Trees, Plants, &c., &c.

There is no better and more complete outfit for so little money. The "Perfect Success" Pump, remember, includes "Bordeaux" Nozzle and a special greenhouse nozzle, also 7-foot section hose and pole connection for tree spraying. Price \$6.00.

LAWN SPRINKLERS, ETC., ETC.

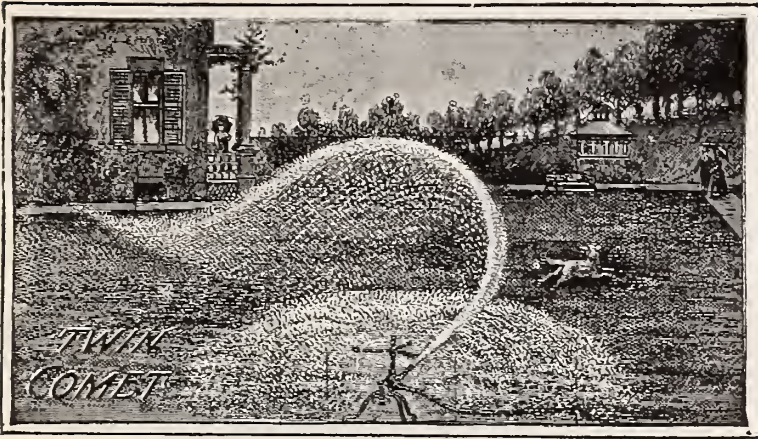

The Twin Comet Lawn Sprinkler.

\$5 00 each. Will sprinkle an area four times greater than any other sprinkler made. Endorsed and adopted by Mr. Wm. Doogue, Superintendent of the Public Grounds of Boston, and in hundreds of other places.

We have a very large assortment of all kinds of Lawn Sprinklers. 25c. to \$5.00 each.



Lyon's Fertilizing Lawn Feeder.

(Odorless)

It is a neat, light, little device, attached between the end of the hose and the nozzle, which automatically dissolves a stick of Lyon's Concentrated Lawn Food, diffusing it through as much water as will pass through an ordinary garden hose in 40 minutes. It is clean, odorless, non-poisonous, and will give perceptible results after one week's use on your lawn. It produces a dark green foliage and a healthy growth.

Complete outfit, consisting of one holder and twelve sticks of the food, by mail, postpaid, 75c.

Additional Fertilizing Sticks, 50c. per box of 2 dozen

"ELI" SPRAYERS. \$1.00 each.

GALVANIZED WATER POTS

The best and most durable watering pot made. Each has two roses—one fine and one coarse.

4 quart, round,	\$1.50	Oval,	\$1.75
6 " " "	1.75	" "	2.00
8 " " "	2.00	" "	2.25
10 " " "	2.25	" "	2.50
12 " " "	2.50	" "	2.75
16 " " "	3.00	" "	3.25

Galvanized Iron Clad WATERING CANS.

The best cheap watering can in the market. Very durable. Sizes 4 to 20 quarts, 50c. to \$1.50 each.

Wotherspoon's Make.

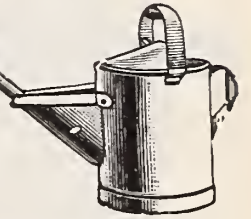

WATER TRUCK AND BARREL.

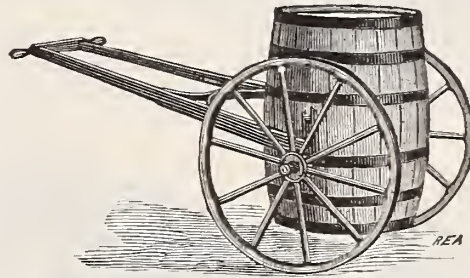

Barrel can be detached from truck without difficulty, or tilted to empty contents. Other barrels can be used and extra irons furnished if desired. The weight is balanced over the axle.

2 1/2 inch wheels.....	\$7.25
3 1/2 " "	8.00
4 " "	9.50
Large box to fit on truck, extra	2.50
Leaf rack attachment to the water truck	4.00
Sprinkling attachment.....	2.50

LEAF RACK.

Light and durable. Can be easily folded and detached, and the truck used with water barrel.

1 1/2 in. wheel	\$9 00
2 1/2 " "	9.50
4 " "	10.25



Cataract Insect Exterminator.

All brass. Cannot rust. Price \$1.50 each.

These machines have been used by the leading florists and gardeners in the United States, with the greatest degree of satisfaction. It throws a spray as fine as a cloud of smoke, which being damp, adheres to the plant; it is worth its cost many times each season. Kerosene Emulsion may be used on most any kind of plant without harming same.

WHEN USING OPERATE WITH A QUICK STROKE.

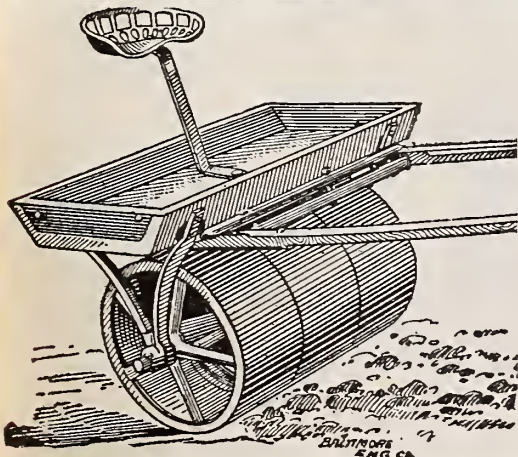
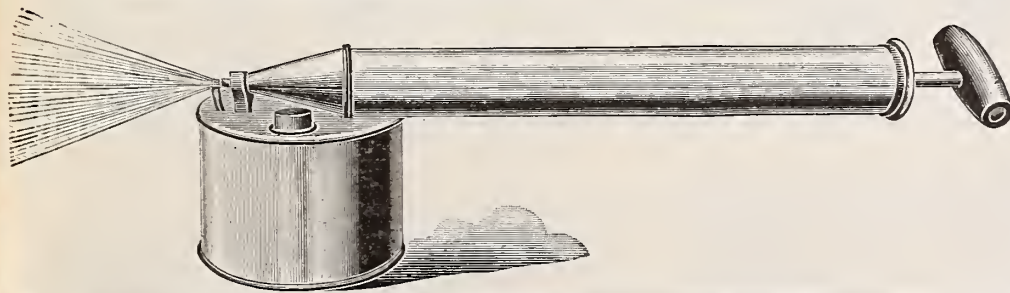

"Champion" Steel Lawn and Field Rollers.

These rollers are made of the best wrought steel and filled with concrete to give them additional weight, and are preferable to cast iron, as they are not so liable to break.

24 in. diam., 30 in. long, weight about 450 pounds,	\$37.50.
24 in. diam., 36 in. long, weight about 550 pounds,	\$40.00.

Special prices quoted on application for larger sizes.

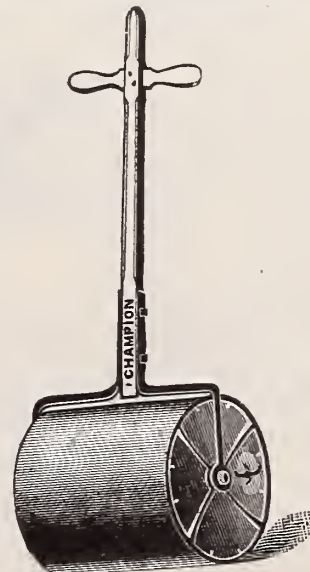

Wrought Steel Garden and Lawn Rollers.

Made of the best wrought steel, and filled with concrete to give additional weight.

10 in. diameter, 13 in. long, weight about 130 lbs.,	\$6 80.
12 in. diameter, 18 in. long, weight about 200 lbs.,	\$8 50.
14 in. diameter, 21 in. long, weight about 300 lbs.,	\$9.35.

ALSO, A FULL LINE

OF LARGER SIZES.

MISCELLANEOUS MATERIALS.

..SOUTH BEND..

Considered to be the best all-around plow on the market.
 No. 1, one horse\$5.00
 No. 2, one horse 7.00
 No. 3, two horse12.00

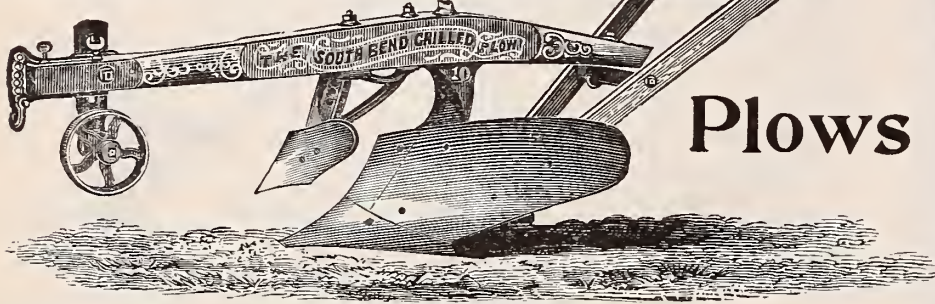

Plows

..SUBSOIL PLOWS..

Best quality\$7.00 each.
 P. S.—We carry on hand all the shares and parts of the South Bend and Gale Plows. We can also furnish Syracuse Steel Beam and other plows also parts for same.

DIAMOND TOOTH EXPANDING HARROW.

Complete with lever, price\$4.50
 Without lever, price 3.75

"KAIN" HARROWS.

24 tooth \$5.00; 30 tooth \$6.00;
 40 tooth \$11.00.

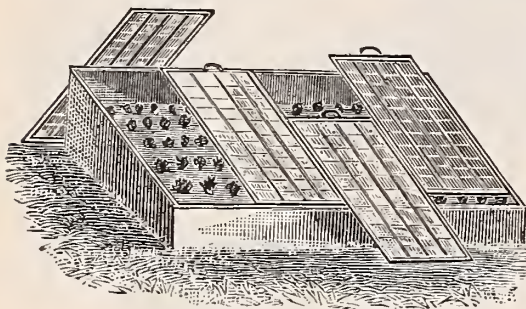

HOT BED SASH.

3 ft. 2 in. x 6 ft. 2 in.
 Unglazed, \$1.00 each.

Special price will be quoted on quantities, also on glazed and painted complete sash.



PLANT BED CLOTH.

A Substitute for Glass Sash on Hot-beds and Cold Frames.

LIGHT GRADE. Mostly used for shading greenhouses. Per yard, 4c.; by the piece of 68 yards, 3½c. yard.

MEDIUM GRADE. The best for general purposes. Yard, 8c.; by the piece of 50 yards, 7c. yard.

HEAVY GRADE. Water-proof and advised for States north of Pennsylvania. Per yard, 10½c., by the piece of 40 yards, 10c. per yard.

Putty

Bulbs.

Used for Applying Putty when Glazing.

85c. each.

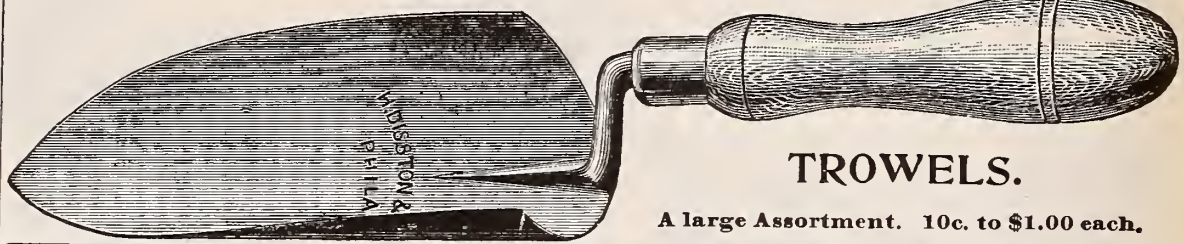

TROWELS.

A large Assortment. 10c. to \$1.00 each.

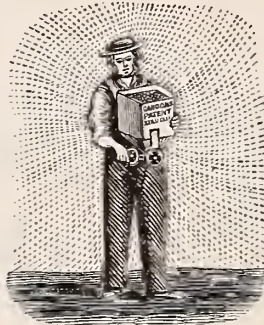

Seed Sower.

CAHOON'S BROADCAST SEED SOWER.

The most practical and satisfactory machine for accurately sowing Timothy, Clover and other similar seeds. Price\$3.50 each.

VAN REYPER'S PERFECT GLAZING POINTS.

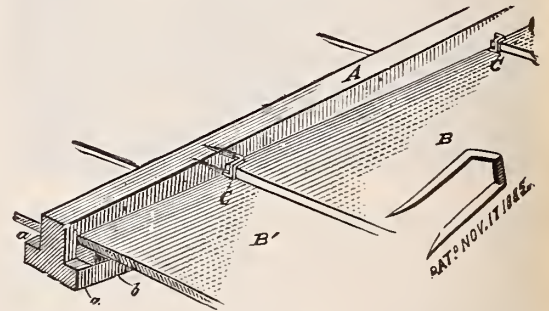

These are made of steel wire and galvanized, having double points and lap over the glass in such a manner as to positively keep it from sliding. They may be used on either side of the sash bar, thus preventing the annoyance of rights and lefts.

Per box of 1000, 60c., 5000 lots at 55c. per 1000.
 Pincers for driving, 50c.

HUDSON'S GARDEN HOSE MENDER for mending garden hose.

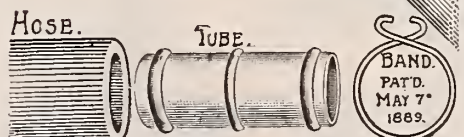
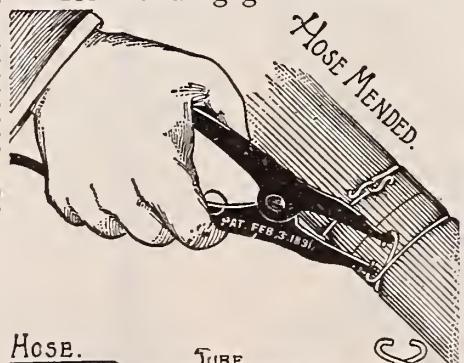

One box containing 6 Tubes, 20 Bands, 1 Pair Pliers, postpaid, 75c. Extra parts sold separately.
 In orders give inside diameter of hose.
 50 cents a box
HENRY F. MICHELL,
 1018 Market St., Phila.



Mastica

FOR GLAZING GREENHOUSES

(New or Old).

Machine for applying Mastica.

Elastic, adhesive, easy to apply. Used now extensively, and highly recommended by all the up-to-date gardeners and florists. Immense quantities were used last season. Remains in elastic, pliable condition for years; does not become hard.

One gallon will cover about 300 running feet.

Per gal. \$1.00; half gal. 60 cts.; 5 gals. \$4.50.

Machines for applying Mastica, \$1.00 each,

PLANT STAKES, LABELS, ETC.

PLANT STAKES

PAINTED STAKES

	Doz.	100		Doz.	100
1½ ft., painted green	\$0.15	\$0.90	3 ft. heavy or dahlia	\$0.67	\$4.30
2 " " " "	.25	1.55	3½ " " " "	.73	5.00
2½ " " " "	.38	2.35	4 " " " "	.88	5.70
3 " " " "	.46	2.95	5 " " " "	1.10	7.10
3½ " " " "	.58	3.70	6 " " " "	1.30	8.50
4 " " " "	.67	4.30			

BAMBOO OR CANE STAKES.

Always on hand.

	Per 100	Per 1000
8 to 12 feet long (250 for \$2.00)	\$1.00	\$6.50

UNPAINTED STAKES OR DOWELS

	Per 100	Per 1000
36 inches long, ¼ inch diameter	\$0.55	\$4.75
42 " " " "	.65	5.00
42 " " 5/8 " " "	.75	6.00
42 " " 1/2 " " "	1.00	7.50

GALVANIZED STEEL PLANT STAKES

Used by leading gardeners and florists for Roses, Carnations, etc. They are neat and durable.

	Per 100	Per 1000		Per 100	Per 1000
2 feet long,	\$0.70	\$5.50	4 feet long,	\$1.15	\$10.00
2½ " " "	.80	6.50	4½ " " "	1.25	10.75
3 " " "	.90	7.50	5 " " "	1.40	11.50
3½ " " "	1.00	8.50			

GALVANIZED WIRE IN ROLLS

No. 16 and No. 18, 8 cts. per lb.; 75 cts. per roll of 12 lbs.
No. 20, 10 cts. per lb.; 85 cts. per roll of 12 lbs.

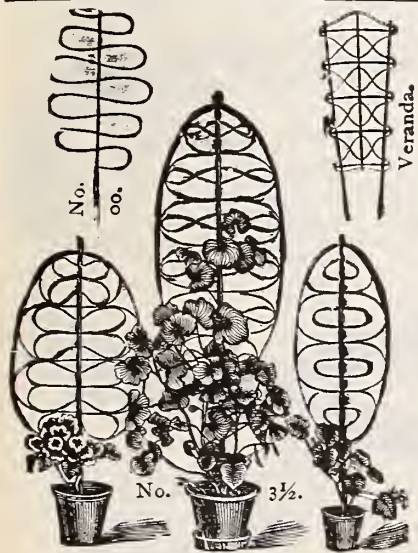

TRELLISES

For Training Vines. Each 10c. to \$1.00.



GARDEN REELS

Galvanized, \$1.25 and \$1.50 each.

GARDEN LINE

30c. to 60c. per hank.

P L A N T

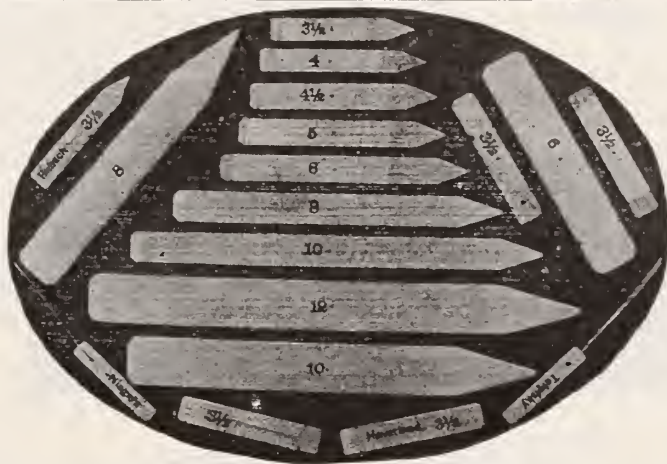

L A B E L S

PAINTED POT LABELS

	Per 100	Per 1000		Per 100	Per 1000
3½ inch	\$0.10	\$0.75	6 inch	\$0.25	\$1.25
4 " "	.12	.85	8 " "	.35	2.50
4½ " "	.15	1.00	10 " "	.50	4.00
5 " "	.20	1.10	12 " "	.75	5.25

PAINTED TREE LABELS

3½ inch, notched or pierced. Per 100 15c., per 1000 \$1.00. **Copper Wired** \$1.25 per 1000.

INDESTRUCTIBLE COPPER LABELS

Made of prepared copper, thin and pliable; can be written on with a pencil, which indents the copper, leaving a permanent impression. A little white lead, rubbed with the finger on the face of the label before the name is written, will make it more conspicuous. Per doz. 20c., per 100 \$1.00.

DODGE'S EVERLASTING GLASS LABELS. Will never wear out. Sample mailed free on application. 50c. per doz., \$3.50 per 100.

INDELIBLE MARKING PENCIL

Purple. 10c. each.



TYING MATERIALS

Green Silkaine. The best material for tying; does not fade; is very strong and durable. 20c. per spool, \$1.50 per lb.

Raffia. For tying. 20c. per lb.

String. For tying. All sizes. 5c. to 20c. per ball.

Thermometers.



Dairy Thermometers 30c. each

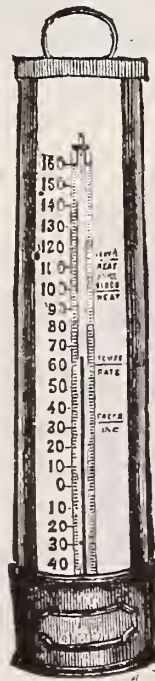

Greenhouse Thermometers 15c. to \$1.00 each



MAXIMUM AND MINIMUM THERMOMETERS
Registering the coldest and warmest temperature. \$2.50 and \$3.00 each

MUSHROOM OR HOTBED THERMOMETERS \$1.25 each.

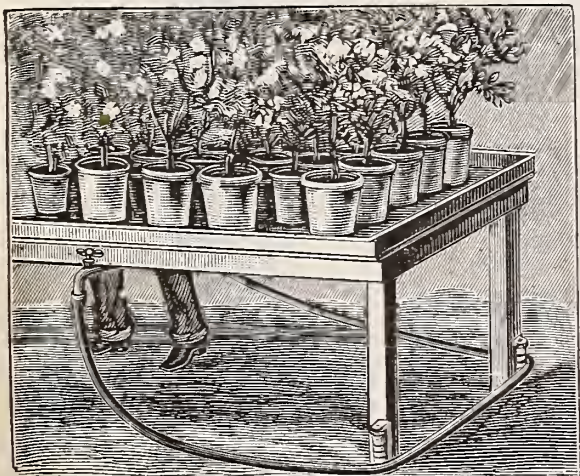

Schuck's Hose Protector

Just the proper thing. 30c each; \$3.00 per doz.

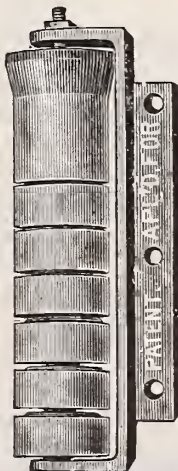

Soil or Sand Sieves

We can supply any size mesh, from No. 1 to 30. Made extra strong. Extra heavy, 20 inch diameter 75c., 18 inch 60c. Medium, 20 inch diameter, 60c., 18 inch 55c., 16 inch 50c.

MICHELL'S CATALOGUE OF SEEDS, ETC.

GARDEN TOOLS AND IMPLEMENTS.



SHEEP OR GRASS SHEARS.
30c. to \$1.25 each.

GARDEN AND LAWN RAKES
We carry a full stock of all the best improved steel
Wooden and Wire Rakes. 30c. to \$1.00 each.

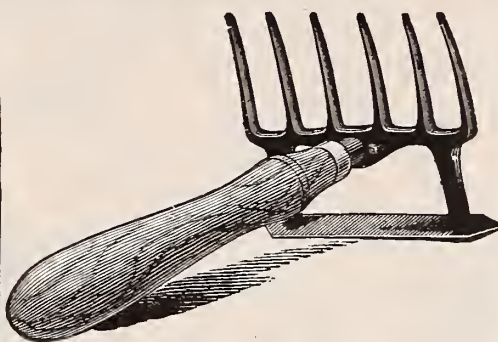
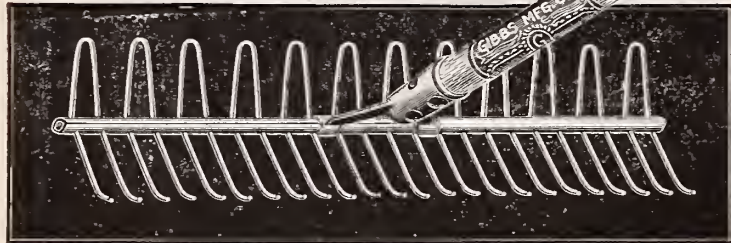

HAND WEEDERS.
Large assortment. All the latest makes.
10c. to 30c. each.



**WATER'S
IMPROVED TREE
PRUNERS.**

4 ft. pole,\$0.75
6 "85
8 " 1.00
10 " 1.20
12 " 1.40
14 " 1.60

**Extra Blades,
25c. each.**



PRUNING SHEARS
Very large assortment. 30c. to \$1.50
each.

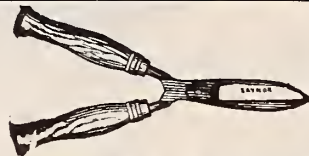

**Hedge
Shears**

All sizes. \$1.50 to \$2.50 each.

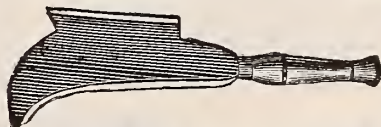

ENGLISH BILL HOOKS
\$1.50 each.



**GRASS
EDGING
KNIVES**

50c. to \$1.50 each.

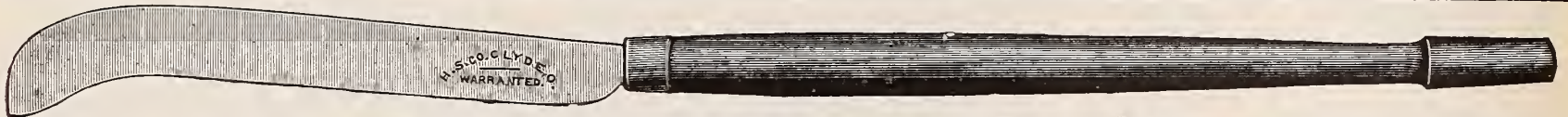

SLASHING HOOK for trimming out small fruits. Price \$1.25.



DISSTON'S PRUNING SAWS
Best quality. 70c. to \$1.25.

AVERY'S DOUBLE EDGE. 80c. each.



**TRANSPLANTING
DIBBLE**
The best and cheapest. 40c.
Brass Dibbles. 50c. each.

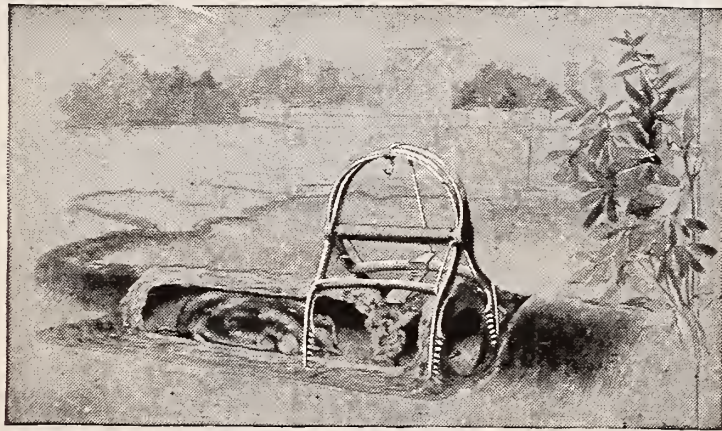

Showing position of trap when set with mole approaching.

**The New
"OUT O SIGHT"
MOLE TRAP.**

Considered to be one of the
best and cheapest Mole Traps
on the market. (Especially
valuable for hot beds and
frames on account of its con-
venient size).

Price \$1.00 each; \$5.00 per
½ doz.; \$9.00 per doz.

Perfection Mole traps, \$2.00
each.

Hale's Mole Traps,
\$2.00 each.

**New Model Mole
Traps,** \$1.50 each.

English Mole Traps,
35c. each.

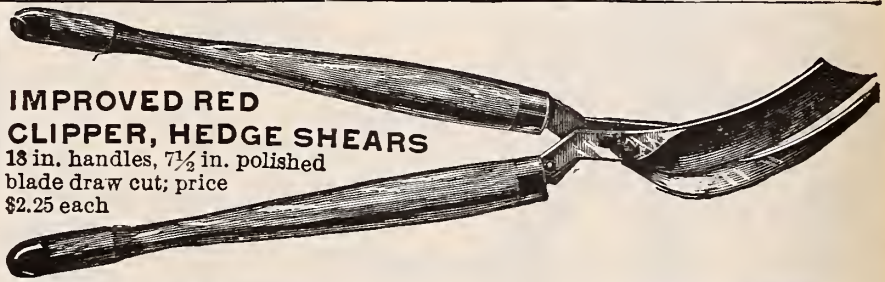

**IMPROVED RED
CLIPPER, HEDGE SHEARS**
18 in. handles, 7½ in. polished
blade draw cut; price
\$2.25 each



**WRIGHT'S
LAWN
WEEDER**

The best weed
extractor.

Each \$1.00

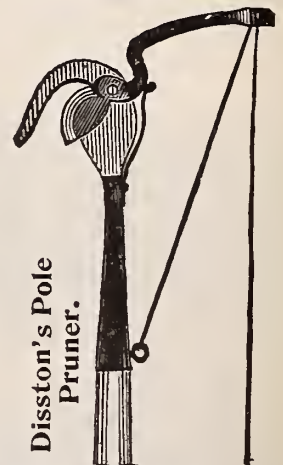

**Disston's Pole
Pruner.**

Disston's Little Giant Pruner
Price \$1.00. With saw \$1.30.



PRUNING AND BUDDING KNIVES
75c. to \$1.25 each.

**Sickles or Grass
Hooks.**

All sizes, 25c., 35c.,
40c., 50c., 60c. and
70c. each.

**English Rivet
Back Lawn
Scythes.**

Each \$1.25, \$1.35,
\$1.50.

American Scythes.
65c. each.

**Snathes for
Scythes.**
65c. each.

**Lawn Border
Shears.**

Each \$2.50 and
\$3.00.

We carry a full stock of
Hoes, Spades, Shovels, Forks, &c.
of the best quality only, at the very
lowest prices.



The Perfect Tomato Trellis

The simplest and best tomato support in use; it is considered, after thorough trial, the most practical on the market; very easily adjusted. Each 15c., per doz. \$1.50.

CARNATION SUPPORTS

"The Only Practical."

Used and praised by the leading carnation growers

24 inches high, with 3 rings, 50c. per doz., \$2.50 per 100, \$22.50 per 1000.

30 inches high, with 3 rings, 60c. per doz., \$3.00 per 100, \$25.00 per 1000.

The "Model" Carnation Supports

With 2 rings, 50c. per doz., \$3.00 per 100, \$27.50 per 1000.

With 3 rings, 65c. per doz., \$3.25 per 100, \$30.00 per 1000.

The "Excelsior" Carnation Supports

2 rings, 40c. per doz., \$2.00 per 100, \$18.00 per 1000.

Sundries

Baskets. For use in garden, oak, 1/2 bush. 35c., 1 bush. 45c., oak, iron bound, 1 bush. 75c.

Cocoa Fibre. Per bush. 70c., per sack of 3 bush. \$1.65.

"Erie" Rat Traps. Always sure. 30c. each.

Grafting Wax. Finest quality, in bars, with directions for use. Lb. 25c.

Jersey Peat. Best quality, barrel \$1.50, five barrel lots \$1.25 per barrel.

Jute Twine. For tying plants or vegetables, 12c. per lb.

Mats (Straw). Extra well made, 3x6 feet, each 75c., per doz. \$8.50; 6x6 feet, each \$1.25, per doz. \$14.00.

Gum Aprons. Well made; will protect your clothing. \$1.25 and \$2.00 each.

Moss (Green). Per barrel \$1.50.

Moss (Sphagnum). Per barrel \$1.25.

Orchid Peat, Lapp's. The best in the market. \$2.00 per barrel.

Propagating Sand. Extra clean, \$1.50 per barrel.

Raffia. The best material for tying plants, vines, etc., per lb. 20c.

Tar Twine. For tying mats, fodder, etc., 10c. per lb., \$8.00 per 100 lbs.

Twine. All sizes, for tying. 5c. to 30c. per ball, 10c. to 30c. per lb.

Palmer's Hot Bed Mats

Frost Proof.

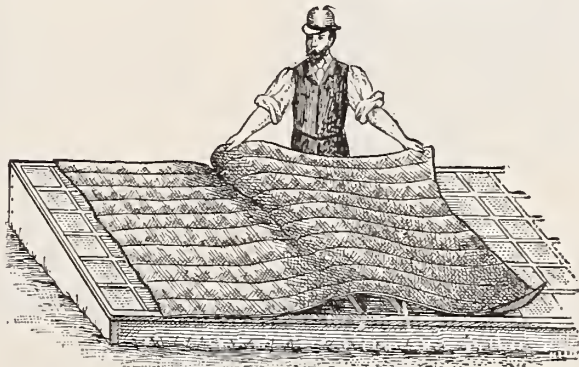

Made expressly for winter covering of hot beds, cold frames, plants and seeds of all kinds.

Indestructible, Cheap and Warm

Will not harbor mice or vermin. Easy handling. Have now been in practical use three years. Costing less than half as much as old-fashioned straw mats and entirely taking their place.

Size 76x76 inches, fully covering two regular size hot bed sash, \$1.25 each; \$13.50 per doz.

Size 40x76 inches, fully covering one hot bed sash, 75c. each; \$8.50 per doz.

Rustic Work

Made Extra Strong and Durable.

Rustic Plant Stands, Chairs and Settees.

A large assortment. \$2.50 to \$6.00 each.

Rustic Hanging Baskets

\$1.00 to \$2.50 each.



Pumps

For Spraying and Syringing.

Made of Brass. Very durable.

- Hydronette or Fountain..... \$5.00
- Excelsior. Deakin's..... 6.50
- Aquarius. Lift and force..... 6.50
- Acme..... 4.00
- "Success." Complete..... 6.00

Rubber Sprinklers

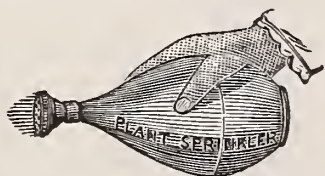

2 sizes. 50c. and 80c. each.

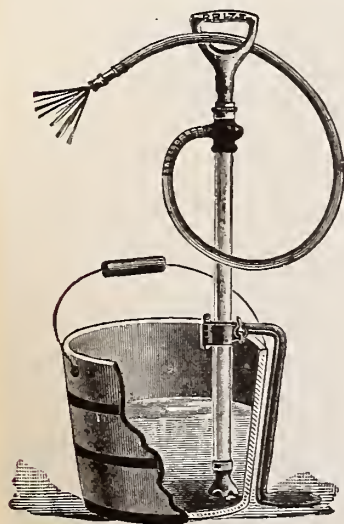

ACME PUMP.

HOSE REELS.

Wirts' All Iron. Very Durable.

- No. 10. Holds 100 feet, . \$2.75
- No. 20. Holds 150 feet, . 3.00
- No. 30. Holds 300 feet, . 5.00

Also a number of other makes \$1.00 to \$2.50 each.

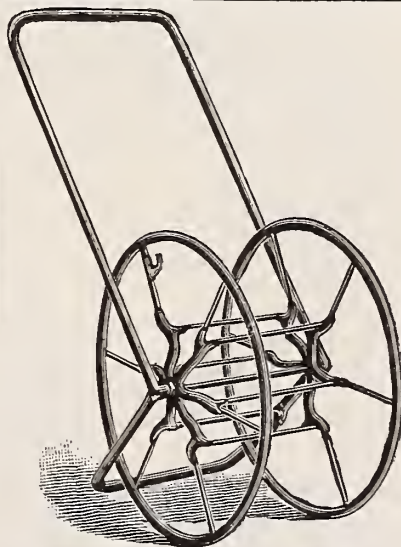

Miller's Patent Sprinkling Wagon.

For Lawns, Parks, Golf Grounds, Cemeteries, &c., &c.,

\$75.00 Net.

Garden Wheel Barrows

Very Strong, Light and Durable.

- No. 2.....\$3.00
- No. 3.....\$3.50
- No. 4.....\$4.00.

Index of Contents of this Catalogue.

...SEEDS...

BIRD SEEDS,	PAGE 17	GRASS SEEDS,	PAGE 18	SUTTON'S SEEDS,	PAGE 18 "C"
CLOVER SEEDS,	18	HERB SEEDS,	8	TIMOTHY SEED,	18
FARM SEEDS,	18	HUNGARIAN SEED,	18	VEGETABLE SEEDS,	
FLOWER SEEDS,		MILLET SEED,	18	In Alphabetical order,	1-17
In Alphabetical order,	19-36	MISCELLANEOUS SEEDS,	17	Vegetable Seeds see also Novelties A	

BULBS, ROOTS AND PLANTS.	PAGE
ABUTILONS	37
Acalypha	37
Akebia Quinata	37
Alternanthera	37
Amaryllis	37
Ampelopsis Veitchii	37
Asparagus Plumosus	37
Asparagus Roots	1
BEGONIAS	37
Blackberries	46
Bouvardias	37
CABBAGE PLANTS	4
Caladium	39
Callas	37
Cannas	38
Carnations	39
Cauliflower Plants	5
Celery Plants	6
Chrysanthemums	40
Cinnamon Vine	37
Clematis	39
Coleus	37
Currants	46
DAHLIAS "H" and	41
GAILLARDIA	42
Gladiolus	42
Gloxinias	43
Gooseberries	46
Grape Vines	46
HELIANTHUS	42
Hollyhocks	42
Honeysuckles	42
Hop Vine Roots	8
Horseradish Roots	8
Hyacinthus Candicans	42
Hydrangea	42
ICELAND POPPIES	43
Iris Kämpferi	42
LETTUCE PLANTS	9
Lilies	42
MADEIRA or Mexican Vine	42
Manettia Vine	42
Moon Flowers	43
ONION SETS	11
Osage Orange	17 and 46
PÆONIES	44
Perennial Phlox	43
Pepper Plants	12
Privet	46
RASPBERRIES	46
Rhododendrons	44
Roses	45
SHRUBS	44
Spider Lily	44
Strawberry Plants	46
Strawberry Raspberry	46
TIGRIDIA	44
Tomato Plants	16
Trees	44
Tritoma	44
Tuberoses	44
VERBENAS	44
Violets	44
WATER HYACINTH	46
Water Lilies	45
Wineberry (Japanese)	46
Wisteria	44

MISCELLANEOUS.	PAGE
AMERICAN GARDENING	48
Animal Meal	55
Ant Exterminator	49
Aprons (Gum)	61
Ashes (Canada)	47
BARLEY	55
Baskets	61
Bellows	49
Bill Hooks	60
Blood (Dried)	47
Bone Black	47
Bone Cutter	55
Bone Flour	47
Bone (Ground)	47
Bone (Granulated)	55
Bone Meal	47
Bone Mill	55
Books on Gardening	3d Cover
Books on Poultry	55
Bordeaux Mixture	49
Bowker's Chemicals	47
Bowker's Food	47
Brooders	54
CATERPILLAR LIME	49
Caponizing Set	55
Carnation Supports	61
Caustic Potash Soap	49
Celery Paper	6
Chairs (Rustic)	61
Charcoal	55
Chick Manna	55
Clay's Fertilizer	47
Cocoa Fibre	61
Condition Powders	55
Copperdine	49
Cotton Seed Meal	47
Cultivators	52 and 53
Cut Clover Hay	55
DALMATION POWDER	49
Death to Lice Powder	55
Dibble	60
EDGING KNIVES	60
Eggs (for Hatching)	55
Eggs (Incubator)	55
Egg Food	55
FERTILIZERS	47
Fibre Saucers	48
Fibre Vases	48
Fir Tree Oil	49
Fir Tree Oil Soap	49
Fish Meal	55
Flower Pots	48
Flower Vases	48
Fostite	49
Fruit Pickers	54
Fumigators	49
GAPE CURE	55
Garden Line	59
Garden Reels	59
Gishurst's Compound	49
Glazing Points	58
Grape Dust	49
Grass Catchers	50
Guano	47
HANGING BASKETS	61
Harrows	58
Hay (Cut Clover)	55
Hellebore	49

	PAGE
Horse Hoes	52 and 53
Horse Boots	50
Hose Band	56
Hose Coupler	56
Hose Crook	56
Hose Menders	56 and 58
Hose Nozzles	56
Hose Protector	59
Hose Reels	61
Hose (Rubber)	56
Hot Bed Sash	58
INSECTICIDES	48
Incubators	54
JUTE TWINE	48
Jadoo	47
KAINIT	47
Kerosene Emulsion	49
Kill-M-Right	49
Kinney Pump	58
Knapsack Sprayer	49
Knives	54
LABELS	59
Land Plaster (Calcined)	47
Lawn Clipper	50
Lawn Feeder	57
Lawn Mowers	50 and 51
Lawn Mower Sharpener	50
Lawn Scythes	52
Lawn Shears	52
Lawn Sprinklers	57
Leaf Rack	57
Lemon Oil	49
Lily Pans	48
Line (Garden)	54
London Purple	49
MAPES' FERTILIZERS	47
Mastica	58
Mats (Burlap)	61
Mats (Straw)	61
Meat for Poultry	55
Mica Crystal	55
Mole Traps	60
Moss (Green)	61
Moss (Sphagnum)	61
Muriate of Potash	47
NEST EGGS	55
Nikoteen	49
Nitrate of Soda	47
OIL HEATERS	48
Orchid Baskets	48
Orchid Peat	61
Oyster Shell	55
Oyster Shell Mill	55
PARIS GREEN	49
Paris Green Duster	49
Peat (Jersey)	61
Pencil (Indelible)	59
Persian Powder	49
Phosphate	47
Planet Jr. Implements	52
Plant Bed Cloth	58
Plant Stakes	59
Plant Stands (Rustic)	61
Plant Tubs	48
Plows	58
Pots	48
Pot Saucers	48
Potato Knives	14
Poultry Supplies	55

	PAGE
Poultry Fountains	55
Pratt's Food	55
Propagating Sand	61
Pruners (Tree)	60
Pruning Knives	60
Pruning Saws	60
Pruning Shears	60
Pumps	61
QUASSINE	49
RAFFEA	61
Rakes	60
Reel (Garden)	59
Rollers	58
Rose Leaf Extract	49
Roup Pills	55
Roup Preparation	55
Rubber Sprinklers	61
Rustic Work	61
SALT (Agricultural)	47
Saucers for Pots	48
Saucers for Plant Tubs	50
Saws	60
Scythes	52
Seal Oil Soap	49
Seed Drills	52 and 53
Seed Pans	48
Seed Sowers	58
Settees (Rustic)	48
Shears (all kinds)	60
Sheep Manure	47
Sickles	60
Sieves	59
Silkaline	59
Slug Shot	49
South Carolina Rock	47
Spray Pumps	56
Springs for Shears	54
Sprinklers	61
Stakes for Plants	54
String	59
Sulphur	49
Sulphuric Acid	47
Sulphate of Ammonia	47
Sulphate of Magnesia	47
Sulphate of Potash	47
Syringes	56
TANKAGE	47
Thermometers	59
Tobacco Dust	49
Tobacco Culture Book	17
Tobacco Soap	49
Tobacco Stems	49
Tomato Trellis	61
Trellises	59
Trowels	58
Twine	61
Tying Materials	54
VASES (for Cut Flowers)	50
Vases (Iron)	50
WATERING POTS	57
Water Trucks	57
Weeders	52
Weed Extractor	49
Weed Killer	49
Whale Oil Soap	49
Wheel Barrows	61
Wheel Hose	51
Wire (Galvanized)	59
Wire Netting	55
Wire (Soft Copper)	59

Guaranteed to hatch 20 per cent. more than any other machine made or you can return the machine after 30 days trial.

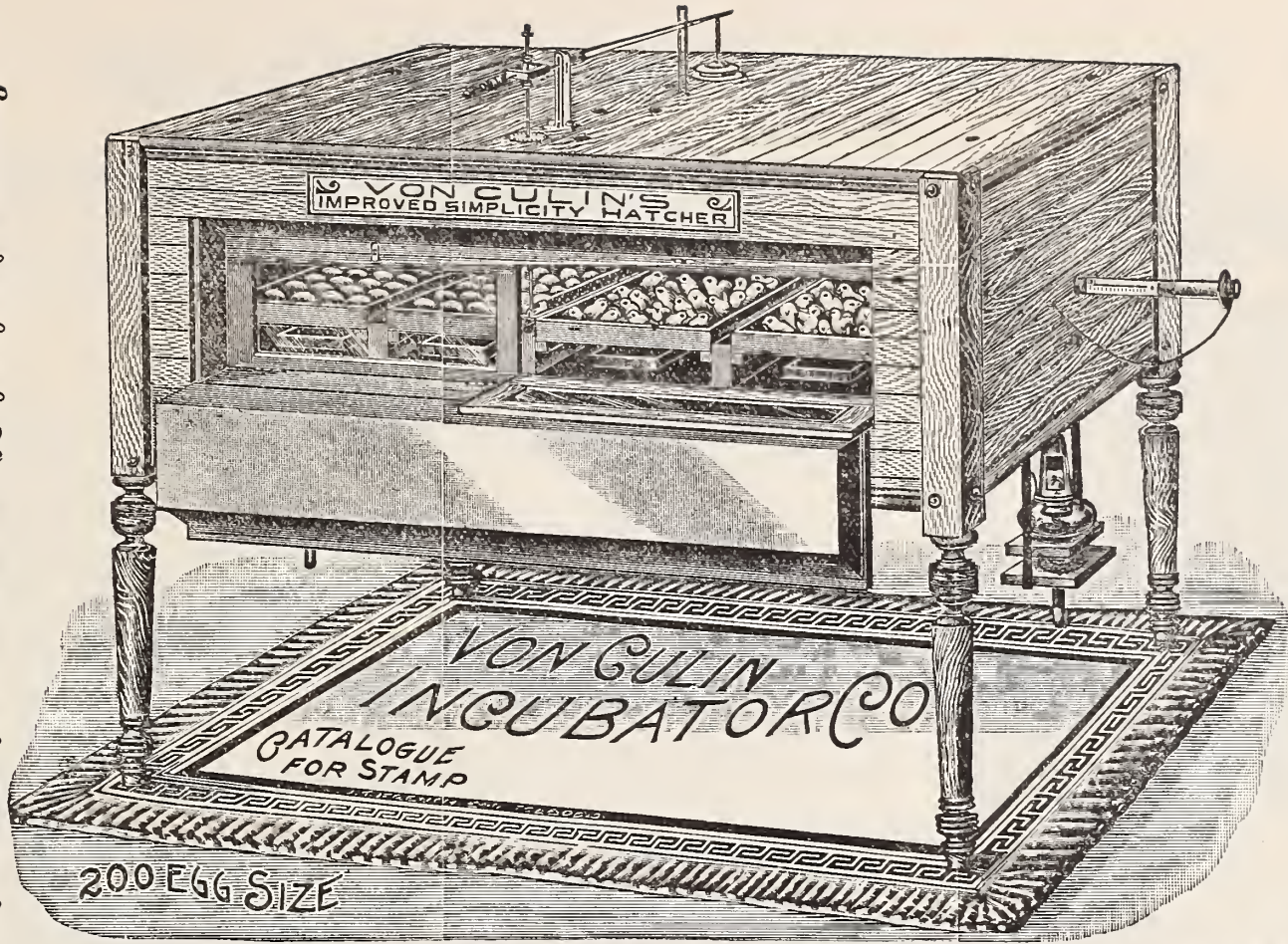

Guaranteed to burn but one-half the oil and takes but one-tenth the attention any other machine and if it don't do all this, you can return it after 30 days trial.

Von Culin Incubators and Brooders

FIRST PRIZE MEDAL AT WORLD'S FAIR 1893.

First Prize Medal at Canadian Exposition 1894.

First Prize Medal at Nashville Exposition 1897.

250 First Prizes at Small State Fairs.

SOLD FOR CASH OR ON TRIAL to Responsible Parties.

Capacity and Price-List.

25 Eggs,	No	0,	Simplicity,	30 days trial	Price,	\$15.00;	Cash Price, \$15.00
80	"	1,	"	"	"	25.00;	" " 22.50
100	"	1½,	"	"	"	28.50;	" " 25.00
140	"	2,	"	"	"	32.00;	" " 29.00
200	"	2½,	"	"	"	39.00;	" " 35.00
250	"	3,	"	"	"	45.00;	" " 40.00
432	"	4,	"	"	"	60.00;	" " 54.00
600	"	5,	"	"	"	80.00;	" " 73.00
160	"	2,	Compartment	"	"	45.00;	" " 40.00
240	"	3,	"	"	"	65.00;	" " 60.00
320	"	4,	"	"	"	80.00;	" " 73.00
400	"	5,	"	"	"	95.00;	" " 87.00
480	"	6,	"	"	"	110.00;	" " 100.50
75 Chicks	"	1,	Inside Brooder,	50 per cent.,	7.00;	" " 5.00	
100	"	2,	"	"	9.00;	" " 6.00	
75	"	1,	Outside Brooder,	"	15.00;	" " 12.00	
100	"	2,	"	"	17.00;	" " 13.50	
450	"	1,	6-Comp. Brooder,	30 per cent.	50.00;	" " 44.00	
450	"	2	"	" with Runs,	60.00;	" " 52.00	

Henry F. Michell,

1018 Market Street, Philadelphia, Pa.

BOOKS ON HORTICULTURAL AND OTHER SUBJECTS.

JUST PUBLISHED **Greenhouse Management.**

A MANUAL FOR FLORISTS AND FLOWER LOVERS ON THE FORCING OF FLOWERS, VEGETABLES AND FRUITS IN GREENHOUSES, AND THE PROPAGATION AND CARE OF HOUSE PLANTS.

By **L. R. TAFT.**

Professor of Horticulture and Landscape Gardening, Michigan Agricultural College, and author of "Greenhouse Construction."

GROWING OF CUT FLOWERS. Treats on plants cultivated by florists and amateurs and explains in a thorough manner the methods that have been found most successful in growing them. Particular attention is paid to the growing of cut flowers, entire chapters being devoted to each of the leading crops, such as roses, carnations, chrysanthemums, violets, bulbs, smilax, ferns, orchids, etc.

GROWING OF FRUITS UNDER GLASS. The growing of fruits under glass is attracting the attention of commercial florists as well as amateurs, and the reader will find separate chapters devoted to the forcing of grapes, strawberries, peaches, and other fruits.

GROWING OF VEGETABLES UNDER GLASS. The forcing of vegetables also receives the attention it deserves, and the raising of lettuce, radishes, cucumbers, tomatoes, mushrooms, etc., is explained thoroughly.

THE CARE OF HOUSE PLANTS. The care of house plants is also treated quite fully, with detailed directions for propagating, preparing the soil, potting, watering and every part of their proper management. A chapter is also given on bedding plants, as well as on ornamental grass, flowering and foliage plants. Other chapters are devoted to the propagation of plants from seeds, cuttings, layers and by grafting and budding. Of special value to many will be the directions for *treating plants when attacked by insects and fungi*. The preparation of the soil, the use of various manures, composts and fertilizers, watering, ventilating, heating, and in fact every detail of the subject to which the work is devoted, receives careful and minute attention.

CONTENTS:—The Forcing of Roses; the Carnation; the Chrysanthemum; the Violet; Bulbs and their Culture; Tuberos Begonias; Orchid Culture; Azaleas; Calceolarias, Cinerarias and Primulas; Ferns, Smilax and Asparagus; Palms, Pandanus and Araucaria; Dracenas and Cordylines; Lettuce Forcing; Cucumbers, Tomatoes and Melons; Mushroom Culture; Asparagus and Rhubarb; Radishes, Carrots, Beets and Beans; Grape Growing Under Glass; Strawberry Growing Under Glass; Fruit Trees Under Glass; Management of House Plants; the Growing of Bedding Plants; Propagation of Plants by Seeds and Cuttings; Propagation by Layering, Grafting and Budding; Insects of the Greenhouse; Diseases of Greenhouse Plants; Insecticides and Their Preparation; Fungicides, Their Preparation and Use; Soil, Manures and Watering; Fuel—Coal, Oil and Gas.

400 pages, with 128 Original and Practical Illustrations. 12mo, cloth, Postpaid, \$1.50.

Every practical Gardener should have this Book for ready reference.



The New and Popular Acalypha Sanderiana.

Books on Vegetables, Fruits, Flowers, Trees, Insects, Birds and Bees, Poultry, Horses, Cattle and Sheep.

New Publication on

LANDSCAPE GARDENING. BY SAMUEL PARSONS, JR. CONTENTS: The Lawn—The treatment of sloping grounds—Spring effects on the lawn—Trees and shrubs for June effects on the lawn—The flowers and foliage of summer—Green autumnal foliage—Autumnal colors on the lawn—Lawn planting for winter effect—Garden flowers—Bedding plants—The ornamentation of ponds and lakes—Lawn planting, etc. Price, \$3 50.

Gardening for Profit. Henderson..... 2 00.
Gardening for Pleasure. Henderson..... 2 00.
Practical Floriculture. Henderson..... 1 50.

Handbook of Plants. Henderson.....\$4 00.
Profit in Poultry..... 1 00.
Grape Growers Guide. Chorlton..... 75.
Chrysanthemum Culture..... 60.
Mushroom Culture. Robinson..... 50.
Mushroom Culture. Falconer..... 1 35.
Nicholson's Dictionary of Gardening (complete) per set, 18 00.

Also numerous other books on Horticultural subjects.

The Water-Lily Garden. WM. TRICKER. An excellent book on the above subject, beautifully illustrated and handsomely bound in cloth..... 2 00.

We Import a Very Extensive Stock and Assortment of

DUTCH BULBS

HYACINTHS, TULIPS, DAFFODILS, EASTER LILIES, Etc., Etc., direct from the most reliable growers in HOLLAND, BERMUDA, JAPAN, FRANCE, etc., arrive from abroad from August to November, according to species. Illustrated catalogue will be mailed to all our customers and applicants.

P. S.—We have established a large trade in booking orders for bulbs EARLY (before May 1st) and sending those orders abroad to be filled there and to be sent over with our own stock. We strongly advise bulb buyers to take advantage of this mode of ordering bulbs, thereby securing extra choice stock at a reduction in price of 10 per cent and over.

QUANTITY OF SEEDS USUALLY SOWN UPON AN ACRE.

lbs. per bus.	lbs. per bus.	lbs. per bus.
Beans, Dwarf, in drills.....60 1½ lbs.	Grass, Orchard.....12 3 bus.	Wrinkled Peas, in drills.....56 1¾ bus.
Beans, Pole, in hill.....60 10 to 12 qts.	Grass, English Bye.....24 3 bus.	Peas, broadcast..... 3 bus.
Beets, Table, in hill..... 6 lbs.	Grass, Red Top.....10 3 bus.	Potatoes (cut tubers).....60 8 bus.
Beets, Mangle Wurzel..... 5 lbs.	Grass, Timothy.....45 ½ bus.	Pumpkin, in hills..... 3 lbs.
Buckwheat.....48 1 bus.	Grass, Hungarian.....48 1 bus.	Radish, in drills..... 8 to 10 lbs.
Cabbage, in beds to transplant..... ¼ bus.	Kale..... 5 lbs.	Rye, broadcast.....56 1½ to 2 bus.
Carrot, in drills..... 3 to 4 lbs.	Melon, Musk, in hills..... 2 to 3 lbs.	Salsify, in drills..... 8 to 10 lbs.
Clover, Red.....60 20 lbs.	Melon, Water, in hills..... 4 to 5 lbs.	Spinach, in drills..... 15 lbs.
Clover, White.....60 12 to 15 lbs.	Millet and Hungarian.....48 1 bus.	Squash, bush varieties, in hills..... 4 lbs.
Clover, Alsike.....60 10 lbs.	Oats, broadcast.....32 2 to 3 bus.	Squash, running varieties, in hills..... 3 lbs.
Clover, Lucerne or Alfalfa.....60 20 lbs.	Onion, in drills..... 6 to 8 lbs.	Timothy Seed..... ½ bus.
Corn, in hills..... 8 to 10 qts.	Onion for Sets, in drills..... 50 lbs.	Tomato, to transplant..... ¼ lb.
Corn for fodder.....56 3 bus.	Onion Sets, in drills..... 6 to 12 bus.	Turnip, in drills..... 2 lbs.
Cucumber, in hills..... 2 lbs.	Parsnip, in drills..... 4 to 6 lbs.	Turnip, broadcast..... 2 lbs.
Grass, Kentucky Blue.....14 3 bus.	Round Peas, in drills.....60 1½ bus.	Wheat, broadcast..... 1½ to 2 bus.

MICHELL'S

HIGHEST QUALITY SEEDS



VIEW OF PART OF FIRST FLOOR.

BULBS, HORTICULTURAL IMPLEMENTS & C.

1018 MARKET ST.