

A CATALOGUE
OF
SURGICAL INSTRUMENTS, APPARATUS,
APPLIANCES, ETC.

MANUFACTURED AND SOLD BY

JOHN WEISS & SON,

62, STRAND, LONDON.

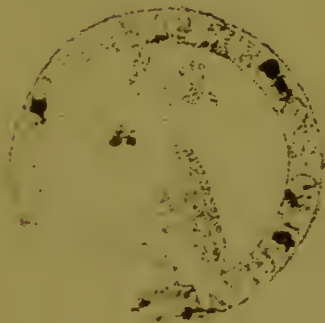

1863.

*RESERVED FOR
Weiss & Son*

LONDON :

M. S. RICKERBY, PRINTER, HAND COURT,
UPPER THAMES STREET.



P R E F A C E.

IN the Illustrations and Letter-press of the present Catalogue the Authors have endeavoured to classify its contents by bringing the Instruments for the various Operations together. In the Illustrations it was found impossible to effect this completely; firstly, in consequence of the continual accession of the number of new Instruments, several having been added at the last moment; and, secondly, because many of the miscellaneous Instruments did not admit of being so classified.

The Letter-press has been divided into several lists or catalogues; first, the Illustrated List, which is interspersed throughout the Plates; second, the Classified List, in which the whole of the Instruments are arranged in the order in which they are required for the various operations, and which at the same time affords descriptions of many of the instruments and apparatus that are not illustrated; third, a list of sets or series of Instruments and appliances, including those required for

the different Government Services and Public Companies ; and, lastly, lists of other appliances, etc.

There are, doubtless, several omissions in the Catalogue which could not well be avoided, but attributable to two causes :—the first, from the desire of the Authors to confine themselves to the enumeration of such Instruments as they believe to be generally employed and approved of ; and secondly, to inadvertency. For the latter they would request kind indulgence.

62, STRAND, LONDON,

July, 1863.

LIST OF PLATES.

	<i>Plate</i>
TOURNIQUETS	I.
AMPUTATING KNIVES, SCALPELS, ARTERY FORCEPS, ETC.	II.
SAWS	III.
BONE FORCEPS	IV.
TREPHINES, GOUGES, CHISELS, ETC.	V.
EYE KNIVES	VI.
Do. NEEDLES AND HOOKS	VII.
Do. SCISSORS AND FORCEPS	VIII.
Do. INSTRUMENTS	IX.
Do. FORCEPS, PROBES, ETC.	X.
Do. INSTRUMENTS AND LARYNGOSCOPES	XI.
DEMONSTRATING OPHTHALMOSCOPE, LARYNGOSCOPE, AND LAMP	XII.
INSTRUMENTS FOR THE MOUTH, LARYNX, AND ESOPHAGUS ...	XIII.
Do. do. do. ESOPHAGUS, NOSE, ETC.	XIV.
Do. do. TRACHEA, ESOPHAGUS, ETC.	XV.
TOOTH FORCEPS	XVI.
Do. do. AND KEY	XVII.
INSTRUMENTS FOR SCALING AND STOPPING TEETH ...	XVIII.
EXCAVATORS AND ELEVATORS FOR THE TEETH	XIX.
AURAL INSTRUMENTS	XX.
INSTRUMENTS FOR THE EAR, ETC.	XXI.
LITHOTOMY INSTRUMENTS	XXII.
Do. do. 	XXIII.
LITHOTRITY do.	XXIV.
URETHRA AND BLADDER INSTRUMENTS	XXV.

	<i>Plate</i>
URETHRA INSTRUMENTS	XXVI.
INSTRUMENTS FOR HERNIA, VARICOCELE, HYDROCELE, ETC.	XXVII.
Do. FOR FEMALE DISEASES	XXVIII.
Do. do.	XXIX.
Do. do.	XXX.
Do. FOR THE RECTUM	XXXI.
Do. FOR OVARIOTOMY, ETC.	XXXII.
ECCRASSEURS, ETC.	XXXIIa.
MIDWIFERY INSTRUMENTS	XXXIII.
Do. do.	XXXIV.
Do. do.	XXXV.
Do. do.	XXXVI.
Do. do.	XXXVII.
DRESSING do.	XXXVIII.
MISCELLANEOUS do.	XXXIX.
Do. do.	XL.
DISLOCATION APPARATUS, ANEURISM TOURNIQUETS, ETC.	XLa.
CHLOROFORM INHALERS	XLI.
INSTRUMENTS FOR DIAGNOSIS	XLII.
POST-MORTEM AND MICROSCOPIC INSTRUMENTS ...	XLIII. and XLIIIa.
OPERATING TABLE	XLIV.
SPLINTS AND FRACTURE APPARATUS	XLV.
INSTRUMENTS FOR DEFORMITY, ETC.	XLVI.
FRACTURE BEDS, INVALID CHAIRS, AIR AND WATER CUSHIONS	XLVII.
BELTS, TRUSSES, PESSARIES, AND URINALS	XLVIII.
ARTIFICIAL LIMBS AND CRUTCHES	XLIX.
FIGURE, FOR MEASUREMENT OF BELTS, BANDAGES, ETC.	L.
DOMESTIC APPLIANCES, ETC.	LI.
SYRINGES AND DOMESTIC APPARATUS	LII.
ACOUSTIC INSTRUMENTS	LIII.

CONTENTS OF CLASSIFIED LIST, SETS OF INSTRUMENTS, ETC.

	<i>Page</i>
Instruments for Amputation, Re-section, Necrosis, and Trepanning	1 to 4
Eye Instruments, etc.	5 to 8
Instruments for the Mouth, Larynx, Trachea, Esophagus, etc.	9 to 14
Do. for the Nose and Ear	14 to 16
Do. for Lithotomy and Lithotrity	16 to 18
Do. for the Urethra and Bladder	19 to 20
Do. for Phymosis, Varicocele, Hydrocele, and Hernia	21
Midwifery Instruments	21 to 24
Instruments for Female Diseases	24 to 27
Do. for Tumours, etc.	27 to 29
Do. for Operations on the Rectum	29 to 30
Aneurism Instruments	30
Miscellaneous Instruments, comprising Bullet Forceps, etc., Tenotomy Knives, and Instruments for Varicose Veins, etc.	30 to 31
Vaccinating, Bleeding, Cupping, and Transfusion Instruments, etc.	31 to 32
Galvanic and Actual Cautery Apparatus	32
Chloroform Inhalers	32
Dressing Instruments	33 to 35
Instruments for Diagnosis, etc.	35 to 36
Operating Tables	36
Post-Mortem Tables	36
Post-Mortem and Microscopic Instruments	36 to 37

	<i>Page</i>
Splints and Fracture Apparatus	37 to 38
Fracture Bandages, and Apparatus for Reducing Dislocations, etc.	39
Belts, Trusses, Urinals, Pessaries, etc.	39 to 41
Fracture Beds, Water Cushions, etc.	42
Artificial Limbs, Crutches, etc.	42 to 43
Instruments for Deformities, etc.	43
Respirators, Syringes, and Domestic Apparatus	44 to 45
Hearing Instruments	45
Sets of Instruments for Private Practice	46 to 55
Army Regulation Cases of Instruments, Apparatus, Appliances, etc.	56 to 59
Sets of Instruments required for the Navy	59 to 60
Instruments required by Public Companies and H.M.'s Emigration Commissioners	61 to 62
Medicine Chests	62 to 63
Appliances, Utensils, etc.	64 to 65

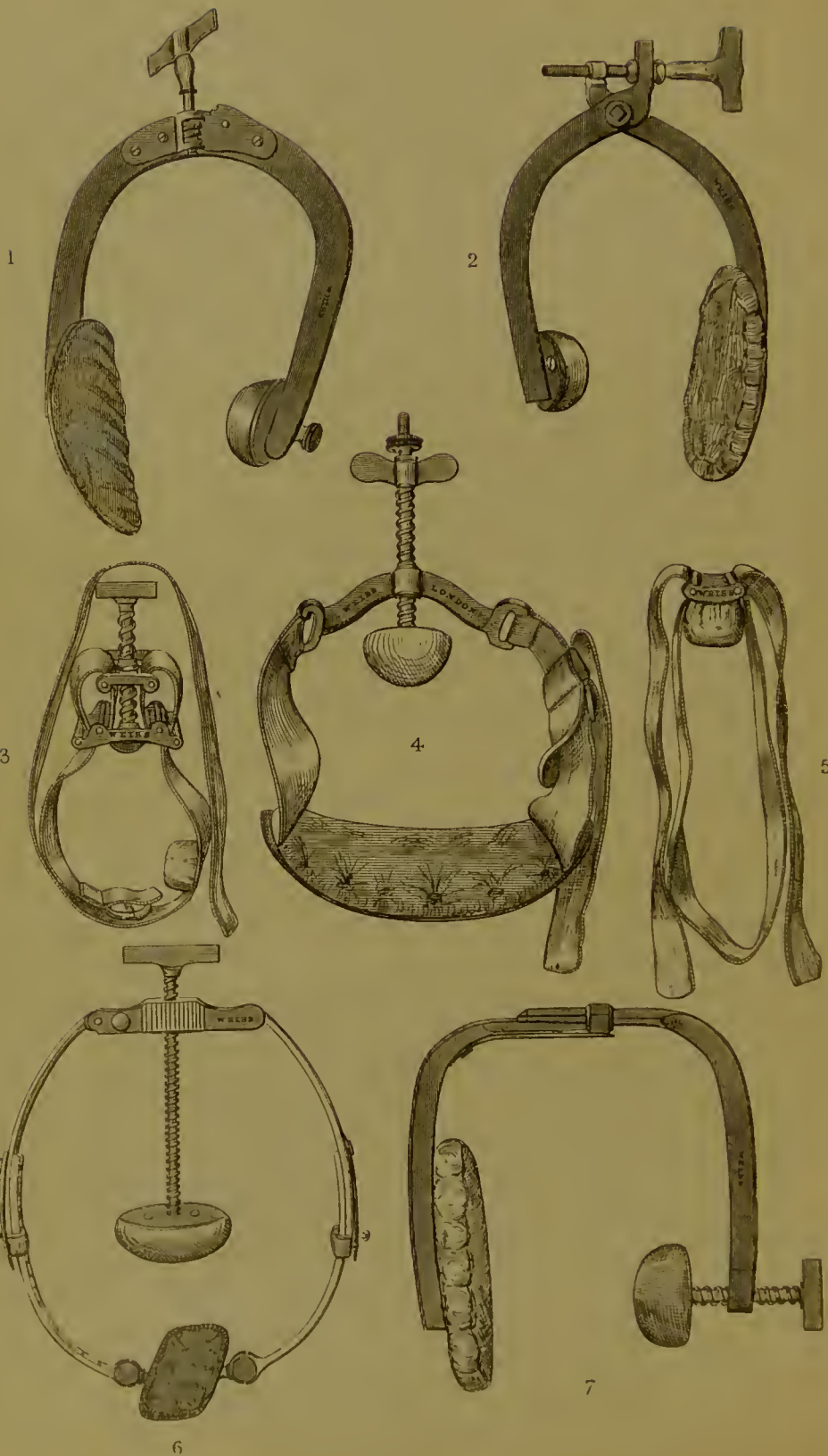

PLATE I.

TOURNIQUETS.

Figure

- 1 SIGNORONI'S TOURNIQUET.
- 2 WEISS' MODIFICATION OF SIGNORONI'S TOURNIQUET.
- 3 PETIT'S SCREW TOURNIQUET.
- 4 WEISS' CONTINUOUS PRESSURE TOURNIQUET.

By means of a spiral spring acting upon the arterial pad, and forcing it forward as the limb contracts from depletion, continuous pressure is ensured. The tourniquet is applied and secured in the usual way, and it only remains to release the spring by turning the screw nut, which is situated above the handle of the screw.

- 5 WEISS' FIELD TOURNIQUET.

This instrument is an improvement upon the old tourniquet, and is so simple in its construction, that non-professional persons can readily apply it in case of accident. Having no buckle, the pad is not liable to displacement.

- 6 SKEY'S TOURNIQUET.
- 7 WEISS' MODIFICATION OF THE CLAMP TOURNIQUET.

The advantage of this modification is, that the clamp is divided, so that one part slides over the other, and is secured at the required distance by a spring bolt. The operator is thus enabled readily to adapt the tourniquet to the size of the limb, and hence perfect steadiness is secured.

PLATE II.

AMPUTATING KNIVES, SCALPELS, ARTERY
FORCEPS, ETC.

Figure

- 1 SIMPSON'S ACU-PRESSURE PIN.
- 2 CURVED SUTURE NEEDLE.
- 3 CURVED POINTED SUTURE NEEDLE.
- 4 LISTON'S ARTERY FORCEPS, or TENACULUM.
- 5 FENESTRATED ARTERY FORCEPS.
- 6 TORSION FORCEPS.

These forceps are made with serrated teeth and a groove in the centre for holding a needle; they are also furnished with a sliding bolt for fixing the blades when holding the object.

- 7 ORDINARY TENACULUM.
- 8 ASSALINI'S TENACULUM.
- 9 DIEFFENBACH'S ARTERY FORCEPS.
- 10 LUKE'S ARTERY FORCEPS.
- 11 WEISS' CROSS-ACTION do.
- 12 MIDDLE POINTED SCALPEL.
- 13 BACK POINTED do.
- 14 LISTON'S FINGER KNIFE.
- 15 LISFRANC'S DOUBLE-EDGED AMPUTATING KNIFE.
- 16 LISTON'S KNIFE for the Flap Operation.
- 17 MORGAN'S KNIFE.
- 18 KNIFE for the Circular Operation.
- 19 CATLIN OR INTER-OSSEUS KNIFE.
- 20 KNIFE for Re-section.

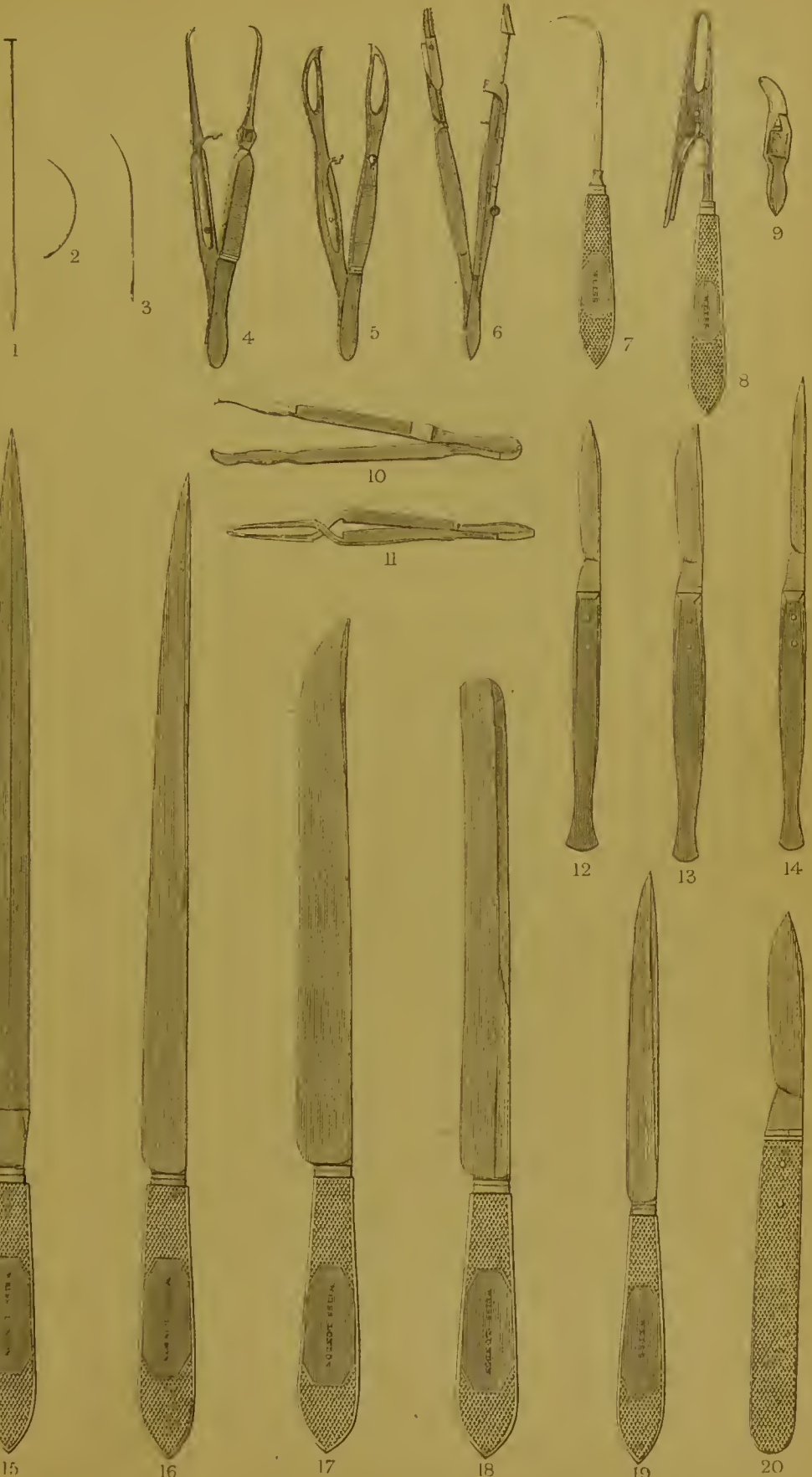

ONE THIRD SIZE.

Vincent Bischoff, del et lith

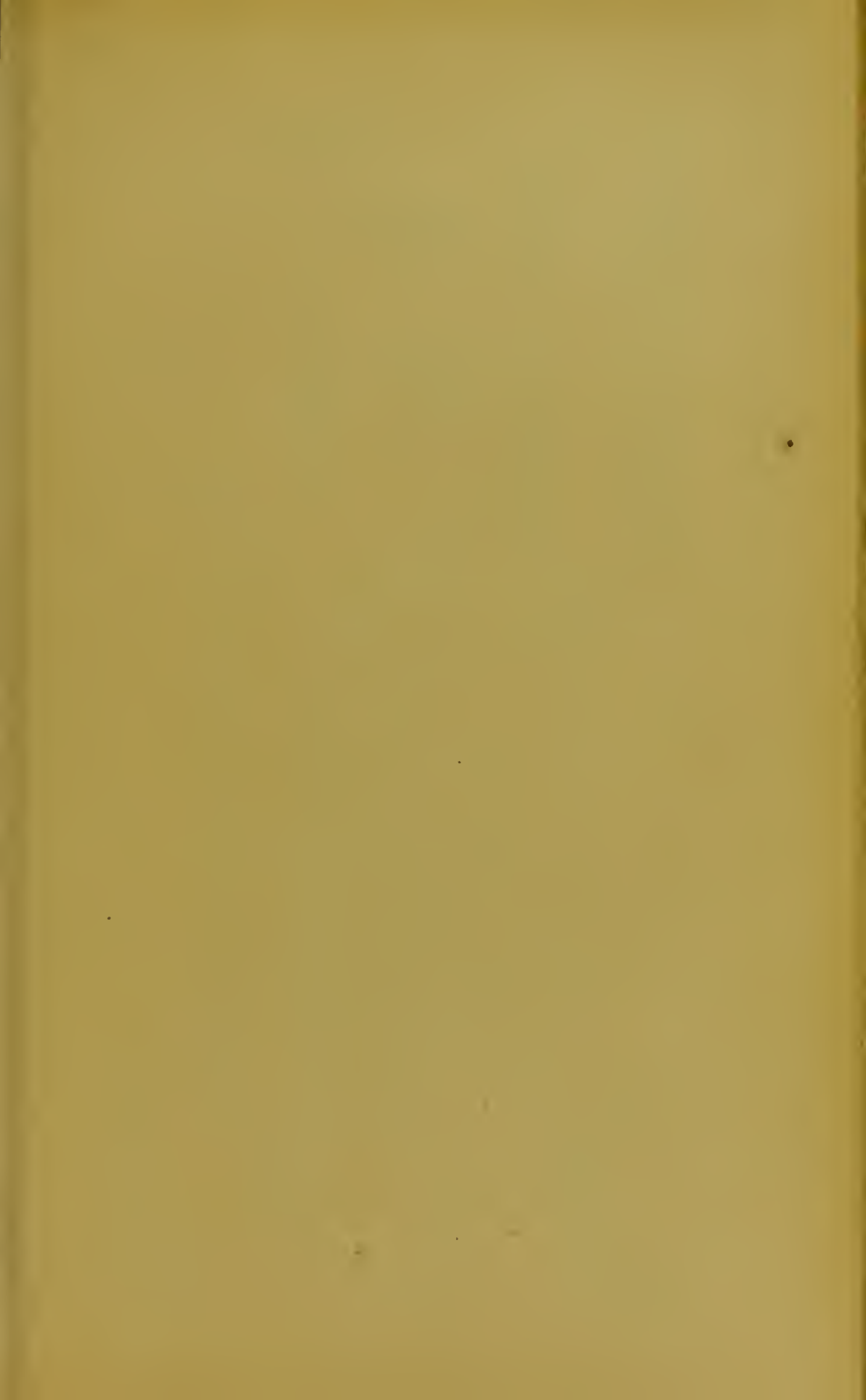

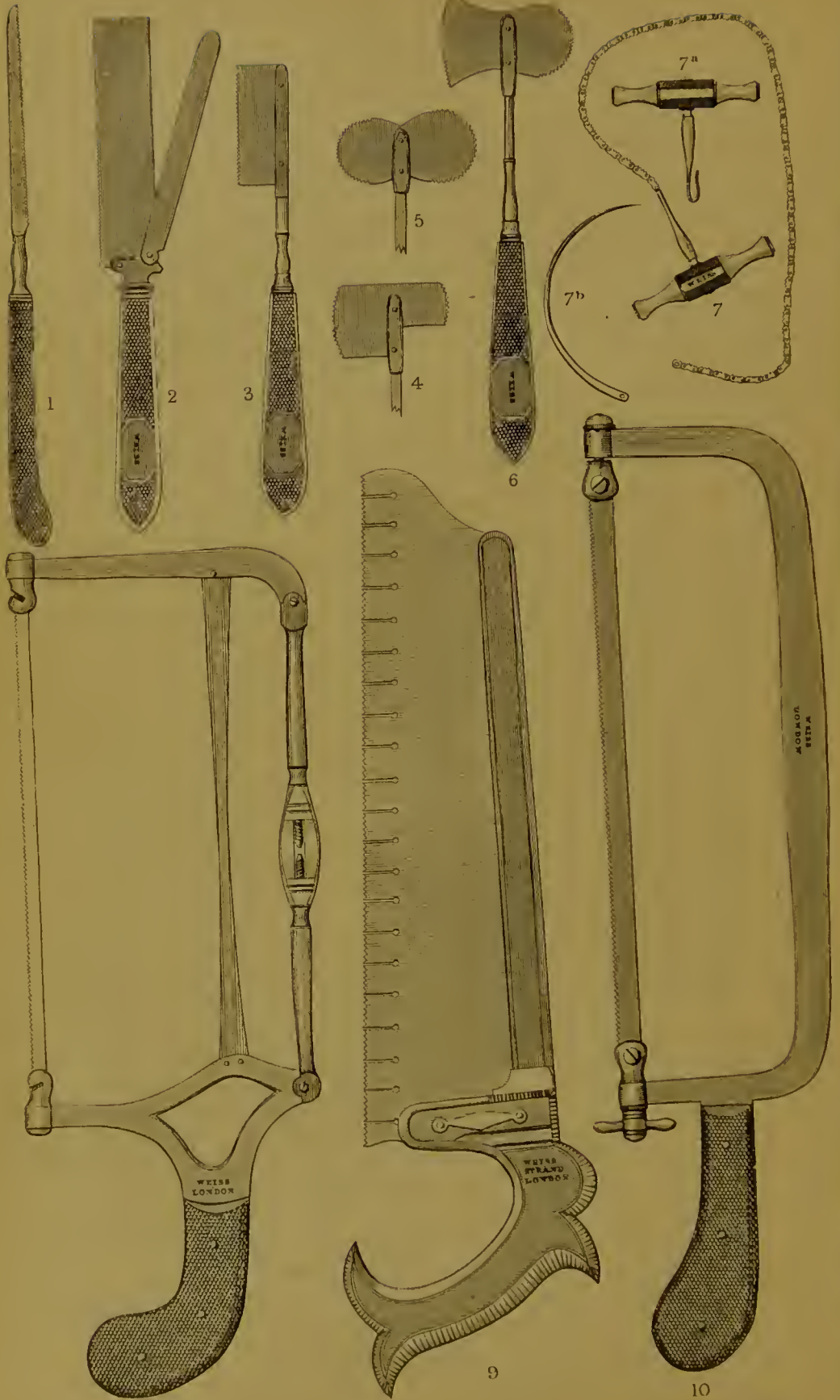

8 ONE-THIRD SIZE.

PLATE III.

SAWS.

Figure

1 FINGER SAW.

2 FERGUSSON'S SAW, with folding back.

3 HEY'S SAW FOR Trepanning and Necrosis.

4 Do. do. } the handles of these Saws are similar to
5 Do. do. } those of Figures 3 and 6.

6 Do. do.

7, 7a, 7b CHAIN SAW.

The needle, 7b, with which the saw is passed round the bone, is attached to the end of the saw with a piece of silk or thread.

8 BUTCHER'S SAW for Amputation and Re-section.

It has three blades of different widths, which can be fixed at any angle, and, being narrow, produce less friction.

9 AMPUTATING SAW, with Weiss' Improvement.

The slots in the blade have the effect of clearing the teeth of the saw during the operation.

10 BOW OR FRAME SAW.

PLATE IV.

BONE FORCEPS.

Figure

1 FERGUSSON'S CURVED BONE FORCEPS.

2 STRAIGHT NECROSIS FORCEPS.

3 GOUGE FORCEPS for Necrosis..

The spring, which folds back when the forceps are not in use, may be applied to any forceps.

4 CURVED NECROSIS FORCEPS.

5 FERGUSSON'S SIDE-CUTTING BONE FORCEPS.

6 Do. NECROSIS FORCEPS.

7 LISTON'S BONE FORCEPS, with eccentric joint.

The eccentric joint increases the power of the instrument. It is only applicable to straight forceps.

8 LISTON'S CURVED RING FORCEPS for the Jaw.

9 FERGUSSON'S LION FORCEPS.

These forceps are used for steadying the bone while using the saw, chisel, or gouge.

10 FERGUSSON'S ANGLED BONE FORCEPS.







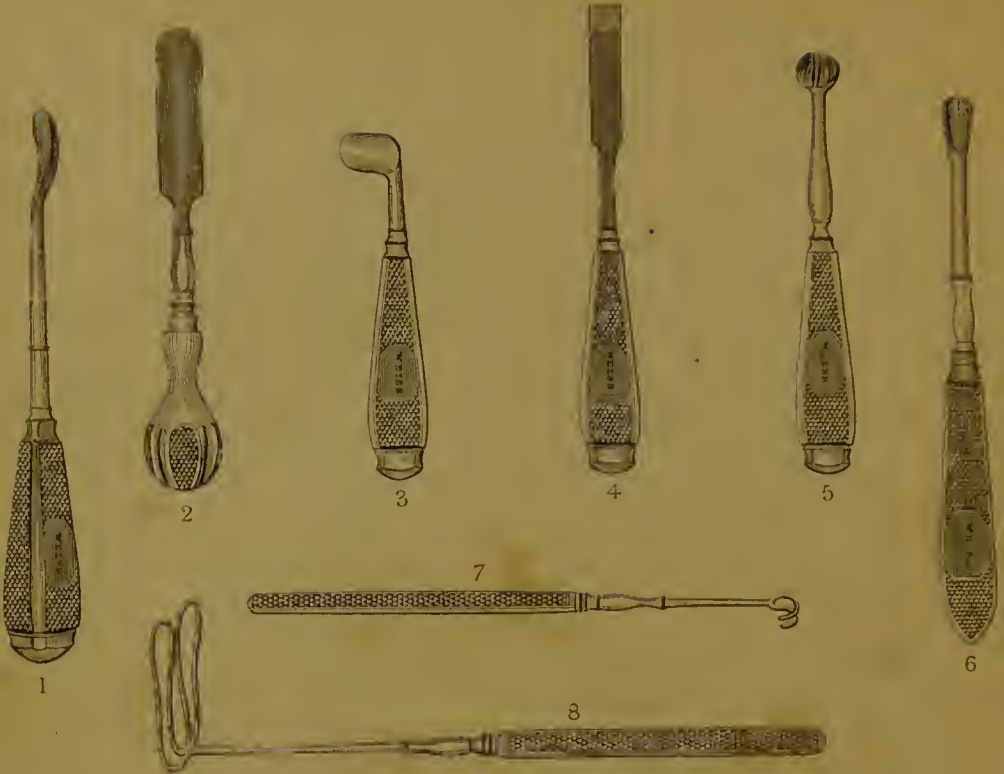

ONE-THIRD SIZE.

Made at Brookfield et lith

PLATE V.

TREPHINES, GOUGES, CHISELS, ETC.

Figure

- 1 CURVED GOUGE for Necrosis.
- 2 STRAIGHT do. do.
- 3 ANGLED do. do.
- 4 CHISEL for Necrosis.
- 5 MARSHALL'S OSTEOTRIBE, or ROSEHEAD, for Necrosis.
- 6 ELEVATOR for Trepanning and Necrosis.
- 7 DOUBLE BLUNT HOOK.
- 8 COPELAND HUTCHINSON'S RETRACTOR.
- 9 SCULL FORCEPS.
- 10 SEMI-CIRCULAR TREPHINE.

It is furnished with a handle similar to that of Fig. 11.

- 11 TREPHINE.
- 12, 12a, 12b MULTIPLYING STOCK, with extra Rosehead and small Trephine.
- 13 WOUND FORCEPS.
- 14 MARSHALL'S OSTEOTRIBE, with cross handle.

PLATE VI.

EYE KNIVES.

Figure

- 1 TYRRELL'S CATARACT KNIFE.
- 2 SICHEL'S do.
- 3 Do. SHORTER CATARACT KNIFE.
- 4 WHITE COOPER'S do.
- 5 DIXON'S do.
- 6 CONVEX SECONDARY KNIFE.
- 7 STRAIGHT do.
- 8 GUTHRIE'S STRABISMUS KNIFE.
- 9 BEER'S CATARACT KNIFE.
- 10 WALTON'S IRIS KNIFE, medium size.
- 11 JAEGER'S STRAIGHT IRIDECTOMY KNIFE.
- 12 Do. CURVED do.
- 13 WALKER'S KNIFE for extraction of the Soft Lens.



9



1



2



3



4



5



6



7



8



10



11



12



13



13

FULL SIZE.

Vincent Brooks, del. et lith.



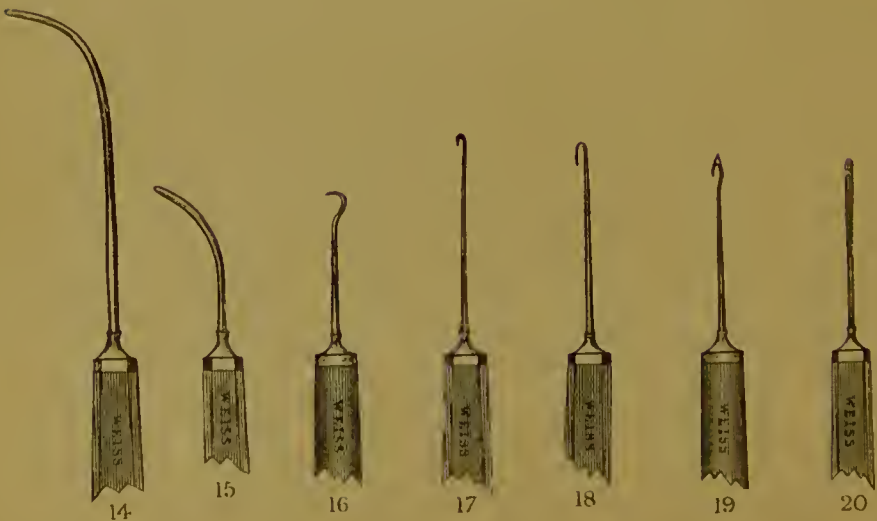
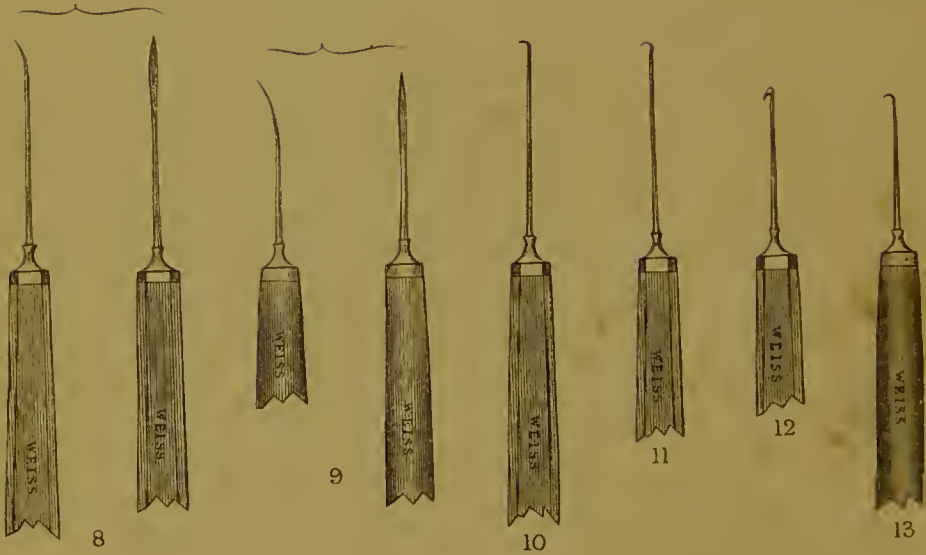
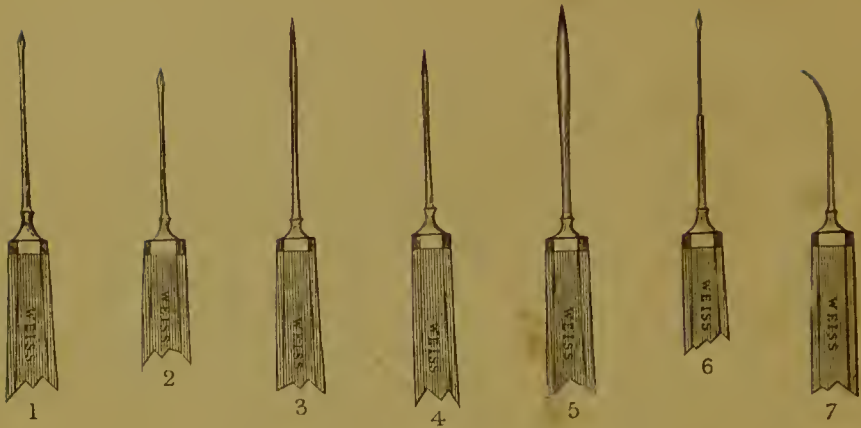

PLATE VII.

EYE NEEDLES AND HOOKS.

Figure

- 1 BEER'S NEEDLE for Solution.
- 2 DALRYMPLE'S do. do.
- 3 SAUNDERS' do. do.
- 4 Do. do. do. shorter.
- 5 BROAD NEEDLE.
- 6 BOWMAN'S STOP NEEDLE.
- 7 JACOB'S NEEDLE.
- 8 SCARPA'S NEEDLE for Reclination.
- 9 WALTON'S do. do.
- 10 LENS HOOK.
- 11 Do.
- 12 WALTON'S HOOK for Artificial Pupil.
- 13 LENS HOOK.
- 14 STRABISMUS HOOK.
- 15 WALTON'S STRABISMUS HOOK.
- 16 Do. ARTIFICIAL PUPIL HOOK.
- 17 TYRRELL'S HOOK, as modified by Mr. Bowman.
- 18 Do. do.

These last two instruments (figs. 17 and 18) are also made in platinum, as suggested by Mr. Bowman, to enable the operator to bend them to any angle. They are generally mounted in one handle.

- 19 BOWMAN'S ARTIFICIAL PUPIL NEEDLE HOOK.
- 20 STREATFEILD'S SPATULA HOOK.

PLATE VIII.

EYE SCISSORS AND FORCEPS.

Figure

- 1 STRAIGHT SCISSORS.
- 2 SICKLE SHAPE do.
- 3 STRABISMUS do.
The points of these scissors are made of various sizes.
- 4 BOWMAN'S STRABISMUS SCISSORS.
- 5 CURVED IRIS FORCEPS.
- 6 Do. SCISSORS.
- 7 MAUNOIR'S do.
- 8 CURVED IRIS FORCEPS.
- 9 STRAIGHT do.
- 10 CILIA do.

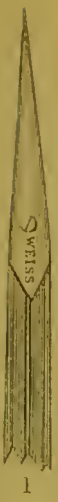

1



2



3



4



5



6



7



9



8

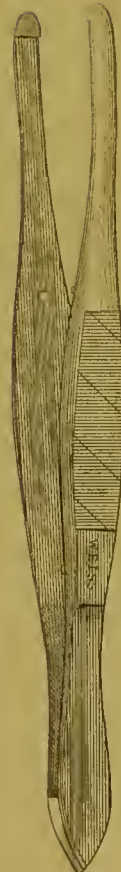

10

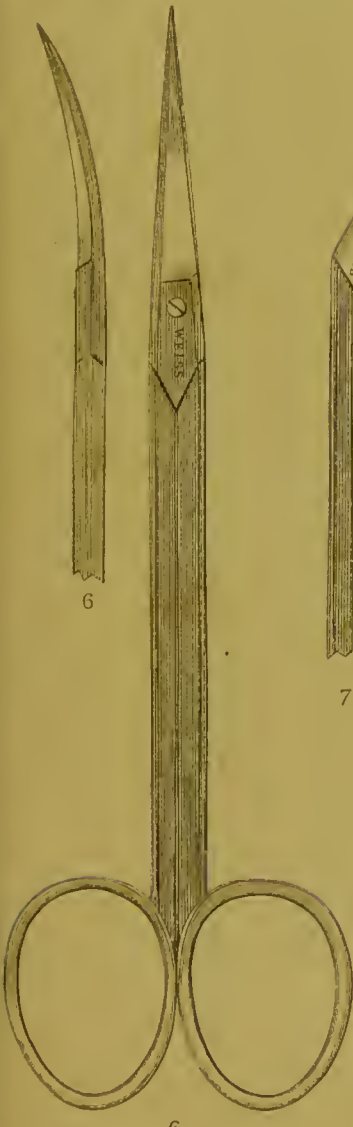

6

FULL SIZE.



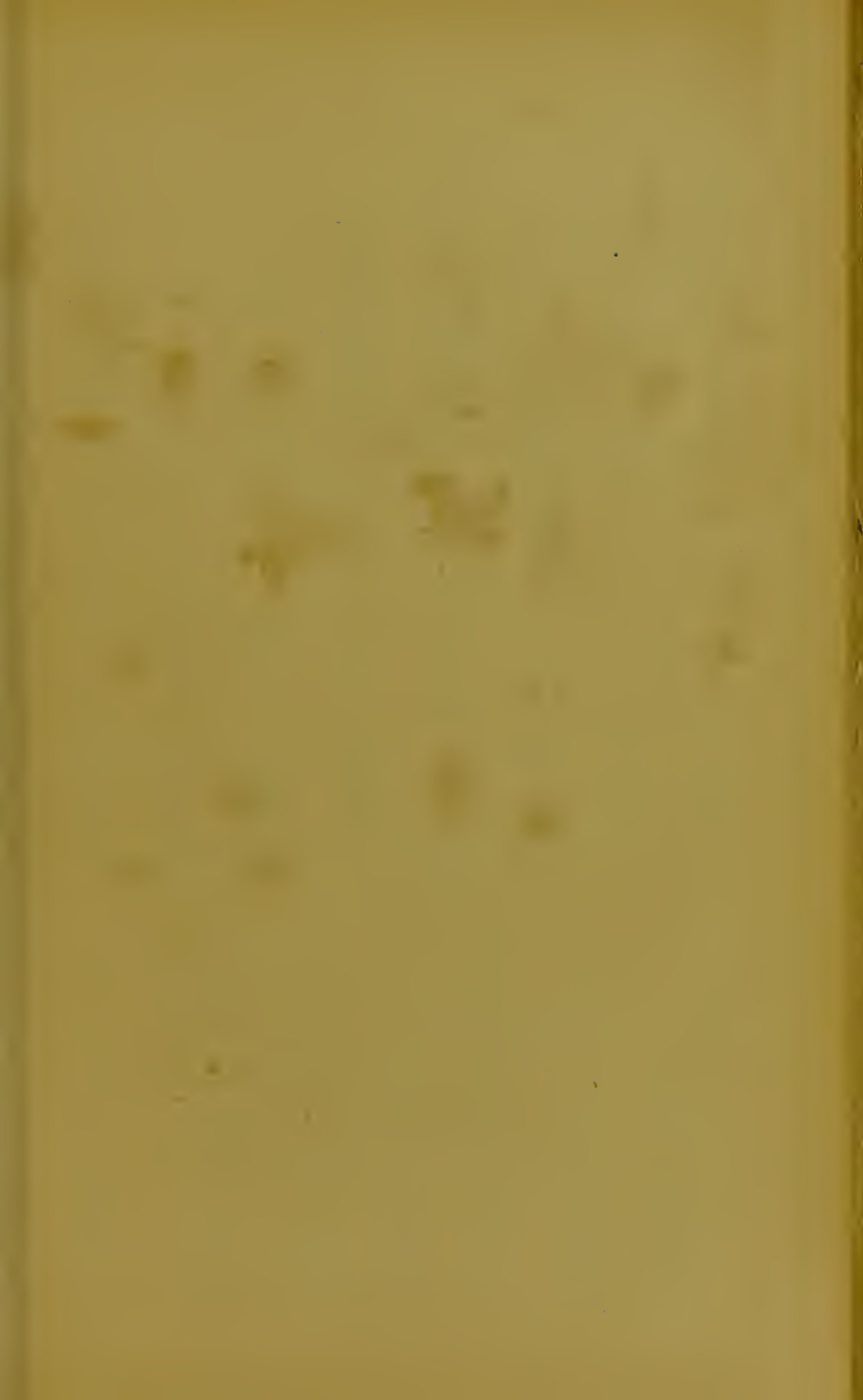

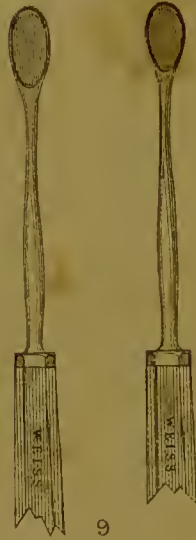
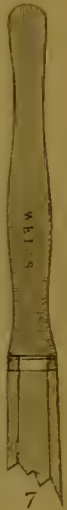
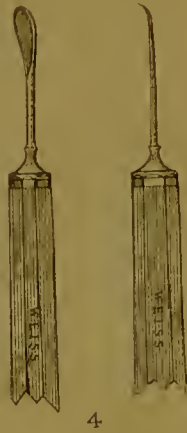

PLATE IX.

—
EYE INSTRUMENTS.

Figure

- 1 WALTON'S KNIFE for the Lachrymal Duct.
- 2 Do. SCALPEL.
- 3 SPUD for removing Foreign Bodies.
- 4 WALTON'S CURETTE and CYSTOTOME.

These instruments are mounted in one handle.

- 5 WALTON'S GOUGE for removing Foreign Bodies.
- 6 BOWMAN'S PUNCTUM KNIFE.
- 7 SCARIFYING KNIFE.
- 8 BOWMAN'S DOUBLE SPUD.

The blades are made of platinum for the convenience of bending them to any angle.

- 9 SCHUFFT'S SPOONS or SCOOPS for Iridectomy.
- 10 Do. do. do.

Two sizes of these scoops are mounted in one handle.

- 11 GRAEFE'S CYSTOTOME and CURETTE.

The two instruments are mounted in one handle.

- 12 GUTHRIE'S DIRECTOR for Strabismus.
- 13 CURETTE and SHARP HOOK.

The two instruments are mounted in one handle.

- 14 WALTON'S LID RETRACTOR.
- 15 Do. PROBE for the Nasal Duct.
- 16 HOOK for steadying the Eyeball in Strabismus.
- 17 HULKE'S SUTURE NEEDLE.

PLATE X.

EYE FORCEPS, PROBES, ETC.

Figure

- 1 CAPSULAR FORCEPS, with Needle-point.
- 2 Do. do.
- 3 Do. do. with curved blades, as suggested by Mr. White Cooper.
- 3a BOWMAN'S DILATOR for the Canaliculus.
The dotted lines show the blades when open.
- 4 WILDE'S IRIS SCISSORS.
- 5 BOWMAN'S STYLE.
This style is cut and shaped by the operator, as the case may require.
- 6 WALTON'S STYLE.
- 7 TAYLOR'S do.
- 8 WHITE COOPER'S ENTROPIUM FORCEPS.
- 9 GUARDED HOOK.
- 10 WALTON'S GUARDED CURETTE.
The engraving shows the instrument open and closed.
- 11 BOWMAN'S CANULA LANCET.
- 12, 13, 14 BOWMAN'S LACHRYMAL PROBES.
The set consists of four probes, there being two of No. 12, curved for the right and left.
- 15 CRITCHETT'S DIRECTOR for the Canaliculus.

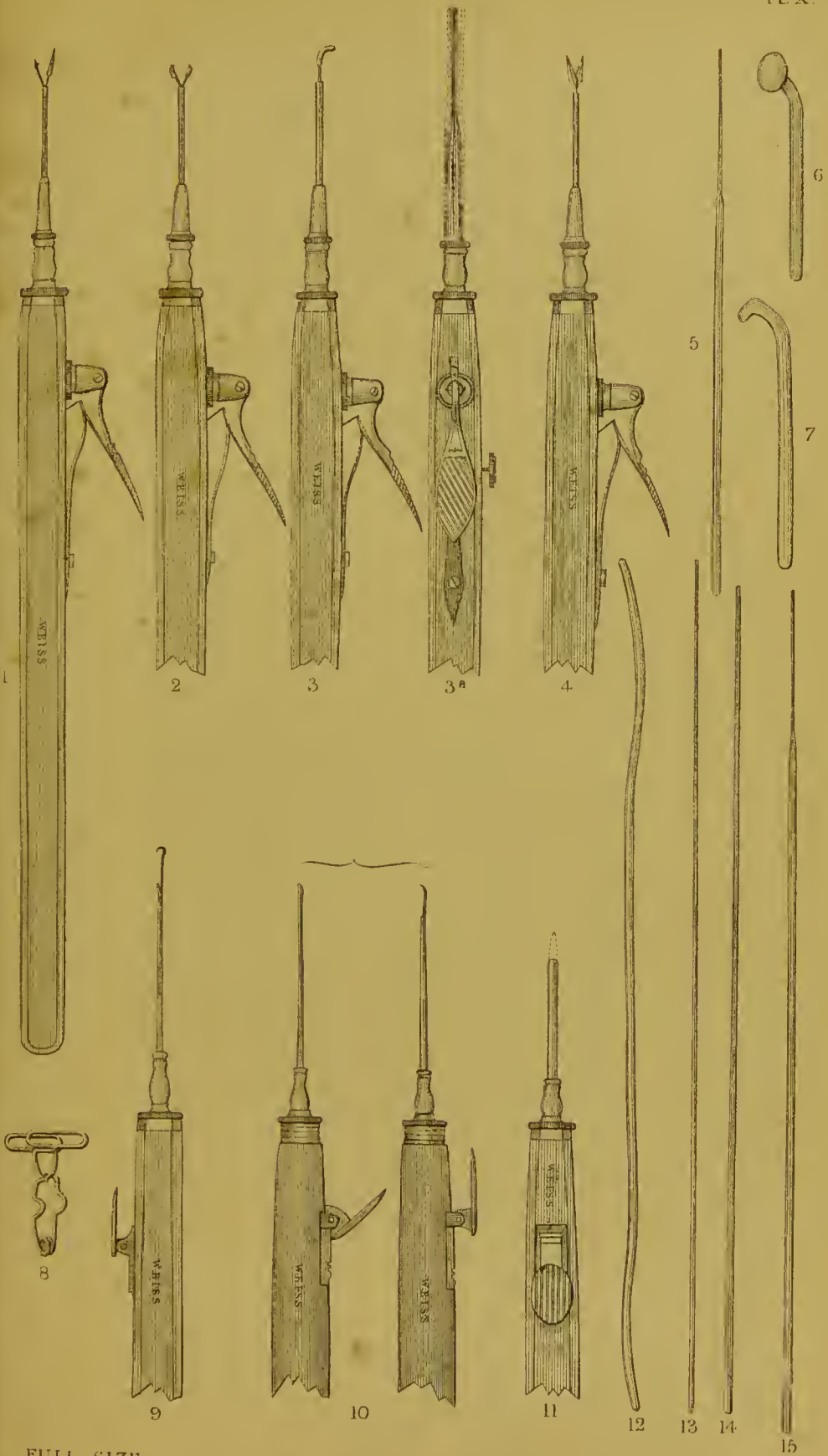

FULL SIZE.





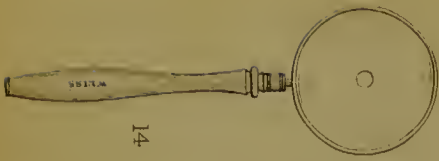
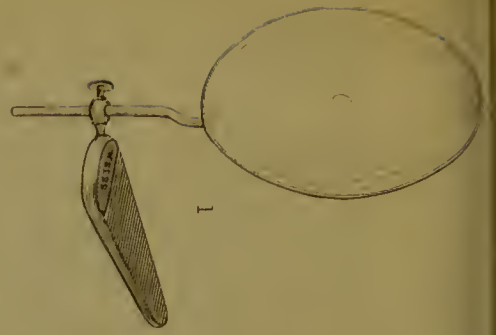

14

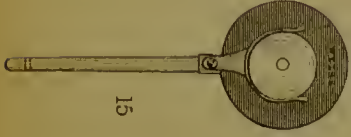

15

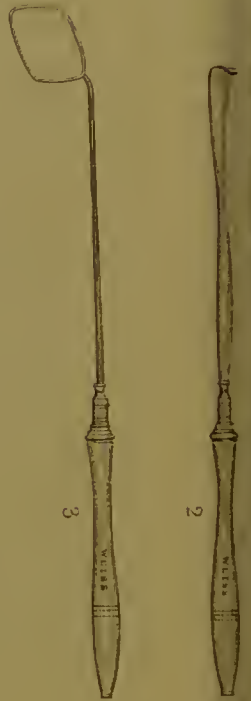

2

3



6

7



9



10



11



12



4

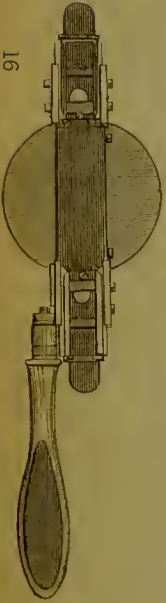

16



17



18

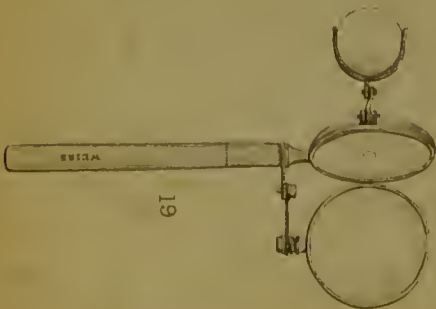

19



13



5

PLATE XI.

EYE INSTRUMENTS AND LARYNGOSCOPES.

Figure

- 1 LARYNGOSCOPE REFLECTOR, with mouthpiece, as used by Czermak.
- 2 UVULA or PALATE HOOK for Rynoscopic Examination.
- 3 GLASS LARYNGEAL MIRROR.

The set consists of five laryngeal mirrors of different sizes, a palate hook and reflector, the latter mounted either with a mouthpiece, as fig. 1, attached to a spectacle frame, as fig. 5, or to a forehead band, as fig. 1, Plate XL. The latter form is that most generally approved.

- 4 DESMARR'S EYELID RETRACTOR.
- 5 LARYNGEAL REFLECTOR attached to Spectacle Frame.
- 6 SPRING EYE SPECULUM.
- 7 Do. do. as applied over the Nose.
- 8 EYELID RETRACTOR.
- 9 GRAEFE'S ENTROPIUM FORCEPS.
- 10 ENTROPIUM FORCEPS.
- 11 WILDE'S TUMOUR FORCEPS.
- 12 DESMARR'S do.

This instrument is made in pairs, right and left.

- 13 EYELID SPATULA, made of ivory, horn, or tortoise-shell.
- 14 OPHTHALMOSCOPE, with glass mirror.
- 15 WEISS' SMALL OPHTHALMOSCOPE.

The engraving shows a jointed lens-holder attached to the back of the mirror, for the purpose of holding convex or concave lenses; it is also made without the lens-holder.

- 16 BINOCULAR OPHTHALMOSCOPE.
- 17 LIEBREICH'S do.

The engraving shows the lens-holder at an angle; when in use its position is horizontal with the back of the mirror.

- 18 CONCENTRATING LENS, such as is usually supplied with Ophthalmoscopes.
- 19 ZEHENDER'S OPHTHALMOSCOPE.

PLATE XII.

Figure

- 1 LIEBREICH'S LARGE OPHTHALMOSCOPE for demonstrating and drawing.

The instrument slides on a brass stem, which is secured to the table by a screw clamp. A rest for the chin also slides on the stem.

- 2 GAS LAMP, suitable for the Microscope, Ophthalmoscope, or Laryngoscope.

The gas burner is made to slide on the stem.

- 3 CZERMAK'S DEMONSTRATING LARYNGOSCOPE.

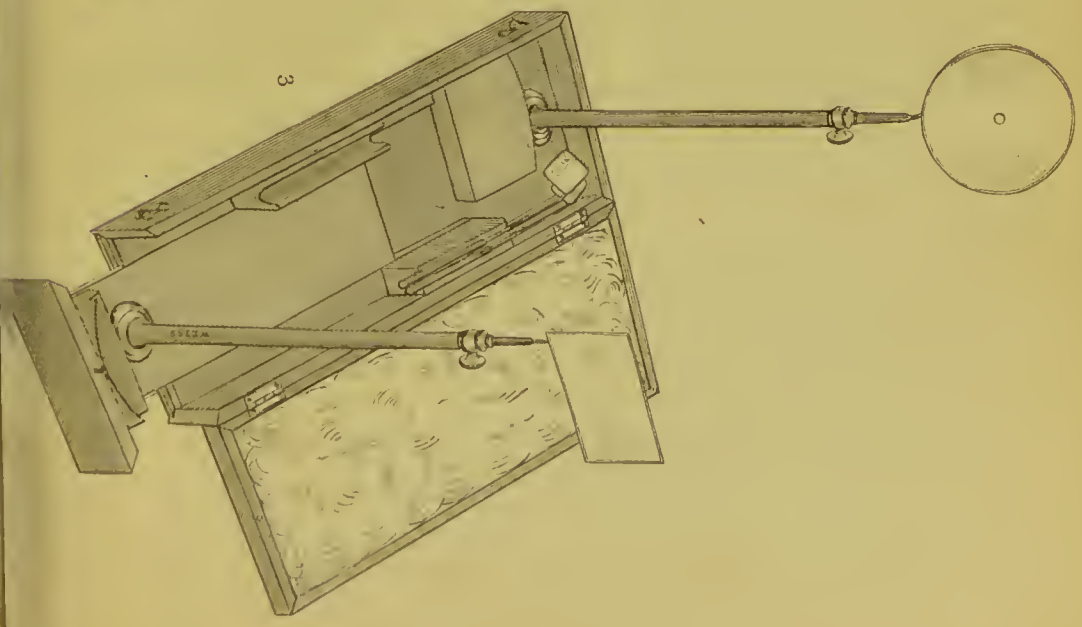
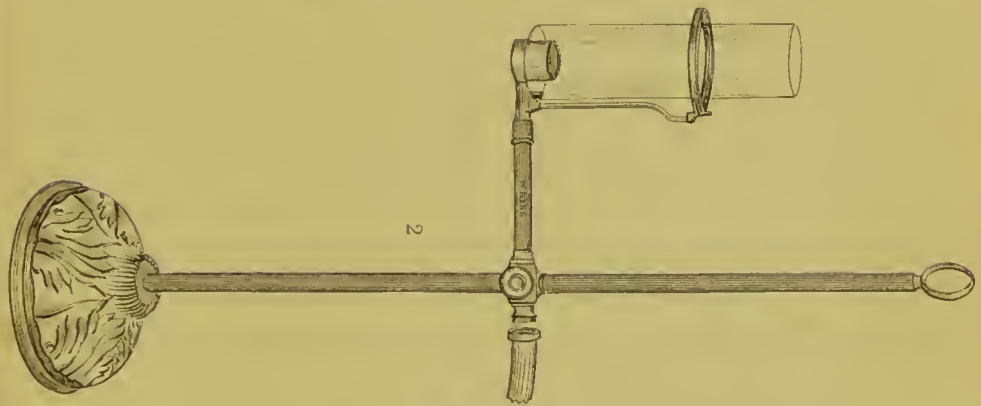
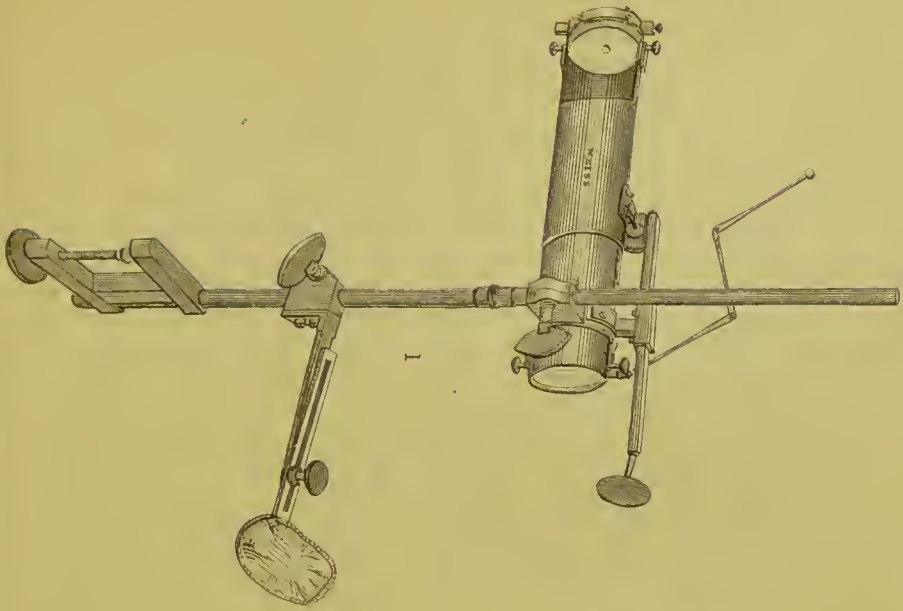

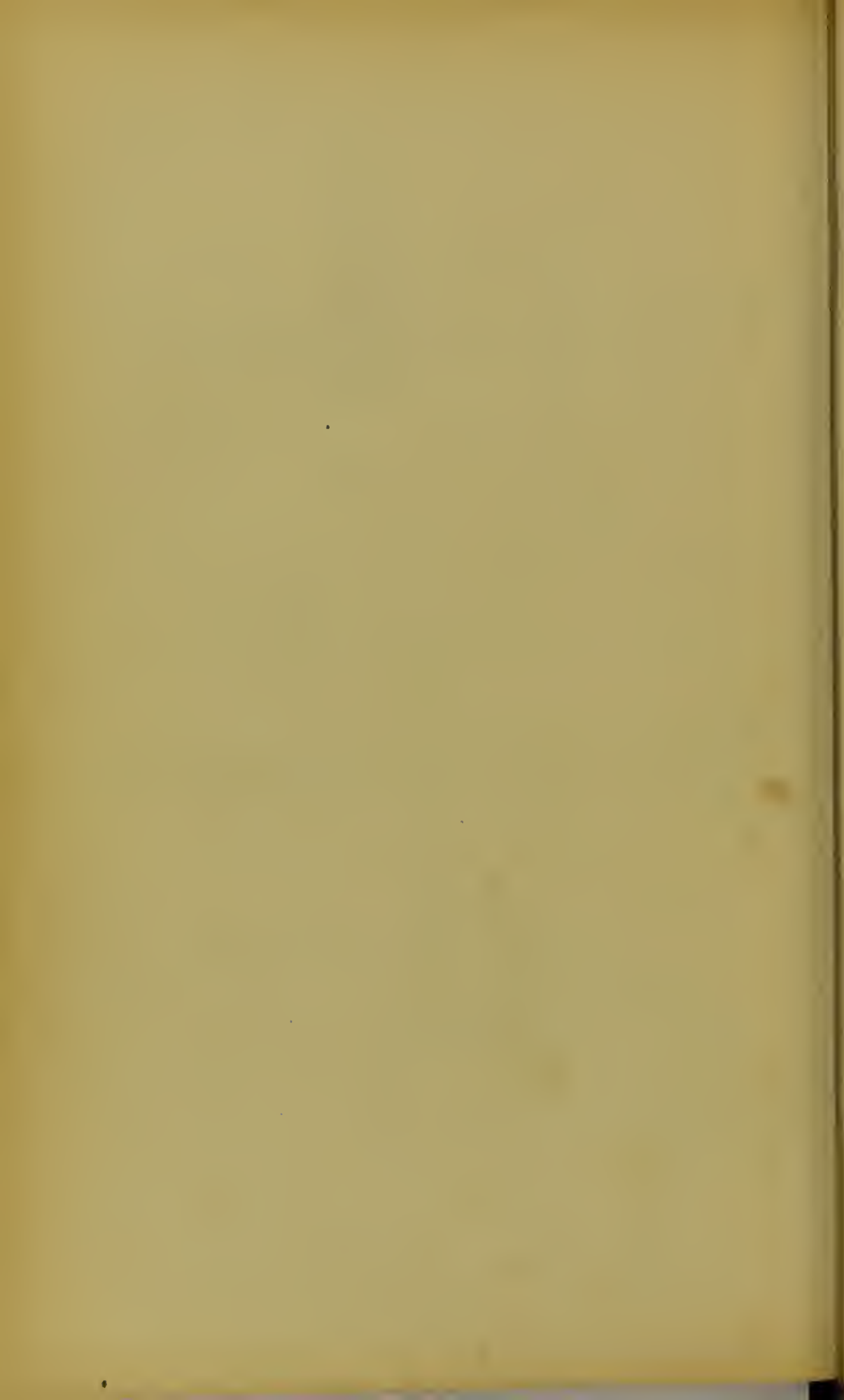

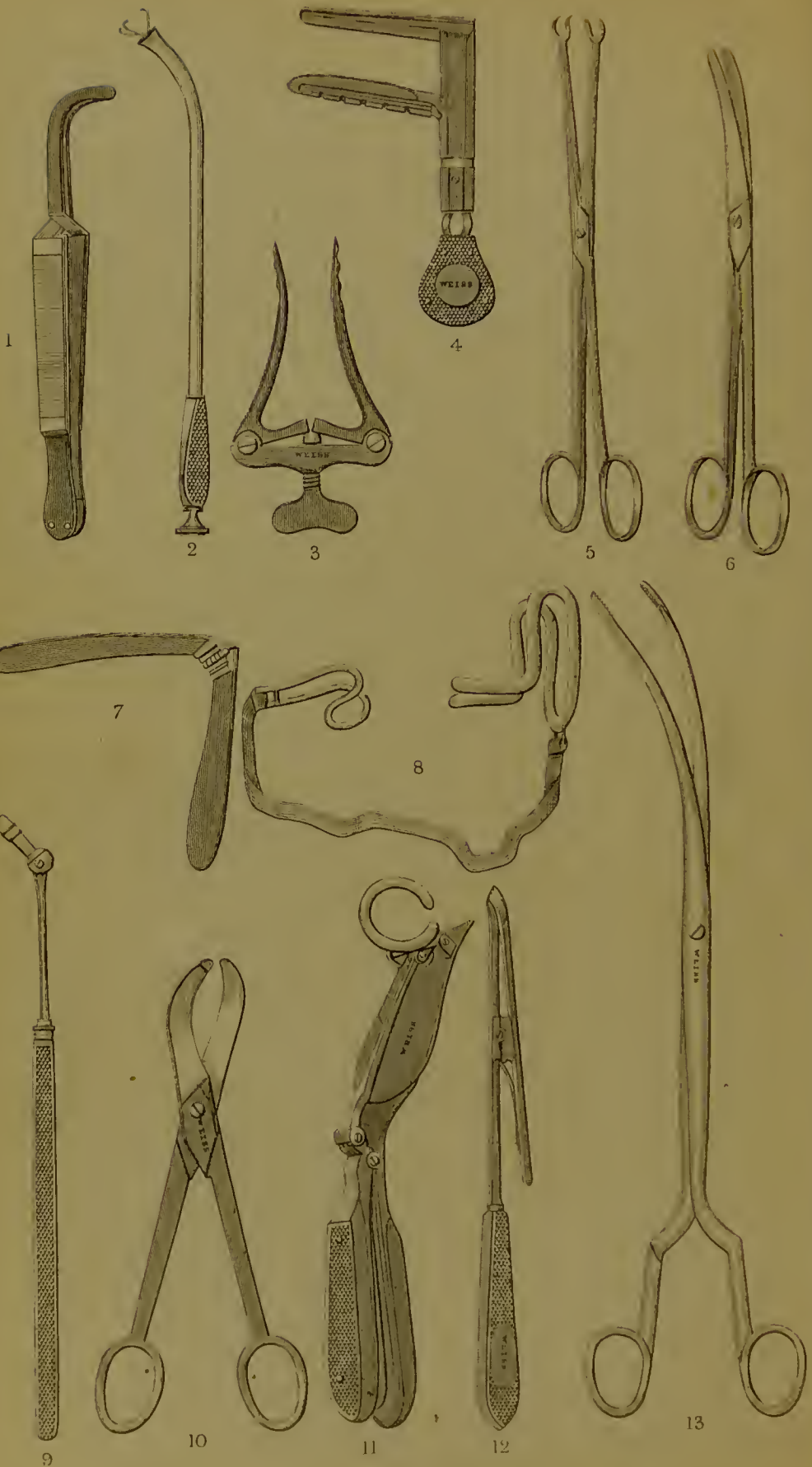

PLATE XIII.

INSTRUMENTS FOR THE MOUTH, LARYNX, AND
ESOPHAGUS.

Figure

- 1 FORCEPS for facilitating the introduction of the Trachea Tube.
- 2 CANULA INSTRUMENT for holding Lint or Sponge.
The sponge having been placed within the prongs, the latter are partly drawn into the canula by the screw-nut at the end of the handle.
- 3 WEDGE-SHAPED DILATOR for opening the Mouth.
This instrument is shown partly opened.
- 4 WEISS' SPECULUM ORIS.
This instrument is shown open. It is furnished with a flat silver plate, fitting into either blade, for the purpose of keeping down the tongue.
- 5 STRAIGHT VULSELLUM.
- 6 CURVED SCISSORS for the Uvula.
- 7 TONGUE DEPRESSOR, folding for portability.
- 8 INSTRUMENT for keeping the Mouth open.
The two blunt prongs being placed between the teeth, and the elastic band passed behind the head, the smaller hook holds back the opposite cheek.
- 9 EARLE'S JOINTED CAUSTIC HOLDER.
- 10 TONSIL SCISSORS.
The blades of these scissors have a double curve.
- 11 CHASSAIGNAC'S SPECULUM ORIS.
The flat part of this instrument depresses the tongue, while the ring keeps the mouth open.
- 12 YEARSLEY'S TONSIL HOOK.
- 13 ESOPHAGUS FORCEPS, with lateral curve.

PLATE XIV.

INSTRUMENTS FOR THE MOUTH, LARYNX,
ESOPHAGUS, NOSE, ETC.

Figure

- 1 NEEDLE with double curve for Staphyloraphia.
- 2 LISTON'S NEEDLE.
- 3 FERGUSSON'S STRAIGHT KNIFE for Staphyloraphia.
- 4 Do. CURVED do.
- 5 POLLOCK'S do. do.
- 6 Do. do. do.
- 7 FERGUSSON'S ANGLED do.
- 8 POLLOCK'S do. do.

By means of a screw at the end of the handle, the operator is enabled to set the knife at any required angle.

- 9 NASAL POLYPUS FORCEPS, curved.
- 10 Do. do. straight.
- 11 Do. do. with fenestrated blades.
- 12 WEISS' SLIDING NEEDLE.

The eye of this needle, which is open at the side to facilitate threading, is closed by a slide while being passed.

- 13 INSTRUMENT for removing Foreign Bodies from the Esophagus.

This instrument acts as an extractor as well as a probang: in the former case it is passed beyond the object, and the net, which is composed of bristles, is expanded (as shown by the dotted lines) by drawing back the handle.

- 14 ERICHSEN'S UVULA SCISSORS.

The blades of these scissors are furnished with hooks to hold the Uvula.



ONE-THIRD SIZE:

Vincent Brooks, del. et lith.



WEISS' ILLUSTRATED CATALOGUE.

Figure

- 15 CANULA for applying a solution of Nitric Acid to the Larynx.
- 16 CROSS-ACTION FORCEPS, with Tenaculum Points for Staphyloraphia.
- 17 CROOKED SCISSORS for do.
- 18 CONCEAL'D TONSIL LANCET.
- 19 FORCEPS for holding and cutting Harelip Pins.
- 20 THOMPSON'S TRACHEOTOME.
- 21 BELOCQ'S SPRING CANULA for Epistaxis.
- 22 LISTON'S POLYPUS FORCEPS.

PLATE XV.

INSTRUMENTS FOR THE MOUTH, TRACHEA,
ESOPHAGUS, ETC.

Figure

- 1 BROOKE'S UVULA FORCEPS.
- 2 PROBE-POINTED TONSIL BISTOURY.
- 3 YEARSLEY'S TONSIL KNIFE.
- 4 MARTIN ST. ANGE'S INSTRUMENT for Epistaxis.

This instrument consists of a silver canula, furnished with a stop-cock at one end, and a bag or bladder at the other extremity. The instrument being applied, the bladder is filled with water.

- 5 EDWARDS' TRACHEOTOMY HOOK.

This instrument has a groove along the back, to guide the knife.

- 6 SINGLE TRACHEOTOMY TUBE.
- 7 DOUBLE do.
- 8 SPRING do.

The principal advantage of this form of tube is facility of introduction, the blades being pressed together for that purpose. An inner tube is furnished with this instrument.

- 9 WEISS' TONSIL GUILLOTINE.
- 10 IMPROVED do.

This instrument requires but one hand to remove the tonsil.

- 11 WEISS' IMPROVED STOMACH PUMP.

The advantages of this syringe are, first, its simplicity, requiring only the movement of a stud or button to reverse the action of the syringe, from filling to emptying the stomach; and, secondly, its possessing a metallic piston, which, when properly made, works better than the ordinary piston, and may be laid by for any length of time without becoming inefficient.



ONE-THIRD SIZE.

Vincent Brooks, del. et lith.



WEISS' ILLUSTRATED CATALOGUE.

12 WEISS' SPIRAL CANULA THROAT FORCEPS.

13 FERGUSON'S NEEDLE for Staphyloraphia.

The needle makes an evolution, as described by the dotted line, upon depressing the lever.

14 BROOKE'S NEEDLE for Staphyloraphia.

The needle performs a similar evolution, though by a more complex action.

15 ROUX'S NEEDLE HOLDER.

An ordinary Suture Needle may be held securely, either in a straight position or at an angle.

16 WEISS' CANULA FORCEPS for Nasal Polypi.

There are two blades supplied with this instrument, curved and straight.

PLATE XVI.

TOOTH FORCEPS.

Figure

- 1 FORCEPS for the lower Molars, where the Crown is broken off.
- 2 FORCEPS for the lower Molars.
- 3 Do. upper do. } Right and left.
- 4 Do. do. do. }

The small full-length engraving shows the form of handle of these forceps.

- 5 FORCEPS for upper Dentes Sapiientia.
- 6 Do. for the lower Molars.
- 7 ROBERTSON'S FORCEPS for lower Molars.

The small full-length engraving shows the form of handle of these forceps.

- 8 FORCEPS for the upper Molars of Children.
These forceps are sold in pairs, right and left.
- 9 FORCEPS for the lower Molars of Children.
- 10 Do. for the second and third lower Molars.

The forceps, which have a double curve, are sold in pairs, right and left.

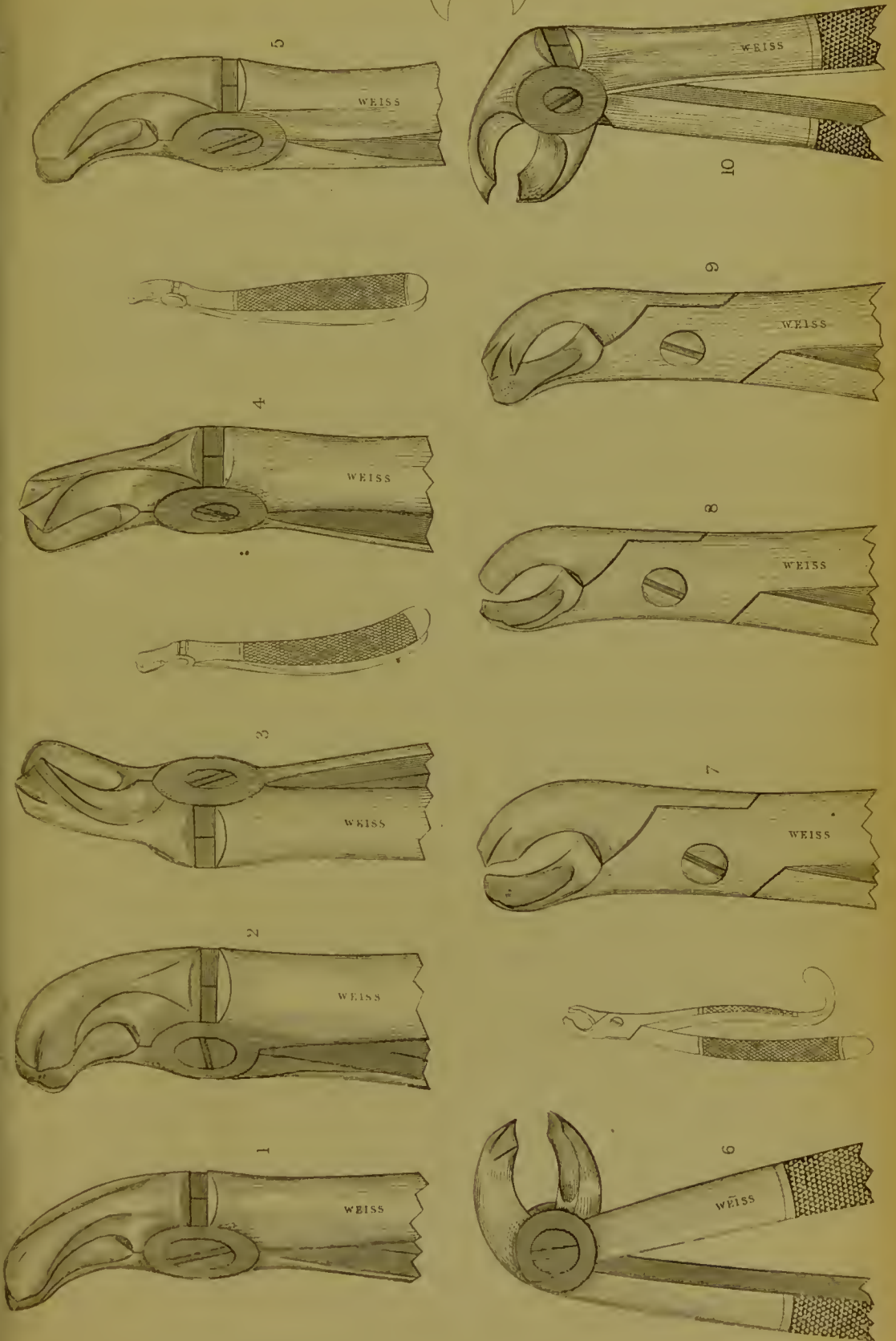





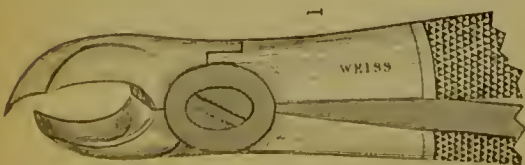
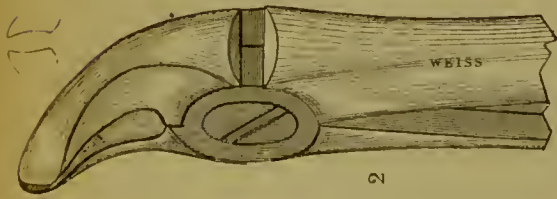
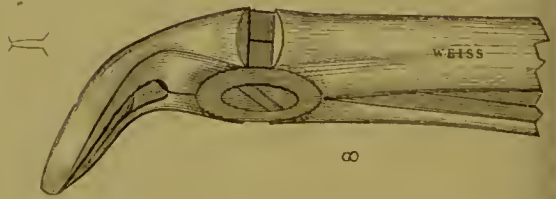
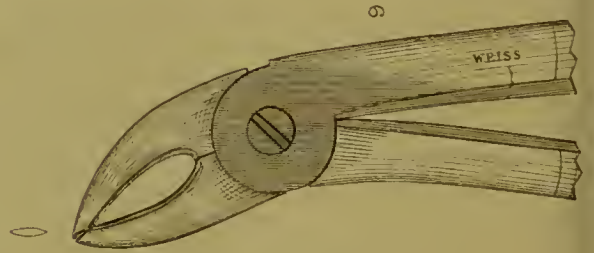
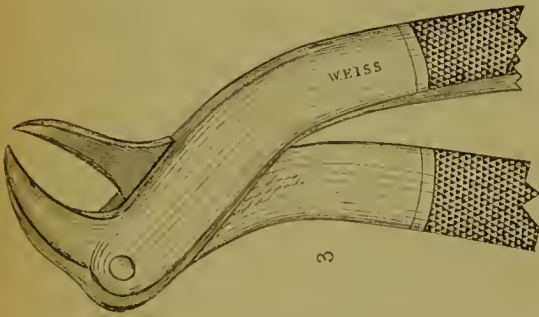
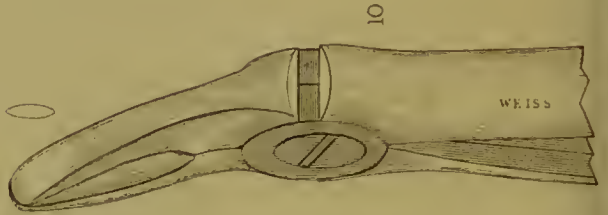
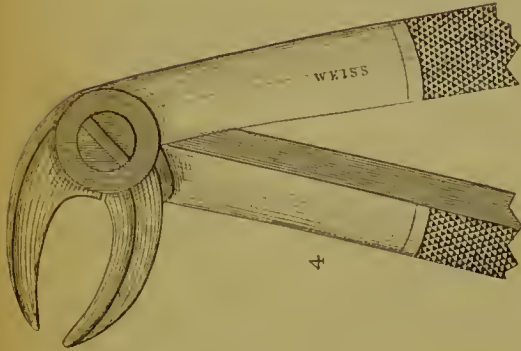
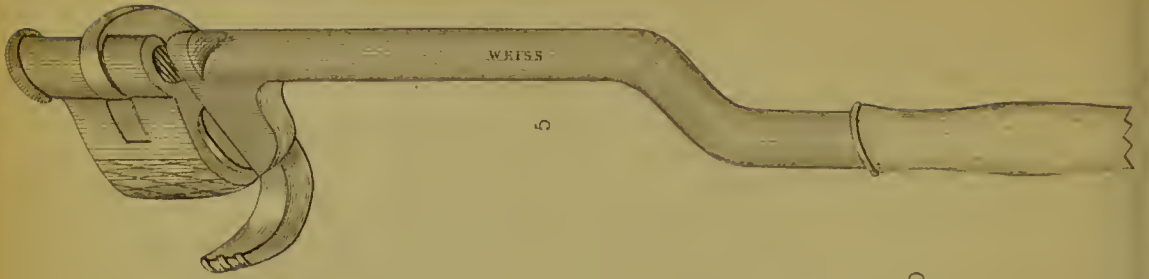

PLATE XVII.

TOOTH FORCEPS AND KEY.

Figure

- 1 FORCEPS for the upper Molars, when the Crown is broken off.
These forceps are sold in pairs, right and left.
- 2 FORCEPS for lower Bicuspides.
- 3 Do. do.
- 4 Do. do.
- 5 FOX'S TOOTH KEY.
- 6 FORCEPS for upper Roots.
- 7 Do. for upper Incisors.
- 8 Do. for lower Roots.
- 9 Do. for lower Incisors.
- 10 Do. for upper Bicuspides.

PLATE XVIII.

INSTRUMENTS FOR SCALING AND STOPPING
TEETH.

Figure

1 to 8 inclusive. SCALING INSTRUMENTS.

9 to 21 INSTRUMENTS for Stopping and Burnishing.



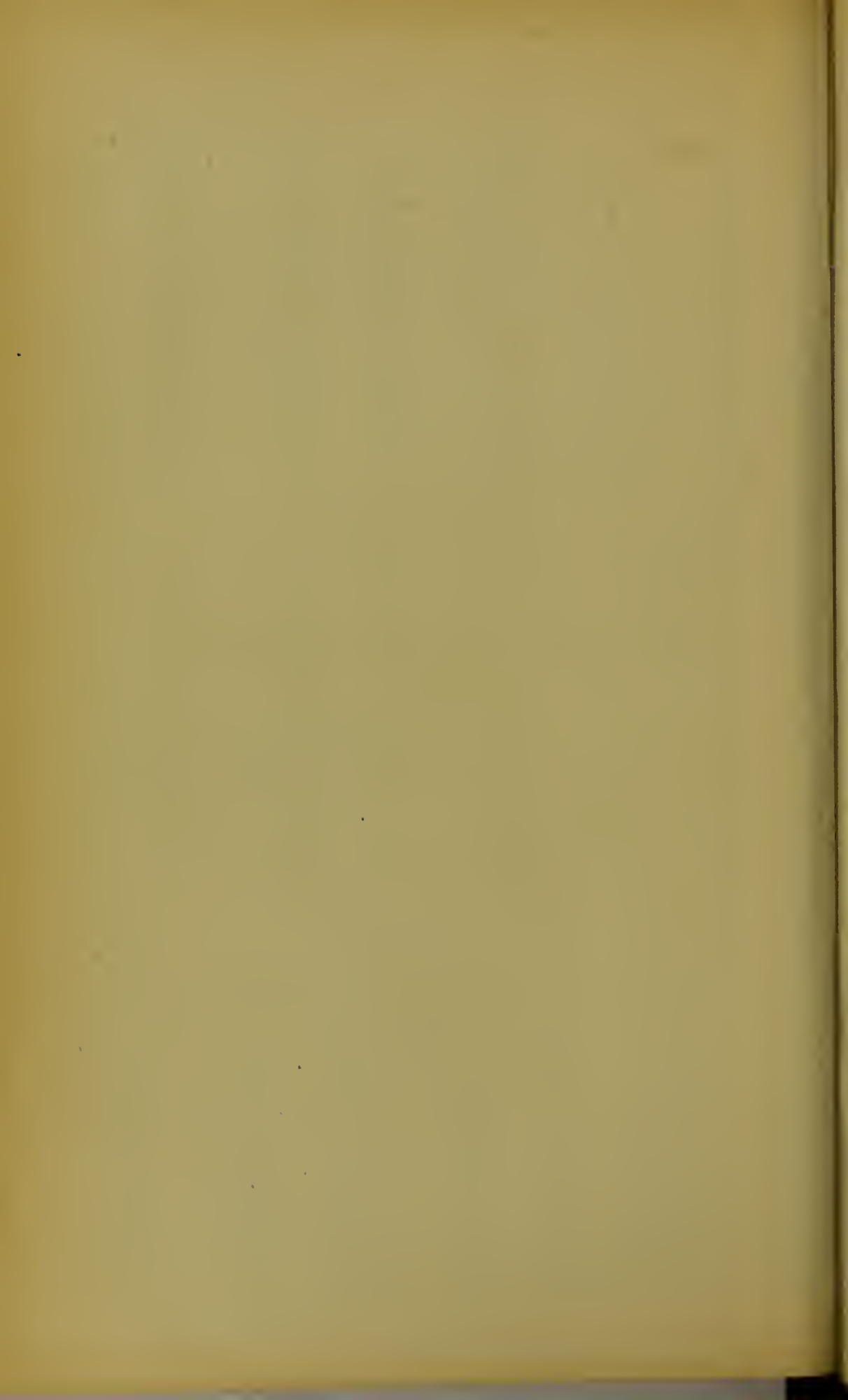

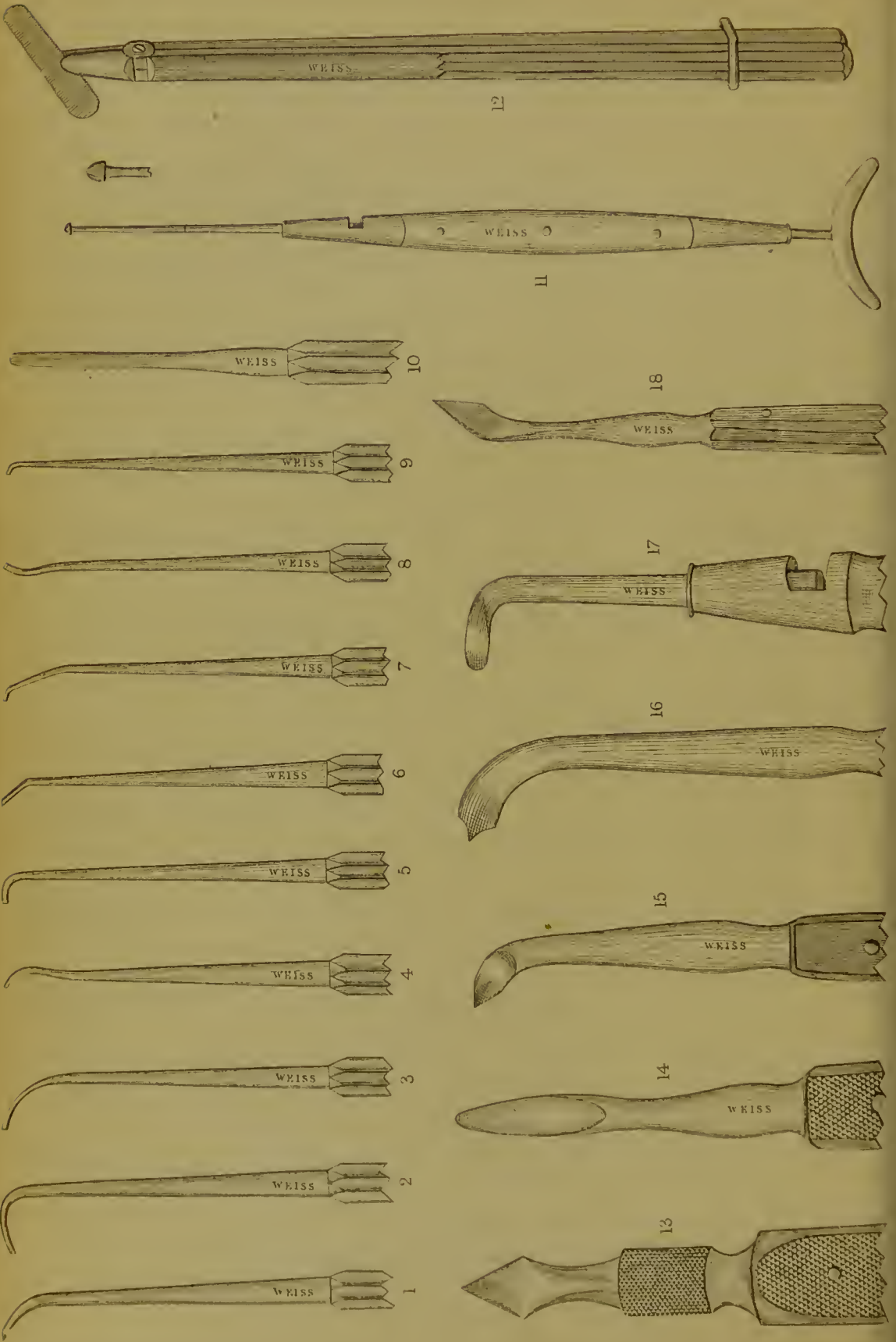

FULL SIZE.

Vincent Brooks, del. et lith.

PLATE XIX.

EXCAVATORS AND ELEVATORS FOR THE TEETH.

Figure

1 to 9 inclusive. EXCAVATORS.

10 ROSEHEAD.

11 HOLDER with Roseheads.

12 FORCEPS for holding pieces of Dentists' Files.

13, 14 ELEVATORS.

15, 16 Do.

· These elevators are made right and left.

17 SOCKET HANDLE with Elevator.

These handles are furnished with a series of elevators, straight and curved.

18 INSTRUMENT for Cutting the Enamel.

PLATE XX.

AURAL INSTRUMENTS.

Figure

- 1 AVERY'S CANULA FORCEPS for Polypus in the Ear.
- 2 TOYNBEE'S EAR SPECULUM.
The small diagram shows the shape of the speculum.
- 3, 4 TOYNBEE'S ARTIFICIAL TYMPANUM.
Figure 3 is the form in general use.
- 5 WILDE'S EAR SPECULUM.
- 6 AVERY'S do.
The small diagrams show the shape of the speculum.
- 7 PILCHER'S EUSTACHIAN CATHETER.
- 8 CRAMER'S do.
- 9 TOYNBEE'S PERFORATOR for the Tympanum.
- 10 Do. CANULA FORCEPS for Polypus in the Ear.
- 11 HARVEY'S DOUBLE HOOK for removing Polypus in the Ear.
- 12 Do. PERFORATOR for the Tympanum.
- 13 FORCEPS for removing Foreign Bodies from the Ear, and
for applying Cotton.
- 14 SCREW INSTRUMENT and SCOOP for removing Foreign
Bodies from the Ear.

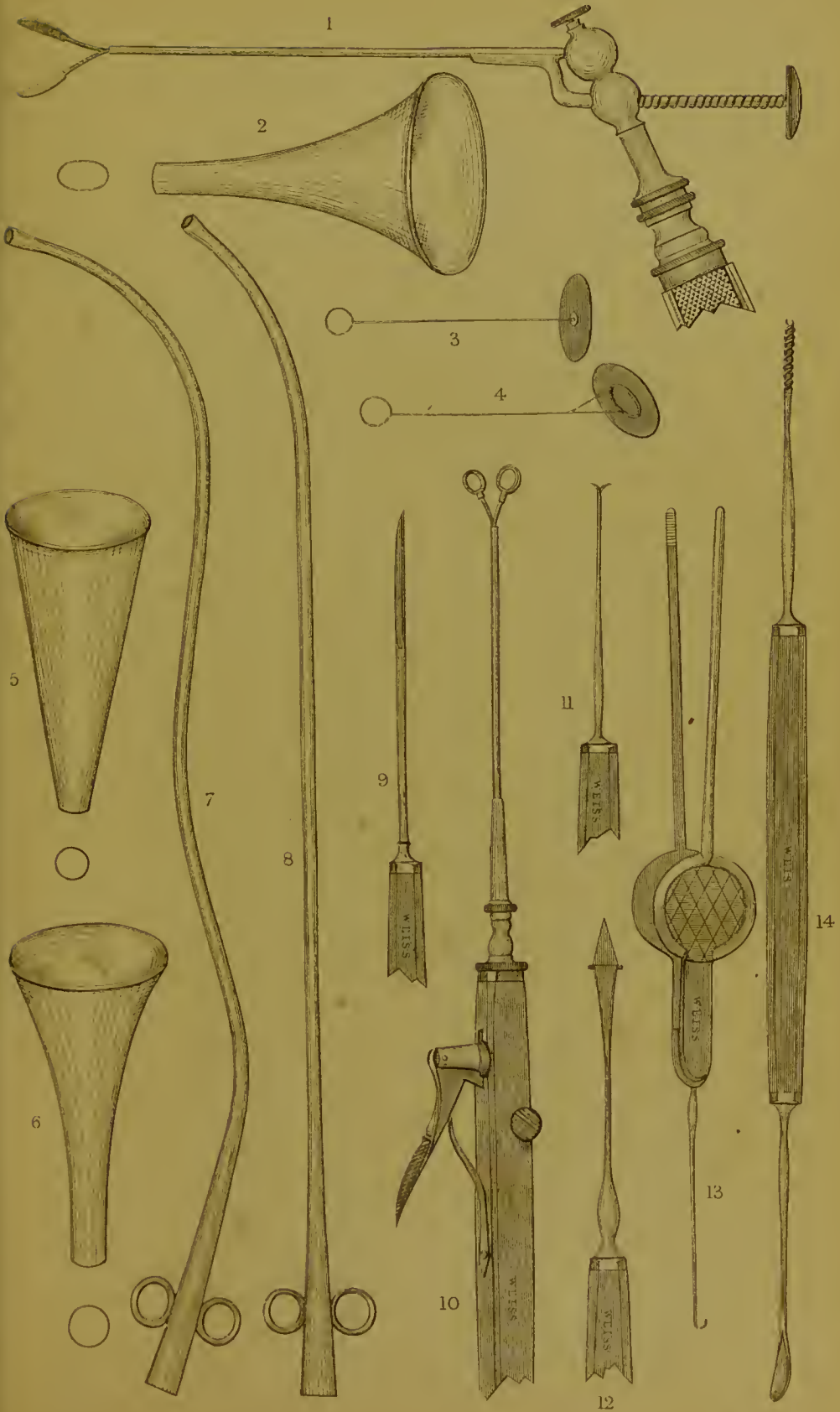

FULL SIZE.

Vincent Broica del. et lith.



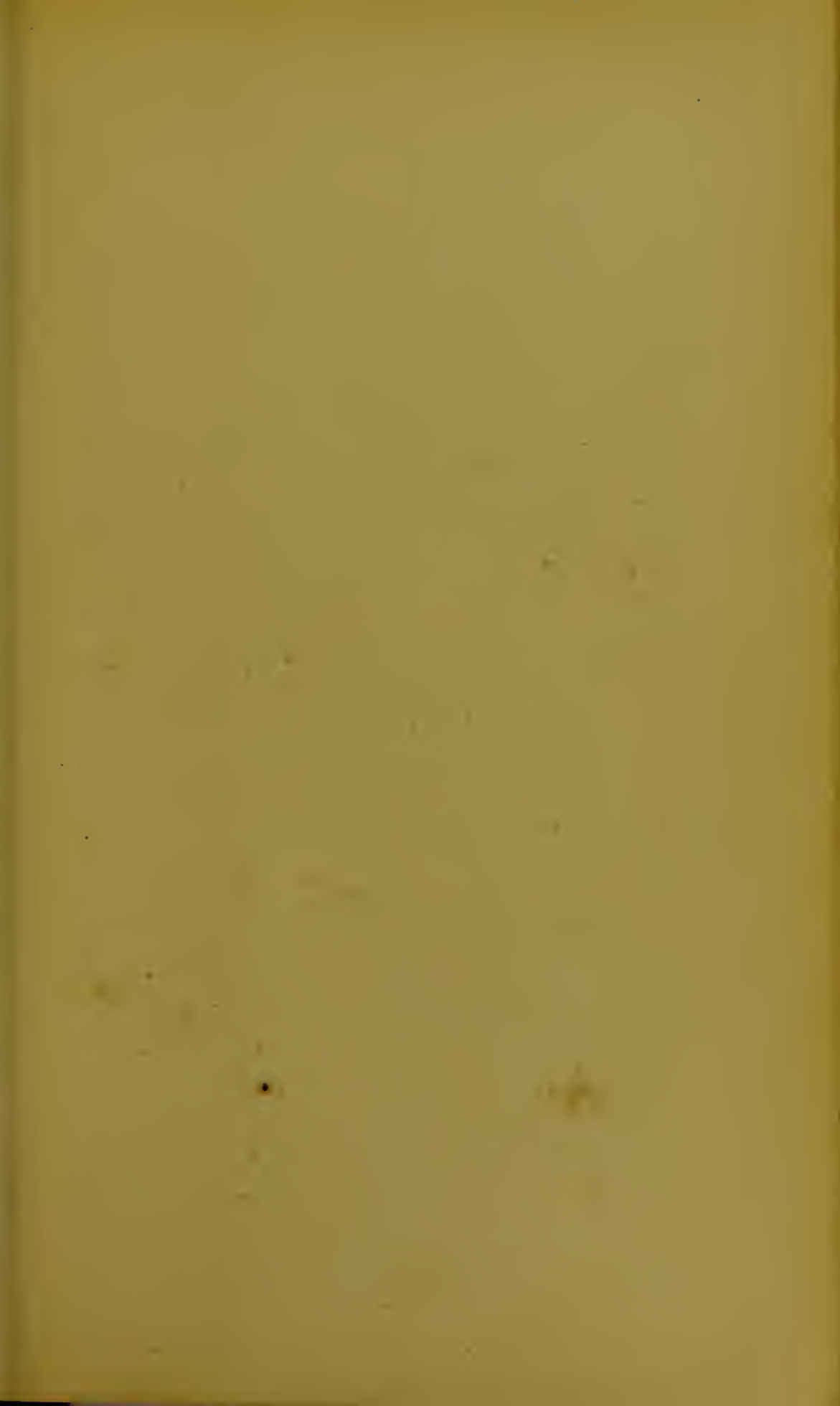

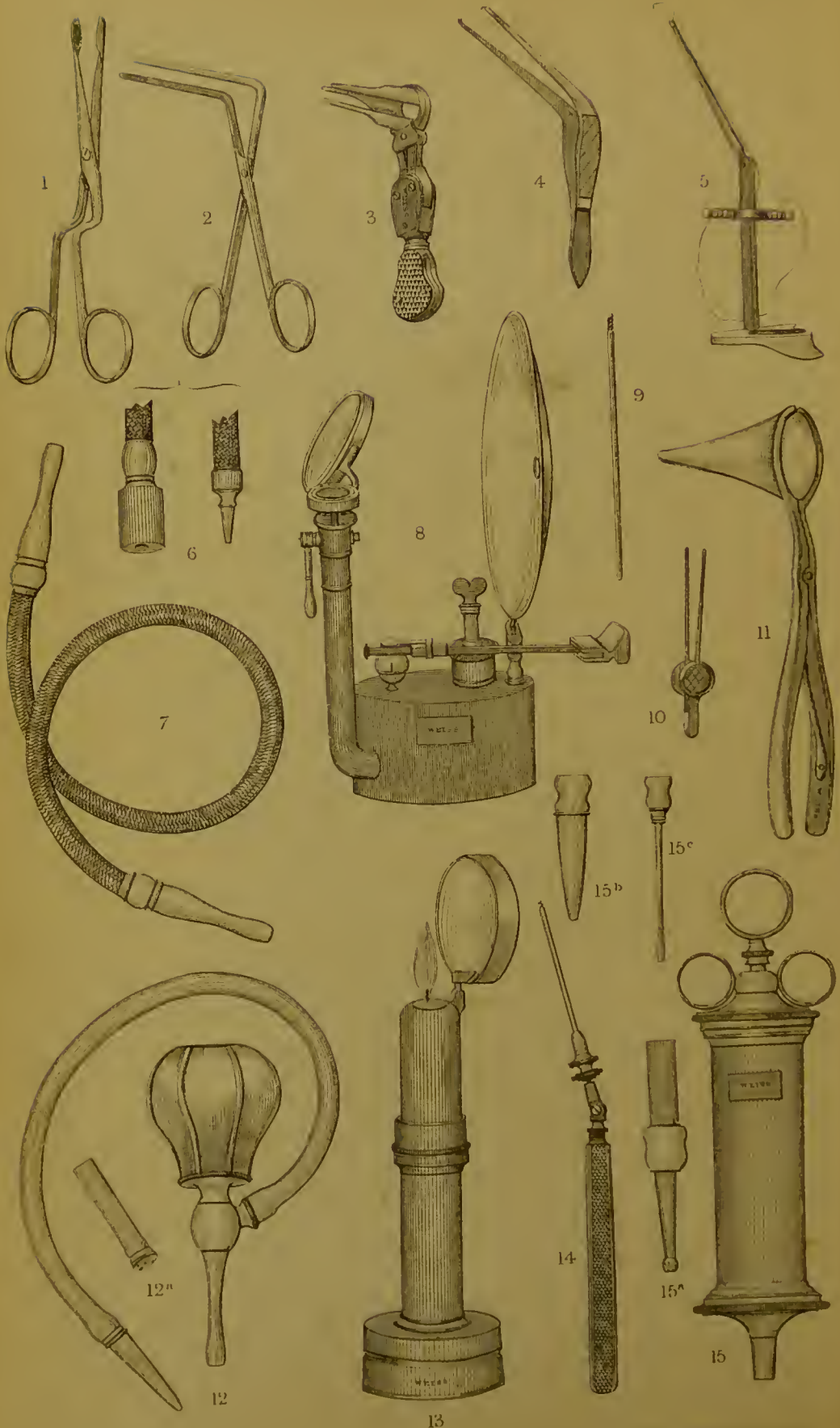

ONE-THIRD SIZE.

Vincent Bischoff, del. et lith.

PLATE XXI.

INSTRUMENTS FOR THE EAR, ETC.

Figure

- 1 FORCEPS for Polypus of the Ear.
This instrument is also made with fenestrated blades.
- 2 TOYNBEE'S ANGULAR FORCEPS.
- 3 WEISS' EAR SPECULUM.
This instrument has also been successfully used in extracting large polypi from the ear.
- 4 WILDE'S EAR FORCEPS.
- 5 SNARE for Polypus of the Ear.
This instrument is also made of a larger size for nasal polypi.
- 6 TOYNBEE'S EXPLORER, used in connexion with the Eustachian Catheter.
The engraving shows only the mounts of the instrument. They are connected by a tube similar to that of fig. 7.
- 7 TOYNBEE'S OTOSCOPE.
- 8 AVERY'S LAMP AND REFLECTOR for examining the Ear, and other parts that require artificial light.
The lamp is constructed to burn gazeine, a mixture of two parts of wood spirit to one of benzole.
- 9 YEARSLEY'S PROBE for inserting and removing Cotton from the Ear.
- 10 YEARSLEY'S FORCEPS for the same.
- 11 HARVEY'S EAR SPECULUM.

WEISS' ILLUSTRATED CATALOGUE.

Figure

12 ELASTIC EAR SYRINGE.

12a Shows a ROSEHEAD attached to a piece of Elastic Tube.
By sliding this over the pipe, the Syringe forms an
Eye Douche.

13 MILLER'S CANDLE LAMP AND REFLECTOR for the Ear.

14 FABRIZZI'S 'TYMPANATOIRE.

15

15a } WEISS' RING EAR SYRINGE AND PIPES.

15b } 15a has an elastic tube, connecting it with the syringe.

15c }

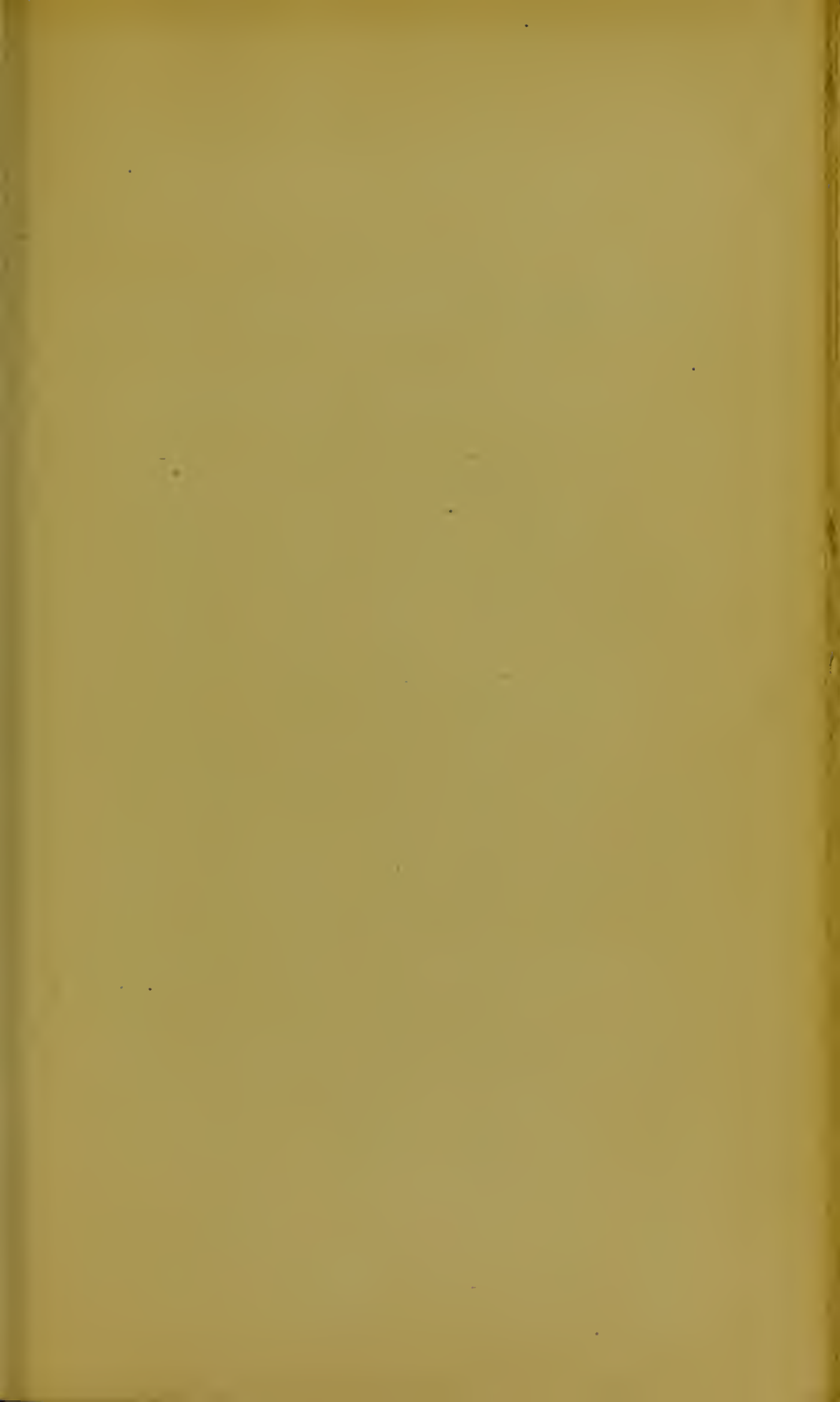



ONE-THIRD SIZE.

Albion Brooks del et lith

PLATE XXII.

LITHOTOMY INSTRUMENTS.

Figure

- 1 CRAMPTON'S FEMALE DILATOR.
The dotted line shows the direction of a conceal'd blade, in case it should be necessary to use it in conjunction with the dilator.
- 2 CONCEAL'D BISTOURY.
The dotted line represents the blade when open.
- 3 FEMALE SOUND.
- 4 FERGUSSON'S SEARCHER.
The point of this searcher or sound is bulbous.
- 5 HOLLOW SOUND.
This instrument may be used for injecting the bladder.
- 6 LISTON'S STAFF WITH SIDE GROOVE.
- 7 BUCHANAN'S STAFF.
- 8 FEMALE do.
- 9 WEISS' LITHOTRITE for crushing a Calculus when too large to pass through the opening.
- 10 LISTON'S URETHRA SCOOP

PLATE XXIII.

LITHOTOMY INSTRUMENTS.

Figure

- 1 ALLARTON'S FORCEPS for the Median Operation.
- 2 Do. KNIFE for do.
- 3 BRODIE'S LITHOTOMY KNIFE.
- 4 BLIZARD'S do.
- 5 KEY'S do.
- 6 FERGUSSON'S do.
- 7 LISTON'S do.
- 8 WEISS' FEMALE DILATOR, with three blades.
- 9 TEALE'S BLUNT GORGET for the Median Operation.
- 10 LITHOTOMY FORCEPS, with Cross-action.
- 11 The same FORCEPS, with curved blades.
- 12 WEISS' JOINTED SCOOP.
By depressing the lever, the end of the scoop may be inclined
to the angle required.
- 13 CURVED LITHOTOMY FORCEPS.
- 14 STRAIGHT LITHOTOMY FORCEPS.
- 15 LITHOTOMY SCOOP.

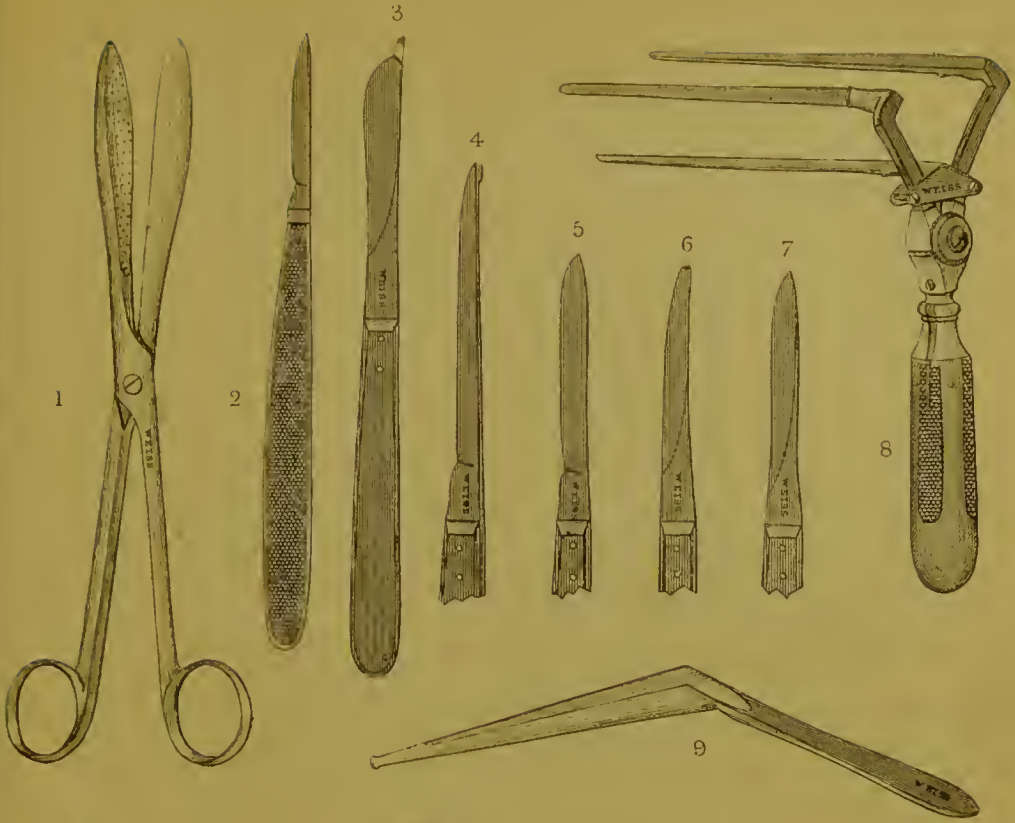

ONE-THIRD SIZE.





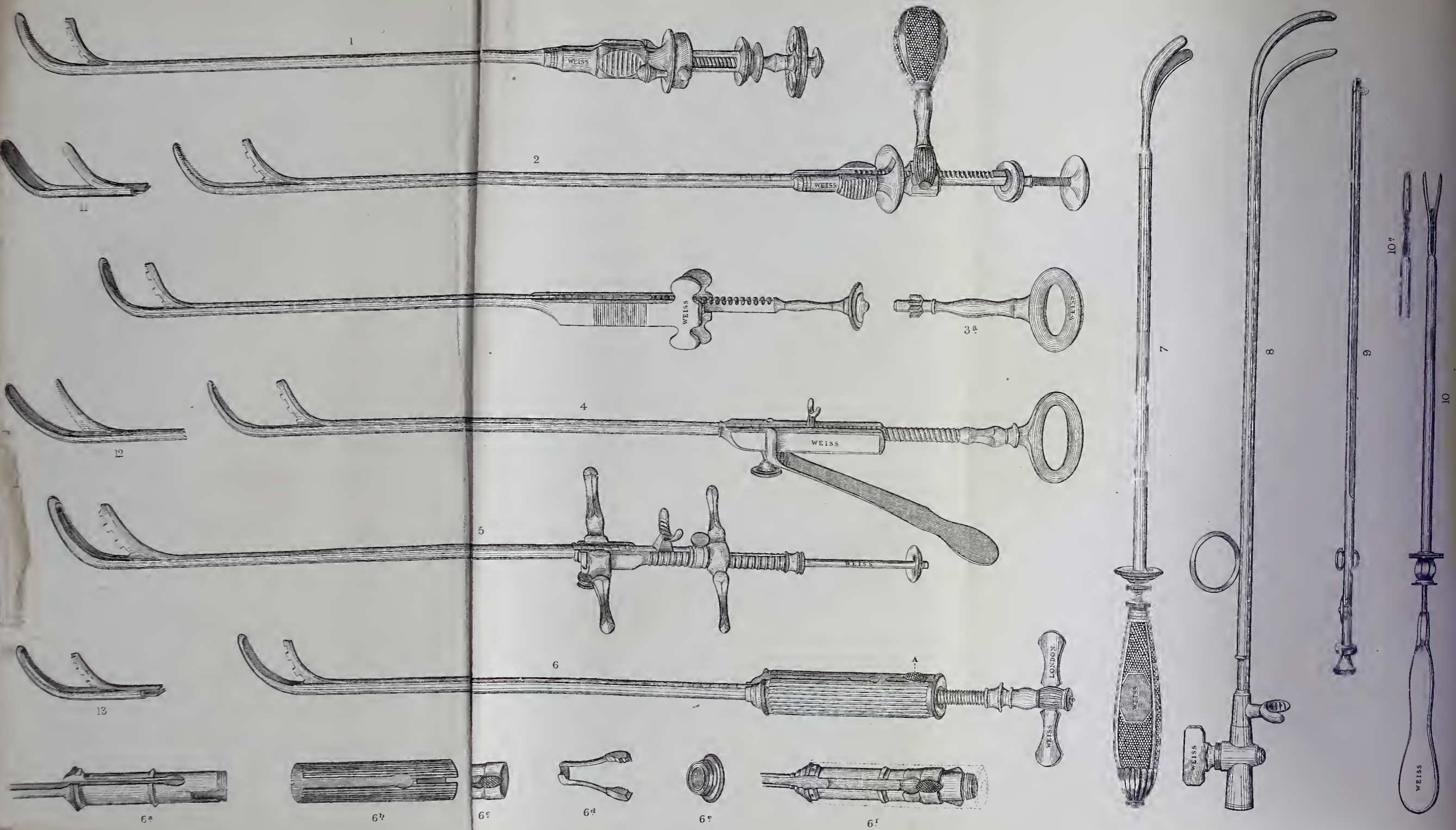

1

2

WEISS

3^a

4

WEISS

5

WEISS

6

WEISS
LONDON

11

12

13

6^a

6^b

6^c

6^d

6^e

6^f

7

8

9

10^a

10

WEISS

PLATE XXIV.

LITHOTRITY INSTRUMENTS.

Figure

1 CIVIALE'S LITHOTRITE.

The mechanism of this instrument enables the operator to attach and release the male from the female screw by turning the revolving cap.

2 RACK and PINION LITHOTRITE.

This instrument differs from Fergusson's rack lithotrite (the original instrument of this construction) inasmuch as the handle, with its pinion extremity, fits into and is held in a socket at the operator's pleasure.

3, 3a FERGUSSON'S LITHOTRITE and KEY.

4 WEISS' LITHOTRITE, as made for Sir Benjamin Brodie.

This instrument can be used either with or without the handle, which latter can be fixed in any position by the small set screw.

5 WEISS' ORIGINAL LITHOTRITE.

With this instrument both percussion and screw power can be employed at pleasure.

6 WEISS' NEWLY-INVENTED LITHOTRITE.

The improvement in this instrument consists in the movement which attaches and releases the screw power in connexion with the male blade; this renders the instrument more simple in its action than Civiale's lithotrite, as the change from the screw to the sliding motion can be effected by placing the thumb or finger of either hand upon the button A, without in the slightest degree relaxing the grasp, and the movement, being effected in a line with the shaft of the instrument, produces much less motion or concussion than the rotary movement of Civiale's. It is also more powerful than the lithotrite just referred to, as the power is more gradually applied. The cylindrical form of the handle is also very advantageous, as it is extremely firm in the hand of the operator, while it admits of the most delicate manipulation, when held between the thumb and finger.

WEISS' ILLUSTRATED CATALOGUE.

Figure

The mechanism is of the simplest and at the same time of the strongest and most solid construction ; it can be readily taken to pieces for cleaning, is as easily re-adjusted, and is not liable to derangement of any kind.

6a, 6b, 6c, 6d, 6e, 6f Illustrate the component parts of the mechanism.

Fig. 6a shows the inner termination of the instrument.

„ 6b, the outer tube or ease of the same.

„ 6c, the sliding tube, which closes the female serew, 6d.

„ 6e, the cap which screws on to the end of instrument and fixes the various parts.

„ 6f shows the different parts when together, the dotted lines denoting the outer tube.

7 WEISS' CANULA FORCEPS, for removing Calculi from the Urethra.

This instrument is supplied with straight and curved blades, either of them being passed through the tube and secured by a small serew nut at the end of the handle, while a revolving disc enables the operator to fix the canula at any part he may require. The advantage which this instrument possess's over ordinary forceps is its more easy manipulation, the blades alone of the instrument being made to open ; it is also well adapted for other foreign bodies in the Urethra.

8 WEISS' CATHETER SCOOP, with stop-cock, as suggested by Mr. Henry Thompson.

This instrument in its original form was constructed for injecting and removing the debris of calculi from the bladder ; by the addition of the stop-cock, it is also useful for measuring the size of the stone and for sounding.

9 LEROY D'ETIOLLE'S JOINTED URETHRA SCOOP.

The point of this instrument, which is jointed on the stem, is turned at the angle indicated by the dotted lines by means of a serew nut at its other extremity.

10 WEISS' CANULA FORCEPS for the Urethra.

10a Shows the blades closed.

11 BLADES OF CIVIALE'S SCOOP.

12 BLADES OF WEISS' do.

13 FENESTRATED BLADE OF LITHOTRITE.



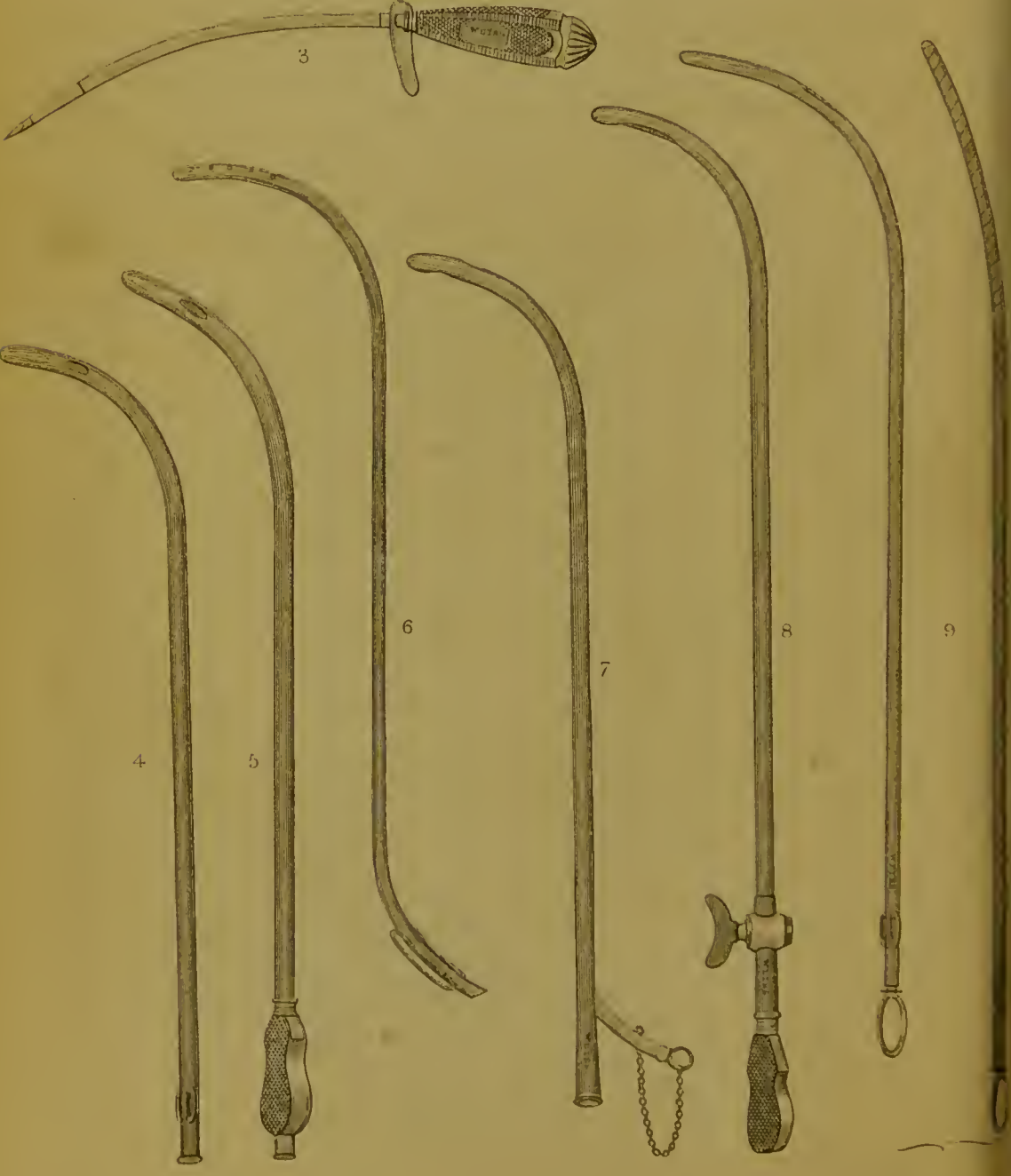
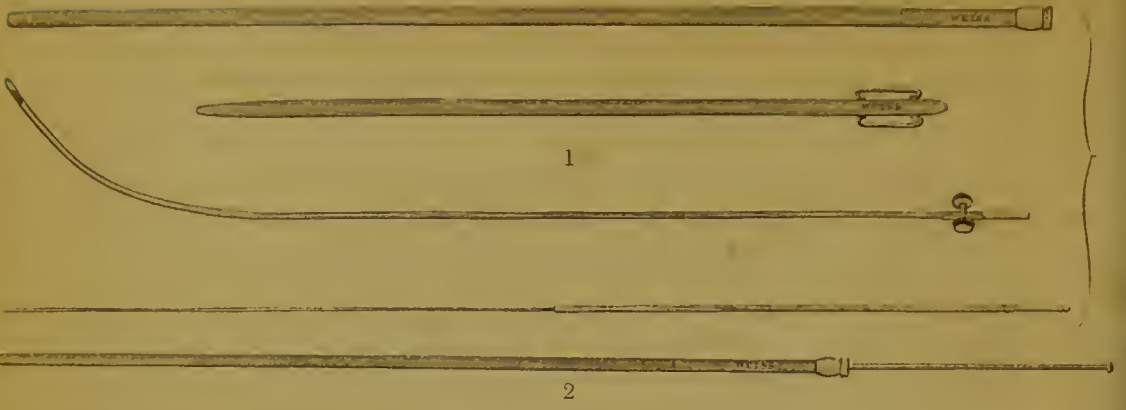

PLATE XXV.

URETHRA AND BLADDER INSTRUMENTS.

Figure

1 WAKLEY'S STRICTURE INSTRUMENTS.

The complete set of these instruments consists of three silver catheters with their stilettes, ten canulas of various sizes, from 3 to 12, and six gum elastic canulas. Smaller sets are made, consisting of one catheter and stilette, with six or eight canulas.

2 PILOT BOUGIE AND CATHETER.

3 CURVED TROCAR for puncturing the Bladder through the Rectum.

The canula may be had of silver or gum elastic.

4 CATHETER of the ordinary curve.

The dotted line shows the position of the eye on the opposite side.

5 BRODIE'S CATHETER, with checker'd ebony handle.

6 FERGUSSON'S do.

7 BRODIE'S DOUBLE CHANNEL'D CATHETER, for injecting the Bladder in a continuous stream.

8 BRODIE'S CATHETER, with Stop Cock and Gum Stilette.

9 PROSTATIC do. with Weiss' Spiral Stilette.

This stilette has the advantage of completely fitting the catheter, and of being easily removed.

PLATE XXVI.

URETHRA INSTRUMENTS.

Figure

- 1 SYME'S STAFF for dividing Stricture of the Urethra.
- 2 FERGUSSON'S STAFF for do.
- 3 Do. KNIFE for do.
- 4 THOMPSON'S URETHROTOME.
This instrument consists of a curved tube, furnished with a blade, which lies concealed in the projecting bulb.
- 5 LYON'S URETHRA DILATOR.
The engraving shows the instrument open. When closed it is cylindrical. The screw at the end of the instrument opens and closes it.
- 6 HOLT'S DILATOR AND TUBE.
- 7 THOMPSON'S STRICTURE CATHETER, with Solid Probe Point.
This instrument is made both in silver and steel.
- 8 L'ALLEMANDE'S INSTRUMENT for applying Nitrate of Silver to the Urethra.
- 9 COULSON'S INSTRUMENT for applying Nitrate of Silver to the neck of the Bladder.
- 10 BRODIE'S BOUGIE.
- 11 THOMPSON'S CANULA for applying a Solution of Nitrate of Silver to the Urethra.

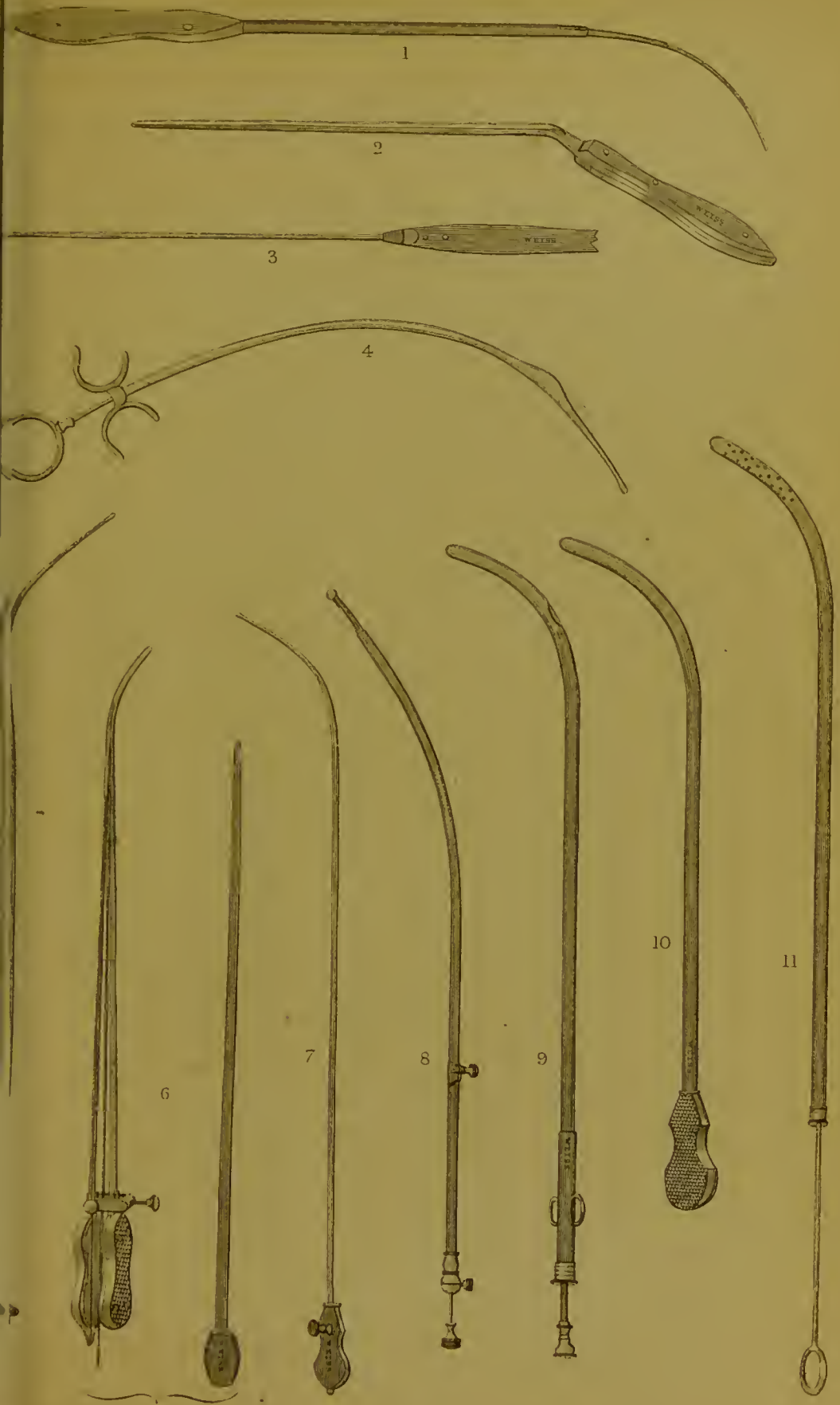

THIRD SIZE.

Vincent Brooks, del et lith





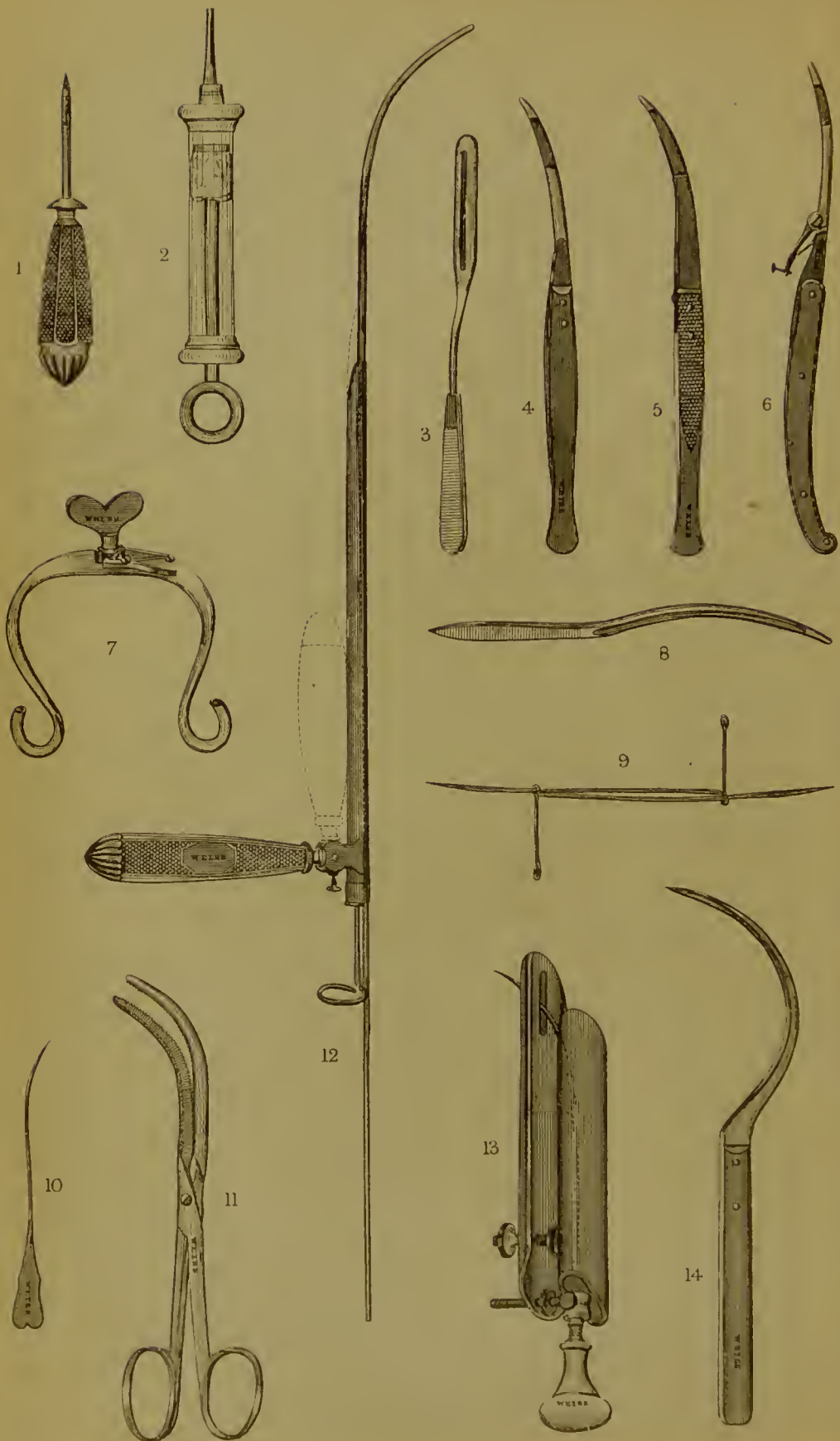

PLATE XXVII.

INSTRUMENTS FOR HERNIA, VARICOCELE,
HYDROCELE, ETC.

Figure

- 1, 2 FERGUSSON'S TROCAR and SYRINGE for Hydrocele.
- 3 FLAT HERNIA DIRECTOR.
- 4 COOPER'S HERNIA BISTOURY.
- 5 WEISS' do. do. with Guard sliding over the edge.
- 6 GUARDED do. do. in folding handle.
The engraving shows the blade guarded; to open it the lever is depressed.
- 7 RICORD'S CLAMP for Varicocele, as modified by Mr. Coulson, jun.
- 8 CURVED HERNIA DIRECTOR.
- 9 WOOD'S NEEDLES for the radical cure of Hernia.
- 10 CURLING'S NEEDLE for Phimosis.
- 11 Do. FORCEPS for do.
- 12 WOOD'S INSTRUMENT for dividing Stricture of the Urethra.
This instrument consists of a small staff, a canula, and a short blade, which lies concealed within the canula, and cuts in the direction indicated by the dotted line. The handle folds back when not in use.
- 13 ROTHMUND'S INSTRUMENT for the radical cure of Hernia.
- 14 WOOD'S NEEDLE for do.
This is the needle generally employed by Mr. Wood.

PLATE XXVIII.

INSTRUMENTS FOR FEMALE DISEASES.

Figure

- 1 COXETER'S BIVALVE SPECULUM.
- 2 WEISS' THREE-BLADED SPECULUM AND DILATOR.
- 3 Do. BIVALVE SPECULUM.

The screw of this instrument, acting directly upon the blade, enables the operator to use a covering of india-rubber to prevent the soft parts from falling between the blades, the power required for distending the covering being considerable. The bell-shaped form of the instrument also facilitates manipulation with other instruments.

- 4 WEISS' DILATING SPECULUM PLUG, OR OBTURATOR.

The engraving only shows the end of this plug; it is covered with rubber, and its stem is attached to an india-rubber bottle. By pressing the bottle the india-rubber is dilated, as shown by the dotted lines, and makes a soft and perfect cushion to the end of the speculum. The plug immediately collapses upon releasing the pressure on the bottle.

- 5 FERGUSSON'S SPECULUM.
- 6 SIM'S DUCK BILL do.
- 7 SIMPSON'S UTERINE DILATOR.
- 8 Do. do. SOUND.

This is made both in silver and German silver.

- 9 UTERINE CAUSTIC HOLDER, mounted in ebony handle.

The dotted line indicates that the holder is furnished with a silver cap.

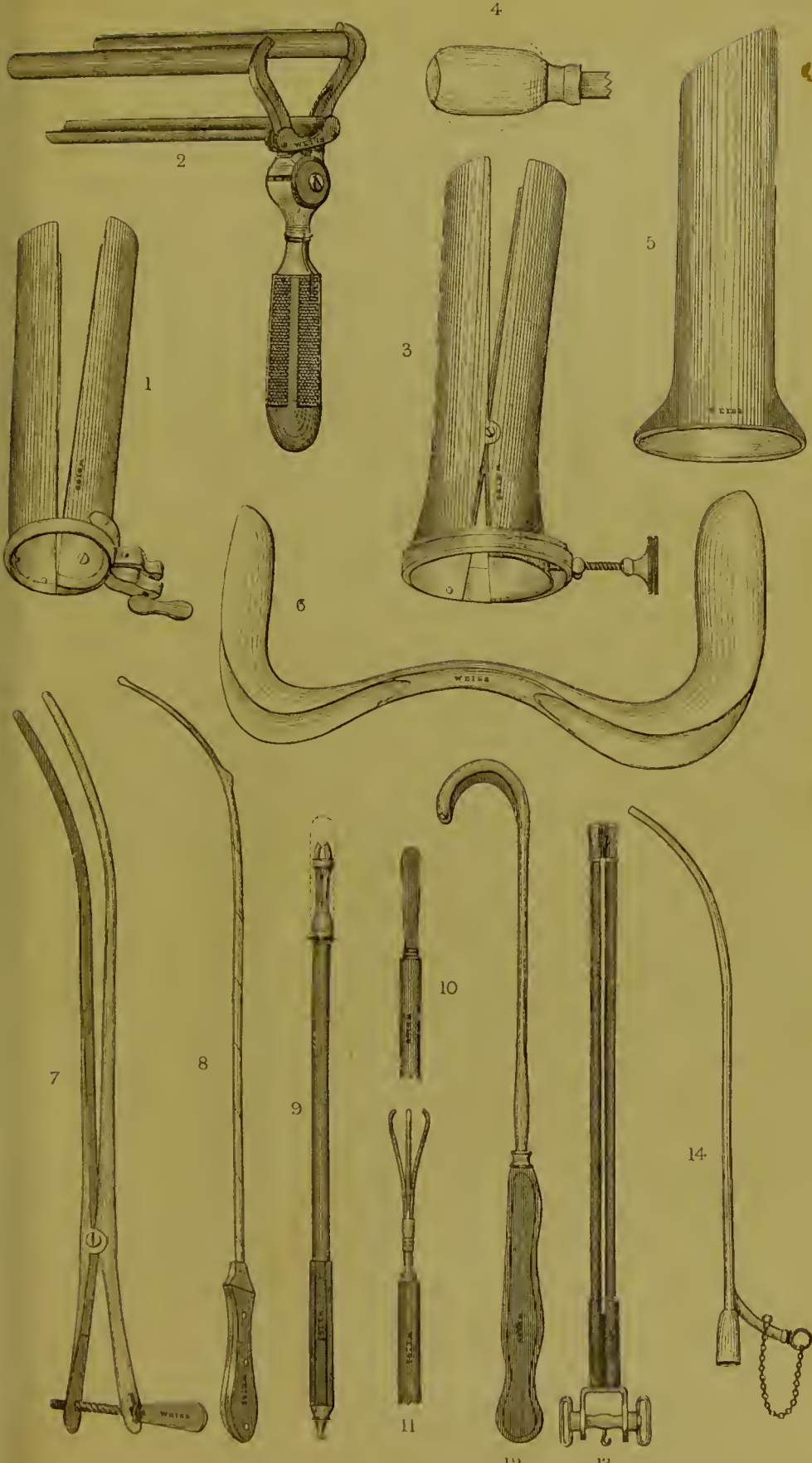

ONE-THIRD SIZE.

Vincent Brooks, del. et lith



WEISS' ILLUSTRATED CATALOGUE.

Figure

10 SCARIFIER FOR THE UTERUS.

11 THREE-PRONGED LINT HOLDER.

Both the instruments are mounted similar to fig. 9.

12 SIMPSON'S POLYTOME.

A blunt hook furnished with a cutting-blade in the curve.

13 GOOCH'S POLYPUS CANULA, with Winch.

14 DOUBLE CHANNEL'D CANULA, for washing out the Uterus and Bladder.

PLATE XXIX.

INSTRUMENTS FOR FEMALE DISEASES.

Figure

- 1 STRAIGHT SCISSORS for Vaginal Fistula.
- 2 SELF-HOLDING FORCEPS for holding a needle and twisting wire.
- 3 BOZEMAN'S DOUBLE CURVED SCISSORS.
These scissors are made right and left.
- 4 SPRING FORCEPS with Vulsellum Points.
- 5 CURVED SCISSORS for Vaginal Fistula.
- 6 SIM'S UTEROTOME, SCARIFYING KNIFE, AND CAUSTIC HOLDER.
This instrument is supplied with two blades and a caustic holder, either of which may be fixed at any required angle by means of the screw at the end of the handle.
- 7 CURVED KNIFE for Vaginal Fistula.
These are made in pairs, right and left; also double-edged, as suggested by Dr. Savage, which renders one knife available for both sides.
- 8 STRAIGHT KNIFE for Vaginal Fistula.
- 9 LONG VULSELLUM FORCEPS.
- 10 SIM'S FORCEPS for holding a needle or twisting wire.
- 11 BAKER BROWN'S SHOT COMPRESSING FORCEPS.
- 12 FORCEPS for Twisting Wire.
- 13 Do. for Uterine Polypi.

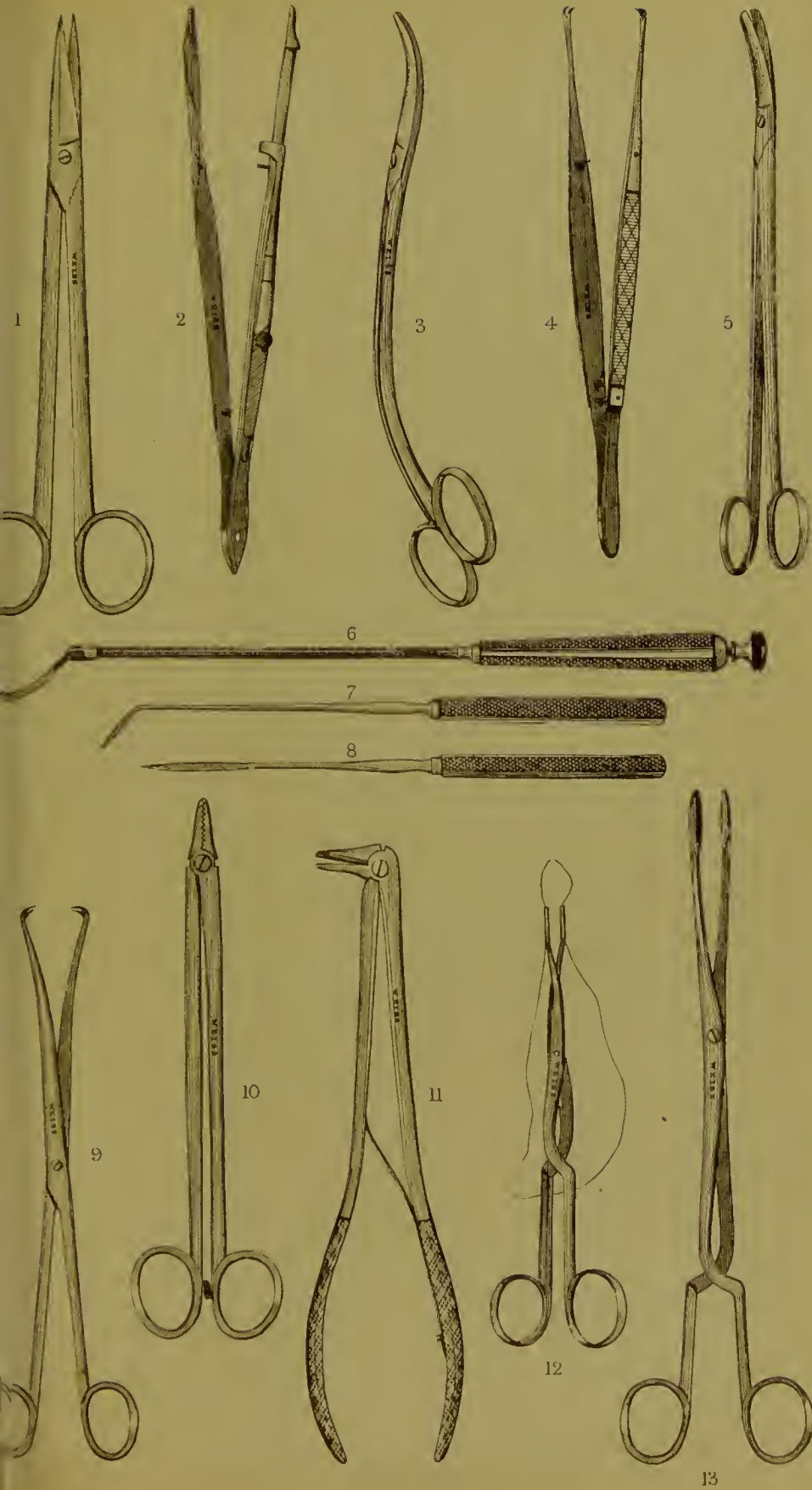







PLATE XXX.

INSTRUMENTS FOR FEMALE DISEASES.

Figure

- 1 NEEDLE HOLDER for Vaginal Fistula.
- 2 NEEDLE do.
- 3 ANGULAR WIRE ADJUSTER for do.
- 4 CURVED do. do.
- 5 SIM'S do. do.
- 6 Do. CATHETER do.
- 7 SHARP HOOK do.
- 8 FORKED WIRE ADJUSTER do.
- 9 SIMPSON'S WIRE SUTURE TWISTER.
- 10 SIM'S SHARP HOOK for facilitating the application of the Sutures.

The point only of this instrument is shown, the stem being similar to the other instruments.
- 11 SIMPSON'S TUBULAR NEEDLE.
- 12 SILVER TUBE, used after incision of the Cervix Uteri.
- 13 SIMPSON'S HYSTEROTOME.
- 14 LONG TENACULUM POINTED FORCEPS for Vaginal Fistula.
- 15 COGHLAN'S HYSTEROTOME.
- 16 GREENHALGH'S do.

This instrument has two concealed blades, which cut from within outwards, in the direction of the dotted lines, the incision being deeper at the base than at the apex. The depth of the incision can also be regulated.

WEISS' ILLUSTRATED CATALOGUE.

Figure

17 SIM'S TENACULUM POINTED FORCEPS.

These forceps answer both for holding the flap and twisting the sutures.

18 SAVAGE'S FORCEPS for applying Caustic and Scarifying the Uterus.

The blades of this instrument are hollow, to receive caustic, and to grasp the blade fig. 18a.

19 ELLIS' CAUSTIC HOLDER.

The advantage of this instrument is that it perfectly secures the caustic. The latter being cast hollow permits of a platinum pin, with a head to it, being passed through it, and secured by a small screw nut.





ONE-THIRD SIZE.

PLATE XXXI.

INSTRUMENTS FOR THE RECTUM.

Figure

- 1 LANE'S THREE-BLADE RECTUM SPECULUM.
- 2 JOINTED GUARD for applying Acids.
- 3 CURLING'S RECTUM SPECULUM.
- 4 Do. FISTULA BISTOURY.
- 5 Do. do. DIRECTOR.

There is an error in this engraving: the point, instead of being sharp, should have been blunt.

- 6 WEISS' FISTULA BISTOURY.

This instrument is provided with a sharp point, sliding within the probe end, which can be withdrawn during the operation, to enable the operator to put his finger on the end of the blade with greater safety.

- 7 FERGUSSON'S RECTUM SPECULUM with bevil'd open end.
- 8 WEISS' TWO-BLADE SPECULUM AND DILATOR.

This instrument is also made with three blades.

- 9 FERGUSSON'S RECTUM SPECULUM with long narrow opening.
- 10 SPRING FORCEPS with sliding catch for Hemorrhoids.
- 11 SALMON'S STRAIGHT SCISSORS for cutting off Piles.
- 12 SALMON'S HOOK for Piles.
- 13 CURLING'S VULSELLUM for Hemorrhoids.
- 14 Do. NEEDLE for Ligature.
- 15 Do. FORCEPS for applying Acids.
- 16 ASHTON'S NEEDLE for Ligature.
- 17 Do. FORCEPS for Hemorrhoids.

PLATE XXXII.

INSTRUMENTS FOR OVARIOTOMY, ETC.

Figure

- 1 SPENCER WELLS' ORIGINAL CLAMP for Ovariectomy.
- 2, 2a, 2b ROPE CLAMP for do.
- 3 FENESTRATED TUMOUR FORCEPS.
- 4 SHARP HOOK for Ovariectomy.
- 5 BAKER BROWN'S INSTRUMENT for breaking up Fibrous Tumours.
- 6 SPENCER WELLS' ELASTIC TROCAR for Ovariectomy.
- 7 Do. APPARATUS for emptying Ovarian Cysts and injecting Iodine.
The trocar, fig. 6, accompanies this apparatus.
- 8 HUTCHINSON'S CLAMP FORCEPS for Ovariectomy.
- 9 LARGE PISTON TROCAR for do.
This instrument is furnished with an elastic tube, which fits on to the side branch.

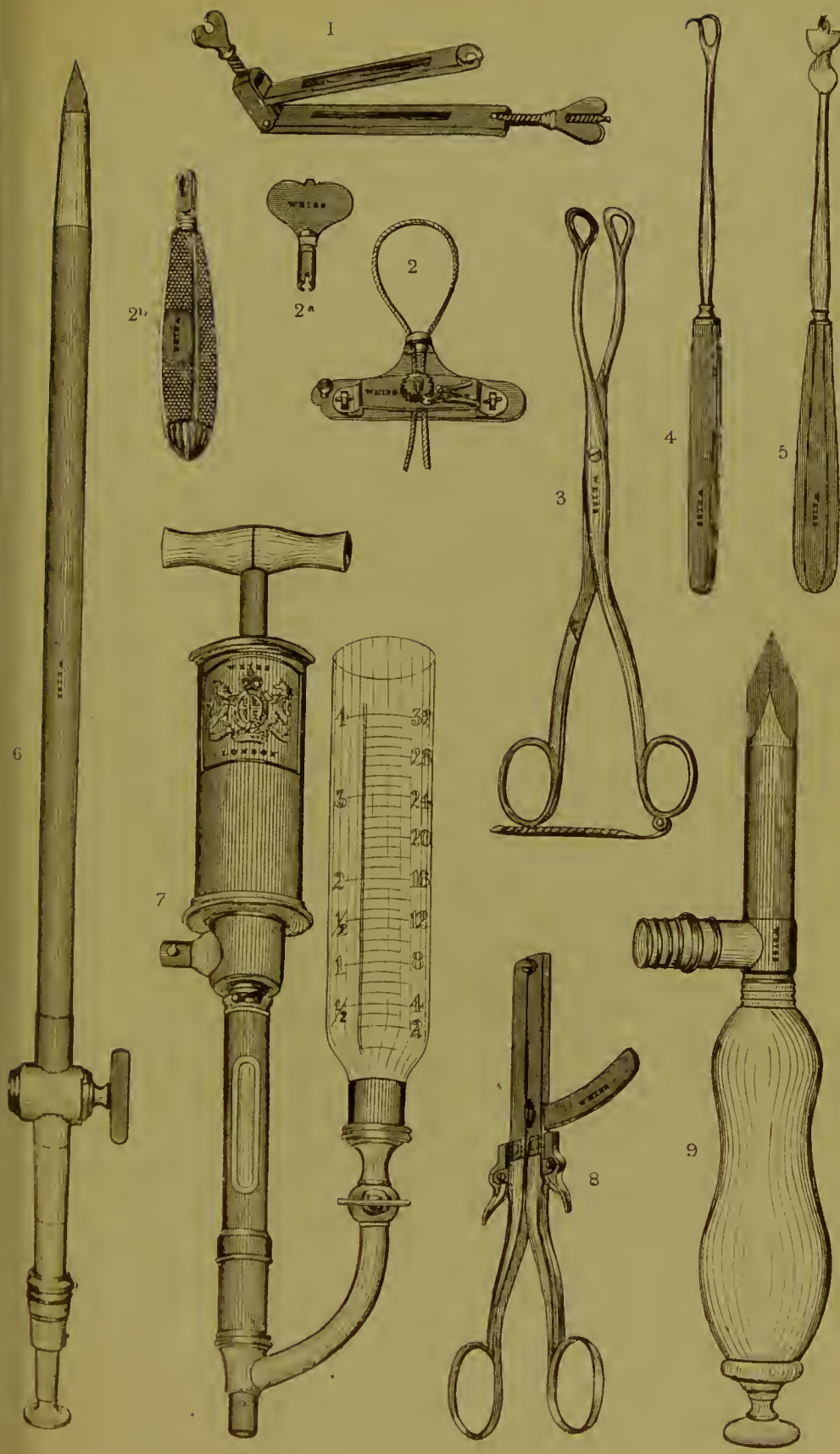

ONE-THIRD SIZE.

Vincent Brooke del. et lcu.





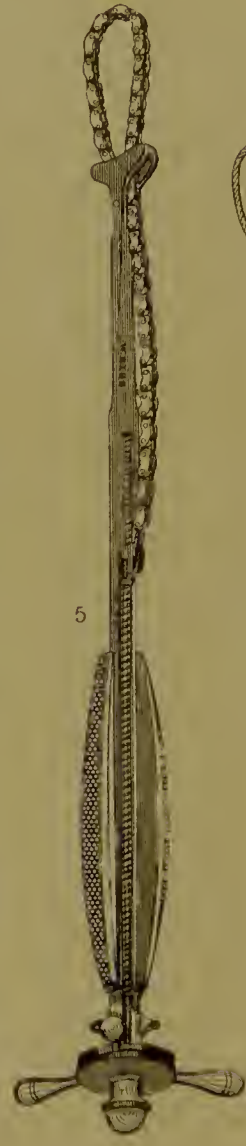
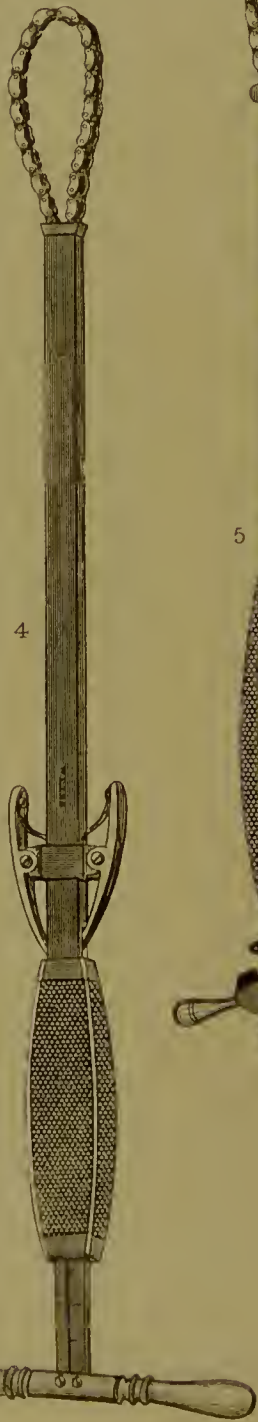
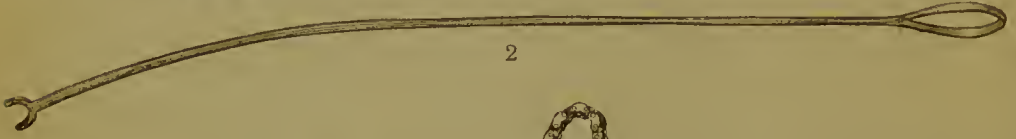
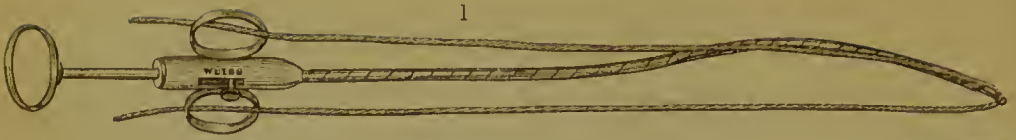

PLATE XXXIIa.

ECRASSEURS, ETC.

Figure

- 1, 2 WEISS' GUIDE AND ADJUSTER for passing a Ligature round a Polypus.
- 3 WEISS' POLYPUS CANULA, with double pinion action.
- 4 CHASSAIGNAC'S ECRASSEUR.
- 5 SCREW ECRASSEUR.
- 6, 6a WEISS' ECRASSEUR, with endless screw action.

The wire rope is wound round a drum which is turned by an endless screw; canula of different curves and sizes may be attached.

PLATE XXXIII.

MIDWIFERY INSTRUMENTS.

Figure

- 1 SIMPSON'S FORCEPS.
- 2 OLDHAM'S do.
- 3 LEVER'S do.
- 4 ROBERTON'S do.
- 5 RAMSBOTHAM'S do.
- 6 ASSALINI'S do.

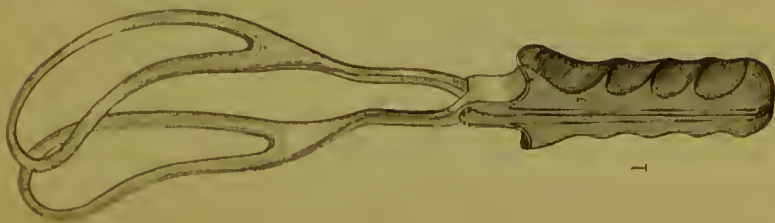
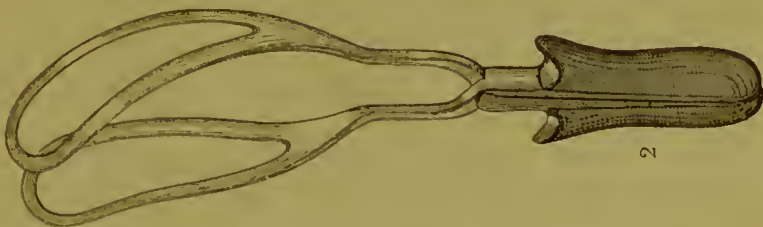
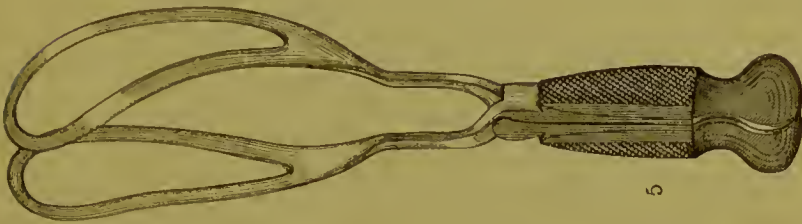
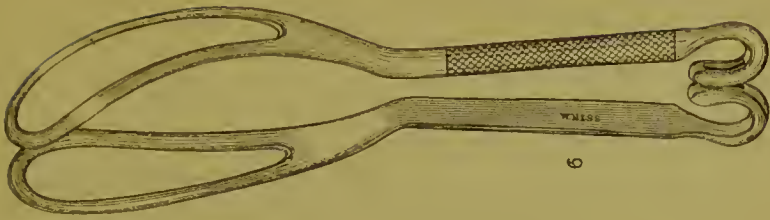





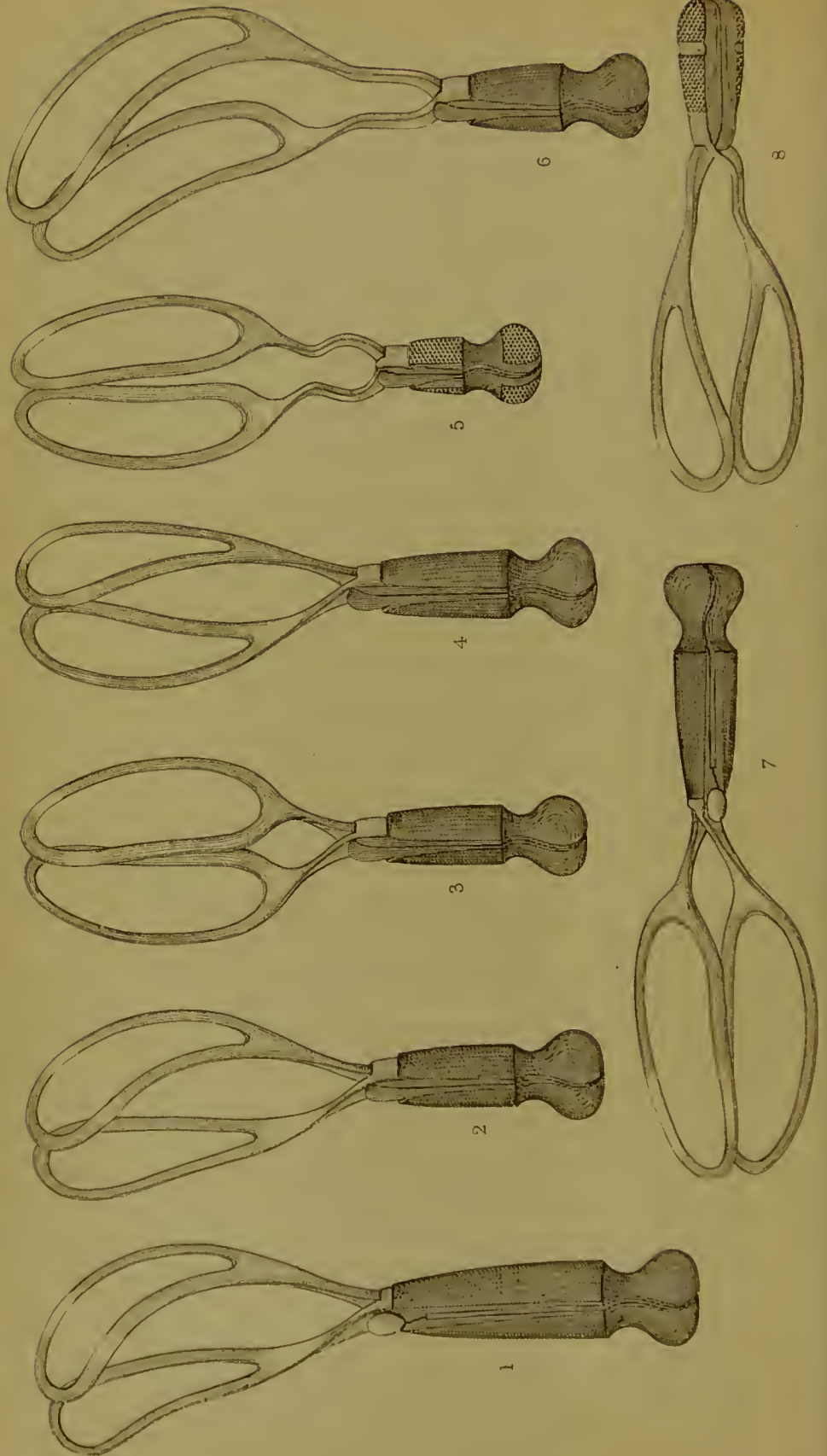

ONE-FOURTH SIZE.

Vincent Brooks, del. et lith.

PLATE XXXIV.

MIDWIFERY INSTRUMENTS.

Figure

- 1 BRÜNNINGHAUSEN'S CURVED FORCEPS, introduced by Rigby.
- 2 CLARKE'S FORCEPS.
- 3 HAIGHTON'S do.
- 4 DENMAN'S do.
- 5 GREENHALGH'S do.
- 6 DAVIES' do.

These forceps are sometimes made with a third blade, shorter than either of the others.

- 7 BRÜNNINGHAUSEN'S SHORT FORCEPS.
- 8 SHORT FORCEPS.

PLATE XXXV.

MIDWIFERY INSTRUMENTS.

Figure

- 1 CONQUEST'S FORCEPS, with screw handle.
- 2 ZIEGLER'S do.
- 3 HOPKINS' do.
- 4 COLLINS' do.
- 5 RAMSBOTHAM'S SHORT do.
- 6 BLUNDEL'S FORCEPS.
- 7 WALLER'S do.
- 8 CHURCHILL'S SHORT do.

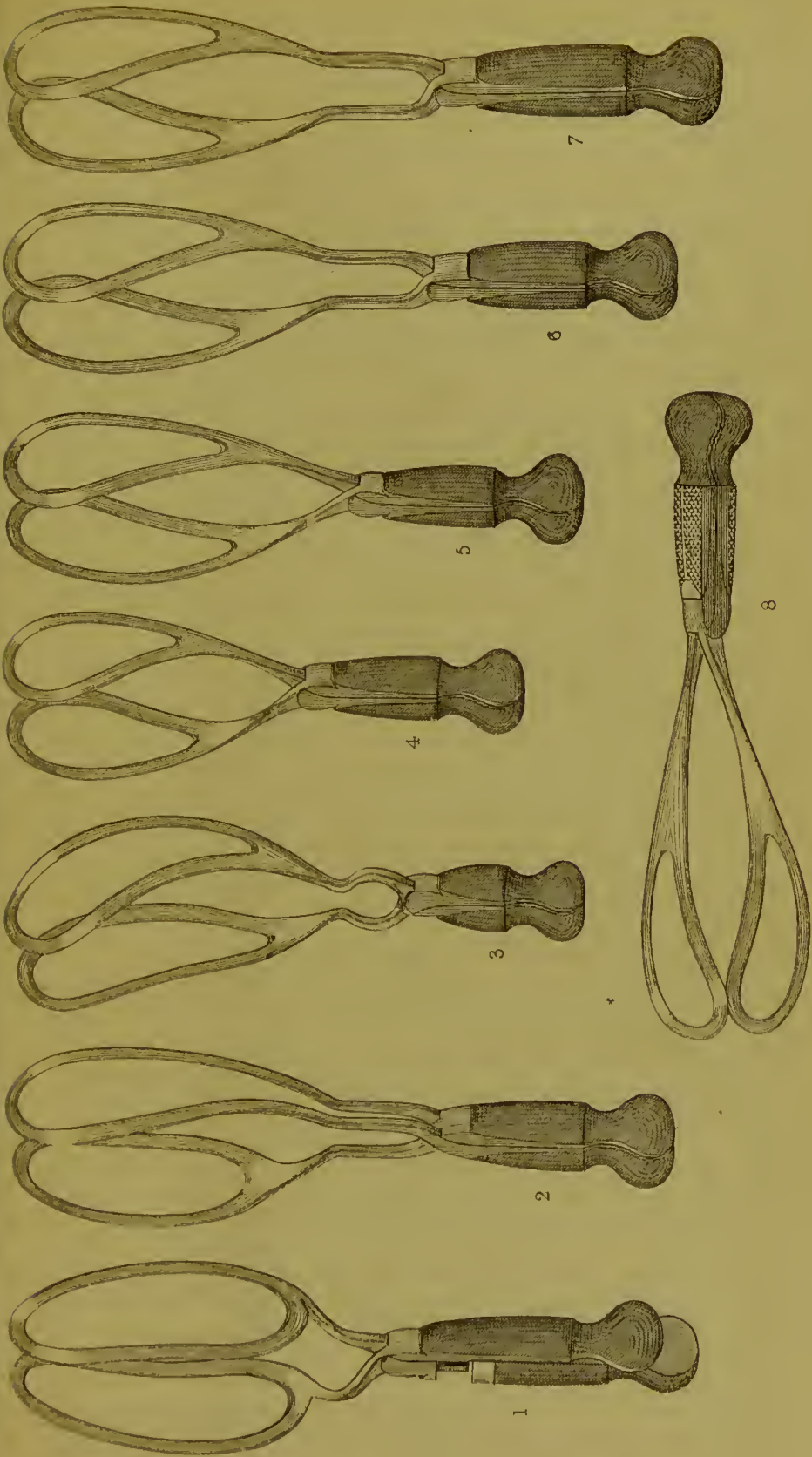



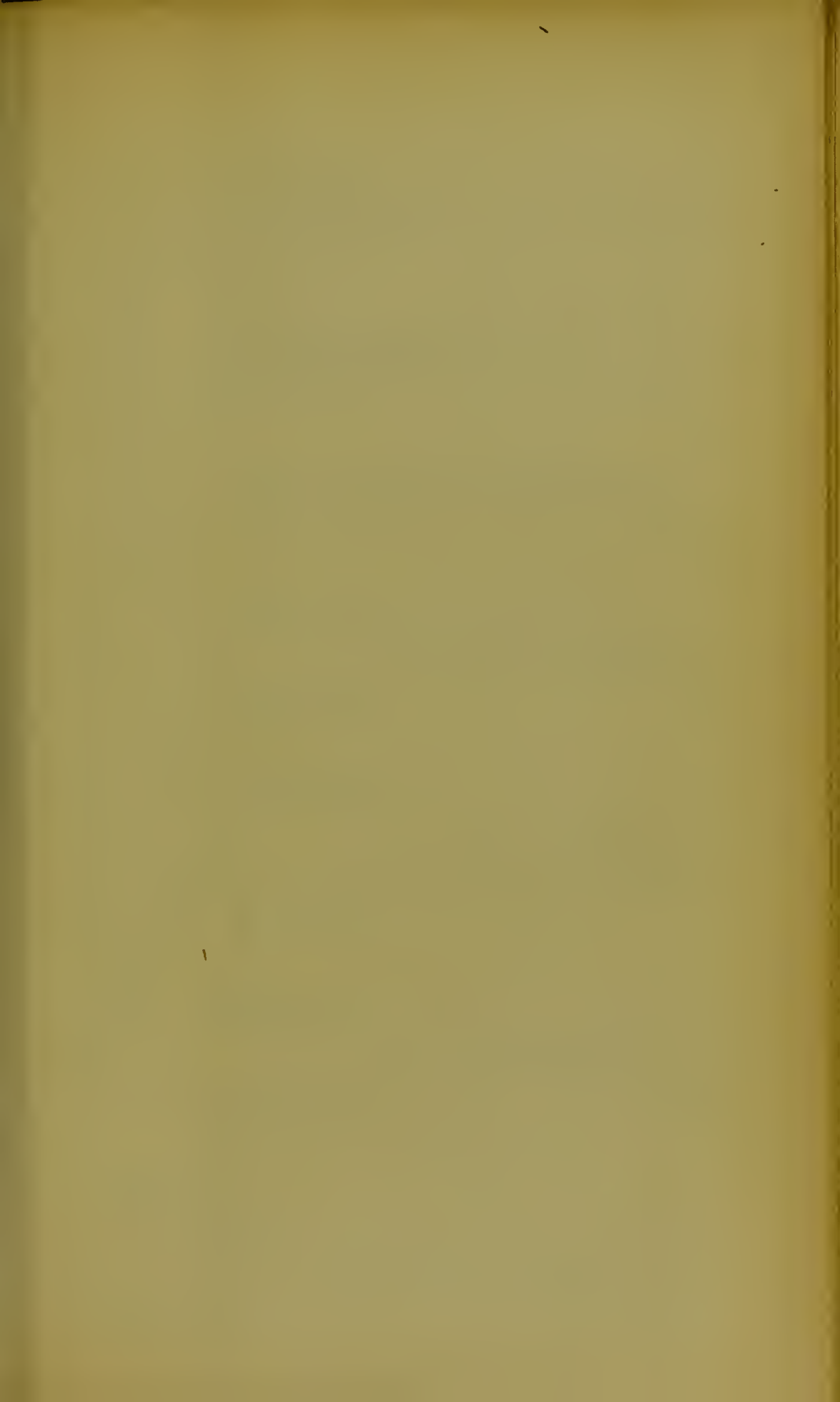

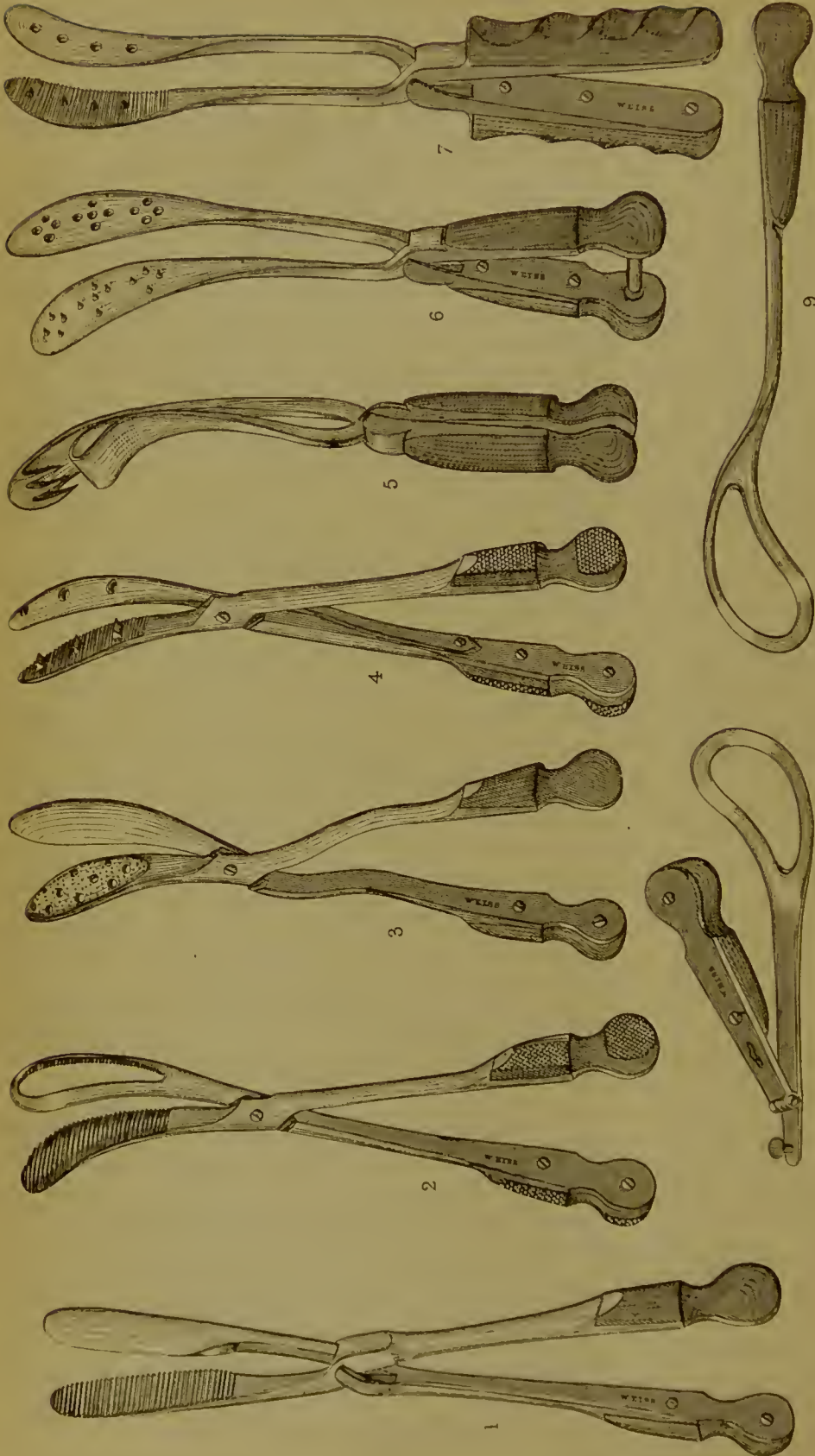

PLATE XXXVI.

MIDWIFERY INSTRUMENTS.

Figure

- 1 LEE'S CRANIOTOMY FORCEPS.
- 2 MURPHY'S do.
- 3 CONQUEST'S do.
- 4 HOLMES' do.
- 5 DAVIES' GUARDED CROTCHET.
- 6 Do. CRANIOTOMY FORCEPS.
- 7 ZIEGLER'S do.
- 8 LEVER, with folding handle.
- 9 Do. with fixed handle.

PLATE XXXVII.

MIDWIFERY INSTRUMENTS.

Figure

- 1 HOLMES' PERFORATOR.
- 2 DAVIES' OSTEOTOMIST.
- 3 SCISSOR PERFORATOR.
- 4 ORDINARY do.
- 5 OVUM FORCEPS.
- 6 WEISS' PERFORATOR.
The blades are opened by turning the handle.
- 7 NAEGLE'S PERFORATOR, modified by Simpson.
- 8 BLUNT HOOK AND CROTCHET.
- 9 LEE'S PERFORATING CANULA.
- 10 DOUBLE BLUNT HOOK.

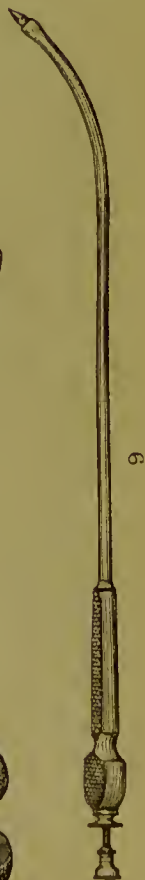
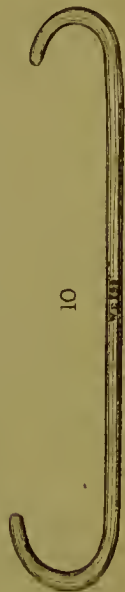
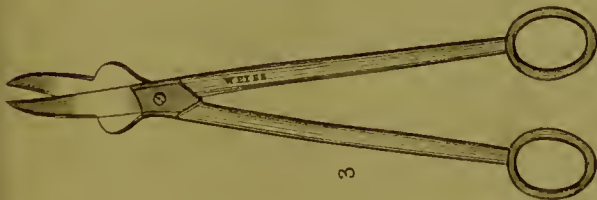
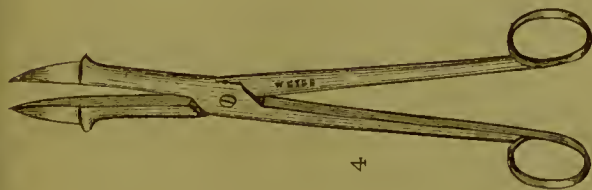
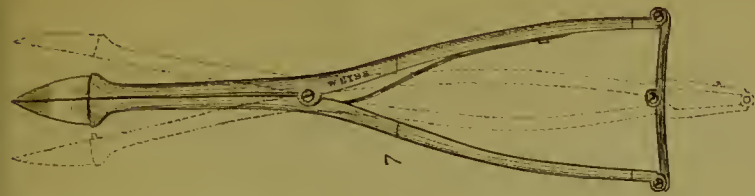

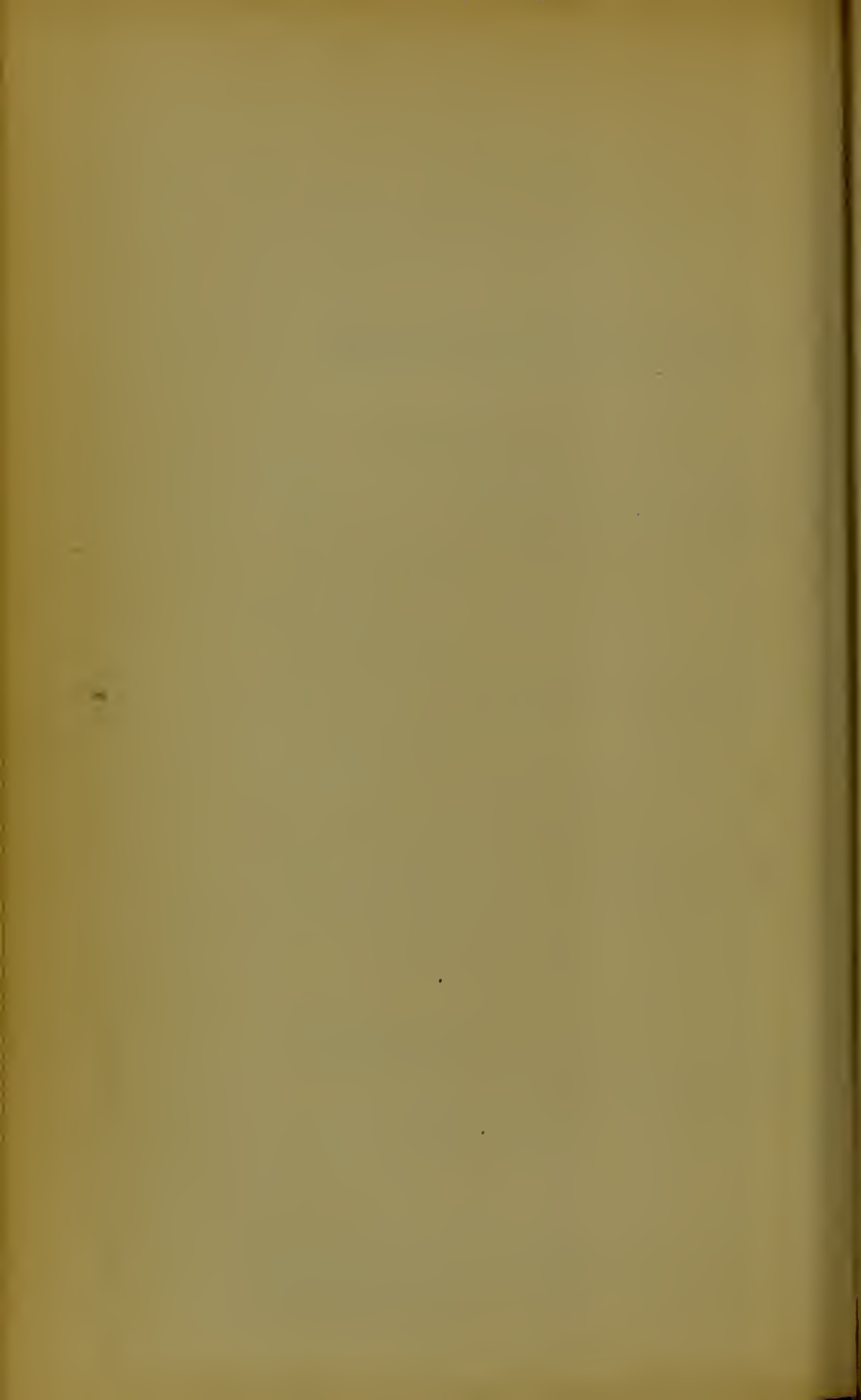

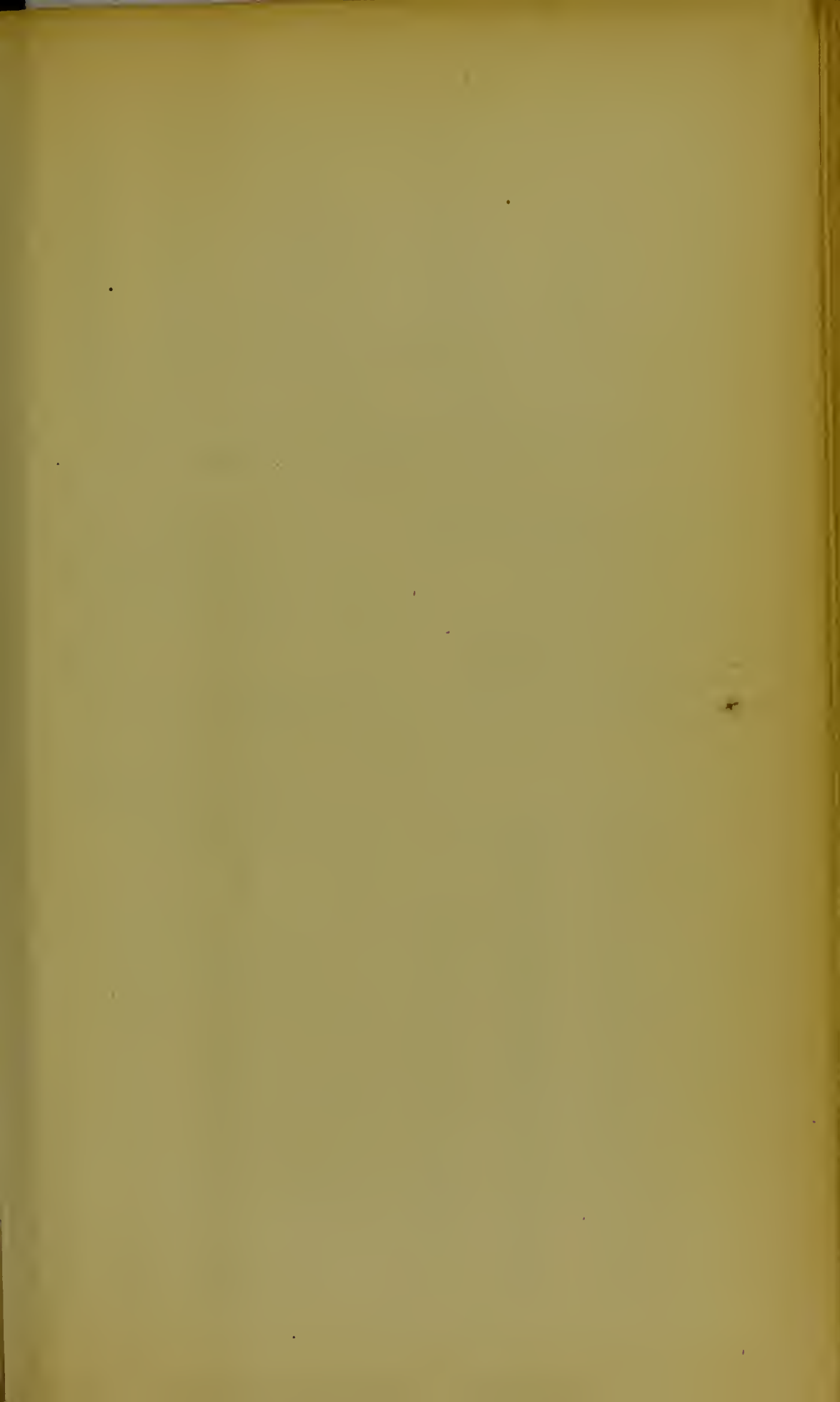

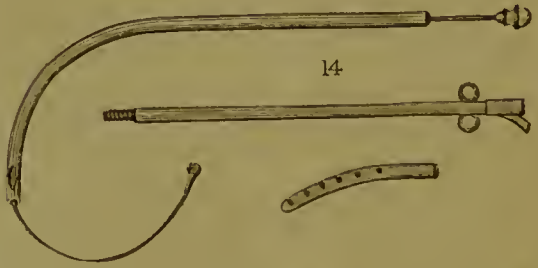
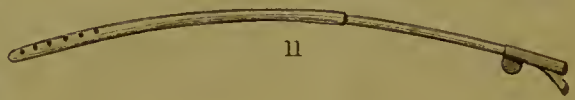
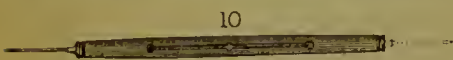
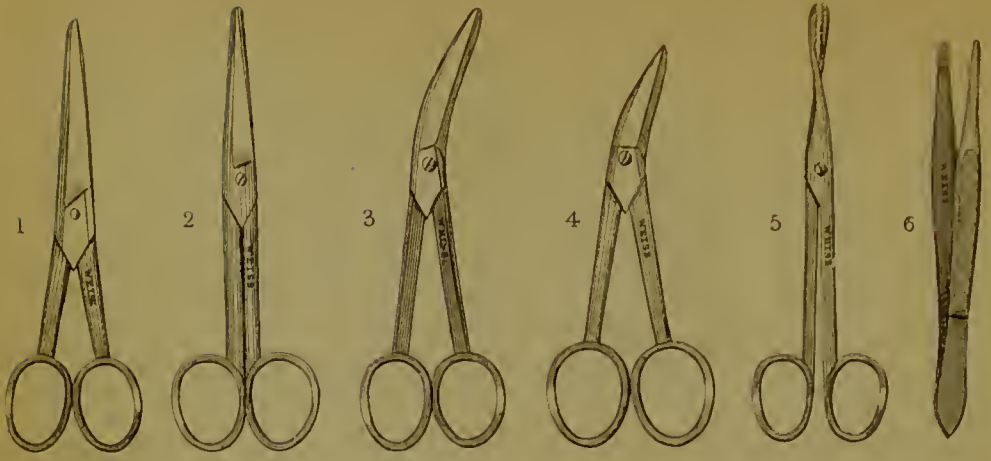

ONE-THIRD SIZE.

Vincent Brooks del. et lith.

PLATE XXXVIII.

POCKET INSTRUMENTS.

Figure

1, 2, 3 DRESSING SCISSORS.

4 SCISSORS for removing the Toe Nail.

5 DRESSING FORCEPS, cross action.

6 SPRING DRESSING FORCEPS.

7 CAUSTIC AND LINT HOLDER.

This instrument is sufficiently long to be used with the speculum, but, closing by means of a slide, will go in a pocket case.

8 CAUSTIC HOLDER.

This instrument is combined with a grooved needle, an exploring trocar, or with another holder for small caustic.

9 EXPLORING TROCAR, in ivory case.

The engraving shows that the handle is hollow; it forms a receptacle for the canula of the trocar.

10 EYE NEEDLE, and WALTON'S GOUGE for removing Foreign Bodies from the Eye.

Both instruments are made to slide into the handle.

11 FEMALE CATHETER, with slide to lengthen or shorten it.

12 SILVER DIRECTOR.

The handle of this instrument forms a guard for dividing the frœnum.

13 DIRECTOR and ANEURISM NEEDLE, combined.

WEISS' ILLUSTRATED CATALOGUE.

Figure

- 14 MALE AND FEMALE CATHETER, combined with Spring for Epistaxis.
- 15 CURVED BISTOURIES, sharp and probe pointed.
- 16 SCALPEL AND FINGER KNIFE.
- 17 SCALPELS, single and double edg'd.
- 18 GUM LANCET AND TENACULUM.
- 19 DOUBLE NEEDLE.
- 20 SYME'S ABSCESS LANCET AND SUBCUTANEOUS KNIFE.
- 21 FINGER KNIFE.
- 22 HERNIA BISTOURY.
- 23 SMALL SAW, in spring handle.



ONE-HALF SCALE

FULL SIZE SCALE

ONE-HALF SCALE

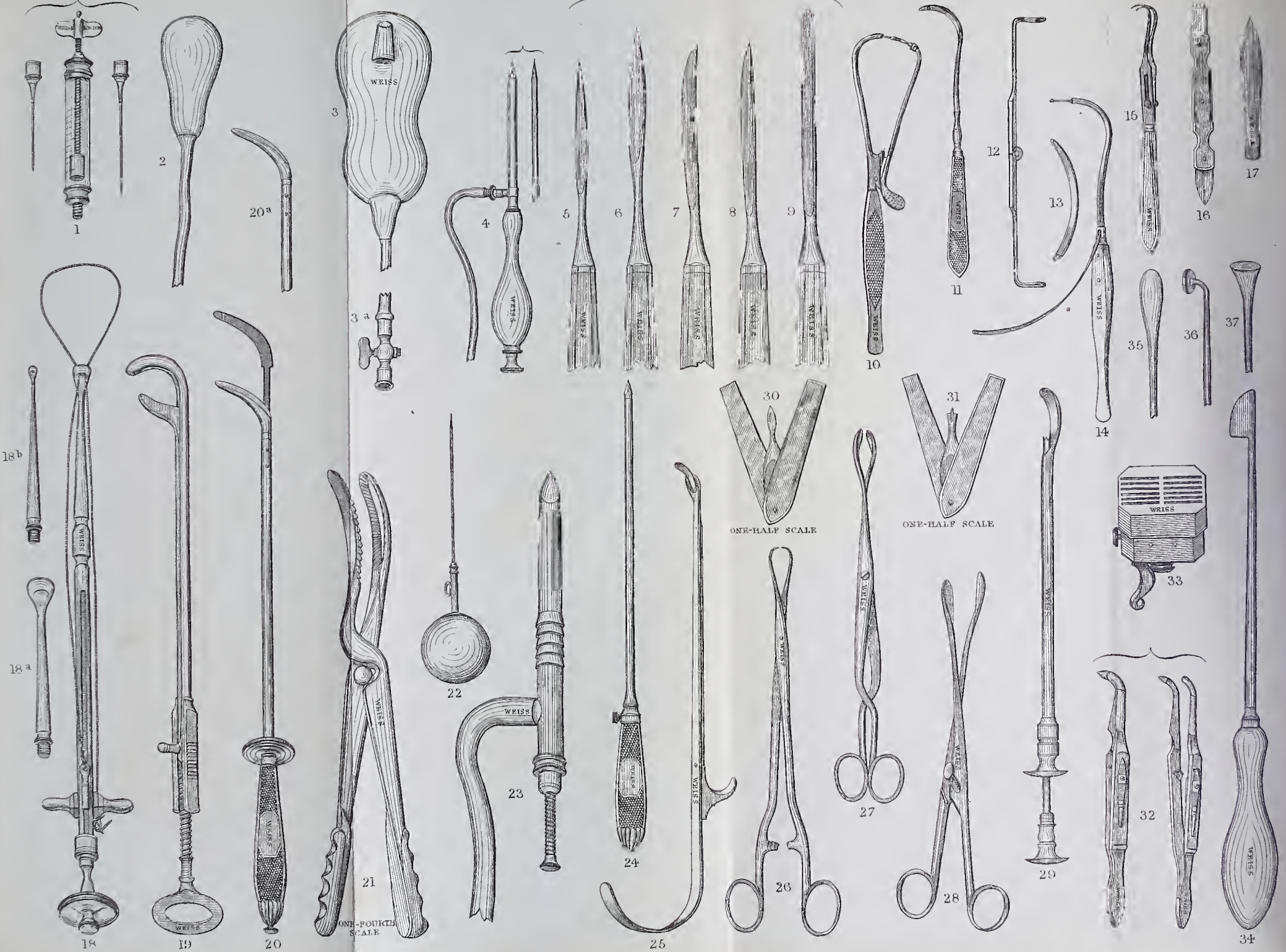

ONE-THIRD SCALE, WITH EXCEPTION OF THOSE ESPECIALLY MARKED.

Vincent Brooks, del. et lith.

PLATE XXXIX.

MISCELLANEOUS INSTRUMENTS.

Figure

1 HUNTER'S HYPODERMIC SYRINGE.

2 BARNES' VAGINAL DILATOR.

This dilator is made of india-rubber, and inflated either with air or water.

3 BARNES' UTERINE DILATOR.

The set consists of three bags or dilators of various sizes. They are made of india-rubber, and are dilated with water by means of a syringe, as shown, fig. 12, plate LII.

4 THOMPSON'S SYPHON CHEST TROCAR.

This trocar was constructed to prevent the admission of air during the operation. The elastic tube attached to the lower part of the canula being immersed in water, the trocar point is withdrawn by means of the button at the end of the handle.

5, 6, 7, 8, 9 TENOTOMY KNIVES of various forms.

10 WEISS' ANEURISM NEEDLE.

11 ORDINARY do.

12 DOUBLE do., curved right and left.

This needle is jointed in the stem for the sake of portability.

13 SILVER ANEURISM NEEDLE.

14 GIBSON'S do.

15 SHARP DOUBLE HOOK.

16 VACCINATING INSTRUMENT.

17 SETON NEEDLE.

WEISS' ILLUSTRATED CATALOGUE.

Figure

18, 18a, 18b BRAXTON HICKS' ROPE ECASSEUR.

This ecrasseur is made to carry ropes of various sizes, being provided with different end pieces to screw on, as shown figs. 18a and 18b.

19 AVELING'S POLYPTRITE for Polypus of the Uterus.

20 WEISS' POLYPUS SCISSORS.

21 BARNES' CRANIOTOMY FORCEPS.

22 EXPLORING TROCAR, with india-rubber Syringe attached.

23 SPENCER WELLS' HOLLOW TROCAR for Ovarian Tumours.

Since the engraving of this trocar has been executed, we have, at the suggestion of Mr. Spencer Wells, added jointed spring hooks or clamps to it; these secure the cyst after the trocar has been introduced.

24 DRAINAGE TROCAR for deep-seated Abscesses.

25 WEISS' BULLET SCOOP.

This scoop is furnished with a sliding spring, which is concealed within the point or scoop, and is pushed forward, and passed behind the bullet after the scoop has been adjusted.

26 LUER'S BULLET FORCEPS.

These forceps are constructed with sharp points to imbed themselves in the bullet.

27 WEISS' BULLET FORCEPS, with cross-action.

28 SAVIGNY'S do.

The blades of these forceps can be introduced separately.

29 COXETER'S BULLET SCOOP.

30 HOLLOW POINTED VACCINATING LANCET.

31 SPRATLEY'S do.

32, 32a CUTTING TRACHEOTOMY FORCEPS.

These forceps are used both for making the incision and dilating the parts, while introducing the tube: the engraving shows them closed and open.

33 WEISS' SCARIFICATOR, the blades cutting outwards.

34 ACTUAL CAUTERY IRON.

35, 36, 37 Show various forms of the same instrument.

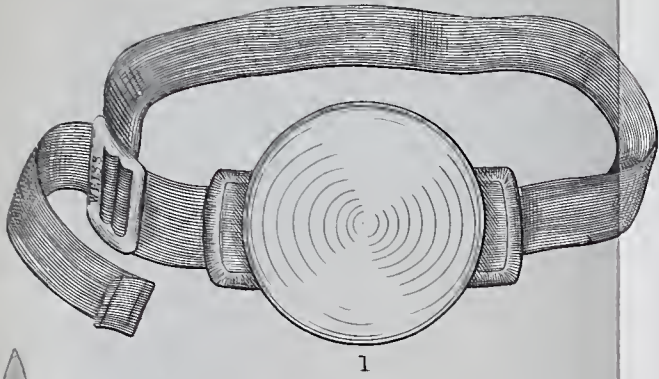

1

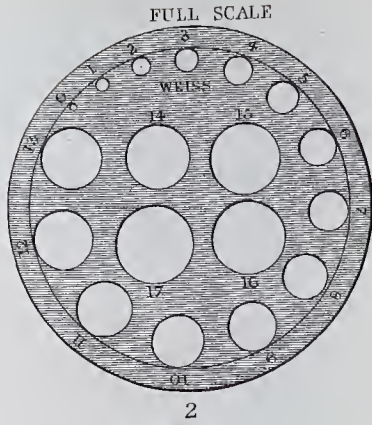

FULL SCALE

2

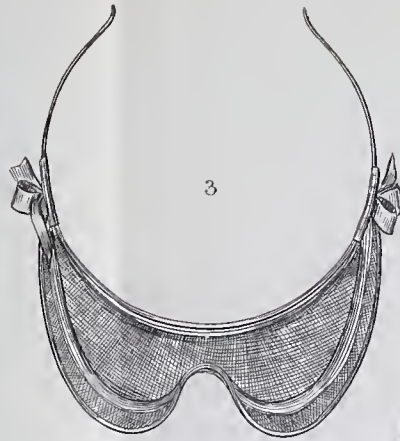

3

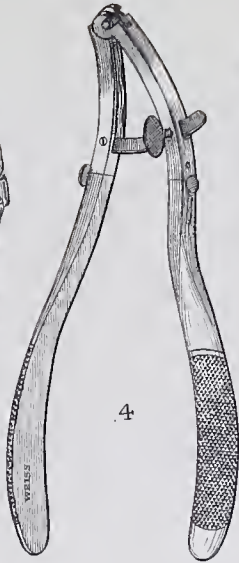

4



V



VI



IV



VII



III



VIII



II

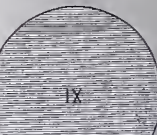

IX



I



X



XI



XII

FULL SCALE



7



8

FULL SCALE



10



11



12



13



14



15

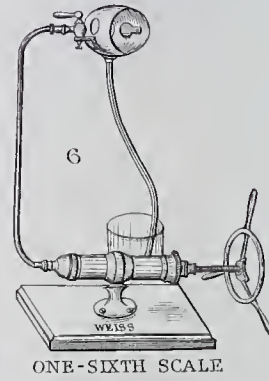

6

ONE-SIXTH SCALE

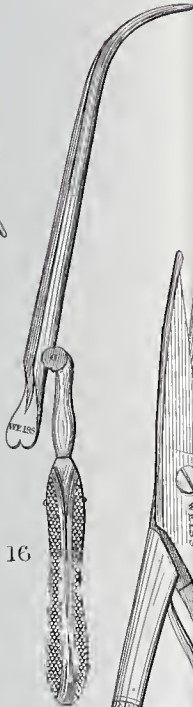

16



17



18

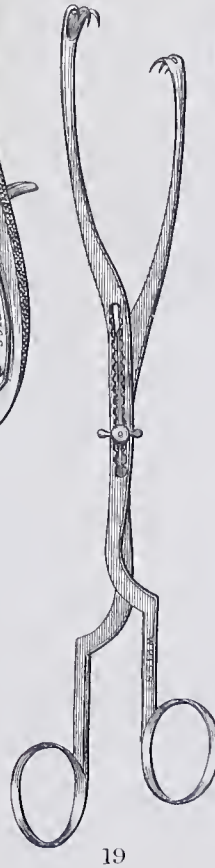

19



20



21

PLATE XL.

MISCELLANEOUS INSTRUMENTS.

Figure

1 LARYNGOSCOPE REFLECTOR AND BAND, as worn on the Forehead.

2 WEISS' PORTABLE CATHETER GAUGE.

3 CALKIN'S OCCHIOMBRA or TRANSPARENT EYE SHADE.

This shade excludes wind and dust, modifies the light, and keeps the eye perfectly cool; it can be worn over spectacles, and is easily removed when required. For hot and dusty climates it is especially advantageous.

4 SPENCER WELLS' OVARIAN CLAMP.

5 SPECTACLE-FRAME for TRIAL GLASSES.

By means of hinged springs the glasses are easily changed.

6 VOLATILIZER or Apparatus for administering fluids in the form of vapour or spray.

This apparatus consists of a syringe fixed to a stand and furnished with a screw piston-rod, worked by a handle in the form of a wheel; to fill the syringe the elastic tube is fitted at the end and placed in a glass of water, and the piston drawn back by reversing the action of the screw; the elastic tube is then taken off and the metal tube fitted on, and by screwing the piston forward, a fine stream of water is sent out with great force through the mount at the end, striking upon the diaphragm in the barrel-shaped tube, from whence it issues in the form of spray; the condensed fluid is carried off by an elastic tube.

7 BOWMAN'S KNIFE AND SCOOP for Tarsal Cysts.

The knife is made to slide into the handle.

WEISS' ILLUSTRATED CATALOGUE.

Figure

- 8 BOWMAN'S GUARDED CANALICULUS KNIFE.
The engraving shows the guard withdrawn to the extent required.
- 9 BOWMAN'S LEVER-GUARDED KNIFE for cutting the Canaliculus laterally.
The engraving shows the lever depressed.
- 10 ASHTON'S HYDROSTATIC DILATOR for the Rectum.
This dilator differs from all previously constructed fluid dilators by reason of the lateral supports which surround the dilating surface, and which have the effect of making equable or lateral dilation, as shown in the engraving. When not distended, the size of the dilating portion of the instrument is the same as that of the point. A ring ear syringe is best adapted for distending this dilator.
- 11 WEISS' THREE-BLADE RECTUM DILATOR.
This instrument, which is exceedingly small when not dilated, is covered with an india-rubber sheath, which prevents the mucous membrane falling in; dilatation is made by holding the cross bars in one hand and turning the handle with the other.
- 12 TODD'S RECTUM DILATOR.
Dilatation is made in the same way as in fig. 11.
- 13 THOMPSON'S URETHRA DILATOR.
This instrument, when not dilated, is the size of a small catheter.
- 14 GIBB'S LARYNGEAL SYRINGE.
The bulbous point of this syringe is made of platinum, and pierced with exceedingly fine holes.
- 15 GIBB'S LARYNGEAL ECRASSEUR.
- 16 JOINTED DIRECTOR for Re-sections.
- 17 SCISSORS for Starched Bandage.
- 18 BUTCHER'S BONE FORCEPS for removing portions of Bone in Hare-lip, etc.

WEISS' ILLUSTRATED CATALOGUE.

Figure

19 SLIDING VULSELLUM FORCEPS for Tumors, etc.

The sliding action enables the operator to apply either blade in the desired spot, and also to make traction with each separately, while the other still retains its grasp.

The desirability of constructing this instrument was suggested to us by Dr. Greenhalgh.

20 THOMPSON'S LITHOTOMY SCOOP, with side curve.

21 GANT'S CONCEAL'D FISTULA KNIFE.

The blade is propelled in a line parallel with the sheath, by pressing a button on the handle.

RECTUM BOUGIES.

The rings, engraved from I. to XII. consecutively, denote the sizes of rectum bougies.

PLATE XL*a*.

DISLOCATION APPARATUS—TOURNIQUETS.

Figure

- 1 PULLIES for Dislocation.
- 2 CRUISE'S APPARATUS for reducing Dislocations.

This apparatus consists of a metal framework, fitted with a revolving drum, to which is attached a cogged wheel, the latter being worked by an endless screw. One end of a leather strap, by which traction is made, is fixed to the drum, and the other end is furnished with a hook. The endless screw and cogged wheel can, for the more convenient adjustment of the length of the strap, be thrown out of gear, by turning the small lever towards A, as indicated by the dotted line.

- 2*a* Is another portion of the apparatus, by means of which the traction on the limb can be instantaneously relieved; it is placed between the bandage and the apparatus with the aid of a cord, and holds the latter by means of a pin, which is hinged to the lower blade, and held securely by the upper blade, until the latter is depressed; this causes the pin to fall outwards in the direction of the dotted line, and to relieve the cord.

The advantage which this apparatus possesses over the ordinary pullies is the complete control which the operator has over the great and gradually applied power of the apparatus, which is equal to three hundred weight; for while one hand is employed in making traction, the other is free to manipulate the limb.

- 3, 3*a* PRITCHARD'S ANKLET AND WRISTBAND for securing the patient's Legs and Arms in Lithotomy.

The two appliances are buckled on before chloroform is administered, and immediately before the operation the hook on the wristband is attached to the loop of the anklet.

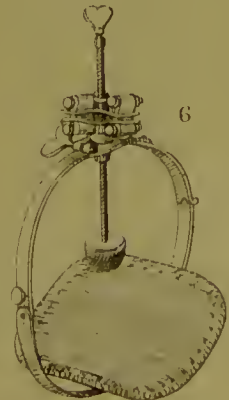
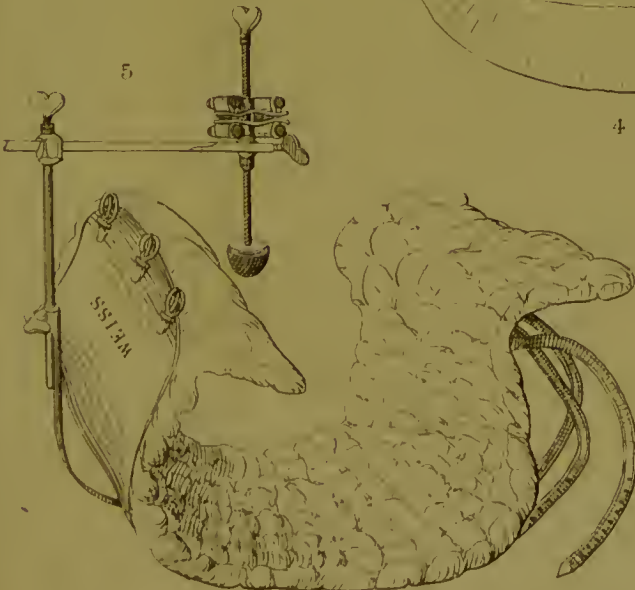
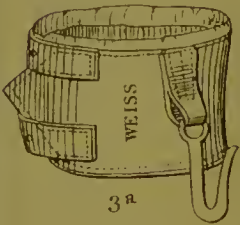
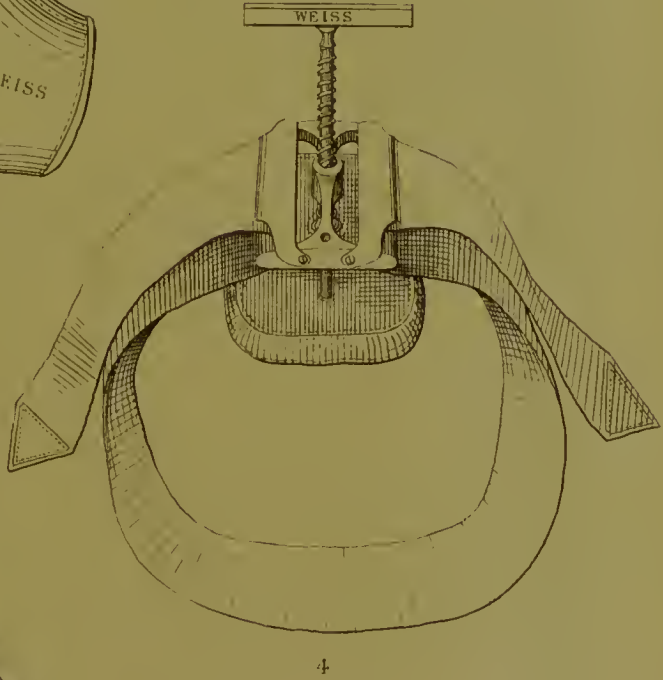
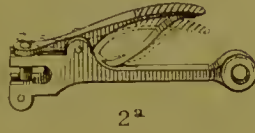
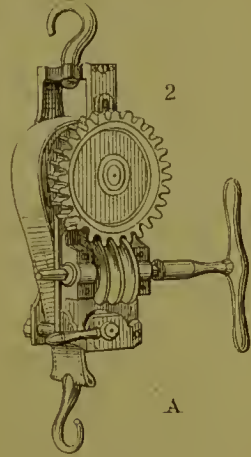
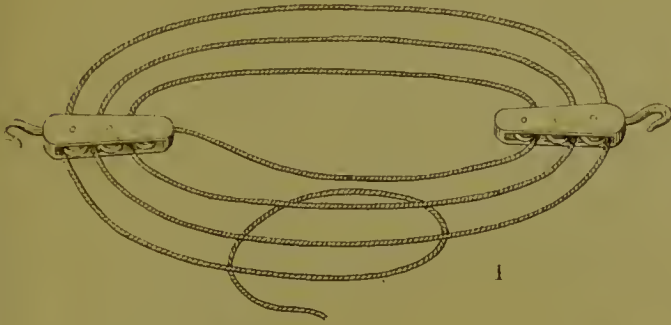



WEISS' ILLUSTRATED CATALOGUE.

Figure

4 MIDWIFERY COMPRESS.

This is an ordinary tourniquet of a large size with a flat pad; the band is passed round the patient's body, through the slots in the tourniquet, and fastened by the pins on the sides; compression is then made by the screw of the tourniquet.

5 CARTE'S ANEURISMAL TOURNIQUET for the Groin.

This apparatus, the most successful of any for the purpose, consists of a padded frame, in which the patient lies. To this is attached an upright bar, carrying another one transversely. On this travels the screw pad, which can be adjusted and fixed in any position by means of set screws. The pad is furnished with india-rubber springs, which give a certain amount of resiliency to the continuous pressure of the screw.

6 CARTE'S ANEURISMAL TOURNIQUET for the Thigh.

This instrument is used in conjunction with that for the groin; thus enabling the operator to diminish and increase the pressure on the upper and lower part of the artery alternately.

PLATE XLI.

CHLOROFORM INHALERS.

Figure

1 WEISS' CHLOROFORM INHALER.

This inhaler registers the quantity of chloroform used, and enables the operator to regulate the admixture of chloroform with air. The upper portion is a graduated glass vessel capable of holding 1 oz. of chloroform, and is furnished with a stop-cock, which allows the chloroform to descend into the lower part: this lower part is divided into two compartments, in one of which is a coil of blotting-paper, and into this the chloroform is allowed to flow; the other is a chamber for atmospheric air, and the two are surrounded by a chamber for hot or cold water to keep the chloroform at an equable temperature. The proportion of vapour and air is regulated by a disk revolving upon the top of the lower part. The inhaler is furnished with three mouthpieces of various sizes, which are connected with it by a joint, allowing of their being adapted to any position of the patient.

2 WEISS' MODIFICATION OF SKINNER'S CHLOROFORM INHALER.

This inhaler consists of a jointed wire frame, so constructed that it may be shut up into small dimensions: it is covered with worsted gauze, and held in position by the centre of the three tubes on the stopper of the chloroform bottle. This tube is an air-tube, and the operator, holding the bottle in his hand, regulates the flow or sprinkling of chloroform, by opening or stopping it with his index finger.

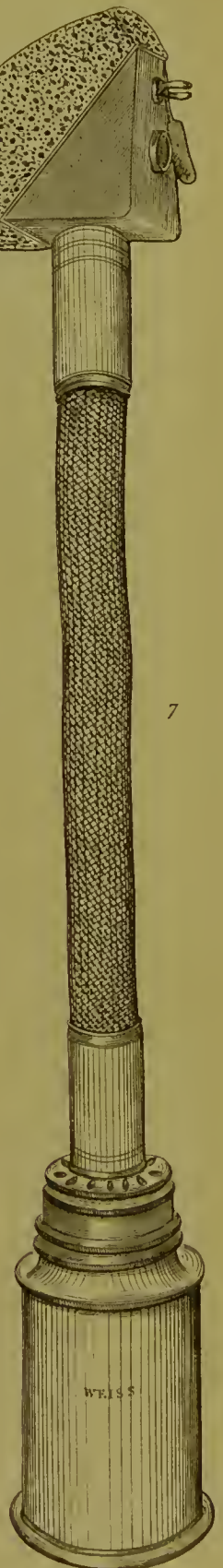
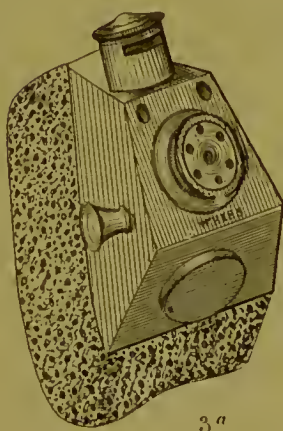
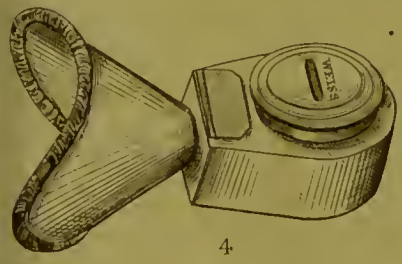
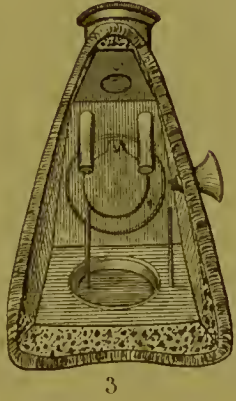
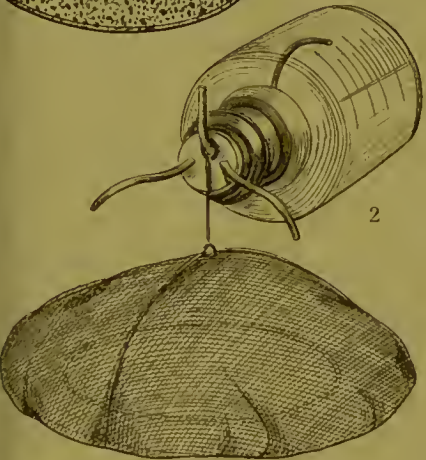
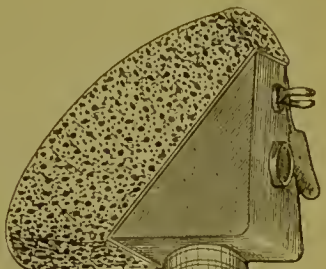
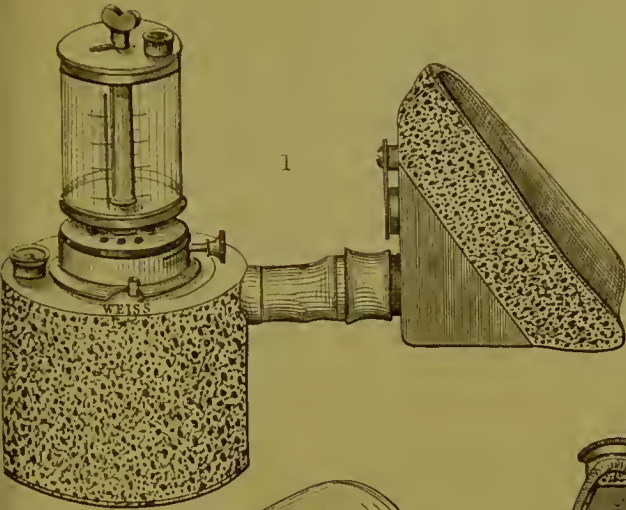



WEISS' ILLUSTRATED CATALOGUE.

Figure

3, 3a TOWNLEY'S INHALER.

The two figures give an inner and outer view of the inhaler. A small piece of sponge is placed on either side, between the side of the inhaler and one of the blunt-pointed wires, which spring from the bottom, and the chloroform or anodyne mixture is dropped from time to time through the funnel-shaped aperture at the side.

4 MURPHY'S INHALER.

5 SNOW'S PORTABLE INHALER.

In this inhaler the angular tube has a coil of blotting-paper placed within it, and the chloroform is poured in through the perforations in the top.

6 SIBSON'S INHALER.

7 SNOW'S do.

This is the original inhaler, and the one most generally used by the inventor, the portable one having been brought out more recently.

PLATE XLII.

INSTRUMENTS FOR DIAGNOSIS.

Figura

1 PERCUSSION THIMBLE.

2 OPTOMETER, or instrument for testing the relative Sight of patients who cannot read.

It consists of a small framework with a series of fine wires drawn across it; these the patient is directed to count; a tape measure is attached to the stem of the instrument to denote the distance at which he can do so.

3 SIBSON'S STETHOMETER for Measuring the Movements of the Chest.

4, 5, 6 PLESSORS AND PLESSIMETER.

7, 8 STETHOSCOPES.

9 LEWIS' SPIROMETER.

This apparatus consists of a graduated glass cylinder with a cover, to which a metal tube is attached reaching across the cylinder to the bottom, and an elastic tube with mouthpiece fitted into a socket on the top. The cylinder being filled with water and placed upon the wooden stand, as shown in the drawing, the patient breathes into it through the elastic tube, and the water is displaced in proportion, running out through the metal tube into a vessel below. The cylinder is then placed upright, and the operator reads off the quantity of water displaced, which agrees with the number of cubic inches of air breathed.

The advantages claimed by the inventor in behalf of this instrument are, simplicity of action, and the absence of all mechanical friction.

ONE - THIRD SCALE

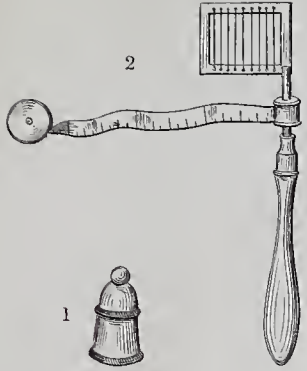

ONE - HALF SCALE

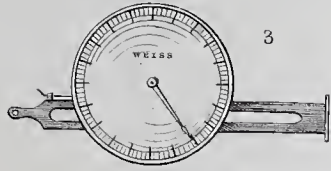

ONE - THIRD SCALE

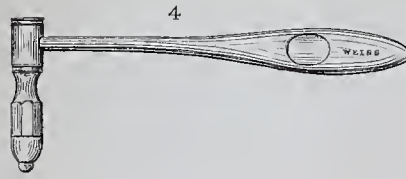

ONE - THIRD SCALE



1



ONE - TWELFTH SCALE

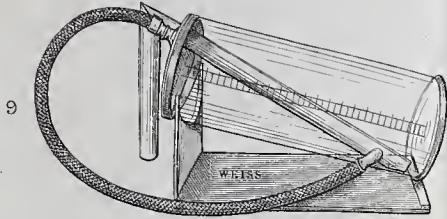

ONE - THIRD SCALE

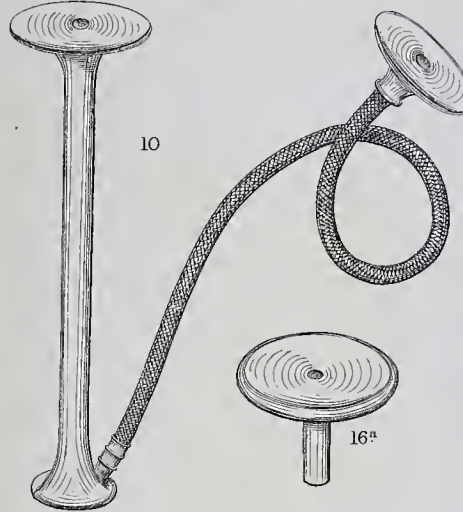

ONE - THIRD SCALE

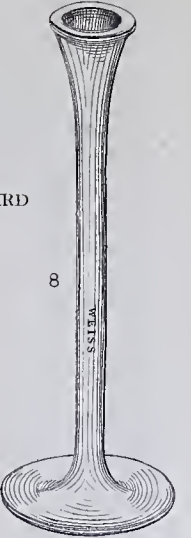

12

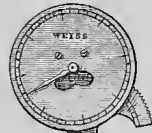
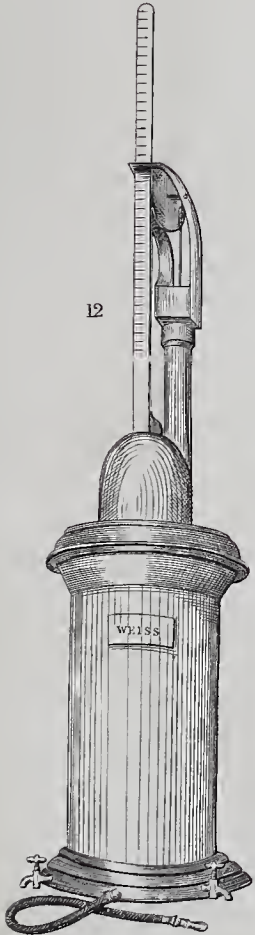

ONE - FOURTH SCALE

13



ONE - THIRD SCALE

14

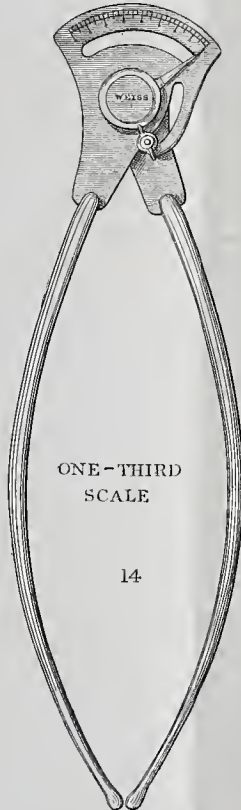

10

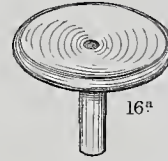

16^a

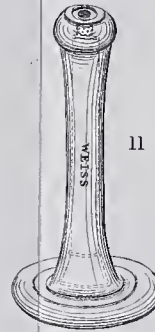

ONE - THIRD SCALE

11

ONE - FOURTH SCALE

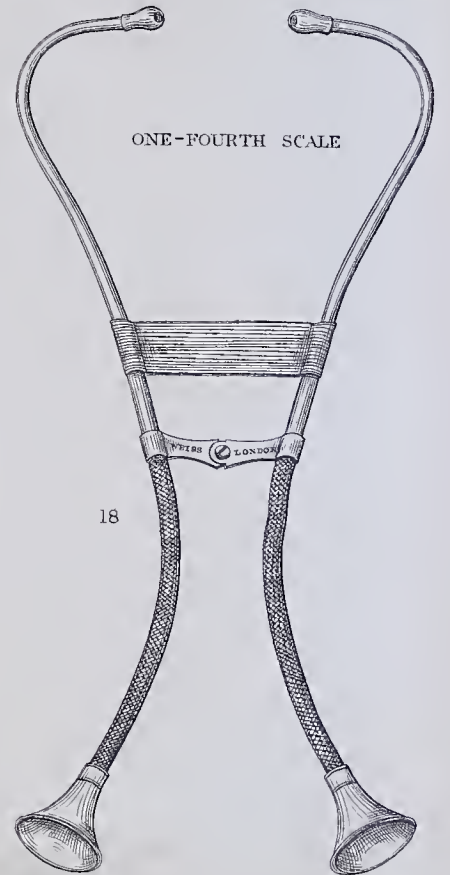

18

15

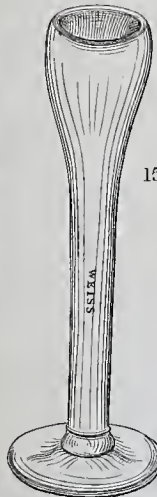

16

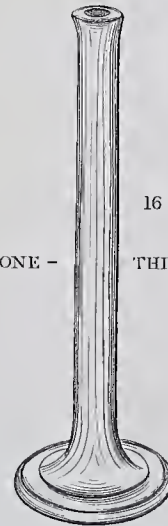

ONE - THIRD SCALE

17

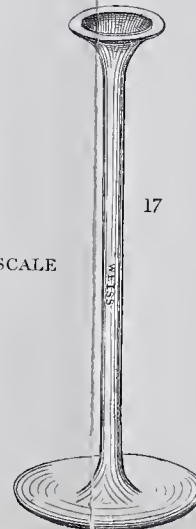

ONE - TWELFTH SCALE



WEISS' ILLUSTRATED CATALOGUE.

Figure

- 10 TODD'S CLASS STETHOSCOPE, which enables two persons to diagnose at the same time.
- 11 PORTABLE STETHOSCOPE.
This instrument unscrews in the middle of the stem, and the one part is screwed into the other.
- 12 WEISS' MODIFICATION OF HUTCHINSON'S SPIROMETER.
There is less mechanical friction in this instrument than in the original one, owing to the substitution of one large pulley for two very small ones.
- 13 EDWARDS' CALLIPERS for ascertaining the Movements of the Chest.
- 14 CALLIPERS for Measuring the Head or Chest.
- 15 STETHOSCOPE.
This instrument is made in two sizes, the sketch representing the large one.
- 16,16a WILLIAMS' STETHOSCOPE.
16a, the ear-plate; this plugs into the lower end, when not in use.
- 17 TODD'S STETHOSCOPE.
The only peculiarity in this instrument is its very slender stem, and large ear-plate.
- 18 SCOTT ALLISON'S DIFFERENTIAL STETHOSCOPE.

PLATE XLIII.

POST MORTEM INSTRUMENTS.

Figure

1, 2, 3 POST MORTEM SAW, CARTILAGE KNIFE, and BRAIN KNIFE, fitting into handle, fig. 7.

4 DOUBLE HOOK.

5 SINGLE HOOK.

6 TANG SCALPEL, of a large size.

7 SPRING HANDLE to fit the Saw and Blades.

8 STRONG DISSECTING SCISSORS.

9 BOWEL SCISSORS.

10 SMALL BLOW-PIPE.

11 CHISEL, or CROSS WRENCH.

The head of this instrument fits the slot in the handle of the post mortem hammer, fig. 13, or Spine Chisel, fig. 15.

12 CHARRIERE'S DOUBLE SAW for the Spine.

The distance between the blades of this instrument can be regulated at pleasure.

13 WEISS' POST MORTEM HAMMER.

The handle of this hammer is entirely of steel, hence more easily cleaned.

14, 14a ANATOMICAL SYRINGE AND EXTRA PIPE.

The pipes are made of various sizes, with or without stop-cocks.

15 SPINE CHISEL.

16 TRIPOD HEAD REST.

17 DISSECTING FORCEPS.

PLATE XLIIIa.

MICROSCOPIC INSTRUMENTS.

Figure

1, 2, 4, 5, 6 SINGLE-EDG'D MICROSCOPIC KNIVES.

3 DOUBLE-EDG'D do. KNIFE.

7 FINE MICROSCOPIC SCISSORS, mounted on handle.

8 CURVED SPRING FORCEPS.

9 VALENTIN'S KNIFE for making fine sections.

The blades of this knife cut parallel at any required distance.

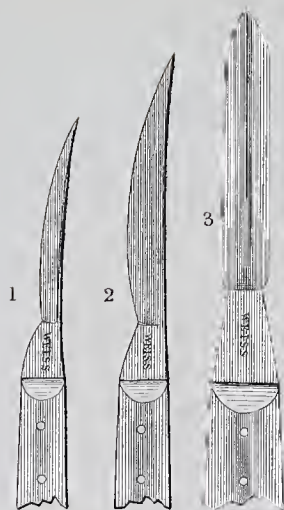
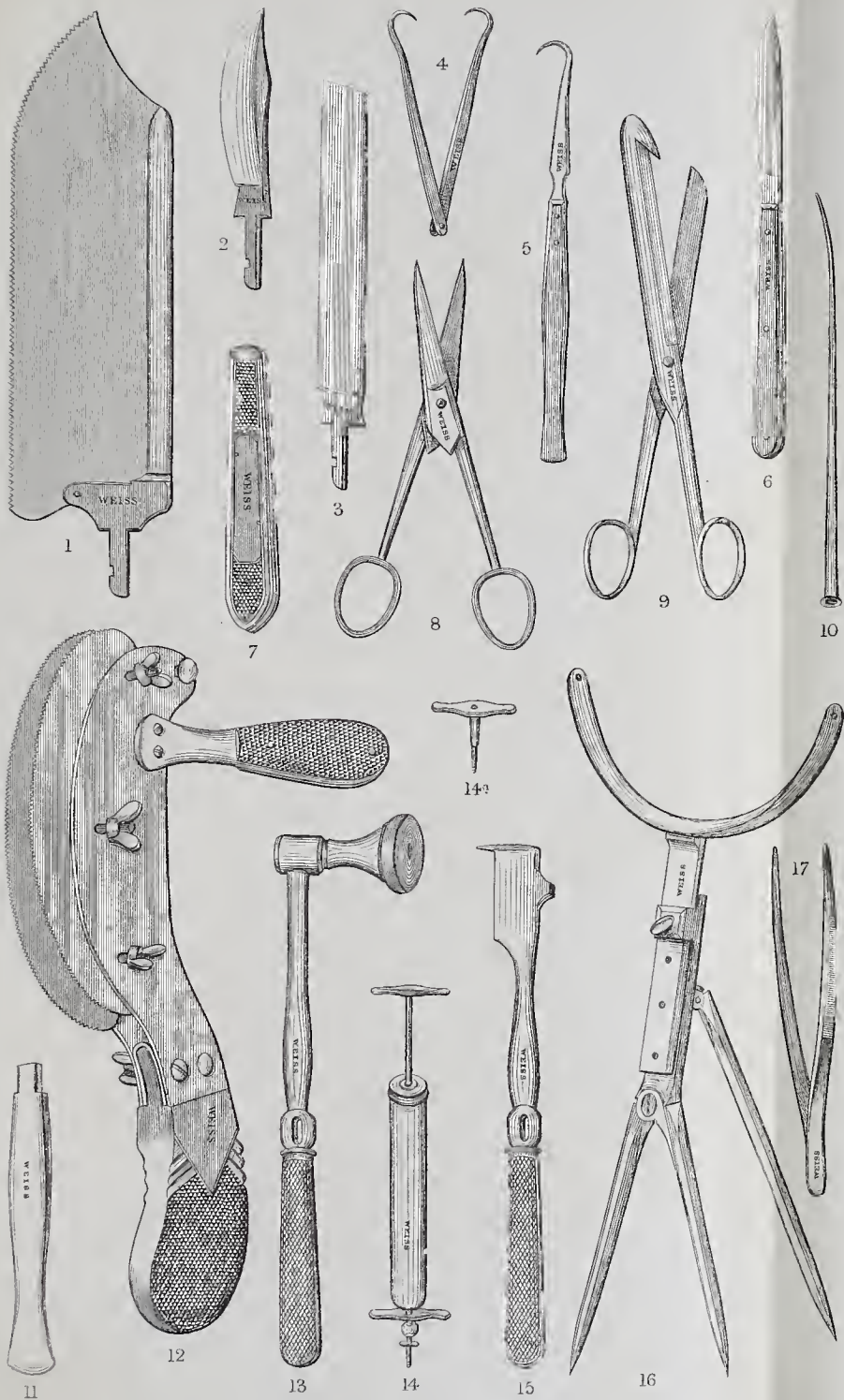

FULL-SIZE SCALE

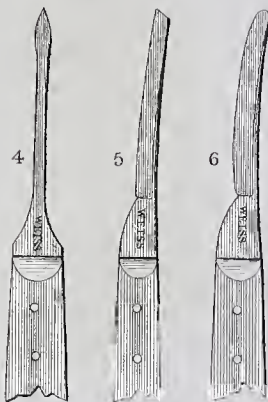

FULL-SIZE SCALE

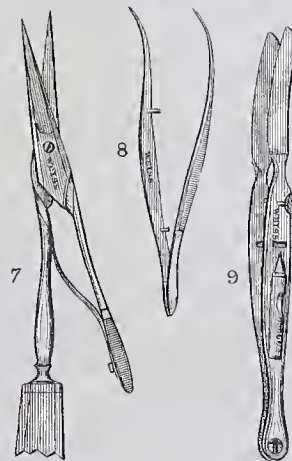

FULL-SIZE

ONE-THIRD SCALE

WEISS' CATALOGUE

PL. XLIV

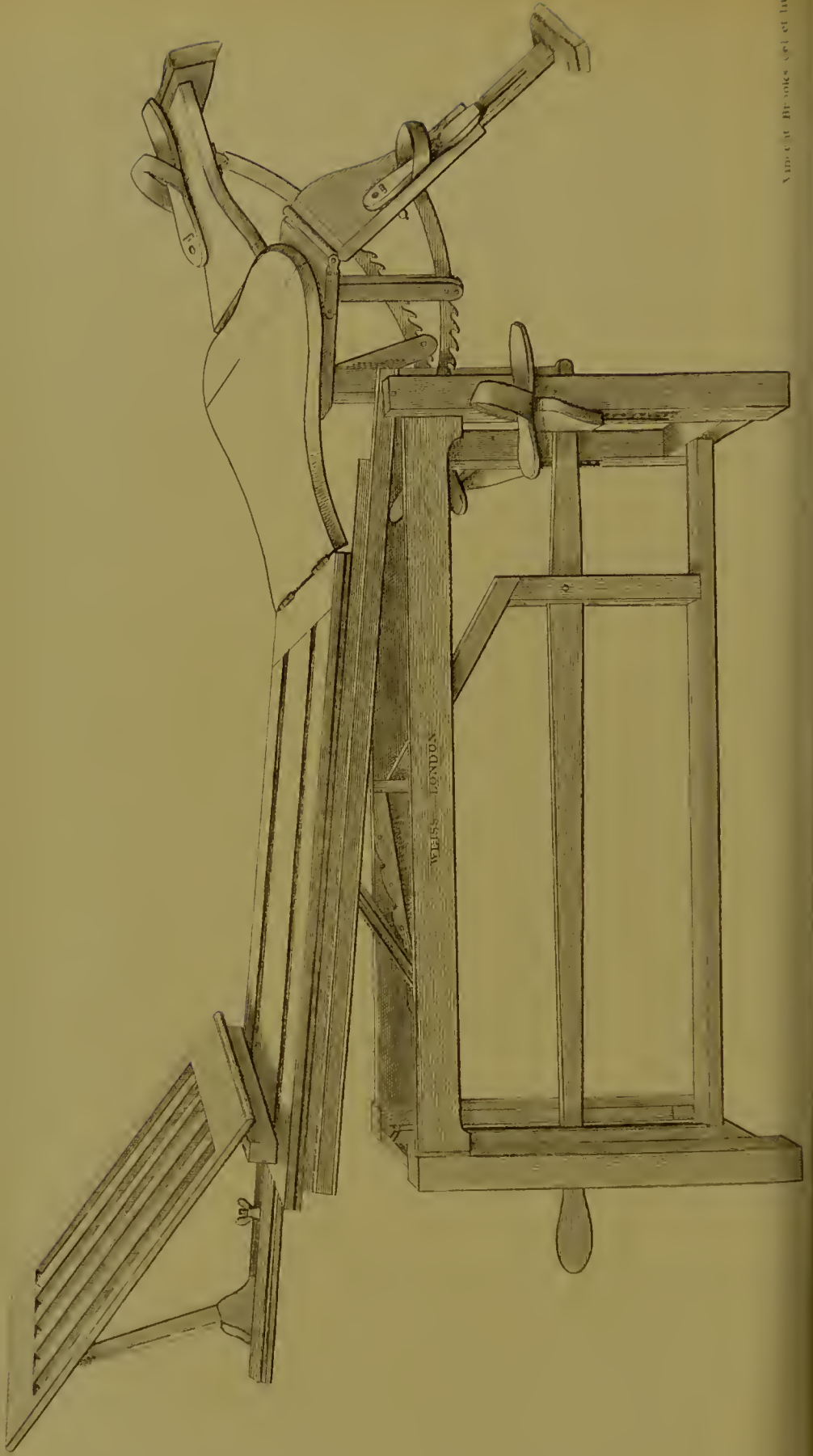

PLATE XLIV.

AN OPERATING TABLE, as used at most of the Metropolitan Hospitals.

By means of this table, the patient can be placed in any required position: the top is made in two parts hinged together, and either part can be raised independently of the other; the support for the back and head slides on the plane of the table, and can be fixed at any required angle; the shorter piece on which the lower part of the body rests is moved by a long lever, which hinges on an upright bar attached to the frame of the table. The supports for the legs revolve in the axis of the plane of the table, and are raised and depressed by a rack action.

This table is frequently made without the revolving action of the supports for the legs, this being only used for female examinations and operations.

PLATE XLV.

SPLINTS AND FRACTURE APPARATUS.

Figure

1 LONSDALE'S SPLINT for fractured Patella.

By the use of this splint the fractured parts are kept in apposition by the two crescent-shaped pads sliding upon the upright bars, and fixed down upon the limb by set screws.

2, 3, 4, 5 CLINE'S ARM SPLINTS.

6 HEATH'S SPLINT for excision of the Elbow Joint.

This splint consists of two padded metal plates, attached by upright pieces to a cross bar; this is placed on the upper side of the arm, and a similar one below, and the two are fastened together by straps and buckles. The bar is jointed in the centre, by which motion can be made with the greatest facility, and it has a right and left screw at either extremity, which, passing through female screws in the upright pieces, enables the operator to separate the ends of the bones to any extent he may require.

7 GRANTHAM'S SPLINT for the Humerus, and WEISS' JOINTED SPLINT for the Elbow.

These two splints are frequently used together, as they give great support to the arm in fractures of the humerus; but they can be separated should the elbow splint alone be required, and may be adjusted for either side.

8 JOINTED ELBOW SPLINTS, made of Perforated Zinc.

These are made in sets of six, of three different sizes.

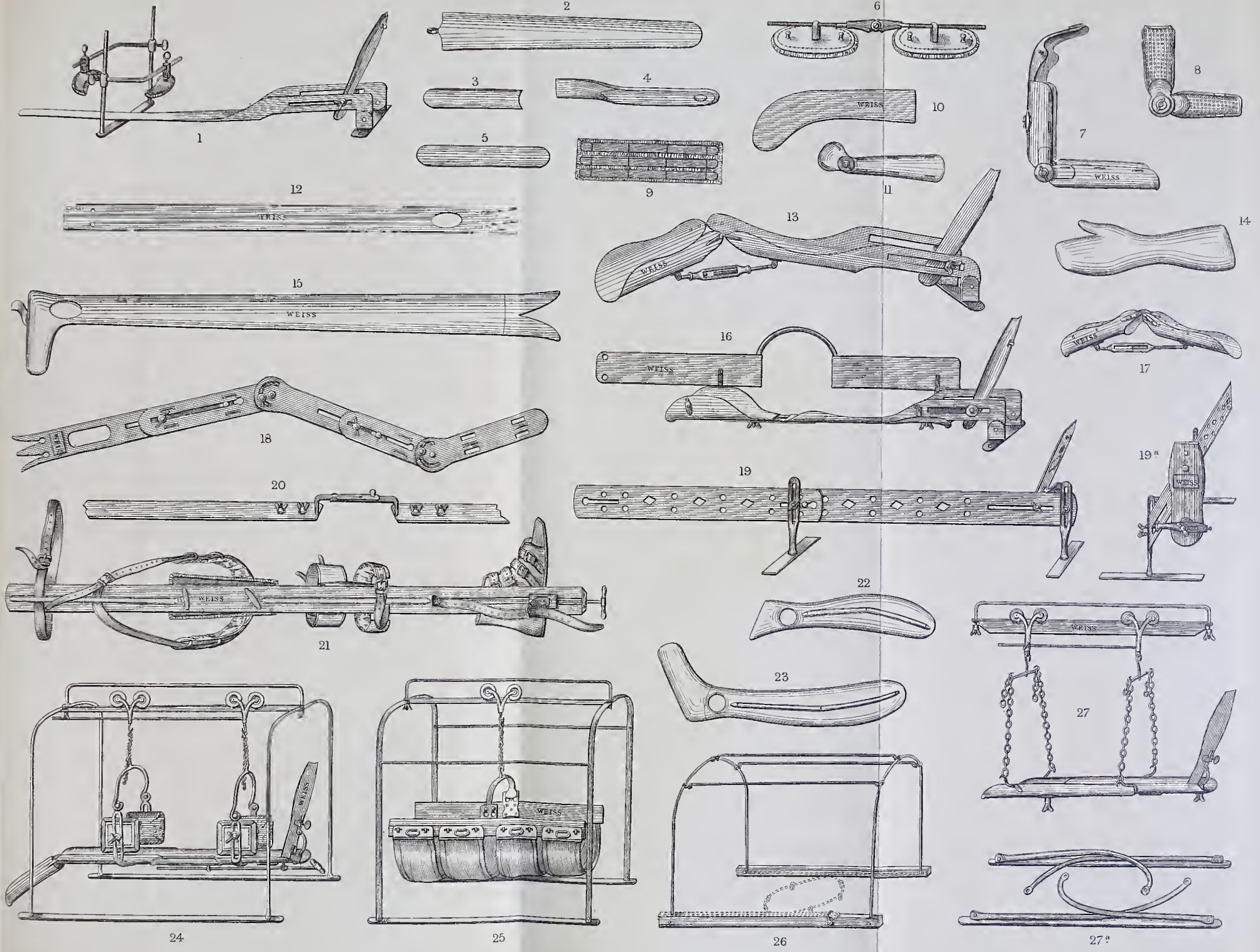

WEISS' ILLUSTRATED CATALOGUE.

Figure

9 PADDED or CRIMEAN SPLINTS.

These splints consist of pads, covered with waterproof or other material, supported by metal ribs, placed longitudinally; they are attached to the limb by straps and buckles, and as, from their flexibility, they embrace the limb at all points, they give a very efficient support.

10 NELATON'S RADIUS SPLINT.

11 WEISS' do. do.

By means of this splint the hand can be set at any required angle; the lower part being jointed upon the upper and fixed by set screws; they are made in sets of three.

12 LISTON'S THIGH SPLINT.

These are made in sets of three, either with or without pads and rollers.

13 LISTON'S LEG SPLINT or DOUBLE INCLINED PLANE.

This splint is also known as Macintyre's, of which it is a modification; it is also made with extending pieces at the thigh and ankle; there are three sizes to a set.

14 PEMBERTON'S HAND SPLINT.

These splints are made in pairs, and of various sizes.

15 DESSAULT'S SPLINT for the Thigh.

To this splint belongs an inner splint; they are sold in pairs, right and left, of different sizes.

16 FERGUSSON'S SPLINT for Excision of the Knee Joint.

17 SPLINT for Contracted Knee.

18 BUSK'S THIGH SPLINT.

This splint being jointed at the knee and the hip, the patient can be placed in any position his case admits of.

19, 19a FERGUSSON'S LEG SPLINT.

Fig. 19a represents the end of the splint, and is intended to show that the footboard may be moved in any direction that may be required.

WEISS' ILLUSTRATED CATALOGUE.

Figure

20 INTERRUPTED THIGH SPLINT.

The clamp which joins the two parts of the splint may be adapted to any ordinary splint, as it is fixed with thumb screws.

21 BULLEY'S EXTENSION SPLINT.

This splint is a modification of Boyer's, but the traction is divided by means of a circular band passing round the thigh, just above the patella, and attached to a strap reaching to the footboard, where it is fastened; it is also furnished with a small splint for preventing excurvation of the thigh; this is placed inside the long splint, and is regulated with the greatest exactness by three screws.

22, 23 CLINE'S LEG SPLINTS.

24 GREENWAY'S FRACTURE CRADLE.

This is an adaptation of Macintyre's splint to the sling. Extension is made by the screw underneath, and the limb is kept in its place by the adjusting pads, which are placed just below the knee and above the ancle; thus obviating the necessity for the use of side splints.*

25 SALTER'S LEG SLING.*

26 WEISS' PORTABLE BED CRADLE.

This cradle may be packed in a small compass, as shown by the dotted lines.

27 WEISS' FRACTURE CRADLE.*

The splint is suspended in a manner similar to fig. 24. Fig. 27*a* shows the cradle or sling folded up.

* These cradles fold up as fig. 27*a*.

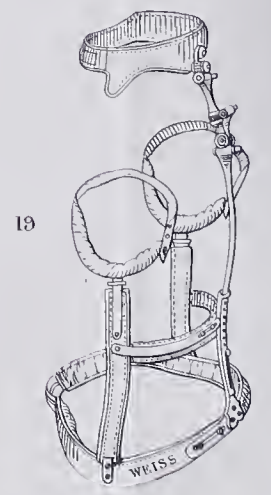
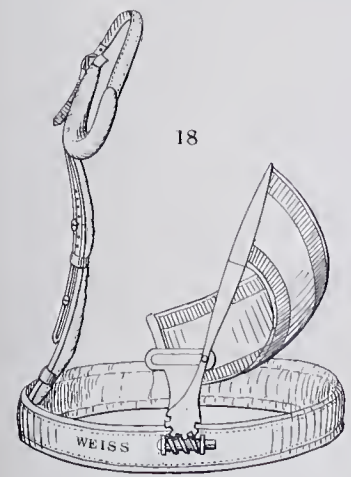
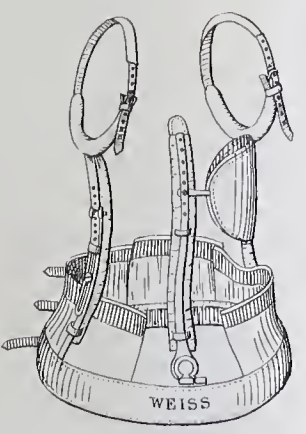
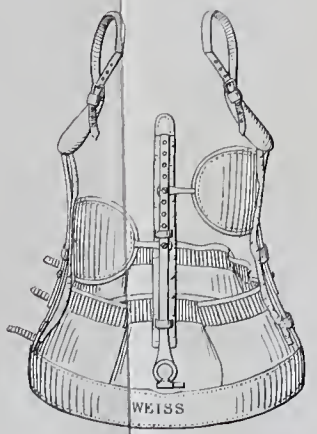
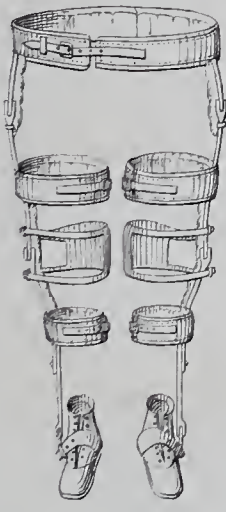
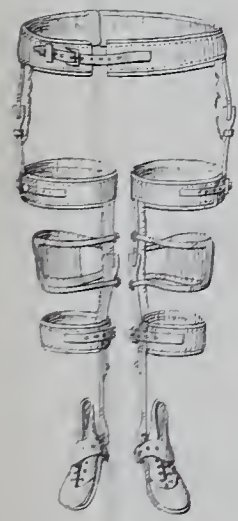
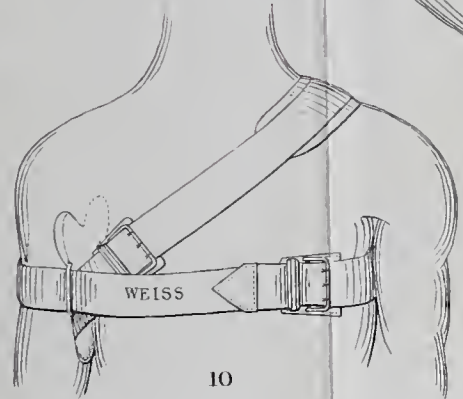
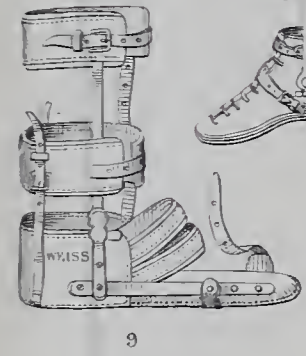
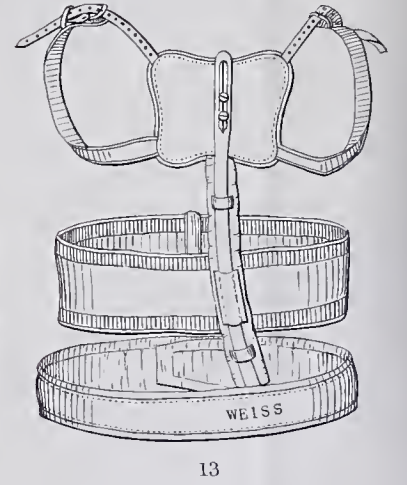
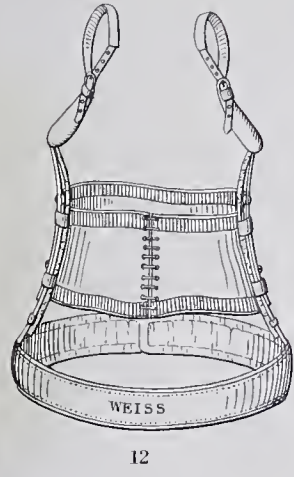
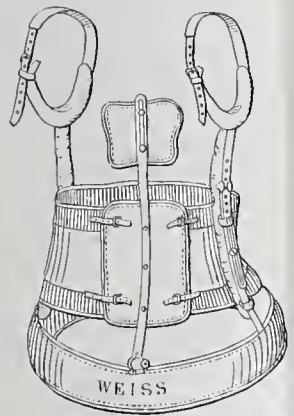
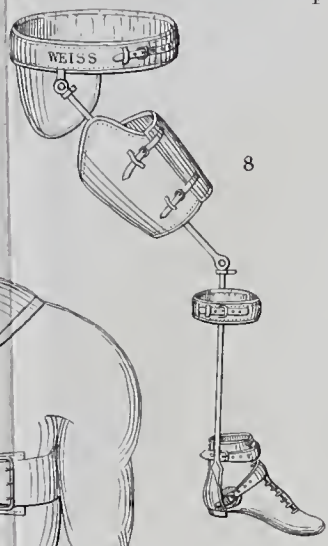
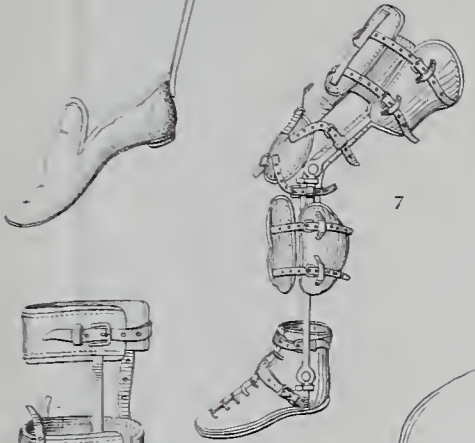
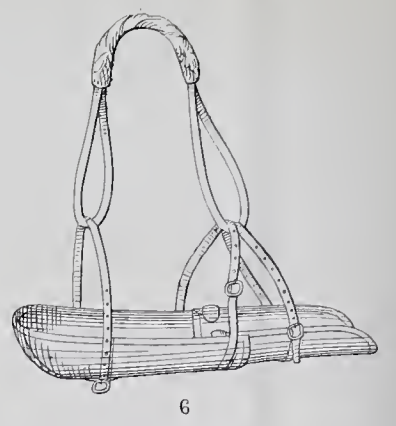
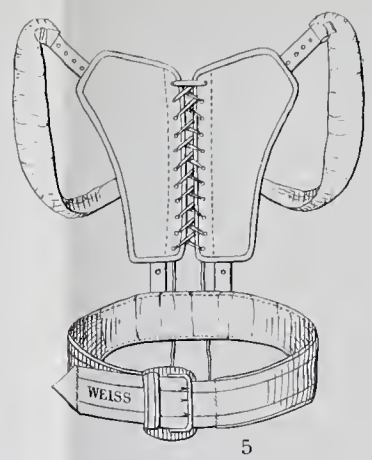
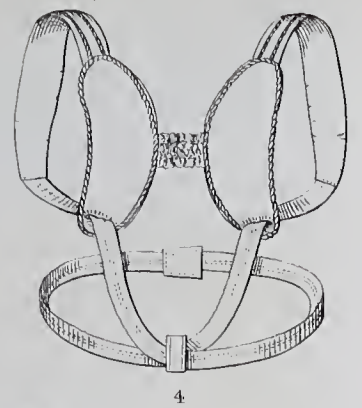
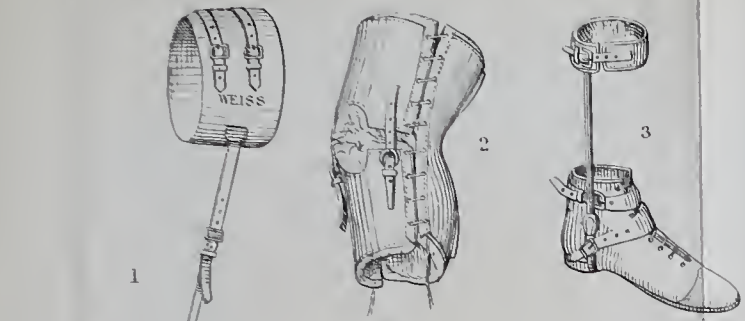

14

15

16

17

18

19

PLATE XLVI.

INSTRUMENTS FOR DEFORMITY, ETC.

Figure

- 1 BANDAGE AND SLIPPER for Ruptured Tendo Achilles.
- 2 SOLID LEATHER KNEE CAP for giving support to the Knee in cases of severe injury.
- 3 INSTRUMENT for Talipes Varus and Talipes Valgus.
- 4 CHEST EXPANDER.
This consists of two straps passing round the shoulders, crossing upon the back, and buckled round the waist; they are attached to and pass through two light pads pressing upon the shoulder blade, and connected by an elastic band, which allows of the motion of the shoulders, but checks any attempt at stooping by rendering it more agreeable to sit upright.
- 5 BRASDOR'S APPARATUS for Fractured Clavicle.
- 6 ARM SLING.
- 7 INSTRUMENT for Contracted Knee.
- 8 Do. Diseased Hip.
- 9 SCARPA'S SHOE for Club Foot.
- 10 ELLIS' APPARATUS for Fractured Clavicle.
This consists of a well-padded crutch to support the shoulder, with belts round the chest and across the opposite shoulder to keep it in position.
- 11 SPINAL APPARATUS for Inward Curvature.
- 12 Do. do. Angular or Outward Curvature.
- 13 Do. do. Dorsal Curvature.
- 14 APPARATUS for Bow Legs.
- 15 Do. Knock Knees.
- 16 Do. Double Lateral Curvature of the SPINE.
- 17 Do. Single do. do.
- 18 LONSDALE'S APPARATUS for do. do.
- 19 SUPPORT for Wry Neck, or for severe injury from a Burn.

PLATE XLVII.

FRACTURE BEDS, INVALID CHAIRS, AIR AND
WATER CUSHIONS.

Figure

- 1 CRESCENT-SHAPED WATER CUSHION for the Sacrum.
- 2 CIRCULAR CUSHION to sit on.

These are made both for water and air.

- 3 INVALID CHAIR.
- 4 AIR CUSHION for the seat and back of an ordinary chair.
- 5 BED CHAIR or REST for supporting invalids while sitting up in bed.
- 6 EARLE'S ORIGINAL FRACTURE BED.
- 7 INVALID MATTRASS.

These mattresses are made both for water and air.

- 8 BED for spinal complaints.
- 9, 9a EARLE'S IMPROV'D FRACTURE BED.

The improvement consists in the substitution of screw power for changing the position of the patient; the motion is gradual and safe, and free from the jerking inseparable from the raising or lowering by hand; it also allows of the change being made by one person; a reading case is attached to the bed. The two engravings illustrate the different positions of the bed.

- 10 A SPINAL CUSHION for Water or Air.

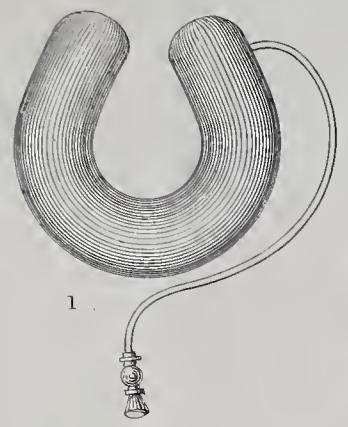

1

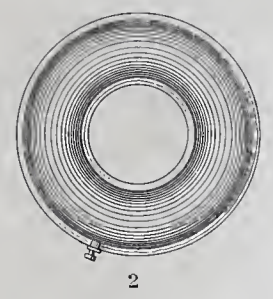

2

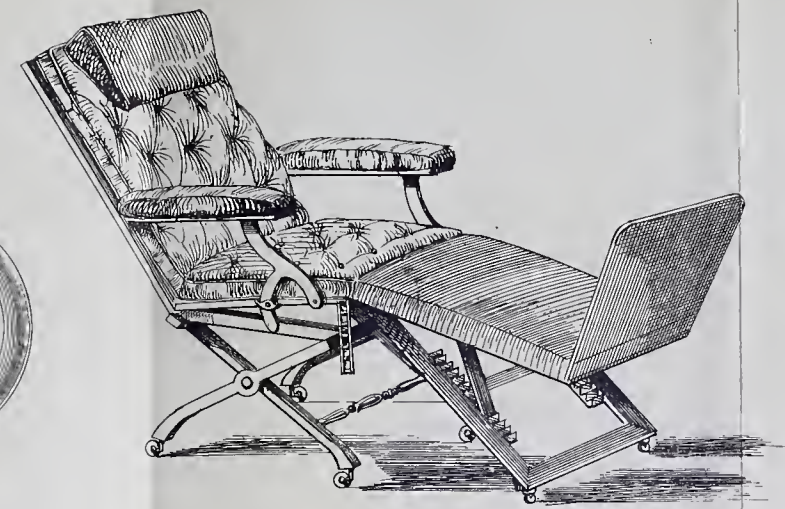

3

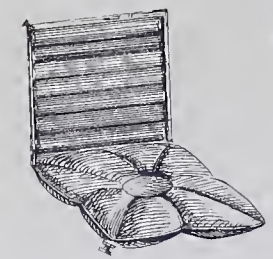

4

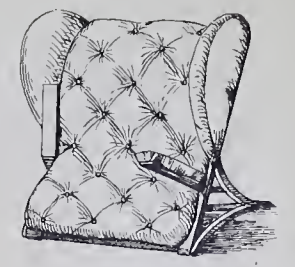

5

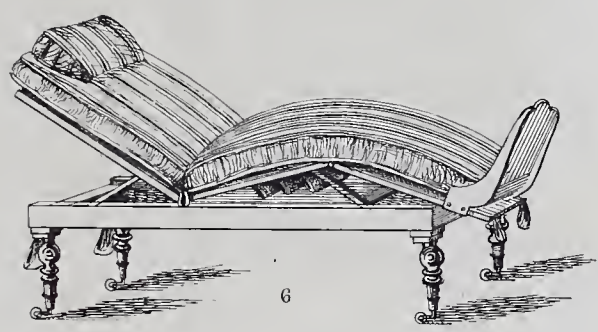

6

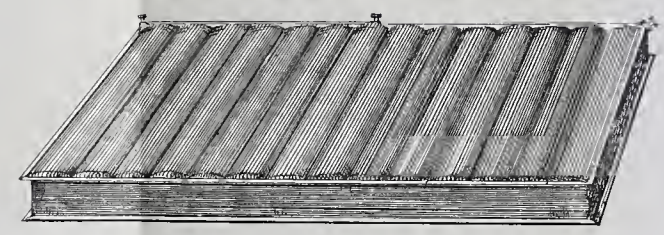

7

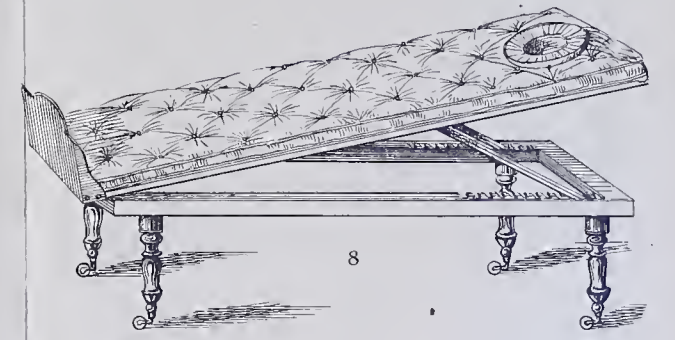

8

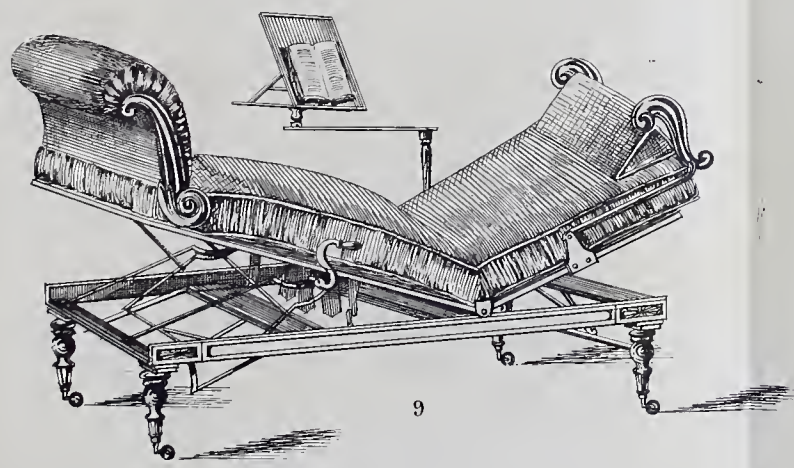

9

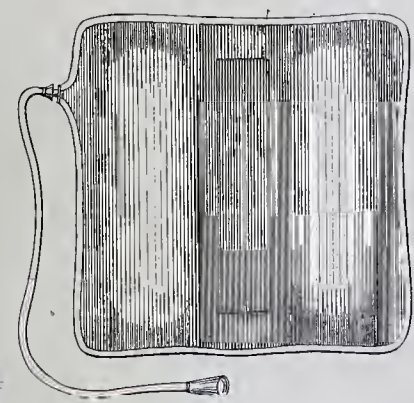

10

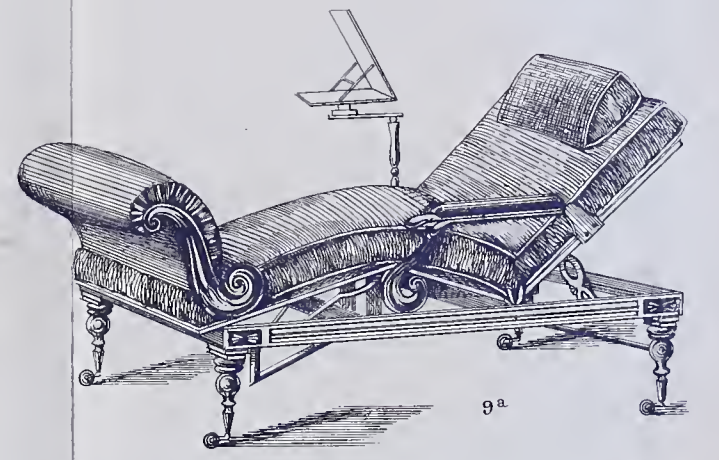

9a

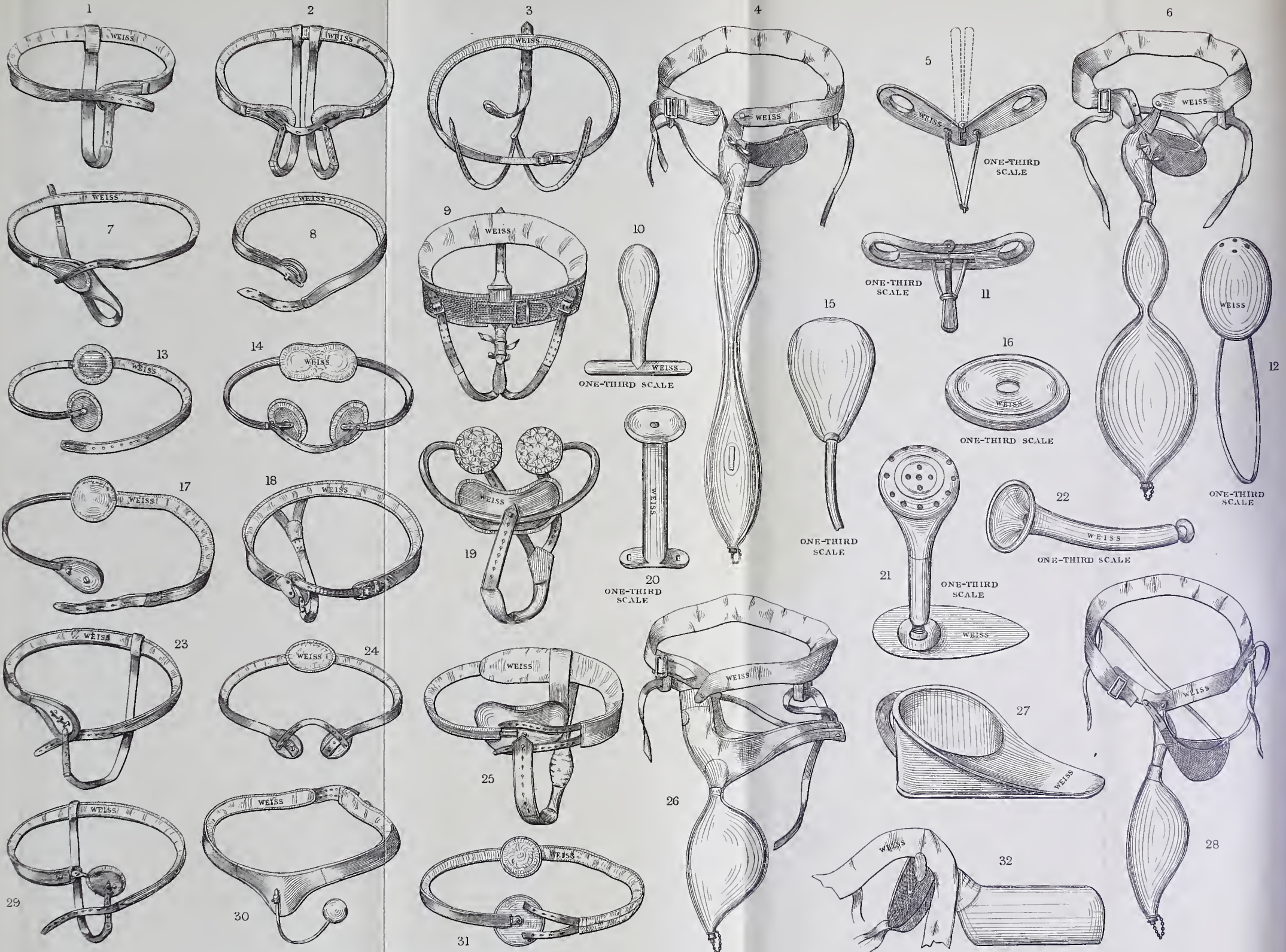

ONE-NINTH SCALE, WITH EXCEPTION OF THOSE ESPECIALLY MARKED.

PLATE XLVIII.

BELTS, TRUSSES, PESSARIES, AND URINALS.

Figure

1 ORDINARY TRUSS, single.

This truss, when properly made and fitted to suit the requirements of the case, rarely fails to answer its desired purpose. The spring should entirely encircle the body.

2 ORDINARY TRUSS, double.

3 PROLAPSUS ANI TRUSS.

A narrow spring band encircles the pelvis, and supports a double-spring with a pad attached to it, which keeps up the prolapsus. Light under straps are attached to the under spring of the pad and fasten to the front of the pelvis band.

4 GENTLEMAN'S DAY URINAL.

A suspender of the required dimensions buckled round the pelvis supports the urinal; the latter is of sufficient length to reach to the ankle, and thus enables the wearer to empty the bag by unscrewing the small cap at the bottom, to which it is secured by a light chain. A valve is placed in such manner that any return of the urine is entirely prevented; and a band, which passes through a loop in the lower part of the bag, encircles the calf to keep the urinal in its place.

5 WEISS' MODIFICATION of ZWANKE'S PESSARY.

This pessary is made of box-wood or ebonite, jointed in the centre and supported by two metal stems; the branches are kept apart by a metal loop attached to the extremity of one of the stems, and for the facility of introduction they can be closed, as shown by the dotted lines.

6 GENTLEMAN'S NIGHT URINAL.

The construction of this urinal is similar to that intended for day use, the only difference being in the form of the bag.

WEISS' ILLUSTRATED CATALOGUE.

Figure

7 TRUSS FOR SCROTAL HERNIA.

This truss differs from the ordinary truss, fig. 1, inasmuch as the pad is made much longer, the elongated portion being soft and conical in form, and well adapted to assist in keeping up the rupture. This, however, is only requisite in very bad cases.

8 TEALE'S TRUSS.

The peculiarity of this truss consists in the pad, which is attached by means of a coiled spring, and thus adapts itself readily to the motion of the body.

9 PROLAPSUS ANI BELT.

This belt differs from the prolapsus ani truss, inasmuch as there are no springs employed. A band of about three inches in width encircles the body and supports the prolapsus by means of an under strap supplied with an ivory or sponge pad, which is easily detached for cleaning.

10 PROLAPSUS ANI PLUG or PESSARY.

11 ZWANKE'S PESSARY.

The description given of fig. 5 applies also to this instrument, with the exception that the branches are kept open by a screw movement, instead of a simple loop.

12 EGG-SHAPED PESSARY.

These pessaries are made in sets of six, varied in size, and are made both in gum and box-wood.

13 SALMON and ODY'S TRUSS, single.

This truss differs from most of the others, the spring being worn on the opposite side, and passing along the front of the body to the rupture; the pad is attached to the spring by a ball and socket joint, which allows of its yielding to the motion of the body; the back pad is a fixture.

14 SALMON and ODY'S TRUSS, double.

In this truss the spring does not cross the body, but is put on in the ordinary way, the pads having the same amount of mobility as in the single one.

15 INFLATING PESSARY of india-rubber.

The advantage which this pessary offers is, facility of introduction, and great comfort to the wearer. The engraving shows a portion of the tube, by means of which the pessary is inflated.

WEISS' ILLUSTRATED CATALOGUE.

Figure

16 FLAT RING PESSARY.

These pessaries are made in gum, india-rubber, and box-wood, in sets of six, varied in size, and are made both oval and circular.

17 COLE'S TRUSS.

The pad of this truss has an inner concealed spring for the purpose of giving an uniform support along its whole length.

18 MOC-MAIN TRUSS.

This truss, unlike those commonly used, has no spring in the band round the body; the pad is kept to its work by means of a lever spring, and is secured by the under strap below.

19 PHELPS' BELT FOR PROLAPSUS UTERI.

This belt consists of a well-hollowed abdominal pad, which is attached to a spring intended to pass over and above the hips, and terminating in two circular pads, which make counter pressure on either side of the back. An under strap, which is attached to the back pads, supports the prolapsus, and the abdominal pad, from its peculiar formation, is found to give great relief by supporting the abdomen.

20 SCHOLFIELD'S PESSARY.

This instrument is made of earthenware, being, in fact, a mere stem, terminating at one end in a cup, and attached to a pelvis band by elastic straps.

21 DUFFIN'S PESSARY.

This pessary consists of a stem with a globular extremity, the upper portion being slightly concave, and perforated with a series of holes: the other end of the stem is attached to a flat plate or shield by means of a ball and socket joint, and fits into a slip or pocket made in an under strap attached to a pelvis band. The pessary is supplied with and without the latter, and is made both in ivory and boxwood.

22 COXETER'S GUTTA PERCHA STEM PESSARY.

A hollow'd and curved stem, having a cup at one end, and a neck at the other extremity, to which the under straps and pelvis band are attached.

WEISS' ILLUSTRATED CATALOGUE.

Figure

23 EDWARDS' TRUSS.

In this truss the pad can be adjusted to any required angle and also elongated in some degree. To effect this the plate in connexion with the spring is pierced by longitudinal and transverse slots, while the pad, which is detached, has two small screws sliding within these slots.

24 DARTNELL'S TRUSS.

25 HULL'S UTERO ABDOMINAL SUPPORTER.

This consists of a front pad, slightly hollowed, which supports the abdomen by means of a spring to which it is attached. The latter ends in a pad, which makes counter-pressure on the sacrum. The covering of the spring is continued round the body and fastens to the abdominal pad, while an under strap, which is buttoned to both pads, supports the perinium. This belt has now been employed for many years, and is greatly approved of.

26 FEMALE URINAL for day use.

The urinal is supported by a band, which is fastened round the pelvis in the same manner as the male urinals.

27 BED SLIPPER, of earthenware.

28 SHORT MALE URINAL.

This urinal differs from figs 4 and 6 only in its length.

29 WEISS' TRUSS.

The pad of this truss may be adjusted to any angle by means of a screw ratchet.

30 BELL'S UTERINE SUPPORT.

This consists of a covered spring belt, to which is attached a curved stem sliding upon the belt, terminating in a ball made of box-wood. The latter supports the uterus.

31 UMBILICAL TRUSS.

An umbilical pad, varying in size according to the necessities of the case, is attached to one end of the spring, and a pad for counter-pressure at the other. The spring is kept in its place by a strap passing from and attached to each of the pads.

32 WEISS' URINAL for night use.

This is made of glass, covered with flannel, and attached to the body by a suspender.

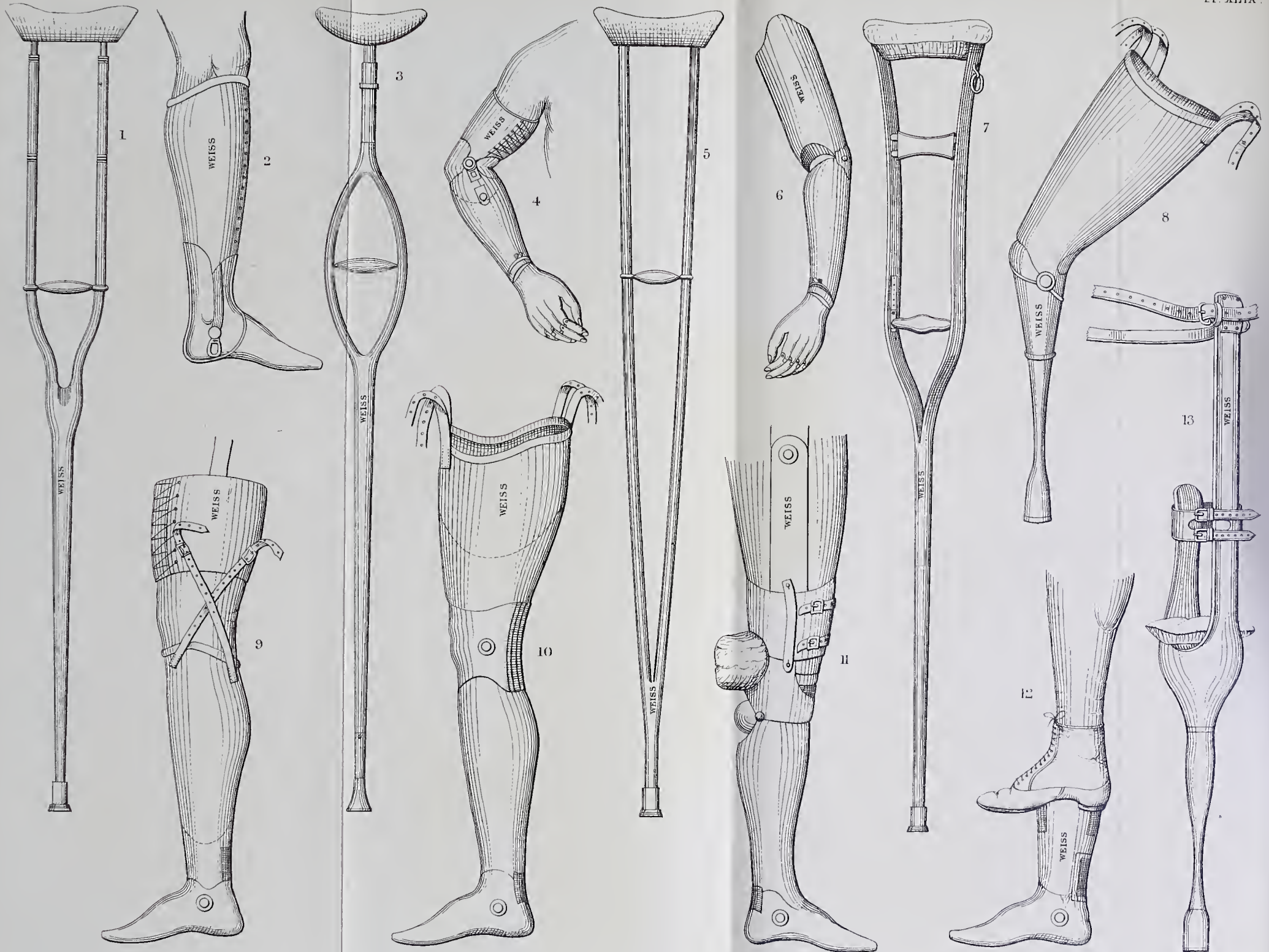

ONE-NINTH SCALE

Vincent Brooks del.

PLATE XLIX.

ARTIFICIAL LIMBS AND CRUTCHES.

Figure

- 1 DOUBLE SPRING CRUTCH.
- 2 ARTIFICIAL LEG for Syme's Operation at the Ankle.
- 3 SINGLE SPRING CRUTCH.
- 4 ARTIFICIAL ARM for Operation below the Elbow.
- 5 DOUBLE STICK CRUTCH, without springs.
- 6 ARTIFICIAL ARM for Operation above the Elbow.
- 7 IMPROVED CRUTCH, with elastic head.
- 8 SOCKET LEG, with KNEE JOINT for Operation above Knee.
- 9 ARTIFICIAL LEG for Operation below Knee.
- 10 Do. do. above Knee.
- 11 Do. do. below Knee, where the joint is contracted or the stump is too short to be of service.
- 12 ARTIFICIAL FOOT for Shortened Limb, where the deficiency is sufficiently great to allow of it.
- 13 KNEELING PIN LEG.

PLATE L.

DIRECTIONS FOR MEASUREMENT OF BELTS,
BANDAGES, ETC.

For SILK, COTTON, and LAC'D ELASTIC ANGLE SOCKS.

The circumference at A, B, and C.

For STOCKINGS.

The circumference at A, B, C, D, and E, and the height from B to E.

For KNEE CAPS.

The circumference at E and F.

For THIGH PIECES.

The circumference at F and G, and the length from F to G.

For SILK, ELASTIC, and SPIRAL SPRING BELTS.

The circumference at H, I, and K, and the depth from the lower part of the abdomen to an inch and a half above the navel.

For PROLAPSUS ANI BELTS.

The circumference round the pelvis.

For SUSPENDERS.

The circumference round the pelvis.

For TRUSSES.

The circumference round the pelvis, and stating the side of the rupture.





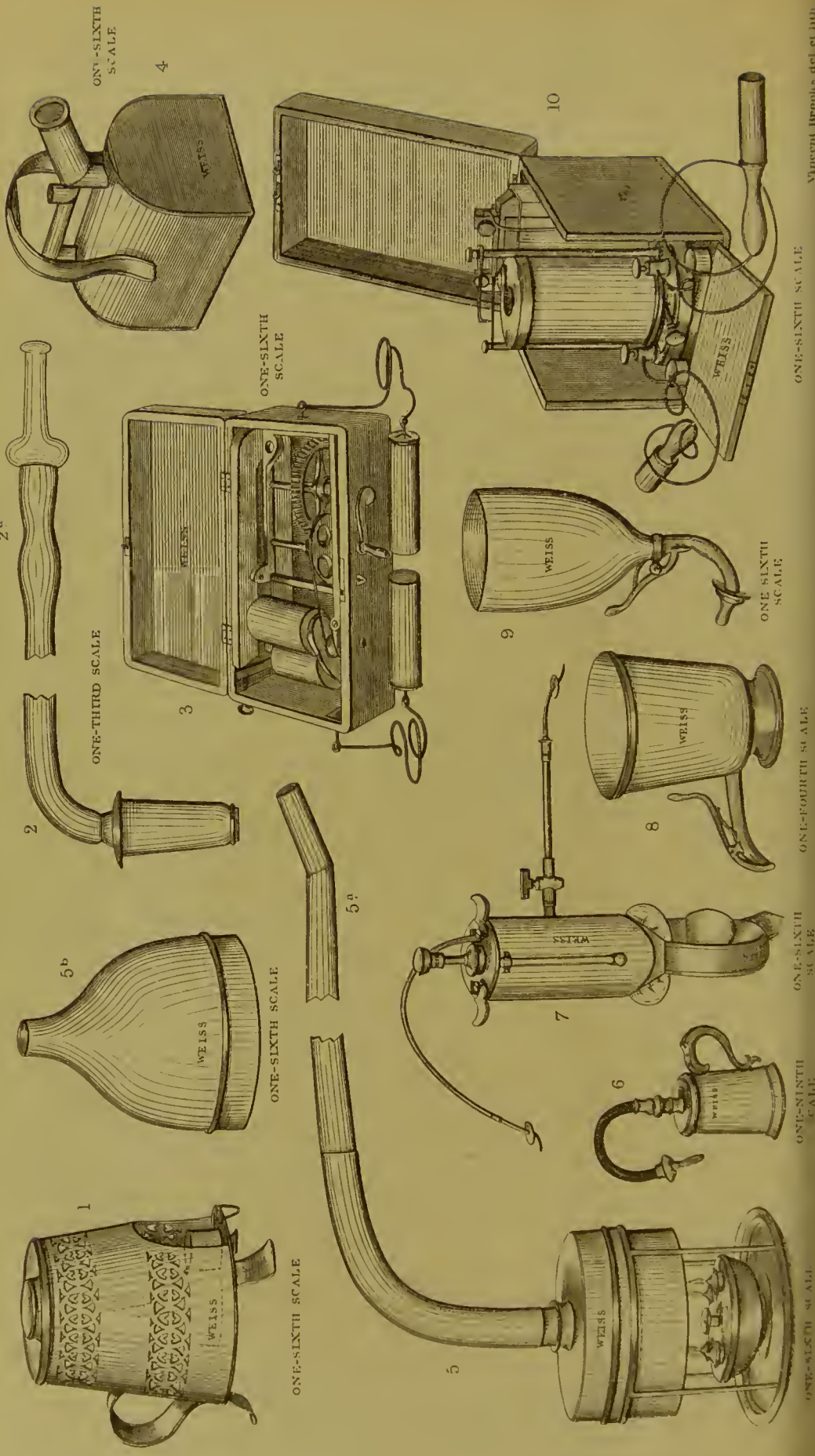

PLATE LI.

DOMESTIC APPLIANCES, ETC.

Figure

1 LEE'S MERCURIAL FUMIGATOR.

This apparatus is made of tin, perforated for the admission of air, having a hollowed top with a small raised saucer in the centre, and a spirit-lamp below. The mercury being placed in the saucer, and the surrounding part filled with water, the lamp is lighted, and the fumes given off by the mercury mingle with the steam.

2 INHALATION TUBE for Carbonic Acid Gas.

This consists of a hollow metal stopper, covered with india-rubber, made to fit an ordinary wine bottle; to this is attached an india-rubber tube with a glass mouthpiece at its other extremity. The elastic tube is of convenient length, being represented in two parts to economise space.

3 ELECTRO MAGNETIC BATTERY.

4 WATSON'S INHALER for Medicated Steam.

5, 5a, 5b DUVAL'S Hot Air and VAPOUR BATHS.

This apparatus is made of copper, and consists of a spirit-lamp with four wicks, a reservoir to contain water, a dome-shaped cover (5a) for hot air, and a tube for conveying the vapor or steam into the bed. When taken upon a chair, a loose wrapper or cloak is required to be put over the patient, and when used in bed, a cradle to support the bed-clothes is found very serviceable.

In administering medicated baths, the sulphurous acid vapour is obtained from the decomposition of sulphuric acid by sawdust and heat; the chlorine vapour, from the chlorides and hydrochloric acid; the vapour of mercury, by dissolving a small quantity of bichloride of mercury in the water; and the sulphuretted hydrogen gas, from the sulphuret of potash by acetic acid, or from the sulphuret of iron by dilute sulphuric acid.

WEISS' ILLUSTRATED CATALOGUE.

Figure

6 MUDGE'S INHALER for Medicated Steam.

7 TRANSFUSION APPARATUS.

The apparatus is attached to the arm of the patient by means of a band and buckle ; it consists of a syringe, surrounded by two chambers, one intended to receive the blood, the other warm water to keep the blood at a proper temperature. An elastic tube, with a fine silver pipe attached to it, is inserted into the vein of the person being bled, and conveys the blood into the inner chamber. In connexion with the latter is a stopcock and elastic tube, which also terminates in a silver pipe to be inserted into the vein of the patient. A glass gauge, attached to the outer cylinder, indicates the quantity of blood in the chamber, when injecting into the vein.

8 HALPHEN'S INVALID DRINKING CUP.

This cup enables the patient to regulate or to check the flow of the liquid by pressing on the handle of the valve. The cup is made of German silver electro-plated.

9 WEISS' FEEDING CUP for INVALIDS and LUNATICS.

This cup, which is also electro-plated, is constructed to feed patients through the nose; a small ivory pipe to be inserted into the nostril is attached to one end of a piece of india-rubber tube, the other end being attached to the cup. A flute key valve presses the india-rubber against the metallic termination of the cup, thus stopping the flow of the liquid at the will of the operator.

10 ELECTRO-GALVANIC BATTERY.



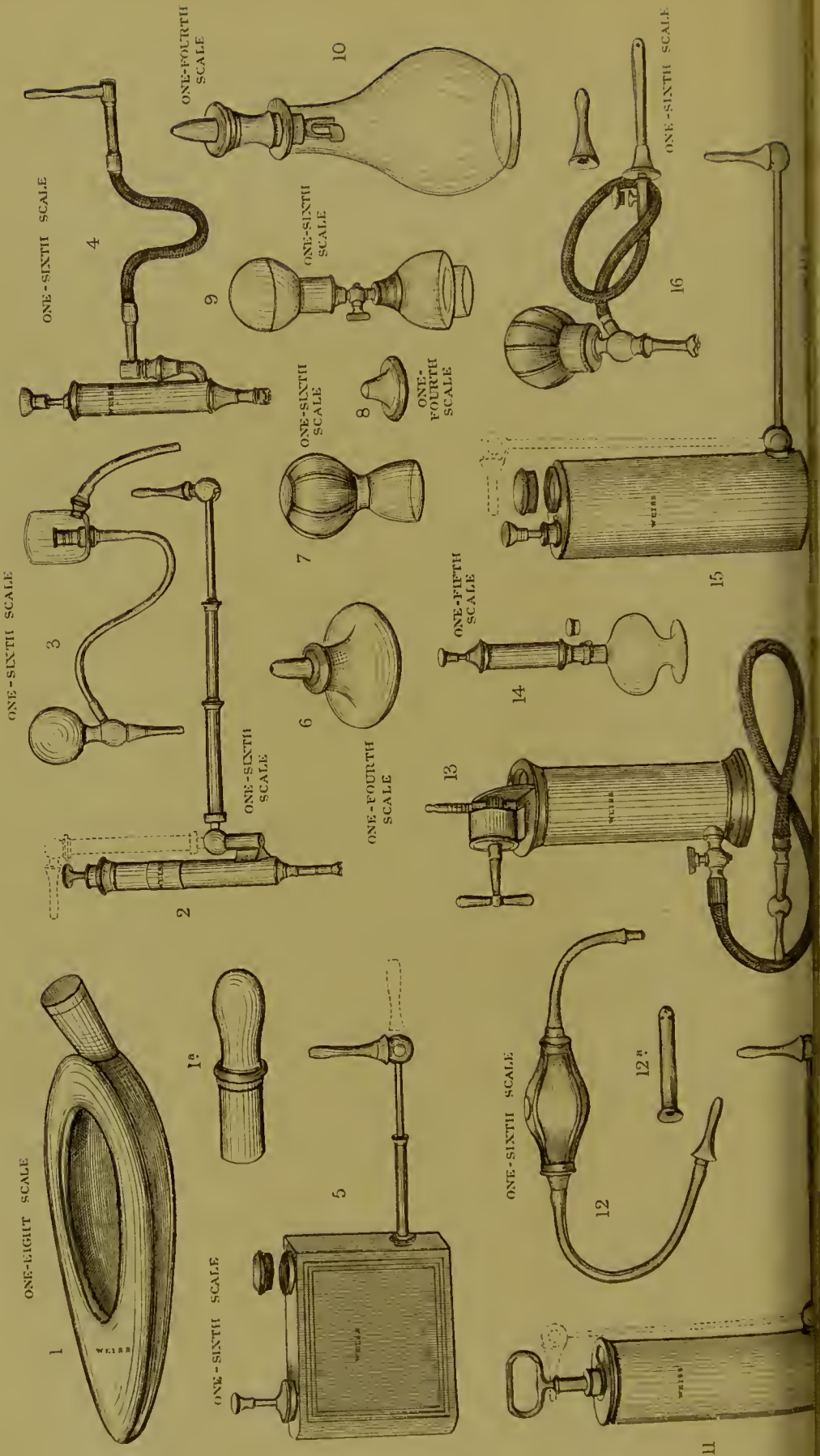

PLATE LII.

SYRINGES AND DOMESTIC APPARATUS.

Figure

1, 1a WEISS' IMPROVED BED PAN.

The wedge-shaped form of this pan considerably facilitates its use, as it obviates the necessity for lifting up the patient.

Fig. 1a represents the handle, which fits into the tube at the end, and is taken out for cleaning; the pan is supplied with a cover for the opening.

2 ENEMA SYRINGE, with sliding metallic tube.

The dotted lines show the position of the latter when shut up.

The piston is of metal, and hence not likely to get out of condition from lying by.

3 EYE DOUCHE.

This douche consists of an elastic syringe, connected by an india-rubber tube with a glass cup for surrounding the eye while being used, and to this cup another tube is attached for carrying off the water.

4 ENEMA SYRINGE, with elastic tube.

This syringe is provided with an angular pipe for self-use, as shown in the engraving, as well as with a straight one to be employed by a nurse. Gum elastic pipes for the rectum and for the vagina can also be fitted.

5 PORTABLE RESERVOIR ENEMA SYRINGE.

The great advantage which reservoir syringes offer is, that besides being more convenient for use, no basin is required. The dotted lines in the engraving indicate that the pipe can be turned in any way, both for self-use and with the aid of another.

6 DARBOS' CORK NIPPLE SHIELD.

The most cleanly of any of the nipple shields yet invented.

WEISS' ILLUSTRATED CATALOGUE.

Figure

7 ELASTIC DRY CUPPING BOTTLE.

A strong india-rubber ball attached to a stout cupping glass.

8 WANSBROUGH'S METALLIC NIPPLE SHIELD or PROTECTOR.

These are much used by patients suffering from sore nipples, as they have a curative effect.

9 CAPRON'S DRY CUPPING INSTRUMENT.

An india-rubber syringe, with valves, which fits cupping glasses of various sizes; it is also used for drawing the breast.

10 DARBO'S FEEDING BOTTLE, with cork nipple.

The same remark applies to this as to the nipple shield.

11 SINGLE STROKE RESERVOIR ENEMA SYRINGE.

The whole contents of the syringe are injected by one stroke of the piston.

12, 12a HIGGINSON'S SYRINGE, with improved form of bott'

This syringe is made of india-rubber. Fig. 12a shows a female pipe, which fits on the one attached to the tube.

13 SELF-ACTING RESERVOIR ENEMA SYRINGE.

The liquid is injected with this syringe by means of spring pressure; to effect this, the stop-cock having been shut, the reservoir is filled from the top and the piston is wound up by the cross key; it is then ready for use, and on the stop-cock being opened, the fluid is forced out by a strong spring acting on the piston rod.

14 BREAST PUMP.

This consists of an air-pump, serewed on to a breast glass. The cap shown close to the syringe in the engraving is intended to screw on the glass when not in use.

15 DOUBLE-ACTION RESERVOIR ENEMA SYRINGE.

By means of this syringe the fluid is injected in a continuous stream.

16 KENNEDY'S ENEMA AND VAGINAL SYRINGE.

1 ONE-FOURTH SCALE

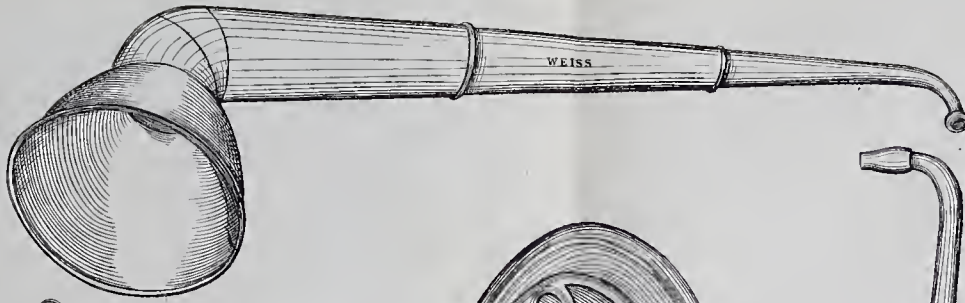

ONE-THIRD SCALE

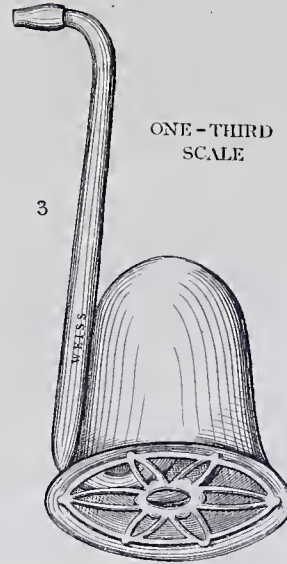

FULL SIZE

2

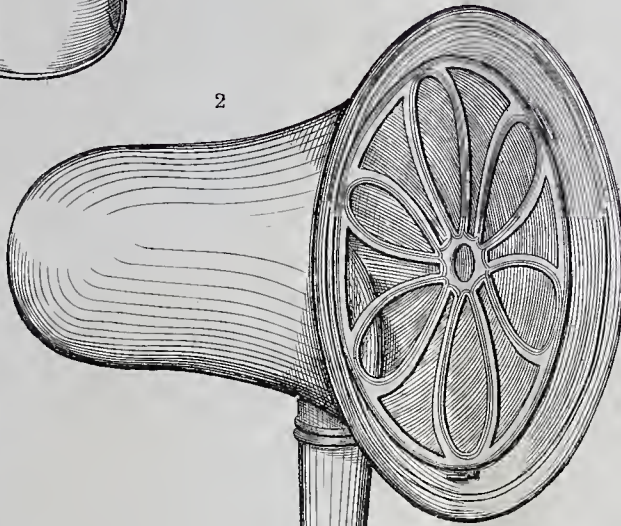

ONE-FOURTH SCALE

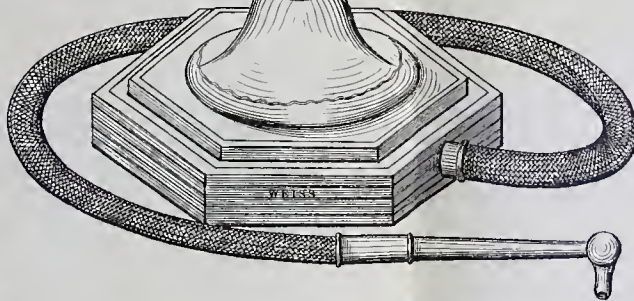

7

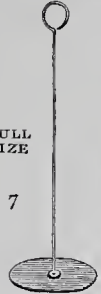

4

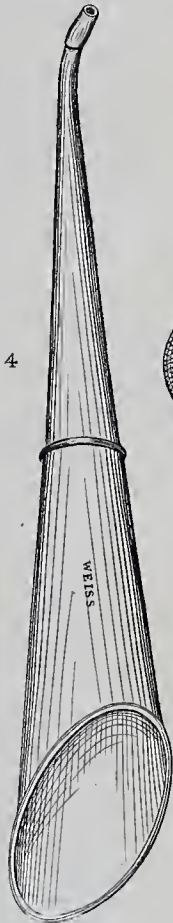

5

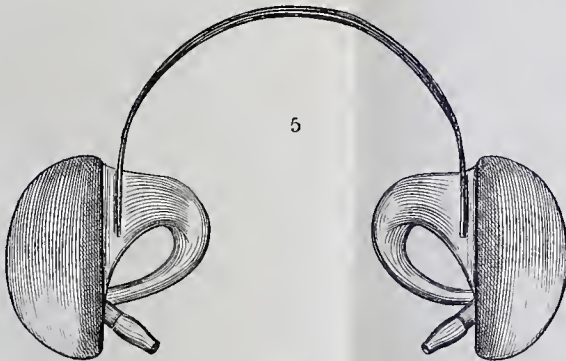

3

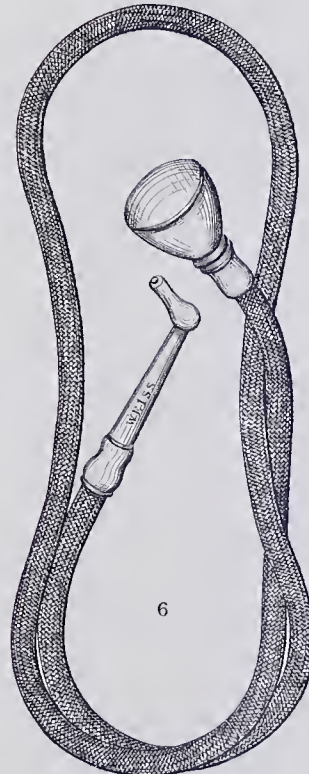

6

ONE-FOURTH SCALE

ONE-THIRD SCALE

ONE-THIRD SCALE

PLATE LIII.

ACOUSTIC INSTRUMENTS.

Figure

1 TELESCOPIC HEARING TUBE.

2 HEARING TRUMPET for the table.

3 MISS MARTINEAU'S HEARING TRUMPET.

These trumpets are made in bronzed metal, plated, and silver, and of various sizes.

4 ORDINARY TELESCOPIC HEARING TRUMPET.

5 HEARING CORNETS.

The spring connecting these cornets fits over the head, and can be adjusted to any size required; where one ear only is imperfect, a single one is used.

6 ELASTIC CONVERSATION TUBE.

The cups and pipes of these tubes are made in ivory, ebony, and silver, and the tubes themselves are made of various sizes and lengths.

7 TOYNBEE'S ARTIFICIAL TYMPANUM.

This little instrument is found perfectly successful in all cases where the tympanum has been ruptured.

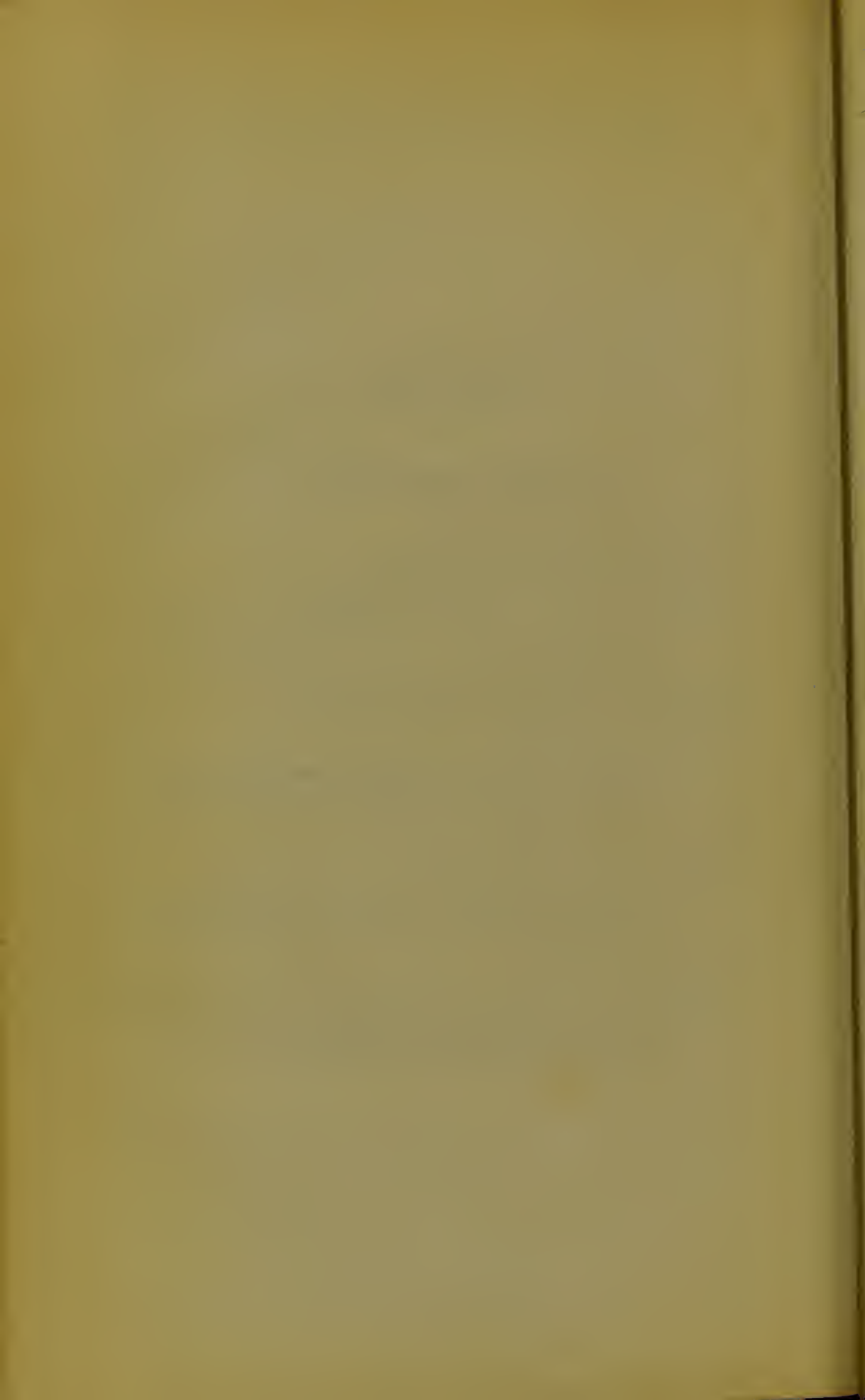

CLASSIFIED LIST.

INSTRUMENTS FOR AMPUTATION, RE-SECTION, NECROSIS, AND TREPANNING.

TOURNIQUETS.

- Tourniquet, by Petit fig. 3, pl. I.
 Do. by Signoroni fig. 1, pl. I.
 Do. Modified by Weiss fig. 2, pl. I.
 Do. by Skey fig. 6, pl. I.

Clamp Tourniquet.

This consists of a steel clamp, having a large counter-pressure pad attached to one end, the arterial pad being attached to a direct acting screw at the opposite end.

- Modification of the Clamp Tourniquet, by Weiss fig. 7, pl. I.
 Tourniquet for keeping up continuous Pressure fig. 4, pl. I.
 Field Tourniquet, by Weiss.

N.B.—All these tourniquets, with the exception of Petit's and the field tourniquet, are constructed to effect the same object, that of compressing the arterial without obstructing the venous circulation.

AMPUTATING KNIVES, SCALPELS, ETC.,

OF VARIOUS SIZES.

- Amputating Knives for the Flap Operation, by Liston, fig. 16, pl. II.
 Do. double edged, by Lisfranc fig. 15, pl. II.
 Do. for the Circular Operation fig. 18, pl. II.

Amputating Knives, by Morgan fig. 17, pl. II.

These knives are used either for the circular or flap operation.

Inter-Osseus Knives or Catlins fig. 19, pl. II.

Knives for Re-section, sharp and blunt-pointed. fig. 20, pl. II.

Scalpels in Fixed Handles, with Middle and Back Points,
figs. 12 and 13, pl. II.

Finger Knives, broad and narrow, by Liston . . . fig. 14, pl. II.

Do. by Lisfranc.

For shape of blade, see fig. 21, pl. XXXVIII.

The above knives are made both with black and ivory handles, chequered and smooth.

SAWS.

Amputating Saws, with and without extra Blades.

Do. with Weiss' Improvement . . . fig. 9, pl. III.

Do. by Fergusson.

The blade of this saw is considerably shorter and rather wider than that of the ordinary saw.

Bow or Frame Amputating Saw, for Amputation or Re-section,
fig. 10, pl. III.

Do. do. by Butcher . . . fig. 8, pl. III.

Do. for the Metacarpal Bone.

The shape is the same as fig. 10, pl. III., only smaller, and the blades are not usually made to turn to different angles.

Metacarpal Saw fig. 1, pl. III.

Trepanning and Necrosis Saws, by Hey, figs. 3, 4, 5, and 6, pl. III.

Necrosis Saw, with folding back, by Fergusson . . . fig. 2, pl. III.

Do. with fixed back do.

Do. Circular, by Heine, Phillips, and Weiss.

Chain Saw fig. 7, pl. III.

Do. mounted in frame, or Bow Saw.

BONE FORCEPS.

Bone Forceps, of various sizes, by Liston.

Do. do. with Eccentric Joint, fig. 7, pl. IV.

Do. angled, curved, and side cutting, by Fergusson,
figs. 1—5 and 10, pl. IV.

Do. of various shapes for removing portions of Bone
in Hare-lip, etc., by Butcher . fig. 18, pl. XL.

Do. ring-shaped for the Upper Jaw, by Liston.

Do. do. curved for the Lower Jaw do.
fig. 8, pl. IV.

Lion Forceps for steadying the Bone while using the Saw, Chisel,
or Gouge, by Fergusson . . . fig. 9, pl. IV.

Necrosis Forceps, of various shapes, straight and curved,
figs. 2 and 4, pl. IV.

Do. by Fergusson fig. 6, pl. IV.

Gouge Forceps for Necrosis fig. 3, pl. IV.

TREPINES, GOUGES, ETC.

Trepines, of various sizes, fitted in cross handles fig. 11, pl. V.

Do. semi-circular fig. 10, pl. V.

Do. small, for Necrosis fig. 12*b*, pl. V.

Multiplying Stock, fitted with Trepines and Osteotribes, or
Roseheads . . . figs. 12, 12*a*, and 12*b*, pl. V.

Osteotribes, or Roseheads, of various sizes, by Marshall, fitted in
straight and cross handles . figs. 5 and 14, pl. V.

Gouges, curved and straight, of various sizes,
figs. 1, 2, and 3, pl. V.

Chisels, of various sizes fig. 4, pl. V.

Scull Forceps fig. 9, pl. V.

Elevators, broad and narrow fig. 6, pl. V.

Do. double.

Retractors, of various sizes, in copper and plated.

Do. by Copeland Hutchinson fig. 8, pl. V.

Blunt Hooks, of various sizes.

Do. double fig. 7, pl. V.

Sharp Hooks, double and single.

Directors, of various sizes.

Do. for Re-section, with jointed handle . . . fig. 16, pl. XL.

ARTERY FORCEPS, ETC.

Tenaculum fig. 7, pl. II.

Do. by Assalini fig. 8, pl. II.

These are also made without handles.

Artery Forceps, by Dieffenbach fig. 9, pl. II.

Do. by Liston fig. 4, pl. II.

Do. by Luke fig. 10, pl. II.

Do. do. with Fenestrated Blades fig. 5, pl. II.

Do. by Weiss, with cross-action . . . fig. 11, pl. II.

Do. sliding.

Do. and Needle-holding Forceps . . . fig. 6, pl. II.

NEEDLES, SILK, ETC.

Curved Needles, of various sizes fig. 2, pl. II.

Curved pointed Needles do. fig. 3, pl. II.

Straight Needles, Triangular and Lancet Pointed.

Needles with two eyes for Wire Sutures.

Murray's Needles for do.

These needles have a hole drilled in a line with the stem, so that the wire offers no resistance in passing.

Hare-lip or Suture Pins, with and without heads.

Acu-pressure Pins, of various sizes, by Simpson . . . fig. 1, pl. II.

Ligature and Suture Silk, of various sizes.

Do. Thread.

Wire for Sutures, iron and silver.

EYE INSTRUMENTS.

KNIVES, ETC.

- Cataract Knives, by Beer fig. 9, pl. VI.
 Do. by White Cooper fig. 4, pl. VI.
 Do. by Dixon fig. 5, pl. VI.
 Do. by Sichel, long and short figs. 2 and 3, pl. VI.
 Do. by Tyrrell fig. 1, pl. VI.
 Convex Secondary Knives fig. 6, pl. VI.
 Concave do.
 Straight do. fig. 7, pl. VI.
 Iridectomy Knives, of various breadths and curves, by Jaeger,
 fig. 12, pl. VI.
 Do. do. straight do. fig. 11, pl. VI.
 Iris Knives, of various sizes, by Walton, three constituting a set,
 fig. 10, pl. VI.
 Knife for Extraction of the Soft Lens, by Walker fig. 13, pl. VI.
 Do. for the Punctum, by Bowman fig. 6, pl. IX.
 Guarded Knife for the Canaliculus, by do. fig. 8, pl. XL.
 Lever do., for cutting the Canaliculus laterally, do. fig. 9, pl. XL.
 Straight and Curved Knives for the Canaliculus, by Critchett
 and Weber.
 Knife for the Lachrymal Duct, by Walton fig. 1, pl. IX.
 Canula Lancet for the Canaliculus, by Bowman fig. 11, pl. X.
 Strabismus Knives, by Guthrie fig. 8, pl. VI.
 Knife and Scoop for Tarsal Cysts, by Bowman fig. 7, pl. XL.
 Scarifying Knives fig. 7, pl. IX.
 Scalpels, of various sizes fig. 2, pl. IX.

NEEDLES, HOOKS, CURETTES, ETC.

- Needles for Solution, by Beer fig. 1, pl. VII.
 Do. by Dalrymple fig. 2, pl. VII.
 Do. by Saunders, long and short, figs 3 and 4,
 pl. VII.

- Broad Needles, of various sizes fig. 5, pl. VII.
 Stop do. by Bowman fig. 6, pl. VII.
 Needles for Reclination fig. 8, pl. VII.
 Do. do. by Walton fig. 9, pl. VII.
 Needles, by Jacob fig. 7, pl. VII.

Do. for removing Foreign Bodies.

These are frequently combined with a small gouge or spud, used for the same purpose, and are made to slide within the handle, for the protection of the points, when carried in the ordinary pocket-case, fig. 10, pl. XXXVIII.

- Curettes, of various kinds figs. 4, 11, and 13, pl. IX.
 Do. guarded, by Walton¹ fig. 10, pl. IX.
 Lens Hooks, of various shapes figs. 10, 11, and 13, pl. VII.
 Do. guarded fig. 9, pl. X.
 Iris Hooks, of various shapes, figs. 12, 16, 17, 18, 19, 20, pl. VII.

Those by Tyrrell, figs. 17 and 18, are also made in platinum, as suggested by Mr. Bowman, to enable the operator to bend the stem to any required angle.

- Strabismus Hooks figs. 14 and 15, pl. VII.
 Hooks for fixing the Eyeball fig. 16, pl. IX.
 Scoops or Spoons by Schuft, of various sizes, for Iridectomy,
 figs. 9 and 10, pl. IX.
 Spuds for removing Foreign Bodies figs. 3 and 8, pl. IX.

The latter is made both in steel and platinum for the facility of bending.

- Gouge for removing Foreign Bodies, by Walton fig. 5, pl. IX.
 Director for Strabismus, by Guthrie fig. 12, pl. IX.
 Probe for the Nasal Duct, by Walton fig. 15, pl. IX.
 Do. do. right and left, by Gensoul.
 Probes for the Caniculus, in gold and silver, by Anel.
 Do. by Bowman figs. 12, 13, and 14, pl. X.
 Do. by Teale.

These are similar to Mr. Bowman's, but with bulbous points.

Probes, double, by Weber.

Dilator for the Canaliculus, by Bowman fig. 3a, pl. X.

Director for do. by Critchett fig. 15, pl. X.

Styles, by Bowman, Taylor, and Walton . figs. 5, 7, and 6, pl. X.

Syringes for the Lachrymal Duet, by Anel and Walton.

Caustic-holder for do.

Lid Retractors, by Walton fig. 14, pl. IX.

Do. by Desmarr fig. 4, pl. XI.

These are made of three sizes.

Do. of silver wire, of various sizes fig. 8, pl. XI.

Spring Specula, of various shapes and sizes, figs. 6 and 7, pl. XI.

Eyelid Spatula, in horn, ivory, or tortoise-shell fig. 13, pl. XI.

Hulke's Suture Needle fig. 17, pl. IX.

Suture Needles, of various curves and sizes.

Silk for Sutures and for Iridesis.

SCISSORS AND FORCEPS.

Canula Scissors for the Iris, by Wilde fig. 4, pl. X.

Curved do. for do. fig. 6, pl. VIII.

Angular do. do. by Maunoir fig. 7, pl. VIII.

Sickle-shaped do. fig. 2, pl. VIII.

Straight Scissors for the Canaliculus fig. 1, pl. VIII.

Do. with probe points for Strabismus, fig. 4, pl. VIII.

Do. with blunt do. do. fig. 3, pl. VIII.

Scissors for dividing the Nerve in extirpation of the Eyeball.

These are the same shape as fig. 6, but stronger,
and blunt-pointed.

Capsular Forceps, with straight and curved blades, figs. 2 and 3,
pl. X.

Do. with needle point fig. 1, pl. X.

Iris Forceps, curved and straight fig. 5, pl. VIII.

Do. by Schuft fig. 8, pl. VIII.

Forceps for fixing the Eyeball fig. 9, pl. VIII.

Do. broad pointed.

Forceps, double pointed, for fixing the Eyeball, by Streatfeild.

These forceps seize the eyeball in two places, and thus secure it more firmly.

Cilia Forceps fig. 10, pl. VIII.

Entropium Forceps figs. 9 and 10, pl. XI.

Do. by White Cooper fig. 8, pl. X.

Do. by Desmarr fig. 12, pl. XI.

Do. by Wilde fig. 11, pl. XI.

Forceps for removing Styles.

OPHTHALMOSCOPES.

Ophthalmoscopes fig. 14, pl. XI.

Do. mounted without handle.

Do. by Liebreich fig. 17, pl. XI.

Do. by Zehender fig. 19, pl. XI.

Do. by Weiss fig. 15, pl. XI.

Binocular Ophthalmoscope fig. 16, pl. XI.

Demonstrating do. by Liebreich fig. 1, pl. XII.

Concentrating Lenses fig. 18, pl. XI.

Do. with short handles.

Do. not mounted.

Lamps for the Ophthalmoscope, Laryngoscope, and Microscope,
fig. 2, pl. XII.

Do. for oil.

Optometers fig. 2, pl. XLII.

Laurence's Instrument for measuring the Eye.

Sets of Cataract Glasses, in horn frames.

Cases containing sets of Cylindrical Trial Glasses and Spectacle
Frame, adapted to hold the various glasses.

Do. with Spherical Glasses, etc.

Drums and Leather for testing Eye Knives, Needles, and Lancets.

Drop Bottles.

Phantome for demonstrating Operations on the Eye, by Jaeger.

Artificial Eyes.

INSTRUMENTS FOR THE MOUTH, LARYNX,
TRACHEA, ESOPHAGUS, ETC.

- Tongue Depressors, fixed and folding fig. 7, pl. XIII.
 Wedge-shaped Dilator for opening the Mouth fig. 3, pl. XIII.
 Speculum Oris, by Chassaignac fig. 11, pl. XIII.
 Do. by Weiss fig. 4, pl. XIII.
 Instrument for keeping the Mouth Open fig. 8, pl. XIII.
 Forceps for holding the Tongue fig. 3, pl. XXXII.

These are the same construction as those described
for tumours.

Laryngoscope, by Czermak,

figs. 1, 2, 3, and 5, pl. XI., and fig. 1, pl. XL.

Since the engravings were executed, the laryngeal
mirrors are made to slide in and out of the
handle, for the convenience of regulating their
length: the various instruments go into a very
small case.

Brushes, mounted on ebony, for applying acids and solution of
nitrate of silver to the Larynx.

Sponge Probangs, for the same.

Laryngeal Syringe, by Gibb, for solution of nitrate of silver,

fig. 14, pl. XL.

Do. with piston, for do. . . . fig. 15, pl. XIV.

Canula Sponge and Lint-holder fig. 2, pl. XIII.

Curved Caustic-holder for the Larynx.

Jointed do. by Earle fig. 9, pl. XIII.

Laryngeal Ecrasseur for removing Polypus, by Gibb,

fig. 15, pl. XL.

Forceps for removing Foreign Bodies from the Larynx, by Liston,
with lateral and perpendicular curves.

Volatilizing Apparatus for applying medicated Fluids in the
form of Spray to the Larynx and Lungs,

fig. 6, pl. XL.

Inhaler, by Mudge fig. 6, pl. LI.

Do. by Ramadge.

Do. by Weiss.

This inhaler is similar in form to Mudge's, but it is furnished with a heater for keeping up the temperature of the fluid, and has a metal instead of an elastic tube.

Do. by Watson fig. 4, pl. LI.

Glass Inhaler for Iodine.

Inhaler for Carbonic Acid Gas fig. 2, pl. LI.

Inhaling Mouthpiece for exercising the Lungs, by Ramadge.

Apparatus for Suspended Animation.

INSTRUMENTS FOR THE TRACHEA.

Tracheotomy Trocars, of various sizes, by Hilton.

Tracheotome, by Thompson fig. 20, pl. XIV.

Do. Hook, by Edwards fig. 5, pl. XV.

Forceps for Cutting and Dilating the Opening in Tracheotomy,
fig. 32, pl. XXXIX.

Do. for Dilating and Facilitating the introduction of the
Tubes fig. 1, pl. XIII.

Do. do. fig. 13, pl. V.

Single Tracheotomy Tubes, of various sizes fig. 6, pl. XV.

Double do. do. fig. 7, pl. XV.

Spring do. do. fig. 8, pl. XV.

ESOPHAGUS INSTRUMENTS.

Bougies, of various sizes.

Dilators for Strictures of the Esophagus, by Wakley.

These instruments are constructed on the same principle as those for the urethra, fig. 1, pl. XXV., that is, an elastic bougie, with a series of gum canulas to pass over it.

Esophagus Forceps, with various curves, lateral and perpendicular fig. 13, pl. XIII.

Spiral Canula do. do. by Weiss fig. 12, pl. XV.

Instrument for removing Foreign Bodies from the Esophagus,
fig. 13, pl. XIV.

Probangs, of various sizes, mounted with sponge or ivory.

Do. with a hook for extracting Foreign Bodies.

Do. do. jointed in the middle for portability.

Stomach Pump, by Weiss.

This syringe is made to act without valves, and can be filled or emptied through either or the same pipe, the action being that of a simple syringe, with the addition of a half-turn of the handle at every stroke of the piston.

Improved Stomach Pump, by Weiss . . . fig. 11, pl. XV.

Both these stomach pumps are fitted with an esophagus-tube, enema-tube, and pipes. They are also occasionally furnished with a smaller esophagus-tube for children, and an O'Beirne's tube for the rectum.

INSTRUMENTS FOR CLEFT, PALATE, THE TONSILS, AND UVULA.

Palate Knives, by Avery, Fergusson, and Pollock,

figs. 3, 4, 5, 6, 7, and 8, pl. XIV.

The curved knives are made of various widths.

Do. Forceps, with cross-action . . . fig. 16, pl. XIV.

Do. with ordinary spring action, tenaculum points.

Do. do. with vulsellum points,
fig. 4, pl. XXIX.

Canula Forceps for holding Needles . . . fig. 15, pl. XV.

Palate Needle, by Brooke . . . fig. 14, pl. XV.

Do. by Ferguson . . . fig. 13, pl. XV.

Do. by Liston, with various curves . fig. 2, pl. XIV.

Do. do. curved right and left fig. 1, pl. XIV.

Do. by Roux.

These needles consist of stems of various curves, and small detached needle-points which fit on to them. The points are made to carry the sutures, and are easily detached from the stem after piercing the parts.

- Palate Needle, with side opening, and slide to close the same,
 by Weiss fig. 12, pl. XIV.
 Angular Palate Scissors, by Roux fig. 17, pl. XIV.
 Uvula Forceps, by Brooke fig. 1, pl. XV.
 Do. Scissors fig. 6, pl. XIII.
 Do. do. with hooks fig. 14, pl. XIV.
 Tonsil Hook, by Yearsley fig. 12, pl. XIII.
 Do. Vulsella, straight and curved fig. 5, pl. XIII.
 Do. Scissors fig. 10, pl. XIII.
 Do. Guillotines figs. 9 and 10, pl. XV.
 Do. do. by Velpeau.
 Do. Bistoury fig. 2, pl. XV.
 Do. Knife, by Yearsley fig. 3, pl. XV.
 Concealed Tonsil Lancets in silver and German-silver sheaths,
 fig. 1, pl. XIV.

Artificial Palates.

HARE-LIP INSTRUMENTS.

Small Narrow Bistouries.

Forceps, with parallel action, for holding and cutting upon.

Do. for holding and cutting Hare-lip Pins fig. 19, pl. XIV.

Scissors, with sliding action.

Hare-lip Pins, with steel and glass heads.

Do. plain.

Do. in silver, with movable steel points.

Compress for keeping the parts in apposition, by Hainsby.

TOOTH INSTRUMENTS.

Tooth Forceps plates XVI. and XVII.

These forceps may be had with smooth or checkered handles.

Tooth Keys, by Fox fig. 5, pl. XVII.

Tooth Keys, by Fox, for Children.

Do. by Snell.

This instrument is made with a movable bolster.

Do. Punches, or Elevators, of various shapes,

figs. 13, 14, 15, 16, and 17, pl. XIX.

Figs. 15 and 16 are made in pairs, right and left.

Fitkin's Patent Safety Elevators for whole Teeth and Stumps.

These instruments consist of a series of fulcrum instruments and elevators, of various curves, to suit the different teeth. The fulcrum instrument is about six inches long, fitted into a handle, and terminating in a bolster, similar to that of a key, with a curved arm, at a right angle, passing over the tooth to be extracted. The elevator is about five inches long, also fitted into a handle, having near its extremity a hole into which the arm of the fulcrum is locked, and terminating in a serrated point, which is applied to the tooth in the operation of extraction.

The advantages which the patentee claims for these instruments are, that the lateral motions of the forceps are dispensed with, one motion only being required, that of depressing the elevator; that the tooth is only touched on one side; that it is raised nearly perpendicular, and causes much less pain than usual. For the extraction of stumps, the advantages must be obvious; all pressure on the gums and alveolar process is avoided, and there is no risk of the elevator slipping and wounding the mouth.

Scalers, Stoppers, and Burnishers, of various shapes,

figs. 1 to 21, pl. XVIII.

Excavators and Roseheads, do. figs. 1 to 10, pl. XIX.

Sets of Roseheads, in socket handles. . . . fig. 11, pl. XIX.

Instrument for Cutting the Enamel. . . . fig. 18, pl. XIX.

Files for the Teeth, straight and curved, cutting on both sides, on one side, and on the edges only.

- Forceps for removing Foreign Bodies from the Ear, angular, by
 Toynbee fig. 2, pl. XXI.
- Do. do. do. by Wilde, fig. 4, pl. XXI.
- Do. for applying Cotton, by Yearsley . . . fig. 10, pl. XXI.
- Snare for removing Polypus of the Ear, by Wilde, fig. 5, pl. XXI.
- Double Canula, for do.
- Specula for the Ear, by Avery (the set consists of three sizes),
 fig. 6, pl. XX.
- Do. do. by Cramer.
- Do. do. by Harvey fig. 11, pl. XXI.
- Do. do. by Pilcher.
- Do. do. by Toynbee (the set consists of three sizes),
 fig. 2, pl. XX.
- Do. do. by Weiss fig. 3, pl. XXI.
- Do. do. by Wilde (the set consists of three sizes),
 fig. 5, pl. XX.
- Prismatic Auriscope, by Warden.
- Lamp for examining the Ear, and other Cavities, by Avery,
 fig. 8, pl. XXI.
- Do. for gas, by Avery.
- This lamp is also very small, and may be used for any
 cavities.
- Do. | for examining the Ear, by Jordan.
- Do. do. and other Cavities, by Miller, fig. 13, pl. XXI.
- Instrument for Puncturing the Tympanum, by Fabbrizzi,
 fig. 14, pl. XXI.
- Do. do. by Harvey, fig. 12, pl. XX.
- Do. do. by Toynbee, fig. 9, pl. XX.
- Do. for removing Foreign Bodies from the Ear, by Harvey,
 figs. 11 and 14, pl. XX.
- Probe for placing and removing Cotton from the Ear, by Yearsley,
 fig. 9, pl. XXI.
- Ear Syringes, of different sizes, with various pipes,
 fig. 15, pl. XXI.

Ear Syringes, of india-rubber fig 12, pl. XXI.

Ear Douche.

This instrument is similar to that described for the eye, fig. 3, pl. LII.; the glass, however, being larger, and furnished with a pipe, which goes into the ear.

Eustachian Catheters, by Cramer fig. 8, pl. XX.

Do. by Pilcher fig. 7, pl. XX.

Frontlet, with Forceps attached, for holding the Eustachian Catheter, by Yearsley.

Artificial Tympanum, by Toynbee figs. 3 and 4, pl. XX.

Do. Cotton, by Yearsley.

Explorer, used in connexion with the Eustachian Catheter, by Toynbee fig. 6, pl. XXI.

Otoscope, by Toynbee fig. 7, pl. XXI.

Acoemeter for testing the Power of Hearing, by Yearsley.

Platinum Spoon for Melting Caustic, by Wilde.

Ear Bath, by do.

Ear Spout for conducting the Water from the Ear.

For hearing instruments, *see* pl. LIII.

INSTRUMENTS FOR LITHOTOMY AND LITHOTRITY.

Steel Sounds, of various sizes and curves, 12 to the set.

Do. do. by Fergusson, fig. 4, pl. XXII.

Do. plated on steel.

Hollow Sounds, with and without stop-cocks, plated on steel, and plain fig. 5, pl. XXII.

Female Sounds, of various sizes fig. 3, pl. XXII.

Staffs, of various sizes, with central and lateral grooves, fig. 6, pl. XXII.

Rectangular staffs, of various sizes, by Buchanan, fig. 7, pl. XXII.
 Female Staffs, of various sizes fig. 8, pl. XXII.

For injecting catheters and syringes. (*See urethra
 and bladder instruments.*)

Lithotomy Knives, of various sizes, by Allarton, fig. 2, pl. XXIII.
 Do. do. by Brodie . fig. 3, pl. XXIII.
 Do. do. by Blizzard, fig. 4, pl. XXIII.
 Do. do. by Fergusson fig. 6, pl. XXIII.
 Do. do. by Key . fig. 5, pl. XXIII.
 Do. do. by Liston. fig. 7, pl. XXIII.

The above knives are mounted, both in fixed and
 folding spring handles.

Concealed Bistouries fig. 2, pl. XXII.
 Do. with two blades, cutting right and left.

Gorgets, sharp and blunt, of various sizes.

Blunt Gorget for the Median Operation, by Teale, fig. 9, pl. XXIII.

Female Dilator, by Crampton fig. 1, pl. XXII.

Do. by Weiss. fig. 8, pl. XXIII.

Dilator for the Median Operation, by Teale.

This instrument is similar in construction to Weiss'
 female dilator, but the blades are longer, larger,
 and bulbous-pointed.

Lithotomy Forceps, of various sizes fig. 14, pl. XXIII.

Do. do. with cross-action, fig. 10, pl. XXIII.

Do. by Allarton, for the Median Operation,
 fig. 1, pl. XXIII.

Any of these forceps may be had with fenestrated
 blades, and also silver plated.

Lithotomy Scoops fig. 15, pl. XXIII.

Do. single, with side curve, by H. Thompson,
 fig. 20, pl. XL.

Jointed Lithotomy Scoop, with lever-action, by Weiss,
 fig. 12, pl. XXIII.

- Large Lithotrite for crushing Stones which are too large to pass through the opening, by Weiss fig. 9, pl. XXII.
- Lithotomy Straps, by Pritchard . . . figs. 3 and 3a, pl. XLa.
- Do. Tapes.
- Do. Tubes, of various sizes.
- Lithotrites, by Weiss, as first made for Sir Benjamin Brodie, fig. 4, pl. XXIV.
- Do. do. with screw and percussion-action combined fig. 5, pl. XXIV.
- Do. with Weiss' recent improvements fig. 6, pl. XXIV.
- Do. by Civiale fig. 1, pl. XXIV.
- Do. with rack-action, by Fergusson . fig. 3, pl. XXIV.
- Do. do. fig. 2, pl. XXIV.

All these lithotrites are made with fenestrated blades, as delineated in fig. 13, pl. XXIV.

Screw Scoops for breaking Fragments.

The blades of these instruments are constructed as shown in figs. 11 and 12, pl. XXIV.; the handles similar to any of the above-mentioned lithotrites.

Catheter Scoops, by Weiss.

- Do. with stop-cock attached, as suggested by Mr. Henry Thompson . . . fig. 8, pl. XXIV.

This instrument acts also as a sound and a lithometer.

Scoops for removing Fragments from the Urethra, by Fergusson and Thompson.

- Do. do. by Liston fig. 10, pl. XXII.
- Articulated Curette for do. by Leroy d'Etiollès, fig. 9, pl. XXIV.
- Urethra Forceps for do. by Brooke.
- Do. for do. by Liston.
- Do. for do. by Weiss . . . fig. 10, pl. XXIV.
- Do. for do. with straight and curved blades, fig. 7, pl. XXIV.

Dinanometer for testing the strength of Lithotrites, by Weiss.

INSTRUMENTS FOR THE URETHRA AND BLADDER.

Bougies, of various sizes, in wax, catgut, gum, soft metal, plated,
and silver, both cylindrical and conical.

Gum Bougies, with bulbous points, of various sizes.

Caustic do.

Short do. in metal, plated, or silver, for Stricture near the
Orifice.

Pilot do. and Canulas, of various sizes . . . fig. 2, pl. XXV.

Catheters, of various sizes, with the ordinary curve,

fig. 4, pl. XXV.

Do. do. by Brodie . . . fig. 5, pl. XXV.

Do. do. by Fergusson . . . fig. 6, pl. XXV.

Do. do. for Stricture, by Thompson,

fig. 7, pl. XXVI.

Prostatic Catheters fig. 9, pl. XXV.

These catheters are made in silver, German silver,
plated, and elastic gum.

Spiral Stilettes for Prostatic Catheters, by Weiss, fig. 9, pl. XXV.

Double Channel'd Catheters for Washing out the Bladder, by

Brodie fig. 7, pl. XXV.

Catheters, with stop-cock for injecting the Bladder, by Brodie,

fig. 8, pl. XXV.

Syringes, with rings for injecting the Bladder, in brass, German
silver, and plated.

The construction of these syringes is similar to those
for the ear, fig. 15, pl. XXI., but larger; they are
made both with leather and metallic pistons.

Do. of india-rubber, with stop-cocks.

Instruments for removing broken Catheters from the Bladder.

Instrument for removing Hairpins and other foreign Bodies from
the Female Bladder.

Catheter Gauge, by Weiss.

Portable do. do. fig. 2, pl. XL.

Trocars for puncturing the Bladder per Rectum, fig. 3, pl. XXV.

Instruments for applying Caustic to the Urethra, by L'Allemande,
fig. 8, pl. XXVI.

Do. do. to the Prostate, by Coulson, fig. 9, pl. XXVI.

Do. do. solution of Caustic to the Urethra,
fig. 11, pl. XXVI.

Do. for dilating Stricture of the Urethra, by Holt,
fig. 6, pl. XXVI.

Do. do. do. by Lyon, fig. 5, pl. XXVI.

Do. do. do. by Sheppard.

This instrument consists of a small grooved catheter,
along which a series of metallic buttons, or tra-
vellers of various sizes, can be pushed by means
of a fine wire which lies in the groove.

Do. for dilating Stricture of the Urethra, by Wakley,
fig. 1, pl. 25.

Do. for dividing do. by Fergusson,
figs. 2 and 3, pl. XXVI.

Do. do. do. by Syme, fig. 1, pl. XXVI.

Do. do. do. by Thompson, fig. 4, pl. XXVI.

Do. do. do. by Wood, fig. 12, pl. XXVII.

Do. do. do. by Charrière, Maunder, and
Stafford.

Syringes for injecting the Urethra, in metal, glass, bone, and
india-rubber.

INSTRUMENTS FOR PHYMOSIS, VARICOCELE,
HYDROCELE, AND HERNIA.

- Phymosis Forceps, by Curling fig. 11, pl. XXVII.
 Do. do. by Dupuytren.
 Do. Pins, by Curling fig. 10, pl. XXVII.
 Do. Dilator, by Weiss.
 Varicocele Clamp, by Riccord.
 Do. do. modified by Coulson fig. 7, pl. XXVII.
 Do. Rings.
 Hydrocele Syringes, in glass, with silver tubes fig. 2, pl. XXVII.
 Do. do. in india-rubber, with stop-cock.
 Do. Trocars fig. 1, pl. XXVII.
 Do. do. mounted in ebony cases, similar to exploring
 Trocars fig. 9, pl. XXXVIII.
 Hernia Bistouries, by Cooper fig. 4, pl. XXVII.
 Do. do. convex.
 Do. do. guarded, by Weiss fig. 5, pl. XXVII.
 Do. do. with lever guard fig. 6, pl. XXVII.
 Do. Directors, by Key fig. 3, pl. XXVII.
 Do. do. by Partridge fig. 8, pl. XXVII.
 Instruments for the Radical cure of Hernia, by Wutzer.
 Do. do. by Rothmund, fig. 13, pl. XXVII.
 Do. do. by Wood fig. 14, pl. XXVII.

MIDWIFERY INSTRUMENTS.

- Midwifery Forceps, by Assalini fig. 6, pl. XXXIII.
 Do. straight, by do.

Midwifery Forceps, by Barnes.

- Do. by Beattie, for unduly elongated Foetal Head.
- Do. by Blundel fig. 6, pl. XXXV.
- Do. by Brünnighausen, straight and curved,
figs. 1 and 7, pl. XXXIV.
- Do. by Churchill fig. 8, pl. XXXV.
- Do. by Clarke fig. 2, pl. XXXIV.
- Do. by Collins fig. 4, pl. XXXV.
- Do. by Conquest fig. 1, pl. XXXV.
- Do. by Davies fig. 6, pl. XXXIV.
- Do. by Denman fig. 4, pl. XXXIV.
- Do. by Greenhalgh fig. 5, pl. XXXIV.
- Do. by Haighton fig. 3, pl. XXXIV.
- Do. by Grailey Hewitt, for unduly elongated
Foetal Head.
- Do. by Lever fig. 3, pl. XXXIII.
- Do. by Oldham fig. 2, pl. XXXIII.
- Do. by Radford, with blades of unequal length.
- Do. by Ramsbotham fig. 5, pl. XXXIII.
- Do. do. short fig. 5, pl. XXXV.
- Do. by Robertson fig. 4, pl. XXXIII.
- Do. by Simpson fig. 1, pl. XXXIII.
- Do. by Waller fig. 7, pl. XXXV.
- Do. by Ziegler fig. 2, pl. XXXV.
- Ovum Forceps fig. 5, pl. XXXVII.
- Levers or Vectis, in fixed handles fig. 9, pl. XXXVI.
- Do. in folding do. fig. 8, pl. XXXVI.
- Do. with Blunt Hook and Crotchet to screw into
one handle.

Jointed Folding Lever, by Weiss.

The blade of this lever can be depressed to any required angle, by turning a screw at the end of the handle.

Blunt Hooks fig. 10, pl. XXXVII.

Blunt Hooks, with Crotchet fig. 8, pl. XXXVII.

Whalebone Loops.

Do. with Blunt Hook.

Crotchets, single, in plain straight handles, and in screw handles,
with Lever and Blunt Hook.

Do. with cross handle, by Churchill.

Do. double, by Smellie.

Do. guarded, by Davies fig. 5, pl. XXXVI.

Craniotomy Forceps, by Barnes fig. 21, pl. XXXIX.

Do. by Conquest fig. 3, pl. XXXVI.

Do. by Davies fig. 6, pl. XXXVI.

Do. by Holmes fig. 4, pl. XXXVI.

Do. by Lee fig. 1, pl. XXXVI.

Do. by Murphy fig. 2, pl. XXXVI.

Do. by Simpson.

Do. by Ziegler fig. 7, pl. XXXVI.

Cephalotribes, by Baudeloque.

Embryotomists, by Davies.

Osteotomists by do. fig. 2, pl. XXXVII.

Instrument for Decapitation, by Ramsbotham.

This is similar in form to a blunt hook, the inner curve
being made to cut.

Perforating Canula, by Lee fig. 9, pl. XXXVII.

Dilators for Premature Labour, by Barnes fig. 3, pl. XXXIX.

The set consists of three, of various sizes, with a
syringe and stop-cock.

Knife for Puncturing the Membrane, by Barnes.

Umbilical Scissors.

Tubes for Inflating the Trachea.

Pelvimeters.

Uterine Tourniquets, by Pretty.

Do. by Weiss fig. 4, pl. XIa.

Accoucheur's Cases, containing three Stopper'd Bottles, Female Catheter, Inflating Tube, and Umbilical Scissors.

Midwifery Pouches and Cases.

Do. Bags, by Barnes.

These bags are made of patent enamelled leather, and fitted with two cap'd and stopper'd bottles, four one ounce bottles, Barnes' dilators and syringe, small chloroform inhaler, and spare pockets; besides the above, there is ample room for any instruments that may be required.

Do. Phantomes for Demonstration.

INSTRUMENTS FOR FEMALE DISEASES.

Vaginal Specula, by Boivin.

Do. by Bennett.

Do. by Coxeter fig. 1, pl. XXVIII.

Do. by Fergusson, in silvered glass, covered with gum, in plain glass, ivory, metal, and electroplated fig. 5, pl. XXVIII.

Do. by Riccord, with two, three, and four blades.

Do. by Sim fig. 6, pl. XXVIII.

Do. by Tyler Smith.

Do. by Prothero Smith.

Do. by Weiss figs. 2 and 3, pl. XXVIII.

Caustic-holder and Scarifying Instruments, in sets,

figs. 9, 10, and 11, pl. XXVIII.

Do. in ivory, ebony, and plated cases.

Do. and Lint-holder, in silver case, with sliding joint for the pocket case, fig. 7, pl. XXXVIII.

Do. by Ellis fig. 19, pl. XXX.

Curved Uterine Caustic-holder, by Simpson.

Forceps for Searifying the Uterus, and applying Caustic, by
Savage fig. 18, pl. XXX.

Instrument, with spring-action, for Searifying the Uterus, by
Weiss.

Uterine Sound, by Simpson, in silver and German silver,
fig. 8, pl. XXVIII.

Do. Dilators, by Coghlan.

Do. do. by Simpson fig. 7, pl. XXVIII.

Intra-Uterine Bougies, by do.

These are made in sets, with an introductory stilette.

Sponge Tents, of various sizes, and Stilettes for introducing them.

Hysterotomes, by Coghlan fig. 15, pl. XXX.

Do. by Greenhalgh fig. 16, pl. XXX.

Do. by Sim fig. 6, pl. XXIX.

Do. by Simpson fig. 13, pl. XXX.

Do. do. improved by Weiss.

The modification consists in a single guard, instead of
the double guard of Simpson's instrument; this
makes the instrument thinner, easier to intro-
duce, and more readily cleaned.

Uterine Canula, for wear after incision of the Cervix Uteri,
fig. 12, pl. XXX.

Vaginal Dilators, by Barnes fig. 2, pl. XXXIX.

Leech Tubes, by Locock.

Glass do.

Uterine Forceps fig. 13, pl. XXIX.

Polypus Scissors, with cross-action.

Do. by Weiss fig. 20, pl. XXXIX.

Polytome, by Simpson fig. 12, pl. XXVIII.

Polyprite, by Aveling fig. 19, pl. XXXIX.

Curette for removing small Polypi.

Double Canula, by Gooch.

Do. with the addition of a winch, fig. 13, pl. XXVIII.

- Polypus Canula, and Ligature Adjusters, by Weiss,
 figs. 1, 2, and 3, pl. XXXIIa.
- Ecrasseurs, by Charrière fig. 5, pl. XXXIIa.
- Do. by Chassaignac fig. 4, pl. XXXIIa.
- Do. by Braxton Hicks fig. 18, pl. XXXIX.
- Do. by Weiss figs. 6 and 6a, pl. XXXIIa.
- For Pessaries, *see* Belts, Urinals, &c., and plate XLVIII.

INSTRUMENTS FOR VAGINAL FISTULA.

- Duck Bill Specula, of two sizes, by Sim . . . fig. 6, pl. XXVIII.
- Self-holding Forceps, with slide fig. 2, pl. XXIX.
- Vulsellum do. figs. 4 and 9, pl. XXIX.
- Tenaculum pointed Forceps fig. 14, pl. XXX.
- Do. do. without spring catch.
- Do. do. with slide, by Sim, fig. 17, pl. XXX.
- Shot-compressing do. by Baker Brown, fig. 11, pl. XXIX.
- Needle-holding do. by Sim fig. 10, pl. XXIX.
- Forceps for Twisting Wire Sutures fig. 12, pl. XXIX.
- Long straight Scissors fig. 1, pl. XXIX.
- Do. curved do. fig. 5, pl. XXIX.
- Double curved do. by Sim fig. 3, pl. XXIX.
- Straight and curved Knives, by Bozeman,
 figs. 7 and 8, pl. XXIX.

Curved Knife, by Savage.

This is made double edged, to render it suitable for either side.

- Needles for Silk and Wire Sutures fig. 2, pl. XXX.
- Do. do. without handles, curved, and
 curve pointed.

These needles are smaller and stronger than ordinary suture needles.

- Tubular Needles, by Simpson fig. 11, pl. XXX.

These needles are made of various curves, Mr. Baker Brown's set consisting of twelve.

- Canula Needle-holder fig. 1, pl. XXX.
 Do. curved.
- Suture Clamps, by Baker Brown.
- Ligature Twister, by Simpson fig. 9, pl. XXX.
- Wire Adjusters figs. 3, 4, 5, and 8, pl. XXX.
- Sharp Hooks figs. 7 and 10, pl. XXX.
- Catheters, by Sim fig. 6, pl. XXX.
- India-rubber Bag and Tube to fit the Catheters.

INSTRUMENTS FOR TUMOURS, ETC.

- Breast-knives and Scalpels, of various sizes, in fixed and spring handles.
- Spring Forceps, with vulsellum points fig. 4, pl. XXIX.
 Do. with tenaculum points fig. 14, pl. XXX.
- Fenestrated Tumour Forceps fig. 3, pl. XXXII.
 These are made of various sizes.
- Vulsella, of various sizes fig. 9, pl. XXIX.
 Do. do. with lateral and perpendicular curves.
 Do. with sliding-action fig. 19, pl. XL.
- Ovarian Clamps, curved and straight, by Spencer Wells,
 fig. 1, pl. XXXII.
- Do. Clamp Forceps, by Clay.
- Do. do. do. by Hutchinson fig. 8, pl. XXXII.
- Do. do. do. by Spencer Wells fig. 4, pl. XL.
- Double Blunt Hooks fig. 7, pl. V.
 Do. Sharp do. fig. 4, pl. XXXII.
 Do. do. do. by Weiss fig. 15, pl. XXXIX.
- Blunt and Sharp Single Hooks.
- Retractors, in copper and German silver.
 Do. by Copeland Hutchinson fig. 8, pl. V.

Needles, of various curves, by Liston . . . fig. 2, pl. XIV.

Do. with side opening, and closing slide, by Weiss,
fig. 12, pl. XIV.

Ecrasseurs, by Chassaignac and Charrière,
figs. 4 and 5, pl. XXXIIa.

The former is also made curved.

Do. by Braxton Hicks fig. 18, pl. XXXIX.

Do. by Weiss fig. 6, pl. XXXIIa.

Instrument for breaking up Fibrous Tumours, by Baker Brown,
fig. 5, pl. XXXII.

Syringe and Trocar for Ovarian Tumours, by Spencer Wells,
figs. 6 and 7, pl. XXXII.

Hypodermic Syringe, by Hunter fig. 1, pl. XXXIX.

This syringe, mounted both in silver and plated, is
made also with a plain piston rod, in place of
the screw one.

Trocars, of various sizes, round and flat, in fixed handles, and
mounted, in cases similar to fig. 9, pl. XXXVIII.

Exploring Trocars, of various sizes fig. 9, pl. XXXVIII.

Do. with grooved stem.

Hollow Trocars for Ovarian Tumours, by Spencer Wells,
fig. 23, pl. XXXIX.

Do. do with Hook Clamps to secure
the Cyst.

Do. of various sizes for Ascites, Hydrocele, and
Exploring.

Piston Trocars, of various sizes, round and flat, for the Abdomen
and Chest, by Thompson fig. 4, pl. XXXIX.

Drainage Trocars, by Chassaignac fig. 24, pl. XXXIX.

Trocars, with stop-cock attached to the Canula.

Do. with india-rubber Syringe attached, fig. 22, pl. XXXIX.

Grooved Needles, of various sizes, in silver and steel, mounted in
ivory cases, and also in silver cases, combined with
Caustic-holders.

Acupuncture Needles.

These are made in sets to screw into one handle, and fitted into a small wood case.

Battery for Actual Caution, by Marshall.

Conductors for do. by do.

Actual Caution Irons, of various forms,

figs. 34, 35, 36, and 37, pl. XXXIX.

INSTRUMENTS FOR OPERATIONS ON THE RECTUM.

Rectum Specula, by Curling fig. 3, pl. XXXI.

Do. by Fergusson figs. 7 and 9, pl. XXXI.

Do. by Hilton.

Do. by Lane fig. 1, pl. XXXI.

Do. by Weiss fig. 8, pl. XXXI.

Do. do. with three blades.

Dilators for Stricture of the Rectum, by Ashton, fig. 10, pl. XL.

Do. do. by Todd fig. 12, pl. XL.

Do. do. by Wakley.

The construction of these dilators is similar to those for the urethra.

Do. do. by Weiss, fig. 11, pl. XL.

Fistula Bistouries, by Ashton.

Do. by Curling fig. 4, pl. XXXI.

Do. by Gant fig. 21, pl. XL.

Do. by Lane.

Do. by Weiss fig. 6, pl. XXXI.

Probe-pointed Director for Fistula, by Brodie.

Do. do. by Curling, fig. 5, pl. XXXI.

Forceps for Artificial Anus, by Dupuytren.

Do. for Hemorrhoids fig. 10, pl. XXXI.

Do. do. by Ashton fig. 17, pl. XXXI.

Forceps for Hemorrhoids,	by Curling	fig. 15, pl. XXXI.
Do.	do. by Smith.	
Vulsellum for	do. by Curling	fig. 13, pl. XXXI.
Do.	do. by Liston.	
Scissors for	do. by Salmon	fig. 11, pl. XXXI.
Do.	do. curved, by do.	
Hook for	do. by do.	fig. 12, pl. XXXI.
Needles for	do. by Ashton.	fig. 16, pl. XXXI.
Do.	do. by Curling	fig. 14, pl. XXXI.
Guards for applying Acid		fig. 2, pl. XXXI.
Bougies for Stricture of the Rectum,	in gum, wax, and metal.	

For sizes, *see* plate XL.

Syringes for Injections pl. LII.
 To any of these syringes an O'Beirne's tube may be fitted.

Suppositories.

For Prolapsus Ani Trusses and Belts, Pessaries, and Artificial Anus Pads, *see* Bandages, etc.

ANEURISM INSTRUMENTS.

Aneurism Needles	figs. 10, 11, 12, 13, and 14, pl. XXXIX.
Do.	Tourniquets for the Groin and Thigh, by Carte, figs. 5 and 6, pl. XL <i>a</i> .
Do.	do. by Bulley.
Do.	do. by Reeve.

MISCELLANEOUS INSTRUMENTS.

Bullet Probes, in metal and silver.

Do.	by Nèlaton.
Do.	Forceps, by Luer fig. 26, pl. XXXIX.
Do.	by Savigny fig. 28, pl. XXXIX.

- Transfusion Apparatus fig. 7, pl. LI.
 Do. consisting of a Stomach Pump and Funnel.
 The latter, which is for the reception of the blood, is surrounded by a warm water chamber, and is attached to the supply pipe of the stomach pump.
- Do. by Whitehouse.
-

GALVANIC AND ACTUAL CAUTERY APPARATUS.

- Galvanic Batteries, of different sizes and power . . . fig. 10, pl. LI.
 Electro-Magnetic Batteries fig. 3, pl. LI.
 Galvanic Chains.
 Battery for Actual Caution, by Marshall.
 Actual Caution Irons, of various forms and sizes,
 figs. 34, 35, 36, and 37, pl. XXXIX.
 Caution Iron, by Corrigan.

This instrument is made very portable, and put into a small case with a spirit lamp.

CHLOROFORM INHALERS.

- Chloroform Inhaler, by Murphy fig. 4, pl. XLI.
 Do. by Sibson fig. 6, pl. XLI.
 Do. by Skinner.
 Do. do. modified by Weiss, fig. 2, pl. XLI.
 Do. by Snow fig. 7, pl. XLI.
 Do. do. portable fig. 5, pl. XLI.
 Do. by Weiss fig. 1, pl. XLI.

DRESSING INSTRUMENTS.

Straight Bistouries, or Finger Knives, in spring handles.

The blades similar to the long blade of fig. 16, pl. XXXVIII.

Do. do. by Lisfranc . . . fig. 21, pl. XXXVIII.

Do. do. with probe points.

Curved do. probe-pointed, in spring handle.

Do. do. sharp-pointed do.

Bistouries, double, sharp and probe-pointed, in spring handle,

fig. 15, pl. XXXVIII.

Do. for Hernia, in spring handle fig. 22, pl. XXXVIII.

Do. do. Convex.

Scalpel, in spring handle.

Do. double, one of them being double-edged,

fig. 17, pl. XXXVIII.

Do. and Finger Knife, in spring handle, fig. 16, pl. XXXVIII.

Abscess Lancets, in spring handle, by Syme.

Do. either with Gum Lancet, or Tenotomy Knife, in spring handle . . . fig. 20, pl. XXXVIII.

Do. ordinary, in folding handle.

Medical Knives, containing magnifying lens for the skin, with Gum and Abscess Lancets, Gum Lancet, and Penknife, or two Gum Lancets.

Gum Lancets, single, double, and triple, in spring handles.

Aneurism Needles, in folding handles.

Do. with joint . . . fig. 12, pl. XXXIX.

Finger Saws, in spring handle . . . fig. 23, pl. XXXVIII.

Tenacula, in folding handles.

Do. in spring handle, with Gum or Abscess Lancet,

fig. 18, pl. XXXVIII.

Do. by Assalini, in folding handles, and without handles,

fig. 8, pl. II.

- Artery Forceps, by Diëffenbach fig. 9, pl. II.
 Do. by Liston fig. 4, pl. II.
 Do. by Luke fig. 10, pl. II.
 Do. do. with fenestrated blades fig. 5, pl. II.
 Do. with cross-action, by Weiss . . fig. 11, pl. II.
 Artery and Needle-holding Forceps fig. 6, pl. II.
 Spring Dressing Forceps, of various sizes, with broad and fine
 points fig. 6, pl. XXXVIII.
 Do. do. with spring catch.
 Do. do. with fine grooved points for removing
 Splinters or Needles.
 Vulsellum-pointed Spring Forceps for Tumours, by Solly.
 Bow Dressing Forceps, of various sizes . . fig. 5, pl. XXXVIII.
 Scissor Forceps, for Twisting and Cutting Wire Sutures, by Clover.
 Broad-pointed Forceps for removing the Toe-nail.
 Dressing Scissors, of various shapes and sizes,
 figs. 1, 2, and 3, pl. XXXVIII.
 Do. curved on the flat.
 Do. for removing Toe-nails, fig. 4, pl. XXXVIII.
 Do. for the Frenum.
 Caustic-holders, with platinum and silver-gilt quills, mounted in
 ebony and silver cases.
 Do. with cross-action, in silver cases.
 Do. with grooved needle.
 Do. with silver lint-holder.
 Do. do. telescopic . . fig. 7, pl. XXXVIII.
 Do. double, for large and small caustic, in silver
 case fig. 8, pl. XXXVIII.
 Female Catheters, plain and sliding . . fig. 11, pl. XXXVIII.
 Male and Female Catheters combined.
 Do. do. with plug for Epistaxis,
 fig. 14, pl. XXXVIII.
 Instrument for removing Foreign Bodies from the Eye,
 fig. 10, pl. XXXVIII.

- Exploring Trocars, in ivory cases . . . fig. 9, pl. XXXVIII.
 Grooved Needles, in silver and ivory cases.
 Directors, with Scoops or Spoons, in silver and German silver.
 Do. combined with Aneurism Needle, fig. 13, pl. XXXVIII.
 Do. with grooved end for the Frænum,
 fig. 12, pl. XXXVIII.
 Probes, with Spear Points and Eyes.
 Do. with Scoop at one end.
 Do. with fine Director at one end.

 INSTRUMENTS FOR DIAGNOSIS, ETC.

- Stethoscopes, of various shapes *see* pl. XLII.
 Differential Stethoscope, by Scott Allison . . . fig. 18, XLII.
 Plessors and Plessimeters figs. 4, 5, and 6, pl. XLII.
 Percussion Thimbles fig. 1, pl. XLII.
 Stethometer, by Sibson fig. 3, pl. XLII.
 Tapes for Measuring the Chest.
 Callipers, of two different sizes fig. 14, pl. XLII.
 Do. by Edwardes fig. 13, pl. XLII.
 Pelvimeters.
 Sphygmographs, by Scott Allison and Marcy.
 Spirometers, by Hutchinson.
 Do. do. modified by Weiss, fig. 12, pl. XLII.
 Do. by Lewis fig. 9, pl. XLII.
 Dynanometers, for testing the strength of the human body.
 Weighing Machines, of various descriptions.
 Urinometers, in glass and metal.
 Test Glasses, graduated and plain.
 Test Tubes, and Pipettes, of various sizes.
 Spirit Lamps do.

Stands to hold Test Glasses and Tubes.

Do. to hold Urinometer, Spirit Lamp, Test Glasses, &c.
Test Paper.

Thermometers, of various sizes, mounted in wood and ivory.

- Do. for the bath.
Do. Atmospheric.
Do. Self-registering.

OPERATING TABLES.

See plate XLIV.

POST-MORTEM TABLES.

POST-MORTEM AND MICROSCOPIC INSTRUMENTS.

- Post-mortem Saws, with spring handle . . . fig. 1, pl. XLIII.
Do. do. with folding handle.
Do. do. with fixed handle.
Do. do. double, for the Spine . . . fig. 12, pl. XLIII.
Do. Scalpels, of various sizes.
Do. do. do. strong. fig. 6, pl. XLIII.
Cartilage Knives, with fixed handles.
Do. with spring handles . . . fig. 2, pl. XLIII.
Brain Knives, with fixed handles.
Do. with spring handles . . . fig. 3, pl. XLIII.
Dissecting Forceps, of various sizes . . . fig. 17, pl. XLIII.
Do. Scissors do. . . . fig. 8, pl. XLIII.
Bowel do. or Entretome fig. 9, pl. XLIII.

Chisels, or Cross Wrenches, in fixed handles.

Do. do. to fit handle of hammer or spine chisel,
fig. 11, pl. XLIII.

Do. for the Spine fig. 15, pl. XLIII.

Double do. do.

Hammers fig. 13, pl. XLIII.

Head-rests fig. 16, pl. XLIII.

Double Dissecting Hooks fig. 4, pl. XLIII.

Single do. fig. 5, pl. XLIII.

Chain Hooks.

Blow Pipes, of various sizes fig. 10, pl. XLIII.

Needles, of various sizes.

Anatomical Syringes, of various sizes, fitted with large and small
pipes, with and without stop-cocks, fig. 14, pl. XLIII.

Microscopic Knives, of various shapes, single and double-edged,
figs. 1 to 6, pl. XLIIIa.

Valentin's Knife fig. 9, pl. XLIIIa.

Curved Spring Forceps fig. 8, pl. XLIIIa.

Straight do.

Scissors, straight and curved.

Do. mounted on handle fig. 7, pl. XLIIIa.

Spring Scissors, by Queckett.

Needle-holders.

SPLINTS AND FRACTURE APPARATUS.

Hand Splints, by Pemberton fig. 14, pl. XLV.

Radius do. by Nélaton fig. 10, pl. XLV.

Do. do. by Weiss fig. 11, pl. XLV.

Arm do. by Cline figs. 3, 4, and 5, pl. XLV.

Do. do. by Gibbs.

Do. do. by Weiss.

Do. do. padded fig. 9, pl. XLV.

Jointed Elbow Splints, of zinc or tin . . . fig. 8, pl. XLV.

Splints for Excision of the Elbow, by Heath . fig. 6, pl. XLV.

These are also made with elongated pads, to support
the hand and upper part of the arm.

Splints for Contracted Elbow, by Amesbury.

These are similar in construction to those for con-
tracted knee, fig. 17, pl. XLV.

Arm and Humerous Splints fig. 7, pl. XLV.

These are made in sets of three.

Leg Splints, of various sizes, in wood, by Cline,

figs. 22 and 23, pl. XLV.

Do. do. in zinc.

Do. do. by Gibbs.

Do. do. by Fergusson . fig. 19, pl. XLV.

Do. do. by Liston . . fig. 13, pl. XLV.

Leg Slings, by Greenway fig. 24, pl. XLV.

Do. by Hester.

Do. by Luke.

Do. by Salter fig. 25, pl. XLV.

Do. by Weiss fig. 27, pl. XLV.

Splints for Excision of the Knee, by Fergusson, fig. 16, pl. XLV.

Do. for Fractured Patella, by Lonsdale . fig. 1, pl. XLV.

Do. for Contracted Knee, by Amesbury . fig. 17, pl. XLV.

Thigh Splints, of various sizes, by Bulley . fig. 21, pl. XLV.

Do. do. by Busk . . fig. 18, pl. XLV.

Do. do. by Cline . . fig. 2, pl. XLV.

Do. do. by Dessault . fig. 15, pl. XLV.

Do. do. by Gibbs.

Do. do. by Liston . fig. 12, pl. XLV.

Interrupted Leg, Thigh, and Arm Splints.

Clamps of various sizes, which may be adjusted to any splints.

(See fig. 20, pl. XLV.)

Wood Splints, lined, hollow, and packthread.

Splints for Diseased Joints, by Barwell.

FRACTURE BANDAGES AND APPARATUS FOR
REDUCING DISLOCATIONS, ETC.

Bandages for Fractured Ribs.

Do. do. Clavicle, by Brasdor . fig. 5, pl. XLVI.

Do. do. by Ellis . fig. 10, pl. XLVI.

Eighteen-tailed Bandages.

Ordinary Bandages, in calico, linen, and flannel.

Apparatus for Fractured Jaw, by Lonsdale.

Double Hooked Clamp, for Fractured Patella, by Malgaigne.

Forceps for reducing Dislocations of the Thumb.

Pullies for reducing Dislocations fig. 1, pl. XLa.

Belts do. do.

Apparatus do. do. by Cruise . . . fig. 2, pl. XLa.

Forceps for instantaneously releasing the cord, by Cruise,
fig 2a, pl. XLa.

Bandage and Slipper for Ruptured Tendo Achillis,

fig. 1, pl. XLVI.

BELTS, TRUSSES, URINALS, PESSARIES, ETC.

Stockings for Varicose Veins, Sprains, etc., in cotton and silk,

(See pl. L.)

Ankle Socks, in cotton and silk pl. L.

Knee Caps do. pl. L.

Thigh Pieces pl. L.

Elastic Belts, to draw on and to lace, in cotton and silk . pl. L.

Do. with pads for Umbilical Hernia.

Riding Belts.

Suspenders, with cotton and silk nets.

Belts, of various qualities, for Prolapsus Uteri, by Hull,

fig. 25, pl. XLVIII.

Do. do. do. by Lewis, fig. 30, pl. XLVIII.

Do. do. do. by Phelps, fig. 19, pl. XLVIII.

Do. worn previous to and after Confinement.

Do. for Prolapsus Ani fig. 9, pl. XLVIII.

Do. for confining Lunatics.

Straight Waistcoats for do.

Handeuffs for do.

Trusses, single and double, for Inguinal and Femoral Hernia,

figs. 1 and 2, pl. XLVIII.

Do. do. by Cole fig. 17, pl. XLVIII.

Do. do. by Dartnell fig. 24, pl. XLVIII.

Do. do. by Edwards fig. 23, pl. XLVIII.

Do. do. by Ody, figs. 13 and 14, pl. XLVIII.

Do. do. by Teale fig. 8, pl. XLVIII.

Do. do. by Weiss fig. 29, pl. XLVIII.

Do. do. Mocmain, without circular spring,
fig. 18, pl. XLVIII.

Umbilical Trusses fig. 31, pl. XLVIII.

Prolapsus Ani do. fig. 3, pl. XLVIII.

Urinals for Gentlemen, covered in silk and cotton, for Night and
Day use figs. 4, 6, and 28, pl. XLVIII.

Do. in glass, covered with flannel, for Night use,
fig. 32, pl. XLVIII.

Do. do. ordinary, for hand use.

Iugum Penis.

Urinals for Ladies for Day use fig. 26, pl. XLVIII.

Inflating Pessaries, to stop the flow of Urine by making pressure
on the Urethra, by Savage.

Poreelain Bed Slippers for Ladies fig. 27, pl. XLVIII.

Bed Pans, in porecelain and zinc.

Do. wedge-shaped, by Weiss fig. 1, pl. LII.

Pessaries, globular and egg-shaped . . . fig. 12, pl. XLVIII.

Do. circular and oval . . . fig. 16, pl. XLVIII.

The above are made of various sizes, in wood, gum,
and india-rubber.

Do. inflated.

Do. globular and pear-shaped, to inflate with syringe,
fig. 15, pl. XLVIII.

Do. to inflate, by Barnes.

This pessary is somewhat pear-shaped in form, and consists of a curved, solid stem, surrounded with an india-rubber sheath, which is inflated similar to fig. 15, pl. XLVIII. The pessary is supported by under straps and a pelvis band, and this, in conjunction with the solid stem, gives the required support in aggravated cases of prolapsus.

Do. by Read.

This pessary is shaped like the letter V, and cover'd with gum. When applied it assumes the shape of Zwanke's pessary.

Do. by Duffin . . . fig. 21, pl. XLVIII.

Do. by Lund.

This pessary is formed of a conical coil'd spring, cover'd with india-rubber, and supported by under straps and pelvis band.

Do. to inflate, by Savage.

This pessary is also used for incontinance of urine, as it is made to press on the urethra.

Do. of porcelain, by Scholfield . . . fig. 20, pl. XLVIII.

Do. by Zwanke . . . fig. 11, pl. XLVIII.

Do. do. modified by Weiss . . . fig. 5, pl. XLVIII.

Do. of gutta percha . . . fig. 22, pl. XLVIII.

Do. for Retroversion of the Uterus, by Priestley.

Do. do. by Simpson.

FRACTURE BEDS, WATER CUSHIONS, ETC.

- Air and Water Cushions, of various sizes and shapes, such as square, both plain and cellular, round, and crescent-shaped (See pl. XLVII.)
- Spinal Water Cushions fig. 10, pl. XLVII.
- Air Cushion and Back for Chair fig. 4, pl. XLVII.
- Air and Water Mattrasses, of various sizes fig. 7, pl. XLVII.
- Invalid Rests for the Bed fig. 5, pl. XLVII.
- Fracture Bed, by Earle fig. 6, pl. XLVII.
- Do. do. improved with screw adjustments,
figs. 9 and 9a, pl. XLVII.
- Fracture Bed, by Luke.
- Spinal Bed fig. 8, pl. XLVII.
- Hydrostatic Bed, by Arnold.

ARTIFICIAL LIMBS, CRUTCHES, ETC.

- Artificial Legs, suited for the various Amputations,
figs. 2, 9, 10, and 11, pl. XLIX.
- Do. for shortening of the Limb in case of Diseased Hip
Joint fig. 12, pl. XLIX.
- Socket Pin Legs, for Amputations above and below the Knee.
- Do. with Knee Joint fig. 8, pl. XLIX.
- Kneeling Pin Legs fig. 13, pl. XLIX.
- Do. with Knee Joint.
- Artificial Hands and Arms, for Amputations above and below the
Elbow figs. 4 and 6, pl. XLIX.
- These are fitted with a variety of instruments, such as a fork, hook, double hook for riding, brush, card-holder, etc.

Artificial Arms, without the Hand, fitted with a Hook, Fork, etc.
Crutches, of various sizes and constructions. (*See* pl. XLIX.)

INSTRUMENTS FOR DEFORMITIES, ETC.

Apparatus for Wry and Burnt Neck . . . fig. 19, pl. XLVI.

Collar for Wry Neck or Severe Injury, by James.

Apparatus for various Spinal Curvatures,

figs. 11, 12, 13, 16, 17, and 18, pl. XLVI.

Do. for Deformities of the Shoulder.

Do. do. of the Pelvis.

Do. for Diseased Hip fig. 8, pl. XLVI.

Splints for do. by Barwell.

Do. for Contracted Knee, by Amesbury . . . fig. 17, pl. XLV.

Instruments for Bow Legs fig. 14, pl. XLVI.

Do. for Knock Knees fig. 15, pl. XLVI.

Do. for Club Feet.

Shoes for do. by Edwards.

Do. for do. by Scarpa fig. 9, pl. XLVI.

Apparatus for do. by Strohmeyer.

Supports for Talypes Varus and Talypes Valgus, fig. 3, pl. XLVI.

Instruments for Deformities of the Toes.

Do. for do. of the Wrist.

Do. for Contraction of the Fingers.

Chest Expanders fig. 4, pl. XLVI.

The instruments and apparatus for deformities and contractions, etc., vary so much in accordance with the requirements of each case, that the limits of this Catalogue will only permit those in general requisition being illustrated and enumerated.

RESPIRATORS, SYRINGES, AND APPARATUS.

Enema Syringes, of various qualities, with elastic tubes and pipes, for self use, and by the aid of another,
fig. 4, pl. LII.

Do. fitted also with gum elastic pipes, for female use.

Do. with metal piston, and telescopic metal tube,
fig. 2, pl. LII.

Reservoir Syringes, with jointed metallic tube,
figs. 5 and 11, pl. LII.

Do. with spring-action . . . fig. 13, pl. LII.

Do. with double do. . . . fig. 15, pl. LII.

Elastic Syringes, fitted with Enema and Female Pipes, by Kennedy fig. 16, pl. LII.

Do. do. by Higginson.

Do. do. do. modified,
figs. 12 and 12*a*, pl. LII.

Any of the above syringes may be fitted with an O'Beirne's tube.

Clysmaducts.

Bedpans.

Do. wedge-shaped, by Weiss fig. 1, pl. LII.

Urethra Syringes, in glass, metal, and ivory.

Female do. in glass and metal.

Do. do. by Clarke and Hamilton.

Eye Douches fig. 3, pl. LII.

Ear do.

These are constructed in the same manner as the eye douche, with the exception that the glass is larger, and furnished with a pipe which goes partly into the ear.

Eye and Ear Syringes figs. 12 and 12*a*, pl. XXI.

Ear Syringes, of various sizes fig. 15, pl. XXI.

- Ear Syringes, of various sizes, without rings.
- Breast Pumps fig. 14, pl. LII.
- Do. by Capron fig. 9, pl. LII.
- This instrument is fitted both with breast and dry
cupping glasses.
- Breast Bottles, with glass cups fig. 7, pl. LII.
- Nipple Shields, by Darbo, with Cork Nipples, in boxwood and
ivory fig. 6, pl. LII
- Feeding Bottles, by Darbo, with Cork Nipples fig. 10, pl. LII.
- Do. of other various constructions.
- Nipple Protectors, by Wansborough fig. 8, pl. LII.
- Invalid Feeding Cups, by Halphen fig. 8, pl. LI.
- Do. do. for Feeding through the Nose fig. 9, pl. LI.
- Baths for Hot Air and Medicated Vapours, by Duval, fig. 5, pl. LI.
- Mercurial Fumigator, by Lee fig. 1, pl. LI.
- Copper and Iron Fumigators.
- Foot-warmers, by Weiss.
- Respirators, of various qualities, for ladies and gentlemen, both
oral and orinasal.
- Do. by Jeffries.

HEARING INSTRUMENTS.

- Artificial Tympana, by Toynbee fig. 7, pl. LIII.
- Single and Double Cornets, of various sizes fig. 5, pl. LIII.
- Hearing Trumpets, by Martineau, of various sizes, japanned
and plated fig. 3, pl. LIII.
- Telescopic Hearing Trumpets figs. 1 and 4, pl. LIII.
- Table Trumpets, for general conversation fig. 2, pl. LIII.
- Hearing Tubes, of various lengths, fitted with ivory and ebony
cups and mounts fig. 6, pl. LIII.

SETS OF INSTRUMENTS.

GENERAL OPERATING CASE FOR PRIVATE PRACTICE, No. 1.

Amputating Saw—3 Knives for the Flap Operation—2 Knives for the Circular Operation—Catlin—2 Finger Knives, broad and narrow—4 Scalpels—Tang Scalpel—Tenaculum—Artery Forceps—Torsion Forceps—2 Dieffenbach's Forceps—Signoroni's Tourniquet—Screw Tourniquet—Bone Forceps—Fergusson's Curved Bone Forceps for Necrosis—Fergusson's Lion Forceps—Gouge Forceps—2 Gouges, broad and narrow—Chisel—Marshall's Osteotribe—2 Necrosis Forceps, straight and curved—3 Trephines, one of them small for Necrosis—2 Hey's Saws—Fergusson's Saw, with folding back—Elevator—Lenticular—Scull Forceps—Brush—2 Trocars for Ascites—Trocac for Hydrocele—Curved Trocar for Puncturing the Bladder per Rectum—2 Polypus Forceps, straight and curved—Throat Forceps—2 Double Trachea Tubes, large and small—Bullet Forceps—Bullet Probe—Vulsellum—Spring Dressing Forceps—Probe and sharp-pointed Bistouries—Hernia Bistoury—Hernia Director—Aneurism Needle—Probang—2 Gum Elastic and 2 Silver Catheters—Needles and Silk.

GENERAL OPERATING CASE FOR PRIVATE PRACTICE, No. 2.

Amputating Saw—Finger Saw—3 Knives for the Flap Operation—Catlin—Finger Knife—2 Scalpels—Tang Scalpel—

Tenaculum—Artery Forceps—2 Dieffenbach's Forceps—Screw Tourniquet—Bone Forceps—Fergusson's Lion Forceps—Gouge—Chisel—Marshall's Osteotribe—Necrosis Forceps—2 Trephines—Hey's Saw—Elevator—Scull Forceps—Brush—Trocars for Ascites and Hydrocele—Forceps for Polypus of the Nose—Throat Forceps—Double Trachea Tube—Bullet Forceps and Probe—Sharp, Probe-pointed, and Hernia Bistouries—Aneurism Needle—Probang—2 Silver and 1 Gum Catheter—Needles and Silk.

AMPUTATING, NECROSIS, AND TREPANNING CASE.

Amputating Saw—Mr. Butcher's Saw—Fergusson's Saw, with folding back—3 Knives for the Flap Operation—Catlin—2 Finger Knives, broad and narrow—3 Scalpels—Tang Scalpel—Tenaculum—Artery Forceps—Spring Forceps—2 Dieffenbach's Forceps—Tourniquet—Straight and curved Bone Forceps—Fergusson's Lion Forceps—Gouge Forceps—2 Gouges, broad and narrow—Chisel—Marshall's Osteotribe—2 Necrosis Forceps—3 Trephines, one of them for Necrosis—Hey's Saw—2 Elevators—Lenticular—Scull Forceps and Brush—Needles and Silk.

NECROSIS CASE.

Fergusson's Saw, with folding back—3 Hey's Saws—Chain Saw—2 Fergusson's Bone Forceps—Fergusson's Lion Forceps—Straight and curved Necrosis Forceps—Gouge Forceps—Curved Gouge—2 Straight Gouges—Chisel—2 Marshall's Osteotribes—Necrosis Trephine—Blunt and Sharp Hooks—3 Scalpels—Tang Scalpel.

LARGE AMPUTATING CASE.

Amputating Saw—Metacarpal Saw—3 Knives for the Flap Operation—2 Knives for the Circular Operation—Catlin—

2 Finger Knives, broad and narrow—3 Scalpels—Tenaculum—
2 Artery Forceps—2 Dieffenbach's Forceps—Bone Forceps—
Fergusson's Lion Forceps—Signoroni's or other improved Tourniquet—Screw Tourniquet—Needles and Silk.

SMALL AMPUTATING CASE.

Amputating Saw—Metacarpal Saw—3 Knives for the Flap Operation—Finger Knife—2 Scalpels—Tenaculum—Artery Forceps—Bone Forceps—Screw Tourniquet—Needles and Silk.

TREPANNING CASE.

3 Trephines, of different sizes—3 Hey's Saws, of different forms—2 Elevators—Lenticular—Tang Scalpel—Brush—Scull Forceps.

INSTRUMENTS FOR MINOR OPERATIONS, No. 1.

Bone Forceps—Fergusson's Saw—2 Finger Knives—Sharp-pointed, Probe, and Hernia Bistouries—3 Scalpels—2 Tenotomy Knives—Liston's Needle—Tenaculum—Aneurism Needle—Straight and curved Scissors—Dressing Forceps—Vulsellum—Liston's Tenaculum—Spring Forceps—2 Dieffenbach's Forceps—Hernia Director—Exploring Trocar—Needles and Silk.

INSTRUMENTS FOR MINOR OPERATIONS, No. 2.

Bone Forceps—Fergusson's Saw—2 Finger Knives—Sharp-pointed, Probe, and Hernia Bistouries—Liston's Needle—2 Scalpels—2 Tenotomy Knives—Tenaculum—Assalini's Tenaculum—Aneurism Needle—Straight and curved Scissors—Hernia Director—Spring Forceps—Needles and Silk.

INSTRUMENTS FOR MINOR OPERATIONS, No. 3.

Finger Knife—Sharp-pointed, Probe, and Hernia Bistouries—Liston's Needle—2 Scalpels—Assalini's Tenaculum—Aneurism Needle—Straight Scissors—Hernia Director—Spring Forceps—6 Needles.

INSTRUMENTS FOR MINOR OPERATIONS,

AS RECOMMENDED BY MR. PARTRIDGE.

Catlin, $4\frac{1}{2}$ inches long—Bone Forceps—Sequestra Forceps—Fergusson's Saw—2 Finger Knives, broad and narrow—Straight Probe-pointed Bistoury—Sharp-pointed, Probe, and Hernia Bistouries—4 Scalpels—Tenaculum—Liston's Needle—Aneurism Needle—Double Tumour Hook—Straight and curved Scissors—Dressing Forceps—Vulsellum—Liston's Tenaculum—Artery and Needle-holding Forceps—Spring Forceps—Tumour Forceps—2 Dieffenbach's Forceps—Hernia Director—Exploring Trocar—Double Tracheotomy Tube—Director and 2 Probes—Brodie's Fistula Director—Flexible Needle—Double Scoop—Needles and Silk.

POCKET CASE, No. 1.

Probe and Sharp-pointed Bistouries—Hernia Bistoury—2 Scalpels, 1 double-edged—Finger Knife—Fine Saw—Gum Lancet and Tenaculum—Abscess Lancet and Tenotomy Knife—Double Needle—Straight and crooked Scissors—Dressing Forceps—Torsion and Needle-holding Forceps—Artery Forceps—Caustic Case and Exploring Needle—Male and Female Catheter, with spring for Epistaxis—Director and Probes—Spatula—2 Lancets and 1 Vaccine Lancet—Needles.

POCKET CASE, No. 2.

Probe and Sharp-pointed Bistouries—Scalpel and Finger Knife—Abscess Lancet and Tenotomy Knife—Gum Lancet and Tenaculum—Scissors—Forceps, spring or dressing—Artery Forceps—Caustic Case and Exploring Needle—Male and Female Catheter—Director and Probes—Spatula—Needles.

POCKET CASE, No. 3.

Probe and Sharp-pointed Bistouries—Scalpel and Finger Knife—Abscess Lancet and Tenaculum, or Gum Lancet—Scissors—Dressing or Spring Forceps—Artery Forceps—Caustic Case—Director and Probes—Spatula—Needles.

CASE OF EYE INSTRUMENTS, No. 1.

4 Cataract Knives—Secondary Knife—Curette—Tyrrell's Hook—6 Needles—2 Iris Scissors—2 Iris Forceps—2 Iridectomy Knives—Schuft's Double Spoon—Schuft's Forceps—Set of Bowman's Probes—Critchett's Director and Knife—Fine straight Scissors—Strabismus Scissors—Hook Forceps—Entropium Forceps—Hulke's Needle for Sutures—2 Spring Specula—Needles and Silk.

CASE No. 2.

2 Cataract Knives—Secondary Knife—Curette—Tyrrell's Hook—5 Needles—2 Iris Scissors—2 Forceps—Cilia Forceps—Set of Probes—Director and Knife—Strabismus Hook—Scissors—Forceps—2 Spring Specula.

CASE No. 3.

2 Cataract Knives—Curette—Tyrrell's Hook—4 Needles—Iris Scissors—Iris Forceps—Cilia Forceps—Set of Probes and Director—Spring Speculum.

MR. BOWMAN'S CASE.

3 Sichel's Knives—2 Angular Iridectomy Knives, broad and narrow—Stop Needle, and small-sized broad Cutting Needle, in sliding handle—Stop Needle and broad Cutting Needle, in sliding handle—Curette and Pricker—Spatula and Lenshook, in platinum—Double Tyrrell's Hook, in platinum—Knife and Scoop for Tarsal Cysts—Lever Canula Instrument, with blunt and sharp Forceps and Scissors—Canula Lancet—Guarded Canaliculus Knife—Lever-guarded Canaliculus Knife—Lever Canaliculus Dilator—Hulke's Needle, with double curve—Schuft's Spoon—Maunoir's Iris Scissors—Curved Excision Scissors—2 Curved Iris Forceps—Cilia Forceps—Set of Probes and Director—Wire Speculum—2 Entropium Compressors—Strabismus Scissors—Strabismus Hook—2 Forceps for fixing the Eyeball, etc., broad and narrow—Curved Suture Needle—Silk, white and black.

MR. CRITCHETT'S CASE.

2 Sichel's Knives—4 Iridectomy Knives, straight and curved, and of different breadths—2 Broad Needles, one Cutting—4 Dalrymple's Needles—Curette—Spatula—Sharp Hook—2 Tyrrell's Hooks—Hulke's Needle for Sutures—Canula Forceps—2 pairs Schuft's Spoons—Schuft's Forceps—Straight Iris Forceps—Cilia Forceps—Curved Iris Scissors—2 Small Scalpels—2 Entropium Forceps—2 Spring Specula—Fine Needles and Silk—Fine Scissors for the Canaliculus—Teales' Probes, six sizes—Critchett's Director and Knife—Curved Knife—Bowman's Guarded Knife—6 Catgut Bougies or Styles—Strabismus Scissors, Hook, and Forceps.

MR. HANCOCK'S CASE.

4 Beer's Knives—2 Secondary Knives, straight and convex—4 Iridectomy Knives, straight and curved—4 Beer's Needles—

2 Scarpa's Needles—Curette—2 Tyrrell's Hooks—Spud for removing Foreign Bodies—Lever Forceps—2 Iris Forceps, straight and curved—Schuft's Forceps—Cilia Forceps—2 Iris Scissors—2 Specula—2 pairs Schuft's Spoons—Scissors for the Canaliculus—Knife and Director for the same—Set of Probes—6 Styles—Strabismus Scissors, Hook, and Forceps—Guthrie's Knife and Director—Entropium Forceps—Hulke's Suture Needle—6 Suture Needles—Fine Silk—Drum for testing the Instruments.

MR. WALTON'S CASE.

4 Sichel's Knives, long and short—2 Secondary Knives, straight and convex—Curette—Broad Needle—3 Iris Knives, of different breadths—2 Tyrrell's Hooks—2 Dalrymple's Needles—2 Scarpa's Needles—2 Canula Forceps, blunt and needle-pointed—Guarded Curette—Dalrymple's Forceps—2 Iris Forceps, straight and curved—Cilia Forceps—Lid Retractor—2 Scissors—3 Spring Specula—2 Iridectomy Knives—Double Scoop—Schuft's Forceps—Critchett's Knife and Director, with handle—Style Knife—3 Probes, graduated to six sizes—2 Straight strong Probes—6 Styles—Syringe—Forceps, with cross points—6 Fine Scalpels—Small Needles and Silk—Scissors—Hook and Forceps for Strabismus—Drum and Leather for testing the Instruments.

LITHOTOMY CASE, No. 1.

4 Straight and 4 Curved Lithotomy Forceps—6 Lithotomy Knives—4 Scalpels—6 Lateral and 6 Central grooved Staffs—2 Female Staffs—12 Sounds—2 Female Sounds—Double Lithotomy Scoop—Single Lithotomy Scoop, with side curve—2 Blunt Gorgets—Strong Lithotrite, for Stones which are too large to pass the opening—Weiss' Female Dilator—Male and Female double-channelled Catheters—Lithotomy Tapes.

LITHOTOMY CASE, No. 2.

3 Straight and 3 curved Lithotomy Forceps—4 Lithotomy Knives—2 Scalpels—4 Lateral and 4 Central grooved Staffs—2 Female Staffs—8 Sounds—2 Female Sounds—Double Lithotomy Scoop—Weiss' Female Dilator—Lithotomy Tapes.

LITHOTOMY CASE, No. 3.

3 Straight and 1 curved Lithotomy Forceps—2 Lithotomy Knives—1 Scalpel—3 Lateral and 3 Central grooved Staffs—1 Female Staff—4 Sounds—1 Female Sound—Scoop—Lithotomy Tapes.

LITHOTRITY CASE, No. 1.

4 Lithotrites, of various sizes, for Adults and Children—2 Screw Scoops—Catheter Scoop—Long Canula Forceps, with straight and curved blades—Urethra Forceps—Articulated Curette, for removing Fragments—Syringe and Stop-cock—3 Catheters, to fit Syringe.

LITHOTRITY CASE, No. 2.

2 Lithotrites—1 Screw Scoop—Catheter Scoop—Forceps, for removing Fragments from the Urethra—Syringe and Stop-cock.

Mr. SPENCER WELLS' OVARIOTOMY CASE.

Double Spring Scalpel, middle-point blades—Probe-pointed Bistoury—Adams' Sharp Double Hook—Key's Hernia Director—Trocar—Vulsellum—Sharp Double Hook, large size—Clamp Forceps, with three blades—4 Dieffenbach's Forceps—Liston's Tenaculum—Spring Forceps—Long Tenaculum-pointed Forceps—Needle-holding Forceps—12 Glover's Needles—2 Liston's Needles—3 Reels of Silk—Tin box of Plaster—Bent and straight Scissors—Skinner's Chloroform Inhaler and Bottle.

VAGINAL FISTULA CASE.

One or two Sim's Duck-bill Specula—Straight and curved Scissors—Double-curved Scissors, right and left—Straight and curved Knives—Vulsellum and Tenaculum-pointed Forceps—Sim's Needle-holding Forceps—2 Self-holding Forceps—3 Simpson's Needles, of various curves—Simpson's Wire Suture Twister—4 Wire Adjusters, various—Sharp Hook—Sim's Sharp Hook—Sim's Catheter—Straight and curved Needles, and Silver Wire.

UTERINE CASE.

Speculum Vaginae, with two or three blades—3 Fergusson's Specula, in glass or plated metal—Caustic and Lint-holder and Scarifier—Simpson's Sound—Speculum Forceps—Simpson's Uterine Dilator—Polytome or Polyprite—Gooch's Canula, with Winch—Hysterotome—Ecrasseur.

RECTUM CASE.

Metallic Speculum, either tubular, or with two or three blades—Glass Speculum—2 Fistula Knives—2 Bistouries—2 Scalpels—Dressing Scissors—Hemorrhoidal Scissors—Hemorrhoidal Forceps—Vulsellum—Guard for applying Acid—Director—Needles.

CUPPING CASE, No. 1.

Large and Small Scarificators, with extra Lancets—Cupping Syringe and 4 Stop-cocks—8 mounted Glasses for Stop-cocks—8 Plain Glasses—Spirit Lamp and Bottle.

CUPPING CASE, No. 2.

Large and Small Scarificators, with extra Lancets—8 Glasses—Spirit Lamp and Bottle.

CUPPING CASE, No. 3.

Scarificator—6 Glasses—Spirit Lamp and Torch.

POST-MORTEM CASE, No. 1.

Large Saw—Double Saw for the Spine—Cartilage and Brain Knives—2 strong Scalpels—4 Scalpels—Bowel and Dissecting Scissors—2 Forceps—Hammer—Spine Chisel—Cross Wrench—Head Rest—Large and Small Blow Pipes—Sharp Hook—Double Hook—Chain Hooks—Needles.

POST-MORTEM CASE, No. 2.

Saw—Cartilage and Brain Knives—3 Scalpels and strong Scalpel—Bowel and Dissecting Scissors—Forceps—Hammer—Spine Chisel—Cross Wrench—Chain Hooks—Blow Pipe—Needles.

POST-MORTEM CASE, No. 3.

Saw, Cartilage and Brain Knife, fitting into one handle—Dissecting and Bowel Scissors—Forceps—Hammer—Spine Chisel—Cross Wrench—2 Scalpels and strong Scalpel—Chain Hooks—Blow Pipe—Needles.

DISSECTING CASES,

Of the ordinary sizes, with 4 or 6 Scalpel Scissors, Forceps, &c.

MR. PARTRIDGE'S DISSECTING CASE.

6 Scalpels—Strong Scalpel—Nerve Knife—Straight and curved Scissors, large size—Forceps—Chain Hooks—Blow Pipe.

ARMY REGULATION CASE.

Amputating Saw — 4 Flap Knives — Mr. Butcher's Saw — Bone Forceps — Spring Forceps — Tenaculum — Liston's Tenaculum — Syme's Artery Forceps — 4 Dieffenbach's Forceps — Straight Scissors — Fergusson's Lion Forceps — 2 Trephines — Elevator — Gouge — Gouge Forceps — Necrosis Forceps — Hey's Saw — Tang Scalpel — 6 Scalpels — 3 Curved Bistouries — 2 Straight and 1 Probe Bistoury — Liston's Needle — Tenotomy Knife — Large Trocar — Hydrocele Trocar and Glass Syringe — Exploring Trocar — Silver Director — Hernia Director — Aneurism Needle — Bullet Forceps — Coxeter's Ball Extractor — Bullet Probe — Eye Needle and Spud for extracting Foreign Bodies — Case of Probes and Styles — Wire Nippers — Denman's Midwifery Forceps — 2 Double Tracheotomy Canulas — Double Probang — 3 Silver Male Catheters — 4 Gum Catheters — Female Catheter — Screw and Field Tourniquet — 12 Needles — Silver Wire and 2 Needles — Case for Plaster — Bottle — Ligature Silk and Thread.

DETACHMENT CASE.

Amputating Saw — 3 Flap Knives — Fergusson's Saw — Bone Forceps — Spring Forceps — Tenaculum — Liston's Tenaculum — 2 Dieffenbach's Forceps — Trephine — Elevator — Hey's Saw — Tang Scalpel — 3 Scalpels — 3 Curved Bistouries — 2 Straight and 1 Probe Bistoury — Liston's Needle — Simpson's Needle — Sharp

Hook—Hydrocele Trocar—Silver Director—Hernia Director—Aneurism Needle—Bullet Forceps and Probe—Double Tracheotomy Canula—Double Probang—3 Silver Male Catheters—4 Gum Catheters—Screw and Field Tourniquet—12 Needles—Plated Wire and 2 Needles—Silk and Thread.

POCKET CASE.

Double Bistoury, curved — Double Bistoury, straight — Small straight Bistoury, and double-edged Scalpel—Liston's Needle and Tenaculum—Straight Scissors—Spring Forceps—Liston's Tenaculum—Director and Aneurism Needle—2 Probes, Caustic Holder, with Grooved Needle—Vaccine Instrument, with fine Glass Tubes—Female Catheter—12 Suture Needles—Skein of Silk—Silver Wire and Needle.

TOOTH POUCH.

8 Tomes' Forceps—Elevator—Key—Gum Lancet—5 Excavators to Socket handle.

BOX OF APPARATUS FOR THE TREATMENT OF FRACTURES AND THE REDUCTION OF DISLOCATIONS.

Macintyre's Double Inclined Plane, modified—Liston's Thigh Splint, jointed for portability—Pair of Japanned Leg Splints—Extension Splint for Fracture of the Humerus—Jointed Elbow Splint—Ellis' Clavicle Apparatus—Nelaton's Radius Splint—Set of Lined Splints—6 Pasteboard Splints—1 lb. Gutta Percha—4 Yards Gutta Percha Tissue—Tin Box, containing 2 lb. Dextrine—Tin Box, containing 1 lb. Plaster of Paris—24 loose wove Bandages for Plaster of Paris Bandage—Arm Sling—Salter's Leg Sling—Dislocation Apparatus.

HOSPITAL FIELD PANNIERS.

THE TWO PANNIERS ARE CONSTRUCTED TO FORM TOGETHER A FIELD OPERATING TABLE.

CONTENTS OF No. 1.

MEDICINES.		MATERIALS.	
	Oz.		No.
Ammoniā sesquicarb.....	2	Corkscrew	1
Antimon, potas. tart.	$\frac{1}{2}$	Knives (1 palate and 1 pill)...	2
Acid, sulphuric	2	Scissors	pair 1
Do., nitric pur.	2	Blank Labels.....No. 100	
Æther, chloric	2	India-rubber Enema	1
Argent, nitrat.....	1	Grain Scales and Weights,	
Blistering collodion	2	set	1
Chloroform (in 3 capped bot-			
tles)	9	Pens, ink, and Wafers.	
Collodion	$1\frac{1}{2}$	Gallipots..... doz.	1
Cerat, cetacci	8	Pill-boxes	nest 6
Cupri, sulphat.	1	Corks (vials and quarts) doz.	4
Hydrarg, chlorid.	4	Measures (2 oz. and minim)	
Do. nitrico oxid.	$\frac{1}{4}$	No.	2
Ipecacuanhæ, pulv.	1	Graduated Horn Cup	1
Jalapæ, pulv.	2	Pestle and Mortar	1
Liquor, stypticus	4	Ligatures (silk and thread)	
Liq. ammoniā acet. concent.	4	oz.	2
Morphiæ, acetat.	$\frac{1}{2}$	Needles	doz. 1
Ol, terebinthinā.....	8	Wax	oz. $\frac{1}{4}$
Do. olivæ opt.	4	Tape (broad).....	piece 1
Do. tigllii	$\frac{1}{2}$	Paper of Pins	No. 1
Do. menthœ pip.....	2	Packthread.....	ball 1
Opii, pulv.	2	Surgeon's Sponges.....	No. 6
Pil, colocynth comp.	4	Wax Matches	tin box 1
Pil. hydrarg.....	4	Blotting Box	1
Pulv. ipecacuanha comp. ...	1	Extra Slings Irons.....	No. 4
Do. antimon Jacobi	1	Paper	qr. $\frac{1}{2}$
Do. cretæ. comp. c. opio..	8	Oiled Silk.....	yd. $\frac{1}{2}$
Plumbi, acetat.	2	Gutta Percha Tissue	2
Quinæ, disulph	4	Oiled Paper (substitute for	
Sodæ, bicarb. pulv.	2	Oiled Silk)	sheets 12
Spirit ammoniā aromat.....	6		
Do. æther nitrici	2		
Do. do. comp.	2		
Tinct. ferri sesquichlor	4		
Do. opii	8		
3 Empty bottles for Pills.			
2 bottles for brandy and water.			

Surgeon's full set of Surgical Instruments.—Medical Certificate Book.

Lamp, with reflector, which may be suspended by the moveable hooks at the back. By raising the cover on the top of the lamp, the small tin

saucepan in the other pannier may be fixed there for the purpose of heating a little water for the preparation of tea, &c. The candle tube must always be lowered and fixed at the bottom of the lamp when lighted.

CONTENTS OF No. 2.

In Tin Case.

Field Tourniquets	16
Screw do.	4
Tin Saucepan (for heating water over the lamp)	1
Small Strainer (for making a cup of tea quickly and economically)	1

Place a teaspoonful of tea in the strainer, and pour boiling water upon it.

In Tin Case.

Lint	lb. 2½
Carded Cotton.....	lb. 2
Calico Bandages	48

In Wallet.

Linen Sheeting	yds. 3
Calico.....	„ 2
India-rubber	„ 2

In two Tin Cases.

Emp. adhesivum, on calico yds.	4
Isinglass Plaister	4

In Tin Case.

Wax Candles (for use in the lamp in the other pannier)	26
Wax Matches.....	boxes 2
Splints	set 1
Tin Bed Pan	1
Tin Washing Basin, fitting round the Bed Pan	1

In Tin Case.

Black Tea.....	lb. 1
Lump Sugar.....	„ 2

In Tin Case.

Arrowroot	„ 1
Concentrated Beef Tea ...	„ 1
Cocoa Milk (in ½ lbs.).....	„ 1
Case Book.....	1
Admission and Discharge Book	1

SET OF INSTRUMENTS FOR A SURGEON IN THE NAVY.

An Operating Case, containing:—Amputating Saw, with spare blade—3 Amputating Knives—2 Catlins—Finger Saw, with two blades—Bone Forceps—Artery Forceps—2 Tenacula—3 Trephines—Hey's Saw—Lenticular—Scull Forceps—Elevator—Brush—6 Scalpels—Curved Bistoury, Probe-pointed—Head Razor—2 Trocars—Bullet Forceps—Bullet Scoop and Probe—

Strong Scissors—Tooth Key—2 Foreeps—Punch—Gum Lancet
—2 Seton Needles—2 Probangs—2 Silver and 2 Gum Catheters
—2 Screw Tourniquets—2 Dozen Needles—Thermometers.

APPARATUS FOR RESTORING SUSPENDED
ANIMATION.

SET OF POCKET INSTRUMENTS.

6 Lancets, in case—Cupping Apparatus—2 Dozen Bougies, in
case—2 Pint Pewter Clyster Syringes—6 Pewter Urethra
Syringes—2 Sets common Splints—12 Rollers of Flannel or
Linen—2 Eighteen-tailed Bandages—4 Screw Tourniquets—20
Yards Tourniquet Web—60 Yards Tape—A Paper of Needles.

SET OF INSTRUMENTS FOR AN ASSISTANT-
SURGEON IN THE NAVY.

An Operating Case, containing :—Amputating Saw—2 Ampu-
tating Knives—Catlin—Finger Saw, with two blades—Bone
Forceps—Artery Forceps—2 Tenacula—2 Trephines—Hey's
Saw—Seull Forceps—Elevator—Brush—Scalpel and Raspitory
—5 Scalpels—2 Trocars—Bullet Forceps and Probe—Tooth Key
—2 Foreeps—Punch—Gum Lancet—Seton Needle—Probang—
2 Silver and 1 Gum Catheters—2 Screw Tourniquets—1 Dozen
Needles—Thermometer.

SET OF POCKET INSTRUMENTS.

12 Lancets—6 Pewter Urethra Syringes.

In case of being appointed to a ship not bearing a
surgeon, the following articles will be required in
addition :—

6 Bougies, in case—1 Set Common Splints—3 Rollers.

INSTRUMENTS REQUIRED ON BOARD THE SHIPS
BELONGING TO THE ROYAL MAIL STEAM PACKET
COMPANY.

An Operating Case, containing :—Amputating Saw—2 Flap Knives, Circular Knife and Catlin—Bone Forceps—Finger Saw—2 Tenacula—Assalini's Tenaculum—Artery Forceps—Spring Forceps—Trepine—Elevator—2 Hey's Saws—Brush—Tang Scalpel—2 Scalpels—2 Finger Knives—3 Curved Bistouries—2 Trocars—Bullet Forceps and Probe—Aneurism Needle—Hernia Director—Tourniquet—12 Needles and Silk.

MIDWIFERY POUCH containing :—Forceps—Lever—Perforator—Blunt Hook and Crochet—Craniotomy Forceps.

Pocket Case—Cupping Case—Tooth Pouch—Case of Catheters and Bougies—6 Lancets—Thermometer—Double Probang—Pewter Clyster Syringe—6 Small Pewter Syringes—Weiss' Splint for Leg and Thigh—1 Set Pott's Straight Splints—20 Calico Rollers—Tape and Thread.

A portion of these instruments are supplied by the Company.

INSTRUMENTS REQUIRED ON BOARD THE SHIPS
BELONGING TO THE PENINSULAR AND ORIENTAL
COMPANY.

Amputating and Trepanning Case—Case of Tooth Instruments—Pocket Case—Cupping Case—3 Silver Male Catheters—Female Catheter—6 Metallic Bougies—2 Trocars in Case—Midwifery Forceps—6 Bleeding Lancets.

INSTRUMENTS REQUIRED BY H. M. EMIGRATION
COMMISSIONERS.

Pocket Case—Case of Tooth Instruments—Set of Silver and Gum Elastic Catheters—Female Catheter—Set of Bougies—Midwifery Forceps—Trachea Tube—Case with Amputating Knife and Catlin—Amputating Saw—Hey's Saw—Tourniquet—Needles and Silk—4 Lancets in Case.

In addition to the above, it is recommended that the following instruments be procured;—

Cupping Apparatus—Trocar and Canula—Trepine and Elevator—Craniotomy Forceps—Perforator—Blunt Hook.

MEDICINE CHESTS.

SURGEON'S OR APOTHECARIES' PORTABLE
DISPENSING CABINET.

The Chest contains 82 Stopped Flint Glass Bottles, from 1 oz. to 2 lb. each—10 Drawers, containing 23 Stone Jars, with covers, from 4 oz. to 4 lb. each—2 Mortars, Drop, and Graduated Measures, Funnels, Dispensing Scales, with Brass Pillar, Knives, Spatulas, etc., etc., with ample room for extras. Size 6 ft. 9 in. high, 3 ft. broad, 1 ft. 5 in. deep.

COLONIAL OR EMIGRANT CHESTS, No. 1.

Containing 28 Bottles (fourteen 6 oz., six 4 oz., fourteen 2½ oz., and four 1 oz. Stopped Green Bottles, and Slab at top)—Four pots with Covers—Mortar and Pestle—Graduated Measure, Knife, etc., in the Drawer.

No. 2.

Containing 45 Bottles (4 quart, 8 pint, six 8 oz., eight 4 oz., thirteen $2\frac{1}{2}$ oz., and six 1 oz. Stopped Bottles, with large well for extras at top)—6 Covered Pots, Mortar, Pestle, Slab, Knife, Spatula, Graduated Measure, etc., in the Drawer.

STRONG COMMON CHESTS, FOR SHIP'S USE,

No. 1.

Containing 40 Bottles (10 quart, 8 pint, four 8 oz., five 4 oz., six $2\frac{1}{2}$ oz., and seven 1 oz. Bottles)—Mortar, Pestle, Scales, Slab, Knife, and large space for extras, etc.

No. 2.

Containing 48 Bottles (12 quart, 11 pint, eight 8 oz., five 4 oz., twelve $2\frac{1}{2}$ oz.)—Mortar, Pestle, Measure, Scales, Knife, Scissors, etc., with large space for extras.

DOMESTIC CABINET CHEST.

Containing 28 Bottles (four 5 oz., six 4 oz., four 3 oz., ten $1\frac{1}{2}$ oz., Glass Slab at top)—2 Small Drawers, with slides—2 Larger, containing four 1 oz. Bottles, four Glass Pots, Mortar, Pestle, Measure, Knife, Spatula, and Scales.

* * * The above chests are fitted by the Apothecaries' Company, or any druggist that may be named.

APPLIANCES, UTENSILS, ETC.

Machine Spread Plasters of every description.

Plasters, spread upon leather.

Isinglass Plaster.

Liston's Membrane Plaster.

Adhesive Plaster, on oiled silk.

Lint of various qualities and descriptions.

Cotton Wool.

Tow.

Oiled Silk.

Parhydor, an improved description of oiled silk.

Gutta Percha Tissue.

Do. Cloth.

Waterproof Bed Sheeting.

Vulcanized do.

Spongeo Piline.

Sponge of all qualities.

Gutta Percha, of different thicknesses, for Splints.

Pasteboard do. do.

Thermometers, in boxwood.

Do. Bath.

Do. Atmospheric and self-registering.

Do. Aneroyd.

Cupping Glasses.

Vaccine Tubes and Points.

Spirit Lamps.

Retort Stands.

Test Tubes.

Camel-hair Pencils, bound with wire.

Apothecaries' Scales and Weights, 6 and 7 in. beam, and with
or without Glass Pans.

Do. do. for weighing up to 4 oz.

Counter do. with brass pillar.

Do. Weighing Machines, from 7 to 14 lb.

Do. do. from 7 to 56 lb.

Chemical Scales and Weights.

Pill Machines, with Rollers to cut 24, 30, or 36 Pills.

Do. double, to cut 3 and 5 gr. Pills.

Slabs for Pills, in marble and earthenware.

Screw Powder Folders.

Iron Cork Pressers.

Root Cutters.

Mortars and Pestles, in iron, composition, glass, and marble.

Tincture Presses.

Infusion Pots and Strainers.

Filtering Paper.

Evaporating Dishes, in composition and iron enamelled.

Sieves.

Bolus or Palette Knives.

Do. Stiff for Pills.

Plaster Spatulas.

Pot do.

Bleeding Basins.

Spitting Pots.

Medicine Spoons, in metal and china.

Phials, from $\frac{1}{2}$ oz. to 4 oz.

Squares, from 1 oz. to 8 oz., in white and green glass.

Corks for Phials and Bottles of all sizes.

Gallipots.

Covered Jars.

Glass Jars for Preparations.

Measures, in glass and pewter.

Funnels do.

Pill Boxes, in paper and wood.

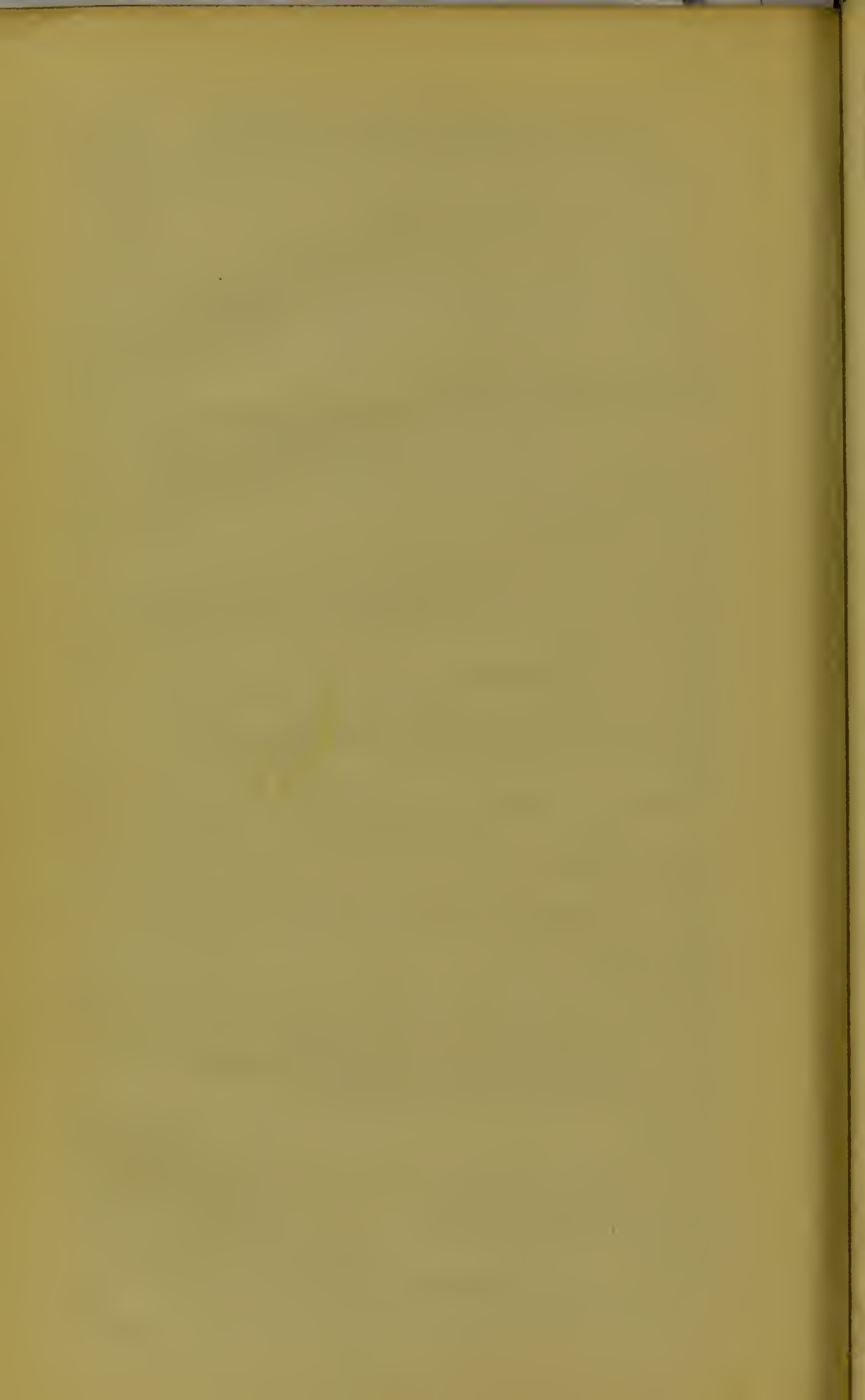

APPENDIX.

APPENDIX.

VETERINARY INSTRUMENTS.

Balling Irons.

Do. with Regulating Screw, by Varnell.

Ball Probang, by Goodwin.

Concealed Bistouries.

Blood Sticks.

Bleeding Cans.

Bronchotomy Tubes.

Castrating Clams.

Do. Irons.

Do. Instruments, in sets.

Catheters for Horses.

Do. for Mares.

Clyster Pipes.

Do. Syringes, pewter.

Do. do. by Weiss.

Cropping Clams.

Dental Instruments, by Gowing.

Dissecting Instruments.

Drawing Knives and Searchers.

Drenching Frames.

Do. Horns.

Docking Machines.

Do. Instruments, in sets.

Firing Irons, single, or in sets.

Fleams, with one, two, or three blades.

Do. Patent, by Weiss.

Foaling Instruments.

Hobbles for Casting, with Gloag's Rope and Chain.

Lanects, bleeding and abscess.

Do. with stop.

Do. small, for Dogs.

Mane Pullers.

Neurotomy Instruments.

Pereosteotomy do.

Pocket Cases.

Post-Mortem Instruments.

Probangs.

Rasps for the Mouth and Hoof.

Seton Needles, various.

Do. with sliding guard.

Seissors, various.

Shoing Tools, in sets.

Singeing Apparatus.

Spatulas.

Suture Needles.

Needle Forceps.

Syringes, various, in Pewter and Glass.

Troears.

Do. for piercing Hoven Cattle.

Do. Tracheotomy, by Gowing.

Tracheotomy Instruments, by Spooner.

CUTLERY, ETC.

TABLE, DESSERT KNIVES AND CARVERS, with silver and electro-plated handles.

Do. with fluted or carved ivory handles, of various patterns.

Do. with plain ivory handles, silver ferruled.

Do. with plain balance handles.

Do. with buckhorn handles.

Do. with horn and wood handles.

Large and Small FORKS to correspond with any of the above.

STEELS AND KNIFE SHARPENERS.

KNIFE CASES to contain sets of Knives from one to six dozen of each, with Carvers, etc.

BREAD KNIVES, of various shapes, with wood and ivory handles, both plain and carved.

BREAD PLATTERS, of various designs.

BUTTER KNIVES, with silver, plated, and steel Blades.

ONE ARM KNIVES, with steel and silver Fork Prongs.

MASTICATING KNIVES, with fixed and folding Blades.

COOK'S KNIVES, with wood and ivory handles.

DESSERT KNIVES, with silver and plated Blades, and silver, silver gilt, agate, pearl, ivory, and plated handles.

FISH EATING KNIVES AND FORKS, of various designs.

FISH CARVERS do. do.

Electro-plated SPOONS and FORKS, of various patterns and qualities.

Electro-plated CHEESE SCOOPS, ASPARAGUS 'TONGS, CRUMB
SCOOPS, ICE 'TONGS, etc.

GRAPE SCISSORS, plain and plated.

NUTCRACKS, of various patterns, in steel and plated.

CHAMPAGNE NIPPERS AND KNIVES.

CORKSCREWS, with patent rack-action, in steel and bronze.

Do. with double screw-action.

Do. with Lund's patent Lever.

Do. plain, in wood handles.

Do. in steel, to fold for the pocket.

Do. small for scent.

RAZORS of various qualities and patterns, with pearl, tortoise-
shell, ivory, and horn handles.

Sets of four, six, and seven RAZORS, in cases.

WEISS' RAZOR STROPS, of various sizes.

WEISS' FLINT POWDER, for dressing Razor Stropps.

HUNTING KNIVES, in fixed handles and scabbards, of various
patterns.

BELTS and FROGS for do.

HUNTING KNIVES, in folding spring handles.

SPORTSMAN'S KNIVES, of all varieties.

FISHING KNIVES, of do.

POCKET KNIVES, of do.

PEN KNIVES, of do.

DESK KNIVES, in ivory and wood handles.

PRUNING KNIVES, of various sizes, in fixed and spring handles.

Do. SCISSORS, of various sizes.

BUDDING KNIVES, in fixed and spring handles.

CORN KNIVES, of various shapes, in ivory and ebony handles.

SETS of CORN-CUITING INSTRUMENTS, in cases.

SCISSORS for LADIES, of various qualities and patterns.

Do. for NAILS.

SETS of LADIES' SCISSORS, containing from three to seven
Scissors.

NAIL NIPPERS, of various patterns.

LADIES' NEEDLES, with gold and silver Eyes.

LADIES' COMPANIONS, of various patterns, containing Cutlery.

DRESSING CASES, in wood and leather, fitted with Cutlery, silver or electro-plated fittings, etc.

TRAVELLING BAGS, fitted with Cutlery, silver or electro-plated fittings.

DRESSING CASE INSTRUMENTS.

PIC-NIC CASES, fitted with Cup, Knife, Fork, and Spoon, in spring handles, Corkscrew, etc.

LEATHER POUCHES, containing from two to six of each Table and Dessert Knives, and the same number of electro-plated Table, Dessert, and Teaspoons, large and small Forks, Egg, Salt, and Mustard Spoons.

DRINKING CUPS, of horn, plain, and mounted with silver.

DRINKING FLASKS, of various sizes.

LAZY TONGS.

INVALID TONGS, by Weiss, for reaching light objects from the bed or sofa, etc.



