

Historic, Archive Document

Do not assume content reflects current scientific knowledge, policies, or practices.

MICHELL'S

AUTUMN
CATALOGUE

OF BULBS

1899

WILHELMINA

QUEEN OF HOLLAND

SEEDS,
PLANTS,
TOOLS,
& C.

HENRY F. MICHELL, 1013 MARKET ST. Philadelphia, Pa.

Most Gratifying Reports From Our Bulbs

CLIPPING
from the
PUBLIC LEDGER

APRIL 29TH, 1899

A MOST BEAUTIFUL SIGHT

is to be seen this week in Independence Square, back of the old State House, where nearly 50,000 Hyacinths, Tulips and Daffodils are now in full bloom. They were planted in most artistic designs last autumn, and every bulb bloomed and proved true to name and color. All these bulbs were especially selected and supplied by **HENRY F. MICHELL, 1018 Market Street, Philadelphia**, who has furnished ALL THE BULBS planted by the City during the past three years, and has again been awarded the contract for the display in 1900.

DEPARTMENT OF PUBLIC SAFETY.



GEO. G. PIERIE,
Chief of Bureau.

Philadelphia, April 27th, 1899.

HENRY F. MICHELL,
1018 Market Street,
Philadelphia, Pa.

Dear Sirs:

As a rule I am somewhat tardy in testifying to the merits of matters pertaining to my profession, and only in extraordinary cases am I inclined to do so, but on this occasion this restraint is relaxed, and I hasten to inform you, that during the forty years of my professional life I have never seen either in England, on the Continent, Canada or in the United States, finer results than those produced and now in evidence in our City small Parks and Squares, and while as a mass, the display everywhere is faultless, at the same time, each individual bulb of the 60,000 Hyacinths, Tulips, Narcissus, etc., supplied by you, are perfect specimens in themselves, and true to their names, type, and color, which fact is attested by the many thousands of people who have witnessed the display. I congratulate you on the success you have attained, and the point of excellence to which you have brought the Bulb section of your business.

Yours very truly,

JOHN C. LEWIS,

City Forester and Landscape Gardener.

High Praise for Our
Bulbs.

CLIPPING
from the
PHILADA. RECORD

APRIL 28TH, 1899

There has never been a finer display of flowers in the public squares than at present.

One of our many
unsolicited testimonials

COATESVILLE,
5 mo. 6, 1899.

Henry F. Michell,
Respected Sir:

I want to tell you that the Tulip beds planted last Fall of bulbs bought from you, together with some Kaiser-kroons I had from previous year's bed, have been the admiration of the neighborhood, they grew so evenly and in such neat shape.

Yours, etc.,

Chas. L. Huston.

HENRY F. MICHELL

HENRY F. MICHELL
FRED'K J. MICHELL

1018 Market Street

Telephone 3-55-43-A

... PHILADELPHIA

WE herewith take pleasure in submitting our Catalogue and Price List of **Bulbs** and Seeds for Autumn planting. We have endeavored to procure the **very best bulbs** produced, and we **guarantee to our patrons complete satisfaction.** By the **personal** inspection of growing crops, both in this country and in Europe, we are placed in position to select only the **very best** and **most reliable** growers to grow our **Bulbs** and Seeds. **Our first aim is quality,** and we feel sure that our prices have been made as low as possible, considering the high quality of the **Bulbs** and Seeds that we supply.

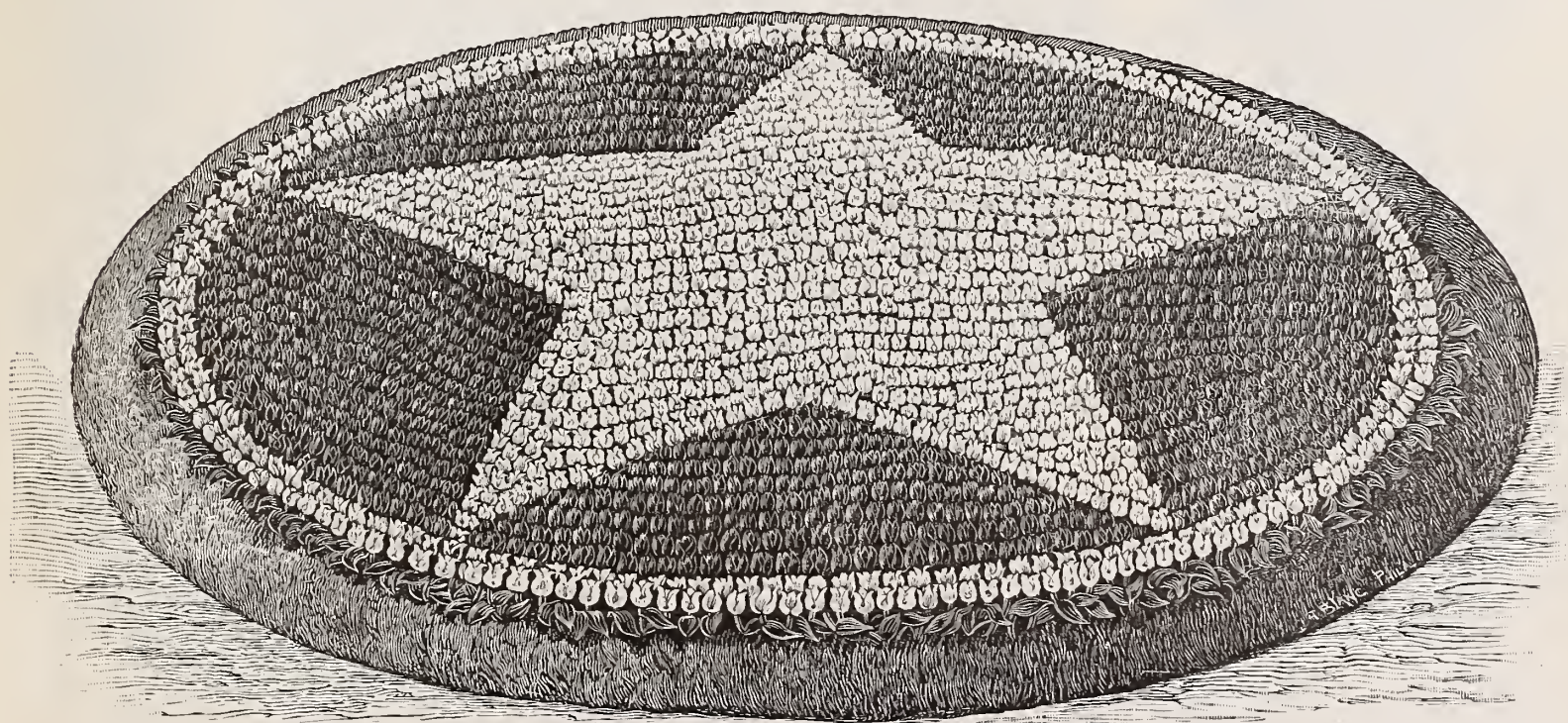

...PHOTOGRAPH OF A BED OF MICHELL'S TULIPS...

In the grounds of MRS. J. W. M. CARDEZA, at Germantown, Philadelphia, taken last Spring.

ALL BULBS SUPPLIED BY US.

Designed and planted by Edward Jones, gardener, who writes us as follows: "Enclosed you will find photo of tulip bed, which did remarkably well this season. A remarkable feature of this bed was, in spite of an elevation of three feet at centre, the design came out perfect all over. The bed was 30 feet across, and the design, a star of five points, coming down to within one and one-half feet of edge of bed. 2,100 bulbs of YELLOW PRINCE Tulips were planted five inches apart, and a delightful fragrance from that variety filled the air for thirty feet. Between points of star, right down to edging, forming a perfect ground I had planted 2,500 VERMILION BRILLIANT Tulips, four inches apart, which color was very intense. The edging was made of 400 LA REINE Tulips, planted six inches apart, of double row, very close together".

HYACINTHS.

Directions for planting in the open ground.—October and November is the proper time, but they can be set out at any time, as long as the ground is open and the bulbs remain sound. The best compost for their culture is the following: one-third river or sea sand, one-third well-rotted cow manure, and one-third good garden mould; or, where the soil is naturally light, well-rotted cow manure liberally intermixed is all-sufficient. The beds composed of the above compost should be well dug to a depth of fourteen inches, and raised from two to four inches above the level of the walks. The bulbs should be planted evenly about six inches deep (to the bottom of the bulbs) and from five to six inches apart; *if planted at uneven depths they will not bloom at the same time, but irregularly.* Care must be taken not to press the earth too firmly around and over the bulbs; some successful gardeners follow the plan of setting each bulb in a handful of clean sand, which insures drainage. After planting rake the bed smooth, and after the ground has frozen tolerably hard in early winter cover with dry litter, leaves or coarse manure. If this covering be applied before freezing weather, it renders the bulbs liable to the predations of field-mice.

For culture in pots.—Prepare the above compost, adding, if possible a quantity of leaf mould. The most favorable time for planting is September, October and November. The size of the pot depends on the number of bulbs planted in a single one; three bulbs in a pot of say six inches in diameter have a rich massive effect; one or two bulbs in each may be planted in proportionately smaller pots—two bulbs in each are very effective. In potting, each bulb should remain one-half above the surface of the soil; when thus planted, water them well, to imbed the bulbs firmly in the soil, allowing them to remain in this condition one or two days; then bury the pots in the open ground to the depth of six inches for eight weeks, in which condition the preparatory root growth necessary to a vigorous development of their flower scapes is made. After this period take up the pots and remove them to a room not heated, but not so cold as to freeze. Being exposed to the light for the first time, they are, of course, very delicate. Care should therefore be exercised not to place them in the direct rays of the sun for two or three days. When about ready to flower bring them to the ordinary living-room, where the warmth will soon cause them to bloom. By so bringing them out, a few at a time, you can secure a beautiful succession of flowers all winter. They will need occasional watering until they begin to grow, when they should have an abundance of air in mild weather, and plenty of water.

For Growing in glasses.—Single Hyacinths do better than double-in glasses, as they produce a much larger and more showy spike or truss. Place the bulb in the glass, which should be filled with water so it touches the bottom of the bulb, place them in a close box in a cool place, or on a shelf in the dark part of the cellar, change the water every ten days or two weeks; keep them in the dark, cool place from six to eight weeks, then remove them to the light (not too strong). If then kept in a cool room they will produce very fine spikes and remain in bloom a long time.



**** Hyacinths
FOR POTS.



Hyacinths
FOR GLASSES

NAMED HYACINTHS

← FIRST SIZE SELECTED BULBS →
The varieties are the very best and will produce large flower stalks, and are the sort which usually takes the prizes at exhibitions.

SINGLE RED AND PINK.—First Size, Selected.

	Each	Per doz.	Per 100
Cosmos. Deep rich pink	\$0.12	\$1.25	\$7.50
Gertrude. Bright pink, extra large truss. . .	.10	.90	6.50
General Pelissier. Rich crimson, large spike. .	.12	1.25	7.50
Gigantea. Pink. Large truss10	1.00	7.50
Lord Macauley. Bright red12	1.25	7.50
Norma. Pink, large flowers10	.90	7.00
Robert Steiger. Crimson.10	.90	6.50

SINGLE WHITE.—First Size, Selected.

	Each	Per doz.	Per 100
Alba Superbissima. Pure white12	1.20	8.00
Baron von Thuyl. Pure white, very early . .	.12	1.20	8.00
Grandeur a Merveille. Blush white10	1.00	7.50
La Grandesse. Pure white15	1.50	11.50
Mad. Vander Hoop. Pure white, compact . .	.12	1.20	8.00

SINGLE BLUE.—First Size, Selected.

	Each	Per doz.	Per 100
Chas. Dickens. Porcelain10	1.00	7.00
Czar Peter. Rich porcelain blue, ex. large spike	.15	1.40	11.00
Grand Maitre. Bright10	1.00	7.50
Blue Mourant. Deep10	.90	6.50
King of the Blues. The best bright blue . .	.10	1.00	7.50
Haydn. Best violet, good spike15	1.50	10.00
Leonidas. Light, large10	1.00	7.50

SINGLE YELLOW.—First Size, Selected.

	Each	Per doz.	Per 100
Hermann Orange.12	1.20	8.50
Ida. Bright yellow15	1.50	10.00
King of the Yellows.15	1.50	11.00
La Citroniere. Lemon yellow15	1.50	10.00

DOUBLE RED AND PINK.—First Size, Selected.

	Each	Per doz.	Per 100
Boquet Tendre. Dark red, large truss10	1.00	7.00
Czar Nicholas. Pink10	1.00	7.00
Noble Par Merite. Pink, large truss10	1.00	7.00

DOUBLE WHITE.—First Size, Selected.

	Each	Per doz.	Per 100
La Virginite. Cream10	.90	6.00
La Tour de Auvergne. Pure white, perfect spike	.12	1.25	8.50
Prince of Waterloo. Pure white, extra large	.12	1.25	8.50

DOUBLE BLUE.—First Size, Selected.

	Each	Per doz.	Per 100
Blocksberg. Porcelain, large bells and spike	.10	1.00	7.50
Garrick. Deep, very good10	1.00	7.50
Mignon Van Dryfhout. Light blue, large bulb and spike10	1.00	7.00

DOUBLE YELLOW.—First Size, Selected.

	Each	Per doz.	Per 100
Boquet de Orange.10	1.00	7.50
Goethe. Rich yellow10	1.00	7.50

BELGIAN **IN**

Hyacinth Glasses **ALL**

15 cts. each, \$1.50 per doz., 2 doz. for \$2.75.

PATENT HYACINTH GLASSES in 2 parts, the bulbs and roots are not disturbed and broken, when the water is changed.

All colors, 25c. each; \$2.50 per doz.

... WE CAN ALSO SUPPLY ALL OTHER NAMED VARIETIES ...

6 BULBS OF ANY ONE VARIETY AT DOZEN RATES; 25 AT 100 RATES; 250 AT 1000 RATES.

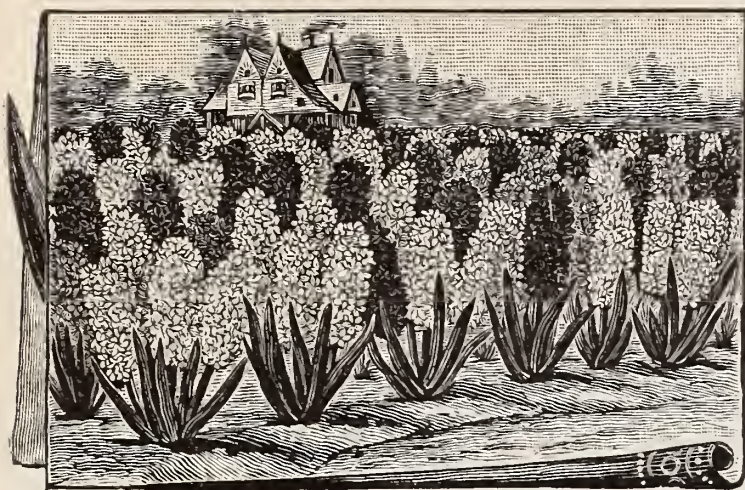

Hyacinths.

In Separate Colors.

These are the best quality unnamed bulbs and are used principally for outside planting, they can also be used for indoors but will not produce as large spikes as the first and second size named bulbs.

SINGLE.

	Each	Per doz.	Per 100	Per 1000
Red. All shades, including Pink,	\$0.06	\$0.65	\$4.75	\$42.50
White. All shades inc. pure white,	.06	.65	4.75	42.50
Blue. All shades, including purple,	.06	.65	4.75	42.50
Yellow. All shades	.06	.65	4.75	42.50
Pink.	.06	.65	4.75	42.50
Dark Red.	.06	.65	4.75	42.50
Pure White.	.06	.65	4.75	42.50
Blush White.	.06	.65	4.75	42.50
Light Blue.	.06	.65	4.75	42.50
Dark Blue and Purple.	.06	.65	4.75	42.50
Mixed. All colors	.05	.60	4.50	41.50

DOUBLE HYACINTHS.

	Each	Per doz.	Per 100	Per 1000
Red. All shades	\$0.06	\$0.65	\$4.75	\$42.50
Pink.	.06	.65	4.75	42.50
White. All shades	.06	.65	4.75	42.50
Blue. All shades	.06	.65	4.75	42.50
Yellow.	.06	.65	4.75	42.50
Mixed. All colors	.05	.60	4.50	41.50

Named Hyacinths.

(Second Size.)

For customers not wishing to purchase the first size named bulbs.

The following sorts have proven to be the very best.

They produce well-shaped, full and compact spikes. It pays well to plant only the named sorts, as they are far superior to the regular separate color quality (which we recommend now only for outside planting.)

Price 85 cts. per doz.; \$6.50 per 100; \$60.00 per 1000.

- Single Pink, Gigantea.**
- “ “ Chas. Dickens.
- “ “ Baron V. Thuyl.
- “ **Red,** Gen'l Pellissier.
- “ “ Robt. Steiger.
- “ “ Gertrude.
- “ **White,** Alba Superbissima
- “ “ La Grandesse.
- “ “ Baron V. Thuyl.
- “ “ Mad. Vander Hoop
- “ **Blue,** Chas. Dickens
- “ “ (Light)
- “ “ Baron V. Thuyl
- “ “ (Dark)
- “ “ Grand Maitre
- “ “ (Bright)
- “ “ King of the Blues
- “ “ (Dark)

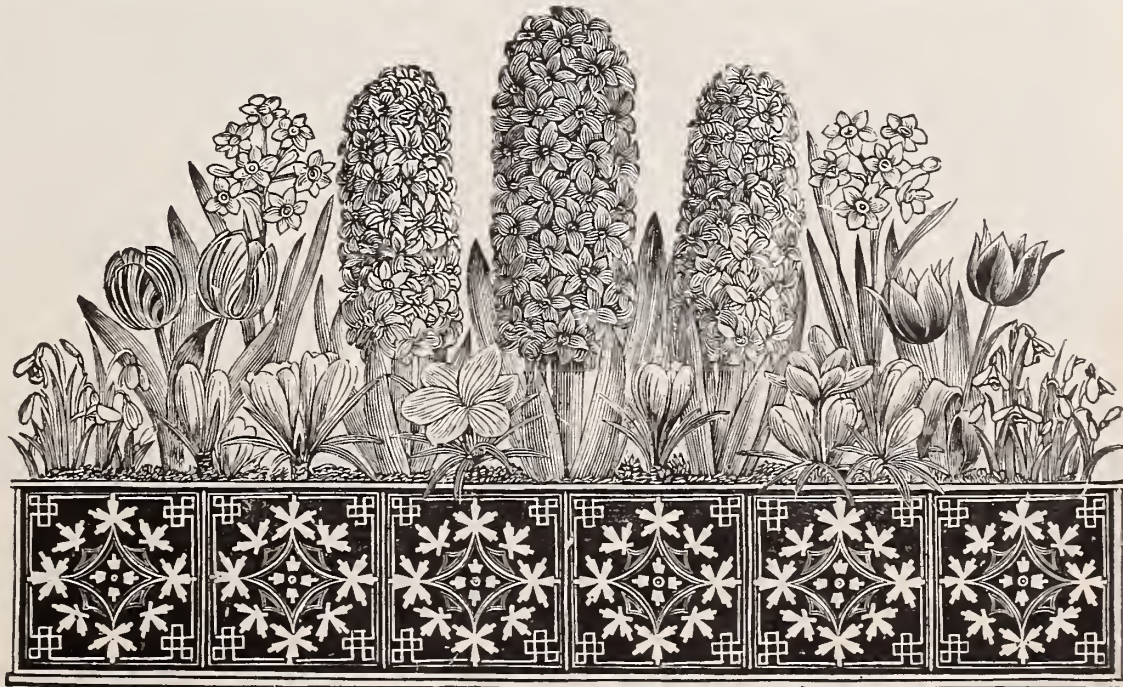

A WINDOW BOX FULL OF BULBS IN BLOOM.

6 BULBS OF ANY ONE VARIETY AT DOZEN RATES; 25 AT 100 RATES; 250 AT 1000 RATES.

R
O
M
A
N



H
Y
A
C
I
N
T
H
S

FRENCH ROMAN HYACINTHS.

Specially adapted for forcing in greenhouse or growing in the house. Very showy when planted in a window box or in six or seven inch pots, three or four bulbs in a pot.

	Each	Per doz.	Per 100	Pe 1000
Pure White. 12 to 15 ctm. bulbs,	\$0.04	\$0.35	\$2.50	\$20.00
“ “ Mammoth Bulbs,	.05	.45	3.00	25.00
“ “ Giant Bulbs,	.06	.55	4.00	35.00
“ “ 11 to 12 ctm. bulbs,	.03	.30	2.00	17.50
Pink.	.05	.35	2.25	20.00
Blue.	.05	.35	2.25	20.00
Italian. (Rosy white)	.04	.35	2.50	21.00

Miniature or Dutch Roman Hyacinths

Excellent for growing in pots, pans or boxes, blooming freely and early, producing three or four spikes. They may be planted close together either in pans or pots, or in the open ground.

	Each	Per doz.	Per 100
Red. Choicest named sorts	\$0.05	\$0.50	\$3.50
White. “ “ “	.05	.50	3.50
Pink. “ “ “	.05	.50	3.50
Blue. “ “ “	.05	.50	3.50

Please notice that these are the named varieties which are far superior to the separate color grade usually offered.

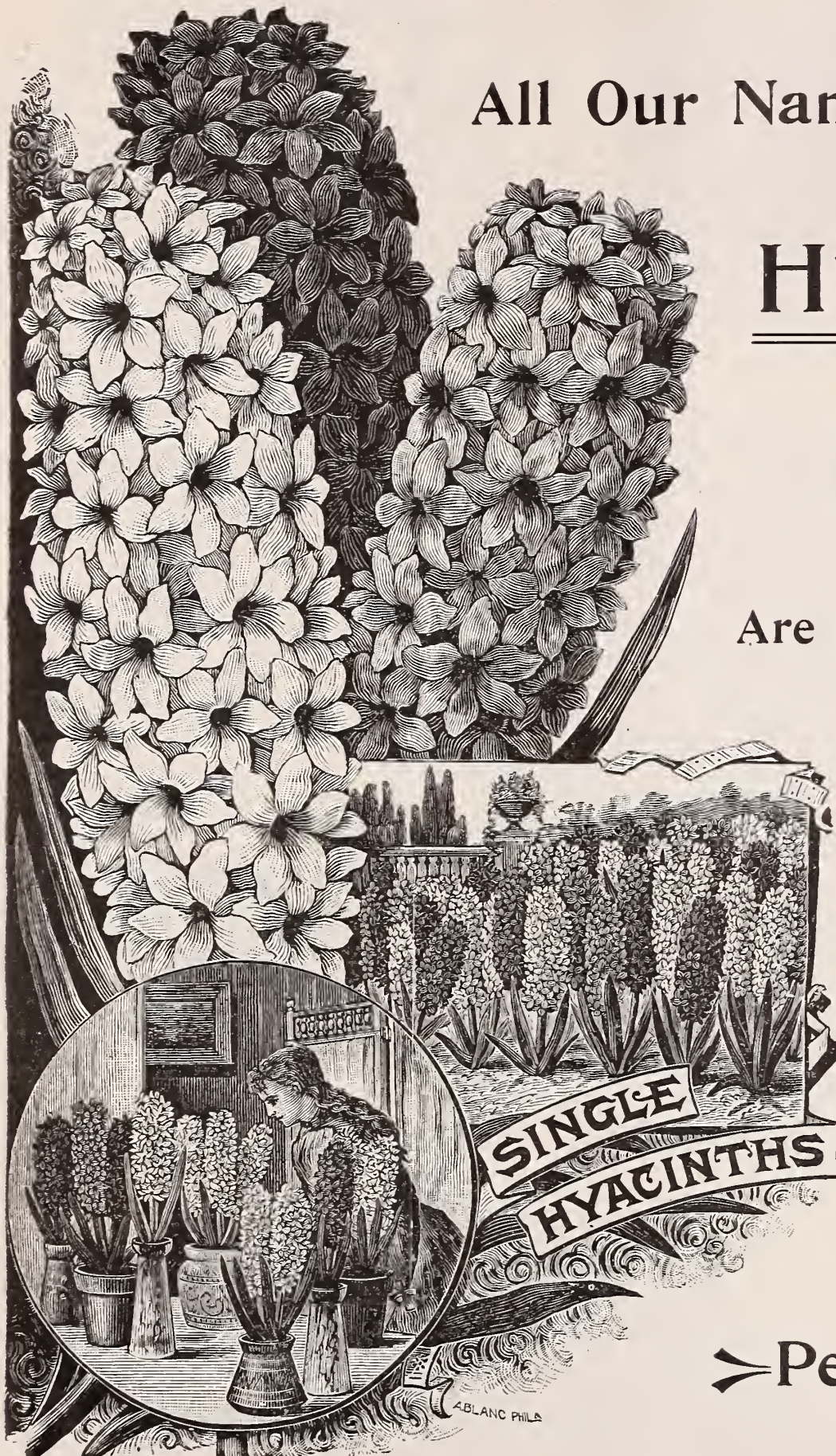

All Our Named

HYACINTH

BULBS

Are especially

Selected

from Varieties

which Produce

the Largest

and most

> Perfect Spikes.

The First Premium at the last Spring Exhibition of the

..Pennsylvania Horticultural Society..

Was awarded to the exhibit of Bulbs purchased of us by
Mr. Canning, gardener to Mrs. C. F. Berwind, Wynnewood, Pa.



..BUTTERFLY BED OF TULIPS..

Designed and planted last autumn at Clifton Park, Baltimore, Md., under the direction of N. F. Flitton, Superintendent. *Bulbs supplied by us.* The dimension from tip to tip of wings was seventy-three feet, six inches; total number of bulbs planted, 4480, as follows: 200 Vermilion Brilliant, 2070 Belle Alliance, 500 La Reine, 1650 Chrysolora. This bed was one of the greatest attractions in the Park during the Spring season.



A Design for a Bed, 6 feet in Diameter of Hyacinths in Five Colors.

This is very effective, and should be planted as follows :

- | | |
|--|---|
| 12 King of Blues, (Blue) in centre. | 15 Alba Superbissima, (White) next to centre. |
| 22 Gertrude, (Deep Pink) for third row. | 27 Alba Superb, (White) for fourth row. |
| 34 Robert Steiger, (Red) for fifth or outside row. | |

110 Bulbs in all. Price \$6.75.

Another striking and satisfactory bed of Hyacinths is one of *three colors, Red, White and Blue.* This is a very appropriate way of displaying our beautiful *National Colors, and the result is most gratifying.*

We suggest a bed about six feet in diameter (18 feet in circumference) which will require 110 bulbs (to be planted six inches apart) as follows :

- | |
|---|
| 35 King of the Blues (<i>centre</i> of circle). |
| 35 Alba Superbissima (White) (<i>middle</i> of circle). |
| 40 Robert Steiger or Gen'l Pelissier (Red) (<i>outside</i> of circle). |

110 Bulbs in all. Price \$6.75.

Any other design can be made if desired.

M
I
C
H
E
L
L
'S

T
U
L
I
P
S



A very "Effective and Practical Bed" of Single Tulips.

Everybody should have one of these effective beds at this small cost. Eight feet in diameter or twenty-four feet in circumference, requires 250 bulbs, planted five inches apart. 125 Chrysolora, rich yellow, and 125 Belle Alliance or Verboom, brilliant scarlet—these are planted as per above illustration. Price for the 250 bulbs, \$3.50.

TULIPS EARLY SINGLE **TULIPS**
STRICTLY TRUE TO NAME AND COLOR

NOTHING is more beautiful than a bed of tulips in the spring. They are the showiest flower in bloom at that time of the year. They should be planted in beds of any design, made of a good portion of loam and manure mixed well with the soil; the distance apart should be about four inches. The bulbs must be planted about four inches deep. A covering of long manure or straw for over winter is very beneficial for the bed. Tulips are also excellent for growing in the house; four or five bulbs to six or seven inch pots, or they can be forced in the greenhouse with good results.

EARLY SINGLE.

In. high.		¼ doz.	Per doz.	Per 100	Per 1000
8	Artus. Bright red	\$0.07	\$0.20	\$1.00	\$8.00
8	Belle Alliance. Scarlet, large08	.25	1.50	11.50
9	Canary Bird. Clear yellow10	.25	1.75	14.00
9	Chrysolora. Golden yellow, large08	.25	1.75	14.00
9	Couleur de Cardinal. Red10	.30	2.25	20.00
8	Cottage Maid. White, large pk br.10	.25	2.00	15.00
9	Colour Ponceau. Cherry red10	.25	1.50	12.00
9	Crimson King. Bright crimson08	.20	1.00	7.50
7	Duc van Thol. Scarlet05	.20	1.00	9.00
7	" " " White10	.25	1.75	15.00
7	" " " Yellow10	.30	2.00	17.50
7	" " " Pink07	.25	1.50	12.50
7	" " " Red, yellow edge05	.15	1.00	8.50
7	" " " Gold striped06	.20	1.25	10.00
9	Duchesse de Parma. Red, yellow border08	.15	1.00	8.00
8	Grand Master of Malta. Crimson and white10	.30	1.75	15.00
10	Keizer Kroon. Red with broad yellow edge, very large07	.25	1.50	12.50
8	Jagt von Delft. White08	.25	1.50	11.00
9	Joost van Vondel. Bright pink with white stripes08	.25	1.50	12.50
	L'Immaculee. Pure white07	.20	1.20	10.00
8	La Reine (Queen Victoria). Blush white, very good08	.20	1.20	9.00
9	Ophir de Or. Mammoth yellow15	.50	3.00	25.00
10	Pottebakker. Yellow, large10	.30	2.00	16.00
10	" " White, large10	.30	2.00	15.00
10	" " Scarlet08	.25	1.50	11.50
10	Prince of Austria. Red12	.30	2.25	20.00
10	Procerpine. Very large, glossy, brilliant pink12	.35	2.25	20.00
9	Rachel Rutsh. Pink10	.25	1.25	11.00
9	Rose Grisdeltin. Bright pink10	.30	2.00	16.00
9	Rose Mundt (Huickman). Pink08	.20	1.50	13.00
8	Verboom. Bright rich scarlet08	.25	1.50	12.50
9	Vermillion Brilliant. Brilliant scarlet12	.40	3.00	26.00
9	Waterloo. Large scarlet10	.30	1.50	12.50
9	Wouwerman. Violet, large08	.20	1.00	8.00
8	Yellow Prince. Large flower10	.25	1.75	14.00
	Fine Mixed. All colors03	.15	.80	6.00
	Superfine Mixture. Very best, large flowering, bright colors04	.20	1.00	8.00



EARLY SINGLE TULIPS IN MIXTURE.

	Per doz.	Per 100	Per 1000.
Fine Mixed. All colors	\$0.15	\$0.80	\$6.00
Superfine Mixed. All colors. Our choicest mixture20	1.00	8.00

TULIPS

True to Name

and Color



T
U
L
I
P
S

EARLY DOUBLE.

In. high.		¼ doz.	Per doz.	Per 100	Per 1000
6	Duc van Thol. Red and yellow . . .	\$0.07	\$0.20	\$1.00	\$7.00
9	Duke of York. Red with white edge07	.20	1.25	9.50
9	Gloria Solis. Red, yellow border07	.20	1.25	9.50
9	Imperator Rubrorum. Brilliant scarlet10	.30	2.00	19.00
9	La Candeur. Pure white07	.20	1.25	10.00
9	Le Blason. Pink10	.30	1.50	13.50
9	Murillo. Pink10	.35	2.75	25.00
9	Pacony Red. Deep08	.25	1.25	8.50
9	Rex Rubrorum. Scarlet10	.30	2.00	17.50
8	Rose Blanche. Pure white10	.25	1.25	10.00
8	Titian. Red with yellow border10	.25	1.25	10.00
8	Tournesol. Red, yellow border10	.30	2.00	18.00
8	Tournesol. Yellow15	.45	3.50	32.50
8	Yellow Rose. Pure yellow08	.20	1.25	10.00
	Choice Mixed. All colors05	.15	.80	7.00
	Superfine Mixture. Very best, large flowering, bright colors08	.20	1.00	8.50

LATE FLOWERING DOUBLE TULIPS.

Choicest Mixed. All colors. 20c. per doz.; \$1.00 per 100; \$8.50 per 1000.

LATE FLOWERING SINGLE SHOW TULIPS.

Gesneriana. The tallest, largest flowered and showiest of all late tulips for bedding out in masses. Height, two to three feet. Flowers of enormous size, on strong stems; keeps perfect several weeks, flowering in May. Color rich crimson scarlet, with glittering blue-black centre. Per doz., 25 cts.; per 100, \$1.35; per 1000, \$11.50.

Gesneriana Rosea. Rich pink. ¼ doz., 8 cts.; per doz., 20 cts.; per 100, \$1.00; per 1000, \$8.00.

Late Flowering Single Show Tulips—Continued.

Gesneriana. Yellow. 25 cts. per doz.; \$1.35 per 100; \$11.50 per 1000.

Greigit. Called by some the "Queen of Tulips." Very handsome and distinct species; flowers very large, of brilliant orange scarlet with a yellow and black centre. Each, 15 cts.; per doz., \$1.50.



LATE SINGLE TULIPS.

Bybloemen. Very showy, large flowers, white ground with stripes and markings of pink, scarlet and crimson. Per doz., 25 cts.; per 100, \$1.25; per 1000, \$10.00.

Bizarres. Beautiful showy flowers, yellow ground stripes, and markings of red, white and orange. Per doz., 20 cts.; per 100, \$1.00; per 1000, \$8.00.

PARROT TULIPS.

Choicest Mixed. Per doz. Per 100 Per 1000
 \$0.20 \$1.00 \$9.00



...NARCISSUS...

A beautiful class of early blooming flowers, becoming more popular each season, both for outdoor blooming and for use as cut flowers in the house. The double and single sorts are perfectly hardy, and need not be disturbed oftener than once in three or four years, and not then unless they have become too much crowded by offsets. Plant in the fall in good garden soil about three or four inches deep, and four to six inches apart, or plant in pots in the house.

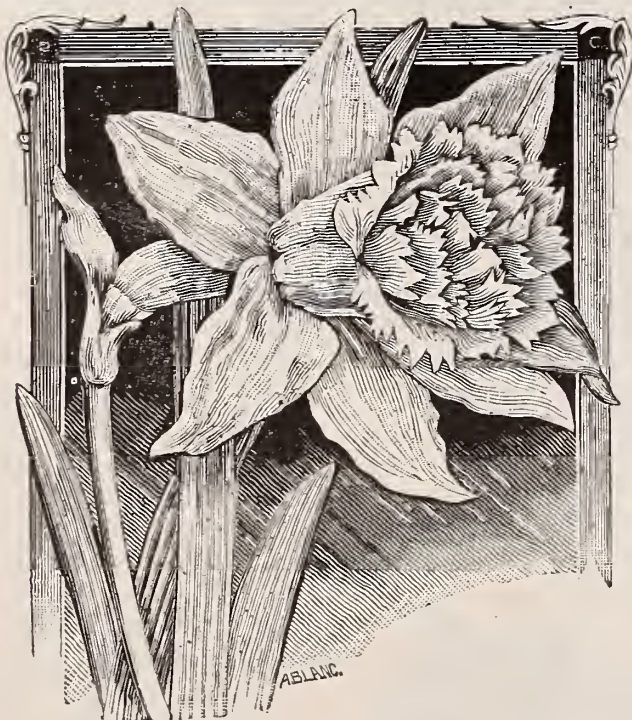

Von Ston, Popular Double Yellow Daffodil.

Double Narcissus.

Von Ston. Extra fine Holland-grown bulbs, which are considered better than Irish or English bulbs, as the color of the flower is a bright yellow, devoid of the green tips often found in the cheaper stock. Each, 4 cts.; per doz., 30 cts.; per 100, \$2.00; per 1000, \$16.00.

Von Ston. Extra large, two-nosed bulbs. Will produce 175 blooms from 100 bulbs. Per doz., 40 cts.; per 100, \$2.75; per 1000, \$22.50.

Alba Plena Odorata. (Double White Daffodil). Deliciously fragrant, Each, 3 cts.; per doz., 20 cts.; per 100, \$1.25; per 1000, \$9.00.

Incomparable Double. (Butter and Eggs). Each, 3 cts.; per doz., 20 cts.; per 100, \$1.25; per 1000, \$10.00.

Double Roman. (Polyanthus). Clusters of double white flowers with yellow centre; and excellent variety for forcing. Each, 3 cts.; per doz., 25 cts.; per 100, \$1.75; per 1000, \$12.00.



Narcissus Paper White Grandiflora.

Paper White Grandiflora. (Polyanthus.) New, very large flowering, the favorite forcing variety, superior to the old sort, specially desirable for cutting. Each, 4 cts.; per doz., 30 cts.; per 100, \$1.75; per 1000 \$12.50.

Paper White. First size bulbs. Each, 3 cts.; per doz., 20 cts.; per 100, \$1.25; per 1000, \$10.00.

Polyanthus Narcissus. Choice mixed, of all sorts; splendid large bulbs. Per doz., 25 cts.; per 100, \$1.50; per 1000, \$10.00.

Grand Soliel d'Or. (Polyanthus). A charming rich, yellow flower with deep reddish cup. Each, 5 cts.; per doz., 40 cts.; per 100, \$2.75; per 1000 \$25.00.

CAUSE OF DAFFODILS NOT BLOOMING

SPECIAL NOTICE. Complaint is sometimes made that the daffodil bulbs will not bloom. They throw up an abundance of vigorous foliage, but no flowers. This is not an uncommon occurrence, even with the professional florist who plants daffodil bulbs in his greenhouse to raise winter flowers for market. Such bulbs he calls "blind bulbs," because the eye, or flower germ, is without life. Bulbs of this character are mostly from the southern part of France. Those grown in Holland are rarely, if ever diseased or deficient in the vitality of the flower germ. We import and send out Daffodil Bulbs grown in Holland exclusively.



Golden Spur Narcissus or Daffodil.

Ard Righ, or Irish King. Rich yellow. Per doz., 75 cts.; per 100, \$1.00.

Golden Spur. One of the grandest daffodils, with extra large, bold, rich yellow flowers, foliage very broad and striking. It is of unusually robust habit and unsurpassed for gardens, pots or forcing. Each, 10 cts.; per doz., 85 cts.; per 100, \$5.00; per 1000, \$45.00.

Emperor. One of the finest daffodils in cultivation, flower of the richest yellow, trumpet of immense size, the petals of the perianth measure 3½ inches across. Each, 15 cts.; per doz., \$1.50; per 100, \$10.00.

Empress. Perianth snow-white, trumpet rich yellow; valuable for cutting. Each, 15 cts.; per doz., \$1.25; per 100, \$8.50.

Giant Princeps. Large golden yellow trumpet. Each, 4 cts.; per doz., 25 cts.; per 100, \$1.75; per 1000, \$15.00.

Trumpet Major. The large yellow favorite. Each, 4 cts.; per doz., 25 cts.; per 100, \$1.75; per 1000, \$15.00.

Horsfieldi Bicolor. Very large, perianth white, trumpet golden yellow; the finest of all. Each, 10 cts.; per doz., \$1.00; per 100, \$6.00.

Stella Incomparabilis. White star-shaped flower, with distinct yellow trumpet. Three for 10 cts.; per doz., 25 cts.; per 100, \$1.50.

Hoop Petticoat. (*Bulbocodium*). Of rich golden yellow color. Bears from six to twelve flowers to each bulb. Three to six bulbs may be placed in a six-inch pot. A dry and sheltered situation suits it best when planted in the open ground. Per doz., 75 cts.; per 100, \$5.00.



Poeticus Ornatus (Pheasant's Eye).

Poeticus. (*Hardy Pheasant's Eye*). Fragrant white flowers with orange cups. Per doz., 15 cts.; per 100, 70 cts.; per 1000, \$5.00.

Poeticus Ornatus. Similar to Poeticus, but larger and four weeks earlier. Magnificent cut flowers. Per doz., 25 cts.; per 100, \$1.40; per 1000, \$12.00.

Narcissus . . .

or DAFFODILS

JONQUILS



JONQUILS

Jonquils, Sweet Scented.

JONQUILS. (*Campanelles*). Choice, hardy, very sweet-scented flowers, much in demand for cutting.

Single. Very sweet scented. Each, 3 cts.; per doz., 20 cts.; per 100, \$1.00; per 1000, \$7.00.

Double. Each, 5 cts.; per doz., 50 cts.; per 100, \$3.00; per 1000, \$25.00.

Campanelle Phylogine Rugulosus. Large single, excellent for forcing; an improvement on the old Campanelle. Each, 3 cts.; per doz., 20 cts.; per 100, \$1.25; per 1000, \$9.00.

Campanelle. Each, 3 cts.; per doz., 15c.; per 100, \$1.00; per 1000 \$7.50.

H
A
R
D
Y



H
A
R
D
Y

Mixed Narcissus.

Mixed Narcissus. Double and single; splendid for garden planting; increase from year to year and make excellent clumps. Each, 3 cts.; per doz., 20 cts.; per 100, \$1.00; per 1000, \$7.50



True Easter Lily.

Lilium Harrisii

(TRUE BERMUDA EASTER LILY.)

Our stock of these is very large, and from the best grower in Bermuda. The bulbs can be relied upon to give satisfactory results. The bulbs should be potted in early fall in rich soil, and the pots plunged in sand, where they should be allowed to remain until the approach of cold weather; The aim should be to prevent the tops starting until the roots have become strong and vigorous, when they may be brought in and placed in gentle heat. It can be forced into bloom at any desired time, and the freedom with which the flowers are produced is truly remarkable; even the smallest bulbs will bloom. For outdoor planting it is already recognized as a very desirable acquisition, as it is perfectly hardy, easy of culture, and one of the finest plants for garden or cemetery decoration. A bulb once planted will last for years.

Size of Bulbs.	Each	Per doz.	Per 100
5 to 7 inch	\$0.08	\$0.80	\$6.50
7 to 9 inch15	1.75	13.50
9 to 11 inch30	3.50	25.00
11 to 13 inch60	6.50	50.00

Lilium Longiflorum.

(BEST BERMUDA GROWN.)

Size of Bulbs.	Each	Per doz.	Per 100
5 to 7 inches	\$0.08	\$0.80	\$6.50
7 to 9 "15	1.75	13.50
9 to 11 " extra large35	3.75	25.00

(BEST JAPAN GROWN.)

6 to 8 inches10	.75	5.00
7 to 9 "15	1.25	8.00
9 to 10 "20	2.00	15.00

HARDY GARDEN LILIES



LILIUM CANDIDUM.

Annunciation, or St. Joseph's Lily. The old-fashioned pure white garden lily; one of the hardiest. Flowers snow-white with heavy yellow stamens and sweetest fragrance; bears from five to twenty blossoms. It must be planted in the early autumn to succeed well, as it makes its leaf growth at once after planting and prepares itself for early flowering. Immense size bulbs, each, 10 cts.; per doz., \$1.00; per 100, \$6.00.

LILIUM TENUIFOLIUM.

(CORAL LILY OF SIBERIA.)

Beautiful scarlet lilies, 1 ft. high. 20 cts. each; \$2.00 per doz.



Lilium Auratum (Golden Banded Japan).

JAPAN LILIES

HARDY JAPAN LILIES.

Auratum (Golden-banded Japan). Extra large bulbs, each 25 cts.; per doz., \$2.50; per 100, \$15.00.
 Very fine blooming bulbs, 9 to 11 inch, each, 15 cts.; per doz., \$1.50; per 100, \$10.00.
Lancifolium Speciosum Album. Pure white Japan Lily. Each, 25 cts.; per doz., \$2.25; per 100, \$14.00.
Lancifolium Speciosum Rubrum. Pink. Very Large bulbs. Each, 15 cts.; per doz., \$1.50; per 100, \$10.00.
Melpomene. Very large, rich crimson. 15 cts. each; \$1.50 per doz.; \$10.00 per 100.

H
O
L
Y
L
A
N
D



B
L
A
C
K
C
A
L
L
A

Black Calla.

(ARUM SANCTUM.)

A magnificent variety from the Holy Land; leaves large and wavy, of a rich green color. The flower is about fourteen inches long and four inches broad, of a brilliant dark purple color and green underneath. The plant makes a most stately appearance.

Selected Bulbs. Each, 15 cts.; per doz., \$1.50.

White Calla Lily.

The old favorite "Lily of the Nile," They flourish best in a warm, damp place, and require plenty of water after the leaves have formed. Pot the bulbs in September; give but little water until November. First size bulbs, each 15 cts.; per doz., \$1.50; extra large, each, 20 cts.; per doz., \$2.00; monster bulbs, 25c. each; \$2.50 per doz.

Spotted Calla.

These are very ornamental and flower freely. The foliage is beautifully spotted and the flowers are pure white.

Dry Bulbs. Each, 10 cts.; per doz., \$1 00.

L
I
T
T
L
E
G
E
M



D
W
A
R
F
C
A
L
L
A

Dwarf Calla, "Little Gem"

Indeed a "Pigmy," scarcely ever exceeding the height of one foot, yet producing good sized flowers in great abundance. Each, 15 cts.; per doz., \$1.50.

YELLOW CALLA.

50 cts. each.

Allium.



Neapolitanum.

Excellent for winter flowering, extensively forced for cut flowers, pure white with green stamens, borne in large loose umbels. Height 15 to 18 inches. 3 cts. each; 20 cts. per doz.; \$1.00 per 100; \$7.50 per 1000.

Allium.



Freesias.

Refracta Alba. A favorite plant for parlor culture, the ready facility with which it can be forced into bloom makes it highly prized. The flowers are pure white, blotched with yellow on the lower petals, are deliciously fragrant, and are borne profusely. The bulbs should be potted in good soil mixed with sand or peat. First size bulbs, 15 cts. per doz.; 75 cts. per 100; \$6 00 per 1000. Mammoth bulbs, 20 cts. per doz.; \$1.50 per 100. Monster size bulbs, 35 cts. per doz.; \$2.25 per 100.

Leichtlini. Pale yellow, fragrant. Per doz., 25 cts.; per 100, \$1.75.

SCARLET FREESIA.

(ANOMATHECA CRUENTA.)

A native of South Africa. Grows 9 to 12 inches high, produces freely a quantity of pretty scarlet flowers, very similar in shape to the popular Freesia. 25c. per doz.; \$1.75 per 100.



Chinese Sacred Lily.

READY IN OCTOBER.

The "Shui Sin Far" or Flower of the Gods, bears in profusion flowers of silvery-white with golden-yellow cups; are of exquisite beauty and entrancing perfume. The short time required to bring the bulbs into bloom (four to six weeks after planting) is one of the wonders of nature. You can almost see them grow, succeeding almost everywhere and with everybody. They do well in pots of earth, but are more novel and beautiful grown in shallow bowls of water, with enough fancy pebbles to keep them from topping over when in bloom. A dozen bulbs started at intervals will give a succession of flowers; succeed best in a cool room where no coal-gas will interfere with growing. We import direct from China mammoth bulbs of the true, large flowering variety. Each, 10 cts.; per doz., 90 cts.; original basket of 30 bulbs, \$2.00

We have a choice lot of BOWLS and DISHES suitable for Chinese Lilies at reasonable prices; also the Pebbles at 5 cts. per quart.

LILY OF THE VALLEY.

READY IN NOVEMBER.

It is now a most popular plant for forcing, which is easily done by planting the pips in pots, from six to twelve in each, watering freely, keeping in a cool cellar and starting from week to week, to keep up a succession. They generally flower in three or four weeks after planting. They require a considerable amount of heat to force them. They are also very desirable for planting out doors, as they are perfectly hardy and increase every year. Our roots are specially selected at an advance of cost by a Berlin grower. Per doz., 25 cts.; 25 for 40 cts.; per 100, \$1.50; per 1,000, \$12.50.

Large clumps, each, 25 cts.; per doz., \$2.50; per 100, \$17 50



We beg to call the attention of the trade to our New large Flowering Lily of the Valley. RUSSIAN, which is without question, the highest grade of Valley ever received in this country.

Per doz.	\$0.35
" 100	2 25
" 250	5.00
" 1000	16.00



Pink Lily of the Valley.

The color is quite novel in this favorite flower, being a delicate pink. Each, 5 cts.; per doz., 50 cts.; per 100, \$4.00

ACONITE (Winter.)

In early spring the golden-yellow blossoms of the Winter Aconite look charming, and form a striking contrast to the pure white snowdrop, spring snowflake, and the beautiful blue scillas and chionodoxa. Especially valuable under trees and in moist places, where few other flowering plants thrive. Height, 3 to 8 ins. Each, 3 cts.; per doz., 20 cts.; per 100, \$1.00.



AMARYLLIS.

AMARYLLIS.

- Hybrids of Vittata.** Large bulbs. Each, 50 cts.; \$5.00 doz.
- Johnsoni.** Very large flower, rich crimson-scarlet color, striped with white. Each, 25 cts.; per doz., \$2.50.
- Treatiæ Alba.** Pure white, blossoms the entire summer. Each, 5 cts.; per doz., 40 cts.; per 100, \$3.00.
- Treatiæ Rosea.** Bright rose. Each, 5 cts.; per doz., 40 cts.
- Belladonna Major.** Bri't pink. Each, 15 cts.; per doz., \$1.50
- Formosissima (Jacobæan Lily).** Crimson, blooming early in the summer. Each, 5 cts.; per doz., 50 cts.

Anemones

Suitable for pot or border culture, when planted in masses are most effective; succeed best in a light, rich, well-drained loam. Plant in October or November. Cover with leaves, straw or long manure on approach of winter. For pot culture, fill with any rich porous compost, with good drainage, planting four roots in a six-inch pot; place in cold frame or any moderately cool situation, giving very little water until plants appear, then remove to greenhouse or sitting-room window.

	Each.	Per Doz.	Per 100
Double Mixed. All colors	\$0.03	\$0.25	\$1.50
Single. Scarlet03	.20	1.00
Single Mixed. All colors03	.20	1.00
Fulgens. Scarlet Windflower04	.30	2.00

Begonia, Tuberous Rooted.

Extra Strong Bulbs WILL BE READY ABOUT NOVEMBER FIRST.

- Separate Colors.** Single. Yellow, pink, scarlet, white and crimson. 6 cts. each; 60 cts. per doz.; \$4.50 per 100; \$35.00 per 1000.
- Mixed,** of all colors. Single. 5 cts. each; 50 cts. per doz.; \$4.00 per 100; \$30.00 per 1000.
- Double Separate Colors.** 15 cts. each; \$1.50 per doz.; \$11.00 per 100.
- Double Mixed.** All colors. 12 cts. each; \$1.35 per doz.; \$10.00 per 100.

Chionodoxa, Glory of the Snow.

- Chionodoxa Luciliae.** A most exquisite early spring flowering plant, thoroughly hardy, and will thrive well in any soil; flowers of a brilliant sky-blue color with white centre. 3 cts. each; per doz., 20 cts.; per 100, \$1.25.
- Chionodoxa Sardensis.** Beautiful deep blue flowers. A gem among spring bulbs. Per doz., 20 cts.; per 100, \$1.25; \$10.00 per 1000.
- Chionodoxa Gigantea (New).** A very distinct species with very large lavender-blue flowers with white centre. Each, 3 cts.; per doz., 25 cts.; per 100, \$1.50; \$10.00 per 1000.



G
I
A
N
T



C
Y
C
L
A
M
E
N

Cyclamen Giganteum.

Strong Bulbs, Well Started in Pots.

Giganteum. White	Each, \$0.25;	per doz., \$2.50
Giganteum. Red	" .25;	" 2.50
Giganteum. Pink	" .25;	" 2.50

Colchicum Autumnale.

Large purple flowers. Each, 5 cts.; per doz., 50 cts.; \$3.50 per 100.

Ixias.

Charming pot plants for the conservatory. Plant (six or eight to a five-inch pot) in sandy loam, one inch deep, pressing the soil firmly over the bulbs.

Fine Mixed Varieties. Per doz., 15 cts.; per 100, \$1.00.
Crateroides. Fiery scarlet. Per doz., 25 cts.; \$1.50 per 100.

CROCUS.

	Per Doz.	Per 100	Per 1000
Prince Albert. Large blue	\$0.12	\$0.60	\$5.00
Queen Victoria. Large white12	.60	5.00
Sir Walter Scott. Large, striped12	.60	5.00
Yellow Giant. Extra large bulbs15	.75	6.00
EXTRA LARGE CROCUS IN SEPARATE COLORS.			
Blue and Purple.10	.40	3.50
White.10	.40	3.50
Striped10	.40	3.50
Yellow10	.40	3.50
Cloth of Gold. Golden yellow10	.40	3.50
Cloth of Silver. Silvery white, striped with purple12	.60	5.00
Mixed. All colors, large10	.35	3.00

Crown Imperials.

Very showy, early spring-blooming bulbs. The bulbs should be planted fully six inches deep, and be left undisturbed. A slight covering during winter will be beneficial. The ground should be well drained.

Bright, Red, Sulphur Orange	Each, \$0.20
Mixed	Per doz., \$1.00; " .10
Double Red	" .30

Dielytra (Bleeding Heart).

Spectabilis. Strong Roots. Ready in November. Each, 15 cts.; per doz, \$1.50; \$11.00 per 100.
Eximia (Beautiful). Each, 15 cts.; per doz., \$1.50.

Gloxinia Crass. Grandiflora.

Extra Strong Bulbs will be ready about November 1st.

Choicest Mixed. Per doz., \$1.00; per 100, \$6.00.

Iris.

- English.** Large flowers, rich blue shades predominating, mixed. Each, 3 cts.; per doz., 25 cts.; per 100, \$1.50.
- Spanish.** Specially desirable for pot culture. Mixed varieties. Per doz., 12 cts.; per 100, 90 cts.
- Susiana.** Very large and odd in shape. Each, 15 cts.; \$1.50 per doz.

Iris Kaempferi (Japanese).

Named Varieties. The very best. Per clump, 25 cts.; per doz., \$2.50.
Mixed. All colors. Extra choice. Per clump, 15 cts.; per doz., \$1.50.

E
X
C
E
L
L
E
N
T



The Bride Gladiolus.

GLADIOLUS. READY IN NOVEMBER.

The Bride. A lovely pure white gladiolus. The flowers are freely borne on long stems, and can be forced into bloom when flowers are scarce. Six bulbs can be planted in a six-inch pot. Each, 2 cts.; per doz., 20 cts.; per 100, \$1.00.
Pink (Bride). Same as the above, but pink in color. Very handsome. Per doz., 30 cts.; per 100, \$2.00.



Ornithogalum arabicum.

ORNITHOGALUM ARABICUM. STAR OF BETHLEHEM.

The flowers are large and attractive, of a pure milk-white color, with a shiny black spot in the centre. It blooms as readily in the house as it does in the garden. The individual blossoms are fragrant, and are borne in umbels four to six inches across. Each, 5 cts.; per doz., 40 cts.; per 100, \$2.50.

LACHENALIA 'PENDULA.

Very desirable for pot or hanging-basket culture. Each, 20 cts.; per doz., \$2.00; per 100, \$12.50.

R
F
O
R
F
O
R
C
I
N
G

O
X
A
L
I
S



Oxalis Bowei.

OXALIS

Bowei. Flowers large, most brilliant rose color, produced in great profusion. Each, 3 cts.; per doz., 25 cts.; per 100, \$1.75.
Pink. Each, 3 cts.; per doz., 25 cts.; per 100, \$1.50.
White. Each, 3 cts.; per doz., 25 cts.; per 100, \$1.50.
Yellow. Each, 3 cts.; per doz., 25 cts.; per 100, \$1.50.
Versicolor. Red, violet and white. Each, 3 cts.; per doz., 25 cts.; per 100, \$1.50.
Mixed. All colors; each, 2 cts., per doz., 15 cts.; per 100, \$1.00.
Double Yellow. Each, 4 cts.; per doz., 30 cts.; per 100, \$2.25.



OXALIS. Bermuda Buttercup.

An unrivalled Winter-flowering Pot Plant, of the easiest culture, succeeding with everybody.

One of the finest winter-flowering plants for pot culture; it is such a strong, luxuriant grower that one bulb will be sufficient for a six-inch pot. Place in a dark, cool position for a few weeks to root thoroughly, and remove to a sunny situation in the window or conservatory and the great profusion of bloom produced in uninterrupted abundance for weeks will astonish and delight you. The flowers are of the purest bright buttercup yellow. Well-grown plants have produced as high as seventy flower stems at one time, and over 1000 flowers in one season. The flowers, and frequently the leaves, fold up at night and open again the next morning, but when grown in a partially shaded situation the flowers remain open all the time. Properly treated the plants will flower in six weeks from the time the bulbs are planted. **Extra large bulbs, each 4 cts.; per doz., 30 cts.; per 100, \$2.00.**

O
X
A
L
I
S



PÆONIES. Ready November 1st.

Extra fine large clumps, will bloom next spring.

Double, Pink	Each 25 cts.; per doz.,	\$2.50
Double, White	" 25 " "	2.50
Double, Red	" 25 " "	2.50
Double, Mixed colors	" 25 " "	2.25

RANUNCULUS, or BUTTERCUPS.

Turban, or Turkish. Very double and distinctly marked.

Finest mixed, per doz., 20 cts.; per 100, \$1.00.

Persian. Finest mixed, per doz., 20 cts.; per 100, \$1.00.



SNOWDROPS.

SNOWDROP TIME.

"It's rather dark in the earth to-day,"
Said one little bulb to his brother;
"But I thought that I felt a sunbeam ray—
We must strive and grow 'till we find the way!"
And they nestled close to each other.
Then they struggled and toiled by day and by night,
Till two little snowdrops, in green and white,
Rose out of the darkness and into the light,
And softly kissed one another.

Set about two or three inches deep, and one inch apart in clumps or triple rows (if planted singly they are not conspicuous).

Single	Per doz., 15 cts.; per 100, \$1.00; per 1000, \$7.00
Elwee's Giant " 15 " "	1.00; 7.00
Double " 20 " "	1.50; 12.50



Spirea Astilboides Floribunda.

SPIREA (Astilbe).

READY IN NOVEMBER.

A splendid plant for forcing in the greenhouse or the conservatory, where it produces beautiful sprays of silvery-white flowers during February and March.

Japonica. Extra strong clumps, 10 cts. each; per doz., \$1.00; per 100, \$5.00.

Compacta Multiflora. Superior to Japonica, of more compact habit, flowers more freely and closer; foliage beautiful dark green. Extra strong clumps, each, 12 cts.; per doz., \$1.25; per 100, \$7.00.

Astilboides floribunda. An improvement on the common Astilboides; large, pure white plumes, with bright green foliage; more free-flowering than other varieties. Each, 12 cts.; per doz., \$1.25, per 100, \$7.50.

Palmata. A most beautiful variety, bearing rich crimson flowers, excellent for forcing or outdoor culture. 15 cts. each; \$1.50 per doz.; \$10.00 per 100.

S
I
B
E
R
I
A
N



S
C
I
L
L
A
S

SCILLA SIBERICA.

Hardy, pretty blue flowers, for the house or garden. Per doz., 15 cts.; per 100, 75 cts.; per 1000, \$5.50.

SMILAX.

Plants, each, 10 cts.; per doz., \$1.00; per 100, \$5.00.

SPARAXIS.

A beautiful class of bulbs, allied to the Ixias and requiring the same treatment, producing spikes of the most exquisite flowers. Mixed varieties. Per doz., 20 cts.; per 100, \$1.25.

New Crop Flower Seeds

... FOR FALL PLANTING ...

For a more complete list of Flower Seeds see Spring Catalogue

ANTIRRHINUM.

(Snap Dragon)

Sutton's "Aurora" (New). Original pkt. 25 cts.
Dwarf Mixed. Finest Tom Thumb. Pkt., 5 cts.; oz., 50c.
Tall Mixed. Pkt., 5 cts. Pure white, pkt., 10 cts.
Imported Collections. Ten dwarf varieties, 40 cts.
Imported Collections. Ten tall varieties, 40 cts.

AQUILEGIA COLUMBINE.

Chrysantha. (Golden Spurred). Yellow flowers. Pkt. 10 cts.
Cœrulea. Very large, violet blue, and pure white. Pkt. 10 cts.
Single. All colors mixed; two feet high. Pkt., 5 cts.; oz., 30 cts.
Double. All colors mixed. Pkt., 5 cts.; oz., 40 cts.

AURICULA.

A well-known favorite; seed saved from splendid varieties.
Mixed. Pkt. 20 cts.

BROWALLIA.

Speciosa Major. A beautiful new large flowering variety of the most brilliant ultramarine blue, a rare color; especially desirable as a pot plant for Winter and early Spring flowering either in conservatory or greenhouse. 15c. per pkt.; 2 pkts for 25c.



Michell's Giant Prize Cineraria.

SCHOOL LANE, GERMANTOWN.

The Cineraria seed I had from you has given excellent results. The colors were all that could be desired, while many of the blooms measured 11 inches in circumference. It is the best strain of Cineraria seed I have handled.

Yours very truly,

JOHN McCLEARY,
Gardener to Wm. Weightman, Esq.

CINERARIA.

Strain finest to be had, size of flowers immense, color and shape most perfect. No flower measures less than six inches in circumference; majority of them much larger. -
Michell's Large Flowering Prize, Dwarf. Best sort as a pot plant. Pkt., 35c.; 3 pkts. for \$1.00.
Michell's Large Flowering Prize, Medium Tall. Desirable to grow as a decorative plant, also for cutting. Pkt., 35 cts.; 3 pkts. for \$1.00.
Stellata. (New.) 65 cts. per pkt.
Sutton's Superb Mixed. Per original pkt., 60 cts.
James' Superb Strain, Mixed. Pkt., 50 cts.
Michell's Large Flowering Crimson. Pkt., 40 cts.
" " " White. Pkt. 40 cts.
" " " Blue. Pkt., 40 cts.
Dwarf Mixed. Flowers not as large as the "Prize," 25 cts.
Tall Mixed. Same as above but taller in growth. Pkt., 25c.
Choicest Double Mixed. Beautiful. Pkt., 50 cts.



CYCLAMEN GIGANTEUM.

Beautiful mottled leaves, broad petals and stout flower stalks, throwing the giant flowers well above the foliage.

Sutton's Giant Mixed. 60 cts. per original pkt.
Sutton's Collection of 6 Varieties of Giganteum. Price \$2 50.
Rubrum. Red. Pkt., 35 cts.; 100 seeds, \$1.25.
Album. White. Pkt., 35 cts.; 100 seeds, \$1.25.
Roseum. Pink. Pkt., 35 cts.; 100 seeds, \$1.25.
Mixed. All Giant. Pkt., 25 cts.; 100 seeds, \$1.00.
New Feathered. 60 cts. per pkt.
Persicum. Choice mixed. Pkt., 10 cts.



CALCEOLARIA.

An ornamental plant, and a favorite for the greenhouse.
Sutton's Perfection. 75 cts. per original pkt.
James' Superb Strain, Choicest Mixed. Contains the self-colored and tigered sorts. Pkt. 50 cts.
Hybrida Grandiflora, Tall Mixed. Large flowering, completely covered with beautiful rich, self-colored flowers, saved from choice collection; all colors. Pkt. 25 cts.
Hybrida Grandiflora, Pumila Compacta. Dwarf compact, robust growth, producing varied brilliant self-colored and spotted flowers. Pkt. 40 cts.
Rugosa, Mixed (Shrubby). Small flowering varieties for bedding; of the finest colors. Two feet high. Pkt. 50 cts.

DOUBLE DAISY.

BELLIS PERENNIS.

Sow in August and September and treat similar to pansies.
New Double Giant White. Extra large and very double. Per pkt., 15 cts.; 4 pkts. for 50 cts.
New Double Giant Mixed. Contains the red and white. Per pkt., 15 cts., 4 pkts. for 50 cts.
Snowball. Best white, very double. Per pkt., 10 cts.
Longfellow Red. Double. Per pkt., 10 cts.
Choice Double Mixed. Per pkt., 10 cts.

CAMPANULA.

(CANTERBURY BELL.)

Double Mixed. Pkt., 5 cts.
Single Mixed. Pkt., 5 cts.
Cup and Saucer. A beautiful variety. The bell or trumpet is nearly four inches in diameter, presenting the form of a saucer, hence its name. Pkt., 10 cts.

DELPHINIUM.

(PERENNIAL LARKSPUR.)

Sow very early in spring or in August and September.
Formosum. Beautiful spikes of brilliant rich blue flowers, with a white centre; thirty inches high. Per pkt., 10 cts.
Nudicaule. Spikes of bright scarlet flowers. Pkt. 10 cts.
Hybrid Mixed. Pkt., 10 cts.
Zalil. Beautiful sulphur yellow. Pkt. 10 cts.

GLOXINIA.

(CRASSIFOLIA GRANDIFLORA.)

Sutton's Prize Mixed. Original pkt., 60 cts.
International Mixture. Embracing all the choicest self-color and tigered flowers. Pkt., 25 cts.
Queen Victoria. New white. 15 cts. per pkt.
Scarlet Queen. Improved. 15 cts. per pkt.

HOLLYHOCK.

(CHATER'S EXTRA DOUBLE.)

This strain is of the very best, saved from the most double flowers by a specialist. Sow seeds in August and September to have strong blooming plants for next summer.
Allegheny. New fringed. Mixed. 15 cts. per pkt.
Snowball. Pure white. Per pkt., 10 cts.; per oz., \$1.00.
Bright Red. Per pkt., 10 cts.; per oz., \$1.00.
Yellow. Per pkt., 10 cts.; per oz., \$1.00.
Pink. Per pkt., 10 cts.; per oz., \$1.00.
Salmon. Per pkt., 10 cts.; per oz., \$1.00.
Choice Mixed. Per pkt., 10 cts.; per oz. 80 cts.
Collections. Containing twelve separate colors, \$1.00.

MYOSOTIS (Forget-Me-Not).

Alpestris Victoria. One of the very best. The plants are compact, the flowers are rich blue with white centre. Per pkt., 10 cts.
Eliza Fourobert. Very large flowering. Per pkt. 10 cts.
Dissitiflora. Compact habit; pinkish blue. Pkt., 10 cts.
Palustris Semperflorens. The most desirable sort for cutting or greenhouse use. Pkt., 10 cts.
Alpestris (Alpine). Blue. Pkt., 5 cts.; per oz., 75 cts.
Nixenauga (New). Rich blue. Pkt., 15 cts.

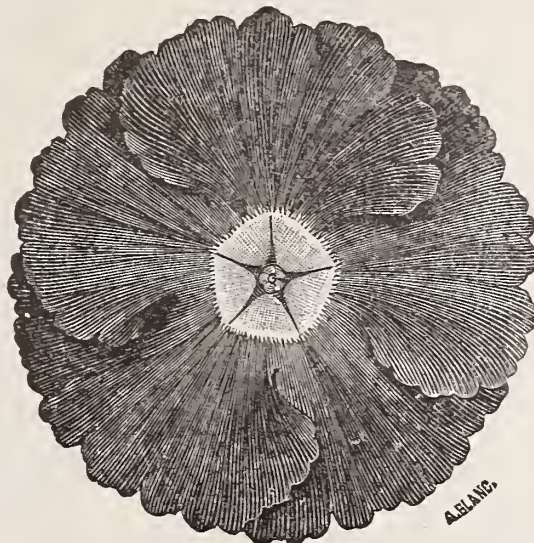

SINENSIS

PRIMROSE

PRIMULA.

(SINENSIS FIMBRIATA—CHINESE PRIMROSE.)

Michell's Prize Mixture. Grown by a specialist who has received prizes wherever he has exhibited the plants. Pkt., 25 cts.; 1/2 oz., \$1.00.
Stellata. Sutton's New Star. \$1.25 per original pkt.
Sutton's Giant. Mixed fringed. Per original pkt., \$1.25.
Williams' Superb Strain. Choicest mixture, can be relied upon. Pkt., 40 cts.
Kermessina Splendens. Brilliant red with yellow centre. Pkt., 25 cts.
Holborn Blue. Fully 50 per cent. will come blue if given warmer treatment than other sorts. Pkt., 40 cts.

Alba Magnifica. Trusses of very large white flowers with a showy citron eye. Pkt., 40 cts.
Obconica Grandiflora Fimbriata. Flowers much larger than the old variety. Pkt., 15 cts.
Forbesi. New beautiful miniature primrose. Pkt., 25 cts.
Floribunda. Beautiful and fragrant; yellow. Pkt., 25 cts.

DOUBLE PRIMROSE.

Pure White. Per pkt., 50 cts.
Choice Mixed. Per pkt., 50 cts.

HARDY PRIMROSE.

Primula Veris (English Cowslip). Flowers of different colors. Very fragrant. Pkt., 10 cts.
Primula Vulgaris. The common hardy English variety, light canary-yellow color. Pkt., 10 cts.

MIGNONETTE.

Defiance. Per pkt., 10 cts.; 1/4 oz., 50 cts.
Sutton's Giant. Original pkt., 25 cts.
Bird's Mammoth. Per pkt., 10 cts.; per oz., 65 cts.
Machet. Improved. Per pkt., 10 cts.; per oz., 65 cts.
Mignonette thrives best in rich deep soil.



ALLEN'S DEFIANCE MIGNONETTE. \$1.00 per trade pkt. 25c. per 1-5 pkt.
 This is the only true strain; grown by Mr. Allen all under glass and can be relied upon to produce mammoth spikes.

P
A
N
S
I
E
S



Michell's . . .

Special
Mixture of
Giant
Exhibition
Pansy Seed.

New Crop of Seed
Just Received In
Fine Condition.

New Crop Pansy Seed.

MR. MICHELL,
Dear Sir:—I am pleased to inform you that from one packet of Michell's Giant Exhibition Pansy I raised about 900 plants, producing extra large flowers of the most beautiful shades of color. Everyone who has seen them say they never saw such a fine strain of pansies; always sure to ask where such a fine strain of seed could be procured.
Gardener to Yours truly, DAVID POWERS.
F. P. Hays, Esq. Overbrook, Phila.

Michell's Giant Exhibition Pansy, Mixed. A strain which we have secured from one of the leading pansy specialists in Germany to which we added the cream of the Paris strain, also the choicest to be had from Scotland. It can be relied upon to give flowers of immense size, very heavy texture, and of the most brilliant colors. Per pkt., 25 cts.; per 1/8 oz., \$1.00; per oz., \$6.00. The seed as per test made by us germinated 95 per cent.

Bugnot's Giant French Mixed. Per pkt. 25 cts.; per 1/4 oz. 2.50.

Cassier's Strain, Odier. Of very large blotched flowers in mixture, per pkt., 25 cts.; per 1/4 oz., \$2.00.

Empress Augusta Victoria. (New). A charming new variety of the Giant Pansies. The prime color is a pretty porcelain white. The upper two petals are violet-edged, while each of the three lower petals is marked with a large violet blue spot, contrasting very pleasantly with the golden-yellow eye. At the Horticultural Exhibition at Hamburg this novelty was awarded a silver medal. 20 cts. per pkt.; 3 pkts. for 50 cts.

Roemer's Superb Giant Prize Pansy "Bronze color." The strain includes the different shades of light and dark bronze, that makes the large flowering section so desirable. But the flowers of this novelty are up to three inches

across, of good substance and noble form, the three lower petals are marked with distinct blotches. 20 cts. per pkt.
Roemer's Superb Giant Prize Pansy "Prince Bismark." By this novelty I am able to offer this distinct color in the Giant Pansies. The flowers measure up to 3 inches in diameter, and are of a rich yellowish bronze color. The well defined eyes are of a dark brown color. 25 cts. per pkt.

- Giant Prize, Black blue** Pkt., 25c.; 1/8 oz. 50c.
- " " Azure blue " " "
- " " Lord Beaconsfield (rich blue) " " "
- " " Striped and Mottled " " "
- " " White with Eye " " "
- " " Snowflake, pure white without eye. " " "
- " " Yellow with eye " " "
- " " Brown and red " " "

Trimardeau. Choicest mixed. Per pkt. 20 cts.; per oz. \$3.50

Snow Queen. Large white, Per pkt., 10 cts.; per oz. \$1.25

Faust. Black. Per pkt., 10 cts.; per oz., \$1.00.

Yellow Gem. Per pkt., 10 cts.; per oz., \$1.25.

Emperor William. Per pkt., 10 cts.; per oz., \$1.00.

Lord Beaconsfield. The best rich blue. Per pkt., 10 cts.; per oz., \$1.25.

Striped. Per pkt., 10 cts.; per oz., \$1.00.

Havana Brown. Per pkt., 10 cts.

Purple. Silver edged. Per pkt., 10 cts.; per oz., \$1.00.

Gold Margined. Per pkt., 10 cts.; per oz., \$1.00.

Silver Edged. Pkt., 10 cts.; per oz., \$1.00.

Very Large Flowering. Choicest mixed. Per pkt., 10 cts.; oz. \$1.50.

Choice Mixed, First quality. Per pkt., 5 cts.; per oz. 75c.

Collection. Containing 6 pkts. in six colors, 40 cts.

Collection. Containing twelve pkts, twelve colors, 75 cts.



POPPY.

BEST PERENNIAL SORTS.

- Iceland.** Double scarlet. 10 cts. per pkt.
- Iceland.** Choicest mixed colors. 10 cts. per pkt.
- Oriental Giant.** Choicest mixed. 10 cts. per pkt.
- Giant Orange.** Per pkt., 10 cts.; three for 25 cts.
- Giant Scarlet.** Per pkt., 10 cts.; three for 25 cts.
- Collection of eight varieties.** Per pkt., 40 cts.

TEN-WEEK STOCKS.

(LARGE FLOWERING DWARF SORTS.)

White, Pink, Blood Red, Blue, Purple, Mixed. Each 10 cts. per pkt.

SWEET WILLIAM, (Dianthus Barbatus.)

A well-known plant which has been greatly improved of late years, producing splendid effect in beds and shrubbery; hardy perennial.

- Auricula-flowered Mixed.** A beautiful class of "eyed" single varieties, all colors. Pkt., 5 cts.; oz., 40 cts.
- Double Mixed.** Finest colors. Pkt. 10 cts.; oz., \$1.00.

VINCA, (Madagascar Periwinkle.)

- Rosea.** Rose, with dark eye. Pkt., 10 cts.; oz., \$1.00.
- Alba.** White, with crimson eye. Pkt., 10 cts.; oz., \$1.00.
- Alba Pura.** Beautiful pure white. Pkt., 10 cts.; oz., \$1.00.
- Mixed.** Pkt., 10 cts.; oz., \$1.00.

WALLFLOWER.

Well-known fragrant garden plants, blooming early in the spring with large spikes of flowers; they should be protected in a cold frame in the winter, and planted out in May; half-hardy perennials.

- Single Mixed.** All colors. Pkt. 5 cts.
- Finest Double Mixed.** All colors. Pkt., 10 cts.
- Collection** containing eight double varieties. Pkt., 50 cts.

SWEET PEAS

One pound will sow a row 100 feet long.

Can be grown very successfully by sowing seeds in October or November in open ground. Sow in rows about six inches deep, cover with rich, sandy soil and some straw to protect them over a severe winter. A large number of Sweet Peas have been grown in this way with excellent results.

Eckford's New Mammoth Flowering.

- Choicest Mixed** of over 50 of the best varieties and brightest colors. Per pkt., 5 cts.; per oz., 10 cts.; per lb., 60 cts.
- Extra Early Blanche Ferry.** For forcing. 10 cts. per oz.; 75 cents per lb.
- We have all the very best named varieties. 10 cts. per oz., 75 cts. per lb.

Our "SUPERIOR BRAND" English Mushroom Spawn

Arrives fresh every month from the Leading and most Reliable Mushroom Grower in England. P.S.—We supply a large number of the largest Mushroom Growers with their supply of Spawn.

MICHELL'S MUSHROOMS.



OUR SPECIAL STOCK. ENGLISH MUSHROOM SPAWN.

School Lane, Germantown, Pa.
Dear Sir;
Your Mushroom Spawn has proved to my satisfaction, that it is really *AT*. Our beds have done and are doing unexceptionally well. We have never had such a splendid showing of mushrooms.
Yours very truly,
JOHN McCLEARY.
Gardener to
Wm. Weightman, Esq.

Wm. Falconer's
Book on...
MUSHROOM CULTURE
PRICE, \$1.25

Mushroom Bed Thermometers with
Brass Insert Tip, \$1.50.

Robinson's
Book on
MUSHROOM CULTURE
PRICE, 50 CTS.

Per Brick, 15 cts.; per doz. Bricks, \$1.75; 25 lbs., \$2.25; \$8.00 per 100 lbs.; \$60.00 per 1000 lbs.

VEGETABLE SEEDS FOR FALL ...SOWING

ASPARAGUS ROOTS.

For Autumn planting, ready October 1st.
Barr's Mammoth and Conover's Colossal. Extra strong two-year old roots. Per 100, 75 cts.; per 500, \$3.00; per 1000, \$6.00.

BEANS, for Forcing.

Sion House. Improved. One of the best and most desirable. 50 cts. per qt.

CABBAGE.

Early Jersey Wakefield. The best for early use; of excellent quality, good size and sure to head; extra fine selected stock. Per pkt., 10 cts.; per oz., 25 cts.; per lb. \$2.50
Henderson's Early Summer. A second early sort with large, solid heads, coming in a few days later than the Wakefield. Per pkt., 10 cts.; per oz., 25 cts.; per lb., \$2.50.

CAULIFLOWER.

Sow for early use about middle of September or October in a bed of rich earth. transplant in frames, cover with sashes and shutters during severe weather, giving light and air every mild day.

Early Snowstorm. The earliest and best of all for forcing; must be kept growing constantly; will not stand a check at any period of its growth. Per pkt., 25 cts.; per oz., \$5.00.

Selected Dwarf Erfurt. Per pkt., 20 cts.; per oz., \$2.50

Sutton's First Crop. 50 cts. per original pkt.

Lenormand's Short Stem. Per pkt., 10 cts.; per oz., 75 cts.

Veitch's Autumn Giant. Per pkt., 10 cts., per oz. \$1.00.
Snowball. Per pkt., 20 cts.; per oz., \$2.50.

CUCUMBER.

English Prize.

Sow the seeds in small pots about the middle of January; when they have grown to three leaves plant in prepared hill of rich, loose soil in the centre of a sash.

New Ideal. Per pkt., 25 cts.

Rockford's Market. Per pkt., 25 cts.

Sutton's Matchless. 50 cts. per pkt.

Tender and True. Per pkt., 20 cts.

Long Gun. (Pierson's.) The best of all. Per pkt., 20 cts.

Telegraph. Per pkt., 20 cts.

ALSO ALL OTHER VARIETIES.

CORN SALAD.

(FETTICUS).

Large Seeded. Best for market. For winter and early spring use, sow in drills in August and September. Per pkt. 5 cts.. per oz., 10 cts.; per ¼ lb. 15 cts.. per lb., 50 cts.

KALE.

For early use sow in September. Protect in winter.
Dwarf Green Curled German. Pkt., 5 cts.; oz., 10 cts.; ¼ lb., 25 cts.; per lb., 65 cts.
Imperial Long Standing. A first-class curled sort. Pkt., 5 cts.; oz., 10 cts.; ¼ lb., 25 cents; per lb., 75 cts.

LETTUCE.

Forcing Emperor. Per pkt., 10 cts.; per oz., 30 cts.
Early Tennisball. Per pkt., 5 cts.; per oz., 15 cts.; per ¼ lb., 40 cts.; per lb., \$1.25.
Boston Market. Per pkt., 5 cts.; per oz., 15 cts.; per ¼ lb., 40 cts.; per lb., \$1.25.
Early Dutch Butter, Spotted. Per pkt., 5 cts.; per oz. 15 cts.; per ¼ lb., 40 cts.; per lb., \$1.50.
Early Cabbage, or White Butter. Per pkt., 5 cts.. per oz., 15 cts.; per ¼ lb., 40 cts.; per lb., \$1.25.
Golden Queen. Pkt., 10 cts.; per oz., 20 cts.

ALSO OTHER VARIETIES.

RADISH.

Triumph. (New.) Oval shape, extra early, scarlet. 10 cts. per pkt.
First Number. (Extra Early). Scarlet forcing. 15 cts. per pkt.
Sutton's Earliest of All, Red. 20 cts. per original ounce pkt.
Cardinal, or Scarlet Globe. One of the very best for forcing. Per pkt., 5 cts.; per oz., 10 cts.; per ¼ lb., 25 cts.; per lb., 75 cts.
Round Red Forcing, or Button. Per pkt., 5 cts.; per oz., 10 cts.; per ¼ lb., 20 cts.; per lb., 60 cts.
Round White Forcing. Per pkt., 5 cts.; per oz., 10 cts.; per ¼ lb., 20 cts.; per lb., 60 cts.
Early French Breakfast. Per pkt., 5 cts.; per oz., 10 cts.; per ¼ lb., 20 cts.; per lb., 60 cts.

SPINACH.

Victoria. A new variety; dark green leaves; long standing. We can recommend this very highly, Pkt., 5 cts.; oz., 10 cts.; ¼ lb., 15 cts.; lb., 40 cts.
Bloomsdale Round-Seeded Savoy. The best for family purposes. Per oz., 5 cts.; per lb., 40 cts.
Long Standing Round-Seeded. Per oz., 5 cts.; per lb., 30 cts.
Prickly Seeded. Per oz., 5 cts.; per lb., 30 cts.

TOMATO.

For Forcing.

Sutton's Best of All. 40 cts per original pkt.
Lorillard. Per pkt., 10 cts.; per oz., 30 cts.
Livingston's Favorite. Per pkt., 10 cts.; per oz., 25 cts.
Stone. Per pkt., 10 cts.; per oz., 25 cts.
Mayflower. Per pkt., 10 cts.; per oz., 25 cts.

GRASS AND CLOVER SEEDS

Michell's None Superior Evergreen Lawn Grass Seed. Composed of a mixture of ten best short-growing grasses, forming a sward resembling a sheet of velvet. Sow in September if you wish an early lawn next spring. Qt., 25 cts.; 4 qts., 60 cts.; bush., (20 lbs) \$4.00.

Fairmount or Central Park Mixture: A very fine mixture which we can highly recommend. Qt., 20 cts.; peck, 75 cts.; bush., (15 lbs) \$2.50. (5 to 10 bush. lots, \$2.25 per bush).

Flint's Mixture for Permanent Pasture Lands. This is a mixture made of ten of the best and most hardy grasses to form a permanent pasture. Sow two bushels to the acre. Qt., 15 cts.; (bush. 20 lbs) \$3.00; 5 bush. lots and over, \$2.85 per bush.

Fancy Clean Kentucky Blue Grass. Qt., 15 cts.; bush. (14 lbs) \$1.75; in original sacks of 8 bush., \$1.50 per bush.

Fancy Cleaned Herd or Red Top. Very heavy seed. 15 cts. per lb.; \$12.00 per 100 lbs.

Herd, or Red Top Grass. Qt., 10 cts.; bush. (10 lbs) 90 cts.; per sack of 50 lbs.; \$4.00.

Natural Green Grass. Forms a heavy sward, but does not retain its color as well as Blue Grass. Qt., 20 cts., bu. (14 lbs.) \$2.00.

White Dutch Clover. Per lb., 25 cts.; 10 lbs. at 20 cts. per lb.. \$18.00 per 100 lbs.

Red Clover, Extra Re-cleaned. \$5.00 per bush.

Scarlet, or Crimson Clover. New crop, \$5.00 per bu.

Prime Timothy Seed. New crop, \$1.75 per bush.

WHEAT AND RYE.

SEED WHEAT. Best quality About \$1.25 per bush. Special price on larger quantities.

SEED RYE. About \$1.00 per bush. Special price on larger quantities.

ALSO ALL OTHER VARIETIES AT VERY LOWEST MARKET PRICES.

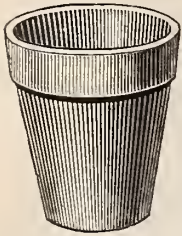

FLOWER POTS.

STANDARD FLOWER POTS.
Full inside measurement, height and width.
No Charge for Barrels or Packing.
6 Supplied at Dozen Rates.
50 Supplied at 100 Rates.
500 Supplied at 1000 Rates.
Please note the Reduction in Price.
Compare with Others.



Sizes	Price per doz.	Price per 100	Price per 1000
1 1/4 inch Height and width inside	\$0.06	\$0.44	\$3.46
2 " " " " " "	.07	.50	3.96
2 1/4 " " " " " "	.08	.56	4.45
2 1/2 " " " " " "	.09	.69	5.45
3 " " " " " "	.11	.88	6.93
3 1/2 " " " " " "	.14	1.06	8.41
4 " " " " " "	.18	1.38	10.89
4 1/4 " " " " " "	.20	1.56	12.37
4 1/2 " " " " " "	.24	1.88	14.85
5 " " " " " "	.32	2.50	19.80
5 1/2 " " " " " "	.41	3.13	24.75
6 " " " " " "	.49	3.75	29.70
6 1/2 " " " " " "	.62	4.80	44.00
7 " " " " " "	.78	6.00	55.00
8 " " " " " "	1.09	8.40	77.00
9 " " " " " "	1.56	12.00	110.00
10 " " " " " "	2.11	16.20	148.50
11 " " " " " "	2.81	21.60	
12 " " " " " "	3.90	30.00	
14 " " " " " "	7.80	60.00	

We can also supply the Old Fashioned Hand Made Pots.
Price List sent on application.



SEED PANS (Earthenware).

6 inch	per doz., \$2.00
8 " "	" " 2.50
10 " "	" " 3.00
12 " "	" " 3.50

Improved White Cedar Plant Tubs.

Made of white cedar, bound with extra heavy iron hoops. Drop handles of special pattern, serving as hooks. Substantial iron feet of original design. Removable perforated bottoms, painted green outside and brown inside.

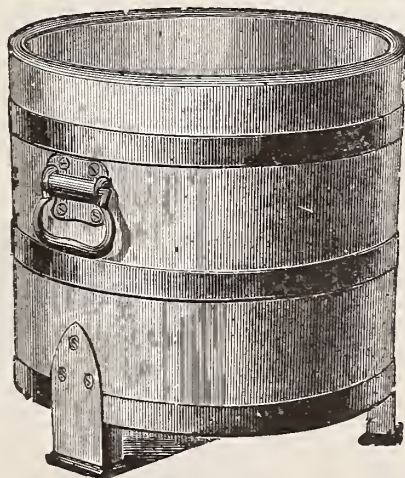

(MACHINE MADE.)

No.	Outside diam.	Length of stave.	Price
0	27 in.	24 in.	\$6.00
1	25 "	22 "	5.00
2	23 "	20 "	4.25
3	21 "	18 "	3.75
4	18 "	16 "	3.25
5	16 "	14 "	2.75
6	14 "	12 "	2.30
7	13 "	11 "	2.10
9	12 "	10 "	1.85

Improved White Cedar Plant Tubs.



(HAND MADE.)

No.	Outside diam.	Length of stave.	Price
0	27 in.	24 in.	\$5.00
1	25 "	22 "	4.50
2	23 "	20 "	3.75
3	21 "	18 "	3.25
4	19 1/2 "	16 "	2.75
5	18 "	14 "	2.40
6	16 1/2 "	13 "	2.00
7	15 "	12 "	1.75
8	14 "	10 "	1.50

Columbia Plant Tubs.

We have had numerous demands for low priced tubs and find these suitable, ornamental and durable.
12 in. diam. x 11 in. high, each, \$1.00
15 " " x 14 " " " " 1.50
18 " " x 16 " " " " 2.00
21 " " x 18 " " " " 2.50
24 " " x 20 " " " " 3.00

Galvanized and Painted Saucers.

Especially made for us to fit all the above sizes of plant tubs.
40 cts. to \$1.00 each, according to size.

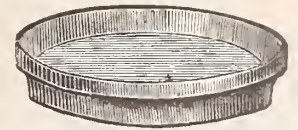
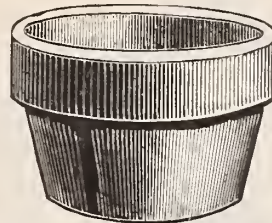

BULB PANS (Earthenware).

(Earthenware.)

Width	Height	Per doz.	Per 100	Per doz.	Per 100
6 in.	3 in.	\$0.68	\$3.75	4 in.	\$0.15 \$1.12
7 "	3 1/2 "	.78	4.80	5 "	.18 1.40
8 "	4 "	.98	6.00	6 "	.24 1.88
9 "	4 1/2 "	1.30	8.40	7 "	.31 2.40
10 "	5 "	1.63	10.80	8 "	.47 3.60
12 "	6 "	2.28	15.00	9 "	.62 4.80
14 "	7 "	4.55	30.00	10 "	.78 6.00
16 "	8 "	7.80	60.00	11 "	.94 7.20
18 "	9 "	11.70	90.00	12 "	1.17 9.00
				14 "	1.95 15.00

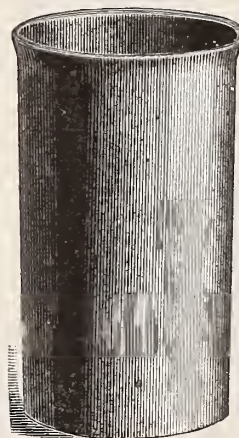

CUT FLOWER VASES.

Made of Wood Fibre. Unbreakable and Practical.

No.	Diam. in. inside.	Depth in. inside.	Each.	Per doz.
0	8	13	\$0.45	\$4.80
1	5 1/2	10	.40	4.20
2	4 1/2	9	.35	3.60
3	4	6	.30	3.00
4	3	4 1/2	.25	2.40
22	4 1/2	15	.15	4.80
33	4	12	.40	4.20
44	3	9	.35	3.60
00	9	21	.90	9.00
11	5	18	.60	6.00

FLOWER POT SAUCERS.

Made of Wood Fibre.

Unbreakable. Are not porous, and will protect woodwork, tables, etc., on which plants are to stand.

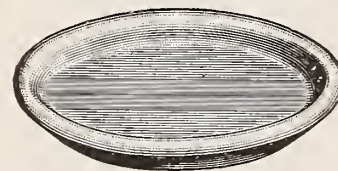

	Per doz.	Per 100		Per doz.	Per 100
4 inch	\$0.75	\$6.00	10 in. in crate	\$1.05	\$8.70
5 " "	.80	6.25	100 " "	9.10	50 " "
6 " "	.85	6.75	100 " "	1.20	9.10
7 " "	.90	7.10	100 " "	1.35	10.00
8 " "	.95	7.60	100 " "	1.50	12.00
9 " "	1.00	8.20	50 " "	2.00	15.00

ROLLING STANDS.

For Heavy Plants and Palms.

Made of Indurated Fibre Ware.



Will not soak or rust. Casters have ball bearings. Every heavy plant sold needs one to save carpets and floors, and to enable carpets and floors to be readily cleaned.
13 inch, 3 casters Each, \$0.70 Per doz., \$7.20
17 " 4 " " .85 " 9.00

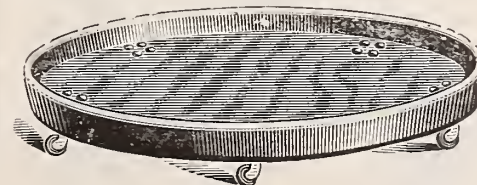

These larger sizes, (18, 20 and 22 inch) are very heavy, and will carry safely 200 pounds.

	Each.	Per doz.
18 inch (16 inch diam.) 4 casters	\$1.10	\$12.00
20 " (18 " " ") 4 "	1.35	15.00
22 " (20 " " ") 5 "	1.65	18.00

ORCHID BASKETS.

EARTHENWARE.

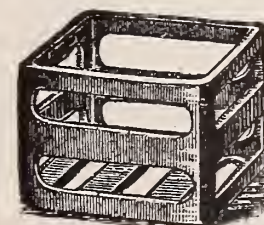

	Each	Per doz.
Square, 4 in.	\$0.15	\$1.35
" 6 "25	2.25
" 7 "30	3.00
Round, 6 "20	1.80
" 8 "30	2.50
" 10 "40	3.60

WOOD ORCHID BASKETS.

	Each	Per doz.	Each	Per doz.
6 in.	\$0.35	\$4.00	10 in.	\$0.55 \$6.00
8 "45	5.00	12 "70 7.00

WIRE...

Plant Stands

A Large Assortment.

- 1 step . . . \$2.00
- 2 " . . . 3.00
- 3 " . . . 3.75

WOODEN

Plant Stands

Very neat and Durable..

- Each.
- 3 shelves . . \$1.25
- 4 " . . . 1.50



LEAF RACK.

Light and durable. Can be easily folded and detached and the truck used with water barrel.

- 1 1/2 in. wheel, \$9.00
- 2 1/2 in. " 9.75
- 3 1/2 in. " 10.50



LAWN RAKES.

Davis Wire Rake . . . \$1.50	Lawn King, 36 teeth, .75
Gem Wire Rake50	" 22 " .40
Champion Wire Rake .50	" 26 " .50
Diamond Wire Rake .50	Automatic 22 " .60
Lawn King, 50 teeth, 4 feet long . . . 1.00	" 26 " .70
Regular Wooden Lawn and Straw Rakes, each .35	" 36 " 1.00

Rubber Sprinklers

Scollay's Make

For sprinkling flowers and plants.

Each, 85c. Small size, 50c.



Putty Distributors

for glazing, 90c. each.

Galvanized Water Pots.

(WOTHERSPOON'S MAKE).

4 qt. . . . \$1.50		The best and most durable watering pot made. Each has two roses—one fine and one coarse. . . .
6 qt. . . . 1.75		
8 qt. . . . 2.00		
10 qt. . . . 2.25		
12 qt. . . . 2.50		
16 qt. . . . 3.00		

DEAKIN'S BRASS GARDEN SYRINGES.

BEST PHILADELPHIA MAKE.

No. A . . . \$2.00
Length of Barrel, 13 1/2 in.; diam, 1 1/8
" C . . . 3.25
" 2 . . . 4.00
" 3 . . . 5.00
" 5 . . . 6.00

GALVANIZED WIRE IN ROLLS.

No. 16 and No. 18, 8 cts. per lb.; 80 cts. per roll of 12 lbs.
No. 20, 10 cts. per lb.; 90 cts. per roll of 12 lbs.

FLOWER POT BRACKETS.

To hold one pot 20 cts., 25 cts. 35 cts. each.
To hold two pots 40 cts., 60 cts. each.

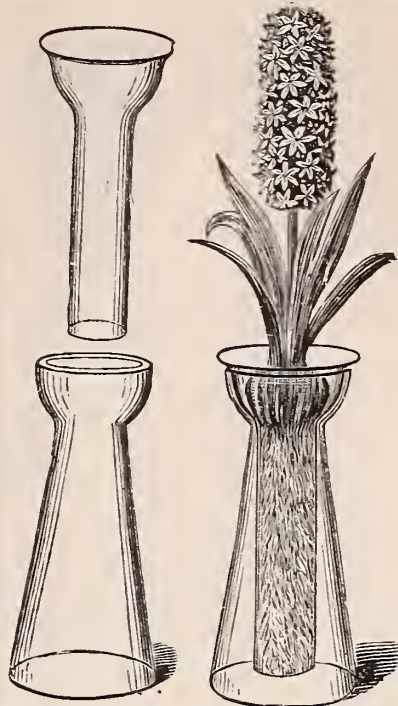

Hyacinth Glasses..

Each.	Per doz.
Belgian, . . \$0.15	\$1.50
Tubular, In-	
cluding tube .25	2.50
American, blue .13	1.25

PLANT STAKES.

Southern Cane. Always on hand.
Per 100 Per 1000
8 to 12 feet long (250 for \$2.00) \$1.00 \$6.50

UNPAINTED STAKES OR DOWELS.

36 inches long, 1/4 inch diameter \$0.55	Per 100	Per 1000
42 " " 1/4 " "65		5.00
42 " " 3/8 " "75		6.00
42 " " 1/2 " " 1.00		7.50

GALVANIZED STEEL PLANT STAKES.

Used by leading gardeners and florists for Roses, Carnations, etc. They are neat and durable.

2 feet long . . \$0.65	Per 100	Per 1000	4 feet long . . \$1.25	Per 100	Per 1000
2 1/2 " " . . .80	6.50		4 1/2 " " . . 1.40	12.00	
3 " " . . .95	7.50		5 " " . . 1.55	13.50	
3 1/2 " " . . 1.10	8.50		6 " " . . 1.85	16.50	

PAINTED STAKES.

1 1/2 ft., painted green . . . \$0.15	Doz.	100	3 ft. heavy or dahlia . . . \$0.67	Doz.	100
2 " " "25	1.33		3 1/2 " " "78	5.00	
2 1/2 " " "38	2.35		4 " " "88	5.70	
3 " " "46	2.95		5 " " " 1.10	7.10	
3 1/2 " " "58	3.70		6 " " " 1.30	8.50	
4 " " "67	4.30				

Rubber Hose



SPHINCTER GRIP ARMORED Pat. 1882, '85, '86, '88, '90, '91

In 25, 30 and 50 foot lengths, 16 cts. per foot. No. 1, extra 4-ply, guaranteed, 13 1/2 cts. per foot. No. 1, extra 3-ply guaranteed, 10 cts per foot.

WOODASON'S HOSE MENDERS.

Best and cheapest. 3/4 inch, each, 5 cts.; per doz., 50 cts.

HUDSON'S HOSE MENDERS.

Complete with pliers and six menders 60 cts.
Also Wires and Menders separate.

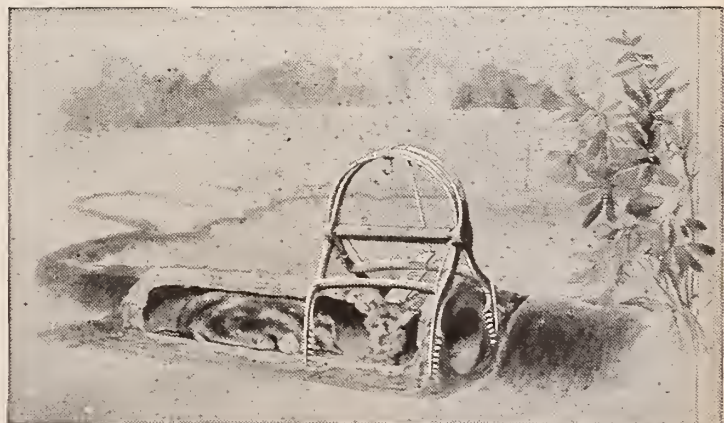

Showing position of trap when set with mole approaching.

MOLE TRAPS. The New "Out o' Sight" Mole Trap.

Considered to be one of the best and cheapest Mole Traps on the market. (Especially valuable for hot-beds and frames on account of its convenient size.) Price, \$1.00 each; \$5.00 per 1/2 doz.; \$9.00 per doz.

Per'ec'ion Mole Traps, \$2.00 each. | New Model Mole Traps, \$1.50 each
Hale's Mole Traps, \$2.00 each. | English Mole Traps, 35 cts. each.

Insect Destroyers.

Ant Exterminator. Very effectual for destroying Ants in gardens and lawns. Per package. 25c., 50c., \$1.00.

Bordeaux Mixture. For black rot, downy mildew, and anthracnose of grape, potato blight, potato rot, leaf blight of cherry, pear, quince, and other fungus diseases. 5 lbs. 60c., makes 25 gallons spray; 10 lbs. \$1.00, makes 50 gallons spray; 25 lb. box, makes 125 gallons, \$2.50.

Bordeaux Mixture. In liquid form. 40c. per qt., \$1.00 per gal.

Caterpillar Lime, Ermish's. Cans of 5 lbs. \$1.00, 10 lbs. \$1.75, kegs of 25 lbs. \$3.75; 50 lbs. \$6.75.

Copperdine. For black rot, carnation rust and anthracnose of the grape, pear, leaf blight, apple scab and powdery mildew. One gallon can (makes 100 gallons wash), per qt, 50c., per gal. \$1.50, five gal. can, \$6.25.

Dalmatian or Persian Powder. Per 1/4 lb. 15c., lb. 40c.

Fir Tree Oil. For destroying insects, such as mealy bug, red spider, scale, thrip, green fly, etc. Full directions with each can. Qt. \$1.50, pt. 75c., 1/2 pt. 50c., small bottle, 25c.

Fir Tree Oil Soap. Per can, 25c. and 50c. each.

Fostite. Prevents mildew. 5 lbs. 50c., 25 lbs. \$2.00.

Gishurst's Compound. Extensively used for preventing and destroying green fly, mildew, thrip, mealy bug and scale; Box 50c., 3 lb. box \$1.00.

Good's Caustic Potash Whale Oil Soap. Per 50 lb. keg \$3.00, per lb. 10c.

Grape Dust. Best remedy for mildew. 5-lb. package, 30c., 100 lb. keg \$5.00.

Hellebore. For destroying rose slugs. With directions. Lb. 25c., 1/2 lb. 15c.

Kerosene Emulsion. For plant lice of any kind, cabbage worms, scale, insects on apple, pear, orange, lemon and other trees. 5-lb. can 60c., makes 50 gallons of spray; 25-lb. can, \$2.50, makes 250 gallons of spray.

Kraft's Palm Wash 75c. per qt., \$1.40 per 1/2 gallon, \$2.65 per gallon.

Kraft's Tonic and Insecticide. 25c. per bottle, 75c. per qt., \$2.65 per gallon.

Lemon Oil. One of the best and cheapest insecticides on the market. Used now by nearly all the leading gardeners and florists to destroy mealy bug, scale, thrip, red spider, etc. Half pint 25c., pint 40c., qt. 75c., 1/2 gallon \$1.25, gallon \$2.00, 5-gallon keg \$9.00.

London Purple. Cheaper and less dangerous than Paris green. Lb. 20c., 5 lbs. 90c. Special price on larger quantity.

Nikoteen. One of the most economical and powerful nicotine extracts. One part to 600 of water is sufficiently strong to kill all insects, except spore, for which use one part to 400 parts of water. Per pt. \$1.50. Outfit for using Nikoteen, \$3.00 complete.

Paris Green, Pure. Lb. 25c., 5 lbs. \$1.25, 14 lb. buckets, \$3.00.

Rose Leaf Extract of Tobacco. Per qt. 50c., per gal. \$1.25, 5-gal. \$4.25.

Seal Oil Soap. 1 lb. can 25c., 10 lbs. for \$2.00.

Slug Shot. 5 lbs. 25c., 100 lbs. \$4.25. Bulk, in barrels weighing about 225 lbs., 3 3/4c. per lb.

Sulphur. A preventive and cure for mildew. Lb. 7c., 5 lbs. 30c., 100 lbs. \$4.00.

Tobacco Dust. Cheaper than snuff and quite as effectual. Sure remedy for green fly. 5 lb. pkge. 25c., 100 lbs. \$3.00.

Tobacco Soap. (Pinner's.) For destroying insects, parasites and their eggs, infesting either plants or animals. Lb. 40c.

Tobacco Stems, Fresh. For fumigating. Lb. 10c., bbl. \$1.00, bales of about 250 lbs. \$2.00, per 1/2 ton \$6.00, per ton \$12.00.

Whale Oil Soap. For destroying and preventing insects on plants, trees, vines, etc.: for washing down the bark of trees, grape vines, etc. In cans with directions. 20c., 35c., and 50c.; in bulk, 10 lbs. 90c.

Fertilizers.

Michell's (Strictly Pure and Fresh) Bone Meal. 3 lb. 15 cts., 5 lbs. 25 cts., 10 lbs. 40 cts., 25 lbs. 75 cts., 100 lbs. \$2.00, 200 lb. \$3.50, ton \$30.00.

Pure Bone Flour. 5 lbs. 25 cts., 25 lbs. \$1.25, 100 lbs. \$3.00, 200 lbs. \$5.00.

Wood Ashes. 100 lbs. \$1.50, 250 lbs. \$2.50, per ton \$18.00.

Native Poudrette. One of the best general fertilizers now on the market. Very rich and effective. 10 lbs. for 25 cts., \$1.50 per 100 lb. bag, \$22.50 per ton.

Peruvian Guano. 1 1/2 lbs. 15 cts., 3 1/2 lbs. 25 cts., 100 lbs. \$3.00, 200 lbs. \$5.00.

Pulverized Sheep Manure (Elliott's Brand, very best). 2 lb. 15 cts., 4 lbs. 25 cts., 25 lbs. \$1.00, 100 lbs. \$2.50.

Clay's Fertilizer. Imported manure especially recommended for flowers or vegetables to bring the highest perfection. Should be used in potting soil, and spread on staging of greenhouses planted with flowering plants. Per bag of 25 lbs. \$2.00, 50 lbs. \$3.50, 100 lbs. \$6.50.

Bowker's Chemical Fertilizer. FOR FORCING LETTUCE, CABBAGE PLANTS, TOMATO PLANTS, ETC., apply from four to six pounds per one hundred square feet, thoroughly mixed with the soil. Half the quantity may be applied a month later.

FOR CARNATIONS, VIOLETS, and similar plants, use at the rate of four to six pounds for every one hundred square feet, or two to three pounds may be applied at one dressing, and then a month later apply two or three pounds more. More explicit directions sent on application. 5 lbs. 50 cts., 10 lbs. 75 cts., 25 lbs. \$1.25, 50 lbs. \$2.00, 100 lbs. \$3.50.

Bowker's Ammoniated Food for Flowers. Made especially for plants grown in conservatory, house or garden. Clean, free from offensive odor. Full directions with each package. 15 cts. and 25 cts.

"Excelstor" Plant Food. 15 and 25 cts. per package.

WEED KILLER (FAIRMOUNT).

A great English remedy for killing weeds in gravel and other walks and drives. Price 75 cts. per can, sufficient to make 25 gallons liquid; large can \$1.25. will make 50 gallons.

Fumigators.

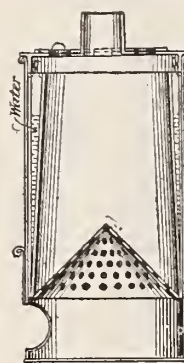

Water Tank Fumigator.

TOBACCO STEMS. (Fresh.) For fumigating. 5 lbs. for 25c., \$1.00 per bbl., \$2.00 per bale of 250 lbs.

Perfection, No. 1, holds 1 pk. of stems, \$3.00.

Perfection, No. 2, holds 1/2 bush. of stems, \$3.50.

Perfection, No. 3, holds 3/4 bush. of stems, \$4.00.

Perfection, No. 4, holds 1 bush. of stems, \$5.50.

The "New Model." Manufactured by a practical gardener. No. 1 \$3.00 each, No. 2 \$4.00 each, No. 3 \$5.00 each.

Eureka, No. 1, height 12 in., for a house 10x20 ft., \$1.25.

Eureka, No. 2, height 16 in., for a house 12x40 ft., \$1.75.

Eureka, No. 3, height 20 in., for a house 15x100 ft., \$2.25.

Eureka, No. 4, height 24 in., for a house 20x100 ft., \$3.25.

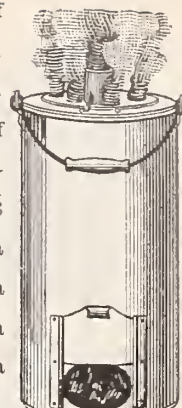

"Perfection."

Bellows.

For Applying the Insect Destroyers.

Large Double Cone.	Each, \$2.75	Liquid Spraying.	Each, \$1.00
Large Single Cone.	" 1.75	and \$2.00.	
Small Single Cone.	" 1.00	Sulphur Bellows.	Each, \$1.50

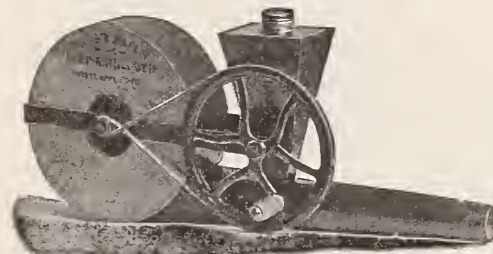

"PEERLESS" SULPHUR AND... INSECTICIDE BLOWER.

This is the most satisfactory distributor of Sulphur and other Insecticide in powder form. Will never wear out. Satisfaction guaranteed. Price \$4.75.

"JADOO" FERTILIZER.

The Great New, Popular and Practical Fertilizer.

The following is the description given by the introducer:
Suits all kinds of plants.
It increases size, brilliancy and intensity of color in flowers.
It increases the size and enhances the flavor of fruits and vegetables.
Seeds germinate more quickly in "JADOO" Fibre than in earth.
Favorite plants in a dying condition can be restored to vigorous life and growth in "JADOO" Fibre.
"JADOO" Fibre is not a chemical manure.
It always remains sweet and does away with the smell of sour earth in rooms.
Price of "Jadoo" Fibre. 5 lb. box 30 cts.; 10 lb. box 50 cts.; 25 lbs. for \$1.10; in full bag lots, about 100 lbs., 3 cts. per lb.; 500 lbs. \$10.00. Special prices on larger quantities on application.
Full Directions accompany each package.

CONCENTRATED "JADOO" LIQUID.

Is the cheapest Fertilizer sold. Both meat and drink to plants. Re-vides drooping plants, strengthens the weak and nourishes the strong; above all, it increases the size, causes greater profusion of bloom, and heightens the colors of all flowers and plants. Can be used on flowers or plants that are grown in earth or "JADOO" FIBRE.

Price of "Jadoo" Liquid. 25 cts. per pint bottle; \$1.50 per 2 gallon jug.

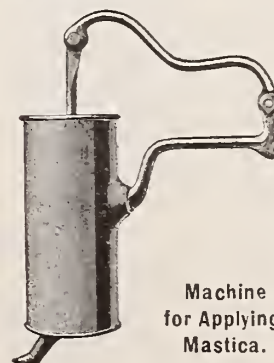

MASTICA

For Glazing Greenhouses,

(NEW OR OLD.)

Elastic, adhesive, easy to apply. Used now extensively and highly recommended by all the up-to-date gardeners and florists. Immense quantities were used last season.

Machine Per gallon \$1.25, half gallon 70 cts., 5 gallons \$5.75.
Mastica. Machines for applying Mastica, \$1.00 each.

Van Reyper's Perfect Glazing Points.

These are made of steel wire and galvanized, having double points, and lap over the glass in such a manner as to positively keep it from sliding. They may be used on either side of the sash bar, thus preventing the annoyance of rights and lefts.

Per box of 1000, 60c.

5000 lots at 55c. per 1000.

Pincers for Driving, 50 cts.

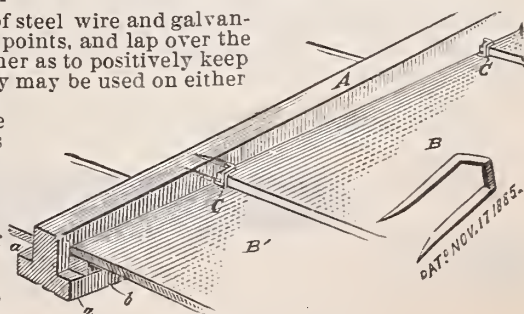

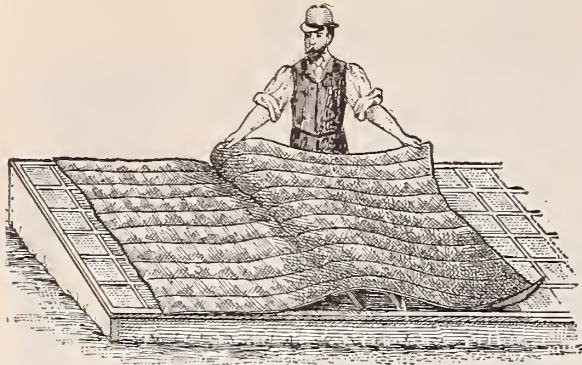

**Palmer's
Burlap
Hot Bed
Mats.
Frost
Proof.**

Made expressly for winter covering of hot beds, cold frames, plants and seeds of all kinds.

Indestructible, Cheap and Warm.

Will not harbor mice or vermin. Easy handling. Have now been in practical use three years. Costing less than half as much as old-fashioned straw mats and entirely taking their place.

Size 76 x 76 inches, fully covering two regular size hot bed sash, \$1.25 each, \$13.50 per dozen.

Size 40 x 76 inches, fully covering one hot bed sash, 90c. each, \$9.50 per doz.

We also can supply these mats made of one-half Burlap and one-half duck, also made of water-proof material. Special prices will be quoted upon application.

STRAW MATS. For Covering Hot Beds and Frames.

3x6 ft., 85c. each, \$9.00 per doz. | 6x6 ft., \$1.25 each, \$14.00 doz.

RATTAN HOT BED MATS.

These are the most durable yet introduced and will probably supersede all others when their merits are known. Size 72x74 in., covering two frames, \$2.00 each, \$22.00 per doz.



**OILED MUSLIN
—OR—
FIBRE CLOTH.**

Light Grade. 4c. per yd.; piece about 65 yds., 3 1/2 c. per yd.
Medium Grade. 8c. per yd.; piece of about 55 yds., 7c. per yd.
Heavy Grade. 10 1/2 c. per yd.; piece of about 40 yds., 10c. per yd. Samples mailed upon application.
The light and medium grades are now extensively used for shading the greenhouses, the heavy grade as a protecting cloth.

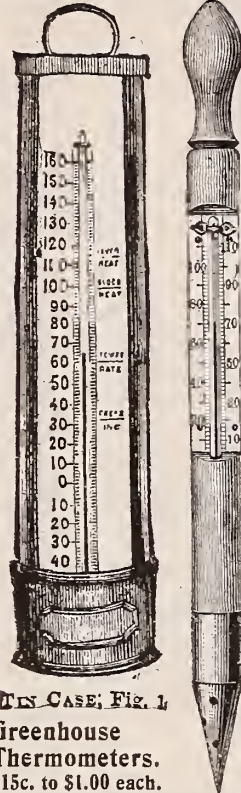

**IN CASE, FIG. 1
Greenhouse
Thermometers.
15c. to \$1.00 each.**

**Maximum and Minimum
Thermometers.**

Registering the coldest and warmest temperature.

\$2.25 and \$2.75 each.

**Mushroom or Hot Bed
Thermometers.**

\$1.50 each.

Painted Pot Labels.

	Per 100	Per 1000	Per 100	Per 1000
3 1/2 in.	\$0.10	\$0.75	6 in.	\$0.25 \$1.25
4 "	.12	.85	8 "	.35 2.50
4 1/2 "	.15	1.00	10 "	.50 4.00
5 "	.20	1.10	12 "	.75 5.25

PAINTED TREE LABELS.

3 1/2 inch, notched or pierced. Per 100 15c., per 1000 \$1.00.

TYING MATERIALS.

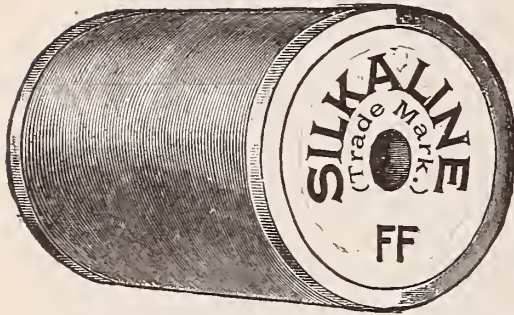

Green Silkaline.
The best material for tying. Does not fade, is very strong and durable 20c. per spool, \$1.50 per lb.

Raffia. For tying. 20c per lb., 3 lbs. for 50c.

String. For tying. All sizes, 5 to 20c. per ball.

INDELIBLE MARKING PENCIL. 10c. each.

INDESTRUCTIBLE COPPER WIRE LABELS.

Made of prepared copper, thin and pliable; can be written on with a pencil, which indents the copper, leaving a permanent impression. A little white lead rubbed with the finger on the face of the label before the name is written, will make it more conspicuous. Per doz. 20c.; per 100 \$1.00.

COPPER WIRE.

For tree labels. Bunch 10c ; lb. 70c.; per lb. spool 85c.

PRUNING SHEARS, SAWS AND KNIVES.



Pruning Shears.

Very large assortment. 30c. to \$1.50 each.

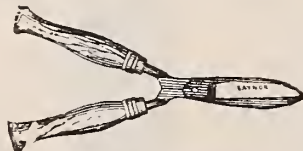

Hedge Shears.

All sizes. \$1.50 to \$2.50 each.

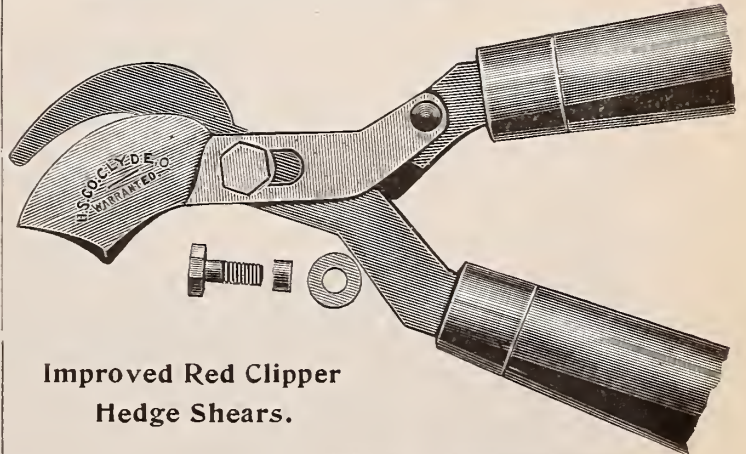

**Improved Red Clipper
Hedge Shears.**

Fruit Pickers. All the best kinds. 35c. to \$1.00 each.

American Hand Pruning Shears. Price 40c., 50c., and 60c.

Hedge Shears. Best quality. 8 in. \$1.50; 9 in. \$1.75; 10 in. \$2.00. The above sizes with notch, 25c. extra.

Pruning and Budding Knives. A large assortment. 50c. to \$1.25 each.

**BEST
QUALITY**

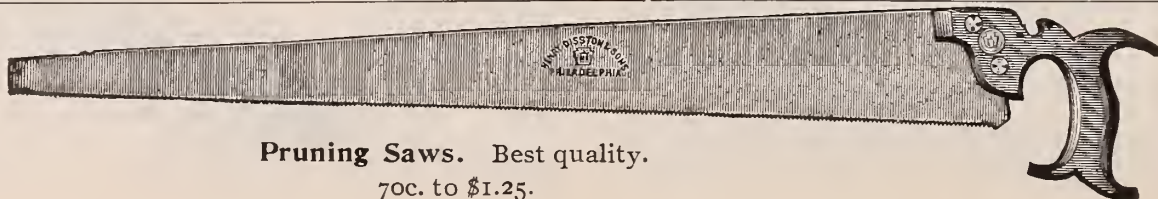

**Pruning Saws. Best quality.
70c. to \$1.25.**

**DISSTON'S
MAKE**

.. SUNDRIES ..

Cocoa Fibre. Per bush., 70 cts.; per sack of 3 bush., \$1.65.
Grafting Wax. Finest quality, with directions, lb., 25 cts.
Moss (Green.) Per barrel, \$1.50.
Moss (Sphagnum.) Green or live, per barrel, \$1.25.
Peat (Jersey.) Best quality, barrel, \$1.50; 5 barrel lots, \$1.25 per barrel.
Prepared Soil for Potting. 50 cts. per bushel, \$1.25 per barrel.

Peat. Per barrel, \$2.00
Propagating Sand. Extra clean, per barrel, \$1.50.
Raffia. The best material for tying plants, vines, etc., lb. 20c.
Jute Twine. For tying plants or vegetables, 12 cts. per lb.
Tar Twine. For tying mats, fodder, etc., 10 cts. per lb.; \$9.00 per 100 lbs.
Twine. All sizes, for tying, ball 15 cts.
White Cotton. For tying, 20 cts. per lb.

Carnation Supports.

Michell's Practical.

	Doz	100	1000
24 inch, 2 rings,	\$0.35	\$2.50	\$22.50
30 " 3 "	.40	3.00	27.50

"Model."

	Doz.	100	1000
2 rings40	3.00	27.50
3 "50	3.50	30.00

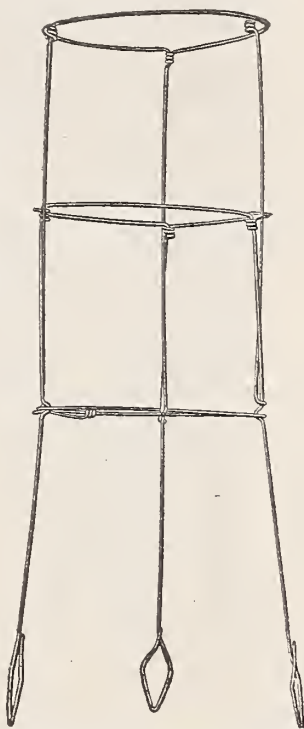

"Model," Three Ring.

"Haines."
 Consisting of one cypress wood stake and three copper wire rings. Doz., 35c.; 100, \$.250; 1000, \$20.00.

Stoneware Poultry Founts

Capacity	Each	Doz.
1 pint	\$0.20	\$2.00
1 quart30	3.00
2 "40	4.00
3 "50	5.00
4 "70	7.00
6 "80	8.00
8 "90	9.00

"Climax" Poultry Drinking Fountains

1 gallon capacity . 90c. each
 2 gallon capacity, \$1.15 "
 3 gallon capacity, 1.40 "

. . . Made extra strong of Galvanized Iron . . .

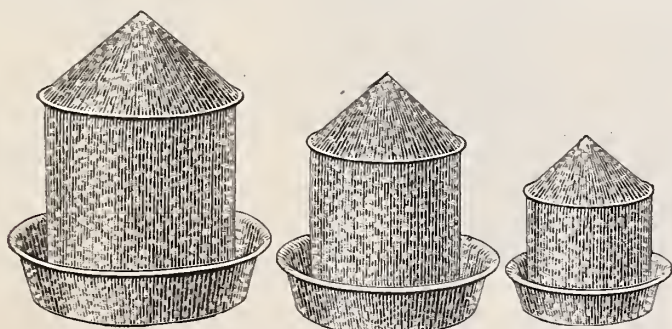

Philadelphia Poultry Fountain.

The above cut illustrates our "Philadelphia" Fountains. They are made in two parts, the pan and the cone. They are thus easily cleaned and filled. All thoroughly galvanized. Price, No. 1, (2 qts.) 35 cts. each, \$3.50 per doz.; No. 2, (4 qts.) 50 cts. each, \$5.00 per doz.; No. 3, (8 qts.) 75 cts. each, \$7.00 per doz.

Mann's Swinging Feed Tray

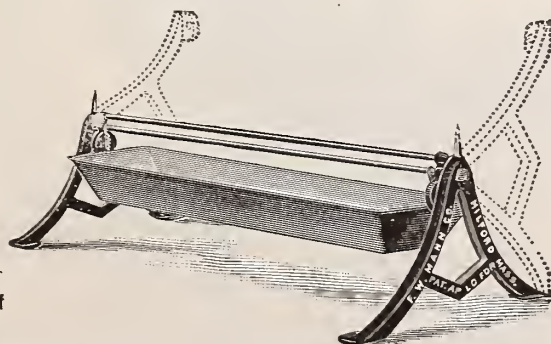

FOR POULTRY

Saves all Waste of Food.

Hens cannot scratch the food out of the dirt in. Weight of hen tips the tray and throws her off. Upper rod tips up also if hen tries to roost over pan. Legs fasten anywhere. Trays are 6½ inches wide, 3 inches deep, made from one piece of galvanized iron; water-tight, will not rust. Prices:

18-inch, \$1.00. 27-inch, \$1.25. 36. inch, \$1.50.

MANN'S Green Bone Cutters

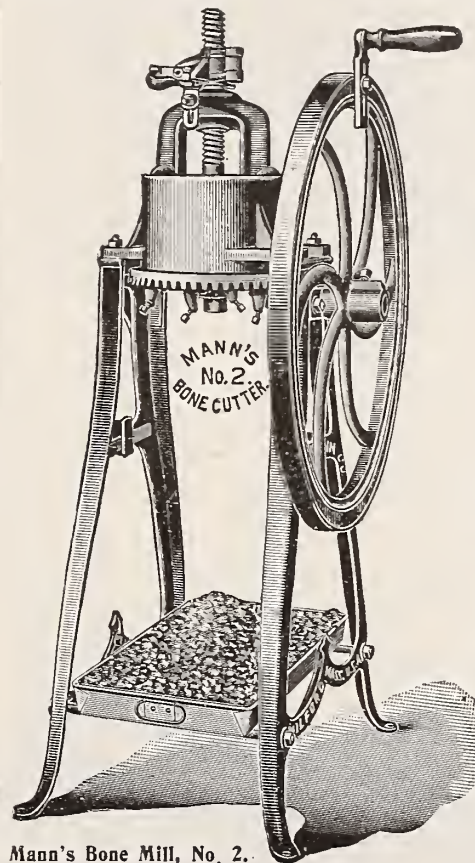

Mann's Bone Mill, No. 2.

Will successfully cut **Fresh Market Bones**, with the Meat and Gristle attached suitable **For Poultry Food.**

No. 1 C, without balance wheel	\$6.00
No. 1 B., with balance wheel,	8.00
No. 1 B.M., with balance wheel and feet	10.40
No. 2 B.M., with balance wheel and stand	18.40
No. 4 B.M., with balance wheel and feet	17.00
Clover Cutter (Mann's) with stand	10.00
Clover Cutter (Mann's) without stand	8.00
Wilson's Dry Bone and Oyster Shell Mill, without legs	5.00
" " " " " with legs	6.00

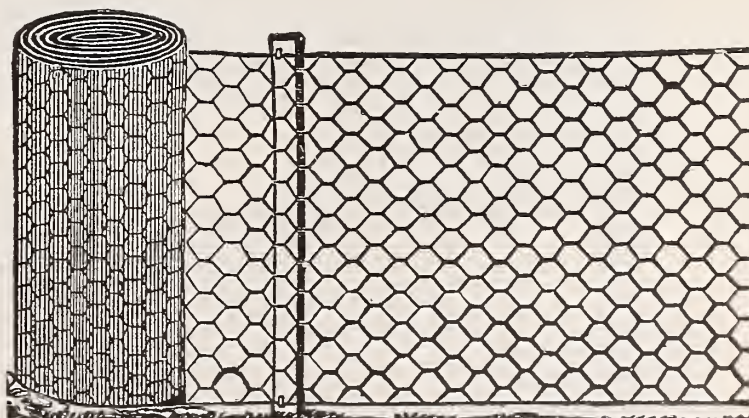

Galvanized No. 19 Wire Netting.

Notice these low prices (less than ½ cent per square foot) for No. 19 Wire, galvanized after the netting is made, which makes it stronger and more durable.

Prices are subject to change. Ask for Special Estimate before purchasing.

The best thing for making poultry yards: better locking and cheaper than laths, and permits more light and air to enter.

12 in. wide, per bale 150 lineal ft	\$0.72	42 in. wide, per bale 150 lineal ft.	\$2.40
18 " " " 150 " "	1.05	48 " " " 150 " "	2.60
24 " " " 150 " "	1.30	60 " " " 150 " "	3.25
30 " " " 150 " "	1.80	72 " " " 150 " "	3.85
36 " " " 150 " "	1.95		

Any required length cut from above sizes at 1 cent per square foot. Galvanized staples for fastening, 10 cents per pound.

One-Inch Mesh Galvanized Wire Netting.

In rolls 150 feet long.

12 inches wide, 150 square feet, per roll	\$1.65
18 " " 225 " "	2.45
24 " " 300 " "	3.20

In less quantity than full roll, 2 cents per square foot.

VERY BEST QUALITY POULTRY FOODS AND SUPPLIES.

Animal Meal. (Bowkers.) 5 lbs. for 20c., 10 lbs. 40c., 25 lbs. 75c., 50 lbs. \$1.25, 100 lbs. \$2.25.
Barley. Per qt. 15c., bush. about \$1.00.
Bone (Granulated). The use of ground bone tends to keep fowls in good health, and materially aids laying hens. 5 lb. pkge. 20c., 25 lbs. \$1.00, 100 lbs. \$2.25, 200 lb. bag \$4.00.
Buckwheat. For pigeons and young poultry. Per qt. 10c., peck 30c., bush. about \$1.00.
Clover Meal (Pioneer). Best quality. 5 lbs. 25c., 25 lbs. 75c., 50 lbs. \$1.00, 100 lbs. \$2.00.
Charcoal (Ground). A little ground charcoal mixed with the soft feed in the morning, once or twice a week, keeps them healthy. 1 lb. 10c., 5 lbs. 40c., 10 lbs. 75c., \$5.00 per 100 lbs.
Cut Clover Hay. Excellent food for winter and early spring. 40 lb. bag \$1.00, 100 lbs. \$2.00.
F. P. C. Chick Manna, or Food for Little Chicks. Specially prepared for little chicks when first hatched. Should be the first and only food, and continued for 10 or 12 days before feeding anything else. Directions for feeding on each package. 1 lb. 10c., by mail 25c.; 5 lb. pkge. 40c.; 15 lb. pkge. \$1.10; 60 lb. box, bulk, \$4.20.
Death to Lice Powder. (Lambert's.) 15 oz. box 25c., 48 oz. box 50c., 100 oz. box \$1.00.
Eggs. Thoroughbred poultry; for hatching; 30 varieties. Satisfaction guaranteed. Per 13 \$1.50, per 26 \$2.50.
Incubator Eggs. Per 100 \$6.00.
Eggs (Nest). Porcelain, each 3c., per doz. 25c. Medicated, each 4c., per doz. 40c.
Gape Cure. (Madoc.) 6 oz. can 20c., 7/8 lb. can 35c.
Hemp Seed. Used largely for feeding birds and pigeons. Per qt. 15c., peck 60c., bush. about \$2.00.
"H. O." Poultry Food. 5 lbs. 25c., 10 lbs. 40c., 25 lbs. 65c., \$1.60 per 100 lbs. Special price on larger quantities.

Imperial Egg Food. For making hens lay winter and summer; keeps the fowls in the best condition. 1 lb. pkge. 30c., by mail 45c.; 2 1/2 lb. pkge. 70c., by mail \$1.00.
Lambert's Death to Lice. 15 oz. box 25c., 48 oz. box 50c., 100 oz. box \$1.00.
Meat for Poultry (Prepared). This is prepared with great care. It is the finest thing we know of to cause hens to lay during the winter; extremely profitable to feed. 10 lbs. 40c., 50 lbs. \$1.25, 100 lbs. \$2.25, 500 lbs. \$12.00, ton \$42.00.
Mica Crystal. For digestion. 5 lbs. for 15c., 10 lbs. 25c., 25 lbs. 40c., 100 lbs. \$1.00. Two grades, fine and coarse.
Oyster Shell (Fresh Ground). The finest article to feed for shell making. 5 lbs. 15c., 25 lb. bag 40c., 100 lbs. \$1.00, ton, \$12.00.
Peas (Canada Field). Per qt. 10c., peck 50c., bush. 1.10.
Pratt's Food. Will make hens lay all the year, and is excellent for feeding to young chicks. For large fowls mix one ounce with the food for fifteen or twenty. For fifteen or twenty chicks give one-half ounce every other day. 1 1/2 lb. pkge. 25c., 5 lb. pkge. 60c., 12 lb. bag \$1.25, 25 lb. bag \$2.50.
Roup Preparation. Sure cure. 1/2 lb. pkge. 20c., 1 lb. pkge. 40c.
Roup Pills. (Havens) Per box 25c., per doz. boxes \$2.50, per box of 250 pills \$1.00.
Rust's Egg Producer. 1 lb. 25c., 2 1/2 lbs. 50c., 6 lbs. \$1.00, 10 lbs. \$1.50, 25 lbs. \$3.50.
Sheridan's Condition Powder. 4 oz. pkge. 25c., 2 1/4 lb. can \$1.00, six 2 1/4 lb. cans \$5.00.
Sunflower Seed, Mammoth Russian. Per qt. 10c., peck 50c., bush. \$1.75.

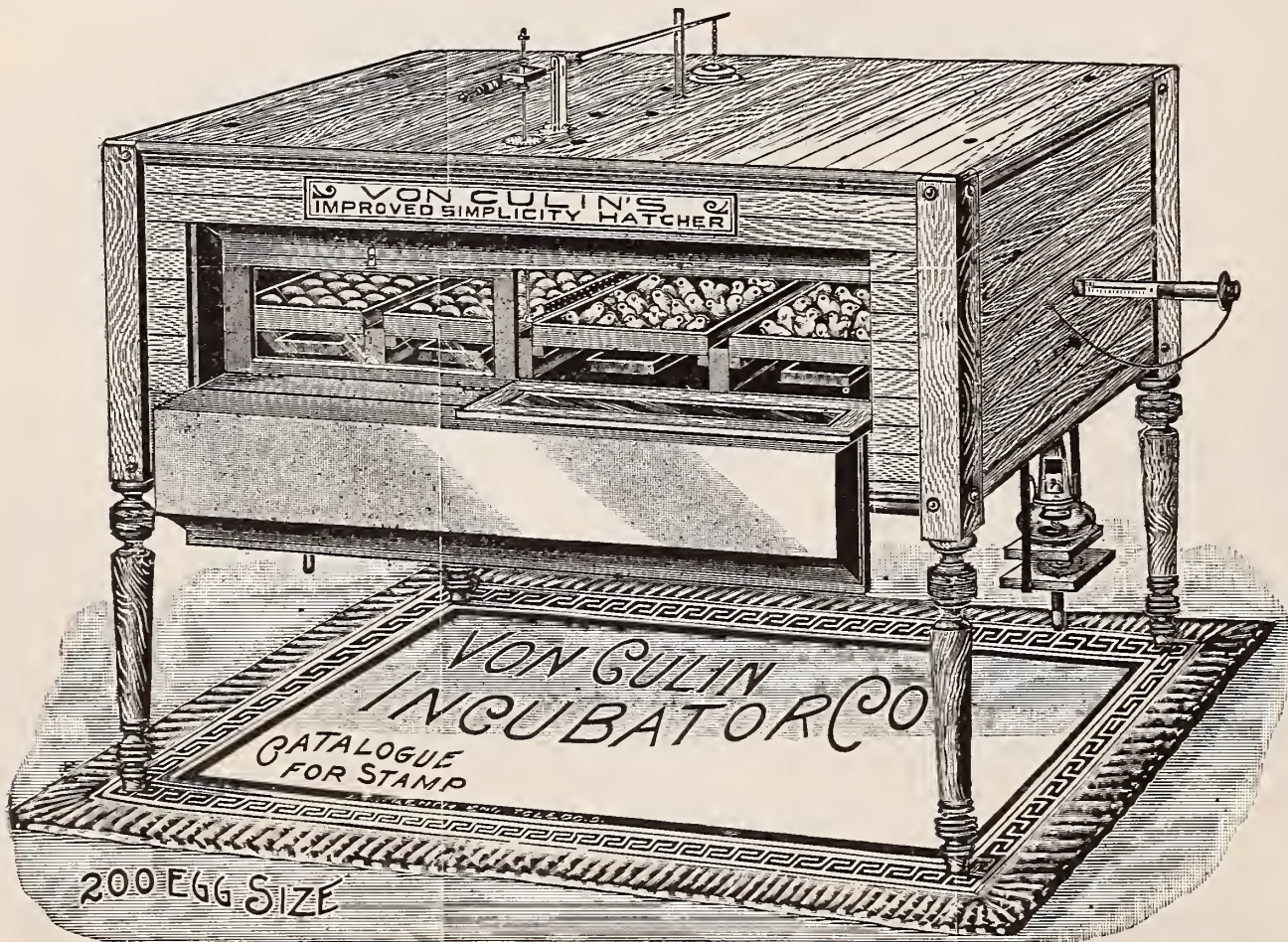

Von Culin Incubators.

Guaranteed to hatch 20 per cent. more than any other machine made or you can return the machine after 30 days trial.
 Guaranteed to burn one-half the oil and takes but one-tenth the attention of any other machine, and if it don't do all this, you can return it after 30 days trial.

First Prize Medal at World's Fair, 1893.
 First Prize Medal at Canadian Exposition, 1894.
 First Prize Medal at Nashville Exposition, 1897.
 First and only Prize awarded at the Omaha Exhibition, 1898.
 250 First Prizes at small State Fairs.

The Von Culin Incubators are extensively used and very highly recommended by MR. PEDER PEDERSEN, manager for John Pitcairn, Esq., Bethayres, Pa., also by every poultry raiser who are using them.

Von Culin's Brooders.

For convenience and simplicity it has no equal. It is impossible for chicks to crowd.
 You cannot afford to trifle with brooders that have not had a practical test and are only built to sell.
 This brooder is exactly on the same principle as those used in the large brooding houses built and operated by C. Von Culin and others.
"GEM" INSIDE SAFETY BROODER.
 125 Chick capacity \$8.00 | 250 Chick capacity \$15.00
 We supply either with end or centre heater.
 P. S.—The above prices are subject to a discount of 5 per cent. for cash if paid within 30 days.

We send with every incubator one Egg Tester, one Extra Tray for turning eggs, one Incubator Thermometer and Tray Guards.

Net Price List of INCUBATORS

25 Eggs capacity	\$12.75	200 Eggs capacity	\$31.00
80 " " " " " " " " " " " "	21.25	250 " " " " " " " " " " " "	36.00
100 " " " " " " " " " " " "	24.00	450 " " " " " " " " " " " "	48.00
140 " " " " " " " " " " " "	27.00	600 " " " " " " " " " " " "	54.00

Net Price List of COMPARTMENT INCUBATORS.

2 compartment, 160 Egg capacity . . .	\$36.00
3 " " " " " " " " " " " "	52.00
4 " " " " " " " " " " " "	64.00
5 " " " " " " " " " " " "	75.00
6 " " " " " " " " " " " "	88.00

We also supply CLARK'S NEW PREMIER INCUBATOR. Let us quote you prices.

P. S.—The above prices are subject to a discount of 5 per cent. for cash if paid within 30 days.



CARNATIONS

Carnation Plants

Per doz.	Clumps	\$2.00
" 100	"	11.00
" 50	"	6.00

We can supply these grown by a carnation specialist in very fine condition. Clumps of the following leading varieties, for Autumn and Winter blooming.

BEST WHITE VARIETIES.

- Alba Superba.** Pure white. Very large.
- Lizzie McGowan.** Fine pure white and for all purposes the best white carnation we have.
- Flora Hill.** \$3.00 per doz.
- Mrs. Fisher.** This is a grand white carnation and great bloomer.

BEST SCARLET VARIETIES.

- Portia.** This lovely carnation is the cream of its color and always a favorite.
- Jubilee.** *New.* Brilliant red.
- Sport, No. 1.** Brilliant red.
- Rosemont.** One of the very best. Very free bloomer.

BEST PINK VARIETIES.

- Daybreak.** Considered to be best pink.
- Wm. Scott.** An improvement on Grace Wilder, beautiful bright pink color.
- Victor.** Considered and pronounced the best.

BEST STRIPED AND YELLOW VARIETIES.

- Gold Finch.**
- Buttercup.** One of the best standard sorts of yellow.
- Eldorado.** Finest yellow slightly tinted with scarlet.
- Helen Keller.** White striped with red.
- Armazinda.** White striped with pink.

ALSO OTHER VARIETIES.

ROSES, Hardy, Hybrid, Perpetual.

Strong plants on their own roots. Grown by a specialist. \$2.00 per doz.; \$13.00 per 100. (25 at 100 rates).
New Rose "Liberty." The very finest red forcing rose yet introduced. We are now booking orders for next spring delivery.
 Price: Own root plants, 75c. each; \$7.20 doz.; 25 plants \$12.50
 " Grafted " \$1.00 " 9.00 " 25 " 15.00

ZEPHYRANTHES (Atamasco Lily.)

Beautiful amaryllis-shaped flowers. Free and easy bloomers.

- White.** Each, 5 cts.; per doz., 40 cts.; per 100, \$2.50.
- Pink.** " 10 " " 75 " " 5.00



... VIOLETS ...

For Planting in Frames and Greenhouses; in fine, healthy condition, free from rust and disease; grown by specialists.

Clayton, Del., Sept., 28, 1899.

The violets have been received in fine condition. Am much pleased with them and only wish that we had given you our whole order.

Mrs. M. E. Reynolds.

- La France.** *New.* Very large. The best up to date. 20 cts. each; \$2.00 per doz.
- Admiral Avellan.** *New.* Large single. \$1.50 per doz.; \$11.00 per 100.
- Luxonne.** Flowers as large as the California, but appears nearly double its size, as the petals all open out flat, and has the advantage of flowering continuously from early in September until April. It is of a beautiful rich soft violet color, with strong stout stems from 9 to 12 inches long, very fragrant. Clumps 15 cts. each; \$1.50 per doz.; \$12.00 per 100.
- Princess of Wales.** \$1.50 per doz.; \$12.00 per 100.
- California.** The largely advertised variety—considered the largest single blue violet in cultivation. Strong clumps, per doz., \$1.50; per 100, \$12.00.
- Lady Hume Campbell** Double blue. This lovely violet is a great acquisition to our Winter flowering violets, the plants grow clean and hearty. Flowers extra large and very productive, color fine, shade of azure blue, with fine long stiff stems. Field clumps, per doz., \$1.50; per 100, \$10.00.
- Marie Louise.** The old and well known double blue variety. Strong clumps, per doz., \$1.50; per 100, \$10.00.
- Shoenbrun.** Large single blue. Per doz. \$1.50; per 100 \$10.00.
- Double Russian.** Dark blue. Per doz. \$1.50; per 100 \$10.00.
- Swanley White.** Strong clumps. Per doz. \$1.50; per 100 \$11.00.



AZALEAS. 75 cts. to \$1.50 each; \$7.50 to \$15.00 per doz., according to size.

Swainsonia Alba. A desirable ever-blooming plant, with pure white flowers. As a greenhouse or conservatory plant it will give much satisfaction. Strong plants, \$1.50 per doz.

PLANTS FOR HOUSE AND GREENHOUSE.



Araucaria

(Norfolk Island Pine).

One of the most beautiful decorative plants. Easily kept in the house.

6 inches high . . .	\$0.75 each;	\$7.50 per doz.
8 " " . . .	1.00 " "	10.00 " "
12 " " . . .	1.50 " "	15.00 " "
15 to 18 in. high . . .	2.00 " "	21.00 " "



The Plants we send out have all been grown in cool greenhouses, and are therefore more desirable than those grown in very hot houses.

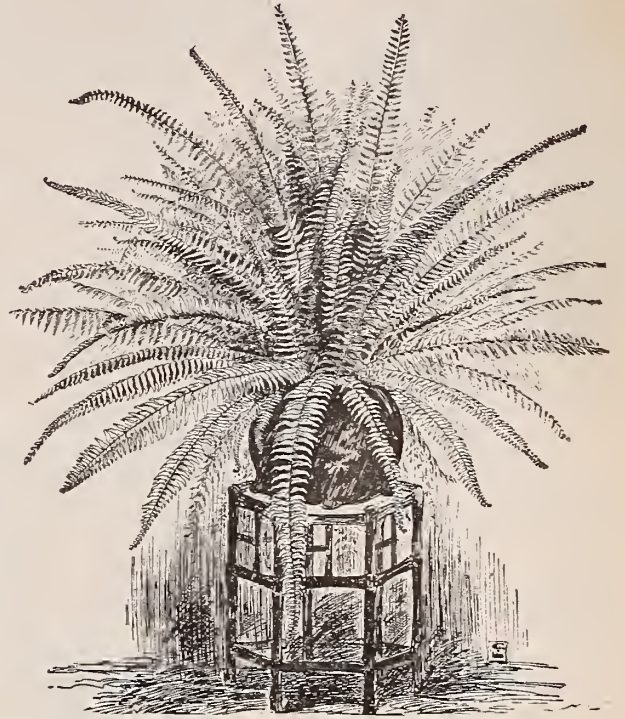

The New Boston Fern.

Without exception the most desirable fern. It is very easily kept in the house, and grows into fine, graceful, fountain shape specimens.

Good young plants,	\$0.25 each;	\$2.50 per doz.
Strong plants50 " "	5.00 " "
Large plants . . .	1.00 " "	10.00 " "
Specimen plants,	\$2.00 to \$5.00 each.	



RUBBER PLANTS.

RUBBER

All perfect shape, healthy plants. For house decoration they have no superior.

PLANTS

12 inches high,	\$0.50 each;	\$5.00 per dozen.
15 " "75 " "	7.50 " "
18 " " . . .	1.00 " "	10.00 " "
24 " " . . .	1.50 " "	18.00 " "

WE CAN ALSO SUPPLY ALL OTHER PLANTS AT MODERATE PRICES.

STRAWBERRY PLANTS.

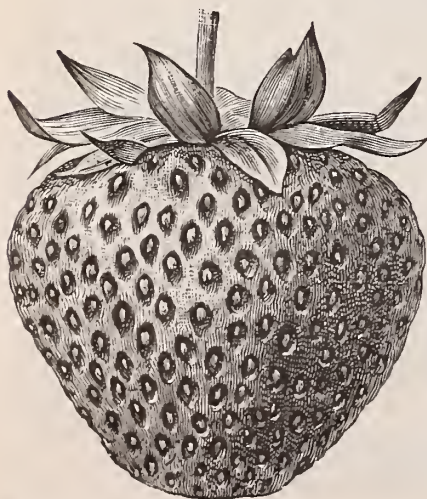

Pot Grown Plants.

READY NOW.

	Time	Per 100	Per 1000	Per 100	Per 250	Per 500	Per 1000
Brandywine, large size berry	(Late)	3.00	25.00	\$1.00	\$2.00	\$3.00	\$5.00
Bubach, large size berry	(Medium)	3.00	25.00	1.00	2.00	3.00	5.00
Crescent, medium size berry	(Early)	3.00	25.00	1.00	2.00	3.00	5.00
Cumberland Triumph, large size berry	(Early)	3.00	25.00	1.00	2.00	3.00	5.00
Gandy, large size berry	(Late)	3.00	25.00	1.00	2.00	3.00	5.00
Glen Mary, large size berry	(Medium)	4.00	35.00	1.25	2.25	3.50	6.00
Haverland, large size berry	(Early)	3.00	25.00	1.00	2.00	3.00	5.00
Marshall, large size berry	(Medium)	3.00	25.00	1.00	2.00	3.00	5.00
Michell's Early, med. size berry	(Early)	3.00	25.00	1.00	2.00	3.00	5.00
Parker Earle, large size berry	(Early)	3.00	25.00	1.00	2.00	3.00	5.00
Sharpless, large size berry	(Medium)	3.00	25.00	1.00	2.00	3.00	5.00
Timbrell, large size berry	(Late)	3.00	25.00	1.00	2.00	3.00	5.00

Layer Plants.

READY SEPT. 15.

Blackberry Plants.

50 cts. per doz.
\$2.50 per 100.

Raspberry Plants.

50 cts. per doz.
\$2.50 per 100.

Currants.

\$1.00 per doz.
\$6.00 per 100.

Gooseberry Plants.

Leading Varieties, \$1.00 per doz.,
\$6.00 per 100.
"Industry," \$2.00 per doz.,
\$12.00 per 100.

READY IN OCTOBER.

READY IN OCTOBER.

FERNS

Desirable Varieties Special for Filling Fern Dishes or Pans - -



FERNS

2½ inch pots, per doz., \$1.00 - - -
per 100, \$7.50.
3 in. pots, per doz., \$1.25;
per 100, \$10.00 -

FANCY DISHES FOR FERNS
\$1.00
\$1.25
\$1.50
EACH

CHOICE PALMS AND FERNS.



PALMS.

Grown in COOL greenhouses, preferable and more satisfactory than those grown in HOT houses.

KENTIAS. Each.
15 in. high, 5 to 6 leaves, \$1.00
20 " " 6 " 7 " 1.50
24 to 30 in. high, 6 to 7 leaves, 2.00
Also larger sizes, from \$2.50 to \$5.00 each.

LATANIAS (Fan Leaved Palm). Each.
5 to 6 leaves, 15 in. high, \$.50
6 well developed leaves, 15 in. high, 1.00
6 to 7 well developed leaves, 20 in. high, 1 50
Also larger sizes, from \$2.00 to \$5.00 each.

ARAUCARIAS.

(NORFOLK ISLAND PINE.)
6 inches high, . . . \$.75 each.
8 " " . . . 1.00 "
12 " " . . . 1.50 "
15 " " . . . 2.00 "

RUBBER PLANTS.

10 inches high, . . . \$.50 each.
15 " " 75 "
20 " " 1.00 "
25 " " 1.50 "

BOSTON FERNS.

THE MOST POPULAR VARIETY.

Each.
Young good shape plants, . . \$.25
Strong " " " 50
Large " " " 1.00
Specimen plants, . . \$1.50 to 3.00

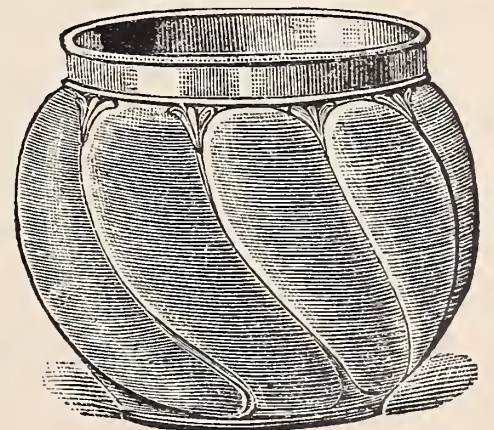

JARDINIERES.

ALL THE CHOICEST SELECTIONS.

4 inches in diameter, \$.40 each.
6 " " " 75 "
8 " " " 1.00 "
10 " " " \$1.50 to 2.50 "

FERN DISHES.

ROUND . . in beautiful Designs, \$1.00 each.
OVAL . . . " " " 1.25 "
SQUARE . . " " " 1.50 "

MICHELL'S BULBS

HIGHEST QUALITY

SEEDS, PLANTS,
HORTICULTURAL
IMPLEMENTS.



Partial view of Independence Square, taken April 28, 1899, showing part of 65,000 Hyacinths, Tulips, Daffodils, Etc., Etc., planted under directions of City Forester JOHN C. LEWIS, who reported that every bulb bloomed and was true to name and color. All bulbs supplied by us. We have again been awarded the contract for the display of 1900.

HENRY F. MICHELL 1018 MARKET ST.
PHILADELPHIA