

8 x 6 3/4

2473

THE BOTANICAL GAZETTE

71

THE UNIVERSITY OF CHICAGO PRESS  
CHICAGO, ILLINOIS

---

THE CAMBRIDGE UNIVERSITY PRESS  
LONDON

THE MARUZEN-KABUSHIKI-KAISHA  
TOKYO, OSAKA, KYOTO, FUKUOKA, SENDAI

THE MISSION BOOK COMPANY  
SHANGHAI

af QK1  
. B468  
71

THE  
BOTANICAL GAZETTE

---

EDITOR  
JOHN MERLE COULTER

---

VOLUME LXXI  
JANUARY-JUNE 1921

---

WITH THIRTY-THREE PLATES AND NINETY-THREE FIGURES



THE UNIVERSITY OF CHICAGO PRESS  
CHICAGO, ILLINOIS



Published  
January, February, March, April, May, June, 1921

Composed and Printed By  
The University of Chicago Press  
Chicago, Illinois, U.S.A.

## TABLE OF CONTENTS

---

	PAGE
Physiological and morphological correlations in herbaceous Angiosperms (with plates I-VII and four figures) - - - - -	<i>E. C. Jeffrey</i> and <i>R. E. Torrey</i> <b>I</b>
After-ripening and germination of <i>Juniperus</i> seeds. Contributions from the Hull Botanical Laboratory 275 (with one figure) - - - - -	<i>Dean A. Pack</i> <b>32</b>
Gametophyte and sex organs of <i>Reboulia hemisphaerica</i> . Contributions from the Hull Botanical Laboratory 276 (with twenty-one figures) -	<i>Arthur W. Haupt</i> <b>61</b>
A chemical and physiological study of mottling of leaves. Contributions from the Hull Botanical Laboratory 277 (with six figures) - - - - -	<i>F. M. Schertz</i> <b>81</b>
Gametophytic development of blister rusts (with four figures) - - - - -	<i>J. F. Adams</i> <b>131</b>
Development of head and flower of <i>Dipsacus sylvestris</i> . Contributions from the Hull Botanical Laboratory 278 (with fourteen figures) - -	<i>Hilary S. Jurica</i> <b>138</b>
Reserve food materials in vegetative tissues - -	<i>Gwynethe M. Tuttle</i> <b>146</b>
Leaf spots of the elm (with plates VIII-X and one figure) - - - - -	<i>L. E. Miles</i> <b>161</b>
Influence of environment on sexual expression in hemp (with plate XI and one figure) - -	<i>John H. Schaffner</i> <b>197</b>
Experimental investigations on birch and oak (with plates XII-XV and four figures) - - - -	<i>Edith S. Whitaker</i> <b>220</b>
Effect of light on germination of light-sensitive seeds. Contributions from the Hull Botanical Laboratory 279 - - - - -	<i>Wright A. Gardner</i> <b>249</b>
Ecology of <i>Tilia americana</i> . II. Comparative studies of the foliar transpiring power (with ten figures) - - - - -	<i>James E. Cribbs</i> <b>289</b>

	PAGE
The vessel in seed plants (with plates XVI-XX) - <i>Mary C. Bliss</i>	314
A convenient thermoregulator (with two figures) <i>Heinrich Hasselbring</i>	327
Dormancy and hardiness in the plum. Contributions from the Hull Botanical Laboratory 280 (with four figures) - - - - - <i>P. D. Strausbaugh</i>	337
Evolution of zooecidia (with plates XXI, XXII) - <i>B. W. Wells</i>	358
The gametophytes of <i>Equisetum laevigatum</i> (with plates XXIII, XXIV, and three figures) - - <i>Elda R. Walker</i>	378
Comparison of development in dodder and morning glory (with plates XXV-XXVII) - - - <i>Gertrude E. Macpherson</i>	392
Chemical changes in wheat during germination. Contributions from the Hull Botanical Laboratory 281 (with plate XXVIII and two figures) - - - - - <i>Helen A. Choate</i>	409
Undescribed willows of the section <i>Cordatae</i> (with one figure) - - - - - <i>Carleton R. Ball</i>	426
Vessels of the Gnetalean type in Angiosperms (with plates XXIX-XXXII) - - - - - <i>R. C. MacDuffie</i>	438
Embryogeny and sporogenesis in <i>Reboulia hemisphaerica</i> (with plate XXXIII and eleven figures) - - - - - <i>Arthur W. Haupt</i>	446
Diameter growth in box elder and blue spruce (with three figures) - - - - - <i>C. F. Korstian</i>	454
BRIEFER ARTICLES—	
Biographical sketch of Wilhelm Pfeffer (with portrait) - - - - - <i>F. C. Newcombe</i>	152
Biographical sketch of John Macoun (with portrait) <i>Theo. Holm</i>	236
Biographical sketch of William Harris (with portrait) - - - - - <i>D. S. Johnson</i>	331
Simple device for weighing seeds (with one figure) - <i>Karl Sax</i>	399
Use of chloriodide of zinc in plant histology - - <i>Ernst Artschwager</i>	400
Biographical sketch of Alfred Gabriel Nathorst (with portrait) - - - - - <i>A. C. Seward</i>	462

	PAGE
CURRENT LITERATURE - - - - -	75, 155, 238, 334, 401, 466

For titles of book reviews see index under author's name and reviews

Papers noticed in "Notes for Students" are indexed under author's name and subjects

---

#### DATES OF PUBLICATION

No. 1, January 20; No. 2, February 15; No. 3, March 17; No. 4, April 15; No. 5, May 16; No. 6, June 17.

---

#### ERRATA

##### VOL. LXX

P. 399, line 4 from bottom, for "trichostigmae" read "trichostigmatis"

##### VOL. LXXI

P. 67, line 2, for "(fig. 8)" read "in the superficial portion of the antheridium"

P. 67, line 13, for "Fig. 8" read "Fig. 7"

P. 67, line 14, after "*Reboulia*" add "but fig. 8 indicates that the sequence may be irregular"

P. 67, last line, for "appears" read "walls appear"

P. 116, line 12, for "carotin" read  $\frac{\text{"carotin}}{\text{xanthophyll}}$

P. 137, line 16, for "3" read "2"

P. 255, line 8 from bottom, omit "108 *N. affinis*"

P. 323, line 11 from bottom, for "*Gnetum*" read "*Gnetum Gnemon*"

P. 339, line 12, for "are" read "is"

P. 348, line 2 of legend, for "acids" read "acid"

P. 349, line 4 of legend, for "C" read "O"

P. 357, citation 8, for "ber" read "Über"

THE  
BOTANICAL GAZETTE

JANUARY 1921

PHYSIOLOGICAL AND MORPHOLOGICAL  
CORRELATIONS IN HERBACEOUS  
ANGIOSPERMS<sup>1</sup>

E. C. JEFFREY AND R. E. TORREY

(WITH PLATES I-VII AND FOUR FIGURES)

The general significance of the herbaceous type seems to have first been clearly realized in the classification of plants put forward by CLUSIUS in the seventeenth century. This author divided plants into large groups based on their habit, much in the same manner that the earlier zoological classifications summarized animals under such groups as flying, creeping, swimming, etc. The idea, however, has long been abandoned that the habit of life can serve as a satisfactory basis for either systematic or phylogenetic classification. This consideration does not in any way eliminate the herbaceous type as a physiological assemblage of the greatest importance in the present epoch of the history of the earth. In this connection the question arises as to the origin of a physiological group which is of such high significance. The older view implicitly, if not in actual statement, assumed for the herbaceous type a position of primitiveness. This attitude is well illustrated by such classics as GRAY'S *Structural Botany* and SACHS'S *Lehrbuch*. In these works the woody stem is represented diagrammatically as originating from the linking up of originally

<sup>1</sup> Contribution from the Laboratories of Plant Morphology of Harvard University.



separate fibrovascular bundles by a so-called interfascicular cambium. The parts of the woody cylinder corresponding to the supposed primitive bundles are known in this connection as fascicular wood, and the sometimes depressed segments which intervene as interfascicular wood. When the sunken segments occur (comparatively rarely, and not widely enough distributed to warrant a hypothesis of the origin of the woody stem in general), the old view regarded their sunken topography as resulting from their later origin through the activity of the belated so-called interfascicular cambium. As has been shown by previous reports from this laboratory, the depression of segments of the stem in trees, vines, and woody herbs is a question of growth mechanics and has nothing to do with belated cambial activity. It is intimately connected, in fact, with the appearance of approximated pairs of large rays, resulting from a process of aggregation of the smaller rays of the general wood in proximity to the entering leaf traces. The large rays undoubtedly make their appearance to supply the greater storage necessities, which are a special feature of the more efficient representatives of the dicotyledonous Angiosperms. In other words, the large rays so universally characteristic of the thicker and more woody regions of herbs, whether aerial or terrestrial, are clearly a physiological response to the climatic conditions of modern times in cooler latitudes and higher altitudes, where storage either in stem or seeds becomes of paramount importance.

Since it obviously can no longer be maintained that the woody stem is derived from the apparently simpler herbaceous axis, the question naturally arises whether the reverse relation of origin exists between the two types. To those possessing a knowledge of the past of the great groups of vascular plants this possibility presents no difficulties whatever, since it is certainly known that many of the herbaceous living representatives of cryptogamic groups have had as ancestors forms of strikingly arboreal habit. This situation indeed provoked a long continued contest as to whether the treelike Cryptogams of the paleozoic periods were not in reality seed plants, as are arboreal types with secondary growth at the present day. It has been emphasized

by one of us (4), however, that the herbaceous Cryptogams are distinctly the result of degenerative changes in the older and ancestral forms. The herbaceous type in the Angiosperms, as will be pointed out in the sequel, has had an entirely different mode of origin from that illustrated by many existing herbaceous Cryptogams.

Nearly a decade ago EAMES (2), in a publication from this laboratory, made a comparative study of the herbaceous type, which was particularly focussed on the Rosaceae, since this group presents in relative abundance closely related forms of woody and herbaceous texture. This investigator concluded that there is clear evidence in the Rosaceae for the origin of herbaceous stems from woody, as a consequence of the formation of large storage rays in relation to the incoming foliar traces. These rays usually extend some distance below the foliar trace, and also may be developed above it. In the horizontal aspect of the axis, in the region of the node of stems with a well developed fibrovascular cylinder, the storage parenchyma related to the leaf traces can be seen subtending them externally. The development of these masses of storage tissues in woody stems and in correlation to the vascular supply of the leaves (since the masses in question not only subtend the foliar traces vertically but, in cylinders of any thickness, likewise in the radial dimension as well) automatically results in the transformation of the continuous dicotyledonous woody cylinder (ultimately at any rate) into a circular series of discontinuous fibrovascular segments, the fibrovascular bundles so characteristic of herbaceous stems. Accompanying the development of the large foliar rays, as pointed out by EAMES, is the final degeneracy of the rays of moderate size, which are normally characteristic of the woody cylinder of arboreal Angiosperms.

In an article published a few years later, SINNOTT and BAILEY (5) attack EAMES'S conclusions, and while admitting the derivation of herbaceous forms from arboreal or woody, they question the existence of foliar rays subtending the foliar traces vertically and horizontally. They admit the frequent presence of foliar rays in the subterranean stem of herbs, but deny that this has any bearing on the question of the origin of the herbaceous type. They

consider that the presence of foliar rays in aerial stems is rare, and that this supposed absence constitutes a weak point of the hypothesis of the derivation of the herbaceous type, which they ascribe to the senior author of the present article. In a recent article WHITAKER (4) has demonstrated clearly the insecure basis of the assertion of SINNOTT and BAILEY as to the absence of foliar rays in the aerial axis of the Compositae, perhaps the most important and certainly the most easily available group which is represented in temperate climates by typical herbs. One of us (4) has likewise recently discussed the anatomy of the flowering leafy stem of *Helianthus*, with similar conclusions.

It will serve a useful purpose to begin the description of the herbaceous stem, from the aspects included in the present discussion, with a description of the aerial stem in certain common Compositae. Fig. 1 shows a transverse section of the stem of *Aster novae-angliae*, common in the eastern states. The lower region of the axis above ground is represented. To the left at the top of the figure can be seen a marked depression of the surface of the stem. This corresponds to the median foliar ray of a leaf attached to the stem slightly above the plane of section. This ray is characterized not only by the depression it causes on the periphery of the stem, but also by the absence of vessels in its external region. Below this ray and on the left occurs another foliar ray, corresponding to one of the two lateral traces of the leaf under consideration. This ray is substantially like the one subtending the median trace, but is smaller in size and causes a less marked depression on the surface of the woody cylinder and on the periphery. The foliar ray of the right-hand lateral trace is about as far to the right of the median ray as the left ray is on the opposite side. It will be noted that the depression in this case is very slight, and that the foliar ray is deeper radially and less broad than the other two similar structures. Since the traces do not always penetrate the stem at the same level, the rays which correspond to the three traces of the same leaf usually do not present the same appearance in details in a given section. An examination of the rest of the woody cylinder in fig. 1 shows that no foliar rays closely resembling the three under discussion can be distinguished. This results from the fact that

the foliar rays of the species of *Aster* under consideration extend only a slight distance downward in their normal form, and as a consequence in the lower and stouter region of the part of the stem above ground usually only three typical leaf rays can be seen in a given plane of section.

Fig. 2 shows a transverse view of the same *Aster* in the upper region of the aerial stem. Here the woody cylinder appears much thinner, in spite of the fact that the magnification is considerably higher than in fig. 1. A projection on the upper surface marks the position of the median trace of a leaf belonging to the nodal region from which the section has been made. The higher part of the stem, as is often the case in above ground herbaceous axes, shows the leaf traces and their corresponding foliar rays as projections from the surface of the woody cylinder, and not depressed, as is the normal condition for these structures in herbs of woody texture or in the woody lower region of the aerial stem of more typically herbaceous axes. In addition to the three projecting leaf traces and their corresponding foliar rays, which occupy adjacent positions on the upper surface of the woody cylinder in fig. 2, are to be seen 5 or 6 less prominent traces and corresponding foliar rays belonging to leaves higher up on the stem. In figs. 3-5 is reproduced the whole of the woody cylinder of fig. 2, on a somewhat higher scale of magnification. It will be seen from figs. 2-5 that there are 8 leaf traces clearly obvious, alternating with as many "common" or "cauline" segments. This interesting situation results from the fact that in the upper more herbaceous region of the stem the foliar rays extend, as such, much deeper down than in the case of the lower woody region of the same aerial axis. Consequently a number of leaf rays corresponding to the traces of leaves at several nodes can be distinguished in a single transverse section through the higher region of the stem. SINNOTT and BAILEY (5) have denied the possibility of the conditions represented in figs. 2-5. The topography in question is in fact extremely common in herbs of a certain degree of advance from the woody primitive ancestral forms. Naturally it does not occur in extremely woody herbs, on the one hand, because in these very few foliar rays can usually be seen at one time, and these in rather close vertical

proximity to the next superior node. In extremely slender herbaceous stems, on the other hand, by the thinning of the woody cylinder, the foliar ray radially external to the leaf trace is eliminated, and only the flanking portions of the ray on either side of the foliar trace in its upward vertical course in the stem can be distinguished. It follows that an alternation of foliar rays and stem bundles is extremely common in herbs which are transitional in their texture, but naturally does not occur in either extremely woody herbs or in those which are strikingly herbaceous.

In fig. 6 is shown the foliar ray and its inwardly subtending leaf trace. The foliar trace may be recognized as radially disposed groups of vessels separated by equally radial bands of parenchyma. Externally the vessels give place to fibers and parenchyma, which constitute the external or confronting portion of the foliar ray. Lateral to the vascular leaf trace on either side can be distinguished the flanking portions of the foliar ray. It follows that a foliar ray may consist of parts flanking the leaf trace and separating it from the adjacent stem segments, as well as a region subtending the foliar strand externally. In thinner stems the latter portion progressively disappears, until only the flanking portions of the ray persist. This situation has recently been represented in diagram by WHITAKER. SINNOTT and BAILEY (6) have, however, quite failed to understand the situation. Since the genus *Aster* is a somewhat woody herb the topography represented in figs. 2-5 is usual in the upper region of the stem of various species.

We may now pass to a more herbaceous illustration of the Compositae, namely *Helianthus*, which has already been used (4) to exemplify the anatomical conditions in regard to the topography of the foliar rays. Corresponding to its less woody structure is the fact that foliar rays possessing depth enough to subtend as well as flank the leaf trace are confined usually to the lower portions of the aerial stem. In the superior portion of the latter the leaf rays are purely flanking in their development, on account of the slender nature of the woody cylinder. Disregarding the latter condition for the moment, we may turn our attention to the lower region of the subaerial stem. Fig. 7 is a foliar ray from the base of the stem of *Helianthus annuus*. Obviously the continuity of the woody cylinder is broken by a strongly developed radial band

of storage parenchyma, the foliar ray subtending the leaf trace in its vertical course in the stem. Along the inner margin of the ray may be seen the elements constituting the foliar trace. Fig. 8 represents the foliar ray of *Helianthus orgyalis*, a perennial and somewhat more woody species than *H. annuus*. This is in accordance with a general principle, for, other things being equal, the more woody an herb is, the longer radial and the less tangential and vertical extension have its foliar rays. Conversely, the more herbaceous the texture, the shorter the radial extension of the leaf rays and the greater their vertical length. Another feature of contrast can be distinguished between the rays shown in figs. 7 and 8. In the former the ray is quite homogeneous in structure, while in the latter narrower fibrous elements constitute radial bands in the substance of the ray. This contrast is a common one between the foliar rays of woody and more advanced herbs.

We may now turn to the relative size of the foliar traces and rays in more and less herbaceous forms, as well as the contrasts in the structure of the rays presented in these various modifications of the herbaceous type. The best way to make these important features clear is to choose corresponding regions of the stem, progressively more herbaceous in their texture, from different species of the same genus. Fig. 10 shows the vertical tangential view of a foliar ray from the lowest region of the aerial stem of the somewhat woody *Helianthus hirsutus*. It will be observed that the structure of the foliar ray in this instance is far from homogeneous, since bands of fibers are common in its substance, and with them vessels likewise occur. In this instance the foliar ray is obviously in the process of organization from the ordinary wood, namely, from smaller rays, separated by strands of vessels and fibers. In more advanced herbs belonging to *Helianthus*, as will shortly appear, the fibers and vessels progressively disappear, until the final result is a large mass of radial and longitudinal storage tissue, the typical foliar ray.

Fig. 10 represents the foliar ray in a condition of aggregation from smaller rays. SINNOTT and BAILEY (6) have denied the possibility of the appearance of foliar rays as the result of aggregation. Their error in this respect has been pointed out recently by HOAR (3), and consequently need not be referred to further here.

In one of the uppermost members of the aggregation (fig. 10) may be seen a darker dot, representing the transverse section of the outgoing foliar trace. The trace is obviously extremely small in size. Fig. 14 illustrates a portion of fig. 10 under a higher degree of magnification. The composite character of the foliar ray is now more easily seen, for rays, fibers, and vessels are all evident as component parts of the aggregate foliar ray. Fig. 11 is a tangential view of the foliar ray of *H. tuberosus*, on the same scale of magnification as fig. 10, representing a similar aspect of the ray in *H. hirsutus*. The contrasts between the two figures are both interesting and important from the standpoint of the question of the origin of the herbaceous type. The leaf ray in fig. 11 is much more clearly developed than in fig. 10. The fibers are much reduced in quantity and very few vessels are to be seen. Another important contrast is presented both by the size of the foliar ray and of the foliar trace to which it is related. The leaf strand appears as a dark, somewhat triangular spot in the upper part of the ray, as shown in fig. 11. In fig. 9 is shown a portion of the ray of *H. tuberosus*, under somewhat higher magnification than fig. 11. By comparing figs. 9 and 14, which represent details of the foliar rays of *H. tuberosus* and *H. hirsutus* under the same degree of magnification, it is clear that the ray in the former and more herbaceous species is much larger, and also contains more parenchymatous storage tissue than in the latter and more woody species.

The greatest contrast in every detail of organization, as well as in relative size, however, is presented by *H. annuus*, the most herbaceous of the three compared species. In fig. 12 is shown the tangential view of the leaf ray of this sunflower, under the same magnification as in figs. 10 and 11. The huge size of the ray is clearly seen. Not less striking is its homogeneous organization, resulting from the virtual disappearance of the fibers and vessels, which betray the aggregated character of the rays in *H. hirsutus* and *H. tuberosus*. The foliar ray in *H. annuus* is of the type which we have called compound, since with a homogeneous structure it still betrays evidence (from the comparative anatomical standpoint) of having been organized by the fusion of a number of ordinary wood rays in the vicinity of the foliar trace, with the

concurrent transformation of their separating fibers and vessels into storage elements. This results in the final formation of a large homogeneous complex of radial storage tissue, intimately connected both topographically and physiologically with the leaf trace. Fig. 12 shows also the leaf trace enlarged to the same proportionate size as the huge storage ray to which it belongs.

It is clear from the comparison of the foliar rays in the species of sunflower that the size of the ray, the size of the leaf trace, and the degree of parenchymatous homogeneity of the foliar ray, all directly correspond to the degree of herbaceous development of the species. *Helianthus annuus*, which is not only the most herbaceous of the three, but is of such vigor as to be able to proceed from seed to seed in a single season, is characterized by marked superiority in all three particulars. Fig. 13, showing the structure of the leaf ray of *H. annuus* under the same enhanced magnification as the other two species in figs. 9 and 14, makes it clear that the structure of the foliar ray in the former species is characterized by enough variety in the dimensions of its constituent elements to reveal its composite derivation from the modification of wood rays, fibers, and vessels.

Having made a comparative study of the foliar ray in progressively more herbaceous species of *Helianthus* in the lower region of the aerial stem, attention may be given now to the considerations represented in the upper nodes of the axis. Fig. 15 illustrates the outstanding leaf trace of an upper node of the stem of *H. tuberosus*. It is separated from the stem bundles on either side by flanking parenchymatous bands of the foliar ray. The large radial extension of the foliar ray which marks its organization in the lowest part of the stem has become progressively reduced in the region of higher nodes, until at the level of fig. 15 it has entirely disappeared. This simple geometrical condition has been diagrammed recently by WHITAKER (7) and need not be further considered here.

Another feature of interest, which is particularly obvious in the upper nodes, is the condition of cambial activity in the foliar and cauline bundles respectively. Fig. 16 represents the stem or "common" bundle immediately to the right of the foliar trace in fig. 15. Above is to be seen the fibrous pericycle of the bundle



protecting the phloem. Separating the phloem from the xylem is a well marked cambial region, characterized by the regularly seriate arrangement of its cells. Fig. 17 represents the foliar trace of fig. 15, under the same magnification as fig. 16. It is clear that the cambial activity found in the stem bundle is conspicuous by its absence in the leaf trace, since there are no regularly radially arranged cells intervening between xylem and phloem.

Before discussing the significance from the evolutionary standpoint of the facts elucidated in figs. 15-17, it will be well to consider the conditions present in the bundles of the root, using *Aster*, since this genus presents a more illuminating range of organization in the root than that which characterizes *Helianthus*. Fig. 18 represents a transverse section of the mature root of *Aster Shortii*. Root hairs are conspicuous by their absence, and the strong development of the secondary wood is very obvious. In the midst of the secondary organization of the wood can be seen a small 5-angled star of primary xylem, the points of which alternate with the 5 dark hued masses of phloem seen on the margin of the fibrovascular cylinder of the root. Fig. 19 is a transverse section of a young root of the same species of *Aster*, in which the secondary growth of the xylem is just beginning. The primary xylem star with its 5 points alternating with 5 angles of phloem can distinctly be seen. Root hairs are present on the surface of the root, but are beginning to disappear, as is normally the case in roots in which secondary structures have begun to form. Fig. 20 represents a very different type of root, in which the organs are distinguished by the indefinite persistence of the root hairs. This condition is well shown by the varieties of the somewhat inconstant species *Aster umbellatus*. Here the roots continue as hirsute structures for several years, and in fact this condition persists until they have become quite dark with age and have begun to decay. Fig. 20, which represents an old root of this species, shows that the persistence of the root hairs is paralleled by the absence of secondary structures in the cylinder of the organ. This is an interesting general condition of the organization of permanently hairy, and, as a consequence, presumably persistently absorbent roots.

Fig. 21 shows the very herbaceous stem of *Aster tataricus*, which differs from the American species in the strikingly soft texture and great vigor and thickness of its stem. This condition is shown in the transverse section by the large pith surrounded by a series of a distinctly separated and slender fibrovascular bundles. Another distinguishing feature is the large number of foliar traces which proceed from each leaf, these being as many as 7 (as may be seen in the upper region of the figure) in contrast with the 3 which mark the numerous woody species of *Aster*. It is clear, therefore, that *A. tataricus* is a particularly well developed herb, and in this respect presents a marked contrast with the predominantly woody herbaceous species of *Aster*. The roots of *A. tataricus* are like those of *A. umbellatus* in that they are permanently without development of the secondary wood, and likewise have persistent root hairs, albeit these are much more delicate than in the latter species.

Bringing together these results, we conclude that in woody species of *Aster* persistent root hairs and absence of secondary wood are correlated features of the organization of the root. In roots with evanescent root hairs the disappearance of these marks the beginning of the secondary activities in the wood. In *Aster tataricus*, which is remarkably herbaceous in its general habit in contrast with the species of the genus as a whole, a similar correlation is found between the persistence of root hairs and the absence of secondary growth. This will not be discussed further at the present time, but it will elsewhere be shown that there is a general correlation between a high absorptive capacity of the root (associated morphologically with persistent root hairs) and the absence of secondary woody developments in the central cylinder of the root. In other words, the herbaceous habit in roots is marked both by high absorptive efficiency and by the absence of secondary woody growth.

In the light of these preliminary results in the case of the root, the situation already described for the leaf traces of *Helianthus* becomes particularly significant. A general examination of the species of this genus, particularly of those presenting in a more marked degree the herbaceous habit, indicates that cambial activity

is very generally absent in the strands which conduct the assimilates from the leaf into the stem. The conducting efficiency of the foliar trace would obviously be considerably reduced were part of the assimilates to be used in the growth of the bundles of the foliar traces instead of being transferred intact to storage in the stem or seeds. High conductive efficiency, notably correlated in herbs with the assimilative productiveness of the leaf, as will be pointed out later, is in general associated with the loss of cambial activity in the foliar traces as they enter the cylinder of the stem. In the root the most obvious interpretation of the absence of secondary woody growth is the unfavorable effect that a jacket of secondary elements would have on the ease of penetration of the water absorbed by the root hairs into the water-conducting tissues of the central cylinder. Since the essential conditions of the loss of a cambium are different in stem and root, it is clear that both may not present the feature of the loss of secondary activities in their fibrovascular structures at the same time. In other words, the stem may be herbaceous and the root woody; or vice versa, the stem may be woody and the root herbaceous. The former condition is well exemplified by certain species of *Papaver*, while *Aster* furnishes examples of the latter.

We may now turn to a type which is still more delicate in its herbaceous texture than are either *Aster* or *Helianthus*. Like the sunflower, the buttercup often serves as an example of the herbaceous type in laboratory exercises, and for that reason it is chosen in this connection, as illustrating a common and easily obtained plant. Fig. 22 illustrates the organization of a small stem of *Ranunculus acris* in the region of the branching node. The larger cylinder below represents that of the main axis, while the branch cylinder is smaller and appears above. Inclosing the branch and fused with it is the base of a leaf, in which may be distinguished 5 fibrovascular bundles, the leaf traces. As the cylinders of axis and branch come together, the phloem of their uppermost and lowest bundles respectively face one another. In fig. 23 is shown a somewhat lower plane of section in a rather larger stem than that illustrated in fig. 22. Here the union of secondary and main axes has taken place with interesting results. In the

outer region of the pith corresponding to the medulla of the secondary axis are several amphivasal concentric fibrovascular bundles, precisely similar to those so commonly found in the stem of monocotyledons. The amphivasal strands are the result of the fusion of the confronting bundles of main axis and lateral branch by their phloems. This condition is not an uncommon one for dicotyledonous stems of marked herbaceous nature, particularly when they bear large leaves with many foliar traces entering the axis at the nodes. Other examples of this feature will be supplied later.

Fig. 24 shows a section of the stem of a buttercup at some distance below the node. A rather old stem has purposely been chosen, so that the identity of the foliar traces in the stem may readily be distinguished. In such stems, in the later summer, gummosis invades the cavities of the vessels of the foliar traces, a feature which makes the leaf traces stand out even in low magnifications. To the extreme right is seen the median trace of the leaf, and above and below on either hand are the lateral traces, two on either side. The foliar traces are emphasized by their blackness, resulting from the mucilaginous contents of their vessels. Fig. 25 is a portion of a section similar to that illustrated in fig. 24, somewhat more highly magnified. It is now quite easy to discern that the two outside bundles have vessels plugged with darkened contents, while the vascular structures in the central bundles appear quite clear and devoid of gummosis. Fig. 26 furnishes a further example of the phenomenon of gummosis in the external bundles, which here as in the other instances are foliar traces. The leaf trace to the right is much smaller than its counterpart on the left, and represents in fact an extreme lateral trace of the leaf.

In fig. 27 appears a part of a stem preserved in the early summer, in which as a consequence gummosis is not present in the vessels of the foliar traces. The magnification is greater than in the two preceding figures, and more details of the structure of the fibrovascular bundles are evident. Obviously the two larger bundles at the ends present a different structure from those toward the center. This expresses itself in a more parenchymatous organization of the xylem, in which comparatively few vessels are distributed

in a large amount of heavily pitted wood parenchyma. In the cauline strands, on the contrary, the xylem is more vascular and the parenchymatous elements are less abundant and thinner-walled. A further distinction is the absence of cambial activity in the foliar traces, a situation which leads to a less regular arrangement of the cells than is found in the central strands. In fig. 29 appears another illustration on a somewhat higher scale of magnification than that in fig. 27. The bundle to the right, which is a cauline strand, shows distinct evidence of cambial activity such as is figured in STRASBURGER'S *Botanische Practicum*. On the other hand, the foliar strand, which here lies to the left, is without cambial activity, as indicated by radial regularity. Fig. 31 is a partial view of another transverse section, in which a large cauline bundle lies on the left, while on the right is another foliar bundle, in this case also distinguished by the absence of cambial activity. To make clear that cambial activity is really absent in the foliar strands of the buttercup in the upper part of their course in the cylinder of the axis, several figures under considerable magnification have been introduced. Fig. 28 shows a foliar strand under a moderately high magnification. It is clear that cambial activity is absent here, since there are no regularly radially arranged rows of cells intervening between xylem and phloem as is the case with the stem bundles. Moreover, the less woody organization of the xylem is a further consequence of this absence of cambial increments. Fig. 30 shows another foliar bundle in the stem under somewhat higher magnification. The absence of cambial growth is here still clearer. Fig. 32 shows a still more enlarged view of one of the leaf traces in the stem, and the absence of any evidence of secondary activity is apparent.

It is obvious that in the buttercup, precisely as in the sunflower and to a less degree in the aster, there is a distinct and striking intermission of cambial activity in those fibrovascular strands in the stem which have entered from the leaves. In the case of *Aster* attention has been called to the absence of secondary additions of the xylem in the case of species in which the root hairs are indefinitely persistent. The root of the buttercup, as has long been known, is without secondary accretions to the wood. Fig. 33

shows the root of *Ranunculus acris*. The absence of secondary activities is striking. Sections through the subterranean perennial stem of the buttercup show leaf traces and root bundles in the axial region, both contrasting with the bundles of the stem proper by the entire absence of cambial activity. It is clear that in the buttercup the herbaceous habit has completely taken possession of both stem and root, so that secondary activities are equally conspicuous by their absence, both in strands destined to the leaves and to the roots. Even in the perennial and often rather thickened subterranean stem of *R. acris*, the fibrovascular tissues do not ordinarily show themselves so well developed as to manifest the presence of typical foliar rays subtending the foliar traces. One can easily find such rays in the perennial subterranean stem of *Thalictrum*, however, and also in the aerial stem of various woody species of *Clematis*. It is obvious that typical foliar rays associated with distinctly woody perennial stems lie in the phylogenetic past of extremely herbaceous representatives of the Ranunculaceae, precisely as they do in the case of the more woody herbaceous types which ordinarily and likewise represent the Compositae in temperate climates.

We may now pass to other illustrations of the herbaceous type as characterized by delicate stems and numerous leaf traces entering the stem at the node. The Umbelliferae will serve as our first illustration in this connection. Fig. 34 is a total transverse section of a node in the aerial axis of a species of *Sanicula*. Uppermost and toward the right is a leaf base in the act of fusing with the stem. It shows the presence of a considerable number of foliar traces, which become still more numerous a little lower down by subdivisions of the original strands. Axillary to the foliar base is the cylinder of a lateral branch. This spreads out laterally over the surface of the main cylinder, in such a manner that the bundles of the branch present themselves to those of the main axis by their phloems. Fusion of these mutually confronting strands takes place in such a manner that a number of amphivasal strands results. The formation of these begins in the axillary region and proceeds progressively downward on either side. In fig. 35 appears a section somewhat lower down on the same axis as that shown

in fig. 34. The foliar traces are more numerous at this level, and are beginning to draw in toward the fibrovascular cylinder of the main axis. It will be seen that the bundles of the axis are amphivasal in the upper middle region. On the left is one of the bundles of the branch pursuing a tangential course to become fused with the face of the more lateral bundles of the cylinder of the main axis. The bundles of the main stem become amphivasal for nearly two-thirds of the perimeter of the cylinder before the union of the branch with the parent axis is completed. One of the amphivasal strands from the median upper region of fusion is shown in fig. 36. It is clear that the organization is quite similar to that of the Monocotyledons, the only contrast being in the presence of secondary growth. This, however, is not a matter of great importance from the evolutionary standpoint, since often in the Monocotyledons secondary activities can be recognized in the nodal region of the stem, as has been pointed out by CHRYSLER (1) and others. It is of interest to observe that in this genus the fusions which result in the formation of amphivasal bundles take place on the outside of the fibrovascular ring and not internally as in the buttercup. This situation seems to be rather a common one for the Umbelliferae as a whole. As the nodal region is passed the amphivasal bundles open up toward the outside of the stem and constitute dense, flat, fibrovascular segments of collateral organization. Similar conditions in regard to the resolution of the amphivasal strands are found in the buttercup.

Fig. 37 illustrates the organization of the stem in the nodal region of *Rumex* sp. The foliar traces are numerous, and to a large extent have passed into the cylinder. The periphery of the medullary region is occupied by a number of fibrovascular bundles of amphivasal organization. These are the result of the fusions of strands of the secondary and main axes by their phloems. The amphivasal strands in lower regions of the internode undergo fusions with the bundles of the cylinder, and finally completely disappear before the next node is reached. Fig. 38 shows a part of fig. 37 more highly magnified. The amphivasal strands can be seen on the medullary side of the collateral bundles which constitute the main cylinder.

These illustrations, which might be indefinitely multiplied from the nodes of herbaceous Dicotyledons, make it clear that amphivasal bundles resembling those of the Monocotyledons are frequently present in the nodal regions of dicotyledonous herbs, and result from the fusion of strands by their phloem faces. The similarity of the conditions in the two great divisions of the Angiosperms may be confirmed by an illustration taken from the grasses. Fig. 39 shows the nodal region of the upper part of the aerial stem of *Zea*. A leaf base is uniting with the stem, and on the upper left the fusion of the foliar vascular supply with that of the axis is farther advanced than it is on the lower right side of the illustration. This condition is due to the fact that either the section is not exactly transverse, or else the fusion of the leaf base is not effected in an exactly horizontal plane. It matters little which explanation be adopted. The bundles which enter the stem from the leaf are obviously extremely numerous, and their accommodation in the stem is accordingly a matter of some complexity. The device by which their reception is effected is by means of fusions similar to but more complicated than those exemplified in the dicotyledonous types figured. Fig. 40 shows a part of the upper left hand portion of fig. 39 more highly magnified. Three amphivasal bundles can be seen forming an oblique line from the lower left to the upper right of the figure. Between these lie other bundles which are in the act of fusing. A characteristic feature of the nodes of the aerial stem of grasses, sedges, and rushes is the presence of amphivasal bundles in the region of the nodes, resulting from the fusions effected in connection with the entry of the numerous foliar bundles into the stem. In the mass of Monocotyledons these amphivasal fusions are no longer found in the often highly specialized, annual, aerial axis, but are confined to the more primitive, perennial, subterranean stem. In the Scitamineae and true palms amphivasal bundles are usually entirely absent.

We may now turn to further illustrations of the absence of cambial activity in foliar strands which have recently entered the stem in the dicotyledonous Angiosperms. The legumes are a very important family of Dicotyledons, which are represented in temperate regions by many herbaceous forms. Fig. 41 shows the



infranodal region of the common garden bean. Since the lower part of the aerial stem is represented, the cylinder is somewhat thick and woody, as well as round in form. A leaf trace occupies the central region of the figure, and it is clearly marked by the absence of the dark cambial zone, which marks the stem bundles on either side. It is evident that absence of secondary activity is a feature of the leaf trace in a form which for many years has served in the laboratory for an example in studying the anatomy of the herbaceous dicotyledonous stem. As a further illustration the aerial axis of the common red clover (*Trifolium pratense*) may be used. Fig. 42 makes clear the conditions found in the nodal region of this species. A well marked black band indicates the cambial activity of the bundles of the stem proper. In the median region appears a leaf trace which is quite conspicuously without cambial activity, and in this respect presents a marked contrast with the cauline bundles which are adjacent to it on either flank. These illustrations, which might be indefinitely multiplied from the common leguminous types, clearly show that in this group the tendency toward the elimination of cambial activity in the leaf trace makes itself obvious.

The garden poppy will supply an example from another and somewhat distant group. In fig. 43 is shown the region of the node in the annual garden poppy of hybrid origin (*Papaver* cross). The foliar traces in many cases in this genus enter the stem as double strands. One of these pairs appears in the center of the figure, and it can easily be seen that its constituent strands are without the secondary activity due to the presence of the cambium, exemplified in the cauline bundles on either side of the foliar pair. Fig. 44 shows a total transverse section of the stem of the wild morning glory (*Convolvulus* sp.). On the upper side of the cylinder is shown a broad arc breaking away from the fibrovascular ring. This is the leaf trace of the leaf attached to the next node above. Nearly opposite, but somewhat obliquely placed, is a trace of a still higher leaf. It is clear that the foliar traces show a considerably less degree of secondary growth than is found in the fibrovascular tissues of the stem proper.

An examination of many nodes in herbaceous Dicotyledons has made it clear that there is a strong tendency for cambial activity to disappear in the leaf traces as they enter the cylinder of the stem. Even when the foliar trace does not intermit its secondary growth, there is always a considerable reduction of activity in this respect. This phenomenon, in fact, is not confined to Dicotyledons, but is also exemplified in Gymnosperms, both living and extinct, and in Cryptogams where secondary woody tissues are developed. There is an obvious advantage to the plant in the elimination or reduction of cambial activity in the foliar strands, since the food materials elaborated in the leaves are thus more certainly assured of transfer, without essential loss, to the storage regions of the stem. In the case of the herbaceous Dicotyledons, however, the much greater degree of assimilative activity causes so great an emphasis of the limitation of cambial activity in the leaf traces that in a large number of cases it disappears altogether. This feature, together with the usual multiplication of leaf traces in the more pronounced herbs, has produced in extreme instances among the Dicotyledons conditions which are not essentially different from those obtaining in the anatomical organization of the Monocotyledons.

In text fig. 1 is shown a stereodiagram of the stem of *Helianthus* in the region of a node. The node chosen is neither from the extremely upper region of the aerial stem, nor from its stout woody base. There are six leaf traces present, three facing, and three on the opposite side of the stem. Each trio of traces belongs to one of the opposite leaves. On the remote side the lateral traces are represented as passing into the leaf base, while the median is still in the axis. The nearer aspect of the stem is deprived of its superficial tissues, so that the relation of the traces to the organization of the wood may easily be seen. In the transverse aspect each leaf trace is clearly subtended and flanked by the storage tissues of the foliar rays. As the leaf rays descend in the stem they fork as a result of the intrusion of a median tongue of wood into the ray from below. Each foliar strand in the not too slender axis of *Helianthus* is accordingly related to a foliar ray which subtends it radially and at the same time accompanies it on either flank.



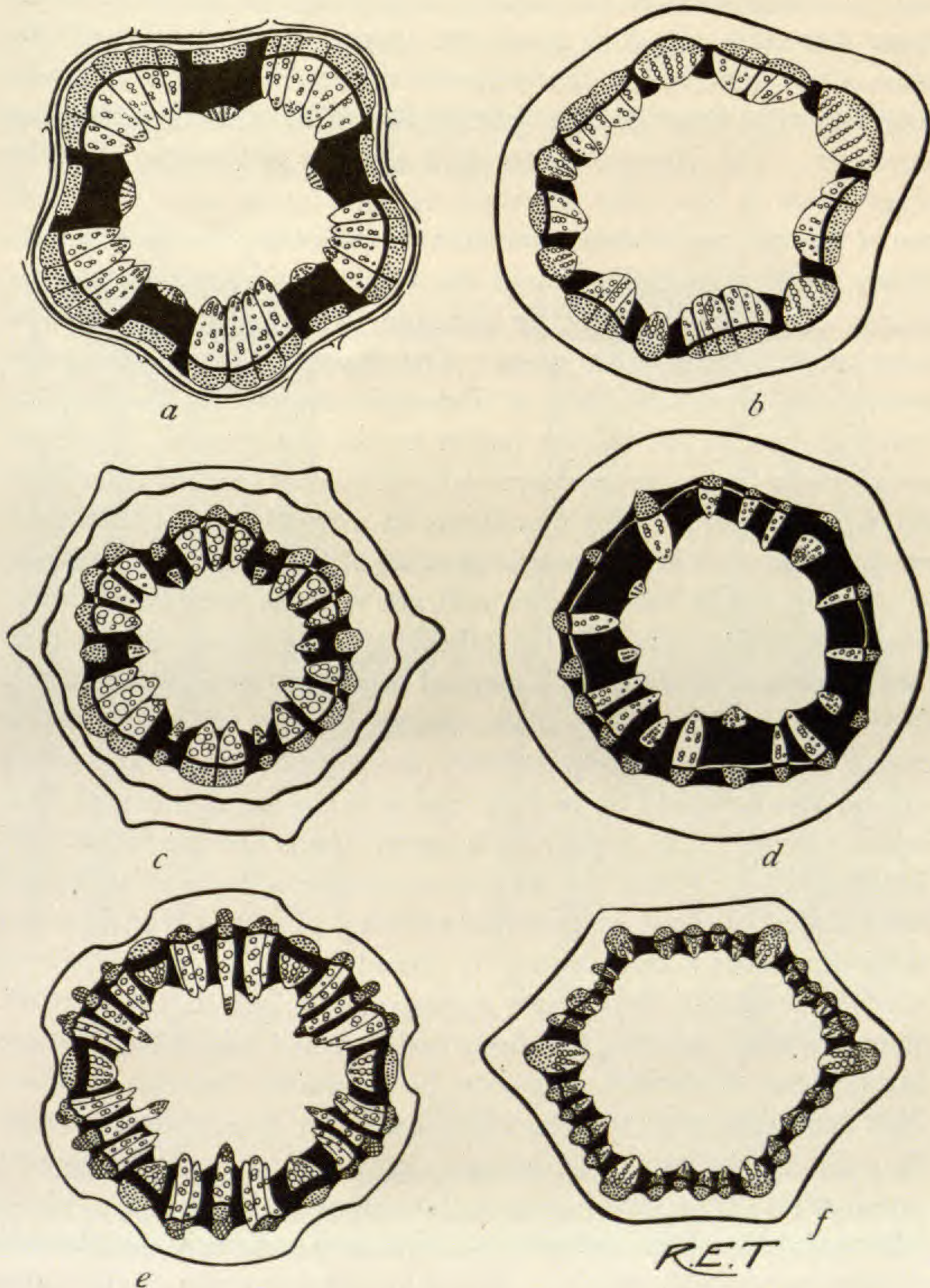

FIG. 2

traces. There is little or no cambial activity to be observed in these segments. In *b* is shown the upper slender region of the same aerial stem. Here the segments corresponding to leaf traces contrast with those in the former figure by their outstanding character. The absence of cambial activity, however, is to be observed as in the foliar segments of the stouter axis. The leaf traces are also more numerous than in the other instance, a condition not at all uncommon in the upper regions of herbaceous stems. This phenomenon, for example, is found in the common bean, and in many other cases. The depressed segments in the slender portion of the stem of *Potentilla* correspond to the outstanding ones in the thicker region nearer the ground. Cambial activity is indicated in the depressed portions of the stem separating xylem and phloem. The conditions in a woody axis of *Clematis* are shown in *c*. The depressed segments of the cylinder correspond in position to the foliar traces, and are without cambial activity. The outstanding arcs, on the other hand, represent the cauline bundle system, in which well marked secondary growth is present. In *d* is shown the subterranean perennial stem of *Actaea*, as an example of the essential similarity in organization of terrestrial axes to that found in the woody region of the aerial stems of herbaceous types. The broad, black, radial bands are the foliar rays. In proximity to a node the leaf ray is subtended by a broad radial band of storage tissue, and cambial activity, as represented by a line separating xylem and phloem, is absent. In the case of traces which are remote from their corresponding leaf in the vertical plane, cambial activity has been restored and the foliar storage parenchyma is divided into two by a woody central isthmus. This condition may well be compared with that shown in text fig. 1 for *Helianthus*. The topography of a moderately thick and woody node of the aerial stem of *Helianthus* is shown in *e*. The 6 foliar segments of the cylinder are depressed and show the absence of distinct cambial activity. The subtending portion of the foliar ray is only moderately well developed in this instance to correspond to the slight degree of thickening of the stem. In the outstanding portions of the cylinder a cambium is present and is conventionally represented by heavy lines separating xylem and phloem. In *f* is

shown an upper slender region of the stem in the sunflower. In accordance with the general principles formulated in the other examples, the foliar segments are here both outstanding and devoid of cambial activity. The remaining bundles are depressed and show the presence of secondary growth.

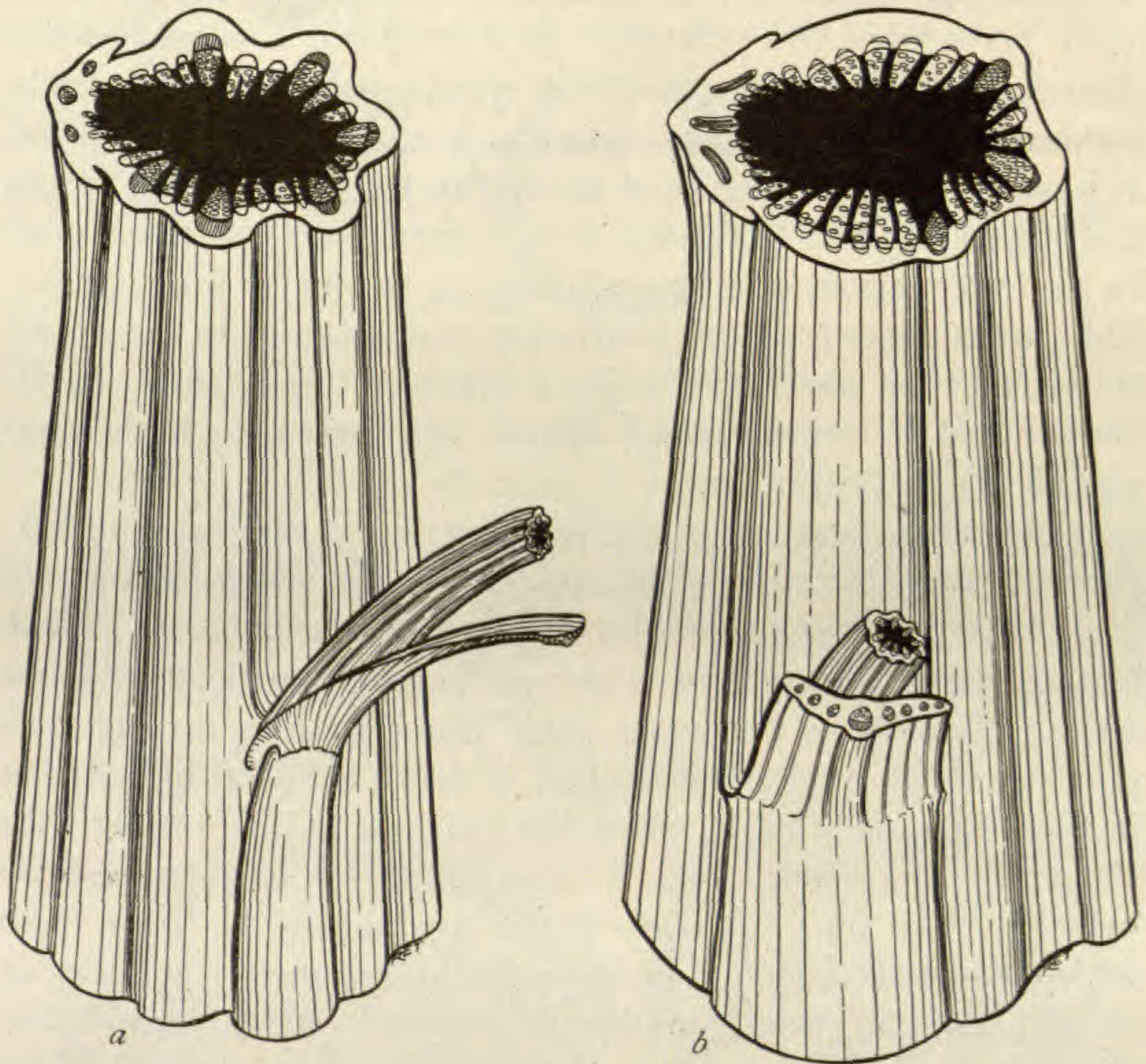

FIG. 3

Attention has already been given to the distribution of cambial activities in the nodal regions of herbaceous Dicotyledons. Another important factor in the development of the herbaceous type is shown in text fig. 3, which represents diagrammatically the stems of *Helianthus annuus* and *H. orgyalis*. In the former more herbaceous species a leaf base is represented on the left, at the upper end of the figure. This has 3 traces, as is normally the case in the genus. In addition to the 3 traces entering at the node, from the

leaf base are 6 others, emphasized in the diagram by the radial hatching of their outer regions. It is obvious that the traces of 3 leaves can be seen simultaneously in transverse sections of the stem. In other words, the leaf traces, together with their accompanying leaf rays, by their much elongated downward extension constitute an important topographical feature of the stem in many herbaceous Dicotyledons. In *b* is shown a corresponding diagram for *H. orgyalis*, a perennial species and one less typically herbaceous than *H. annuus*. Here only the traces of one other leaf can be seen. A feature of interest in the development of the herbaceous habit in *Helianthus* is the arrangement of the leaves. In the lower regions of intermediate types the leaves are opposite, while in the upper nodes the phyllotaxy is alternate. In the woody *H. hirsutus* the phyllotaxy is often opposite throughout. In *H. annuus* and *H. argyrophyllus*, annual and extremely herbaceous species, the leaf arrangement is generally entirely alternate.

Outstanding features of the organization of the extreme herbaceous type illustrated by the Monocotyledons are the occurrence of medullary strands and amphivasal fibrovascular bundles. These features are likewise present in extreme herbs in the dicotyledonous series. Text fig. 4 illustrates these characteristics for the two divisions of the Angiosperms. In *a* is shown the stem of *Sanicula* in the region of the node, where the leaf base is just uniting with the axis. An axillary bud is represented by its fibrovascular cylinder. The inner bundles of this are uniting by their faces with the opposite bundles of the main axis in such a manner as to give rise to typical amphivasal strands. These are clearly shown in *b*, which represents a lower plane of section than *a*. On the upper side of the cylinder are a number of amphivasal strands resulting from fusions between the bundles of axis and branch. In *c* the amphivasal strands have become collateral once more and the numerous foliar traces are seen entering the stem. In *d* is shown the nodal region of *Rumex* sp. The same method of formation of amphivasal strands is seen as in *Sanicula*, namely, by fusions between opposed strands of axis and branch. In this case the concentric bundles are so numerous as to be brought into the medullary region. In *e* is represented a lower plane of section

with a greater number of amphivasal bundles. In *f* the strands in the pith have reached their maximum number and are beginning to undergo fusions with the bundles of the wall of the cylinder.

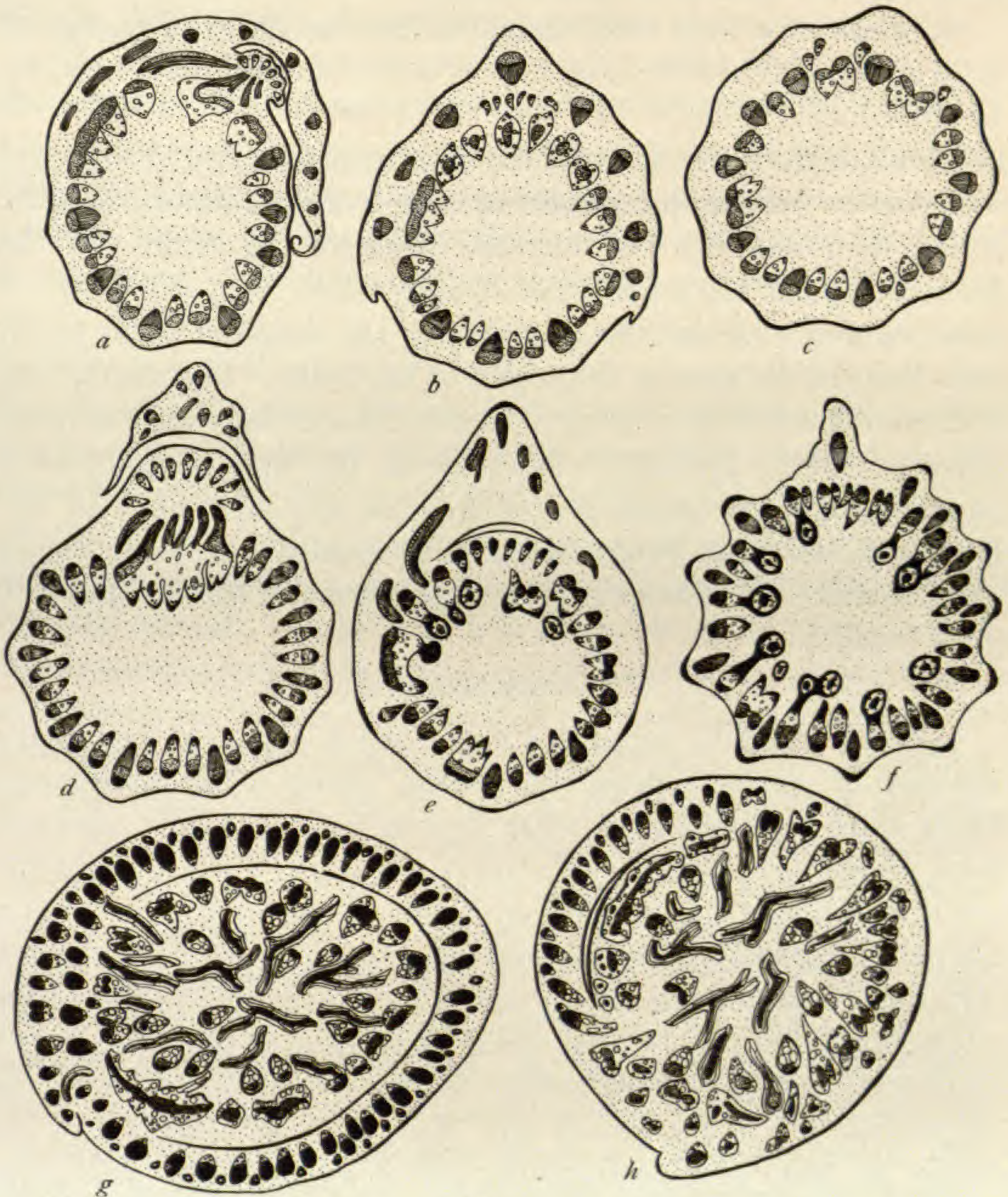

FIG. 4

The foliar traces are very numerous here as in *Sanicula*. In *g* and *h* are represented nodal sections of *Zea*. In *h* the leaf base has just fused with the axis and shows a very large number of bundles. In the central region of the stem many horizontal and vertical



unions of bundles are taking place, with the initiation of some amphivasal strands. In *h* the fibrovascular union of leaf and axis has advanced still farther, and many amphivasal bundles are present in the stem as a consequence.

It seems clear from these examples that the entry of numerous foliar strands at the node is correlated with the formation of amphivasal medullary strands. In most Dicotyledons these strands are the result of the facial fusion of the bundles of axis and branch, but such fusions are usually associated with a large number of foliar traces simultaneously entering the stem at the node. In the Monocotyledons the amphivasal strands result from the fusion of stem bundles with one another, or from the fusion of foliar traces with those of the stem in the region of the node. The amphivasal strand so characteristic of many higher Dicotyledons and the lower Monocotyledons probably originated in the first instance as a consequence of the fusions of stem bundles with stem bundles, and later, with the still further multiplied number of foliar traces characteristic of the Monocotyledons, by fusions of leaf bundles with stem bundles.

### Conclusions

The various data introduced in this paper appear to justify the drawing of certain general conclusions. First of all, statements made as to the absence of foliar rays in herbs are not consistent with the facts of anatomy. Such rays are so characteristic a feature of organization of the more woody region of the aerial axis of herbs that they constitute a well marked diagnostic feature of such forms. The foliar rays of herbs are the result of the aggregation and fusion of the ordinary rays of woody stems, in relation to the foliar traces. Accompanying and characteristic of the process of fusion is the transformation of the vessels into fibers and the septation of the latter in turn into parenchymatous elements. The final consequence of this activity is the formation of large masses of storage tissue in relation to the incoming foliar traces. By comparison of nearly related species of the same genus, which are progressively more herbaceous, the following interesting conditions can often be observed. The accentuation of the herbaceous habit is accompanied by marked increase in the size of the leaf trace and of the

foliar ray to which it is related. Further, the foliar ray becomes much more homogeneously parenchymatous in more advanced and herbaceous species, and does not contain the admixture of vascular and fibrous elements which reveal the mode of origin of the foliar rays in more woody and primitive species.

The foliar ray surrounding and subtending the leaf trace is characteristic of the less advanced dicotyledonous herbs and of the lower more woody region of those higher in the herbaceous sequence. This type of ray gives place, by the later thinning of the woody cylinder, to one in which the storage tissue is confined to the flanks of the traces. The long vertical extension of these flanking rays results in the division of the originally continuous woody cylinder of the ancestral Dicotyledons into a circle of separate strands, the fibrovascular bundles. Of the strands thus resulting, those more closely related to leaves manifest an interesting contrast to the others because they very frequently manifest an absence of cambial activity. This cambial inactivity seems to be a safeguard against the undue consumption of assimilates in the growth in thickness of the foliar strands. Such growth in thickness would clearly not be advantageous to organisms dependent for their success in the struggle for existence on the amount of food stored up either in their stems or their seeds. The correctness of this interpretation of the undoubted fact that foliar traces lose or tend to lose their cambial activity in the stem of herbaceous Dicotyledons is vouched for by conditions observed in roots, to be enlarged upon in another connection. Roots permanently and perennially provided with root hairs are usually without secondary activity in the woody cylinder, while roots of allied species without persistent root hairs have the secondary tissues well developed. In other words, the more efficiently absorptive roots are without secondary growth, while roots of allied woody and less efficient species are well provided in this respect. In advanced herbs, such as the members of *Ranunculus*, the traces of leaves and roots stand out conspicuously in the subterranean stem by the absence of the secondary growth characteristically present in the fibrovascular strands of the stem proper.

It appears clear from these considerations that the herbaceous type is the extreme expression of efficiency, and that the correlated

reduction in or complete loss of secondary growth is physiologically advantageous to the plant.

An incidental and probably less essential modification in extreme herbs is the concurrence of medullary and amphivasal strands. These are apparently the result of the entry of very numerous bundles at the nodes, a feature of many advanced and angiospermous herbs. The resulting difficulties of accommodation are most readily overcome by the scattering and fusion of the crowded strands. In lower types the amphivasal and medullary bundles are the consequence of the fusion of facing cauline bundles of axis and lateral branch. In the highest herbs the foliar traces are concerned in the formation of medullary strands and in the scattered distribution of bundles throughout the transverse sections of the stem.

### Summary

1. Herbaceous Dicotyledons have developed from arboreal dicotyledonous types by the formation of storage rays about the leaf traces.

2. In the more primitive herbs the foliar rays are shallow longitudinally, but of considerable radial depth.

3. In higher herbaceous Dicotyledons the foliar rays lose in radial dimensions as a result of the thinning of the woody cylinder, but this loss is largely compensated for by their increasing vertical extension, which often carries them through several internodes.

4. In the higher herbaceous Dicotyledons the foliar traces tend to multiply in number with the increased efficiency of the leaf.

5. Another important development in advanced dicotyledonous herbs is the progressive disappearance of cambial activity in the foliar trace, which often, in spite of this, is larger in size than the bundles of the stem.

6. The increase in number and importance of the foliar traces, as well as the greater relative importance of secondary axes in high herbs, leads to the crowding of strands at the node, which in turn results on the one hand in scattered distribution of the bundles in the stem, and on the other to formation of amphivasal strands.

7. The disappearance of secondary growth in foliar traces of advanced dicotyledonous herbs appears to be explainable on the grounds of physiological advantage.

8. Absence of secondary growth extends from the leaf traces to the rest of the bundles situated in the stem, and a condition practically monocotyledonous results.

HARVARD UNIVERSITY

### LITERATURE CITED

1. CHRYSLER, M. A., The nodes of grasses. *BOT. GAZ.* 41:1-16. 1906.
2. EAMES, A. J., The herbaceous type in angiosperms. *Ann. Botany* 25:215-224. 1911.
3. HOAR, C. S., The anatomy and phylogenetic position of the Betulaceae. *Amer. Jour. Bot.* 3:415-534. 1916.
4. JEFFREY, E. C., The anatomy of woody plants. University of Chicago Press. 1917.
5. SINNOTT, E. W., and BAILEY, I. W., The origin and dispersal of herbaceous angiosperms. *Ann. Botany* 28:547-600. 1914.
6. ———, Anatomical evidence of reduction in certain Amentiferae. *BOT. GAZ.* 58:36-60. 1914.
7. WHITAKER, EDITH S., The anatomy of certain goldenrods. *BOT. GAZ.* 65:250-260. 1918.

### EXPLANATION OF PLATES I-VII

#### PLATE I

FIG. 1.—Transverse section of lower region of aerial stem of *Aster novae-angliae*, slightly magnified to show presence of foliar rays on upper left hand.

FIG. 2.—Transverse section of extreme upper slender portion of stem of *Aster novae-angliae*, slightly magnified to show alternation of leaf traces and leaf rays with ordinary stem bundles (approximately 8 of each).

FIG. 3.—Part of fig. 2, more highly magnified.

FIG. 4.—Part of fig. 2, more highly magnified.

FIG. 5.—Part of fig. 2, more highly magnified.

FIG. 6.—Leaf trace and subtending and flanking storage tissue, from slender upper portion of stem of *Aster novae-angliae*.

FIG. 7.—Leaf ray of *Helianthus annuus* in transverse section, slightly magnified.

#### PLATE II

FIG. 8.—Transverse section of foliar ray of *Helianthus orgyalis*, moderately magnified.

FIG. 9.—Longitudinal section of foliar ray of *H. tuberosus*, somewhat highly magnified to show mixed organization consisting of rays, fibers, and vessels.

FIG. 10.—Tangential section of leaf ray of *H. hirsutus*, showing it as yet incompletely aggregated from elements of ordinary wood and consequently consisting of an obviously mixed assemblage of wood rays, vessels, and fibers.

FIG. 11.—Tangential section of foliar ray of *H. tuberosus*, showing more advanced condition of foliar ray in more advanced herb; ray is broader, leaf trace larger, and structure more homogeneous than in fig. 10, which has same degree of magnification.

FIG. 12.—Foliar ray of *H. annuus*, very marked herbaceous species of the genus; magnification same as in two preceding figures, and shows that leaf trace is much larger, as is also the accompanying ray, which is further marked by a much greater advance toward homogeneity than two foregoing figures.

FIG. 13.—Part of fig. 12, more highly magnified to show presence of some degree of variety in elements composing foliar ray; magnification same as fig. 9, of *Helianthus tuberosus*.

FIG. 14.—Magnified view of part of fig. 10, representing ray of *H. hirsutus*; for purposes of comparison magnification is identical with figs. 9 and 13.

#### PLATE III

FIG. 15.—Transverse section of one of angles of upper region of aerial stem of *Helianthus tuberosus*, showing leaf trace in center flanked by stem bundles on either hand.

FIG. 16.—Right hand stem bundle of last figure, more highly magnified to show presence of cambial activity between xylem and phloem.

FIG. 17.—Transverse section of leaf trace in fig. 15, more highly magnified to show absence of cambial activity in foliar strand.

FIG. 18.—Transverse section of mature root of *Aster Shortii*, showing pentarchous organization with well developed secondary growth; root hairs have disappeared.

FIG. 19.—Transverse section of younger root of *A. Shortii*, about phase when secondary growth is beginning; root hairs still present but beginning to wither away.

FIG. 20.—Transverse section of persistently hairy root of *Aster umbellatus*; continued presence of root hairs correlated with absence of secondary growth.

#### PLATE IV

FIG. 21.—Transverse section of very herbaceous species of *Aster*, *A. tataricus*; normal woody structure of *Aster* replaced by herbaceous texture and by more foliar traces (7) than those usually present in species of the genus (3).

FIG. 22.—Transverse section of small branching stem of *Ranunculus acris*.

FIG. 23.—Transverse section of nodal region of larger branching stem of *R. acris*.

FIG. 24.—Transverse section of stem of *R. acris*, below node; 5 foliar traces in axis appear darker than stem bundles by reason of their vessels being occupied by gummosis.

FIG. 25.—Part of section similar to that shown in fig. 24, more highly magnified to show characteristic difference between foliar and cauline bundles.

FIG. 26.—Another of the same, showing different bundles.

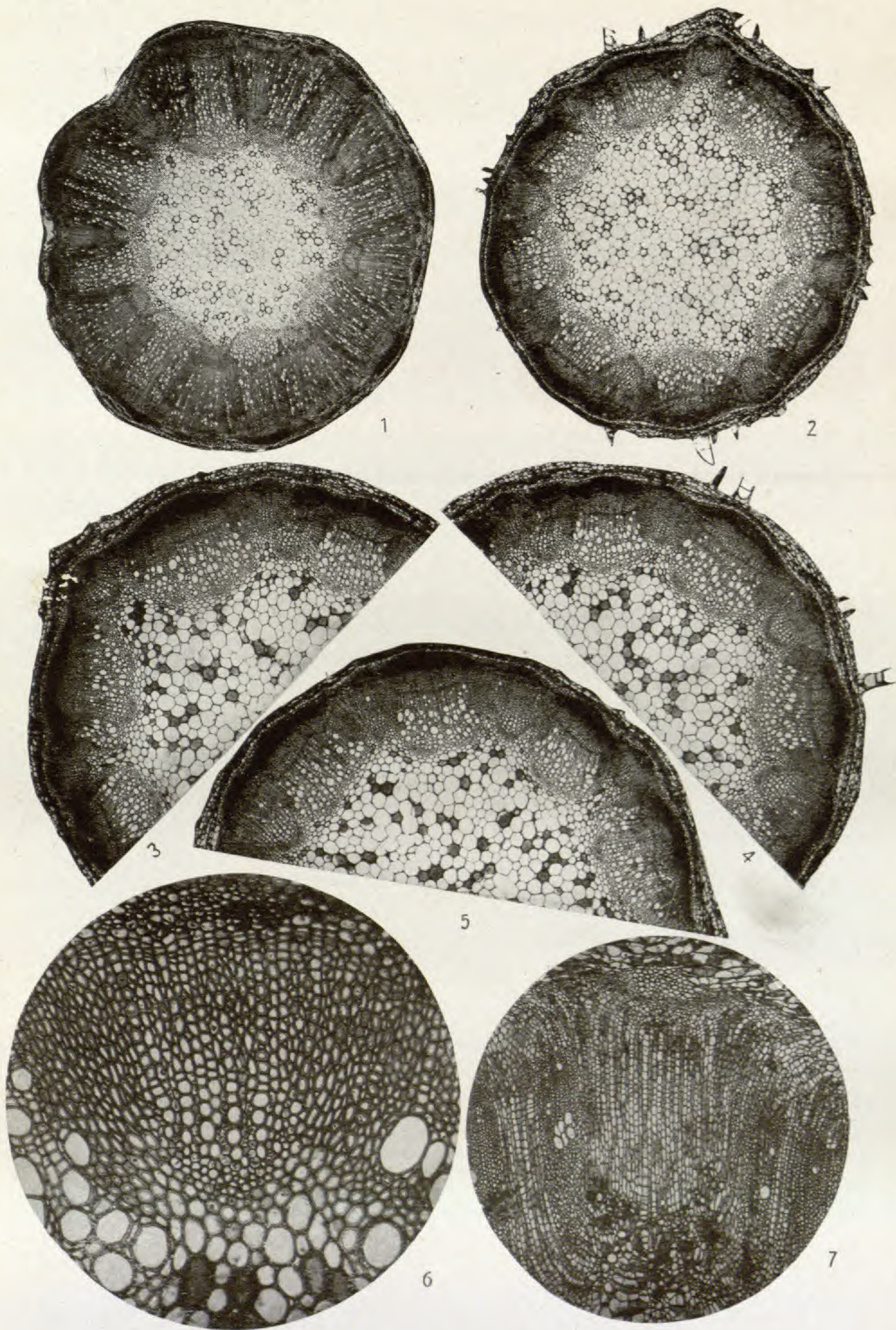

JEFFREY and TORREY on ANGIOSPERMS

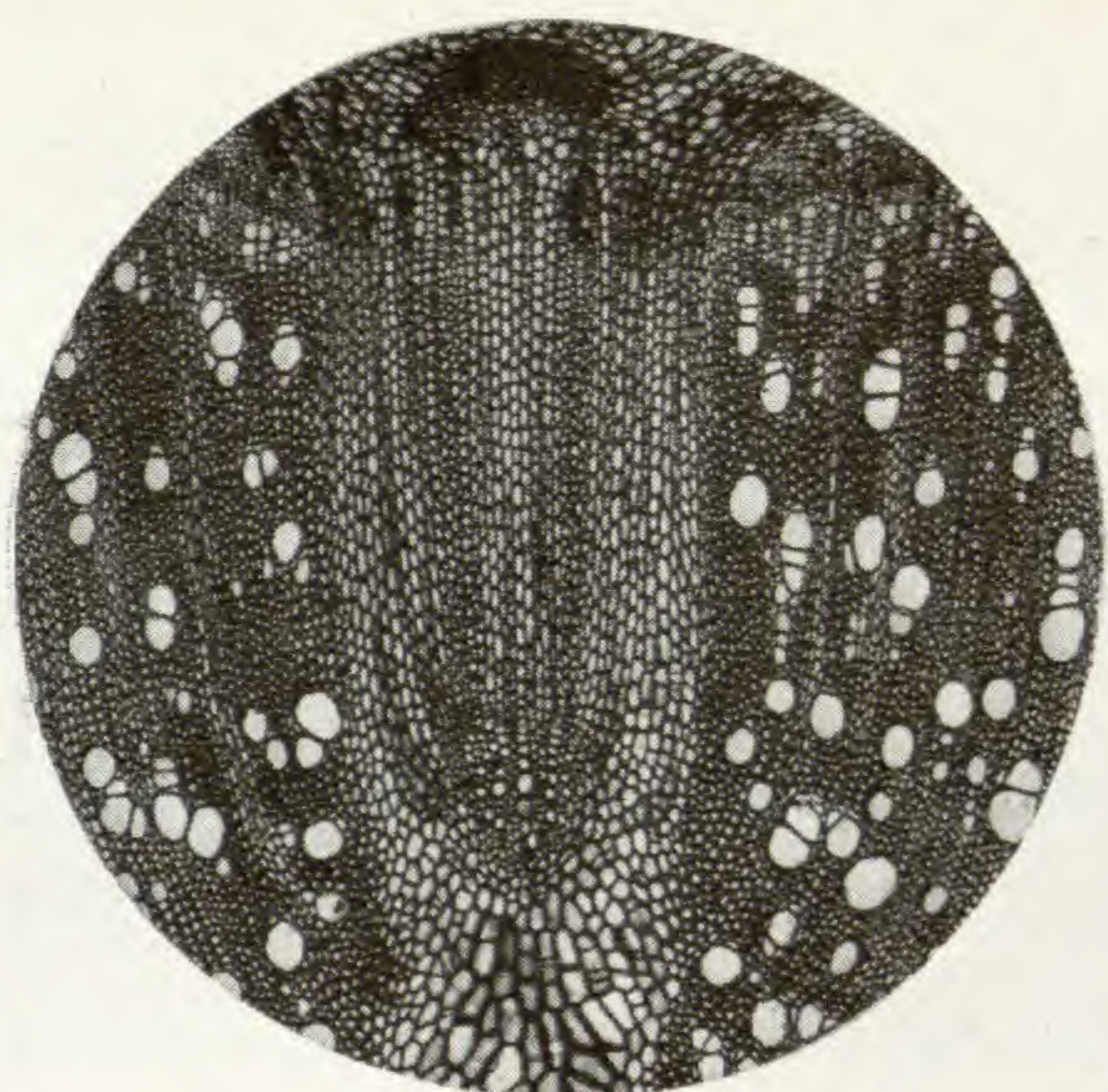

8

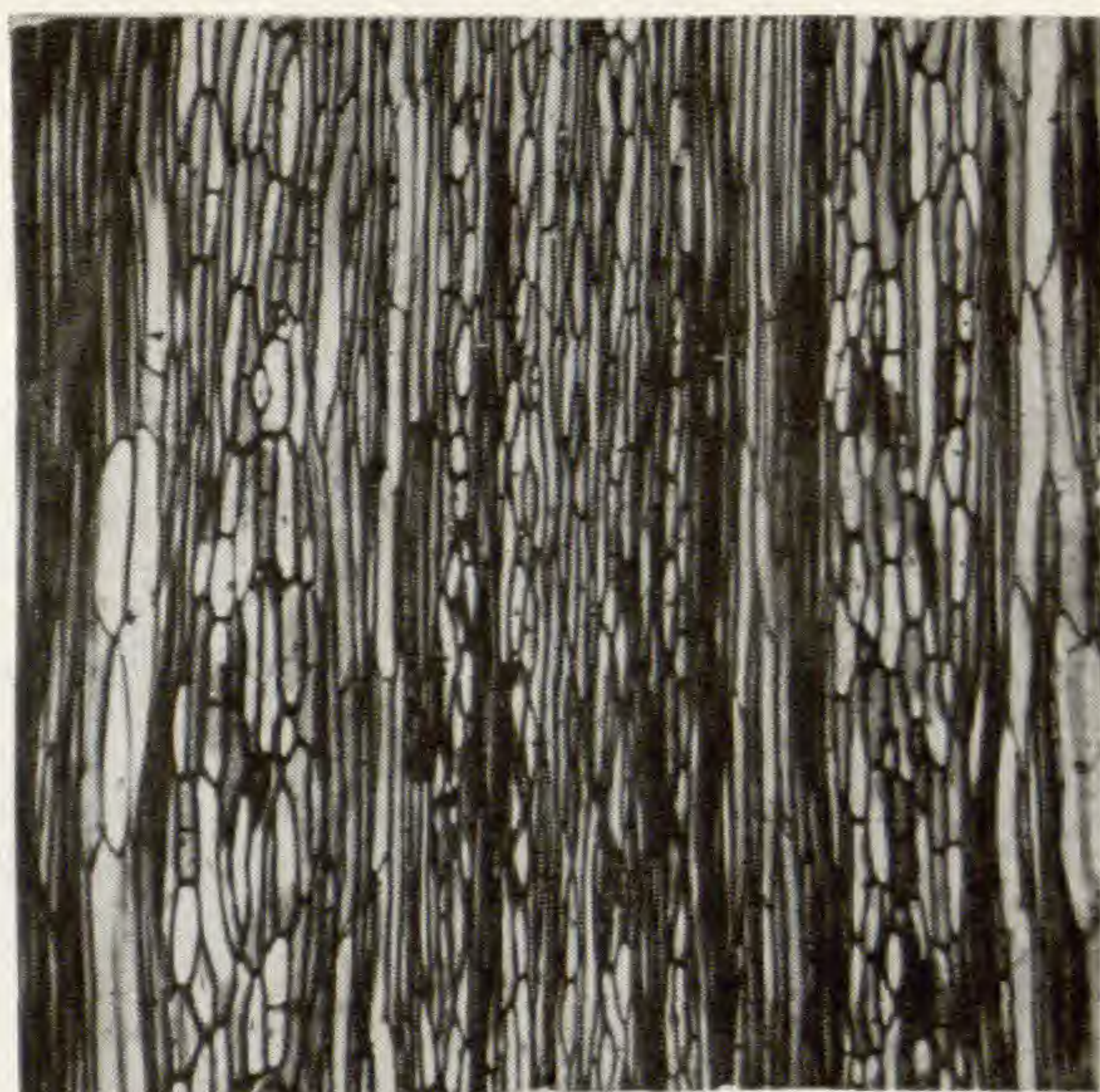

9



10

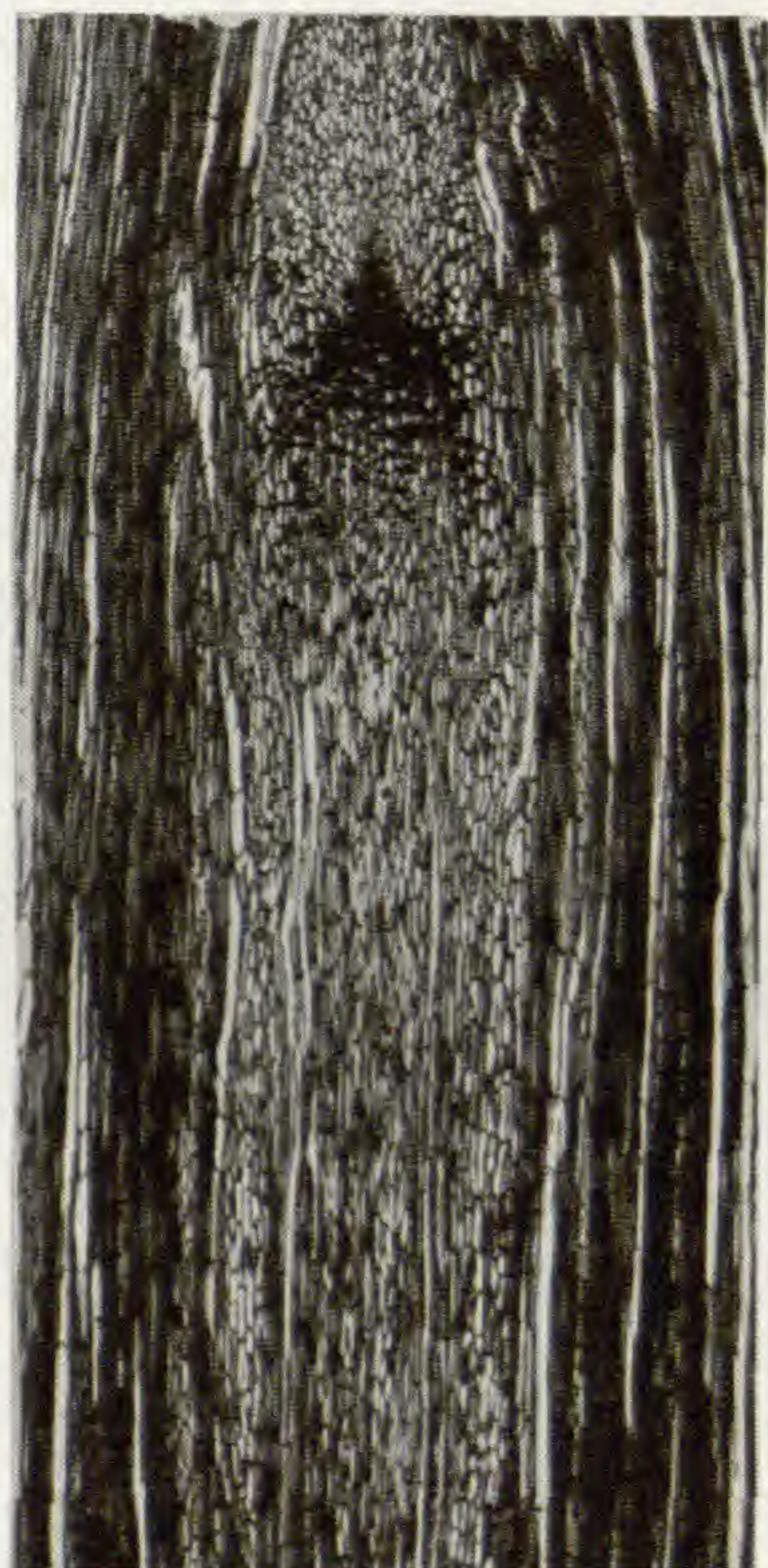

11



12

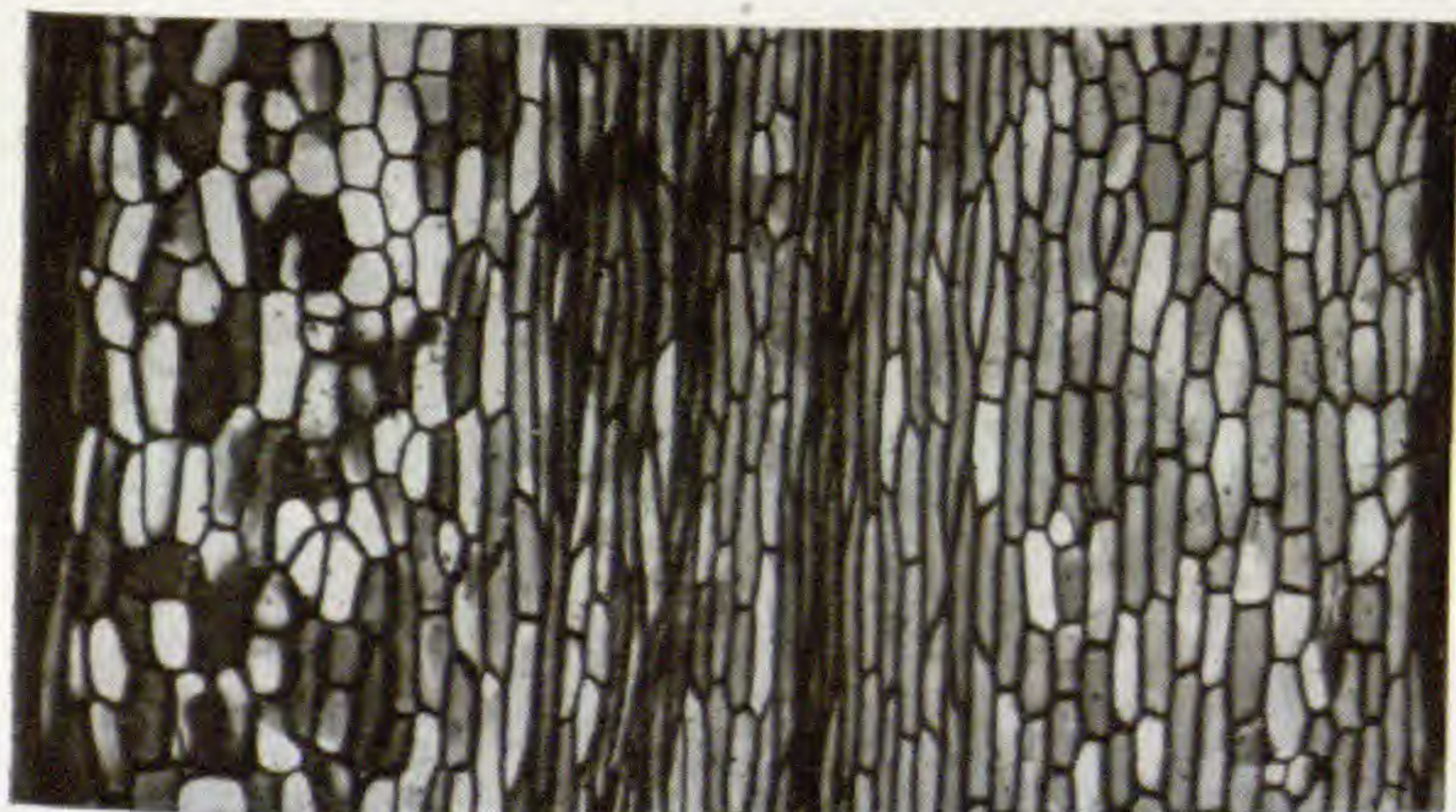

13

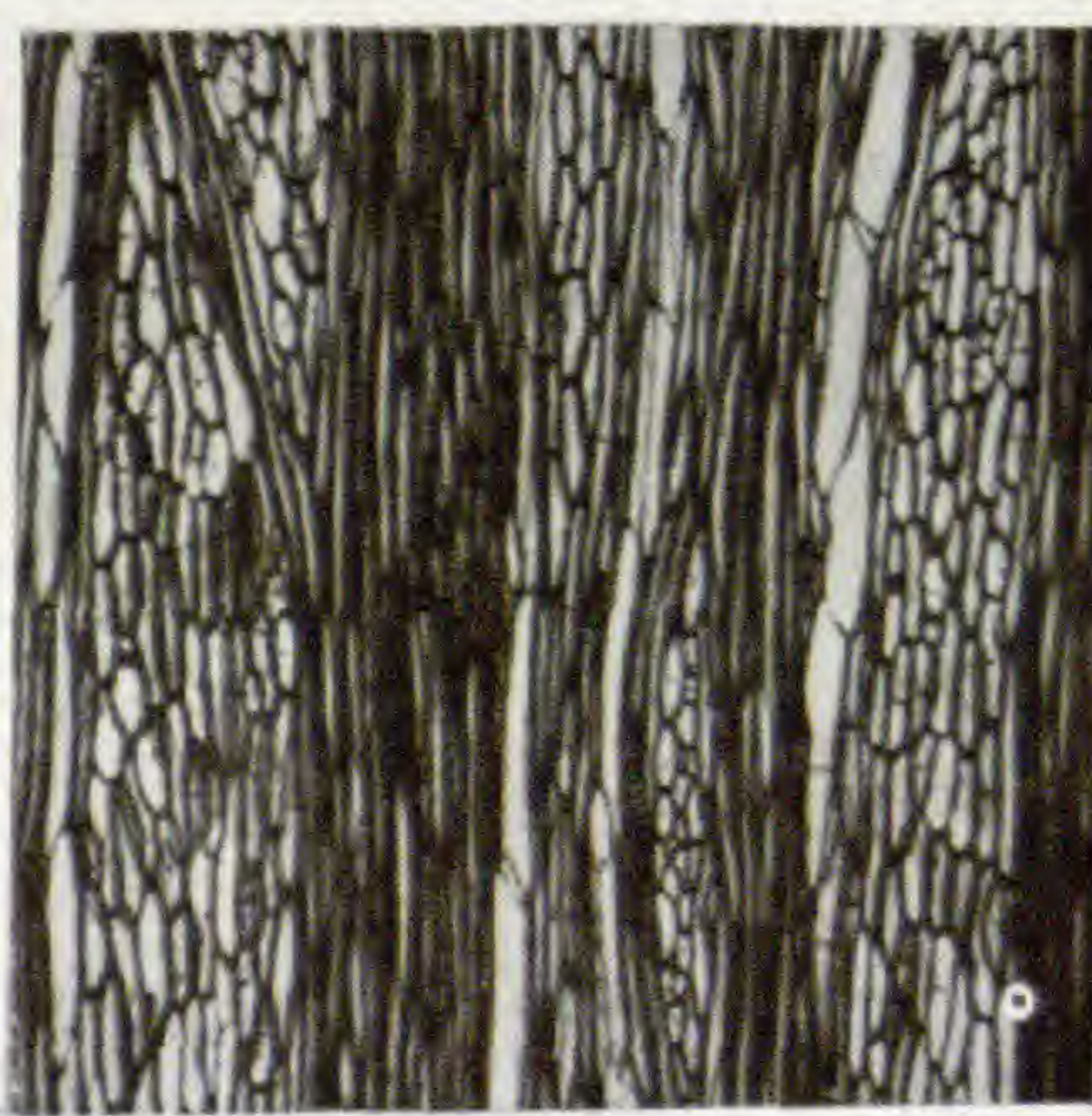

14

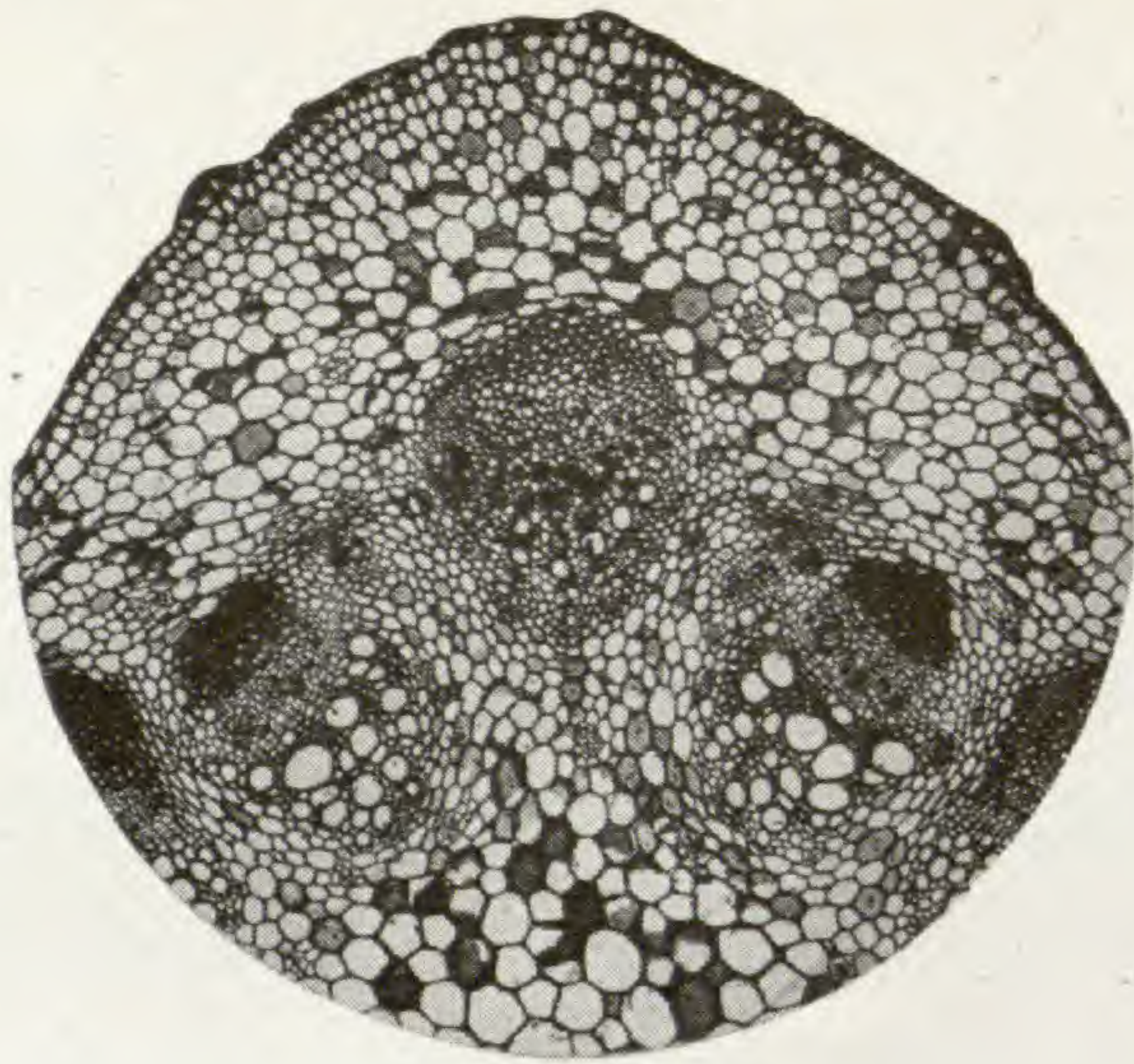

15

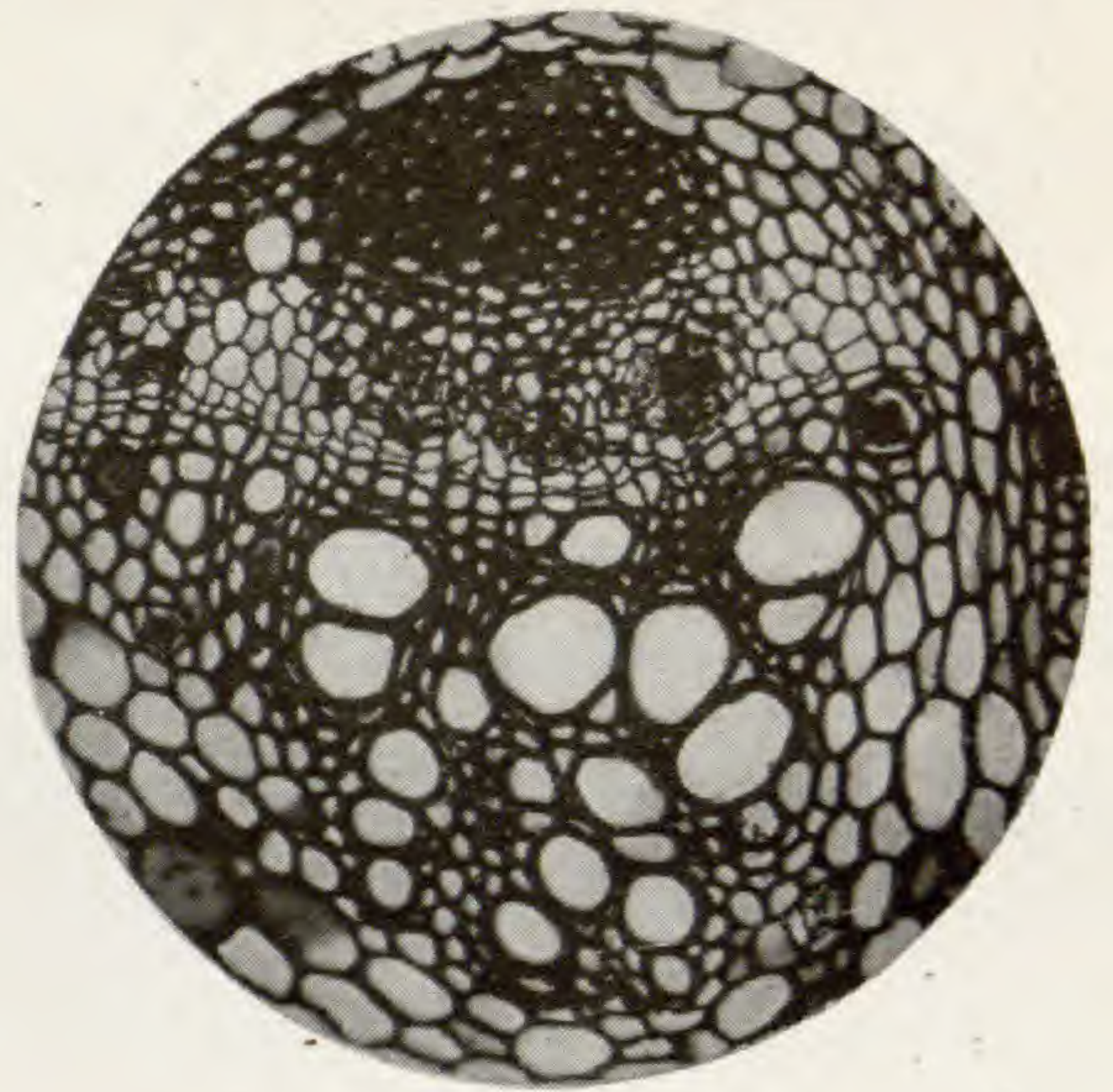

16

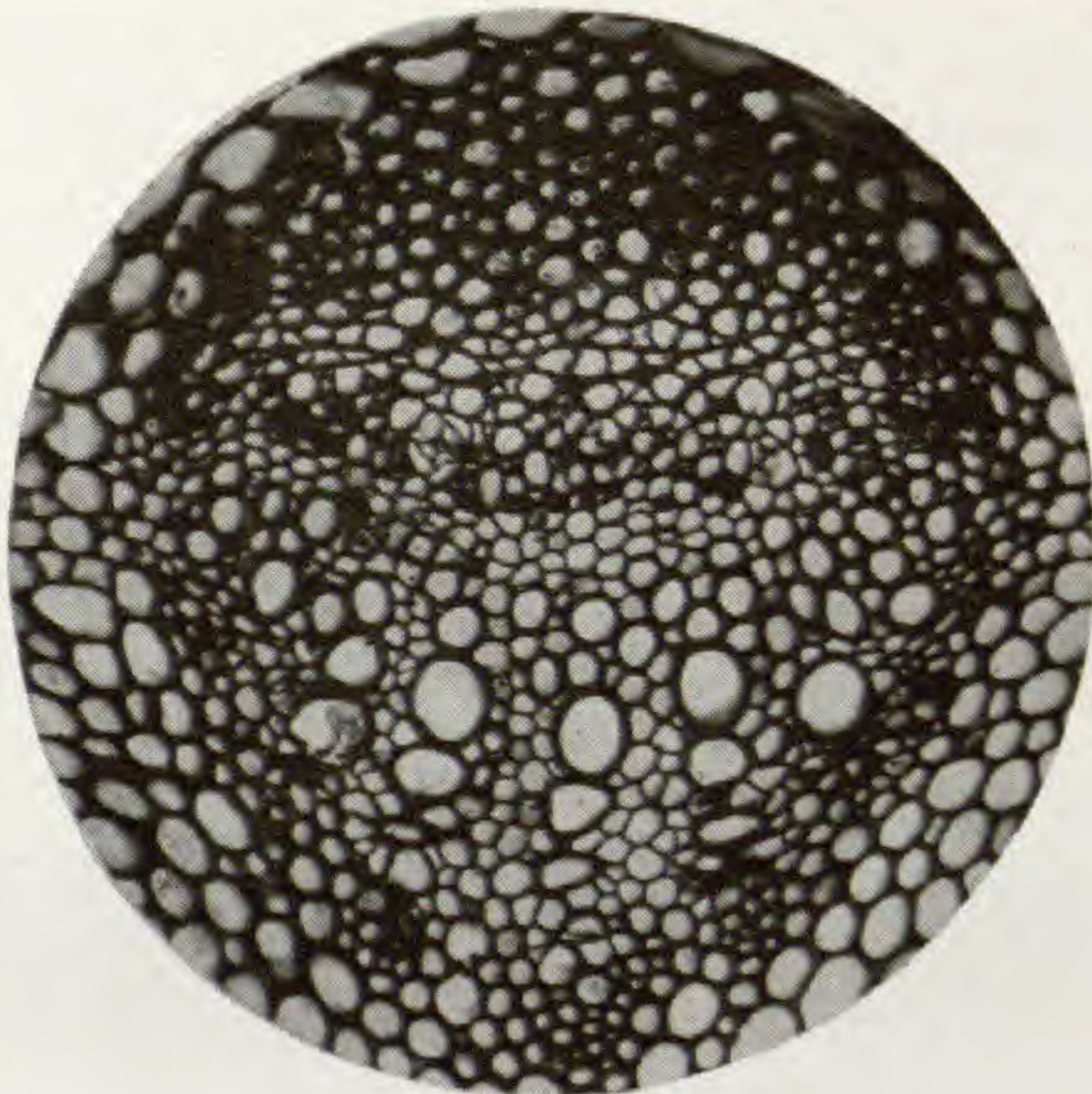

17



18

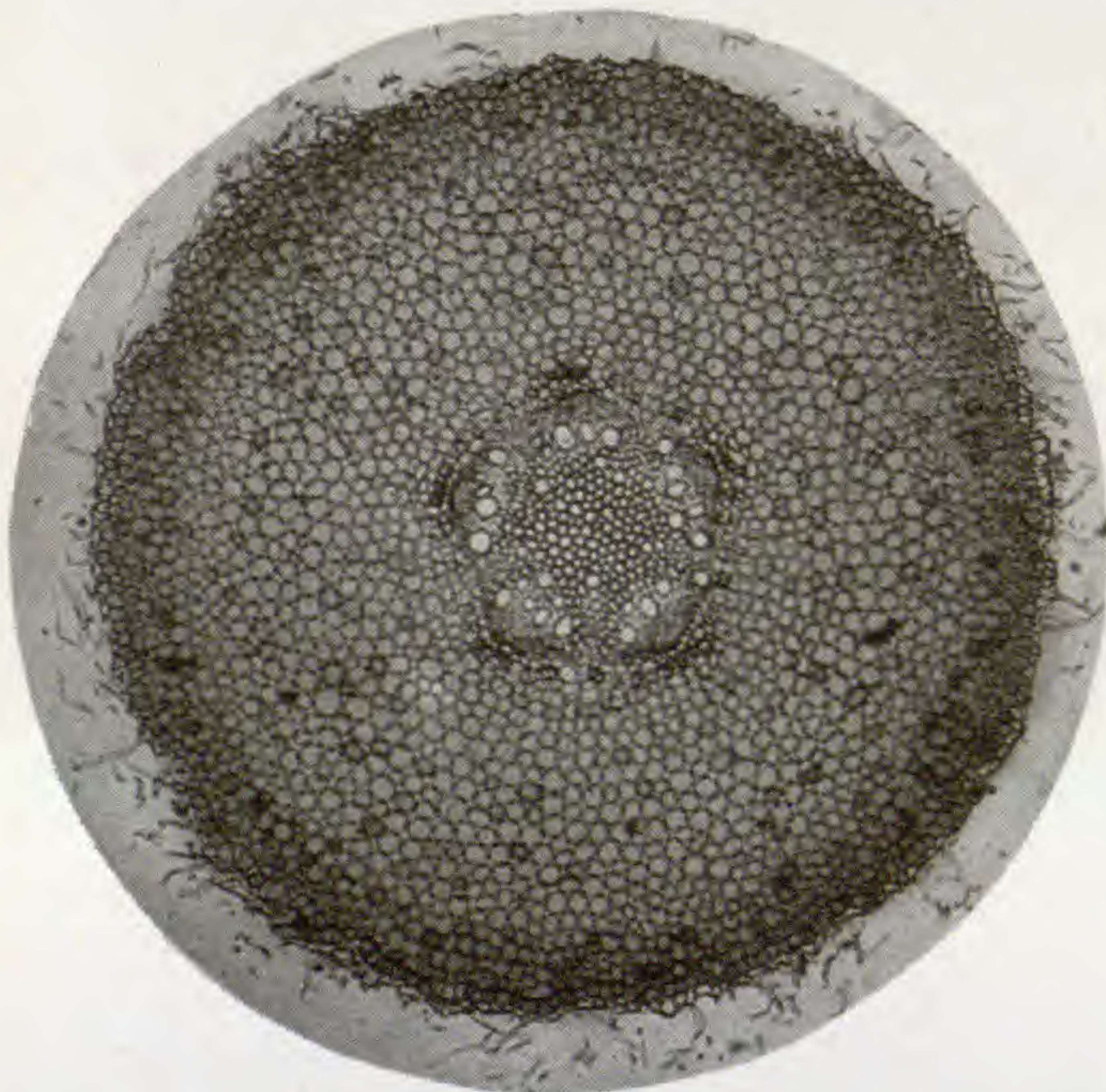

19

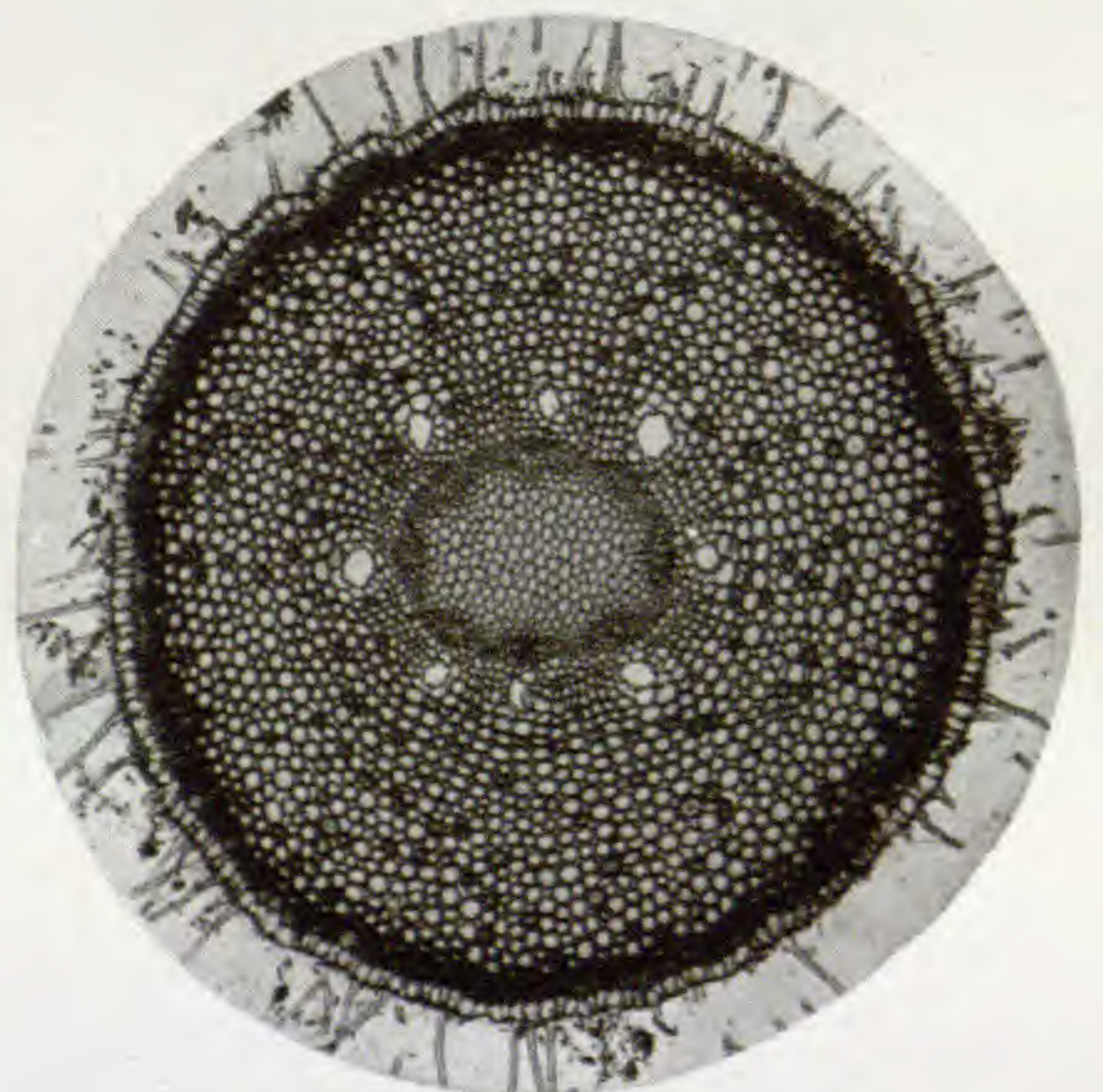

20



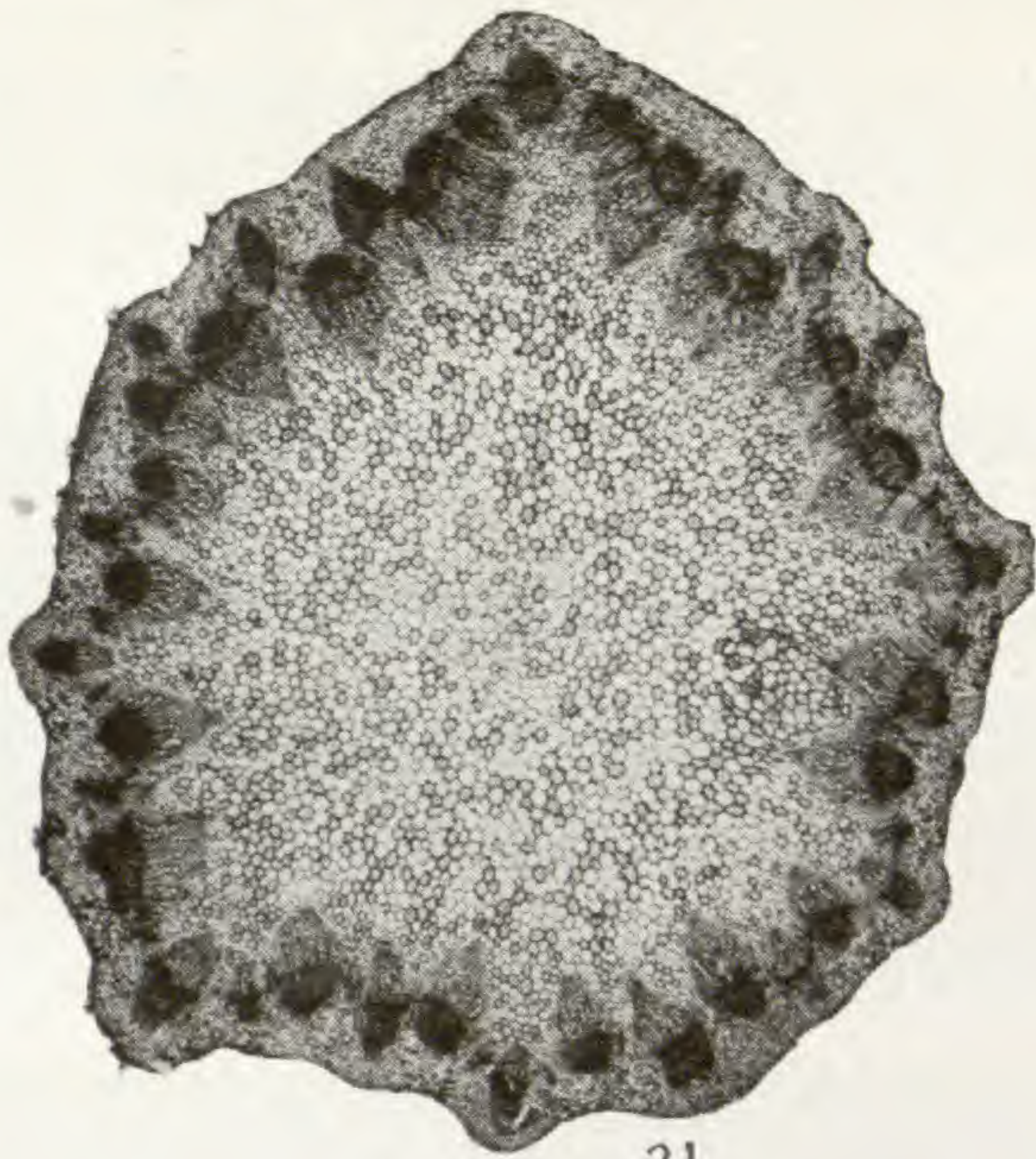

21

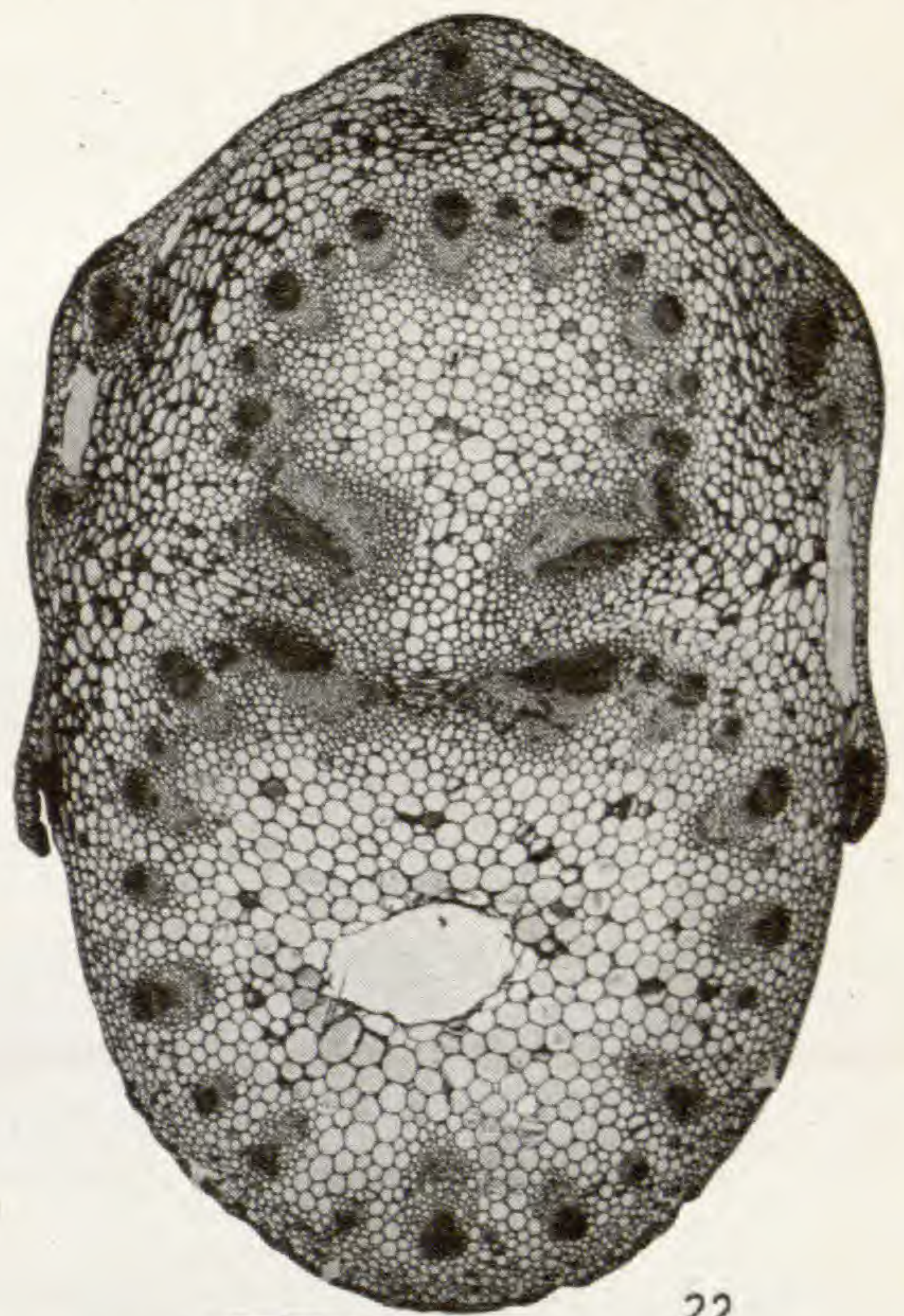

22



23

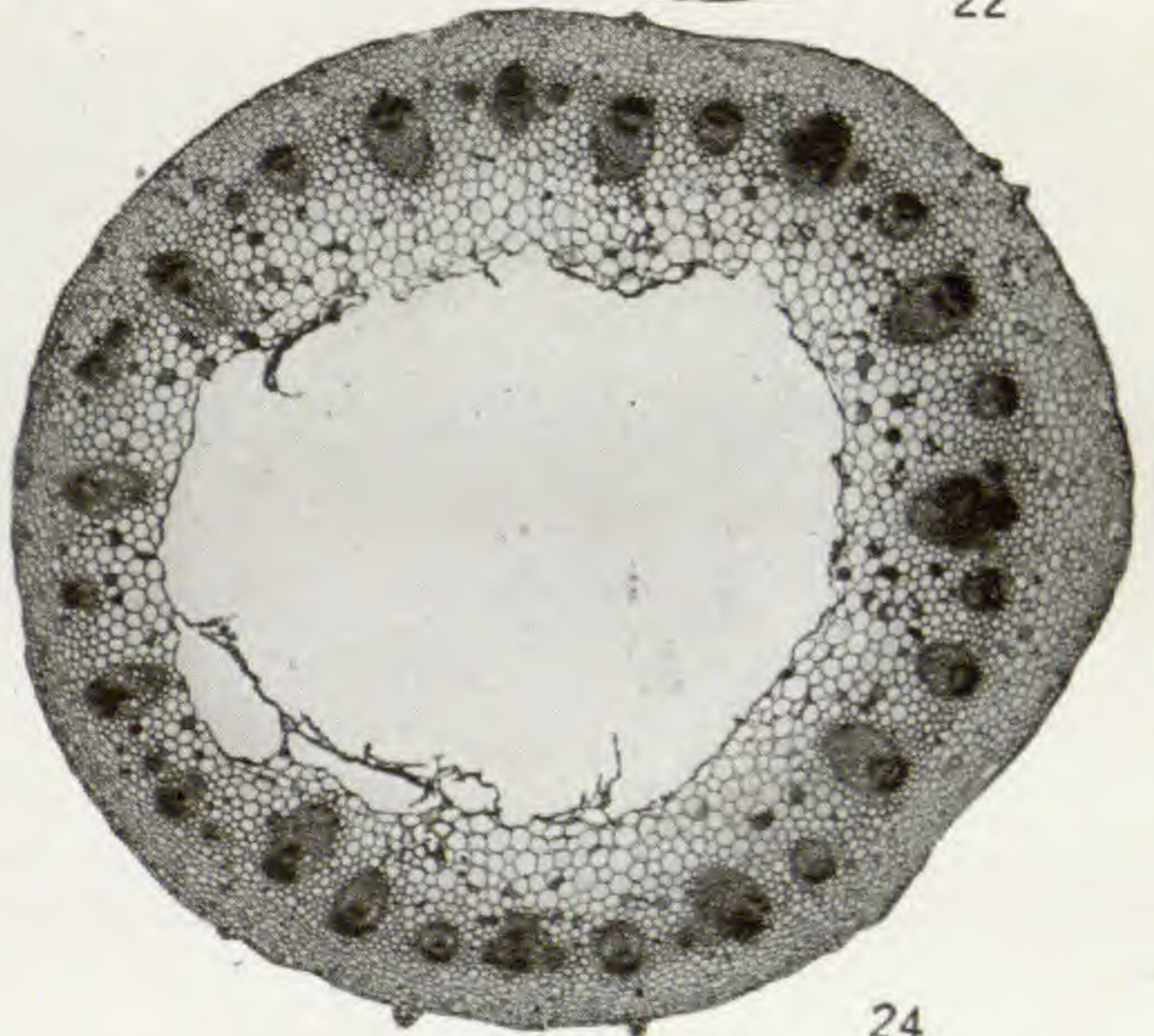

24



25



26

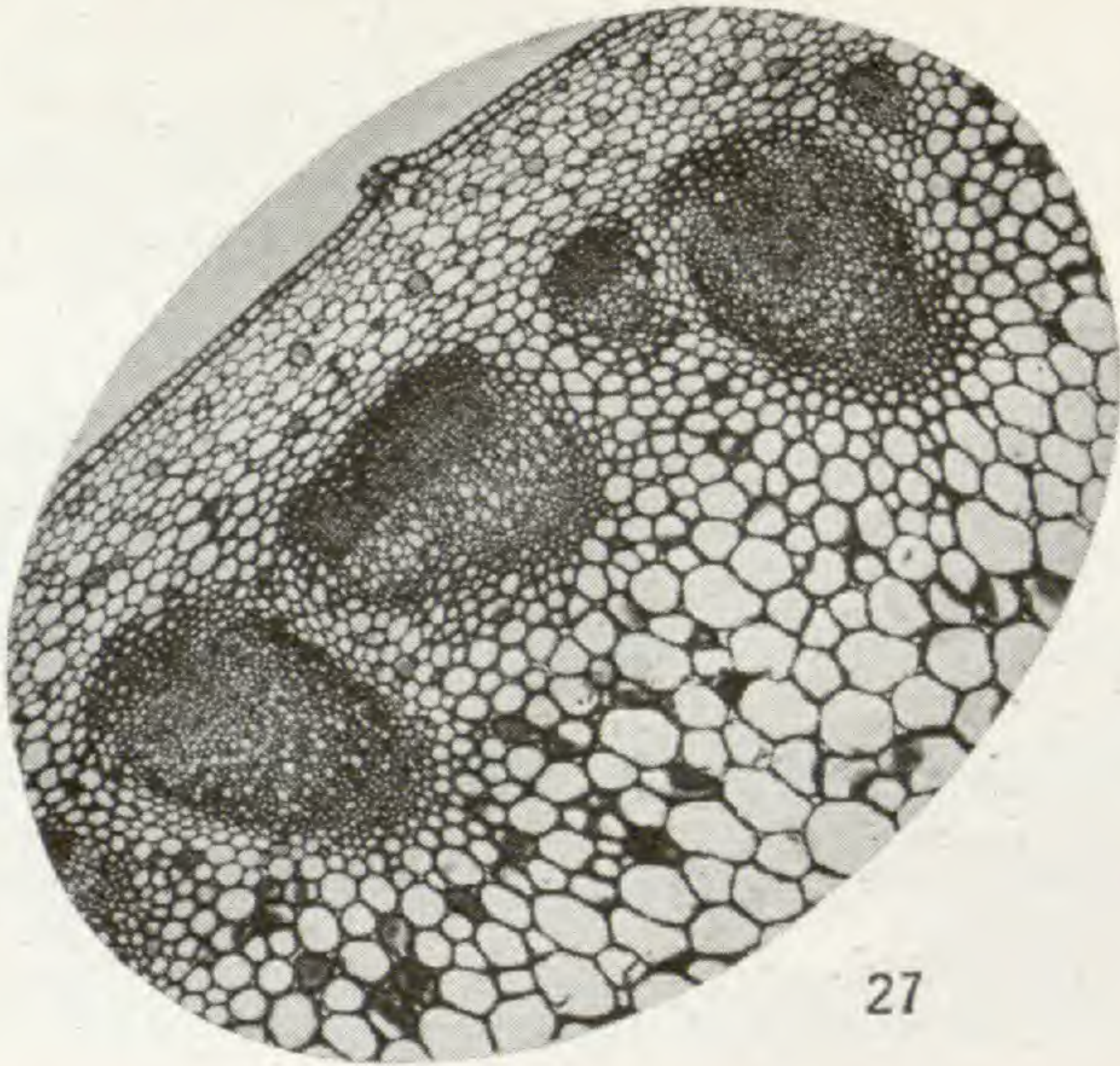

27

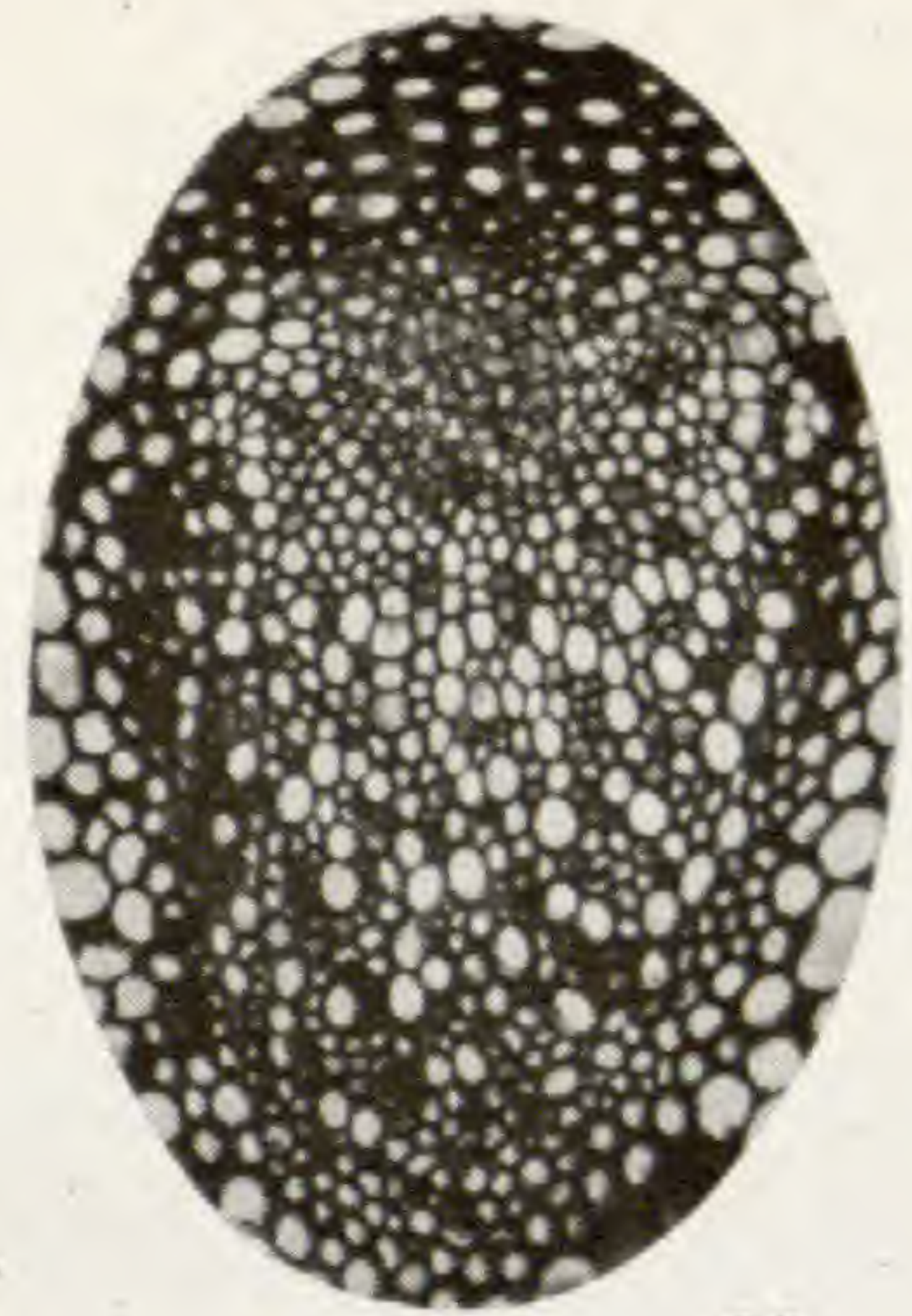

28

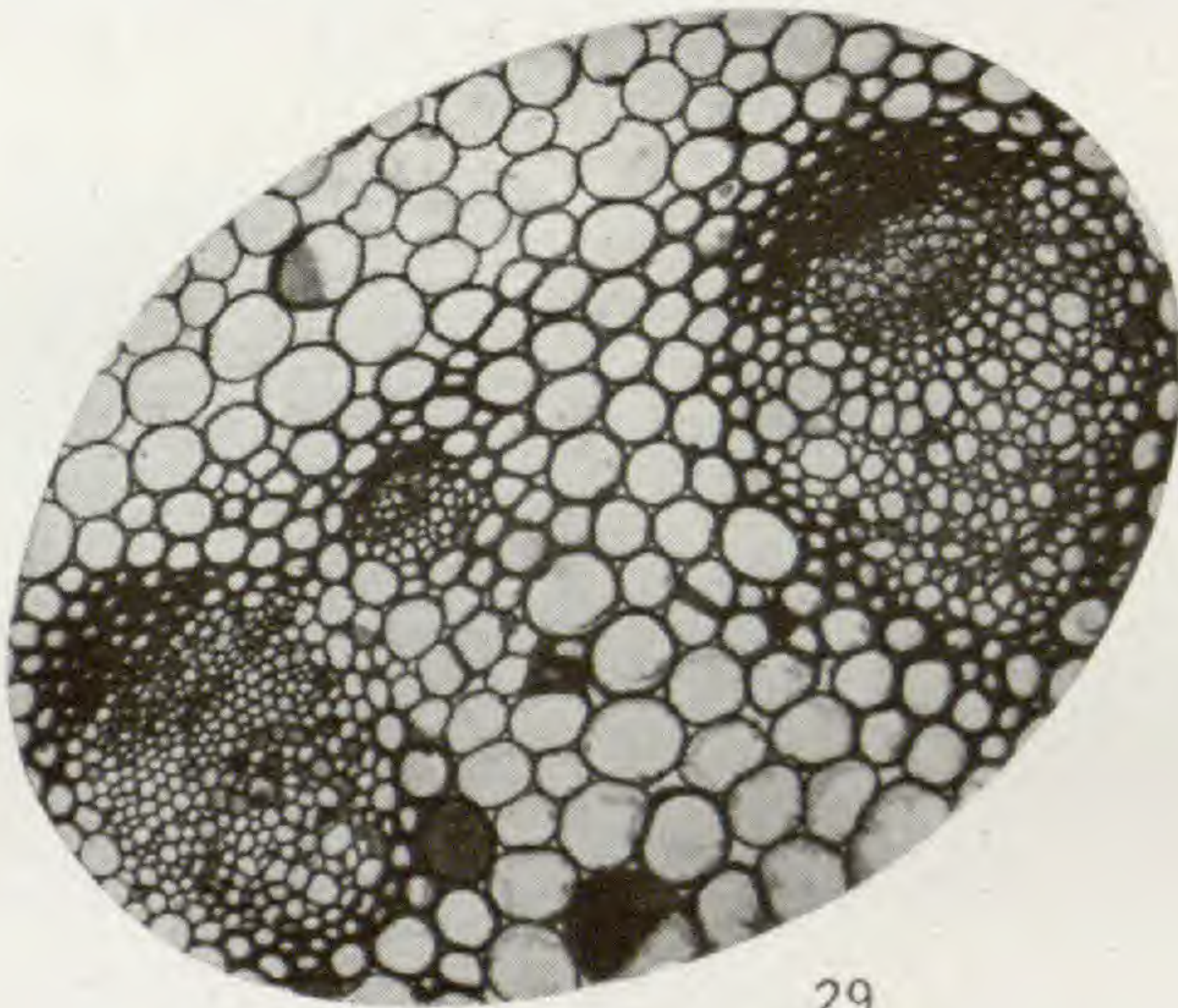

29

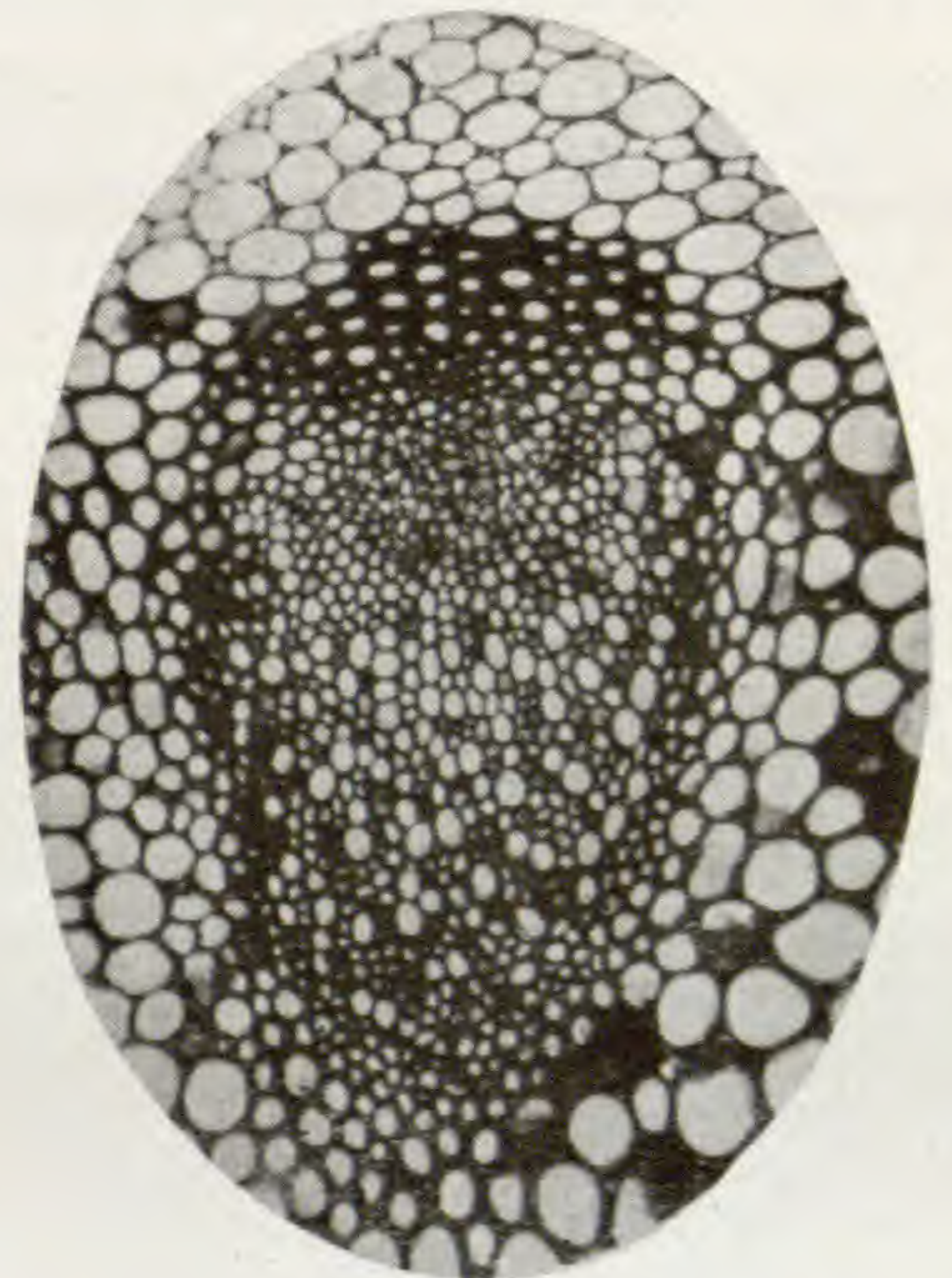

30



31

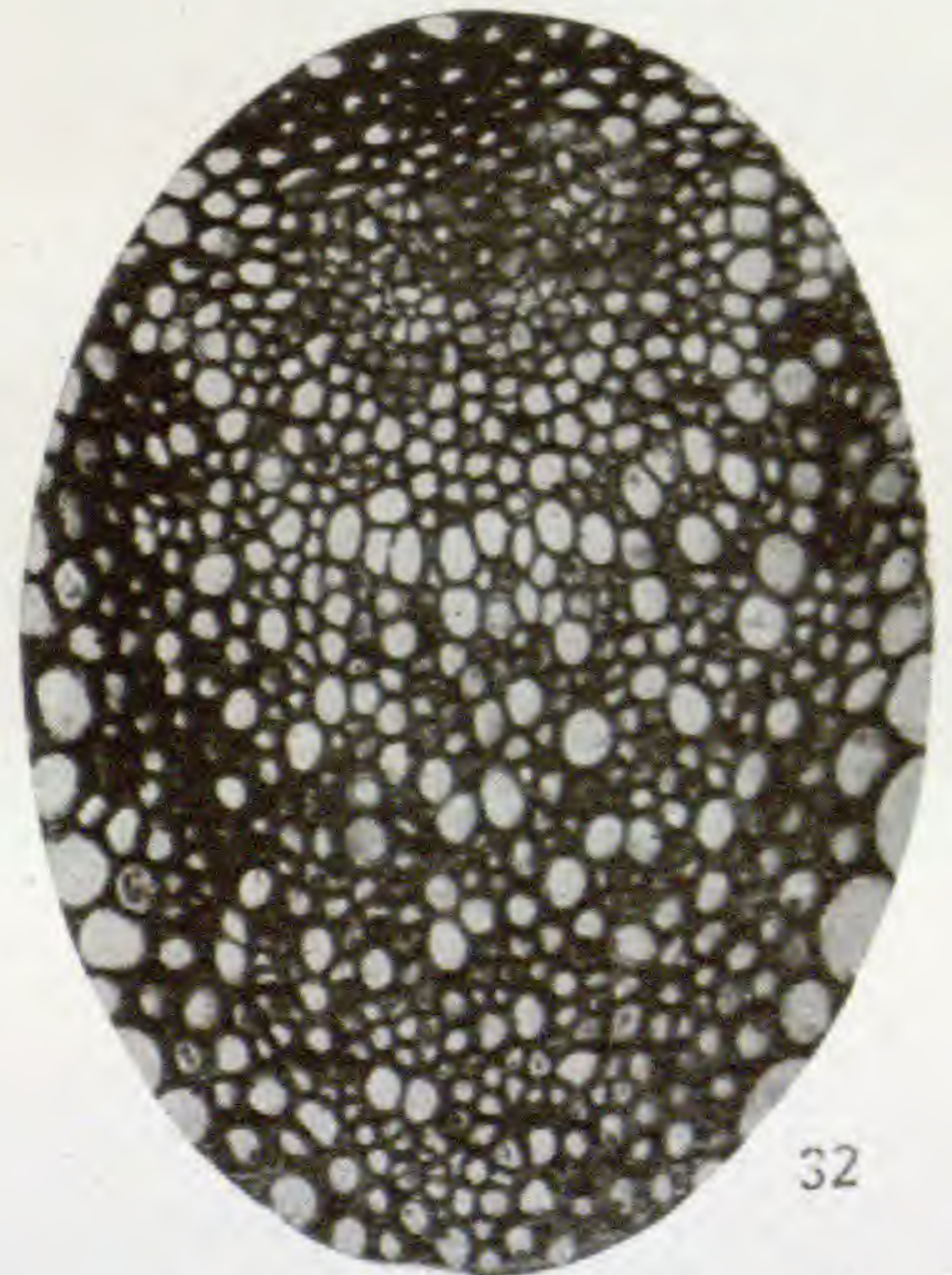

32

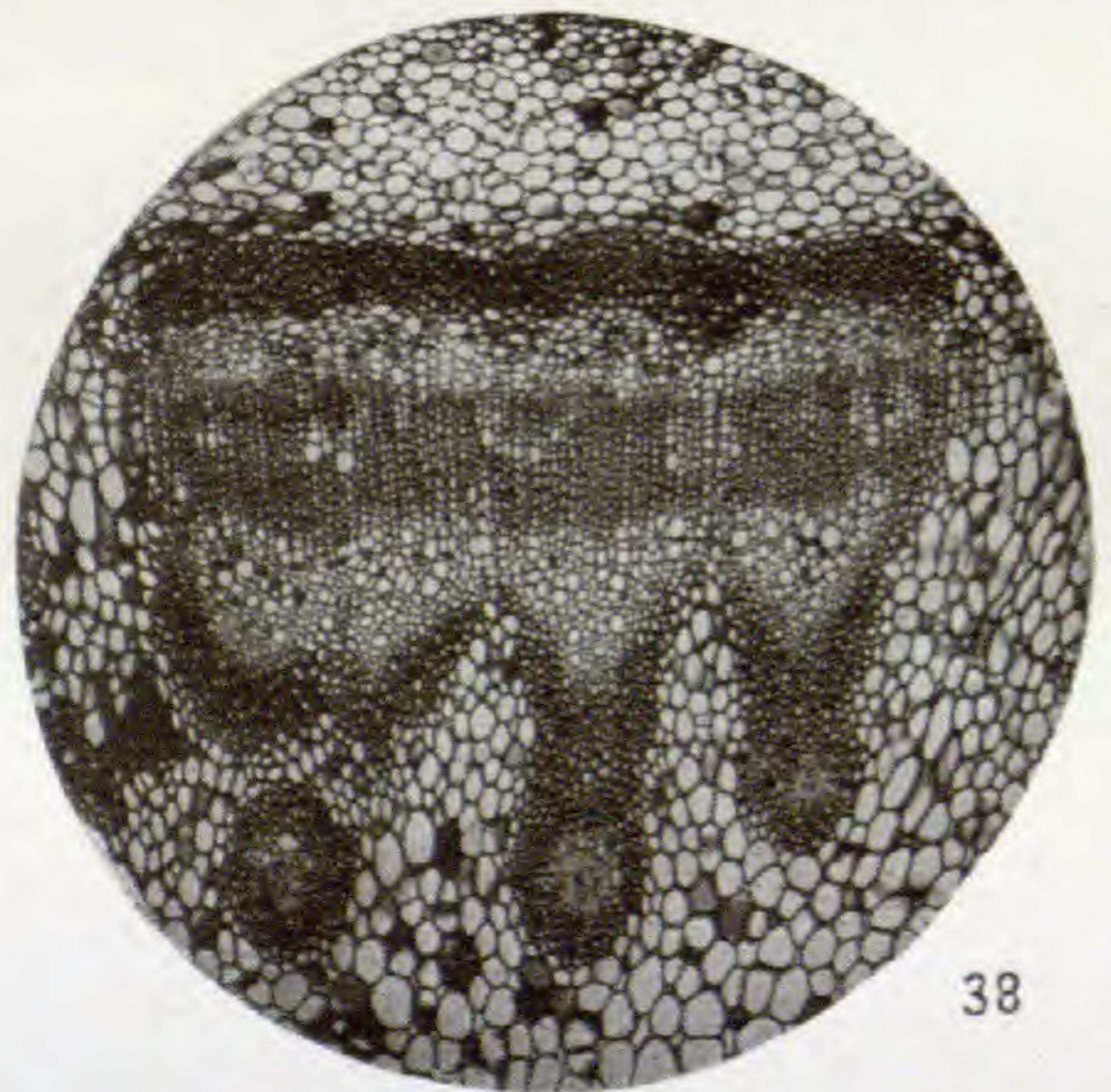
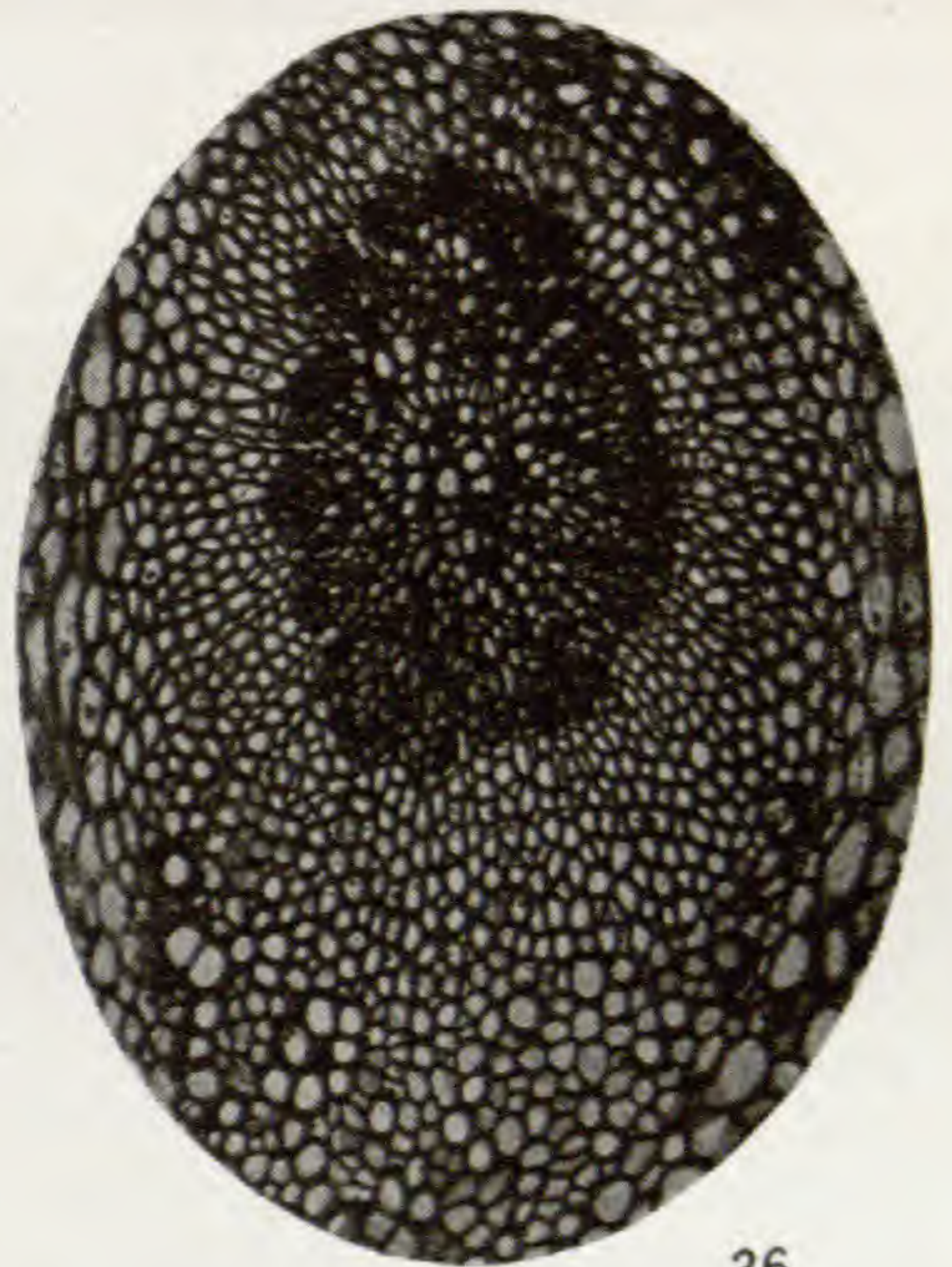
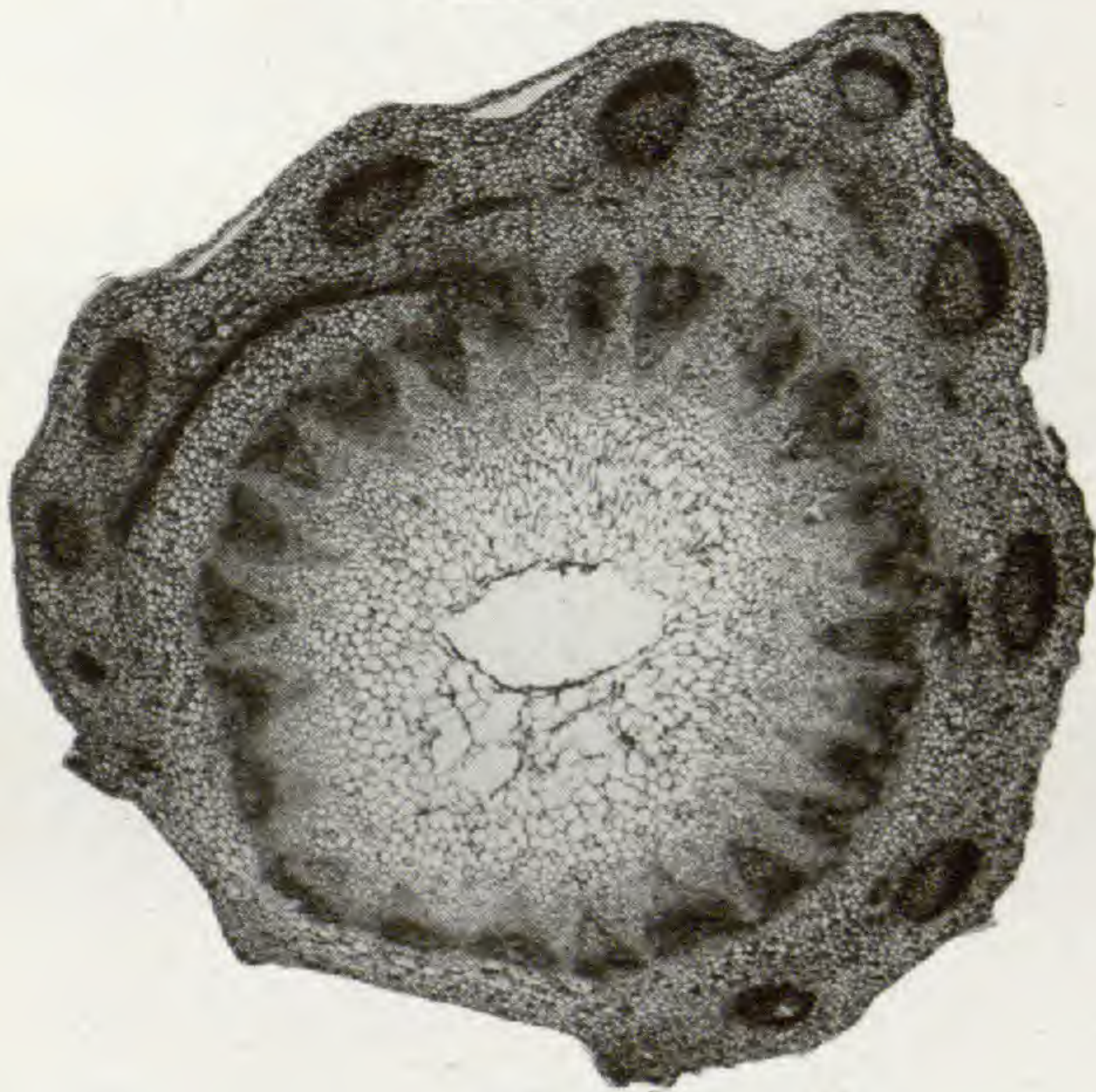
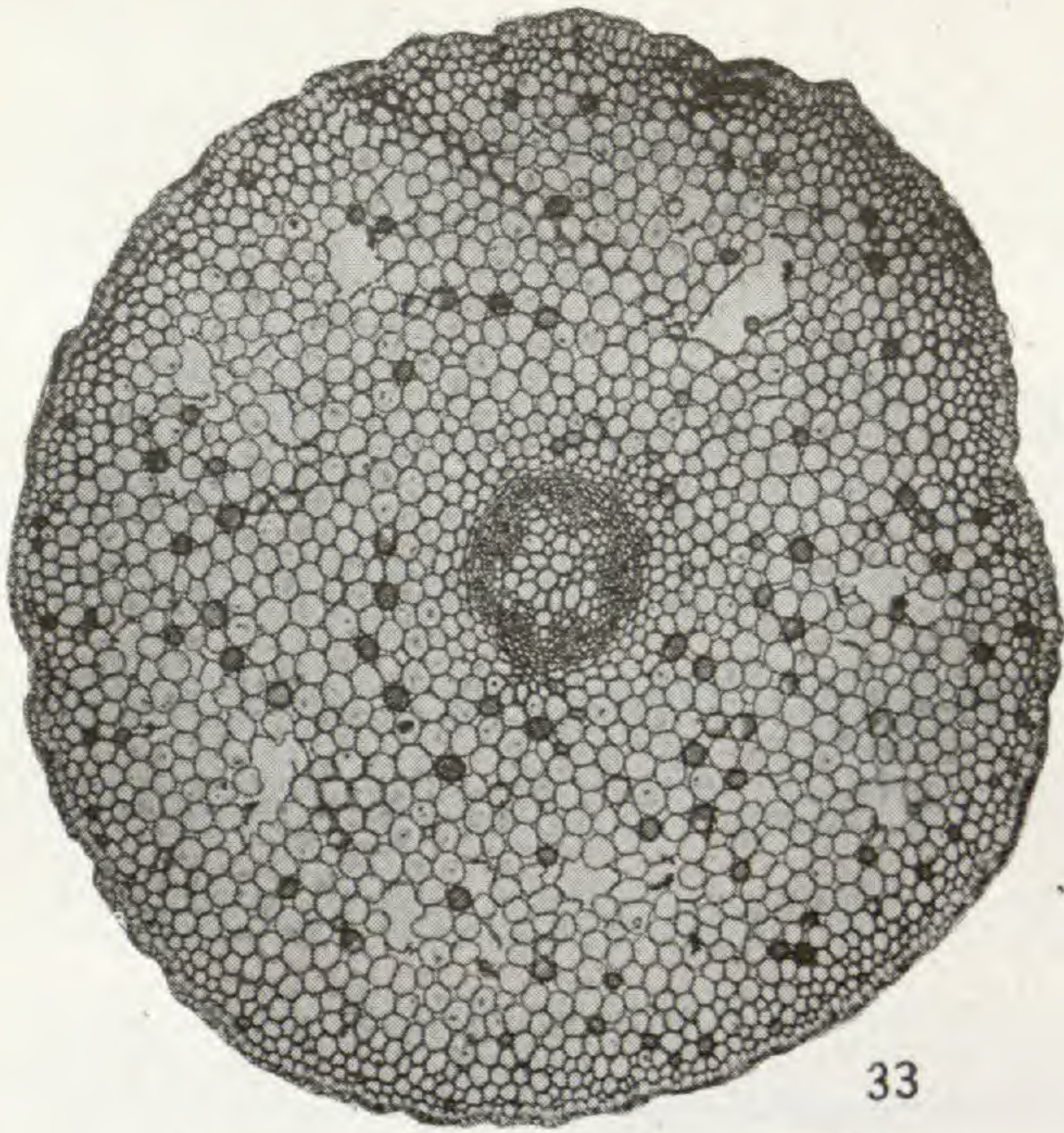

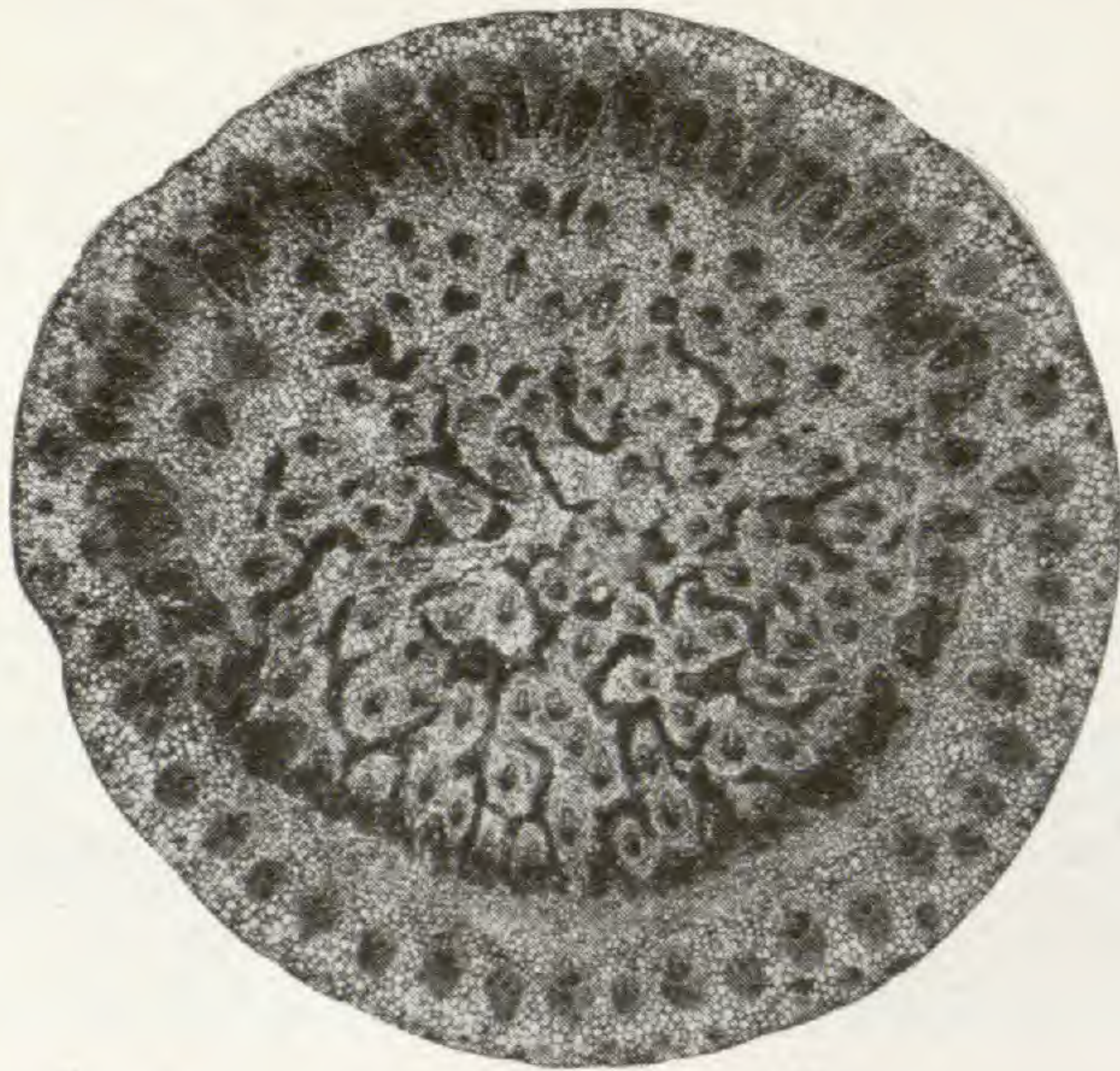

39

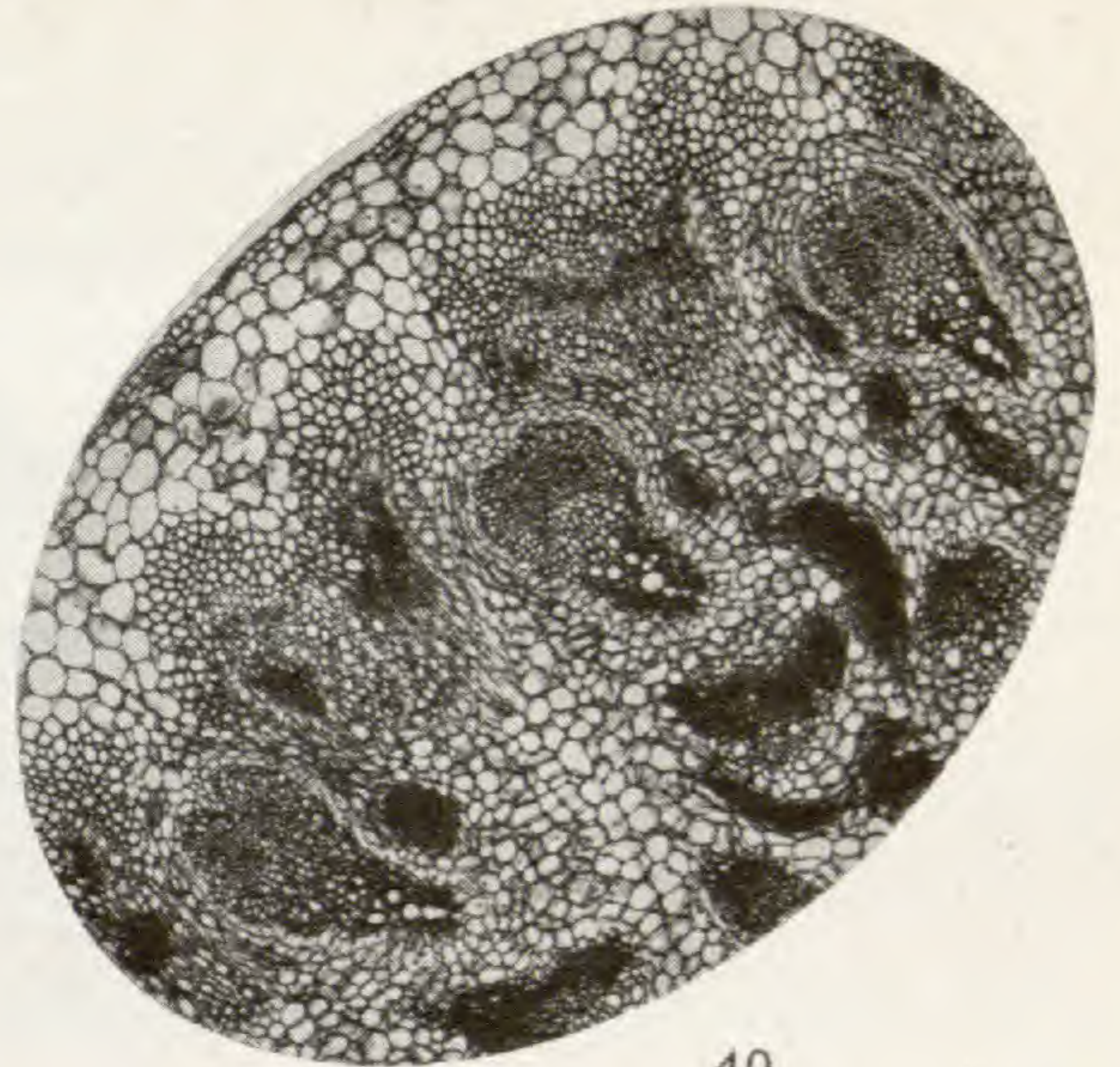

40

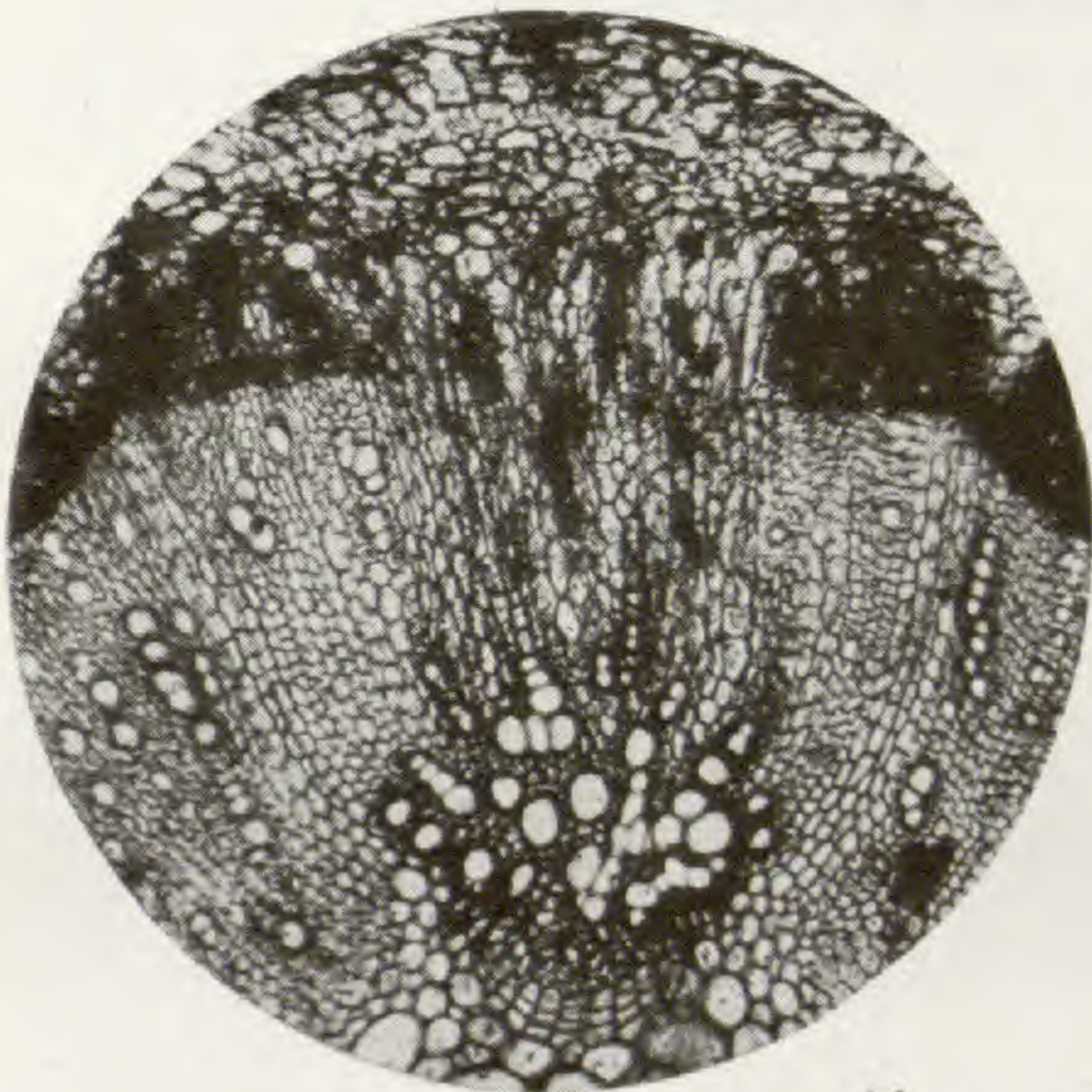

41

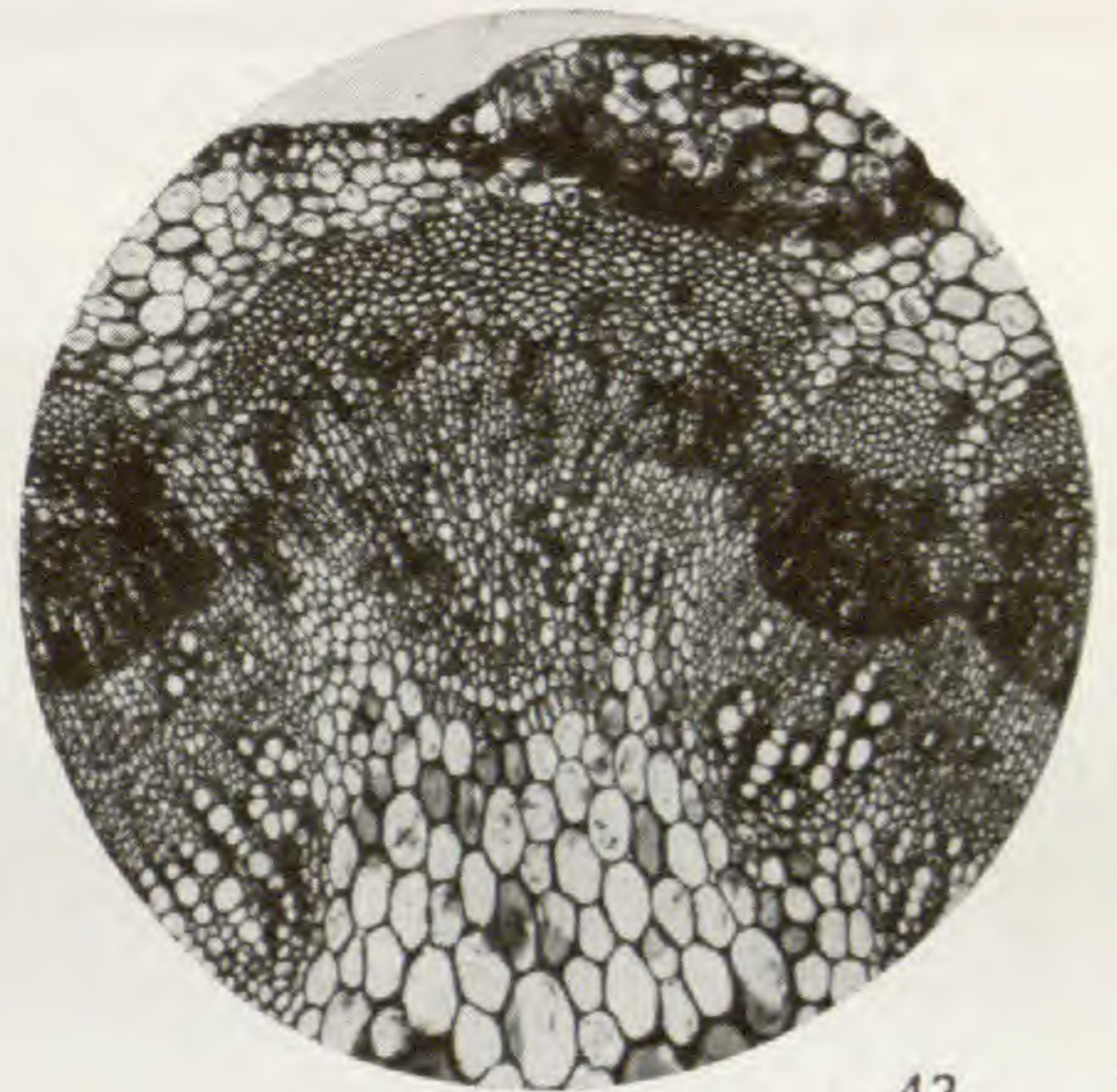

42

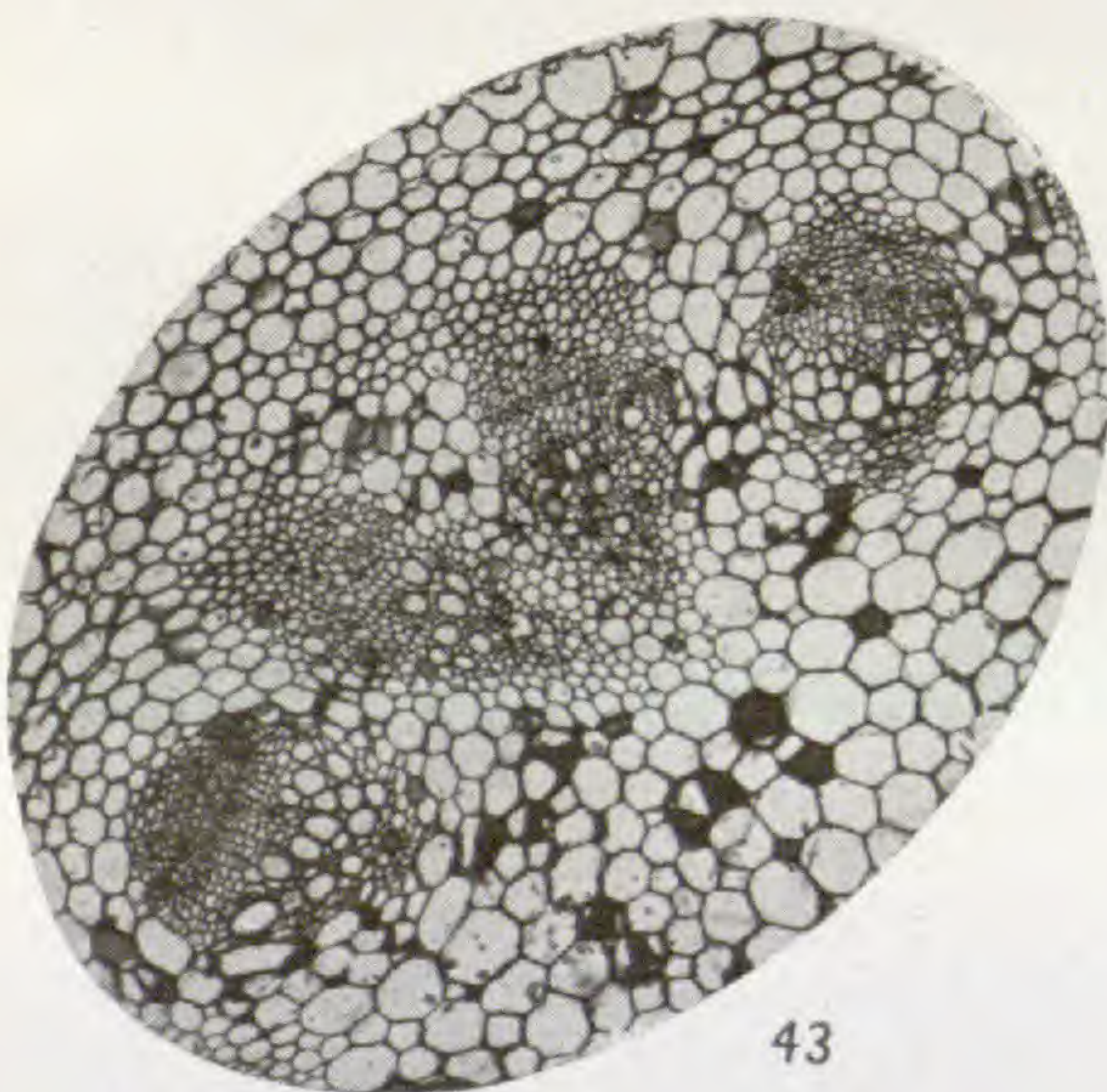

43

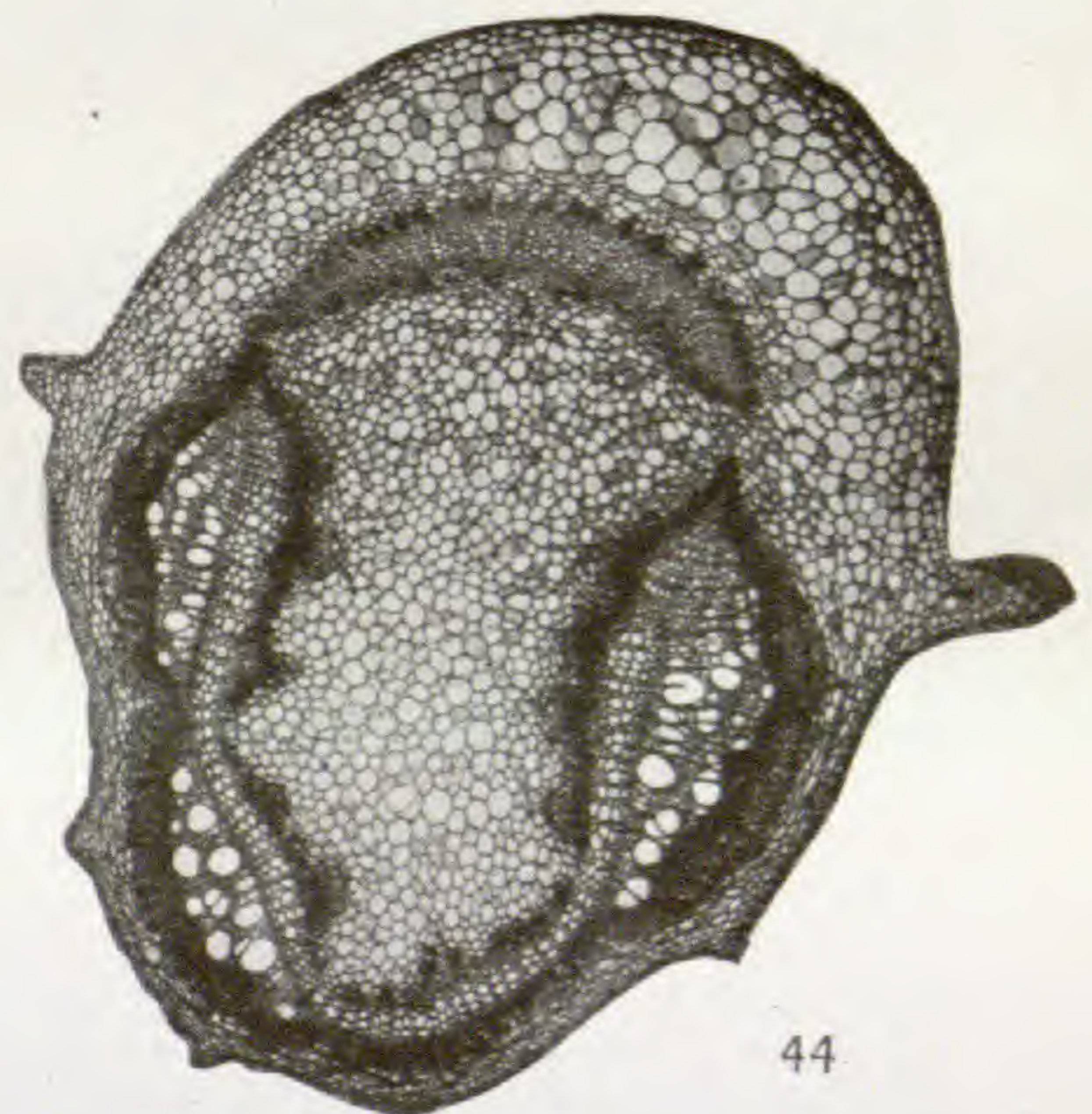

44

## PLATE V

FIG. 27.—Part of transverse section of infranodal region of stem of *R. acris*, showing bundles under slightly higher magnification than in previous two figures.

FIG. 28.—Foliar trace of *R. acris*, somewhat more highly magnified to show absence of cambial activity.

FIG. 29.—Leaf (left) and stem bundle (right) of *R. acris*, showing absence and presence of cambium.

FIG. 30.—Leaf trace of *R. acris*, somewhat highly magnified to show absence of cambial activity.

FIG. 31.—Stem and leaf bundles of *R. acris*, moderately magnified.

FIG. 32.—Leaf trace of *R. acris*, somewhat highly magnified to show absence of cambium.

## PLATE VI

FIG. 33.—Transverse section of old root of *R. acris*, showing absence of cambial growth.

FIG. 34.—Transverse section of stem of *Sanicula*, in region of branching node.

FIG. 35.—Transverse section of same, slightly lower down in axis than in previous figure.

FIG. 36.—One of amphivasal concentric strands occurring in nodal region of stem of *Sanicula*.

FIG. 37.—Transverse section in region of node of *Rumex*, showing presence of numerous medullary amphivasal strands, resulting from fusion of bundles in region of node.

FIG. 38.—Part of fig. 37, more highly magnified to show details of organization.

## PLATE VII

FIG. 39.—Transverse section through upper node of *Zea*, showing fusion of leaf base and bundles with corresponding structures in axis.

FIG. 40.—Part of upper left hand portion of fig. 39, more highly magnified to show presence of amphivasal strands resulting from fusions in region of node.

FIG. 41.—Foliar segment from lower woody region of axis of wax bean, showing absence of cambial activity in region of foliar trace.

FIG. 42.—Transverse section through foliar segment of red clover, showing absence of cambial activity in foliar trace.

FIG. 43.—Transverse section through nodal region of *Papaver* sp., showing two leaf traces in center, in contrast to stem bundles, on either side, by absence of cambial activity.

FIG. 44.—Transverse section of stem of *Convolvulus* sp., showing reduction of cambial activity in leaf segments as contrasted with those of stem.

# AFTER-RIPENING AND GERMINATION OF JUNIPERUS SEEDS

CONTRIBUTIONS FROM THE HULL BOTANICAL LABORATORY 275

DEAN A. PACK

(WITH ONE FIGURE)

Some seeds fail to germinate in compensating percentages or even at all when placed under ordinary germination conditions. Because of inquiries directed to this laboratory from various growers concerning the best methods of handling juniper seeds, there was conducted a careful study of after-ripening, germination, and seedling development, as well as some of the chemical and physiological changes involved in these processes. Strict quarantine laws, recently put into effect, will mean that many species of decorative plants that were formerly grown from seeds in foreign countries and brought to America as plants, must now be grown from seeds by American nurserymen. This will doubtless promote study of the germinative behavior of many refractory seeds in the future.

## Literature

Wild plants of the temperate zone produce seeds that usually have a rest period, which varies as to length and cause with the different species and kinds of seeds. This dormancy is found to be characteristic of the seeds of 75 per cent of the wild and the cultivated plants studied by HOWARD (18). Although the rest period of most seeds is only a few months, it may be years, as in the case of some Conifers (21) and of *Euphorbia Cyparissias* (19). CROCKER (5) states that delayed germination is due to one or more of the following conditions: (1) rudimentary embryo, (2) dormant embryo, (3) coats inhibiting embryo expansion, (4) coats inhibiting gas exchange, (5) coats inhibiting water absorption, (6) a combination of two or more of these, and (7) secondary dormancy. Up to date seeds have been studied that represent each of these different types of dormancy.

As it has been impossible to dispense with this rest period in all cases, many substances have been used to reduce dormancy and force seeds to germinate. Concentrated sulphuric acid has been used by HILTNER and KINZEL (17), ROSTRUP (32), and others with positive results. Among the salts ROSE (31) noted that the sulphates and nitrates were the better forcing agents. Hydrogen peroxide and increased oxygen pressure forced the germination of *Xanthium* seeds (5). Wounding and treatment with ether stimulated the germination process (3). Light has been found to force or to inhibit germination depending on the seed (12, 20). The New York Experiment Station (24) and many others have shown that desiccation improves the germinating power of corn. The hot bath has been used with success on some seeds (4). Alternating temperatures have been used to force grass seeds in the Seed-testing Laboratories of the Bureau of Plant Industry. With these much has been claimed for freezing and thawing as a forcing agent (29). LAKON (21), however, found that the germination of *Pinus Peuce*, *P. Cembra*, *P. Strobus*, and *P. silvestris* could not be accelerated by treatment with dry heat, warm bath, file injury, ether, chloroform, salt solutions, concentrated sulphuric, or dilute acids.

Seeds with dormant embryos must go through a series of changes (after-ripening) before germination can occur (5). The after-ripening of hawthorn seeds proceeds fastest at 5-6° C. according to DAVIS and ROSE (8). An idea of this after-ripening process may be gained by following the results of LAKON on a protein and ECKERSON (10) on a fatty seed. LAKON (22), in studying the changes that precede germination of *Fraxinus excelsior*, found very little increase in water absorption. From the tenth day on, starch accumulated in the embryo cells, with a corresponding disappearance of protein from the endosperm cells. In place of the disappearing protein a turbid emulsion formed, which later was digested. At no time did starch appear in these endosperm cells. The embryo doubled its length during this process of "Vorkeimung." ECKERSON (10) studied the changes occurring in the hawthorn seed during after-ripening, and reported an increasing acidity and water absorbing power of the dormant organ. The catalase, peroxidase, and oxidase activity increased as after-ripening and

germination proceeded. Germination was accompanied by a decrease of stored fats and an increase of sugar. Although the details varied somewhat, both seeds passed through a period of preparation for germination.

### Material and preliminary study

The *Juniperus* plants are erect or prostrate dioecious Cupresseae distributed over the Northern Hemisphere. They are used in landscape decoration, serving as hedges and screens up to 30 ft. high. In early spring the flowers appear in the leaf axils, forming many carpel whorls, of which only the upper one develops. This whorl bears 3 ovules, which grow together and form a spherical fruit, which requires two years to ripen, and contains 1-3 seeds.

TABLE I  
MATERIAL SECURED

Species	Lot	Date	Place
<i>J. virginiana</i> L. . . . .	1	November 11, 1918	West Newberry, Massachusetts
<i>J. c. depressa</i> Pursh. . . .	2	January 1, 1919	Boxford, Massachusetts
<i>J. communis</i> L. . . . .	3	January 1, 1919	Vermont
<i>J. prostrata</i> Pres. . . . .	4	January 1, 1919	Vermont
<i>J. virginiana</i> L. . . . .	5	January 1, 1919	Vermont
<i>J. communis</i> L. . . . .	6	April 19, 1919	Near Chicago, Illinois
<i>J. virginiana</i> L. . . . .	7	April 19, 1919	Near Chicago, Illinois
<i>J. communis</i> L. . . . .	8	September 19, 1919	Near Chicago, Illinois
<i>J. virginiana</i> L. . . . .	9	September 19, 1919	Near Chicago, Illinois

*Juniperus* seeds were gathered in the fruit condition, and those used in these experiments were collected as stated in table I.

The seeds freed from the fruit vary with the species as to color, shape, size, and quality. Those of *J. virginiana* are light brown, smooth, brittle, 3-4 mm. long, and when air-dry weigh about 0.009 gm. each. Seeds of *J. c. depressa*, *J. communis*, and *J. prostrata* are much alike. These seeds are dark amber, rough, 4-6 mm. long, narrower and less brittle than those of *J. virginiana*. Some of the *J. virginiana* material proved to be badly worm eaten, while the other lots were quite free from worms. Seeds collected in Vermont were generally good. Table II gives the percentage of bad seeds due to worms and lack of development.



Fig. 1 shows the structure of the seed of *J. virginiana*, with its many membranes and protective layers. In strong contrast with the hard brown coat are the clear white endosperm and embryo. The hard coat consists of three layers: the outer fleshy (*a*), the stony (*b*), and the heavy inner fleshy (*c*). In the outer fleshy layer are found pectic substances and methyl pentosans. The stony layer is lignified and contains other substances, as calcium, pectates, and pentoses. The inner fleshy layer is well developed and consists of suberin with some little cellulose. Of the endosperm, embryo, etc., one distinguishes the nucellus (*d*), the mass of distorted tissue (*e*), the hypocotyl cap (*f*), the megaspore membrane (*j*), the endosperm wall (*k*), the endosperm (*g*), and the embryo (*h*).

TABLE II

PERCENTAGE OF IMPERFECT SEEDS IN LOTS 1, 3, 4, AND 5

Species	Lot	No. examined	Percentage imperfect
<i>J. virginiana</i> .....	1	100	59
<i>J. virginiana</i> .....	1	50	63
<i>J. virginiana</i> .....	1	100	61
<i>J. virginiana</i> .....	1	2000	60
<i>J. communis</i> .....	3	1000	26
<i>J. prostrata</i> .....	4	1000	20
<i>J. virginiana</i> .....	5	2000	22.5

The nucellus is constructed of long narrow cells which give tests for cellulose and pectic acid. The mass of tissue (*e*) protecting the hypocotyl consists of cellulose, pectic substances, and some other groups of substances such as fats and gums. Between this mass and the hypocotyl is a cap of very fine and firm cells (*i*), which are made up of cellulose and hemicellulose. The megaspore membrane (*j*) is very thin and stains with ruthenium red. Examination shows that the outer wall of the outer layer of endosperm cells has been developed into a suberin wall (*k*). This wall is insoluble in concentrated  $H_2SO_4$ , 50 per cent chromic acid, and gives the phellic acid reaction. The endosperm cell walls are rather thick and made up of cellulose. Cell walls of the embryo are thin and consist of pectose and cellulose.

The storage substances of the resting seed are mentioned here, but they are later taken up in detail with the changes accompanying germination. Tannin is generally distributed throughout the coat. Some is stored in the nucellus, endosperm wall, and hypocotyl cap, but none was found in the endosperm or embryo. The embryo and endosperm are stored with an abundance of protein and fat, and also a trace of glucose. No starch was found in either endosperm or embryo. Histidine, tyrosine, and arginine are found in both endosperm and embryo. There is also a trace of leucine and probably cystine.

Catalase activity of the embryo and endosperm is low, while that of the coat is negligible. The seed shows peroxidase activity, with a mere trace of oxidase activity.

The resting seed embryo has a  $P_H$  value of about 8, while the endosperm has a  $P_H$  value of about 5. Thus the embryo is basic, while the endosperm is acid, a condition opposite to that usually found in seeds which are ready for germination.

#### Treatment of material

After collection the larger part of the fruit or berry was removed from the seed by running the berries through a coffee mill so wide open as not to injure the seed. Next the seeds were sifted and the milling and sifting repeated. The seed material was then rubbed between two sieves in the presence of an abundance of water. In this way all the berry and excess tissues which prevent

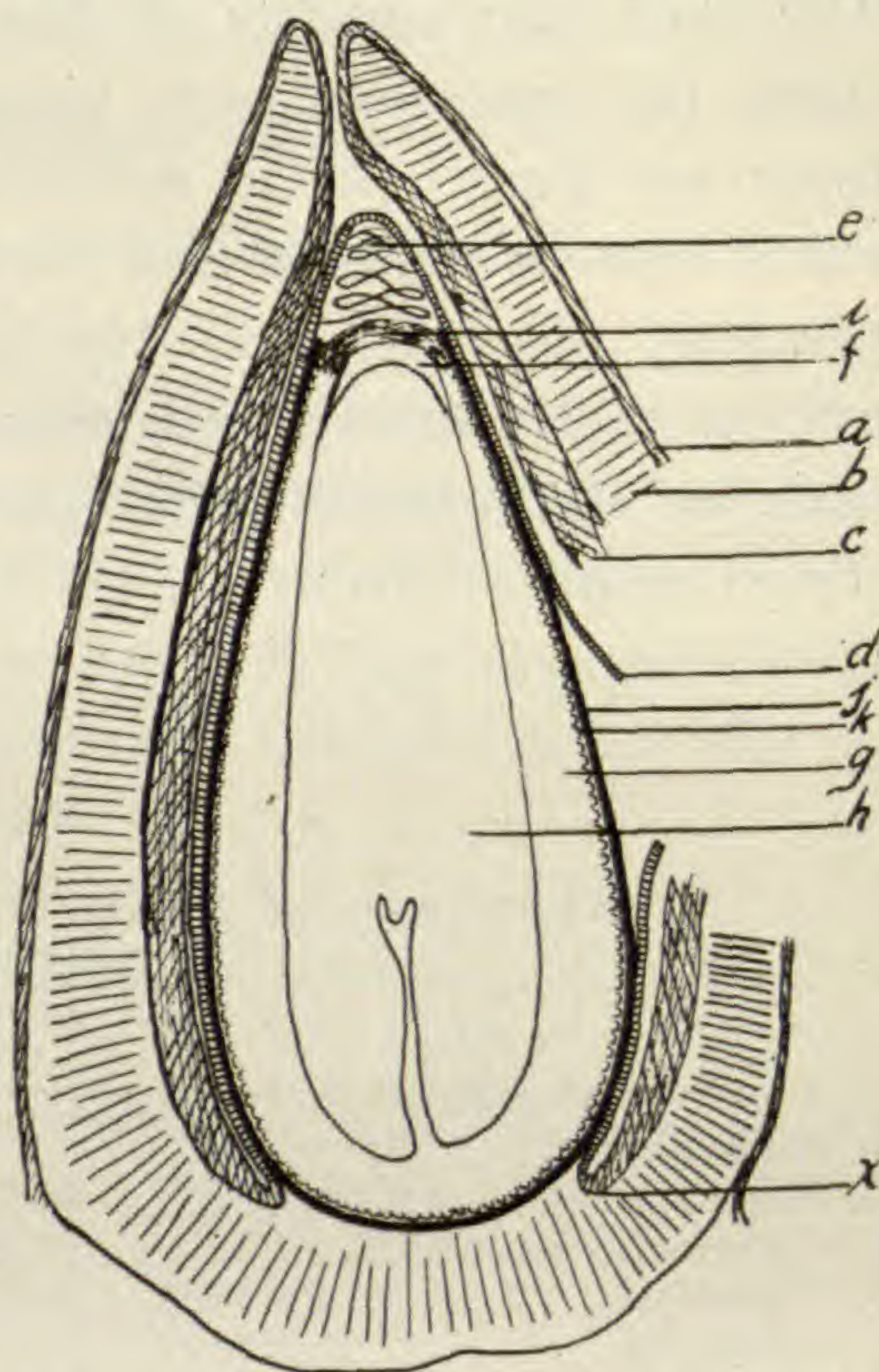

FIG. 1.—Longitudinal section of seed of *Juniperus virginiana* with part of nucellus and integument removed from one side: *a*, outer fleshy; *b*, stony; *c*, inner fleshy; *d*, nucellus; *e*, distorted tissue; *f*, hypocotyl cap; *i*, protective cap; *j*, megaspore membrane; *k*, endosperm wall; *g*, endosperm; *h*, embryo.

sterilization were easily and quickly removed. The bad seeds were floated off with water, and the good seeds rinsed and permitted to dry before sterilization.

After some testing, a 5 per cent solution of formalin acting for 2.5 minutes was selected as the best sterilizing agent for juniper seeds. It was found that formalin did not readily penetrate the coat, reduce the catalase activity, or hinder germination. The permeability of the coat was studied as follows. Seeds were submerged in different solutions for a definite time, removed, washed in distilled water, the coats removed, the seeds sectioned with a freezing microtome, and the sections tested for the respective solutions. Table III shows that the coat was very permeable to water, bases, and salts, but not permeable to stains and acids.

TABLE III

PERMEABILITY OF COATS TO WATER, STAINS, ACIDS, BASES, FORMALIN, AND SALTS

Substance	Permeability	Substance	Permeability
Eosin (dilute).....	Impermeable	Water.....	Very permeable
Eosin (strong).....	Impermeable	C <sub>2</sub> H <sub>5</sub> OH.....	Very permeable
Neutral red (dilute)..	Impermeable	NaOH.....	Very permeable
Neutral red (strong).	Impermeable	KOH.....	Permeable
Formalin.....	Slowly permeable	NH <sub>4</sub> OH.....	Permeable
HCl N/100.....	Very impermeable	AgNO <sub>3</sub> .....	Very permeable
H <sub>2</sub> SO <sub>4</sub> N/100.....	Very impermeable	HgCl <sub>2</sub> .....	Very permeable

That the salts (AgNO<sub>3</sub> and HgCl<sub>2</sub>) penetrated the coats is shown by the catalase activity of the seeds with coats removed (table IV). These seeds, after being sterilized, washed, and incubated at 9° C. for 48 hours, had coats removed, and were ground for catalase activity determinations. It was further shown that AgNO<sub>3</sub> penetrated the coats by the fact that seeds so treated were killed. Seeds sterilized in formalin germinated, and therefore most of the seeds used in these experiments were sterilized 2.5 minutes in 5 per cent formalin. In this connection it should be noted that SCHROEDER (33) and GROVES (14) found that the coat of the wheat seed was practically impermeable to AgNO<sub>3</sub>, and that this solution was a good sterilizing agent for wheat. This shows how the permeability of seed coats may vary with different seeds.

For some experiments the seeds were freed from the probable inhibiting influence of the hard coats by one of the three following treatments: (1) dry seeds were put into concentrated  $H_2SO_4$  and the rate of penetration followed by testing with congo red; it required 24 hours to entirely carbonize the coat; the carbonized coats were rubbed off with filter paper and the seeds rinsed in a suspension of  $CaCO_3$  and distilled water; (2) seed coats were also removed with seed nippers; (3) in other experiments only the end of the coat was cut away. The sterile seeds were put into sterile wide mouthed bottles, Petri dishes, or flasks for germination. Those cultures

TABLE IV

EFFECT OF STERILIZING AGENTS ON CATALASE ACTIVITY OF SEEDS, TREATED 2 MINUTES (40 SEED COATS REMOVED)

STERILIZING AGENTS	OXYGEN IN CC. LIBERATED DURING		
	1 min.	5 min.	10 min.
Water (check).....	9.0	20.0	24.3
Water (check).....	8.9	19.0	24.0
Formalin 5 per cent.....	8.5	21.0	24.8
Formalin 5 per cent.....	8.8	21.2	24.4
$AgNO_3$ 2 per cent.....	3.0	6.0	8.0
$AgNO_3$ 2 per cent.....	3.1	6.4	8.1
$HgCl_2$ 1 per cent.....	4.0	11.2	13.0
$HgCl_2$ 1 per cent.....	4.1	10.0	11.8

which required good ventilation were protected against infection by a system of tubes plugged with cotton. The seeds were left on the moist walls of the containers or on moist filter paper, depending upon the conditions of the experiments. In the determination of the effect of solutions as forcing agents, no foreign absorbing material was allowed in the flasks with the seeds. In all other cases, except where mentioned, the seeds were placed on moist filter paper.

#### Forcing agents

The change of the catalase activity and the ability of the seeds to germinate were used as standards to determine whether or not the substance or treatment under examination was a forcing agent for the juniper seed.

**METHODS.**—As it has been shown that catalase activity increases with after-ripening of the dormant-embryo seeds (6, 10), catalase activity was chosen as the first standard. Germination, the production of independent seedlings, was selected as the final standard. Great care was found necessary in the preparation of material and the manipulation of the catalase apparatus. As the berry has a high catalase activity, every trace of fruit was removed before grinding. The grinding was carried out under similar conditions, and with a definite amount of water and no. 2 sand per unit weight of seed material. The dioxogen was neutralized with N/10 NaOH at the time of using. All determinations were made with the bath at 25° C., and the drive wheel of the apparatus regulated to make 30 revolutions per 10 seconds. No explanation is needed for germination as a standard.

**FORCING AGENTS.**—Among the common forcing agents tried on the juniper seeds were high temperatures, alternating temperatures, removal of coats, hydrogen peroxide, dilute acids, carbon dioxide, light, soil, mercuric chloride, ether, and oxygen. The first seven of these had very little effect on the catalase activity and did not force germination. While the treatments with mercuric chloride, ether, and oxygen did not force germination, each had its influence upon catalase activity.

CROCKER and HARRINGTON, in an unpublished work at the Seed-testing Laboratories of the Bureau of Plant Industry, have found that  $\text{HgCl}_2$  was a good forcing agent for Johnson grass. Juniper seeds were sterilized and put into flasks containing the following concentrations of  $\text{HgCl}_2$ . After 24 hours the excess of liquid was poured off. The results are given in table V. These data, as well as those obtained by grinding the seeds for catalase activity in the same concentrations, show that  $\text{HgCl}_2$  reduced catalase activity in the higher concentrations. None of the seeds treated with  $\text{HgCl}_2$  germinated.

In studying the effect of ether, seeds were sterilized, put into Petri dishes without covers, and exposed to air containing various amounts of ether by sealing in 9 liter cans. After a certain exposure the seeds were removed, aired, and placed to germinate. Table VI gives the catalase activity for seeds that were exposed to ether

6 days and then left in the germinator 95 days at 25° C. Seeds similarly treated, except that they were exposed only 2 days, gave less marked catalase activity. The point to be noted in table VI is the increased activity which was given by seeds treated with the larger amounts of ether. Of added interest is the fact that there

TABLE V

CATALASE ACTIVITY OF SEEDS TREATED 95 DAYS WITH HgCl<sub>2</sub> SOLUTIONS AND PERCENTAGE OF GERMINATION AFTER 6 MONTHS

CONCENTRATION OF HgCl <sub>2</sub> USED	OXYGEN IN CC. LIBERATED DURING		
	1 min.	5 min.	10 min.
N/800.....	0.5	2.3	2.9
N/1600.....	1.6	3.0	3.4
N/3200.....	1.3	3.1	3.9
N/6400.....	2.5	3.5	4.0
N/12800.....	3.0	4.0	4.6
N/25600.....	3.0	4.5	5.0
N/51200.....	3.2	5.0	5.9
N/102400.....	2.9	5.5	6.2
Water (check).....	2.8	5.5	6.0

TABLE VI

EFFECT OF ETHER ON CATALASE ACTIVITY OF JUNIPER SEEDS KEPT AT 25° C.

AMOUNT OF ETHER PER 0 LITERS OF AIR	OXYGEN IN CC. LIBERATED DURING		
	1 min.	5 min.	10 min.
1.4 cc.....	2.9	6.0	6.1
2.8 cc.....	3.5	7.8	8.4
5.6 cc.....	4.8	10.0	10.9
8.4 cc.....	5.0	10.5	11.0
16.8 cc.....	5.6	11.0	11.5
Without ether (check).....	2.8	5.5	6.0

was no germination. It is suggested, therefore, that one may have an enormous increase of catalase activity without a corresponding after-ripening of the dormant embryo.

To study the effect of oxygen, seeds were sterilized and exposed to air containing the following percentages of oxygen. Table VII gives the catalase activity for seeds at the end of 45 days. With the higher percentage of oxygen there was an increase of catalase

activity. At the forty-fifth day the remaining seeds were exposed to atmospheric air. Table VIII gives the catalase activity for the same lot of seeds at the end of 95 days, 50 days after replacing the oxygen by air. The point of interest here is the fall in catalase

TABLE VII

EFFECT OF OXYGEN ON CATALASE ACTIVITY OF SEEDS STORED  
45 DAYS AT 25° C.

PERCENTAGE OF OXYGEN	LOT	OXYGEN IN CC. LIBERATED DURING		
		1 min.	5 min.	10 min.
30.....	1	2.5	4.4	4.8
55.....	2	3.4	5.3	5.6
80.....	3	3.7	6.2	6.6
100.....	4	4.8	7.5	8.8
Air (check).....	.....	3.8	6.2	6.9

TABLE VIII

REDUCED CATALASE ACTIVITY IN OXYGEN TREATED SEEDS WITH  
DECREASE IN PERCENTAGE OF OXYGEN

LOT	OXYGEN IN CC. LIBERATED DURING		
	1 min.	5 min.	10 min.
1.....	2.8	5.0	6.0
2.....	2.9	5.1	6.1
3.....	2.7	5.0	5.8
4.....	2.8	5.0	5.6
Air (check).....	2.8	5.5	6.0

activity, at the ninety-fifth day, for the seeds that were exposed to 100 per cent O<sub>2</sub> during the first 45 days. None of these seeds germinated.

TEMPERATURE.—No other condition affected the development of the juniper seeds to the extent that temperature did. Both alternating and constant temperatures ranging from 15–30° C. were found to reduce the catalase activity and inhibit germination. Seeds exposed to winter weather (in soil and on moist filter paper) gave about 1 per cent germination. Those subjected to a temperature of 10–12° C. in running water showed a steady increase of catalase activity up to the time of germination. Between the

fourth and sixth month the germination reached 10 per cent, a very marked increase over that obtained at the higher temperatures. When the temperature of the water rose much above  $12^{\circ}$  C. germination ceased. These results show that the increased germination was not due to the removal of inhibiting substances from the coat, but to the effect of the low constant temperature.

Although many observers (11, 20, 29, 30) have reported a forcing action for freezing and freezing with thawing, these results show that when freezing really occurs it is very injurious. On March 14, 1919, 1000 air-dry seeds and 1000 moist seeds were placed at a constant temperature of  $-23^{\circ}$  C.; and 1000 air-dry and 1000 moist seeds were subjected to an alternation of temperature between  $-23^{\circ}$  and  $10^{\circ}$  C. The latter seeds were left at each temperature for one week. After 45, 95, and 150 days of exposure samples were removed for study. The catalase activity of these seeds for 45 and 95 days is given in table IX. The catalase activity of seeds stored dry at  $-23^{\circ}$  C. equaled that of untreated seeds, while that of seeds stored wet at  $-23^{\circ}$  C. and wet or dry at the alternating temperature showed a marked decrease. There was no change in the oxidase or peroxidase activity. The seeds stored dry at  $-23^{\circ}$  C. showed no increase of  $H^{+}$  ion or titratable acid over that of the untreated seed. All other seeds showed a slight increase of sugar content and of  $H^{+}$  ion concentration; also a 40 per cent gain of titratable acid. Both embryo and endosperm of these seeds, stored at the alternating temperatures, had the same  $H^{+}$  ion concentration. The fats in these seeds were very soluble, not characteristic, and diffused throughout the endosperm and embryo. This general diffusion of the fats and the equal  $H^{+}$  ion concentration for the embryo and endosperm indicate that the membranes had become more permeable by freezing (16). On staining these seeds with methylene blue they appeared to be dead. Samples of all seeds were put under favorable conditions for after-ripening and germination, but only the seeds that were stored dry at  $-23^{\circ}$  C. after-ripened and germinated. These results prove that these low temperatures are very injurious unless the seeds are dry. It is probable that seeds stored at this low constant temperature and protected from moisture would retain their viability many years.



The alternation of temperature between  $-23^{\circ}$  and  $10^{\circ}$  C. kills moist *Juniperus* seeds very soon, and in no sense can be looked upon as a forcing agent.

One lot of moist seeds was subjected to a temperature of  $-5^{\circ}$  C., and a second lot to an alternating temperature of  $-5$  and  $5^{\circ}$  C. The latter was exposed to each temperature for one week

TABLE IX

EFFECT OF TEMPERATURE ON CATALASE ACTIVITY OF JUNIPER SEEDS (NO. 10)

MATERIAL AND TREATMENT		O <sub>2</sub> IN CC. LIBERATED DURING			TOTAL LOSS OR GAIN OVER THAT OF DRY SEEDS (CC.)	
Condition	Weight in gm.	Temperature °C.	1 min.	5 min.		10 min.
Stored 45 days						
Dry.....	0.025	.....	2.6	5.4	5.8	.....
Dry.....	0.025	-23	2.5	5.4	5.7	-0.1
Wet.....	0.026	-23	2.4	5.0	5.5	-0.3
Dry.....	0.023	-23 and +10*	2.2	4.9	5.4	-0.4
Wet.....	0.026	-23 and +10*	1.6	3.2	3.6	-2.2
Wet.....	0.025	-5	3.0	5.1	5.8	0.0
Wet.....	0.025	0	3.0	6.0	6.5	+0.7
Wet.....	0.026	-5 and +5*	3.5	6.8	7.0	+1.2
Wet.....	0.026	+5	3.6	7.5	9.1	+3.3
Wet.....	0.026	+10	3.5	6.6	7.0	+1.2
Wet.....	0.026	+25	3.0	6.2	6.9	+1.1
Stored 95 days						
Dry.....	0.023	-23	2.3	5.5	5.8	0.0
Wet.....	0.023	-23	2.4	5.1	5.7	-0.1
Dry.....	0.026	-23 and +10*	2.0	4.2	5.0	-0.8
Wet.....	0.025	-23 and +10*	1.0	2.8	3.1	-2.7
Wet.....	0.025	-5	3.0	6.4	6.5	+0.7
Wet.....	0.025	0	3.4	7.0	8.0	+2.2
Wet.....	0.026	-5 and +5*	3.8	8.0	9.0	+3.2
Wet.....	0.026	+5	5.0	9.1	12.0	+6.2
Wet.....	0.026	+10	3.9	8.2	9.2	+3.4
Wet.....	0.026	+25	2.8	5.5	6.0	+0.2

\*Weekly alternated between the two temperatures.

at a time. Table IX shows the catalase activity of these seeds for 45 and 95 days exposure. The lot stored at  $-5^{\circ}$  C. showed scarcely any increase of catalase activity, while the lot exposed to the alternating temperature was more active. Both lots appeared morphologically and physiologically in good condition. There was a slight accumulation of sugar in all seeds. The first showed

no germination, but some of the latter germinated after about 6 months. While exposure to  $-5^{\circ}\text{C}$ . was not sufficient to injure the ungerminated seeds, it proved fatal to the germinated seeds. This is due to the fact that when the coat splits open the endosperm and embryo just doubles its water content and thereby dilutes the cell sap to a degree which permits ice crystals to form. Seeds at this period and later periods of development were killed by exposure to  $-5^{\circ}\text{C}$ . for seven days or less. The after-ripening and gain in catalase activity was a little more than enough to account for the sum of the effect at  $5^{\circ}\text{C}$ . These results show that the alternation of temperature between  $-5^{\circ}$  and  $5^{\circ}\text{C}$ . had slight forcing action. This forcing action is equal to that obtained by keeping seeds in running water at  $10^{\circ}\text{C}$ . It is also evident that seeds ready to germinate should not be subjected to  $-5^{\circ}\text{C}$ .

The early changes taking place in seeds put to germinate at  $0\pm 1^{\circ}\text{C}$ . were similar to those at  $5^{\circ}\text{C}$ . except for being retarded. At this temperature the increase in catalase activity was very much retarded, although it was over 3 times that gained by seeds stored at  $-5^{\circ}\text{C}$ . per unit time. These seeds were studied as to storage material,  $\text{H}^{+}$  ion concentration, and permeability, and found in good condition. The *Juniperus* seeds not only after-ripened but germinated at  $0\pm 1^{\circ}\text{C}$ ., even though it required 5 or 6 months.

Moist seeds were placed at  $5^{\circ}\text{C}$ . for germination. At this temperature the catalase activity increased most rapidly. The physiological changes occurring in the seed at  $5^{\circ}\text{C}$ . were most rapid, and will be discussed in detail under changes preparatory to germination. This constant temperature of  $5^{\circ}\text{C}$ . also gave rise to by far the largest percentage of germination, and the most vigorous seedlings.

It is evident from these germination experiments that: (1) temperatures above  $10^{\circ}\text{C}$ . and below  $0^{\circ}\text{C}$ . are not favorable for after-ripening and germination; (2) no one of the forcing agents as used was of value in germination; (3) the inclosing structures do not inhibit germination; (4) but the inhibiting conditions are to be found in the endosperm and embryo. These facts indicate that the juniper seed has a dormant embryo that must go through

a series of fundamental changes before germination. Of the many points of attack that are suggested by these experiments two were chosen: (1) changes preparatory to germination, and (2) means of shortening the after-ripening period.

### Changes preparatory to germination

These are the changes that occur in the seeds stored at 5° C. which prepare them for germination. As the embryo of the dry seed is morphologically complete, increases very little in size, and shows only the transformation of cell contents, these processes could be spoken of as "foregermination"; but as this term has not been used in this country these processes will be referred to as after-ripening. The first point studied was the imbibition of water.

TABLE X

SHOWING PERCENTAGE ABSORPTION OF WATER  
(SEEDS DRIED AT 105° C. FOR MOISTURE DETERMINATION)

Material	Percentage water	Weight	Weight after submergence for hours indicated									Percentage water at maximum imbibition
			2	4	8	16	24	72	96	120	360	
Entire seed .....	7.00	2.0018	2.16	2.37	2.40	2.41	2.42	2.42	2.43	2.42	2.39	23.22
Endosperm and embryo coats off during imbibition .....	7.19	0.290	.....	.....	.....	.....	0.37	0.38	.....	0.37	.....	28.94
Endosperm and embryo coats on during imbibition .....	7.19	0.291	.....	.....	.....	.....	.....	.....	0.375	.....	.....	24.84

Table X shows that the seeds decreased slightly in weight after a few days, even when submerged in water. In examining the tables given by LAKON for the water absorption of seeds of *Pinus*, it was noted that he incidentally obtained similar results. To follow this more closely, seeds with coats on were placed on moist filter paper at 5° C., and at times samples were selected, coats removed, and the percentage of water in the seed, exclusive of coat, determined. Table XI gives these results and the percentage of water in the seedlings as well. It should be noted that the water content of the seed decreased gradually until germination, when there appeared a very marked increase up to the time of the developed seedling. This percentage of water seems to be related to the change in the water absorbing power of seed contents, and

not to changes in the permeability of the coat, as later experiments show.

Table XII gives the changes of  $H^+$  ion concentration as  $P_H$  values for the endosperm and different parts of the embryo during storage at  $5^\circ C$ . The outer cells of the embryo and its hypocotyl were the first parts to show an increased  $H^+$  ion concentration.

TABLE XI

PERCENTAGE OF WATER IN SEEDS TAKEN FROM COATS AFTER DIFFERENT PERIODS OF EXPOSURE TO  $5^\circ C$ .

Seeds	Percentage water
Dry.....	7.19
After 5 days at $5^\circ C$ .....	24.84
After 15 days at $5^\circ C$ .....	23.34
After 30 days at $5^\circ C$ .....	23.09
After 60 days at $5^\circ C$ .....	23.00
After 90 days at $5^\circ C$ .....	23.21
After 100 days at $5^\circ C$ . (coat splitting open).....	52.64
After 130 days at $5^\circ C$ . (seedlings 25 mm. long)....	88.38

TABLE XII

$H^+$ ION CONCENTRATION OF SEEDS DURING AFTER-RIPENING\*

Condition	Part of seed	$P_H$
Dry.....	Endosperm	4.4-6.0
Dry.....	Embryo	8.4-8.8
After 30 days at $5^\circ C$ .....	Endosperm	4.6-5.2
After 30 days at $5^\circ C$ .....	Embryo	6.8-7.6
After 60 days at $5^\circ C$ .....	Endosperm	4.4-6.0
After 60 days at $5^\circ C$ .....	Embryo	6.8-7.6
After 90 days at $5^\circ C$ .....	Embryo hypocotyl	6.0-6.8
After 90 days at $5^\circ C$ .....	Endosperm	4.4-5.2
After 90 days at $5^\circ C$ .....	Embryo outer cells and hypocotyl	4.4-5.2
After 90 days at $5^\circ C$ .....	Embryo inner cells	4.6-6.0

\* These determinations were made with the Clark and Lubs indicators.

The embryo showed a marked increase of  $H^+$  ion concentration during after-ripening, while the endosperm with  $P_H$  value of 4.4 (concentration of  $H^+$  ions  $\times N = 0.72 \times 10^{-4}$ ), being already acid, showed very little change. This may indicate that the embryo is the principal seat of dormancy. Table XIII gives the increase of titratable acid in the endosperm and embryo during after-ripening. The increased acid was determined by titrating with  $N/50$  NaOH,

using phenolphthalein as the indicator. To show that this increased acid content is real the calculated dry weight of the seed material used is given.

The fat of the dry seeds is stored as very large globules, contrary to the statements of CZAPEK, which divide and become continually smaller as after-ripening goes on. Just preceding germination these fat globules, in the active growing cells, become reduced to microscopic size, although CZAPEK states that the microscopically divided fat of dry seeds collects into globules with early

TABLE XIII

INCREASE OF TITRATABLE ACID IN ENDOSPERM AND EMBRYO

Condition	No.	Dry weight in gm.	N/50 NaOH in cc.	Increased acid per unit volume of water
Dry.....	80	0.165	0.56	.....
Dry.....	160	0.348	1.25	.....
Dry.....	80	0.160	0.53	.....
Dry.....	80	0.164	0.55	0.0254
After 15 days at 5° C.....	80	0.163	0.57	0.0989
After 30 days at 5° C.....	80	0.172	0.58	.....
After 30 days at 5° C.....	80	0.172	0.60	0.0866
After 60 days at 5° C.....	80	0.169	0.70	.....
After 60 days at 5° C.....	80	0.167	0.70	0.0685
After 95 days at 5° C.....	80	0.157	0.85	.....
After 95 days at 5° C.....	80	0.163	0.90	0.0564
Open seeds.....	80	0.189	1.50	0.1426
Hypocotyl 2 mm.....	80	0.195	2.60	0.1615
Seedlings.....	80	0.210	8.00	.....
Seedlings.....	80	0.204	8.00	0.1865

growth (7). This dispersion of the fatty material brings clearly into play surface tension, adsorption power, and many other forces resulting from the great increase of specific surface. Such a dispersion could lead to a more rapid digestion of the fats, thus materially aiding the transformation of fats to carbohydrates and the accumulation of energy for germination. The importance of making the fats more capable of transformation to carbohydrates should not be overlooked. It is also probable that this dispersion reaches a degree of division where it could aid in the translocation of fats as such. Thus highly dispersed fatty material would be carried through the cell walls at points of protoplasmic connection.

Early during the process of after-ripening there was a slight decrease in the fat content of the endosperm cells surrounding the embryo. The most rapid disappearance of fat occurred in the hypocotyl end of the endosperm at approximately the ninety-fifth day. This rapid decrease of fat was accompanied by an increase in the sugar content of the adjoining hypocotyl cells. This was the first noticeable increase of sugar during after-ripening. At this time the coat splits open, probably partly due to the increased osmotic pressure of the newly synthesized sugar. With these changes the first detectable starch was found. It increased very rapidly in these cells, until they seemed to be completely packed. Traces of starch appeared in the cotyledons and they soon became green, a point to be taken up later. Thus during the preparation for germination the stored fat was transformed into carbohydrates. Not all the fat is changed directly into carbohydrates. Under certain conditions it seems to be changed into forms more capable of translocation and used to synthesize other compounds, or even stored again. It seems that a large part of the food material of these seeds during after-ripening, germination, and the development of the seedling is translocated in this form.

Amino acids appear in both ungerminated (dry) and germinated seeds. Table XIV gives the amino acids found in these seeds, as well as a rough estimate of their quantities. The histidine in the endosperm was used up completely during the after-ripening.

Table XV gives the changes occurring in the proteins of *Juniperus* seeds during germination as indicated by color reaction. These results show that soluble proteins increased during after-ripening. It was also shown that the proteins were hydrolyzed during after-ripening by the determination of amino nitrogen and the formal titration. Table XVI gives the results of the VAN SLYKE determination for amino acids. This table shows that the 5 minute reaction period was too short, which indicates the presence of amino acids with other than  $\alpha$ -amino groups. The arginine found would account for the increase under 30 minutes reaction. These figures prove that there was a marked hydrolysis of the proteins during after-ripening, as well as during germination and the development of

seedlings. As this protein digestion goes on, the number of free amino groups increases because of the splitting amino-carboxyl linkings. When hydrogen of the free amino group is replaced by

TABLE XIV  
TESTS FOR AMINO ACIDS IN JUNIPER SEEDS

AMINO ACIDS	CRYSTALLI- ZATION	COLOR REACTIONS	AMOUNT OF AMINO ACIDS IN			
			Dry seeds		After-ripened seeds	
			Endosperm	Embryo	Endosperm	Embryo
Histidine....	+	Ehrlich's diazo	+++	+++	+	++
Tyrosine....	+	Ehrlich's diazo	+	+	++	++
Tyrosine....	+	Millons	+	+	++	++
Tyrosine....	+	Xanthroproteic	+	+	++	++
Cystine....	+	Sulphur reduction	+	+	+	+
Leucine....	+	.....	+	+	++	++
Arginine....	+	.....	+	+	++	++

TABLE XV  
CHANGES IN STORED PROTEIN FOOD DURING GERMINATION

REACTIONS	DRY SEEDS			AFTER-RIPENED SEEDS		
	Endosperm	Embryo	Hypocotyl	Endosperm	Embryo	Hypocotyl
Biuret.....	++	+++	+++	+	+	++
Millons.....	+++	+++	+++	++	++	+
Xanthroproteic.....	+++	++	++	+++	++	+
Berlin blue.....	+	?	?	+	++	+++

TABLE XVI  
INCREASE OF AMINO NITROGEN DURING AFTER-RIPENING AND GERMINATION

Condition of seed material	Time of reaction (min.)	N (cc.)	Temperature	Pressure (mm.)	Nitrogen obtained (mg.)	Amino acid as percentage of dry weight
Dry or resting.....	5	0.25	23.2	753.2	0.138	0.035
Coats bursted after 100 days at 5° C.....	5	0.50	24.7	750.8	0.274	0.270
Hypocotyl 3 mm. long or after 105 days at 5° C.....	5	0.59	24.5	751.0	0.324	0.275
Developed seedling or after 130 days at 5° C.....	5	1.41	24.5	751.3	0.775	0.921
Dry or resting.....	30	0.60	23.2	753.2	0.332	0.036
Coats bursted after 100 days at 5° C.....	30	0.84	24.2	750.7	0.462	0.279
Hypocotyl 3 mm. long or after 105 days at 5° C.....	30	1.17	24.5	750.7	0.642	0.280
Developed seedling or after 130 days at 5° C.....	30	1.97	25.2	750.7	1.078	0.935

methylene, the basicity becomes reduced; and the substituted acid can then be titrated with sodium hydrate as a measure of protein hydrolysis. Titrations made on a second lot of seeds according to the SORENSEN method gave results similar to the VAN SLYKE determinations.

The growth in these seeds occurring before germination is very meager. There is no morphological change in endosperm or embryo, although the latter increased slightly in length. After the appearance of sugar the hypocotyl exerts a forward pressure, separating the sides of the swelling cap which forces the coat open. At this moment the cap is under so much pressure that it is distorted, and a sharp angle is formed between its end and sides. The growth following this stage will be discussed later.

TABLE XVII

RESPIRATION OF SEEDS AT DIFFERENT PERIODS OF DEVELOPMENT AT 25° C.  
(7 CC. VOLUME)

Condition of seeds	No.	Green weight	Days	Percentage CO <sub>2</sub>	Percentage CO <sub>2</sub> +O <sub>2</sub>	Percentage O <sub>2</sub> used	CO <sub>2</sub> / O <sub>2</sub>	Mgm. CO <sub>2</sub> per hour per gm.	Mgm. O <sub>2</sub> per hour per gm.
Dry.....	500	1.250	5	1.18	20.82	1.57	0.76	0.00098	0.0011
After 5 days at 5° C.	50	0.125	1	3.15	20.39	3.77	0.84	0.1311	0.1347
After 30 days at 5° C.	10	0.030	3	3.78	20.82	3.98	0.94	0.218	0.1976
After 60 days at 5° C.	10	0.027	3	3.80	20.70	3.90	0.97	0.2352	0.2151
After 90 days at 5° C.	10	0.028	3	3.80	20.68	3.90	0.97	0.2354	0.2075
After 100 days at 5° C.	10	0.028	3	4.10	20.00	6.00	0.68	0.2486	0.3192
After 130 days at 5° C.	10	0.099	1	9.30	20.56	9.74	0.95	0.4890	0.4398

Table XVII gives the results of the respiration experiments obtained by the use of the Bonnier and Mangin apparatus. There was a great increase in the respiratory intensity during the first 5 days and after the seeds split open. These are the periods when the seed increased in water content. There was a very slow increase in the respiratory intensity during after-ripening, even though the water content decreased. The respiration quotient increased very slightly during after-ripening, but decreased to a minimum at germination. Not only does this low respiratory quotient of 0.68 indicate the time of intense fat metabolism, but at this particular period it was found that the fats were being transformed into carbohydrates. It would be interesting to know this quotient at 5° C., as it would probably be much lower. After germination



the seedlings gradually attained the ratio 1:1. This rise in the respiratory quotient was probably due to the oxidation of carbohydrates and the more intense respiration of the seedlings.

Table XVIII gives the results of intramolecular respiration. The method used was that of NICOLAS (26). The point to be noted here is the low  $r/N$  ratio (the intramolecular or anaerobic respiration divided by the normal respiration) for the seedlings.

Peroxidase was more generally present than oxidase. Quantitative oxidase activity determinations were made with the Bunzel apparatus. These results showed that there was no appreciable increase of oxidase activity until after germination.

TABLE XVIII

INTRAMOLECULAR RESPIRATION OF JUNIPER SEEDS, NO. 10, AT 25° C. (7 CC. VOLUME)

Condition of seeds	Weight	Days	Percentage CO <sub>2</sub>	$r/N$ ratio
After 30 days at 5° C.....	0.030	3	1.70	0.44
After 90 days at 5° C.....	0.028	3	1.67	0.43
After 100 days at 5° C.....	0.028	3	1.66	0.40
After 130 days at 5° C.....	0.099	1	0.95	0.10

The results of catalase determinations are given in table IX, which gives the average of a great number of experiments. It was found that (1) when seeds were placed under ordinary germination conditions at 5° C. the increase of catalase activity gave a measure of the after-ripening; (2) the gain in catalase activity above that of air-dry seeds was greatest at 5° C. in a germinator; (3) the gain at the other temperatures was slow at best; and (4) seeds soon lose their catalase activity when in a germinator at temperatures above 25° C. The precautions used in the catalase determinations have been stated.

CROCKER (6) speaks of the rise in vigor of seeds, as shown by their resistance to fungal attack, during after-ripening. The juniper seed is protected against fungi before germination by the heavy lignin coat. It was found that juniper seeds which had not been after-ripened soon succumbed to fungal growths with the removal of the coats. After-ripened juniper seeds, however, when freed from the coats, withstood dense fungal growths.

Many such experiments indicate that the vigor and resistance of the seed to fungi increased greatly during the after-ripening process. These results prove that the juniper seed has a dormant embryo that goes through certain definite and well defined fundamental chemical and physical changes before germination can occur. Some changes occur also in the endosperm.

SHORTENING AFTER-RIPENING PERIOD AT 5° C.—The after-ripening period was shortened considerably by the constant temperature of 5° C., as has been shown, but attempts to shorten further this after-ripening period at 5° C. seemed to meet with difficulties. GUPPY'S (15) method of forcing seeds to germinate by placing the soft pre-resting seeds (caught before going into the rest period) at 20° C. was tested. None of these seeds germinated, and it is evident that the juniper seed must pass through a more or less definite rest and after-ripening period. This period was not shortened by the removal of the seed coats. ECKERSON (10) states that dilute acids greatly shorten the after-ripening period of the hawthorn. Dilutions of HCl between N/100 and N/3200 had no effect upon the juniper seed. Neither sugar, enzyme, nor vitamine solutions shortened this period. Hydrogen peroxide gave no results. In the treatment with different percentages of oxygen, it was found that the catalase activity increased slightly with increased oxygen pressure, and that the germination was retarded two months. Seeds were treated with different percentages of ether ranging from 0.002 to 6.000. As long as these seeds were under the influence of ether they showed a decrease in catalase activity proportional to the percentage of ether used. After atmospheric conditions were restored, all seeds recovered their catalase activity, but the after-ripening period was lengthened from 1 to 3 months depending on the low and higher percentages of ether. If the ether acted by decreasing the permeability, then it was evidently reversible, contrary to the work of OSTERHOUT (27). It is more probable, however, that the ether acted as a narcotic agent. This is also shown by the behavior of the seed. Carbon dioxide was used in concentrations ranging from 0.5 to 100 per cent with a six day exposure. The higher percentages increased the catalase activity and shortened slightly the after-ripening period. The action here

was probably due to increased acidulation in the presence of an abundance of  $\text{CO}_2$  and  $\text{H}_2\text{O}$  which could favor the digestion of fats and germination (25). Desiccation and moistening again of seeds at about the forty-fifth day after being placed in the germinator shortens the after-ripening period from 5 to 10 days. This may be due to one of the following causes: (1) earlier after-ripening of the coats, as they are found to split off more readily when desiccated, (2) upsetting of the chemical equilibrium by the great extraction of water, or (3) the increase of  $\text{H}^+$  ion concentrations.

### Discussion

CATALASE.—The catalase activity, as has been noted by previous investigators (1, 6), was found to bear some relation to respiration. Increased catalase activity accompanied the intense respiration of *Juniperus* seeds stored in high percentages of oxygen, as decreased

TABLE XIX

INCREASED CATALASE ACTIVITY WITH DEVELOPMENT (FIGURED PER UNIT DRY WEIGHT)

CONDITION OF SEEDS	OXYGEN IN CC. LIBERATED DURING		
	1 min.	5 min.	10 min.
Air dry.....	2.5	5.4	5.8
After 45 days at 5° C.....	3.6	7.5	9.1
After 95 days at 5° C.....	5.0	9.1	12.0
After 100 days at 5° C. (coats split).....	5.3	12.2	14.4
After 130 days at 5° C. (seedlings).....	10.5	23.1	28.5

catalase activity accompanied the low respiration of seeds stored in low percentages of oxygen. With the intense respiration at high temperatures there was an increased catalase activity, even though the seeds did not after-ripen or germinate. The highest catalase activity and the most intense respiration per unit of dry weight was found in the seedling stage (cf. tables XIX and XVII). The desiccation of seeds to a slight extent, which makes for a rapid absorption of oxygen through the coat, increased the catalase activity. Desiccation to the extent of retarding respiration reduced the catalase activity. Table XX shows these results. Both the respiration and the catalase activity of seeds were reduced at will

by submerging them in water. Although increased catalase activity generally accompanied intense respiration, this relationship did not always hold, for when seeds were submerged a long time the catalase activity slowly increased, but there was no increase of respiration intensity. An examination of tables IX and XVII will show that the catalase gain was proportionally very much larger than the respiration gain during after-ripening. It will also be noted that the catalase gain was greatest at 5° C., where the respiration was low. It is evident, therefore, that there may be increased catalase activity without an increase of respiration.

TABLE XX

CATALASE ACTIVITY OF AFTER-RIPENED AND DESICCATED SEEDS,  
NO. 30 (CALCULATED DRY WEIGHT 0.0696)

Treatment	O <sub>2</sub> cc. liberated after 10 min.
Complete imbibition.....	33
Slight desiccation.....	38
Strong desiccation.....	32
Second imbibition.....	36

**RATE AND PERCENTAGE OF GERMINATION.**—Juniper seeds germinate most readily at the low temperature of 5° C. These seeds germinate, although very slowly, at 0±1° C. They also germinate at 10° C. Seeds after-ripened at 5° C. and then placed at 10° C. germinated slower than those left at 5° C. After-ripened seeds were thrown into a state of secondary dormancy by exposure to temperatures above 12° C. Their catalase activity gradually decreased and germination ceased. After being thrown into secondary dormancy, several weeks at 5° C. were required to after-ripen the seeds again. The seeds which sank in water gave between 75 and 80 per cent germination at 5° C.

**GROWTH OF SEEDLING.**—Table XXI gives the rate and extent of growth for seedlings exposed to the light or the dark at different temperatures. All seeds were germinated at 5° C. and then transferred to the different temperatures. The length of the extending hypocotyl at the time of transfer was 0–1 mm. The seedlings grew the longest and fastest at 25° C. At 30° C. they never attained

a normal length, while at  $0 \pm 1^\circ \text{C}$ . there was a slow but definite growth. It is important to note that  $15^\circ \text{C}$ . seedlings developed first and appeared the most healthy and sturdy. These seedlings

TABLE XXI

EFFECT OF LIGHT AND TEMPERATURE ON RATE AND EXTENT OF GROWTH\*

TEMPERATURE	LIGHT	LENGTH OF HYPOCOTYL IN MM. FROM TIME OF TRANSFER					
		3 days	7 days	11 days	13 days	18 days	26 days
$30^\circ \text{C}$ ...	Dark	1	5	7	12	18	20
$25^\circ \text{C}$ ...	Dark	10	35	40	55	60	Seedling
$15^\circ \text{C}$ ...	Dark	4	18	29	Seedling	.....	.....
$10^\circ \text{C}$ ...	Dark	3	10	30	35	Seedling	.....
$10^\circ \text{C}$ ...	Light	3	11	29	30	Seedling	.....
$5^\circ \text{C}$ ...	Dark	2.5	4	12	15	26	35
$0 \pm 1^\circ \text{C}$ ...	Dark	0	1	2	3	4	5
$-5^\circ \text{C}$ ...	Dark	0	Killed	0	0	0	0

\*Average of 50 trials.

at  $15^\circ \text{C}$ . also showed the earliest and greatest development of chlorophyll. Light did not seem to affect unusually the extent or rate of growth.

PIGMENTS.—Carbohydrates and temperature may condition chlorophyll development. The seedling was found to develop chlorophyll in total darkness. Thus the cotyledons become green long before they break out of the coat. Chlorophyll appeared first in the cotyledons and accompanied the formation of starch. This points to the conclusion that soluble carbohydrates are necessary for the formation of chlorophyll, the view advanced by PALLADIN (28). Table XXII gives the results of experiments planned to determine the effect of light and temperature on greening. This shows that light affects in no way the rate or apparent depth of greening. It also shows that at  $30^\circ \text{C}$ . and at  $0 \pm 1^\circ \text{C}$ . chlorophyll did not develop. As the plastids were found to be in good condition, it was thought probable that a lack of building material was inhibiting chlorophyll development. Glucose cultures were made, therefore, but the seedlings again failed to develop chlorophyll. This indicates that a certain temperature is necessary for chlorophyll development, regardless of carbohydrate supply,

the maximum, optimum, and minimum temperatures for chlorophyll formation in the seedlings being represented by temperatures somewhat below 30, 15, and somewhat above 0° C.

Seedlings grown at 0±1° C. developed anthocyanin, while those grown at 30° C. developed xanthophyll. When cultures at 0±1° C. were supplied with glucose they developed more anthocyanin. The seedlings grown at 30° C. were made to develop anthocyanin by the addition of glucose. From the foregoing it appears that the seedlings form various pigments according to their reserve sugar

TABLE XXII

EFFECT OF LIGHT AND TEMPERATURE ON DEVELOPMENT OF CHLOROPHYLL\*

TEMPERATURE	LIGHT	ESTIMATED PERCENTAGE OF COLOR AFTER TRANSFER								
		1 day	4 days	6 days	8 days	11 days	13 days	18 days	26 days	50 days
30° C. ....	Light	0	0	0	0	0	0	0	0	0
25° C. ....	Light	5	25	50	50	50	65	.....	.....	.....
15° C. ....	Light	5	25	50	75	75	100	.....	.....	.....
10° C. ....	Light	5	25	50	75	.....	.....	100	.....	.....
10° C. ....	Dark	5	25	50	75	.....	.....	100	.....	.....
5° C. ....	Light	.....	.....	.....	5	.....	.....	50	.....	.....
5° C. ....	Dark	.....	.....	.....	5	.....	.....	50	.....	.....
0# 1° C. ....	Light	.....	.....	.....	.....	.....	.....	.....	.....	0
0# 1° C. ....	Dark	.....	.....	.....	.....	.....	.....	.....	.....	0

\*Average of 50 trials.

supply. Seedlings with little sugar tend to develop xanthophyll, those with more sugar chlorophyll, and those with an abundance of sugar anthocyanin.

PRACTICAL APPLICATION.—The foregoing experiments make it possible to devise an outline for the practical production of juniper plants. This should be of interest to growers, since it has furnished a means of increasing many fold the percentage of germination and of developed seedlings. After collection, the seeds are freed from the berries, sorted, and sterilized as has been described. The seeds are then put into Petri dishes or covered flat vessels on filter paper supported by wet cotton. These vessels of seeds are kept at a constant temperature of about 5° C. (41° F.) for after-ripening, which takes about 100 days. This after-ripening period can be shortened 10 days by drying slightly and moistening again the seeds at about the forty-fifth day. When the coats have split

open and the hypocotyls are  $\frac{1}{8}$  in. long, the seedlings are transferred to pans or beds of leaf mold and sand kept at  $15^{\circ}$  C. ( $60^{\circ}$  F.). In no case should ungerminated seeds (seeds that have not split open and developed a short hypocotyl) be transferred from the germinator at  $5^{\circ}$  C. ( $41^{\circ}$  F.). The germinated seeds, after being transferred to beds or pans, should be protected by glass plates and paper for the first few days.

Although these seeds have been germinating during every month of the year, advantage can be taken of the temperature conditions by placing them in the germinator about January. The importance of this after-ripening and germination at  $5^{\circ}$  C. cannot be overemphasized.

### Summary

1. The germination of non-after-ripened juniper seeds under ordinary conditions is very low, amounting to 1 per cent.

2. These seeds are protected by a semipermeable and thick coat which makes up 75 per cent by weight of the entire seed. Acids enter very slowly, while bases, silver and mercury salts, enter rapidly. While the coat serves as a protection against fungal attack and prevents water-imbibed seeds from expanding and rupturing the tissues before after-ripening is accomplished, it takes little or no part in the dormancy or after-ripening of the seed.

3. Food material in the resting seed is stored in the form of fats and proteins, with traces of glucose but no starch. The resting seed endosperm has a  $P_H$  value of about 5, while that of the embryo is about 8.

4. Although some forcing agents changed the respiration and catalase activity of seeds, it was not possible to force the germination of non-after-ripening juniper seeds by high temperature, alternating temperature, wounding, warm bath, dry air, removal of coats, treatment with hydrogen peroxide, mercuric chloride, ether, carbon dioxide, oxygen, light, soil, dilute acids, dilute bases, nitrates, sulphates, or strong acids.

5. Freezing and thawing as such has no forcing action on the germination of juniper seeds, neither does it hasten after-ripening. Freezing and thawing produces marked chemical changes in this

seed, but these changes, as has been outlined, are quite different from those occurring during after-ripening. Seeds ready to germinate (after the coat is cracked and their water content increased to 52 per cent) are killed by an exposure to  $-5^{\circ}$  C.

6. The juniper seed has a dormant embryo that must after-ripen before germination. After-ripening occurs at temperatures between  $0 \pm 1^{\circ}$  C. and  $10^{\circ}$  C., although fastest at about  $5^{\circ}$  C.

7. The changes that accompany after-ripening of the juniper seed at  $5^{\circ}$  C. were found to be as follows: (1) rather rapid and complete imbibition, followed by a steady slow decrease in water content during after-ripening or until near germination; (2) increased  $H^{+}$  ion concentration, especially of the embryo; (3) an increment of titratable acid; (4) a steady and enormous increase in the degree of dispersion of the stored fat; (5) decrease in the amount of stored fat and protein, with an increase of sugar content and the first appearance of starch; (6) the translocation of food in the form of fat or fatty acids from endosperm to embryo; (7) a seven-fold increase in the amino acid content, and a complete disappearance of histidine from the endosperm; (8) an increase of soluble proteins, with a marked hydrolysis of the stored proteins; (9) slight growth of embryo; (10) very slight increase of the respiration intensity; (11) increased respiratory quotient; (12) decreased intramolecular respiration; (13) a doubling of the catalase activity; and (14) the rise in vigor of seeds as shown by their resistance to fungal attack.

8. In conjunction with after-ripening at  $5^{\circ}$  C., desiccation seems to be the only promising means of shortening this after-ripening period.

9. The time at which the hypocotyl breaks through the nucellus was fixed as the end of after-ripening and the beginning of germination.

10. Neither the resting nor the after-ripened juniper seeds yield more than about 1 per cent germination at temperatures above  $15^{\circ}$  C. Seeds after-ripened at  $5^{\circ}$  C., then placed at  $10^{\circ}$  C., germinate slower than those left at  $5^{\circ}$  C. When after-ripened seeds are transferred from  $5^{\circ}$  C. to temperatures above  $15^{\circ}$  C. they are thrown into a state of secondary dormancy. Hence these seeds require a low temperature for germination as well as for after-ripening, and therefore no seed should be transferred to



higher temperatures until germination has started. If these seeds are given sufficient time they will germinate, even at  $0 \pm 1^{\circ}$  C.

11. Subsequent to after-ripening and germination at  $5^{\circ}$  C., the best temperature for seedling development is  $15^{\circ}$  C.

12. The development of chlorophyll in the juniper seed and seedling was found to be independent of light, but conditioned by the temperature range. Seedlings grown at temperatures of  $0 \pm 1^{\circ}$  C. or  $30^{\circ}$  C. never developed chlorophyll. Anthocyanin development in seedlings seems to depend upon relative temperature and carbohydrate supply.

13. A more complete chemical analysis of these seeds at different stages of development will be given in a later paper.

Acknowledgments are due Dr. WILLIAM CROCKER and Dr. S. H. ECKERSON, under whose direction and criticism this work was carried on.

A. AND M. COLLEGE  
COLLEGE STATION, TEXAS

#### LITERATURE CITED

1. APPLEMAN, C. O., Relation of oxidases and catalase to respiration in plants. Amer. Jour. Bot. 3:223-233. 1916.
2. ATWOOD, W. M., A physiological study of the germination of *Avena fatua*. BOT. GAZ. 57:386-414. 1914.
3. BEHRENS, W., Über die Beeinflussung der Keimfähigkeit gewisser Samen durch Narkose und Verwundung. Bericht. Grossh. Bad. Landw. Versuch. Augustenberg. S. 60-64. 1906.
4. BRUYNING, J. F., On the use of hot water for forcing germination of hard coated seeds. Jour. Landw. 41:86. 1896.
5. CROCKER, W., Mechanics of dormancy. Amer. Jour. Bot. 3:99-120. 1916.
6. CROCKER, W., and HARRINGTON, G. T., Catalase and oxidase content of seeds in relation to their dormancy, age, vitality, and respiration. Jour. Agric. Res. 15:137-174. 1918.
7. CZAPEK, F., Biochemie der Pflanzen. 1:710. Jena. 1913.
- ✓ 8. DAVIS, W. E., and ROSE, R. C., The effect of external conditions upon the after-ripening of the seeds of *Crataegus mollis*. BOT. GAZ. 54:49-62. 1912.
9. DUTCHER, R. ADAMS, Vitamine studies. Jour. Biol. Chem. 36:63-72. 1918.
10. ECKERSON, S. H., A physiological and chemical study of after-ripening. BOT. GAZ. 55:286-299. 1913.

- ✓11. FAWCETT, H. S., Viability of weed seeds under different conditions of treatment and study of their dormant periods. Proc. Iowa Acad. Sci. pp. 25-45. 1908.
12. GASSNER, GUSTAV, Untersuchungen über die Wirkung des Lichtes und das Temperaturwechsels auf die Keimung von *Chloris ciliata*. Jahrb. Hamburg. Wiss. Anstalt. 3:1-121. 1911.
13. GOEBEL, K., Organographie der Pflanzen. Arch. und Samenpfl. Jena. 1913 (p. 476).
14. GROVES, J. F., Temperature and life duration of seeds. BOT. GAZ. 63:169-189. 1917.
15. GUPPY, H. B., Studies in seeds and fruits. London. 1912 (pp. 417-437).
16. HARVEY, R. B., Hardening process in plants and developments from frost injury. Jour. Agric. Res. 15:83-113. 1918.
17. HILTNER, L., and KINZEL, W., Über die Ursachen und die Beseitigung der Keimungshemmungen bei verschiedenen praktisch wichtigeren Samenarten. Naturwiss. Zeitschr. Forst. und Landw. 4:36-50, 194-204. 1906.
- ✓18. HOWARD, W. L., Mo. Agric. Exp. Sta. Res. Bull. pp. 5-105. 1910.
19. JOST, L., Plant Physiology. Eng. Edition. 1907 (p. 342).
20. KINZEL, W., Frost und Licht als beeinflussende Kräfte bei der Samenkeimung. Stuttgart. 1913.
21. LAKON, GEORG I., Der Keimverzug bei den Koniferen und hartschaligen Leguminosensamen. Naturwiss. Zeitschr. Forst. und Landw. 9:226-237. 1911.
22. ———, Zur Anatomie und Keimungsphysiologie der Eschensamen. Naturwiss. Zeitschr. Forst. und Landw. 9:285-298. 1911.
23. MEYERS, Grosses Konversations-lexikon. 6:68; 7:758. 1902.
24. New York Agric. Exp. Sta. Germination experiments. 4:84-97. 1885.
25. NICLOUX, MAURICE, Germination of oily seeds. Compt. Rend. 139:143-145. 1904.
26. NICOLAS, G., Contribution a l'étude des variations de la respirations des végétaux avec l'age. Rev. Gén. Botanique. no. 355. 209-226. 1918.
27. OSTERHOUT, W. J. V., The decrease of permeability produced by anesthetics. BOT. GAZ. 61:148-158. 1916.
28. PALLADIN, V. I., Plant physiology. 1918 (p. 17).
- ✓29. PAMMEL, L. H., and KING, C. M., Results of seed investigations for 1908-1909. Bull. 115. pp. 159-177. 1910.
- ✓30. PAMMEL, L. H., and LUMMIS, G. M., The germination of weed seeds. Proc. Soc. Prom. Agric. Sci. 89-92. 1903.
- ✓31. ROSE, R. C., After-ripening and germination of seeds of *Tilia*, *Sambucus*, and *Rubus*. BOT. GAZ. 67:281-308. 1919.
32. ROSTRUP, O., Rept. Danish seed control for 1896-1897. p. 37. 1898; review E. S. R. 10:53. 1898.
33. SCHROEDER, H., Über die Einwirkung von Silbernitrat auf die Keimfähigkeit von Getreidkörnern. Biol. Centralb. 35:8-24. 1915.

# GAMETOPHYTE AND SEX ORGANS OF REBOULIA HEMISPHERICA

CONTRIBUTIONS FROM THE HULL BOTANICAL LABORATORY 276

ARTHUR W. HAUPT

(WITH TWENTY-ONE FIGURES)

The Marchantiales represent a very natural group of liverworts whose evolutionary tendencies are more obvious and striking than those of any other order of Bryophytes. The characters which distinguish them from the Jungermanniales are remarkably constant, and yet the structural changes which one meets in passing from the lower to the higher forms are represented by an almost complete series of intergrades. In order to determine the phylogenetic relationships of the little investigated genus *Reboulia*, the present study was undertaken.

According to SCHIFFNER (7), *Reboulia* comprises 2 species: one confined to Java, and the other, *R. hemisphaerica*, a polymorphic species, cosmopolitan in distribution. STEPHANI (9) recognizes only *R. hemisphaerica* as a single polymorphic species, including as synonyms several other forms which various authors have raised to specific rank. CH. and R. DOUIN (3) have described 2 new species from France and other parts of Europe which they have named *R. occidentalis* and *R. Charrieri*. These are distinguished from *R. hemisphaerica* chiefly on the basis of the size and wall markings of the mature spores, the size and number of lobes of the female receptacle, and the position and behavior of the male receptacle. The latter forms two groups which come to occupy marginal positions on the thallus instead of remaining undivided and median as in *R. hemisphaerica*. The writer has observed this in rare cases in *R. hemisphaerica*, and if the small size of certain parts be explained on the basis of impoverished vegetative conditions, there seems to be little justification for the establishment of these 2 new species.

SCHIFFNER (7) divides the Marchantiaceae into the 3 subfamilies, Corsinioideae, Targionioideae, and Marchantioideae.

Following LEITGEB (6), he further separates the Marchantioideae into the Astroporeae, Operculatae, and Compositae. CAVERS (2) has shown that the characters which separate these groups are not entirely constant; yet he recognizes their individuality, but elevates them to the rank of families and renames them Cleveaceae, Aytoniaceae, and Marchantiaceae. *Reboulia* belongs to the Operculatae of LEITGEB or to the Aytoniaceae of CAVERS.

### Material

The writer is indebted to Dr. W. J. G. LAND for the material used in this investigation. Four collections were made by him over a period of 10 years during the months of September, October, and November at Rome, Indiana. A few of the slides were made by Mr. S. A. IVES, but most of them were prepared by the writer.

### Thallus

The gametophyte plant body of *Reboulia hemisphaerica* is a pale green, dichotomously branched thallus with slightly undulate margins and a distinct midrib. Rhizoids and scales arise from the ventral surface. Both smooth and pegged rhizoids occur, their ends often being highly contorted when in contact with soil particles. The dark red ventral scales are 2-ranked and point diagonally forward and outward. They do not arise from the splitting of a single scale as in most species of *Riccia*, but are separate from the beginning. The scales are 1 cell thick except near their place of attachment to the thallus where they are often 2 cells thick. They are unappendaged.

The body of the thallus is differentiated into a lower colorless region of compact elongated cells with rather thick walls, and an upper region of loose chlorophyllose tissue containing large air chambers. Intracellular fungi live in the lower region (fig. 5). The walls of the epidermal cells are slightly thickened and are devoid of chloroplasts except near the growing point of the thallus (fig. 2). The plastids in the air chamber region are rather large and contain several starch grains with distinct hila. Plastids in the cells in the growing region are small and contain no starch. The development of the large starch-producing plastids was

studied, and a series obtained as illustrated by fig. 6 *a-d*. Small oil globules are very abundant in the apical cell region and occur less abundantly in the cells of the older parts of the thallus. The

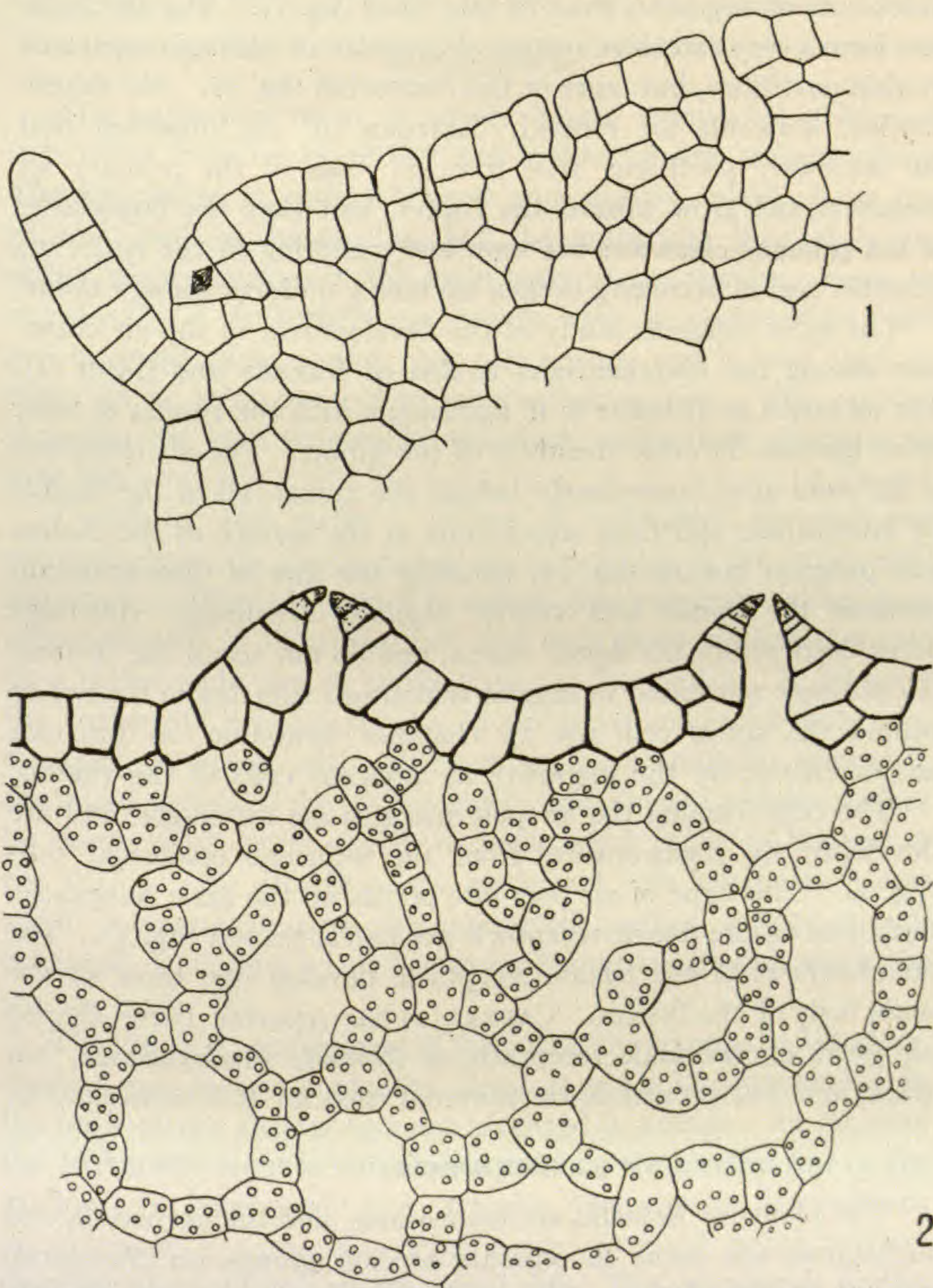

FIGS. 1, 2.—Fig. 1, apical cell of thallus and young air chambers,  $\times 470$ ; fig. 2, upper region of thallus showing air chambers and pores,  $\times 250$ .

formation of a definite oil cell from an ordinary vegetative cell is a common feature of the genus. No gemmae are produced.

The thallus grows by means of a single cuneate apical cell which cuts off segments from its four sides (fig. 1). The air chambers form a very extensive system of irregular air passages separated by thin partitions, but more or less connected (fig. 2). No chlorophyllose filaments are formed. LEITGEB (6) has observed that the secondary partitions arise from all sides of the primary air chambers and grow toward the center, and that the boundaries of the primary chambers are soon lost, resulting in the entire air chamber region becoming broken up into a uniform spongy tissue.

The most complete study of the development of the air chambers among the Marchantiales is that of BARNES and LAND (1). The situation in *Reboulia* is in agreement with the results of their investigations on other members of the group. The air chambers of *Reboulia* arise immediately behind the apical cell of the thallus by intercellular splittings which start at the surface of the thallus and progress inward (fig. 1), reaching the line of differentiation between the dorsal and ventral regions. Secondary splittings occur deep within the dorsal region, and do not reach the surface. No evidence was found to suggest centrifugal splitting in the region behind the apical cell, nor air chamber formation, as LEITGEB has described, by the upgrowth of adjacent cells of the thallus.

The cells forming the air pore margins are attenuate, and are developed by segmentation from the adjacent epidermal cells (fig. 2). This type of air pore also occurs on the male receptacle, but those on the female receptacle are barrel-shaped (fig. 4). The air chambers in the female receptacle develop like those of the main body of the thallus. CAVERS (2) has reported barrel-shaped air pores on the male receptacle of *Reboulia hemisphaerica*, but these were not present in the material used for this investigation.

### Sex organs

The plants of *Reboulia* are monoecious, and the antheridia and archegonia are borne in separate median groups on the dorsal surface of the thallus. The antheridial group is only slightly raised above the general surface of the thallus, and the archegonial

receptacle becomes lifted up on a stalk only after the sporophytes are approaching maturity. The archegonia appear in the autumn, fertilization occurs, and the embryo develops immediately. The sporophyte, however, does not mature until the following spring.

#### ANTHERIDIUM

The antheridia occur in sessile lunate receptacles which are sometimes irregular in outline and broken up into several pieces. The receptacle is cushion-shaped and slightly raised above the general level of the thallus, but the antheridia themselves are rather deeply sunken in the main body of the thallus. Four, or occasionally 5, antheridia are usually seen in cross-section, and 4-6 in longitudinal section, but often more, and in rare cases as many as 24 were counted in longitudinal section. The number of antheridia in a receptacle, therefore, varies from about 16 to over 100.

Usually 2 and rarely 3 groups of antheridia are produced successively on the thallus before the appearance of the archegonial receptacle. They are formed in rather close proximity (about 7-10 cells removed) to the apical cell, and each group becomes isolated by a rather wide area of sterile tissue of the thallus. In all cases the antheridia develop strictly in acropetal succession from segments of the apical cell. Air chambers are abundantly formed in the raised portion of the thallus which communicate with the surface by means of air pores similar to those which occur on the rest of the thallus. By growth of the epidermal cells around the pores which communicate with the antheridial cavities, a plate of cells is formed containing a small central perforation through which the sperms escape (fig. 3).

The simplest arrangement of the antheridia among the Marchantioidae may be represented by *Clevea*, in which they are sunken in the back of the thallus and not arranged in groups. In *Sauteria* the antheridia occur in raised groups along the median line of the thallus. In *Fimbriaria* and *Reboulia* there is an intermittent development of antheridia, which occurs in raised groups without checking the activities of the apical cell. The situation is similar in *Aytonia* (*Plagiochasma*), except that the apical cell does not

function while the antheridial group is developing, but later continues the growth of the thallus. In *Dumortiera* the antheridial receptacle is lifted up on a short stalk and represents a definite branch system which terminates apical growth of the thallus. In *Marchantia* the situation is similar, but the stalk is long.

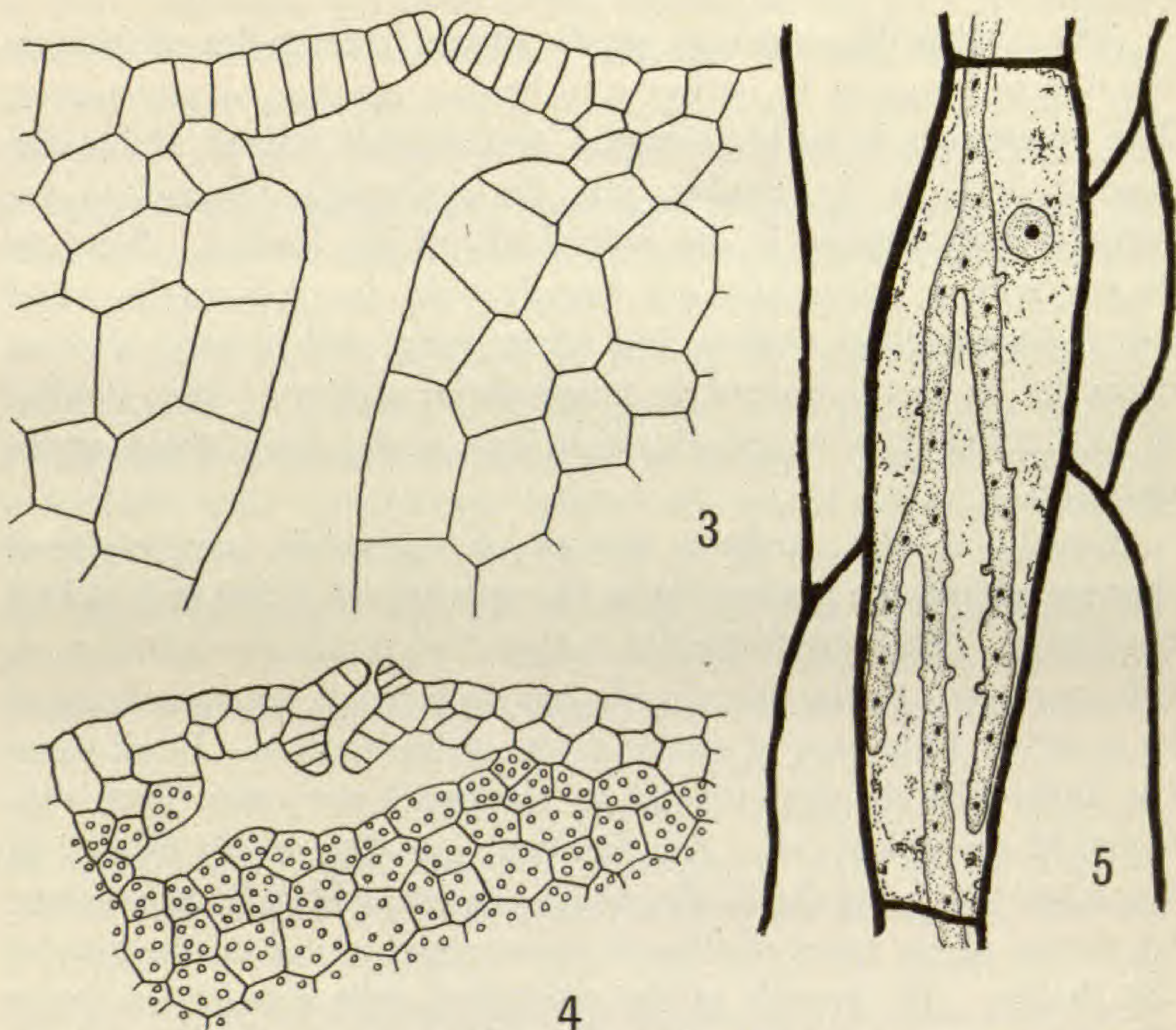

FIGS. 3-5.—Fig. 3, pore on male receptacle through which sperms escape,  $\times 470$ ; fig. 4, air chambers and pore in female receptacle,  $\times 250$ ; fig. 5, cell from ventral region showing intracellular fungus,  $\times 470$ .

The development of the antheridia of *Reboulia* is similar to that of the other Marchantiales which have been investigated. The superficial papillate initial is soon overgrown by the adjacent cells of the thallus, so that the antheridium comes to lie in a pit; the development of the antheridial pit is therefore very different from that of the air chambers. The first division of the initial is transverse and separates the imbedded portion of the stalk from the rest of the antheridium (fig. 7). Additional transverse walls



appear in the outer cell without a definite sequence, resulting in a filament of 4 cells (fig. 8). Vertical walls are then formed in two planes at right angles to each other, which usually are first developed in the basal tiers, or sometimes elsewhere (fig. 9). After the formation of the first vertical walls in the lower tiers, additional transverse divisions usually occur below, and as a consequence 5 or 6 tiers of cells are formed (fig. 10).

In *Marchantia polymorpha* STRASBURGER (10) has reported that the 3 transverse walls in the outer cell appear in centrifugal succession, although he shows no mitotic figures to prove this. Fig. 8 suggests that this may occur in *Reboulia*. STRASBURGER has also shown that the vertical walls appear in the 4-celled stage, but that no additional transverse walls are formed until the wall

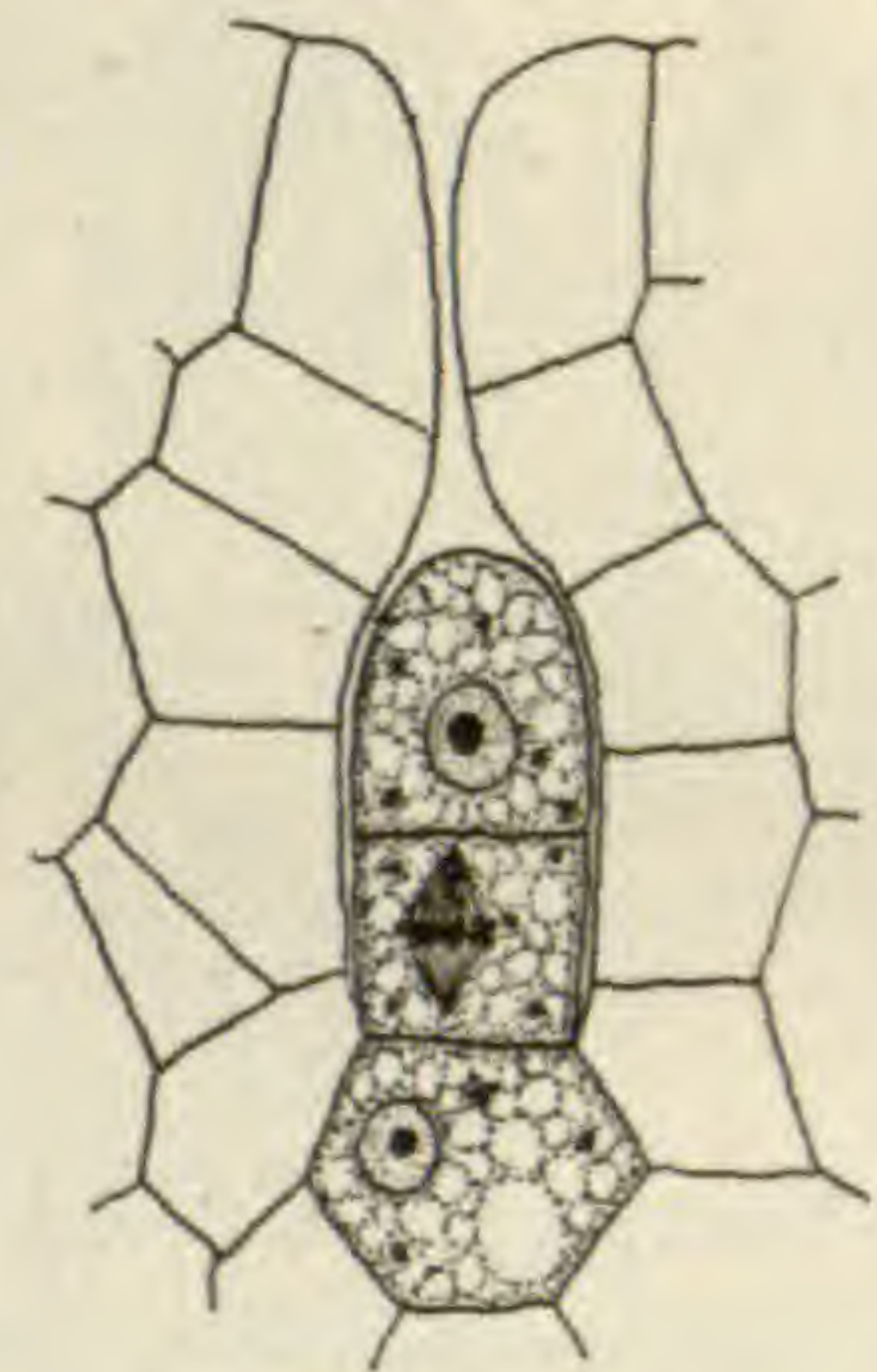
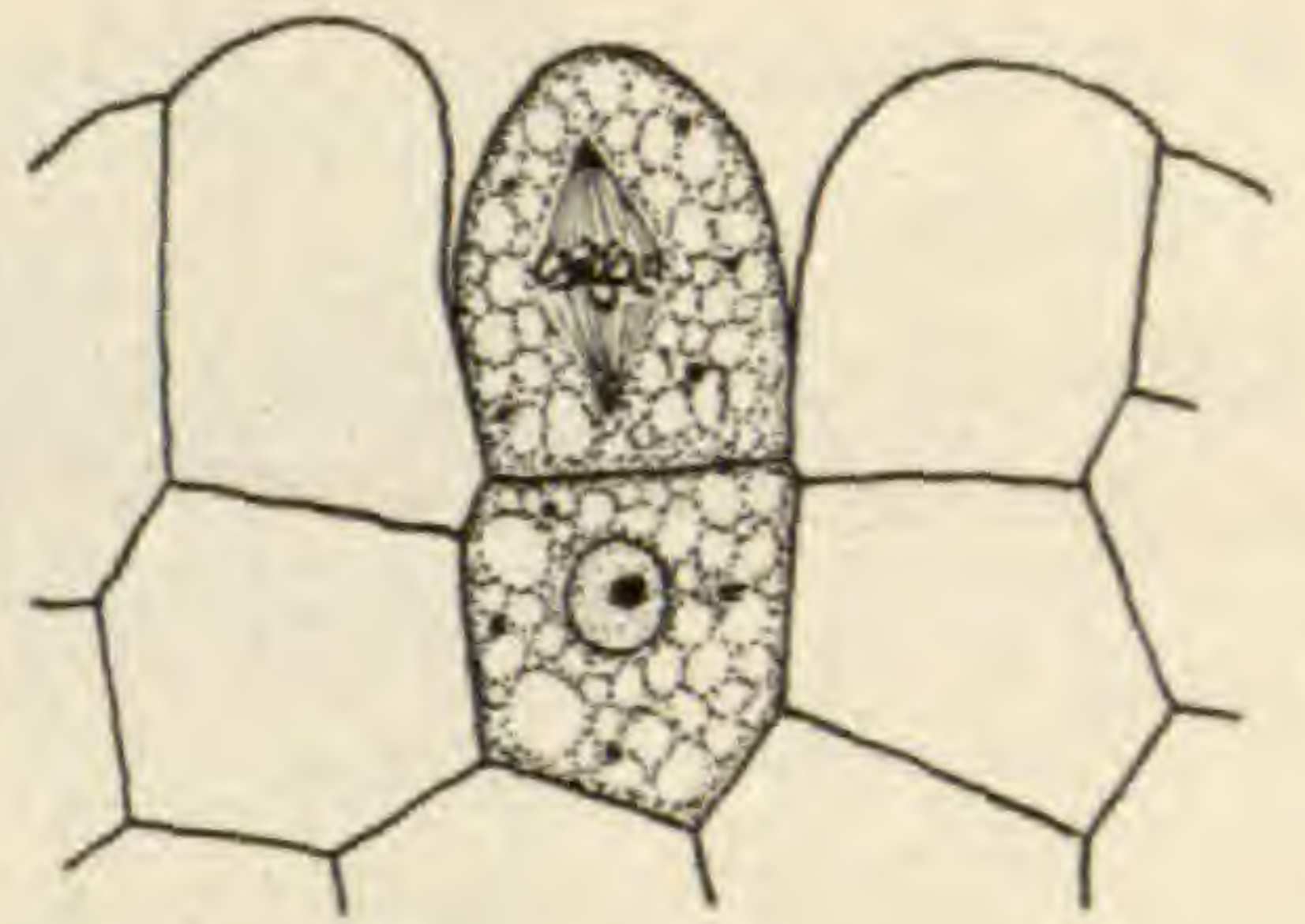

FIGS. 6-8.—Fig. 6, series showing development of starch grains in plastids,  $\times 1850$ ; fig. 7, first division of outer segment of antheridial initial,  $\times 790$ ; fig. 8, division of the lower segment of the outer cell,  $\times 790$ .

and spermatogenous cells are differentiated. *Marchantia* therefore seems to be somewhat more advanced in this respect. DURAND (4), however, who also studied *M. polymorpha*, has found that additional transverse walls may follow the appearance of the vertical walls, but in no observed case did he find that they preceded the first vertical walls.

Periclinal divisions next occur invariably in the 3 uppermost tiers of cells (figs. 11-13), separating the inner spermatogenous cells from the outer sterile wall cells. The cells in which no periclinal appears form the stalk. The further development of the

spermatogenous tissue is like that of the other Marchantiales. The sperms differ in no way from those of the other members of the group.

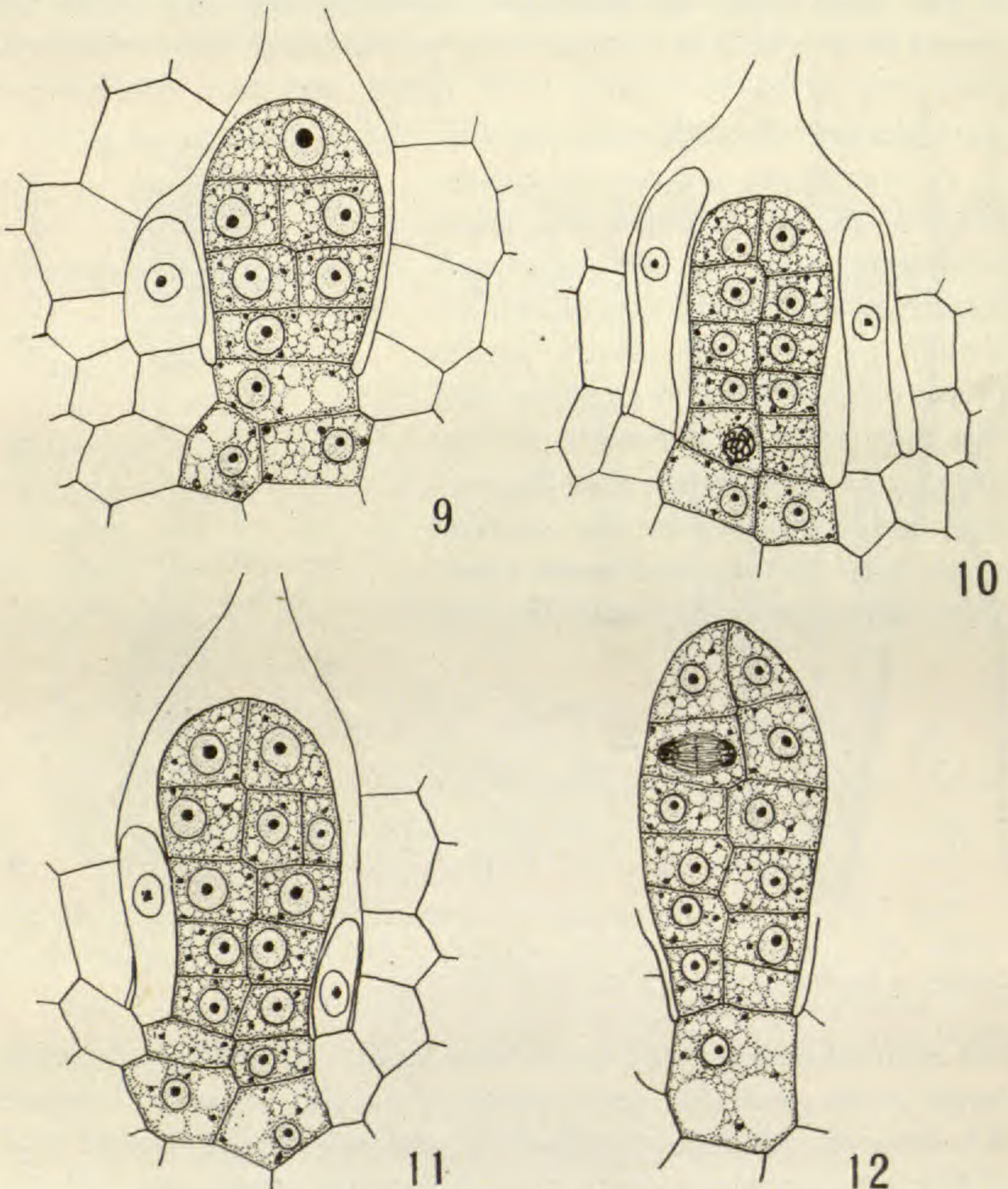

FIGS. 9-12.—Older antheridia: fig. 9, vertical walls appearing in middle tiers,  $\times 790$ ; fig. 10, complete development of vertical walls and appearance of transverse walls below,  $\times 790$ ; figs. 11, 12, appearance of periclinal walls,  $\times 790$ .

With the coming in of the first vertical walls in the young antheridium, several mucilage hairs arise from the cells which line the antheridial cavity. These arise near the base of the

antheridial stalk as 1-celled, slightly elongated structures with a nucleus and a highly vacuolated cytoplasm (figs. 9-13). They elongate considerably and secrete abundant mucilage around the mature antheridia.

### ARCHEGONIUM

The archegonia are borne on receptacles which arise as dome-like areas at the growing point of the thallus. The formation of the archegonial receptacle involves the apical cell of the thallus, so that growth for the season is checked. Several (up to 6) growing points are organized in the young receptacle from segments of the main apical cell of the thallus, and thereby a new apical cell is formed in each receptacle notch.

In the simpler Marchantiidae, as in *Clevea* and *Aytonia*, the main apical cell of the thallus is not involved in the formation of the archegonial receptacle, so that several successive groups of archegonia may be formed on the same thallus, or, as Miss STARR (8) has reported in *Aytonia*, an antheridial receptacle may follow the formation of an archegonial receptacle. Thus in these forms the archegonial receptacle represents a simple dorsal upgrowth of the thallus. In *Fimbriaria* and *Grimaldia* LEITGEB has shown that the apical cell is involved in the formation of the archegonial receptacle, and this is the situation in *Reboulia*. In the higher Marchantiidae this condition prevails, and further advance is shown merely by the greater production of archegonia over a longer period, and the formation of a long receptacle stalk earlier in the life history of the archegonia.

The archegonium initials arise from the third or fourth segment of each apical cell, and do not appear until the young receptacle is conspicuously dome-shaped. LEITGEB figures a very young

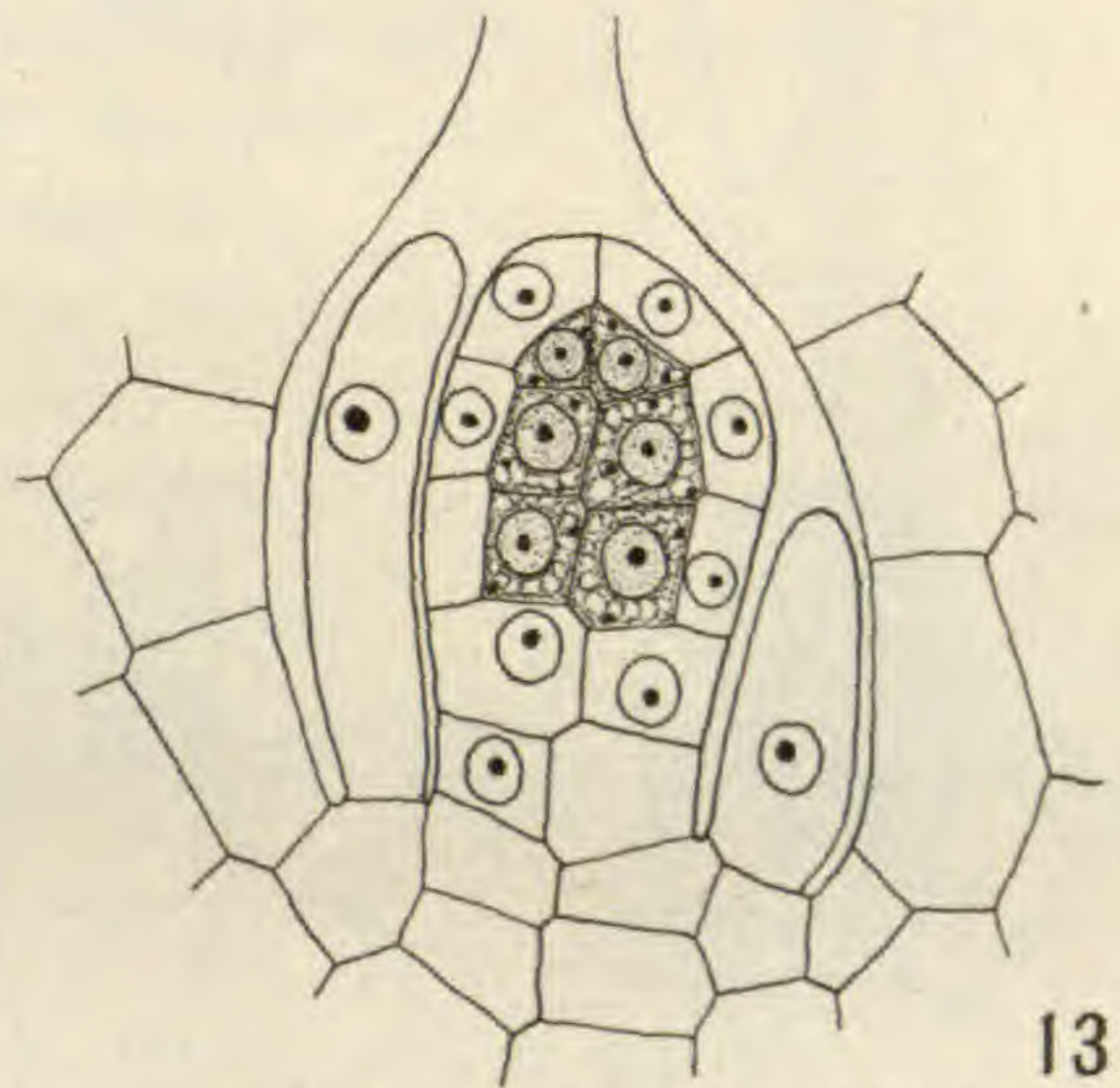
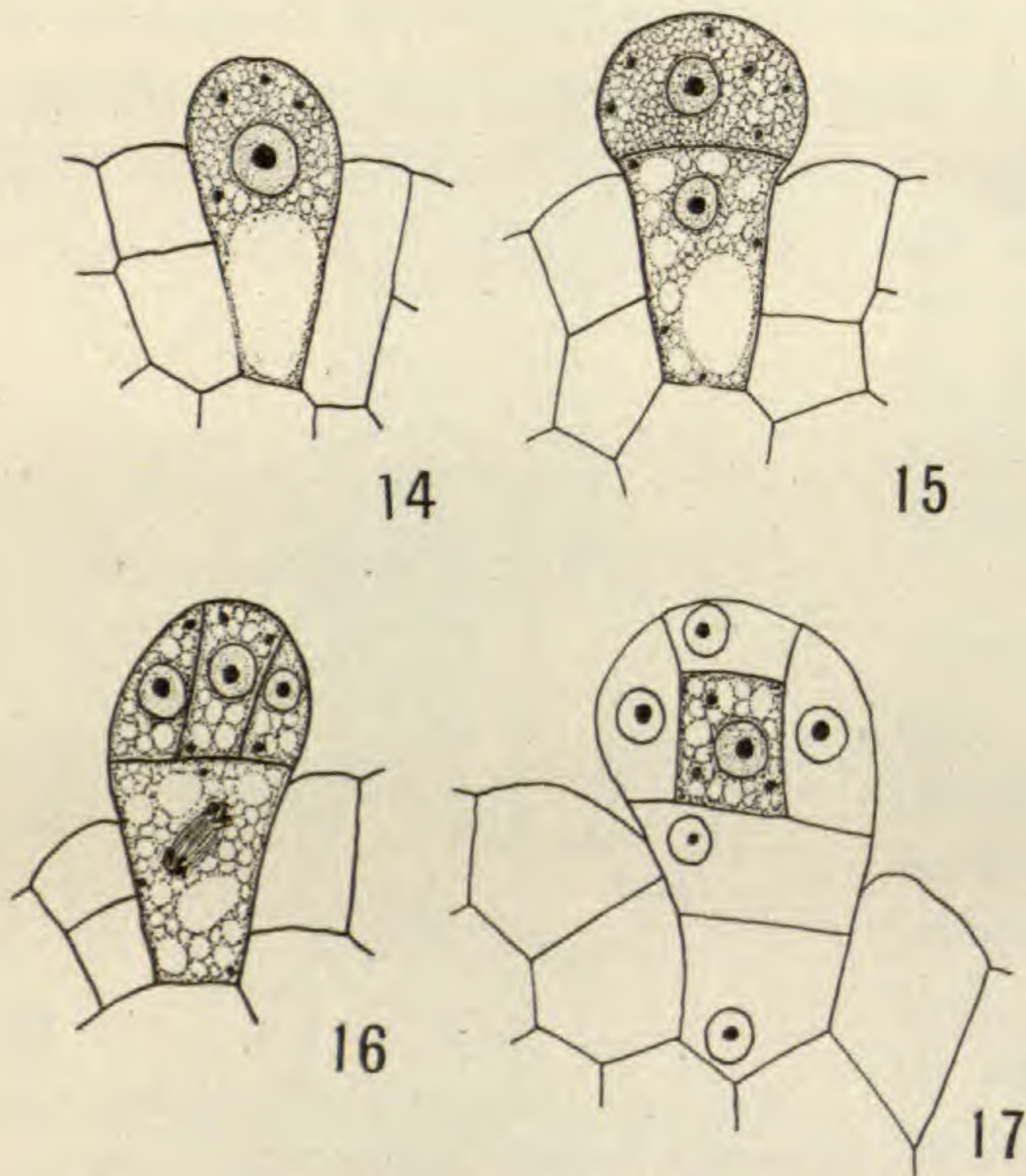

FIG. 13.—Completion of periclinal wall formation in young antheridium,  $\times 790$ .

receptacle bearing an archegonium in which the cover cell has been formed, but no such condition was observed by the writer in the material used in this study. The initial arises as a superficial cell which becomes papillate, and the first transverse wall cuts off a basal cell from an outer cell (figs. 14, 15). Three vertical walls then appear in the outer cell, and the primary axial cell and primary

wall cells are differentiated as in all of the Bryophytes (fig. 16). The basal cell usually divides by a transverse (figs. 16, 17) or vertical wall, but in no case was this division observed as taking place before the appearance of the 3 vertical walls. STRASBURGER (10) has reported that in *Marchantia* the outer cell undergoes a transverse division before the coming in of the 3 vertical walls, and JANCZEWSKI (5) has found a similar situation in *Preissia*. These investigators



FIGS. 14-17.—Fig. 14, archegonium initial,  $\times 790$ ; fig. 15, appearance of transverse wall cutting off basal cell from outer cell,  $\times 790$ ; fig. 16, division of basal cell and differentiation of primary axial cell and primary wall cells,  $\times 790$ ; fig. 17, differentiation of cover cell and central cell,  $\times 790$ .

may have mistaken an early division in the basal cell for one in the outer cell, as they show no mitotic figures which would prove the case. LEITGEB figures a young archegonium of *Reboulia* in which the 3 vertical walls have followed the transverse division of the archegonium initial, and DURAND observed the same condition in *Marchantia polymorpha*. Miss STARR'S figures also indicate that the early development of the archegonium of *Aytonia* is like that of *Reboulia*.

Further development of the archegonium is typical (figs. 17-20). The cover cell divides by a vertical wall which accompanies the first division of the primary neck canal cell. No evidence was found to lead to the suspicion that earlier than this stage the cover cell contributes to the development of the neck cells. Numerous mitotic figures in the neck cells prove that they increase in number by intercalary divisions.

The ventral canal cell and egg are formed from the primary ventral cell rather early (fig. 20), and the former is unusually small. As soon as the egg is formed, the venter of the archegonium develops 2 layers of cells, and this condition prevails until after fertilization. The archegonial stalk is short, and the neck invari-

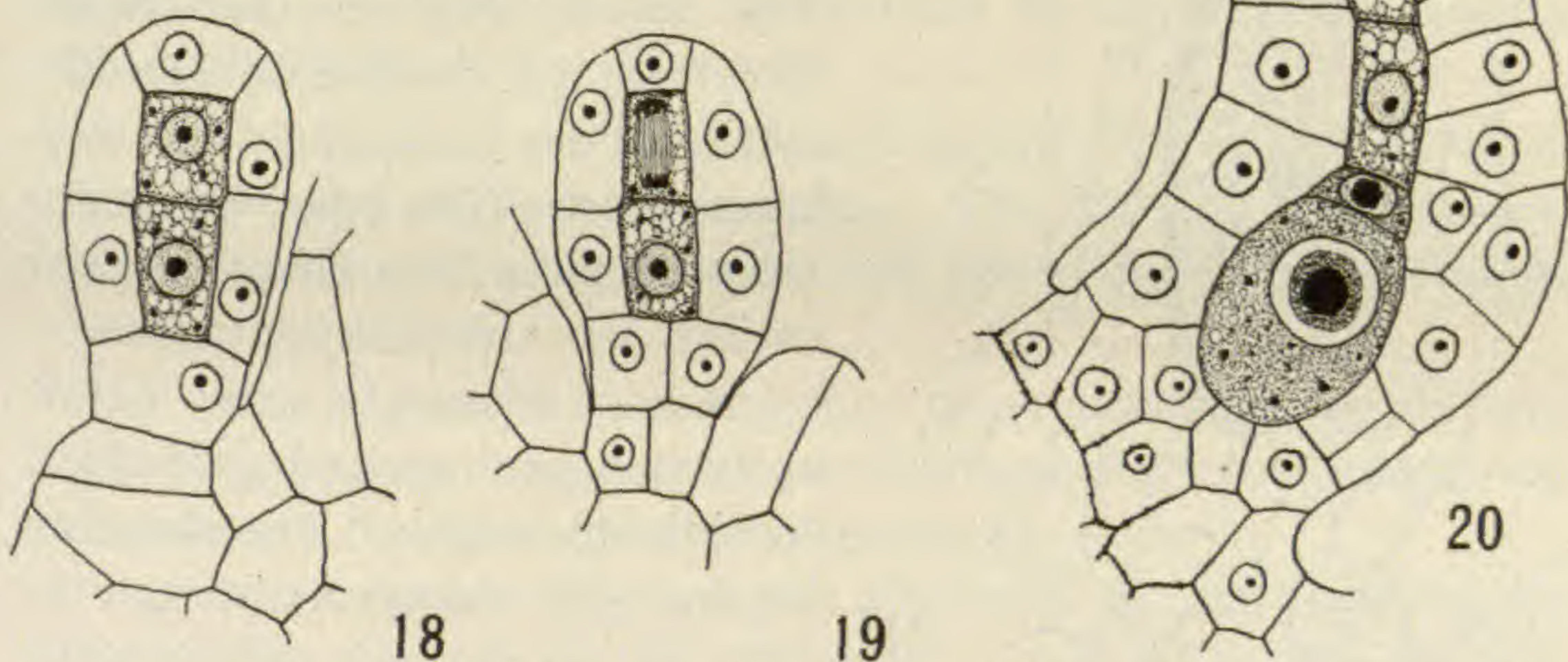

FIGS. 18-20.—Older archegonia: fig. 18, formation of primary neck canal cell and ventral cell from central cell,  $\times 790$ ; fig. 19, division of primary ventral canal cell,  $\times 790$ ; fig. 20, older archegonium showing formation of ventral canal cell and egg,  $\times 790$ .

ably curves outward and upward (fig. 21) so as to facilitate the entrance of the sperms, as in other forms in which the archegonia are borne similarly. The mature archegonium contains 18-20 neck canal cells which break down soon after their formation. The neck in all cases shows 6 cells in cross-section, as among other Marchantiales. JANCZEWSKI states that the number of neck canal cells in *Reboulia* is 4. He probably observed a nearly mature stage like fig. 20.

In the great majority of cases only one archegonium is formed from a single segment of each apical cell, and usually the egg of each develops a sporophyte. In one case, however, 2 archegonia were observed which had developed from segments of the same apical cell. This indicates a reversion to a condition as seen in *Marchantia*, which from the standpoint of number of archegonia

is very primitive. The tendency to reduce the number of archegonia among the Marchantiales reaches its highest expression in forms like *Reboulia*. CAVERS has also reported that in *Reboulia* occasionally 2 archegonia may be produced in the same receptacle notch. The apical cells of the female receptacle are checked by the formation of the archegonia and soon become lost. The lobes which develop between the archegonia grow entirely by intercalary divisions.

Slender filaments arise below each archegonium, and grow to a considerable length. The filaments become quite numerous in each receptacle notch, and persist until the spores are shed. They are probably protective in function. The mature egg is oval and contains many plastids and several large oil globules (fig. 21). These

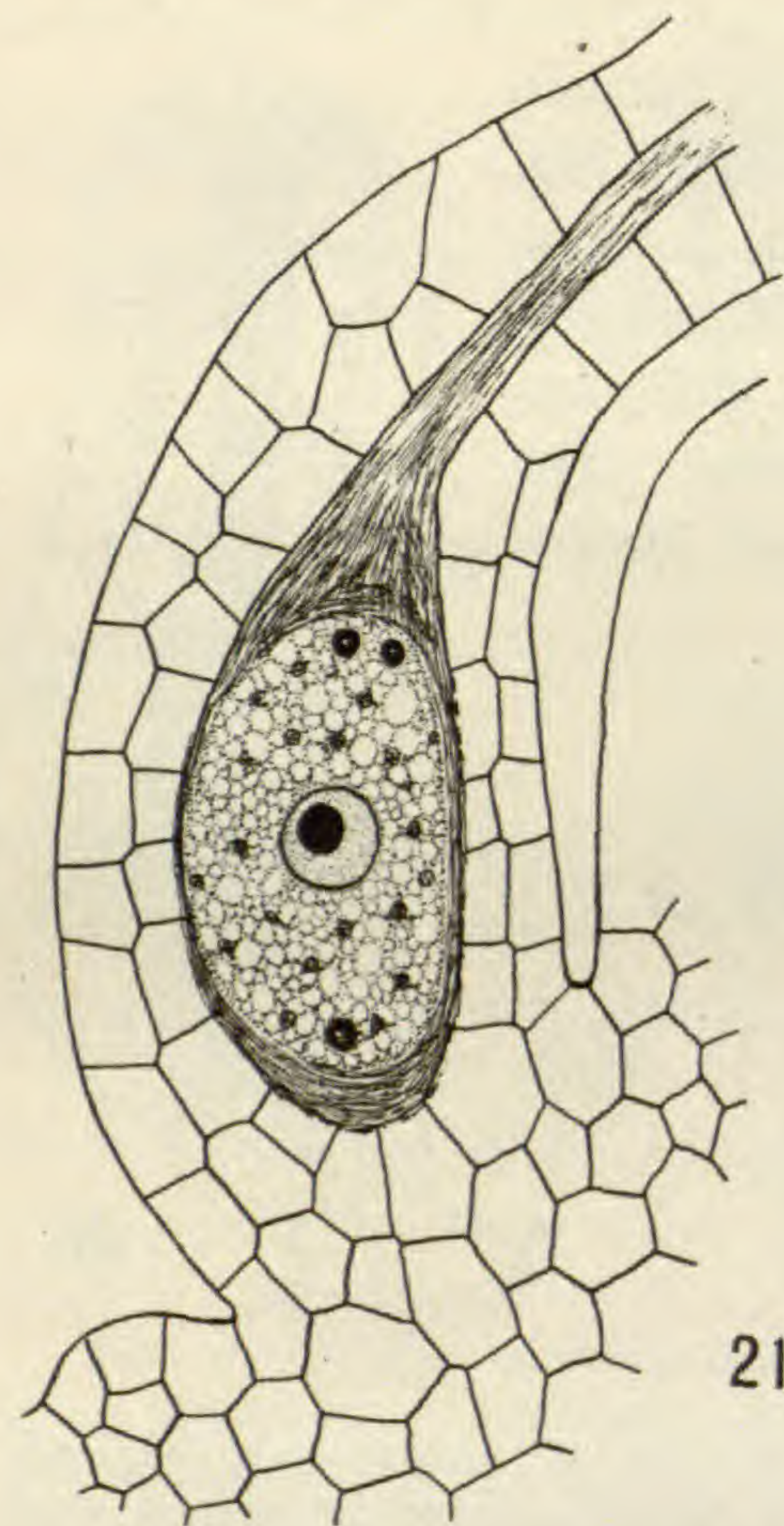

FIG. 21.—Venter of mature archegonium showing egg ready for fertilization,  $\times 660$ .

oil drops are much larger than those found in the cells of the thallus, and they persist in the early stages of the embryo. The mature egg does not develop a cellulose wall until after fertilization.

The number of lobes developed by the mature female receptacle corresponds with the number of growing points organized in the young receptacle. The lobes are not conspicuous. In their paper CH. and R. DOUIN distinguish very carefully between the

use of the terms "rays" and "lobes" as applied to the female receptacle of the Marchantiales, as follows:

Nous appellerons donc les rayons les divisions du capitule qui protègent les cavités pilifères, et nous réserverons le nom de lobes aux parties du capitule, qui recouvrent et protègent les involucre.

According to their interpretation and statements, neither rays nor lobes occur in *Clevea*, *Sauteria*, and *Peltolepis*; in some species of *Marchantia* and in all of the other genera of the order lobes only occur, while in most species of *Marchantia* true rays are formed. In *Preissia* both rays and lobes occur, but the rays are reduced, and the lobes very indistinct.

### Summary

1. *Reboulia* comprises a single polymorphic species, *R. hemisphaerica*, belonging to the Operculatae division of the subfamily Marchantioideae.

2. The thallus bears smooth and pegged rhizoids and 2-ranked ventral scales without appendages. The body is differentiated into a dorsal and ventral region, and grows by means of a single cuneate apical cell.

3. Air chambers are abundantly formed and develop by centripetal splittings. Secondary partitions separate the primary air chambers. No chlorophyllose filaments are formed.

4. Barrel-shaped air pores are developed on the female receptacle. Those of the thallus and male receptacle are made up of a single layer of concentric cells.

5. *Reboulia* is monoecious (autoicous). The antheridial receptacle is sessile, and several may be produced during the growing season, but the formation of the archegonial receptacle terminates apical growth of the thallus and represents a definite branch system, as among the higher members of the order.

6. The antheridia develop like those of the other Marchantiales.

7. In the development of the archegonium the 3 vertical walls follow the appearance of a transverse wall in the initial cell, and further development is typical. Eighteen to 20 neck canal cells are formed, but only 4 are present at the time of division of the ventral cell.

8. Several growing points are organized in the female receptacle from segments of the apical cell of the thallus, and each new apical cell comes to lie in a receptacle notch. Only 1 (rarely 2) archegonium is formed from the immediate segment of each apical cell.

The writer is very grateful to Dr. W. J. G. LAND for the material used in the investigation and for his encouragement and suggestions during the course of the study.

ST. LAWRENCE UNIVERSITY  
CANTON, N.Y.

#### LITERATURE CITED

1. BARNES, CHARLES R., and LAND, W. J. G., Bryological papers. I. The origin of air chambers. *BOT. GAZ.* 44:97-186. 1910.
2. CAVERS, F., The interrelationships of the Bryophyta. II. Marchantiales. *New Phytol.* 9:93-112, 157-186. 1910.
3. DOUIN, CH. and R., *Le Reboulia Raddi*. *Rev. Gén. Bot.* 30:129-145. 1918.
4. DURAND, E. J., The development of the sex organs and sporogonium of *Marchantia polymorpha*. *Bull. Torr. Bot. Club* 35:321-335. 1908.
5. JANCZEWSKI, ED. VON, Vergleichende Untersuchungen über die Entwicklungsgeschichte des Archegoniums. *Bot. Zeit.* 30:386-389. 1872.
6. LEITGEB, H., Untersuchungen über die Lebermoose. 6. Die Marchantieen. Graz. 1881.
7. SCHIFFNER, V., Hepaticae in *Engler and Prantl's "Natürliche Pflanzenfamilien."* 13:1-38. 1909.
8. STARR, ANNA M., A Mexican *Aytonia*. *BOT. GAZ.* 61:48-58. 1916.
9. STEPHANI, F., *Species Hepaticarum*. *Bull. Herb. Boissier* 6:790-799. 1898.
10. STRASBURGER, E., Die Geschlechtsorgane und die Befruchtung bei *Marchantia polymorpha*, L. *Jahrb. Wiss. Bot.* 7:409-422. 1869-1870.



# CURRENT LITERATURE

## NOTES FOR STUDENTS

**Mucor and Chaetocladium.**—BURGEFF<sup>1</sup> has given an interesting account of the relations between the parasite *Chaetocladium* and the host *Mucor*. The *Chaetocladium* investigated reacts physiologically like *C. Fresenianum*, but morphologically more like *C. Brefeldi*, although its spores are larger than in the latter species. The *Mucor* host was a variety of *Mucor mucedo* which BURGEFF describes as *Mucor mucedo dependens*.

The course of infection was followed in both fixed and living condition. Fortunately the plasma of the parasite stains more deeply than that of the host, so that host and parasite can be distinguished in sectioned material. When growing together the filaments of the *Mucor* host are attracted by those of *Chaetocladium*. Filaments of the parasite apparently are not attracted by those of the host until they are within a very short distance of each other. Contact of the two kinds of filaments is a stimulus which causes a slight thickening of the tip of the *Chaetocladium* hypha, inhibits its growth in length, and finally causes the formation of a cross wall cutting off the terminal portion of the filament of the parasite, which becomes the gall cell. The adjacent walls of the host and parasite dissolve, and plasma and nuclei of the host enter the gall cell, which at once swells and branches. In the gall cell the nuclei of the host are arranged peripherally and undergo division, while those of the parasite are centrally located and apparently do not divide. The gall cell is termed heterocaryotic (or a mixochimaera), since it contains two kinds of nuclei in contrast with the homocaryotic hyphae of the host and of the parasite. It is in open communication with the host hypha, but separated from the parasite by a membrane. Some of the branches from the primary gall are heterocaryotic and some homocaryotic, containing only *Mucor* nuclei. These latter branches form secondary galls in contact with pure *Chaetocladium* filaments. Apparently gall branches never contain only *Chaetocladium* nuclei, perhaps because the latter do not divide when in association with the host plasma. Branches of *Chaetocladium* from below the gall intermingle with those of the latter, thus increasing the area of contact between the gall and parasite. Apparently it is only at contact surfaces between the heterocaryotic gall and the *Chaetocladium* hyphae that diffusion to the advantage of the parasite can take place. At any rate, after contact of *Chaetocladium*

<sup>1</sup> BURGEFF, H., Über den Parasitismus des *Chaetocladium* und die heterocaryotische Natur der von ihm auf Mucorineen erzeugten Gallen. Zeitsch. Botanik 12:1-35. figs. 36. 1920.

filaments with these gall cells the parasite grows out into fruiting branches. Single nuclei enter the single-spored sporangium and later divide twice, producing the four nuclei of each spore (rarely two or more than four).

The association of the plasma of host and parasite in a mixochimaera is supposed to render the protoplasmic membranes of the host permeable to diffusion of the material necessary to the normal growth of the parasite. The galls are also supposed to serve as a means of bringing about a branching of the host hypha in places such as old sporangiophores, where the ability to branch has been lost.

In seeking for a possible origin of the "sikyotic" parasitism (from *σικυα* = a cupping-glass) of *Chaetocladium*, BURGEFF discusses other cases of fusions in the fungi. In the anastomoses found in *Mortierella*, *Syncephalis*, Ascomycetes, and Basidiomycetes, a cross wall, if formed, is produced after the fusion, as shown by KNIEP, but in this case the process is connected with the distribution of nuclei in a diploid mycelium. Failing to find an analogy with vegetative processes, BURGEFF suggests that the curious type of parasitism which he has studied may have originated by way of sexual fusions; and in support of this suggestion points out the similarities between the processes involved in conjugation in the Mucors and those in the formation of his sikyotic galls in *Chaetocladium*. The suggestion is believed to need strengthening by tests with plus and minus races of host and parasite.—A. F. BLAKESLEE.

**Calcium.**—SHEDD<sup>2</sup> has found that the procedure which has been adopted by the Association of Official Agricultural Chemists for determination of calcium in soil solution does not give accurate results, due to the occlusion of calcium on the iron and aluminum precipitate that goes through the filter. He has evolved a new method which is simpler and avoids the errors of the present methods. The following findings for the Kentucky soils are of great interest. Cultivation has caused a considerable loss of calcium from these soils. The best types of these soils have the highest calcium content, and the poorest have the lowest. "Many samples have been found to be so low in calcium that their deficiency in this constituent requires consideration as well as their low phosphorus and nitrogen supply. The application of a ton of limestone or of rock phosphate per acre to such soils frequently adds more calcium than is already present. There is no doubt that, in such cases, these materials, or even moderate applications of some commercial fertilizers, are beneficial because of the plant food (calcium) they supply in addition to other good effects they may accomplish."

NELLER,<sup>3</sup> working on limed and unlimed plots of the New Jersey Experiment Station, finds that the oxidizing power of the limed plots is approxi-

<sup>2</sup> SHEDD, O. M., A proposed method for the estimation of total calcium in soils and the significance of the element in soil fertility. *Soil Science* 10:1-14. 1920.

<sup>3</sup> NELLER, J. R., The oxidizing power of soil from limed and unlimed plots and its relation to other factors. *Soil Science* 10:29-37. 1920.

mately 40 per cent higher than the unlimed; that the oxidizing power varies inversely with its lime requirement; that nitrate accumulation and bacterial numbers were higher on the limed soils, whereas the ammonia accumulation was about the same for all of the plots; that the average crop yield for the past 10 years varies closely with the present oxidizing power of the soils; and that there is a noticeable correlation between crop yield, nitrate accumulation, and bacterial numbers, but not between crop yield and ammonia accumulation.

PARKER and TRUOG<sup>4</sup> find a rather close relation between the calcium and nitrogen content of plants. The contents of potassium, phosphorus, and magnesium do not bear this close relation to the nitrogen content. There are two groups of agricultural plants, those having a low calcium-nitrogen ratio and a low lime requirement, and those having a high calcium-nitrogen ratio and a higher lime requirement.—WM. CROCKER.

**Arctic Caryophyllaceae.**—A critical study of the morphology and ecology of the Caryophyllaceae is one of WARMING'S<sup>5</sup> most recent contributions to the science of ecology. He divides his report into four parts, dealing respectively with (1) morphology and vegetative propagation, (2) leaf anatomy, (3) adaptations to environment, and (4) flower biology and seed reproduction.

In the first section he recognizes and describes several growth forms, illustrating by drawings of typical plants and listing the species to be referred to each form. Numerous variations of the rosette and cushion forms are distinguished, and multiplication by buds, offshoots, runners, and layers is carefully discussed. The details of the leaf structure are to be obtained from the drawings, the most important generalization being the usual absence of xeromorphic features. Palisade tissue is poorly differentiated, the mesophyll has abundant large intercellular spaces, stomata usually occur on both surfaces, and the epidermis is thin-walled and but slightly cutinized, the leaves thus resembling those of hydrophytes or shade plants. In this respect they form a striking contrast with the xeromorphic leaves of the woody evergreens of the same regions.

Among the most conspicuous features of the flower biology is the common occurrence of both protandry and polygamy, the latter being accompanied by varying degrees of reduction of stamens in the ovulate flowers. Very frequently the corolla is decidedly smaller in the ovulate flowers.—GEO. D. FULLER.

**Awn and barley yield.**—HARLAN and ANTHONY<sup>6</sup> have found that early removal of the awns of barley greatly reduces the volume and dry matter of

<sup>4</sup> PARKER, F. W., and TRUOG, E., The relation between the calcium and the nitrogen content of plants and the function of calcium. *Soil Science* 10:49-56. 1920.

<sup>5</sup> WARMING, ENG., The structure and biology of Arctic flowering plants. 13. Caryophyllaceae. *Meddelelser om Grönland* 37:228-342. *figs.* 44. 1920.

<sup>6</sup> HARLAN, H. V., and ANTHONY, S., Development of barley kernels in normal and clipped spikes and the limitations of awnless and hooded varieties. *Jour. Agric. Research* 19:431-472. 1920.

the kernels at maturity. The effect is not due to shock injury, for it does not manifest itself until at least a week after removal. The rachis of the clipped spikes contains about 25 per cent more ash than the unclipped. This is probably due to the fact that the awn when present is a great ash storage organ. The high ash content of the rachis probably accounts for the marked shattering in the clipped heads. The authors say: "Hooded and awnless barleys generally yield less and shatter more than awned varieties, and there seem to be physiological reasons for this fact." It may be possible to produce non-shattering hooded and awnless sorts by using parents which normally have a low percentage of ash in the rachises. It may also be possible to obtain strains that will give good yields under arid conditions. Under humid conditions it is likely that the objections to the awns are more easily met by the use of strains with smooth awns, which, so far as known at present, have no physiological limitations.—WM. CROCKER.

**A subterranean algal flora.**—MOORE and KARRER<sup>7</sup> have demonstrated the existence of a subterranean algal flora, independent of the terrestrial flora and to a great degree of the character and locality of the soil. The investigation included an analysis of a variety of soils collected in Missouri, California, and Massachusetts. The samples were collected at different depths under sterile conditions and in localities where the soil had not been disturbed for a number of years. These were placed in bottles containing an amount of sterile algal nutrient solution and sterile sand. The growth was examined at the end of several weeks, and in this manner the algae which occurred in small amounts could easily be studied. From these investigations it was shown that algae exist in the soil to a depth of 1 m. at least under conditions which preclude the possibility of surface infection. A wide variety of species was not found, but of particular interest is the fact that *Protoderma viride* (Kützing) occurred at all depths and in all the samples obtained in the widely separated localities.—JOANNE KARRER.

**Odor constituents of apples.**—POWER and CHESTNUT<sup>8</sup> have found that the odor constituents of apples consist essentially of amylesters of formic, acetic, and capsoic acids, with a very small amount of caprylic ester and a considerable proportion of acetaldehyde. The acids mentioned are probably present also in the free state. These essential oils constitute only about 0.0007–0.0013 of 1 per cent of the weight of the entire ripe fruit. "Although amyl valerate is generally designated in chemical literature as 'apple oil,' it is quite certain that this compound has never been identified as a constituent of apples." The difference in odor of various apples is due to the difference in proportions of the oils mentioned.—WM. CROCKER.

<sup>7</sup> MOORE, G. T., and KARRER, JOANNE L., A subterranean algal flora. *Ann. Mo. Bot. Gard.* 6:281–307. 1919.

<sup>8</sup> POWER, F. B., and CHESTNUT, V. K., The odorous constituents of apples; emanation of acetaldehyde from the ripe fruit. *Jour. Amer. Chem. Soc.* 42:1509–1526. 1920.

**Ferns of Papua.**—BRAUSE<sup>9</sup> has published a list of Papuan ferns collected by LEDERMANN in the expedition of 1912-1913, in connection with a study of the Papuan flora by LAUTERBACH. It illustrates how any investigation of the tropics increases very materially the number of known ferns. The present list includes 555 species, distributed among 43 genera. The following 9 genera include 400 of the species: *Dryopteris* (112), *Asplenium* (52), *Trichomanes* (51), *Hymenophyllum* (35), *Alsophila* (34), *Lindsaya* (31), *Diplazium* (31), *Aspidium* (29), *Cyathea* (25). There are described 78 new species, *Dryopteris* including 24, *Alsophila* 13, *Cyathea* 7, and *Blechnum* 7, the remaining 27 new species being distributed among 12 genera.—J. M. C.

**Gentes Herbarum.**—Under this title BAILEY<sup>10</sup> has begun a new serial publication, the first fascicle containing an extensive list of plants which he collected in China in the spring and summer of 1917. The several localities are in central China, and the cultivated plants are not neglected. The collection includes 20 new species distributed among 13 genera, and 15 new varieties and forms. There are also transfers and new combinations. "The total systematic novelties and taxonomic changes are 44." The report contains also some very attractive photographs of topography and "interesting trees."—J. M. C.

**Seedling anatomy.**—HOLDEN,<sup>11</sup> in continuing studies of the anatomy of teratological seedlings, has investigated atypical seedlings of *Impatiens Roylei*, an Indian species naturalized in England. One of the two groups of these seedlings shows a very complete series illustrating the development of a "closely syncotylous condition" from the normal; while the other group shows a single cotyledon with no "macroscopic evidence" of syncotylous origin. The relation of the facts to the origin of monocotyledony is evident, but a number of alternative conclusions are still in evidence.—J. M. C.

**Apogamy in Osmunda.**—Mrs. BROWN<sup>12</sup> has succeeded in securing apogamous outgrowths in cultures of *Osmunda cinnamomea* and *O. Claytoniana*. It is stated that the only reported case of apogamy in this genus is given by LEITGEB, presumably using *O. regalis*. His observations have never been confirmed, although investigators since have tried to induce apogamy in this species under varied cultural conditions. Mrs. BROWN included *O. regalis*

<sup>9</sup> BRAUSE, G., Beiträge zur Flora von Papuasien. VII. Bot. Jahrb. 56:31-160. 1920.

<sup>10</sup> BAILEY, L. H., Gentes Herbarum. I. A collection of plants in China. 1:1-49. figs. 17. 1920.

<sup>11</sup> HOLDEN, H. S., Observations on the anatomy of teratological seedlings. III. On the anatomy of some atypical seedlings of *Impatiens Roylei* Walp. Ann. Botany 34:321-344. figs. 113. 1920.

<sup>12</sup> BROWN, ELIZABETH DOROTHY WUIST, Apogamy in *Osmunda cinnamomea* and *O. Claytoniana*. Bull. Torr. Bot. Club 47:339-345. figs. 7. 1920.

in her cultures and obtained "apogamous outgrowths" in that species also.—J. M. C.

**Peat soils.**—In a discussion of the agricultural possibilities of the vast peat areas of Minnesota, estimated at 7,000,000 acres, ALWAY<sup>13</sup> has shown the close relationship between agricultural and ecological problems. There is a general discussion of peat soils, a synopsis of the history of peat-land control in Europe, and a review of the literature. The two systems of control discussed are those by chemical treatment and those by burning. Toxic substances in the peat and in the substratum are also considered.—GEO. D. FULLER.

**Ultra-violet light and yeast.**—FEUER and TANNER<sup>14</sup> have studied the effect of ultra-violet light on 30 different species, strains, and varieties of yeastlike fungi, and conclude that these organisms are not very resistant to ultra-violet light, and that this might be used in controlling developing yeast in the industries. Further quantitative work is under way.—WM. CROCKER.

**A non-absorbing atmometer mounting.**—LIVINGSTON and THONE<sup>15</sup> have devised a new and much simplified mounting for porous cup atmometers which prevents absorption during periods of precipitation. The necessary valve is constructed in a simple straight glass tube by the use of a piece of mineral wool and a drop of mercury.—GEO. D. FULLER.

**Internal stomata.**—BERGMAN,<sup>16</sup> having observed stomata in the endocarp of the cultivated cranberry, extended his observations to numerous ericads, finding internal stomata in a number of them. Experiments indicated that they had not retained their ability to function, and the general conclusion is advanced that they are relics retained by a "modified leaf."—J. M. C.

---

<sup>13</sup> ALWAY, F. J., Agricultural value and reclamation of Minnesota peat soils. Univ. Minn. Agric. Exper. Sta. Bull. 188. pp. 136. *figs.* 54. 1920.

<sup>14</sup> FEUER, B., and TANNER, F. R., The action of ultra-violet light on the yeastlike fungi. Jour. Ind. Eng. Chem. 12:740, 741. 1920.

<sup>15</sup> LIVINGSTON, B. E., and THONE, FRANK, A simplified non-absorbing mounting for porous porcelain atmometers. Science N.S. 52:85-87. 1920.

<sup>16</sup> BERGMAN, H. F., Internal stomata in ericaceous and other unrelated fruits. Bull. Torr. Bot. Club 47:213-221. *figs.* 9. 1920.

THE  
BOTANICAL GAZETTE

FEBRUARY 1921

A CHEMICAL AND PHYSIOLOGICAL STUDY OF  
MOTTLING OF LEAVES

CONTRIBUTIONS FROM THE HULL BOTANICAL LABORATORY 277

F. M. SCHERTZ

(WITH SIX FIGURES)

**Introduction**

During the year 1917 SAMPSON (43) used *Coleus Blumei* (var. Golden Bedder) for studying the chemistry and physiology of leaf fall. He noticed that when the leaves were ready to drop they had completely or almost completely lost their chlorophyll, and that in general they were inclined to lose their chlorophyll or to mottle. It was thought that this accentuated material might be excellent for the study of the factors involved in mottling of leaves in general.

Loss of chlorophyll from plant organs is a very general phenomenon. It is thought of as an orderly and natural thing in autumnal coloration, but is considered a diseased condition when it occurs during the growing season. In the latter case it is spoken of as mottling or chlorosis. It is not at all improbable that a study which throws new light on mottling will also illuminate autumnal coloration. Indeed, this work indicates that the two have many things in common.

BORESCH (6) found that algae growing for some time on nutrient solutions gradually changed from a dark green to gold or red brown. If nitrate solution was added to these cultures, the algae regained

their normal green color. Extracts made from the algae showed that chlorophyll decreased while carotin increased in the algae as they browned. ARTARI (2) grew algae in the dark and found that with an organic source of nitrogen they remained green, but with potassium nitrate as the source of nitrogen the algae lost their green color. With potassium nitrate as the source of nitrogen the colorless algae would regain a normal green when placed in the light.

SWART (48), working on spring and autumn leaves, found that just as the leaves were ready to fall they usually became yellow, and this was accompanied by a decrease in protein, nitrogen, phosphorus, and potassium. WILLSTÄTTER (53) noticed that in autumn, as the leaves yellowed, their chlorophyll content became less.

BRIGGS, LYMAN, JENSEN, and McLANE (7) have summarized the suggested causes of mottling in various plants. Excess of lime, magnesium, organic matter, or some essential element, deficiency in lime, iron, organic matter, or some essential element, low humus, high nitrogen, inorganic manures, frost, poor drainage, wind, sunlight, irregular supply of plant food and moisture, fungi or bacteria, nematodes, a filterable virus, and other causes are claimed by some to produce mottling. Chlorophyll may disappear owing to the absence of some essential constituent in the leaf, or to the presence of some deleterious substance. They thought that the soil was the cause of the mottling of citrus leaves and consequently analyzed it. It was found that mottling diminished as the humus ratio increased. Most of the trees which bore mottled leaves grew in soil which had a low nitrogen content. They believed that the mottling of the orange trees was definitely correlated with the low humus content of the soil, for mottling diminishes as the humus content increases. Alfalfa and bean straw were recommended for use in mulching the citrus trees.

JENSEN (25) analyzed green and mottled leaves, since it is known that organic matter attacks the soil minerals and sets free Ca, Fe, Mg, and  $PO_4$ , because these elements are closely connected with the formation of chlorophyll. It was found that badly mottled leaves from orange and lemon trees always contained a higher percentage of iron, calcium, magnesium, and phosphorus than the



healthy green leaves. Leaves in the medium stage of mottling sometimes contained more and sometimes less of these four elements. Midribs of the healthy leaves contained less of these elements than the mesophyll, while in badly mottled leaves the midribs contained more calcium and more phosphorus. The petioles contained less iron, calcium, and magnesium than either midrib or mesophyll in healthy and mottled leaves, while in badly mottled leaves the petioles contained more iron, calcium, and magnesium than either the midrib or mesophyll. Old leaves were found to contain more calcium and magnesium than new leaves. The yellow spots in the mottled leaves contained less calcium, magnesium, and phosphorus than the green parts of the same leaf. In working on the golden privet JENSEN found that the yellowed leaves contained more iron and 2.5 times as much phosphorus as the green ones. The increased amount of iron, calcium, magnesium, and phosphorus in the conducting tissues of the badly mottled leaves indicated that there was difficulty in the transfer of these materials to and fro.

MCBETH (37) found that plots receiving large applications of commercial fertilizers generally bore trees with badly mottled leaves, while trees receiving no nitrogen or barnyard manure generally showed little mottling. In other groves extreme mottling was frequently associated with a high nitrogen content. Moisture and nitrogen content of the mottled leaves were found to be higher than in the normal green leaves. His work seemed to indicate that too much nitrogen caused the mottling of citrus trees.

### Investigation

The mottling of *Coleus* leaves occurs in a regular manner, proceeding from the edge inward and toward the base of the leaf. The edge usually yellows first, while only in rare cases do yellow spots develop in the central part before the edges become yellow. The basal portion seems to retain its green color longer than the tip, and the veins or the region near the veins are the last to lose their green color. The leaves on plants in good soil often die at the tip about the time of mottling, while the leaves on plants in poor soil rarely show this characteristic. Usually the leaves from plants

in good soil only partially yellow before they drop, while the leaves on plants in poor soil always completely yellow before dropping. This might suggest that mottling and dropping involve different factors.

MEYER (38) points out that leaves of *Tropaeolum* passed through the following stages: dark green 25 days, green 6 days, bright green 12 days, yellow green-yellow 3 days, and then bright yellow. The young leaves at the top of the stem were dark green, while those at the bottom were yellow or wilting. The yellowing he believed to be due to the aging of the leaves. The change from bright green to yellow green was very rapid, and took place in much the same manner as that described for *Coleus*.

#### MORPHOLOGICAL EXAMINATION

In comparing microscopically the green with the mottling leaf, several striking differences were observed. In the green leaf the chloroplasts were large and blue-green, and one to three or more starch grains were clearly visible in the chloroplasts. The guard cells seemed to retain their coloring matter longer than the adjoining cells. In the mottled leaf the chloroplasts were yellowish, fewer in number, much smaller, without a green tint, and without starch grains. The chloroplasts were clustered about the apparently normal nuclei or distributed throughout other parts of the cells. Also the general appearance of bacteria being active here was observed, and will be discussed later. The chloroplasts in the palisade cells of the normal green leaves were 2-5  $\mu$  in diameter, while those in the mottled leaves were 1  $\mu$  or less in diameter. The chloroplasts in the guard cells of the green leaves, as well as those in the mottled leaves, were about 1  $\mu$  in diameter. SWART observed that in the aging of leaves the chloroplasts broke down and the starch disappeared, but the nuclei and the plasma layers remained. He was not certain whether the chlorophyll escaped from the cell or not. The chloroplasts of the deep green leaves of *Tropaeolum majus*, as noted by MEYER, were larger than those of the pale green leaves. Since he made some very accurate determinations of the sizes of the chloroplasts and correlated the size with the color of the leaves, it will not be out of place here to quote him rather fully.

MEYER found that the protein of the palisade cells is located chiefly in the chloroplasts, which he looks upon as the birthplace of the proteins, hence one can see why the color of the leaves and the protein content are so intimately related. He observed also

TABLE I

COMPARISON OF CHLOROPLASTS OF PALISADE CELLS IN *Tropaeolum*

Color of leaves	Deep dark green	Deep green	Green	Bright green	Yellow
Relation of diameters.....	126	100	86	72	52
Relation of volumes.....	200	100	64	38	14

that as the leaves yellowed there was little change in the size of the nucleus, the nucleolus, or in the protein content of the cytoplasm. He inferred that the formation of chlorophyll in the chloroplasts follows the development of protein in the leaves.

## CULTURES

The plants were grown in the purest fine quartz sand, in new 4-inch flower pots. Experiments were conducted in which the sand was watered with nutrient solutions bearing all of the necessary elements for plant nutrition, or lacking either Ca, Mg, P, Fe, or N. Twenty-six plants were used in each of the six sets, making 156 in all. The set of plants receiving the complete nutrient was watered with Pfeffer's solution as given by DUGGAR (14). When iron, calcium, magnesium, phosphorus, or nitrogen was omitted from the complete solution, the salts suggested by DUGGAR were substituted. In the solution lacking iron,  $\text{Ca}(\text{NO}_3)_2$ ,  $\text{KNO}_3$ ,  $\text{MgSO}_4$ ,  $\text{KCl}$ , and  $\text{KH}_2\text{PO}_4$  were used; in that lacking magnesium,  $\text{KNO}_3$ ,  $\text{Ca}(\text{NO}_3)_2$ ,  $\text{Na}_2\text{SO}_4$ ,  $\text{FeCl}_3$ ,  $\text{KH}_2\text{PO}_4$ , and  $\text{KCl}$ ; in that lacking phosphate,  $\text{Ca}(\text{NO}_3)_2$ ,  $\text{KNO}_3$ ,  $\text{MgSO}_4$ ,  $\text{KCl}$ , and  $\text{FeCl}_3$ ; in that lacking nitrate,  $\text{CaCl}_2$ ,  $\text{KCl}$ ,  $\text{MgSO}_4$ ,  $\text{KH}_2\text{PO}_4$ ,  $\text{KCl}$ , and  $\text{FeCl}_3$ ; in that lacking calcium,  $\text{NaNO}_3$ ,  $\text{KNO}_3$ ,  $\text{MgSO}_4$ ,  $\text{KH}_2\text{PO}_4$ ,  $\text{KCl}$ , and  $\text{FeCl}_3$ . All of these were made up according to DUGGAR. Cuttings were made of the plants, which were then rooted in sand for two weeks. The freshly potted plants were watered first with nutrient solutions and then every morning with distilled water. About every week another application of the nutrients was made. The plants were

grown from May 1 to August 1. The effect of lack of nitrogen was evidenced in four or five days by noticeable yellowing.

Fig. 1 shows the condition of the various cultures on August 1. The plants with complete nutrient solution, and those without calcium, magnesium, or iron, grew about equally well. There was evidently enough of each of these elements already in the cuttings to care for considerable additional growth. All these plants had a good green color, indicating a plentiful chlorophyll supply. The effect of the absence of  $\text{PO}_4$  or  $\text{NO}_3$  was especially striking. A considerable nitrogen and phosphate supply evidently was necessary

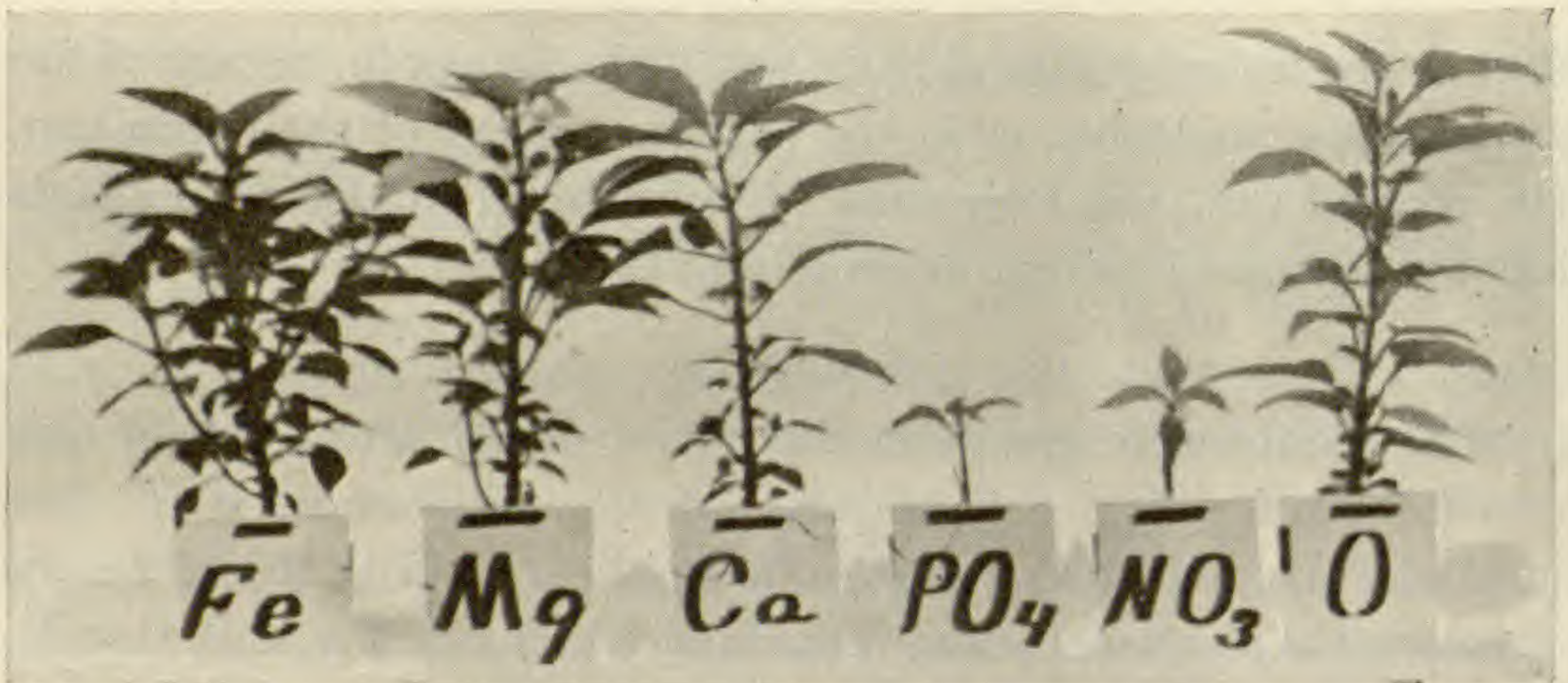

FIG. 1.—*Coleus* plants grown in various nutrient solutions: —Fe, iron lacking but all other essential elements present; —Mg, magnesium lacking, etc.; —O, all essential elements present; notice dwarfed condition of plants lacking phosphate or nitrate.

to cause any increment in the growth of the plants. The plants grown without  $\text{PO}_4$  were very small, but the leaves were a deep green, even greener than any of the plants in the best soil. While addition of phosphorus was needed for any considerable growth of the plant, it was not needed for the maintenance of the chlorophyll. The deep green in the phosphorus-lacking plants probably was due to the high nitrate supply in proportion to the size of the plant, for here, as in all of this work, nitrate supply or its deficiency seemed to determine the development or the disappearance of chlorophyll. The plants grown in solutions lacking one of the elements Ca, Mg, or Fe, and those in complete nutrient solutions

all showed branches developing in axils of the leaves. The branching was especially prominent in the plants watered with nutrient solution lacking iron. No branches developed on the plants watered with nutrient solutions lacking  $\text{PO}_4$  or  $\text{NO}_3$ .

On August 1 (3 months after planting) the number of pairs of leaves still attached was counted and compared with the number of pairs which had fallen. The plants were similar when the experiment was begun. Each group contained 26 plants and the average of these was taken.

Table II shows that when phosphate or nitrate was lacking a greater percentage of the leaves fell compared with any other element. This may partially be accounted for because plants lacking  $\text{NO}_3$  or  $\text{PO}_4$  had a smaller percentage of new leaves, and

TABLE II  
EFFECT OF NUTRIENT ON LEAF FALL

LEAVES	ELEMENT LACKING					
	Fe	Mg	Ca	$\text{PO}_4$	$\text{NO}_3$	None
Average number of pairs dropped per plant. . . . .	7	7	6	7	5	6
Average number of pairs still attached. . . . .	9	9	9	3	4	9
Percentage dropped. . . . .	45	45	40	70	56	40

consequently a smaller percentage of leaf fall. This did not account for the fact that when phosphate was lacking 14 per cent more of the leaves fell than when nitrate was lacking. The plants lacking Fe and those lacking Mg during the course of the experiment grew 16 pairs of leaves; those lacking Ca and those on complete nutrient solution each grew 15 pairs of leaves; those lacking  $\text{PO}_4$  grew 10 pairs of leaves; and those lacking  $\text{NO}_3$  grew only 9 pairs.

To 8 of the plants (2.5 months old) which were grown in sand cultures with  $\text{NO}_3$  or  $\text{PO}_4$  lacking, one watering was made with a solution which contained the lacking element. The effect is shown in fig. 2. Two weeks after the watering the height of the treated plants was about twice that of those which had no nitrate or no phosphate added, and the area of the new leaves put forth was from three to four times the area of the old leaves below them.

The plants to which nitrate was added showed noticeable greening in 4 or 5 days, and somewhat later became a normal green. Not only did the new leaves put forth become green, but even the light yellow leaves which were on at the time the nitrate was added became green.

Another set of experiments was carried out in which the elements Mg, N, P, Ca, and Fe were added to plants growing in pots in ordinary potting soil (figs. 3, 4). The solutions used were 2 per cent  $\text{FeCl}_3$ , 1 per cent  $\text{MgCl}_2$ , 6 per cent  $\text{CaCl}_2$ , 2 per cent  $\text{KH}_2\text{PO}_4$ , and 8 per cent  $\text{NaNO}_3$ . Eight plants were used for each treatment and 8 for controls, making 48 in all. In each case 0.25 cc. of the salt solution, diluted to 6.25 cc., was applied to the soil in the pots three times a week. In addition to this the plants were watered daily with tap water. The plants to which iron was added were given two or three drops of the iron solution each week. Some of the plants before being placed under treatment had already begun to mottle, but those to which nitrate was added rapidly regained their normal green. All of the plants to which nitrate was added retained their normal green and held their leaves better than the other cultures; also they branched and were sturdier than the rest. The plants shown in fig. 3 were grown 4 months in 2-inch pots, while those shown in fig. 4 were grown 4 months in 3-inch pots. Plants which were used as controls did not seem to do as well as the others, while the plants which received phosphate lost a large percentage of their leaves. The plants which received magnesium, calcium, or iron grew about equally well. The data given in table II show that lack of phosphate seemed to cause leaf fall, while here its addition caused the same effect. The lack of phosphates caused the leaf to fall, while the addition of phosphates alone to the soil, the nutrients not being present in a balanced ratio, produced the same effect.

DICKSON'S (12) work on oats is of interest in this connection. He found that oat seedlings grown in solutions deficient in phosphorus or nitrogen produced but one slender shoot. Plants grown in solutions deficient in Ca or Mg stooled heavily before those grown in complete nutrient solutions, and later the plants grown in solutions deficient in magnesium showed marked striping



FIG. 2.—Plants 3 months old: one labeled  $-NO_3$  grown full time with  $NO_3$  lacking in nutrient solution; one labeled  $+NO_3$  grown with  $NO_3$  lacking in nutrient solution for 2.5 months and then one dose of  $NO_3$  added, after which plants grown for 2 weeks more; plants labeled  $-PO_4$  and  $+PO_4$  similarly treated; here  $PO_4$  was substance lacking or added.

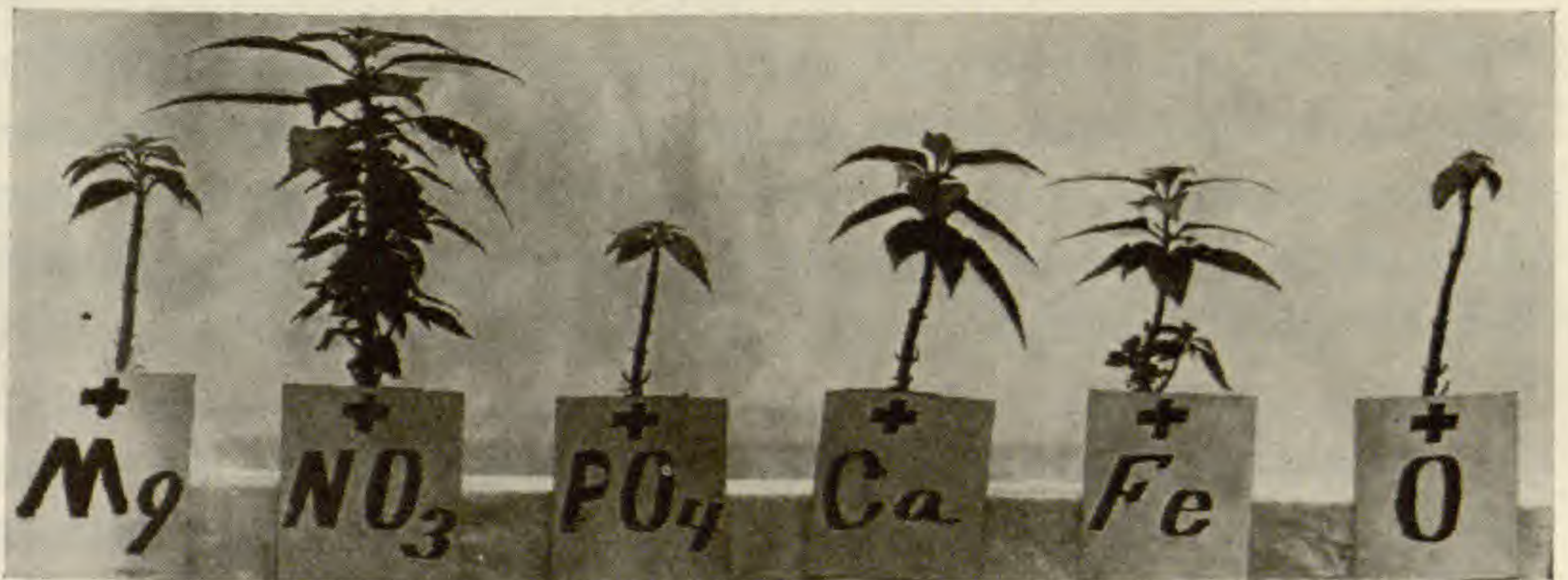

FIG. 3.—Plants 4 months old, during which time solutions containing Mg, N, P, Ca, Fe, or nothing were added to soil in respective pots; effect of addition of N shown by greater development of plant, as well as healthier color of leaves.

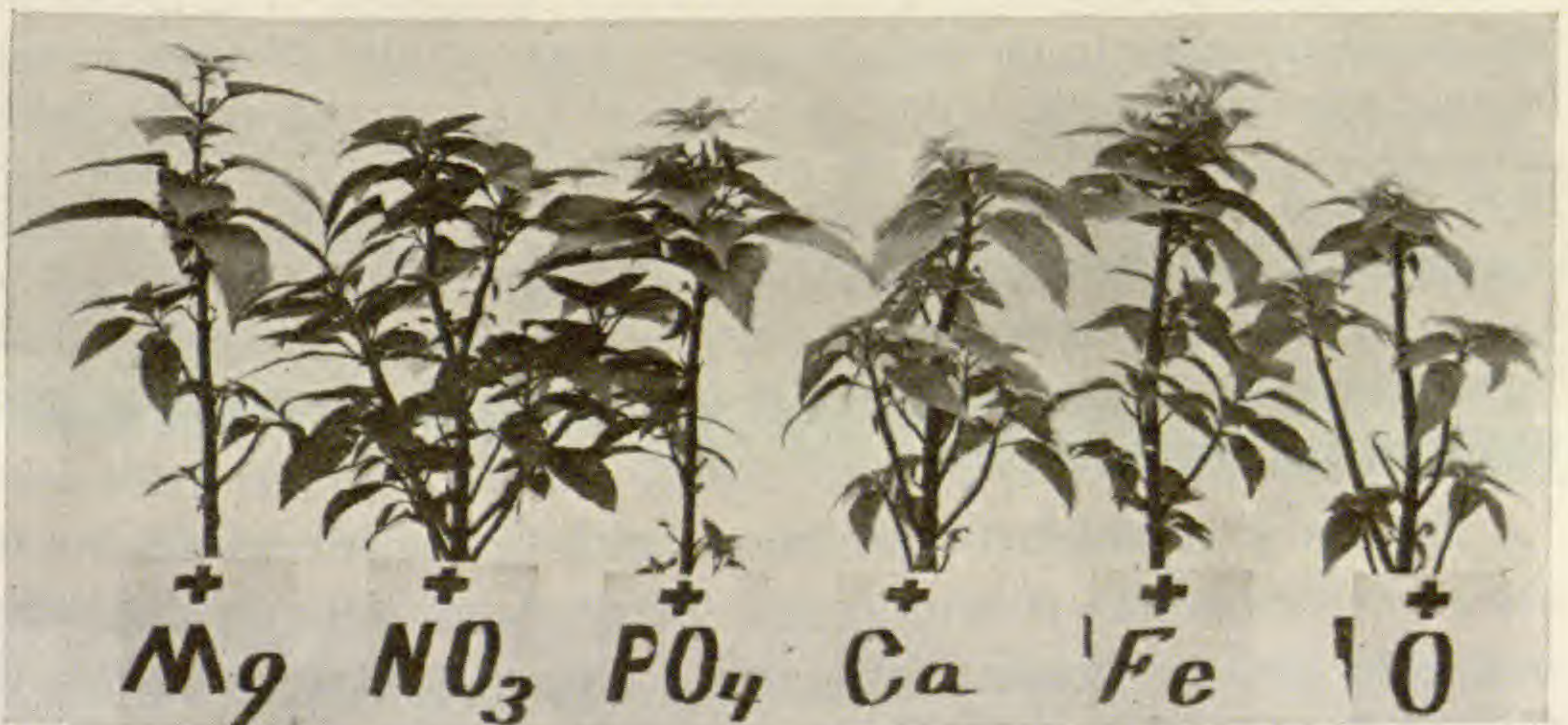

FIG. 4.—Plants similar to those in fig. 3, but grown in pots 1 inch larger

as the chlorophyll disappeared between the veins. Leaves and stems of plants grown in culture solutions deficient in phosphorus were purplish green. This color is apparently due to the presence of a purplish colloidal substance (perhaps a result of the decomposition of the chlorophyll) intermixed with the chlorophyll. Oat plants grown in solutions weak in nitrogen produced narrow purplish green leaves. Microscopical examination showed the chloroplasts more or less disorganized. A deficiency in phosphorus or in nitrogen produced a markedly unfavorable effect by causing a great decrease in the vegetative growth.

JOST (27) asserts that two *Helianthus* plants growing to maturity in three months used 1.4 gm. of  $\text{KNO}_3$ . These experiments with *Coleus* plants showed that one *Coleus* plant growing in soil in a 3-inch pot used the equivalent of 1 gm. of  $\text{KNO}_3$ , in addition to the nitrate which was in the soil, and then did not reach maturity. This shows that *Coleus*, being a plant much smaller than the sunflower, seems to use large quantities of nitrate. During the course of the experiment, if the nitrogen supply was discontinued at any time, the plants began to mottle at the margin of the leaves, but the leaves greened when the supply was again added. This shows that the plant was using the nitrate which was added to the soil in the pot. BURD (9) computed from the crop the amount of nitrate one barley plant used, and found that about 1.1 gm., calculated as potassium nitrate, was sufficient to bring the plant to maturity. PALLADIN (40) states as follows:

Carbohydrates are essential to the formation of chlorophyll. Plants fall into two groups according to the carbohydrate content of their etiolated leaves. In one group (for example, barley) the etiolated leaves contain much soluble carbohydrate material, while in the other group (as beans and lupines) the etiolated leaves contain very little carbohydrate. If etiolated leaves of these plants are removed and floated upon water in the light, those of barley become green, while almost all the bean leaves and all those of lupine remain yellow. If the latter are floated, not upon water but upon a saccharose or glucose solution, then they also become green.

The writer conducted experiments with *Coleus* leaves similar to these of PALLADIN. Young *Coleus* plants were kept in darkness until the leaves became etiolated. These etiolated leaves of *Coleus* when floated on distilled water in the light remained yellow,



those on  $\text{KNO}_3$  solution died, while those on a 5 per cent sugar solution greened slightly. On the other hand, *Coleus* leaves which had mottled in the light did not green again when floated on any of these solutions. In the case of etiolated *Coleus* leaves it apparently is true that they do not form chlorophyll because of the lack of carbohydrates. The case of the mottled leaves cannot be explained on this basis. The catalase experiments (see later) show that the vigor of the mottled leaves is greatly reduced, and this would account for the inability of the mottled leaves to green again. In the case of mottled leaves carbohydrates are evidently not the limiting factor, for tests for carbohydrates showed that plenty of starch was present in the leaves.

### Microchemical analysis

The differences between the normal green and the mottled leaf were determined by microchemical methods. The tests used were those given by MOLISCH and TUNMANN in their texts on microchemistry, and generally several tests were applied in order to determine the presence or absence of a substance.

Tests for starch were made upon the two types of leaves. Green and mottled leaves gathered before 8 o'clock (sun time) showed a wide variation. The guard cells of the mottled leaves were especially full of starch, while some starch was found in the other parts of the leaves; the whole leaf had a bright blue color after testing with iodine. Much starch was found in all parts of the green leaf, and it was colored deep violet to black by the iodine used. In the evening, after a bright sunny day, leaves were collected and the amount of starch again determined. The guard cells of the mottled leaves were well filled with starch, and the other cells had much more starch than they had in the morning. The chloroplasts which were present appeared to be active in forming starch, even though no chlorophyll seemed to be present. Since this investigation the writer has had occasion to make some very accurate tests for small amounts of chlorophyll, and it is doubtless true that if solutions of the pigments of mottled leaves of *Coleus* had been subjected to spectrophotometric tests, chlorophyll would have been discovered, at least in small amounts. All cells

of the green leaf were completely filled with starch, which was present in larger grains than it was in the mottled leaves. The masses of starch here appeared to be about five times the diameter of the masses in the mottled leaves. At noon, a healthy plant which had the lower leaves mottled was placed in the dark. Immediately one-third of the tip end of one of the green leaves was cut off, then in 6 hours another one-third was cut off, and at the end of 18 hours the remainder of the leaf was removed. The same was done with the mottled leaf.

Table III shows that the translocation power of the leaf was still active, and proves that diastase was not inhibited by oxidizing enzymes, as was believed by WOODS (18) in the case of mosaic leaf of tobacco.

TABLE III  
TRANSLOCATION OF STARCH

Leaf	Placed in darkness	After 6 hours	After 18 hours
Green.....	Much	Medium	Little
Mottled.....	Fair amount	Less starch	Minute traces

Tests for iron in the chloroplasts were made with potassium ferrocyanide. Both the green and the mottled leaves had iron in their chloroplasts. The chloroplasts which were present in the mottled leaf were colored about as deeply as those in the green leaf. From the blue tint which was produced in the leaves, the green ones appeared to have more iron than the mottled ones. From the macrochemical results which follow, it is evident that some of the iron in the leaves is "masked."

In comparing the amount of ammonium magnesium phosphate crystals which were formed in the two leaves on the addition of sodium ammonium phosphate, there appeared to be slightly more crystals formed in the cells of the mottled leaf blade. In both green and mottled leaves less magnesium was found in the upper part of the petiole than in the part of the petiole nearest the stem. The petioles of young green leaves had about the same amount of magnesium as the petioles of strongly mottled leaves. In the petioles about one crystal of ammonium magnesium phosphate

per cell was formed in the cortex and in the pith. In the plant with mottled leaves 2 or 3 crystals were formed in each pith cell of the stem. Magnesium was also present in the xylem, phloem, cortex, and epidermal cells.

In making comparative tests of the leaves for calcium, apparently a few more calcium sulphate crystals were formed in the cells of the mottled than the green leaves. In the green leaves much calcium was found in the epidermis of the petioles, some in the xylem and phloem regions, and little in the parenchyma. The same was true of the mottled leaves. In the stems many calcium sulphate crystals were formed in the pith cells on the addition of  $H_2SO_4$ . If there was any difference, more crystals were formed in the stems of the mottled plants. Calcium sulphate crystals were also formed in the xylem, phloem, cambium, and cortical regions. The fact that the mottled leaves and stems were always older than the green leaves and stems of the same plant would account for more crystals being formed in their cells.

In testing for phosphates by the addition of ammonium and magnesium chloride, only a very few crystals of ammonium magnesium phosphate were formed in the green leaves or in the mottled ones. Evidently the phosphorus must have been in some organic form in which it is not readily reactive with the reagents used, hence no conclusion can be drawn from this test regarding the metabolic disturbances which may be produced by it.

The test for nitrates gave the most interesting result. All of the green leaves gave tests which showed that an abundance of nitrate was present, while no positive results were obtained from the completely mottled leaves. It is of value to compare the progress of the mottling of the leaf with the absence of nitrates. The first signs of mottling usually appeared at or near the lobes of the leaf, and it was here that the test for nitrates was first negative. At this stage the greatest amount of nitrates was found in the conducting tissues of the leaf. Also in the deepest green leaves the conducting tissues contained the most nitrate. As the green disappeared from the tip of the leaf, more and more nitrates were found only in the veins close to the base. At this stage only a little greenish tint remained in the leaves. Usually as long as the

veins still showed a greenish tint some nitrates were found to be present. The last traces of nitrate in the leaf were found only in the petioles. In a moderately yellowed plant whose leaves were very slightly green, nitrates were found only in the pith region at the base of the stem; hence nitrates began to disappear at the very tip of the leaves and were last found only at the base of the stem. The nitrates disappeared last in the storage regions.

Among other workers in microchemistry, SWART (48) found that in yellow leaves in autumn the amount of phosphorus, nitrogen, and potassium decreased shortly before the leaves fell. Comparing this with the mosaic disease of tobacco, FREIBERG (18) reports that more proteins were present in the lighter areas of the leaves than in the darker. Nitrates were present in about the same quantities in healthy and diseased areas. Ammonium salts, iron, calcium, magnesium, potassium, phosphorus, and sulphur were also present in the same quantities in the chlorotic and in the dark green areas. By employing Folin's micro-Kjeldahl method less nitrogen was found in the dark areas than in the lighter diseased areas. Diseased areas of the tobacco leaf gave a more pronounced reaction with Millon's reagent, the xanthoproteic reaction, and the biuret test than did the healthy areas. More carbohydrates were always present in the dark green or healthy areas.

### Macrochemical analysis

Since the whole leaf of the plant mottled completely, it was easy to compare the green with the mottled leaves by an analysis of the leaves, including the petioles, for the presence or absence of the substances which were suspected of causing the disturbance. In making the following analyses, controls were always run on a known sample, and in many cases several methods of analysis were tried and the one which gave the best theoretical results was used.

In estimating the amount of iron present in the leaves, the method described by MARRIOTT and WOLF (34) was used. The blade, petioles, and region of the abscission layer were analyzed separately. A piece 3-4 mm. long was used for the analysis of iron in the abscission layer, and the petiole was cut off at the base

of the leaf. The leaves were taken from the same plants, which were grown in ordinary potting soil, dried to constant weight at 100° C., and then the dry material ashed at a low red heat. The iron was calculated as free iron.

The analysis for iron showed that the amount of iron increased in the abscission layer, in the petioles, and in the leaf blades in

TABLE IV

COMPARISON OF AMOUNTS OF IRON IN GREEN AND MOTTLED LEAVES

Material	Wet weight	Dry weight	Percentage dry weight	Grams of iron	Grams of iron per gram of dry weight	Grams of iron per 100 grams of dry weight (average)
Mottled leaves						
Abscission layer....	{ 0.3450 0.2585 0.2660	{ 0.0200 0.0146 0.0166	{ 5.79 5.65 6.24	{ 0.000,016 0.000,014 0.000,024	{ 0.000,80 0.000,98 0.001,47	0.108
Petioles.....	{ 2.0320 1.5550 1.4080	{ 0.0865 0.0582 0.0588	{ 4.25 3.74 4.17	{ 0.000,042 0.000,036 0.000,009	{ 0.000,49 0.000,62 0.000,15	0.042
Leaf blade.....	{ 8.5660 5.4694 6.4706	{ 0.4930 0.3008 0.4520	{ 5.75 5.50 6.98	{ 0.000,81 0.000,37 0.000,48	{ 0.001,64 0.001,21 0.001,06	0.130
Green leaves						
Abscission layer....	{ 0.6450 0.4224 0.3980	{ 0.0300 0.0206 0.0192	{ 4.65 4.87 4.82	{ 0.000,02 0.000,02 0.000,02	{ 0.000,666 0.000,970 0.000,729	0.079
Petioles.....	{ 4.7160 2.4650 1.5780	{ 0.1690 0.0992 0.0988	{ 3.58 4.02 6.26	{ 0.000,045 0.000,038 0.000,024	{ 0.000,266 0.000,383 0.000,239	0.030
Leaf blade.....	{ 17.4220 8.1016 10.3500	{ 1.2100 0.5575 0.8080	{ 6.94 6.88 7.80	{ 0.000,47 0.000,39 0.000,90	{ 0.000,388 0.000,699 0.001,110	0.073

the mottled leaves. This result disagreed with the microchemical report, perhaps owing to the fact that the iron was bound in some way and was released only by ashing the leaf. It showed that about 1.55 per cent of the ash of the green leaves was  $Fe_2O_3$ . According to PALLADIN (40), beech leaves have 2.30 per cent of  $Fe_2O_3$  in the ash, while JOST (27) states that tobacco leaves have 1.95 per cent. According to PALLADIN 0.09 per cent of the dry weight of pea

leaves and 0.11 per cent of the dry weight of bean leaves was  $\text{Fe}_2\text{O}_3$ , while *Coleus* leaves had 0.23 per cent as  $\text{Fe}_2\text{O}_3$ . The  $\text{Fe}_2\text{O}_3$  in beech leaves increased from 0.8 per cent of the ash in May to 1.3 per cent of the ash in October. One concludes that the mottling of the *Coleus* leaves was not due to a deficiency in iron, for at all times the leaves had enough iron, when compared with



FIGS. 5, 6.—Fig. 5, plants from which leaves were taken for analysis: leaves missing on upper part of plant at left taken for analysis; lower leaves mottled and fallen off; lower pair of leaves still on each plant partially mottled; plant at left type *A*, plant at right type *B*; fig. 6, another group of plants from which leaves were taken for analysis: plant at right type *A*, plant at left type *B*; lower pair of leaves still on each plant partially mottled; plants grown close together to produce larger leaves, accounting for leaflessness of stems.

other plants, to carry on their metabolic activities in a normal manner. This fully agrees with the conclusions drawn from the cultures.

Two types of plants were used for the analyses which follow. Plants of type *A* were grown in 3- and 4-inch pots, until ready for repotting, and then put into 6- and 8-inch pots, using ordinary

potting soil for repotting. Plants of type *B* were taken from the same group as *A*, and were repotted in pots of the same size as *A*, but sand was used instead of soil. In this way the plants were grown under exactly the same conditions of light and moisture as were the plants of type *A*, but the amount of soil nutrient was considerably reduced. The larger plant in each figure (figs. 5, 6) is of type *A*. The two plants shown in fig. 6 were grown in 6-inch pots, while those in fig. 5 were grown in 8-inch pots. All the leaves designated "green" were picked from plants of type *A*, and the "mottled" leaves were picked from both sets of plants and were analyzed separately. The mottled leaves from plants of type *A* as a rule were only partially mottled, while those from type *B* were always completely mottled. The green leaves were picked from the plant 3 or 4 nodes above the yellowing leaves,

TABLE V  
MAGNESIUM

Leaf	Sample no. I	Sample no. II	Sample no. III	Average	Per 100 gm. dry weight
Green.....	0.0922	0.0980	0.0952	0.0951	1.50
Mottled <i>A</i> .....	0.0883	0.0892	0.0935	0.0903	1.66
Mottled <i>B</i> .....	0.0938	0.0740	0.0840	0.0839	1.35

and the mottled leaves from types *A* and *B* were picked just about the time they were ready to fall. The leaves were always picked before 8:00 A.M. in order that the results might better be compared.

The amounts of magnesium and calcium were determined according to the methods given in Bulletin 107 of the Bureau of Chemistry (8). In each case 40 gm. of green material was used for the determinations, and the results are given in grams of the free element per 100 gm. of wet material. The leaves were dried at 100° C. before being analyzed, and the dry weights found were used in calculating the grams of calcium and magnesium per 100 gm. of dry weight.

The magnesium content of mottled *Coleus* leaves differed little from that of green ones, and the magnesium content of both was somewhat higher than that reported for other leaves. As calculated from table V, the ash of green *Coleus* leaves was 17.5

per cent MgO, while according to PALLADIN (40) that of beech leaves was 7.20 per cent MgO, and according to JOST that of tobacco leaves was 7.36 per cent MgO. PALLADIN states that 1.02 per cent of the dry weight of pea leaves was MgO, while 0.66 per cent of bean leaves was MgO. The writer found that 2.48 per cent of the dry weight of green leaves was MgO. In agreement with the results from cultures, the analytical data also indicated that the magnesium was in excess of the needs of the plant, and that decomposition of chlorophyll in these leaves was not due to a shortage in magnesium.

The amount of calcium present in mottled leaves of *Coleus* was slightly greater than that in green, and the calcium content of both was less than that found in tobacco and beech leaves, while it was more than that found in pea and bean leaves. As

TABLE VI  
CALCIUM

Leaf	Sample no. I	Sample no. II	Sample no. III	Average	Per 100 gm. dry weight
Green.....	0.206	0.222	0.284	0.237	3.31
Mottled A.....	0.215	0.255	0.283	0.251	3.93
Mottled B.....	0.169	0.225	0.240	0.211	3.03

calculated from table VI, the ash of green *Coleus* leaves was 33.2 per cent CaO, while according to JOST that of tobacco leaves was 36 per cent CaO, and according to PALLADIN (40) that of beech leaves was 44.3 per cent CaO. PALLADIN found that 3.21 per cent of the dry weight of pea leaves was CaO, and of bean leaves 1.33 per cent was CaO. The increase of calcium (based on dry weight) from 3.31 per cent in the green *Coleus* leaves to 3.93 per cent in the mottled is easily accounted for by the fact that the older leaves have different ash constituents (44) from the young leaves. In beech leaves (40) the MgO content (based on dry weight) increased from 4.3 per cent in May to 5.6 per cent in July, and then decreased to 4.1 per cent in October. These data and the culture experiments showed that the amount of calcium present at all times was sufficient to care for the physiological needs of the plant.



Phosphates were determined by the NEUMANN-PEMBERTON (35) method and the result is given as free phosphorus. In each analysis 20 gm. of fresh leaves was used, and before being analyzed was dried at 100° C. in order to determine the dry weight.

The amount of phosphorus present in mottled *Coleus* leaves was considerably less than in green ones, and the phosphorus content of the green leaves was about the same as that of other leaves (tobacco and beech), but the phosphorus content of pea and bean leaves was higher than that of green *Coleus* leaves. As calculated from table VII, the ash of green *Coleus* leaves was 6.41 per cent  $P_2O_5$ , while according to PALLADIN (40) the ash of beech leaves was 7.80 per cent  $P_2O_5$ , and according to JOST the ash of tobacco leaves was 4.66 per cent  $P_2O_5$ . Of the dry weight of

TABLE VII  
PHOSPHORUS

Leaf	Sample no. I	Sample no. II	Sample no. III	Average	Grams of phosphorus per 100 gm. dry weight
Green.....	0.031	0.032	0.019	0.027	0.398
Mottled A.....	0.011	0.011	0.010	0.011	0.181
Mottled B.....	0.010	0.010	0.011	0.011	0.176

the green *Coleus* leaves, 0.91 per cent was  $P_2O_5$ , while according to PALLADIN pea leaves had 1.67 and bean leaves 2.19 per cent  $P_2O_5$ . With mottling the total percentage of phosphorus in the leaf of *Coleus* calculated as  $P_2O_5$  (on ash basis) had decreased from 6.41 to 2.88 per cent, or somewhat over 50 per cent. In the case of beech leaves, PALLADIN found that in May the  $P_2O_5$  content was 32.4 per cent of the ash, while in October it was only 5.1 per cent. The percentage decrease of  $P_2O_5$  in *Coleus* leaves was not due to an accumulation of ash, but apparently to the decrease in the  $P_2O_5$  before the leaf fell, for when one calculated the amount of  $P_2O_5$  present in the green and in the mottled leaves, there was always a reduction of 50 per cent or more, whether the calculation was based on dry weight, wet weight, or ash. This reduction in the phosphate content of *Coleus* leaves was similar to that found by SWART (48) for other leaves, and in all probability the changes

which took place in *Coleus* are of a similar nature to those accompanying the yellowing of leaves in the autumn. Since the green and mottled leaves of *Coleus* were about the same size, and since there was only two or three weeks' difference at the most in the ages of the leaves of *Coleus*, it is hardly possible that the differences could be accounted for in any way except that the  $P_2O_5$  content actually decreased, and this would mean a transfer of materials from the leaf to the stem. If the amount of phosphorus were figured per leaf, then, since the leaves were about the same size, there would be nearly a 50 per cent reduction in the amount of phosphorus. Such a conclusion is in harmony with results from the cultures, for they showed that phosphate was necessary for growth of the plant, and when phosphates were deficient a larger percentage of the leaves fell. This conclusion is not out of

TABLE VIII

PHOSPHORIC ACID CONTENT OF LEAVES OF *Acer Negundo*

Phosphoric acid	May 7	June 6	July 5	August 2	September 3	September 25
Percentage dry weight. . .	1.500	0.801	0.705	0.580	0.586	0.333
Grams per 200 leaves. . .	0.256	0.200	0.210	0.134	0.147	0.099
$P_2O_5$ as percentage of ash	20.8	10.7	8.8	6.3	6.2	2.9

harmony with the work of SCHULZE and SCHÜTZ (44). In working on *Acer Negundo* these investigators showed that the phosphorus content decreased gradually and quite definitely from May to September, whether the phosphorus content was calculated as percentage of dry weight, grams per 200 leaves, or calculated from the ash. Only the results of their work on leaves collected in the morning will be given here, as they are most directly comparable with those of the writer, yet it is worthy of note that nearly always the phosphorus content of the leaves in the evening was greater than in the morning. This seems to indicate storage and synthesis during the day and a loss of phosphorus compounds during the night. The phosphoric acid content of the leaves is summarized in table VIII.

This work shows that the amount of phosphoric acid in the leaves of *Acer Negundo* decreases as the season advances. From these data one cannot agree with WEHMER or RIESMÜLLER (as

cited by PALLADIN 41), who believe that the absolute amounts of phosphoric acid do not diminish as the season progresses. The writer must agree with SCHULZE and SCHÜTZ, who find that the phosphoric acid content decreases as the leaves age or as autumn approaches.

Further evidence for the correctness of these views is presented by TUCKER and TOLLENS (49), who have shown that phosphorus decreased markedly in the leaves of the plane tree on or about October 8. The amount of phosphorus in the leaves at the end of the growing season was less than 50 per cent of that found in the leaves during the earlier part of the year. They believe that the three plant nutrients (nitrogen, phosphorus, and potash)

TABLE IX

## PROTEIN NITROGEN

Leaf	Sample no. I	Sample no. II	Sample no. III	Average	Grams of nitrogen per 100 gm. dry weight
Green.....	0.189	0.243	0.207	0.213	3.35
Mottled A.....	0.076	0.080	0.087	0.081	1.39
Mottled B.....	0.073	0.064	0.079	0.072	1.14

passed from the leaves into the stems as the leaves aged, and were not washed out by rains.

Protein nitrogen was determined by the Gunning-Arnold modification of the Kjeldahl process. In each case 10 gm. samples of the fresh leaves were used, and the results as given in table IX are grams of nitrogen per 100 gm. of fresh leaves.

The green leaves contained 1.33 per cent protein ( $N \times 6.25$ ), while the mottled leaves contained 0.51 per cent, and those on poor soil *B* 0.45 per cent, when calculated on the wet weight of the leaves. Based on the weight of the dry leaves, the green ones contained 20.9 per cent, the mottled *A* contained 8.7, and *B* 7.13 per cent protein. PALLADIN found considerable variation in the percentage of total nitrogen and protein nitrogen between etiolated and green leaves of various plants, but the difference was not always in the same direction. OTTO and KOOPER, and LECLERC DU SABLON (19) found that leaves decrease in their protein content

from spring to autumn. It is evident that the protein content of green and mottled *Coleus* leaves does not parallel that of the green and etiolated leaves of PALLADIN. If it resembles the protein change with progress of the growing season, it is at least much more rapid. It is probably quite similar to the rapid changes just preceding leaf fall in autumn.

The work of SCHULZE and SCHÜTZ (44) may again be relied upon to show the normal changes which take place in *Acer Negundo*.

TABLE X

NITROGEN PRESENT IN *Acer Negundo* LEAVES AT VARIOUS TIMES OF YEAR

Protein N	May 7	June 6	July 5	August 2	September 3	September 25
In 200 leaves.....	0.734	0.973	1.211	0.864	0.791	0.628
Percentage in dry material	4.304	3.906	4.068	3.745	3.163	2.110

The magnitude of the changes in the protein content of *Acer Negundo* is in harmony with that of *Coleus*, except that the changes in the latter are much more precipitous.

MEYER (38) made macroscopic tests for proteins in the leaves of *Tropaeolum* by means of the xanthoproteic reaction. The natural color of the leaves was noted and compared with the depth of color which was produced by the xanthoproteic test. He found that as the green color of the leaf disappeared, the xanthoproteic reaction became less and less, or, in other words, as the protein of the chloroplast decreased, the chlorophyll in the chloroplast decreased also.

TABLE XI

XANTHOPROTEIC REACTION OF NORMAL ILLUMINATED  
GROWING LEAVES OF *Tropaeolum*

Dark green leaves.....	5 to 4*
Green.....	3 to 4
Bright green.....	3
Yellow green.....	2 to 3
Yellow.....	2
Bright yellow.....	1 to 2

\*The larger the number the greater the amount of protein present.

In the leaves of the plane tree (*Platanus occidentalis*) TUCKER and TOLLENS found that the protein nitrogen decreased gradually

per unit area from July 15 until November 5. Over three-fourths of the nitrogen disappeared in this time.

In analyzing the leaves for total nitrogen when nitrates are present the method as described in Bulletin 107 (8) was used, with zinc as the reducing agent. Samples (10 gm.) of fresh leaves were used, and the results were calculated to grams of nitrogen per 100 gm. of fresh leaves. This analysis gives the total of the three forms (31) of nitrogen which may be found in organic matter (such as leaves), namely, nitrogen in a state of organic combination, nitrogen in ammonia or its combinations, and nitrogen in a more highly oxidized state as salts of nitrous or nitric acid. Table XII shows that there is a marked reduction in the total nitrogen content of the leaf with mottling. BONCQUET (5) found that the total

TABLE XII

PROTEIN NITROGEN+NITRATE NITROGEN+AMMONIUM SALTS

Leaf	Sample no. I	Sample no. II	Sample no. III	Average	Grams of nitrogen per 100 gm. dry weight
Green.....	0.283	0.267	0.249	0.266	4.19
Mottled A.....	0.117	0.107	0.103	0.109	1.87
Mottled B.....	0.074	0.071	0.060	0.068	1.09

nitrogen calculated on the basis of ash was always less in the diseased leaves than in the healthy ones.

The amount of nitrogen present in the leaves as  $\text{NO}_3$  was determined by the Schlösing-Wagner method as given in Bulletin 107. For each determination 25 gm. of leaves was used. The leaves were finely ground in a mortar with quartz sand, boiled for 2 hours, made up to a definite volume, filtered through cheesecloth, and the amount of nitrate estimated in an aliquot part. The amount of gas as nitric oxide set free was then measured in the burette of a Van Slyke apparatus (35), and the nitric oxide was absorbed in a Hempel pipette containing  $\text{NaOH}$  and  $\text{KMnO}_4$ . The residual gas was then measured in the burette. The difference gave the amount of nitric oxide, which was reduced to standard temperature and pressure, and was calculated to grams of nitrogen per 100 gm. of wet weight, as given in table XIII, which shows an

enormous reduction in the percentage of nitrate nitrogen with mottling.

TABLE XIII  
NITRATE NITROGEN

Leaf	Sample no. I	Sample no. II	Sample no. III	Average	Grams of nitrogen per 100 gm. dry weight
Green.....	0.004,28	0.002,78	0.002,68	0.003,25	0.0485
Mottled A.....	0.001,90	0.000,80	0.000,72	0.001,14	0.0196
Mottled B.....	0.000,05	0.000,10	0.000,05	0.000,07	0.0011

Table XIV summarizes the results given in tables IX, XII, and XIII, and shows the following changes in the nitrogen compounds of the leaf with mottling. When the green leaves of *Coleus* were

TABLE XIV  
COMPARISON OF NITROGEN FOUND

Form of nitrogen	Percentage wet weight	Percentage distribution of the three forms of N	Percentage dry weight
Green			
Protein nitrogen.....	0.213	80	3.35
N as ammonium salts.....	0.050	18.8	0.79
N as nitrate.....	0.003	1.2	0.05
Total.....	0.266	100.01	4.19
Mottled A			
Protein nitrogen.....	0.081	74.3	1.39
N as ammonium salts.....	0.027	24.8	0.46
N as nitrate.....	0.001	0.9	0.02
Total.....	0.109	100.01	1.87
Mottled B			
Protein nitrogen.....	0.072	.....	1.14
N as ammonium salts.....	-0.004	.....	-0.05
N as nitrate.....	0.0001	.....	0.0011
Total.....	0.068	.....	1.09

compared with the mottled, it was found that the amount of protein nitrogen, nitrogen as ammonium salts, and nitrogen as nitrates disappeared as the leaves mottled. The greatest decrease was found in the protein nitrogen, which showed that the protein

compounds were rapidly being broken down. In this connection SAMPSON (43) showed that the amino acid nitrogen of *Coleus* (based on dry weight) increased from 0.056 to 0.072 per cent as the leaves mottled. Table XIV shows further that when the leaves were completely mottled the nitrate nitrogen almost disappeared, which is in complete accord with the microchemical determinations. The table shows also that inorganic forms of nitrates were used up before the protein nitrogen was exhausted. PALLADIN shows that such was the case in starving plants. BONCQUET (4) believed that the plants he worked on were starving, due to lack of nitrogen.

Free ammonia was determined by a modification of the FOLIN method (35). Twenty-five gm. of the fresh leaves was finely ground with quartz sand, placed in an aeration tube, and ammonia-

TABLE XV  
FREE AMMONIA

Leaf	Sample no. I	Sample no. II	Sample no. III	Average	Nitrogen per 100 gm. dry weight
Green.....	None	None	None	None	None
Mottled A.....	None	None	None	None	None
Mottled B.....	0.000,18	0.000,14	0.000,21	0.000,18	0.003,25

free air drawn through the tube for 2 hours. The ammonia which came from the leaves was absorbed in an aeration tube which contained 0.1N H<sub>2</sub>SO<sub>4</sub>. The ammonia set free was distilled off, after adding NaOH, and Nesslerized (33). Especial care was taken to use materials absolutely free from ammonia. The ammonia is calculated as grams of nitrogen per 100 gm. of wet weight. For the analysis leaves were selected which were free from mechanical injuries or drying at the tips. The mottled leaves A still had some green in them, while those of B were wholly yellow.

Other forms of ammonia were determined, such as albuminoid ammonia. The method as outlined by MASON (33) was followed, in which 10 gm. of the fresh leaves was distilled in the presence of NaOH and KMnO<sub>4</sub>, 600 cc. of distillate distilled off and then a portion of it Nesslerized. The results calculated as grams of

nitrogen per 100 gm. of wet weight show that the mottled leaves had much less of the albuminoid ammonia.

Distillation of the leaves with  $\text{Na}_2\text{CO}_3$  was also undertaken. Twenty-five gm. of the leaves was distilled in a flask with 2 gm.

TABLE XVI  
ALBUMINOID AMMONIA

Leaf	Sample no. I	Sample no. II	Sample no. III	Average	Grams of nitrogen per 100 gm. dry weight
Green.....	0.050	0.120	0.064	0.079	1.18
Mottled A.....	0.019	0.035	0.019	0.024	0.41
Mottled B.....	0.018	0.024	0.013	0.018	0.29

of  $\text{Na}_2\text{CO}_3$  until 600 cc. of distillate was collected. An aliquot portion of it was Nesslerized and calculated as grams of nitrogen per 100 gm. of wet weight. Table XVII shows that the mottled leaves were lower in the amount of ammonia set free.

TABLE XVII  
AMMONIA FROM DISTILLATION WITH  $\text{Na}_2\text{CO}_3$

Leaf	Sample no. I	Sample no. II	Sample no. III	Average	Grams of nitrogen per 100 gm. dry weight
Green.....	0.012	0.0044	0.019	0.012	0.18
Mottled A.....	0.0073	0.0031	0.0095	0.0066	0.11
Mottled B.....	0.0056	0.0040	0.0064	0.0053	0.085

Nitrites were determined by the method as given by DAVISSON (11). Attempts were made to determine the amount of nitrite by colorimetric methods (29), but the presence of anthocyanins which could not be precipitated out with lead subacetate interfered.

TABLE XVIII  
NITROGEN AS NITRITE

Leaf	Sample no. I	Sample no. II	Sample no. III	Average	Grams of nitrogen per 100 gm. dry weight
Green.....	None	None	None	None	None
Mottled.....	0.001,12	0.001,32	0.001,42	0.001,29	0.021,5



The fresh leaves (25 gm.) were ground finely with quartz sand, placed in the flask, and titrated as suggested by DAVISSON.

ASO and SEKINE (3) found that there was about 0.000,78 per cent N in the healthy buds of *Sagittaria sagittifolia*, when calculated on the basis of wet weight, or 7.8 parts N per million of material. In mottled *Coleus* leaves there are 12.9 parts per million, but not a detectable amount in green leaves. BONCQUET (4) reports the presence of nitrite and ammonia in various plants which were diseased. The diseases were of the physiological type such as curly leaf of sugar beets, curly dwarf of potatoes, mottled leaf of potatoes, and mosaic disease of the tobacco. He believes that

TABLE XIX  
CARBOHYDRATES

Leaf	Sample no. I	Sample no. II	Sample no. III	Average	Grams per 100 gm. dry weight
A. M.					
Green.....	0.890	0.855	1.050	0.932	13.93
Mottled A.....	0.740	0.820	0.685	0.748	12.89
Mottled B.....	1.110	1.090	0.935	1.044	16.84
P. M.					
Green.....	1.435	1.370	1.430	1.412	21.08
Mottled A.....	0.780	0.850	0.825	0.822	14.17
Mottled B.....	1.020	1.040	1.155	1.073	17.30

nitrogen starvation is brought about by bacterial reduction of the nitrates to nitrites and ammonia, after the nitrates have been taken up by the roots. The response of the plant to the stimulus, he says, is manifested in biochemical, physiological, and morphological changes.

The amount of carbohydrate material in the leaves was estimated by first boiling (2.5 hours) 10 gm. of the freshly ground leaves in 100 cc. of water, to which 10 cc. of HCl (sp. gr. 1.125) was added. The sugars were then determined as dextrose by the BERTRAND (31) volumetric method. The calculations are given as grams of dextrose per 100 gm. of wet weight. Sugars were determined both in the morning and in the evening after a bright day,

to ascertain the relative amounts of photosynthetic activity in the green and mottled leaves.

The green leaves gained 0.48 gm. (as dextrose) during the day, mottled *A* gained 0.074 gm., and mottled *B* 0.029 per 100 gm. of wet weight, which shows that the photosynthetic activity was greatly reduced by mottling. In the morning the carbohydrate content of the mottled leaves in all probability consisted mainly of substances of an aplastic nature, such as the hemicellulose of the cell wall which by hydrolysis forms galactose, xylose, mannose, etc. Since the carbohydrate content probably was made up mainly of substances of an aplastic nature, one would not expect them to be exhausted by respiration or to be translocated from the leaf. WILLSTÄTTER (table XXVIII) has shown that the carbon dioxide assimilated per hour was greatly reduced as the leaves yellowed.

#### Water content and ash

For each determination 20 gm. of fresh leaves was used; the leaves were dried at 100° C. and then ashed at a dull red heat.

TABLE XX

DRY WEIGHT

Leaf	Sample no. I	Sample no. II	Average
Green.....	7.22	6.88	7.05
Mottled <i>A</i> .....	5.80	5.58	5.69
Mottled <i>B</i> .....	5.79	6.60	6.20

This decrease in dry weight is in harmony with the work of BONCQUET, or, in other words, leaves of mottled plants have a higher water content. WILLSTÄTTER (table XXVIII) showed that the water content of the leaves increased as yellowing progressed. This is due either to the fact that the materials were transported from the leaf or that respiration decreased the amount of dry matter present.

Table XXI shows that the percentage of ash when calculated on the dry weight of the leaves increased 3-7 per cent during mottling. Analyses of leaves as given by SWART (48) show that as a rule the yellow leaves gave a larger percentage of ash than

the green ones. One might construe this to mean that materials are not transported from the leaf as it yellows, for if they were transported, presumably the salts would be carried along and the ash would decrease. It seems more probable that since the assimilative activity is reduced, the respiratory products pass off as gas and so leave the salts behind. BONCQUET (4) found that plants affected with nitrogen starvation have a higher percentage of ash (when based on dry weight) than normal plants, as is shown by beets, tobacco, and potatoes.

SCHULZE and SCHÜTZ (44) have shown that the ash content of leaves of *Acer Negundo* increases as autumn approaches. The

TABLE XXI

## ASH

Leaf	Sample no. I	Sample no. II	Average	Grams ash per 100 gm. dry weight
Green.....	1.05	0.89	0.97	13.8
Mottled A.....	0.97	0.93	0.95	16.7
Mottled B.....	1.23	1.32	1.28	20.7

TABLE XXII

## ASH IN DRY SUBSTANCE

	May 7	June 6	July 5	August 2	September 3	September 25
Percentage of ash.....	7.23	7.52	8.06	9.17	9.43	11.29

ash of the leaves increased 4 per cent, while the ash of *Coleus* leaves increased 3-7 per cent. Ash of the plane tree leaves per unit area of leaf was shown by TUCKER and TOLLENS (49) to increase gradually until October 8, after which there was a slight decrease.

## Catalase

In determinations of catalase activity only the blades of *Coleus*, exclusive of the primary veins, were used. For each determination 0.5 gm. of the leaf material was ground for 2 minutes with a little quartz sand and powdered calcium carbonate as a neutralizer. The determination was run according to the method described by

APPLEMAN (1), using 10 cc. of dioxogen as the hydrogen peroxide and suspending the plant material in 10 cc. of water. Tables XXIII and XXIV show the cubic centimeters of oxygen liberated per 0.5 gm. of fresh weight of leaves at 25° C. during 10 minutes of activity. Table XXIII shows that the catalase activity gradually

TABLE XXIII

## EFFECT OF AGE OF LEAF ON CATALASE ACTIVITY

OXYGEN LIBERATED	
82.0 cc.....	Top pair of leaves
88.5.....	Second pair of leaves
93.0.....	Third pair of leaves
86.0.....	Fourth pair of leaves
80.0.....	Fifth pair of leaves
74.0.....	Sixth pair of leaves
51.5*	Seventh pair of leaves
32.0†	Eighth pair of leaves

\* Leaves still green.  
† Leaves half mottled.

increased and reached a maximum in the third or fourth pair of leaves, and then decreased gradually until the leaf mottled. With mottling of the leaf it was noticed that the catalase activity dropped enormously.

From table XXIV it is evident that as the leaves mottled the catalase activity decreased greatly, even reaching a value of less

TABLE XXIV

## COMPARISON OF CATALASE IN GREEN AND MOTTLED LEAVES

COMPLETELY MOTTLED	GREEN
6.3	103.0
10.0	95.0
8.0	90.0

than 1/10 that of the healthy leaves. The mottled leaves were taken from the plant 3 or 4 nodes below the green ones, and therefore age would be a factor, but it is not sufficient to account for the enormous decrease in the catalase activity.

An analysis of the leaves was made to determine the amount of nitrogen and phosphates in the  $F_1$ ,  $F_2$ , and  $F_3$  of the three types of leaves. Each morning the leaves were collected until 80 gm. was obtained for each sample; the leaves as collected were preserved in 95 per cent alcohol in ground glass stoppered, wide-mouthed bottles, and kept there until needed for analysis. An extraction

was made in 95 per cent alcohol at the temperature of the boiling solvent for 20 hours, and then for 4 hours in ether at the temperature of the boiling ether. The residue was dried, weighed, and called  $F_3$ , the ether-alcohol extract was  $F_1$  and  $F_2$  combined. The ether-alcohol extract was evaporated to dryness in a Freas vacuum oven at  $70^\circ\text{C}$ ., weighed, and the portion of it which was soluble in anhydrous ether at room temperature was called  $F_1$ , and the weighed residue  $F_2$ . Aliquot parts of the three fractions were analyzed and results were calculated to grams of N or P per 100 gm. of fresh leaves.

TABLE XXV

PROPORTIONS OF VARIOUS FRACTIONS IN GREEN AND MOTTLED LEAVES, WEIGHTS OF  $F_1$ ,  $F_2$ , AND  $F_3$

Leaf	Sample no. I	Sample no. II	Sample no. III	Average
Green $F_3$ .....	4.41	4.78	4.60	4.60
Green $F_2$ .....	1.39	1.23	1.38	1.33
Green $F_1$ .....	0.63	0.65	0.69	0.66
Total dry weight.....	6.43	6.66	6.67	6.59
Mottled A, $F_3$ .....	3.66	3.94	3.74	3.78
Mottled A, $F_2$ .....	1.61	1.46	1.68	1.58
Mottled A, $F_1$ .....	0.16	0.13	0.10	0.13
Total dry weight.....	5.43	5.53	5.52	5.49
Mottled B, $F_3$ .....	4.53	4.77	4.31	4.54
Mottled B, $F_2$ .....	1.55	1.55	1.38	1.49
Mottled B, $F_1$ .....	0.20	0.40	0.39	0.33
Total dry weight.....	6.28	6.72	6.08	6.36

In comparing the weights of  $F_3$ , it is seen that there was a decrease in weight as the leaves mottled, while the weight of  $F_2$  increased and  $F_1$  greatly decreased. The decrease in weight of  $F_3$  is accounted for by the fact that the carbohydrate synthesis is considerably reduced, as was shown in table XIX, where the carbohydrates of the leaf were compared in the morning and in the evening. The increase of the weight of  $F_2$  can be accounted for by the accumulation of salts in the older leaf. The results of  $F_1$  showed that the sulphatides, phosphatides, nucleo-proteins, fats, etc., were greatly reduced in the mottled leaves, and many of these were nitrogen complexes.

The nitrogen in  $F_3$  was reduced one-half or more, the nitrogen in  $F_2$  was changed very little, while the nitrogen entirely disappeared in  $F_1$  as the leaves mottled. This would mean that such compounds as nucleoproteins, glycoproteins, phosphoproteins, albumins, and globulins were rapidly being broken down, while the amount of derived proteins, amino acids, prolamines, ammonia compounds, and other nucleic acid metabolic products remained practically constant. Since the nitrogen in  $F_1$  practically disappeared, it would seem that the phospholipins and amines were breaking down,

TABLE XXVI

NITROGEN OF VARIOUS FRACTIONS IN GREEN AND MOTTLED LEAVES

Leaf	Sample no. I	Sample no. II	Sample no. III	Average	Grams of nitrogen per 100 gm. dry weight
Green $F_3$ .....	0.17	0.17	0.19	0.18	3.91
Green $F_2$ .....	0.018	0.017	0.021	0.019	1.43
Green $F_1$ .....	0.005	0.002	0.004	0.004	0.61
Total dry weight.....	0.193	0.189	0.215	0.203	.....
Mottled A, $F_3$ .....	0.06	0.06	0.08	0.07	1.86
Mottled A, $F_2$ .....	0.017	0.018	0.027	0.021	1.33
Mottled A, $F_1$ .....	None	None	None	None	None
Total dry weight.....	0.077	0.078	0.107	0.091	.....
Mottled B, $F_3$ .....	0.05	0.05	0.05	0.05	1.10
Mottled B, $F_2$ .....	0.015	0.010	0.006	0.010	0.67
Mottled B, $F_1$ .....	None	None	None	None	None
Total dry weight.....	0.065	0.060	0.056	0.060	.....

and that the plant must be drawing upon its last sources of nitrogen before death ensues. In this connection the work of KORAPETOVA and SOBASHNIKOVA (40) is very significant. They grew seedlings of rye and barley in inadequate nutrient solutions and found that the total amount of proteins decreased as growth progressed. In mottling of *Coleus* one likewise seems to be dealing with inadequate (especially nitrogen) nutrition. Here too proteins are decomposed, probably owing to the shortage of nitrogen.

In mottled leaves the phosphates of  $F_3$  were reduced to one-third that of the green leaves, while the phosphates in  $F_2$  increased

about 30 per cent, and those in  $F_1$  had almost disappeared. As the main part of the phosphorus in  $F_3$  probably existed as phosphoprotein, there was apparently a hydrolysis of this going on to form hydrolytic products of nucleic acids. Since little or no phosphorus was found in  $F_1$ , apparently the phosphatides had nearly all disappeared. Germination (40) in darkness appears to be correlated with a pronounced decomposition of phosphorus containing proteins. Apparently during the mottling of *Coleus* there is a similar phenomenon. PALLADIN (40) showed that as

TABLE XXVII  
PHOSPHATES

Leaf	Sample no. I	Sample no. II	Sample no. III	Average	Grams of phosphorus per 100 gm. dry weight
Green $F_3$ .....	0.0330	0.0184	0.0213	0.0242	0.526
Green $F_2$ .....	0.0013	0.0008	0.0007	0.0009	0.068
Green $F_1$ .....	0.0027	0.0026	0.0030	0.0028	0.425
Total dry weight.....	0.0370	0.0218	0.0250	0.0279	.....
Mottled A, $F_3$ .....	0.0069	0.0068	0.0056	0.0064	0.169
Mottled A, $F_2$ .....	0.0018	0.0014	0.0018	0.0017	0.107
Mottled A, $F_1$ .....	None	None	None	None	None
Total dry weight.....	0.0087	0.0082	0.0074	0.0081	.....
Mottled B, $F_3$ .....	0.0067	0.0095	0.0080	0.0081	0.178
Mottled B, $F_2$ .....	0.0018	0.0012	0.0012	0.0014	0.094
Mottled B, $F_1$ .....	None	0.0010	0.0010	0.0007	0.212
Total dry weight.....	0.0085	0.0017	0.0102	0.0102	.....

proteins decomposed the inorganic phosphates increased. From table XXVII it is apparent that the phosphoproteins were being rapidly decomposed as the leaves mottled. If the phospholipins are estimated according to CZAPEK (10), by multiplying the amount of magnesium pyrophosphate in the ether extract by 7.27, then 0.073 per cent of the wet green leaves and 1.009 per cent of the dry weight is lecithin. In the mottled leaves the phospholipins have almost entirely disappeared. The ratio of phosphorus (table XXVII) to nitrogen (table XXVI) is about 1 to 7 in the green leaves, while in the mottled leaves the ratio is about 1 to 11.

### Leaf pigments

CHLOROPHYLL *a* AND *b*.—The amount of leaf pigments of *Coleus* was compared with the amount of leaf pigments in the lilac, according to the method given by WILLSTÄTTER and STOLL (53). The ether extracts of the pigments were compared spectroscopically, and the amount of chlorophyll present in the lilac and in the *Coleus* was compared by the width of the absorption bands in the red end of the spectrum. In this comparison the band lying between the Fraunhofer lines *B* and *C* was used, since it was the most distinct. The extract of the *Coleus* leaves absorbed the rays from  $685.5 \mu\mu$  to  $674.5 \mu\mu$ . The chlorophyll solution from the lilac leaves was then diluted until it gave an absorption band of the same width. It was found that the chlorophyll *a* and *b* content of the healthy green leaves of lilac was five times as great as the chlorophyll content of the healthy green leaves of *Coleus*. Not even a trace of absorption in the red end of the spectrum was observed in the ether extract of the completely mottled leaves.

The four leaf pigments (chlorophyll *a* and *b*, carotin, and xanthophyll) of green and completely mottled leaves of *Coleus* and of green leaves of lilac were then separated according to the method given by WILLSTÄTTER and STOLL,<sup>1</sup> and the extractions tested spectroscopically to make sure of the purity of each extraction. The amount of each of the four pigments in the various leaves was then compared by means of a Schreiner colorimeter. The amount of chlorophyll *a* and *b* in the lilac leaves was taken as a standard, and the amount of green pigments in the *Coleus* leaves was compared with that of the lilac leaves. The writer realizes the limits of such a standard and regrets that there is not some stable dye or color which would serve as a basis for determining the exact amount of chlorophyll pigments in a leaf. The extraction of the pure pigments is a rather lengthy and expensive process, and when the pure pigments are once obtained some of them apparently do not keep well.<sup>2</sup> By colorimetric comparison the lilac leaves were

<sup>1</sup> A method for the quantitative estimation of the four pigments of green leaves will be published later.

<sup>2</sup> Preparation of these pigments, their keeping qualities, and some spectrophotometric data will be published soon.



found to have about five times as much phytochlorine as the *Coleus* leaves (based on the wet weight). The same relation was found to hold for phytorhodin *g*. This means that the two leaves bear *a* and *b* chlorophyll in the same proportions, but that the lilac has about five times as much of each as the green *Coleus*. Assuming that the lilac leaves contain 0.8 per cent (the average percentage for green leaves) of chlorophyll, then *Coleus* leaves contain only 0.16 per cent of chlorophyll, based on the dry weight of the leaves.

Table XXVIII, quoted from WILLSTÄTTER, shows the relation between autumnal yellowing, chlorophyll content, and photosynthetic activity. These changes agree generally with the writer's results in the mottling of *Coleus* in mid-season.

TABLE XXVIII

CHANGES AS LEAVES YELLOW IN AUTUMN (LEAVES ALL OF SAME SPECIES)

Leaf	Date	Dry weight in gm.	Chlorophyll content	CO <sub>2</sub> assimilated per hour
Deep green.....	July 30	1.55	19.7	0.080
Green.....	September 17	1.55	12.5	.....
Green with yellow spots....	October 5	1.45	7.8	0.064
Almost yellow.....	October 19	1.35	2.1	0.010

In alfalfa hay JACOBSON (23) has shown that 0.68 per cent of chlorophyll and 0.28 per cent of yellow coloring matter were present. The chlorophyll was estimated after the method of MARCHLEWSKI, and was shown to contain 66 per cent neochlorophyll and 34 per cent allochlorophyll. He believed that this ratio would vary, depending upon the conditions of growth.

XANTHOPHYLL.—The xanthophyll in the leaves was estimated by comparing the extracted pigment with a standard solution of potassium dichromate, as recommended by JÖRGENSEN and STILES (26). There was found to be present in 1000 gm. of fresh lilac leaves 0.273 gm. of xanthophyll, in the green *Coleus* leaves 0.087 gm., and in the mottled *Coleus* leaves 0.239 gm. From this it is seen that green *Coleus* has about one-third as much xanthophyll as lilac, while fully mottled *Coleus* has nearly as much as lilac. The amount of xanthophyll present in lilac was about the same as that present in *Sambucus nigra* (0.250). The amount of

xanthophyll in green *Coleus* leaves was about one-third of the amount present in most leaves.

CAROTIN.—Mottled *Coleus* leaves were\* found to contain about 0.3575 gm. of carotin per 1000 gm. of fresh leaves, while green *Coleus* leaves had 0.0894 gm. and green lilac leaves had 0.1324 gm. None of the leaves analyzed by WILLSTÄTTER gave as much carotin as did the mottled *Coleus* leaves. Poplar leaves (0.097) had about the same amount of carotin in them as did green *Coleus* leaves, while the leaves of *Sambucus nigra* (0.134) and *Fagus silvatica* (0.131) had about the same amount of carotin in them as did lilac leaves.

The ratio of carotin in lilac leaves was found to be  $\frac{0.1324}{0.2730}$ , or 0.48; for green *Coleus* leaves  $\frac{0.0894}{0.0870}$ , or 1.05; for mottled *Coleus* leaves  $\frac{0.3575}{0.2390}$ , or 1.49. WILLSTÄTTER found that the average ratio was  $0.603 \pm 0.1$ . Even in green *Coleus* leaves the carotin was higher than the average, and the ratio in the mottled leaves was greatly increased over what it should be if the leaf were normal as to its yellow pigments.<sup>3</sup>

### Discussion of leaf pigments

Various theories have been proposed to explain how the pigments change as the leaf yellows. SWART (48) found that yellowing of leaves which are dying begins in that part of the parenchyma which is farthest from the vascular bundles, and takes place last in the largest vascular bundles. In connection with the disappearance of chlorophyll on aging of the leaf SWART mentioned three possibilities: the chlorophyll either was transported or it remained in the leaf when it broke down, and if it broke down in the leaf the decomposition products either were transported to the stem or else remained in the leaf. He thought that chlorophyll in the form of decomposition products passed from the leaves into the stem, while the yellow pigments remained in the leaf.

<sup>3</sup> For comparative work on the yellow pigments Lovibond slides have been found to be quite satisfactory.

STAHL also believes that the products of chlorophyll decomposition do not remain in the leaf, but diffuse through the veins to the stem. He gave as proof the fact that if the veins of a *Ginkgo* leaf are severed, the chlorophyll remains longer than it does in a control leaf. Similar experiments were conducted on the leaves of *Coleus* by the writer, but the leaves yellowed just the same.<sup>4</sup> The types of leaves are entirely unlike, hence it is not surprising that the results were different. STAHL believes further that, since the yellow pigments (carotin and xanthophyll) consist of carbohydrate materials only, they were not needed by the plant and so were left behind, but the green chlorophyll pigments which contained magnesium and nitrogen were decomposed, and these elements were carried away to meet the requirements of the plant.

SWART has shown that it is unlikely that magnesium is withdrawn from the leaf. Table V shows that the plant does not lack magnesium, and consequently there would be no occasion for it to draw upon its chlorophyll supply for the very small quantity which is present in the chlorophyll molecule. On the other hand, all the data tend to show that nitrogen is the element lacking, and therefore it is quite possible that either the chlorophyll would be prevented from forming, or if formed would be decomposed, if the law of mass action plays any part at all in the process.

The situation is summarized by MEYER (38) in the case of yellowing of *Tropaeolum* leaves. As the leaves age they become weakened. This weakening of the leaves results in curtailed assimilation, which is limited because the chloroplasts become smaller and the organs are weakened. This weakening of the organs is a primary cause, while the decomposition of the protein follows because of this. Lastly, the decomposition of the protein accelerates the yellowing of the leaf. MEYER believes that the chlorophyll decomposes and is then borne away, while the yellow pigments remain as they were in the leaf, neither increasing nor decreasing in quantity. Since he made no quantitative determinations on the pigments of the leaves, it is easy to see how he might have deduced such a conclusion in regard to the yellow

<sup>4</sup>On the leaves of *Ginkgo*, during the summer and autumn of 1920, at Washington, D.C., the experiments of STAHL could not be confirmed.

pigments. Had MEYER availed himself of methods of estimating the yellow pigments, he doubtless would have reported differently.

KOHL (30) has written extensively on carotin. He has shown that in *Vicia Faba* seedlings carotin forms and increases in the dark; in the light, at a low temperature, chlorophyll formation is suppressed, while the carotin increases; increase of light and temperature accelerates chlorophyll formation. Working with several species of plants, he concluded that etiolated plant organs owe their color almost exclusively to carotin. When some etiolated plants greened, the carotin content was found to increase sometimes as much as 125 per cent, and in all cases was found to increase to some extent. He did not believe that chlorophyll was formed at the expense of the carotin, however, nor did he think the chlorophyll was changed to carotin in autumnal coloration. His experiments on coloration led him to conclude that the carotin content (evidently including carotin and xanthophyll) of the leaves increases. His results show that the carotin content of old leaves of *Sambucus nigra* is to the carotin content of young leaves of the same plant as 183:170. Color changes which he describes are very similar to those described by MEYER in autumnal yellowing.

STOKLASA, SEBOR, and SENFT (47) believe that the autumnal changes of color depend on the hydrolytic fission of chlorophyll and the formation of phaeophytin and phosphatides; these substances, which themselves have a brownish color, allow the red and yellow of carotin and of xanthophyll to appear. The colorless lecithin and choline derivatives are not combined with chlorophyll, but are merely admixed and possibly intimately associated with the chlorolecithins. The writer has shown that the yellow pigments in *Coleus* greatly increase as the leaf mottles. The yellow pigments are not simply left behind when the other pigments are translocated, but are being continually formed.

WILLSTÄTTER stated that the proportion of chlorophyll *a* and *b* to the yellow pigments was 3.07 to 1 in sun leaves, while in shade leaves it was 4.68-6 to 1. IWANOWSKI (22) found that less chlorophyll was broken up by light when the yellow pigments were in greater concentration. He concluded that the protective action of the yellow pigments could no longer be doubted. The yellow

pigments absorb blue and especially violet rays, whose power to break down chlorophyll is especially high. It is of interest to notice how the carotin content varies under different conditions. The amount of carotin in a leaf varies according to the seasons of the year (40), being greatest during the flowering period in nettles and horse chestnuts. In vetch (40) about five times as much carotin exists in the green leaves as in the etiolated ones.

EWART (16) has shown that when mustard seedlings were grown in the absence of carbon dioxide, more carotin was produced than when carbon dioxide was present. He remarks that his method of analysis was not wholly accurate, however, and that during the separation of the pigments the losses were so great that the exact estimation of the amounts originally present was impossible. The seedlings grown in air deprived of carbon dioxide were

TABLE XXIX

AMOUNTS OF PIGMENTS PRODUCED IN MUSTARD SEEDLINGS  
(PER 100 GM. OF FRESH MATERIAL)

CO <sub>2</sub>	Chlorophyll	Carotin	Xanthophyll
Present.....	0.474	0.11	0.15
Absent.....	0.271	0.275	0.12

smaller, darker, and more bluish green. This blue green seemed to be due not to an excess of chlorophyll, but rather to the more compact character of the tissues, and it appears that chlorophyll develops most rapidly when its normal functional activity can be exercised. EWART believes that he is justified in concluding that the carotin supplied at least a part of the carbon and hydrogen for the construction of chlorophyll.

KOHL (30) showed that etiolated seedlings contained carotin in abundance, and even doubted whether any other pigment was present. He found that the percentage of carotin did not decrease when the etiolated seedlings were exposed to light and chlorophyll was formed. He thus denied that carotin was converted into chlorophyll as was believed by EWART. EWART states that while food materials were abundant the production of carotin continued at a greater rate than it was used in the formation of chlorophyll.

He showed that etiolated wheat seedlings contained 8-10 parts of carotin to one of xanthophyll, and that leaves of *Hordeum murinum* when kept in darkness turned yellow or yellowish red. When analyzed for plant pigments, the leaves were found to contain chlorophyll, xanthophyll, and carotin in the proportions 1, 3, and 12, respectively, and in addition a red pigment, which was apparently a flavone, believed to be a decomposition product of chlorophyll. His suggested explanation of the greening of etiolated plants is unique. When an etiolated plant turns green in light, the carotin undergoes photo-oxidation. The bleached carotin residue combines with glaucophyllin, converting it into the tri-carboxylic chlorophyll.

WILLSTÄTTER found that a weak alcoholic oxalic acid solution splits (in the cold) magnesium out of the chlorophyll molecule. On this basis SWART assumes that the decomposition of chlorophyll in yellowing leaves is due to acids, thus splitting the chlorophyll molecule. This postulates an increase of acidity with yellowing, a theory for which there is no evidence. SAMPSON (43), in testing the acidity of *Coleus* leaves, found that fresh yellow leaves in the act of abscising had an acidity equivalent to 0.0069 cc. of N acid per gram of wet weight, while fresh green leaves had an acidity equivalent to 0.0089 cc. of N acid. Since the green leaves are more acid (at least as measured by their base absorbing power) than the yellow ones, if SWART'S assumption is correct, one would expect to see the top leaves of the plant yellow instead of green. It is hardly probable that the splitting of magnesium out of the chlorophyll molecule, due to acid accumulation, is the first step in chlorophyll decomposition. PALLADIN (40) pointed out that carbohydrates are essential to the formation of chlorophyll. From the sand culture experiments with *Coleus* one could hardly say that the deficiency in carbohydrates caused the chlorophyll to disappear. It would be more accurate to say that the carbohydrate output was decreased, owing to the deficiency in chlorophyll.

WIESNER (52) supposed that the chlorophyll in the living leaf was dissolved in an oil, in which the concentration of chlorophyll was very high and the decomposition very low. IWANOWSKI (21) agreed with WIESNER in regard to the concentration of the chloro-

phyll, and has proved that plants with much chlorophyll show little or no breaking up of chlorophyll by light, and that plants with little chlorophyll (as *Elodea*) show as much as 31 per cent of the chlorophyll broken up by light in seven hours. IWANOWSKI also showed that colloidal solutions were about sixteen times as light stable as molecular solutions, and the more concentrated the colloidal solution the more light stable it becomes. HERLITZKA (20) also found that the chlorophyll exists in the leaf in the colloidal state.

In view of these facts one might expect light lability to enter as a factor in the decomposition of chlorophyll in *Coleus*, for the chlorophyll is only one-fifth as concentrated as it is in most other sun plants.

BORESCH (6) in his experiments on algae (*Phormidium corium*) showed that the algae when grown on nutrient media changed from a dark green, after two months, to gold or red brown. Addition of more of the nutrient media caused them to resume again their green color. He believes that the change of color back to the natural green was due to the presence of the nitrogen in the potassium nitrate. Any nitrate, ammonium salt, or other nitrogen compound would do the same. Other plants, such as *Chlamydomonas*, *Hydrodictyon*, and *Oedogonium*, depend upon nitrogen compounds for their existence, and also the building and accumulation of chlorophyll depends upon the available nitrogen supply. Extractions of the pigments were made by BORESCH, who found that the green Cyanophyceae showed the normal colors (chlorophyll, phycocyan, and carotin), while the brownish extracts of these algae showed little chlorophyll and much of the carotin. He believes that the brown color was due to the breaking down of the chlorophyll and phycocyan, which are closely related in their origin. He also noted that the carotin increased as the chlorophyll and phycocyan broke down. In the case of higher plants, BORESCH noticed that nitrogen had a greening effect upon the plants. When nitrogen was failing and the leaves were getting yellow, additions of manure kept them green. ARTARI (2) found that chlorophyll formation and the quantity of chlorophyll depend upon the substratum. *Stichococcus bacillaris*, when grown in the dark with

nitrogen sources such as asparagin, peptone, and ammonium nitrate, greened, and when potassium nitrate was used it became pale or colorless. If *Stichococcus* were grown in the light and fed upon rich organic nutrients (maltose, glucose), it lost its chlorophyll. If the colorless algae which had been growing in the dark were placed in the light and given potassium nitrate as nutrient, they regained their normal color and the chromatophores became normal again. He did not know whether the chromatophores were built up anew or not. ARTARI also found that when he placed the colorless algal cells on a nutrient solution which contained either asparagin or ammonium nitrate, and placed them in the dark, the algae greened again.

TABLE XXX

COMPARISON OF GREEN AND YELLOW PIGMENTS IN LEAVES  
OF HEMP PLANTS UNDER DIFFERENT TREATMENTS

Process	Chlorophyll	Carotin
Intense manuring.....	100	100
Complete manuring.....	74	90
Nutrients lacking nitrogen.....	38	57
Nutrients lacking phosphates...	71	80
Nutrients lacking potassium....	66	72
Nutrients lacking calcium.....	72	90
No nutrients added.....	53	71

The effect of the various nutrient elements is perhaps best described by VILLE (51). He experimented upon the effect produced on the color of many field plants by a deficiency in nitrogen, calcium, phosphate or potassium, and no manuring. He found that nitrogen affects chiefly the color of the plants, and if it is deficient the plants become brown, while if the dose of nitrogen is increased or diminished, the color increases or diminishes accordingly. He made crude extracts of the leaves of hemp and compared the green and yellow pigments in them. Table XXX shows the results of VILLE'S experiments.

The *Coleus* here studied seems to be on the verge of nitrogen starvation at all times under ordinary greenhouse conditions. It is only with considerable nitrate additions that the nitrogen supply of the leaf can be maintained sufficiently to avoid chlorophyll



decomposition. It is a great nitrogen user, and it is difficult to know what use is made of all the nitrates it consumes. One wonders whether there is a denitrifying process going on within the leaves which keeps the nitrates more or less depleted, and in case of lack of continuous additions completely removes them. This or some draft on the nitrogen of the leaf leads to a decomposition of nitrogen compounds of the leaf, including proteins, phospholipines, and chlorophyll, the decomposition of the latter producing the mottling. All the experimental evidence points to the shortage of nitrogen as the cause of chlorophyll decomposition in the plant studied, a plant very prone to mottling. One would hardly expect the same limiting factor to determine chlorophyll decomposition in plant organs in all cases, but many of the cases of chlorophyll loss discussed, whether involving loss from plants grown in cultural solutions, or in soils in the midst of the growing season, or loss accompanying autumnal coloration, point in the same direction. In the *Coleus* studied it is evident that there is little ground for SWART'S view that high acidity of the leaves leads to a decomposition of chlorophyll by splitting magnesium out of the molecule. Cultures with cuttings of this variety of *Coleus* also show that under ordinary cultural conditions the plant bears little margin of phosphate supply, while it bears a great excess of calcium, magnesium, and iron. The narrow margin of phosphate supply does not manifest itself in mottling, but only in limited growth. The narrow margin of nitrogen, on the other hand, manifests itself both in limited growth and in mottling. If IWANOWSKI is correct in his assertion that carotin and xanthophyll render chlorophyll more nearly light stable, an increase in these pigments during mottling may act in a protective way against decomposition of chlorophyll.

From the various investigations presented two things are of striking interest: the decomposition of chlorophyll and the great amounts of yellow pigments which are present when chlorophyll is absent, whether it is in etiolated plants, algae grown in the dark, plants which have poor nutrition, or when leaves mottle. Since the carotin is present in greater amounts when chlorophyll is absent, and since carotin apparently decreases as chlorophyll

increases, one would naturally seek the cause of this, and is led to investigate the relationships which may exist between the various plant pigments.

EWART (16, 17) believes that carotin after photo-oxidation or partial disintegration forms a massive hydrocarbon combination (the phytol radicle of chlorophyll) whose addition is necessary to convert the dicarboxylic glaucophyllin into the tricarboxylic chlorophyll. Perhaps this might explain the disappearance of carotin as chlorophyll forms. The bridge between the two yellow pigments is not so difficult to cross, for one of them (xanthophyll) is simply the oxidation product of the other (carotin).

Some believe that chlorophyll may act as a sensitizer, and others that it may act as a photic or lytase enzyme which converts carbon dioxide and water into carbohydrates. EWART (16) has shown that chlorophyll may act as an enzyme according to the following three equations:

(1)  $2 C_{31} H_{29} N_4 Mg(COOH) (COOCH_3) (COOC_{20} H_{39}) + 36 CO_2 + 16 H_2 O = 2 C_{40} H_{56} O_2 + 44 O_2 + 2 C_{31} H_{30} N_4 Mg(COOH)_2$  Amorphous chlorophyll + carbon dioxide and water would form xanthophyll or carotin, oxygen, and glaucophyllin. (2)  $C_{40} H_{56} O_2 + 24 H_2 O + 7 O_2 = 2 C_{20} H_{39} OH + 3 C_6 H_{12} O_6 + 3 C_6 H_{12} O_6 + 4 HCHO$ . Carotin or xanthophyll + water + oxygen equals phytol + levulose + glucose + formaldehyde. (3)  $2 C_{20} H_{39} OH + 2 C_{31} H_{30} N_4 Mg (COOH)_2 + 4 CO_2 = 2 C_{31} H_{29} N_4 Mg (COOH) (COOCH_3) (COOC_{20} H_{39}) + 3 O_2$ . Phytol + glaucophyllin and carbon dioxide form amorphous chlorophyll and oxygen.

Reaction 2 takes place in the light with the aid of an oxidase enzyme.

Since many chemical reactions are reversible, and since phytol splits off the chlorophyll molecule easily, it is possible that the sugars and phytol may react to form carotin or xanthophyll, which would account for the greater accumulation of yellow pigments in autumn leaves and also for the disappearance of the chlorophyll. Film experiments carried out by EWART (17) showed that carbon dioxide combines with chlorophyll to form xanthophyll and a colorless waxy substance. The combination takes place in the presence of water and is accelerated by sunlight. It is thus seen

how the yellow pigments in the leaf may increase at the expense of the chlorophyll.

### Bacteria

The leaves of *Coleus* were examined closely for the presence of bacteria. In the healthy green leaves a few bacteria of the coccus type were observed, while in the fully mottled leaves many bacteria of this type were found. A few of the bacillus type were also present in the cells. The presence of ammonia and nitrite can possibly be accounted for by their activity. Plates were made of the leaves under sterile conditions so as to get only those bacteria which were inside the cells, and always a much greater bacterial count was obtained from the mottled leaves. It is realized that the bacterial side of this question is really a problem in itself, and that this phase of the subject ought to be further investigated.

The juice of the mottled leaves was placed on the under side of the healthy green leaves and rubbed around; in other cases, in addition to rubbing the juice on the leaf, the veins were injured mechanically. The leaves in these cases mottled no sooner than did the leaves of the untreated plants, and they mottled in exactly the same manner as untreated plants. The writer believes that the bacteria get a better hold as the leaf weakens from nitrogen starvation. Evidently the organism present is a denitrifying one, which develops somewhat in the green leaf, and as the leaf weakens or mottles the organism develops more rapidly.

It will be worth while to summarize what other workers have discovered about certain bacterial and physiological diseases which in some respects appear to be similar to the mottling of *Coleus*. FREIBERG (18) inoculated varieties of pumpkins, squash, watermelon, cucumber, citron, muskmelon, and others, and not a single infection resulted from his inoculations, yet during the same season other plants of these same varieties contracted the mosaic disease. JAGGER (24) and DOOLITTLE (13) report that the mosaic leaf disease of cucumber is transmissible by rubbing the healthy plants with crushed diseased leaves, and have proved that *Aphis Gossypii* transmits the mottled leaf disease of the cucumber. SMITH and BONCQUET (45) state that *Eutettix tenella* is the only carrier

of the disease-producing agent of the curly leaf of sugar beet. STEWART and REDDICK (46) report that the mosaic disease of beans is transmitted through the seeds, and that healthy seedlings rubbed with crushed diseased leaves showed infection four weeks later. McCLINTOCK (36) noticed that several varieties of lima beans mottle, while the larger variety growing with these does not mottle. He thought that the bean mosaic disease was carried by the seed. EDSON and SCHREINER (15) state that ORTON observed a potato disease characterized by bronzing and later browning of the leaf. This disease appeared in New Jersey, but was absent in areas which were treated with potash or stable manure. They believed that the primary cause was insufficient potash or perhaps an excess of nitrates in the presence of a minimum potash supply.

BONCQUET (5) found that the mottled leaf of beets, tobacco leaves, mottled potato leaves, and many other mottled leaves were associated with bacteria. The normal green leaves of these plants gave no nitrite or ammonia tests, while usually the mottled leaves showed the presence of nitrites and free ammonia. The fact that a leaf is yellow, however, is no sign that nitrite or ammonia is present in it. BONCQUET thought that the mottling of the leaves was a pathological disturbance brought about by the partial and local nitrogen starvation of the tissues. Nitrogen starvation in the leaves around nitrate-reducing foci explained the mosaic nature of the leaf diseases in which an abundance of nitrite was detected. Potato plants growing in soil rich in nitrate may yellow and mottle, owing to the presence of nitrate-reducing bacteria in abundance.

### Summary

1. The leaves of *Coleus Blumei* (var. Golden Bedder) are very prone to mottling or loss of chlorophyll. Mottling progresses from the lower leaves upward. Mottling of the leaves takes place first at the edge of the leaf and progresses slowly toward the veins and to the base of the leaf. Usually the pair of leaves immediately above these mottles next, and so on as the plant grows.

2. In mottling the chloroplasts lose their green color, become reduced in size, and carry on very little photosynthesis.

3. In the usual greenhouse cultural conditions, this plant has within it phosphorus and nitrogen little in excess of its immediate needs. This was shown by cuttings grown in phosphate-free nutrient mixtures; failure to grow was noticeable, although the plant maintained a healthy green color. When the plants were transferred to nitrate-free mixtures, they failed to grow and also lost their natural green color.

4. Under usual cultural conditions these plants seemed to have within their tissue magnesium, calcium, and iron greatly in excess of their immediate needs. Cuttings grown in nutrient mixtures lacking any one of these elements grew and maintained their normal green quite as well as in the complete nutrient mixtures.

5. A deficiency of magnesium or calcium apparently has nothing to do with mottling.

6. More iron was found in all parts of the mottled than in the green leaf.

7. A deficiency in phosphorus caused a larger percentage of the leaves to drop than did a deficiency in iron, magnesium, calcium, or nitrate.

8. A deficiency in phosphorus caused more of the leaves to drop, while a surplus of phosphorus did not prevent them from falling if nitrogen was deficient.

9. The effect of adding nitrogen to a plant or withholding it was shown in a very few days by the change in color of the leaves.

10. Addition of a nitrogen compound (sodium nitrate) to a plant potted in soil kept the leaves on and the plant green, while the addition of iron, magnesium, calcium, or phosphate made very little change in the appearance of the plant.

11. In order to maintain a healthy condition and a green color the plants seemed to require more nitrate than other plants of which we have a record.

12. The mottled leaves always had a lower percentage of nitrate nitrogen, protein nitrogen, ammonium salts, and albuminoid ammonia than did the green leaves; mottled leaves had nitrites and free ammonia present in them.

13. The general appearance of the mottling was the same as that of the leaf of citrus fruit trees.

14. Mottling of the leaves greatly lessened the carbohydrate output.

15. The catalase activity of the leaves was very greatly reduced as the leaves mottled.

16. The dry weight of the mottled leaves was less and the ash greater than that of healthy green leaves.

17. In mottled leaves the weight of  $F_1$  and of  $F_3$  was less, while that of  $F_2$  was more than that of the green leaves.

18. Protein nitrogen decreased in all of the three fractions as the leaves mottled, while phosphates decreased in  $F_3$ , increased in  $F_2$ , and almost disappeared in  $F_1$ .

19. The amount of chlorophyll (*a* and *b*) was about one-fifth of that of lilac leaves; the proportion of *a* to *b* was the same as in other plants (lilac).

20. The carotin and xanthophyll content greatly increased as the leaves mottled.

21. Bacteria were found within the cells of the mottled leaves, but it is not known whether they bear a causal relation to mottling or not.

Great indebtedness is due to Professor WILLIAM CROCKER for his keen analytical interest and advice, and to Dr. S. H. ECKERSON for her untiring interest and suggestions on the problem.

BUREAU OF PLANT INDUSTRY  
WASHINGTON, D.C.

#### LITERATURE CITED

1. APPLEMAN, C. O., Some observations on catalase. *BOT. GAZ.* 50:182-192. 1910.
2. ARTARI, ALEXANDER, Über die Bildung des Chlorophylls durch grüne Algen. *Ber. Deutsch. Bot. Gessells.* 20:201-207. 1902.
3. ASO, K., and SEKINE, T., Über das vorkommen von nitriten in Pflanzen. *Beih. Bot. Centralbl.* 32:146-147. 1914.
4. BONCQUET, P. A., Presence of nitrites and ammonia in diseased plants. Its significance with regard to crop rotation and soil depletion. *Jour. Amer. Chem. Soc.* 38:2572-2576. 1916.
5. BONCQUET, P. A., and BONCQUET, MARY, Presence of nitrites and ammonia in diseased plants. Oxidases and diastases; their relation to the disturbance. *Jour. Amer. Chem. Soc.* 39:2088-2093. 1917.

6. BORESCH, KARL, Die Färbung von Cyanophyceen und Chlorophyceen in ihrer Abhängigkeit vom Stickstoffgehalt des Substrates. *Jahrb. Wiss. Bot.* 52:145-185. 1913.
7. BRIGGS, LYMAN J., JENSEN, C. A., and McLANE, J. W., Mottled leaf of citrus trees in relation to soil conditions. *Jour. Agric. Res.* 6:721-739. 1916.
8. Bulletin no. 107, Bur. of Chem. 1912.
9. BURD, JOHN S., Water extractions of soils as criteria of their crop producing power. *Jour. Agric. Res.* 12:297-309. 1918.
10. CZAPEK, FRIEDRICH, *Biochemie der Pflanzen.* 1913.
11. DAVISSON, B. S., Titrametric determinations of nitrites. *Jour. Amer. Chem. Soc.* 38:1683-1687. 1916.
12. DICKSON, J. G., The value of certain nutritive elements in the development of the oat plant. *Amer. Jour. Bot.* 5:301-325. 1918.
13. DOOLITTLE, S. P., A new infectious mosaic disease of cucumber. *Phytopath.* 6:145-147. 1916.
14. DUGGAR, B. M., *Plant physiology.* 1911.
15. EDSON, H. A., and SCHREINER, O., Notes on a malnutrition disease of the Irish potato, and its control. *Phytopath.* 7:70. 1917.
16. EWART, A. J., On chlorophyll, carotin, and xanthophyll, and on the production of sugar from formaldehyde. *Proc. Roy. Soc. Victoria* 30:178-209. 1918.
17. ———, On the function of chlorophyll. *Proc. Roy. Soc. London* 89:1-17. 1915.
18. FREIBERG, G. W., Studies in the mosaic diseases of plants. *Ann. Mo. Bot. Gard.* 4:175-232. 1917.
19. HAAS, PAUL, and HILL, T. G., *Chemistry of plant products.* 1913.
20. HERLITZKA, AMEDO, Über den Zustand des Chlorophylls in der Pflanze und über kolloidale Chlorophyll. *Biochem. Zeitschr.* 38:321-330. 1912.
21. IWANOWSKI, D., Über das Verhalten des Lebenden Chlorophylls zum Lichte. *Ber. Deutsch. Bot. Gessells.* 31:600-612. 1913.
22. ———, Über die Rolle der Gelben Pigments in den Chloroplasten. *Ber. Deutsch. Bot. Gessells.* 31:613-617. 1913.
23. JACOBSON, C. A., On the coloring matter in alfalfa. *Alfalfa investigations.* III. *Jour. Amer. Chem. Soc.* 34:1263-1265. 1912.
24. JAGGER, I. C., Experiments with the cucumber mosaic disease. *Phytopath.* 6:148-151. 1916; 7:71. 1917.
25. JENSEN, C. A., Composition of citrus leaves at various stages of mottling. *Jour. Agric. Res.* 9:157-166. 1917.
26. JÖRGENSEN, INGVAR, and STILES, WALTER, *New Phytol.* Reprint no. 10. 1-180. 1917.
27. JOST, LUDWIG, *Plant physiology.* Engl. transl. 1907.
28. KELLERMAN, K. F., and WRIGHT, R. C., Relation of bacterial transformations of soil nitrogen to nutrition of citrus plants. *Jour. Agric. Res.* 2:101-113. 1914.
29. KLEIN, RICHARD, Über nachweis und Vorkommen von Nitraten und Nitriten in Pflanzen. *Beih. Bot. Centralbl.* 30:141-166. 1913.

30. KOHL, F. G., Untersuchungen über das Carotin und seine physiologische Bedeutung in der Pflanze. Leipzig. 1902.
31. LINCOLN, A. T., and WALTON, J. H., Elementary quantitative agricultural chemical analysis. 1918.
32. LIPMAN, C. B., A suggestion of a new phase of the problem of physiological diseases of plants. *Phytopath.* 5:111-117. 1915.
33. MASON, W. P., The examination of water. 4th ed. revised. 1913.
34. MARRIOTT, W. MCKIM, and WOLF, C. G. L., The determination of small quantities of iron. *Jour. Biol. Chem.* 1:451-461. 1906.
35. MATHEWS, A. P., *Physiological chemistry.* 1916.
36. MCCLINTOCK, J. A., Notes on the lima bean mosaic. *Phytopath.* 7:60. 1917.
37. MCBETH, I. G., Relation of the transformation and distribution of soil nitrogen to the nutrition of citrus plants. *Jour. Agric. Res.* 9:183-252. 1917.
38. MEYER, ARTHUR, Eiweissstoffwechsel und Vergilben der Laubblätter von *Tropaeolum majus*. *Flora* 111-112:85-127. 1918.
39. MOLISCH, HANS, *Mikrochemie der Pflanze.* Jena. 1913.
40. PALLADIN, V. I., *Plant physiology.* Engl. transl. 1917.
41. ———, Eiweissgehalt der grünen und etiolirten Blätter. *Ber. Deutsch. Bot. Gessells.* 9:194-199. 1891.
42. RUSSELL, E. J., *Soil conditions and plant growth.* 3d ed. 1917.
43. SAMPSON, H. C., Chemical changes accompanying abscission in *Coleus Blumei*. *BOT. GAZ.* 66:32-53. 1918.
44. SCHULZE, B. (Ref.), and SCHÜTZ, J., Die Stoffwandlungen in den Laubblättern des Baumes, Insbesondere in ihren Beziehungen zum herbstlichen Blattfall. *Die Landw. Versuchsst.* 71:299-352. 1909.
45. SMITH, R. E., and BONCQUET, P. A., Connection of a bacterial organism with curly leaf of sugar beet. *Phytopath.* 5:335-343. 1915.
46. STEWART, V. B., and REDDICK, DONALD, Notes on bean mosaic. *Phytopath.* 7:60. 1917.
47. STOKLASA, JULIUS, SEBOR, JOHANN, and SENFT, EMMANUEL, Review in *Jour. Chem. Soc.* 106:423-424. 1914.
48. SWART, NICHOLAS, Die Stoffwanderung in ablebenden Blättern. Jena. 1914.
49. TUCKER, G. M., and TOLLENS, B., Über den Gehalt der Platenenblätter an Nährstoffen und die Wanderung dieser Nährstoffe beim Wachsen und Absterben der Blätter. *Jour. Landwirtschaft.* 48:39-63. 1900.
50. TUNMANN, O., *Die Pflanzenmikrochemie.* Berlin. 1913.
51. VILLE, GEORGES, Recherches sur les relations qui existent entre la couleur des plantes et la richesse des terres en agents de fertilité. *Compt. Rend.* 109:397-400. 1889.
52. WIESNER, JULIUS, Untersuchungen über die Beziehungen des Lichtes zum Chlorophyll. *Sitzungsber. Akad. Wiss. Wien.* 69<sup>1</sup>:327-385. 1874.
53. WILLSTÄTTER, R., and STOLL, A., Untersuchungen über Chlorophyll. 1913.



# GAMETOPHYTIC DEVELOPMENT OF BLISTER RUSTS<sup>1</sup>

J. F. ADAMS

(WITH FOUR FIGURES)

Since the discovery of the pycnial stages for the stem forms of blister rusts on pines, several interesting points have arisen with respect to their alternation with the aecial stage. The pycnial stage of rusts on Angiosperms usually precedes the appearance of the subsequent stage (aecia, primary uredinia, or telia) by a few days to several weeks. The interval of time in completing the gametophytic development in the case of the stem rusts on pines is materially different.

WEIR and HUBERT (9) have added much to our knowledge regarding the appearance of pycnia of several blister rusts. Pycnia of *Cronartium cerebrum* on *Pinus Banksiana* were collected as early as May 12, 1916. Four of the galls developed aecia within 4 or 5 mm. from the pycnial exudations on the same galls, but not from identical pycnial areas. The pycniospores of *C. Comptoniae* developed similarly to those of *C. Comandrae* in respect to their appearance on previously unruptured tissue. They secured exudation of pycniospores by laboratory forcing methods from specimens collected on May 12, 1916, at Cass Lake, Minnesota. They report as follows:

In *Cronartium coleosporoides* the pycniospores are produced on old galls previously ruptured, as well as on unruptured infected tissues . . . . In a period from April 4 to 15, 1916, abundant pycnial exudations containing pycniospores were obtained from galls of *C. coleosporoides* . . . . The pycniospores of *C. Comandrae* apparently develop but once on the same tissue preceding the appearance of the aeciospores. The production of aecia kills the infected tissues which are included in the aecial ruptures. The tissues bordering this area are invaded by the mycelium of the fungus, produce swellings, and give rise to pycniospores, either in early spring or in late summer and fall, whenever sufficient time has elapsed from the last production of aecia. In the cases recorded the pycniospores appeared in the same season following the production of aecia, with only five months intervening, but not from the identical area from which the pycnia were produced.

<sup>1</sup> Contribution from the Department of Botany, The Pennsylvania State College, no. 27.

BOYCE (2) first observed the pycnia of *Peridermium pyriforme* on *Pinus ponderosa* near Castella, Shasta County, California, July 21, 1916. He states that "the pines are probably infected in the summer or fall of one season, pycnia do not appear until the summer of the next season at the earliest, while mature aecia are produced in the late spring or early summer of the third season."

HEDGCOCK, BETHEL, and HUNT (6) state that the pycnia of *Peridermium pyriforme* are borne on areas of the bark of pines contiguous to the aecia and preceding them by one year. They are produced in the portions most recently invaded, commonly on the trunks and limbs. In both *P. pyriforme* and *P. filamentosum* the pycnia most frequently appear at a date later in the season than the aecia.

HEDGCOCK and LONG (7), from field observations during a period of four years, find that in the swellings of *Peridermium cerebrum* or *Pinus virginiana* the pycnia precede the aecia one year, instead of preceding them during the same spring. In other words, the pycnia and aecia occur during alternate years, and two years is the time required for a life cycle of all forms of spores of the rusts.

DODGE and ADAMS (5) studied material of *P. cerebrum* on *Pinus rigida* and *P. virginiana*, and our observations indicate that there is an alternation of aecia and pycnia.

We have not seen in any instance spermatial hyphae developing in the tissue overlying that in which the aecidia are being formed. Cross-sections of the Virginia material developing both spermatial and aecidial fructifications on the same gall show that there is no sharp line of demarcation between the two. In one burl there was a space of only 700  $\mu$  separating them.

SHIRAI (8) has shown by culture experiments the connection of *Peridermium giganteum* and *Cronartium quercuum*, which has been considered the same as the form of *P. cerebrum* in North America. In an illustration he shows the extended pycnial layer in the tissue overlying the aecia, and states:

The spermagonia of this fungus are formed in the month of January in the intercellular spaces between the corky bark and the corticial parenchyma. . . . In consequence of the formation of the spermagonia and the subsequent cracking of the corky bark, the pressure of the latter on the inner bark greatly lessens, and thus secures the formation of the aecidial layers in the deeper tissues.

I have examined specimens of *Peridermium Strobi* collected May 5 and 21, 1917, in New Hampshire by Dr. L. O. OVERHOLTS. The specimens were in sporulating condition. In every instance the mature pycnial layer was found intact in the tissue overlying the aecia. COLLEY also states that "the pycnia of *Cronartium ribicola* precede the aecia by at least one growing season on any given area of infection, and succeeding generations of pycnia and aecia follow a more or less definite schedule." In this case the perennial infection is not restricted, as found with some other stem rusts. It is a typical progressive infection. The development of pycnia and aecia of the leaf rusts of conifers apparently is correlated with the time of infection. In the case of *Peridermium acicolum* mature spermagonia have been found as early as March 1, and the aecial primordia developing May 25, 1917, only an interval of about three months intervening between the appearance of pycnia and aecia. The infection of the needles occurs the preceding fall. Mature aecia of *Peridermium Peckii* were collected May 20, 1917, at Pine Grove Mills, Center County, Pennsylvania. The pycnia precede the aecia by two to three weeks, according to field observations. The same condition occurs in *Coeloma Abietis-canadensis*, which is found on the cones and new terminal growth of *Tsuga canadensis*. The infection with these two species occurs the same spring. These observations indicate that with respect to the seasonal interval there are at least three methods in the sequence of pycnia and aecia (or the completion of the gametophytic development on any given infected area).

1. The first method is the alternation of pycnia and aecia in *Peridermium cerebrum*, as reported by HEDGCOCK and LONG (7), and DODGE and ADAMS (5). The evidence supports the contention that it takes two years to complete the gametophytic period of development on any given infected area. The pycnia appear in spring and are sloughed off about the middle or end of the same growing season. The following spring the aecia are developed. It is not until the third season that the pycnia again are developed. This condition may occur on the same gall, in which case apparently one part is an older infection. It is usually found that such areas represent different stages of maturity, and are differentiated by furrows.

Whether the form of *Peridermium cerebrum* is the same as *P. giganteum* remains to be established. SHIRAI describes as well as illustrates the pycnia in the tissue overlying the aecia, which would not agree with our observations on the American form. It is possible that environmental conditions may be concerned in this instance.

2. The second method is that in which maturity of the pycnia precedes the aecia in adjacent as well as the overlying tissue within a period of about six months. The full cycle of development of pycnia and aecia on the coniferous host in the same area is completed within a period of twelve months. In contrast with the first method the pycnia and aecia are sloughed off at the same time. The writer (1) has shown that the pycnia occur in the tissue overlying the aecia in *Peridermium Comptoniae* and *P. pyriforme*. Being sloughed off at the same time indicates there is no alternation as found with *P. cerebrum*. It was not known when the pycnia developed, since the exudation of pycniospores was never observed in the field when this material was collected. The presence of the pycnial layer, however, could be recognized by carefully removing the bark. At this time the pycnia appeared as an extensive olive green layer, irregular in outline, and mature. On October 17, 1919, in the vicinity of State College several infections of *Peridermium Comptoniae* on *Pinus virginiana* were observed with exudations of pycniospores. Their appearance was similar to the description given by WEIR and HUBERT. On removing the bark the pycnial layer was lemon yellow in color. Cross-sections showed the usual extensive crustlike layer of the pycnia. There were extensive pycnial primordia which indicate the immature development of the pycnial layer. From these observations and others it would appear that *P. Comptoniae*, *P. pyriforme*, *P. coleosporoides*, and *P. Strobi* represent a group of species in which the pycnia and aecia complete their period of development within twelve months. No doubt certain environments or other conditions may alternate the period of time the pycnia may appear in one season, but it seems probable that this sequence is more or less regular after the first period of development has been completed. The completion of the initial gametophytic period of development

appears to be variable. CLINTON (3, 4) has shown, by infection of white pines with telia of *Cronartium ribicola*, that the pycnia may appear with the initial infection after a period of six months, one year, two years, and sometimes three years.

3. The third method is found with the leaf rusts of conifers when the period of development is completed within one growing season. This is similar to the period of pycnial and aecial develop-

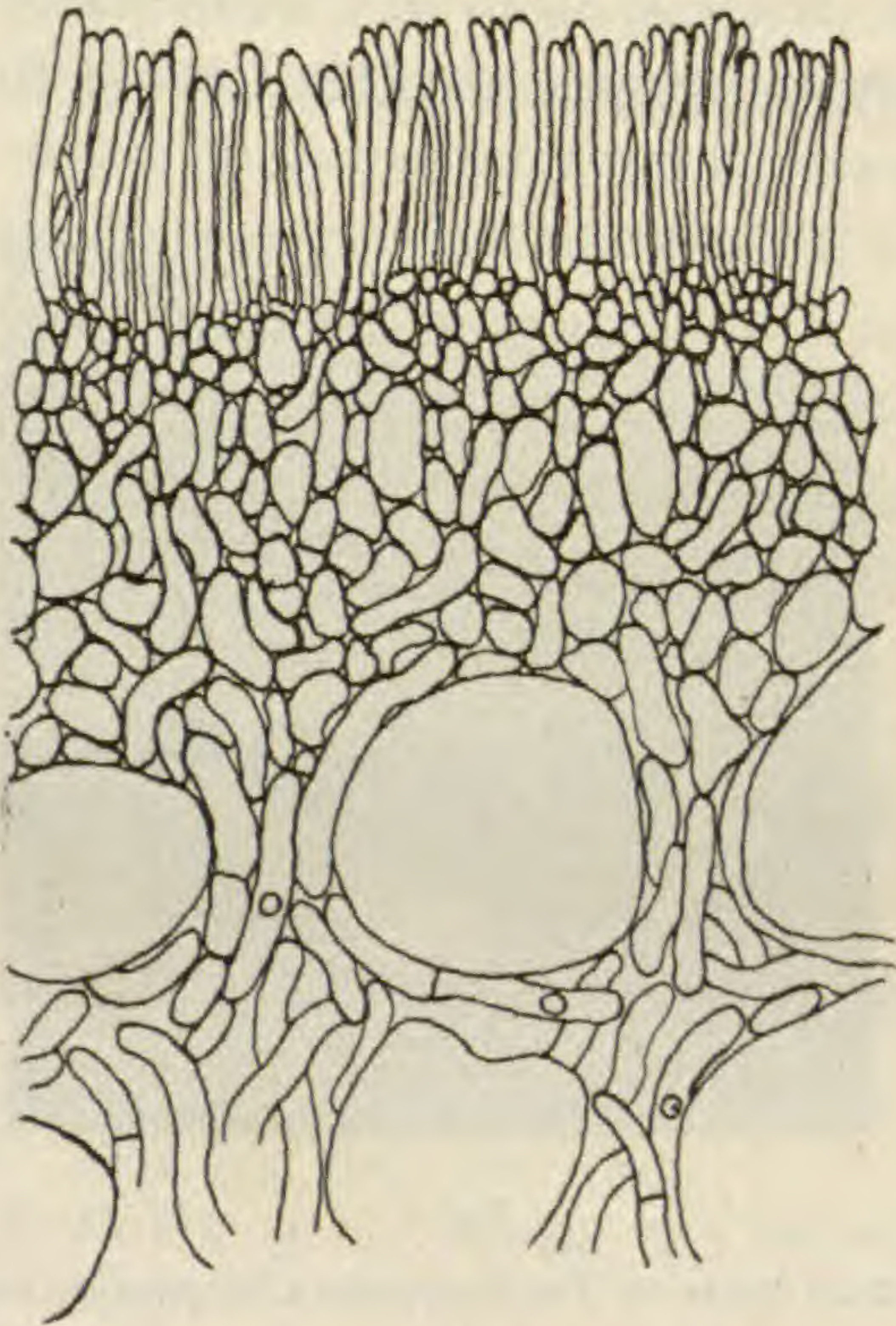

FIG. 1

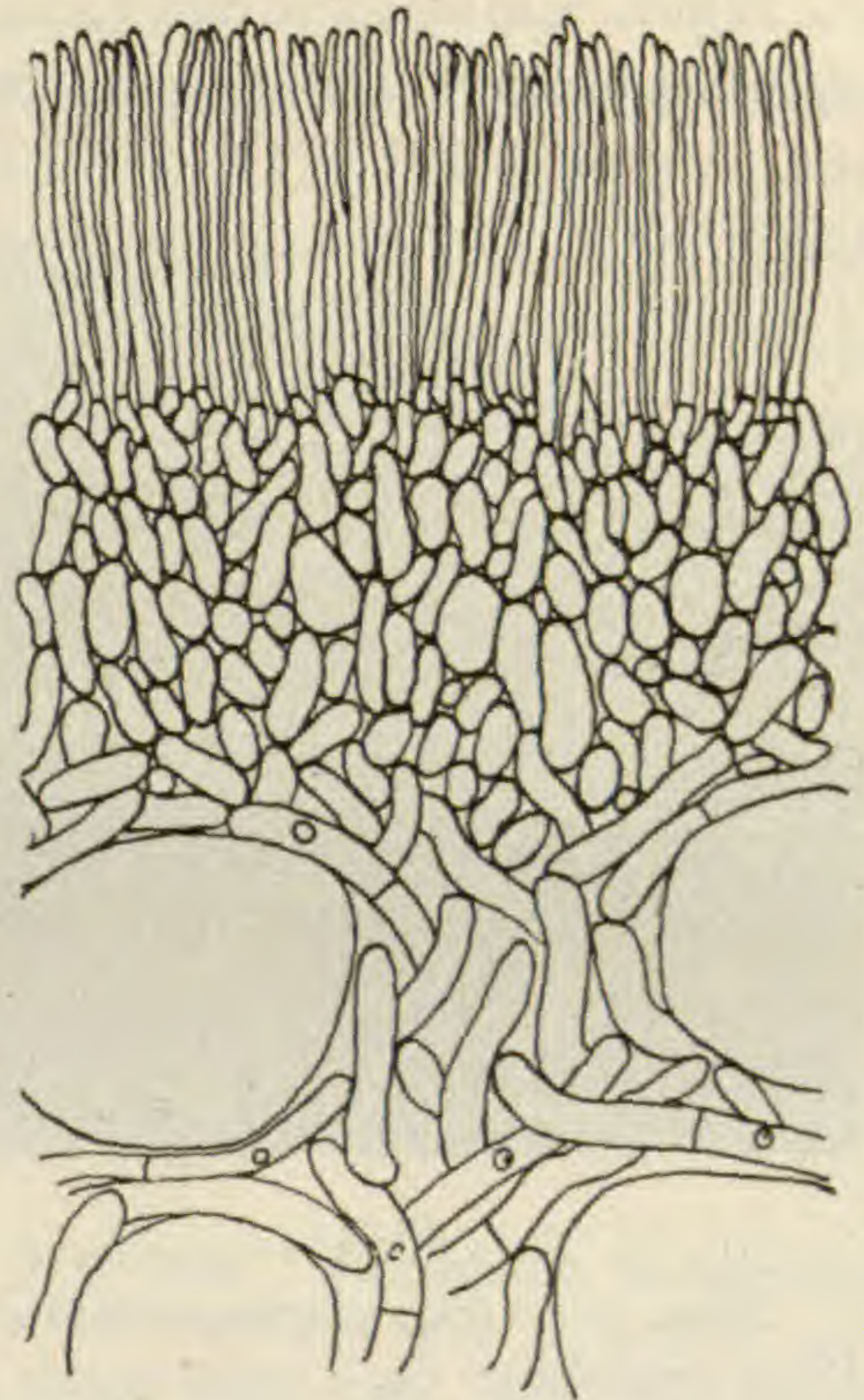

FIG. 2

FIGS. 1, 2.—Fig. 1, cross-section of pycnial layer of *Peridermium Comptoniae* on *Pinus virginiana*; fig. 2, cross-section of pycnial layer of *Peridermium cerebrum* on *Pinus rigida*; drawn with camera lucida at same magnification.

ment of Angiosperms. I have found mature pycnia of *Peridermium acicolum* March 1, 1917, at Pine Grove Mills, Center County, Pennsylvania, while mature aecia were collected May 25, 1917. In the case of *P. Peckii* the pycnia were observed to precede the aecia by only two or three weeks; this difference may be correlated with the time of infection. With *P. acicolum* infection occurs in the fall; while with *P. Peckii* infection occurs after the new growth is developed in the spring.

The first method is in striking contrast with the usual pycnial and aecial relation of rusts on the Angiosperms; the second method appears to be intermediate; while the third method apparently is the one most prevalent with all species of rust. Perennial infection on the Angiosperms is found to complete the gametophytic development in one season, regardless of being heteroecious or autoecious.

Much confusion arises as to the determination of *Peridermium cerebrum* and *P. Comptoniae* on certain species of pines, owing to

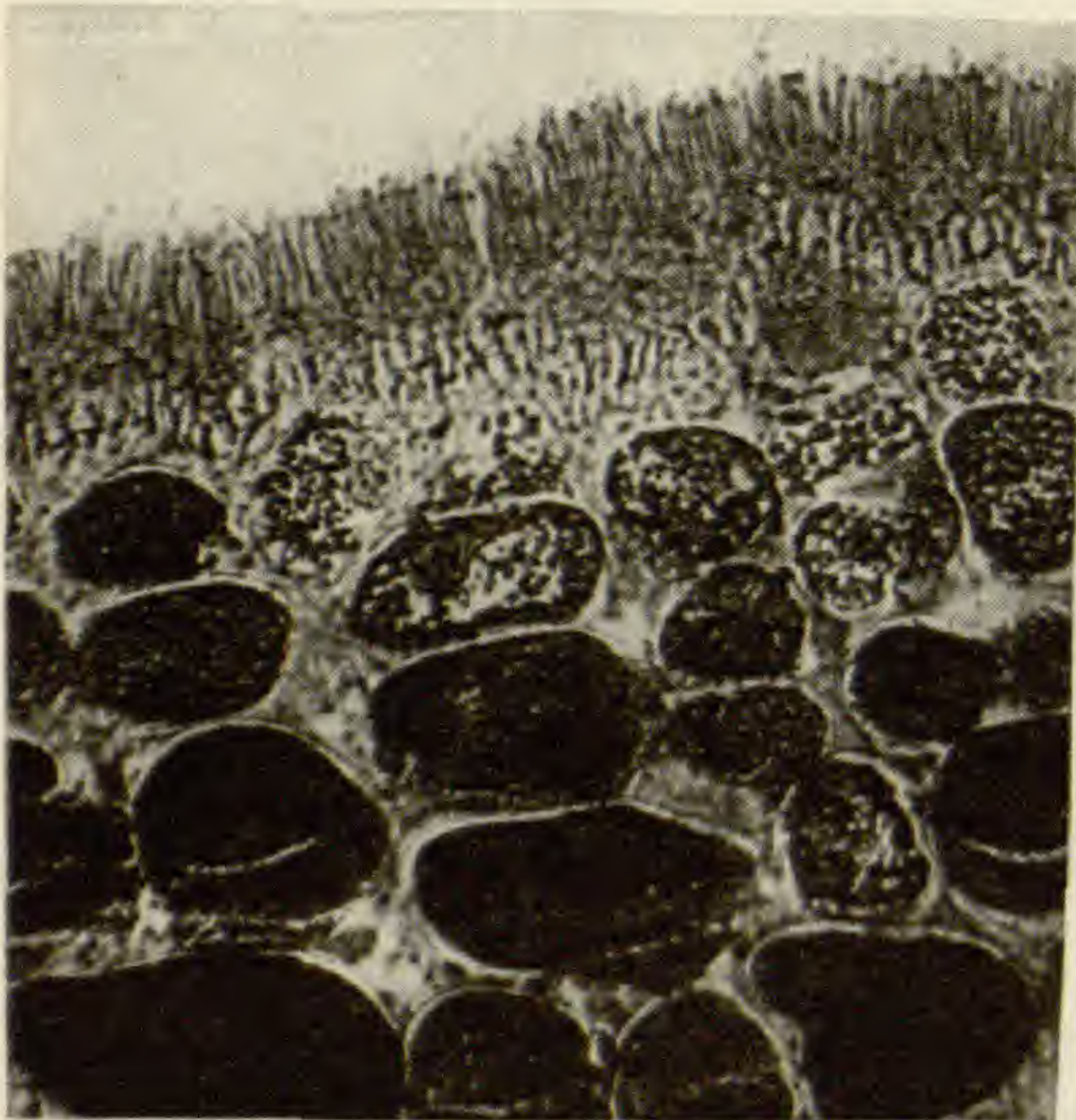

FIG. 3

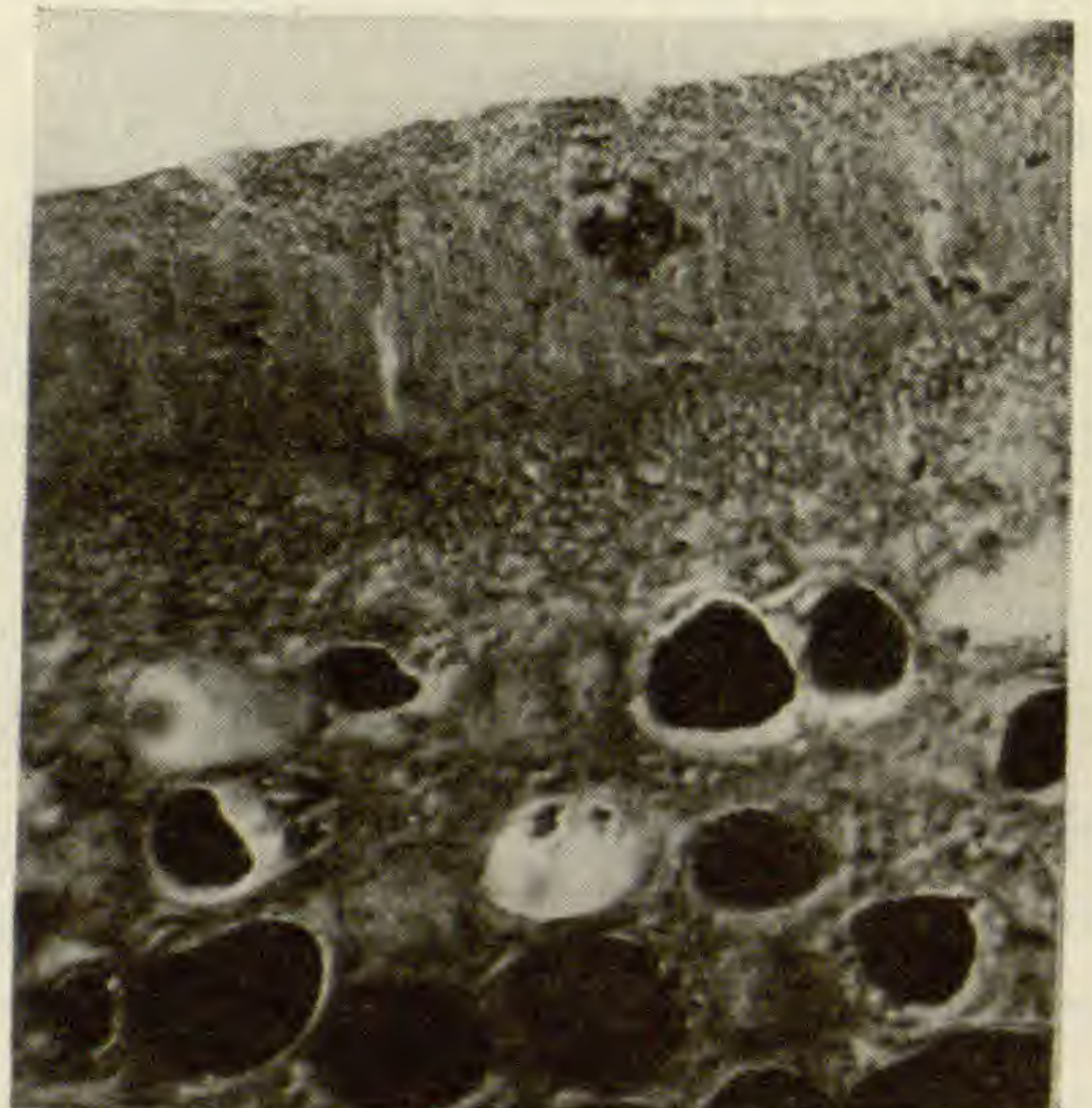

FIG. 4

FIGS. 3, 4.—Fig. 3, cross-section of pycnial layer of *Peridermium Comptoniae* on *Pinus virginiana*; fig. 4, cross-section of pycnial layer of *Peridermium cerebrum* on *Pinus rigida*; photomicrographs taken at same magnifications.

the similarity of infection upon the host. The types of infection are represented by fusiform, globoid, and semigloboid swellings. While the peridium and dehiscence of the aecia are good characters for differentiating these two species, it often occurs that specimens are immature or past their maturity for these characters to be depended upon. Under such conditions material collected in the spring or late summer may be differentiated by the pycnial characters. If the aecia are mature one can examine for the presence of pycnia in the overlying tissue. Providing pycnia are found, the form would agree with *P. Comptoniae*; if pycnia were absent, the form would agree with *P. cerebrum*. Exudation of pycniospores

does not have to be depended upon. The presence of pycnia is best determined by carefully removing the overlying bark from the cortex. The pycnia develop in the subcorticular tissue. Free-hand sections can easily be cut and mounted with a little dilute alcoholic eosin which provides a satisfactory means for examination. The pycniophores of *P. Comptoniae* are shorter and more uniform in diameter throughout their length than those of *P. cerebrum* (figs. 1-4). It is found that the pycniophores are longer and more tapering with *P. cerebrum*. No conspicuous difference in size could be found between the pycniospores of the two species. The following measurements for comparison are taken from killed material and stained with Fleming's Triple. The length of the pycniophores was taken from the sub-basal cell to the tip, and for *Peridermium Comptoniae* was 15-27  $\mu$ ; while for *Peridermium cerebrum* it was 30-36  $\mu$ . A comparison of the pycniophores in these two species is shown in figs. 1 and 3, drawn at the same magnification.

STATE COLLEGE, PA.

#### LITERATURE CITED

1. ADAMS, J. F., Rusts on conifers in Pennsylvania. Penn. State Coll. Agric. Exp. Sta. Bull. 160. 1919.
2. BOYCE, J. S., Pycnia of *Cronartium pyriforme*. Phytopath. 6:446-447. 1916.
3. CLINTON, G. P., Rep. Sta. Bot. Conn. Agric. Exp. Sta. Bull. 214. 1919.
4. ———, Artificial infection of *Ribes* species and white pine with *Cronartium ribicola*. Amer. Plant Pest Committee Bull. 2. 1-15. 1919.
5. DODGE, B. O., and ADAMS, J. F., Some observations on the development of *Peridermium cerebrum*. Mem. Torr. Bot. Club 17:253-261. 1918.
6. HEDGCOCK, G. C., BETHEL, E., and HUNT, N. R., Notes on some western Uredineae. Abst. Phyt. 8:73. 1918.
7. HEDGCOCK, G. C., and LONG, W. H., Identity of *Peridermium fusiforme* with *Peridermium cerebrum*. Jour. Agric. Res. 2:247-249. 1914.
8. SHIRAI, M., On the genetic connection between *Peridermium giganteum* (Mayr.) Tubeuf and *Cronartium quercuum* (Cooke) Miyabe. Bot. Mag. Tokyo 13:74-79. 1899.
9. WEIR, J. R., and HUBERT, E. E., Pycnial stages of important forest tree rusts. Phytopath. 7:135-139. 1917.

# DEVELOPMENT OF HEAD AND FLOWER OF DIPSACUS SYLVESTRIS

CONTRIBUTIONS FROM THE HULL BOTANICAL LABORATORY 278

HILARY S. JURICA

(WITH FOURTEEN FIGURES)

## Introduction

Epigyny and its occurrence among the upper Sympetalae have frequently been studied, but epigyny begins with the Rubiales, and while almost every family in this region has received attention in this regard, the Dipsaceae have been overlooked altogether. Accordingly this investigation was begun in an endeavor to fill this vacancy. During the course of the study, however, the development of the head was found to be interesting, and since it raised the question as to the relation the developing head bears to the general topography of the plant, it was thought best to include both of these phases in the present work.

For the material used in this study I am indebted to the generosity of CHARLES C. DEAM, State Forester of Indiana, who not only collected the necessary plants at repeated intervals, but also loaned a number of mounted specimens from his herbarium. The fresh material was killed in a stock solution of chromoacetic acid and stained for the greater part with safranin, Delafield's haematoxylin, and orange G, the latter stain being omitted in a few cases.

My acknowledgment is due to Professor CHARLES J. CHAMBERLAIN, at whose suggestion the work was undertaken, for valuable assistance rendered during the course of the investigation.

## General topography

*Dipsacus sylvestris* is a biennial propagated by seeds. During the first season the plant develops a very flat rosette of crinkled leaves (2). These are oblong to lance-shaped, obtuse, tapering at the base and scalloped toothed. The surface of the wrinkled



leaves is deep green, while the veins and midribs are nearly white and beset with spines. A stout taproot, often more than a foot long and with many branching rootlets, serves to anchor the plant. During the second season the flat rosette sends out a shoot, which develops into a stout, erect, and strongly ridged stem, beset with sharp spines (3), which often grows to a height of 3-6 ft., the degree of branching depending upon the richness of the soil. If viewed in cross-section, the stem is rather tough and woody, characterized by a large pith, which gradually breaks down, so that the older portions of the stem are hollow. No attempt has been made to include a study of the anatomical features. The stem leaves occur in pairs, opposite each other, with their bases so closely clasping the stem that often they are united at the base, and thus form cups which retain water (3). The clasping leaves do not make their appearance on the stem in the same plane, but observe some degree of regular alternation. Thus, if one pair of leaves is pointing north and south, the alternating pairs (the next pairs immediately above and below) point east and west (2).

According to VELENOVSKY (8), the axils of leaves as a rule contain an active meristem, which may give rise to new branches or axillary shoots. This is precisely what takes place in *D. sylvestris*, although with some modification. New branches or shoots do not develop from the axils of all clasping leaves, for some abortion takes place, especially in the case of plants growing in poor rocky soil. In such an environment the plants of this species are branched very little, and in some cases not at all. Whenever new shoots or branches are given off, however, they always occur in the axils of the clasping leaves. If two or more succeeding pairs of clasping leaves give rise to lateral branches, as is often the case with *D. sylvestris* found growing in a slightly better soil, the shoots make their appearance at right angles to the ones above and below. While the lateral branches are still small and scarcely noticeable, except upon closer examination, in turn they also give rise to new daughter shoots from the axils of their clasping leaves, which follow the same general plan of development as those arising from the main or central stem. Plants with secondary branches are common, whereas plants with tertiary or quaternary branching are less

frequent, being met with generally only in more favorable environments (figs. 1, 2).

The occurrence of clasping leaves on a lateral branch has considerable uniformity, at least for the individual plant. Ordinarily a lateral branch has but one pair of clasping leaves, and its



FIGS. 1, 2.—Fig. 1, showing general topography and mode of branching, with single pair of clasping leaves per branch; positions of leaves indicated by lines; fig. 2, plant with two pairs of clasping leaves per branch, secondary branching being absent altogether.

daughter branches likewise have but a single pair; that is, the secondary, tertiary, etc., branches, each have but one pair of clasping leaves. Plants having two pairs of clasping leaves on every branch are also characterized by a similar uniformity, consisting of the total absence of further or secondary branching

(fig. 2). Probably the presence of an additional pair of clasping leaves per lateral branch is responsible for the total absence of secondary branching, especially since all the specimens examined showed this regularity. For the sake of certainty in this regard, however, a more extensive field study is necessary. Another noteworthy feature in regard to the development of new branches is the inequality of a developing pair. At times this inequality is so marked that a given shoot or branch happens to be three or even five times as long as its immediate neighbor, arising from the axil of the leaf directly opposite. This undoubtedly is due to the fact that the development of both members of a pair of lateral branches is not simultaneous.

### Floral head

The type of inflorescence of *D. sylvestris* is a head or capitulum, surrounded by an involucre of long upcurving spiny bracts arranged in cycles of five, with the members of the outer cycle extending beyond the head, which they encircle. The bracts forming the succeeding inner cycles gradually become shorter, so much so that the members comprising the fifth inner cycle are almost equivalent in length to that of the bracts subtending the individual flowers of the head.

In its development the floral head is intimately associated with the origin of lateral or secondary branches, for the central or main stem, as well as every individual branch, is terminated by this type of inflorescence. The minute protuberance arising from the axil of a clasping leaf, and destined to develop into a new branch, is in reality a capitulum initial. Insignificant though it is at first, it immediately begins to round out, and the bracts which enter into the composition of the involucre are prompt in making their appearance (fig. 4). Almost concomitant, or at least following in close succession, are the clasping leaves of the new shoot, which appear as lateral outgrowths or papillae just below the origin of the bracts (fig. 5). As soon as the initials of these members are differentiated, the entire new shoot becomes one mass of growth. Not only does a rapid elongation of the region, both directly above and below the origin of the leaf initials, set in, but this elongation

itself has hardly had an opportunity to proceed at all, nor have the clasping leaves developed to any extent, when in their axils an active meristem begins to give rise to the initials of another floral head. By this time the outermost cycle of bracts forming the involucre has fairly grown beyond the floral head, which they encircle, and the entire capitulum becomes one mass of protuberances, the initials of the bracts, which later subtend individual flowers.

### Flowers

The flowers of *D. sylvestris* are arranged in the capitulum in the form of a low spiral, and so appear to be set in diagonal rows (figs. 3-14). The method of blossoming is unique. Ordinarily one would expect the blossoming to begin at the base and extend toward the tip, but the blossom tide begins at the middle and extends both ways (2). The flower itself consists of a white tube, which is divided at its end into four purple lobes. Of these four lobes the lowest is a trifle longer than the others and turns up slightly at its tip. Alternating with the lobes are four stamens, inserted on the tube of the corolla. A much reduced calyx, which encircles the base of the corolla, adheres to the inferior ovary. This typical epigynous flower is further characterized by a four-leaved calyx-like involucre, which invests the ovary and fruit (fig. 14.) The individual flowers begin their development as axial outgrowths of the bracts besetting the capitulum. This undifferentiated mass of cells, somewhat rounded at first, soon broadens a little, and the distinct lobes of the corolla appear on the peripheral portion (fig. 10). Next in appearance are the primordia of the stamens, which form the succeeding inner cycle (fig. 11). Soon after this the tissue below the lobes of the corolla and stamen initials begins to elongate en masse, forming a tubular ring. Following so soon that it would almost seem to be simultaneous, is the appearance of a twofold lateral swelling just below the base of the corolla (fig. 11). The upper protuberances are the primordia of the calyx and the lower develop into a calyx-like involucre, which later invests the ovary and fruit (figs. 11, 14). The last to make their appearance are the carpel lobes, which appear as basal outgrowths from the inner surface of the tubular cavity (fig. 12).

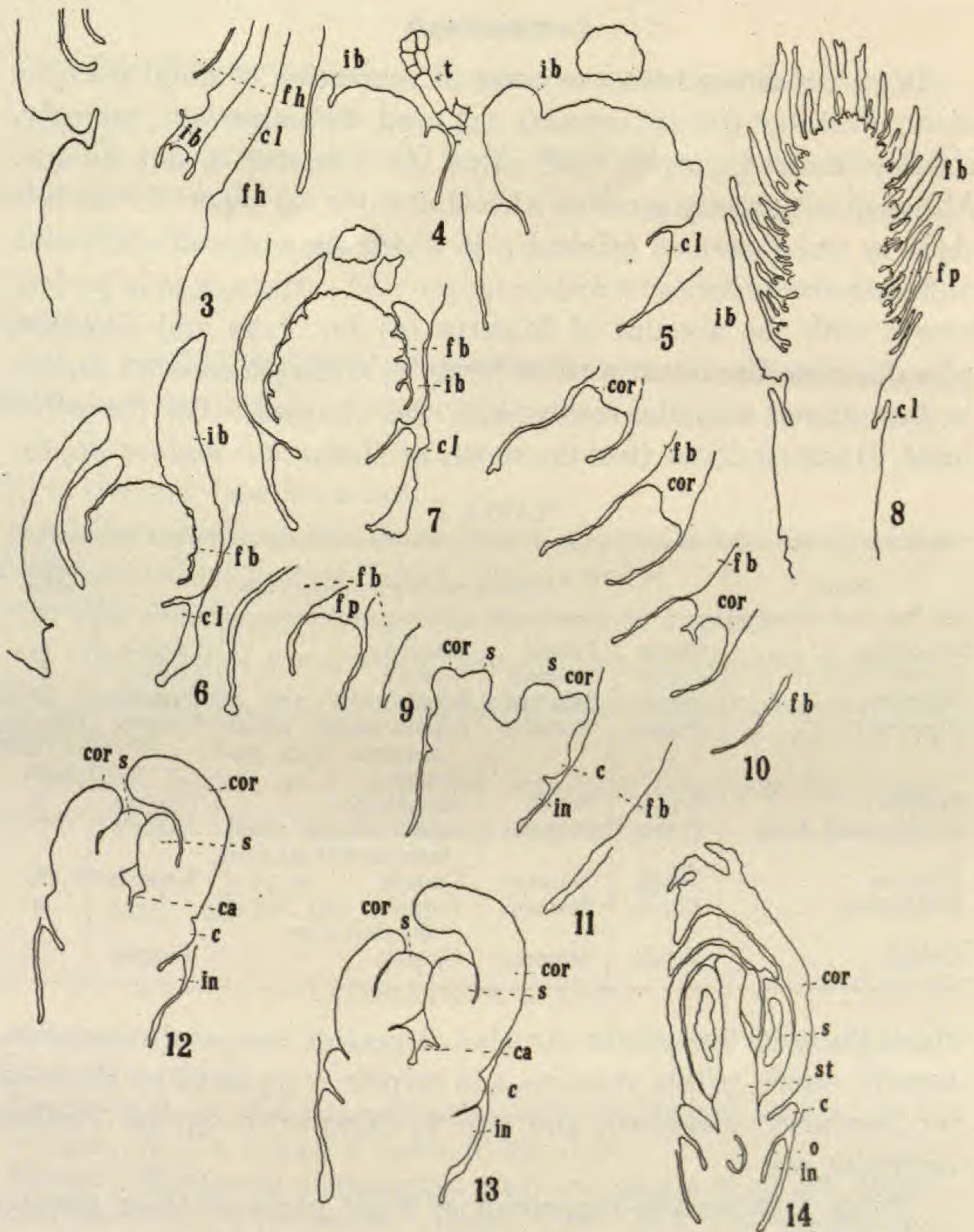

FIGS. 3-14.—Fig. 3, longitudinal section of young floral head showing origin of another head (daughter branch) in axils of clasping leaf; fig. 4, daughter floral head enlarged showing initials of involucral bracts; *t*, trichome included to show relative size of floral head at time of origin; fig. 5, later stage of floral head showing the clasping leaf; figs. 6, 7, still later stage showing initials of individual floral bracts; fig. 8, young floral head in longitudinal section; fig. 9, papilla of single flower; fig. 10, young flower showing origin of corolla; fig. 11, later stage showing beginning of stamens, calyx, and involucl; fig. 12, beginning of carpels; figs. 13, 14, later stages; abbreviations: *fh*, floral head; *cl*, clasping leaf; *ib*, involucral bract; *fb*, floral bract; *fp*, floral papilla; *cor*, corolla; *s*, stamen; *c*, calyx; *in*, involucl; *st*, style; *o*, ovule; *ca*, carpel.

### Comparisons

In its departure from the order of succession of floral parts as exemplified by *Cnicus arvensis* (1) and *Silphium* (7), namely, corolla, stamens, carpels, and calyx, *D. sylvestris* is not unique. Although not exactly agreeing with HANNAH'S (4) report for *Galium Aparine* and *Valeriana officinalis*, in which the order of succession of floral parts is petals, stamens, sepals, and carpels, it is in perfect accord with the account of MARTIN (6) for *Aster* and *Solidago*, who describes the calyx in those forms as arising somewhat earlier, in fact almost simultaneously with the stamens. On the other hand, HANNAH states that the sepals of *Helianthus annuus* appear

TABLE I

Genus	Order of succession of floral parts				Investigator
	Sepals	Petals	Stamens	Carpels	
<i>Sambucus</i> .....	Sepals	Petals	Stamens	Carpels	4
<i>Galium</i> .....	Petals	Stamens	Sepals	Carpels	4
<i>Valeriana</i> .....	Petals	Stamens	Sepals	Carpels	4
<i>Dipsacus</i> .....	Petals	Stamens	Sepals almost simultaneous with stamens	Carpels	Figs. 9-14, this paper
<i>Fevillea</i> .....	Sepals	Petals	Staminodia	Carpels	5
<i>Solidago</i> and <i>Aster</i> ...	Petals	Stamens	Sepals almost simultaneous with stamens	Carpels	6
<i>Silphium</i> .....	Petals	Stamens	Carpels	Pappus	7
<i>Helianthus</i> .....	Petals	Stamens	Carpels and sepals simultaneous		4
<i>Cnicus</i> .....	Petals	Stamens	Carpels	Pappus	1

about the same time as the carpels. A perfect acropetal succession, namely, sepals, petals, stamens, and carpels, is reported by HANNAH for *Sambucus canadensis*, and also by KIRKWOOD (5) for *Fevillea cordifolia*, etc.

Table I shows the succession of floral parts of these genera, members of closely related families.

It is seen that, at least so far as the forms in which the sepals are much reduced or modified are concerned, the order of succession of floral parts is uniform for petals and stamens only. Since the primordia of either sepals or carpels may be third in appearance or even simultaneous, it is evident that a more extensive study of epigyny is necessary before any safe conclusion can be reached.

### Summary

1. The mode of branching is uniform for each individual plant.
2. New branches arise from the axils of clasping leaves.
3. The capitulum, or floral head, which terminates each branch is the first to make its appearance in the development of a branch.
4. The primordia of the bracts forming the involucre of the capitulum appear early, followed quickly by the initials of clasping leaves.
5. A twofold region of elongation sets in immediately above and below the initials of the clasping leaves of the new branch.
6. Secondary branches appear very early in the axils of the leaves clasping new branches.
7. The initials of the floral bracts appear before the papillae of the individual flowers, which they subtend.
8. The flowers are arranged in the form of a spiral.
9. The order of succession of floral members is corolla, stamens, calyx, and carpels, the calyx appearing almost simultaneously with the stamens.
10. The initials of a calyx-like involucre investing the ovary appear shortly after the initials of the calyx.

ST. PROCOPIUS COLLEGE  
LISLE, ILL.

### LITERATURE CITED

1. COULTER, J. M., and CHAMBERLAIN, C. J., Morphology of angiosperms. 1903 (p. 17, fig. 3).
2. COMSTOCK, A. B., Handbook of nature study, pp. 586-588. 1911.
3. GEORGIA, ADA, A manual of weeds, p. 403. 1919.
4. HANNAH, MARGARET, Comparative study of epigyny in certain Monocotyledons and Dicotyledons. Trans. Amer. Micr. Soc. 35:207-220. 1916.
5. KIRKWOOD, J. E., The comparative embryology of the Cucurbitaceae. Bull. N.Y. Bot. Gard. 3:313-402. pls. 58, 69. 1904.
6. MARTIN, G. W., Development of the flower and embryo sac in *Aster* and *Solidago*. BOT. GAZ. 17:353-358, 406-411. 1892.
7. MERRELL, W. D., A contribution to the life history of *Silphium*. BOT. GAZ. 29:99-133. pls. 3-10. 1900.
8. VELENOVSKY, JOS., Srovnávací Morfologie. 2: p. 504. 1907.

## RESERVE FOOD MATERIALS IN VEGETATIVE TISSUES

G W Y N E T H E M. T U T T L E

In view of the importance of the distribution of starch and fats as food reserve substances in vegetable tissues, and its connection with investigations regarding the effect of low temperatures on cells, it was thought desirable to investigate the conditions prevailing in some trees and shrubs of northern Alberta. Observations by several investigators have been made from other regions in the north temperate belt, such as those of LIDFORSS (3), MIYAKE (4), and SINNOTT (5) from Sweden, Japan, and eastern United States respectively. All of these districts lie between the winter isotherms of 30° and 40° F., whereas northern Alberta lies between those of 10° and 20° F. (1). Furthermore, vegetation in this region is frequently subjected to short periods of very low temperatures during the winter months, reaching -50° F., which makes the problem of resistance to cold a very important one.

LIDFORSS found that all "winter green" leaves are free from starch, but contain sugar and sometimes oil in winter. The starch is replaced by sugar during November, while the reverse change takes place in April. These results were largely confirmed for this region. Much of the material examined by SINNOTT retained starch as a food reserve throughout the winter, although many of the species were characterized by an oily reserve. He found that starch was most common in regions remote from the conducting channels, and fat most abundant in and near the phloem, close to the vessels. His "starch" trees were characterized by thick, squarish medullary ray cells with strongly lignified and small pitted walls; while the "fat" trees showed medullary ray cells with thin or unlignified walls and large pits. This he interpreted as indicating that "the character of the food reserve in any cell depends primarily upon the ease with which water, or substances carried by water, have access to the cell. Where the movement is apparently slow and difficult, the reserve persists as



starch; where such movement is easy, starch disappears at the beginning of winter and fat is produced.”

A representative number of trees, shrubs, and perennial herbaceous plants of the region round Edmonton were examined. As the number of native plants with “winter green” leaves was very limited, tests of the stems of the deciduous types were included in the observations. Sections of the leaf, stem, and bud were tested with iodine solution and osmic acid at intervals from October to June. Records extending over three seasons show very little variation during October. Starch was quite abundant in the medullary ray cells, phloem, and cortex. Oils and fats were present in nearly all cells of the phloem and cortex and in the medullary ray cells of some plants. In several cases cortical cells contained food reserve which did not react to either iodine or osmic acid, suggesting the “transitory substance” mentioned by SINNOTT. Various tests were applied, but the identity of the substance was not determined. Some of the material was tested microchemically for sugar by means of the Flückiger reaction (6). Heavy precipitates of cuprous oxide were obtained (on heating) in *Syringa*, *Populus*, *Prunus*, *Salix*, *Shepherdia*, *Ribes*, *Picea*, *Pinus*, *Rosa*, *Pyrola*, *Cornus*, and *Eleagnus*, indicating the presence of glucose and dextrans. A positive determination of sugars could not be obtained by this means, on account of the possibility of the presence of a large number of other reducing substances in the cells; and in the absence of a satisfactory microchemical test for sugars, the work was not continued. Quantitative determinations of the sugar contents of a few cell saps made in another investigation have been recorded (2), where it was found that the total sugars varied from 0.5 to 2 per cent. The condition of the starch and oil reserve, tested at different seasons, is shown in table I.

In the majority of cases starch disappeared from the local plants during October and early November. Oils and fats were abundant in all of the species examined, with the exception of *Lonicera* and *Crataegus*. In view of the fact that a few species showed a trace of starch in their tissues quite late in winter, anatomical examinations were made and the two types described by SINNOTT

as "fat" and "starch" trees were recognized. Those species which retained small quantities of starch corresponded in all cases to the structure of "starch" trees, whereas those in which conversion was most rapid were of the "fat" tree type. Although species which retained definite starch reserve during the winter are absent from this locality, certain of the facts seemed to give limited support to the

TABLE I

Material	October	December	February	May
<i>Populus tremuloides</i> .....	S and O	O	O	S and O
<i>Populus balsamifera</i> .....	S and O	O	O	.....
<i>Salix rubra</i> .....	S and O	O	O	.....
<i>Shepherdia canadense</i> .....	S and O	O	O	S and O
<i>Betula subcordata</i> .....	S and O	.....	O	.....
<i>Amelanchier alnifolia</i> .....	S and O	.....	O	S and O
<i>Alnus incana</i> .....	S and O	.....	O	S and O
<i>Pyrola rotundifolia</i> .....	SS and O	O	O	O
<i>Cornus canadensis</i> .....	O	O	O	O
<i>Linnaea borealis</i> var. <i>americana</i> .....	SS and O	O	O	O
<i>Mitella nuda</i> .....	SS and O	O	O	.....
<i>Corylus rostrata</i> .....	S and O	.....	O	S and O
<i>Picea canadensis</i> .....	SS and O	O	O	.....
<i>Pinus Banksiana</i> .....	O	O	O	.....
<i>Ledum groenlandicum</i> .....	SS and O	.....	.....	S and O
<i>Arctostaphylos Uva-ursi</i> .....	O	O	O	S and O
<i>Vaccinium Vitis-Idaea</i> .....	SS and O	.....	.....	.....
<i>Viburnum pauciflorum</i> .....	S and O	O	O	S and O
<i>Prunus pennsylvanica</i> .....	S and O	O	O	.....
<i>Ribes setosum</i> .....	S and O	SS and O	SS and O	S and O
<i>Symphoricarpos occidentalis</i> .....	S and O	SS and O	SS and O	S and O
<i>Rosa arkansana</i> .....	S and O	SS and O	SS and O	S and O
<i>Eleagnus argentea</i> .....	S and O	SS and O	O	S and O
<i>Cornus stolonifera</i> .....	S and O	SS and O	O	S and O
<i>Crataegus tomentosa</i> .....	S and O	SS and O	O	S and O
<i>Lonicera glaucescens</i> .....	S	S	.....	S
Exotic shrubs				
<i>Syringa vulgaris</i> .....	S and O	SS and O	O	SS and O
<i>Carragana</i> sp.....	S	SS	No starch	S
<i>Ribes</i> sp.....	S and O	SS and O	O	.....
<i>Acer Negundo</i> .....	S and O	SS and O	SS and O	.....

S, starch; SS, slight starch reaction; O, oils and fats.

view recently suggested by SINNOTT in regard to the relation of structure to the nature of food reserve.

Tests were made of the leaves of the majority of the local deciduous trees and shrubs at the time of leaf fall. The 15 species examined were characterized by the absence of starch, except in

*Ribes* and *Cornus*, which were found to contain minute quantities, whereas all showed a relatively high oil and fat content. The winter buds of the same trees showed a high percentage of starch at this time. It would seem that the starch had either been converted in the mature leaves before leaf fall or else translocated to other regions of the plant. Table II records the leaf material tested.

TABLE II

MATERIAL	FOOD RESERVE
<i>Symphoricarpos</i> sp. . . . .	Oils and fats
<i>Symphoricarpos occidentalis</i> . . . . .	Oils and fats
<i>Ribes</i> sp. . . . .	Oils and fats
<i>Ribes setosum</i> . . . . .	Trace of starch
<i>Betula subcordata</i> . . . . .	Oils and fats
<i>Rubus</i> sp. . . . .	Oils and fats
<i>Corylus rostrata</i> . . . . .	Oils and fats
<i>Fragaria</i> sp. . . . .	Oils and fats
<i>Corydalis</i> sp. . . . .	Oils and fats
<i>Ledum groenlandicum</i> . . . . .	Oils and fats
<i>Arctostaphylos Uva-ursi</i> . . . . .	Oils and fats
<i>Vaccinium Vitis-Idaea</i> . . . . .	Oils and fats
<i>Syringa vulgaris</i> . . . . .	Trace of starch
<i>Cornus stolonifera</i> . . . . .	Oils and fats

Several species of Salicaceae and Ericaceae were examined from high elevations in the mountains of Alberta and British Columbia, with a view to determining any difference in food reserve due to the different habitat. Herbarium specimens were used for the tests as fresh material was not obtainable. As these had been quickly and carefully dried, there is no reason to suppose that the starch or fat content of the cells would have been affected. Material of the stem was softened in water and tested immediately. Very definite reactions were obtained. Most of the material had been collected at the height of the vegetative season for the elevations at which it occurred. It was not possible to establish any connection between high elevation and a difference of food reserve. The majority of the species examined showed the presence of both starch and oil during the vegetative season, although a few contained only oil, as shown in table III.

TABLE III

MATERIAL	ELEVATION IN FT.	DATE OF COLLECTION
Starch and oil present		
<i>Salix glaucops</i> . . . . .	6000	August 9
<i>Salix nivalis</i> . . . . .	7500	July 18
<i>Salix herbacea</i> . . . . .	8200	July 23
<i>Phyllodoce empetriformis</i> . . . . .	7200	July 12
<i>Kalmia glauca</i> . . . . .	5000	August 25
<i>Phyllodoce glanduliflora</i> . . . . .	7500	July 18
<i>Arctostaphylos Uva-ursi</i> . . . . .	5000	July
<i>Ledum groenlandicum</i> . . . . .	5000	July
<i>Rhododendron albiflorum</i> . . . . .	7500	July 27
<i>Menziesia glabella</i> . . . . .	6000	July 3
<i>Vaccinium scoparium</i> . . . . .	6500	June 26
<i>Arctostaphylos alpina</i> . . . . .	Lowland	August 4
<i>Arctostaphylos alpina</i> . . . . .	6700	June 25
<i>Cassiope Mertensiana</i> . . . . .	4000	August
Oils and fats only		
<i>Salix vestita</i> . . . . .	6400	July 17
<i>Salix arctica</i> . . . . .	7100	July 26
<i>Gaultheria ovatifolia</i> . . . . .	Lowland	August 15
<i>Arctostaphylos erythrocarpa</i> . . . . .	5000	August 15
<i>Empetrum nigrum</i> . . . . .	5100	August 15

### Summary

1. All the species examined showed a high starch content during the summer, which disappeared during October.

2. All the trees and shrubs of this district which were examined contained oils and fats as food reserve during winter with the exception of *Lonicera glaucescens* and *Crataegus* sp. The presence of sugar was demonstrated in many of the species. Quantitative determinations in a few places gave a total sugar content of 0.5-2 per cent.

3. Deciduous leaves, at the time of leaf fall, were devoid of starch, but contained oils and fats.

4. Most of the species of alpine Salicaceae and Ericaceae examined showed the presence of both starch and oil during the vegetative season. *Gaultheria ovatifolia*, a lowland species, showed only oil. Hence the ability to form starch does not seem to be associated with climatic conditions, resulting from high altitudes.

## LITERATURE CITED

1. BARTHOLOMEW, J. G., Physical atlas, vol. 3. 1899.
2. LEWIS, F. J., and TUTTLE, GWYNETHE M., Osmotic properties of some plant cells at low temperatures. *Ann. Botany* 34:405-416. 1920.
3. LIDFORSS, B., Die wintergrüne Flora. *Lunds Universitets Arsskrift* 2: no. 13. 1907.
4. MIYAKE, KUCHI, On the starch of evergreen leaves and its relation to photosynthesis during the winter. *BOT. GAZ.* 33:321-340. 1902.
5. SINNOTT, E. W., Factors determining the character and distribution of food reserve in woody plants. *BOT. GAZ.* 66:162-175. 1918.
6. TUNMANN, O., *Pflanzenmikrochemie*. 1913.

# BRIEFER ARTICLES

## WILHELM PFEFFER

(WITH PORTRAIT)

WILHELM PFEFFER was born March 9, 1845, the son of a pharmacist, and died January 31, 1920. He studied at Göttingen, Marburg, Berlin, and Würzburg, taking his doctor's degree at Göttingen in 1865. He held university positions in Marburg, Bonn, Basel, and Tübingen before



going to Leipzig in 1887, where he spent the rest of his life. It was here that he developed a laboratory and garden exactly according to his ideas, and this equipment probably held him at Leipzig in spite of calls elsewhere. PFEFFER probably shares with STRASBURGER the distinction of having more foreign students in his laboratory than any other German professor. His contribution to plant physiology, therefore, included not only his own researches, but also the stimulus of his ideas and methods to many productive students. He had what may be called an unusual perspective in

connection with problems, seeing the various directions of attack, and the relations of results to the general field.

His publications, 96 in number, began with an ecological paper on mosses and some embryological papers, but soon passed into plant physiology. The sequence from the decomposition of carbon dioxide

by green plants, and the transformation of proteins during seed germination, to the investigation of tropisms and osmosis is familiar to all botanists. The influence of this work on osmosis extended beyond the botanical field into physics and chemistry. Of more general interest is his *Handbuch der Pflanzenphysiologie*, a notable reference text, the second edition of which was translated into English by EWART.

A sketch of PFEFFER'S scientific career has appeared in *Science* (51:291. 1920), so that I shall attempt to supplement this by the presentation of some personal traits. When known to the writer PFEFFER lived in the second story of the Botanical Institute in the University Botanical Garden. He was a tall man and spare, with black hair and beard, and with a pleasing and kindly face that immediately put one at ease in meeting him. The portrait accompanying this sketch makes him look more austere than was his wont, otherwise it represents him as he looked in 1892, at the age of 48.

PFEFFER was a hard and continuous worker, and was rarely absent from the Institute, except for the four to six weeks' vacation which he generally took with his family in August and September in Switzerland or on the Baltic. He arose at six in the morning, lectured at seven, worked in his own rooms until eleven, then made the rounds of his students' tables, gave the noon hour to visitors, had luncheon, and worked again until five. From five to six he walked, and generally worked again in the evening. Besides keeping himself informed on the progress of science, especially physics and chemistry, he was always on the watch for new apparatus and new mechanical devices. Leipzig maintained a continuous mechanical and electrical exposition, and this PFEFFER frequently visited. He delighted in contemplating every new machine.

PFEFFER'S attitude toward his students was friendly and cordial. Regularly he visited the research laboratories at eleven, discussed with each man his problem, designed apparatus, and pointed out lines of experiment, frequently calling in the first assistant to receive direction for providing what the worker needed. If any student needed more time than could be given in the forenoon visit, the Professor would come again in the afternoon. The first assistant was always conversant with the work of each student, and made the rounds forenoon and afternoon, besides always being on call when any help was needed. Each research man was given a key admitting him to the laboratory, and no restrictions were placed on his coming or going. Under PFEFFER'S rule work had to make progress. There was patience, but there was

insistence on continuous work. Although students, especially the German students, treated the *Geheimrath* with the greatest deference, PFEFFER opened the way to the greatest freedom of intercourse, and the *Botanischer Abend*, held twice a month in some small room of a hotel, and attended by staff and research students, was notably a social occasion, giving opportunity for lively discourse and debate.

As was the lot of many other intellectuals in Europe, PFEFFER'S last days fell upon evil times. The bare necessities of life were difficult to obtain; his only child, a son of 34 years, who had attained some prominence as a chemist, was killed in battle near the close of the war; the end of his professorship was near, by the rules of the new government; his country had fallen from her commanding position. The burden was too much for his sensitive soul, and it crushed him. Yet his life was successful beyond that of most men. There are few fields in plant physiology that have not been extended by his researches. Physics, chemistry, and general biology have profited by his classical monographs. His pupils are professors and teachers over the whole world.—F. C. NEWCOMBE, *University of Michigan, Ann Arbor, Mich.*



# CURRENT LITERATURE

## BOOK REVIEWS

### Hydrogen ion determination

Hydrogen ion determinations are of ever increasing interest and importance to investigators in physiological and other fields of botany. Two methods of making such determinations are more or less widely known and well standardized: the electrometric and colorimetric methods. Both the history of the development and accounts of the practical operation of making such determinations have heretofore existed in scattered periodicals, and a student desiring to follow one of the methods had the choice of searching through several periodicals for the necessary information or of consulting such works as MICHAELIS.<sup>1</sup> A book by CLARK<sup>2</sup> has recently appeared which will be welcomed by students of hydrogen ion concentration, both on account of its detailed information and authoritative nature, written as it is by one who has made many contributions toward the development of methods for measurements of this sort. Chapter i deals with "General relations among acids and bases"; then follow 59 pages on the colorimetric determination of hydrogen ion, 108 pages on electrometric measurements, a short chapter of 5 pages on "Supplementary methods," and lastly a chapter of 29 pages on "Applications." The book also includes a very complete bibliography and an appendix containing tables for converting  $P_H$  to hydrogen ion concentration, other tables applicable to  $P_H$  measurements, and a list of representative potentiometer equipment.

Under "General relations among acids and bases" the author discusses the theory of dissociation in solution, and develops the related equations. The following 59 pages on colorimetric determinations include a chapter on the general method, two chapters on the theory and choice of indicators, another chapter devoted to buffer solutions, and two chapters concerning errors of the method and practical determinations with indicators. The author includes tables showing Sorensen's indicators, Clark and Lubs series, and Gillespie's drop-ratio series, giving their  $P_H$  ranges and other data necessary in using them. The section dealing with electrometric measurements is divided into ten chapters. They include a short outline of the method, the theory of the hydrogen electrode, discussion and illustration of various types of electrode vessels, potentiometers and other electrical apparatus, hydrogen generators

---

<sup>1</sup> MICHAELIS, LEONOR, *Die Wasserstoffionenkonzentration*. Berlin: Julius Springer Co. 1914.

<sup>2</sup> CLARK, W. MANSFIELD, *The determination of hydrogen ions*. pp. 317. Baltimore: Williams & Wilkins Co. 1920.

and temperature control, discussion of reduction potential and its relation to hydrogen electrode potential, sources of error, standard solutions for checking such measurements, and a chapter on  $P_H$  standardization, the last including a "Proposal of standard values." The chapter on "Supplementary methods" deals with the conductivity and other methods which have been used in special cases in estimating hydrogen ion concentrations. The final chapter on "Applications" groups the literature according to subject matter, and according to the author constitutes an index to the bibliography which follows.

The reviewer was especially interested in the details which the writer has added from his experience in the manipulation of apparatus. Among these are the charging of storage batteries using an ordinary electric light current, the effects of various substances (carbon dioxide, phenol, toluol, oxygen, etc.) in solution upon the hydrogen electrode, purification of mercury, construction of a constant temperature box, and lists and discussion of possible potentiometer equipment. For the student already engaged in making hydrogen ion determinations the book contains many valuable suggestions, and forms a ready reference to literature, while to the student who contemplates making such measurements it represents a manual, an outline of procedure.—J. M. ARTHUR.

#### A chemistry of plant products

HAAS and HILL'S, *An introduction to the chemistry of plant products*, which first appeared in 1913 and was reviewed in this journal,<sup>3</sup> has now reached a second edition.<sup>4</sup> From its first appearance it has been recognized as a book filling a long felt want. It was intended to supply the botanist, and especially the plant physiologist, with chemical knowledge and methods not found in the ordinary textbooks on chemistry. It has filled its purpose admirably. Although written primarily for the plant physiologist, the avoidance of a technical method of treatment makes it a useful book for the botanist of limited chemical training, who is working on problems involving a knowledge of plant materials. Thus at the present time, when the synthetic viewpoint of botany in relation to the other sciences is coming to the front, when it is coming to be recognized that botany and chemistry must unite forces in solving many problems, the method of treatment used in the book has increased significance. It is a significant commentary on the amount of work being done by WILLSTÄTTER and his coworkers, and by others no doubt inspired by them, that the major changes in the book have been made in the chapter on pigments. This chapter has been entirely rewritten and much new material incorporated, especially in the part dealing with chlorophyll. A few other important additions have been made to the text, and a number of references have been added

<sup>3</sup> BOT. GAZ. 56:343. 1913.

<sup>4</sup> HAAS, PAUL, and HILL, T. G., *An introduction to the chemistry of plant products*. 2d ed. pp. xii+411. London: Longmans, Green. 1917.

to the literature, all serving to bring the work up to date. It will continue to be a book which the plant physiologist and anyone interested at all in the chemistry of plant materials will want on his shelf.—S. V. EATON.

### Soil alkali

HARRIS<sup>5</sup> has written an excellent critical little book on soil alkali. The author says: "It has been estimated that about 13 per cent of the irrigated land of the United States contains sufficient alkali to be harmful. This means that there are over 9,000,000 acres of land under present canal systems that are affected with alkali. There are many more million acres of alkaline land in the United States that do not lie under irrigation systems. Similar figures might also be given for other countries of this continent and for all other continents. The alkali problem is one of no mean importance to farmers, nor to any who are interested in the world's food supply.

In a strictly chemical sense the word alkali refers to a substance having a basic reaction. As applied to the soil, however, this restricted meaning does not hold, and alkali refers to any soluble salts that make the soil solution sufficiently concentrated to injure plants. This includes the chlorides, sulphates, carbonates, and nitrates of sodium, potassium, and magnesium, and the chloride and nitrate of calcium. The sulphate and carbonate of calcium are not sufficiently soluble to be injurious to crops. Most of the alkalies are in reality neutral salts. It may be somewhat unfortunate to use for general substances a word that has become so well established in agricultural literature that it would now be very difficult to change it." The author also emphasizes the great number of purely scientific problems connected with alkali soils and the need of much fundamental research in this field.

The book includes 16 chapters: 1. Introduction; 2. Geographical distribution; 3. Origin of alkali; 4. Nature of alkali injury to plant; 5. Toxic limits of alkali; 6. Native vegetation as an indicator of alkali; 7. Chemical methods of determining alkalis; 8. Chemical equilibrium and antagonism; 9. Relation of alkali to physical conditions in the soil; 10. Relation of alkali to biological conditions in the soil; 11. Movement of soluble salts through the soil; 12. Methods of reclaiming alkali lands; 13. Practical drainage; 14. Crops for alkali land; 15. Alkali water for irrigation; 16. Judging alkali land.—WM. CROCKER.

### NOTES FOR STUDENTS

**Vegetation of Tasmanian mountains.**—In reporting in some detail a study of the mountain vegetation of Tasmania, Miss GIBBS<sup>6</sup> sketches the position of the geological history of the island that most directly concerns its

<sup>5</sup> HARRIS, F. S., *Soil alkali, its origin, nature, and treatment.* pp. xvi+258. Wiley & Sons. 1920.

<sup>6</sup> GIBBS, L. S., *Notes on the phytogeography and flora of the mountain summit plateaux of Tasmania.* *Jour. Ecol.* 8:1-17, 89-117. 1920.

present vegetation. The present area of 27,000 sq. mi. seems to have been much reduced during the latest glacial period, subsequent to its separation from Australia, now 184 miles distant. Its vegetation during that period consisted probably of moss and low shrubs only. As its present configuration comes from the dissection of one huge plateau, there are within the island no important barriers to migration, and the elevations do not exceed 5000 ft. The annual rainfall varies from 112 to 165 inches, while high winds are incessant upon the more elevated portions.

The *Eucalyptus* forests of the lowlands, the mixed forest of the west coast, and the vegetation of the tablelands and mountains constitute the three main plant formations of the island. These formations with their main subdivisions are briefly characterized, but only the higher elevations are considered in detail, and their vegetation is regarded as austral-montane rather than alpine. The higher plateaus range from 3500 to 4000 ft. in altitude, with a few rock masses higher. There are no glaciers or permanent snow fields, although during the winter months the mountains are often snow-covered, and this, together with heavy rains during the rest of the year and persistently high winds, constitutes a fairly rigorous climate, which results in a vegetation that is shrubby and spreading in habit, with small coriaceous leaves, and almost wholly without herbaceous forms except on the highest peak, where the snow remains late in the season. There a mosaic of low mosslike plants is developed, the individuals often taking the form of cushions.

Shrub associations dominate the more exposed plateau summits. Here the vegetation reaches a height of 1-1.5 m., and is decidedly xerophytic in aspect, showing rigid branching, small evergreen leaves, and often terminal flower clusters. These shrub associations vary from a very scattered display upon broken rock to dense masses with a well developed undergrowth where soil conditions are more favorable. Usually there is no massing of a single species, but several mingle freely. In one situation the endemic *Microcachrys* formed a dense green carpet for yards around well isolated groups of *Diselma Archeri*, *Podocarpus alpina*, *Coprosoma nitida*, and *Olearia pinifolia*. Other abundant genera are *Orites*, *Richea*, *Bauera*, *Epacris*, and *Helichrysum*. At somewhat lower altitudes the shrubs pass into the dwarf montane forest, one type of which consisted of trees like *Phyllocladus aspleniifolius*, *Arthrotaxis selaginoides*, *A. laxifolia*, and *Atherosperma* crowded together with shrubby *Diselma*, *Orites Milligani*, *Fagus Gunnii*, *Drimys aromatica*, *Telopea*, *Tetracarpaea*, and *Richea pandanifolia*, all about 2 m. in height. In more sheltered situations these forests reach a height of 3-5 m., and may pass to *Eucalyptus* scrub.

The conditions of low temperature, intense illumination, with high winds and heavy rainfall, here limited to high altitudes, in the antarctic region are found at sea level and result in similar vegetation; hence it is not inappropriate to apply the term "antarctic" to this montane flora. The practical absence of annual leaf fall, and the entire absence of leguminous plants which act as

nitrifying agents, are considered responsible for the lack of progressive improvement of soil conditions and the persistence of xerophytes. The same factors account for the relative absence of herbaceous plants. In seeking for the origin of this flora, after an examination of the available evidence, Miss GIBBS concludes that the mountains of New Guinea may be considered as the focus of development and distribution of the so-called "antarctic" plants, justifying the term Papuan austral-montane for this group, of which, even on the limited basis of our present knowledge, nearly one-half of its most characteristic genera are now known from New Guinea. The author also contends that the north-westerly poleward wind which sweeps persistently over the mountains of New Guinea above tree level, in a constant direction and at a constant altitude, decreasing in height in its progress southward, is the agency by which this flora has been transported. Once established, the elements remain within the radius of the lower but equally constant circumpolar wind.

Collections from these montane associations show 108 species of vascular plants, of which 67 are endemic, the most remarkable family being the Coniferae with 7 genera and 9 species, 3 genera and 8 species being endemic. Other large families are the Proteaceae with 8 species, all endemic, the Myrtaceae with 5 species, 3 being endemic, the Epacridaceae with 20 species, of which 16 are endemic, and the Compositae with 19 species, 12 being endemic. Among families well represented in boreal montane regions, but much less conspicuous in Tasmania, are the Cyperaceae, Ranunculaceae, Cruciferae, Rosaceae, and Ericaceae, each represented by only a single species.—GEO. D. FULLER.

**Aluminum and soil acidity.**—MIRASOL<sup>7</sup> has done a piece of work on the relation of aluminum to soil acidity, working on three different acid silt loams from southern Illinois. "In the absence of some calcium compounds as a source of calcium, aluminum salts were highly toxic to sweet clover when applied in amounts chemically equivalent to five times the acidity of the soil. In the presence of calcium silicate, aluminum nitrate was more toxic than aluminum sulphate. . . . Aluminum mono-hydroxide did not have any effect on sweet clover when other plant food elements were added in the soluble form. Calcium carbonate in sufficient amount corrected the toxicity of aluminum salts, by precipitating aluminum as calcium aluminate, an insoluble compound. Acid phosphate applied at the rate of 400 pounds per acre reduced the toxicity of aluminum salts by forming aluminum phosphate, an insoluble compound." Like HARTWELL and PEMBER, in an article recently reviewed in this journal, MIRASOL found that acid phosphate precipitates soluble aluminum, but in contrast to these investigators he found that acid phosphate decreases the acidity rather than increases it as they had assumed. "The form of aluminum immediately concerned in the unproductivity of acid soils in the soluble form is the salts. . . . In soils sufficiently provided with calcium,

<sup>7</sup> MIRASOL, J. J., Aluminum as a factor in soil fertility. *Soil Science* 10:153-193. 1920.

toxic aluminum salts may never be found, but in soils deficient in calcium and other bases, as in acid soils, toxic aluminum salts are largely the end products of sulphofication and nitrification. It is not denied that iron and manganese may become contributing factors in the unproductivity of some acid soils, but the preponderance of evidence points to aluminum as the determining factor in the acidity of the soils under investigation."—WM. CROCKER.

**Soluble substances in soils.**—MCCOOL and MILLAR<sup>8</sup> have studied the rate at which substances become soluble in soils of various origins, types, ages, etc. The solubility was determined by the Bouyoucos freezing point method. The soils were leached free from soluble materials and then allowed to stand in water for various periods (5, 10, 30, and 60 days), and the freezing points determined at the ends of these periods. Contrary to the common view, soils from regions of lower precipitations are not more soluble than those from higher precipitations. The so-called new soils are less active than those somewhat older, and aged soils are almost inert. Subsoils liberate soluble salts very slowly, there being little activity below 6 inches. Sand particles are very inactive, and silts and clays are mainly responsible for the soluble materials. Grinding increases solubility. When soils were treated with 0.1N NaNO<sub>3</sub> and then washed free of soluble materials, the rate of dissolving was measurably affected. Western soils responded somewhat more readily than others. The Michigan Agricultural Experiment Station is studying this problem from several angles (composition of the soil, solutions on cropped and uncropped soils, residuary effects of salts on soils of different texture) and the work promises to be a valuable contribution to our knowledge of soil fertility.—WM. CROCKER.

**Dormancy in trees.**—COVILLE<sup>9</sup> has emphasized the significance of cold in forcing trees out of their autumn dormancy. He finds temperatures of 32–40° F. the most effective, and emphasizes the transformation of starches to sugars as an important result of the low temperature. The effective temperatures agree well with those found for the after-ripening of dormant embryos in this laboratory.—WM. CROCKER.

**Living stumps.**—The continued growth of stumps and the healing over of the cut surface is not uncommon in the case of *Pseudotsuga*. PEMBERTON,<sup>10</sup> investigating the phenomenon on Vancouver Island, British Columbia, finds the continued growth of the stumps due to the transference of food from living trees connected with stumps by means of subterranean root grafts. Instances are cited when growth ceased immediately with the cutting of the host tree.—GEO. D. FULLER.

<sup>8</sup> MCCOOL, M. M., and MILLAR, C. E., The formation of soluble substances in soils taken from widely separated regions. *Soil Science* 10:219–235. 1920.

<sup>9</sup> COVILLE, F. V., The influence of cold in stimulating the growth of plants. *Nat. Acad. Sci.* 6:434–435. 1920.

<sup>10</sup> PEMBERTON, C. C., Living stumps of trees. *Amer. Forestry* 26:614–616. *figs. 6.* 1920.

THE  
BOTANICAL GAZETTE

MARCH 1921

LEAF SPOTS OF THE ELM

L. E. MILES

(WITH PLATES VIII-X AND ONE FIGURE)

**Introduction**

About eighteen species of the genus *Ulmus* are known (2), widely distributed throughout the cold and temperate regions of the Northern Hemisphere. Six of these species, *U. americana*, *U. fulva*, *U. racemosa*, *U. alata*, *U. serotina*, and *U. crassifolia*, are native to America and occur naturally from Labrador to southern Mexico. None, however, occur west of the Rocky Mountains. *U. alata*, *U. crassifolia*, and *U. serotina* are tender and do not grow well in the northern states, but are quite extensively used for lawn and avenue trees in the south. *U. americana*, the most widely distributed American species, occurs in practically every state east of the Rocky Mountains, and in Canada. It is the most characteristic tree of the northeastern states, and is very widely used for street planting and as an ornamental tree for lawns.

Among the fungous enemies of the elm are a number of forms which cause leaf spots, the most important of which will be discussed in this paper. Ordinarily none of these diseases is of much importance economically, but in severe cases they may injure the tree materially by causing premature defoliation. This saps the vigor of the tree, and if the severe attack is repeated during a number of consecutive seasons, may even result in its death, or at

least may weaken it to such an extent that it is not able to withstand the adverse factors in its environment. In a nursery of young elm trees these leaf spots may do much more damage than when they occur on older trees.

### Most important American leaf spot

#### DISTRIBUTION AND HISTORY

Chief among the fungi causing leaf spots of the elm in this country is *Gnomonia ulmea* (Schw.) Thüm. This disease, known as the elm leaf spot or elm leaf scab, occurs most commonly on

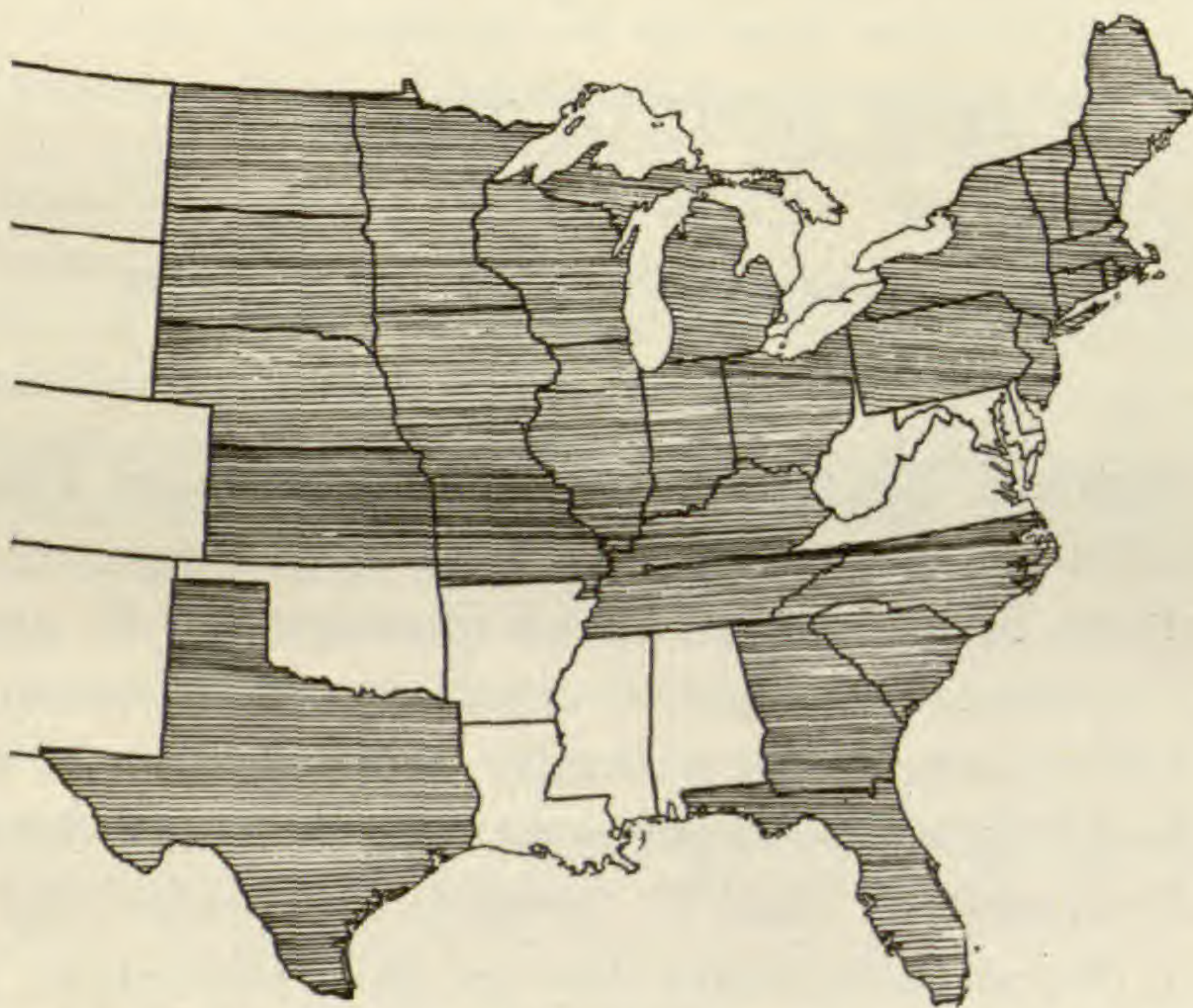

FIG. 1.—Distribution of *Gnomonia ulmea* in United States

*U. americana*, and is found in greater or less degree throughout the entire range of its host. The writer has examined exsiccated specimens of it which were collected in New York, Massachusetts, Vermont, Maine, New Hampshire, Rhode Island, Connecticut, Pennsylvania, Ohio, Michigan, Indiana, Illinois, Wisconsin, North Dakota, Iowa, Nebraska, South Dakota, Missouri, Kentucky, Tennessee, North Carolina, Georgia, South Carolina, and Texas, as well as several from Canada. Text fig. 1 gives a better idea of its wide distribution than does this list of states. It is more than probable that it occurs also in the remainder of the states east of



the Rocky Mountains, but has not been reported. In addition to the normal host, *U. americana*, specimens have been examined on *U. fulva*, *U. alata*, *U. crassifolia*, and *U. racemosa*, and it is quite probable that it may occur also on *U. serotina*, the only other American species. It has not been seen on any European or other foreign elm, however, collected either in this country or abroad, nor is there any account in literature of its occurrence on such. It may be concluded, therefore, that this fungus is strictly an American species.

The fungus was first described by SCHWEINITZ (34) as *Xyloma ulmeum*, in 1818, on leaves collected at Aiken, South Carolina. His material was immature, and consequently his description was incomplete and inadequate. Fig. 7 is a leaf from the type collection from which his description was taken. This specimen is one of SCHWEINITZ' exsiccati in the Museum of the Academy of Natural Sciences at Philadelphia. Comparison of this figure with figs. 3-5, showing infected leaves collected by the writer, indicates that the fungus with which SCHWEINITZ worked and the one discussed in the early part of this paper are identical.

A few years after SCHWEINITZ' original description, FRIES (19) described a disease of the American elm as caused by *Sphaeria ulmea* Fr., but gave *Xyloma ulmeum* Schw. as a synonym, showing that he had seen SCHWEINITZ' previous description and recognized that he was dealing with the same organism. His description added but little to the earlier one of SCHWEINITZ. The next change in the taxonomic position of the fungus was made in 1878 by VON THÜMEN (39) when he placed it in the genus *Gnomonia* without explanatory comment or additional description. In his *Sylloge Fungorum* SACCARDO seems to have accepted this change with some reservations, since he placed the fungus in the section *Dubiae* of the *Sphaeriales*, under the name *Gnomonia ulmea* (Schw.) Thüm., without, however, explaining his reasons for doing so.

In 1892 ELLIS and EVERHART (16) made a further change in the name and taxonomic position of the fungus, apparently without being acquainted with the previous work of VON THÜMEN, since they made no mention either of his name or of *Gnomonia* in

their account of the synonymy of the organism. They called it *Dothidella ulmea* (Schw.) E. and E., thereby placing it among the Dothidiales, although they acknowledge that it is "anomalous on account of its ascigerous cells assuming the characters of perithecia." In 1915 THIESSEN and SYDOW (38), in a monograph of the Dothidiales, excluded it from that group and referred it back again to *Gnomonia* in the Sphaeriales, where it had previously been placed by VON THÜMEN. In addition to these various names, the fungus has been much confused by American plant pathologists and mycologists with an organism causing a leaf spot of European elms in Europe, *Systemma Ulmi* (Schleich.) Thiess. and Syd. (38), to which it has a superficial resemblance, and it has often been collected and reported under one or another of various lists of synonyms pertaining to that fungus.

In 1901 and 1902 STONE and SMITH (37) from Massachusetts reported attempts at controlling the disease by spraying with Bordeaux mixture, referring to the fungus as *Dothidea Ulmi* (Duv.) Wint., a synonym of *Systemma Ulmi*, in the first paper, and as *Dothidella ulmea*, a synonym of *Gnomonia ulmea*, in the second, although they made no reference to the discrepancy. In 1910 GÜSSOW (21) reported it from Canada as extending back upon the petioles of young shoots to their tips, which twisted downward and finally died. He stated that in no case did the young shoots so infected recover. In this same year CLINTON (8) from Connecticut reported that by July or earlier some trees had shed almost all their leaves. He stated that these trees later put forth a new crop of foliage which was entirely free from the disease, but that the other trees, not so severely infected in the beginning, showed all their leaves more or less affected, and shed them continuously throughout the season. He stated that when defoliation was most severe the young branches of the season also had fallen off. This latter observation confirms that made by GÜSSOW in Canada. The writer has seldom seen so severe an infection as either of these, although in some localities the disease is severe enough each year to cause an incessant dropping of leaves throughout the summer and fall, which is a far from desirable characteristic in a lawn and avenue tree like *U. americana*.

## SYMPTOMS

The disease makes its appearance early in the spring, the amount of primary infection apparently being dependent to a considerable degree on the weather conditions, as it is much worse on the same tree in some years than in others. CLINTON expressed the opinion that the only infection which occurred was the primary spring infection, and that there was no further spread during the summer. The fact that no conidial or summer stage had ever been found connected with the disease, and also his observation of trees which shed all their leaves early in the season and which later produced a new crop of foliage entirely free from spots, would tend to support this conclusion. The absence of the disease on the new crop of leaves, however, might have been due to weather conditions which were not favorable to the spread of the organism at that time. In any case, the writer has found a conidial stage constantly associated with the disease in every specimen examined, and the connection between the two stages will be clearly shown later. Observations show also that the primary infection is confined almost exclusively to the lowest leaves, and that it is much more abundant on the young seedlings, whose leaves are naturally closer to the ground, and to the ascospores which are the source of this early infection. Moreover, it is only on these young seedlings that twig and petiole infection has been observed, although there it is often quite severe, killing off the entire new growth.

The first evidence of the disease is a small whitish or yellowish fleck or blotch on the upper side of the leaf shortly after it has unfolded. This spot increases in size, and soon a number of small black specks begin to appear within the whitened area. As these enlarge they sometimes coalesce to form a single, coal black, stroma-like, subcuticular structure which is quite irregular in outline and varies from 0.5 to 2 or 3 mm. in diameter. As a rule, however, the individual stromata remain separate, when they appear to be somewhat concentrically arranged, forming a distinct spot, in most cases surrounded by a narrow band of whitish dead tissue as shown in fig. 12. Occasionally the black stroma, or the group of separate stromata, so closely grouped together as to seem to the naked eye to be a single one, may cover the entire discolored

area, without a border of whitish or lighter colored dead tissue. In this case it appears almost like a tar spot on the normal green leaf tissue, and reminds one of some of the species of *Rhytisma*. Later in the season the cuticle which covers the stroma wears away and gives the spot an ashen appearance, which is most pronounced near the edge. These black spots may be so numerous as to practically cover the entire upper surface of the leaf.

In addition to these black stromata, and much more prominent in the early stages of infection, although the reverse is the case later in the season, are the pustules of the conidial stage. They are quite abundant and conspicuous in the early spring, and it is hard to understand how they can have been overlooked for so long a time. They are subcuticular, irregular in outline, and dark, owing to the cuticle which is stained by the fungus, and which splits irregularly to allow the dispersal of the spores, which are extruded in small white masses. The pustules formed earliest seem to have but little or no stromatic base, although those formed later in the summer are almost invariably situated on a distinct stroma, which they may or may not entirely cover. This conidial stage will be discussed more in detail later.

#### DEVELOPMENT OF STROMATA

Beneath each one of the small, black, subcuticular stromata, as represented in fig. 13, early in its development, beginning about the latter part of May, there commences the development of the young perithecium of the causative fungus. The stroma now becomes somewhat looser in structure near its central region, beneath which the perithecium is to be formed. The normal cells of which the stromatic hyphae are made up are short, approximately isodiametrical (fig. 16), and contain comparatively little protoplasm, which little soon disappears, except in the basal layer of cells, and in those which are actively engaged in extending the edges of the stroma. They are more or less olivaceous to dilute brown in color, the depth of the hue depending on the age of the cell, but the very dark appearance of the stroma is due principally to a dark coloring matter which is not present in the cell wall to any extent, but seems to be excreted by the cells of the fungus

and deposited between their walls. A similar excretion of coloring matter was noted by KLEBAHN (22) in working with *Gnomonia veneta* (Sacc. and Speg.) Kleb. Within the looser portion of the stroma are to be found in this stage of its development other hyphae, which are very thin-walled, entirely filled with a very dense protoplasm, and have comparatively few septa. They stain pink or red with Pianezze IIIb stain (41), as do the other hyphae which enter into the formation of the young perithecium, but much more intensely. The ordinary stromatic elements, which have become comparatively inactive, take a green color with this stain. These deeply staining active hyphae ramify through the lower, looser portion of the stroma, a number of them turning upward near the center and breaking through to the outside, extending above the leaf surface as shown in fig. 16.

#### ASCOGONIUM

Immediately beneath this portion of the stroma there grows downward into the leaf tissue, between the epidermal cells and between the cells of the upper palisade tier (usually to a point near the lower edge of that layer), one of these hyphae which has become slightly larger in diameter. For convenience this hypha may be termed an "infection thread" or "suspensor," since it is the first of the fungal hyphae to invade the tissue of the host beneath the epidermal layer, and since in the early stages of its development the young perithecium gives the appearance of being suspended from the subcuticular stroma above by means of it. This hypha is accompanied in its growth downward into the host tissue by a number of other hyphae, consisting of short isodiametrical cells, which arise from the basal layers of the stroma and contain comparatively little protoplasm. They form a sheath for the broader, more deeply staining hypha, which for convenience only has been designated as an infection thread or suspensor. After growing to a point about midway down in the palisade layer, this cuts off a number of cells at its extreme end (fig. 16), usually three or four, which coil somewhat in the form of a spiral. Each one of these cells contains two or more nuclei, while the cells of the hyphae which constitute the sheath are uninucleate. These hyphae

meanwhile have continued their growth, dividing in such a manner as to produce a larger number of chains of cells which arrange themselves spirally about the central coil and form what is to become the wall of the perithecium.

This coiled structure is the ascogonium or "Woronin's hypha," described by various workers in a considerable number of Ascomycetes. I do not consider the hypha connecting it with the stroma above in any way analogous to a trichogyne, however, but rather as being similar to and corresponding to the hypha described by Miss DAWSON (14) as leading from the stroma beneath and giving rise to "Woronin's hypha" in *Poronia punctata*. The apparent differences between the two cases are that in *Poronia* the perithecium is formed in the upper part of the stroma, and the hypha which gives rise to the ascogonial coil comes up from below and does not leave the stroma; while in *Gnomonia ulmea* the perithecium is formed beneath the stroma in the tissue of the host, which renders it necessary for the thread which is to give rise to the ascogonium to leave the stroma and grow downward into the leaf tissue. In each case the hypha enters the perithecial primordium at a point which is finally located in the basal portion of the mature perithecium. In *Poronia*, however, after coiling to form the ascogonium, it continues to grow on beyond the perithecium to the outer surface of the stroma as a somewhat narrower thread, which reminds one of the trichogyne of *Collema*, as described by BACHMAN (3), of *Physcia* by DARBISHIRE (11), and of *Polystigma* by FRANK (18) and FISCH (17), but not by BLACKMAN and WELLSFORD (4). This "trichogyne" was not present in *Gnomonia ulmea*.

BROOKS (6), in working with *Gnomonia erythrostroma* (Auers.) Kleb., found an ascogonium similar to the one described for *G. ulmea*, and also certain structures which he called trichogynes. He was able to trace a connection between these hyphae and the peripheral layers of the young perithecium only, never with the ascogonium itself. These peripheral layers would correspond in fig. 16 to the sheathing hyphae *a*. Since more than one trichogyne passed through a single stoma in the case in which he was working, BROOKS concluded that more than one series of trichogynes was

connected with a single ascogonial coil. In *G. ulmea* also, as previously stated, one finds (fig. 16) certain hyphae which pass out through the upper leaf surface in a quite similar manner, although not through a stoma in this case, since stomata are absent on the upper surface of an elm leaf. In this case, however, there is no possibility of their being mistaken for anything else than vegetative hyphae. It is quite likely that those of *G. erythrostroma* are of a similar nature. BLACKMAN and WELLSFORD described in *Polystigma rubrum* trichogynes similar to those of BROOKS, but on account of an inability to trace a direct connection with the ascogonium, concluded that they were merely vegetative. In earlier papers FISCH (17) and FRANK (18) had both described and figured such connections and had designated the hyphae as true trichogynes. Although BROOKS continued to call the projecting hyphae in *G. erythrostroma* trichogynes, and although he found both ascogonia and spermatia present, he concluded that the trichogynes were no longer functional, and that fertilization did not actually occur through their agency. He suggested as a present function for them that they might serve as respiratory channels for the fungal hyphae within the leaf, where the assimilatory processes must necessarily have been considerably curtailed by the dying of the tissue. Such a function would also give reason for the existence of similar hyphae in *G. ulmea*, especially since the presence of the black stroma would tend even more to impair the respiratory processes in the host tissue beneath it.

The ascogonium in the young perithecium of *G. ulmea* soon begins to break up into segments, each cell becoming separated from the others. BROWN (7) noticed a similar segmentation of the ascogonium of *Xylaria tentaculata*, as did also Miss DAWSON in *Poronia*. They found that those segments gave rise to the ascogenous hyphae in the fungi with which they were working, but I have been unable to ascertain this fact with certainty in *G. ulmea* with the material at hand. It is almost a certainty, however, that this is the case here also, since the segments of the ascogonial coil can be distinguished near the base of the perithecium until after the asci have commenced their development.

## FURTHER DEVELOPMENT OF PERITHECIUM

In the further development of the young perithecium all sign of the connection with the subcutaneous stroma soon disappears, as is shown in fig. 2, which is a slightly older stage. The structure has increased in size, chiefly by the enlargement of the portion which is later to become the perithecial cavity, but which is now filled with a dense pseudoparenchyma. The wall has also increased somewhat in thickness by the formation of new layers on the inside. As yet there is no sign of a beak or ostiole, although the wall cells on the lower side of the perithecium, opposite the stroma, are somewhat denser in protoplasmic contents, as is shown by the slightly darker color. Fig. 8 shows a still later stage of development in which the perithecium has practically doubled in size, since the two figures are of the same degree of enlargement. The central area has enlarged and the wall become still thicker. The darkly stained portion is composed of young asci which are not yet clearly differentiated. On account of the nature of the material, the leaves showing this stage of development having first been collected and dried and later softened with lactophenol, as well as on account of the very small size of the nuclei, the cytological and other minute details of this development could not be accurately determined. The main portion of the perithecial cavity is entirely filled with a very fine pseudoparenchymatous material, which when crushed or teased out appears merely granular in structure, with some slight evidence of anastomosing hyphae. In the original description of the fungus, SCHWEINITZ mentions the granular nature of the perithecial contents. The beak or rostrum and the ostiole are here seen in the earliest stages of their development. The same group of more deeply staining wall cells, mentioned in connection with fig. 2, is still evident, but has increased in size to form a sort of plug of tissue, which by its growth forces the outer layers of the perithecial wall outward and downward on the lower side to form the outer wall of the beak. As the multiplication of these actively dividing cells continues, their long axis changes from horizontal, as at first, to a direction parallel to that in which the beak is being developed. The cells nearest the center of this elongating beak separate in their continued growth, leaving a



channel throughout its entire length which becomes the ostiole. This channel is lined with periphyses or hairlike structures which are hyphal outgrowths of the inner or lining layer of cells. These periphyses all point in a direction outward from the perithecial cavity, and so form a one-way passage from the spore bearing portion to the outside of the leaf. As the development of the beak nears completion, each layer of cells, whose increase has brought about its elongation, produces at its lower end one or more of these periphyses to each cell, so that the lower end or outer opening of the ostiole is surrounded by a considerable brush of them. These later stages of the development of the ostiole are seen in fig. 1, which shows two perithecia in an almost mature condition. The beaks are slightly longer than normal at this stage of maturity, but in all other respects the perithecia are typical. No further elongation of the beaks occurs until the ascospores are fully mature and ready to be discharged, sometime in the early spring, at which time they again begin growth and continue until they have just broken through the lower epidermis. In this stage, which is the condition in which they pass the winter, the lower end of the beak is still within the leaf tissue and merely pushes out the lower epidermis in the form of a hump or tubercle. In the spring, when they have just broken through, these beaks, although short, are quite conspicuous on account of their fresh dark brown or almost black color.

The asci in the figure last referred to are not yet mature, and it will be seen that the pseudoparenchyma is still present. This tissue is composed of small hyaline cells, filled with a very dense granular protoplasm, and with very thin walls; in fact, the walls are little more than membranes. It occupies the entire central region before the development of the asci, which grow out into it, and apparently it is used up by the asci in their growth, as no crowding of the tissue is apparent ahead of them. Such an interascicular pseudoparenchyma has been described by STEVENS (35), who used it as the basis for the formation of a new genus, *Desmotascus*. He considered it an instance of delayed dissolution of the pseudoparenchymatous central region of the developing perithecium to form the central cavity, and suggested that, since this

structure was not clearly seen without good thin microtome sections, the same thing may exist in other perithecia and have been overlooked because the microtome was not used. The finding of such a structure in *Gnomonia ulmea* would tend to support such a hypothesis. REDDICK (29), working with *Guignardia bidwellii*, found that when the first asci were developing not nearly all the pseudoparenchyma was gone, and that, when crowded together by the growth and expansion of two asci, it gave the impression that paraphyses were present. He also expressed the opinion that these cells were absorbed by the growing asci. This case differs from that found in *Gnomonia ulmea* and also from that described by STEVENS in *Desmotascus* only in that the pseudoparenchymatous cells in the latter two fungi never appear to be crowded by the invasion of the asci.

The asci originate from the basal portion of the perithecial cavity, and also from the sides to a point about halfway to the top. The perithecial walls are composed of from 10 to 12 rows of cells (fig. 1), the outer one or two layers of which have assumed a bright golden brown color. It is at about the time when the ostiole is being developed that this coloration of the wall begins. Until that time the wall has been entirely hyaline. From this time on, as the perithecia age, this color becomes constantly darker, until about midwinter, when it is almost black. The outer surface of the perithecium is smooth, and there are no loose hyphae connecting it with the leaf tissue in which it is borne.

When mature the perithecia are nearly spherical or usually somewhat wider than deep. They vary considerably in size, but average about 250–300  $\mu$  in diameter and 150–200  $\mu$  in depth. The ostiole is usually about 100  $\mu$  long and 75  $\mu$  wide, but may reach a considerably greater length. The size of the perithecium is so great that the upper epidermis is elevated in the form of small tubercles, and the beaks push out the lower epidermis in the same manner, before they break through it. They do not extend any distance beyond the outer surface of the lower epidermis, as do so many of the species of *Gnomonia*, but merely reach through it. When the over-wintered leaves have been soaked in water, the perithecia may be picked out with the point of a sharp scalpel, and

on account of the absence of any hyphae connecting them with the leaf tissue, they leave a smooth cavity or locule in the leaf.

#### ASCI AND ASCOSPORES

In mature perithecia the asci are very much confused in their arrangement, owing to the fact that the older ones are broken loose from their attachment and pushed toward the top of the perithecial cavity by the younger ones. There are no paraphyses. The asci are oblong-cylindrical or somewhat club-shaped in form, and have a short stalk at the base which may be either straight or bent toward one side. The wall is hyaline, thin below, but thickened in the upper half (fig. 19), and does not color with iodine. At the upper end of the ascus is a pore surrounded by a ring of thickened tissue which is strongly refractive toward light. In optical section as seen from the side this ring presents the appearance of two small spheres arranged side by side in the apex of the ascus. The asci measure  $45-55 \times 9-11 \mu$ . The spores are very characteristic also. They are hyaline, elongate-elliptical, or obovate-oblong, and have a septum near the lower end, thus becoming unequally two-celled. They are eight in number, sub-biseriate, and measure  $8-10 \times 3-3.5 \mu$ . The small cell at the lower end of the spore averages about  $2 \mu$  both in length and breadth. There is a slight constriction at the septum. Some epiplasm is present in the mature ascus along with the spores.

#### EXPULSION AND GERMINATION OF ASCOSPORES

As previously stated, the asci in a mature perithecium become loosened from their attachment at the base and crowded toward the apex of the perithecial cavity in a somewhat disordered mass. In the process of expulsion of ascospores an entire ascus enters the lower part of the ostiole and is held in place by the periphyses until the pressure produced by the absorption of water, which must be present to allow the ascospores to be discharged, becomes sufficient to bring about the discharge of the spores. These pass outward through the periphysis-lined ostiolar channel to the surface of the ostiole, where they are expelled with some force, and under natural conditions are evidently dispersed by currents of air. Early in March leaves were found which had passed the

winter in the open under natural conditions, on which occurred perithecia in such a stage of development as to expel ascospores within two days after being brought into the laboratory. It was found that spore expulsion was very slow and limited or did not occur at all when the leaves were kept too moist or when maintained in a saturated atmosphere, such as occurs when they are placed on moistened filter or blotting paper in a closed Petri dish. When the lid of the dish is removed, however, and the leaves are alternately allowed to become dry and again moistened by adding water to the filter paper beneath them, the spores are expelled in considerable quantities. If they are then caught on a glass slide, either dry or coated with a thin film of egg albumin, glycerine, or some such adhesive, it is found that the spores are deposited in clusters or groups of eight. Later, as a very large number of spores are discharged from a single ostiole, this grouping of course is not apparent. The best method for catching the expelled spores was that used by ANDERSON and RANKIN (1) in working with *Endothia parasitica*, as described previously. The glass slide was suspended by means of match sticks fastened to it near the ends, thus bringing it 3 or 4 mm. above the opening of the ostiole.

KLEBAHN (27) has shown that this method of spore expulsion is general to *Gnomonia* and to many other fungi which have *Gnomonia*-like, beaked ostioles. The expulsion of the asci into the neck of the ostiole appears largely due to the swelling pressure of the ascus. When dry, the ascus with its contained spores occupies considerably smaller space than after it has been moistened with water. Many workers have maintained that ascospores are ordinarily liberated one at a time, and such may be the case here, since I have been unable to observe the actual act of expulsion of the spores from the ascus, but the clusters of the spores intercepted on a glass slide suspended above the opening of the ostiole are always in groups of eight, and give the impression of having been expelled in a group, as was found by ANDERSON and RANKIN to occur in *Endothia parasitica*.

Many attempts have been made to germinate the ascospores of *Gnomonia ulmea* under various conditions, and on a number of different nutrient media, ranging from distilled water, tap water,

extract of dried elm leaves, and sugar solutions, to solid media such as the agars of cornmeal, bean, potato, Brazil nut, onion, elm leaf, and plain washed agar. In distilled or tap water the spores swelled considerably, especially the larger cell, and sometimes a spore would give the appearance of being on the point of sending out a germ tube from the side of the larger cell, but this never occurred. This is in accordance with the results obtained by KLEBAHN (27) in *Gnomonia alniella* and *Gnomoniella tubiformis*, which he was not able to grow in culture, but is contrary to his results with *Gnomonia platani* and *G. leptostyla*, both of which grew well on nutrient media, the latter even producing the perithecial stage in such cultures. It would seem that the ascospores of *Gnomonia ulmea*, as in *G. alniella* and *Gnomoniella tubiformis*, require the stimulation given by the green leaf of the host plant itself in order to induce germination. WOLF (42) found that this was the case in *Diplocarpon rosae*, the ascospores of which would not even germinate in a drop of water in which a portion of a green leaf of the host had been placed, but must be placed in a drop of water directly on the living leaf itself. This assumption was later confirmed by experimentation. Toward the middle of March a number of twigs were cut from an elm and placed in the greenhouse with their cut ends immersed in water. In about three weeks the buds on these twigs unfolded. A number of the young leaves were removed and placed in a moist chamber with their surfaces in contact with a slide on which a large number of the expelled spores of *Gnomonia ulmea* had been intercepted as previously described. Intimate contact was secured by moistening the surface of the slide to which the spores adhered with a drop of water. By removing the leaf it was possible to examine the spores on the slide by means of a microscope, but never was one of them found to have germinated. Later, when the leaves on the trees outside the greenhouse had begun to unfold, the same experiment was attempted again, and in twelve hours it was found that a considerable number of the spores in contact with the leaves had germinated. This led to an examination of the tree from which the leaves used in the first experiment had been obtained, and it was ascertained to be an English elm, *Ulmus campestris*.

This led to a further attempt to germinate the spores on the leaves of both the English and the Scotch elm, *U. glabra*, but without success in either case. A considerable percentage of germination, however, was always obtained with *U. americana*. These experiments would seem to indicate that the germination of the ascospores of *Gnomonia ulmea* is dependent on a special stimulus of some sort exerted by the leaves of susceptible species of *Ulmus*, but which is absent in the leaves of other species of the same genus, just as it is absent in tap or distilled water, and the various liquid and solid nutrient media in which attempts were made to grow the fungus.

At the end of twelve hours of contact with the leaf of the American elm under suitable moisture conditions, as previously stated, the spores were found in various stages of germination. Wherever two spores lay in contact with each other and also with the leaf, there was noted a brown coloring matter deposited between them. This coloring matter is similar to that previously mentioned as being deposited between the hyphae of the stroma and on the lower side of the cuticle. The germ tube usually arises from the large cell of the spore only, as shown by fig. 20, although in a very few instances the small cell also may send out one. Germination apparently can occur from any point in the spore, although usually the germ tube makes its exit from the side of the large cell. One can tell where the germ tube is going to form even before any swelling occurs by the excretion of the brown coloring matter on the outside of the spore wall at that point. As the tube grows, the coloring substance is deposited along its entire length, except at the extreme apex, but in considerably greater density at the point where it leaves the spore. The substance is present in greater abundance also wherever two germ tubes touch or cross each other.

#### INOCULATION WITH ASCOSPORES

On April 6 a number of abscised twigs of *Ulmus campestris*, whose leaves had unfolded in the greenhouse, were inoculated with the ascospores of *Gnomonia ulmea*. Twelve twigs were used, six being sprayed by means of an atomizer with a suspension of spores, while six similar ones were sprayed with sterile distilled

water to serve as checks. Each set was kept under a bell jar, whose inner surface had been lined with moist filter paper, for a period of 42 hours, after which they were left in the normal atmosphere of the greenhouse. A like number of twigs of *U. americana*, whose leaves had unfolded normally outside the greenhouse, were treated in a similar manner. As was to be expected from the failure to secure germination of the ascospores on the leaves of the English elm, no infection occurred on that host. On April 25, however, or after a period of about three weeks, eight leaves of the American elm were found to bear well defined spots quite characteristic of the early stages of *Gnomonia ulmea*. Two of these leaves bore three spots each, another one two, and the other six had only a single one on each. These spots showed well developed pustules of the conidial stage, which is to be described later. In addition to these well defined spots a number of leaves showed small whitish flecks or blotches, thereby indicating that if the experiment had been allowed to continue for a longer period the percentage of infection would have been higher.

#### OBSERVATIONS ON OVER-WINTERING

A number of observations have been made on the over-wintering of the fungus on elm leaves under various conditions, and some attempts have been made to hasten its development by placing the leaves under various controlled conditions. Leaves on which the spots occurred were brought into the laboratory, both before and after they had been severely frosted, and some were immersed in water, both at room temperature and in the refrigerator. Others were placed in a moist chamber suspended over water, both in the laboratory and refrigerator, and others were placed in each of these places under their normal conditions of humidity. Still others were suspended over calcium chloride in each of these temperatures in order to assure a dry atmosphere. It was found that no further development occurred in the leaves which were immersed in water, and that the fungus soon died, the perithecia becoming mere empty husks. This was confirmed by comparison with leaves which had wintered normally outside the laboratory. On leaves which had been buried slightly in the soil or were in close

contact with the soil underneath a layer of other leaves, the perithecia were found in early spring to be in approximately the same condition. No further development of the fungus occurred on the leaves either suspended above the calcium chloride or in the normal humidity conditions of the laboratory or of the refrigerator. The fungus in the leaves which had been suspended above water in a moist chamber, however, did continue its development, and by midwinter a few perithecia were found in which the spores were apparently practically mature. In most, and finally in all cases, however, numerous saprophytes developed in such abundance that the *Gnomonia* fungus was overgrown and destroyed before the spores could mature. Other leaves from outdoors were brought into the laboratory at various times throughout the winter and placed in moist chambers, but the same development of extraneous saprophytes soon stopped the observations. In a number of instances observed the *Gnomonia*, apparently in an effort to counteract and overcome the encroachments of the more rapidly developing saprophytic fungi, began to grow vegetatively, and the entire perithecial cavity as well as the ostiolar canal became filled with a mass of interlaced and anastomosed hyphae, so compacted together that under pressure the perithecial wall would break away, but the interior mass would tend to retain its spherical shape. This tissue later died and disintegrated, however, leaving the empty husk of the perithecium. Among the saprophytes which hindered observations a number of forms were invariably present. They were, in the main, *Cephalothecium roseum*, *Phycomyces nitens*, several species of *Penicillium* and *Aspergillus*, an *Alternaria*, a *Pleospora*, a *Crytostyctis*, and a Myxomycete.

Various observations also were made on leaves wintered outside the laboratory. Some leaves were placed on shelves of a wire cage, others were placed on the ground and covered with other leaves and soil, while still others were wrapped in cheesecloth and placed on the surface of the ground. In the leaves placed on the shelves and on the surface of the ground the fungus was found to mature more rapidly than on those leaves covered with other leaves and soil, and a very few perithecia were found on such, which



contained some spores apparently almost mature as early as the middle of February. On only one leaf, however, were any of the perithecia at that time mature enough to expel spores. This leaf was on the shelf of the wire cage, which was placed directly against the south wall of the greenhouse, and was exposed both to the direct rays of the sun and also to the heat rays radiated from the cement wall. In most cases at that time the asci were somewhat more developed than when observed in the fall, but the spores were not yet differentiated. The normal development during the winter, therefore, seemed to be very slow. In leaves which were in especially damp situations, as those buried in the soil or those in intimate contact with the soil under a cover of other leaves, most of the perithecia were found to be dead and disintegrated. In general, it seemed that leaves neither in too exposed nor too moist a situation, as for instance those toward the middle of a pile of leaves, showed the greatest development of the fungus late in winter and early in the spring.

#### CONIDIAL STAGE

In every specimen examined in which the ascigerous stage of *Gnomonia ulmea* occurred, I have found constantly associated with it an imperfect or conidial form. This stage was found present from early spring until late fall on every leaf collected, and also on all exsiccati material examined, even the Schweinitzian type specimen previously mentioned. I have examined all available published exsiccati specimens of *Gnomonia ulmea*, as well as more than 100 other specimens obtained for purposes of comparison from various educational institutions and private individuals, including several from the Royal Botanical Gardens, Kew, England, and the herbarium of the University of Geneva, Geneva, Switzerland. The published exsiccati specimens examined are as follows: RAVENEL Fung. Amer. Exsic. no. 752; RAVENEL Fung. Carol., Fasc. II, no. 63; ELLIS and EVERHART Fung. Col. nos. 239, 2928, and 3422; SEYMOUR and EARLE Econ. Fung. nos. 155a and 155b; ELLIS N. Am. Fung. no. 1347; BRECKLE Fung. Dakotensis no. 329; RABENHORST-WINTER Fung. Eur. nos. 3661a and 3661b; and VON THÜMEN Myc. Univ. no. 1155.

The conidial layer develops on the stroma which is found on the upper surface of the leaf above the base of the young perithecium (fig. 14). It may cover only a portion of the stroma, and there may be two or even more of them on a single one of the stromata. Again, a stroma may develop, to all appearances identical with those formed above the bases of the young perithecia, but the perithecium be lacking. In this case the conidial pustule invariably covers the entire surface of the stroma. Moreover, in the case of the first pustules formed in the spring, there is usually little or no stromatic base present.

The conidial pustules are quite irregular in outline (fig. 18), although usually approaching a somewhat circular shape. Unless two or more of them coalesce, which frequently, in fact usually, happens, they may become considerably elongated and variously lobed. The size also varies to a considerable extent, due to the coalescing of a number of different pustules. The average size is about 0.5 mm. in diameter, although they may be considerably smaller, and have been seen as large as 0.8 mm. The upper layers of cells of the subcuticular stroma elongate in a direction at right angles to the surface of the leaf and form the conidiophores. These press closely against the cuticle and lift it up somewhat in the course of their development. At the same time they give off a brown coloring matter which is deposited on the inner or lower side of the cuticle, which itself remains colorless. This coloring substance is deposited more deeply at the points between the conidiophores than directly above them, so that the darkened cuticle presents a somewhat reticulate or netted marking, and on casual observation appears to be composed of fungal tissue. This gives the impression that the conidial pustule is of the nature of a dimidiate pycnidium. Closer observation, however, shows that no fungal hyphae enter into this covering layer, and the structure consequently is found to be melanconiaceous in character. The deposition of coloring matter on the cuticular coverings of such acervuli has been noted by KLEBAHN in connection with the conidial stages of *Gnomonia padicola* (23), *G. leptostroma* (22), and *Gnomoniella tubiformis* (24). As previously stated, the same substance is deposited between the cells of the hyphae which make up the

stroma, and which now have become the cells of the hymenial layer from which the conidiophores arise. It is also frequently found deposited between the cells of the epidermis immediately beneath the stroma.

These epidermal cells are not changed to any considerable extent except for crystalline substances occasionally found deposited in them. The fungal hyphae grow down between them and crowd them apart somewhat, but they do not lose their arrangement as a definite layer. The hyphae of the fungus do not penetrate the cells of the host. The conidiophores are crowded together into a very compact layer, and are 8–12  $\mu$  long by 1.5–2.5  $\mu$  thick. They are without septa, except for an occasional one near the base, and terminate in a threadlike projection on which the spores are borne. The conidia are elongate-oblong or cylindrical, bacillar, pointed at one or both ends, straight or sometimes slightly curved, one-celled, hyaline, and measure 5–6  $\times$  1–1.5  $\mu$  (fig. 15) in a dry state, but 8–10  $\times$  2–2.5  $\mu$  when freshly collected.

Since there is no fungal covering to the conidial layer, the fungus falls into the family Melanconiaceae, and its other characters indicate beyond a doubt that it is a member of the genus *Gloeosporium*. It seems to be quite characteristic of *Gnomonia* to have a conidial stage which is melanconiaceous in character. *Gnomonia padicola* has as an imperfect stage *Asteroma Padi*, but according to KLEBAHN (26) no true pycnidium is formed. *Gloeosporium nervisequum* is connected with *Gnomonia veneta*, *Marssonina Juglandis* with *G. leptostyla*, *Gloeosporium quercinum* with *G. quercina*, *Gloeosporium Caryae* with *G. Caryae*, *Gloeosporium Tiliae* with *G. Tiliae*, and *Leptothyrium alneum* with *Gnomoniella tubiformis*. KLEBAHN (25) has shown also in connection with *Leptothyrium alneum* that no true pycnidial covering is formed, and that consequently it is melanconiaceous in structure. SACCARDO (30) also remarks concerning this species "(perithecio) subinde tamen spurio et ex epidermide mutata et atrata formato."

The genus *Gnomonia* contains a number of species which form no conidial stage, or at least whose conidial stage has not yet been discovered. In so far, however, as the conidial stages have been established in the genus, it is evident that they conform to a

more or less close resemblance to *Gloeosporium*. The *Leptothyrium* of *Gnomoniella tubiformis* is scarcely to be distinguished from a *Gloeosporium*; *Asteroma* of *Gnomonia padicola* differs from it only in the production of superficial mycelium; and *Marssonina* of *Gnomonia leptostyla* only in its two-celled conidia.

Among the many fungous diseases occurring on the leaves of the elm, only a few have been found whose causative organisms are located in the Melanconiaceae. Three of these belong to the American flora, namely, *Goryneum tumoricolum* Peck, *Septogloeum profusum* (Ell. and Ev.) Sacc., and *Cylindrosporium ulmicolum* Ell. and Ev. I have not seen ELLIS and EVERHART'S specimen of *Cylindrosporium ulmicolum*, and it may be identical with *Phleospora Ulmi* (Fr.) Wallr., since the two descriptions appear very much alike. *Septogloeum profusum* has been reported as occurring on the leaves of *Ulmus alata* and *U. americana*, although it was originally described on *Corylus americana*. Two species of *Gloeosporium*, or rather one species and a variety of the same, have been described on the elm in Europe. One of these, *Gloeosporium inconspicuum* Cav., was described on *Ulmus americana* in Italy, but has never been reported in this country. It was distributed by BRIOSI and CAVARA in "Funghi parassiti" as no. 350. It causes large ochraceous spots on the upper side of the leaf, and has very small bacteriform spores, only 1-2  $\mu$  in length. A variety of this species, *Gloeosporium inconspicuum* Cav. var. *campestris* Dor. (15), has been described on *Ulmus campestris* in Russia. From the description this is quite similar in external appearance to the preceding species, but the spores and conidiophores are considerably larger, the spores measuring 3-6 (sometimes 9)  $\times$  1-2  $\mu$ . The fungus described as occurring on *Ulmus americana* and other species of elm in America in connection with *Gnomonia ulmea* does not agree in any particular with any of these, and therefore I propose for it the name *Gloeosporium ulmeum*, with the following formal description.

***Gloeosporium ulmeum***, sp. nov.—Acervuli somewhat gregarious, often confluent, borne on black stromata, usually over the base of the developing perithecium of *Gnomonia ulmea*, covered by the darkened cuticle, which later splits and cracks irregularly

and finally breaks away entirely, subrotund or irregular, averaging  $500\ \mu$  in diameter, but often as large as  $800\ \mu$ , epiphyllous, very rarely hypophyllous; conidiophores cylindrical, crowded, occasionally with a septum near the base,  $8-12 \times 1.5-2\ \mu$ , terminating in a threadlike projection on which the spores are borne; conidia elongate-oblong or cylindric, bacillar, pointed at one or both ends, straight or very slightly curved, hyaline, one-celled,  $5-6 \times 1-1.5\ \mu$  in a dry condition or  $8-10 \times 2-2.5\ \mu$  when freshly collected, and extruded in small white masses.

Habitat on the living leaves of *Ulmus americana*, *U. fulva*, *U. alata*, *U. racemosa*, and *U. crassifolia*. Common. Conidial stage of *Gnomonia ulmea* (Schw.) Thüm. and constantly associated with it, the two stages occurring concurrently on the same leaf and spot. Type specimen on *U. americana*, collected at Urbana, Illinois, August 1919, and deposited in the herbarium of the University of Illinois. Differs from *Gloeosporium inconspicuum* Cav. in the very different appearance of the spots and in the larger size of its spores, and from *Gloeosporium inconspicuum* Cav. var. *campestris* Dor. in the character of the spots.

#### INOCULATIONS WITH CONIDIA

On April 25 a number of leaves of the American elm were placed in a moist chamber lined with filter paper, and at a definite point on each was placed a drop of distilled water containing a considerable number of spores of *Gloeosporium ulmeum*, the conidial stage of *Gnomonia ulmea*. On June 2 most of these spots were lighter in color than the remainder of the leaf, and on June 5 a few of them showed distinct conidial pustules entirely characteristic of the fungus with which the leaf had been inoculated. On the same day on which this experiment was started a number of leaves of a seedling elm, quite healthy in appearance and growing naturally in the open, were sprayed with a suspension of the same spores in distilled water by means of an atomizer, and the entire twig was inserted into an Ehrlenmeyer flask. The mouth of the flask was closed by means of a split cork in which a channel had been hollowed to fit about the twig. The flask was supported by means of props in such a manner that the twig remained in its proper position. On June 5 the entire new growth of the twig was found to be covered with a practically continuous layer of pustules of *Gloeosporium ulmeum*, all of which were extruding

spores copiously. Not only were the leaves badly infected, but also the petioles and the stem itself.

These experiments, together with the production of the conidial stage on the leaves of the American elm inoculated with the ascospores of *Gnomonia ulmea*, prove conclusively that the two forms are merely stages of the same fungus. The enormous number of spores produced by the conidial stage, as well as the fact that infection secured from inoculations with such spores was much more pronounced and occurred in a somewhat shorter period of time than from inoculation with ascospores, would seem to indicate that the *Gloeosporium* stage is the chief agency through which widespread dissemination occurs in the spring and early summer.

#### Another *Gloeosporium* on elm

While working with this fungus, a single tree in a nursery at Oconomowoc, Wisconsin, was found on which the leaf spots were quite different in external appearance from those on the surrounding trees, most of which were abundantly spotted with the *Gnomonia* disease, although the trees were of the same species and had apparently been planted at the same time. Fig. 9 shows a leaf from this collection. The leaf spot is raised considerably more than is the case in the preceding species, giving the portion of the leaf on which it occurs a crumpled appearance where the spot becomes large, and is confined quite closely to the leaf veins, along which it spreads, often extending the entire distance from the midrib to the edge of the leaf, thus forming elongated streaks. The leaf veins also become browned for some distance beyond the spots, although the remainder of the leaf is a normal green. The spots present a gray salt-and-pepper aspect, due to the whitened epidermis over which the black conidial pustules are thickly scattered. The whitened appearance is due also to the disappearance of the contents of the epidermal cells and from the cells of the palisade layer immediately beneath them. This disappearance of cell contents is much more pronounced than in the *Gnomonia ulmea* spot.

The acervuli are very numerous in a single spot and are quite commonly confluent. They are orbicular to oblong in shape, very irregular in outline, and are covered by the darkened cuticle

which persists for a long time, finally cracking and breaking irregularly to allow the dispersal of the spores. They average  $800\ \mu$  in diameter. The hymenial layer is pseudoparenchymatous, composed of practically colorless cells which are almost isodiametrical in shape. This layer may be even thicker than that described for *Gloeosporium ulmeum*, although it presents an entirely different appearance, and on account of the absence of color does not at all suggest a stromatic base. The layer appears even thicker than it really is on account of the absence of all color from the epidermal cells, which have become entirely filled with small colorless crystals. This is true to a less extent of the adjacent layers of palisade tissue. The conidiophores are closely packed together, and are quite similar to those of *Gloeosporium ulmeum* except for their larger measurements, being  $10-15 \times 2-3\ \mu$ . They are not as darkly colored as are those of the preceding species, although they are not entirely hyaline. The apex is rather blunt, and the conidiophore terminates rather abruptly in a sterigma-like projection on which the spore is borne. Occasionally two of these sterigma-like processes occur on a single conidiophore. The conidia are much larger, especially in width, and vary considerably in form, from oblong-cylindric to ovate, elliptical, and even pyriform. They measure  $8-10 \times 3-3.5\ \mu$  (fig. 17), are one-celled, rounded at both ends, straight, and hyaline. In no case was the perithecium of *Gnomonia* or any similar fungus found associated with this spot. I consider it entirely distinct from the conidial stage of *Gnomonia ulmea*, and propose for the fungus the following name and description.

***Gloeosporium ulmicolum***, sp. nov.—Spots epiphyllous, raised, gray on account of the black acervuli thickly scattered over the whitened epidermal cells, elongated, following the leaf veins, often extending the entire length of the secondary veins which have become browned far beyond the limits of the spot; acervuli epiphyllous, gregarious, subcutaneous, covered by the persistent darkened cuticle which finally ruptures irregularly to allow the dispersal of the spores, averaging  $800\ \mu$  in diameter, irregular in outline but usually elongated suborbicular; conidiophores in a closely packed layer, dilute-brown, cylindrical, usually nonseptate

but occasionally with a septum near the base, seated on a pseudo-parenchymatous hymenial base which is colorless,  $10-15 \times 2-3 \mu$ , terminating rather abruptly at the apex in a sterigma-like projection on which the spores are borne; conidia hyaline, one-celled, straight, rounded at both ends, oblong-cylindrical, ovate, elliptical, or even pyriform,  $8-10 \times 3-3.5 \mu$ .

Habitat on living leaves of *Ulmus americana*. Oconomowoc, Wisconsin, August 22, 1919. Type specimen deposited in the herbarium of the University of Illinois. This species differs from *Gloeosporium ulmeum* in the shape and appearance of the spots, in the fact that it is not associated with a perithecial stage as that fungus constantly is, in the absence of a black basal stroma, and in the larger spores. In external appearance the two forms are quite distinct. It differs also from *Gloeosporium inconspicuum* Cav. and *G. inconspicuum* Cav. var. *campestris* Dor. in the character and appearance of the spot and in the much larger spores.

### Principal European leaf spot

SYSTEMMA ULMI (Schleich.) Thiess. and Syd.—The leaf spot of the elm occurring in Europe on *Ulmus campestris*, *U. effusa*, and *U. glabra* has a somewhat superficial resemblance to that produced in this country by *Gnomonia ulmea* (Schw.) Thüm. This may readily be seen by comparing fig. 6, which shows the European spot on a leaf of *Ulmus campestris*, with figs. 4 and 5, which are leaves of *U. americana* affected by the *Gnomonia*. The two diseases have been much confused in this country, and it has been quite common for American plant pathologists and mycologists to speak of the latter fungus under the name of the European organism. In examining specimens of the *Gnomonia* spot in various collections in this country, I have found it quite as often referred to in this manner as under its true name or synonyms. There are two references in literature to the occurrence of the disease caused by *Systemma Ulmi* in America, in addition to various others which are clearly due to a confusion of the two forms. One of these cases is in the report by TRELEASE (40) of the presence in Wisconsin of *Phyllachora Ulmi* Fuck., which name is a synonym of *Systemma Ulmi*. On examination of the specimen, which is in the museum of the Shaw Botanical Gardens at St. Louis, Missouri, it was found that the disease was the American form, caused by



*Gnomonia ulmea*. TRELEASE also reported the presence on the same leaf of *Septoria Ulmi* Fr., a synonym of *Phleospora Ulmi* (Fr.) Wallr., which at that time was thought to be the conidial stage of *Phyllachora Ulmi*, but I was unable to find any trace of it on the specimen examined. In material sent from the University of Geneva, Switzerland, I found another specimen, evidently from this same collection by TRELEASE and labeled in the same manner. It also was *Gnomonia ulmea*.

The second reference to the occurrence of *Systemma Ulmi* in this country is by ELLIS and EVERHART (16), who stated that a specimen of *Dothidella Ulmi* (Duv.) Wint., which name is merely another of the numerous synonyms under which the European organism is known, was sent to SCHWEINITZ by TORREY from New York. They added that they could not find any other references to this species being found in this country, and that they have seen no American specimens. I find in SACCARDO'S (33) *Sylloge Fungorum* in the description of *Sphaeria apertiuscula* Schw. on *Ulmus fulva*, collected by TORREY in New York, the statement added that the upper side of the leaf is covered with *Dothidea Ulmi*. This is evidently the specimen to which ELLIS and EVERHART were referring, as both the names used are synonyms of *Systemma Ulmi*. I have not seen this specimen, and there is a possibility that it is really a specimen of the European leaf spot, but it is hardly likely, especially since it has never been collected in this country since, nor has it ever been reported as occurring on *Ulmus fulva* at any other time, either previous to that collection or later.

I found in specimens sent from the Royal Botanical Gardens at Kew, England, among those labeled as belonging to the herbarium of BERKELEY, three specimens purporting to have been collected by DRUMMOND in arctic America. These were undoubtedly specimens of *Systemma Ulmi*, and, although the host was not named, the leaves possessed the somewhat three-lobed character peculiar to the Scotch elm, *U. glabra*. This is not native to America, and one would hardly expect to encounter an introduced species in the arctic regions. For these reasons I believe that these three specimens represent some European collection

which has in some manner accidentally become mixed with DRUMMOND'S arctic collections while they were in the process of being mounted at the museum. This seems all the more probable when it is noted that the handwriting on the labels is the same as that on a great many of the other specimens from the same museum. It would seem, therefore, quite probable that *Systremma Ulmi* does not occur at all in America. Although ELLIS and EVERHART place the causative organisms of the two diseases in the same genus, they express a caution against confusing the two, stating that although they have spores essentially the same they differ very markedly in other characteristics. In spite of the fact that the external appearances of the two spots seem quite similar to the casual observer, as soon as one sections them the very marked differences between the two fungi become apparent. Fig. 10 represents a section through the stroma of *Systremma Ulmi*. It will be seen that the black stroma, to which the external resemblance between the two forms is due, is in this case subepidermal, while in *Gnomonia ulmea* it is subcuticular only. In the *Systremma* the asci are produced in locules without true perithecial walls, which are imbedded in the stroma and open on the upper side of the leaf, while in *Gnomonia* the perithecia, truly sphaeriaceous in character, are located in the leaf tissue beneath the stroma and open on the under side of the leaf. *Gnomonia ulmea*, therefore, belongs to the Sphaeriales, while *Systremma Ulmi* belongs to an entirely different order, the Dothidiales. Although the asci and spores of the two differ but little in form, both are slightly larger in *Systremma* than in *Gnomonia*.

I have examined all available published exsiccati specimens of this fungus, as well as about 200 other specimens borrowed for purposes of examination and comparison from the Royal Botanical Gardens at Kew, and from the University of Geneva, and from a number of institutions and individuals in this country. The published exsiccati of this fungus examined were as follows: BERKELEY Brit. Fung. no. 192; VIZE Mic.-Fung. Brit. no. 277; COOKE Fung. Brit., Ser. I, no. 184; BRIOSI and CAVARA Fung. paras. no. 73; POLLACCI Fung. Longobardiae Exsic. no. 287; SACCARDO Myc. Ven. nos. 231 and 642; ROUMEGERE Fung. Sel. Exsic. nos. 466 and

5761; Fl. Gall. et Germ. Exsic. no. 1000; SCHLEICHER Crypt. Exsic. no. 73; HOLL, SCHMIDT, und KUNZE Deut. Schwamme no. 32; DESMAZIERES Crypt. Fr., Ser. I, no. 284; MONGIER et NESTLER Stirpes Crypt. no. 766; VON THÜMEN Fung. Austr. no. 499; VON THÜMEN Myc. Univ. no. 2064; FÜCKEL Fung. Rhen. nos. 1013 and 2265; SYDOW Myc. Mart. no. 256; LUNDH. Fung. Hung. no. 374; RABENHORST Herb. Myc. no. 658; WESTEND. Herb. Crypt. no. 1111; KRUEGER Fung. Sax. no. 1514; ERIKSSON F. Scand. nos. 292a and 292b.

The synonymy of the fungus is as follows: *Systemma Ulmi* (Schleich.) Thiess. and Syd., Die Dothidiales, Ann. Myc. 13:334. 1915; *Sphaeria Ulmi* Schleich., Crypt. Exsic. no. 73, sec. de Candolle Fl. Franc. 2:288. 1805; *Sphaeria xylomoides* DC., Fl. Franc. 2:288. 1805; *Sphaeria Ulmi* Duv., Hoppe's Bot. Taschenb., 105. 1809; *Xyloma sticticum* Mart., Crypt. Flor Erlang., 309. 1817; *Sphaeria ulmaria* Sow., Eng. Fung., pl. 374. fig. 3; *Polystigma Ulmi* Link, Rab. Handb. 1:167; *Dothidea Ulmi* Fr., Syst. 2:555. 1823; *Phyllachora Ulmi* Fuck., Symb. 218; Sacc. Syll. Fung. 2:594. 1883; *Euryachora Ulmi* Schroeter, Crypt. Fl. Schles. 3<sup>2</sup>:473.

The conidial stage of this fungus is *Piggotia astroidea* B. and Br.

### Other leaf spots of elm

#### IN AMERICA

MYCOSPHERELLA ULMI Kleb. (28).—This is the ascigerous stage of *Phleospora Ulmi* (Fr.) Wallr., which has been reported both in America and Europe as the cause of a leaf spot on *Ulmus campestris*, *U. glabra*, and *U. americana*. In the conidial stage it is said sometimes to do considerable damage to nursery stock and young trees. STEWART (36) states that it has been observed several times to cause extensive defoliation of young elms in New York. Numerous, small, reddish-brown spots appear on the upper side of the leaves, which in consequence gradually turn yellow, the margin becomes brown and rolls up, and they fall early in the season. The spores ooze out in minute cirrhi which dry on the lower side of the leaf surface and form small whitish patches. SACCARDO (31) states that on account of the absence of pycnidia it leans toward *Septogloeum*, and it is sometimes known by that

name. CLINTON (9) and BRIOSI and CAVARA (5) also maintain that it belongs to that genus and call it *Septogloeum Ulmi* (Fr.) Bri. and Cav. CLINTON also suggests that *Cylindrosporium ulmicolum* Ell. and Ev. is possibly not distinct from this species. I have not seen the ELLIS and EVERHART specimen, and admittedly the two descriptions are very similar, especially when one takes into consideration the very great differences in spore measurements recorded by various collectors of *Phleospora Ulmi*. STEWART records as follows: "As we have found them, they (the spores) are 3- or 4-septate, usually quite strongly curved, and measure  $34-38 \times 5.5-6.5 \mu$ . In no. 157 of *Seymour and Earle's Economic Fungi*, on *Ulmus fulva*, the spores are 3-septate, straight, and measure  $33.5 \times 6.3 \mu$ . In no. 648 of *Krieger's Fungi Saxonici*, on *Ulmus campestris*, they are 3- or 4-septate, strongly curved, and measure  $49.5 \times 4.7 \mu$ ." Under the name of *Septoria Ulmi* Fr., this fungus was regarded by FÜCKEL as the spermagonial stage of *Phyllachora Ulmi*, a synonym of *Systemma Ulmi*, but it was shown by KLEBAHN (23) that it had no connection with that fungus, but was the conidial stage of *Mycosphaerella Ulmi*, which develops on the dead leaves in the spring.

CYLINDROSPORIUM ULMICOLUM Ell. and Ev.—Spots becoming flavous; acervuli minute, hypophyllous; conidia cylindraceous,  $45-65 \times 4 \mu$ , hyaline, multinucleate, coming out in minute white caespitules. Reported on leaves of *Ulmus alata* in Mississippi. In spite of the differences in spore measurements, the possibility has been suggested that this is not different from *Phleospora Ulmi*.

SEPTOGLOEUM PROFUSUM (Ell. and Ev.) Sacc.—Spots epiphyllous, flavous; acervuli scattered, hypophyllous, large; conidia coming out in white cirrhi, cylindrical, oblong, granular, 3-septate,  $25-30 \times 6-7 \mu$ . Reported on living leaves of *Ulmus americana* and *U. alata*, although it was first described on *Corylus americana*.

CERATOPHORUM ULMICOLUM Ell. and Hark.—Causes small, suborbicular, dirty-brown, amphigenous spots with a white center, 0.5-1 cm. in diameter, on living leaves of *Ulmus fulva*. Noted from several places in the United States.

PHYLLOSTICTA ULMICOLA Sacc.—Reported as being present in Wisconsin by DAVIS (13) who states as follows:

Under this name I am recording the occurrence of a fungus having the following characteristics: Spots indefinite, immarginate, orbicular, light-brown, becoming cinereous above and lacerate, finally falling away in fragments, 3-7 mm. in diameter, sometimes confluent; pycnidia epiphyllous, scattered, black, globose to depressed, 60-80  $\mu$ ; sporules globose to elliptical, olivaceous-hyaline, continuous, 3-6  $\times$  2-3  $\mu$ . On *Ulmus americana*, Tisch Mills, August 3, 1917. *Ulmus racemosa*, August 5, 1917. This is probably a member of a group of forms of which various names have been applied in Europe and America.

It has also been reported from a number of other states, among them Michigan, where it is said to occur on *Ulmus fulva*.

PHYLLOSTICTA CONFERTISSIMA Ell. and Ev.—Spots red-black, amphigenous; pycnidia 75  $\mu$  in diameter; spores allantoid, hyaline, 3-4  $\times$  1  $\mu$ . On leaves of *Ulmus fulva* in Kansas.

PHOMA CINCTA B. and C.—Spots irregular, depressed, with a white border; spores oblong, narrow, 6-8  $\mu$  long. Reported on leaves of *Ulmus americana* in South Carolina.

EXCIPULA ULMICOLA Schw.—Causes widely expanded indeterminate spots on the upper side of the leaf, becoming somewhat spotted with gray on both sides, with a broad, fuscous margin; pycnidia copious, immersed, excipuloid, punctiform, black, depressed in center and becoming gray. Reported as somewhat rare on cast-off leaves of *Ulmus fulva* about Bethlehem, Pennsylvania.

CORYNEUM TUMORICOLUM Peck.—Forming scattered, suborbicular, pale spots, bounded by a red-brown border on living leaves of *Ulmus americana* in the Adirondack Mountains.

SPHAERIA APERTIUSCULA Schw.—Scattered, fuscous-black, minute, arising from the swollen parenchyma; at first innate, at length opening by a very wide mouth, but evacuate within; resembles a small *Peziza*. Recorded as occurring on the lower side of leaves of *Ulmus fulva* in New York.

RHYTISMA ULMI Fr.—Minute, difformous, gyrose with an elevated margin, at length dehiscing labiately. Reported on leaves of *Ulmus* in North America.

MELASMIA ULMICOLA B. and C.—Spots reddish, indefinite; pycnidia punctiform; spores minute, oblong-botuliform. Cook (10) speaks of it as the *Melasmia* stage of *Rhytisma Ulmi*, and reports it as very common in New Jersey.

## LIST OF SPECIES OCCURRING IN EUROPE ONLY

*Acremoniella pallida* Cooke and Mass., *Actinonema Ulmi* Alleschr., *Ascochyta ulmella* Sacc., *Asteroma angulatum* Desm., *A. Fuckelii* Sacc., *Cladosporium hypophyllum* Fuck., *Exoascus campester* Sacc., *Gloeosporium inconspicuum* Cav., *G. inconspicuum* Cav. var. *campestris* Dor., *Laestadia comedens* (Pass.) Sacc., *Pestalozzia maculicola* Rostr., *Phyllosticta bellunensis* Mart., *P. lacerans* Pass., *P. ulmaria* Pass., *P. Ulmi* West., *Sphaerella Oedema* (Fr.) Fuck., *S. insularis* Wallr., *Sphaeria ulmifolia* Pass., *Sporodesmium Ulmi* Fuck., *Stagonospora ulmifolia* (Pass.) Sacc., *Stigmella Castagneana* (Mont.) Sacc., and *Taphrina Ulmi* Johans.

## FOSSIL LEAF SPOTS OF ELM

IN MESCHINELLI'S *Fungorum Fossilium Iconographia* seven species are given occurring on leaves of fossil elms. Plates and figures are included for six of these, but they are very unsatisfactory in most cases, and in some instances one cannot be at all sure that the spot is even of fungal origin. The species are as follows: *Sphaerites perforans* Goepf., *S. glomeratus* (Engelh.) Mesch., *S. rhytismoides* (Ettingsh.) Mesch., *Rhytismites ulmicola* (Ettingsh.) Mesch., *R. Ulmi* (Ludw.) Mesch., *Depazites Ulmi* (Ettingsh.) Mesch., and *Xylomites* sp. (Boulay) Mesch.

## Summary

1. *Gnomonia ulmea* (Schw.) Thüm., the cause of the most common elm leaf spot in America, has been reported as occurring on five of the six native species of elm in this country and is of wide distribution, being found throughout the entire range of its hosts. Its normal host, on which it is most commonly found, is *Ulmus americana*. The fungus is not ordinarily of much economic importance, but may cause considerable injury to seedlings and young trees in nurseries by producing premature defoliation.

2. Unlike most of the Ascomycetes, the perithecial stage of the fungus begins its development in the living leaf early in the spring. The young perithecium develops in the palisade tissue beneath a subcuticular black stroma.

3. An ascogonium is found in the young perithecium, but there is no trichogyne.

4. An interascicular pseudoparenchyma is found present in the perithecium almost until the period of maturity.

5. In the process of ascospore expulsion an entire ascus enters the lower part of the ostiolar canal, and the eight spores are apparently discharged simultaneously.

6. The ascospores could not be made to germinate either in tap or distilled water, in nutrient solutions, on solid media, or on the living leaves of the English or Scotch elm. They germinated readily on the leaves of the American elm, however, thus indicating that they require a special stimulus of some sort which is present in the leaves of some species of *Ulmus*, but absent in others.

7. The fungus matures most rapidly during the winter on leaves which are neither too exposed nor in too damp a situation. When immersed in water or in intimate contact with the soil, the fungus dies, and only the empty husks of the perithecia remain.

8. A conidial stage was found constantly associated with this ascigerous form. It is described as a new species, *Gloeosporium ulmeum*.

9. The connection between the two forms was conclusively proven by inoculations. The ascospores of *Gnomonia ulmea* gave rise to spots on the leaves of *Ulmus americana* which were entirely typical of *Gnomonia*, and which bore the acervuli of *Gloeosporium ulmeum*. The spores of this form also readily infected the leaves of the American elm, and appeared even more virulent than were the ascospores, indicating that this form is probably the agent by which extensive dissemination of the fungus is assured in spring and early summer.

10. A new leaf spot of the American elm, caused by *Gloeosporium ulmicolum*, another new species, is described. This species differs from the one previously described in the characters of the spot and in the larger size of the spores.

11. *Systemma Ulmi* (Schleich.) Thiess. and Syd. causes a leaf spot of the European elms in Europe. *Gnomonia ulmea* has been very much confused with this fungus, and as a consequence has gotten into the literature as occurring in this country. The probability is, however, that it does not occur in America at all.

It is a member of the Dothidiales, while *Gnomonia ulmea* belongs to the Sphaeriales.

12. Other species of fungi producing leaf spots on the elm are listed with a brief comment on each of the American forms.

13. Seven species of fungi are listed on the leaves of fossil elms.

STATE PLANT BOARD  
AGRICULTURAL COLLEGE, MISS.

### LITERATURE CITED

1. ANDERSON, P. J., and RANKIN, W. H., *Endothia* canker of chestnut. Cornell Univ. Agric. Exp. Sta. Bull. no. 347. 1914.
2. BAILEY, L. H., Standard Cyclopedia of Horticulture. 1917.
3. BACHMAN, F. M., A new type of spermogonium and fertilization in *Collema*. Ann. Botany 26:747-760. 1912.
4. BLACKMAN, V. N., and WELLSFORD, E. J., The development of the perithecium of *Polystigma rubrum* DC. Ann. Botany 26:761. 1912.
5. BRIOSI, G., and CAVARA, F., I funghi parassiti delle piante coltivate od utile essiccati delineati e descritti, no. 98. 1890.
6. BROOKS, F. T., Development of *Gnomonia erythrostroma* Pers. Ann. Botany 24:585. 1910.
7. BROWN, H. B., Studies in the development of *Xylaria*. Ann. Mycol. 11:1-13. 1913.
8. CLINTON, G. P., Notes on plant diseases in Connecticut. Conn. Agric. Exp. Sta. Rept. 1909-1910 (p. 713).
9. ———, Idem (p. 727).
10. COOK, M. T., Report of the department of plant pathology. N.J. Agric. Exp. Sta. Rept. 1915 (p. 370).
11. DARBISHIRE, O. V., Über die Apothecienentwicklung der Flechte *Physcia pulverulenta* (Schreb.) Nyl. Jahrb. Wiss. Bot. 34:329-345. 1900.
12. DAVIS, J. J., Notes on parasitic fungi of Wisconsin. IV. Trans. Wis. Acad. Sci. 19:672. 1919.
13. ———, Notes on parasitic fungi of Wisconsin. VI. Trans. Wis. Acad. Sci. 19:711. 1919.
14. DAWSON, MARIA, On the biology of *Poronia punctata*. Ann Botany 14:245-260. 1900.
15. DOROGIN, G., Eine Pilzkrankheit auf den Blättern von *Ulmus campestris*. Zeitschr. Pflanzenkr. 20:261-263. 1910.
16. ELLIS, J. B., and EVERHART, B. M., North American Pyrenomycetes. 608.
17. FISCH, C., Beiträge zur Entwicklungsgeschichte einiger Ascomyceten. Bot Zeit. 40:850. 1882.
18. FRANK, B., Über einige neue oder weniger bekannte Pflanzenkrankheiten. Ber. Deutsch. Bot. Gesells. 1:58. 1883.



19. FRIES, ELIAS, Syst. Myc. 2:436.
20. FUCKEL, L., Symb. Myc. 218.
21. GÜSSOW, H. T., Report of botanist on plant diseases. Canada. 1910.
22. KLEBAHN, H., Untersuchung über einige Fungi Imperfecti und die zuhoerigen Ascomycetenformen. Jahrb. Wiss. Bot. 41:518. 1905.
23. ———, Idem. Zeitschr. Pflanzenkr. 18:129-140. 1908.
24. ———, Idem. Zeitschr. Pflanzenkr. 18:140-154. 1908.
25. ———, Idem. Zeitschr. Pflanzenkr. 17:223-237. 1907.
26. ———, Idem. Jahrb. Wiss. Bot. 41:492-518. 1905.
27. ———, Aus der Biologie der Askomyzeten. Ber. Deutsch. Bot. Gesells. 36:47-62. 1919.
28. MASSEE, G., Diseases of cultivated plants and trees, 216. 1910.
29. REDDICK, D., Black rot of grapes. Cornell Univ. Agric. Exp. Sta. Bull. 293. 1911.
30. SACCARDO, P. A., Syll. Fung. 3:626. 1884.
31. ———, Syll. Fung. 3:578. 1884.
32. ———, Syll. Fung. 1:570. 1882.
33. ———, Syll. Fung. 2:440. 1883.
34. SCHWEINITZ, L. D. VON, Syll. Fung. Carol. Sup. 55. no. 288.
35. STEVENS, F. L., Perithecia with an interascicular pseudoparenchyma. BOT. GAZ. 68:474-476. 1919.
36. STEWART, F. C., Notes on New York plant diseases. II. N.Y. Agric. Exp. Sta. Bull. 463. 1919.
37. STONE, G. E., and SMITH, R. E., Report of botanist. Mass. Agric. Exp. Sta. Rept. 1901, p. 57; 1902, p. 27.
38. THIESSEN, F., and SYDOW, H., Die Dothidiales. Ann. Mycol. 13:325. 1915.
39. THÜMEN, F. VON, Flora. 1878, p. 178.
40. TRELEASE, W., Preliminary list of parasitic fungi of Wisconsin. Trans. Wis. Acad. Sci. 6:10. 1884.
41. VAUGHN, R. E., A method of differential staining of fungus and host cells. Ann. Mo. Bot. Gard. 1:241-242. 1914.
42. WOLF, W. A., The perfect stage of *Actinonema rosae*. BOT. GAZ. 54:218-234. 1912.

## EXPLANATION OF PLATES VIII-X

### PLATE VIII

FIG. 1.—Two perithecia of *Gnomonia ulmea* in almost mature condition, showing interascicular pseudoparenchyma, and also elongated beaks and periphyses-lined ostiolar canal.

FIG. 2.—Early stage in development of perithecium of *Gnomonia ulmea*, showing position in palisade layer; subcuticular stroma above has given rise to acervulus of imperfect form of fungus, *Gloeosporium ulmeum*.

FIG. 3.—Elm leaf, showing one type of *Gnomonia* spot; note absence of border of dead or browned tissue and that stromata tend to coalesce.

FIG. 4.—Elm leaf, showing another type of spot; black stromata surrounded by border of light brown dead tissue.

FIG. 5.—Same as fig. 4 except that epidermis covering stromata has begun to wear away, giving spot a lighter, somewhat ashen, appearance.

PLATE IX

FIG. 6.—Leaf of English elm, showing leaf spot caused by *Systemma Ulmi*; note that each spot is but a single stroma, much more definite in outline than that caused by coalesced stromata of *Gnomonia ulmea*, and that they are raised much more above surface of leaf; note also wrinkled or papillate appearance of stroma.

FIG. 7.—Schweinitzian type specimen of *Gnomonia ulmea*.

FIG. 8.—Perithecium of *Gnomonia ulmea* at earliest stage in development of beak and ostiole; dark portion of perithecium represents young asci just beginning development; note psuedoparenchymatous contents of perithecium.

FIG. 9.—Elm leaf, showing spots caused by *Gloeosporium ulmicolum*, sp. nov.; note manner in which spots follow the veins; compare with figs. 3, 4, 5, 7, and 12 for differences from spot caused by *Gnomonia ulmea*.

FIG. 10.—Section through stroma of *Systemma Ulmi*, subepidermal in origin; note absence of perithecial walls, and that asci are borne in locules in stroma which open on upper side of leaf.

FIG. 11.—Single spot, fig. 12a, enlarged 10 diameters, showing isolated character of stromata of *Gnomonia ulmea*.

FIG. 12.—Elm leaf, showing stromata of *Gnomonia ulmea* as they sometimes appear, widely separated in spot and somewhat concentrically arranged.

FIG. 13.—Very young stage in development of perithecium of *Gnomonia ulmea*, showing pyriform shape at this stage, and connection with stroma.

PLATE X

FIG. 14.—Acervulus of conidial stage, *Gloeosporium ulmeum*, sp. nov., formed above young perithecium of ascigerous stage, *Gnomonia ulmea*.

FIG. 15.—Spores of *Gloeosporium ulmeum*.

FIG. 16.—Very young stage in development of *Gnomonia ulmea*: a, sheathing hypha; b, ascogonium; c, "suspensor" or "infection thread"; d, vegetative hyphae which break through stroma to outer surface.

FIG. 17.—Spores of *Gloeosporium ulmicolum*.

FIG. 18.—Single acervulus of *Gloeosporium* stage of *Gnomonia ulmea*, showing manner of cracking to allow dispersal of spores; hyphae about acervulus are those of basal stroma as viewed from above.

FIG. 19.—Ascus and ascospores of *Gnomonia ulmea*.

FIG. 20.—Germinating spores of *Gnomonia ulmea*.

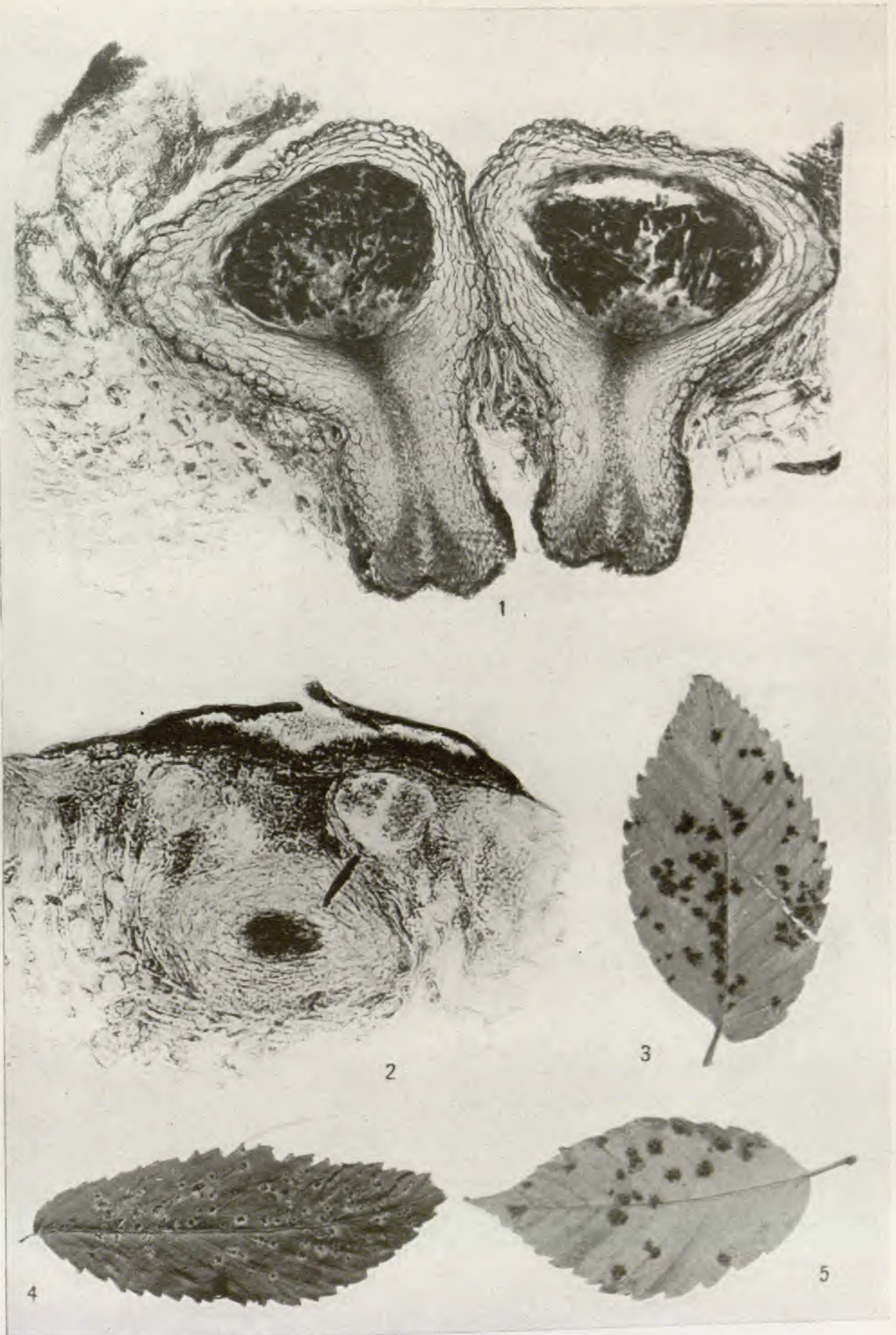

MILES on LEAF SPOTS

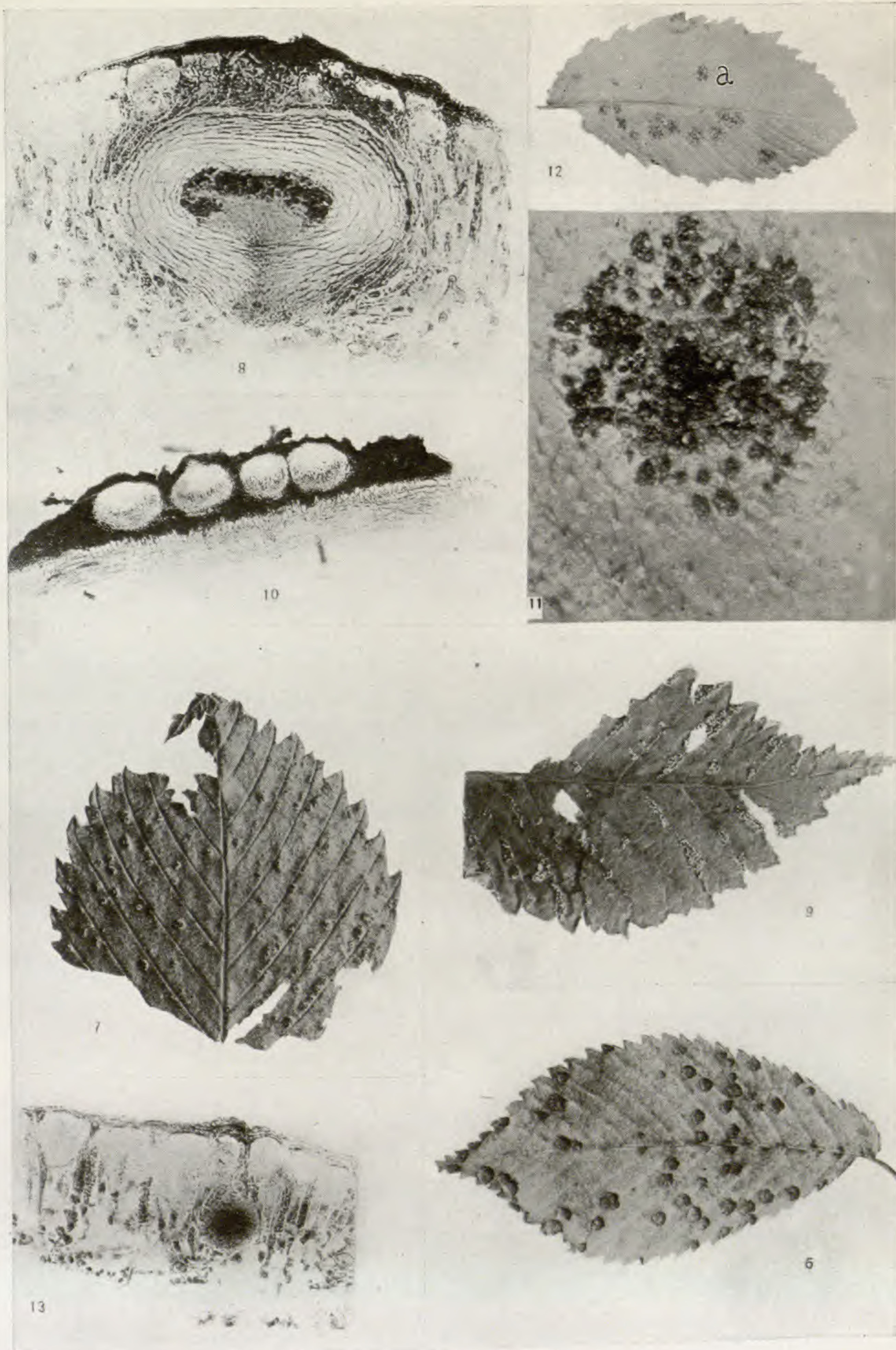

MILES on LEAF SPOTS

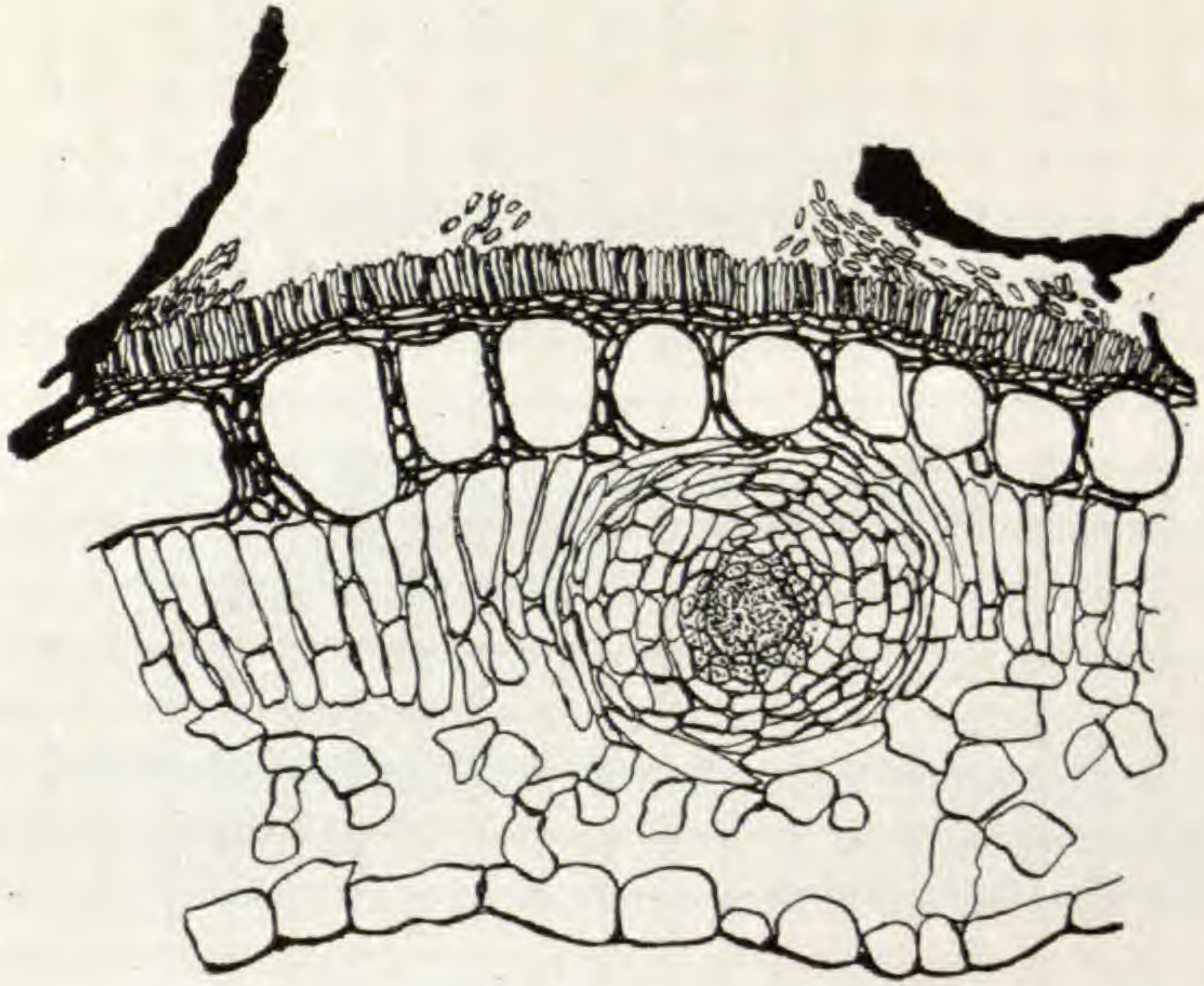

14



15

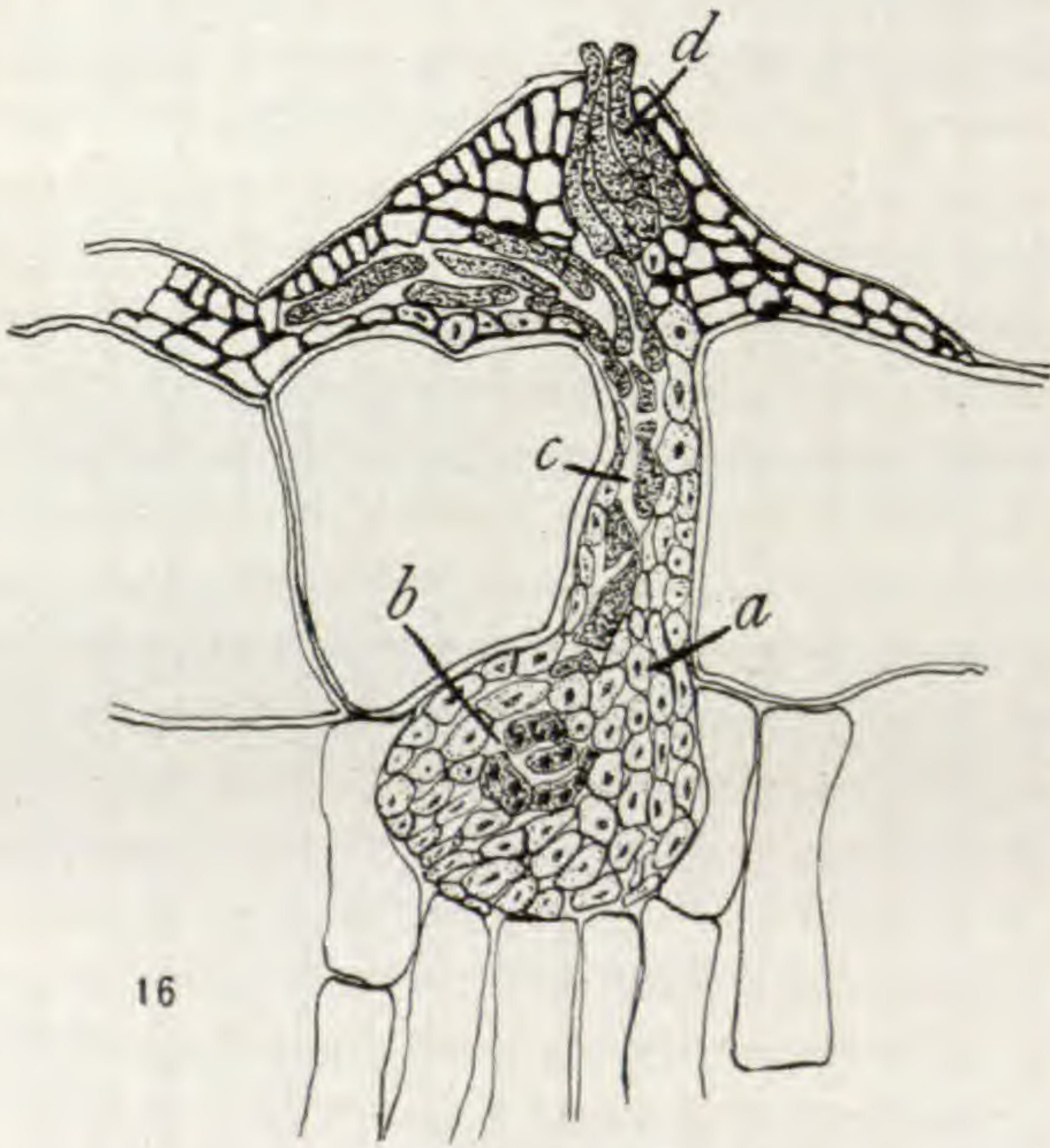

16



17



18



20



19

# INFLUENCE OF ENVIRONMENT ON SEXUAL EXPRESSION IN HEMP<sup>1</sup>

JOHN H. SCHAFFNER

(WITH PLATE XI AND ONE FIGURE)

The study of hemp, *Cannabis sativa* L., was originally undertaken by the writer to determine what influence the environment might have on the sex ratio between staminate and carpellate plants. During the progress of the investigation, other problems in relation to sex presented themselves which were of more immediate importance than the mere determination of the factors which might be the cause of variation in the expected number of staminate or carpellate individuals. The first plantings were made in the fall of 1913, but little was accomplished at that time because the department of botany was preparing to move into a new building, and, as is commonly the case in such ventures, several years were consumed in bringing the new plant into proper working order. The investigation was resumed in the fall of 1916, from which time on plantings have been made each year out of doors in the spring and each winter in the greenhouse, excepting the winter of 1917-1918, which was spent in Florida.

As stated, it soon became evident that far more fundamental problems were presented for solution than the mere changing of sex ratios. Intermediate plants appeared, bearing both stamens and carpels. There was also an endless profusion of abnormal flowers involving all sorts of sexual expressions; and, most remarkable of all, complete reversal of sexual expression under the influence of an abnormal environment presented itself as the most interesting phenomenon to be studied. The last three years, therefore, have mainly been devoted to a study of abnormal flowers and sex reversal.

Examination of the plants in the beds was greatly facilitated by the use of a Bausch and Lomb binocular magnifier. The

<sup>1</sup> Papers from the Department of Botany, the Ohio State University, no. 120.

detailed study of flowers and other parts was carried on mainly with the aid of a binocular dissecting microscope.

Previous reference to the abnormal behavior of the hemp under the imposed abnormal conditions was made by the writer (3) as follows: "Not only did typical staminate plants sometimes produce bisporangiate flowers with more or less normal gynoecia, but some carpellate plants even produced stamens. This in spite of the fact that the plants were differentiated in their vegetative parts as typically carpellate." A preliminary notice (5) of the complete reversal of sex was published in 1919. In 1916 PRICHARD (2) published the results of experiments on hemp, in which changes in sexual expression were shown to take place as the result of various treatments, such as removal of flowers, etc.

### Record of seed and plantings

The original seeds were bought from a seed house in Columbus, Ohio, their origin being unknown.

Plot 1, planted January 1917, in botanical greenhouse. Numerous sex intergrades and sex reversals were observed. Intermediate plants and abnormal flowers studied.

Plot 2, planted in the garden May 1918, with part of the original seeds. The plants were apparently all pure carpellate and pure staminate. No intermediates of any kind were found.

Plot 3, planted in the greenhouse on December 23, 1918. Seeds from individual plant of plot no. 2. Flowers began to open February 1, 1919. There were 73 carpellate and 77 staminate plants. Many were intermediate in sexual expression, or later reversed their sexual condition. These plants were mainly studied for abnormalities in sexual expression in the flowers.

Plot 4, planted in the greenhouse January 22, 1919. Plants in bloom on March 17. Seeds from an individual of plot 2.

Plot 5, planted in the greenhouse February 1, 1919. Seeds from an individual of plot 2. Seeds came up February 6 and 7. Plants began to bloom March 5.

Plot 6, planted in the garden early in May 1919. Seeds from an individual of plot 2. In this plot there were 124 pure carpellate and 122 pure staminate plants. There were no intermediates and no sex reversals of any kind.

Plot 7, planted in the garden June 24, 1919. Seeds from a plant of plot 2. In bloom August 18. There were 86 pure carpellate and 83 pure staminate plants. No intermediates or reversals of any kind appeared.

Plot 8, planted in the greenhouse November 26, 1919. Seeds from a red colored individual of plot 7. First flowers opened January 6, 1920. Plants dying and the last pulled up May 12, 1920.

Plot 9, planted in the greenhouse November 26, 1919, with seeds from a normal green leaved individual from plot 7. First flowers opened January 6, 1920. All the plants had been pulled up or were dying May 12, 1920.

Plot 10, planted in the greenhouse on the north side December 4, 1919, with seeds from an individual of plot 7. First flowers in bloom January 13, 1920. All the plants had reversed their sex or were dying by May 4, 1920.

Plot 11, planted in the greenhouse on the north side December 19, 1919. Seeds from an individual of plot 7. The plants had two pairs of leaves when the flowers began to open January 30, 1920. All of the plants had reversed their sex or were dying May 1, 1920.

Plot 12, planted in the greenhouse on the north side on December 19, 1919. Seeds from the red leaved individual used for plot 8. Flowers began to open on February 1, 1920, when most of the individuals had but two pairs of leaves. All of the plants had reversed their sex or were dying May 4, 1920.

Plot 13, planted in the greenhouse on December 19, 1919. Seeds from the same red leaved individual as used for plots 8 and 12. Flowers began to open February 6, 1920. All plants had shown sex reversal or were dying and pulled up by May 12, 1920.

Plot 14, planted December 19, 1919, in the greenhouse with seeds from an individual of plot 7. Flowers were opening on February 6, 1920. All plants had reversed their sex or were dying and pulled up by May 12, 1920.

Plot 15, consisting of special plantings from seeds obtained from individuals raised in the greenhouse in the winter of 1918-1919: (1) Seeds from a plant which produced staminate flowers before it died; two plants were obtained, one staminate and one



carpellate; both were intermediate in sexual expression and of the same character as intermediate plants obtained from seeds from pure parents; (2) seeds from a carpellate plant which developed three staminate flowers before it died; three plants were obtained, which were carpellate but produced stamens before they died; two individuals became decidedly staminate and one slightly so; (3) seeds from an apparently pure carpellate plant but pollinated with pollen from an intermediate staminate plant; two carpellate plants were secured which later produced stamens.

### Cultural conditions

The various plantings in the garden were perfectly normal, and not a single individual gave any indication of an intermediate or monoecious condition, and there was no sex reversal. The plants raised in the greenhouse during the winter were growing in a very abnormal environment. The aim was to change the environmental factors controlling growth and nutrition as much as possible without interfering entirely with reproduction. Accordingly a rich soil was used, with abundance of water and the ordinary temperatures used in greenhouses during the winter months. The light conditions were very low, the soil in the benches was shallow, about 3 in. deep, and the main source of heat was immediately beneath the benches. Under these conditions the hemp matured very early, and in those plants which had the poorest illumination the inflorescence usually appeared when but two pairs of leaves were present. The plants were never more than a few inches high, and the first staminate flowers usually opened in 32 or 33 days from the time of planting.

No attempt was made to discover which abnormal condition or set of conditions was mainly responsible for the changed morphology and sexuality, but apparently the reduction in the quantity and intensity of light, with its effect on the nutritive process, is the chief factor involved. Good illumination with low temperature would probably give much the same results. The influence of the abnormal conditions on sexual expression, as will appear later, is very great. Commonly more than 75 per cent of the individuals showed mixed sexual expression or a reversal of the sex before the

end of life. The staminate plants usually began to die soon after the first inflorescence had come to bloom, while the carpellate plants usually lived for several months, after the first seeds had ripened, and continued to bloom from new lateral branches. Occasionally a carpellate plant was entirely rejuvenated and put out a second system of shoots which had all the signs and characteristics of the original sprout coming from the seed. A few staminate plants transplanted and carefully nurtured also showed some rejuvenation and continued to produce branches below for some time, but they mostly became senile and died after the blooming of the first inflorescence was completed.

### Sexual dimorphism

Hemp as grown under normal conditions is distinctly dimorphic, both as to flowers and vegetative characters. The vegetative dimorphism, however, is much greater in plants grown under the abnormal greenhouse environment (text fig. 1, *a* and *b*).

The plants experimented with, of course, had their sexual state already established in the embryo of the seed, and whatever changes were induced had their origin during the vegetative growth, between the period of sprouting and the origin of the

incepts of the opposite types of flowers. This must be true for all plants, except perhaps for the few intermediate individuals in which the confused condition of sexual expression might have been due to a definite genetic constitution which would allow of a mixed sexual



FIG. 1.—*Cannabis sativa*: staminate (*a*) and carpellate plant (*b*) of same age, grown in greenhouse in winter, showing decided sexual dimorphism; each plant showed reversal of sex and produced sporophylls of opposite nature; plants transferred from plot in greenhouse to pots just before being photographed.

expression under any ordinary environmental conditions. The only other available hypothesis, according to the writer's views, would be to assume that sex is not determined in the seed, but only after vegetative growth has begun.

The ratio between carpellate and staminate plants is 1:1, with considerable fluctuation in either direction for any given planting. The vegetative dimorphism is the same for individuals which show no tendency to change their sexual expression and those which do so sooner or later. The main sexual differences are as follows.

**Carpellate plant.**—A broad flat crown of leaves; vigorous appearance but not so tall as the staminate plant; robust stem; large root system; large leaf blades with more numerous leaflets, usually five or more; terminal inflorescence usually leafy; petioles longer and more robust; carpellate flowers with the perianth a closed sacklike sheath with no vestigial stamens; weight at beginning of the flowering period nearly twice as much as that of the staminate plant of the same age; a longer period of life and growth.

**Staminate plant.**—A slender, spindling habit and taller than the carpellate plant through the very rapid elongation of the internodes just before anthesis; root system smaller than in the carpellate plant; smaller leaf blades with fewer leaflets; shorter and more slender petioles; terminal inflorescence with few or no leaves; staminate flowers with 3–6 separate sepals (usually 4 or 5) with no vestige of a gynoeceium; weight about half that of the carpellate plant at time of anthesis; a much shorter life than the carpellate plant.

The weights of a dozen individuals of the same age, from the same plot, were determined as follows. Staminate and carpellate plants were cut off at the cotyledon node and immediately placed in glass jars with ground glass stoppers. They were thus weighed without loss of water. After weighing, the stoppers were removed and the jars with the specimens kept in the oven at 50°C. After three days they were placed in an oven at 110°C. and heated for two hours. The stoppers were then replaced, and after cooling the final weights were made of the dried plants. Table I gives the individual weights, the totals, and the averages. It will be seen that the carpellate plants average nearly twice the weight

of the staminate plants. Probably if the root systems had also been weighed the ratio would have been very nearly 2:1. Apparently there is very little if any difference in the ratio between the dry matter and water of the carpellate plants and that of the staminate plants. On account of the decided vegetative dimorphism of the winter plants, a number of interesting differential physiological studies might easily be carried on with the hemp.

TABLE I

WEIGHTS OF 12 PLANTS AT BEGINNING OF ANTHESIS

PLANT NO.	CARPELLATE			PLANT NO.	STAMINATE		
	Green weight	Dry weight	Water		Green weight	Dry weight	Water
1...	3.35 gm.	0.58 gm.	2.77 gm.	2...	1.91 gm.	0.38 gm.	1.53 gm.
3...	3.01	0.62	2.39	4...	2.25	0.34	1.91
5...	2.70	0.52	2.18	6...	1.47	0.31	1.16
7...	2.42	0.44	1.98	8...	2.17	0.41	1.76
9...	2.95	0.53	2.42	10...	0.87	0.17	0.70
11...	2.58	0.45	2.13	12...	1.03	0.20	0.82
Total	17.01	3.14	13.87	Total	9.70	1.81	7.89
Average.	2.835	.523	2.311	Average	1.616	.301	1.315

### Abnormal, irregular, and bisporangiate flowers

Plots 1 and 3 were mainly studied for irregularities in the flowers. These were so remarkable that chief attention was diverted to their morphology in relation to sexual expression, while the remaining greenhouse plantings were studied for sex ratios and sex reversals. In all the winter plantings there was a great assortment of sexual expression in the flowers. One could find almost any conceivable combination of perfect and imperfect sporophylls. Figs. 1-12 were selected, not as an exhaustive set of examples, but simply to indicate the general character of the confusion displayed by the spore bearing organs. They show that any attempt to bring these sexual expressions within the bounds of Mendelian heredity would be out of the question. Fig. 1 is a typical staminate flower from a staminate plant, and fig. 2 is a normal carpellate flower, with the sheath cut open,

from a carpellate plant. The staminate flower has four distinct sepals and the normal gynoecium has two stigmas. In some cases nearly typical carpellate flowers appear on staminate plants (fig. 3), and carpellate plants often bear normal staminate flowers toward the end of their life. A common abnormality is the development of a typical stigma or one of varying degrees of perfection at the outer end of an anther (figs. 4, 7, 9a, also 6, 8, 11). Occasionally a stamen grows directly out of the side of an ovulary (fig. 5), or the ovulary may have more or less perfectly developed microsporangia on one side. Fig. 10 represents such a structure from the tip of the inflorescence of a carpellate plant. This flower has the characteristic staminate perianth, although in other respects it is more carpellate in nature. Figs. 6 and 7 represent two types of abnormal flowers, both from a carpellate plant. Fig. 6 has one good and nearly normal stamen. Fig. 8 is a stamen-carpel complex from the center of a staminate flower with four normal stamens, taken from a staminate plant. Apparently an attempt was made to develop a normal bicarpellary gynoecium. The one side has an imperfect ovulary with a normal stigma, while the other has a distorted anther with two microsporangia ending in an imperfect stigma. Figs. 9 and 9a represent a flower from a staminate plant with an imperfectly developed gynoecium in the center. The separated stamen (fig. 9a) has a well developed stigma, and one other stamen has a rudimentary structure at the tip which shows a slight development in the direction of a stigma. Fig. 11 represents a staminate flower from a carpellate plant with three stamens on a central stalk, the normal position for the gynoecium, two of the stamens having rudimentary stigmas. Fig. 12 is an imperfectly bisporangiate flower from a staminate plant. As intimated, a great number of such variations and abnormalities of every conceivable diversity appear on both staminate and carpellate plants. They are readily intelligible on the theory that they are caused by varying and reversible sexual states. Any attempt to bring such phenomena within the limits of discrete Mendelian units, segregated and combined normally or abnormally during the reduction and fertilization stages, would appear extremely absurd to the writer.

### Diversity of flower types on individual plants

Plant no. 1, a carpellate plant which had besides the normal carpellate flowers: two flowers each with 3 stigmas united below; one flower with 3 small but perfect stamens and a gynoecium with 2 stigmas; one flower with 3 sepals and a gynoecium with 1 stigma; one flower with 4 sepals, 1 stamen, and a gynoecium with 3 stigmas.

Plant no. 2, a staminate plant which had besides the numerous normal staminate flowers: one carpellate flower with a normal gynoecium with 2 stigmas but with 4 small sepals; one flower with 4 sepals and a central structure developed as a stamen on one side ending in a stigma and an ovulary on the other also ending in a stigma; one staminate flower with 4 sepals, 2 normal stamens, 1 rudimentary stamen, and 1 stamen with a stigma projecting from its side; one staminate flower with 4 sepals, 1 normal stamen, and 1 structure with 2 microsporangia and a rudimentary ovulary with 2 stigmas; one flower with 5 sepals and a central structure, part stamen with 4 microsporangia and a rudimentary ovulary with 2 stigmas; one staminate flower with 4 sepals, 4 normal stamens in a cycle, 1 centrally placed normal stamen, and beside this a rudimentary ovulary with a normal stigma; one staminate flower with 6 sepals, 5 normal stamens in a cycle, and a central stamen which was thick and short; one staminate flower with 5 sepals and with 5 stamens in a cycle one of which ended in a stigma; one flower with 4 sepals, 4 stamens, and 1 apparently normally placed central ovulary with a stigma and beside this a rudimentary ovulary also ending in a stigma; one flower with 5 sepals, 5 stamens, and a central rudimentary gynoecium with stigma.

Plant no. 3, a carpellate plant which had besides normal carpellate flowers: one flower with 4 sepals, 2 normal stamens, and a central rudimentary ovulary with 2 stigmas; one flower with 4 sepals, 3 normal stamens, and a carpellate structure with 5 stigmas; one flower with 4 sepals and a bladderly ovulary with 4 stigmas.

Plant no. 4, a carpellate plant which had besides numerous normal carpellate flowers: one carpellate flower with a microsporangium in the side of the ovulary; one staminate flower with

5 sepals and 4 stamens, one of the stamens with 2 microsporangia and stigma; one flower with a gynoecium with 2 stigmas, and a normal stamen connected with the base of the ovulary; one flower with 3 sepals, 2 normal stamens, and 2 stamens grown together by their filaments, the one with 4 microsporangia and a rudimentary ovulary in its side, the other with 2 microsporangia and an ovulary with a normal stigma in its side; one staminate flower with 2 sepals and 3 normal stamens; one staminate flower with 4 sepals and 2 normal stamens.

Plant no. 5, a staminate plant having besides the usual types of staminate flowers: one flower with 3 sepals, 3 stamens, and in the center 1 normal carpel with a stigma and 1 rudimentary carpel with a stigma; one flower with 6 sepals, 4 normal stamens, 1 rudimentary stamen, and a central gynoecium with 3 stigmas; one flower with 5 sepals, 3 normal stamens, and a central structure staminate on one side with 4 microsporangia, and carpellate on the other side with a typical stigma; one flower with 5 sepals and 5 stamens, one of the stamens with a stigma; one flower with 5 sepals, 2 normal stamens, a rudimentary structure of indefinite nature, and a gynoecium with 1 normal stigma and 1 rudimentary stigma.

Such is the usual character of the plants with reversed and confused sexuality. They can be obtained in great numbers in the winter and are very convenient for study. There is also much diversity in the time and degree of reversal of the sexual state in the long-lived carpellate individuals. Two individual records follow:

Plant no. 1 was a decidedly carpellate plant which produced eight seeds and was strong and vigorous. It sprouted at the lower nodes of the inflorescence and produced abundant carpellate flowers on these branches also, while the top of the main stem was dying off. This plant was at first taken to be a pure carpellate individual, but later two flowers developed on a branch, each with a fully developed stamen.

Plant no. 2 was a carpellate plant which produced seed and later developed a lateral branch with typical carpellate flowers, and at the same time continued to grow at the tip of the main axis on

which a staminate flower was produced. One cannot tell, therefore, whether a plant will continue "pure" or whether it will reverse its sexual state until it actually begins to die.

### Sex intergrades and sex reversals

Plots 2, 6, and 7 were planted out of doors under normal conditions. Not a single intermediate plant was developed, and not a sign of sexual confusion in the floral characters was found. Plots 6 and 7 were studied with great care. No record was kept of the ratio between staminate and carpellate plants of plot 2. Plot 6 had 124 carpellate and 122 staminate plants, all absolutely pure in sexual expression. Plot 7 had 86 carpellate and 83 staminate plants, all pure as to sexual expression. Plots 4, 5, 8, 9, 10, 11, 12, 13, and 14 were studied for sex ratios and ratios of pure plants to those of mixed sexual expression. The numbers of carpellate to staminate plants in the greenhouse experiments, of which definite records were kept, are shown in table II.

TABLE II

Plot no.	Carpellate plants	Staminate plants
3.....	73	77
4.....	114	132
5.....	53	39
8.....	44	41
9.....	43	34
10.....	23	30
11.....	18	13
12.....	36	17
13.....	43	31
14.....	47	23
Total.....	494	437

The percentages of plants with mixed sexual expression to those of pure sexual expression are given in table III. The plants were removed as soon as they showed a definite reversal to the opposite sexual state, or if they had not reversed they were pulled up when they began to die. In the nine plots which were studied for purity, reversal, or mixed sexual characters, therefore, the following proportions were found. Out of a total of 421 carpellate plants 167 were pure and 254 were of mixed sexual expression, or 39+



per cent pure and 60+ per cent mixed. Of the 360 staminate plants 144 were pure in sexual expression and 216 mixed, or 40 per cent pure and 60 per cent mixed. It will be noted that a much higher percentage of intermediates was obtained in the plantings of the winter of 1919-1920 than in the winter of 1918-1919. This is apparently due to the fact that the plants in 1919-1920 received the minimum amount of light, since the plantings were made in November and December, instead of in January and February. Plots 11 and 12 show the greatest degree of reversal of sex, and these plots were planted on December 19 in the north side room of the greenhouse which receives the minimum amount of light and was also kept at a lower temperature.

TABLE III

PLOT NO.	CARPELLATE PLANTS		STAMINATE PLANTS	
	Pure	Mixed	Pure	Mixed
4.....	60	54	75	57
5.....	23	30	19	20
8.....	25	19	12	29
9.....	19	24	5	29
10.....	7	16	13	17
11.....	2	16	2	11
12.....	4	32	4	13
13.....	17	26	9	22
14.....	10	37	5	18
Total.....	167	254	144	216

The ratios of plot 11 are as follows: carpellate individuals, 11+ per cent pure carpellate and 88+ per cent intermediates; staminate individuals, 15+ per cent pure staminate and 84+ per cent intermediates. Taking the two plots together the ratio is 11+ per cent pure carpellate to 88+ per cent intermediate carpellate, and 20 per cent pure staminate to 80 per cent intermediate staminate. It is probable that if these plants had been more carefully spaced and cared for, every individual, both staminate and carpellate, would have developed both sexual states sooner or later.

It will be noted that the plants of plots 8-14 had two generations of known sporophyte ancestors which had shown no confusion of sex. Plots 3, 4, 5, 6, and 7 had pure sporophyte parents, but plots

3, 4, and 5 produced large numbers of intermediates and reversals, while plots 6 and 7 produced only pure carpellate and pure staminate plants. It is evident, therefore, that the large numbers of intermediates and reversals of plots 3, 4, and 5 were due entirely to the conditions of environment and not to a difference in genetical constitution as compared with the plants of plots 6 and 7. The abnormal environment caused a reversal in the staminate seedling from the male to the female state, and this resulted in the expression of carpellate structures in varying degrees of extent and intensity. The same environmental conditions caused a reversal in the carpellate plants from a female to a male condition, either in the early seedling stage or at any later time until the approach of old age and death. This reversal is also of varying degrees of extent and intensity as in the staminate plant. In extreme cases the carpellate plants produced normal stamens with fully developed pollen, which is shed in the usual manner. In other cases, although stamens were developed, the pollen was imperfect and the anthers dried off without dehiscing. In the reversal of the staminate plant there were also occasional normal carpellate flowers produced with their entire morphology typically carpellate, but usually the structures were abnormal.

Enough progress has now been made in the direction of sex control in the hemp to take a quantity of seeds and produce at will either a stand consisting of individuals with pure male or female expression, pure staminate or carpellate plants, or a stand of individuals in which 50-90 per cent are of mixed sexual expression, although the sex was apparently already definitely determined as male or female in the sporophyte embryo.

#### Character and degree of sexual reversal

The carpellate plants, which are somewhat intermediate from the first, or which sooner or later reverse their sexual expression, produce normal seeds, and some plants were grown from such seeds in the greenhouse. Since the greater part of the development of the individual is complete before anthesis, the carpellate plants continue to appear typically carpellate after reversal except in the floral structures. If partial reversal takes place much before

anthesis, it would be difficult to detect, because the young plants are not so dimorphic as the mature individuals. The time of reversal after anthesis may be at any stage until extreme old age. As stated, some individuals produce only imperfect stamens with defective pollen and indehiscent anthers, while others produce normal staminate flowers with dehiscent anthers and pollen which appears normal in every respect. In such cases the sexual expression usually involves the entire flower, and the perianth is typically staminate, like the perianth on a staminate plant. The reversal from femaleness to maleness is of varying degrees, both as to the perfection of the stamens and the number of flowers produced.

The staminate plants of an intermediate sexual expression are usually so at the beginning of anthesis, few staminate individuals developing carpellate structures at a later stage unless they do so from the beginning. Some, however, continue to be more or less intermediate up to the time of old age and death. If some method of rejuvenation could be employed, it is probable that plants purely staminate at first might be induced to become carpellate later, but under ordinary conditions the change in the staminate plants, as in the carpellate plants, progresses from femaleness to maleness. The reversal in the staminate plants is usually less complete than in the carpellate plants, probably for the reason that senility usually sets in soon after the beginning of anthesis, while in the carpellate plants the long active period after anthesis has begun permits the efficient environmental factors to have full effect in the growing vegetative tissues.

A few special cases were carefully studied in relation to the progressive change in sexual expression. A number of individuals appeared normally carpellate and produced two or three normal seeds, and then gradually changed to the staminate condition, until finally, before they began to die of old age, purely male sex was being expressed. Nothing but typical staminate flowers with dehiscent anthers and normal pollen were being produced. Femaleness had been changed completely to maleness; and this change had taken place in plants which in the seedling stage had been determined as carpellate individuals with decided characters peculiar to the female state. There is but one inevitable rational

conclusion. The decided sexual dimorphism exhibited by the sporophyte of the hemp is not due to some homozygous or heterozygous condition, and is not due to the absence of one or the other sex potentialities. The dimorphism depends on a fundamental state inherent in the cells, either male or female, which can be reversed by the operation of an abnormal environment in the vegetative tissues during the life of the individual. The sexual state is not controlled by segregating Mendelian units. The reversions and transformations are not related to the synaptic associations and segregations of chromosomes in the reduction division, nor in the homozygous or heterozygous mixtures of chromosomes during fertilization. There can be no question that it would be possible with proper environmental control of the original gametes and zygote to determine the original sexual state of the embryo as readily as the established sexual state can be shifted later, either from male to female or from female to male.

In the winter plots a few individuals approached what might be regarded as a monoecious condition. These plants were intermediate in robustness and about as tall as the staminate plants. They developed stamens and gynoecia and abnormal sporophyll structures from the beginning and continued to do so to the end. It is suggested that these individuals were either of a distinct genetic constitution like a typical monoecious plant with the vegetative tissues in a neutral state in respect to sex until the incepts of the flower buds appear, or else the sporophyte embryos were determined as staminate plants of only a slight degree of maleness, and were then reversed to a neutral condition, as in the ordinary types, by the influence of the environment at an early stage, perhaps soon after sprouting. From the neutral meristematic tissue the floral parts would then be thrown either into the male or female state. In cases where a sporophyll is partly staminate and partly carpellate, it must be assumed that the determination of the sexual state was delayed until the tissues were considerably developed, and that then maleness was established at one point and femaleness at another, probably depending on the metabolic level of the cells involved. If the intermediate nature of these plants is due to some definite genetic constitution,

it should be possible to develop a race of hemp which would show monoeciousness under ordinary field conditions. The genetic change from a dioecious to a monoecious condition would be caused by some change in one or more hereditary factors or one or more mutative additions or losses. Such factors, of course, may be present in any number of species, but the point to be emphasized is that such factors or states have no fundamental relation to the sexual nature of the plant, but are only causes which determine more or less definitely at what stage of the ontogeny the sexual state is established. Whether there are special factors in chromosomes for monoeciousness and dioeciousness appears not to be definitely known. In any event, the monosporangiateness or bisporangiateness must not be confused with the sexual state. The one condition or the other simply determines at what stage of the life history a definite sexual state is established, depending on a certain metabolic level, a certain degree of senility of the tissues, or a certain differentiation of the cells. Whether the bisporangiate monoecious and dioecious conditions are due to definite factors or simply to a difference in general constitution, the sexual state in either case could be changed by external causes. There is no fundamental difference between an organism with bisporangiate flowers and one with monoecious flowers as regards sex. The main difference is simply an earlier or later stage of vegetative growth at which the one or the other sexual state is established in a given cell, tissue, or organ. Since it is plain that this is the case, it is not reasonable to suppose that any new principle is involved in passing from a monoecious to a dioecious species, since we know that there is every gradation between bisporangiateness and dioeciousness. The experiments on hemp show that even in a dioecious species with marked dimorphism the male state or the female state is possible in any tissue of a sexual organism, the readiness or difficulty of inducing a change from the one condition to the other depending on various internal and external causes.

Several seeds were obtained from decidedly intermediate plants, but none of them sprouted. This does not necessarily imply any constitutional defect, since many of the seeds from the

dwarfed ordinary carpellate plants are also defective and do not sprout so readily as those grown under normal conditions.

Seeds collected from carpellate plants which later developed stamens were planted in plot 15. There was apparently no difference in the behavior of the plants from these seeds from those raised from seeds obtained from pure parents out of doors, but the number of plants was too small to draw any definite conclusions. One would expect that the embryos of seeds developed under abnormal conditions would show less fixity of the sexual state than those developed under normal conditions. Since practically all the seeds from the out of doors "pure" parents will show reversal of sex with proper abnormal conditions, however, probably the only way to get any definite data indicating a difference would be to test such seeds out of doors in comparison with ordinary seeds. In such an experiment, however, the plants should be grown in an environment which will just keep the plants from normal seeds pure. Such limits can probably be discovered.

### Recent work

Various investigators have made observations on the sex ratio of hemp. It is not necessary to refer to the older papers here except to state that a considerable diversity in the proportion of the staminate and carpellate plants has been found. Roughly speaking, the ratio of carpellate to staminate plants is 1:1, with a deviation in either direction of at least 50 per cent in extreme cases, even when large numbers are counted.

In 1916 PRICHARD (2) published his results on changing the sex in hemp by mutilation. By removal of leaves and flowers, and by certain other treatments, he was able to obtain 17.8 per cent of reversals in the established sexual state. In all, 25 carpellate and 4 staminate plants showed reversal of sex.

YAMPOLSKY (7), working with *Mercurialis annua* L., found that some carpellate plants produced staminate flowers and some staminate plants produced carpellate flowers, and that both staminate and carpellate plants showed gradations in degree of maleness and femaleness. He also found that the offspring of

selfed carpellate plants are carpellate or prevailingly carpellate, and the offspring of staminate plants are staminate or prevailingly staminate. This condition is probably what should be expected if the seedlings are grown in the same environment as the parents. It would be interesting to know whether this condition could be modified by raising the seedlings in a fundamentally different environment. The writer knows from experience, however, that *Mercurialis* is a much less satisfactory plant for study than hemp, because of its minute flowers, less prominent dimorphism, difficulty of gathering seed, etc. YAMPOLSKY (8) also found flowers with confused sexual expression much like what is reported in this paper for hemp. He rightly concludes that "a factorial hypothesis of sex cannot explain these results," that is, the periodic alternation of sex in the course of the plant's development.

I have already shown (3) the significance of the change in the sexual state of a bisporangiate flower, taking as examples the cones of a *Selaginella* and the flowers of a *Bromus*, and showing that the establishment of the sexual state in the organs involved had nothing to do with a Mendelian segregation depending on the synapsis and segregation of chromosomes.

STOUT (6) has made a study of intersexuality in *Plantago lanceolata*, and found that there is a wide range of variation in the degree in which maleness is expressed. He also found that femaleness varies in the degree of its expression.

DAVEY and GIBSON (1) found that the changes in the sexual state, which they studied in *Myrica Gale*, were in some way associated with environmental conditions. The relative proportion of carpellate plants was found to be greater in the wet than in the dry areas. *Myrica Gale* would probably be a desirable perennial species for experiments on the environmental control of the sexual state, as the hemp is for a short-lived annual.

The writer (4), while studying the intermediate plants of *Morus alba*, found a staminate tree that had one large reversed lateral branch and a second small one at the top. These branches were bearing fruit, but although they were decidedly carpellate, they were so only to a degree, for both were still producing staminate catkins. The seeds of this fruit were perfectly normal, and the

· writer now has a progeny of young trees from this "male individual." This reversal of the sexual state took place in the meristematic tissue of the staminate sporophyte. A state which in general always causes the expression of male characters through some internal cause was changed to a new sexual state or a neutral condition by which the sexual expression in the incipient aments was easily thrown into the female or the male state, while the rest of the tree, consisting of numerous large branches, was in such a sexual state that maleness was invariably expressed in the incipient aments. This tree functions the same from year to year. All such cases, as well as the remarkable behavior of hemp, show that a Mendelian hypothesis of sex is at present not only untenable, but is absurd in the extreme. It is not even necessary to have such a hypothesis as an explanation of sex in the higher animals in which the nuclei of the two sexes show an allosome difference.

I have stated (3) that the great abundance of intermediates among the winter hemp plants was probably due to the abnormal environment, mainly a lack of light. The statement was also made that hemp was "a dioecious plant which shows sexual dimorphism even in its remote vegetative parts, but numerous individuals which are thus specialized have the ability to produce the opposite primary sexual generation and sexual cells, without any manipulation whatever being employed, except that they were grown in an unusual environment." It behooves the advocates of the hypothesis of homozygous and heterozygous constitutions to show how their hypothesis works in these numerous examples now on record before attempting to confuse biological literature with an apparently untenable theory. The present work on hemp shows that the attempt to analyze the sexual constitution of monosporangiate or bisporangiate plants from ratios which appear in cultures is of little value unless it has previously been shown that the plant reacts the same to all environments. In any dioecious species which has sex intergrades, and there are apparently few which do not have them, it is of no genetic importance to discover that a certain "pedigreed" individual has produced so many "males," "females," and "hermaphrodites," unless it is definitely known that the same kind of seeds would not give a different progeny if



grown in an entirely different environment. Sex goes beyond the organized visible structure of the protoplasm, and is probably bound up with the atomic or molecular structure, or dependent on some physical state which is reversible in most cells. It seems impossible to explain the known facts of sexuality and sexual morphology by any activities or movements of the larger structural units of the protoplast, such as chromosomes, chromatin granules, centrosomes, nucleoli, chondriosomes, etc.

The geneticist must give as much attention to the expression of heredity as to the analysis of hereditary factors, and it is becoming more and more apparent that the environment plays a very prominent part in such expression, the characteristics of the individual being decidedly different when developed under one environment from what they would be if developed under another. So far as sexuality is concerned, the cells may be in such a state of equilibrium that closely associated groups may be thrown into the opposite sexual state and be differentiated as such simply because the one area is at a different metabolic level from the other. It is a common occurrence, therefore, not only in hemp but in great numbers of species, for sporophylls to be microsporangiate in one part and megasporangiate in another, or to have the characters peculiar to maleness in one part and those peculiar to femaleness in the other.

Hemp is recommended as perhaps the most convenient plant to grow for experimental purposes, for classes in genetics, and to illustrate confusion of sexual expression and sex reversal. The flowers appear in from 30 to 36 days if planted about December 10, and the staminate plants can mostly be studied before it is necessary to pay attention to the carpellate individuals. The extreme dimorphism, the lack of vestigial parts in the normal flowers of the opposite set of sporophylls, the response in size of the plant at various seasons, and other peculiarities combine to make hemp of unusual interest to the student.

The writer is under obligations to Mrs. BAYARD TAYLOR for much assistance in the work on plots 8, 9, 13, and 14; and to Mr. R. J. SIM for assistance in the illustrations.

### Summary

1. Hemp planted in spring in the open, under normal conditions, developed as pure carpellate and pure staminate individuals. There is no confusion of sexuality.

2. The ratio between carpellate and staminate individuals is about 1:1, with a large deviation in either direction for various plots.

3. Hemp planted in winter in the greenhouse on shallow benches with low light intensity showed great confusion in sexual expression. Abundant irregularities were produced, such as stamens with normal stigmas and structures partly carpellate and partly staminate, as well as more typically bisporangiate flowers and flowers typical of the opposite sexual state.

4. Both carpellate and staminate plants showed reversal in their growing period to the opposite sexual state.

5. In extreme cases 88+ per cent of carpellate plants showed reversal to maleness, and 80 per cent of staminate plants showed reversal to femaleness.

6. Both staminate and carpellate plants, although they showed decided sexual dimorphism, contained all the factors and abilities of both sexes. There is no question of a homozygous or heterozygous condition involved. The staminate and carpellate individuals contain the potentialities for the perfect development of the opposite sex. Reversal of the sexual state takes place in the vegetative tissues, and has no relation to a reduction or segregation of chromosomes or their possible hereditary factors.

7. The sexual reversal is of all degrees of intensity, from very imperfect expressions of the opposite organs to completely normal development.

8. Sexuality is a state or condition not Mendelian in nature, but related to the functional activity of the plant and profoundly influenced by environment. Maleness and femaleness in hemp are probably controlled by the metabolic level of the cells, and sex reversal takes place when the metabolic level is decidedly changed or disturbed.

9. Any tissue in its growth may be in a neutral state of varying degrees of intensity, and during its continued growth can pass

from one state to the other without any reference to chromosome segregation or combination which are the ordinary causes of Mendelian phenomena.

10. Sex is subject to experimental control in the individual in such dimorphic, dioecious species as hemp, and such control can be exercised in various ways by changing the ordinary factors of environment, and, therefore, presumably also by chemical and physical stimuli of various kinds.

OHIO STATE UNIVERSITY  
COLUMBUS, OHIO

#### LITERATURE CITED

1. DAVEY, A. J., and GIBSON, C. M., Note on the distribution of sexes in *Myrica Gale*. *New Phytol.* 16:147-151. 1917.
2. PRICHARD, F. J., Change of sex in hemp. *Jour. Heredity* 7:325-329. 1916.
3. SCHAFFNER, JOHN H., The expression of sexual dimorphism in heterosporous sporophytes. *Ohio Jour. Sci.* 18:101-125. 1918.
4. ———, The nature of the dioecious condition in *Morus alba* and *Salix amygdaloides*. *Ohio Jour. Sci.* 19:409-416. 1919.
5. ———, Complete reversal of sex in hemp. *Science N.S.* 50:311-312. 1919.
6. STOUT, A. B., Intersexes in *Plantago lanceolata*. *BOT. GAZ.* 68:109-133. 1919.
7. YAMPOLSKY, CECIL, Inheritance of sex in *Mercurialis annua*. *Amer. Jour. Bot.* 6:410-442. 1919.
8. ———, Sex intergradation in the flowers of *Mercurialis annua*. *Amer. Jour. Bot.* 7:95-100. 1920.

#### EXPLANATION OF PLATE XI

All the figures are slightly magnified.

FIG. 1.—Normal staminate flower from staminate plant just before dehiscence of anthers.

FIG. 2.—Normal carpellate flower from carpellate plant; perianth is sheath with oblique limb; sheath or calyx cut open to expose ovulary.

FIG. 3.—Nearly perfect carpellate flower from base of staminate inflorescence on staminate plant; 4 sepals fused together; side of calyx torn open to expose ovulary; in staminate plants usually most perfect carpellate flowers develop first.

FIG. 4.—Stamen with stigma; from staminate plant.

FIG. 5.—Ovulary from carpellate plant with stamen growing from one side; ovulary is flat on side from which anther projects.

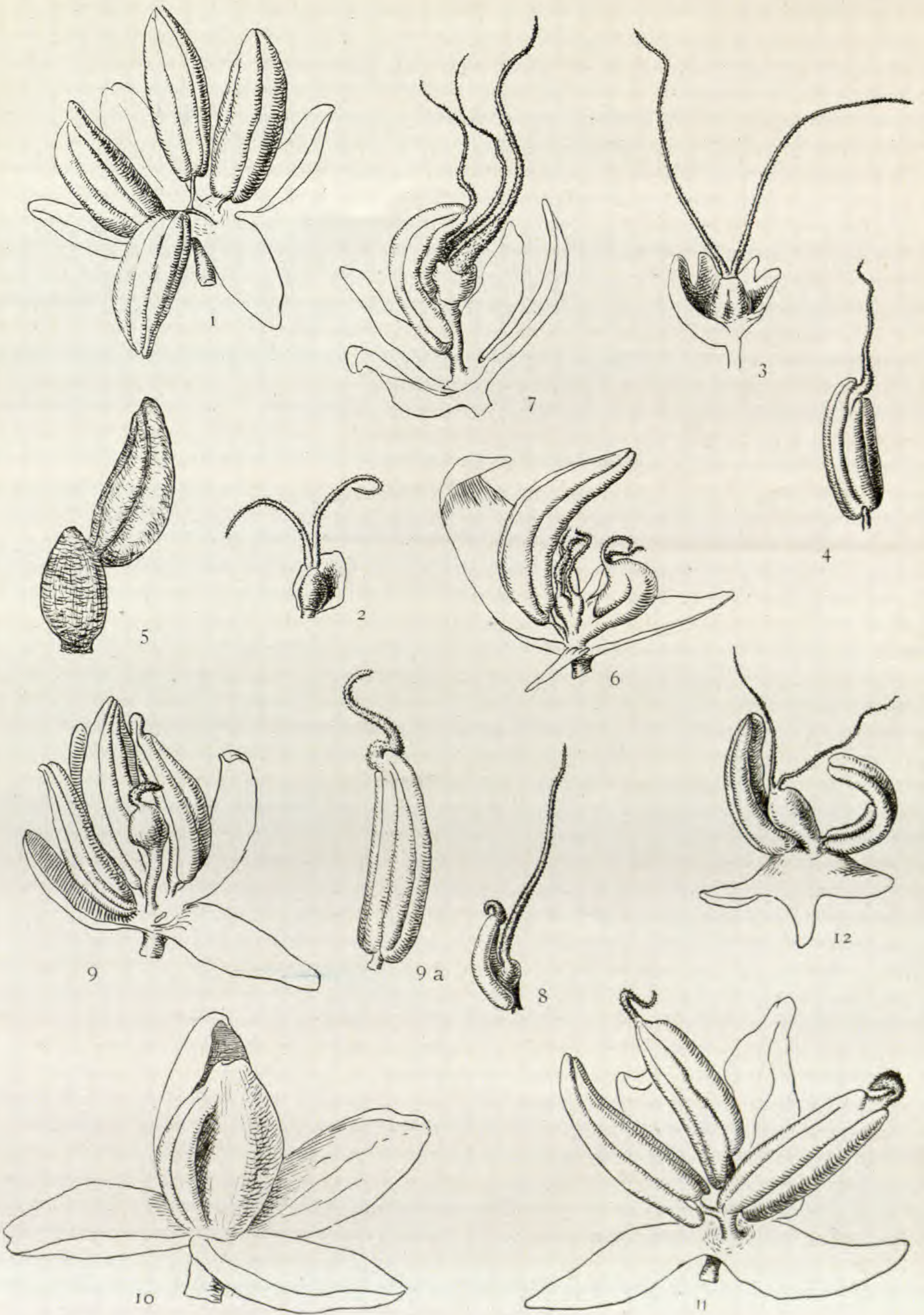

SCHAFFNER on HEMP

FIG. 6.—Distorted flower from tip of inflorescence of carpellate plant, with 1 good stamen and 1 reduced and distorted stamen with 2 stigmas connected at base with double structure halfway between anther and ovulary in character, having 3 stigmas; stamen side of flower has sepal of normal size; such perianths often staminate in character on one side and more or less carpellate on other.

FIG. 7.—Abnormal flower from same carpellate plant as fig. 6, showing distorted stamen with stigma and distorted ovulary with 2 stigmas, all on central stalk; 4 sepals.

FIG. 8.—Stamen-carpel complex from center of staminate flower, from staminate plant; 4 normal stamens present; bilocular stamen ends in short filament and imperfect ovulary has 1 prominent stigma.

FIGS. 9. and 9a.—Distorted staminate flower from staminate plant with stalked rudimentary gynoecium ending in small stigma and with 4 stamens; 2 stamens normal, one has projection like incipient stigma, and one (fig. 9a) has prominent stigma; 4 sepals.

FIG. 10.—Tip flower from inflorescence of carpellate plant showing 4 free sepals characteristic of staminate flower and one side of ovulary developed into anther-like structure with imperfect microsporangia.

FIG. 11.—Staminate flower from carpellate plant; 3 stamens on stalk in center of flower, 2 having small stigmas; 4 sepals.

FIG. 12.—Abnormal flower from staminate plant expressing femaleness; abnormal ovulary with 2 stigmas united with 1 anther not normally developed; on anther side perianth sheath has 3 lobes and is thus somewhat carpellate in nature; other stamen normal; sheath split open and turned down to expose ovulary.

# EXPERIMENTAL INVESTIGATIONS ON BIRCH AND OAK<sup>1</sup>

EDITH S. WHITAKER

(WITH PLATES XII-XV AND FOUR FIGURES)

At the present time experimental investigations have a well merited vogue, especially in genetical and morphological fields. Until recently, however, little has been done in this connection on the structure of woody plants. This has been due largely to the fact that the history of woody plants has not been sufficiently understood to warrant their interpretation. The doctrine of evolution was formulated mainly through the study of comparative anatomy in the absence of a fossil record. Plant tissues, however, are more resistant to decay than animal tissues (with the exception of bones), and as a consequence their historical relations and affinities have become available for comparison with existing forms and structures. The comparative anatomical study of existing and fossil plants has led to the conclusion that there are certain general principles which not only hold true for a group of plants in which there is a fossil record, but also may be applied to other groups in which, as in the Angiosperms, there is as yet no complete geological record. Certain general conclusions thus inductively established make it possible to apply the same principles in judging anatomical features and interpreting structural relationships in the Angiosperms, in absence of fossil record (4, 5, 7).

The first principle established as a result of comparative anatomical study and knowledge of fossil forms, and one employed by zoölogists, is based on the fact that in the course of their development organisms may pass through conditions now lost in adult life, but once possessed by the organism in its mature state. This is called the law of recapitulation, and holds true in plants also. For example, certain of the Cupressineae which have small leaves in the adult plant, in their seedling development have the larger leaves characteristic of the more ancient flora.

<sup>1</sup> Contribution from the Laboratories of Plant Morphology of Harvard University.

A comparative anatomical study of existing and fossil plants, especially the Gymnosperms, has shown that certain parts of plants (as the root, leaf, first annual ring, and reproductive axis) may have a different organization of tissues from the stem, which is more highly specialized. This fact has been responsible for the theory of retention, or, as it has been more recently called, the doctrine of conservative organs (7).

The third principle is based on the fact that upon injury certain structures and types of organization appear which are characteristic of older forms and more conservative regions of the plant. It is less well understood than the other two, and is capable of more misinterpretation. It is the one of chief interest in the present investigation. It should be pointed out, however, that only those structures occurring as a result of wounding which are comparable to conditions presented by the seedling and the conservative organs (root, leaf, etc.) can be relied upon in the interpretation of wound reactions.

Experimental work on woody tissues is of interest not only from a general biological standpoint, but is also of importance from the point of view of plant pathology. It may be pointed out also that such investigations are of interest from an economic point of view, since they suggest the possibility of producing experimentally valuable ornamental woods.

As the subject of wound reactions is a large and complicated one, for the purposes of brevity and clearness I have confined myself to those traumatic features which are connected with ray structures only. Other reversions and reactions consequent upon injury in the birch and oak, therefore, may be conveniently postponed until a later date.

### Ray organization in Angiosperms

The three types of broad rays characteristic of the angiospermous forest trees are all found in different species of the isolated and probably ancient genus *Casuarina*. A synoptic diagram illustrating these types as seen in *Casuarina* is given in text fig. 1. The simple or uniseriate ray which is a feature of the wood organization of the Conifers is also found in Angiosperms, and its occurrence

need only be noted in the present connection. In the center of text fig. 1 is the type of ray known as the aggregate ray ( $A, A'$ ). This is a radial band composed of congeries of small or uniseriate rays and clusters of fibers. The leaf trace is represented in solid black at the interior of the segment. The aggregate ray originated probably in the clustering of uniseriate rays around the outgoing leaf trace, and seems to be the most ancient type of broad ray found in forest trees. It is found in the root and seedling stem of

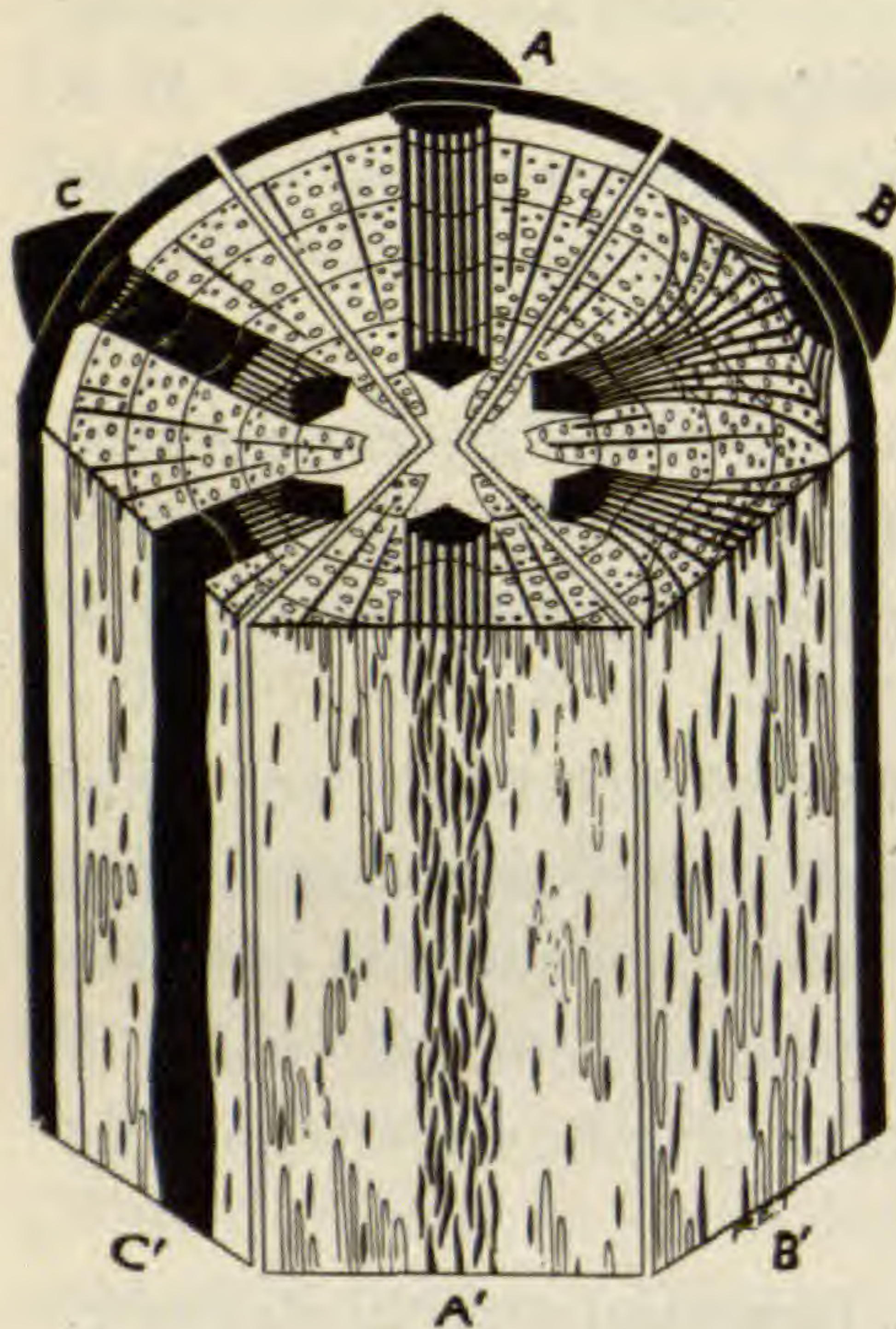

FIG. 1

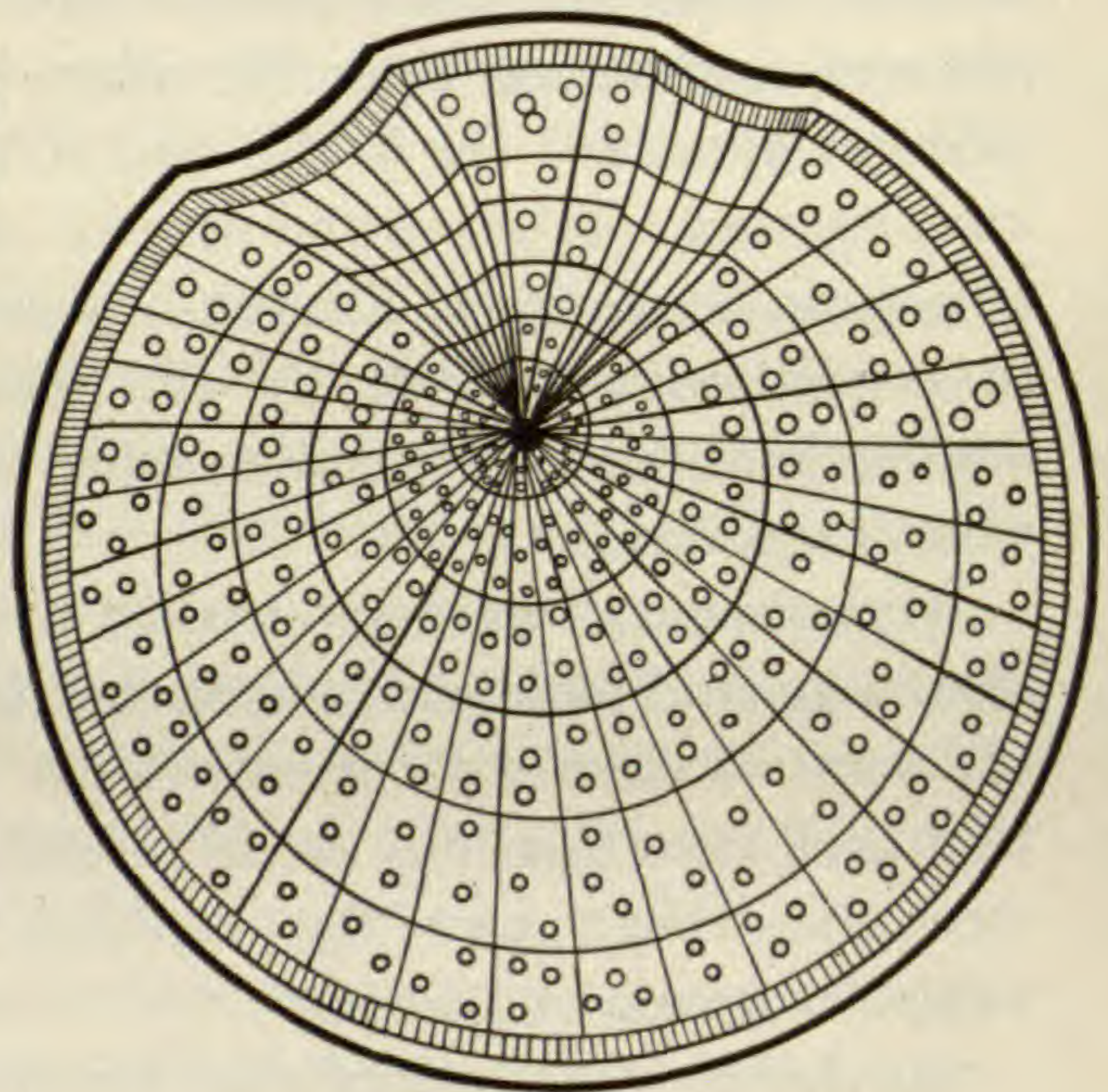

FIG. 2

FIGS. 1, 2.—Fig. 1, synoptic diagram illustrating ray situation in *Casuarina*; fig. 2, diagram of birch root.

*Casuarina*, and persists in the adult axis of *C. torulosa*. It is also characteristic of the adult stem wood of the alder and of the southern oaks.

The second type of angiospermous ray, represented at the left of the diagram, is known as the compound ray. It is found in *Casuarina Fraseri*, in the mature axes of oaks of northern range, and in herbaceous Dicotyledons. Immediately outside of and subtending the leaf trace (black) is the aggregate condition already mentioned. Farther out toward the periphery of the stele, however, the fibrous parts of the ray have undergone a parenchymatous



metamorphosis. The homogeneous character of the ray is indicated by solid black. The depressions of the cylinder, corresponding in position to the large rays in the vicinity of the annual ring, are to be noted.

The type of ray characteristic of the majority of our forest trees is the diffuse ray. The organization of this is shown at the right (*B, B'*). Just outside the leaf trace (black) the ray is characteristically aggregate, a situation parallel to that of the early organization of the compound ray. Farther out, however, the rays spread out and subdivide, instead of being more closely united, and vessels and fibers again appear in the foliar segment. This permits the passage of more water and food substance, and is of advantage to trees subject to the rigors of a northern winter. In tangential aspect the rays are several cells wide, which differentiates them from the simple or uniseriate rays of the Conifers. This type of ray is found in the mature stem of *C. stricta* and *C. equisetifolia*.

#### Ray organization in birch and oak

BIRCH.—Fig. 1 represents a transverse section through the stem wood of *Betula nigra*, and shows the type of ray characteristic of most of our forest trees. Fig. 2 shows some of these diffuse rays in tangential aspect. They are about three or four cells in width, but without any interspersed fibers. It is an interesting fact that most birches of southern origin or affinity retain the aggregate type of ray organization in their vegetative axes, while those of northern range are characterized by the diffuse type of ray. \**B. populifolia*, for instance, which is essentially a southern birch, has persistent aggregate rays in the normal stem wood. *B. pumila* and *B. lutea* may be taken as examples of the northern species. This difference in ray organization would seem to indicate the evolutionary relationships occurring in response to weather exigencies.

*B. alba*, an introduced and also indigenous species, may be taken as an example of a birch belonging to the temperate region, and will be used in this investigation because of its intermediate position geographically and structurally, where no special advantage is to be gained by recourse to other species.

OAK.—The oak is the outstanding arboreal form with compound rays. It is this that makes oak wood in great demand for building purposes. The northern oaks show the compound type of ray structure, while on the other hand the southern oaks retain the aggregate type of organization in the mature stem wood. Discoveries of fossil oaks (1, 2) from the gold gravels of California (Miocene) indicate that the aggregate condition was the general one in previous geological epochs. Hence on the basis of comparative anatomy and of geological record the aggregate ray seems to be the primitive one for the oak.

The compound ray was apparently an evolutionary response to the demands of a rigorous winter and to the need of storing up food in abundance. The fact, observable on any hillside in winter, that the oaks of northern latitudes, particularly the seedlings or saplings, retain their leaves late into the winter is an interesting evidence of their southern derivation. The older trees gradually become early deciduous.

Fig. 3 shows a transverse section of a stem of *Quercus rubra*. In the center is a compound ray, composed undoubtedly of homogeneous cells from which vessels and fibers are conspicuously absent. Fig. 4 shows some of these compound rays of the same species in tangential aspect. These may advantageously be compared with the tangential view of the aggregate rays of the birch as shown in fig. 2.

### Birch

WOUNDED STEMS.—Fig. 5 represents the polished disk of a wounded birch log, in which the wound has become so nearly healed that it appears far on the inside of the stem, and would not be discernible from the outside. The return to apparent normal conditions of growth is often very complete in the birch, and bark forms again on the outside. It also occasionally happens that bark grows over wounds of such large extent that the two edges of the injury have not grown together. This region of overgrowth or hypertrophy is known as the wound cap, and is represented at the top of the figure, above the wound. It may be noted in this connection that growth on the side of the stem which has

been wounded has been more rapid than on the lower side where there has been no disturbing influence.

The place in which reversionary structures make their appearance (in this case the aggregate rays) is usually not in the region of the wound nor yet in the wound cap, but in the region of slower growth opposite the wound. This fact will be more apparent when the microscopic features are discussed.

ROOT AND VEGETATIVE STEM OF *B. NIGRA*.—One of the most conservative organs of a plant is the root. Fig. 7 is a transverse section of a root of *B. nigra* showing two rays related to root traces. That these rays are aggregate in organization, and not diffuse, as are the leaf rays of the stem in figs. 1 and 2, may be seen by referring to a still higher magnification of these rays in fig. 8. Taking the root as an organ in which primitive features are long retained after they have been lost in the vegetative axis, it would seem that the aggregate ray is the primitive one for *B. nigra*.

Another conservative region is the node of the stem, and ancestral features are often found here in connection with the leaf ray. Fig. 9 shows a part of such a stem in this critical region in transverse section of *B. nigra*. Although the normal adult stem is characterized by diffuse rays, the aggregate type of organization is present in the first formed annual ring, itself a conservative region.

ROOT, SEEDLING, AND REPRODUCTIVE AXIS OF *B. ALBA*.—Passing from a species with typically diffuse rays, even in the reproductive axis, it is of interest to note the ray organization in significant regions of *B. alba*. As stated, the root which longest retains the older type of ray structure shows such a close resemblance to that of *B. nigra* in important anatomical features that for comparative purposes fig. 7 will illustrate the situation found in the root of *B. alba* sufficiently well. In both the ray organization is aggregate.

Fig. 10 represents a seedling of *B. alba* in transverse aspect, and even under low power the ray structure may be noted as aggregate. A higher magnification to show the detailed organization of one of the rays is not necessary, as they are anatomically similar to that shown in fig. 12 (a leaf ray through the reproductive stem of the same species). Fig. 11 is a low power magnification of a reproductive axis of *B. alba*. Here the decided aggregation of rays in

the foliar segment is a marked feature of the woody cylinder, in connection with contrast with that shown in fig. 9 for *B. nigra*. Fig. 12 shows one of these aggregate rays under a higher magnification.

Since the root, seedling, and reproductive axis of *B. alba* show the presence of aggregate rays, it may be assumed, on the basis of principles derived from the study of living and extinct Gymnosperms, etc., that the aggregate condition is the primitive or ancestral one in these species. This interpretation will be used in the present connection for determining the traumatic responses in wounded stems.

WOUNDED STEMS OF *B. ALBA*.—Fig. 13 represents a transverse section made through a wounded vegetative axis of *B. alba*. The marked acceleration in growth in the wound cap which appears at the top is to be noted, as well as the corresponding retarding on the opposite side. Even under low power the flutings in the annual rings formed after injury may be seen on the side of the stem away from or opposite the wound. These crenulations represent aggregate rays, which are not present in the normal wood, and mark the position where reversionary or traumatic features appear in wounded birch stems. The excessive hypertrophy which is so marked a characteristic of wounded birch stems does not seem to be favorable to reversion, since only diffuse rays are found in the wound cap itself. Fig. 14 is a tangential section through the region opposite the wound of the stem figured in fig. 13. The undoubtedly aggregate nature of the rays is evident. Fig. 15 shows some of these rays under a higher magnification, and the aggregation of rays and fibers is even more apparent.

WOUNDED SEEDLING OF *B. PAPYRIFERA*.—A species closely allied to *B. alba*, and having the normal wood structure of northern birches is *B. papyrifera*. Fig. 16 represents a transverse view of a wounded seedling of this species. The region where reversionary structures might be expected to occur is opposite the wound (X). Fig. 17 illustrates the condition in the immediate region of the hypertrophy. This is typical of the region of the wound cap in the birches in general. The ray organization in this instance is undoubtedly diffuse, and similar to that shown in the case of the normal stem wood of *B. nigra* (fig. 1).

Fig. 18 is a higher magnification of part of the region indicated by *X*, and is in decided contrast with fig. 17 in ray structure. Here the rays are aggregate in organization at the outer edge of the stem, in that part of the wood laid down after the stem had been wounded. The central part of the stem shows only diffuse rays similar to those in fig. 17. These aggregate rays are true reversions, and the place at which they appear (opposite the wound) is significant for the birches.

WOUNDED SEEDLING OF *B. POPULIFOLIA*.—Since aggregate rays are present as a typical feature of the normal stem wood of *B. populifolia*, it might be expected that they would die out in the region of the wound. This is precisely what does happen. Farther back, laterally, they make their appearance in the cylinder but not as traumatic features.

SUMMARY.—Text fig. 2 represents diagrammatically the ray situation obtaining in the root of *B. alba*, and of the genus as well. In the Betulaceae the aggregate type of ray is found universally in the root, essentially a conservative organ. This ray is in definite relation to the root traces, and is the primitive or ancestral type of ray for the genus.

Text fig. 3 represents a wounded stem of *B. alba*, and shows the comparative acceleration in growth of the wound cap and the rest of the cylinder. No aggregate rays appear in this region of marked hypertrophy. The reversionary structures appear opposite or behind the wound, on either side of the stem, and extend in some instances to the extreme opposite side of the woody axis. The seedling condition is represented in the central part of the figure, the aggregate rays appearing in connection with the foliar segment. The leaf gap is shown in black. The aggregate rays related to the foliar segment persist only through two or three annual rings, and then gradually become diffuse, the diffusion taking place first on the sides of the rays. The reproductive axis is also figured in connection with the foliar segments by supposing that the aggregation does not give way to the diffuse type of ray as in the seedling, but continues aggregate out into the cortex.

CONCLUSIONS.—That the aggregate ray is the primitive one for the birches is borne out by the fact that it is the type of ray

organization that persists in the roots of all species of the genus. The aggregate ray is also found in the reproductive axes of certain species, notably *B. alba*. It appears in the seedling in the mature stem of southern species, and as a result of injury when not normally present in the stem. *B. nigra*, which has diffuse rays in the stem, recalls the aggregate type upon injury to the vegetative axis, and shows an aggregation normally in connection with the root trace. *B. papyrifera*, a northern species, recalls aggregate rays in

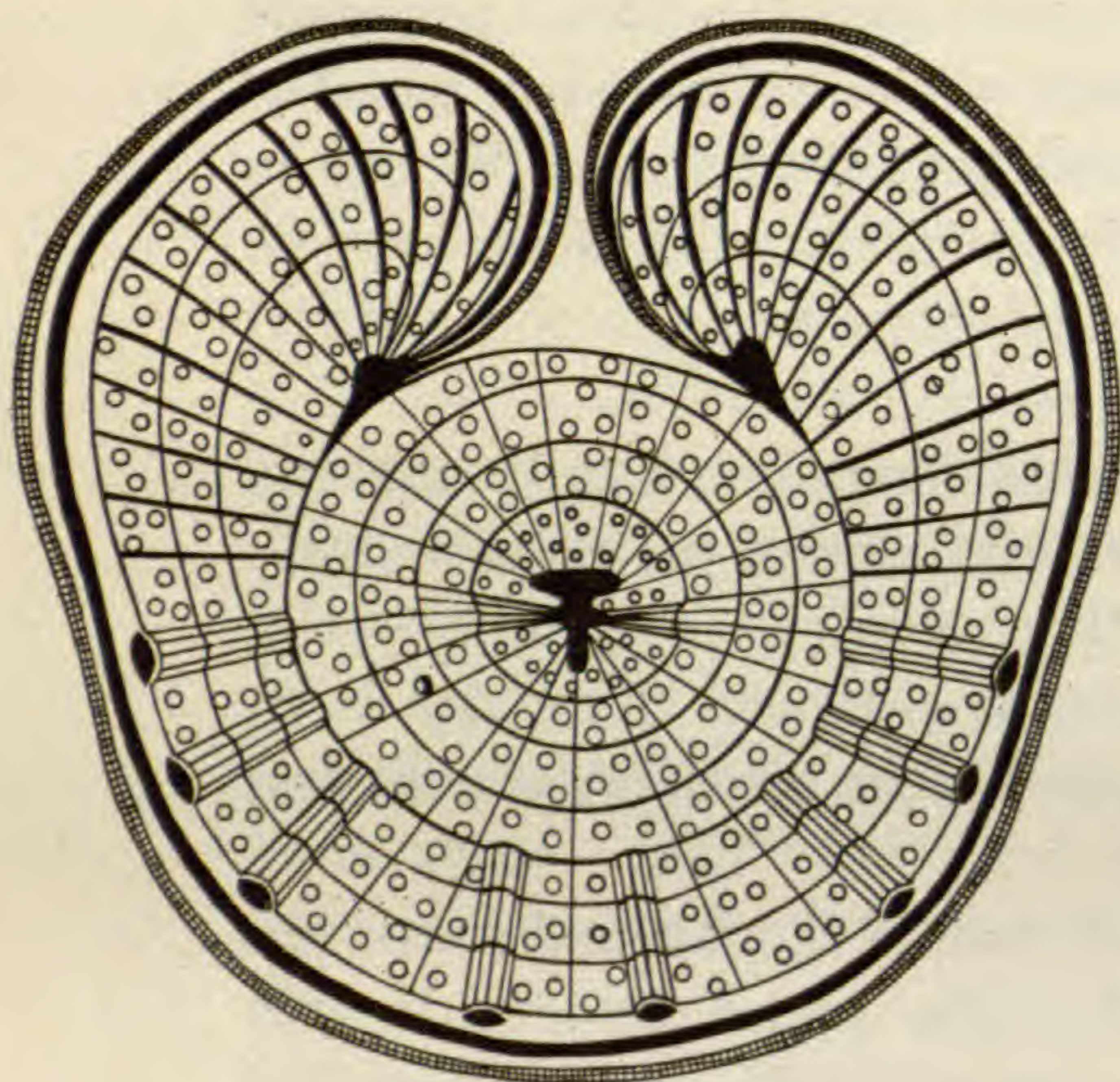

FIG. 3

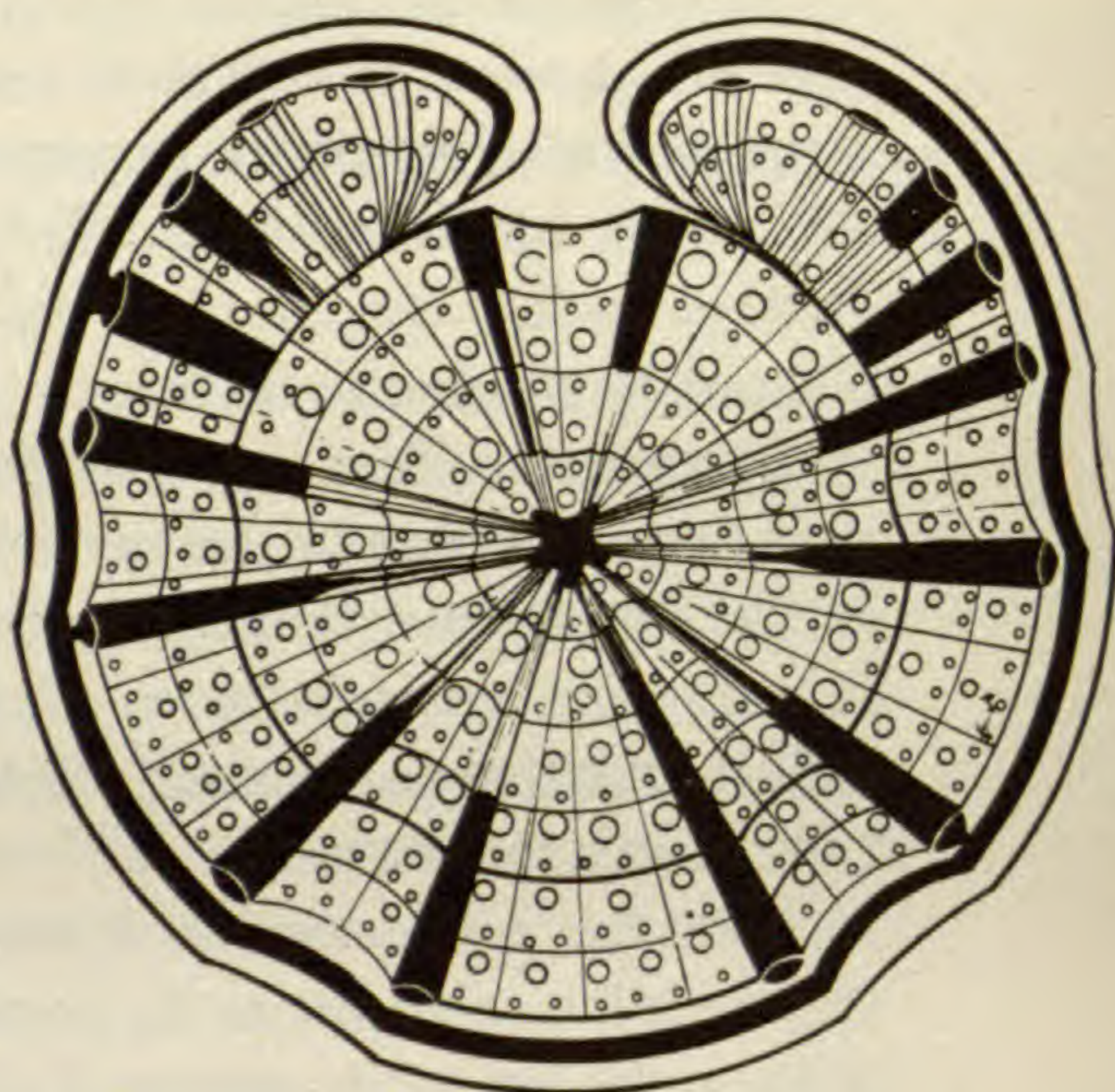

FIG. 4

FIGS. 3, 4.—Fig. 3, diagram of wounded birch stem, showing relations and positions of traumatic features; fig. 4, diagram of oak stem, showing seedling condition and traumatic behavior of ray structures.

the seedling as a consequence of injury. Traumatic reactions should be interpreted in the light of data gained from the organization of conservative regions, etc.

Reactions occurring in the wound cap are the result of hypertrophy and are not to be considered as reversions, since they are not correlated with structures that are known from their distribution in the seedling and conservative regions to be primitive. True reversions in the birch, as exemplified in this investigation by *B. alba* and *B. papyrifera*, occur opposite the wound and not in the wound cap. *B. populifolia*, which has aggregate rays in the

normal wood, loses them as a result of wounding except in connection with the appendage, when they may appear in the wound cap.

### Abies

It will be helpful to summarize the wound reaction situation in Conifers. From the point of view of wound reactions two features are significant, resin canals and ray tracheids. The Abietae show a simplification or reduction of wood organization in lacking both of these characters in the normal wood (3). The root, however, has resin canals as a normal feature of its structure.

In *Abies*, which has neither resin canals nor marginal ray tracheids in the normal stem wood, the situation in regard to reversion is interesting, because both resin canals and ray tracheids are recalled as a result of injury. There is a significant feature, however, in connection with the reappearance of these traumatic characters which parallels the situation obtaining in the angiospermous groups under consideration. It has been pointed out by THOMPSON (8) that marginal ray tracheids which are not normally present in the fir may be recalled as a consequence of injury, and that reversion takes place opposite the wound. JEFFREY (6) had earlier shown that in the case of a wounded stem of *Cunninghamia sinensis* marginal ray tracheids, which are not a feature of normal stem organization, are recalled, and that these make their appearance opposite the wounded region.

The appearance of traumatic resin canals as a result of injury is of special interest from the fact that they do not reappear in the region opposite the wound, as do the marginal tracheids, but in the wound cap itself. This condition, as will be evident later, parallels the situation in *Quercus* in connection with reversionary ray structures.

### Oak

WOUNDED STEMS.—Fig. 6 represents the polished end of a wounded oak log *Q. rubra*. In this instance the healing has not been so complete as it was in the birch, and therefore the wound cap is restricted to the sides of the actual injury. This would be expected as a result of the slow growth of the oak, and accordingly reversionary structures will be expected in the wound cap itself, and

not in the region opposite. Thus it is seen that the place at which reversionary structures occur depends on the localization and nature of the hypertrophy.

ROOT OF *Q. RUBRA*.—The ray structure of the roots of northern oaks is aggregate. Fig. 19 shows a transverse section of a root of *Q. rubra* in which the aggregate nature of the rays is apparent. The details of the aggregation may be seen to better advantage in fig. 20, which represents one of these rays under higher magnification. In the central part of the ray the organization is more parenchymatous than on the outer edges. The aggregate condition persists in the roots of the most mature trees, and is good evidence that the ancestral type of oak ray is aggregate, if it be admitted that the root more than any other organ longest retains primitive features.

Fig. 21 is a tangential section through a root of *Q. rubra*, and the undoubtedly aggregate condition that it presents may be compared with the tangential aspect of ray organization in the stem as represented in fig. 4.

SEEDLING.—The oak seedling in its younger stages has clearly developed aggregate rays. In the older saplings the aggregation may be noted in the first formed annual rings. In the successive annual rings the aggregate type passes over into the compound ray. No separate illustration of this is given because it resembles so nearly that described for the root. Seedlings of *Q. rubra*, *Q. velutina*, and *Q. alba* all show aggregate rays, so it may be assumed that it is a general situation for the genus.

REPRODUCTIVE AXIS.—The reproductive axis of the oak does not show aggregate rays. They have disappeared in the genus probably because there is no longer any definite localization of the acorn-bearing branches, as in the ovuliferous aments of birches. Species of oak of extra-tropical range have in general lost the catkin-bearing habit (in the case of the female flowers).

STEM.—The situation in the oak regarding wounding is somewhat different from that of the birch. The recovery from injury is much slower, and the conditions of atrophy are more marked in the region of the wound than those of hypertrophy. Aggregate rays (1), similar to those figured as normal in the root and seedling,



however, appear in response to a mechanical stimulus, as in the birch.

Fig. 22 represents a transverse section of a wounded stem of *Q. velutina*. The extent of the wound is considerable, and healing has taken place to a comparatively small degree. The wound cap is restricted as a consequence to the edges of the wound, and it is here that reversionary structures make their appearance. The immediate region of the wound cap blots out all large rays, but directly behind this laterally the rays become aggregate, and finally compound again as they approach the back of the stem. Fig. 23 shows some of the rays in the wound cap of fig. 22 under higher magnification. Here the aggregate nature of the rays is quite apparent, especially if it be compared with that showing a typical compound ray (fig. 3). In the immediate vicinity of the wound the rays are all small, and in tangential section appear similar to the diffuse rays of the birch. If one were to interpret conditions here as being reversions, with no reference to the other parts of the stem or to conservative regions, he would have to postulate the diffuse ray as the primitive one for the oak, a situation which is in no wise borne out by the facts of the case, as in neither fossil forms nor in conservative regions of existing species are diffuse rays found. This illustrates the danger of judging traumatic features on their face value without regard to other organs or to the past history of the plant. Only those structures occurring as a result of wounding which can be shown to be characteristic of southern and fossil forms, or of the seedling or conservative regions, can be accepted as significant in connection with wounding in the northern species.

Fig. 24 represents under fairly high magnification a traumatic wood ray of *Q. velutina* in transverse section. It is also illustrative of the manner in which the aggregate ray of the seedling becomes compounded in the older saplings.

It is of interest to note in connection with wound reactions that oak galls produce a return to aggregate condition similar to that ensuing when a stem is wounded in any other way. The organization of the gall itself is complicated, and need not be considered in the present connection.

SUMMARY.—The general situation obtaining in seedling oaks and wounded stems may be seen by referring to text fig. 4, which is a schematic representation of a wounded oak stem, and illustrates the position of reversionary features on the edge of the wound cap. These reversionary rays are represented by a series of parallel lines, in contrast with the compound rays, which are solid black. Traumatic aggregate rays occur in the wound cap itself, and laterally they pass over into the normal compound type. A comparison with text fig. 3, representing a wounded birch stem, brings out the important difference in respect to wound reaction and the position of traumatic features in *Betula* and *Quercus*. The transition from aggregate to compound ray in the seedling stem is shown in the center, in which the compound character of the ray is represented in solid black as the ray approaches the periphery of the stem.

CONCLUSIONS.—The northern oaks in their vegetative axes have the compound type of ray typical of the herbaceous forms. On the other hand, the southern oaks have aggregate rays in the adult stem, and fossil representatives of the genus are likewise characterized by the presence of aggregate rays. The seedling and the root of living northern species possess aggregate rays. There is no special localization of the reproductive branches in the oak as in the amentiferous forms like the birch. This region, therefore, which is ordinarily of importance in connection with the determination of primitive structure, is of no value here.

Wounding brings back aggregate rays in the adult axis, and in the older seedlings which have begun to form compound rays. The results of injury here, as in the birch, must be interpreted with reference to the nature and extent of the wound. The wound cap of the oak is much smaller than that of the birch, and does not so often show hypertrophy to any marked extent. Reversionary structures accordingly appear on the edge of the wound in the wound cap proper, slightly behind the immediate region of injury. Oak galls stimulate reversion to an aggregate type of ray structure.

### Summary

1. Experimental investigations are of interest in connection with woody plants both from a general biological point of view,

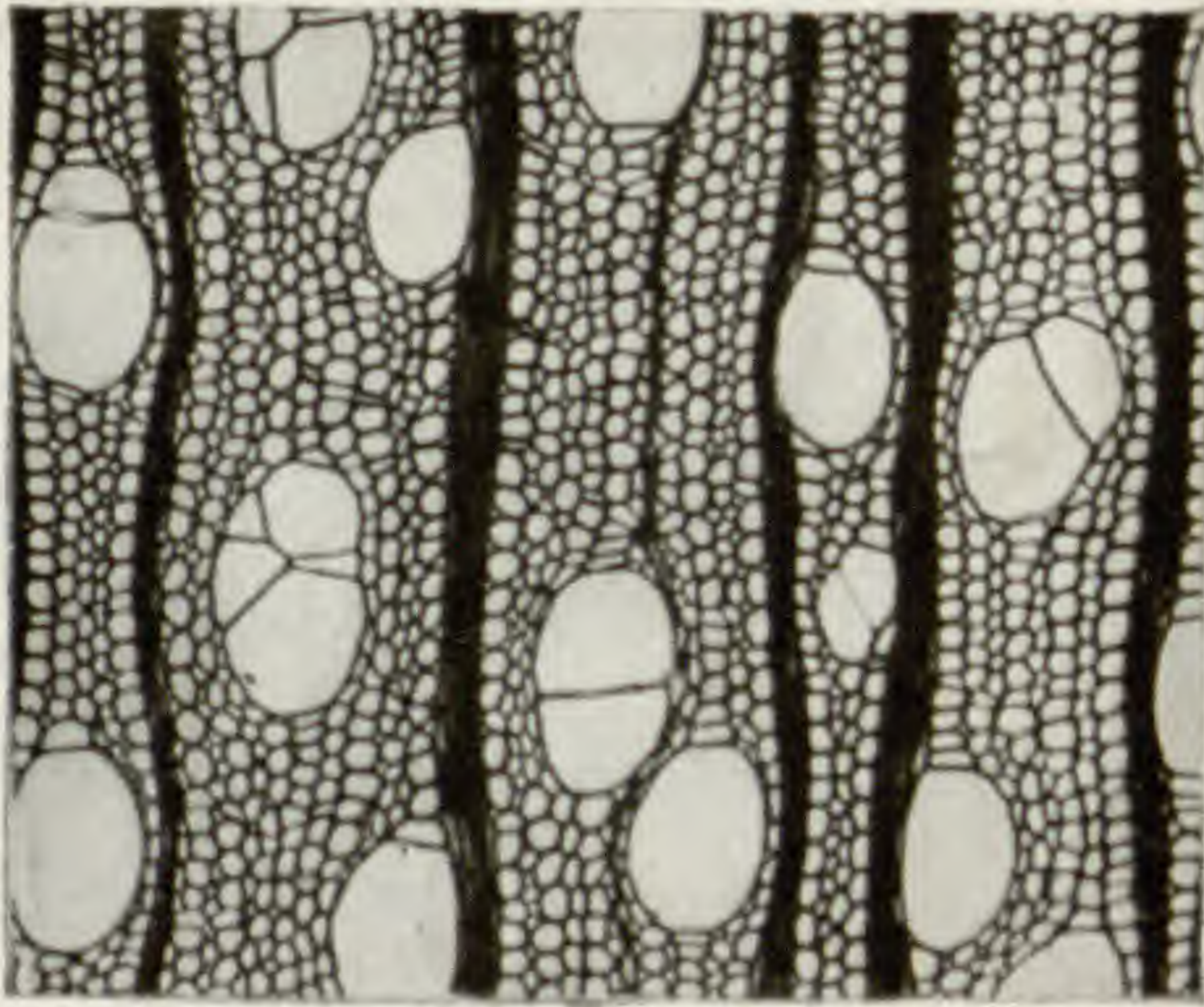

1



2

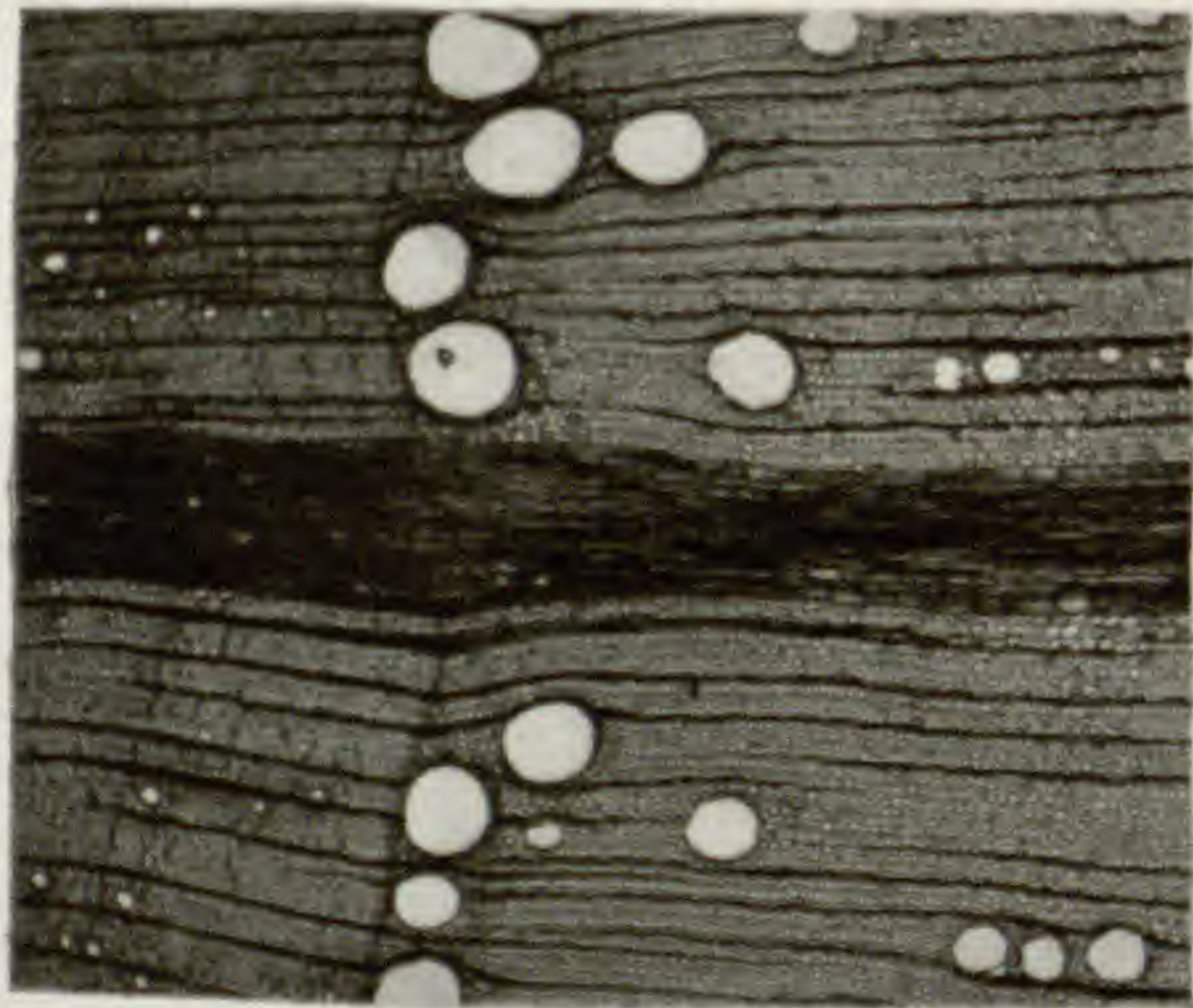

3



4



5



6

WHITAKER on BIRCH and OAK



7

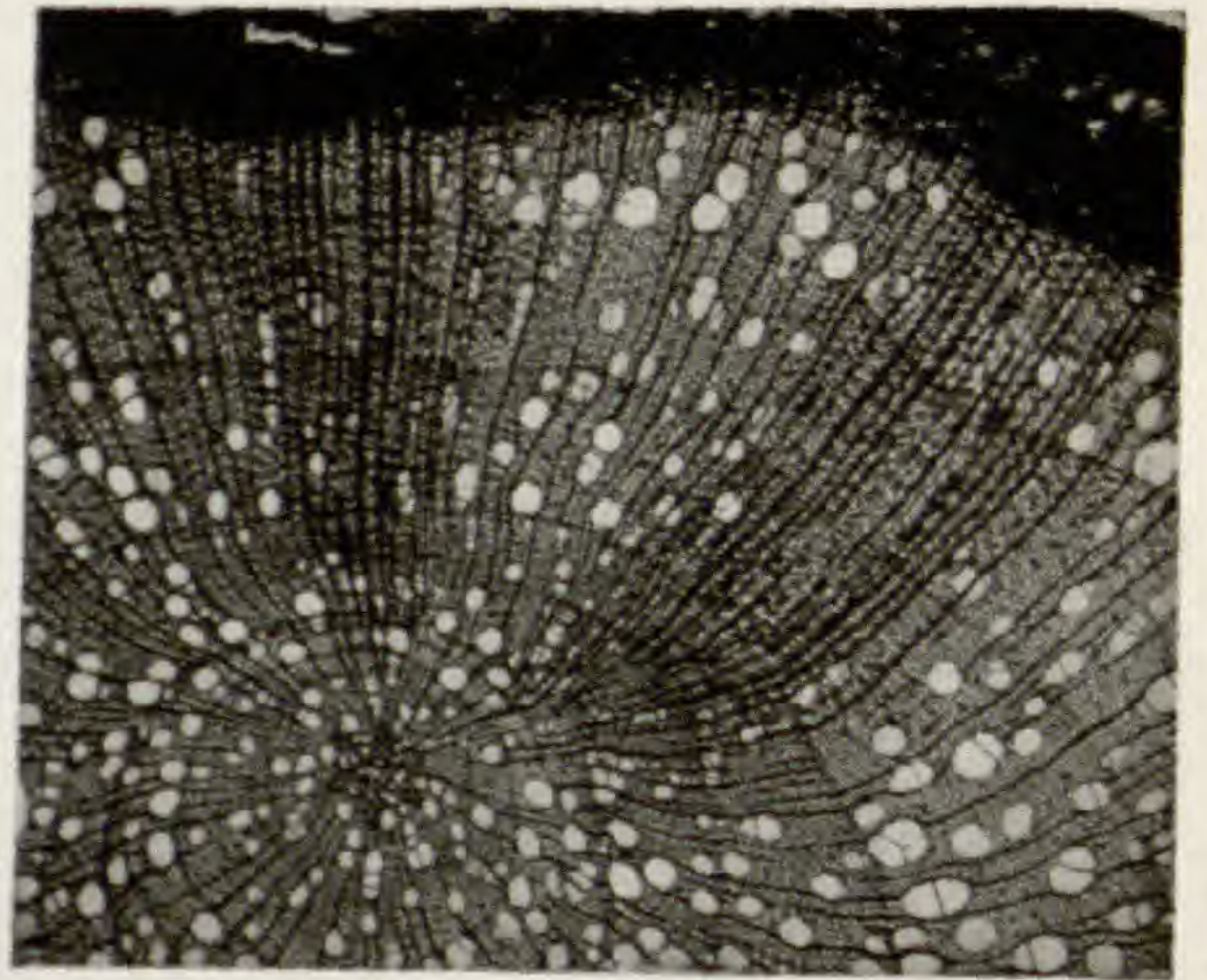

8

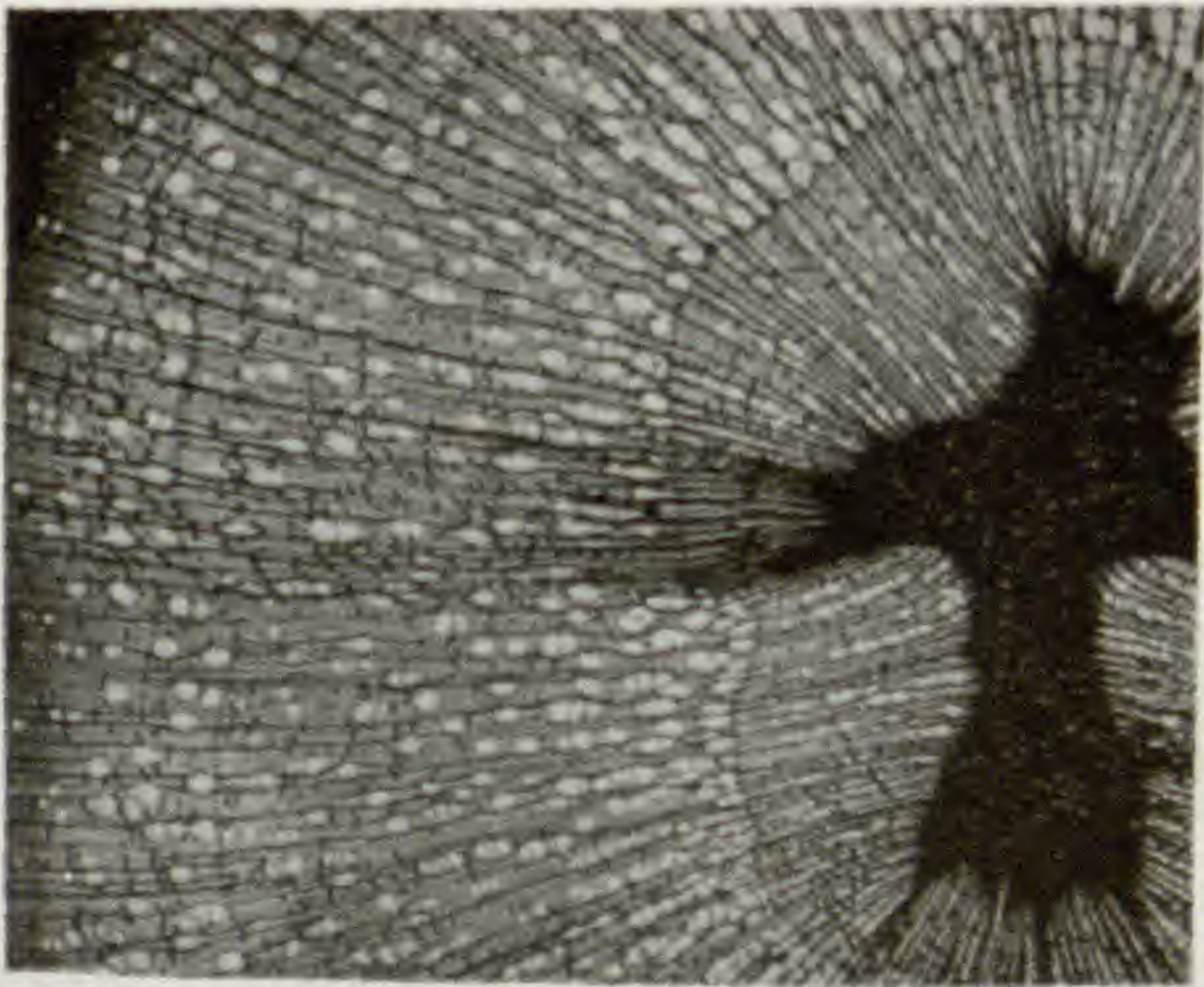

9



10



11

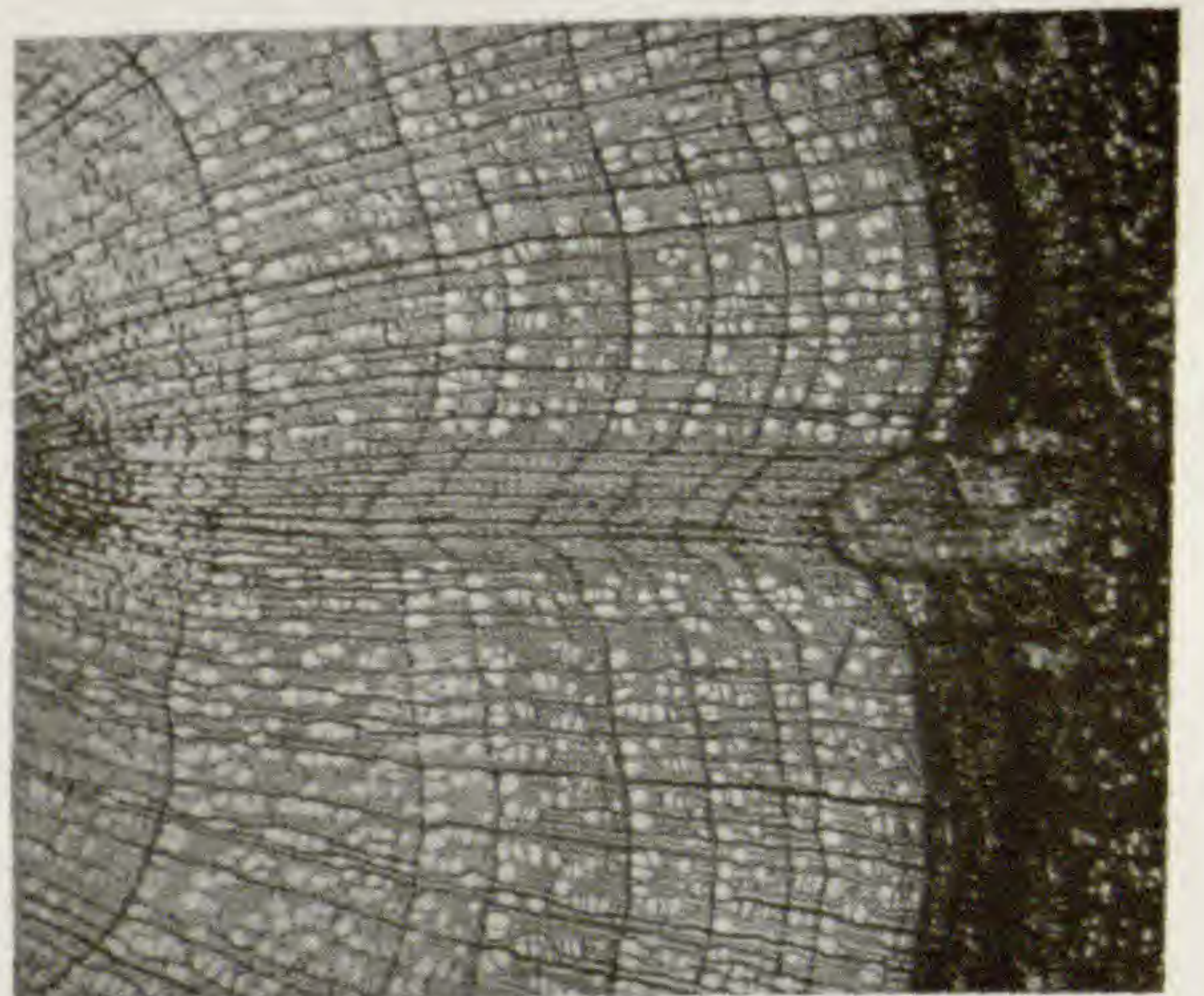

12

WHITAKER on BIRCH and OAK



13

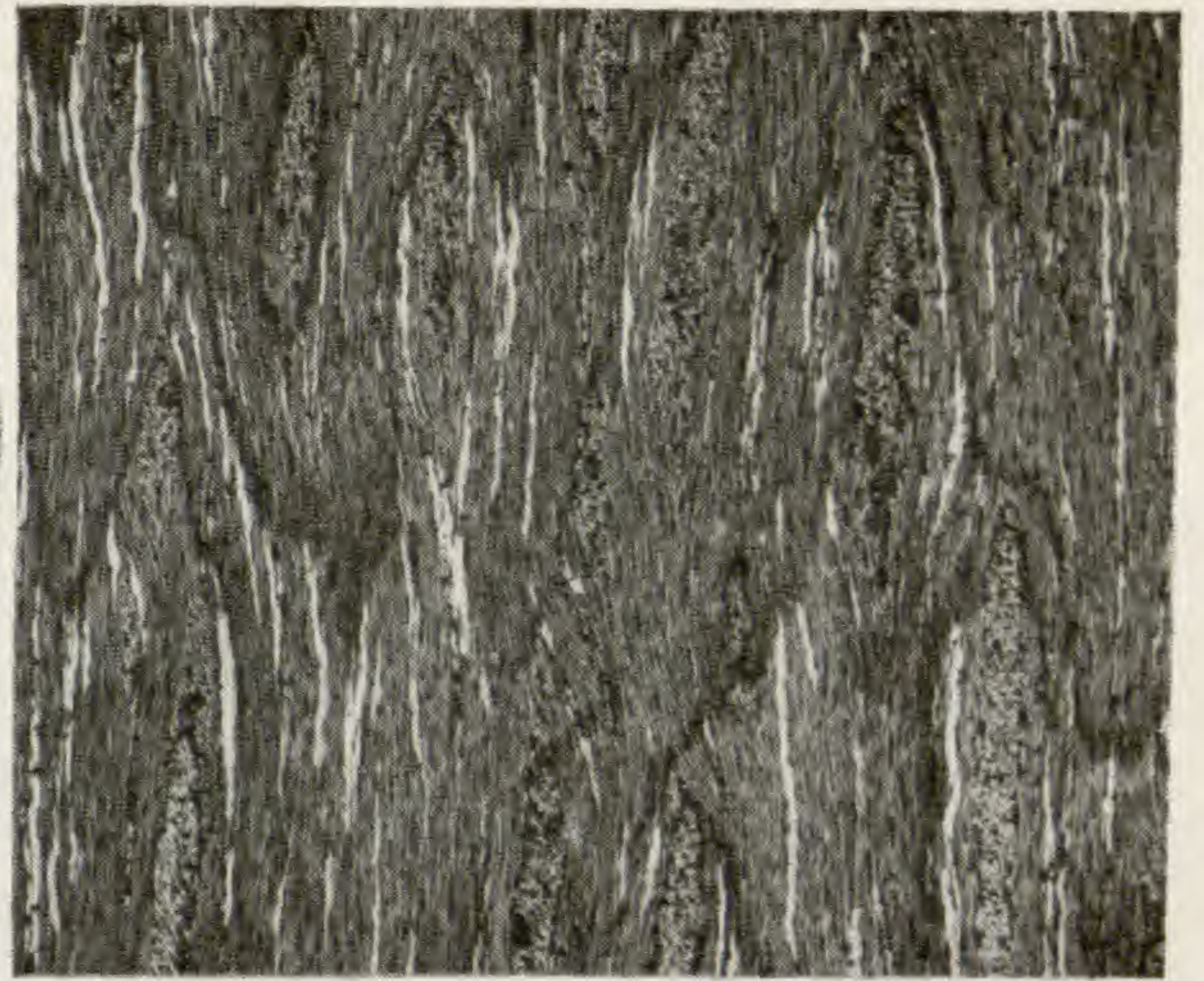

14

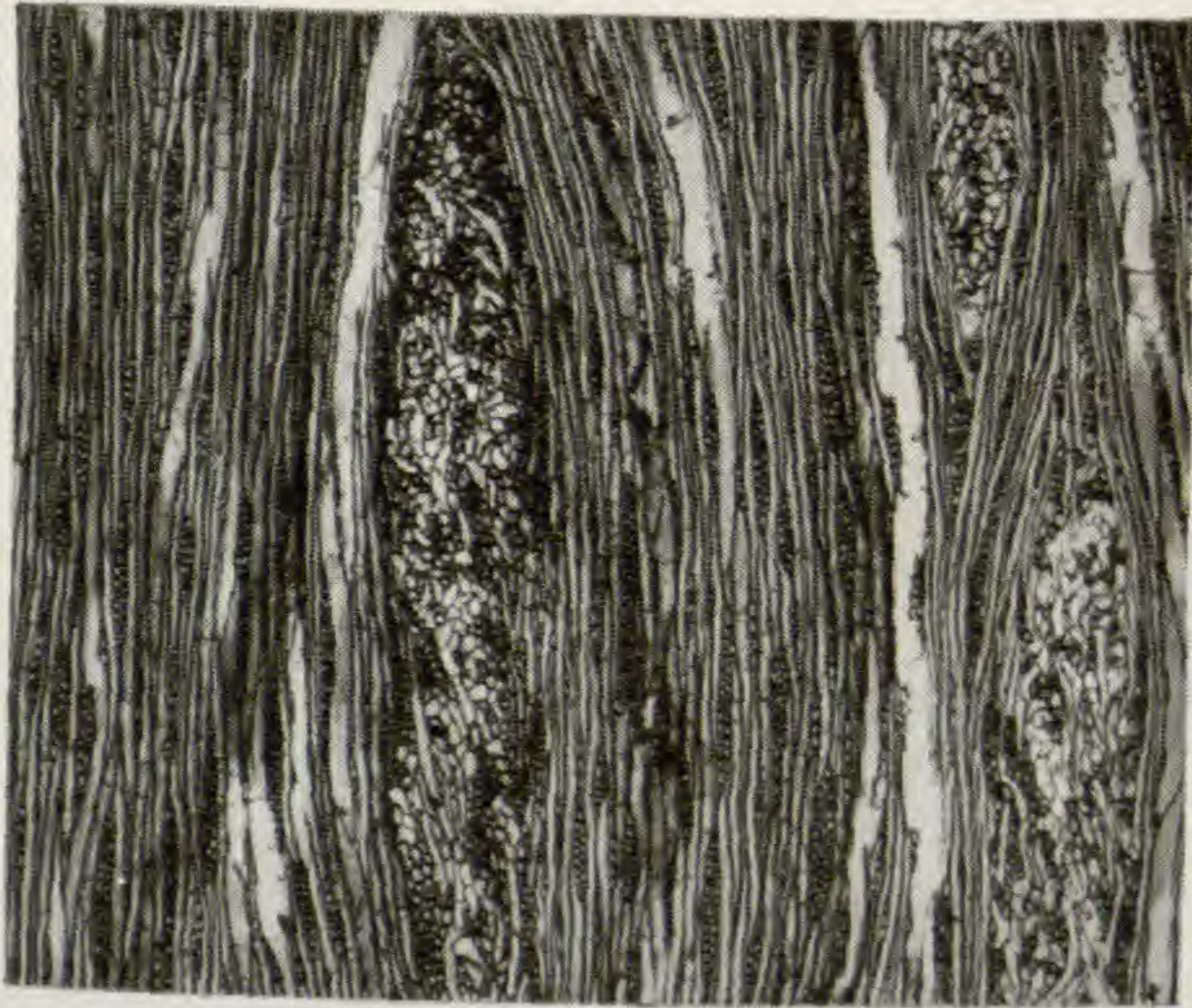

15

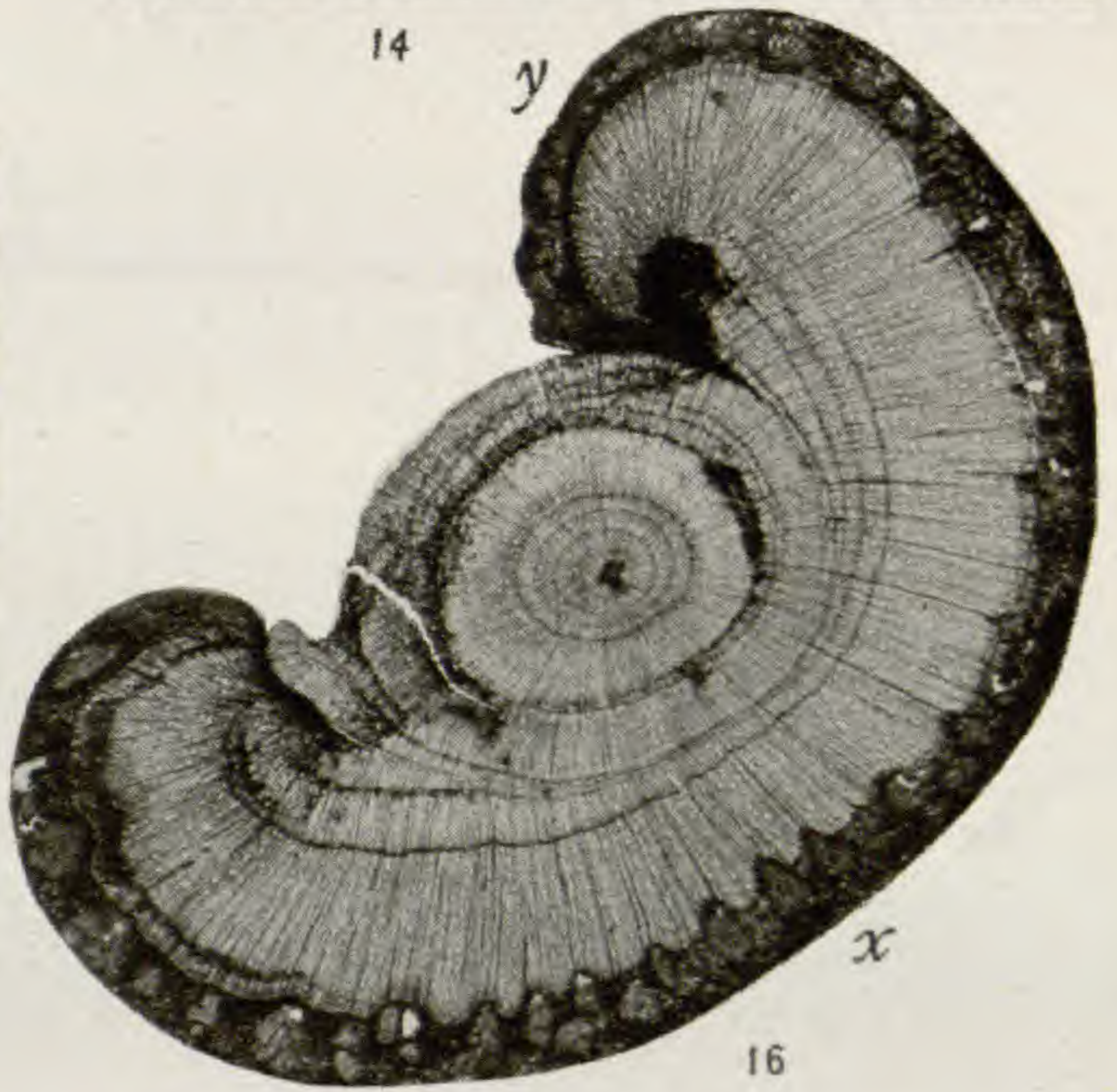

16

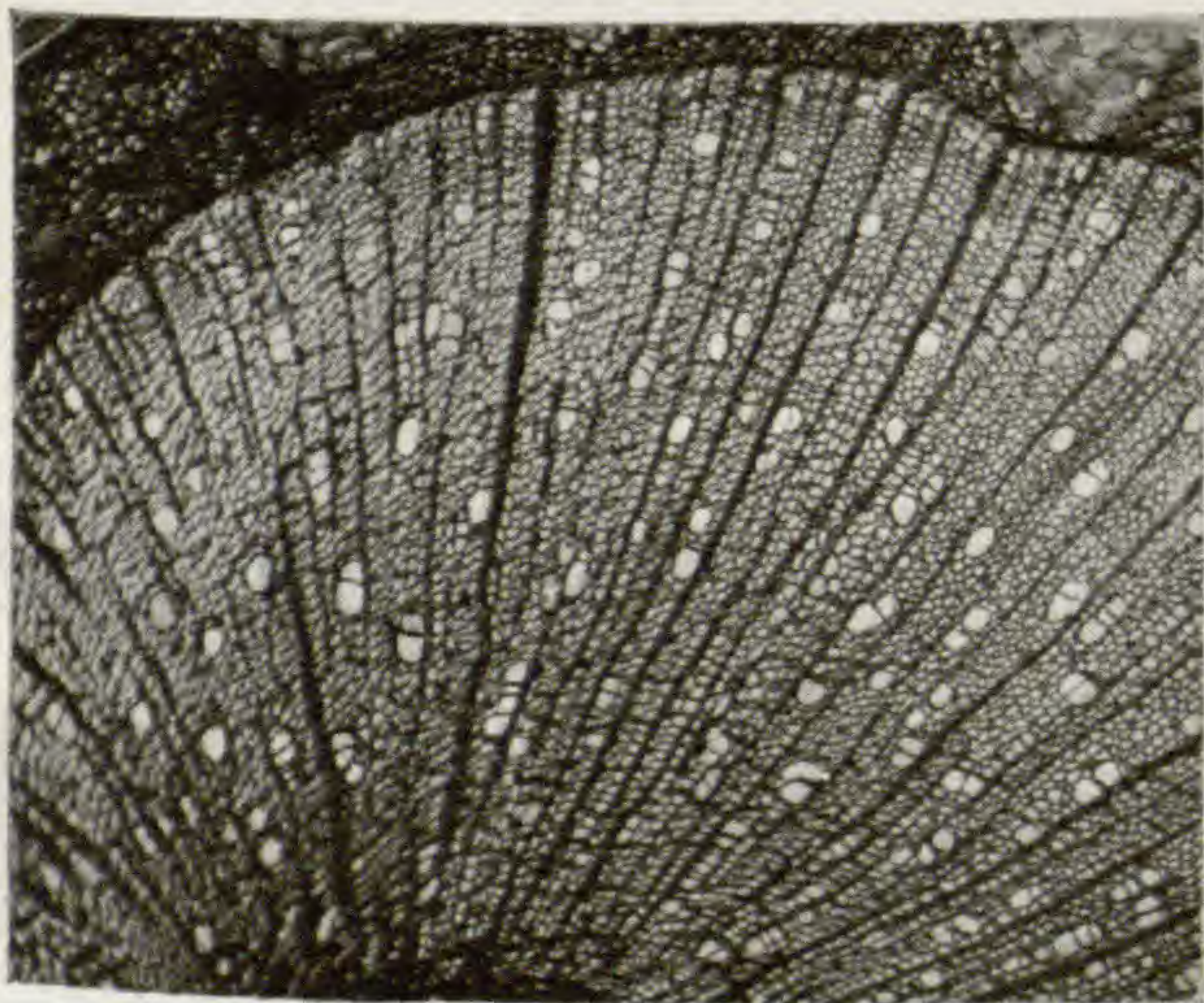

y

17

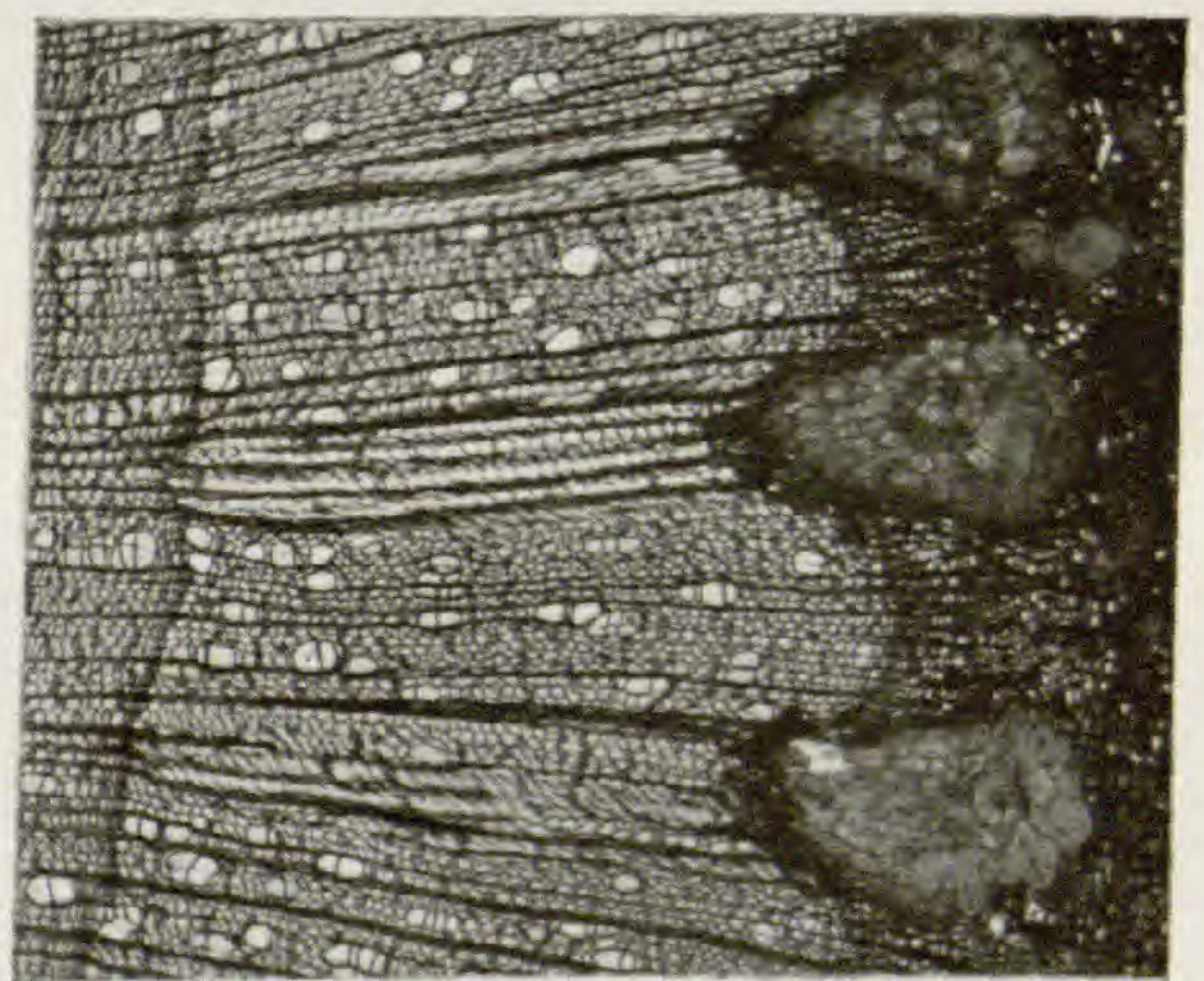

x

18

WHITAKER on BIRCH and OAK

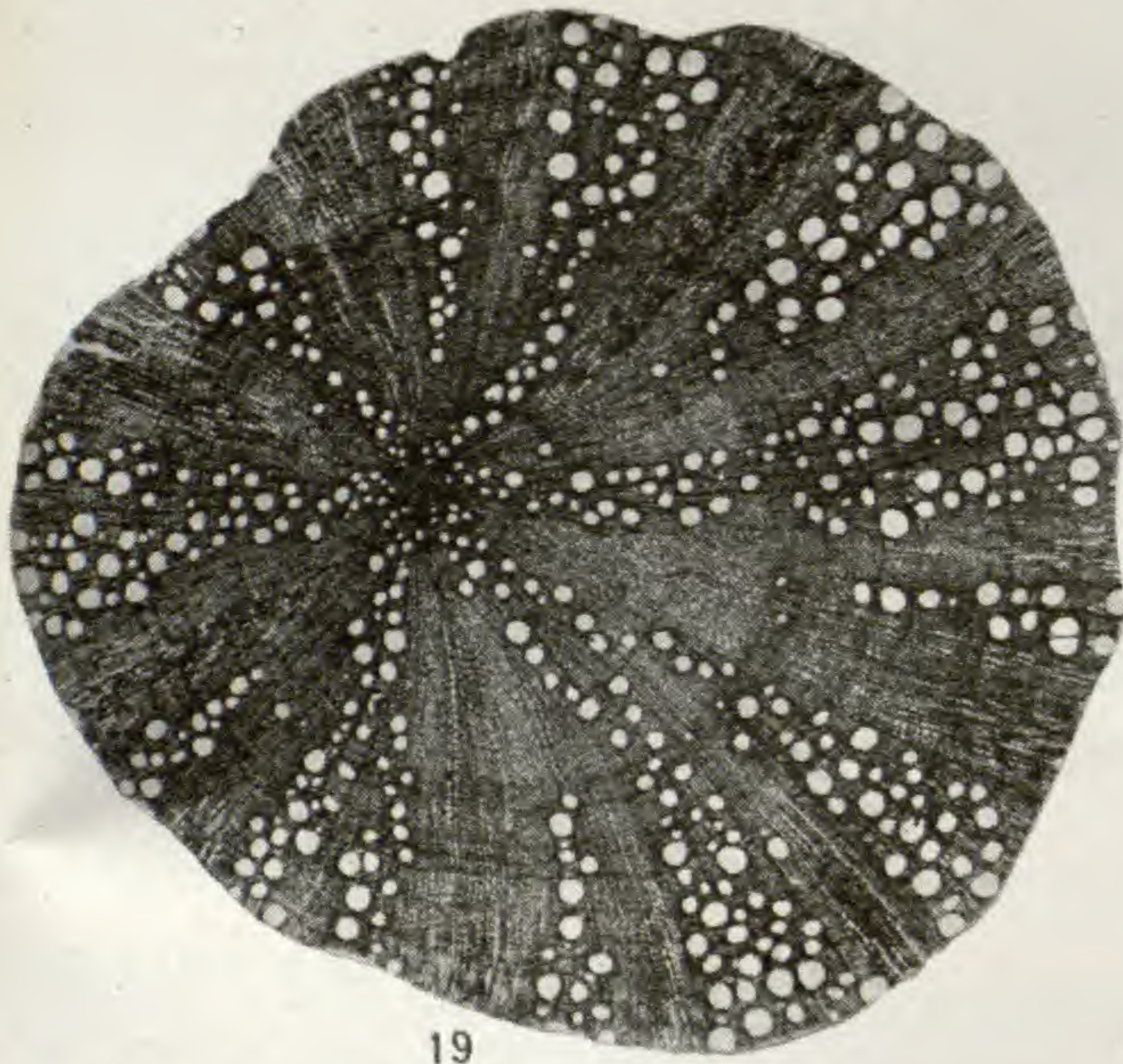

19

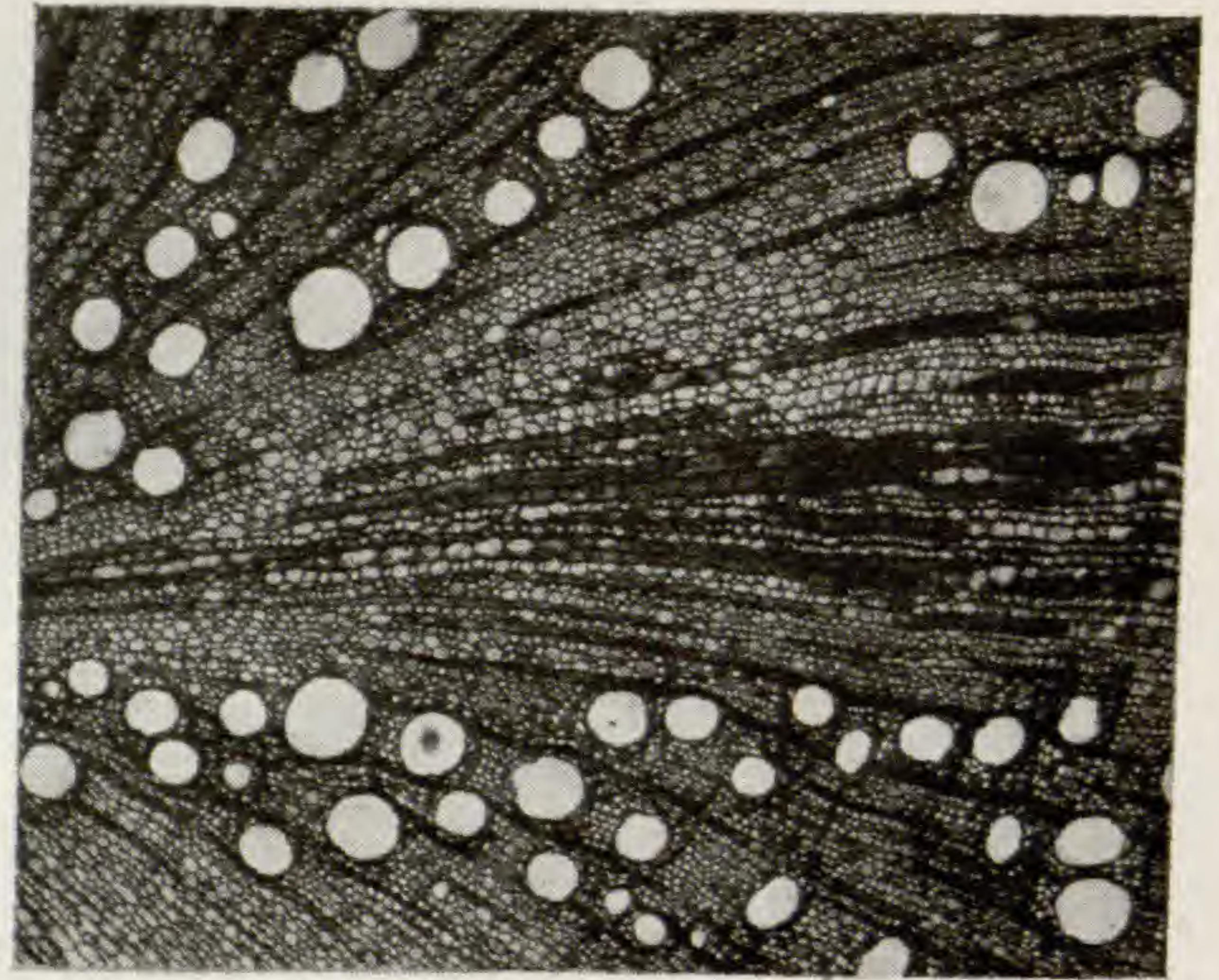

20

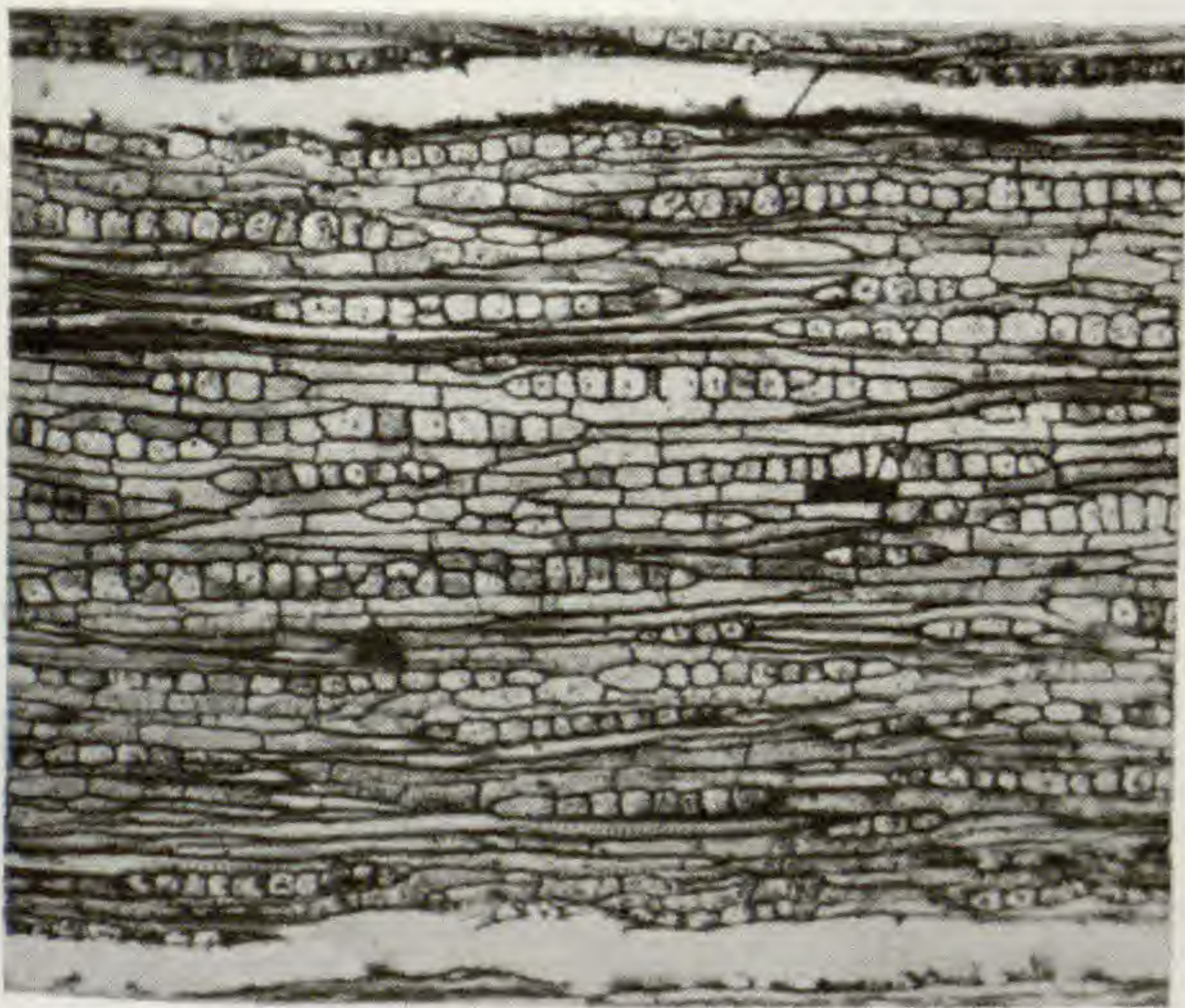

21

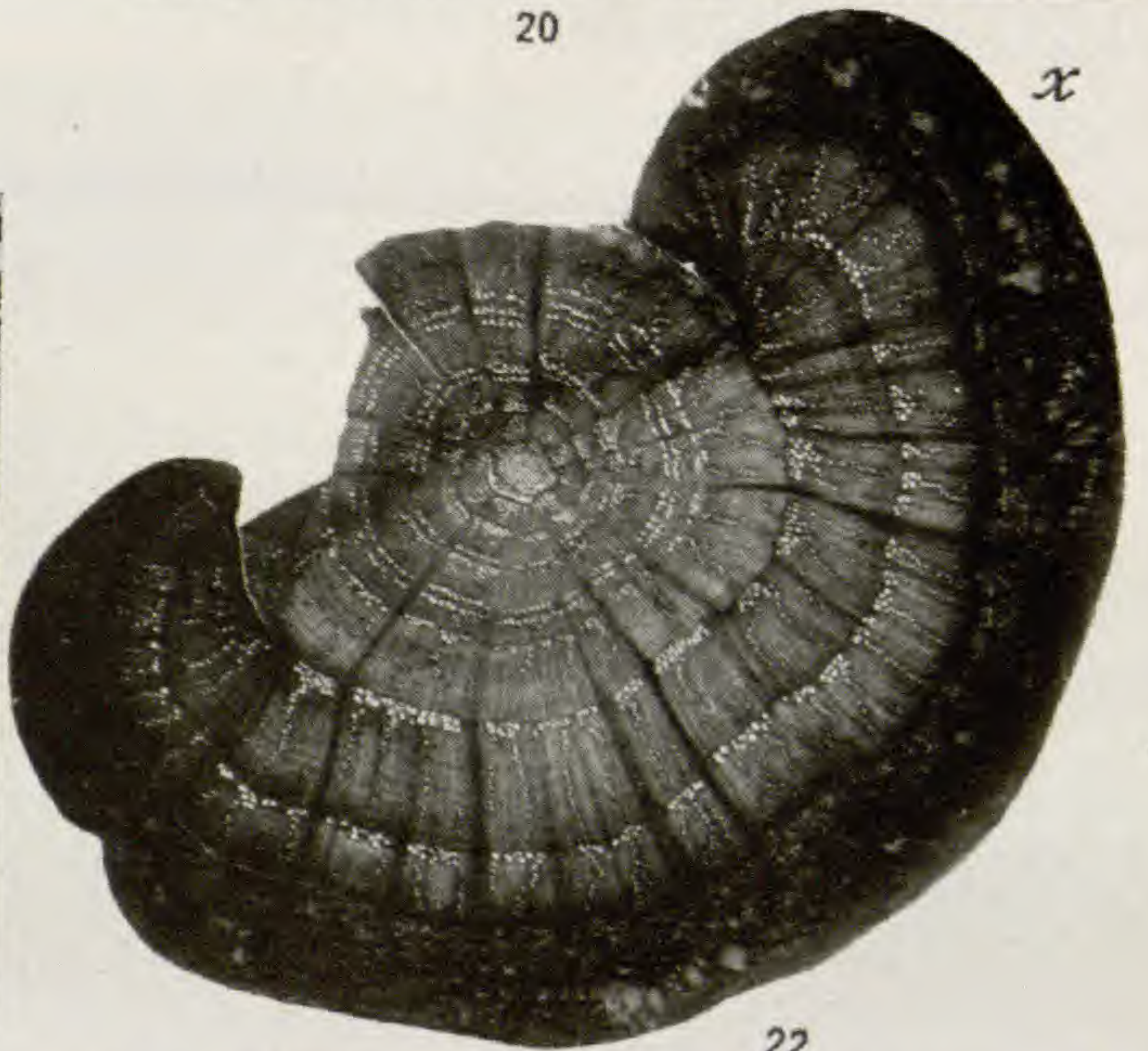

x

22

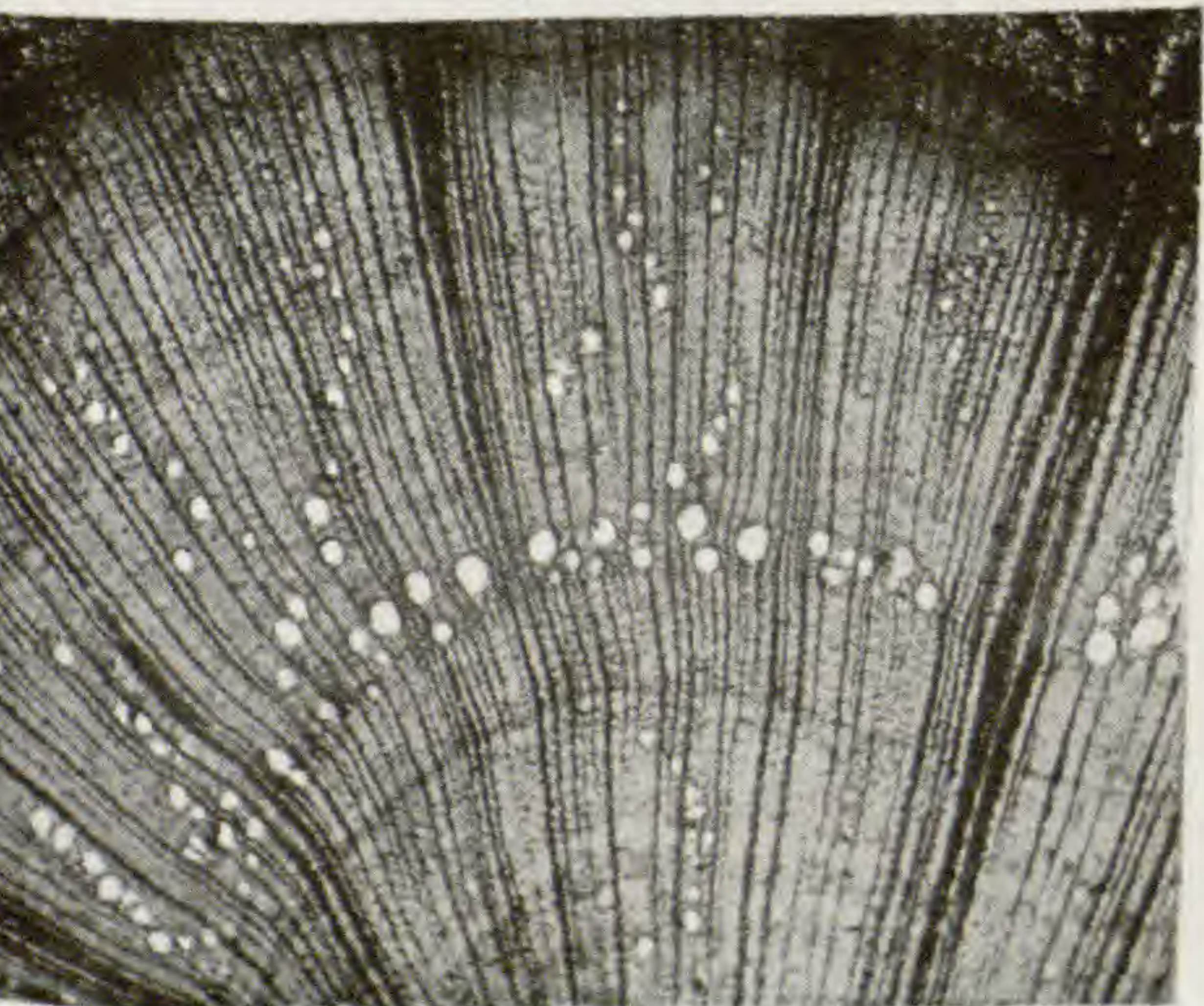

23

x

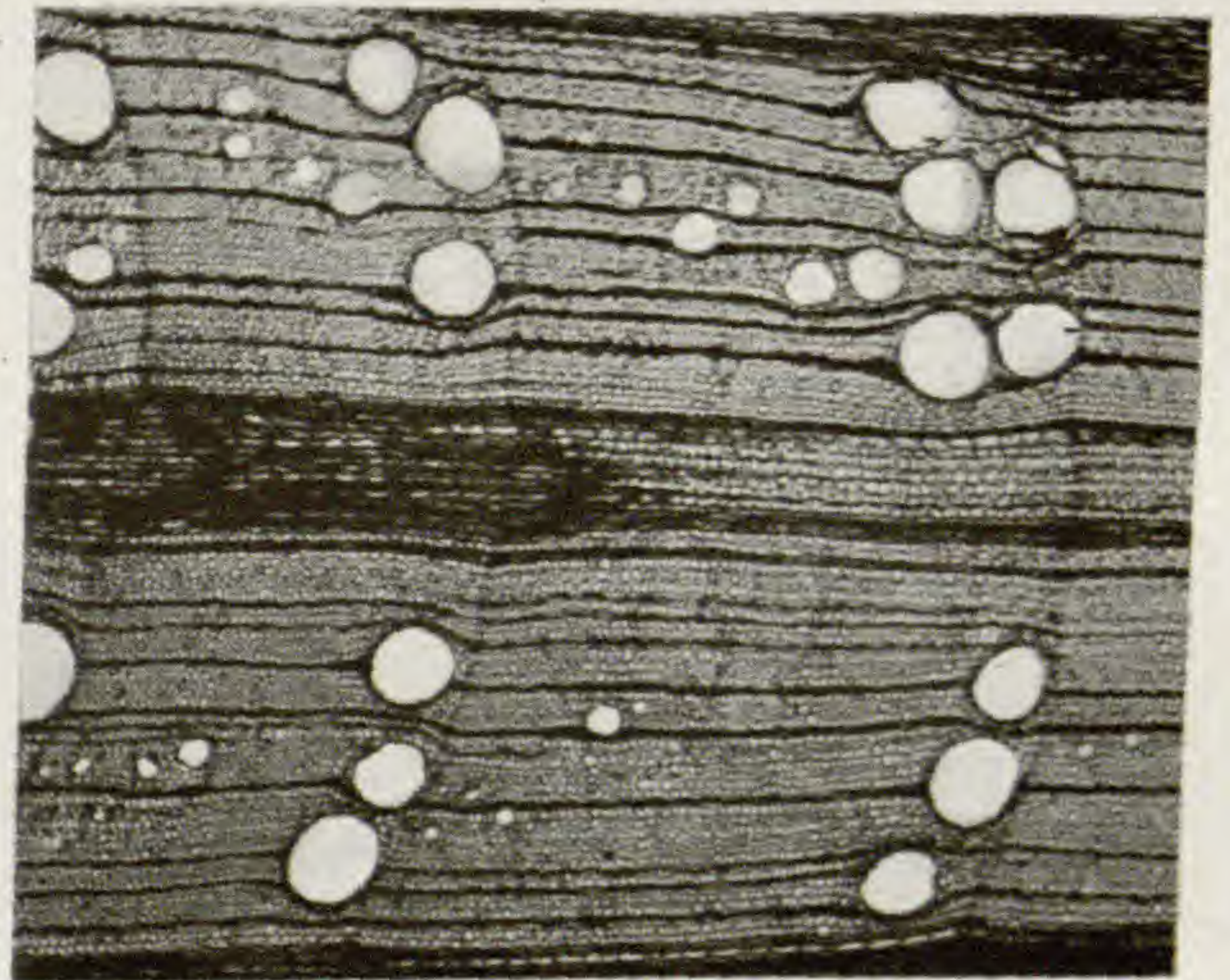

24

and also from the standpoint of plant pathology. They are also of interest because they suggest the possibility of producing ornamental woods experimentally.

2. Three types of rays, aggregate, compound, and diffuse, which persist contemporaneously in *Casuarina*, are characteristic of angiospermous trees. The aggregate seems to be the more primitive one, from which the diffuse and compound have been derived by different processes of evolution.

3. Wound reactions in woody forms must be considered with reference to the conservative regions, the seedling structures, and fossil record, because only those structures occurring as a consequence of injury which have parallel conditions in these parts can be regarded as true reversions.

4. Work on living and extinct Gymnosperms has established certain principles on the basis of which experimental investigations in angiospermous woods may proceed a priori.

5. All reactions following wounding are not true reversions. In general extreme hypertrophy is not favorable to reversion.

6. The details of wound reaction in the birch and oak are different. In the birch the wound cap is large, the hypertrophy being very marked. As a consequence the traumatic or reversionary features are not found in this region, but in that part of the cylinder opposite the wound.

7. *Abies* recalls marginal ray tracheids as a consequence of wounding. These are found in the regions remote from the wound and parallel the situation obtaining in the birch. On the other hand, the mode of appearance of traumatic resin canals is similar to that of the aggregate rays resulting from injury to northern oaks, as the reversionary resin canals occur in the immediate region of the wound cap.

8. In the oaks the wound cap is small and does not show hypertrophy to any marked extent. Correlated with this, reversionary features appear in the wound cap proper, in contrast to the birches.

In conclusion, I wish to thank Professor E. C. JEFFREY, under whose direction this investigation has been made, for advice, material, and the use of text fig. 1 from his recent book, *The Anatomy of Woody Plants*; also my father for assistance in securing material.

## LITERATURE CITED

1. BAILEY, I. W., Reversionary characters of traumatic oak woods. BOT. GAZ. 50:374-380. 1910.
2. EAMES, A. J., On the origin of the broad ray in *Quercus*. BOT. GAZ. 49:161-167. 1910.
3. HOLDEN, R., Ray tracheids in Coniferales. BOT. GAZ. 55:55-66. 1913.
4. JEFFREY, E. C., The comparative anatomy and phylogeny of the Coniferales. Part I. The genus *Sequoia*. Mem. Bos. Soc. Nat. Hist., Nov., 1903.
5. ———, *Ibid.*, Part II. The Abietineae. Mem. Bos. Soc. Nat. Hist., Jan., 1905.
6. ———, Traumatic ray-tracheids in *Cunninghamia sinensis*. Ann. Botany 22:593-602. 1908.
7. ———, The anatomy of woody plants. University of Chicago Press. 1917.
8. THOMPSON, W. P., Ray tracheids in *Abies*. BOT. GAZ. 53:331-338. 1912.

## EXPLANATION OF PLATES XII-XV

## PLATE XII

FIG. 1.—Transverse section of normal stem wood of *Betula nigra*, showing diffuse rays.

FIG. 2.—Tangential view of same.

FIG. 3.—Transverse section of normal stem of *Quercus rubra*, showing compound ray.

FIG. 4.—Longitudinal section of same, showing compound ray in tangential aspect.

FIG. 5.—Transverse view of wounded stem of *Betula alba*.

FIG. 6.—Transverse section of wounded stem of *Quercus rubra*.

## PLATE XIII

FIG. 7.—Transverse section of root of *Betula nigra*.

FIG. 8.—Part of same more highly magnified to show aggregate ray.

FIG. 9.—Transverse section through nodal region of *B. nigra*, showing one of leaf traces.

FIG. 10.—Transverse section of seedling stem of *B. alba*.

FIG. 11.—Transverse section of reproductive axis of *B. alba*.

FIG. 12.—Part of same more highly magnified.

## PLATE XIV

FIG. 13.—Transverse section of wounded stem of *Betula alba*.

FIG. 14.—Tangential section through region opposite wound in stem of *B. alba*.

FIG. 15.—Part of same more highly magnified to show aggregate character of rays.



FIG. 16.—Transverse section of wounded seedling stem of *B. papyrifera*.

FIG. 17.—Part of same in wound cap, more highly magnified, showing diffuse type of ray structure.

FIG. 18.—Part of same opposite wound, showing aggregate character of rays.

PLATE XV

FIG. 19.—Transverse section of root of *Quercus rubra*.

FIG. 20.—Part of same more highly magnified, illustrating aggregate character of ray organization and showing transformation into parenchyma taking place in central part of ray.

FIG. 21.—Tangential section through root of *Q. rubra*, showing aggregate ray structure.

FIG. 22.—Transverse section of wounded stem of *Q. velutina*.

FIG. 23.—Part of same through wound cap, more highly magnified to show aggregate rays.

FIG. 24.—Transverse section through wound cap of another specimen of same species, showing transformation from aggregate to compound type of ray organization.

## BRIEFER ARTICLES

---

JOHN MACOUN

(WITH PORTRAIT)

Professor JOHN MACOUN, the well known Canadian naturalist, died July 18, 1920, at Sidney, British Columbia, after a long career in natural science, having given much to the world and brought great credit to the Dominion and to himself.

Being equally well versed in zoology and botany, his death is a severe loss to natural science. Even at the age of 89 years, Professor MACOUN

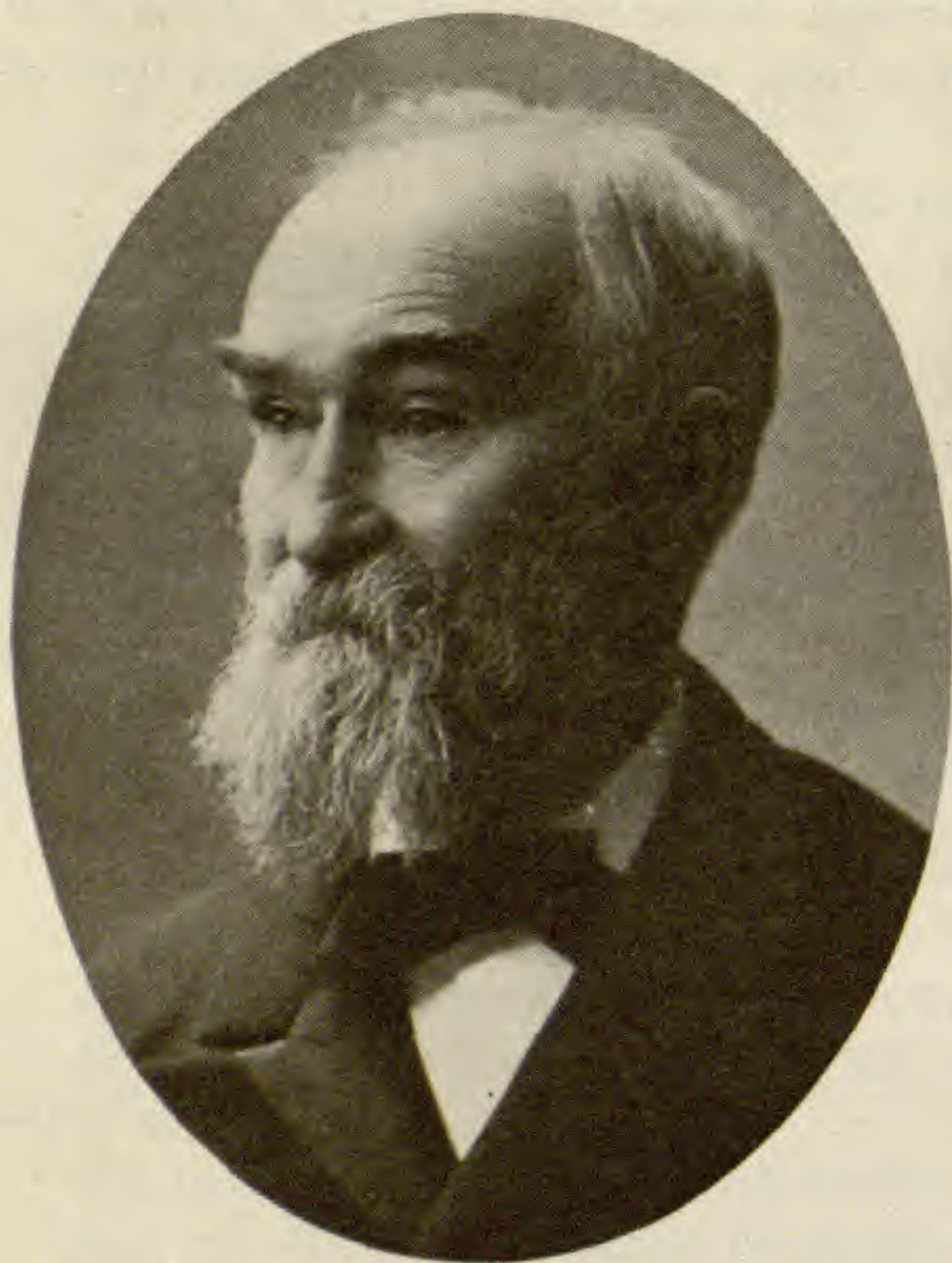

was still active, and never lost his energy and interest for his science. He was born near Belfast, Ireland, in 1831, and came to Canada in 1850, when 20 years of age, with his mother and two brothers, and the family settled near Campbellford, Northumberland County. For a number of years Professor MACOUN taught school, and became professor of natural science at Albert College in Belleville. The greater part of his work was the exploration of the then unknown west; in 1872 he was invited by Sir SANFORD FLEMING, the supervising engineer, to accompany him as

botanist in a tour across Canada, in connection with the surveys for the proposed Pacific railway. This tour forms the theme of Principal GEORGE M. GRANT'S well known *Ocean to ocean*, Dr. GRANT being one of the party. In 1875 Professor MACOUN accompanied Dr. SELWYN on the expedition to the Peace River District, where he made extensive collections of plants and animals for the Museum at Ottawa. Four years later, in 1879, he was sent by Sir CHARLES TUPPER to the north-

west to make some observations, and then began the collection of data upon which the *Catalogue of Canadian birds* is based, and which is the standard authority on that subject. The summers of 1879 and 1880 were spent on the prairies, ten parties having been sent to examine the country and ascertain its possibilities. Professor MACOUN was actively engaged in those two years, and in 1881 spent a considerable time in northern Manitoba. This long apprenticeship for the government service secured his appointment to the Geological and Natural History Survey in January, 1882, and the summers of 1882 and 1883 were spent around the lower St. Lawrence. In 1884 Professor MACOUN was located at Lake Nipigon, and in 1885 came back to British Columbia, operating in the Selkirks and Rockies. In 1887 he came to Vancouver Island again, and the next year moved to the Atlantic, working in Prince Edward Island in 1888. He was then promoted to assistant director and naturalist of the Survey, which position he continued to fill for many years. Since then Professor MACOUN made several long excursions to the East and West, and had the opportunity to even visit the little known Yukon Valley. In 1912 Professor MACOUN moved to Sidney, British Columbia, where he resided until his death.

The scientific work of Professor MACOUN covers a wide range in botany and zoology. He was remarkably gifted as an observer and collector. As an author botanists are familiar with his numerous publications on natural science, among which the *Catalogue of Canadian plants* is to his credit, representing an immense amount of work done by himself and his faithful assistant, his son, the late JAMES M. MACOUN. Both father and son devoted all their time to the development of natural science in Canada. The work they have left is an ample testimony of their united labors to promote science, and by their death the Canadian Dominion has lost two of its most brilliant and faithful servants.—  
THEO. HOLM, *Clinton, Md.*

# CURRENT LITERATURE

## BOOK REVIEWS

### New text books of paleobotany

The first volume of SCOTT'S *Studies*<sup>1</sup> appeared in the third edition during the autumn of 1920. The present volume treats of the Pteridophytes, and includes a new chapter on the recently discovered early Devonian Psilophytales from the Rhynie chert bed in Scotland. Other additions are an account of the Lycopodineous fructification *Mazocarpon* and further information about the leaves of Calamites, the roots of *Sphenophyllum*, and the root zone in *Psaronius*. The chapter on the Botryopterideae is completely rewritten, in accordance with the recent discoveries by PAUL BERTRAND, KIDSTON, and GORDON. It is to be hoped that the next volume containing the Gymnosperms will soon appear. SCOTT'S *Studies* is unquestionably the most thorough treatment of fossil plants for the student of morphology, and the great value of the book is increased by the large number of excellent illustrations to which the author has devoted his careful attention in the successive editions.

No other text book of paleobotany has reached three editions, and only one was published a second time. This is POTONIÉ'S *Lehrbuch*,<sup>2</sup> which is now being re-edited by POTONIÉ'S successor, W. GOTHAN in Berlin. It has been carried as far as the Coniferales, and when completed will probably include the only modern treatment of Angiosperms in the literature of fossil botany. It is really an entirely new book, completely rewritten after POTONIÉ'S death (1917). The illustrations are well chosen and numerous, and, in accordance with POTONIÉ'S and GOTHAN'S training as state geologists of Prussia, attention is paid to the geologic history of plants, although stratigraphic observations are merely scattered through the text and not combined into independent chapters. A fairly complete treatment of the stratigraphic aspects of paleobotany would be highly desirable if offered in the yet unpublished portions of the book.

For the present we possess a short survey of stratigraphic paleobotany in up-to-date form only in BERRY'S last publication,<sup>3</sup> whose second part deals

<sup>1</sup> SCOTT, D. H., *Studies in fossil botany*. 3d ed. Vol. I. 8vo. pp. vi+434. *figs.* 190. London. 1920.

<sup>2</sup> POTONIÉ'S *Lehrbuch der Paläobotanik*. 2. Umgearbeitete Auflage von W. Gothan. Erste und zweite Lieferung. Berlin. 1919-1920.

<sup>3</sup> BERRY, E. W., *Paleobotany: A sketch of the origin and evolution of floras*. From the Smithsonian Report for 1918. pp. 289-407. *pls.* 6. Washington. 1920.

with this topic, while in the first part the status of biological paleobotany is outlined. How welcome a new presentation of the geologic history of plants must be to any paleontologist we can conclude from the fact that the only available books on the subject are W. P. SCHIMPER'S *Traité de paléontologie végétale* (1869-1874) and Sir J. WILLIAM DAWSON'S *Geological history of plants* (1888). Both books are out of date now. BERRY is probably the only living paleobotanist who could give us an exhaustive treatment of our present knowledge of fossil plants, including the Angiosperms, and of their geological distribution. It is to be hoped that his *Sketch* may soon be followed by a fuller treatment of the same subject.

No survey of the latest general treatises on paleobotany would be approximately complete without paying due respect to the concluding volumes of SEWARD'S great reference book,<sup>4</sup> which represents the most exhaustive treatment of our present information on fossil Cryptogams and Gymnosperms. The last two volumes deal with the Pteridosperms, Cycadofilicales, Cordaitales, Cycadophyta, Ginkgoales, Coniferales, and Gnetales, to use SEWARD'S own terminology. His book will remain for a long time the standard work on fossil botany and the main reference book for the students of this subject. The author promises in his preface to the fourth volume to publish in an independent volume a general review of the floras of the past, and the energy which allowed him to complete his monumental work after it had been started twenty-one years ago gives hope that he may fulfil his promise in the near future. The fact that neither SCOTT nor SEWARD dared to attack the intricate problems of the fossil Angiosperms shows clearly how much this great plant division is still in need of investigation. The morphological treatment of fossil Pteridophytes and Gymnosperms has lately absorbed the main attention of paleobotanists, to the great detriment of the higher orders. It is very much to be desired that this deficiency should soon be corrected.—A. C. NOÉ.

### Botany of Iceland

The first part of the second volume of this publication, under the editorship of ROSENVINGE and WARMING, includes contributions by ØSTRUP<sup>5</sup>, and GALLØE.<sup>6</sup> ØSTRUP has investigated the fresh-water diatom material of Copenhagen University, which had been assembled by 16 collectors. The list includes 468 species in 40 genera, 55 of the species being described as new. An instructive tabular survey of distribution is given under the two general heads of "universal distribution" and "distribution in the different parts of Iceland." The table shows that 95 per cent of the Icelandic forms occur in the rest of Europe, and about 50 per cent in Asia and America. In the arctic

<sup>4</sup> SEWARD, A. C., Fossil plants. Vols. III and IV. Cambridge. 1917 and 1919.

<sup>5</sup> ØSTRUP, ERNST, Fresh-water diatoms from Iceland. pp. 1-98. pls. 5. 1920.

<sup>6</sup> GALLØE, OLAF, The lichen flora and lichen vegetation of Iceland. pp. 101-247. 1920.

regions, Greenland "stands highest," with 41 per cent of the Icelandic forms, but the total number of species in Iceland exceeds that of any other arctic region.

GALLØE presents the lichen flora under six aspects: (1) a list of species (284 species in 55 genera); (2) the means of propagation and dispersal; (3) the "biology" under four categories, bark lichens, epiphyllous lichens, earth lichens, and rock lichens; (4) the classification of the lichens into associations; (5) the vertical distribution of the lichens; and (6) the abundance of lichens in Iceland. The classification into associations is based upon the character of the substratum and of the vascular plants. Iceland is shown to have a lichen vegetation poor in species in proportion to its area. Epiphyllous lichens are entirely lacking in such a climate, and bark lichens are scanty in their occurrence. On the contrary, the conditions for the development of earth and rock lichens are better than in the temperate or tropical regions. It follows that, in spite of the rigorous climate, the soil and rocks show a large number of specimens. The lack of data regarding moss development is regretted, and an effort is made to remedy it by presenting the frequency of occurrence according to the RAUNKIAER method.—J. M. C.

#### MINOR NOTICES

**North American flora.**—The fourth part of Volume 7 continues the Aecidiaceae by J. C. ARTHUR, who in collaboration with F. D. FROMME presents *Dicaeoma* on Poaceae, 88 of the 269 species listed in the analytical key being included in the present part, 43 of the names being new combinations. The tangle of synonymy involved in such a group is very impressive.—J. M. C.

#### NOTES FOR STUDENTS

**Taxonomic notes.**—BRITTON,<sup>7</sup> in collaboration with several botanists, has published descriptions of 170 new species of Cuban plants, distributed among many families, and including 10 new genera as follows: *Bembicidium* and *Cānizatesia* in Leguminosae; *Ramsdenia*, *Roigia*, and *Dimorphocladium* in Euphorbiaceae; *Cheilophyllum*, *Silvinula*, *Naiadothrix*, and *Anisantherina* in Scrophulariaceae; and *Cotema* in Bignoniaceae.

WILLIAMS,<sup>8</sup> in anticipation of publication in the *North American flora*, has presented the results of his study of the Calymperaceae, "partly to allow the illustration of cross-sections of the leaves to be issued with the descriptions." This family of mosses includes only the genera *Syrrhopodon* and *Calymperes*, the former containing 18 species (1 new) and the latter 12 species (3 new).

<sup>7</sup> BRITTON, N. L., Descriptions of Cuban plants new to science. Mem. Torr. Bot. Club 16:57-118. 1920.

<sup>8</sup> WILLIAMS, R. S., Calymperaceae of North America. Bull. Torr. Bot. Club 47:367-396. pls. 15-17. 1920.

ARTHUR,<sup>9</sup> in his twelfth paper describing new species of Uredineae, has published 19 new species, 12 of which are under *Aecidium*. In addition, there are several new combinations and new names.

HITCHCOCK<sup>10</sup> has published revisions of the four genera of Paniceae: *Isachne* (8 spp.), *Oplismenus* (4 spp.), *Echinochloa* (7 spp.), and *Chaetochloa* (26 spp.). Full synonymy, often very extensive, and distribution are given in addition to the detailed descriptions. Although no new species are described, there are many transfers.

STANDLEY<sup>11</sup> has begun the publication of an account of the trees and shrubs of Mexico, the first paper extending from Gleicheniaceae to Betulaceae, certain families being contributed by specialists. In addition to a general explanatory introduction, there is an interesting history of botanical exploration in Mexico. The Pteridophytes are represented by 28 species, and the Gymnosperms by 56, *Pinus* being credited with 26. The largest genus included is *Agave*, presented by TRELEASE. It is credited with 170 species, 31 of which are described as new. Since 46 other species are credited to TRELEASE, his relationship to the genus is obvious. The next largest genus is *Piper*, with 59 species, the majority of which are credited to the late CASIMIR DE CANDOLLE.

FITZPATRICK<sup>12</sup> has published a detailed monograph of the Coryneliaceae (Perisporiales), the majority of whose species occur only in tropical or subtropical regions. The family includes 14 species, representing 4 genera. The largest genus is *Corynelia*, with 9 species, 5 of which are described as new.

PENNELL<sup>13</sup> has begun the publication of his studies of the Scrophulariaceae of Colombia, based on an exploration of the region for a period of eight months during 1917 and 1918. The first paper includes the Antirrhinoideae, in which 23 genera are recognized, 2 of them being described as new (*Monocardia* and *Unanuea*). Much the largest genus is *Fagelia*, with 18 species (10 new), all the other 22 genera including 31 species (12 new).

BURT,<sup>14</sup> in his twelfth paper on the Thelephoraceae of North America, presents the genus *Stereum*, recognizing 77 species, 12 of which are new.

---

<sup>9</sup> ARTHUR, J. C., New species of Uredineae. XII. Bull. Torr. Bot. Club 47: 465-480. 1920.

<sup>10</sup> HITCHCOCK, A. S., Revisions of North American grasses: *Isachne*, *Oplismenus*, *Echinochloa*, and *Chaetochloa*. Contrib. U.S. Nat. Herb. 22:115-208. pls. 25-32. figs. 21-62. 1920.

<sup>11</sup> STANDLEY, P. C., Trees and shrubs of Mexico (Gleicheniaceae-Betulaceae). Contrib. U.S. Nat. Herb. 23:1-169. 1920.

<sup>12</sup> FITZPATRICK, H. M., Monograph of the Coryneliaceae. Mycol. 12:206-267. pls. 12-18. 1920.

<sup>13</sup> PENNELL, F. W., Scrophulariaceae of Colombia. I. Proc. Acad. Nat. Sci. Philadelphia 72:136-188. 1920.

<sup>14</sup> BURT, E. A., The Thelephoraceae of North America. XII. Ann. Mo. Bot. Gard. 7:81-240. pls. 9. 1920.

The full descriptions, detailed lists of stations, and numerous text cuts leave nothing to be desired in the way of information.

MAXON<sup>15</sup> has described 6 new species of *Selaginella* from southern California, New Mexico, Arizona, and Glacier National Park.

WILDEMAN<sup>16</sup> has published another fascicle of additions to the flora of the Congo, illustrating the abundance of material that continues to be discovered in that interesting territory. A full list of collectors and stations is given, and frequently also full descriptions based upon fresh material. There is also included an account of *Meliola* as represented in the Congo country, with descriptions of new species and varieties, and *Meliolinopsis* is established as a new genus.

ROBINSON,<sup>17</sup> in connection with his study of the Bolivian representatives of *Eupatorium*, has described certain novelties of the tribe. New species are described in *Micania* (19), *Eupatorium* (6), *Ageratum*, and *Alomia*, while *Sphaereupatorium* is established as a new genus and credited to KUNTZE. In the Eupatoriums of Bolivia, 68 species are recognized, 29 of which are endemic. In this connection the following statement is made: "The endemism of Bolivia as illustrated by this group is thus about 43 per cent as against about 55 per cent in Peru and 59 per cent in Colombia. After deducting the 29 endemic species, there remain 39 Bolivian Eupatoriums which extend to other countries. Of these only 18 are known in Peru, while nearly all the others are species common to south-central Brazil and northern Argentina. Beyond a very few species of wide distribution there is a surprisingly slight common element between the Bolivian and Paraguayan members of the genus, although *Eupatorium* is pretty well represented in both of these contiguous countries." —J. M. C.

**Reproduction of Douglas fir forests.**—The great importance of the Douglas fir forest region may be appreciated from the estimate by MUNGER<sup>18</sup> that the stand within Washington and Oregon amounts to 560 billion feet of merchantable timber, while the amount in the adjacent forests of British Columbia according to WHITFORD<sup>19</sup> is not less than 350 billion feet. It seems certain that the amount destroyed by comparatively recent fires is almost if not quite

<sup>15</sup> MAXON, W. R., New Selaginellas from the western United States. *Smithson. Miscell. Coll.* 72: no. 5. pp. 10. pls. 6. 1920.

<sup>16</sup> WILDEMAN, E. DE, Additions à la flore du Congo. *Bull. Jard. Bot. Bruxelles* 7:1-160. 1920.

<sup>17</sup> ROBINSON, B. L., I. Further diagnoses and notes on tropical American Eupatorieae. II. The Eupatoriums of Bolivia. *Contrib. Gray Herb. New Series.* no. 61. pp. 80. 1920.

<sup>18</sup> MUNGER, T. T., Forestry in the Douglas fir region. *Amer. Forestry* 26:199-205. figs. 7. 1920.

<sup>19</sup> WHITFORD, H. N., and CRAIG, R. D., Forests of British Columbia. pp. 409. pls. 28. maps 21. Commission of Conservation, Canada. Ottawa. 1918.



equal to that now standing. The character and extent of the destruction are indicated by MUNGER, and have been given in more detail by HOFMANN<sup>20</sup> in a most interesting article. A great burn occurring in 1902 in south-central Washington, and devastating more than half a million acres, was made the site of an important investigation of some of the problems of natural reforestation. The resulting report<sup>21</sup> shows the importance of a careful ecological study of all the factors concerned. In spite of the complete and apparently hopeless desolation succeeding this fire, typical of hundreds of similar conflagrations in the Douglas fir region, HOFMANN found that a good even-aged stand of reproduction immediately followed. This extended over the greater portion of the devastated area, regardless of the presence or absence of surviving seed trees, and was shown to be due to an abundance of seed stored in the duff of the forest floor and retaining its viability through the fire. The efficiency of seed trees in restocking the ground was found to be limited to a radius not exceeding 300 feet from the parent tree, hence they were not important in the reforestation of so large an area. Local failure in reforestation within this area was found to be due either to the complete destruction of all the duff, with its contained seed, over certain portions of the area and more particularly upon the drier southern slopes, or to the occurrence of a second fire after all the viable stored seed had germinated. This resulted in the destruction of all the seedlings before they were old enough to bear seed to restock the forest floor. The burial of seeds and cones by rodents was found to be an important factor in stocking the duff.

More recent investigations by HOFMANN<sup>22</sup> of the ecology of these forests show the *Pseudotsuga* to be unable to withstand shade, and hence to constitute the principal member of a pioneer forest of which *Thuja* and *Tsuga* form the climax. The characteristics of the Douglas fir which give it such a prominent place in the Washington and British Columbia region are given as follows: "The production of heavy crops of seed which is the favorite food of the indigenous rodents; caching of seed by rodents in the forest floor; ability of the seed to retain its viability while stored in the forest floor and to live through forest fires; early and quick germination of the seed under favorable conditions; and a rapid development of a long radicle."

Many of these factors are somewhat within the control of man, and upon them the scientific management of Douglas fir forests must be based. Such a system has been described by MUNGER (*loc. cit.*) and in its bare outline consists in: (1) logging clean, (2) falling dead trees or "snags," which

<sup>20</sup> HOFMANN, J. V., How fires destroy our forests. *Amer. Forestry* 26:329-336. *figs.* 7. 1920.

<sup>21</sup> ———, Natural reproduction from seed stored in the forest floor. *Jour. Agric. Res.* 11:1-26. *pls.* 7. 1917.

<sup>22</sup> ———, The establishment of a Douglas fir forest. *Ecology* 1:49-53. *fig.* 1. 1920.

are a fire menace, (3) burning the slash broadcast the first spring or fall after logging, and (4) keeping subsequent fires out of all areas once burned. These constitute the methods now followed within the national forests of Washington and Oregon to secure the reforestation of lumbered areas.—GEO. D. FULLER.

**Plants of acid soils.**—A method of determining the acidity or alkalinity of soils according to the hydrogen-ion concentration, and adapted to use in the field, has been developed by WHERRY.<sup>23</sup> He has also used the method in determining the character of the soil in which certain "oxylophytes" are usually found growing.<sup>24</sup> Based upon the reaction of the soil solution, the soils were classified for the purpose of this study as "superacid," "mediacid," "subacid," and "minimacid," containing respectively more than 1000 times the acid of pure water, 100 to 1000 times, 10 to 100 times, and up to 10 times, with a similar evaluation of the alkaline soils. It is then pointed out that oxylophytes may be regarded as plants of mediacid soils and calcicoles of neutral or minimalkaline soils. Tables based upon soil tests show that among the heath plants of New England, those of the Pyroloideae are most characteristic of subacid soils, while the Ericoideae and Vaccinoideae most usually reach best development upon mediacid soils, many upon subacid and minimacid soils, and a few upon neutral soils. A further list of plants upon mediacid soils includes such species as *Aspidium spinulosum*, *Lycopodium Selago*, *Clintonia borealis*, *Coptis trifolia*, *Cornus canadensis*, and *Linnaea borealis*. Another list is compiled of plants upon circumneutral soils.

Similar methods applied to the study of certain coastal areas also give most interesting results.<sup>25</sup> A strip of land between the pine barrens and the salt marshes of New Jersey and populated by plants characteristic of the upland woods of the northern part of the state showed a specific acidity of 10 or less, so that the soil may be classified as circumneutral. On closely associated areas are found plants which grow elsewhere in southern New Jersey only in the sand barrens. These soils, in spite of their proximity to the salt marsh, showed a specific acidity of 300, or practically the same as that of the pine barren sands themselves. The border of some salt marshes on the Massachusetts coast showed plant associations usually found inland on peat or wet sand, and again tests proved the soil to be strongly acid. The explanation of these strongly acid soils bordering the alkaline salt marsh areas is that from the sea water drawn by capillarity into the soil the bases

<sup>23</sup> WHERRY, EDGAR T., Determining soil acidity and alkalinity by indicators in the field. Jour. Wash. Acad. Sci. 10:217-223. 1920.

———, Soil acidity and a field method of its measurement. Ecology 1:160-173. pl. 1. 1920.

<sup>24</sup> ———, Soil tests of Ericaceae and other reaction-sensitive families in northern Vermont and New Hampshire. Rhodora 22:33-49. 1920.

<sup>25</sup> ———, Plant distribution around salt marshes in relation to soil acidity. Ecology 1:42-48. 1920.

are adsorbed by the clay and humus, and the acids set free. In such areas the reaction is often found to change sharply within a few centimeters from a specific alkalinity of 30 to a specific acidity of 300. These methods and results seem likely to place the old contention of the relative importance of the physical and chemical properties of soil upon a new experimental basis, and to result in a much clearer conception of the meaning and application of the terms "oxylophytes" and "calcicoles."—GEO. D. FULLER.

**Seacoast vegetation.**—A description of the vegetation of the eroding seashores of Connecticut has been added by NICHOLS<sup>26</sup> to his other studies of the vegetation of the state previously noted in this journal.<sup>27</sup> He groups the important factors as those relating to submergence, such as salinity, tides, illumination, and temperature of the water, those relating to physiography, and those to atmospheric influences. The eroding seashores of the state are developed either in rock or glacial drift, and from each of these situations distinctive associations are described. The range of the studies is from the sublittoral algal associations to the forests which fringe the shores.

The depositing shores present even more diverse conditions,<sup>28</sup> depending principally upon the character of the soil, stony, sandy, and muddy areas, each having characteristic series of associations. The various associations are carefully described, and in the actual succession along muddy shores there is found evidence of coastal subsidence similar to that presented by GANONG, PENHALLOW, BARTLETT, and others.

Some attention is devoted to the salt marsh depressions or "pans" which appear to have various origins. Some are due to the destruction of the ordinary salt marsh vegetation by the decay of masses of plant remains swept over the surface during times of unusually high water, but others result from the partial filling and obstructing of tidal creeks and lagoons or by the building of tidal levees and the consequent ponding of water, between tides, in the lower parts of the marsh.—GEO. D. FULLER.

**Crown gall of alfalfa.**—WILSON<sup>29</sup> has described and figured in some detail the fungus causing crown gall of alfalfa. He concludes that the parasite is present in the gall in the form of a plasmodium, formed by the fusion of amoeboid cells in the host cells. He thinks that it spreads through the host tissues as a streaming mass or network of naked protoplasm, and that any mycelium observed has no connection with the gall forming organism. This plasmodial

---

<sup>26</sup> NICHOLS, GEO. E., The vegetation of Connecticut. VI. The plant associations of eroding areas along the seacoast. Bull. Torr. Bot. Club 47:89-117. fig. 6. 1920.

<sup>27</sup> ———, BOT. GAZ. 59:159-160. 1915; 65:572. 1918.

<sup>28</sup> ———, The vegetation of Connecticut. VII. The associations of depositing areas along the seacoast. Bull. Torr. Bot. Club 47:511-548. fig. 10. 1920.

<sup>29</sup> BOT. GAZ. 70:51. 1920.

state of the fungus was not observed by VON LAGERHEIM,<sup>30</sup> or by MAGNUS,<sup>31</sup> and has never been found by the reviewer. Even at a very early stage a definite mycelium appears to be present in the host plant, the hyphae of which are bounded by a thin wall. The ends of these hyphae form small swellings or vesicles which are active in dissolving the walls of the host cells. The method of branching of the hyphae and the development of the resting spore have been studied, and they seem to agree very closely with the descriptions given by SCHROETER,<sup>32</sup> MAGNUS, and VON LAGERHEIM for this fungus and for others which they consider closely allied to it. It is hoped to publish shortly a full account of this investigation and of a number of infection experiments undertaken in connection with several outbreaks of the disease in this country.—JAMES LINE, *Botany School, Cambridge, England.*

**Radio-active material.**—BLACKMAN<sup>33</sup> gives an extremely clear statement of the possible significance of radio-activity in normal physiological processes. He discusses mainly the work of the Dutch investigator H. ZWAARDEMAKER (*Jour. Physiol.* 53:273-289. 1920), in which he found that various radio-active materials would maintain or induce heartbeat in a potassium-free Ringer solution. This is taken as evidence that the effectiveness of potassium salts on heartbeat is due to the radio-activity of potassium, for in equal radio-active concentration uranium and radium were equally effective with potassium. Potassium gives only  $\beta$ -radiations. Elements that emit only  $\alpha$ -radiations were also effective in inducing and effecting heartbeat.

“The mode of action of these corpuscular radiations is not clear. The charged particles as they shoot along will act by induction, detaching everywhere electrons from these atoms; they also transfer kinetic energy, and when they come to rest on, say, some colloidal complex of the cell, they will transfer their electric charge and so may set free some ion absorbed on the surface. Whatever the nature of the action, ZWAARDEMAKER concludes that radio-activity is a mighty biological factor capable of restoring a lost function.” BLACKMAN believes that this may explain, in part, the function of potassium in the plant.—WM. CROCKER.

**Subalpine lake shore vegetation.**—To his already extensive studies of Colorado mountain vegetation, RAMALEY<sup>34</sup> has recently added a report based upon a ten years' study of numerous subalpine lakes located at altitudes of 10,000-11,300 ft. in the Rocky Mountains of Colorado. Data are presented

<sup>30</sup> VON LAGERHEIM, G., *Bihang K. Svenska Vet. Akad. Hand.* 24: no. 4. 1898.

<sup>31</sup> MAGNUS, P., *Ann. Botany* 11:87. 1897; *Ber. Deutsch. Bot. Gesells.* 20:291-296.

<sup>32</sup> SCHROETER, J., *Bot. Centralbl.* 11:219-221. 1882.

<sup>33</sup> BLACKMAN, V. H., *Radio-activity and normal physiological function.* *Ann. Botany* 34:299-302. 1920.

<sup>34</sup> RAMALEY, F., *Subalpine lake shore vegetation in north central Colorado.* *Amer. Jour. Bot.* 7:57-74. *figs. 6.* 1920.

regarding topography, climate, and soil, and the typical zonation of the vegetation is outlined. These lakes are within the limits of the *Picea Engelmanni* forest, and the succession from the water's edge includes moor, heath, and meadow associations. Different expressions of these types are to be seen about the various lakes, the moor, with its variations of moss moor, sedge moor, rush moor, willow moor, and meadow moor, usually occupying a large proportion of the area. Perhaps the most interesting of the communities is the heath, in which *Gaultheria humifusa*, *Vaccinium caespitosum*, and *Kalmia microphylla* are conspicuous. Any one of these small undershrubs or a combination of all three may dominate a comparatively narrow belt of vegetation midway between the lake and the forest. The several aspects of the associations are noted, the meadows affording the most brilliant and varied display. Maps, diagrams, quadrats, and lists of species make the report graphic and exact.—GEO. D. FULLER.

**Accessory foods for plants.**—BOTTOMLEY<sup>35</sup> has found several chlorophyll bearing water plants unable to develop normally in nutrient salt solutions not bearing accessory organic foods. The plants worked on were as follows, naming them in descending order of their dependence upon the organic material: *Lemna major* and *L. minor*, *Salvinia natans*, *Azolla filiculoides*, and *Limnobium stoloniferum*.

"The effective organic substances were found to be present in an autoclaved growth of *Azotobacter chroococcum*, crude nucleic acid derivatives from raw peat, and a water extract of bacterized peat. . . . In no case did the organic substance supplied exceed 184 parts per million, while the concentration of inorganic salts in the culture solution totaled 5500 parts per million."

The author thinks that these plants in nature secure their necessary organic materials from the waters in which they grow. From the work of BOTTOMLEY and of several other investigators who have recently published their results, it appears that accessory foods may have considerable significance in plant development, as they have very great significance in animal nutrition and growth.—WM. CROCKER.

**Rate of photosynthesis in the field**—MCLEAN<sup>36</sup> of the Philippines has worked up a simple method of measuring the amount of carbon dioxide absorbed by leaves in the open. There is certainly great need of such methods for determining photosynthetic rates as well as the rates of other plant processes occurring in the field. Recently a farmer who had fertilized heavily with rock phosphate and limestone asked why his corn with about the same foliage stores more than twice as much starch in the ears as his neighbor's corn for

<sup>35</sup> BOTTOMLEY, W. B., The effect of organic matter on the growth of various water plants in culture solutions. *Ann. Botany* 34:353-365. 1920.

<sup>36</sup> MCLEAN, F. T., Field studies of the carbon dioxide absorption of coconut leaves. *Ann. Botany* 34:367-389. 1920.

which no phosphate or lime was used. Good field methods along with laboratory methods are necessary for answering such questions.

MCLEAN finds that middle aged leaves of the coconut absorb carbon dioxide faster than either immature or old leaves. These leaves also show a maximum in the morning, a depression at midday, a second rise in the afternoon, followed by the final decline at sunset. Detached coconut leaves showed about the same rate of absorption as attached ones, but the maxima occurred at different times of day. Sugar-cane leaves absorb much more rapidly than coconut.—WM. CROCKER.

**Nitrites and nitrates in plants.**—STROWD<sup>37</sup> has worked on the relative accuracy of various methods for determining nitrites and nitrates in plant tissues. He finds that both the Devarda and Schloesing methods with proper modifications give fair accuracy. Various other methods tried proved unsatisfactory. STROWD<sup>38</sup> also finds strong evidence that the reason for failure of nodule production (in soy bean) in the presence of nitrates is due at least in part to the effect of the high concentration of nitrate in the sap upon the growth and reproduction of *Rhizobium leguminosarum*. He finds that the amount of sugar present decreased with an increase in nitrates, but that some sugar was always present. It is unknown to what extent shortage of sugar is significant. The concentration of nitrates in the roots is far in excess of the concentration in the soil bathing the roots.—WM. CROCKER.

**Humidity and irrigation.**—In the Imperial Valley, California, the irrigation of 400,000 acres of arid lands is commonly supposed to have been accompanied by a decided increase in atmospheric humidity. That this is not the case is shown by data collected by MCGREGOR,<sup>39</sup> who concludes that no appreciable influence is exerted upon atmospheric humidity by the amount of irrigation water used, seasonal fluctuations in humidity being accounted for through factors of much greater geographical extent.—GEO. D. FULLER.

**Conifer grafting.**—The case of a natural grafting of spruce upon pine is reported by ROMELL,<sup>40</sup> who has also investigated the nature of the union as seen in the structure of the wood cells. Along the line of contact there was found evidence of the character of the pits of each being influenced by the proximity of the tissues of the other.—GEO. D. FULLER.

<sup>37</sup> STROWD, W. H., The determination of nitrites and nitrates in plant tissue. *Soil Science* 10:333-342. 1920.

<sup>38</sup> ———, The relation of nitrates to nodule production. *Soil Science* 10:343-356. 1920.

<sup>39</sup> MCGREGOR, E. A., The relation of irrigation to humidity in a recently reclaimed desert. *Plant World* 22:45-52. *figs.* 3. 1919.

<sup>40</sup> ROMELL, LARS-GUNNAR, Anatomy of a grafting of spruce on pine. *Meddel. Från Statens Skogsförs.* 16:61-66. *figs.* 2. 1919.

THE  
BOTANICAL GAZETTE

*APRIL 1921*

EFFECT OF LIGHT ON GERMINATION OF  
LIGHT-SENSITIVE SEEDS

CONTRIBUTIONS FROM THE HULL BOTANICAL LABORATORY 279

WRIGHT A. GARDNER

**Historical**

Various explanations have been offered for the germination of light-sensitive seeds, and several conditions have been shown to favor or make possible the germination of such seeds. Rupture of coats, increased water supply, variation of quantity and intensity of light, reciprocal relation of heat and light, reaction of substratum and embryo, activation of enzymes, increased oxygen pressure, increased carbon dioxide pressure, and "certain inhibiting agencies" have been suggested as factors affecting the germination of light-sensitive seeds. Although quite possible, it seems hardly probable that no one of these is the fundamental or controlling factor. It would seem quite probable that one or two of these agencies are fundamental and the others are accessory means of setting in motion the processes that finally bring about germination. Enzyme action has been suggested repeatedly as a fundamental cause of germination, but no one has ventured to demonstrate the relation of enzymes to the germination of light-sensitive seeds.

An attempt has been made in this investigation to discover the fundamental relation of light to the germination of seeds, and to show just what light does to start germination. The effect of light on the germination of seeds has interested botanists for many years.

The first known publications on this subject were made by CASPARY (4) in 1860, when he announced that the seeds of *Bulliarda aquatica* are strongly light sensitive. In 1867 he (5) discussed the germination of seeds of *Pinguicula vulgaris*. In 1876 NOBBE (38) made the statement that germination was neither favored nor influenced by light. After WIESNER (51) had published the statement that the germination of seeds of *Viscum album* is favored by light, and STEBLER (48) had shown that *Poa pratensis* and *P. nemoralis* germinated up to 60 per cent in light and only up to 7 per cent in darkness, NOBBE (39) published results of experiments with grass seeds, including *Poa pratensis*, *Zea Mays*, and some other large seeds to uphold his earlier contention. PAUCHON'S (41) results supported NOBBE in the controversy. In 1883 CIESLAR (6) confirmed and extended STEBLER'S results, reporting *Agrostis stolonifera* and *Nicotiana macrophylla* as light sensitive. He made a careful study of the influence of temperature in connection with light, and showed that small seeds poor in reserve materials germinate better in white light, while large seeds are usually indifferent to light, and that seeds of *Poa nemoralis* germinate better in yellow light than in violet. LIEBENBERG (35) in 1894 confirmed STEBLER'S results, but referred to them as temperature effects.

In 1893 JÖNSSON (23) showed that after-ripening has a definite influence on the action of light in germination, that light increases the percentage of germination, that heat rays are unimportant, that intermittent light is as effective as continuous light, and that intermittent temperature may be substituted for light in the germination of such seeds as *Poa pratensis*, *P. nemoralis*, *Agrostis stolonifera*, and *Daucus Carota*.

In 1899 HEINRICHER (19) began publishing the results of his work on light germination. He (20) reported that seeds of *Pitcairnia maydifolia* germinate only in light, that the germination of *Veronica peregrina* seeds is hastened and several other small seeds are favored in germination by light. He considered the factors to be age, quickness of drying, moisture, illumination of parent plant, and light of different colors. He (21) concluded that the effect of light is a matter of activation of reserve materials, that the benefit of light is not due to its causing early carbon assimilation,



but rather to its effect on the enzyme activity in the production and digestion of stored foods. RACIBORSKI (43) found that tobacco seeds germinate in diffused light after 1-5 hours' illumination, a longer time being required if the intensity of light is low. In 1900 TAMMES (49) declared that the exposure of dry seeds to direct sunlight did not affect their later germination, and in 1902 LAURENT (29) made the same statement. REMER (44) reported that light hinders the germination of *Phacelia tanacetifolia*, but offered no explanation of the light relations. LASCHKE (28) confirmed earlier results with *Poa*, and stated that light cannot be replaced by higher temperatures. In the same year FIGDOR (10) made a report on the influence of light on the germination of seeds of Gesneriaceae. In 1912 he (11) reported that seeds of 12 species of this family are favored by light. In 1908 BESSEY (3) found that seeds of the epiphytic *Ficus aurea* and *F. populnea* germinate only in light.

KINZEL (24) in 1907 reported that the germination of freshly harvested seeds of *Nigella sativa* was prevented by light, while similar seed germinated up to 94 per cent in darkness. Even three minutes' illumination after 24 hours' incubation in darkness had a marked retarding effect. He considered the effect of light as photochemical, and designated such seeds as "light hard." The germination of some light-sensitive seeds in darkness was hastened by soaking in a solution of an enzyme such as papayotin (25). He (26) also published a long list of light-sensitive seeds, to which still others were added in his later work (27). He recognized as important factors in germination of seeds age of seed, character of seed coats, and color of light. LEHMANN'S work (30, 31, 32, 33, 34), begun in 1909, continued through 1915. Most of his experiments were conducted with seed of *Verbascum Thapsus*, *V. thapsiforme*, *Epilobium roseum*, and *Ranunculus sceleratus*. He showed the effects of substratum on germination in light, found the age of seeds to be an important factor, used Knop's nutrient solution as a stimulus instead of light, and found that salts favored germination of light-sensitive seeds in darkness. He claimed that light exerts its influence by starting or stopping some chemical changes in the seed, and established a relation between light and temperature. He also punctured seed coats as a substitute for light. LEHMANN

and OTTENWÄLDER (36) experimented with *Epilobium hirsutum* and other seeds and showed that acid solutions and proteolytic enzymes can be substituted for light. They referred the light effect to activation of enzymes, but did little to prove their hypothesis. PICKHÖLTZ (42) connected light effects and temperature variations, and concluded that the influence of direct sunlight was mainly due to the heat rays which raised the temperature. Alternating temperatures helped the germination at different stages of maturity.

In 1912 a number of workers reported on the problem of light germination. BAAR (1) investigated seeds of several Amarantaceae and found that most seeds of this family (*Amaranthus*, *Celosia*, and *Blitum*) have an aversion to light. He considered the age of seeds generally important for the occurrence and intensity of the light effect, and also related the light effect to substratum and temperature variations. BECKER (2) brought forward a long list of examples of the light effect on germination of seeds. HAACK (18) in his work on the Scotch pines demonstrated the influence of heat, and reported that temperature variations act as a stimulus to light-sensitive seeds, and that blue light is more favorable to germination than darkness. SIMON (47) reported that the salts of iron hindered germination of seeds in darkness, but increased it in light. GASSNER (12) first reported on the germination of seeds of *Chloris ciliata* in 1910. He found three factors which may be substituted for light, namely, increased oxygen supply, after-ripening, and high temperature. He claimed that light offsets the effect of the limiting factor, and showed that the chaff of *Chloris ciliata* prevents easy germination. His later work (14, 15) took up the action of chemicals. He considered the latent influence of light as related to seed bed, temperature, and after-ripening, the influence of light on germination, the influence of desiccation, and the relations between light and media favoring or hindering germination. From a tabulation of tests with seeds of different families he concluded that in these cases nitrogen, variously combined in the media, shows the same favorable action as light, but he included contradictory results. He considered the favorable effect of Knop's nutrient solution as due only to the nitrates present. He reported the seeds

of *Ranunculus sceleratus* and *Oenothera biennis* as favorably influenced by light and by inorganic salts containing nitrogen, through a wide range of concentrations. OTTENWÄLDER (40), working with *Epilobium hirsutum* seeds, found that the light requirement as regards intensity is closely related to temperature, the former increasing as the latter is lowered. The illumination period is related also to the temperature, but more closely to light intensity. Light-sensitive seeds are also favorably and strongly influenced by weak acids. The hypothesis of a catalytic influence of light is said to have received support from these observations.

### Materials

A preliminary examination of 115 samples of seeds collected from Shaw's Gardens, the Botanical Gardens of the University of Michigan, waysides, swamps, and fields indicated the following as available for the study of the effect of light in germination: *Daucus Carota*, *Nicotiana Tabacum*, *N. sylvestris*, *N. affinis*, *Nicotiana* hybrids, *Gentiana Saponaria*, *G. pannonica*, *Oenothera biennis*, *Verbascum Thapsus*, *Amaranthus caudatus*, *Rumex crispus*, *Phoradendron flavescens*, and *Datura Stramonium*. Of those mentioned, the writer has been unable to find any previous report of light sensitiveness of seeds of *Rumex crispus*, *Datura Stramonium*, and *Phoradendron flavescens*. Of the light-sensitive seeds not previously reported, seeds of *Rumex crispus* and *Phoradendron flavescens* are favored by light in germination, while seeds of *Datura Stramonium* are inhibited from germinating by light, as will be shown later.

JÖNSSON (23) in 1893 reported the seed of *Daucus Carota* as favored by light in germination. *Nicotiana Tabacum* seeds were first reported as light sensitive by RACIBORSKI (43) in 1900. The seeds of *Gentiana Saponaria*, *G. pannonica*, *Verbascum Thapsus*, and *Oenothera biennis* were reported as light sensitive by KINZEL (24) in 1907. BAAR (1) reported *Amaranthus caudatus* seeds as hindered in germination by light. The seeds of *Gentiana* are not conveniently suited to the purposes of this investigation on account of the longer incubation period. The seed of *Amaranthus caudatus* are not used because they are light-inhibited seeds. The seeds

of *Datura Stramonium* have been found by careful experiments to be light inhibited and to require total darkness and a temperature of about 30° C. for germination. They are accordingly reserved for a future study. Detailed study of the germination of *Phoradendron flavescens* seeds was deferred on account of the peculiar slimy ovary and the chlorophyll-bearing embryo. Seeds of *Nicotiana Tabacum*, *Rumex crispus*, *Oenothera biennis*, *Verbascum Thapsus*, and *Daucus Carota* were selected for this research because of their abundance and similar incubation periods.

### Germination in light and darkness

Preliminary tests of *Rumex crispus* seeds on wet filter paper gave a germination of 84 per cent in light and 16 per cent in darkness after 8 days of incubation.

TABLE I

Treatment	Percentage germination in light	Percentage germination in darkness
Cleaned, dried, and soaked in flowing water for 24 hours and incubated.....	16	6
Cleaned, dried, and incubated	24	6
Cleaned, soaked for 4 days, and incubated.....	12	2

Preliminary tests of germination of seeds of *Phoradendron flavescens*, suggested by WIESNER'S (51) results with seeds of *Viscum album*, are given in table I. Seeds prepared as indicated in table I were counted into Petri dishes containing wet filter paper as substratum and placed in light and total darkness to incubate at room temperature, which ranged from 18–25° C. The incubation period was 27 days. These results indicate that light favors the germination of seeds of *Phoradendron flavescens*. On account of the sticky nature of the pulpy ovary and the succulence of the single fleshy green embryo, it was almost impossible to remove the mass of enveloping material without leaving a favorable substratum for molds and bacteria on the one hand, and without injury to the embryo on the other hand. Moreover, with the best of care many of the seeds failed to germinate and became moldy. With these

conditions we can understand the relatively low germination, and yet see that light favors the germination of these seeds.

Seeds of *Datura Stramonium* were treated as shown in table II. Seeds were allowed to incubate for 17 days, and the results indicate clearly an inhibitory action of light on their germination. The

TABLE II

Treatment	Percentage germination in light	Percentage germination in darkness
On soil, 26-30° C . . . . .	6	98
On sand, 26-30° C . . . . .	2	22
On filter paper, 20° C. . . . .	0	0
On filter paper, 24° C. . . . .	0	4
On filter paper, 30° C. . . . .	4	60

constituents of the soil solution seem to promote materially the germination of these seeds in darkness but not in light. *Datura Stramonium* seeds require different treatment from any of the other seeds tested, and accordingly are reserved for separate study.

#### Light sensitiveness, after-ripening, and viability

To establish standards for comparison with other data, and to indicate the degree of light sensitiveness, various light-sensitive seeds were incubated from time to time at room temperature (20-28° C.) on filter paper in light and darkness respectively. The results given in table III are fairly representative of these tests.

These data indicate what may be expected of the various light-sensitive seeds under investigation when subjected to germinating conditions at room temperature 20-28° C. on wet filter paper in Petri dishes. It appears that the seeds of some kinds of tobacco are less light favored than others (3. *Nicotiana affinis*, 108. *N. affinis*, 1. *Nicotiana* hybrid, and 117. Pennsylvania Havana tobacco). The results also indicate that not all of the seeds under investigation are entirely dependent on light for germination. A certain percentage of each lot of *Rumex crispus* and *Daucus Carota* seeds usually germinates in darkness. It is also noteworthy that seeds of *Oenothera biennis* do not always germinate, even in light. The seeds under investigation seem to retain their light sensitiveness

for long periods and to a rather high degree, especially those of *Verbascum Thapsus* and *Nicotiana Tabacum*. Attention should be called to low germination of newly harvested seeds of *Oenothera biennis*, *Daucus Carota*, and *Rumex crispus*. Tests for evidence of

TABLE III

SEEDS	INCUBATED 9-18-15 TO 9-29-15		INCUBATED 10-28-15 TO 11-5-15		INCUBATED 5-30-16 TO 6-6-16		INCUBATED 6-20-18 TO 6-28-18	
	Light	Dark- ness	Light	Dark- ness	Light	Dark- ness	Light	Dark- ness
Collected in 1914								
1. <i>Nicotiana hybrid</i> . . .	91	56	87	65	87	60	84	45
3. <i>Nicotiana affinis</i> . . .	79	57	87	45	74	43	82	19
8. <i>Nicotiana hybrid</i> . . .	48	1	58	5	74	35	67	13
13. <i>Nicotiana hybrid</i> . . .	84	0	89	2	89	6	80	0
22. <i>Nicotiana hybrid</i> . . .	55	0	73	0	61	0	55	0
55. <i>Verbascum Thapsus</i> . . .	81	1	80	0	87	0	53	0
61. <i>Daucus Carota</i> . . . . .	63	19	78	10	71	20	32	7
66. <i>Oenothera biennis</i> . . .	4	2	76	10	51	4	0	0
68. <i>Rumex crispus</i> . . . . .	39	8	88	18	75	31	60	1
92. <i>Nicotiana Tabacum</i> . . .	77	1	.....	.....	90	4	30	0
96. <i>Daucus Carota</i> . . . . .	1	0	52	6	.....	.....	.....	.....
Collected in 1915								
97. <i>Verbascum Thapsus</i> . . .	94	0	94	0	82	0	.....	.....
98. <i>Oenothera biennis</i> . . .	2	0	48	0	61	1	.....	.....
99. <i>Rumex crispus</i> . . . . .	36	0	82	4	80	40	66	0
100. <i>Verbascum Thapsus</i> . . .	74	1	73	0	39	0	60	0
101. <i>Rumex crispus</i> . . . . .	61	0	94	0	92	2	30	0
102. <i>Daucus Carota</i> . . . . .	.....	.....	45	1	44	11	.....	.....
103. <i>Oenothera biennis</i> . . .	.....	.....	63	0	61	0	.....	.....
104. <i>Rumex crispus</i> . . . . .	.....	.....	94	1	79	11	.....	.....
105. Pennsylvania seed- leaf tobacco . . . . .	.....	.....	.....	.....	75	24	.....	.....
111. Connecticut seedleaf tobacco . . . . .	.....	.....	.....	.....	75	0	.....	.....
112. Honduras tobacco . . . . .	.....	.....	.....	.....	49	0	.....	.....
113. Cuban tobacco . . . . .	.....	.....	.....	.....	81	0	.....	.....
117. Pennsylvania Ha- vana tobacco . . . . .	.....	.....	.....	.....	100	71	.....	.....
118. Ohio seedleaf tobacco . . .	.....	.....	.....	.....	86	2	.....	.....

a period of after-ripening in *Verbascum Thapsus* were quite negative. Newly harvested seeds of *V. Thapsus* germinate above 90 per cent in light and only about 2 per cent in darkness. Tests of still older seeds indicate that they retain light sensitiveness as long as they are viable.

### Mechanical rupture

In 1906 CROCKER (7) succeeded in germinating a number of different kinds of seeds after breaking the seed coats. KINZEL (24) found that puncturing coats of some of his light sensitive seeds gave better germination in darkness. GASSNER (13) found that rupture of the coats of seeds of *Chloris ciliata* permitted good germination in darkness at 34° C. Thus it seemed quite possible that the seeds under investigation might be brought to germination by such treatment. Accordingly a more carefully controlled experiment was made to determine the rôle of the several seed coats in germination. Seeds of each kind were rubbed on fine sandpaper and placed on moist filter paper in Petri dishes. The Petri dishes were carefully wrapped in black cloth and placed in a dark room at 24-30° C. for 8 days. Concurrently, sets of unabraded seeds were placed to germinate in light and darkness.

TABLE IV

SEEDS	NOT ABRADED		ABRADED	NOT ABRADED
	Light	Darkness	Darkness	Darkness
<i>Nicotiana Tabacum</i> .....	60, 61	0, 0	0, 1	0, 1
<i>Rumex crispus</i> .....	30, 16	0, 1	40, 66*	0, ..
<i>Verbascum Thapsus</i> .....	75, 32	0, 8	6, ..	1, 3
<i>Oenothera biennis</i> .....	10, 39	3, 0	3, 5	7, 1
<i>Daucus Carota</i> .....	60, 20	27, 7	25, 15	21, 17

\* Coats off.

Mechanical abrasion of seed coats for various periods in rotating cylinders containing coarse quartz sand gave similar results. An examination of the data in table IV reveals the beneficial effect of abrasion of seed coats in but one instance. In the case of *Rumex crispus* abrasion of the seed coats yielded a percentage of germination slightly exceeding that for light in the control, while the removal of the coats yields a percentage of germination even more than double that in light. This suggests that the seed coats of *Rumex crispus* inhibit or retard the entrance of some necessary factor, or perhaps retard the exit of some inhibiting factor, and that light in some way favors these movements.

### Rupture by sulphuric acid

As long ago as 1896 ROSTRUP (45) of the Danish Seed Control found that concentrated sulphuric acid treatment hastened germination of hard seeds of *Lathyrus sylvestris*. TODARO (50) used concentrated sulphuric acid on red clover seed with beneficial results. He also reported that various weed seeds, including those of *Rumex crispus*, were all destroyed by a brief immersion in sulphuric acid. Accordingly, to determine more certainly the rôle of seed coats in the germination of the five kinds of seeds, they were treated with concentrated sulphuric acid for periods previously determined, carefully washed in carbonate of soda solution, then in distilled water, and placed in germinators as previously described.

TABLE V

SEEDS	TREATED WITH CONCENTRATED SULPHURIC ACID			UNTREATED		
	Minutes in H <sub>2</sub> SO <sub>4</sub>	Germinated in darkness			In light 8 days	In darkness 8 days
		8 days (1)	10 days (2)	8 days (3)		
Nicotiana Tabacum.....	0.5	0	0	0	42	0
Nicotiana Tabacum.....	1	0	0	0	42	0
Verbascum Thapsus.....	0.5	0	0	0	72	0
Verbascum Thapsus.....	1	0	0	0	72	0
Daucus Carota.....	0.5	23	8	0	31	25
Daucus Carota.....	1	1	6	0	31	25
Rumex crispus.....	6	27	37	17	88	0
Rumex crispus.....	8	62	59	0	88	0
Oenothera biennis.....	8	38	34	41	78	0
Oenothera biennis.....	10	1	19	23	78	0

Table V indicates that treatment of seeds of *Rumex crispus* and *Oenothera biennis* with concentrated sulphuric acid yields an increased percentage of germination in darkness. Treatment with concentrated sulphuric acid for longer or shorter periods than indicated gives no better germination of the seeds in darkness. In *Daucus Carota* there is apparently an injury. This experiment indicates that light acts on the coat of *Rumex crispus* seeds, and points in that direction in case of seed coats of *Oenothera biennis*. These results in the main agree with those of the experiment on abrasion of coats. They confirm the results with seeds of *Rumex*



*crispus* and include the seeds of *Oenothera biennis* as being benefited in germination by acid treatment. Why the seeds of *Oenothera biennis* germinate better after treatment with  $H_2SO_4$  and not by abrasion is unexplained.

### Temperature and light

OTTENWÄLDER (40) claimed that within the range of temperatures which permit germination, light can be substituted for heat at low temperatures and heat for light at high temperatures. With *Verbascum Thapsus* and other seeds he found that germination occurred at high temperature in darkness and at low temperature

TABLE VI

Seeds	Temperature centigrade							
	10°	15°	19°	24°	27°	30°	35°	40°
	Light							
Nicotiana Tabacum.....	0	0	23	62	55	40	.....	.....
Verbascum Thapsus.....	0	0	0	77	82	84	.....	.....
Daucus Carota.....	0	12	21	36	33	25	.....	.....
Oenothera biennis.....	0	0	0	28	.....	6	.....	.....
Rumex crispus.....	0	1	42	65	22	5	.....	.....
	Darkness							
Nicotiana Tabacum.....	0	0	0	11	6	2	0	0
Verbascum Thapsus.....	0	0	0	7	14	15	3	1
Daucus Carota.....	0	4	7	16	12	12	4	0
Oenothera biennis.....	0	0	0	5	4	2	0	0
Rumex crispus.....	0	1	3	8	8	4	0	0

in light. In order to test this for American *Verbascum Thapsus* and to see whether it is generally true, the different seeds under investigation were placed to germinate in light and darkness at different temperatures. It was not possible to control closely temperature and prevent small fluctuations. These changes of temperature were never sudden, however, and had no effect except to increase slightly the percentage of germination in both light and darkness. The data reported represent results obtained from five different sets of determinations. Seeds were placed to germinate in Petri dishes on filter paper wetted with distilled water at temperatures indicated in table VI and allowed to incubate for 9 days.

These data offer no evidence of a reciprocal relation between heat and light as suggested by LEHMANN and OTTENWÄLDER, not even in the case of seeds of *Verbascum Thapsus*, nor have any of the various tests indicated this reciprocal relation in the seeds. Indeed, in each kind of seed under investigation the optimum temperature for germination in light is very close to that for germination in darkness. In germination in darkness the results show rather definite minimum and maximum as well as optimum temperatures. It is especially noteworthy that high temperature and darkness did not induce germination of *Verbascum Thapsus* seeds, as claimed by OTTENWÄLDER (40). No specific experiments were performed to determine the effect of light intensity on germination, although early in this investigation it became a very familiar fact that very little illumination would induce germination. Good germination in darkness was frequently the occasion for repetition of an experiment, only to find that germination had been induced by leaks in the light screens. A comparison of table VI with data given elsewhere indicates that highest germination of light-sensitive seeds does not occur at constant temperature, but at temperatures fluctuating between 20 and 27° C.

#### Effects of alternation of temperature, light, and darkness

As long ago as 1882 NOBBE (39) and his students used alternating temperatures to promote germination, and in 1884 LIEBENBERG (35) referred light effects to variations of temperature in the germination of seeds of *Poa pratensis*. As recently as 1911 PICKHOLTZ (42) referred the action of light in promoting germination to the effects of heat rays. In an attempt to distinguish the effects of light from those of temperature the following experiments were performed. Seeds of each kind were counted into Petri dishes with filter paper wetted with distilled water as substratum. One lot of cultures was placed in darkness on February 9 at 40° C., where it remained for 17 days. Another lot of cultures was placed in darkness at temperatures ranging from 0 to 12° C. for 17 days. Another lot was kept in darkness and subjected alternately to high temperature (40° C.) and low temperature (0-12° C.) for nearly equal periods throughout the 17 days. The low temperature and the

alternating temperature cultures were frozen on the morning of February 26. On this date observations were made and the cultures placed in light at room temperature to test viability.

As shown in table VII, the constant high temperature effectively inhibited the germination of all seeds except those of *Verbascum Thapsus*. The subsequent incubation in light at room temperature showed fatal injury to the embryos of *Daucus Carota*, *Oenothera biennis*, and *Nicotiana Tabacum*. The constant low temperature delayed germination, but seemed to induce increased germination in light in seeds of *Daucus Carota*, *Oenothera biennis*, and *Verbascum Thapsus*. This is especially noticeable in *Oenothera biennis* seeds.

TABLE VII

SEEDS	CONSTANTLY AT 40° C. IN DARKNESS FOR 17 DAYS (a) AND THEN AT ROOM TEMPERATURE IN LIGHT FOR 12 DAYS (b)		CONSTANTLY AT 0-12° C. IN DARKNESS FOR 17 DAYS (a) AND THEN AT ROOM TEMPERATURE IN LIGHT FOR 12 DAYS (b)		ALTERNATELY AT 40 AND 0-12° C. IN DARKNESS FOR 17 DAYS (a) AND THEN AT ROOM TEMPERATURE IN LIGHT FOR 12 DAYS (b)		CONTROL AT ROOM TEMPERATURE FOR 11 DAYS	
	(a)	(b)	(a)	(b)	(a)	(b)	Light	Darkness
<i>Verbascum Thapsus</i> . . . . .	14	78	0	86	6	90	76	2
<i>Rumex crispus</i> . . . . .	0	54	0	58	0	56	82	30
<i>Daucus Carota</i> . . . . .	0	1	0	60	0	8	32	6
<i>Oenothera biennis</i> . . . . .	0	4	0	64	0	90	14	0
<i>Nicotiana Tabacum</i> . . . . .	0	0	0	40	0	26	58	0

The alternating high and low temperature treatment delayed the germination in the same way as did constant low temperature. As shown by the subsequent incubation, *Daucus Carota* seeds were injured most. The germination of seeds of *Nicotiana Tabacum* and *Rumex crispus* was materially reduced by this treatment, while the germination of seeds of *Verbascum Thapsus* was favored, and the germination of seeds of *Oenothera biennis* very greatly increased.

In a further effort to distinguish effects of light and temperature an experiment was carried out as follows. Seeds were counted into Petri dishes, having filter paper wetted with distilled water for substratum, and placed under the following conditions: set *a* in light at 10° C. for 8 days and then at 25° C. for 8 days; set *b* in darkness at 10° C. for 8 days and then at 25° C. for 8 days; set *c*

in light at 10° C. for 8 days and then in darkness at 25° C. for 8 days; set *d* in darkness at 10° C. for 8 days, then at 40° C. for 4 days, followed by 4 days at 25° C. At the end of the 16 days' treatment all of the cultures were placed in light for 8 days at room temperature. The experiment was begun July 24.

Comparison of the data in *a* of table VIII with the control indicates that incubation in light at low temperature followed by incubation at room temperature results in reduction of percentage of germination of *Daucus Carota* seed. A comparison of *a* and the control indicates that alternating temperatures may in a measure replace light in the case of germination of *Verbascum*

TABLE VIII

SEEDS	CONSTANTLY AT 25° C. FOR 24 DAYS		(a)			(b)			(c)			(d)		
	Light	Darkness	In light at 10° C. for 8 days	Then at 25° C. for 8 days	Then at 25° C. for 8 days	In darkness at 10° C. for 8 days	Then at 25° C. for 8 days	Then in light at 25° C. for 8 days	In light at 10° C. for 8 days	Then in darkness at 25° C. for 8 days	Then in light at 25° C. for 8 days	In darkness at 10° C. for 8 days	Then at 40° C. for 4 days, then at 25° C. for 4 days	Then at 25° C. in light for 8 days
<i>Verbascum Thapsus</i>	94	0	0	95	98	0	64	83	0	71	71	0	1	88
<i>Rumex crispus</i> . . . .	89	2	0	98	98	0	2	63	0	94	97	0	31	34
<i>Daucus Carota</i> . . . .	60	4	0	14	15	0	2	16	0	11	11	0	13	13
<i>Oenothera biennis</i> .	85	0	0	69	69	0	16	16	0	2	2	0	4	12
<i>Nicotiana Tabacum</i>	53	0	0	70	72	0	0	3	0	35	35	0	0	1

*Thapsus* seeds, that it is an important factor in the germination of *Rumex crispus* seeds, and further indicates the necessity of light in the early periods of incubation of *Daucus Carota*, *Oenothera biennis*, and *Nicotiana Tabacum*. A comparison of *b* with *a* points again to the necessity of light in *Rumex crispus*, *Daucus Carota*, *Oenothera biennis*, and *Nicotiana Tabacum*, and indicates that some inhibiting factor developed during the 8 days in darkness in the case of *Oenothera biennis* and *Nicotiana Tabacum*. A comparison of *c* with the control indicates that light does its work on such seeds as *Verbascum Thapsus*, *Rumex crispus*, and in a measure on *Nicotiana Tabacum* even at low temperature, and that as soon as heat is supplied germination occurs. Incubating *Daucus Carota* and *Oenothera biennis* seeds at low temperature for a period of 8

days, in light or darkness, produces a condition from which they do not recover when incubated at 25° C. in light or in darkness. A comparison of *d* with control *a*, *b*, and *c* indicates that sudden changes from extremes of temperature may delay germination of *Verbascum Thapsus* seeds, that such treatment inhibits the germination of a large percentage of *Rumex crispus* seeds, and that it almost entirely inhibits the germination of seeds of *Nicotiana Tabacum*. The results in *d* confirm the observations on *Daucus Carota* and *Oenothera biennis* made in connection with *b*, namely, that some limiting factor develops during incubation in darkness at low temperature which is not easily overcome. The most noteworthy result of this treatment is the complete inhibition of germination of seeds of *Nicotiana Tabacum*. This is in agreement with that found in *b*. Together these results when compared with the control indicate a light requirement for *Nicotiana Tabacum* seeds which is not replaced by any temperature combination tried.

To summarize, this experiment shows that alternating temperature may replace light in germination of *Verbascum Thapsus* seeds, that light is necessary for optimum germination of entire seeds of *Rumex crispus*, although change of temperature in a measure replaces light. The results of this experiment indicate that seeds of *Oenothera biennis* and *Daucus Carota* require light and medium temperature for optimum germination, and that incubation at low temperature in darkness permits a change which is not overcome by transfer to high temperature in darkness. Moreover, in *Daucus Carota* exposures to light at 25° C. did not bring about germination of these changed seeds. Incubation of *Nicotiana Tabacum* in darkness at 10° C. did not result in increased percentage of germination in darkness. Incubation of *Nicotiana Tabacum* seeds in light at 10° C. promoted subsequent germination in darkness.

#### Hot water treatment

In a further attempt to induce germination in darkness, an adaptation of the warm bath method of MOLISCH (37) was employed. The seeds were counted, wrapped in filter paper, inclosed in little bags of cheesecloth, and plunged into hot distilled water for 0.25 minute and 0.5 minute respectively. Great care

was taken to plunge them promptly into cold distilled water, when the hot water was squeezed out. The seeds were then placed to germinate for 7 days at room temperature under the usual conditions. Table IX indicates what may be expected of hot water treatment of seeds. Treatment at lower temperatures was ineffective and so was not tabulated. The experiment was begun March 4.

The results of the warm bath treatment are mostly negative. The percentage of germination of *Rumex crispus* in darkness is

TABLE IX

SEEDS	TIME (IN MINUTES) IN HOT WATER	TREATMENT AT 90° C.; GERMINA- TION AT ROOM TEMPERATURE FOR 7 DAYS		TREATMENT AT 75° C.; GERMINA- TION AT ROOM TEMPERATURE FOR 7 DAYS		TREATMENT AT 60° C.; GERMINA- TION AT ROOM TEMPERATURE FOR 7 DAYS		UNTREATED; GERMINATION AT ROOM TEMPERATURE FOR 7 DAYS	
		Light	Dark- ness	Light	Dark- ness	Light	Dark- ness	Light	Dark- ness
NicotianaTabacum	0.25	4	2	0	0	42	11	62	2
NicotianaTabacum	0.5	0	0	0	0	50	34	.....	.....
Daucus Carota...	0.25	22	0	24	6	20	3	52	2
Daucus Carota...	0.5	22	0	36	8	40	8	.....	.....
VerbascumThapsus	0.25	0	0	75	10	67	20	78	0
VerbascumThapsus	0.5	0	0	75	8	65	15	.....	.....
Oenothera biennis.	0.25	70	22	76	20	40	8	50	6
Oenothera biennis.	0.5	0	6	80	48	28	20	.....	.....
Rumex crispus....	0.25	68	40	34	12	58	35	66	18
Rumex crispus....	0.5	66	36	58	10	86	28	.....	.....

increased somewhat by treatment with hot water at 90° C., while that of *Oenothera biennis* is increased somewhat by treatment with hot water at 75° C. and 90° C. These results indicate the coat as the limiting factor in their germination. Treatment at 100° C. for short periods might furnish interesting information.

### Water absorption

To determine the relation of water absorption to germination in light and darkness, 2 to 3 gm. of each of the different kinds of seeds were weighed separately and placed under favorable conditions for germination. As soon as the first germination in light was observed, the seeds were dried rapidly and weighed carefully, and the percentage of water absorbed was computed on the dry

weight basis. To confirm the results obtained a second series was treated similarly. Failing to obtain concordant results, two additional series of determinations were made. The variation in time of the appearance of the first hypocotyls and the uneven surfaces of the seed coats account for much of the variation in the amount of water absorbed. The results are given in table X.

In view of the small size of the seeds, their irregular surfaces, the difficulty of uniform drying, and the increase of weight on account of germination, the data of these determinations are not

TABLE X

SEEDS	SERIES 1		SERIES 2		SERIES 3		SERIES 4	
	Percent- age of imbibed water	No. of sprouts	Percent- age of imbibed water	No. of sprouts	Percent- age of imbibed water	No. of sprouts	Percent- age of imbibed water	No. of sprouts
Light								
Nicotiana Tabacum.....	92.9	13	82.3	10	108.5	3	65.5	8
Verbascum Thapsus.....	93.3	12	58.8	2	199.0	25	93.3	6
Daucus Carota.....	114.5	2	92.4	4	85.7	4	64.8	3
Oenothera biennis.....	40.7	1	48.5	4	61.7	7	39.4	11
Rumex crispus.....	48.4	3	43.4	2	54.3	5	52.7	29
Darkness								
Nicotiana Tabacum.....	60.0	0	50.0	0	67.7	1	63.6	0
Verbascum Thapsus.....	81.2	0	68.0	0	90.0	2	76.9	0
Daucus Carota.....	90.7	0	46.1	1	97.3	1	64.0	6
Oenothera biennis.....	45.1	0	108.5	1	49.4	1	49.9	11
Rumex crispus.....	53.1	8	52.4	1	48.9	1	45.8	10

surprisingly discordant. In some cases the high percentages of water absorbed is accounted for by the many and large seedlings which could not be removed without more seriously changing the data. After eliminating the cases open to suspicion on account of the numerous sprouts, imperfect drying, etc., there appears to be relatively little difference in the percentage of moisture absorbed by seeds germinated in light and darkness. In *Nicotiana Tabacum* seeds of series 4 the imbibition is 65.5 per cent with 8 sprouts in light, while in series 3 the imbibition is 67.7 per cent with one sprout in darkness, from which it appears that germination may occur even though a smaller percentage of water is absorbed. A

comparison of determinations of absorption by *Verbascum Thapsus* seeds in light (series 2) and in darkness (series 4) indicates the same general relations. The data for the other seeds show similar results. From this experiment it appears that light is not necessary for the absorption of sufficient water for germination.

### Injection of seeds with water

DE VRIES (8), having abandoned variation of temperatures, high temperatures (40–50° C.), and other treatments of seeds of *Oenothera biennis* as means of securing complete germination, injected soaked seeds with water under pressure of 6–8 atmospheres, after which he frequently secured germination of 100 per cent. The

TABLE XI

SEEDS	DARKNESS FOR 17 DAYS	THEN IN LIGHT FOR 7 DAYS	DARKNESS FOR 15 DAYS	THEN IN LIGHT FOR 7 DAYS	UNTREATED	
	(a)		(b)		Light	Darkness
<i>Verbascum Thapsus</i> .....	1	4	0	24	81	0
<i>Daucus Carota</i> .....	6	10	8	12	61	21
<i>Oenothera biennis</i> .....	8	43	5	55	33	8
<i>Rumex crispus</i> .....	5	8	11	56	71	31
<i>Nicotiana Tabacum</i> .....	4	54	5	60	83	0

seeds (table XI, a) accordingly were soaked overnight at a temperature of 25–28° C., wrapped in filter paper, placed in water, exhausted of the air in their intercellular spaces by reducing the atmospheric pressure to 20 mm. for 1 hour, and then subjected to hydrogen gas pressure of 575–675 pounds per square inch for 24 hours. The seeds were then placed to germinate in darkness under the usual conditions. A second lot (b) was treated in the same way except that it was subjected to a pressure of 500–650 pounds per square inch for 48 hours. Both lots were germinated at room temperature. Evidently injection with water does not increase the germination of seeds of *Oenothera biennis*, *Nicotiana Tabacum*, *Daucus Carota*, or *Rumex crispus* in darkness. When the seeds are subsequently exposed to light, they germinate in one or both tests. These results confirm the conclusion arrived at in the weighing experiments, that impermeability to water is not the limiting factor in light germi-



nation. Perhaps better illumination of the injected *Oenothera biennis* seeds made possible the increased germination reported by DE VRIES.

#### Increased oxygen supply

In his investigation of the delayed germination of seeds of *Xanthium*, CROCKER (7) found that the seed coat excludes oxygen, while SHULL (46) found a very definite relation between the oxygen supply and the percentage of germination in seeds of *Xanthium*. In order to discover if increased oxygen supply would promote the germination of the light-sensitive seeds in darkness, the following experiment was performed. Counted seeds were placed on wet filter paper in open dishes and placed under water-sealed glass cylinders containing 40, 50, 60, 70, and 80 per cent oxygen respectively (table XII). Each cylinder was placed in a dark room at 23–28° C. and covered with a light-tight metallic cylinder.

TABLE XII

Seeds	Percentage of germination in oxygen				
	40	50	60	70	80
<i>Nicotiana Tabacum</i> .....	0	0	0	0	0
<i>Verbascum Thapsus</i> .....	0	0	0	0	0
<i>Daucus Carota</i> .....	3	3	9	15	24
<i>Oenothera biennis</i> .....	.....	1	1	1	3
<i>Rumex crispus</i> .....	8	.....	19	18	23

A comparison of the germination in darkness in the presence of different percentages of oxygen shows an increase of germination of seeds of *Daucus Carota* and *Rumex crispus* with an increase of oxygen supply. Other conditions in each of the cylinders being the same so far as known, this must be attributed to increased oxygen supply. A similar experiment with higher and lower percentages of oxygen would have been interesting, especially a test of germination in 20 per cent oxygen (ordinary air) under these conditions. It would probably have given results similar to those in 40 per cent oxygen and would have been rather more conclusive. The regularity of the increased percentage of germination, however, due to increased concentration of oxygen, indicates the reliability of the results. Clearly this experiment does not indicate an oxygen

deficiency in seeds of *Nicotiana Tabacum*, *Verbascum Thapsus*, and *Oenothera biennis*.

### Substrata

LEHMANN (30) reported increased germination in darkness of light-sensitive seeds such as *Ranunculus sceleratus* with soil as substratum. BAAR (1) obtained an increased percentage of germination of seeds of *Amaranthus* when he substituted earth for filter paper as a substratum, but OTTENWÄLDER (40), who used soil and sand as well as filter paper as substrata for his *Epilobium hirsutum* seeds, found beneficial results in his experiments with only one lot of sand. Investigation showed that the sand had been treated with acid which had not been thoroughly washed out.

TABLE XIII

PERCENTAGE OF GERMINATION AFTER 18 DAYS

SEEDS	ON SOIL		ON SAND		IN SOIL	IN SAND	ON FILTER PAPER	
	Light	Darkness	Light	Darkness	Light	Light	Light	Darkness
<i>Verbascum Thapsus</i> . . . . .	40	34	30	20	2	24	41	3
<i>Daucus Carota</i> . . . . .	56	28	54	28	32	58	63	19
<i>Oenothera biennis</i> . . . . .	2	0	2	2	0	6	3	2
<i>Rumex crispus</i> . . . . .	68	2	46	10	12	38	42	8
<i>Nicotiana Tabacum</i> . . . . .	70	6	78	0	56	76	71	1

In view of the divergent results with the different seeds, it was deemed desirable to determine the relation of sand and soil to germination in darkness of these light-sensitive seeds. Also the question arose as to whether light was as necessary under natural conditions as under laboratory conditions for the germination of light-sensitive seeds. The substrata were carefully sterilized, uniformly wetted, and prepared for the seeds. The seeds in "sand" and in "soil" were buried to a depth of 0.25 inch. All were put under the same temperature conditions (23-26° C.). The results are shown in table XIII. The experiment was begun May 13 and closed June 1.

The germination of seeds of *Verbascum Thapsus* on soil and sand in darkness is somewhat higher than that on filter paper. The substratum appears to have exerted a slightly favorable effect on the germination of seeds of *Daucus Carota*, but none on the other

seeds. Such results suggest a beneficial effect on some particular constituent contained only in seeds of *Verbascum Thapsus*. In light the percentage of germination seems to correspond roughly to the light intensity. Where the lighting is good, as on the filter paper or sand, the germination is good. Where it is diminished, as in the case of seeds buried in sand or soil, the germination is reduced. The increase of germination of seeds on sand or soil in darkness may be referred largely to the action of constituents of the soil and sand. The low germination of seeds of *Oenothera biennis* may be due to periodicity in dormancy, since seeds from the same lot gave a germination of 78 per cent in light and 0 per cent in darkness in October. From these results it appears that constituents of soil may only partially substitute for light with some seeds and not at all with others.

#### Effects of electrolytes

The effects of electrolytes on the germination of light-sensitive seeds have been variously reported. Beneficial effects on germination in darkness of *Ranunculus sceleratus* from hot water extracts of soils, Knop's nutrient solution, and salt solutions have been reported by LEHMANN (30). He reported no benefit from cold water extracts of soils. LEHMANN and OTTENWÄLDER (36) found that weak acid solutions promote germination in darkness of seeds of *Verbascum Thapsus*, *V. thapsiforme*, and *Lythrum Salicaria*. OTTENWÄLDER (40) reported that acids promote the germination of seeds of *Epilobium hirsutum* in darkness. GASSNER (15) reported that nitrogen compounds such as nitrates, nitrites, and ammonium salts through a wide range of concentrations favor the germination of seeds of *Chloris ciliata* in darkness. As many of the electrolytes reported by these investigators belonged to the lyophobic or lyophilic series, a systematic study of their effects was undertaken, to discover, if possible, some relation between electrolytes and germination. Lots of 100 seeds each were counted into test tubes, about 2 cc. of a solution of an electrolyte added, and the tubes placed in darkness. After 24 hours most of the solution was drained from each test tube, which was promptly returned to the dark chamber for the seeds to germinate. The period allowed for germination was 7 days after soaking. The results are given in table XIV.

TABLE XIV  
GERMINATION IN DARKNESS IN VARIOUS CONCENTRATIONS

SEEDS	N	0.1 N	0.01 N	0.001 N	0.0001 N	0.00001 N	SEEDS	N	0.1 N	0.01 N	0.001 N	0.0001 N	0.00001 N
Verbascum Thapsus....	0	0	77	79	86	....	Verbascum Thapsus....	....	....	37	94	62	....
Rumex crispus.....	0	0	29	23	0	....	Rumex crispus.....	....	....	0	0	1	....
Daucus Carota.....	0	0	1	3	4	....	Daucus Carota.....	....	....	4	3	0	....
Oenothera biennis.....	0	8	48	42	53	....	Oenothera biennis.....	....	....	42	72	49	....
Nicotiana Tabacum....	0	0	27	46	23	....	Nicotiana Tabacum....	....	....	1	2	3	....
Butyric acid							Sulphuric acid						
Verbascum Thapsus....	0	0	0	80	86	....	Verbascum Thapsus....	....	....	8	35	94	97
Rumex crispus.....	0	0	0	6	2	....	Rumex crispus.....	....	....	0	1	0	0
Daucus Carota.....	0	0	0	1	6	....	Daucus Carota.....	....	....	0	12	3	7
Oenothera biennis.....	0	0	0	45	50	....	Oenothera biennis.....	....	....	25	36	34	40
Nicotiana Tabacum....	0	0	0	38	10	....	Nicotiana Tabacum....	....	....	2	24	9	2
Citric acid							Potassium sulphate						
Verbascum Thapsus....	....	0	40	95	98	....	Verbascum Thapsus....	....	....	87	89	100	....
Rumex crispus.....	....	6	11	8	13	....	Rumex crispus.....	....	....	1	0	1	....
Daucus Carota.....	....	0	10	5	12	....	Daucus Carota.....	....	....	1	0	1	....
Oenothera biennis.....	....	38	61	52	68	....	Oenothera biennis.....	....	....	44	58	38	....
Nicotiana Tabacum....	....	36	35	54	58	....	Nicotiana Tabacum....	....	....	12	5	8	....
Tartaric acid							Ammonium sulphate						
Verbascum Thapsus....	....	0	14	81	53	....	Verbascum Thapsus....	0	51*	92	87	98	....
Rumex crispus.....	....	7	7	10	0	....	Rumex crispus.....	0	3	7	5	9	....
Daucus Carota.....	....	1	0	13	8	....	Daucus Carota.....	0	0	1	4	15	....
Oenothera biennis.....	....	2	52	75	67	....	Oenothera biennis.....	0	44*	53	54	65	....
Nicotiana Tabacum....	....	21	59	50	27	....	Nicotiana Tabacum....	0	36*	44	40	23	....
Malic acid							Sodium sulphate						
Verbascum Thapsus....	....	5	64	100	91	....	Verbascum Thapsus....	....	....	91	94	88	....
Rumex crispus.....	....	1	22	13	6	....	Rumex crispus.....	....	....	2	0	2	....
Daucus Carota.....	....	0	3	7	1	....	Daucus Carota.....	....	....	1	6	0	....
Oenothera biennis.....	....	27	55	54	60	....	Oenothera biennis.....	....	....	58	48	41	....
Nicotiana Tabacum....	....	40	43	31	83	....	Nicotiana Tabacum....	....	....	4	9	10	....
Potassium sulphocyanate							Lithium sulphate						
Verbascum Thapsus....	....	....	80	75	88	....	Verbascum Thapsus....	....	....	93	91	90	....
Rumex crispus.....	....	....	0	2	2	....	Rumex crispus.....	....	....	3	0	1	....
Daucus Carota.....	....	....	8	4	2	....	Daucus Carota.....	....	....	2	3	0	....
Oenothera biennis.....	....	....	70	65	61	....	Oenothera biennis.....	....	....	46	53	37	....
Nicotiana Tabacum....	....	....	3	1	7	....	Nicotiana Tabacum....	....	....	17	12	9	....
Sodium sulphocyanate							Nickel sulphate						
Verbascum Thapsus....	....	....	0	93	52	....	Verbascum Thapsus....	....	....	63†	62	86	....
Rumex crispus.....	....	....	0	0	1	....	Rumex crispus.....	....	....	3	2	0	....
Daucus Carota.....	....	....	2	4	0	....	Daucus Carota.....	....	....	5	28	21	....
Oenothera biennis.....	....	....	63	57	53	....	Oenothera biennis.....	....	....	33	40	37	....
Nicotiana Tabacum....	....	....	9	9	14	....	Nicotiana Tabacum....	....	....	2	13	9	....

\* Little more than swelling.

† Injured.

TABLE XIV—Continued

SEEDS	N	0.1N	0.10N	0.100N	0.1000N	0.10000N	SEEDS	N	0.1N	0.10N	0.100N	0.1000N	0.10000N
	Zinc sulphate							Cobalt nitrate					
Verbascum Thapsus.....	.....	.....	41	80	97	.....	Verbascum Thapsus....	.....	.....	31*	99	93	.....
Rumex crispus.....	.....	.....	0	0	0	.....	Rumex crispus.....	.....	.....	1	4	2	.....
Daucus Carota.....	.....	.....	2	1	1	.....	Daucus Carota.....	.....	.....	4	2	8	.....
Oenothera biennis.....	.....	.....	37	40	51	.....	Oenothera biennis.....	.....	.....	45	57	16	.....
Nicotiana Tabacum.....	.....	.....	8	3	2	.....	Nicotiana Tabacum....	.....	.....	13	15	10	.....
Potassium nitrate						Potassium hydroxide							
Verbascum Thapsus.....	.....	.....	36	82	95	.....	Verbascum Thapsus....	.....	0	84	100	98	.....
Rumex crispus.....	.....	.....	3	2	0	.....	Rumex crispus.....	.....	0	6	6	9	.....
Daucus Carota.....	.....	.....	8	18	8	.....	Daucus Carota.....	.....	0	7	9	4	.....
Oenothera biennis.....	.....	.....	55	61	55	.....	Oenothera biennis.....	.....	0	44	55	42	.....
Nicotiana Tabacum.....	.....	.....	50	23	23	.....	Nicotiana Tabacum....	.....	0	17	34	53	.....
Ammonium nitrate						Ammonium hydroxide							
Verbascum Thapsus....	0	62	100	82	93	.....	Verbascum Thapsus....	.....	.....	1	90	95	.....
Rumex crispus.....	0	3	14	11	8	.....	Rumex crispus.....	.....	.....	0	0	1	.....
Daucus Carota.....	0	0	0	1	1	.....	Daucus Carota.....	.....	.....	0	1	3	.....
Oenothera biennis.....	0	70	66	68	64	.....	Oenothera biennis.....	.....	.....	31	.....	56	.....
Nicotiana Tabacum....	0	54	73	34	28	.....	Nicotiana Tabacum....	.....	.....	1	15	12	.....
Sodium nitrate						Sodium hydroxide							
Verbascum Thapsus....	0	64	100	98	91	.....	Verbascum Thapsus....	.....	0	81	96	83	.....
Rumex crispus.....	0	14	26	4	15	.....	Rumex crispus.....	.....	0	1	2	2	.....
Daucus Carota.....	0	6	1	6	4	.....	Daucus Carota.....	.....	0	3	11	6	.....
Oenothera biennis.....	0	60	67	67	50	.....	Oenothera biennis.....	.....	0	50	57	0	.....
Nicotiana Tabacum....	0	38	34	29	11	.....	Nicotiana Tabacum....	.....	0	21	3	16	.....
Aluminum nitrate						Hydrochloric acid							
Verbascum Thapsus....	.....	.....	55	98	93	.....	Verbascum Thapsus....	.....	.....	0	38	61	92
Rumex crispus.....	.....	.....	1	1	0	.....	Rumex crispus.....	.....	.....	0	0	0	0
Daucus Carota.....	.....	.....	2	3	9	.....	Daucus Carota.....	.....	.....	0	5	4	2
Oenothera biennis.....	.....	.....	12	57	55	.....	Oenothera biennis.....	.....	.....	5	61	56	60
Nicotiana Tabacum....	.....	.....	0	10	14	.....	Nicotiana Tabacum....	.....	.....	0	10	22	10

\* Little more than swelling.

From table XIV it appears that organic acids, bases, and salts of monovalent, bivalent, and trivalent ions induce germination in darkness of seeds of *Verbascum Thapsus* (80–100 per cent), *Oenothera biennis* (40–60 per cent), and *Nicotiana Tabacum* (10–50 per cent), while they inhibit the germination of seeds of *Rumex crispus* and *Daucus Carota*. These results were confirmed in an attempt to determine the minimum effective concentration of the electrolytes. In this attempt it was found that as good germination in darkness

occurs in ten-millionth normal solutions as in one-thousandth normal solutions. These results indicate no definite relation between the nature of the ion and germination. In another series of experiments on the relation of electrolytes to germination, with seeds from another crop, it was found that the germination of *Verbascum Thapsus*, *Oenothera biennis*, and *Nicotiana Tabacum* was inhibited, while the germination of *Rumex crispus* seeds was promoted in darkness by the action of the various electrolytes. This suggests that something in the conditions of growth, maturing, harvesting, or storage may have changed the sign of the charge of the ionizable constituents of the seeds. Further work on the effects of electrolytes on the germination of these seeds is highly desirable.

#### Soaking in solutions of electrolytes

It is generally believed that forcing agents of germination such as light, enzymes, and electrolytes are most effective during the early stages of incubation. KINZEL (24) by soaking seeds of *Nigella sativa* in a solution of papayotin and asparagin for 5 hours and then in water for 24 hours secured a 30 per cent increase of germination of "light hard" seed. OTTENWÄLDER (40) has reported that 24 hours is not sufficient time to secure the full effect of the acid on the germination of seed of *Epilobium hirsutum*, and that about 48 hours' soaking was necessary to get the best results from the action of the acid. An attempt was made, therefore, to determine whether soaking in solutions of electrolytes could promote the germination of light-sensitive seeds.

Seeds were soaked in the various solutions for 24-28 hours and washed in distilled water until all of the solution was removed. To avoid light effects, care was taken to work in very diffuse light. The seeds were spread on filter paper in Petri dishes and placed to germinate in light and darkness respectively, at room temperature, for 8 days.

An examination of table XV A shows that soaking in rather strong solutions of hydrochloric acid promotes the germination in darkness of seeds of *Nicotiana Tabacum*, *Verbascum Thapsus*, *Oenothera biennis*, and *Rumex crispus*, while it hinders the germination of seeds of *Daucus Carota* in light. The beneficial effects of solutions

of sulphuric acid appear only in the germination of seeds of *Daucus Carota* in darkness. Soaking seeds of *Nicotiana Tabacum* and

TABLE XVA

SEEDS	LIGHT				DARKNESS			
	N	0.1 N	0.01 N	∞	N	0.1 N	0.01 N	∞
Hydrochloric acid (soaked 26 hours)								
<i>Nicotiana Tabacum</i> .....	83	70	70	65	16	35	22	11
<i>Verbascum Thapsus</i> .....	34	85	87	85	1	22	24	3
<i>Daucus Carota</i> .....	0	0	0	54	0	18	25	19
<i>Oenothera biennis</i> .....	76	92	87	78	37	33	.....	8
<i>Rumex crispus</i> .....	80	84	72	.....	23	35	35	15
Sulphuric acid (soaked 28 hours)								
<i>Nicotiana Tabacum</i> .....	.....	76	76	71	.....	10	26	21
<i>Verbascum Thapsus</i> .....	.....	79	87	81	.....	2	10	0
<i>Daucus Carota</i> .....	.....	72	66	61	.....	12	38	21
<i>Oenothera biennis</i> .....	.....	83	51	62	.....	10	11	8
<i>Rumex crispus</i> .....	.....	69	73	71	.....	24	30	31
Sodium sulphocyanate (soaked 28 hours)								
<i>Nicotiana Tabacum</i> .....	68	.....	.....	74	48	.....	.....	19
<i>Verbascum Thapsus</i> .....	57	.....	.....	83	0	.....	.....	5
<i>Daucus Carota</i> .....	36	.....	.....	75	12	.....	.....	26
<i>Oenothera biennis</i> .....	51	.....	.....	52	0	.....	.....	12
<i>Rumex crispus</i> .....	52	.....	.....	68	54	.....	.....	24
Sodium hydroxide (soaked 24 hours)								
<i>Nicotiana Tabacum</i> .....	0	81	61	74	0	26	25	19
<i>Verbascum Thapsus</i> .....	0	63	86	83	0	10	19	5
<i>Daucus Carota</i> .....	0	77	63	75	0	30	45	26
<i>Oenothera biennis</i> .....	1	87	42	51	0	22	12	12
<i>Rumex crispus</i> .....	0	59	76	68	0	17	26	24

TABLE XV B

SEEDS	PERCENTAGE OF HYDROGEN PEROXIDE (SOAKED 27 HOURS)									
	Light					Darkness				
	50	20	10	5	∞	50	20	10	5	∞
<i>Nicotiana Tabacum</i> .....	15	75	72	56	74	6	38	81	46	19
<i>Verbascum Thapsus</i> .....	12	70	75	68	83	0	0	6	2	5
<i>Daucus Carota</i> .....	76	83	94	78	75	26	48	61	53	26
<i>Oenothera biennis</i> .....	18	33	33	40	51	0	5	12	10	12
<i>Rumex crispus</i> .....	73	66	73	77	68	43	36	70	39	24

*Rumex crispus* in solutions of sodium sulphocyanate appeared to promote their germination in darkness. Soaking in potassium sulphocyanate gave similar results. Soaking in solutions of hydrogen peroxide promoted the germination of seeds of *Nicotiana Tabacum*, *Daucus Carota*, and *Rumex crispus* in darkness (table XV B). Germination in 0.001 N sodium hydroxide was about the same as in 0.01 N. Soaking in solutions of sodium hydroxide gave increased germination in darkness of seeds of *Verbascum Thapsus*, *Daucus Carota*, and *Oenothera biennis*. These results were confirmed by another set of tests.

The reaction of the seeds to the different electrolytes indicates that the ions of the electrolytes are acting on different constituents of different seeds. While, as shown in the preceding experiment, the use of hydrochloric acid, sodium sulphocyanate, and hydrogen peroxide as substrata yields no increase of germination of *Rumex crispus* in darkness, this experiment shows that soaking for a short period (24-28 hours) in solutions of these electrolytes does promote their germination in darkness. As *Rumex crispus* seeds were brought to germination in darkness by abrading and removing the coats, and by the action of concentrated sulphuric acid, their germination may naturally be referred to coat effects, the compounds acting on some constituent of the coat. The germination of *Daucus Carota* is not so easily accounted for. The germination in darkness was only slightly promoted by increased oxygen supply and on soil as substratum. The hydrogen peroxide may yield an increased oxygen supply and thus promote the germination of these seeds, but an explanation of the beneficial effects of sulphuric acid and sodium hydroxide on the same material is not easily made unless we refer to coat effects which have not been clearly indicated by other treatment. A longer period of soaking (48 hours) might have yielded data to settle this, as well as the failure of germination of the other seeds in certain solutions.

### Lipoid solvents

Finding that lipoids occur in the coats and embryos of all the seeds and in the endosperm of four of them, it was thought desirable to determine the effect of acetone, alcohol, and ether on their



germination. Seeds of each kind were soaked in acetone for 15, 30, and 60 minutes respectively, air dried for two hours, and placed under favorable conditions for germination in darkness. At the end of 8 days of incubation (in darkness) the seeds were placed in light for 8 days, where none of them germinated. Other seeds were similarly treated with alcohol with similar results. A few seeds of *Daucus Carota* and *Oenothera biennis* survived the alcohol treatment and germinated in light and darkness. Other seeds were treated with ether, as indicated in table XVI.

The results show no promotion of germination of light-sensitive seeds in darkness when treated with lipoid solvents, but rather show inhibition or diminution of subsequent germination in light. This is especially true for acetone and alcohol. Ether inhibited germina-

TABLE XVI

SEEDS	SOAKED IN ETHER 15 MINUTES		SOAKED IN ETHER 30 MINUTES		SOAKED IN ETHER 60 MINUTES	
	Darkness	Light	Darkness	Light	Darkness	Light
<i>Verbascum Thapsus</i> .....	0	28	0	30	0	0
<i>Rumex crispus</i> .....	0	35	0	3	0	2
<i>Daucus Carota</i> .....	15	17	17	17	12	12
<i>Oenothera biennis</i> .....	0	76	0	74	0	62
<i>Nicotiana Tabacum</i> .....	0	43	0	64	0	31

tion in darkness of all seeds except *Daucus Carota*, and diminished the subsequent germination in light of seeds of *Verbascum Thapsus*, *Rumex crispus*, and *Nicotiana Tabacum*. Ether treatment did not affect the subsequent germination of seeds of *Oenothera biennis* in light.

### Microchemistry

In an attempt to find the substance responding to the action of light, an examination of the seeds was undertaken by microchemical methods suggested by ECKERSON (9), and the nature and distribution of the different structural and nutritive materials were determined. Much of the information thus obtained has no evident bearing on the problem of light germination and may best be presented in a separate publication. Some of the substances and conditions in these seeds which may function in light germination are fat, suberin, starch, and reaction.

Starch occurs in the endosperm of seeds of *Rumex crispus* and *Daucus Carota*. It does not occur in the embryo of any seeds under investigation. Moreover, the hydrogen ion concentration is not likely to be materially changed by such hydrolysis of starch as may occur during their germination, and therefore we need not consider starch an important factor in their germination. Since suberin is found in the coats of *Oenothera biennis* and *Daucus Carota*, but not elsewhere, it can hardly be considered a common limiting factor in the germination of the light-sensitive seeds studied. Oily or fatty substances were found in the cell contents of coats, endosperms, and embryos of each of the seeds, appearing as small droplets of substance readily stained with Soudan III or Scharlach R. These lipoids almost never occurred as continuous layers which might obstruct the entrance of water or other substance necessary for germination, but usually as emulsions of fats in the cell sap. The results of the experiments on the absorption of water support the observation that there is no important obstruction of water by the constituents of the coats. Hence suberin and lipoids need no further consideration as limiting factors in absorption of water by these seeds.

Using neutral red as an indicator, seeds soaked in water in light and in darkness, as well as dry seeds, were tested for the reaction of the different parts with results shown in table XVII.

The outstanding result of the microchemical examination is the greater acidity of seeds incubated in light as compared with those incubated in darkness. This was found to be the case in each of the five kinds of light-sensitive seeds. The embryos incubated in light had a higher hydrogen ion concentration than those of the same kind incubated in darkness. This was especially noticeable in the hypocotyls. This result is contrary to HEINRICHER'S (21) unsupported assumption that the effectiveness of the fat splitting lipase was favored by the increased acid formation in darkness in *Phacelia tanacetifolia*. Moreover, HEINRICHER offered no experimental evidence of increased acid formation in darkness. Having all known external factors, except illumination, alike for the seeds under investigation, we may properly conclude that the varying factor, light, in some way brings about increased acidity of their embryos.

TABLE XVII

SEEDS	COATS	ENDOSPERM	EMBRYO
<i>Verbascum Thapsus</i>			
Dry.....	Acid	Cell walls acid; contents neutral	Cell walls acid; contents neutral
Soaked in darkness.....	Acid	Cell walls acid; contents neutral	Outer cell walls and contents alkaline to neutral; inner cell walls acid; contents alkaline
Soaked in light..	Acid	Walls acid; contents acid	Walls and contents acid
<i>Rumex crispus</i>			
Dry.....	Acid	Outer layer acid; cell contents neutral	Walls and contents neutral
Soaked in darkness.....	Acid	Outer layer acid; contents mostly acid	Walls acid; contents neutral
Soaked in light..	Acid	Walls acid; contents acid	Walls and contents acid
<i>Daucus Carota</i>			
Dry.....	Outer walls acid; inner alkaline	Cell walls acid to alkaline; contents neutral to alkaline	Alkaline
Soaked in darkness.....	Outer acid; inner alkaline	Walls acid to alkaline; contents neutral to alkaline	Alkaline except at tip of hypocotyl
Soaked in light..	Outer acid; inner alkaline	Walls acid to alkaline; contents neutral	Walls and contents acid
<i>Nicotiana Tabacum</i>			
Dry.....	Acid	Cell walls acid; contents neutral to alkaline	Cell walls acid; contents neutral to alkaline
Soaked in darkness.....	Acid	Walls acid; contents alkaline to neutral	Cell walls acid; contents partly alkaline, partly neutral
Soaked in light..	Acid	Walls acid; contents neutral to acid	Walls acid; contents acid except at base of cotyledons

TABLE XVII—Continued

SEEDS	COATS	ENDOSPERM	EMBRYO
<i>Oenothera biennis</i>			
Dry.....	Partly acid	Slightly acid or neutral	Cell walls acid; contents neutral
Soaked in darkness.....	Mostly acid	Slightly acid to neutral	Cell walls acid to neutral; contents alkaline to neutral
Soaked in light..	Partly acid	Neutral to acid	Walls and contents acid

### Quantitative determination of acidity

To verify the results of the microchemical examination, 5 gm. of each kind of seed incubated in light for five days and 5 gm. of each kind incubated in darkness for five days were separately ground, digested in neutral alcohol and ether, and then titrated with  $N/10$  NaOH. The results obtained were as follows:

Seed	Light	Darkness
Rumex crispus.....	3.5 cc.	2.8 cc.
Daucus Carota.....	3.3	2.8
Verbascum Thapsus.....	4.8	4.4
Nicotiana Tabacum.....	3.9	2.8

These results show greater acidity of seeds incubated in light than of those incubated in darkness, and confirm the findings of the microchemical examination. While the increase of titratable acidity was not large, it was measurable and repeatedly obtained, and apparently was sufficient in each instance to determine germination. Since light is the variable factor in this and the preceding experiment, we may properly conclude that light initiates changes which produce the increased acidity of seeds incubated in light over those incubated in darkness. These results establish the fact that light functions in some way to bring about increased acidity in these light-sensitive seeds. There remains to show in the following experiment, if possible, how the acidity is increased.

### Effect of germination on substratum

Having found that the embryos of these seeds become acid in reaction by incubation in light, it was thought that testing the

reaction of the substratum after a period of incubation might throw some light on what was happening in the seeds. A small quantity of each kind of seed was soaked in distilled water, 0.01 N  $\text{NH}_4\text{NO}_3$  solution, and 0.01 N  $\text{NaNO}_3$  solution at room temperature, and the substratum tested for reaction with neutral red. The results are shown in table XVIII.

TABLE XVIII

SEEDS	SOAKED 18 HOURS IN DISTILLED WATER		SOAKED 24 HOURS IN 0.01 N $\text{NH}_4\text{NO}_3$		SOAKED 24 HOURS IN 0.01 N $\text{NaNO}_3$	
	Light	Darkness	Light	Darkness	Light	Darkness
<i>Verbascum Thapsus</i> . . . . .	Alkaline	Alkaline	Alkaline	Alkaline	Alkaline	Alkaline
<i>Rumex crispus</i> . . . . .	Acid	Acid	Acid	Acid	Acid	Acid
<i>Daucus Carota</i> . . . . .	Alkaline	Alkaline	Alkaline	Alkaline	Alkaline	Alkaline
<i>Oenothera biennis</i> . . . . .	Neutral	Neutral	Alkaline	Neutral	Alkaline	Neutral
<i>Nicotiana Tabacum</i> . . . . .	.....	.....	Alkaline	Alkaline	Alkaline	Alkaline

From the results it appears that seeds of *Verbascum Thapsus*, *Daucus Carota*, and *Nicotiana Tabacum* excrete an alkaline substance in darkness as well as in light; that seeds of *Rumex crispus* excrete an acid substance in darkness as well as in light; and that seeds of *Oenothera biennis* excrete an alkaline substance in light.

A quantitative experiment also verifies a part of these results. Weighed quantities of each of the five kinds of seeds were incubated in light for five days in tubes containing 2 cc. of 0.01 N  $\text{NaNO}_3$  respectively. The results are given in table XIX.

TABLE XIX

Seeds	Weight of seeds (gm.)	Required to titrate
<i>Verbascum Thapsus</i> . . . . .	0.7406	1.0 cc. 0.01 N HCl
<i>Rumex crispus</i> . . . . .	1.3385	1.5 cc. 0.01 N NaOH
<i>Daucus Carota</i> . . . . .	0.6510	0.9 cc. 0.01 N HCl
<i>Oenothera biennis</i> . . . . .	0.7580	0.5 cc. 0.01 N HCl
<i>Nicotiana Tabacum</i> . . . . .	0.8403	1.8 cc. 0.01 N HCl

The longer period of incubation evidently allowed time for the excretion of a measurable amount of acid or base by each kind of seed. From these results it appears that seeds of *Rumex crispus* excrete measurable amounts of acid substance during incubation, while the other kinds excrete alkaline substances.

### Enzymes

The favorable effects of light on the germination of seeds of *Veronica peregrina* in the early work of HEINRICHER (19) was referred to its effect upon chemical actions connected with the reactivation of reserve materials, and later (21) to its effect upon enzyme activity in the production and digestion of stored foods. He (22) referred the retarding effect of light on the germination of seeds of *Phacelia tanacetifolia* to its photochemical action on reserve materials, and assumed that the effectiveness of the fat splitting lipase was favored by the increased acid formation in darkness, while the irrefrangible light or the rays of the first half of the spectrum interfered, neutralizing the acid and thereby checking the decomposition of fat.

It seemed possible that enzymes of some kind might be active agents, and light the stimulus or trigger in the germination of certain seeds. Just what kinds of enzymes function most in the germination of light-sensitive seeds has not been shown. To determine whether proteolytic enzymes were the important enzymes for the seeds, as LEHMANN and OTTENWÄLDER (36) believed for seed of *Epilobium hirsutum*, seeds of *Verbascum Thapsus* and *Nicotiana Tabacum* were incubated in light and darkness respectively for four days and promptly ground in a little 50 per cent water solution of glycerine to which a crystal of thymol had been added. Small drops of extract from each kind of seed were put on nutrient gelatin according to the method of GIESEN (16). After 30 minutes the extract was taken up with soft filter paper. There were very shallow pits formed where the extracts incubated in light had been. There were also shallow pits formed on the gelatin where the extract incubated in darkness had been. In fact, the pits produced by the extract germinated in darkness were deeper than those produced by the extract incubated in light. To verify these observations, the tests were repeated after allowing a more complete extraction of the enzyme. The extracts of seeds incubated in light were put in light, and the extracts of seeds incubated in darkness were put in darkness. The following day the same tests were repeated. Extracts from each lot of seeds were tested for their action by putting loopfuls on gelatin. After 30 minutes the extracts were removed separately, when it was

found that well defined pits had been formed in the gelatin. Moreover, where the extract was left on the gelatin for 24 hours, the pits became quite deep, even though there was abundance of thymol to inhibit bacterial action. These results were confirmed by the method of GRÜSS (17).

Since the activity on gelatin of enzymes of seeds incubated in darkness was equal to or greater than that of seeds incubated in light, the favorable effect of light on germination of *Nicotiana Tabacum* and *Verbascum Thapsus* cannot be referred to activation of proteolytic enzymes.

It has already been seen that starch does not occur in the embryos of any of these light-sensitive seeds, and that it occurs only in the endosperms of *Daucus Carota* and *Rumex crispus*. From these facts it is evident that hydrolysis of contained starch can increase the hydrogen ion of the embryos little if any. It has been seen that proteolytic enzymes develop equally well in darkness and light in these seeds, hence they can be rejected as important factors in determining light germination. Also, incubation in light does result in increased acidity of embryos over those incubated in darkness.

It has been shown that the embryos of these seeds all contain fatty substances. The generally accepted method of demonstrating the presence of lipolytic enzymes is by the increase of acidity in the presence of fats. Inasmuch as development of acidity in the presence of light and fatty substance has been clearly demonstrated, it may be concluded that light activates the lipolytic enzyme to split the fatty substance to yield an acid. The results obtained with enzymes of seeds of *Verbascum Thapsus* and *Nicotiana Tabacum* do not support HEINRICHER'S (22) assumption that light inhibited the action of lipase in seeds of *Phacelia tanacetifolia*. On the other hand, the results indicate that light favored the action of lipase in seeds of *Verbascum Thapsus* and *Nicotiana Tabacum*.

## Discussion

### COAT EFFECTS

The light relation of seeds of *Rumex crispus* is largely one affecting the coats, as is indicated by increased germination in darkness following abrasion and removal of coats, treatment with

concentrated sulphuric acid, and increased oxygen pressure. Light may bring about some change in the coats of *Rumex crispus* to admit oxygen or other required substance, or permit the escape of some inhibiting substance such as an organic acid. It may change the relation of the lipoids from the oil water phase to the water oil phase, or break up a nearly continuous oil layer in the coat, thus allowing entrance or escape of some limiting factor. The presence of lipoids in the coats and the excretion of an acid instead of an alkaline substance during germination suggest that an enzyme acting in the coats hydrolyzes the lipoids, thus yielding acid and making the coats permeable to some required substance, or permitting the elimination of some inhibitory substance.

There is some evidence of a coat effect in the germination of seeds of *Oenothera biennis*. While abrasion of the coats does not yield increased germination, hot water treatment and sulphuric acid treatment both yield considerable increases of germination in darkness. The presence of lipoids in the coats suggests the same explanation of the action of light as in the seeds of *Rumex crispus*, with the addition that the light may also have a beneficial effect on the constituents of the embryo.

In the seeds of *Nicotiana Tabacum*, *Verbascum Thapsus*, and *Daucus Carota* there is little evidence of coat effects, there being no increased germination caused by abrasion, sulphuric acid treatment, hot water treatment, or increased oxygen pressure. The only results suggesting coat effects are increased germination of *Daucus Carota* and *Nicotiana Tabacum* when soaked in hydrogen peroxide. This increased germination might be referred to the effects on the embryos.

The seeds of this investigation fall into three groups. The first is represented by the seeds of *Rumex crispus*, in which the coats must be made permeable to some external or internal substance by light, abrasion, or other agency before abundant germination occurs. The second group is represented by the seeds of *Oenothera biennis*, whose germination is partly dependent on the coats being made permeable, and partly on the activation of the embryos by light or chemical agencies. The third group is represented by seeds of *Nicotiana Tabacum*, *Daucus Carota*, and *Verbascum Thapsus*,



whose germination is not increased simply by making the coats permeable, but requires the action of light or a suitable substitute to induce good germination.

#### MICROCHEMISTRY

The results of the various mechanical, physical, and chemical treatments of the light-sensitive seeds have offered few suggestions as to the nature of the effects of light on their constituents in inducing germination. The substitution of these various agencies for light has contributed little to an acceptable explanation of how light functions to bring about germination. These treatments, however, have served to localize the action of light and to determine the part of the seed affected. On the other hand, the microchemical examination yielded results which point to an acceptable explanation of the action of light on light-sensitive seeds. The outstanding findings of the microchemical studies were abundance of lipoids in each kind of seed and increased acidity of seeds incubated in light. Thus there are linked together light, lipoids, and increased acidity.

#### ENZYMES

Since starch and other carbohydrates were not found in the embryos of these seeds and in the endosperms of but two of them, it is not necessary to give serious consideration to the probable reaction of the products of their hydrolysis. Moreover, since proteolytic enzymes were found to be equally active in light and darkness in *Nicotiana Tabacum* and *Verbascum Thapsus* seeds, they need not be considered as important causes of increased acidity of the seeds incubated in light. It remains to be considered whether the products of the hydrolysis of the lipoids are the cause of the increased acidity in light.

The development of acidity in the watery extract of an oily seed like that of the castor bean is generally considered evidence of the presence of lipase. Such development of increased acidity in light was demonstrated quantitatively for four of the five kinds of seeds, thus confirming the results of the microchemical examination, and giving reasonable ground for inferring that lipase splits the fats thus yielding fatty acids in seeds germinated in light.

Again, the presence of neutral or very faintly alkaline fats in the cells of the dry embryos and the development of acids in embryos incubated in light and no change or development of slight alkalinity when incubated in darkness is very significant. It is generally assumed that increased acidity of fatty substances indicates hydrolysis due to the action of enzymes. If this assumption be granted, the admission is necessary that light initiates processes which in some way result in increased acidity, which is followed by germination, and that where light is not admitted acidity does not develop sufficiently to cause good germination. Three explanations of how light acts may be offered: (1) light may act directly to split the fats to fatty acids and glycerine; (2) light may activate the lipolytic enzyme which splits the fats; (3) light may initiate some change that produces a little acid which may activate the lipolytic enzyme which splits the fats.

While it is possible and even probable that light can act directly on the inclusions of cells to produce such changes as the formation of acid, it is hardly necessary to make this assumption. The proteolytic enzymes become active in the absence of light when the seeds are put under the usual conditions for germination. A certain percentage germinate in darkness even though they have not been treated with electrolytes or other stimulating agencies. Moreover, the amount of acid produced, though small, is relatively more than might be expected from the chemical action of light on lipoids. The evidence of the existence of lipase rather indicates either of the other explanations as much more acceptable. There is little choice between light activating the enzyme and light initiating some change which produces a little acid which may activate the lipolytic enzyme which splits fats. In either case light is the stimulus which initiates the changes leading to germination.

### Summary

1. The seeds of *Rumex crispus*, *Datura Stramonium*, and *Phoradendron flavescens* were found to be light sensitive. The germination of seeds of *Rumex crispus* and *Phoradendron flavescens* was promoted by light; the germination of seeds of *Datura Stramonium* was hindered by light.

2. Abrasion and removal of coats (ovary walls) of *Rumex crispus* seeds promoted their germination in darkness.
3. Treatment of seeds of *Rumex crispus* and *Oenothera biennis* with concentrated sulphuric acid caused an increase in the percentage of germination in darkness.
4. No reciprocal relation between the effects of light and temperature was found.
5. Light was not necessary for the absorption of sufficient water for germination.
6. Injection of water did not yield increased germination in darkness.
7. Almost all kinds of single electrolytes, regardless of the nature of the ions, seemed to promote germination of seeds of *Oenothera biennis*, *Nicotiana Tabacum*, and *Verbascum Thapsus* in darkness.
8. Embryos of seeds incubated in light became more acid than those incubated in darkness.
9. Light seemed to activate lipolytic enzymes which hydrolyzed fats to fatty acids.
10. The germination of seeds of *Rumex crispus* in darkness was promoted (increased) by hot water treatment, abrasion, treatment with concentrated sulphuric acid, increased oxygen pressure, fluctuating temperatures, and soaking in solutions of hydrochloric acid, sodium sulphocyanate, and hydrogen peroxide.
11. The germination of seeds of *Nicotiana Tabacum* in darkness was promoted by soaking in solutions of hydrochloric acid, sodium sulphocyanate, and hydrogen peroxide, as well as by the use of many single electrolytes as substrata.
12. The germination of seeds of *Verbascum Thapsus* in darkness was promoted by the action of light, fluctuation of temperature during incubation, alternating high and low temperatures, soil, and many single electrolytes as substrata.
13. The germination of seeds of *Oenothera biennis* in darkness was promoted during certain seasons by hot water treatment, sulphuric acid, preliminary incubation at low temperature, incubation in alternating high and low temperatures, and single electrolytes as substrata.

14. The germination of seeds of *Daucus Carota* in darkness was promoted by increased oxygen pressure and preliminary incubation at low temperature, while it was hindered by soaking in hydrochloric acid and by the use of single electrolytes as substrata.

The writer gratefully acknowledges the kindly advice and direction of Professor F. C. NEWCOMBE, in whose laboratory this investigation was begun; and also the valuable suggestions and criticisms of Professor WILLIAM CROCKER, under whose direction this investigation was completed.

ALABAMA POLYTECHNIC INSTITUTE  
AUBURN, ALA.

#### LITERATURE CITED

1. BAAR, H., Über den Einfluss des Lichtes auf die Samenkeimung und seine Abhängigkeit von andern Factoren. Sitzungsber. Kaiserl. Akad. Wiss. Wien. Math.-Naturwiss. 121:667-705. 1912.
2. BECKER, H., Über die Keimung verschiedenartiger Früchte und Samen bei derselben Spezies. Beih. Bot. Centralbl. 1912:1-129.
3. BESSEY, E. A., The Florida strangling figs. Rep. Mo. Bot. Garden 19:25-33. 1909.
4. CASPARY, M., *Bulliarda aquatica* DC. Schr. Physik. Ökonom. Gesells. Königsberg. 1860. pp. 66-82.
5. ———, Über Samen und Keimung von *Pinguicula vulgaris*. Schr. Physik. Ökonom. Gesells. Königsberg. 1867. p. 17.
6. CIESLAR, ADOLF, Untersuchung über den Einfluss des Lichtes auf die Keimung der Samen. Forsch. Geb. Agrik. Physik. 6:270-295. 1883.
7. CROCKER, WM., Rôle of seed coats in delaying germination. BOT. GAZ. 42:265-291. 1906.
8. DE VRIES, HUGO, Über künstliche Beschleunigung der Wasseraufnahme in Samen durch Druck. Biol. Centralbl. 35:161-176. 1915.
9. ECKERSON, SOPHIA H., A physiological and chemical study of after-ripening. BOT. GAZ. 55:286-299. 1913.
10. FIGDOR, W., Über den Einfluss des Lichtes auf die Keimung der Samen einiger Gesneriaceen. Ber. Deutsch. Bot. Gesells. 25:582-585. 1907.
11. ———, Weitere Untersuchungen über den Einfluss des Lichtes auf die Keimung der Gesneriaceen. Ber. Deutsch. Bot. Gesells. 30:648-653. 1912.
12. GASSNER, G., Über Keimungsbedingungen einiger südamerikanischer Gramineensamen. Ber. Deutsch. Bot. Gesells. 28:350. 1910.
13. ———, Untersuchungen über die Wirkung des Lichtes und des Temperaturwechsels auf die Keimung von *Chloris ciliata*. Jahrb. Hamberg. Wiss. 29: 1911.

14. GASSNER, G., Beiträge zur Frage der Lichtkeimung. Zeitschr. Bot. 7:609-661. 1915.
15. ———, Einige neue Fälle von Keimungsauslösender Wirkung der Stickstoffverbindungen auf lichtempfindliche Samen. Ber. Deutsch. Bot. Gesells. 33:217-232. 1915.
16. GIESEN, R., Über die proteolytischen Fermente der als Futtermittel benutzten Körnerfrüchte. Inaug. Diss. Univ. Bern. pp. 34. 1909.
17. GRÜSS, J., Biologie und Kapillaranalyse der Enzyme. 1912.
18. HAACK, —, Die Prüfung des Kiefernnsamens. Zeitsch. Forst- und Jagdwesen. pp. 1-64. 1912.
19. HEINRICHER, E., Ein Fall beschleunigender Wirkung des Lichtes auf die Samenkeimung. Ber. Deutsch. Bot. Gesells. 17:308-311. 1899.
20. ———, Notwendigkeit des Lichtes und befördernde Wirkung desselben bei der Samenkeimung. Beih. Bot. Centralbl. 13:164-172. 1902.
21. ———, Die Beeinflussung der Samenkeimung durch das Licht. Wiesner Festschrift. Wien. 263-279. 1908.
22. ———, Keimung von *Phacelia tanacetifolia* Benth. und das Licht. Bot. Zeitschr. 67:47-66. 1909.
23. JÖNSSON, B., Jaktagelsen of ver Ljusetse Betydelse for Frens Groning. Lunds Univ. Arsskr. 29:40-47. 1893.
24. KINZEL, W., Über den Einfluss des Lichtes auf die Keimung. Ber. Deutsch. Bot. Gesells. 25:269-276. 1907.
25. ———, Lichtkeimung: Einige bestätigende und ergänzende Bemerkungen zu den vorläufigen Mittheilungen von 1907-1908. Ber. Deutsch. Bot. Gesells. 261:631-645. 1908.
26. ———, Lichtkeimung: Weitere bestätigende und ergänzende Bemerkungen zu den vorläufigen Mittheilungen von 1907-1908. Ber. Deutsch. Bot. Gesells. 261:655-665. 1908.
27. ———, Lichtkeimung: Erläuterungen und Ergänzungen. Ber. Deutsch. Bot. Gesells. 27:536-545. 1909.
28. LASCHKE, W., Einige vergleichende Untersuchungen über den Einfluss des Keimbettes sowie des Lichtes auf die Keimung verschiedener Samereien. 65:295-300. 1907.
29. LAURENT, E., Sur le pouvoir germanatif des graines à la lumière solaire. Compt. Rend. Acad. Sci. 29:1295-1298. 1902.
30. LEHMANN, E., Zur Keimungs-physiologie und Biologie von *Ranunculus sceleratus* und einiger anderen Samen. Ber. Deutsch. Bot. Gesells. 27:476-494. 1909.
31. ———, Temperatur und Temperaturwechsel in ihrer Wirkung auf die Keimung lichtempfindlicher Samen. Ber. Deutsch. Bot. Gesells. 29:577-589. 1911.
32. ———, Über die Beeinflussung der Keimung lichtempfindlicher Samen durch die Temperatur. Zeits. für Bot. 4:465-529. 1912.

33. LEHMANN, E., Über katalytische Lichtwirkung bei der Samenkeimung. *Biochem. Zeitschr.* 50:338-392. 1913.
34. ———, Lichtkeimungsfragen. *Zeits. für Bot.* 7:560-580. 1915.
35. LIEBENBERG, A., Über den Einfluss des Lichtes intermittierender Erwärmung auf die Keimung von Samen. *Bot. Centralbl.* 18:21-26. 1884.
36. LEHMANN, E., and OTTENWÄLDER, A., Über katalytische Wirkung des Lichtes bei der Keimung lichtempfindlicher Samen. *Zeits. für Bot.* 5:337-364. 1913.
37. MOLISCH, H., Über ein einfaches Verfahren Pflanzen zu treiben (Warmbad Methode). *Sitzungber. Kaiserl. Akad. Wissensch.* 117:87-117. 1908.
38. NOBBE, FR., *Handbuch der Samen Runde.* 1876.
39. ———, Übt das Licht einen vorteilhaften Einfluss auf das Keimung des Grassamen. *Land. Vers. Stat.* 27:347-355. 1882.
40. OTTENWÄLDER, A., Lichtintensität und Substrat bei der Lichtkeimung. *Zeits. für Bot.* 6:785-848. 1914.
41. PAUCHON, A., Recherches sur le rôle de la lumière dans la germin. Étude historique, critique et physiologique. *Ann. Sci. Nat. Bot. VI.* 10: 1880.
42. PICKHOLTZ, L., Ein Beitrag zur Frage über die Wirkung des Lichtes und intermittierender Temperatur auf die Keimung von Samen, sowie über die Rolle des Wassergehaltes der Samen bei dieser Wirkung. *Zeitschr. Landw. Versuch. Osterreich.* 14:124-151. 1911.
43. RACIBORSKI, W., Über die Keimung der Tobaksamen. *Bull. Inst. Bot. Buitenzorg.* No. 6. 1900.
44. REMER, W., Der Einfluss des Lichtes auf die Keimung bei *Phacelia tanacetifolia* Benth. *Ber. Deutsch. Bot. Gesells.* 22:328-329. 1906.
45. ROSTRUP, O., Aarberetning fra Dansk Froekontroll. 1896; rev. *Exper. Sta. Record* 10:53-54. 1898.
46. SHULL, C. A., Oxygen minimum and the germination of *Xanthium* seed. *BOT. GAZ.* 52:453-477. 1911.
47. SIMON, FR., Über die Keimung zuvor belichteter und chemische vorbehandelter Samen. *Biochem. Zeits.* 48:410-417. 1913.
48. STEBLER, E. G., Über den Einfluss des Lichtes auf die Keimung. *Bot. Centralbl.* 7:157-158. 1881.
49. TAMMES, T., Über den Einfluss der Sonnenstrahlen auf die Keimfähigkeit von Samen. *Landw. Jahrb.* 29:467-482. 1900.
50. TODARO, F., Action of sulphuric acid upon seed, particularly upon the hard seeds of certain Leguminosae. *Staz. Sper. Agr. Ital.* 34:613-689. 1901.
51. WIESNER, J., *Viscum album.* *Denkschrift Wiener. Akad. Wissensch.* 1878.

## ECOLOGY OF *TILIA AMERICANA*

### II. COMPARATIVE STUDIES OF THE FOLIAR TRANSPIRING POWER

JAMES E. CRIBBS

(WITH TEN FIGURES)

A comparative study of the foliar transpiring power of *Tilia* as recorded in the field for dune environments (1) preceded this work, which is an extension of the former investigations, and is concerned with the data recorded for the same species as obtained from a wide range of habitats on clay soils.

The methods employed were essentially the same as described in the former discussion of the dune series. A 3 per cent cobalt chloride standard paper was used in all the work for determining the relative transpiring power, and was applied by means of the clip devised by LIVINGSTON (4). As in the former experiments, readings were taken on two leaves at each station, the same leaves being employed in subsequent readings. Records were taken at approximately hourly intervals, and as recorded represent the average of four to six readings. Curves are plotted for both leaves. The slight difference observed in the readings for the two leaves, which occasionally became considerable, was in most instances attributed to the relative maturity and specialization of the epidermis and cuticle.

Measurements of the chief environmental factors were recorded, and special features of the environment taken into consideration. The chief factors measured were evaporation, relative humidity, atmospheric temperature, soil temperature, wilting coefficient, and growth water. The occurrence of alternate sun and shade, velocity of the wind, fog, and passing thunder showers were special features which were found to bear a definite relation to the oscillating behavior of the transpiration stream. Measurement and computation of these factors were carried out in the same manner as in the preceding experiments.

Nine different stations were chosen, representing the range of habitats frequented by *Tilia* on clay soils. Stations *F*, *G*, and *K* are located on the old Lake Chicago plain, *K* being in Washington Park at Chicago, while *F* and *G* are located in an open forest on the flood plain of the Des Plaines River. These are environments having a strong prairie influence both as to environmental factors and flora composition. Station *H* is located in a mesophytic forest on a glacial upland in western Pennsylvania, where the chief components of the lower flora include such members as *Adiantum*, *Actaea alba*, *Osmorrhiza*, *Botrychium virginianum*, *Aralia quinquefolia*, etc. Station *I* is near *H*, but occupies a position at the edge of an evergreen swamp which lies between glacial moraines. The soil here is of heavy blue clay overlaid by a few inches of rich humus. The undergrowth is composed largely of *Taxus*, *Arisaema*, *Veratrum viride*, and *Symplocarpus*. Station *J* is located at the foot of a steep east-facing embankment at the edge of a creek where the water content of the soil is always high and insulation is low. Station *M* is in a partially wooded rocky ravine where the chief members of the ground flora are *Adiantum*, *Osmunda*, *Arisaema*, etc. Station *N* is near the opening of the same ravine in a more exposed location on alluvial soil washed down from above by the stream. Station *L* is on the flood plain of the Neosho River in Kansas, and represents the species on the western prairie tension line.

This series includes *Tilia* both in its normal environment, the mesophytic forest, and in abnormal ones when considered from an ecological standpoint. It also includes the species near the center of its distribution and on the limits of its range, where it is eliminated by members of another climax series, the prairie. Data have been presented in graph form to better illustrate such correlations as exist between the recorded factors. Graphs for all readings are not presented, because of the recurrence of very similar data at some of the stations. Those recorded, however, represent all the essential facts observed in the work at the various stations.

#### Normal features of transpiration curve

It has been a commonly observed feature in work on foliar transpiration that the curve representing its index rises quite



rapidly in the morning, beginning at dawn or shortly after. This early rise was attributed by LLOYD (7) to the opening of the

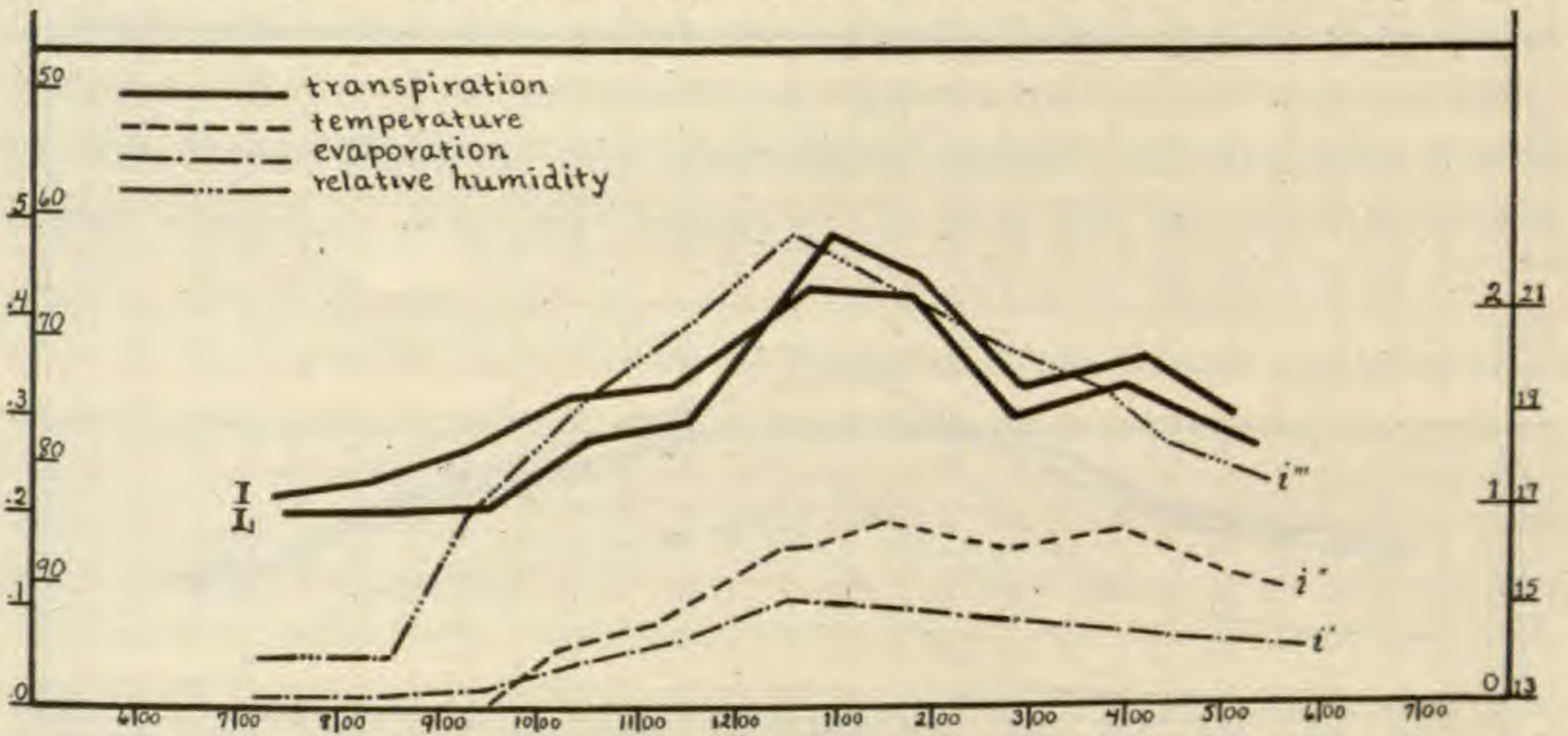

FIG. 1.—Data taken at station I on June 7, showing approximate concurrence of maxima in different curves; legend applies to all figures except fig. 7.

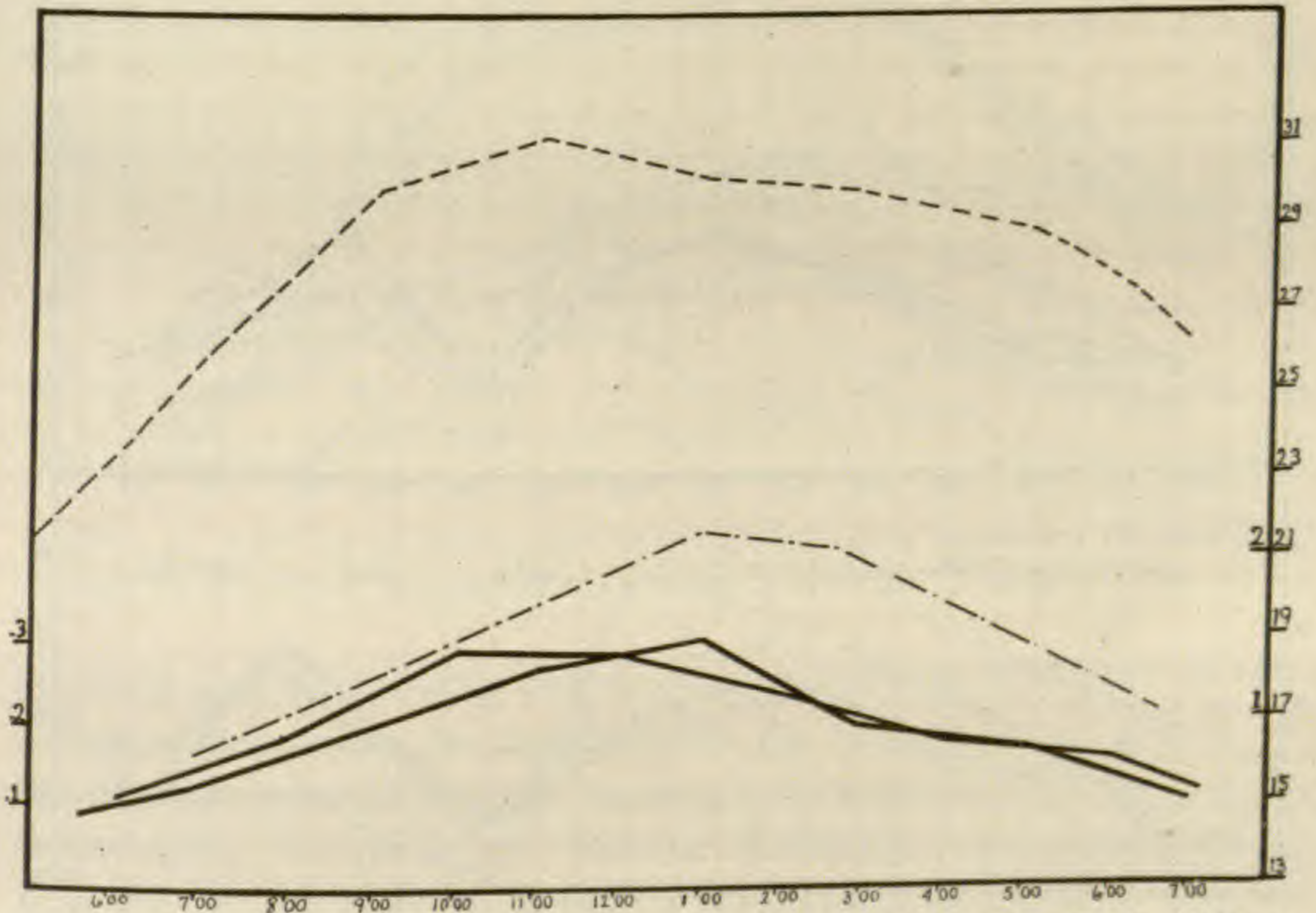

FIG. 2.—Record of data for station K, taken in Washington Park, Chicago, August 16; note gradual rise and decline of transpiration curve.

stomata under the influence of light. That there is a sudden opening at this time has been verified by direct examination recently by SAYRE (8). In working on *Nicotiana* and *Verbascum*

he found that the stomata opened rapidly, beginning at about 5:00 A.M. and reaching a maximum about 8:00-9:00 A.M. The study

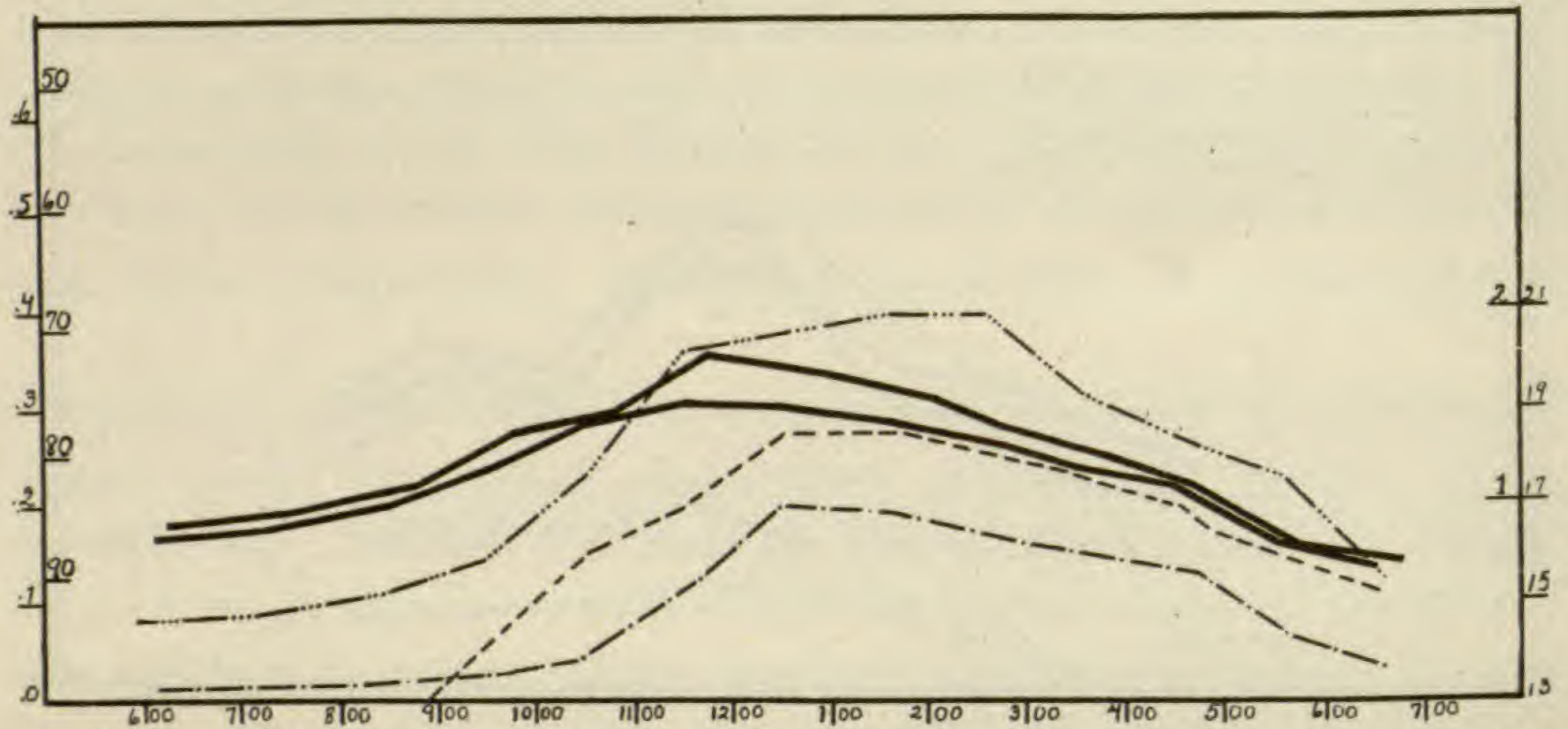

FIG. 3.—Records for station *N*, taken September 2, showing gradual rise and decline in transpiration index, with approximate concurrence of maxima.

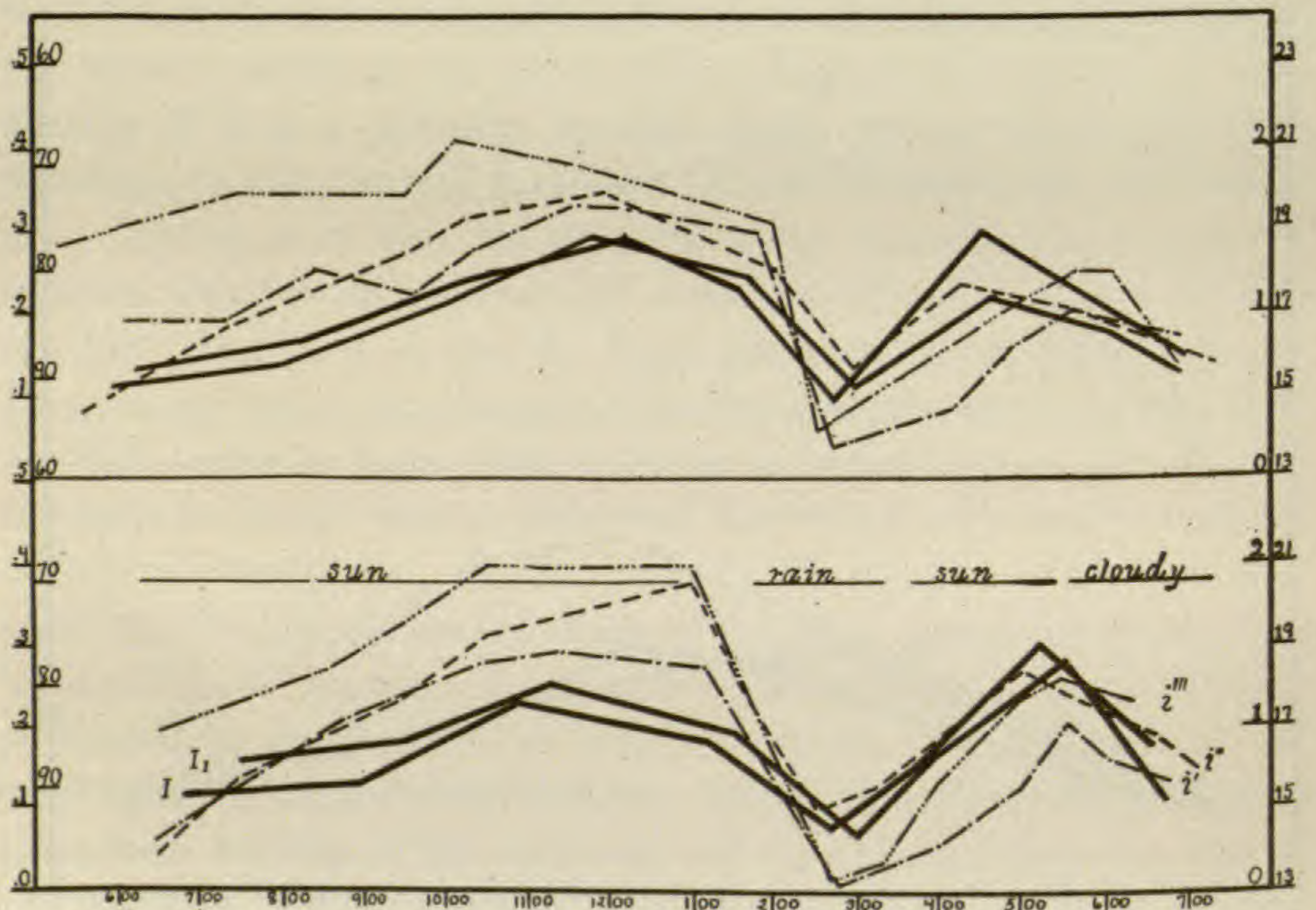

FIG. 4.—Graphs for stations *H* and *I*, taken on June 8, illustrating pronounced depression in transpiration index caused by precipitation; note that both temperature and evaporation curves show like depression and subsequent rise.

of *Tilia* in its more normal habitats on clay has shown a variation from this behavior. Figs. 1, 2, 3, and 4 show that, quite unlike the customary behavior in positions strongly exposed to light, the

transpiration index as recorded in forest habitats more frequently showed a slow steady rise, beginning with the morning opening of the stomata and continuing to a maximum which usually occurred about midday. The maximum was approximately three hours later in the forest than on the open dune sands. It was also much lower relatively than was found to be true for the sand environment. In only one instance was the coefficient observed to reach 0:5 on the forested clay, while in the former case it not infrequently

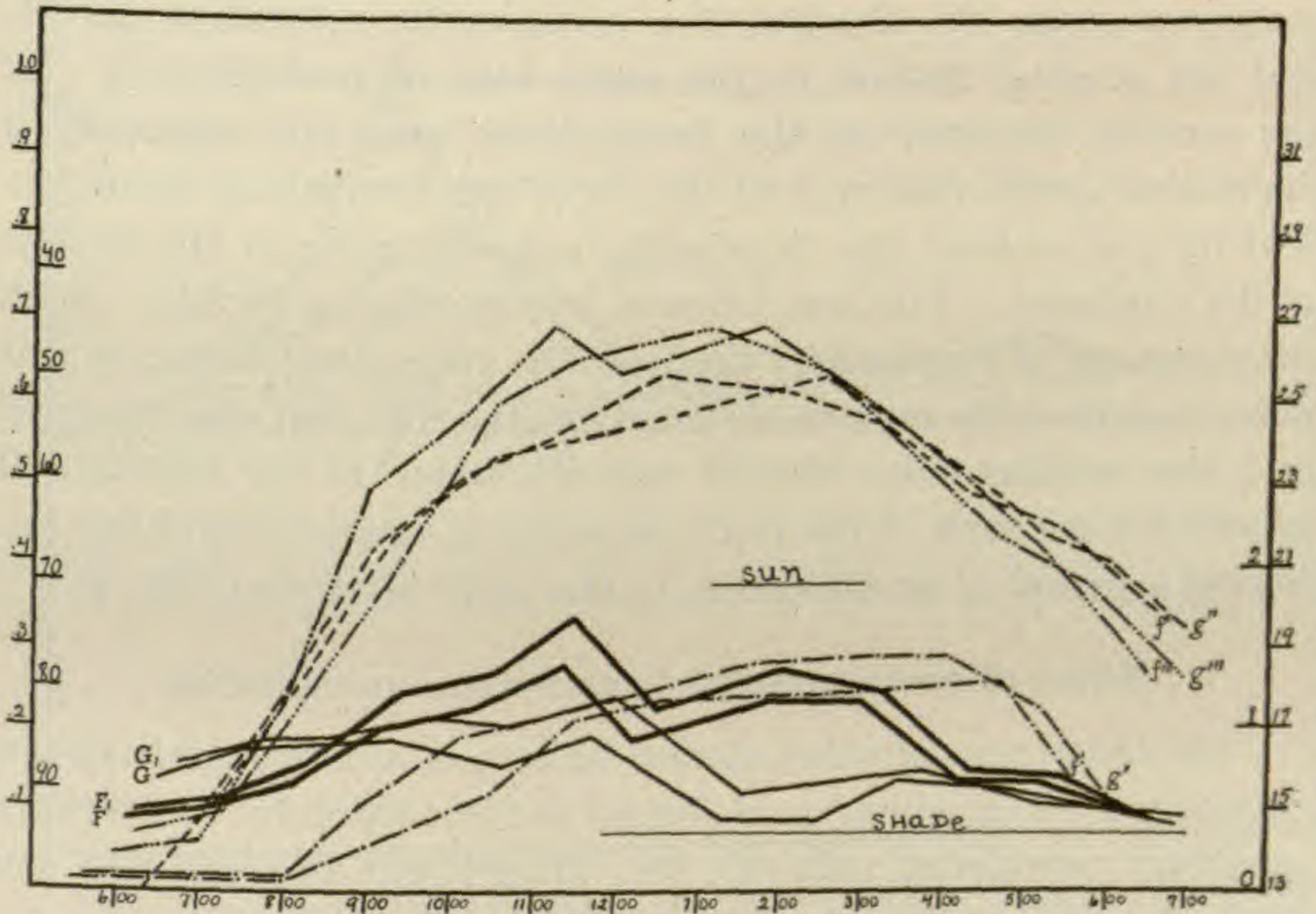

FIG. 5.—Data for stations *F* and *G* in prairie flood plain forest near Chicago; both readings for August 18; stronger saturation deficit recorded for station *G* than for *F*.

attained 0:9. Following the morning maximum, a feature of the transpiration curve, as pointed out by various investigators, is the depression which occurs, causing a divergence from the curves representing temperature, relative humidity, and evaporation. This has been thought to be due to the creation of a deficit of water in the mesophyll cells. Such depressions are strongly evident in the dune graphs, but were inconspicuous throughout the work on *Tilia* in clay habitats. Fig. 5 shows a deficit depression in the graph representing station *G*. It is less evident at station *F* for the same day. Figs. 2 and 3 show a slight divergence from the

evaporation curve, but in all instances the deficit is relatively slight when compared with that recorded in the former studies of this species. The fall of the transpiration curve in the afternoon was just as gradual and slow as the morning rise, by 7:00 P.M. or soon after, reaching approximately the same level as that recorded for 5:00 or 6:00 A.M. preceding the first rise.

The prominent features of the curves as found in this series of studies were a gradual rise, a low maximum which comes approximately at noon, the absence of a conspicuous saturation deficit, and the gradual decline to the night rate of transpiration. In the records obtained on the dunes there was very generally a depression about midday, and the curve was frequently characterized by a secondary rise developing a lower mode in the middle of the afternoon. This was followed by the evening decline. Such development of a secondary mode in the transpiration curves was not a feature of the records obtained on clay soils, but was observed in a few readings only, when it was attributed to the influence of special factors such as the rapid decrease in relative humidity following a period of precipitation in the early afternoon (fig. 4).

#### **Effect of environmental factors upon transpiration**

The foliar transpiration stream undergoes various fluctuations, occasioned by the stimulus of certain factors which by temporarily exerting a dominating influence may bring about a pronounced and rapid response in the rate of water loss.

PRECIPITATION.—Passing thunder showers usually caused the coefficient of transpiration to fall very rapidly. Fig. 4 shows the effect of a shower at stations *H* and *I*, these graphs being plotted from data secured on June 8. The general atmospheric conditions other than recorded in the graphs are indicated in the lower figure. It will be seen that at the two stations the same depression appears during the period of precipitation. The corresponding depression in evaporation, temperature, and relative humidity curves shows these factors all working together to produce the same result, namely, a lower transpiration rate. Immediately following the shower, which lasted one and one-half hours, there was a sudden and rapid rise in the transpiration curve, accompanied by a cor-

responding elevation on those of temperature, evaporation, and saturation deficit of the air. The height of the rise was on the whole rather unexpected, inasmuch as the late afternoon was regularly characterized by a steady decline, during which time the stomata were closing. Similar reactions during brief periods of precipitation were recorded during investigation on the dunes, where the depressions were commonly less pronounced.

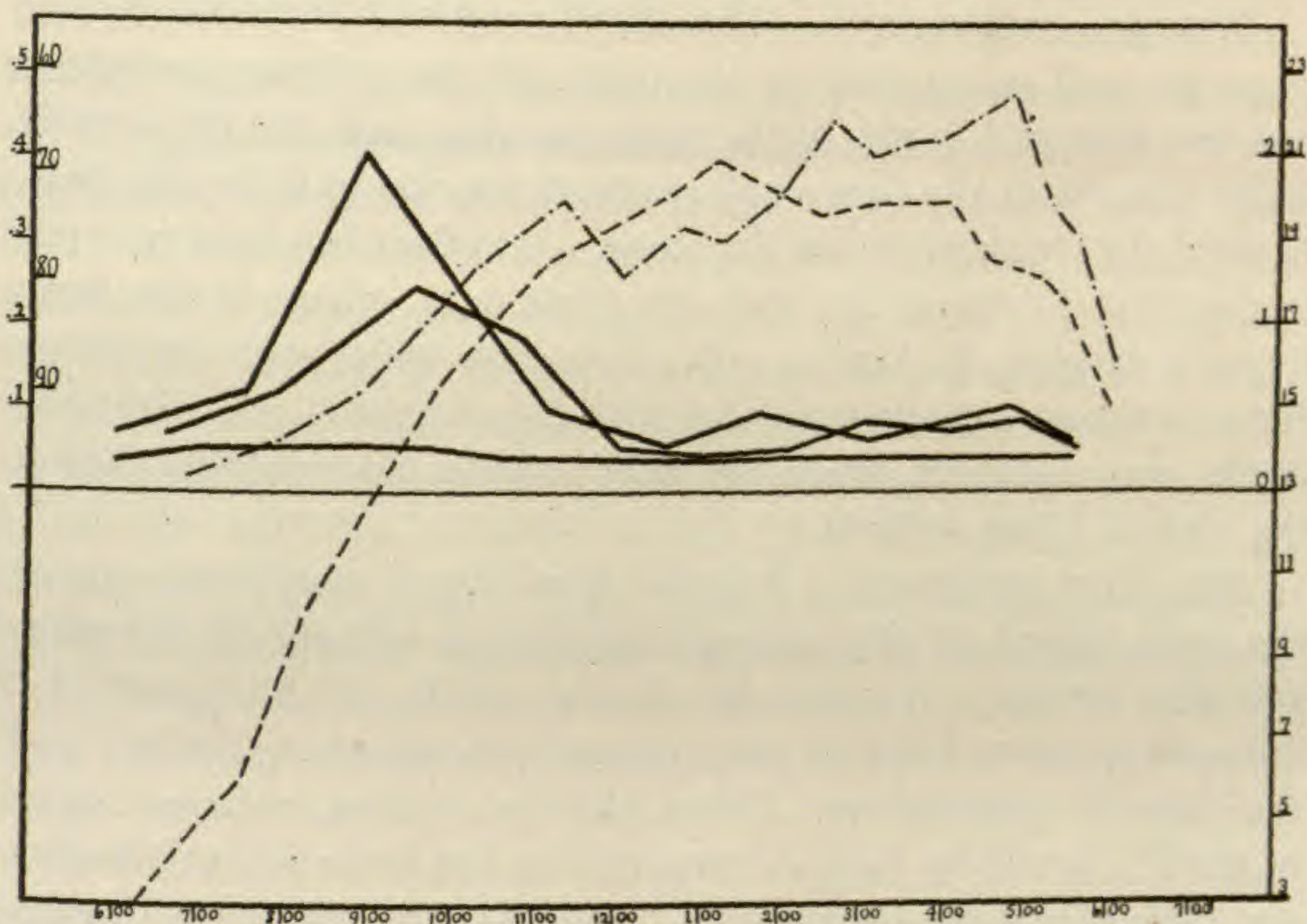

FIG. 6.—Data for station *J*, taken September 3, showing depression in transpiration as result of visible wilting caused by abscission; third solid line represents cuticular transpiration as recorded for adaxial side of leaf; note low temperature in morning.

**ABSCISSION.**—Fig. 6 shows a curve which is strikingly different from the typical one recorded during this work. It is characterized by a rapid rise to a fairly high maximum which occurred early, about 9:00 A.M. Following the maximum there was a decline, which by midday had almost reached the level of cuticular transpiration. This condition prevailed throughout the remainder of the day, there being a slight and very gradual rise until about 5:00 o'clock. The mesophyll saturation deficit recorded is very conspicuous. This curve is very similar to those described as occurring at stations *A* and *B* on the dunes taken on August 26 (fig. 9, graph 3). In that

instance it was found that the low curve was caused by the soil water being reduced to the wilting coefficient. Such could not be true in this case, however, as the growth water was in excess all the time. The cause of depression at station *J* was found to be associated with abscission. This was likewise an influencing factor in the similar depression formerly referred to, being induced there by the inadequacy of water supply.

**WILTING COEFFICIENT.**—The effect produced on transpiration when the soil water falls to the point of the wilting coefficient was not observed in any of the work on clay soils, for the growth water content at the time of all readings was found to be adequate to meet the requirements of the plant. Its effect has been referred to, however, in connection with the dune data, where in the dune forest it develops in August. Transpiration under such conditions remains almost entirely cuticular, with the exception of a slight rise in the early morning, when the reserve water accumulated during the night is being utilized.

**RELATIVE HUMIDITY.**—Relative humidity is considered one of the most potent of the atmospheric factors influencing the transpiration stream. It is the direct cause of the establishment of a diffusion gradient between the internal atmosphere of the leaf and the external atmosphere. Other physical factors initiate change in relative humidity, such as temperature, but because transpiration is a molecular diffusion problem, it should be interpreted as bearing its closest relation to those factors which initiate and directly influence this process. Relative humidity has this close relationship to the foliar water loss, and slight sudden changes in this factor are usually registered in the transpiration curve, even though the porous cup makes no record of it. Reference to fig. 9, graph 2, will illustrate this relation. CURTIS (2), in observing the effect of relative humidity, states that an increase of 8 per cent was followed by a pronounced reduction in the transpiration rate.

**EVAPORATION.**—The relative humidity and evaporation curves do not always show so close a parallel as might be expected (fig. 9, graph 3), so that in some instances there is greater correlation between those representing temperature and evaporation than between relative humidity and the latter. This divergence is very

largely due to the effect of winds, which, without affecting the humidity, accelerate the loss of water from the porous cup, and may to a less degree affect the transpiration rate. The atmometer shows greater sensitiveness to the influence of wind than does the leaf.

TEMPERATURE.—Temperature exerts a very important influence in the transpiration process by affecting the surface tension films of the mesophyll cells and changing their rate of molecular diffusion. LIVINGSTON (6) has referred to temperature as the probable controlling factor in causing fluctuations in the transpiration stream. An increase in temperature accelerates the diffusion from the mesophyll cells, setting up an increase in the vapor pressure within the leaf. At the same time it also increases the saturation deficit of the external atmosphere, and sets up between the internal and external atmospheres a steeper diffusion gradient, thus leading to a more rapid diffusion of water vapor through the stomata.

Temperature, evaporation, and relative humidity do not explain in full the variation recorded in the foliar transpiring ability of the plant from day to day. Figs. 2 and 5 show transpiration curves typically alike except for a slight depression in the latter at noon. The averages of the relative foliar transpiring power in each of these two cases are almost identical, being 0.198 and 0.193 respectively, yet the atmospheric factors were all exerting the greater physical demand for water at station *K*. Again, if we compare figs. 2 and 3, we find two transpiration curves of the same type, that in fig. 3 being throughout the day approximately 0.05 higher than that at station *K*. Despite this discrepancy the physical factors would call for a transpiration rate considerably lower at station *N* than at station *K*. Moreover, if we compare the graphs represented in figs. 1 and 3, we find that fig. 1 has a higher transpiration rate throughout the afternoon, although the relative humidity is almost the same, and both evaporation and temperature are lower, thus theoretically calling for a lower rate. This failure of the transpiration stream to bear a consistent relationship to the factors of temperature, evaporation, and relative humidity was formerly interpreted as being the influence of stomatal movements, but the fallacy of such interpretation has been pointed out by LLOYD (7) and others. Direct investigation has shown that the stomata open quite early

in the morning, reaching a maximum early (8:00–10:00 A.M.), after which there is a gradual closing until dark, about which time they approximate the closed night condition. During the day it seems that the maximum water loss is always less than the maximum amount which may be diffused from the open stomata, so that the lower general average for certain days must be referred to other causes.

On the sand dunes there is a strong tendency to high transpiration, as is evidenced by the graph representing station *D* for September 2 (1, fig. 8). The evaporation and relative humidity in this instance were closely similar to that recorded for station *N* (fig. 3). The temperature, which registered the greatest degree of difference, averaged about 4 per cent higher, yet the transpiration index was just 100 per cent greater, averaging 0.23 in the latter instance and 0.46 in the former. Thus in any given situation the transpiration may be high or low irrespective of the relative humidity, temperature, and evaporation, although these factors are certainly instrumental in influencing fluctuations in the transpiration stream. In other words, *Tilia* on the open dunes will transpire more actively than the same species in the mesophytic forest, irrespective of atmospheric conditions; and, with similar weather conditions prevailing, in clay environments there may be a considerable variation in the transpiration index from day to day. It is the opinion of the writer that the former of these conditions may be associated with structural differences, and investigations are being made with the hope of giving further light upon this phase of the problem.

GROWTH WATER.—The relation of growth water to the transpiration index has proved interesting. This is the soil moisture content minus the wilting coefficient as expressed by FULLER (3). Fig. 7 illustrates the relation between growth water and transpiration as recorded in the field during the course of investigation. The five stations located on the dune sands are represented by *A*, *B*, *C*, *D*, and *E*. It will be noted that the growth water is very low, ranging from an average of 1.25 to 2.60 per cent. Furthermore, the water loss by transpiration is found to be greatest at the most exposed station, where the growth water average is lowest, and decreases rapidly to a level, which is found at stations *A* and *B*



to be similar to the average rate for the clay positions, where the growth water percentage is relatively high. The average transpiration rate for the mesophytic clays is approximately one-half that exhibited on the open sands. The growth water in the mesophytic forest, despite the lower transpiration rate there, is on the average at least six times as great as on the dunes.

Reference to data for stations located on clay shows that the growth water for these positions fluctuates about 18 per cent,

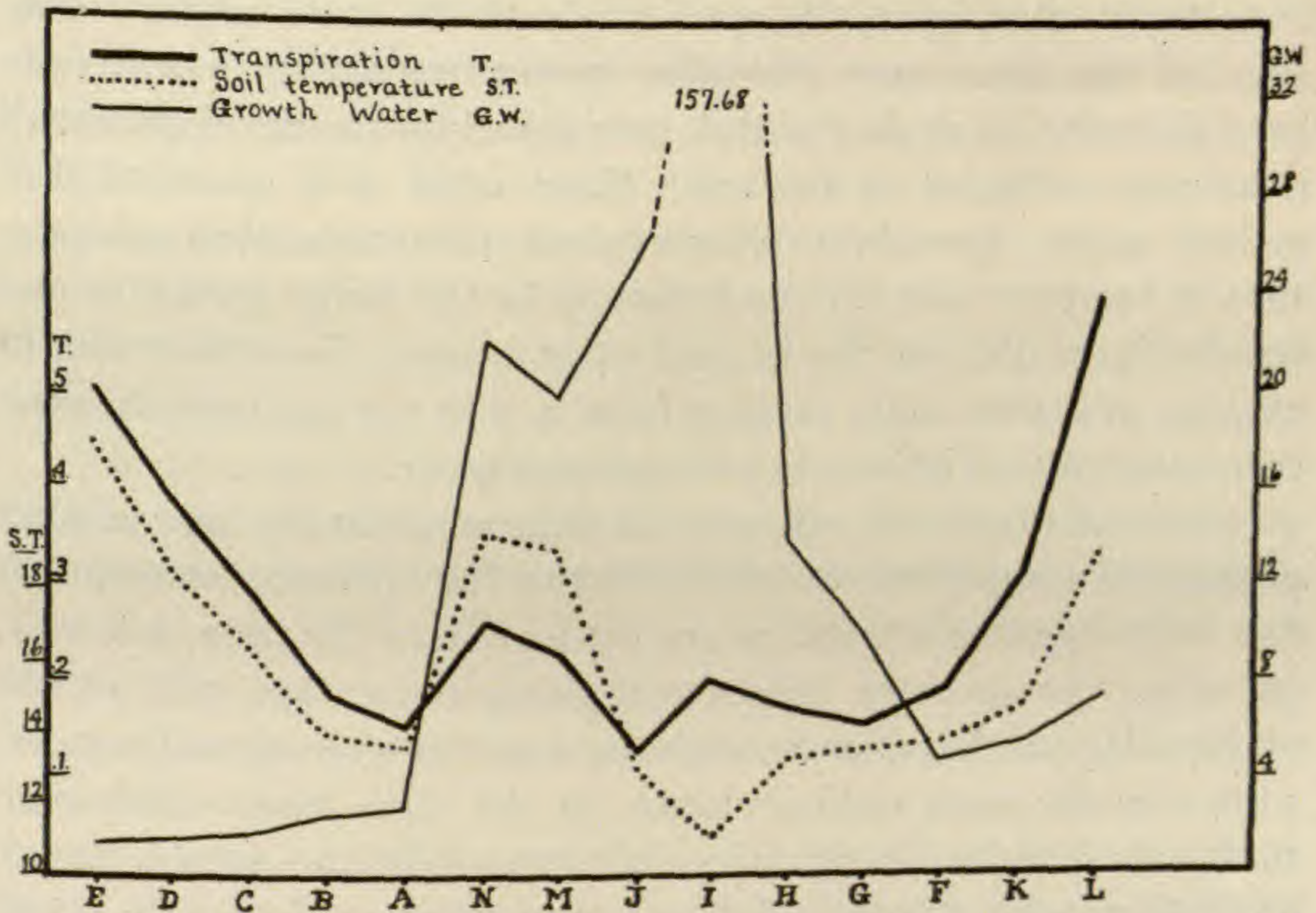

FIG. 7.—Data for soil temperatures, growth water, and transpiration as recorded at all stations on sand and clay; note high transpiration associated with low growth water and high soil temperatures.

being above more often than below this average. Notwithstanding the fact that growth water is always relatively abundant, the transpiring ability is proportionately low, with but two exceptions not exceeding 0.5 at any time during the investigations. The close approximation of the average transpiration rate on the mesophytic clay soils to that of stations *A* and *B* in the dune forest is also evident in fig. 7. Thus the comparative equality in the transpiring power, while the growth water ranges from an average of 2.25 per cent at station *A* to 157.68 per cent at station *I*, strongly indicates

that growth water influences the transpiring ability of the foliage leaves to a less extent than do the atmospheric factors. The only critical evidence of growth water influence during these studies was when it diminished until it approached the wilting coefficient. Visible wilting may then occur, accompanied by a rapid reduction in transpiration until it becomes almost entirely cuticular. Repeated reduction to the wilting coefficient was found to induce early abscission of the leaves, a phenomenon found to take place earlier in the dune forest than upon the open sands of the same region. The effect of abscission upon the foliar transpiring ability has already been shown to be similar to that occasioned by the development of a wilting coefficient in the soil. Thus while it is essential that growth water be available for the plant, there was little evidence that it exerts a conspicuous influence in the daily variation and hourly fluctuation of the transpiration stream, for differences in average available water ranging from 2.5 to 157 per cent show no corresponding variations in transpiring power.

SOIL TEMPERATURE.—It was not determined in the field to what extent soil temperatures influenced the transpiration stream. A few very significant features are evident from the data, however, as when the average foliar transpiring power for each of the stations is considered, and correlated with the average soil temperatures for the same stations, taken on the same days. This comparison is indicated in fig. 7 by the heavy solid and dotted curves, the latter being the curve for soil temperature. It will be noted that the temperature of the soil is high where the transpiration is high and low where the transpiration is low. There was but one instance when a decrease in soil temperature was not accompanied by a corresponding reduction in the transpiration index, this being registered for the swamp habitat. A close parallel was found between average soil temperatures and average transpiration indices.

A second feature is recorded in the relations of growth water and soil temperature. It will be noted that the soil temperature decreases as the growth water increases, so that the lowest soil temperatures are found where the water is most abundant and the highest temperatures where the water is least. The records for

stations *M* and *N* (fig. 7) show a variation from the behavior recorded for the other stations. The readings for these two were taken on one day only, and hence, not being an average of several days' data, are not considered typical. This is especially true as these records were taken in early September during a period of dry hot weather, and hence represent maximum figures for these stations. There is no doubt that the average transpiration and soil temperatures would have been very close to those of station *J* had readings been taken in the late spring and early summer, as was done at the other stations. To what extent this low soil temperature is associated with low transpiring power and high soil temperatures with high transpiring power, cannot be adequately stated at present, but it is known that low soil temperatures produce an inhibiting effect on water absorption by the root system, and would therefore be expected to lead to a lower rate of water loss from the leaf.

The average soil temperature of station *E* is slightly more than double that recorded for station *I*, and the fact that the transpiration index is likewise a little more than doubled is very suggestive. The close parallel recorded between average soil temperatures and average transpiration indices throughout these experiments may be considered evidence that this factor is influential in limiting the foliar water loss.

SUNLIGHT.—Sunlight directly or indirectly produces an effect upon transpiration, inducing a rise in its index. This was pointed out by LIVINGSTON (5) as the result of studies on the effect of light intensities upon the transpiration rate in *Xanthium*, *Physalis*, and *Martynia*. Fig. 6 shows in the morning rise a response to sunlight. The transpiration index in this instance did not show the characteristic response until two hours after daylight, whereas usually the rise begins about dawn. On this day transpiration increased rapidly, beginning when the sunlight fell directly upon the station. The failure to develop an earlier response is attributed to the very low temperature, which was at that time but slightly above the freezing-point. Sunlight falling upon the leaf is followed by the absorption of certain rays which leads to an increase in temperature sufficient to accelerate the diffusion of water from the mesophyll

cells, thus affecting the diffusion gradient and resulting in a greater water loss.

### Comparison of swamp and upland mesophytic types

As previously stated, station *H* is located in a typical upland mesophytic forest on mixed morainic clay, and station *I* is located on the border of a swamp where the undergrowth is composed largely of *Taxus* and spring perennials, and where the tree stand

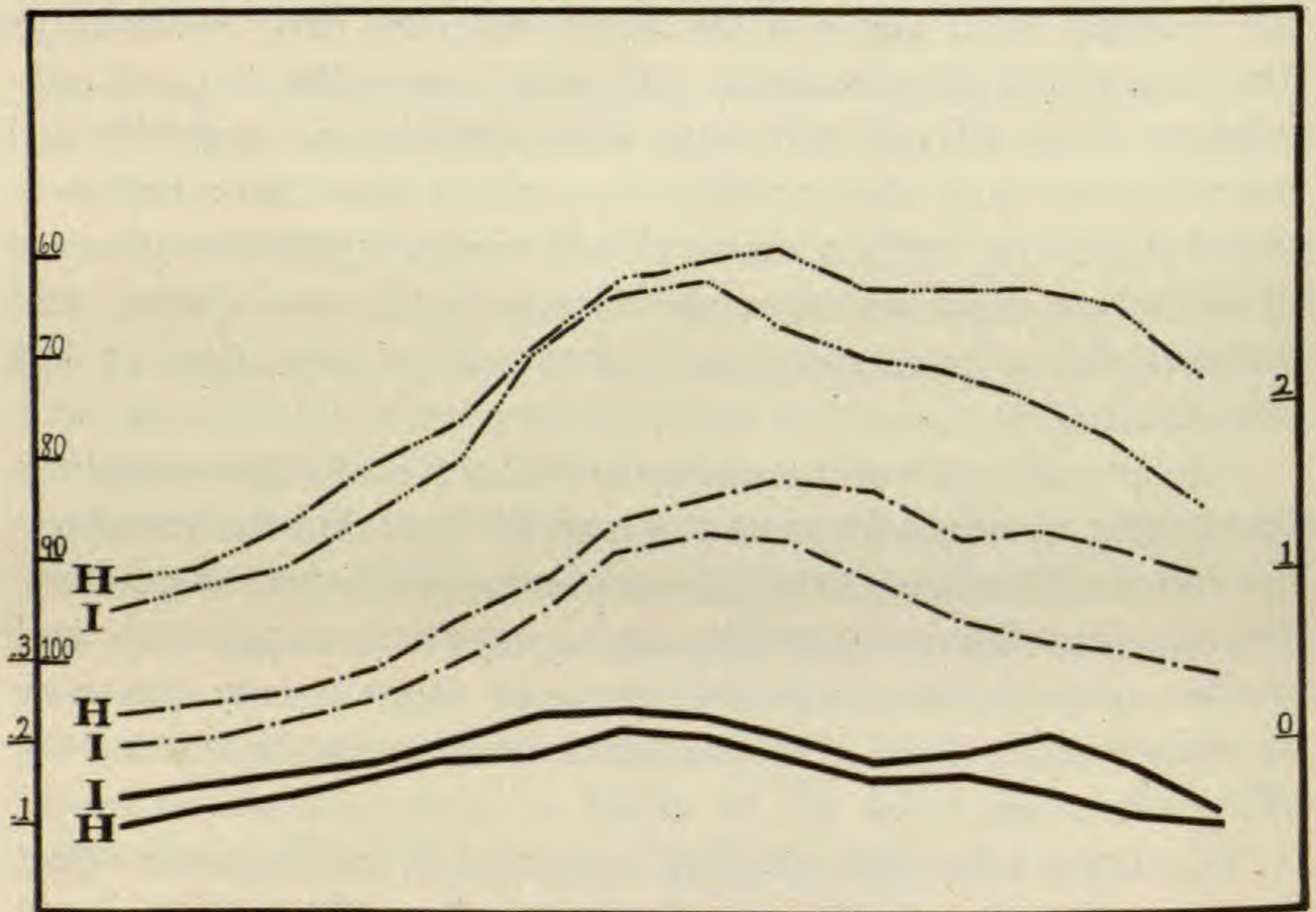

FIG. 8.—Relative humidity, evaporation, and transpiration for stations *H* and *I*, showing average of 5 days' readings at each station.

includes *Tsuga*, *Fraxinus*, and *Acer*. Beneath the humus at station *I* is a heavy blue clay soil which is saturated during practically the entire growing season, and *Tilia*, as do most other forms of vegetation in similar situations, grows to form a low broad hummock, because the roots, being unable to penetrate deeply, spread out on the surface. In this supersaturated environment a peculiar behavior was observed in the transpiration stream. This is shown in fig. 8, which is a composite graph, each curve representing the average of five separate days' readings and including relative humidity, evaporation, and transpiration. It will be noticed that both

relative humidity and evaporation show curves which indicate greater mesophytism at station *I* than at station *H*, but contrary to expectation the transpiration record at the latter is higher throughout the period than in the mesophytic forest. The transpiration curve was higher than that recorded for the much more open forest on the old Lake Chicago bed, where there is a strong prairie influence. Fig. 7 shows that, although the transpiration is relatively high, as on the sand series, the factors of soil temperature and growth water at station *I* are excessive in their extreme opposite relation to the dune condition. Insolation is probably the most influential factor leading to a higher transpiration at this place. It would seem from the relations worked out between transpiration and stomatal aperture by various investigators that the stomata should not prove a limiting factor at the forest station, for the light intensity would seem adequate to insure an opening there which is sufficient to permit a much greater diffusion from the leaves than actually occurs. That increased exposure to light is accompanied by the absorption of light rays by the mesophyll which produce heat and a greater molecular pressure on the water films in the cell walls, and hence leads to a more rapid diffusion of water, seems a reasonable explanation and one which is substantiated by the work of LIVINGSTON (5) on the effect of this factor on transpiration.

#### Daily variation in transpiring ability

In the former discussion of transpiration on the dunes it was pointed out that if the index of foliar transpiring power were to be utilized in an endeavor to measure the mesophytism of a plant, it should be based on the records of more than a single day, since the variability in the foliar transpiring power is very noticeable from day to day. There is a great daily fluctuation in the transpiring power, just as there is a great hourly fluctuation, and both hourly and diurnal variations are more pronounced on the dunes and prairie than on the forested clays.

Fig. 9 indicates the transpiring ability as recorded at station *C* on the dunes for July 16, 21, and August 26, and it will be observed that on these three days there chanced to be striking differences in the course of the curves representing water loss from the leaves.

The curve for July 16 shows that it is characterized by a late morning rise, a feature quite unusual for the dune series. In addition, the maximum is reached at 1:00 P.M., when the usual occurrence in this environment was a depression at that hour. There was also a high transpiration recorded during the afternoon without the appearance of a secondary mode at 4:00 to 5:00 P.M.

The first of these features, the late morning rise, is attributed to the atmospheric conditions, which show a very low temperature

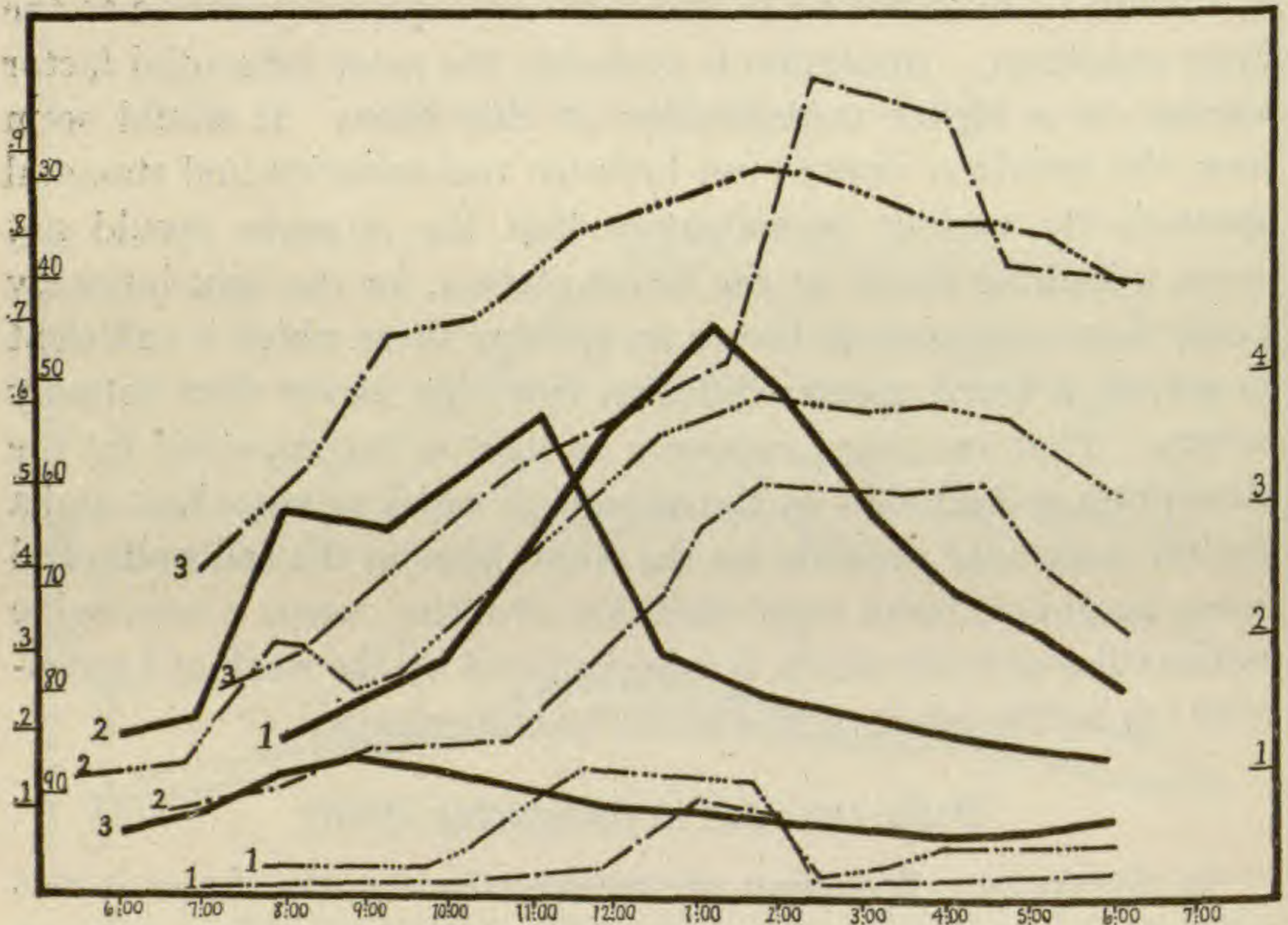

FIG. 9.—Record of readings at station C for July 16, 21, and August 26, showing 3 distinct types of curves although records were taken from same leaves.

(about  $17^{\circ}$ ), but especially a low evaporation rate and a high relative humidity. The general weather conditions show a cloudy period, following precipitation from about 5:00 to 6:20 A.M. At 10:00 A.M. the weather became clear, followed by a slight increase in temperature, evaporation, and saturation deficit of the air. Notwithstanding the slow increase in these factors, the foliar transpiration was found to increase much more rapidly in proportion. Thus the maximum transpiration index was greater than was observed to occur under similar conditions on the clays, except

on the prairie, where the factors in general approximate those of the open sands of Lake Michigan, except for the soil type. The high maximum is attributed to the late morning rise and the failure to develop a saturation deficit in the leaves; the factors tending to this end all being impotent throughout the day, namely, high temperature, high evaporation, low relative humidity, high wind velocity, and wide open stomata. A light precipitation in the early afternoon was accompanied by a lowering of temperature and evaporation and an increase in relative humidity to a point approaching saturation, while the transpiration index fell more slowly than was commonly true under such circumstances.

Transpiration curve no. 2 represents the relative foliar water loss for July 21. This curve is characterized by a very early rise because the weather was at that time clear. The rapid ascent was interrupted at 8:00 A.M. owing to the influence of relative humidity. At this time there was a period of cloudiness for an hour or more, when a thunder shower passed just southward without giving precipitation at the station. At 11:00 A.M. the transpiration index had attained its maximum, and conspicuous depreciation between the curves of water loss and evaporation was then developed. There occurred then a period of six hours when the factors for high transpiration increased, but the index nevertheless continued to fall throughout the period. No visible wilting took place on this day, and there appears no evident reason why the transpiration index should not have exceeded that for July 16, judging from the relative humidity, evaporation, and temperature. The difference might be attributed to the less amount of growth water (4.537 per cent) in comparison with that of the latter date (5.910 per cent). I do not believe, however, that the quantity of available water influenced the transpiration very strongly in this instance, for, as already stated, higher indices were regularly attained on the open sands where the growth water was as low as 1.25 per cent. It would seem that the depression takes place at the time the reserve water, accumulated during the night, and held by the translocating system and leaves, plus that continually being added by absorption from the root system, is equalized by diffusion from the leaf. If the water content of the soil is not a limiting

factor, the ability to absorb and translocate very probably becomes so. This would then be a typical "saturation deficit." If this be true, then the maximum to be very high will evidently occur after a very rapid rise, while a less rapid but prevailingly high transpiration rate will utilize the reserve water and reach the limit entailed by anatomical features without having so high an index. There is evidence for support of this in the two curves in question; the average of the indices for the first six hourly readings for July 21 being 0.396, while the average for July 16, computed from the same leaves, for the first six hours preceding the maximum is 0.391, which means that the water loss from a unit area from the first rise in the morning until the attainment of the maximum was practically the same. Granting that the translocating ability limits the maximum rate of transpiration, then, since we are considering data calculated from the same individual with an interval of but five days, we would expect the water loss up to the time of incipient drying to be approximately the same, when the time periods are the same. We may further assume that the water reserve will be quite constant for the same individual on consecutive days when the growth water is adequate to meet all the needs of the plant, for this will be dependent upon the structural features of the plant, which remain quite constant. A slight variation in the reserve would follow a variation in food storage, which is a fluctuating factor, and slight differences in the total transpiration up to the time of the deficit depression will result from different absorption rates which fluctuate with soil temperature. If the transpiration index is high in the morning, the maximum transpiring power will of necessity appear early, for the reserve is utilized rapidly. If the rate is low in the morning, the maximum, if it is attained, will occur relatively late. The maximum transpiring ability is limited by the rapidity of rise in the index and the translocation-absorption ability. The maximum translocation doubtless occurs when the protoplasmic condensation within the mesophyll of the leaf is greatest, since at that time the osmotic pressure within the cells is highest, and the cells will exhibit their greatest affinity for water. This occurs two or three hours after the maximum transpiration. The relatively high transpiration index preceding



the attainment of maximum absorption is possible because of the reserve water which is available in excess of that supplied by the translocation stream.

Curve no. 3, which indicates the transpiration for August 26, shows some features conspicuously unlike those recorded for the two preceding readings. The maximum is lower in this instance than was the minimum index for either of the preceding days. The low amount of growth water, which was only 0.480 per cent at 2.5 dm., was a prominent cause for the lower transpiring power. At 10:00 A.M. visible wilting occurred, and turgidity was not restored within the mesophyll cells of the leaves until about 5:00 P.M. The development of absciss tissue may be considered as contributing to the reduced rate, being earlier at this station than on the open sand, owing to the more frequent production of a wilting coefficient. Evaporation and relative humidity show curves which lie much higher than do those of July 16 and 21. The extremely high evaporation from about 1:30 to 4:30 P.M. was due to high wind velocity.

It will be seen that on different days readings from the same leaves may give widely different results. The three days' readings shown in this instance present different combinations of potent factors, one being a cloudy day with plenty of available water, one a clear day with sufficient growth water, and the third a clear day with low humidity and soil water reduced to the wilting coefficient. Thus the environmental factors which initiate variation in the daily transpiration rate at any given station were found to be the same as those which led to different averages for the various stations. This daily variation is more marked on the sand series than on the clays, although the same phenomena were characteristic of the latter situations. There was found to be more variation in transpiring power between cloudy and clear days than was registered for days when the atmospheric conditions were similar, whether cloudy or clear.

### Transpiration on prairie

The transpiration index as recorded for *Tilia* on the prairie indicates that there the species is subjected to a physiological stress in most respects very similar to that found on the dunes (fig. 10).

There is the same tendency on the prairie toward an early rapid rise in the index, and for a maximum which occurs from one to two hours earlier than is characteristic of *Tilia* at the other stations on clay soils. The maximum is relatively very high on the prairie, and is followed quite regularly by a saturation deficit which is more pronounced than that recorded for any other habitat except upon the open dune complex.

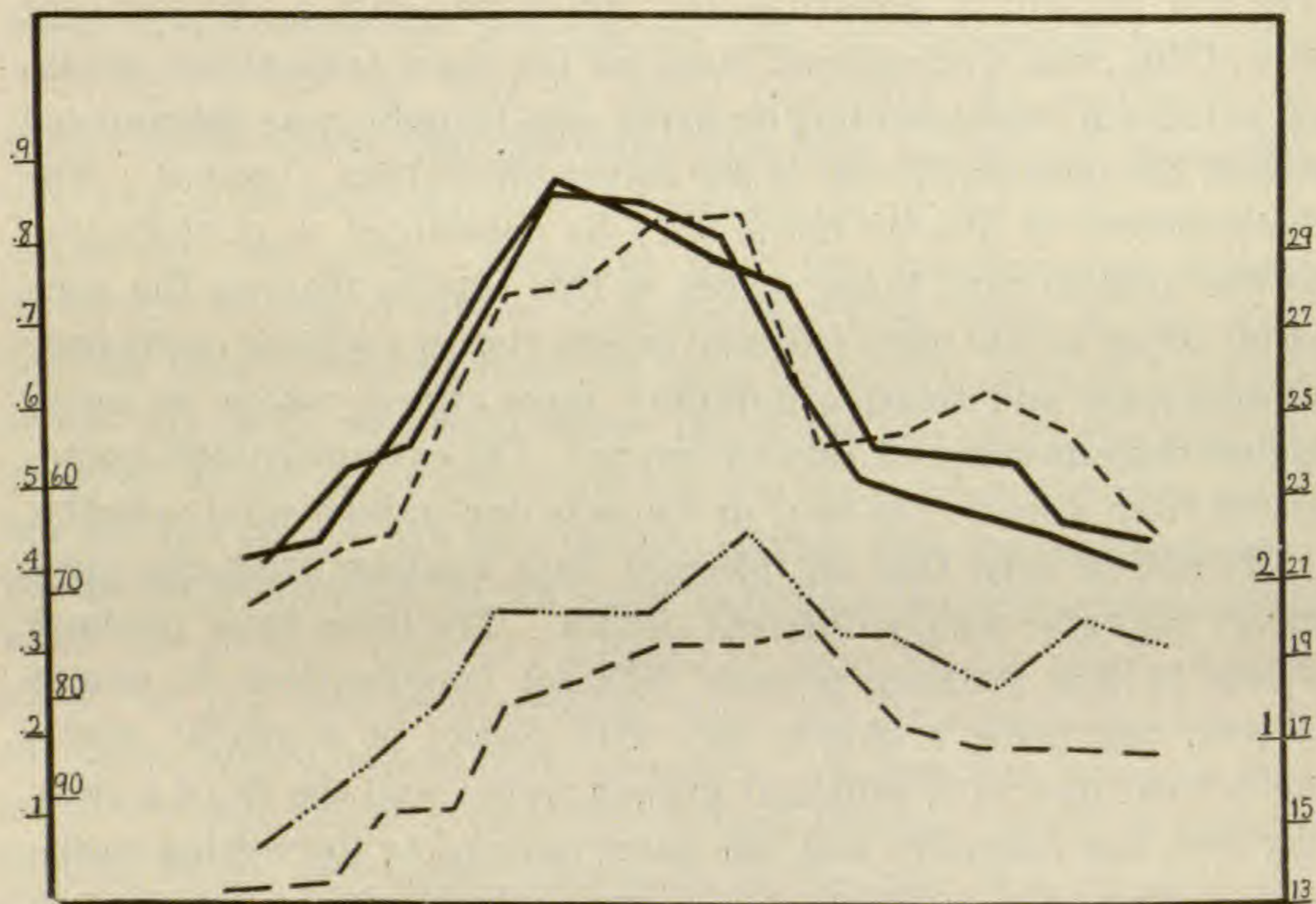

FIG. 10.—Data for station *L* for September 6; note exceptionally high transpiration index characteristic of prairie tension zone; transpiration is great although relative humidity is high and evaporation low.

The prevailing environmental factors show a close similarity to those of the open sands. The growth water is low during much of the summer, the insolation is correspondingly high, the influence of winds is strong and quite constant, prevailing temperatures are higher and are associated with a relative humidity which is low (fig. 10). Thus the features of these two types of associations show remarkable similarity, with the exception of the soil composition and growth water. The growth water falls rapidly during the months of August and September and approaches the dune condition. These factors in conjunction exert an influence which

leads to a high transpiration rate and to the development of morphological features in the leaves which are very similar to those recorded at station *E* on the dunes.

### Transpiration in relation to mesophytism

Water content of the soil has long been recognized as a factor which directly influences the climax type of flora that may develop in any given region. The relatively high content as shown for the mesophytic forest has quite generally been ascribed as the reason for the development of the larger thin type of leaf characteristic of that region, in contrast with the smaller more thickened type characterizing open associations. Correlated with this concept frequently has been the idea that transpiration in the mesophytic forest is very high. Observations on the foliar transpiring power of *Tilia* throughout its range of habitats, from the most to the least mesophytic conditions under which it develops, have led to a conclusion in regard to this species which is quite different from that just stated. The greatest transpiring ability was exhibited in the most open situations where the available growth water was least, and the transpiring ability was found to be least in the dense shade of the mesophytic forest and moist ravines where the growth water was relatively very high. It may be asked why the water loss is less in the forest. The question is answered by pointing out that the environmental factors for high transpiration are less potent in the forest than in more exposed positions. Relative humidity is greater, evaporation is less, temperature is lower, light is less intense, soil temperature is lower, and winds are less effective. All of these physical factors combine to give a lower rate of transpiration than occurs in the exposed open situations.

### Summary and conclusions

1. The morning rise in the foliar transpiration index for *Tilia* is commonly much slower for the clay series of environments than for the sand dunes, and the maximum attained is comparatively much lower.

2. The time of maximum transpiration is usually from 12:00 to 1:00 P.M. on clay soils, whereas on the sands it occurred from 9:00

to 10:00 A.M. This difference is ascribed to the more rapid utilization of the reserve water which is stored up in the leaves and translocating system of the plant during the night. Thus on the dunes, where the reserve is utilized more rapidly than it is restored by absorption and translocation, there will occur a depression in the index later in the day. On the clay soils, the rise being slower, frequently the reserve is not utilized until midday; hence there occurs a lower maximum and a much less noticeable saturation deficit, or none at all. This means that the maxima of temperature, relative humidity, and evaporation concur in time or more nearly approximate doing so than for the dune series. The closest approximation to this concurrence on the sands was recorded for cloudy days with low temperature and evaporation and a high relative humidity. All these conditions of environment are tendencies toward the prevailing condition in the forest, in contrast with those characterizing open dune situations.

3. The transpiration stream shows a simple curve for readings taken on forested clays, rising gradually to a maximum at noon and falling at approximately the same rate to the night level.

4. The effect of thunder showers is recorded in a sharp reduction in the transpiration index. Frequently when the precipitation occurs in the early afternoon there is a second rise in the transpiration curve to a level in excess of the normal rate for that time, probably owing to the accumulation of a slight reserve, while the transpiration rate is lower than that of absorption.

5. Partial abscission produces an effect not unlike that found accompanying the development of a wilting coefficient. Under these circumstances there is a low morning rise which quite early reaches a maximum, and is followed by a rapid decline accompanied by the closure of stomata and visible wilting, the transpiration falling until it becomes almost entirely cuticular. The morning rise takes place in this instance because of the slight water reserve accumulated during the night.

6. A wilting coefficient did not develop in any of the clay soils, and there was always a considerable amount of growth water available, but its occurrence on the sand series produced an effect closely similar to that occasioned by abscission.

7. Sunlight affects the transpiration stream through its influence in initiating stomatal movements, and has particular reference to the morning rise. Direct sunlight accelerates the water loss, due apparently to a rise in temperature of the mesophyll cells which would be followed by a greater molecular diffusion of water from the cell walls into the lacunae of the leaf, thus increasing the diffusion gradient.

8. Relative humidity is a very potent factor in influencing the transpiration index. By increasing or decreasing, it affects directly the diffusion gradient between the external and internal atmospheres. Sudden changes in this factor almost invariably affected the transpiration stream, even when the atmometer failed to register it. When the relative humidity is great there seldom is any saturation deficit developed, but when it is low and the evaporation rate increases greatly the reserve will probably be consumed and a saturation deficit will follow. Relative humidity is considered a very potent factor leading to such depression in the curve.

9. Growth water exerted less influence in modifying the transpiration rate than did most of the atmospheric factors. There is little evidence that it is a potent factor at all on the clay series. Its direct effect is most noticeable when it approximates the wilting coefficient as was recorded on the sand dunes, when the index is observed to fall rapidly. The growth water was always more than could be utilized in the clay environments, and hence never proved a limiting factor.

10. The part played by soil temperature in maintaining the transpiration stream is considered more important than has generally been ascribed to this factor. The close parallel of the soil temperature and transpiration curves is strongly indicative of its influence (fig. 7), and especially is this significant since there is strong evidence that the absorption rate often becomes a limiting factor. I believe that since soil temperature bears a direct relation to absorption it will eventually be found to be of great significance in limiting the foliar transpiring ability.

11. The highest average transpiring power recorded for the clays, with the exception of the prairie data, was that registered for the swamp habitat. In this environment *Tilia*, while producing

a relatively high water loss as on the dunes, is growing in the very opposite environment in reference to its physical factors. The growth water and relative humidity are greater here than at any other station, while soil temperature, evaporation, and atmospheric temperature are lowest. Of these factors, measured soil moisture might be cited as the causal factor leading to increased transpiration, but it seems improbable that this factor can be responsible for the higher water loss. It is more probably associated with structural features, the correlation of root and leaf development, or the greater exposure to light.

12. The variation in average transpiring power from day to day as recorded for the same leaves is greater for the mesophytic forest than is the difference between the average rates for the most mesophytic and most xerophytic stations, if we consider the clay series only and disregard the prairie record. The converse is true for the dune series.

13. Daily variations in the transpiration stream are most pronounced in the xerophytic situations, and least so in the strongly mesophytic ones.

14. The average transpiring power is less in deep forests and moist ravines than in open woodlands, and less in open forests than in exposed positions on clay. The greatest transpiring ability was recorded on the open sands where there was no humus, and on the prairie.

15. The transpiration curve characteristic of the prairie station is closely similar in its essential features to the curves representing the open dune sands. There is a more rapid morning rise as compared with the forest, owing to the greater light exposure at that period, a tendency to an earlier maximum due to a greater water reserve, a more frequent recurrence of a saturation deficit, and finally a steeper afternoon decline than is commonly recorded for the clay environments.

16. The highest transpiration rates are found to be associated with a low growth water, which is not interpreted as being in any way causal, but as evidence that growth water is of relatively little significance so far as transpiration is concerned until it approaches the wilting coefficient.

17. High mesophytism leads to low transpiration in *Tilia*, and large leaves of thin texture transpire at slower rates than do smaller leaves which are more leathery and resistant in nature.

DRURY COLLEGE  
SPRINGFIELD, MO.

#### LITERATURE CITED

1. CRIBBS, J. E., Ecology of *Tilia americana*. I. Comparative studies of the foliar transpiring power. *BOT. GAZ.* 68:262-286. 1919.
2. CURTIS, C. C., Some observations on transpiration. *Bull. Torr. Bot. Club* 29:360-373. 1902.
3. FULLER, G. D., Evaporation and soil moisture in relation to the succession of plant associations. *BOT. GAZ.* 58:193-234. 1914.
4. LIVINGSTON, B. E., The resistance offered by leaves to transpiration water loss. *Plant World* 16:1-35. 1913.
5. ———, Light intensity and transpiration. *BOT. GAZ.* 52:417-438. 1911.
6. LIVINGSTON, B. E., and BROWN, W. H., Relation of the daily march of transpiration to the variation of the water content of foliage leaves. *BOT. GAZ.* 53:309-330. 1912.
7. LLOYD, F. E., The physiology of stomata. *Carnegie Inst. Wash. Publ.* no. 82. 1908.
8. SAYRE, J. D., Factors controlling variations in the rate of transpiration. *Ohio Jour. Sci.* 19:491-509. 1919.

## THE VESSEL IN SEED PLANTS<sup>1</sup>

MARY C. BLISS

(WITH PLATES XVI-XX)

In view of the recent discussion of the evolution of the vessel in Gnetales and Angiosperms by THOMPSON (5), it was suggested to the writer that a comparative study of the vessel in seed plants would be of interest in bringing forward more evidence which might have weight for or against the theory that the presence of vessels in these two groups is an argument for genetic relationship. The discussion of scalariform pitting in the secondary wood of Angiosperms by BROWN (2) also suggested the larger question of the origin of the vessel in seed plants, that is, has it been derived from the pitted tracheids of the more primitive plants, or is the scalariform vessel the more primitive, from which the pitted vessel has been derived?

By way of introduction I wish to discuss briefly the vessel of *Pteris aquilina* as an example of the lower vascular plants. The side wall, usually at a definite angle with the end wall, is marked with scalariform bordered pits (fig. 1, right). The borders are very clearly evident in the profile view of the vessel (fig. 4). The typical end wall of the vessel is characterized by scalariform perforations in which the border has wholly disappeared at the center, but is still visible at both ends of the perforation (fig. 3). The difference between the openings in the side and end walls is again very clearly seen in the profile view of the vessel (fig. 4). The border has practically disappeared from the perforation, although occasionally it is evident near the juncture of the end wall with the side wall. Another striking difference in the perforations of side and end walls is the reaction to stains. The end wall gives a definite cellulose reaction with haematoxylin, while in the side wall blue is present only in the middle lamella and the pit membrane, the border of the perforation taking a definite lignin stain with

<sup>1</sup> Contribution from the Laboratories of Plant Morphology of Harvard University.



safranin. This difference separates very distinctly the side and end walls when viewed under the microscope. An interesting condition is seen in fig. 1, where the end wall at the center is perforated by a series of bordered pits which gradually grade into scalariform pits and perforations at the lower end of the figure. Fig. 2 shows an end wall which is clearly reticulated, a stage intermediate between the typical scalariform perforation and the more unusual pitted type. It is interesting to note in this connection that in the higher groups of the Filicales (Osmundaceae and Ophioglossaceae) the side wall of the vessel is likewise pitted and not scalariform as in most ferns. These observations as seen in figs. 1 and 2 give weight to the view that the end wall is the more specialized portion of the vessel and more advanced in its organization, and that in the pitted end wall of *Pteris* we have the forerunner of the pitted type of perforation characteristic of the lateral walls of the element in the higher groups.

### Gnetales

Turning now to the vessels of the seed plants, we may consider first the vessels of Gnetales. The vessels in the young twig of *Ephedra* (fig. 5) show perforations which are clearly bordered pits. Although the torus has entirely disappeared and the border is very much reduced in nearly all of the pits, the torus is present in two of the pits in the upper portion of the vessel at the right. Fig. 6 shows larger vessels of an older twig, the vessel at the right being more advanced than the vessel at the left. Here the perforation consists of a series of bordered pits in which the membrane has entirely disappeared. Since the end wall of the vessel is the most specialized, it would naturally show the greatest advance in development, and this is true in the higher types of Gnetales. In radial sections of the stem of the *Gnetum Gnemon* type (figs. 7, 8) all stages are found, from the clustered bordered pits of the *Ephedra* type to the open pore of the higher forms, and transitional fusion perforations are clearly seen (fig. 7). The mature stem of the *Gnetum Gnemon* type is illustrated in fig. 9, where the vessels are characterized by the typical porous perforations of the higher forms. In contrast with the *Gnetum Gnemon* type, *Gnetum scandens*, an advanced vine species of the genus, is interesting.

While the vessels of this type in the mature secondary wood of the stem are also characterized by the large bordered open pores, a consideration of the primitive regions, such as the primary wood and the wood of the leaf trace, shows that the open pore has been derived from pit fusions. Fig. 10 illustrates a radial section of the stem of *Gnetum scandens* cut directly through the primary wood. A protoxylem element with its spiral markings is visible just at the left of the vessel. At the lower part of the figure the pits are quite distinct, suggesting the *Ephedra* type, but in the center the fusion is practically complete. In the leaf trace of *Gnetum scandens* (figs. 11, 13) is a condition similar to the perforation found in the older twig of *Ephedra*, showing the scalariform pits obviously the result of the fusion of bordered pits. A higher magnification of a similar perforation is shown in fig. 12, bringing out more clearly the borders of the pits. Thus in *Gnetum scandens* we do not find always the fusion of pits haphazardly arranged as THOMPSON (5) describes for *Gnetum*, but fusion of pits side by side (figs. 12, 13), a condition which, as shown later, is paralleled in the fusion of pits in the vessels of Angiosperms.

*Welwitschia* shows the open bordered pore type of perforation in the vessel of the mature wood (fig. 14). The border of the pit is clearly visible in the vessel to the left, while in the vessel to the right the edge of the perforation faces the observer. The vessel of the leaf trace in *Welwitschia* (fig. 15) shows the more primitive type of vessel as found in *Ephedra*. Thus the monotypic genus *Welwitschia* illustrates the same general principles shown for *Gnetum*, namely, that in the vessel wall of primitive regions is found the *Ephedra*-like type of vessel with pitted perforation. It may be added that *Welwitschia* and *Gnetum* are usually distinguished from *Ephedra* by absence of the torus in the bordered pit.

### Angiosperms

*Liriodendron* and *Magnolia* may be considered as representatives of a possibly primitive group of Angiosperms, the Magnoliaceae. In the side wall of the vessel is the same general principle illustrated in the end wall of the Gnetales. Fig. 16 shows vessels in the mature secondary wood of a small twig of *Liriodendron Tulipifera*. Here

the vessels, both the lateral wall and the perforations, are obviously scalariform. This situation has recently been emphasized by BROWN (2) as showing the derivation of the vessel of Angiosperms from the scalariform tracheid. The condition found in the primitive regions of *Liriodendron*, however, particularly the primary wood of the root, by no means seems to justify this conclusion. Fig. 17 shows a radial section in the region of the primary wood of the root of *Liriodendron Tulipifera*. All three vessels are characterized by pitted lateral walls and not by scalariform sculpture. A higher magnification of a portion of the vessel seen at the extreme right is shown in fig. 18. The center of the vessel exhibits scalariform perforations. It is equally clear that this scalariform perforation passes gradually into pits both above and below. Fig. 19 shows the perforation above and the lateral wall of the vessel below, with the gradual transitions from pits to perforations particularly clear. The perforations show the so-called "ghosts" of former pits, which become more and more pitlike as one passes downward, until the typical bordered pits become clearly recognizable. Still another illustration of the same phenomenon is seen in fig. 20. It is clear from these illustrations that in *Liriodendron Tulipifera* there is a gradual transition from pits to scalariform perforations in the vessels of the primary wood.

It is evident that the perforations of the vessels in Filicales and Gnetales represent the most advanced condition of the vessel wall. The obvious interpretation, as seen in *Liriodendron*, is that the side wall represents the primitive pitted condition, while the perforation has been derived from the fusion of pits precisely as in *Gnetum* and *Welwitschia*. The seriation of events cannot possibly be regarded as reversible, for if that were the case, we should have to regard the perforation as representing the primitive condition of the vessel wall, a position which is untenable.

*Magnolia Frazeri* has a greater tendency to scalariform perforations and lateral pitting than the other species of the genus which have been observed. As in *Liriodendron*, the most interesting condition here is found in the region of the primary wood of the root. Fig. 21 shows a radial section through this region. The perforation in the center gradually grades into pits above and below,

a condition practically identical with a similar section of the root of *Liriodendron* as seen in fig. 18. Fig. 22 illustrates the character of the vessel in the first annual ring of a branch of *Magnolia Frazeri*. The perforation is obviously scalariform, while the lateral wall is characterized by typical pits. The end wall perforations again show evidence of fusion of pits in the "ghosts" and indentations on the scalariform openings. In many instances scalariform perforations may be seen to grade into pits in the wood of the stem of *Magnolia Frazeri*. It seems clear from a study of the primary wood region of the root of *Liriodendron* and *Magnolia* that the vessel with pitted walls is antecedent to the vessel with scalariform walls, and further that the scalariform perforations which are universal in the vessels of *Liriodendron Tulipifera* and are likewise found frequently in the vessels of species of *Magnolia* are the result of fusions of pits precisely as in the case of the perforations of the vessels of *Gnetum* and *Welwitschia* in Gnetales. Since evidence from primitive regions in Gnetales has been used by THOMPSON (6) in tracing the origin of the perforations in vessels of that group, the validity of a similar procedure as regards the evidence in the Magnoliaceae obviously must be admitted.

As another representative of the Ranales, the ranunculaceous genus *Paeonia* is interesting as showing in the vessels of the stem typical scalariform perforations (fig. 23). This observation confirms SOLEREDER'S (4) statement that "only simple perforations have been observed in the woody and herbaceous genera of this group with the single exception of *Paeonia*." In the leaf trace of a species of *Paeonia* (figs. 24, 25) in the region of the primary wood, the perforations show the more primitive pitted condition combined more or less with the more modern scalariform condition. The protoxylem elements are visible at the left of the figures, and here again in close proximity to the primary wood (fig. 25) we have the vessel with the pitted side wall.

The Betulaceae, a group of the Angiosperms often regarded as primitive, is of importance in regard to the evolution of the angiospermous vessel as compared with the origin of the vessel in Gnetales. THOMPSON (5) concludes that the mode of origin of vessels in the two groups is quite different. Moreover, he states

that "since the Gnetalean vessel usually has only two rows of circular pits, no matter how the fusions take place no scalariform bars can result." It has already been seen that in *Gnetum scandens* (figs. 12, 13) the scalariform perforations are very evidently the result of fusion of opposite circular pits. Further evidence of such progression in the evolution of the perforation is seen in the Betulaceae. The typical end wall of the vessel in this group is scalariform. Such an end wall is seen in the stem wood of *Betula alba* in radial aspect in fig. 28. In this type of scalariform end wall there is usually no indication of the derivation of the scalariform perforation from fusion of pits, although instances of this condition are not infrequent even in the mature wood. It is the vessels which lie near the primary wood which are of greatest interest from an evolutionary standpoint. Fig. 26 shows three such vessels, the spiral elements of the protoxylem lying to the left of them. The vessel nearest the protoxylem has a perforation which is intermediate between scalariform and pitted, this condition being most clearly recognizable at the middle of the figure. In the vessel next to the right the transitions appear only at the top and bottom of the perforation, while in the third vessel the fusion of pits is practically complete. Haphazard fusion is evident in the lower portion of the perforation. Fig. 27 illustrates another vessel taken from a different preparation, in which the perforation is much less extensive than in the preceding figure, and the derivation of the scalariform perforation from pit fusions at the top and bottom is particularly clear.

The same conditions which have been noted for *Betula* are found also in *Alnus*. The typical end wall of the vessel is scalariform, as seen in fig. 31. Practically no indication of pit fusions is seen, but fig. 29 is evidence that such fusion has taken place. In the lower part of the figure more or less haphazard fusion is evident, while in the upper region two elongated pits are still distinct. A higher magnification of the same end wall is seen in fig. 30. It is clear for the Betulaceae as exemplified by *Betula* and *Alnus*, as for the Magnoliaceae, that the scalariform perforation as shown by primitive regions is derived from pit fusions and does not represent the persistence of a primitive scalariform condition of the vessel wall.

Passing to a consideration of a type of vessel in the Angiosperms which is characterized by porous and not scalariform perforations, and taking a form nearly allied to the Betulaceae, *Quercus velutina*, we invariably find in the mature wood porous perforations which in the smaller vessels sometimes show a border like that characteristic of similar perforations in *Gnetum*. SOLEREDER (4) has already pointed out in the oak and other representatives of the Fagaceae that scalariform perforations are characteristic of regions near the primary wood. I have been able to confirm this general statement of SOLEREDER in regard to the oak. A radial section of *Quercus velutina* (fig. 32) through the primary wood of the leaf trace shows a very interesting condition in the perforation. The transition from the pitted to the scalariform condition is very clear. Usually the perforations of the vessels in the primitive region of *Quercus* are scalariform only, without transition from the pitted condition. In *Fagus* one frequently finds vessels with scalariform perforations even in the mature wood.

We may now consider the Rosaceae, a higher group, characterized in general by porous perforations of the vessels. Taking first a herbaceous representative of the family, fig. 33 shows a vessel in the region of the primary wood of the stem of *Potentilla monspeliensis*, an annual herb. The vessels in this region have scalariform perforations which pass gradually, by the disappearance of transverse bars, into porous perforations. SOLEREDER has described a similar condition in *Potentilla fruticosa*, and it appears to be widespread in the genus. As a woody representative of the group, *Cydonia* is interesting as showing the scalariform perforation of the vessel in the region of the primary wood (fig. 34), as found in *Potentilla*. An interesting situation is presented by the organization of the vessel in the primitive region of the leaf trace, in its course in the stem of *Cydonia japonica* (fig. 35), in which the perforation is pitted, a very significant condition. Taking the Rosaceae as illustrated by *Potentilla* and *Cydonia*, it seems clear that the porous condition of the perforation has been preceded by the scalariform, and the scalariform in turn by the pitted.

In the Vitaceae the lateral walls of the vessels in contact with other vessels are practically universally scalariform. This condition is of particular interest because the scalariform lateral sculpture of vessels is a phenomenon of rare occurrence in most angiospermous orders, being usually confined to a single genus and occasionally to a single species. If we examine the primitive region of the stem near the primary wood, vessels with pitted lateral walls may often be found (fig. 37). A further fact which has some bearing on the situation is the occurrence of pits on those walls of the vessels which are in contact with the vasicentric parenchyma, characteristic of this group. This situation is not the less striking because ray cells and even longitudinal parenchymatous elements in the Angiosperms in general are frequently related to vessels by means of fusion pits of a scalariform nature. This condition is widespread among the Angiosperms. It has been pointed out by BAILEY (1) in this connection that in modern species of *Pinus* the lateral pits of the rays often undergo fusions. Similar conditions are often found in the Podocarpaceae, Taxodineae, and Cupressineae, and has even been found in Paleozoic Gymnosperms. Fig. 38, illustrating the same section as fig. 37, farther out from the primary wood, shows the type of vessel characteristic of the mature wood of the Vitaceae as a group, with scalariform sculpture. It is apparently quite clear that the vessel with scalariform lateral pits in the Vitaceae has been derived from a pitted predecessor, and that it is not a primitive vessel type in this family.

Turning now to the perforation of the vessels in the Vitaceae in the mature wood of *Leea* and *Vitis*, the vessels are characterized by large open terminal pores. This confirms SOLEREDER's statement that the vessels in the Vitaceae "have simple circular or elliptical perforations." Such a perforation is seen in the radial section of the stem of a species of *Leea* in the region of the primary wood (fig. 36) at the right of the figure. A very interesting fusion scalariform perforation is seen in the vessel on the left. The photograph in this case is not clear, owing to the thickness of the section, but seen under the microscope it is an unusually vivid demonstration of the course of events in the evolution of the open

pore. Fig. 39 shows vessels from the leaf trace of *Vitis* in its course in the stem. On the left in the region of the primary wood two vessels show scalariform perforations; to the right is the single open pore typical of the vessels of the group. An interesting reversion to the primitive type of perforation in this genus is seen in the radial section at the end of the annual ring (fig. 40). The spring vessels show the open pore characteristic of the mature wood, but in the summer wood, which is in some respects a primitive region, we have the reversion to the scalariform type of perforation characteristic of the regions of the primary wood and of the leaf trace. From the evidence given it seems clear that in the Dicotyledons as in the Gnetales the scalariform perforations have arisen by the fusion of pits, and that this fusion may be haphazard or serial.

### Conclusions

This investigation covers the origin of the vessel in *Pteris*, in Gnetales, and in dicotyledonous Angiosperms. In *Pteris* the primitive condition of the vessel is scalariform, with the obvious tendency to the development of pitted sculpture in the end wall of the element. It is of interest to note that in the Osmundaceae and Ophioglossaceae the pitted as contrasted with the scalariform sculpture appears in the side walls of the vascular elements.

In Gnetales the vessels have obviously been derived from pitted and not from scalariform tracheids. Their evolution is connected with the appearance of particularly large pits in the end walls of the vascular elements, which first lose their membranes and subsequently undergo fusions, either transversely or irregularly. As in *Pteris*, it is the perforation region of the vessel which shows the greatest advance and specialization. In the Dicotyledons two general types of vessels are found, those with scalariform perforations and those with porous perforations. Investigation of the first type from the Magnoliaceae and Betulaceae appears to establish the fact that the perforations have arisen by pit fusions precisely as in the higher Gnetales. In the second type the vessel with porous perforation, often with bordered margins as in *Gnetum*, in most cases in the Angiosperms has had its immediate origin from the vessel with scalariform perforations. These in turn, as illus-



trated by *Quercus* and *Cydonia*, have been derived from the fusion of pitted perforations. It follows that the mode of origin of the vessel in the Dicotyledons and Gnetales is essentially similar, in both cases being the consequence of the fusion of open bordered pits, either in rows or irregularly.

These remarks apply to the end wall of the vessel, particularly to the perforation. In the few cases among the Angiosperms where the lateral vascular walls are scalariform, it appears clear that the scalariform lateral pits have resulted from the horizontal fusion of circular or oval pits. It is further to be noted that the scalariform sculpture appears first in the terminal region of the vessel and may later appear in the side wall, always resulting from pit fusions. It follows that the vessel of the Angiosperms as of the Gnetales has been derived not from the scalariform but from the pitted tracheid. In this respect the vessel is in harmony with the other evolutionary developments in the wood, since according to the best established view both the mechanical fibers and the longitudinal parenchymatous elements of higher plants have been derived from the pitted tracheid (3). It would be surprising if the vessel, which is much later in geological times than longitudinal storage elements and mechanical elements of strength, should have originated from a type more primitive than the pitted tracheid.

### Summary

1. In *Pteris* the scalariform perforation of the vascular end wall often becomes pitted.

2. In the *Gnetum* type of vessel the fusion of pits to form the porous perforation is haphazard, but in *Gnetum scandens* the fusion of pits is often more regular, resulting in a scalariform perforation.

3. Haphazard fusion of pits is also found in *Paeonia*, *Cydonia*, and *Leea*; while in *Liriodendron*, *Magnolia*, *Paeonia*, *Betula*, *Alnus*, *Quercus*, and *Vitis* the fusion is often serial, resulting in scalariform perforations.

4. The evolution of the perforations of the vessels in Gnetales and Dicotyledons is similar, and in both cases is the result of pit fusions.

5. From evidence derived from a consideration of primitive and conservative regions in *Liriodendron*, *Magnolia*, *Paeonia*, and *Vitis*, it may be concluded that the primitive type of vessel in the Angiosperms is pitted, and has been derived from the pitted tracheid as have the mechanical and longitudinal storage elements of the wood.

This investigation has been carried on in the laboratories of plant morphology at Harvard University under the direction of Dr. E. C. JEFFREY. In conclusion I wish to express my thanks to him for the material supplied and for his invaluable aid throughout the work.

WELLESLEY COLLEGE

#### LITERATURE CITED

1. BAILEY, I. W., Anatomical characters in the evolution of *Pinus*. Amer. Nat. 44:284-293. 1910.
2. BROWN, F. B. G., Scalariform pitting a primitive feature in angiospermous secondary wood. Science N.S. 48:16-18. 1918.
3. JEFFREY, E. C., Anatomy of woody plants. University of Chicago Press. 1917.
4. SOLEREDER, HANS, Systematic anatomy of the Dicotyledons. Trans. by BOODLE and FRITSCH. Oxford. Clarendon Press. 1908.
5. THOMPSON, W. P., Independent evolution of vessels in Gnetales and Angiosperms. BOT. GAZ. 65:89-90. 1918.
6. ———, Anatomy and relationships of the Gnetales. I. *Ephedra*. Ann. Botany 26:1077-1104. 1912.

#### EXPLANATION OF PLATES XVI-XX

##### PLATE XVI

FIG. 1.—Longitudinal radial section of bundle of rhizome of *Pteris aquilina*;  $\times 250$ .

FIG. 2.—End wall of vessel of *Pteris aquilina* in face view, reticulated type;  $\times 250$ .

FIG. 3.—End wall of vessel of *Pteris aquilina* in face view, scalariform type;  $\times 250$ .

FIG. 4.—Portion of vessel of *Pteris aquilina*, profile view;  $\times 166$ .

FIG. 5.—Longitudinal radial section of young twig of *Ephedra*;  $\times 125$ .

FIG. 6.—Longitudinal radial section of older twig of *Ephedra*;  $\times 250$ .

FIG. 7.—Longitudinal radial section of stem of *Gnetum Gnemon* type;  $\times 62$ .

FIG. 8.—Longitudinal radial section of stem of *Gnetum Gnemon* type;  $\times 187$ .

## PLATE XVII

FIG. 9.—Longitudinal radial section of stem of *Gnetum Gnemon* type;  $\times 250$ .

FIG. 10.—Longitudinal radial section of stem of *Gnetum scandens* in region of primary wood;  $\times 250$ .

FIG. 11.—Longitudinal radial section of leaf trace of *Gnetum scandens*;  $\times 40$ .

FIG. 12.—Longitudinal radial section of leaf trace of *Gnetum scandens* showing end wall;  $\times 250$ .

FIG. 13.—Longitudinal radial section of leaf trace of *Gnetum scandens*;  $\times 125$ .

FIG. 14.—Longitudinal radial section of mature wood of *Welwitschia mirabilis*;  $\times 250$ .

FIG. 15.—Longitudinal radial section of leaf trace of *Welwitschia mirabilis*;  $\times 250$ .

FIG. 16.—Longitudinal radial section of mature secondary wood of small twig of *Liriodendron Tulipifera*;  $\times 250$ .

## PLATE XVIII

FIG. 17.—Longitudinal radial section of root of *Liriodendron Tulipifera* in region of primary wood;  $\times 187$ .

FIGS. 18-20.—Longitudinal radial section of root of *Liriodendron Tulipifera* in region of primary wood;  $\times 250$ .

FIG. 21.—Longitudinal radial section of root of *Magnolia Frazeri* in region of primary wood;  $\times 250$ .

FIG. 22.—Longitudinal radial section of first annual ring in stem of *Magnolia Frazeri*;  $\times 250$ .

FIG. 23.—Longitudinal radial section of stem of *Paeonia moutan*;  $\times 125$ .

FIG. 24.—Longitudinal radial section of leaf trace of species of *Paeonia*;  $\times 250$ .

## PLATE XIX

FIG. 25.—Longitudinal radial section of leaf trace in species of *Paeonia*;  $\times 250$ .

FIG. 26.—Longitudinal radial section of stem of *Betula alba* in region of primary wood;  $\times 250$ .

FIG. 27.—Longitudinal radial section of vessel of *Betula alba* in region of primary wood;  $\times 375$ .

FIG. 28.—Longitudinal radial section of secondary wood of *Betula alba*;  $\times 250$ .

FIG. 29.—Longitudinal radial section of stem of *Alnus incana* in region of primary wood;  $\times 250$ .

FIG. 30.—Same as fig. 29;  $\times 375$ .

FIG. 31.—Longitudinal radial section of secondary wood of *Alnus incana*;  $\times 375$ .

FIG. 32.—Longitudinal radial section of leaf trace of *Quercus velutina* in region of primary wood;  $\times 375$ .

## PLATE XX

FIG. 33.—Longitudinal radial section of stem of *Potentilla monspeliensis* in region of primary wood;  $\times 250$ .

FIG. 34.—Longitudinal radial section of stem of *Cydonia vulgaris* in region of primary wood;  $\times 250$ .

FIG. 35.—Longitudinal radial section of leaf trace of *Cydonia japonica*;  $\times 250$ .

FIG. 36.—Longitudinal radial section of stem of species of *Leea* in region of primary wood;  $\times 250$ .

FIG. 37.—Longitudinal radial section of stem of species of *Vitis* in region of primary wood;  $\times 250$ .

FIG. 38.—Same as fig. 37, farther out from primary wood;  $\times 250$ .

FIG. 39.—Longitudinal radial section of leaf trace of species of *Vitis*;  $\times 250$ .

FIG. 40.—Longitudinal radial section of spring and summer wood in species of *Vitis*;  $\times 250$ .

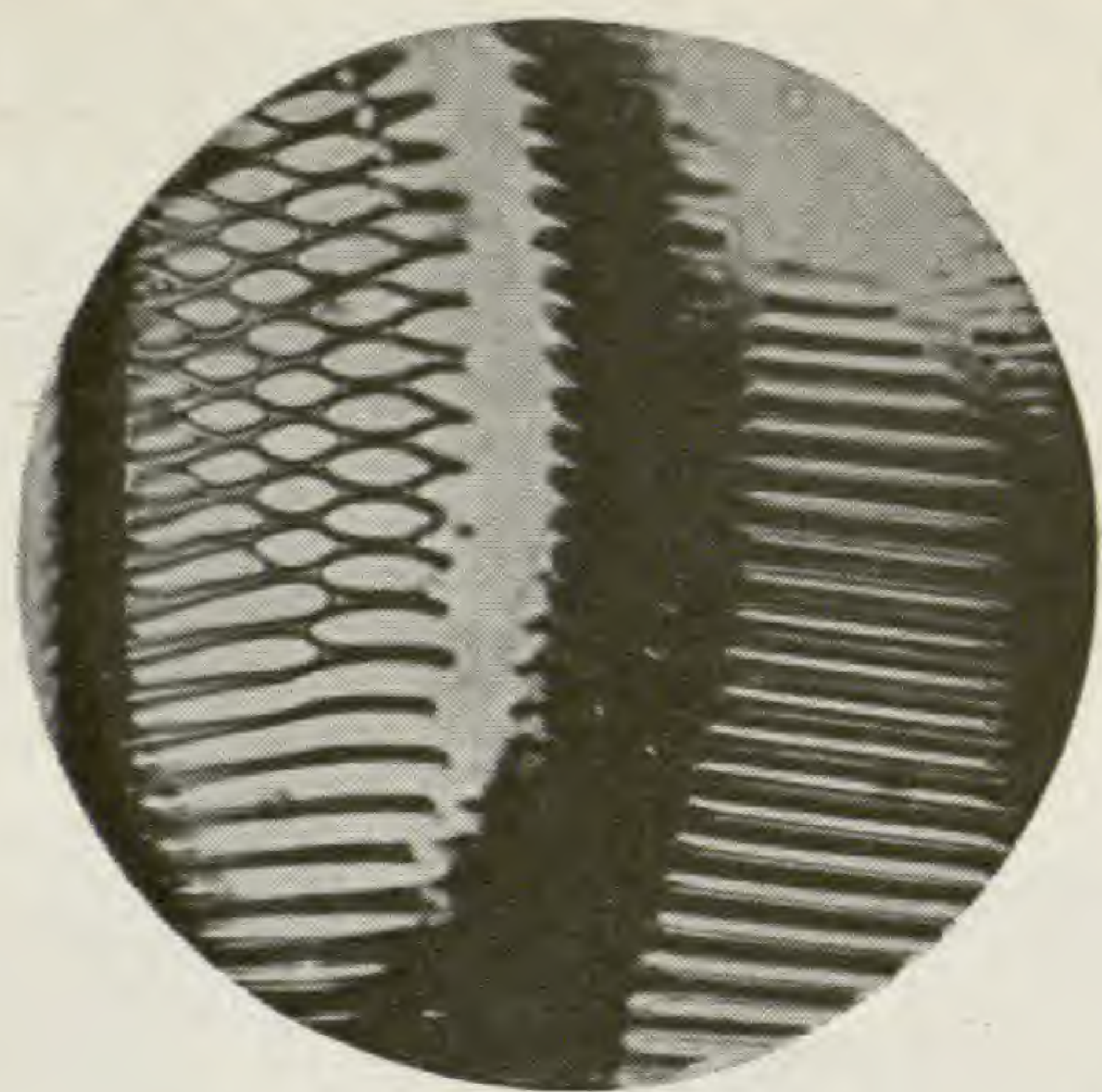

1



2

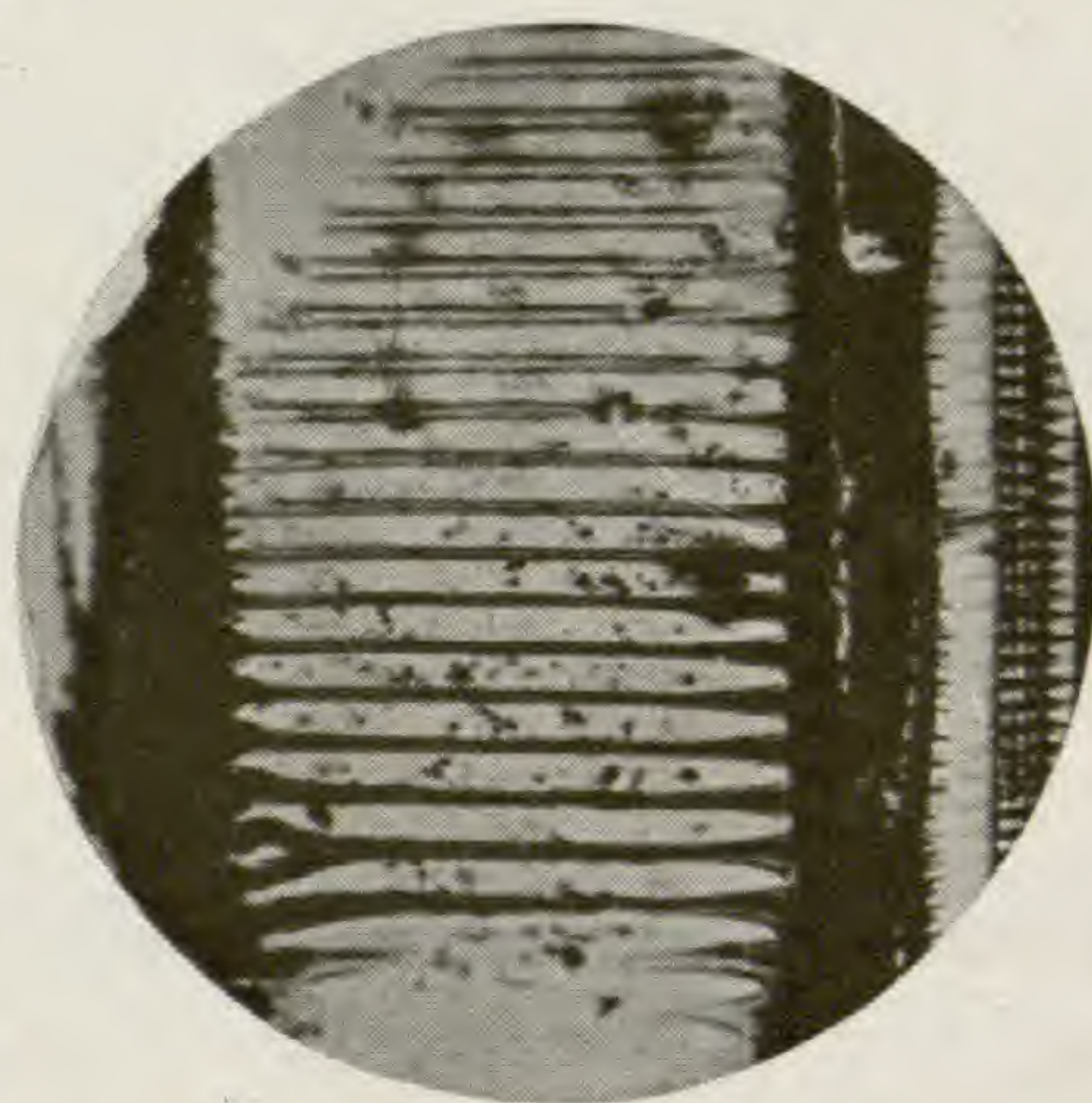

3

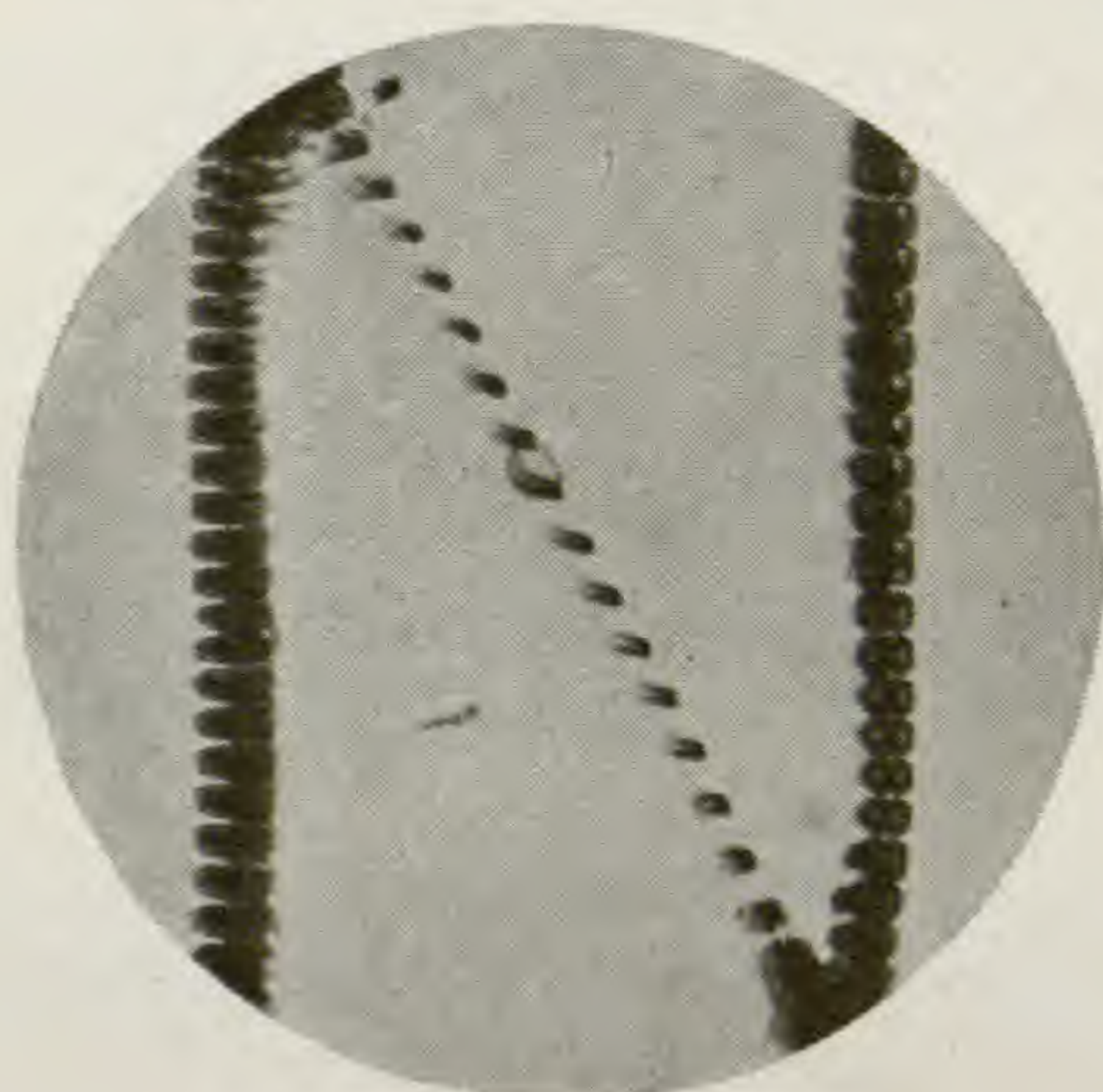

4

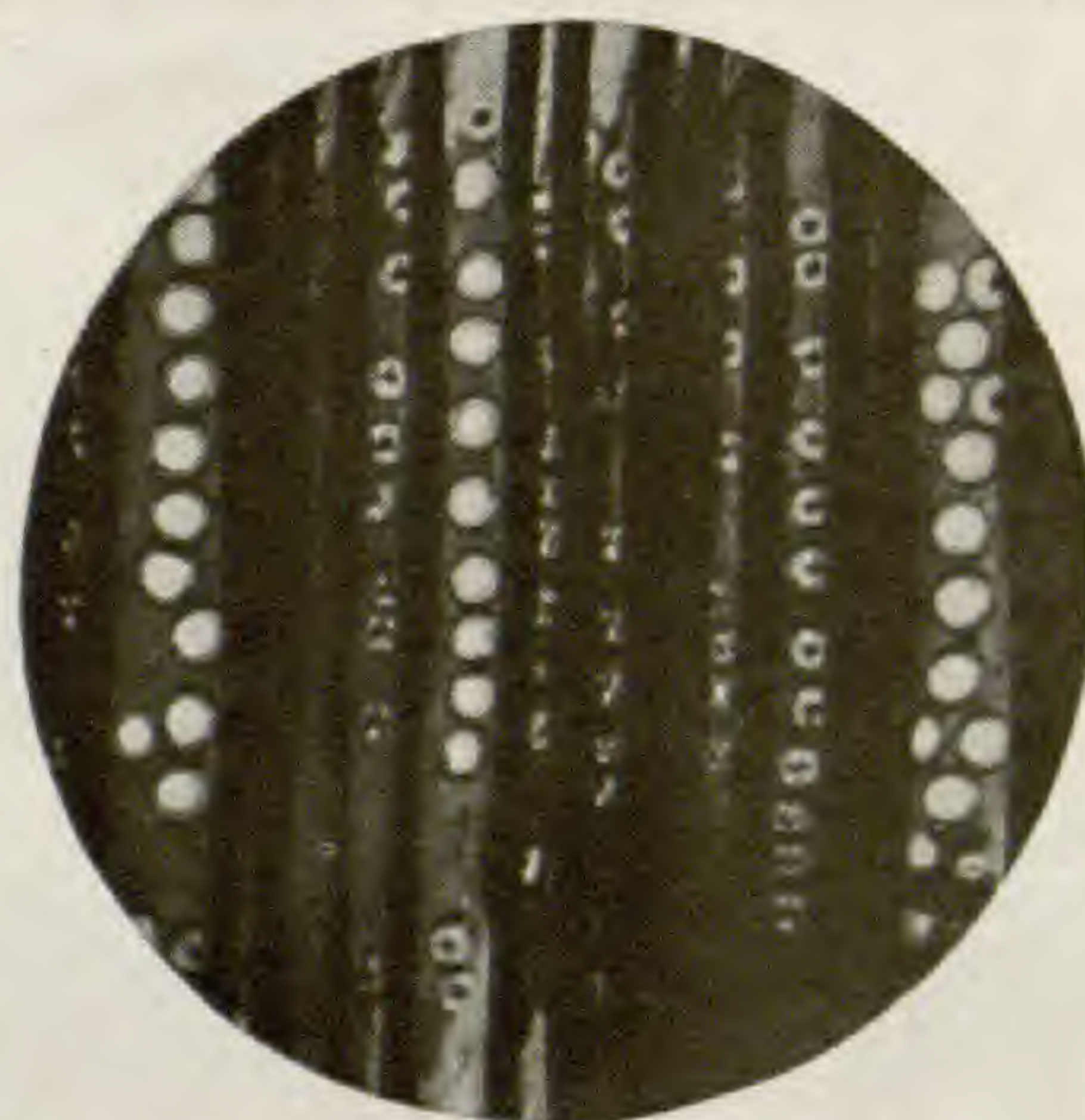

5

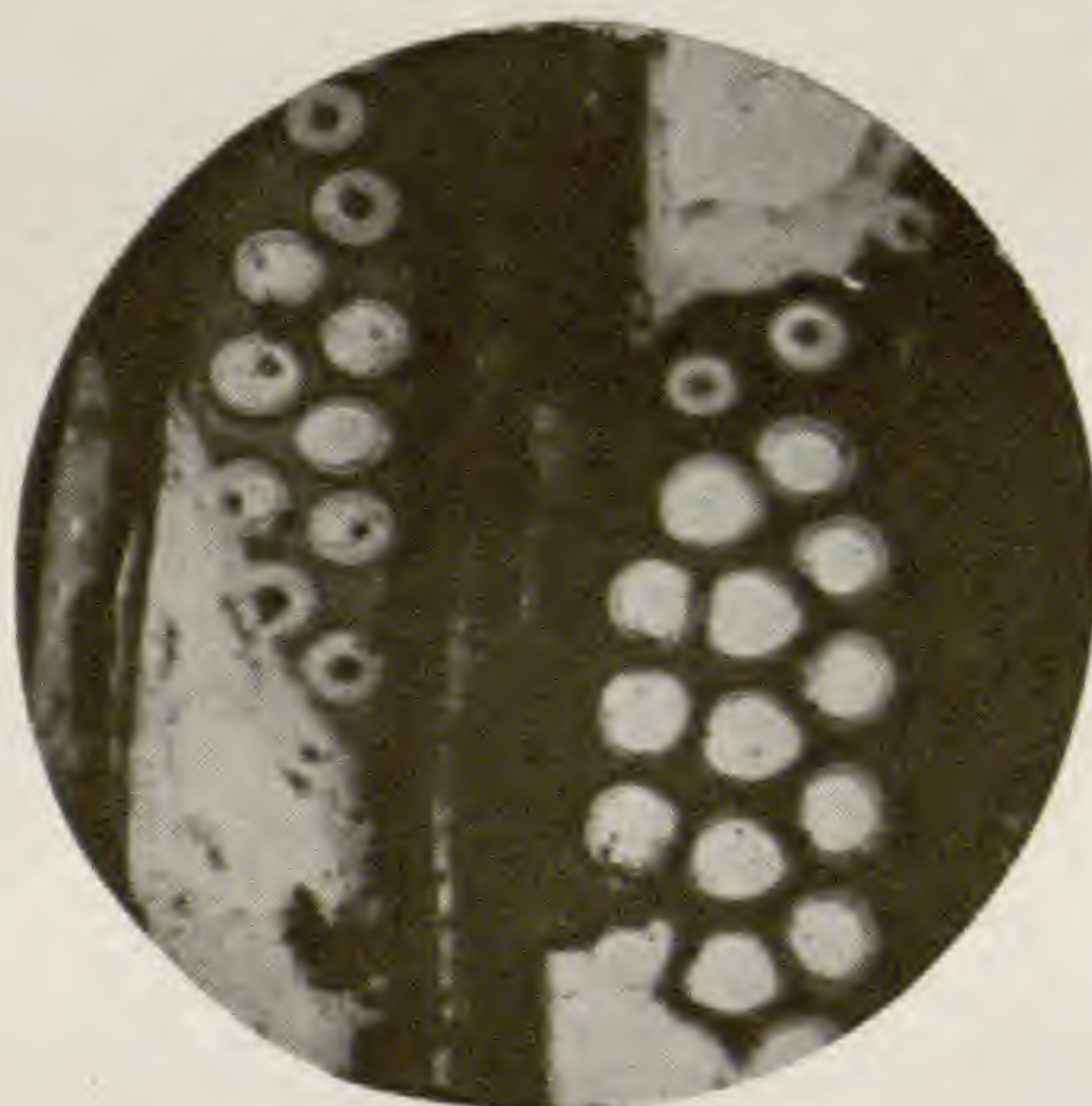

6

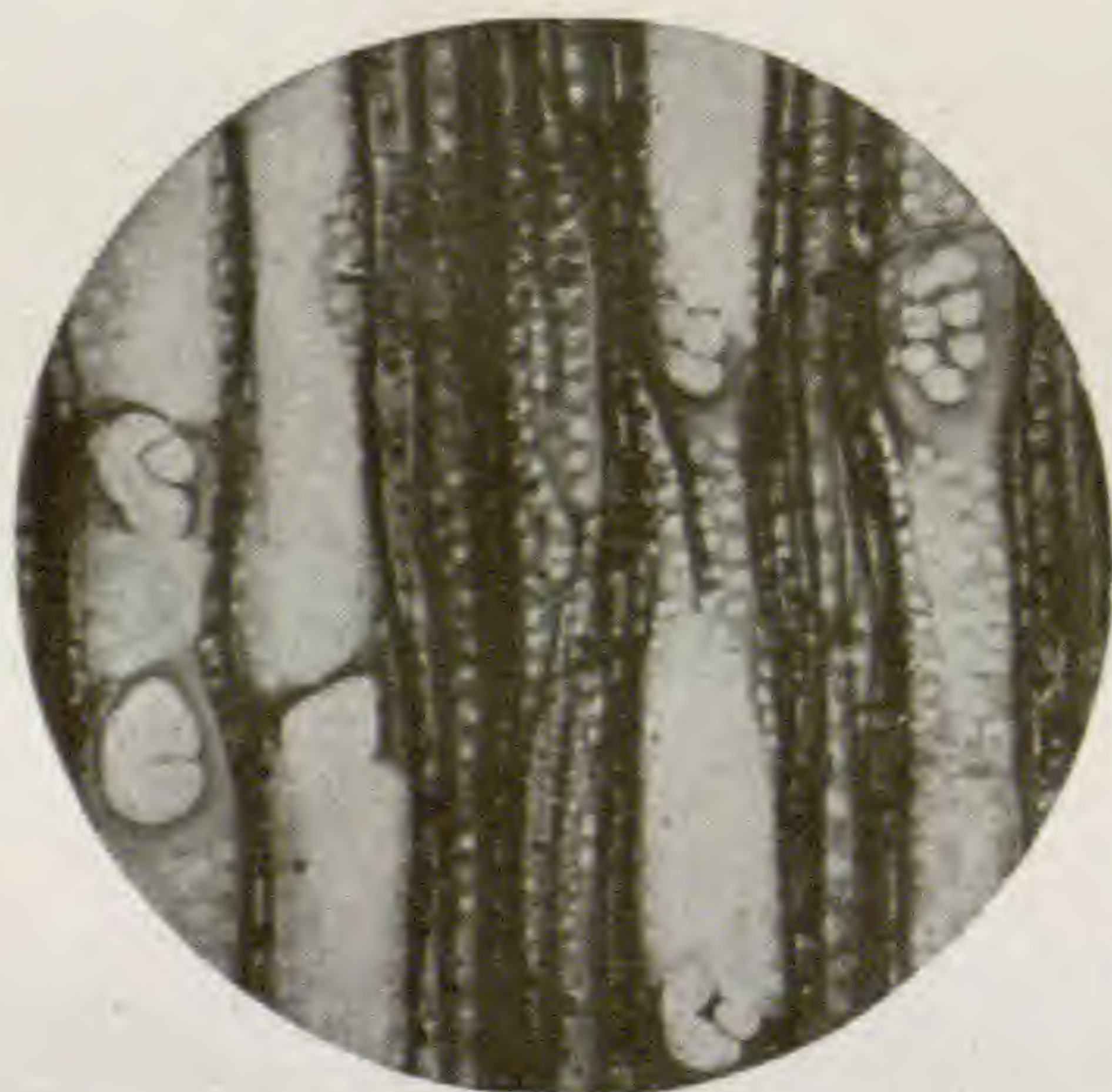

7



8

BLISS on VESSEL IN SEED PLANTS

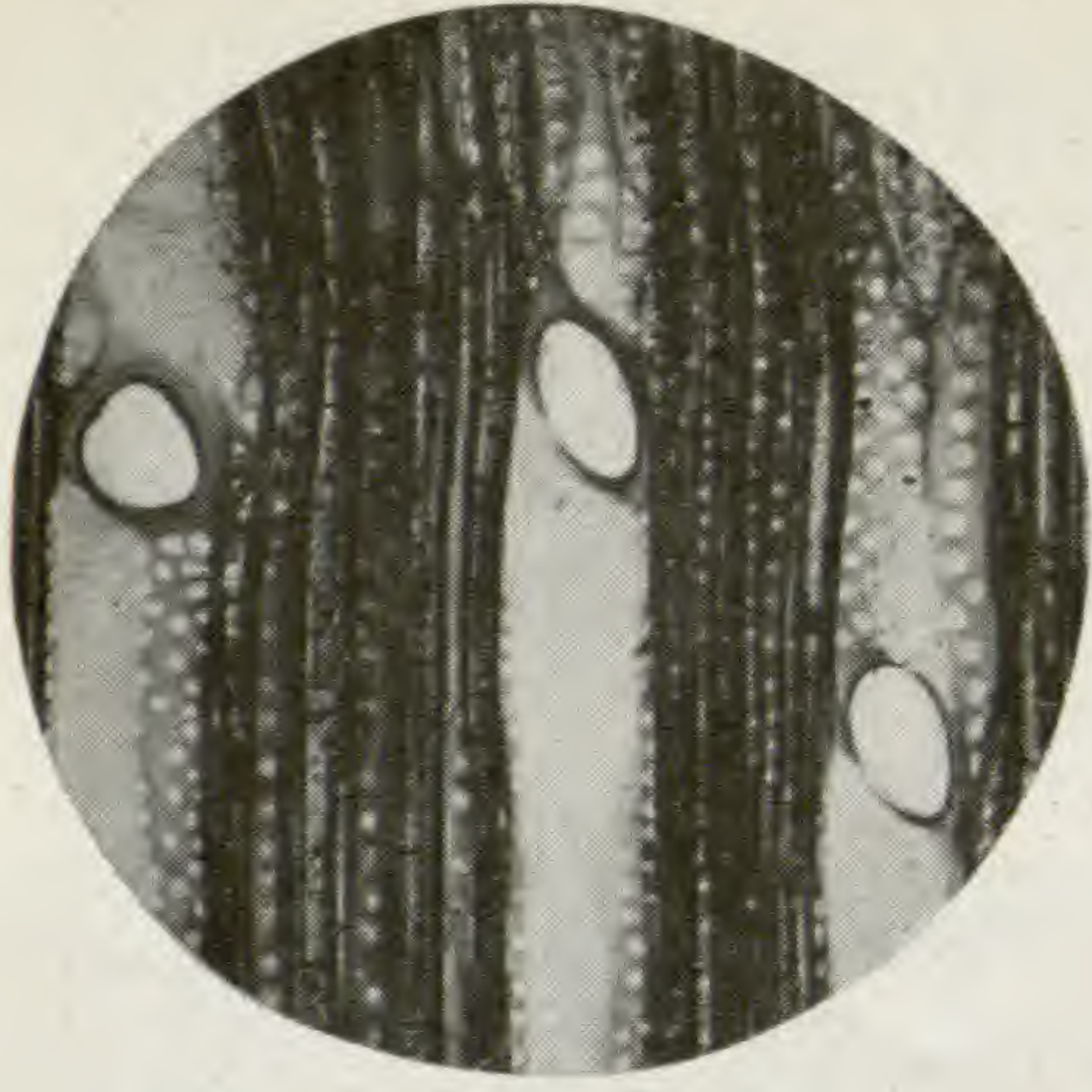

9

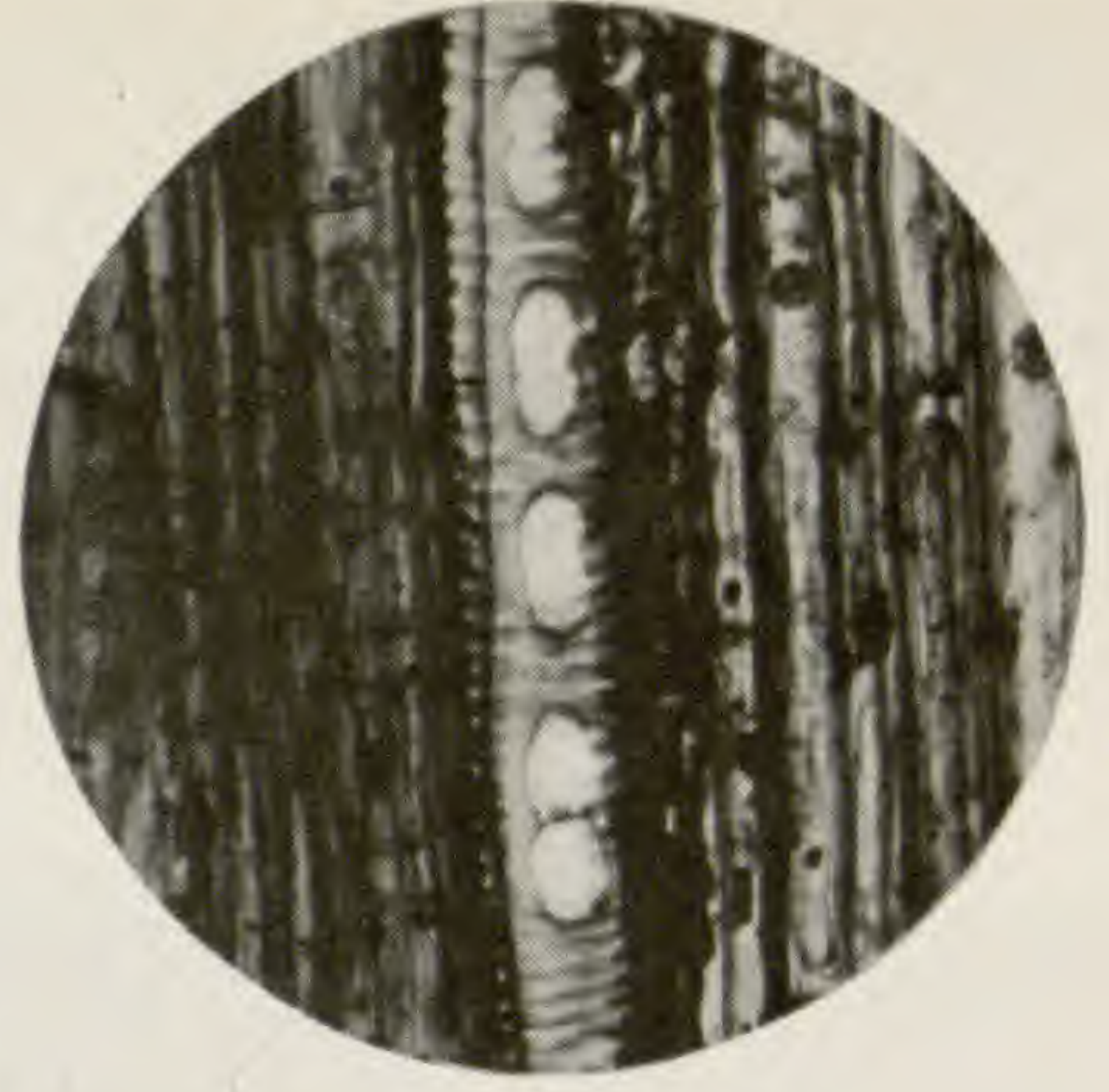

10



11

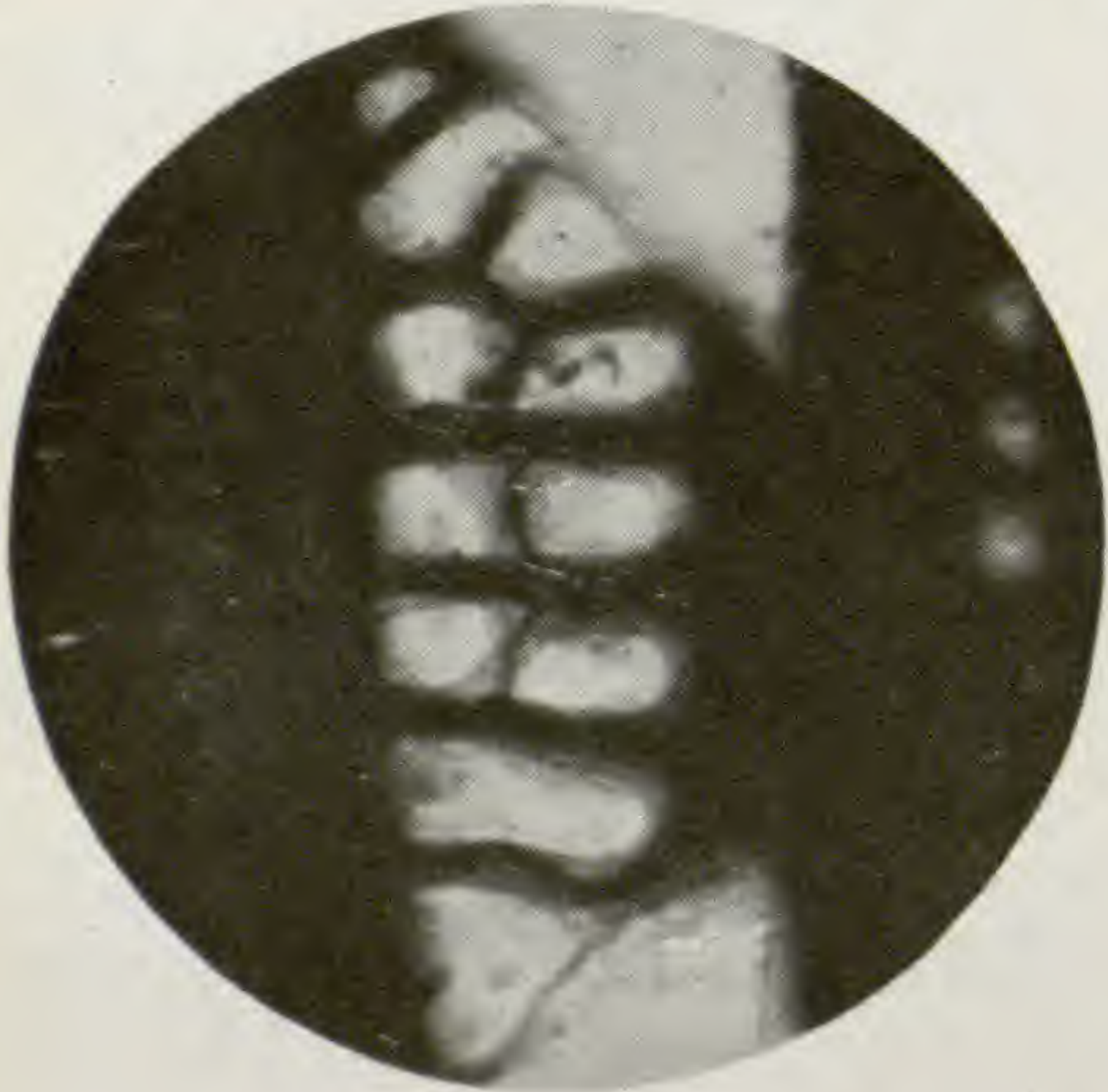

12



13



14

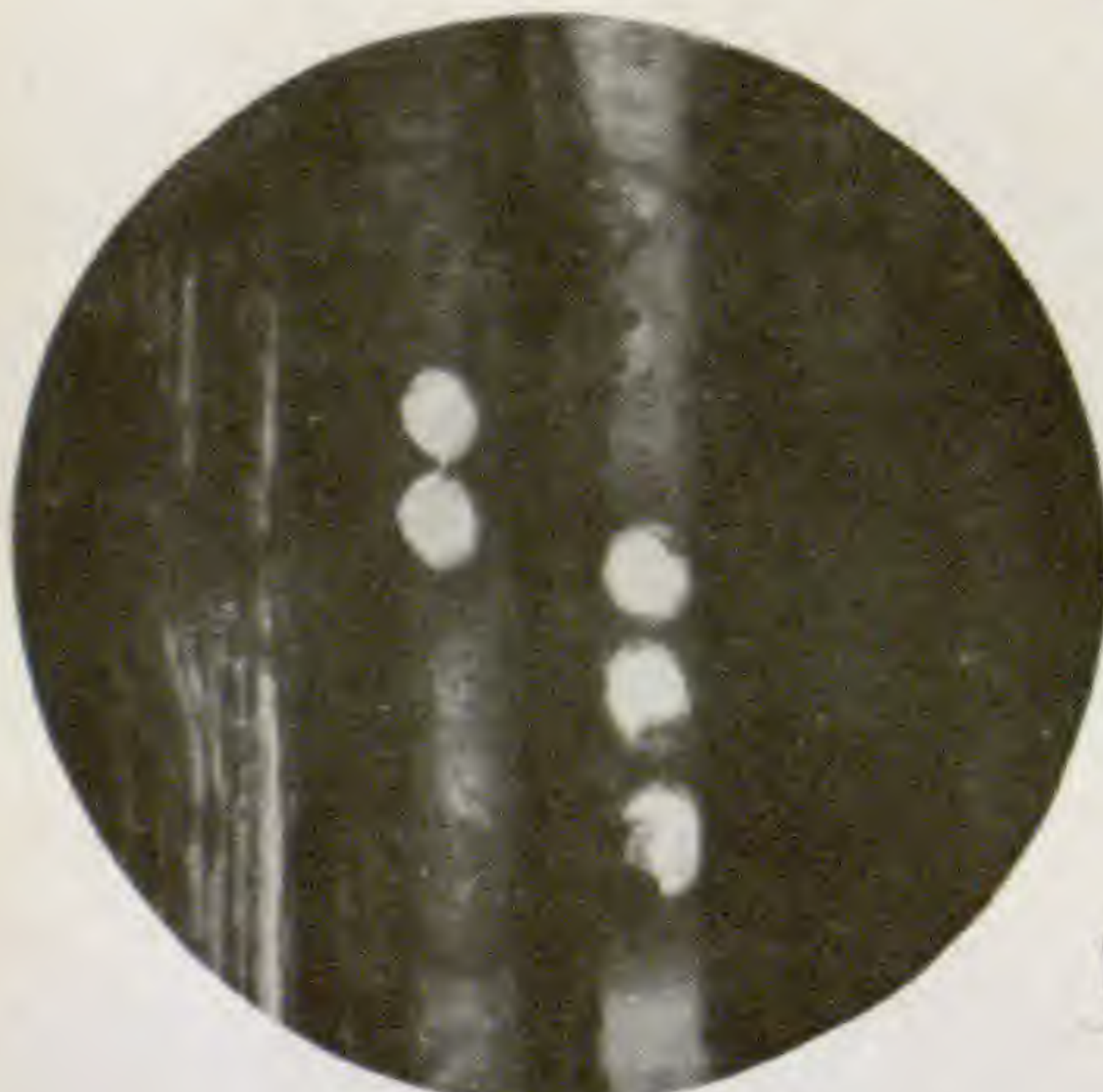

15



16

BLISS on VESSEL IN SEED PLANTS



17



18



19

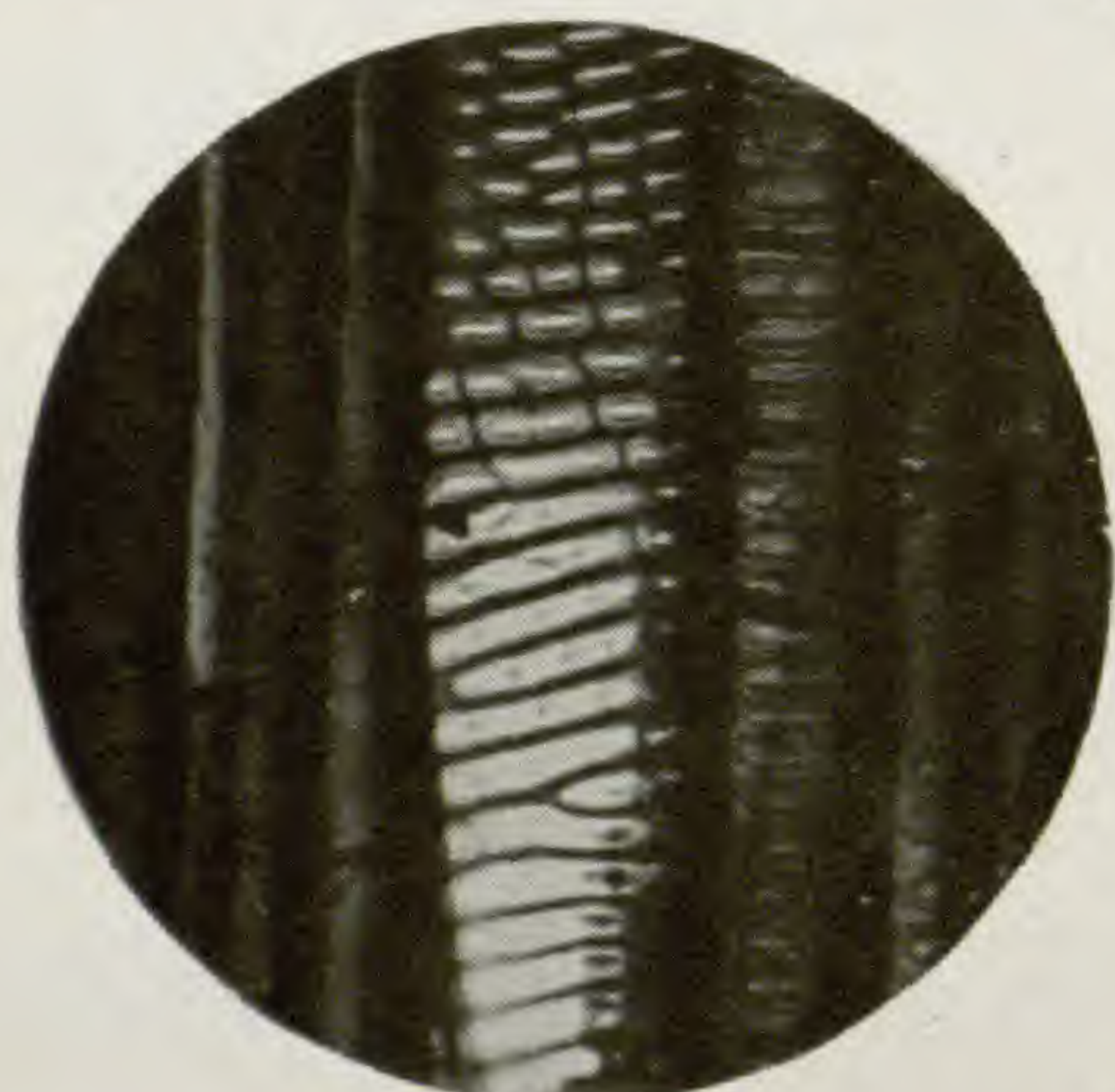

20



21



22



23

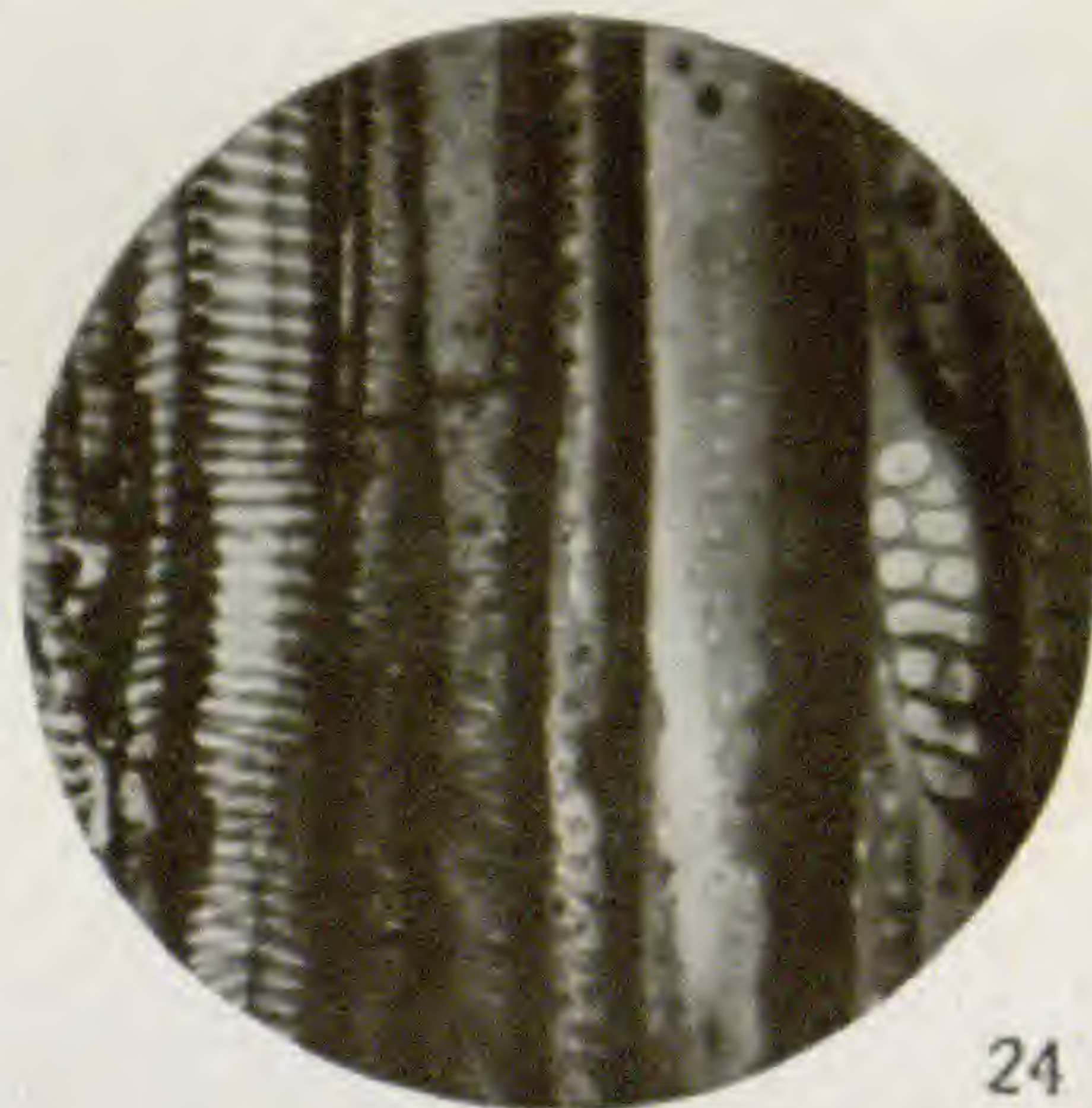

24

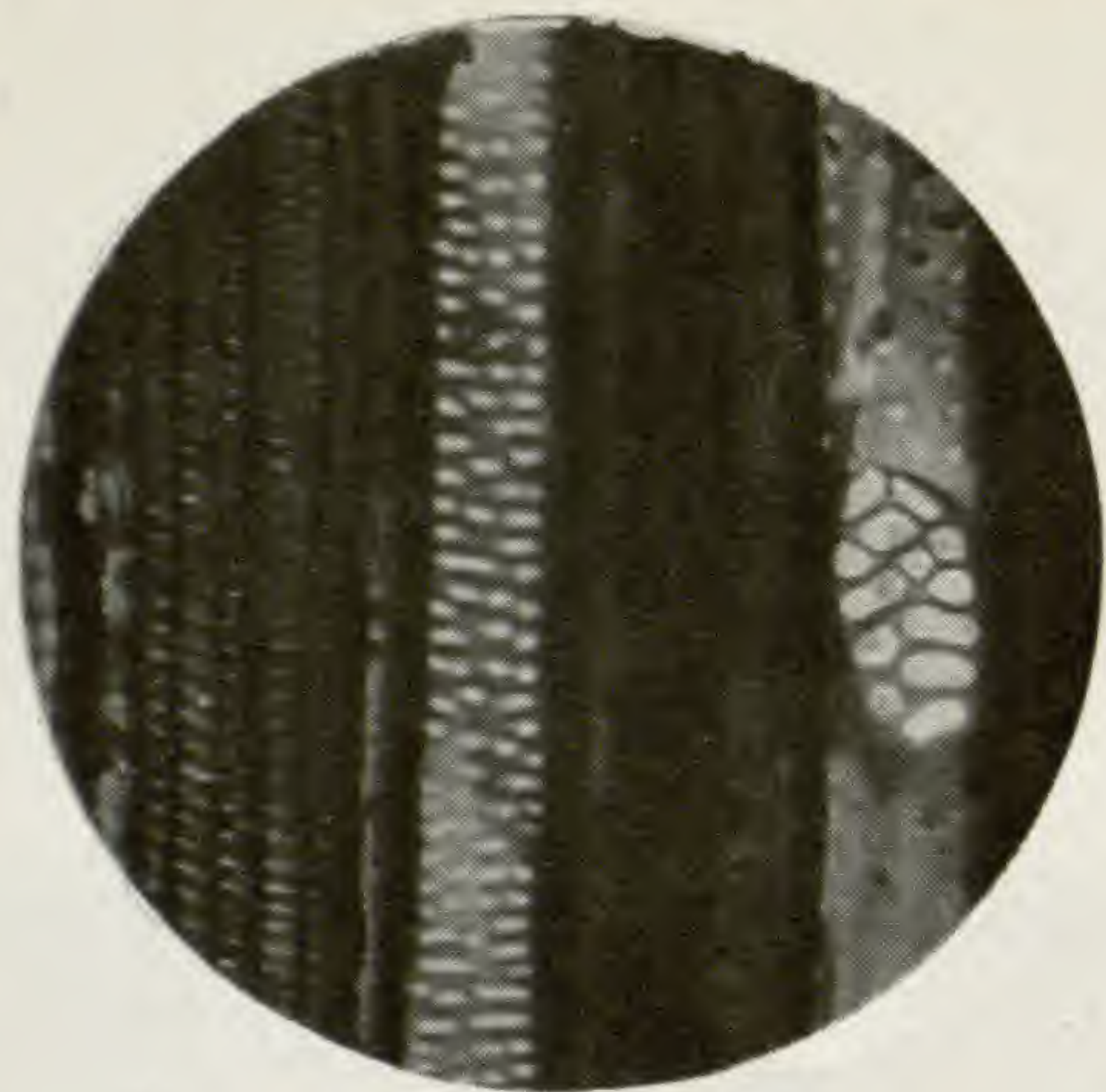

25



26



27

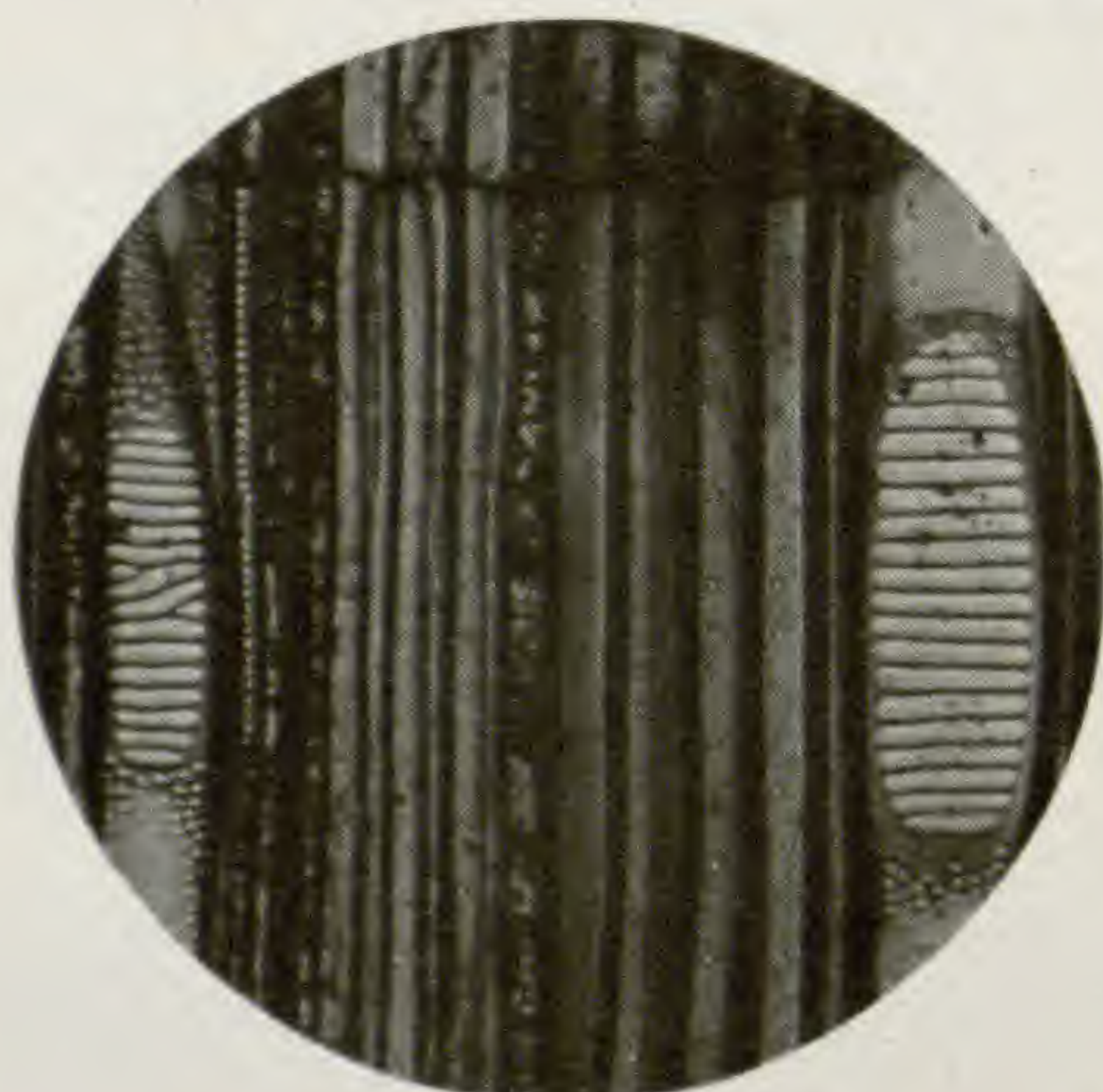

28



29



30

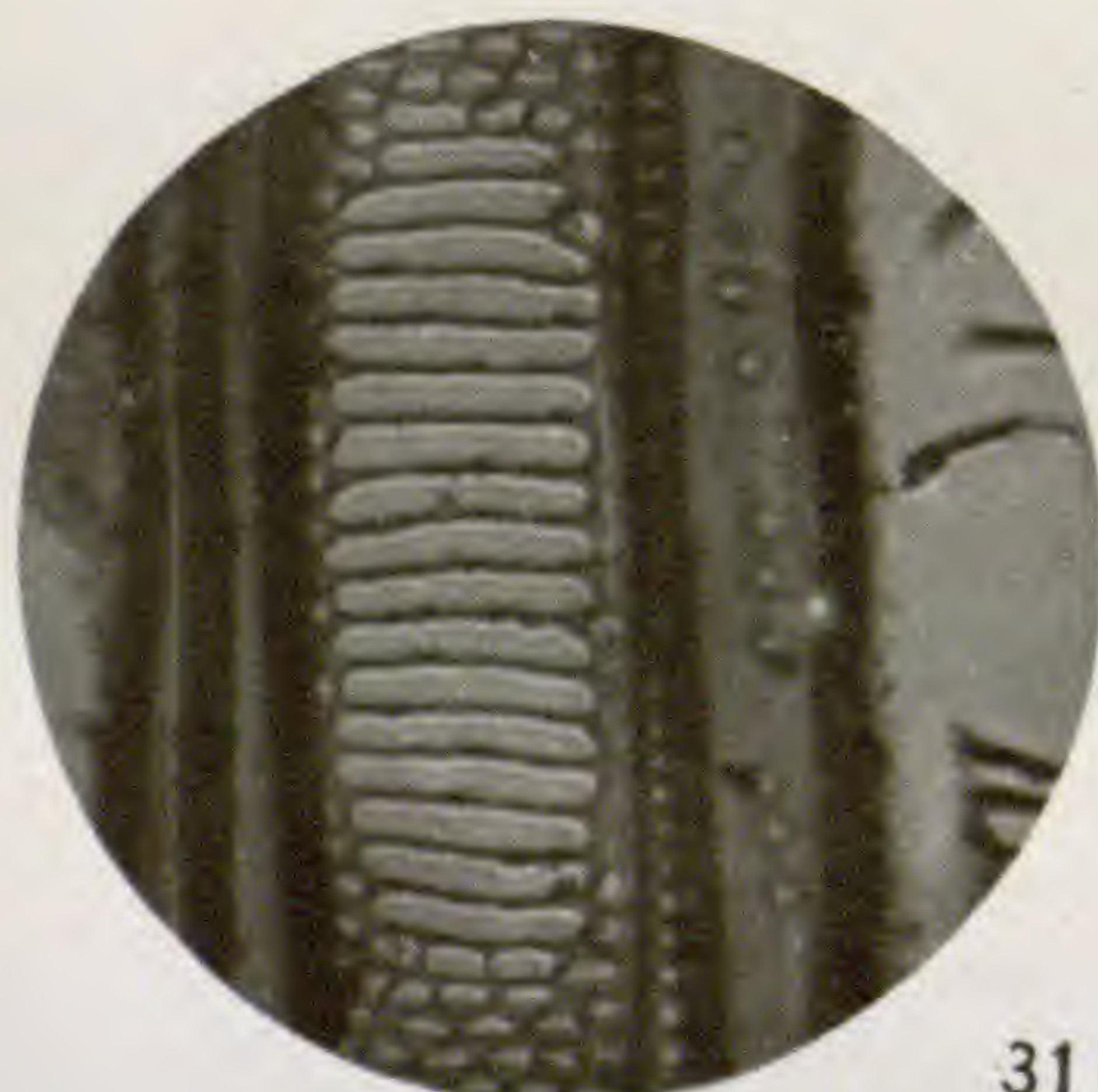

31

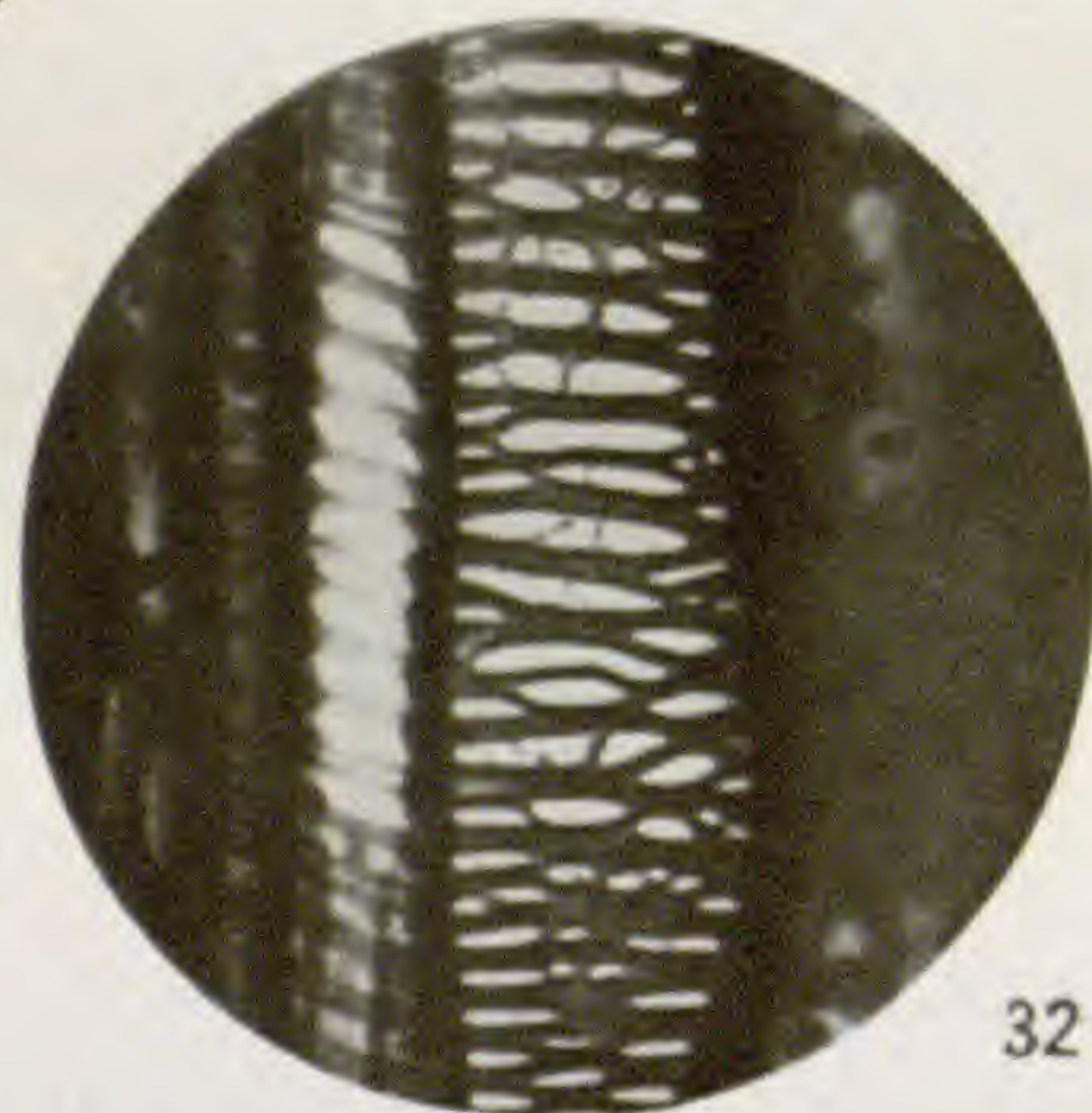

32



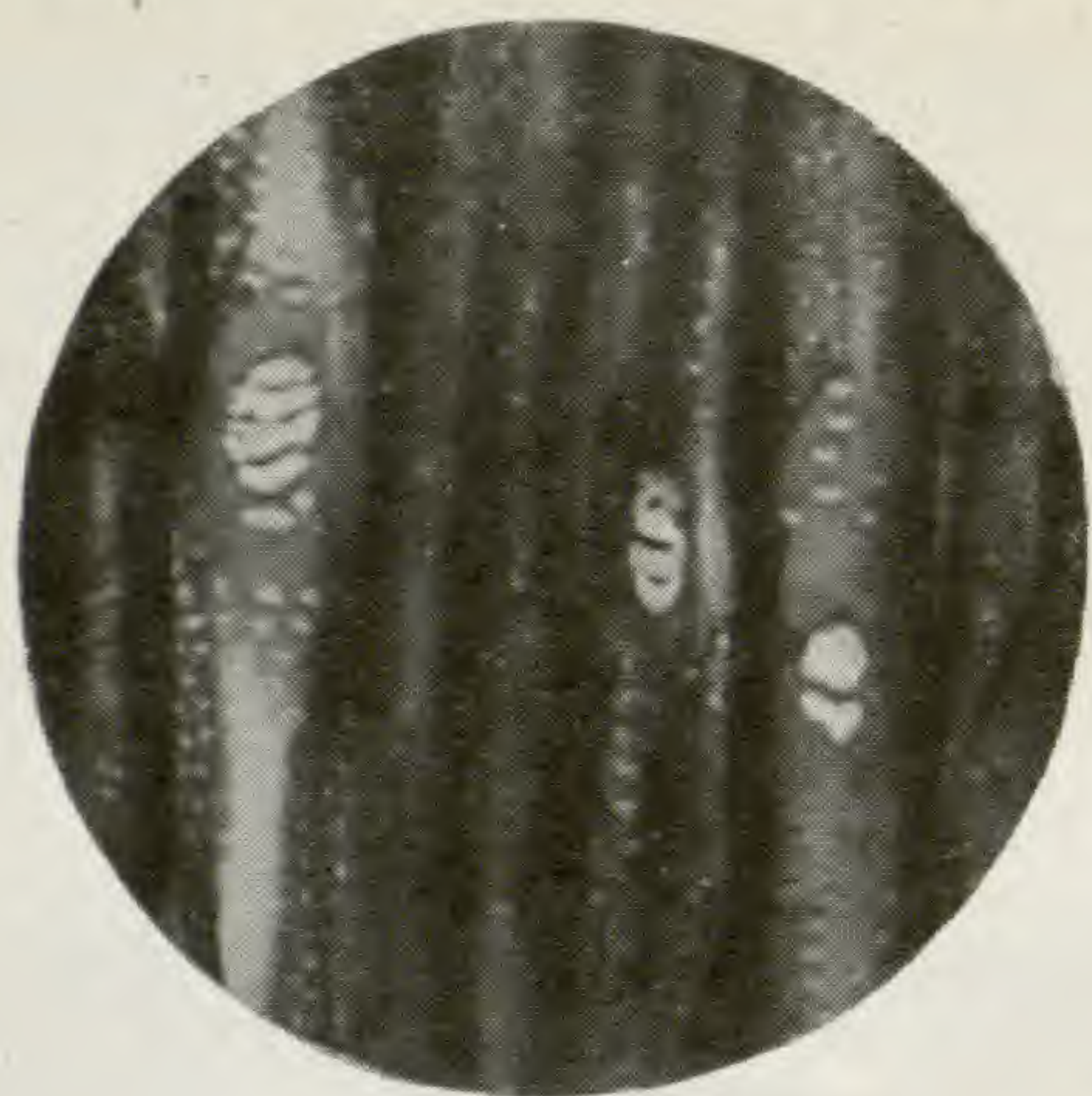

33



34



35

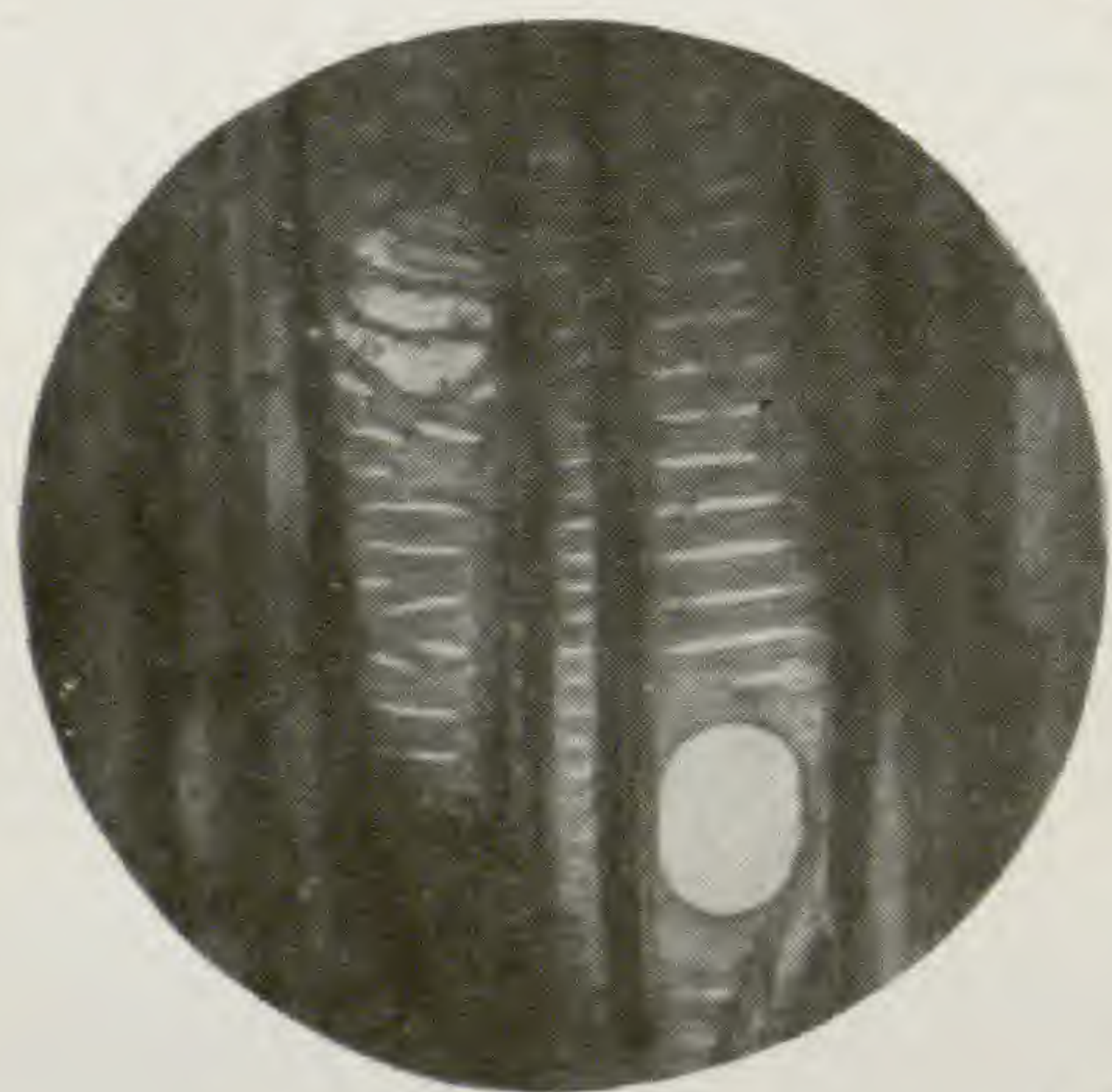

36

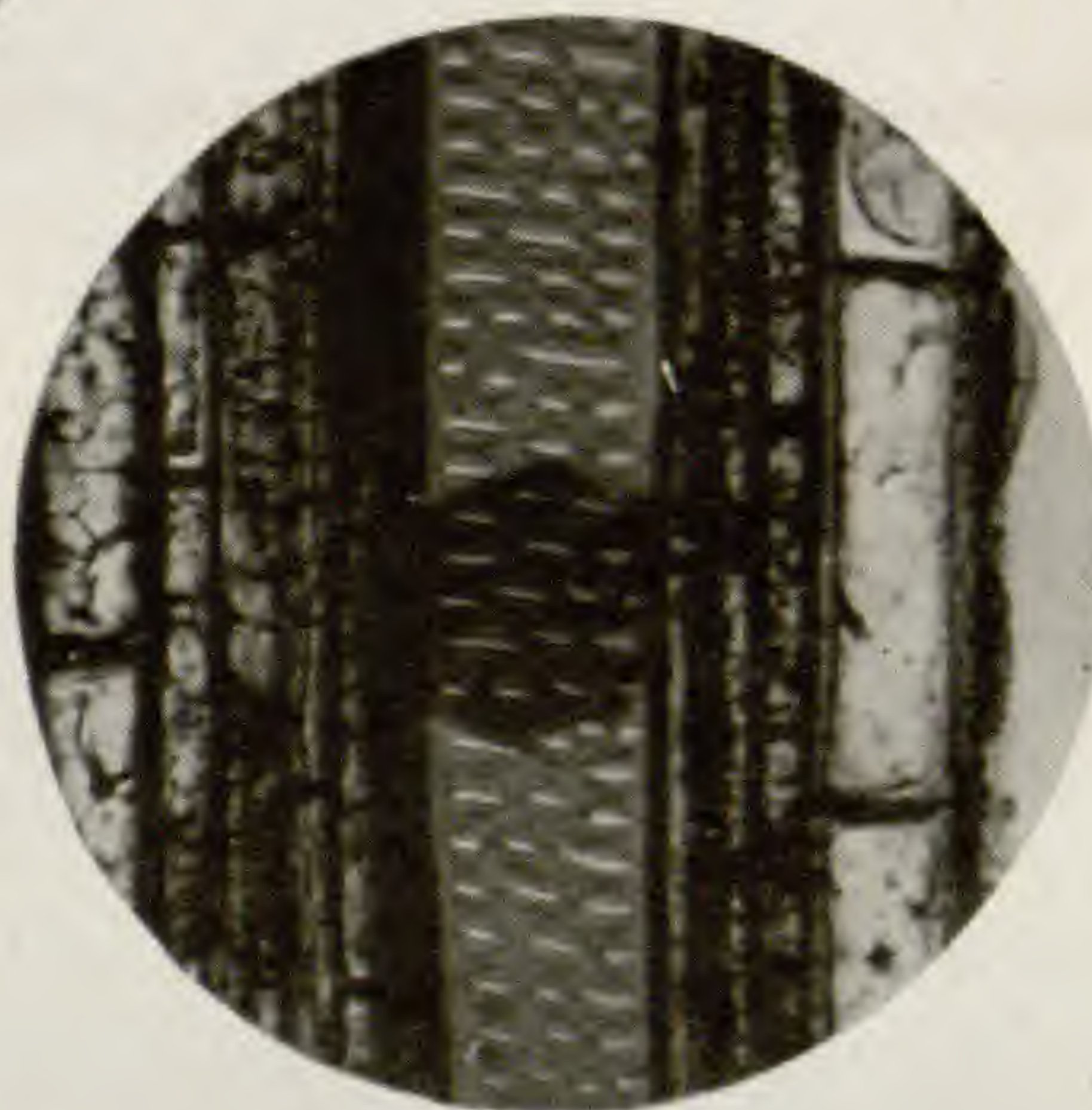

37



38



39



40

BLISS on VESSEL IN SEED PLANTS

## A CONVENIENT THERMOREGULATOR

HEINRICH HASSELBRING

(WITH TWO FIGURES)

A convenient form of thermoregulator which has now been in use in several laboratories of the Bureau of Plant Industry, United States Department of Agriculture, for nearly ten years is shown in fig. 1. On account of its compactness and its adaptability to constant temperature baths and chambers of various kinds, where extreme sensitiveness is required, it may perhaps be worth while to give a brief description of the instrument and its installation in order to make it more generally available.

The instrument consists of a thermometer tube about 30 cm. long, the upper end of which is bent over and enlarged into a bulb to serve as a reservoir for excess mercury. The thermometer bulb at the bottom should be about 7 or 8 cm. long. Platinum contacts leading to the binding posts clamped on the thermometer are sealed into the capillary at *A* and *B*. At a point (*C*) some distance from the upper contact a slight constriction is formed in the thermometer capillary. This point may be marked on the tube. For ordinary incubator temperatures the constriction should be about 2.5 cm. above the upper contact; for temperatures around zero it should be 5 or 6 cm. above.

Experience with many of these instruments has shown that in their manufacture the observance of several points is absolutely essential. (1) The space above the mercury must be entirely free from gas. The presence of a trace of gas prevents the union of mercury from the reservoir with that of the capillary and makes the instrument entirely useless. (2) The platinum wires must project far enough into the capillary to make contact with the mercury, but not so far that they interfere with the motion of the mercury column. If the wire projects too far into the capillary

the mercury will hang on the wire, and regulation thereby becomes impossible. The seal must be gas-tight. (3) The constriction of the capillary at C must be narrow enough so that a short section of the mercury column above will not slide down past the constriction even with slight jarring. It must be possible, however, to shake mercury down past the constriction. (4) The band holding the upper contact wire should not cover the contact point itself, otherwise adjustment is difficult.

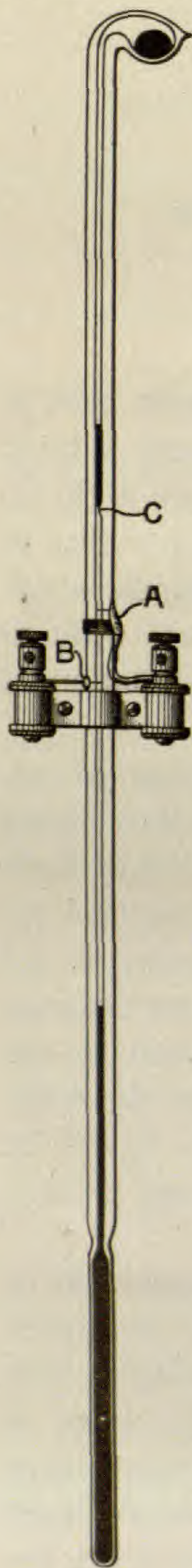

FIG. 1

To adjust the instrument for a given temperature an excess of mercury is shaken down below the constriction to unite with the column in the capillary. The remainder of the mercury above the constriction is allowed to flow, with gentle tapping or shaking, if necessary, into the upper bulb, the thermometer being inclined during the process. The constriction should be narrow enough to prevent the mercury below from flowing past it. The bulb of the regulator is now plunged into a large beaker of water kept exactly at the temperature for which the regulator is to be set. The mercury column will stand a little above the upper contact, since an excess of mercury was first shaken down past the constriction. The length of the mercury column above the contact is noted, and a section of nearly the same length is forced above the constriction by carefully lowering the bulb into another vessel of water kept at a sufficiently higher temperature. The bulb is then replaced in the first vessel and the process repeated. Finally, only single globules are forced past the constriction until the end of the column stands exactly at the upper contact wire, when the bulb is kept in water at the desired temperature. If the constriction has been properly made, the short piece of mercury column above it may be left in place.

This regulator is designed to actuate a telegraphic relay which interrupts the heating current. The installation shown in fig. 2

requires but little explanation. The current passing through the regulator and actuating the relay may be taken either from a line circuit or from a constant circuit battery. In either case the current should be so reduced by means of resistance and by reduction of the voltage that the current passing through the regulator does not exceed 0.015 of an ampere. Larger currents damage the regulator. Various types of heaters may be used, but in general the current to be interrupted by the relay should be as small as possible. Where high temperatures are to be maintained, it is usually best to have an auxiliary heater which by running con-

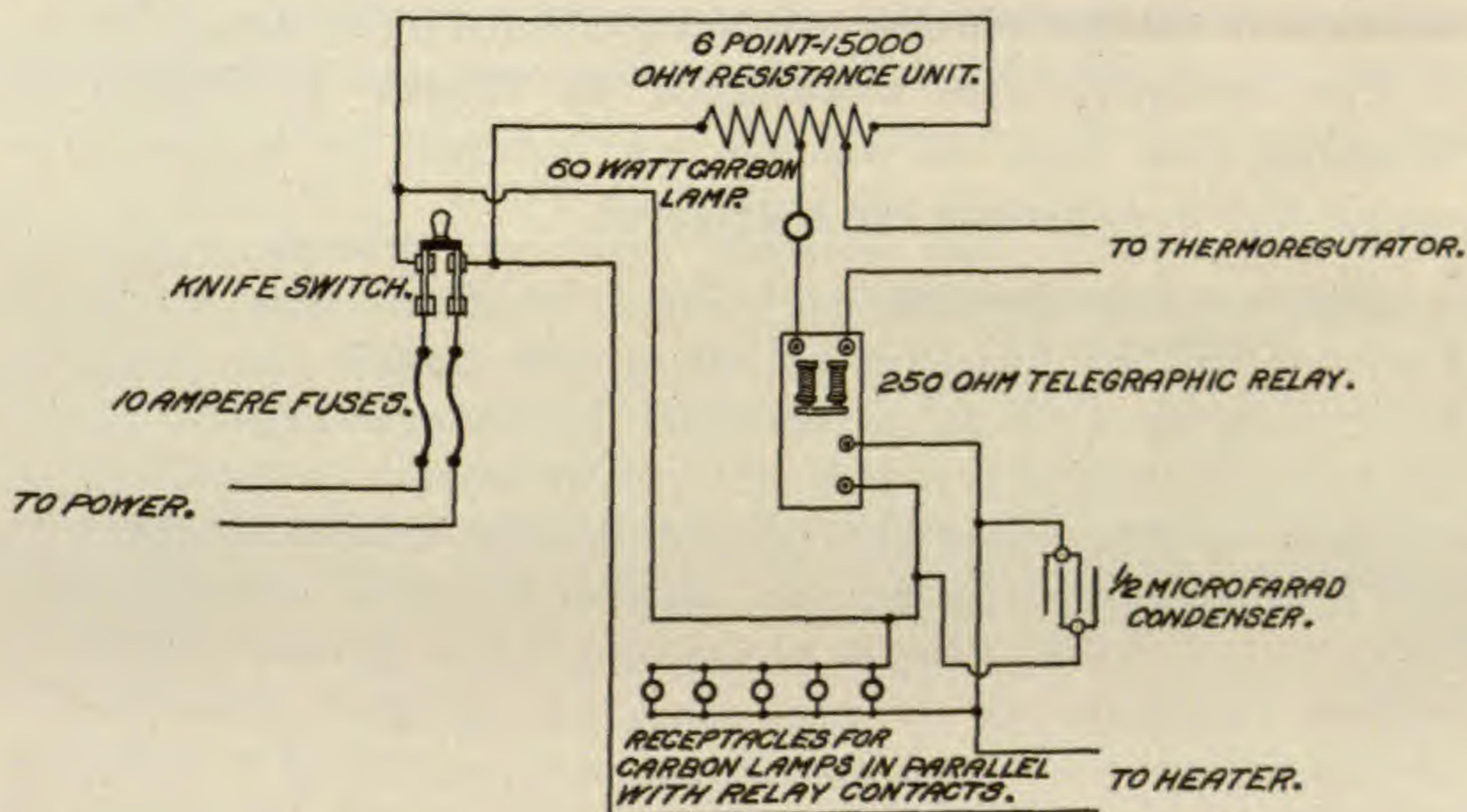

FIG. 2

stantly maintains the temperature nearly at the desired point. The deficiency is controlled by a heater of smaller capacity regulated by the relay. If only one heater is employed, a large portion of the current may be made to flow continuously by inserting one or a number of carbon lamps in the circuit in parallel with the relay. The sparking at the relay contacts is thus greatly reduced. It is scarcely necessary to state that the relay magnets, armature spring, and contact points of the relay should be adjusted very carefully. When all adjustments of the installation are perfect, there is practically no spark at the relay contacts when the heating current is interrupted, and a barely audible click of the armature. With proper installation, ordinary telegraphic relays of 250 ohms' resistance will break a current of 2 amperes with practically no spark at

the contacts. For larger currents it is better to use some form of solenoid control switch actuated by the relay.

The installation shown in fig. 2 is adapted for a direct current circuit. In this case the current for the relay magnets is taken from the line as shown. If alternating current only is available, the current for actuating the relay should be supplied by a suitable constant circuit battery. Dry cells may be used if the current is on only for comparatively short intervals. In either case the current should not exceed 0.015 of an ampere. If an alternating current is used in the heating circuit, the condenser is not necessary, the reduction of the spark in that case being effected by the lamps alone.

The regulators were constructed by HENRY J. GREEN, of Brooklyn, New York, to whom I am indebted for interest and cooperation in perfecting the instrument.

BUREAU OF PLANT INDUSTRY  
WASHINGTON, D.C.

# BRIEFER ARTICLES

## WILLIAM HARRIS

(WITH PORTRAIT)

WILLIAM HARRIS was born November 15, 1860, at Enniskillen on Lough Erie, in County Fermanagh, northern Ireland, and was of Scotch descent. In 1881 he went to Jamaica, and left there for the first time in September 1920, when he came to the United States to receive medical treatment for an inflammation of the esophagus. He died at the home of his elder son in Kansas City, Missouri, on October 11, 1920.

After receiving his earlier education from tutors at home, and spending some months at Cowan's Nurseries, Liverpool, at the age of eighteen Mr. HARRIS went to the Royal Botanic Gardens at Kew to study botany and gardening. Before he was twenty-one he was appointed from Kew to be superintendent in the Botanical Department of Jamaica. In 1899 the value of his botanical work was recognized by his election to the Linnaean Society of London. In 1908 he became Superintendent of Public Gardens and Plantations in Jamaica, and in 1917 was made Government Botanist. In April 1920 he was appointed Assistant Director of Agriculture, retaining also the office of Government Botanist. In his several official positions he showed a high degree of administrative ability. He possessed not only the capacity for looking after essential details in carrying out plans, but had also the imagination necessary for planning new projects. During the war Mr. HARRIS served with untiring energy as secretary to the Advisory Board on Food Production.

Mr. HARRIS was a naturalist from boyhood. This was perhaps to be expected of one whose father was devoted to plants and gardening, and whose youth was spent amid the lakes and rugged hills about his birth-place. Throughout his life, in spite of many administrative duties, he remained an ardent and keenly observant field naturalist. Although his interest was primarily in plants, it also embraced animals. The writer, for example, recalls participating in a rather exciting chase of a 4 ft. iguana, which seemed ignominiously ended with the big lizard ensconced in a narrow mouthed pocket in a limestone ledge, but Mr. HARRIS volunteered to seize the ugly jawed creature by the neck and so to pull

it from its retreat. The animal was thus captured without being mutilated, and later became a much prized specimen of the United States National Museum. A similar enthusiasm, coupled in this case with marked endurance, was shown

by the more than 100 monthly trips made over the rough mountain trails from Cinchona to Blue Mountain peak, to secure records of the climatic peculiarities of this highest elevation in Jamaica. These records are probably the only ones yet made at any such elevation (7428 ft.) in the West Indies, or for that matter in all eastern North America. During these trips, as on his official journeys to other parts of the island, he persistently observed and collected the native plants.

The chief contributions to botanical science made by Mr. HARRIS were those to plant taxonomy and floristic geography. While the herbarium at Hope Gardens (it was at Cinchona until 1897) was under his care, that is, from 1908 to 1920, as well as for two previous decades while under the supervision of the Director of Agriculture, the Honorable William Fawcett, thousands of specimens were added to it, collected chiefly by Mr.

Harris himself. These plants were gathered not only during his official trips to various parts of the island, but also while on special expeditions to the less settled parts of Jamaica. Thus he accompanied expeditions sent by the New York Botanical Garden to the "Cockpit country" of central Jamaica in 1906; one to the Santa Cruz Mountains in 1907; around the whole coast and to the Blue Mountains in 1908; and one to the John Crow Mountains of eastern Jamaica in 1909. Dr. BRITTON, in recalling these expeditions, pays this tribute to HARRIS as a co-worker: "He was one of the most enjoyable scientific companions I have ever known, always cheerful, active, and original." Of the 8000 Jamaican species added to the herbarium at Hope during the 29 years



it was under the care of Mr. HARRIS, several dozens were new to science, while scores or probably hundreds were of species known elsewhere but hitherto unreported in Jamaica. Because of this wide experience in the field, coupled with his remarkably retentive memory of the appearance of any plant that he had once seen, he probably knew the characters and distribution of the vascular plants of Jamaica more thoroughly than they had been known by any earlier botanist. The herbarium built up under his care is perhaps the most important in the West Indies.

The publications of Mr. HARRIS include several considerable pamphlets published separately and numerous briefer articles and reports in the Bulletin of the Botanical Department of Jamaica. Most of these were on the economic and ornamental plants of the island. It is fitting that his services to botany should be commemorated in the names of the plants he discovered. This is done by the generic names *Harrisia* (Cactaceae) and *Harrisiella* (Orchidaceae), as well as by the specific names *Harrisii* or *Harrisiana* given to a score or so of ferns and seed plants, which will serve to remind future botanists of the part he played in West Indian botany.

It is due to the alertness and initiative of Mr. HARRIS that the Cinchona Tropical Station has been open to American botanists during the past 18 years. On each of the several occasions when Cinchona seemed likely to be diverted from the botanical service for which it is so eminently fitted, it was he who made the first move toward insuring its continuance as a botanical station. All American botanists who have worked in Jamaica have a very warm appreciation of the keenly intelligent assistance rendered them by Mr. HARRIS on every occasion. Those of us who may be fortunate enough to work in Jamaica again will miss his courteous and resourceful aid. Most of all will we miss his cordial welcome to the hospitality of Hope Gardens and the stimulating contact with an enthusiastic naturalist and an altogether delightful man.—D. S. JOHNSON, *The Johns Hopkins University, Baltimore, Md.*



# CURRENT LITERATURE

## NOTES FOR STUDENTS

**Ecological classification.**—In a moderate discussion of the classification of vegetation, TANSLEY<sup>1</sup> has clarified some obscure points and made several good suggestions. He insists that it is absolutely necessary to consider the units of vegetation as they actually occur in nature, and not to attempt to classify vegetation either by life forms or habitats. The natural units of vegetation to be employed in any system of classification in the first instance must be determined empirically. These units are essentially topographical units, and are to be grouped according to development. While differing in many ways from true organisms, they may most conveniently and most correctly be regarded as quasi-organisms. In this respect the author takes what appears to be a safe stand midway between such extreme views as those of CLEMENTS, who regards vegetational units as true organisms, and those of GLEASON, who refuses to consider a unit of vegetation as an organic entity. The plant "association" is regarded as the primary and fundamental unit of vegetation. In this TANSLEY is in agreement with a majority of ecological investigators, although he lays great stress upon the limitation of the term to mature units in relatively stable equilibrium with their environment. Transitory plant communities are differentiated from fully developed ones, and are termed "associes." For parts of associations and associes dominated by a single species, it is suggested that CLEMENTS' usage be followed by designating them respectively "consociations" and "consocies."

The continued use of "formation" is recommended. The formation must be determined empirically, and it consists of a set of plant communities related developmentally and culminating in one or more associations. It is regarded as possible to distinguish climatic and physiographic (edaphic) formations, although not so sharply as has been done by NICHOLS, because of the frequent replacement of climatic by physiographic factors which is gradual in the transition region between two climatic regions. It is recommended that plant associations be named by their dominant species, and the formations, whenever it is possible to do so, from the form of the vegetation.—GEO. D. FULLER.

**Anatomy of Equisetum.**—Several recent papers help considerably to settle the controversy over the fundamental nature of the bundles and the stele in *Equisetum*. MEYER<sup>2</sup> presents a detailed review of the vascular anatomy of

<sup>1</sup> TANSLEY, A. G., The classification of vegetation and the concept of development. *Jour. Ecol.* 8: 118-149. 1920.

<sup>2</sup> MEYER, F. J., Das Leitungssystem von *Equisetum arvense*. *Jahrb. Wiss. Bot.* 59: 263-286. *figs.* 7. 1920.

one species, paying particular attention to the node. Miss BARRATT<sup>3</sup> treats several species in a thorough manner, especially the anatomy of sporelings. Lady ISABEL BROWN<sup>4</sup> is continuing her painstaking studies of the anatomy of the cone, adding two more species to those now known in detail. She has also<sup>5</sup> given her attention more fully to the broader aspect of the comparative morphology. These students of *Equisetum* all present convincing evidence of great reduction in the vascular tissues. All are of the opinion that the internodal ring of vascular bundles represents a more extensive and continuous mass in ancestral forms, and believe the three separated xylem strands of each bundle to be the remains of one continuous strand, except that Miss BARRATT considers the protoxylem is always an independent strand. The phylogenetic unity of the individual bundle in *Equisetum* seems well established. Leaf gaps do not exist; the gaps in the cone stele have no morphological value. Nodes and internodes do not exist in the cone, and the sporangiophores are organs *sui generis*. No true secondary growth occurs at the nodal ring.—  
I. W. BAILEY.

**Ecology.**—Although one of the youngest members in the group of biological sciences, ecology in America has already passed two conspicuous milestones of progress. The first was the establishment in 1915 of the Ecological Society of America, which now has a membership of over 350, and usually supplements its annual meeting in December with a summer gathering upon the Pacific Coast. The appearance during 1920 of the four numbers constituting the first volume of a journal<sup>6</sup> devoted entirely to the interest of ecologists marks the passing of the second milestone.

The purpose of the new journal is well expressed in the "foreword" contained in the first number: "This journal is issued to meet the demand for the collective publication of articles on ecology. Its pages are open to all who have material of ecological interest from whatever field of biology. While the variety of fields may cause diversity of treatment, yet the ecological significance of the papers will make them of general interest. Specialization is inevitable, but makes more urgent the need for cooperation. To approach different subjects from similar points of view is to lay the foundation of cooperation." An examination of the first volume shows that all phases of the subject are being cared for. This is evidenced by the inclusion of 10 articles dealing with the more general aspects or including a discussion of both plants and animals, while an equal number deal rather exclusively with plants and six

<sup>3</sup> BARRATT, KATE, A contribution to our knowledge of the vascular system of the genus *Equisetum*. *Ann. Botany* 34: 173-200. pls. 6, 7. figs. 24. 1920.

<sup>4</sup> BROWN, ISABEL M. P., A third contribution to our knowledge of the anatomy of the cone and fertile stem of *Equisetum*. *Ann. Botany* 34: 237-263. pls. 8, 9. figs. 7. 1920.

<sup>5</sup> ———, Phylogenetic considerations on the internodal vascular strands of *Equisetum*. *New Phytol.* 19: 11-25. figs. 7. 1920.

<sup>6</sup> Ecology (continuing the Plant World). Quarterly Journal. BARRINGTON MOORE, editor; Brooklyn Botanic Garden, publisher. 1: pp. 313. 1920.

articles relate to animal ecology. The new journal compares favorably in general appearance and typography with the *Plant World*, which it replaces, and seems likely to reflect credit upon its editor, with his associated editorial board, as well as upon the Ecological Society of America.—GEO. D. FULLER.

**Marine algae of Beaufort.**—HOYT<sup>7</sup> has published a very full account of the marine algae of the region adjacent to the biological station of the Bureau of Fisheries at Beaufort, N.C. The ecological data are fully covered in a general description of the region, the variation in the floras of different parts of it, the conditions of temperature, light, salt content of water, turbidity, water movements, and habitats, and finally the regional, seasonal, vertical, and horizontal distribution of algae. Methods for collecting and preserving algae are given, and also some account of their economic uses. In the classification and description of the algae of the region, 128 species are included, distributed as follows: Myxophyceae 10, Chlorophyceae 23, Phaeophyceae 25, and Rhodophyceae 70. An artificial key to genera and a full bibliography are also provided.

The Bureau of Fisheries is to be commended for such a publication. It feels called upon to give the following explanation: "The question may be asked, Why should the Bureau of Fisheries be interested in marine algae? Excluding purely scientific considerations, there may be recalled the well known fact that all animals depend on plants for food, and this is as true of water animals as of land animals."—J. M. C.

**Ecology of algae.**—In the sandhill region of western Nebraska are numerous small lakes, all comparatively shallow, and varying much in alkalinity. ANDERSEN and WALKER<sup>8</sup> have studied the algal vegetation of several of these and endeavored to measure the controlling factors. They found the means available for measuring light were entirely insufficient and resulted in nothing but the crudest approximations. The mineral and gas content of the water, however, showed a direct relation to the algal flora. A rather definite seasonable periodicity was manifest, and in the extensive lists of species this relationship is indicated.—GEO. D. FULLER.

**Montane plants of the southern Rockies.**—Continuing his studies of the flora of the Rockies, RYDBERG<sup>9</sup> has analyzed the plant population of the southern portion of the range. The formations distinguished are the pine forest, spruce forest, aspen and poplar groves, alder-willow swamps, copses, and sage brush. Lists of species are given for each formation.—GEO. D. FULLER.

<sup>7</sup> Hoyt, W. D., Marine algae of Beaufort, N.C., and adjacent regions. Bull. Bur. Fisheries 36:371-556. pls. 84-119. 1920.

<sup>8</sup> ANDERSEN, EMMA N., and WALKER, ELDA R., An ecological study of the algae of some sandhill lakes. Trans. Amer. Micr. Soc. 39:51-85. pls. 3-12. fig. 1. 1920.

<sup>9</sup> RYDBERG, P. A., Phytogeographical notes on the Rocky Mountain region. IX. Wooded formations of the mountain zone of the Southern Rockies. Bull. Torr. Bot. Club. 47:441-455. 1920.

THE  
BOTANICAL GAZETTE

*MAY 1921*

DORMANCY AND HARDINESS IN THE PLUM

CONTRIBUTIONS FROM THE HULL BOTANICAL LABORATORY 280

P. D. STRAUSBAUGH

(WITH FOUR FIGURES)

It is a well known fact that the trees of our latitude develop buds during the period of vegetative activity, which remain inactive or dormant throughout the succeeding period of climatic conditions unfavorable for growth and development (ASKENASY 1). Although these dormant structures have been recognized for a long time, practically nothing is known concerning the factors involved in their development or the internal conditions that obtain during the time of their relative inactivity. Growth and development take place normally up to a certain point and then suddenly cease, in some instances several weeks earlier than the occurrence of temperatures sufficiently low to arrest growth activity. In late winter, the rest period is broken in many species, and growth changes are manifested long before the incipency of warmer weather. Up to the present no specific experiments have dealt with the nature of the forces that induce cessation of growth in these bud structures, or the changes involved, either internal or external, in the resumption of the activity after a certain period of rest. The term "rest" as used here refers to a condition of greatly reduced, or possibly (for very short periods under certain conditions) a complete arrest of growth activity. Although no growth effects

are visible during dormancy, the metabolic processes are probably continued most of the time at a very greatly retarded rate.

In the plum there is a very definite relation between dormancy and hardiness or the ability to withstand low temperatures without suffering injury. Different species and varieties manifest widely differing degrees of dormancy, and in general the more profound the dormancy, the greater is the degree of hardiness. Furthermore, there is a close correlation in the plum between early maturity and deep dormancy, because those forms which show evidence of the earliest maturation in autumn are likewise the ones possessing the greatest degree of dormancy. This is a very significant relationship, for according to CHANDLER (4) maturity is "the most important factor affecting the hardiness of plant tissue."

Dormancy in seeds has been studied quite extensively, but little has been done to ascertain the nature of the dormancy that occurs in buds. The literature extant deals largely with the possible effects that external factors and forcing agents may have upon the rest period. SCHIMPER (10) maintains that "the protoplasm of the plants of temperate zones exists in two conditions, one active and one quiescent, and that the regular periodic alternation of these conditions is occasioned by inherent hereditary characters." HOWARD (6) asserts that "the rest sets in on account of the inhibition of enzymic activity due to over-accumulation of the products of their work." He holds that respiration and enzyme activity, continuing at a reduced rate, gradually remove the surplus of accumulated carbohydrates, and as a result the condition of dormancy is gradually lost. He further states that the fact "that the main dormant period happens to be coincident with the winter season is doubtless a mere coincidence, as the winter per se may, and probably does, have nothing to do with the beginning of the rest." This coincidence in all probability has a deeper significance than that which appears in this brief statement. Dormancy, whatever it involves, certainly represents an accumulation of tendencies which have been occasioned in the experience of the plant by marked changes in its environmental relations. Within the history of the plant kingdom striking temperature changes have occurred, and those forms which failed in the development of a

dormant condition, capable of resisting low temperatures, were eliminated from the field, and the forms which became dormant survived. Thus this coincidence is a direct result of adaptive reactions which have become a part of the heritage of the species. KLEBS (8) succeeded in preventing dormancy by controlling culture conditions, and MOLISCH (9) could break dormancy at will by subjecting the twigs to a water bath at high temperatures for a period of 10-12 hours.

While the knowledge of the external factors which affect dormancy gives a clearer comprehension of the phenomenon, an intensive chemical and physiological study of the changes in the bud at all stages in the growth cycle are required to discover the internal changes which parallel or precede the visible external changes. From such studies only can the facts be obtained which are essential to a full understanding of the changes that induce the rest period, the conditions that obtain during dormancy, or the initial changes in the resumption of growth.

Accordingly this investigation was begun with the object of determining some of the conditions which prevail in plum buds during the dormant period. Chief attention has been given to differences in the degree of dormancy in certain hardy and semi-hardy varieties, and to determining what relation (if any) might exist between the moisture content or moisture retention of dormant buds in different species and the relative resistance of these buds to low temperatures.

### Material and methods

All the material used in this investigation was obtained from the University of Minnesota Fruit Breeding Farm at Zumbra Heights. Three varieties differing in hardiness were selected for study. The hardiest form, Assiniboine, is a variety of *Prunus nigra*, and has suffered little if any bud injury in Minnesota, even during the severest winters. Tonka is a cross between *P. triflora* var. Burbank and *P. americana* var. Wolf. The other variety, Stella, which has been used extensively, like Tonka, is a cross between *P. triflora* and *P. americana*. These two varieties differ markedly from Assiniboine in that during the most severe winters

as many as 50 per cent of the flower buds may be killed; consequently they may be placed in the semihardy group for a considerable portion of the state. The trees of each of these varieties from which material was obtained are about eight years old, and are growing in a dark, rich, silt loam soil. All are under clean cultivation without cover crops.

In making the moisture determinations, fruit buds were collected at the Fruit Breeding Farm in glass weighing dishes provided with closely fitted covers, at intervals varying from one to two weeks during the months from November 2 to March 31. On the evening of the same day the dishes containing the buds were brought into the laboratory, carefully weighed, and placed in an electric vacuum oven at 95°–98° C., with the pressure reduced to 8.5 cm. of mercury. The buds were kept in the oven until successive weighings indicated that all of the water had been removed from the tissues. In all determinations made before the middle of January it required about 72 hours to bring the buds to constant weight. After this date the desiccation began to take place more rapidly, and during the latter part of February the moisture could be completely evaporated in 24 hours. The extremely small size of the buds made it practically impossible to secure large samples for these determinations, since 200–250 buds were required for a single gram, wet weight. In the dehydration experiments the usual method was followed, in which the buds or twigs were placed in sealed chambers over sulphuric acid.

#### **Relative degree of dormancy in hardy and semihardy forms**

In determining differences in the degree of dormancy between the hardy and semihardy varieties, twigs were cut at intervals between October 3 and March 5 inclusive, and placed in water in the laboratory or greenhouse. In this way the fruit and flower buds were exposed to ordinary room temperatures, and careful notice was taken of all visible changes undergone, as well as the time required for anthesis. The results of these studies are shown in table I.

It is quite evident from these data that the buds of the semihardy varieties possess a very light dormancy, for when placed

under favorable conditions of temperature development proceeds normally, no matter at what stage of the dormant period the collection is made. On the other hand, the buds of Assiniboine collected before the middle of January are so deeply dormant that under the same conditions of temperature no visible change takes place and no blossoms are produced. Buds of Assiniboine, collected on January 24, bloomed 26 days later, on February 18. As this is the first visible response of these hardy buds, it is assumed to indicate the previous occurrence of some internal change which determines the breaking of the dormant condition. At this same

TABLE I

DEGREE OF DORMANCY OBTAINING IN HARDY AND SEMIHARDY BUDS AS MEASURED BY TIME REQUIRED FOR BLOOMING UNDER LABORATORY CONDITIONS AT DIFFERENT INTERVALS DURING SEASON OF DORMANCY

STELLA			TONKA			ASSINIBOINE		
Date of collection	Date of bloom	Time required for bloom	Date of collection	Date of bloom	Time required for bloom	Date of collection	Date of bloom	Time required for bloom
Oct. 3	Oct. 17	15	Oct. 3	Oct. 17	15	Oct. 3	.....	.....
Nov. 8	Nov. 22	15	Nov. 8	Nov. 22	15	Nov. 8	.....	.....
Nov. 19	Dec. 4	16	Nov. 19	Dec. 4	16	Nov. 19	.....	.....
Jan. 24	Feb. 2	10	Jan. 24	Feb. 2	10	Jan. 24	Feb. 18	26
Feb. 6	Feb. 15	10	Feb. 6	Feb. 15	10	Feb. 6	Feb. 23	18
Feb. 21	Mar. 2	11	Feb. 21	Mar. 2	11	Feb. 21	Mar. 8	17
Feb. 28	Mar. 7	9	Feb. 28	Mar. 7	9	Feb. 28	Mar. 14	16
Mar. 5	Mar. 13	9	Mar. 5	Mar. 13	9	Mar. 5	Mar. 19	15

time some change takes place also in the semihardy buds, for the period of development is shortened from 16 to 10 days. From January 24 throughout the remainder of the winter the degree of dormancy continues to decrease, and collections made on March 5 show that the length of time required for anthesis has been shortened to 9 days in the case of Stella and Tonka, and to 15 days in the case of Assiniboine. It must not be inferred that the time at which the break in dormancy occurs can be assigned to any particular day, for undoubtedly the changes involved proceed slowly, and development is initiated gradually. January 24 is emphasized as the time when the first evidence of a break in dormancy was observed, while in reality the changes involved may



extend through several weeks, taking place at a constantly accelerated rate as the season advances. It will be observed (figs. 1, 2) that the moisture content curve for Assiniboine shows some tendency

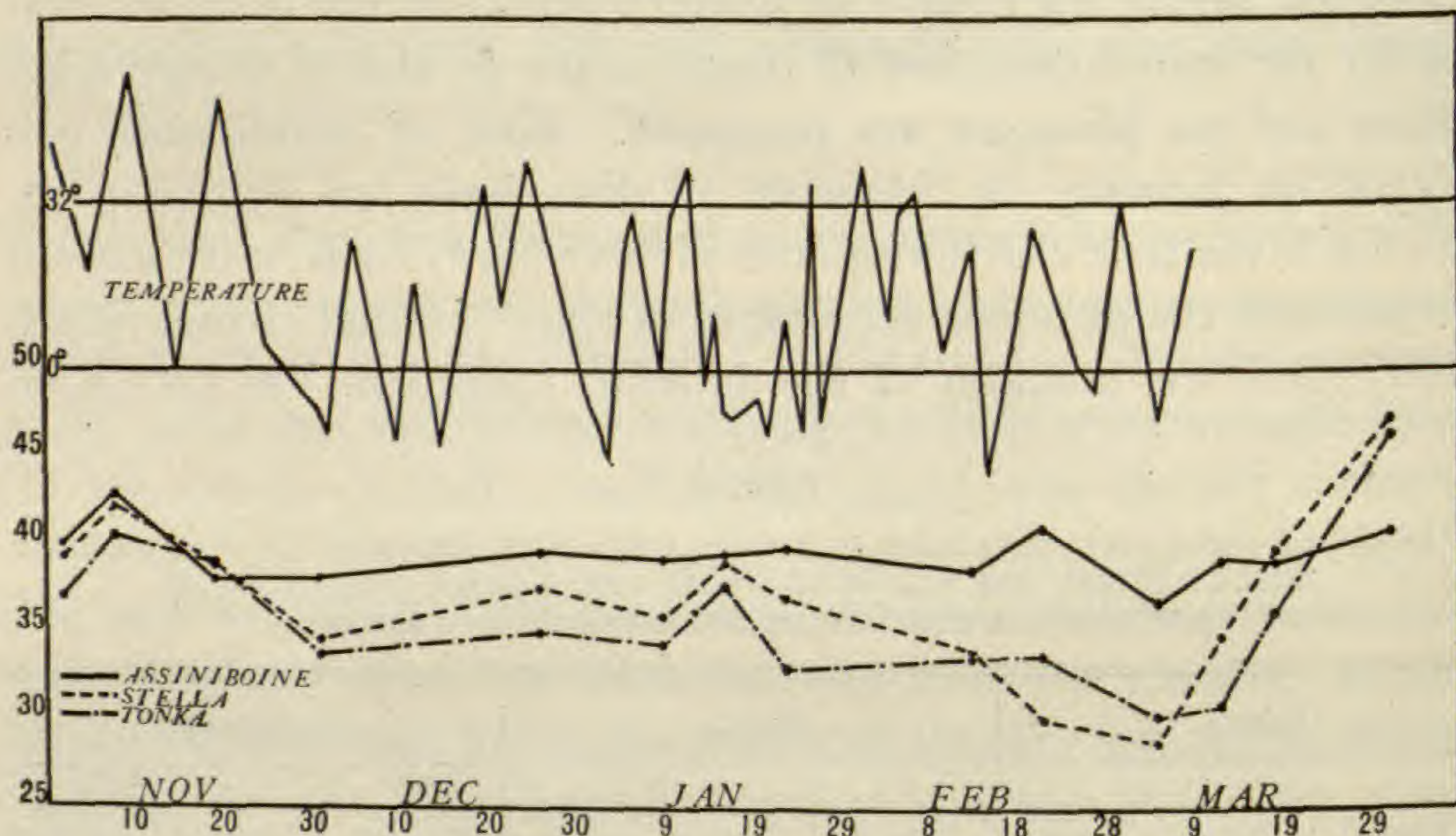

FIG. 1.—Moisture content fluctuations of leaf buds as related to temperature.

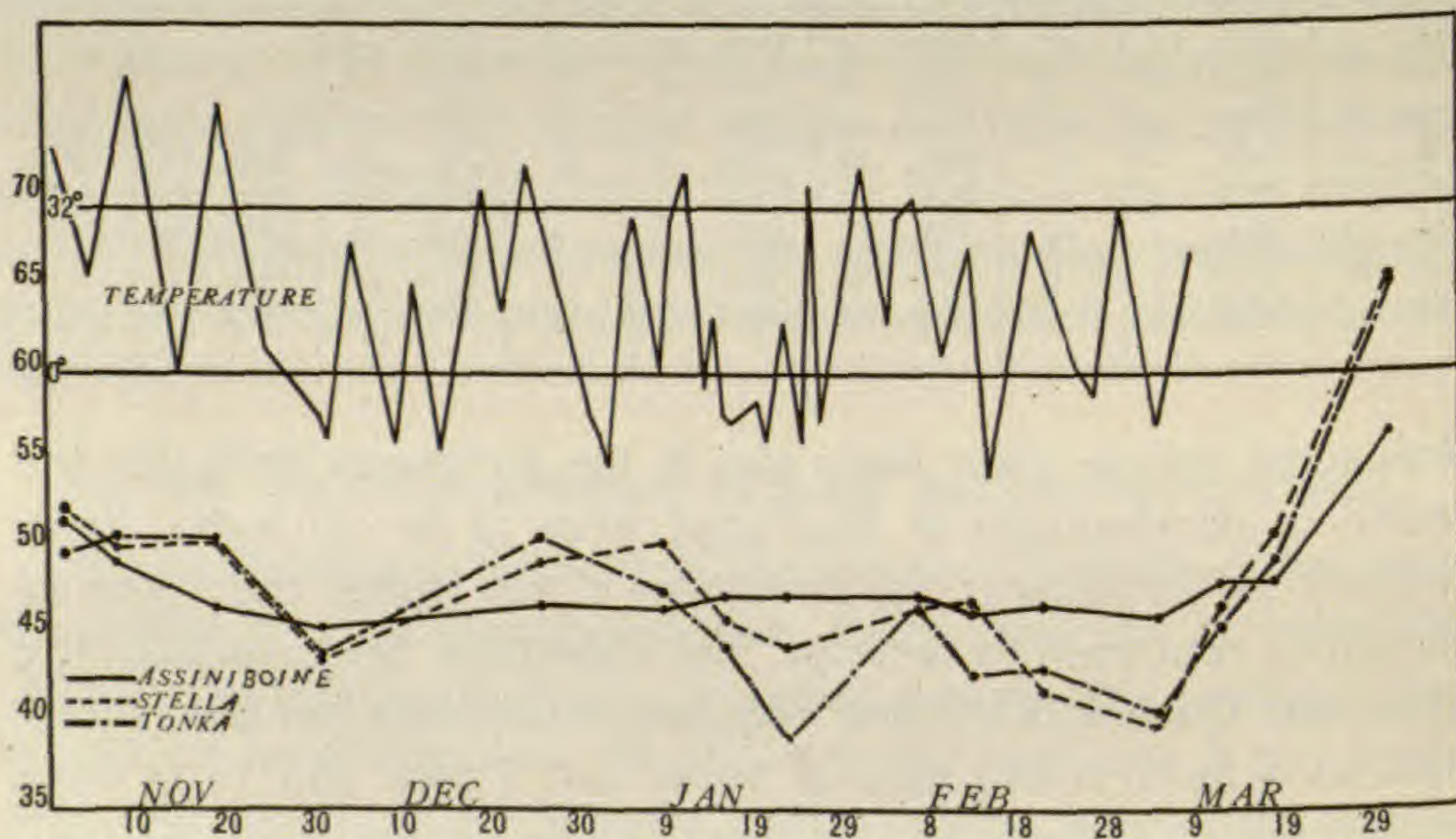

FIG. 2.—Moisture content fluctuations of fruit buds as related to temperature.

to become more irregular after January 25, and it may be that these fluctuations are due, in some measure at least, to internal changes incident to or causative of this break in dormancy. It is also significant to note here that the greatest injury to buds occurs

during the portion of the winter following this date, which marks an apparent (if not actual) break in dormancy (DORSEY and STRAUSBAUGH 5).

### Moisture content and movement of water in hardy and semihardy buds

As in the break of dormancy, marked differences are also found in the moisture content of the hardy and semihardy buds. In both fruit and foliage buds of Assiniboine the moisture falls to a certain point early in the season, and then remains almost constant throughout the remainder of the winter up to the initiation of growth activity in the spring. In the buds of Stella and Tonka the moisture content undergoes some marked fluctuations during the course of the winter, and these coincide, in a general way at least, with corresponding fluctuations in temperature. The plotted

TABLE II

WATER LOSS FROM SEMIHARDY BUDS ACCOMPANYING MARKED LOWERING OF TEMPERATURES

VARIETY	FOLIAGE BUDS			FRUIT BUDS		
	Novem-ber 19	December 1	Loss	Novem-ber 19	December 1	Loss
Stella.....	39.08	34.68	4.40	50.38	43.51	6.87
Tonka.....	39.08	33.94	5.14	50.51	43.93	6.58
Assiniboine.....	38.12	38.30	.....	46.51	45.49	1.02

curves show three distinct periods at which such a behavior in water movement in relation to temperature is indicated, namely, on December 1, January 23, and March 5. On November 30 the temperature fell to 8° F., and on December 1 the thermometer registered -12° F. Bud collections made at this time showed a decrease in moisture content as indicated in table II.

From the data of this table it will be noted that while the moisture content of the foliage buds decreased 4.4 per cent and 5.14 per cent respectively in Stella and Tonka, the foliage buds of Assiniboine showed practically no change. In the case of the fruit buds the loss in Stella and Tonka is 6.87 per cent and 6.58 per cent, while those of Assiniboine show the very slight loss of 1.02 per cent.

On January 21 the temperature again fell to  $-12^{\circ}$  F. and remained approximately at zero through the following day. Bud collections were made on January 23. The losses in moisture at this time are set forth in table III.

TABLE III

WATER LOSS FROM SEMIHARDY BUDS AS COMPARED WITH HARDY BUDS LATER IN THE SEASON

VARIETY	FOLIAGE BUDS			FRUIT BUDS		
	January 16	January 23	Loss	January 16	January 23	Loss
Stella.....	39.23	37.17	2.06	45.98	44.34	1.64
Tonka.....	37.83	33.13	4.70	44.41	39.16	5.25
Assiniboine.....	39.61	39.95	.....	47.36	47.31	0.05

In this instance it will be observed that the foliage buds in Stella and Tonka lose 2.06 per cent and 4.7 per cent respectively, while there is still practically no change in those of Assiniboine. Likewise the fruit buds in Stella and Tonka show a loss of 1.64 per cent and 5.25 per cent, while Assiniboine fruit buds show the almost inappreciable loss of 0.05 per cent. Again, on March 4, the temperature fell to  $0^{\circ}$  F. and on March 5 to  $-9^{\circ}$  F. Bud collections made on March 5 showed losses in moisture content, as given in table IV.

TABLE IV

WATER LOSS FROM BUDS ACCOMPANYING MARKED LOWERING OF TEMPERATURE STILL LATER IN THE SEASON

VARIETY	FOLIAGE BUDS			FRUIT BUDS		
	February 21	March 5	Loss	February 21	March 5	Loss
Stella.....	30.25	28.87	1.38	41.98	39.78	2.20
Tonka.....	33.82	30.22	3.60	43.24	40.46	2.78
Assiniboine.....	41.20	36.87	4.33	46.83	46.16	0.67

On this date the moisture content of foliage buds in Stella decreased 1.38 per cent and in Tonka 3.6 per cent. The foliage buds of Assiniboine here show a loss of 4.33 per cent, which is not in accord with the data shown in tables II and III. This high percentage, however, is undoubtedly due to some error in the determination of moisture content for February 21, the value

(41.20 per cent) obtained on this date being too high to agree with the general results of the other determinations. The fruit buds of Stella and Tonka show losses of 2.2 per cent and 2.78 per cent, while those of Assiniboine show a loss of only 0.67 per cent. The changes in moisture content as shown in tables III and IV are not so great as those observed in table II. The curves (figs. 1, 2) show this relation much more clearly. It would have been interesting, for the sake of comparison, to have made determinations on February 15, when the lowest temperature of the winter was reached, but unfortunately no collections were made between February 13 and February 21.

TABLE V

INCREASE IN WATER CONTENT OF SEMIHARDY BUDS ACCOMPANYING MARKED RISE IN TEMPERATURE

VARIETY	FOLIAGE BUDS			FRUIT BUDS		
	Decem-ber 1	Decem-ber 26	Increase	Decem-ber 1	Decem-ber 26	Increase
Stella.....	34.68	37.6	2.92	43.51	49.3	5.79
Tonka.....	33.94	35.2	1.26	43.93	50.7	6.77
Assiniboine.....	38.30	39.7	1.40	45.94	46.80	0.86

It will now be interesting to note what effect a marked rise in temperature will have upon the water content. The temperature from December 20 to December 26 was relatively high, ranging well over 20° throughout this time and reaching a maximum of 40°. Bud collection made on December 25 showed a moisture content as given in table V. In this table it appears that the moisture content under certain conditions may increase with rise in temperature. Foliage buds of Stella showed an increase of 2.92 per cent, those of Tonka 1.26 per cent, while those of Assiniboine showed an increase of 1.4 per cent. In comparison with the foliage buds, the fruit buds of Stella and Tonka increased their moisture content 5.79 per cent and 6.77 per cent respectively; and in contrast the fruit buds of Assiniboine showed a strikingly slight increase of only 0.86 per cent. Thus it seems evident that the movement of water in the semihardy twigs and buds is easily influenced by fluctuations in temperature, but the response in

hardy buds to the same conditions is more tardy and much less pronounced. In March when the buds begin to swell the moisture content increases very rapidly, as is shown in table VI.

Table VI shows clearly the slower movement of water in the hardy form, for while the moisture content in the foliage buds of the

TABLE VI

INCREASE IN WATER CONTENT WHEN BUDS ARE RESUMING GROWTH ACTIVITY IN SPRING

VARIETY	FOLIAGE BUDS			FRUIT BUDS		
	March 5	March 31	Increase	March 5	March 31	Increase
Stella.....	28.87	47.28	18.41	39.78	65.58	25.80
Tonka.....	30.22	46.27	16.05	40.46	65.37	24.91
Assiniboine.....	36.87	40.70	3.83	46.16	56.52	10.36

TABLE VII

SUMMARY OF DATA ON MOISTURE CONTENT OF LEAF AND FRUIT BUDS FOR NOVEMBER 8 TO MARCH 31

DATE	TONKA		STELLA		ASSINIBOINE	
	Leaf bud	Fruit bud	Leaf bud	Fruit bud	Leaf bud	Fruit bud
November 8.....	40.57	50.64	42.34	50.01	43.15	49.38
November 19.....	39.08	50.51	39.08	50.38	38.12	46.51
December 1.....	33.94	43.93	34.68	43.51	38.30	45.49
December 26.....	35.2	50.7	37.6	49.3	39.7	46.8
January 9.....	34.4	47.5	36.0	50.3	39.03	46.6
January 16.....	37.83	44.41	39.23	45.98	39.61	47.36
January 23.....	33.13	39.16	37.17	44.34	39.95	47.31
February 6.....		46.55(?)	34.29	46.54		47.43
February 13.....	33.74	42.89	34.14	47.17	38.64	46.44
February 21.....	33.82	43.24	30.25	41.98	41.20	46.83
March 6.....	30.22	40.46	28.87	39.78	36.87	46.16
March 12.....	30.83	45.51	34.83	46.75	39.37	48.12
March 18.....	36.20	49.43	39.71	50.93	39.03	48.04
March 31.....	46.27	65.37	47.28	65.58	40.70	56.52

semihardy varieties increased 18.41 per cent and 16.05 per cent, that of the hardy Assiniboine increased only 3.83 per cent. In the fruit buds of Stella and Tonka the increase was 25.8 per cent and 24.91 per cent, while that of Assiniboine was only 10.36 per cent. It will be seen that marked and well defined changes take place in the water content of buds under different sets of conditions.

These changes appear conspicuously when the data for the entire dormant season are presented.

An examination of the data of Table VII reveals three very significant facts. First it will be noticed that throughout the period of dormancy the moisture content of the leaf buds of a given variety is considerably lower than that of the fruit buds. This may be a factor in the greater resistance of the leaf buds to low temperatures. In the second place it will be observed that the moisture content of the leaf buds of Assiniboine is uniformly higher than that of the leaf buds of the other two varieties. Lastly the moisture content of the fruit buds of Assiniboine is lower or higher than that of the fruit buds of Stella and Tonka according to the temperatures prevailing at the time the collections are made.

#### **Dehydration of buds by sulphuric acid**

When the marked differences in moisture content and moisture retention of leaf and fruit buds in these varieties with different degrees of hardiness became apparent, it seemed advisable to investigate such differences further. Accordingly a series of experiments was undertaken, first with buds alone, and later with buds attached to the twigs, to study the movement of moisture by carefully controlled laboratory methods. Fruit buds were collected in small weighing dishes provided with closely fitting covers. These dishes were then placed uncovered in sealed chambers containing different concentrations of sulphuric acid. The buds were weighed before being placed in the chambers, and subsequently at intervals of 12-48 hours, to determine the water loss. When the weighings were being made the lids were placed on the dishes while they were out of the chambers.

The results of the experiment with buds alone were not entirely satisfactory, and consequently it was repeated with one very essential modification, namely, the fruit and flower buds were not detached from the twigs. In the repetition experiment entire twigs 10-12 inches in length, with buds attached, were removed from the tree and placed in sealed chambers so that the twig-bud system as a unit was exposed to the air inclosed over different concentrations of sulphuric acid. In determining the moisture losses

weighings were made as before. The desiccators in these experiments were kept in a refrigeration room where the temperature remained quite constant at about 34° F. This low temperature

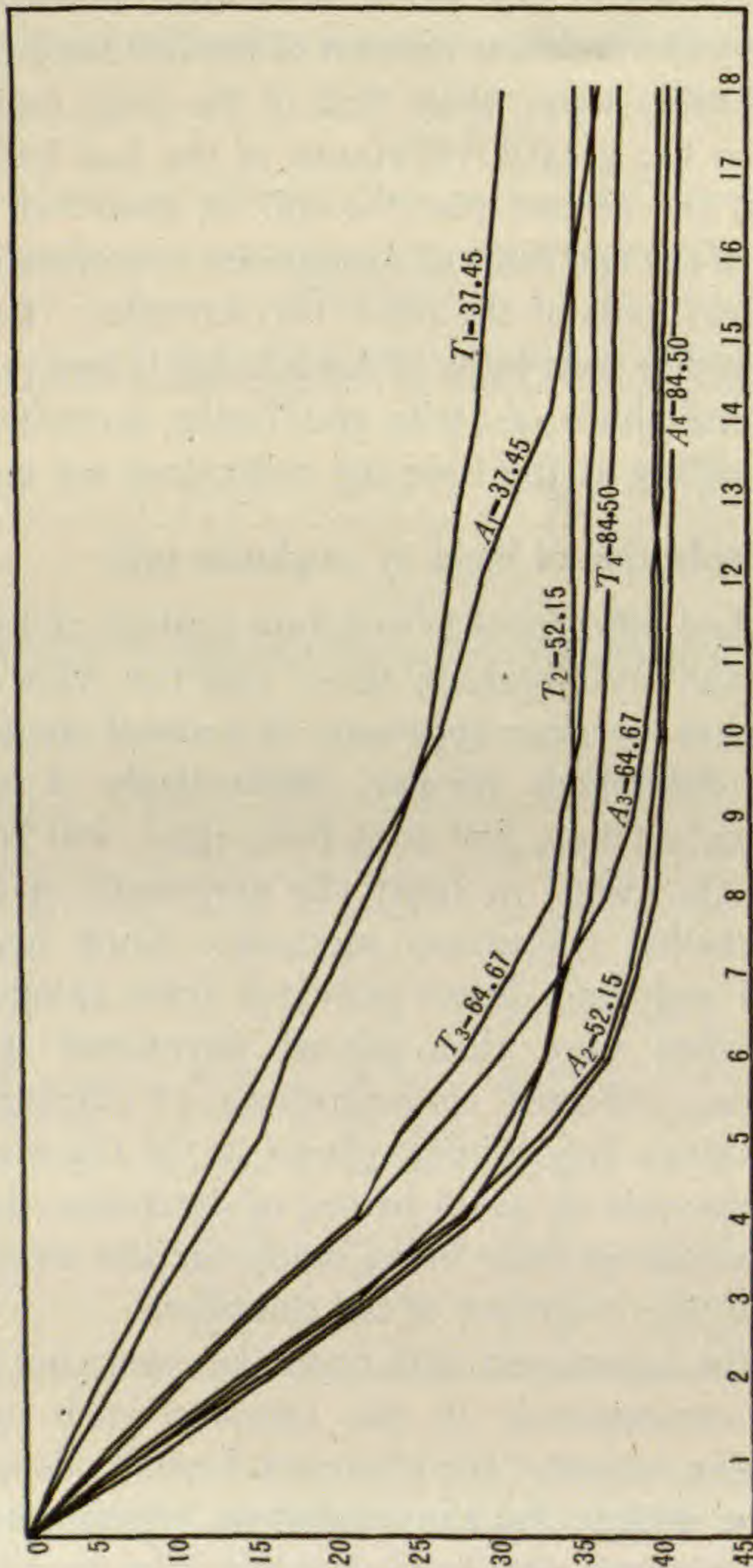

FIG. 3.—Loss of moisture from detached buds exposed to an atmosphere inclosed over sulphuric acid of different concentrations; A, Assiniboine; T, Tonka; numbers indicate concentration of acids; C, distilled water check.

was chosen as a precautionary measure against the possibility of the occurrence of any growth changes. Fig. 3 shows that the loss is almost uniform in both hardy and semihardy buds in every case

except those in which the more dilute acids were used. Since this uniformity of water movement in both hardy and semihardy buds was not in accord with the behavior of the buds under normal conditions, it was thought that it might be due to the escape of

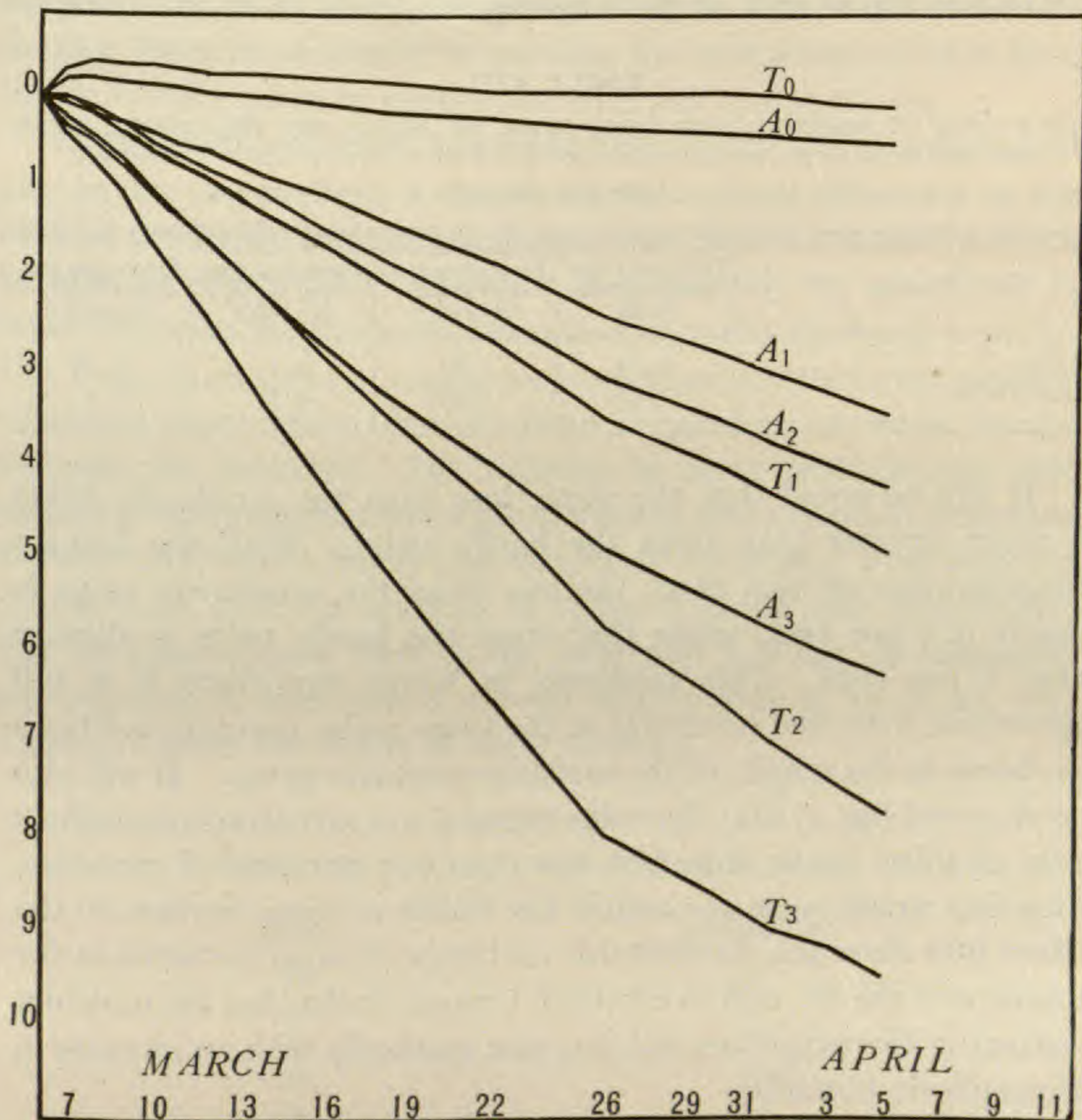

FIG. 4.—Loss of moisture from twigs with buds attached when exposed to atmosphere inclosed over sulphuric acid of different concentrations; A, Assiniboine; T, Tonka; concentrations of acid as follows: (1) 24.12 per cent, (2) 37.45 per cent, and (3) 84.50 per cent; C, distilled water check.

moisture through the wound surface made in severing the buds from the twigs. To test this assumption a collection of twigs with the buds in place was introduced into the sealed chambers and weighed at regular intervals of 24-48 hours. The cut ends of the



twigs were sealed with paraffin immediately after they were removed from the tree, so that all escape of water from the tissues must have taken place in a manner similar to that which occurs under normal conditions when the twigs remain on the tree. Fig. 4 and table VIII show the results of this experiment.

TABLE VIII

PERCENTAGE OF MOISTURE LOST FROM TWIGS OF TONKA AND ASSINIBOINE WHEN EXPOSED TO AN ATMOSPHERE OVER DIFFERENT CONCENTRATIONS OF SULPHURIC ACID FOR 28 DAYS

Variety	Percentage loss over distilled water	Percentage loss over H <sub>2</sub> SO <sub>4</sub> (24.12%)	Percentage loss over H <sub>2</sub> SO <sub>4</sub> (37.45%)	Percentage loss over H <sub>2</sub> SO <sub>4</sub> (84.50%)
Tonka.....	0.04	4.83	7.7	9.49
Assiniboine.....	0.48	3.38	4.17	6.2

It will be noted that the water loss from the semihardy twigs is much greater than from the hardy twigs. With the highest concentration of acid used, the loss from the semihardy twigs is nearly 9.5 per cent, while that from the hardy twigs is slightly over 6 per cent. This tardiness in water movement is in full agreement with that occurring in the twigs under normal conditions as shown in the graphs of the moisture content curves. It will also be observed (fig. 4) that the twigs exposed to a saturated atmosphere over distilled water absorbed less than 0.5 per cent of moisture. This fact would seem to counter the claims of some workers to the effect that there is a considerable exchange of moisture between the tissues and the air, and to establish beyond doubt that the moisture content of the twigs does not increase markedly with an increase in atmospheric humidity.

In order to determine the relative amounts of moisture given off from the twigs to the air through evaporation caused by winds, twigs of four varieties, including hardy and semihardy forms, were removed from the trees and the cut ends immediately sealed with paraffin. These twigs were then supported upright in Petri dishes by means of paraffin, and after being weighed were placed in a strong current of air produced by two large electric fans. The dishes containing the twigs were weighed daily, and at the end of

three days the loss in all cases was found to be practically negligible, the greatest loss being only 0.7 gm. from a total weight of 137.47 gm., or a little more than 0.5 per cent. Thus it seems quite evident that there is little exchange of moisture between the air and the tissues of the twigs due to evaporation alone, but that some dehydrating force is necessary to account for such losses as have been shown to take place in connection with low temperatures.

In the studies of water loss from twigs in the acid chambers and also by the fan method, a conspicuous structural difference in the bark of the hardy form as compared with that of semihardy forms became evident. This difference may possibly be associated in some way with the slower movement of water in the hardy variety. The twigs in all three of the forms studied are covered with a heavy suberized layer which renders them impervious to water except through the lenticels. The number of these lenticels per unit surface is fairly constant for a given variety, but a marked difference is observed between hardy and semihardy varieties. Five separate counts were made on sections of twigs of Stella and Assiniboine. The sections chosen were 5 cm. long and 1.2 cm. in diameter, representing in each case a curved surface area of 18.85 sq. cm. Table IX gives the result of these counts.

TABLE IX  
NUMBER OF LENTICELS PRESENT ON 18.85 SQ. CM.  
OF TWIG SURFACE

STELLA	ASSINIBOINE
49	12
54	10
48	8
39	13
54	11

As these lenticels are approximately the same size in each variety, it will be seen that the total lenticel area in the semihardy form is from 3 to 6 times that occurring in the hardy variety. The exact significance of this marked difference in bark character is not fully clear, but that it may be related in some way to the more tardy movement of water from the twigs of Assiniboine is a possibility that seems worthy of consideration.

### Discussion

In recent years the horticulturists of the northern United States and Canada have been greatly interested in the breeding of hardy fruits capable of resisting the low temperatures of this latitude. One of the difficulties met with in this work has been the amount of time required to test new seedlings for hardiness. Various attempts have been made to discover some means of detecting hardiness by direct observation at an early period in the development of the seedling.

BEACH and ALLEN (3) made a rather extensive series of microscopical, mechanical, and specific gravity tests of apple twigs to ascertain whether "the hardiness of a tree could be determined while it was still in the nursery." They concluded that "from the practical point of view as yet it is impossible to name any one test by which the degree of constitutional hardiness of a seedling apple may be foretold." This work, however, has revealed some very interesting and suggestive facts that may have a fundamental value in the physiological study of hardiness. Among other things they found that "the hardier varieties on the average had a slightly lower moisture content than the more tender varieties," and that "this difference is more marked during the growing season." They state that this "difference in water content can be explained partly at least by the fact that the more tender sorts evaporate water more rapidly than do the hardy varieties. Freezing tends to dry the twig out, and after a period of very cold weather the twigs of the hardy varieties are generally found to contain the most moisture."

JOHNSTON (7) found that "as the season advances the difference between the water content of fruit buds of the Elberta and Greensboro peach becomes more marked, the values for the Elberta being the greater." Since the Greensboro peach is considered more hardy than the Elberta, the inference is that the more tender buds have the highest moisture content. In these determinations only 10 buds were used in a sample, and it would seem that larger amounts of the tissue might give more reliable results.

SHUTT (11) found the moisture content of apple twigs of tender varieties higher than that of hardy twigs. He stated "that we have

direct and definite proof that there is distinct relationship between the moisture content of the twig and its power to resist the action of frost, and that those trees whose new growth contains the largest percentage of water as winter approaches are in all probability the most tender." He also believes that hardiness is a quality that can be affected by cultural methods. He says that "hardiness is evidently something more than an inherited tendency. It seems probable that it is a quality largely under the influence of the soil conditions as regards moisture and temperature in the late summer and autumn months, and probably these factors rather than the severity of the succeeding winter determine the tree's immunity from frost. If in northern latitudes vegetative growth be early arrested and ripening of the new wood thus induced, either by artificial means (pruning and cover crops) or by a dry and cold autumn, varieties now considered tender might prove hardy."

There can be no doubt as to the effect of cultural methods upon the ability of certain plants to withstand low temperatures. This effect is shown by the work of BATCHELOR and REED (2), who found that one of the factors in the winter injury of the Persian walnut (*Juglans regia*) was winter drought. The injury referred to is a killing of the distal ends of the branches rather than that of the buds alone. Under certain conditions they were able to prevent winter injury by irrigating heavily late in the season, after maturation had been induced by withholding the water supply during the latter part of the summer. Their work shows a very evident relation between soil moisture and winter injury.

In the introduction attention was called to the fact that dormancy occurs in widely varying degrees. The range extends from no dormancy at all to profound dormancy, with every degree of intergrading conditions. If in perennial woody plants there is a positive correlation between dormancy and hardiness, it follows that there must be a corresponding range of hardy conditions. If the forms under consideration chance to be closely related as to position in the series, or closely adjusted to the equilibrium of the external environment, it is easily conceivable that cultural methods may affect the relative degree of hardiness within certain limits. Such a case would seem to be exemplified by the Persian walnut

grown under California conditions. On the other hand, it must be admitted that other factors are operating when we have to deal with forms whose requirements lie well within the limits of physical environment, or with forms widely separated in respect to the degree of hardiness they possess. It is difficult to conceive of any modification of external conditions that could induce a degree of hardiness in Tonka and Stella which would even approach the hardy condition that obtains in Assiniboine. The fact should be kept in mind, however, that Assiniboine belongs to a different species from Stella and Tonka, and also that what is true of the apple need not of necessity be true of the plum or the peach.

The investigations show a higher moisture content for tender apple twigs and tender peach buds than that of the hardier forms. In the plum, however, at least during the period of dormancy, it is not the relative amount of water present in the buds, but the relative water-retaining capacity that constitutes a distinct difference between hardy and semihardy forms. In the apple, BEACH and ALLEN found that the greater moisture content of the tender twigs as compared with hardy twigs was much more pronounced during the growing season. Whether such a relation obtains between hardy and tender varieties of the plum during the period of vegetative activity has not yet been determined. It may easily be possible that the problem of hardiness will require specific investigation for each species in question, and that as yet no very far reaching generalizations on the subject can be made.

In the case of the plum, microchemical studies (5) indicate that the dormant condition of the buds involves a protoplasmic change of some sort which is much more marked in the buds of the hardy variety. There is an evident modification in the proteins of the buds, but practically nothing is known at present concerning the nature of this change. It is possible that there is induced as a result of these modifications a very decided change in the colloidal condition within the cells which increases the force of imbibition, so that the water of the protoplast is retained against the dehydrating force of freezing, and the protoplasm is not disorganized. There is no evidence that the hardy buds contain less moisture than the tender buds during the dormant period; in fact, when the temperature drops very low the hardy buds contain the most water

(figs. 1, 2 and table VII). The point that must be emphasized, however, is that the hardy buds have the capacity to retain their moisture at a certain definite and fairly constant minimum throughout the period of dormancy regardless of all fluctuations in temperature, and that this capacity is not a characteristic of the semihardy or tender buds. WIEGAND (12) states as follows:

Every cell has its critical point, the withdrawal of water beyond which will cause the death of the cell, whether by ordinary evaporation or by other means. It may be supposed that the delicate structure of the protoplasm necessary to constitute living matter can no longer sustain itself when too many molecules of water are removed from its support. In the great majority of plants this point lies so high in the water content that it is passed very soon after the inception of ice formation, hence the death of so many plants at this period. Others may be able to exist with so little water that a very low temperature is necessary before a sufficient quantity is abstracted to cause death. From some plants enough water cannot be extracted by cold to kill them.

The hardy plum, Assiniboine, lies very close to the last mentioned class of plants. It requires exceedingly low temperatures to cause it injury, and the explanation of this fact seems to lie in its ability to retain its moisture. Water movement in its tissues seems to be much slower, so that it matures earlier in the autumn and assumes its maximum water content more slowly in the spring. The fact that it blooms from two to three days earlier than the semihardy varieties may be due to the possibility of growth activities taking place with a much lower water content.

The moisture relations that obtain between the hardy and semihardy buds of the plum indicate a wide difference in their physiological reactions. These reactions arise from specific conditions within the cells, and therefore it is assumed that the protoplasmic structure of the hardy tissues is different from that of the semihardy tissues. These differences are inherent, so that they furnish a basis for the work of the plant breeder. There is a suggestion here, therefore, that a study of the moisture relations of seedling plants during both the dormant and vegetative conditions may afford a tentative basis for determining selections.

### Summary

1. In the plum there are widely differing degrees of dormancy among the different species and varieties. There appears to be a

definite relation between dormancy and hardiness. Assiniboine is extremely hardy and its dormancy is very profound, in contrast with Tonka and Stella, two semihardy varieties in Minnesota, which appear to enter real dormancy for only a very short period in early winter, if they do so at all.

2. During the period of dormancy the moisture content of the semihardy varieties fluctuates with the temperature. Periods of low temperatures are accompanied by a loss of moisture from the leaf and fruit buds, and higher winter temperatures, which are seldom above freezing in Minnesota, by an increase in moisture content. In comparison with the semihardy varieties the moisture content of Assiniboine remains at a definite and fairly constant minimum throughout dormancy.

3. When the fluctuations in the moisture content of buds were found to occur under orchard conditions, this phase of the problem was checked under control in the laboratory by placing the twig-bud-system in sealed chambers over different concentrations of sulphuric acid. By this method water movement in the tissues of Assiniboine was found to take place more slowly than in Stella and Tonka. Lenticel number per unit area was found to be correlated with the difference in moisture retaining capacity.

4. Somewhere near the mid-point of the dormant period fundamental metabolic changes occur which affect the ecological reactions of apparently dormant plum trees in a striking manner. As a result of these changes, or at least coincident with them, winter killing in the flower buds is found for the first time, the moisture retaining capacity of the fruit and leaf buds is changed, and anthesis occurs when fruit buds are subjected to favorable growth temperatures in the greenhouse. These changes are interpreted as indicating the time when the rest period is broken.

5. The dormant condition reached by the hardy forms, such as Assiniboine, appears to involve fundamental protoplasmic changes. Among these there may be a change in colloidal properties creating an increased imbibition which may account for the marked retention of water against the force of dehydration.

6. This investigation has a direct bearing upon the applied problem of selecting seedling fruits for hardiness. A study of the

moisture relations in forms differing in hardiness may furnish the fruit breeder with a criterion, correlated with hardiness, which will hasten markedly the final selections.

This investigation was carried on in the laboratory of Dr. M. J. DORSEY, in charge of the Section of Fruit Breeding, Department of Horticulture, University of Minnesota. The writer is very grateful for all the favors accorded him, and especially for the constant aid and valuable suggestions received from Dr. DORSEY. I also wish to acknowledge the helpful criticism and advice given by Dr. SOPHIA H. ECKERSON, Dr. WILLIAM CROCKER, Dr. J. J. WILLAMAN, and Dr. L. I. KNIGHT. I am also greatly indebted to Messrs J. W. BUSHNELL, J. H. BEAUMONT, and A. C. HILDRETH for assistance in collecting material and data.

COLLEGE OF WOOSTER  
WOOSTER, OHIO

#### LITERATURE CITED

1. ASKENASY, E., Über die jährliche Period der Knospen. *Bot. Zeit.* 37:———. 1877.
2. BATCHELOR, L. D., and REED, H. S., Winter injury or die-back of the walnut. *Calif. Coll. Agric., Exp. Sta. Circ. no. 216.* 1919.
3. BEACH, S. A., and ALLEN, F. W., Hardiness in the apple as correlated with structure and composition. *Iowa State Coll. Agric., Research Bull. no. 21.* 1915.
4. CHANDLER, W. H., The killing of plant tissues by low temperatures. *Univ. Mo. Coll. Agric., Exp. Sta. Research Bull. no. 8.* 1913.
5. DORSEY, M. J., and STRAUSBAUGH, P. D., A study of winter injury to the plum during dormancy. Unpublished.
6. HOWARD, W. L., An experimental study of the rest period in plants. *Research Bull. no. 21. Univ. Mo. Coll. Agric., Exp. Sta.* 1915.
7. JOHNSTON, E. S., An index of hardiness in peach buds. *Amer. Jour. Bot.* 6:373-379. 1919.
8. KLEBS, G., über das Treiben der einheimischen Bäume speziell der Buche. *Akad. Wis.* 3:1-116. 1914.
9. MOLISCH, H., Das Warmbad als Mittel zum Treiben der Pflanzen. *Jena.* 1909.
10. SCHIMPER, A. F. W., *Plant geography upon a physiological basis.* 1903.
11. SHUTT, F. T., On the relation of moisture content to hardiness in apple twigs. *Proc. Trans. Roy. Soc. Canada II.* 9:149-153. 1903.
12. WIEGAND, K. M., Some studies regarding the biology of buds and twigs in winter. *BOT. GAZ.* 41:373-424. 1906.



# EVOLUTION OF ZOOCECIDIA

B. W. WELLS

(WITH PLATES XXI, XXII)

The basic conceptions back of the present treatment of the zoocecidial problem are those connoted by the word evolution. For some time the idea that galls have had their phylogeny along with other organisms and parts of organisms has occupied a prominent place in the mind of the writer. Definite attention to this phase of the zoocecidial problem has resulted in the development of outlines of the probable evolution in the various gall groups. This paper is an attempt to give in outline merely the phylogeny of zoocecidia, based in lesser part on embryological data, in greater part on comparative morphological material. Paleontological research has brought so few forms to light that no assistance can be gained from that source. A discussion of the conceptions which are basic for such a treatment of zoocecidia is also given, together with the elucidation of a new interpretation pertaining to the relation of the lower and higher galls.

## Historical

In very few papers dealing with the comparative morphological aspects of galls has any attention been devoted to phylogenetic problems; the emphasis has been on the delineation of anatomical detail. No definite studies from a strictly phylogenetic point of view seem to have been made by Europeans. KÜSTER'S recent and extensive studies (9, 10) do not include this point of view, at least not as gall phylogeny is interpreted by the writer.

At the outset careful distinction must be made between conceptions which are basic for the development of phylogenetic outlines and the phylogenetic outlines or "trees" themselves. Historically two interpretations which are basic for the development of zoocecidial phylogenies are extant: (1) gall characters are merely the reappearance of the host plant characters, either those immediately present or those hypothetically latent in the germ

plasm (meristem); (2) gall characters are the result of the influence of both the plant and the animal, chiefly the plant in the lower galls and chiefly the animal in the higher galls. In connection with the first interpretation, KÜSTER (10) expresses his astonishment at the multiplicity of the possibilities possessed by the cells composing the leaves. This consideration of the exceptional normal forms does not enable him to foresee this multiplicity, and throughout his writings there is the same emphasis. The plant cells are loaded with reaction possibilities, due, as KÜSTER intimates, to the retention of an array of latent characters acquired in the course of evolution. His example of the *Adelges* gall on spruce as being similar to the normal cone of *Sciadopitys* is a case in point.

COSENS and SINCLAIR (4), in a study of certain willow galls, present a similar interpretation. They say "The reinstatement in a gall of vestigial characteristics of the plant has an important bearing on the question of gall formation." They recognize, however, "a directive control over the activities of the protoplasm of the host" on the part of the cecidozoon, the result of which is referred to as an "environmental modification." The force of this recognition is weakened by their final statement that "there remains no authentic instance of any organ or tissue in a gall that is new, ontogenetically or phylogenetically, to the host."

With regard to the second interpretation, although a number of European writers, ADLER, FOCKEU, and others, have recognized the essential "independence" of the higher galls (prosoplasmas of KÜSTER), they have not gone so far as to formulate any definite conceptions of gall phylogeny; only the recognition of the fact that certain galls show characters which could not possibly have sprung from the plant has been given.

For the introduction of some genuine phylogenetic theories we must refer to COOK'S (2) study, which gives such statements as the following:

The morphological character of the gall depends upon the genus of the insect producing it rather than upon the plant on which it is produced. The families show parallel lines of development from a low form up to a high form. The Acarin may be considered the lowest group of galls, the Aphidid the next higher, the Cecidomyia galls the next higher, and the Cynipidous galls the highest. However, many of the Cynipidous galls are lower than the Aphidid galls.

Thus COOK, in his recognition of the correlation between the taxonomic position of the gall-making animal groups and the degree of complexity of the galls produced by them respectively, has laid, in part, the foundation for the present discussion. In COOK's papers, however, anatomy and etiology are his major concern. Only in the instance of a few cynipid galls did he present the probable phylogenetic relationships.

### Basic data involved in phylogenies

BEYERINCK (1), in his primary division of galls into those characterized by indefinite growth and those exhibiting definite growth, made an initial contribution of great significance. KÜSTER amplified this conception into the following two groups: (1) *Kataplasmata*; all those galls which are characterized by inconstancy and indefiniteness with regard to size and tissue form characters; there is also associated an indefinite time element; they invariably fall below corresponding normal parts in their differentiation, and what differentiation does ensue shows no new fundamental orientation of tissues as contrasted with the normal arrangement; (2) *Prosoplasmas*; all those galls which are characterized by definite size, tissue form, and time of development; in their differentiation they are not so much below the normal as they are different from the normal; in their form characters and orientation of tissues they are fundamentally different from the normal; they may be different in other characters as well, such as quality and quantity of organic substances contained.

KÜSTER (9, 10) has a preliminary division, his so-called "organoides and histoides" groups. Since the first, consisting of very slight modifications of normal organs, can be interpreted as very primitive *kataplasmata*, there is no significance to this classification; in the opinion of the writer it may well be discounted.

### Major phylogenetic factors

I. THE PLANT.—The influence of the plant and its evolution are most strikingly observed in the *kataplasmata*, since these structures are for the most part not very far removed in their constitution from the condition obtaining in the normal plant. They

vary from the simplest type in which there is but a slight inhibition of differentiation, to the advanced condition in which differentiation is practically inhibited, only a mass of homogeneous tissue resulting. In the prosoplasmas the contribution of the plant is practically confined to the furnishing of cell types merely, and not differentiation and tissue form conditions.

2. THE ADULT CECIDOZOOON (IMAGO).—(a) *Structural aspects*.—In the lowest cecidozoons, Rotifera, Copepoda, Nematoda, and Acarina, the adult stages as well as the larval stages are concerned in gall-making. With some unimportant exceptions in the Acarina galls, the cecidia are all kataplasmas. Above these groups we have but one genus in which the adult is concerned in definite gall formation, the genus *Pontania* of the Tenthredinidae (saw flies). The terebra's mechanical injury plus the introduction of a specific liquid substance results in a kataplasma of an advanced type, for the lack of differentiated tissues is a striking characteristic of these galls. The prevailing condition among insect cecidozoons, however, is that in which the larval stages only are concerned in gall formation. This is invariably true if the galls are prosoplasmas.

(b) *Behavior aspects*.—Throughout all gall-making groups the instinctive behavior of the adults is a factor with regard to resultant gall conditions. Choice of plant part attacked, number of eggs laid at one point, time of attack, all have something to do with resultant characters. From the standpoint of the fundamental nature and specificity of the individual gall, however, these behavior aspects play but a very minor rôle.

3. THE LARVAL CECIDOZOOON.—In the larval cecidozoon and its evolution we find par excellence the creators of phylogenetic lines, for all prosoplasmas, as heretofore indicated, are the result of larval and not adult activity. Another generalization is the fact that prosoplasmas are practically confined to the Insecta; only a few low prosoplasmas of the Acarina are an exception.

#### Phylogenies of zoocecidia

Before presenting the outlines of the phylogeny in the various groups it will be desirable to point out some fundamental relationships between the kataplasmas and the prosoplasmas. KÜSTER,

although accurately distinguishing these two groups, curiously enough failed to see any relationship between them from an evolutionary standpoint. Nor has any other writer since this classification has been developed pointed out the very evident situation which exists. That the prosoplasmas in all cases are derived from the kataplasmas is self evident. This fundamental conception, together with an interpretation of it to be given later, forms the central thesis of this paper. On it has been built the diagrammatic presentation of the phylogenetic lines of the higher cecidozoon groups. Following the explanation of these which follows, a more detailed discussion of the general theoretical situation will be presented.

### The phylogenetic lines

Attention should be called to the polyphyletic origin of galls, the cecidia-making habit having appeared independently in many diverse groups. Within certain phyla (ex. Nematoda) it appeared among a few closely related genera, while in certain families (ex. Itonididae) it probably had an independent origin in many genera. The "phylogenetic trees" of the various groups (pls. XXI, XXII) are arranged horizontally with some regard to the evolutionary position of the cecidozoon groups. Vertically, the figures are arranged on the basis of their classification into kataplasmas or prosoplasmas. The figures of the galls, while drawn more or less diagrammatically, are based on actual species. They have been chosen to represent fundamental types only. Practically all of them show the galls as seen in section, this being necessary to bring out such salient characters as position of cecidozoon, orientation with regard to plant parts, and the differentiation of sclerenchyma in certain prosoplasmas, this latter being indicated by a dark layer within the body of the gall. The lines or "trees" are based on cecidozoon groups of varying degrees of position in the systematic scale. None below families have been attempted, although an ideal study would present the genus as the unit. At the present time, however, this is not possible through lack of anatomical data. In the discussion of each group some mention will be made relative to the number of genera involved.

ROTIFERA (pl. XXI).—Only one rotifer gall is known. It consists of simple enlargements of the ends of filaments of *Vaucheria* (1) which harbor at their center the cecidozoon. They are to be regarded as extremely simple kataplasmas.

COPEPODA (pl. XXI).—Represented by one form only, a simple kataplasma (1).

NEMATODA (pl. XXI).—Represented by two genera, one using the roots (1), the other the aerial parts (2), producing simple kataplasmas in both instances. The root inhabiting form produces the greatest modification.

ACARINA (pl. XXI).—These galls are chiefly the work of the members of the genus *Eriophyes*. Two fundamental lines of evolution are evident: the production of numerous aborted parts (kataplasmas) from stems, buds, and leaves (1, 2); and a leaf gall line beginning with the erineum (mat of trichomes) stage (3) and passing into the diverticulum condition (5) or the leaf edge-roll state (6). From the leaf blade the erineum-forming type may change its point of attack to the rachis or petiole with more or less hyperplasia and hypertrophy of the hypodermal cells. Such an unusual form is seen in (4). The shallow diverticulum has given origin to the elementary prosoplasma leaf types as represented by (7-10). The figures with their connecting arrows are self-explanatory. It is believed that a type like that shown in (9), which is devoid of trichomes, has been derived from the trichome-bearing kinds. The prosoplasmas of the *Acarina* are of the simplest variety. In the entire absence of sclerenchyma layers and in the non-deviation from the primitive pouch type they constitute as a group the lowest of the prosoplasmas.

ORTHOPTERA (pl. XXI).—Only one genus is represented (1), forming an inconsiderable kataplasma consisting of aborted stem and leaves.

NEUROPTERA (pl. XXI).—A simple cortical swelling constituting a very primitive kataplasma (1) is only reported for this group.

THYSANOPTERA (pl. XXI).—These tropical galls are all of the kataplasmic type, the most primitive of which is the simple leaf fold (1), from which the more specialized condition shown in (2) has been derived. A simple curled edge probably represents

another derived type (3), although this may be interpreted as having an independent origin.

COLEOPTERA (pl. XXI).—Despite the vast size of this order and the intimate food relation many of its members hold with living plants, there has been but a slight development of the gall-making habit. They may all be included under the type shown (1), which is a simple cortical kataplasma.

LEPIDOPTERA (pl. XXI).—These are all stem galls of simple constitution. A number of the insect families are involved. The hyperplasia commonly affects all tissues about equally, so that there is merely a local enlargement of the stem (1), with a cavity occupying the pith region. The differentiation is uniformly weaker than in the normal stem; it is a low kataplasma.

The Lepidoptera and the Coleoptera are commonly given a higher position than the Hemiptera which follow. Since they show no complex gall phylogenies, they are placed out of position near a few other unimportant groups.

PSYLLIDAE (Hemiptera) (pl. XXI).—Three original lines of attack on the plant appear to have been made in this group, two of which (1 and 10) end blindly in inconsequential kataplasmas. The third primitive form, simple leaf fold (2), is probably ancestral to the simple leaf edge-roll (9) and a diverticulum kataplasma (3), from which type certain highly specialized prosoplasmas are believed to have sprung. The psyllid prosoplasmas, which are only known from America where they occur on the buds and leaves of the hackberry (*Celtis*), constitute in themselves an excellent evolutionary series, the main outlines of which are indicated in the diagram (4-8). The presence in all of them of specific sclerenchyma layers, together with other highly defined tissue form characters, makes them striking examples of prosoplasmas. No related kataplasmas, that is, on the same host, are now existent.

APHIDIDAE (Hemiptera) (pl. XXI).—All of the galls of this group probably have sprung from the simple leaf fold (1), which, since the insects are commonly numerous locally, appears in the highly variable compound form or the crumpled, wrinkled, or otherwise distorted blade. The number of these primitive aphid leaf convolutions is legion. From these have sprung the indefinite edge-

roll condition (7) and the variable pouch type (2). This latter in turn has given origin to such a kataplasma as shown in (3); which represents the work of many individuals, and the prosoplasma (5), which represents the work of but one insect, the stem mother. From the former has been derived such a spine-bearing prosoplasma as outlined in (4), from the latter the walled forms, the "umwallungen Gallen" of KÜSTER (6), have had their origin. In these no diverticulum structure whatever appears, but the larva is walled in by a vertical upgrowth from the blade. Once this type of gall is attained, the insect is able to use the more rigid parts of the plant, namely, petioles and stems of the season, as a basis for gall formation. None of the aphid prosoplasmas have reached the level at which a sclerenchyma layer is differentiated in them.

COCCIDAE (Hemiptera) (pl. XXI).—Three fundamental primitive kataplasmas can be distinguished in the Coccidae forms, the simple umbo on the stem (1), the shallow leaf pocket (5), and the saucer-shaped incept of the up-walled type. From the latter have arisen those remarkable Australian prosoplasmas characterized by differentiation on the sex basis, that is, the male and female larvae produce differently shaped and constructed galls (4*a*, male; 4*b*, female). One of these (3) shows the development of appendages borne on radiating arms. Its form is more primitive than the gall of (4), and in the absence of anatomical data pertaining to any of these forms, it is tentatively given a lower position. I can only find the statement that the female galls are "woody"; the information as to whether or not specific sclerenchyma layers are differentiated has not been obtained.

MUSIDAE (Diptera) (pl. XXII).—Gathered together under this superfamily name are a number of related dipterous families which are represented by kataplasmas only. Three fundamental beginning stages can be distinguished, related to the plant part attacked: a simple rosette resulting from the abortion of the stem axis with concomitant abortion of leaf elements (1), a simple cortical swelling (2), and the hyperplasia of the floral disk in certain Compositae (4). As an advance on the second are those cases in which the larva goes deeper, taking a central position in the stem, giving the intercalate globular type (3).



ITONIDIDAE (Diptera) (pl. XXII).—Numerically this is the largest group of gall producers. Many of the galls attain high evolutionary level, but not as high as many cecidia of the Cynipidae (Hymenoptera), which rivals this group in number and complexity. The most primitive gall of the Itonididae (Cecidomyiidae) is the simple leaf fold, a principal vein constituting the gall axis (1). Conceivably all others may be derived from this, if we grant the possibility of the necessary changes in the insect's instinctive behavior so that other plant parts are persistently attacked and used. Certain of these primitive galls, however, might have appeared independently. Both situations are shown in the diagram.

From the initial leaf fold was evolved the variable ill-defined pocket type (2), which in turn gave rise to the simple prosoplasma of (3). This advances either through the differentiation within it of a sclerenchyma layer (4), or through the partial transfer of the gall toward the upper side of the leaf (5). From this type we have a striking advance through the sclerenchymatized cecidium (6) to the type characterized by a dehiscing larval cell formed by the lignified tissue together with the lining of parenchymatous nutritive tissue. In (8) we have the attainment of the full up-walled ("umwallungen") condition which is believed to have been derived, as indicated, from the diverticulum or pouch form. The majority of up-walled galls show the advanced state, however, through their containing a scleride zone (9). From the up-walled type (8) there has also been derived the interesting double chambered form (11), with the type shown in (10) as an intermediate condition. Excellent examples illustrating all stages of this latter evolution series have been described by the writer (11) from the hickory (*Carya*).

Originating either independently or from the itonid insect which produces the simplest leaf type, we have the burrowing form which causes the "blister" gall (14). A form of this kind attacking the embryonic fruit gives the situation shown in (15), or becoming more specialized on the leaf gives us the prosoplasma (16), or attacking the stem initiates a series of stem galls (17-20), going over into the prosoplasma region with the attainment of

sclerenchyma layers around the larval chambers. If the apical meristem is used as a basis of operation, we get such a primitive gall as shown in (21), and, either through a burying process on the part of the larva or through the up-walling mode of overgrowth, we pass through such a stage as (22) to the prosoplasmatic condition of (23), ending in such a highly specialized type as shown in (24).

CHALCIDAE (Hymenoptera) (pl. XXII).—This family is represented very insignificantly by a few genera producing simple cortical enlargements (1).

TENTHREDINIDAE (Hymenoptera) (pl. XXII).—A few genera of gall makers represent this family. Some species form simple, cortical stem hyperplasias (1); others a rather well defined leaf gall with such homogeneous tissue within it that it may be regarded as but a high kataplasma (2). One European form produces a very low kataplasma in inducing an enrolled condition of the leaf (3). The second form is of especial interest because its initial stages are known to be induced through the action of a chemical stimulus emitted by the adult female at the time of egg-laying.

CYNIPIDAE (Hymenoptera) (pl. XXII).—This family is recognized by all students to be the most remarkable from the standpoint of variety and complexity of the galls produced. This is true even though the largest number of these galls is found on one host genus (*Quercus*). The vast majority of cynipid galls are prosoplasmas. Four independent points of origin are presented, though three of these may conceivably have been derived from the primitive leaf kataplasma (10), as indicated by the arrow lines.

In the evolution of the stem galls we find a progressive series (1-4) related to the orientation of the larva within the stem. This situation is related primarily to the placing of the egg by the ovipositor of the adult females, for so far as known these larvae are not migratory. Any of the stem kataplasmas shown may become elementary prosoplasmas through the differentiation of a sclerenchyma layer around the larval chambers, a parenchymatous nutritive layer being left as a lining. In the diagram only the medullary (4) and cortical (5) types of prosoplasmas are shown. From the latter has been evolved the interesting dehiscence form shown in (6).

The bud and apical meristem galls are shown in (7-9). In (7) a number of the bud leaves merely become fused, while the other two show the transition from the sclerenchymatized polythalamous condition with relatively long, aborted leaves forming an involucre to the sclerenchymatized monothalamous state with shorter, involucre-like elements. In many prosoplasmas of this type the involucre structures are suppressed altogether.

The most primitive cynipid gall is believed to be the variable, generally polythalamous, slightly differentiated kataplasma shown in (10). From this type through the attainment of the "protective" layers the simple prosoplasma (13) is reached, from which by reduction to the monothalamous stage an important stock type (14) is obtained. This latter, however, may also have been evolved through reduction of chamber number before sclerenchymatization had taken place (11). The gall is shown in its primitive intercalate position in the leaf. The prosoplasma variant from the latter is shown in (12).

From the concentrically built stock type (14), which is regarded as an appendicular form, the greatest evolution in prosoplasmas has taken place. Six fundamental lines appear to have sprung from it. Certain characters evolved in and characteristic of these different lines are in special instances combined in the same gall. For example, the stalked type (19) may also exhibit the free larval cell condition of (22), as found in *Dryophanta pedunculata* Bass. The combination, however, of two or more of these fundamental type characters in the same gall is the less common condition; for the most part the galls can be associated with one or the other of the structural evolutionary lines. The same tendency, previously observed in the Itonididae, toward the formation of a distal false chamber, is found (15). This culminates in such a bizarre bracteate form as that shown in (16), a new gall discovered recently by the writer in North Carolina.

Another striking series is that of the evolution of the radiate-fiber type of gall. This begins with the appearance of aeriferous tissue in the cortical region (17), and ends with the condition in which only the fibrovascular bundles traverse the cortical region (18). The type shown in (22) may have been derived from the

latter through the elimination of the bundles, but it may also have had an independent origin from the stock type; embryological evidence in this connection is not available.

The pedicellate condition (19) constitutes the culmination of another line, in which all possible stages may be found in the oak cynipids.

A special place has been given to those galls (20) which bear appendages on the gall body proper (larva containing region). It is believed these bracteate forms for the most part are derived from the non-bracteate forms. There are, however, such possible exceptions as the gall of *Rhodites rosae* L. or *R. bicolor* Harr., in which instances the appendages might be interpreted to be but the reappearance of certain normal parts. In so far as this is true they would be kataplasmic.

In (21) is represented a type possessing highly elongated trichomes. All gradations from the smooth stock type (14) to extreme pubescence are known in the cynipid cecidial biota.

It is better for the present to consider the free larval cell type (22) as an independent line, although, as already indicated, it may have been derived from the radiate-fiber form.

A final line is that leading to the obliteration of the parenchymatous cortical region (23), resulting in a firm, thin-walled structure. These galls are all very small.

Before closing the account of the Cynipidae, mention should be made of the kataplasma shown in (24). Larva cells are organized in the homogeneous tissue of the acorn. This may have arisen independently, or with greater probability it was derived through a change in point of attack on the part of insects forming a primitive leaf gall.

#### Summary of phylogenetic data

It will be desirable to point out certain major evolutionary tendencies appearing in widely separated groups which point toward an orthogenetic interpretation. (1) The tendency toward specific sclerenchymatization in the formation of the lignified tissue forming the so-called protective layers in the galls. This has appeared independently in Psyllidae, Itonididae, and Cynipidae;

in all of which it is a prominent character in the majority of their prosoplasmas. (2) The tendency toward the up-walled ("umwallungen") condition. This is partially attained in the Acarina and Psyllidae, fully attained in the Aphididae, Coccidae, Itonididae, and is superimposed as the distal false chamber on certain galls of the Itonididae and Cynipidae. (3) The tendency toward the dehiscent type. This is much more restricted, appearing only in the Itonididae and the Cynipidae. (4) The tendency toward appendicular structures borne by the galls. This tendency is almost confined to the Cynipidae. It has appeared in a weak degree in other groups, as in the Aphididae and in certain hickory itonids in which the gall base flares out into ill-defined processes. In the Cynipidae a great variety of appendages is found for which it is not possible to find homologues anywhere on the host plant. Many minor tendencies can be traced out in gall phylogeny studies which may only be mentioned in this general paper. Among such are those toward certain forms, those toward certain orientations of tissues, those toward specializations with regard to certain chemical content (high tannin deposition, etc.), and those associated with the transition from the polythalamous to the monothalamous condition.

### Recapitulation data

If zooecidia are amenable to the same evolutionary interpretations as are used in the study of plant and animal parts, then VON BAER'S law should apply to the situation, and this is exactly what is found. Striking examples of recapitulation phenomena may be found in all the larger gall groups, yet, strangely enough, so far as the writer knows, no one has called attention to them or even to the possibility of the law applying in the zooecidial field. The most fundamental fact in this connection is that all prosoplasmas in their ontogeny recapitulate the kataplasma stage. The initial stages of all prosoplasma galls (so far as known), which begin on partially differentiated host tissue, involve a process of dedifferentiation; the tissue is thrown back into a homogeneous condition (full kataplasmic state) out of which grows the new structure. Of course in those instances in which the larva

is from the beginning in contact with meristem, no such regression is possible or necessary. This situation will be developed at greater length in the general discussion.

Within the prosoplasmas themselves innumerable examples of recapitulation may be pointed out, two of which may be mentioned. In the ontogeny of the cecidium *Amphibolips inanis*, the gall passes through the spongy stage illustrated by *Amphibolips confluentus* before it reaches the mature condition with radiating fibers. In the ontogeny of *Oligotrophus annulipes* (European) a juvenile stage is passed through which is almost exactly reproduced in an adult gall (*Cecidomyia* sp.) on the same host. HOUARD (7), in reporting the resemblance of these two stages, fails to suggest the evident recapitulation interpretation.

### Discussion

The foregoing part of this paper presents the results gained in the application of certain fundamental conceptions regarding cecidia which are concerned with the evolution of these structures. These conceptions have their historical background, as already indicated, but it will be well to review them in the light of modern genetic and phylogenetic theories, and point out their synthesis which, with the application of them in constructing the phylogenetic trees, constitutes the chief contribution of the present paper.

Before entering upon this constructive work, however, it will be necessary to clear the ground of certain false conceptions which have held sway to the present time, such as the interpretation of KÜSTER, COSENS, and others, who hold that all gall characters are but the expression of active or latent normal host plant characters. COSENS and SINCLAIR (4) state that there remains no authentic instance of any organ or tissue in a gall that is new, ontogenetically or phylogenetically. This interpretation is clearly fallacious, for it is the essential newness of prosoplasmas which constitutes their most important characteristic. This newness appears perhaps in its most striking manner in the form characters of the tissues, which implies of course the form of the gall as a whole. Since form characters are of utmost importance

throughout all taxonomic, genetic, and evolutionary studies, certainly these characters must be taken into account by the cecidologist. When the counterparts of these characters cannot be found associated with any normal tissue mass of any plant, they must be regarded as new and not as having had their origin from the plant side. As pointed out by the writer in a previous paper (12), "in prosoplasmas the types of cells found are closely comparable to those of normal plant parts, but the tissue forms (in prosoplasmas) are fundamentally new." KÜSTER (10) speaks very properly of "Die prosoplasmatische Neubildungen," recognizing the fundamentally independent character of the higher galls, but like COSENS fails to recognize that the origin in evolution of the prosoplasmas lies elsewhere than in the constitution of the plant or of the plant's ancestors.

COOK (2) arrived at a proper basis for advance when he saw that "the morphological character of the gall depends upon the genus of insect producing it, rather than upon the plant on which it is produced." COOK, however, failed to use BEYERINCK'S (1) early division of galls into the "indefinite" and "definite" groups (a fundamental situation which KÜSTER later developed), so that his work fell short of a full analysis; for, as has been indicated, the phylogenetic origin of the prosoplasmas from the kataplasmas (within cecidozoon groups) is all important.

This leads to the nucleus of the present interpretation, which holds that in the contemplation of zooecidia two fundamental groups must be recognized, kataplasmas and prosoplasmas, and that there exists a phylogenetic relation between them. The most interesting and significant situation in this connection is that, whether viewed ontogenetically or phylogenetically, kataplastic development progresses, through a process of increasing inhibition of host characters, from the normal host differentiation to complete homogeneity, upon the attainment of which prosoplastic development may commence the construction of new differentiations and new forms. The embryological and comparative morphological evidence for this interpretation is overwhelming, as has been indicated in the foregoing accounts of phylogenies and of recapitulation phenomena.

It would appear then, in zoocecidial ontogeny or zoocecidial evolution, that there occurs at first an overcoming or breaking down of the differentiation and morphogenetic mechanisms which bring about the normal expression of the host plant characters. When this has gone on to the point where no differentiation whatever ensues, the new advance is made in the direction of the prosoplasmas in which fundamentally new characters are caused to appear. Thus we have a remarkable turning point in gall evolution, namely, that at which the normal expression of the plant's potentialities, locked up in its meristem, is inhibited. All gall forms, from the most insignificant interference with normal differentiation to total suppression, are kataplasmas, and all those types arising as definite new structures from the final kataplastic condition are prosoplasmas.

As pointed out in connection with the recapitulation data, all prosoplasmas in their ontogeny pass through the kataplastic stage, either in the actual reversion of partially differentiated tissue to the undifferentiated condition; or, if the cecidozoon is in contact with the meristem, there occurs the equivalent, namely, the complete suppression of the plant's tissue characters, only the new ones of the prosoplasma appearing.

For the sake of clarity the situation has been presented in positive, mutually exclusive terms. There exists, as would be expected, a small minority of galls which occupy the transition region between the kataplasmas and the prosoplasmas. In certain of these, for example, prosoplastic characters may exist along with kataplastic ones. Such a gall is that of *Phytophaga rigidae* O.S. discussed by COSENS and SINCLAIR (4), in which aeriferous tissue is found which they explain on the latent character hypothesis. According to this view the gall is kataplastic, but if we take into consideration the specialized structure, the "beak," of the distal end of the gall (an "umwallungen" development), the form character of the scleridal and nutritive tissues (counterparts of which are not to be found in any normal part of the host or its relatives), we must conclude that this gall is also definitely prosoplastic in nature. Thus in many forms both types of tissue characters may appear. It will be questioned at



once in the evolution or ontogeny of zooecidia, how is such a retrogression followed by a progression in a new direction possible? What is the mechanism involved? The effort of all students in attacking this so-called stimulus problem has signally failed to elucidate the situation. In the opinion of the writer this is because the problem goes much deeper than our present technique is able to penetrate, for it is to be classed with the general unsolved problems of growth (ontogeny) and evolution (phylogeny). Just as a mass of cells in an apical growing point, in some unknown manner, certainly has much to do with the differentiation products of that stem, so has the mass of embryonic cells constituting the prosoplasma-making larva much to do with the differentiation products, not only of itself but of the plant tissue around it. It has extended its control (mechanistically interpreted) in the field of form characters (and others to a less degree) beyond the borders of its own body. As FOCKEU (6) has put it: "La feuille est en rapport avec les phenomenes vitaux de la larve" rather than with the normal leaf itself (we would append to bring out the contrast). In other words, we would hold that the development of prosoplasmas is brought about through the superposition of embryonic animal tissue (the cecidozoon larva) on that of embryonic plant tissue with a relation in growth which is an essentially normal one, that is, the mechanism of morphogenesis is operative, but the primary control is with the larva.

This leads to a final statement, one given earlier by the writer (12), to the effect that "the germ plasm of the cecidozoon is the place of origin of gall forms." This, of course, merely falls in with the current general ideas concerning the significance of the germ plasm in evolution. In the germ plasm of the animal originated the factorial conditions which, phylogenetically considered, first gave the embryonic cecidozoon the ability to break up the normal operation of the plant's factors making possible normal plant differentiation, and secondly the factors which initiate the development of new form and other characters expressed in the plant cell masses.

Zooecidial evolution then is a complex in which, in its early stages (kataplasmas) with regard to certain characters, the plant's

germ plasm dominates, while in its later stages (prosoplasmas) the animal's germ plasm gains control; the whole, however, constituting a single progressive series of factorial transformation as far as the changes in the animal germ plasm are concerned.

### Summary

1. KÜSTER'S groups, kataplasmas (lower galls of indefinite nature, differentiation conditions similar to, but in complexity below that of normal plant) and prosoplasmas (higher galls of definite nature, differentiation conditions new) are basic for the present paper.

2. Evolutionary concepts are introduced in pointing out that prosoplasmas have arisen from kataplasmas. The probable main outlines (phylogenetic trees) of the natural cecidozoon gall groups are presented for the first time.

3. Kataplastic evolution is held to be a process of progressive inhibition of differentiation ending with tissue homogeneity. Prosoplastic evolution may only begin when homogeneity has been attained, and consists in the development of new form and tissue orientation characters chiefly. In prosoplasma formation, whether viewed ontogenetically or phylogenetically, the insect larva has gained control of the differentiation and morphogenetic mechanisms, so that animal factors come to expression in plant tissue.

4. Origin of significant characters of prosoplasmas lies in change in factorial situation in animal's germ plasm.

NORTH CAROLINA STATE COLLEGE  
RALEIGH, N.C.

### LITERATURE CITED

1. BEYERINCK, M. W., Über Pflanzengallen. *Bot. Zeit.* 35:17-23. 1877.
2. COOK, M. T., Galls and insects producing them. *Ohio Naturalist* 2:263-278. 1902; 3:419-436. 1903; 4:115-147. 1904.
3. COSENS, A., A contribution to the morphology and biology of insect galls. *Trans. Canadian Inst.* 9:297-387. *pls.* 12. 1912.
4. COSENS, A., and SINCLAIR, T. A., Aeriferous tissue in willow galls. *BOT. GAZ.* 62:210-225. 1916.
5. FELT, E. P., Key to American insect galls. *N.Y. State Mus. Bull.* 200. pp. 310. 1918.

6. FOCKEU, H., Recherches anatomiques sur les galles. Soc. d'Editions Sci. pp. 162. pls. 12. Paris. 1896.
7. HOUARD, C., Sur quelques zooecidies de l'Asie Mineure et du Caucase. Marcellia 1:50-53. 1902.
8. ———, Les zooecidies des plantes d'Europe et du bassin de la Mediteranee. Vols. 2 and 3. Paris. 1909 and 1913.
9. KÜSTER, E., Die Gallen der Pflanzen. Leipzig. 1911.
10. ———, Pathologische Pflanzenanatomie. Jena. 1916.
11. WELLS, B. W., A survey of the zooecidia on species of *Hicoria* (*Carya*) caused by parasites belonging to the Eriophyidae and the Itonindidae (Cecidomyiidae). Ohio Jour. Sci. 16:37-57. 1915.
12. ———, The comparative morphology of the zooecidia of *Celtis occidentalis*. Ohio Jour. Sci. 14:249-290. 1916.

## EXPLANATION OF PLATES XXI, XXII

### Plate XXI

Rotifera: (1) *Notammata Werneckii* Ehrenb. on *Vaucheria*.

Copepoda: (1) *Harpacticus chelifer* Müller on *Rhodomenia*.

Nematoda: (1) *Heterodera raditicola* Greef on *Lycopersicum*; (2) *Tylenchus devastatrix* Kühn on *Trifolium*.

Acarina: (1) *Eriophyes* sp. on *Fraxinus*; (2) *Eriophyes populi* Nal. on *Populus*; (3) *Eriophyes* sp. on *Fagus*; (4) *Eriophyes* sp. (*anomalum* Cook) on *Juglans*; (5) *Eriophyes* sp. (*querci* Garman) on *Quercus*; (6) *Eriophyes goniothorax* Nal. on *Crataegus*; (7) *Eriophyes* sp. on *Cephalanthus*; (8) *Eriophyes* sp. (*abnormis* Garman) on *Tilia*; (9) *Eriophyes* sp. on *Salix*; (10) *Eriophyes* sp. on *Acer*.

Orthoptera: (1) *Meconema varium* Fabr. on *Quercus*.

Neuroptera: (1) *Lestes viridis* Van der Lind on *Fagus*.

Thysanoptera: (1) *Thrips* sp. on *Piper*; (2) *Thrips* sp. (host not given); (3) *Mesothrips melastomae* Zimm. on *Melastoma*.

Coleoptera: (1) *Mecas inornata* Say on *Populus*.

Lepidoptera: (1) *Gnorimoschema gallaesolidaginis* Riley on *Solidago*.

Psyllidae: (1) *Psylla crataegi* Schrank on *Crataegus*; (2) *Psylla ledi* Flor. on *Ledum*; (3) *Trioza Kiefferi* Giard on *Rhamnus*; (4) *Pachypsylla vesiculum* Riley on *Celtis*; (5) *Pachypsylla gemma* Riley on *Celtis*; (6) *Pachypsylla mamma* Riley on *Celtis*; (7) *Pachypsylla asteriscus* Riley on *Celtis*; (8) *Pachypsylla venusta* Riley on *Celtis*; (9) *Trichopsylla Walkeri* Forster on *Rhamnus*; (10) *Livia maculipennis* Fitch on *Juncus*.

Aphididae: (1) *Myzus ribis* L. on *Ribes*; (2) *Pachypappa marsupialis* Koch on *Populus*; (3) *Pemphigus vagabundus* Walsh on *Populus*; (4) *Hamamelistes spinosus* Shimer on *Hamamelis*; (5) *Phylloxera conica* Shimer on *Carya*; (6) *Phylloxera caryaecaulis* Fitch on *Carya*; (7) *Chaitophorus leucomelas* Koch on *Populus*.

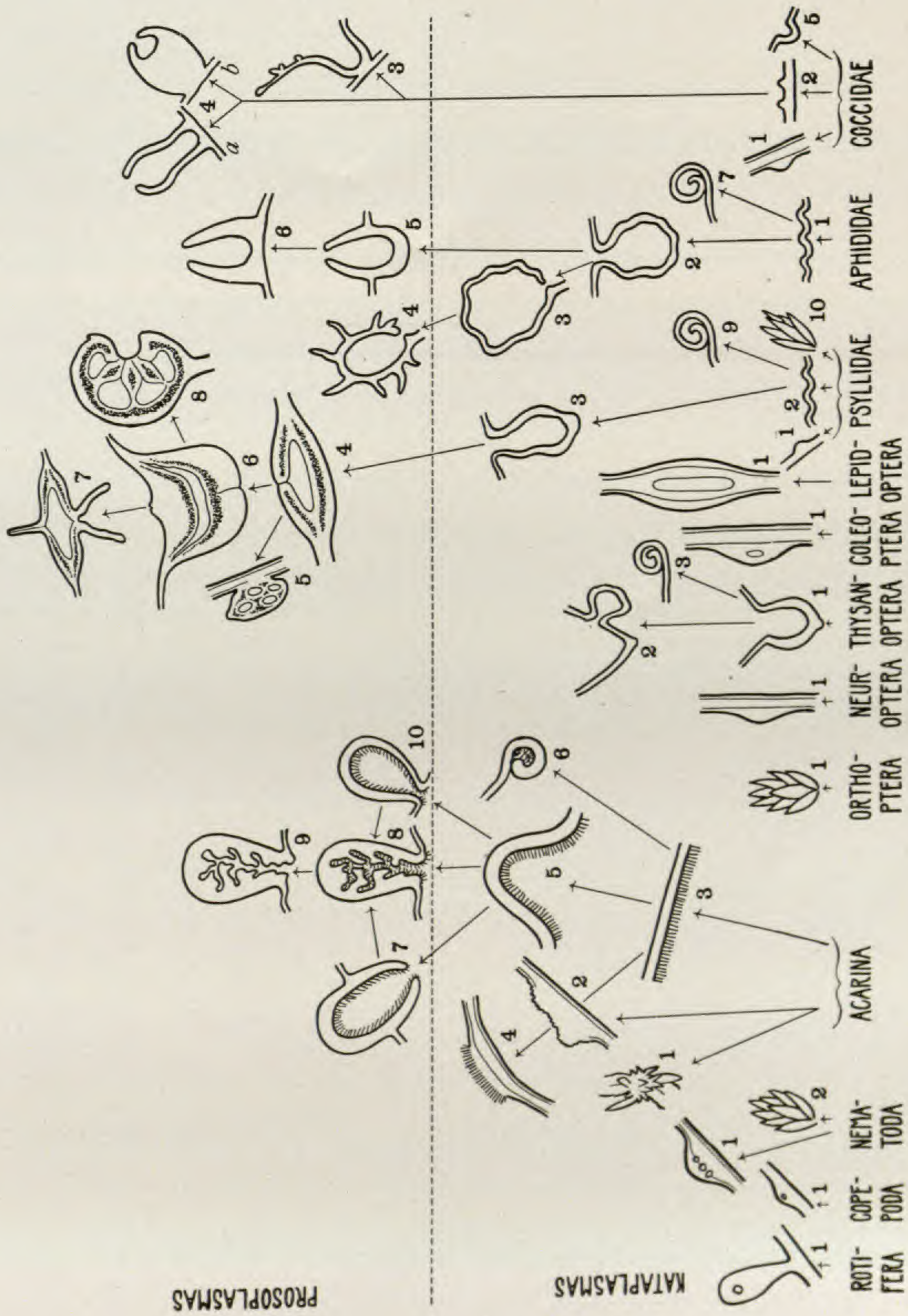

PROSOPPLASMAS

KATAPLASMAS

ROTI-FERA  
COPE-PODA

NEMA-TODA

ACARINA

ORTHOPTERA

NEUROPTERA  
THYSANOPTERA

COLEOPTERA  
LEPIDOPTERA

PSYLLIDAE

APHIDIDAE

COCCIDAE

WELLS on ZOOCECIDIA

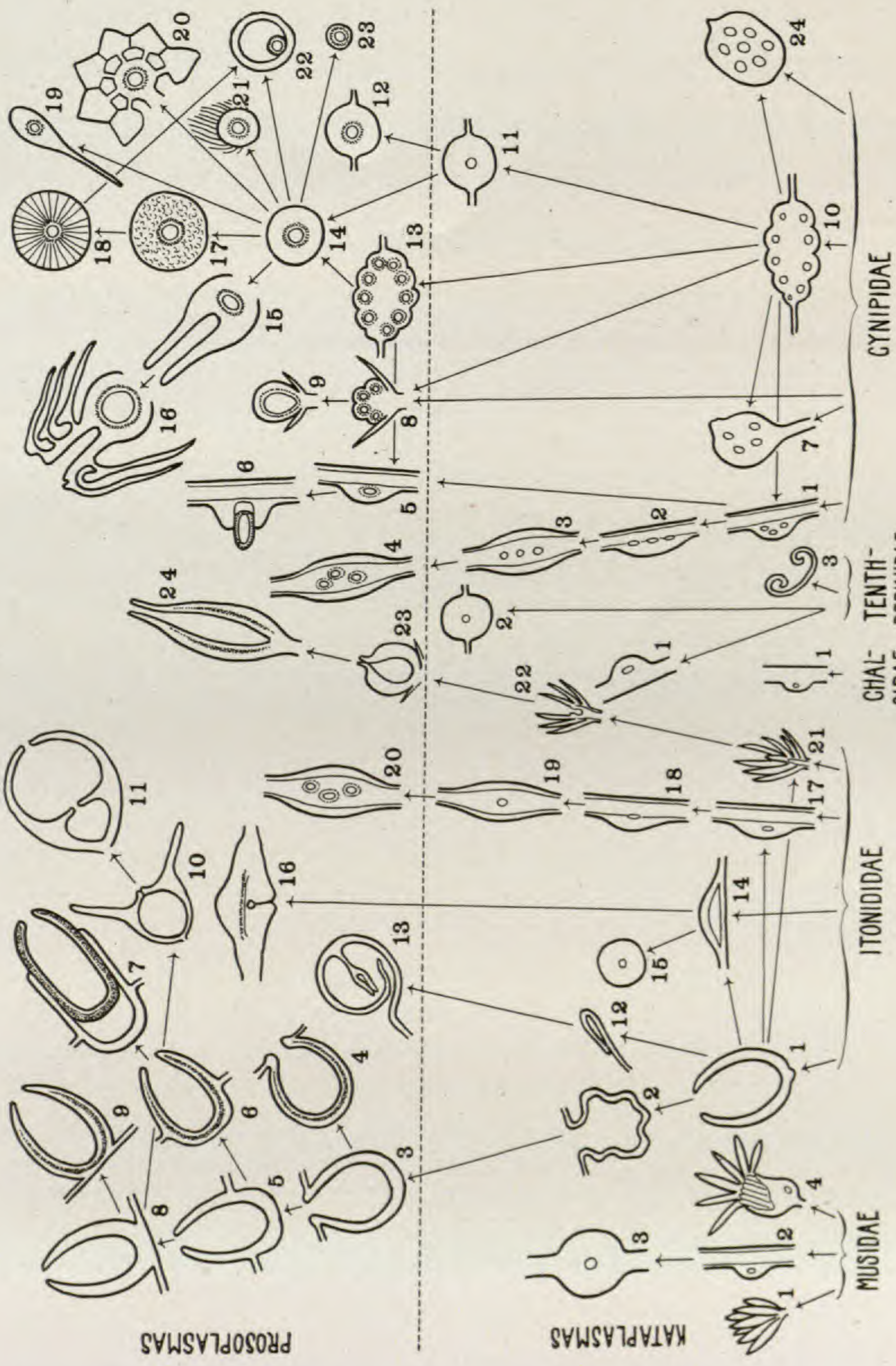

PROSOPLASMAS

KATAPLASMAS

MUSIDAE

ITONIDAE

CHALCIDAE  
TENTHREDINIDAE

CYNIPIDAE

WELLS on ZOOCYCEDIA

Coccidae: (1) *Planchonia fimbriata* on *Coronilla*; (2) *Asterodiaspis quercicola* Bonché on *Quercus*; (3) *Apiomorpha cornifex* on *Eucalyptus*; (4) *Brachyscelis oricola* on *Eucalyptus* (a, gall produced by male; b, gall produced by female).

Plate XXII

Musidae: (1) *Lipara lucens* Meigen on *Phragmites*; (2) *Agromyza Kiefferi* Tavares on *Cytisus*; (3) *Eurosta solidaginis* Fitch on *Solidago*; (4) *Phorbia seneciella* Meade on *Senecio*.

Itonididae: (1) *Dasyneura gleditschiae* O.S. on *Gleditsia*; (2) *Contarinia negundifolia* Felt on *Negundo*; (3) *Lobopteromyia venae* Felt on *Crataegus*; (4) *Mikiola fagi* Hartig on *Fagus*; (5) *Cecidomyia* sp. on *Amelanchier*; (6) *Cecidomyia* sp. on *Populus*; (7) *Cecidomyia* sp. on *Celtis*; (8) *Rhopalomyia anthophila* O.S. on *Solidago*; (9) *Cecidomyia unguicola* Beutm. on *Celtis*; (10) *Cecidomyia* sp. on *Carya*; (11) *Caryomyia inanis* Felt on *Carya*; (12) *Itonida foliora* Russell and Hooker on *Quercus*; (13) *Cecidomyia* sp. on *Populus*; (14) *Cincticornia* sp. on *Quercus*; (15) *Contarinia virginiana* Felt on *Prunus*; (16) *Cecidomyia verrucicola* O.S. on *Tilia*; (17) *Neolasioptera cornicola* Beutm. on *Cornus*; (18) hypothetical; (19) *Lasioptera clavula* Beutm. on *Cornus*; (20) *Rhabdophaga batatas* Walsh on *Salix*; (21) *Rhabdophaga strobiloides* Walsh on *Salix*; (22) *Rhopalomyia* sp. on *Solidago*; (23) *Rhopalomyia hirtipes* O.S. on *Solidago*; (24) *Phytophaga rigida* O.S. on *Salix*.

Chalcidae: (1) *Isosoma tritici* Fitch on *Triticum*.

Tenthredinidae: (1) *Cryptocampus nodus* Walsh on *Salix*; (2) *Pontania pomum* Walsh on *Salix*; (3) *Blenocampa pusilla* Klug on *Rosa*.

Cynipidae: (1) *Neuroterus batatas* Fitch on *Quercus*; (2) *Andricus punctatus* Bass. on *Quercus*; (3) *Aulacidea tumida* Bass. on *Lactuca*; (4) *Neuroterus majalis* Bass. on *Quercus*; (5) *Neuroterus rileyi* Bass. on *Quercus*; (6) *Andricus excavatus* Ashm. on *Quercus*; (7) *Andricus clavula* Bass. on *Quercus*; (8) *Andricus frondosa* Bass. on *Quercus*; (9) *Andricus topiarius* Ashm. on *Quercus*; (10) *Aylax taraxici* Ashm. on *Taraxacum* or *Callirhytis tumifica* O.S. on *Quercus*; (11) *Callirhytis tumifica* O.S., monothalamous form on *Quercus*; (12) *Rhodites rosaeifoliae* Cockll. on *Rosa*; (13) *Neuroterus irregularis* O.S. on *Quercus*; (14) *Biorhiza mellea* Ashm. on *Quercus*; (15) *Xystoteras volutellae* Ashm. on *Quercus*; (16) *Cynips* sp. on *Quercus*; (17) *Amphibolips confluentus* Harris on *Quercus*; (18) *Amphibolips inanis* O.S. on *Quercus*; (19) *Andricus capsulus* Bass. on *Quercus*; (20) *Cynips Hartigi* Hartig on *Quercus*; (21) *Neuroterus floccosus* Bass. on *Quercus*; (22) *Dryophanta palustris* O.S. on *Quercus*; (23) *Neuroterus saltatorius* Edwards on *Quercus*; (24) *Callirhytis fruticola* Ashm. on *Quercus*.

# THE GAMETOPHYTES OF *EQUISETUM LAEVIGATUM*<sup>1</sup>

ELDA R. WALKER

(WITH PLATES XXIII, XXIV AND THREE FIGURES)

## Introduction

According to BUCHTIEN (1), gametophytes of *Equisetum* were first found by VAUCHER in 1826, and later by BISCHOFF in 1829, and MILDE in 1852. The finding of *Equisetum* gametophytes, however, has been rare. When in August 1916, ROBERT A. NESBIT, at that time a student in the University of Nebraska, found large numbers of them near Tekamah, Nebraska, it was hardly expected that the discovery would soon be repeated. The gametophytes, however, have since been found in several localities, usually in Nebraska, by a number of persons. At the suggestion of Dr. CHARLES J. CHAMBERLAIN the writer undertook a study of these gametophytes with the results here reported.

## Distribution

The discovery of *Equisetum* gametophytes by Mr. NESBIT called the attention of local botanists to the possibility of finding them. The result is that they have been observed in recent years as follows:

*Robert A. Nesbit*, Tekamah, Nebraska, August and September 1916; *N. F. Petersen*, Osborn, Indiana, August 2, 1917; Manhattan, Kansas, September 1917; Reno, Nevada, July 1918; Pilger, Nebraska, September 25, 1920; Lincoln, Nebraska, October 9, 1920; Florence, Nebraska, November 5, 1920; South Sioux City, Nebraska, November 7, 1920; *F. C. Jean*, Peru, Nebraska, August 1917; *Elda R. Walker*, *Doris Hayes*, and *Katherine Wolfe*, Lincoln, Nebraska, October 12, 17, 24, and November 14, 1920.

Since learning of these recent observations, Professor O. A. STEVENS has told the writer of finding a considerable number of *Equisetum* gametophytes on the banks of the Big Blue River and a drainage ditch emptying into it, at Manhattan, Kansas, in Septem-

<sup>1</sup> Contributions from department of botany, University of Nebraska, new series, no. 33.

ber 1908. Mrs. T. J. FITZPATRICK also found large numbers of them on the banks of the Iowa River at Iowa City, Iowa, during the years 1884-1888. At Osborn, Indiana, Manhattan, Kansas, and Reno, Nevada, Professor N. F. PETERSEN found only a few specimens. At all other points, except Lincoln, they were present in large quantities. They were on the banks of every creek but one examined in the neighborhood of Lincoln, but were not abundant in any place. Mr. NESBIT describes the habitat in which they grew at Tekamah, Nebraska, as follows:

These were found along both banks of a typical prairie creek from the point where it emerges from the hills for a distance of at least four miles upstream. They occurred almost continuously throughout this distance. The creek is subject to overflow several times a year, and has built up a narrow floodplain of rich soil. The creek bed itself is about 15 ft. below the level of the floodplain, and is shaded by trees throughout most of its course. Near the water there is usually a belt of mud or very moist soil, varying in width from a few inches to several feet, and sloping gradually upward to the beginning of the more precipitous slope of the banks. . . . The gametophytes, varying in size from 1 mm. to about 1 cm. in diameter, occurred on this mud. They were abundant, in many places being separated by an average distance of not more than 3 cm. In other places they were more scattered, and occasionally, where the mud belt was too soft, they were lacking entirely. . . . There were very few other plants growing in this mud belt, *Riccia* being the only form that appeared constantly.

For all the localities in Nebraska, Kansas, and Iowa the same description in general holds true. They were found along streams of all sizes, from the smallest creeks and drainage ditches to the Missouri River, and in all cases were on the mud belt and associated with *Riccia*. At Osborn, Indiana, the gametophytes grew in a ditch by a railroad on soil where ties had been burned. This had destroyed other vegetation, and mosses were just starting with the *Equisetum*. At Reno, Nevada, they were growing beside a waterfall.

#### Identification of species

In no case in Nebraska were mature *Equisetum* sporophytes found on the creek banks on which the gametophytes were growing. As a rule the only spore-producing plants within many miles were *E. arvense* and *E. laevigatum*, strictly prairie forms. Spores of *E. arvense*, *E. robustum*, and *E. laevigatum* have been grown in



culture, and the wild gametophytes were compared with them. They resembled closely the two latter, but were definitely different from *E. arvense*.

In eastern Nebraska but two other species of *Equisetum* are known, *E. robustum* and *E. variegatum*, according to FITZPATRICK (4). Of these *E. variegatum* is rare; *E. robustum* is seldom found except along the banks of the Missouri River and its larger tributaries. The gametophytes found on the river banks at Florence and South Sioux City were slightly larger than the others and might belong to this species. FITZPATRICK, however, who examined the young sporophytes of all of the collections, failed to find on these evidence of the characters of *E. robustum*. Like those of all the other Nebraska gametophytes, he found that they resembled more closely *E. laevigatum*. These last bore so many large sporophytes that the gametophyte tissue was badly disorganized and of little use for study; consequently the microscopic studies were limited to the gametophytes from Tekamah, Pilger, and Lincoln. As at these places *E. robustum* is not present, and as the gametophytes do not resemble *E. arvense*, they are undoubtedly *E. laevigatum*.

The gametophytes from Osborn, Indiana, are without question *E. arvense*. Adult plants of the species occurred near by, and the gametophytes agree with those grown in culture. Those from Manhattan, Kansas, Iowa City, Iowa, and Reno, Nevada, were not seen by the writer, nor were those from Peru, Nebraska. Abundant specimens from the other localities, however, have been examined.<sup>2</sup>

### Gametophytes

The gametophytes appear as circular cushions (figs. 1-5, 7, 10, and text fig. 1) varying in diameter from 1 mm. to 1 cm. They are a dull green with a slight brownish tint, making them inconspicuous as they grow on the wet soil. In many cases the writer looked at a given spot several seconds before her eye differentiated the form of the gametophytes, even where there were some of the larger ones. This may account in part for their not having been found more frequently.

<sup>2</sup> Sections made by STEVENS of the gametophytes found by him at Manhattan, Kansas, have been examined. These agree entirely with the gametophytes of *E. laevigatum*.

Each gametophyte consists of a flat circular disk (shown entire in fig. 6, which is a ventral view, and in section in figs. 8 and 9) of large-celled compact tissue 1-10 mm. in diameter and bearing many upright green branches on its upper surface. It is usually indented deeply at one side (figs. 1, 5, 6) and may be more or less lobed at the periphery, where it is surrounded by a heavy band of meristem (figs. 6, 8, 9) so long as growth continues. This meristem is often more active at some points than at others, which causes the marginal lobing. Fig. 6 shows the under side of the gametophyte whose upper surface is shown in fig. 1. The thallus was killed and

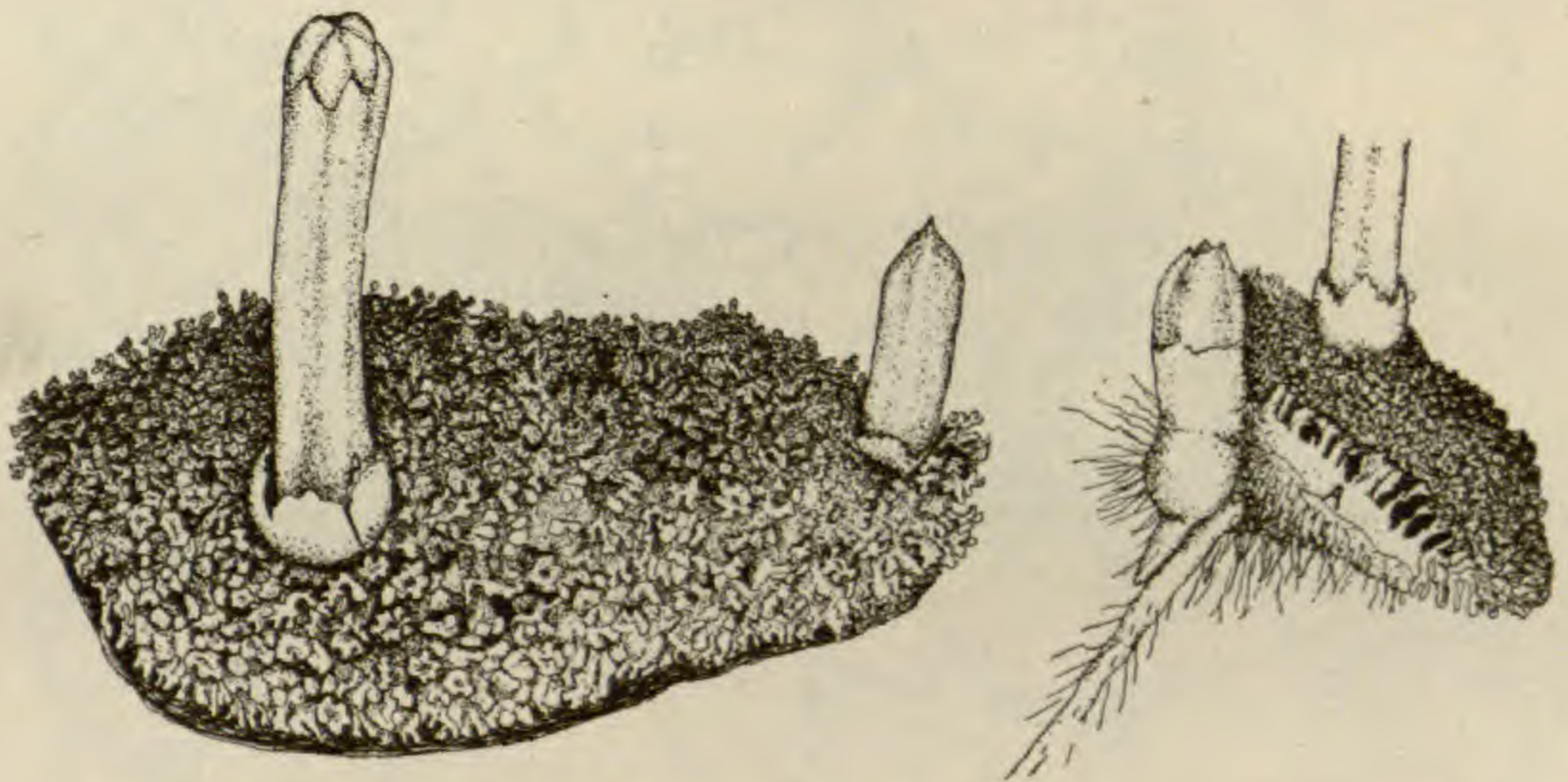

FIG. 1.—*E. laevigatum*: at left gametophyte with two sporophytes; at right gametophyte with sporophyte having developed a second shoot and root; gametophyte tissues cut away at A; section of sporophyte shown in fig. 11;  $\times 10$ .

cleared in glycerine and then photographed from below to show the meristem band about the periphery and the slight lobing often present. It is this peripheral meristem that continues the growth of the thallus and gives rise to the upright branches and the sex organs. Fig. 8 shows this meristem at each end of the section producing archegonia. Fig. 9 shows the same structure, but at the left the meristem band contains two antheridia, and at the right a sporophyte with foot, root, stem, and leaves differentiated. The entire upper surface of the thallus is covered by the upright green branches. These branch more or less above and are wider at the tip than at the base (fig. 8). Very little chlorophyll is present in the

large cells composing the disk. The under surface is richly supplied with rhizoids.

The gametophytes are typically monoecious. Over fifty specimens of all sizes have been examined in paraffin sections and a large number of others in freehand sections, and still others without sectioning. None has been found without old archegonia. Many, about 30 per cent, also bear antheridia that are still active, and others show the scars of antheridia that have discharged their sperms. Only in a few cases was it impossible to find some trace of

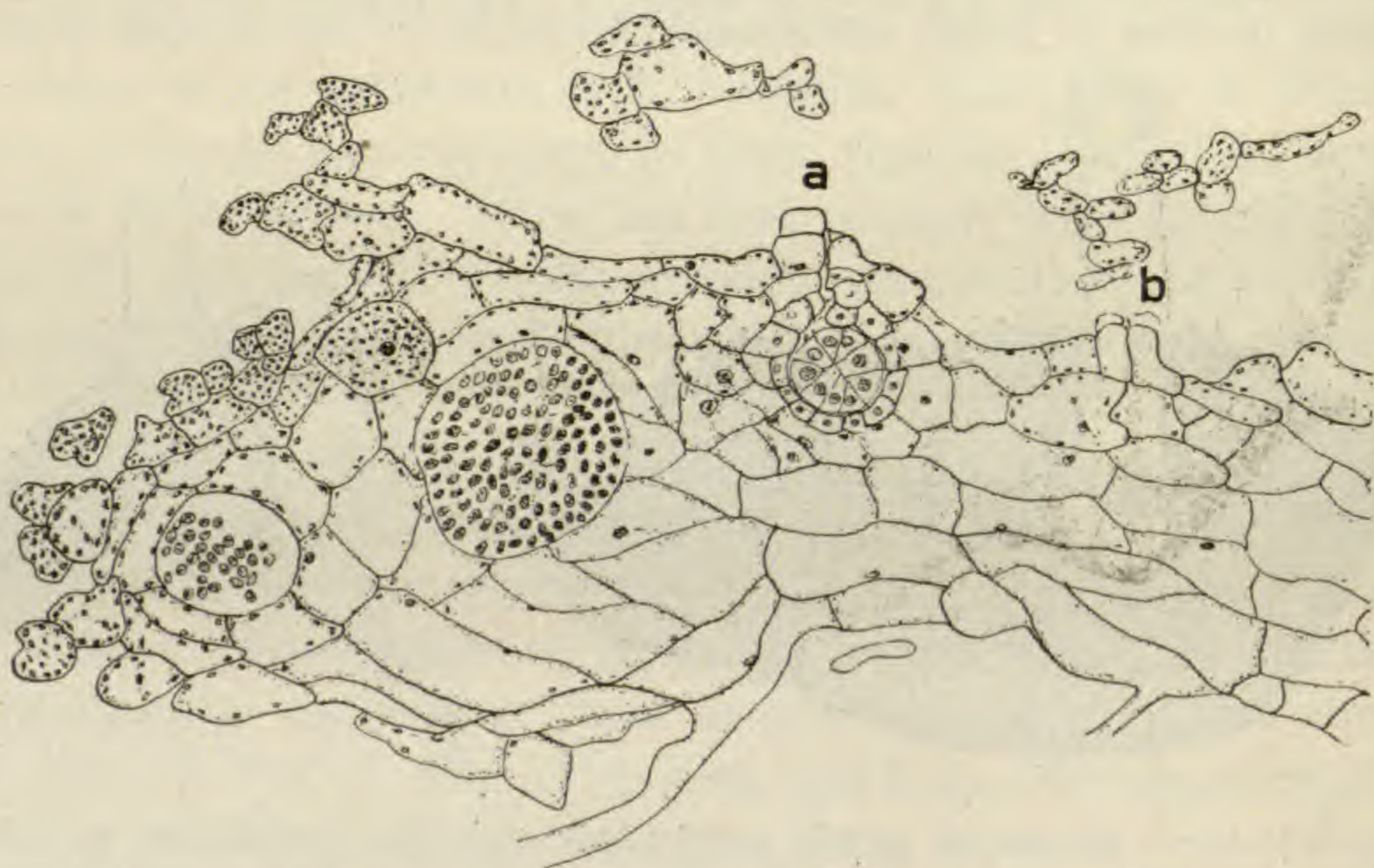

FIG. 2.—*E. laevigatum* (vertical section): at left two mature antheridia; at *a* archegonium containing young sporophyte; at *b* neck cells of functionless archegonium;  $\times 75$ .

them. Antheridia, archegonia, and sporophytes often show in the same section. Fig. 9 shows antheridia on the left and a sporophyte on the right. The same thallus showed in other sections young and old archegonia. Fig. 17, whose detail is shown in text fig. 2, shows a vertical section through the periphery of a thallus. At the left are two mature antheridia. At the center above at *a* is an archegonium containing in its venter a young sporophyte of about thirty-two cells. At *b* are the four neck cells of an old functionless archegonium. Text fig. 3 shows part of a section of another thallus. On the left is a young antheridium in which the sperm

mother-cells are not yet differentiated. Two cells to the right of it is the venter of an archegonium surrounded by its jacket cells and containing a mature egg cell. Above at *a* are the neck cells in oblique section.

Figs. 12 and 13 are near sections, cut horizontally. In fig. 12 are shown twelve antheridia in various stages of development.

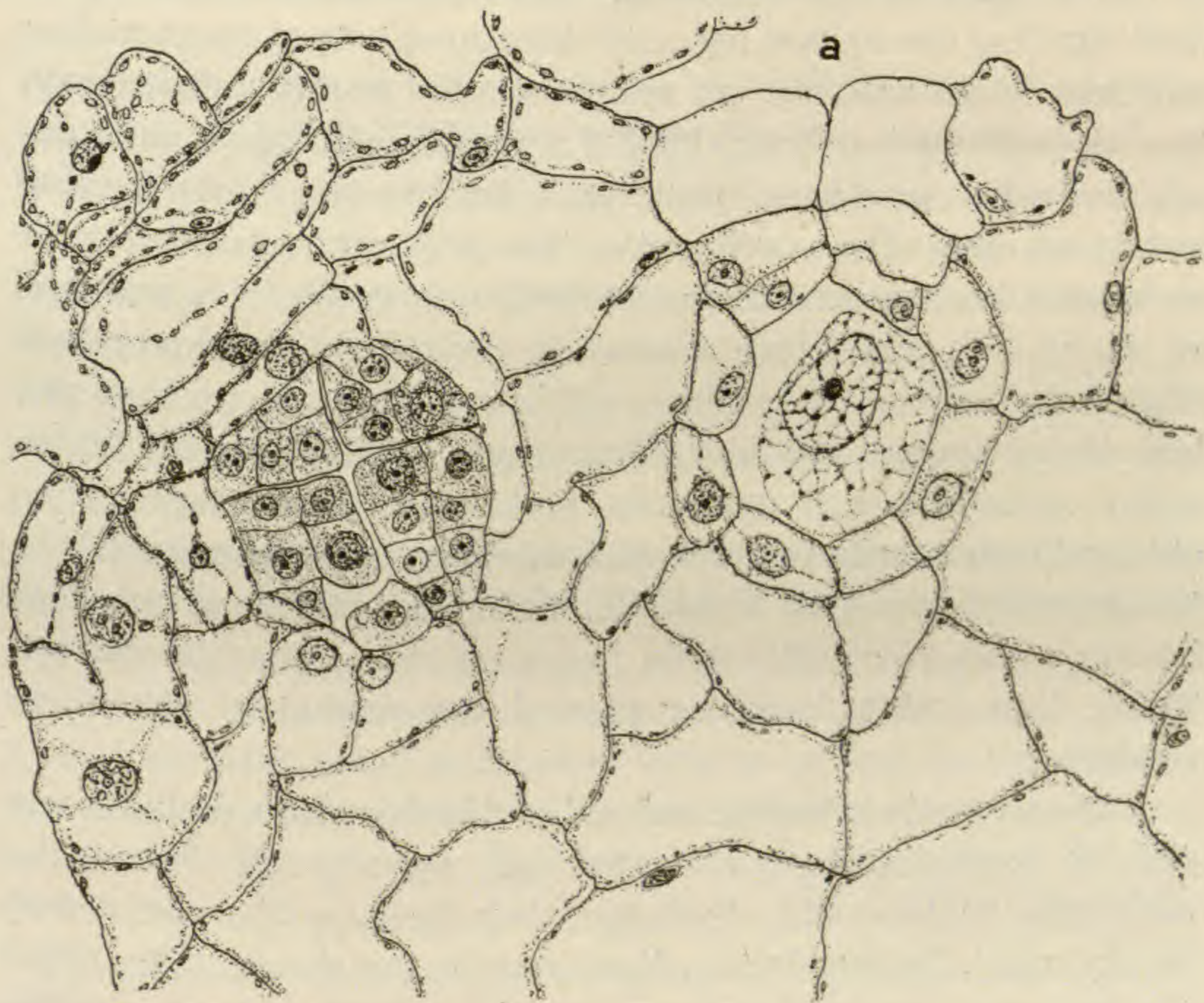

FIG. 3.—*E. laevigatum* (vertical section): at left young antheridium; at right archegonium with egg; below *a* neck cells cut obliquely;  $\times 380$ .

In the smaller lobe only two cells from a young antheridium is the neck (*a*) of an archegonium, whose venter containing a mature egg is shown in a deeper section, fig. 13 below *a*. Fig. 14 shows a vertical section of an archegonium containing a young sporophyte. Fig. 15 is a vertical section showing two mature antheridia at the left. Directly below *a* and *a* are the necks of two old archegonia that have failed to be fertilized. In fig. 16 above is a mature antheridium and a very young one. At the extreme left (*B*) and

also to the right (*B*) of the lobe bearing the antheridia are old antheridia whose outer walls have broken away. Some sperm cells are still present. At the extreme right below *a* is one of the four neck cells of an old archegonium whose venter has become brown with age. This same method of antheridial dehiscence is shown in fig. 19*B*.

On the peripheral meristem young archegonia or antheridia or both (figs. 8, 9, 12-19, text figs. 2, 3) develop so long as the meristem continues its growth, but are not distributed in any definite way. In some individuals only one kind of sex organ will appear throughout the entire periphery, while on others certain lobes develop archegonia and others antheridia. On still other gametophytes archegonia and antheridia occur together (text figs. 2, 3 and figs. 12, 13, 15, 17), mixed indiscriminately around the entire meristem ring on the various thallus lobes. One gametophyte, for example, bore eleven sporophytes in various stages of development, fifteen active antheridia, and numerous archegonia in all stages, from old functionless ones to those still in stages of development. In the gametophytes from Tekamah, Nebraska, of the 30 per cent bearing young active antheridia 70 per cent also bore sporophytes. Those from other localities showed approximately the same condition.

Old ruptured antheridia and old archegonia show within a few cells of young active sex organs (figs. 15, 16, 17). When the antheridia mature and discharge their sperms, the outer wall breaks away, leaving but a slight scar in the tissue. The other tissues may or may not push up over this. In the former case the walls of the antheridium collapse and show as a brown line between the vegetative cells; in the latter case the scar is only a ragged break in the periphery (figs. 16, 19). These are recognized with difficulty, which no doubt accounts for the apparent absence of old antheridia on some of the thalli. On many bearing only archegonia, however, it was possible to identify definitely the scars of old antheridia. There were a few actively growing individuals on which antheridia were not definitely located. In the case of gametophytes bearing large or numerous sporophytes, the tissue was so shrunken and broken down that it was often difficult to identify old arche-

gonia, which are usually conspicuous, and in such cases no traces of antheridia could be found.

In general it seems that the thallus continues to grow, forming new sex organs until sporophytes have developed to such an extent that the tissues are exhausted. If a sporophyte starts when the thallus is small, one rarely finds young sex organs developing later. If, however, fertilization does not occur, the archegonia dry up and new ones, and often antheridia also, are formed until fertilization is accomplished. If the thallus has attained considerable size before any fertilization occurs, a large number of sporophytes may be supported by it without injury, and in such cases the development of sex organs may continue until many archegonia have been formed and fertilized, and until the sporophytes are well advanced. The sporophytes invariably occur near the periphery, as shown in figs. 4, 7, 9, 10, and 11 of the thallus, while old functionless archegonia often show between the branches entirely across the surface.

The younger sporophytes are nearer the edge of the disk, and the active archegonia and antheridia are in the peripheral meristem (figs. 8, 9, 12-19, and text figs. 2, 3). Eleven sporophytes in early stages have been seen on one gametophyte, but not more than seven have been found sufficiently large to be seen by the unaided eye. In a few cases dead young sporophytes were observed, but in the majority of cases they looked in good condition. As the growing season was nearing its close, however, it is hardly probable that sporophytes not yet having secured a foothold in the ground could mature.

BISCHOFF, according to BUCHTIEN (1), reported finding monoecious gametophytes of *E. sylvaticum* bearing archegonia on their older parts and antheridia on the younger parts, and stated that monoecious gametophytes are not so rare as commonly believed. He found them occasionally in all his cultures. He also found the gametophytes of *E. sylvaticum* to be largely male, but many bore archegonia, and among these a comparatively large percentage bore antheridia also. He considered that the antheridia were formed after archegonia ceased to develop, but some bore them on different parts of the spreading meristem at the same time.

KASHYAP (7, 8), however, describes for *E. debile* much the condition found in these gametophytes of *E. laevigatum*, except that he rarely found antheridia occurring on gametophytes bearing sporophytes. Evidently the gametophytes examined by BUCHTIEN and KASHYAP very closely resembled those of *E. laevigatum* under consideration.

### Sex organs

Archegonia (figs. 8, 13, 14) were present in all stages of development and agree closely with those described by BUCHTIEN (1), SADEBECK (9), CAMPBELL (2), HOFMEISTER (5), GOEBEL (3), and others. The only point of disagreement as to the archegonia of *Equisetum* appears in connection with the neck canal cells. In *E. laevigatum* the condition does not seem uniform. In many cases there is evidently only one neck canal cell. In a few archegonia, however, the vertical division had occurred and given rise to the two characteristic boot-shaped cells. The archegonial initial appears at any point on the peripheral meristem, not always on the under side, but in all cases the archegonia are pushed to the upper surface by the growth of the meristem below (figs. 8, 14). Branches usually develop at each side of an archegonium (fig. 14), so that when mature it lies between two branches.

Antheridia in large numbers also were present in all stages. They showed but one type of development, that characteristic of eusporangiate ferns. In the examination of more than fifty gametophytes in paraffin sections, only half a dozen antheridia were found on the upright branches. These (fig. 18), however, were not at the tip of the branch, but showed definitely the same development as others, which were developed in the massive meristem at the periphery of the thallus (figs. 9, 12, 13, 15-17). It is interesting to note that BUCHTIEN (1) considers even the antheridia developing at the tips of branches to be of the eusporangiate type. He says it seems that the antheridia at the tip of a filament and those in a cell mass develop differently, but it is only an apparent difference. In a filament there are no suitable conditions for antheridial development, so three vertical walls cut out surrounding cells which take the place of a thallus mass. Then the real antheridial initial is not the end cell of the filament, but the tetrahedral cell surrounded

by the three cells. This cell divides transversely and forms an antheridium exactly as is the case in the antheridia produced in the tissue. This is an interesting interpretation of the development of antheridia at the tip of a slender branch. As no such antheridia were found in these wild gametophytes, however, it does not apply to this case. The antheridia open by the disorganization of the entire outer wall as previously mentioned. In *E. laevigatum*, as was found by KASHYAP (7) to be the case in *E. debile*, antheridia often occur between the upright branches in exactly the position characteristic for archegonia. Figs. 12, 15, 17, and 19 show the beginning of these branches between antheridia.

### Embryo

Embryo sporophytes in all stages, from a few cells to those with the third shoot an inch long, were abundant in most of the collections. The development was entirely characteristic of that commonly described for the group (JEFFREY 6, and others) (figs. 9, 11, and text fig. 1). The number of leaves on the primary shoot varies from three to four, and on the second shoot from four to five. Fig. 14 shows a very young sporophyte at about the 16-cell stage. In fig. 17 and text fig. 2 the sporophyte is still larger, while in fig. 9 the sporophyte shows all the body regions well organized. Fig. 11, a section of the plant shown at the right in text fig. 1, shows the primary branch well developed, with its first whorl of four leaves at the base. Its root emerges from the ventral side of the thallus. In text fig. 1 (at the right) part of the periphery of the thallus was cut away at *A*, where the cut surface shows. At the left of the gametophyte to the right in text fig. 1 and at the right of fig. 11 is the second shoot with several whorls of leaves and with its root emerging below. In this specimen the leaves on the second shoot were four in a whorl, the same as on the first shoot. In fig. 11 the bud for a third shoot shows at *B*. In text fig. 1 the sporophytes also show four leaves on the first shoot. This, however, was not universally true, many showing but three leaves (figs. 4, 7, 10). The roots for these shoots were well developed and deeply buried in the soil. Plants transferred to pots in the greenhouse are still growing vigorously (March 1).



### Culture method

In connection with the study of the wild gametophytes, spores were planted in flats in the greenhouse and studies of young gametophytes and their development are under way. For a number of years gametophytes of *E. arvense* have been grown with considerable success. Each year sporophytes have lived until the primary shoot was a couple of inches tall, and in some cases the secondary shoot has developed. Because of this the same culture method was tried with *E. laevigatum*. The method used was as follows. An ordinary greenhouse flat was filled with sifted soil, a mixture of loam and sand being used. The soil was then smoothed and pressed down until a firm hard surface was formed an inch or more below the top of the flat. This was then flooded with water and allowed to stand until the water sank into the soil. Just as the water sank to the top of the soil the spores were shaken from the cones on to the soil. This was done by tapping the cone hard enough to shake the spores from the sporangia. The flat was then covered with a piece of glass and set in a sunny room of the greenhouse. Usually no more water was needed until the gametophytes were 1 mm. or more in diameter. If, however, the flats became too dry, they were watered by holding them in a tank of water until the soil became wet from below. After the gametophytes were 1 mm. in diameter they were sprinkled with an ordinary garden sprinkler. No attempt was made to sterilize the soil, nor were any special methods of watering used.

Flats of *E. laevigatum* planted in this manner in the middle of June grew well and developed archegonia and antheridia until the first of September. During the writer's absence of two weeks the greenhouse attendants changed and the flats were permitted to dry up. All were killed except one flat, in which sifted cinders from a railroad track were used instead of the usual soil. This flat survived the drought, and during the middle of September was full of sporophytes. Slugs ate these off as fast as they grew, however, so that none reached a height of more than a few millimeters. The gametophytes continued to grow, however, and new sporophytes developed only to meet the same fate. As winter approached the growth became slower and new sex organs did not

appear. Many gametophytes died, while others continued a sluggish growth. They are still alive (March 1) and show some growth, although on the whole no increase in size is observable.

By this same method spores of *E. arvense*, *E. telmateia*, and *E. robustum* sent from western Oregon, and of *E. arvense* from Chicago were also grown. These spores were planted about a week after gathering, and all grew well. *E. arvense* and *E. telmateia* developed sporophytes freely, but *E. robustum* never developed sporophytes, although the thalli lived until September 1 and attained a diameter of nearly 1 cm. before they died.

The fact that these spores grew well led the writer to plan some experiments in order to test the vitality of spores. Cones were taken when so green that the spores would not leave the sporangia. The cones were crushed and sprinkled on the soil. Others were planted when the spores were just ripe. Still others were kept in the laboratory in an open box for nine days. The cones were so dry they could be pulverized between the fingers when they were planted. In all cases equally abundant germination was observed, but the older the spores the longer the period before germination took place. Spores from green cones produced gametophytes of two and three cells during the first twenty-four hours, while gametophytes from spores dried for nine days required a week or more to reach the same stage. After being started they also developed more slowly. This agrees with BUCHTIEN'S results. He found that after fifteen days germination decreased greatly, and after twenty-one days only about 1 per cent germinated, and the growth was much slower. Studies of these gametophytes and their development are in progress, and the results will be given in another paper.

### Summary

The investigation of large numbers of gametophytes of *E. laevigatum* found growing in their native habitat yielded results which may be summarized as follows:

1. The gametophytes are all of one kind.
2. They consist of a flat circular disk 1-10 mm. in diameter bearing numerous upright green branches on their upper surface,

and surrounded by a band of meristem which continues the growth of the thallus and produces archegonia and antheridia.

3. The gametophytes are typically monoecious. All bear archegonia and many antheridia also. Antheridia and archegonia occur without order on the thalli and often within a few cells of each other and of sporophytes.

4. Antheridia and archegonia may continue to develop until one or more sporophytes have attained considerable size.

5. Antheridia all develop as is characteristic of eusporangiate ferns, whether in a massive tissue or on a slender branch.

6. Archegonia develop as is characteristic of the group.

7. Sporophyte development is in agreement with common descriptions. The leaves of the first shoot are three or four in number, of the second shoot four or five.

8. Gametophytes grow to maturity under simple methods of culture.

The writer is indebted to Professor CHARLES J. CHAMBERLAIN for his interest and helpful suggestions during the progress of these studies, and for spores for culture growth; also to Mr. C. T. WALKER for spores sent from western Oregon, to Professor T. J. FITZPATRICK for the identification of sporophytes and for the careful reading of manuscript and proof, and to Mr. GEORGE SWALE, without whose efficient care of the greenhouse and cultures the experiments could not have been carried out.

UNIVERSITY OF NEBRASKA  
LINCOLN, NEB.

#### LITERATURE CITED

1. BUCHTIEN, OTTO, Entwicklungsgeschichte des Prothallium von *Equisetum*. Bibliotheca Botanica 8. 1887.
2. CAMPBELL, D. H., The structure and development of mosses and ferns (Archegoniatae). New York. 1895.
3. GOEBEL, K., Organography of plants. Transl. by I. B. BALFOUR. Oxford. 1900.
4. FITZPATRICK, T. J., The fern flora of Nebraska. Amer. Fern Jour. 10:6-15, 34-44. 1920.
5. HOFMEISTER, W., The higher Cryptogamia. Ray Soc. transl. by F. CURREY. 1862.

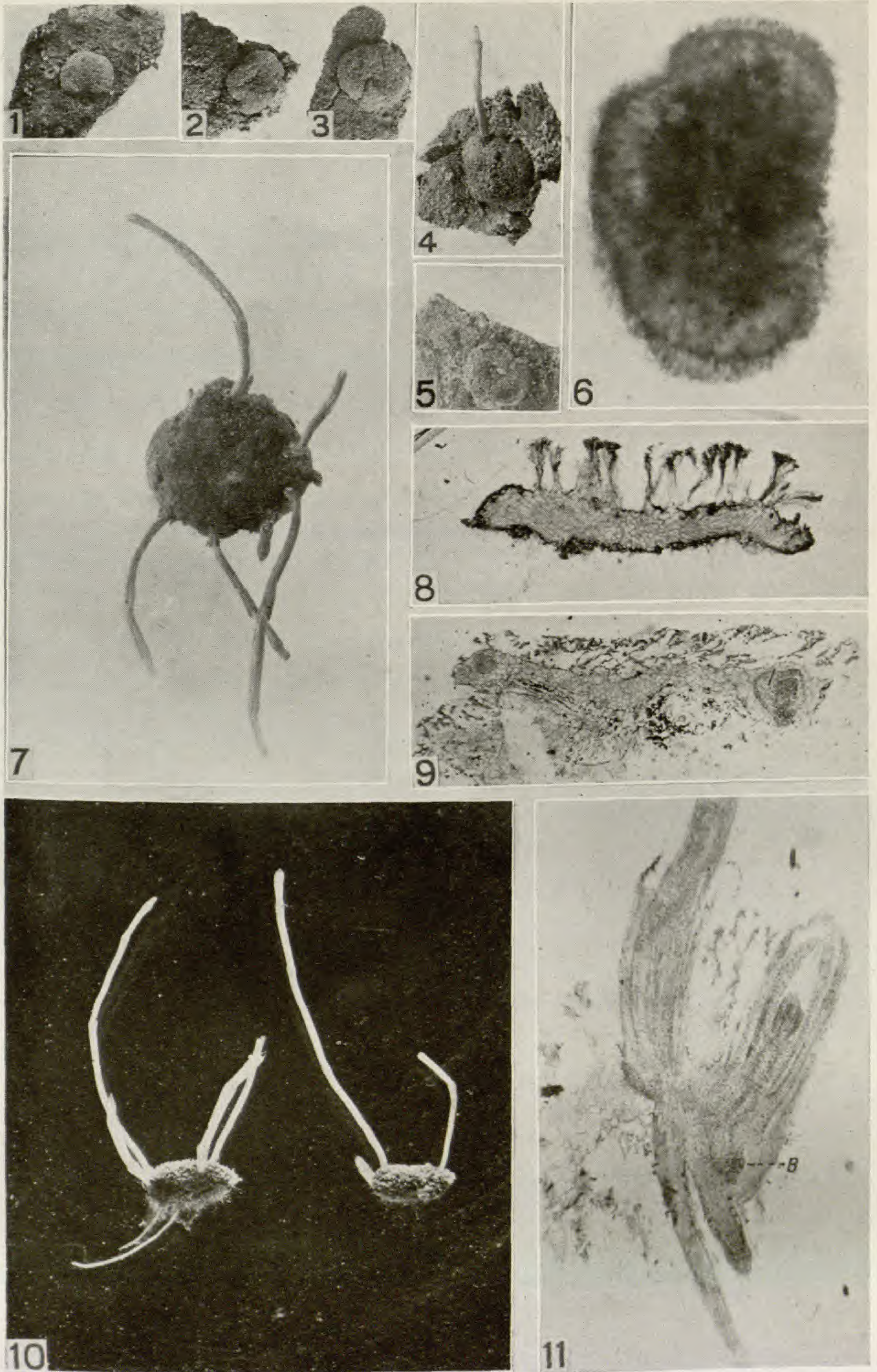

WALKER on EQUISETUM

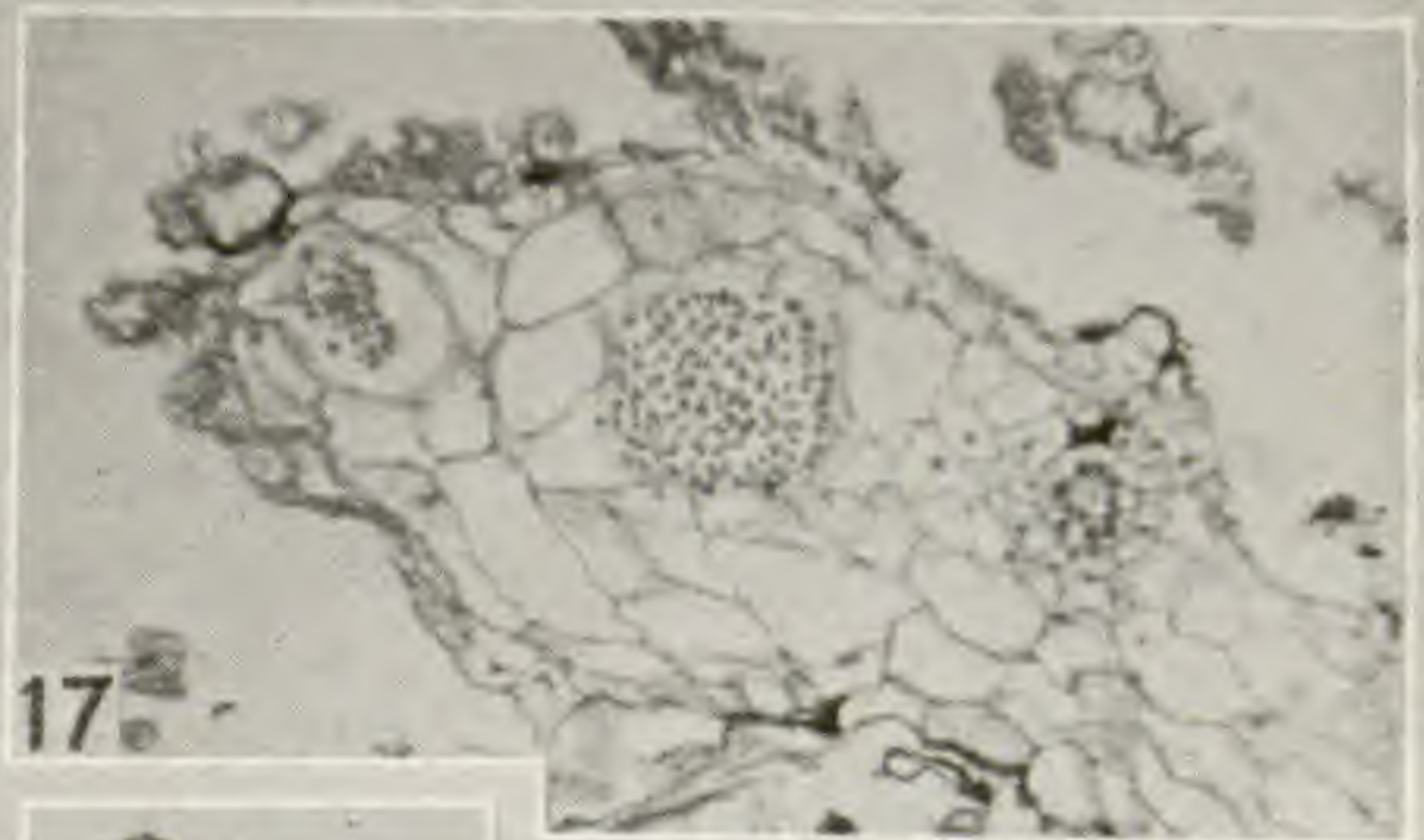
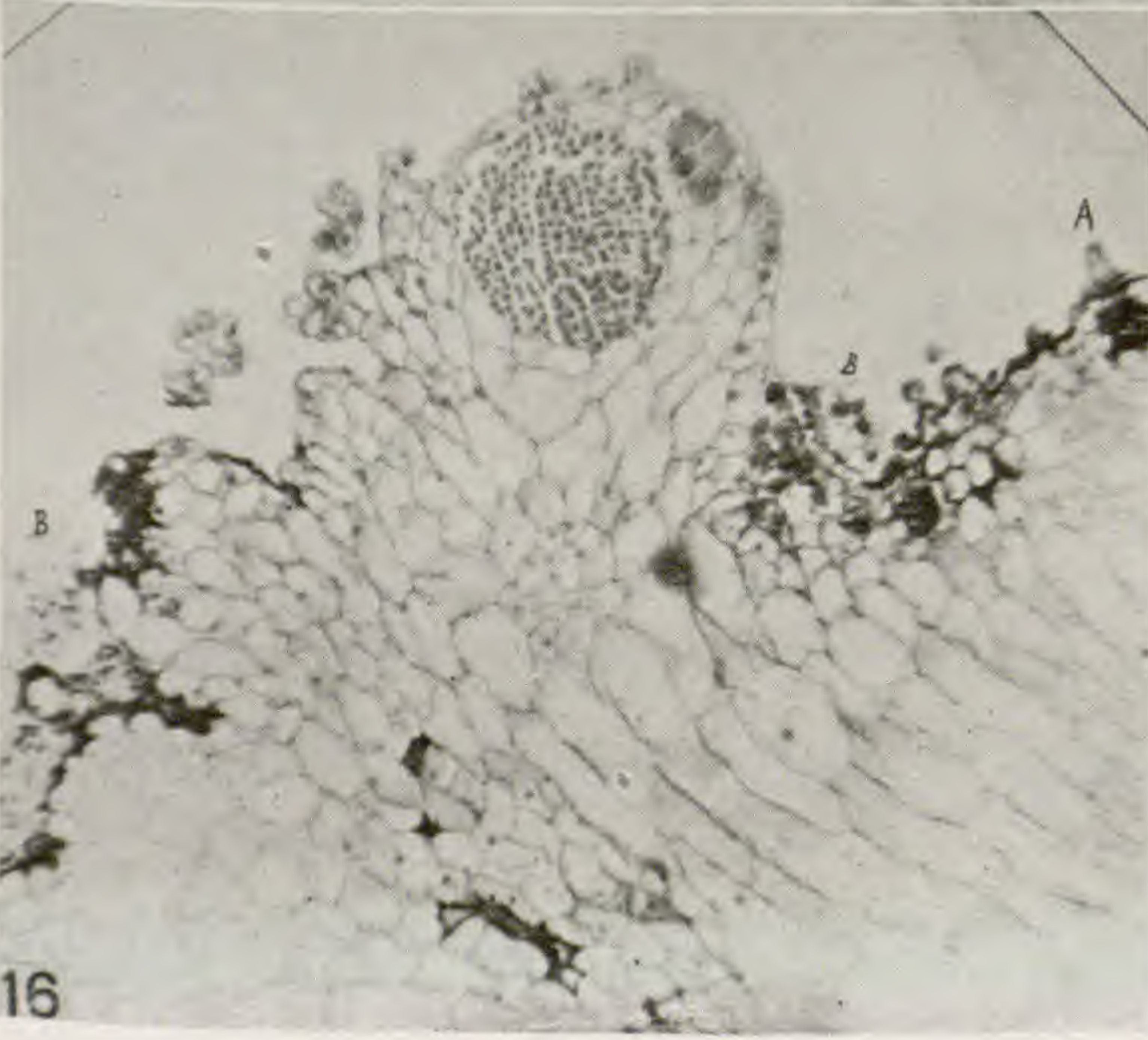
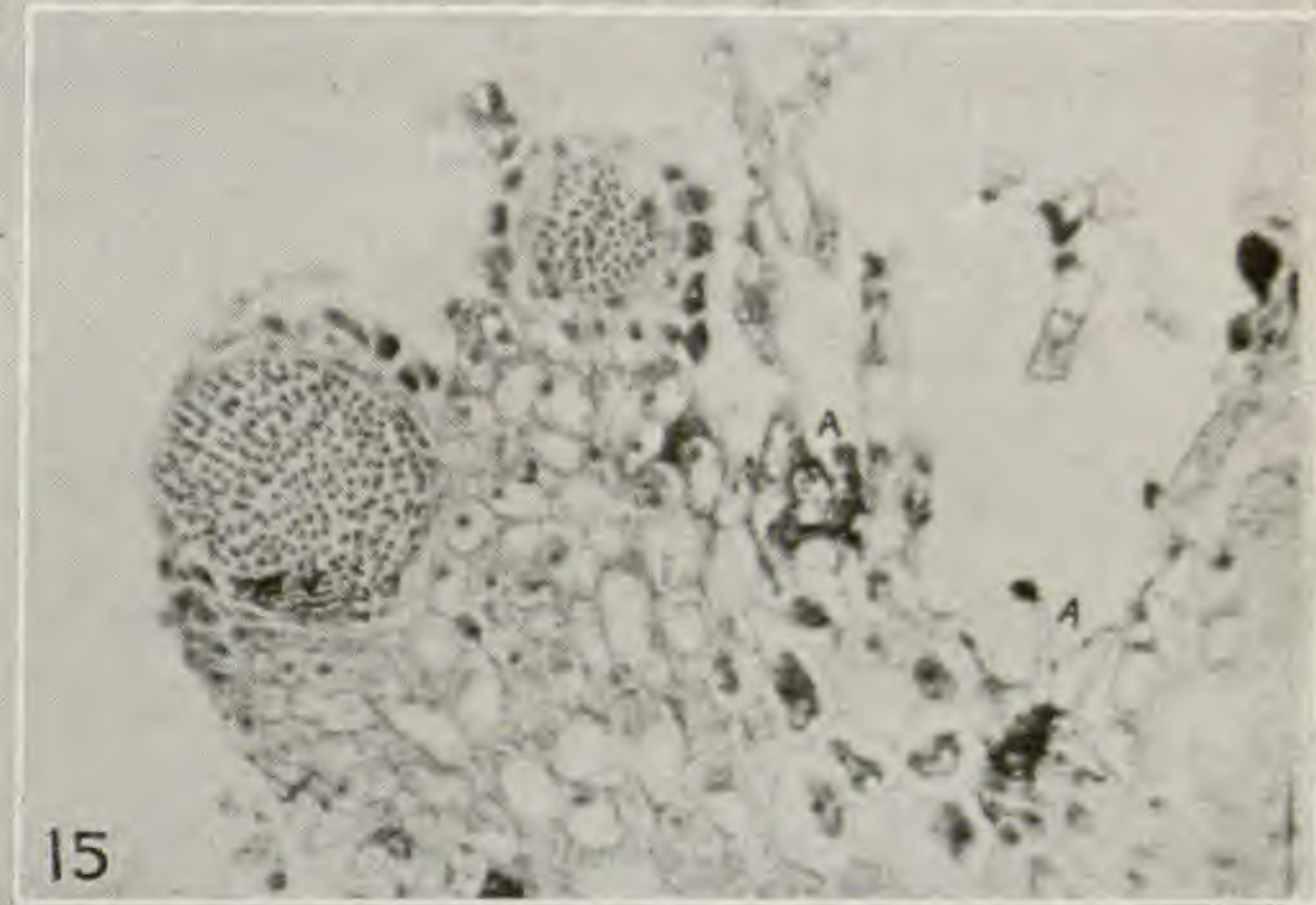
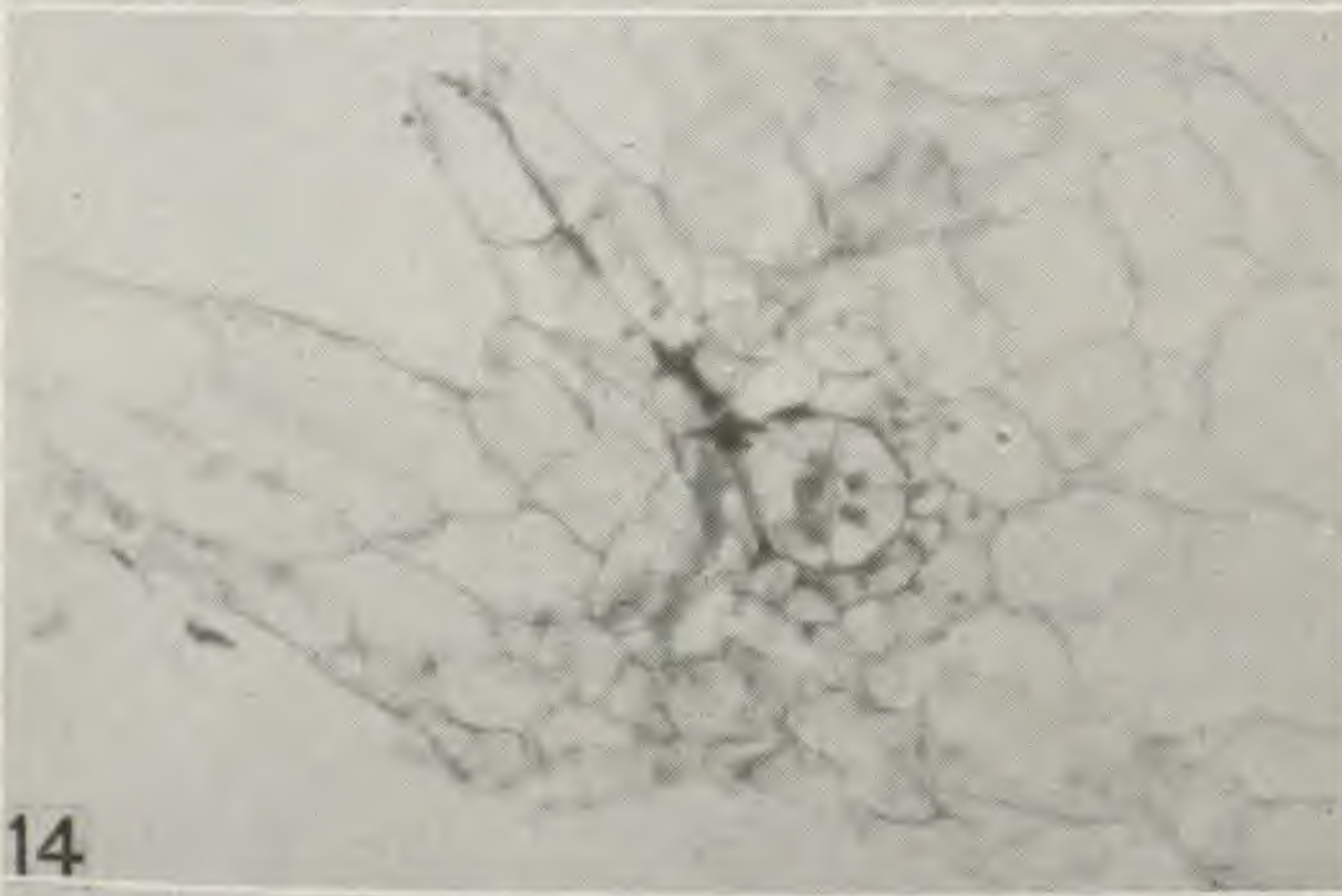
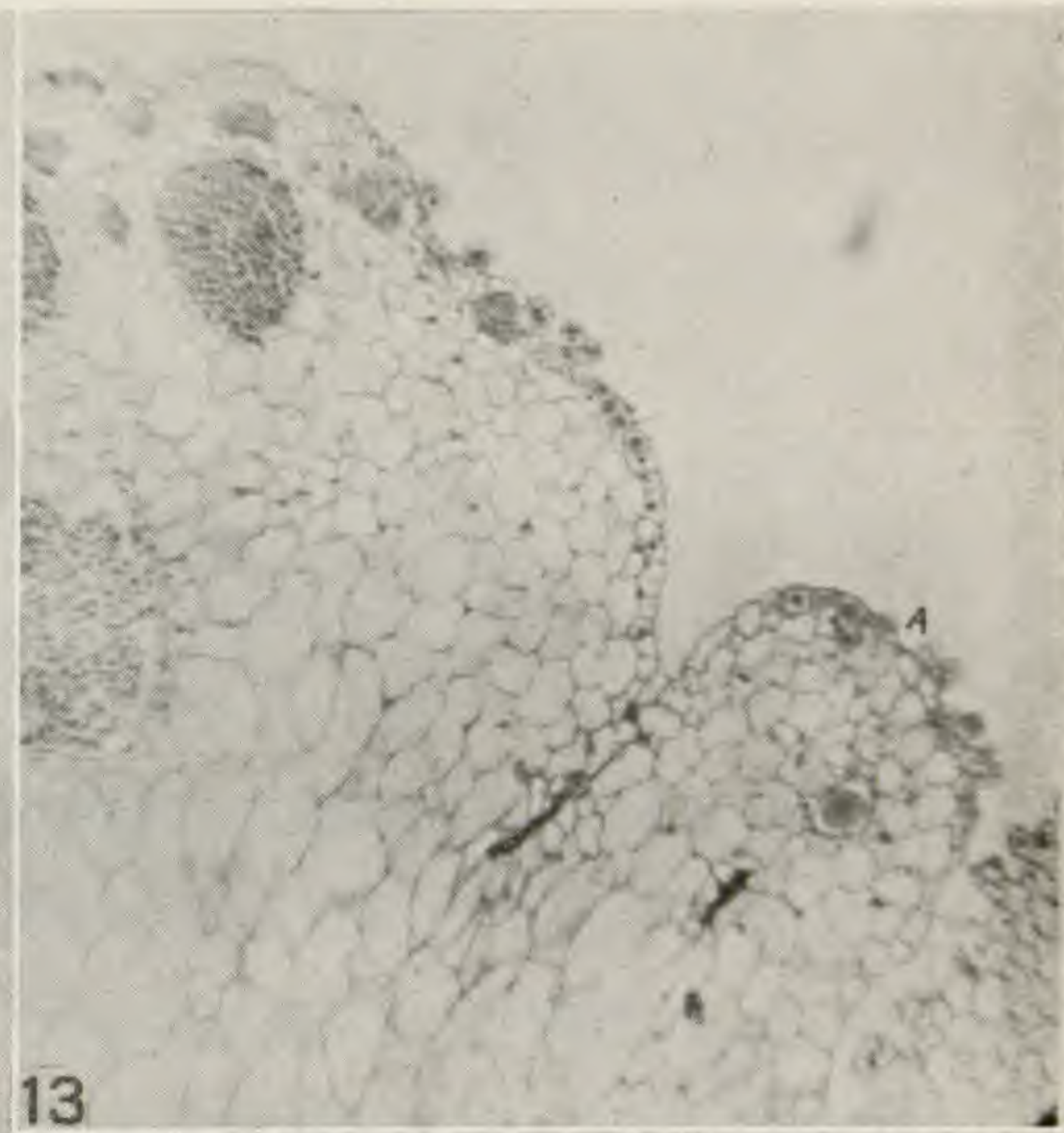
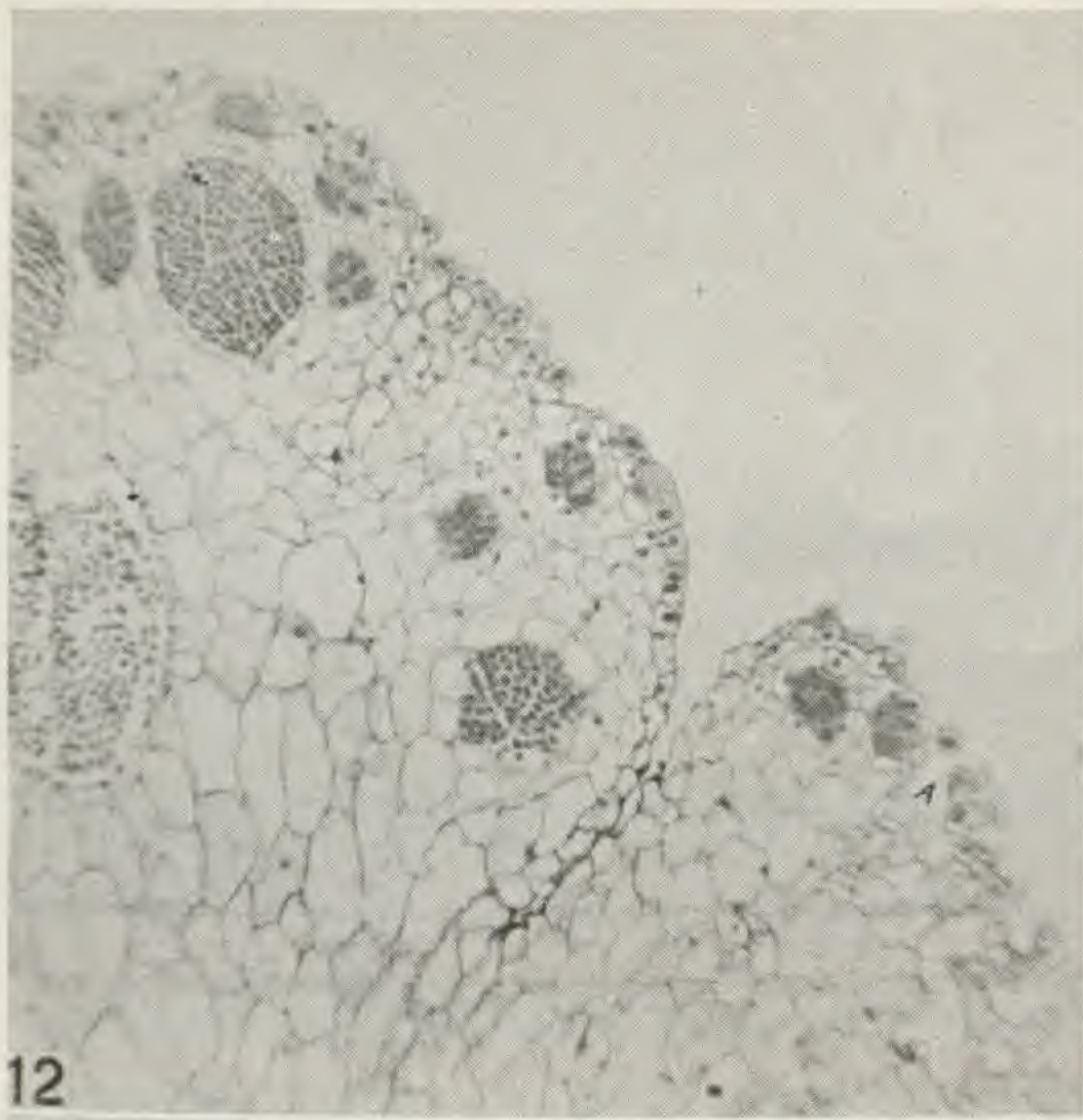

WALKER on EQUISETUM

6. JEFFREY, E. C., The development, structure, and affinities of the genus *Equisetum*. Mem. Boston Soc. Nat. Hist. 5: no. 5. 1899.
7. KASHYAP, SHIV RAM, The structure and development of the prothallus of *Equisetum debile* Roxb. Ann. Botany 28: 163-181. 1914.
8. ———, Notes on *Equisetum debile* Roxb. Ann. Botany 31: 439-445. 1917.
9. SADEBECK, R., Die Entwicklung des Keimes der Schachtelhalme. Jahrb. Wiss. Bot. 11: 575. 1878.

## EXPLANATION OF PLATES XXIII, XXIV

## PLATE XXIII

FIGS. 1-5.—Gametophytes attached to soil;  $\times 2$ .

FIG. 6.—Under side of gametophyte in fig. 1 showing peripheral meristem, cleared in glycerine;  $\times 11$ .

FIG. 7.—Gametophyte with five sporophytes at periphery;  $\times 2$ .

FIG. 8.—Freehand vertical section of gametophyte showing massive parenchyma with upright branches and peripheral meristem bearing archegonia;  $\times 12$ .

FIG. 9.—Vertical section of gametophyte showing two antheridia and one sporophyte;  $\times 12$ .

FIG. 10.—Two gametophytes with soil removed (photographed under water);  $\times 2$ .

FIG. 11.—Part of vertical section of gametophyte with sporophyte shown in text fig. 1 at right;  $\times 18$ .

## PLATE XXIV

FIGS. 12, 13.—Parts of horizontal section through peripheral meristem showing twelve antheridia and one archegonium;  $\times 50$ .

FIG. 14.—Vertical section of archegonium with young sporophyte in venter;  $\times 120$ .

FIG. 15.—Vertical section showing at left two antheridia; at right (*A, A*) necks of two old archegonia;  $\times 50$ .

FIG. 16.—Horizontal section; above two antheridia intact; to their right and left (*B*) old ruptured antheridia; at extreme right (*A*) an old archegonium;  $\times 50$ .

FIG. 17.—Vertical section showing two antheridia and archegonium containing young sporophyte;  $\times 50$ .

FIG. 18.—Vertical section of upright branch with antheridium below tip;  $\times 80$ .

FIG. 19.—Horizontal section; upper of three antheridia ruptured;  $\times 60$ .

# COMPARISON OF DEVELOPMENT IN DODDER AND MORNING GLORY<sup>1</sup>

GERTRUDE ELIZABETH MACPHERSON

(WITH PLATES XXV-XXVII)

The embryo of *Cuscuta Gronovii* Willd. is described in BRITTON and BROWN'S *Flora of the Northern United States and Canada* as follows: "Embryo linear, terete, curved or spiral, its apex bearing 1-4 minute scales; endosperm fleshy, cotyledons none." The purpose of this study was to determine whether there might not be at least a trace of cotyledonary development. In examining embryos of *Cuscuta*, which is a parasite, for indications of a rudimentary development of cotyledons, it seemed desirable to make a comparison with some non-parasitic species of the same family, and *Convolvulus sepium* L. was selected for this purpose.

By far the larger number of previous studies of *Cuscuta* have been concerned with the physiology of the plant, its host relationships, or geographical distribution, and few with the life history and morphology.<sup>2</sup> Miss HOOKER mentions the presence of scales on the inner and outer surface of the curve of the coiled embryo, but states that their position does not justify considering them cotyledons. The remainder of her paper discusses the habits of growth of *Cuscuta Gronovii*. COULTER and CHAMBERLAIN,<sup>3</sup> in discussing the endosperm, remark that, contrary to the usual course of development in parasites, the endosperm of *Cuscuta* is formed by free nuclear division, and later in treating of the types of embryos in Angiosperms they state that the embryo of *Cuscuta* is also an exception to the morphology of parasites in that it is large and well developed. These are the only important references to the embryo of *Cuscuta* that have come to the writer's attention.

<sup>1</sup> Paper no. 14 of the technical series, New Jersey Agricultural Experiment Station, department of plant pathology.

<sup>2</sup> HOOKER, HENRIETTA E., On *Cuscuta Gronovii*. BOT. GAZ. 14:31-37. 1899.

<sup>3</sup> COULTER, J. M., and CHAMBERLAIN, C. J., Morphology of angiosperms. Chicago. 1903 (pp. 174, 176).

The material was collected in September. The *Cuscuta* material was killed, part in a chromo-acetic solution and part in a picro-acetic solution, and the germinated seeds in a fixing solution consisting of 60 cc. of 95 per cent alcohol, 35 cc. of water, 5 cc. of formaldehyde, and 2 cc. of glacial acetic acid. All the *Convolvulus* material was killed in this latter fixing solution. The *Cuscuta* and *Convolvulus* were treated in the usual way and imbedded in paraffine, sectioned, and stained, some in haematoxylin, some in haematoxylin and eosin, and the larger part in iron-alum haematoxylin. The sections of *Cuscuta* were cut about 25  $\mu$  in thickness and those of *Convolvulus* about 10  $\mu$  in thickness.

The ovule in both species is anatropous (figs. 1, 20). The development of the embryo sac up to and including the 8-celled stage both for *Cuscuta* and *Convolvulus* follows the usual method. In the 2-celled stage of the embryo sac of *Cuscuta Gronovii* (fig. 2) there is a dense mass of protoplasm lying between and surrounding the two nuclei which are located at the ends of the sac. In the 4-celled stage (fig. 3) the sac is much larger and the protoplasm less dense. In the 8-celled stage (fig. 4) the sac is somewhat larger, and the protoplasm is most abundant immediately surrounding the polar nuclei. The synergids and egg are large, prominent, and somewhat irregular, but conform to the usual type. The antipodals are much smaller, but very distinct and well defined. The polars are oval, intermediate in size between those of the egg apparatus and the antipodals, and vacuolate. At this time the cells of the nucellus show the presence of a large quantity of starch grains (fig. 4), which, on account of their taking the stain so much more readily, render the nucellus very conspicuous. The cells of the nucellus are rich in starch, and those immediately surrounding the embryo sac show indications of rapid disintegration, accompanying the enlargement of the sac.

As previously stated, COULTER and CHAMBERLAIN describe the endosperm of *Cuscuta* as arising by free nuclear divisions and not by continuation of the process of cell division, with the formation of walls. This is contrary to the usual course of development of the endosperm in saprophytic and parasitic dicotyledonous



species. In most saprophytic and parasitic dicotyledonous plants the first division of the endosperm nucleus is accompanied by the formation of a wall which divides the sac into two chambers; but this is not true in *Cuscuta Gronovii*. The endosperm at all times is rather scanty, and this is especially true in the mature seed. The cells of the endosperm are elongated, with more or less elliptical nuclei, and are most frequently seen clustered around the embryo, rather than lining the sac as in *Piper medium*, *Potamogeton* sp., etc. (figs. 18, 19).

The youngest embryo observed in *Cuscuta* was a 2-celled stage (fig. 5). It was spherical, and the basal cell was larger than the apical cell, both cells showing large, well defined nuclei. The two cells were evidently formed by transverse division of the fertilized egg. The later stages (figs. 5-7) appear to be the result of division in a number of planes and in no fixed order, resulting in embryos of irregular forms. The most usual form is an elongated type with a swollen base (fig. 8), having a suspensor of one cell, or no suspensor. There is a spherical type (figs. 9, 10) which is much less common. In later stages of development both spherical and elongated forms are found, in some cases with a 2-celled suspensor (figs. 11, 12), but more often with none. In neither spherical nor elongated forms is there any differentiation into dermatogen, nor later is there any indication of plerome or periblem. In some of the embryos where the shape is rather urnlike, the swollen base is formed by lateral enlargements (figs. 13, 14), but these cannot be an indication of cotyledons, for the cells of which they are formed are not differentiated in any manner from the rest of the embryonic tissue. Both the spherical and urnlike embryos continue to elongate (fig. 15) without any trace of differentiation, and finally form a long coiled embryo (fig. 16), large and well developed, and consisting of about two spirals, lying in the rather scant endosperm of the mature seed. The embryo of the mature seed bears two small scales near the apex (fig. 17*a* and *b*), one on the inner surface of the coil and the other slightly below this on the outer surface. Neither of these scales, however, from their relation to the other parts of the embryo, can be considered as cotyledons.

The stages in the embryo sac of *Convolvulus* are virtually the same, but smaller than in *Cuscuta Gronovii* (fig. 21). In the 8-celled stage the protoplasm is more dense than that occupying a similar position in the 8-celled sac of *Cuscuta Gronovii*. The synergids and egg do not differ much in size as in *Cuscuta*. The polar nuclei and antipodals are of similar appearance, but the polar nuclei usually stand out more prominently than the other nuclei. Here also the nucellar cells show evidence of degenerating rapidly. Starch grains are present in these cells, but not in the quantities in which they are found in *Cuscuta*.

The difference in the position of the nuclei in the sac is the most noticeable feature. In *Cuscuta* the nuclei extend from one end of the sac to the other, with protoplasmic connections between, while in *Convolvulus* the nuclei are gathered nearer the micropylar end of the sac, where the protoplasm is aggregated. The first division of the fertilized egg in *Convolvulus sepium* was transverse (figs. 22*b*, 23), and resulted in the formation of an embryo very similar to that of *Cuscuta Gronovii*. The 4- and 8-celled stages (figs. 24, 25) were elongated and somewhat irregular in form, and much the same as in *Cuscuta*, but never exhibited the pronounced urnlike form. In stages of more than eight cells the embryo of *Convolvulus* is spherical (figs. 27, 29) in form, with a rather pronounced dermatogen in the majority of cases (figs. 28, 29). The embryo continues its growth until in the mature seed it appears surrounded by scant endosperm, the two large cotyledons folded around the hypocotyl (fig. 30). No stages of the embryo intermediate between those of the period of development of fig. 29 and the mature seeds were studied, but these indicate that the differentiation into tissues must have been in accord with the stages of normal embryonic development. In these advanced stages there is a very large suspensor (fig. 27) consisting of large, very vacuolated, uninucleate cells, which completely fill the micropylar end of the sac and force the embryo well out into the sac. The enormous development of the suspensor is much more rapid than that of the rest of the embryo, from which its separation is not always definite. There is also more endosperm than in the corresponding stage of *Cuscuta*. The endosperm forms

more of a lining for the sac than in *Cuscuta*, and is also associated with abundant perisperm in a number of cases (figs. 26, 31). The entrance of the pollen tube through the micropyle can easily be traced in *Convolvulus*, although it is not apparent in *Cuscuta*. The pollen tube remains in *Convolvulus* (fig. 32a and b) as late as the 4-celled stage of the embryo or later, apparently without being ruptured. The actual fusion of the tube and egg nucleus was not observed.

One of the striking points about the embryo of *Convolvulus* is the frequent occurrence of polyembryony. In *Cuscuta* not one case was observed, but in *Convolvulus* it soon became evident that polyembryony was not the exception to the rule, but a usual occurrence in the development of the embryo. Polyembryony may be observed from the earliest stages until quite a highly developed embryo is present. In one case several embryos were lying in the micropylar end of the sac, two of them consisting of two cells with a 1-celled embryo also present (fig. 22a and b), and 8-celled stages with one or more 1- or 2-celled embryos present were frequently observed (fig. 25), as were larger embryos that had the dermatogen developed (fig. 26). These extra embryos never developed at the antipodal end of the sac, and do not appear to be formed by the budding off from the fertilized egg. They seem rather to be formed from the synergids, or it may be that some of what appear to be 1-celled embryos are rather persistent synergids that have not developed any further and have not been absorbed. There may be some basis for assuming that polyembryony is the result of parthenogenesis.

### Summary

1. Except for the enlargements of undifferentiated tissue on the sides of some of the embryos of *Cuscuta*, there appears to be no cotyledonary development.
2. The development of a large vacuolate suspensor is typical of the older embryos of *Convolvulus*.
3. Polyembryony is the rule rather than the exception in the development of the embryos of *Convolvulus*.

4. Multiple embryos in *Convolvulus* seem to be developed from the synergids.

5. The endosperm in *Cuscuta* is scanty, and in both *Convolvulus* and *Cuscuta* is the result of free nuclear division.

The writer wishes to thank Dr. MEL. T. COOK for suggesting this problem, and for his interest and assistance throughout the course of the investigation.

RUTGERS COLLEGE  
NEW BRUNSWICK, N.J.

## EXPLANATION OF PLATES XXV-XXVII

### PLATE XXV

FIG. 1.—Longitudinal section of flower of *Cuscuta Gronovii*, showing position of ovule.

FIG. 2.—Longitudinal section of *Cuscuta Gronovii*, showing 2-nucleate stage of embryo sac.

FIG. 3.—Four-nucleate stage of embryo sac.

FIG. 4.—Eight-nucleate stage of embryo sac before mature organization, showing degenerating cells of nucellus, rendered prominent by presence of large number of starch grains.

FIG. 5.—Two-celled embryo.

FIG. 6.—Four-celled embryo with suspensor.

FIG. 7.—Eight-celled embryo, elongated type with swollen base.

FIG. 8.—Older embryos, same type as fig. 7.

FIG. 9.—Embryo of more spherical type.

FIG. 10.—Advanced embryo of elongated form.

FIG. 11.—Advanced embryo of spherical form with 2-celled suspensor.

FIG. 12.—Same type of embryo as fig. 11.

### PLATE XXVI

FIG. 13.—Advanced embryo of urnlike form.

FIG. 14.—Urnlike embryo slightly older than fig. 13.

FIG. 15.—Very advanced embryo, showing elongation not accompanied by differentiation of embryonic tissue.

FIG. 16.—Coiled embryo as found in mature seed.

FIG. 17.—Apex of embryo showing two scales (a); apex of embryo showing structure of scale (b).

FIG. 18.—Endosperm in *Cuscuta* surrounding embryo rather closely.

FIG. 19.—Perisperm sometimes seen accompanying endosperm in *Cuscuta*.

FIG. 20.—Longitudinal section of *Convolvulus sepium*, showing type of ovule.

FIG. 21.—Eight-nucleate stage of embryo sac.

PLATE XXVII

FIG. 22.—Sac showing polyembryonic condition, containing 1- and 2-celled embryos (*a*); 1- and 2-celled embryos (*b*).

FIG. 23.—Two-celled embryo.

FIG. 24.—Four-celled embryo.

FIG. 25.—Older embryo and smaller one.

FIG. 26.—Older embryo with several 1- and 2-celled embryos, accompanied by abundant perisperm.

FIG. 27.—Young spherical embryo with suspensor of many vacuolate cells.

FIG. 28.—Older embryo and suspensor.

FIG. 29.—Advanced embryo of spherical type.

FIG. 30.—Embryo as found in mature seed, showing cotyledons and hypocotyl.

FIG. 31.—Endosperm in *Convolvulus* lying next to nucellus rather than close to embryo.

FIG. 32.—Sac containing many-celled embryo, showing entrance of pollen tube and inflated tip, with no indications of rupturing (*a*); same view showing micropylar end of sac (*b*).

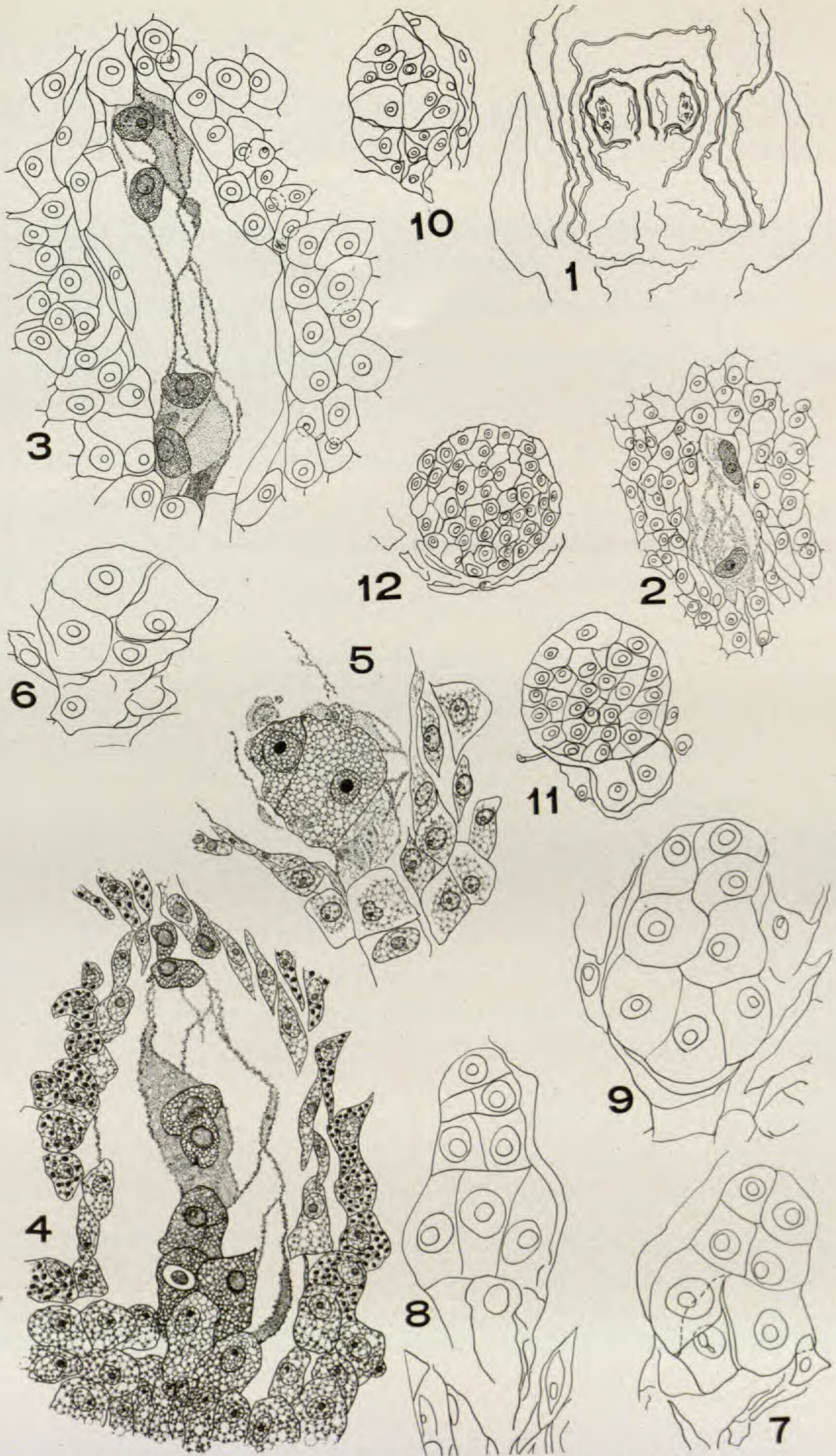

MACPHERSON on CUSCUTA and CONVOLVULUS

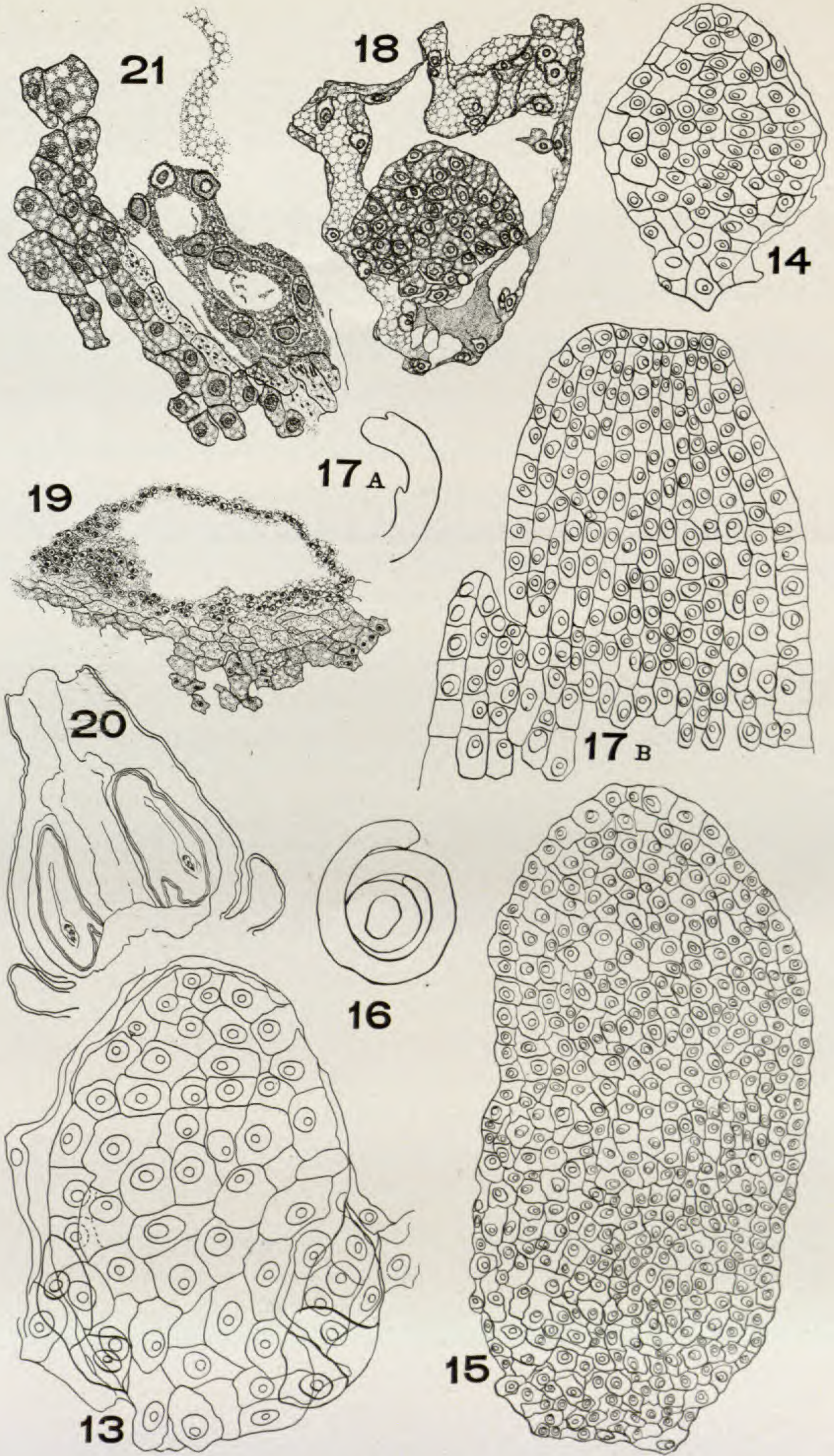

MACPHERSON on CUSCUTA and CONVULVULUS

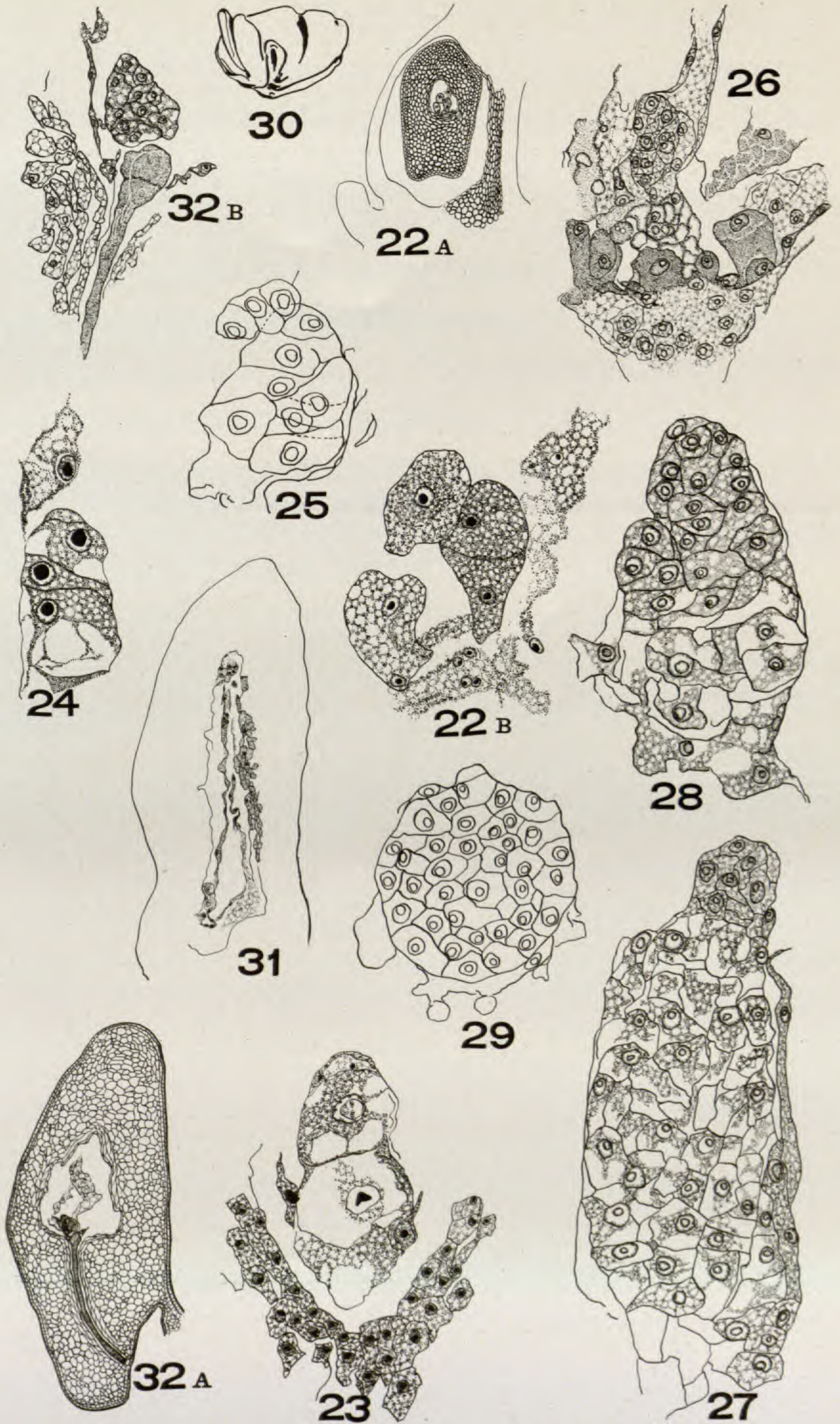

MACPHERSON on CUSCUTA and CONVOLVULUS



# BRIEFER ARTICLES

## SIMPLE DEVICE FOR WEIGHING SEEDS

(WITH ONE FIGURE)

In biological work it is often necessary to determine the weight of individual seeds. The use of the usual analytical balance is too slow if large quantities are to be weighed, and the spiral spring balances are often not delicate enough to weigh small seeds.

A glass scale can be made in a short time which is accurate and permits rapid work. A piece of glass tubing is heated over a Bunsen burner and drawn into a long rod. The rod should be about 1 or 1.5

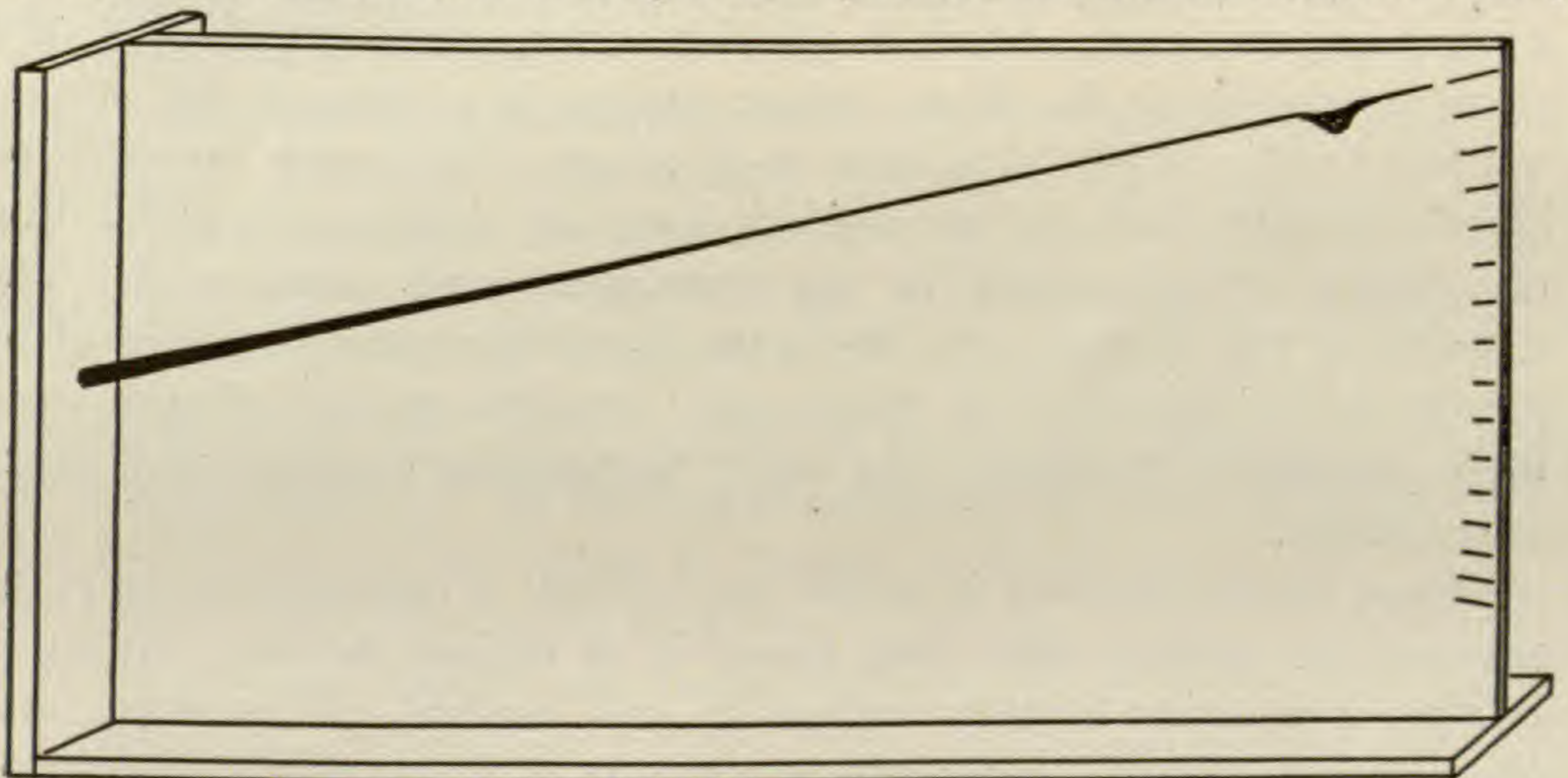

FIG. 1

mm. thick and 50 cm. long for weighing seeds of corn or beans. The tip of the rod should be bent and a paper tray glued on. A bristle or piece of fine wire attached to the tray serves as a pointer. The base of the rod is inserted in a hole bored in the upright base board. The scale is graduated by using the weights for the analytical balance (fig. 1). The writer has two scales on the same stand, one for beans and corn which is accurate to one centigram, and one for wheat and oats which is fairly accurate to one miligram.

If the forefinger of the left hand is placed under the tray while placing the grains on with a pair of forceps the pointer will come to rest almost immediately. With a little practice 300-400 seeds can be weighed per hour. Constant use for several weeks at a time does not seem to cause any loss in elasticity of the glass rod, but the scale should be checked occasionally.—KARL SAX, *Maine Agricultural Experiment Station, Orono, Maine.*

## USE OF CHLOROIODIDE OF ZINC IN PLANT HISTOLOGY

Chloroiodide of zinc has fallen more or less into disuse in the botanical laboratory, perhaps because of its apparent vicissitudes. Since it is unequaled in usefulness in histological work, however, it is advantageous to workers who still believe in the practicability of the old-fashioned hand-section razor to obtain a working knowledge of this reagent.

By the use of the "one solution" mixture (Behrens: 25g  $ZnCl_2$ , 8g KI, 1.5g I, 8cc water) negative results are often obtained, but when properly prepared and kept from deterioration, the solution may be used for a number of years. To insure uniform results, the two solution mixture, first suggested by NOVOPOKROWSKY, is recommended. Solution *A*, iodine potassium iodide 1:1:100; solution *B*, zinc chloride 2 parts, water 1 part. Stain in solution *A* for a few seconds and then transfer to solution *B*. Keep object moving in a drop of this second solution until a bright blue color is obtained. To hasten the reaction and to intensify the color it sometimes becomes necessary to add a drop of solution *A* subsequent to the treatment with solution *B*. The rapidity of the staining and the intensity of the color obtained often depend on the nature of the membrane. Certain tissues will stain only after prolonged treatment, but most herbaceous material will react very readily.

Since iodine dissolves in water very slowly, it becomes necessary to prepare the reagent some time before it is desired for use. When a section of a potato stem is stained by this method, for example, and the preparation viewed under the microscope, it is seen that the cellulose membranes are a bright blue, lignified, cutinized, and suberized walls a yellowish brown. Young phloem fibers and immature xylem cells, of course, take the cellulose stain. The staining reaction of the sieve tubes of the primary phloem groups is most striking in cross-sections. Their intenser stain and the heavier walls stand out conspicuously in contrast with the phloem parenchyma cells, which stain like ordinary parenchyma of pith or cortex. The pathological anatomist finds the chloroiodide of zinc especially useful in the study of necrotic tissues, since the double staining obtained by this method permits of a more searching inquiry into the nature of the cell wall changes than is possible with a one-sided differential stain like the classic phloroglucin-HCl reagent. The use of the chloroiodide of zinc stain may occasionally call for some patience, but the results obtained warrant and reward it in every case.—ERNST ARTSCHWAGER, *Cornell University*.

# CURRENT LITERATURE

## BOOK REVIEWS

### Bacterial diseases of plants

This volume by SMITH,<sup>1</sup> as its name indicates, is intended to serve students as an introduction to that group of plant diseases caused by bacteria. An unusual proportion of the text is based upon the work of the author and those associated with him in his laboratories. The wealth of illustration, including reproductions of photographs and drawings, is particularly striking. There are 237 full-page illustrations, and smaller illustrations bring the total to about half of the book.

The first 64 pages are devoted to "A conspectus of bacterial diseases of plants," including tables of plant families and genera in which bacterial diseases are known. Of particular interest are the summaries of agents of transmission and on plant reactions. "Methods of research" are discussed in about 50 pages. In most cases details of culture media and technique are omitted, reference being made to suitable sources of information.

Part III, the principal portion of the text, is devoted to a "Synopsis of selected diseases." Of the fourteen organisms discussed, eight were named by the author, and two others by workers in his laboratory, and all have been worked over by him or his associates, so that statements are in general authoritative. The diseases and causal organisms discussed are those which have been most studied in the United States. For each disease there is given, first, a brief description of the pathology, plants affected, and distribution; second, a condensed description of the causal organism, including morphology, staining characters, culture, and physiology; and third, the special technique required in studying the relationships of parasite and host. In each instance this is followed by a laboratory guide, indicating the points to be studied and the special observations to be made. A brief index to the more important literature is included. The directions are full of suggestions for experimentation and the development of original problems.

The next 100 pages are included in a section termed "Miscellaneous." Brief notes on additional diseases are followed by a chapter on suggestions of subjects for special study. The next three chapters are devoted to tumors and teratoses produced in plants in the absence of parasites. They are of great interest, but would seem to belong rather to a treatise on general plant pathology than in one devoted to bacterial diseases.

<sup>1</sup> SMITH, ERWIN F., An introduction to bacterial diseases of plants. pp. xxx+688. figs. 453. Philadelphia: Saunders Co. 1920.

The last section on "General observations" is unique. It consists of about 30 pages of advice to students and investigators. It is well written, interesting, and stimulating. It is to be regretted that it should have been published where it will necessarily have relatively so small a circle of readers. The ideas running through the section may be indicated by some of the headings, as "On subsidiary studies," "On beginning work thoughtlessly," "On repetition of experiments, other people's, one's own," "On publication," "On keeping one's own counsel," "On sharing credits," and "On attending meetings and keeping up membership in societies, and on being generally public spirited and helpful in science." An excellent index is provided.—R. E. BUCHANAN.

### Geography of plants

In a compact volume, HARDY<sup>2</sup> has given a comprehensive review of the vegetation of the world in very readable form. Maps of such climatic factors as rainfall and temperature, as well as of the vegetation itself, are upon a small scale, but seem very accurate, although necessarily lacking in detail and expressing a much greater rigidity than obtains in nature. The general characterization of the vegetation is fairly accurate, although one is often at a loss to know just what genera and species are intended on account of the rather complete absence of scientific names. The few scientific terms employed are so lacking in accuracy as to shake one's confidence in the facts presented with which he is not already familiar. Irregularities in spelling and capitalization might be overlooked, but to designate the long-leaved pine on the Atlantic slope as *Pinus Lambertiana*, or to refer any of the North American "cedars" to the genus *Cedrus* is certainly unpardonable. Such inaccuracies in terminology, together with an entire absence of citations of the sources of data, will prevent the book being used by advanced classes, although it will probably be found useful for imparting general impressions and in sketching in broad outline the vegetation of the various continents.—GEO. D. FULLER.

### MINOR NOTICES

**Practical botany.**—MARTIN'S textbook entitled *Botany for Agricultural Students* has appeared in a second edition and with a new title.<sup>3</sup> The general purpose of the text was stated in a previous review.<sup>4</sup> In the new edition portions of the text have been re-written, to correct errors and to increase clearness, but the chief changes occur in the treatment of heredity and evolution, a chapter on variation being added. The matter is well presented, clear in style and organization, and is certainly well adapted to its constituency.—J. M. C.

<sup>2</sup> HARDY, M. E., *The geography of plants*. 12mo. pp. xix+327. *figs.* 115. Oxford: Clarendon Press. 1920.

<sup>3</sup> MARTIN, J. N., *Botany with agricultural applications*. 8vo. pp. xii+604. *figs.* 490. New York: Wiley & Sons. 1920.

<sup>4</sup> BOT. GAZ. 68:308. 1919.

## NOTES FOR STUDENTS

**Ecological concepts and nomenclature.**—All recent discussions of the classification of vegetation make it evident that ecologists are far from agreement upon any one system. The resulting ambiguity and confusion are deplored by both TANSLEY<sup>5</sup> and PAVILLARD.<sup>6</sup> The latter gives further emphasis to his former statement that the species and the association constitute the two fundamental unities of ecology or geobotany, and his two main divisions of the subject are based on these unities. As each of these units may be considered from the floristic, the genetic, and the ecological viewpoint, there results six subdivisions of the science. Considering the desirable implications of the term "phytosociology" when used to designate the study of plant communities, and translating PAVILLARD's terms freely, the six subdivisions of ecology may be designated: (1) floristic geobotany, (2) genetic geobotany, (3) ecologic geobotany, (4) floristic phytosociology, (5) genetic phytosociology, and (6) ecologic phytosociology. The first three are devoted to the consideration of the species and the others to the problems of the associations. Something of the content of the various subdivisions has been noted in a previous review.<sup>7</sup>

In the present article PAVILLARD devotes much attention to the considerations which would establish the association as the fundamental unit in the investigation of vegetation. With this TANSLEY seems in agreement, and further holds that such a unit of vegetation should correctly and usefully be regarded as an organic unity or quasi-organism. TANSLEY, however, would limit the application of the term "association" to mature units in relatively stable equilibrium with their environment. These are the climax associations or permanent associations of other ecologists. To transitory or developmental associations he would apply CLEMENTS' term of "associes."

Being in agreement that the association is the fundamental unit of phytosociology, TANSLEY and PAVILLARD emphasize the importance of the study of its development, the former clearly recognizing the principal of "succession" and the existence of both climatic and physiographic (edaphic) climaxes, and the latter devoting one of his subdivisions of the science ("genetic phytosociology") to problems of the development of associations, although he points out that such studies are not often undertaken or appreciated in continental Europe. TANSLEY insists upon the study of the morphology of associations, that they are essentially topographical units, and are in the first instance to be determined empirically, while PAVILLARD regards floristic composition as their most essential characteristic. This floristic composition includes not only accurate lists of the species, but also consideration of the

<sup>5</sup> TANSLEY, A. G., The classification of vegetation and the concept of development. *Jour. Ecol.* 8:118-149. 1920.

<sup>6</sup> PAVILLARD, J., *Espèces et associations; essai phytosociologique.* Montpellier. pp. 34. Oct. 1920.

<sup>7</sup> *BOT. GAZ.* 70:183-185. 1920.

“sociological value of the species,” and here perhaps lies the most valuable and suggestive portion of the French writer’s contribution. He asserts that the “sociological value” of species depends upon their abundance, dominance, sociability, constancy, affiliation (*fidélité*), and genetic importance. When “abundance” and “dominance” are determined in a quantitative manner according to RAUNKIAER’S<sup>8</sup> methods, “constancy” according to DU RIETZ, affiliation according to BRAUN-BLANQUET, and “genetic importance” according to PAVILLARD, the results will greatly clarify our concept of the association and give a new importance to its floristic study. The “genetic coefficient” expressing the relative importance of the species in the development of the association is perhaps the most important of these concepts and represents a decided contribution from PAVILLARD.

While there is practical agreement as to the importance of associations and little difference as to the use of the term, these two writers fail to agree when it comes to the consideration of units of a higher order. TANSLEY holds that the “formation” corresponds to habitat and cannot be satisfactorily characterized by life forms. He applies the term “formation” to a set of plant communities related developmentally and culminating in one or more associations. On the contrary, PAVILLARD regards life form as the only characteristic of a “formation,” which may thus be a community that is but a fragment of an association or one that contains several associations. He does not think that a satisfactory system of classification of plant associations is practicable in the present state of our knowledge.

In attempting, in his admirable discussion, to harmonize the widely divergent opinions and the diverse attitudes of different ecologists, TANSLEY has been the first, perhaps, to appreciate fully the influence not only of difference of training and of centers of interest but also of geographical situation. To himself it is not surprising that American ecologists, with their abundance of entirely natural areas, should belong to a school favoring a system based upon climatic climaxes and succession, or that those located in the middle west or northeast of the United States should appreciate the importance of edaphic factors and distinguish their action from those of climatic origin.

A similar consideration of the influence of geographical situation would probably have been useful to ROMELL<sup>9</sup> in explaining the segregation of Swiss and Scandinavian ecologists in the “inductionist” school, and the American and English scientists in the “successionist” school. He shows, however, that some of the former, notably SERNANDER, have appreciated the dynamics of vegetation and employed many of the methods of the latter. His plea for the use of hypotheses and of experimental methods is excellent, and the

---

<sup>8</sup> RAUNKIAER, C., *Recherches statistiques sur les formations végétales*. Det. Kgl. Danske Videirkabernes Selskabe Biol. Meddeleser I. 3: pp. 80. 1918.

<sup>9</sup> ROMELL, LARS-GUNNAR, *Physionomistique et écologie raisonnée*. Svensk Bot. Tidsk. 14:136-146. 1920.

reviewer is ready to agree with his conclusion that "the watchwords of a rational and reasonable ecology are logic, common sense, and physiological experimentation," and perhaps to echo his "We do not need their dogmatism nor their abominable nomenclature; we have enough of our own."—GEO. D. FULLER.

**Alpine adaptations.**—In 1884 BONNIER began his classical experiments upon the structural changes induced by growing plants at various altitudes. Plantations were made in the lowlands and at various altitudes in the Alps, so arranged that the two individuals to be compared were produced by dividing one plant. Similar experiments were begun in the Pyrenees in 1886, and the botanical world is familiar with the remarkable results as reported in BONNIER'S earlier publications. Now after a lapse of over 30 years he makes a summary of what are probably the most notable and prolonged experiments of their kind on record.<sup>10</sup>

A few of the plants taken from the plains to alpine stations died, but a list is given of 58 species that proved able to maintain themselves at high altitudes. These have all undergone changes which make them closely resemble indigenous alpine plants. The principal changes are relatively large development of the subterranean as compared with aerial parts, shortening of the leaves and of the internodes of stems, increased hairiness, and relatively larger development of bark and protective tissue. The leaves became thicker in proportion to their surface and are a deeper green, with more highly developed palisade tissue and a larger number of chloroplasts, while the flowers are larger and more highly colored. In at least 17 species the changes are so great that the plants have apparently been transformed into distinct alpine "species." Thus *Lotus corniculatus* L. began to show decided modifications within 10 years, and finally became identical with *L. alpinus* Schleich; *Helianthemum vulgare* Gaertn. has in 30 years become *H. grandiflorum* DC.; while *Leontodon proteiformis* Vill. in 6 years is completely transformed into *L. alpinum* Vill.

For all the species able to maintain themselves with considerable altitudinal range, there seems to be an optimum altitude at which the transformations are most rapid, most complete, and where intensity of color and development of chlorenchyma reach a climax. Species of *Potentilla* may be cited as indicating individual differences of range. Thus the optimum conditions for *P. argentea* appear to be found at 1050 m., for *P. reptans* at 1500 m., and for *P. tormentilla* at about 2000 m. Cultures of alpine plants at lower altitudes showed reversed although less marked transformations. Alpine species, able to maintain themselves at various altitudes, at the lower stations gradually lost many of their typically alpine characteristics, and a list of 14 species showing such changes is given. Certain annuals taken from the

<sup>10</sup> BONNIER, GASTON, Nouvelles observations sur les cultures expérimentales à diverses altitudes et cultures par semis. Rev. Gén. Bot. 32:305-326. pls 2. figs. 4. 1920.

plains and transplanted to high altitudes became biennials or perennials, as *Poa annua* and *Senecio viscosus*, while *Calamintha acinos* became not only perennial but subfruticose.

In 1919 seeds from known individuals were sown on July 1 at Fontainebleau at an altitude of 78 m., and in the Pyrenees at 2000 m. The resulting plants were compared on September 30, and all at the alpine station showed decided dwarfing. In spite of the fact that many species did not reach maturity in the mountains, several showed the mature form of leaf earlier than in the lowland. Some species, such as *Sinapis arvensis* and *Centaurea cyanus*, proved by their flowering that the dwarfed alpine individuals were quite mature. Many of the alpine forms exhibited a decidedly increased development of hairs and of anthocyan.—GEO. D. FULLER.

**Lycopodium.**—HOLLOWAY,<sup>11</sup> in his fourth paper on New Zealand species of *Lycopodium*, presents sections PHLEGMARIA and CERNUA, the former represented by *L. Billardieri*, with its var. *gracile*, and *L. varium*, the latter by *L. cernuum*, *L. laterale*, and *L. ramulosum*.

In the PHLEGMARIA group the general form of the prothallium "consists essentially of a central body of tissue which may be either bulky or more or less elongated, and a number of branches which arise adventitiously from the central body." The plants are dorsiventral and the sex organs zonate. The latter arise "immediately behind the apex" of either the main body or the branches, and are associated with numerous paraphyses. The archegonia occur only on the central body. The endophytic fungus may occupy the entire mass of cells of the main body when young, except the generative tip and the epidermis. In the older plants there is a central layer of elongated cells free from the fungus, probably functioning as "translocation tissue." The identity of the fungus has not been settled, but HOLLOWAY has shown the sporelike bodies observed by other investigators. His figures of the fungus in *L. Billardieri* show exactly the habit of the fungus in the prothallia of *L. lucidulum* observed by the reviewer. The same thing is probably to be found in the prothallium of *L. Selago*. The relationship of the four embryonic organs is well shown in fig. 34.

There is an excellent discussion of body form, comparing prothallia of this section with those of the *Selago* group. HOLLOWAY states that the *Phlegmaria* type of prothallia is "the extreme attained by the cylindrical type of growth"; and that the *clavatum* type is "the extreme attained by the continued conelike manner of growth."

In considering the representatives of CERNUA, most attention is given to *L. ramulosum*. It is an interesting fact that chlorophyll never occurs in the lower part of the prothallium. The fungus is limited to shallow zones, is

<sup>11</sup>HOLLOWAY, Rev. J. E., Studies in the New Zealand species of the genus *Lycopodium*. IV. Trans. New Zealand Inst. 52:193-239. 1920.



epidermal, and both intercellular and intracellular. In the protocorm "it seems to be always present in an intercellular position in the central tissues." The demonstration of the fungus in this structure inclines the author toward "BOWER'S suggestion" concerning the phylogenetic importance of the protocorm. The most interesting thing to the reviewer is HOLLOWAY'S discovery that the germinating spore sometimes develops a filament before the "primary tubercle" stage of TREUB is reached. This fact throws some light upon the phylogenetic history of the *Lycopodium* prothallium.

In a discussion of the cause of such a variety of form in the prothallia of *Lycopodium* and *Tmesipteris*, the author says "One cannot avoid the suggestion that the dominating factor . . . is the presence of the fungus." He suggests that the primary tubercle may be a secondary growth rather than a primary one.—E. A. SPESSARD.

**Wilting coefficient studies.**—Considerable surprise was expressed at the announcement by BRIGGS and SHANTZ of the "wilting coefficient" as an important critical factor in the relation of soil moisture to the plant, and at their statement that the wilting coefficient was practically the same for all classes of plants and showed little or no variation in response to atmospheric changes. Many seemed to doubt the accuracy of these statements, and several unsuccessful attempts were made to demonstrate a relationship between the evaporating power of the air and the wilting coefficient. SHULL<sup>12</sup> showed rather conclusively that the wilting coefficient is a function of the movement of water in the soil rather than a lack of gradient of forces tending to move the water toward the plant. As a function of the soil finding an expression through plants, rather than a function of the relationship of the forces exerted by the plant, it does not seem surprising that the wilting coefficient is much the same for all plants and for all atmospheric conditions.

Attacking the problem from a somewhat different angle, LIVINGSTON and KOKETSU<sup>13</sup> show even more conclusively that the wilting coefficient is a function of water movement in the soil. These workers made use of small porous porcelain cones or "soil-points" which, while dry, were thrust into the soil. At the end of a suitable period they were withdrawn, and by weighing the amount of water absorption was determined. The data obtained indicated that at permanent wilting the water supplying power of the soil was the same for the different plants used and also for different soils within certain limits. They regard this present report a tentative and preliminary one, but in the soil-point method there seems to be much promise of a complement to the porous cup atmometer investigations of the moisture conditions of the atmosphere.—GEO. D. FULLER.

<sup>12</sup> SHULL, C. A., Measurement of the surface forces in soils. BOT. GAZ. 62:1-29. figs. 5. 1916.

<sup>13</sup> LIVINGSTON, B. E., and KOKETSU, R., The water supplying power of the soil as related to the wilting of plants. Soil Science 9:469-485. 1920.

**Studies of cambium.**—BAILEY,<sup>14</sup> in continuation of his studies of cambium, has considered the size variations of cambial initials in Gymnosperms and Angiosperms, making an extensive reconnaissance through the representatives of these groups, tabulating measurements of 13 species of Gymnosperms and 54 species of Dicotyledons. He finds striking variations in the dimensions of the cells of the cambium and secondary xylem, some of the variations being purely somatic, while others are germinal. He finds that in many plants the dimensions of tracheary cells are determined by those of the cambium initials, while in other plants the dimensions are due to changes during the differentiation of the xylem. He concludes that these fundamental types of size variations and the fluctuations in form and structure are significant in the investigation of certain cytological, morphological, and physiological problems. He calls attention to the fact that the cambium is an unusually favorable medium for the study of problems relating to cell size and body size, the working sphere of the nucleus, the nucleocytoplasmic relation, and phenomena of cytokinesis in somatic tissues.—J. M. C.

**Morphology of *Larix*.**—In a study of various stages in the life history of *Larix leptolepis*, DOYLE<sup>15</sup> brings out some points of interest. His study of the cavities at the apex of the microsporophyll leads him to conclude that they are homologous with similar cavities in the vegetative leaves, and that they do not represent abortive sporangia. He also suggests that similar cavities in *Ginkgo*, *Torreya*, and other forms may have as little relation to a previous spore-producing function. The microspore, which is wingless, is shed with the stalk and body cells already formed, as in *Abies*. Some of the figures would indicate that the nuclear membrane in the stalk and body cells had been overlooked and only the nucleolus recorded. The amount of variation and the number of peculiar conditions are about what one might anticipate in a thorough study of almost any Gymnosperm. In the ovulate cone there is a gradual transition from vegetative leaves to cone bracts, as in *Pseudotsuga*. The general conclusion is that numerous similarities indicate a distinct natural affinity between *Larix* and *Pseudotsuga*.—C. J. CHAMBERLAIN.

**North American Flora.**—Parts 5 and 6 of volume 7 include a continuation of Aecidiaceae by ARTHUR and his colleagues, chiefly the genus *Dicaeoma*, under which 269 species are recognized. The following genera are also included: *Pucciniola* (25 spp.), *Allodus* (49 spp.), and *Klebahnia* (8 spp.).—J. M. C.

<sup>14</sup> BAILEY, I. W., The cambium and its derivative tissues. II. Size variations of cambial initials in Gymnosperms and Angiosperms. Amer. Jour. Bot. 7:355-367. figs. 3. 1920.

<sup>15</sup> DOYLE, J. D., Observations on the morphology of *Larix leptolepis*. Sci. Proc. Roy. Dublin Soc. 15:310-330. pls. 17, 18. 1918.

THE  
BOTANICAL GAZETTE

*JUNE 1921*

CHEMICAL CHANGES IN WHEAT DURING  
GERMINATION

CONTRIBUTIONS FROM THE HULL BOTANICAL LABORATORY 281

HELEN A. CHOATE

(WITH PLATE XXVIII AND TWO FIGURES)

**Introduction**

The subject of germination has received much attention of late, and the literature is extensive. In general, however, investigations have been directed toward two phases of the subject: (1) the external factors necessary for and affecting germination, and (2) the chemical changes occurring within the various parts of the seed during the process. The earlier investigations of this second phase, to which fuller reference will be made later, dealt directly with the chemical changes occurring within endosperm or storage substances of the embryo as germination advanced; but as a rule each of these studies has been limited to the consideration of some one substance, and hardly any two investigations have dealt with the same kind of plant. More recent work bearing upon chemical phenomena has been directed toward the problem of delayed germination. The results as summarized by CROCKER (8) show that in most cases this delay is due either to conditions existing within the seed coat, or to a morphological or physiological immaturity within the embryo, leading in the latter case to phenomena of after-ripening. This investigation is an attempt to determine somewhat more comprehensively the principal chemical

changes occurring in a single kind of normally germinating seed, and thus to contribute to the facts of germination in general, and at the same time to provide a possible basis of comparison for some of the still unsolved problems of delayed germination and after-ripening.

### Historical

DETMER (9) in 1880 presented a comprehensive summary of the work done up to that time by himself and others on the physiology of germination, and in the section dealing with the metabolism of storage substances he outlined the general facts in regard to the appearance, in various parts of the embryo, of starch, sugar, and nitrogenous compounds following the breaking down of reserve substances. BROWN and MORRIS (5), working on barley, found that the first visible change is the appearance of starch in the embryo, and localized the secretion of diastase in the epithelial cells of the scutellum. They also stated that the endosperm is a dead tissue incapable of self-depletion, although a few years later, after further work, BROWN and ESCOMBE (4) concluded that the aleurone layer is a living tissue by whose activity depletion of the endosperm might occur in the absence of the embryo. HANSTEEN (12) and PURIEWITSCH (17), however, maintained that the endosperm is capable of self-depletion provided the hydrolytic products are removed. The later work of Miss BRUSCHI (6) harmonizes these divergent views by showing that while self-digestion can occur in various kinds of grains, it does so to such different degrees that earlier investigators, working each upon a single form only, reached contradictory conclusions.

Of more direct bearing upon the subject is the work of LECLERC and BREAZEALE (14), in which by macrochemical analyses a quantitative study was made of the effects of different culture media upon the amounts of various organic and inorganic substances found in the several portions of the wheat seedling at different stages of germination. One of the latest contributions to the question of chemical changes during germination is that of Miss ECKERSON (11), who finds that in light-sensitive seeds active hydrolysis of hemicelluloses, fats, and proteins in the endosperm occurs in both light and darkness, but that in the light this process

begins toward the outside of the endosperm, the resulting substances diffusing out and away from the embryo, while in the dark it begins near the embryo, which can then make use of the hydrolytic products. The presence of iron in the seed coat, acting catalytically in the light, is undoubtedly a factor in the first case.

With the development of microchemical technique a method has become available by which qualitative determinations can be made for the presence or absence of many substances without an undue expenditure of time, and in this way, especially when checked with macrochemical analyses at crucial points, the time and place of chemical changes can be determined with greater accuracy than heretofore, as the following results show.

### Method

The material used in this study was Marquis wheat, a hard spring wheat, procured from the Albert Dickinson Company of Chicago in the fall of 1917 and again in 1919. In most cases the ungerminated grains were soaked for two hours in distilled water in order to facilitate sectioning. No differences could be observed in the chemical condition of grains thus soaked as compared with unsoaked ones. For germinated material the grains were soaked for two hours and then placed in covered Petri dishes with moist filter paper on the bottom. These dishes were placed in a dark room kept at 16°–20° C., unless otherwise noted. When the period of germination covered several days the dishes were opened daily and the air renewed. Sections were cut freehand, and the microchemical tests employed were those recommended in the standard works by MOLISCH, TUNNMANN, and CHAMOT. A list of the tests used will be found at the end of this paper. Methods used in determinations other than microchemical ones are described in appropriate places. The germination period was regarded as seven days, in part because of the difficulty of growing seedlings longer under the given conditions, but mainly because by the end of that time the seedlings had so far developed that, had they been growing under field conditions, they would have been making their own food, without dependence upon the endosperm.

## Microchemical study

### UNGERMINATED GRAIN

**COAT.**—As the coat of the grain is easily permeable and in no way delays germination, no particular study was made of it. In general it consists of four layers: (1) the outer portion of the pericarp, consisting of one or more layers of cells whose walls contain some pectic substance, (2) the inner epidermis of the pericarp, in which lignification has occurred, (3) the testa, also lignified, and (4) the suberized remnant of the nucellar tissue. Glucose is present in the pericarp, undoubtedly a remnant of that originally present in the pericarp of the developing fruit (ECKERSON 10).

**ENDOSPERM.**—*Carbohydrates.*—Large amounts of starch are found in the endosperm, except in the aleurone layer, where it is entirely lacking. No reducing sugars are present, but a small amount of sucrose can be identified.

*Fats.*—Most of the cells of the endosperm contain very little fat, but it is abundant in the aleurone cells.

*Proteins.*—Proteins also are found in the starch-containing cells of the endosperm, and these are known to be almost entirely the storage proteins, glutenin and gliadin (OSBORNE 16). These cannot be distinguished from each other by microchemical methods. In the aleurone cells storage proteins are absent, but other protein material is present in considerable quantity.

*Oxidizing enzymes.*—No oxidase is found, but both peroxidase and catalase are present.

*Minerals.*—Little potassium is present, but considerable calcium and magnesium. Small amounts of phosphates were detected, while the aleurone layer has much iron. As noted under the embryo, no sulphur could be identified.

**EMBRYO.**—*Carbohydrates.*—Sucrose is the only storage carbohydrate found in the embryo of the Marquis wheat. In some forms, such as Emmer, starch is found in the scutellum.

*Fats.*—Fats are found in all parts of the embryo.

*Protein.*—The embryo gives a strong protein reaction, although probably no storage proteins are present. No amino acids can be detected by microchemical methods.

*Oxidizing enzymes.*—As in the endosperm, oxidase is lacking, but peroxidase and catalase are present.

*Minerals.*—Potassium and magnesium are present in considerable quantities. Calcium and phosphates could not definitely be identified, although undoubtedly present. Iron is found in abundance in the cells just under the epithelial layer. Sulphur could not be detected by any known microchemical methods.

#### GERMINATING GRAIN

*Carbohydrates.*—No change is apparent in the contents of the grain (aside from the swelling due to absorption of water and softening of the tissues) until 10–12 hours after the material has been put into germinating dishes. At this time dextrin appears in the scutellum and coleorhiza, and starch in the root cap. At about the same time dextrin appears in the coleoptile and shortly afterward in the plumule. After 12 hours reducing sugar is found in the coleorhiza and appears also in the root, endosperm, coleoptile, plumule, and scutellum by the end of 24, 36, 48, and 96 hours respectively. After the appearance of the sugar in the coleorhiza and coleoptile, the amount of dextrin present decreases and the amount of sugar increases. In the root the amount of sugar increases up to the fourth day, after which the sugar content does not increase proportionately with the increase in the root tissue. At all times it is found most abundantly in the zone of the root hairs. In the endosperm reducing sugar is first found near the basal end of the embryo, but eventually is found throughout the whole tissue. All tests indicate that this reducing sugar is glucose. At the end of seven days starch is still present in the greatly disorganized endosperm, although practically all the grains still remaining show marked corrosion. A summary of this microchemical study will be found in table I.

The following quantitative study of the sugars in germinating wheat made by LECLERC and BREAZEAL (14) is of interest in checking up these microchemical findings. As the seedlings studied by these investigators were apparently grown in the light, photosynthesis may have influenced the result, although within the period of only seven days this would hardly be an appreciable

TABLE I  
 SUMMARY OF MICROCHEMICAL ANALYSES FOR DETERMINING PRESENCE OF STARCH AND REDUCING SUGARS IN GERMINATING  
 WHEAT (16°-20°C.); +, PRESENT; ++, PRESENT IN ABUNDANCE.

HOURS IN GER- MINATOR	LENGTH OF COLE- OPTILE (MM.)	ENDOSPERM		SCUTELLUM		COLEORHIZA		ROOT CAP		ROOT TIP		ROOT		COLEOPTILE		PLUMULE	
		Starch	Reduc- ing sugar	Starch	Reduc- ing sugar	Starch	Reduc- ing sugar	Starch	Reduc- ing sugar	Starch	Reduc- ing sugar	Starch	Reduc- ing sugar	Starch	Reduc- ing sugar	Starch	Reduc- ing sugar
6.....	0*	+	0	0	0	0	0	0	0	0	0	0	0	0	0	0	0
10.....	0	+	0	+	0	+	0	+	0	0	0	0	0	0	0	0	0
12.....	0	+	0	+	0	+	0	+	0	0	0	0	0	0	0	0	0
18.....	0	+	0	+	0	+	0	+	0	0	0	0	0	0	0	0	0
24.....	0	+	0	+	0	+	0	+	0	0	0	0	0	0	0	0	0
36.....	0	+	0	+	0	+	0	+	0	0	0	0	0	0	0	0	0
48.....	2.7	+	+	+	+	+	+	+	+	0	0	+	+	+	+	+	+
72.....	3.1	+	+	+	+	+	+	+	+	0	0	+	+	+	+	+	+
96.....	6.6	+	+	+	+	+	+	+	+	0	0	+	+	+	+	+	+
120.....	16.8	+	+	+	+	+	+	+	+	0	0	+	+	+	+	+	+
144.....	32	+	+	+	+	+	+	+	+	0	0	+	+	+	+	+	+
168.....	49	+	+	+	+	+	+	+	+	0	0	+	+	+	+	+	+

\* Plumule not well through coat until 36 hours.

† Dextrin.



factor. No statement is made in regard to the variety of wheat used. Table II is the summary of results, as given by LECLERC and BREAZEALE.

TABLE II

Part of plant and age	Reducing sugar as dextrose (mg.)	Hydrolyzable sugar as dextrose (mg.)
For 100 seeds		
Original seed.....	0	96
Seeds		
3 days.....	98.6	60
5 days.....	192.4	53
7 days.....	193.8	60
Axes		
3 days.....	148.0	50
5 days.....	253.7	42
7 days.....	267.9	46
Total plants		
3 days.....	246.6	110
5 days.....	446.1	95
7 days.....	461.7	106

*Proteins.*—Although both embryo and endosperm in the ungerminated grain give protein reaction, the storage proteins are known to exist only in the endosperm. During germination these are broken down, and at the end of seven days the nearly exhausted remnant of the endosperm gives only a very slight protein reaction. At this time, however, the aleurone layer is still intact, apparently unchanged.

No satisfactory microchemical tests are known for the derived proteins such as proteoses and peptones, so that no determination could be made for these substances. Some of the amino acids can be crystallized out of the tissue and the crystals identified by their chemical and optical properties. The first amino compound to be identified is asparagine, which was observed in the coleoptile on the fourth day and slightly later in the root. After the first appearance of asparagine in the coleoptile it accumulates there rapidly. A further discussion of the amino compounds in the seedling will be found in a later paragraph. At all times a marked protein reaction is obtainable in the stem and root tip, especially the latter (text fig. 1).

*Oxidizing enzymes.*—At no time was oxidase found in any part of the germinating seedling, but peroxidase and catalase were

present in all parts. In view of the increasing interest in the question of catalase activity, quantitative determinations were made on the seedlings on each successive day of the germination period.

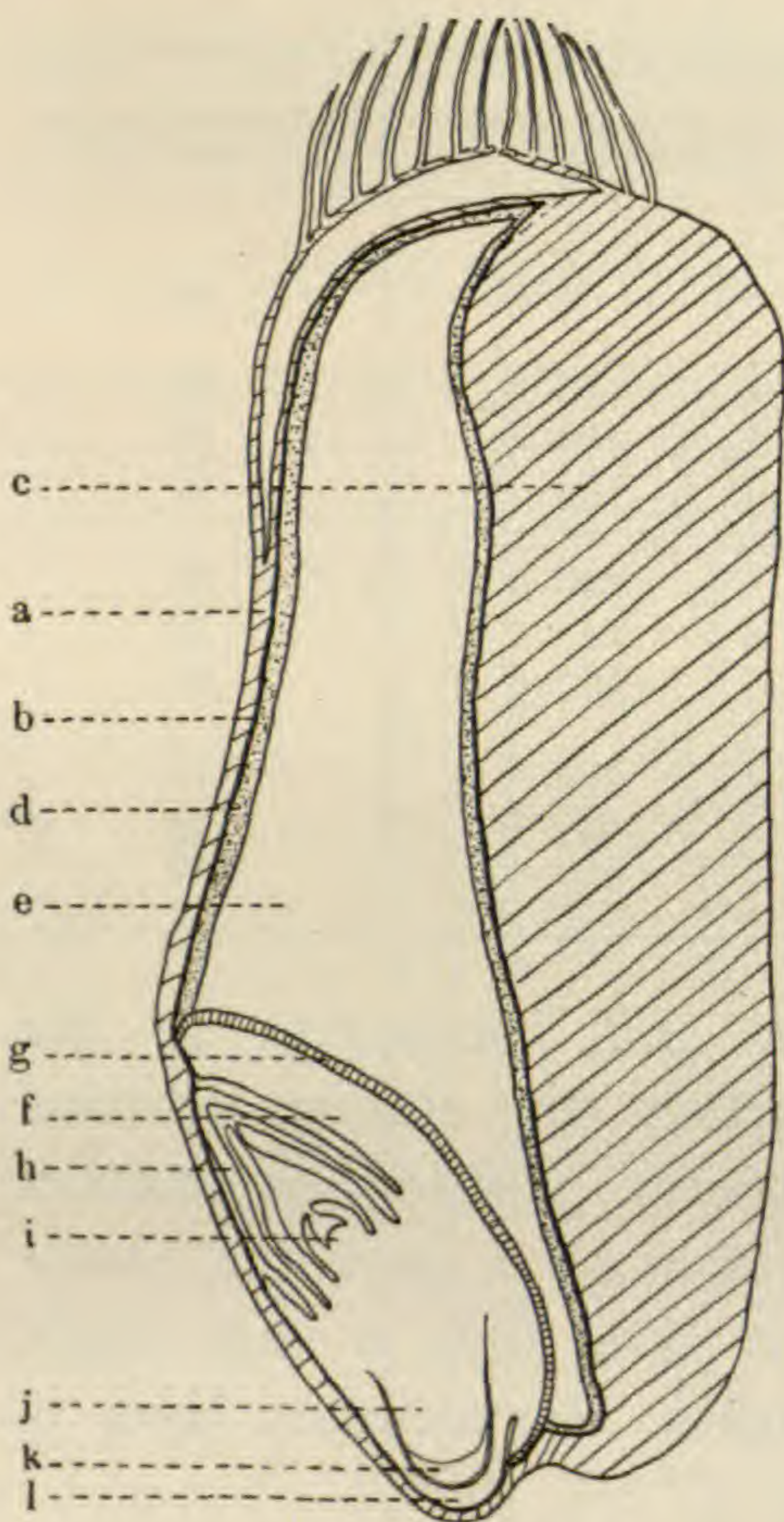

FIG. 1.—Longitudinal section of grain of wheat: *a*, pericarp and testa; *b*, suberized nucellar tissue; *c*, furrow in grain; *d*, aleurone layer; *e*, starchy endosperm; *f*, scutellum; *g*, epithelial layer; *h*, coleoptile; *i*, plumule; *j*, hypocotyl; *k*, root cap; *l*, coleorhiza.

increase in the respiration. RISCHAVI'S (18) standard work has given excellent data on the respiration of wheat as indicated by the release of  $\text{CO}_2$  during a period of 21 days. Text fig. 2 shows the comparative curves of the rate of respiration as plotted from RISCHAVI'S figures for the first seven days, and that of catalytic activity during a similar period from the figures obtained as given in table III. As in the investigations cited, there is here a close parallel between respiratory activity and catalytic activity.

The method employed was that of APPLEMAN (1, 2) as used by JONES (13). In each instance three sets of 5 grains each were used. The air-dry weight of each set was determined; one set was then used for determining the final dry weight, and duplicate determinations were made on the other two, the results of which are given in table III. This shows that there is a marked and continuous increase in the catalytic activity of the seedlings during the first seven days of germination. Within the past few years investigations upon both plants and animals have shown a striking relation between the rate of catalytic activity and that of respiration. BURGE (7) showed a marked correspondence between the amount of catalase in different muscles of the body and the amount of work done by these muscles, and APPLEMAN (1, 2) has shown a direct increase in the catalase content in potatoes and corn with an

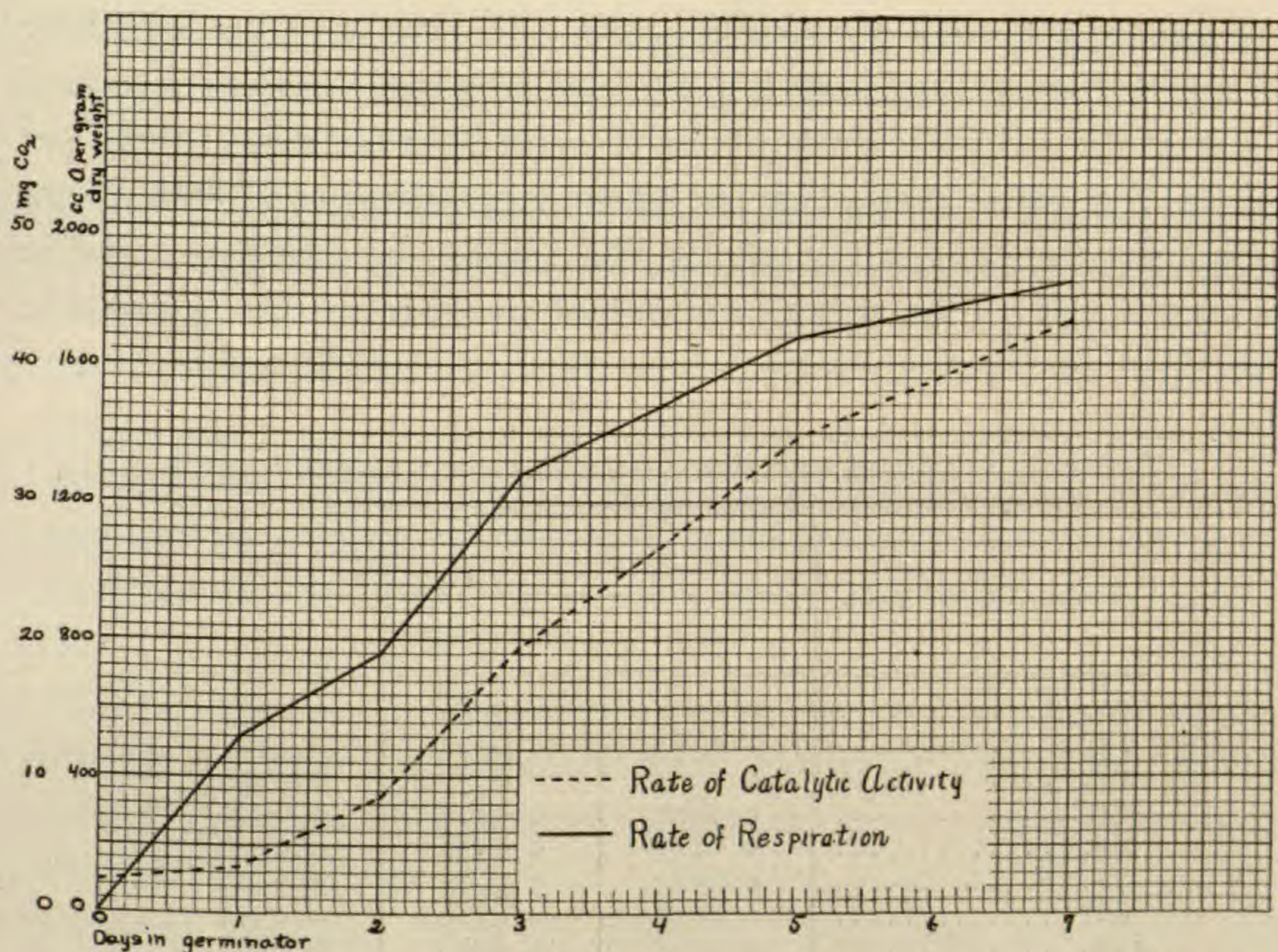

FIG. 2.—Relative rates of catalytic and respiratory activity (latter from RISHCHAVI'S data).

TABLE III  
CATALASE ACTIVITY OF GERMINATING WHEAT

Days in germinator	Original dry weight (gm.)	Final dry weight (gm.)	Oxygen (cc.) released in 10 min.	Oxygen (cc.) released per gm. of dry weight (calculated)	Average
0.....	{ 0.146 0.1496 }	{ 0.12848 0.1316 }	{ 10 12 }	{ 78 91 }	84.5
1.....	{ 0.1406 0.1401 }	{ 0.1251 0.12468 }	{ 14.6 18.6 }	{ 116 149 }	132.5
2.....	{ 0.1482 0.1331 }	{ 0.12967 0.11646 }	{ 42.2 40 }	{ 325 343 }	334
3.....	{ 0.143 0.1446 }	{ 0.1222 0.1236 }	{ 93.4 93.6 }	{ 764 781 }	772
4.....	{ 0.1485 0.1438 }	{ 0.1179 0.1141 }	{ 122 127 }	{ 1034 1113 }	1073
5.....	{ 0.1286 0.120 }	{ 0.10288 0.0768 }	{ 126 119.6 }	{ 1224 1570 }	1379
6*.....					
7.....	{ 0.1582 0.134 }	{ 0.11849 0.10036 }	{ 198.4 178.6 }	{ 1674 1779 }	1726.5

\* Complete data lacking.

*Increase in length of epithelial cells.*—During germination there is a marked increase in length in the epithelial cells of the scutellum. In wheat this increase amounts at the end of seven days to 119 per cent in the distal cells, that is, those near the brush end of the grain; 161 per cent in the intermediate cells; and 165 per cent in the basal cells. The actual amount of increase in size is given in table IV.

TABLE IV

INCREASE IN LENGTH OF EPITHELIAL CELLS DURING GERMINATION

HOURS IN GERMINATOR	LENGTH OF EPITHELIAL CELLS IN MM.		
	Distal	Intermediate	Basal
0.....	0.0347	0.0346	0.0273
12.....	0.0388	0.0402	0.0305
18.....	0.0377	0.0377	0.0314
24.....	0.0407	0.0429	0.0340
48.....	0.0455	0.0568	0.0436
72.....	0.0573	0.0703	0.0518
96.....	0.0638	0.0821	0.0592
120.....	0.0629	0.0880	0.0562
144.....	0.0769	0.0899	0.0677
168.....	0.0762	0.0906	0.0725

From the physiological studies of BROWN and MORRIS (5) and such cytological work as that of TORREY (22), it was believed that these epithelial cells actually secreted the diastase used in the hydrolysis of the starchy endosperm, and that this increase in size accompanied an increasing secretion of diastase. Miss BRUSCHI (6), however, stated that while there is a marked increase in the size of the epithelial cells at this time, the hydrolysis of the starch is due, not to diastase secreted by them, but to that developed from a proenzyme existing within the amyliiferous endosperm cells, and that it is the action of this enzyme which causes the self-depletion of the endosperm even in the absence of the scutellum, while the scutellum itself, when separated from the endosperm and grown under sterile conditions, produces no diastase.

#### Quantitative study of amino nitrogen content

The crystallization of amino acids from wheat by microchemical methods is difficult, probably because of the large amount of storage

protein present, and accordingly in order to obtain more exact knowledge on this point macrochemical analyses were made.

Miss ECKERSON (10) has shown that in ripening wheat asparagine, arginine, histidine, and leucine are present. As the formation of the proteins proceeds during desiccation, these amino acids disappear almost entirely, and only a trace of asparagine is left in the ripened grain. LEHMAN and OLTENWÄLDER (15) stated that unripened seeds frequently germinate more readily than wholly ripened ones because of the presence in the former of amino acids and active proteolytic enzymes, while in fully ripened seeds these enzymes which hydrolyze the storage proteins into more available forms are not always present in an active state. All investigations thus far indicate an increase in the amino acid content of seedlings during germination. Undoubtedly the most important work on this subject has been done by SCHULZE and his associates (19, 20) on the seedlings of *Lupinus luteus* and other leguminous plants, although in most cases on seedlings older than the wheat under consideration. In general he found that the first amino acids to appear are leucine, tyrosine, and the hexone bases, and concluded that the asparagine found somewhat later is a secondary product, formed from the mono-amino acids which serve as a storage substance to be used again in protein building. As the growth of the seedling advances, the asparagine content increases, while the amounts of the earlier formed acids decrease. The earlier theory of DETMER'S (9) that asparagine is a primary product of protein hydrolysis, and that its accumulation in seedlings grown in the dark is due to the absence of carbohydrates to unite with it to form new protein, seems improbable, as SCHULZE found almost as much in seedlings grown in the light as in the dark, and microchemical analysis clearly shows large quantities of sugar present in the coleoptile together with the asparagine in the seedlings over four days old.

The object of the analysis recorded in table V was not to isolate individual amino acids, but simply to determine the total amount of such substances. Determinations were made at three stages: (A) the ungerminated grain, (B) seedlings 3.5 days old, and (C) seedlings 6 days old. The temperature of the

dark room in which these seedlings were grown was 21°–23° C., which probably accounts for the greater length of coleoptile and root as compared with seedlings of the same age used in studying the carbohydrates. In sample *A* the air-dry wheat was finely ground in a food chopper, and in *B* and *C* the seedlings were cut up into small pieces with scissors immediately after removal from the germinating dishes. In all cases the material was preserved in 70 per cent alcohol. After extraction in hot alcohol

TABLE V

ANALYSIS OF MARQUIS WHEAT (1917) FOR AMINO NITROGEN CONTENT

Sample	Percentage	Percentage dry weight	Percentage soluble nitrogen
<i>A</i> (ungerminated)			
Moisture.....	10.78	.....	.....
Soluble nitrogen.....	.....	0.164	.....
Amino nitrogen.....	.....	0.0275	16.76
Length of coleoptile 50 mm.			
<i>B</i> (germinated 3.5 days)			
Moisture.....	68.71	.....	.....
Soluble nitrogen.....	.....	0.837	.....
Amino nitrogen.....	.....	0.29	35.53
Length of coleoptile 90 mm.			
<i>C</i> (germinated 6 days)			
Moisture.....	82.83	.....	.....
Soluble nitrogen.....	.....	1.66	.....
Amino nitrogen.....	.....	0.63	37.79

for six hours the material was ground in a mortar and a hot water extract made. As the presence of so much colloidal material (starch and protein) made it impossible to separate at all accurately the water from the solid matter, the entire mass was made up to 75 per cent alcohol, and all colloidal material precipitated by shaking with NaCl. The material was then filtered and the filtrate combined with the alcohol extracts and condensed in vacuo at 60°–70° C. to approximately 50 cc. This amount was then made up to volume (100 cc.) with distilled water. Determinations were made on this material for total nitrogen and

amino nitrogen. The former determinations were made by the BOCK and BENEDICT modification of the FOLIN-FARMER procedure (3), and this nitrogen is regarded as "soluble nitrogen" in table V. Determinations were made for amino nitrogen by the VAN SLYKE method. The results of these determinations are given in table V, from which it is seen that there is a considerable amount of amino nitrogen in the ungerminated grain, and that during germination this amount increases rapidly, while the increase in soluble nitrogen is less rapid. In comparison with these results, those obtained by THOMPSON (21) on the Alaska pea seedling are of interest. They are as follows:

PEAS	PERCENTAGE OF DRY MATERIAL	
	Total N	Amino N
Dry.....	.....	0.088
3 days old.....	3.28	0.337
6 days old.....	3.48	0.747

It is also evident from the results given in table V. that microchemical methods for identifying amino acids are not very satisfactory in the case of germinating wheat, probably for several reasons. The amino acids may be present in such small amounts that, although totaling an appreciable quantity, they cannot be detected individually; they may be those for which no satisfactory microchemical test has yet been found; or, as suggested earlier, other material present may prevent normal reactions from occurring. In the case of wheat such substances as storage proteins might easily interfere with the crystallization of the amino acids and so prevent their identification.

### Summary

1. The principal storage carbohydrate of Marquis wheat is starch in the endosperm. A small amount of sucrose is also present in the endosperm and embryo.

2. The first noticeable chemical change during germination is the appearance in the scutellum and coleorhiza of dextrin, and in the root cap of starch. These substances appear simultaneously after about ten hours in the germinator (16°-20° C.). Later dextrin appears in the coleoptile and plumule.

3. Reducing sugar (probably all glucose) appears in the embryo after 18 hours in the germinator. It is first found in the coleorhiza, but soon afterwards appears in considerable quantity in all parts of the seedling, especially in the zone of root hairs and coleoptile.

4. During the germination period studied the increase in length of epithelial cells averaged 150 per cent.

5. Peroxidase and catalase are present in all parts of the grain both before and during germination. The amount of catalase present increases during the first seven days at a rate corresponding to the rate of increase in the respiratory activity.

6. During germination the protein content of the endosperm, except for that of the aleurone layer, decreases greatly.

7. Microchemical analyses show the presence of amino acids in the ungerminated grain and their increase in amount during germination. Microchemical analyses fail to indicate any amino nitrogen until the fourth day of germination. Asparagine is the only form that can then be so identified. This appears only in the root and coleoptile, accumulating in the latter in considerable quantity.

#### Microchemical tests

*Pectic substances.*—Ruthenium red, red color; methylene blue, violet color.

*Lignin.*—Phloroglucin and HCl, violet red color obtained without heating.

*Suberin.*—Insoluble in cold 50 per cent chromic acid.

*Starch.*—Iodine-potassium iodide, blue color.

*Dextrin.*—Amylo-dextrin, iodine-potassium iodide, red color; dextrin, precipitation of cuprous oxide upon long heating with Flückiger's reagent (see under fructose).

*Fructose.*—Flückiger's reaction; copper tartrate dissolved in 15–20 per cent NaOH, red precipitate obtained at once without heating.

*Glucose.*—Flückiger's reaction; red precipitate of cuprous oxide on heating 1–2 minutes; osazone crystals with phenyl-hydrazine reaction.



*Sucrose*.—First remove any fructose or glucose present as follows: apply Flückiger's reagent and, to remove any precipitate formed after heating for 2–3 minutes, wash with dilute tartaric acid solution, add warm concentrated magnesium chloride, and wash again in tartaric acid; then invert with invertase or dilute acid and test again with Flückiger's reagent.

*Proteins (general)*.—Biuret reaction; xanthoproteic reaction.

*Storage proteins*.—Add  $\text{AlSO}_4$  to form aluminium proteinate and then stain with logwood solution; not a specific reaction for individual proteins.

*Amino acids and amides*.—General test: Crystallize out in absolute alcohol; crystals of asparagine, glutamine, tyrosine, leucine, proline, and potassium nitrate may appear.

Specific tests: comparison with known crystal forms; observation with polarized light: asparagine, place sections in copper acetate, add absolute alcohol slowly and crystals of copper asparaginate appear; leucine, sublimation; arginine and histidine, picrolonic acid gives yellow crystalline precipitate.

*Oxidizing enzymes*.—Oxidase, blue color upon addition of guiaconic acid; peroxidase, blue color with guiaconic acid and  $\text{H}_2\text{O}_2$ ; catalase, evolution of gas with addition of  $\text{H}_2\text{O}_2$ .

*Minerals*.—Calcium, with  $\text{H}_2\text{SO}_4$  have calcium sulphate crystals; magnesium, formation of ammonium magnesium phosphate crystals; potassium, crystals of potassium-platinum-chloride upon addition of platinum chloride; iron, Berlin blue reaction (potassium ferrocyanide and  $\text{HCl}$ ); phosphates, upon addition of magnesium mixture formation of ammonium magnesium phosphate crystals, upon addition of ammonium molybdate in nitric acid formation of ammonium phospho-molybdate crystals; sulphates, formation of benzidine sulphate crystals on addition of benzidine chloride.

The writer wishes to express her thanks to Dr. WILLIAM CROCKER, Dr. SOPHIA ECKERSON, and Dr. FRED C. KOCH for suggestions and criticism in carrying on this work.

## LITERATURE CITED

1. APPLEMAN, C. O., Relation of oxidases and catalase to respiration in plants. Amer. Jour. Bot. 3:223-233. 1916.
2. ———, Some observations on catalase. BOT. GAZ. 50:182-192. 1910.
3. BOCK, J. C., and BENEDICT, S. R., An examination of the Folin-Farmer method for the colorimetric estimation of nitrogen. Jour. Biol. Chem. 20:47-59. 1915.
4. BROWN, H. T., and ESCOMBE, F., On the depletion of the endosperm of *Hordeum vulgare* during germination. Proc. Roy. Soc. London 63B:3-25. 1898.
5. BROWN, H. T., and MORRIS, G. H., Researches on the germination of some of the Gramineae. Jour. Chem. Soc. 57:458-528. 1890.
6. BRUSCHI, DIANA, Self-digestion of the endosperm of some of the Gramineae. Ann. Botany 22:448-463. 1908.
7. BURGE, W. E., Relation between the amount of catalase in the different muscles of the body and the amount of work done by these muscles. Amer. Jour. Physiol. 41:153-161. 1916.
8. CROCKER, W., Mechanics of dormancy in seeds. Amer. Jour. Bot. 3:99-120. 1916.
9. DETMER, W., Vergleichende Physiologie des Keimungsprocesses der Samen. Jena. 1880.
10. ECKERSON, SOPHIA H., Microchemical studies in the progressive development of the wheat plant. Bull. 139, Agric. Exp. Sta. State College, Washington. 1917.
11. ———, Chemical changes induced by light in light-sensitive seeds (unpublished).
12. HANSTEEN, B., Über die Ursachen der Entleerung der Reservestoffe aus Samen. Flora. 79:419-429. 1894.
13. JONES, H. A., Physiological study of maple seeds. BOT. GAZ. 69:126-152. 1920.
14. LECLERC, J. A., and BREAZEALE, J. F., Translocation of plant food and elaboration of organic plant material in wheat seedlings. Bull. 138, Bur. Chem. U.S. Dept. Agric. 1911.
15. LEHMAN, E., and OLTENWÄLDER, A., Über katalytischer Wirkung des Lichtes bei der Keimung lichtempfindlicher Samen. Zeit. Botanik. 5:337-365. 1913.
16. OSBORNE, T. B., The proteins of the wheat kernel. Publ. 84, Carnegie Inst. Washington. 1907.
17. PURIEWITSCH, K., Über die Entleerung der Reservestoffbehälter. Jahrb. Wiss. Bot. 31:1-76. 1897.
18. RISCHAVI, L., Einige Versuche über die Athmung der Pflanzen. Landwirt. Vers. Stat. 19:320-341. 1876.

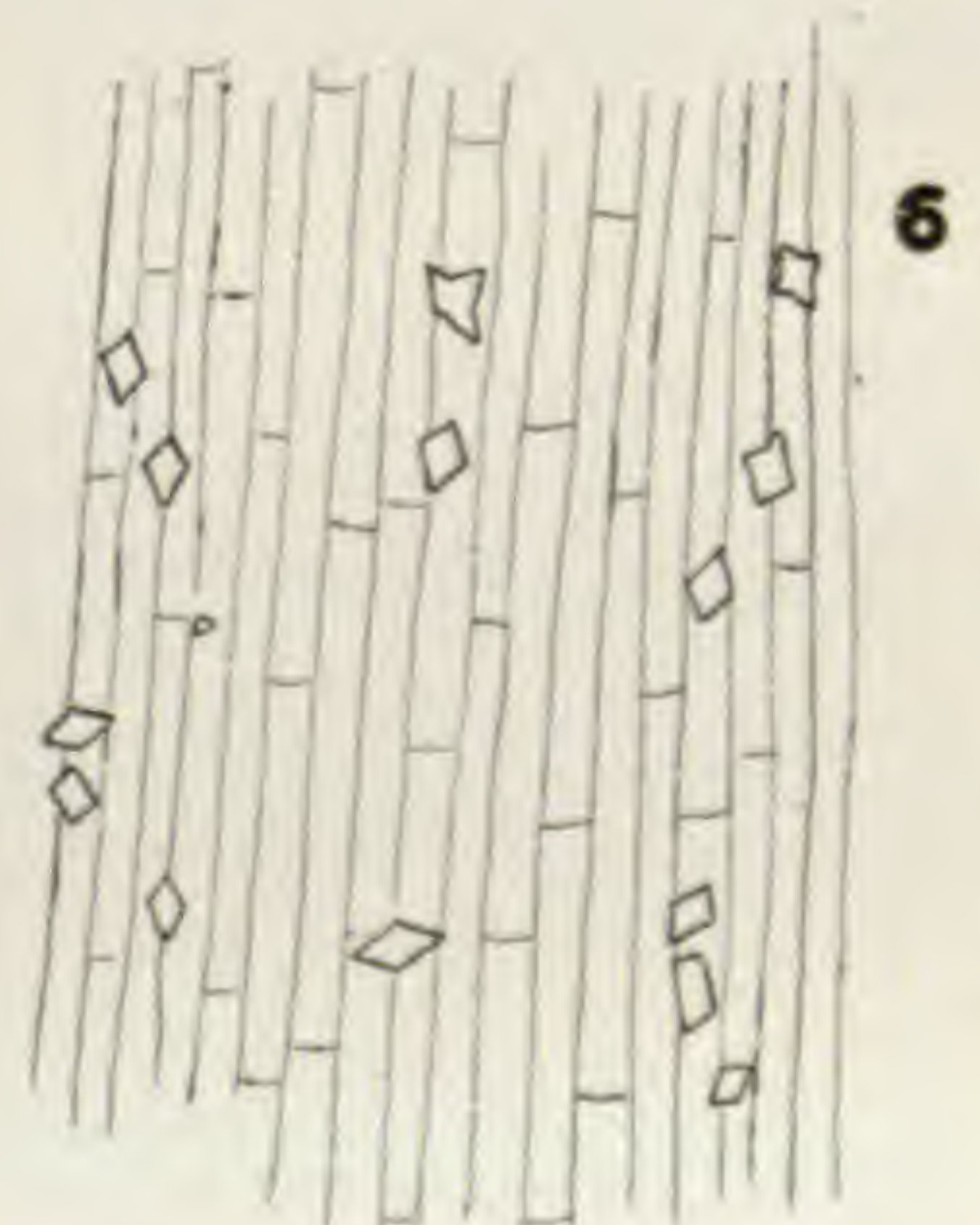
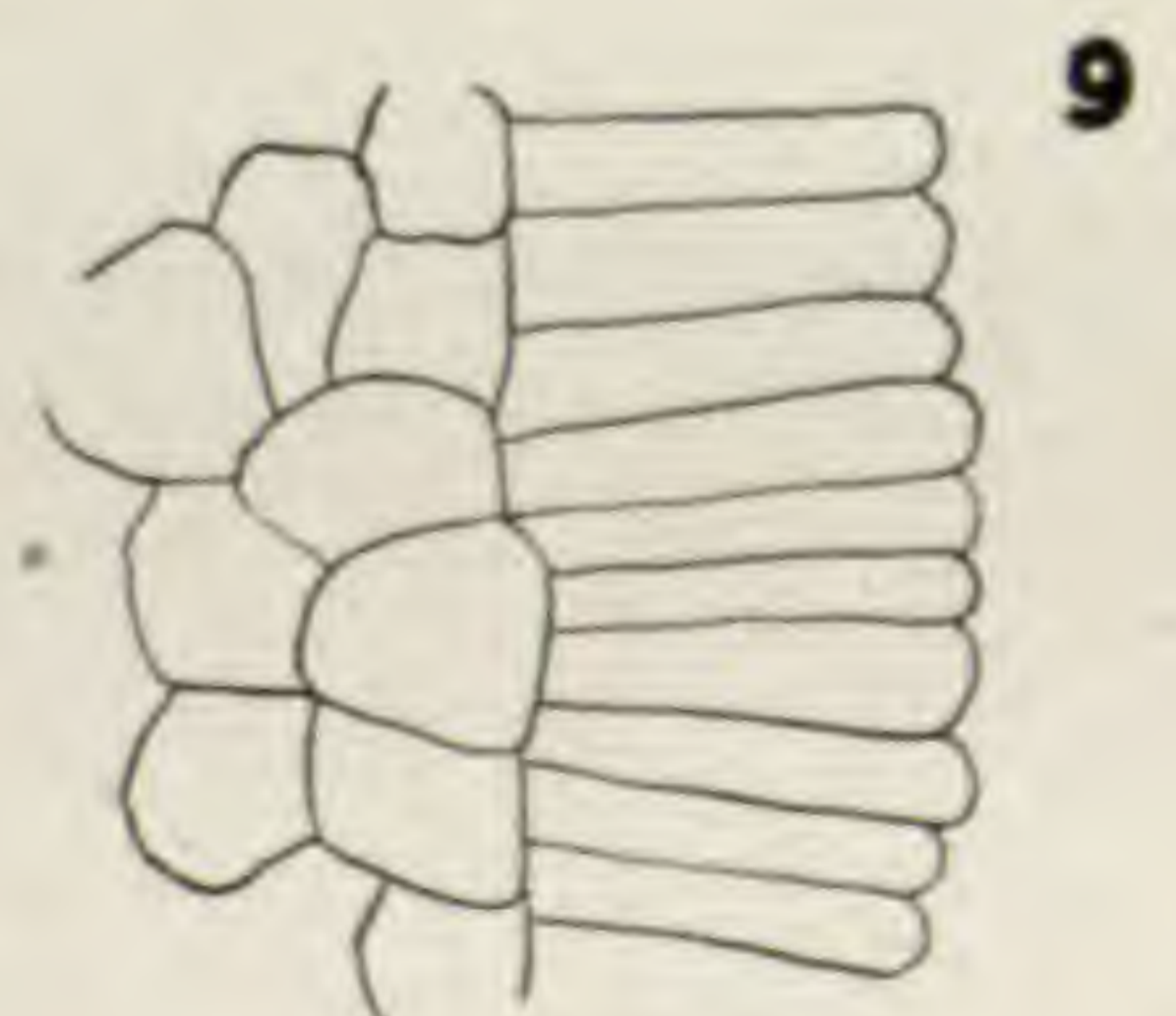
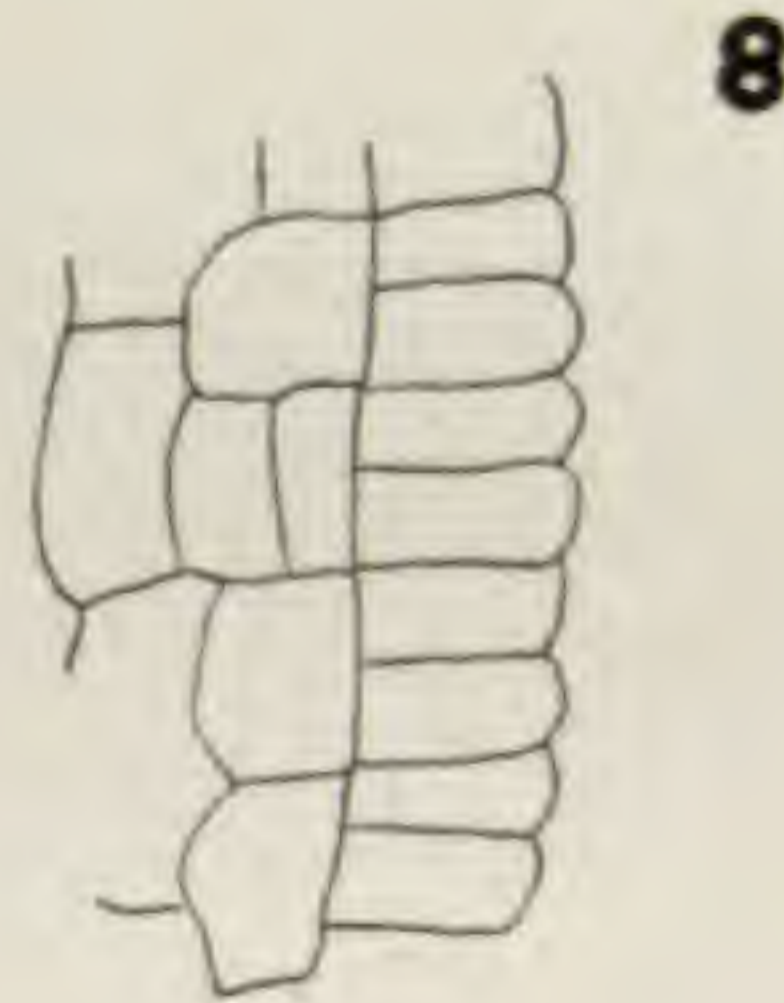
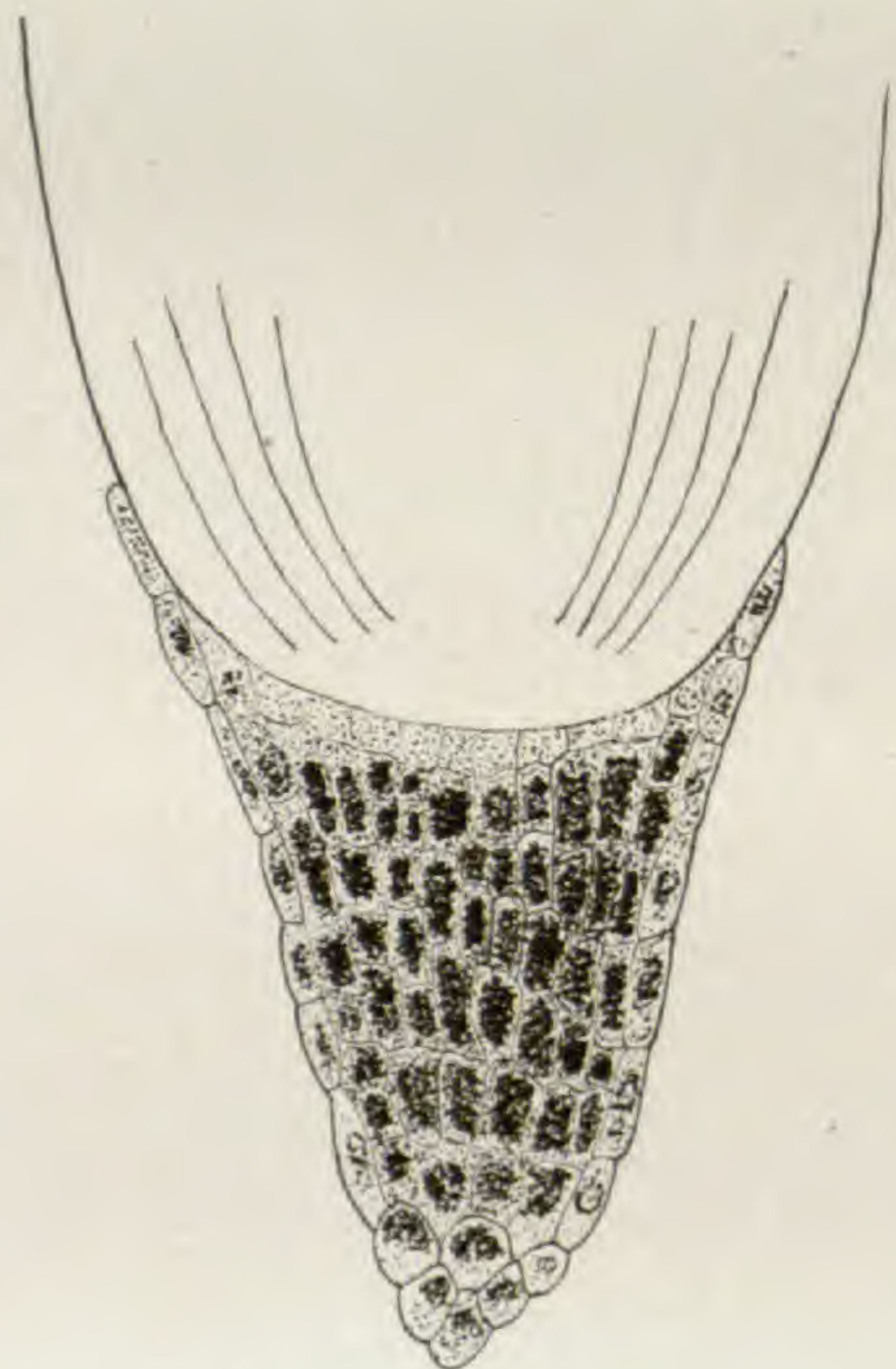
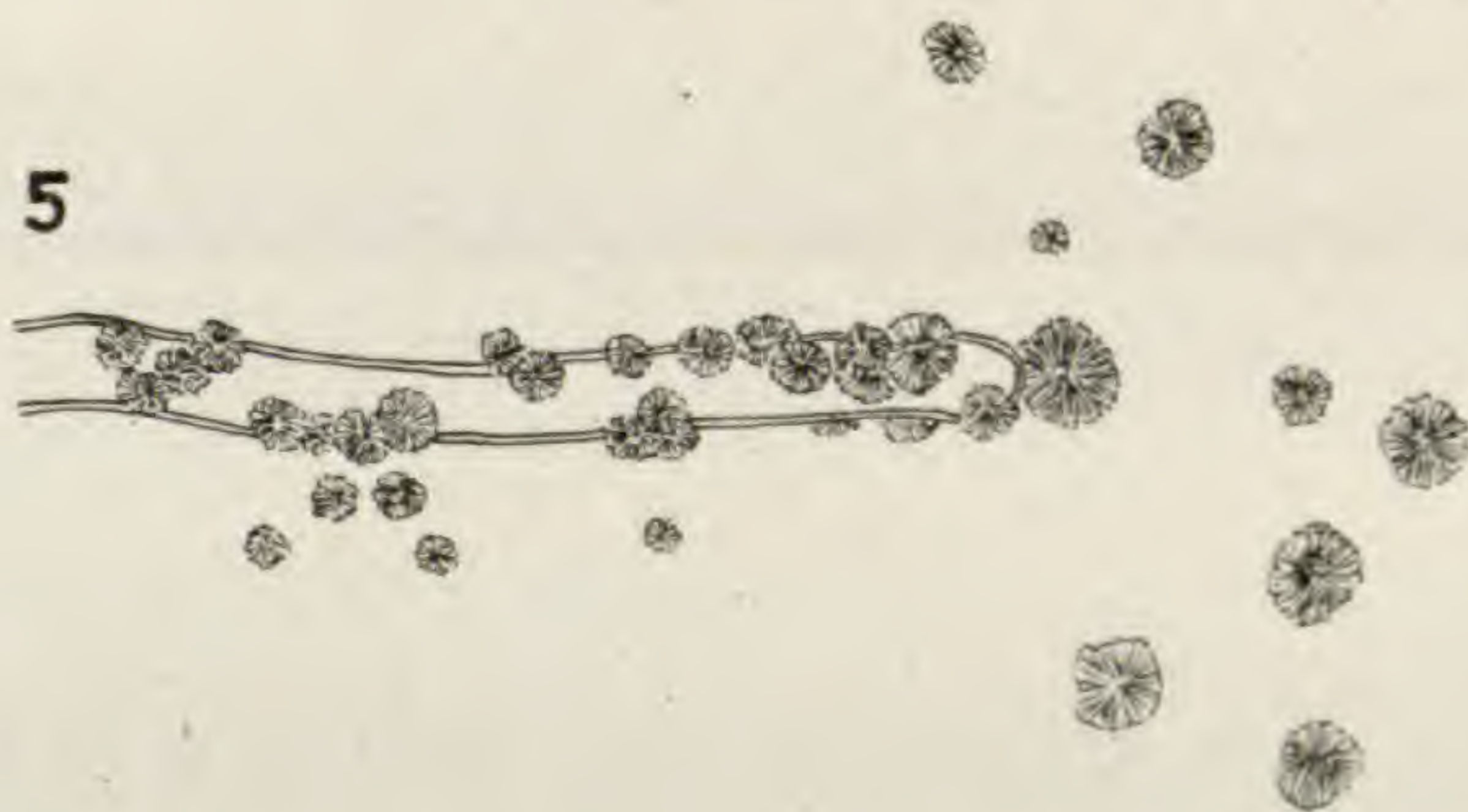
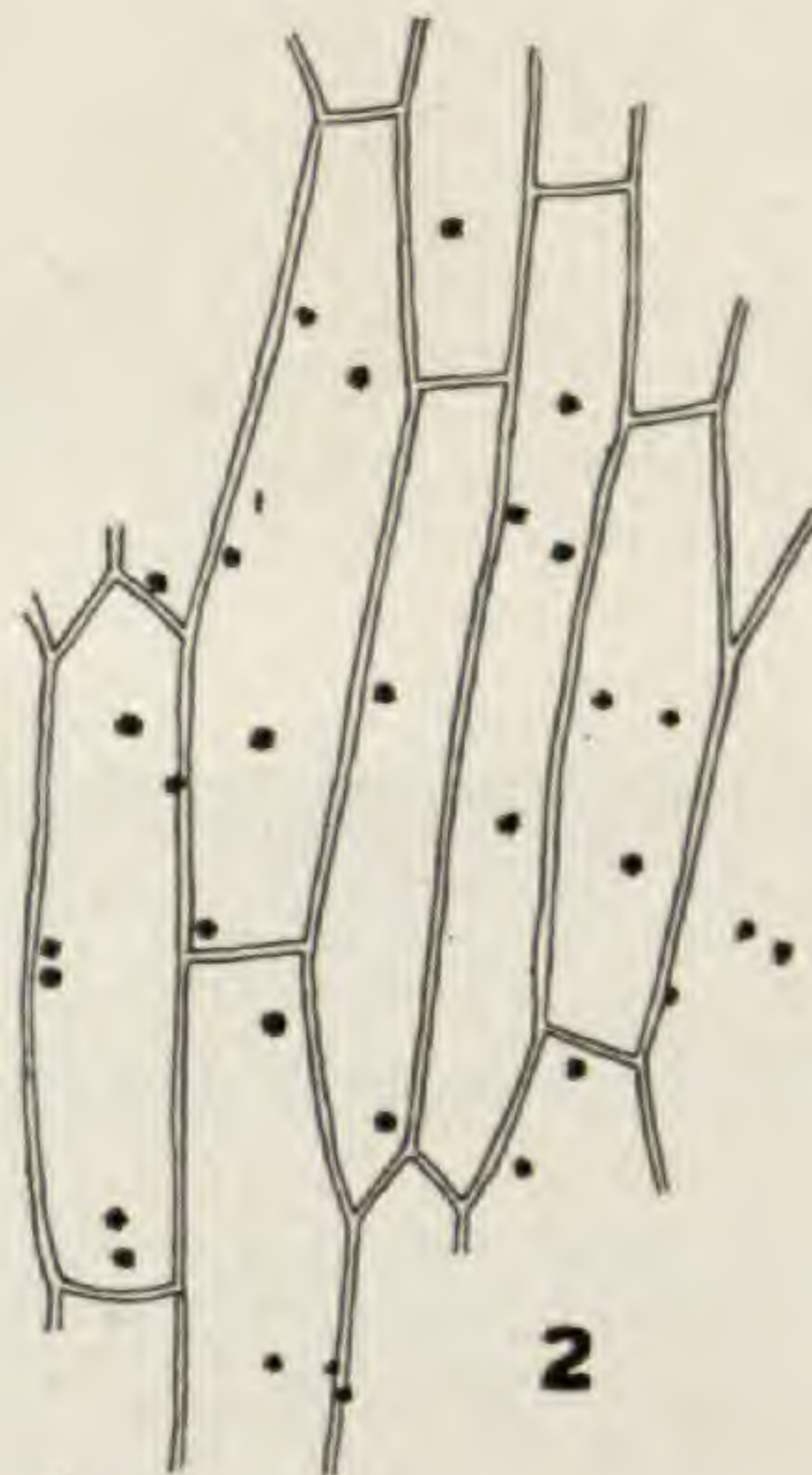
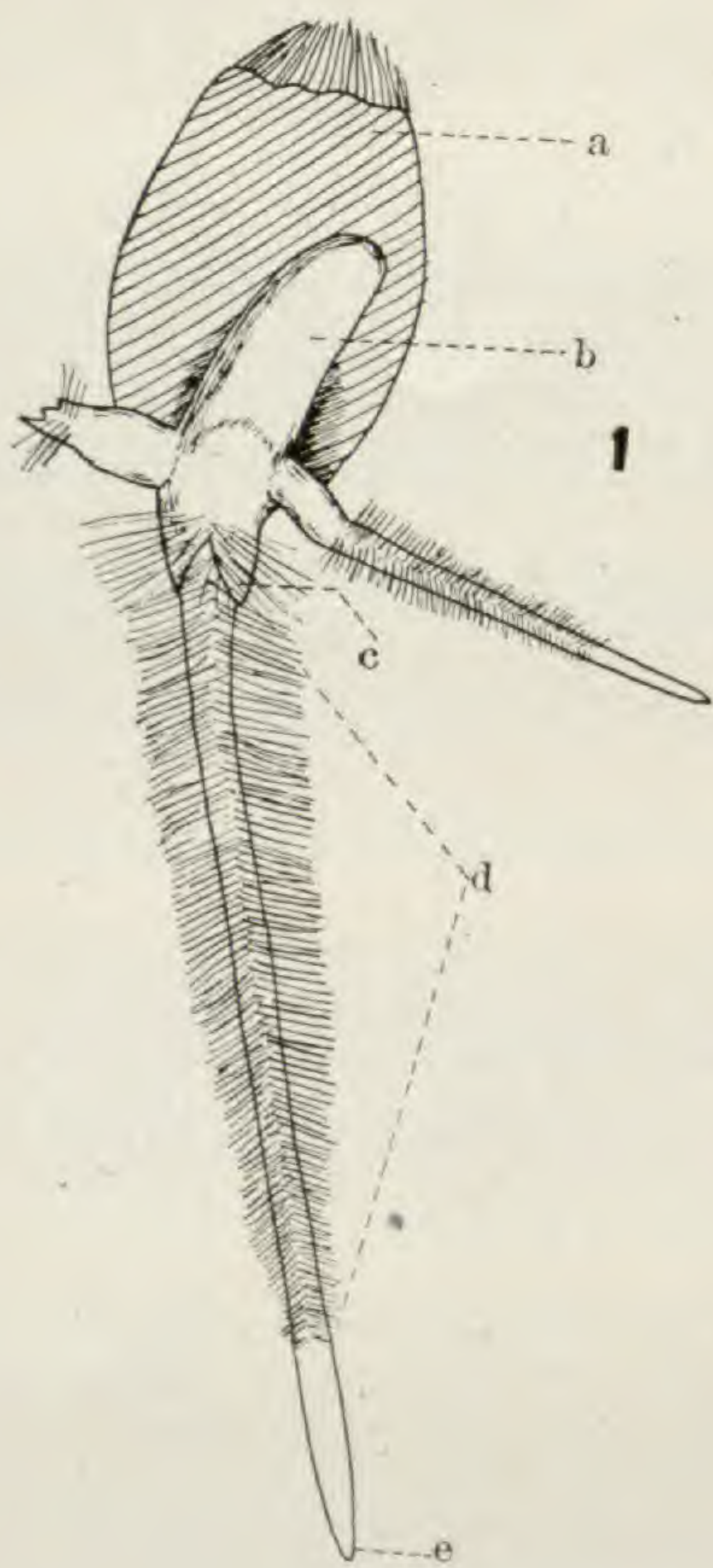

CHOATE on WHEAT

19. SCHULZE, E., Über den Umsatz der Eiweissstoffe in der lebenden Pflanze. *Zeit. Phys. Chemie* 30:241-312. 1900.
20. SCHULZE, E., and CASTRO, N., Beiträge zur Kenntniss der Zusammensetzung und des Stoffwechsels der Keimpflanzen. *Zeit. Phys. Chemie* 38:199-258. 1903.
21. THOMPSON, T. G., Total amino nitrogen in the seedlings of the Alaska pea. *Jour. Amer. Chem. Soc.* 37:230-235. 1915.
22. TORREY, J. C., Cytological changes accompanying the secretion of diastase. *Bull. Torr. Bot. Club* 29:221-235. 1902.

#### EXPLANATION OF PLATE XXVIII

FIG. 1.—Wheat seedling, two days old: *a*, old kernel; *b*, coleoptile; *c*, coleorhiza; *d*, zone of root hairs; *e*, root cap;  $\times 4.5$ .

FIG. 2.—Outer layer of pericarp showing cuprous oxide precipitated by Flückiger's reagent;  $\times 150$ .

FIG. 3.—Root cap, showing starch stained with iodine (3 days old);  $\times 112$ .

FIG. 4.—Detail of root cap;  $\times 175$ .

FIG. 5.—Root hair showing crystals formed by osazone test;  $\times 275$ .

FIG. 6.—Asparagine crystallized out in absolute alcohol in coleoptile (material 7 days old);  $\times 45$ .

FIG. 7.—Copper asparaginate formed by addition of copper acetate and absolute alcohol in coleoptile (material 7 days old);  $\times 150$ .

FIG. 8.—Epithelial cells of scutellum when placed in germinator;  $\times 150$ .

FIG. 9.—Epithelial cells of scutellum after 7 days in germinator;  $\times 150$ .

# UNDESCRIBED WILLOWS OF THE SECTION CORDATAE

CARLETON R. BALL

(WITH ONE FIGURE)

While this paper is a continuation of the series which has appeared under the title *Notes on North American willows*,<sup>1</sup> this general title is dropped now in favor of a specific one for each contribution. This seems desirable because it will permit a clear indication of the contents of each paper in the title thereof. These papers have resulted chiefly from studies made in preparing the treatment of the genus *Salix* for different floras and manuals of botany.<sup>2</sup>

The location of the herbarium material cited is indicated by capital letters in parentheses, as follows: B, herbarium C. R. Ball; C, herbarium Canadian Geological Survey, Ottawa; F, Field Museum, Chicago; FBb, Bebb Herbarium of Field Museum; Fs, Forest Service, United States Department of Agriculture; G, Gray Herbarium, Harvard University; I, Iowa Agricultural College; N, United States National Herbarium; R, Rocky Mountain Herbarium, University of Wyoming; RMP, herbarium of Rocky Mountains Park, Banff, Alberta, Canada.

*SALIX LUTEA famelica*, n.var.—Shrub or small tree, 3–6 m. tall; branchlets grayish, those of the season yellow, rather short and divaricate, glabrous: leaves small, stipulate; stipules mostly minute, 1–3 mm. long, ovate to lanceolate, acute; petioles slender, 4–8 mm. long, yellowish, glabrous; blades linear-ob lanceolate, narrowed and acutish or somewhat rounded at base, acute to

<sup>1</sup> BOT. GAZ. 40:376–380. pls. 12, 13. 1905; 60:45–54. figs. 1–3. 1915; 60:391–399. 1915.

<sup>2</sup> BALL, CARLETON R., *Salix* in COULTER and NELSON, Man. Bot. Rocky Mountain Region, pp. 128–139. 1909.

———, *Salix* in PIPER and BEATTIE, Flora of the Northwest Coast. pp. 113–118. November 1915.

———, *Salix* in P. C. STANDLEY, Flora of Glacier National Park, Contrib. U.S. Nat. Herb. 22:319–324. March 1921.

———, *Salix* in CHAS. C. DEAM, Trees of Indiana, revised ed. pp. 34–45. pls. 10–14. 1921.

acuminate at apex, 5-6 cm. long, 8-10 mm. wide, on vigorous shoots 7-10 cm. long, 12-20 mm. wide, yellowish green, glaucous beneath, glabrous and strongly reticulate on both sides, margins cartilaginous and shallowly serrulate, or subentire: pistillate aments small, 2-3 cm. long, on short peduncles 1-3 mm. long, subtended by 2 or 3 small leaves: capsule glabrous, lanceolate, 4.5-5 mm. long; pedicel 1-1.8 mm. long.

This variety differs from *S. lutea* chiefly in the very small and more strongly nerved leaves. The aments and the pedicels both are shorter than the average for the species. It holds much the same relation to *S. lutea* as var. *angustata* does to *S. cordata*. The demarcation seems sharper in the present case, but this may be due to the limited number of specimens in hand. The name means starved or hungry, and is suggested by the attenuate leaves with their prominent "ribs."

The earliest collection seen by the writer was made in 1883 by *L. F. Ward*, on an island in the Yellowstone River, 12 miles above Glendive, Montana. The type was collected by the writer about 120 miles farther up the Yellowstone River. *S. lutea* is very abundant on the floodplain of the river at Forsyth, Montana. Several clumps of shrubs were examined, probably fifteen or twenty in all, but only one was referable to the present variety. It consisted of only two or three stems, 8-10 cm. in diameter at the base, and 5-6 m. tall, located scarcely more than 10 rods from the north edge of the little town. It was recognized at sight as differing in some way from the other clumps, and this difference was found to be in the size of the leaves.

WARD'S specimen almost exactly matches the type, although the leaves are younger and smaller, the date of collection being six weeks earlier. The specimen from the Bellefourche River in South Dakota resembles *S. cordata angustata* a little more, just as the specimens of *S. lutea* from the Black Hills vary somewhat toward *S. cordata*. Further search probably will locate the variety in other parts of the Yellowstone Valley and in other districts. The first four specimens cited are all from one general district. The Bitter Root specimen is fragmentary and not well preserved, and hence somewhat doubtfully referred here.

SOUTH DAKOTA.—Bellefourche, along Bellefourche River, *C. R. Ball* 1347, September 19, 1908 (B).

NORTH DAKOTA.—Marmarth, wet bottoms, Little Missouri River, *L. C. Moyer* 469, June 6, 1914 (B).

MONTANA.—Osprey Island in Yellowstone River, 12 miles above Glendive, *L. F. Ward*, July 17, 1883 (FBb 2380); Forsyth, north edge of town, *C. R. Ball* 1304, September 1, 1908 (B, type; N); Bitter Root Valley and Mountains, Warm Springs Creek, alt. 7500 ft., *Pammel* and *Fawcett*, August 21-September 2, 1904 (B, I).

*SALIX LUTEA ligulifolia*, n. var.—*S. cordata*, in part, as interpreted by BEBB, *Willows of California*, 85, 1879, and BEBB in COULTER, *Man. Bot. Rocky Mt. Reg.* p. 335. 1885.—*S. cordata Watsoni*, in part, as interpreted by BALL, in COULTER and NELSON, *New Man. Rocky Mt. Bot.* p. 132. 1909.

When first studied this willow was regarded as a species intermediate between *S. cordata* and *S. lutea*, and a detailed description was written. Later it was considered more properly placed as a variety of *S. lutea*, but the complete description has been allowed to stand. It is hoped that fuller field study may be given to this interesting form.

Shrub with clustered stems 1.5–3.5 m. tall; bark dark gray; branchlets elongated, dark brown or somewhat yellowish, glabrous and usually shining, or the youngest pubescent; buds ovate-lanceolate, 5–10 mm. long, acute or obtusish, glabrous or pubescent, bright chestnut to dark brown, drying black: leaves mid-sized, petiolate, stipulate; stipules semicordate and acute to semilunate and obtuse, 4–10 or more mm. long, entire or serrulate, glabrous, glaucous beneath; petioles 6–10 mm. long, dark brown, glabrous to puberulent to pubescent, as the twigs; blades ligulate-lanceolate or oblong-lanceolate (narrowly oblanceolate when young), acute or very short-acuminate, rounded or subcordate and usually oblique at base, 5–10 cm. long, 1–2 cm. wide, common sizes 5 by 1.2–1.5, 7 by 1.3–1.8, 8 by 2, 9 by 1.5–2, and 10 by 2, cm., entire or (especially on vigorous sterile shoots) shallowly and remotely serrulate or glandular-serrulate, reticulate on both sides, especially beneath, dark green above, pale and at maturity usually white glaucous beneath, glabrous throughout or the white midrib puberulent above near base: aments appearing with the leaves or somewhat precocious, sessile, or the pistillate on peduncles 3–5 mm. long; pistillate aments 2–3.5 cm. long, subsessile, or on peduncles 3–5 mm. long, subtended by 2–4 very small leaves; scales elliptic-oblong, obtusish, drying black, glabrate outside at apex, basal portion and inside densely white-tomentose: capsule small, lanceolate or ovate-lanceolate, 4–5.5 mm. long, glabrous; pedicel 1–1.5 mm. long, glabrous; style 0.3–0.5 mm. long; stigmas short, entire, notched or bifid: staminate aments sessile, naked at base, or with one or two small bracts, slender, 2–3 cm. long, 4–8 mm. wide;

stamens 2, filaments slender, glabrous, free; scales as in pistillate ament.

*S. lutea ligulifolia* is a mountain-loving form. It is found in the Rocky Mountain system from the Black Hills of South Dakota, and the Laramie Hills and Medicine Bow Mountains of southeastern Wyoming, south to southern New Mexico and central Arizona. An isolated distribution occurs in extreme western Nevada and the adjacent Yosemite Valley of California. It appears to be confined to stream banks in mountain canyons at elevations from 5000 ft. (1500 m.) to probably 9000 ft. (2700 m.), although its upper limits are unknown as yet. It flowers from the last week in April until well into May, and fruits in due season thereafter.

It is distinguished from typical *S. lutea* by usually dark brown branchlets, longer and narrower, straplike, usually dark green leaves, with the margins often nearly parallel and usually entire or only shallowly serrulate. The capsules also are shorter and on fairly short pedicels. Specimens collected when the leaves are just unfolding resemble *S. irrorata*, but may be distinguished by somewhat lighter colored twigs, without the glaucous bloom, and by the broader, less oblanceolate leaves and longer pedicels. The following specimens are referred here.

CALIFORNIA.—Yosemite Valley, *H. N. Bolander* 6331, June 3, 1866 (FBb 6335, N).

NEVADA.—Washoe County, Hunter's Canyon, vicinity of Reno, 1350–1500 m., *A. E. Hitchcock* 455, July 18, 1913 (N); no locality (probably Washoe County) *Lieut. Wheeler*, 1872 (N, twig densely pubescent); Soda Springs Canyon, Mineral (Esmeralda) County, *W. H. Shockley* 363, May 1886 (FBb).

ARIZONA.—Grand Canyon, Indian Gardens, alt. 3800 ft., *E. A. Goldman* 2237, August 25, 1913 (N, twig densely pubescent); Navajo County, Black Mesa Forest Reserve: Black Canyon, Houck's Ranch, *F. V. Coville* 1084, June 5, 1900; along creek at Showlow, *Coville* 1091, June 8, 1900; 2022, July 4, 1904 (N, both specimens with pubescent-pilose young twigs and broader and more serrulate leaves); Apache County, Springerville, alt. 7000 ft., *E. A. Goldman* 2446, June 8, 1915 (N); White Mountain Indian Reservation; watershed of White River, above Ft. Apache, *Coville* 1977 (N 500639, type), 1981, June 30, 1904 (N); White Mountains, south of Thomas Peak, *Coville* 2014, July 2, 1904 (N); along White River near Ft. Apache, *Coville* 2016 and 2020 (seasonal twigs pubescent, leaves broader and more serrulate), July 3, 1904 (N); White Mountains, head of Black River, *L. N. Goodding* 1212, July 18, 1912 (N); White Mountain Apache Reservation, *Myrtle Zuck*, June 25, 1907 (N).

UTAH.—Kane County, Three Lakes, north of Kanab, *I. Tidestrom* 2417, July 9, 1909 (B).

NEW MEXICO.—No locality (probably Silver City, Grant County), *E. L. Greene* (FBb 3908, in part); Grant County, Ft. Bayard, Stephen's



Ranch, *J. C. Blumer* 171, November 15, 1905 (B); Lincoln County, White Mountains, alt. 7000 ft., *E. O. Wooton* 307, August 10, 1897 (N); Union County, Cross L. Ranch, head of Cimarron Canyon, *D. Griffiths* 4305, May 11, 1903 (B, N).

COLORADO.—Montezuma County, Mancos, *Alice Eastwood* 22, June 1891 (N); La Plata County, Durango, *Alice Eastwood* 23, June 1891 (N); Saguache County, Cochetopa National Forest, near Big Meadows, alt. 9500 ft., *W. O. Sanders*, July 8, 1916 (B); Conejos County, Los Pinos, alt. 7000 ft., *C. F. Baker* 270 (in part), May 1899 (F, N); Las Animas County, Stonewall, *Johnston and Hedgcock* 498, June 18, 1917 (B); Costilla County, Blanca, alt. 7752 ft., *E. R. Warren* 72; July 16, 1912 (B); Pikes Peak district, Little Fountain Creek, *J. C. Blumer* 5, 6, September 5, 1903 (B); Manitou, alt. 6000 ft., *M. E. Jones* 30, May 8, 1878 (N, twigs pubescent); Park County, Cassells, *E. W. Cathcart*, June 1904 (N); Lat. 39°–41°, *Hall and Harbour* 524, 1862 (FBb); Routt County, Walcott, *Alice Eastwood* 17 (in part), July 1891 (FBb).

SOUTH DAKOTA.—Custer County (Black Hills), Beaver Creek, Mayo, *W. H. Over* 1857, June 18, 1914 (N).

WYOMING.—Albany County, Little Laramie River, *L. N. Goodding* 5, 6, June 14, 1901 (B); foothills west of Islay, alt. 7300 ft., *Merritt Cary* 313a, June 25, 1909 (N).

**SALIX LUTEA platyphylla**, n. var.—*S. cordata* var. *Bebb* in KING, U.S. Geol. Explor. 40th Parallel 5:325. 1871.—Shrub or small tree 3–6 m. tall; branchlets virgate or somewhat divaricate, yellow, shining, glabrous; buds yellow: stipules mostly small, semicordate to sublunate; petioles very slender, 8–15 mm. long, yellow, glabrous; blades differing from those of the species in being broader and shorter, elliptic-obovate, acute or short-acuminate at apex, broad and rounded or obliquely subcordate to cordate at base, 1.5–3 cm. wide, 4–8 cm. long, common sizes being 2 by 4, 2–2.5 by 5, 2–2.5 by 6, and 2.5 by 7 cm., while sprout leaves reach such dimensions as 3.5 by 8, 4.5 by 9, and 4–4.5 by 11 cm.: aments same as in the species except that capsules are longer stalked, pedicels ranging from 1 to 2.5 or sometimes 3 mm. in length.

This variety occurs rather commonly in the Wasatch Mountain system from southwestern Utah to Idaho and ranges thence northwestward into Oregon. It is probable that it is more abundant than the specimens cited would indicate. It is separated from *S. lutea* by the broad, ovate-lanceolate leaves and the more elongated pedicels, 1.5–2.5 or 3 mm. long. In flowering specimens, however, neither the broad leaves nor the elongated pedicels are certainly distinguishable. It is almost exactly the form described by *BEBB* as "*S. cordata* var." *NUTTALL* describes *S. lutea* as having ovate-lanceolate

leaves, but states that they are more lanceolate than ovate. This statement agrees with NUTTALL'S figure (*Sylva* 1:63. *pl.* 19) and with the form of leaf on the cotype specimen, in which the pedicels are very short, scarcely exceeding 1 mm. The following specimens are referred to this variety.

UTAH.—Beaver County, Milford, *L. N. Goodding* 1020, June 4, 1902 (B, N); Juab County, Nephi, *C. R. Ball* 94, October 8, 1907 (B, N) and (by *F. D. Farrell* from same plant) June 19, 1909 (B); San Pete County, common in Coal Canyon, San Pitch Mountains, *I. Tidestrom* 1304, June 24, 1908 (N); Carbon County, Indianola, *I. Tidestrom* 2247, June 17, 1909 (B); Salt Lake City, City Creek Canyon, alt. about 6000 ft., *M. E. Jones* 1702, May 11, 1880 (N); alt. 5000 ft., *S. G. Stokes*, May 1, 1900 (N); *P. A. Rydberg* 6040, June 9, 1905 (N); *C. R. Ball* 1335, 1336 (B, type) September 11, 1908 (B, N); Farmington Canyon, near Salt Lake City, *Pammel* and *Blackwood* 3618, July 14, 1902 (B, I); Peterson, Weber River, alt. 6500 ft., *Pammel* and *Blackwood* 3903, July 18–24, 1902 (B, I); Ogden Canyon, Ogden, *A. E. Hitchcock* 1481, August 19, 1913 (N); Ogden, alt. 4300 ft., *M. E. Jones* 6552, May 29, 1889 (N).

WYOMING.—Sweetwater County, Bush Ranch, *A. Nelson* 7103, June 10, 1900 (B).

IDAHO.—Bear Lake County, Montpelier, *J. F. McBride* 17, May 15, 1910 (G, N with specimen of *S. caudata*); Canyon County, along the river, Emmett, alt. 2200 ft., *J. F. McBride* 790, April 29, 1911 (N).

OREGON.—Blue Mountains, head of Otis Creek, *W. C. Cusick* 1645, June 15, 1897 (N); Sherman County, Moro, *C. R. Ball* 1853, August 4, 1914 (B, N), *C. R. Ball* 2010, 2011, June 29, 1915 (B, C, F, G, I, N, R); Grass Valley, *C. R. Ball* 2012, June 30, 1915 (B); Des(c)hutes River, *Thos. Howell*, May 1886 (N).

NEVADA.—Humboldt County, Santa Rosa National Forest, mouth of Hansen Creek Canyon, alt. 4800 ft., *B. S. Martineau* 26 (in part), May 7, 1915 (B, Fs).

***Salix monochroma*, n. sp.**—*S. cordata* in part, of various authors treating of the Pacific northwest, not of Muhl.—*S. pyrifolia* as interpreted by BALL, in COULTER and NELSON, *New Man. Rocky Mt. Bot.* p. 133. 1909, not of ANDERSSON, 1867, or of SCHLEICHER, 1815.—*S. rotundifolia* Nutt., *N. A. Sylva* 1:75. 1842, not TRAUTVETTER, 1832.—Low shrub, with slender, glabrous, shining branchlets and small stipules: leaves obovate-oval or ovate, short-acuminate, 4–8 cm. long, crenulate-serrulate, thin, deep green and glabrous on both sides: aments appearing with the leaves, pistillate short-pedicelled lax; scales lanceolate-oblong, acute, dark, thinly pilose; capsule lanceolate, acute, 5–6.5 mm. long, glabrous; pedicel 2–4 mm. long, style about 0.5 mm. long; staminate ament sessile, slender; stamens 2, filaments glabrous, more or less united.



FIG. 1.—*Salix monochroma* Ball: portion of Coville and Kearney 241, from Idaho; leaves typical but ament smaller than usual (about two-thirds natural size).

Low shrub, 1-3 m. high; bark gray; branchlets slender, mostly elongated and virgate, sometimes shorter and divaricate, yellowish or bright chestnut to brown, glabrous, shining, full of leaf scars; buds slender, 4-7 mm. long, acute, chestnut to dark brown, glabrous, inconspicuous: leaves stipulate, petiolate; stipules narrowly ovate to lunate, crenate-serrulate to denticulate, color and texture as in blades; petioles slender, 4-8 or 10 mm. long, or to 15 mm. long on sprout leaves, yellowish to dark brown, glabrous or puberulent; blades elliptic-oblong to obovate-oval or ovate, acute to short-acuminate, or distal ones acuminate, 4-8 cm. long, 1.5-4 cm. wide, common sizes being 4 by 2, 5 by 2.5, 6 by 2.5-3.3, 7 by 2.5-3.5, 8 by 3, rounded to truncate or slightly cordate at base, glandular crenate-serrulate, those on luxuriant sterile branchlets and sprouts much larger, 8 by 4 or 10 by 3.5 cm., all thin, translucent, deep rich green on both sides, primary and secondary veins slender and somewhat raised on both surfaces, glabrous, at first thinly pilose-pubescent: aments slender, lax, appearing with the leaves, on short leafy peduncles; pistillate peduncle 5-8 or sometimes 13 mm. long, pubescent, bearing 2-4 small leaves 1-3 cm. long; staminate aments nearly sessile; pistillate ament 2.5-6 cm. long, 1.5-2 cm. wide, lax; capsule lanceolate or rostrate from a sub-ovoid base, 5-7 mm. long, glabrous; pedicel slender, 2-4 mm. long; style 0.4-0.6 mm. long, stigmas short, stout, mostly notched; scales elliptical-oblong or oblong, light brown, drying black, acute or obtusish, thinly clothed outside and more densely so inside with long crinkly hairs; gland 1, linear-clavate, elongated, sometimes 1.3 mm. long, usually shorter; staminate aments sessile, 2.5-6 cm. long (subtended by 2-3 leaves 1-2 cm. long), 1 cm. wide, slender, scales as in pistillate aments; stamens 2, filaments glabrous, united for 0.5-0.7 of their length.

*S. monochroma* ranges from the Yellowstone Park of northwestern Wyoming and adjacent Montana to the Willamette Valley of western Oregon and north to southern British Columbia and southern Alberta. It is a shrub of stream banks in the mountains of this section. Apparently it ranges in altitude from about sea level (Portland) to 5000 or 6000 ft. (1500 to 1800 m.) in the mountains, or occasionally to somewhat higher elevations. The flowers appear from about April 15 to May 15, and fruit follows in due season. At the higher altitudes the dates are considerably later. The writer was in error in placing

this species under the name *S. pyrifolia* in the *New Manual of Rocky Mountain Botany*. This was due to a misinterpretation of ANDERSSON'S species. This species is found quite commonly in at least four states and sparingly in others, and is represented by fairly abundant herbarium material. It seems never to have been described previously, however, unless NUTTALL'S *rotundifolia* is correctly interpreted as belonging here. *Nelson's* 6101 from the Yellowstone Park comes the nearest of any of the specimens cited to matching NUTTALL'S description.

*S. monochroma* is most closely related to *S. mackenziana* on the one hand, and to *S. pseudomyrsinites* on the other. From *S. mackenziana* it is separated by the very thin leaves, more ovate in outline and never even glaucescent, but colored deep green alike on both sides. From *S. pseudomyrsinites* it may be separated by the much thinner and broader leaves, less glandular, and with much more slender veins. The pedicels also are shorter and usually glabrous. The following specimens are referred to this species.

WYOMING.—Yellowstone National Park, *E. A. Mearns* 633, May 11, 1112, June 15, 1363, June 24, 1902 (N); in a ravine in the woods, Obsidian Creek, 2-4 ft. high, *Aven Nelson* 6101, July 24, 1899 (B).

MONTANA.—Livingston, *E. W. Scheuber*, June 1, 1901 (N).

IDAHO.—No locality (probably Boise or northward), *Coville* and *Kearney* 241 (N), 244, May 1899 (B, N); Cuddy Mountains, Washington County, alt. 6000 ft., *M. E. Jones* 6547, July 11, 1899 (N); Nez Perces County, valley of Hatwai Creek, *Sandberg*, *MacDougal*, and *Heller* 39, April 24 (G, N, 935072, type, female; 242995, type, male), 70, April 28 (N); valley of Clearwater River (on island) 96, May 2 (F, G, N); valley of Peter Creek, 117, May 4 (FBb 2679, G, N); canyons, valley of Lake Waha, 215, May 21 (FBb 2828, G, N); along Hatwai or Peter Creeks, 1046, May 4, or 10, 1892 (N, 2 sheets); about Lewiston, *A. A. and E. G. Heller* 2942, April 23, 1896 (N); Latah County: *L. F. Henderson* 2880 (Wessels), 7894 (FBb); along Paradise Creek, near Moscow, *Henderson* 2882 (in part), June 2, 1894 (FBb); along the Potlatch River, near Juliaetta, *Henderson* 2883, April 21, 1894 (FBb).

OREGON.—Blue Mountains, mostly Union County: common along streams, Union County, *Cusick* 875, 1880; alt. 8000 ft., *Cusick* 968 (in part), September 1882 (N); Crane Prairie, South Blue Mountains, *Cusick* 1652 (in part), June 17, 1897 (N); stream banks, *Cusick* 1845, April 26, May 9, September 1898 (N); bank of Catherine Creek, alt. 3500 ft., *Cusick* 2383, May 30, June 28, 1900 (F, G, N); Union, *G. R. Hyslop* 2058, July 18, 1916 (B); Wallowa County: along Chesnimnus Creek, Chico Station, Imnaha National Forest, alt. about 1000 m., *Coville* 2328, May 27, 1907 (N); Headwaters of Mud Creek, alt. about 1350 m., *Coville* 2390, June 8, 1907 (N); Umatilla County, ford of Umatilla River, South of Mission and 5 miles east of Pendleton, *C. R. Ball* 2089, August 20, 1917 (B); Grant County, Izee, *Griffiths* and *Hunter* 199, July 15, 1902 (B); Deschutes River, *Thomas Howell*, May 9, 1885 (FBb); Bend, on Deschutes River, *E. Nelson*, May 22, 1905 (B); Linn County, Fish

Lake, *F. A. Walpole* 305, August 1, 1899 (N); Portland, *L. F. Henderson*, 1886 (FBb 6234).

WASHINGTON.—Whitman County, Pullman, *A. D. E. Elmer* 1111, May 1897 (B); *C. V. Piper* 3598, May 13, 1898 (B); Walla Walla County, Waitsburg, *R. M. Horner* 446, April 22 (N), 447, April 9, 1897 (N); (west) Klickitat County, Columbia River, *W. N. Suksdorf* 40, April 25, 1884 (B); no locality, probably Klickitat County, *E. P. Sheldon* 8124, 1897 (N); Kittitas County, Wenatchee Mountains, *Coville* 1177, September 4, 1901 (N); Okanogan County, along Ashnola River, Sheep Mountain—Bald Mountain Trail, Okanogan Forest, alt. 1630 m., *W. W. Eggleston* 13395, August 2, 1916 (N).

ALBERTA.—Rocky Mountain Park, vicinity of Banff, *N. B. Sanson* 119, June 9 and 20, 1911; 257, 260, 262, 263, 264, 266, 267, 299, 302, 311, between July 4 and July 15, 1911; 341, 380, 387, 2038, between August 2 and August 14, 1911; 511, June 29, 1912, = July 1, 1912 (B, RMP).

**SALIX FARRAE Walpoleii** Coville and Ball, n. var.—Low shrub, 0.5–2.5 m. high; bark probably dark gray; branchlets stoutish, the older dark gray to brown, those of the season, or of two years' growth, mostly short, divaricate, dark brown to black, the youngest pubescent with gray hairs, becoming glabrate or glabrous, all rather closely beset with bud scars; buds (seen only on flowering and fruiting specimens) minute or small, 1–3 mm. long, lanceolate-conic, black, thinly pubescent or glabrous: leaves mid-sized, petiolate, minutely stipulate; stipules minute to small, lanceolate or semicordate to ovate, acute, entire or denticulate, 1–5 mm. long; petioles slender, 2–10 mm. long, yellowish to dark brown, pubescent, becoming glabrous; blades elliptic-lanceolate to obovate, acute or abruptly short-acuminate, 4–8 cm. long, 2–3.3 cm. wide, common sizes being 5 by 2–2.5, 6 by 2–2.5, 7 by 2.4–3, and 8 by 3.3 cm., narrowed to somewhat rounded at base, entire or shallowly and rather remotely crenulate, thin, glabrous, green above, glaucous beneath, coarsely reticulate with slender veins on both surfaces: aments slender, rather lax, appearing with the leaves, on leafy peduncles; pistillate peduncle 1–2 cm. long, bearing 2–4 leaves 2–4 cm. long; the staminate 5–10 mm. long, bearing 2–3 leaves 1.5–2.5 cm. long: pistillate aments 2–5 or 6 cm. long, 12–15 mm. wide, lax in fruit, rachis scantily tomentose; capsule narrowly lanceolate-rostrate, or conic-rostrate, 5–7 mm. long, mostly obtuse, brown, glabrous; pedicel slender to stoutish, 1–1.5 mm. long, glabrous; style very short, 0.2–0.3 mm. long, stigmas short,

notched; gland about 0.5 mm. long; scales oblanceolate, obtusish or acute, pale brown, nearly glabrous outside, thinly pilose inside, about 0.8 mm. long: staminate aments slender, spreading, 2-3 cm. long, 1 cm. wide; stamens 2, filaments glabrous, free; anthers short, obovate to nearly round, reddish or purplish; scales as in pistillate ament.

*Salix Farrae Walpoleii* is separated readily from the species by the pubescent-pilose young twigs, the broader, more obovate leaves, the longer and laxer aments, and the shorter styles. *Walpole's* no. 1624 in the United States National Herbarium is designated as the pistillate type. His no. 1742 has the best aments of any of the three staminate specimens seen and is designated as the staminate type. The variety flowers from about June 20 onward through July or early August, according to location. This willow rather closely resembles *S. balsamifera* (Hooker) Barratt, from which, however, it is readily separated by the entire leaves, seldom rounded and never cordate at base, the short pedicels, and somewhat shorter styles. Its nearest relative on the *S. cordata* side is *S. mackenziana* (Hook.) Barr., from which it is separated easily by the thin, entire, elliptic-obovate leaves, and more especially by the short pedicels. The variety is named for F. A. WALPOLE, since deceased, who collected several specimens of it in the vicinity of Port Clarence, near Cape Prince of Wales, Bering Strait, the most western locality at which it has been found. The specimens referred to it are cited later. So far as known, it is the only member of the section CORDATAE with an exclusively Arctic distribution.

ALASKA.—Vicinity of Port Clarence; north side and east end of Grantley Harbor, *F. A. Walpole* 1594, 3-4 ft. high, July 29, 1901 (N); rocky banks, northwest shore of Imunik Basin, *F. A. Walpole* 1624, 5-8 ft. high, July 30, 1901 (N, type); banks of Fuksuk Channel, *F. A. Walpole* 1742, 3-4 ft. high, August 5, 1901 (B, N); Cape Nome, *F. O. Blaisdell*, summer 1900; Fort Hamlin, Yukon River, to Bergman, Koyukuk River, Dall River, 75 miles above the mouth, *W. C. Mendenhall*, June 25, 1901 (N, two sheets); Valley of Alaskuk River, small willow, 2-4 ft. high, found along river, 30 miles above its mouth, *W. C. Mendenhall*, July 21, 1901 (N); along Help-me-Jack Creek, near camp, *W. C. Mendenhall*, common in river bottoms, about 5 ft. high, July 26, 1901 (N); Valley of Kobuck River, small bushy willow about 4 ft. high, on bank of small stream, *W. C. Mendenhall*, July 20, 1901 (N); Seward Peninsula, *A. J. Collier*, 1900 (N).

**SALIX LASIOLEPIS Bakeri** (v. Seem.), n. comb.—*S. Bakeri* von Seemen, Bull. Torr. Bot. Club 30:635. 1903.—A shrub or small tree essentially like *S. lasiolepis* in most respects, except that the capsule is thinly pubescent, especially toward the apex. The

capsule, 5-6 mm. long, also appears to be slightly larger than in the species and the style slightly longer.

When VON SEEMEN described *S. Bakeri* he did not compare it with *S. lasiolepis* or mention that species in any way. He published two other species in the same paper, *S. franciscana* and *S. ormsbyensis*. In neither case did he indicate their relationships or mention other species in connection with them. We might infer either that American species were not well represented in the Berlin herbarium or that VON SEEMEN did not look them over. His description of *S. Bakeri* fits *S. lasiolepis* perfectly except in the one phrase "apex with short gray hairs" in reference to the capsule. All the evidence goes to show that the describer was unaware of *S. lasiolepis* rather than that he knowingly was segregating from it a new species with pubescent capsules. This variety is comparable to var. *puberula* under *S. commutata*.

Two specimens collected by *F. A. Walpole*, at Modoc Point, Klamath County (2198, 2200), on June 5, 1902 (N), are similar to the specimens cited later. The capsule in the Klamath specimens, however, is longer (6-8 mm.), much resembling that of *S. scouleriana*. I have considered these two, therefore, to be hybrids between *S. lasiolepis* and *S. scouleriana*. It is possible that the plants here referred to var. *Bakeri* are hybrids also, but this is less probable. One striking character in the Klamath specimens is the elongated pedicel, 1.5-2.5 mm. in no. 2198, which is longer than in either supposed parent.

CALIFORNIA.—Foothills near Stanford University, Santa Clara County, *C. F. Baker* 274, March 9 and May 10, 1902 (N, cotype); Berkeley, *W. L. Jepson*, March 24, August 15, 1891 (N).

BUREAU OF PLANT INDUSTRY  
WASHINGTON, D.C.



# VESSELS OF THE GNETALEAN TYPE IN ANGIOSPERMS<sup>1</sup>

R. C. MACDUFFIE

(WITH PLATES XXIX-XXXII)

A common feature of Gnetales and Angiosperms is the possession of true vessels. The evolution of the vessel perforation and its typical form have long been matters of investigation. THOMPSON<sup>2</sup> has stated recently that the derivation and evolution of the vessel in Gnetales is distinct and different from that found in Angiosperms. On the other hand, SOLEREDER<sup>3</sup> and DEBARY<sup>4</sup> mention the existence among certain Angiosperms of the peculiar bordered pore which THOMPSON so definitely limits to the Gnetales. The present investigation, which covers a number of species of Angiosperms and Gnetales, confirms and extends the observations of SOLEREDER and DEBARY on Angiosperms and of THOMPSON on Gnetales. The writer finds it necessary, however, to differ from the conclusions of THOMPSON on Angiosperms.

## Gnetales

In *Ephedra*, the lowest genus of Gnetales, primitive conditions of vessel organization are found. Fig. 1 is a section of wood taken in a primitive region near the pith. To the extreme left are the long slender tracheids with their characteristic pits, bordered and containing a torus. In the center are two large vessels which, in their several ways, show a distinct relation to and evolution from the tracheid condition. The vessel more to the left has pits of ordinary tracheary type at either end, except that they are somewhat enlarged in the vessel condition, but retain both border and

<sup>1</sup> Contribution from the Laboratories of Plant Morphology of Harvard University.

<sup>2</sup> THOMPSON, W. P., Independent evolution of vessels in Gnetales and Angiosperms. *BOT. GAZ.* 65:83-90. 1918.

———, Anatomy and relationships of the Gnetales. 1. *Ephedra*. *Ann. Botany* 26:1077-1104. 1912.

<sup>3</sup> SOLEREDER, HANS, Systematische Anatomie der Dicotyledonen, Stuttgart. 1899.

<sup>4</sup> DEBARY, H. A., Comparative anatomy of the vegetative organs of the Phanerogams and Ferns. Trans. by F. O. BOWER and D. H. SCOTT. Oxford. 1884.

torus. In the center of the same vessel, passing upward from the lower end, is one pit which retains its border but has lost the torus and membrane. The center of this vessel shows as many as five perforations which have gone a long way in evolution and have lost both membrane and torus. It is to be concluded that these are perforations highly specialized to carry on the vascular function. The vessel to the right has a precisely similar condition at either end, namely enlarged tracheary pits. Toward the center of this vessel from top or bottom are three pits in the first case, and two in the second which retain border and torus, but have reached distinctly the size characteristic of vessels. The eight more central pits retain a definite border, but each shows an absence of membrane and torus. This vessel is obviously less specialized, and therefore less efficient than the one previously considered; nevertheless it shows marked progress in the line of development. To the extreme right are typical tracheids, once again proving that these two vessels occur side by side with the elements from which they originate.

In *Gnetum*, the highest genus of Gnetales, conditions are especially interesting. Fig. 2 shows a longitudinal section, in rather low magnification, taken from the medullary region. The first vessel to the left has pits of the tracheary type at its top. These are many, crowded, and retain border and membrane, there being usually no torus in *Gnetum*. Toward the center the pits are somewhat enlarged, although still retaining the border. In the region of the perforation of the vessel there is a group of seven pits. These are distinctly larger than those on the side wall of the vessel and larger than those of most tracheids, and their borders are still distinct. The most interesting feature of this group, however, is found in the two lowest pits whose adjacent borders have broken down and show well defined fusion. This is the first example of pit fusion to be described, and is clear and convincing. Moreover, this is obviously a step higher than the conditions found in *Ephedra*, and foreshadows the more extensive fusion of pits to form a single large opening, which is the natural outcome from such conditions. In the same figure to the right are two large vessels in series. The higher vessel shows a large perforation resulting from pit fusion.

About this perforation is a well defined border, and except for a vestige of a cross wall that runs into it from the left, we should find here the simple large open perforation which is the result of complete fusion; in other words, the type characteristic of the more advanced species of *Gnetum*. The vessel below shows an imperfect perforation resulting from the more or less complete fusion of a number of large open bordered pits.

Fig. 3 presents a higher magnification of two large vessels, the one to the extreme left showing a group of four large tracheary pits arranged suggestively for fusion. To the right is a vessel with a single large opening as its perforation, this being the typical condition in more advanced species of *Gnetum*. The border is distinct, and by its slightly irregular outline, which shows especially well at the upper right side of the perforation, reveals its origin from a type like the vessel on the left in the same figure. Fig. 4 is a high magnification of an intermediate stage of fusion, showing the remains of a transverse process about to disappear.

### Angiosperms

In Angiosperms the evolution of the vessel from the tracheid proceeds along the same lines as in Gnetales. Fig. 5 shows the organization of the mature wood in *Alnus japonica*. Here is seen the scalariform perforation characteristic of the Betulaceae and other presumably primitive Angiosperms. The pits, which are many and crowded, have fused in horizontal rows to form scalariform pits. The condition is seen even more clearly to be decidedly scalariform under higher magnification, as in fig. 6.

A section through the medullary region of *Alnus japonica* is shown in fig. 7. This is a rather low magnification, but shows clearly the primitive spiral and scalariform tracheids to the left. The three vessels to the right of these tracheids show all transitional stages from small pits to the scalariform perforations. The occurrence of this form of vessel perforation side by side with scalariform tracheids proves that it is indeed a primitive type for this genus of the woody Angiosperms. Fig. 8 shows these same vessels and tracheids under higher magnification. Fig. 9 is still another

high magnification of a vessel in *Alnus japonica*, in which the origin of the scalariform perforation from fusions of rows of pits is clear and convincing.

We pass now from woody Angiosperms to the consideration of the herbs and vines among Angiosperms, which in their vascular structures more closely resemble the conditions found in *Gnetum*, and show stages of perforation strikingly like those found in that genus. Fig. 10 is a section through the wood near the pith of *Potentilla palustris*. Several vessels are shown in the figure with a rather advanced development of the scalariform pits in the region of perforation. This condition resembles that found in the mature wood of *Alnus*. Fig. 11 is a section taken from the medullary region of *Potentilla monspeliensis*, an annual species. To the left are the characteristic spiral and scalariform tracheids of the protoxylem, and to the right are vessels with scalariform perforations on the end wall. Of these vessels, the one to the right shows a tendency at its lower end toward fusion of the scalariform pits. To the extreme right of the same figure is a vessel, low in the field, with the single large bordered pore characteristic of the mature wood of *Potentilla* as well as of the vessels of *Gnetum*. A further example of the close relation to the Gnetalean pitting is found in fig. 12, another section of the wood of *Potentilla monspeliensis*. To the left are two vessels in series. Both have the small pits grouped for fusion as in *Ephedra* and in certain species of *Gnetum* (figs. 1-3); in fact several of the pits have already fused in the higher vessel. To the extreme right is a vessel with a large *Gnetum*-like pore. Fig. 13, another section of *Potentilla monspeliensis*, shows three other vessels in the region of perforation. The vascular element to the left has again *Ephedra*-like pits grouped and fusing. The two vessels to the right in series have a curious S-shaped fusion of pits, quite out of keeping with any mode of origin save a haphazard union of pits. Fig. 14 shows part of the same field under higher magnification. It is clear that the two vessels here manifest the process of fusion of numbers of small pits. Fig. 15 is a high magnification of a similar condition in the same genus. Examples of like conditions might be indefinitely multiplied from

the study of this and other species of *Potentilla*. From the mode of perforations found in *Potentilla* it is seen that both the scalariform type and the *Gnetum*-like type, resulting from haphazard fusion, occur side by side and sometimes in the same species. It thus appears that both *Ephedra* and *Gnetum*-like types of perforation occur in this instance, and undoubtedly the bordered open pore has originated here from the grouped pits, either by horizontal or haphazard fusions. The possession of the scalariform type of perforation thus loses significance as a phylogenetic criterion and has only the importance of an anatomical detail. Further, the open bordered pore has often the same derivation in *Potentilla* and in other herbaceous Rosaceae as the similar bordered pore in *Gnetum*.

We pass now to the Geraniales, a group systematically remote from the Rosaceae. Fig. 16 shows a longitudinal section of the wood of *Pelargonium*. In the center is the region of perforation of a vessel, showing the bordered pore typical of the more advanced species of *Gnetum*. Even the border is clearly evident, a condition which THOMPSON apparently has failed to observe as occurring in the so-called porous perforation characteristic of the vessels of many Angiosperms, particularly (although not exclusively) those of herbaceous and liana-like habit. Fig. 17 shows another vessel of *Pelargonium* which illustrates an *Ephedra*-like perforation in this genus. There is obviously no difference here from the vessel perforation found in *Ephedra* except that the pits are small and both torus and membrane are always absent. There is no reason to believe that these pits are to fuse to form scalariform perforations, rather there is every evidence to infer a prospective haphazard fusion from the two or three instances of union manifested along the lower border of the perforation. This type precedes the open pore of fig. 16. Additional proof of this conclusion is supplied in fig. 18 from the same genus (*Pelargonium*). The vessel to the left has an interesting perforation. Small pits in the process of fusion surround an open bordered pore. When fusion is complete the enlargement of the central bordered porous opening will result. In the vessel adjacent to this is the large open bordered pore characteristic of the vessels of the Geraniales, and below it is

another similar perforation. Fig. 19 shows a higher magnification of the same vessel as presented in fig. 18. The details of border in the large central pore demonstrate the existence in Angiosperms of the *Gnetum*-like pore. Fig. 20 illustrates another vessel of *Pelargonium* showing two perforations in series. The upper perforation manifests a transitional stage of fusion. The high degree of magnification furnishes undoubted evidence that the complete fusion of pits will result in a large bordered perforation precisely as in *Gnetum*. Below is a bordered porous perforation.

Fig. 21 shows the partially pitted perforation of another vessel of *Pelargonium*. Fusion for the most part has already taken place, but enough small pits remain to establish a definite origin of the open bordered pore by *Gnetum*-like haphazard fusion. Fig. 22 shows a scalariform perforation in the same species of *Pelargonium*. The existence of this type, together with the bordered perforation derived from the fusion of *Ephedra*-like terminal pits, illustrated in the Rosaceae, shows again that the scalariform type of perforation is not exclusively present in or solely characteristic of Angiosperms. There is undoubted similarity between perforations of the Rosaceae and the Geraniales and those obtaining in *Gnetum* itself.

Fig. 23 shows two interesting vessels of the wood of *Tropaeolum* as a further illustration of the Geraniales. Both vessels have the *Ephedra*-like grouping of pits, although the size is obviously smaller than in that genus. Close scrutiny reveals the fusion to be haphazard-oblique and marginal, and not resulting in horizontal scalariform perforations. Most of the vessels in *Tropaeolum* have the *Gnetum*-like bordered terminal pore. Fig. 24 shows a section through the wood of *Clematis* species, an example of the Ranunculaceae. The margin of an open bordered perforation is shown, and around its inner edge is seen a fringe of haphazardly fusing pits. Vessels of the *Gnetum* type are practically universal in the Ranunculaceae.

### Conclusions

Conditions similar to those illustrated for the Rosaceae, Geraniales, and Ranunculaceae are widespread among dicotyledonous Angiosperms, particularly those of herbaceous and climbing habit.

It seems unnecessary to exemplify further the occurrence of perforations identical with those characteristic of the Gnetales in the Angiosperms, since the examples furnished, which could be indefinitely multiplied, show that the vessels of Angiosperms can and often do originate precisely as in the highest group of the Gymnosperms, the Gnetales. It accordingly appears clear that THOMPSON'S assumption of a distinct origin for the Gnetales on the basis of a different mode of derivation of their vessels falls to the ground. This author has pointed out that the types of rays found in the Gnetales are strikingly similar in their mode of origin to those of the Angiosperms. He has further recently drawn attention to the nuclear fusions in the embryo sac of *Gnetum*, which he compares with the well known nuclear fusions in the female gametophyte of Angiosperms. It would appear, therefore, that far from demonstrating by his description of the mode of origin of vessels in *Gnetum* the separate derivation of the Angiosperms from the Gnetales, in reality this author has furnished additional conclusive evidence of their descent from a common stock. It is apparently clear from the present investigation that many herbaceous and vinelike Angiosperms, from the lowest to the highest groups, show types of vessel perforation identical with those found in the usually vinelike *Gnetum*. Even the Monocotyledons manifest very commonly the *Gnetum* type of vessel, which is further quite universal in the Compositae.

### Summary

1. Vessels with scalariform perforations of the angiospermous type and bordered porous perforations of the *Gnetum* type occur side by side in the Rosaceae, being found even in the same species of *Potentilla*.

2. Similar observations are recorded for the Geraniales and Ranunculaceae, and these might be indefinitely multiplied from other herbaceous Angiosperms.

3. Recent statements that the types of vessels in the Gnetales and Angiosperms are distinct in their mode of derivation are accordingly without foundation in fact.

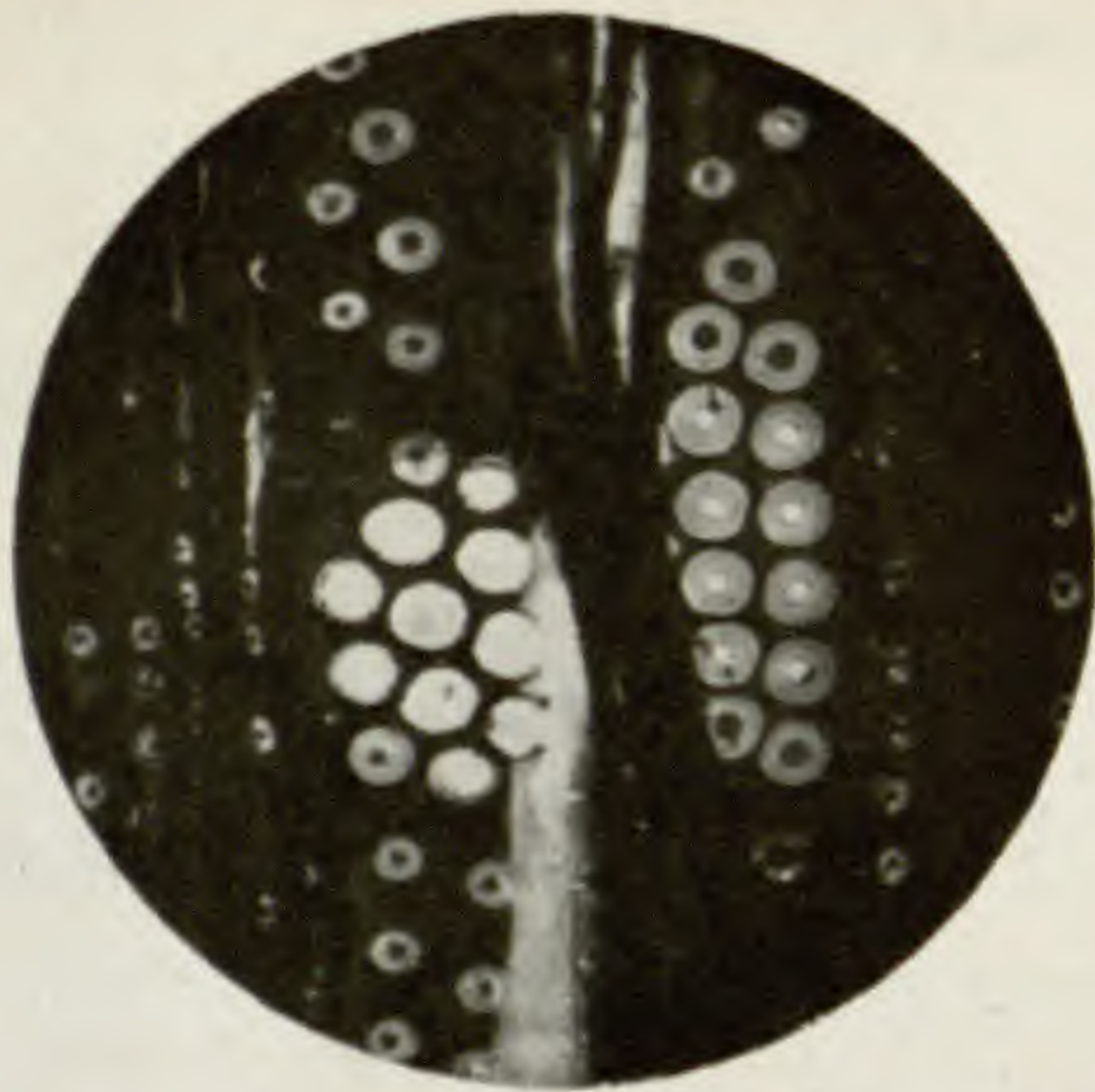

1



2



3

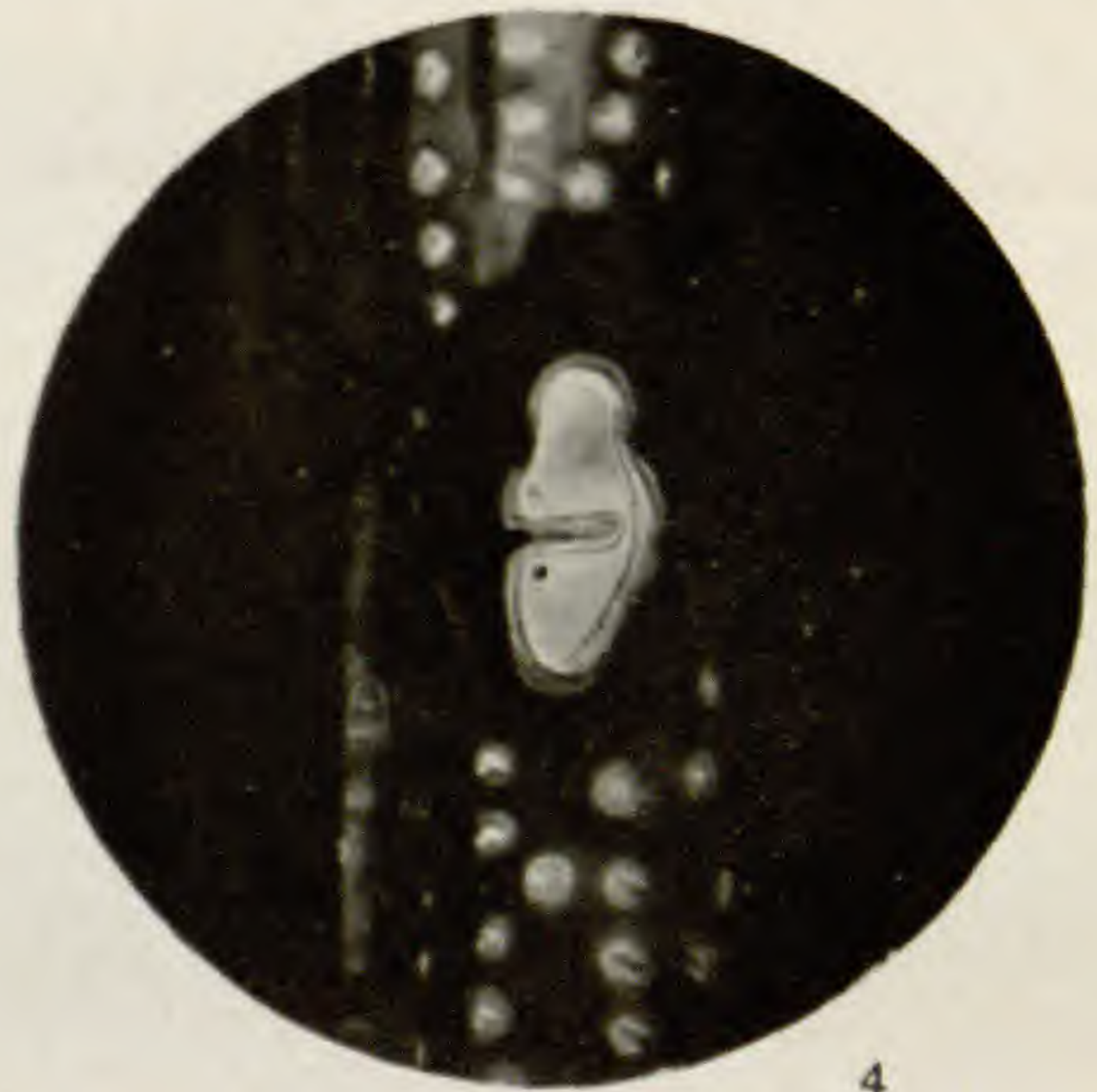

4



5

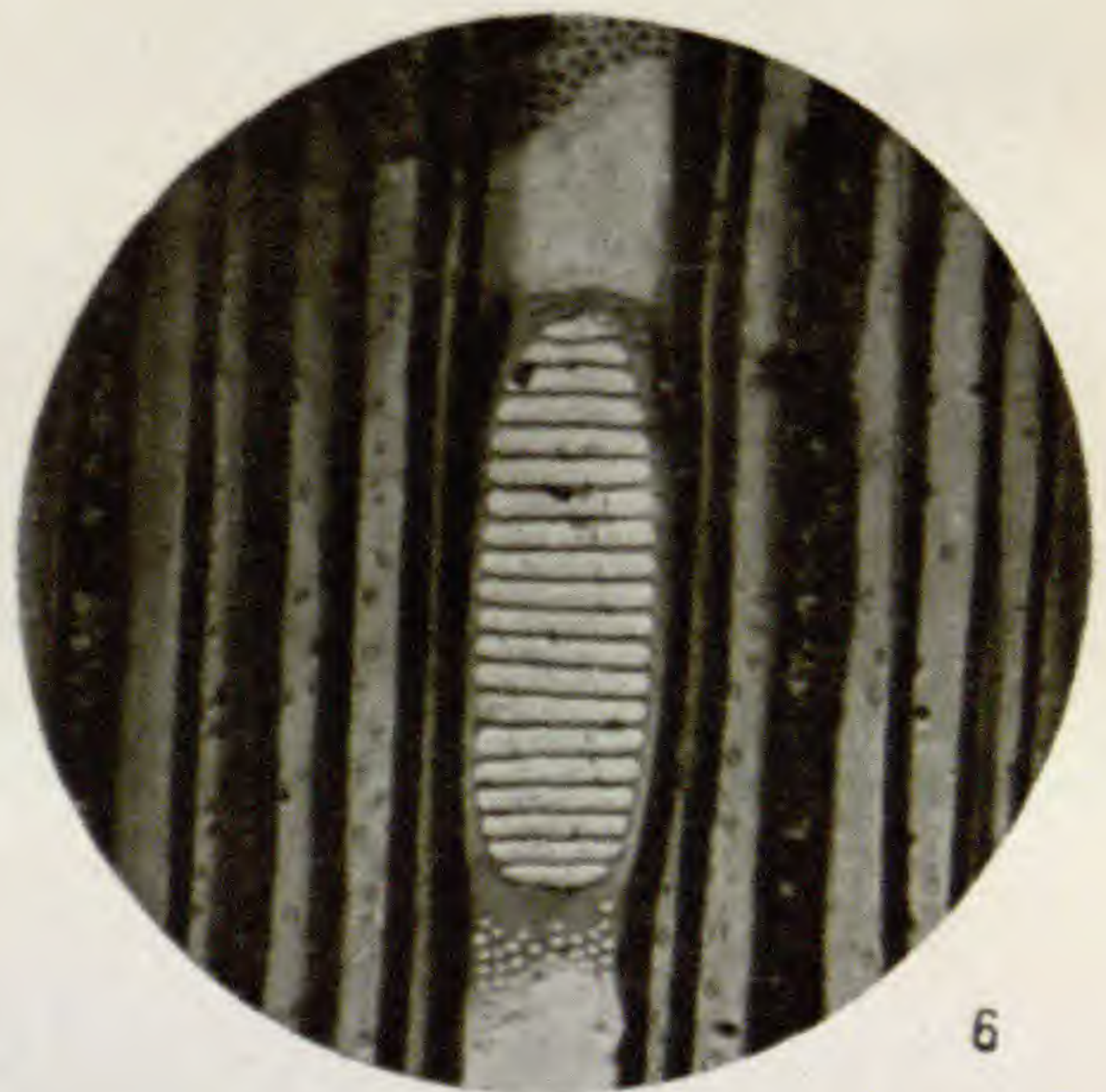

6





7



8



9



10



11



12



13

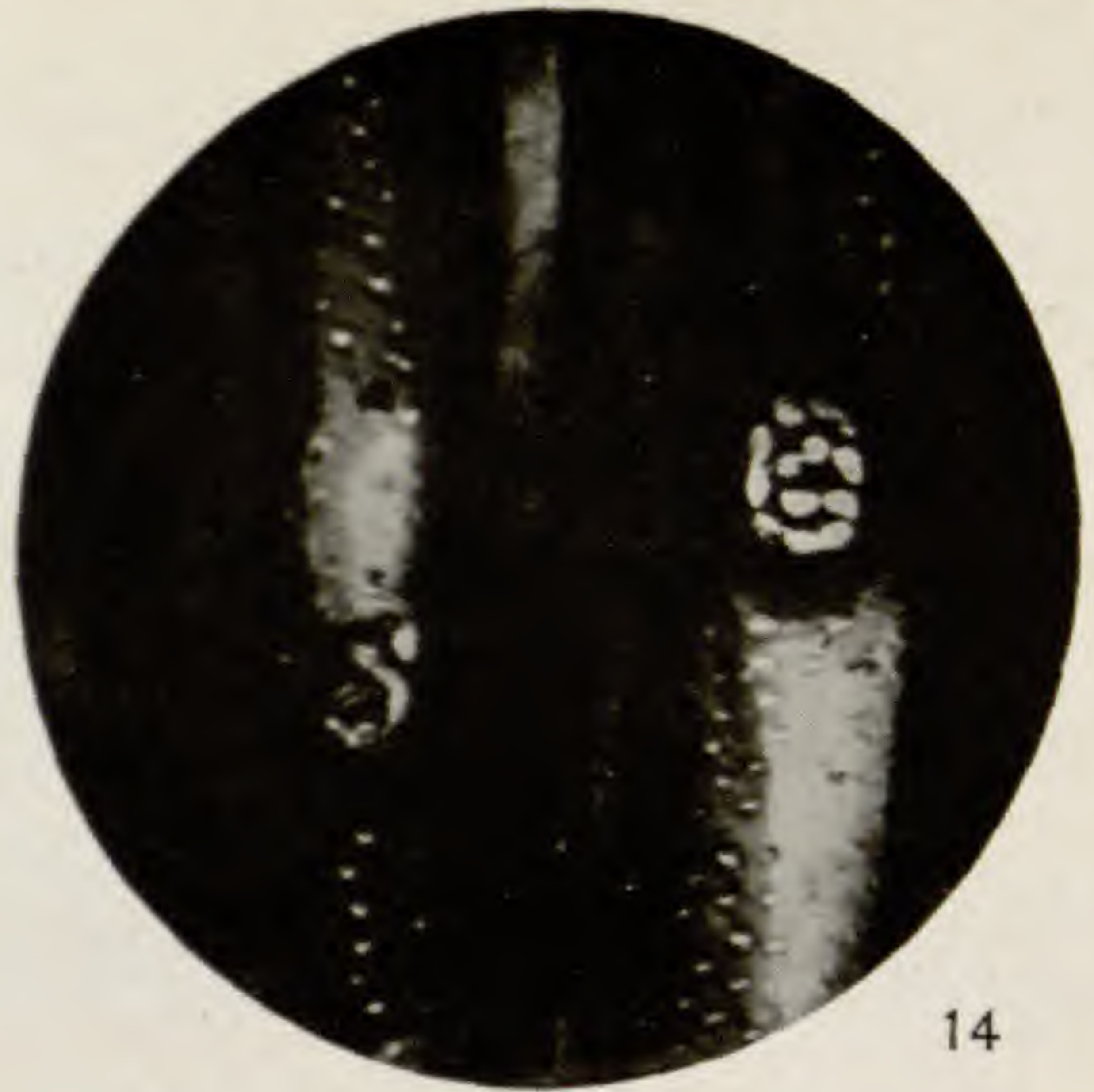

14



15



16



17

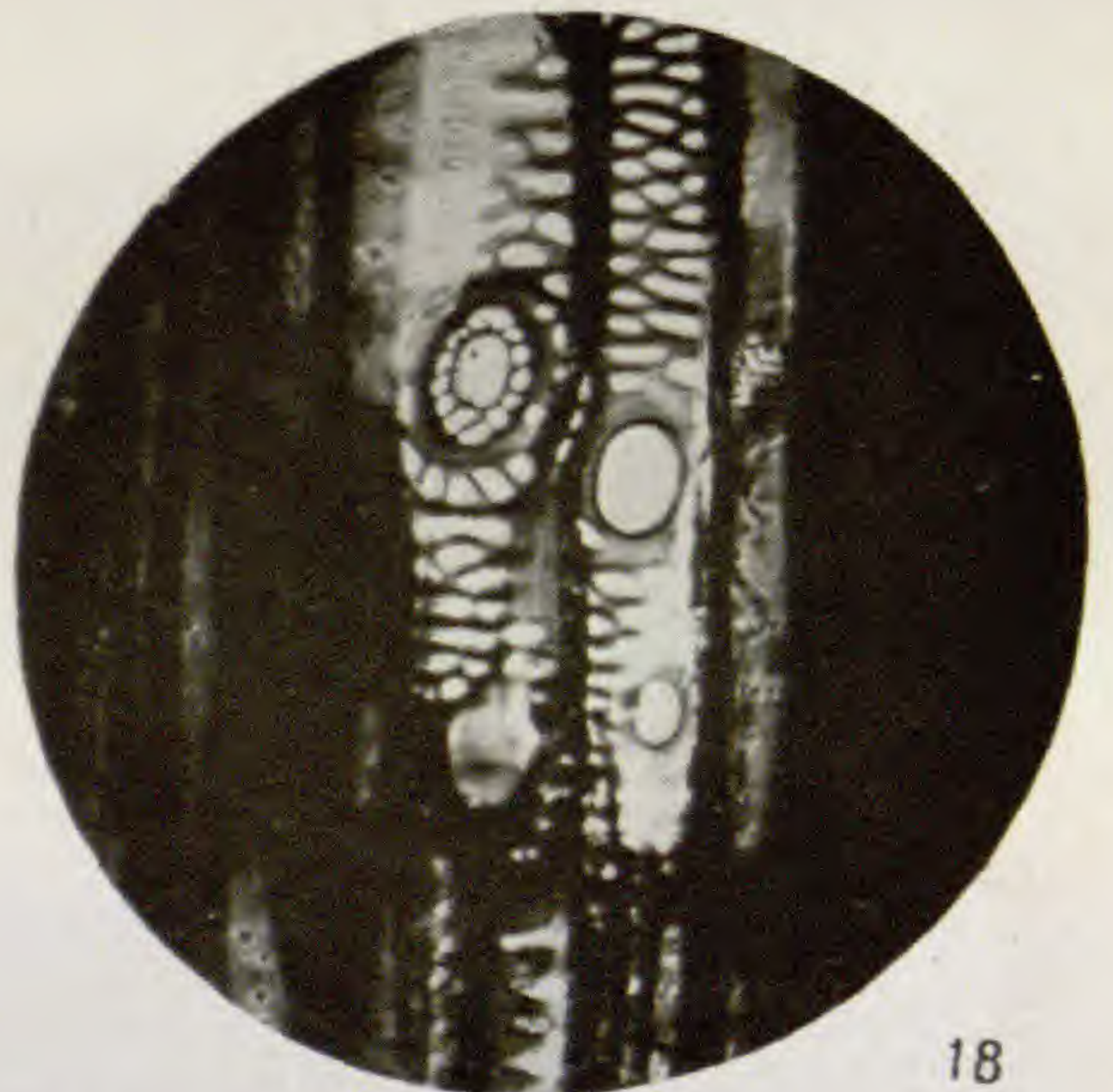

18

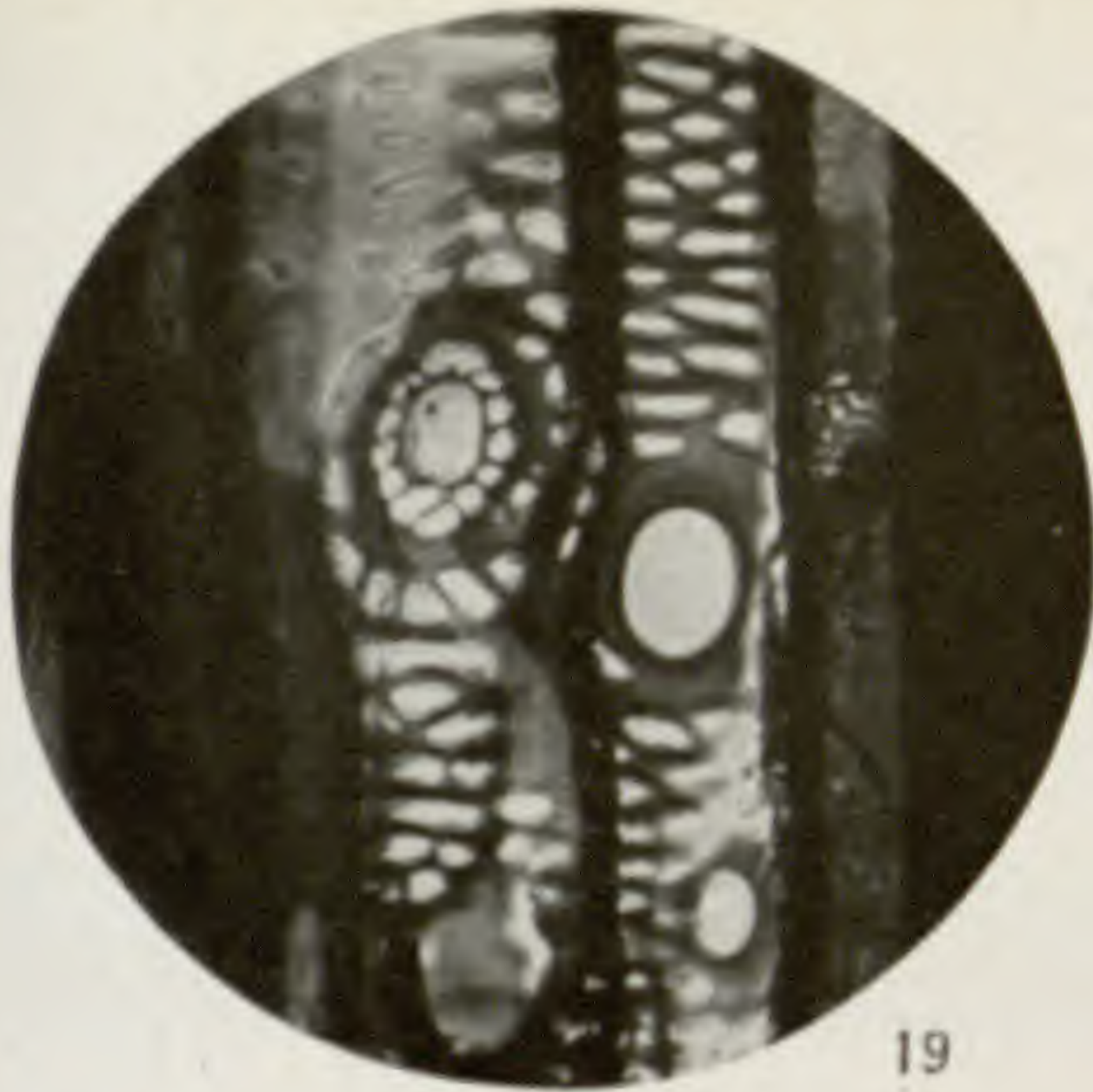

19

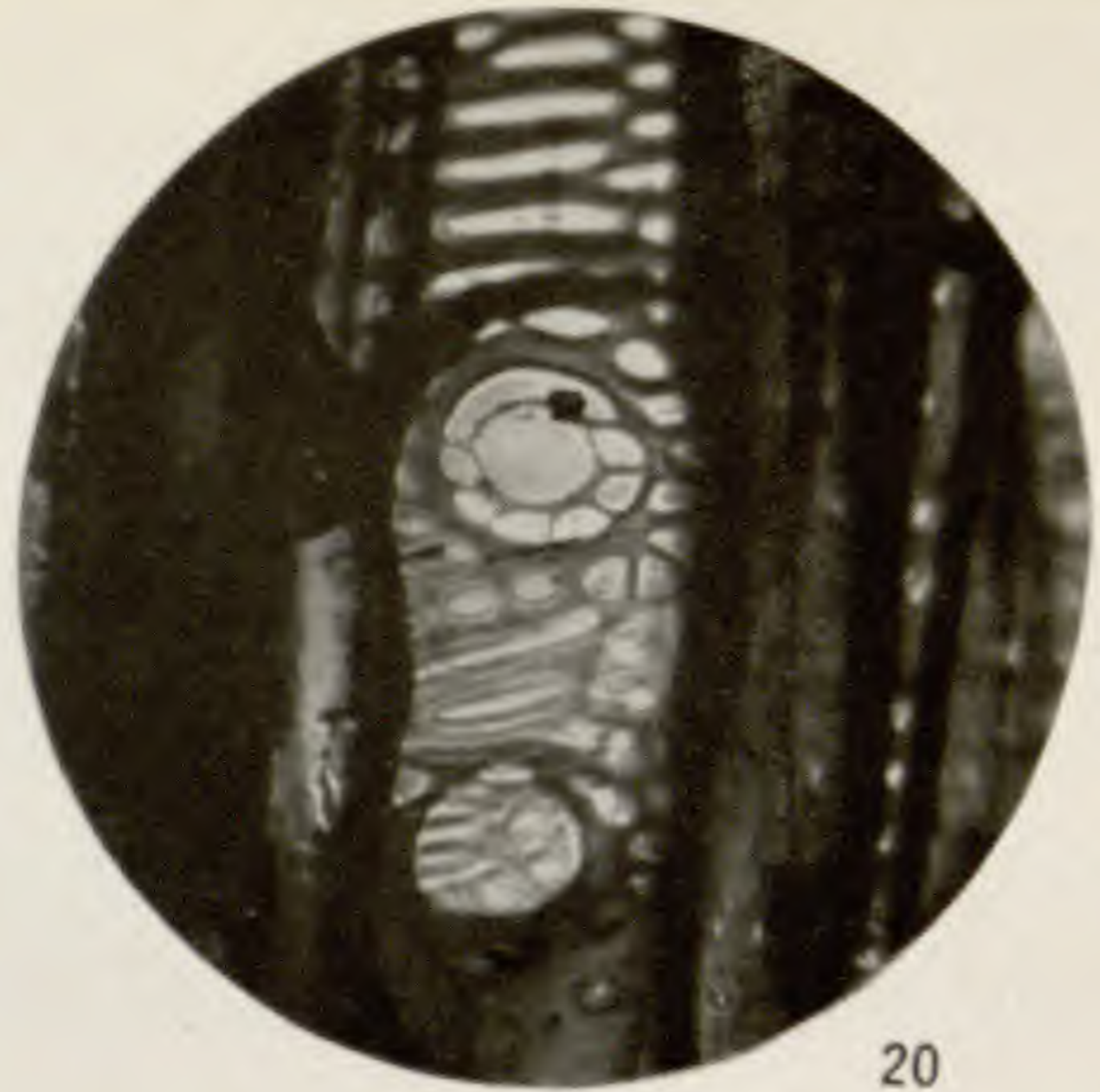

20



21



22



23

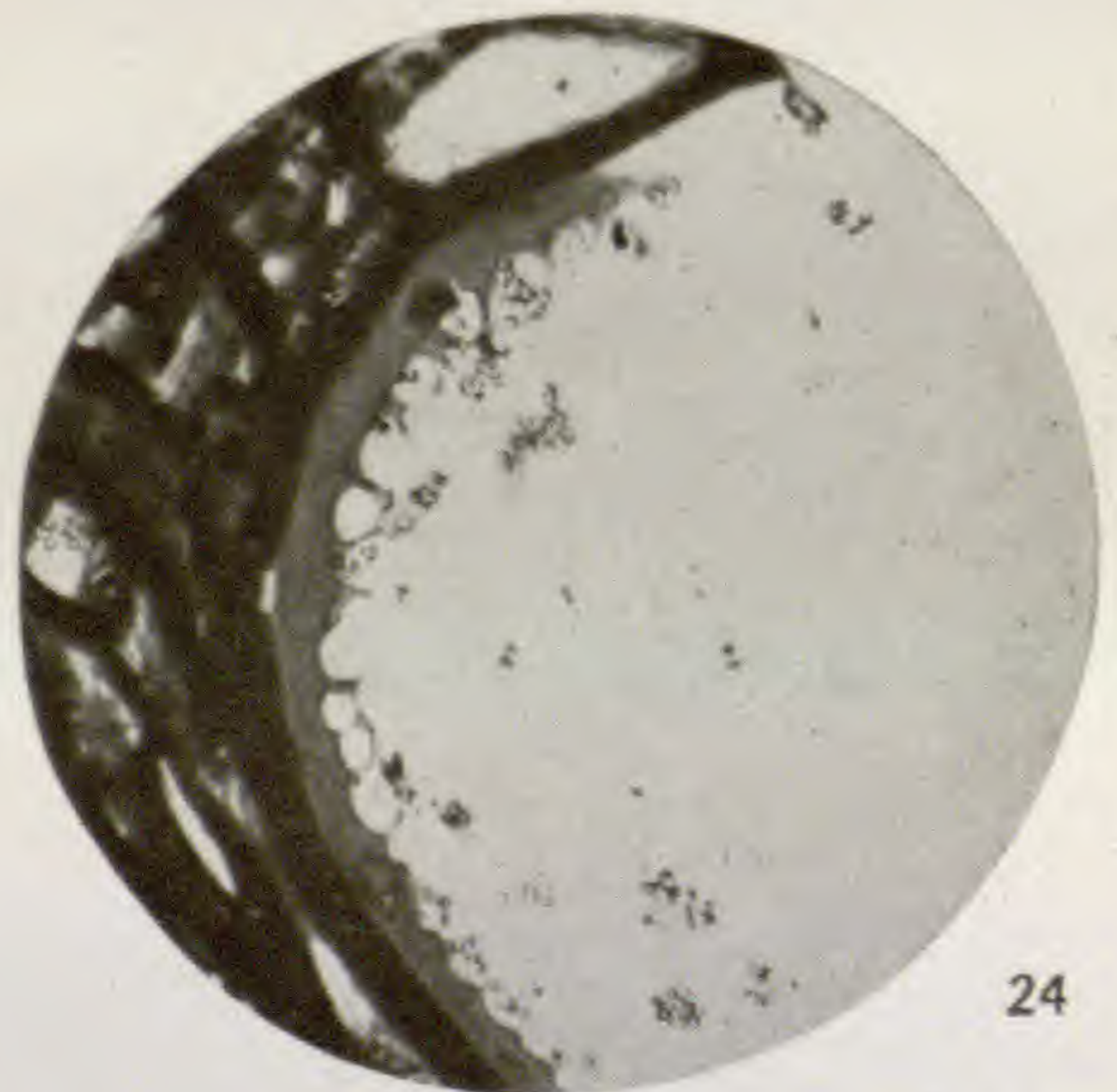

24

## EXPLANATION OF PLATES XXIX-XXXII

## PLATE XXIX

- FIG. 1.—Radial section of wood of *Ephedra trifurca*;  $\times 300$ .  
 FIG. 2.—Radial section of wood of *Gnetum* sp.;  $\times 150$ .  
 FIG. 3.—Radial section of wood of *Gnetum* sp.;  $\times 300$ .  
 FIG. 4.—Radial section of wood of *Gnetum* sp.;  $\times 400$ .  
 FIG. 5.—Radial section of mature wood of *Alnus japonica*;  $\times 200$ .  
 FIG. 6.—Radial section of mature wood of *Alnus japonica*;  $\times 300$ .

## PLATE XXX

- FIG. 7.—Radial section of wood of *Alnus japonica* near pith;  $\times 200$ .  
 FIG. 8.—Radial section of wood of *Alnus japonica* near pith;  $\times 300$ .  
 FIG. 9.—Radial section of vessel of *Alnus japonica* near pith;  $\times 400$ .  
 FIG. 10.—Radial section of wood of *Potentilla palustris* near pith;  $\times 300$ .  
 FIG. 11.—Radial section of wood of *Potentilla monspeliensis* near pith;  $\times 300$ .  
 FIG. 12.—Radial section of wood of *Potentilla monspeliensis*;  $\times 200$ .

## PLATE XXXI

- FIG. 13.—Radial section of wood of *Potentilla monspeliensis*;  $\times 200$ .  
 FIG. 14.—Radial section of lower part of same more highly magnified;  $\times 400$ .  
 FIG. 15.—Radial section of another vessel of same species;  $\times 400$ .  
 FIG. 16.—Radial section of vessel of *Pelargonium* sp.;  $\times 400$ .  
 FIG. 17.—Radial section of *Ephedra* or *Gnetum*-like vessel perforation in *Pelargonium* sp.;  $\times 400$ .  
 FIG. 18.—Radial section showing two vessels of *Pelargonium* sp.;  $\times 200$ .

## PLATE XXXII

- FIG. 19.—Radial section of wood of *Pelargonium* sp., showing same two vessels more highly magnified;  $\times 400$ .  
 FIG. 20.—Radial section of another vessel of same species;  $\times 400$ .  
 FIG. 21.—Radial section of another vessel of same species;  $\times 400$ .  
 FIG. 22.—Radial section of another vessel of same species;  $\times 400$ .  
 FIG. 23.—Radial section of wood of *Tropaeolum* sp.;  $\times 400$ .  
 FIG. 24.—Transverse section of wood of *Clematis* sp.;  $\times 500$ .

# EMBRYOGENY AND SPOROGENESIS IN REBOULIA HEMISPHAERICA

ARTHUR W. HAUPT

(WITH PLATE XXXIII AND ELEVEN FIGURES)

The present paper is a continuation of the writer's earlier morphological study of *Reboulia* (5). The systematic position of the genus and its phylogenetic relationships, as revealed by the structure and development of the gametophyte and sex organs, has already been discussed. To determine the affinities of *Reboulia* to other Marchantiaceae, as shown by the development of its sporophyte, was the purpose for which the present investigation was undertaken.

## Material

Material furnished by Dr. W. J. G. LAND for the earlier study, and collected by him at Rome, Indiana, served to illustrate a number of stages in the embryogeny. Most of the material, however, was collected by the writer during the autumn of 1919 and the spring of 1920 in the vicinity of Hamilton, Hancock County, Illinois. In this locality *Reboulia* occurs in abundance beneath moist ledges of sandstone. Material was also obtained from the region about Dakota, Illinois, through the kindness of Mr. EARL L. LAMBERT.

## Embryo

The first division of the fertilized egg of *Reboulia* is invariably accompanied by a transverse wall (figs. 1, 2), the two segments being approximately equal in size. From a careful study of later stages the conclusion is reached that the epibasal segment gives rise to both the seta and capsule, while the hypobasal segment forms the foot. In a recent preliminary paper on *Reboulia*, WOODBURN (8) is in agreement with this interpretation. The next division results in the formation of a transverse wall in the epibasal cell which differentiates the cells which are to form the seta and capsule (fig. 3). A tier of 3 horizontally superimposed cells is thus developed. The lowest cell may again divide by a vertical wall (fig. 3), but more

commonly the uppermost cell divides again transversely before the appearance of the vertical wall in the basal cell, so that the young embryo consists of 4 superimposed cells (fig. 4). The latter condition has also been noted by WOODBURN.

The formation of 3 transverse walls in the early embryo of *Reboulia* represents a behavior quite different from that of the other Marchantiaceae which have been studied. The appearance

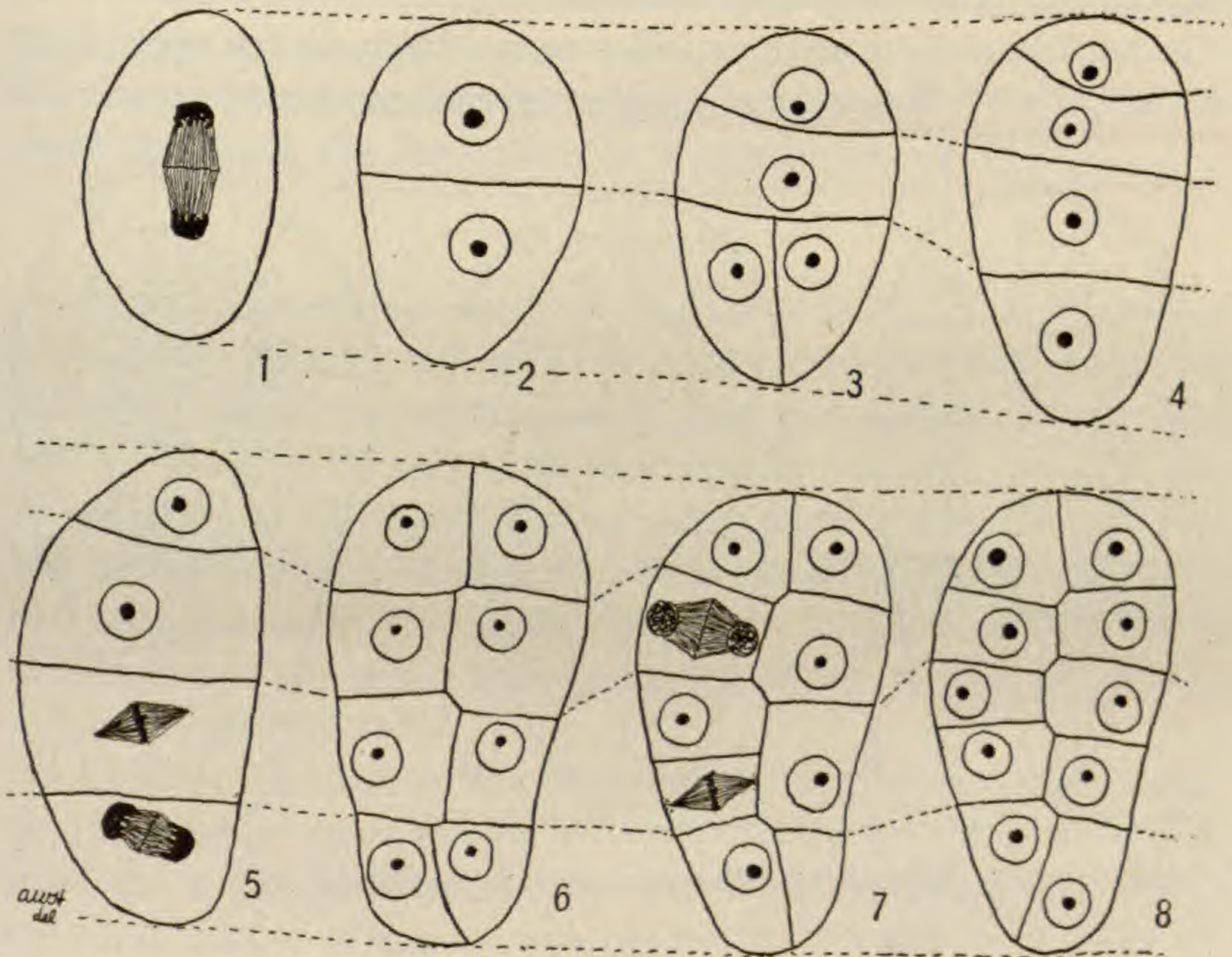

FIGS. 1-8.—Stages in development of embryo;  $\times 475$ .

of 2 vertical walls which intersect each other, after the first transverse division of the fertilized egg, has been shown by KIENITZGERLOFF (6) and DURAND (3) to be a constant feature of *Marchantia*. CAMPBELL (1) has demonstrated the regular formation of an octant in the early embryo of *Fimbriaria californica*, while CAVERS (2) has claimed that a similar condition prevails in *Reboulia*. KIENITZGERLOFF has also stated that the embryos of *Preissia* and *Grimaldia* develop like those of *Marchantia*, but his figures show no early stages, and are accordingly unconvincing. Following the

formation of the 3 transverse walls, vertical walls appear at right angles to each other in each horizontal tier (fig. 6), although the lowest cell may divide vertically before the appearance of the third transverse wall, as previously stated. These vertical divisions begin at the lower end of the embryo (fig. 5), a feature which is also noted by WOODBURN'S figures. Additional cross-walls then come in, and an embryo consisting of 5-7 tiers of cells is thereby formed (figs. 7, 8). This was a very common stage seen in the preparations. The additional transverse divisions occur chiefly in the upper part of the embryo. WOODBURN has observed the occasional formation of

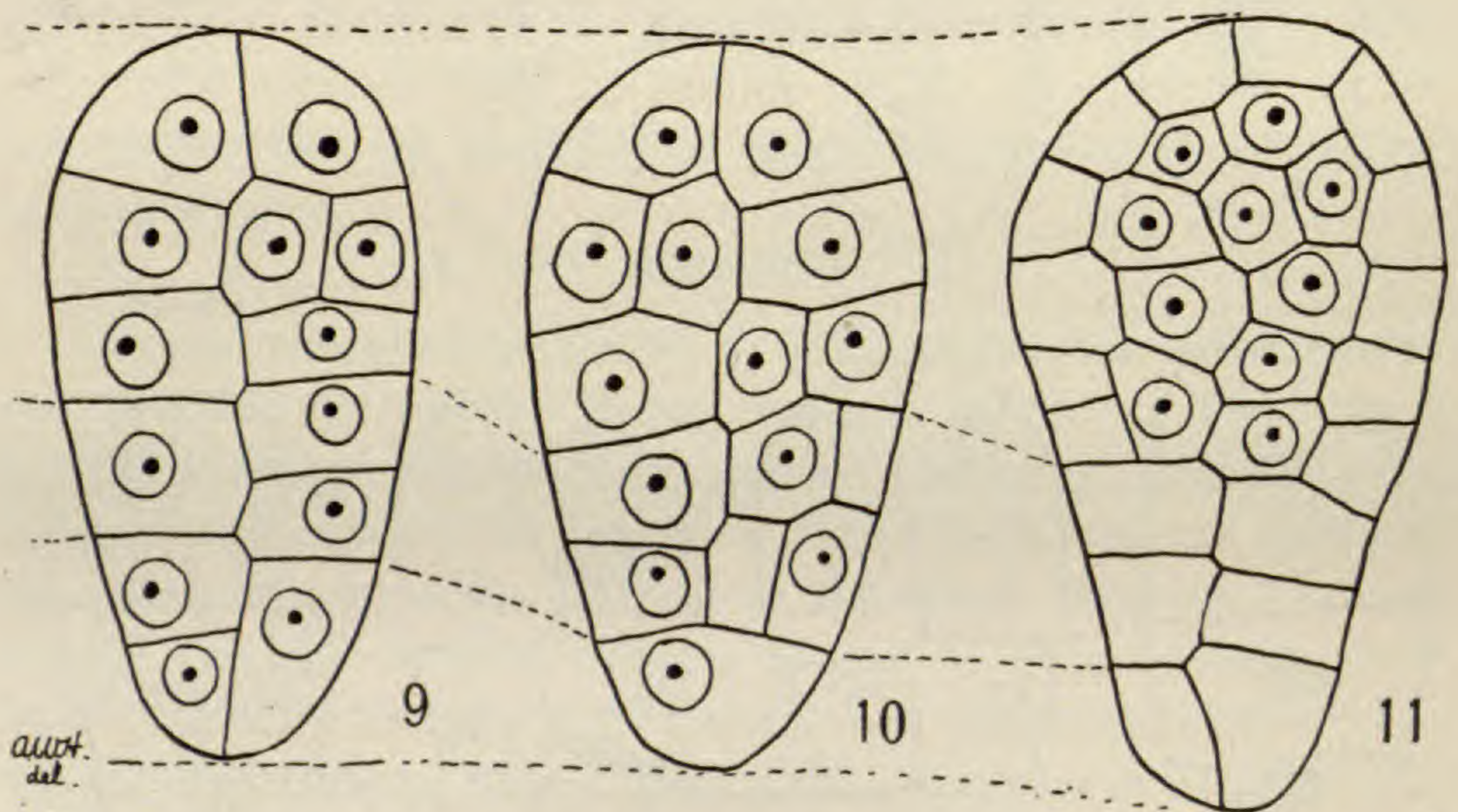

FIGS. 9-11.—Older stages in embryogeny;  $\times 475$ .

a triangular-shaped apical cell in the young embryo, and often of both triangular apical and basal cells. The writer has seen stages similar to those figured by WOODBURN, but found that the triangular form of the uppermost cell invariably resulted from an obliquely cut section. A truly median section has never revealed the presence of a triangular apical cell.

With the definite establishment of the vertical walls in the embryo, both transverse and vertical divisions occur chiefly in its upper portion (fig. 7, 9, 10), and finally the sporogenous tissue is delimited from the amphithecium (fig. 11). Further development is typical of that of other Marchantiaceae which have been investigated.

With the development of the sporogenous tissue and the cells of the foot, the young sporophyte gradually assumes a dumb-bell shape. The seta remains short throughout the entire history of the sporophyte. The calyptra, formed entirely from the venter of the archegonium, is 3-5 cells thick in this dumb-bell-like stage of the sporophyte. As development proceeds, the margins of the receptacle lobes grow up around the sporophyte to form a simple 2-valved involucre. No perianth is developed, as in certain other genera of the Marchantiaceae. The receptacle stalk is very short at a stage in which the sporophytes are developed as far as has been described, and they pass the winter in this condition.

### Sporogenesis

In the early spring, about the last week in March in the region where this material was collected, the receptacle stalk begins to elongate, and further development of the sporogenous tissue takes place. In the early spring the sporogenous cells give no indication of which are to form spore mother cells and which elaters (fig. 12), but by the first part of May the walls separating the protoplasts of the sporogenous tissue break down and form an abundance of mucilage, and the young spore mother cells and elaters are clearly differentiated (fig. 13).

A striking feature of the sporogenesis of *Reboulia* is shown by the fact that the spore mother and elater primordial cells are derived from the undifferentiated sporogenous tissue by the same number of cell divisions. Thus an elater is not homologous with a row of spore mother cells, as in *Marchantia*, but with a single spore mother cell. Potentially sporogenous tissue is thus diverted to form elaters later than in *Marchantia*, and in this respect the sporophyte of *Reboulia* is primitive.

With the breaking down of the sporogenous cell walls, the protoplasts of the young spore mother cells become withdrawn within the cell cavities and assume an amoeboid form, while those of the young elaters become elongated (fig. 13). This behavior was constant in all of the preparations examined, and in material collected in both of the localities in Illinois to which reference has been made.



Miss McCORMICK (7) has shown in *Symphyogyna* that the spore mother cells assume an amoeboid form in connection with the development of the 4 lobes which characterize the spore mother cells of the Jungermanniales, and the same behavior has been observed in *Pallavicinia* (4). The assumption of an amoeboid character by the young spore mother cells of *Reboulia*, in which no lobes develop, clearly demonstrates that this behavior is not necessarily related to the formation of lobed spore mother cells.

With the gradual dissolution of the old spore walls, the spore mother cells lose their amoeboid form and become globular, gradually growing larger and becoming increasingly more dense by the accumulation of food material (figs. 14, 15). Thus the writer is inclined to regard the amoeboid development as a feature related to the nourishment of the spore mother cells. Their increase in size and globular form is certainly not due to the release of pressure upon the cells of the sporogenous tissue occasioned by the increased size of the capsular cavity, for no such enlargement or acquisition of food material is shown by the elaters.

The mucilaginous substance around the spore mother cells and elaters presents a foamlike appearance as these changes are going on, and becomes increasingly less dense. Both the spore mother cells and elaters form a new cellulose wall after the former have reached their maximum size (fig. 15). The new spore wall around the spore mother cells becomes thick and is differentiated into a thin intine and a heavy exine. Their protoplasts are now extremely dense, so that even in sections cut to a thickness of  $3\ \mu$  it is very difficult to study nuclear details.

With the development of the walls in the spore mother cell to form the tetrad, a thin episporium is laid down (fig. 16). The elaters, which elongate considerably as the spore mother cells develop, have merely a thin cellulose wall when the tetrad stage in sporogenesis is reached, and their protoplasm is slightly withdrawn inside of the cell cavity.

With the separation of the spores from their tetrads, all of the mucilage is gone. The episporium develops prominences by a process of outbulging (fig. 17), so that the mature spore when seen from the surface is described as having a thick "tuberculate" episporium.

The protoplasm of the elaters becomes further withdrawn from the cell wall, and a double spiral band appears in the form of a local thickening on the inside of the elater wall. Finally all of the protoplasm is lost, as its substance seems to contribute to the further development of the spiral band.

The relation between the protoplasmic contents of the elaters and the formation of their spiral band was studied in all available stages in their development. In no case was a behavior observed such as has been described by CAMPBELL (1) for *Fimbriaria californica*:

The elaters are at first elongated thin-walled cells with a distinct although small nucleus, and nearly uniformly granular cytoplasm. As they grow the cytoplasm loses this uniform appearance, and a careful examination, especially of sections, shows that the granular part of the cytoplasm begins to form a spiral band, recalling somewhat the chlorophyll band of *Spirogyra*. This is the beginning of the characteristic spiral thickening of the cell wall, and while at first irregular, the arrangement of the granular matter becomes more definite, and following the line of this spiral band of granules in the cytoplasm, there is formed upon the inner surface of the wall the regular spiral band of the complete elater.

The mature elaters average slightly over 1.0 mm. in length, the longest one measured being 1.36 mm. and the shortest 0.94 mm. The mature spores average 70–80  $\mu$  in diameter. The mature sporophyte reaches a length of 1.6–2.0 mm. The capsule is oval or slightly obovate; its wall is but 1 cell thick except near the apex, where a cap 3 or 4 layers of cells in thickness is formed. The outer wall cells develop simple annular and half-ring fibers. Dehiscence of the capsule was not observed, but it is probable that the apical cap comes off. The seta of the mature sporophyte is comparatively very short, and the foot is bulbous, never anchor-like.

### Summary

1. The embryo of *Reboulia* develops without the formation of an octant stage characteristic of certain other Marchantiaceae.

2. The first transverse wall in the fertilized egg separates the cell which is to form the foot from that which is to form the seta and capsule. Four horizontally superimposed cells are usually formed, each new division occurring in the outermost segment. Of

these the lowest cell forms the foot, the next one the seta, and the upper two the capsule.

3. The sporogenous tissue is formed relatively early in the history of the sporophyte.

4. In the development of spore mother cells and elaters the walls around the sporogenous cells become mucilaginous, the protoplasts of the former assume an amoeboid form and finally become large and spherical, while those of the latter are slender and elongated. A new cell wall is laid down around both spore mother cells and elaters.

5. The assumption of an amoeboid form by the young spore mother cells is a feature related to their nutrition.

6. An elater in *Reboulia* is homologous with a single spore mother cell, and not with a row of them.

7. The exine and intine are differentiated in the tetrad stage, and the epispore has begun to develop. The formation of a double spiral band on the elaters is accompanied by a condensation and ultimate disappearance of the protoplasm.

8. The short seta and bulbous foot are primitive features of the genus.

ST. LAWRENCE UNIVERSITY  
CANTON, N.Y.

#### LITERATURE CITED

1. CAMPBELL, D. H., Mosses and ferns. New York. 1905.
2. CAVERS, F., Contributions to the biology of the Hepaticae. Part I. *Targionia*, *Reboulia*, *Preissia*, *Monoclea*. Leeds and London. 1904.
3. DURAND, E. J., The development of the sex organs and sporogonium of *Marchantia polymorpha*. Bull. Torr. Bot. Club 35:321-335. 1908.
4. HAUPT, A. W., A morphological study of *Pallavicinia Lyellii*. BOT. GAZ. 66:524-533. 1918.
5. ———, Gametophyte and sex organs of *Reboulia hemisphaerica*. BOT. GAZ. 71:61-74. 1921.
6. KIENITZ-GERLOFF, F., Vergleichende Untersuchungen über die Entwicklungsgeschichte des Lebermoossporogons. Bot. Zeit. 32:161-172; 33:777-782. 1875.
7. MCCORMICK, FLORENCE A., A study of *Symphyogyna aspera*. BOT. GAZ. 58:401-418. 1914.
8. WOODBURN, W. L., Preliminary notes on the embryology of *Reboulia hemisphaerica*. Bull. Torr. Bot. Club 46:461-464. 1920.

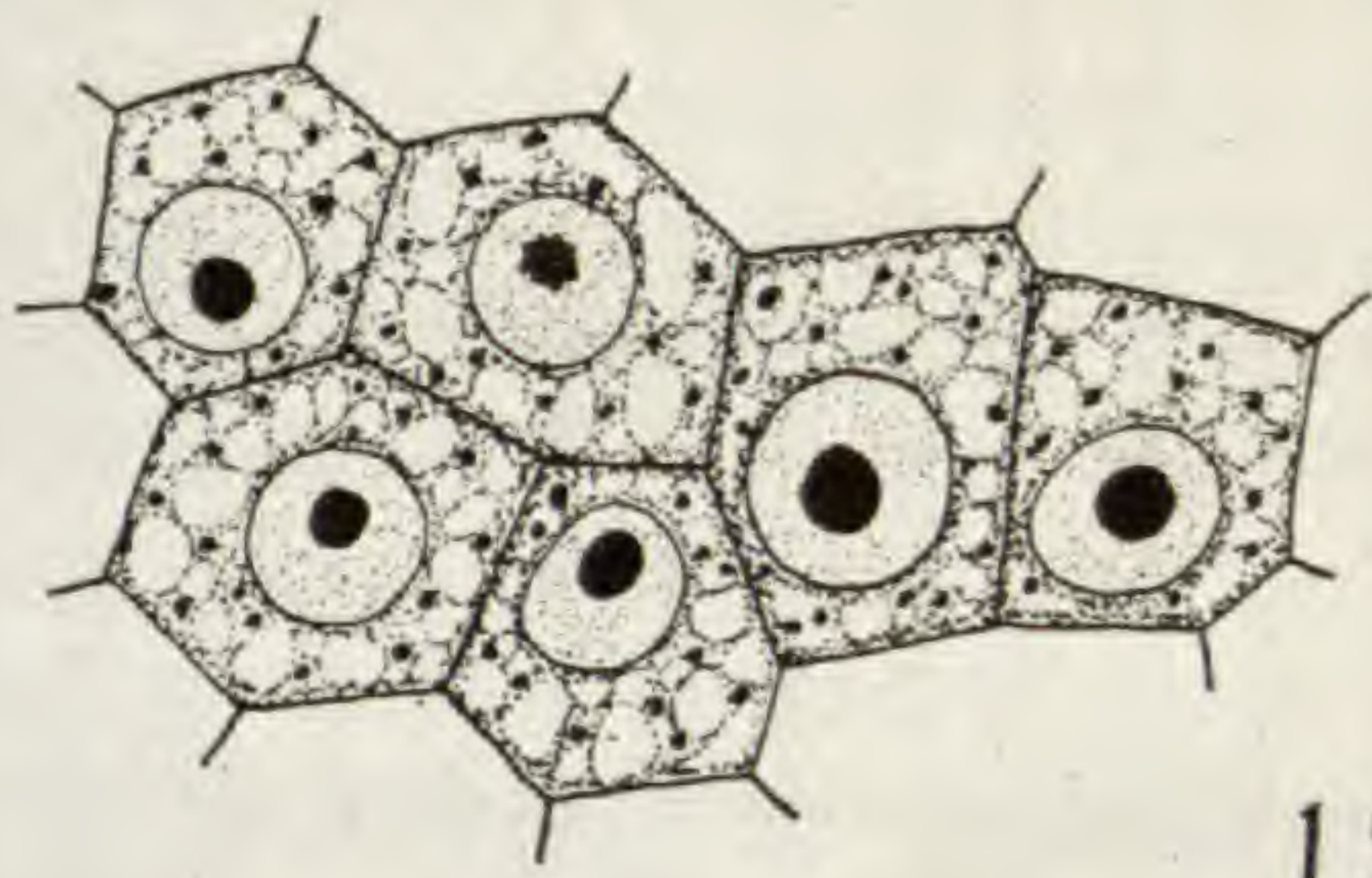

12

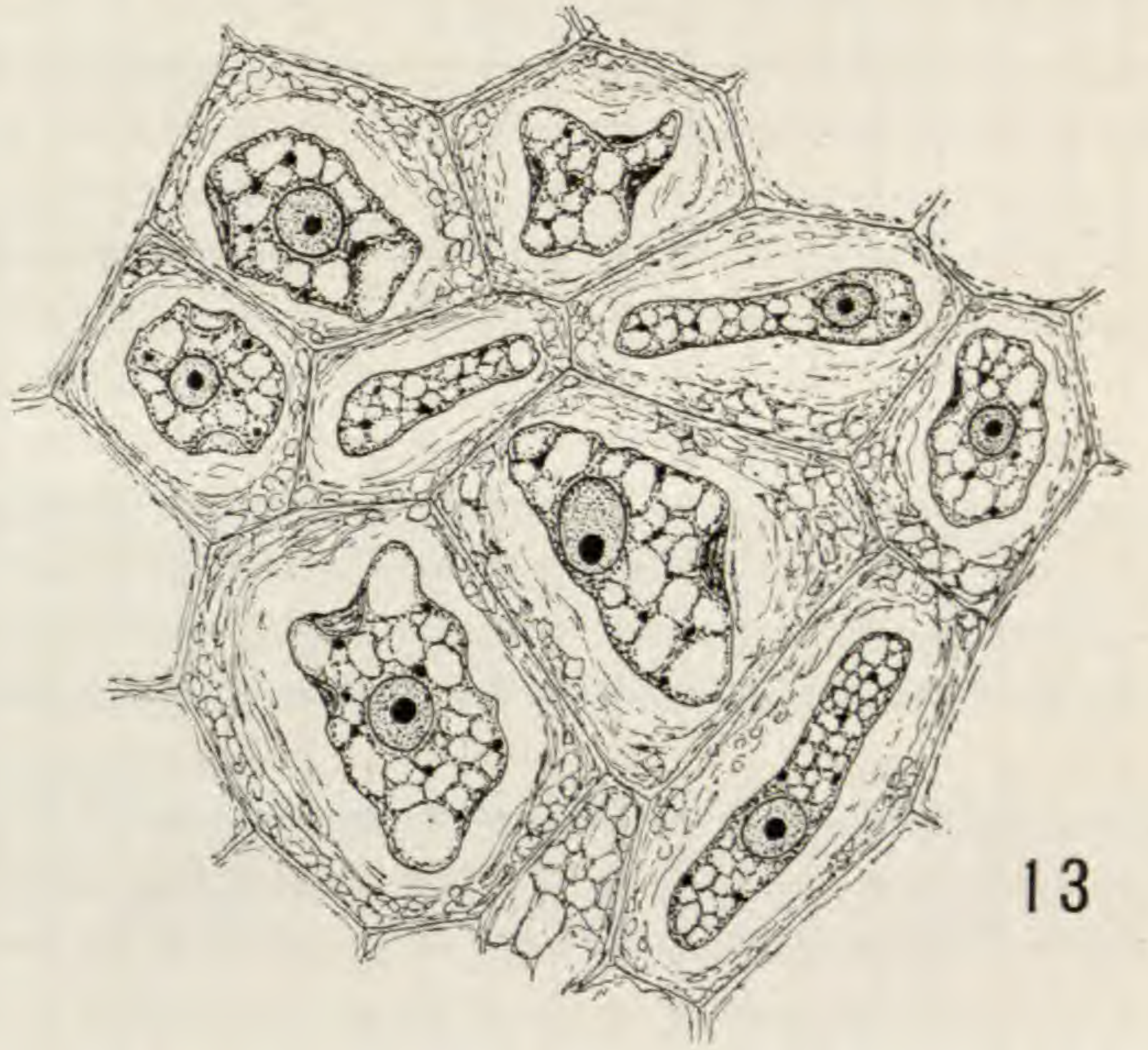

13

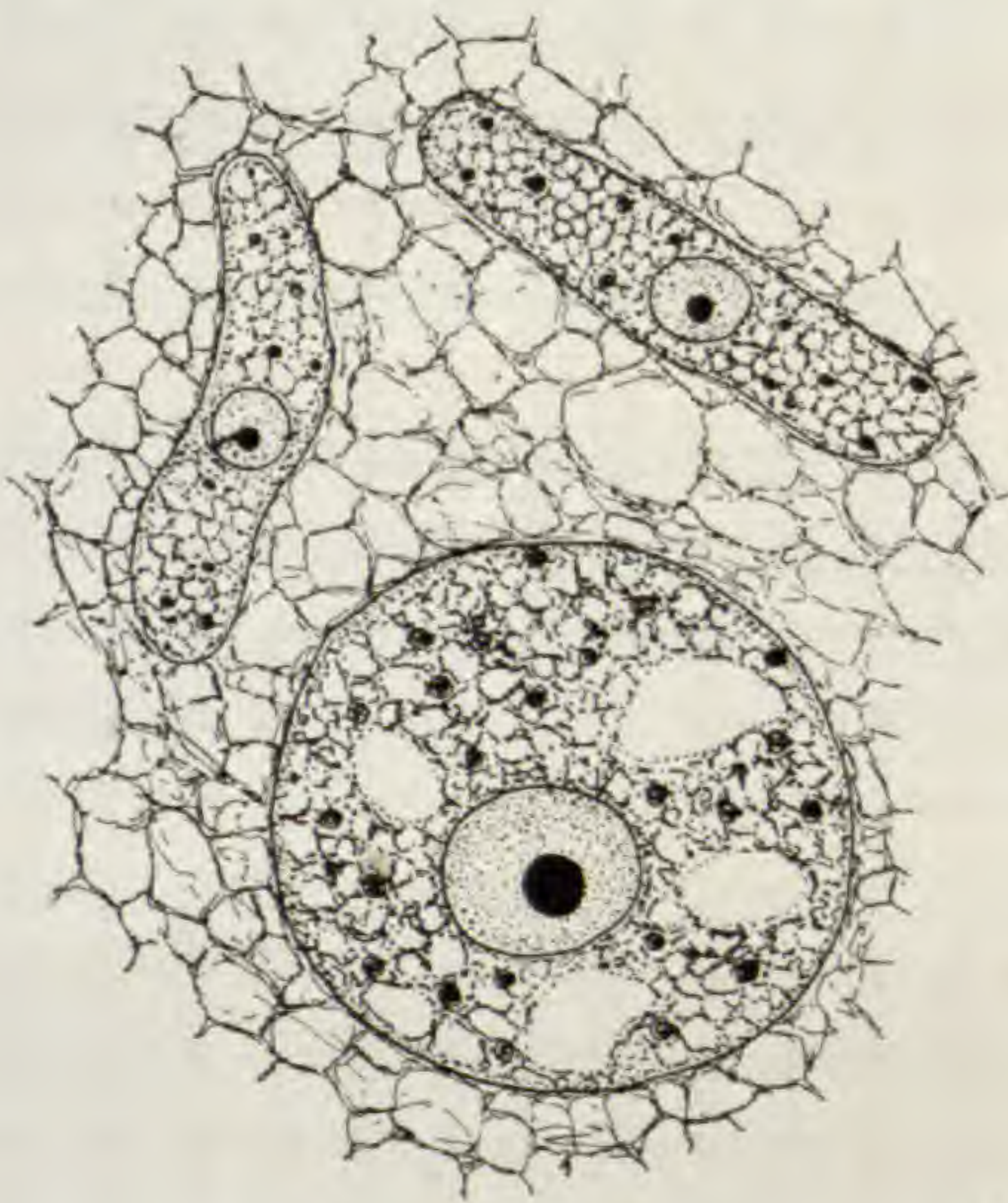

14

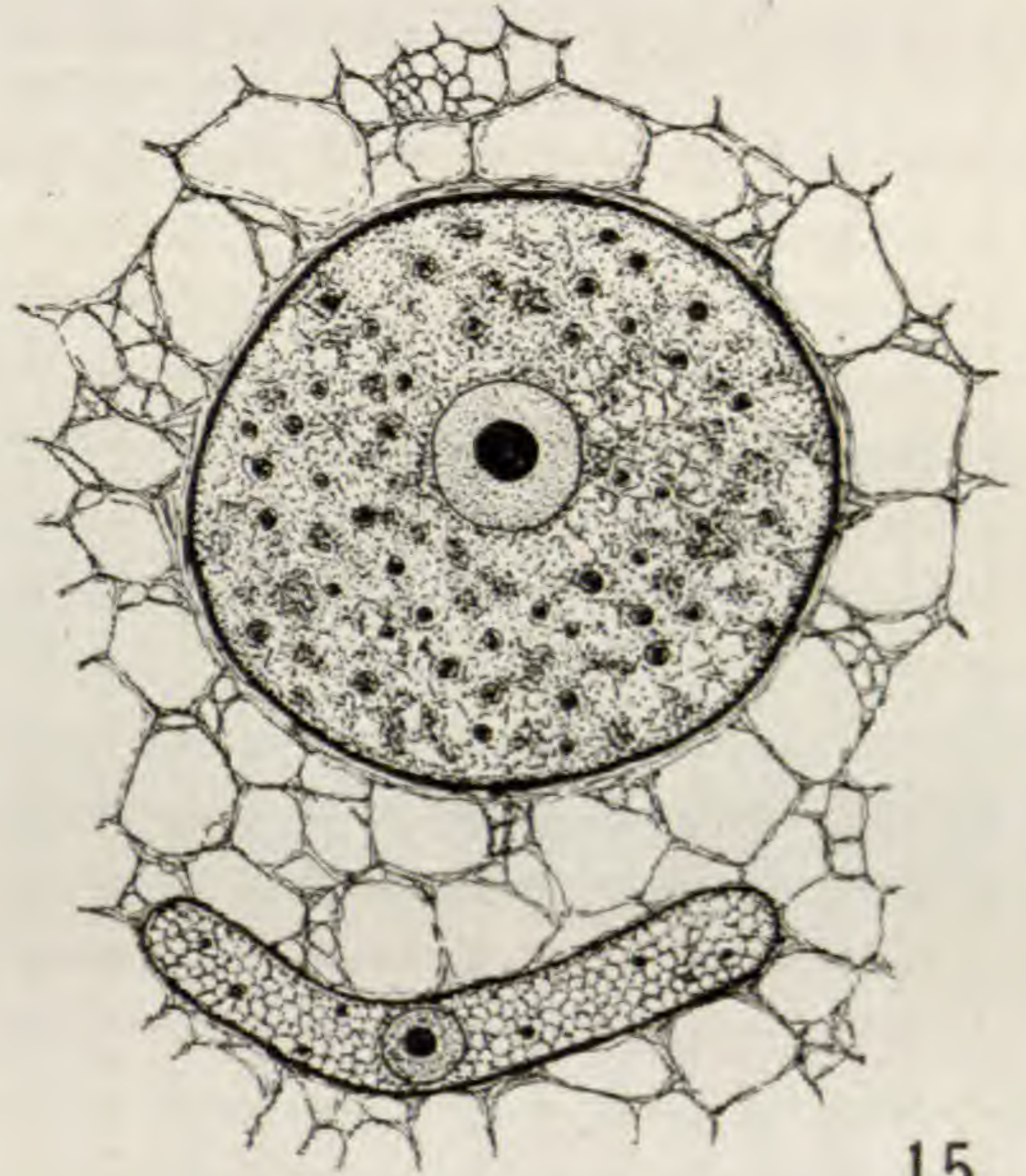

15

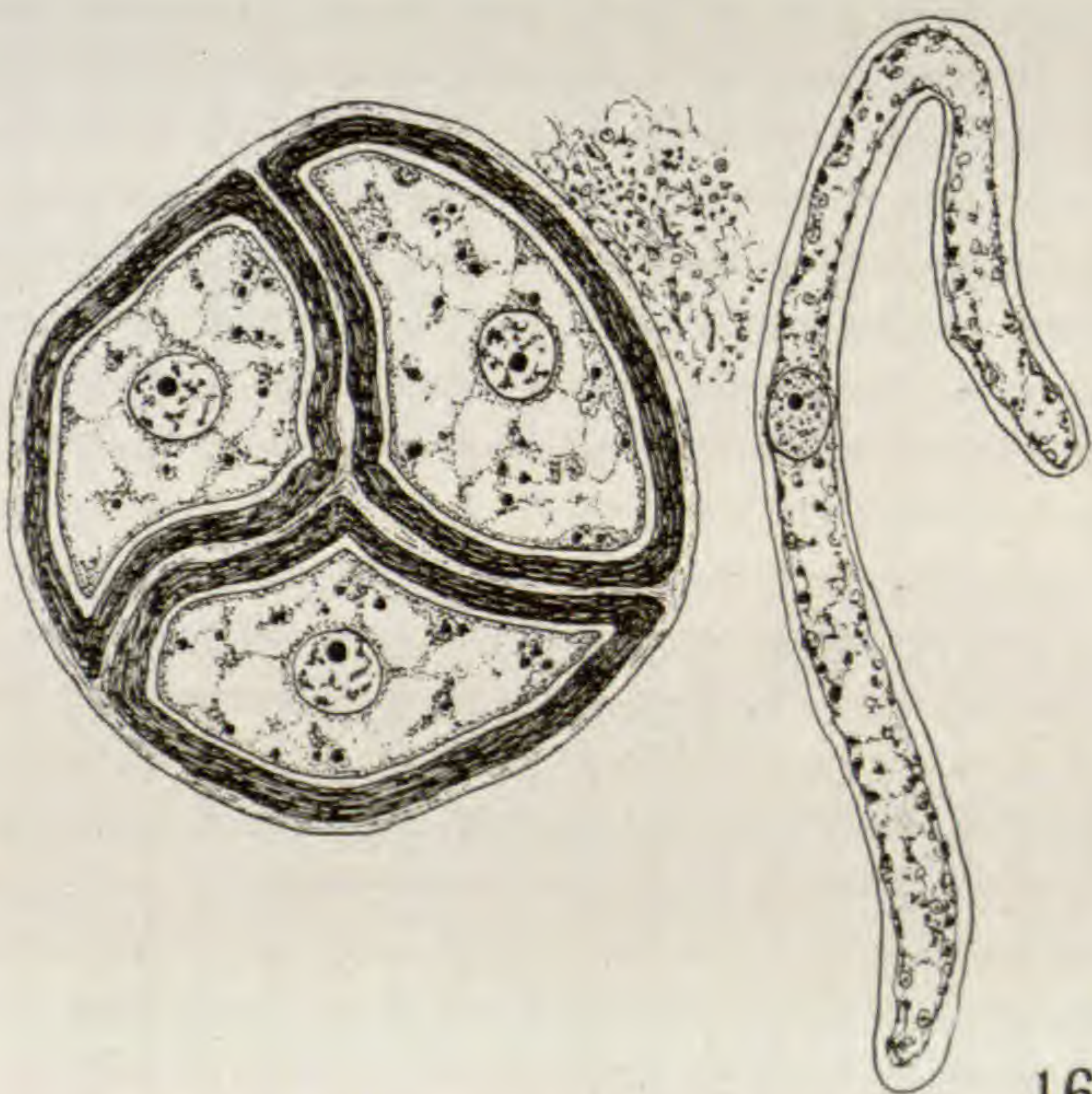

16

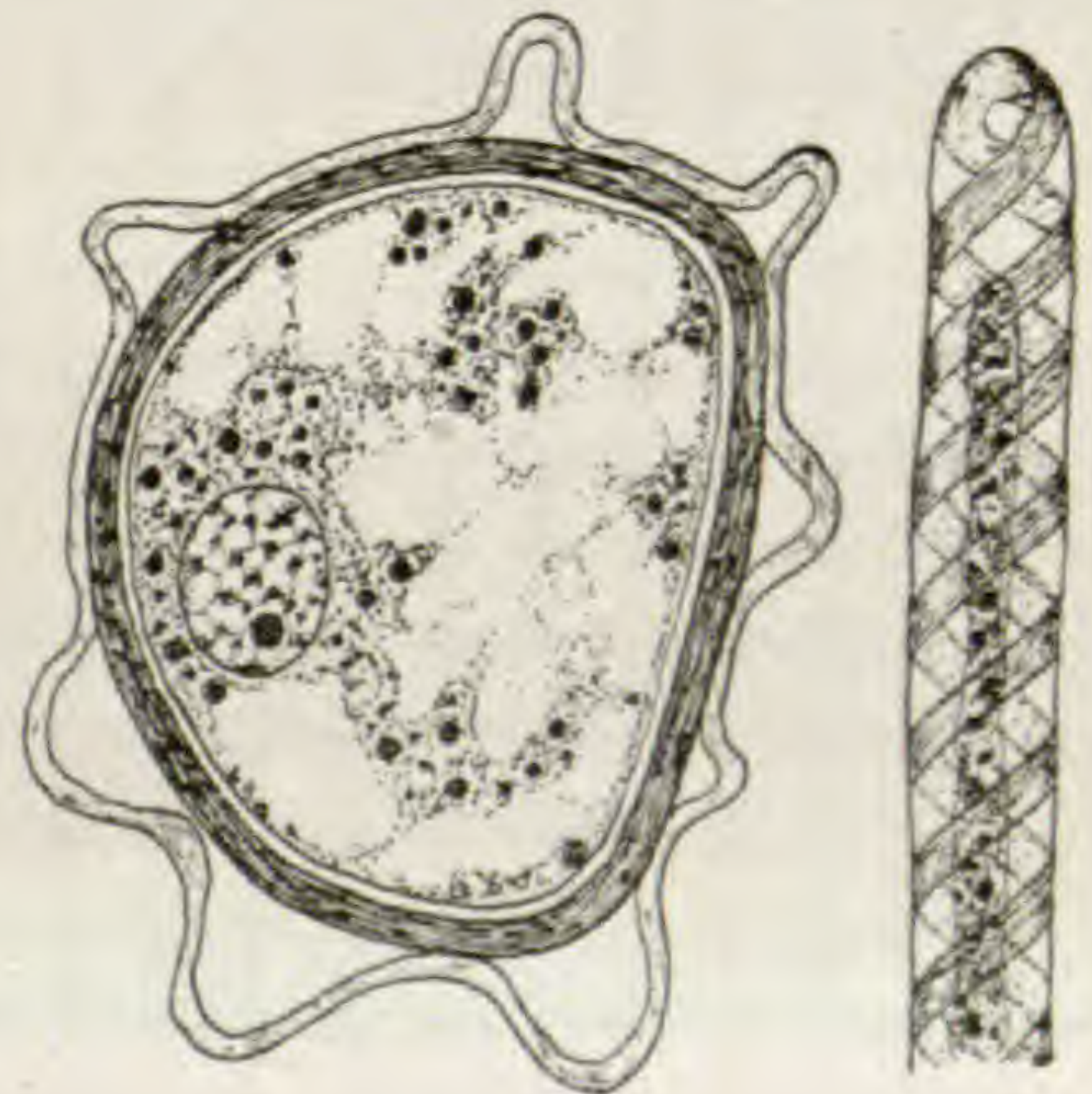

17

## EXPLANATION OF PLATE XXXIII

FIG. 12.—Sporogenous tissue;  $\times 720$ .

FIG. 13.—Young spore mother cells in amoeboid stage and young elaters;  $\times 720$ .

FIG. 14.—Older stage showing development of cell walls around spore mother cells and elaters;  $\times 720$ .

FIG. 15.—Older stage of same;  $\times 720$ .

FIG. 16.—Spore tetrad showing development of spore coats and elater;  $\times 720$ .

FIG. 17.—Nearly mature spore and elater showing development of episporium on former and double spiral band on latter;  $\times 720$ .

## DIAMETER GROWTH IN BOX ELDER AND BLUE SPRUCE

C. F. KORSTIAN

(WITH THREE FIGURES)

It is the common belief that trees grow throughout the greater part of the vegetative period, the commonly called "growing season," which is roughly defined as being limited to the period from the last killing frost in the spring to the first killing frost in the fall, when the broad-leaved hardwoods such as maple, ash, and aspen show their autumnal colors. In the Rocky Mountain forest region this period comprises from 75 to 100 days. Until recently little was known as to the exact time at which trees actually make their diameter growth. Neither has the course of growth nor the formation of the annual rings or cones of wood been measured until recently.

About twenty-five years ago FRIEDRICH (2), an Austrian forester, devised instruments capable of measuring the daily growth in diameter of trees. Somewhat later he improved his accretion autograph, as it was called, by adding an electric attachment which recorded the growth in the investigator's office. He would entertain his visitors by telling them that while they could not hear grass grow, they could not only see but hear the tree in the park grow, the increase in the periphery being announced by the sounding of a signal.

In 1918 MACDOUGAL devised a new instrument for recording in minute detail the daily and seasonal growth and all changes in the size of the trunk of a tree. The instrument is called a dendrograph. The essential part of it consists of a yoke composed of slotted bars of some alloy, such as bario or invar, which has a very low temperature coefficient. This is held in place by upright pieces of brass wire seated in small brass plates, which afford flexible supports capable of uniformly adjusting any tension which may be developed. These plates are clamped to a belt of wooden blocks hinged together and fastened securely to the tree, serving

as a rigid support for the instrument. As this belt comes in tangential contact with the tree at only a few points, it interferes very little with its normal growth. The recording apparatus consists of a drum carrying a record sheet, the drum being rotated by clock work. In order to minimize the effect of the shrinkage and expansion of the bark, it is rasped or shaved down so that a very thin layer of cork covers the living inner bark on small spots just large enough to give suitable bearings under the contact screw and under the end of the bearing lever. Changes in the diameter of the tree trunk, that is, between the contact screw on the opposite side of the tree and the arm of the bearing lever, are accurately traced on the sheet of record paper on the drum by the recording pen. In this way a continuous curve is traced on the revolving drum as it passes beneath the point of the pen, the position of which is gradually changed as the tree trunk expands in the process of growing. The instrument is protected from the weather by a tin cover attached to the tree. The clock requires winding and the record sheet must be changed at least every seventh day. When the instrument is once properly adjusted it requires no further adjustment except such as may become necessary owing to the growth of the tree. Fig. 1 shows the dendrograph on a blue spruce tree, with tin cover removed to show the recording mechanism.

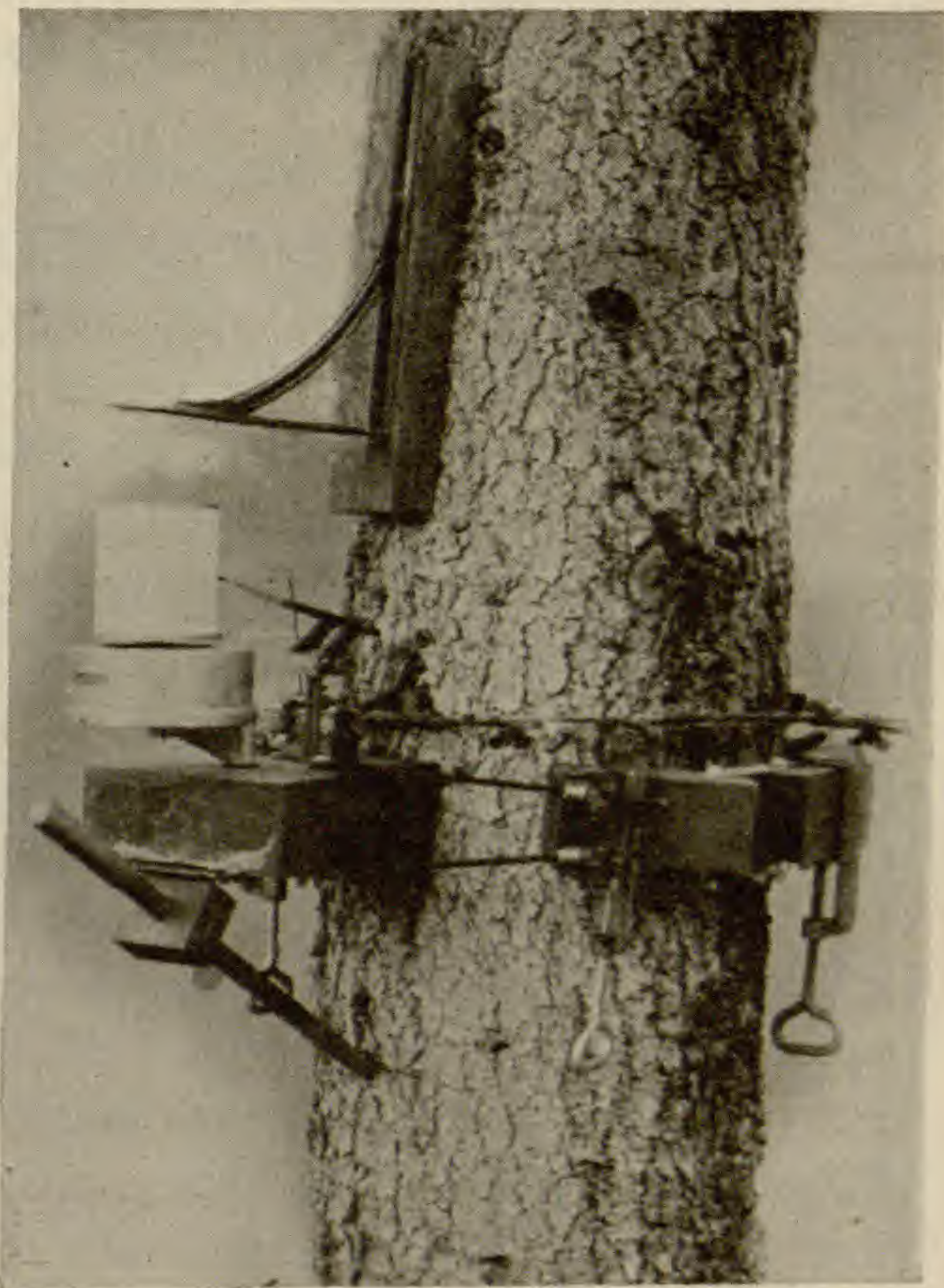

FIG. 1.—MacDougal dendrograph in operation on a blue spruce, showing encircling belt of wooden blocks and yoke of invar, but with tin cover removed to show recording mechanism.

During the spring and summer of 1920 the writer had the privilege of operating one of MACDOUGAL'S dendrographs in cooperation with him. Because of the backward season in the mountains, the instrument was placed on a specimen of *Acer Negundo* in the city of Ogden, Utah, on April 1, 1920, for the purpose of determining when growth actually begins in this species. A period of unusually cold stormy weather followed the installation of the instrument, during which quiescence and alternate shrinkage and enlargement were recorded. The tree showed some enlargement April 10-14, which, however, did not continue during the following four days when high winds prevailed. Diameter growth did not properly begin until May 19. The buds were just beginning to swell on April 1. By April 27 practically all of the leaves had unfolded, and on May 5 they were about one-fourth full size. The leaves had reached about one-half their natural size before the main period of growth began on May 19.

Fig. 2 shows the daily march of the diameter changes. In order to afford a closer correlation, the march of the daily mean temperature of the air and of the cortical layer adjacent to the cambium or the zone of living tissue where the diameter growth actually occurs is plotted in the lower part of the figure. The greatest and smallest diameters reached during the day are plotted in the upper graph to show the diurnal variations. These diurnal changes apparently vary to some extent with the range in temperature. On cool cloudy days with relatively warm nights, which have small temperature ranges, the diurnal change in the diameter is slight, while on warmer clear days with cool nights, having a great diurnal temperature range, the diurnal shrinkage or expansion may amount to as much as 0.5 mm., indicating a direct temperature relationship. Moisture conditions are not considered among the critical factors causing the commencement of growth in the spring, because the soil is abundantly supplied with moisture from the melting of the winter snows and from the spring rains, until considerable growth has been made and fairly high temperatures obtain. As might be expected, there is a somewhat close correspondence between the trend of the two graphs, although the cambial temperature does not usually attain the extremes reached by the air temperature.



On June 7 the dendrograph was moved to the Cottonwood Nursery, twenty-five miles southeast of Salt Lake City, Utah, and placed on a specimen of *Picea Parryana* growing in the nursery grounds at an elevation of 7400 feet. At this time the spruce buds were bursting open and diameter growth was already under way,

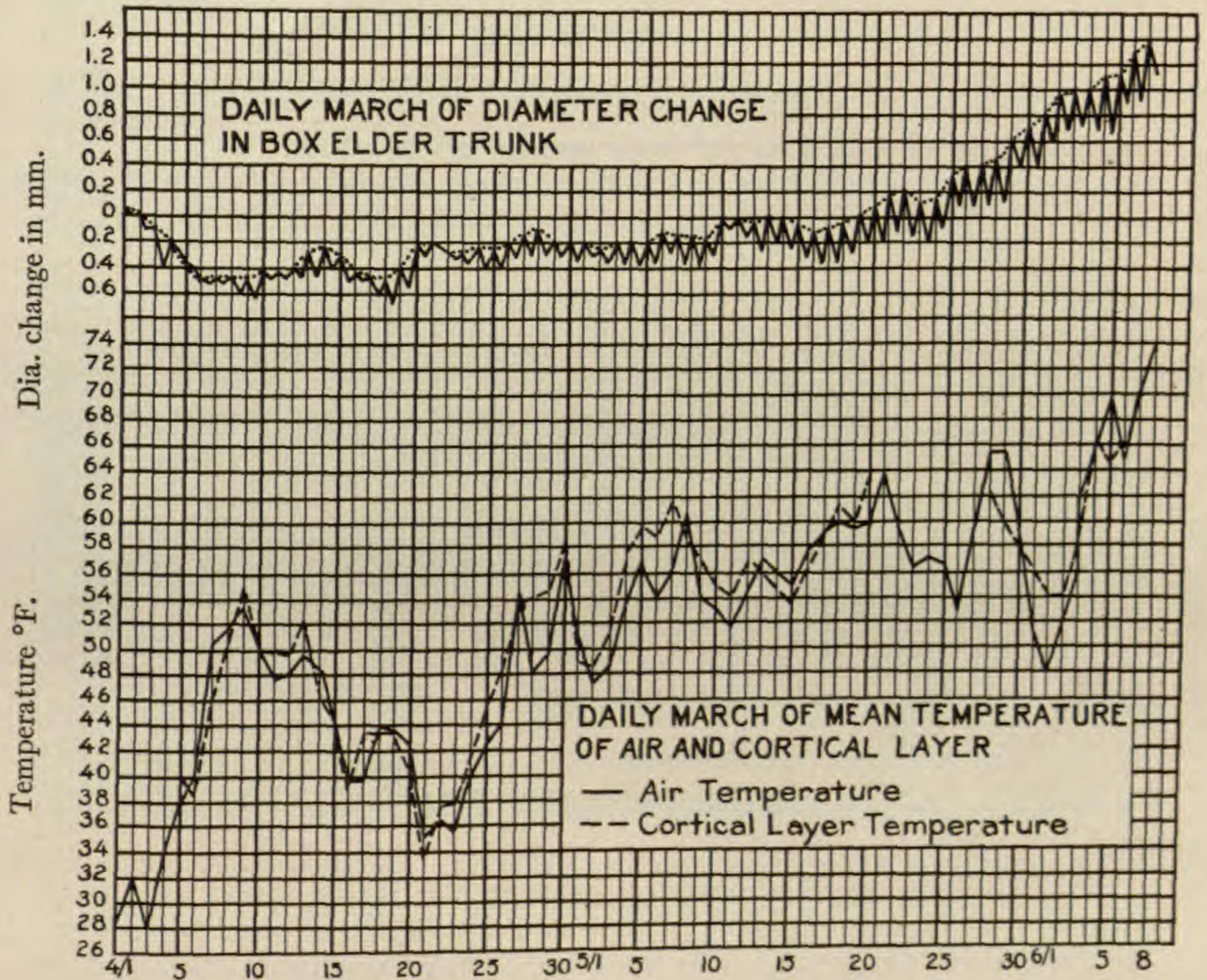

FIG. 2.—Daily march of diameter change in box elder trunk, daily mean temperature of air and cortical layer adjacent to cambium; Ogden, Utah, April 1–June 8, 1920.

as indicated by fig. 3, although it is not probable that much growth had taken place before the record began. Growth continued for slightly more than five weeks, except for two rest periods of two days each (June 19–20 and June 26–27). The shrinkage noted on June 9 and 10 may be a rest period, or it may possibly be due to a shrinkage occasioned by the drying out of the thin layer of cortical tissue after the main portion of the outer bark had been removed. In addition to the mean daily temperatures of the air and the cortical layer adjacent to the cambium, the mean daily

temperature of the soil at a depth of 12 inches is also shown in the same figure for comparative purposes. No direct correlation between the march of diameter growth and current temperatures was found. A careful study of the graphs leads to the inference

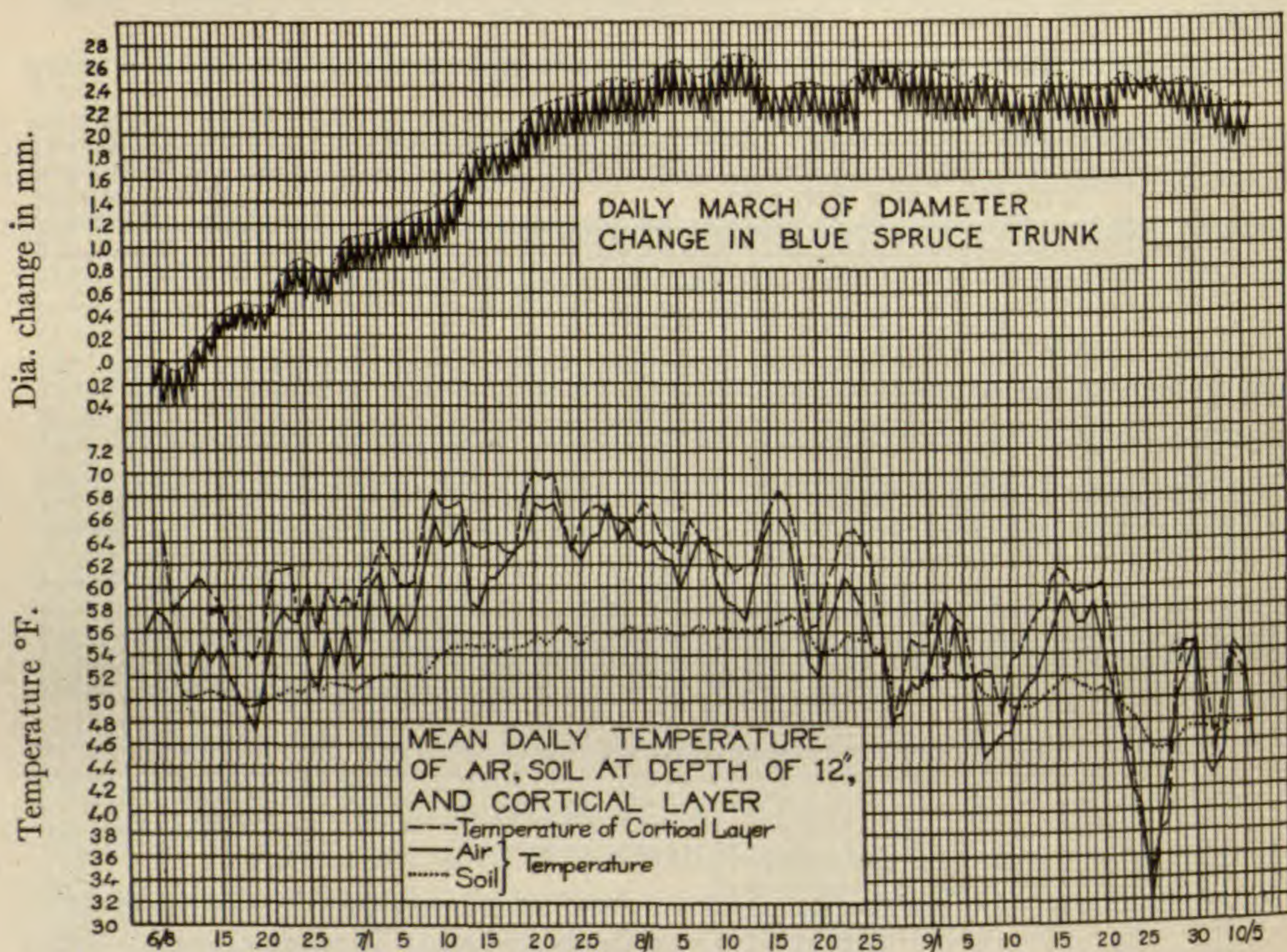

FIG. 3.—Daily march of diameter change in blue spruce trunk, daily mean temperature of air, soil at depth of 12 inches, and cortical layer adjacent to cambium; Big Cottonwood Canyon, 25 miles southeast of Salt Lake City, Utah, June 8–October 6, 1920.

that the growth response lags behind the temperature, a marked drop in the temperature causing a decrease in or even a cessation of growth<sup>1</sup>. HARTIG (4), as a result of extensive investigations, advanced the theory that the awakening of cambial activity was

<sup>1</sup> Since writing the preceding, an interesting temperature relationship was observed on a blue spruce tree growing on the writer's lawn in Ogden, Utah. On May 12, 1921, the buds on the north side of the tree had swollen and were just beginning to open, while on the south side practically all buds were open and new growth of 3–5 cm. had taken place on the tips of the branches. This difference in the inception of growth is believed to be due to the higher temperatures to which the buds on the south side of the tree were subjected.

dependent upon temperature, and that soil temperature, insolation, and the thickness of the bark were influential factors also.

GROSSENBACHER (3) has reviewed the varied and rather contradictory literature concerning radial growth in trees, the time of beginning and ending of cambial activity, and the factors thought to determine its distribution. He found a rather general agreement that, in our zone, wood formation generally ceases by mid-August, while that of the phloem continues practically to the end of the vegetative season. HARTIG (5) concluded that cambial activity first began in the youngest twigs and then gradually proceeded downward. HASTINGS (6) found that radial growth commenced first behind the opening terminal buds in broad-leaved trees and proceeded toward the base. By the time the five to six-year branches were forming new wood, radial growth had become general all over the trees. In the case of pine radial growth apparently commenced on the two or three-year old portions of branches before the buds opened. Growth started on the two-year pine branches possibly because the leaves were retained two years, for it was noted that in hemlock, where the leaves were retained six to seven years, radial growth appeared to have started first on six-year old branches. In *Taxodium distichum* radial growth started first just behind the opening terminal buds, as in broad-leaved trees, in which diameter increase did not begin until the buds had opened. REICHE (8) also noted that radial growth of trees in Chile began after the buds burst, and that it did not occur unless bud development preceded it. BUCKHOUT (1) reported diameter increase in *Larix europaea* to be practically coincident with the formation of new leaves.

KNUDSON (7), as a result of several years of investigation, including microscopical studies, found that the development of xylem in *Larix laricina* began a month later than the commencement of leaf formation, and ascribed BUCKHOUT's observed diameter increase mainly to a preliminary swelling of the tissues. From his results and those of other investigators, KNUDSON believes it probable that in general diameter growth does not begin until the leaves have developed and have become sufficiently active photosynthetically to supply the requirements of rapid cell formation. The reserve food materials stored up in the autumn are probably

largely utilized in leaf and also in blossom formation, when the latter precedes leaf formation.

The most interesting fundamental principle of growth exhibited by the records obtained from the box elder and blue spruce trees is that growth evidently does not begin in deciduous hardwood trees and in evergreen conifers at the same time. These observations in general agree with the conclusions of KNUDSON. It would appear reasonable to assume that diameter growth proper, as distinguished from any preliminary swelling of the tissues which might occur, may be delayed until the new leaves are sufficiently developed to elaborate the supply of food needed for the rapid growth which takes place. The supply of stored food which is present in the spring is largely consumed in the formation and development of the new crop of leaves to a stage when they can supply the quantity of elaborated food necessary for the growth processes. On the other hand, the evergreen conifers, having an adequate amount of living leaf tissue, are capable of supplying the requisite materials for growth as soon as growing temperatures are reached in the spring. In other words, the inception of diameter growth in evergreen conifers may practically be simultaneous with the bursting of the buds, while in deciduous-leaved hardwoods it may be delayed until the new leaves have attained a sufficient size to manufacture their own food.

It will be noted that the march of diameter growth is interrupted by rest periods of rather short duration. These rest periods are held to be essential for the maintenance of the proper health and optimum efficiency of the vital activities of the tree.

Figs. 2 and 3 combined outline the seasonal course of diameter growth as follows. It begins slowly, and after a variable period increases rapidly by leaps and bounds, alternating with rest periods, until a maximum rate is attained; after a short time it gradually decreases to a minimum, and then ceases altogether, when the usual alternate shrinkage and expansion (due to the changes in temperature and moisture conditions of the tree trunk) are exhibited.

Aside from the scientific consideration of the fundamental principles of growth, the use of such an instrument as the dendro-

graph has several practical applications. In connection with the measurement of permanent sample plots, the question has often confronted the forester as to when diameter growth occurs and whether it is coincident with height growth. It is very frequently much more desirable from the standpoint of expediency to measure the plots during the summer than in the fall and winter, when the trees are known to be in a dormant condition. An economic consideration is in connection with the peeling of logs and poles, where this practice is necessary. It is a well known fact that peeling is most easily done when the sap is flowing freely, which is also the time of the greatest growth activity. It can be seen, therefore, that a determination of the beginning and ending of the period of actual growth will suggest the time during which peeling can be accomplished most easily. An accurate record of the march of diameter growth, when correlated with the different site factors, will aid materially in the determination of those factors most influential in conditioning tree growth, which is necessary as a basis for a rational silvicultural practice.

UNITED STATES FOREST SERVICE  
OGDEN, UTAH

#### LITERATURE CITED

1. BUCKHOUT, W. A., The formation of the annual ring of wood in the European larch and the white pine. *Forestry Quarterly* 5:259-267. 1907.
2. FRIEDRICH, DR., Zuwachsaufograph. *Centralbl. gesammte Forstwesen*. November, 1905 (pp. 456-461).
3. GROSSENBACHER, J. G., The periodicity and distribution of radial growth in trees and their relation to the development of "annual" rings. *Trans. Wis. Acad. Sci.* 18:1-77. 1915 (with an appended bibliography of 119 citations).
4. HARTIG, ROBT., *Das Holz der deutschen Nadelwaldbäume*. 1885 (pp. 35-38).
5. HARTIG, TH., *Anatomie und Physiologie der Holzpflanzen*. 1878 (p. 368).
6. HASTINGS, G. T., When increase in thickness begins in our trees. *Science* 12:585-586. 1900.
7. KNUDSON, L., Observations on the inception, season, and duration of cambium development in the American larch (*Larix laricina*). *Bull. Torr. Bot. Club* 40:271-293. 1913.
8. REICHE, K., Zur Kenntniss der Lebensthätigkeit einiger chilenischen Holzgewächse. *Jahrb. Wiss. Bot.* 30:81-115. 1897.

# BRIEFER ARTICLES

ALFRED GABRIEL NATHORST

(WITH PORTRAIT)

ALFRED GABRIEL NATHORST was born on November 7, 1850, and died at Stockholm on January 20, 1921. Three years before his death, having reached the age limit of active service, he retired from the directorship of the Paleobotanical Museum of the Swedish Academy, a post which he had held for many years to the great benefit of his favorite science. In 1917 he wrote, "I am growing old and my health

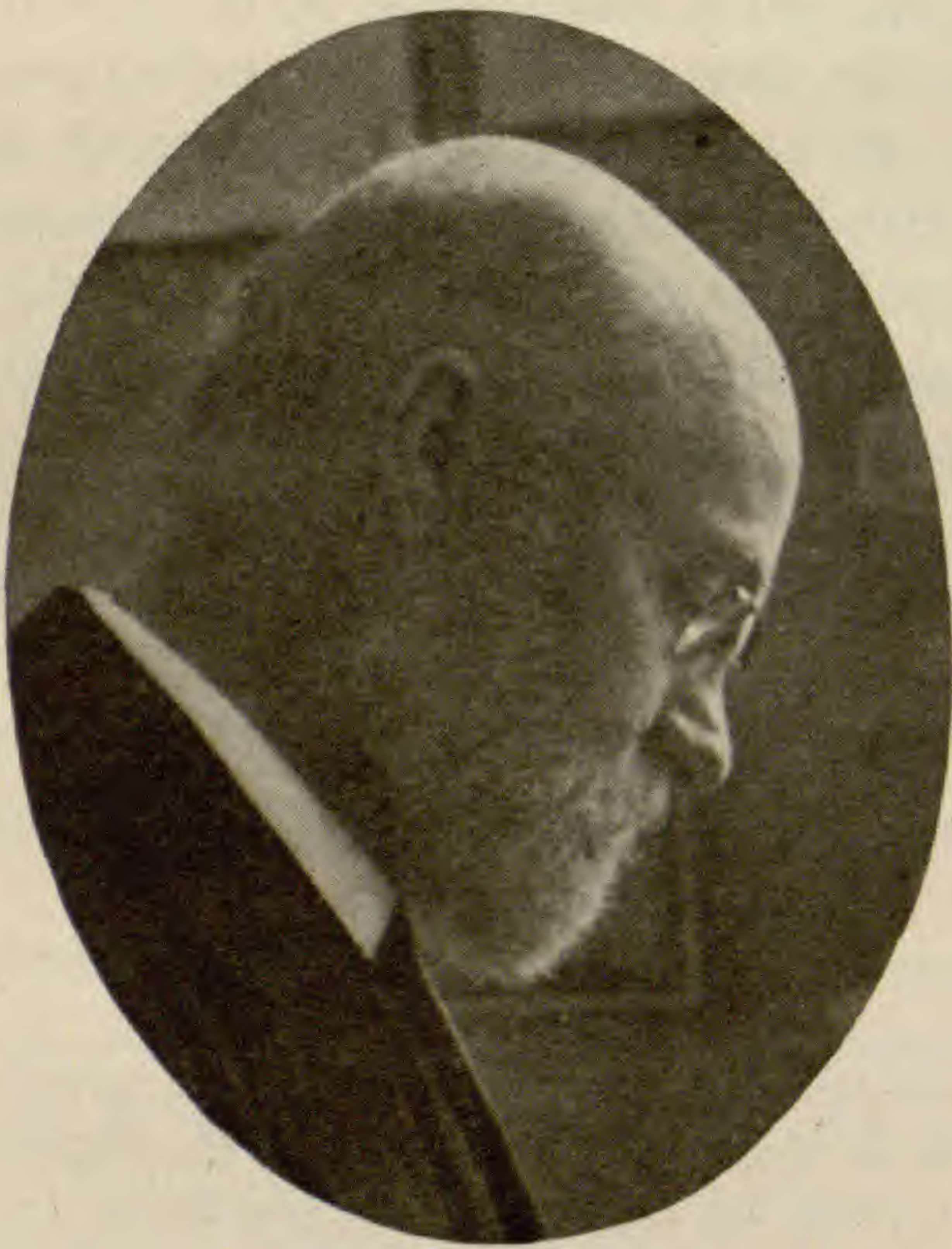

has been much weakened in consequence of a disease of the heart for the last one and a-half years"; again in October, 1919, "I have not been able to work seriously since 1916, but now I hope to have regained so much of my strength that I may complete an additional work on the Lower Carboniferous at Spitzbergen." This hope was fulfilled, and in 1920 was published the last of a remarkable series of memoirs on Arctic floras.

NATHORST'S contributions to knowledge cover a period of fifty-one years. His first paper, on Cambrian rocks of Scania, was published in 1869. The range of subjects is exceptionally wide, and everything he touched he illuminated.

A few years before his death, NATHORST had the satisfaction of seeing his beloved collections installed in a new and worthier home outside the city, under the guardianship of his former pupil and assistant, Dr. HALLE, to whose able hands he was well content to intrust the reputation of the museum as a center of paleobotanical research. In

1905 NATHORST visited several scientific institutions in England and on the continent, in company with a Swedish architect, for the purpose of obtaining information in preparation for the new building, toward the erection of which parliament subsequently voted £140,000. Three years later he wrote, "I am happy to have founded this museum for the sake of paleobotany and my successors."

It was my good fortune on two occasions to spend several days in the old museum with NATHORST, and it will always be the small and crowded rooms in the heart of Stockholm that some of us will remember with feelings of admiration, gratitude, and affection. The accompanying photograph, taken by my colleague W. HANISHAW THOMAS, and regarded by NATHORST as the best of his portraits, shows the director at work in his private room. Other museums may be larger and more imposing, but none contain as many treasures or form a more impressive monument to the life-long devotion of a conscientious and whole-hearted student of nature.

NATHORST was universally regarded as a master in paleobotany; a geologist of the first rank; an Arctic explorer whose extended geological and geographical researches in Spitzbergen, Bear Island, King Charles Land, Ellesmere Land, and other regions in the course of several expeditions, notably that of 1898-1899 of which he was the scientific leader, were fruitful in results of the greatest importance; and an expert systematic botanist. He was an exceptionally all-round naturalist, in whom were happily combined sound learning, breadth of view, and a natural modesty. Although seriously handicapped by his almost complete deafness, he was intensely happy in his work. He spoke English and German with surprising fluency and correctness, and wrote in both these languages and in French. In one of his letters he said, "It is easier for me to write in German than in English, but I think it would have been better if I had published my papers in English, as paleobotany is now (1908) chiefly and with best results studied in England and America."

In 1872, at the age of twenty-one, he paid his first visit to England, when he met Sir CHARLES LYELL, whose *Principles of Geology* awakened his love for that science. In 1907 he came as a delegate to the centenary of the Geological Society of London, and in 1909 to the Darwin Celebrations at Cambridge, a visit which he thoroughly enjoyed in company with Professor ZEILLER of Paris, of whom he afterward spoke as "our dear, noble, and lamented friend." NATHORST never visited the United States. In 1914 he wrote, "I really should like to study

the flora of eastern North America in connection with the Tertiary flora of Spitzbergen." He was deeply interested in Dr. WIELAND'S work on the fossil Cycads, for which he had a great regard, although he did not approve of the application of the term Cycad to the fossil stems which he maintained differed too widely in the fertile shoots from the Cycadales to be placed in that group. NATHORST'S own works on the Cycadophyta (a class designation which he instituted) not only added greatly to our knowledge of the extinct types, but stimulated other workers in the same field.

It is impossible in a short article to give an adequate idea of NATHORST'S contributions to paleobotany. Among his better known researches are those on Arctic floras from Devonian to Tertiary, his series of *Paleobotanische Mitteilungen* in which many new types, notably Devonian and Rhaetic genera, are described, his thorough study of the Rhaetic and Liassic floras of Scania, the series of papers on supposed fossil algae which were revolutionary and had a far reaching and salutary influence, his work on the distribution of Arctic plants during the Glacial period inspired by his first-hand knowledge of recent Arctic plants, his numerous contributions to our knowledge of Mesozoic floras in widely separated parts of the world, from Graham Land and the Falkland Islands to the new Liberian Islands, and his stimulating papers on British fossil plants. Although he did not concern himself with the investigation of petrifications, his skilful use of improved methods which he invented for examining the mummified cuticles of impressions led to astonishing results.

NATHORST had the true scientific spirit. His work was based on a firm foundation of accurate and wide knowledge of botany and geology; he recognized the limitations of his material and never ventured to deal with matters on which he was not competent to speak with the authority of a specialist. In 1895 he wrote in one of a long succession of most helpful letters, "The chief rule in dealing with fossil plants is that one ought to say precisely as much as the material allows, neither more nor less. This is the ideal, but one cannot help sometimes saying a little too much in consequence of what one besides (that is, beyond the available evidence) does believe!" He strongly deprecated the overconfidence of some paleobotanists and their departure from a wholesome skepticism. In 1919 he wrote in a letter, "The longer I live, the more my skepticism is developed, although my projected great work on *Skepticism in paleobotany* in twelve volumes will probably never appear!" He took a delight in helping others with kindly encourage-



ment and frank criticism. For him, purely destructive criticism had no charm; he always took pains to be stimulating and constructive. His sincerity and generosity inspired confidence and affection. He had a keen sense of humor, and with a boyish sense of fun he combined the mature judgment and cautious outlook of a philosopher. He loved to write and talk of his work: "You can hardly imagine how isolated I am here. My correspondence with friends and fellow-workers has been a great source of joy and satisfaction."

It was a privilege to know NATHORST. His achievements won for him a preeminent position among his colleagues, but one thinks of him, now that he has gone, not so much as the stimulating teacher that he unquestionably was, but more especially as a very human friend, the memory of whose generous spirit and affectionate regard is a precious possession.—A. C. SEWARD, *Cambridge, England*.

# CURRENT LITERATURE

## NOTES FOR STUDENTS

**Applied ecology.**—Increasing attention is being paid to the application of ecological principles to problems in plant and animal agriculture, horticulture, and forestry. Among the more important recent papers in this field are three contributions by SAMPSON,<sup>1</sup> and one by SAMPSON in conjunction with WEYL.<sup>2</sup> The first of these is an attempt to show a correlation between climate, vegetative associations, and crop production. Stations for instrumental work were established in the Manti National Forest of Utah at three different elevations, one in the oak-brush association which ranges from 6500 to 7800 ft. in altitude, a second in the aspen-fir association which ranges from 7500 to 9500 ft., and a third in the spruce-fir association which ranges from 9000 to 11,000 ft. The plants used in the experiments were field peas, Kubanka wheat, and the mountain brome grass (*Bromus marginatus*). Measurement was made of transpiration, wind velocity, temperature, rainfall, evaporation, sunshine, and barometric pressure, and comparisons were made with plant growth and water requirement. The number of growing days varies from 120 at the lowest to 70 days at the highest station. The greatest rainfall is at the middle station, being about twice that of the station below. The evaporation is greatest at the lowest station, but is almost as great at the highest station, owing to wind velocity. The necessary effective heat units for wheat and field peas exist only at the lowest station, where the water supply is inadequate unless supplied artificially.

SAMPSON'S paper on plant succession in relation to range management is a peculiarly apt illustration of the importance of ecological principles in the treatment of range lands. To most agriculturists it would seem a far cry from an academic study of plant succession to the practical treatment of range land and pasture, but SAMPSON makes it very clear that the relation between the two is fundamental. Stockmen have generally recognized that overgrazing is a common result of their practice, but they have for the most part been unable to detect overgrazing in time to stop the damage. SAMPSON has

---

<sup>1</sup> SAMPSON, ARTHUR W., Climate and plant growth in certain vegetative associations. Bull. 700, U.S. Dept. Agric. pp. 72. *figs.* 37. 1918.

———, Plant succession in relation to range management. Bull. 791, U.S. Dept. Agric. pp. 76. *pls.* 2. *figs.* 26. 1919.

———, Effect of grazing upon aspen reproduction. Bull. 741, U.S. Dept. Agric. pp. 29. *pls.* 5. *figs.* 7. 1919.

<sup>2</sup> ———, and WEYL, L. H., Range preservation and its relation to erosion control on western grazing lands. Bull. 675, U.S. Dept. Agric. pp. 35. *pls.* 6. *figs.* 8. 1918.

shown that grazing results in retrogression, the more stable or climax forms being gradually eliminated and their place being taken by plants characteristic of more primitive successions. The key to the situation, therefore, is the invasion of the more stable or climax formations by relatively pioneer forms. If such invasion is detected in time, grazing may be reduced or wholly abandoned for a time, thus giving the more desirable species characteristic of the higher successional stages an opportunity to reestablish themselves. The region under consideration in this paper is the neighborhood of the Great Basin Experiment Station in the Manti National Forest. Here four major successional stages are recognized: the first or early weed stage, characterized by ruderals; the second or late weed stage, with foxglove (*Pentstemon procerus*), sweet sage (*Artemisia discolor*), and yarrow (*Achillea lanulosa*) as leading species; the mixed grass and weed stage, with porcupine grass (*Stipa minor*) and yellow brush (*Chrysothamnus lanceolatus*) dominant; and the sub-climax or wheat-grass (*Agropyron* spp.) stage. The wheat-grasses constitute the climax herbaceous cover and are desirable range grasses. Overgrazing induces the appearance of species characteristic of the next lower stage, and continued overgrazing may even result in the appearance of the more primitive weed stages. The most representative indicator of retrograding wheat-grass land is *Chrysothamnus*. The *Stipa-Chrysothamnus* stage is equal or slightly superior to the *Agropyron* stage for range land purposes. Retrogression to the *Pentstemon-Artemisia-Achillea* stage is distinctly undesirable, although sheep do well here. Retrogression to the first or ruderal stage may be disastrous. If grazing is permitted here, all vegetation may disappear and finally the soil itself, through the action of erosion, in which event recovery is difficult or even impossible. In the treatment of the different vegetational stages, the writer considers in detail the conditions of growth and reproduction, the soil water content, the root relations of the characteristic species, the effect of disturbing factors, palatability, and forage production. All-in-all this is one of the most important papers in the field of applied ecology, and may well serve as a model to investigators everywhere.

The studies resulting in SAMPSON'S paper on the effect of grazing on aspen reproduction were also carried on in the Manti National Forest. This paper recommends that an attempt be made to work out a proper balance between the production of meat and timber. As the aspen does not reproduce effectively in its own shade, it is recommended that the timber be clearcut, and that the new growth be exempted from grazing or be grazed moderately by cattle rather than by sheep, which are much more destructive. When the new shoots reach a height of 45 inches (which results generally in about three years), they are effectively out of the reach of sheep, so that from then on to timber maturity grazing by sheep may be permitted.

Another paper resulting from studies in the Manti National Forest is the one by SAMPSON and WEYL on range preservation and erosion control. Overgrazing in this region, especially by sheep, has resulted in such a serious

destruction of the vegetation carpet as to have given rise to further and more serious loss through erosion. The peak of this destruction has been in the spruce-fir basins, above 9000 ft., where slopes are steep and summer grazing is excellent. Deferred and rotation grazing are necessary to prevent the destruction of these areas for grazing purposes; once erosion has set in, grazing should be abandoned, and an attempt made to re-create good grazing conditions by terracing, planting, and the construction of dams.

In connection with these bulletins there may be mentioned one on the general principles underlying range management in the National Forests,<sup>3</sup> in which such topics are considered as the determination of the class of stock to which the range is best suited, grazing periods, grazing capacity, management of cattle on the range, management of sheep on the range, range reseeding, and timber protection. Very full lists of references are given.

The ecological study of pastures has been taken up also in foreign lands. The work of BEWS in South Africa has already been noted in these pages.<sup>4</sup> An interesting study of Scottish hill pastures has been made by SMITH.<sup>5</sup> A hill pasture is defined as an area that is uninclosed and unploughed. Sixty per cent of the area of Scotland, or 18,000 square miles, comes under this category, although much of this is unsuitable for grazing. The different plant associations of these lands are mentioned and characterized, and it is clearly brought out that each association represents a particular combination of climate, soil, and grazing animals. The improvement of pasture land is based on the fundamental principle that the herbage changes as the growth conditions change. The foundation of hill pasturage is in the alluvial and flush grasslands, where the vegetation is rich and palatable; these areas may be extended by irrigation, diversion of surface water, and drainage. Bracken (*Pteris aquilina*) land is flush grassland with a luxuriant growth of the bracken. This land makes excellent pasturage if the bracken is removed by cutting or by spraying with 5 per cent sulphuric acid. Heather (*Calluna*) land is valuable for sheep grazing, but it should be burned over every few years, to stimulate the increased development of palatable green shoots. Peaty lands may be improved by drainage or burning. Considerable areas are characterized by rough grasses of low grazing value, notable among which are *Nardus stricta* and *Molinia coerulea*. It is desirable to replace these by finer herbage, by flushing, or by diverting surface water.

Quite another sort of applied ecology is represented in a paper by COKER<sup>6</sup> on pisciculture. Plants are the chief oxygenators in confined ponds, and are

<sup>3</sup> JARDINE, JAMES T., and ANDERSON, MARK, Range management on the National Forests. Bull. 790, U.S. Dept. Agric. pp. 98. pls. 32, figs. 4. 1919.

<sup>4</sup> BOT. GAZ. 67:370. 1919.

<sup>5</sup> SMITH, W. G., The improvement of hill pasture. Reprint from Scottish Jour. Agric. pp. 8. 1918.

<sup>6</sup> COKER, R. E., Principles and problems of fish culture in ponds. Scientific Monthly 7:120-129. figs. 2. 1918.

therefore of fundamental importance in fish culture. Although little is known yet as to which plant species are best for oxygenation, it is probable that evergreen species with finely divided leaves are the most satisfactory. It has long been known, of course, that plants are the basis of all fish food, but we are only just beginning to determine which species have the greater food values. Another thing of importance is the determination of the optimum association of species in a pond.—H. C. COWLES.

**Cytology of *Synchytrium* and *Urophlyctis*.**—Within a year considerable light has been shed on the puzzling problems of cytomorphology in the Chytriales by reinvestigations of *Synchytrium* (*Chrysophlyctis*) *endobioticum* and *Urophlyctis alfalfae*. The careful and thorough studies of Miss CURTIS<sup>7</sup> on *Synchytrium* and of JONES and DRECHSLER<sup>8</sup> on *Urophlyctis* deserve particular notice. The most noteworthy results of Miss CURTIS' study of *Synchytrium* are the establishment of the occurrence of gametic fusions in the life cycle and the demonstration that a prosorus is regularly antecedent to the development of the sporangial sorus, the contents of this body passing into the host cell where segmentation into sporangia and production of zoospores take place. During the development of the prosorus from the infecting zoospore a series of nucleolar discharges of chromatin occurs, and the five chromosomes originate also from the nucleolus; but all divisions from the primary nucleus to the zoospore primordia are typically mitotic. The asexual or sexual nature of the motile cells terminating this series appears to depend on the availability or lack of water during maturation; if water becomes tardily available simultaneous germination of a number of sporangia occurs and their zoospores pair, probably exogamously. Unpaired zoospores and zygotes penetrate growing parts of potato plants; the former reproduce the prosorus phase, but the zygotes develop into resting sporangia. In the production of the latter no form of mitotic division was observed. Chromatic granules appear in the cytoplasm following nucleolar discharges, and after a further loss of chromatin (a process homologized with reduction) the granules become zoospore primordia. The existence of sexual fusions between facultative gametes is hypothesized for all Synchytriaceae which produce true resting spores. The validity of *Chrysophlyctis* is rejected, and the writer prefers the broader generic name *Synchytrium* to *Pycnochytrium*, to which the organism in all respects conforms.

The absence of mitosis in the development of the resting sporangium and the conception of nucleolar gemmation taking the place of meiotic divisions

---

<sup>7</sup> CURTIS, K. M., The life history and cytology of *Synchytrium endobioticum* (Schilb.) Perc., the cause of wart disease in potato. Phil. Trans. Roy. Soc. London. B 210:409-478. pls. 12-16. 1921.

<sup>8</sup> JONES, F. R., and DRECHSLER, CHARLES, Crown wart of alfalfa caused by *Urophlyctis alfalfae*. Jour. Agric. Res. 20:295-324. pls. 47-56. 1920.

will still be unsatisfactory to cytologists who hope to standardize the essentials of nuclear behavior practically throughout the plant realm; and the conviction will persist that imperfect fixation within the resistant walls of the resting body has masked the appearance of mitotic divisions conforming to those of the prosorus in this species, of the resting sporangium in *S. decipiens* and *S. puerariae*, of *Rhodochytrium*, and others.

This work affords no support to the view advanced by ORTON<sup>9</sup> and KERN that the "primordial sphere" in *Synchytrium* is a chimera composed of a parasitic plasmodium enveloping an almost unmodified host nucleus. Figures of the type on which this view is based are interpreted as resulting from multiple infections, by which a number of zoospores come to lie about a single host nucleus. Subsequent divisions of the host cell distribute the supernumerary spores, leaving usually only one in each host cell. The reviewer, however, has observed two and even three cysts within one host cell in all stages of development up to resting sporangia. Furthermore, a series of preparations is readily obtained showing that, contrary to the view of ORTON and KERN, the primary nucleus of the cyst is the direct outgrowth of the zoospore nucleus, the host cell nucleus being crowded off to one side of the cyst, where it finally disintegrates.

WILSON<sup>10</sup> has published a more detailed account of the work on which his preliminary paper<sup>11</sup> on *Urophlyctis* was based, but the conclusions of both are identical. The direct functioning of the resting body as a sporangium, and the production of the resting "spores" in lysigenous cavities developed in the host tissues by a parasitic plasmodium are maintained.

SCOTT<sup>12</sup> found that the resting spores germinate by the proliferation of one to fifteen sporangia through pores of which the zoospores escape. JONES'S and DRECHSLER'S limited observations on germination are in agreement with the latter. As for the accounts of cytological details and life cycle of the pathogen, it seems evident that JONES and DRECHSLER have made their observations upon very different material and probably a different organism from that studied by WILSON. Judgment as to which is actually the crown wart disease of alfalfa and which is *Urophlyctis alfalfae*, if that name is to survive, must remain temporarily suspended, but the fine preparations of JONES and DRECHSLER obtained by dissecting the parasite from infected tissues and showing in detail the relations of turbinate cells, hyphae, resting spores, and haustoria leave no doubt that the organism which is the type for *Urophlyctis* is the one they studied. On the other hand, WILSON has made

<sup>9</sup> ORTON, C. R., and KERN, F. D., The potato wart disease. Penn. State College Agric. Exp. Sta. Bull. 156. pp. 16. figs 4. 1919.

<sup>10</sup> WILSON, O. T., Crown-gall of alfalfa. BOT. GAZ. 70:51-68. pls. 7-10. 1920.

<sup>11</sup> ———, The crown-gall of alfalfa. Science 41:797. 1915.

<sup>12</sup> SCOTT, C. E., A preliminary note on the germination of *Urophlyctis alfalfae*. Science 52:225-226. 1920.

the association between resting spores and plasmodium on the basis of similarity of contents. The plasmodium may well be a secondary parasite. The existence of an antheridial-oogonial sexual apparatus in *Urophlyctis* is definitely disproved, but WILSON'S description of fusion between unlike zoospores must await confirmation.—FREEMAN WEISS.

**Taxonomic notes.**—HOCHREUTNER<sup>13</sup>, in studying the Andean genus *Cristaria* (Malvaceae), has established two new subgenera (*Septaria* and *Aseptaria*), each including two new sections, besides describing several new species. In *Bakeridesia* also two new subgenera (*Monopteron* and *Dipteron*) are described, and one (*Pseudabutulastrum*) in *Malvastrum*.

DUNN<sup>14</sup> has described a new genus of Dipterocarpaceae (*Dioticarpus*) from Southern India. It is a valuable timber tree closely related to *Balanocarpus*.

WILDEMAN<sup>15</sup> has discussed various representatives of the African flora. *Clerodendron* (Verbenaceae) is represented by 31 species, 8 of which are described as new. *Acioa* (an African genus of Rosaceae) is credited with 37 species, 15 of which are new. A number of genera of Leguminosae are presented, including 23 new species distributed among 10 genera.

MOORE<sup>16</sup> has published the result of a study of the Australian collections at the British Museum, describing 89 new species in various families, and also a new genus (*Leptospermopsis*) of Myrtaceae.

DOP<sup>17</sup> has published 13 new species of *Clerodendron* (Verbenaceae) from Indo-China.

GAGNEPAIN<sup>18</sup> has published four new genera of Compositae from the Orient, as follows: *Camchaya*, *Iodocephalus*, and *Thorelia*, all belonging to Vernoniaceae, and *Colobogyne*, belonging to Coreopsidae.—J. M. C.

**Welwitschia mirabilis.**—When the third edition of *Morphology of Gymnosperms* by COULTER and CHAMBERLAIN was published in 1917, an important investigation of the floral structures of *Welwitschia* was overlooked. CHURCH<sup>19</sup>

<sup>13</sup> HOCHREUTNER, B. P. G., Notes sur les genres *Cristaria*, *Bakeridesia*, *Malvastrum*. Ann. Conserv. Jard. Bot. Geneve 21:405-428. 1920.

<sup>14</sup> Decades Kewenses: C.-CI. Kew Bull. 1920: no. 10. 1920.

<sup>15</sup> WILDEMAN, É. DE, Notes sur quelques espèces Africaines du genre *Clerodendron*. Bull. Jard. Bot. Bruxelles 7:161-270. 1920.

<sup>16</sup> MOORE, S. LEM., A contribution to the flora of Australia. Jour. Linn. Soc. 45:159-220. pls. 11, 12. 1920.

<sup>17</sup> DOP, PAUL, *Clerodendron* nouveaux de l'Indochine de l'herbier du muséum. Notulae Syst. Herb. Mus. Paris 4:7-14. 1920.

<sup>18</sup> GAGNEPAIN, F., Quatre genres nouveaux de Composees. Notulae Syst. Herb. Mus. Paris 4:14-19. 1920.

<sup>19</sup> CHURCH, A. H., On the floral mechanism of *Welwitschia mirabilis* Hooker. Phil. Trans. Roy. Soc. London 205:115-151. pls. 9-13. 1914.

secured a very complete series of stages in the organogeny of both staminate and ovulate flowers from material furnished by PEARSON. The illustrations are so carefully drawn and the stages so close together, that one can study the problem for himself, from the first divergence in the topography of the staminate and ovulate flowers, up to the condition at the time of pollination. The facts of development are made still more valuable by detailed descriptions which prevent any misinterpretation of the figures.

When it comes to conclusions, however, each one will probably have his own theories in regard to the plant which so thoroughly deserves its specific name. That the ancestral flowers were functionally bisporangiate, all students of comparative morphology must agree. The evidence in favor of insect pollination is also rather complete. CHURCH does not believe that the evidence supports the contention that the "perianth" consists of decussate bracts. He believes that the reductions which have brought about a dioecious condition from an originally bisporangiate flower are of the same type as those known in *Cycadeoidea* and *Williamsomia*, but that no relationship is involved in the similarity. He also fails to see any relationship to the flowers of Angiosperms, the resemblances being merely a "parallel progression of physiological mechanism devoted to seed production."—C. J. CHAMBERLAIN.

**Myrmecophilous plants.**—CHODAT and CARISSO<sup>20</sup> have found that in certain plants the relationship of the symbiotic ants is a secondary matter, the excrescences which they inhabit being really galls caused by hymenopterous larvae. All stages in the gall formation, from the deposition of the egg to the escape of the larva leaving a hole for the entry of the ants, were found in several South American species of *Cordia* (Boraginaceae) and in *Acacia Cavenia*. It is also pointed out that the symbiosis could not be regarded, as heretofore, as a protection against leaf-cutting ants, since the inhabitants of the galls on *Cordia* are themselves leaf-cutters, and their "ant gardens" within the galls are composed of bits of leaves and flowers which they have cut off and brought in.—GEO. D. FULLER.

**Umbelliferous cushion plants.**—Two closely related umbelliferous genera, *Azorella* and *Bolax*, are notable for their compact cushion habit. They occur in the high Andes, in Patagonia, and in the subantarctic portions of South America. HAUMAN<sup>21</sup> has reviewed the 24 species occurring in Argentine, giving ecological and taxonomic notes and describing one new species, *A. yareta*. The vegetation of the celebrated "balsam bogs" of Tierra del Fuego has *Bolax gummifera* as its characteristic species. A key has been constructed for the determination of the species and a very complete bibliography given.—GEO. D. FULLER.

<sup>20</sup> CHODAT, R., and CARISSO, LUIS, Une nouvelle théorie de la myrmécophilie Compt. Rend. Soc. Phys. et Hist. Nat. Genève. 37:9-12. 1920.

<sup>21</sup> HAUMAN, LUCIEN, Notes sur les espèces Argentine des genres *Azorella* et *Bolax*, Rev. Soc. Arg. Ciens. Nat. 4:468-500. figs. 7. 1919.



## GENERAL INDEX

Classified entries will be found under Contributors and Reviewers. New names and names of new genera, species, and varieties are printed in **bold-face** type; synonyms in *italic*.

### A

Accessory foods for plants 247  
Acer Negundo, diameter growth in 454  
Acid soils, plants of 244  
Adams, J. F. 131  
African flora 471  
After-ripening and germination of Juniperus seeds 32  
Algae, ecology of 336; marine, of Beaufort 336; subterranean flora 78  
Alpine adaptations 405  
Aluminum and soil acidity 159  
Alway, F. J., work of 80  
Andersen, Emma N., work of 336  
Anderson, M., work of 468  
Angiosperms, correlations in herbaceous 1; Gnetalean vessels of 438  
Anisantherina 240  
Anthony, S., work of 77  
Apogamy in Osmunda 79  
Apples, odor constituents of 78  
Arthur, J. C., work of 241  
Arthur, J. M. 155  
Artschwager, E. 400  
Aseptaria 471  
Atmometer, non-absorbing mounting 80  
Australian flora 471  
Awn and barley yield 77

### B

Bacterial diseases of plants 401  
Bailey, I. W. 334; work of 408  
Bailey, L. H., work of 79  
Ball, C. R. 426  
Barley yield 77  
Barratt, Kate, work of 335  
Bembicidium 240  
Bergman, H. F., work of 80  
Berry, E. W., "Paleobotany" 238  
Birch, experimental investigations on 220  
Blackman, V. H., work of 246  
Blakeslee, A. F. 75  
Bliss, Mary C. 314  
Blister rusts, gametophytic development of 131

Bonnier, G., work of 405  
Bottomley, W. B., work of 247  
Brause, G., work of 79  
Britton, N. L., work of 240  
Brown, Elizabeth Dorothy Wuist, work of 79  
Brown, Isabel M. P., work of 335  
Buchanan, R. E. 401  
Burgeff, H., work of 75  
Burt, E. A., work of 241

### C

Calcium 76  
Calymperaceae 240  
Cambium, studies of 408  
Camchaya 471  
Cânizatesia 240  
Carisso, L., work of 472  
Caryophyllaceae, arctic 77  
Ceratophorum ulmicolum 190  
Chaetocladium and Mucor 75  
Chamberlain, C. J. 408, 471  
Cheilophyllum 240  
Chestnut, V. K., work of 78  
Chloriodide of zinc in plant histology 400  
Choate, Helen A. 409  
Chodat, R., work of 472  
Church, A. H., work of 471  
Clark, W. M., "The determination of hydrogen ions" 155  
Clerodendron in Indo-China 471  
Coker, R. E., work of 468  
Colobogyne 471  
Colombia, Scrophulariaceae of 241  
Congo, flora of 242  
Conifer grafting 248  
Contributors: Adams, J. F. 131; Arthur, J. M. 155; Artschwager, E. 400; Bailey, I. W. 334; Ball, C. R. 426; Blakeslee, A. F. 75; Bliss, Mary C. 314; Buchanan, R. E. 401; Chamberlain, C. J. 408, 471; Choate, Helen A. 409; Coulter, J. M. 79, 80, 239, 240, 336, 402, 408, 471; Cowles, H. C. 466; Cribbs, J. E. 289; Crocker, W. 76, 77,

78, 80, 157, 159, 160, 246, 247, 248;  
Eaton, S. V. 156; Fuller, G. D. 77, 80,  
157, 160, 242, 244, 245, 246, 248, 334,  
335, 336, 402, 403, 405, 407, 472;  
Gardner, W. A. 249; Hasselbring, H.  
327; Haupt, A. W. 61, 446; Holm, T.  
236; Jeffrey, E. C. 1; Johnson, D. S.  
331; Jurica, H. S. 138; Karrer, Joanne  
78; Korstian, C. F. 454; Line, J. 245;  
MacDuffie, R. C. 438; Macpherson,  
Gertrude E., 392; Miles, L. E. 161;  
Newcombe, F. C. 152; Noé, A. C. 238;  
Pack, D. A. 32; Sax, K. 399; Schaff-  
ner, J. H. 197; Schertz, F. M. 81;  
Seward, A. C. 462; Spessard, E. A.  
406; Strausbaugh, P. D. 337; Torrey,  
R. E. 1; Tuttle, Gwynethe M. 146;  
Walker, Elda R. 378; Weiss, F. 469;  
Wells, B. W. 358; Whitaker, Edith  
S. 220

Convolvulus, development in 392

Coryneliaceae 241

Coryneum tumoricolum 191

Cotema 240

Coulter, J. M. 79, 80, 239, 240, 336, 402,  
408, 471

Coville, F. V., work of 160

Cowles, H. C. 466

Craig, R. D., work of 242

Cribbs, J. E. 289

Crocker, W. 76, 77, 78, 80, 157, 159,  
160, 246, 247, 248

Crown gall of alfalfa 245

Curtis, K. M., work of 469

Cuscuta, development in 392

Cushion plants 472

Cylindrosporium ulmicolum 190

## D

Dimorphocladium 240

Diotocarpus 471

Dipsacus, development of head and  
flower 138

Dipteron 471

Dodder, development in 392

Dop, P., work of 471

Dormancy, and hardiness in plum 337;  
in trees 160

Douglas fir forests, reproduction of 242

Doyle, J. D., work of 408

Drechsler, C., work of 469

## E

Eaton, S. V. 156

Ecology, applied 466; a new journal of  
335; concepts and nomenclature 403

Elm, leaf spots of 161

Equisetum, anatomy of 334; laevigatum,  
gametophytes of 378

Eupatorium, Bolivian species of 242

Excipula ulmicola 191

## F

Ferns of Papua 79

Feuer, B., work of 80

Fitzpatrick, H. M., work of 241

Fuller, G. D. 77, 80, 157, 160, 242, 244,  
245, 246, 248, 334, 335, 336, 402, 403,  
405, 407, 472

## G

Gagnepain, F., work of 471

Galløe, O., "The lichen flora and lichen  
vegetation of Iceland" 239

Gametophytes of Equisetum laevigatum  
378

Gardner, W. A. 249

Gentes Herbarum 79

Geography of plants 402

Germination, and after-ripening of Ju-  
niperus seeds 32; chemical changes in  
wheat 409; effect of light on 249

Gibbs, L. S., work of 157

Gloeosporium ulmeum 182; ulmicolum  
185

Gnetalean vessels in Angiosperms 438

Gnomonia ulmea 162

## H

Haas, P., "An introduction to the chem-  
istry of plant products" 156

Hardy, M. E., "Geography of plants"  
402

Harlan, H. V., work of 77

Harris, F. S., "Soil alkali" 157

Harris, W., biographical sketch of 331

Hasselbring, H. 327

Hauman, L., work of 472

Haupt, A. W. 61, 446

Hemp, sexual expression in 197

Hill, T. G., "An introduction to the  
chemistry of plant products" 156

Hitchcock, A. S., work of 241

Hochreutiner, B. P. G., work of 471

Hofmann, J. V., work of 243

Holden, H. S., work of 79

Holloway, J. E., work of 406

Holm, T. 236

Hoyt, W. D., work of 336

Humidity and irrigation 248, 336

Hydrogen ion determination 155

## I

Iceland, botany of 239

Iodocephalus 471

Irrigation and humidity 248, 336

## J

- Jardine, J. T., work of 468  
 Jeffrey, E. C. 1  
 Johnson, D. S. 331  
 Jones, F. R., work of 469  
 Juniperus, after-ripening and germination  
 of seeds 32  
 Jurica, H. S. 138

A

## K

- Karrer, Joanne 78  
 Kern, F. D., work of 470  
 Koketsu, R., work of 407  
 Korstian, C. F. 454

## L

- Larix, morphology of 408  
 Leaf spots of elm 161  
 Leaves, mottling of 81  
 Leptospermopsis 471  
 Light, effect on germination 249  
 Line, J. 245  
 Livingston, B. E., work of 80, 407  
 Lycopodium 406

## M

- MacDuffie, R. C. 438  
 Macoun, John, biographical sketch of  
 236  
 Macpherson, Gertrude E. 392  
 McCool, M. M., work of 160  
 McGregor, E. A., work of 248, 336  
 McLean, F. T., work of 247  
 Magnus, P., work of 246  
 Martin, J. N., "Botany with agricul-  
 tural applications" 402  
 Maxon, W. R., work of 242  
 Melasmia ulmicola 191  
 Mexican trees and shrubs 241  
 Meyer, F. J., work of 334  
 Michaelis, L., work of 155  
 Miles, L. E. 161  
 Millar, C. E., work of 160  
 Mirasol, J. J., work of 159  
 Monocardia 241  
 Monopteron 471  
 Moore, G. T., work of 78  
 Moore, S. LeM., work of 471  
 Morning glory, development in 392  
 Mottling of leaves 81  
 Mucor and Chaetocladium 75  
 Munger, T. T., work of 242  
 Mycosphaerella ulmi 189  
 Myrmecophilous plants 472

## N

- Naiadothrix 240  
 Nathorst, A. G., biographical sketch of  
 462  
 Neller, J. R., work of 76  
 Newcombe, F. C. 152  
 Nichols, G. E., work of 245  
 Nitrites and nitrates in plants 248  
 Noé, A. C. 238  
 North American flora 240, 408

## O

- Oak, experimental investigations on 220  
 Orton, C. R., work of 470  
 Osmunda, apogamy in 79  
 Østrup, E., "Fresh-water diatoms from  
 Iceland" 239

## P

- Pack, D. A. 32  
 Paleobotany, textbooks of 238  
 Paniceae 241  
 Papua, ferns of 79  
 Parker, F. W., work of 77  
 Pavillard, J., work of 403  
 Peat soils 80  
 Pemberton, C. C., work of 160  
 Pennell, F. W., work of 241  
 Pfeffer, Wilhelm, biographical sketch of  
 152  
 Phoma cincta 191  
 Photosynthesis, rate of 247  
 Phyllosticta confertissima 191; ulmi-  
 cola 190  
 Picea Parryana, diameter growth in 454  
 Plant products, chemistry of 156  
 Plum, dormancy and hardiness in 337  
 Potonié, H., "Lehrbuch der Paläobot-  
 anik" 238  
 Power, F. B., work of 78  
 Practical botany 402  
 Pseudabutilastrum 471

## R

- Radio-active material 246  
 Ramaley, F., work of 246  
 Ramsdenia 240  
 Raunkiaer, C., work of 404  
 Reboulia, embryogeny and sporogenesis  
 in 446; gametophyte and sex organs  
 of 61  
 Reserve food in vegetative tissues 146  
 Reviews: Berry's "Paleobotany" 238;  
 Clark's "The determination of hydro-  
 gen ions" 155; Galløe's "The lichen  
 flora and lichen vegetation of Iceland"

239; Haas' "An introduction to the chemistry of plant products" 156; Hardy's "Geography of plants" 402; Harris's "Soil alkali" 157; Hill's "An introduction to the chemistry of plant products" 156; Martin's "Botany with agricultural applications" 402; Østrup's "Fresh-water diatoms from Iceland" 239; Potonié's "Lehrbuch der Paläobotanik" 238; Scott's "Studies in fossil botany" 238; Smith's "Bacterial diseases of plants" 401  
 Rhytisma ulmi 191  
 Robinson, B. L., work of 242  
 Roigia 240  
 Romell, Lars-Gunnar, work of 248, 404

## S

Salix Farrae **Walpoleii** 435; lasiolepis **Bakeri** 436; lutea **famelica** 426; lutea **ligulifolia** 428; lutea **platyphylla** 430; **monochroma** 431  
 Sampson, A. W., work of 466  
 Sax, K. 399  
 Schaffner, J. H. 197  
 Schertz, F. M. 81  
 Schroeter, J., work of 246  
 Scott, C. E., work of 470  
 Scott, D. H., "Studies in fossil botany" 238  
 Seacoast vegetation 245  
 Seedling anatomy 79  
 Seeds, device for weighing 399; effect of light on germination 249  
 Selaginella 242  
 Septaria 471  
 Septogloeum profusum 190  
 Seward, A. C. 462  
 Sexual expression in hemp 197  
 Shedd, O. M., work of 76  
 Shull, C. A., work of 407  
 Silvinula 240  
 Smith, E. F., "Bacterial diseases of plants" 401  
 Smith, W. G., work of 468  
 Soil, acidity and aluminum 159; alkali 157; soluble substances in 160  
 Spessard, E. A. 406  
 Sphaereupatorium 242  
 Sphaeria apertiuscula 191  
 Standley, P. C., work of 241  
 Stoma, internal 80  
 Strausbaugh, P. D. 337  
 Strowd, W. H., work of 248  
 Stumps, living 160  
 Subalpine lake shore vegetation 246

Subterranean algal flora 78  
 Synchytrium, cytology of 469  
 Systremma ulmi 186

## T

Tanner, F. R., work of 80  
 Tansley, A. G., work of 334, 403  
 Tasmanian mountains, vegetation of 157  
 Thelephoraceae 241  
 Thermoregulator 327  
 Thone, F., work of 80  
 Thorelia 471  
 Tilia americana, ecology of 289  
 Torrey, R. E. 1  
 Transpiration, comparative studies of 289  
 Trees, dormancy in 160  
 Truog, E., work of 77  
 Tuttle, Gwynethe M. 146

## U

Ultra-violet light and yeast 80  
 Unanuea 241  
 Uredineae 241  
 Urophlyctis, cytology of 469

## V

Vessel in seed plants 314  
 Von Lagerheim, G., work of 246

## W

Walker, Elda R. 378  
 Warming, E., work of 77  
 Weiss, F. 469  
 Wells, B. W. 358  
 Welwitschia mirabilis 471  
 Weyl, L. H., work of 466  
 Wheat, chemical changes in germination 409  
 Wherry, E. T., work of 244  
 Whitaker, Edith S. 220  
 Whitford, H. M., work of 242  
 Wildeman, E. de, work of 242, 471  
 Williams, R. S., work of 240  
 Wilting coefficient studies 407

## Y

Yeast, and ultra-violet light 80

## Z

Zooecidia, evolution of 358